



# IBM InfoColor 70 and 3170 Print Media Guide





# IBM InfoColor 70 and 3170 Print Media Guide

### **First Edition (June 1998)**

The following paragraph does not apply to any other country where such provisions are inconsistent with local law.

INTERNATIONAL BUSINESS MACHINES CORPORATION PROVIDES THIS PUBLICATION "AS IS" WITHOUT WARRANTY OF ANY KIND, EITHER EXPRESS OR IMPLIED, INCLUDING, BUT NOT LIMITED TO THE IMPLIED WARRANTIES OF MERCHANTABILITY OR FITNESS FOR A PARTICULAR PURPOSE. Some states do not allow disclaimers of express or implied warranties in certain transactions, therefore, this statement may not apply to you.

Order publications through your IBM representative or the IBM branch office serving your locality. Publications are not stocked at the address given below.

The IBM Printing Systems Company welcomes your comments. A form for readers' comments is provided at the back of this publication. If the form has been removed, you may send your comments to the following address:

IBM Printing Systems Company  
Information Development  
Department H7FE, Building 003G  
P.O. Box 1900  
Boulder, CO 80301-9191  
U.S.A

If you prefer to send comments electronically, use one of the following methods:

Internet: [print\\_pubs@vnet.ibm.com](mailto:print_pubs@vnet.ibm.com)

Fax: 1-800-524-1519

Visit our home page at <http://www.printers.ibm.com/>.

When you send information to IBM, you grant a nonexclusive right to use or distribute the information in any way IBM believes appropriate without incurring any obligation to you.

© **Copyright International Business Machines Corporation 1998 All rights reserved.**

Note to U.S. Government Users – Documentation related to restricted rights – Use, duplication or disclosure is subject to restrictions set forth in GSA ADP Schedule Contract with IBM Corp.

<b>IBM InfoColor 70 and 3170 Print Media Guide</b>	<b>1</b>
<b>Purpose of this manual</b>	<b>3</b>
<b>Requesting a Print Medium Test</b>	<b>5</b>
Importance of Print Medium Testing .....	5
Procedures.....	5
Test Results, Medium Performance and Script.....	9
Rush Testing .....	9
<b>Basic Paper Types and Their Properties</b>	<b>11</b>
Basic paper types.....	11
Uncoated paper .....	11
Coated paper .....	12
Speciality paper .....	12
Paper properties.....	13
<b>Guidelines for Print Medium Quality Inspection</b>	<b>15</b>
Check Paper Quality .....	15
Guidelines for Print Medium Storage and Handling .....	16
Splicing.....	17
Roll inspection.....	17
Paper Waste During Printing and Waste Reduction (3.02 code or higher) .....	18
Start of a Print Job .....	18
Auto Mode .....	18
Manual Mode.....	18
Finishing the Print Job .....	18
Changing the Paper Roll.....	19
Operator Skills .....	19
Paper Quality .....	19
Environment.....	19
<b>Artifact Samples</b>	<b>21</b>
Low-density cloudiness .....	22
High-density cloudiness .....	22
High-frequency cloudiness.....	23
Periodic low-density bands .....	23
Weak cloudiness .....	24
Low-density speckles.....	24
Low-density spots .....	25
Gloss too low.....	25
GEM hot offset .....	26
Worm like streaks.....	26
Wrinkling in the PRS .....	27
Non-uniform transfer quality across the web.....	28
Micro-blistering from the fuser.....	29
<b>Description of paper-dependent parameters</b>	<b>31</b>
<b>List of IBM Recommended Print Media for IBM 3170 and InfoColor 70</b>	<b>35</b>



---

# IBM InfoColor 70 and 3170 Print Media Guide





---

## Purpose of this manual

- A guide to have print medium tested through a certified agency
- To provide information on basic paper quality requirements for the InfoColor 70 Printer.
- To provide information on proper paper handling and storage
- To provide information about how paper is tested at the certified agency.
- To provide information on the basic paper types and properties.
- To assist in understanding the media limitations of InfoColor 70 Printer.
- To provide Artifact Samples to assist in print quality troubleshooting.



---

# Requesting a Print Medium Test

---

## Importance of Print Medium Testing

InfoColor 70/3170 Print Medium testing is needed to adjust and optimize a set of control parameters to obtain the best print quality.

Using a tested and supported print medium offers you the following advantages:

- Stable print quality
- Minimum quantity of wasted paper
- Minimum printing problems, such as paper jams
- Minimum contamination of the InfoColor 70/3170 print engine; thereby reducing machine intervention and frequency of service.

---

## Procedures

1. Before considering a print medium test, request the latest IBM InfoColor 70 Print Media List from your account representative. Make sure that there is not a similar stock on this list before you initiate a request for a test.
2. Make sure there is full support from the Medium Manufacturer.
3. Contact IBM certified Medium Test Agencies  
For US region contact RIT (Lisa Ford, Tel: 716-475-5593, Fax: 716-475-5250, Email: LM-FASP@RIT.EDU).

For EMEA regions, contact Pira (Mike Chamberlain, Tel: 44-1372-802000, Fax: 44-1372-802238/46, E-mail: paper@pira.co.uk or printing@pira.co.uk)

4. The test will cost the medium manufacturer or the customer about \$240/hour. It usually takes about 2.5 - 3 hours for one medium test. The turn around time is about 2 to 6 months depending on the agencies current work load. A paper may also be tested on an emergency basis with a shorter turn around time for a cost premium.
5. Paper Test Agencies will request the following information from the medium manufacturer through two different forms as a pre-requisite for testing. The following is a sample of these forms:

**Form 1: Substrate Qualification Data Collection Worksheet**

Product Name:	
Manufacture:	
<b>Company Contact</b>	
Name:	
Title:	
Address:	
City:	
State:	
Country:	
Postal Code:	
Telephone Number:	
Fax Number:	
Email:	
<b>Paper Classification</b>	<b>X</b>
Uncoated Super Calandered	
Uncoated Calandered	
Uncoated Uncalandered	
Uncoated Pigmented	
Matt Coated	
Satin Coated	
Glossy Coated	
Single-sided Cast Coated	
Recycled Coated	
Latex Impregnated Paper	
Film	
Others (Please specify)	
<b>Material Properties (Fill-in or attach documentation)</b>	
Grammage (GSM)	
Caliper(micron)	
Brightness (ISO%)	
Opacity(%)	

Smoothness (PPS micron/Sheffield units)	
Moisture Content (% AH)	
Certificate of Non-toxicity (Please Attach)	
Guarantee Splice Free	
<b>Marketing Contact:</b>	
Name:	
Title:	
Address:	
City:	
State:	
Country:	
Postal Code:	
Telephone Number:	
Fax Number:	
Email:	
<b>Technical Contact:</b>	
Name:	
Title:	
Address:	
City:	
State:	
Country:	
Postal Code:	
Telephone Number:	
Fax Number:	
Email:	
Distribution List (Please attach)	

**Form 2: Specifications for Print Media Qualification on the IBM InfoColor 70 Print Engine**

<b>Roll Dimensions</b>		
Description	Dimension (USA)	Dimension (EU)
Inner Core Diameter	6"-0/+0.02	150mm+/-0.5
Outer Core Diameter	7.1"	174mm
Maximum Roll Diameter	19.7"	500mm
Typical Roll Diameter	15.75"	400mm
Maximum Roll Weight	88lbs	40kg
Roll Width	12.6"	320mm

<b>Roll Specifications</b>
The paper must be free from splices, tears, dents, holes and other physical defects. The paper should be flush with the core and must not slide axially over the core.

<b>Paper Weight</b>
60 to 250GSM are specification limits for InfoColor 70 engine.
200GSM and above require GEM unit.

<b>Temperature Resistance</b>
The paper must withstand prolonged (1 hour minimum) heating to 100°C and heating to 200°C for 5 seconds without physical or chemical degradation. Under these conditions, the paper should not release any toxic substances.

**Demonstrated Paper Properties**

<p>The following data must be submitted for each substrate to be tested.</p> <ul style="list-style-type: none"> <li>• Weight (grams/m<sup>2</sup>)</li> <li>• Caliper (micron)</li> <li>• Brightness (ISO%)</li> <li>• Opacity (%)</li> <li>• Smoothness (pps/sheffield units)</li> <li>• Moisture Content (%AH)</li> </ul> <p>A certificate of non-toxicity is required. This must contain the following statement: "The print medium will not release toxic gasses when heated up to 200°C during 5 seconds and during prolonged heating at 100°C."</p> <p><b>Note:</b> The above properties can be tested at the Agencies for a fee.</p>
---

---

## Test Results, Medium Performance and Script

Once the print medium is tested, the performance of the medium is reviewed. All the information of the paper and scripts will be shared information.

The tested print medium will be rated at 1A, 1B, 2, 3 performance level. These performance levels are defined as follows:

- 1A – Good print quality is easy to obtain and rather stable without any finishing or stacking problems.
- 1B – Good print quality is not very easy to obtain. It requires close monitoring to maintain good and stable print quality. No finishing or stacking problems.
- 2 – Minor print quality problems and/or finishing problems.
- 3 – Severe print quality and finishing problems.

IBM has chosen to support 1A level media only. IBM allows customer to use 1B level media and a select few others at their own risk. IBM provides these scripts to its customers through IBM Service Engineers. They can update the InfoColor 70 with the latest print medium scripts upon your request.

---

## Rush Testing

In a situation where paper needs to be tested in a short period of time, paper test agencies may offer testing on rush basis for a surcharge. IBM may also offer medium testing under some limitations. To qualify for testing at IBM, you need to contact your account manager. Your account manager will need to petition the marketing organization for an evaluation and approval. IBM marketing will evaluate the following key areas:

1. Does IBM already provide support for a similar stock?
2. Does this print medium open a new market for InfoColor 70 print business?
3. Does this new print media bring additional IBM sales opportunities?

If you are approved for testing at IBM, you will need to submit the same pre-requisite medium information and prepare a medium sample (3 rolls) just as you would do for certified agencies. The turn around time at IBM is usually about 3 to 6 weeks depending on work load.





# Basic Paper Types and Their Properties

## Basic paper types

In order to understand fully what requirements have to be met by the paper, it is important that you know how paper types are distinguished:

Paper types	Uncoated paper	Uncalendered
		calendered
		Supercalendered
	Coated paper	Matt
		Satin
		Glossy
		High-gloss
	Speciality paper	Embossed
		Watermarked
		Recycled
		Tinted & Colored
		Translucent
Parchment		

## Uncoated paper

Paper, the surface of which is not covered with an additional coating. It is only composed of pulp, containing cellulose fibers, fillers, binders, pigments, etc.. The various types of uncoated paper are listed in the table below.

Uncoated paper types	Description
Uncalendered paper	Paper which was not submitted to the calendering process. See below.
Calendered paper	During the calendering process the paper passes through a number of calendering rolls made of steel, in order to make it more compact and smoother by increasing influences of temperature and pressure on the paper.
Supercalendered paper	During the supercalendering process the paper passes through a number of calendering rolls made alternately of steel and cotton, in order to make it even more compact and smoother.

## Coated paper

Paper, the surface of which is covered with a coating, in order to alter the surface properties of the original paper such as smoothness, gloss and water resistance.

Gloss property	Description
Matt coated paper	Coated paper, which was not submitted to the calendering process, or which passed through only one pair of calendars.
Satin coated paper	Coated paper, which was submitted to the calendering process.
Glossy and high-gloss coated paper	Coated paper, which was submitted to the supercalendering process.

Depending on the production method, coated papers can also be divided as follows:

Coated paper type	Description
Machine coated paper	Coating is applied by means of a dosing roll and the excess coating is removed with a scraper. The gloss is achieved by calendering. The coating thickness is variable on the scale of the paper's relief.
Cast coated paper	The gloss of the coated paper is obtained by passing the paper over a very smooth chromium roll. This results in very high-gloss coated paper. The coating thickness is uniform.

## Speciality paper

Paper, which has special properties, intended for special purpose use.

Feature	Description
Embossed paper	Paper with an amount of relief which is produced by pressing it between a rotary embosser, i.e. a metal roll having a embossing pattern.
Recycled paper	Paper that is made of pulp containing fibers of paper that has already been used and to which new fibers are added. Sometimes all fibers are recycled.
Tinted and Colored paper	Paper that is made of pulp containing an amount of colored pigments. Colored paper has a more saturated color than tinted paper.

Feature	Description
Watermarked paper	With a roll similar to an embosser, paper, that is still very wet in the paper machine, is processed. This causes thickness variations that creates different transparency levels.
Translucent paper	Paper which is highly transparent due to a special way of crushing the fibers.

---

## Paper properties

Paper property	Description
Weight	In grams per square meter ( $\text{g/m}^2$ ).
Caliper	Thickness of the paper expressed in $\mu\text{m}$ .
Absolute moisture content	The absolute moisture content is the ratio between the total amount of water in the paper and the weight of the paper (including fibers, fillers, binders and water).
Relative moisture content	The relative moisture content equals the relative humidity of the surrounding air, in equilibrium with the paper.
Smoothness	A paper property characterized by the roughness value, i.e. the size of tips and valleys on the paper's surface measured in PPS $\mu\text{m}$ , Bendtsen, Bekk, or sheffield.
Brightness	Total amount of visible light reflected by the paper. Adequate paper brightness is necessary to provide high-contrast images.
Bulk	The thickness of paper, in terms of the number of pages per inch for a given basis weight.
Formation	The formation of paper depends on the structure of cellulose fibers, which, in turn, depends on the construction of the paper machine and the composition of the pulp.
Opacity	Opacity is the opposite of transparency. The lower the opacity, the more you can see through the paper. Thin papers usually have a lower opacity.
Gloss	The amount of incident light under a certain angle that the paper reflects with the same angle.



---

## Guidelines for Print Medium Quality Inspection

---

### Check Paper Quality

1. Compare the manufacturer's Packaging and Reel Formation information with the Paper Roll specifications listed in the following table.

<b>Roll Dimensions</b>		
Description	Dimension (USA)	Dimension (EU)
Inner Core Diameter	6"-0/+0.02	150mm+/-0.5
Outer Core Diameter	7.1"	174mm
Maximum Roll Diameter	19.7"	500mm
Typical Roll Diameter	15.75"	400mm
Maximum Roll Weight	88lbs	40kg
Roll Width	12.6"	320mm

<b>Roll Specifications</b>
----------------------------

The paper must be free from splices, tears, dents, holes and other physical defects. The paper should be flush with the core and must not slide axially over the core.
--

2. Paper Formation  
Good paper formation is very important to obtaining good print and finish quality. A paper with poor formation quality produces a high degree of uneven print, mottling, and release of fibers. Non-uniform texture affects the uniformity of resistivity, causing uneven toner transfer to the paper.
3. Moisture content  
Moisture content should be consistent from roll to roll and also within a roll. Uneven moisture content can cause unstable print quality. Too high a moisture content can cause wrinkling (especially with thin paper), curling, and poor print quality. See "Artifact Samples" on page 21.
4. Surface smoothness  
A smooth paper surface greatly improves print quality because the contact area between the paper and the imaging drum is more uniform.

## Guidelines for Print Medium Storage and Handling

- Print Medium for IBM InfoColor 70 needs to be wrapped moisture tight on a continuous basis (including unused partial roll).
- Print Medium for IBM InfoColor 70 needs to be stored on a wood shelf, moisture tight, for 48 hours or longer to allow the paper to reach equilibrium with the printing room environment prior to printing.
- The moisture content of the print medium (especially paper) for the IBM InfoColor 70 should not be allowed to vary. The variation needs to be within  $\pm 0.1\%$ . If the moisture content varies outside of this range within the roll or from roll to roll, the paper conditioning script may not work consistently.

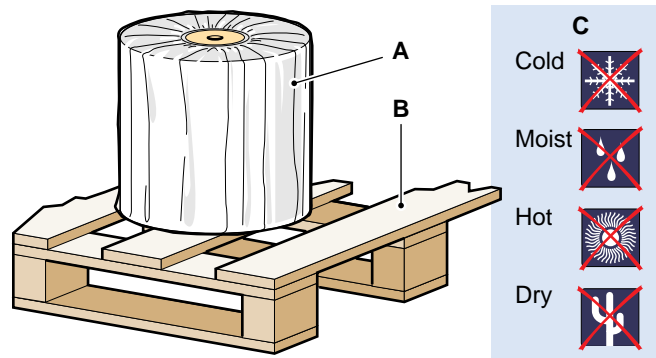

Precaution	Reason
Store the rolls in their original package in the printer room for 48 hours or longer, depending on the difference between the ambient temperature and that of the roll. (A)	During long term storage the paper roll needs to retain the moisture content as shipped from the paper mill. If the paper roll is at a different temperature from that of the print room while printing, the paper can lose or absorb moisture, causing print quality problems.
Store rolls on a pallet, not on a cold or warm surface. (B)	A roll containing warmer or colder areas cannot be conditioned uniformly in the paper supply (PRS) of the InfoColor 70.
Store rolls under normal ambient conditions. Avoid extreme temperature and moisture conditions. (C)	If the rolls are stored under extreme conditions, the paper-dependent parameters will not match the paper properties.
Remove the roll from the paper supply of the machine after printing and wrap the roll in its original package.	Over night the outer windings of a paper roll may attract or lose a substantial amount of moisture.

## Splicing

Always make sure that no adhesive substance is left near the splice on either side of the web.

Apply an additional single-sided tape over the exposed edge if you are making a splice between two different print media, as shown in the table below. This will minimize jams and broken splices.

Print medium in paper supply	Print medium in engine
label stock	any medium
film	any medium
any medium	film
stiff material (250 g/m <sup>2</sup> paper)	any medium

## Roll inspection

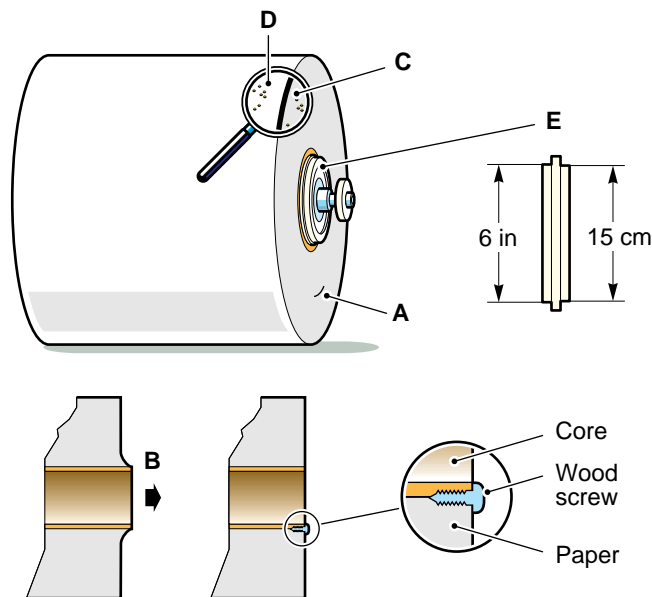

1. Check whether the roll is guaranteed splice free. (A)
  - a. If there is a factory splice. Stop printing as soon as the splice lies within a few millimeters of the outer windings.
  - b. Cut the paper at the splice table and unwind the roll until you can remove the factory splice.
  - c. Then splice the paper together again using the standard splicing procedure.
2. Check whether the paper is wound around the core tightly to prevent the web from shifting left/right. (B)
  - a. If the paper is not tightly wound around the core a wood screw can be used as a “first-aid solution” to secure the paper to the core. See illustration above.
  - b. If this situation occurs, contact your paper supplier and report a quality issue.
3. Check for dust on roll sides and surface.

**Note:** Do Not put the brake onto the roll before you have removed any dust.

  - a. Remove dust from the sides of the roll using either an adhesive rubber roller or a vacuum cleaner. (C)
  - b. Remove dust from the roll surface by removing the first winding of paper. (D)

- c. If dust appears on the paper surface of the entire roll, contact your paper supplier.
4. Verify that the paper axle mounting flanges are mounted correctly for the current paper roll inner core diameter. (E)

---

## Paper Waste During Printing and Waste Reduction (3.02 code or higher)

Paper waste is one of the biggest concerns to the press industry. To reduce the amount of paper waste to minimum levels, you must first understand the causes of paper waste in the IBM InfoColor 70. This section explains where paper waste occurs when printing with the IBM InfoColor 70 and how to minimize it.

### Start of a Print Job

Whenever you send a job to print, the printer will always respond by cutting one blank page (size varies). The printer will then stop and wait for the fuser to reach its set point.

#### Auto Mode

1. Paper conditioning

Normally, you need to run 18 to 25 blank pages minimum of about A4 size to get the paper conditioning system to reach its required criteria. Some paper types may take a longer time (more paper) depending on the quality of the paper. The Gloss Enhancement Module (GEM) also requires additional time to warm up. It can take 20 to 25 blank pages minimum of about A4 size (depending on parameters set) to get the GEM to warm from 30°C to 100°C during a typical first run in the morning. The GEM starts to warm up at the same time the PRS begins to condition the paper. Usually it takes a little longer to get paper conditioned when you start the machine and print the first job of the day. Or right after you have changed to a different paper. This is because the machine has not yet determined the conditioning temperature needed for your specific environment, specific paper and the initial values to be used.

2. Starting the image

Once the paper has reached the proper condition, and the GEM is at the correct temperature, the printer will begin imaging. After imaging starts, the machine will cut 18 to 20 pages, of about A4 size, plus two blank pages of the job size before your job will appear at the cutter.

#### Manual Mode

In Manual print mode the number of blank pages can be either reduced or increased, depending on the quality of the material, the experience of the operator, the quality requirements for the print job, and other factors.

### Finishing the Print Job

1. At the end of the last job, the printer will cut 2 blank pages of about A4 size.
2. Between jobs, if the 1st and 2nd jobs are both simplex<sup>1</sup> (or both duplex<sup>2</sup>), the printer will output 2 blank pages the size of the second job. Otherwise, it will output 8 A4 size blank pages plus 2 blank pages the size of the 2nd job.
3. In the situation that the 2nd job has not been completely downloaded to memory (non-collator models) before the 1st job is completed, the 1st job ends normally and the printer will output blank pages until the 2nd job is downloaded and begins imaging. The number of blank pages output depends on the timing of when the second job is ready to begin imaging. The collator model is faster in this regard when compared to the non-collator model.

---

1. Must be printing from the same tower (either X or Y).

2. Must have image data on both sides of paper for both jobs. If a duplex job does not have an image on one side it is treated as a simplex job.



## Changing the Paper Roll

1. Paper left over from a previous roll also contributes to paper waste. The Operator needs to replace the paper roll when receiving the "Paper Low" alarm. Close to the end of the paper roll, the paper tension is not very stable. This condition can cause a print quality problem. The Operator must avoid running the end of the paper through the printer. Running the end of the paper through the printer can cause damage to sensitive parts, taking the printer down for several hours while the damage is repaired.
2. When a new roll is spliced in, the splice must be completely driven through the printer before starting (or resuming) a print job. The engine will stop driving the paper out at about one meter past the splice. This can be controlled by the operator or by changing the splice\_delay value in the params.set file. If needed, ask your IBM Customer Engineer to change this value.

## Operator Skills

Operator inexperience can cause additional unusable prints and/or blank pages due to (but not limited to):

1. Out of specification densities.
2. Out of specification registration.
3. Dirty corona wires causing print defects.
4. Starting to print before the printer is conditioned to the correct temperature and humidity.
5. Reloading the conditioning script when a new roll of the same media is mounted.
6. The GEM is switched On and Off during printing.
7. The job is sent to print before the heating drum reaches its standby temperature.
8. The job is sent to print in the non-GEM mode before the GEM has cooled.

## Paper Quality

Paper Quality can be affected by improper manufacturing, handling, or storage. This can cause unstable conditioning and registration, contributing to the number of unusable prints or blank pages. You should always protect stored paper in moisture tight packaging. Do not use the paper before it reaches the same temperature as the print room.

## Environment

In a humid print room environment, paper can easily become curled, wavy, or even wrinkled depending on its thickness. These conditions can be minimized by reducing the fusing temperature, GEM temperature, or possibly the U2 value.



---

## Artifact Samples

There are a number of common artifacts that can be corrected by optimizing parameters. See the section “Description of paper-dependent parameters” on page 31 for additional information on machine/paper parameters.

The following artifact samples (and the suggested actions) should not be used until the following items have been addressed.

1. Has periodic maintenance/cleaning been performed?
2. Has the new medium been acclimated (at least 48 hours)?
3. Is current print quality, on a known paper, good?

If you answered No, to any of the above questions Do Not proceed until the machine is clean, functioning properly and the new medium has been acclimated.

Artifact	Page No.
Low-density cloudiness	22
High-density cloudiness	22
High-frequency cloudiness	23
Periodic low-density bands	23
Weak cloudiness	24
Low-density speckles	24
Low-density spots	25
Gloss too low	25
GEM hot offset	26
Worm like streaks	26
Wrinkling in the PRS	27
Non-uniform transfer quality across the web	28
Micro-blistering from the fuser	29

**Note:** This book is being distributed in both hard copy and online versions. If you are using the online version to print a copy, be aware that your choice of paper and the print quality of the printer that you use to print it on can affect the appearance of the artifact samples. Use a known paper, that has excellent print quality characteristics on a printer that does not have any print quality problems.

## Low-density cloudiness

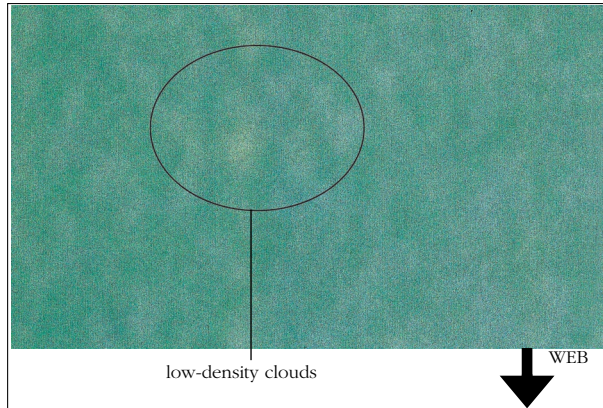

Description	Cause	Solution
Light clouds of 0.5 to 1cm in diameter in a darker surrounding. They have a reduced density and occur against a background of normal density. They are not clearly edged.	Transfer currents too low.	Increase transfer currents in steps of 20%.

## High-density cloudiness

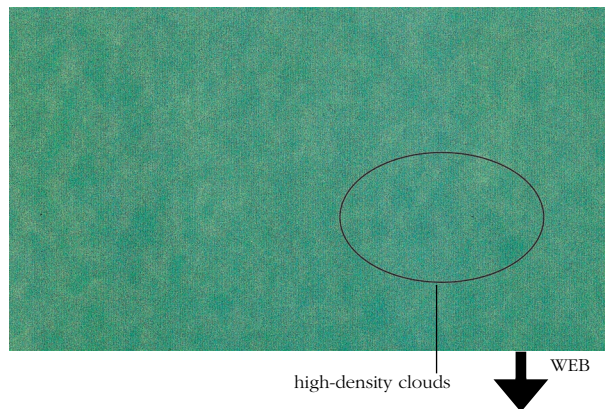

Description	Cause	Solution
Dark clouds of 0.1 to 0.5cm in diameter in a lighter surrounding, equivalent to the mottle structure of the paper. They have a normal density and appear against a background of reduced density. They are clearly edged.	Transfer currents too high.	Decrease transfer currents in steps of 20%.

## High-frequency cloudiness

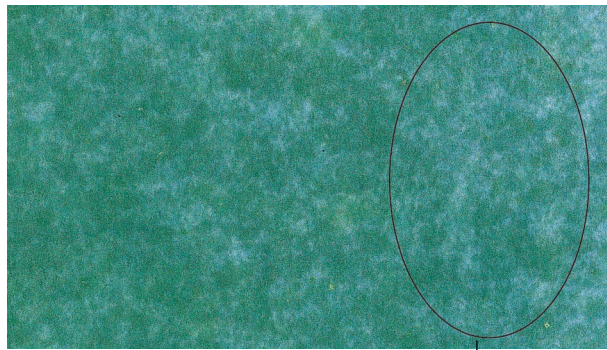

high-frequency clouds

WEB

Description	Cause	Solution
Irregular low-density clouds, especially occurring at the borders of the web.	Duplex currents too high.	Decrease positive duplex currents in steps of 20 $\mu$ A and negative duplex currents in steps of 10 $\mu$ A.

## Periodic low-density bands

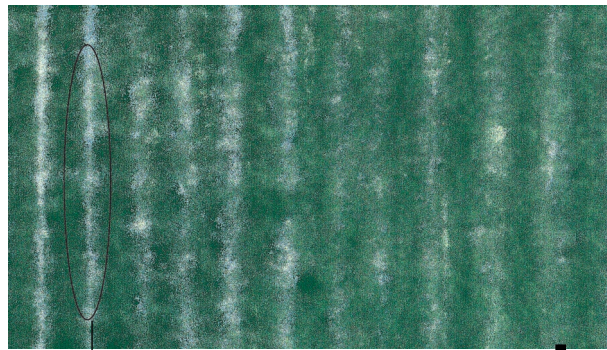

low-density band

WEB

Description	Cause	Solution
Low-density bands along the web, appearing in duo-color planes over the whole web width. They do not occur in mono-color planes.	Duplex currents too low.	Increase the positive duplex currents in steps of 10 $\mu$ A and the negative duplex currents in steps of 5 $\mu$ A.

## Weak cloudiness



Description	Cause	Solution
Small amount of cloudiness. It is not easy to determine what type of cloudiness it is.	Transfer current too high or too low.  Duplex currents too high or too low.	Decrease or increase the transfer current in steps of 10 $\mu$ A.  Decrease or increase the duplex current in steps of 10 $\mu$ A (positive) and 5 $\mu$ A (negative).

## Low-density speckles

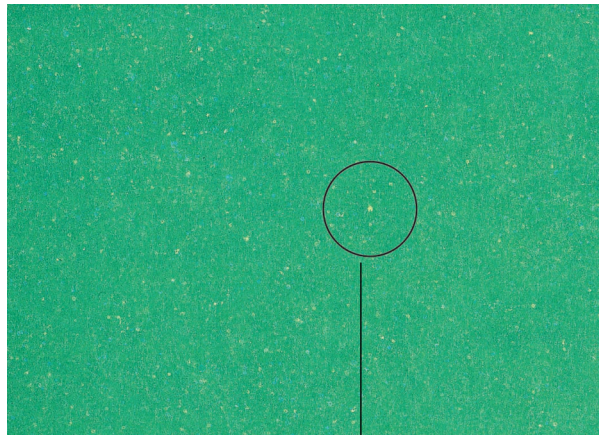

Description	Cause	Solution
Tiny round speckles ranging from 1 to 2mm in diameter with reduced density and sharply outlined.	Transfer currents too high.	First, reduce IPS/U2.N2 in steps of 20V. Decrease transfer currents in steps of 10 $\mu$ A. Increasing duplex currents may also be desirable but not always necessary.

## Low-density spots

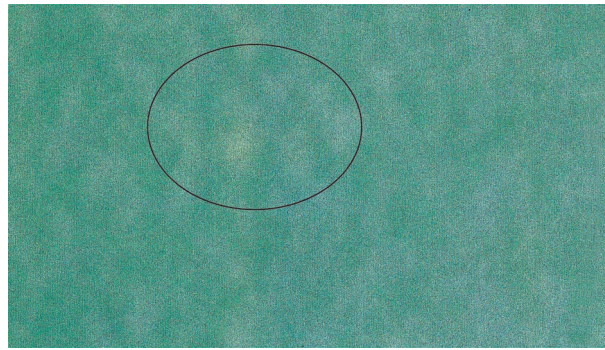

Description	Cause	Solution
Spots having an irregular shape and not sharply outlined.	Paper surface too rough.	Owing to the cause, this artifact cannot be eliminated.

## Gloss too low

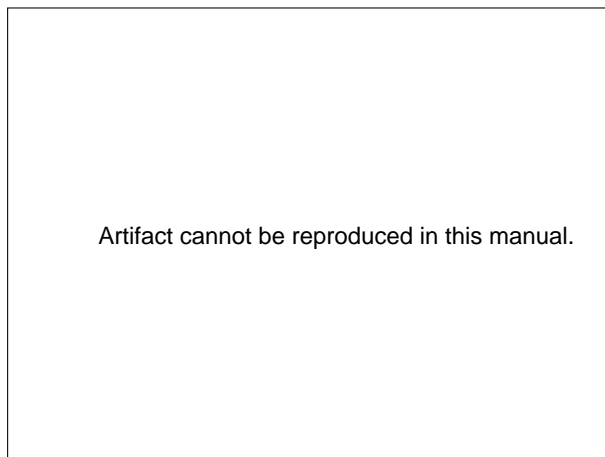

Description	Cause	Solution
The gloss is visibly too low.	Temperature set points IFX/T5.N22 and IFX/T6.N22 are too low.	Increase temperature set points IFX/T5.N22 and IFX/T6.N22 of both roll pairs in steps of 2°C.
		If IFX/T5.N22 and IFX/T6.N22 are too high, GEM hot offset will appear. Therefore, decrease temperature set points IFX/T5.N22 and IFX/T6.N22 again by 2°C until the lines disappear (see "GEM hot offset" on page 26).

## GEM hot offset

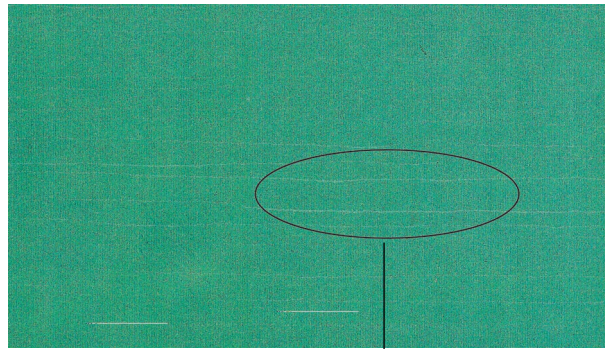

hot offset line



Description	Cause	Solution
When looking at the gloss of the image, recurrent very narrow lines, similar to scratches or cracks across the web, are visible.	Temperature set points IFX/T5.N22 and IFX/T6.N22 are too high.	Decrease temperature set points IFX/T5.N22 and IFX/T6.N22 of both roll pairs in steps of 2°C until the offset lines disappear.

## Worm like streaks

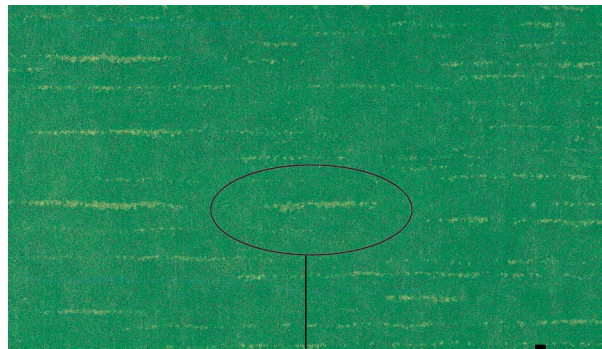

wormlike streak



Description	Cause	Solution
Tiny snakes, especially visible in duo-colors and on papers weighing more than 150 g/m <sup>2</sup> .	Erase voltage is too high.	Consult your service technician to reduce the erase voltage.
	IPS/U2.N2 is too high (if erase voltage was correct).	To eliminate the worms completely, reduce IPS/U2.N2 in steps of 20 to 40V (depending on the quantity and severity of the worms). Then, transfer currents must always be decreased.



## Wrinkling in the PRS

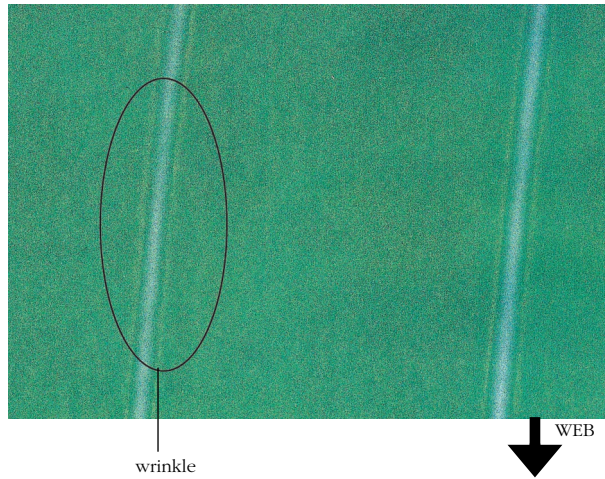

Description	Cause	Solution
Bent and slanted wrinkles across the whole web on print media weighing less than 100 g/m <sup>2</sup> . Since the wrinkles occur before the paper is printed, weak transfer occurs in and around the wrinkles.	Pre-heating roll temperature is too high, causing temperature shock.	Decrease paper conductivity set point IPS/U2.N2 in steps of 20V, so that the pre-heater's temperature decreases. Transfer currents must also be decreased.

## Non-uniform transfer quality across the web

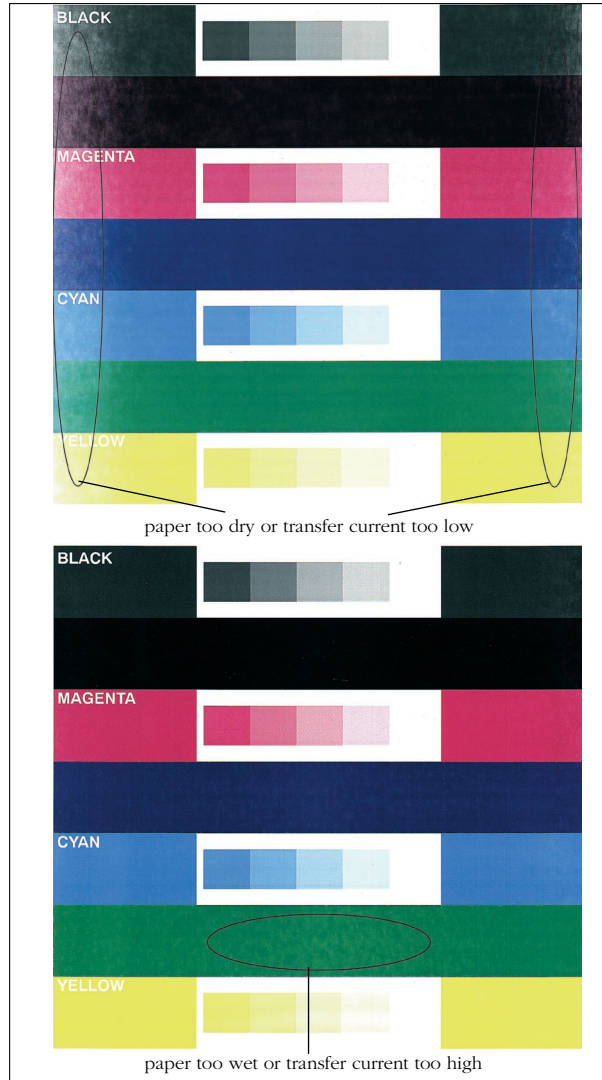

Description	Cause	Solution
Either transfer quality is good in the center of the web, and poor at the border, or vice versa. The image will always be clouded either in the center (high-density clouds because of transfer current too high) or at the border (low-density clouds because of transfer current too low).	Moisture content of the paper too high.	Due to the limited drying capacity of the pre-heater, this artifact cannot be eliminated.
	Inappropriate storage of paper reels (more moisture towards the edges).	Paper reel cannot be used. To prevent this problem, wrap each reel in a moisture-tight package.

## Micro-blistering from the fuser



Description	Cause	Solution
Tiny craters are visible (you can see the underlying toner) and tangible (the printed surface is rough and the tops of the craters can be rubbed away). Sometimes, only the underlying toner and small glossy dots are visible.	Due to the high temperature of the paper traveling through the fuser; excess moisture in the paper erupts like tiny volcanos, especially in high coverage areas.	Reduce IFX/T3.N2 in steps of 5°C until the artifact disappears.



## Description of paper-dependent parameters

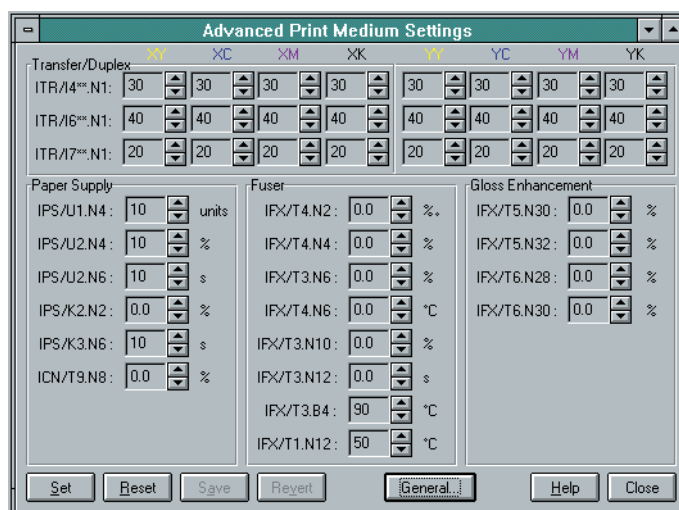
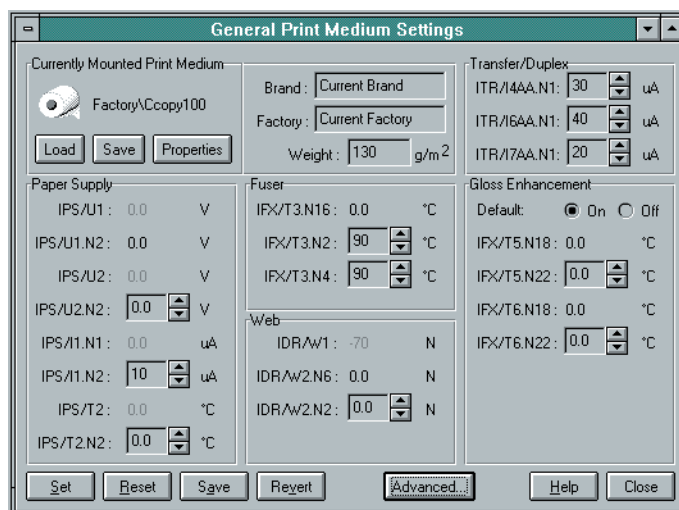

The table below briefly describes the paper-dependent parameters that can be found in XPOSE.

Parameter	Description
<b>web</b>	
IDR/W2.N2	Web tension set point
<b>paper conditioning</b>	
IPS/T2.N2	Temperature set point of the pre-heating roll before printing.
IPS/T2.N40	Temperature set point of the pre-heating roll during standby.
IPS/K2.N2	Fixed power applied to the pre-heating roll during start-up of the web (in % of the nominal power rating of the heating lamp).
IPS/U1.N4	Time constant of the SW-integrating controller for U1.

Parameter	Description
IPS/U2.N4	Amplification constant of the SW-proportional-integrating controller for U2.
IPS/U2.N6	Time constant of the SW-proportional-integrating controller for U2.
IPS/I1.N2	Limitation for the control variable I1 applied during start-up of the U1 controller.
IPS/K3.N6	Time that K2.N2 is applied during start-up of the web.
IPS/U1.N2	Set point for the initial paper charge for the paper conductivity measurement.
IPS/U2.N2	Set point for the desired conductivity of the paper before printing.
ICN/T9.N8	Amount of water flowing through the radiator of the PRS cooling unit.
<b>duplex/transfer</b>	
ITR/I4AA.N1	Current applied to the back of the paper, exerting an electrostatic force onto the toner. This force holds the toner against the paper when loosening the paper from the drum.
ITR/I6AA.N1 ITR/I7AA.N1	The positive and negative current respectively, applied to the pair of duplex coronas positioned between two successive stations. They inversely charge the toner transferred to the paper by the lower printing stations.
<b>fuser</b>	
IFX/T3.N2	Temperature set point of the web leaving the fuser; when the GEM is "off"
IFX/T3.N4	Temperature set point of the web leaving fuser; when the GEM is "on"
IFX/T3.N10	Amplification constant of the SW-proportional-integrating controller for T3.
IFX/T3.N12	Time constant of the SW-proportional-integrating controller for T3.
IFX/T4.N2	Constant A of warm-up temperature of fuser elements (= T3 x T4 dependency).
IFX/T4.N4	Constant B of warm-up temperature of fuser elements (= T4 dependency).
IFX/T3.N6	Constant C of warm-up temperature of fuser elements (= T3 dependency).
IFX/T4.N6	Constant D of warm-up temperature of fuser elements (= constant term). Factors A to D are the paper-dependent constants in the formula for the SW calculation of the warm-up temperature of the fuser elements IFX/T1.
IFX/T3.B4	Alarm level that triggers an alarm when the paper temperature IFX/T3 exceeds it.
IFX/T1.N12	Temperature set point of the fuser elements during stand-by.
<b>GEM</b>	

<b>Parameter</b>	<b>Description</b>
IFX/T7.N4	GEM on/off
IFX/T5.N22	Temperature set point first nip rolls
IFX/T5.N30	Pre-set duty cycle first nip rolls -20°C
IFX/T5.N32	Pre-set duty cycle first nip rolls -100°C
IFX/T6.N22	Temperature set point later nip rolls
IFX/T6.N28	Pre-set duty cycle latter nip rolls -20°C





## List of IBM Recommended Print Media for IBM 3170 and InfoColor 70

Script names match the May 1998 script release for 3.02PES

Please visit <http://www.printers.ibm.com/pbin-psc/go?manuals/ic70m.html> for the latest list.

### Uncoated Paper

Paper Script Location: PrintMedia\Paper\

Brand Name	Weight	Type/Description	Manufacture/Distribution	Script	Performance
DigiSmooth 60	60GSM	Uncalendered	Enso Group / 201-635-3530 US	FACTORY\UNCOATED\DIGISM60	1A
Mitsubishi II	60GSM	Contact IBM Japan for more information	Mitsubishi Japan	IBM\JAPAN\JM60G	1G
Nopasat/Nopacolor Digiprint/ Nopacolor Gigi 60	60GSM	SuperCalendered	Nordland(Kymmene) / 914-332-4444 US	FACTORY\ UNCOATED\NOCOD060	1A
Compat Clearbrite 17#	63GSM	Translucent uncalendered	Nationwide Papers / 800-323-1003 US	IBM\NATIONWD\NW63CB	IG
Mitsubishi I	64GSM	Contact IBM Japan for more information	Mitsubishi Japan	IBM\JAPAN\JM64G	IG
Digital Publishing Text	66GSM	Calendered	Georgia Pacific / 800-386-8118 US	IBM\GPACIFIC\GP66MCDI	IG
Westminster Trade Book	66GSM	Calendered with Vellum Finish	Georgia Pacific	IBM\GPACIFIC\GP66WMTB	IG
Springhill Incentive 100 DP 50#	74GSM	Calendered, 100% Recycled	International Paper / 814-870-6282 US	IBM\INTPAPER\SPIDP074	IG
4CC New 80	80GSM	SuperCalendered	Enso Group	FACTORY\ UNCOATED\4CCN080	1A
Digisuperior 80	80GSM	Calendered	Enso Group	IBM\ENSO\DISUP080	IG
Hokuetsu	80GSM	Contact IBM Japan for more information	Hokuetsu Japan	IBM\JAPAN\JH80G	IG
Lenza-Top-Recycling *Choose to use it carefully	80GSM	Calendered, 100% Recycled, Rough surface.	Lenzing Papier AG / 43-7672-701-3465 Austria	IBM\LENZING\LENTRO80	IG

Brand Name	Weight	Type/Description	Manufacture/Distribution	Script	Performance
Lenza-Top-Recycling-Super *Choose to use it carefully	80GSM	Calendered, 100% Recycled, Rough surface.	Lenzing Papier AG / 43-7672-701-3465 Austria	IBM\LENZING\LENTRS080	IG
Nopasat/Nopacolor Digiprint/ Nopacolor Gigi 80	80GSM	SuperCalendered	Nordland(Kymmene) / Russell-Field	FACTORY\ UNCOATED\NOCOD080	1A
Artica Digital Rolls 88	88GSM	Calendered	Avenor Inc. 905-793-0707 Canada 630-955-4566 US	FACTORY\ UNCOATED\AVEAD088	1A
Artica Digital Rolls Recycled 88	88GSM	Calendered, Recycled	Avenor Inc. 905-793-0707 Canada 630-955-4566 US	FACTORY\ UNCOATED\AVEDR088	1A
Arctica Premium 88	88GSM	Calendered	Avenor Inc. 905-793-0707 Canada 630-955-4566 US	FACTORY\ UNCOATED\AVEAP088	1A
Arctica Premium Recycled 88	88GSM	Calendered, Recycled	Avenor Inc. 905-793-0707 Canada 630-955-4566 US	FACTORY\ UNCOATED\AVEPR088	1A
60lb Satin-Kote 89	89GSM	Calendered, Pigmented	Plainwell Paper Co. 616-685-2553 US	FACTORY\ UNCOATED\PLSK089	1A
Hamermill Accent Opaque Luster White 60#	89GSM	Calendered	International Paper 814-870-6282 US	IBM\INTPAPER\HMAOW089	IG
Springhill Opaque Smooth 60#	89GSM	Calendered	International Paper 814-870-6282 US	IBM\INTPAPER\SPHOS089	IG
Brazil Chamex Premium 90	90GSM	Calendered, Woodfree	Champion, Brazil	IBM\CHAMPION\CHMEX090	IG
Microprint DCP	90GSM	Calendered	Georgia Pacific 800-386-8118 US	IBM\GPACIFIC\GP90MDCP	IG
Color Copy R 90	90GSM	Calendered	Neusiedler	FACTORY\ UNCOATED\COCOR090	1A
Rolltek Opaque Text 60#	90GSM	Uncalendered	Rollsource 612-331-2900 US	IBM\ROLLTEK\RT90-OPQ	IG
MultiCopy 90	90GSM	Calendered	Stora Kabel	IBM\STORA\STMLC090	IG
Lightening Laser 24#	90GSM	Calendered	Union Camp 804-569-5131 US	IBM\UNCAMP\UCLL090	IG

Brand Name	Weight	Type/Description	Manufacture/Distribution	Script	Performance
IvoLaser 95	95GSM	Calendered	Steinbach Intermill / Russell-Field	FACTORY\ UNCOATED\IVOL095	1A
4CC New 100	100GSM	SuperCalendered	Enso Group 201-635-3530 US	FACTORY\ UNCOATED\4CCN100	1A
Aussedat Rey Zanders Imaging Natura 100	100GSM	Calendered	Aussedat Rey Zanders	FACTORY\ UNCOATED\ARZIN100	1B
Color Copy R 100	100GSM	Calendered	Neusiedler	FACTORY\ UNCOATED\COCOR100	1A
Color Press Smooth Pigmented 100 / Anitec Aussedat Rey Zanders Satin 100	100GSM	Pigmented	Aussedat Rey / International Paper	FACTORY\ UNCOATED\CPSP100	1A
DCP 100	100GSM	Calendered	Clairefontaine	FACTORY\ UNCOATED\DCP100	1A
Galilei Opal 100	100GSM	Calendered	Metsä-Serla 358-1046-45346 Finland	FACTORY\ UNCOATED\MSGO100	1A
Mellotex Smooth Brilliant White 100	100GSM	Calendered	Tullis Russell	FACTORY\ UNCOATED\MLSBW100	1A
MoDo Ebene Satin/Data-copy Digital 100	100GSM	Calendered	MoDo Paper PSM	IBM\MODO\MOEBS100	IG
Nopasat/Nopacolor Digiprint/ Nopacolor Digi 100	100GSM	SuperCalendered	Nordland(Kymmene) / Russell-Field	FACTORY\ UNCOATED\NOCOD100	1A
Presentation 100	100GSM	Calendered	Federal Tait	FACTORY\ UNCOATED\PRESE100	1B
Splendorgel 100	100GSM	Calendered	Fedrigoni	FACTORY\ UNCOATED\SPLEN100	1A
Versoix-Digital ECF 100	100GSM	Uncalendered	Papeterie de Versoix	FACTORY\ UNCOATED\VEDIE100	1A
Versoix-Digital TCF 100	100GSM	Uncalendered	Papeterie de Versoix	FACTORY\ UNCOATED\VEDIT100	1A
Artica Digital Rolls 104	104GSM	Calendered	Avenor Inc. 905-793-0707 Canada 630-955-4566 US	FACTORY\ UNCOATED\AVEAD104	1A
Artica Digital Rolls Recycled 104	104GSM	Calendered, Recycled	Avenor Inc.	FACTORY\ UNCOATED\AVEDR104	1A
Artica Premium 104	104GSM	Calendered	Avenor Inc.	FACTORY\ UNCOATED\AVEAP104	1A

Brand Name	Weight	Type/Description	Manufacture/Distribution	Script	Performance
Artica Premium Recycled 104	104GSM	Calendered, Recycled	Avenor Inc.	FACTORY\ UNCOATED\AVEPR104	1A
Beckett Expression Text Snow Smooth 70#	104GSM	Calendered	International Paper 814-870-6282 US	IBM\INTPAPER\BKETS104	IG
Carnival Smooth Text 104	104GSM	Calendered	Champion International 203-358-6931 US	FACTORY\ UNCOATED\CHACS104	1B
MohawkNavajo Brilliant 104	104GSM	Calendered	Mohawk Paper Mills 800-843-6455 US	FACTORY\ UNCOATED\MOHNA104	1A
Plainfield Offset Opaque Plus, Smooth 104	104GSM	Calendered	Domtar Inc. 514-848-5292 Canada	FACTORY\ UNCOATED\DOPLO104	1A
Recycled Super Smooth 70# Text	104GSM	Uncalendered, Recycled	Nationwide Papers	IBM\NATIONWD\NW104RSS	IG
70lb Text Color Copy 105	105GSM	Calendered	Wausau Paper Mills 715-675-9891 ext.5504 US	FACTORY\ UNCOATED\WATCC105	1A
Hokuetsu	105GSM	Contact IBM Japan for more information	Hokuetsu Japan	IBM\JAPAN\JH105G	IG
IvoLaser 105	105GSM	Calendered	Steibach Intermill	FACTORY\ UNCOATED\IVOL105	1A
Mitsubishi	106GSM	Contact IBM Japan for more information	Mitsubishi Japan	IBM\JAPAN\JM106G	IG
Lenza-Plakat * Choose to use it carefully	110GSM	Uncalendered, Rough surface	Lenzing Papier AG 43-7672-701-3465 Austria	IBM\LENZING\LENPL110	IG
Esse Text Smooth White 80lb	118GSM	Calendered	Gilbert Paper 414-729-7734 US	FACTORY\UNCOATED\GILET080	1A
Mohawk Navajo Brillaint White 118	118GSM	Calendered	Mohawk Paper Mills 800-843-6455 US	FACTORY\ UNCOATED\MOHNA118	1A
Mohawk Options 118	118GSM	Calendered	Mohawk Paper Mills 800-843-6455 US	FACTORY\ UNCOATED\MOHOP118	1A
Solar White Classic Crest 80# Text	118GSM	Calendered	Neenah 800-558-5061 US	IBM\NEENAH\NNSW118	IG

Brand Name	Weight	Type/Description	Manufacture/Distribution	Script	Performance
Lightening DCP 73#	118GSM	Calendered	Union Camp 804-569-5131 US	IBMUNCAMP\UCLD118	IG
Pageantry Smooth Text 118	118GSM	Calendered	Champion International 203-358-6931 US	FACTORY\ UNCOATED\CHAPS118	1A
Conqueror CX-22 120	120GSM	Calendered	Arjo Wiggins 44-1322-397176 England	FACTORY\UNCOATED\COCX120	1A
Galilei Opal 120	120GSM	Calendered	Metsä-Serla 358-1046-45346 Finland	FACTORY\ UNCOATED\MSGO120	1A
Microprint DCP, Natural Text 120	120GSM	Calendered	Georgia-Pacific Corp. 800-386-8118 US	FACTORY\UNCOATED\DCPNA118	1B
Presentation 120	120GSM	Calendered	Federal Tait	FACTORY\ UNCOATED\PRESE120	1B
Microprint DCP	120GSM	Calendered	Georgia Pacific 800-386-8118 US	IBMGPACIFIC\GP120MDC	IG
Color Copy R 120	120GSM	Calendered	Neusiedler	FACTORY\ UNCOATED\COCOR120	1A
Nopasat/Nopacolor Digiprint/ Nopacolor Gigi 120	120GSM	SuperCalendered	Nordland(Kymmene) / Russell-Field	FACTORY\ UNCOATED\NOCOD120	1A
Color Press Smooth Pig- mented 130 / Anitec Ausedat Rey Zanders Satin 130	130GSM	Pigmented	Ausedat Rey / Interna- tional Paper	FACTORY\ UNCOATED\CPSP130	1A
DCP 130	130GSM	Calendered	Clairefontaine	FACTORY\ UNCOATED\DCP130	1A
4CC New 130	130GSM	SuperCalendered	Enso Group 201-635-3530 US	FACTORY\ UNCOATED\4CCN130	1A
IvoLaser 135	135GSM	Calendered	Steibach Intermill / Rus- sell-Field	FACTORY\UNCOATED\IVOL135	1A
Mellotex Smooth Brilliant White 135	135GSM	Calendered	Tullis Russell	FACTORY\UNCOATED\MLSBW135	1A
Splendorgel 140	140GSM	Calendered	Fedrigoni	FACTORY\UNCOATED\SPLEN140	1A
Pageantry Smooth Text 148	148GSM	Calendered	Champion International 203-358-6931 US	FACTORY\UNCOATED\CHAPS148	1B
Carnival Smooth Text 148	148GSM	Calendered	Champion International	FACTORY\UNCOATED\CHACS148	1B

Brand Name	Weight	Type/Description	Manufacture/Distribution	Script	Performance
Book Design Smooth 150	150GSM	Calendered	Klippan AB 46-478-10600 Sweden	FACTORY\UNCOATED\KLIBD150	1A
Nopasat/Nopacolor Digiprint/ Nopacolor Gigi 150	150GSM	SuperCalendered	Nordland(Kymmene) / Russell-Field	FACTORY\UNCOATED\NOCOD150	1A
4CC New 160	160GSM	SuperCalendered	Enso Group 201-635-3530 US	FACTORY\UNCOATED\4CCN160	1A
Color Press Smooth Pig- mented 160 / Anitec Ausedat Rey Zanders Satin 160	160GSM	Pigmented	Ausedat Rey / Interna- tional Paper	FACTORY\UNCOATED\CPSP160	1A
DCP 160	160GSM	Calendered	Clairefontaine	FACTORY\UNCOATED\DCP160	1A
Galilei Opal 160	160GSM	Calendered	Metsä-Serla 358-1046-45346 Finland	FACTORY\ UNCOATED\MSGO160	1A
High Tech Special 160	160GSM	Calendered	Klippan AB 46-478-10600 Sweden	FACTORY\UNCOATED\KLIHT160	1A
Presentation 160	160GSM	Calendered	Federal Tait	FACTORY\UNCOATED\PRESE160	1B
Splendorgel 160	160GSM	Calendered	Fedrigoni	FACTORY\UNCOATED\SPLEN160	1A
Color Copy R 160	160GSM	Calendered	Neusiedler	FACTORY\UNCOATED\COCOR160	1A
IvoLaser 160	160GSM	Calendered	Steinbach Intermill / Rus- sell-Field	FACTORY\UNCOATED\IVOL160	1A
Mellotex Smooth Brilliant White 160	160GSM	Calendered	Tullis Russell	FACTORY\UNCOATED\MLSBW160	1A
110 Index	163GSM	Super Calendered, 9pt Recycled	Dunsirn Industries 800-593-1588 US	IBMDUNSIRN\DI163IN	IG
Microprint DCP 100# Text	163GSM	Calendered	Georgia Pacific 800-386-8118 US	IBM\GPACIFIC\GP163MDC	IG
60lb Cover Color Copy 165	165GSM	Calendered	Wausau Paper Mills 715-675-9891 ext.5504 US	FACTORY\ UNCOATED\WACCC165	1B
Nopasat/Nopacolor Digiprint/ Nopacolor Gigi 170	170GSM	SuperCalendered	Nordland(Kymmene) / Russell-Field	FACTORY\UNCOATED\NOCOD170	1A

Brand Name	Weight	Type/Description	Manufacture/Distribution	Script	Performance
Sweprint Digital 170	170GSM	Calendered	Klippan AB 46-478-10600 Sweden	FACTORY\UNCOATED\KLISD170	1B
Mohawk Options Bright White 176	176GSM	Calendered	Mohawk Paper Mills 800-843-6455 US	FACTORY\UNCOATED\MOHOP176	1A
Mohawk Navajo Brilliant White 176	176GSM	Calendered	Mohawk Paper Mills	FACTORY\UNCOATED\MOHNA176	1A
Solar White Classic Crest 65#cvr	176GSM	Calendered	Neenah 800-558-5061 US	IBMNEENAH\NNSW176	IG
Mellotex Smooth Brilliant White 180	180GSM	Calendered	Tullis Russell	FACTORY\UNCOATED\MLSBW180	1A
DCP 190	190GSM	Calendered	Clairefontaine	FACTORY\UNCOATED\DCP190	1A
4CC New 190	190GSM	SuperCalendered	Enso Group	FACTORY\UNCOATED\4CCN190	1A
Nopasat/Nopacolor Digiprint/ Nopacolor Gigi 190	190GSM	SuperCalendered	Nordland(Kymmene) / Russell-Field	FACTORY\UNCOATED\NOCOD190	1A
IvoLaser 190	190GSM	Calendered	Steibach Intermill / Rus- sell-Field	FACTORY\UNCOATED\IVOL190	1A
Color Press Smooth Pig- mented 200 / Anitec Ausedat Rey Zanders Satin 200	200GSM	Pigmented	Ausedat Rey / Interna- tional Paper	FACTORY\UNCOATED\CPSP200	1B
Data Copy Digital 200	200GSM	Calendered	MoDo Paper PSM	FACTORY\ UNCOATED\DACOD200	1A
Color Copy R 200	200GSM	Calendered	Neusiedler	FACTORY\UNCOATED\COCOR200	1A
Mellotex Smooth Brilliant White 200	200GSM	Calendered	Tullis Russell	FACTORY\UNCOATED\MLSBW200	1A
Mohawk Navajo Brilliant White 216	216GSM	Calendered	Mohawk Paper Mills	FACTORY\UNCOATED\MOHNA216	1B
4CC New 220 * Make sure the stock is man- ufactured after 08/97	220GSM	SuperCalendered	Enso Group	FACTORY\UNCOATED\4CCN220	2A
Splendorgel 230	230GSM	Calendered	Fedrigoni	FACTORY\UNCOATED\SPLEN230	2A

Brand Name	Weight	Type/Description	Manufacture/Distribution	Script	Performance
Color Press Smooth Pigmented 240 / Anitec Ausedat Rey Zanders Satin 240	240GSM	Pigmented	Ausedat Rey / International Paper	FACTORY\UNCOATED\CPSP240	2A
IvoLaser 240	240GSM	Calendered	Steibach Intermill / Russell-Field	FACTORY\UNCOATED\IVOL240	2A
4CC New 250 * Make sure the Stock is manufactured after 08/97	250GSM	SuperCalendered	Enso Group	FACTORY\UNCOATED\4CCN250	2B
Data Copy Digital 250	250GSM	Calendered	MoDo Paper PSM	FACTORY\UNCOATED\DACOD250	2A
Color Copy R 250	250GSM	Calendered	Neusiedler	FACTORY\UNCOATED\COCOR250	2A
Mellotex Smooth Brilliant White 250	250GSM	Calendered	Tullis Russell	FACTORY\UNCOATED\MLSBW250	2B



## Coated Paper

Paper Script Location: PrintMedia\Paper\

Brand Name	Weight	Type/Description	Manufacture/Distribution	Script	Performance
Terratec Matt 70	70GSM	Matte	Stora Kabel	FACTORY\COATED_M\TERMA070	1B
HANNO'ART tecgloss 80	80GSM	Gloss	Sappi Europe	FACTORY\COATED_G\HAGLO080	1B
HANNO'ART tecsilks 80	80GSM	Matte	Sappi Europe	FACTORY\COATED_M\HASIL080	1B
Terratec Matt 80	80GSM	Matte	Stora Kabel	FACTORY\COATED_M\TERMA080	1B
60# Semi-gloss CS2 Web	90GSM	Gloss, Web Enamel	Dunsirn Industries 800-593-1588 US	IBM\DUNSIRN\DI90SGL	IG
DigiSilk 90/4CCSilk 90	90GSM	Satin	Enso Group 201-635-3530 US	FACTORY\COATED_S\DIGIS090	1B
DigiArt 90/4CCArt 90	90GSM	Gloss	Enso Group	FACTORY\COATED_G\DIGIA090	1A
HANNO'ART tecgloss 90	90GSM	Gloss	Sappi Europe	FACTORY\COATED_G\HAGLO09	1B
HANNO'ART tecsilks 90	90GSM	Matte	Sappi Europe	FACTORY\COATED_M\HASIL090	1B
Lazulis Brillant 90	90GSM	Gloss	Smurfit Condat	FACTORY\COATED_G\LAZBR090	1A
DigiArt 100/4CCArt 100	100GSM	Gloss	Enso Group	FACTORY\COATED_G\DIGIA100	1A
DigiSilk 100/4CCSilk 100	100GSM	Satin	Enso Group	FACTORY\COATED_S\DIGIS100	1B
Data Copy Option 100 / MoDo Dian	100GSM	Matte	MoDo Paper PSM / Rus- sell-Field	FACTORY\COATED_M\DACOP100	1A
HANNO'ART tecgloss 100	100GSM	Gloss	Sappi Europe	FACTORY\COATED_G\HAGLO100	1B
HANNO'ART tecsilks 100	100GSM	Matte	Sappi Europe	FACTORY\COATED_M\HASIL100	1B
Lazulis Brillant 100	100GSM	Gloss	Smurfit Condat	FACTORY\COATED_G\LAZBR100	1A
Terratec Matte 100	100GSM	Matte	Stora Kabel	FACTORY\COATED_M\TERMA100	1B
Champion Courtland Matte	105GSM	Matte	Champion	IBM\CHAMPION\CH105CM	IG
70# Semi-gloss CS2 Web	105GSM	Gloss, Web Enamel	Dunsirn Industries 800-593-1588 US	IBM\DUNSIRN\DI105SGL	IG
Aussedat Rey Zanders Imag- ing Matte 115	115GSM	Matte	International Paper Zanders	FACTORY\COATED_M\MARZIM115	1A

Brand Name	Weight	Type/Description	Manufacture/Distribution	Script	Performance
Aussedat Rey Zanders Imaging Gloss 115	115GSM	Gloss	International Paper Zanders	FACTORY\COATED_M\MARZIG115	1A
DigiSilk 115/4CCSilk 115	115GSM	Satin	Enso Group 201-635-3530 US	FACTORY\COATED_S\DIGIS115	1B
DigiArt 115/4CCArt 115	115GSM	Gloss	Enso Group	FACTORY\COATED_G\DIGIA115	1A
Royal Digital Gloss 115 (new) * Packed in Round Box	115GSM	Gloss	KNP Leykam 32-897-19645 Belgium	FACTORY\COATED_G\RDGLS115	1A
Royal Digital Silk 115 (new) * Packed in Round Box	115GSM	Satin	KNP Leykam	FACTORY\COATED_S\RDSIL115	1A
HANNO'ART tecgloss 115	115GSM	Gloss	Sappi Europe	FACTORY\COATED_G\HAGLO115	1B
HANNO'ART tecsilks 115	115GSM	Matte	Sappi Europe	FACTORY\COATED_M\HASIL115	1B
Lazulis Brillant 115	115GSM	Gloss	Smurfit Condat	FACTORY\COATED_G\LAZBR115	1A
80lb Gloss White Text 118	118GSM	Gloss	Plainwell Paper Company 616-685-2553 US	FACTORY\COATED_G\PLGWT118	1A
Champion Influence Soft Gloss 118GSM	118GSM	Gloss	Champion 203-358-6931 US	IBM\CHAMPION\CH118ISG	IG
Champion Influence White	118GSM	Gloss	Champion	IBM\CHAMPION\CH118IW	IG
Champion Preference White	118GSM	Gloss	Champion	IBM\CHAMPION\CH118PW	IG
Golden Web Gloss 80# Text	118GSM	Gloss	Nationwide Papers 800-323-1003 US	IBM\NATIONWD\NW118GW	IG
Rolltek Gloss Text	118GSM	Gloss	Rollsource 612-331-2900 US	IBM\ROLLTEK\RT118GLT	IG
Rolltek Matte Text	118GSM	Matte	Rollsource	IBM\ROLLTEK\RT118MTT	IG
Lustro Web Gloss 80# Text	118GSM	Gloss	S.D. Warren 303-721-7383 US	IBM\SDWARREN\WA118LWG	IG
Champion Courtland Gloss	120GSM	Gloss	Champion	IBM\CHAMPION\CH120CG	IG
NopaCoat 120	120GSM	Gloss	Kymenne Nordland / Russell-Field	IBM\NORDLAND\NOPAC120	IG

Brand Name	Weight	Type/Description	Manufacture/Distribution	Script	Performance
Data Copy Option 120 / MoDo Dian	120GSM	Matte	MoDo Paper PSM	FACTORY\COATED_M\DACOP120	1A
DigiArt 130/4CCArt 130	130GSM	Gloss	Enso Group 201-635-3530 US	FACTORY\COATED_G\DIGIA130	1A
DigiSilk 130/4CCSilk 130	130GSM	Satin	Enso Group	FACTORY\COATED_S\DIGIS130	1B
DigiMagic/Magic Gloss 86# Text	130GSM	Gloss	Enso Group	IBM\ENSO\MG130G	IG
Galilei Art Silk 130	130GSM	Satin	Metsä-Serla, Kangas Mill 358-1046-45346 Finland	FACTORY\COATED_S\MSGAS130	1B
Galilei Art Gloss 130	130GSM	Gloss	Metsä-Serla, Kangas Mill	FACTORY\COATED_S\MSGAG130	1B
MoDo Silverblade Matte 130	130GSM	Matte	MoDo Paper PSM	IBM\MODO\MOSIM130	IG
Silverblade Gloss 130	130GSM	Gloss	MoDo Paper PSM	FACTORY\COATED_G\SILGL130	1A
Aussedat Rey Zanders Imaging Matte 135	135GSM	Matte	International Paper Zanders	FACTORY\COATED_M\MARZIM135	1A
Aussedat Rey Zanders Imaging Gloss 135	135GSM	Gloss	International Paper Zanders	FACTORY\COATED_M\MARZIG135	1A
Color Press Gloss Coated 135	135GSM	Gloss	Aussedat Rey	FACTORY\COATED_G\CPGC135	1A
Royal Digital Gloss 135 (new) * Packed in round box	135GSM	Gloss	KNP Leykam 32-897-19645 Belgium	FACTORY\COATED_G\RDGLS135	1A
Royal Digital Silk 135 (new) * Packed in round box	135GSM	Satin	KNP Leykam	FACTORY\COATED_S\RDSIL135	1A
Data Copy Option 135 / MoDo Dian	135GSM	Matte	MoDo Paper PSM	FACTORY\COATED_M\DACOP135	1A
Satin Matte 135	135GSM	Matte	Russell-Field 800-323-1947 US	IBM\RSLFIELD\SATMT135	IG
Satin Gloss 135	135GSM	Gloss	Russell-Field	IBM\RSLFIELD\SATGL135	IG
HANNO'ART tecgloss 135	135GSM	Gloss	Sappi Europe	FACTORY\COATED_G\HAGLO135	1B
HANNO'ART tecsilks 135	135GSM	Matte	Sappi Europe	FACTORY\COATED_M\HASIL135	1B
Lazulis Brillant 135	135GSM	Gloss	Smurfit Condat	FACTORY\COATED_G\LAZBR135	1A

Brand Name	Weight	Type/Description	Manufacture/Distribution	Script	Performance
Imaging Digital Matte 135	135GSM	Matte	Zanders	FACTORY\COATED_M\DIMAT135	1B
Rolltek Gloss Text	148GSM	Gloss	Rollsource	IBM\ROLLTEK\RT148GLT	IG
Lustro Web Dull 100# Text	148GSM	Dull	S.D. Warren	IBM\SDWARREN\WA148LWD	IG
Aussedat Rey Zanders Imaging Matte 150	150GSM	Matte	International Paper Zanders	FACTORY\COATED_M\MARZIM150	1A
Aussedat Rey Zanders Imaging Gloss 150	150GSM	Gloss	International Paper Zanders	FACTORY\COATED_M\MARZIG150	1A
Digimatt/Matte Art	150GSM	Matte	Enso Group	IBM\ENSO\MA150G	IG
DigiSilk 150/4CCSilk 150	150GSM	Satin	Enso Group	FACTORY\COATED_S\SDIGIS150	1B
DigiArt 150/4CCArt 150	150GSM	Gloss	Enso Group	FACTORY\COATED_G\SDIGIA150	1A
Galilei Art Silk 150	150GSM	Satin	Metsä-Serla, Kangas Mill 358-1046-45346 Finland	FACTORY\COATED_S\MSGAS150	1B
Royal Digital Gloss 150 (new) * Packed in round box	150GSM	Gloss	KNP Leykam	FACTORY\COATED_G\RDGLS150	1A
Royal Digital Silk 150 (new) * Packed in round box	150GSM	Satin	KNP Leykam	FACTORY\COATED_S\RDLSIL150	1A
Data Copy Option 150 / MoDo Dian	150GSM	Matte	MoDo Paper PSM	FACTORY\COATED_M\DACOP150	1A
Silverblade Gloss 150	150GSM	Gloss	MoDo Paper PSM	FACTORY\COATED_G\SILGL150	1A
Lazulis Brillant 150	150GSM	Gloss	Smurfit Condat	FACTORY\COATED_G\LAZBR150	1A
Imaging Digital Matte 150	150GSM	Matte	Zanders	FACTORY\COATED_M\DIMAT150	1B
Color Press Gloss Coated 155	155GSM	Gloss	Aussedat Rey	FACTORY\COATED_G\CPGC155	1B
Rolltek Gloss Cover	162GSM	Gloss	Rollsource 612-331-2900 US	IBM\ROLLTEK\RT162GLC	IG
Colorprint Castcote 110# Text	163GSM	Castcoate	Nationwide Papers 800-323-1003 US	IBM\NATIONWD\NW163CC	IG
DigiSilk 170/4CCSilk 170	170GSM	Satin	Enso Group 201-635-3530 US	FACTORY\COATED_S\SDIGIS170	1B

Brand Name	Weight	Type/Description	Manufacture/Distribution	Script	Performance
DigiArt 170/4CCArt 170	170GSM	Gloss	Enso Group	FACTORY\COATED_G\DIGIA17	1A
Galilei Art Silk 170	170GSM	Satin	Metsä-Serla, Kangas Mill 358-1046-45346 Finland	FACTORY\COATED_S\MSGAS170	1B
Galilei Art Gloss 170	170GSM	Gloss	Metsä-Serla, Kangas Mill	FACTORY\COATED_S\MSGAG170	1B
Royal Digital Gloss 170 (new) * Packed in round box	170GSM	Gloss	KNP Leykam 32-897-19645 Belgium	FACTORY\COATED_G\RDGLS170	1A
Royal Digital Silk 170 (new) * Packed in round box	170GSM	Satin	KNP Leykam	FACTORY\COATED_S\RDSIL170	1A
Data Copy Option 170 / MoDo Dian	170GSM	Matte	MoDo Paper PSM / Rus- sell-Field	FACTORY\COATED_M\DACOP170	1A
Silverblade Gloss 170	170GSM	Gloss	MoDo Paper PSM	FACTORY\COATED_G\SILGL170	1A
Lazulis Brillant 170	170GSM	Gloss	Smurfit Condat	FACTORY\COATED_G\LAZBR170	1A
Rolltek Matte Cover 7pt.	176GSM	Matte	Rollsource	IBM\ROLLTEK\RT176MTC	IG
Aussedat Rey Zanders Imag- ing Gloss 200	200GSM	Gloss	International Paper Zanders	FACTORY\COATED_M\MARZIG200	1A
Royal Digital Gloss 200 (new) * Packed in round box	200GSM	Gloss	KNP Leykam	FACTORY\COATED_G\RDGLS200	1A
Royal Digital Silk 200 (new) * Packed in round box	200GSM	Satin	KNP Leykam	FACTORY\COATED_S\RDSIL200	1A
***NopaCoat 200 - under problem checking status	200GSM	Gloss	Kymenne Nordland / Russell-Field	IBM\NORDLAND\NOPAC200	IG
Data Copy Option 200 / MoDo Dian	200GSM	Matte	MoDo Paper PSM / Rus- sell-Field	FACTORY\COATED_M\DACOP200	1A
Silverblade Gloss 200	200GSM	Gloss	MoDo Paper PSM	FACTORY\COATED_G\SILGL200	1A
Lazulis Brillant 200	200GSM	Gloss	Smurfit Condat	FACTORY\COATED_G\LAZBR200	1A
Imaging Digital Matte 200	200GSM	Matte	Zanders	FACTORY\COATED_M\DIMAT200	1B
Rolltek Gloss Cover 80#	216GSM	Gloss	Rollsource	IBM\ROLLTEK\RT216GLC	2IG
Lazulis Brillant 225	225GSM	Gloss	Smurfit Condat	FACTORY\COATED_G\LAZBR225	2A

<b>Brand Name</b>	<b>Weight</b>	<b>Type/Description</b>	<b>Manufacture/Distribution</b>	<b>Script</b>	<b>Performance</b>
Silverblade Gloss 240	240GSM	Gloss	MoDo Paper PSM	FACTORY\COATED_G\SILGL240	2B
Data Copy Option 250 / MoDo Dian	250GSM	Matte	MoDo Paper PSM	FACTORY\COATED_M\DACOP250	2A

## Specialty Paper

Paper Script Location: PrintMedia\Paper\

Brand Name	Weight	Type/Description	Manufacture/Distribution	Script	Performance
Autocopy Laser CF		Carbonless Paper	Zanders Feinpapiere 49-2202-156565 Ger- many	FACTORY\SPECIAL\AUTOCHF	1B
Autocopy Laser CFB		Carbonless Paper	Zanders Feinpapiere	FACTORY\SPECIAL\AUTOCFB	1B
Autocopy Laser CB		Carbonless Paper	Zanders Feinpapiere	FACTORY\SPECIAL\AUTOCB	1B
Idem Superior CB	80GSM	Carbonless Paper	Arjo Wiggins Ltd. 44-1494-652275 England	FACTORY\SPECIAL\AWCB_080	1B
Idem Superior CFB	80GSM	Carbonless Paper	Arjo Wiggins Ltd.	FACTORY\SPECIAL\AWCFB_080	1A
Copy Fantasy CTM 1500 * Use with understanding		Heat Transfer Paper	Meserli	FACTORY\COPFAN15	May experi- ence print quality and finishing problem.
Photo-TransÆ SC *Use with understanding		Heat Transfer Paper	Wyndstone 800-395-8870 US	IBMWSTONEWSPHOTSC	Need low fusing. Image quality is moderate for fabric
Supergloss 80	80GSM	Single-side castcoate	Zanders	FACTORY\SPECIAL\SUGLO080	1A
Classic Laid 90	90GSM	Creamy Color Water Marked Paper with Parchment Surface	Neenah 800-558-5061 US	IBM\NEENAH\NNCLD090	IG
DigiTerreus 100	100 GSM	Embossed	Enso Group 201-635-3530 US	FACTORY\SPECIAL\DITER100	1B
Oxford Text White 80lb	118 GSM	Uncoated embossed	Gilbert Paper 414-729-7734 US	FACTORY\SPECIAL\GILOT080	1B
Corolla Book Ivory 120	120 GSM	Watermarked	Fedrigoni	FACTORY\SPECIAL\COBOI120	1A
Pretex Manual 120	120GSM	Impregnated, High tear/ fold resistant	Papierfabrik Lahnstein, Holland	FACTORY\SPECIAL\PRETE120	1B

Brand Name	Weight	Type/Description	Manufacture/Distribution	Script	Performance
ImagEase Ferenze 135	135GSM	1-side Gloss Coated, Leather Look Finish, Latex Saturated	Rexam DSI / Russell-Field	FACTORY\SPECIAL\IMAFI135	1A
ImagEase Linenweave 135	135GSM	1-side Gloss Coated, Linen finish, Latex Saturated	Rexam DSI / Russell-Field	FACTORY\SPECIAL\IMALI135	1A
ImagEase Chrome 135	135GSM	1-side Gloss Coated, Latex Saturated	Rexam DSI / Russell-Field	FACTORY\SPECIAL\IMACH135	1A
IvoLaser Antique 135	135 GSM	Tinted Paper	Steinbach Intermills	FACTORY\SPECIAL\IVOA135	1A
IvoLaser Antique TM 135	135 GSM	Embossed	Steinbach Intermills	FACTORY\SPECIAL\IVOAT135	1A
Supergloss 135	135GSM	Single-side castcoate	Zanders	FACTORY\SPECIAL\SUGLO135	1A
Conqueror Laid 150	150GSM	Watermarked, Uncoated Calendered	Arjo Wiggins 44-1322-397176 England	FACTORY\SPECIAL\COLAI150	1A
Marina Conchiglia 175	175 GSM	Parchment	Fedrigoni	FACTORY\SPECIAL\MARCO175	1A
Supergloss 180	180GSM	Single-side castcoate	Zanders	FACTORY\SPECIAL\SUGLO180	1A
IvoLaser Antique 190	190 GSM	Tinted Paper	Steinbach Intermills	FACTORY\SPECIAL\IVOA190	1A
IvoLaser Antique TM 190	190 GSM	Embossed	Steinbach Intermills	FACTORY\SPECIAL\IVOAT190	1A
IvoLaser TM 190	190 GSM	Embossed	Steinbach Intermills	FACTORY\SPECIAL\IVOT190	1A
ImagEase 212 Chrome	212 GSM	1-side Gloss Coated, Latex Saturated	Rexam / Russell-Field	IBM\REXAM\RXIME212	2IG
IvoLaser TM 240	240 GSM	Embossed	Steinbach Intermills	FACTORY\SPECIAL\IVOT240	2A



## Label Materials

Paper Script Location: PrintMedia\Label\  
Sorted by manufacturer

Brand Name	Weight	Type/Description	Manufacture/Distribution	Script	Performance
White 2 mil Vinyl Thermal Transfer Film Label 3690E		2mil face, 1mil adhesive, 3.2mil paper liner	3M 800-328-1681 US	IBM\3M\3M3690E	IG
5mil Gloss White Acrylate Thermal Transfer Film Label 3921		5mil face, 1mil adhesive, 4.6mil paper liner	3M	IBM\3M\3M3921	IG
1.5mil Gloss Clear Polyester Press Printable Film Label 7753		1.5mil face, 0.7mil adhesive, 1.5mil polyester film liner	3M	IBM\3M\3M7753	IG
Matte White 7mil TeslinTM Polyolefin Laser Imageable Label 7841		7mil face, 0.8mil adhesive, 3.2mil paper liner	3M	IBM\3M\3M7841	IG
Fasson Digital Print Media High Gloss 7250/10112	50# MF liner	Coated Paper Label, Permenant Adhesive	Avery Dennison 800-443-9380 US	IBM\FASSON\F7250	IG
Fasson Digital Print Media Uncoated 7251/10111	50# MF liner	Uncoated Paper Label, Permenant Adhesive	Avery Dennison	IBM\FASSON\F7251	IG
Fasson Digital Print Media 3.4 mil White Flex Vinyle 7252/73180	78# liner	Vinyle Label, Permenant Adhesive	Avery Dennison	IBM\FASSON\F7252	IG
Fasson Vellum DI-CP WA1525 Matte Paper Label	80 micron face, 100 micron liner	Uncoated Paper Label with Paper Liner	Avery Dennison (Europe)	FACTORY\FASVEL	1A
Fasson MCWhite DI-CP WA1533 Semi-gloss Paper Label	80GSM face, 100GSM liner	Satin Machine Coated Paper Label with Paper Liner	Avery Dennison (Europe)	FACTORY\FASMCW	1A
Fasson HGW DI-CP WA1541 High-gloss Paper Label	80GSM face, 100GSM liner	High Gloss Cast Coated Paper Label with Paper Liner	Avery Dennison (Europe)	FACTORY\FASHGW	1A

Brand Name	Weight	Type/Description	Manufacture/Distribution	Script	Performance
Fasson MCWhite DI-CP WA 1962 Coated Paper Label	80GSM face, 85GSM liner	Semi-gloss Paper Label with Scored Liner	Avery Dennison (Europe)	FACTORY\FASMCWS	1A
Classic Plus 41405	50# liner	4 mil Vinyl Aggressive, 1 mil Permanent acrylic adhesive, 3.0 mil paper liner	Flexcon 508-885-8420 US	IBM\FLEXCON\FL41405	IG
IMAGin™ TF6628	50# face, 50# liner	Uncoated paper face, permanent adhesive, white Kraft liner	MACtac 800-334-7310 US	FACTORY\TF6628	1B
IMAGin™ TF6628PS	50# face, 60# liner	Uncoated paper label with scored whit Kraft liner, permanent adhesive	MACtac	FACTORY\TF6628PS	1A
IMAGin™ TF6623		Uncoated opaque paper label	MACtac	FACTORY\TF6623	1A
IMAGin™ TF6627 PS	50# face, 60# liner	White semi-gloss paper face, permanent adhesive, scored white Kraft liner	MACtac	FACTORY\TF6627PS	1B
IMAGin™ TF6627	50# face, 50# liner	White semi-gloss paper face, permanent adhesive, white Kraft liner	MACtac	FACTORY\TF6627	1B
IMAGin™ TF6728		PET face with paper liner	MACtac	FACTORY\TF6728	1A
Digi Vellum		Matt coated paper face, permanent adhesive, scored kraft liner	Raflatac	FACTORY\RAFDIVEL	1B
Digi Castgloss		Cast gloss coated paper face, permanent adhesive, scored kraft liner	Raflatac	FACTORY\RAFDICGL	1B

## Film Materials

Paper Script Location: PrintMedia\Film\

Brand Name	Weight	Type/Description	Manufacture/Distribution	Script	Performance
ODP Imaging Opaque Film	100 micron	White PET Film	Anitec, International Paper	FACTORY\ANOPD100	1A
XEWHIT03 White Film 75	75 micron	White PET Film with High Gloss	Lanco Systems 32-10-400258 Belgium 44-161-747-4757 UK	FACTORY\LANWH075	1B
XEWHIT04 White Film 100	100 micron	White PET Film with High Gloss	Lanco Systems	FACTORY\LANWH100	1A
XEMatt03 Matt Film		Matt translucent PET Film	Lanco Systems	FACTORY\LANMATT	1A
XETRAN04 Transparent Film		White PET Film	Lanco Systems	FACTORY\LANTRANS	1A
DigiTex 160	160 GSM	Coated Textile	ICG 312-421-4030 X210 US	FACTORY\DITEX160	1A
DigiPrint - XE/CL	100 micron	Clear Transparent PET	Folex	FACTORY\FOXECL	1A
DigiPrint - XE/WM 130	130 micron	White Opaque PET	Folex	FACTORY\FOXEWO	1A
DigiPrint - XE/MA	90 micron	Matte translucent PET	Folex	FACTORY\FOXEMA	1A
DuraKote White 100			Hanita	FACTORY\DKW100	1A
DuraKote White 125			Hanita	FACTORY\DKW125	1A
DuraKote Clear 120			Hanita	FACTORY\DKC120	1A
DuraKote Super Clear			Hanita	FACTORY\DKSC110	1B
ICI OLMEC Digital Press Film DPW 4 mil	100 micron	White Opaque	ICI 302-887-2060 US	FACTORY\DPWHITE	1B
ICI OLMEC Digital Press Film DPB 4 mil	100 micron	Backlit Translucent	ICI	FACTORY\DPBACK	1A
ICI OLMEC Digital Press Film DPC 4 mil	100 micron	Clear	ICI	FACTORY\DPCLEAR	1A
Amoartes WM			Messerli	FACTORY\AMOAWM	1A

Brand Name	Weight	Type/Description	Manufacture/Distribution	Script	Performance
Amoartes DM			Messerli	FACTORY\AMOADM	1A
Amoartes K			Messerli	FACTORY\AMOAK	1A
ODP Imaging Digital Opaque	100 micron	White PET film	Anitec / International Paper	FACTORY\ANOPD100	1A
Teslin SP1000 Digital * Use with understanding, Contact IBM Service	254 micron	White, Porous	PPG Industries 412-257-4680 US	FACTORY\TESL1000	May experience print quality and finishing problems

---

# Readers' Comments – We'd Like to Hear from You

IBM InfoColor 70 and 3170  
Print Media Guide

Overall, how satisfied are you with the information in this book?

	Very Satisfied	Satisfied	Neutral	Dissatisfied	Very Dissatisfied
Overall satisfaction	<input type="checkbox"/>	<input type="checkbox"/>	<input type="checkbox"/>	<input type="checkbox"/>	<input type="checkbox"/>

How satisfied are you that the information in this book is:

	Very Satisfied	Satisfied	Neutral	Dissatisfied	Very Dissatisfied
Accurate	<input type="checkbox"/>	<input type="checkbox"/>	<input type="checkbox"/>	<input type="checkbox"/>	<input type="checkbox"/>
Complete	<input type="checkbox"/>	<input type="checkbox"/>	<input type="checkbox"/>	<input type="checkbox"/>	<input type="checkbox"/>
Easy to find	<input type="checkbox"/>	<input type="checkbox"/>	<input type="checkbox"/>	<input type="checkbox"/>	<input type="checkbox"/>
Easy to understand	<input type="checkbox"/>	<input type="checkbox"/>	<input type="checkbox"/>	<input type="checkbox"/>	<input type="checkbox"/>
Well organized	<input type="checkbox"/>	<input type="checkbox"/>	<input type="checkbox"/>	<input type="checkbox"/>	<input type="checkbox"/>
Applicable to your tasks	<input type="checkbox"/>	<input type="checkbox"/>	<input type="checkbox"/>	<input type="checkbox"/>	<input type="checkbox"/>

Please tell us how we can improve this book:

Thank you for your responses. May we contact you?  Yes  No

When you send comments to IBM, you grant IBM nonexclusive right to use or distribute your comments in any way it believes appropriate without incurring any obligation to you.

---

Name

---

Address

---

Company or Organization

---

Phone No.



Fold and Tape

Please do not staple

Fold and Tape



NO POSTAGE  
NECESSARY  
IF MAILED IN THE  
UNITED STATES

# BUSINESS REPLY MAIL

FIRST CLASS MAIL PERMIT NO. 40 ARMONK, NEW YORK

POSTAGE WILL BE PAID BY ADDRESSEE

IBM CORPORATION  
Department H7FE Building 003G  
IBM Printing Systems Company  
Information Development  
PO Box 1900  
Boulder CO USA  
80301-9191

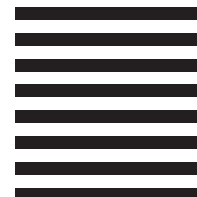

Fold and Tape

Please do not staple

Fold and Tape



