

Wind Systems for Pumping Water: A Training Manual (Peace Corps, 1984, 93 p.)



(introduction...)



Acknowledgments



Introduction to training



Training guidelines



Objectives for wind system construction training



Session 1 Introduction and objectives



Session 2 History of wind systems



Session 3 Large projects and community analysis









Session 4 Shop safety and tool care







Session 5 Representative drawings for construction

-  **Session 6 Shafts and bearings**
-  **Session 7 Strengths and testing**
-  **Session 8 Joinery**
-  **Session 9 Pumps and pump design**
-  **Session 10 Siting considerations**
-  **Session 11 Sizing wind water pumping systems**
-  **Session 12 Design considerations for pumps and windmills**
-  **Session 13 How to design**
-  **Session 14 Presentation of designs**
-  **Session 15 Construction of wind measuring poles**
-  **Session 16 Exportation for wind sites**
-  **Session 17 Tower raising**
-  **Session 18 Plumbing the wind system**
-  **Session 19 Testing installed wind system**
-  **Session 20 Presentation of projects**

-  **Session 21 Maintenance - preventive and routine**
-  **Bibliography**
-  **Construction materials list**
-  **Tool list for 24 participants**
-  **Technical vocabulary**
-  **Report on the wind-powered in-service training**
-  **Recommendations**



[Home](#) "" "" "" "" "" "" "" "" > [ar.cn.de.en.es.fr.id.it.ph.po.ru.sw](#)

-  **Wind Systems for Pumping Water: A Training Manual (Peace Corps, 1984, 93 p.)**
-  **(*introduction...*)**
-  **Acknowledgments**
-  **Introduction to training**
-  **Training guidelines**

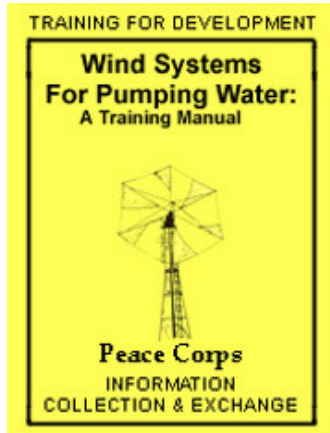

-  **Objectives for wind system construction training**
-  **Session 1 Introduction and objectives**
-  **Session 2 History of wind systems**
-  **Session 3 Large projects and community analysis**
-  **Session 4 Shop safety and tool care**
-  **Session 5 Representative drawings for construction**
-  **Session 6 Shafts and bearings**
-  **Session 7 Strengths and testing**
-  **Session 8 Joinery**
-  **Session 9 Pumps and pump design**
-  **Session 10 Siting considerations**
-  **Session 11 Sizing wind water pumping systems**
-  **Session 12 Design considerations for pumps and windmills**

-  **Session 13 How to design**
-  **Session 14 Presentation of designs**
-  **Session 15 Construction of wind measuring poles**
-  **Session 16 Exportation for wind sites**
-  **Session 17 Tower raising**
-  **Session 18 Plumbing the wind system**
-  **Session 19 Testing installed wind system**
-  **Session 20 Presentation of projects**
-  **Session 21 Maintenance - preventive and routine**
-  **Bibliography**
-  **Construction materials list**
-  **Tool list for 24 participants**
-  **Technical vocabulary**
-  **Report on the wind-powered in-service training**



Recommendations

TRAINING FOR DEVELOPMENT

Peace Corps

INFORMATION COLLECTION & EXCHANGE

TRAINING MANUAL NO. T-25

INFORMATION COLLECTION & EXCHANGE

Peace Corps' Information Collection & Exchange (ICE) was established so that the strategies and technologies developed by Peace Corps Volunteers, their co-workers and their counterparts could be made available to the wide range of development organizations and individual workers who might find them useful. Training guides, curricula, lesson plans, project reports, manuals and other Peace Corps-generated materials developed in the field are collected and reviewed. Some are reprinted "as is"; others provide a source of field based information for the production of manuals or for research in particular program areas. Materials that you submit to ICE thus become part of the Peace Corps' larger contribution to development.

Information about ICE publications and services is available through:

The Peace Corps Internet Web Site address:

<http://www.peacecorps.gov>

Please note the new Peace Corps Mailing Address from July 1998 on is:

ICE/ Peace Corps
1111 20th Street N.W.
Washington, DC 20526
USA

Add your experience to the ICE Resource Center. Send materials that you have prepared so that we can share them with others working in the development field. Your technical insights serve as the basis for the generation of ICE manuals, reprints, and resource packets, and also ensure that ICE is providing the most up-to-date, innovative problem solving techniques and information available to you and your fellow development

workers.

Peace Corps

**WIND SYSTEMS FOR PUMPING WATER:
A training manual**

**Prepared by
WILLIS ESCHENBACH**

**in collaboration with
Domestic Technology International, Inc.
and
Denver Research Institute**

**Edited by
Malcolm Lillywhite
Domestic Technology International, Inc.**

**Peace Corps
Information Collection and Exchange
Energy Sector/OTAPS**

Contract # PC-283-1007

May 1984



[Home](#) > [ar](#).[cn](#).[de](#).[en](#).[es](#).[fr](#).[id](#).[it](#).[ph](#).[po](#).[ru](#).[sw](#)

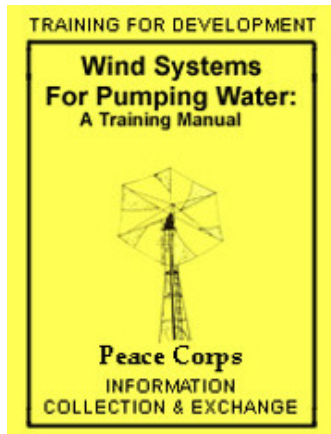

Wind Systems for Pumping Water: A Training Manual (Peace Corps, 1984, 93 p.)



(introduction...)



Acknowledgments



Introduction to training



Training guidelines



Objectives for wind system construction training

















Session 1 Introduction and objectives



Session 2 History of wind systems



Session 3 Large projects and community analysis

-  **Session 4 Shop safety and tool care**
-  **Session 5 Representative drawings for construction**
-  **Session 6 Shafts and bearings**
-  **Session 7 Strengths and testing**
-  **Session 8 Joinery**
-  **Session 9 Pumps and pump design**
-  **Session 10 Siting considerations**
-  **Session 11 Sizing wind water pumping systems**
-  **Session 12 Design considerations for pumps and windmills**
-  **Session 13 How to design**
-  **Session 14 Presentation of designs**
-  **Session 15 Construction of wind measuring poles**
-  **Session 16 Exportation for wind sites**
-  **Session 17 Tower raising**



Session 18 Plumbing the wind system

Session 19 Testing installed wind system



Session 20 Presentation of projects



Session 21 Maintenance - preventive and routine



Bibliography



Construction materials list



Tool list for 24 participants



Technical vocabulary



Report on the wind-powered in-service training



Recommendations

Session 5 Representative drawings for construction

TOTAL TIME: 1 Hour

OBJECTIVES: To arrive at an understanding of the different types

of drawings used to represent design of machinery for construction.

To practice drawing and tracing.

To learn the names of the parts of windmills using drawings.

MATERIALS: Pencils, typewriter paper and straight-edge for all participants.

PROCEDURES:

Step 1: 5 minutes

Pass out pencils, paper, and examples of two and three dimensional and exploded or isometric drawings.

Step 2: 10 minutes

Compare types of drawings and practice drawing or tracing them.

Trainer Note

If possible, have scale model of a type of mill that is to be built during this training. Point out the features of this mill that correspond to the drawings.

Step 3: 5 minutes

Pass out overhead, front, and side view drawings and compare them.

Step 4:

Pass out and discuss cross-sectional drawings, making sure that everyone understands them and how they differ from the previous handouts.

Step 5: 35 minutes

Draw or trace the examples.

RESOURCES: Copies of Attachments 5-A and 5-B

Figure 1: 3-Dimensional (Isometric) View (Scale $\frac{1}{4}$ in. = 1 ft.)

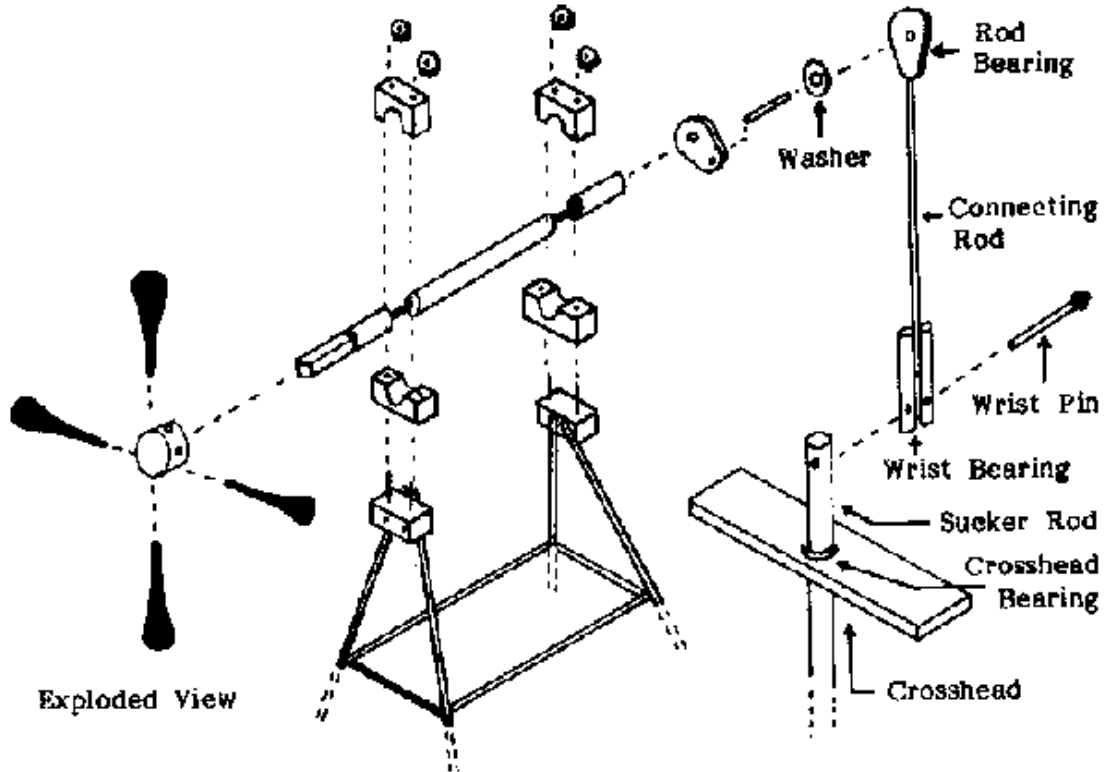

Exploded View

Figure a

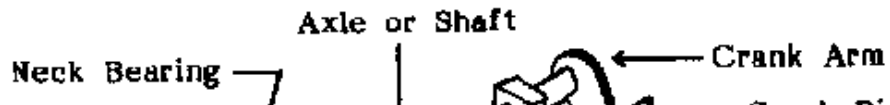

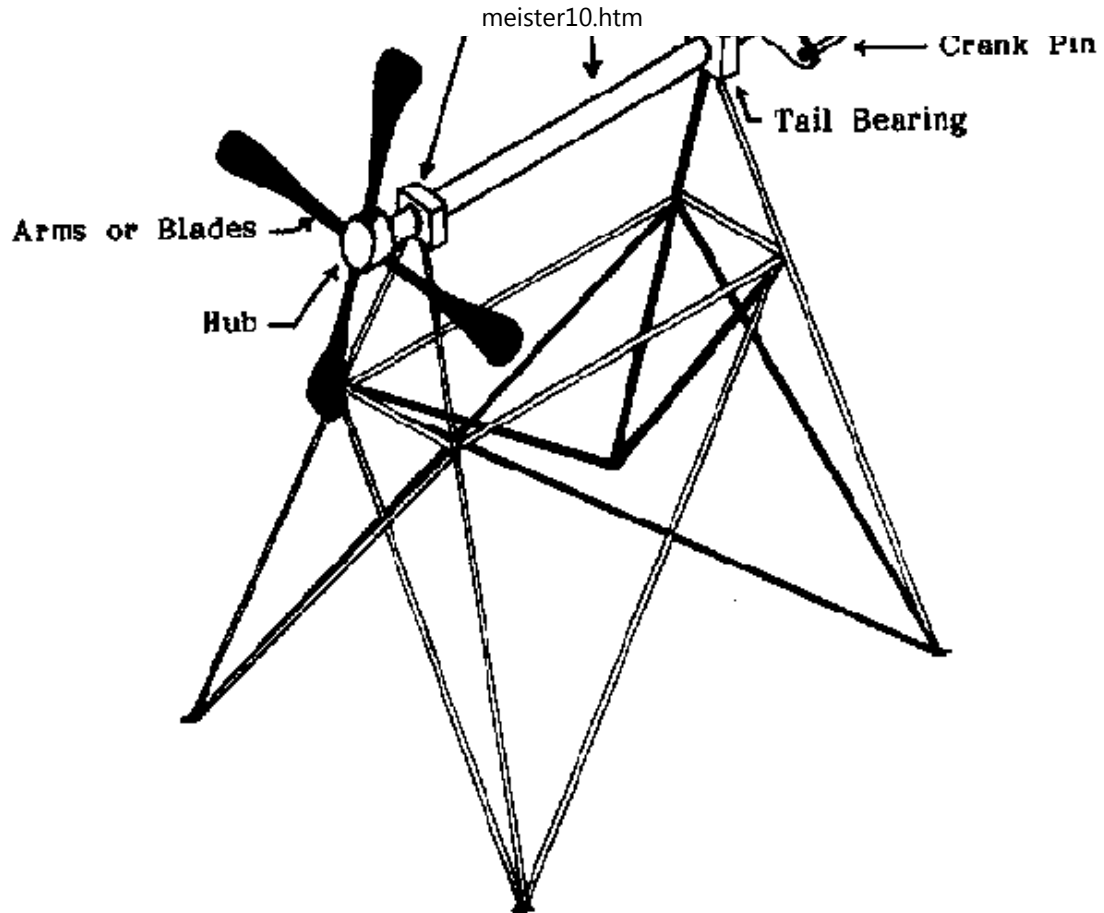
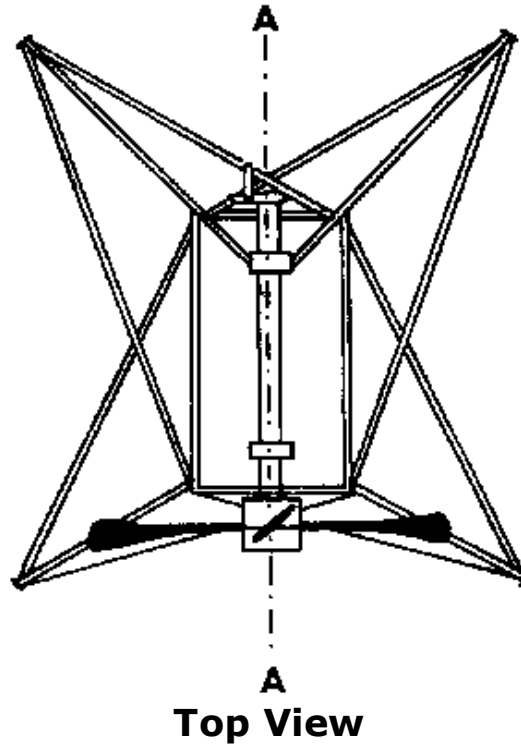
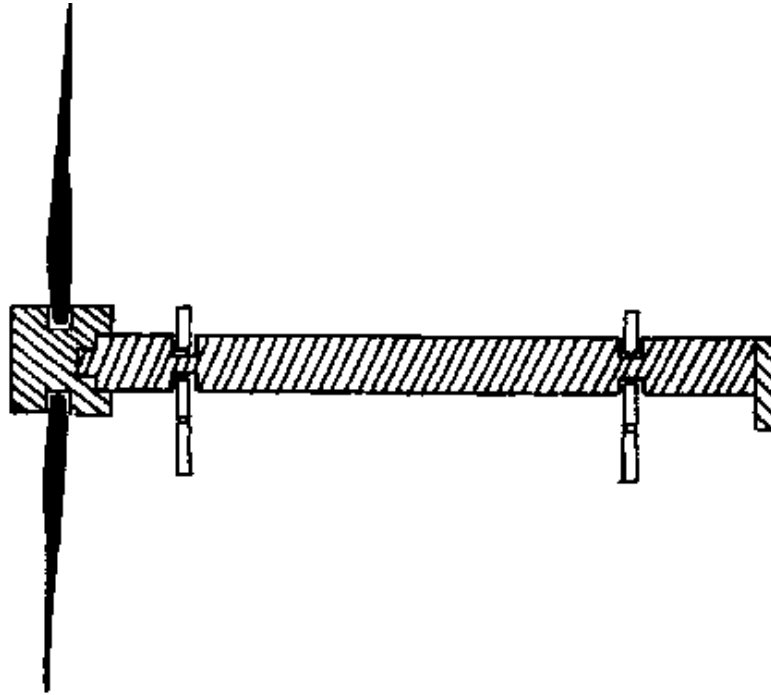

Figure b

Attachment 5-A

Figure 2: 3-Dimensional (Isometric) View (Scale 1/4 in. = 1 in.)





Cross Section Through Along Dotted Line from A to A (Scale $\frac{1}{4}$ in. = 6 ft.)

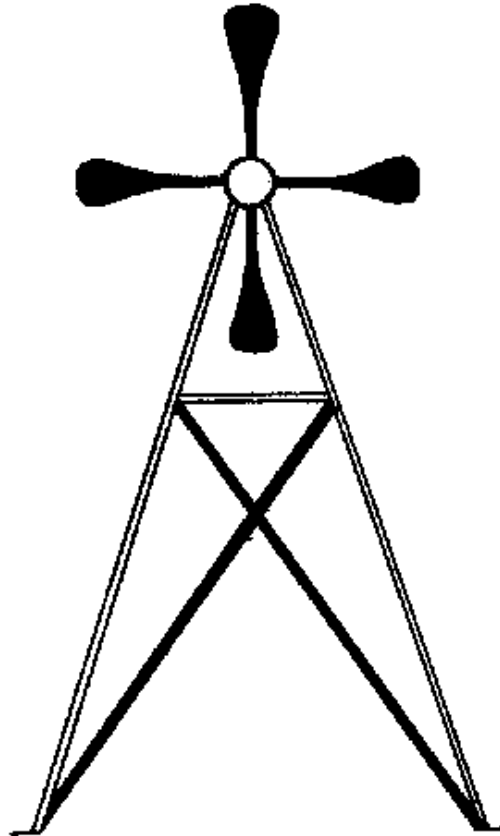

Front View

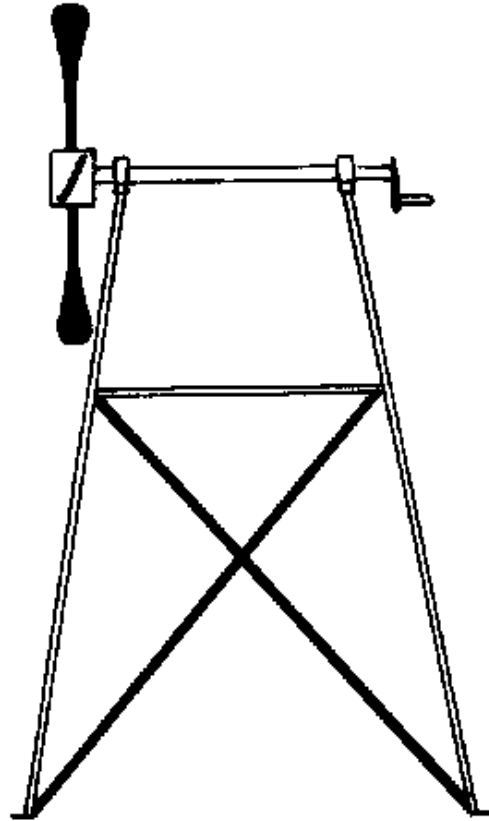

Side View



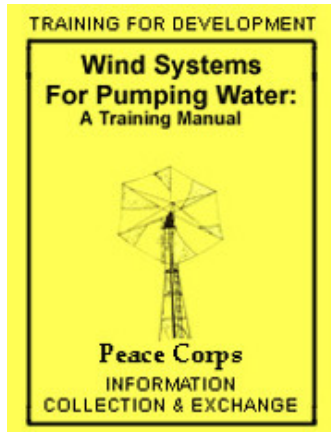

Wind Systems for Pumping Water: A Training Manual (Peace Corps, 1984, 93 p.)



(introduction...)



Acknowledgments



Introduction to training



Training guidelines



Objectives for wind system construction training



Session 1 Introduction and objectives



Session 2 History of wind systems



Session 3 Large projects and community analysis



Session 4 Shop safety and tool care









Session 5 Representative drawings for construction



Session 6 Shafts and bearings

-  **Session 7 Strengths and testing**
-  **Session 8 Joinery**
-  **Session 9 Pumps and pump design**
-  **Session 10 Siting considerations**
-  **Session 11 Sizing wind water pumping systems**
-  **Session 12 Design considerations for pumps and windmills**
-  **Session 13 How to design**
-  **Session 14 Presentation of designs**
-  **Session 15 Construction of wind measuring poles**

-  **Session 16 Exportation for wind sites**
-  **Session 17 Tower raising**
-  **Session 18 Plumbing the wind system**
-  **Session 19 Testing installed wind system**
- 

-  **Session 20 Presentation of projects and routine**
-  **Bibliography**
-  **Construction materials list**
-  **Tool list for 24 participants**
-  **Technical vocabulary**
-  **Report on the wind-powered in-service training**
-  **Recommendations**

Session 6 Shafts and bearings

TOTAL TIME: 1 to 2 Hours

OBJECTIVES: To begin learning about how power is transmitted by shaft and bearing mechanisms.

To work with the models of shaft and bearing systems.

MATERIALS: Model materials & supplies, wood, wire, glue, pins,

construction paper, etc.

Shaft and bearing materials or examples (rear auto axle or similar parts).

PROCEDURES:

Step 1: 10 minutes

Discuss the different materials used for bearings and pass around examples of bearings.

Step 2: 10 minutes

Discuss the type of bearings to be used in the mill being built during the training program.

Trainer Note

Oil soaked or greased wood bearings make excellent low-cost bearings. If they are to be used, discuss their maintenance needs and their limitations.

Step 3: 40 minutes

Construct and work with models, making various shaft and bearing combinations.

Trainer Note

For groups with very little experience with machinery and power, a model making kit consisting of 1 Erector Set, 1 Tinkertoy and 1 Lincoln Log, plus an assortment of small screws and bolts can be used. Encourage the use of models at all stages of the building process.



[Home](#)"" """"> [ar.cn.de.en.es.fr.id.it.ph.po.ru.sw](#)









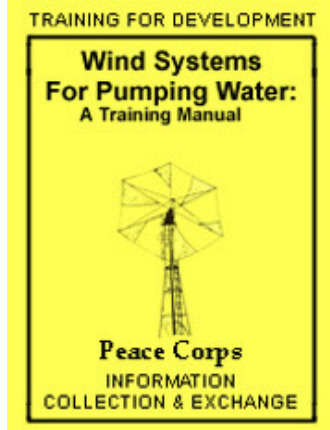







Wind Systems for Pumping Water: A Training Manual (Peace Corps, 1984, 93 p.)



(introduction...)



-  **Acknowledgments**
-  **Introduction to training**
-  **Training guidelines**
-  **Objectives for wind system construction training**
-  **Session 1 Introduction and objectives**
-  **Session 2 History of wind systems**
-  **Session 3 Large projects and community analysis**
-  **Session 4 Shop safety and tool care**
-  **Session 5 Representative drawings for construction**
-  **Session 6 Shafts and bearings**
-  **Session 7 Strengths and testing**
-  **Session 8 Joinery**
-  **Session 9 Pumps and pump design**
-  **Session 10 Siting considerations**
-  **Session 11 Sizing wind water pumping**

-  **systems**
-  **Session 12 Design considerations for pumps and windmills**
-  **Session 13 How to design**
-  **Session 14 Presentation of designs**
-  **Session 15 Construction of wind measuring poles**
-  **Session 16 Exportation for wind sites**
-  **Session 17 Tower raising**
-  **Session 18 Plumbing the wind system**
-  **Session 19 Testing installed wind system**

-  **Session 20 Presentation of projects**
-  **Session 21 Maintenance - preventive and routine**
-  **Bibliography**
-  **Construction materials list**
-  **Tool list for 24 participants**



Technical vocabulary Report on the wind-powered in-service training



Recommendations

Session 7 Strengths and testing

TOTAL TIME: 2 Hours

OBJECTIVES: Familiarize participants with the strengths and characteristics of the local materials.

Discover what is available in the way of local building materials.

MATERIALS: Small poles, pipe, bamboo, and whatever materials you wish to examine and test to use in wind system construction.

PROCEDURES:

Step 1: 30 minutes

Walk around the site looking at the types of materials available

for use. Comment on and discuss the uses, qualities, strengths and weaknesses of the various types of materials represented.

Step 2: 15 minutes

Explain the method of destructive testing-pushing things to their limits.

Step 3: 15 minutes

Test some poles by supporting them at varying distances horizontally along their lengths and having someone stand on the middle of the poles.

Step 4: 5 minutes

Make some educated guesses at the stresses involved.

Step 5: 30 minutes

Discuss the forces on a mill and give some idea of the size of the forces-wind load and centrifugal load on the rotor and tower, as

well as the pump loads.

Trainer Note

Approximate stresses on the windmill are given in the handout titled "Rules of Thumb for Wind Waterpumps"

Step 6: 25 minutes

Test more materials for strength and flexibility.

RESOURCES: Copies of Attachment 7-A

**Attachment 7-A
Material Strengths & Testing**

RULES OF THUMB FOR WIND WATERPUMPS

Centrifugal Force - (assuming a rotor tip speed ratio of approximately 1)

1 pound at one foot from the hub exerts with a force of 55

pounds in a 60 mph wind.

1 kilogram at 1 meter from the hub exerts with a force of 180 kilograms in a 100 km. per hour wind.

Maximum Windmill Drag Approximation - (in a 60+ mph (100+ km. per hour) wind)

10 pounds per square foot

45 kilograms per square meter

Power Calculation -

One horsepower is equal to lifting 400 gallons of water to a height of 10 feet in one minute.

One horsepower is equal to lifting 1500 liters of water to a height of 3 meters in one minute.

This formula is for theoretical horsepower and does not include the efficiency (or inefficiency) of the pump or the hydraulic

friction losses in the pipe or the mechanical friction. For real life, use about one quarter of these figures for single acting pumps, and one half of these figures for double acting pumps.

Pumping Capacity

A 2" pump puts out a quart for every 18 inches of stroke

A 2" x 2" square pump puts out a quart in 14" of stroke

A 3" pump puts out a quart for every 8 inches of stroke

A 5 cm. pump puts out a liter for every 50 cm. of stroke

A 5 cm. x 5 cm. pump puts out a liter each 40 em. of stroke

A 8 cm. pump puts out a liter for every 20 cm. of stroke









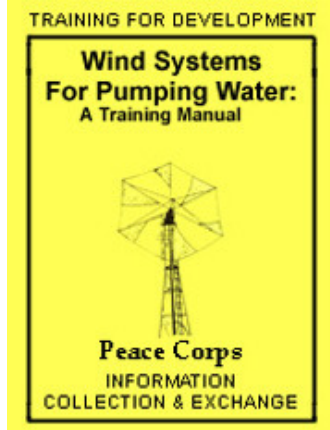







[Home](#) > [ar](#).[cn](#).[de](#).[en](#).[es](#).[fr](#).[id](#).[it](#).[ph](#).[po](#).[ru](#).[sw](#)



Wind Systems for Pumping Water: A Training Manual (Peace Corps, 1984, 93 p.)



-  **(introduction...)**
-  **Acknowledgments**
-  **Introduction to training**
-  **Training guidelines**
-  **Objectives for wind system construction training**
-  **Session 1 Introduction and objectives**
-  **Session 2 History of wind systems**
-  **Session 3 Large projects and community analysis**
-  **Session 4 Shop safety and tool care**
-  **Session 5 Representative drawings for construction**
-  **Session 6 Shafts and bearings**
-  **Session 7 Strengths and testing**
-  **Session 8 Joinery**
-  **Session 9 Pumps and pump design**
-  **Session 10**



-  **Session 10 Sizing wind water pumping systems**
-  **Session 12 Design considerations for pumps and windmills**
-  **Session 13 How to design**
-  **Session 14 Presentation of designs**
-  **Session 15 Construction of wind measuring poles**
-  **Session 16 Exportation for wind sites**
-  **Session 17 Tower raising**
-  **Session 18 Plumbing the wind system**
-  **Session 19 Testing installed wind system**

-  **Session 20 Presentation of projects**
-  **Session 21 Maintenance - preventive and routine**
-  **Bibliography**
-  **Construction materials list**



Tool list for 24 participants



Technical vocabulary



Report on the wind-powered in-service training



Recommendations

Session 8 Joinery

TOTAL TIME: 2 Hours

OBJECTIVES: To investigate some of the methods used to join materials.

To join different materials in 8 variety of ways and test the joints.

To learn about triangulation as a simple method of improving support structures.

MATERIALS: Small poles or lumber, pipes, fastening materials (rope, nails, wire, screws, bolts, rawhide, etc., as available)

Tools for the above as necessary from the shop.

PROCEDURES:

Step 1: 30 minutes

Discuss the different types of fastening techniques available.

Trainer Note

In a discussion, solicit local knowledge about local methods and materials for fastening and joining materials. Show samples and do demonstrations whenever possible using local participants.

Step 2: 30 minutes

Attach some poles or pipes using the various methods. Giving projects to groups of 2 or 3.

Trainer Note

Poles can be fastened with metal pins made from concrete

reinforcing rod or other similar metal. Drill the holes, insert the pin, put washers on the ends, bend the ends of the pin over to form a tight connection.

Step 3: 30 minutes

Test some of the materials and attachment methods.

Trainer Note

Employ destructive testing and show how it can be done without instruments by estimating the forces involved.

Step 4: 15 minutes

Make squares and triangles using lashings. Build a hoisting tripod.

Step 5: 15 Minutes

Test them and discuss triangulation for bracing.

RESOURCES: Copies of Attachments 8-A, 8-B, and 8-C.

Attachment 8-A

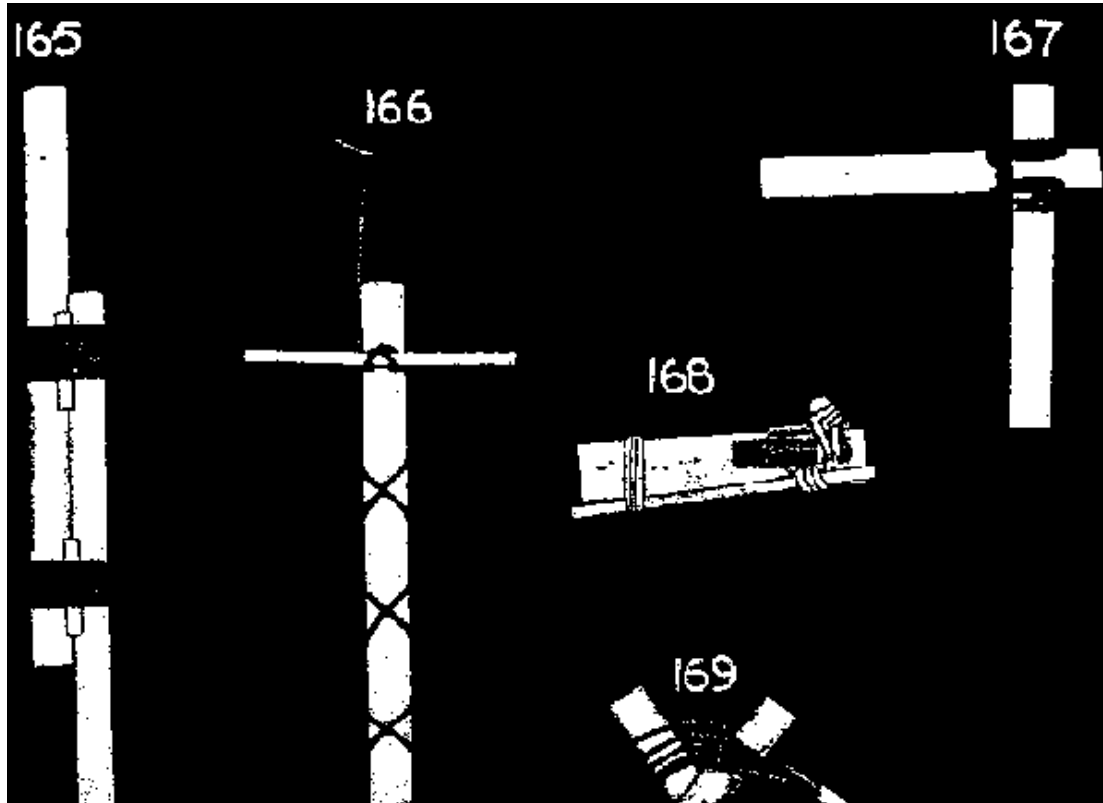

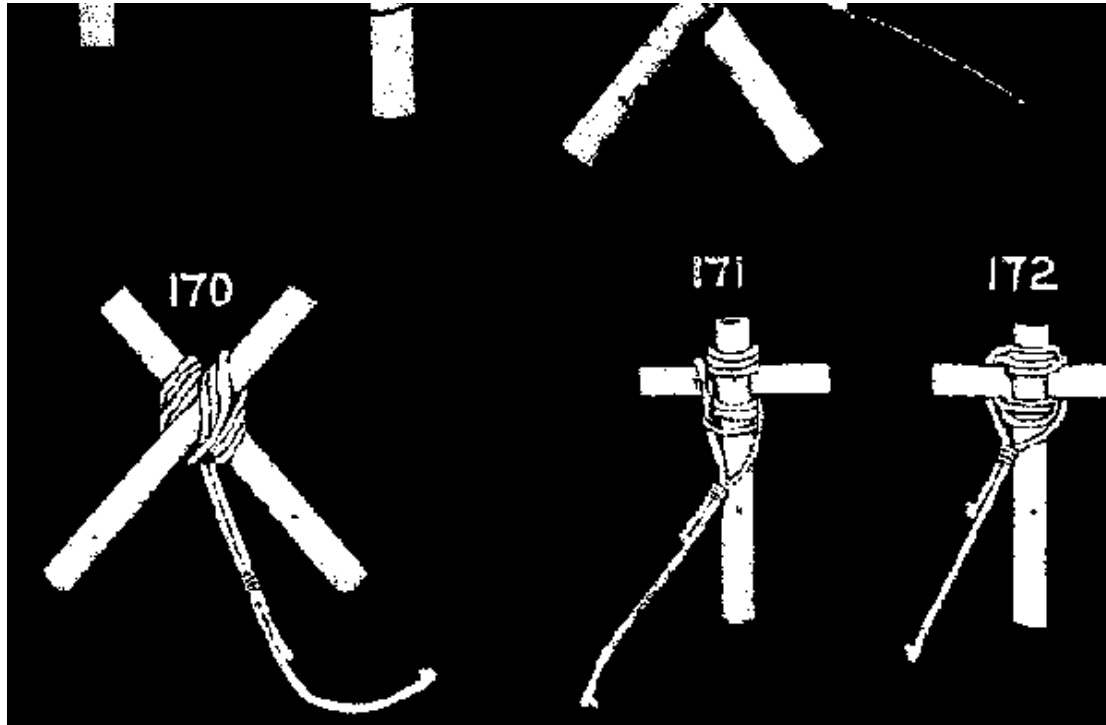
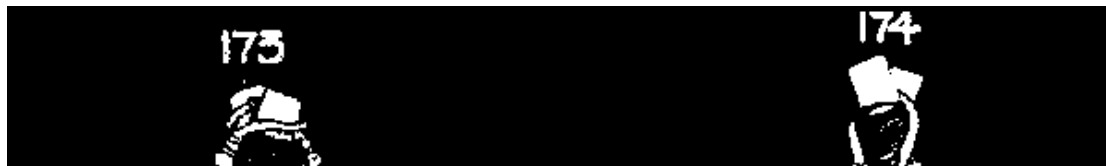

Figure 1: Various Types of Pole Lashings



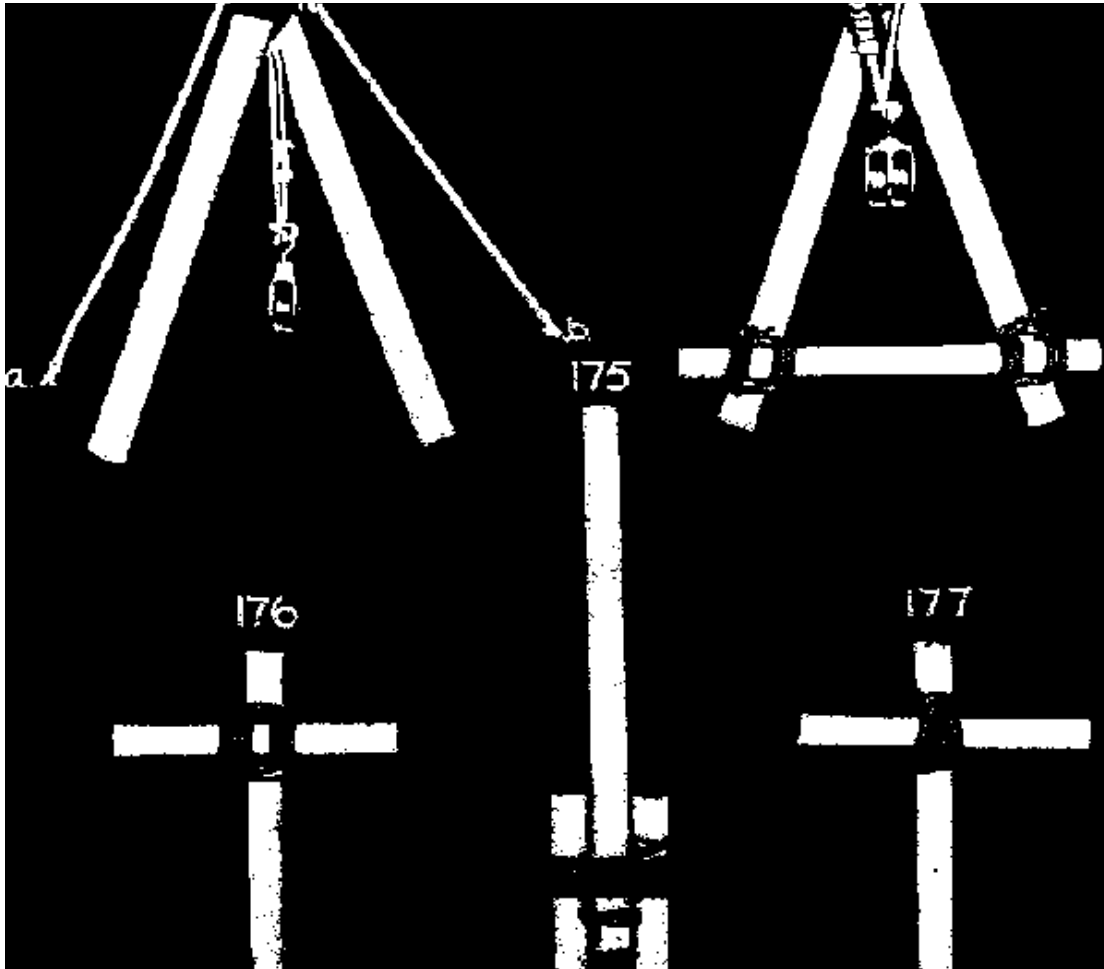



Figure 2: Tripod, Shear Leg, and Other Pole Lashings

Attachment 8-A

MISCELLANEOUS KNOTTING

Fig. 165: Poles Lashed and Wedged in the manner shown in this illustration are held securely, with but little liability of their slipping or working loose. After the lashings have been applied, small wooden wedges are driven between them and the poles as shown. This tends to take up any slack in the lashings.

Fig. 166: The Telegraph Hitch is used on long poles and piles

when it is required to hoist them vertically. To make the hitch take a piece of line of sufficient length, middle it and make cross turns around the pole as shown. A short bar is then placed under the final cross turn and a turn is taken about it, after which the ends of the rope are secured with a Reef Knot forming a bight for the hoisting hook.

Fig. 167: The Putlog Lashing is employed when it is required to lash two square timbers together. The manner in which it is formed is clearly shown in the illustration.

Fig. 168: The Packing Knot is frequently used to hold large pieces of timber together. It is also used in stone quarries to secure large blocks of stone on the cars which haul them. The small block of wood used in the illustration is intended to represent a slab of stone. Two or three turns with a heavy line are taken around both the slab of stone and the dolly or car upon which the stone rests. A piece of timber or a metal bar is then inserted under the lashing rope and it is twisted until all of the slack is taken out of the lashing. The piece of timber used as a lever is then in turn lashed to the body of the dolly as illustrated.

Fig. 169: The Double Chain Lashing shows the manner of making a line fast to a pair of crossed shears. The end is seized to the standing part of the rope after a sufficient number of turns have been taken about the shears.

Fig. 170: A Loop Lashing such as that shown serves to illustrate the manner in which the bight of a hawser is made fast to a pair of crossed shears. The bight of the hawser is passed over, under, and around the legs of the shears in the manner shown, after which the loop of the bight is placed over the top of one of the legs, leaving the standing part of the hawser as shown.

Fig. 171: The Crossed Lashing is another method used to make a line fast on the head of a pair of crossed shears. Any number of turns may be taken as shown, being crossed in back, after which the end of the lashing is made fast to its standing part with a seizing.

Fig. 172: The Square Lashing shown in this illustration is used for much the same purpose as that shown above. It is made in the same manner except that the turns are parallel and not crossed.

Fig. 173: The Shear Head Lashing is used to lash the heads of a pair of shears together. The shears are laid parallel to each other on the ground; a number of turns are taken around them, after which several cross turns are taken. The ends are then finished off with a Reef Knot.

Fig. 174: The Shear Leg Lashing is employed to attach a cross member to the lower ends of the legs of a pair of crossed shears. The methods employed are clearly evident in the illustration.

Fig. 175: The Tripod Lashing is an interesting method frequently employed for holding the three legs of a tripod together. The three members are first placed in the position shown and a strong lashing is passed around all of them. Cross turns are then made between the shear heads, and the ends of this line are secured with Clove Hitches as shown.

Fig. 176: The Square Cross Shear Lashing is a very simple but secure method of passing a lashing which is commonly used.

Fig. 177: The Herringbone Cross Shear Lashing is made by taking

a number of Figure-of-Eight Turns about the two members after which cross turns are added above and below the cross shear. These tend to make the lashing more secure.

Reference - Encyclopedia of Knots and Fancy Rope Work



[Home](#)''' '''> [ar.cn.de.en.es.fr.id.it.ph.po.ru.sw](#)

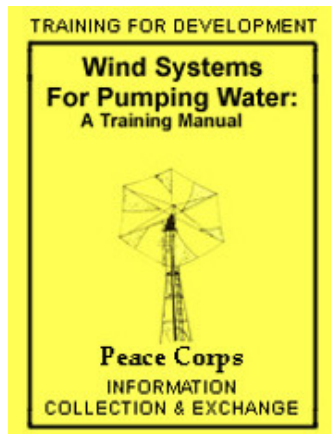

Wind Systems for Pumping Water: A Training Manual (Peace Corps, 1984, 93 p.)



(introduction...)



Acknowledgments



Introduction to training



Training guidelines















Objectives for wind system construction training



Session 1 Introduction and objectives

-  **Session 2 History of wind systems**
-  **Session 3 Large projects and community analysis**
-  **Session 4 Shop safety and tool care**
-  **Session 5 Representative drawings for construction**
-  **Session 6 Shafts and bearings**
-  **Session 7 Strengths and testing**
-  **Session 8 Joinery**
-  **Session 9 Pumps and pump design**
-  **Session 10 Siting considerations**
-  **Session 11 Sizing wind water pumping systems**
-  **Session 12 Design considerations for pumps and windmills**
-  **Session 13 How to design**
-  **Session 14 Presentation of designs**
-  **Session 15 Construction of wind**

-  **measuring poles**
-  **Session 16 Exportation for wind sites**
-  **Session 17 Tower raising**
-  **Session 18 Plumbing the wind system**
-  **Session 19 Testing installed wind system**
-  **Session 20 Presentation of projects**
-  **Session 21 Maintenance - preventive and routine**
-  **Bibliography**
-  **Construction materials list**

-  **Tool list for 24 participants**
-  **Technical vocabulary**
-  **Report on the wind-powered in-service training**
-  **Recommendations**

Session 9 Pumps and pump design

TOTAL TIME: 1 to 2 Hours

OBJECTIVES: To investigate pump design by reviewing a variety of pumps

To learn the basic operating principles common to all displacement pumps

MATERIALS: Blackboard or equivalent

Drawings of pumps or actual pumps and pump components (old and new if possible)

PROCEDURES:

Step 1: 30 minutes

Begin by discussing the pump design shown in the accompanying attachments. Discuss the various methods for attaching the pump to the mill and the necessity of securing the sections of sucker rod firmly together. Explain the construction and use of swivels and crossheads.

Trainer Note

Either examples or models of the things you are talking about are invaluable here. Have good flipchart-sized drawings of the things of which you do not have any hardware samples.

Step 2: 15 minutes

Extract from the examples the minimum parts common to the displacement type pump-inlet valve, outlet valve, something to displace the water.

Trainer Note

If building a pump is part of the training, then have a finished example of that pump available for inspection.

Step 3: 15 minutes

Discuss the difference between a pump that works submerged in water (borehole type) and a pump that works above the water level and must suck water up to it. Note the approximately 20

foot (7 meter) limit in height the pump can be located above the water level for the non-submersible pump.

Trainer Note

If the training is done at high altitudes, the height a lift pump can draw water decreases. The decrease is at the rate of 1 meter per 1000 meters (3300 ft) of elevation above sea level.

RESOURCES:

**Copies of "Rules of Thumb for Wind Waterpumps"
Session 7 (Attachment 7-A)
Copies of Attachment 9-A**

Attachment 9-A

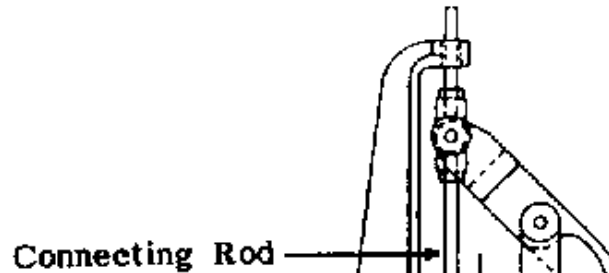

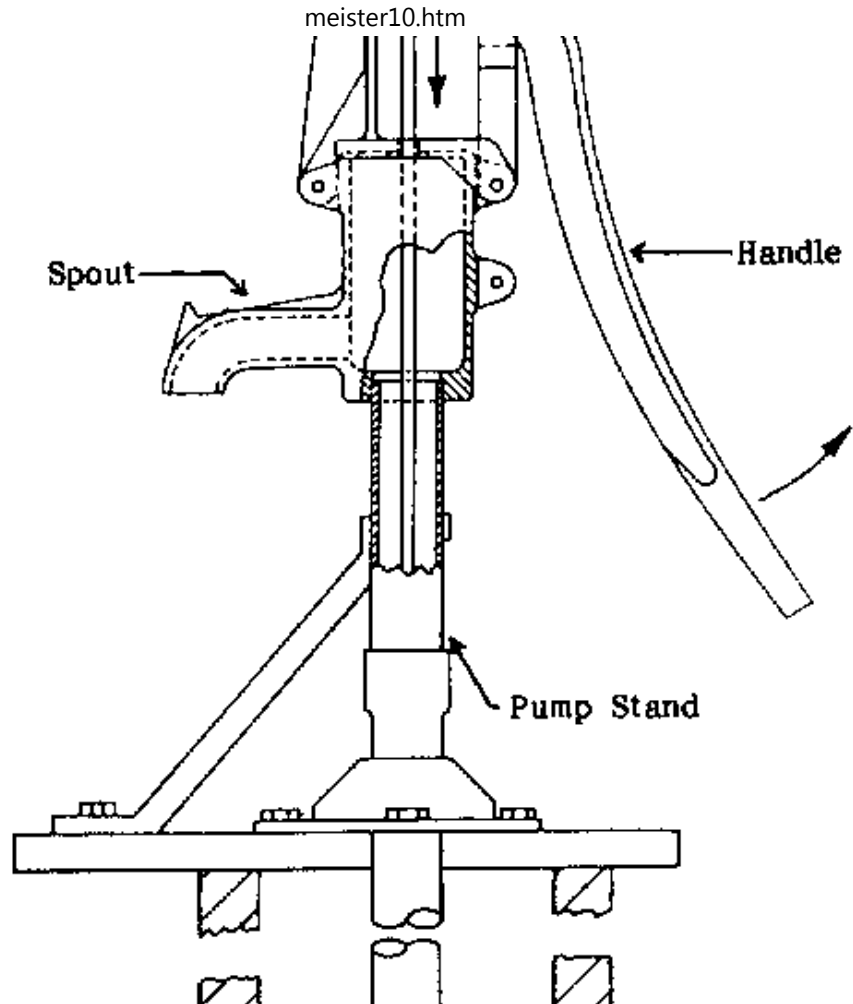

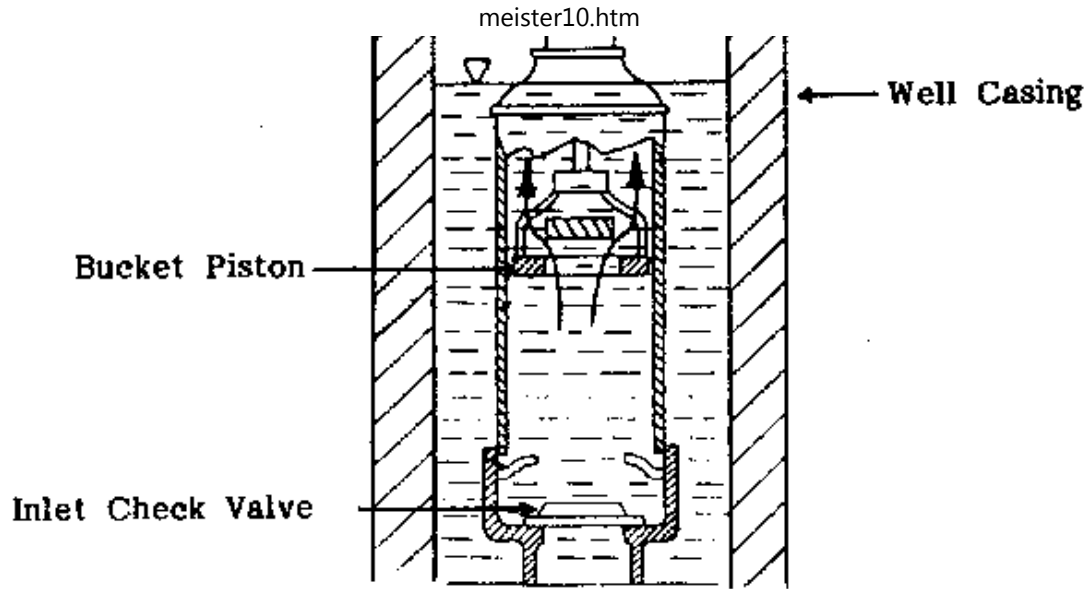
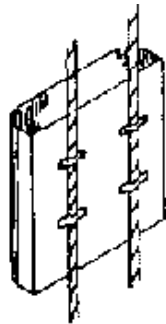

Figure 1: "Hand Pump" with Single-acting, Bucket-piston



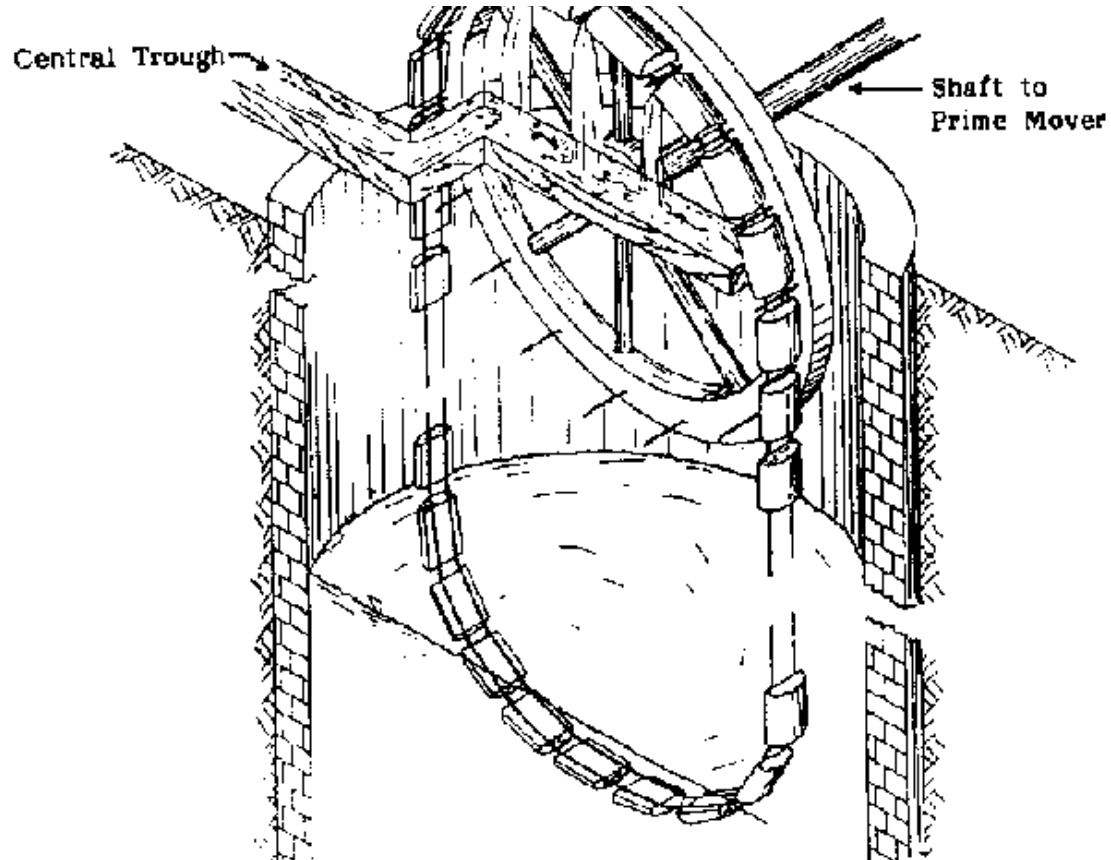

Figure 2: Persian Wheel with Portgarland Drive Wheel and Horizontal Drive Shaft

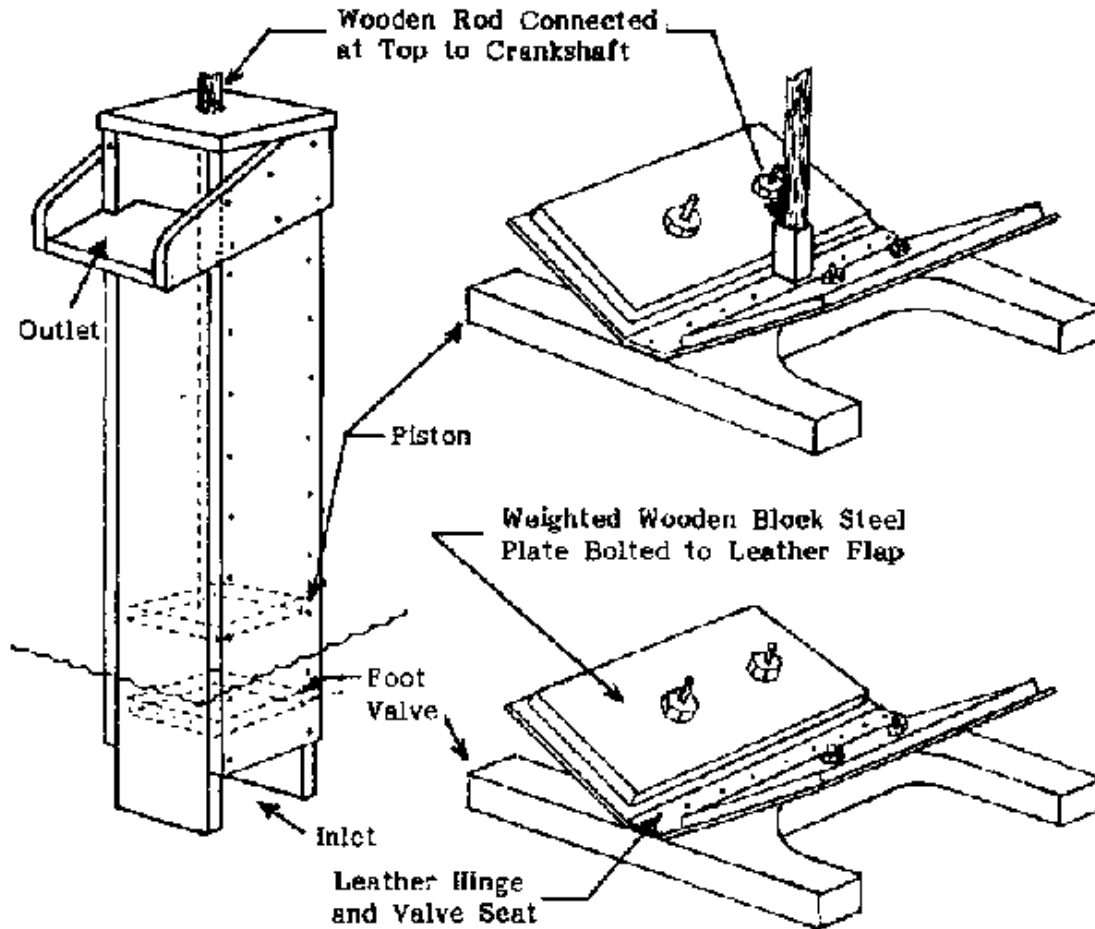

Figure 3: Square Wooden Piston-type Water Pump

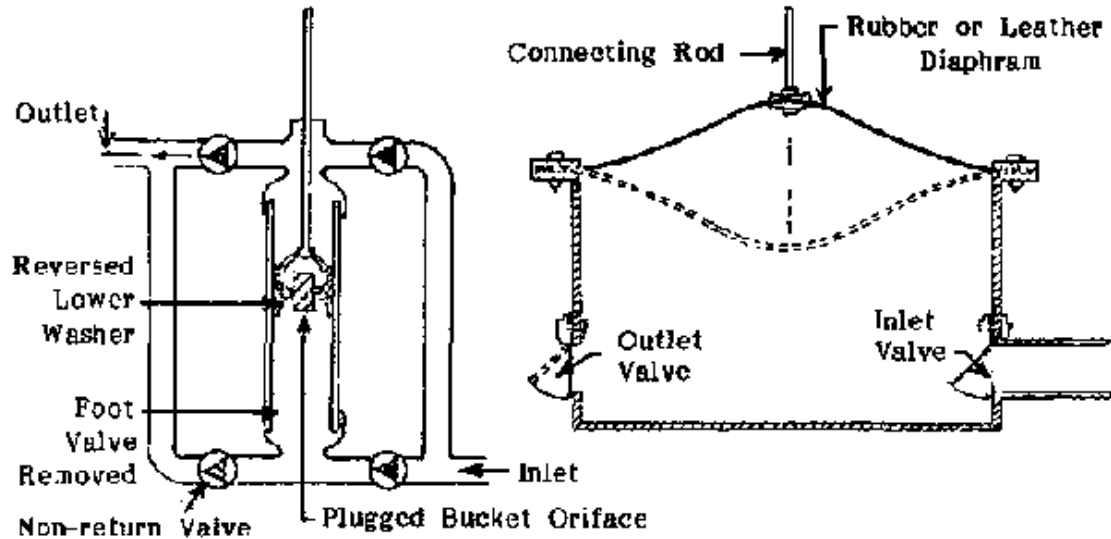

Figure 4: Double-acting Piston-type Water Pump

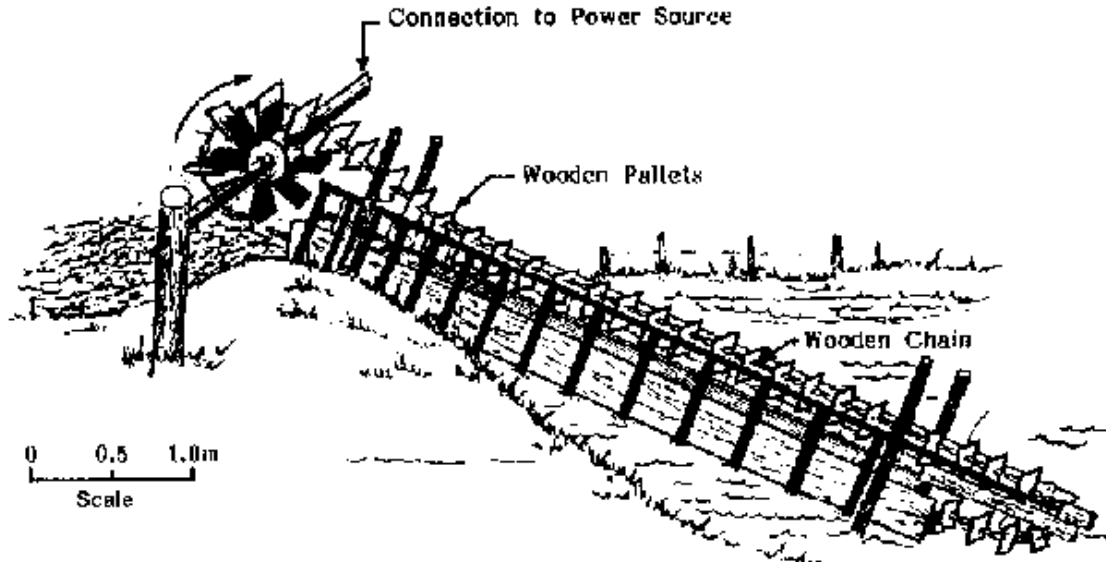
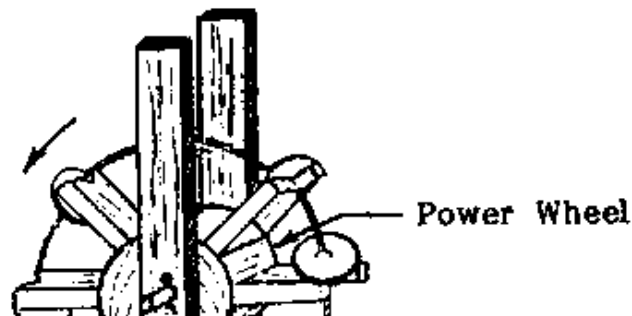
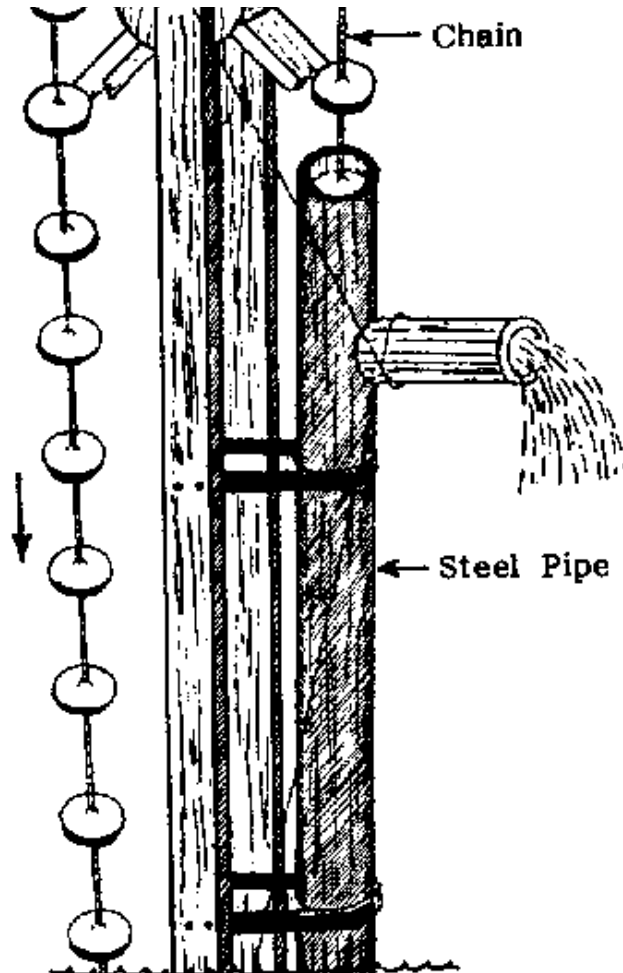

Figure 5: Wooden-pallet-type Water Pump





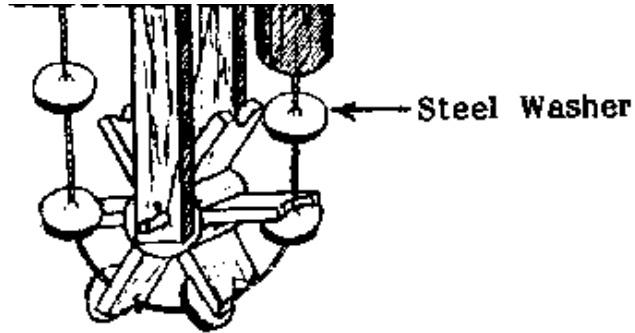
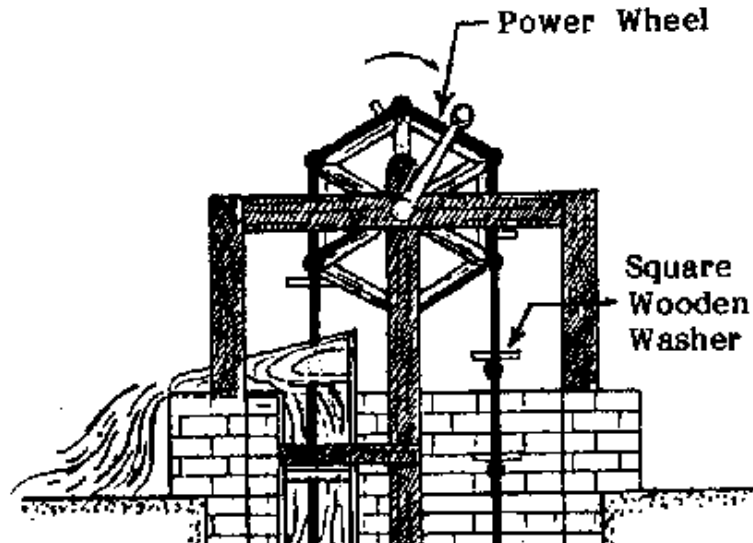

Figure 6: Steel-washer Chain-type Water Pump



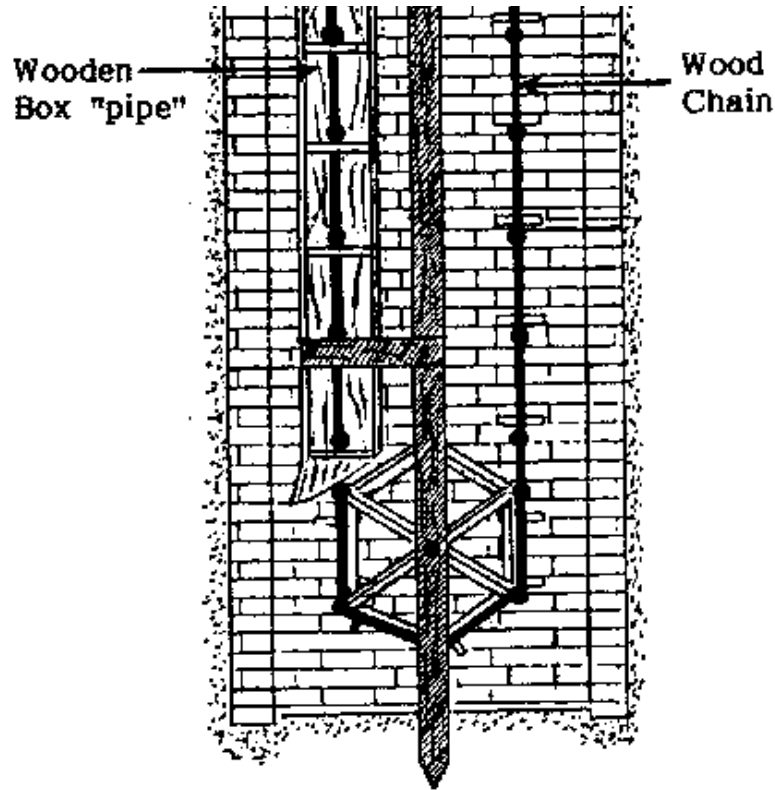
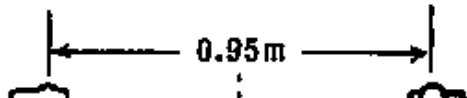

Figure 7: Square Wooden Enclosed Chain-type Water Pump



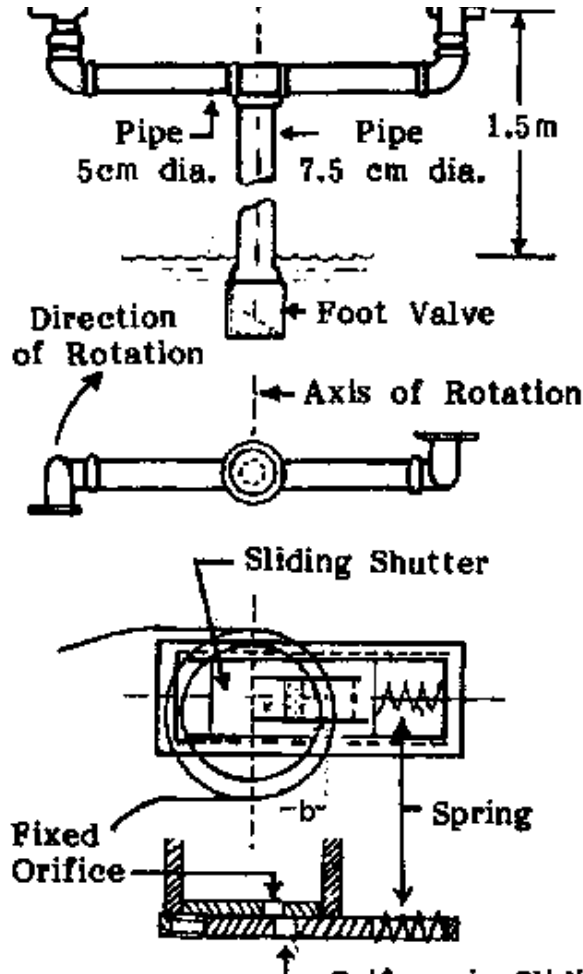

Figure 8: Centrifugal Reaction-type Water Pump

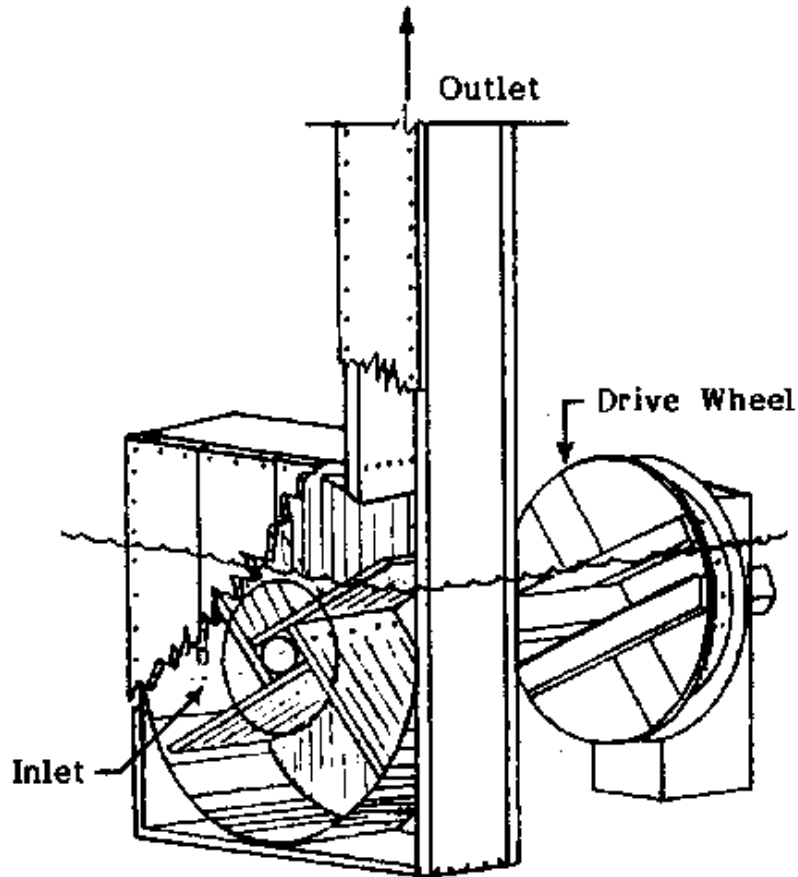

Figure 9: Large-diameter Slow-speed Centrifugal-type Water

Pump

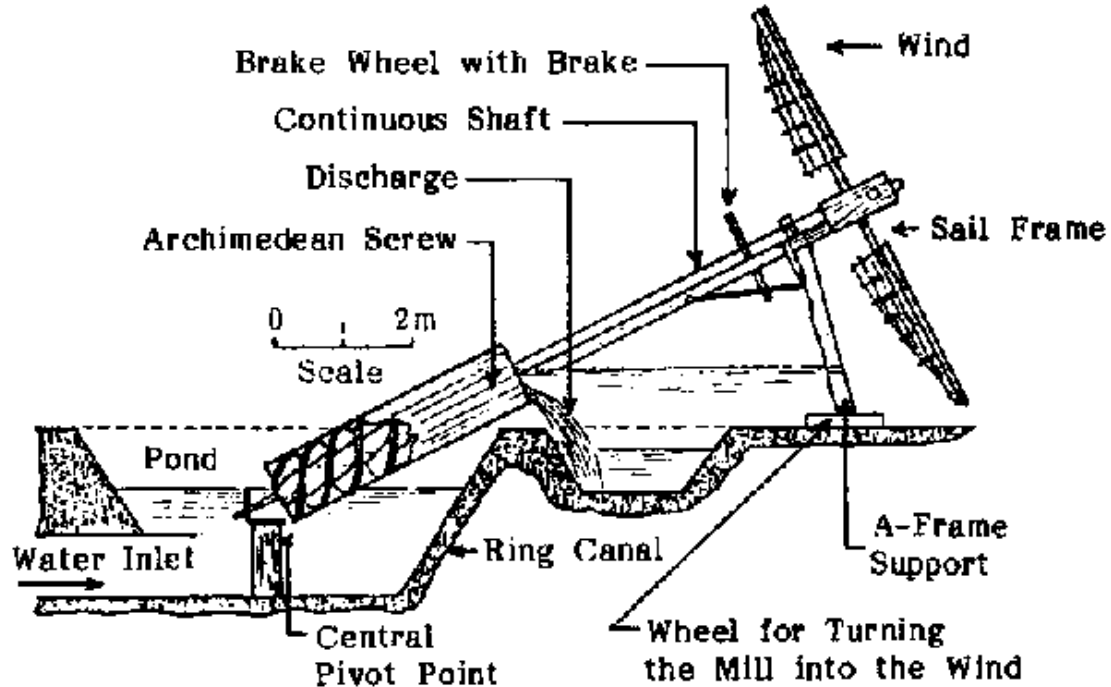

Figure 10: Netherlands "Tjasker" - type Rotor and Water Pump

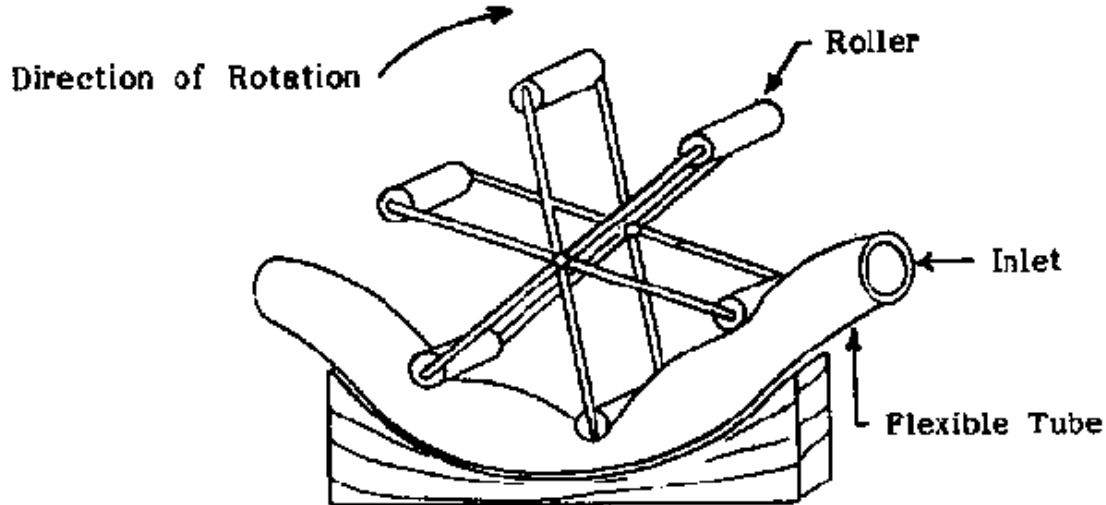

Figure 11: Peristaltic-type Water Pump

Attachment 9-A

MISCELLANEOUS PUMPS

1. Reciprocating Pumps

Most reciprocating pumps have the disadvantage that the torque lead is not constant, thus requiring a higher wind velocity for

starting, and variable stresses on the system when in operation.

(a) The single-acting cylindrical piston pump is most frequently used in wind-powered pumping systems. It consists of a cylinder with an inlet pipe and valve at the base, a leather-sealed piston with a one-way valve and a water outlet at the top, water passing through the pump only on the lifting stroke of the piston. This type of pump is used to pump water from any depth, with an operating speed of up to 40 strokes per minute.

(b) A square wooden single-acting piston pump is commonly used by fishermen in eastern Canada (figure 3) and has recently been adapted to wind power. A square wooden pump powered by the wind has been powered for use in Thailand. The height of lift is limited by the amount of water pressure that can be sustained by the wooden joints, although the simple construction is well adapted to basic carpentering skills.

(c) The double-acting piston pump (figure 4) is similar to the single-acting pump, except that there is no valve or passage of water through the piston, the water by-passing the piston

cylinder through pipes and valves under pressure during both the upstroke and the downstroke. The advantage of this pump over the single-acting pump is that the load of the power source is more constant, but it is not usually used in wind pumping systems because any compression load during the downstroke could buckle the long piston rod leading from the top of the tower; this problem could be avoided if a very short piston rod were connected to an immediately adjacent rotary power transfer mechanism powered by a long belt leading directly from the rotor shaft.

(d) The diaphragm pump (figure 4) consists of a cylinder closed at the lower end, with a circular diaphragm of rubber or some other material fixed at the top end. A reciprocating connecting rod is fixed to the center of the diaphragm and, upon vertical movement causes volumetric displacement in the cylinder. An arrangement of valves allows water movement in only one direction through the cylinder. The difficulty with this pump is the high rate of wear on the diaphragm at its connection with the cylinder and connecting rod. A diaphragm pump has been developed for use with a Savonius rotor.

(e) The inertia pump (figure 3) is a very simple and efficient device that depends upon the vertical inertia of a body of water in a reciprocating pipe to expel water at the end of the upstroke of the pipe. A one-way flap valve in the pipe is closed during the upstroke, and inertia is imparted to a fresh volume of water by the lifting force on the pipe. This pump must operate at a constant frequency which is dependent upon the mass of water in the pipe and the pipe itself. This recently popularized pump has probably not yet been used with wind power.

2. Rotary-Motion Pumps

Continuous rotary-motion pumps are well adapted to operation by wind power because they require a constant torque load and generally operate at a variable low speed.

(a) The square-wooden-pallet chain pump (figure 5) is commonly used in China and southeast Asia for lifts up to 3m and consists of rectangular wooden pallets or paddles mounted on a continuous wooden chain that runs up an inclined square-section open wooden trough. The paddles and chain pass around a large

wooden driving gear wheel at the top and around a small passive gear wheel at the base of the trough which is submerged in water. This type of pump is commonly used with Chinese vertical-axis wind pumping systems and with Thai high-speed wooden rotors and Thai sail rotors.

(b) The round-steel-washer chain pump (figure 6) is used in conjunction with human and animal power and consists of a continuous steel chain upon which are mounted steel discs with rubber or leather washers. The chain passes around an upper gear wheel, down the well, under the water source, around and then up into the bottom of a pipe with inner diameter the same as the washers. Water is lifted up within the pipe and expelled at the top. A square wooden adaptation of this pump is shown in figure 7.

(c) Large-diameter slow-speed centrifugal pumps (figure 8) have good potential for low-lift pumping. The meadow type wind pump of the Netherlands are fitted with centrifugal pumps 1m in diameter and 0.2m high, with four wooden blades, and have an efficiency of 30 per cent and an output of up to 100 m³ per hour

in a strong wind. Further design development and quantification of design variables of these pumps could be undertaken.

Another type of centrifugal pump is the centrifugal reaction pump (figure 9) which consists of a vertical pipe with a T-joint at the top, from which extend two pipes whose length is dependent upon the rate of rotation of the assembly in operation. An orifice at the end of each pipe arm points 90° away from the arm. When the assembly is filled with water and rotated in the direction opposite to the orifices, the water is forced out through the orifices by centrifugal force and replenished by water coming up through a valve in the bottom of the vertical pipe. This pump is well adapted to variable low speeds, and construction is simple. One of these pumps, connected to a 3m diameter high-speed wind rotor, pumped 30 m³ per hour at a head of 4.5m in a 29 km/in wind.

(d) Axial-flow pumps have good potential for low-lift pumping because of their relatively simple construction and high efficiency. No use of these pumps with wind rotors is recorded, but it has been suggested that axial-flow pumps would be

appropriate for high-volume pumping of sewage wastes in oxidation ponds. Theoretical studies of wind-powered axial-flow pumps are being carried out at the National Aeronautical Laboratory in India.

(e) Archimedian screws are very simple and have efficiencies up to 80 percent. They have been used in the Netherlands for large-scale drainage requiring a lift of up to 5m. Three basic versions are known:

(i) The type with a rotating cylinder made of strips of wood and having a spiral partition inside (figure 10), as in the Tjasker type of wind pump in the Netherlands, requires a footstep bearing below the water level, and demands a fairly sophisticated level of construction skill. It can be made large in diameter and so suitable for slow-speed operation. Such a screw, 2.7m long, 0.56m diameter and lifting through 1.3m at a speed of about 30 rev/min gives an output of 32.4 m³ per hour.

(ii) The type in which the outer casing is stationary and the helical rotor is supported on bearings at either end, attached to

the casing, are normally of smaller diameter and run at a high speed, e.g. 12-cm diameter up to 200 rev/min, 40-cm diameter up to 127 rev/min. An advantage of this type is that the casing and rotor form a self-contained assembly which does not require external bearings but only simple supports to maintain it at the correct angle and axial position. The screw is made by rolling a flat steel strip between rollers set at an inclination to each other to squeeze one edge of the strip and hence cause it to curl into a helix, which is then welded to an inner cylindrical pipe.

(iii) A third method of constructing an Archimedian screw is to coil a section of pipe into a cylindrical helix. A particular type has recently been evolved for field drainage in which the tubing is corrugated with a fine pitch to strengthen it and to allow coiling to a small radius. This could form the basis of a simple low-cost pump, since most of the construction could be done locally. For example, a stout bamboo could serve as the main axle, and the coil of pipe could be held in place by lashing with rope, wire, or any suitable local fibre, using longitudinal strips of bamboo or other wood to form a supporting cage on the inside of the coils.

(f) The peristaltic pump (figure 11) consists of a flexible hose with a series of rollers along the length of the hose in order to squeeze water through the hose. The type of pump has reportedly been adapted to a Greek sail wind rotor at the Malaysian Agricultural Research and Development Institute.



[Home](#) > [ar](#).[cn](#).[de](#).[en](#).[es](#).[fr](#).[id](#).[it](#).[ph](#).[po](#).[ru](#).[sw](#)

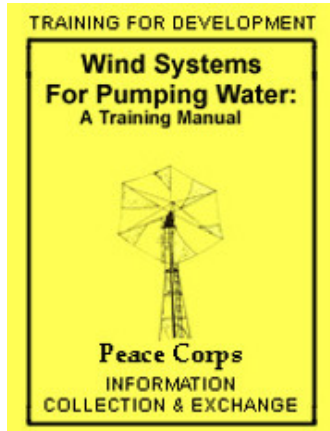

Wind Systems for Pumping Water: A Training Manual (Peace Corps, 1984, 93 p.)



(introduction...)



Acknowledgments



Introduction to training



Training guidelines















Objectives for wind system construction training



Session 1 Introduction and objectives

-  **Session 2 History of wind systems**
-  **Session 3 Large projects and community analysis**
-  **Session 4 Shop safety and tool care**
-  **Session 5 Representative drawings for construction**
-  **Session 6 Shafts and bearings**
-  **Session 7 Strengths and testing**
-  **Session 8 Joinery**
-  **Session 9 Pumps and pump design**
-  **Session 10 Siting considerations**
-  **Session 11 Sizing wind water pumping systems**
-  **Session 12 Design considerations for pumps and windmills**
-  **Session 13 How to design**
-  **Session 14 Presentation of designs**
-  **Session 15 Construction of wind**

-  **measuring poles**
-  **Session 16 Exportation for wind sites**
-  **Session 17 Tower raising**
-  **Session 18 Plumbing the wind system**
-  **Session 19 Testing installed wind system**
-  **Session 20 Presentation of projects**
-  **Session 21 Maintenance - preventive and routine**
-  **Bibliography**
-  **Construction materials list**
-  **Tool list for 24 participants**
-  **Technical vocabulary**
-  **Report on the wind-powered in-service training**
-  **Recommendations**

Session 10 Siting considerations

TOTAL TIME: 1 Hour

OBJECTIVES: To learn how to distinguish a good wind site from an inadequate site.

To understand the rules of thumb for siting windpumps

MATERIALS: Blackboard or equivalent

PROCEDURES:

Step 1: 30 minutes

Water availability, depth, proximity to users, and wind velocities and abundance are of primary concern for the siting of wind powered pumps. Discuss trees, buildings and topographical features and their effect on the wind which blows near the water supply.

Step 2: 20 minutes

Discuss other factors affecting site selection.

- Ground- Is the ground firm enough to support a tower or structure?
Can the structure be anchored?
- Winds - Seasonal variations - measure velocities Establish a projected annual wind resource availability if possible, using local individuals and government agencies.
- River - If site is located near a river, determine if flooding is a problem. Is erosion along river bank a problem?
- Ownership Who will own, maintain and allocate water?
 - This should be established before project construction begins?
- Other Consider weather extremes (hurricanes, tornadoes, etc.),
Factors - noise or other factors which are important to users or as a demonstration project.

Step 3: 10 minutes

Finally, discuss the use of wire lines to transmit mechanical power for use at the distant site. Use model to demonstrate the principles and note the 1/4 mile limitation using this system.



[Home](#) > [ar](#).[cn](#).[de](#).[en](#).[es](#).[fr](#).[id](#).[it](#).[ph](#).[po](#).[ru](#).[sw](#)

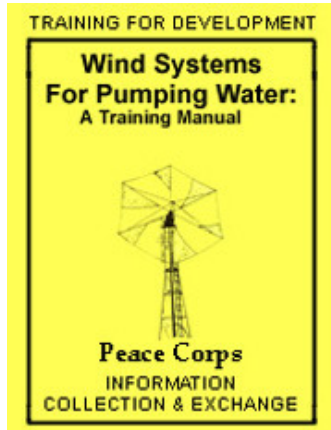

Wind Systems for Pumping Water: A Training Manual (Peace Corps, 1984, 93 p.)



(introduction...)



Acknowledgments



Introduction to training



Training guidelines



Objectives for wind system construction training



Session 1 Introduction and objectives

















Session 2 History of wind systems











Session 3 Large projects and community analysis



Session 4 Shop safety and tool care

-  **Session 5 Representative drawings for construction**
-  **Session 6 Shafts and bearings**
-  **Session 7 Strengths and testing**
-  **Session 8 Joinery**
-  **Session 9 Pumps and pump design**
-  **Session 10 Siting considerations**
-   **Session 11 Sizing wind water pumping systems**
-  **Session 12 Design considerations for pumps and windmills**
-  **Session 13 How to design**
-  **Session 14 Presentation of designs**
-  **Session 15 Construction of wind measuring poles**
-  **Session 16 Exportation for wind sites**
-  **Session 17 Tower raising**
-  **Session 18 Plumbing the wind system**
-  **Session 19 Testing installed wind**

- system**
-  **Session 20 Presentation of projects**
-  **Session 21 Maintenance - preventive and routine**
-  **Bibliography**
-  **Construction materials list**
-  **Tool list for 24 participants**
-  **Technical vocabulary**
-  **Report on the wind-powered in-service training**

-  **Recommendations**

Session 11 Sizing wind water pumping systems

TOTAL TIME: 2 Hours

OBJECTIVES: To learn how to size wind systems and pumps using as few formulas and engineering information as possible.

MATERIALS: Blackboard or equivalent

PROCEDURES:

Step 1: 20 minutes

Discuss the "Aermotor Pumping Capacity" chart, using examples.

Step 2: 10 minutes

Have a volunteer or local participant do a sample problem.

Step 3: 10 minutes

Discuss "Recommended Size, Standard Steel Pipe" chart, using examples.

Step 4: 10 minutes

Have a volunteer or local participant do a sample sizing problem.

Step 5: 10 minutes

Have a volunteer or local participant do a sample combined sizing problem using what they have learned so far.

Trainer Note

Everyone can do the sample problems along with the volunteers.

Step 6: 10 minutes

Discuss any difficulties in using the charts.

Step 7: 45 minutes

Distribute some material regarding a hypothetical windsite which has typical wind conditions for the area. Have participants determine the size of the system to be built.

Trainer Note

Use data gathered in earlier sessions if possible, or data for the site where the windmill is to be installed.

RESOURCES: Copies of Attachments 7-A, 11-A, and 11-B

Attachment 11-A Sizing Wind Water Pumping Systems

AERMOTOR PUMPING CAPACITY

Diameter of Cylinder (inches)	Gallons pumped per hour in a 15-mile per hour wind	Total height that the water is lifted (in feet)		
		WINDMILL SIZE		
		8 Foot	12 Foot	16 Foot
1.75	150	185	420	1000
2.00	190	140	320	750
2.50	325	94	210	490
3.00	470	68	180	425
4.00	830	39	86	200
5.00	1300	25	55	130

6.00	1875	17	38	85
8.00	3300	Too Big	22	50

NOTE: Pumping ability of the mill decreases about 3% for every additional 1000 feet (300 Meters) above sea level

PUMPING CAPACITY OF SIX-FOOT AERMOTORS

Diameter of Cylinder (inches)	Gallons pumped per hour in a 15-mile per hour wind	Total height that the water is lifted (in feet)
1.75	105	130
2.00	130	95
2.50	225	65
3.00	320	47
4.00	570	27
5.00	900	17
6.00	Too Big	Too Big

8.00

Too Big

Too Big

Attachment 11-B Sizing Wind Water Pumping Systems

RECOMMENDED SIZES - STANDARD STEEL PIPE

Flow/Gallons per minute	Flow/Gallons per hour	Recommended Pipe Size	Flow/Liters per minute	Flow/Liters per hour
1	60	1/2 inch	4	240
3	180	3/4 inch	11	660
5.5	330	1 inch	21	1260
10	600	1-1/4 inch	38	2280
16	960	1-1/2 inch	61	3660
32	1920	2 inch	122	7320

RECOMMENDED SIZES- PLASTIC PIPE

Flow/Gallons	Flow/Gallons	Recommended	Flow/Liters	Flow/Liters
--------------	--------------	-------------	-------------	-------------

per minute	per hour	Pipe Size	per minute	per hour
1.5	90	1/2 inch	8	300
4.5	270	3/4 inch	17	1020
8	480	1 inch	30	1800
15	900	1-1/4 inch	57	3420
24	1440	1-1/2 inch	91	5460
48	2880	2 inch	182	10920

NOTE: These sizes will give fairly low flow speed, which is desirable because it keeps friction losses small. Friction loss in all cases is about 5% of the length of the pipe. This is the same as having to pump 5 feet (or meters) higher for every 100 feet (or meters) of pipe in the system.



[Home](#) > [ar](#).[cn](#).[de](#).[en](#).[es](#).[fr](#).[id](#).[it](#).[ph](#).[po](#).[ru](#).[sw](#)



Wind Systems for Pumping Water: A Training Manual (Peace Corps, 1984, 93

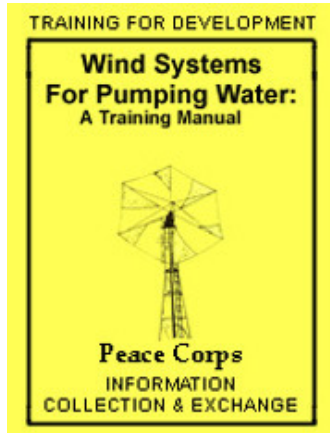

p.)



(introduction...)



Acknowledgments



Introduction to training



Training guidelines



Objectives for wind system construction training



Session 1 Introduction and objectives



Session 2 History of wind systems



Session 3 Large projects and community analysis



Session 4 Shop safety and tool care



Session 5 Representative drawings for construction



Session 6 Shafts and bearings

















Session 7 Strengths and testing



Session 8 Joinery



Session 9 Pumps and pump design

-  **Session 10 Siting considerations**
-  **Session 11 Sizing wind water pumping systems**
-   **Session 12 Design considerations for pumps and windmills**
-  **Session 13 How to design**
-  **Session 14 Presentation of designs**
-  **Session 15 Construction of wind measuring poles**
-  **Session 16 Exportation for wind sites**
-  **Session 17 Tower raising**
-  **Session 18 Plumbing the wind system**
-  **Session 19 Testing installed wind system**
-  **Session 20 Presentation of projects**
-  **Session 21 Maintenance - preventive and routine**
-  **Bibliography**



Construction materials list
Tool list for 24 participants



Technical vocabulary



Report on the wind-powered in-service training



Recommendations

Session 12 Design considerations for pumps and windmills

TOTAL TIME: 1 Hour

OBJECTIVES: To discuss and list factors which must be considered in selecting wind system components.

To identify and discuss technical and cultural factors to be considered when designing wind pump systems

MATERIALS: Blackboard or large paper and felt tip pens

PROCEDURES:

Step 1: 10 minutes

Have the participants name two or three items that they might choose for application in the wind pump experience for everyday living in the country.

Step 2: 15 minutes

Invite suggestions for a list of the technical and cultural factors that might be used in selecting each item.

Step 3: 10 minutes

Have the people examine the lists and suggest changes in the lists that they might make if they were selecting wind systems and pumps.

Step 4: 20 minutes

Discuss the environmental impact of various different types of wind systems and pumps.

Trainer Note

Include overall appearance of the finished wind system and the fact that in wooded areas it may be necessary to cut trees to get enough wind.

Step 5: 5 minutes

Summarize, including the fact that some of the factors are more important to a given person than other factors.



[Home](#)''' ''''''> [ar.cn.de.en.es.fr.id.it.ph.po.ru.sw](#)



Wind Systems for Pumping Water: A Training Manual (Peace Corps, 1984, 93 p.)



(introduction...)



Acknowledgments



Introduction to training





Training guidelines

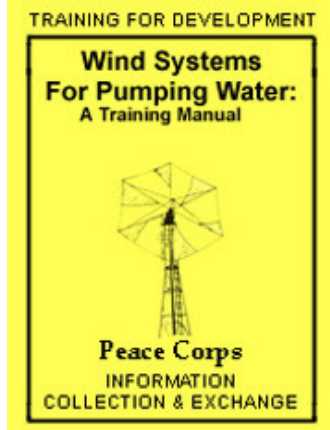





Objectives for wind system construction training

-  **Session 1 Introduction and objectives**
-  **Session 2 History of wind systems**
-  **Session 3 Large projects and community analysis**
-  **Session 4 Shop safety and tool care**
-  **Session 5 Representative drawings for construction**
-  **Session 6 Shafts and bearings**
-  **Session 7 Strengths and testing**
-  **Session 8 Joinery**
-  **Session 9 Pumps and pump design**
-  **Session 10 Siting considerations**
-  **Session 11 Sizing wind water pumping systems**
-  **Session 12 Design considerations for pumps and windmills**
-  **Session 13 How to design**

-  **Session 14 Presentation of designs**
-  **Session 15 Construction of wind measuring poles**
-  **Session 16 Exportation for wind sites**
-  **Session 17 Tower raising**
-  **Session 18 Plumbing the wind system**
-  **Session 19 Testing installed wind system**
-  **Session 20 Presentation of projects**
-  **Session 21 Maintenance - preventive and routine**

-  **Bibliography**
-  **Construction materials list**
-  **Tool list for 24 participants**
-  **Technical vocabulary**
-  **Report on the wind-powered in-service training**
-  **Recommendations**

Session 13 How to design

TOTAL TIME: 3 Hours

OBJECTIVES: To investigate and learn about the design process

To design some pumps and wind systems

Trainer Note

This session is to be used only if the participants are going to do actual design work.

MATERIALS: Model materials & supplies, wood, wire, glue, pins, construction paper, etc.

Blackboard or equivalent

PROCEDURES:

Step 1: 5 minutes

Review and clarify the objectives of the session.

Step 2: 1 hour

Examine and expand on the design process using examples. Give design process sequence, outline and procedure.

Step 3: 5 minutes

Form design and construction groups. Explain that these groups will actually construct what they design.

Step 4: 2 hours

Have the groups design the wind system that they are going to build.

Trainer Note

Note at the beginning and the close of the session that presentation of designs will be the following morning.

RESOURCES: Copies of Attachment 13-A

Books - Make sure that all reference books are there on site, because this session involves research.

Attachment 13-A

THE DESIGN PROCESS

I. Overview of the Whole Design Process

Design it

Build it

Test it

Redesign it

Figure A

II. A Closer Look at the Design Part

Establish Criteria.

- **Be specific, for example:**
- **It must be buildable in 20 hours.**
- **It must weigh less than 25 pounds.**
- **It must use only wood.**
- **It must be built only with hand tools.**
- **It must be usable by both sexes, etc.**

Establish Priorities of Criteria.

Create Three Proposed Designs.

Select the Best Design.



[Home](#) > [ar](#).[cn](#).[de](#).[en](#).[es](#).[fr](#).[id](#).[it](#).[ph](#).[po](#).[ru](#).[sw](#)









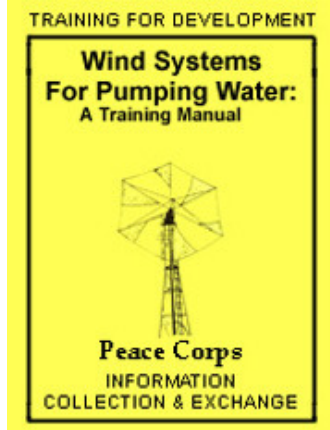





















**Wind Systems for Pumping Water: A
Training Manual (Peace Corps, 1984, 93
p.)**



(introduction...)



-  **Acknowledgments**
-  **Introduction to training**
-  **Training guidelines**
-  **Objectives for wind system construction training**
-  **Session 1 Introduction and objectives**
-  **Session 2 History of wind systems**
-  **Session 3 Large projects and community analysis**
-  **Session 4 Shop safety and tool care**
-  **Session 5 Representative drawings for construction**
-  **Session 6 Shafts and bearings**
-  **Session 7 Strengths and testing**
-  **Session 8 Joinery**
-  **Session 9 Pumps and pump design**
-  **Session 10 Siting considerations**
-  **Session 11 Sizing wind water pumping**

-  **systems**
-  **Session 12 Design considerations for pumps and windmills**
-  **Session 13 How to design**
-  **Session 14 Presentation of designs**
-  **Session 15 Construction of wind measuring poles**
-  **Session 16 Exportation for wind sites**
-  **Session 17 Tower raising**
-  **Session 18 Plumbing the wind system**
-  **Session 19 Testing installed wind system**
-  **Session 20 Presentation of projects**
-  **Session 21 Maintenance - preventive and routine**
-  **Bibliography**
-  **Construction materials list**
-  **Tool list for 24 participants**
-  **Technical vocabulary**



Report on the wind-powered in-service training



Recommendations

Session 14 Presentation of designs

TOTAL TIME: 1 to 2 Hours

OBJECTIVES: To present, discuss and evaluate the wind system and pump designs done the previous afternoon (Session 13)

To prepare for the construction

MATERIALS: Models, blackboard, paper, or any other visual aids as decided on by the groups doing the presentations

Overview of construction schedule of the remainder of the training program

PROCEDURES:

Step 1: 10 minutes

Have each group present their designs.

Step 2: 10 minutes

After each presentation, review and discuss the presentation of the design. Ask for comments about the design and presentation process. Note on flipchart what did and what didn't work about the design and presentation process. Discuss this list in light of future presentations.

Step 3: 10 minutes

Then review the design itself, asking for comments and suggestions from the group.

Trainer Note

Use this time to encourage design changes if necessary to prevent failure but allow people to make minor errors if you feel that they will learn from the experience and if these errors won't waste too much time, money or materials.

Step 4: 5 minutes

After all groups have presented their designs, post the schedule for the remainder of the training, pointing out how many hours of construction time remain.

Step 5: 25 minutes

Divide into appropriate construction groups and discuss how to get the most productivity out of these groups. Suggest that each group select a moderator or coordinator and that each group have a planning session at the start of each day. This facilitates tasks and planning construction.



[Home](#) > [ar](#).[cn](#).[de](#).[en](#).[es](#).[fr](#).[id](#).[it](#).[ph](#).[po](#).[ru](#).[sw](#)



Wind Systems for Pumping Water: A Training Manual (Peace Corps, 1984, 93 p.)

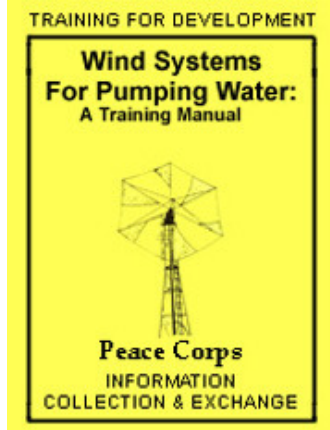

- ➔ **(introduction)**
Acknowledgments
- Introduction to training**
- Training guidelines**
- Objectives for wind system construction training**
- Session 1 Introduction and objectives**
- Session 2 History of wind systems**
- Session 3 Large projects and community analysis**
- Session 4 Shop safety and tool care**
- Session 5 Representative drawings for construction**
- Session 6 Shafts and bearings**
- Session 7 Strengths and testing**
- Session 8 Joinery**
- Session 9 Pumps and pump design**
- Session 10 Siting considerations**
- Session 11 Sizing wind water pumping**

systems



Session 12 Design considerations for pumps and windmills



Session 13 How to design



Session 14 Presentation of designs



Session 15 Construction of wind measuring poles



Session 16 Exportation for wind sites



Session 17 Tower raising



Session 18 Plumbing the wind system



Session 19 Testing installed wind system



Session 20 Presentation of projects



Session 21 Maintenance - preventive and routine



Bibliography



Construction materials list



Tool list for 24 participants



Technical vocabulary



Report on the wind-powered in-service training



Recommendations

Acknowledgments

I should like to thank Ada Jo Mann and Paul Jankura of the office of Training and Program Support, who conceived and guided this program. Also, my thanks to Andrew Atkeison, Dale Krenek, and Suellen Eschenbach, who worked on putting on the pilot training which led to the creation of this manual.

Thanks also to Cristopher Szecsey, Howard Raik, and Malcolm and Lynda Lillywhite for their support and assistance during this time. None of this would have been possible without the work of the Peace Corps staff and volunteers in the countries where the pilot training was done. Special thanks to Ned Benner and Napo Cervillos in Ecuador, and to John and Ann Heard, Pedro Souza, and Jose Kyle in Paraguay.

Finally, acknowledgment is due to the participants in the pilot

training sessions whose enthusiasm and suggestions helped bring the training to its present form. And, as in all undertakings of this size, there are all the people I did not mention who freely gave of their time and knowledge and ability to assist me in this work: thanks to all of you.

Willis Eschenbach



[Home](#)"" """"> [ar.cn.de.en.es.fr.id.it.ph.po.ru.sw](#)

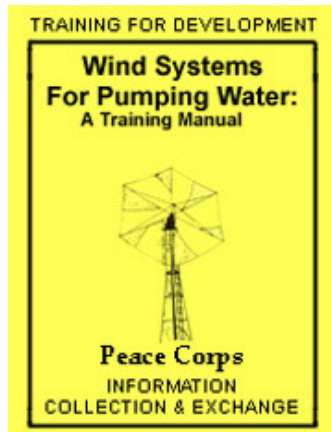

Wind Systems for Pumping Water: A Training Manual (Peace Corps, 1984, 93 p.)



(introduction...)



Acknowledgments



Introduction to training



Training guidelines



Objectives for wind system construction

training



Session 1 Introduction and objectives



Session 2 History of wind systems



Session 3 Large projects and community analysis



Session 4 Shop safety and tool care



Session 5 Representative drawings for construction



Session 6 Shafts and bearings



Session 7 Strengths and testing



Session 8 Joinery



Session 9 Pumps and pump design



Session 10 Siting considerations















Session 11 Sizing wind water pumping systems



Session 12 Design considerations for pumps and windmills



-  **Session 14 Presentation of designs**
-  **Session 15 Construction of wind measuring poles**
-  **Session 16 Exportation for wind sites**
-  **Session 17 Tower raising**
-  **Session 18 Plumbing the wind system**
-  **Session 19 Testing installed wind system**
-  **Session 20 Presentation of projects**
-  **Session 21 Maintenance - preventive and routine**

-  **Bibliography**
-  **Construction materials list**
-  **Tool list for 24 participants**
-  **Technical vocabulary**
-  **Report on the wind-powered in-service training**
- 

Recommendations

Session 15 Construction of wind measuring poles

TOTAL TIME: 2 Hours

OBJECTIVES: To construct several wind measuring devices

To calibrate these devices

To discuss some of the variables regarding wind measurement

MATERIALS: 20 foot (7 meter) or longer light poles or bamboo, ball of red or brightly colored yarn, small beads or nuts of about the same weight, fastenings (nails, lashing material)

PROCEDURES:

Step 1: 5 minutes

Discuss difficulties involved in measuring the wind speed and frequency (daily and seasonal changes, height above ground, etc.)

Step 2: 20 minutes

Discuss ways to measure the wind velocities, anemometers, wet fingers, kites, effect on the trees and buildings, wind pole, bubbles.

Trainer Note

Have everyone become familiar with the Beaufort scale. During training have people guess the wind speed and then check it, using the Beaufort scale, in order to improve their estimation abilities.

Step 3: 5 minutes

Explain the construction of the wind measuring pole.

Step 4: 1 hour

Break up into construction groups. Each group should build a measuring pole. If poles are of significantly different lengths or are used at different elevations the resulting wind velocities can

be compared.

Step 5: 30 minutes

Examine and "calibrate" each pole and then use them to measure wind speeds.

**RESOURCES: Copies of Attachment 15-A
Anemometer of some type**

Attachment 15-A Construction of Wind Measuring Poles

THE BEAUFORT SCALE OF WIND SPEEDS

Beaufort No.	Description	Miles/Hour	Kilom/Hour	Effect
0	Calm	0	0	Still: smoke rises vertically
1	Light air	1-3	1-5	Smoke drifts
2	Light breeze	4-7	6-11	Wind felt on face

2	Light breeze	4-7	8-11	Wind felt on face, leaves rustle.
3	Gentle breeze	8-12	12-19	Leaves & small twigs move constantly, streamer extended.
4	Moderate breeze	13-18	20-29	Raises dust & papers moves twigs & thin branches.
5	Fresh breeze	19-24	30-38	Small trees in leaf begin to sway.
6	Strong wind	25-31	39-50	Large branches move, overhead, wires whistle, umbrellas hard to control.
7	Moderate gale	32-38	51-61	Whole trees move, offers some resistance to walker.
8	Fresh gale	39-46	62-74	Twigs break off trees, hard to walk.

9	Strong gale	47-54	75-86	Blows off roof shingles
10	Whole gale	55-63	87-100	Trees uprooted, much structural damage.
11	Storm	64-72	101-115	Widespread damage (rare inland)



[Home](#) > [ar](#).[cn](#).[de](#).[en](#).[es](#).[fr](#).[id](#).[it](#).[ph](#).[po](#).[ru](#).[sw](#)

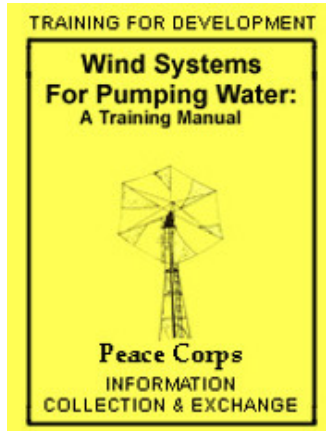

Wind Systems for Pumping Water: A Training Manual (Peace Corps, 1984, 93 p.)



(introduction...)



Acknowledgments



Introduction to training



Training guidelines



Objectives for wind system construction

training



Session 1 Introduction and objectives



Session 2 History of wind systems



Session 3 Large projects and community analysis



Session 4 Shop safety and tool care



Session 5 Representative drawings for construction



Session 6 Shafts and bearings



Session 7 Strengths and testing



Session 8 Joinery



Session 9 Pumps and pump design



Session 10 Siting considerations



Session 11 Sizing wind water pumping systems



Session 12 Design considerations for pumps and windmills



Session 13 How to design

-  **Session 14 Presentation of designs**
-  **Session 15 Construction of wind measuring poles**
-   **Session 16 Exportation for wind sites**
-  **Session 17 Tower raising**
-  **Session 18 Plumbing the wind system**
-  **Session 19 Testing installed wind system**
-  **Session 20 Presentation of projects**
-  **Session 21 Maintenance - preventive and routine**
-  **Bibliography**
-  **Construction materials list**
-  **Tool list for 24 participants**
-  **Technical vocabulary**
-  **Report on the wind-powered in-service training**
-  **Recommendations**

Session 16 Exportation for wind sites

TOTAL TIME: 2 Hours

OBJECTIVES: To learn how to visualize the flow of the wind

To locate the good windsites on or around the training area

To learn about wind movement characteristics

MATERIALS: Bubble materials (soap, wire hoop & water container)

Trainer Note

Bubble materials are the best way to see the small scale variations of the wind flow in an area. Make bubbles using flow of wind if velocities are sufficient or by moving wire hoop through air. Track the bubbles noting their path and movement.

PROCEDURES:

Step I: 2 Hours

This is an outdoor session. Walk around the area and investigate the wind using bubbles to show the wind flow in various areas.

Notice areas of stronger wind and quiet low velocity areas.

Notice areas of turbulence and areas of smooth flow.

Discuss the causes of the differences, noting that the wind has the same kinds of motion that water has (eddies, backflows, rough and smooth turbulent areas, etc.)

Discuss the use of vegetation as an aid to judging average wind speed, pointing out examples.

Explain the local peculiarities of wind flow-flow over ridges, flow in valleys, day and night winds. Explain solar heating and the resulting connection and downslope cooling connection.

Note some sites to avoid (side of the hill, just beyond the ridge line, near trees or buildings).

Discuss and select the best local site for a windmill.

Trainer Note

Distribute and discuss handout before going outdoors.

RESOURCES: Copies of Attachment 16-A

Attachment 16-A

ECOLOGICAL INDICATORS OF SITE SUITABILITY

Vegetation deformed by high average winds can be used both to estimate the average speed (thus power) and to compare candidate sites. This technique works best in three regions: (1) along coasts, (2) in river valleys and gorges exhibiting strong channeling of the wind, and (3) in mountainous terrain.

Ecological indicators are especially useful in remote mountainous terrain not only because there are little wind data, but also because the winds are often highly variable over small areas and difficult to characterize. The most easily observed deformities of trees (illustrated in Figure 1) are listed and defined below:

- * BRUSHING-** Branches and twigs bend downwind like the hair of a pelt that has been brushed in one direction only., This deformity can be observed in deciduous trees after their leaves have fallen. It is the most sensitive indicator of light winds.
- * FLAGGING-** Branches stream downwind, and the upwind branches are short or have been stripped away.
- * THROWING -** A tree is wind thrown when the main trunk and the branches bend away from the prevailing wind.
- * CARPETING-** This deformity occurs because the winds are so strong that every twig reaching more than several inches above the ground is killed, allowing the carpet to extend far downward.

Figure 1 is one of the best guides to ranking tree deformities by wind speed. Both a top view and a side view of the tree are shown to demonstrate the brushing of individual twigs and branches and the shape of the tree trunk and crown. The figure uses the Griggs-Putnam classification of tree deformities described by indices from 0 to VII. When WECS sites are ranked by this scheme, only like species of trees should be compared, because different types of trees may not be deformed to the same degree.

Another good indicator of relative wind speeds is the deformation ratio (Hewson, Wade and Baker, 1977). It also measures how much the tree crown has been flagged and thrown. Figure 2 shows the tree angles, A, B, and C, that must be measured to compute the deformation ratio "D". To measure these angles, the trees can either be photographed or sketched to scale. (The user might sketch the tree on clear acetate while he looks at it through the acetate.)

He should draw or take the tree pictures while viewing the tree perpendicular to the prevailing wind direction so that he can see the full effects of nagging and throwing.

To compute D, the three angles shown in the figure (A on the downwind side, B on the upwind side, and C, the angle of deflection) should be measured in degrees using a protractor. The larger the value of D, the stronger the average wind speed.

Mean annual wind speed is correlated with the Griggs-Putnam Index (Figure 1) in Table 1, and with the deformation ratio (Figure 2) in Table 2. These reflect only preliminary research

results based on studies of two species of conifers, the Douglas Fir and the Ponderosa Pine. Further studies are examining these and other tree species to improve predictions of mean annual winds with ecological indicators. However, these tables do agree well with similar research conducted by Griggs and Putnam on Balsam and Fir trees in the Northeast (Frost and Nowak, 1977).

Estimates of mean annual wind speed using vegetation can be improved if several trees in a siting area are sampled, using the Griggs-Putnam Index and the deformation ratio. The results of all the sampling should then be averaged. However,, ecological indicators should be used primarily to identify possible high wind areas, to locate candidate sites, and to establish roughly the annual average wind speed. Selection of a WECS should not be based solely on ecological indicators; WECS economics and performance analysis should include either a wind measurement program or available wind data in addition to ecological indicators.

Though the presence of one type of deformity (or a combination) may indicate an area of high average winds and the degree of

deformity may give estimates of the relative strengths of the winds, there are still pitfalls to rating sites according to tree deformity. Because past or present growing conditions can greatly affect the size and shape of trees, only isolated trees appearing to have grown under similar conditions should be compared. For example, a tree in or near a dense stand of timber should not be compared to an isolated tree. In addition, trees being compared should be of nearly the same height (preferably 30 ft. or more). Another fact to be aware of is: limbs are stripped from trees not only by strong nagging. They can be damaged by man, disease, other trees that once grew nearby, or possibly ice storms. Misinterpreting such signs could lead to the wrong assumptions about the prevailing wind direction and the average speed. Common sense, however, should reveal whether or not all the deformities observed in an area fit together into a consistent pattern.

Attachment 16-A

TABLE 1

MEAN ANNUAL WIND SPEED VERSUS THE GRIGGS-PUTTNAM INDEX*

Griggs Putnam Index (as in Figure 1)	I	II	III	IV	V	VI
Probable Mean Annual Wind Speed Range (mph)	7-9	9-11	11-13	13-16	15-18	16-21

TABLE 2

MEAN ANNUAL WIND SPEED VERSUS THE DEFORMATION RATIO*

Deformation Ratio (as in Figure 2)	I	II	III	IV	V	VI
Probable Mean Annual Wind Speed Range (mph)	5-9	8-11	10-13	12-16	14-18	15-21

*** These data were prepared by E. W. Hewson, J. E. Wade, and R. W. Baker of Oregon State University.**

The following guidelines summarize this section and suggest how

to use ecological indicators effectively:

- 1. direct ecological indicators of strong wind;**
- 2. compare isolated trees of the same species and height within the strong wind areas to select candidate sites;**
- 3. consider flow patterns over barriers, terrain features, and surface roughness in the final selection;**
- 4. measure the wind in complex terrain to ensure that a suitable site is selected; and**
- 5. base selection of a particular WECS and any detailed estimation of its power output on wind measurements, not on ecological indicators alone.**

Prevailing Wind →

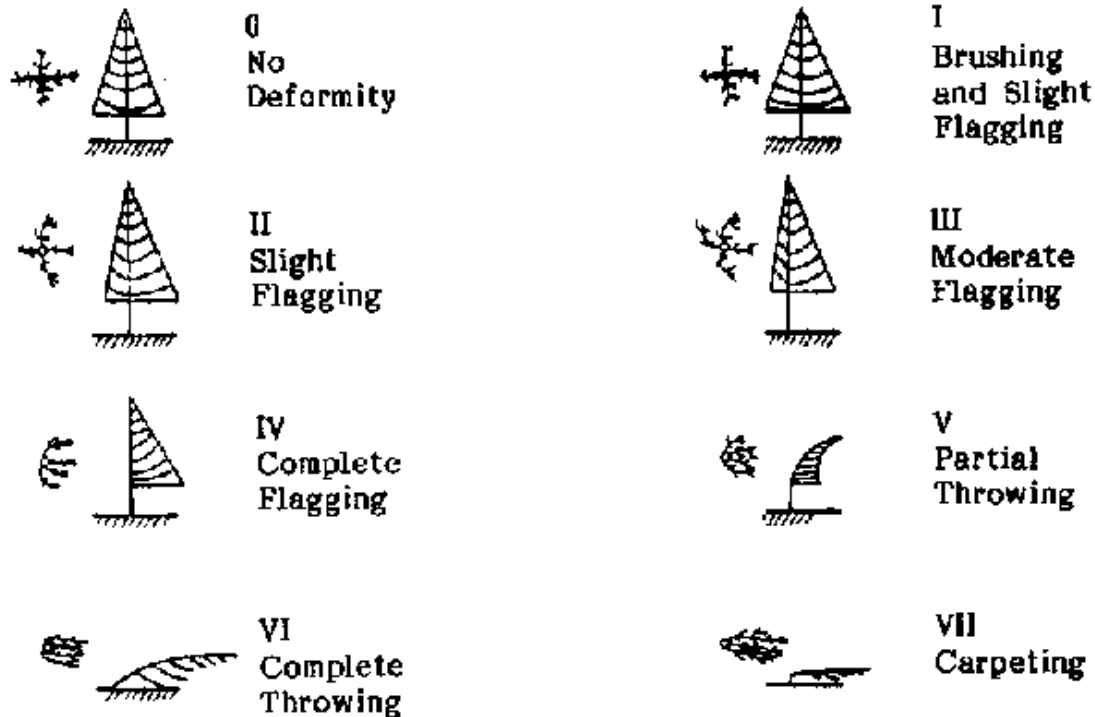

Figure 1: Wind Speed Rating Scale Based on the Shape of the Crown and Degree Twigs, Branches, and Trunk are Bent (Griggs-Putnam Index; Hewson, Wade and Baker, 1977)

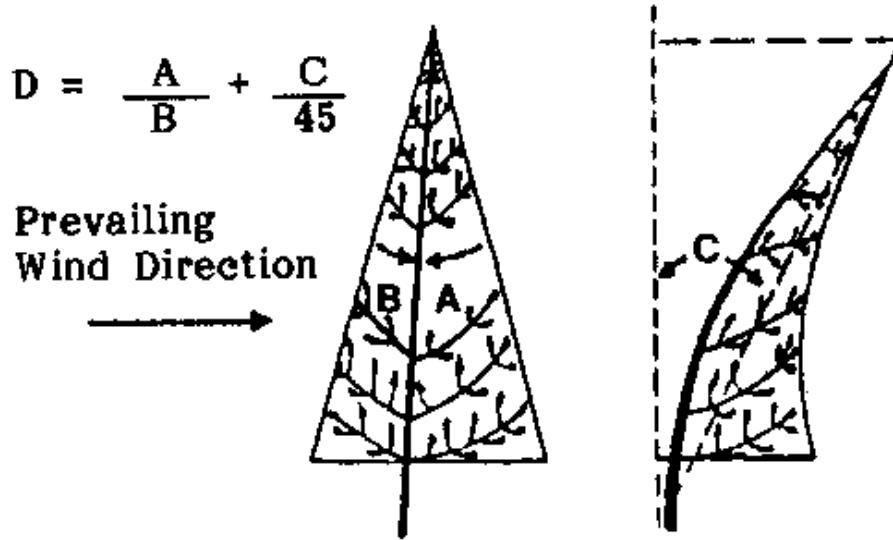

Figure 2: Deformation Ratio Computed as a Measure of the Degree of Flagging and Throwing (Hewson, Wade, and Baker, 1977)









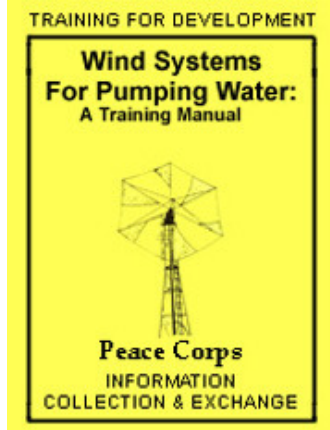





[Home](#) > [ar.cn.de.en.es.fr.id.it.ph.po.ru.sw](#)











Wind Systems for Pumping Water: A



Training Manual (Peace Corps, 1984, 93 p.)

-  **(introduction...)**
-  **Acknowledgments**
-  **Introduction to training**
-  **Training guidelines**
-  **Objectives for wind system construction training**
-  **Session 1 Introduction and objectives**
-  **Session 2 History of wind systems**
-  **Session 3 Large projects and community analysis**
-  **Session 4 Shop safety and tool care**
-  **Session 5 Representative drawings for construction**
-  **Session 6 Shafts and bearings**
-  **Session 7 Strengths and testing**
-  **Session 8 Joinery**

-  **Session 9 Pumps and pump design**
-  **Session 10 Siting considerations**
-  **Session 11 Sizing wind water pumping systems**
-  **Session 12 Design considerations for pumps and windmills**
-  **Session 13 How to design**
-  **Session 14 Presentation of designs**
-  **Session 15 Construction of wind measuring poles**
-  **Session 16 Exportation for wind sites**
-  **Session 17 Tower raising**
-  **Session 18 Plumbing the wind system**
-  **Session 19 Testing installed wind system**
-  **Session 20 Presentation of projects**
-  **Session 21 Maintenance - preventive and routine**
- 



Bibliography materials list



Tool list for 24 participants



Technical vocabulary



Report on the wind-powered in-service training



Recommendations

Session 17 Tower raising

TOTAL TIME: 8 Hours

OBJECTIVES: To raise tower safely and securely.

To install transfer gearbox on tower properly

MATERIALS: Shovels, picks, tamping bars or poles

Tower poles, gin poles, 4060 meters of rope, diagonal bracing poles

Modeling construction materials

PROCEDURES:

Step 1: 15 minutes

By using a model demonstrate the action and sequence of raising a large timber or tower.

Step 2: 15 minutes

Discuss and explain safety considerations (falling off tower, ropes breaking, tower or poles falling, dropping tools from hands and pockets while on the tower.

Trainer Note

This is potentially the most dangerous session of the training. Stress the importance of moving slowly and of moving together as a group.

Step 3: 4 hours

Assemble the tower; measure and dig footing holes.

Prepare for raising, including last minute safety precautions.

Step 4: 1 hour

Raise the tower using gin pole- if necessary.

Trainer Note

Explain what is going to happen very clearly and make sure that everyone understands their part. Keep a close eye out for people doing things which may be dangerous.

Step 5: 2 hours

Level and center the tower and pour concrete footings. Prepare transfer gearbox and rotor for installation.

Step 6: 1 hour

Install machine.



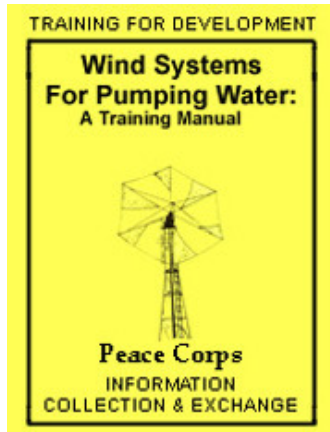

Wind Systems for Pumping Water: A Training Manual (Peace Corps, 1984, 93 p.)



(introduction...)



Acknowledgments



Introduction to training



Training guidelines



Objectives for wind system construction training



Session 1 Introduction and objectives



Session 2 History of wind systems



Session 3 Large projects and community analysis



Session 4 Shop safety and tool care



Session 5 Representative drawings for construction









Session 6 Shafts and bearings

-  **Session 7 Strengths and testing**
-  **Session 8 Joinery**
-  **Session 9 Pumps and pump design**
-  **Session 10 Siting considerations**
-  **Session 11 Sizing wind water pumping systems**
-  **Session 12 Design considerations for pumps and windmills**
-  **Session 13 How to design**
-  **Session 14 Presentation of designs**
-  **Session 15 Construction of wind measuring poles**

-  **Session 16 Exportation for wind sites**
-  **Session 17 Tower raising**
-  **Session 18 Plumbing the wind system**
-  **Session 19 Testing installed wind system**
-  **Session 20 Presentation of projects**



-  **Session 21 Maintenance - preventive and routine**
-  **Bibliography**
-  **Construction materials list**
-  **Tool list for 24 participants**
-  **Technical vocabulary**
-  **Report on the wind-powered in-service training**
-  **Recommendations**

Session 18 Plumbing the wind system

TOTAL TIME: 4 Hours

OBJECTIVES: To hook up and connect the pipes, pumps, connecting rods and wind systems into one operating unit.

MATERIALS: Pumps, windblade (or transfer gearbox if not installed during Session #17), pipes, and other plumbing parts. Posts and stakes to hold pumps and hoses secure.

PROCEDURES:

Trainer Note

It is not possible to specify the exact kind and order of events for this session, since it depends on the type of wind system that is being built and the type of pump that is being used. Some typical activities are listed below:

If necessary, mount the pumps securely using posts and fasteners.

If pump system has a crosshead, mount that.

Center both the pump and the gearbox in the middle of each of their strokes and measure for the length of the connecting rod.

Cut the connecting rod to length and install.

Trainer Note

Be sure to turn windmill by hand through its complete pumping

cycle before allowing it to be turned by the wind.

Connect hoses or pipes.

Prime the pump (if necessary) and let it spin.



[Home](#) > [ar](#).[cn](#).[de](#).[en](#).[es](#).[fr](#).[id](#).[it](#).[ph](#).[po](#).[ru](#).[sw](#)

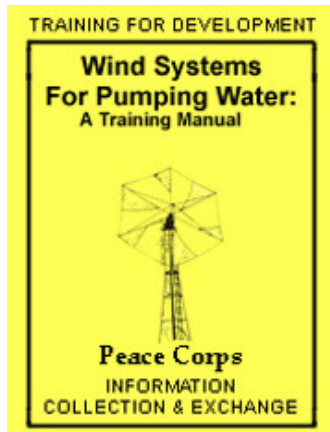

Wind Systems for Pumping Water: A Training Manual (Peace Corps, 1984, 93 p.)



(introduction...)



Acknowledgments



Introduction to training













Training guidelines



















Objectives for wind system construction training



Session 1 Introduction and objectives

-  **Session 2 History of wind systems**
-  **Session 3 Large projects and community analysis**
-  **Session 4 Shop safety and tool care**
-  **Session 5 Representative drawings for construction**
-  **Session 6 Shafts and bearings**
-  **Session 7 Strengths and testing**
-  **Session 8 Joinery**
-  **Session 9 Pumps and pump design**
-  **Session 10 Siting considerations**
-  **Session 11 Sizing wind water pumping systems**
-  **Session 12 Design considerations for pumps and windmills**

-  **Session 13 How to design**
-  **Session 14 Presentation of designs**
-  **Session 15 Construction of wind**

-  **measuring poles**
-  **Session 16 Exportation for wind sites**
-  **Session 17 Tower raising**
-  **Session 18 Plumbing the wind system**
-   **Session 19 Testing installed wind system**
-  **Session 20 Presentation of projects**
-  **Session 21 Maintenance - preventive and routine**
-  **Bibliography**
-  **Construction materials list**
-  **Tool list for 24 participants**
-  **Technical vocabulary**
-  **Report on the wind-powered in-service training**
-  **Recommendations**

Session 19 Testing installed wind system

TOTAL TIME: 2 Hours

OBJECTIVES: To set up test conditions to allow testing of what has been built.

To gather DATA on the performance of the system which has been built.

MATERIALS: Two 5-gallon drums (kerosene cans), watch, and anemometer Water supply (pond, well, river, tank or 55-gallon oil drum)

PROCEDURES:**Step 1: 15 minutes**

Assemble the test apparatus, which consists of a hose or pipe that can reach from the outlet of the pump system to a container of known volume. Then monitor the amount of water pumped in a given amount of time by a certain wind speed.

Step 2: 1 hour

When the test apparatus is set up, allow the pump to fill the container at a specified time. Record the amount pumped in a minute and the windspeed every 10 seconds during that minute. If possible, change stroke length and repeat the test to optimize pumping rate.

Trainer Note

For the data collection, accurate recording of windspeed, height pumped, amount pumped, and time pumped are required. In addition, the exact capacity of the cans used must be known. Make a number of runs at various speeds. Then make a graph of windspeed versus foot-gallons per minute (or meter-liters per minute).

Step 3: 45 minutes

Calculate and graph or chart results.



[Home](#)"" """"> [ar](#).[cn](#).[de](#).[en](#).[es](#).[fr](#).[id](#).[it](#).[ph](#).[po](#).[ru](#).[sw](#)

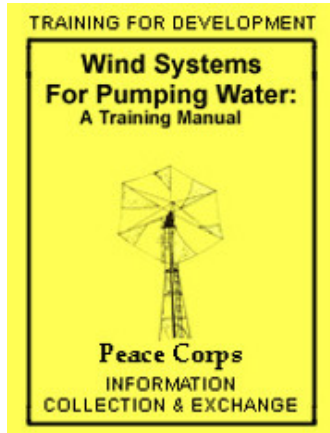

Wind Systems for Pumping Water: A Training Manual (Peace Corps, 1984, 93 p.)



(introduction...)



Acknowledgments



Introduction to training



Training guidelines



Objectives for wind system construction training



Session 1 Introduction and objectives



Session 2 History of wind systems



Session 3 Large projects and community analysis



















Session 4 Shop safety and tool care



Session 5 Representative drawings for construction



Session 6 Shafts and bearings

-  **Session 7 Strengths and testing**
-  **Session 8 Joinery**
-  **Session 9 Pumps and pump design**
-  **Session 10 Siting considerations**
-  **Session 11 Sizing wind water pumping systems**
-  **Session 12 Design considerations for pumps and windmills**
-  **Session 13 How to design**
-  **Session 14 Presentation of designs**
-  **Session 15 Construction of wind measuring poles**
-  **Session 16 Exportation for wind sites**
-  **Session 17 Tower raising**
-  **Session 18 Plumbing the wind system**
-  **Session 19 Testing installed wind system**
-   **Session 20 Presentation of projects**
- 

Session 21 Maintenance - preventive



**and routine
Bibliography**



Construction materials list



Tool list for 24 participants



Technical vocabulary



**Report on the wind-powered in-service
training**



Recommendations

Session 20 Presentation of projects

TOTAL TIME: 1 to 2 Hours

OBJECTIVES: To have participants present the different sub-construction projects of the wind powered water pump systems using simple presentation methods in layman's language.

To discuss and evaluate the systems built.

MATERIALS: Wind powered pump systems (complete) Other

materials as determined by the participants and the nature of their presentations

PROCEDURES:

Step 1: 15 minutes

Have each group present their sub-system report.

Step 2: 15 minutes

Review and discuss each presentation. Was it effective? Did the important points get across? What worked, what didn't?

Step 3: 30 minutes

Then review the system itself. What works best about the system? What works least? Which part is likely to fail first? Was it easy to build and repair? Is it easy to use and adjust? What changes in the design would you make as a result of building it?

Trainer Note

Distribute and discuss what the presentations should cover, as well as the handout on extension skills prior to having the participants prepare the demonstrations. Invite local people to attend the presentations. Emphasize the need to present the demonstrations as simply as possible since the local people have not had the advantage of the training program and may not be familiar with the various technologies discussed.

RESOURCES: Copies of Attachment 20-A

EXTENSION SKILLS: Important Points to be Considered for Successful Education and Communication

- 1. Be prepared. Know what you are doing, where you are going and what you want your audience to know when they leave. Do not prepare your talk an hour before you give it.**
- 2. Always do a practice run of whatever it is you are demonstrating before you get up in front of the group to teach.**
- 3. Start off with a very small chunk of information to be taught.**

For example, "How to Build a Stove" would be too broad a topic. Change it to "Building the Base."

4. People learn best by doing. The more concrete you can be, the better. For example, if you are doing a talk on how to make a particular type of soup, have everyone make it and taste the soup.

5. People remember main points better when presented with visual aids. Illustrate your main points and use the drawings during your talk. Also, people tend to understand complex or abstract concepts if they can visualize them. Also, remember that points or concepts you find simple, others may find difficult. Be sensitive to your audience and explain points thoroughly.

6. Visual aids and/or graphs should be clear, depicting objects with which the people are familiar. Photographs or pictures cut from magazines are of ten more easily understood than hand-drawn pictures.

7. Changing color and lettering can draw more attention to the

visual aids. However, visual aids may be distracting, confusing, or misunderstood when they do not mirror people's reality.

8. A vocabulary list of important things, steps, and materials in the demonstration can be useful to the demonstrator as well as to the audience.

9. The demonstration should never take place above the audience's line of vision.

10. People remember things that are unusual and make them laugh. But do not overdo it.

11. Physical conditions are important. The demonstration should take place in the lightest part of the room or area. Rooms should be freed of all other distractions. Effort should be made to make everybody physically comfortable, etc.

12. It is better to have an active audience than a passive one.

13. Do not read your material.

14. Keep eye contact with your audience. In this way, you will build a rapport with them. Also, they will feel that you are talking to them not at them.

15. Respect the audience members who already know how to do the things that you are demonstrating and get them involved in helping you with the presentation.

16. Repeat the main points. For example, state them at the beginning of your talk, in the middle and at the end. Again the next day, repeat the main points or elicit them from your group before you go into any new information. In other words, build on the previous information.

17. Reinforcement activities following a talk can facilitate learning.

18. Always minimize the cost of the thing being demonstrated, making sure that the people have the economic resources necessary to do it on their own. Try to utilize materials found in the immediate area.

19. When the demonstration involves making something, it is always a good idea to have a finished example to show to the audience.

20. Variety in presentation styles and environment are important.

21. Your talk should contain an introduction that gives a purpose for the information you are going to give. Set the stage for your talk.

22. Try not to use very technical words in the demonstration.

23. Organize your information. For example, time/order, cause/effect, etc.

24. Whenever possible, relate what you are demonstrating to the local customs.

25. Keep your demonstration short and limited to the time of day and amount of time that the people have free.

26. If the demonstration involves several steps, either write or

draw them so the audience has something to follow as you go, but be sensitive to the fact that some people do not know how to read or follow diagrams.

27. Try to involve as many of the people's senses as possible: taste, smell, touch, sight, sound.

28. Your personality is important. Smile and be friendly.

29. Speak slowly and clearly. You are probably speaking enough, when you think you are going too slowly.

30. Do not talk down to your audience. Show them the respect you want them to show you.

31. At the beginning of the demonstration, explain briefly what you are intending to do. At the end, summarize what it is that you have done.

32. Be sensitive to your audience. If they are getting restless, you may be going too fast, going on for too long, or they may not be understanding you.

33. BE YOURSELF!



[Home](#) > [ar](#).[cn](#).[de](#).[en](#).[es](#).[fr](#).[id](#).[it](#).[ph](#).[po](#).[ru](#).[sw](#)

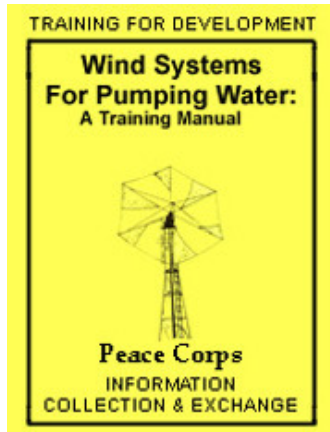

Wind Systems for Pumping Water: A Training Manual (Peace Corps, 1984, 93 p.)



(introduction...)



Acknowledgments



Introduction to training



Training guidelines



Objectives for wind system construction training



Session 1 Introduction and objectives



Session 2 History of wind systems



Session 3 Large projects and community analysis

 **Session 4 Shop safety and tool care**
Session 5 Representative drawings for construction

 **Session 6 Shafts and bearings**

 **Session 7 Strengths and testing**

 **Session 8 Joinery**

 **Session 9 Pumps and pump design**

 **Session 10 Siting considerations**

 **Session 11 Sizing wind water pumping systems**

 **Session 12 Design considerations for pumps and windmills**

 **Session 13 How to design**











 **Session 14 Presentation of designs**

 **Session 15 Construction of wind measuring poles**

 **Session 16 Exportation for wind sites**

 **Session 17 Tower raising**



-  **Session 18 Plumbing the wind system**
-  **Session 19 Testing installed wind system**
-  **Session 20 Presentation of projects**
-  **Session 21 Maintenance - preventive and routine**
-  **Bibliography**
-  **Construction materials list**
-  **Tool list for 24 participants**
-  **Technical vocabulary**
-  **Report on the wind-powered in-service training**
-  **Recommendations**

Session 21 Maintenance - preventive and routine

TOTAL TIME: 1 to 2 Hours

OBJECTIVES: To understand the maintenance needs of various types of wind systems and pumps

To learn maintenance techniques

To experience maintenance on a wind system

MATERIALS: Blackboard & wind waterpump system on site

PROCEDURES:

Step 1: 30 minutes

Have the group develop a list of the various parts of the wind system and pumps that will wear out, and, in a parallel column, list what will cause the wear to be maximal or minimal.

Step 2: 30 minutes

Have the group develop another list showing the maintenance necessary to prevent wear of the parts listed. Using a parallel column, make an estimate of the frequency of maintenance necessary for that part.

Trainer Note

Emphasize that wind systems, with the exception of sealed, oil bath commercial units, are usually a high maintenance technology.

Step 3: 1 hour

Have small groups perform lubrication and simulated maintenance on a working or broken wind waterpump system (if possible).

RESOURCES: Copies of Attachment 21-A

Attachment 21-A

MILL MAINTENANCE

The oil in the bowl of the windmill should be changed at least once a year with a good grade of low temperature oil. This should be done in the fall of the year, prior to the winter months, because all moisture, or water, must be removed from the bowl.

Water in the oil can accumulate as a result of changing

temperatures on the humid air, which has a tendency to drive the water from the air, and because of the total enclosure, the water is then dispersed into the oil.

It has been known that, in some instances, where the mill was neglected, sufficient water had gathered in the bowl to freeze and cause breakage of the bowl. It is for this reason that we recommend that the lubricant be removed from the windmill bowl in the fall of the year, and the user should be sure that all the liquid content is removed.

When the mill is being serviced, the user may find that the oil bowl has become laden with a thick sludge, usually resulting from the use of a lower quality of oil. If the user finds the situation to be thus, then we would suggested that after he has removed the drain plug and drained out most of the material in the bowl, he use some gasoline or coal oil and rinse off all the operating parts so that the sludge that may hang on will be removed.

This sludge, if not removed regularly, can move through the

bearing and into the return oil slot, and it is possible that the bearing would begin to wear.

If sludge is present in the bowl when the mill is serviced, something should be done in the way of rinsing all of it free and flushing it from the bowl before refilling with new oil.

THE PULL OUT CABLE SHOULD BE INSPECTED AT LEAST TWICE A YEAR AND, IF THE CABLE STRANDS ARE FOUND TO BE FRAYING, THE CABLE SHOULD BE REPLACED.



[Home](#) > [ar](#).[cn](#).[de](#).[en](#).[es](#).[fr](#).[id](#).[it](#).[ph](#).[po](#).[ru](#).[sw](#)



Wind Systems for Pumping Water: A Training Manual (Peace Corps, 1984, 93 p.)



(introduction...)









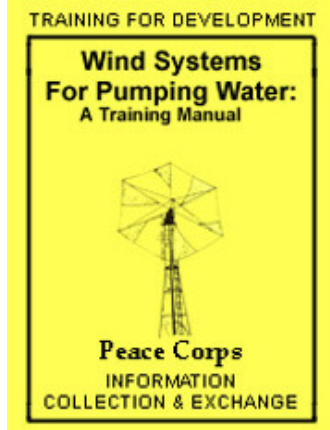









Acknowledgments



Introduction to training



-  **Training guidelines**
-  **Objectives for wind system construction training**
-  **Session 1 Introduction and objectives**
-  **Session 2 History of wind systems**
-  **Session 3 Large projects and community analysis**
-  **Session 4 Shop safety and tool care**
-  **Session 5 Representative drawings for construction**
-  **Session 6 Shafts and bearings**
-  **Session 7 Strengths and testing**
-  **Session 8 Joinery**
-  **Session 9 Pumps and pump design**
-  **Session 10 Siting considerations**
-  **Session 11 Sizing wind water pumping systems**
-  **Session 12 Design considerations for**

-  **pumps and windmills**
-  **Session 13 How to design**
-  **Session 14 Presentation of designs**
-  **Session 15 Construction of wind measuring poles**
-  **Session 16 Exportation for wind sites**
-  **Session 17 Tower raising**
-  **Session 18 Plumbing the wind system**
-  **Session 19 Testing installed wind system**
-  **Session 20 Presentation of projects**
-  **Session 21 Maintenance - preventive and routine**
-   **Bibliography**
-  **Construction materials list**
-  **Tool list for 24 participants**
-  **Technical vocabulary**
-  **Report on the wind-powered in-service training**



Recommendations

Bibliography

DESCRIPTIVE BIBLIOGRAPHY OF WINDMILLS

Darrow, Ken and Pam, Rick. Appropriate Technology Sourcebook. Two Volumes. Available from: Appropriate Technology Project, Volunteers in Asia, Box 4543, Stanford, CA.

An excellent book on where to find information. It reviews hundreds of books and papers on all aspects of appropriate technology.

Van de yen, N. Construction Manual for a Cretan Windmill. Pub. # SWD 77-4. Available from: Steering Committee for Windenergy in Developing Countries, P. O. Box 85, 3800 AB Amersfoort, The Netherlands.

The best book I know of on building sail-powered windmills mostly from wood. Very detailed, with complete instructions for construction.

Mann, R. D. How to Build a 'Cretan Sail' Windpump. Available from Intermediate Technology Publications Ltd., 9 King Street, London WC2E 8HN, U.K.

A how-to book about the author's experiences in building metal windmills in Africa.

"Proceedings of the Meeting of the Expert Working Group on the Use of Solar and Wind Energy." Energy Resources Development Series, No. 16, United Nations. Sales Number E.76.II.F.13.

Fairly technical, with an interesting section on historical pump types.

Wood, A.D., Ruff, J.F., and Richardson, E.V. Pumps and Water Lifters for Rural Development. Colorado State University, Ft. Collins, Colorado, U.S.A. (CER76-77ADW-JFR-EVR61)

An excellent resource on low-cost, locally built pumping mechanisms of all types, including animal powered pumps.

Barbour, Erwin. The Homemade Windmills of Nebraska. Available

**from: The Farallones Institute, 15290 Coleman Valley Road,
Occidental, CA. 95465**

A report of the author's trips through Nebraska in the last 1890's and the marvelous windmills he found and photographed there. A testament to the ingenuity of the windmill builders. Highly usable in developing countries.

Reynolds, John. Windmills and Watermills. Published by: Praeger Publishers, Inc. 111 Fourth Avenue, New York, New York 10003. (\$17.50)

Many photos and line drawings show the internal workings of many historical mills. A marvelous book.



[Home](#)"" """"> [ar.cn.de.en.es.fr.id.it.ph.po.ru.sw](#)



**Wind Systems for Pumping Water: A
Training Manual (Peace Corps, 1984, 93**

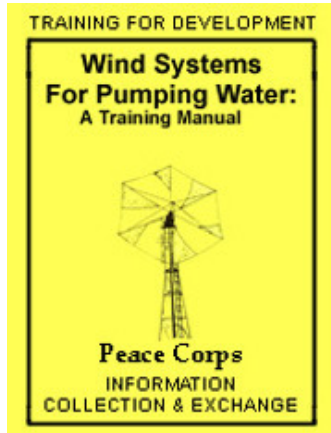

p.)



(introduction...)



Acknowledgments



Introduction to training



Training guidelines



Objectives for wind system construction training



Session 1 Introduction and objectives



Session 2 History of wind systems



Session 3 Large projects and community analysis



Session 4 Shop safety and tool care



Session 5 Representative drawings for construction



Session 6 Shafts and bearings



Session 7 Strengths and testing



Session 8 Joinery



-  **Session 9 Pumps and pump design**
-  **Session 10 Pumping considerations**
-  **Session 11 Sizing wind water pumping systems**
-  **Session 12 Design considerations for pumps and windmills**
-  **Session 13 How to design**
-  **Session 14 Presentation of designs**
-  **Session 15 Construction of wind measuring poles**
-  **Session 16 Exportation for wind sites**
-  **Session 17 Tower raising**
-  **Session 18 Plumbing the wind system**
-  **Session 19 Testing installed wind system**
-  **Session 20 Presentation of projects**
-  **Session 21 Maintenance - preventive and routine**
-  **Bibliography**



Construction materials list Tool list for 24 participants



Technical vocabulary



Report on the wind-powered in-service training



Recommendations

Construction materials list

One 6-foot battleaxe

Shaft - 6-foot piece of 6-inch pole

Tower - Four 20 foot 9 to 10 inch poles

Eight 10 foot 2 to 3 inch poles for diagonals

Ten 8 foot 2 to 3 inch poles for bracing

Spikes or bolts or rope

Arms - Four 3 foot poles

Blades - Enough material to cover four 2x2 squares

Wire - 30 feet baling type wire

Bearings and fasteners

Crank arm, crank pin and fasteners

Con rod and bolts or pins

One 4½ by 6-foot jumbo

Shaft - One 6 foot 4 inch pole

Arms - Eight 6 foot 2 inch poles

Fans - Enough material to cover four - 1 foot by 4½ foot fans (8 pieces of 6 foot 1 by 6)

Box - Four 3 foot corner posts - enough planking to cover two 3 foot by 4¼ foot sides and two 3 foot by 6 foot sides

Tower - Same as above

Bearings and fasteners

Crank arm, crank pin and fasteners

Con rod and bolts or pins

One 6 foot sailmill

Shaft - 8 foot piece of 6 inch pole

Tower - Four 16 foot 9 to 10 inch poles

Four 10 foot 2 to 3 inch poles for diagonals

Ten 8 foot 2 to 3 inch poles for bracing and steps

Spikes or bolts or rope or rebar

Arms - Three 6 foot poles (2-3")

Sails - Enough material to make six 2½ x 2½ foot triangles

Wire - 150 feet baling type wire

Bearings and fasteners

Crank arm, crank pin and fasteners

Con rod and bolts or pins

Twelve or more nails or hooks to hold sails on with

One wooden 3" pump, pitcher style

4 boards for sides

1 bottom piece

sucker rod

valve weights

rubber

piston and piston seal

rod seal

fasteners

crosshead
wrist pin
spout parts

One plastic 3" pump, borehole style

1 cylinder pipe

1 top and one bottom piece

sucker rod (pipe)

valve plates, plastic

rubber

piston and piston seal

rod seal (plastic tee and reducers)

fasteners

crosshead

wrist pin

pipe for down the hole

One metal 3" pump, borehole style

1 cylinder pipe

1 top and one bottom piece, wooden

sucker rod

valve plates, wooden

rubber

piston and piston seal

rod seal

fasteners

crosshead

wrist pin

floor flange for pipe

MISCELLANEOUS

Plastic pipe to water

Hose and hose clamps

Fittings- metal to plastic

Secure

Cloth sacks

Tin

Paint

Grease

Pencils

Paper

Extra post material

Rope and more rope

Materials for windpoles

20 foot or longer bamboo or light wood

crosspieces

1 ball red yarn

small nuts or beads

fasteners



[Home](#)"" """"""> **[ar.cn.de.en.es.fr.id.it.ph.po.ru.sw](#)**

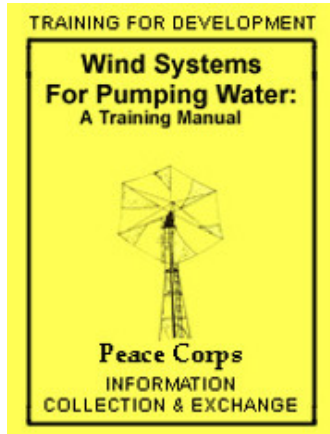

Wind Systems for Pumping Water: A Training Manual (Peace Corps, 1984, 93 p.)



(introduction...)



Acknowledgments



Introduction to training



Training guidelines



Objectives for wind system construction training



Session 1 Introduction and objectives



Session 2 History of wind systems



Session 3 Large projects and community analysis



Session 4 Shop safety and tool care









Session 5 Representative drawings for construction



Session 6 Shafts and bearings

-  **Session 7 Strengths and testing**
-  **Session 8 Joinery**
-  **Session 9 Pumps and pump design**
-  **Session 10 Siting considerations**
-  **Session 11 Sizing wind water pumping systems**
-  **Session 12 Design considerations for pumps and windmills**
-  **Session 13 How to design**
-  **Session 14 Presentation of designs**
-  **Session 15 Construction of wind measuring poles**
-  **Session 16 Exportation for wind sites**
-  **Session 17 Tower raising**
-  **Session 18 Plumbing the wind system**
-  **Session 19 Testing installed wind system**
-  **Session 20 Presentation of projects**
-  **Session 21 Maintenance - preventive**

-  **and routine Bibliography**
-  **Construction materials list**
-  **Tool list for 24 participants**
-  **Technical vocabulary**
-  **Report on the wind-powered in-service training**
-  **Recommendations**

Tool list for 24 participants

- 6 hammers
- 2 machetes
- 3 hand saws

- 2 drills plus bits
- 1 hand sledge
- 4 pkgs. sandpaper

1 each rat-tail file and flat file

2 screwdriver
2 shovels
1 pkgs. hack saw blades
2 vice grips
1 each chisels, 1", 3/4", 1/2", 1/4"
1 pick
2 adjustable wrenches
1 grindstone
5 tape measures
2 pipe wrenches
2 combination squares
2 5-gallon containers
1 handheld anemometer (Dwyer)
grease oil
oil
6 paintbrushes
30 pencils



[Home](#) > [ar](#).[cn](#).[de](#).[en](#).[es](#).[fr](#).[id](#).[it](#).[ph](#).[po](#).[ru](#).[sw](#)

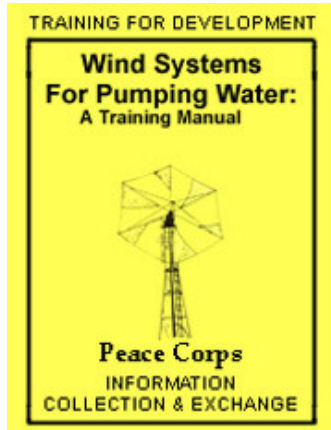

Wind Systems for Pumping Water: A Training Manual (Peace Corps, 1984, 93 p.)



(introduction...)



Acknowledgments



Introduction to training



Training guidelines



Objectives for wind system construction training



Session 1 Introduction and objectives



Session 2 History of wind systems



Session 3 Large projects and community analysis











Session 4 Shop safety and tool care



Session 5 Representative drawings for

-  **construction**
-  **Session 6 Shafts and bearings**
-  **Session 7 Strengths and testing**
-  **Session 8 Joinery**
-  **Session 9 Pumps and pump design**
-  **Session 10 Siting considerations**
-  **Session 11 Sizing wind water pumping systems**
-  **Session 12 Design considerations for pumps and windmills**
-  **Session 13 How to design**
-  **Session 14 Presentation of designs**
-  **Session 15 Construction of wind measuring poles**
-  **Session 16 Exportation for wind sites**
-  **Session 17 Tower raising**
-  **Session 18 Plumbing the wind system**
-  **Session 19 Testing installed wind system**

-  **Session 20 Presentation of projects**
-  **Session 21 Maintenance - preventive and routine**
-  **Bibliography**
-  **Construction materials list**
-  **Tool list for 24 participants**
-  **Technical vocabulary**
-  **Report on the wind-powered in-service training**

-  **Recommendations**

Introduction to training

The first thing to understand about this training is the fact that it is centered around the needs of the people and the place in which it is carried out. Traditional training programs of this type focus on particular technology. In this case, the emphasis is on the people participating; their skills, their needs and the things about which they want to learn.

There are several implications of this adaptive training approach. One is that the projects (machinery) selected to be built must be easily constructed from local materials. Another is that the sessions to be used should be selected from the possible sessions listed in the manual, and they should be selected on the basis of what the participants need to do and know. A choice also needs to be made as to how much mathematics to include. Optional evening sessions might be needed, if some of the participants are not familiar with the use of the tools or with the materials selected for construction. The skills of the participants and the general skill level of the people who are the eventual users of the wind pumping system also need to be considered.

In short, every time this training is done in a different place and for another group of people it should be adapted accordingly. Everyone has something to learn from this training including the trainers themselves.

Although this particular training program is designed to train people in the design construction and maintenance of wind systems it was developed in a more general format which can be

used for design and construction training of any type of simple device or machinery. The trainer is encouraged to substitute sessions as the need arises and include the sessions that apply to the larger issues of siting design methods and material testing to name a few.

The training program is divided into two basic forms: in one form a session on the design process is included and the participants are expected to do some design work in groups. The other form uses a preselected design and does not include the design process. In either case a clear explanation of the considerations and constraints leading to the selection of the finished designs should be and is included. The session "Design Consideration for Pumps and Windmills" is used for this purpose.

The order and content of the sample schedule or the sessions in the manual is not fixed. For example mathematics may be postponed until such a time that people are familiar with the situation and are therefore more at ease to begin calculations. The trainers should consider the order and the particular training needs for their situation then arrange the training curriculum

accordingly. Include sessions on a need-to-know basis and leave most of your time for construction if you are planning a big project. Fit the training program to the participants' training needs.

The opening session is very important. Everyone comes to a training with different expectations based on varying degrees of truth rumor wishful thinking and selective listening. A common expectation is extensive information on wind-generated electricity. How much time will you spend on that? Everyone should know from the start what can and cannot be accomplished given the time and the resources. Clarity in the beginning can save much difficulty later.

The beginning session is also used to explore what the people in the group know and what they have done in their lives. Those who have experience in the theory, tools, or materials should be invited to share their skills and knowledge with the rest of the group. This is also the time to find out what the people do not know and what they would like to learn. The training can then be best designed to fill the needs of the participants.

The training can be centered around either the construction of a preselected wind system design or around group design and construction of a wind system based on a proven concept. The "Construction Manual for a Cretan Windmill" was used as the construction text in the Paraguay training program, and the system described in the text was built with minor variations. It is an excellent text and also contains a section on building a treadle-powered lathe which could be adapted to wind power.

The key text, however, is "The Homemade Windmills of Nebraska." This book has line drawings of the wind systems put together by the farmers of Nebraska in the late 1890's, mills made of every conceivable material. The book is very innovative where the application of wood, wire, nails, and whatever is handy is concerned. It also contains descriptions of the use and construction of the illustrated windmills.

The final reports on the two pilot trainings and the schedule for each of these trainings as appendices are included. Also, a bibliography and a list of construction materials is included.

20/10/2011

meister10.htm

