



TR-RWH 08

The plastic tube tank - instructions for manufacture

Abstract

The plastic tube tank was also developed as part of the DTU programme in Uganda. It uses off the shelf plastic tube to line a pit. It has a capacity of

approximately 600 litres. Here instructions are given for manufacturing this jar, based on experiences in Uganda in 2000. A full costing is also given





Full document withdrawn pending modifications



[home.cd3wd.ar.cn.de.en.es.fr.id.it.ph.po.ru.sw](#)

[home.cd3wd.ar.cn.de.en.es.fr.id.it.ph.po.ru.sw](#)

Case Study 19

Low cost water tank (1500 litres 23,000 litres) made of bamboo and plastic film

Appropriate Rural Technology Institute (ARTI), Pune, India

The low-cost water tank is made of bamboo and plastic film. Villagers in India use a large bamboo basket shaped like a silo, for storing grain. If this silo is internally lined with a food grade polythene film, it can be used as a water tank. The bamboo is made non-biodegradable by soaking it in a solution containing 450g of sodium dichromate, 300g of copper sulphate and 150g of boric acid dissolved in 10 litres of water. Such treated bamboo has an outside life of between 10 and 20 years. The cost of a tank having a capacity of 1500 litres is Rs.1000 (US\$1 = Rs.43). If a larger tank is required, one makes a plinth of cement and stones having the desired diameter, and by using chemically treated bamboo poles, a palisade of bamboo is erected along the periphery of the plinth, like a fencing. The distance between adjacent bamboo poles is about 50-60 cm. The plinth can have a diameter of up to 5 or 6m, but the height of the bamboo palisade should not exceed 120cm because the pressure exerted by the water column on the side

walls is determined by the column height. Using the bamboo poles as a skeleton, the entire structure is woven like a wickerwork, using chemically treated bamboo strips. From a distance the structure looks like a giant basket (see Figures 1 and 2). When the structure is internally lined with a food grade polythene film, it can be used as a water storage tank. One can use it to collect run-off water from the roof, or one can even allow the rain to fall directly into the tank. Once the tank is full its top is covered by another film of plastic, which keeps the water clean and prevents evaporation.

[Click here for: Figure 1 - a 1500 litre plastic lined bamboo tank](#)

A tank having a diameter and a height of 1.2m can store 23,000 litres of water, which ensures a daily supply of 60-80 litres of clean drinking water throughout the year. The cost of such a tank comes to about Rs.10,000 (US\$233).

[Click here for: Figure 2 - tank showing cover in place](#)

People often ask if a similar system could be used for lining a pit dug into the soil. We have found at ARTI that the film in such a tank is often punctured by rodents, crabs, insects and even roots of surrounding trees because the bottom of the tank is not surrounded by a rodent or root proof barrier. Because such a tank is below ground level,

a leak in the plastic lining is only noticed after the loss of a considerable quantity of water. And even after detection it cannot be repaired. The above ground tank is not only protected from burrowing animals and from tree roots, but because the tank is above ground level, drawing water from it by means of a siphon is also quite easy.

Many thanks to Dr A. D. Karve (karve@wmi.co.in) of ARTI for all the detail for this Case Study. The project was financially supported by the Science and Society Division, Department of Science and Technology, Ministry of Science and Technology, Government of India, New Delhi.

[home.cd3wd.ar.cn.de.en.es.fr.id.it.ph.po.ru.sw](#)

Case study 1

The Sri Lankan Pumpkin Tank

Background Information

The Sri Lankan Pumpkin Tank, and the associated construction technique, was developed as part of a World Bank sponsored Water and Sanitation Programme which was implemented in the country between 1995 and 1998. The Community Water Supply and Sanitation Programme (CWSSP) covered 3 districts within the country Badulla, Ratnapura and Matara Districts. Hundreds of these tanks were built in areas where conventional supply schemes, such as piped supplies or groundwater supplies, were difficult to provide. In some areas members of the target community were given the choice of a RWH system for individual households or a groundwater supply for a group of households. The choice varied. In all cases there was a choice of type of tank either the Pumpkin tank or an underground tank which is described in Case Study 2. The choice was usually a function of ground conditions rather than personal preference. Both tanks have a capacity of approximately 5m³.

The Abikon family of Demetaralhina in Badulla District chose a pumpkin tank. Their village is in a rural highlands area of the country and the ground conditions were not suitable for a groundwater supply or for digging a pit for a below ground tank. Average annual rainfall is 2250mm with a bimodal rainfall pattern and a dry period, usually between December and April. Their per capita consumption was well below the 20 litres per day that each family member now consumes. The water is used for drinking (but only after boiling), cooking, personal and clothes washing. Mr Abikon also uses the water from their tank to water their 4 cows. Only towards the end of the dry season does the

tank sometimes dry and then the family has to walk to the spring, about a mile from their home.

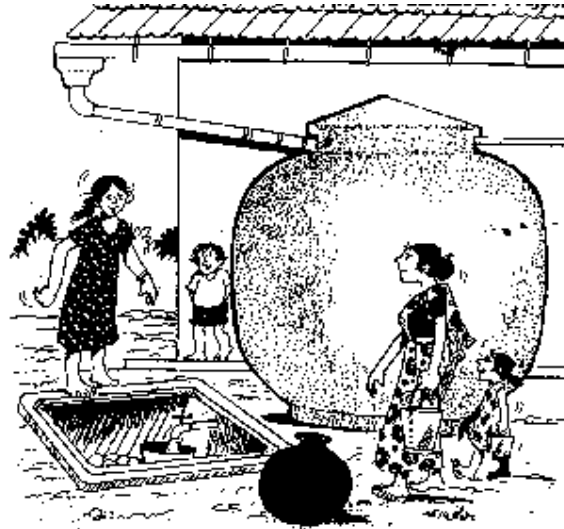

Technical details

Rainwater is collected from only 1 side of the pitched roof, a collection area of 32m^2 . The roofing material is a mix of zinc and asbestos sheeting. The guttering is a PVC U-channel, factory manufactured, found commonly in the nearby town, fitted to a fascia board with similarly manufactured brackets, spaced at 300mm centres. The downpipe is

a standard 3" PVC pipe, although some of the neighbours use less costly downpipes made from string and plastic tubing. The cost of the guttering is approximately SLR5,600, about Sterling 86.00.

This pumpkin tank was built 3 years ago and is in very good condition. The construction is of ferrocement. The construction detail is given later. The cost of the tank is approximately SLR5,000 or Sterling 77.00. The materials and specialist labour for the tank were provided by CWSSP and the guttering was purchased by the Abikon family.

Water extraction is through a tap piped to a point slightly away from the tank, where the ground falls away and allows a bucket to be placed easily under the tap. There is a first flush mechanism fitted in the form of a simple PVC elbow with a length of pipe which diverts the dirty first water away from the

inlet chamber. The inlet chamber also acts as the prefilter chamber. The chamber is approximately 600mm cubed and contains subsequent layers of stone, charcoal and sand, through which rainwater passes.

Construction details:

The following construction details are given in the instructions which are handed out to

masons during their training session:

Pumpkin (Wataka) Tank Construction details

1. Prepare skeleton / framework legs (see Figure 1) as shown in the drawing. 10 no. required. Prepare the crown ring. This can be used again for many tanks.

Figure 1 photo one of the 10 framework legs used as the skeleton for the tank

1. Lay the concrete base using two layers of chicken wire as reinforcing. Allow 300mm of chicken wire to protrude all around the edge of the base. This will be connected to the wall mesh later. Lay 10 anchor bolts for the legs in the base while casting (the diameter will depend on the diameter of the holes in the legs).
1. Leave the base for 7 days to cure, wetting each day.
2. Secure the 10 skeleton legs using the bolts and the crown ring.
3. Take 6mm steel rod and wrap it around the outside of the legs, starting at the bottom and working up at 10cm intervals.
4. Fix 2 layers of chicken wire over the outside of the skeleton. The filter tower can be added at this point if a filter is to be fitted.

Figure 2 photo a Pumpkin tank under construction - image 1

Figure 3 photo a Pumpkin tank under construction - image 2

5. Plaster the outside of the mesh. Leave for 1 day.
6. Go inside the tank and remove the skeleton.
7. Plaster inside the tank and cure for 7 days.

Water proofing can be added to the mortar. This can be a specialist additive or liquid dishwashing soap.

Cure the tank by wetting for 7 10 days. Fill the gradually starting on day 7, filling at a rate of approximately 300mm per day.

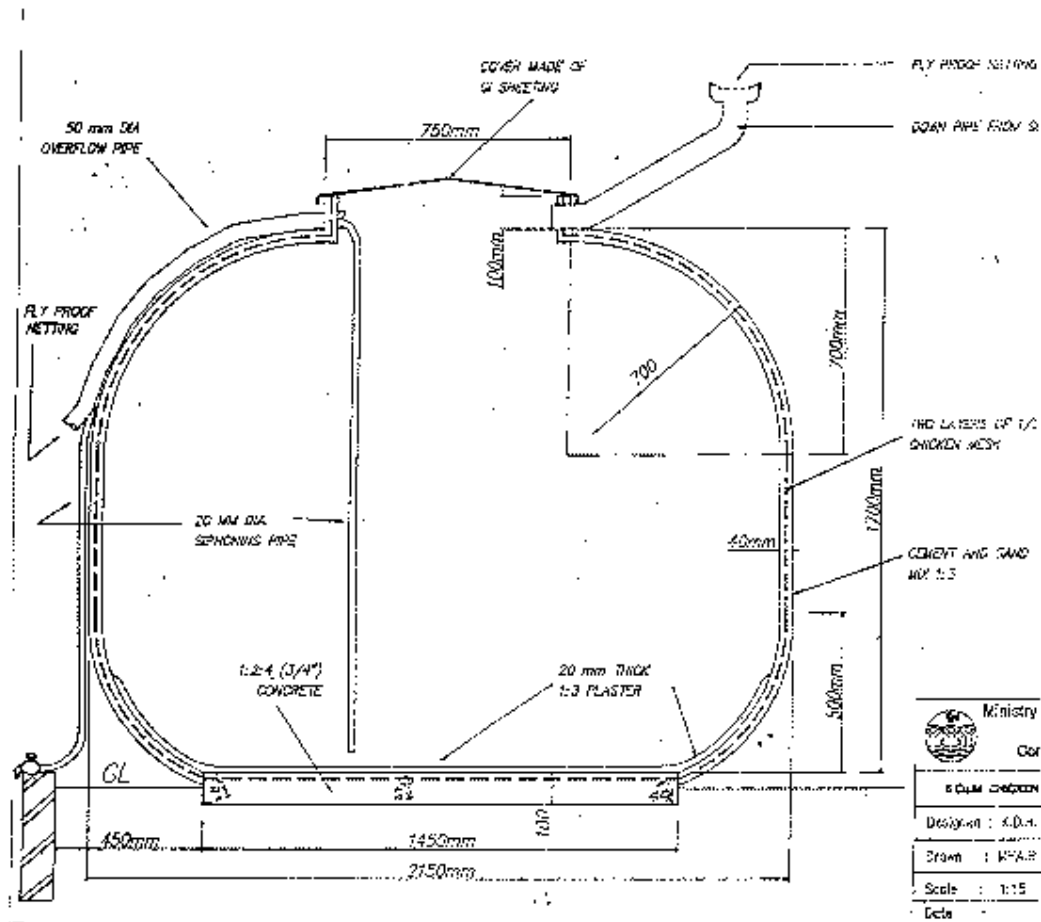

Figure 4 - technical detail of the Pumpkin tank

More Pumpkin Images

[Image 1](#)

[Image 2](#)

[Image 3](#)

Materials and labour breakdown

Material	Unit	Qty	Unit Cost	Total cost
Cement	Bag	8	265	2120
Sand	ft ³	55	3.5	192.5
Metal	ft ³	6	18	108

" Chicken Mesh	ft ²	366	4	1464
Mould		1	325*	325
Transport				500
Skilled labour	hr	56	22	1232
Unskilled labour	hr	112	12.5	1400
			Total	7341.5

*Assuming mould is used for 10 tanks

All costs given in Sri Lankan Rupees

65 SL Rupees = Sterling 1.00

[\(return to top of page\)](#)

[\(return to main case study page\)](#)

[home.cd3wd.ar.cn.de.en.es.fr.id.it.ph.po.ru.sw](#)

Case study 9

RWH in the barrios of Tegucigalpa

Introduction

This case study is drawn for a report produced by UNICEF in 1991. The Barrios of Tegucigalpa, Honduras, are the low-income urban settlements that have developed around the city as tens of thousands of people move, each year, to the city from rural areas. They come in search of better living conditions but often end up in these barrios, where public services and amenities are poor or non-existent. Health statistics show that the residents of the barrios are suffering from a number of water related diseases that could easily be avoided with provision of a reliable, clean water supply. Unfortunately, more than 150,000 residents have to find their own water.

Water vendors sell water at extortionate prices, some families having to spend 30 or 40% of their income on water alone. In 1987, UNICEF, SANAA (National Water and Sewage Service) and UEBM (Unit for Marginal Barrios) started work on an integrated water

supply project that would help the residents to direct their money into providing themselves with clean water. The programme studies several water supply options, including piped networks, groundwater wells, trucking of water and rainwater harvesting.

The report from which this Case Study is drawn studies the indigenous RWH systems in use in two barrios - Israel Norte and Villa Vieva. Although technically unsophisticated and lacking good health practice, the systems described here show what urban settlement have done to improve their own lot. Many of the systems make use of recycled or scavenged materials and some examples show high levels of initiative.

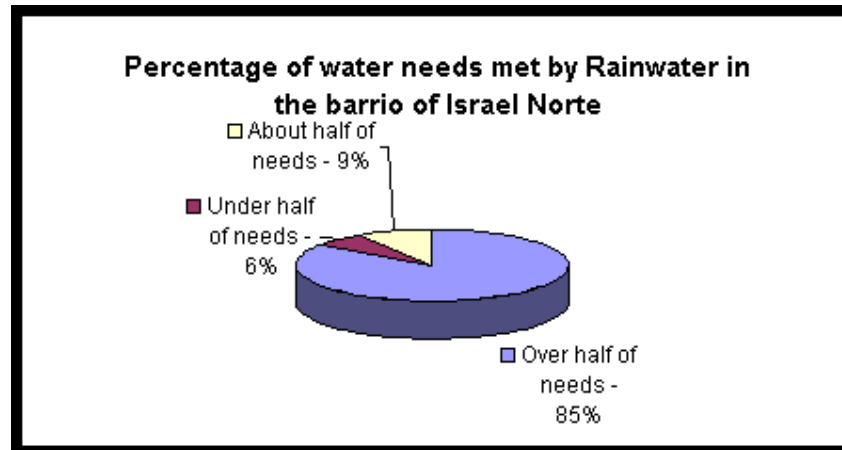
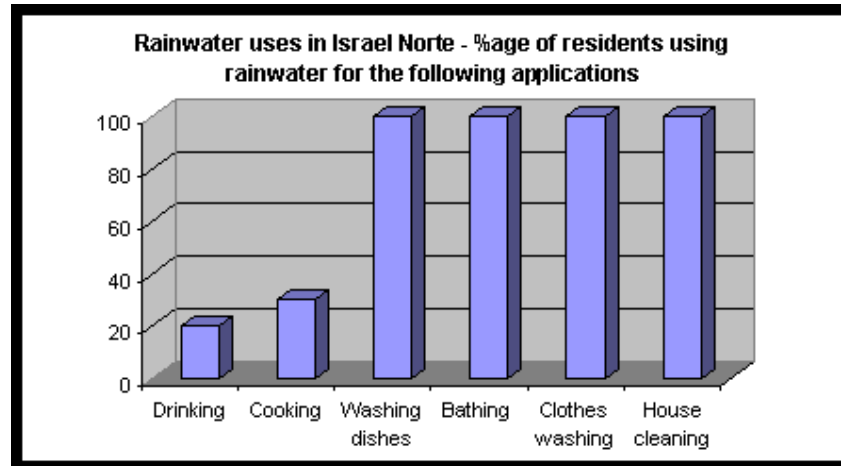

Figure 1 - Percentage of water needs met by rainwater in the barrio of Israel Norte (Brand and Bradford, UNICEF 1991)

Water use

In the two barrios mentioned above, about 90% of the families collect rainwater. The quantity of rainwater collected varies from home to home. Figure 1 shows the percentage of needs met by rainwater in the barrio of Israel Norte.

Figure 2 shows the various uses of rainwater and the percentage of people who use the rainwater for a particular application.



**Figure 3 - percentage of residents using rainwater for given applications
(Brand and Bradford, UNICEF 1991)**

The deficit in drinking and cooking water is usually met by water which is purchased from vendors or from nearby standpipes in middle class residential areas. The rainwater is not seen as being a high-quality source of water.

Rainwater harvesting is popular as there is a direct saving for every litre of water saved. For a household with a 45m² collection surface (the average roof area) the saving is over US\$100 annually.

Technical detail

The RWCSs used in the barrios are rudimentary. The basic system usually has the following components:

Roof collection surface

The average roof area in the Villa Nueva barrio is 45m^2 , with typically half of this area being used for collecting water. The recommended roof area to provide adequate collection area for total rainwater harvesting is 100m^2 . The average rainfall in the area is 788mm, which is quite low and hence the large collection area requirement. The majority of the rainfall (as shown in Figure 3) falls between April and November with two peaks, one in June and one in September.

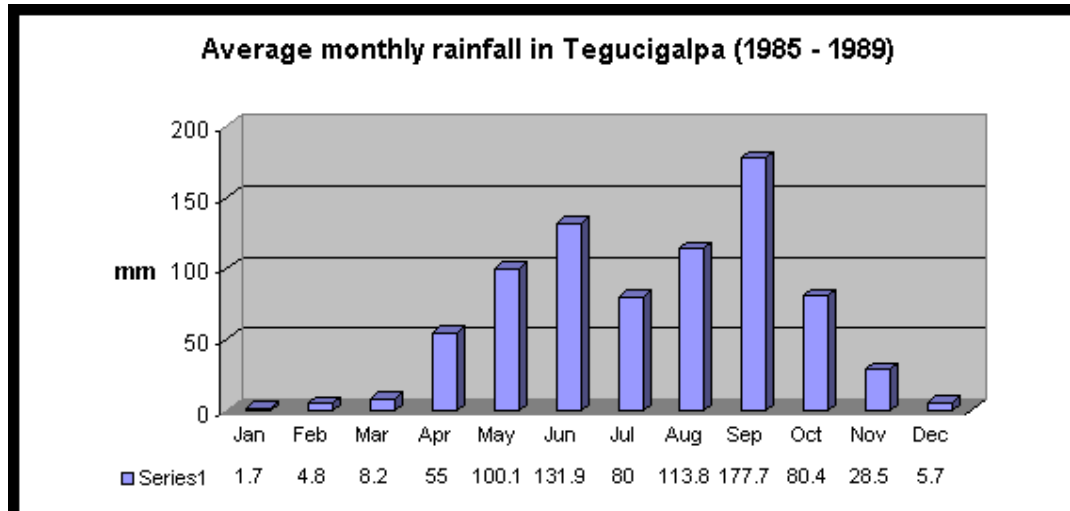

Figure 3 - Average monthly rainfall in Tegucigalpa (Brand and Bradford, UNICEF 1991)

Roofing material varies, but by far the most commonly used material is iron sheet. Other materials used are asbestos/cement sheets, clay tiles, *techon* (a locally produced asphalt treated pressed paper sheet) and a variety of discarded plastics and sheet materials.

Gutters to collect the water from the roof

Again, a variety of materials have been used to make gutters. In the barrio of Villa Norte 75% of the gutters are made from sheet steel. The fabrication technique of steel gutters varies also some have been made from scraps of steel sheet or old, flattened steel

drums. Pre-fabricated gutters are also seen - these are rolled to give a semi-circular trough, and are fitted with a neck to attach the downpipe (where fitted), which can be of PVC. The authors state that the cost of these gutters was US\$36 for a 20 foot length (1991). There are a number of different methods for fixing the gutters, but where high quality gutters are used the quality of the bracket is usually better also, being formed of wood or bent reinforcing bar. Some gutters were poorly mounted with depressions which allows water to stand and corrode the steel. Gutters are typically fitted to one side of the building only.

PVC gutters are formed from 8" PVC pipe which has been cut in half. The cost of a 20 foot length of PVC pipe is US\$38 which provides 2 lengths of guttering when split. The PVC guttering is preferred because it is cheaper and lighter. Many other scavenged materials are used for guttering, including wood and asbestos sheeting.

Downpipe

In Israel Norte barrio, 90% of the systems have no downpipe. The water runs from the gutter directly into the storage vessel. The remainder used either plastic hose, PVC pipe or sheet metal to transport the water to a remote water storage container.

None of the systems studied were fitted with any kind of screen, filter or first flush

mechanism.

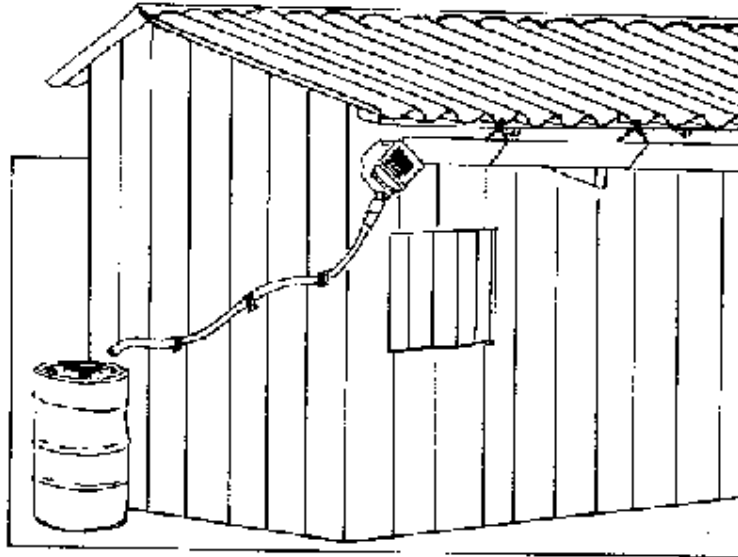

Figure 4 typical RWH system in a barrio of Tegucigalpa, Honduras (Brand and Bradford, UNICEF 1991)

Storage

Water storage facilities at the barrios are, again, basic. The majority are old 200 litre

steel barrels. These are bought (the average price is US\$13) or scavenged and most contained pesticides, chemicals or toxic materials so are not well-suited to water storage. The second most common type of storage is the *pila*, a concrete water tanks of about 500 litre capacity which has an integrated washing board (see Figure 5). These are built by local masons and cost approximately of US\$25. The tanks can be sized to suit the needs and means of the user. Fifteen to 30 % of the residents of the barrios have these pilas.

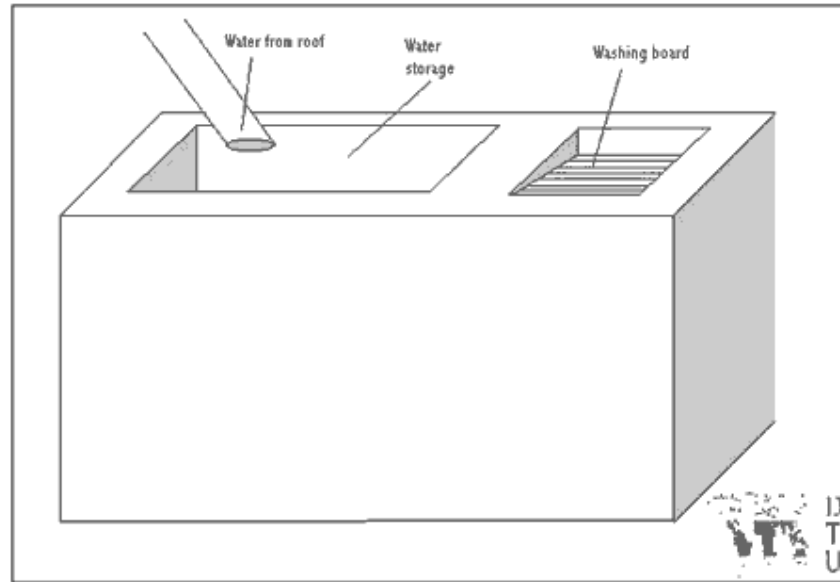

Figure 5 The brick and mortar *pila*, as found in the barrios of Tegucigalpa

Some people have also acquired plastic barrels which may have contained paint, oil or other substance. Only very few of the systems studied had a cover fitted.

Water quality and alternative sources of water

The study team sampled the stored rainwater to find the level of bacteriological contamination present. It was found that where the water was used for drinking, 63% of

the water samples taken contained E.Coli. Where the water was used for other domestic purposes only, 71% of the samples were contaminated. All sample were taken from the storage vessels.

The study team also sampled the alternative sources of water for the two barrios included in the study. Table 1 below shows the results.

Source	Number of Coliforms present (WHO guidelines recommend 0 coliforms in drinking water)
SANAA / UNICEF public taps	0 coliforms
Private water vedors sample taken from hose	Uncountable
Unprotected superficial cells	varies between 650 and uncountable

Store reportedly selling water bought from SANNA truck	0 coliforms
---	-------------

Table 1 Alternative water sources and their quality Villa Nueva barrio

[Return to top of page](#)

[Return to index page](#)

[home.cd3wd.ar.cn.de.en.es.fr.id.it.ph.po.ru.sw](#)

Case Study 15

A pictorial guide for the construction of a ferrocement Rainwater Harvesting Tank

Thanks to Renu Gera, Projects Officer, WESS (<mailto:%20rgera@uncdel.ernet.in>) of UNICEF, Mumbai, India for providing the information included in this Case Study.

The pictorial detail given in this case study covers the technique only. Please contact

UNICEF India for further information on to construct this type of tank.

Please click on each intruction or thumbnail to see the relevant picture



[Draw a circle where the footings will sit](#)



[Dig to a sufficient depth to lay the foundations](#)



Lay the foundation



Erect the mould skeleton



Fix the galvanised iron (GI) sheets to the mould and cover them with

two layers of chicken mesh



Add two further layers of chicken mesh at the bottom of the tank



Plaster from the outside



Remove the mould



Plaster from the inside



Cure the structure by draping wet hessian sacks



Making the cover - start with the reinforcing bars



Plastering the access cover



Plaster the three peices of the cover



Fitting the filter



Filling the filter with filter media



Completed tank

[home.cd3wd.ar.cn.de.en.es.fr.id.it.ph.po.ru.sw](#)

DTU Technical Release Series TR-RWH 03

Experimental Rammed Earth Tanks - Instructions for manufacture

(based on the construction of an experimental rammed earth tank at Kyera Farm, Mbarara, Uganda)

Prepared by Dai Rees
September 2000

Content:

[Introduction](#)

[Tank specification](#)

[Glossary](#)

[Tools and equipment required](#)

[Soil preparation](#)

[Marking out the site and laying the base](#)

[Ramming the first section of wall](#)

[Completing the first ring](#)

[Ramming subsequent lifts](#)

[Rendering the tank](#)

[Fitting the cover](#)

[Water extraction](#)

[External finish](#)



Introduction

The guidelines for manufacture given below are based on an experimental tank built at Kyera Farm, Mbarara, Uganda during June and July 2000. This type of tank is still at the experimental stage and is NOT recommended for manufacture as yet. The tank described below failed after being filled, but was due to a poor lining, which was the result of bad workmanship.

Tank specification

Tank internal diameter	2.0m
Tank external diameter	2.4m
Tank height	2.0m
Tank capacity	approximately 6 cubic metres

Base	100mm stone with 50mm concrete or 50mm compacted stabilised soil, 2.8m diameter
Wall	Stabilised soil, 0.2m thickness
Reinforcement	barbed wire hoops at 50-60mm spacing in rammed earth sections
Soil make-up	10% clay, 15 30% silt, 50 70% sand, 10 20% gravel, 4% cement stabilisation
Tank lining	plastic or cement render lining (latter described below)
Water extraction	by gravity or by siphonic tap (latter described below)
Cover	DTU thin-shell ferrocement cover with extended eave

Glossary

- Section A quadrant of rammed earth wall (see Figure 1)
- Lift One complete ring or 4 sections
- Pour Earth is poured to a depth of 100mm before being rammed. This is known as a pour

[Figure 1 a Section of rammed earth tank wall](#)

Tools and equipment required

- Shuttering and tie rods (see Figure 1 and Figure 4 details for manufacture available upon request)
- Rammers (both flat and V) (see Figure 5)
- Spirit level (600mm)
- Hammer
- Spades or shovels (2)
- Buckets
- Soil preparation equipment

Soil preparation

- Find suitable soil field and lab tests are required to confirm suitable soils and some

modification of the soil may be needed

- Transport soil to site. It is good to find soil as close to the site as possible.
- Prepare the soil using suitable equipment (e.g. hammers, groundnut mill, sieves or mechanised equipment). The soil needs to be made fine enough to allow good mixing.

[Figure 2 A groundnut sheller fitted with 4mm sieve being used to break down soil ready for mixing](#)

- Calculate the amount of soil required for one section using the following formulas:

$$\text{Volume, } V = \pi (r_o^2 - r_i^2) \times h/4$$

$$\text{Weight, } W = \text{Volume} \times \text{Material density}$$

$$\text{where, } \pi = 3.142$$

r_o = outer radius of tank

r_i = inner radius of tank

h = height of one lift

Take material density to be 2000kg/m^3 , where actual figures are not available.

- Mix soil in the correct proportions if soil modification is needed (in the case of the Mbarara tank we used 80% anthill soil, 16% coarse murram [and 4% cement]). Mix enough for one section at a time and then add cement to enough soil for one pour at a time.
- When ready to pour, add the cement to give a 4% stabilisation and mix the soil thoroughly and add enough water to satisfy the drop test.
- The soil should be kept dry if not used and soil that has had cement added should be discarded if not used.

[Figure 3 Mix soils together and then add cement and water only enough for one pour at a time](#)

Marking out the site and laying the base

- Find a suitable location for the tank enough space and close enough to the catchment

area

- Level the ground to provide a circular area whose radius is at least 0.5m greater than the tank (external) radius
- Where the ground is soft, a stone base of 150mm deep is required whose surface is 50mm below the normal ground level (NGL). The diameter of the stone foundation and base is 2.5m.
- The type of base used depends on whether a plastic or render liner will be used:
 - Where a plastic liner is used, the remaining 50mm is filled with stabilised soil and rammed to provide a firm base for the tank.
 - Where a render lining is used, the base is constructed using a concrete of mix 4:2:1 to a depth of 50mm.
- Ensure that there is sufficient clear area around the base to place the shuttering

Ramming the first section of wall

- Mark out the inner and outer wall radii, using chalk or a nail scratch mark.
- Place the shuttering such that it sits in the correct position, straddling the inner and outer marks

Figure 4 Showing the shuttering located over the marked radii with end stops and tie rods in place, ready for the soil to be poured.

Figure 5 Rammers or tamps used for compacting the soil. The V tamp is used to create the shear bond between pours.

- Ensure that the end stops are in place and that the tie rods are in place but not fully tight (Figure 4)
- Level the mould both vertically and horizontally while tightening the tie rods fully. Check well on all faces for level and plumb
- Pour the mixed soil between the shuttering to a depth of 100mm. This can be made easier by marking 100mm onto a stick and using this as a guide.
- The soil is then rammed lightly using the flat rammer (Figure 5). The ramming pattern should be kept even to ensure uniform compaction.
- The soil is then rammed again more firmly until there is a solid feel. Again the ramming pattern should be kept uniform.
- The rammed pour is then finished with the V rammer. This aids bonding between the rammed pours and helps prevent shear (Figure 5).
- A 2.3m length of barbed wire is cut and placed in the V trough. This should give an overlap of 300mm at either end which is used for tying the wire to the next length. The

end of the wire is folded upward so that it can be pulled out easily later (Figure 6).

Figure 6 shows the tails of the barbed wire that has been rammed into the earth wall. These tails are tied to next piece of wire to form a continuous loop within the cylindrical wall.

- A further 100mm is poured into the mould and rammed in the same way as described above.
- This is continued until the section is complete.
- The tie rods are removed (they will be tight due to the compaction pressure) and the shuttering moved very carefully away from the wall section.

Figure 7 The shuttering is removed to reveal the first completed section of rammed earth wall.

Completing the first ring

- The shuttering is moved around and replaced in such a way that the part of the shuttering beyond the tie rod holes clamp lightly onto the finished section of wall. The tie

rods are butted against the end of the completed wall section. The two end stops are both inserted in the open end.

- The section is then rammed in the same way as the first section.
- Barbed wire is tied to the tails as required and rammed into the wall, as with the first section.

[Figure 8 - The first ring is complete and the shuttering is lifted up to start the next lift.](#)

- When the second section is complete, the third is rammed in the same way.
- Finally the fourth section is rammed. The shuttering overlaps both the third and the first sections now and no end stops are required.
- Usually, it is possible to complete one ring per day. Cover each section with polythene sheet, weighed down with stone, to prevent rapid moisture loss. Remember that the cement has to be cured, just like concrete.

Ramming subsequent lifts

- The subsequent lifts are rammed in the same way as the first.
- The shuttering is now, however, clamped onto the previous lift and the tie rods rest

on top of the soil wall of the lower sections

- The sections are built 45° out of phase with the section below (as with brick wall building), to obtain a well-bonded structure.
- Where the geometry of the tank is lost slightly and the shuttering no longer fits properly (this sometimes happens due to poor levelling), the soil can be cut away carefully with a machete.

[Figure 9 The fifth lift is being rammed here and scaffolding is being used to allow the workers easy access to the work](#)

- Scaffolding is used to access the work once it becomes difficult to do so without.
- The overflow pipe is cut in during the last lift keep the pipe invert at 100mm below the top wall level. Give the pipe a slight gradient outward.
- If a siphonic water extraction system is being used (see later), provision should be made for a " pipe to be brought out at the top of the tank.
- The tank should be cured for 2 weeks under plastic before the next stage.

Rendering the tank

- The tank is rendered internally with a cement mortar. The mortar is a 1:4 mix with waterproofing agent. Two coats are applied, approximately 10mm each coat.
- Firstly the walls are cleaned to remove any loose material and then scratched with a nail brush (or similar) to provide a key for the render. The walls are damped before the render is applied to prevent the walls sucking the moisture out of the render.

Figure 10 The tank is internally rendered with 1:4 mix sand cement mortar. Ensure a good joint between the wall and the base as this can be a point of weakness

- The waterproofing agent usually comes in powder form in 1kg bags. 1kg is added for every 50kg of OPC.
- Ensure a very good bond between the render and the floor of the tank and use a good fillet to seal the joint well. This is a point of weakness.

Fitting the cover

- For this tank, a thin-shell, ferrocement cover is used. The construction of this cover is dealt with in another DTU Technical Paper. The cover is altered slightly to give

overhanging eaves, which help to protect the tank from rain.

- When complete the cover is lifted into place by about 6 people and the joint between the wall and cover rendered to make a good seal.
- A basin is used as the cover hatch and this is also used a filter. The basin is filled with coarse gravel and cloth is tied over the top, which prevents any organic matter or larger debris from entering the tank.

[Figure 11 Technical drawing of the RE tank](#)

Water extraction

- There are two methods described here for water extraction; one is the siphonic system and the other the gravity system.

[Figure 12 Showing the overflow and the overhanging eaves of the thin-shell, ferrocement cover](#)

- The siphonic system is shown in Figure 11. It works as a simple siphon, which once started, is controlled by the outlet tap. The floating off-take shown in Figure 12 helps ensure that only the cleaner water at the surface is drawn off first more detail of the

floating off-take is given another DTU Technical Paper titled A Manual for the Construction of Direct Action Handpumps for use with Rainwater Harvesting Tanks. The benefit of the siphonic system is that the tank wall need not be pierced.

- The gravity system is the type more commonly fitted to rainwater tanks. This type of system can also be used but then the outlet pipe needs to be incorporated during the ramming of the first ring.

External finish

- The tank can be finished externally using cement render if required. Figure 13 below shows a tank finished with rough cast (a cheap option) and fitted with a gravity water extraction system.

[Figure 13 Showing the completed tank](#)

[return to index page](#)

[home.cd3wd.ar.cn.de.en.es.fr.id.it.ph.po.ru.sw](#)

home.cd3wd.ar.cn.de.en.es.fr.id.it.ph.po.ru.sw

DTU Technical Release Series - TR-RWH05

Tarpaulin Tank (approx 5000 litres)

Prepared by Dai Rees
September 2000

This Technical Release is still under preparation. In the meantime we have posted a number of photographs that will guide anyone wanting to build such a tank. They are in sequence.

General background information about this tank can be found in [Case Studies 20](#)

[Digging the pit](#)
[Building the frame 1](#)



[Building the frame 2](#)

[Building the frame 3](#)

[Plastering the frame with mud](#)

[The plastered frame](#)

[Roofing the tank](#)

[Lining the tank with tarpaulin](#)

[The door of the tank](#)

Termites have proven to be a problem - [they eat through the poles of the frame](#). To avoid this the poles are soaked in old engine oil and the side of [the plastered tank is smeared with oil](#) before the tarpaulin is inserted.

[return to index page](#)

[home.cd3wd.ar.cn.de.en.es.fr.id.it.ph.po.ru.sw](#)

Case study 2

Underground brick dome tank, Sri Lanka

Background

This is another RWH system, as with the previous case study, which was developed by the CWSSP programme in Sri Lanka (see Case Study 1 for more detail). The tank, a 5m³ underground brick built tank, is based loosely on the design of the Chinese below ground biogas tank. Indeed, the Sri Lankan engineer who designed the system had studied for some years in China. This is a good example of cross fertilisation of technologies across cultures, as well as the application of appropriate technology.

Again, this system was introduced due to the difficulties faced in bringing water to this community in a conventional manner. There was a lot of opposition to the RWH technology in the area at first, as it was a technology which was not widely known in the. Now, after 2 years using the rainwater falling on her roof, Mrs. Emsayakar, of Batalahena Village near the town Matara, sees things very differently.

The alternative offered by CWSSP was a handpump per 10 households. This still means walking to collect water. Mrs. Emsayakar joked that they can still use the handpump of their neighbours when they wish. She has not, however, had to do so yet as the harvested water meet all the needs of the family of 5, as long as they conserve water carefully. She also said, however, that she would prefer a piped / pumped supply which

would mean that they could use as much water as they wish.

Technical detail

The tank

The tank is a 5m³ below ground cylindrical brick construction based on the design of a Chinese biogas digester (see Figure 1 below). It has a diameter of 2.5m and a height of 1.3m to the base of the cover. The cover is a constructed using a clever brick dome design which can be left open to provide access. Water extraction is either by bucket, by handpump (more detail later) or by gravity through a pipe / tap arrangement where the topography and ground conditions are suitable. The cost of the tank is in the region of Rps.6,500 (UK100). The construction details given to local masons are given below.

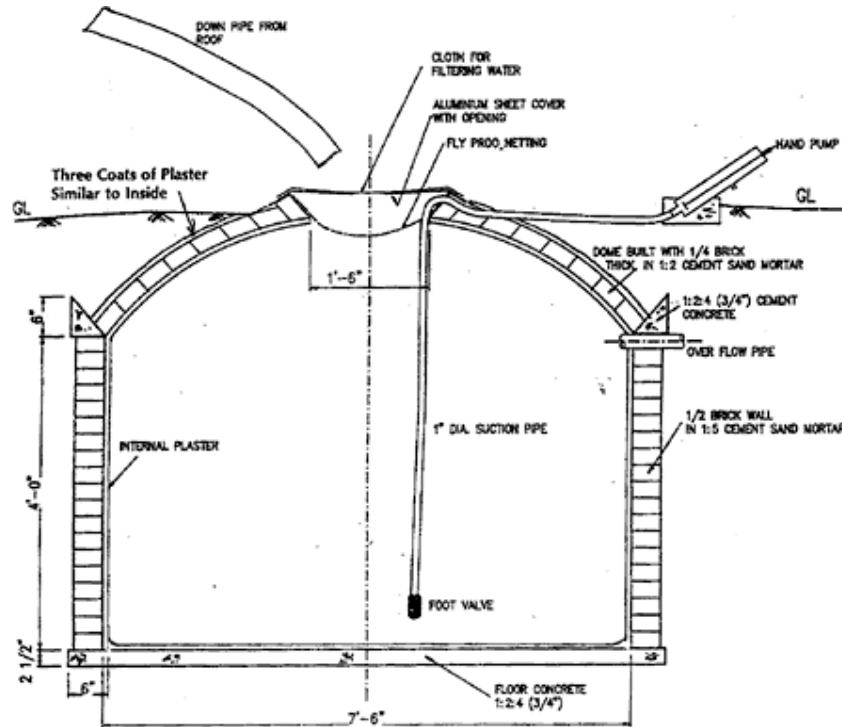

Figure 1 detail drawing of the Sri Lankan brick dome tank

The Sri Lanka Brick Dome Tank Construction details

1. Find suitable site
2. Dig pit 0.5m larger than the tank diameter
3. Plant an iron rod in the centre of the pit, making sure it is vertical.
4. Construct concrete base.
5. Start constructing walls using wire from iron rod to maintain the radius.
6. Once walls are complete backfill the gap between wall and pit with sand.
7. Make concrete ring beam to the shape shown. No reinforcing is required. Fit overflow pipe at this point if required.
8. Prepare two wooden sticks one end an L shape and the other a V shape. The length of the stick is $\frac{2}{3}$ that of the internal diameter of the tank.
9. Keeping the L shaped end of the stick to top of the tank wall, place the V end against the iron rod and wrap string or wire around the rod to support the stick.
10. Start to build the dome shaped roof of the tank with dry bricks.
11. To start, stick the first brick to the lintel with mortar and support it with the first stick.
12. For the second brick, stick this to the lintel and the first brick and support it with the second stick.
13. Push the third brick into place (with mortar) next to the second brick and move the second stick to hold the third brick.
14. Continue the process as with brick 3 until the first course is almost complete.
15. The final key brick should be shaped to fit tightly allowing for the mortar.

16. Remove the sticks once the first course is complete.
17. Continue in this fashion for the subsequent courses.
18. The dome mouth is constructed in a similar way, but using the bricks length-ways.
19. Plaster the outside of the dome, then plaster the inside of the dome.
20. Plaster the inside of the tank.
21. Plaster the floor o the tank
22. Cure the tank by wetting for 7 10 days. Fill the gradually starting on day 7, filling at a rate of approximately 300mm per day.

Water proofing can be added to the mortar. This can be specialist additive or liquid dishwashing soap.

Water extraction is performed, at this sight, by two methods. A tap is fitted which allows water to flow by gravity from the tank, as shown if Figure 2. The second option is a simple handpump which has been developed, as part of the CWSSP programme, for use with below ground tanks. The pump is known as the Tamana pump, after the Pacific island on which its predecessor was originally observed.

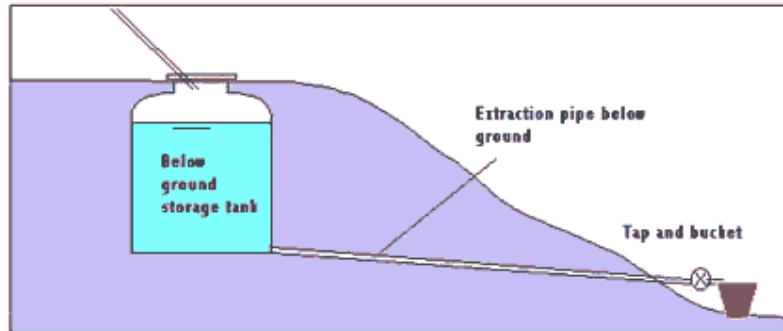

Figure 2 Water is fed by gravity from the tank when the conditions are favourable

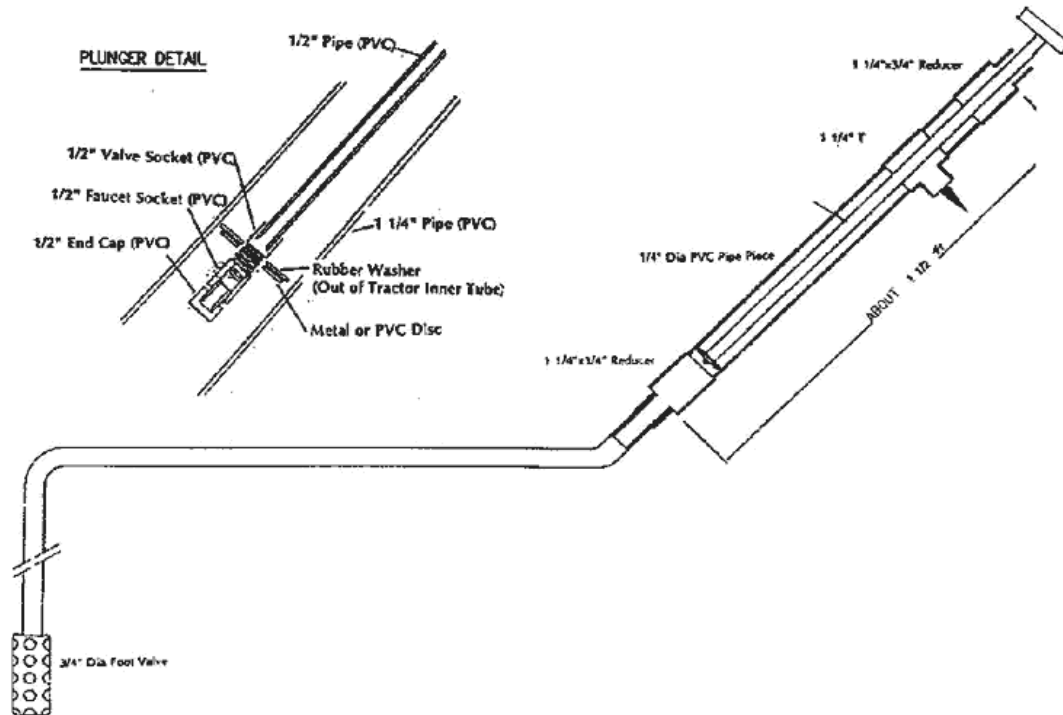

Figure 3 The Tamana pump design drawings

The Tamana pump is designed to be very low cost, approximately UK5, using only locally

available PVC fittings and rubber from a tractor inner tube. The location of the pump is shown in Figure 1 and technical details of the pump are shown in figure 3. This particular pump was fitted by the owners son, a mechanic, who has fitted many of these pumps for other community members. The pump has been brought via a " PVC pipe to the kitchen of the house.

[Figure 4 photo the Tamana pump installed at Batalahena \(click on text to see photo\)](#)

The first flush system is quite simple the inlet chamber has a hole in its bottom, which is plugged with a bottle. When the bottle is removed water is allowed to flow away from the tank (See figure 5). The inlet chamber leads otherwise to a pre-filter chamber which contains layers of stone, charcoal and sand. The owner has experienced some problems with infestations of ants in this chamber. The inlet pipe to the tank has a protective mosquito mesh to stop mosquitoes entering and breeding in the tank.

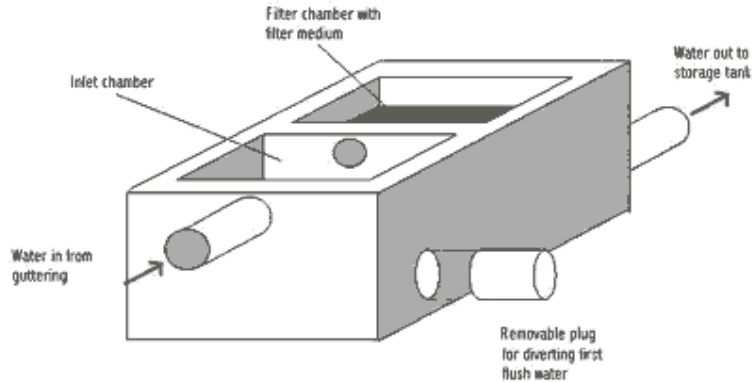

Figure 5 first flush system

Catchment area

The catchment area is the roof of the dwelling. This is a pitched roof of pantiles. Only one side of the roof is used. The other side is actually used to supply water for a neighbours tank which is situated at the other side of the house. The guttering is a factory manufactured U section type fitted to a fascia board with specialist clips. The cost of the guttering is 1000 Rps. (UK15.50). There is only about 8m of guttering for the 28m² of catchment surface.

Photos (click on text to see)

Below ground tank - photo 1**Below ground tank - photo 2***User pattern*

Average annual rainfall is 2600mm with a bimodal rainfall pattern and a dry season which lasts for 3 months. When properly managed the water collected can last throughout the dry period, with occasional trips to the nearby well for washing water. The average consumption rate for the whole family is about 75 litres per day but this is reduced during the dry season. The water is used for all domestic applications and there is no anxiety about the quality of the water, as is seen often where rainwater is used.

Item	Unit	Unit cost	Quantity	Cost (SL Rupees)
Cement	bag	310	8.5	2635
Sand	m ³	1700	0.4	680
" Metal bar	m ³	4000	0.1	400
Brick	Number	2.10	800	1680

Padlo cement	kg	100	0.5	50
Skilled labour	days	250	4	1000
Unskilled labour	days	150	12	1800
			Total	8245
The unskilled labour is often provided by the recipient hence reducing the cost of the tank.				

Many thanks to Deva Hapugoda (Consultant Engineer), Tanuja Ariyananda (LRHF) and members of CWSSP Programme for their valuable contributions.

[\(return to top of page\)](#)

[\(back to case studies main page\)](#)

[home.cd3wd.ar.cn.de.en.es.fr.id.it.ph.po.ru.sw](#)

Case Study 16

Stabilised soil block tanks in Kampala, Uganda



In March 2000, two experimental cylindrical water tanks were built at Kawempwe, Kampala in collaboration with Dr Moses Musaaazi, a lecturer at Makerere University. Both were built above ground of curved stabilised-soil blocks with end interlocking, 280mm x 140mm x 110mm high, made with an Approtec (Kenyan) manual block press. The soil used was a red somewhat pozzolanic local soil previously known to make strong blocks. The tanks were built on concrete plinths, lined with 'waterproofed' mortar (3 parts sand,

1 part cement and .02 parts 'Leak Seal' waterproofing compound). There was no metal reinforcing.

Tank 1 is 2050mm high, has internal diameter 1300mm, wall thickness 140mm (+ 15mm render) and used 15 x 15 = 225 blocks incorporating 6% cement (100 blocks per 50kg bag). It has been filled with water and therefore has withstood a maximum head of 2.05m at the wall bottom. Volume = 2720 litres, max hoop stress = 0.19 MPa

Click on the thumbnails below to see:

1. The Aprotect curved interlocking block making machine
2. The finished curved interlocking blocks
3. A small diameter tank under construction
4. The 5m high SSB tank built for pressure testing purposes



Tank 2, for test purposes, has been built to 5m high, has internal diameter 1000mm and

the same wall thickness, but with only 3% cement (180 blocks per 50 kg bag). It has been filled with water and therefore withstood a head of 5.0m at the wall bottom.

Materials used for a standard 2 m high tank included 1 packet (50kg costing \$_{US}11) of cement for the render, 1 packet for a conical (reinforced) lid, 1 packet for mortar between the blocks and 1/2 packet in the foundation. Thus only 20% to 25% of the cement is in the blocks themselves. Experiments to achieve curved blocks with *vertical* interlocking, if successful, will significantly reduce the quantity of mortar needed for block-laying. The lid may well be made more cheaply, as that employed was designed to carry certain testing devices.

Report by Dr Terry Thomas of the DTU

[Return to Case Studies index page](#)

[home.cd3wd.ar.cn.de.en.es.fr.id.it.ph.po.ru.sw](#)

Case study 6

Below ground low cost water

storage cistern 4 to 10 cubic metres, Uganda

Introduction

This tank (or cistern) was developed in Uganda by members of the Development Technology Unit, Warwick University and members of the Uganda Rural Development and Training Programme (URDT), between 1995 and 1997. Work is still continuing on the refinement of the tank. URDT is a service NGO located at Kagadi in Mid-Western Uganda. Several of these cisterns were built and tested with the aim of developing a low cost (under US\$150), alley, domestic, water storage technology for the surrounding region. The information for this Case Study is taken from a document titled Underground storage of rainwater for domestic use by T. H. Thomas and B. McGeever, which is available as a working paper from the Development Technology Unit (see the list of partners on our home page).

Uganda is well suited to RWH practice for several reasons:

- rainwater harvesting is a technology which is traditional to Uganda, albeit on a very ad hoc, very low-tech basis, e.g. buckets under the eaves to catch water during storms, or old 200 litre oil drums used for short term storage.
- it has a bimodal rainfall pattern with very short dry seasons which are rarely

completely dry.

- annual rainfall in many parts of the country is in excess of 1200mm, which means that even the smallest house would have sufficient roof collection area to provide sufficient rainwater to meet demand (based on 15 litres per capita per day).
- corrugated iron roofs are becoming common, even in rural areas .
- the lateritic soils in the area make well sinking a difficult task (yet provide ideal ground conditions for below ground tank construction).
- there are many hilly areas where water (for irrigation and domestic use) has to be carried uphill from the valleys.
- gravity fed piped water is rare outside the main towns both because it is technically difficult (absence of strong high level springs, lack of mains electricity) and because the organisation to install and operate gravity water supplies is lacking in rural areas.

Ntale¹⁹⁹⁶ carried out a study of costs of existing water storage technologies based on a tank capacity of 8000 litres. The results are shown below.

- \$340 in total for unreinforced mortar jars (at least 4 jars),
- \$390 for a brickwork tank, 50% more if reinforcing is deemed necessary,
- \$450 for a galvanised iron tank,
- \$1432 for a PVC tank,

- \$480 to \$880 (various sources for E Africa) for a ferrocement tank,
- \$182 (quoted from Brazil) for a plastered tank of stabilised rammed earth, a material currently hardly known in Uganda..

These sums seem generally beyond the purchasing capacity of Ugandan rural households where even finding \$200 for an iron roof is often not possible, although the last technique has promise.

Technical detail

Materials, tools and skills

The paper describes how to make a 6,000 to 10,000 litre underground cistern, suitable for construction where the soil is firm and hard but not rocky. *Variant A* has a 20 mm thick cement-mortar dome (mix = 1:3), a 25 mm cement mortar lining to its Chamber, and employs a little chicken mesh reinforcing. *Variant B* has a 20 mm cement/lime-plastered Chamber. Both variants have similar shapes and construction procedures. The materials necessary for the tanks construction meet the test of ready availability even in African small towns. They are, for an 8,000 litre cistern:

Material	Quantities
----------	------------

	Variant A	Variant B
bags (ea. 50 kg) cement	5 ^{1/2}	3 ^{1/2}
bags (ea. 25 kg) lime	0	3
wheelbarrows of sand	15	15
lengths (ea. 12m) of 6mm reinforcing bar	1	1
chicken mesh (1.8m width)	1.5m	0
plastic bucket, say 10 litre	1	1

(also wood to make the template mentioned under *Step 1* below - 130 cm x 100 cm thin ply or 3m x 300 mm x 20 mm plank - and a large plastic washing bowl)

The tools needed for tank production are:

- digging and plastering tools

- a large plastic basin (say 45 cm diameter)
- a bucket on a rope for lifting out soil
- a spirit level
- a template for the dome (see *Step 1*)

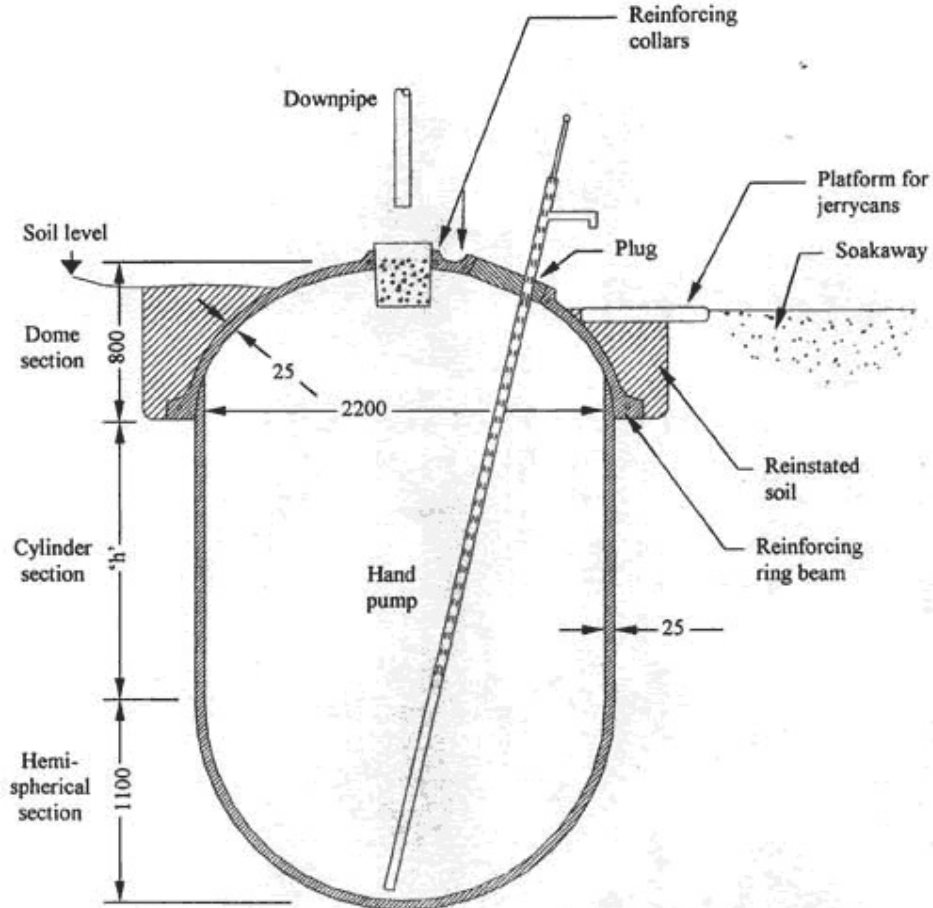

Figure 1 - General side view of cistern with pump

Parts of the DTU/URDT rainwater storage cistern and steps in its construction

The cistern is divided into four parts, namely the Chamber, the Cover, the Pump and Extras. Figure 1 shows a sectioned elevation view of the tank and pump (what you would see if you could dig it out and cut it in half from top to bottom).

The Chamber has to have adequate volume and be waterproof. Because the overall cost of a cistern is dominated by the cost of the walls and cover, these should be as small as possible. For a given cistern volume, their total area is a minimum, for either a rectangular or cylindrical tank, when the tanks depth equals its width. However for certain sorts of cover it is difficult to span widths of more than say 7 feet (2.2 meters). The cistern we are about to describe has a rounded Cover and a rounded bottom and has an internal diameter of 2.2 meters. The depth of the straight part of its sides for different capacities is as follows:

usable capacity in litres	4,000	6,000	8,000	10,000
depth of cylindrical	0	0.5 m	1.0 m	1.5 m

sides

meters

depth from dome to bottom 1.9 m 2.4 m 2.9 m 3.4 m

The Cover has to stop the water from evaporating, keep the water clean, prevent anyone falling into it and keep out light and mosquitoes. It has to be pierced by a big hole to let the rainwater in very rapidly and smaller hole through which water can be pumped out. These holes must also be mosquito and light proof, and at least one of them must be large enough for a man to squeeze through in order to inspect or replaster the inside of the tank. It is recommended that the Chamber is excavated through the main hole in the Cover. This method allows the cover to be cast easily in situ without the need for shuttering or special tools. An earth mound is constructed for this purpose below ground level, as shown in Figure XX. The Cover should be shaped so that it leads any run-off from nearby ground away from its inlet. It must be strong enough to bear the weight of many people, provided that it has been covered with earth so that only the top of the dome is above the ground.

The pump

Thomas and McGeever discuss the requirements of a handpump for poor rural communities in Uganda:

A pump for a household cistern should:

- be cheap (in Uganda a ceiling price of USh.15,000 = \$US15 was chosen);
- permit an adult to raise 10 litres per minute (a rate generally obtained from protected wells) from a depth of 4 meters without undue effort and also be usable by a child of 6 years;
- be self-priming, delivering water within a few strokes of starting to pump even when the pump has been out of use for some days;
- reach water within 20 cm of the bottom of a tank;
- fit into the mortar plug in the cover (dome) of a cistern so that light, mosquitoes and surface water cannot enter, yet permit the riser pipe and foot valve to be withdrawn through that plug whenever they need any maintenance;
- lift at least 100,000 litres under household conditions of use before requiring replacement;
- lift at least 10,000 litres before requiring maintenance, all such maintenance being possible using skills and materials available in most African villages;
- be economically manufacturable in each country of use;
- discharge conveniently into a jerrycan or other collection vessel.

In addition it is desirable that:

- the foot valve does not leak faster than 0.1 litre per minute, so that if the pump is used twice within say 10 minutes it does not have to be (self) re-primed for the second use;
- the intake is constrained to avoid drawing up sediment in the tank by being located say 10 cm above the tank bottom; however for cleaning purposes it is helpful if dirtied wash water can be lifted from as little as 2 cm from the tank bottom.

Some development of a handpump which aimed at achieving this specification was carried out, but the authors feel that it was far from ideal. We will not, therefore, consider this pump in this case study.

The Extras include some means of seeing the water level inside the tank without having to open the Cover, a coarse filter for water entering the tank and provision for safe disposal of any overflow water. There is some interest in putting a layer of sand at the bottom of the tank as an output filter, however this would require the pump intake to be connected to a perforated pipe running under the sand. (Experiments to test such a filters performance have yet to be done.)

During construction of any cistern, there are three choices in how one might combine the Cover and the Chamber. In some cistern designs, the Chamber is dug first and then the Cover built over the Chamber. In other designs the Cover and Chamber are made

side-by-side and then the cover is lifted onto the top of the Chamber. For our design, we recommend a third method: the Cover is made first (in its final position at ground level) and then the Chamber is dug through an access hole in the Cover. It is not too difficult to do this if excavation is manual (although the procedure effectively excludes mechanical excavation and is therefore not recommended for high-wage countries) and it allows the use a cheaper dome-shaped Cover than if the cover had to be lifted. So the sequence for construction is as follows:

Steps in Constructing the Cistern

- (If necessary), make a new template to shape the dome with, as shown in Figure 2
- Mark and dig out the ring trench; use the template to shape the mound of soil above it, as shown in Figure 4

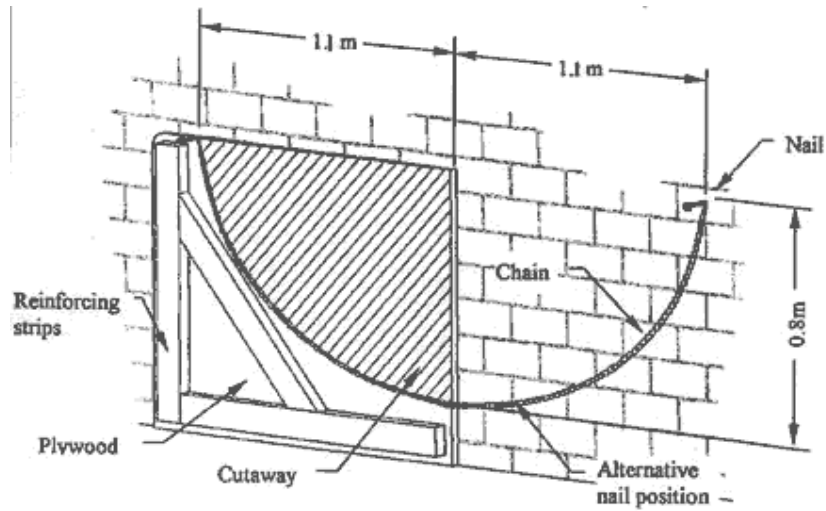

Figure 2 - Making the template

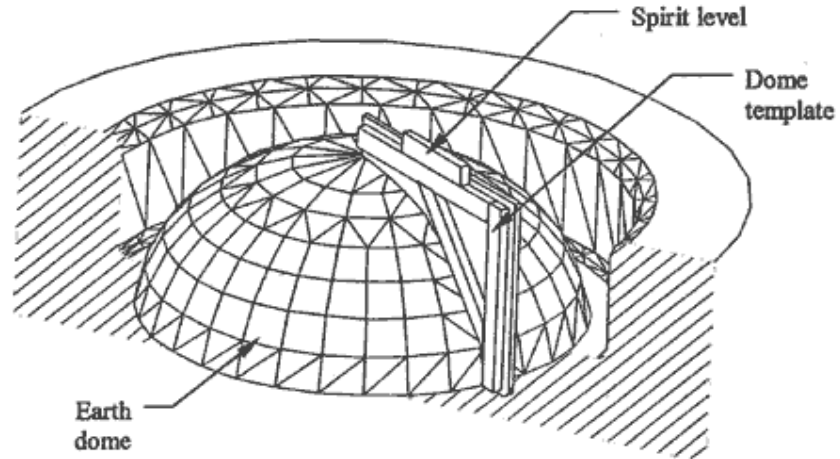

Figure 3 - Forming the earth dome mound

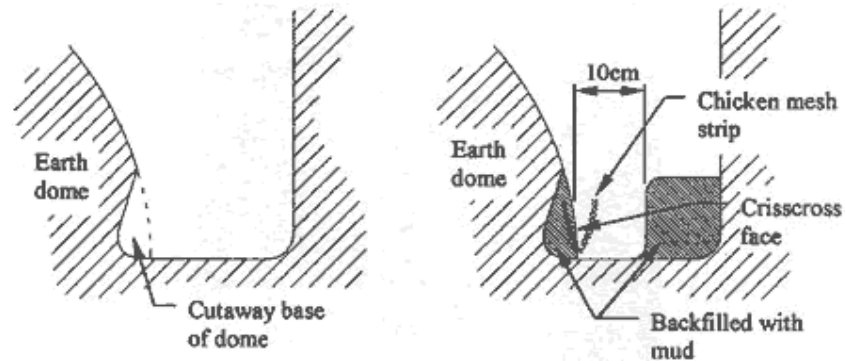

Figure 4 Detail of joint between dome and wall

- Prepare reinforcing bar (and perhaps mesh) to place in the trench and round each hole in the dome
- Place mortar to form the ring beam and the dome with its two holes
- Cure the mortar then cover the dome with soil

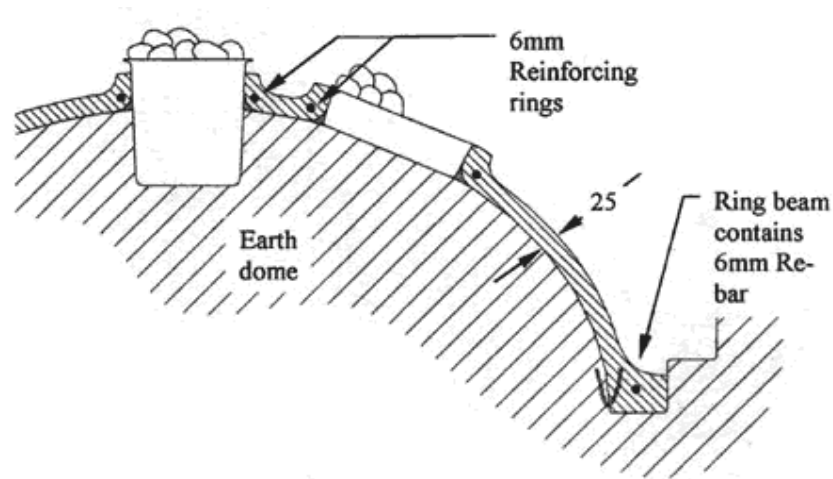

Figure 5 - Completed dome showing the position of the bucket and basin during casting

- Through the larger hole dig out the Chamber
- Plaster the inside of the chamber and allow this plaster to cure
- Make the pump
- Set the pump into the dome
- Construct the tank inlet with its gravel filter

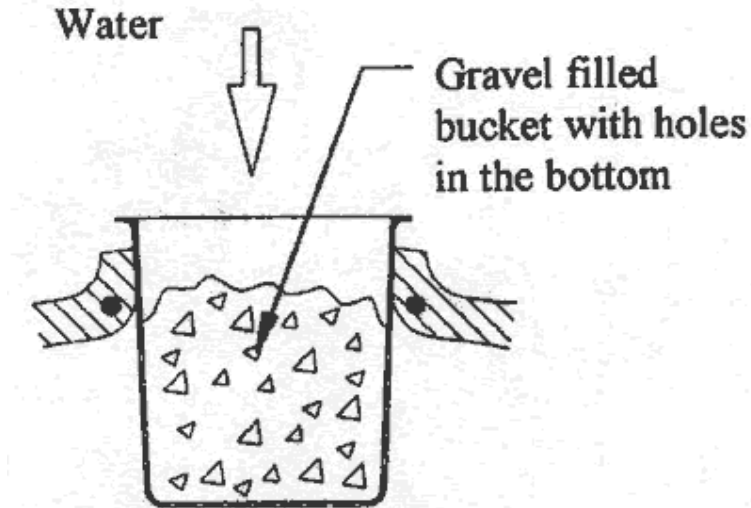

Figure 6 - Water inlet with coarse gravel filter

- Provide drainage and arrange the hard standing for pumper and water containers

The tank takes about 24 man-days to construct. However the mortar dome and later the plaster in the chamber should each be left to cure for 2 weeks, so it needs a minimum of 6 weeks from when construction starts to when the tank can be used. Most of the work

is digging but for 2 days an experienced plasterer is required. The pump can be made in a few hours.

Further work and field trials

Three tanks of 8000 litres were built and tested in the town of Kagadi. Tests on dome strength, leakage and chamber integrity and flexure were carried out and the results were very reassuring. Tests were also carried out a very low-cost pump design which proved to be unreliable and has therefore not been included in this Case Study.

Tank costs

Cistern costs (8,000 litre capacity with 20 mm dome and 2-coat chamber lining)

<i>Item</i>	<i>Quantity</i>	<i>Cost (US\$)</i>
Cement/lime (including transport)	250 kg	65
Sand (assumed from a nearby source)	18 wheel-barrows	3
6 mm reinforcing bar	12m	5

Chicken mesh	3 m ²	4
PVC Bucket + 0.5 m of 50 mm piping		3
Unskilled labour for digging (9 m ³) etc.	20 person days	40
Plasterer	2 person days	8
Supervisor + say 25 km travel	1 person day	10
Tools (say)		5
	Total	143

Design variants

Some design variations have been discussed in this paper.

The dome of the tanks built in 1996 were 25 to 30 mm thick. Those recently tested for

strength were 20 mm thick and performed well. 20 mm will be used henceforth as a norm. Moreover both mortar and concrete have been used for the dome. Concrete uses less cement, but requires fine aggregate (which is not widely available in rural areas) and is much harder to work smoothly as a plaster. There is some danger that these workability problems could lead to serious cracks in inexperienced hands. The mortar dome looks better. Mortar is more vulnerable than concrete to shrinkage during curing, but this should not matter in a largely unconstrained dome. On balance we recommend mortar despite the 33% higher cement requirement.

The chambers of the 1996 cisterns were single plastered to a thickness of 30 mm. The later tanks are using 20 mm applied as two layers (e.g. 15 mm plus 5 mm) rather than one. The tank most in danger of earth tremors has just been plastered with a 2-layer lime-cement mortar; it may take some years before the benefits of using this slower curing but more flexible plaster can be assessed.

[Return to index page](#)

[home.cd3wd.ar.cn.de.en.es.fr.id.it.ph.po.ru.sw](#)

DEVELOPMENT
TECHNOLOGY
UNIT



Working Paper No. 49

Underground storage of rainwater for
domestic use including construction details of a low-
cost cistern and pumps

July 1997

Terry Thomas, Ben McGeever and members of URDT, Kagadi, Uganda

Development Technology Unit
Department of Engineering, University of Warwick
Coventry CV4 7AL UK
Tel: +44 (0) 2476 523122 Fax: (0) 2476 418922
email: dtu@eng.warwick.ac.uk

ABSTRACT

This Working Paper describes the construction and initial testing of low-cost underground rainwater storage tanks and of cheap but crude pumps by which water can be extracted from them. Several of these tanks have been constructed around Kagadi in Western Uganda between January 1996 and March 1997 as part of a programme attempting to develop an all-year domestic rainwater harvesting system costing under \$150 per household. Initial leakage of the cisterns after several cycles of filling and emptying has been satisfactorily low.

CONTENTS

- [1. Introduction](#)
 - [2. Choosing the size of a rainwater cistern](#)
 - [3. Comparison of types of water storage container](#)
 - [4. Pump specification](#)
 - [5. Materials, tools and skills](#)
 - [6. Parts of the DTU/URDT rainwater storage cistern and steps in its construction](#)
 - [7. Making the Cover \(steps 1 - 5\)](#)
 - [8. Making the Chamber \(steps 6 - 7\)](#)
 - [9. Making Pumps \(steps 8a and 8b\)](#)
 - [10. Completing the cistern \(steps 9 - 11\)](#)
 - [11. Possible failure modes](#)
 - [12. Test results: leakage, dome strength, chamber flexing, pump performance](#)
 - [13. Costs](#)
 - [14. Conclusions, design variants, and further work](#)
 - [15. References](#)
-

* Although the writing of this Working Paper and the opinions in it are the responsibility of the named authors, much of the construction work and some of the design work

reported in it were carried out by members of Uganda Rural Development and Training Programme (URDT), a Ugandan NGO. The contributions of the following people were particularly important : Chilampa Hardman, Turyamureba Victor, Mugisa Kimarakwija and Byaruhanga Moses, as was the support of Mwalimu Musheshe and Rutaboba Ephrem of URDTs management.

URDTs Communications Office is in Ambassador House, Kampala Road, Kampala, Uganda.

Postal address P.O.Box 16253, Kampala; tel (0 or 00 256) 41 256704; fax 242270; email URDT@mukla.gn.apc.org

URDTs Main Office is at Kagadi (P.O.Box 24), Kibaale District, Uganda; tel (0) 483 22821.

1 INTRODUCTION

Rainwater has been captured for use as a domestic water source for thousands of years. Urban civilisations have been based, in arid zones, on the seasonal storage of rainwater

in underground cisterns. In very wet areas, the capture of rainwater from roofs on a daily basis is common, especially where for some reason water is not conveniently available from streams or wells. In recent years, most of the interest in rainwater harvesting has been concentrated in dry regions where alternative water sources are particularly rare. By contrast, this paper is about rainwater collection in a country, Uganda, with a generally high rainfall and (due to its straddling the Equator) a favourable bimodal rainfall distribution.

Rainwater collection requires a collection surface (usually a roof), a water guidance system such as guttering and a storage tank big enough to supply water throughout any gap between significant rainfall events. If that gap is only 24 hours, the storage volume can be quite small. Many households collect run-off in bowls and buckets placed under the edges of roofs; short iron-sheet gutters without downpipes sometimes aid this process. Traditionally rainwater is also collected from trees in Uganda, using banana leaves or stems as temporary gutters; up to 200 litres may be collected from a large tree in a single storm. If the gap between rain events is a dry season of several months, the storage volume has to be several thousand litres. In many parts of Uganda the rainfall pattern is such that for a household using 90 litres per day to rely wholly on rainwater for its domestic needs, a water storage capacity of about 8,000 litres (as will be discussed later) is needed. The cost of such a big tank is a problem for most households as has been pointed out in two recent Ugandan studies (Ntale ¹⁹⁹⁶, Rugumayo ¹⁹⁹⁵).

Yet Uganda is a better place for domestic rainwater harvesting than most others in Africa because in most Districts:

- the (two) dry seasons are usually quite short and rarely completely dry;
- rainfall exceeds 1200 mm a year so that even a fairly small house has a big enough roof to collect the water (assumed to be 15 litres per person per day) that a poor family needs;
- corrugated iron roofs are becoming common, even in rural areas;
- the lateritic soil is permeable, so that wells to reach the water table have to be very deep unless they are in valleys: deep *dug* wells are very rare although the excavation of latrine pits 10m deep is common; boreholes are expensive and often unreliable;
- in the many hilly areas, where there is usually water in valleys, much effort is expended in carrying it up steep and sometimes very slippery slopes to where most farms are located (on the ridges and hillsides): by contrast rainwater collection offers on-the-spot water at the homestead;
- the soil type and the low water table make it quite easy to dig underground water storage tanks which are generally cheaper than above-ground tanks of the same capacity;
- gravity-fed piped water is rare outside the main towns both because it is technically difficult (absence of strong high level springs, lack of mains electricity) and because

the organisation to install and operate gravity water supplies is lacking in rural areas.

From late 1995 to early 1997, the DTU authors named above worked with members of Uganda Rural Development and Training Programme (URDT, a service NGO located at Kagadi in Mid-Western Uganda) to develop a cheap water-storage technology for the surrounding region. This Working Paper describes the initial findings of a programme of rainwater harvesting development that is still continuing.

2 CHOOSING THE SIZE OF A RAINWATER CISTERN

The literature contains discussion of several ways of sizing rainwater stores. The different methods almost all assume that water consumption is at a constant daily rate throughout the year. They require as data inputs: that daily rate, details of roof plan area, rainwater catchment efficiency and rainfall distribution. Their outputs are recommended store sizes for one or more probabilities of storage failure (i.e. tank runs dry). The methods are well reviewed by Ntale (Ntale ¹⁹⁹⁶) who shows that in a not untypical particular location in Uganda, 100 km east of Kampala, the crudest method (*Mean Dry-season Deficit*) gives a storage size very much less than given by more elaborate and accurate methods.

Table 1 Ntales Comparison of Tank Sizing Methods (in Mokono District, Uganda)

Constant Yearly Assumed Demand = 67% of Average Annual Rainwater available from roof.

+ indicates extension of the data by the present authors.

Mean Dry-season Deficit method using MEAN monthly precipitation

Recommended storage = $0.015 \times$ yearly demand. Failure fraction (of time) = approx. 40%

(any month during which the storage tank is at some point empty is deemed a failure month)

⁺ *Adjusted Dry Season Deficit method* using (MEAN - 0.5 x SD) of monthly precipitation

Recommended storage = $0.063 \times$ yearly demand. Failure fraction = approx. 10%

⁺ *Adjusted Dry Season Deficit method* using (MEAN - 1.0 x SD) of monthly precipitation

Recommended storage = $0.173 \times$ yearly demand. Failure fraction < 1%

Cumulative Deficit method (maximum local drop in the cumulative supply-minus-demand curve over the period for which rainfall records are available)

Recommended storage = 0.167 x yearly demand Failure fraction < 1%

Actual Storage Behaviour method (historical rainfalls combined with various tank sizes)

Tank size/annual demand	.027	.056	.111	.167	.278
Failure fraction	21%	11%	3.6%	<1%*	<1%*

* the precise failure fraction depends at what month in year 1 the tank was commissioned

Clearly the *Mean Dry-season Deficit* method is unsatisfactory in situations where rainfall is very variable from year to year. In Ntales rainfall data there is a very high coefficient of variation (= S.D./mean). This coefficient exceeded 60% for each of the 5 driest months of the year, although for the year as a whole was much lower. Popular belief in Uganda is that rainfall is getting even more erratic. The failure fractions shown in the table would also rise sharply if the ratio of annual usage to capturable runoff were raised from the fairly low figure used (67%) in the modelling. Assuming that 80% of rainfall is capturable

and that households make some adjustment to their water usage in exceptionally dry seasons, we have developed the following recommendation:

For a bimodal rainfall pattern and where the annual rainfall (mm) x the roof plan area (m²) is at least 1.5 times the intended annual water consumption (in litres), we recommend 25% of annual demand as a suitable tank size - say 8000 litres for a rural household using 90 litres a day..

In the debate between rough and ready methods of sizing storage (Pacey ¹⁹⁸⁶) and more exact methods (Heggen ¹⁹⁹³) it should be remembered that:

- Uninterrupted rainfall records are not available (or are not readily accessible) in most developing countries, especially to householders or builders deciding tank sizes who need simple rules such as "700 litres storage is needed per roofing sheet".
- In the case of poor wet seasons leading to incomplete tank filling, householders are likely to reduce usage in the subsequent dry season; Ntale documents significant seasonal differences in consumption rates at present due to variations in the effort required to obtain water in different months. It would probably be realistic to set dry season water consumption at 90% of wet season consumption, e.g. 14 and 16 litres per day respectively where the annual average is 15.
- It is not clear that households will discipline themselves to keep to the water usage

rates assumed in any storage sizing exercise; certainly household occupancy can fluctuate and unplanned activities consume unplanned quantities of water. A per-capita rate of 15 litres water consumption per day has been assumed (giving 90 litres per day for a 6-person household). This is higher than current practice but reflects movement towards the national target of 20 litres/day and the likely rise in consumption when it is not effort-limited.

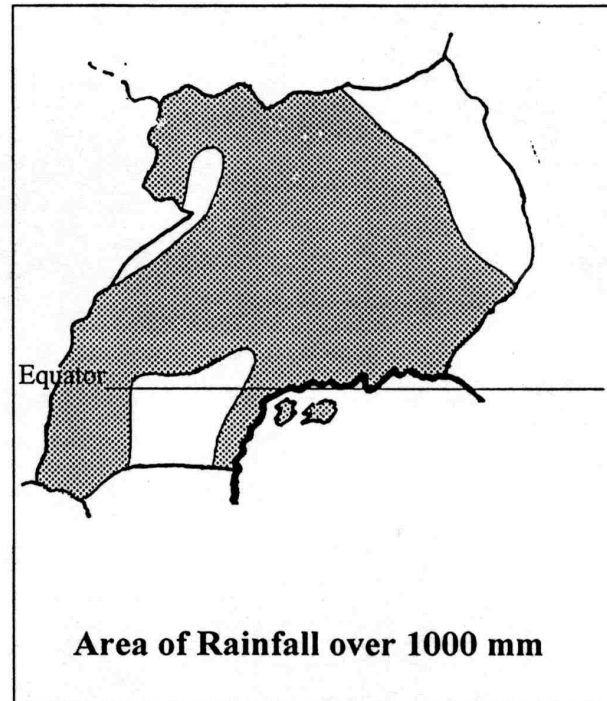
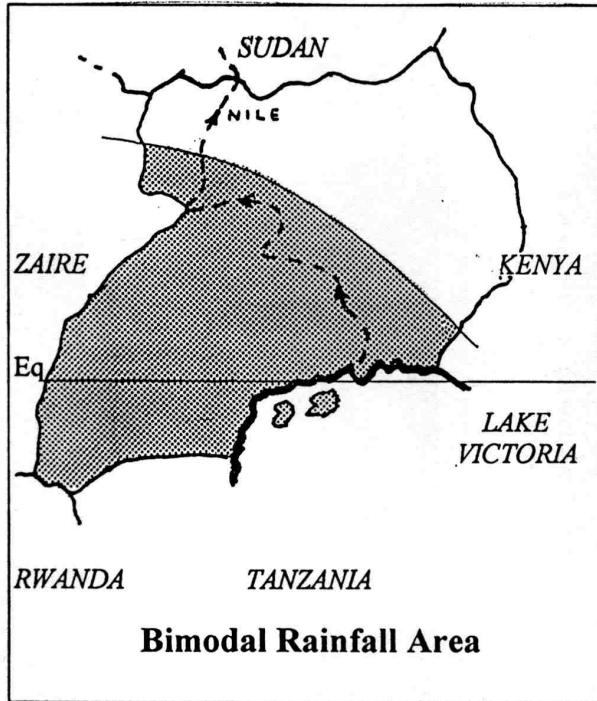

Map of Uganda showing bimodal rainfall areas

3 COMPARISON OF TYPES OF WATER STORAGE CONTAINER

The main domestic options for storing rainwater are plastic bowls/jerrycans, clay jars, cement jars, above-ground tanks and underground cisterns. For wet season domestic rainwater harvesting (the low-cost variant of DRWH which requires only about 200 litres storage per household) the first three options above are relevant. For all-year supply requiring over 5000 litres storage, only the last three options are suitable. Cement jars

overlap both scenarios as they may be made in sizes from 100 to 1500 litres.

This Working Paper is about constructing low-cost underground water tanks ("cisterns") next to individual houses. Underground tanks, compared with above-ground ones, have advantages and disadvantages.

On the plus side

- they are generally cheaper as mentioned above;
- they cannot be emptied by such accidents as a child leaving a tap open all night;
- they take up little room;
- they do not require the transport of heavy items like cement jars.

On the minus side

- any cracks and leaks are hard to find and repair;
- a pump is needed to lift the water out of the tank;
- there could be a danger of pollution by surface water getting into the tank;
- there could be pollution if effluent from a latrine was able to migrate into the tank;
- any leakage out of a cistern may create moist zones that attract tree roots which could later further open cracks in the cistern walls;
- if the water table were to rise very high during floods *and* the tank was empty, the

tank could float up out of the ground;

- if access holes were left open, a child might fall into the tank and drown;
- a heavy vehicle might drive over the tank and break its cover.

Fortunately the ground water level, in Western Uganda at least, is usually well below the bottom of any underground cistern as can be seen by the great depth (over 10 meters) to which latrines are commonly dug in the area. Thus the dangers either of pollution by groundwater or of floating up do not seem significant.

Ntale¹⁹⁹⁶ suggests that to achieve 8000 litres of water storage in 1996 costs about:

- \$340 in total for unreinforced mortar jars (at least 4 jars),
- \$390 for a brickwork tank, 50% more if reinforcing is deemed necessary,
- \$450 for a galvanised iron tank,
- \$1432 for a PVC tank,
- \$480 to \$880 (various sources for E Africa) for a ferrocement tank,
- \$182 (quoted from Brazil) for a plastered tank of stabilised rammed earth, a material currently hardly known in Uganda..

These sums seem generally beyond the purchasing capacity of Ugandan rural households where even finding \$200 for an iron roof is often not possible, although the last

technique has promise.

4 PUMP SPECIFICATION

If an underground tank is to be used, the hand-pump required to extract water from it must be specified. In rural houses where there is a solar electricity supply and some wealth, low-voltage submersible electric pumps constitute a serious option. They can be used to raise water from the underground cistern into a small day tank located in the roof rafters from which a gravity feed is possible. Solar electricity is spreading, but in Africa reliance on hand-pumping should still be the basis of any specification.

A pump for a household cistern should

a/ be cheap (in Uganda we chose a ceiling price of USh.15,000 = \$_{US}15);

b/ permit an adult to raise 10 litres per minute (a rate generally obtained from protected wells) from a depth of 4 meters without undue effort and also be usable by a child of 6 years;

- c/ be self-priming, delivering water within a few strokes of starting to pump even when the pump has been out of use for some days;
- d/ reach water within 20 cm of the bottom of a tank;
- e/ fit into the mortar plug in the cover (dome) of a cistern so that light, mosquitoes and surface water cannot enter, yet permit the riser pipe and foot valve to be withdrawn through that plug whenever they need any maintenance;
- f/ lift at least 100,000 litres under household conditions of use before requiring replacement;
- g/ lift at least 10,000 litres before requiring maintenance, all such maintenance being possible using skills and materials available in most African villages;
- h/ be economically manufacturable in each country of use;
- i/ discharge conveniently into a jerrycan or other collection vessel.

In addition it is desirable that

- j/ the foot valve does not leak faster than 0.1 litre per minute, so that if the pump is used twice within say 10 minutes it does not have to be (self) re-primed for the second use;
- k/ the intake is constrained to avoid drawing up sediment in the tank by being located say 10 cm above the tank bottom; however for cleaning purposes it is helpful if dirtied wash water can be lifted from as little as 2 cm from the tank bottom.

5 MATERIALS, TOOLS AND SKILLS

This paper describes how to make a particular 6,000 to 10,000 litre underground cistern, suitable for construction where the soil is firm and hard but not rocky, and a cheap hand-pump to fit into it. *Variant A* has a 20 mm thick cement-mortar dome (mix = 1:3), a 25 mm cement mortar lining to its Chamber, and employs a little chicken mesh reinforcing. *Variant B* has a 20 mm cement/lime-plastered Chamber. Both variants have similar shapes and construction procedures. The materials necessary for the tanks construction meet the test of ready availability even in African small towns. They are, for an 8,000 litre cistern:

<i>Material Quantities</i>	<i>Variant A</i>	<i>Variant B</i>
bags (ea. 50 kg) cement	5 ¹ / ₂ (275 kg)	3 ¹ / ₂ (175 kg)
bags (ea. 25 kg) lime	0	3 (75kg)
wheelbarrows of sand	15	15
lengths (ea. 12m) of 6mm reinforcing bar	1	1
chicken mesh (1.8m width)	1.5m	0
plastic bucket, say 10 litre	1	1

(also wood to make the template mentioned under *Step 1* below - 130 cm x 100 cm thin

ply or 3m x 300 mm x 20 mm plank - and a large plastic washing bowl)

The materials needed for the pump are slightly more specialised and may need to be obtained from a capital city. They are;

<i>Material</i>	<i>Quantities</i>
50 mm OD PVC pipe	0.5m
40 mm OD PVC pipe	4m
30 mm OD plastic pipe (nominal 1" bore; varies with foot valve type)	0.3m
20 mm plastic conduit tubing	3m
40 mm PVC tee and a piston (e.g. stirrup pump leather cup)	1 off each

(*plus* binding wire, solvent cement for PVC, rubber strips (ex inner tubes), wooden handle)

The tank and its pump must be locally maintained, and at least the former must be locally made. For these reasons a design specification was chosen that included the condition that both tank and pump should be fabricable using skills, materials and *hand-*tools readily obtainable in a small African town and maintainable using village-level facilities. A suitable pump is not available in Uganda, but as its performance

specification is so modest it could no doubt be readily mass-produced if a sufficiently large market existed. In the short term however a locally-made pump (whose production entails no special jigs) is required if underground cisterns are to be promoted. The tools needed for tank and pump production are:

<i>Tank</i>	<i>Pump</i>
digging and plastering tools	hacksaw blade and file
a large plastic basin (say 45 cm diameter)	knife
a bucket on a rope for lifting out soil	& depending on type of foot valve:
a spirit level	tin snips, hand drill or large nail
a template for the dome (see <i>Step 1</i>)	

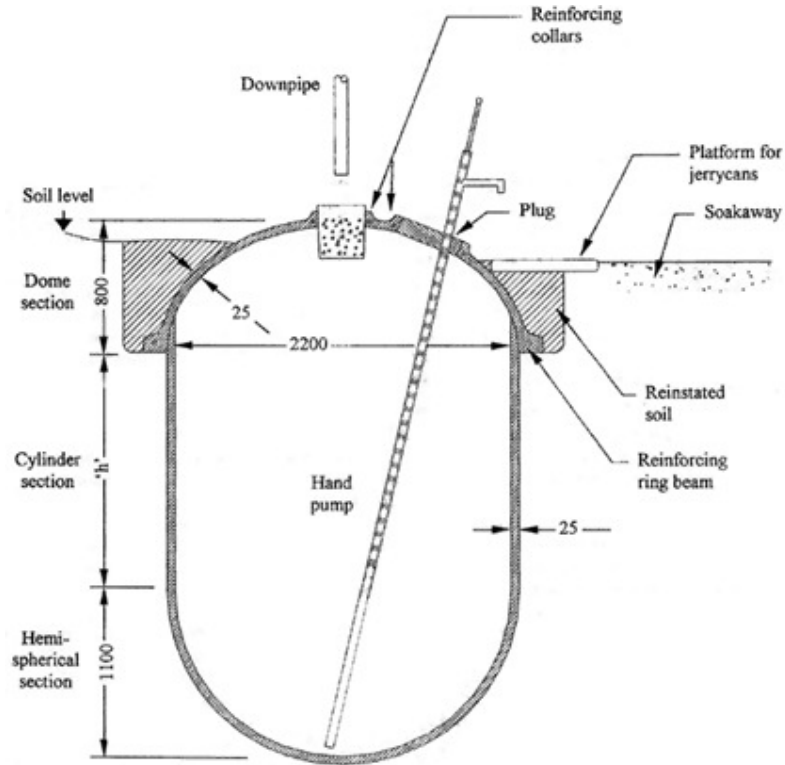

Figure 1 General side view of cistern with pump

6 PARTS OF THE DTU/URDT RAINWATER STORAGE CISTERN AND STEPS IN ITS CONSTRUCTION

We can divide an underground cistern into four parts, namely the Chamber, the Cover, the Pump and Extras. Figure 1 shows a sectioned-elevation view of the tank and pump (what you would see if you could dig it out and cut it in half from top to bottom).

The Chamber has to have adequate volume and be waterproof. Because the overall cost of a cistern is dominated by the cost of the walls and cover, we should like these to be as small as possible. For a given cistern volume, their total area is a minimum, for either a rectangular or cylindrical tank, when the tanks depth equals its width. However for certain sorts of cover it is difficult to span widths of more than say 7 feet (2.2 meters). The cistern we are about to describe has a rounded Cover and a rounded bottom and has an internal diameter of 2.2 meters. The depth of the straight part of its sides for different capacities is as follows:

usable capacity in litres 4,000 6,000 8,000 10,000

depth of cylindrical sides 0 meters 0.5 m 1.0 m 1.5 m

depth from dome to bottom 1.9 m 2.4 m 2.9 m 3.4 m

For volumes of more than 10,000 litres, build more than one tank, (however tanks larger than 10,000 litres are discussed briefly in Section 14). For volumes of less than 5,000 litres one might choose to make a narrower tank. This means changing the dome template to a smaller one. All the dimensions for such a small-tank template could be 20% less than those shown in Figure 3. The capacity table above would have to be replaced by another.

The Cover has to stop the water from evaporating, keep the water clean, prevent anyone falling into it and keep out light and mosquitoes. It has to be pierced by a big hole to let the rainwater in very rapidly and smaller hole through which water can be pumped out. These holes must also be mosquito and light proof, and at least one of them must be large enough for a man to squeeze through in order to inspect or replaster the inside of the tank. As you will see later, we recommend that the Chamber is excavated through the main hole in the Cover. The Cover should be shaped so that it leads any run-off from nearby ground away from its inlet. It must be strong enough to bear the weight of many people, provided that it has been covered with earth so that only the top of the dome is above the ground.

The Pump has to be simple and cheap. With a 10,000 litre tank and a spout 0.6 meters

off the ground, the pump has to lift the water through a maximum of 4 meters when the tank is almost empty. When the tank is completely full the lift is only about 0.5 meters. 4 meters is much less than the lift from a borehole or from many wells, so the pump can be worked faster than in those situations and does not need to be so strong. A full pump specification was given in section 4 above.

The Extras include some means of seeing the water level inside the tank without having to open the Cover, a coarse filter for water entering the tank and provision for safe disposal of any overflow water. There is some interest in putting a layer of sand at the bottom of the tank as an output filter, however this would require the pump intake to be connected to a perforated pipe running under the sand. (Experiments to test such a filters performance have yet to be done.)

During construction of any cistern, there are three choices in how one might combine the Cover and the Chamber. In some cistern designs, the Chamber is dug first and then the Cover built over the Chamber. In other designs the Cover and Chamber are made side-by-side and then the cover is lifted onto the top of the Chamber. For our design, we recommend a third method: the Cover is made first (in its final position at ground level) and then the Chamber is dug through an access hole in the Cover. It is not too difficult

to do this if excavation is manual (although the procedure effectively excludes mechanical excavation and is therefore not recommended for high-wage countries) and it allows us to use a cheaper dome-shaped Cover than if we had to lift it. So the sequence is as follows:

Steps in Constructing the Cistern

- *(If necessary), make a new template to shape the dome with, as shown in Figure 3*
- *Mark and dig out the ring trench; use the template to shape the mound of soil above it*
- *Prepare reinforcing bar (and perhaps mesh) to place in the trench and round each hole in the dome*
- *Place mortar to form the ring beam and the dome with its two holes*
- *Cure the mortar then cover the dome with soil*
- *Through the larger hole dig out the Chamber*
- *Plaster the inside of the chamber and allow this plaster to cure*
- *Make the pump (two variants are considered)*
- *Set the pump into the dome*
- *Construct the tank inlet with its gravel filter*
- *Provide drainage and arrange the hard-standing for pumper and water containers*

The tank takes about 24 man-days to construct. However the mortar dome and later the plaster in the chamber should each be left to cure for 2 weeks, so it needs a minimum of 6 weeks from when construction starts to when the tank can be used. Most of the work is digging but for 2 days an experienced plasterer is required. The pump can be made in a few hours.

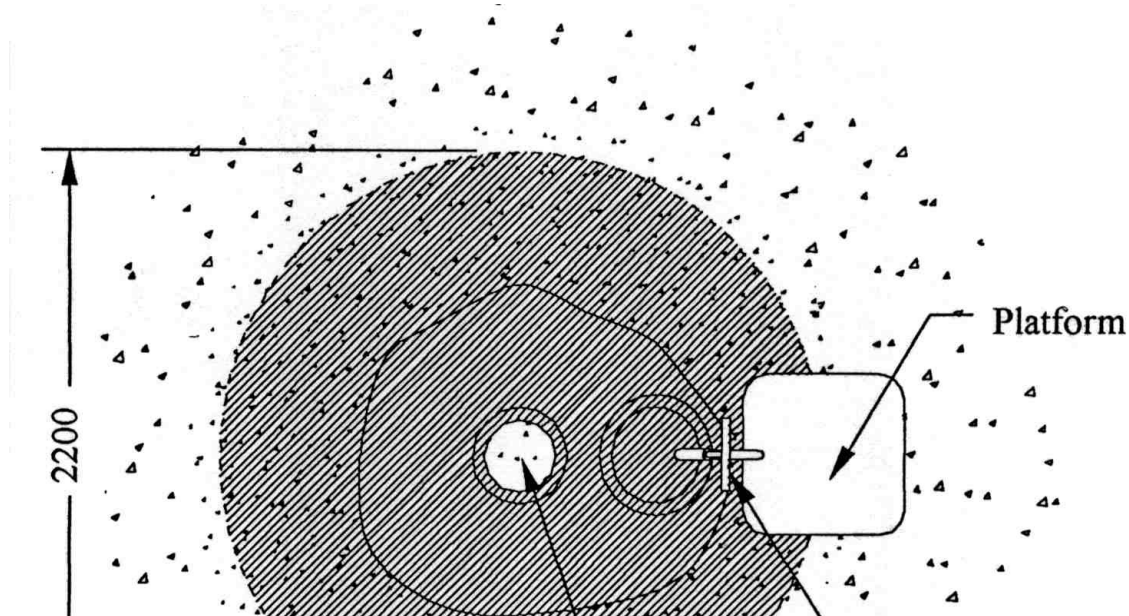

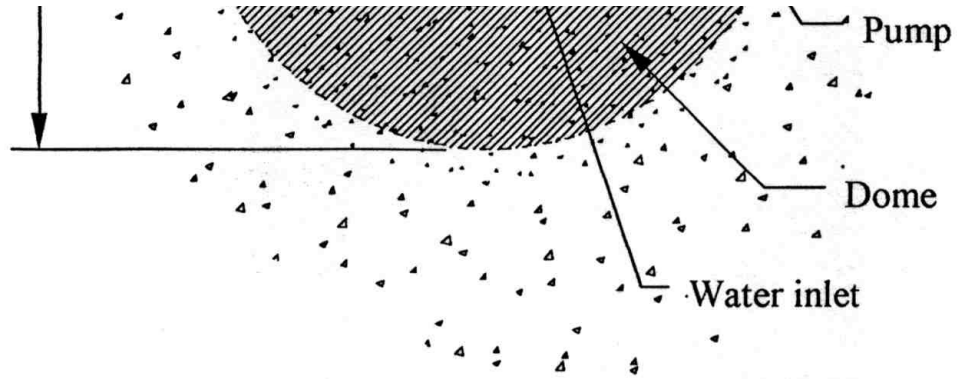

Figure 2 Plan of tank

7 Making the COVER (steps 1 - 5)

The Cover is a dome of mortar (containing almost no reinforcement) connected to a reinforced ring beam set into the ground. The mortar dome and the ring are made at the same time over a carefully shaped mound of earth. Set into the mound are a bucket and a large plastic bowl. The bucket is to create a way for the rainwater to enter. The bowl is to create a hole to hold the plug in which the pump is set. It has to be large enough (e.g. 0.45 meter diameter) for a man to enter through. Figure 2 shows the Cover in plan (when looked at from above). The 5 steps in making the dome will now be explained in turn.

Step 1 Making the template for shaping the dome

The shape of the mortar dome comes from the shape of the mound of earth it is built on. We therefore need a template to accurately form that mound of earth. Before building the first tank it is necessary to cut this wooden template. Once made, the template becomes a tool that can be used for many more tanks. The template must be the right shape and also strong enough to carry around and use without getting broken. It therefore consists of a piece of plywood, or thin planks, cut to that shape and stiffened by strips of thicker wood.

The right shape for the dome is approximately a upwards catenary. A downwards catenary is the shape taken by a chain hanging between two nails on a wall, so we mark the template out using such a chain (e.g. 1 or 2 lengths of bicycle chain) and then turn it upside down.

First cut the plywood so that it measures 125 cm by 100 cm and has square corners. Figure 3a shows 2 nails spaced 2.2 meters apart on a horizontal line drawn across a flat wall using a spirit level. Draw a vertical line down the wall from midway between these two nails and mark a short line (the mark) across it 80 cm below the horizontal line. Hang a light chain between the two outside nails and adjust its length until it just reaches down to this mark. (If you do not have enough chain to do this, see the alternative below.) Slide the thin plywood behind the chain without touching it, so that the long top of the plywood touches the left-hand nail and the right side of the plywood

lies along the vertical line. With a pen, copy the shape of the hanging chain onto the plywood, remove the plywood from the wall and saw along the line you have just marked. (Using planks instead of plywood, first nail them rigidly to their stiffening bar so that they can be placed behind the hanging chain; then continue as for plywood).

Although it is easiest to make the catenary with two bicycle chains joined end to end, it can also be done with only one. This has to be hung so that it forms just over half the full U-shaped catenary: one end of the chain is attached to the left-hand nail, the other end is held low and pulled until the *lowest* point of the chain falls exactly over the mark. You can now drive in another nail (alternative nail position in Figure 3) to attach the chain to, while you are copying the chains shape onto the plywood.

It is necessary that the chain has no twists and that it hangs freely, otherwise it might take up the wrong shape. The right shape ensures that the mortar dome is strong (by being everywhere in compression). Rope is not usually suitable instead of chain, because most ropes twist and are not heavy enough to hang properly.

To finish the template, stiffen it with good wooden strips. Now turn the template over so that the long straight side is on top and write the word TOP next to it. Smooth the sharp corners to make it safer to carry.

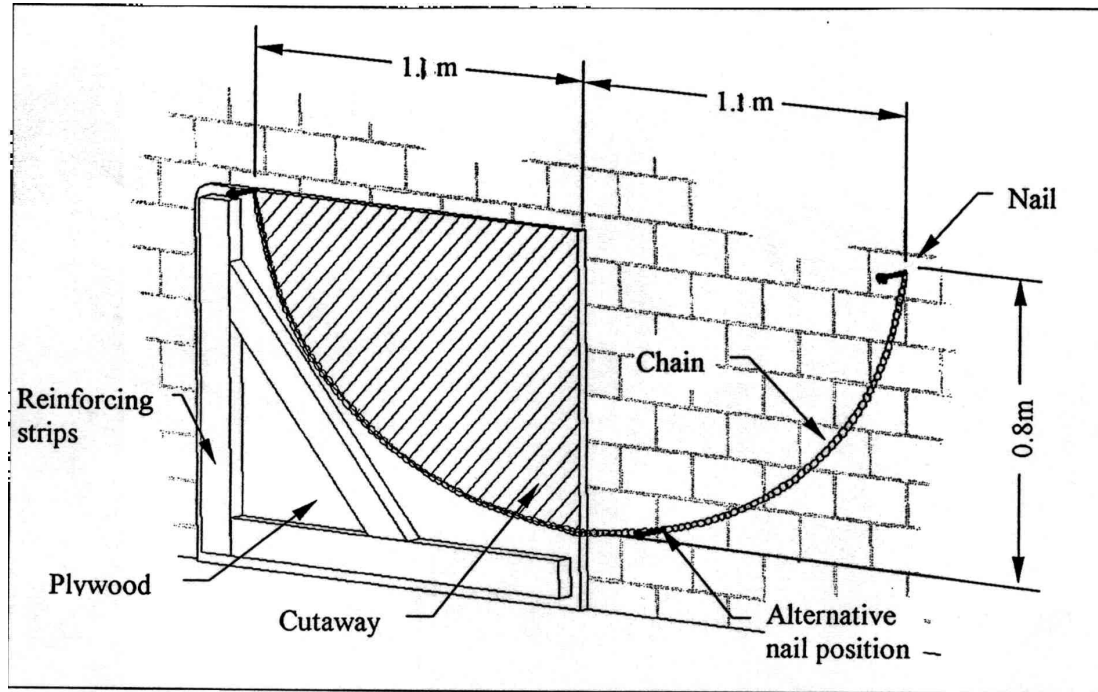

Figure 3 Making the template

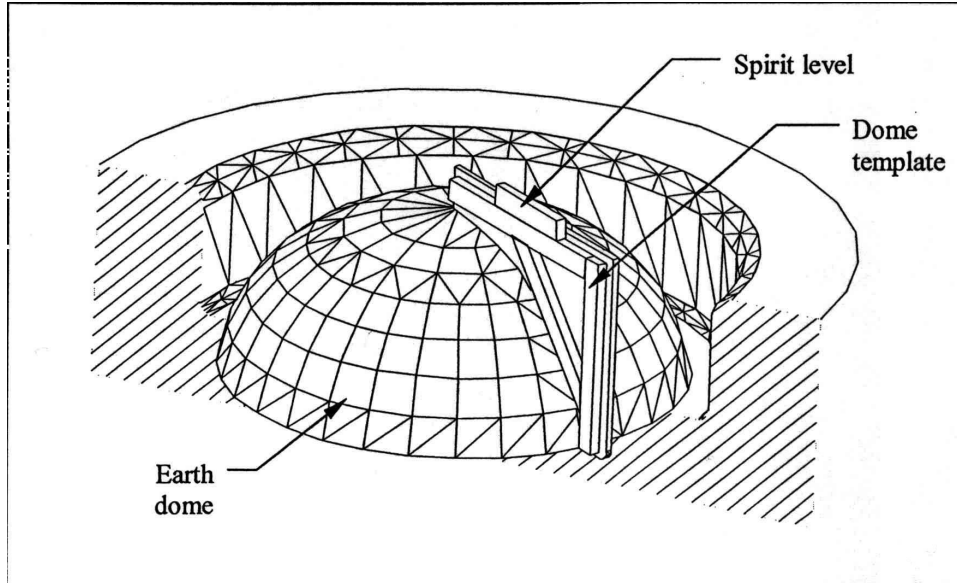

Figure 4 Forming the earth mound

Step 2 Marking out and making the trench and earth mound

The position of the tank should take into account several factors like nearness to the roof, distance from trees and convenience to the water users.

If the roof slopes only one way, as in many shops, a good place for a tank is near the middle of the single gutter or in a corner where two gutters meet. If gutters on both sides of a house have to be used, the tank might go near the middle of a (gable) end wall. Short gutters are easier to hang, can be made smaller and cheaper, and look neater than long gutters. Reducing the distance from gutter to tank reduces the cost of the downpipe. However a tank should not come closer than 50 cm from a wall's foundations, which means that the centre of the domed cover should be at least 2 meters from the nearest house wall.

A tank might be damaged by a car or heavy cart rolling over it, so it should either be fenced or put where vehicles cannot reach. It is also best if people do not often walk over it.

The tank sticks up only slightly above the ground and is mostly covered with earth. It is not good if during storms, water running across the ground goes over the tank. Roof water is clean, but ground runoff is not and must not enter the tank. So the drainage around the tank should divert such runoff. It should also allow the tank input to overflow - which it will do if it is already full when the rain starts - without washing away the covering earth.

Tree roots are a potential danger: they might penetrate and enlarge a tiny crack in the

tank wall. We suggest the tank is at least 10 meters from any large tree and 5 meters from small trees that will not grow large later. It is not always possible to satisfy this condition.

Once the tank position has been decided and the ground levelled, its centre should be marked by a firm and vertical (use a spirit level) thin stake. Make a clear ink mark or cut a ring round the stake about 30 cm above the ground. Using a string 220 cm long looped once round the stake, mark out a circle of diameter 220 cm on the ground. This circle marks the inside edge of the trench in which the ring beam will be cast.

Dig a narrow trench (one hoes width) outside this circle and throw some of the soil into the centre round the pole. The idea is to dig down 50 cm leaving a mound of firm soil inside the ring rising up to the ring round the stake. The shape can constantly be checked using the template - now with TOP at the top - placed against the stake and rotated like a scraper. The template should be kept level by means of a spirit level and at the right height with its lower corner touching the ring marked on the stake. This is shown in Figure 4.

If the mound is rough or loose or fissured by drying, it can be plastered with more mud and wooden floated to make it smooth and firm.

Chicken mesh can be fixed in the trench so that later on it can be used to improve the

joint between the mortar lining the chamber and the mortar of the ring beam. Make a single strip of mesh by cutting a 1.5 meter length into 5 strips each about 18 cm wide and twist joining them end to end - the final strip should be adjusted to fit round the *inside* face of the trench like a ring. This ring should now be folded longwise into the vee-shape shown in Figure 5 and the inside half buried in the earth of the dome. To do this you will have to cut out some earth from the inside of the trench, place the chicken mesh then plaster back the earth again.

The trench is now too wide for the ring beam, so fill back a step 10 cm high round its *outside* so that its bottom becomes only as wide as your foot - about 10 cm. (You will need to walk round this slot when you are plastering the dome). This too is shown in Figure 5. The bottom of the earth dome that faces into the trench should be grooved with a trowel or stick: these grooves will be copied onto the inner edge of the ring beam and will later help key the plaster joint to be formed there.

Finally place the bucket and the basin on the dome as shown in Figure 6. The bucket (the inlet) should be on the side nearest the house, with its edge touching the stake. The large basin (for the excavation access and later the pump hole) should be on the other side of the stake and with its edge 25 cm from the stake. Weight down the bucket and basin with stones and push them into the soil mound so that they do not rock; local excavation will allow the bucket to be sunk a desirable 20 cm into the soil. Put a small

fillet of mud round each bowl as shown.

Pull out the stake without disturbing the mound.

Step 3 Preparing the reinforcing bars

Use 6 mm bar; it does not matter whether it is round or knobbly. Make a ring whose diameter is 230 cm, folding over and linking the ends and hammered the link tight so that there is no play in the joint. This ring will take about 8 meters of bar. Test that the ring will sit in the middle of trench without getting close to either its inner or outer edge.

Make two further such rings but much smaller, one each for the bucket and the bowl. Each ring should have a diameter bigger than its bucket/bowl so as to leave a clearance of 3 cm all round it where it enters the soil dome.

Step 4 Casting the ring beam and the pierced dome

The dome and the ring beam that forms its bottom edge are made of strong mortar in the manner shown in Figure 7. The mix is 1:3 (cement : sand) and 2 bags of cement should be ample. Concrete, mixed 1:4:2 (cement : sand : small sharp aggregate), is an

alternative where such aggregate is available or can be made; a concrete dome needs only 1.5 bags of cement. (Concrete is more difficult to place as a plaster than is mortar and the surface finish achievable is not so good.) The ring beam is about 10 cm x 10 cm, while the rest of the dome is covered with 2 cm of mortar. However round the bucket and bowl this depth is increased locally to about 8 cm to make a good lip to hold the bucket/bowl and to cover the reinforcing rings there. As usual all three rings of reinforcing bar must be in the middle of the mortar with several centimetres of cover on all sides. So they must be placed as the mortaring progresses. The big ring, in the ring beam, is therefore placed only after 5 cm of mortar is already in the trench.

It is important to check the mortar thickness nowhere gets less than 2 cm as you work up the dome. There should be no joints in the mortar: the whole dome and ring beam should be made (plastered) in a single session with a mix that is dry enough not to slump. As the soil dome may suck water out of the mortar or concrete applied on top of it, it should be thoroughly wetted before plastering the dome starts. Moreover in a hot climate it is wise to do this plastering early in the day so that the new dome can be covered with wet straw before the sun gets very hot.

Step 5 Curing the dome

As soon as the mortar is firm, gently remove the bucket and basin from the top of the dome.

Once the dome is cast it needs to cure under moist conditions for 14 days to develop a high strength. The simplest way to ensure it is kept moist is to cover it with plenty of grass and douse this with a jerrycan of water every morning and afternoon.

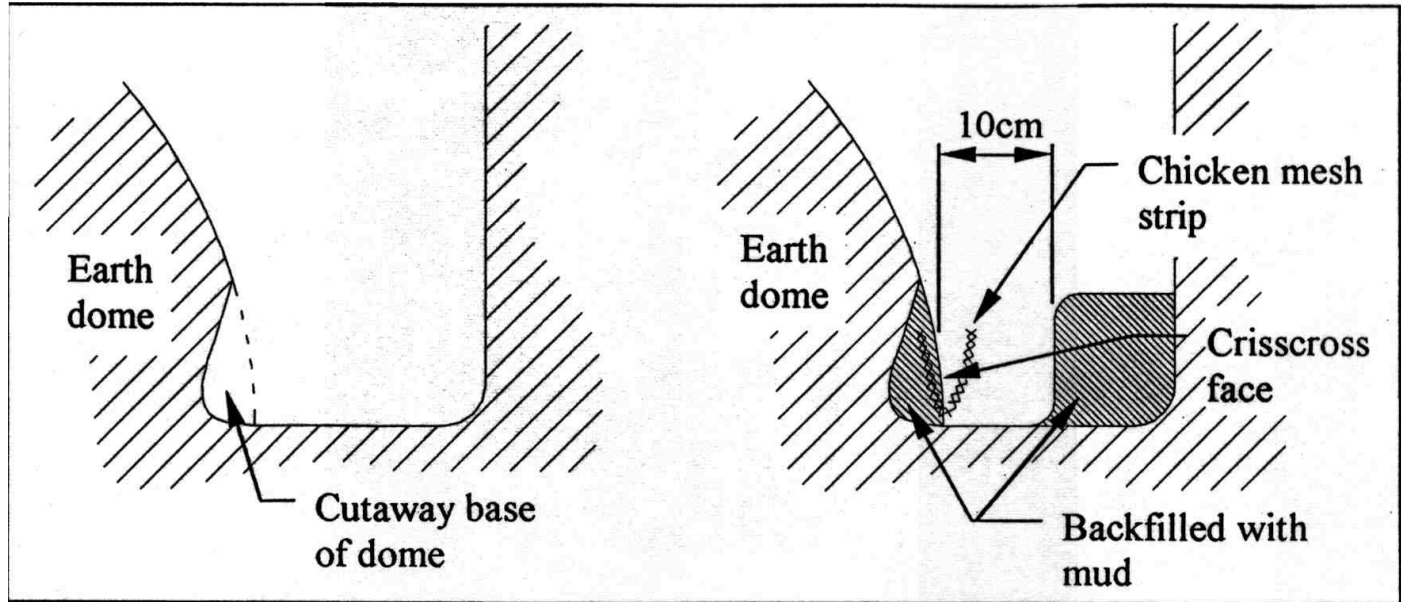

Figure 5 Details of trench (mesh is optional)

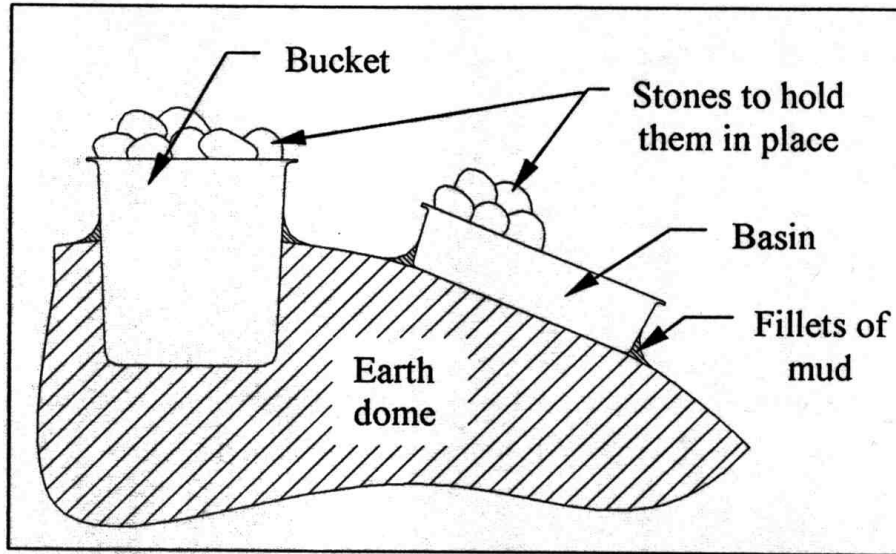

Figure 6 Basin and bucket on mound

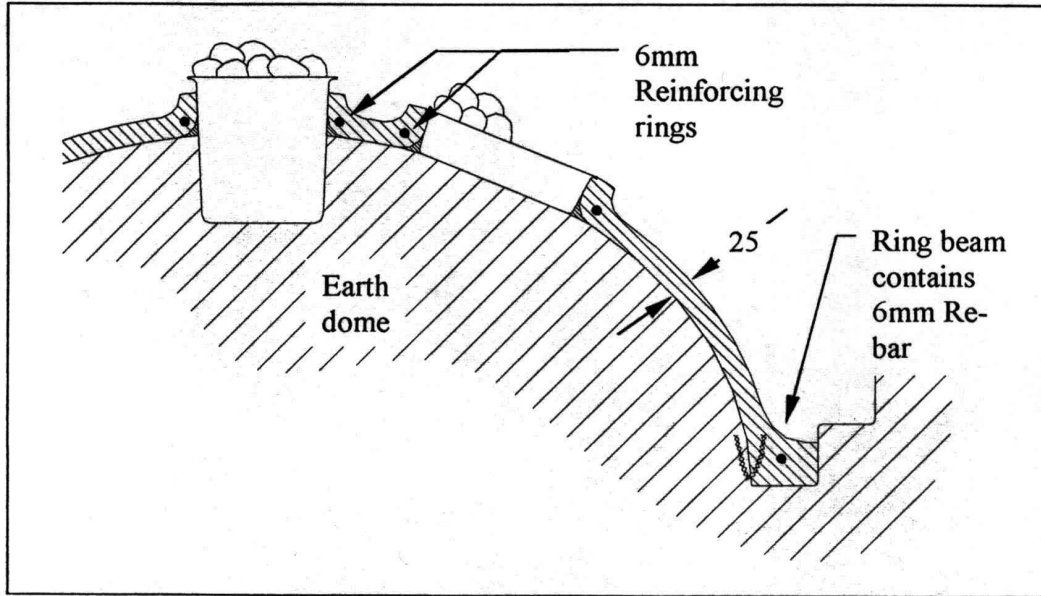

Figure 7 Completed dome

8 Making the Chamber (steps 6 - 7)

The chamber is a dug cylinder with a fully rounded bottom which is lined with mortar to make it waterproof. All the digging spoil has to come out through the two holes in the dome. The chamber must be the right diameter, which is 220 cm, so that it joins properly with the dome and does not undermine the ring beam. It has no corners or sudden changes of direction, since these could be places where the lining mortar cracks.

Step 6 Excavating the chamber

The dome should be strong, but to make sure it is safe it should be inspected for serious cracks. Any big cracks or holes show the dome is a failure and should not be used (because it might collapse while the chamber underneath it is being excavated).

If the dome passes this inspection, start excavating underneath it by reaching through the two holes in the dome. Use the excavated soil to cover the ring beam and lower parts of the dome. When you feel you have dug out enough that the underside of the dome is no longer resting on soil, perform the following safety test. Have 7 people standing close together on the top of the dome. It should not break (as described later under testing, these domes have withstood the equivalent of 25 peoples weight without failing). If it does collapse because of some serious defect in materials or craftsmanship, the people will only fall a short distance and you will have prevented a serious accident later on.

Assuming the dome has passed this test, carry on digging, using the soil to cover the dome up to the edge of the holes. This cover protects the dome from being damaged by heavy objects dropping on it. However during the rest of the excavation make sure there

are never many people standing on the dome and that it is not struck by tools. When you lift buckets of soil out through the access hole, take care that they do not strike the underside of the dome on their way up.

Soil is removed until there is room for a person to dig from inside the dome. Then that person digs from inside until there is room for two people.

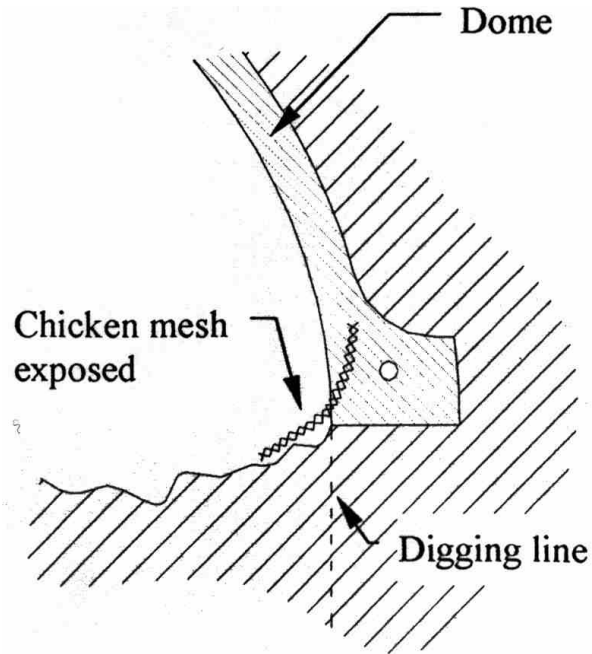

Figure 8 Digging past the ring beam

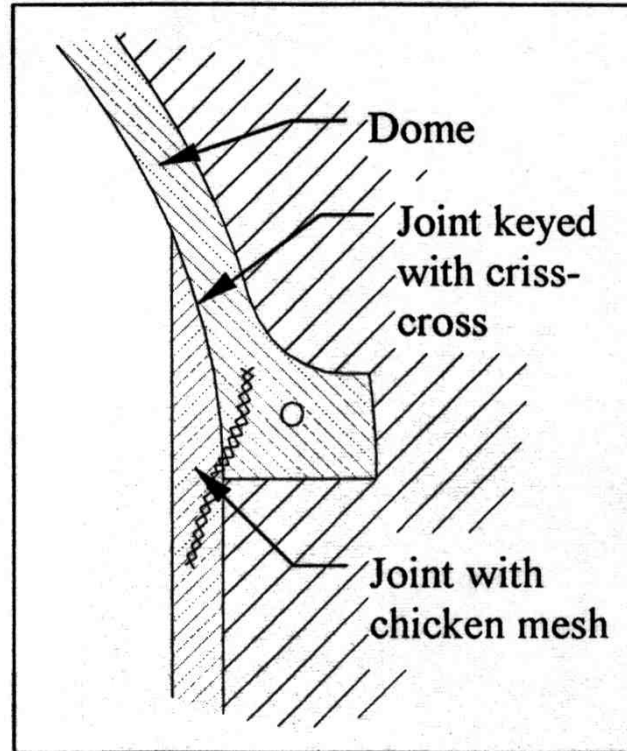

Figure 9 Plastering the pit-dome joint

Digging continues exposing the underside of the dome until the ring beam is reached and the chicken mesh is found. It is most important not to dig directly under this beam because you would be removing the soil in which the whole dome is supposed to be supported. Instead, on reaching the edge of the ring beam you should dig straight

downwards as shown in Figure 8.

Soil can be thrown up through the access hole or removed from the pit using a bucket on a rope. The speed of excavation usual depends mainly on how fast you can remove the soil, not on how fast you can dig. If there are two people in the pit, one can dig and the other can keep filling the bucket.

Before the pit is so deep that you cannot easily reach up to the underside of the dome, clean off all the soil sticking to this underside with a trowel then brush and wash it.

The chamber sides are supposed to be vertical, so check them from time to time with a spirit level or plumb bob. It is not necessary to be very accurate. You may come across areas where the soil of the pit sides is loose and powdery, or you may encounter roots. If you do, dig them out and replace with a mortar of firm soil. This is because the mortar lining you will later apply to the chamber sides must be completely supported by them to prevent it cracking.

When the height of the walls has reached the size you want (1 meter for an 8000 litre tank or other sizes as shown in the table on page 9), dig out the base of the chamber into the shape of a round bowl about 1 meter deep.

Once the required chamber size and shape is reached, the final finishing can be done.

The soil walls should be scraped smooth, with special care being taken at the edge of the ring beam. All loose soil should be removed from the bottom of the chamber.

Step 7 Lining the chamber

The soil walls are plastered with 2 to 3 cm of ordinary mortar which is finished smooth with a wooden float. The mortar mix is 1:3 and three bags of cement should be ample. The walls need to be plastered in one session so that there are no joints in it. When you reach the ring beam (which is the beginning of the dome) bend down the chicken mesh so that it lies within the mortar. Carry the mortar plaster straight up so that it overlaps the bottom of the dome for 20 cm or more - as shown on Figure 9. The scoring you did in Step 2 will help the plaster overlap to grip. The very bottom of the chamber can be used to store the mortar while plastering the rest of the chamber. This bottom is smoothed last of all, perhaps using the feet of a plasterer who is hanging from the hands of a colleague reaching down through the hole.

This plaster needs curing for 14 days under moist conditions. The walls should be splashed with water every day and the access holes should be covered, to prevent any drying out, for the rest of the time. The chamber walls need finally to be sealed with a

paint or wash made from cement and water. The walls need to be wetted before this paint is applied. 24 hours after this sealing, the cistern is ready to be filled with rainwater.

An alternative technique, reported as being in use for brick-lined tanks in Brazil, is to apply the plaster in two 1 cm coats with a sealing layer of cement wash between them. The first layer should be left rough enough for the second layer to key onto despite the rather smooth cement wash. In Brazil the mortar was made with lime (strengthened with 1 part of cement per 9 parts of lime). In Uganda lime currently costs exactly the same as cement per kilogram so there is no financial saving from using it. However its greater flexibility is attractive if small earth movements are feared. Lime/cement mortar takes over 30 days to cure well.

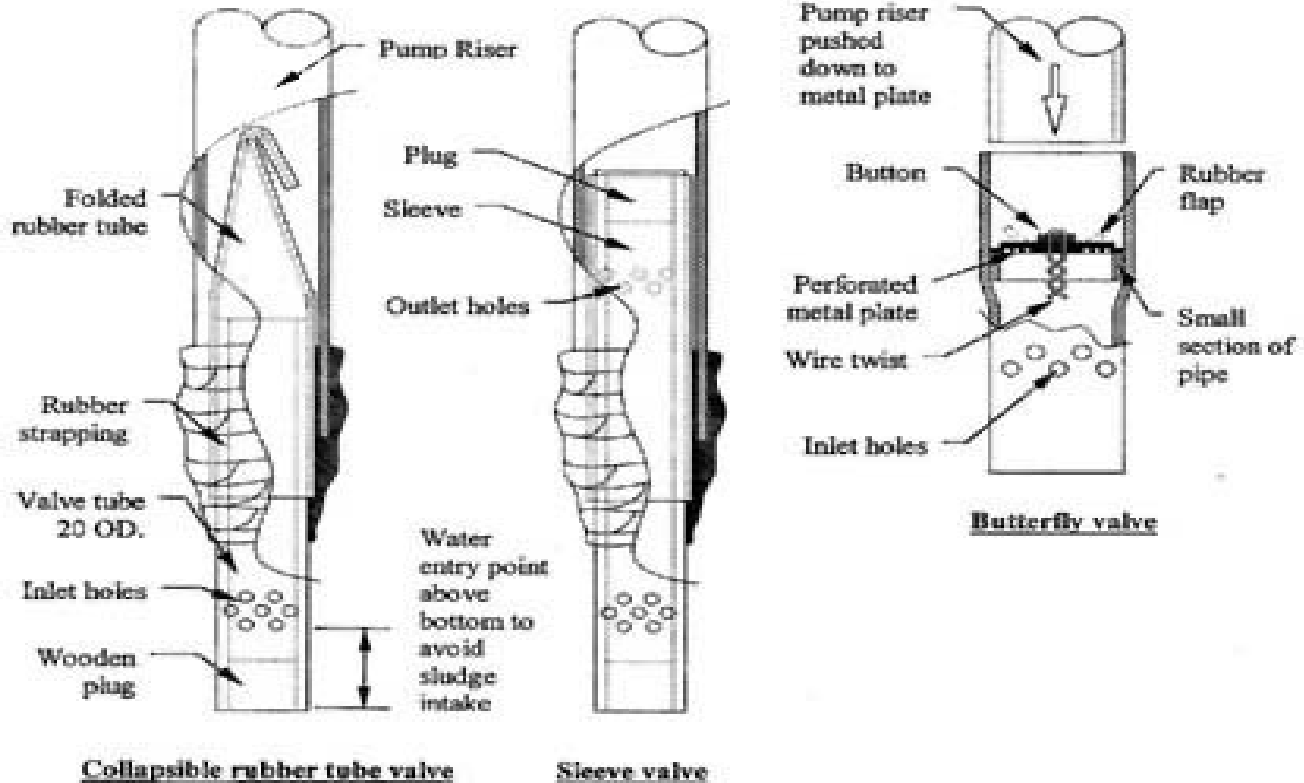

Figure 10 Three designs of foot-valve for a piston pump (wavy line shows riser cut away)

9 MAKING PUMPS (steps 8a and 8b)

Step 8a Making a foot valve

Any piston pump requires a foot valve. This is a non-return valve placed near the bottom of the riser pipe immediately above the intake. It should have a low resistance to the upwards flow of water and a high resistance to downwards flow (leakage). As the change-over from upstroke to down-stroke takes only a few milliseconds, the valve should move quickly from its open to its closed position. Delays in doing so will result in lost effort.

Figure 10 shows three designs of foot valve, which we may call tube, sleeve and butterfly respectively. All work satisfactorily; each has its merits.

The **butterfly foot valve** on the right of Figure 10 is the simplest to make, but when fitted in a small pipe has a rather high resistance to upwards flow. Moreover the extension piece on the bottom of the riser pipe has a larger diameter than the riser itself, which complicates drawing the whole assembly up through the plug in the tank top.

The valve consists of a thin perforated metal disc (for example cut from galvanised steel roofing sheet) covered by a rubber disc (usually made from bicycle inner tube). The perforations in the metal can be made downwards with a hammer and large nail, the top of metal being then hammered and filed flat. The metal disc should have a larger diameter than the inside of the riser pipe but smaller than that of its belled end. The rubber disc is attached along its centre line to the metal by a twist of wire so that it can

only flex in the manner of a butterfly's two wings. It should be large enough to cover all the holes in the metal yet small enough to be able to flex upwards without touching the sides of the riser pipe. A nail with its head cut off, or a long button, makes a suitable bar to restrain the rubber disc.

The metal disc itself sits on a small ring cut off the riser pipe and glued into a socket on a short pipe extension as shown in the figure. It is held in position by the extension being forced up onto the bottom of the riser pipe and jammed there with glue or a slip of paper. A good seal fit is obtained if the metal is heated before insertion, so that it melts into the plastic. The actual socket has an inside diameter equal to the outside diameter of the pipe it terminates. It is formed by pushing/rotating a wooden tool or a soft-drink bottle into the heated end of the riser pipe - a procedure that takes a little practice to do well.

The **sleeve valve in the centre** of Figure 10 has a small diameter (e.g. 25 mm OD) inner pipe covered by a loose-fitting sleeve of cycle inner tube. The relative sizes of the sleeve and inner pipe are important and therefore need to be matched by trial and error. Too large a sleeve and the valve leaks downwards; too small a sleeve and the resistance to upwards flow is too high. The short inner pipe is perforated at two levels by rings of holes. The lower ring (single or double) is where the water enters; its location determines the clearance above tank-bottom sludge. The upper ring is where the water

emerges under the sleeve into the riser. The top of the inner pipe is sealed either by a bung or by heating and clamping flat. For both binding the sleeve onto the inner pipe (below the upper ring of holes) and for jamming the inner pipe into the bottom of the riser pipe, long narrow rubber strips are used. This cheap and useful material, cut from old inner tubes, is sold by bike mechanics throughout Africa. With a little practice it can be used to make firm watertight joints of sufficient strength to resist significant forces.

Unlike the butterfly design, the sleeve valve does not require bellling of the bottom of the riser pipe, but instead fits within the risers diameter. For desludging a tank, the inner pipe can be pushed up higher inside the riser; this forces all water to enter via the very bottom. The sleeve valve is prone to damage by small gravel being drawn into the space between inner pipe and sleeve, so it should be cleaned after use for desludging. Indeed except when desludging it is helpful to bung the bottom of the inner pipe to prevent ingress of tank-bottom grit.

The **tube foot valve** on the left of Figure 10 is an unusual new design. It requires a permanent fold to be made across a short length of inner tube. Water can flow upwards by pushing the fold open, but when water tries to flow downwards the fold is pressed shut. To make such a permanent fold, the tube must be clamped to create a temporary fold then immersed in a very hot liquid. We have found that brake fluid (for a car) is a suitable fluid. It boils at a much higher temperature than water, so the fold will set

permanently if it is placed for half a minute in nearly boiling fluid. Other oils do not work because they attack the rubber. Naturally it helps to make an experiment to find out the right immersion time. Take care with the hot oil and wait for the rubber to cool before touching it! The folded rubber tube is now tied over a valve tube and the whole assembly is strapped very tightly onto the bottom of the riser pipe. As with the sleeve design, it is a nuisance if the inner pipe falls off and lies at the bottom of the tank.

All of these foot valve designs need some care in adjustment. Their performance may be crudely tested by blowing and sucking to detect that there is a difference between their upwards (low) and downwards (high) flow resistance. The latter can also be tested by filling a riser pipe - fitted with the foot valve - with water and checking that the leakage flow does not exceed 1 litre per minute.



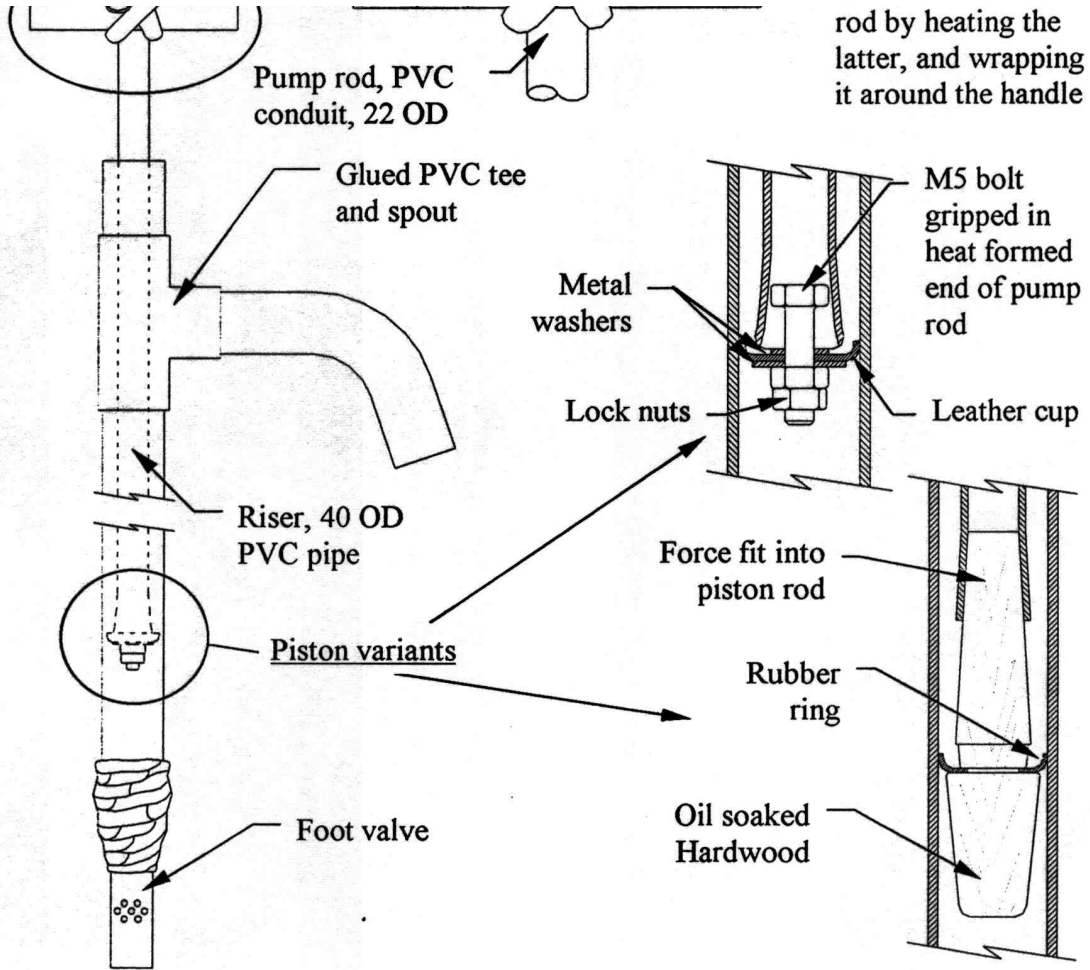



Figure 11 Piston pump with two piston options

Step 8b Piston manufacture and pump assembly

The piston itself must allow water to pass round its edges when it is pushed down, but not when it is pulled up. It therefore requires a slightly flexible skirt. Figure 11 shows two variants. The wooden variant shown bottom right uses a pierced disc of inner-tube rubber to achieve this flexibility. The boiled-in-oil wooden plug (which has a diameter about 3 mm smaller than the risers bore) allows the disc to flex upwards but not downwards. The leather variant (middle right) uses a classic cup piston made of leather taken from a motorcycle stirrup pump (bicycle pump pistons are rather too small). Although the cup has some flexibility, it has to fit fairly closely into the riser pipe.

Nominal $1\frac{1}{4}$ " PVC pipe (40 mm outside diameter) is a suitable size for the riser to use with this piston. There may be other pipe-cup combinations available. The behaviour of leather cups is rather unpredictable. Some wear quickly and some go stiff if repeatedly cycled through wet and dry states. It is helpful to grease the cup. Small cups are usually cheap and available (less than \$1 in Ugandan trading posts) and are fairly easy to replace. Note however that the nuts retaining the piston need to be locked together using two spanners/pliers, otherwise they will soon loosen.

The piston rod is made of plastic conduit (made to guide electrical wires through concrete floors) whose outside diameter is commonly 22 mm. Conduit is cheap but not very stiff. It can be given extra stiffness by pushing a 6mm steel reinforcing bar down it

or filling it with mortar. Such stiffening is however not essential. When heated such conduit can be easily moulded. For example it can be pushed hot over the end of the wooden plug of the first piston variant or crimped round the head of the bolt to which the cup piston is fixed. It can also be wrapped hot like a flat strip round the pump handle (Figure 11 centre top) and held in position until cool. The ideal diameter of the piston rod is 70% of the risers bore. This gives an almost steady flow from the pump - the delivery flow during the down-stroke is the same as during the up-stroke. Other diameters between 50% and 80% are acceptable. The length of the piston rod should allow the piston to approach within 2 meters of the top of the foot-valve. If the rod is too long there is a danger of hitting the foot-valve. If it is too short the pump may be hard to get started (self-prime), especially if the flexible skirt of the piston is worn or if the pump is used at places very high above sea level. Priming is quickest if long strokes are used until water appears at the spout. Calculations (see Table below) show that if the piston at its lowest position is 2 meters above the water level in the tank, then even with a perfectly sealing piston priming requires a stroke length of at least 0.1 meters. If the piston leaks a bit this stroke length needs to be significantly longer. Once a piston pump is primed, however, short strokes can be used.

The pump needs a spout. PVC tee connectors make the simplest way of joining the spout to the riser providing PVC cement is available. An alternative to cement is to wedge the pipe into the tee with a layer of paper and reinforce with rubber strip wrappings.

TABLE OF MAXIMUM SUCTION HEADS ASSUMING PERFECT PISTON SEALING
(suction head = height of bottom point of piston stroke above the water level in the
tank)
(compression of air during priming down-strokes is assumed adiabatic, with $\gamma = 1.2$)

Stroke of piston		0.1 m	0.2 m	0.3 m	0.4 m	0.5 m	0.6 m
Altitude	Pressure	Maximum Suction Head in meters					
Sea level	1.0 bar	2.1	2.85	3.5	3.95	4.35	4.7
+ 800 m	0.9 bar	2.0	2.7	3.3	3.7	4.1	4.4
+1600 m	0.8 bar	1.85	2.55	3.1	3.5	3.85	4.15

10 Completing the Cistern

Step 9 Setting the pump in position

The pump riser penetrates the top of the tank via a mortar plug made to fit the larger hole in the dome (the plug is moulded with the same basin as was used during dome construction and sealed into position with mud). The plug carries a sleeve (see Figure 12) through which the pump riser passes, which should be angled so that it points at the tank bottom. Heavily scratching the outside of the sleeve should be sufficient to make it bond to the concrete. For an even better bond a strip of pvc - cut from the riser piping - can be glued onto the outside of the riser where it passes through the plug.

With any piston pump, significant downwards *and upwards* forces are transmitted into the riser from the pump handle. In consequence the riser needs to be held firmly in the sleeve. Downwards movement can be resisted by using a rubber-strip wrapping on the riser that jams into the top of the sleeve. Some adjustment is usually needed to ensure that the intake pipe of the foot valve reaches the tank bottom at the same time as the riser jams tightly down into its sleeve. Resting on the bottom in this way ensures the

foot valve does not get pushed out during a down stroke. Upwards movement of the riser can be resisted by wiring the spout tee down to the lifting handles of 6 mm reinforcing bar set into the plug.

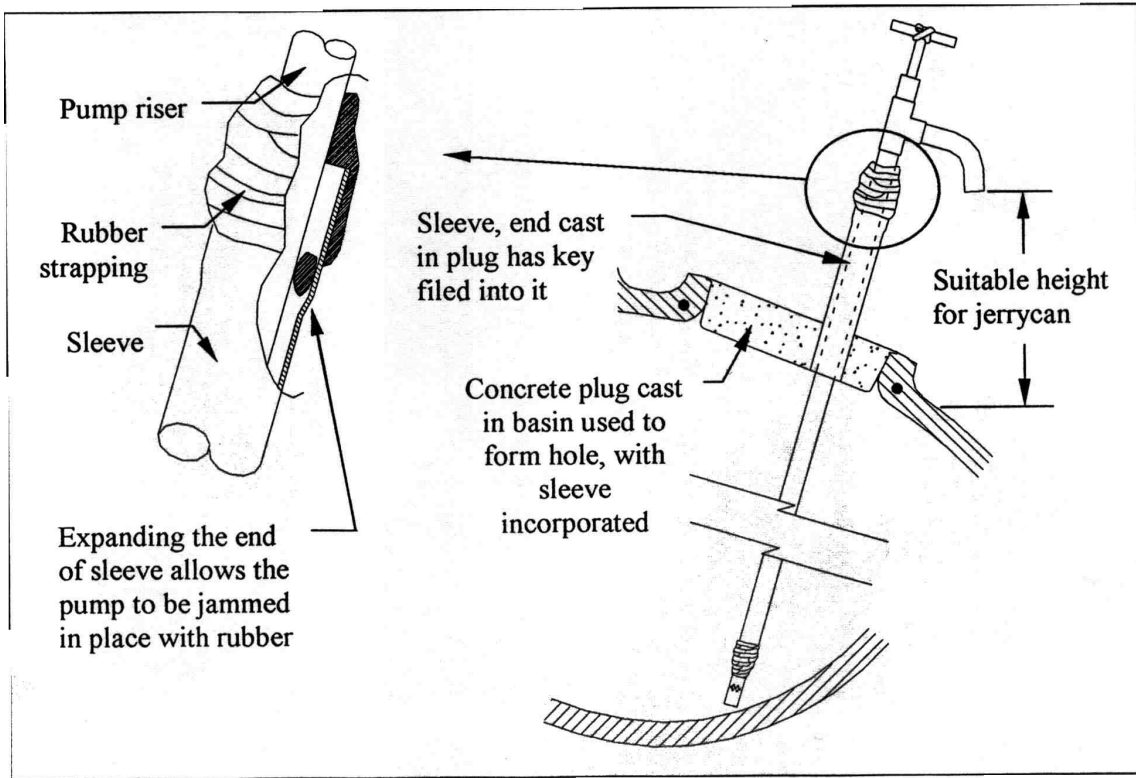

Figure 12 Fitting the pump to the tank

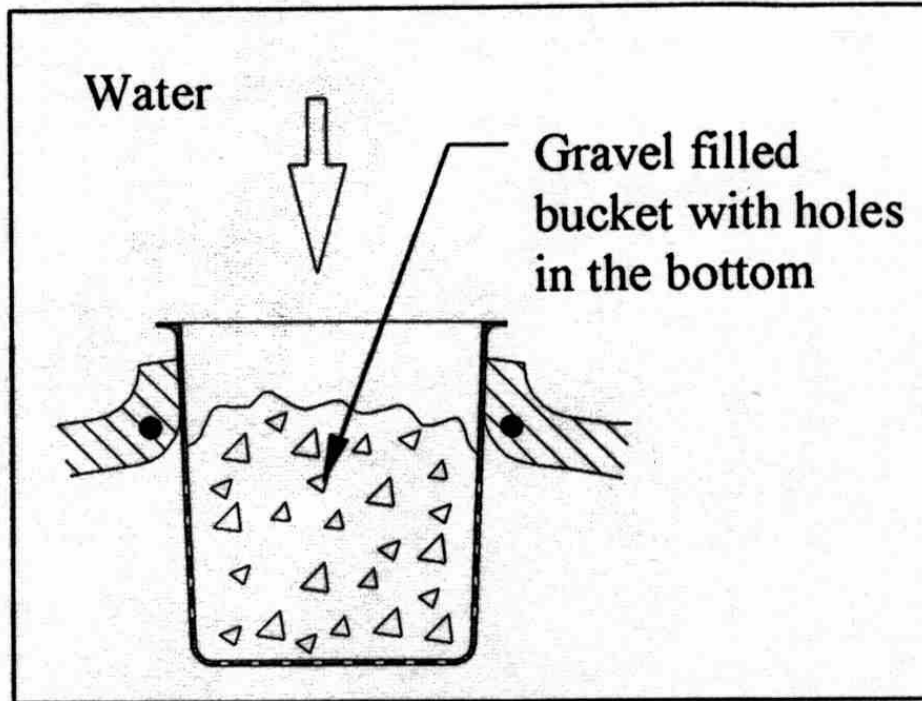

Figure 13 Water inlet filter

Step 10 Making the inlet filter

Water enters the cistern rapidly during heavy rain. The inlet should be able to handle flows up to 120 litres per minute (e.g. 4 mm/minute falling on 30 m² of roof) without overflowing. At such high flowrates only coarse inlet filtering is usually possible, namely

the prevention of twigs and leaves from entering the cistern. The inlet to the cistern should also meet the criteria of excluding light, being impenetrable to mosquitoes, not presenting a danger to children, preventing the inflow from stirring up any sediment in the bottom of the chamber and being able to handle cistern overflow. Any material retained by a filter (or by a sedimentation chamber) must ultimately be removed from it, so ease of cleaning is also desirable.

One inlet design that meets these various criteria is shown in Figure 13. The bucket is the same one that was used to mould the inlet collar in *Step 2* and should therefore fit closely into that collar. Being set low, little of its exterior is exposed to sunlight and hence UV degradation. The primary filtration mechanism is a coarse cloth stretched over its top and tied under the bucket's edge - this can be removed for back-washing. A gravel filling to the bucket weights it down, reducing the chance of its removal by children. It also supplies back-up filtration in case the cloth is missing or torn, it excludes light and it prevents a heavy inflow from splashing out again. The bucket should be pierced in many places, in its base and the lower part of its sides, by holes whose total area should exceed 20 cm^2 . 80 holes of 6 mm diameter should suffice to carry the peak flow without the bucket overflowing. The presence of so many holes means that within the cistern the inflow becomes a spray rather than a downwards jet. Such a spray does not stir up the cistern contents as a free-falling jet might. Of course the gravel must be larger than the holes in the bucket.

Should the cistern be already full when it rains, the inlet bucket will overflow. Its spout (formed by heating if not initially large enough) should direct this overflow to the drainage provided for spillage from the pump or the collecting vessels.

Step 11 Making the hard standing and drainage

Below the spout of the pump (itself of height suitable for the collecting vessels in local use) there must be easily cleanable hard standing for both the collecting vessel and for the person pumping. This hard-standing requires proper run-off or drainage provision, so that puddles do not form for mosquitoes to breed in and the soil covering the edge of the dome does not become saturated. A proper soakaway, situated well outside the cisterns ring beam may be needed , but often the slope of the land enables a simple channel to suffice.

11 POSSIBLE FAILURE MODES

We might divide failures into dangerous failures (DFs) that threaten human life, total failures (TFs) that require the cistern to be abandoned and partial failures (PFs) requiring repair or degrading the cisterns performance.

Dangerous failures include:

DF1 inwards collapse of the dome during excavation of the chamber or later during tank use,

DF2 significant ingress of polluted surface water or of latrine effluent,

DF3 providing a breeding ground for mosquitoes close to a dwelling,

DF4 children falling in and drowning.

DF5 collapse of the chamber during digging.

Failure DF1 is not easy to design against because the forces on the dome are imperfectly known in size and direction. The dome shape (catenary) is the optimum to resist its self weight and good for resisting top loading. It is less good for resisting outwards pressure forces when the tank is completely full, but any failure they could cause would not normally be dangerous so is discussed under PF1 below. The simple test mentioned in *Step 6* should identify major dome defects, while the test programme described in section 12 below indicates a satisfactory safety factor. Attempts will be made during 1997 to apply complex computer finite element methods to analyse this shell.

Failure mode DF2 is combated by the raising of the inlet collar above likely surface flow levels, the sealing in (usually with clay) of the mortar plug to the access hole, keeping the cistern well apart from latrines and not digging below the rainy season water table.

Failure mode DF3 is avoided if the inlet filter is properly made. and the spillage drainage is adequate.

Avoidance of failure mode DF4 depends upon care by the household owning the cistern; design features can never totally remove the need for social controls like forbidding children from trying to swim in a cistern. Weighting the inlet filter bucket and sealing the access hole plug will normally be sufficient for DF4 avoidance, but fencing off the cistern area would add extra safety for babies.

To avoid the possibility of DF5 collapses, shoring the chamber during its excavation would be required by some countries building safety codes. This would significantly increase the difficulty of both excavating and subsequent rendering the chamber. Where deep latrines are already normally dug without shoring (e.g. as in the trial country, Uganda), excavating the significantly shallower cisterns should incur no danger.

Possible catastrophic failures are

TF1 cistern collapse during earthquake

TF2 slumping or other movement of the soil walls of the chamber to the extent that the chamber lining becomes unsupported and cannot contain the water pressures

TF3 an empty cistern floating out of the ground.

Until further experience is gained, avoidance of TF1 requires that these cisterns are not built in seismic zones. In fact some of the prototypes have survived minor tremors and one has been deliberately built in a seismic zone to test its durability there.

Because of the possibility of TF2, wall slumping, the construction technique described is not suitable for loose sandy soils, highly expansive clay soils or areas where the water table sometimes rises within say 3 meters of ground level.

Avoidance of TF3, flotation, also requires that the water table does not rise higher than say 0.7 meters above the bottom of the chamber. Fortunately it is very unlikely for a cistern to be empty following rains heavy enough to raise the water table so high.

Partial failures include:

PF1 cracking in the dome

PF2 localised cracking of the chamber lining leading to leakage

PF3 ingress of tree roots

PF4 heavy sedimentation leading to pump blockage or loss of storage capacity.

Serious cracking of the dome, PF1, due to water pressure could result in leakage resulting in effective loss of about 1000 litres of capacity. As it is undesirable for the dome mortar to anywhere go into tension, the inwards forces due to soil loading should largely (or even completely) counterbalance any outwards water-pressure forces. Even dry soil has a higher density than water, so this condition is usually satisfied. In fact mortars and concrete should be able to carry tensile stresses up to say 0.5 MPa. In the absence of four features (ring beam tension, dome taper, dome self-weight and overburden weight) the maximum tensile hoop stress due to water pressure could reach $80 \text{ kPa} \times D/2t = \text{say } 4 \text{ MPa}$, where D is the dome diameter and t its thickness.. This is considerably more than the tensile strength given above. The presence of each of the four features however significantly reduces the hoop stress.

Localised chamber cracking, PF2, could lead to loss of all water. Outward leakage under the ground may be difficult to locate. Once a leak has been located, however, repair is straightforward as the cistern can be entered to cut out and re-render cracked walls or to apply another cement wash.

Tree roots, PF3, are attracted by minor leakage or may reach the chamber even without such leakage. Live roots in a tank are initially a minor nuisance until they become numerous or exacerbate cracks by their expansion. Dead roots may rot, creating leakage paths and possibly de-oxygenating the water. Roots can be detected and initially trimmed during annual cleaning. In time they will require cutting back and local replastering.

Sediment is often present in roof run-off and needs periodic removal (PF4) . This can be done by entering the tank or perhaps by sluicing while pumping out.

12 TEST RESULTS: LEAKAGE, DOME STRENGTH, CHAMBER FLEXING, PUMP PERFORMANCE

Leakage tests

Three tanks were built in early 1996 at Kagadi. None showed serious leakage by early 1997. One was cycled (full/empty) a number of times and tested for leakage after each filling. The water loss rate averaged 3.6 litres per 24 hours. Further leakage tests on these and on four further tanks completed in March/April 1997 will be carried out when the overdue March rains have filled them. However leakage is not easy to measure - to

demonstrate that leakage is under 1 litre per day requires measurement of water level changes to a resolution of 0.2 mm/day. Such precision is not possible under field conditions. Indeed it is difficult to guard a tank against being used for as long as 24 hours. In practice a leakage of up to 5 litres/day (1 mm/day) would be acceptable and this rate of level change is just measurable without special instruments. As 1 mm/day is less than the evaporation (typically 6 mm/day) from an open tropical water surface, it is important that measurements are made with the tank well covered so that the air above the stored water is at 100% relative humidity. Even where this is done, it is found that the level of a newly filled cistern may *initially* fall at over 1 mm/day even though it subsequently stabilises. This initial fall may be due to evaporation to saturate the air in the cistern, absorption by the wall plaster or soil movement .

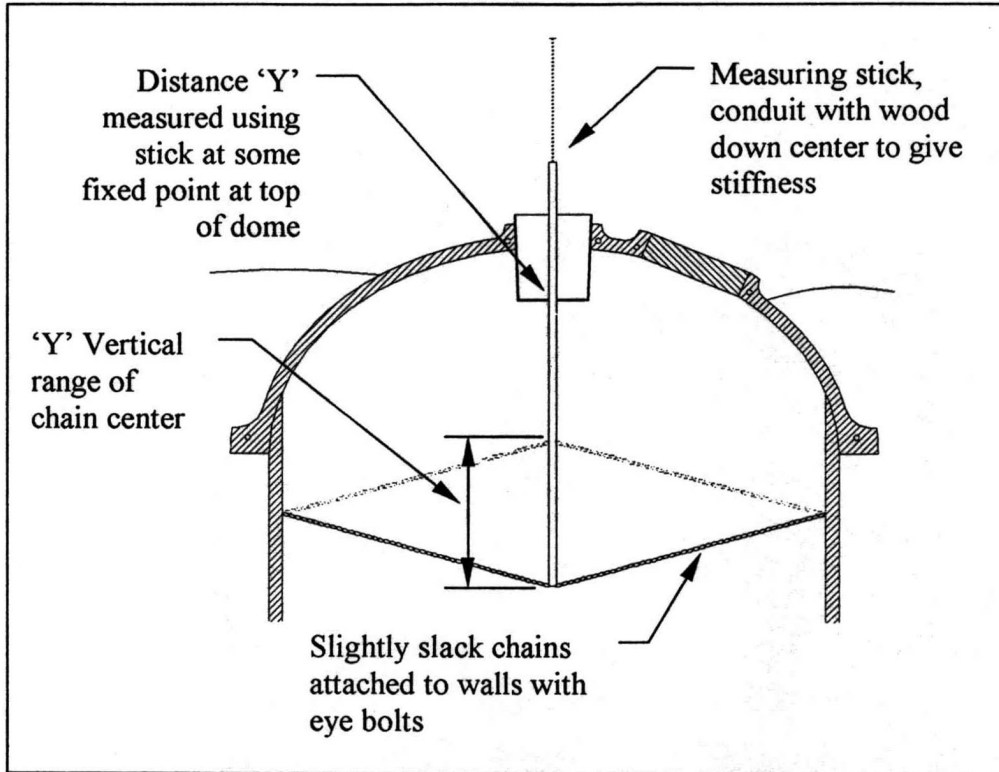

Figure 14 Testing the expansion of a cistern

Dome loading tests

We are of course interested in the integrity of the dome: sudden dome failure during

construction or later could endanger lives. The dome is subject to the following forces

- (a) its own weight of about 300 kg
- (b) the weight of builders or users standing on it, say 6 x 60 kg
- (c) the weight of soil placed upon it (typically 800 kg, mostly acting close to the outer edge of the dome)
- (d) water pressure acting outwards when the cistern is completely full.

The last two forces are to some extent counteracting, both being generally perpendicular to the local dome surface, with the soil pressure acting inwards and the water pressure outwards. Inwards forces compress the dome to which forces it has a high compressive strength, while outwards forces lead to hoop tensions to which it has poor resistance. Neither of these forces impinge on the central part (i.e. the top) of the dome whose failure would be most dangerous.

The first two forces act downwards and are translated into compressive stresses in the mortar by the domes catenary shape. It is these forces that might collapse the top of the dome inwards.

Two domes were therefore subjected to large downwards forces in the central part by loading them with bricks. It proved necessary to mortar a locating ring of bricks onto the dome, about 300 mm above the ring beam, to prevent the column of test load bricks slipping off the curved dome surface. Thus the test load was applied approximately uniformly over a circular area of diameter 1900 mm (to be compared with about 2250 mm for the domes junction with its restraining ring beam) corresponding to 70% of the domes plan area. The test column of bricks was assembled in a way that encouraged transmission of its weight along paths through the domes shell rather than directly to the locating ring.

Using all the bricks (and peoples weight) available, loads of 1500 kg and 1700 kg were applied to the mortar and concrete domes respectively. Both domes were 20 mm thick. Following normal civil engineering practice, the maximum expected dead and live loads (namely loads (a) and (b) above) were multiplied by factors of 1.4 and 1.6 respectively, giving a design load of 996 kg. Thus including a self weight of 300 kg, the test loads represented safety factors of $1800/996 = 1.8$ and $2000/996 = 2.0$ respectively.

Neither dome showed any signs of cracking. Although the test were rather crude, they give reasonable confidence in the design.

Chamber Flexure Test

The chamber walls consist of mortar against undisturbed soil. Concrete or mortar is usually assumed to be able to tolerate a tensile strain of not more than 100 microstrain (0.1%). Tests were undertaken with two chambers to measure their expansion when filled with water and therefore check if the circumferential strain was excessive. Arrangements to measure variations in mid-height diameter due to variation in water pressure were made in both chambers. The measurement was not simple since a resolution of less than 1 mm is required and the measurement points are inaccessibly submerged. Slightly slack chains (see Figure 15) were stretched between eye bolts in facing walls of each chamber and the vertical ranges of the chain centres were measured. This range y is the distance between the highest point to which the chain centre can be pulled up and the lowest point to which it can be pushed down. Tensions in the chains were kept low and repeatable, so that variation in chain lengths were negligible. It can be shown by Pythagoras theorem that movement in the walls that increases the chamber diameter by x will reduce the vertical range from y_1 to y_2 where $x = (y_1^2 - y_2^2)/2L$. L is the length of the chain, very nearly equal to the chamber diameter of 2200 mm.

By pumping water back and forth between two cisterns of approximately equal size, the

following results were obtained after 2 days of pumping. (Note that 2L = 4400 mm.)

Description of cistern	A - height = 2850 mm			B - height = 3200 mm		
	state	water depth/mm	y/mm	state	water depth/mm	y/mm
Values at 1130 on 21/3/97	full	2160	305	empty	450	235
Values at 1830 on 21/3/97	empty	1180	306	full	1330	239
Values at 0930 on 22/3/97	empty	810	316	full	1490	234

Values at 1730 on 22/3/97	full	2100	310	empty	250	235
$(y_{\max}^2 - y_{\min}^2)/4400$	1.55 mm (equiv. to 706 PPM)			0.54 mm (equiv. to 243 PPM)		
$(y_{\text{mean empty}}^2 - y_{\text{mean full}}^2)/4400$	0.49 mm (equiv. to 224 PPM)			0.16 mm (equiv. to 73 PPM)		
Mean change in water depth	1135 mm			1060 mm		

While more results would give greater statistical confidence, in the face of a measurement uncertainty in y of up to 2 mm, it seems that the soil walls are successfully supporting the mortar lining, since the strain in the mortar plaster is probably under 250 PPM. Strains over 100 PPM may produce fine cracks but the curing conditions are so

good and the mortar is worked so dry that these should not be serious. Reinforcing may be desirable to prevent concentration of strain onto a few large cracks.

Pump Testing

Pumps need testing for their performance and their durability. The first is straightforward and has been done at Kagadi and at Warwick University. The latter is laborious and uncertain (in the absence of large experimental samples) but has been commenced at Kagadi. Cistern pumps are being installed alongside the main metal pump on a shallow well that is very heavily used (50,000 litres per day) and has long queues. This duty is much more onerous than pumping from a household cistern and therefore represents accelerated testing.

Laboratory tests with the piston pump using either piston variant showed that over 15 litres per minute could be raised from a depth of 4 meters using moderate effort. Brief field tests with both variants of piston lifted 27 litres per minute from 2 meters. The wood and rubber piston sometimes unrolled when used in a dry riser: the rubber needs to locate tightly on the wood to prevent this from happening. Wiring down the pump onto the concrete plug, as described on page 22, gave it a better stiffness and pumping

feel. The tube type footvalve has not undergone any field trials: the other two have.

13 COSTS

The current costs of producing cisterns and pumps may be divided into costs of materials and labour on the one hand and the cost of management on the other. Set out below are materials and labour costs based upon conditions in rural Uganda in 1996-7 and converted to US dollars at a rate of \$1 = USh.1,000. Certain items like sand and unskilled labour may be provided by householders outside the monetary economy although of course they still incur costs and may indeed also raise actual monetary supervision costs.

Cistern costs (8,000 litre capacity with 20 mm dome and 2-coat chamber lining)

<u>Item</u>	<u>Quantity</u>	<u>Cost / \$</u>
Cement/lime (including transport)	250kg	65
Sand (assumed from a nearby source)	18 wheel barrows	3
6 mm reinforcing bar	12m	5
Chicken mesh	3 m ²	4
PVC Bucket + 0.5 m of 50 mm piping		3

Unskilled labour for digging (9 m ³) etc.	20 person days	40
Plastere	2 person days	8
Supervisor + say 25 km travel	1 person day	10
Tools		(say) 5
	TOTAL	143

Pump costs

<u>Item</u>	<u>Quantity</u>	<u>Cost / \$</u>
50 mm OD medium PVC pipe	0.5m	1.2
40 mm OD medium PVC pipe	4m	8
25 mm OD heavy plastic pipe (nom 3/4" bore)	0.3m*	1
20 mm plastic conduit tubing	2m	2.5
40 mm PVC tee and a piston	1 off*	2.8
Manufacturing labour	0.5 day	2
Wire, PVC cement, rubber, wood		1

Notes: * Piston pump assumed to have sleeve type foot-valve & leather cup piston

TOTAL for CISTERN + PUMP \$160

14 CONCLUSIONS, DESIGN VARIANTS AND FURTHER WORK

Conclusions

Under favourable soil and meteorological conditions and where the cost of labour for digging is low, the cistern design described above seems capable of bringing all-year domestic rainwater harvesting within the financial reach of many rural households. It has been developed for Ugandan conditions where it may cost around \$160 to produce (for 8000 litres storage capacity and including a hand pump). This is substantially less than the alternatives available in that country. The design is likely to find some application in other countries close to the Equator, and in urban as well as rural situations.

The cistern relies on the support of the soil in which it is dug. It is not normal practice to assume such support, so the design may be regarded as somewhat risky. The limited field evidence to date suggests that the risk is not severe. The three tanks already in use

for over twelve months are performing satisfactorily. The tests already performed on two of them indicate low initial leakage, little wall movement under cyclic water loading (under 250? PPM strain) and a safety factor of 2 over a pessimistic design load for the covering shell (dome).

In the absence of a suitable commercial pump, two designs of hand-pump have been developed to meet a particular performance, maintenance and (low) cost specification. These have performed satisfactorily in the short term but their durability is not yet determined.

Design variants

Some design variations have been discussed in this paper.

The dome of the tanks built in 1996 were 25 to 30 mm thick. Those recently tested for strength were 20 mm thick and performed well. 20 mm will be used henceforth as a norm. Moreover both mortar and concrete have been used for the dome. Concrete uses less cement, but requires fine aggregate (which is not widely available in rural areas) and is much harder to work smoothly as a plaster. There is some danger that these workability problems could lead to serious cracks in inexperienced hands. The mortar

dome looks better. Mortar is more vulnerable than concrete to shrinkage during curing, but this should not matter in a largely unconstrained dome. On balance we recommend mortar despite the 33% higher cement requirement.

The chambers of the 1996 cisterns were single plastered to a thickness of 30 mm. The later tanks are using 20 mm applied as two layers (e.g. 15 mm plus 5 mm) rather than one. The tank most in danger of earth tremors has just been plastered with a 2-layer lime-cement mortar; it may take some years before the benefits of using this slower curing but more flexible plaster can be assessed.

The piston pump appears to be easy to use but its durability is not well tested. Both piston variants and all three foot valve designs seem satisfactory.

A variant of considerable interest to users is a much bigger cistern - say one of 20,000 litres capacity. This could be used with institutional roofs like those of schools and churches. Such a cistern must either be very deep (e.g. 7 meters) or wide. A diameter of 3 meters (40% more than current designs) and a depth of 4 meters (dome top to chamber bottom) would give adequate capacity. Almost certainly a 30 mm dome of this span would be safe, so such a large tank looks feasible.

Further work

Further leakage tests, performed on a number of tanks, are underway. They should increase confidence in the design and may lead to exploration of repairing cracks or giving tanks a further cement wash. Theoretical modelling of both dome and chamber may indicate the need for a modified construction procedure - such as filling a tank during its curing period to pre-stress its lining. The uncertainty about the forces generated by the undisturbed chamber walls and by the back-fill over the dome makes such analysis of limited value.

Depending upon the outcome of funding discussions, tanks and pumps may be built in several of Ugandas 40 Districts during 1997, in order to check their local costs, construction time and performance. Other desirable further work concerns the development of ancillaries such as a very cheap water-consumption gauge and an in-tank slow sand filter.

15 REFERENCES

BAMBRAH G K, (1995) Rainwater Tanks - Technical Note No.2, *Raindrop*, Ser 2, Vol 3, pp i-iv (based in part on *A Workshop Design for Rainwater Roof Catchment Systems WASH Tech Rep No 27*)

HEGGEN R J, (1993) Value of daily data for rainwater catchment, *Proc 6th Internat Conf on Rainwater Catchment Systems, Nairobi, Kenya*

KYAMBADDE E & THOMAS T H, (1997) *Traditional Methods of Domestic Rainwater Harvesting used in Buyaga County, Western Uganda*, URDT/DTU Research Note No.1, Kagadi, Uganda / Coventry, UK, 6pp

NTALE H K, (1996) *Overcoming the Hindrances in Rainwater*, Report (to UNICEF) of Civil Engineering Dept., Makerere University, Uganda

PACEY A & CULLIS A, (1986), *Rainwater Harvesting: The collection of rainfall and runoff in rural areas*, Intermediate Technology Pubs.

RUGUMAYO A I, (1995) Rainwater Harvesting in Uganda, *Sustainability of Water Supply and Sanitation Systems* (Proc 21st WEDC Conf, Kampala), WEDC Loughborough University, UK, pp 226-231

SKINNER B, (1995) Ferrocement Water Storage Tanks Ibid., pp 241-4

THOMAS T H, (1995) *Preliminary Study of Rainwater Harvesting in Mid-West Uganda*, Working Paper 45, Development Technology Unit, Warwick University, UK , 6pp

THOMAS T H, (April 1997) *Guttering Design for Rainwater Harvesting with special reference to conditions in Uganda*, URDT/DTU Rainwater Harvesting Research Note No.2, Kagadi, Uganda / Coventry, UK

[\(Return to top of Document\)](#)

[home.cd3wd.ar.cn.de.en.es.fr.id.it.ph.po.ru.sw](#)

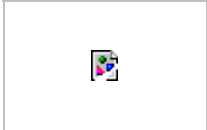

**DEVELOPMENT
TECHNOLOGY
UNIT**

Working Paper No. 50

(also published as URDT Rainwater Harvesting Research Note No.2)

Guttering Design for Rainwater Harvesting

with special reference to conditions in Uganda

October 1997

T.H. Thomas

**Development Technology
Unit
School of Engineering
University of Warwick
Coventry CV4 7AL, UK**
Telephone (+44/ 0) 2476
522339
(Director) 523122

**Uganda Rural Development and Training Programme
(URDT)**
P.O.Box 16253, Kampala, Uganda
& P.O.Box 24, Kagadi, Kibaale
Tel. (+256/0) 41 256704, Fax. 242270
& Kagadi Tel. 483 22821
Email: URDT@mukla.ac.ug

Fax (+44/0) 2476 418922

Email: dtu@eng.warwick.ac.uk

Abstract

The way that rain runs off an unguttered roof is discussed and supported by findings from laboratory experiments. The purpose of and constraints upon guttering are identified. The principles of guttering design are developed and the trade-offs between cost, effectiveness in intercepting run-off, capacity to carry flow and architectural impact are discussed. Several low-cost guttering variants are identified, as are different ways of fixing gutters onto simple buildings. Initial field trials in Uganda are reported.

Contents

[1 Introduction](#)

[2 Guttering Design](#)

2.1 Choosing the slope

2.2 Choosing the shape

2.3 Guttering materials

2.4 Fixing gutters

[3 Laboratory Experimentals](#)

3.1 Experimental arrangements and results

3.2 Discussion of findings

[4 Results of initial field experiments](#)

[5 Conclusions](#)

[Appendix A Measured runoff trajectories from corrugated roofing](#)

[Appendix B Theory of flow down corrugations](#)

List of Figures

[Figure 1 Water falling from a roof](#)

[Figure 2 Gutter slope](#)

(a) close-fit gutter with very small slope

(b) gutter with uniform slope

(c) roof edge sloping with the gutter

(d) gutter with slope increasing towards the discharge end

[Figure 3 Gutter shapes evaluated in Table](#)

[Figure 4 Roof edge detail and some gutter supports](#)

(a) typical roof edge

(b) wiring to roof sheet or wooden spar

(c) tube and nail connection to fascia board

(d) shaped bar connected to purlin

(e) strip or bar connected to rafter end

[Figure 5 Trajectories of falling water](#)

[Figure 6 Effect of roof length on throw](#)

List of Tables and Graphs

[Table 1 Gutter capacity](#)

[Table 2 Shape factors for gutters](#)

[Table 3 Compressed data from indoor experiments](#)

[Table 4 Throw at a drop of 300 mm and constant furrow discharge](#)

[Table 5 Throw from an actual roof](#)

Notes: This version of the Working Paper is provisional and it is hoped to replace it by a fuller version in 1998 after further experiments have been undertaken.

The Kagadi data was recorded by Mr Turyamureba Victor of URDT.

1 INTRODUCTION

The main components of a rainwater harvesting system fed by run-off from a roof are a tank and guttering, where guttering includes both the actual gutters and the downpipe connecting gutters to tank. This paper examines the factors that control the design of good gutters. (Downpipes will be treated in the revision to this Working Paper planned for April 1998 following further fieldwork.) It reports work done within a programme to reduce the cost of the different components of domestic rainwater harvesting systems. Target costs of \$50 and \$200 have been chosen for respectively wet season only and all year water supply systems. Guttering represents about 30% of the cost of a wet season only system, built to provide domestic water for about 8 months per year in Uganda, but only about 10% of the cost of an all-year system in which the water storage capacity is large and expensive. Many gutters in Uganda perform badly and some are unsightly (for example large troughs made by cutting corrugated sheets). The majority of buildings are unguttered and need to be fitted if rainwater is to be harvested. For reasons not discussed in this paper, rainwater harvesting is likely to increase substantially in Uganda in the next few years.

Rain falling upon a sloping roof runs towards its lower edge and, if there are no gutters, from there falls to the ground. A little of the rain hitting the roof may evaporate at once from the roof surface, but typically over 95% will run off. By the time that the water reaches the edge of the roof it has acquired a velocity v parallel to the roof surface. This velocity increases with

- a. the intensity I of the rainfall during the last few seconds (e.g. in millimetres per minute)
- b. the length L of the roof, from ridge to edge in the direction of water flow
- c. the slope of the roof S
- d. the smoothness and shape of the roofing material.

During rain, even very heavy rain, the film of water on a roof is quite thin. On a plane roof it rarely exceeds 0.4 mm and in the furrows of a corrugated roof it rarely exceeds 1.5 mm. This shallow flow is subject to frictional drag as it moves down the roof. *If* there were no water-roof friction, quite high speeds would be reached - up to 5 meters per second on a typical roof. However there is friction and actual speeds are much lower than this, typically under 0.5 m/s. As rainwater flows down a roof from its top, being augmented as it goes, the film gets both deeper and faster. It usually has reached an equilibrium speed at which the pull of gravity on the water is exactly balanced by the friction drag force on it. This equilibrium speed is about twice as high for a corrugated roof as for a plane or ribbed roof, and about 50% higher for a shiny metal roof than for a rough tiled one. (See Appendix B)

Because the runoff velocity at the bottom of the roof is not zero, the water does not fall vertically from the roof edge but instead follows a curved trajectory. Figure 1 shows such a trajectory. Under windless conditions, the no-wind outward throw x increases with

drop y from the roof edge. For each run-off velocity v there will be a different curve: the higher the velocity, the greater the throw x .

It is common to experience strong winds during rainfall and these further disturb the stream of falling water, causing the actual throw x_w to vary continuously about its windless value x . For any particular roof therefore, the throw x_w for a given drop y varies predictably with rainfall intensity and unpredictably with wind. These variations make the design of guttering systems more difficult. It *may* be possible to obtain data about rainfall intensity - for example what fraction of annual rainfall occurs during storms exceeding a given intensity - and use this to aid guttering design. It is rarely possible to obtain relevant windspeed data or to use it in design, so it is desirable to undertake experiments to measure the statistical distribution of throw over a typical year before deciding guttering norms.

Where there are no gutters, water falls freely from roof edge to ground. There it may cause erosion of the soils and splashing of the bottom part of the buildings walls. It is usual to make unguttered roofs overhang the walls by 300 to 600 mm to minimise damage to walls or foundations (and in hot climates also to shade the walls). Even so, it is common to find serious gully erosion around unguttered houses in tropical towns. In temperate climates almost all buildings are guttered and roof overhangs are often as little as 50 mm.

Gutters are fitted to roofs to channel the run-off into a drain or, in the case of rainwater harvesting, into a collecting vessel. (Water *can* be collected in wide-mouthed ground-level vessels even without using gutters but this process has several difficulties.) A gutter has essentially two functions

- a. to intercept the run-off on its way from roof edge to the ground
- b. to transport the intercepted water sideways towards some concentration point (usually to a downpipe).

For either of these functions the gutter may be less than 100% effective. If it is not wide enough some of the run-off may overshoot it and not be intercepted. If its carrying capacity is inadequate, it will overflow during heavy storms and lose some of the water that it has intercepted. Unfortunately, as will be shown later, some of the techniques for increasing capacity also reduce the fraction of water that is intercepted.

Because gutters have to be open-topped, they are not very suitable for conveying water downwards to the drain or collecting vessel. This task of vertical transport is usually performed by a closed downpipe. To connect the gutter to the downpipe there may be a specially shaped junction called a gully. Alternatives to the use of a downpipe are to let the water stream free-fall from the end of the gutter or to guide it by means of a rod or chain to which the water sticks by surface tension.

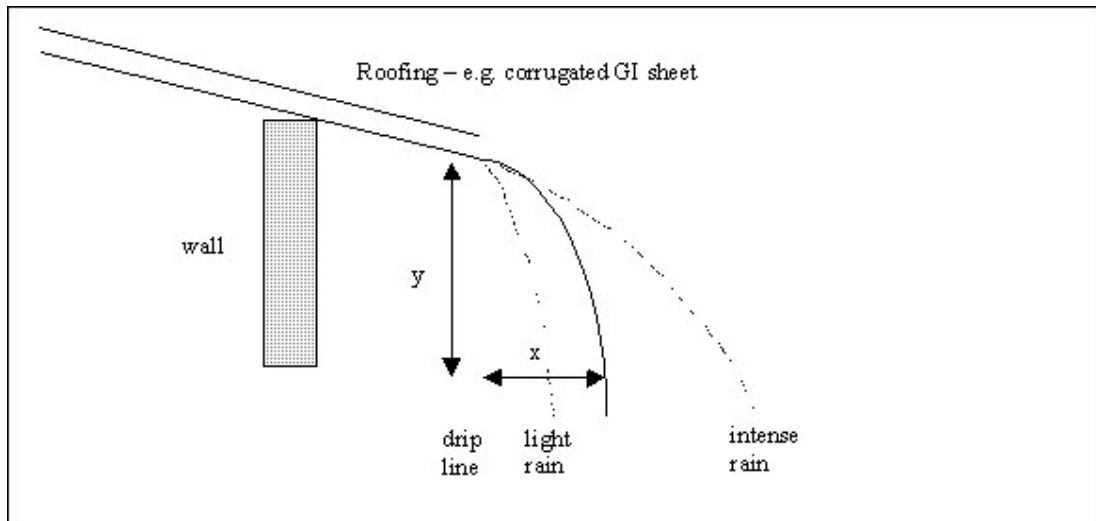
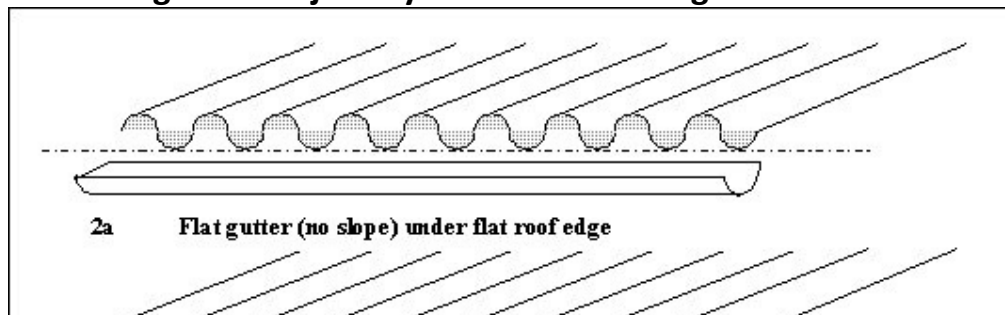

Figure 1 Trajectory of flow off an un-guttered roof



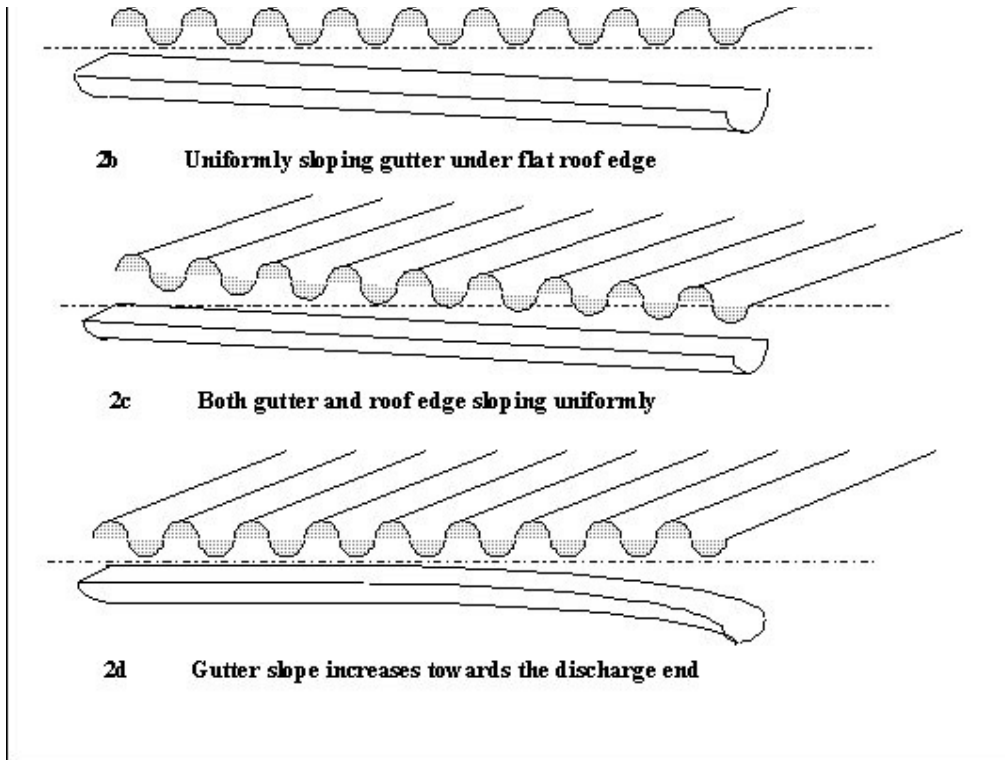

Figure 2 Gutter slope

[\(Return to top of document\)](#)

2 GUTTERING DESIGN

Our general design objective is to find the cheapest guttering arrangement that will achieve an agreed level of performance (such as to collect 95% of annual roof run-off). We need to select the slope, size, shape and material of the gutter.

2.1 Choosing the slope

The capacity of a gutter, i.e. the flow Q_C it can carry without over-topping, depends on several factors, especially:

- a. its cross-sectional area A
- b. its hydraulic radius $R=A/P$, where P is the length of the perimeter of the wetted cross-section when full, (for a square gutter $R = 0.33 \times$ width, for a semicircular gutter running full $R = 0.25 \times$ diameter, for a semi-circular gutter or roof furrow carrying a shallow flow $R = 0.67 \times$ depth of water)
- c. its slope S
- d. its roughness.

The standard formula is Mannings. Using the realistic value 0.01 for Mannings n gives:

$$\text{Flow in m}^3 \text{ per second, } Q_C = 100 A R^{0.67} S^{0.5} \text{ [Eq.1]}$$

(To convert Q_C to litres/minute, multiply the value given by this formula by 60 000.)

We can thus see that doubling the size of a gutter (for example its diameter) and hence increasing its area four-fold will multiply its capacity by 6.4 ($= 4 \times 2^{0.67}$). Doubling the slope S will only multiply it by 1.41 ($= 2$).

In an area subject to tropical rainfall, we might design gutters for rainfall intensities up to 4 mm per minute (i.e. to carry up to 4 litres per minute run-off per square meter of roof area). Some representative gutter capacities for comparison are

Gutter description	Capacity in litres per minute at the specified slope (m ² of roof that can be drained at rainfall of 4 mm/min is shown in brackets)			
	Slope =	1%	2%	3%
semicircular, 50 mm ID	32 (8)	45 (11)	55 (14)	64 (16)
semicircular, 75 mm	95 (24)	132 (34)	162 (41)	190 (48)

ID				
semicircular, 100 mm ID	201 (50)	285 (71)	349 (87)	403 (101)
rectangular, 25mm x 50mm wide	40 (10)	57 (14)	70 (18)	82 (21)
square, 75 mm x 75 mm	285 (71)	403 (101)	494 (124)	570 (143)
square, 100 mm x 100 mm	614 (151)	868 (217)	1076 (267)	1228 (307)

Table 1 : Gutter capacity related to size, type and slope

From this table, and remembering that more than one gutter would normally be used, we can see that 75 mm width should be adequate for most domestic roofs and even only 50 mm might suffice.

Many gutters are laid almost level (with slope S less than 1%), close below the roof edge, as is shown in Figure 2a. In this position the drop y from furrow mouth to gutter is very

small, perhaps only 20 mm, so both the mean throw (= no-wind throw x) and the variation in throw due to wind are small. Even a narrow gutter may be able to intercept all the run-off. However the small slope means that to achieve adequate carrying capacity the gutter must be large and costly. Architecturally this arrangement is neat: the gutter is unobtrusive and even where the eaves are low, the gutter can be kept above head height.

An alternative, as shown in Figure 2b, is to make the gutter steeper - say having a slope of 4% (for example a fall of 200 mm over a typical 5 m length). The formula above shows that for a given size the bigger slope increases capacity Q_C ; as we are designing for a particular capacity, using the bigger slope allows us to reduce the gutter size and hence its cost. Unfortunately the discharge end of a sloping gutter will be some way below the roof edge, and at this end may not intercept all the water coming off the roof. So we have the conflict that increasing the slope S will increase capacity but may reduce interception efficiency E_{Int} (= fraction of run-off that is intercepted).

There are three techniques for resolving this conflict so that steep slopes can be used safely. The first is to keep the gutter as short as possible, by putting downpipes in the centre of a long gutter rather than at one end of it. This has the effect of creating two half-length gutters, each dropping towards the centre. Architecture may prevent the location of a downpipe exactly in the middle of a wall, but it is often possible to locate it

somewhere near the middle. The custom of placing rainwater collection tanks at the corner of a building, or worse underneath the gable ends, means large gutters must be used. Moving the down-pipe from the gutters end to a midway position means that for a given roof catchment the gutter can be about 32% smaller in diameter and therefore significantly cheaper.

The second technique is shown in Figure 2c. Here the purlin and hence the roof edge itself falls at a slope of several %, following the slope desired for the gutter. The gutter fits tightly under the roof edge all along its length, so there is no danger of failure to intercept run-off near its lower end. Of course this is against normal building practice, but it is easy to construct and not unsightly in simple buildings.

The third technique is to use a gutter slope that increases towards the discharge end, as shown in Figure 2d. As one moves along the gutter from its closed end to its discharge end (left to right in the figure) the flow increases, reaching a maximum at the discharge point. Ideally we should correspondingly increase either the slope or the size of the gutter as we approach that point. Generally it is not convenient to vary the gutter size along its length, but most gutters are sufficiently flexible that their slope can be varied. The most efficient curve for the gutter to follow is

$$y_F = K z^3 \text{ [Eq.2]}$$

where y_F is the fall of the gutter below the height of its closed end at a distance z from that end, and the constant K equals $S_{\max} / 3L^2$. L is the length of the gutter and S_{\max} is the slope needed to give enough capacity at the discharge end.

Comparing Figure 2d (where the gutter has this ideal varying slope) with Figure 2b (where the slope is fixed at $S = S_{\max}$), we find that the fall at the discharge end is reduced by a factor of 3. For example we might compare a 6m gutter sloping uniformly (as Figure 2b) at 4% with a gutter made of 3 x 2m sections sloped at 0%, 1% and 4% respectively (which approximately follows the ideal curve). The first arrangement falls 24 cm along its length, the second falls only 9 cm, giving a substantial and useful reduction.

2.2 Choosing the shape

The cost of a gutter is dominated by the amount of material in it. As gutters are generally made of material of constant thickness, this amount is usually proportional to the width of the strip from which it was formed. This width is the same as the perimeter distance P used in the flow formula, Eq.1. We therefore seek to minimise P while maintaining the properties that we require, namely adequate capacity, high run-off interception and sufficient stiffness to allow the gutter supports to be widely spaced.

For good interception we require a big gutter aperture W . The run-off stream should also

hit a gutter surface that is angled to reflect the stream into the gutter rather than outside it. Figure 3 shows some good and bad gutter shapes from these two points of view.

For high flow capacity the area A should be as large as possible, while for high stiffness D^3 should be maximised (D is depth). We can express the interception efficiency, flow capacity and stiffness obtainable in relation to the width P of guttering material by three dimensionless ratios. These are: area ratio = A/P^2 , aperture ratio = W/P and stiffness ratio = D^3/P^3 . They have the following values for the various shapes shown in Figure 3.

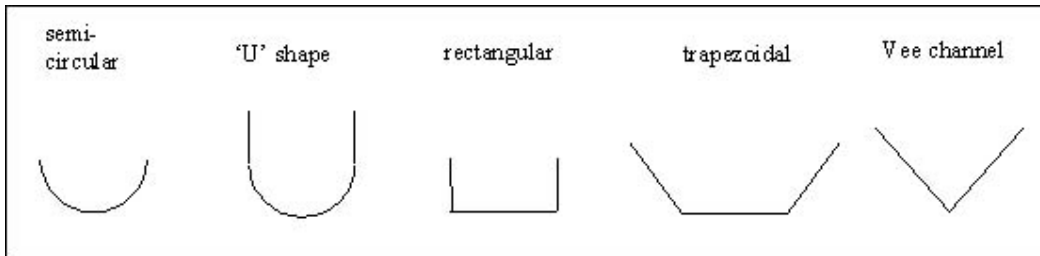

Figure 3 Shapes for gutters

	area ratio	aperture ratio	stiffness ratio

Semicircular trough	$A/p^2 =$ 0.159	$W/P =$ 0.64	$D^3/p^3 =$ 0.032
'U' whose height equals its width	$A/p^2 =$ 0.135	$W/P =$ 0.39	$D^3/p^3 =$ 0.059
Rectangular channel ($h=1/2w$)	$A/p^2 =$ 0.125	$W/P =$ 0.50	$D^3/p^3 =$ 0.016
45 deg. trapezoidal channel with sides equal to base	$A/p^2 =$ 0.134	$W/P =$ 0.80	$D^3/p^3 =$ 0.013
90 deg. 'V' channel	$A/p^2 =$ 0.124	$W/P =$ 0.71	$D^3/p^3 =$ 0.044

Table 2 : Shape factors for gutters (the higher the values, the better)

Resistance to twisting is poor for any open section. For a given perimeter P it does not vary with gutter shape. Resistance to bending is determined by the second moment of area about a horizontal axis, which is approximately proportional to the cube of the gutter depth.

Thus the *semicircular trough* has about the best combination of properties, moreover it

is fairly easy to make in metal and in plastic may be obtained by slicing a pipe in half. The resistance to vertical bending can be improved if periodic spacers are used to maintain the semi-circular shape against the tendency to flatten during bending.

[\(Return to top of document\)](#)

2.3 Guttering Materials

Modern materials are generally expensive in Uganda and are difficult to obtain outside Kampala or Jinja. Even substantial towns lack steel or plastic stockists although corrugated GI sheeting and plastic mouldings like bowls are available even in tiny trading posts.

Temporary gutters are often made of banana stems or bamboo. More permanent materials are extruded PVC, galvanised iron sheet, aluminium sheet and wood.

Wooden gutters need much skill or machinery to make watertight and are prone to warping and cracking as humidity changes. Moreover planks thinner than 25 mm are not available in most parts of the country, so wooden gutters are also heavy. They are not commonly found.

Aluminium sheet is more expensive and much less widely available than steel. Its

workability is similar to steel and its resistance to corrosion is higher than galvanised iron (galvanised mild steel). Ugandan industry does not have the capacity to extrude aluminium sections, nor are many imported.

PVC is the standard guttering material in temperate countries but has a shorter life under tropical levels of ultra-violet radiation. Extruded purpose-made gutters are not yet widely available in Uganda, so slit PVC piping has to be used (which lacks desirable thickening at the edges and sealable joints). PVC costs about twice as much as galvanised steel. If rainwater harvesting becomes more common, Ugandan manufacturers of extruded plastic products may add gutters and associated fittings to their range. Meanwhile PVC and (more flexible and durable) HDPE tubing is suitable for downpipes, while gutter-downpipe junctions can be fabricated from plastic containers such as 3 litre oil cans.

At least in the short term GI sheeting (preferably not already corrugated) is the most suitable material for gutter construction. It requires folding at the edges to reduce sharpness. Such doubling increases torsional stiffness and may aid location in supports; it does however complicate jointing and the sealing of blind ends. Both rectangular and curved GI guttering is available on the market (at about \$2 per meter for semicircular guttering of 80 mm diameter) being produced by very small enterprises by folding or rolling. All fittings must be made by the installer. Soldered or crimped GI tubes are

widely used for downpipes but they are often crudely made, leak at elbows, fail to fit well and are more prone to rusting than GI gutters.

[\(Return to top of document\)](#)

2.4 Fixing Gutters

The fixing of gutters has to permit them to be given the appropriate slope and centreline location. Fixings have to resist wind forces, the weight of water, forces due to arresting the fall of the water stream and miscellaneous forces such as being stood on by someone mounting the roof. This last force is usually the largest and it is prudent to support gutters such that a 70 kg weight could be momentarily hung on any part without causing permanent displacement. For gutters up to 100 mm diameter, the weight of water and of momentum transfer is unlikely to exceed 10 kg per meter run.

Figure 4a shows a roof-edge detail typical of Ugandan houses with corrugated iron (CI) roofs. (Almost all buildings are single storey with CI or grass roofs). Few buildings have fascia boards, however where one is present the gutter can be nailed directly to it as shown in Figure 4c. The simplest fixing uses a nail longer than the gutter width driven through the gutter into the fascia. To prevent the gutter collapsing, a sleeve of metal pipe or plastic conduit should surround the nail where it crosses from one side of the gutter to the other. The best support comes where the fascia is backed by a rafter end.

Vertical adjustment has to be done before the nails are driven. The fascia board may have to be packed out to the right position behind the roof edge. In the absence of a fascia, gutters have to be supported from one of the following:

- a) the purlin - usually a 80 mm x 50 mm timber, see Figure 4d (bracket wired to purlin or put through a hole drilled in the purlin)
- b) the rafter ends, see Figure 4e
- c) the roof sheets themselves, see Figure 4b
- d) the wall, which is usually 300 mm to 600 mm behind the roof edge
- e) the ground (typically 2.2m below the roof edge).

In practice a) and b) offer the only simple fixings. Hanging from the roof edge with wire encourages rusting at the hole made in the sheet and gives poor control against wind forces or gutter twisting. The wire soon rusts too.

Many buildings are only approximately horizontal so it is not easy to install gutters with a specified slope. Purlins offer greater scope for achieving suitable support spacing, rafter ends allow easier vertical adjustment. Notice with both Figures 4d and 4e that the

bar or strip is bent back at its outer end to restrain the gutter. A suitable material is 6 mm reinforcing bar and this may easily be hammered into the right shape; to attach bar to a rafter it may be locally flattened and pierced by a blacksmith or it may be held with staples. With both 4d and 4e fixings, adjusting the vertical height of the gutter is likely to result in some rotation. Clearly the ideal is for the outer edge of the gutter to be as high as (or even higher than) its inner edge. In the position shown in Figure 4d, the purlin bar has inadequate vertical support. There are several options for locating it more rigidly. The first is to wire it tightly to the purlin. The second is to drill a (6 mm?) hole through the purlin, pass the bar through this hole and then bend the inwards end of the bar down behind it. The third is to give the bar a long tail that lies along the underside of a corrugation. Since both rafters and purlins vary considerably in size and location, some adjustment of the fixings by the installer will almost certainly be required to achieve the right gutter slope, distance out from the roof edge and rotation. This is an area of weakness since few installers are conscious of guttering design or possess tools like levels or hand drills. There is not yet in Uganda the custom of selling building products with installation advice notes, but such a practice may prove necessary for gutters.

In addition to facilitating slope adjustment, the fixing should resist the likely forces (including upwards wind forces), be durable, available and cheap, and should help the gutter retain its optimum shape. Mass-produced fixings are not available on the Ugandan market, so fixings are usually improvised by house-holders or builders with the

aid of very the simple hand-tools.

Gutters are often made of several sections joined together. With mass-produced PVC guttering these joints are made with special injection-moulded connectors. With rural guttering in Africa, joints are made without such fittings. Successive gutter sections are overlapped, with the upstream section lying inside the downstream section. An overlap of 150 mm is common. The overlapped section should ideally be over a support. To hold the sections together they may be bound with rubber strip, or in the case of metal gutters they may be riveted. The upstream end of a gutter needs to be blocked to ensure all water flows to the downstream (outlet) end. A wooden disc that just fills the trough (held in position with a rubber strip) can be used to block the end of plastic guttering. For guttering made from sheet metal it is usually easier to make an end stop by folding up the metal.

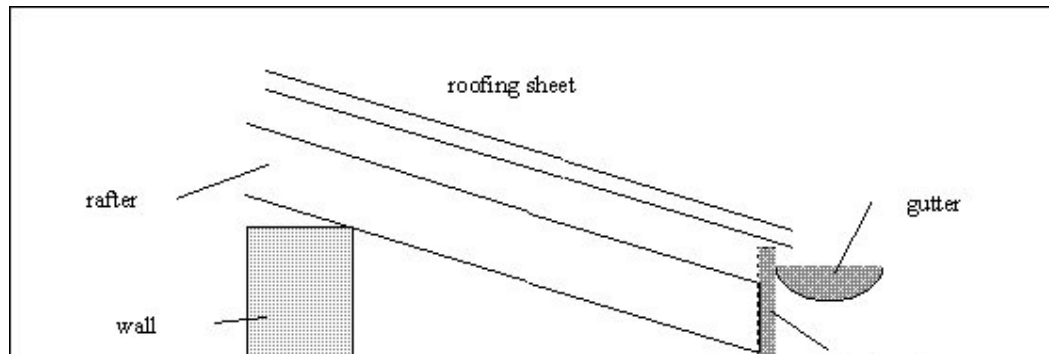



fascia board
(optional)

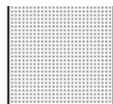

4a - Typical roof edge

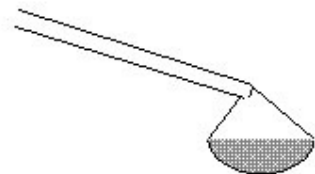

4b - Wiring to roof edge or spar

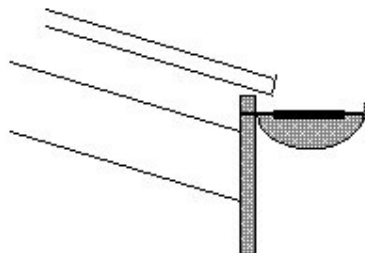

4c - Nailing to fascia board - plastic or metal tube inside gutter prevents the nail from collapsing it

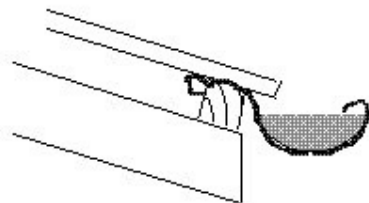

4d - Shaped bar connected to purlin

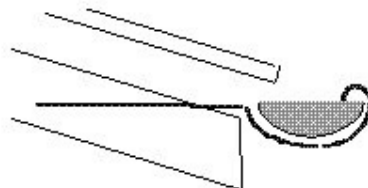

4e - Strip connected to end of rafter

Figure 4 Roof-edge details and some gutter supports

[\(Return to top of document\)](#)

3 LABORATORY EXPERIMENTS

3.1 Experimental arrangements and results

In the laboratory it is possible to set the rainfall fairly carefully and to observe the resultant run-off behaviour. However it is not easy to mimic the effects of wind. The laboratory data reported below therefore relates to the no wind trajectory of the water leaving a roof. Corrugated galvanised iron roofing was used (furrow pitch = 80 mm).

An apparatus was built which allowed the following roof parameters to be set:

roof slope ($\sin \theta = \text{rise/length}$) = 0.1 (v. shallow), 0.2, 0.4, 0.6 and 0.8 (v. steep)

roof length = 0.7, 1.4, 2.1, 2.8, 3.5 and 4.2 meters

rainfall intensity = 0.5 mm/minute (light), 1 (heavy), 2 (very heavy) and 4 (cloudburst)

For each combination of slope, length and rainfall intensity, the throw x was measured at four different values (100 mm, 200 mm, 1000 mm and 2000 mm) of the drop y . The throw was measured relative to a vertical line descending from the lip of each corrugation (furrow). The rain was simulated by a calibrated (2%) 3-jet spray applied at

the centre of each 0.7 meter length of furrow. At low rainfall intensities this spray spread over only a few cm of furrow. At maximum intensity it spread over the entire 0.7 meter length. It is not thought that this distribution has significantly distorted the data (compared with the ideal of a uniform distribution). The maximum rainfall intensity chosen (4 mm per minute) is likely to occur for only a few minutes a year even in the tropics. From a rainwater harvesting point of view, to be able to intercept run-off at all intensities up to 2 mm per minute would be quite good enough.

Spray bars were placed horizontally across the roofing so that the various furrow length could be simulated by having a particular furrow fed from 1 or 2 or 3 etc. bars. Unfortunately this means that a different furrow is used for each length, so that the effect of any imperfections in the furrow lip falsely appear in the data as length effects. The rig also had an unintentional short section (0.3 m) of unsprayed roof immediately above the furrow lips. It might be thought that the water would accelerate down this section and give an upwards bias to the throw data. However the discharge velocities are found to be only about 10% of those calculated assuming no water friction in the furrows. This suggests that the flow reaches a velocity equilibrium almost immediately - within a few cm of the rain impact point. So no corrections have been made for this unintended dry section.

A further small experiment was undertaken to check that the flow down a roof quickly

reaches equilibrium. A flow was generated by spraying various parts of a roof in such a way that the discharge from each furrow was held constant. It was found that if the rain was sprayed near the top of the roof (i.e. between about 3.2 m and 4.5 m from the roof edge) the discharge velocity was 10% to 15% higher than when it was sprayed near the bottom of the roof (i.e between about 0.4 m and 1.7 m from the roof edge). This suggests that it is strictly untrue to say that equilibrium velocities are almost instantly reached: the water is still accelerating when it reaches the roof edge. However for practical purposes we can use equilibrium theory to roughly estimate the thickness of the water film (observed above to be under 1 mm) and the effect of corrugations in increasing the discharge velocity (by a factor of from 1.5 to 2.5) over that observable with other roofing profiles.

Slope	Length	Throw (mm) at a drop of 100 mm for the rainfall intensities below											
		0.5 mm/min			1.0 mm/min			2.0 mm/min			4.0 mm/min		
arcsine	m	<i>min</i>	<i>max</i>	<i>ave</i>	<i>min</i>	<i>max</i>	<i>ave</i>	<i>min</i>	<i>max</i>	<i>ave</i>	<i>min</i>	<i>max</i>	<i>ave</i>
0.1	1.05	0	0	0	0	2	*1	15	27	21	43	55	49
	2.45	0	0	0	5	38	22	57	67	62	68	82	75

	3.85	5	40	*22	37	50	43	75	90	82	77	91	84
0.2	1.05	0	0	0	0	2	*1	25	37	31	57	67	62
	2.45	0	15	*7	27	55	41	70	95	82	83	97	90
	3.85	7	45	*26	48	72	60	85	105	95	92	108	100
0.4	1.05	0	5	*2	0	14	*7	37	47	42	70	85	77
	2.45	12	37	*24	15	67	41	70	85	77	100	112	106
	3.85	27	55	41	42	82	62	75	95	85	100	117	113
0.6	1.05	0	10	*5	0	15	*7	45	53	49	60	80	70
	2.45	2	45	*23	20	72	46	75	95	85	82	95	88
	3.85	35	70	52	40	77	+58	95	107	101	90	102	96
0.8	1.05	2	12	*7	0	17	*8	45	57	51	60	75	67
	2.45	10	35	*22	30	62	46	70	85	77	75	80	77

	3.85	20	75	47	35	67	51	80	92	86	80	87	84
--	------	----	----	----	----	----	----	----	----	----	----	----	----

Table 3 Compressed data from indoor experiments: Throw at 100 mm below lip

Combination of measures for roof lengths (0.7 & 1.4), (2.1 & 2.8), (3.5 & 4.2)

For throws at 300 mm, 1000 mm and 2000 mm below lip multiply data by 1.7, 3.0 and 4.5 except data shown *, in which case use factors 1.2, 2.0 and 3.0.

The typical figure shown in bold (**+58 mm**) corresponds to a water velocity of 0.70 m/s.

[\(Return to top of document\)](#)

3.2 Discussion of findings

Examination of this data indicates that *even in the absence of wind*, a gutter 100 mm below a roof edge (say with 4 m long furrows and a typical slope of 0.6) needs to be at least 100 mm wide to catch all the run-off at rainfall intensities from 0 to 2 mm/minute. At 300 mm below the roof edge a 150 mm gutter would be needed. A gutter or trough placed at ground level, say 2 m below the roof edge, correspondingly needs to be about 500 mm wide. The presence of wind would considerably increase these widths necessary for effective (say 98%) interception. Wind particularly effects lighter precipitation. Whilst this lighter rain may not constitute the major part of total annual precipitation in a tropical location, it may include particularly valuable supplies during drier months.

The flow observed from the roof edge showed some instability, especially at low flow rates when surface tension may cause the jet to adhere to the lip of the furrow and leave it with negligible horizontal velocity (and therefore negligible throw). The flowrate at which this surface tension adhesion is first broken depends upon the fine detail of the lip and upon the roof slope. For a shallow roof with standard 80 mm pitch corrugations it is about 0.15 litres per minute per furrow, corresponding to a medium rainfall intensity of say 0.7 mm/minute (40 mm/hour) falling on a 3-meter roof. Thus for much of a typical rainfall event we can treat the water as dropping vertically from the edge of a *shallow* roof unless it is displaced by wind. Figure 6 shows the phenomenon. For steeper roofs the break-away occurs at lower flows.

Another form of flow-instability visible in roof furrows is pulsation. The water travels down a furrow in waves and in consequence the jet leaving its lip is pulsating. The throw for any given drop therefore varies cyclically between a maximum value and a minimum one whose ratio exceeds 2:1 for all but the heaviest flows. Often the minimum throw is zero due to surface-tension adhesion even when the maximum throw is quite large. In all the following discussion, the data we will use is the mean of these pulsation minima and maxima.

The trajectory followed by the falling spout is not the exact parabola we should expect in the absence of air friction. Friction has the effect of reducing the throw at long drops.

For example if we compare the throws at drops of 2000 mm and at 100 mm (which in the absence of friction would be in the ratio of $(2000/100) = 4.5$) we find an actual throw ratio varying from 3.0 at very low discharges to 4.5 for medium and high discharges.

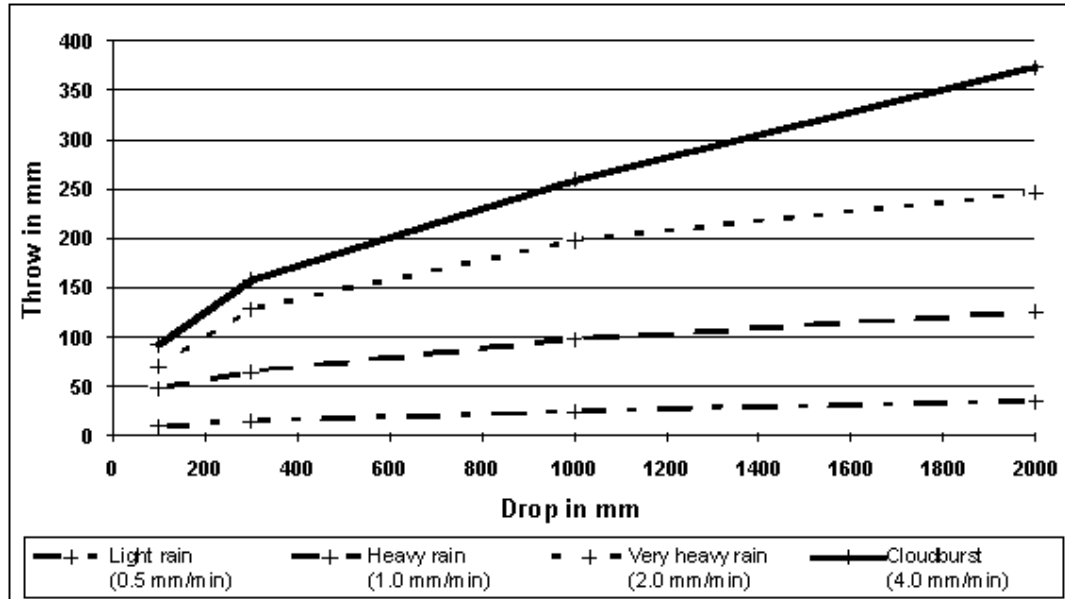

Figure 5 Trajectory of falling water : Throw in mm

(Roof is of length 2.8 m and of shallow slope $\sin \theta = 0.2$)

For a given roof slope, the mean throw at a given drop depends mainly on the flowrate discharging from the lip, and not so much upon the particular combination of rainfall intensity and furrow length producing that discharge. Table 4 below shows throw, at a given drop, for a fixed furrow discharge but for various intensity-furrow length combinations. (The individual table entries show much scatter due to lip variations). Interestingly the average throw reaches a maximum at a roof slope of about 60% ($\theta \cong 40^0$, a common roof slope) and declines as slope increases beyond this.

Rain Intensity	Furrow Length	Roof Slope			
		0.2	0.4	0.6	0.8
mm/min	m				
1	2.8	86	120	113	105
2	1.4	68	53	113	73
4	0.7	65	78	115	78

Average of the three throws above	73	84	114	85
--------------------------------------	----	----	-----	----

Table 4 Throw (mm) at a drop of 300 mm and constant furrow discharge of 0.22 l/min

As long furrows collect more rain than short ones, we should expect throw to increase with furrow length. Indeed observing buildings whose roofs contain sheets of different lengths reveals a great dependence of throw upon furrow length. In the same storm, 3 meter furrows may only dribble whilst 5 meter ones gush. Graph 2 shows this effect as furrow initially lengthen, but then rather surprisingly the throw tends to a limit as the furrow lengthens further. This phenomena depends on furrow shape: the experimental data was obtained from sinusoidal furrows.

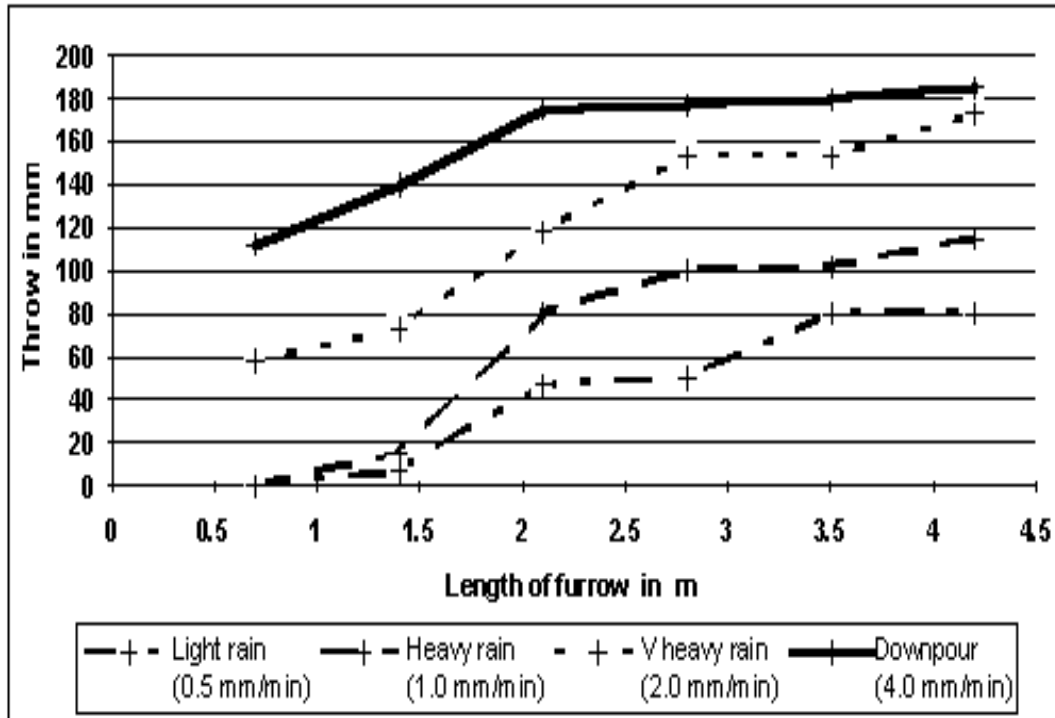

Figure 6 Effect of Roof length on Throw in mm
(Roof slope is 0.6, Drop is 300 mm)

To summarise these laboratory findings:

- 1 even in the absence of wind, a wide gutter (over 75 mm wide) is needed to intercept intense rainfall if the drop from roof edge to gutter exceeds more than about 10 cm;
- 2 the jet leaving a furrow pulsates significantly;
- 3 the trajectory of the jet is nearly parabolic during intense rainfall, but is affected by air friction (throw is less than expected at large drops) during normal or light rainfall;
- 4 for a given roof slope and rain intensity, the jet velocity (and hence throw) increases with furrow length only up to a certain point then tends to a constant (*the theory presented in Appendix B suggests that throw might increase with furrow-length^{1/4} : this is broadly compatible with the shape of the curves in figure 6*);
- 5 at low flows, the surface tension at the lip of the furrow prevents the jet from detaching from the lip except in a vertically downwards direction, thus at low flows there is no throw.

[\(Return to top of document\)](#)

4 RESULTS OF INITIAL FIELD EXPERIMENTS

The flow off a long shallow unguttered roof in Western Uganda was studied. (Roof-

furrow length was 5.7 meters and the furrows sloped at $\sin \theta = 0.09$). The roof was supported by walls with full length unglazed openings immediately under the roof edge. This meant that wind could blow through these walls, a situation not representative of solid walls where wind can only blow parallel them. For this reason, the flow from roof edge to ground was highly affected by wind, sometimes blowing into the building (a chicken house).

Collecting vessels (plastic 3-litre vegetable oil containers, inverted and with an 75 mm x 80 mm aperture cut in their base) were placed in a row out from the wall. The aperture width corresponded to the width of the roofing corrugations, so each vessel intercepted flow from only one furrow. Seven such vessels were placed at various distances from the drip line from the roof edge. Relative to the drip line, the vessel centres were at the distances shown below. Thus vessel *B* was placed to receive any drips from the roof when no wind was blowing, vessel *A* was closer to the building, vessels *C* to *G* were progressively further out from the building.

Vessel		<i>A</i>	<i>B</i>	<i>C</i>	<i>D</i>	<i>E</i>	<i>F</i>	<i>G</i>	<i>ALL</i>
Throw at centre		-75	0	+75	+150	+225	+300	+375	

(mm)									
	Rainfall (mm)	Percentage of expected run-off collected in vessel (*indicates vessel overflowed at 3 litres)							
Rain event 1	47.0	5.3	8.7*	8.7*	8.7*	8.7*	1.8	3.4	45*
Rain event 2	12.5	16,9	33.3*	33.3*	1.4	0.8	1.1	1.0	88*
Rain event 3	38.0	5.4	10.9*	10.9*	8.1	3.3	1.5	1.2	41*
Rain event 4	8.5	0.8	26.4	48.5*	28.0	3.1	2.3	0.1	109
Rain event	16.0	9.9	19.8	25.8*	5.4	1.7	0.8	0.8	64

5									
Rain event 6	3.5	11.3	45.2	35.8	0	0.8	0	0	93
Rain event 7	24.5	5.7	13.5	13.5	2.3	3.0	1.5	1.6	41
Rain event 8	26.0	5.1	12.1	13.6	13.2	3.0	1.5	1.4	50
Rain event 9	12.5	1.4	2.5	28.0	2.1	1.6	1.6	1.6	39

Table 5 Throw from an actual roof, 300 mm below the roof edge

It is not easy to interpret this data, as it is much affected by overflow of the collecting vessels which should have been much larger. (During Rain event 1, for example, run-off

per furrow exceeded 20 litres but under 15 litres was collected). Moreover during Rain event 5, despite some loss due to overflow, the total water collected exceeded that calculated from rainfall records to have fallen on the furrow. By contrast during Rain events 7, 8 and 9 where there was no overflow the total collected was less than half the calculated precipitation. This may be due to differences in storm intensity over the 100 meters that separated the rain gauge from the roof or due to inadequate experimental design. It was not possible to measure minute-by-minute rainfall, but only the total precipitation in a Rainfall event lasting up to six hours: it seems unlikely that instantaneous rainfall intensities ever exceeded 2 mm per minute.

We may however observe that a significant fraction (possibly over 30% during heavy rain) of run-off was intercepted by vessels *D* to *G* and hence would have overshot a 75 mm gutter centred 300 mm under the roof edge. Moving such a gutter outwards (so that its inner edge was directly under the roof edge) would have resulted in its catching some of this overshoot but missing all the flow into vessel *A* which was 10% or more of expected run-off.

Clearly much more careful experimentation - with a more typical roof and wall combination, and including measurement of rainfall *intensities* - is needed before strong conclusions can be drawn about what gutter width is adequate at various drops. The indications are however that guttering systems allowing water to fall more than about

100 mm from the roof edge are likely to be expensive (wide gutters) or ineffective in intercepting intense rainfall. Some crude field experiments at the same site, which compared the water quantities collected by several 75 mm wide gutters set at different distances below the roof edge, supported these indications.

[\(Return to top of document\)](#)

5 CONCLUSIONS

For economy, gutters should not be laid horizontal, but at an angle that ideally increases towards the discharge end. Unfortunately the combination of a sloping gutter and a horizontal roof edge results in the drop from the latter to the former that increases towards the discharge end. Experiment and theory suggest that this drop should be kept less than 100 mm if intense rainfall from a *corrugated* domestic roof is all to be intercepted by a 75 mm (3") gutter. A hemispherical gutter of such a size, laid at 4% slope at its discharge end, should be able to carry all the precipitation on a domestic size roof (up to 40 m²) even during intense storms of up to 4 mm rainfall per minute. The requirements of 4% *final* slope and not more than 100 mm drop restrict the gutter length to 7.5 m. However if the primary purpose of the gutter is to collect water (rather than protect the lower wall from rain) a lower design standard should suffice. Rainfall intensities up to only 1 mm per minute need be wholly intercepted, since only a tiny

fraction of annual precipitation occurs at intensities higher than this. Strong winds will however result in some loss of interception even where the roofedge-to-gutter drop is kept small.

Gutters for domestic buildings therefore do not need to be large, but the problem of attaching and aligning them to achieve adequate slope yet only a small drop has to be solved. Moreover proper alignment of the gutter so that its inner edge lies just inside the drip line from the roof edge is necessary if small gutters are to be used. Some ways of doing this were discussed in Section 2.4.

Where flat, ribbed or tiled roofing material is used, there should be little occurrence of run-off overshooting a gutter unless the drop is large or the wind very strong.

[\(Return to top of Document\)](#)

Appendix A Measured Runoff Trajectories from corrugated roofing

(Data from laboratory experiments described in Section 3)

(available upon request from DTU)

[\(Return to top of document\)](#)

Appendix B Theory of flow down corrugations

The furrow of a corrugated iron roof has an approximately parabolic shape described by the equation

$$y = a x^2 \quad [1]$$

where y is the rise above the furrow bottom at a distance x from its centre. The constant a is normally approximately equal to $1/W$ where W is the pitch of the corrugations (typically 0.08 m). The cross-sectional area of a flow that is of depth y is

$$A = \frac{4}{3} a x^3 \text{ and the hydraulic radius is approximately } R = \frac{2}{3} y = \frac{2}{3} a x^2$$

giving (at equilibrium):

$$\text{flowrate } Q = A R^{2/3} S^{1/2} / n x^{13/3} \text{ and velocity } v = Q/A x^{4/3} Q^{4/13} \quad [2]$$

Thus a doubling of the flowrate (due to a doubling in rainfall intensity or of roof length) will increase the run-off velocity by only 24%. Most of any increase in flowrate is accommodated by an increase in the depth (y) and hence area (A) of the flow; rather

than the increase in velocity.

Taking a representative flow of $5 \times 10^{-6} \text{ m}^3/\text{s}$ (1 mm/minute falling on a furrow 4.2 m long x 8 cm pitch), a slope of $S = 0.5$ and a value of .01 for Mannings n , we get an equilibrium velocity of $v = 0.50 \text{ m/s}$ and a flow depth of $y = 0.9 \text{ mm}$.

(This velocity of 0.5 m/s corresponds to a free fall of only 12 mm, i.e. 0.025 m of furrow length, so we may assume that flow velocity is always close to its equilibrium value.)

In order to make comparisons with measurements, we need to be able to convert velocity v to throw at some specified drop. The following table does so for a drop of 100 mm. (The relationship between run-off velocity and throw is a complex one; however for velocities less than say 0.5 m/s we can use the approximation throw is proportional to velocity.)

	$v = 0 \text{ m/s}$	$v = 0.5 \text{ m/s}$	$v = 1.0 \text{ m/s}$	v
Throw for $S = 0.2$	0 mm	65 mm	120 mm	490 mm

Throw for $S =$	0 mm	51 mm	86 mm	173 mm
-----------------	------	-------	-------	--------

Thus for $v = 0.50$ m and $S = 0.5$ we should expect a throw of 51 mm. The corresponding measured value for a roof only 4.2 m long (mean of readings for $S = 0.4$ and $S = 0.6$) is 65 mm, which is 27% higher than expected. The disagreement could be due to the furrow curvature being greater than assumed.

The same rainfall on a plane roof of similar slope and roughness gives

$v = 0.32$ m/s and a flow depth of $y = 0.31$ mm.

Any change from a plane roof to a corrugated one therefore substantially increases the run-off velocity (by 56% in this example). Indeed only corrugated roofs usually give rise to significant gutter overshoot problems.

[Return to top of page](#)

[home.cd3wd.ar.cn.de.en.es.fr.id.it.ph.po.ru.sw](#)