

## **Science Experiments for Primary Schools – A Guide for Teachers**

<http://cd3wd.com/dvd/> - filename: z\_science\_exp\_ 1 of 598

z\_science\_exp\_0001.jpg

<http://cd3wd.com/dvd/> - filename: z\_science\_exp\_2 of 598

<http://cd3wd.com/dvd/> - filename: z\_science\_exp\_ 2 of 598

z\_science\_exp\_0002.jpg

## Table of Contents

<b>Science Experiments for Primary Schools – A Guide for Teachers</b> .....	<b>1</b>
<b>INTRODUCTION</b> .....	<b>1</b>
<b>1. BOTANY</b> .....	<b>2</b>
1.1. THE EXPANSION IN VOLUME OF SWELLING SEEDS.....	2
1.2. THE TASK OF THE SEED LEAVES (COTYLEDONS) OF BEAN OR PEA SEEDLINGS.....	3
1.3. SEEDS DO NOT GERMINATE IN FRUITS.....	5
1.4. PLANTS DO NOT GROW WITHOUT LIGHT.....	6
1.5. PLANTS GROW TOWARDS THE LIGHT.....	8
1.6. PLANTS TRANSPORT WATER.....	9
1.7. THE WATER EVAPORATION OF PLANTS.....	11
1.8. THE IMPORTANCE OF MINERAL SALTS.....	13
1.9. PLANTS PRODUCE OXYGEN.....	14
1.10. STARCH FORMATION IN LEAVES.....	16
1.11. THE PRODUCTION OF GASES BY PLANTS UNDER DIFFERENT CONDITIONS.....	17
1.12. THE TRANSPIRATION OF PLANTS.....	18
1.13. GERMINATING PLANTS IN DIFFERENT CONDITIONS.....	19
<b>2. HUMAN BIOLOGY</b> .....	<b>20</b>
2.1. HEAT RADIATION OF THE HUMAN BODY.....	20
2.2. SENSATION OF WARMTH AND COLD.....	21
2.3. THE TASTE BUDS ON THE TONGUE.....	23
2.4. THE SENSATION OF TASTE AND SMELL.....	25
2.5. STARCH BREAKDOWN IN THE MOUTH.....	27
2.6. THE CINEMA EFFECT.....	28
2.7. THE BLIND SPOT.....	29
2.8. A MODEL DEMONSTRATING THE FLEXIBILITY OF THE SPINE.....	31
2.9. COSTAL RESPIRATION.....	32
2.10. IDENTIFICATION OF CARBON DIOXIDE IN EXHALED AIR.....	34
2.11. THE SKIN RELEASES SODIUM CHLORIDE.....	35
2.12. FINGERPRINTS.....	37
2.13. DISTINGUISHING SEVERAL MATERIALS BY TOUCHING THEM WITH THE FINGER.....	39
<b>TIPS</b> .....	<b>39</b>

2.13. <u>DISTINGUISHING SEVERAL MATERIALS BY TOUCHING THEM WITH THE FINGER</u>	
<u>TIPS</u>	39
2.14. <u>TESTING PULSE FREQUENCY UNDER DIFFERENT CONDITIONS</u>	40
2.15. <u>DETERMINING THE DIRECTION FROM WHICH A NOISE COMES</u>	41
2.16. <u>THE SENSITIVITY OF OUR HEARING</u>	42
3. <u>INORGANIC CHEMISTRY</u>	43
3.1. <u>COMBUSTION ZONES OF A CANDLE FLAME</u>	43
3.2. <u>THE CANDLE FLAME AND ITS DAUGHTER FLAME</u>	45
3.3. <u>COMBUSTION PRODUCTS OF A CANDLE</u>	46
3.4. <u>THE DETERMINATION OF OXYGEN CONCENTRATION IN THE AIR</u>	48
3.5. <u>NITROGEN EXTINGUISHES A CANDLE FLAME</u>	50
3.6. <u>ATMOSPHERIC OXYGEN SUPPORTS COMBUSTION</u>	52
3.7. <u>CARBON DIOXIDE AS A FIRE EXTINGUISHER</u>	53
3.8. <u>THE FORMATION OF CRYSTALS</u>	55
3.9. <u>SALT WATER IS HEAVIER THAN DRINKING WATER</u>	56
3.10. <u>SEPARATION OF SOLID MIXTURES</u>	58
3.11. <u>THE CORROSION OF IRON</u>	60
3.12. <u>THE IMPORTANCE OF AIR DURING THE PROCESS OF CORROSION</u>	61
3.13. <u>TINS ARE PROTECTED AGAINST RUST</u>	63
3.14. <u>INVESTIGATION OF RUST</u>	64
3.15. <u>THE ELECTROLYSIS OF SODIUM CHLORIDE</u>	65
3.16. <u>THE ELECTROLYSIS OF WATER</u>	67
3.17. <u>THE EXPLODING TIN</u>	69
3.18. <u>VEGETABLE INDICATOR – ANTHOCYAN</u>	72
3.19. <u>ACID AIR – ACID RAIN</u>	73
4. <u>ORGANIC CHEMISTRY</u>	75
4.1. <u>SUGAR CONTAINS CARBON</u>	75
4.2. <u>PROTEINS CONTAIN NITROGEN</u>	77
4.3. <u>PROTEIN CONTAINS SULPHUR</u>	78
4.4. <u>IDENTIFICATION OF STARCH IN FOOD</u>	80
4.5. <u>CARBON DIOXIDE IS PRODUCED DURING THE PROCESS OF FERMENTATION</u>	81

## Table of Contents

### Science Experiments for Primary Schools – A Guide for Teachers

<u>5. PHASE TRANSITION</u> .....	83
<u>5.1. MELTING AND SOLIDIFICATION</u> .....	83
<u>5.2. EVAPORATION AND CONDENSATION</u> .....	85
<u>5.3. SUBLIMATION AND RESUBLIMATION</u> .....	86
<u>5.4. LAUNDRY DRIES WHEN THE WATER EVAPORATES</u> .....	88
<u>5.5. WATER EVAPORATION – DEPENDANT ON THE SURFACE SIZE</u> .....	90
<u>5.6. WATER EXPANDS WHEN IT SOLIDIFIES</u> .....	91
<u>5.7. ICE FLOATS ON TOP OF WATER</u> .....	93
<u>5.8. ICE MELTS WHEN THE PRESSURE INCREASES</u> .....	94
<u>6. WARMTH AND COLD</u> .....	96
<u>6.1. METALS EXPAND WHEN HEATED</u> .....	96
<u>6.2. THE THERMAL CONDUCTIVITY OF DIFFERENT KINDS OF MATERIALS</u> .....	98
<u>6.3. THE THERMAL CONDUCTIVITY OF WATER</u> .....	100
<u>6.4. THE HEAT “STREAMING”</u> .....	101
<u>6.5. DENSITY DIFFERENCE BETWEEN WARM AND COLD WATER</u> .....	102
<u>6.6. HEAT RADIATION</u> .....	104
<u>6.7. DARK MATERIALS WARM UP FASTER THAN LIGHT ONES</u> .....	105
<u>6.8. DARK MATERIALS COOL DOWN FASTER THAN LIGHT ONES</u> .....	107
<u>6.9. HEATING WITHOUT A FLAME</u> .....	109
<u>7. AIR</u> .....	110
<u>7.1. THE AIR – A BODY</u> .....	110
<u>7.2. WE FIND OUT ABOUT AIR RESISTANCE</u> .....	112
<u>7.3. AIR RESISTANCE</u> .....	113
<u>7.4. THE DIFFUSION OF GASES</u> .....	115
<u>7.5. CARBON DIOXIDE IS HEAVIER THAN AIR</u> .....	116
<u>7.6. THE PHENOMENON OF AIR PRESSURE</u> .....	117
<u>7.7. HOW A DRINKING STRAW WORKS</u> .....	119
<u>7.8. THE DANCING COIN</u> .....	121
<u>7.9. THE BALLOON IN THE BOTTLE</u> .....	123
<u>7.10. THE FOUNTAIN EXPERIMENT</u> .....	124

<u>7.9. THE BALLOON IN THE BOTTLE</u> .....	123
<u>7.10. THE FOUNTAIN EXPERIMENT</u> .....	124
<u>7.11. THE PHENOMENON OF AIR FLOW</u> .....	126
<u>7.12. THE AERODYNAMIC PARADOX</u> .....	128
<u>7.13. THE BOYLE-MARIOTTE LAW</u> .....	129
<b>8. WATER</b> .....	133
<u>8.1. MODEL OF A WATER-PIPELINE</u> .....	133
<u>8.2. THE PRINCIPLE OF A WELL</u> .....	134
<u>8.3. THE SIDE-PRESSURE OF A WATER-COLUMN</u> .....	136
<u>8.4. VOLUME DETERMINATION OF A STONE</u> .....	138
<u>8.5. A RAZOR BLADE FLOATS ON TOP OF WATER</u> .....	139
<u>8.6. WATER HAS A SKIN</u> .....	141
<u>8.7. THE PHENOMENON OF SURFACE TENSION</u> .....	143
<u>8.8. WATER ASCENDS IN SOIL</u> .....	144
<u>8.9. DETERGENTS FACILITATE THE ABILITY OF PERFUSION</u> .....	147
<u>8.10. THE EFFECTS OF DETERGENTS ON DIRT</u> .....	148
<b>9. MECHANICS</b> .....	150
<u>9.1. GEAR MECHANISM – A TRANSMISSION</u> .....	150
<u>9.2. GEAR MECHANISM – A TRANSMISSION TO SLOW DOWN</u> .....	152
<u>9.3. A SEESAW – A TWO-ARMED LEVER</u> .....	154
<u>9.4. MODEL OF A SIMPLE CABLE WINCH</u> .....	155
<u>9.5. INERTIA</u> .....	157
<u>9.6. FRICTION</u> .....	159
<u>9.7. A HEAVER – A ONE-ARMED LEVER</u> .....	160
<b>10. ELECTRICITY</b> .....	162
<u>10.0. THE SCIENCE OF ELECTRICITY</u> .....	162
<u>10.1. A JET OF WATER IS DEFLECTED</u> .....	165
<u>10.2. A SIMPLE CIRCUIT</u> .....	167
<u>10.3. THE PRINCIPLE OF A FLASHLIGHT</u> .....	168
<u>10.4. CONDUCTOR AND NON-CONDUCTOR</u> .....	170
<u>10.5. SERIES CONNECTION</u> .....	172



## Table of Contents

### Science Experiments for Primary Schools – A Guide for Teachers

<u>10.6. PARALLEL CONNECTION.....</u>	173
<u>10.7. ELECTRICAL CURRENT PRODUCES HEAT.....</u>	174
<u>10.8. THE PRINCIPLE OF AN ELECTROMAGNET.....</u>	176
<u>10.9. THE PRINCIPLE OF A BIMETALLIC STRIP.....</u>	178
<u>11. OPTICS.....</u>	179
<u>11.1. A CONVEX LENS.....</u>	179
<u>11.2. THE BURNING GLASS.....</u>	181
<u>11.3. MAGNIFYING GLASS – VIRTUAL IMAGE OF A CONVEX LENS.....</u>	183
<u>11.4. REAL IMAGES WITH CONVEX LENSES.....</u>	184
<u>11.5. THE CONCAVE LENS.....</u>	186
<u>11.6. VIRTUAL IMAGE OF A CONCAVE LENS.....</u>	188
<u>11.7. PINHOLE CAMERA.....</u>	189
<u>GLOSSARY.....</u>	191



<http://cd3wd.com/dvd/> - filename: z\_science\_exp\_6 of 598



## Science Experiments for Primary Schools – A Guide for Teachers



**Deutsche Gesellschaft für  
Technische Zusammenarbeit (GTZ) GmbH**

Published October 1992 by

Deutsche Gesellschaft für Technische Zusammenarbeit (GTZ) GmbH  
Abteilung 411 – Education and Science Division  
P.O. Box 51 80  
D-6236 Eschborn  
Federal Republic of Germany  
Phone: (06196) 79-0 Telex: 41 523-0 gtz d Fax: (06196) 79-11 15

Evaluation of curricula and project documents and compilation of the collection:

Renate Voßwinkel

Professional inputs:

Physics

Prof. Dr. Dieter Nachtigall, University of Dortmund

Biology

Dr. Gernot Strey, University of Göttingen

Illustrations

Darsi Germann

## INTRODUCTION

In many countries, where natural science and technology are only now being called on to help solve the problems facing the land, educational planners and educationalists have to decide how to meet this challenge in science teaching at primary and secondary level. Conventional teaching media, which must generally be imported, are beyond the means of the already stretched education budgets and some teaching aids, that look to promising, do little more than confuse pupils, without helping to answer the questions.

Time, and a detailed knowledge of the regional problems will be needed in order to find a promising future solution for each country.

We would like to present one possible solution in the form of this collection of fundamental scientific experiments, requiring few, simple and readily available materials and inputs. Experience in many and varied projects, along with evaluations of the relevant curricula and of the schooling situation in various countries spurred us to take this step.

What has emerged is a collection, which we feel is in line with the level of previous methodical and didactic knowledge of the teaching staff, who are often inadequately trained for the tasks they are expected to perform. It provides the information needed for an interesting lesson and is meant to appeal the various intellectual faculties of children. To this end the experiments are described in simple, easy to understand language, and designed in the form of lesson blueprints.

Please let us know whether this collection lives up to its goal of providing practical assistance and as many ideas as possible in terms of materials, methods and experiments. We would be interested to hear from you which interests were awakened and what understanding pupils developed as a result of the individual experiments.

We would like to thank all those who contributed information, critical comments and ideas and, above all, the authors whose professional inputs have made this collection possible.

Hubert Hartmann  
GTZ, Education and Science Division

## **1. BOTANY**

### **1.1. THE EXPANSION IN VOLUME OF SWELLING SEEDS**

#### **Main Goal:**

**This experiment illustrates in an impressive way how seeds expand in volume as they steep.**

#### **Information:**

Seeds have a great osmotic pressure, which is responsible for water absorption during the steeping process. (Osmosis is the diffusion of fluids and gases through a membrane or porous partition.)

#### ***Materials and Apparatus:***

*Materials and Apparatus:*

*bean or pea seeds*

*a. sand, water, a bottle, a pierced rubber or cork stopper, bucket;*

*b. gypsum, water, a small cardboard box, a vessel.*

**Procedure:**

a. A bottle is completely filled with either bean or pea seeds and sand. The sand fills the spaces between the seeds. The bottle is tightly sealed with the pierced stopper. The stopper can be secured with wire gauze. The bottle is placed in a bucket filled to the rim with water. The bottle has to be totally submerged.

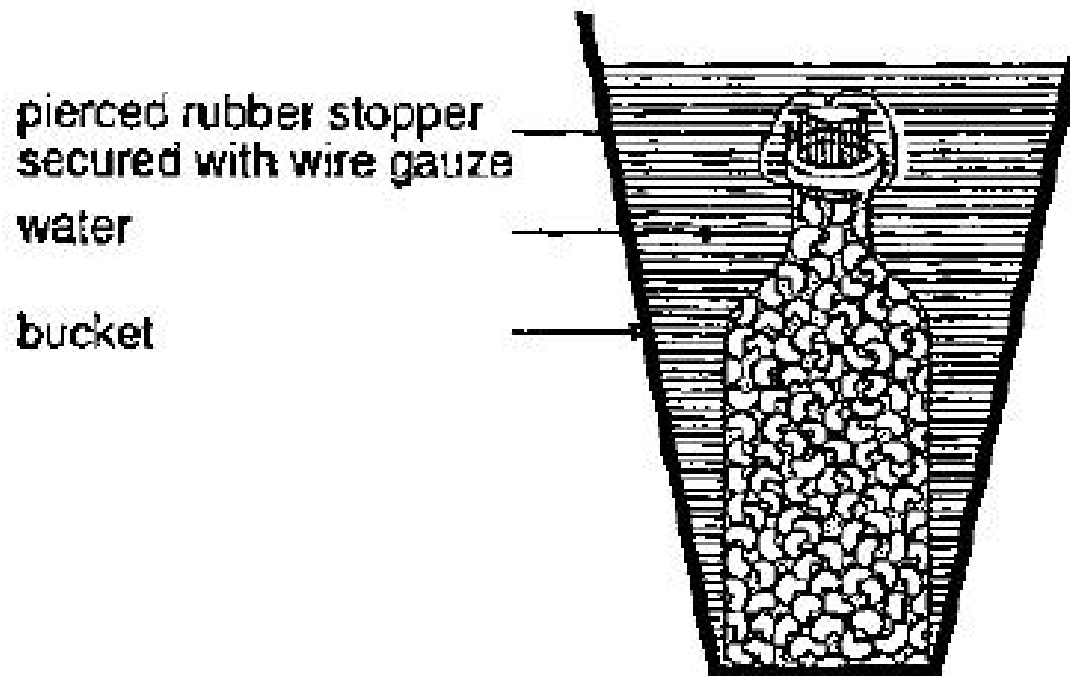



b. The small cardboard box is half filled with plaster of Paris. 15 seeds are placed in this and then the box is immediately completely filled with the plaster of Paris. The gypsum is left to firm completely and then the whole block is placed in water. Instead of a cardboard box you can use any other container, e.g. a plastic yoghurt tub.

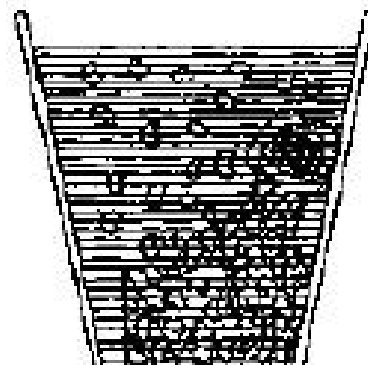
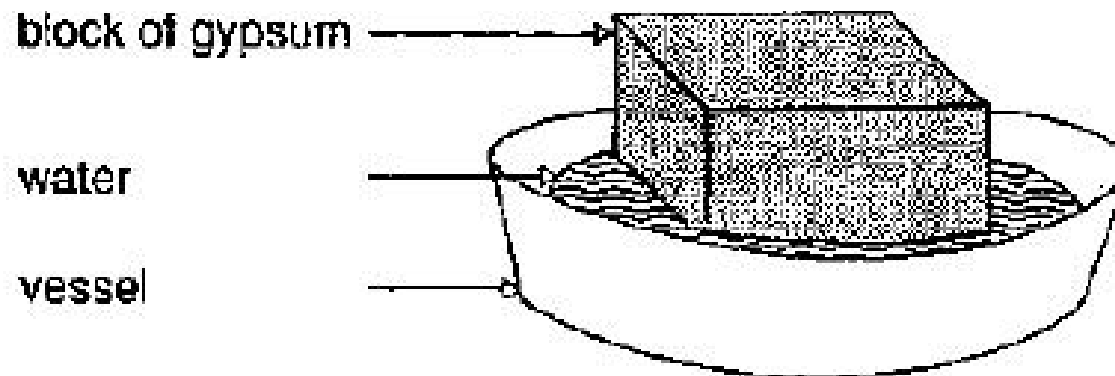
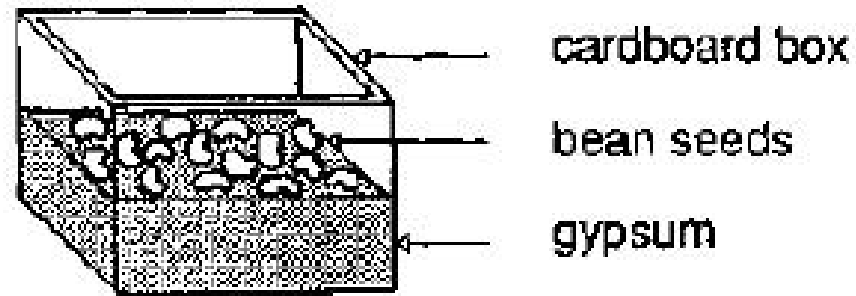

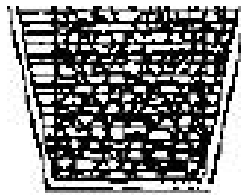

Observation:

After a few days the bottle and the plaster block shatter.

**Analysis:**

**The seeds expand in volume to such a degree that the bottle and the block of gypsum shatter.**

Importance in Nature:

Such power is necessary to push away the ground when the seeds swell in the soil. Otherwise they could not germinate, because they need the intake of water to make the stored nutrients in the seeds usable.

## **1.2. THE TASK OF THE SEED LEAVES (COTYLEDONS) OF BEAN OR PEA SEEDLINGS**

**Main Goal:**

3

<http://cd3wd.com/dvd/> - filename: z\_science\_exp\_9 of 598

**This experiment illustrates that seed leaves (cotyledons) play an important role in the early development of seedlings.**

Information:

The two seed leaves of beans (or peas) contain a certain amount of reserve substances. These nourish the seedling until it is able to absorb mineral salts from the soil through its fully developed roots and carbon dioxide from the air through their leaves.

*Materials and Apparatus:*

*a. 9 seeds capable of germinating (peas) 9 seedlings of the same size 2 pieces of wire gauze or 9 test tubes or flint-pebbles to hold the plants (the size should be such that the seedlings do not fall through the mesh) 1 dish (measuring about 13 cm by 5 cm, and about 7 – 10 cm in height) distilled water (Available in every garage. If distilled water cannot be bought or produced, rain water or tap water may be used).*

Procedure:

- a. Put the beans on the wire gauze. Make sure that they are moistened regularly. Let them germinate. Watch the water. If it becomes grey change it, because there are fungi in the water which may start to destroy the experiment.
- b. When the seedlings are about 1 cm high, both seed leaves are taken from each of three seedlings and one seed leaf from three others. The roots must be kept below the surface of the water. The last three remain unchanged. The experiment is analysed after about a week.

**wire gauze**

**/ dish**

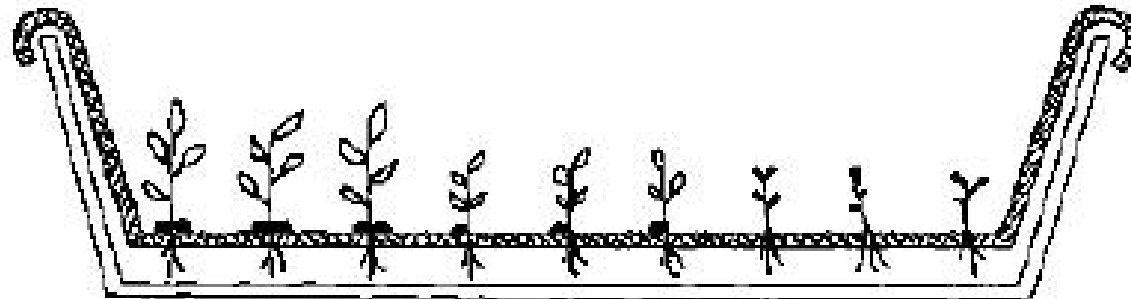

**Observation:**

The seedlings without any seed leaves have not grown.  
Those with just one seed leaf have hardly grown.  
The seedlings with two seed leaves have grown noticeably.  
All of the seed leaves have withered.

**Analysis:**

**The seed leaves nourish the seedlings until they are capable of absorbing mineral salts through their roots.**

Importance in Nature:

The nutrients the seed leaves use when germinating are the same as those we use when we eat beans, peas or other seeds. The reserve substances stored for the seeds themselves give us the feeling that we are full.

### **1.3. SEEDS DO NOT GERMINATE IN FRUITS**

**Main Goal:**

**This experiment illustrates the existence of materials which inhibit the germination of seeds in fruits.**

Information:

In order to germinate, seeds need water as well as air. In most kinds of fruits, seeds do not germinate. One reason, besides the lack of air, is that there are substances in the fruits which prevent germination.

*Materials and Apparatus:*

*different kinds of fruit (e.g. oranges, apples, melons, tomatoes)*  
*40 cress seedlings*  
*4 round filters, or absorbent paper, or cotton wool*  
*5 round dishes, about 10 cm in diameter (e.g. lids of jam jars)*

4 round filters, or absorbent paper, or cotton wool  
5 round dishes, about 10 cm in diameter (e.g. lids of jam jars)  
1 knife water

Procedure:

40 cress plants are soaked for about 10 minutes in one dish filled with water. (The swelling process takes longer if other fruit seeds are used, and some are not capable of germination.)

Meanwhile the moistened filters and the cut parts of the fruits are placed into the other dishes. Ensure that the equipment and your fingers are clean when you cut the fruits and place the parts into the dishes, otherwise you can get blue mould growing on your experiment. If blue mould should grow nevertheless repeat the experiment. The swelled cress seedlings are distributed among the four dishes as shown in the diagram below. They are observed for 4 – 5 days.

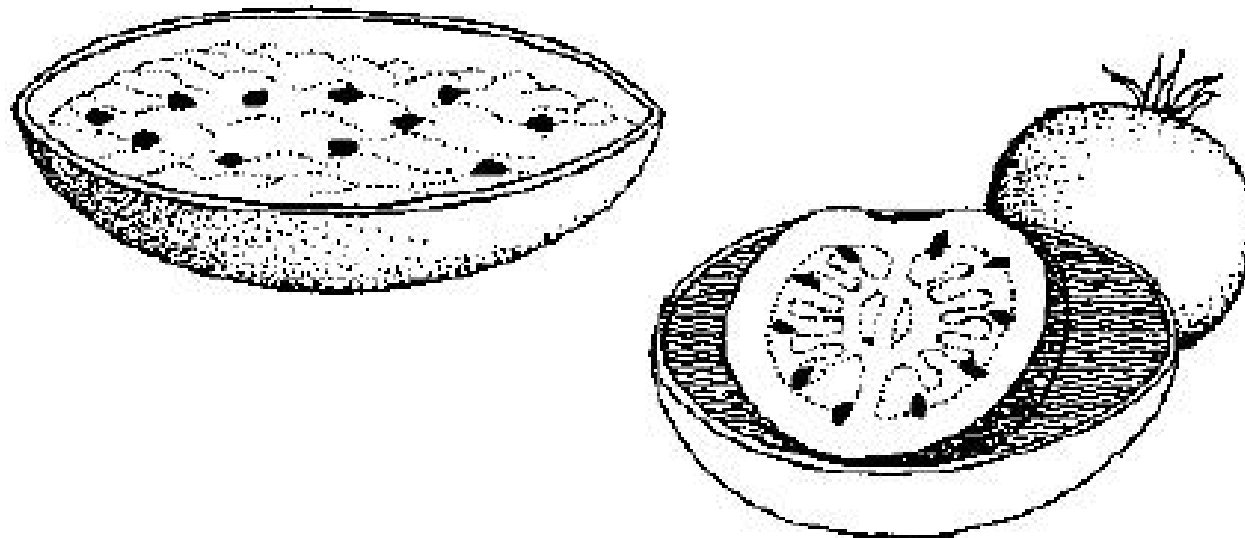

**Observation:**

Although the seeds in all the dishes receive air and water, germination takes place only in those dishes in which they were placed directly on moistened paper. (One or two germinated seeds on the fruit slices do not distort the result. Experiments in biology do not necessarily succeed completely.)

**Analysis:**

**Fruits contain substances which inhibit the germination process. These prevent the germination of seeds. The seeds can only start germination and growing once the fruits are rotten.**

**Importance in Nature:**

Fruit seeds are spread by birds, which are attracted by the coloured fruits. The birds eat them, and drop the seeds with their droppings. The seeds then germinate and grow where they land.

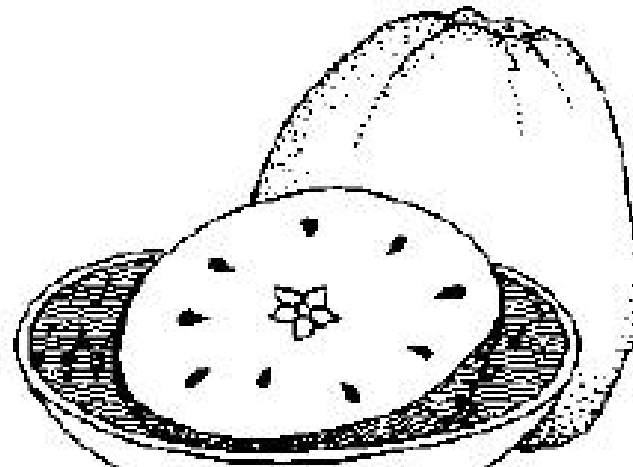

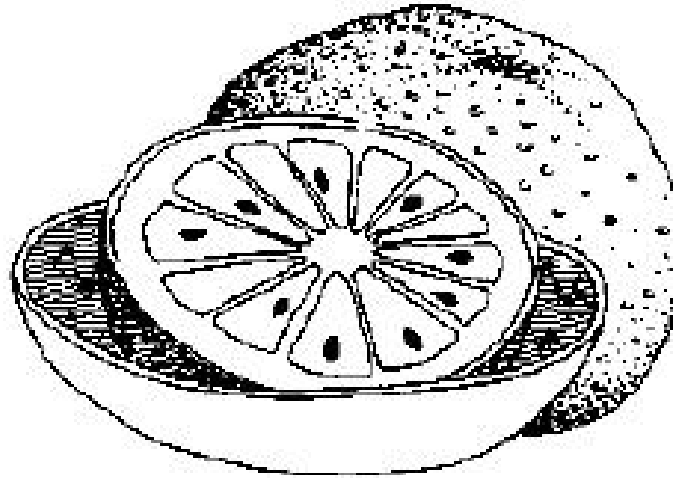

#### 1.4. PLANTS DO NOT GROW WITHOUT LIGHT

##### Main Goal:

**This experiment demonstrates that plants wither without light.**

##### Information:

Plants require light to produce carbohydrates from carbon dioxide and water. (The carbohydrates are decomposed gradually by the metabolism of the plant. During this process,



energy necessary for the vital functions of the plant is liberated.)

*Materials and Apparatus:*

*cress plants (about 30)*

*2 flat receptacles filled with soil (e.g. cut-off tins or plastic mugs)*

*water*

*1 cardboard box*

*Procedure:*

Cress plants are grown in the two receptacles in moist soil until they are approximately 1 cm high. A cardboard box is placed over one of the receptacles (see diagram). The soil is kept moist. (Other plant types may also be used.)

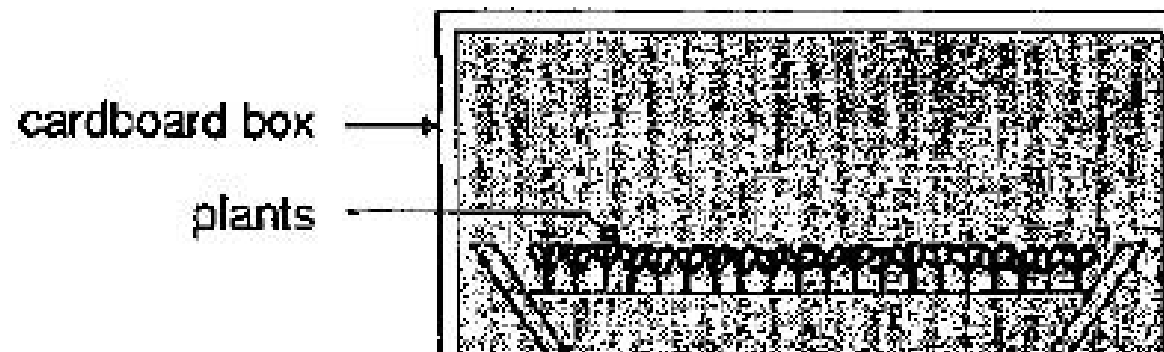
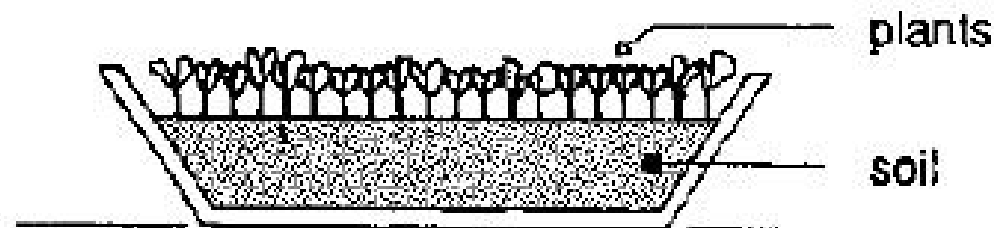



Observation:

After a few days it can be observed that the leaves of the plants under the cardboard box have turned yellow. The plants do not grow further.



Analysis:

7

<http://cd3wd.com/dvd/> - filename: z\_science\_exp\_13 of 598

Besides water and the mineral salts which are found in the soil and carbon dioxide from the air, plants need light to grow.

## 1.5. PLANTS GROW TOWARDS THE LIGHT

### Main Goal:

This experiment demonstrates that plant shoots usually grow towards the light.

### Information:

As a rule, shoots grow towards the light. Light is indispensable for photosynthesis of plants.

### Materials and Apparatus:

*about 20 cress seedlings in soil (mustard seedlings or other kinds of plants can also be used)*

*cardboard box*

*a pair of scissors or a knife*

### Procedure:

A hole measuring some 2 cm<sup>2</sup> is cut in one side of the cardboard box. The hole should be cut at the height of the cress seedlings. This cardboard box is placed over the seedlings. The experiment should be placed beside a window with the hole facing the window.



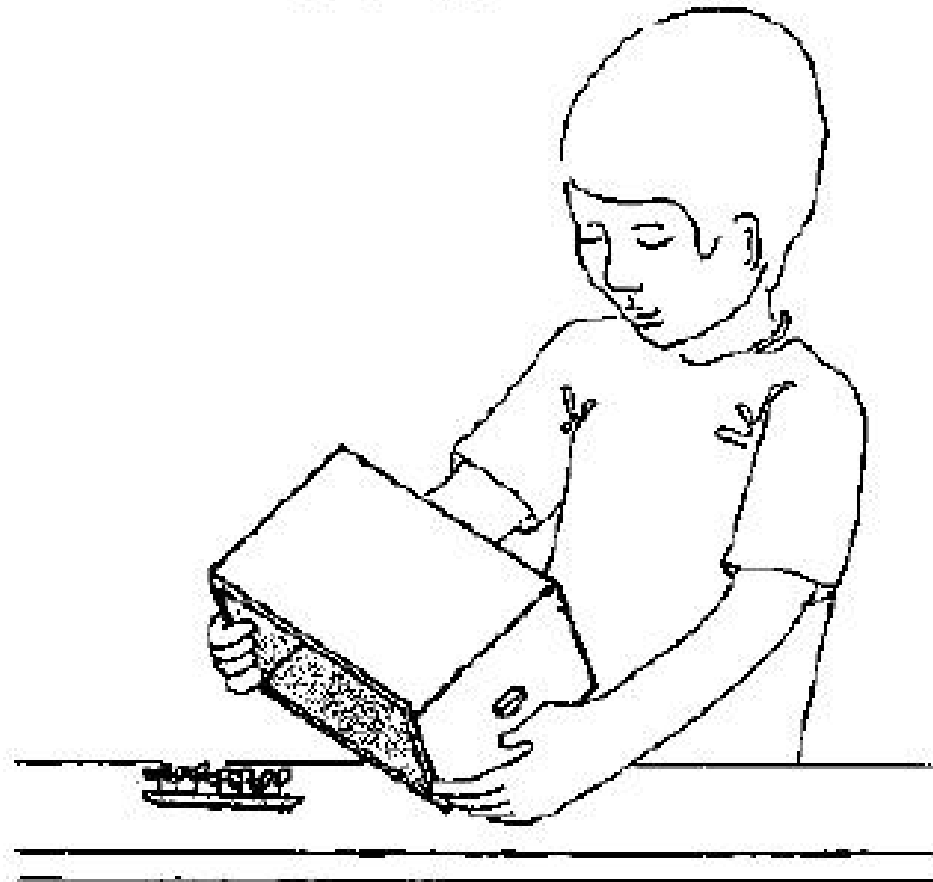
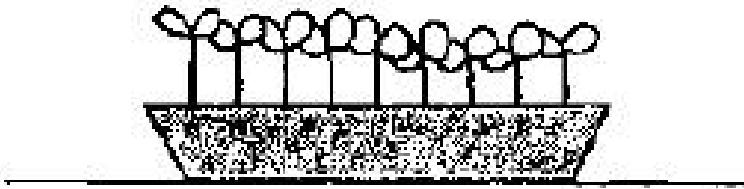

Observation:

After a few days it is observed that the axes of the seedlings bend towards the light source.

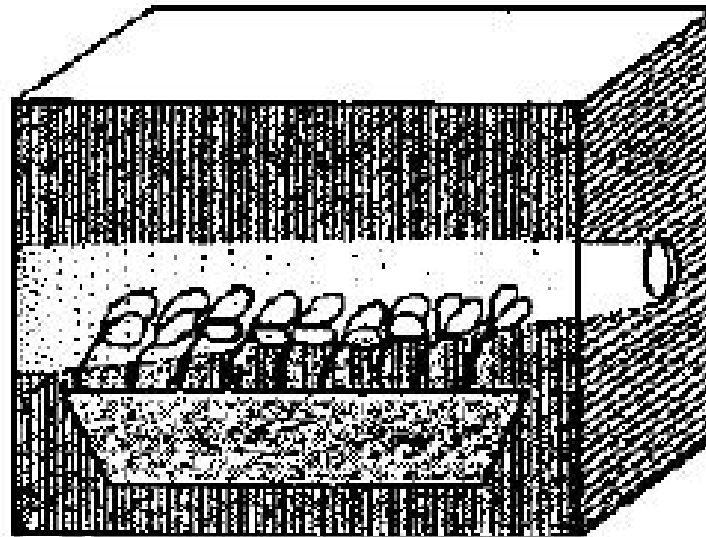

**Analysis:**

**This bending towards the rays of light is known as “phototropism”.**

**Importance in Nature:**

Phototropism helps the plant to get as much light as possible for a maximum photosynthesis. But in nature this involves certain problems: maximum photosynthesis means a maximum of transpiration. High rates of light diminish the growth in length, which can become a problem in competition with other plants. Everywhere in nature we thus see an optimal compromise.

## **1.6. PLANTS TRANSPORT WATER**

**Main Goal:**

**This experiment shows that plants transport water. There are only few flowers which are suitable for this experiment.**

**Information:**

Plants contain vascular tissue. The xylem (woody tissue of a plant) conducts moisture and mineral salts. The phloem (sieve-tube tissue) serves as a path for the distribution of synthesized food.

*Materials and Apparatus:*

*white or yellow flowers like sowbread, snowdrop, white lilies, impatiens and other flowers with somewhat hyaline stalks and petals. You can also use small twigs of deciduous trees with very young leaves. It may be necessary to test some plants available in the country where the experiment will be carried out.*

*water-soluble 1% red or blue colouring  
(red or blue ink, acid solution)*

*1 glass or plastik beaker, approximately 15 cm in height  
(depending on the length of the plant stalks)*

*water  
knife*

**Procedure:**

Some flower stalks are cut obliquely under water and placed in the dish with the colouring solution. The stalks must be cut under water to prevent the appearance of an embolus of air in the lower part of the stalk. That would prevent the coloured water rising in the stalk.

This experiment takes between 30 and 60 minutes, sometimes half a day, depending on the kinds of plant used.

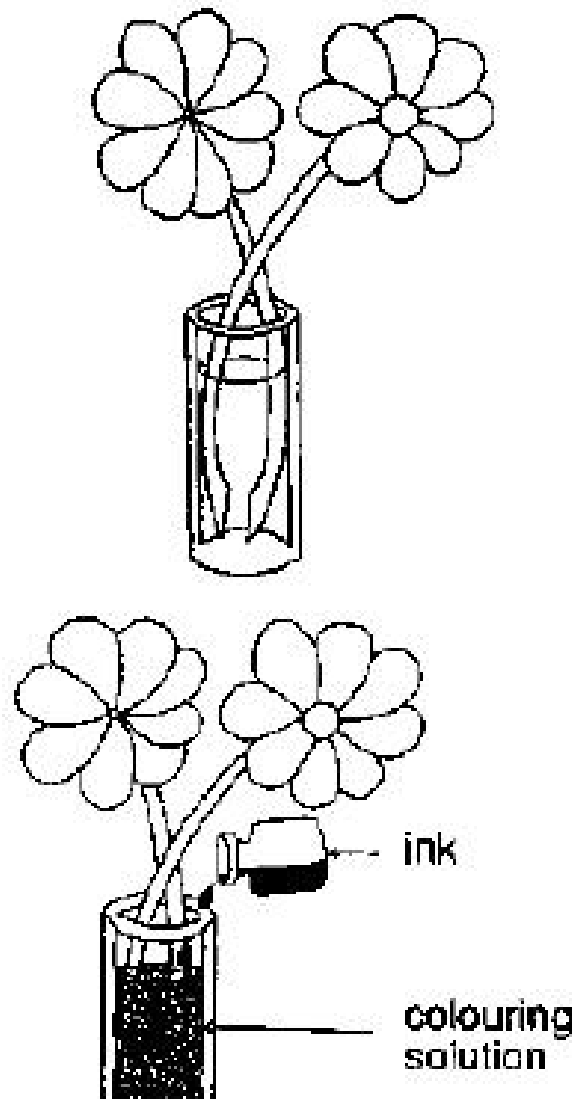

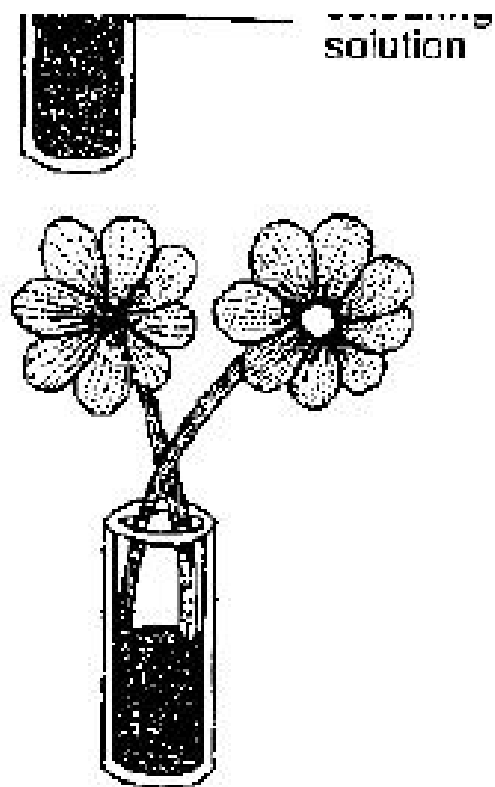

Observation:

The colouring solution can soon be seen in all parts of the plant. The way it moves up the stem can be clearly observed.

**Analysis:**

**Water is conducted into each part of the plant by the plant's vascular tissue. Thus, a permanent water supply is guaranteed.**



Importance in Nature:

The water has to get somewhere. Otherwise the plant would be fully saturated, no more water could rise and there would be no more intake of nutrients from the soil. Here once again we see optimal compromise.

The next experiment looks in more detail at water loss.

## 1.7. THE WATER EVAPORATION OF PLANTS

**Main Goal:**

**This experiment illustrates that plants release water via their leaves.**

Information:

Roots absorb water, which is conducted by the vascular tissue to all parts of the plant. The water evaporates via the leaves, so that a constant flow of water is guaranteed.

*Materials and Apparatus:*

*1 thin (young) branch of a deciduous tree*

*water*

*oil (plant oil as used for cooking will be best. Do not use motoroil at all. It will damage the leaves by releasing poisonous gases).*

*leaves by releasing poisonous gases).*

*1 glass or plastic beaker (about 10 cm in height)*

*1 glass only (about 20 – 25 cm in height)*

**Procedure:**

The branch is cut obliquely under water and then placed in the smaller glass or beaker which is filled 2/3 full with water. The stalks must be cut under water to prevent the appearance of an embolus of air in the lower part of the stalk. That would prevent the water rising in the stalk. Then oil is carefully poured into the glass to form a 0.5 cm layer on top of the water.

The larger glass is placed upside down over the apparatus. Place the experiment in cool surroundings. This is the only way in which you can see the outcome because the evaporated water will only condense on the walls of the glass if the glass is cool.

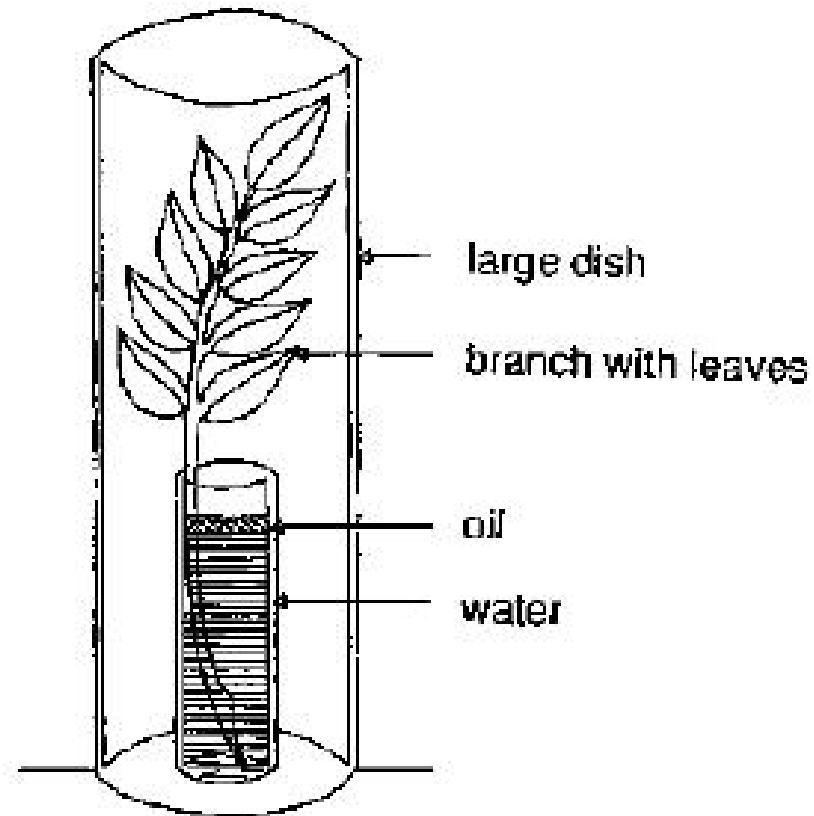

Observation:

Moisture condenses after some time on the inside of the larger glass. The condensed water will firstly form a layer on the wall of the glass and will later flow together to form drops of water.



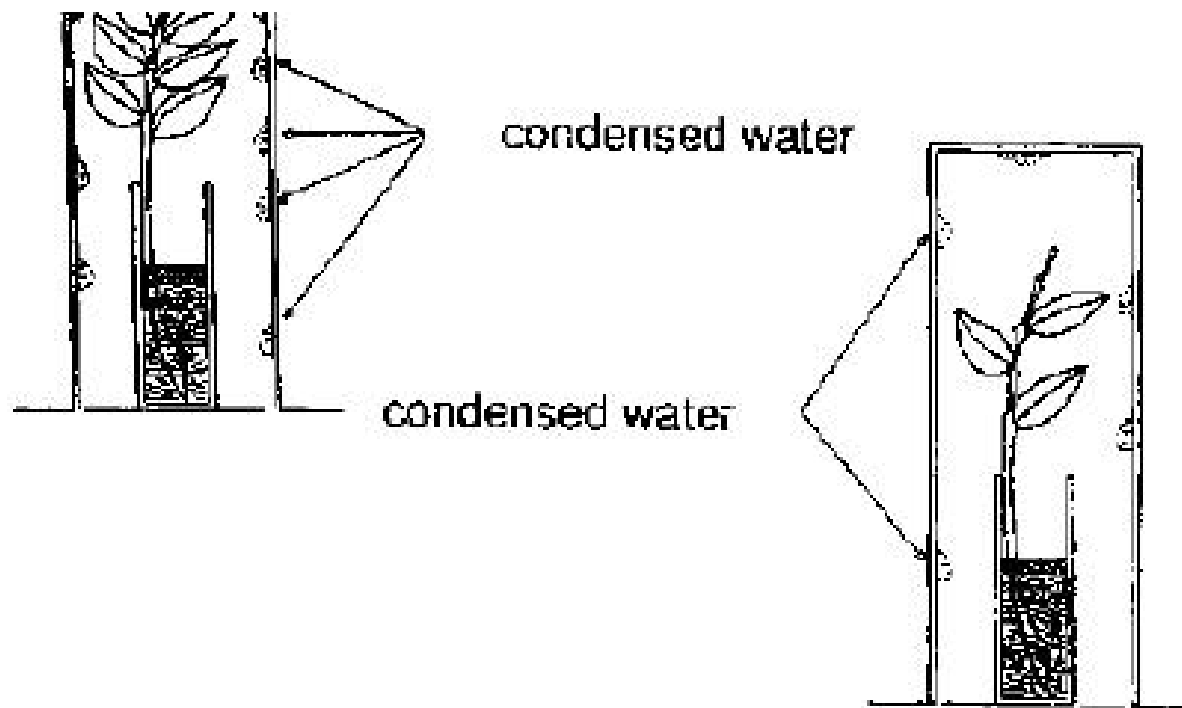

**Analysis:**

The condensation is water, which can only have evaporated via the leaves.

This process is known as transpiration.

The moisture evaporates through tiny holes on the underside of the leaves.

As the number of leaves increases, so too does the transpiration via the leaves.

**Addition:**

The water can be identified with dried white copper sulfate, which turns blue.  
(see experiment: THE COMBUSTION PRODUCTS OF A FLAME.)

Practical Meaning:

There are different devices which prevent a plant drying out.

The plant protects itself by:

- thick leaves covered with a layer of wax;
- thick shoots with a tissue that can store water;
- bark formation;
- closing the stomata in the leaves in certain circumstances;
- growing dry hair on the lower surface of the leaves.

## 1.8. THE IMPORTANCE OF MINERAL SALTS

**Main Goal:**

**This experiment shows that plants cannot live without mineral salts.**

Information:

The seedlings obtain proteins, fats, carbohydrates, the nutrients necessary for their growth from the seed leaves.

To retain their vital functions, plants synthesize the nutrients in various metabolic processes. In order to do this, mineral salts and water are indispensable.

In order to do this, mineral salts and water are indispensable.

Terrestrial plants absorb the mineral salts, which are dissolved in the soil, through their roots.

*Materials and Apparatus:*

*20 beans plants or other plants*

*2 glass or plastic vessels*

*2 pieces of wire gauze (or 8 test tubes with flint pebbles to hold the plants)*

*tap water*

*distilled water*

*1 bucket loamy soil*

**Procedure:**

Put a small shovel of soil into the bucket and add a large amount of water, so that you can stir the soil. Then fill the two dishes with the water obtained from the soil. This water contains nutrients from the soil. Put the gauze onto the dishes and ten beans on each of them. Make sure that the beans are regularly moistened. Watch the experiment to prevent fungi starting to grow. When the beans are about 5 cm high, replace the soily water from one of the dishes and replace it with distilled water. Rinse off the roots of those ten beans thoroughly but very carefully, **without removing them from the gauze**. Then put those beans into the vessel with distilled water.

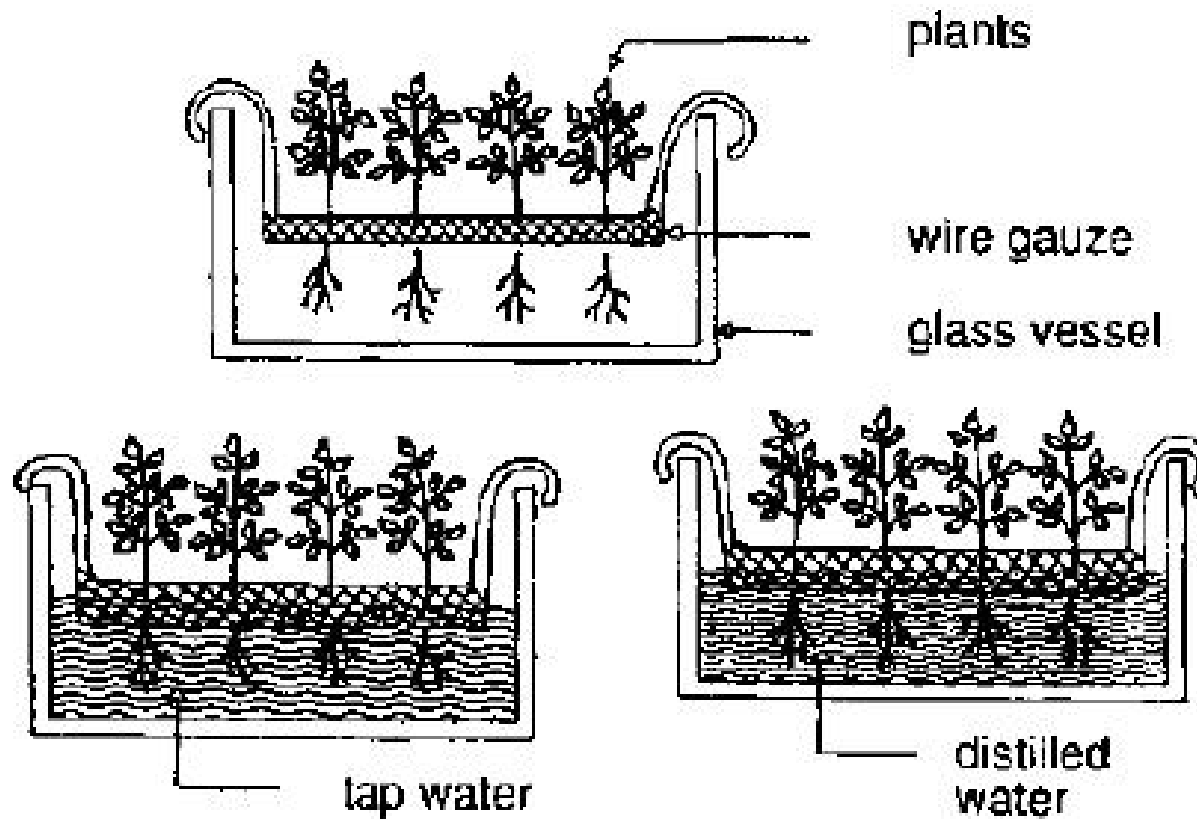

Observation:

After a few days it can be observed that the plants in the distilled water develop poorly.

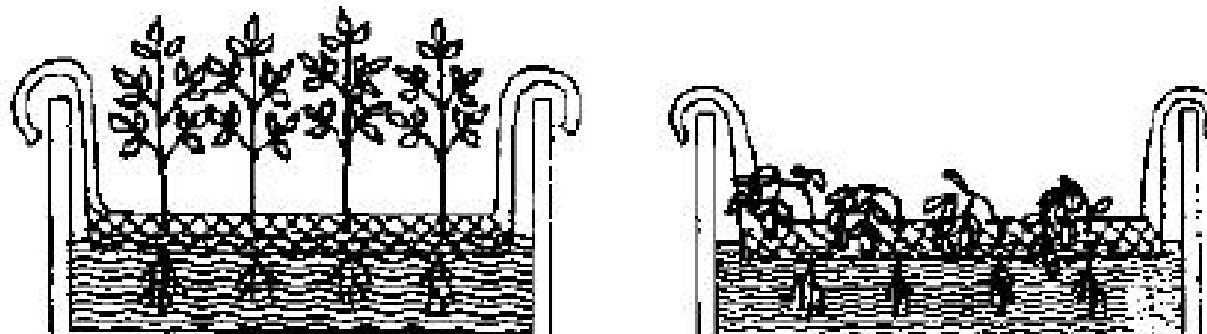



### **Analysis:**

**Distilled water does not contain mineral salts. Like soil, normal water contains mineral salts. These are necessary for the vital functions of the plants.**

## **1.9. PLANTS PRODUCE OXYGEN**

### **Main Goal:**

**This experiment demonstrates that a gas, oxygen, is produced during photosynthesis.**

### **Information:**

In their green leaves, with the help of sunlight, plants produce glucose and oxygen from carbon dioxide and water. This process is called "photosynthesis".

### *Materials and Apparatus:*

*In different countries there may be other plants which are suitable for this experiment, waterweed (elodea)*

*glass vessel*



*funnel with a short or shortened neck (see figures)*

*rubber stopper*

*a wood chip*

*matches*

**Procedure:**

Bind about 15 stems of waterweed together with a piece of thin wire or a thread. Place them in a vessel which is filled with water almost up to the rim. The cut parts of the waterweed must point upwards. Put the funnel over the waterweed. Make sure that the top of the funnel neck is under water. (See figure) Then fill the test tube up to the rim with water. Seal it with your thumb. Turn it over and place it, still sealed with your thumb, into the water in the vessel. Place the tube over the funnel neck without pulling the tube out of the water. This is the only way, of placing the tube over the funnel neck, while retaining the water in the tube. – When the tube is nearly full of gas produced by the waterweed, take a glowing wood chip, remove the test tube from the funnel neck, turn it up and place the glowing wood chip into the tube.

Observe what happens.

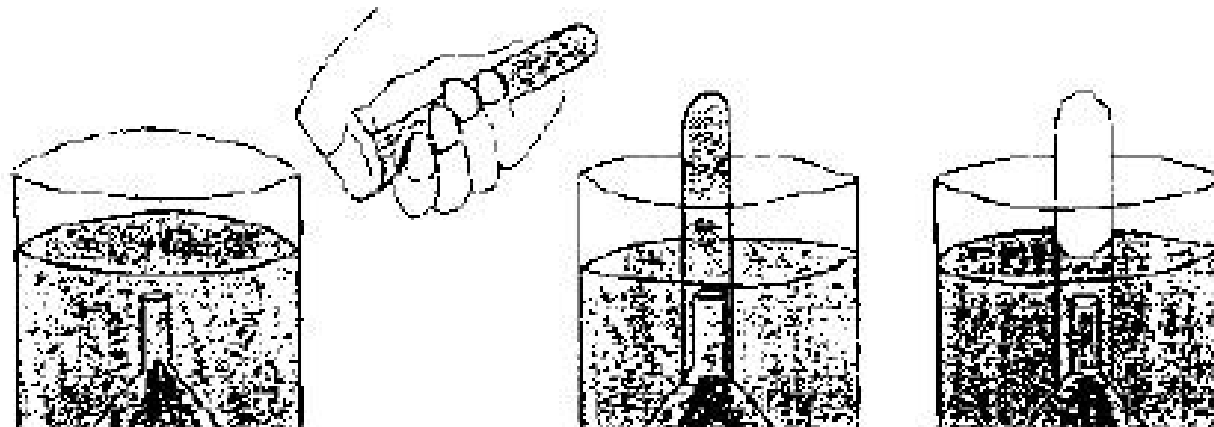

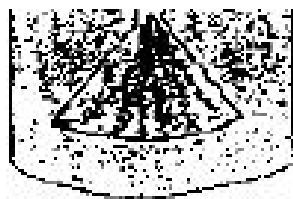

Observation:

Gradually the water in the tube is replaced by gas. The glowing chip lights up.

**Analysis:**

**The gas produced by the waterweed could be oxygen or methane. You can exclude methane since, although it is a gas left by anaerobic bacteria in rotting organic matter, it is poisonous to plants.**

Importance in Nature:

Human beings and animals need oxygen to breathe. That is: We depend on plants producing oxygen, as do all animals. Therefore it is necessary to protect plants and the areas where they grow.

See experiments botany 1.12 und human biology 2.10.

## 1.10. STARCH FORMATION IN LEAVES

### Main Goal:

This experiment serves to identify a product resulting from photosynthesis, namely starch.

### Information:

Starch is one of the most important reserve substances of green plants. It is found as assimilation starch in the chloroplasts of green leaves.

### Materials and Apparatus:

*a. plants with relatively large leaves*

*paper*

*pair of scissors*

*needles*

*b. 3 dishes*

*water*

*alcohol (96%)*

*iodine solution*

*(iodine-potassium iodide solution 1%)*

### Procedure:

a. As shown in the diagram below, the leaves are covered with patterns. The plant stays like this for one day and one night. The experiment to detect starch can be carried out after the plant has been sunlit for at least three hours the next morning.

this for one day and one night. The experiment to detect starch can be carried out after the plant has been sunlit for at least three hours the next morning.

b. The leaves are cut off the plant and the patterns are removed. **Before heating the water put the alcohol aside so that it cannot be inflamed.** Boil the leaves for about five to ten minutes (depending on the hardness of the tissues of the leaves used).

**After extinguishing the burner** the leaves are dipped into the alcohol until the chlorophyll is almost extracted. This should take about five minutes. Then place the leaves upside down on a plate and drop up to five drops of the iodine solution onto each leaf. Rub the solution into the tissue of the leaves with the tip of a small stick. Leave the experiment for about one or two minutes. Then rinse the leaf.

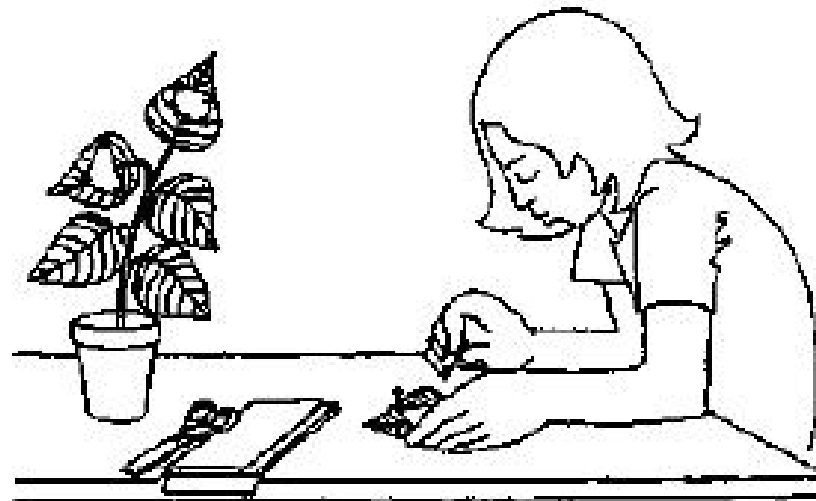

Observation:

Where starch is present the iodine will turn to a bluish brown or a deep dark brown. Parts without starch will become only a little bit yellow brown.

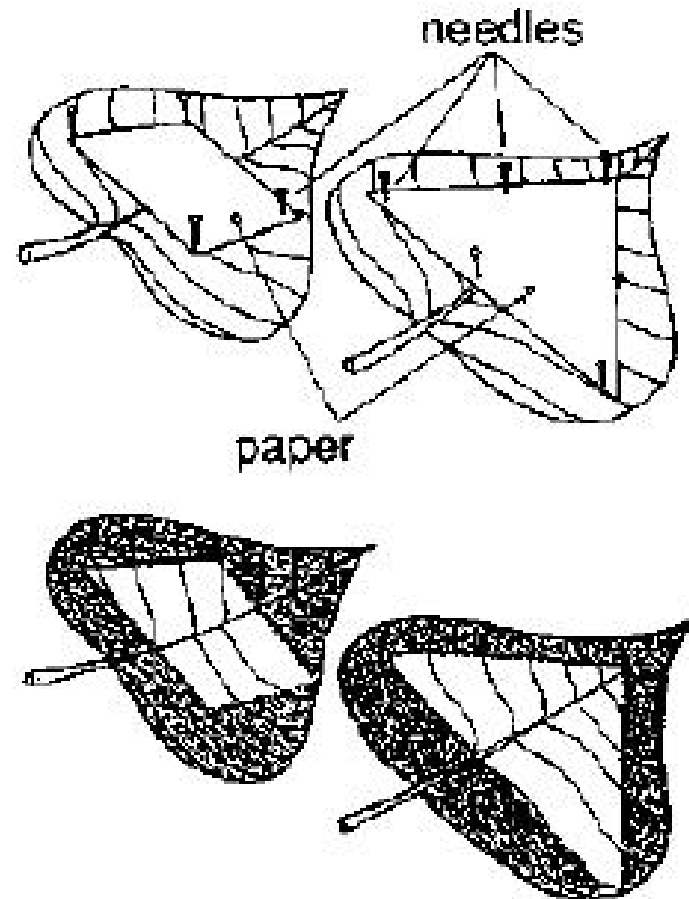

**Analysis:**

Iodine colours starch bluish brown or deep dark brown.

For the starch formation, chlorophyll and light are indispensable.

**Addition:**

Starch is the typical vegetable reserve carbohydrate. e.g. of grain.

Starch is the typical vegetable reserve carbohydrate, e.g. of grain.

Potatoes have a high starch content. When iodine–potassium iodide solution is dropped onto a cut potato, the surface turns a black–blue colour immediately.

(The blue–black colouring results from an inclusion of iodine molecules into the twisted arrangement of the starch molecules.)

### 1.11. THE PRODUCTION OF GASES BY PLANTS UNDER DIFFERENT CONDITIONS

#### Main Goal:

**This experiment demonstrates that the amount of gas produced by plants depends on the amount of carbon dioxide available.**

#### Information:

Plants transform the carbon dioxide from the air or water with water and energy from sunlight into sugar and starch. During this procedure so much oxygen is produced that the plant cannot use it all. This surplus of oxygen escapes from the plant.

#### *Materials and Apparatus:*

*a glass vessel, e.g. a jam jar  
boiled water which has been left to cool down  
soda water*

*waterweed (other plants have to be tested)  
one watch to count minutes*

**Procedure:**

Fill the vessel up to one cm below the rim with tap water. Place a piece of waterweed into the water. Wait one minute. Watch and count the bubbles rising from the stem for exactly one minute. The bubbles are best if they large and discharged at a rate of not more than about ten a minute. Then change the water and place the waterweed into the boiled cooled water. Observe whether the plant continues to produce gas bubbles. After a few minutes pour some soda water into the vessel. Wait a minute and observe the plant. If it starts producing gas again, wait two minutes and then count the bubbles once more for exactly one minute. Compare the results obtained.

**Observation:**

In the first case you will note a few bubbles, in the second case there will be no bubbles, and in the third case you will see more bubbles of gas than in the first case.

**Analysis:**

**Tap water contains a little carbon dioxide, enough for the waterweed to produce sugar and then a surplus of oxygen. In boiled water there is no carbon dioxide and the plant cannot act. The plant is not dead, however as we can see from the fact that it produces a lot of bubbles after adding soda water, which contains a large quantity of carbon dioxide.**

**Importance in Nature:**

Importance in Nature:

With this experiment, botany 1.10 and human biology 2.10 you can explain by yourself the circle of oxygen and carbon dioxide in nature and how animals and human beings depend on plants and vice versa.

## 1.12. THE TRANSPIRATION OF PLANTS

**Main Goal:**

**This experiment shows that a large account of water evaporates through plant leaves (more than evaporates from an open surface of water).**

Information:

Plants transpire through their leaves.

On the lower side of the leaf there are many small pores, stomata, through which the steam escapes. Only one percent of the surface of the leaf is covered with those stomata, but more water escapes there than from a surface of water as large as the whole surface of a leaf.

*Materials and Apparatus:*

*a big beaker (about a litre), e.g.*

*a preserving jar a dish measuring about 20 cm in diameter, e.g. a plate*

*a platform balance with several weights*

*a bunch of twigs with leaves*



**Procedure:**

Put the bunch of twigs into the beaker and fill it up with water. Fill the dish with water too. Put them on the scales so that they balance.

Leave the experiment for about 30 minutes. Then compare the levels of the platforms.

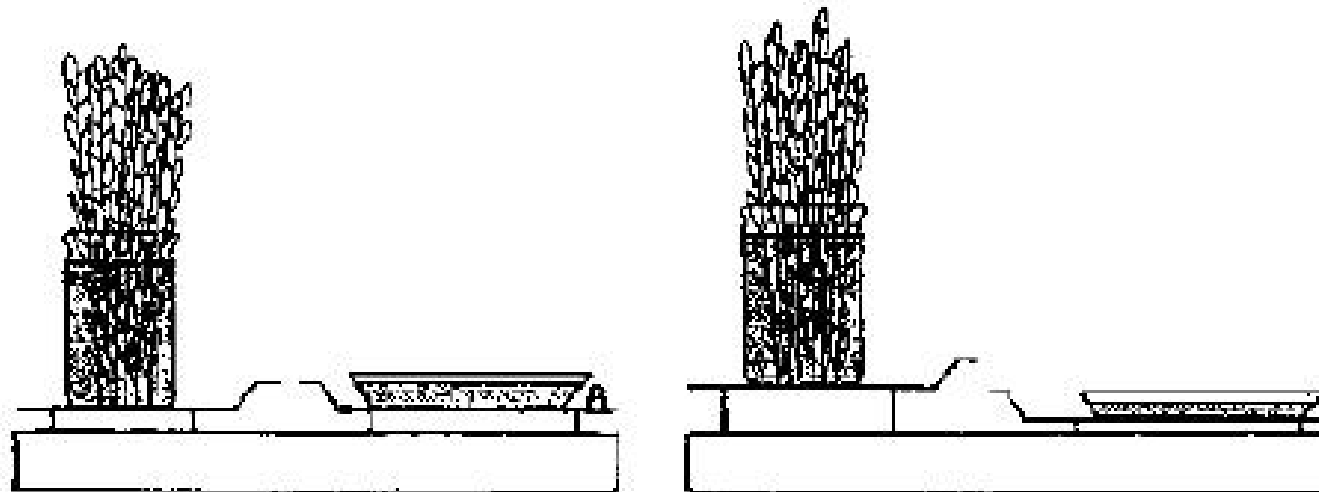

**Observation:**

The platform with the twigs in the beaker will go up, the other one naturally down.

**Analysis:**

**More water has evaporated through the leaves of the bunch of twigs than via the surface of the water in the dish.**

Importance in Nature:

Only a little area of the lower surface of the leaf is needed to release enough water to enable them to take as many minerals from the soil as necessary. The leaf remains stable in this way. There are only small parts where germs can get into the plant. There is another example of optimal compromises in nature.

### 1.13. GERMINATING PLANTS IN DIFFERENT CONDITIONS

**Main Goal:**

**This experiment shows that seeds, in this case pea seeds, need air to germinate.**

Information:

see analysis.

*Materials and Apparatus:*

*ten pea seeds (other seeds have to be tested)  
two dishes with a rim high enough to cover the pea seeds with water  
cotton wool or some other such substance to keep the pea seeds moistened*

Procedure:

Put the cotton wool in one of the dishes and place five pea seeds on it. The other five seeds are placed in the other dish. Fill the first dish with water so that the seeds are just covered. Keep only the cotton wool wet after the seeds have soaked up the water.

Fill the second one up to the rim and keep the water at this level.

Watch the dishes and change water if it becomes grey.

Then there are fungus which will start to destroy the experiment.

#### Observation:

After 24 hours the seeds are swollen.

After another 24 hours the pea seeds on the cotton wool have germinated, while the seeds under water have not germinated or not to any great extent.

#### Analysis:

**Though there is some oxygen soluted in tap water it is not enough to let seeds germinate. Plants can use their nutrients stored in the seed leaves only if there is enough oxygen available to decompose the starch into sugar.**

#### Addition:

Now you know why the earth has to be loose and wet, when you sow seeds in the garden.

## 2. HUMAN BIOLOGY

## 2. HUMAN BIOLOGY

### 2.1. HEAT RADIATION OF THE HUMAN BODY

#### Main Goal:

**This experiment demonstrates that the human body, like all other substances, emits heat to a colder surrounding.**

#### Information:

The average body temperature of a healthy human being is 37° C. This temperature is maintained by the various metabolic processes (see experiment "HEAT RADIATION").

#### *Materials and Apparatus:*

*1 thermometer, if possible filled with alcohol rather than mercury*

#### Procedure:

- a. With the thermometer, the body temperature is measured under the armpits.
- b. Fix the thermometer in a stand (e.g. a small branch in a pot with sand). Put one hand round the lower tip of the thermometer, close to it, but without touching the tip.

Wait about one or two minutes and note what happens.



Observation:

- The thermometer indicates about  $37^{\circ}\text{C}$ .
- The thermometer ascends for two to five degrees, depending on the surrounding temperature.

Analysis:

**The average body temperature of a human being is  $37^{\circ}\text{C}$ .**

The body emits heat to a colder surrounding e.g. the air

**The average body temperature of a human being is 37° C.  
The body emits heat to a colder surrounding, e.g., the air.**

Practical Use:

Human beings choose their clothing according to the outside temperature. To keep the heat radiation of the body at a low level, the Eskimos in Greenland wear thick furs. In southern warm countries, thin and often lightly coloured clothing is worn. It reflects the radiation of the sun better than dark clothing.

## **2.2. SENSATION OF WARMTH AND COLD**

**Main Goal:**

**This experiment illustrates that the sense of temperature cannot register temperature in an **absolute way**.**

Information:

Covering the skin of a human being are about 250 000 receptors to perceive cold and 30 000 to perceive heat. Temperatures which are too high or too low cause a feeling of pain.

*Materials and Apparatus:*

*1 thermometer*

21

*three litres of water one each at a temperature of 5 ° C,  
20 ° C and 40 ° C 3 flat dishes*

Procedure:

One litre of water is cooled down, in a refrigerator, with ice or by placing it outside at night.

Another litre is heated to about 40 ° C, and the last litre to about 20 ° C.

The experiment is set up as shown in the diagram below.

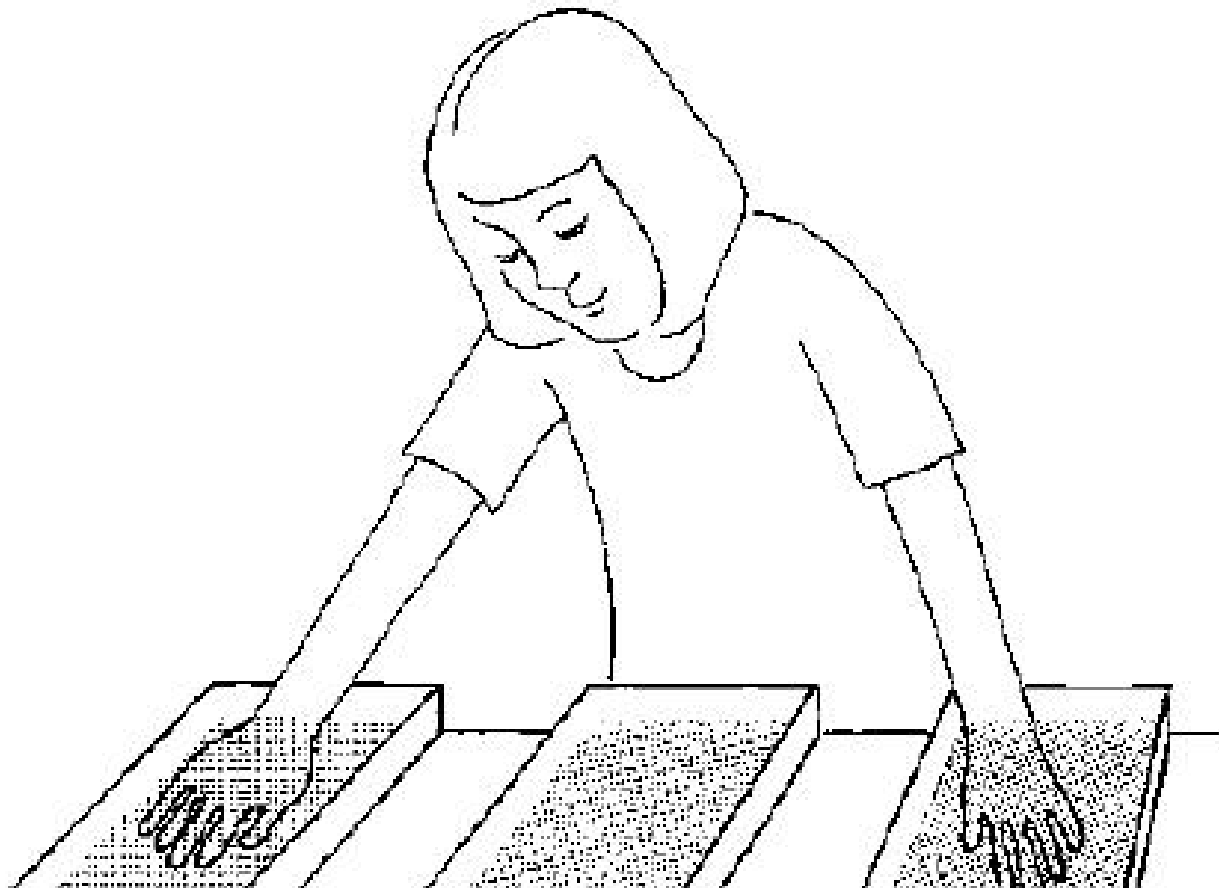

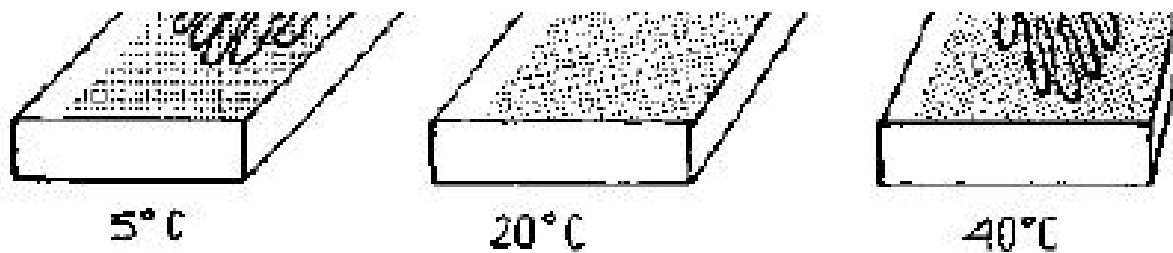

One test person places his left hand into the left-hand dish and the right hand into the right-hand dish. After 5 minutes, both hands are placed simultaneously into the middle dish.

Observation:

The left hand perceives the water in the middle dish to be relatively warm and the right hand perceives it to be relatively cold. After some time the water is perceived as being the same temperature by both hands

**Analysis:**

**Temperatures are perceived with the sense of temperature.**

**The sense of temperature needs some time to adapt to sudden variations in temperature.**

**Thus it is only reliable up to a certain point.**

Addition:



Non-heated rooms such as a cellar, are perceived to be cool in summer and warm in winter, although the temperature is higher in summer than in winter.

### 2.3. THE TASTE BUDS ON THE TONGUE

#### Main Goal:

**This experiment shows that the tongue is divided into various areas which perceive different kinds of tastes.**

#### Information:

On the surface of the tongue are taste bud areas which are capable of distinguishing between sweet, sour, salty and bitter. These areas can be easily located.

#### *Materials and Apparatus:*

*sugar*

*sodium chloride – household salt*

*1 lemon*

*magnesium sulphate or one bitter grapefruit*

*4 cotton buds or wooden spatula*

*4 flat glass receptacles*

*4 cotton buds or wooden spatula*

*4 flat glass receptacles*

*1 cloth*

Procedure:

Watery solutions of each of the above-mentioned substances and fruits should be prepared.  
A test person is blindfolded.

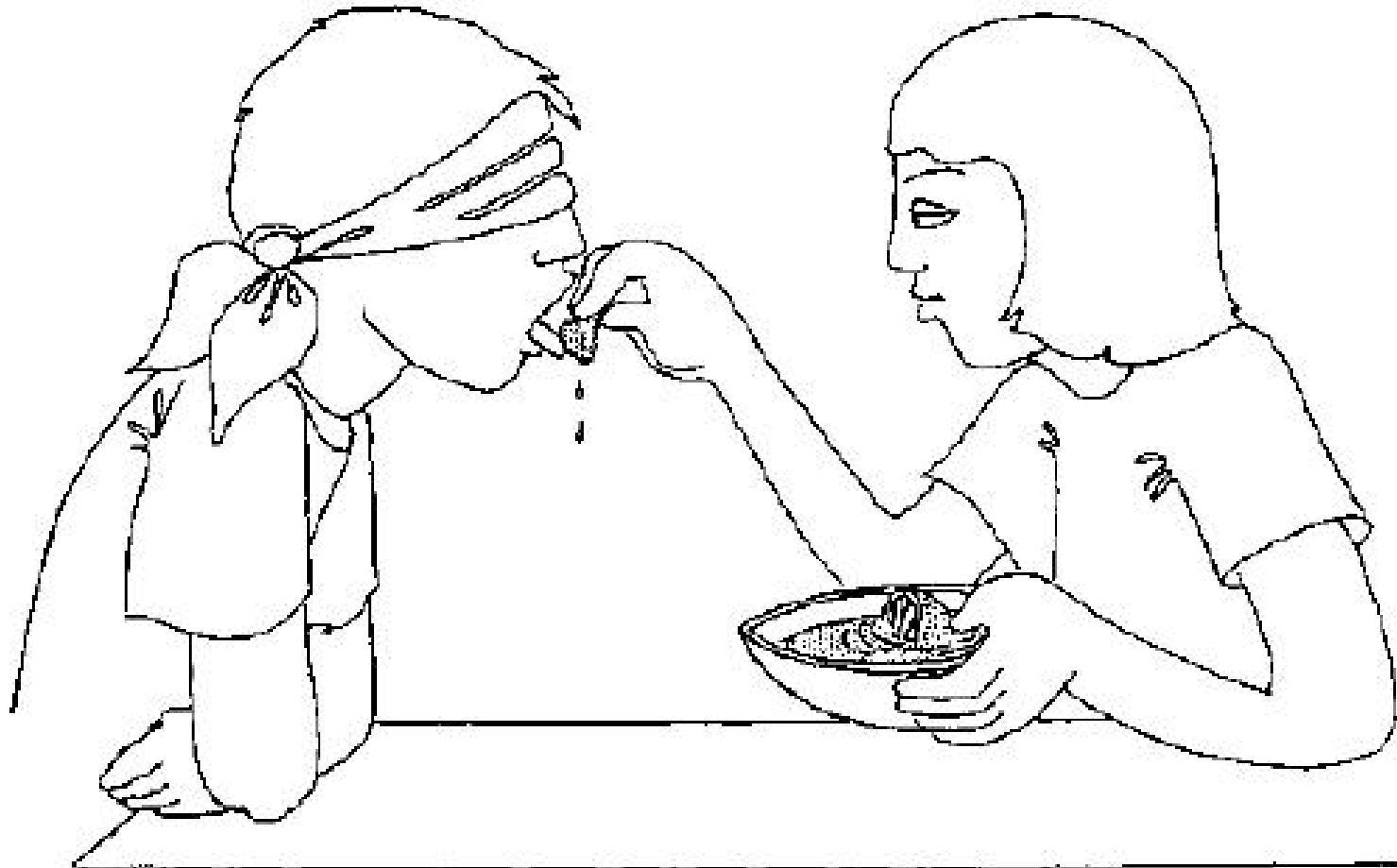

The solutions are placed on his/her tongue with the cotton buds. The test person states on which part of the tongue he tastes the solutions. The test person must rinse out his/her mouth with water between tests.

Observation:

Sweet tastes are perceived on the tip of the tongue.

The front edges of the tongue perceive salty substances.

The front edges of the tongue perceive salty substances.

The rear tongue edges perceive sour substances, and bitter ones are tasted in the retrolingual region.

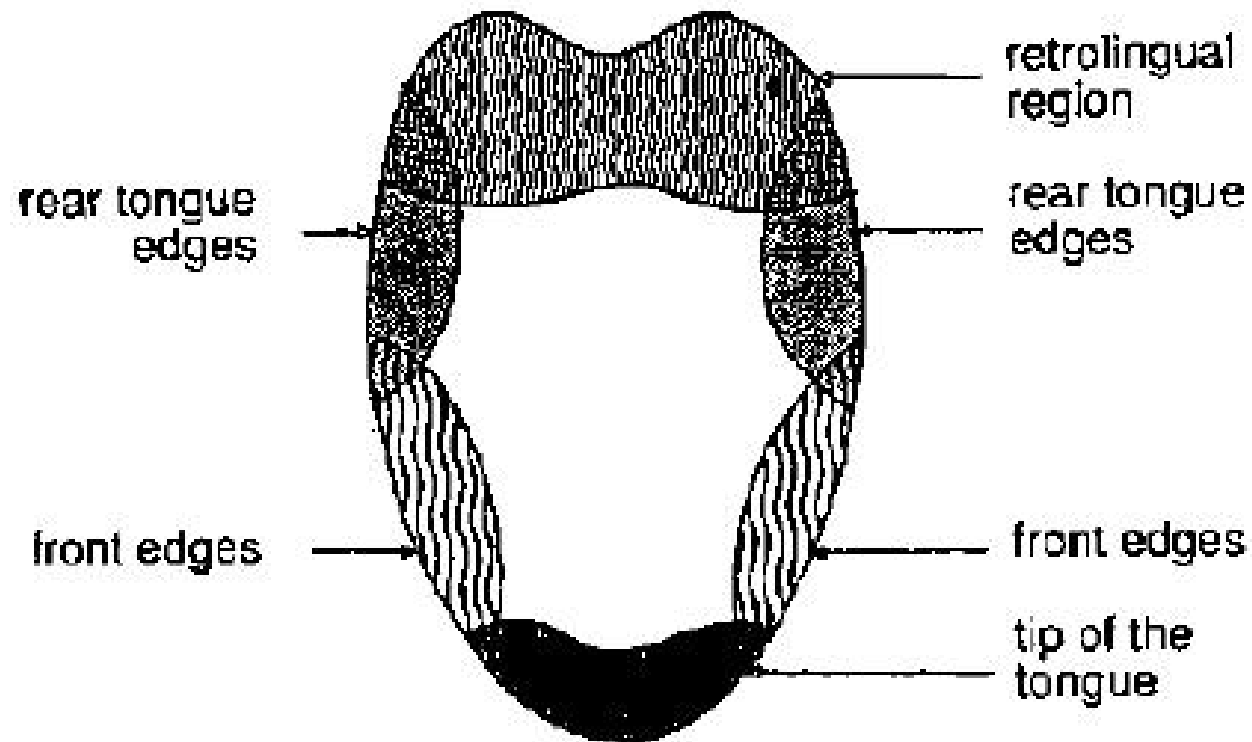

**Analysis:**

The taste bud areas are shown above in the form of a diagram.  
The four different kinds of taste can be perceived best in the above areas.  
The tastes overlap at the extremities of each zone.

Addition:

The knowledge of the places where you perceive the four different tastes is of no use at first, for you will seldom taste only one of the four tastes, when you eat anything. But if you think about your taste of a meal, you can imagine what happens in your mind with all the single tastes, composed in a very tasteful meal: Your tongue distinguish only four different tastes, in your mind find hundreds of different tastes, all composed by only the four, plus the taste "hot".

## 24. THE SENSATION OF TASTE AND SMELL

**Main Goal:**

**This experiment demonstrates the interaction of the senses of smell and taste.**

**Information:**

Four different areas of taste are located on the tongue:

sweet, salty, sour, bitter.

However, feelings of taste are created by an interaction of the sense of taste with the sense of smell. The latter is located on the mucous membrane of the nose. Besides this, the sensation of taste is affected by the sensations of warmth, cold, pain and touch.

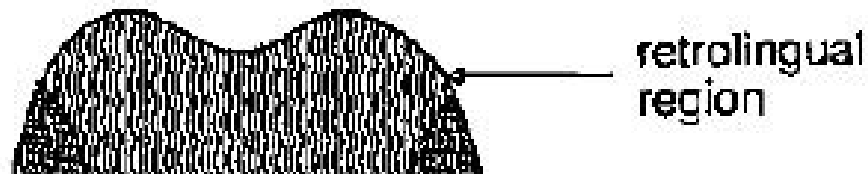

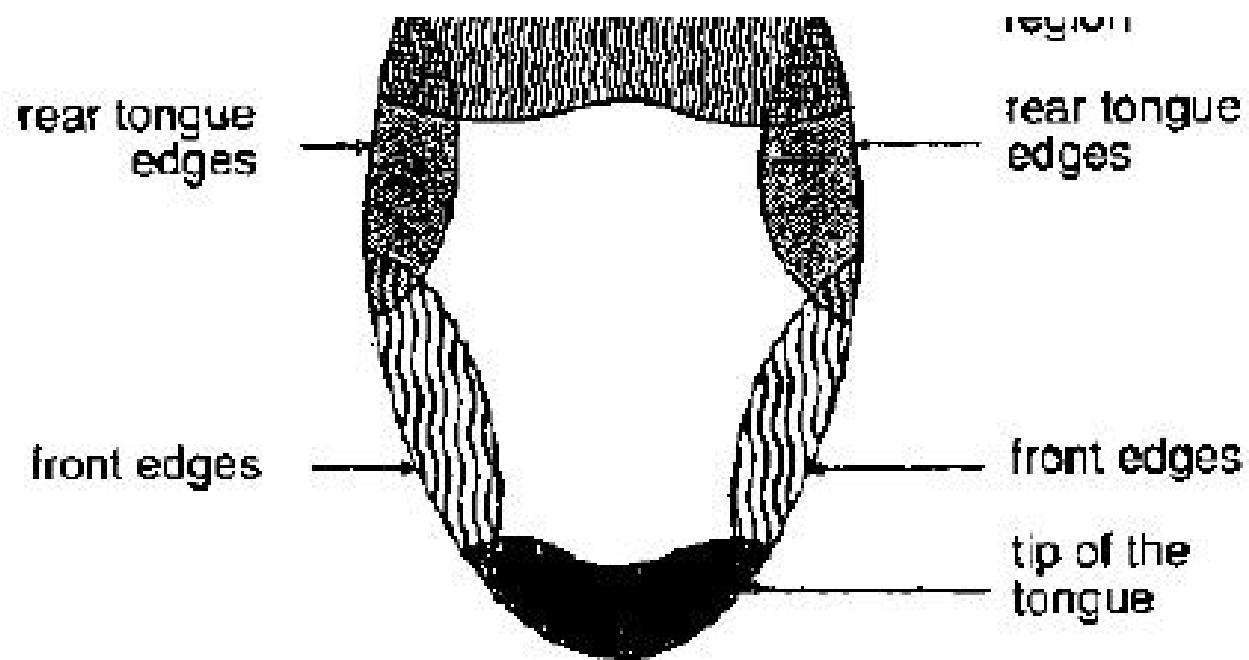

*Materials and Apparatus:*

- 1 apple
- 1 potato
- 1 onion
- 3 spoons
- 1 grater
- 3 dishes
- 1 cloth

*Procedure:*

The fruit and vegetables are grated and placed on the dishes.

One test person is blindfolded.

Using the spoons, the grated apple, potato and onion are put onto the tongue of the test person one after the other. After each test the test person rinses his/her mouth with water. The test person identifies the taste.

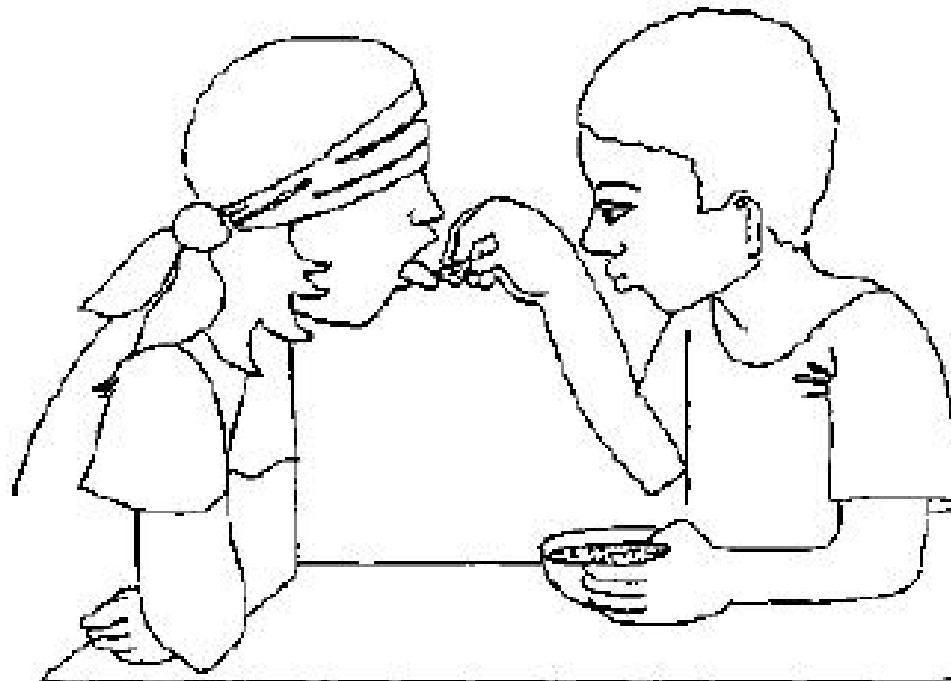

The second test is performed in the same way, but this time the test person holds his/her nose.



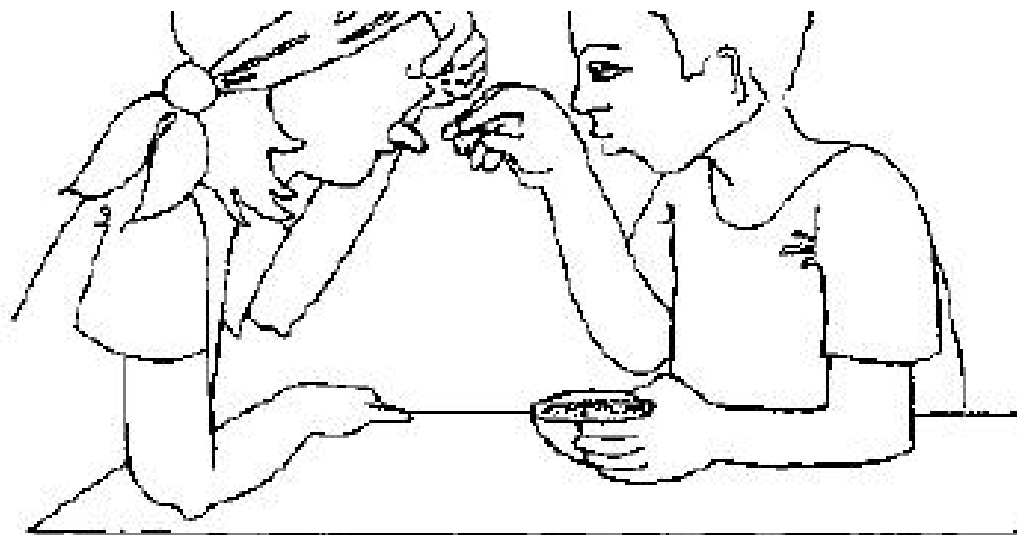

Observation:

When the test person holds his/her nose, the sensation of taste is significantly weaker.

**Analysis:**

**There is an interaction between the sensations of taste and smell.**

Addition:

It is well-known that to a person with a bad cold, food “has no taste”. Refer back to experiment 2.3 and complete your knowledge of tasting a meal.



## 2.5. STARCH BREAKDOWN IN THE MOUTH

### Main Goal:

**This experiment illustrates that starch breakdown starts in the mouth.**

### Information:

In the mouth, food is chewed into small pieces and moistened with saliva. The saliva is formed in the salivary glands, two sublingual, two lower jaw, and two parotid glands.

Saliva consists of mucus and the enzyme "ptyalin". This enzyme causes the catabolism of starch into maltose. This catabolism continues in the stomach until the enzyme is made ineffective by hydrochloric acid, which is found in the stomach.

### Materials:

*a few cubes of bread*

*a few tubes*

*iodine-potassium iodide solution 1%*

### Procedure:

Put one cube of bread into a tube. Then drop so much of your saliva into the tube that the cube of bread becomes wet through. Drop about three drops of the iodine solution onto the cube. It turns dark blue. Keep the tube warm by closing your hand around the tube. Look periodically at the colour in the tube.





Observation:

After several minutes the colour changes from dark blue to light brown.

**Analysis:**

**The enzyme ptyalin has catabolized the starch to sugar. Sugar cannot be tested with iodine solution. Therefore the blue colour disappears. This proves that the digestion of food starts in the mouth.**

## 2.6. THE CINEMA EFFECT

### Main Goal:

**An expressive demonstration of the imperfections of the human eye.**

### Information:

The human eye does not register individual stimuli which hit the retina within less than an eighteenth of a second. One uniform impression is created.

### Materials and Apparatus:

*one cardboard disk, about 5 cm in diameter  
a piece of string  
coloured pencils*

### Procedure:

On one side of the cardboard disk a bird is painted and on the other side an upside-down cage.

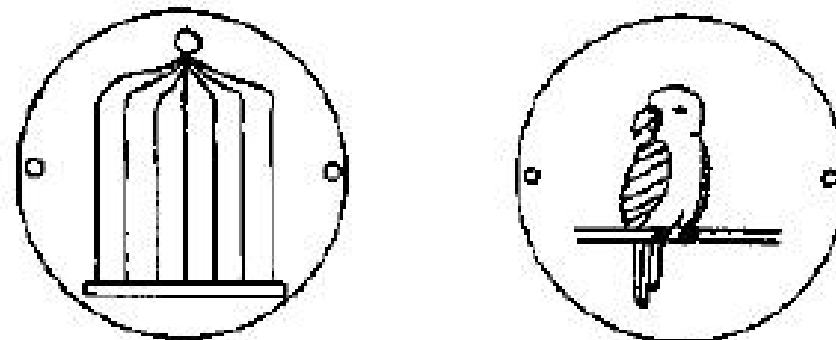

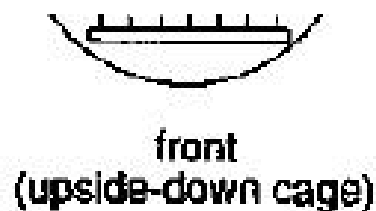

The string is cut into two pieces. Each of them is made into a noose. The nooses are attached to the opposite edges of the disk exactly in the middle of the drawing. (See diagram below.)

The free ends of the strings bands are firmly held, and then the disk is turned until the two strings are completely twisted. Then pull the ends of the strings in opposite directions. (If you pull too strongly you may tear the strings out of the holes in the cardboard.) The disk rotates rapidly and should be allowed to twist the strings in the other direction by loosing the pull on the strings. Then pull again and so on.

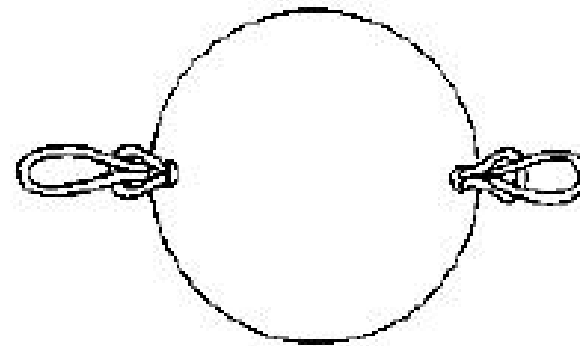
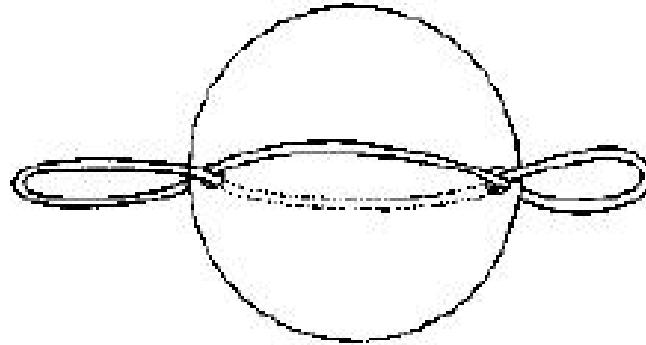

fastening of the strings

Observation:

Initially, the disk turns so quickly that the bird seems to be sitting in the cage.





Analysis:

The rapid sequence of images cannot be separated by the eye into single images. The sluggishness of the eye is responsible for this “cinema effect”, which is the melting together of single images into one animated image. This effect can be produced at a speed of 18 pictures a second. Most films in the cinema and the television work with 24 or 25 pictures a second to avoid any flicker.

## 2.7. THE BLIND SPOT

Main Goal:

An experimental demonstration of the blind spot.

Information:

Rods and cones cells which are sensitive to light, are parts of the retina.

Nerve fibers conduct stimuli to the optic nerve and then to the visual centre of the cerebral cortex.

Where the optic nerve emerges, there are no rods and cones, so that an image cannot be created. This spot is called the "blind spot".

The brain completes the missing part of the image from its surrounding. Thus there is no "hole" in the field of vision.

*Materials and Apparatus:*

*light cardboard, measuring about 10 cm × 3 cm*

*scissors*

*coloured pencil*

*Procedure:*

The cardboard is prepared as shown in the following diagram. (Other symbols can also be used.)

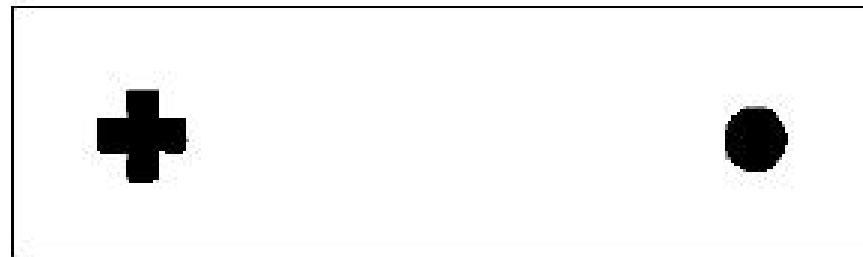

The cardboard is held at arm's length in front of the right eye, and the left eye shut. The right eye focusses on the cross, and then the cardboard is slowly moved towards the eye.



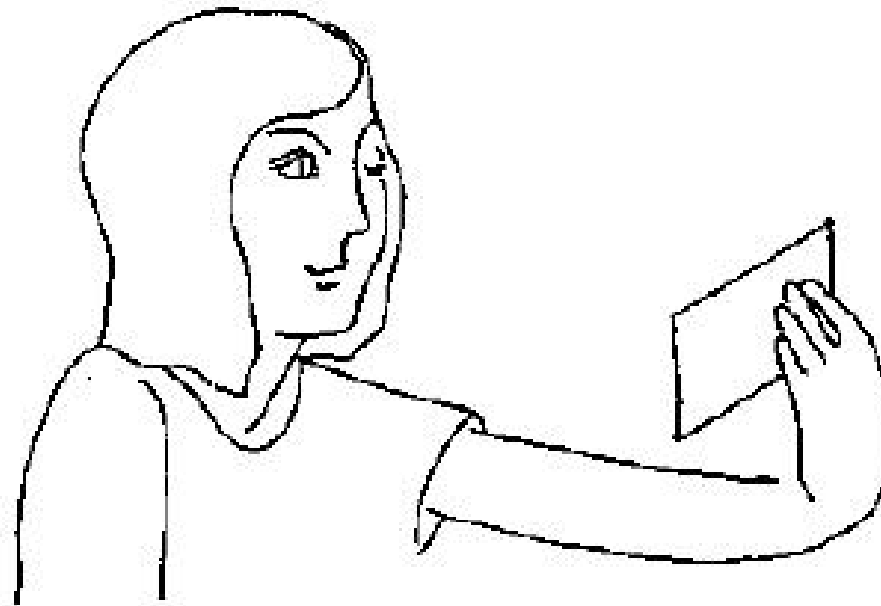

Observation:

The circle "disappears", when the cardboard is a certain distance from the eye.

Analysis:

Light stimuli, which hit the optic nerve, are not transformed into an image. The spot where the optic nerve emerges is called the "blind spot".



## 2.8. A MODEL DEMONSTRATING THE FLEXIBILITY OF THE SPINE

### Main Goal:

**This experiment illustrates the flexibility and the stability of the spine.**

### Information:

The spine of a human being is shaped like a double "S". The spine of a baby or an ape is shaped like a single "S".

### Materials and Apparatus:

*2 solid pieces of wire about 50 cm long*

*a wooden board measuring about 10 cm × 20 cm different weights weighing about 50 – 200 g or other objects which can be hung at the top of the spine models.*

### Procedure:

As shown in the drawing below, the two wires are fastened onto the board and bent. Make sure that the curves are exactly at the same points as shown in the figure. Bend the two spine models so that the top is exactly above the fixing point of the lower part of the spine models. (This is indispensable for the success of the experiment.)

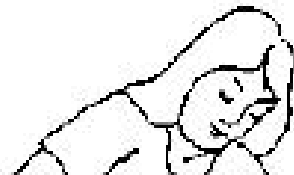

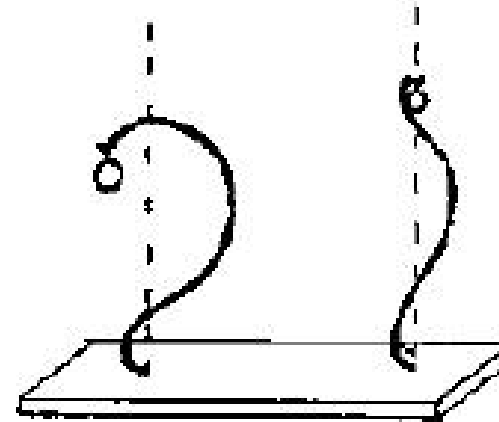
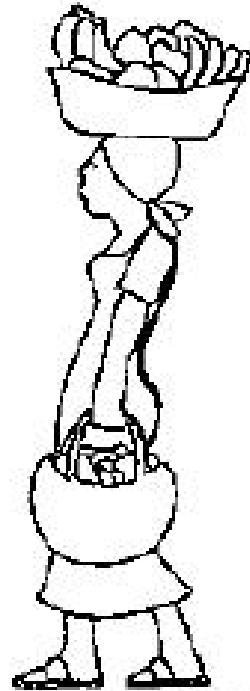
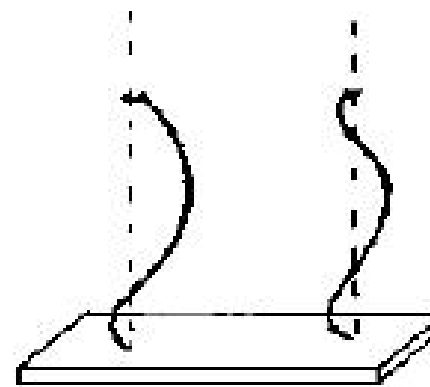
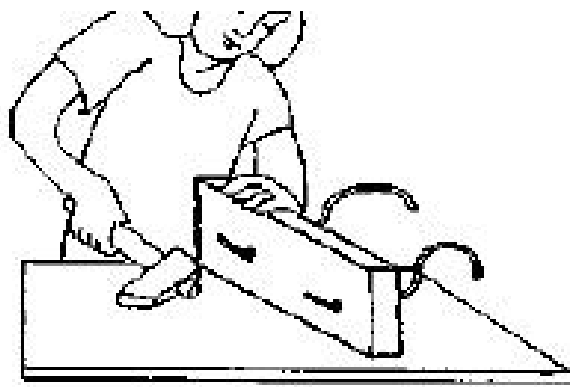

Identical weights are hung from each spine model.

Observation:

The single S-shaped spine sags to a greater extent than the double S-shaped spine.

### **Consequences**

**The double S-shaped spine of adolescents and adults is more stable than the single S-shaped spine of babies and apes.**

Practical Meaning:

The spine of an adult can be subjected to great pressure.

Because it is more flexible, it absorbs vibrations resulting from walking upright. This protects the brain against the usually occurring vibrations.

In many countries, loads, e.g. water jugs, are carried on the head, because this makes the transport easier.

## **2.9. COSTAL RESPIRATION**

**Main Goal:**

**This experiment illustrates costal respiration.**

Information:

When you breathe in, the volume of your chest increases. The muscles between the ribs contract, lifting the ribs, with them the breast bone (sternum) and therefore the complete chest (thorax).

chest (thorax).

Abdominal breathing usually takes place simultaneously with costal respiration.

The muscular diaphragm contracts, so that it flattens, presses onto the internal organs, and moves the abdominal wall forward. The lungs follow this expansion. Breathing out provokes the reverse sequence.

*Materials and Apparatus:*

*cardboard (or stiff paper)*

*scissors*

*cord, paper clips, rubber bands or blades of grass*

Procedure:

A model is made as shown in the following diagram.

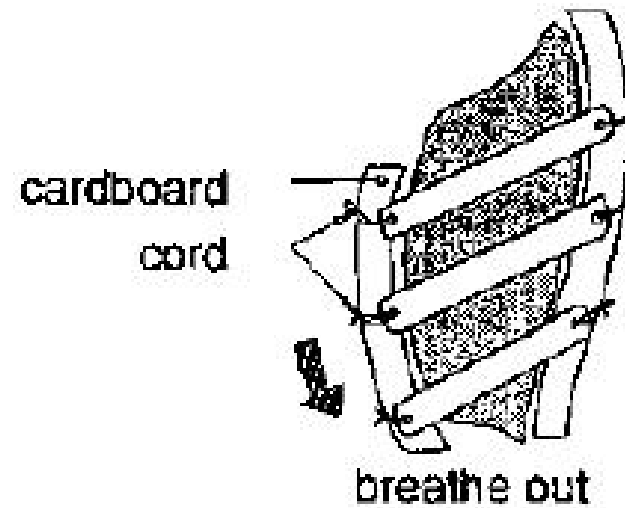
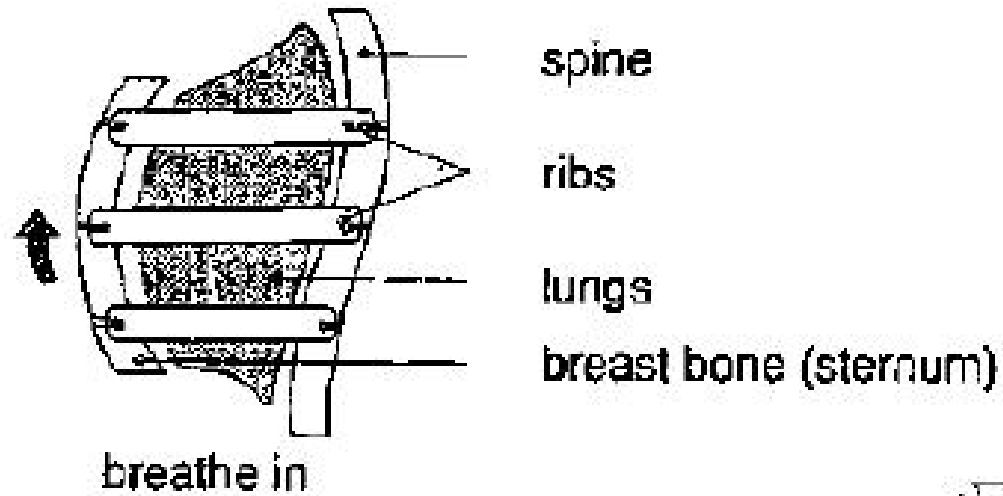

Observation:

If the breast bone is lifted, the chest widens. In reality the lungs expand.



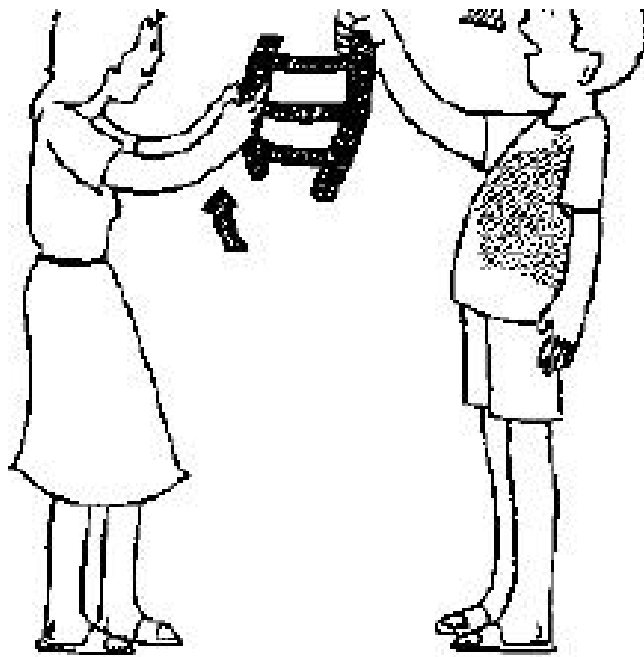

**Analysis:**

**Because of the volume expansion, the air pressure in the lungs drops so that it is lower than the external air pressure. A lower pressure is thus formed and the pressure of the external air forces air into the lungs.**

**When you breathe out the air zone becomes smaller and the air is pressed out.**

**Addition:**

If you pant you will see quite clearly that the abdominal wall arches forward when you inhale. The chest is hardly lifted. If you place one hand flat on the abdominal wall, you can feel the

respiratory movement.

## 2.10. IDENTIFICATION OF CARBON DIOXIDE IN EXHALED AIR

### Main Goal:

**This experiment illustrates that exhaled air contains carbon dioxide.**

### Information:

The constituents of food are catabolized into carbon dioxide, water and urea. Carbon dioxide is exhaled. The carbon dioxide proportion of inhaled air is about 0.03% and the oxygen proportion about 20% volume. The carbon dioxide proportion of exhaled air is approximately 4.5% and the oxygen proportion 15.5% volume.

A solution of limewater ( $\text{Ca}(\text{OH})_2$  in water) or a solution of ( $\text{Ba}(\text{OH})_2$  in water), baryta water, is used as a carbon dioxide indicator.

### *Materials and Apparatus:*

*calcium hydroxide or lime or calcium oxide ( $\text{CaO}$ )*

*barium hydroxide (made from barium oxide)*

*water*

*glass beaker*

*a glass pipe, a straw or a hollow bamboo cane*

*filters or clean paper from a cement sack*

### Procedure:

Procedure:

If no calcium hydroxide (or barium hydroxide) is available, calcium oxide (or barium oxide) should be dissolved in water. These solutions are filtered until they are completely clear.

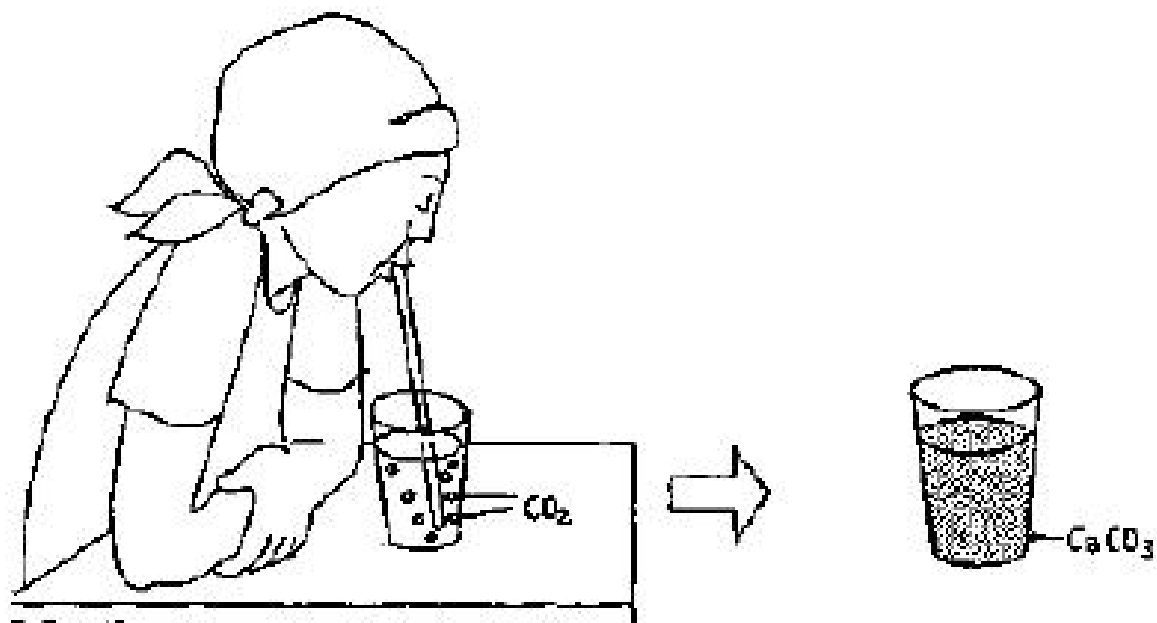



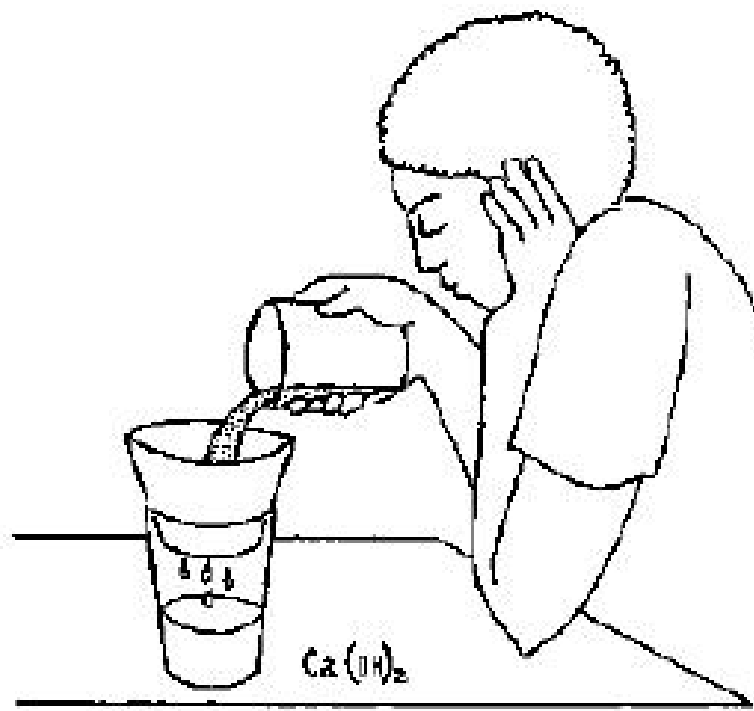

Exhaled air is blown into limewater through the glass pipe.

**Observation:**

The limewater (baryta water) becomes cloudy.  
A white substance is precipitated.

**Analysis:**

Exhaled air contains so much carbon dioxide that it reacts with calcium hydroxide to form white, hardly soluble calcium carbonate. In the reaction with barium hydroxide, white, hardly soluble barium carbonate is precipitated.

**Practical Importance:**

Practical Importance:

With the help of sunlight, plants produce carbohydrates and oxygen from carbon dioxide and water.

Oxygen is essential for human beings and animals.

Addition:



Leaving limewater or baryta water in direct contact with air does not cause clouding because the carbon dioxide concentration is too low.

Look up the experiments botany 1.10 and 1.12. Together with the experiment above you can now explain the circle of oxygen and carbon dioxide in nature.

## 2.11. THE SKIN RELEASES SODIUM CHLORIDE

**Main Goal:**

**This experiment shows that sodium chloride is released by the skin.**

Information:

35

<http://cd3wd.com/dvd/> - filename: z\_science\_exp\_41 of 598

The main task of the perspiratory glands in the skin is to regulate the body temperature. Besides water, sweat contains other products, predominantly sodium chloride – or household salt. This is why perspiration has a salty taste.

*Materials and Apparatus:*

a. *distilled water – available at any garage*

*2% silver nitrate solution ( $\text{AgNO}_3$ ), which can be purchased from a chemist  
large beaker holding 1 – 2 litres*

b. *magnesia sticks, which can be obtained from*

*a chemist  
1 candle*

*Procedure:*

a. The glass dish is filled with distilled water.

A test person places one hand into the water and holds it there for about 10–20 minutes.

Then a few drops of silver nitrate solution are added to the distilled water.



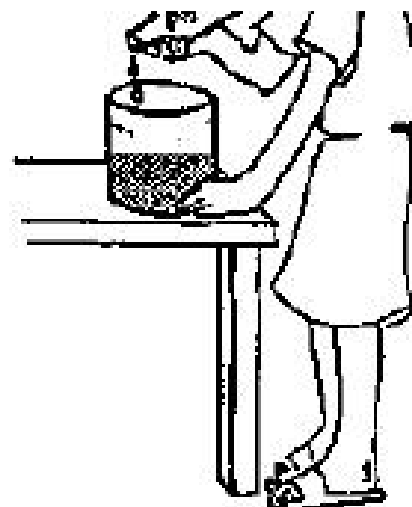
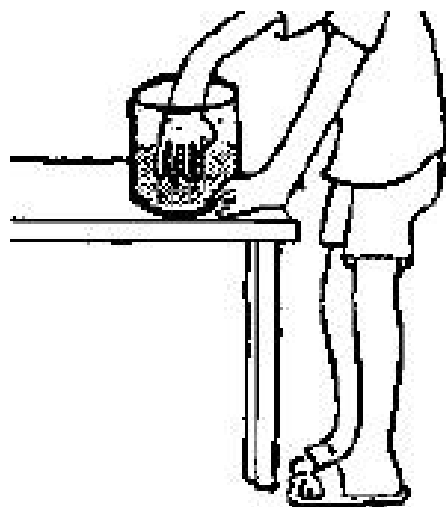

b. Sodium ions can be identified using magnesia sticks and a candle flame. The top of the magnesia stick is moistened with sweat and then held in the candle flame.

Observation:

- a. A white precipitate is formed.
- b. It can be observed that the flame burns yellow.

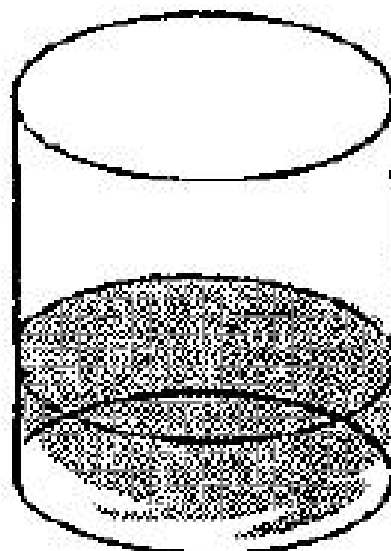

**Analysis:**

- a. The chloride ions together with silver nitrate form white silver chloride.



- b. The yellow colouring of the flame indicates the presence of sodium.

Practical Meaning: The skin releases warmth by evaporating water on the skin and with that a remarkable amount of sodium chloride. The loss of water is as problematic as the loss of sodium chloride. Losing too much water can cause circulatory problems.

In countries where it is always hot, it is important that the body receive sufficient sodium chloride, otherwise the high loss of sodium chloride in perspiration can lead to circulatory disturbances as well.

In the last century British miners became ill, suffering from too little sodium chloride after

In the last century British miners became ill, suffering from too little sodium chloride after sweating very strongly. After drinking weak saltwater they recovered. The products left by perspiration are not all waste products. Nature is not perfect. There are optimal compromises everywhere.

## 2.12. FINGERPRINTS

### Main Goal:

**This experiment shows that fingerprints are a typical characteristic of each individual.**

### Information:

Fingerprints are determined by the structure of the lines of the fingertips.

### *Materials and Apparatus:*

*ink or ink pad*  
*white paper*

### Procedure:

One fingertip is coloured with ink and pressed onto the paper once.

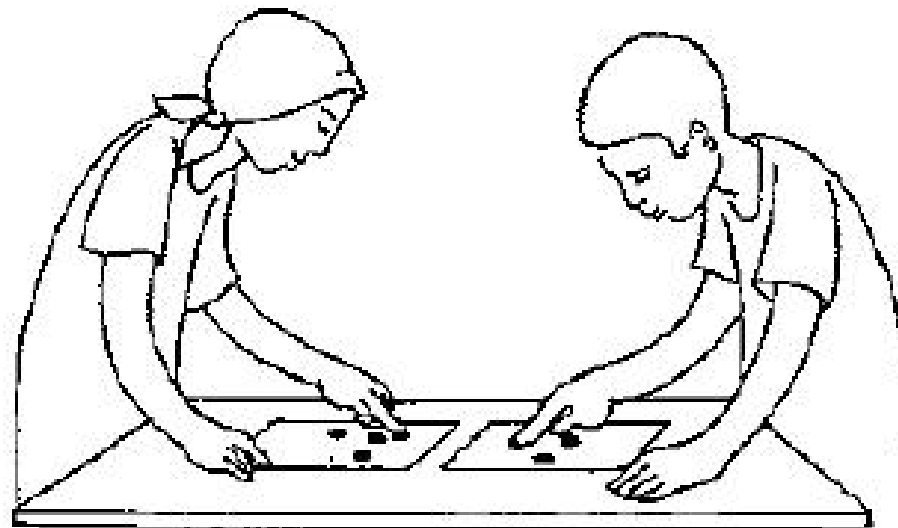
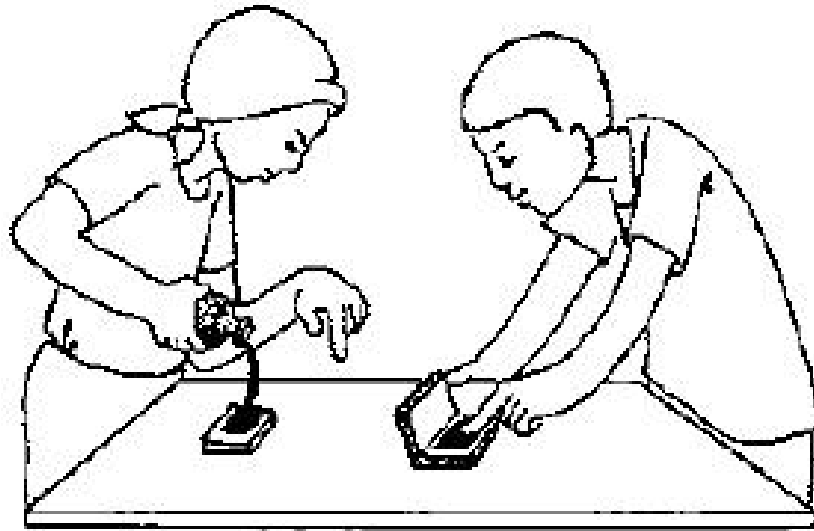

Observation:

Observation:

A pattern of lines can be seen in black. This pattern is the fingerprint.

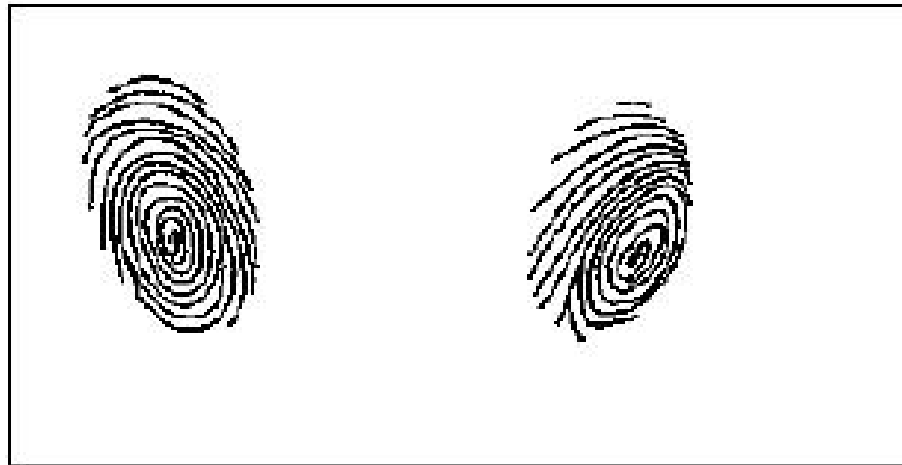

Analysis:

**If the fingerprints of different individuals are compared, it can be seen that all of them are different.**

Practical Use:

As the fingerprints of every human beings are unique, they are used as an important means of identification in criminology, when they can be used to identify a criminal.



### 2.13. DISTINGUISHING SEVERAL MATERIALS BY TOUCHING THEM WITH THE FINGER TIPS

#### Main Goal:

**This experiment demonstrates that your finger tips can be used successfully to identify different surfaces.**

#### Information:

see analysis

#### *Materials and Apparatus:*

*You will require several objects with different surfaces such as a stone, a brick, pieces of bark from different trees, pieces of rough and smoothed wood, different textiles etc.*

*a scarf or shawl to blindfold a person.*

#### Procedure:

One student is blindfolded and is given three objects to touch and retain the feeling. Then the scarf is removed. The student is allowed to test all objects and he/she must then determine which she/he touched while blindfolded.



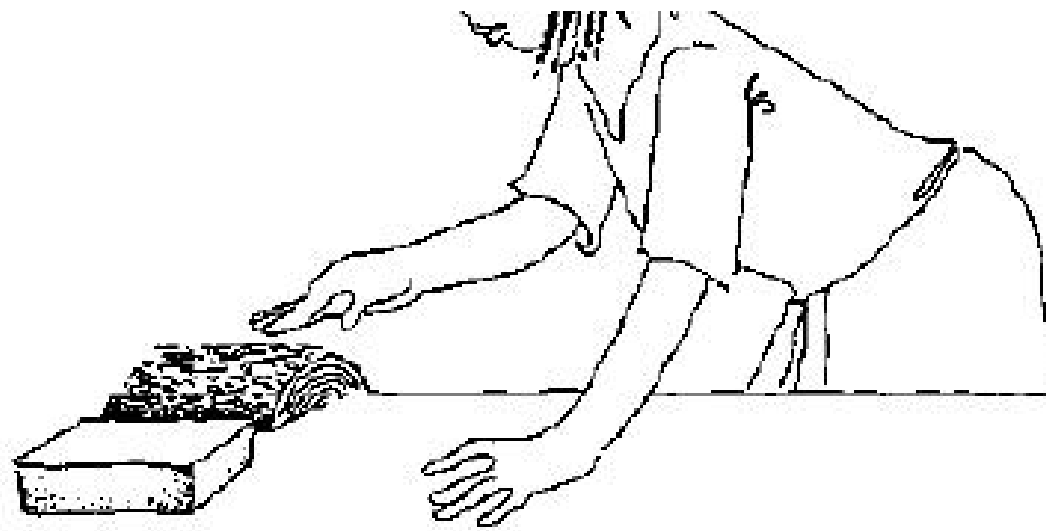

Observation:

Different students will show different abilities to identify the objects they touched while blindfolded. But every one is able to distinguish very different things.

**Analysis:**

**In our finger tips we have many sensory cells for touching far more than e.g. on our back.**

**The more of these cells there are in any area, the better we can identify different surfaces. The largest number of sensory cells for touching per square millimeter are in the tip of our tongue, but you should not test materials which may not be clean with your tongue.**

The differences in the results stem from the different experience in identifying things by touching.

## 2.14. TESTING PULSE FREQUENCY UNDER DIFFERENT CONDITIONS

### Main Goal:

This experiment demonstrates that the rate of the pulse depends on the work done immediately prior to measuring.

### Information:

see analysis

### *Materials and Apparatus:*

*one watch to measure minutes*

### Procedure:

Look for your pulse on your wrist using the thumb of your other hand. You will find it one thumb length away from the back rim of the hand above the sinews of the inner side of your arm.

You will probably need a little while to find it and feel it well.

One person, perhaps your teacher, says, observing the watch: "go" and you start counting the pulse beats. When he says: "stop" (after exactly one minute) you note the number of pulse

One person, perhaps your teacher, says, observing the watch: "go" and you start counting the pulse beats. When he says: "stop" (after exactly one minute) you note the number of pulse beats you counted.

Then everybody does ten knee bends. After this someone gives a starting signal again and you count the pulse beats again for one minute.

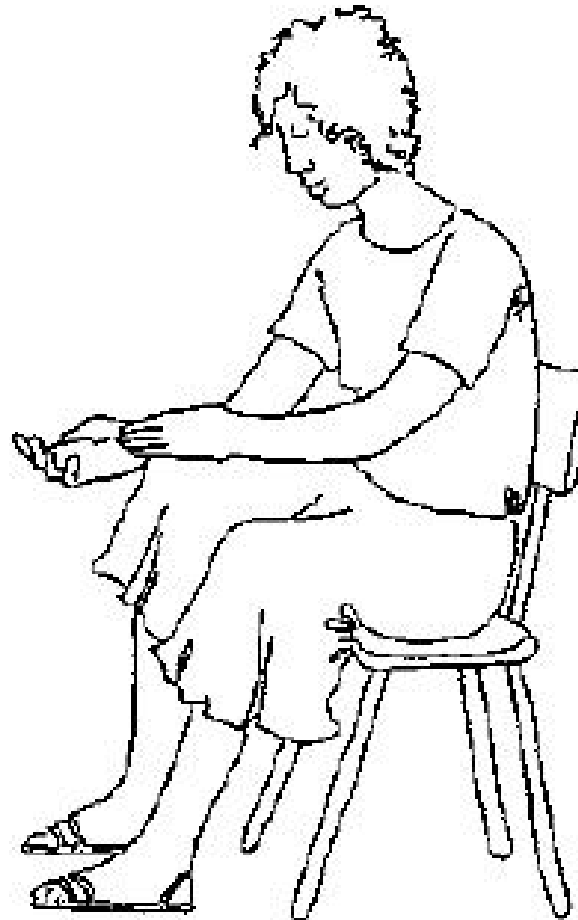

Observation:

In the second case you will count a higher number of pulse beats than in the first. You may also be breathing faster especially if you are unaccustomed to sport and physical exercise.

**Analysis:**

**Your body registers the work you do, in this case the knee bends.**

**It is able to regulate the pulse frequency in order to provide the muscles with enough blood for them to receive sufficient oxygen. That is also why you breath faster.**

## **2.15. DETERMINING THE DIRECTION FROM WHICH A NOISE COMES**

**Main Goal:**

**This experiment demonstrates that with both ears you can better determine the direction from which a noise comes than with only one ear.**

Information:

see analysis

*Materials and Apparatus:*

*a scarf or shawl to blindfold a person*

*a scarf or shawl to blindfold a person*

Procedure:

All students sit in a circle. One of them stands blindfolded in the center of the circle. One student in the circle knocks on something e.g. his chair to produce a noise. The blindfolded student has to point in the direction from which the noise came without turning round.

Another student knocks from a different direction, the blindfolded student points to the source of the second noise.

Repeat the experiment several times.

After ten trials the blindfolded student holds his/her hand over one ear and the experiment is repeated another ten times.



**Observation:**

With both ears the blindfolded student will probably achieve about 9 right answers out of ten.

When holding a hand over one ear though the student might achieve a score of only some five or six correct answers, or less.

**Analysis:**

**Our ears are very sensitive. They can distinguish the time lapse which occurs if a noise does not come from immediately in front or behind us.**

**When one listens with only one ear this time lapse can no longer be heard and it**

When one listens with only one ear this time lapse can no longer be heard and it becomes more difficult to determine the source of the noise.

## 2.16. THE SENSITIVITY OF OUR HEARING

### Main Goal:

This experiment shows how sensitive our sense of hearing is.

### Information:

see analysis

### *Materials and Apparatus:*

*nothing*

### Procedure:

One student stand in front of the classroom with his face to the wall. Another student whispers a number between thirteen and ninety-nine. The first student has to repeat the number.

Try this experiment ten times initially.



The 'listening' student should then cover one ear, and the experiment should be repeated another ten times.

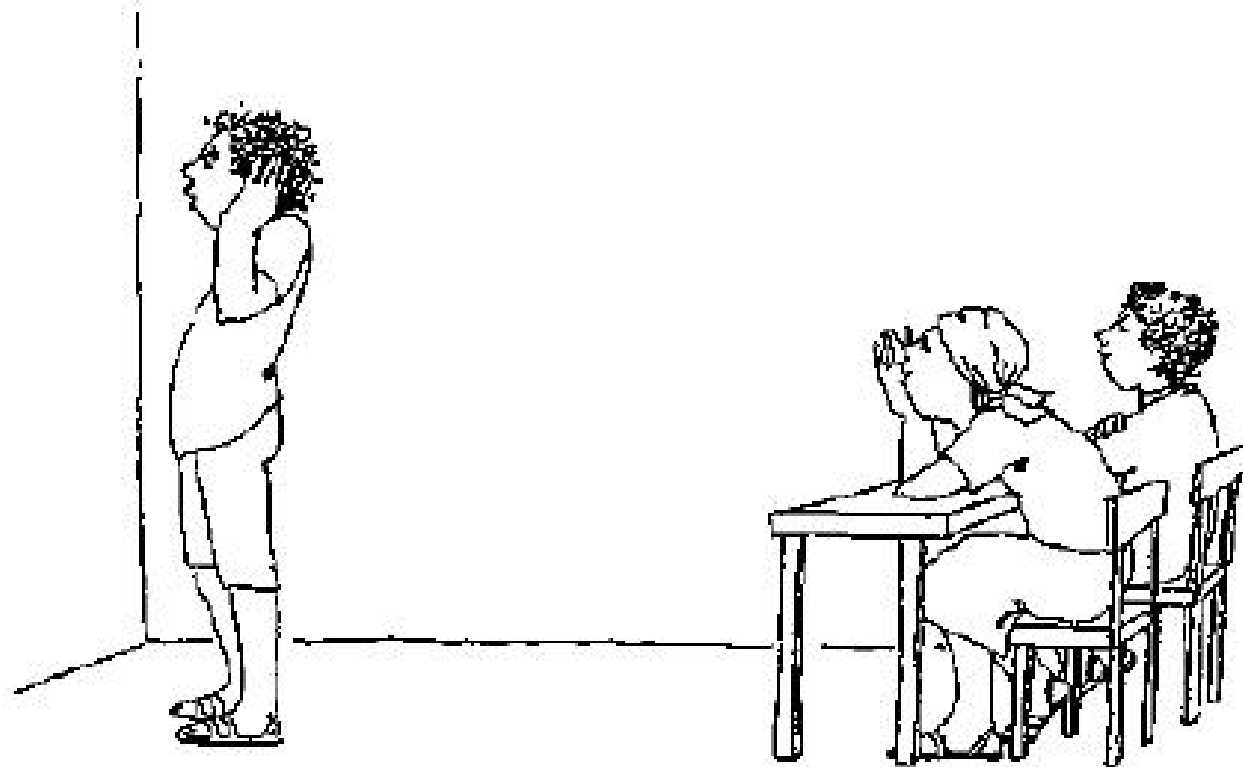

Observation:

In most cases it is not necessary to use both ears to understand whispered numbers.

Where a student does have difficulty he or she may have a hearing impediment.

Analysis:

**Both ears are usually equal sensitive. Thus one ear is sufficient to identify whispered**

**Both ears are usually equal sensitive. Thus one ear is sufficient to identify whispered numbers.**

**This test will demonstrate immediately if a student is particularly hard of hearing in one ear.**

**Hearing difficulties can be caused by many different things and it is always better to consult a doctor immediately.**

### **3. INORGANIC CHEMISTRY**

#### **3.1. COMBUSTION ZONES OF A CANDLE FLAME**

##### **Main Goal:**

**This experiment illustrates that the combustion of the gaseous particles of a candle takes place in the outer, the yellow zones of a flame.**

**In the following text these particles are called “candle gas”.**

##### **Information:**

The yellow colour of the outer zone of the flame is produced when the soot particles (carbon) light up.

The blue zones of the flame contain candle gas, that is not burning.

The temperature of the yellow zone is higher than that of the blue zone.

*Materials and Apparatus:*

*matches, magnesia sticks  
a candle*

*Procedure:*

- a. One match is passed through the flame of the candle (see diagram).
- b. The same experiment is carried out with a magnesia stick.

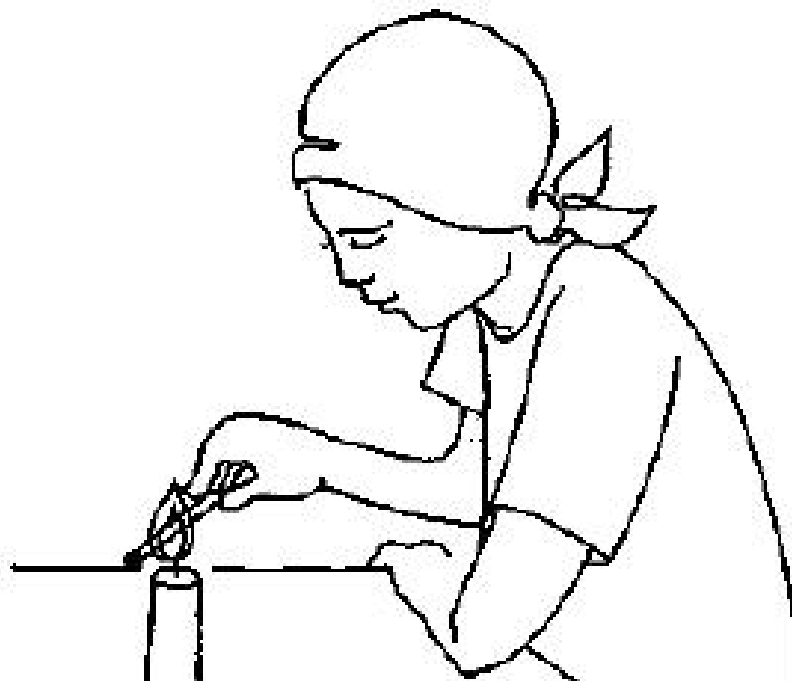

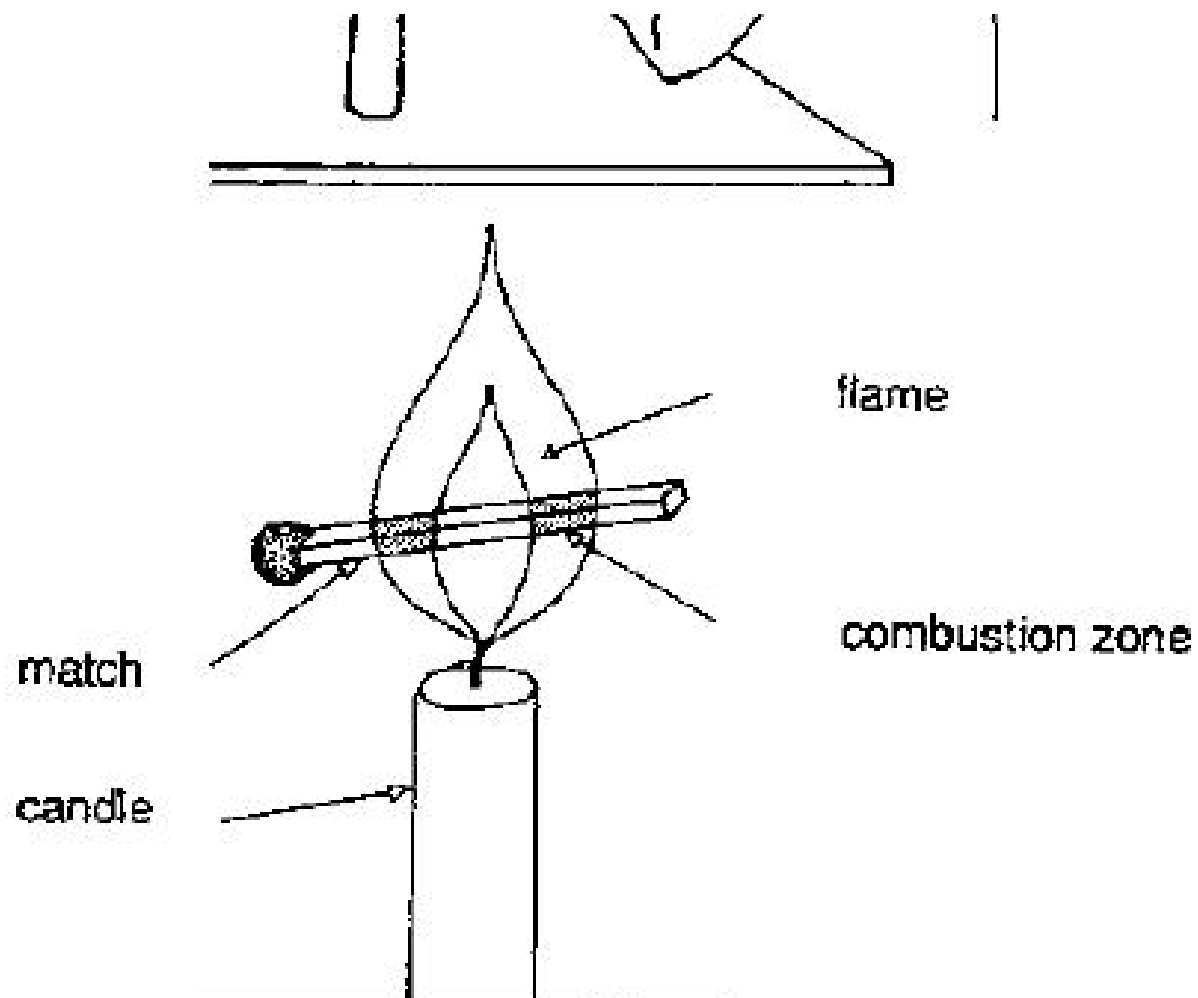

Observation:

- The part of the match in the yellow zone, is burning.
- The part of the magnesia stick in the yellow zone lights up in a yellow–orange colour.

**Analysis:**

The dark burnt parts of the match and the glowing parts of the magnesia stick demonstrate that the temperature in the yellow zone is higher than that in the blue zone. The combustion of the candle gas takes place in the yellow zone, as it is only here at the outer part of the flame, that enough oxygen is available and can mix with the candle gas.

**Practical Meaning:**

With this candle flame experiment the basic characteristics of a common laboratory burner or any other open fire can be demonstrated.

In open fires, a good oxygen supply is required to achieve complete combustion.

### **3.2. THE CANDLE FLAME AND ITS DAUGHTER FLAME**

**Main Goal:**

**This experiment demonstrates that the blue zone of the flame contains unburnt candle gas.**

**Information:**

(see experiment: THE COMBUSTION ZONES OF THE CANDLE FLAME)

*Materials and Apparatus:*

*Materials and Apparatus:*

*2 candles*

*2 tubes (of metal or glass, e.g. eye dropper)*

*1 clothes peg*

*Procedure:*

The candle gas of the blue flame zone is passed through the tube (see diagram).

**tube**  
**flame**  
**blue flame zone**

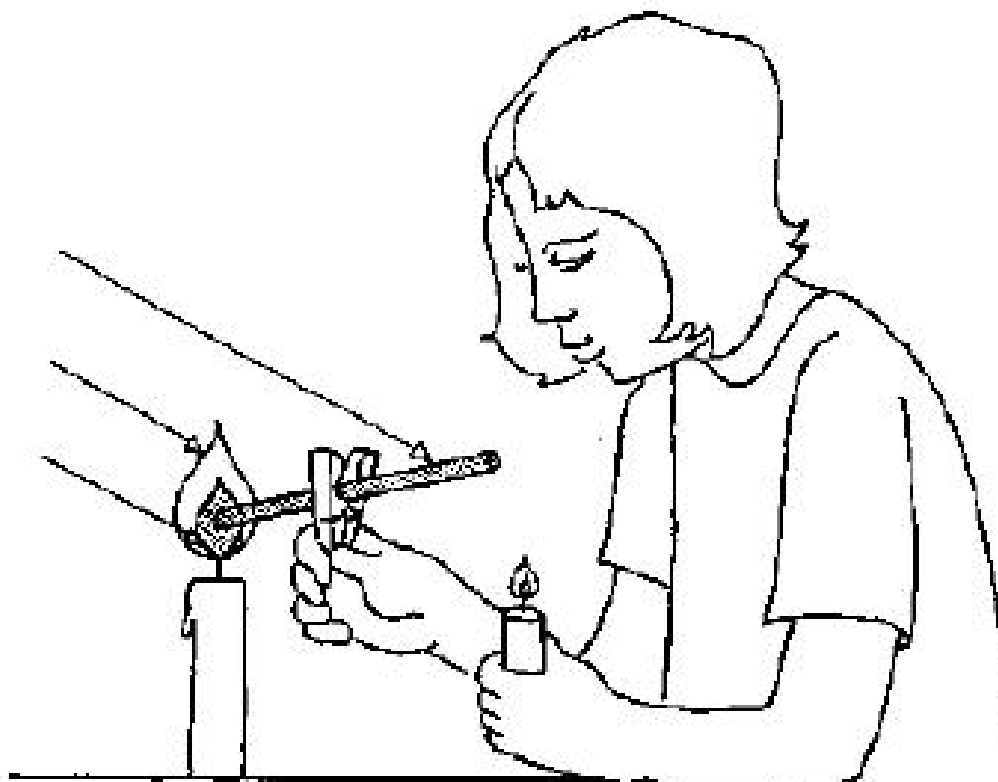

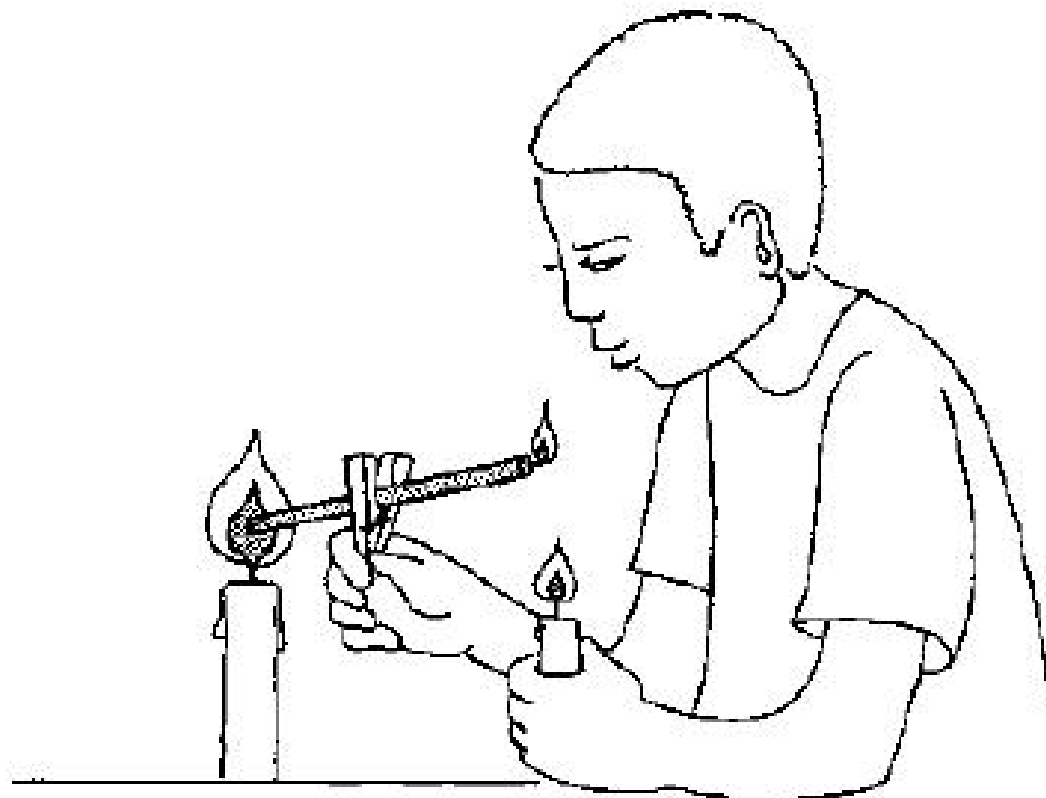

Observation:

This gas can be ignited with a lit candle.

**Analysis:**

**Unburnt candle gas can be found in the blue zone of the flame.**

**When the candle gas from the blue zone reaches the outer zone, it burns, when atmospheric oxygen and candle gas mix in the right proportion.**

**atmospheric oxygen and candle gas mix in the right proportion.**

Practical Use:

The candle flame has the same structure as the flame of bunsen or alcohol burners.

The most important properties of these burners can be demonstrated with a candle flame.

### **3.3. COMBUSTION PRODUCTS OF A CANDLE**

**Main Goal:**

**This experiment demonstrates that a candle forms soot (carbon), carbon dioxide and water when it burns.**

Information:

The candle substance, natural wax or stearin, consists of the elements carbon, hydrogen and oxygen. Carbon can be identified directly as soot, and indirectly as carbon dioxide.

During combustion water is formed. The presence of water provides indirect evidence of the presence of hydrogen.

*Materials and Apparatus:*



*candle*

*glass vessel*

*limewater*

*white copper sulfate (dried blue copper sulfate)*

Procedure:

a. The bottom of a glass vessel is held over a burning candle.

b. A cold glass vessel is held upside down over a burning candle.

The water which is produced can be identified with finely pulverized copper sulfate.

c. A glass vessel is held over a burning candle.

It is then rinsed with limewater to identify the carbon dioxide produced.

(As carbon dioxide is heavier than air, a great amount of it escapes from the glass dish.)

**glass vessel**

**candle**

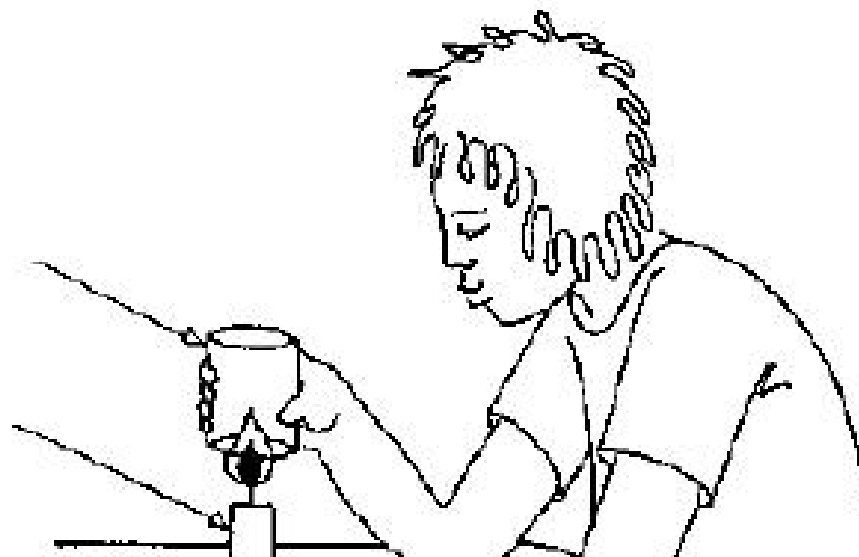



soot

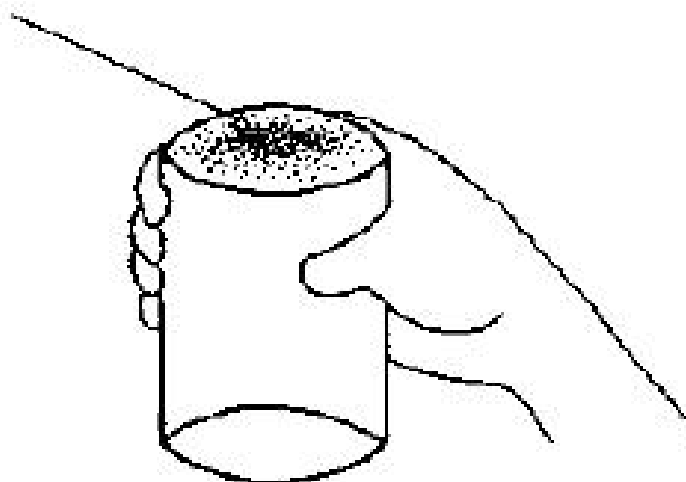

Observation:

- Soot settles on the glass vessel.
- A moist film develops. White copper sulfate turns blue.
- A white precipitate – calcium carbonate – is formed.

Analysis:

The candle substance burns to form soot (carbon), carbon dioxide, and water. Soot is the product of incomplete combustion of the candle substance.

Practical Use:

All organic substances contain carbon and hydrogen.  
These elements can always be identified using the above methods.

### 3.4. THE DETERMINATION OF OXYGEN CONCENTRATION IN THE AIR

**Main Goal:**

**This experiment demonstrates that part of the air is used during combustion.**

Information:

The investigation of air compounds shows that air consists of about 20 parts by volume oxygen and about 78 parts by volume nitrogen. The amount of other gases can be ignored for the purposes of the two following experiments. (These other gases are carbon dioxide and inert gases.)

*Materials and Apparatus:*

*part of a neon lamp (about 30 cm) or a tall glass*  
*small candle – should be light enough to float in water*  
*rubber stopper*  
*large glass dish*  
*a clamp stand if available (if not, the glass can be held as shown below)*

Procedure:

Procedure:

As shown in the following diagram, apparatus is constructed, with which the oxygen content of air can be approximately determined.

During combustion of the candle, the rising water fills the space left vacant by the air used to form carbon dioxide and water.

(The candle is extinguished before all the oxygen is used. The carbon dioxide formed dissolves in the water.)

tall glass upside down  
small candle, standing  
on a piece of wood and  
floating on water

water

glass dish

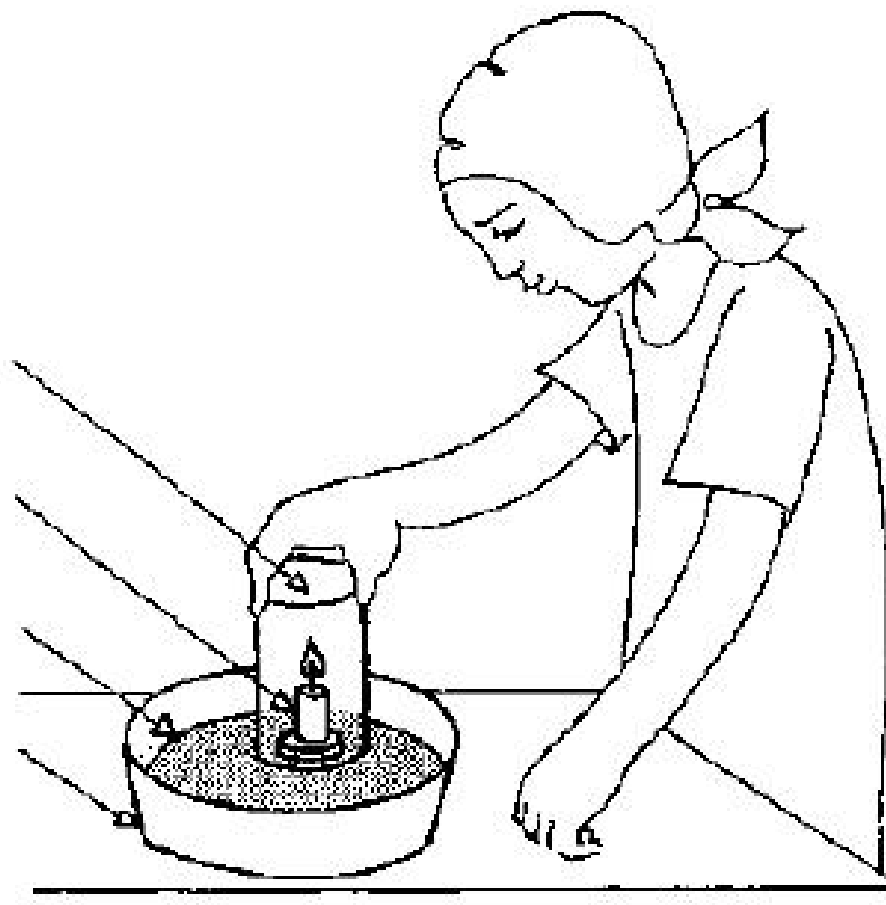

rubber stopper

part of neon lamp

candle

piece of wood

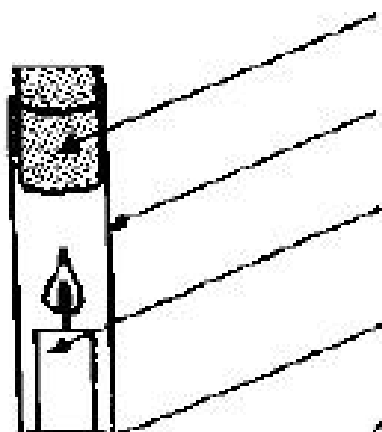

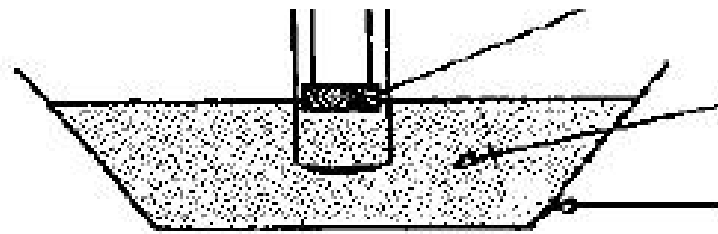

water  
glass dish

Observation:

While the candle light gradually becomes dimmer, the water level in the neon lamp rises. The rising water occupies about one fifth of the air volume which was present at the beginning of the experiment.

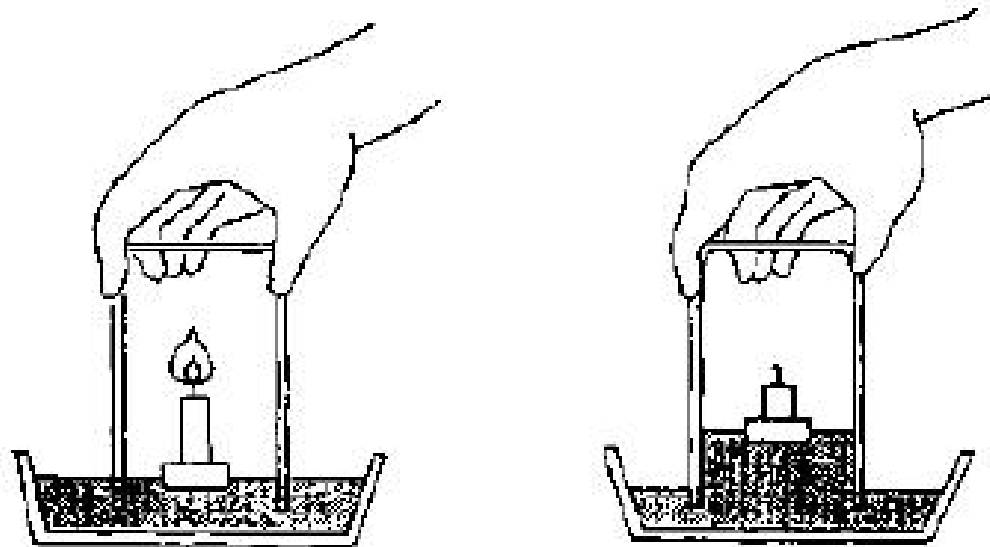

Analysis:

**During combustion, the candle uses about one fifth of the air volume. This part of the air is called oxygen.**

Practical Meaning:

Plants are the sole producers of oxygen on Earth.

They guarantee the constant oxygen content of the air. Any massive disturbance to the plant world would automatically seriously perturb the lives of man and animals. Human beings and animals need atmospheric oxygen to breathe. During the process of metabolism, carbon dioxide is produced in their bodies. With the help of solar energy, plants produce oxygen and carbohydrates from carbon dioxide and water ( $\text{CO}_2$  and  $\text{H}_2\text{O}$ ).

### **3.5. NITROGEN EXTINGUISHES A CANDLE FLAME**

**Main Goal:**

**This experiment demonstrates that a candle, or any other kind of flame, does not burn in nitrogen.**

Information:

(see experiment: DETERMINATION OF OXYGEN CONCENTRATION IN THE AIR)

*Materials and Apparatus:*

*part of a neon lamp (about 30 cm) or a tall glass  
small candle – should be light enough to float in water*

*part of a neon lamp (about 30 cm) or a tall glass*  
*small candle – should be light enough to float in water*  
*rubber stopper*  
*glass dish*  
*a covering plate made of wood, glass, or metal*  
*a candle attached to a wire*  
*a stand if available*

Procedure:

First the experiment "DETERMINATION OF OXYGEN CONCENTRATION IN THE AIR" is carried out. Then the dish is closed under water with the cover plate and turned upside down.



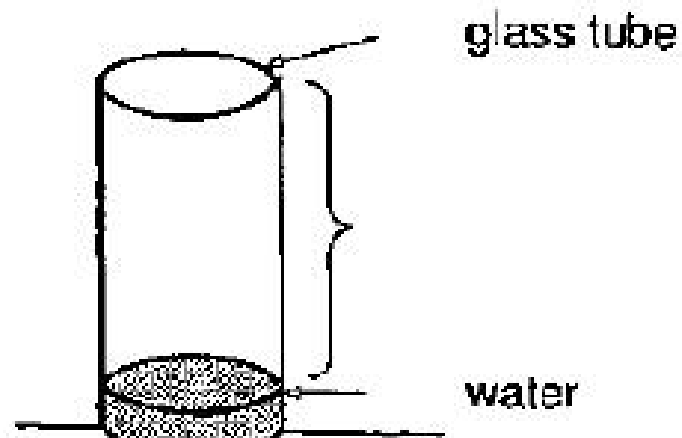
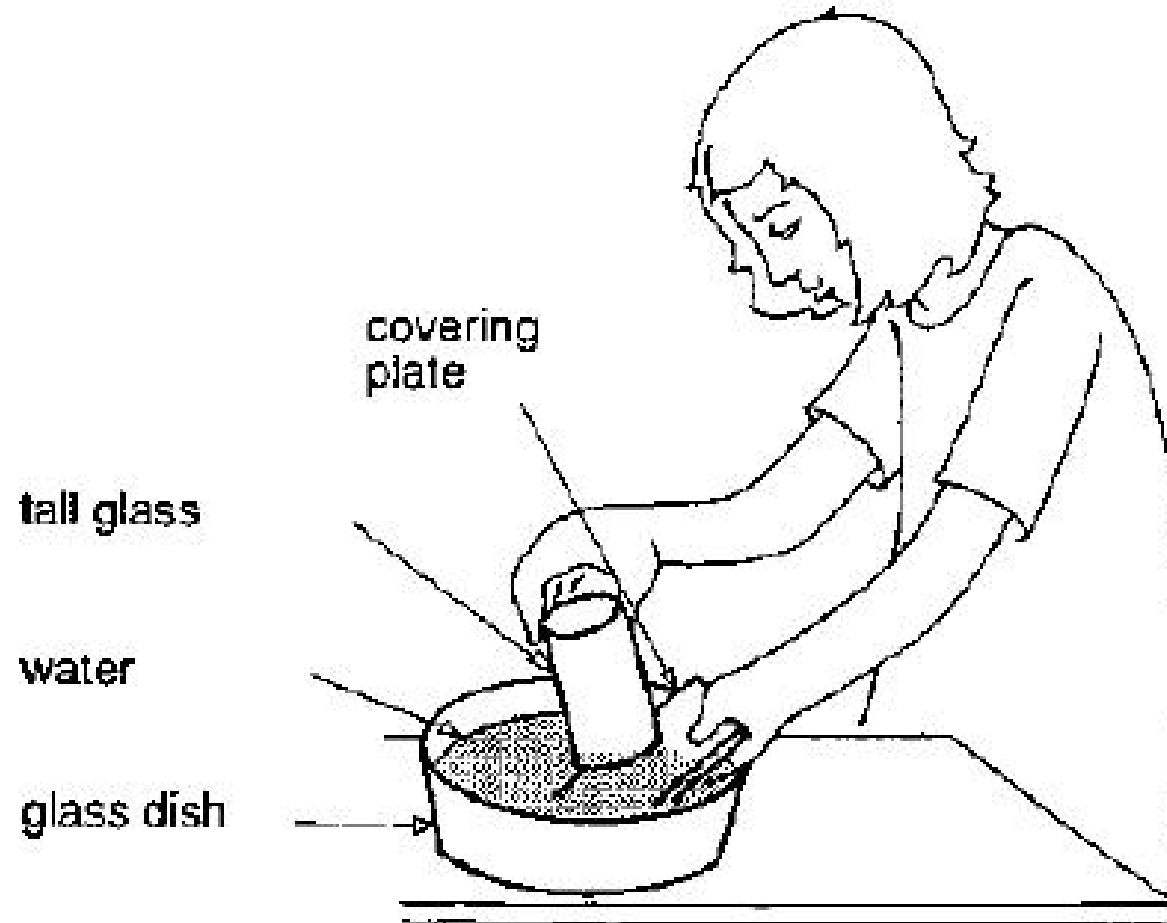

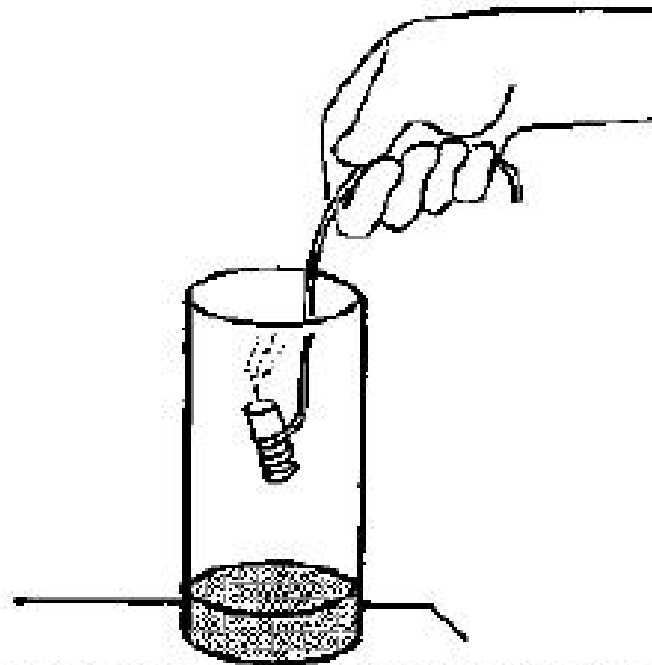
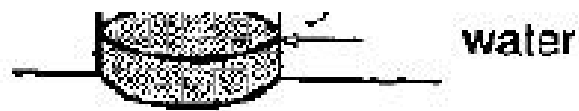

As shown in the diagram below, a burning candle is introduced into the remaining gas.

Observation:

The flame is extinguished.

Analysis:

The remaining gas extinguishes the flame. This gas is called "nitrogen".

51

<http://cd3wd.com/dvd/> - filename: z\_science\_exp\_57 of 598

Air consists of about 78% parts by volume nitrogen. (Oxygen supports combustion. Other gases, e.g. nitrogen, carbon dioxide, inert gases do not support combustion.)

### 3.6. ATMOSPHERIC OXYGEN SUPPORTS COMBUSTION

#### Main Goal:

This experiment illustrates that combustion can only take place if there is a constant supply of oxygen.

#### Information:

Without oxygen, combustion cannot take place.

The oxygen necessary for combustion is present in the air. If a burning candle is placed in a small closed volume, it burns until the available oxygen is nearly used up.

#### *Materials and Apparatus:*

*candle*  
*glass vessel*  
*cover plate*

#### Procedure:

- a. A glass vessel is placed upside down over a burning candle (see diagram).

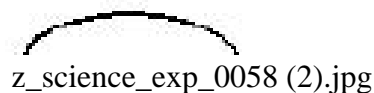



b. A burning candle is placed in an open glass vessel. With the help of the cover plate, the vessel is first half and then completely covered, (see diagram).

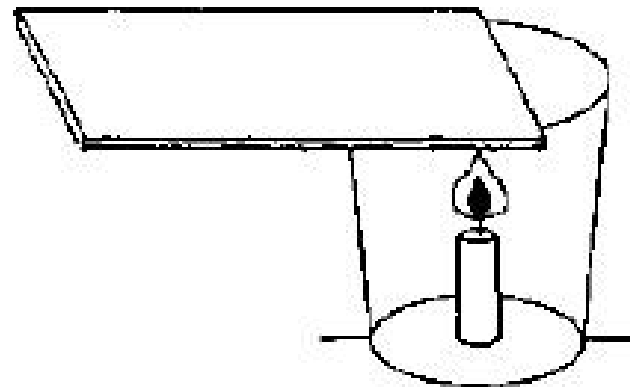

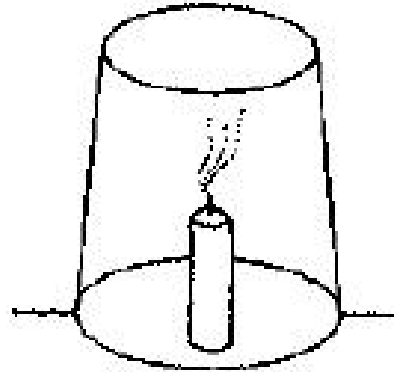

Observation:

- a. During the course of the experiment, the flame gradually becomes smaller until it is finally extinguished.

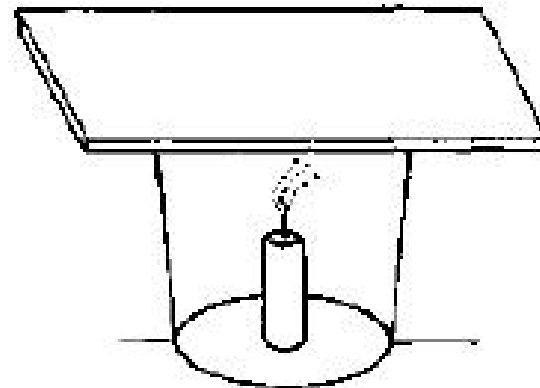

- b. The candle is not extinguished until the vessel is completely covered.

**Analysis:**

**A candle can only burn if there is a constant supply of oxygen.**

**A candle can only burn if there is a constant supply of oxygen.**

**The component of air which the candle needs for combustion is called “oxygen”.**

Practical Use :

The various ways of extinguishing fire all work by preventing the continued supply of oxygen.

Without oxygen combustion does not take place.

Some methods used to extinguish fire include spreading: water, sand, or carbon dioxide over the flames so that oxygen is kept away from them.

### **3.7. CARBON DIOXIDE AS A FIRE EXTINGUISHER**

**Main Goal:**

**This experiment demonstrates that a candle or other burning material is extinguished in carbon dioxide.**

Information:

As carbon dioxide is heavier than air, it sinks when poured out of a dish.

*Materials and Apparatus:*

*candle*  
*glass dish or bottle*  
*Alka Seltzer (1/2 or 1 tablet)*

Procedure:

One Alka Seltzer tablet is mixed with a few drops of water in a glass dish.

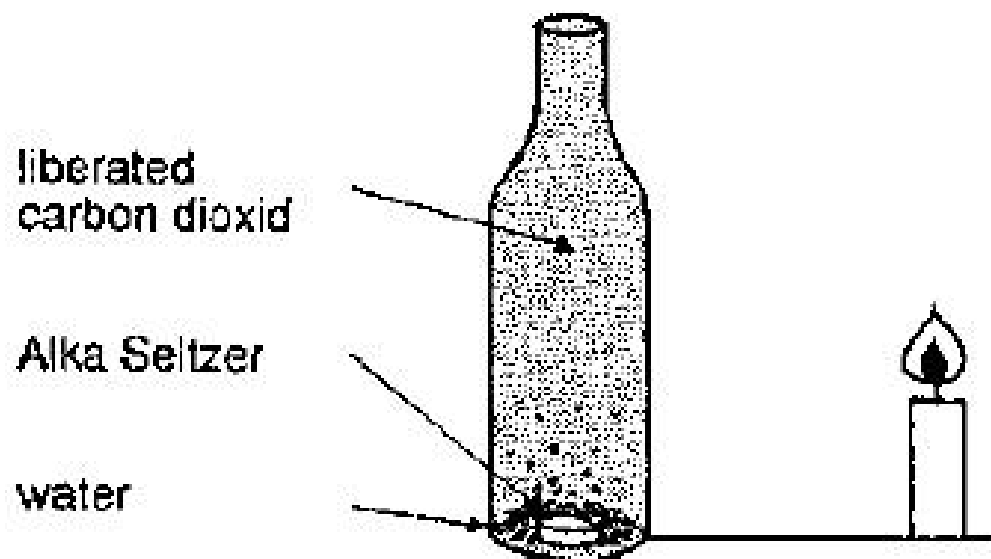

The carbon dioxide liberated is poured over a burning candle.  
(A burning candle can also be dipped into the dish.)



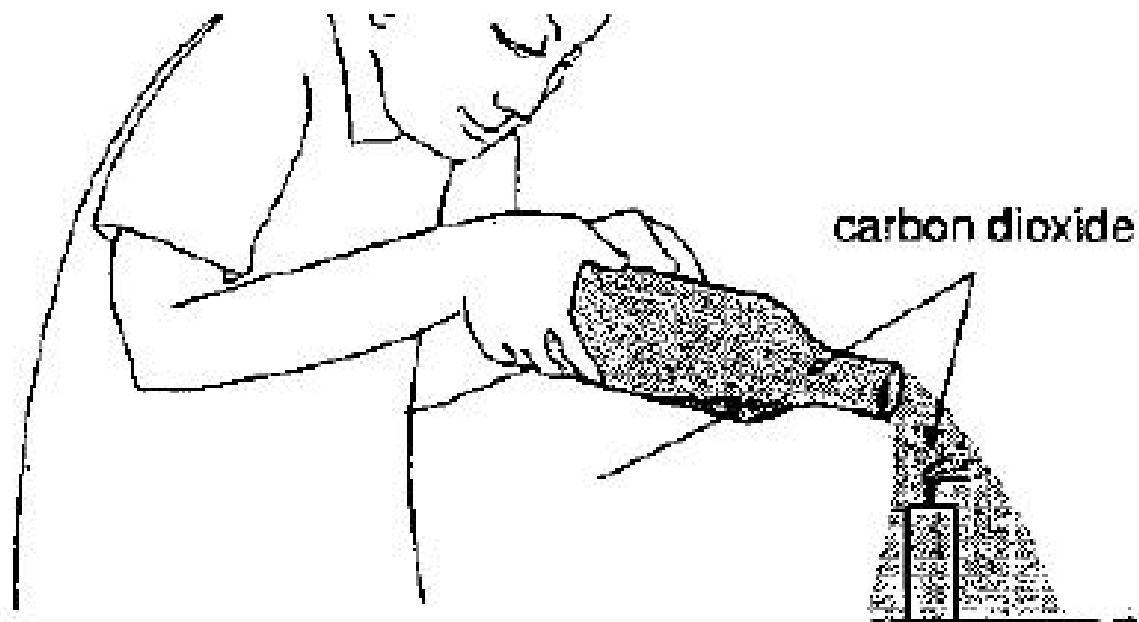

Observation:

The burning candle is extinguished.

Analysis:

**A candle is extinguished in an atmosphere of carbon dioxide. Obviously the carbon dioxide is concentrated at the bottom when poured out of the glass dish.**

Practical Use:



The air contains 0.03 per cent carbon dioxide by volume. If there is more than 5 per cent of this gas in the air, respiration is impeded. Exhaled air contains about 4 per cent carbon dioxide by volume.

Carbon dioxide does not conduct electricity and does not leave any kind of residue. For this reason it is used instead of water as a fire extinguisher in chemical and nuclear plants.

### 3.8. THE FORMATION OF CRYSTALS

#### Main Goal:

**This experiment demonstrates the formation of crystals, and proves that dissolved substances are present in solutions, even if they cannot be seen.**

#### Information:

Salts form crystals. The longer it takes for water to evaporate from a salt solution, the more even the crystals become.

Every salt has a typical crystalline form.

On the basis of this experiment, some further terms can be explained:

- solvent
- dissolved substance
- soluble/insoluble
- water-soluble
- precipitation

*Materials and Apparatus:*

*sodium chloride (household salt)*

*flat dishes*

*1 glass vessel*

*water*

*Procedure:*

Household salt is added to 50 ml of water (the solvent), until no more salt will dissolve.

Be sure that no solid salt is present anymore in the saline solution.



About 5 ml of the saline solution is poured into each of the glass dishes.

The water takes several hours or even a day to evaporate.

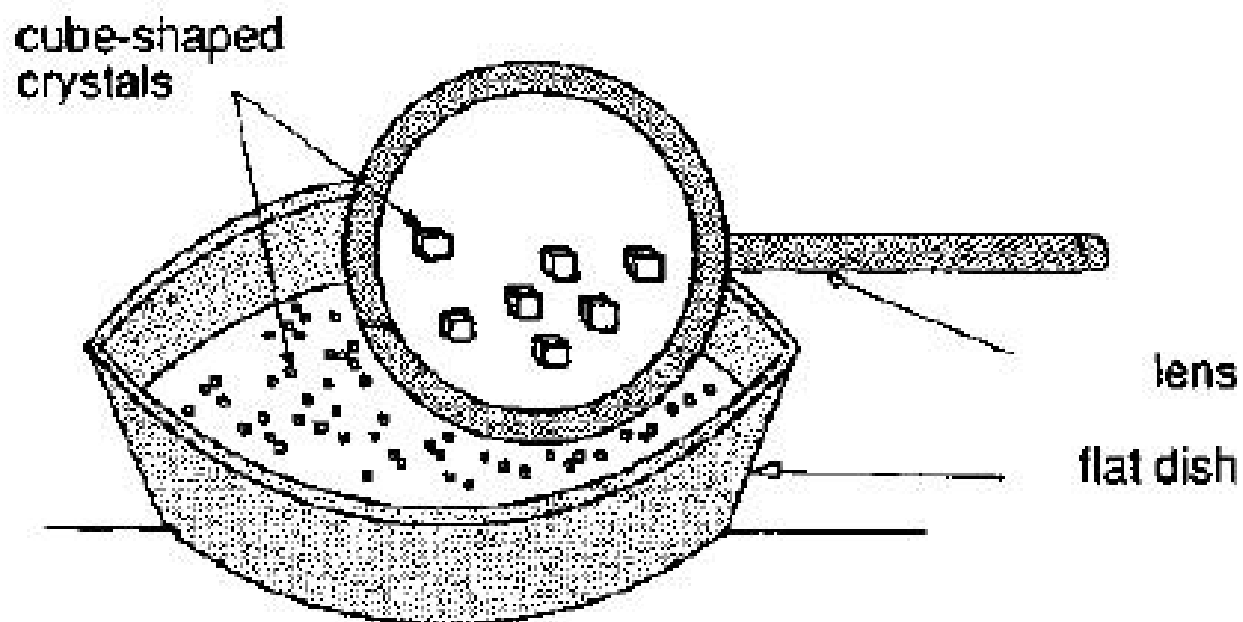

Observation:

The water evaporates.  
Cube-shaped crystals form.

Analysis:

**Sodium chloride forms cube-shaped crystals.**

Addition:

Various substances can be identified from their crystalline form.

Various substances can be identified from their crystalline form.

Practical Meaning:

Salt is obtained from sea water in some hot countries.

The sea water is channeled into flat basins (salterns).

The sun causes the water to evaporate. The salt, which was dissolved in the sea water, is left as residue. Sea water contains 3% sodium chloride (household salt).

### 3.9. SALT WATER IS HEAVIER THAN DRINKING WATER

**Main Goal:**

**Solutions always have a density higher than that of the solvent. That is to say that 1 cm<sup>3</sup> solutions has great mass and weights more than 1 cm<sup>3</sup> of the solvent.**

Information:

see "Main Goal"

*Materials and Apparatus:*

*salt water – sodium chloride dissolved in water*

*drinking water*

*2 glass dishes, glass stick*

*ink or other colours*

Procedure:

2 – 3 drops of ink are added to the salt water, which is then carefully added to the drinking water. This is best done by means of a glass stick along which the salt water runs down.

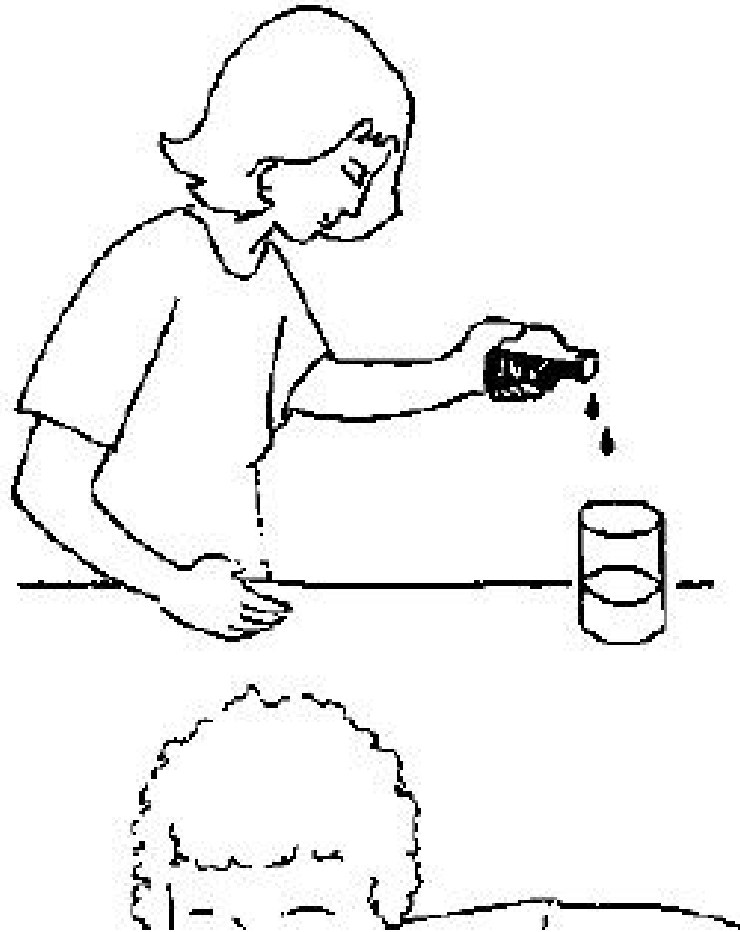

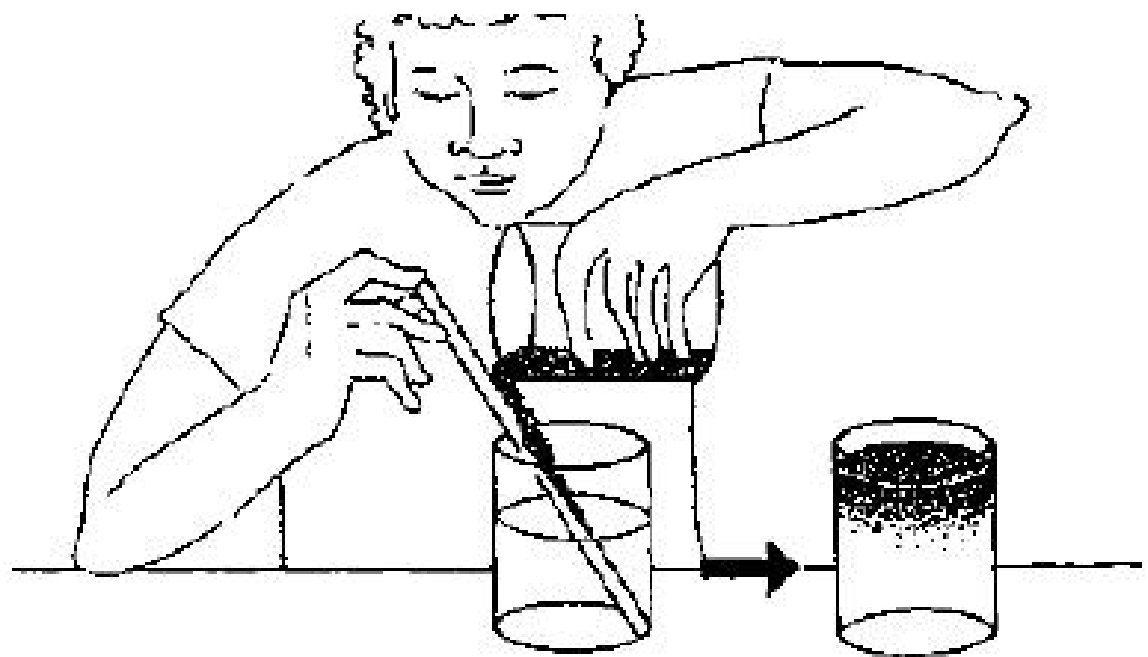

Observation:

The coloured salt water sinks to the bottom of the dish.

Analysis:

**Salt water has a higher density than drinking water. However, drinking water also contains dissolved salts. Therefore, it is heavier than distilled water (completely pure water) without any dissolved salts. Solutions have always a higher density than solvents.**

### 3.10. SEPARATION OF SOLID MIXTURES

#### Main Goal:

The experiment illustrates that solid mixtures can be separated using their physical properties.

#### Information:

In contrast to a compound, the single substances of a solid mixture exist independently in an unaltered form. Their individual physical properties are preserved. Using these known properties, the single substances can be separated from each other.

#### *Materials and Apparatus:*

*salt (sodium chloride)*  
*sand iron filings (cutted iron wool)*  
*magnet*  
*filter papers*  
*filter*  
*glass dish*  
*burner, candle*  
*tripod*  
*paper*  
*water*  
*wooden stick, spoon*

#### Procedure:

Salt, sand and iron cuttings are mixed up on a sheet of paper.

Salt, sand and iron cuttings are mixed up on a sheet of paper.

(1) The iron cuttings are removed from the mixture with the help of the magnet.



 iron filings

 sand

 salt



(2) The salt-sand mixture is added to 30 ml of water, stirred well, and filtered. The filtration residue is rinsed 2 - 3 times with water. Then it is dried in the air.

(3) Using the burner, the filtrate (salt solution) is slowly evaporated until it is dry.

(1) Using the barrier, the mixture (salt solution) is slowly evaporated until it is dry.

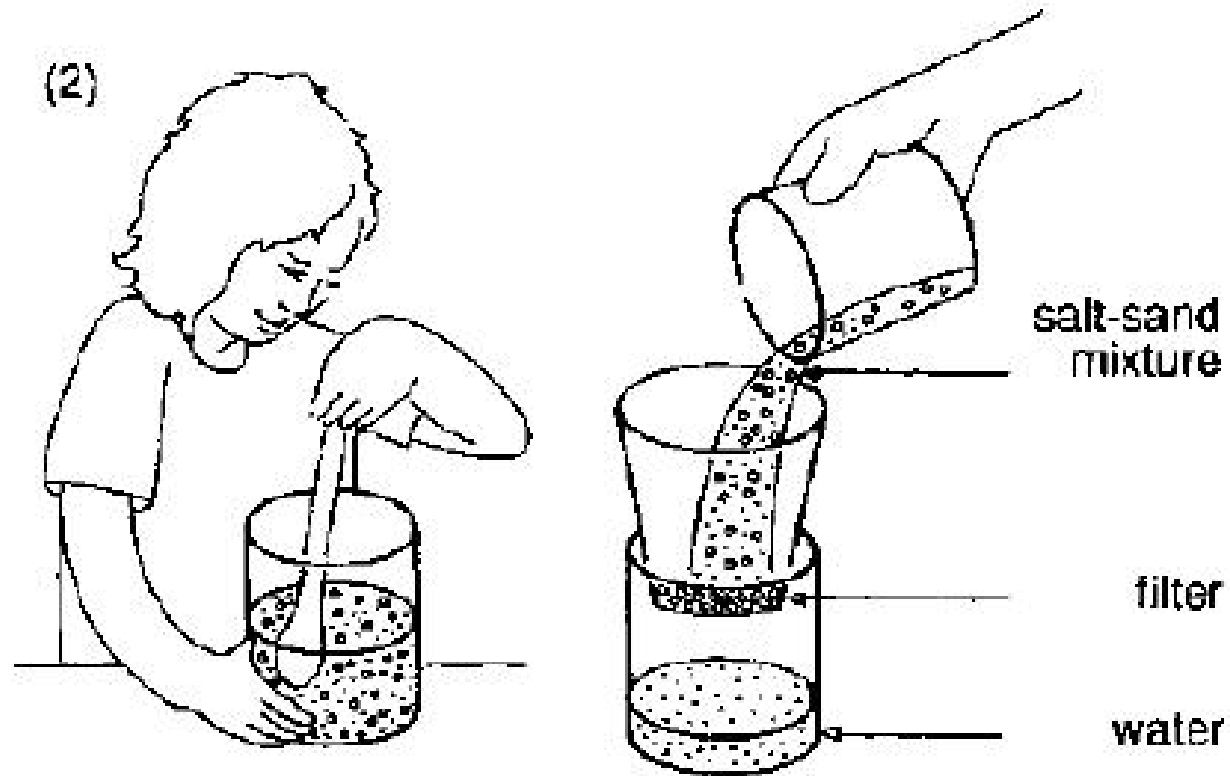

Observation:

The magnet attracts the iron cuttings.

The salt dissolves in water.

The sand does not dissolve but is collected on the filter paper.

After the water evaporates, the salt is left as residue. In a solid mixture, the properties of each substance are preserved.

**Analysis:**

By means of a magnet, iron is separated from other kind of metals and other substances, e.g. in junkyards.

There are several other methods for obtaining salt. One is by evaporation of sea water and another, the washing out of salty soil.

### 3.11. THE CORROSION OF IRON

**Main Goal:**

This experiment demonstrates that moistened iron corrodes faster (corrodere – Latin: to gnaw away), than dry iron.

**Information:**

When the air is humid, iron reacts with oxygen to form rust.

*Materials and Apparatus:*

*iron wool, iron filings  
2 glass vessels  
water*

*water*

Procedure:

- a. Some dry iron wool is put into the first glass vessel,
- b. Some wet iron wool is put into the second glass vessel.

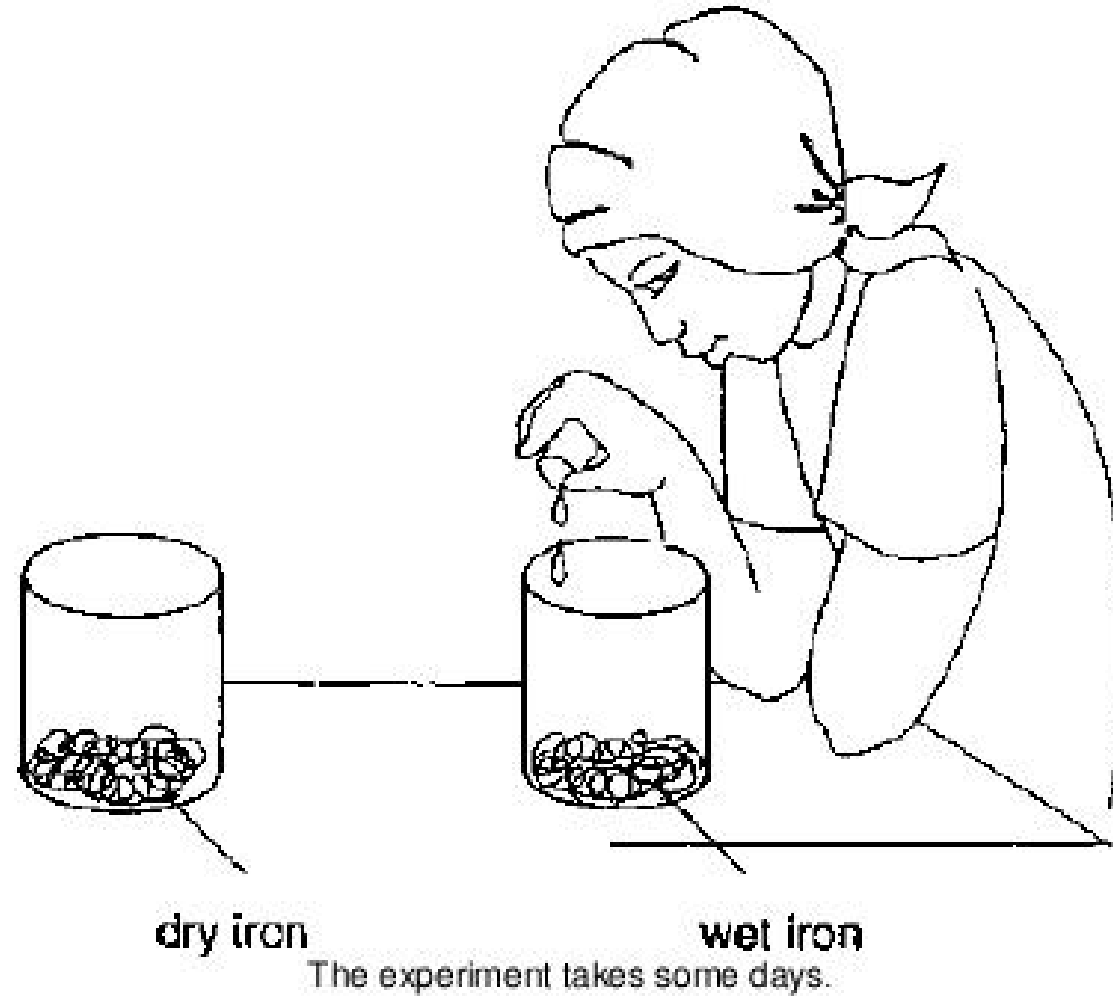

Observation:

The moistened iron wool has turned a brown colour. It has become brittle.

Analysis:

**It can be concluded that rust has been formed.**

**Moisture reacts faster than dry iron**

**It can be concluded that rust has been formed.  
Moist iron rusts faster than dry iron.**

### **3.12. THE IMPORTANCE OF AIR DURING THE PROCESS OF CORROSION**

#### **Main Goal:**

**The experiment demonstrates that air plays a role in the process of corrosion.**

#### Information:

In humid air, iron reacts with oxygen to form rust.

#### *Materials and Apparatus:*

*iron wool  
1 test tube  
1 large glass dish  
water  
sodium chloride*

#### Procedure:

a) The experimental apparatus is constructed as shown in the following diagram and observed for several days.

Leave some space between the open end of the test tube and the bottom of the glass dish.

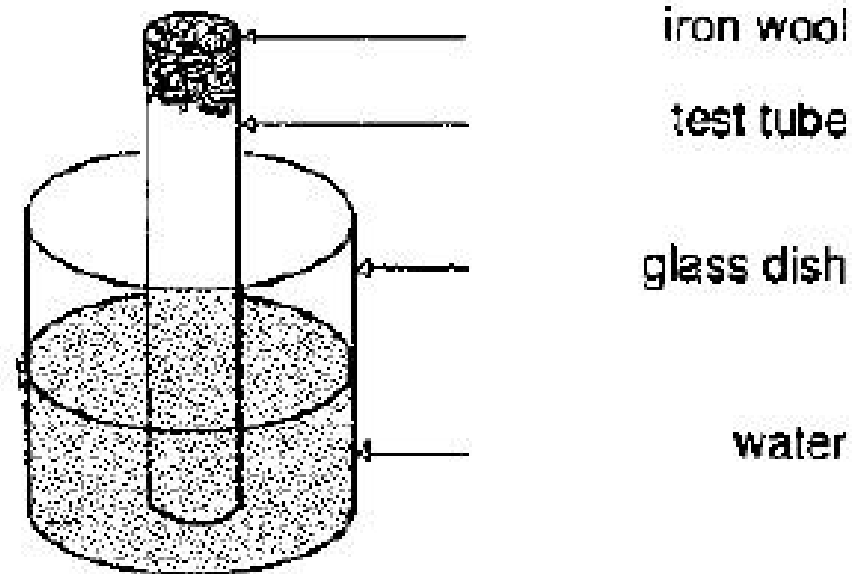

b) Do the same experiment in parallel with salt water in place of water.

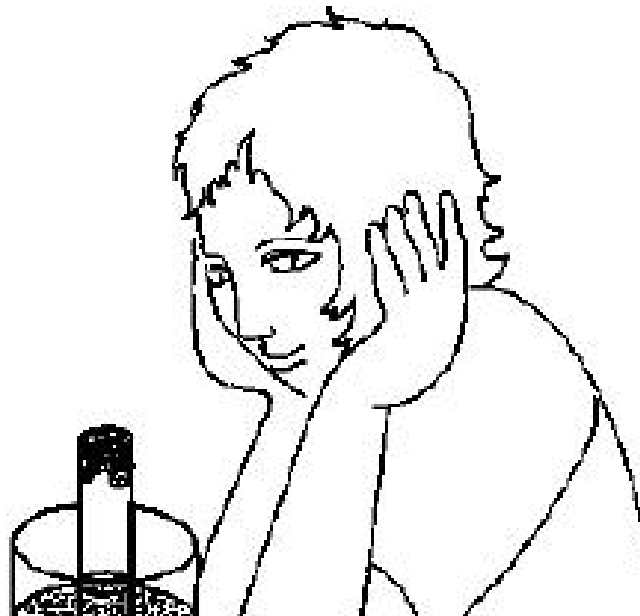

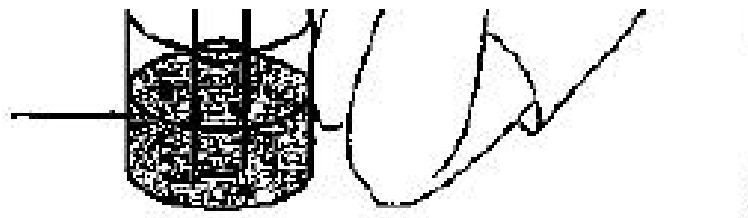

#### Observation:

The iron wool has corroded.  
Some water has entered the test tube.  
The corrosion is faster in the presence of a dissolved salt.

#### Analysis:

**When iron corrodes, a part of the air is used to form rust together with the iron and the water. This proportion of the air is called "oxygen".**

**Iron corrodes when water and oxygen are present. Its formation is increased by the presence of a dissolved salt.**

#### Practical Use:

Iron is protected against corrosion by a rust inhibitor (special paint).



### 3.13. TINS ARE PROTECTED AGAINST RUST

#### Main Goal:

The experiment shows that tins are protected against corrosion.

#### Information:

Tins consist of tinned sheet iron.  
This is iron which is plated with tin.

#### *Materials and Apparatus:*

*2 tins*  
*1 nail*  
*2 rags*  
*water*

#### Procedure:

A pattern is scratched with the nail into one of the tins.



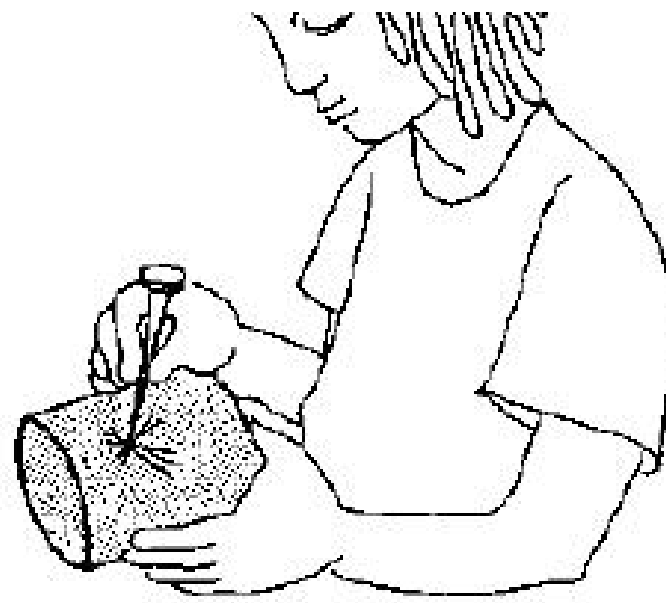

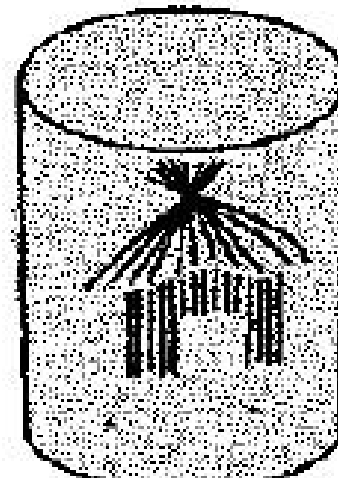



The two tins are wrapped in moistened rags and kept wet for some days.

Observation:

Clearly visible rust traces can be seen along the lines of the pattern, whereas the other tin does not show any signs of rust.

Analysis:

Tins are plated with a protective layer, which prevents corrosion.

### 3.14. INVESTIGATION OF RUST

Main Goal:

The experiment demonstrates that rust is a different material from iron.

Information:

Rust consists of iron oxide (trivalent iron) and iron hydroxides (trivalent iron).

*Materials and Apparatus:*

*rust*  
*iron wool*  
*magnet*

Procedure:

- a. The physical properties of iron are examined, such as flexibility, magnetism and colour.
- b. Rust is examined for the same physical properties.



**Analysis:**

**Iron is attracted by a magnet; we say it is ferromagnetic.**

**As rust and iron display completely different properties, they must be two different materials.**

**Practical Use:**

The porosity of rust encourages the continuing reaction with air and humidity until finally the iron parts rust through.

This can be observed in cars. In technology, different methods are used to prevent corrosion, such as plastic covers, metal covers, and rust inhibiting paint.

**3.15. THE ELECTROLYSIS OF SODIUM CHLORIDE****Main Goal:**

**This experiment illustrates the principle of electrolysis.**

**Information:**

With the help of direct current, chlorine and hydrogen can be separated from a sodium chloride solution. Chlorine develops as gas at the positive pole (anode) and hydrogen gas at

the negative pole (cathode).

Sodium ions are collected also at the cathode where sodium appears as metal.

An additional product is sodium hydroxide solution.

**(Warning:** A detonating mixture of chlorine and hydrogen may be formed. **Chlorine is toxic!**)

*Materials and Apparatus:*

*household salt (sodium chloride) (5–10 g)*

*2 copper wires about 15 cm long, insulated apart from the last 3 cm at each ends of the wires, which shall be knocked flat.*

*glass vessel*

*battery, about 4.5 V*

*(indicator, e.g. litmus, see experiment: VEGETABLE INDICATOR – ANTHOCYANE)*

**Procedure:**

The household salt is dissolved in water.



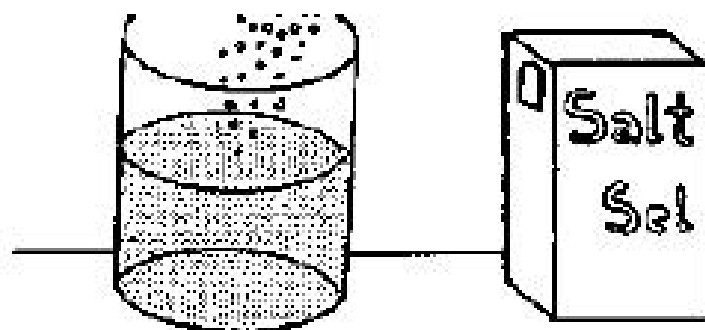

The two electrodes are attached to the battery and then dipped into the solution.

(An indicator can be added to the solution. In addition, the gases which escape can be collected – see experiment: ELECTROLYSIS OF WATER – and then the detonating gas test can be performed.)



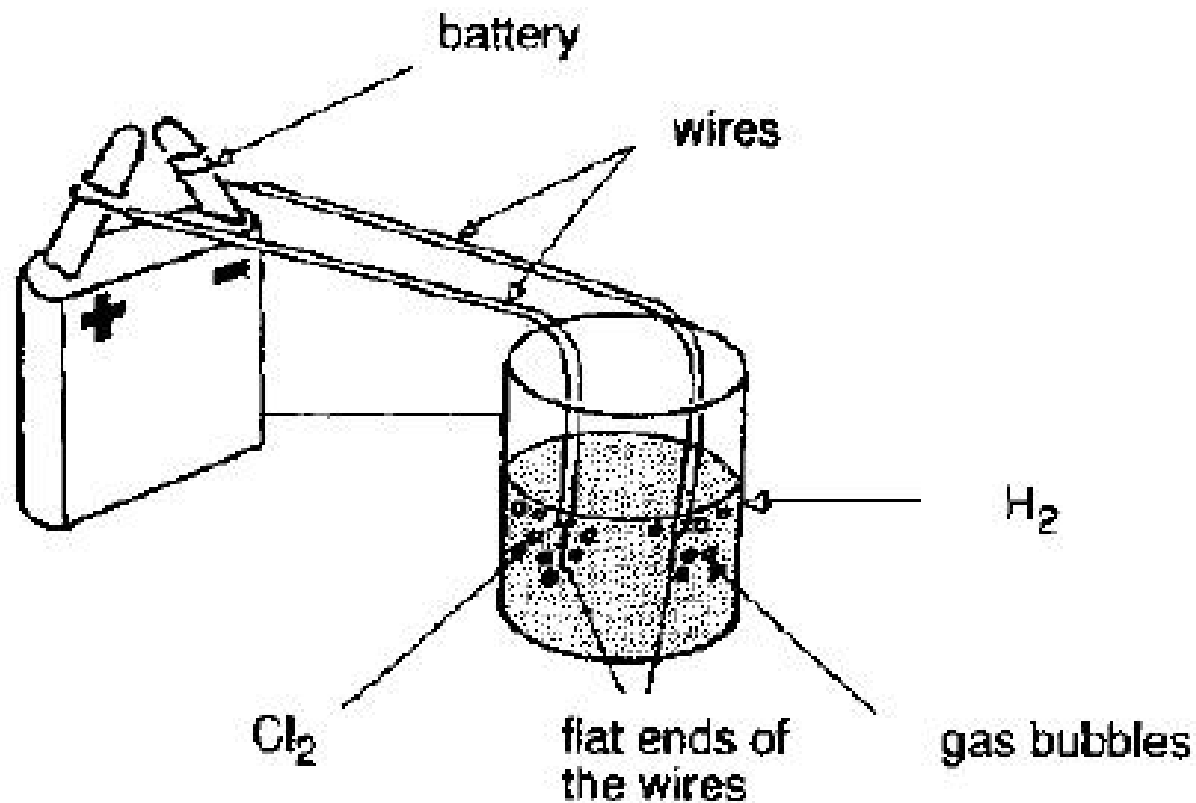

Observation:

Gas bubbles rise at the two poles.

There is a smell of chlorine.

(Near the cathode, the litmus turns blue after a while. Near the anode it is bleached.)

Analysis:

**Chlorine gas is released at the positive pole (anode).**

**Chlorine gas is released at the positive pole (anode).**

**At the negative pole (cathode) hydrogen gas is generated and metallic sodium is collected.**

**(The change of colour indicates an alkali, which is caustic soda solution. Chlorine dissolves well in water and bleaches colours.)**

Practical Use:

The electrolysis of sodium chloride is a technique used to produce chlorine.

Chlorine is used as a disinfectant in swimming pools.

In addition, large quantities of chlorine are used to produce chlorine compounds (e.g., hydrogen chloride (HCl), phosgene ( $\text{COCl}_2$ ), chlorinated hydrocarbons (poly vinyl chloride)). Because metal is deposited at the cathode, electrolysis has important industrial applications for manufacturing metal. Aluminium, magnesium, sodium and zinc are often produced in this way.

### **3.16. THE ELECTROLYSIS OF WATER**

**Main Goal:**

**To demonstrate that water is a compound of hydrogen and oxygen.**

Information:

With a constant voltage of 4.5 V, delivered by a battery, water can be decomposed into hydrogen and oxygen. The effect is more impressive when two batteries in series are used.

*Materials and Apparatus*

*1 glass vessel (beaker), filled with water,*

*copper or iron electrodes*

*insulated wire*

*2 batteries, serially connected, the two electrodes, covered by test tubes, about 1.5 cm separated*

*sulphuric acid*

*wood chip*

*candle, matches*

*wooden board (ca. 10 × 20 cm)*

Procedure:

The following apparatus is set up.

A few drops of sulphuric acid are added to the water. (This increases conductivity.)

A few drops of sulphuric acid are added to the water. (This increases conductivity.)

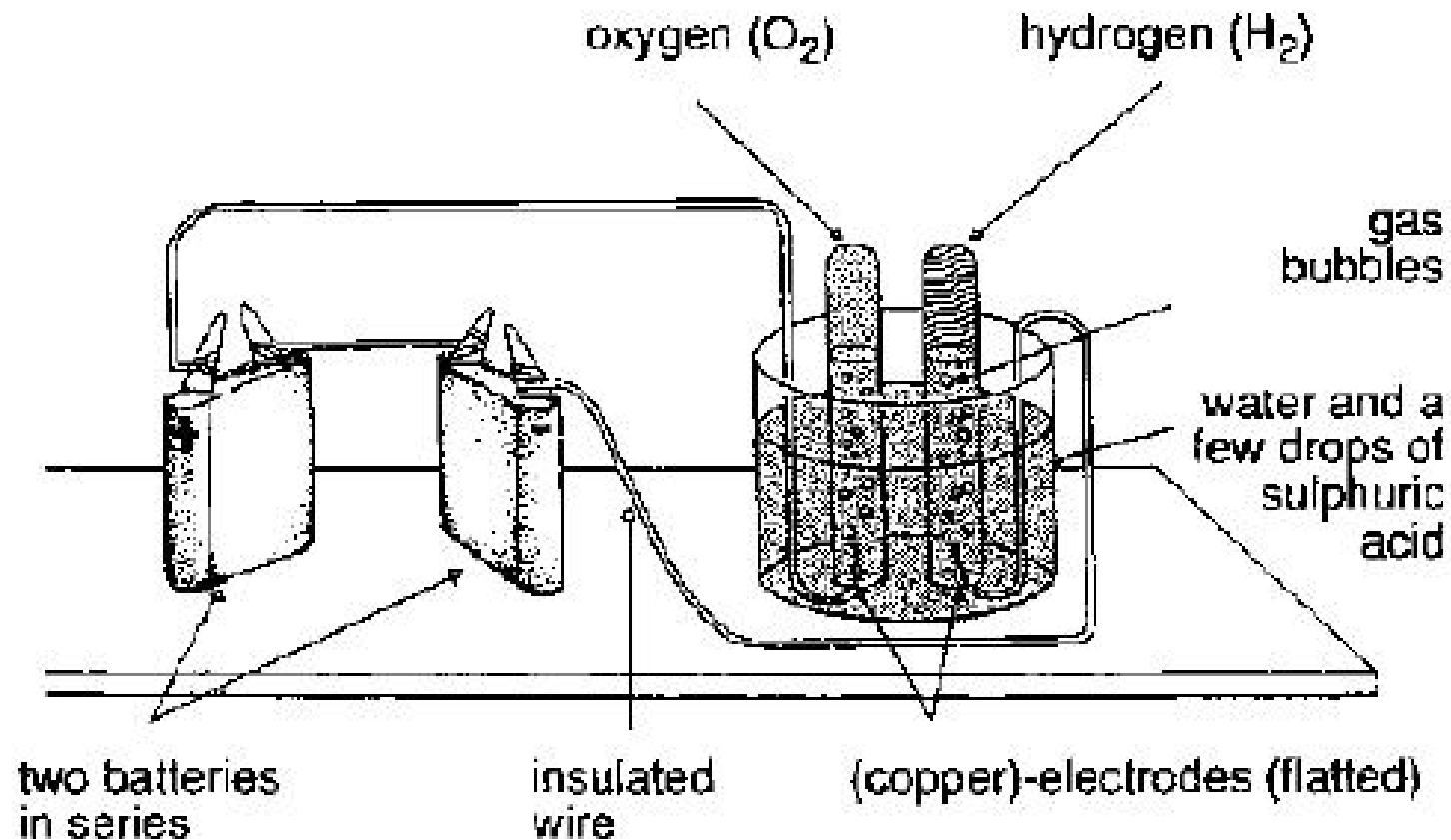

The test tubes are completely filled with the sulphate water, covered with the thumbs and turned upside down over the electrodes.

- When the apparatus is complete, the electrodes are connected.
- Shortly before the right test tube (negative pole) is completely filled with gas, a candle is lit. The test tube is covered with the thumb after the complete displacement of the water. It is taken out of the water and kept upside down.

c. Before the left test tube is taken out of the water in the same manner as the right one, a wood chip is lighted. The glowing wood chip is dipped into the test tube.

**Observation:**

a. Gas bubbles are formed at both poles.

They displace the water from the test tubes.

b. An explosion is heard and perhaps of blue flame may be seen.

c. The glowing wood chip lights up in the test tube.

**Analysis:**

**The two test tubes fill with gas.**

**The gas in test tube (A) is called "hydrogen".  
Hydrogen burns with a blue flame.**

**The gas in test tube (B) is called "oxygen".  
Oxygen supports combustion.**

**Water consists of the element hydrogen and oxygen.**

**to b.) The explosion, which is not dangerous on such a small scale, is the so-called "oxyhydrogen gas reaction".**

**Hydrogen and oxygen react to form water.**





Practical Use:

Pure hydrogen is used for autogenous welding or cutting. In cutting or welding torches, oxygen is directed into a hydrogen stream shortly before its combustion.

With a surplus of oxygen, metals can be cut.

With a surplus of hydrogen, metals can be welded.

### 3.17. THE EXPLODING TIN

**Main Goal:**

**This experiment demonstrates impressively the danger of a hydrogen–oxygen mixture.**

Information:

If a hydrogen–air mixture is ignited, it reacts with a loud explosion, and water is formed. A hydrogen–oxygen mixture with the proportions 2: 1 is dangerous.

*Materials and Apparatus:*

- 1 coke can, or metal tea caddy
- 1 nail
- 1 hammer
- 1 pair of sheet-iron shears
- 1 piece of adhesive tape
- 1 flask of compressed hydrogen matches

Procedure:

The top of the coke can is cut off, using the sheet-iron shears.

As shown in the following diagram, 2 small holes are cut in the can.

These two holes are covered with adhesive tape or adhesive plaster.

As shown in the diagram, the can is filled with hydrogen, taken from the flask, for one minute. It is placed on the table.

The flask with compressed hydrogen is sealed and placed several metres away from the can.

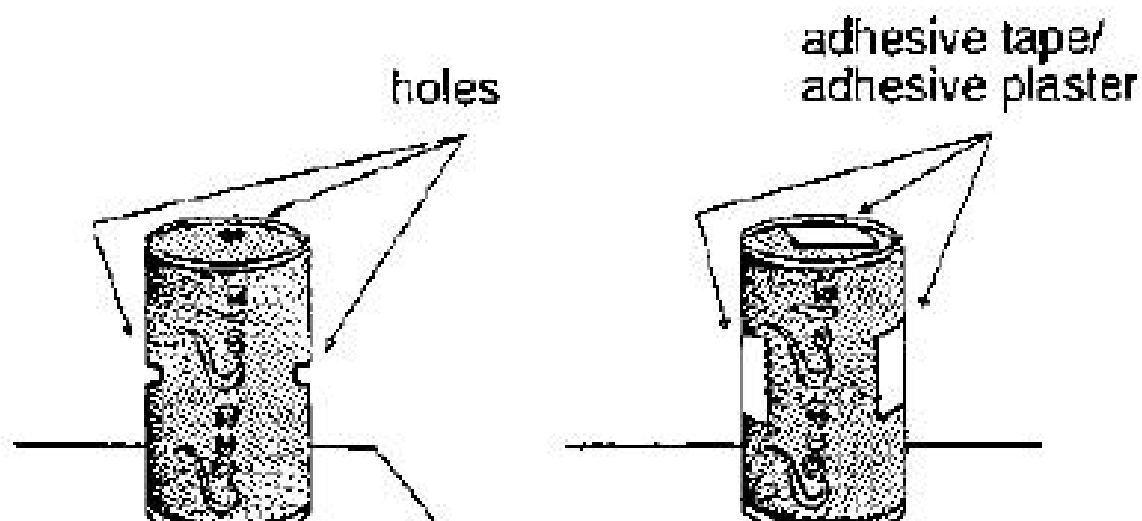



with the  
tube the can is  
filled with hydrogen

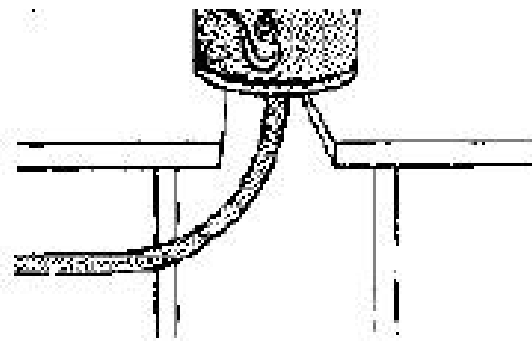

The adhesive tape is removed, a match is lit, and the flame is held close to the upper hole.

Then move back several steps.

(The experiment is very impressive in a darkened room.

However, one window or door should be left open.)



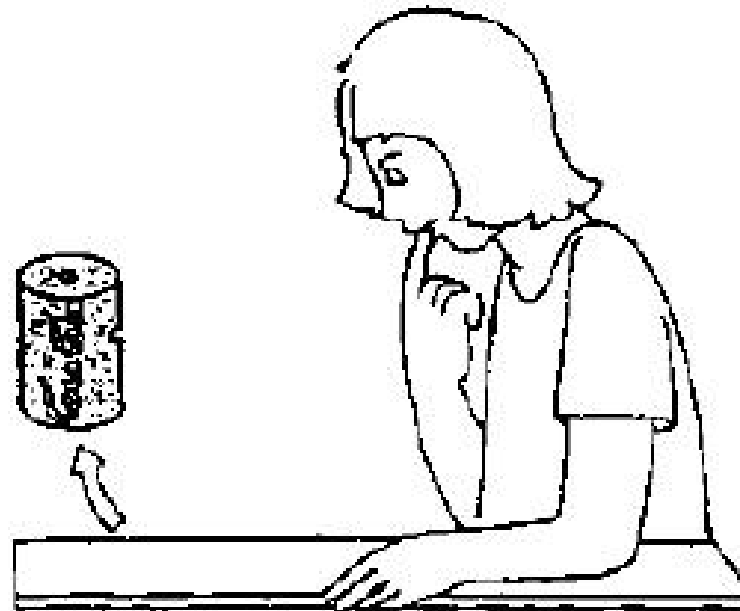

---

Observation:

When the gas is ignited, a light explosion can be heard. The hydrogen burns with a blue flame.

A faint whistling sound, can be heard. It becomes louder, and is followed by a loud bang.

The tin is lifted from the table. A faint flame can be seen.

**Analysis:**

**Air seaks into the tin, through the holes in the sides. The air–hydrogen mixture explodes.**

**Only oxygen and hydrogen produce this reaction, which is known as the “oxyhydrogen gas reaction”.**

**A 2: 1 hydrogen–oxygen mixture is especially dangerous.**



Practical Use:

A high temperature of up to 2000° C is needed to weld iron parts together. This temperature is reached when hydrogen and oxygen reacts.

With a welding torch, this combustion is not dangerous.

### 3.18. VEGETABLE INDICATOR – ANTHOCYAN

#### Main Goal:

**The pupils learn to distinguish between an acid and an alkali with the help of an indicator.**

#### Information:

The word "indicator" is derived from the Latin "indicare": meaning to show. Indicators change colour according to the medium with which they are in contact.

Anthocyanins are vegetable colourings, which form salts with acids and alkalies. The salt formation with an acid gives a red colour and the salt formation with an alkali a blue colour.

Anthocyanins can be produced from red cabbage or red corn.

#### *Materials and Apparatus:*

*red cabbage juice (litmus)*

*a. lemon juice*

*acetic acid*

*a selection of other acids (HCl, H<sub>2</sub>SO<sub>4</sub>, etc.)*

b. a selection of alkalis (NaOH, KOH, etc.)

a few small dishes

Procedure:

The leaves of the red cabbage are cut into small pieces, placed in boiling water. The corn is also pressed and placed in boiling water.



a. 1 ml of each of the various acids and alkalis are poured into separate dishes, one substance per dish.

b. 2–3 drops of indicator are added to each solution.

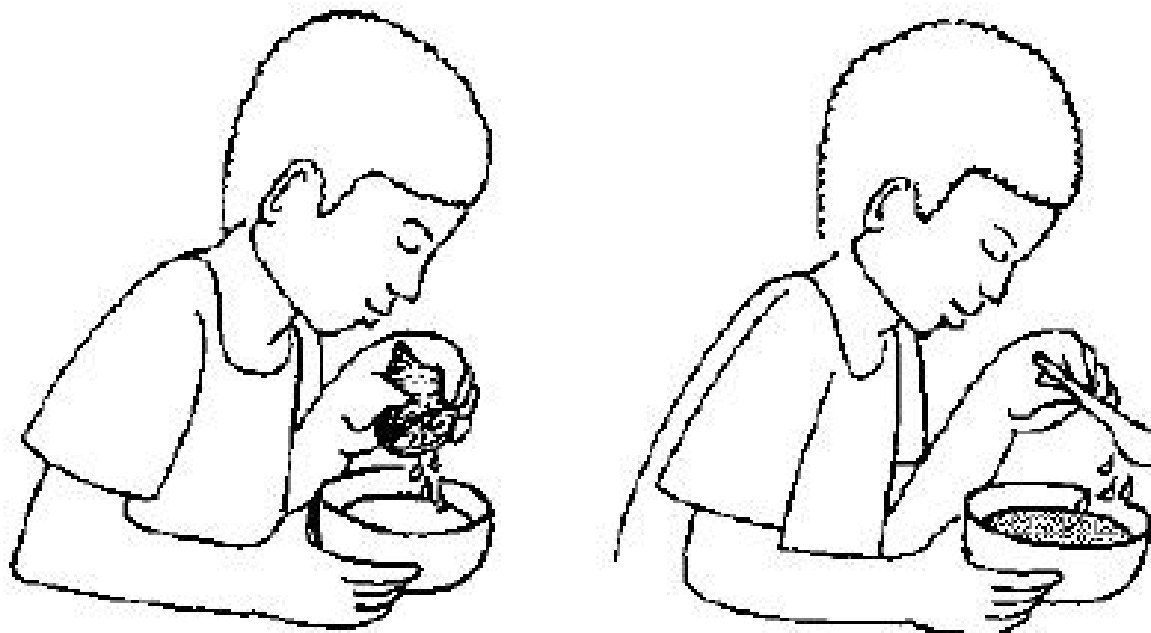

Observation:

The colour of the indicator is red–violet in the acidic range (a.), whereas it is green–yellow in the alkaline range (b.).

Analysis:

With the help of indicators, acids and alkalies can be identified.

### 3.19. ACID AIR – ACID RAIN

Main Goal:

## MAIN GOAL:

This experiment introduces sulphurous acid and the problem of “acid rain”.

## Information:

If sulphur is burned, sulphur dioxide is produced. This gas forms “sulphurous acid” if it is added to water.

Diesel oil and fuel oil both contain sulphur.

This experiment demonstrates that non-metal oxides and water form acids. (Carbon dioxide is also formed.)

## Materials and Apparatus:

*Diesel oil or fuel oil*

*1 wick or cotton thread or rag*

*1 dish*

*1 covering plate (metal) with a hole for the wick*

*1 funnel*

*1 piece of tubing, with a glass-pipe*

*1 tall glass vessel (test tube)*

*water with indicator (fuchsine or litmus solution)*

## Procedure:

The apparatus is set up as shown in the following diagram.

The water contains 2 – 3 drops of the indicator. The glass and the funnel can be supported with one hand.

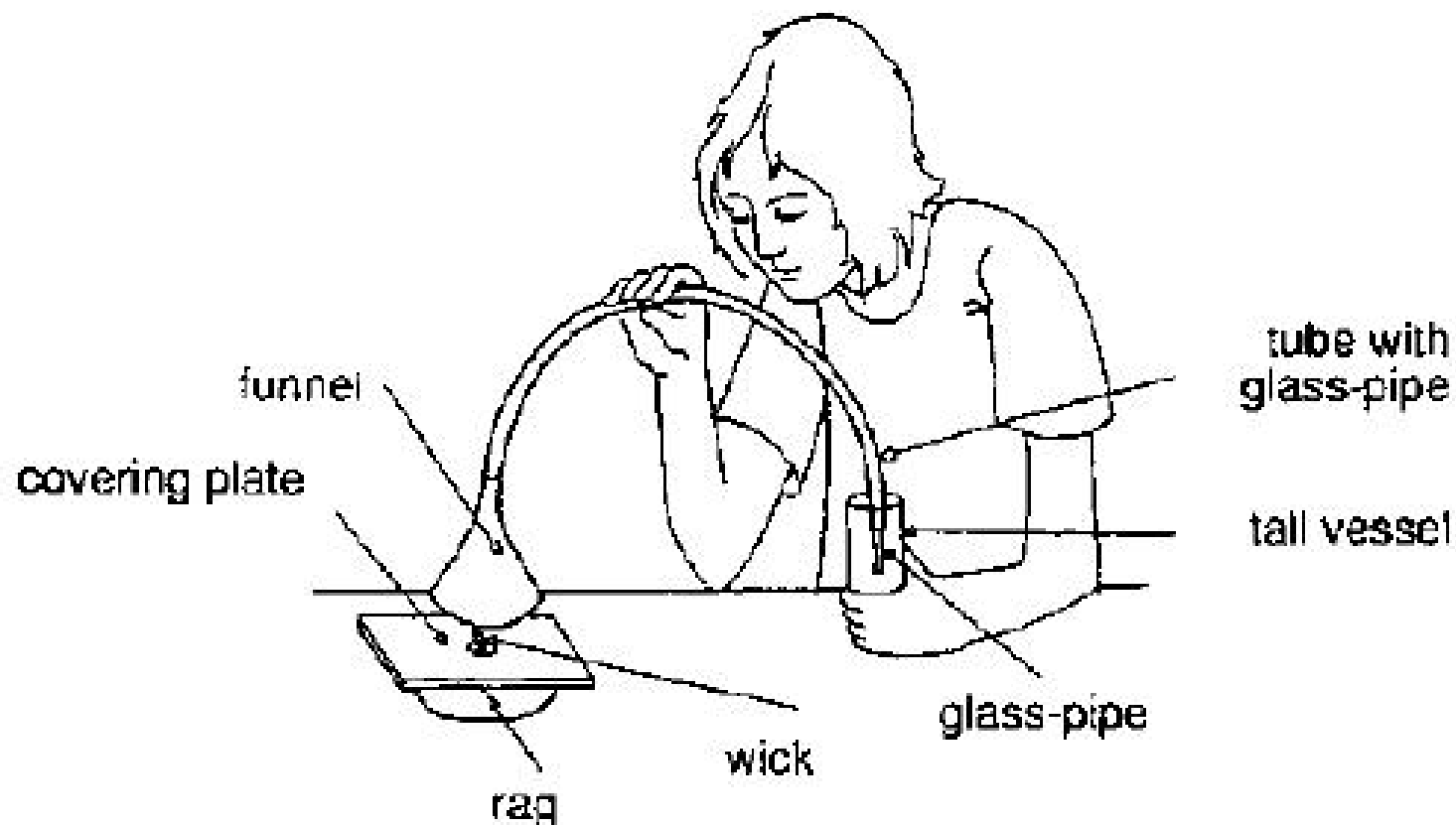

Observation:

Gas bubbles can be observed in the water. The indicator changes colour. The colour change indicates the presence of an acid.

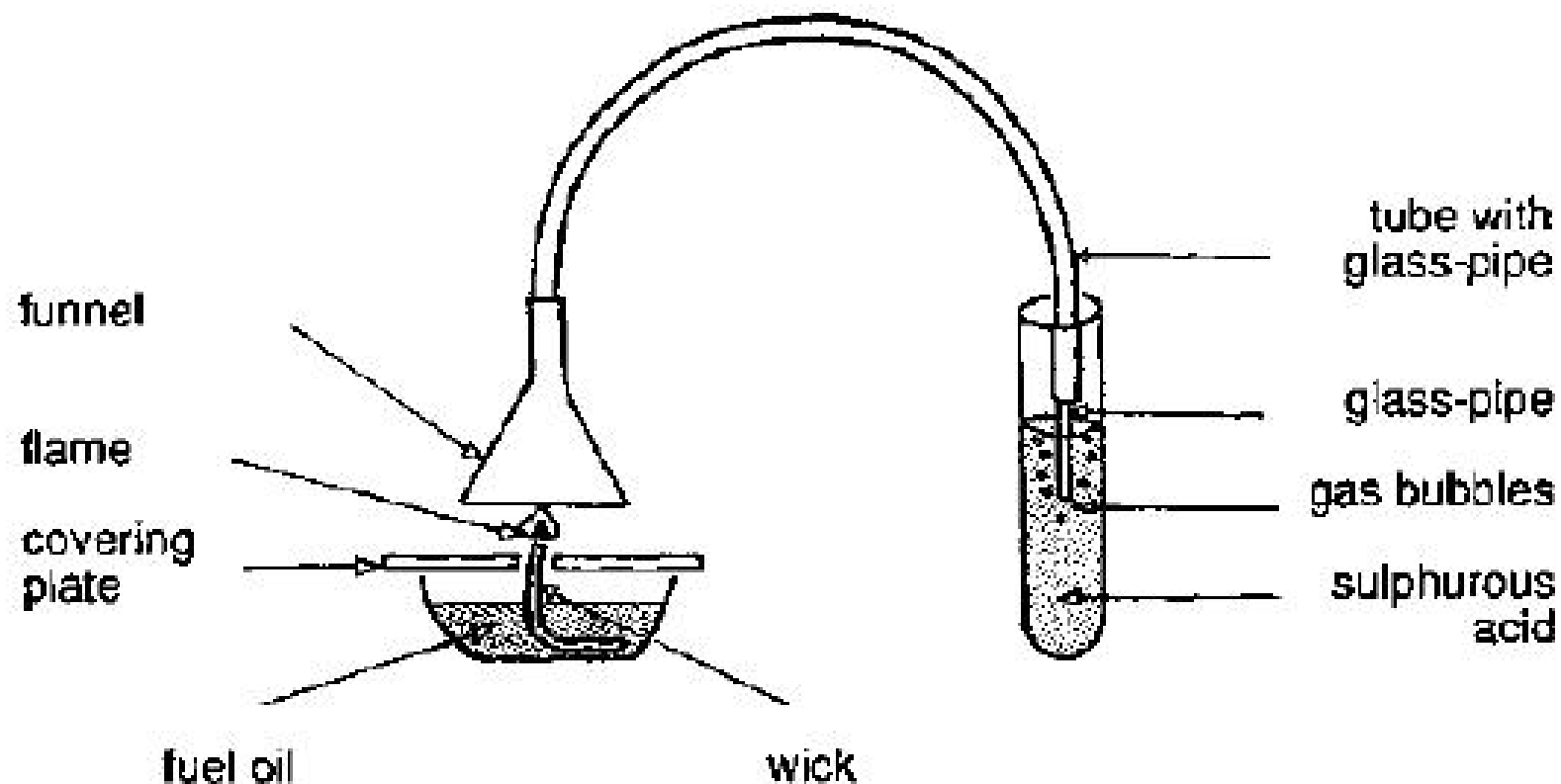

**Analysis:**

When fuel oil is burnt, the sulphur is oxidized to form sulphur dioxide.



Sulphur dioxide can be easily dissolved in water. Sulphurous acid is formed





**Note: A non-metal oxide and water form an acid.**

Practical Meaning:

Sulphur dioxide is one of the components of "acid air".

When combined with water, it forms one essential part of "acid rain".

Sulphur dioxide as well as sulphurous acid damage animate and the inanimate nature. Trees become sick.

It is assumed that what is called "forest die-back" in some industrialized countries might have its origin in acid rain.

(see botany: THE DESTRUCTIVE INFLUENCE OF ACID AIR AND ACID RAIN)

## **4. ORGANIC CHEMISTRY**

### **4.1. SUGAR CONTAINS CARBON**

**Main Goal:**

**Qualitative ultimate analysis.**

**All matter is made out of atoms, tiny particles that cannot be decomposed anymore by chemical methods. Most matter of our environment, and also our body, is made of compounds the building blocks of which are atoms. There are many different sorts of**

chemical methods. Most matter of our environment, and also our body, is made of compounds the building blocks of which are atoms. There are many different sorts of atoms. Each sort has its typical chemical properties. Matter containing one sort of atoms only is called 'element'. Carbon, hydrogen and oxygen are chemical elements. There are just over 100 known elements.

Information:

Carbohydrates contain the elements carbon, hydrogen, and oxygen. Therefore, its a compound.

Some examples of saccharides are grape sugar (glucose), cane sugar, starch, and cellulose.

Within the scope of ultimate analysis, carbon is identified as one of the elements of sugar.

*Materials and Apparatus:*

*glucose or cane sugar*

*water*

*about 10 ml of concentrated sulphuric acid*

*a glass dish which holds about 50 ml or a small beaker*

Procedure:

The beaker is filled to a depth of approximately 1 cm with glucose, which is moistened with a few drops of water.

Sulphuric acid is added carefully until the glucose is just covered. (Wear protective goggles.)

75

<http://cd3wd.com/dvd/> - filename: z\_science\_exp\_81 of 598

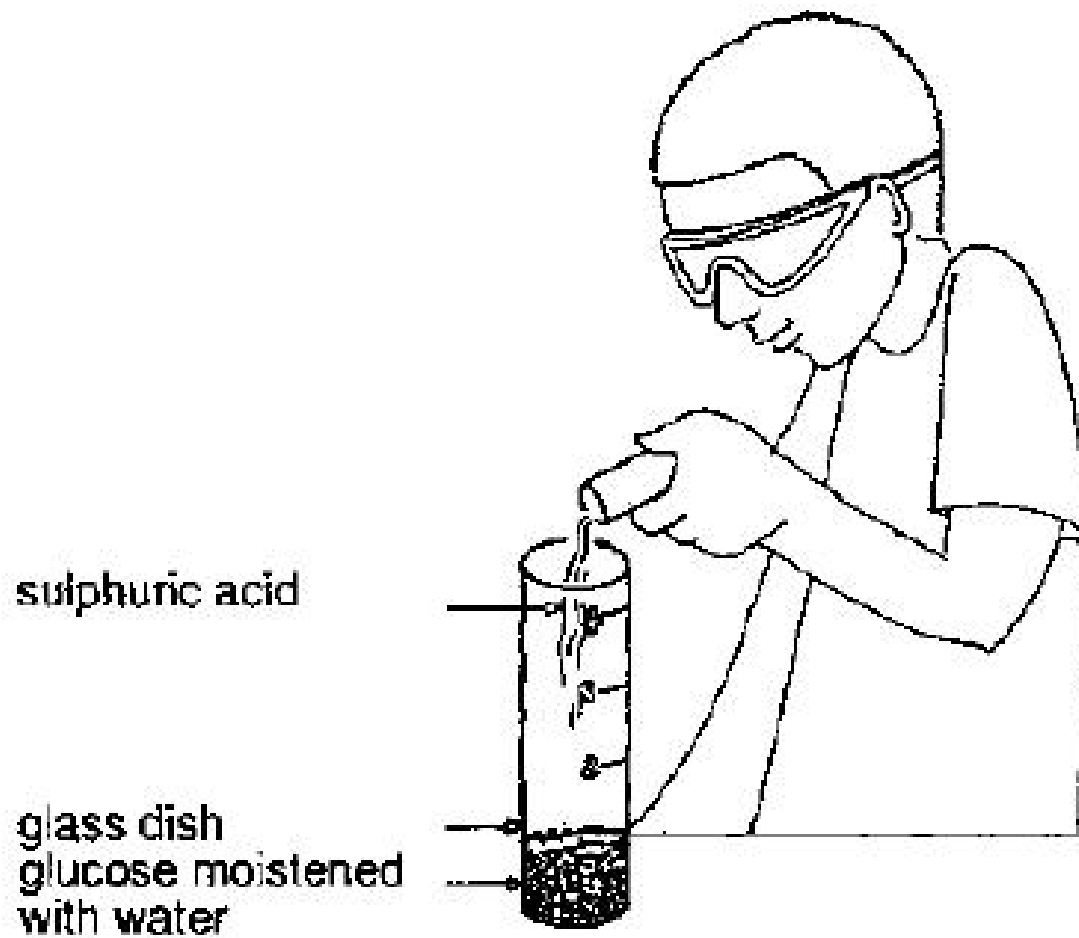

Observation:

A very voluminous black substance is formed.



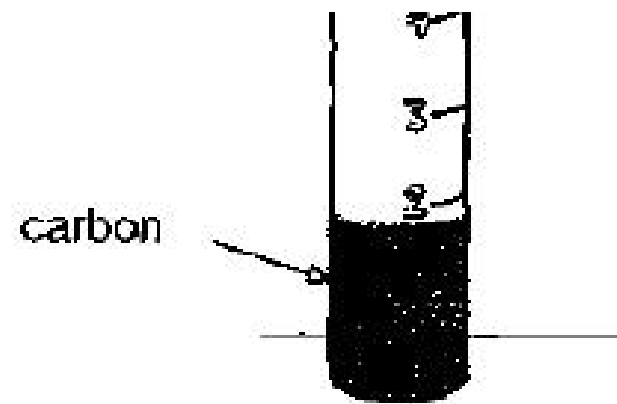

**Analysis:**

**The black substance is carbon.**

**Concentrated sulphuric acid extracts water from glucose.**

**Carbon is left as residue.**

**Practical Meaning:**

When you burn wood you can observe that it passes a state where it appears black (charcoal). Again, the black substance is carbon.

## 4.2. PROTEINS CONTAIN NITROGEN

### Main Goal:

**Qualitative ultimate analysis.**

### Information:

Proteins are organic compounds containing, among other elements, nitrogen, in particular the so called amino group –  $\text{NH}_2$ . Proteins are essential parts of animals' food, and also indispensable for mens' nutrition. Within the scope of ultimate analysis, nitrogen can be indirectly identified. When proteins are heated, ammonium gas is formed.

### *Materials and Apparatus:*

*hard-boiled egg, chicken protein  
moistened litmus paper  
test tube or fire-resistant glass dish  
test tube holder  
burner or candle*

### Procedure:

About 1 – 2  $\text{cm}^3$  of hard boiled egg white is placed into a test tube.

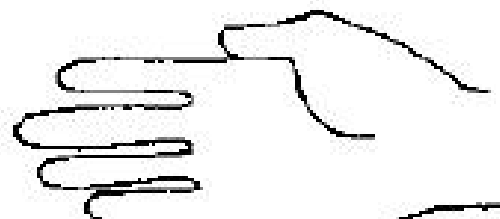

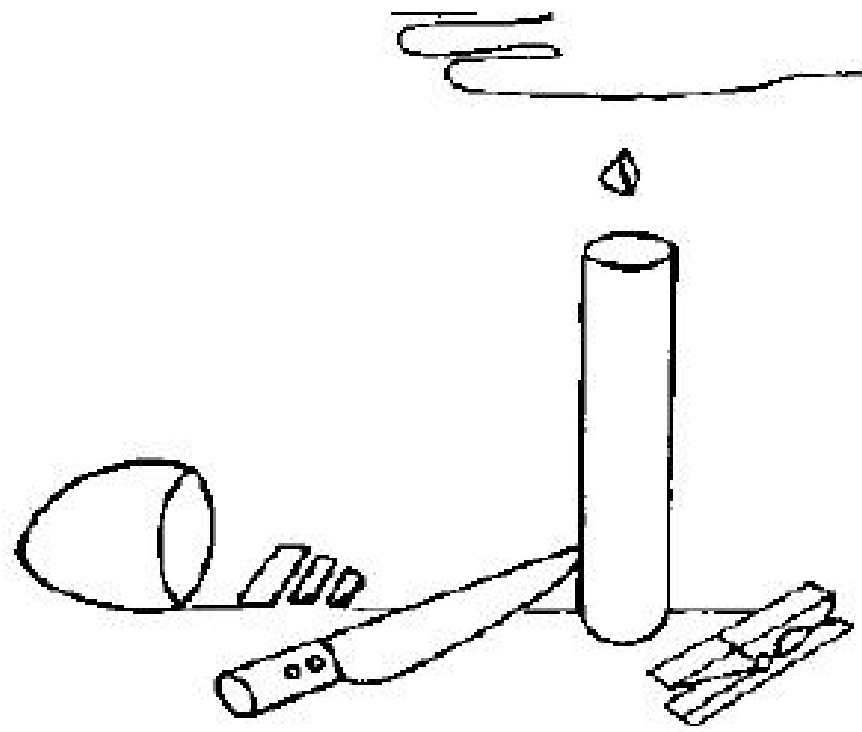

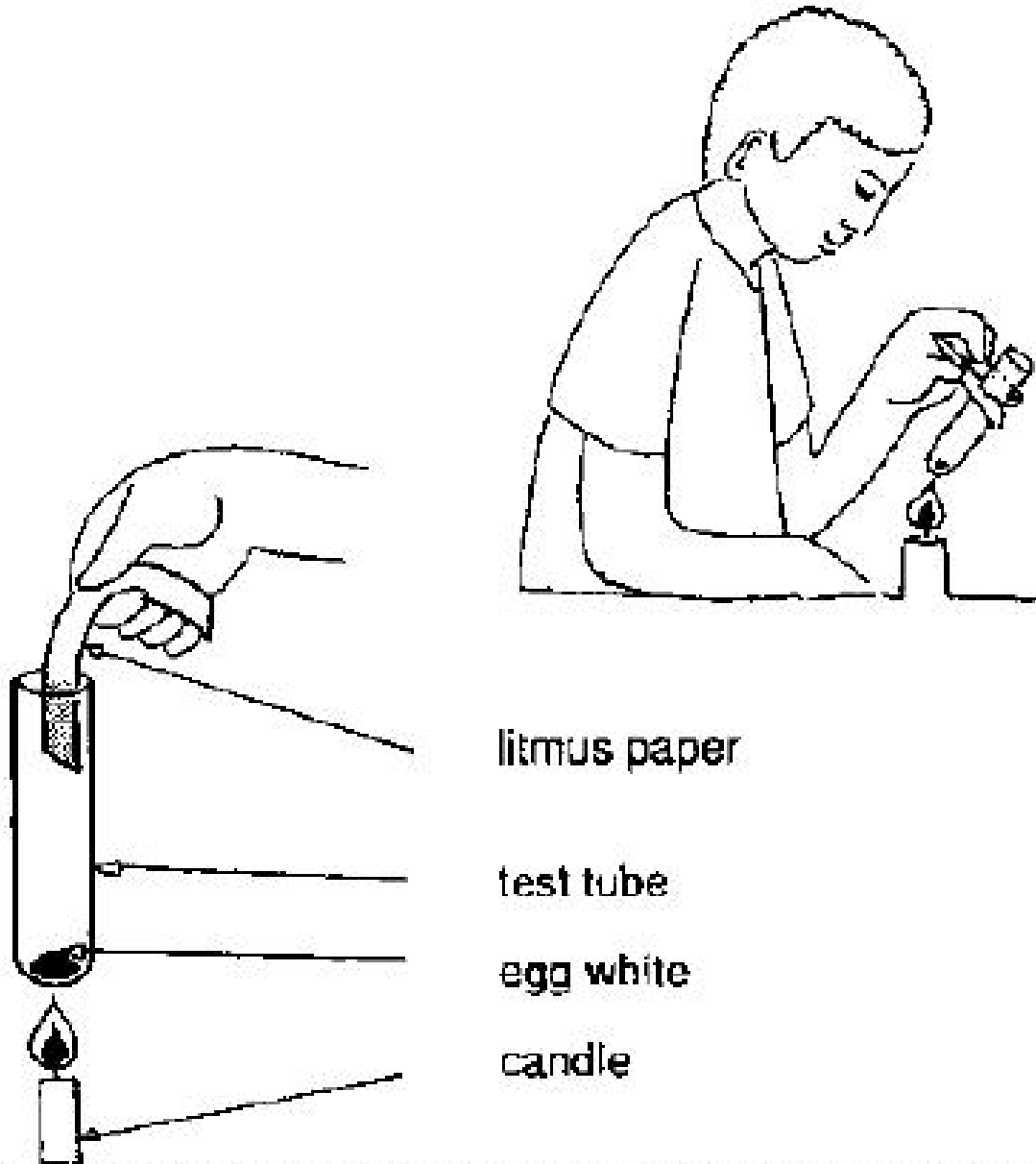

litmus paper

test tube

egg white

candle

The egg white is heated, and after a few minutes the moistened litmus paper is held in the vapour released.

Observation:

#### Observation:

The protein turns black when heated.

The litmus paper changes colour indicating an alkali.

#### Analysis:

When protein is heated, carbon is left as a black residue.

Protein contains nitrogen. When chicken protein is heated, ammonium gas is set free. It forms ammonium hydroxide if water is added.

Ammonium hydroxide changes the colour of indicators.

#### Addition:



### 4.3. PROTEIN CONTAINS SULPHUR

#### Main Goal:

Qualitative ultimate analysis.

#### Information:



Proteins are made up of amino acids. There are two kinds of amino acids which have sulphur in their functional group – cysteine and methionine.

When protein, e.g. chicken protein, is heated, hydrogen sulphide is formed. Sulphur can then be indirectly identified within the scope of ultimate analysis.

*Materials and Apparatus:*

*hard-boiled egg, chicken protein  
moistened lead acetate film  
test tube or glass dish  
test tube holder  
burner*

*Procedure:*

About 1 – 2 cm<sup>3</sup> of hard-boiled egg white is placed into a test tube. The egg white is heated, and after a few minutes the moistened lead acetate paper is held in the vapour released

**test tube**

**clothes-peg**

**egg white**

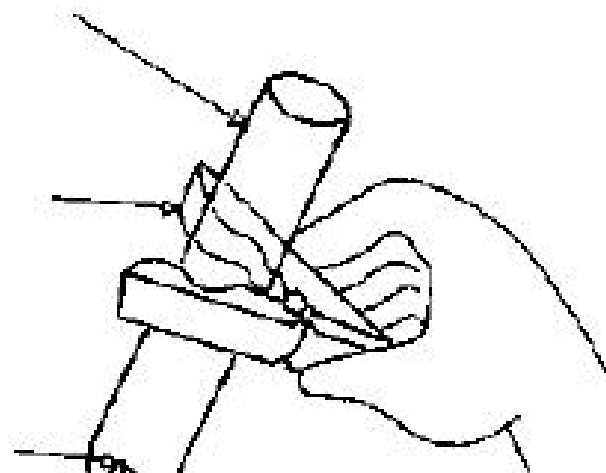

egg white



flame

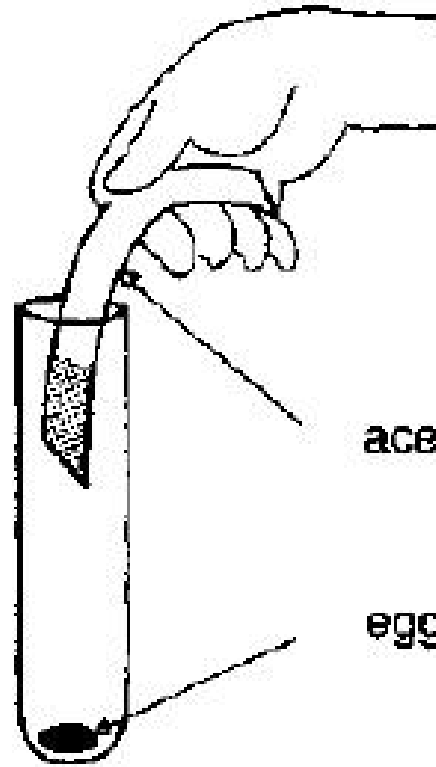
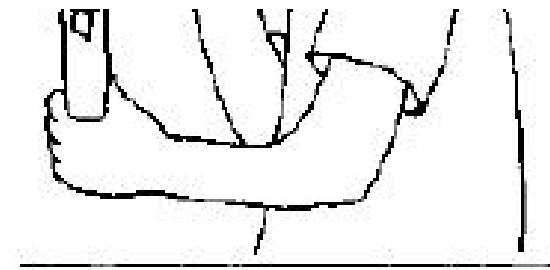
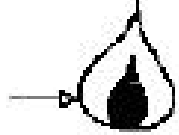

acetate film

egg white (protein)

Observation:

The protein turns black when heated.  
The white lead acetate turns black.

79

<http://cd3wd.com/dvd/> - filename: z\_science\_exp\_85 of 598

**Analysis:**

When protein is heated, carbon is left as black residue.

Chicken protein contains sulphur. When heated, hydrogen sulfide gas is set free. Hydrogen sulfide in combination with lead acetate forms black lead sulfide.

**4.4. IDENTIFICATION OF STARCH IN FOOD**

**Main Goal:**

Starch is identified with iodine potassium iodide solution.

**Information:**

Starch is a polysaccharide and belongs to the class of carbohydrates.

Starch is a vegetable reserve substance, found in grain, potatoes, etc.

*Materials and Apparatus:*

*a. about 0.5 g iodine*

*1 g of potassium iodide*

*100 ml distilled water*

*200 ml brown glass dish which can be tightly closed*

*b. 1 slice of potato*

*1 cube of bread*

Procedure:

- a. The potassium iodide is dissolved in distilled water, and then the iodine is added.
- b. Some drops of the iodine potassium iodide solution are dropped on a cube of bread and a slice of potato.

iodine potassium  
iodide solution

slice of potato



Observation:

The bread and the slice of potato turn a dark blue colour.

Analysis:

The blue colour indicates starch.

Addition:

Starch molecules are coiled in the form of a helix (like a spiral staircase). Iodine molecules accommodate themselves in this starch spiral.

The blue colour is caused by the trapped iodine molecules.

#### **4.5. CARBON DIOXIDE IS PRODUCED DURING THE PROCESS OF FERMENTATION**

**Main Goal:**

**The experiment demonstrates alcoholic fermentation.**

Information:

The oldest chemical synthesis technique of mankind is fermentation. It is the change which takes place when a saccharine solution is exposed to yeast. The products are alcohol (ethanol), carbon dioxide and heat.

*Materials and Apparatus:*

*freshly pressed apple juice or other fresh fruit juice*

*yeast (from a bakery)*

*250 ml glass vessel which can be closed with a rubber stopper*

*a pierced rubber stopper with a fermentation tube*

*limewater (CaO is dissolved in water and filtered)*

**Procedure:**

About 100 ml freshly pressed apple juice is poured into a glass vessel. Then 10 – 20 g yeast is added and the vessel is closed with a rubber stopper. The fermentation tube is filled with limewater (see diagram).

If the fermentation does not start immediately the glass vessel should be warmed in a water bath.

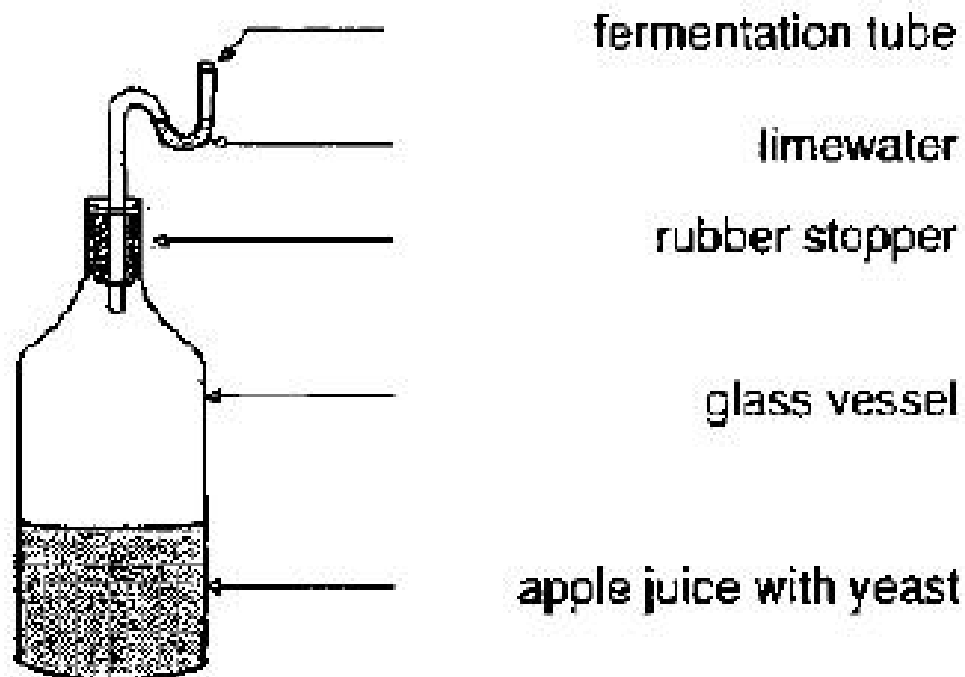



Observation:

After some time gas bubbles form.  
The limewater becomes cloudy.  
A white precipitate settles.  
The glass vessel becomes warmer.

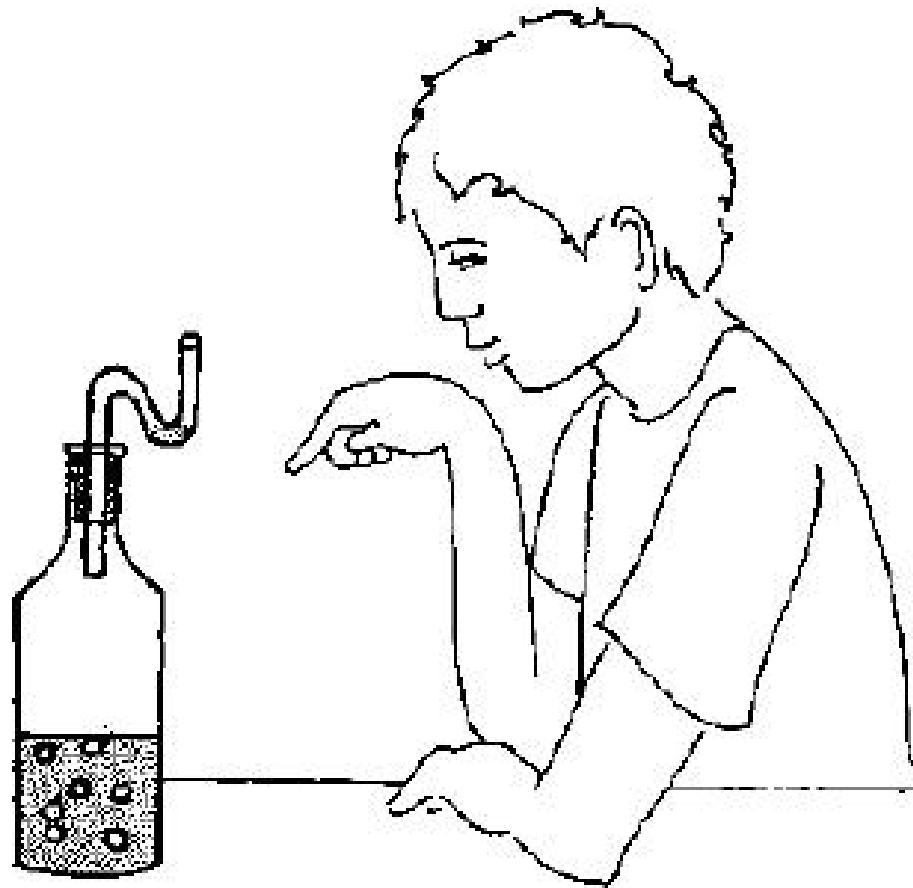



**Analysis:**

The gas formed is carbon dioxide.

Carbon dioxide and calcium hydroxide form white calcium carbonate.



**Addition:**

Fermentation vessels are closed with fermentation tubes which usually contain water. One reason for this is to create an anaerobic medium.

In an anaerobic medium more alcohol is produced than in an aerobic one.

**Practical Use:**

In industry, ethanol is produced in large quantities by alcoholic fermentation.

## **5. PHASE TRANSITION**

### **5.1. MELTING AND SOLIDIFICATION**

**Main Goal:**

**This experiment demonstrates the processes of melting and solidification taking water**

This experiment demonstrates the processes of melting and solidification taking water as an example. Water appears as liquid, vapor and solid (ice). These three modes of appearance are called phases. The transition from one phase to another one is called 'phase transition'. At the melting point solid water changes phase to liquid water. At the freezing point liquid water becomes solid water.

Information:

The melting point and the freezing point, i.e. temperature at which these changes take place, are identical.

These two phase transitions are hardly dependant on air pressure.

*Materials and Apparatus:*

*a. water*

*dish  
refrigerator*

*b. ice*

*glass dish  
thermometer*

Procedure:

83

<http://cd3wd.com/dvd/> - filename: z\_science\_exp\_89 of 598

- a. A little water is poured into a dish and this is then placed in the refrigerator.
- b. Some ice is placed in a glass dish, and the temperature is measured as the ice melts (see drawing).

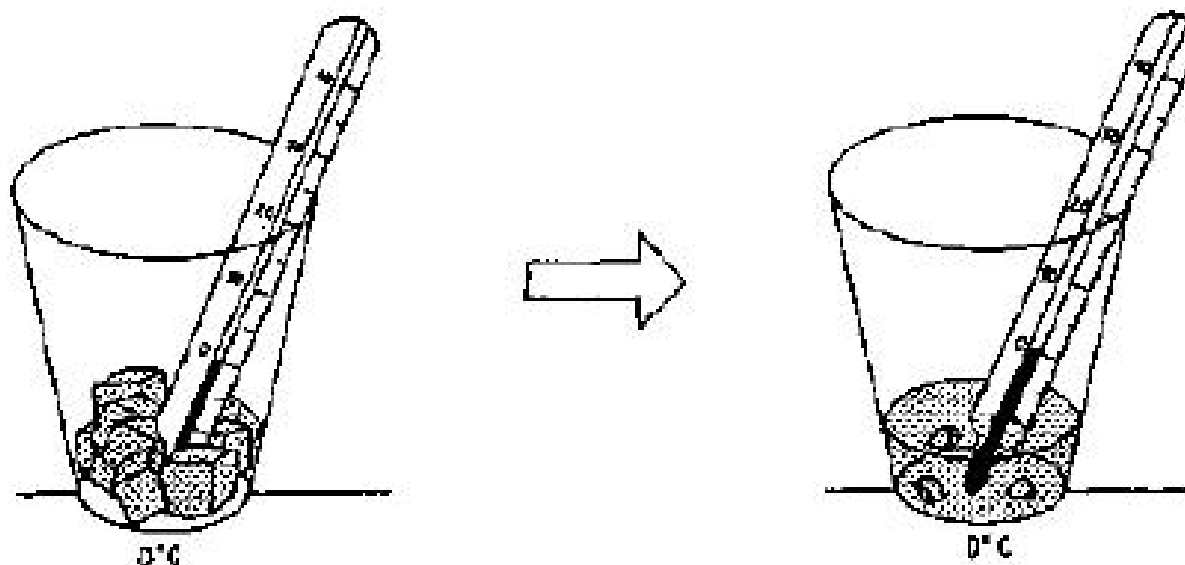

Observation:

- a. After some time the water freezes.
- b. As long as the ice melts, the temperature remains at 0° C.

Analysis:

**The transition from the liquid phase into the solid phase at a particular temperature (point of solidification) is called "solidification".**

**The transition from a solid phase into a liquid phase at a given temperature (melting point) is called "melting".**

The transition from a solid phase into a liquid phase at a given temperature (melting point) is called “melting”.

Thus it is possible to liquefy a solid substance and solidify a liquid.

The melting point (and the freezing point) for water is  $0^{\circ}\text{C}$ .

Practical Use:

The melting point is one means of identifying a material.

Addition:

The melting point of alcohol is  $-114^{\circ}\text{C}$ , its boiling point is  $78^{\circ}\text{C}$ .

For mercury the corresponding data are  $-39^{\circ}\text{C}$  and  $357^{\circ}\text{C}$ .

Further thought:

As long as the ice melts, the temperature remains constant ( $0^{\circ}\text{C}$ ) in spite of the fact that heat is continually being supplied.

Why does the temperature not rise?

## 5.2. EVAPORATION AND CONDENSATION

### Main Goal:

**This experiment illustrates evaporation (boiling) and condensation taking water as an example.**

### Information:

The boiling point and the condensation point of a pure substance are identical.

These two phase transitions are highly dependent on air pressure.

Condensation comes from the Latin "condensare" meaning to thicken.

### *Materials and Apparatus:*

*water  
glass or a pot  
glass vessel  
tripod  
burner  
thermometer*

### Procedure:

a. The apparatus is set up as shown in the diagram below.

The water is heated.

The water is heated.

The temperature at the boiling point is measured using the thermometer. (The temperature should not be taken at the bottom of the dish).

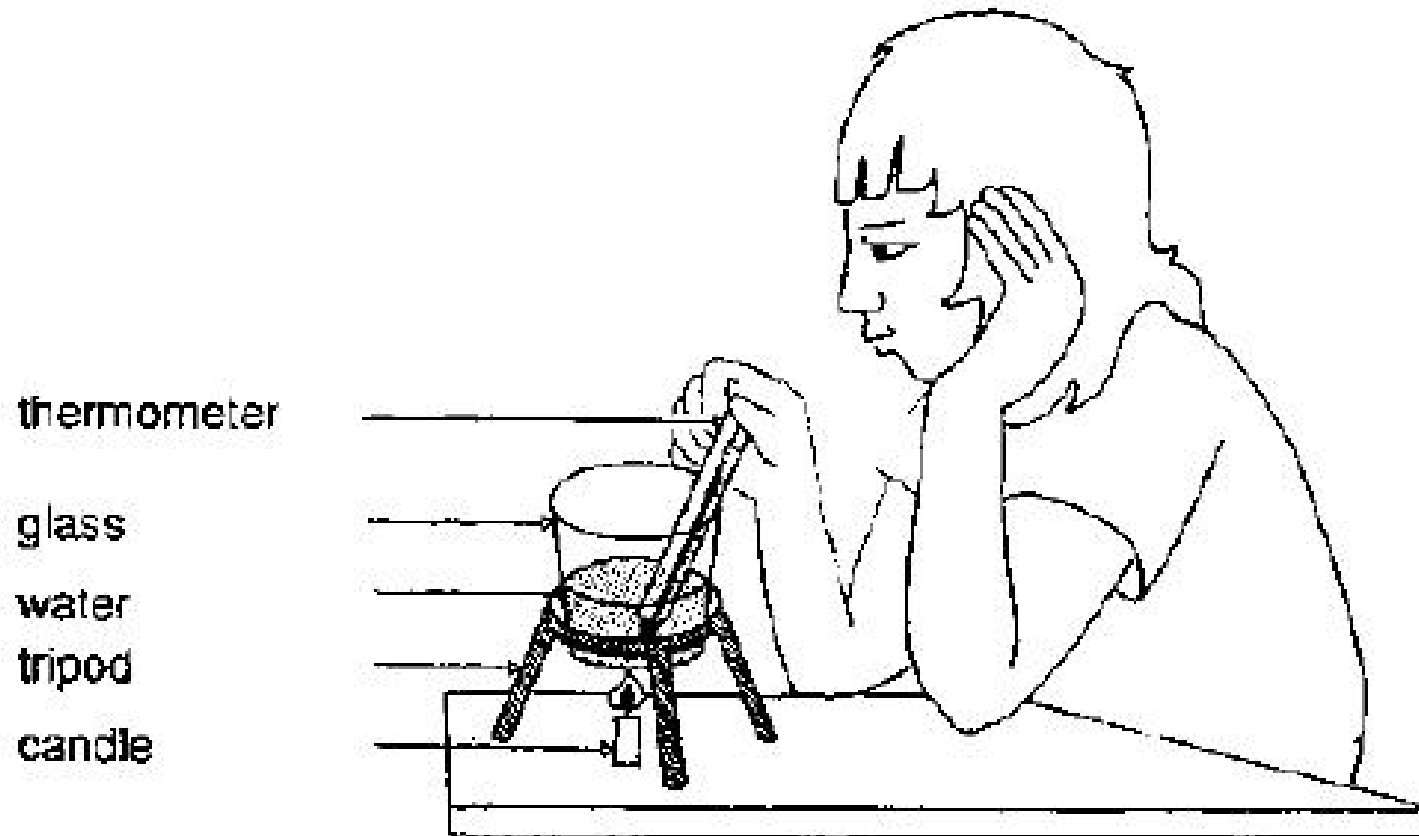

b. Then the second glass vessel is then held in the gaseous water (steam).

condensed water

glass

tripod

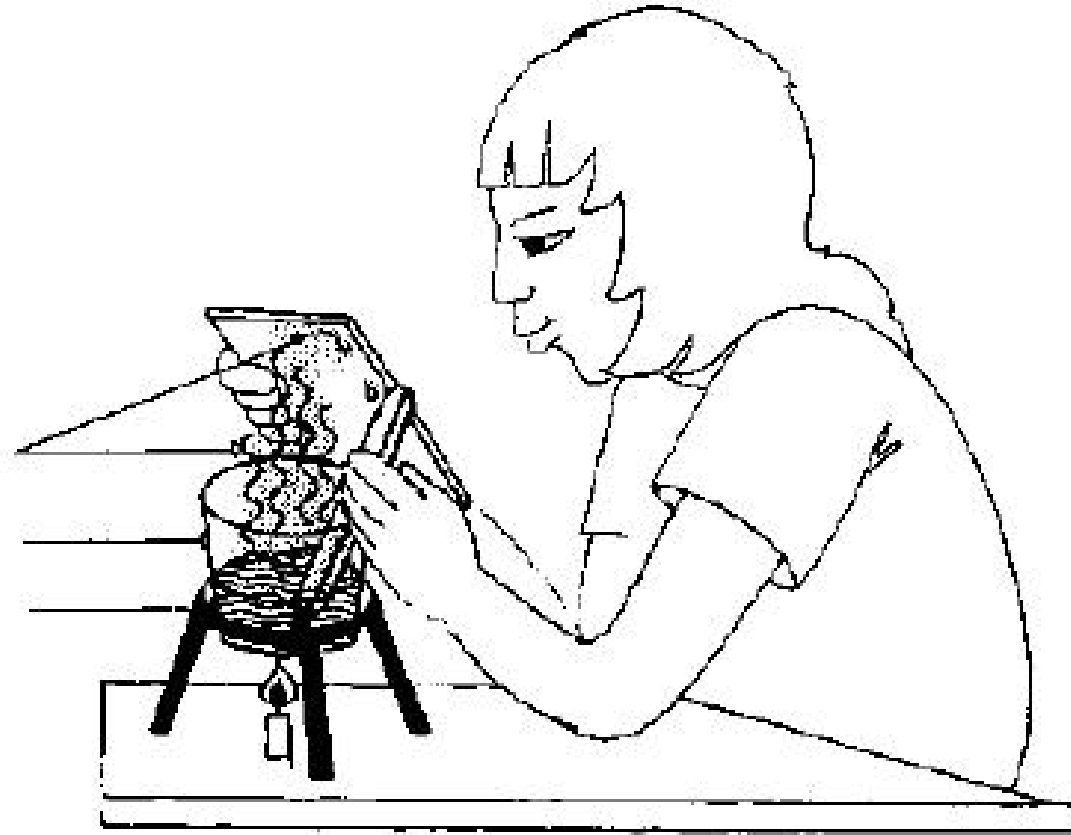

Observation:

- a. The water boils at about  $100^{\circ}\text{C}$  (at normal air pressure).
- b. Moisture condenses on the second glass vessel.

Analysis:

- a. The transition of a liquid to a gas at a certain temperature (the boiling point) is called "evaporation" or "volatilization".

**b. The transition of a gas to a liquid at a certain temperature (condensation point) is called “condensation”.**

Practical Use:

Boiling points are a means of identifying substances.

Air is generally loaded with water vapor. If air rises and reaches colder regions, the vapor condenses. Tiny liquid water drops are formed, clouds develop.

Further thought:

A solid must be heated to melt. A liquid must absorb heat to vaporize. Conversely, what must a gas release to liquefy and a liquid to solidify?

### **5.3. SUBLIMATION AND RESUBLIMATION**

**Main Goal:**

**This experiment demonstrates the processes of sublimation and resublimation taking iodine as an example.**

Information:



Sublimation is the direct transition of a solid body into a gaseous substance. The reverse process is called resublimation.

*Materials and Apparatus:*

*iodine – some crystals*

*sand – 2 or 3 teaspoons*

*porcelain or clay dish*

*funnel or a cut-off bottle neck*

*glass vessel – must be cooled in a freezer prior to the experiment*

*burner or candle*

*tripod*

**Procedure:**

The iodine crystals are mixed with the sand in the porcelain dish.

The apparatus is set up as shown in the diagram below and heated slowly.

**glass vessel**

**funnel**

**porcelain dish**

**iodine crystals  
mixed with sand**

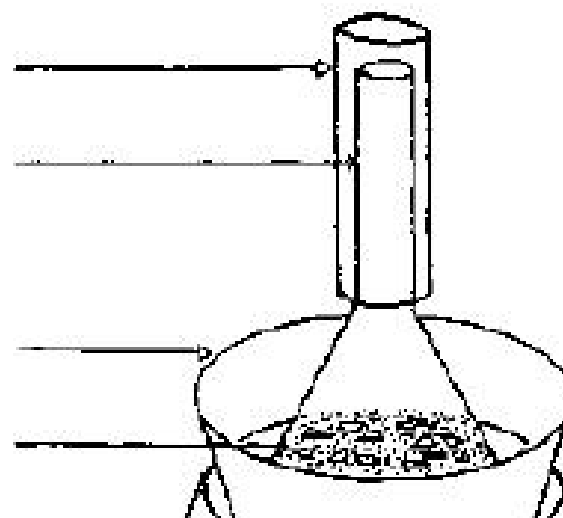

mixed with sand  
tripod  
flame

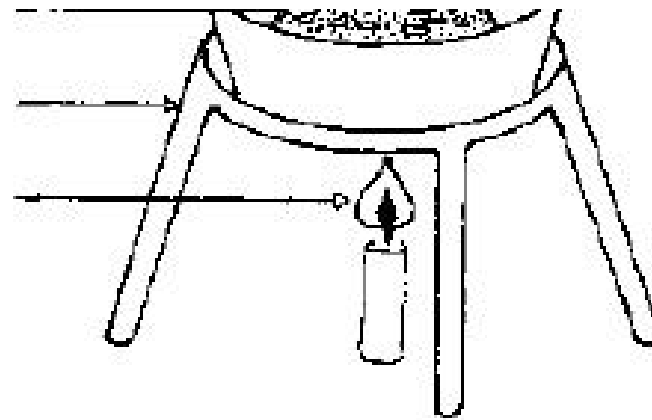

Observation:

Violet vapour appears. The solid iodine becomes a gas without melting. Crystals settle in the glass dish.

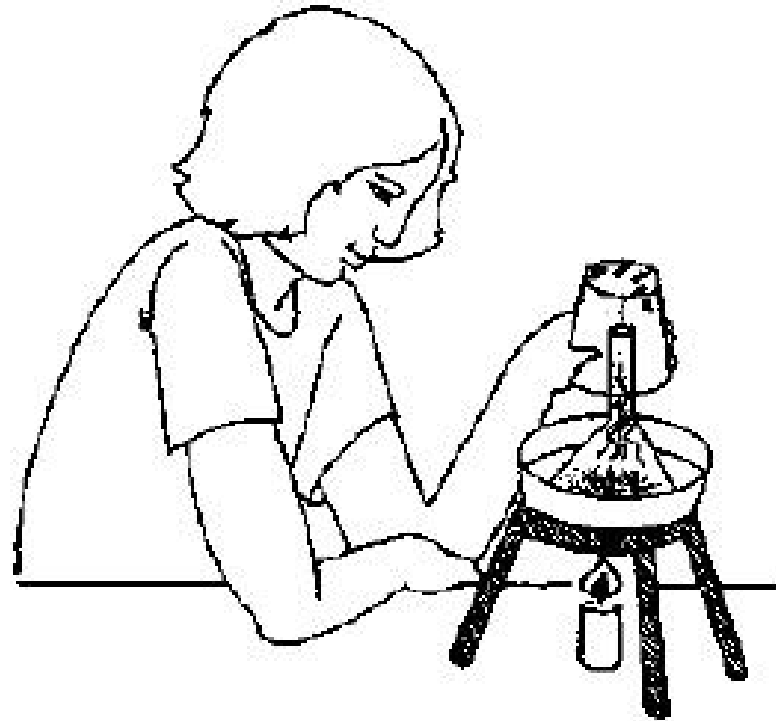

crystals

violet vapour

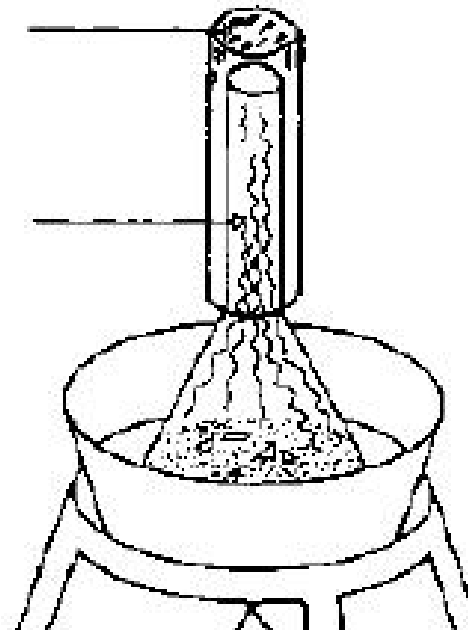

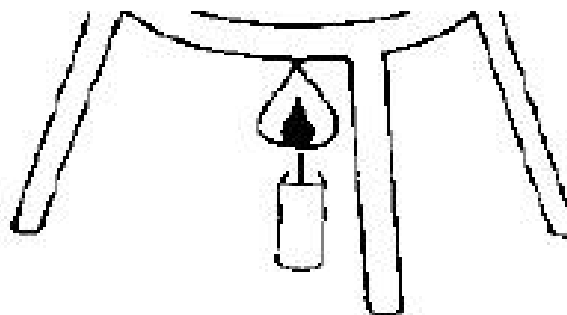

**Analysis:**

This direct transition of a solid substance to a gas is called “sublimation”.

The direct transition of a gas to a solid condition is called “resublimation”.

Further thought:

So-called “dry ice” (a solid) consists of carbon dioxide. At the open air it undergoes sublimation, and i.e. it changes phase directly from solid to gas. Why then is dry ice used in picnic cooler?

#### 5.4. LAUNDRY DRIES WHEN THE WATER EVAPORATES

**Main Goal:**

Through the experiment pupils learn why and how liquids evaporate, taking water as an example.

Information:

Even below the boiling point water can become a gas. This process is called evaporation. The pace of water evaporation is dependent on the factors temperature and vapor saturation of the air (among others). Generally air contains water vapor. The concentration of water vapor i.e. the number of grams of water per cubic meter of air, depends on the temperature of the air. If air of a certain temperature contains the maximum possible amount of water vapor we call this air 'saturated'. The higher the temperature of the air the more water vapor can it contain.

The following experiments illustrate these two interdependent factors.

*Materials and Apparatus:*

*a. 2 dishes of about the same size*

*1 glass vessel*

*b. 2 rags of about the same size*

*(about 15 cm × 15 cm)*

*water*

Procedure:

a. The two dishes are half filled with water. A glass vessel is placed over one of the dishes. The experiment is observed for several days.



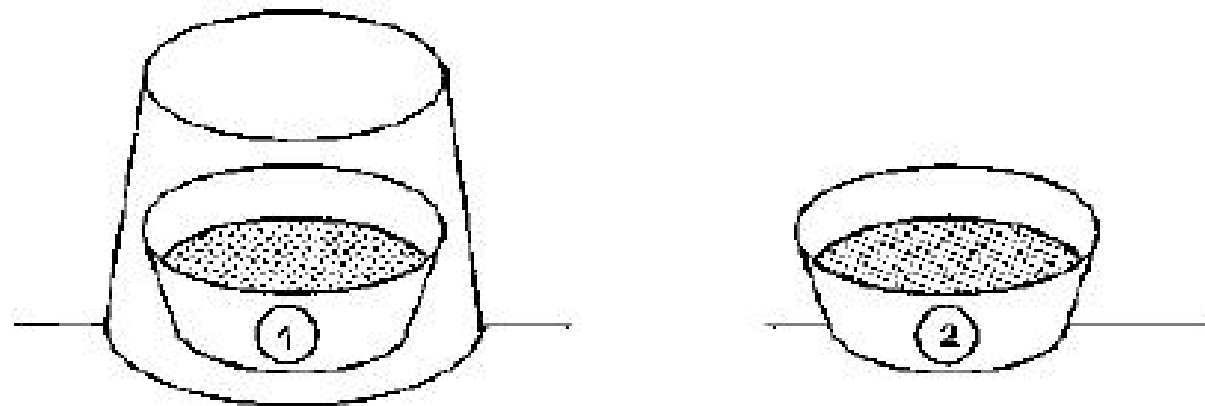

b. The rags are soaked in water. One is dried in the sun and the other one in the shade. The times taken by the rags to dry are compared.

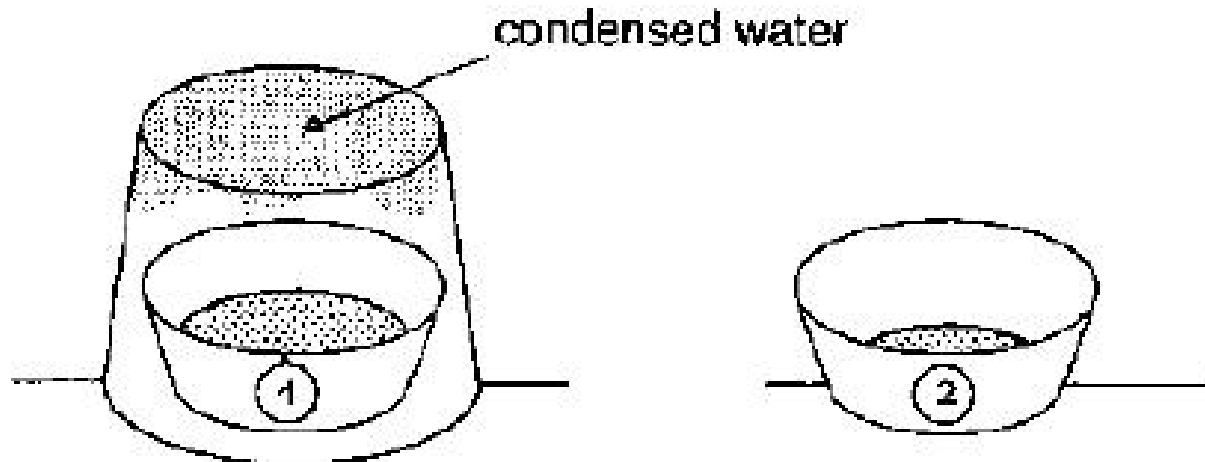

Observation:

a. After a few days (the time depends on the amount of water and the size of the surface) the water in the open dish has completely evaporated. The water in the other dish has only partly

evaporated.

b. The rag in the sun dries more quickly than that in the shade.

### **Analysis:**

**The ambient air takes in the gaseous water particles to a certain degree until the air becomes 'saturated'. This is why the water from the dish with the cover (experiment a.) evaporates only partially. Water evaporates more rapidly in warm air than in cold air.**

**An additional air movement, e.g. caused by wind, moves away the air surrounding the wet rags which is saturated with water vapour.**

**The "dry" air is moved along and the whole process starts again. Thus, the pace of evaporation is increased.**

### **Practical Use:**

A technical way of using water evaporation is the process of refining salt (basically sodium chloride) from sea water in warm countries. The sea water is lead into huge basins. The water evaporates, according to the water circulation, with the help of the sun and the wind.

The salts crystallize out and can then be refined (see experiment: CRYSTAL FORMATION).

### **Further thought:**

The cloth covering canteens are moistened when we want to keep the liquid inside cool.  
Why?

## 5.5. WATER EVAPORATION – DEPENDANT ON THE SURFACE SIZE

### Main Goal:

**The experiment demonstrates to what extent the evaporation of water is dependant on the surface size.**

### Information:

Water also becomes a gas below the boiling point. This process is called evaporation.

(see experiment: LAUDRY DRIES WHEN THE WATER EVAPORATES.)

### *Materials and Apparatus:*

*1 glass vessel with a smaller diameter  
a tin pan  
1 measuring cylinder (scales, measuring vessel)*

### Procedure:

The same amount of water is placed in each of the three vessels. They are then placed in a sunny spot and observed for several days.



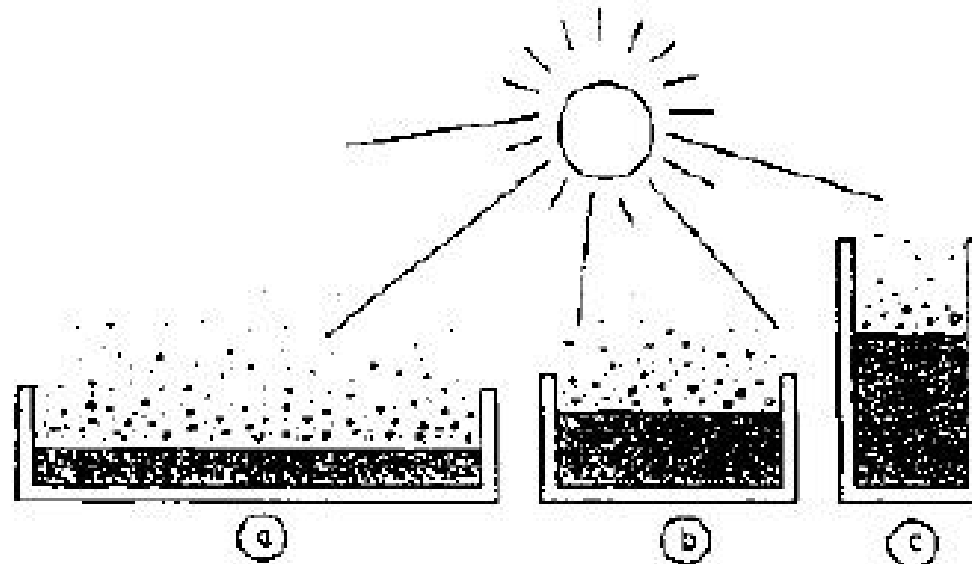

Observation:

The water in the tin pan (a) evaporates faster than that in glass vessel (b). Slowest evaporation takes place in glass vessel (c).

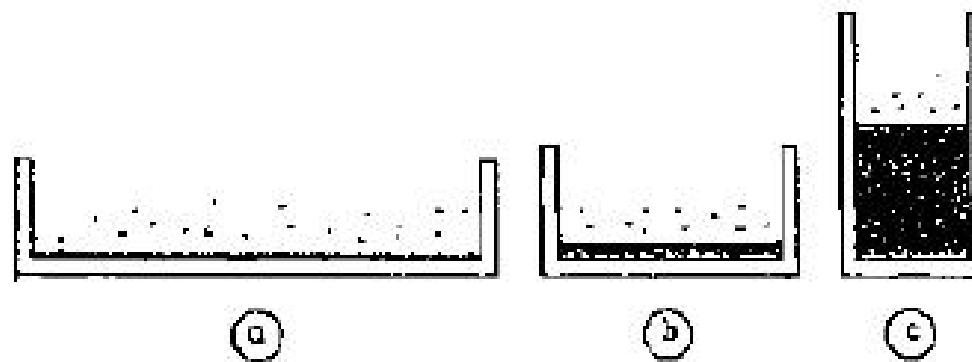

Analysis:

The speed of water evaporation is dependant on the size of the surface. The bigger it

**The speed of water evaporation is dependant on the size of the surface. The bigger it is, the more rapid the evaporation.**

Practical Use:

see experiment: LAUNDRY DRIES.

Laundry dries faster when the surface of the washing is made as big as possible.

Further thought:

What is the effect when rubbing alcohol is poured on your back?

## **5.6. WATER EXPANDS WHEN IT SOLIDIFIES**

**Main Goal:**

**This experiment illustrates the volume expansion of water when it solidifies.**

Information:

Water has its greatest density at 4° C. Above and below this temperature, the density decreases.

The volume expansion of solidified water can be demonstrated impressively by the volume increase undergone by water when it freezes.

This phenomenon, which is a contradiction of accepted, normal laws is called the "density anomaly". The word anomaly comes from the Greek and Latin word "anomalus" meaning: against the law.

*Materials and Apparatus:*

*a bottle or jar with a screw cap  
water which has been boiled and then cooled  
freezer  
plastic bag, paper  
an empty tin*

*Procedure:*

The jar is filled up to the rim with boiled water and the screw cap is tightly closed. Then it is placed in a plastic bag.

The tin is also filled up to 3/4 of its height. The water level is marked.

Both, the bag with the jar and the tin are placed in the freezer for one or two days.



**tin with water,  
level marked**

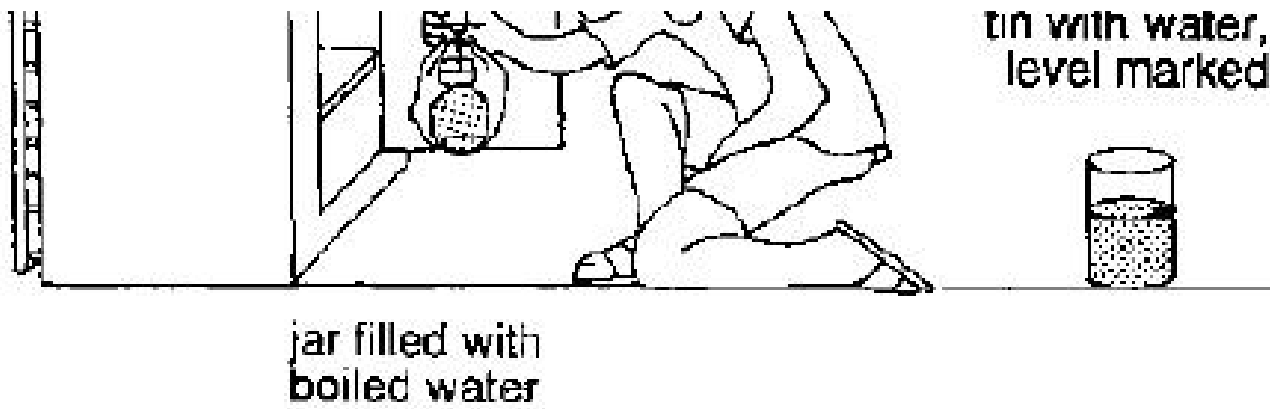

Observation:

The water is frozen, the jar has shattered, the ice in the tin has reached a higher level than the liquid water before.



Analysis:

**Water expands when it solidifies.**

Practical Meaning:

Underground water which freezes causes erosion (from the Latin word "erodere", meaning to gnaw off) in the mountains and streets.

Further thought:

When water solidifies, it not only enlarges its volume but also releases heat into the freezer.

What does the freezer do with this heat?

## **5.7. ICE FLOATS ON TOP OF WATER**

**Main Goal:**

**This experiment demonstrates that ice is less dense than water.**

Information:

At room temperature, the density of water is approximately  $1 \text{ g/cm}^3$  and that of ice about  $0.9 \text{ g/cm}^3$ .

*Materials and Apparatus:*

*ice cubes (if a refrigerator is not available in your school, go to the next bar and ask for some*

*ice cubes (if a refrigerator is not available in your school, go to the next bar and ask for some ice cubes)*

*water*

*drinking glass*

Procedure:

Some ice cubes are placed in a pan with water.

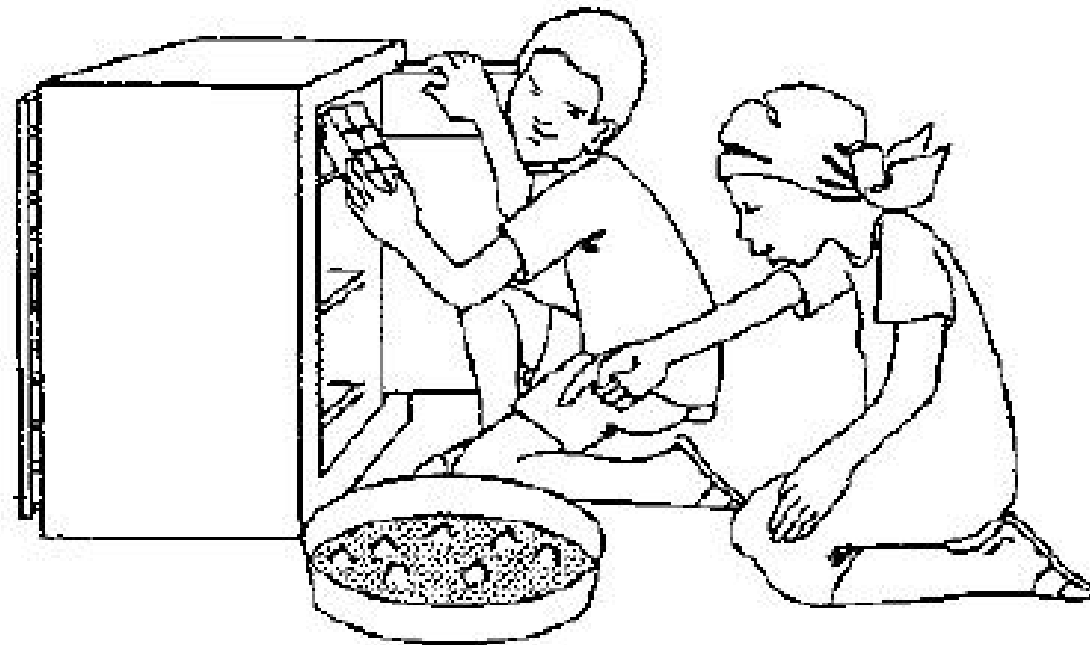

**ice cubes  
in a pan**

Observation:

The ice floats on the water.

**Analysis:**

**We observe that water expands when it solidifies. This means that 1 cm<sup>3</sup> ice weights less than 1 cm<sup>3</sup> liquid water. The bigger volume of ice has the same mass as the water that becomes ice. Therefore, the density, i.e. the mass (in g) per volume (in cm<sup>3</sup>) of ice is smaller than that one of liquid water.**

Further thought:

What happens to the water level in the pan (see drawing) when the ice melts?

## **5.8. ICE MELTS WHEN THE PRESSURE INCREASES**

**Main Goal:**

**This experiment demonstrates that ice melts where locally the pressure is increased.**

Information:

The freezing point, or rather melting point, slides toward lower temperatures as pressure is increased. This is true of water and of the elements mercury and bismuth. Thus, under high pressure ice melts already at  $-5^{\circ}$  C or even lower temperatures.

pressure ice melts already at  $-5^{\circ}\text{C}$  or even lower temperatures.

With all other substances the melting or the freezing point is increased by an increase in pressure.

### *Materials and Apparatus*

*1 ice block*

*1 boulder or big brick (about 5 kg)*

*wire about 30 cm long*

*10 normal bricks*

### Procedure:

The experiment is set up as shown in the diagram below.

The experiment takes about half an hour or longer, depending on the thickness of the ice block, and the weight of the weight.



a)

ice block

bricks

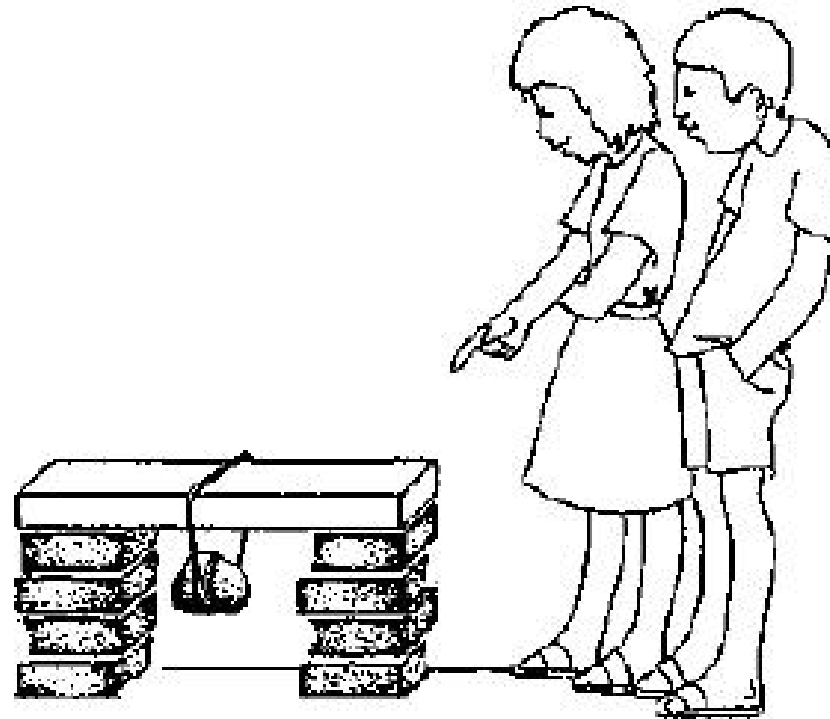

boulder or brick

b)

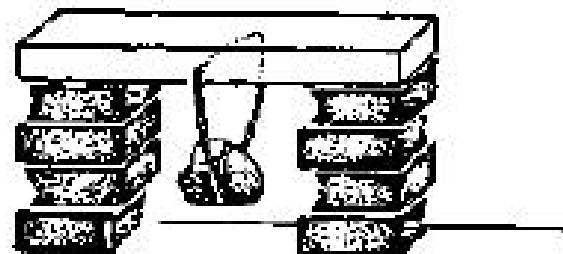

c)

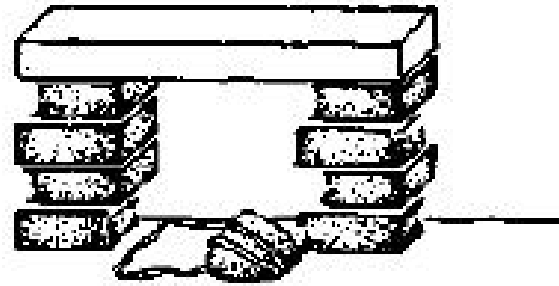

Observation:

The wire moves through the ice block without cutting it into pieces.

Analysis:

**The boulder produces pressure along the line of the wire at the upper surface and at the sides of the ice block. The ice melts because of the pressure transmitted to the ice by the wire. Above the wire the ice freezes again. Under increased pressure, water has a lower freezing or melting point.**

Practical Meaning:

Ice skating is possible due to the increased pressure which is exerted on the ice through the blade of the ice skate. A water film is created which allows skater to glide.

The movement of glaciers can also be explained by the high pressure which the upper layers of snow or ice exert on the lower ones.

95

Further thought:

Look at the ice block in drawing c).

It is not quite correct. The wire when pulled through the ice will leave a trace! Why?

## 6. WARMTH AND COLD

### 6.1. METALS EXPAND WHEN HEATED

**Main Goal:**

**This experiment demonstrates the expansion of metals when heated.**

**Information:**

Some important properties of metals are malleability, thermal conductivity, expansion when heated and electrical conductivity.

The expansion of metal under the influence of heat is very important. The effect is in particular conspicuous for long, thin rods and pipes, which are at high temperatures significantly longer than at low temperatures.

Solid materials do not expand as much as liquids or gases.

*Materials and Apparatus:*

*Materials and Apparatus:*

*1 metal sheet (aluminium or copper)  
1 coin*

*alcohol or gas burner,  
a candle a pair of tongs  
a pair of pliers*

**Procedure:**

An opening is cut into the metal sheet to allow the coin just to pass when cold. The coin is heated as shown in the diagram below. (The time required depends on the material of which the coin is made.) After heating, attempt to put the heated coin through the opening in the metal sheet.

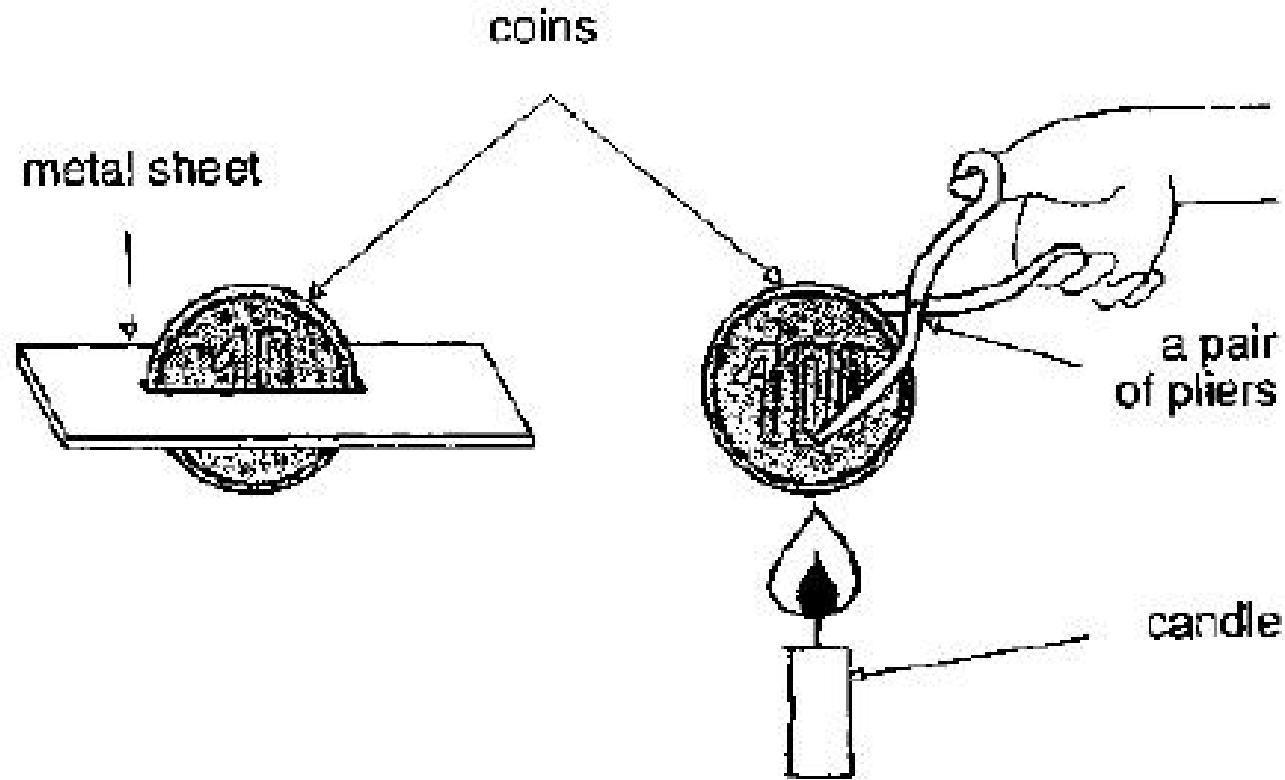

Observation:

The heated coin no longer fits through the opening as before. It jams.

After the coin has cooled down, it fits through the opening again.

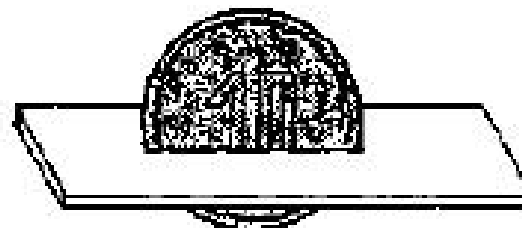



**Analysis:**

**The coin expanded when heated.**

**Metals expand when heated and contract when cooled down.**

**Practical Use:**

The expansion of metals on heating can be observed in the wires of telegraph lines and transmission lines.

During the summer metal wires sag, whereas in winter they tauten again. When metal wires are laid in summer, they should never be tautened.

In winter small gaps between railway tracks can be observed. These close in summer. The length expansion must be taken into consideration to avoid a deformation of the whole track system. Track sections are often welded together today without leaving seams. Iron tyres are fitted on a wooden wheel after having been heated. When they cool down they contract and tighten on the wood.

Metal bridges are set into concrete only at one side of the bridge, so that they do not bend when they expand. Bimetals take advantage of various kinds of length expansions of different sorts of metals.

(see experiment: THE PRINCIPLE OF A BIMETAL)

Further thought:

Mercury, under normal conditions, is a liquid. It expands also when heated. The same happens to glass, even if it is not a metal. Many thermometres are made of glass and mercury. Which material expands more with increasing temperature?

## 6.2. THE THERMAL CONDUCTIVITY OF DIFFERENT KINDS OF MATERIALS

**Main Goal:**

**This experiment shows the good and poor conductivity of various kinds of materials.**

Information:

All kinds of substances conduct heat. The degree of heat conductivity is dependent on the material. If the transport of heat takes place in testing substances, it is said to be heat conduction (in contrast to heat streaming due to differences in density).

*Materials and Apparatus:*

*about 20 cm of copper wire, iron wire and glass rod, each one of the same length and with the same diameter*

*a wooden rack*

*wood auger*

*wax*

wax

3 candles

Procedure:

The experiment is set up as shown in the following diagram.

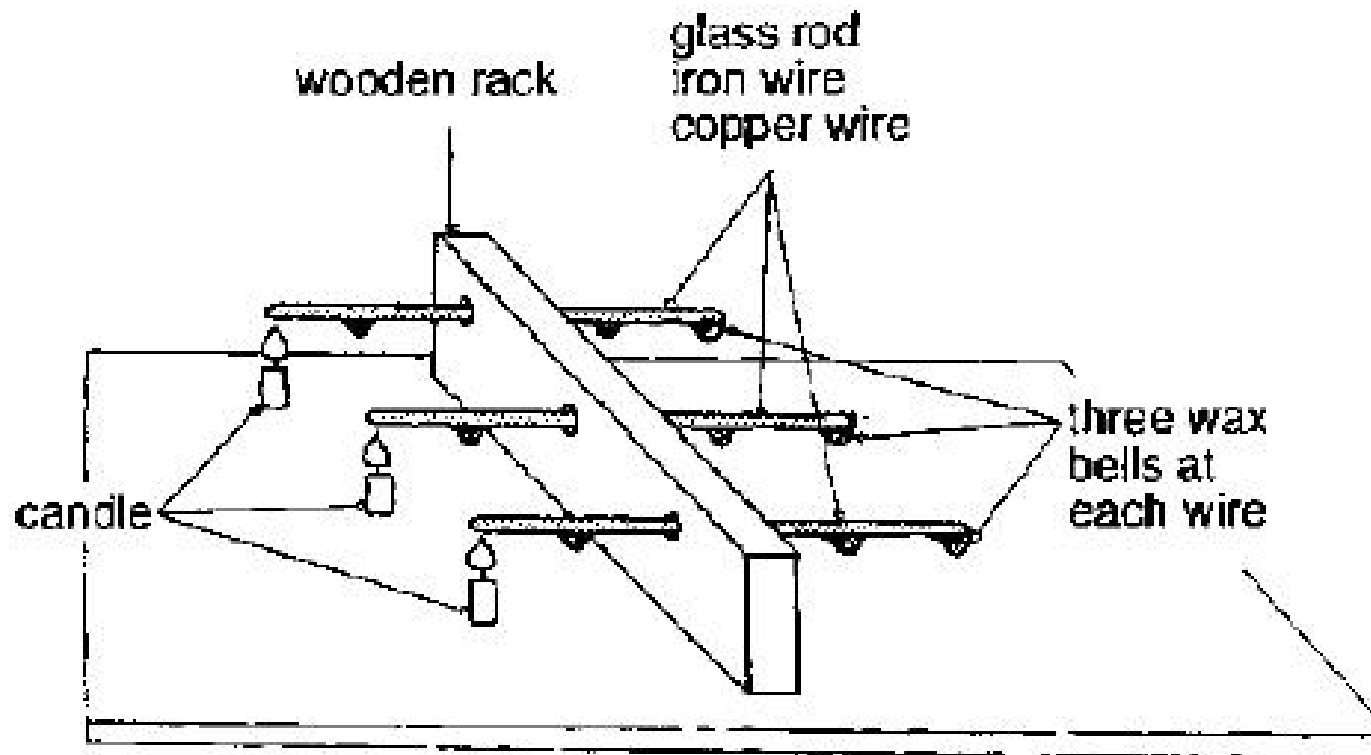



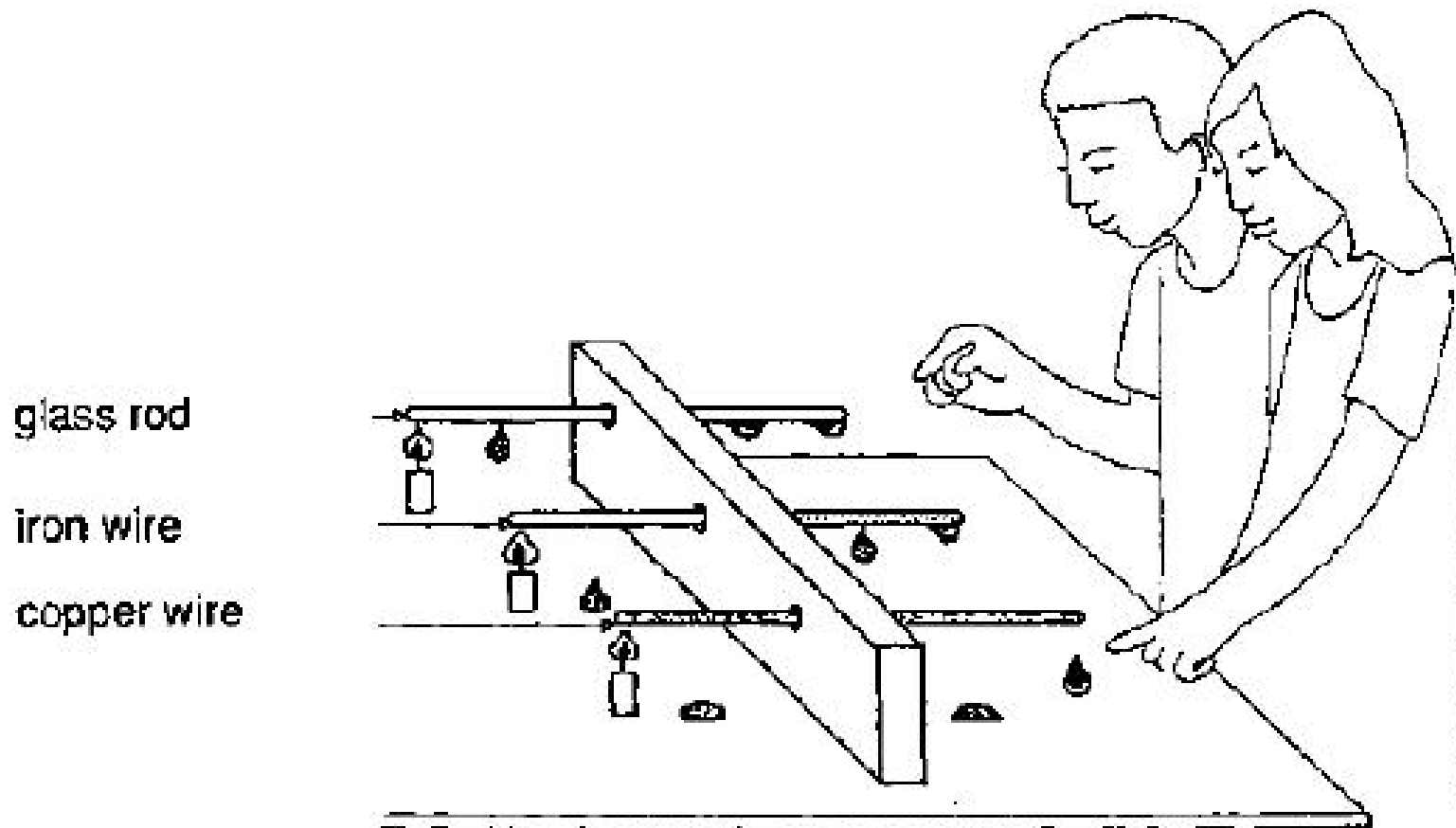

**Observation:**

First the little wax ball at the end of the copper wire melts and then the one on the iron wire. The one at the end of the glass rod does not drop off.

**Analysis:**

Heat needs time to go through. The faster the better the conductivity. Glass is a poor heat conductor. Copper is a better one than iron. The heat conductivity is dependant on the material. There are good, medium and bad heat conductors.

Heat needs time to go through. The faster the better the conductivity. Glass is a poor heat conductor. Copper is a better one than iron. The heat conductivity is dependant on the material. There are good, mediocre and bad heat conductors.

Practical Use:

Good heat conductivity is taken advantage of in the household, e.g. with pots.

Wood conducts heat much worse than brick.

A house made of wood only warms up slowly, which means, it stays cool in summer. In winter it cools down more slowly than houses made of brick.

(The thickness of the wall and its construction also have to be taken into consideration.)

It is recognized that houses made of brick are built in such a way that the bricks include a lot of air, since air is a poor thermal conductor.

On Cabor Verde, holes are punched into mud blocks and gypsum blocks with the help of bottles and tins. This procedure saves material and is insulating.

Futher thought:

Why is it difficult to estimate the temperature of things by touching them?

### 6.3. THE THERMAL CONDUCTIVITY OF WATER

#### Main Goal:

**This experiment demonstrates the thermal conductivity of water.**

#### Information:

see experiment: THE THERMAL CONDUCTIVITY OF DIFFERENT KINDS OF MATERIALS.

#### *Materials and Apparatus:*

*glass tube*  
*cold water*  
*burner or candle*

#### Procedure:

The water is heated in the upper part of the glass tube.

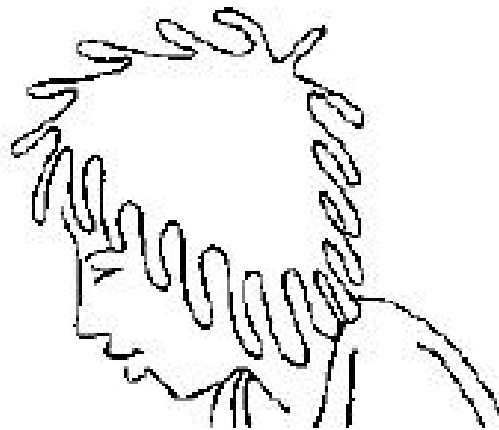

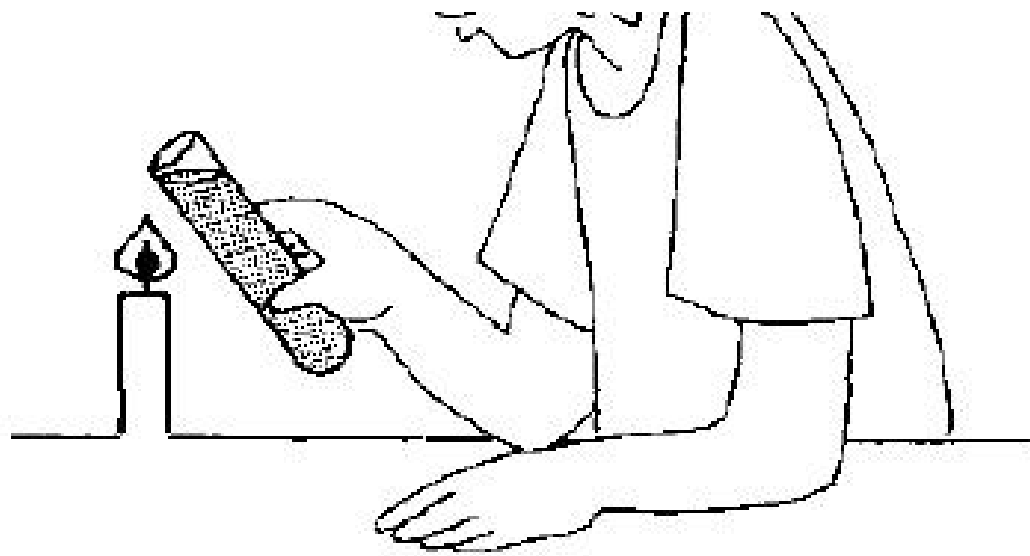

Observation:

The water boils in the upper part of the glass tube.  
The bottom of it hardly warms up.

**Analysis:**

**Heated water expands, the density decreases and it becomes lighter (see experiment 6.4). Therefore, it does not sink down.**

**The water at the bottom of the test tube remains rather cold.**

**Therefore: Water must be a bad heat conductor.**

Further thought:

How can you make this experiment even more dramatic? Think about the usage of ice!

#### 6.4. THE HEAT “STREAMING”

**Main Goal:**

**The experiment demonstrates that the density of water decreases when it is heated.**

**(The density anomaly of water – highest density at 4 ° C – is not taken into account.)**

**Information:**

When water is heated, it expands and its density decreases. It becomes lighter (i.e. 1 cm<sup>3</sup> of hot water is lighter than 1 cm<sup>3</sup> of cold water). If heated at the bottom of a beaker the hot water moves upwards. At the surface it cools down. Its density increases and the water sinks. These processes cause a “heat streaming” in water.

“Heat streaming”, (unaided convection, Latin: convehere to bring along), occurs when the density differences are caused by different temperatures.

*Materials and Apparatus:*

*water, ink  
sawdust, straw, glass pipe, bamboo pipe  
tripod or a similar frame  
candle*

*tripod or a similar frame*

*candle*

*glass beaker*

Procedure:

Ink or another colour is placed at the bottom of the beaker by means of a straw or a glass pipe.

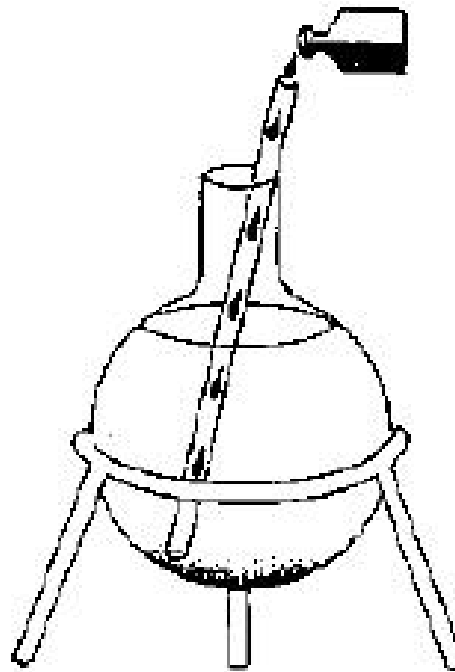

The water is warmed up with the candle at one side of the bottom of the beaker.

glass beaker

water

tripod

colour

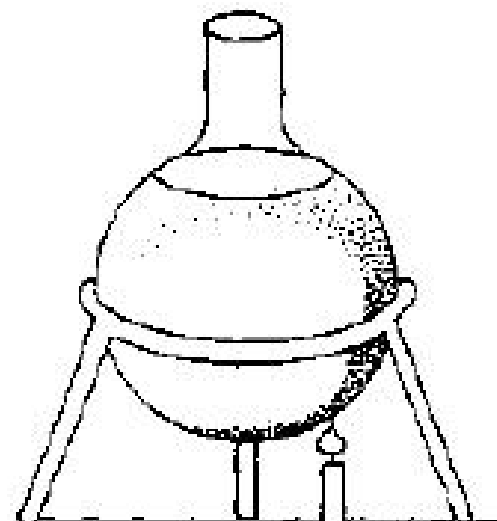
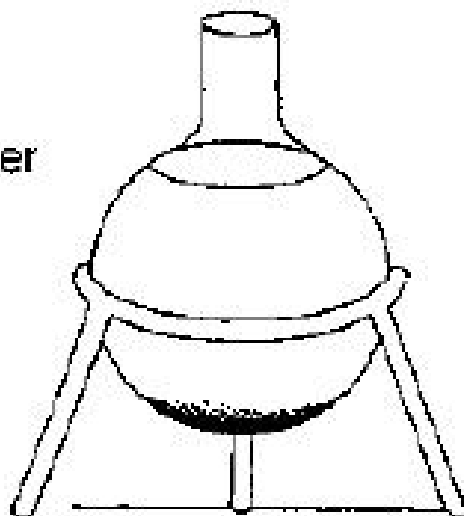

candle

Observation:

The coloured water ascend at the side of the beaker which is heated. At the opposite side the water sinks back to the bottom. After a while it circulates.

Analysis:

The warmed up water ascends and carries the colour with it. The density of heated water is less than that of cold water, which sinks back to the bottom. This "heat streaming" can be observed as long as the water is heated in the way shown.

Practical Use:

This phenomenon is used in warm water heating. In the basement, cold water is warmed up. Warm water ascends into the heating system, cools down and arrives at the boiler over a

This phenomenon is used in warm water heating. In the basement, cold water is warmed up. Warm water ascends into the heating system, cools down and arrives at the boiler over a down-pipe. Today pumps are used to support this cycle.

Further thought:

In this experiment not only water is moving! It carries colour and something else. What?

## 6.5. DENSITY DIFFERENCE BETWEEN WARM AND COLD WATER

**Main Goal:**

**These experiments show that warm water has a lower density than cold water.**

Information:

The greatest density of water is at 4° C. Above and below this temperature, the density of water decreases (see experiment: WATER EXPANDS WHEN IT SOLIDIFIES)

*Materials and Apparatus:*

*a. water heated to about 50° C*

*ink*

*cold water of about 10° C*

*2 glass dishes*



*thermometer*

*b. water heated to about 50 ° C*

*ink*

*cold water of about 10 ° C*

*2 glass dishes*

*thermometer*

Procedure:

- a. The warm water is coloured with 1 – 2 drops of ink and then carefully added to the cold water.
- b. The cold water is coloured with 1 – 2 drops of ink and then carefully added to the warm water.

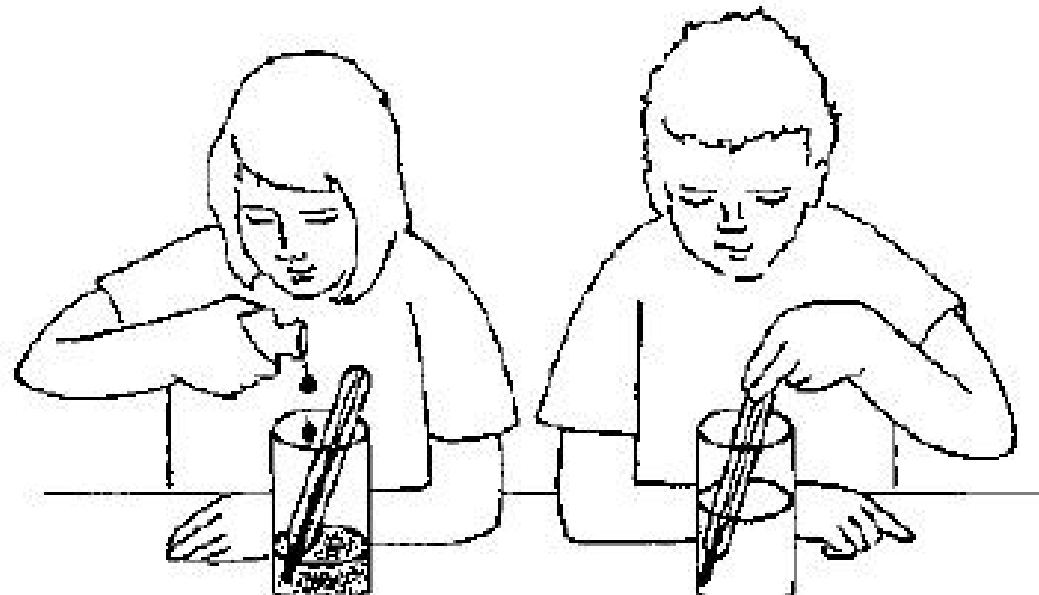



Observation:

a. If added carefully and slowly by means of a glass rod where it 'slides down' to the surface of the cold water, the warm water floats on top of the cold water.

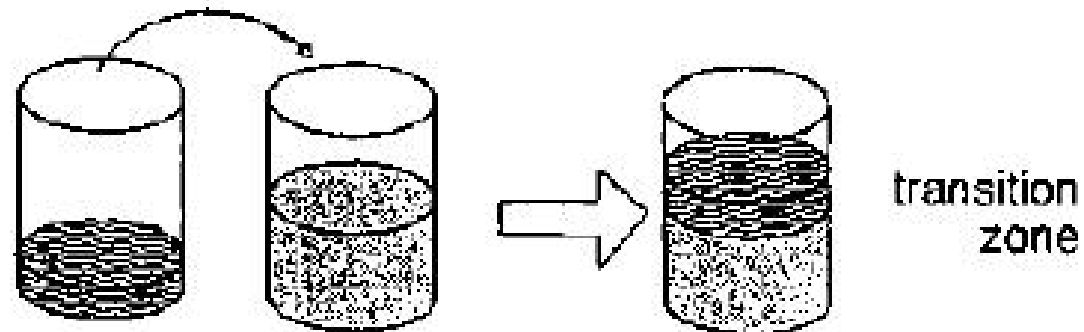

b. Added in the same way to warm water, the cold water sinks more down to the bottom and mixes with the hot water.

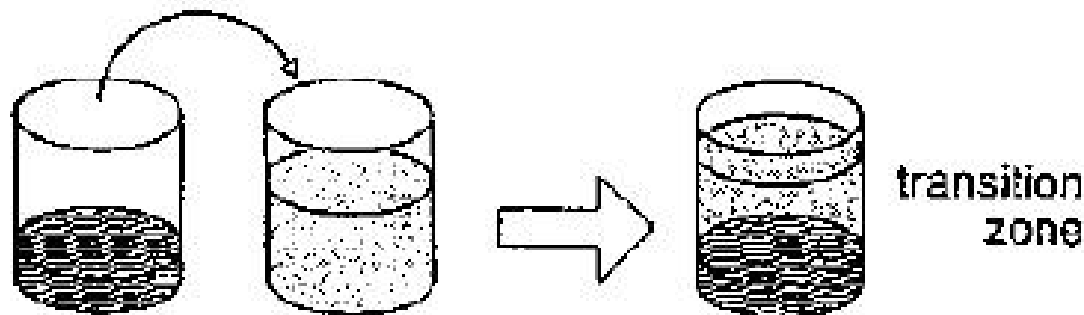

**Analysis:**

**Warm water has a density lower than that of cold water. However this is only true for water above 4° C. Below this temperature, the density of water decreases again. Thus, water of 4° C is 'heaviest'. It has the highest density.**

**Practical Meaning:**

This characteristic of water is important in countries in which the water freezes in winter. On the floors of frozen lakes, the water temperature is 4° C. Therefore, fish and other aquatic animals can survive in the deeper layers of these waters.

**Further thought:**

Suppose that water is used in a thermometer instead of mercury. Suppose further that it is 4° C. Then temperature changes. The thermometer indicates this change. Is this indication unequivocal?

## **6.6. HEAT RADIATION**

**Main Goal:**

**This experiment illustrates heat transmission by means of heat radiation.**

**Information:**

"Heat radiation" is the name given to a process of transmission of energy, which is not linked with any specific kind of substance. Sun rays reach earth through space which is void of air.

"Heat radiation" is the name given to a process of transmission of energy, which is not linked with any specific kind of substance. Sun rays reach earth through space which is void of air. The thermal energy of the sun is transformed into radiant energy and travels in that form through space. When it strikes an object on earth it is retransformed into thermal energy. This is the energy in the object due to the random motion of its molecules. The object, when it has higher temperature than another body or substance in its environment, can lose part of its thermal energy due to flow of heat to the colder body. Therefore, not heat is transmitted in the radiation process but radiant energy.

(see experiment: DARK MATERIALS COOL DOWN FASTER THAN LIGHT ONES)

*Materials and Apparatus:*

*any kind of heating element  
(candle, heater, bunsen burner or burning glass and sunlight)*

*Procedure:*

Hands are held at a distance of about 10 – 20 cm from the heating element.

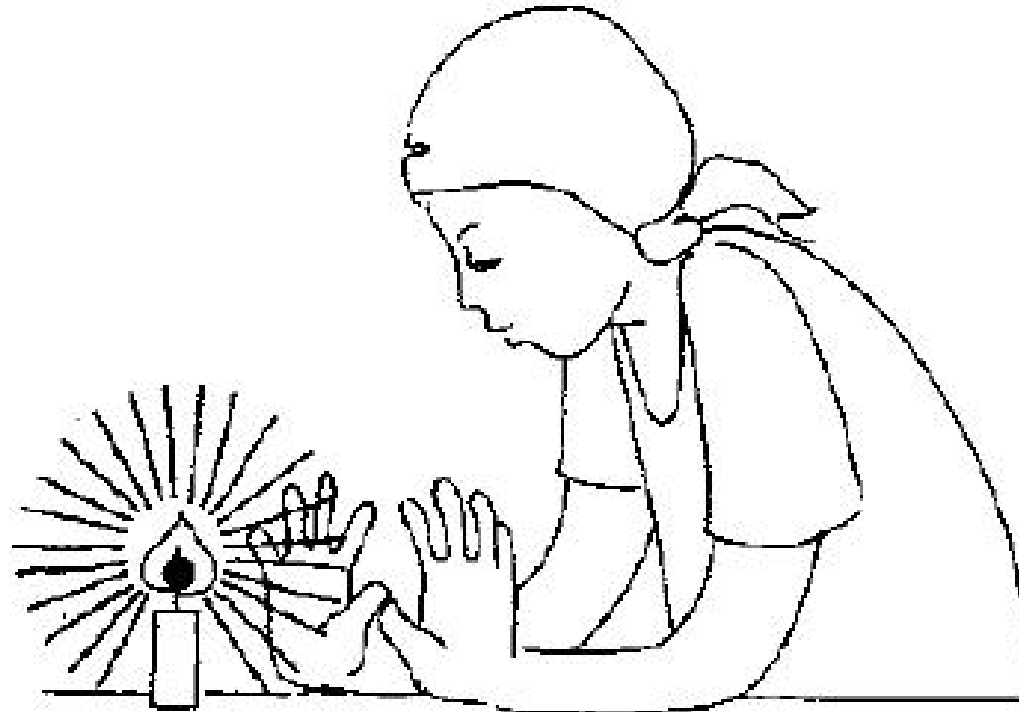

Observation:

A warming sensation is felt on the palms of the hand.

Analysis:

The energy transport hardly takes via heat conduction as air is a poor thermal conductor.

It cannot take place on the basis of heat streaming because warm air rises. The heat transmission in this case is called "heat radiation". Heat radiation is not linked with any specific kind of substance. It needs no medium.

**any specific kind of substance. It needs no medium.**

Practical Use:

Every kind of heating element exploits heat radiation (e.g. open fires, ovens, central heating).

With the help of sun collectors, the heat radiation of the sun is harnessed. Sun collectors include, for example black tubes through which water flows.

Further thought:

The composition of the upper atmosphere is changed. It prevents a greater amount of the earth's "heat radiation" from escaping into the space. What are the consequences?

## **6.7. DARK MATERIALS WARM UP FASTER THAN LIGHT ONES**

**Main Goal:**

**Investigation of how different kinds of materials react to heat radiation.**

Information:

Light materials reflect (from the Latin "reflectare": to throw back) a greater proportion of heat radiation than dark materials.

Dark ones absorb (from Latin "absorbere": to suck up) a greater amount of this radiation.

105

<http://cd3wd.com/dvd/> - filename: z\_science\_exp\_111 of 598

Some investigations have shown that rough surfaces absorb more heat radiation than smooth ones.

*Materials and Apparatus:*

*2 thermometers*

*soot or black paint*

*white paint candle, a gas burner or similar source of heat*

*Procedure:*

The mercury or coloured alcohol-filled bulb at the bottom of one thermometer is painted black with soot or paint. That of the other thermometer is painted white.

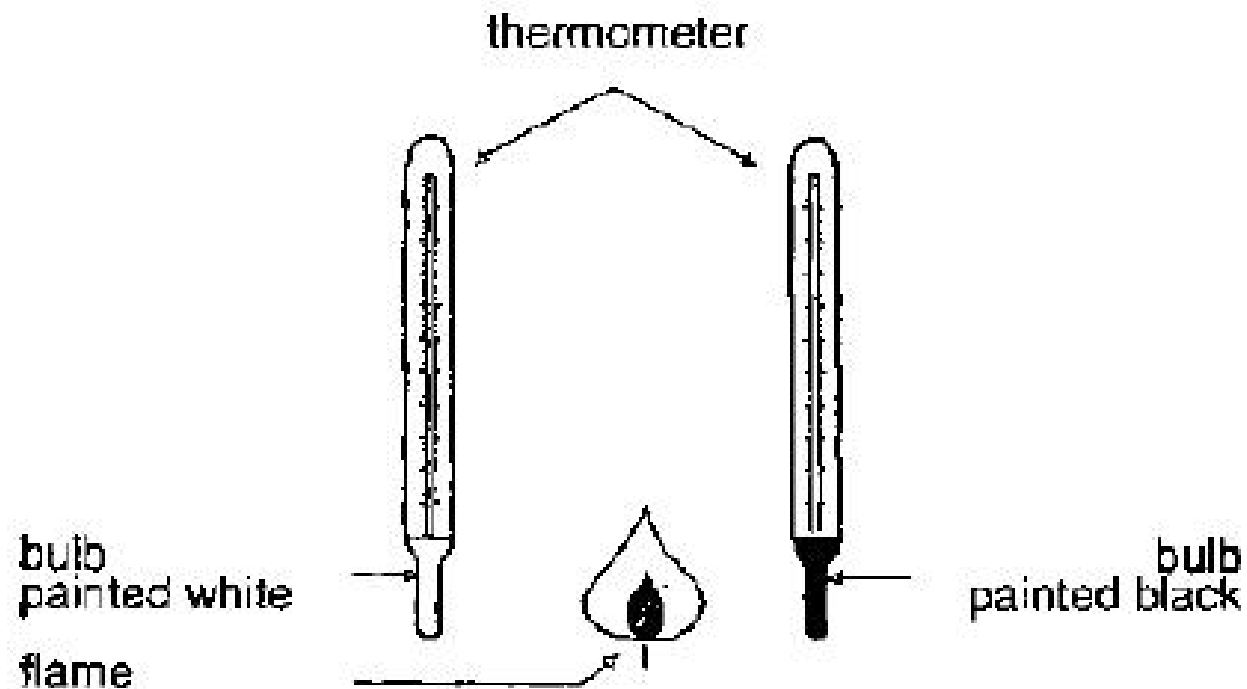

flame

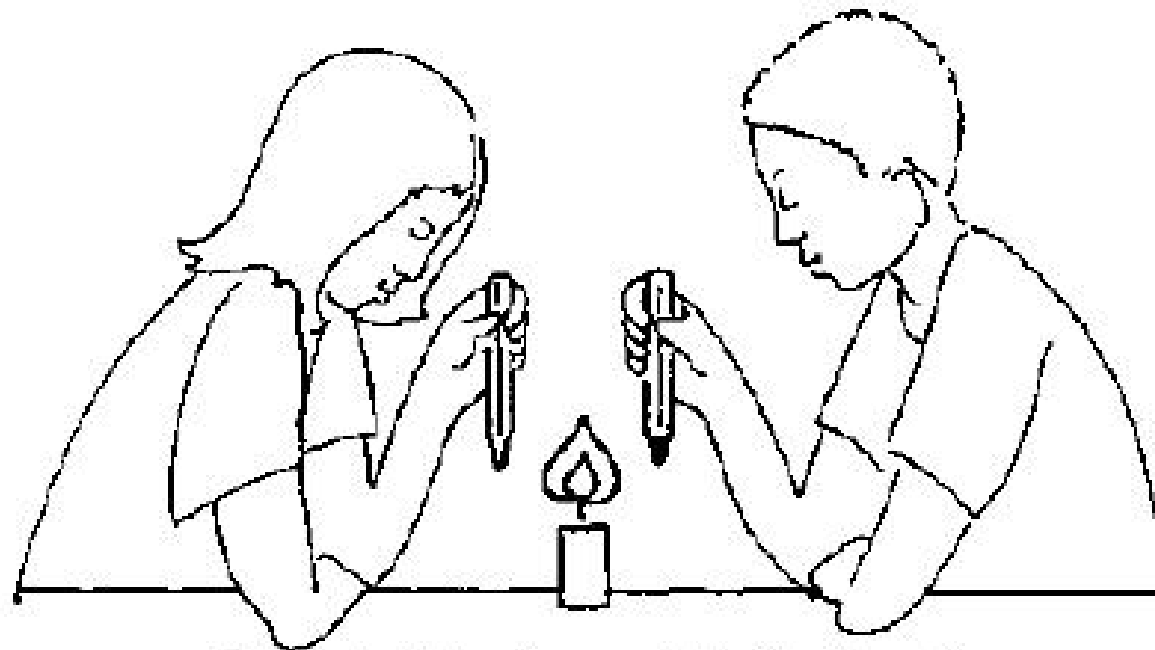

They are held close to some kind of heating unit.

Observation:

After a short time the blackened thermometer indicates a higher temperature than the white one.

Analysis:

Dark materials absorb in the same time and at the same distance from the heat source more heat radiation than light ones. The absorbed heat causes the temperature of the absorbing material to rise.



**Light materials reflect the heat radiation better than dark materials.**

Practical Use:

Refrigerators, freezers and refrigerator vans almost all have white, smooth surfaces so that heat radiation which hits them is well reflected.

In southern countries houses are painted white.

The people in these countries often wear light coloured clothes.

Sun collectors, for instance black tubes through which water flows, are black.

Further thought:

In countries where there is snow you can lay samples of light and dark cloth on the snow.

What can be observed?

## **6.8. DARK MATERIALS COOL DOWN FASTER THAN LIGHT ONES**

**Main Goal:**

**This experiment demonstrates that dark materials cool down faster than light ones.**

Information:

Dark materials emit (from the Latin "emittere": to send out) heat faster than light ones.

Dark materials emit (from the Latin "emittere": to send out) heat faster than light ones.

*Materials and Apparatus:*

*2 tins or glasses*

*2 thermometers*

*boiling water*

*a candle*

*soot or black paint*

*white paint*

*Procedure:*

The outside of the tin is blackened with soot (or with black paint).

The second tin can be painted white although this is not absolutely necessary.

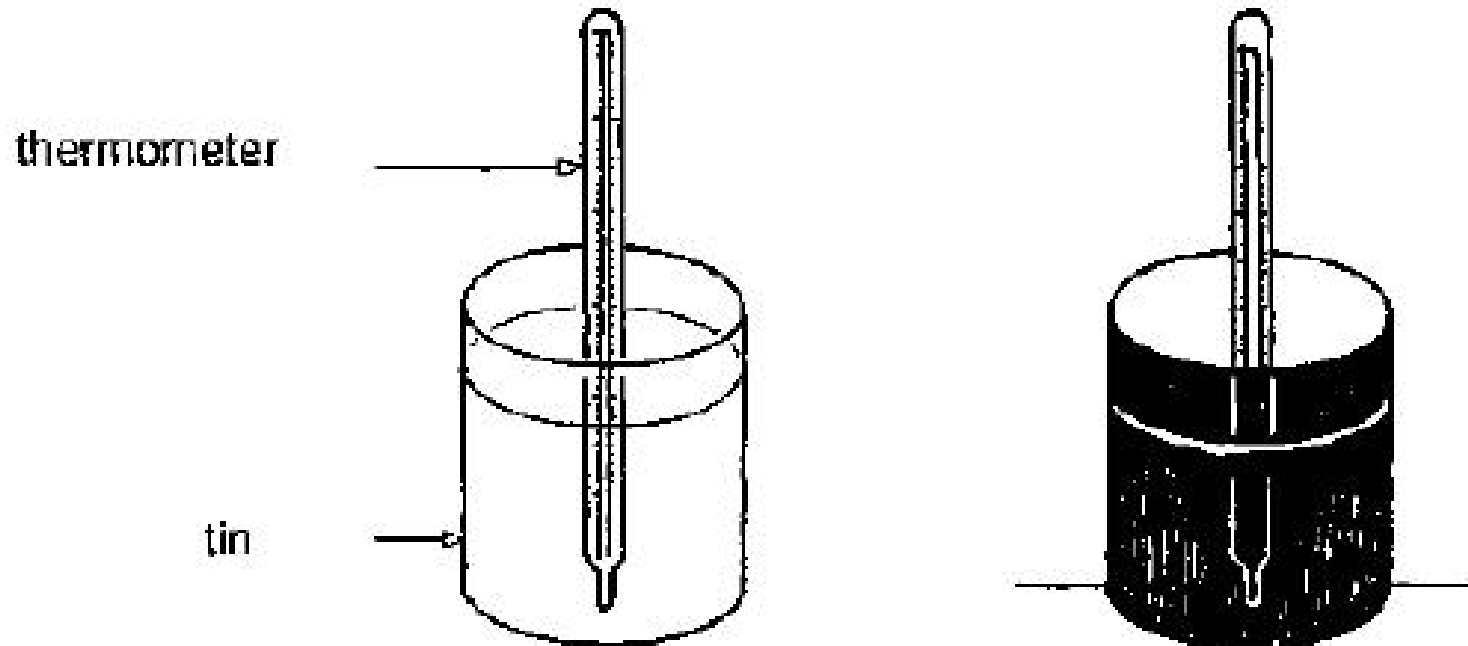

The two tins are filled with boiling water. The temperatures are taken regularly at intervals of 30 seconds or 1 minute. It might be useful to note the temperatures recorded.

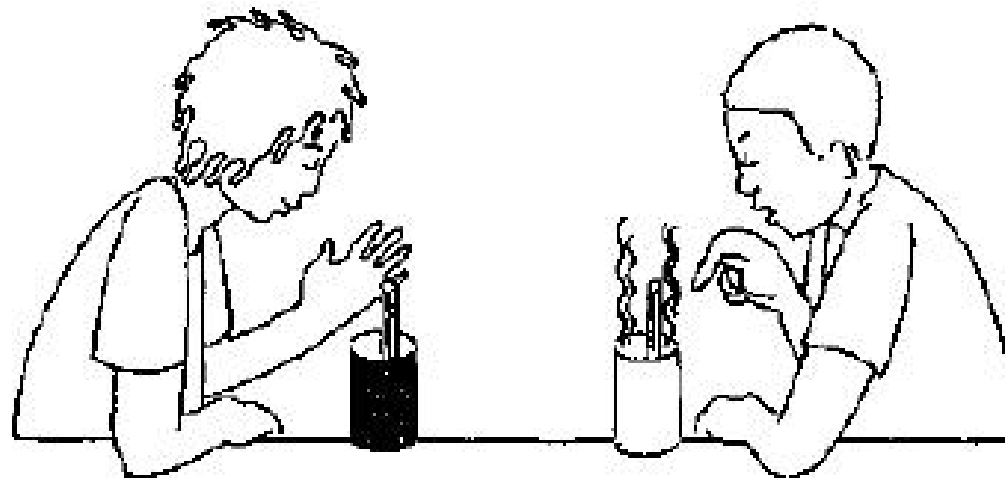

Observation:

Observation:

The temperature of the black tin drops faster than that of the white one.

**Analysis:**

**Black materials do not retain heat as long as light materials. Black materials emit heat faster than light ones. Thus black materials not only absorb heat better than light ones (see 6.7), but also are better emitters.**

Practical Use:

The rays of the sun warm up the dark soil and water in daytime. The dark ground and the water emit heat so that the air warms up. The same amount of heat warms the water less than the ground, because it needs more heat to increase the temperature of 1 kg water than for 1 kg stone or soil.

At the coast it can be observed that the land warms up faster than the sea under the influence of sun radiations. As the air above the land is warmed up more, it ascends and the cooler air above the water streams onto the land. It is the other way round during the night. We perceive this heat streaming in the air as wind. In the daytime the wind blows from the sea onto the land, and during the night from the land to the sea. The degree of heating depends on the angle at which the sun's rays hit the earth and the water. The steeper the angle at which the sun's rays hit the earth, the stronger is the heating effect. This can be explained by the fact that in this case, more rays hit the ground per square metre.

Further thought:

Suppose at a restaurant you get coffee before you are ready to drink it. But you want it hottest when you are ready. When do you add the cream? Right away or when you are ready?

## 6.9. HEATING WITHOUT A FLAME

**Main Goal:**

**The experiment illustrates the warming up of substances by mechanical work.**

**Information:**

In contrast to heating bodies by heat radiation, conduction or streaming solids, liquids and gases can also be heated if they are mechanically worked on.

Work done in that way that friction force is applied on a body, increases the movement of the atoms the body is made of. This increase of (invisible) microscopic motion appears microscopically as an increase of temperature.

*Materials and Apparatus:*

- a. blackboard or a table*
- b. air pump*

**Procedure:**

Procedure:

- a. Vigorously rub a small spot on the blackboard with one finger. Immediately afterwards, feel this spot and its surroundings with the ball of the other hand.

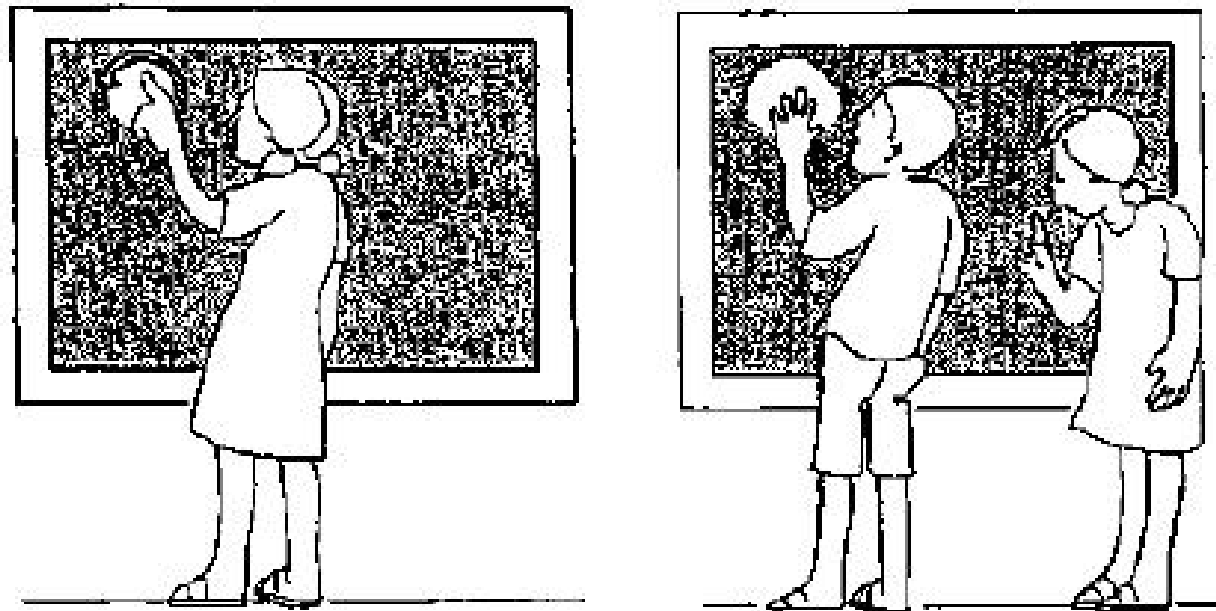

- b. The piston of an air pump is pulled out about 15 cm. The valve is closed with one finger. Then the piston is vigorously pushed into the cylinder.

This process should be repeated several times.

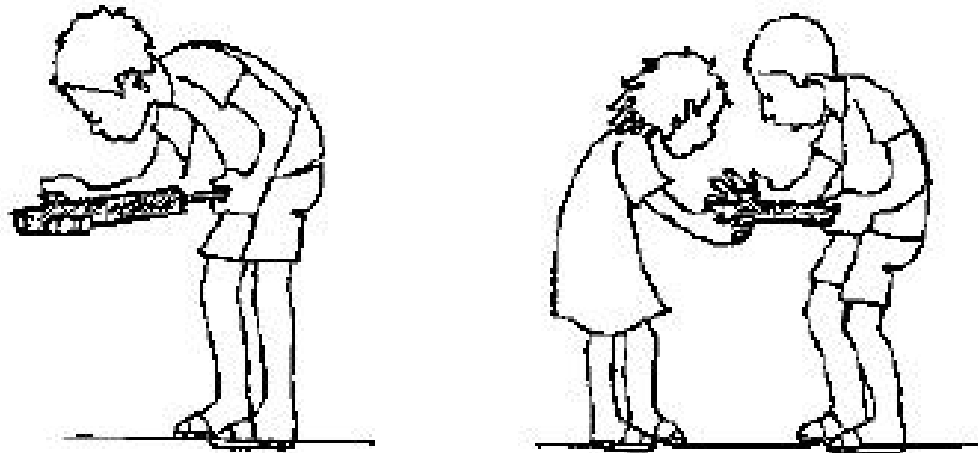

**Observation:**

- a. The blackboard and the fingers become warm.
- b. The cylinder is warm – this is also true of the air in the cylinder.

**Analysis:**

**In both cases, mechanical work is done, which increases the movement of the atoms. In the first case this increase is transmitted by friction and in the second case by a pressure increase as well as by friction.**

**Practical Meaning:**

When a spaceship enters the earth's atmosphere, its cover becomes very hot. The spaceship dives into the air, which presses it together. The strong increase of temperature results from the friction of the air with the spaceship. Friction increases the thermal energy.

If a bucket on a rope is let down into a well quickly, the warming up of the hands can be

If a bucket on a rope is let down into a well quickly, the warming up of the hands can be perceived.

The higher temperature results from the friction of rope and the palms of the hands.

Further thought:

When heat is flowing energy (from hot to cold) and thermal energy is due to random motion of molecules, what then is temperature?

## 7. AIR

### 7.1. THE AIR – A BODY

**Main Goal:**

**The experiment demonstrates that air occupies space.**

Information:

Air is a mixture of gases whose main components are 78.09% by volume nitrogen, 20.95% by volume oxygen, 0.93% by volume inert gases and 0.03% by volume carbon dioxide.



*Materials and Apparatus:*

a. dry glass

basin filled with water

b. funnel

pierced cork or rubber stopper

bottle

water

*Procedure:*

a. As shown in the diagram below, an empty glass is dipped into water, upside down.

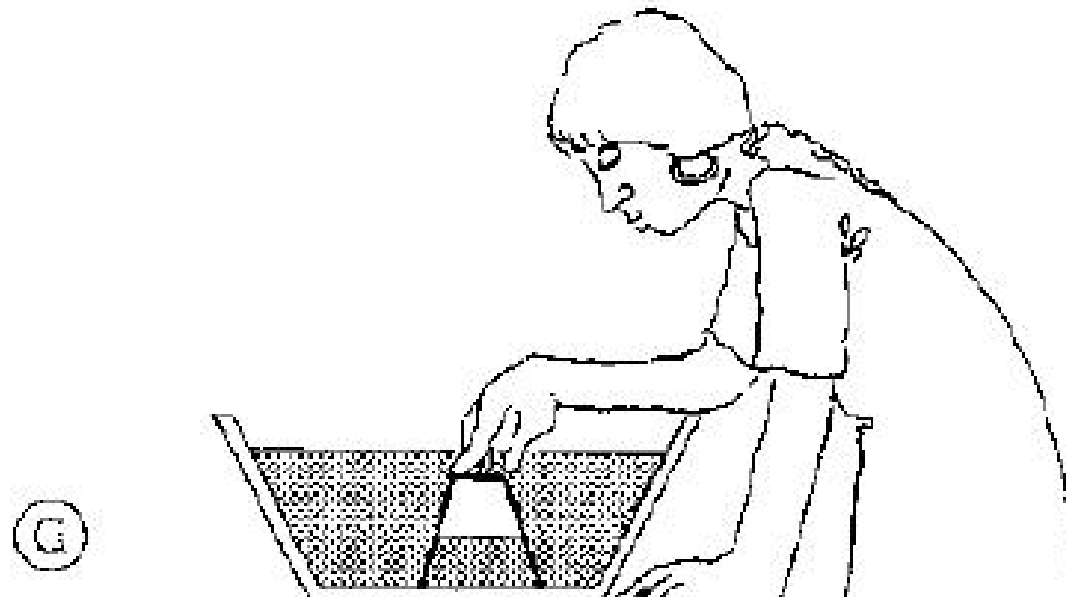

(c)

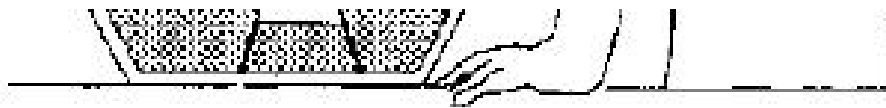

b. The apparatus is set up as shown in the diagram below. The funnel is filled with water, and then the stopper is eased out a little.



Observation:

- a. The water does not completely fill the glass. Part of the glass remains dry (see a).
- b. The water flows into the bottle only after the stopper is loosened.

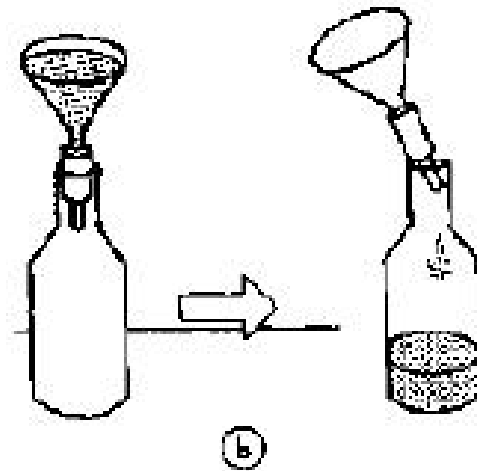

**Analysis:**

**The glass and the bottle both contain air. This space can only be filled with water if the air is compressed or when it can escape. Air occupies space. Thus it is a body.**

Further thought:

Why does a balloon, filled with air, not rise?

**7.2. WE FIND OUT ABOUT AIR RESISTANCE**

**Main Goal:**

**During this experiment the pupils feel air resistance.**

Information:

Information:

Air is a mixture of gases. As gases too are bodies, where one body is, no other body can be. If one body wants to occupy the space where another body is situated, this other body must be displaced. Thus, when you occupy a certain space, you dislodge the air from this space. But air as a body, like all other bodies, offer some resistance against your efforts. Sometimes you can feel this drastically.

*Materials:*

*newspapers or large sheets of cardboard*

Procedure:

The pupils hold very large newspapers in front of their bodies and run quickly across the school yard or through the classroom. While running, they push the newspaper away from their bodies a few times.



**Observation:**

The newspaper is pushed against the body. When it is pushed away from the body, the resistance can be felt.

**Analysis:**

The resistance is caused by your moving against the air. Air consists of gases, which can be visualized as invisible bodies. All bodies offer resistance against their

**The resistance is caused by your moving against the air. Air consists of gases, which can be visualized as invisible bodies. All bodies offer resistance against their displacement.**

Further thought:

It is difficult to breathe when snorkeling at a depth of 1 meter. It is practically impossible at a 2-meter depth. Why?

### **7.3. AIR RESISTANCE**

**Main Goal:**

**This experiment demonstrates air resistance.**

Information:

Air consists of a mixture of gases. As gases too are bodies they offer resistance against change of their place.

*Materials and Apparatus*

*1 sheet of paper  
1 stopwatch, (or someone must count regularly)  
2 cardboards of same size and same thickness*

Procedure:

a) From a height of about 1.5 m, a student lets a sheet of paper fall as demonstrated in the following diagram. The time it needs to reach the floor is measured with the stopwatch.

In further experiments, the sheet of paper is gradually folded up until in the final experiment a ball is formed.

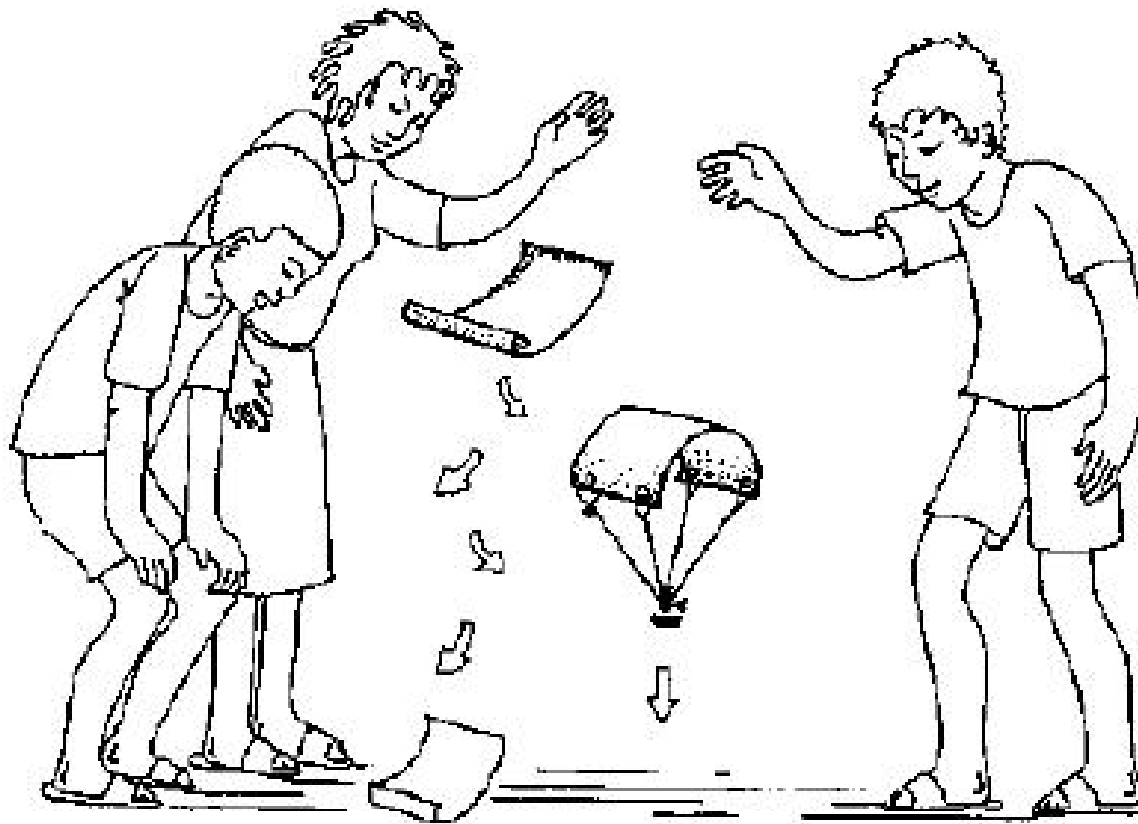

b) Drop the cardboards simultaneously from the same height so that one falls with one edge in front, the other one with a flat side in front.

Which one hits the ground first?

Which one hits the ground first?

Observation:

- a) The smaller the paper is, the faster it falls to the floor.
- b) That one with the edge in front hits first.

**Analysis:**

**The smaller the surface that points in the direction of motion, the less air resistance met. From further experiments it is known that the shape of the falling object also plays a role.**

Practical Use:

Parachutists take advantage of air resistance. The round shape of a parachute significantly increases the time of falling compared to a flatter shape.

The seeds of plants, which are spread by the wind, are also shaped in such a way that they harness the air resistance.

Addition:

In order to make a parachute, four cords of equal length are fastened to the edges of a square cloth. The ends of the cords are tied together and attached to a moderately heavy



screw.

Further thought:

A stone dropped from the top of a tower becomes faster when it falls. A parachutist falls toward the earth with constant speed.

Why this difference?

#### 7.4. THE DIFFUSION OF GASES

**Main Goal:**

**This experiment illustrates the diffusion of gases.**

Information:

Gas particles diffuse into even space, no matter how large it is.

*Materials and Apparatus:*

*perfumed substance perhaps a spraycan or an atomizer with mosquito spray, perfume, or a strongly smelling flower or fruit)*

*vessel*

Procedure:

Procedure:

1 – 2 ml of the perfume are placed into the vessel.

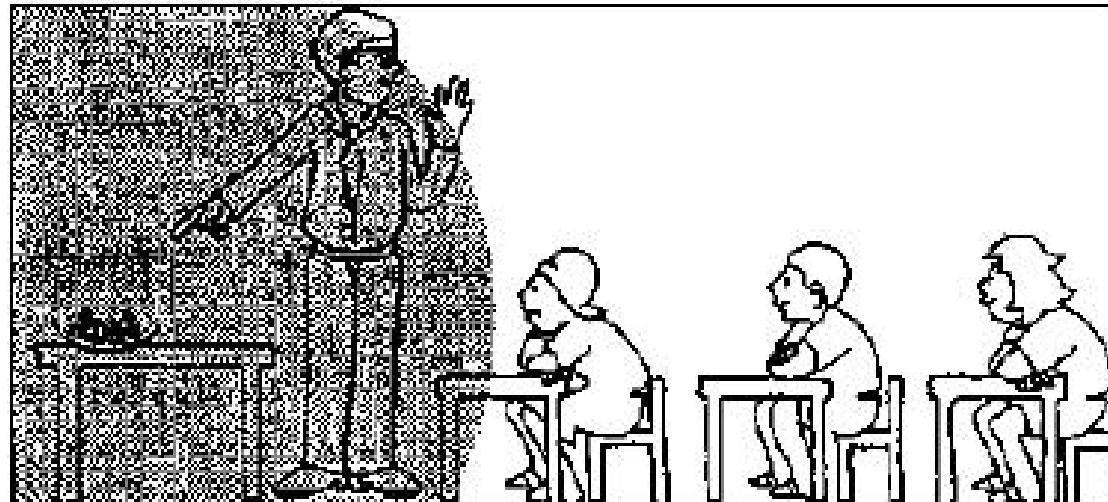
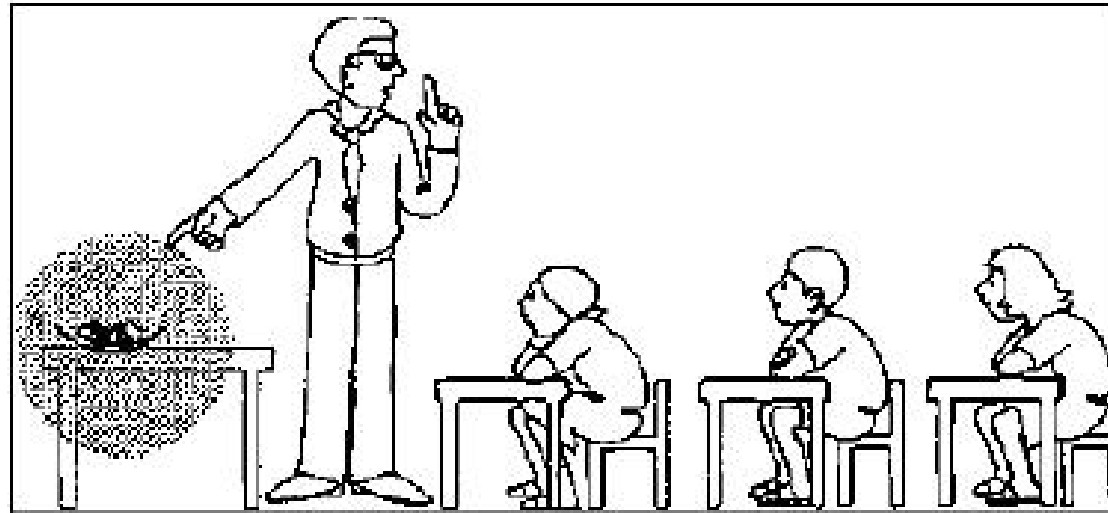

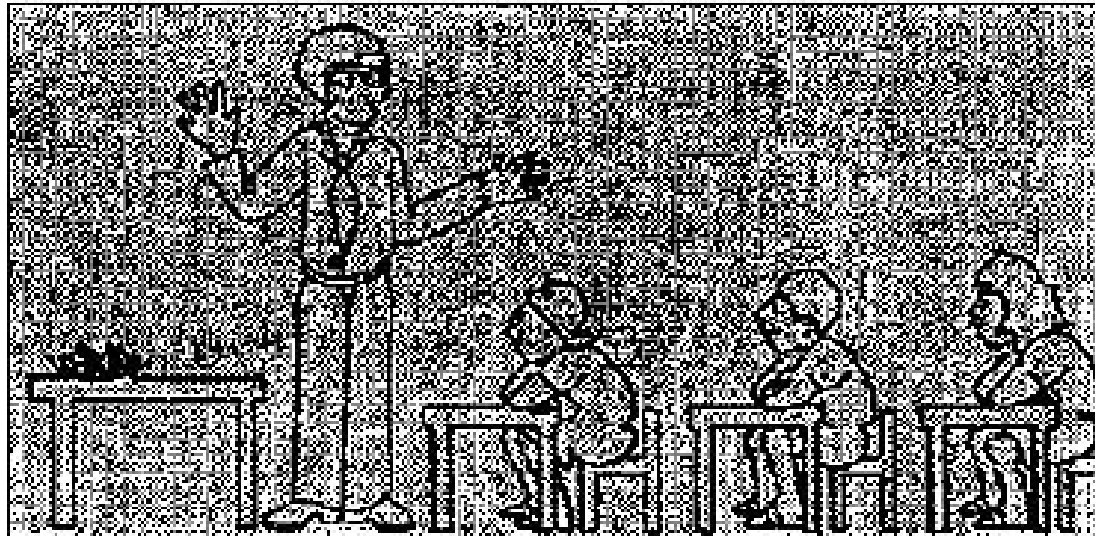

**Observation:**

After a short time the smell can be detected by pupils sitting near the teacher's desk. A little later also pupils in the following rows of seats smell successively the perfume.

**Analysis:**

**Gases diffuse into each space. This unaided distribution of particles is called diffusion. We cannot see the perfume moving through the classroom. It is said that all bodies, also perfume, is made out of atoms. Therefore, atoms must be very very small.**

**Further thought:**

What changes when you heat the perfume?

## 7.5. CARBON DIOXIDE IS HEAVIER THAN AIR

### Main Goal:

**Gases, like solid matter, have different densities.**

### Information:

When carbon dioxide is produced in a vessel, it concentrates first at the bottom of the vessel, as it is heavier than air. Later it completely displaces the air. The carbon dioxide then gradually diffuses evenly. (See experiment: DIFFUSION OF GASES)

### *Materials and Apparatus:*

*3 candles  
empty bottle, tubing, rubber stopper  
Alka Seltzer (or sparkling lemonade)*

### Procedure:

A glass dish is prepared as shown in the diagram below. Using Alka Seltzer and water, both put into the bottle, carbon dioxide is produced and led into the glass dish. (Or, carbon dioxide from lemonade is conducted through the tubing into the dish. It is also possible to exhale air into the dish through the tube.)

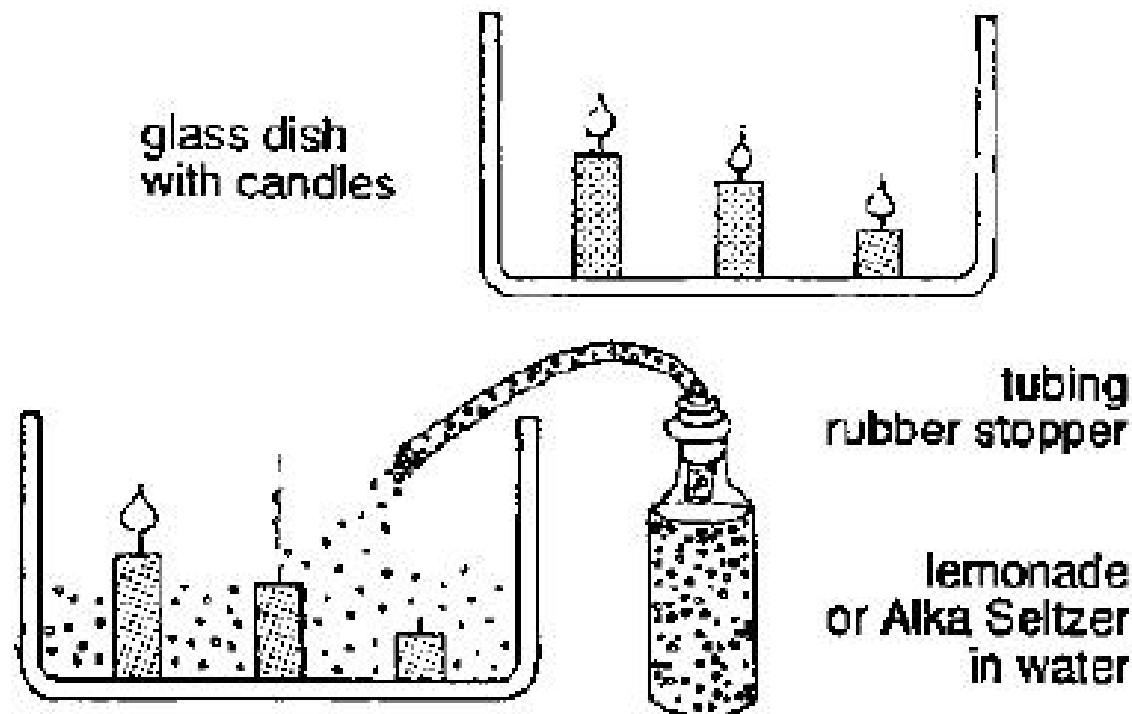

Carbon dioxide from lemonade or Alka Seltzer is conducted through the tubing just to the top of the glass dish.

Observation:

The candles are extinguished one by one because the carbon dioxide sinks down. It is heavier than air. (A burning match is extinguished when dipped into the carbon dioxide atmosphere.)

Analysis:

The carbon dioxide is heavier than air and sinks down and concentrates at the bottom of the dish. The more carbon dioxide is produced, the more air is displaced.

**of the dish. The more carbon dioxide is produced, the more air is displaced.**

Practical Use:

Where it is impossible to use water to extinguish a fire, carbon dioxide is used, e.g. in power stations or in chemical firms. Carbon dioxide leaves no residues and does not conduct electricity.

Human beings and animals breathe in oxygen and exhale carbon dioxide. Plants produce glucose and oxygen from carbon dioxide and light.

Further thought:

The increase of carbon dioxide concentration in air atmosphere has serious consequences (greenhouse effect).

What would be the best 'biological' mean against this effect?

## **7.6. THE PHENOMENON OF AIR PRESSURE**

**Main Goal:**

**This experiment demonstrates the consequences of air pressure.**

Information:

Air is a body and exerts pressure. The average air pressure is 1 bar. This pressure equals water pressure at a depth of 10 m under the water's surface.

With increasing height, e.g. in the mountains, the air pressure decreases.

*Materials and Apparatus:*

*glass, paper, water*

*empty cola can*

*heater*

*bowl with cold water*

*Procedure:*

a) Fill a little water into the empty cola can (four tea spoons are enough). Heat that water so that it boils. Let it boil for a minute. Then dip it –upside down – into the cold water in the bowl. Observe the dramatic effect.

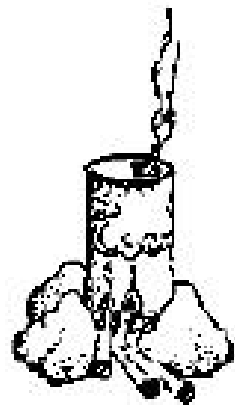

water vapour



damaged can

b) The glass is filled up to the rim with water. Then it is covered with the paper, which is

b) The glass is filled up to the rim with water. Then it is covered with the paper, which is pressed down with the palm of the hand. The paper is held tight until the glass has been turned upside down.

Observation:

- a) The can is compressed and damaged.
- b) From the glass the water does not run out.  
(Warning! After a certain time the paper will be soaked through.)

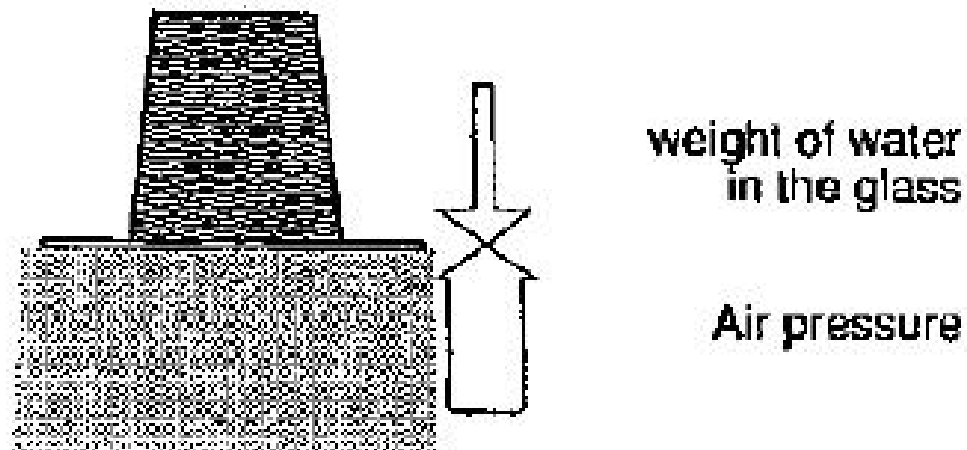

Analysis:

The air in the can is replaced by water vapour. In contact with cold water vapour condenses. Inside the can is suddenly very low pressure, so that the outer air pressure presses the can.



**The external air pressure is greater than the pressure exerted by the water in the glass.**

Practical Use:

To secure the water supply, pressure and suction pumps can be used.

By means of suction pumps, water can theoretically be sucked up to a height of 10 m. However, in practice it can only be sucked up to a height of 8 m, due to the fact that valves are not entirely leaktight.

As there are pipes linked to the pressure pumps, the water is conveyed 10 m high.

Both pumps operate on the principle that, on raising the piston, low pressure is generated. The air pressure then forces the groundwater into the pump. Repeated pumping movements result in the filling of the pump with water, which flows out through a discharge pipe in the case of a suction pump. In a pressure pump the water is forced into a carrying pipe. Valves, which only open under the pressure of the water in the pump, prevent the water flowing back down the vertical pipe.

Further thought:

Make a small hole near the bottom of an open tin can. Fill it with water. It will spurt from the hole. Cover the top of the can firmly with the palm of your hand. What happens? Why?

## **7.7. HOW A DRINKING STRAW WORKS**

**Main Goal:**

**This experiment demonstrates the practical use of air pressure.**

**This experiment demonstrates the practical use of air pressure.**

Information:

Air pressure is caused by randomly moving atoms or clusters of atoms (molecules) bouncing randomly against other matter.

*Materials and Apparatus:*

*water or a beverage  
a drinking straw  
glass*

Procedure:

Some water is sipped through the straw.

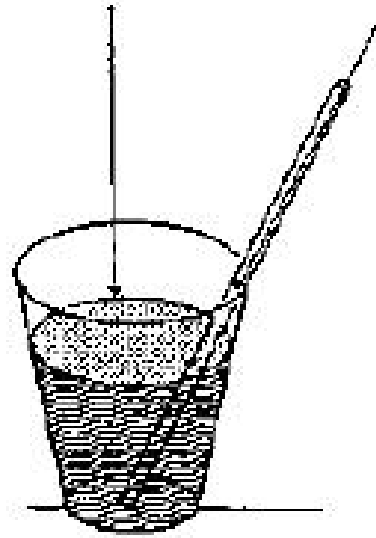

Observation:

see diagram

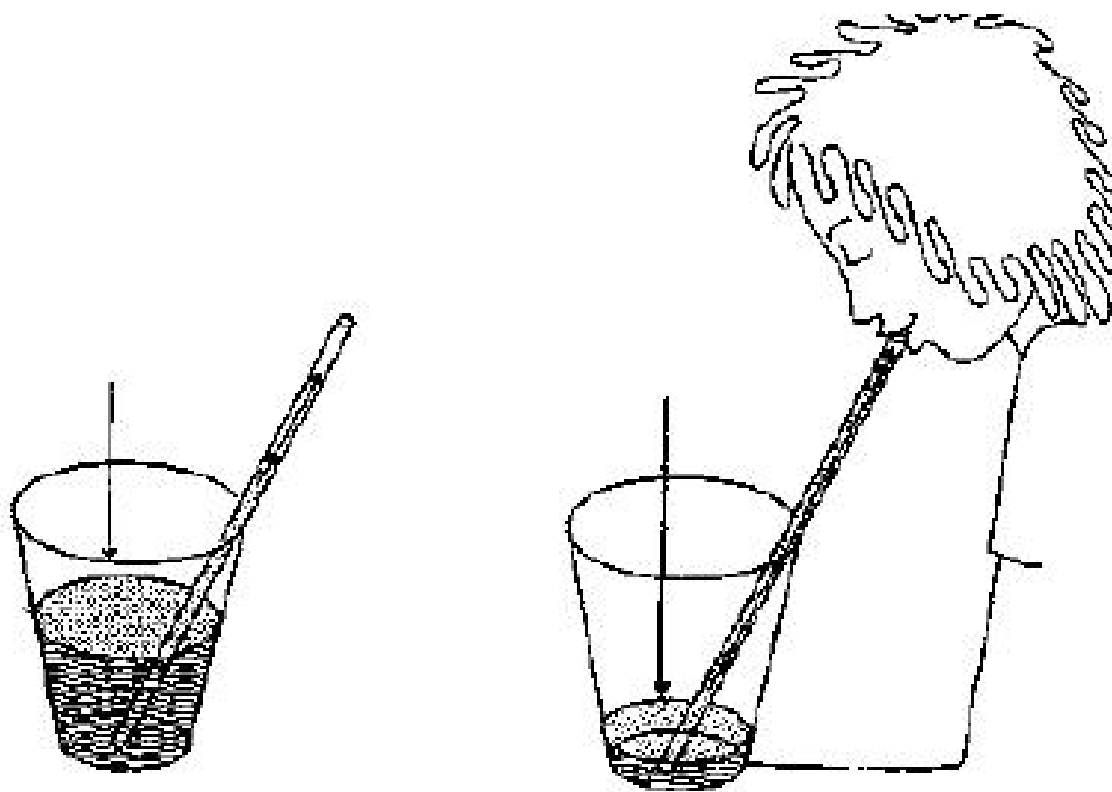

**Analysis:**

First the air is sucked out of the straw. This creates a space in which the air is rarefied and a space with low pressure is formed.

The ambient air pressure, which is higher, presses on the water surface, forcing the water to rise up the straw. A low pressure region is also formed in the mouth, due to the continual sucking. Therefore the water is always pressed into a space in which the air is rarefied.

(see also experiment: THE PHENOMENON OF AIR PRESSURE)

Strictly speaking, one does not suck the water up the straw. One instead reduce pressure in the straw and allow the pressure of the atmosphere to press the water up into the straw.

Further thought:

On the moon there is no air atmosphere.  
Could one drink water this way on the moon?

## 7.8. THE DANCING COIN

**Main Goal:**

**To demonstrate that gases are bodies which expand when heated.**

Information:

Air expands when heated.

*Materials and Apparatus:*

*a bottle – the glass should be very thin  
a coin which covers the opening of the bottle.*

Procedure:

Procedure:

The rim of the bottle neck is wetted with some water, and the opening covered with a coin. When the bottle neck is grasped with both hands, the air in the bottle expands due to the transmission of heat from the hands to the bottle and from the bottle to the air in the bottle.

The pressure in the bottle becomes higher than the ambient air pressure, so that the coin is lifted up briefly again and again.

(The glass also expands a little.)

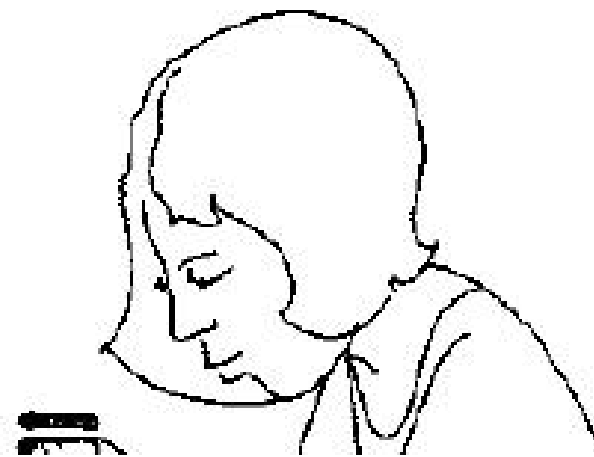
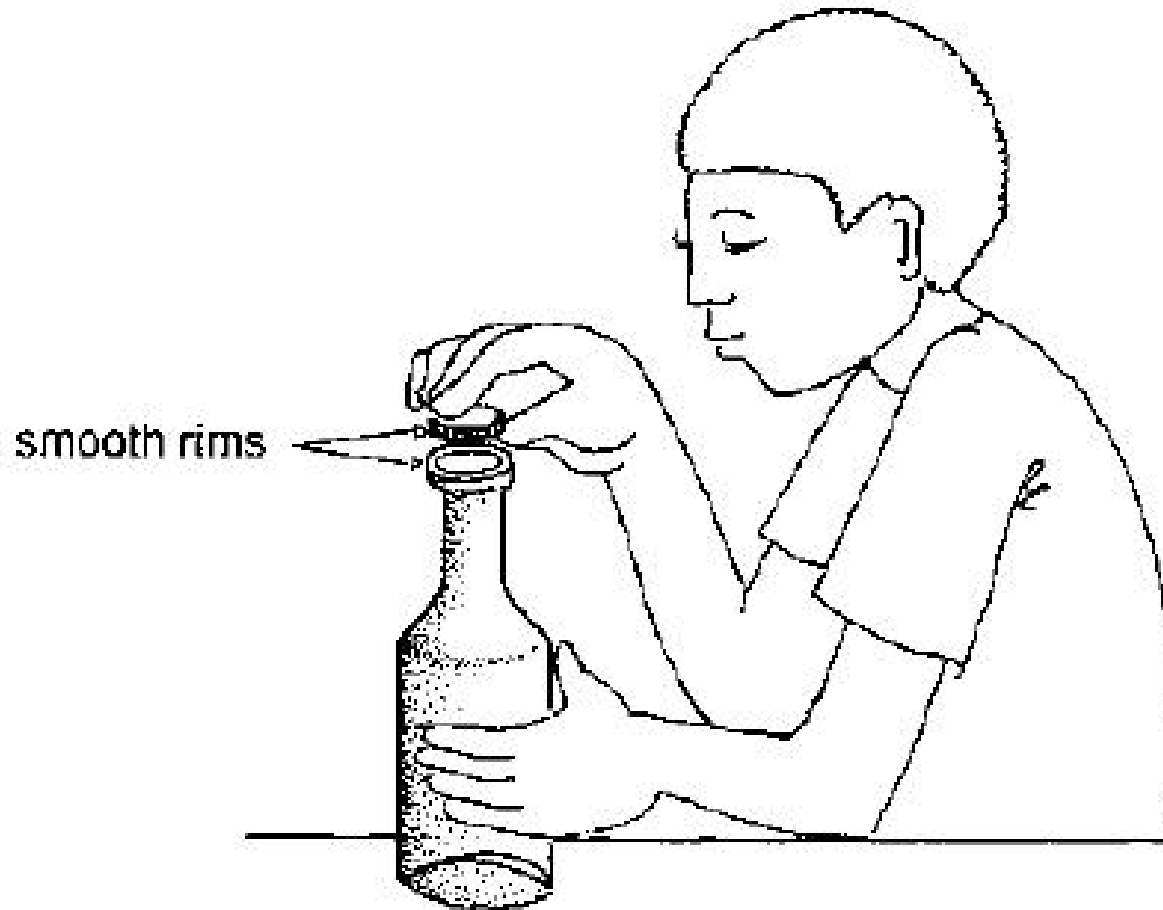

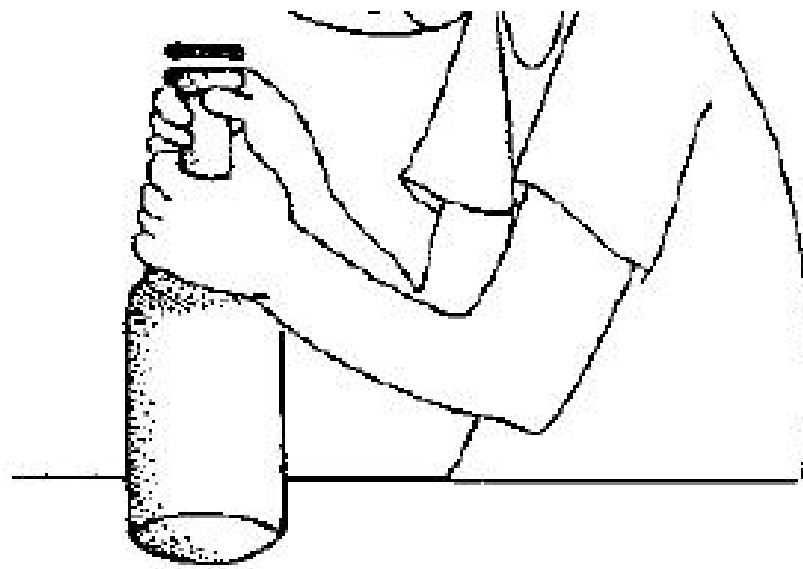

Observation:

The coin "dances" on the bottle neck.

Analysis:

**A transfer of heat causes the air in the bottle expand. The pressure increases, lifts the coin, some air escapes and the pressure is reduced for a moment. Then the heat transmission again expands the air, pressure increases and the coin lifts up again, and so on.**

Practical Use:



All gases expand when heated. Gas tanks have to be protected against the sun, otherwise they eventually would not be able to withstand the excessive pressure of the expanding gas. Fizzy beverages must be chilled to prevent the escape of the carbon dioxide.

Further thought:

When heat is transferred to the air, also glass expands. Then the volume of the bottle must increase. Doesn't this just compensate the air expansion? Obviously not. What kind of conclusion can you draw?

## 7.9. THE BALLOON IN THE BOTTLE

**Main Goal:**

**To demonstrate air pressure, excessive pressure, and vacuum.**

Information:

Warmed air enclosed in a certain volume, expands. The pressure increases and some air escapes.

When cooled down and no air from outside is allowed to enter the volume, low pressure is generated inside that volume.

*Materials and Apparatus:*

*1 bottle*

*1 balloon*

1 balloon

paper

Procedure:

A piece of paper is set on fire in a bottle. A balloon is then placed onto the neck of the bottle, immediately the paper is burnt.

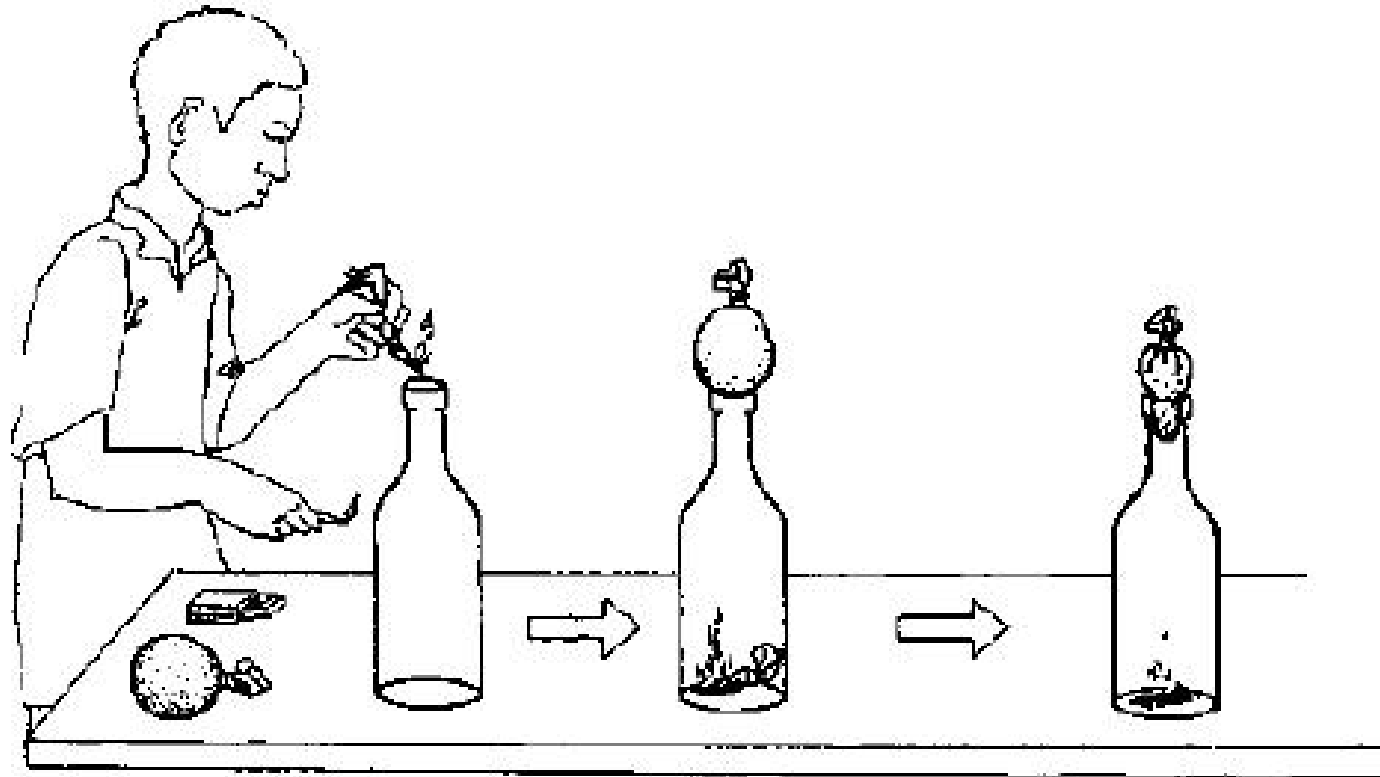

Observation:

123

<http://cd3wd.com/dvd/> - filename: z\_science\_exp\_129 of 598

see diagram

**Analysis:**

**Due to the burning of the paper, the air in the bottle is warmed and some of it escapes. The balloon closes the bottle opening. As the air inside the bottle cools down, less air is now present in the bottle and lower pressure than outside is created. The air pressure outside of the bottle presses the balloon into the bottle neck.**

Further thought:

gas-meter measure the volume of gas you are using.

Who would gain by having gas warmed up before it passes the meter, you or the gas company?

## **7.10. THE FOUNTAIN EXPERIMENT**

**Main Goal:**

**The experiment essentially demonstrates:**

- **gases are bodies**
- **gases expand and contract**
- **the existence of air pressure**

Information:

### Information:

When heated, gases expand much more than solids and liquids. If the pressure remains constant, ideal gases expand when heated by  $1/273$  of their volume  $0^\circ \text{C}$  for every  $1$  degree they are heated.

When cooled down, they contract to the same extent. In the following experiment, most of the air is expelled from a glass vessel by heating. When it cools down, the remaining gas is under lower pressure. The external, higher air pressure presses the water into the glass vessel, until a pressure balance is created.

### *Materials and Apparatus:*

*glass pipe, 20 cm long, which is pointed at one end*

*pierced stopper (rubber or cork)*

*glass flask or bottle made of clear glass*

*glass dish*

*burner (alcohol or gas burner or a candle)*

*water (may be coloured with water soluble eosin or ink)*

### Procedure:

The apparatus is set up as shown in the diagram below. The flask is held at the neck and carefully heated from the side. When there are only a few gas bubbles escaping from the flask, the burner is set aside. The dish is held vertically in such a way that the end of the glass pipe is always submerged.

glass flask

glass pipe

stopper

candle

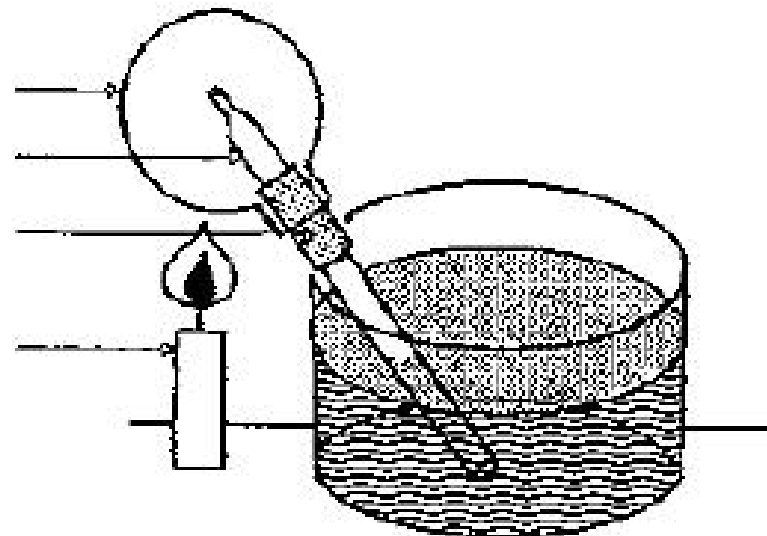

gas bubbles



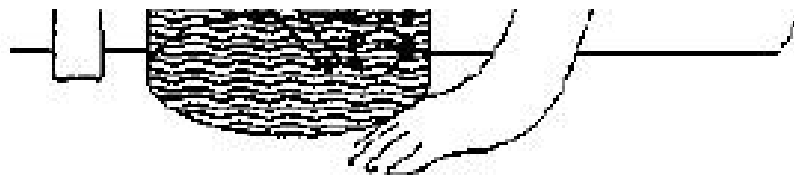

Observation:

When the glass pipe is first heated a large number of gas bubbles escape. The number of gas bubbles decreases gradually. Some time after the burner is removed, water shoots into the flask.

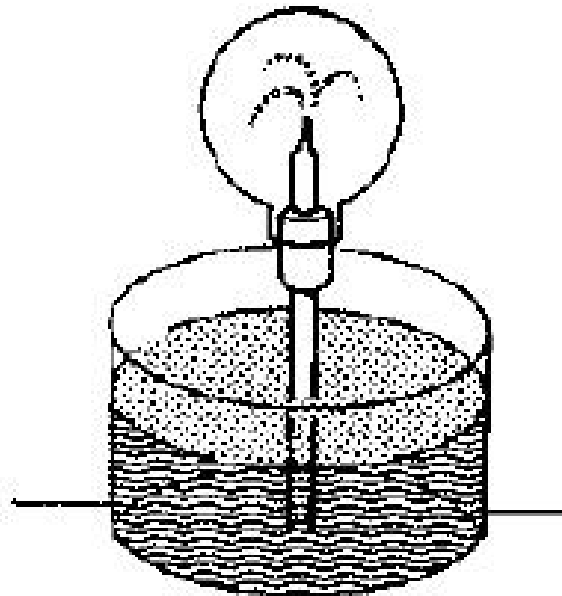

Analysis:

125

<http://cd3wd.com/dvd/> - filename: z\_science\_exp\_131 of 598

When the glass flask is heated, the air expands greatly and part of it escapes. When the burner is removed, the remaining air in the flask cools down. It's now less air inside which needs under normal temperature less space. The gas contracts, and the outer air pressure presses water into the flask until the pressure inside is equal to the pressure outside.

Practical Use:

Bicycle and car tyres can burst if they are over inflated and then exposed to the sun.

Further thought:

Why do the gas bubbles rise?

## 7.11. THE PHENOMENON OF AIR FLOW

**Main Goal:**

**This experiment illustrates air flow.**

Information:

Warm air ascends in a room, so that the lowest temperature is always found at floor level. Heated air expands. Its density is less than that of cold air, and it therefore ascends into the upper layers. Cold air flows in from the surrounding, is also heated, expands and ascends.

*Materials and Apparatus:*

*Materials and Apparatus:*

*thick wire about 20 – 30 cm long*  
*wooden board*  
*a streamer made of thin cardboard*  
*a candle*

**Procedure:**

A spiral shaped streamer is cut out of cardboard.

The experiment is set up as shown in the following diagram.



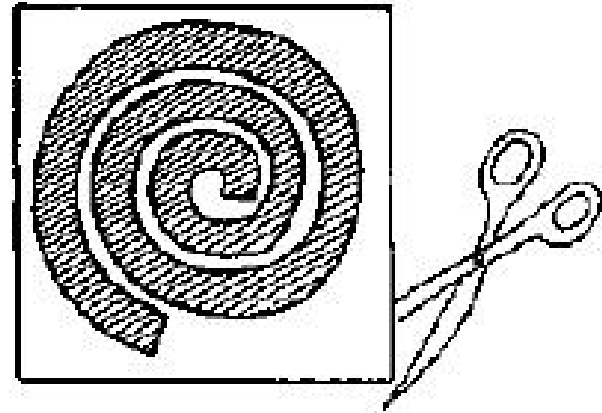

streamer

wire

candle

wooden board

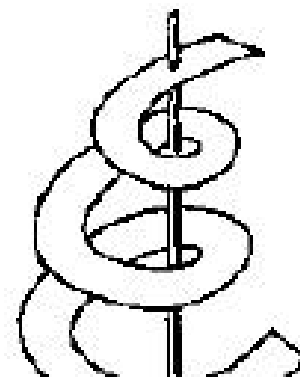
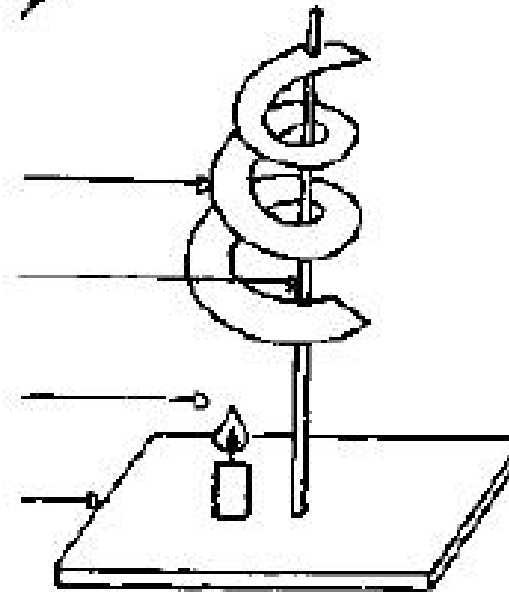

the streamer  
is rotating

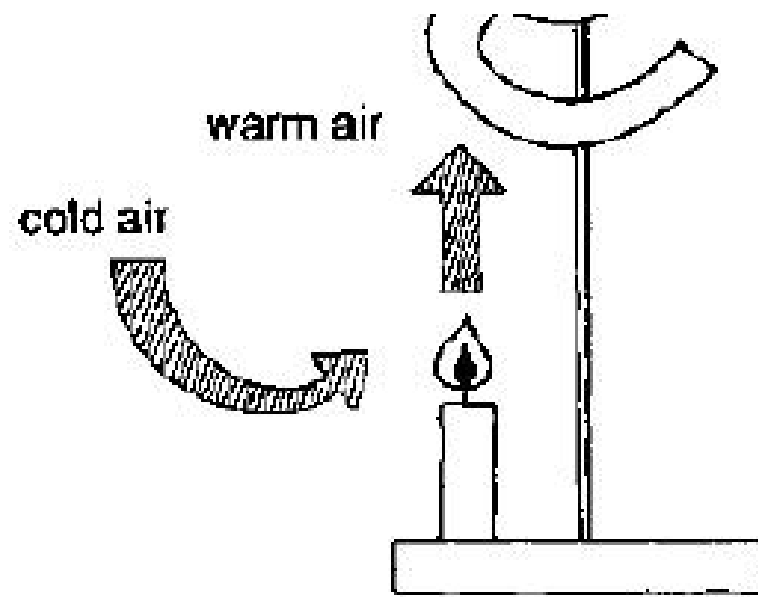

Observation:

The streamer starts rotating.

**Analysis:**

The candle warms the surrounding air. The warm air ascends and causes the streamer to rotate. Cold air flows in to replace the ascending warm air, is also heated, and the process continues.

Practical Meaning:

127

<http://cd3wd.com/dvd/> - filename: z\_science\_exp\_133 of 598

When a house burns, the air is heated strongly, and ascends. Cold air containing oxygen flows in very quickly. This effect causes a strong wind. Open doors and windows support this process, which supports the fire.

Further thought:

How can it happen that birds in the air gain height without moving their wings?

## 7.12. THE AERODYNAMIC PARADOX

### Main Goal:

**This experiment demonstrates that low pressure is generated by streaming air.**

Information:

The aerodynamic paradox it applies also to liquids, where it is called hydrodynamic paradox. It states that, the higher the pace of streaming, the lower the pressure. Consequently, if the pace of streaming increases due to a decrease of the sectional area of a pipe, the pressure within this area decreases.

### *Materials and Apparatus*

*2 sheets of paper*  
*2 wooden rods*

Procedure:

Procedure:

The paper is placed round the wooden rods as shown in the diagram.

Air is blown, alternately lightly and strongly, between the two sheets.

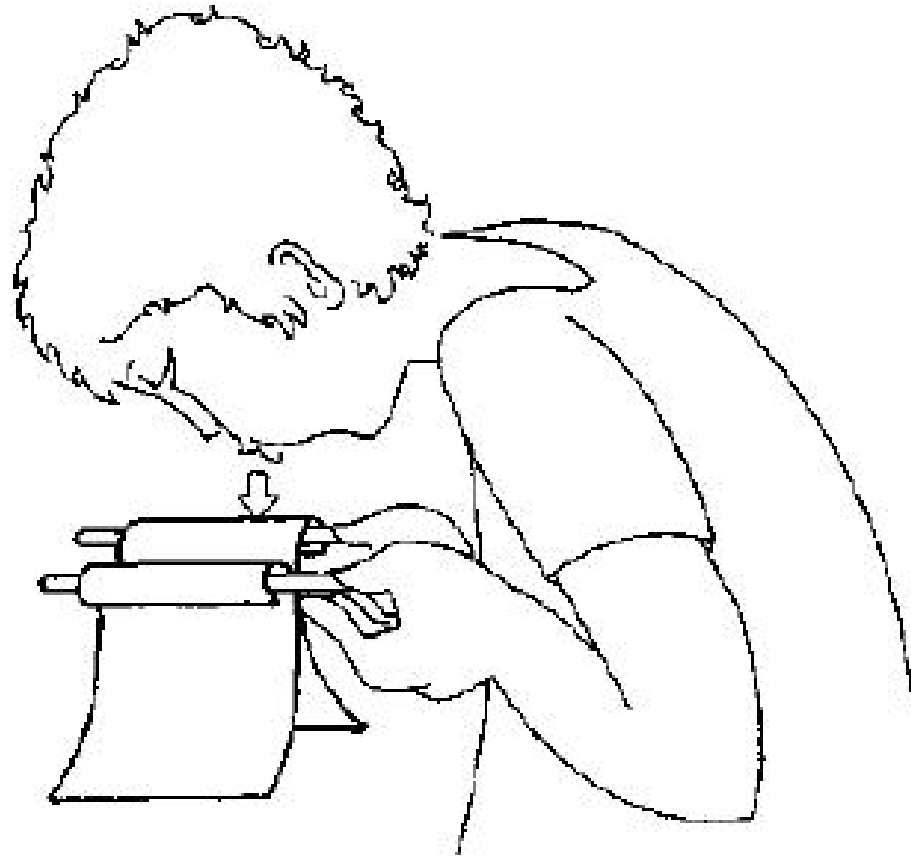

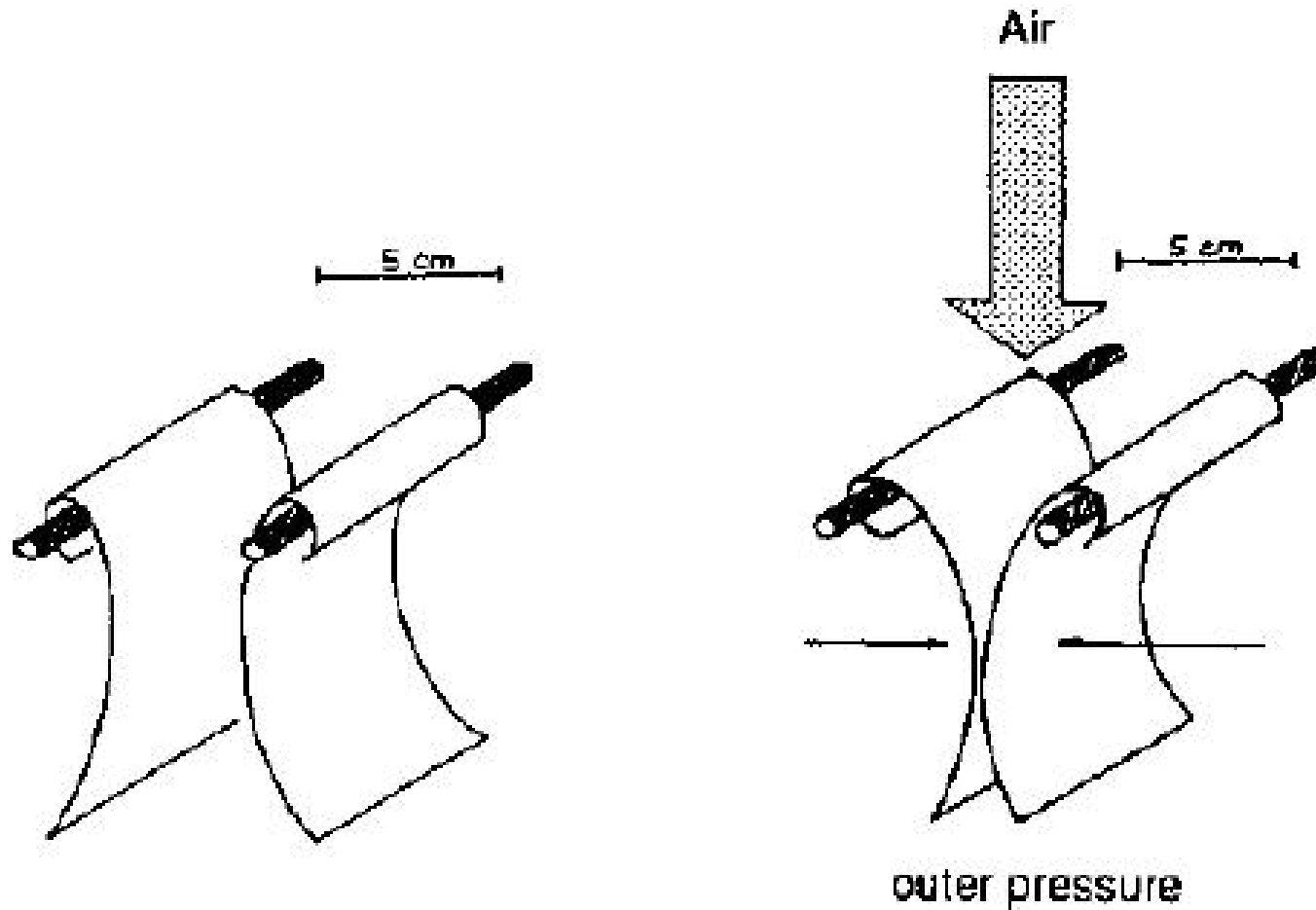

Observation:

Against our intuition the two sheets are drawn towards each other and not apart!

Analysis:

The blown air streams between the two sheets with high pace. An area of low pressure is generated.

**The blown air streams between the two sheets with high pace. An area of low pressure is generated.**

**The faster the pace of the streaming (the more strongly the air is blown), the lower the pressure in the flow. The normal outer air pressure pushes the sheets together.**

Practical Use:

This paradox (it is called paradox because its against our intuition) is harnessed in water jet pumps and in the construction of aeroplane wings.

Further thought:

What is the consequence of this effect with respect to the roofs of houses in case of a strong storm?

### **7.13. THE BOYLE–MARIOTTE LAW**

**Main Goal:**

**This experiment demonstrates the relationship between the volume and pressure of gases.**

Information:

If the pressure exerted on a closed gas volume is increased, the volume decreases.

If the pressure exerted on a closed gas volume is decreased, the volume increases. This means that gas always occupies the whole volume available. Moreover, it tends to expand and to enlarge its volume permanently.

The English physicist Boyle (1627 – 1691) and the French physicist Mariotte (1620 – 1684) discovered this association, which is the basis of a law linking the pressure and volume of gases.

The law states that the product of pressure and volume is constant. It is valid only at constant temperatures.

The pressure of gases can be demonstrated with the help of the model of particles: gas particles are in constant motion, and when they collide with an obstacle, they exert pressure.

*Materials:*

*air pump*

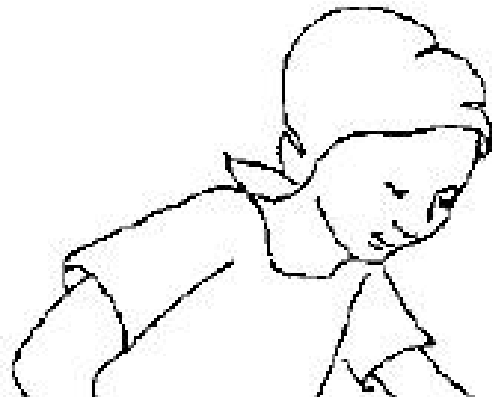

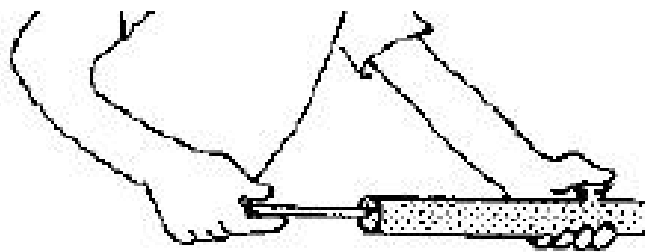

Procedure:

The piston of the air pump is pulled out of the cylinder, and then the valve opening is sealed with one finger. The piston is then pressed as far as possible into the cylinder.

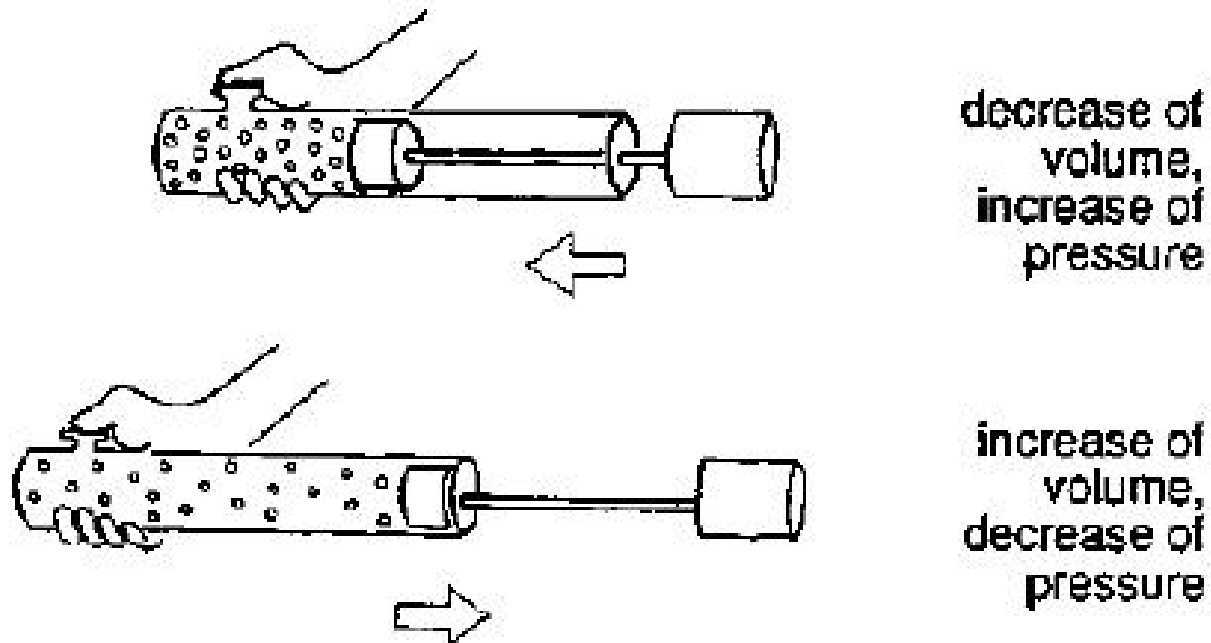

Observation:



Air can be pressed together. The further the piston is pressed into the cylinder, the greater the force required, the greater the pressure of the enclosed air.

The further the piston is pressed into the cylinder, the more quickly it jumps back out when released.

(The air pump and the enclosed air warm up. See experiment: WARMING UP WITHOUT A FLAME)

Therefore, Boyle's Law is not an accurate description of this effect.

**Analysis:**

**If a given gas volume is decreased, its pressure is increased.**

**If a given gas volume is increased, its pressure is decreased.**

Further thought:

Boyle's Law can be written in shorthand notation as a formula

$$p_1 \times V_1 = p_2 \times V_2 = \text{const.}$$

(p = pressure, V = volume)

There are other laws in physics that have the same structure, e.g. the Law of Lever. Compare!

## 7.14. MOVING FORWARD BY REPULSION

**Main Goal:**

**Main Goal:**

**This experiment demonstrates the phenomenon of repulsion.**

**Information:**

Air which escapes from an narrow orifice produces a repulsion.

Two forces always come into play: one in the direction of the streaming, the other in the opposite direction.

*Materials:*

*1 balloon*

**Procedure:**

The ballon is completely blown up.

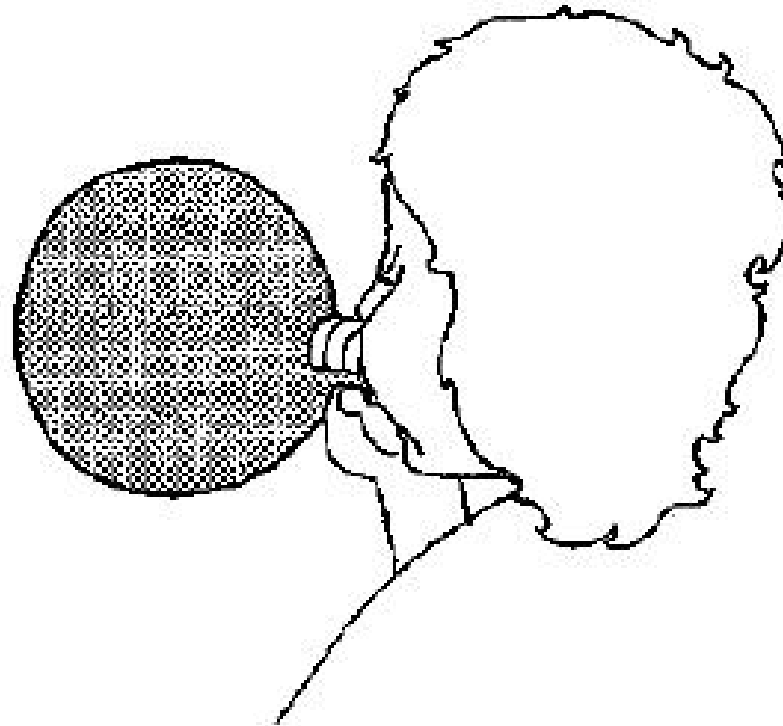

Its opening is first held closed, and then the balloon is released.

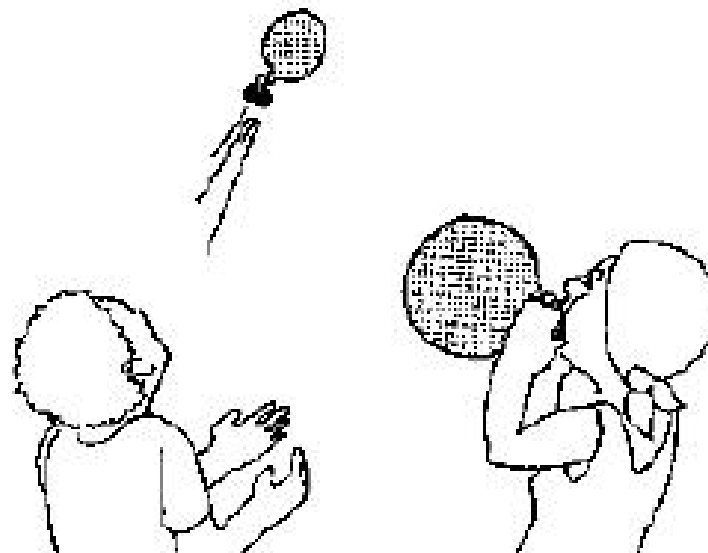

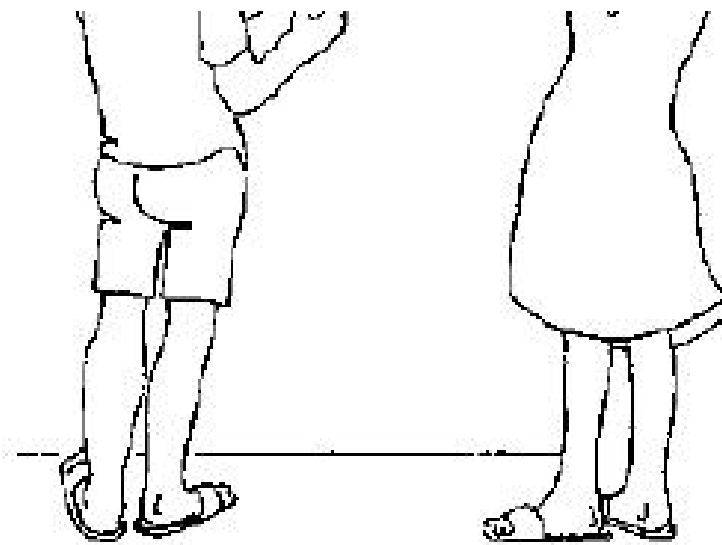

Observation:

The balloon moves around jerkily. First it flies upwards, and then it moves uncontrolled through the room. The escaping air hisses.

Analysis:

**The balloon moves because of the repulsion, in the opposite direction to the escaping air. One force in the direction of streaming. This force stems from the tension of the rubber of the balloon. It pushes the air through the orifice. On the other hand: the air pushes back and causes the balloon to move in the opposite direction. The two forces are equally strong.**

Practical Use:

Jets and rockets move forward due to this principle of repulsion. They are driven forward by combustion gases escaping rapidly.

Further thought:

What happens to a boat when you jump out of it?

## 8. WATER

### 8.1. MODEL OF A WATER-PIPELINE

**Main Goal:**

**The same air pressure acting on the surfaces of a liquid in joint vessels which are opened at the tops causes them to lie at the same level, (exceptions are very narrow vessels because of capillarity.) This principle is applied in water-pipes in technology. (Ground water is pumped into a water-storage tank such as a water-tower. The storage tank must be higher than the taps.)**

*Materials and Apparatus:*

*funnels or bottles from which the bottoms are cut off  
(use caution!) or glass-pipes tubing*

*2 nails*

*hammer*

*rope*

*water*

rope  
water

Procedure:

As demonstrated in the following diagram, the principle of a water-pipeline is illustrated.

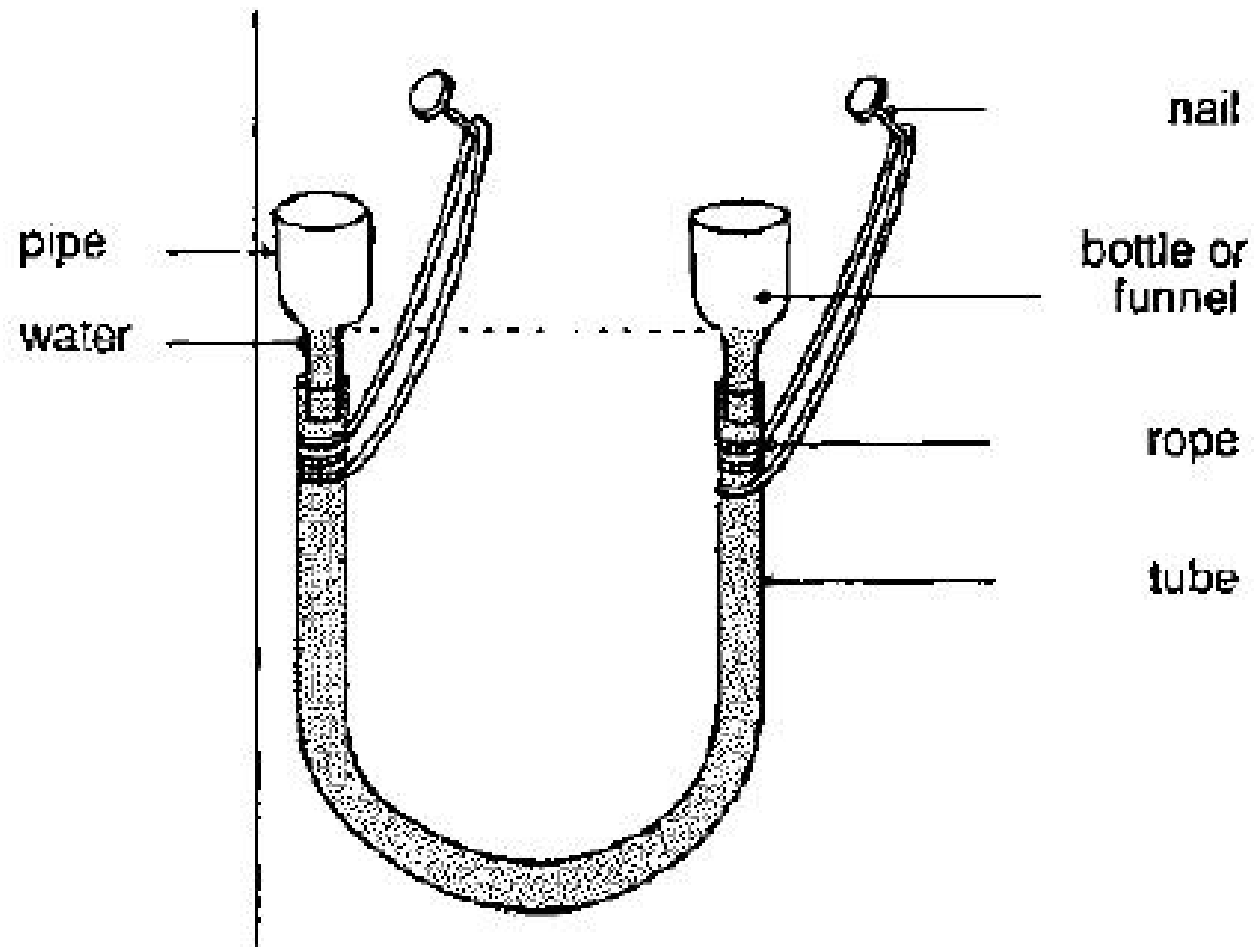

133

<http://cd3wd.com/dvd/> - filename: z\_science\_exp\_139 of 598

z\_science\_exp\_0139.jpg

The bottles (or the funnels) are alternately lifted and lowered. In the beginning, the two water surfaces lie at the same level.

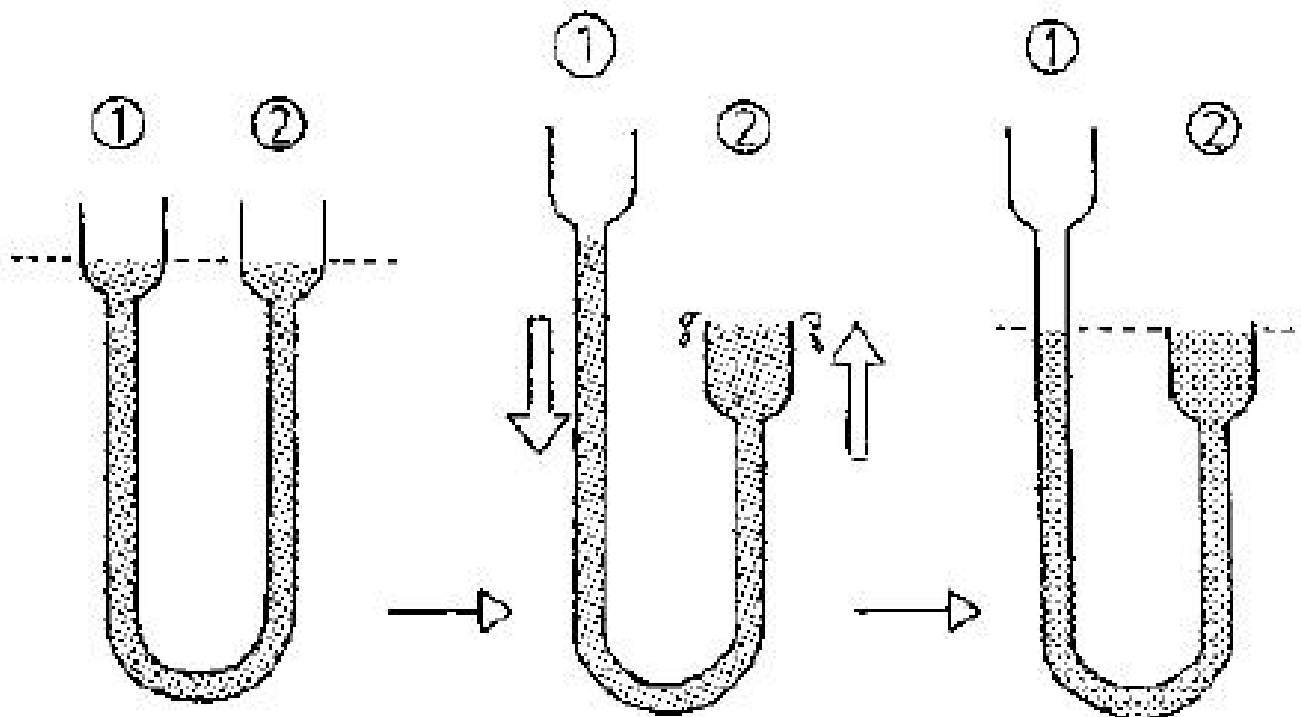

Observation:

If bottle 1 is lifted, the water level in bottle 2 is suddenly lower than that one in bottle 1 and then the water rises into the bottle 2 until the two water columns are equally high.

Analysis:

In joint vessels, water tends to stand at the same level. Thus water can be taken from taps which are placed lower than the water-storage tank. If the bottle 1 is lifted up high enough, water will spout out of the top of bottle 2.

**taps which are placed lower than the water-storage tank. If the bottle 1 is lifted up high enough, water will spout out of the top of bottle 2.**

Practical Use:

The principle of joint vessels is used in floodgates. Ships are lifted or lowered onto an adequate water level with the help of water which flows in and out.

Further practical applications: Roman water pipes, wells, irrigation plants.

Further thought:

This experiment contains implicitly a method to keep a gas volume constant when the temperature rises.

How does it work?

## **8.2. THE PRINCIPLE OF A WELL**

**Main Goal:**

**This experiment demonstrates the working mechanism of joint vessels**

**(see experiment: MODEL OF A WATER-PIPE)**

Information:



In order to obtain drinking-water, a well can be dug into the aqueous layers of the soil. The ground water soaks into the well up to the level of the ground water surface and can be taken from the well with a bucket.

*Materials and Apparatus:*

*tin (cola tin) with the top removed*  
*nail*  
*hammer*  
*glass vessel or a bucket with water*  
*tin-opener or pair of plate-shears*

*Procedure:*

Two to three holes are made with the nail and the hammer in the tin walls.



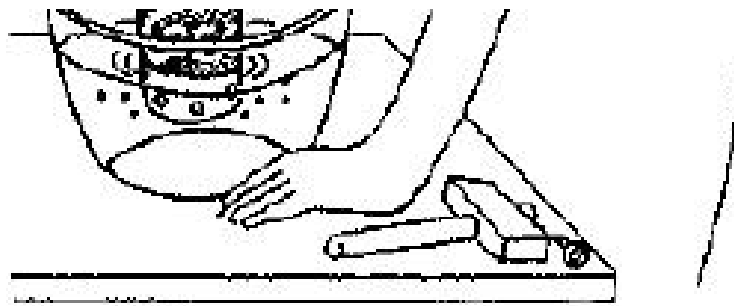

As demonstrated in the diagram below, the tin is dipped into the water.

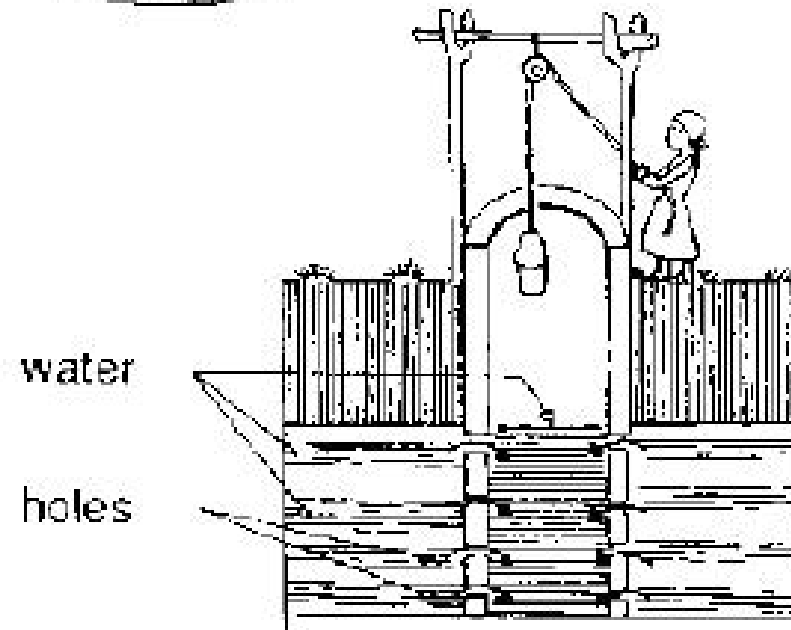
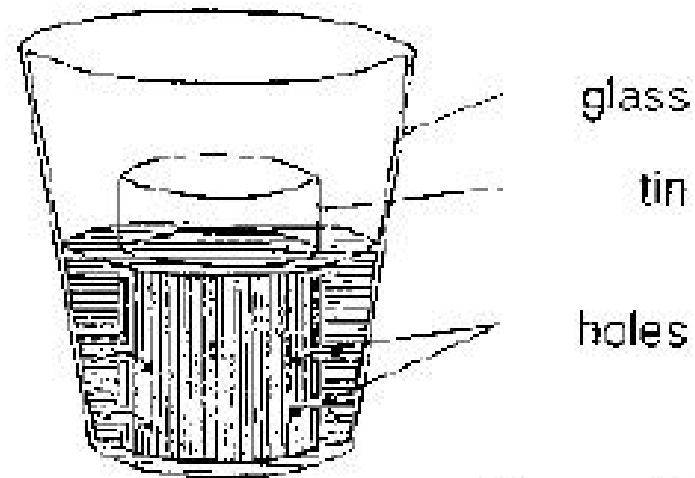

Observation:

The water soaks into the tin through the holes. The water level inside and outside of the tin adjusts itself after a short time.

adjusts itself after a short time.

### **Analysis:**

**The well which is represented by the tin, and the ground water surface represented by the water surface in the vessel are joint vessels. In joint vessels the water surfaces always adjust to each other.**

Further thought:

What is the maximum height to which water could be drink through a straw?

### **8.3. THE SIDE-PRESSURE OF A WATER-COLUMN**

#### **Main Goal:**

**This experiment demonstrates the pressure increase from the top to the bottom of a water column.**

Information:

The pressure of a liquid onto the bottom and sides of a liquid column depends exclusively on its height. The pressure increases towards the bottom. A water-column of 10 m exercises a pressure of 1 atmosphere (about 1.013 bar) onto the bottom.

*Materials and Apparatus*

*container made of sheet metal (tin or cola tin)  
– should be very high and open at the top –  
nail  
hammer  
water  
plate–shears or tin–opener*

*Procedure:*

3 holes are made at different heights in the metal container. Afterwards it is filled with water.

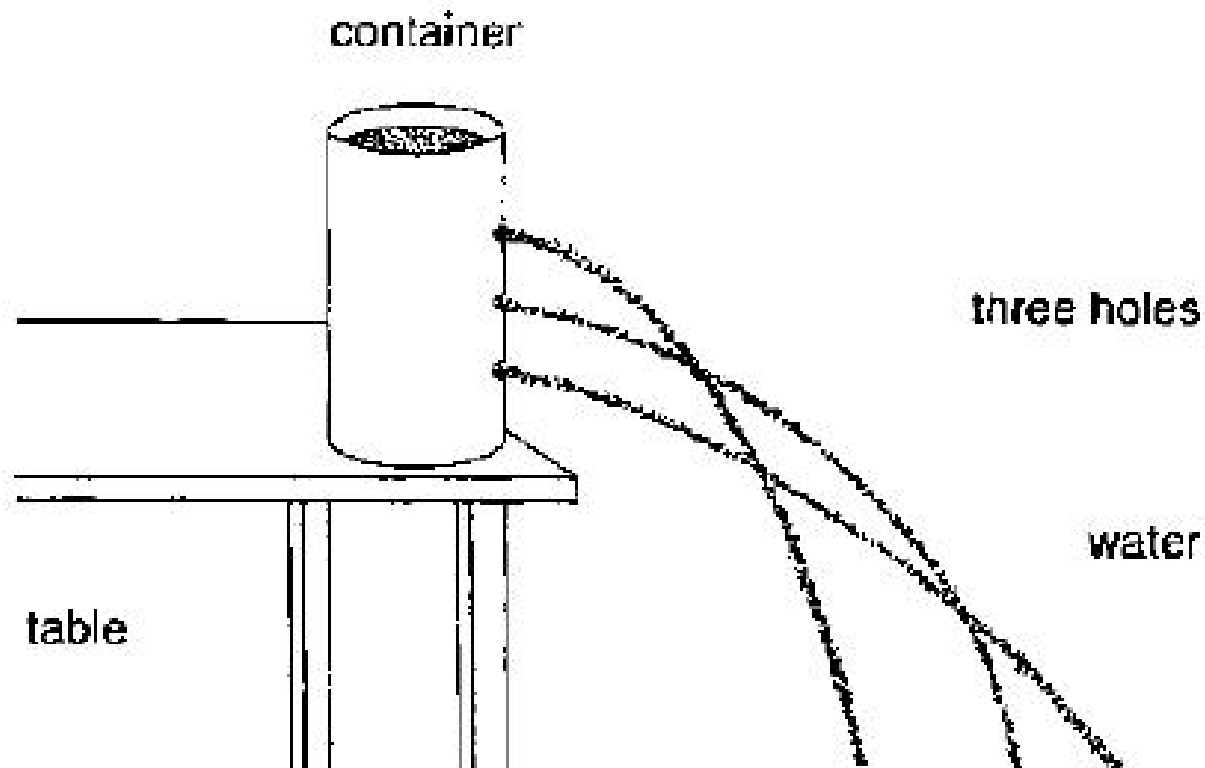

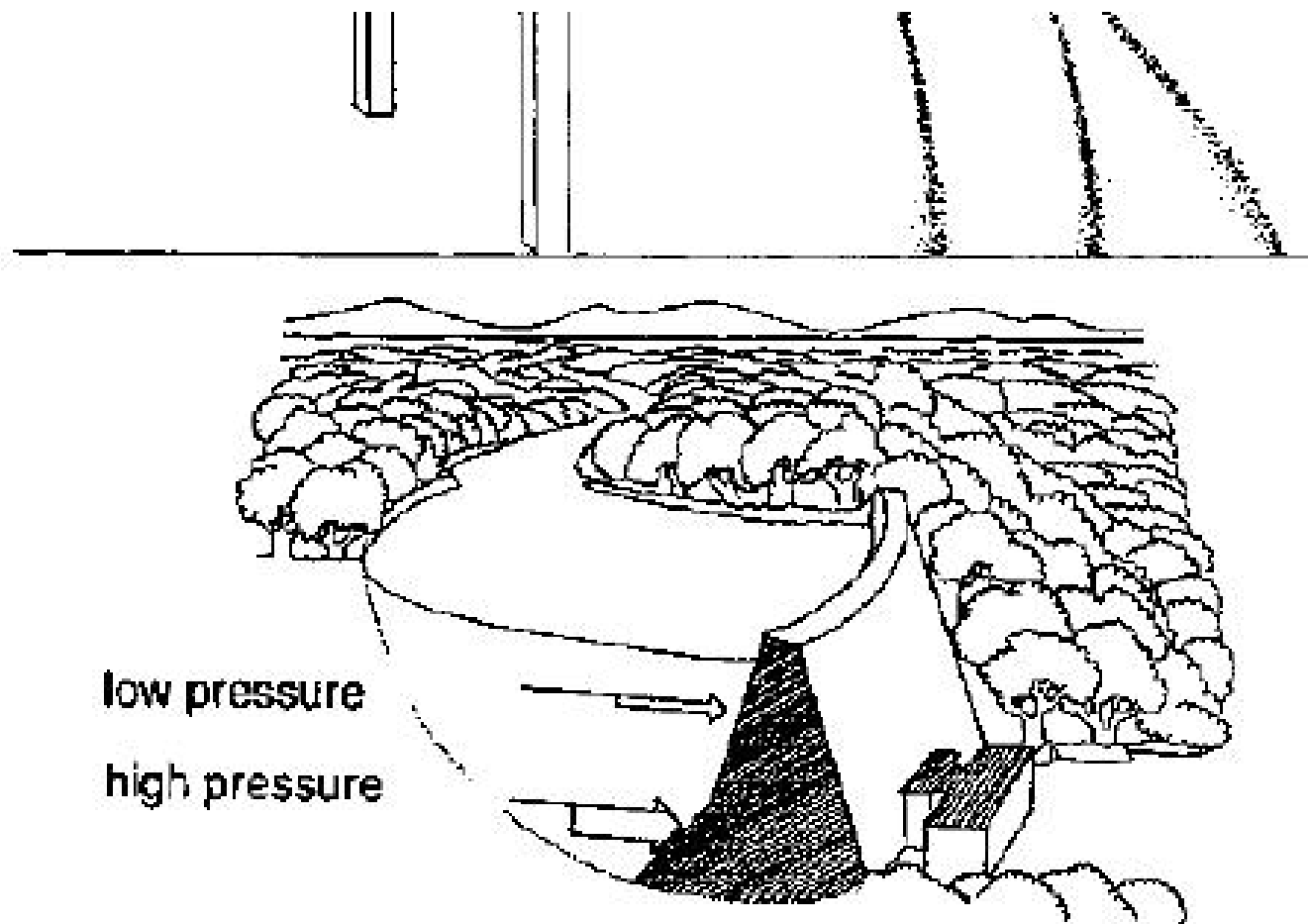

Observation:

see diagram

Analysis:

137

<http://cd3wd.com/dvd/> - filename: z\_science\_exp\_143 of 598

The pressure is exercised onto the sides as well as onto the bottom of the tin. It increases with the height of the water-column, because it's the weight of the water column above the level of the hole that determines the pressure. The more weight, the more pressure.

Practical Use:

When roller dams are built, the walls are reinforced towards the ground, in order to make them withstand the water pressure which increases with the height of the water-column.

Further thought:

Is there any difference concerning the water pressure acting against the bottom of the dam in the drawing, when you have a small volume of water held back or a very big one? The depth shall be the same in both cases.

#### **8.4. VOLUME DETERMINATION OF A STONE**

**Main Goal:**

**This experiment demonstrates how to determine the volume of an uneven solid body on the basis of its liquid displacement. (it is necessary that the body is dipped completely into water.)**

**Information:**

If a stone is placed into water, it displaces as much liquid as corresponds to its volume. (This is also true for other kinds of liquids, such as alcohol, oil and also for all gases.)

If a stone is placed into water, it displaces as much liquid as corresponds to its volume. (This is also true for other kinds of liquids, such as alcohol, oil and also for all gases.)

*Materials and Apparatus:*

*stone*

*measuring cylinder (measuring flask)*

*water*

*Procedure:*

The measuring cylinder is half filled with water. The water level is exactly read before and after inserting the stone.

Take care that no water splashes out of the cylinder when the stone is inserted.



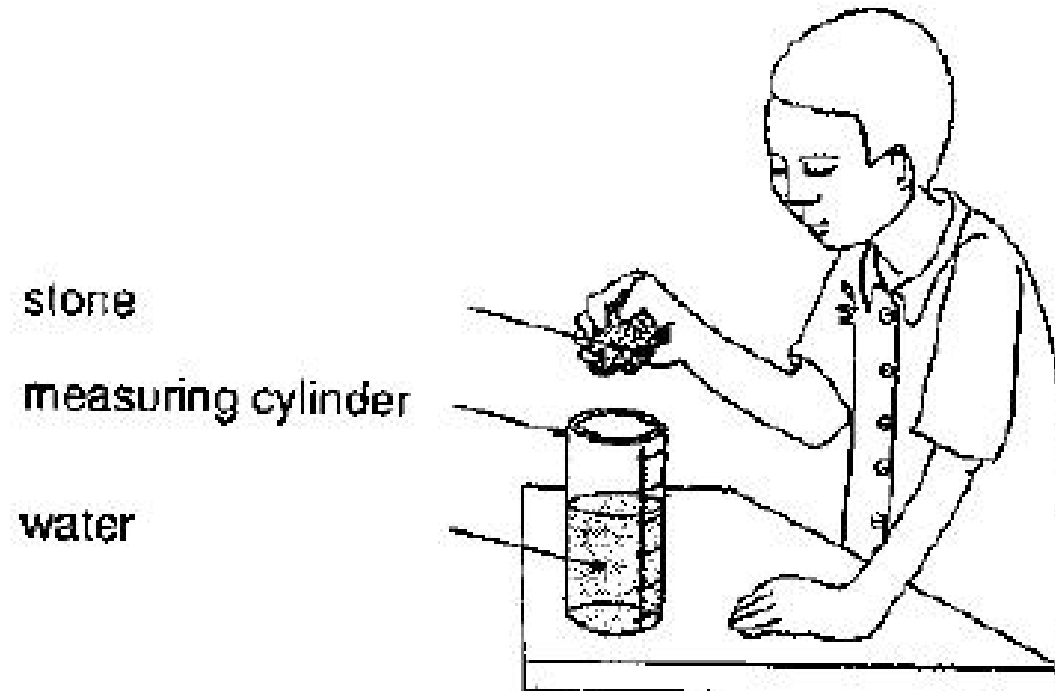

stone

measuring cylinder

water

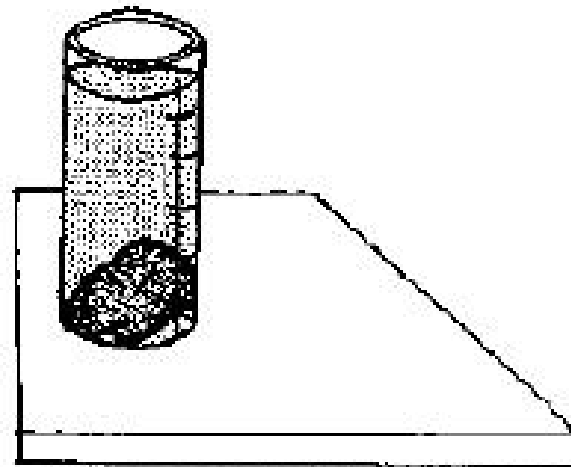

Then the stone is placed into the measuring cylinder.

Observation:

The stone sinks to the bottom, and the water level rises.

The stone sinks to the bottom, and the water level rises.

**Analysis:**

The stone displaces just as much water as it needs to settle in the cylinder.

The water that has been at the place where the stone is now situated had no other choice than to rise and to settle above the stone. Thus, the water level rises.

The amount of water (the volume) has not changed.

The difference between the two readings is a measure of the volume of the stone.

Further thought:

This method functions because the rock (or other solid bodies) doesn't change its volume when submerged in water.

What's about your body when you are submerged? Does the method work too?

## 8.5. A RAZOR BLADE FLOATS ON TOP OF WATER

**Main Goal:**

This experiment illustrates the phenomenon of surface tension.

Information:

At the surfaces of liquids are cohesive forces (Latin: attractive), whose forces are directed inward.

These forces tend to pull the surface molecules inward, which means, to reduce the size of the surface.

This special cohesion between like molecules is called "surface tension".

*Materials and Apparatus:*

*vessel*

*razor blade (greased needle, paper clip)*

*water*

Procedure:

a. One vessel is filled half way with water.

The razor blade is placed flat onto the water surface.

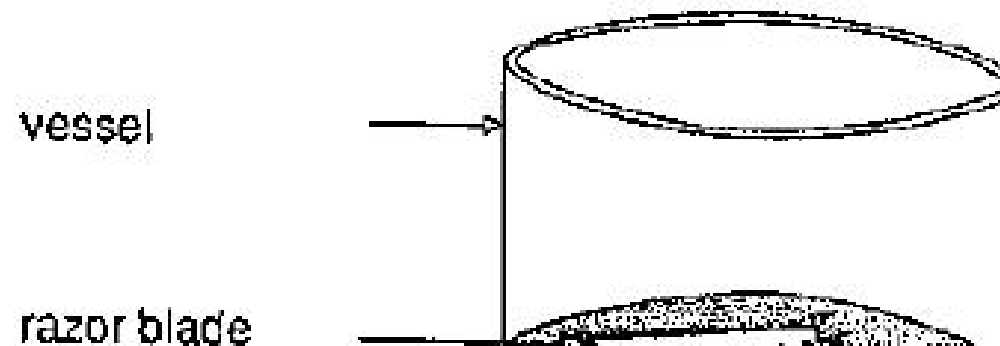

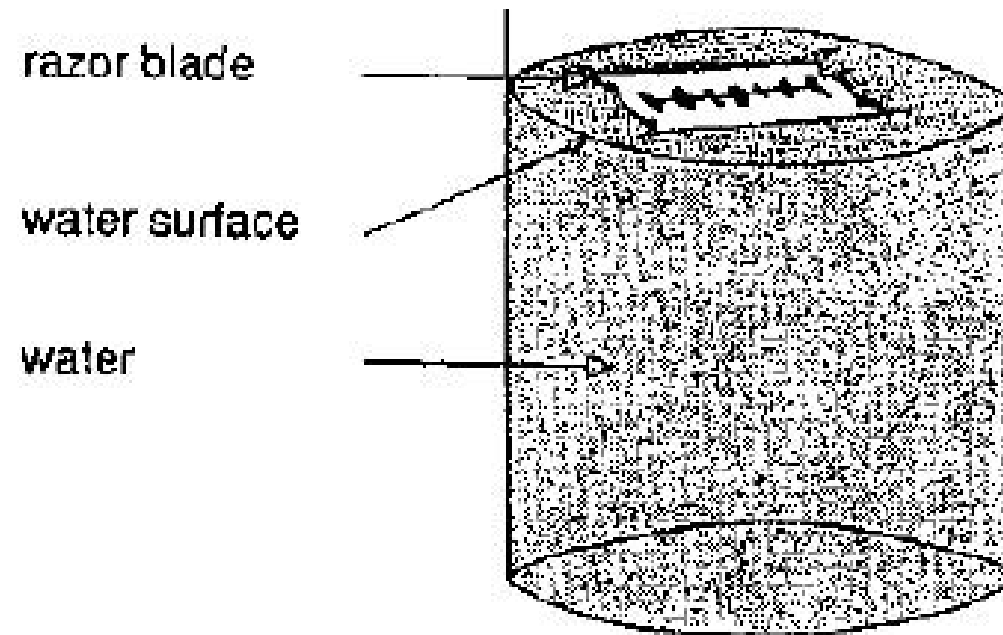

b. An attempt is made to place the razor blade on the water surface on one of the cutting edges.

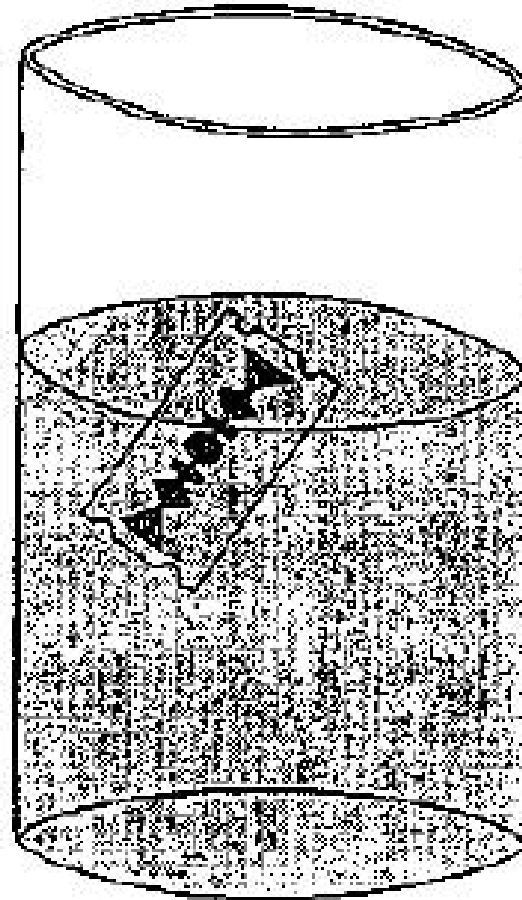

Observation:

- a. The razor blade floats on top of the water.
- b. The razor blade sinks.

Analysis:

The water surface can be imagined as one connected water skin. It is temporarily destroyed when the razor blade sinks in.

The water surface can be imagined as one connected water skin. It is temporarily destroyed when the razor blade sinks in.

This characteristic of liquids is called "surface tension".

Examples:

Insects which run over the water surface can be observed, e.g. the water-runner. Further examples of surface tension are rain drops or dew drops.

Further thought:

Why do rain drops have a spherical shape?

## 8.6. WATER HAS A SKIN

**Main Goal:**

**This experiment demonstrates the phenomenon of surface tension.**

**(see experiment: A RAZOR BLADE FLOATS ON TOP OF WATER)**

*Materials and Apparatus:*

*waxed paper  
pipette (drinking-straw)*

141

<http://cd3wd.com/dvd/> - filename: z\_science\_exp\_147 of 598

water

Procedure:

With the help of a pipette, several small portions of water are dropped onto waxed paper.



waxed paper

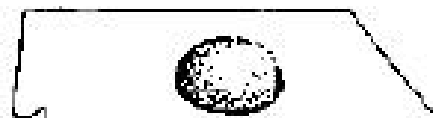



Observation:

Small drops are really spherical. If pushed together, bigger drops are formed that are more tear-shaped.

**Analysis:**

**The high surface tension of water is responsible for the holding together of this "surface skin".**

**The surface tension tends to form the smallest possible surface surrounding the volume of water. 1 sphere has the smallest possible surface.**

Addition:

If some drops of soap solution or some small grains of a detergent are added to the "heap of water", it dissolves at once. The surface tension of water is reduced.

Practical Meaning

The reduction of the surface tension of water is achieved with detergents to increase the wetting ability of dishes or clothing.



(see further experiments with detergents)

Further thought:

What additional effect makes bigger drops more tear-shaped?

## 8.7. THE PHENOMENON OF SURFACE TENSION

**Main Goal:**

**These experiments use a soap solution to illustrate the surface tension.**

Information:

(see experiment: A RAZOR BLADE FLOATS **ON** TOP OF WATER)

*Materials and Apparatus:*

*concentrated soap-solution*

*a. clay pipe or a peashooter*

*b. a ring of wire*

*a loop of thin yarn  
needle*

Procedure:

a. Soap-bubbles are blown with a clay pipe.

The mouthpiece is then released and observed.

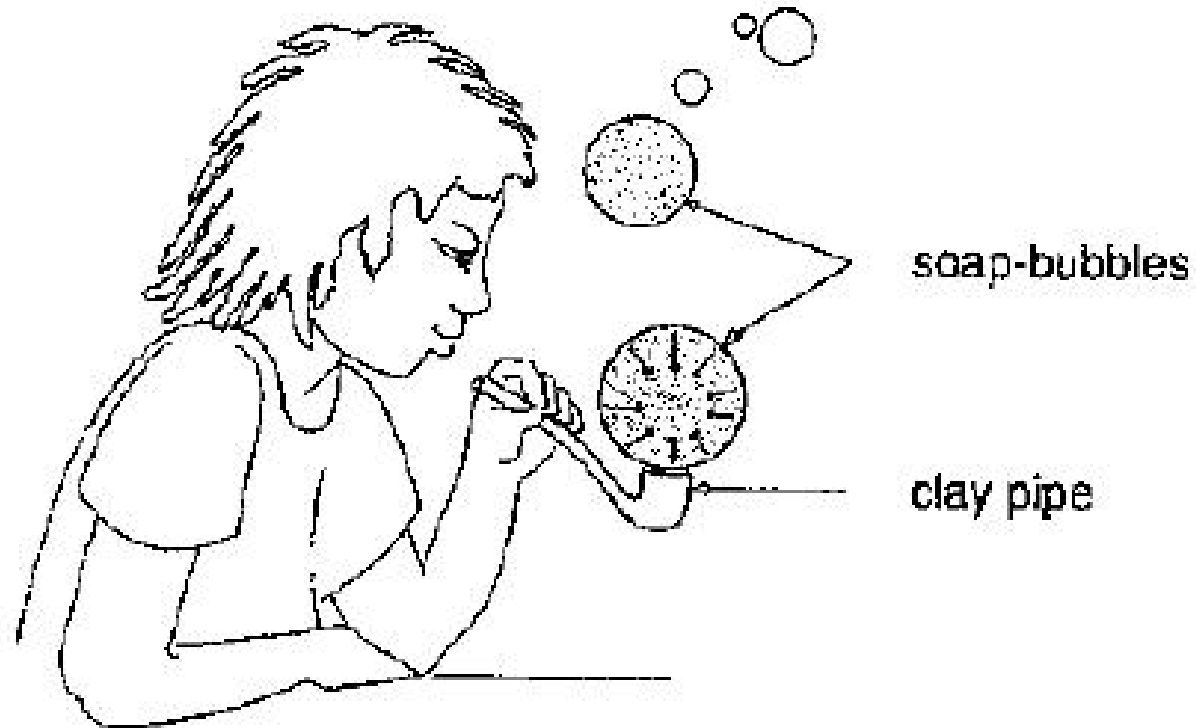

b. As demonstrated in the diagram below, a wetted loop of yarn is placed onto the soap skin. This skin is pricked in the centre of the yarn loop.

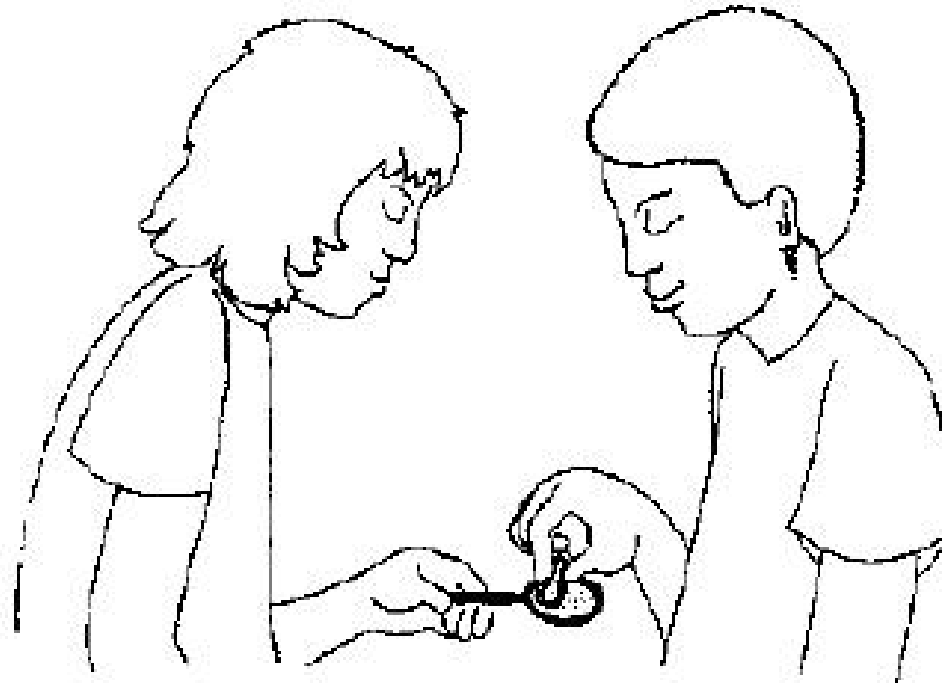

loop of yarn

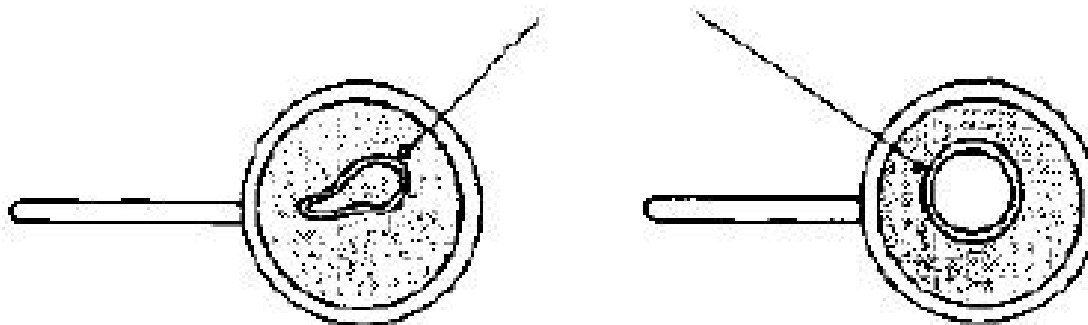

Observation:

- a. The soap-bubbles slowly become smaller.
- b. The loop of yarn is drawn apart.

- a. The soap-bubbles slowly become smaller.
- b. The loop of yarn is drawn apart.

**Analysis:**

- a. Round soap-bubbles develop due to surface tension, which presses the air out of the soap-bubble, so that its surface size decreases. The surface tension tends to minimize the surface area.
- b. The surface tension is responsible for the yarn loop being torn apart. The remaining soap skin has minimum size when the yarn has a circular shape.

The surface tension of different liquids varies.

Water has a very high surface tension, so that it is not possible to form a “water bubble” in analog to the “soap-bubble”.

Further thought:

The surface tension of hot water is smaller than that one of cold water. Why?

## 8.8. WATER ASCENDS IN SOIL

**Main Goal:**

This experiment illustrates the phenomenon of capillary action. (Latin: suction effect of very thin tubes)

Information:

Very thin tubes are called capillary tubes (capillary –Latin: hair-like). In these, water climbs up. The thinner the tube, the higher the water climbs. The cause is the surface tension (see further experiments on surface tension).

Water molecules are attracted to glass or other substances more than to each other. This effect is called adhesion. When a glass tube is dipped into water, the adhesion between glass and water causes a thin film of water to be drawn up over the surface of the tube. Surface tension causes this film to contract. The film on the inner surface continues to contract, raising water with it until the adhesive force is balanced by the weight of the water lifted (see drawings).

capillarity

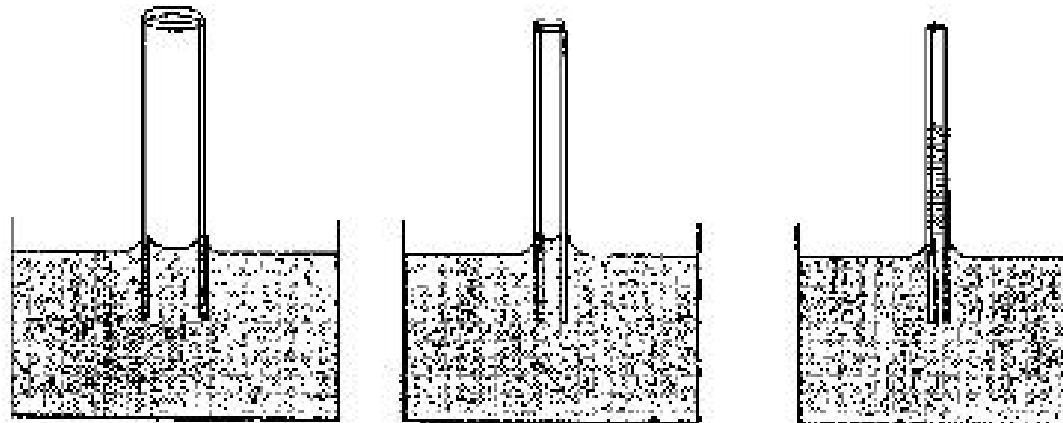

Materials:

*piece of white chalk*  
*ink or coloured water*  
*(transparent tubes of different diameter)*

Procedure:

The chalk is dipped 10 cm into the ink-solution.

After 10 minutes, the piece of chalk is broken into two, at the point to which the coloured solution has climbed.

chalk  
ink-  
solution

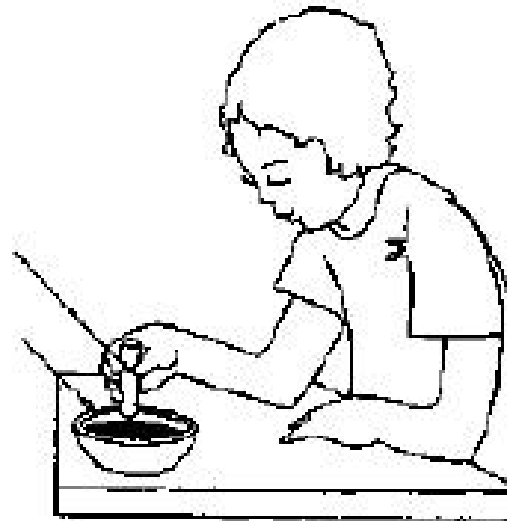

ink-solution

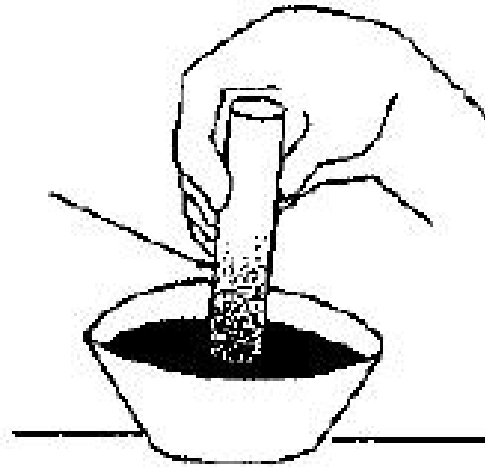

Observation:

The ink climbs up the piece of chalk.

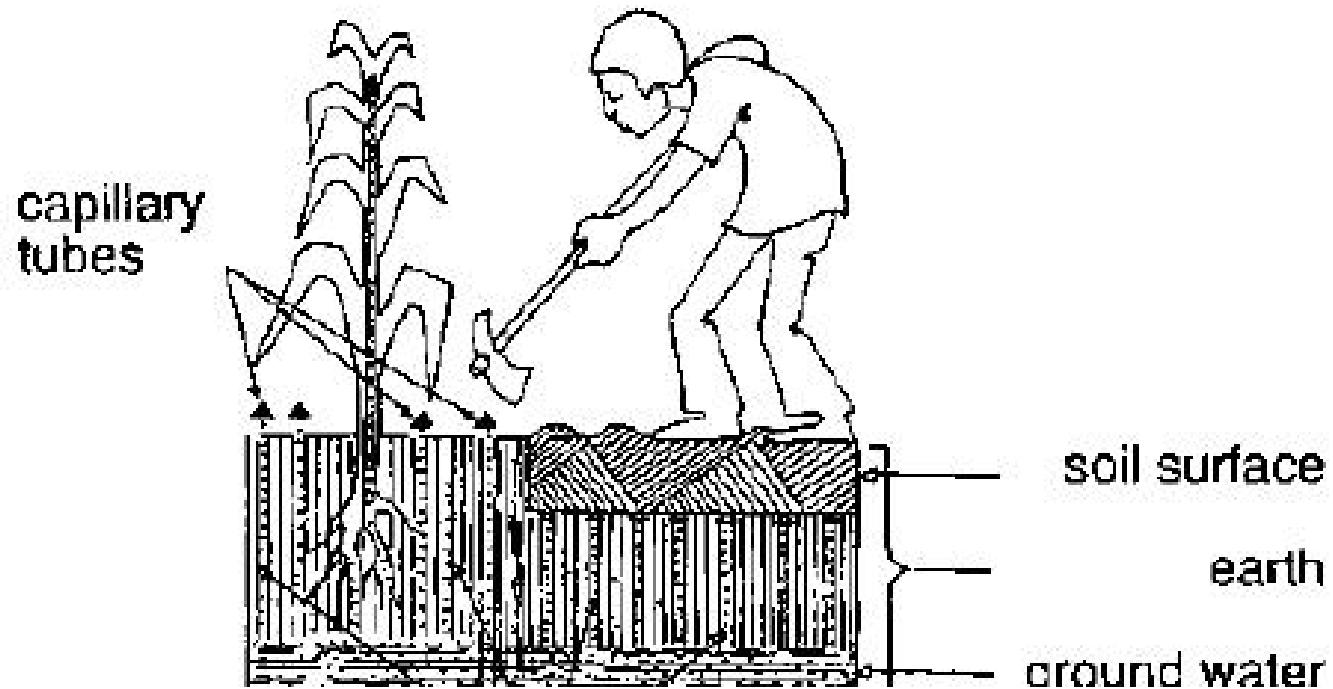



### Analysis:

**This observation is called “capillary action” or the suction effect of hair-like tubes.**

### Practical Meaning:

Ground water climbs up in soil because of capillary action. So the roots of plants are continually supported with water even in dry seasons. (Capillary tubes are formed when the soil sags and rainwater flows slowly in thin streams through the soil.)

Usually the water climbs up to the earth's surface, where it evaporates. When farmers hoe the ground, they make the capillaries wider and the water does not go up. Thus, they hinder this process, as the capillary effect is reduced. Therefore, the water loss of the soil is reduced for some time. Furthermore, the soil surface is loosened and the area of surface is increased.

### Further thought:

Why is oil soaked upward in a lamp wick when one end hang in oil?



## 8.9. DETERGENTS FACILITATE THE ABILITY OF PERFUSION

### Main Goal:

These experiments illustrate the effects of water and a detergent solution on fabric cloth.

### Information:

Soaps and detergents reduce the surface tension of water.

The process of perfusion, which is the absorption of a detergent solution (soap solution) by the fabric cloth, is facilitated.

### *Materials and Apparatus:*

*detergent solution (soap solution)  
(1 g detergent in 100 ml of water)  
water  
2 wool threads  
2 small rags  
2 vessels*

### Procedure:

One vessel is half filled with water; the second is half filled with a detergent-solution.

A wool thread and a small rag are placed into each vessel.

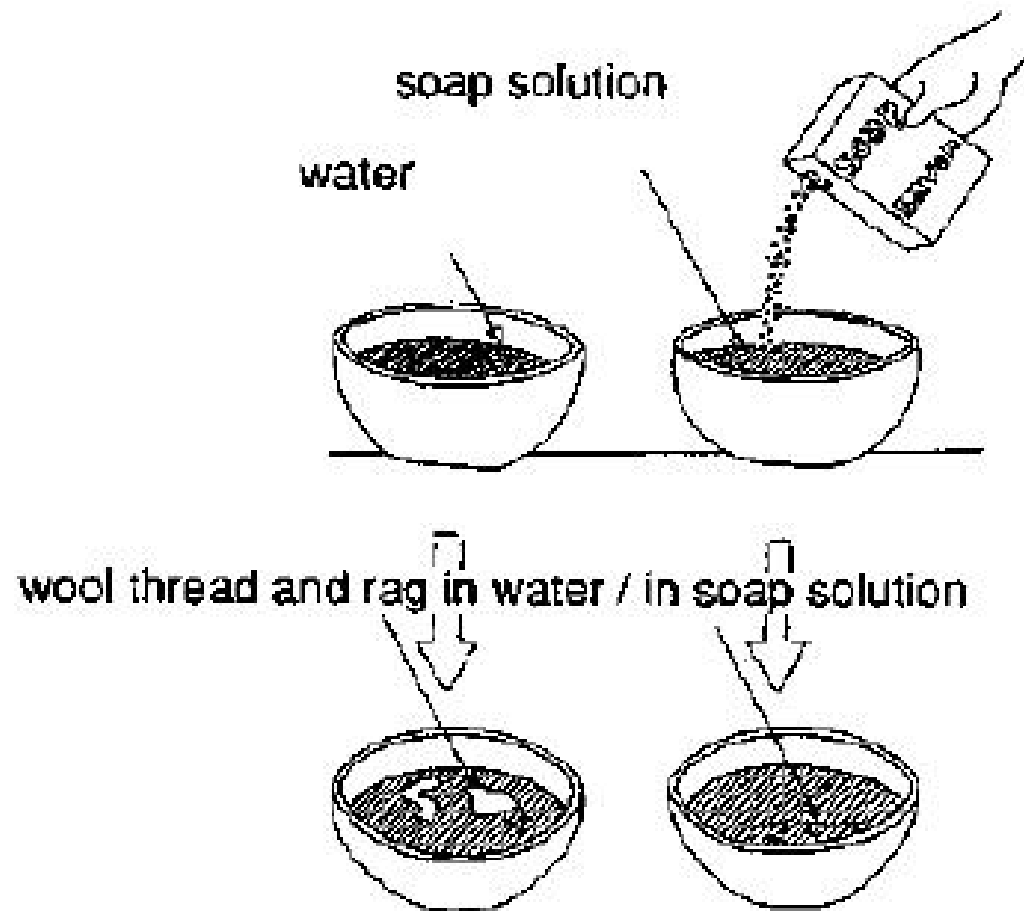

Observation:

The wool thread and rag sink relatively quickly into the detergent solution. The rag sinks much more slowly into pure water, whereas the wool thread hardly sinks or does not sink at all.

**Analysis:**

**Compared to a detergent–solution, pure water soaks more slowly into similar fabric cloths.**

**Practical Use:**

Soaps and modern detergents are used for the cleansing of laundry.

(see experiment: THE EFFECT OF DETERGENTS ON DIRT)

**Further thought:**

If soap reduces surface tension of water, why do we blow soap bubbles instead of water bubbles?

## **8.10. THE EFFECTS OF DETERGENTS ON DIRT**

**Main Goal:**

**This experiment illustrates that dirt is distributed in very small particles in a detergent solution.**

**Information:**

The basic components of dirt are grease, soot, and proteins. Detergent molecules distribute soot and grease particles, in the washing solution so that they can be washed away.

The basic components of dirt are grease, soot, and proteins. Detergent molecules distribute soot and grease particles, in the washing solution so that they can be washed away.

Fruit and vegetable stains are destroyed by bleach. The experiments demonstrate the perfusion of soot and grease by detergents.

*Materials and Apparatus:*

*a. 2 glass dishes (test tubes)*

*soot (activated carbon or wood charcoal)*

*b. 2 glass dishes (test tubes)*

*oil (salad oil, engine oil)*

*detergent solution*

*(about 1 teaspoon of detergent in a big vessel of water)*

*c. 2 funnels*

*2 paper filters*

*2 glass dishes*

*Procedure:*

a. One glass dish is half filled with water;  
a second is half filled with detergent solution.

Some soot (about one spatula tip) is added to each dish, vigorously shaken and then filtered.



b. One glass dish is half filled with water, a second is half filled with detergent solution. About 0.5 ml oil is added to each dish, and then the dishes are vigorously shaken.

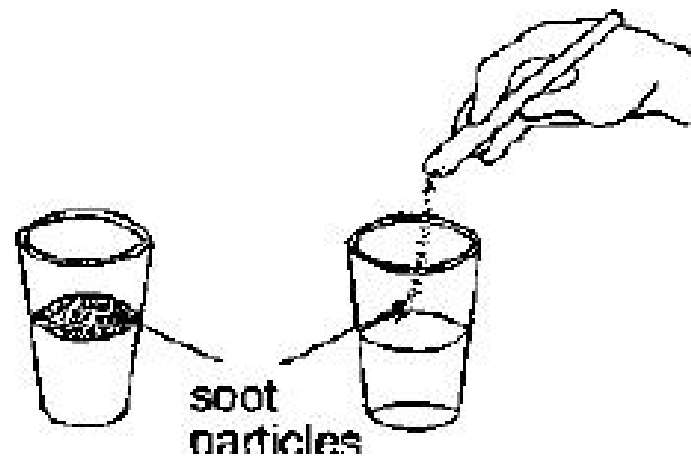

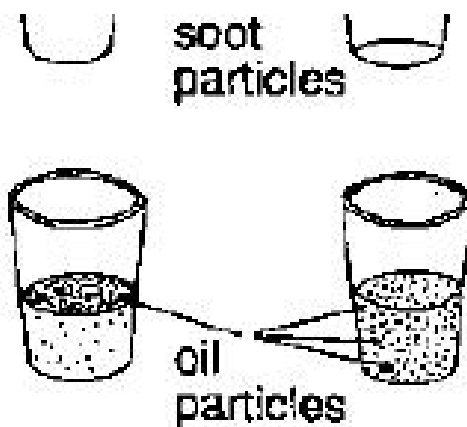

Observation:

- The soot particles in the detergent solution are distributed, whereas those in water recollect on its surface. The soot particles in the detergent solution are hardly retained by the paper filters.
- The oil in the detergent solution is distributed in very small particles, whereas it forms a layer on top of the water.

Analysis:

**Detergents cause oil and soot to be well distributed in water. Oil drops and soot particles are distributed and thus kept floating.**

**Thus, the dirt particles are prevented from being deposited on the fabric cloth again. In the first case of the soot particles in a detergent solution, a suspension is formed. In the case of detergent solution and oil, a suspension is formed.**

(emulsion: a mixture of two liquids; suspension: a mixture of a liquid and one solid, which can not solve in the liquid)

Practical Use:

Soaps and detergents are used to remove dirt from clothes, dishes, and the human body.

Further thought:

We say that some liquids "wet" a surface, whereas other don't do this. What's the difference? Where is it coming from?

## 9. MECHANICS

### 9.1. GEAR MECHANISM – A TRANSMISSION

#### TO SPEED UP

Main Goal:

The pupils become familiar with an important element of machines – the gear transmission.

Information:

In technology, cogwheels serve to transmit rotary motions.

In technology, cogwheels serve to transmit rotary motions.

The simplest kind of gear transmissions consists of a driving gear, an output gear, one crank, two spindles, and two bearings. A gear transmission transmits two unchanging rotary motions, motions into slowness, into speed, in opposed motions and motions into other revolving planes.

If there is a transmission to speed up, the bigger of the two cogwheels is the driving gear and the smaller one is the output gear.

*Materials and Apparatus:*

*firm corrugated board*  
*screws*  
*wire*  
*knife or pair of scissors*  
*coloured pencil*

*Procedure:*

Two cogwheels – one with 20 and the other with 40 cogs are made of the corrugated board. The screws serve as spindles and simultaneously as fastening devices on a sheet of corrugated board. A crank – made of wire – is fastened to the bigger cogwheel.

One cog of each gear is coloured, to determine the number of rotations.

The bigger cogwheel is driven by the smaller one.



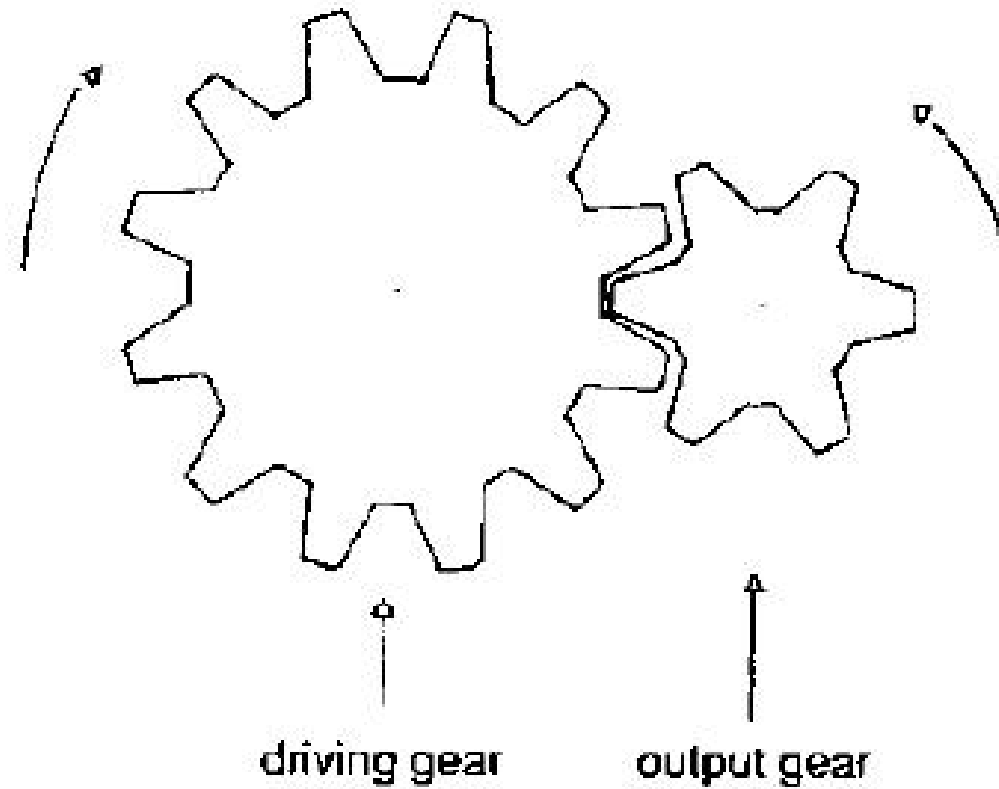
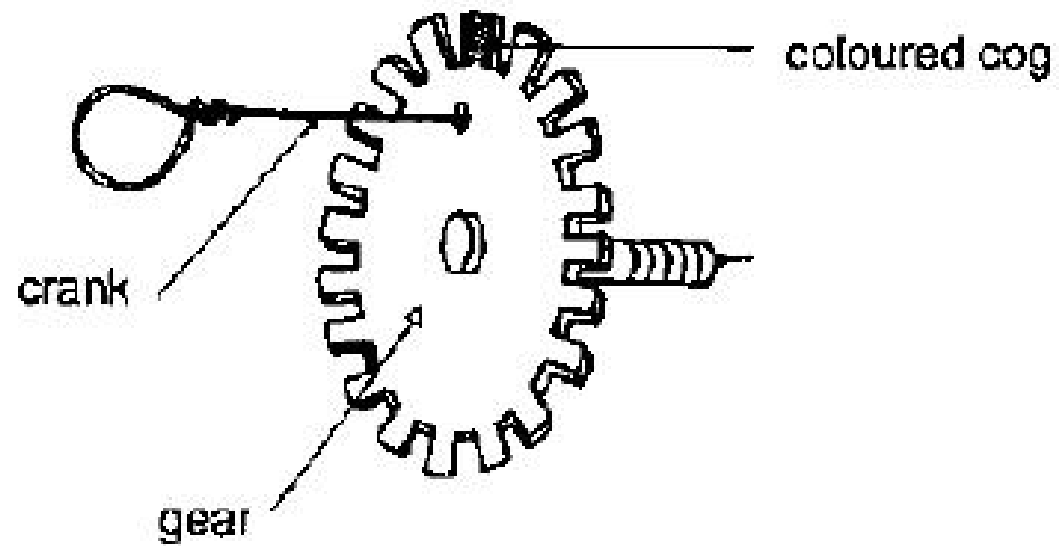

driving gear

output gear

Observation:

Driving gear and output gear rotate in opposite directions. The output gear turns twice as fast as the driving gear.

Analysis:

If a rotary motion is transmitted from a bigger driving gear onto a smaller output gear, the number of rotations of the smaller cogwheel is greater.

The quotient of the number of rotations is called transmission. It is computed by the proportion between the two cogwheel radii or between the proportion of the cogs of the single gears.

$$u = r_1/r_2 = z_1/z_2$$

u: transmission  
r: radius of a gear  
z: number of cogs

Practical Use:

One of the numerous examples of such a transmission is the gear mechanism of a grinding machine. The grindstone (as working element) is connected over a spindle to a smaller output gear, which speeds up. With bicycles, the motion is transmitted over the chain.

151

<http://cd3wd.com/dvd/> - filename: z\_science\_exp\_157 of 598

## 9.2. GEAR MECHANISM – A TRANSMISSION TO SLOW DOWN

### Main Goal:

By means of this experiment the pupils experience an important element of machines – the gear transmission.

This experiment demonstrates a transmission in order to slow down.

### Materials and Apparatus:

*corrugated board*

*screws*

*knife or pair of scissors*

*wire*

*coloured pencil*

### Procedure:

see "GEAR MECHANISM – TRANSMISSION TO SPEED UP"

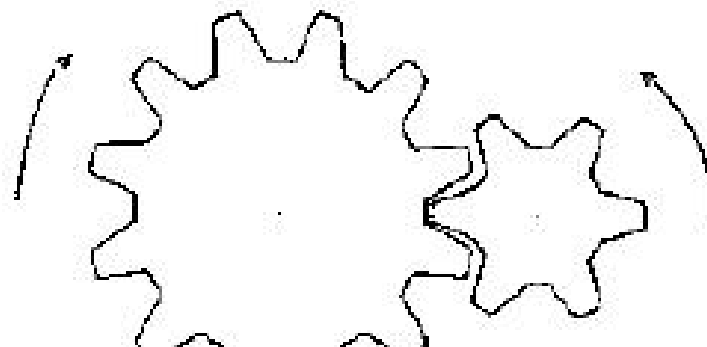

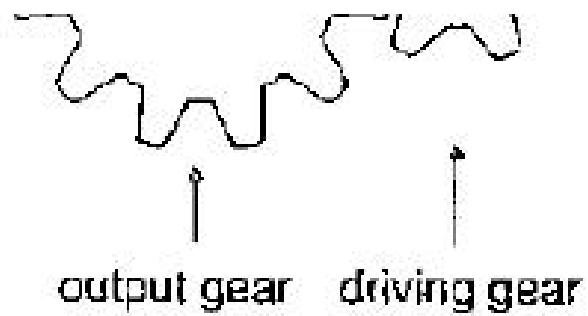

Observation:

Driving gear and output gear turn into the opposite directions. The driving gear turns double as fast as the output gear.

opposite directions

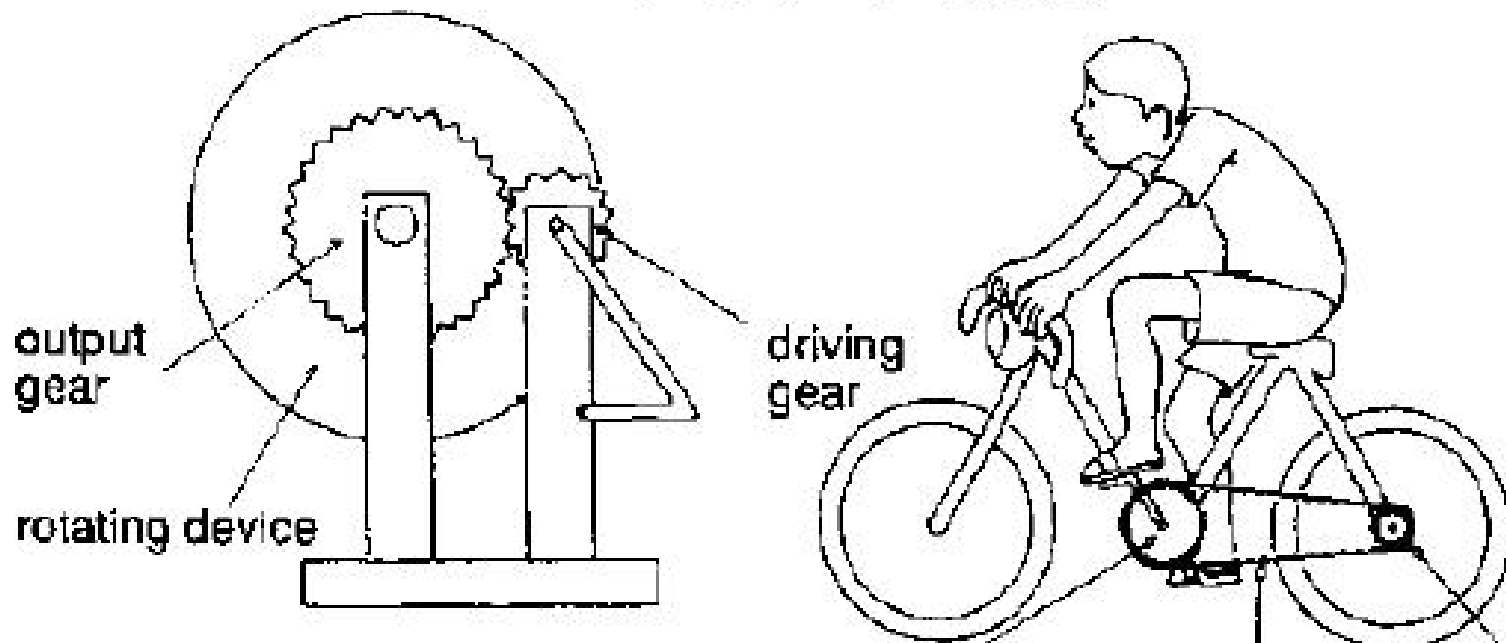
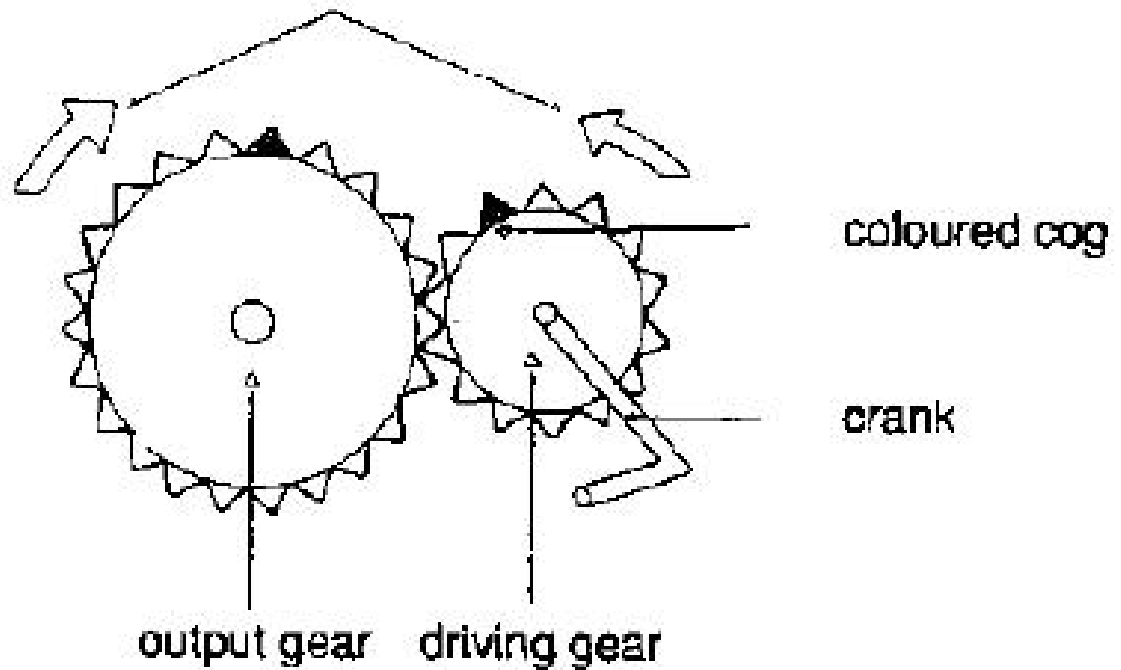

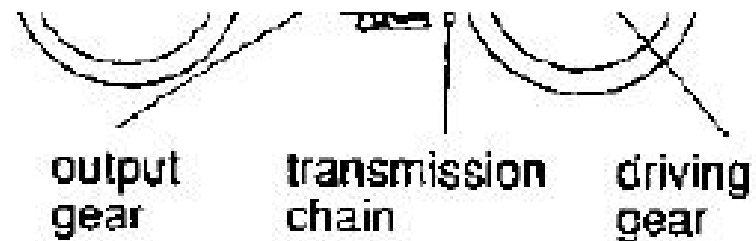

### Analysis:

If a rotary motion is transmitted from a smaller driving gear onto a bigger output gear, the number of rotations of the bigger cogwheel is smaller. The quotient of the number of rotations is called transmission. It is computed by the proportion between the two cogwheel radii or by the proportion between the cogs of each gear.

$$u = r_1/r_2 = z_1/z_2$$

u: transmission  
r: radius of a gear  
z: number of cogs

### Practical Use:

A vivid example of a transmission to slow down is the gear mechanism of a bread-slicing machine. The knife as working element is connected to a big output gear which undergoes a transmission into slowness by a smaller driving gear.

### 9.3. A SEESAW – A TWO-ARMED LEVER

#### Main Goal:

Pupils learn that a seesaw is a two-armed lever and flat in case of equilibrium. There is a special relationship between the length of a levers and the weights resting on them. For older pupils this experiment provides a mathematical basis to approach the law of the lever.

#### Information:

In physics, a lever is a bar, which can turn about one point (axis). This point is called the fulcrum. The fulcrum of a two-armed lever lies between the two attacking forces (see drawing 1). If a lever is in balance, the effects on left and right are equal. These effects are the product of the attacking force and the lever bar (distance between attacking force and the fulcrum). In drawing 1 the attacking forces  $F_1$  and  $F_2$  are the weights of the paper clips.

The law of lever says:

$$F_1 \times L_1 = F_2 \times L_2$$

If  $F_1$  is considered the force that is to balance the load at the right hand side ( $F_2$ ), then we have

$$\text{force} \times \text{force arm (left hand side)} = \text{load} \times \text{load arm (right hand side)}$$

#### *Materials and Apparatus:*

*styrofoam (or soft wood)*  
*thin iron nails*

styrofoam (or soft wood)  
thin iron nails  
paper clips metal rings which are similarly heavy  
(if existing: weights)  
pencil, ruler  
firm, thin wire  
knife

distance between  
attacking force  
and the fulcrum

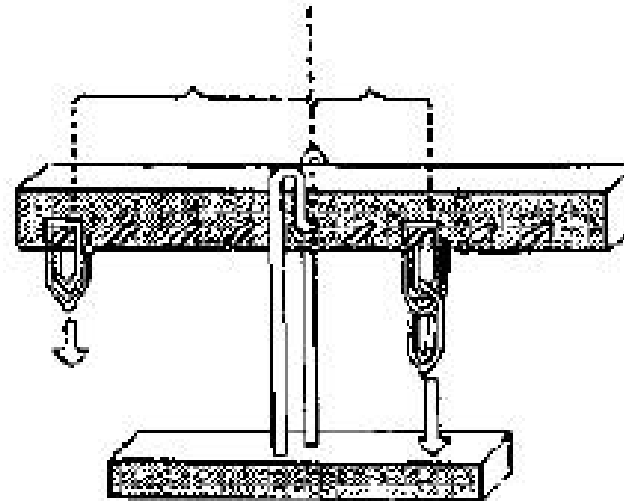

Procedure:

As shown in the drawing 1, a two-armed lever is constructed.

The axle bearing has to enclose the axis in such a way that the lever can freely rotate. However, it should not be too loose. It is favourable to pierce the styrofoam with the wire, which serves as axis and rack. Perhaps the wire should be heated before hand. The weights, e.g. paper clips or metal rings are fastened in different amounts at different distances from the fulcrum.



(This corresponds to the children on a seesaw.)

It is the pupils' task to balance the lever.

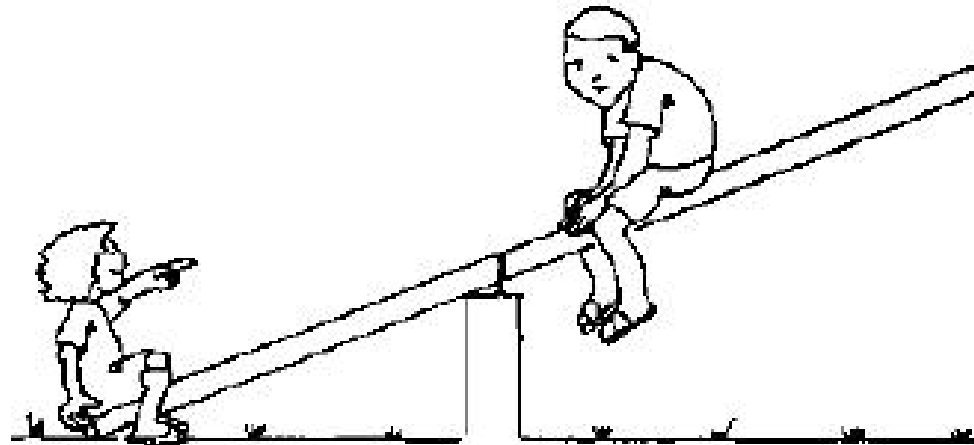

**Observation:**

The lever is balanced if the same number of paper clips is placed on each arm of the lever at the same distance from the fulcrum or, if different weights are fixed, the heavier weight must be closer to the fulcrum in order to balance the lever.

**Analysis:**

**When the lever is balanced, the product of force and force arm equals the product of weight and weight arm.**

**That's to say: the product  $F \times L$  of the left hand side must be equal to the product  $F \times L$  of the right hand side.**

Practical Use:

Examples of two-armed levers include: beam scales, scissors, pliers, and railway-signals.

Further thought:

What must be done in the situation of drawing 2 when the seesaw is to be balanced? There are two possibilities.

#### 9.4. MODEL OF A SIMPLE CABLE WINCH

**Main Goal:**

**Younger pupils learn that loads can be moved more easily with the help of a cable winch. Older pupils trace the cable winch back to a two-armed lever.**

Information:

With the help of a cable winch, loads can be lifted vertically, or pulled closer horizontally more efficiently, i.e. with less effort.

Simple cable winches consist of a cable drum, the cable, and the friction drive. The friction drive can be moved by hand as well as by a motor.

(see experiment: A SEESAW – A TWO-ARMED LEVER)

*Materials and Apparatus:*

*stone as the load*

*rope*

*tin (with 2 holes) filled with sand, (see diagram)*

*pierced cork-stopper*

*stable wire*

*Procedure:*

The experiment is set up as shown in the diagram below. The stone is lifted once with the help of the cable winch, and another time without it.

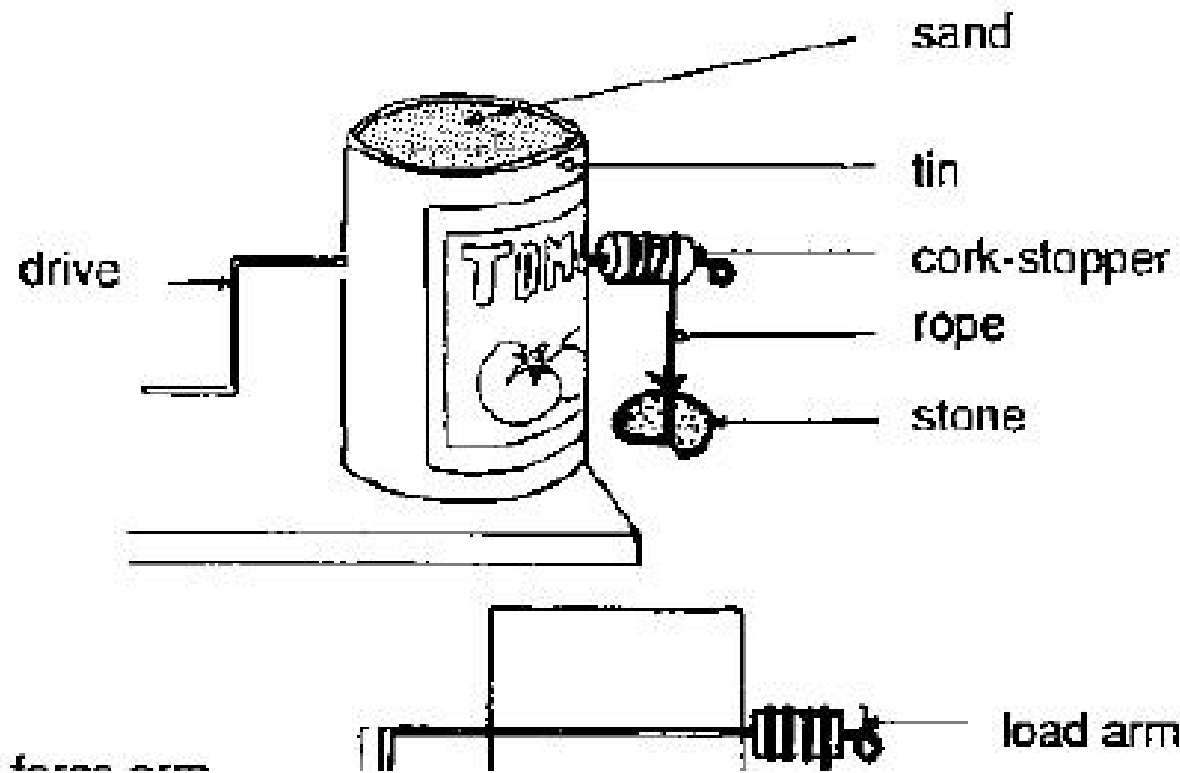

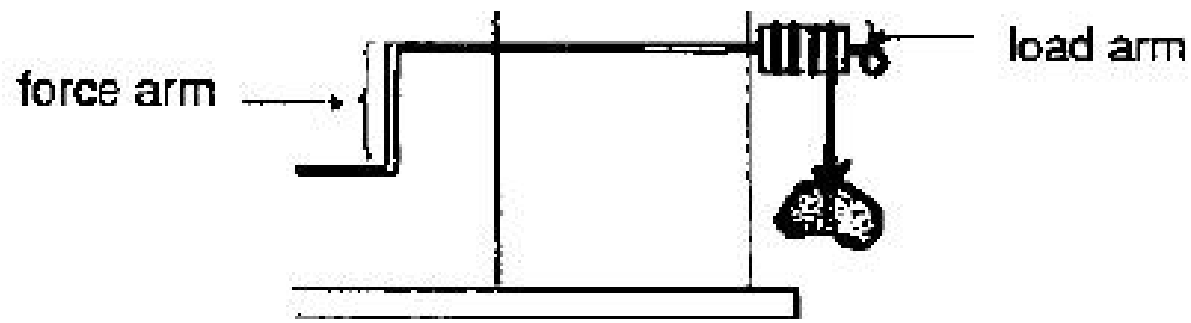

Observation:

The stone can be lifted more easily with the cable winch.

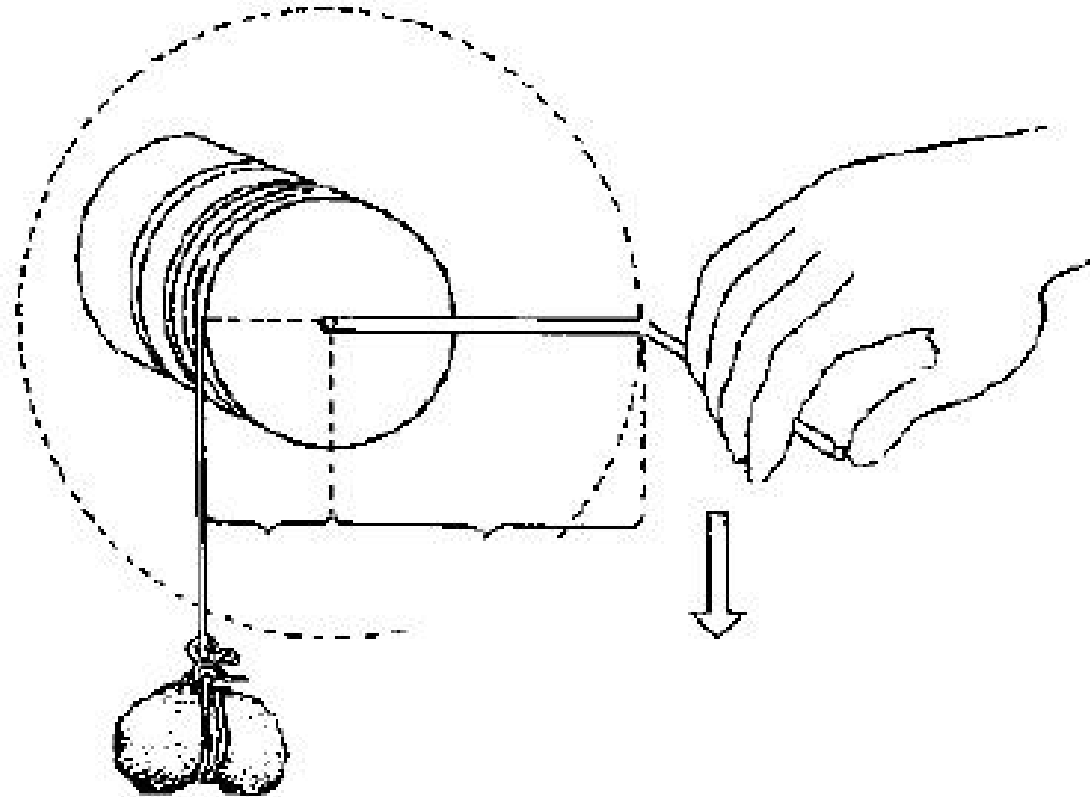

**Analysis:**

The winch presents a two-armed lever. When a load is lifted, force is saved, because the force arm is longer than the load arm. Thus the required force is smaller than the load (weight of the stone).

**Practical Use:**

Uses for winches: water cranes, pit-head frames, lifting device at wheels, etc.

Further thought:

We save force with cable winches or levers.  
Do we get this for granted or do we have somehow to pay for?

## 9.5. INERTIA

### Main Goal:

**The experiment illustrates well-known observations, from which the law of inertia can be derived.**

### Information:

Inertia describes the property of all bodies to counteract a change in motion. That's what experience teaches us.

The heavier a body is, the more inertia it exerts.

It is more difficult to put a heavy body from a position of rest into motion than a light one.

More force is needed to stop a heavy body than to stop a lighter body.

### *Materials and Apparatus:*

*glass, tin etc. with smooth rims*  
*coin*  
*firm paper (cardboard)*

Procedure:

The experiment is prepared as shown in the diagram below.

The paper is pulled away horizontally as quickly as possible.

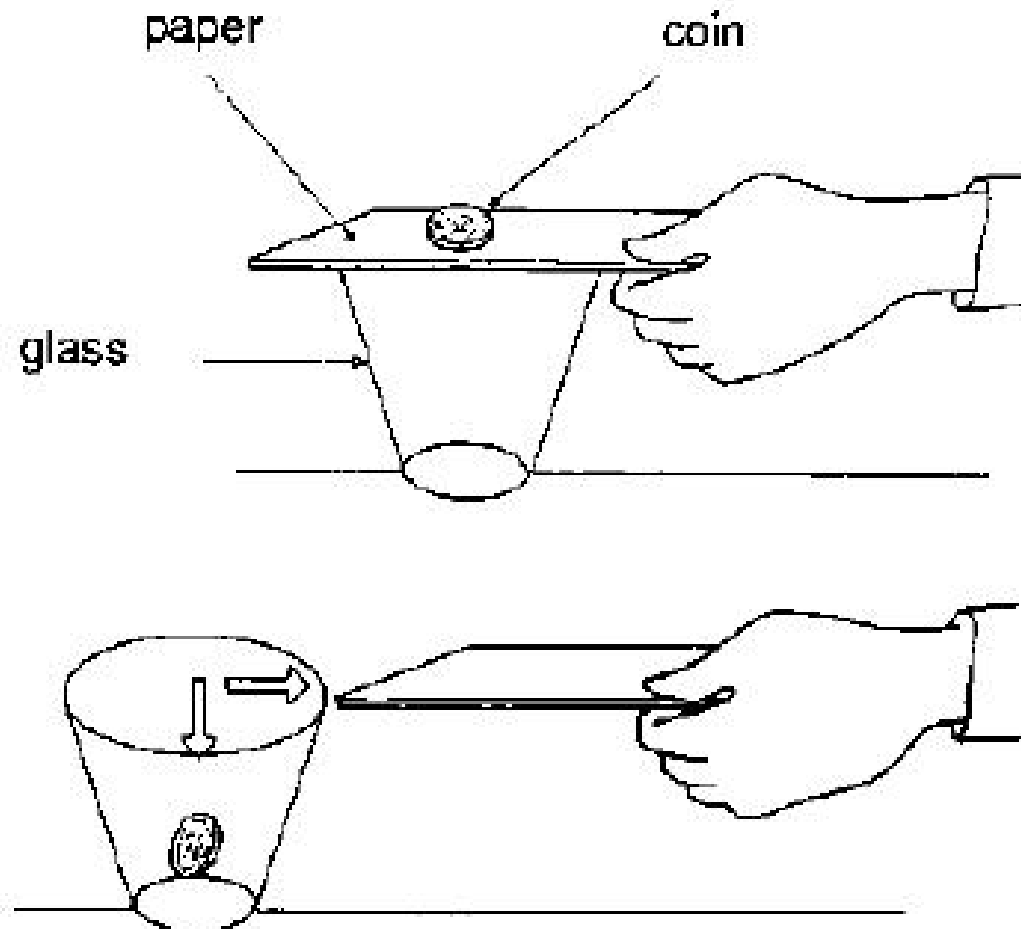



Observation:

The coin falls into the glass. It does not join the movement of the paper.

**Analysis:**

**If stationary bodies try to remain in a position of rest, then, once in motion, they should also try to remain in motion. They should resist to change their state of actual motion. This is, in fact, the case.**

Practical Use:

these principles can be observed with vehicles – cars, buses, trains, aeroplanes. If they suddenly stop, the passengers fall forward. If these vehicles start quickly, the passengers are pressed into their seats.

It is very dangerous to jump on or off a moving train, as our body hardly can balance the sudden change in motion.

Illusionists take advantage of the law of inertia, when they pull a table cloth off a set table as quickly as a flash of lightning. With a little everybody can do this too.

Further thought:



When one pulls slowly, the coin joins the movement of the paper. Why?

## 9.6. FRICTION

### Main Goal:

**These experiments demonstrate the principles of adhesive friction, sliding friction and rolling friction.**

### Information:

1. Friction is the result of mutual contact of irregularities in the surface of sliding objects.  
Three types of friction are distinguishable:

With **adhesive friction**, the force of friction is strongest. It decreases from **sliding friction** to **rolling friction**.

The strength of the frictional force depends on the surfaces of the bodies which rub against each other and on the weight of the upper body.

2. Adhesive friction causes two bodies to stick together.

Sliding friction counteracts the act of gliding.

Rolling friction is created when one body unrolls over another one.

The force of friction can be measured with a dynamometer.

### *Materials and Apparatus:*

*Materials and Apparatus:*

*2 brushes or brooms  
marbles or peas  
sand*

Procedure:

- a. As shown in the diagram, the two brushes are placed on top of each other.
- b. The upper brush is moved to the right side.
- c. The marbles are rolled over a smooth and a sandy (rough) ground. Their initial speed should be nearly the same.

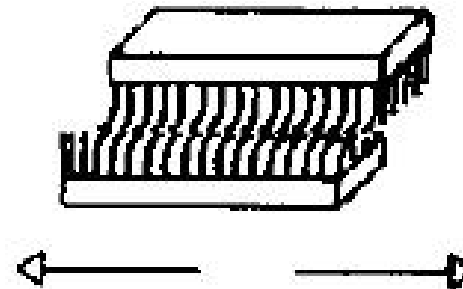

Observation:

- a. The bristles grip one another.

- b. The bristles of the upper brush are twisted to the left and those of the lower brush are twisted to the right side.
- c. The marbles roll further on the smooth ground than on the rough ground.

### **Analysis:**

**Observation (a) is called adhesive friction.**

**The irregularities or unevennesses of the two surfaces grip one another.**

**Observation (b) is called 'gliding friction'.**

**The unevennesses of the two bodies grip each other less strongly than with the adhesive friction.**

**Observation (c) is called 'rolling friction'.**

**Here, the unevennesses can grip each other to an even lesser extent than in sliding friction.**

**The strength of the respective frictional force basically depends on the surfaces of the two bodies, which is made clear in experiment c.**

### **Practical Use:**

For reduction of frictional forces, very smooth surfaces are used in technology. In addition, lubricants, e.g. oil and graphite, are used. Frictional forces should be minimized at those machine parts which move. However, often frictional forces are necessary. Tires need a certain depth of tread patterns, so that the car does not skid on a wet road.

certain depth of tread patterns, so that the car does not skid on a wet road.

The brakes should not be wet or oily, because this would greatly reduce the breaking action (friction).

A nail or a screw stays in a wall or in wood because of frictional forces.

Further thought:

When we walk, has this also to do with friction?

## 9.7. A HEAVER – A ONE-ARMED LEVER

**Main Goal:**

**With a one-armed lever, it can be demonstrated that a weight can be lifted more easily, the longer the force arm of the lever.**

Information:

In physics, a lever is a bar, which can turn about one point (axis). This point is called the fulcrum.

The fulcrum of a one-armed lever lies at its end.

Load arm and force arm of a one-armed lever are resting on the top of one another. Thus, the two forces attack the same side of the lever.

The lever principle is:

$$\text{force} \times \text{force arm} = \text{load} \times \text{load arm}$$

*Materials and Apparatus:*

*one heavy stone or a heavy object as load*  
*one stable wood lath or iron rod*

*Procedure:*

The stone is lifted with the wooden lath as shown in fig. a).

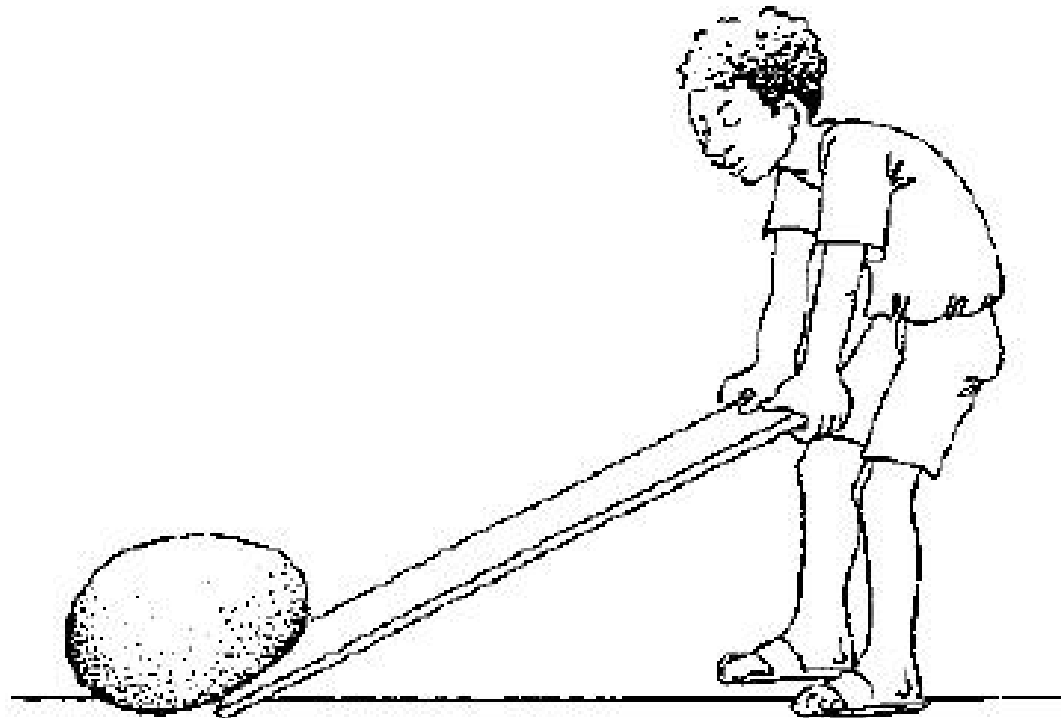

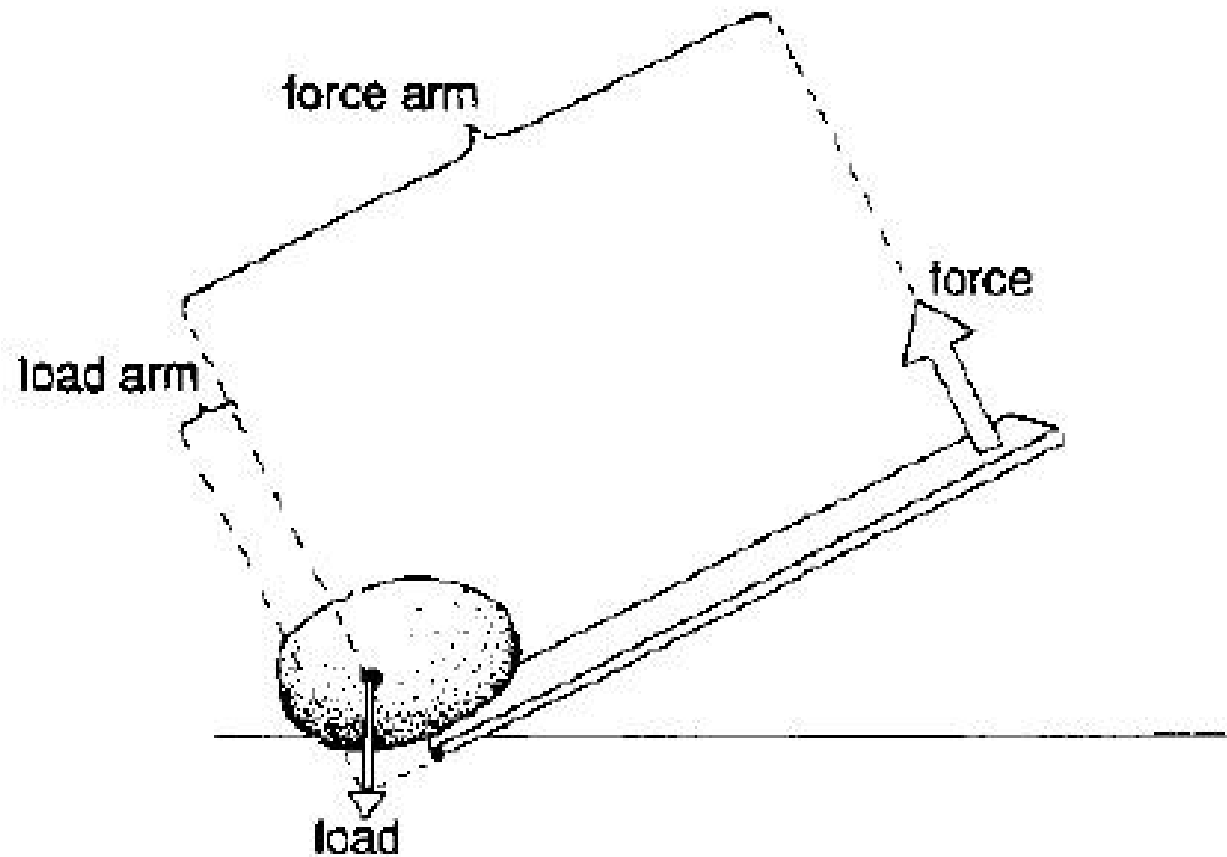

Observation:

The longer the lever, the greater the distance between the fulcrum and the end of the heaver, and the less force is needed to lift the stone.

Analysis:

161

<http://cd3wd.com/dvd/> - filename: z\_science\_exp\_167 of 598

If the lever is in a state of balance, the product of load (weight of the stone) and load arm equals the product of force and force arm.

(A dynamometer is needed to check this principle. It measures the force held against the load.)

Practical Use:

Examples for one-armed levers include:  
a wheel-barrow and a nutcracker.

Further thought:

If we are rowing a boat, do we apply the law of levers?

## 10. ELECTRICITY

### 10.0. THE SCIENCE OF ELECTRICITY

Before we look in detail at the following experiments, here are some suggestions relating to the necessary materials and apparatus.

As the equipment used is always very similar, it is practical to build up one basic board and to put together basic equipment.

N. B.

N. B.

The experiments performed with batteries, can also be performed with a transformer.

(Batteries pollute the environment and are expensive)

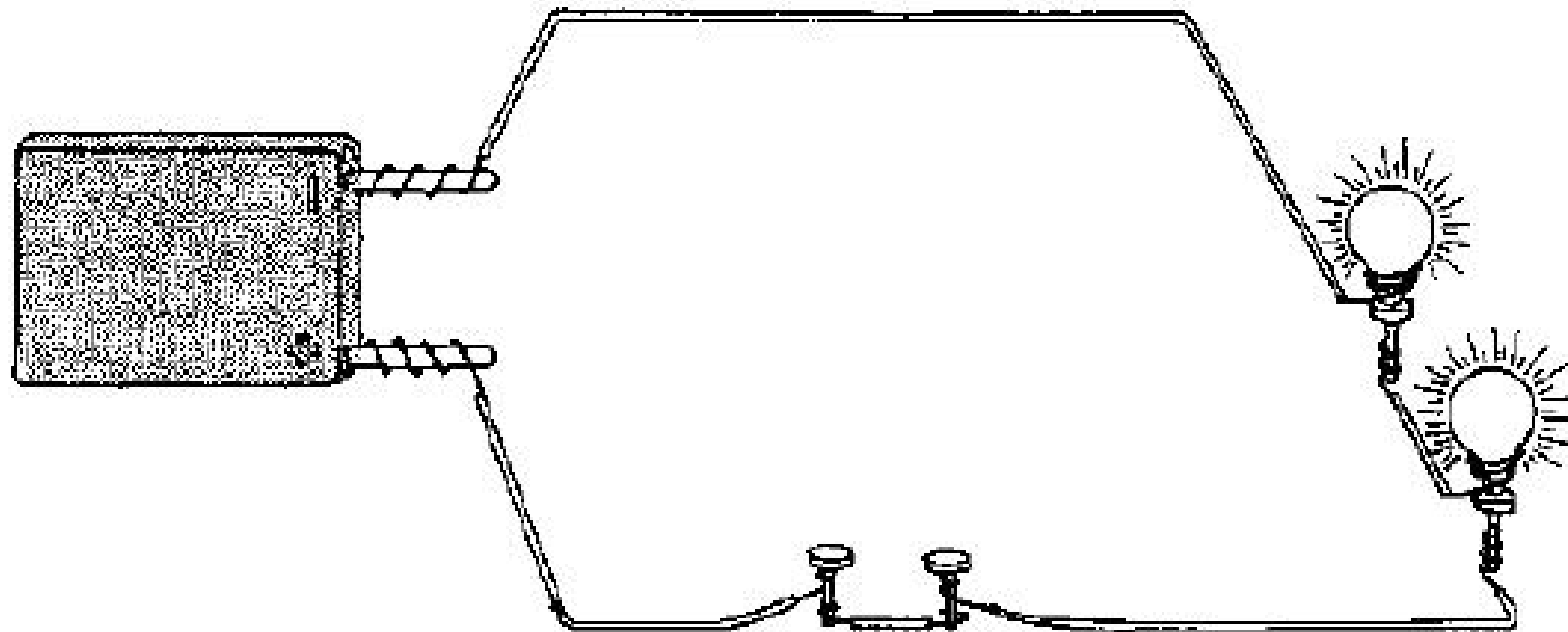

## SUGGESTIONS FOR "SCIENCE OF ELECTRICITY"

### a. MATERIALS

- batteries : flat and round batteries
- small light bulbs : e.g. from flashlights
- metal sheet : thin, made of copper, aluminium, or iron



- wire : single core, length as required
- clothes peg : made of wood or plastic
- drawing-pin, paper clips, different kinds of iron nail,
- screws rubber bands (broad)
- knife, pair of scissors, hammer, screw-driver, pair of pliers.

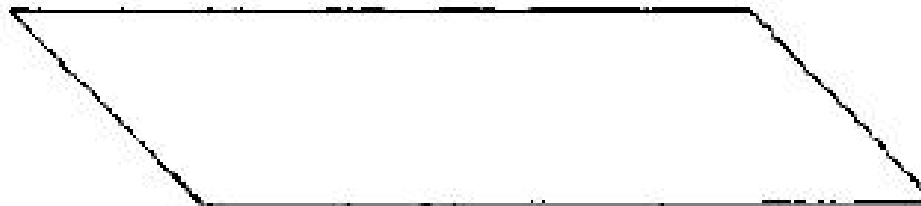
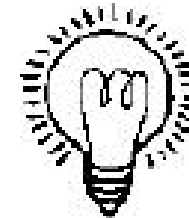
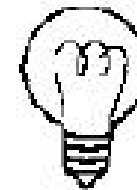
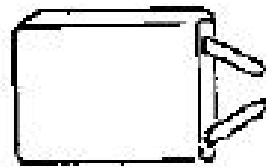



b) Suggestions for the base-plate

base-plate  
flat battery  
metal sheet  
screw

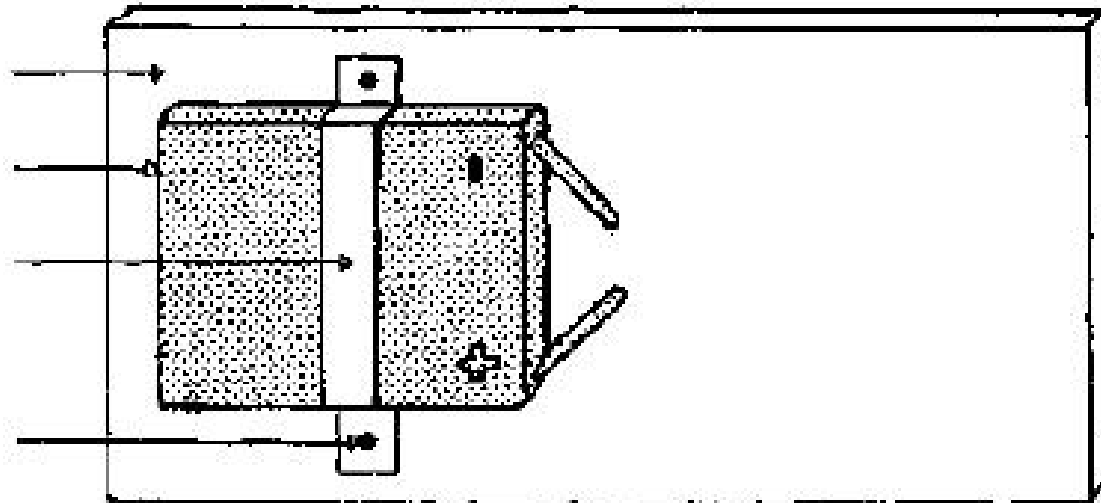

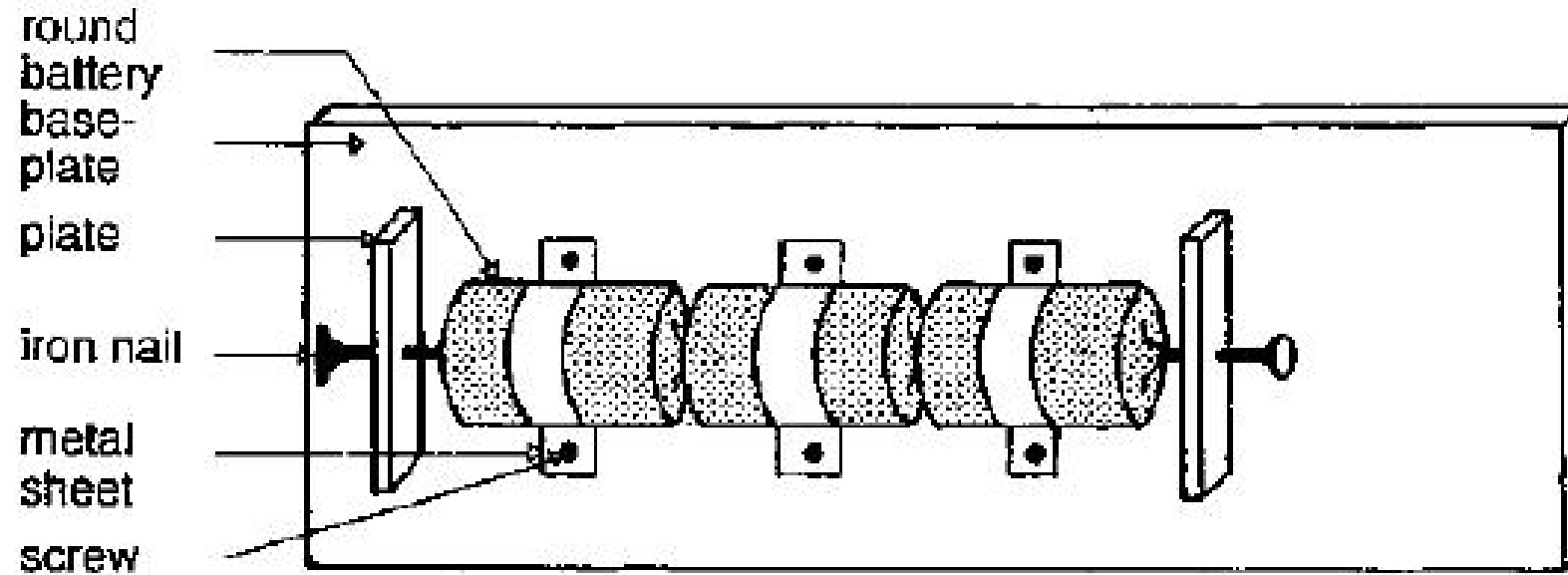

c) Suggestions for the sockets

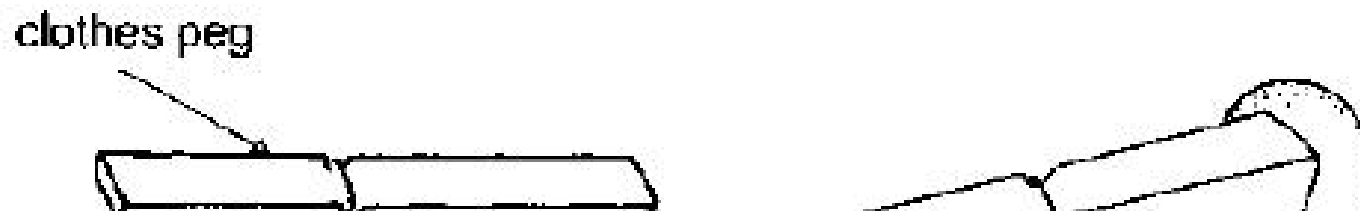
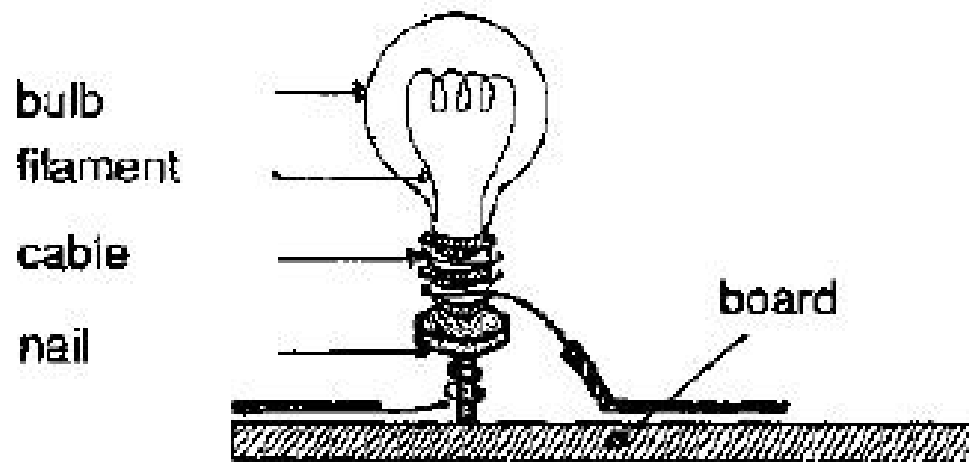

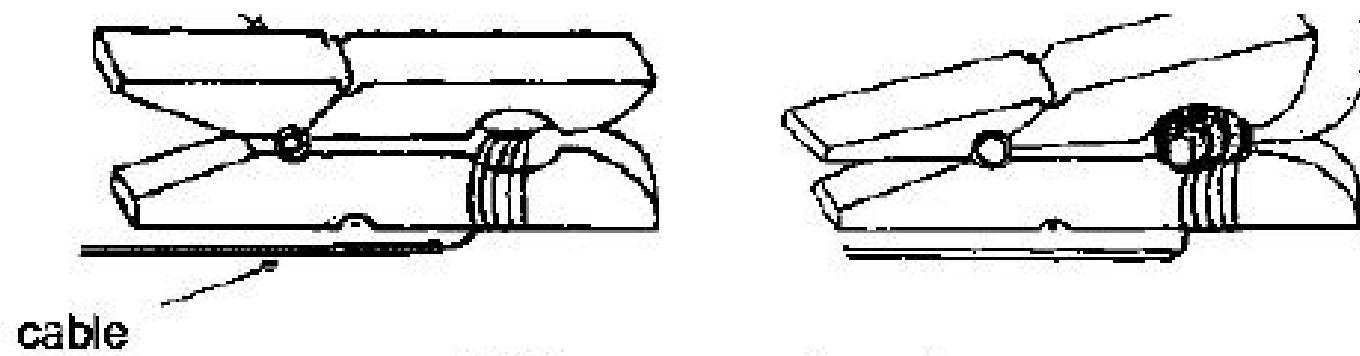

Clothes peg used as clamp

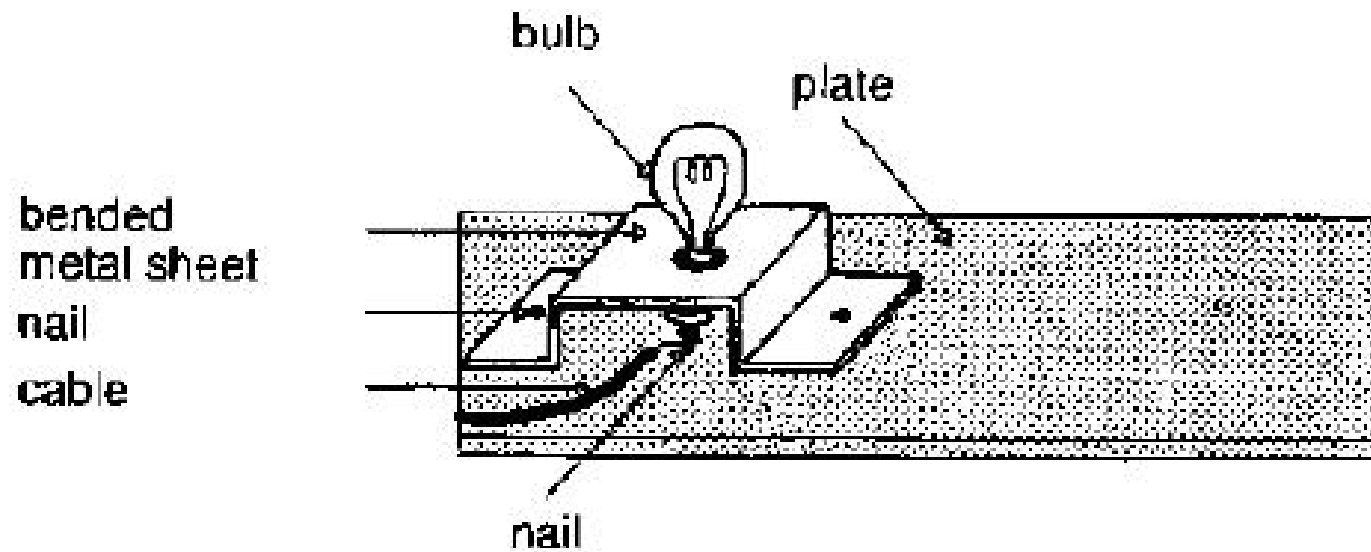

d) Suggestions for the switches

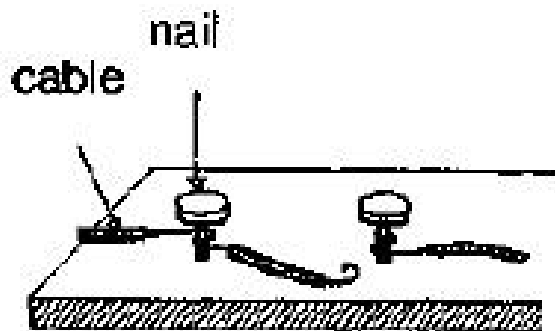

simple switch: off

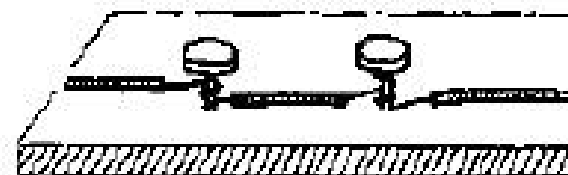

simple switch: on

metal sheet

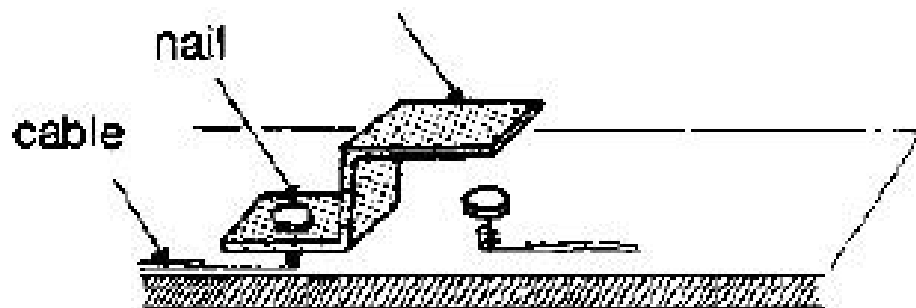

press-switch: off

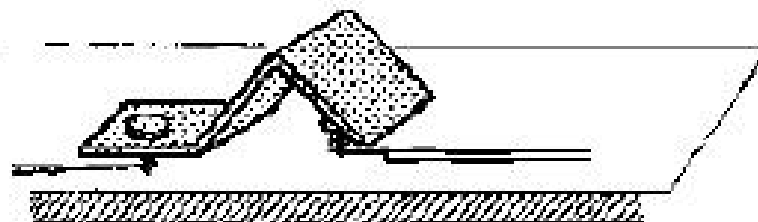

on

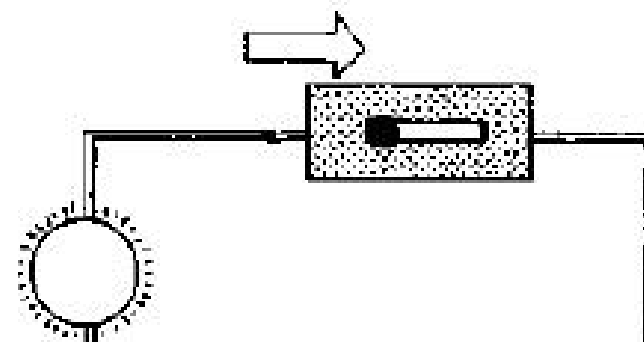
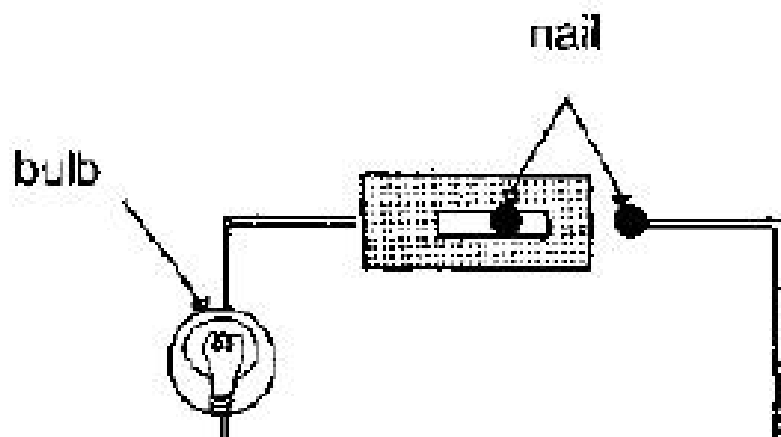

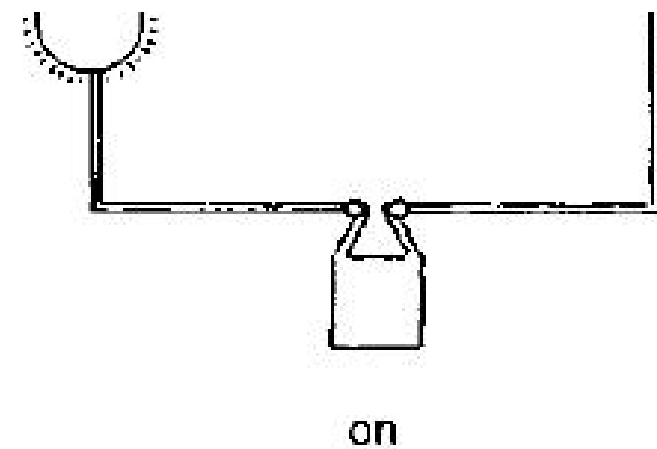
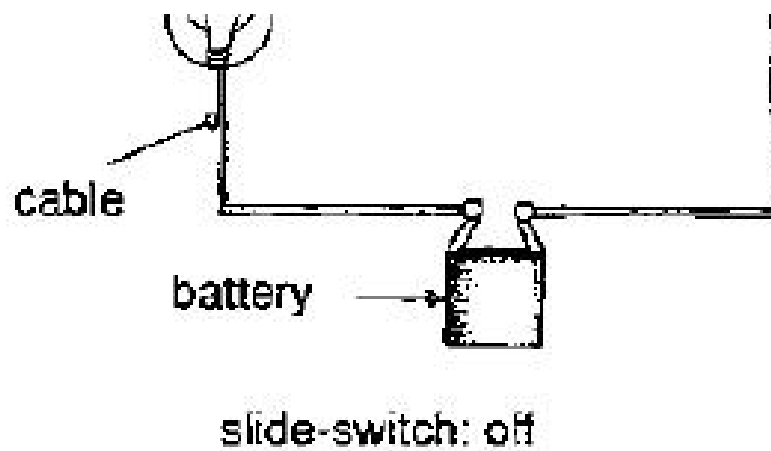

### 10.1. A JET OF WATER IS DEFLECTED

#### Main Goal:

The following experiment demonstrates static electricity, which can be found when a non-conductor is charged due to friction.

#### Information:

Various non-conductors, e.g. rubber, glass, plastic, can be charged electrically by rubbing them with a woollen leather or nylon cloths.

Friction causes an electron surplus or deficiency, depending on the material. (The material, used to rub the non-conductor takes on the opposite electric charge.)

This specific charge is retained for a short period, so that the influence – electrical attraction

or repulsion – may be illustrated.

The experiments can be performed best in very dry air.

*Materials and Apparatus:*

*2 pieces of plastic sheeting, plastic bags, wool cloth  
plastic comb, ball-point pen...  
woollen cloth  
jet or water from a water-pipe or a tin  
2 balloons*

*Procedure:*

a. The sheeting or bags are rubbed vigorously with a woolen cloth and then brought close together.

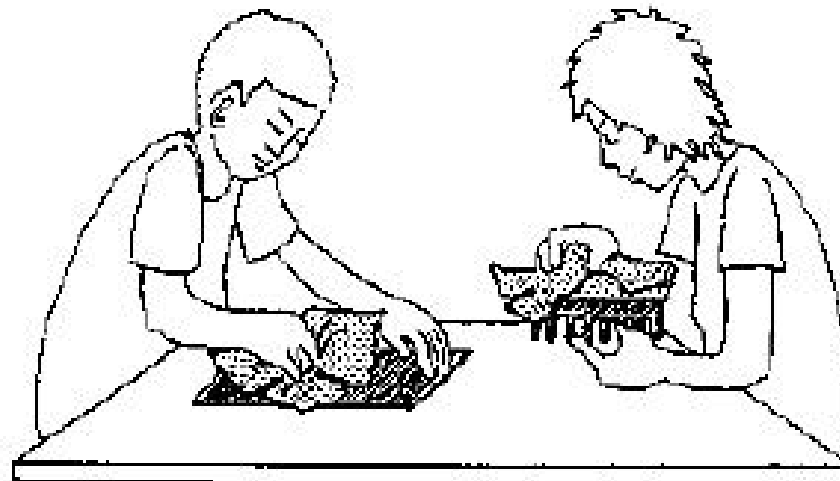

b. One piece of sheeting or bag is charged by rubbing vigorously. A finger is then held very close to it

b. One piece of sheeting or bag is charged by rubbing vigorously. A finger is then held very close to it.

c. The comb is rubbed vigorously with a woollen cloth and then brought close to a thin jet of water.

d. Inflate two balloons, rub them at your woolen pullover and try to get two balloons close together.

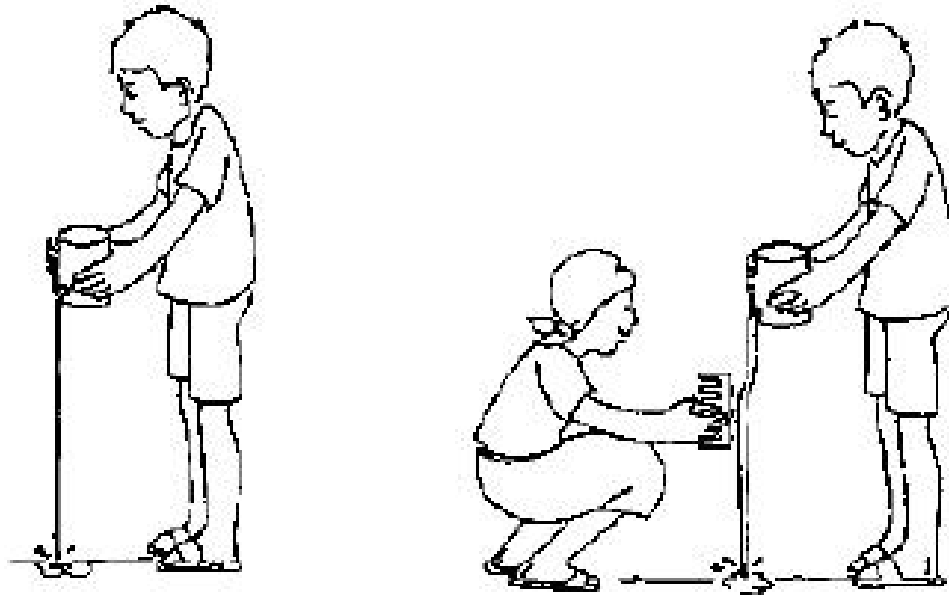

Observation:

- The sheeting or bags repel each other. They do not touch.
- A crackle can be heard. In a darkened room sparks can be seen.
- The jet of water is attracted by the comb.



d. You feel a repelling force.

**Analysis:**

- a. The sheeting/bags carry the same type of charge and repel each other.
- b. Friction of non-conductors produce high voltage electricity. It breaks down immediately when a spark leaps and is not dangerous.
- c. The plastic comb and the jet of water have the opposite electric charges and attract each other.
- d. The same type of charge on the balloons cause them to repel each other.

**Further thought:**

You can put a charged balloon on a wall. It sticks to it. What is the reason?

## **10.2. A SIMPLE CIRCUIT**

**Main Goal:**

**This experiment teaches pupils how a simple circuit is built and how it works.**

**Information:**

When electric charge moves in a circuit, it does work. The rate at which this work is done is called power. Electric power (in watts W) is equal to the product of current (in amperes A) and

When electric charge moves in a circuit, it does work. The rate at which this work is done is called power. Electric power (in watts W) is equal to the product of current (in amperes A) and voltage (in volts V) across the circuit.

Thus power = current  $\times$  voltage,  
in units watts = amperes  $\times$  volts.

A simple circuit can be demonstrated with the help of a battery and a small light bulb.

*Materials and Apparatus:*

*battery (about 4.5 V)*  
*small light bulb (about 2.2 V)*

**Procedure:**

The circuit is closed as illustrated in the diagram below.

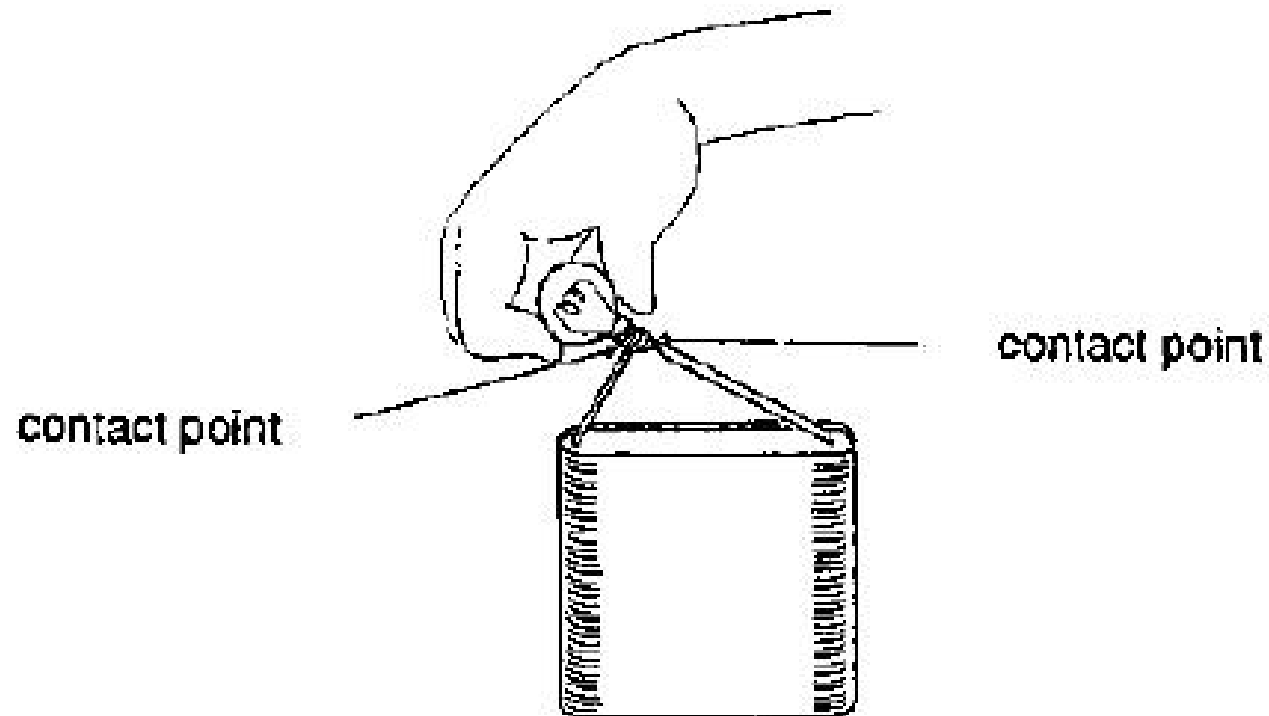

Observation:

The lamp lights up if each of the two contact points are connected with one of the poles.

**Analysis:**

**A simple circuit consists of a battery, that provides the voltage, and of a power consumer, in this case a small light bulb. Electric current only flows if the circuit is closed. When the small bulb lights up, the circuit is closed.**

Practical Use:

Practical Use:

see "Main Goal".

Further thought:

The electric current that flows in the circuit consists of electrons. Where do they originate?

### 10.3. THE PRINCIPLE OF A FLASHLIGHT

**Main Goal:**

**This experiment demonstrates that switches can close and interrupt circuits.**

Information:

Switches connect contacts. Those which are known from the household and engineering include slide switches, rotary switches and button switches.

*Materials and Apparatus:*

*see suggestions "SCIENCE OF ELECTRICITY"*

Procedure:

A circuit is set up as shown in the following diagram. The circuit is closed or interrupted with the switch.

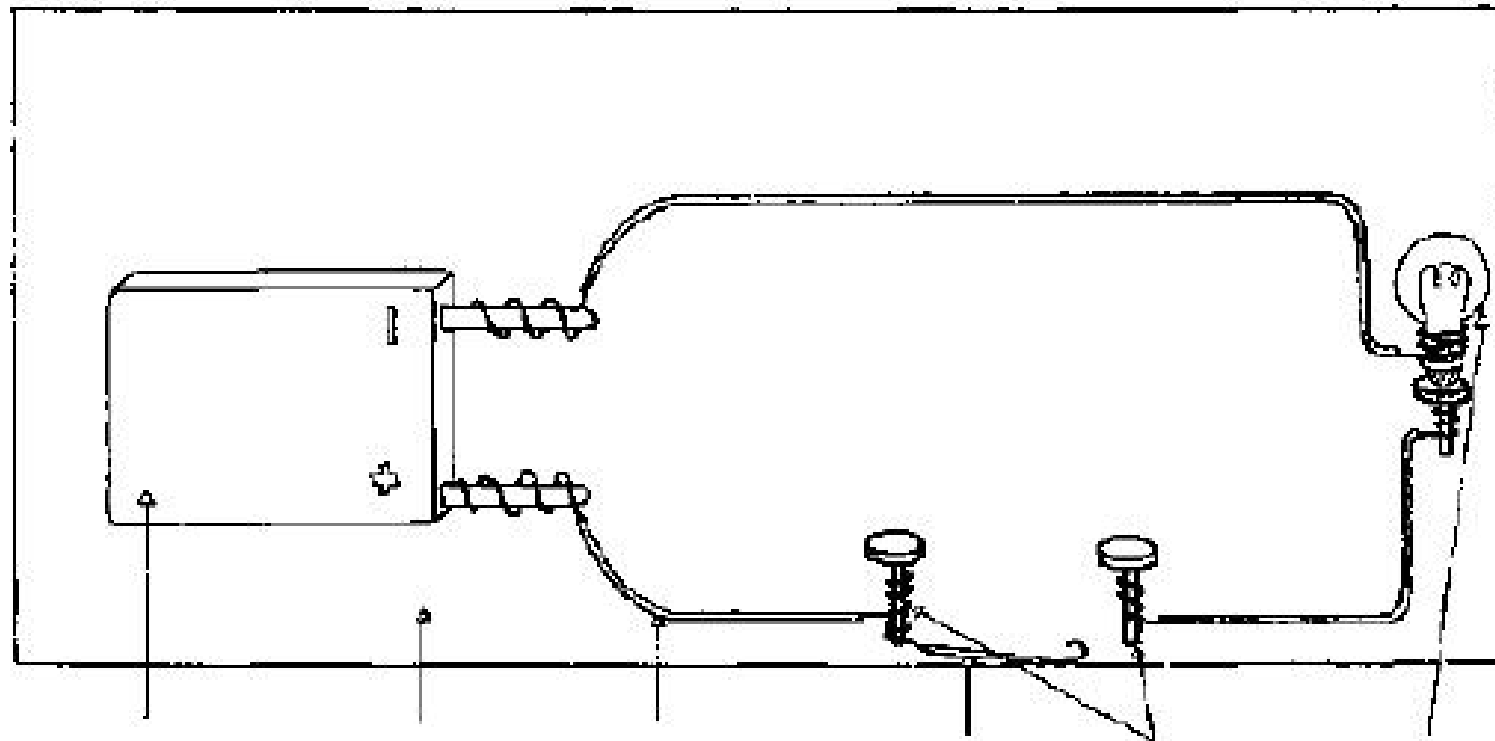

battery  
wood or cardboard      conduction      switch drawing-pins bulb

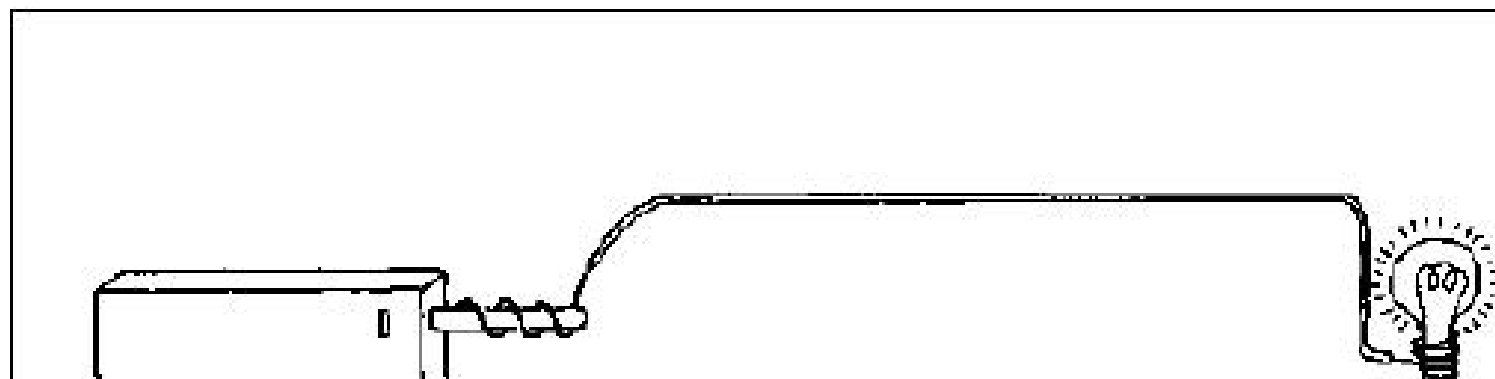

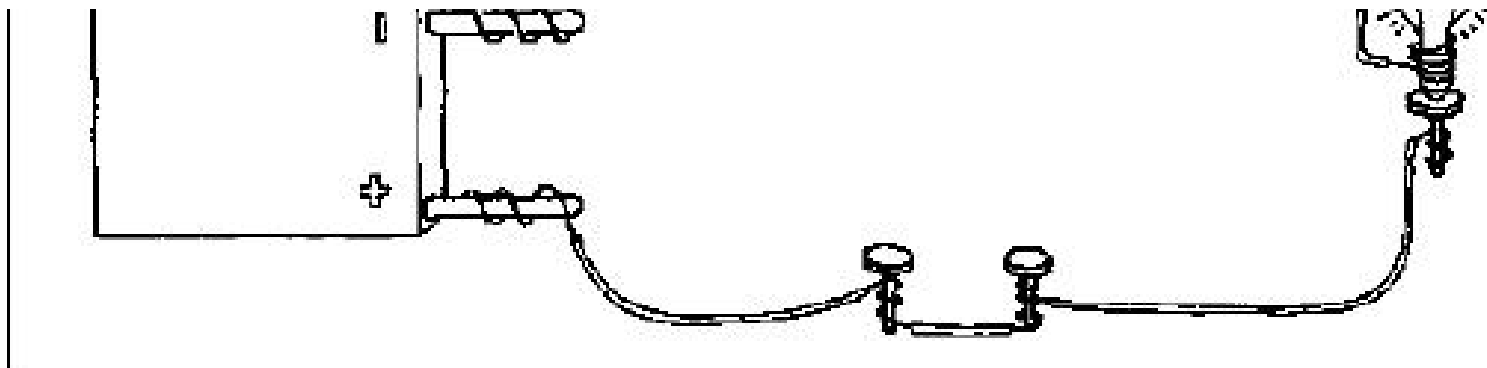

Observation:

The bulb lights up if the switch is connected with the two drawing-pins. The bulb lights off when the switch is 'opened'.

**Analysis:**

**Switches can close or interrupt circuits.**

**They connect or interrupt two conducting parts of a circuit.**

**There is no current when the switch is off.**

**Wood or cardboard seem not to be able to conduct electric current.**

Practical Use:

see "Main Goal".

169

<http://cd3wd.com/dvd/> - filename: z\_science\_exp\_175 of 598

Further thought:

Is there any voltage in the circuit even when the switch is off?  
Is any current possible without voltage?

#### 10.4. CONDUCTOR AND NON-CONDUCTOR

**Main Goal:**

**The pupils learn about the classification of materials as good conductors, not so good conductors, and non-conductors.**

Information:

Metals conduct an electric current very good. Non-metals may be moderate conductors (like ordinary water or wet wood) or bad or very bad conductors (like glass, hard rubber or quartz).

The conductivity is dependant on free electrons.

The flow of current can be equated with the flow of electrons.

(The word "electricity" comes from the Greek word "elektrum" meaning amber. Static electricity was first discovered with amber.)

*Materials and Apparatus:*

*see suggestions – "SCIENCE OF ELECTRICITY".  
See the following chart and select a few materials to test!*

see suggestions – "SCIENCE OF ELECTRICITY".  
See the following chart and select a few materials to test.

Procedure:

A circuit is set up as shown in the following diagram.  
The materials to be tested are connected up between the two iron nails.  
A material conducts electricity when the bulb lights up.

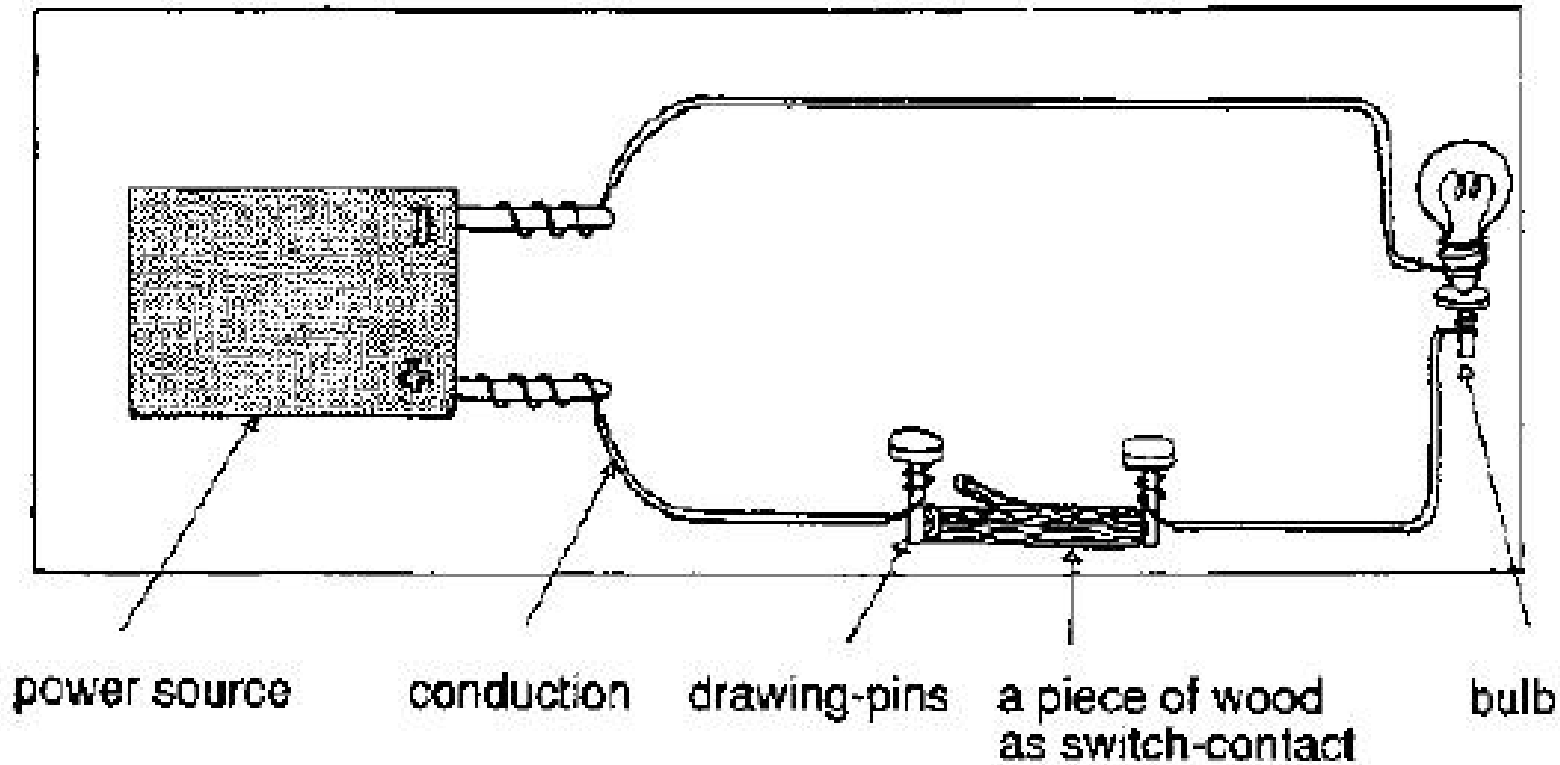



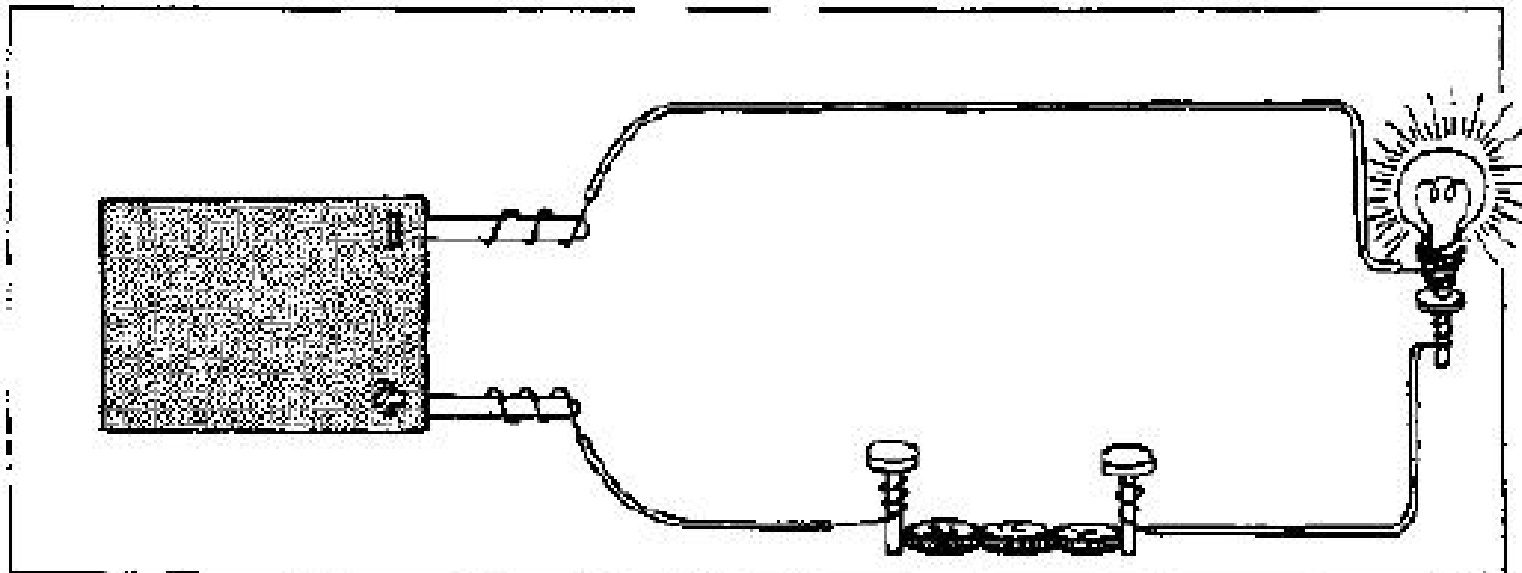

Observation:	material	conducts current	does not conduct current	conducts a little
	wood		-	
	glass		-	
	yarn		-	
	rubber		-	
	paper		-	
	plastic		-	
	coal	+		

coal	+	
paper clip	+	
coin	+	
nail	+	
cigarette paper		
(metal foil)	+	
water		0
wet wood		0

**Analysis:**

**It depends on the material, how good or bad current is conducted.**

**Practical Use:**

Materials which conduct current are insulated with materials which are very bad conductors. Thus, a voltage drop, short circuit, and electro-cution are prevented.

**Further thought:**

Sometimes not good conduction is required, but good non-conduction. So, what kind of material is used as isolators?

## 10.5. SERIES CONNECTION

### Main Goal:

**This example teaches younger pupils the principles of a series connection, in which several consumers are connected up one after the other. The observations are not analysed in detail. Older pupils learn Ohm's law and the meaning of partial resistors.**

### Information:

Electric power consumers are 'consumers' because they convert electric power into heat power or light power. The property that enables 'consumers' to such conversion is called electric resistance. Circuit elements with appreciable resistance are called resistors. Bulbs are such resistors.

If several bulbs – resistors – are connected in series, they scarcely shine if at all.

This is due to the fact that the strength of the current, which is equally large at each partial resistor, drops. To calculate the current, Ohm's law is used.

### *Materials and Apparatus:*

*see suggestion "SCIENCE OF ELECTRICITY"*

### Procedure:

The circuit is set up as shown in the following diagram.

a. One, then two, then three small bulbs, etc., are connected in series.

a. One, then two, then three small bulbs, etc., are connected in series.

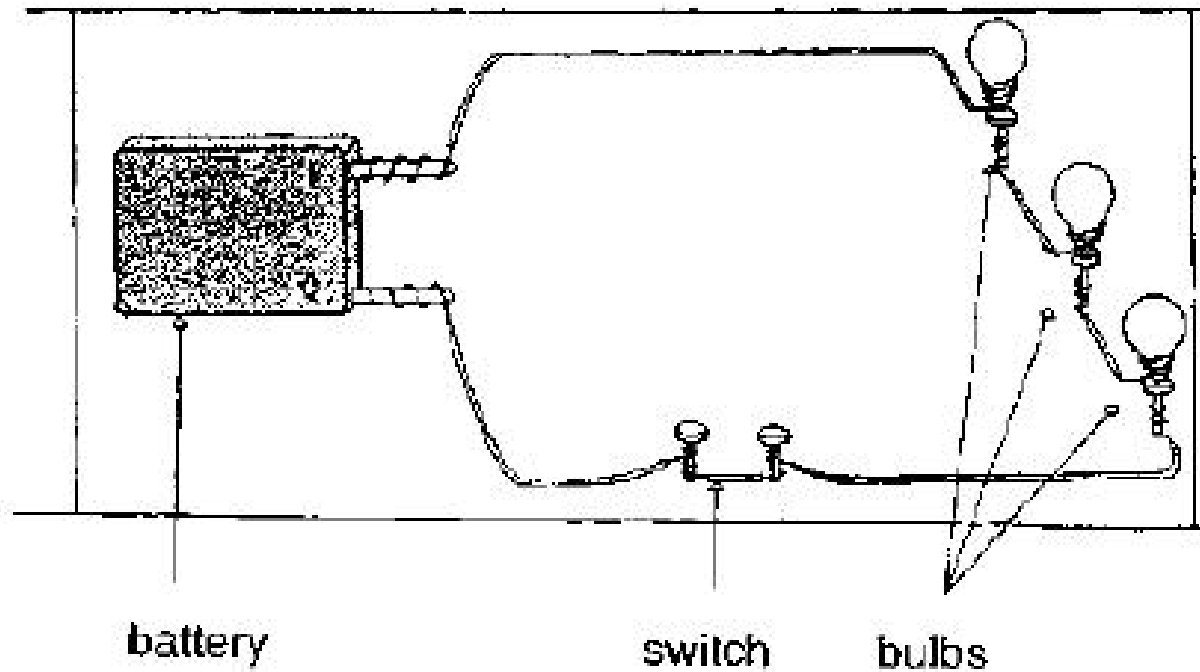

b. When the switch is closed one of the small bulbs are unscrewed then another and so on.

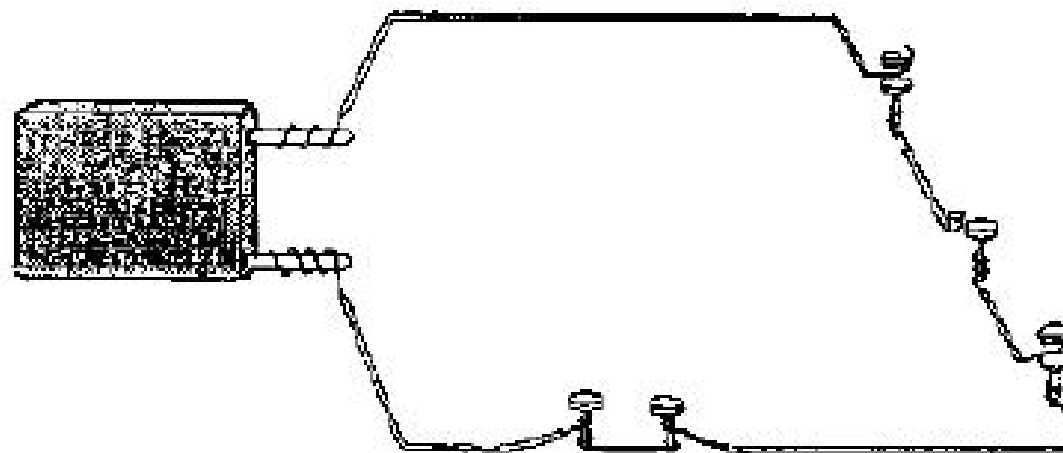

Observation:

- a. The bulbs shine less brightly after every additional connection, until they finally do not shine at all.
- b. If one bulb is unscrewed, all bulbs go out.

**Analysis:**

- a. The strength of the current sinks gradually, so that it is finally not strong enough to make the bulbs light up.**
- b. The circuit is interrupted if one bulb is unscrewed.**

**This means: the bigger the resistance, the smaller the current.**

Practical Use:

see "Main Goal"

Further thought:

But what will happen in case the current is not strong enough anymore to make the bulbs light up, when we take a battery that delivers higher voltage?

## 10.6. PARALLEL CONNECTION

## 10.6. PARALLEL CONNECTION

### Main Goal:

**This example teaches younger pupils the principle of parallel connection. The observations made are not analysed in detail.**

**Older pupils learn Ohm's law in combination with Kirchhoff's law.**

### Information:

If two bulbs – resistors – are connected in parallel circuits, they shine with equal intensity. This is due to the fact that two or more separate circuits exist.

To calculate the current at each resistor, Ohm's law is used.

### *Materials and Apparatus:*

*See suggestions – "SCIENCE OF ELECTRICITY"*

### Procedure:

A circuit is set up as shown in the following diagram.

- a. The small bulbs are connected in parallel circuits.
- b. When the switch is closed, the small bulbs are alternatingly unscrewed.

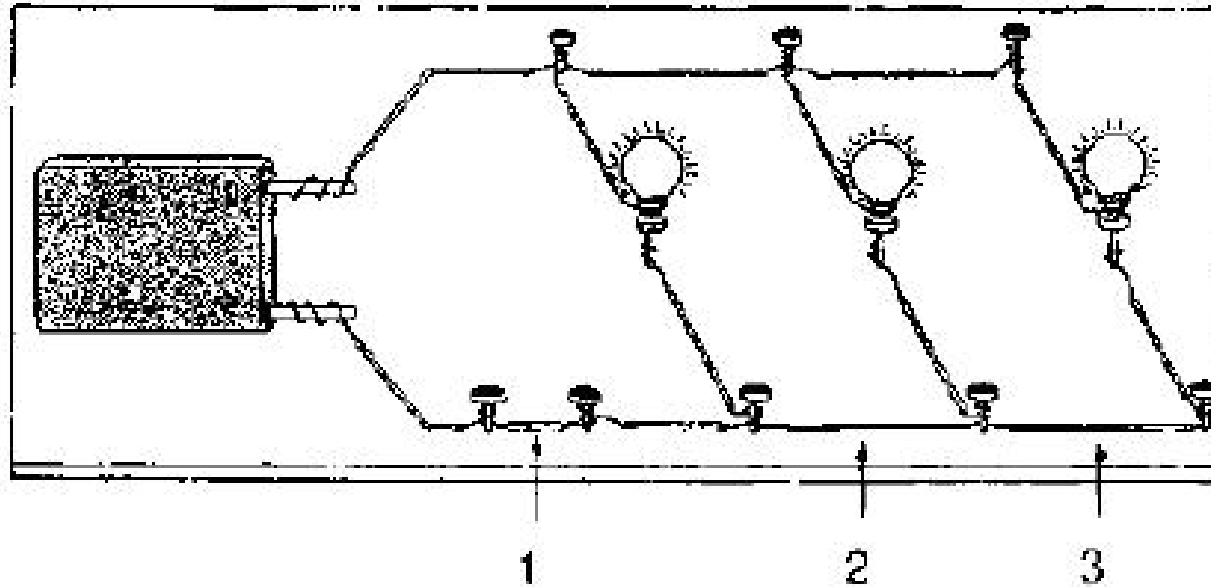

Observation:

- a. The small bulbs light up with equal intensity.
- b. If one bulb is unscrewed, the others still burn.

Analysis:

**Every parallel connection forms an independent circuit. The current through each bulb is only dependant on the output of the battery (i.e. the voltage) and the resistance of the bulb.**

Practical Use:

In all households, outlets and switches are connected in parallel circuits. The electricity meter

In all households, outlets and switches are connected in parallel circuits. The electricity meter is placed in the non-branching part of the electric power supply system. The complete amount of electric current used, runs through the meter (1st law of Kirchhoff).

Because the voltage is standard (220 V or 110 V), power (= voltage × current) times the time for which the power is used in the household is what we have to pay for:

$$\text{power} \times \text{time} = \text{electrical energy}$$

The electrical energy is measured in wattseconds (ws) or kilowatthours (kwh).

Further thought:

What happens when the circuit is interrupted, e.g. at the point 1, or 2, or 3 in the drawing?

## 10.7. ELECTRICAL CURRENT PRODUCES HEAT

**Main Goal:**

**This experiment demonstrates that electrical energy can be transformed into heat.**

**Information:**

If electricity flows through a conductor, the conductor is heated. Depending on the material of which the conductor is made on the voltage, and on the current, the conductor is heated more



or less. In heating instruments a special resistance wire – “constantan wire” – is used. It does not fuse at high temperatures and has a high resistance, which is hardly dependant on temperature.

*Materials and Apparatus:*

*See suggestions – “SCIENCE OF ELECTRICITY”*

*resistance wire (constantan wire)*

*2 iron nails*

*15 V battery (or several batteries connected in series)*

*styrofoam (wood)*

*Procedure:*

A circuit is set up as shown in the following diagram.

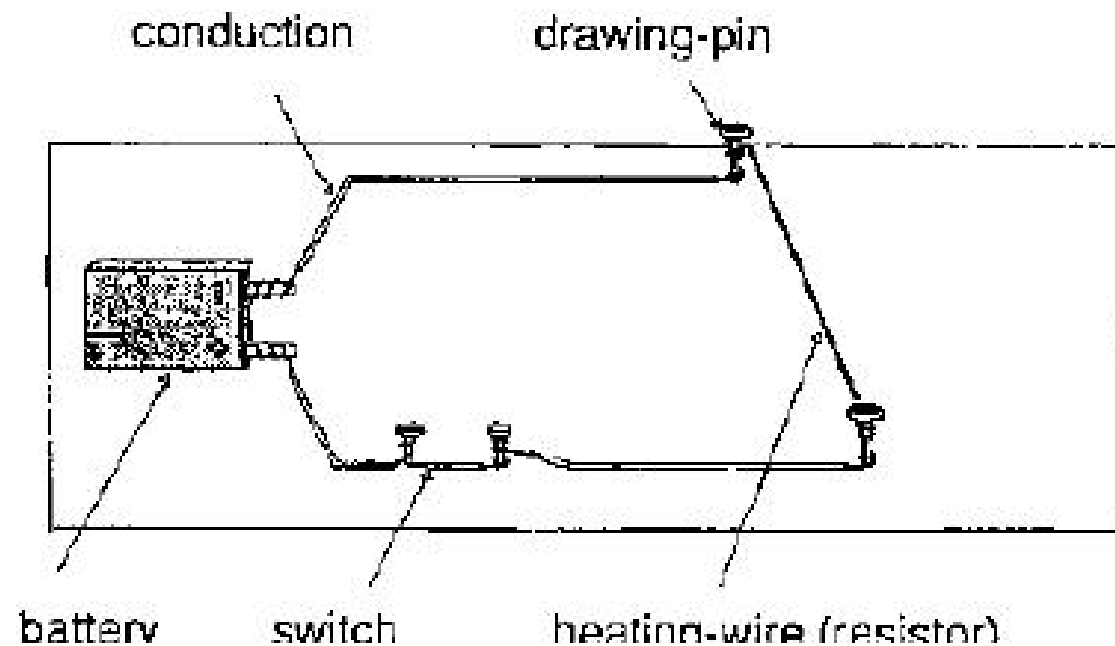

battery

switch

heating-wire (resistor)

When the heating wire is red glowing, it can cut the styrofoam or singe the wood.

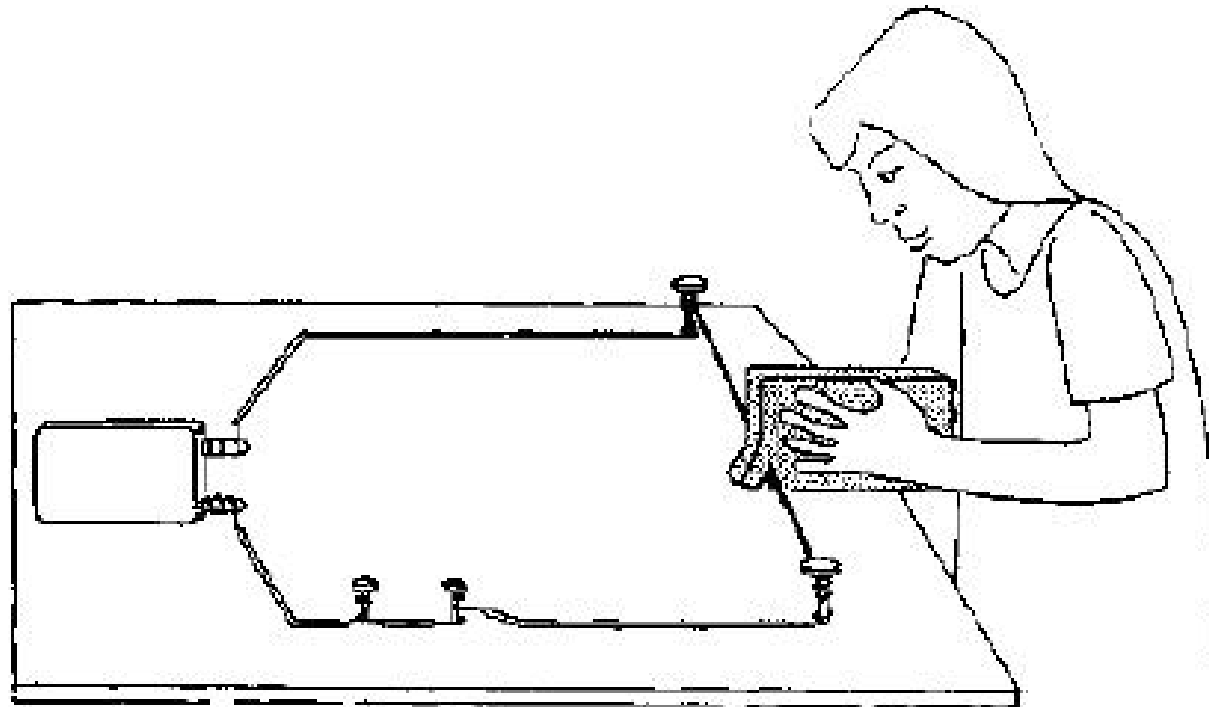

Observation:

The heating wire becomes hot, so that it cuts the styrofoam or singes the wood.

Analysis:

175

<http://cd3wd.com/dvd/> - filename: z\_science\_exp\_181 of 598

**Electrical current produces heat in resistors or power consumers.**

Practical Use:

In the household, a lot of electrical appliances are used which produce heat, e.g.:

- electric heater
- hot-plate
- immersion heater

Further thought:

Sometimes you hear someone say that the electric current in a circuit is used up. Is it really the current, i.e. the flow of electrons, that's 'used up', or what?

## **10.8. THE PRINCIPLE OF AN ELECTROMAGNET**

**Main Goal:**

**The experiment demonstrates the magnetic effect of an electrical current.**

Information:

A current-carrying coil has the same effect as a permanent magnet. If a non-magnetic iron core is placed in the centre of the coil, it too becomes a magnet. The magnetism is intensified by increasing the number of times the coil is wound round the core.

*Materials and Apparatus:*

*see suggestions – "SCIENCE OF ELECTRICITY"*

*iron nail*

*light pieces of iron*

**Procedure:**

A switch circuit is set up as shown in the following diagram.

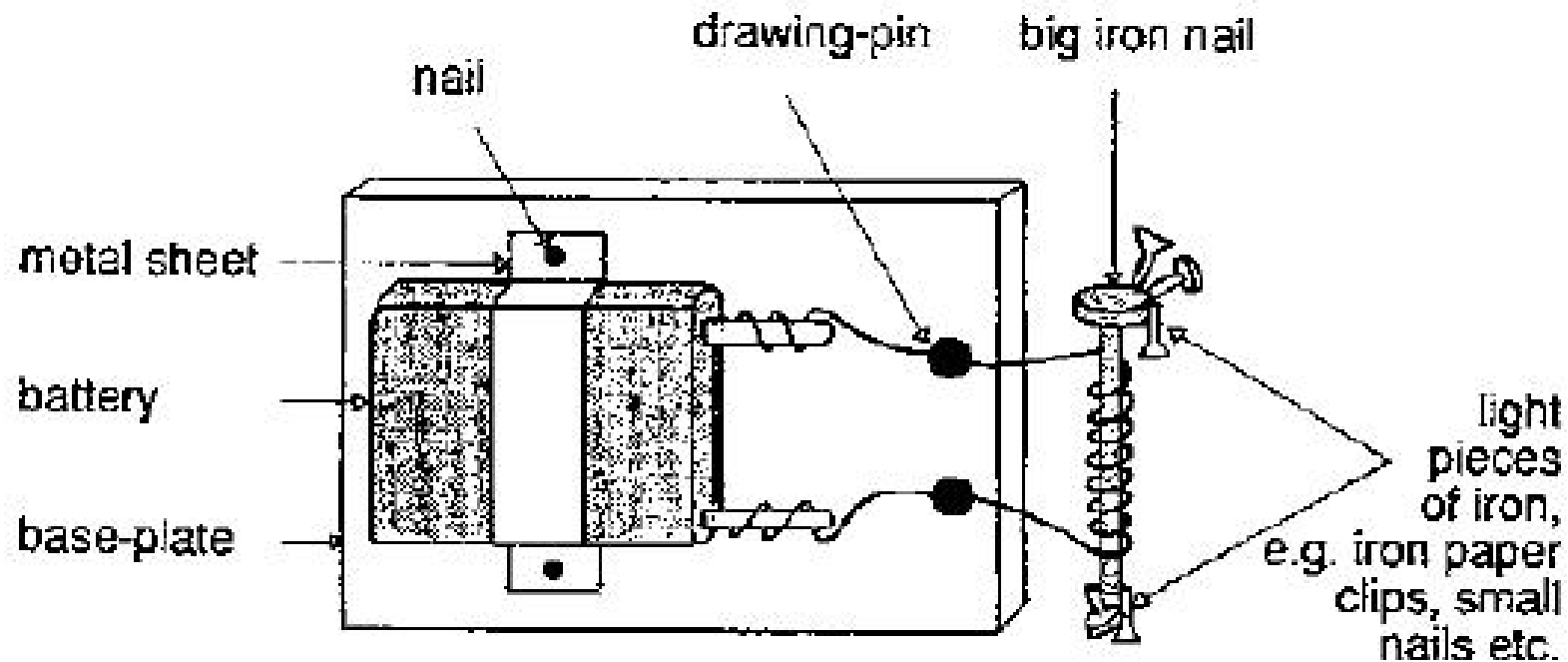

Some experiments which can be performed:

- Try to attract the lighter pieces of iron with the iron nail.
- The pieces of iron can be attracted with the current-carrying coil.
- The big iron core (nail) is placed in the coil.
- The number of times the coil is wound round the nail is increased or decreased.

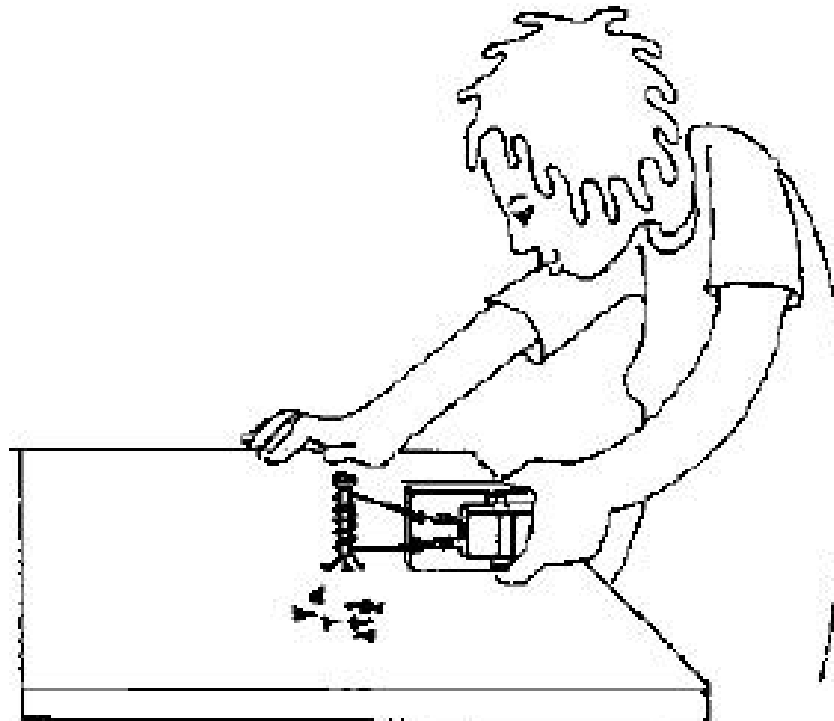

Observation:

- The non-magnetic iron nail does not attract the iron pieces.
- The current-carrying coil attracts the lighter pieces.

- The current-carrying coil attracts the lighter pieces.
- The attraction is increased with the addition of the iron core.
- The attraction is increased or decreased.
- Small current means little attraction, large current strong attraction.

### **Analysis:**

**A coil with an iron core is called an electromagnet. Its attractive power is greater, the higher the number of coil windings and the larger the current. An electromagnet loses almost all its effect when switched off. No current, no magnetic effect.**

### **Practical Use:**

With the help of an electromagnet, iron pieces are transported and sifted out from other metals.

Electromagnets are also used in many electrical appliances. They either close a circuit, as a bell, or interrupt the circuit, as in an electric fuse.

### **Further thought:**

A permanent magnet (e.g. a horse shoe magnet) has a magnetic North-Pole and a magnetic South-Pole. What's about poles of an electro magnet?

## 10.9. THE PRINCIPLE OF A BIMETALLIC STRIP

### Main Goal:

The experiment demonstrates the behaviour of a bimetallic strip when heated.

### Information:

Bimetals consist – as the name suggests – of two strips of different metals, which are either rivetted or soldered together. When heated, a bimetallic strip bends due to the different expansion properties of the different metals.

### *Materials and Apparatus:*

*1 copper and 1 iron strip and 1 aluminium strip and  
1 iron strip (of the same strength)  
hammer  
pair of pliers  
alcohol burner, gas burner or a candle*

### Procedure:

Two metallic strips are joined by twisting their ends as shown below.



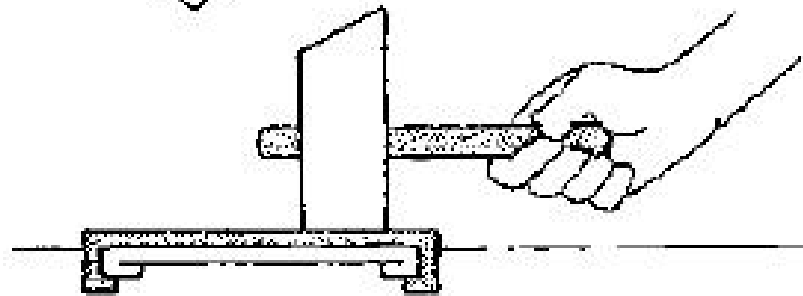
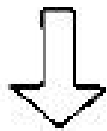
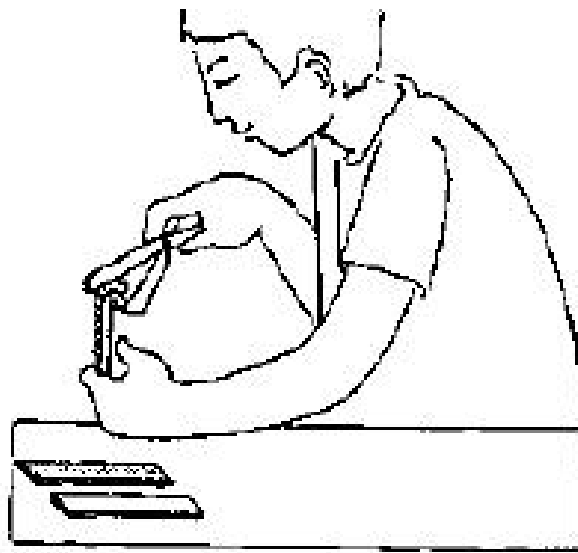

The strips are then hammered flat.



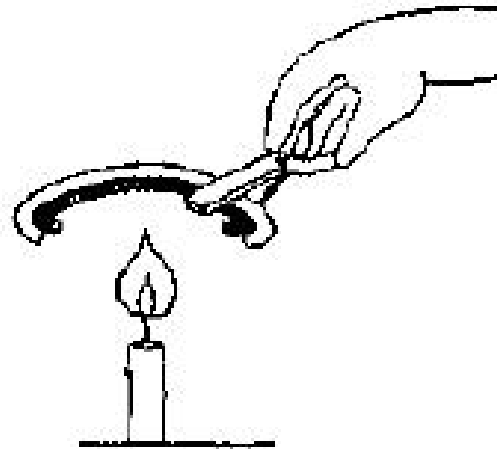

copper strip

aluminium strip



iron strip

iron strip

The bimetallic strip is held in a flame.

Observation:

The bimetallic strip bends when heated.

Analysis:

The copper and the aluminium strip expand more than the iron strip.

Practical Use:

Practical Use:

Bimetallic strips are used wherever it is necessary to interrupt an electrical contact at a specific temperature.

The circuit is interrupted, when the bimetallic strip is twisted.

Thus, bimetallic strips serve in thermostats. They are used in irons, ovens, electrical fuses, refrigerators, etc.

Further thought:

How would you construct a switch (e.g. a thermostat) by the help of a bimetallic strip?

## 11. OPTICS

### 11.1. A CONVEX LENS

**Main Goal:**

**This experiment shows the course of the rays of a convex lens or condensing lens.**

Information:

Convex lenses are thicker in the middle than at the edges. Rays which are parallel to the optical axis, are refracted by a convex lens in such a way that they focus again behind the lens at the focal point. However, the marginal rays are refracted more than those rays which are closer to the optical axis.

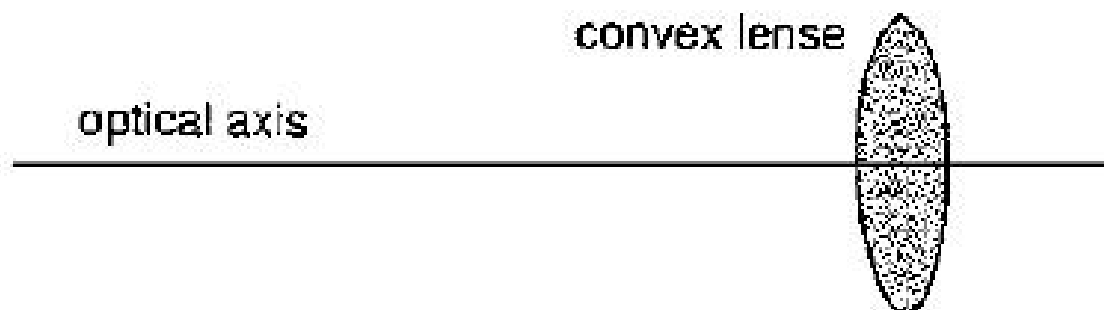

*Materials and Apparatus:*

*magnifying glass –  
(one spectacle–lens for long–sighted people)  
flashlight (maybe a candle)  
rack made of wire for the flashlight*

*Procedure:*

The apparatus is set up as shown in the diagram below.  
The room is darkened and the path of the rays observed.  
This is possible when cigarette smoke is blown into the beam.



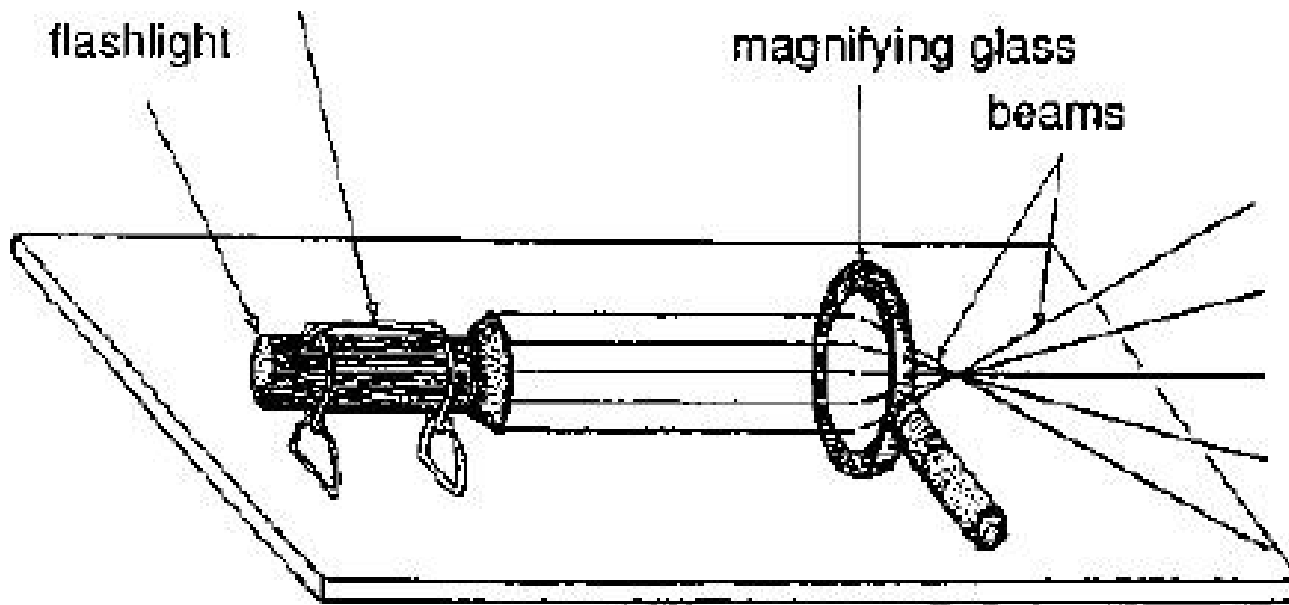

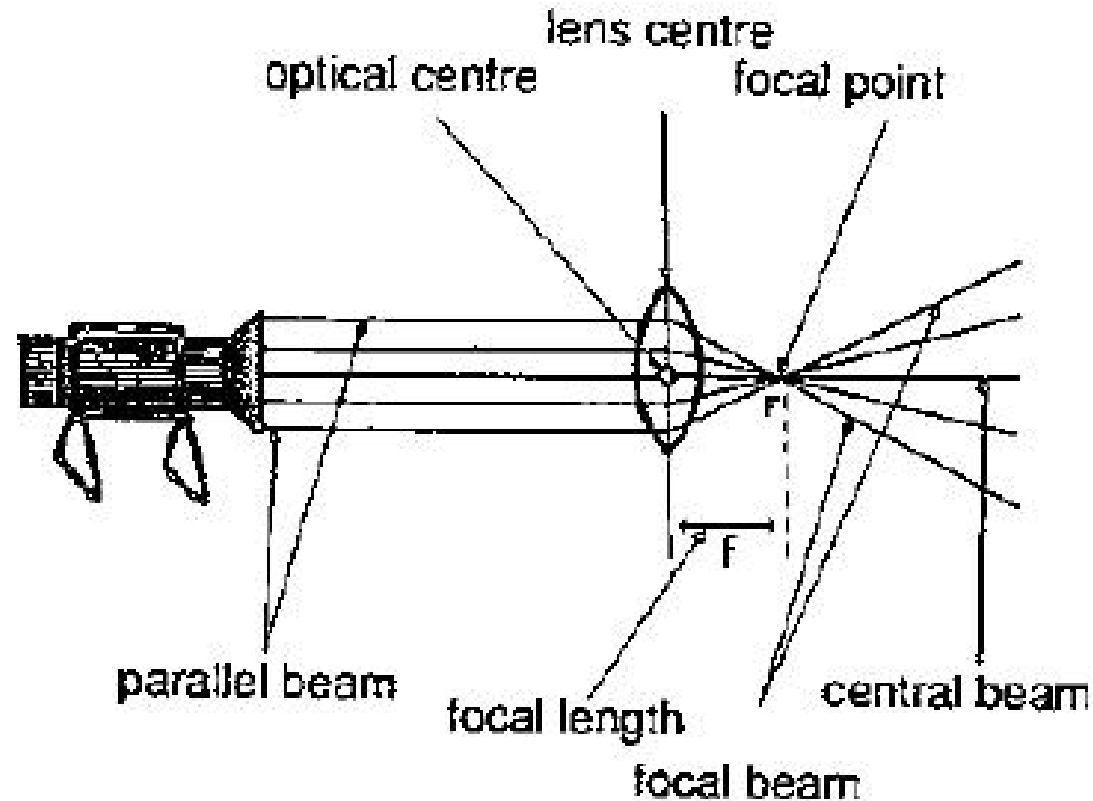

Observation:

The light of the flashlight is focused on one point behind the lens. When parallel light comes in from the right side, there can also a focal point be observed at the left side of the lens.

Analysis:

Lenses, which focus parallel light on one point are called condensing lenses or convex lenses.

The point is called the focal point.

**The point is called the focal point.**

**It is situated on the optical axis.**

**The distance from the lens centre to the focal point is called the focal length (f).**

Practical Use:

Convex lenses are used to correct long-sightedness and in microscopes, cameras, binoculars, etc.

The lens of the human eye is a convex lens.

Further thought:

Optical lenses normally are made of glass. Can one obtain the same effect (focusing of parallel light in one point) with lenses of other material?

## **11.2. THE BURNING GLASS**

**Main Goal:**

**The experiment demonstrates that a convex lens works as burning glass.**

Information:

181

<http://cd3wd.com/dvd/> - filename: z\_science\_exp\_187 of 598

With a convex lens the sun's rays can be collected at the focal point (see experiment: A CONVEX LENS).

If a sheet of paper or the head of a match is held at the focal point, these materials ignite after a short while when the lens is placed perpendicular to the incoming sunlight. This is due to the fact that the energy carried by the sunlight is concentrated at the focal point.

*Materials and Apparatus:*

*magnifying glass (one strong convex lens)*

*paper (match)*

*Procedure:*

Sunlight is collected with a convex lens.

A sheet of paper or a match is placed at the focal point.

The spot of light should be as small as possible.

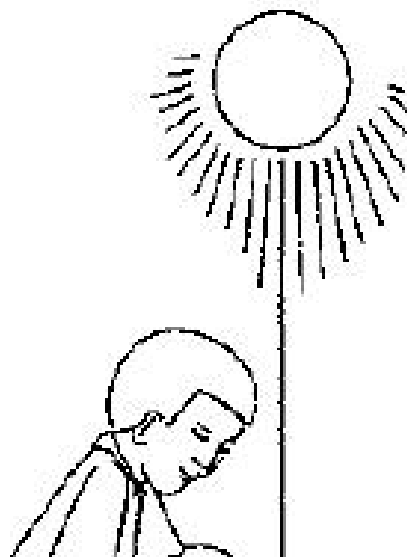

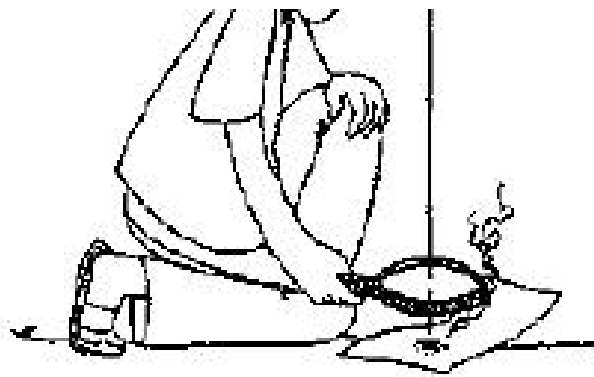

Observation:

The light can be seen as one small spot on the sheet of paper.

Here the paper starts to burn.

**Analysis:**

**A convex lens can be used as a “burning glass”.**

**At the focal point, the sun’s rays and the energy carried by these rays are collected. Here, the energy concentration or energy density is so high that paper can be set on fire.**

Further thought:

Why can you not get the same effect with a flash light as light source?



### 11.3. MAGNIFYING GLASS – VIRTUAL IMAGE OF A CONVEX LENS

#### Main Goal:

**This experiment demonstrates a virtual image of a convex lens.**

#### Information:

If an object is placed at the focal point or between the lens and the focal point, a real image cannot be perceived. If one looks through the lens at the candle however one can perceive a larger non-inverted image. (The eye must be at a greater distance from the lens than of its focal length.)

The image is called a virtual image and is only perceived with the eyes. It cannot be projected on the screen. The virtual image is formed when the eye follows the incoming rays backwards to the seeming point of intersection.

#### *Materials and Apparatus:*

*magnifying glass –  
(one spectacle-lens for long-sighted people)  
candle or other objects such as flowers*

#### Procedure:

The burning candle is placed close to the lens. The candle is observed through the lens.

**image: candle object: candle**

Image: candle object: candle  
magnifying glass/spectacle-lens

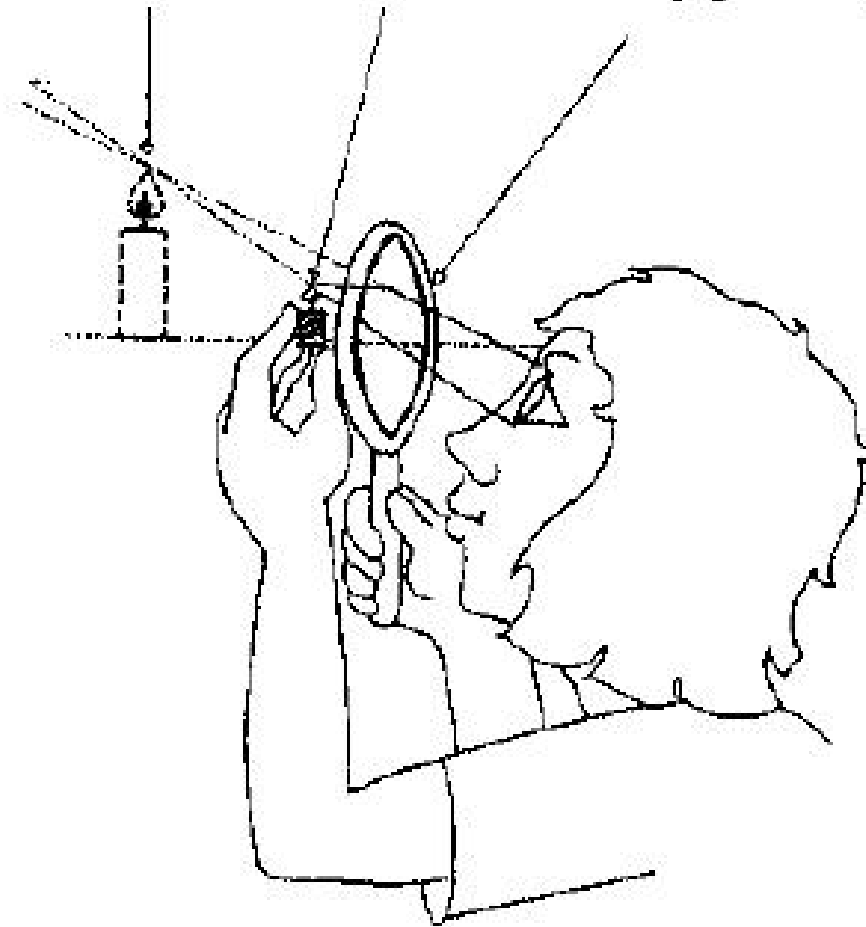

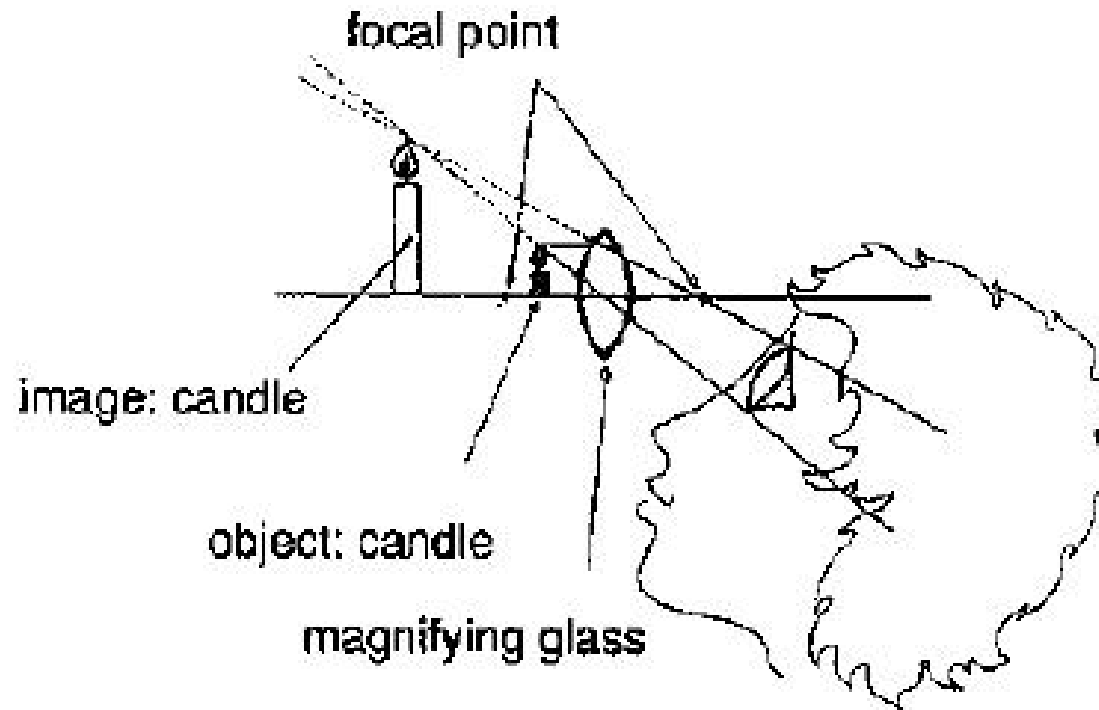

Observation:

Looking through the lens at the candle, non-inverted magnified image can be seen.

Analysis:

**This image cannot be projected onto a screen. It is just the eye which perceives this imaginary or “virtual” image.**

Practical Use:

A convex lens is needed by people who are longsighted.

A convex lens is needed by people who are longsighted.

The eyeball of a long-sighted eye is flattened. Thus, without a convex lens, the incoming rays meet "behind" the retina. The lens corrects this defect.

Further thought:

Within glass light has a lower velocity than in air. Therefore, light going through the middle of the lens, where the glass is thicker, loses more time than light going through the glass at the edge. Is this fact of importance for the image forming?

#### 11.4. REAL IMAGES WITH CONVEX LENSES

**Main Goal:**

**Through this experiment, images created by a convex lens are observed.**

Information:

Convex lenses create images, which can be projected on a screen. They are called real images and appear upside down on the screen.

If an object is moved towards a convex lens, its real image moves further away from the lens and becomes larger.

If the object is located at the focal point, no real image is formed.

If the distance between the object and the lens is equal to twice the focal length, the image is the same size as the object. The distance from the image to the lens also equals twice the focal length.

*Materials and Apparatus:*

*magnifying glass –  
(one spectacle–lens for long–sighted people)  
screen made of cardboard, candle,  
rack made of wire or wooden rack for the magnifying glass, measuring rod.*

*Procedure:*

The apparatus is set up as demonstrated in the diagram below. The candle is placed at one side of the lens. The screen is placed in such a way at the other side that a sharp image is obtained. When the candle is moved gradually towards the lens, the screen is moved correspondingly away from the lens.

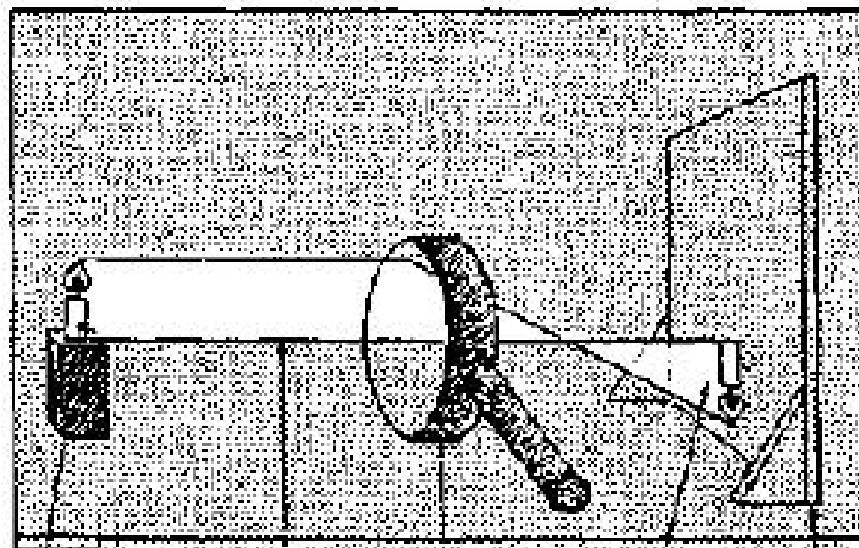

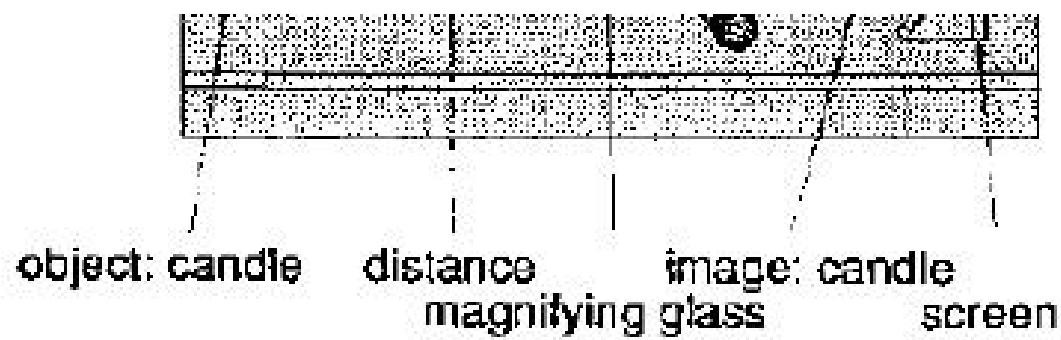

Using the measuring rod, the distance from the candle to the lens, the distance from the image to the lens, the object size and the image size are measured.

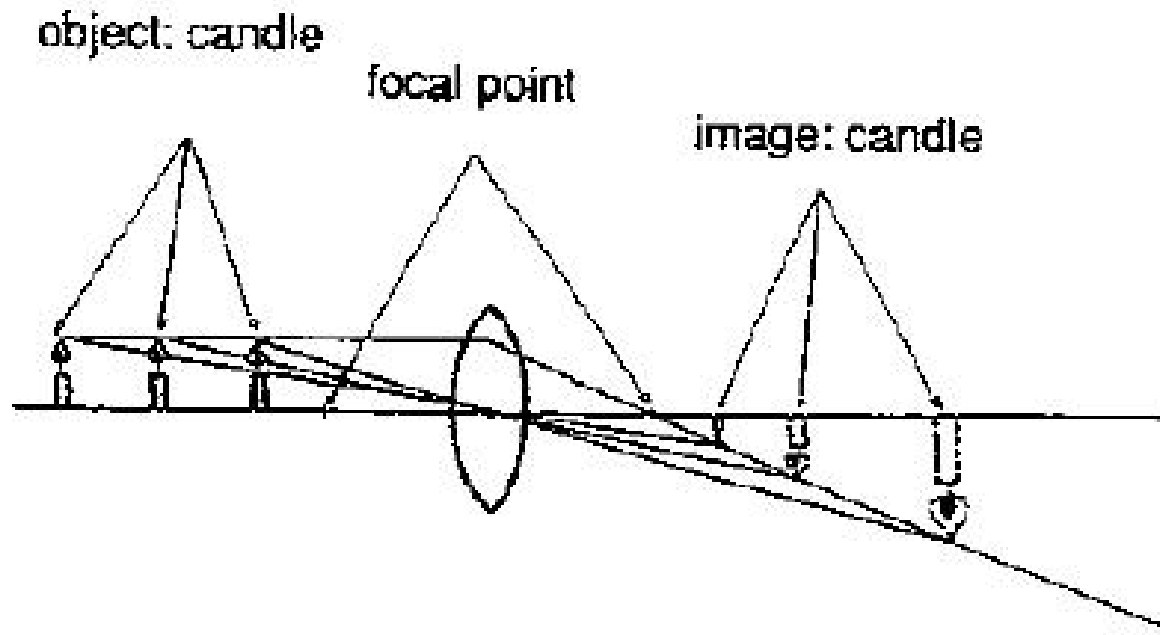

Observation:

185

<http://cd3wd.com/dvd/> - filename: z\_science\_exp\_191 of 598

Upside-down images are created.

The closer the candle is to the convex lens, the further away the image. At a certain distance (twice the focal length) from the lens, the object is the same size as the real image.

If the candle is placed close to the lens, no image is formed at all.

### **Analysis:**

**When the height of the object is equal to the height of the image, the distance from the candle to the lens is equal to the distance from the image to the lens and both are exactly double the focal length.**

**If the candle is placed at the focal point or between focal point and lens, no image can be projected.**

Further thought:

When we want to get a magnified image of the object on the screen in which distance from the lens must the object be placed?

## **11.5. THE CONCAVE LENS**

### **Main Goal:**

**Through this experiment, the course of the rays of a concave lense – diverging lens – can be observed.**

Information:

Diverging lenses are thinner in the middle than at the rim.

Rays parallel to an axis are refracted by a concave lens in such a way that they are refracted off the optical axis.

If the rays are followed backwards, it seems as if they all come from one point. This point is called the "virtual focus" or "point of divergence".

The centre ray remains at the centre. No real image is created.

*Materials and Apparatus:*

*concave lens –  
(one spectacle-lens for short-sighted people)  
flashlight (or maybe a candle)  
rack made of wire for the flashlight*

Procedure:

The apparatus is set up as shown in the following diagram. The room is darkened and the ray path is made visible by means of cigarette smoke or chalk dust.



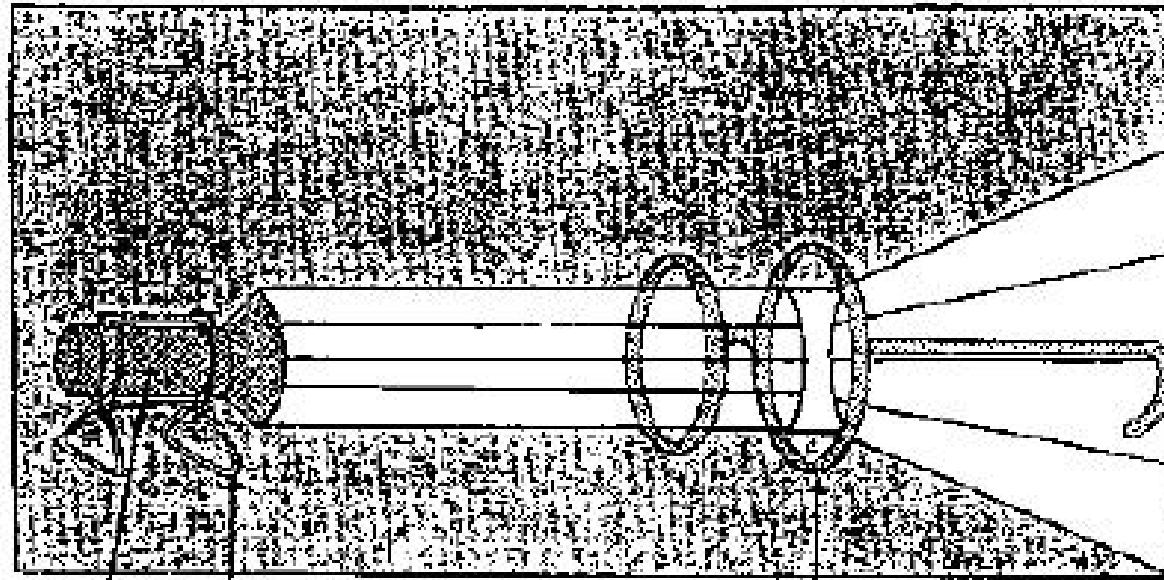

light source

wire-rack

concave lens

parallel beam

virtual focus



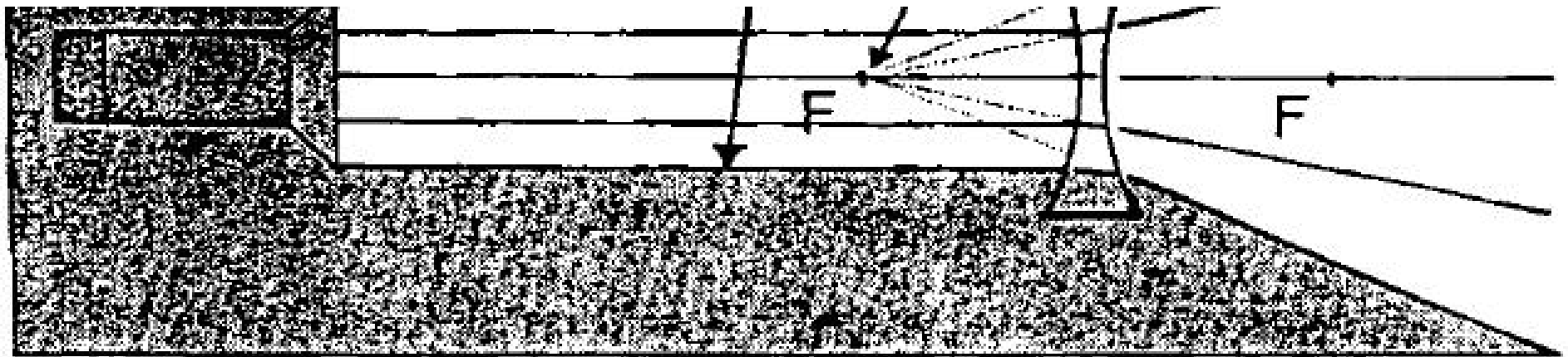

Observation:

Behind the lens, the light of the lamp is diverging in a way that makes them appear to come from a single point in front of the lens.

**Analysis:**

**Lenses which deviate light in such a way that it is spread out or diverges are called concave (or negative) lenses.**

**If the refracted rays are followed backwards, it seems as if they all come from one point.**

**This point is called the virtual focus or point of divergence.**

Practical Use:

187

<http://cd3wd.com/dvd/> - filename: z\_science\_exp\_193 of 598

A concave lens is used in glasses for short-sighted people, in cameras, telescopes, etc.

Further thought:

If light traveled at the same speed in different media, would glass lenses still alter the direction of rays?

## 11.6. VIRTUAL IMAGE OF A CONCAVE LENS

**Main Goal:**

**This experiment demonstrates the virtual image of a concave lens.**

Information:

Looking through a diverging lens towards an object, one can see a virtual, upright image. The image is always smaller than the object.

The course of rays followed by the eye is shown in a diagram.

*Materials and Apparatus:*

*candle  
concave lens –  
(one spectacle-glass for short-sighted people)*

Procedure:

Procedure:

The burning candle is placed at some distance from the lens. The candle is observed through the lens.

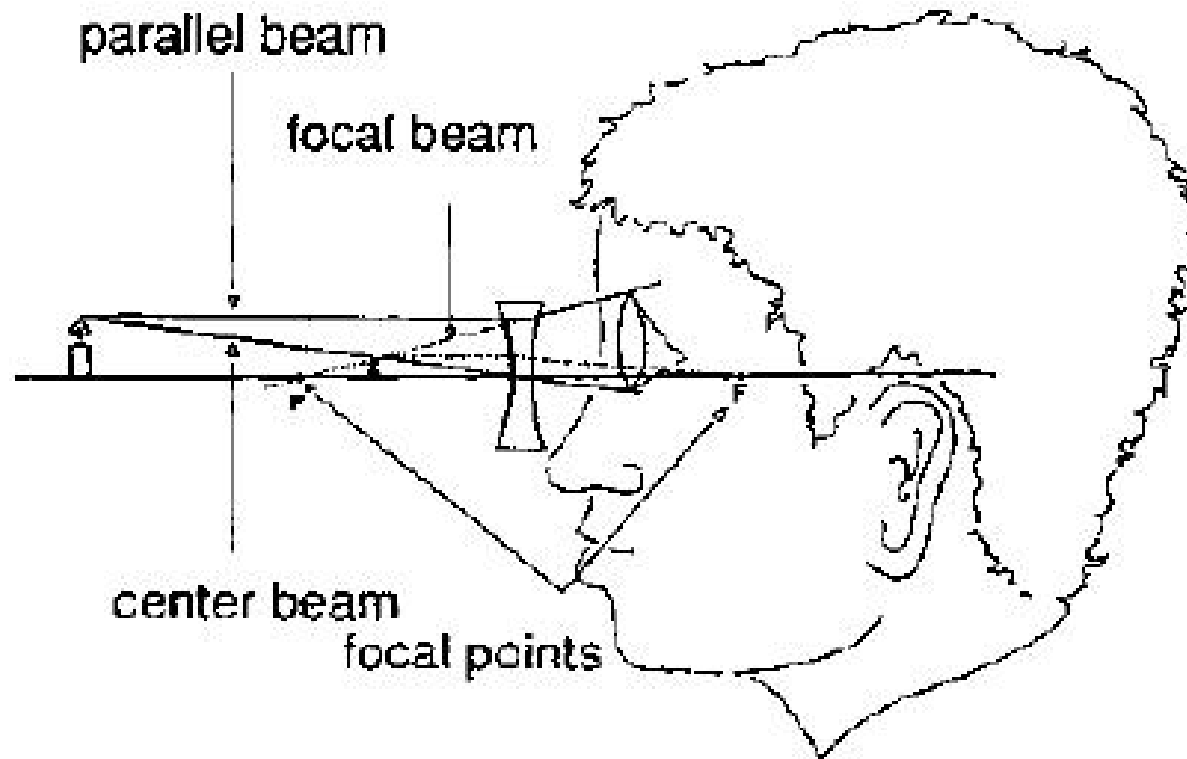

Observation:

An upright image is observed, smaller than the actual candle.

**Analysis:**

**The image can only be observed with the eye or with a camera. It cannot be projected on a screen. For this reason it is called a “virtual image”.**

**Practical Use:**

The concave lens is needed by people who are shortsighted.  
The eyeball of the short-sighted eye is lengthened.  
The incoming rays focus in front of the retina.  
The lens corrects the defect.

**Further thought:**

There are lenses that are at one side convex and at the other side concave. How do they refract the light?

## **11.7. PINHOLE CAMERA**

**Main Goal:**

**Using a pinhole camera, the origin of optical images is demonstrated.**

**Information:**

A pinhole camera creates upside-down, back-to-front images.

A pinhole camera creates upside-down, back-to-front images.

If the object is moved away from the pinhole diaphragm, the size of the image is reduced.

If the object is moved towards the pinhole diaphragm, the image is enlarged.

A small pinhole creates a clearer image but is weaker in light intensity than a bigger pinhole.

The image is created by rays coming from every point of the object. A small number of those rays arrive at the diaphragm opening. These finally focus onto the screen as several light spots. All of these spots together form the image.

*Materials and Apparatus:*

*candle*

*cardboard box (shoe or cigar box)*

*translucent paper, waxed paper*

*pieces of cardboard*

*pair of scissors*

*glue*

*Procedure:*

One of the two small side-walls of the cardboard box is replaced by translucent paper. That's the screen where the image appears.

A hole of 4 mm diameter is cut into the other small side-wall.

Two more holes with smaller diameter (2 or 1 mm) are cut into two other pieces of cardboard. The three card-board pieces with holes are called pinhole apertures.

a. A burning candle is placed before the 4 mm aperture side at a distance of about 20 cm.

The room is darkened.

b. The image is observed. Then the 2 mm aperture is put over the 4 mm aperture. Again the image is observed. Finally the 1 mm aperture is used. The candle is moved away from and toward the apertures.

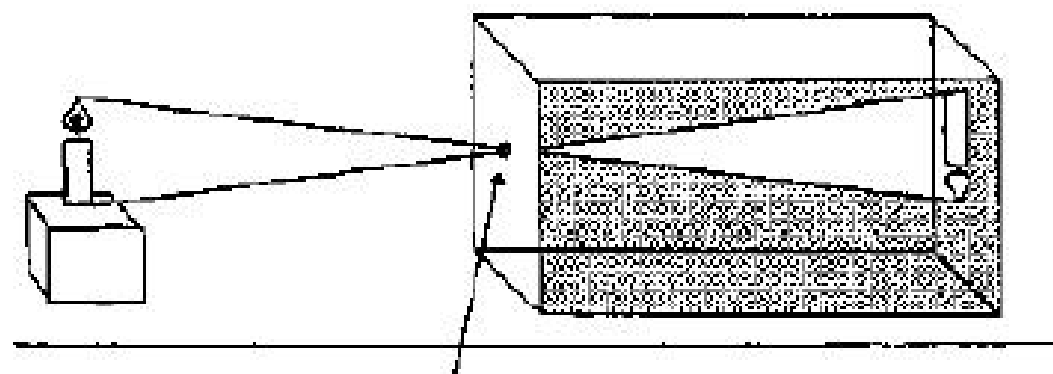

different apertures

Observation:

a. The image is always turned upside-down.

b. The image becomes smaller as the candle is moved away from the diaphragm opening and bigger as it is moved in the other direction.

c. The image created by a larger aperture is of higher light intensity but more blurred than that

c. The image created by a larger aperture is of higher light intensity but more blurred than that created by a smaller opening.

### **Analysis:**

**If good optical images are desired, the aperture, light intensity, and distance of the object from the aperture have to be coordinated.**

### **Practical Use:**

In a camera a condensing lens is placed in front of the diaphragm (see experiments on condensing lenses). This provides better light exposure. The size of an opening can be changed using a mechanism called iris diaphragm.

The human eye lets light penetrate through the pupil. The pupil becomes smaller or larger depending on the intensity of the light. Upside-down, scaled-down images are produced on the retina.

### **Further thought:**

Our optical perception system delivers upside-down-images, but we 'see' things upright. Isn't that a contradiction?



## GLOSSARY

- ACCELERATION : Rate at which velocity changes with time. The change in velocity may be in magnitude (speeding up or slowing down) or in direction or both.
- AMINO ACID : Chemical compounds in which a hydrogen atom in the alkyl group attached to the COOH (carbonyl) group of an organic acid is replaced by an NH<sub>2</sub> group.  
Their common chemical formula is:  
R-CH(NH<sub>2</sub>)-COOH.
- ANODE : anodos – Greek: the way upwards  
It is the electrode which is connected to the positive pole of a voltage source. (Gives off positive ions and towards which negative ions move)
- ASSIMILATION : ad – Latin: to  
similis – Latin: similar  
Synthesis of organic compounds of indigested and digested nutrient materials, e.g. at the photosynthesis.
- ATOM : atomos – Greek: an atom, invisible  
The smallest particle of an element, which does not admit a further division on the basis of chemical processes.

BIMETAL	:	Two different metals which are closely connected to each other
BOILING	:	A rapid state of evaporation which takes place within the liquid well as at the surface.
CAPILLARITY	:	The rise of a liquid in a fine hollow tube or in narrow space due to surface tension.
CARBOHYDRATE	:	Organic compounds of carbon, hydrogen, and oxygen with the general formula $C_n(H_2O)_m$ , e.g. all kinds of sugar, starch, and cellulose.
CATALYZER	:	A substance which induces or accelerates a chemical process, however, is not affected by the reaction.
CATHODE	:	katodos – Greek: the way downwards It is the electrode which is connected to the negative pole of a voltage source. (Emits electrons and gives off negative ions.)

- CELLULOSE : The chief substance composing the cell walls or woody part of plants, a carbohydrate of unknown molecular structure but having the composition represented by the empirical formula  $(C_6H_{10}O_5)_x$  (polysaccharides).
- KINETIC ENERGY : Energy of motion of a body. Is proportional to the mass of the body and to the square of its speed.
- CONDENSATION : Change of state from vapor to liquid.
- CONDUCTOR : Any material through which electric charges easily flow when subject to an applied voltage.
- CONES : Cells which perceive light. About 120 millions are found in the retina. They are responsible for the ability to see in the night, as they work at very low light intensities.
- CONSERVATION OF ENERGY : Experience shows that energy cannot be destroyed. The total amount of energy never changes. But it may be transformed from one form into another one.
- CONSTANTAN WIRE : A special kind of wire which has the same resistance does not expand when heated. It is an alloy made of 60% copper and 40% nickel.

expand when heated. It is an alloy made of 60% copper and 40% nickel.

- CONVECTION : convehere – Latin: to bring together  
The transmission of heat or electricity by the mass movement of the heated or electrified particles as in air, gas, or liquid currents.
- CONVERGING LENSE : A lens that is thicker in the middle than at the edges and refracts parallel rays of light passing through it to a focus.
- COTELYDON : kotyle – Greek: cup  
The seed–leaf, primary or first leaf of an embryonic sporophyte. They are part of the plant embryo in the seed. Those of peas and beans serve as food storage organs for the seedling.
- CRYSTAL : Regular arrangements of atoms, ions or molecules in a pattern as in solid grains, sugar, salt, etc.. The regular arrangements determine the shape of the matter.
- DENSITY : The mass (amount of matter) per unit of volume (space into which the matter is packed)
- density =  $m/v$

$$= m/v \text{ (g/cm}^3 \text{ or kg/m}^3\text{)}$$

The density of solid and liquid matters is dependant on temperature and that of gaseous matters is dependant on temperature and pressure.

- DIFFUSION** : diffundere – Latin: to diffuse  
The gradual permeation or spreading out, e.g. of a substance through a liquid (ink through water) or of a gas or of ions.
- DIVERGING LENSE** : A lens that is thinner in the middle than at the edges, causing light rays passing through it to diverge.
- ELECTROLYSIS** : lysis – Greek: a loosening, decomposition  
The decomposition into ions of a chemical compound by the action of an electric current passing through the solution.
- EMBRYO** : embryon – Greek: seedling  
The rudimentary plant which is usually contained in seeds.
- EMIT** : emittere – Latin: to send out
- ENERGY** : A state of a body or a system of bodies that – among other characteristics – enables the body or the system to do work.

ENERGY	:	A state of a body or a system of bodies that – among other characteristics – enables the body or the system to do work.
ENZYME	:	zymes – Greek: leaven en – Greek: in Any of various complex organic substances, originating from living cells, and capable of producing by catalytic action certain chemical changes.
EROSION	:	erodere – Latin: to gnaw off The process by which the surface of the earth is worn away by the action of water, glaciers, wind, waves etc..
EVAPORATION	:	Change of state at a surface of a liquid as it passes to vapor.
FERMENTATION	:	fermentare – Latin: to cause to rise The breakdown of complex molecules in organic compounds, caused by the influence of organisms; such as yeast or bacteria or enzymes.
FORCE	:	Any influence that can cause a body to be accelerated.

FREEZING	:	Change of state from the liquid to the solid form.
FRICTION	:	A force that arises to oppose the motion or attempted motion of a body pass another with which it is in contact.
INDICATOR	:	indicare – Latin: to show A substance used to indicate by change in colour the acidity or alkalinity of a solution.
INERTIA	:	The sluggishness or apparent resistance a body offers to changes in its state of motion.
INSULATOR	:	Any material through which charge resist flow when subject to an applied voltage.
ION	:	ionos – Greek: to move Electrically charged atoms or molecules, formed by the loss or gain of one or more electrons.
MAGNET	:	An iron-bearing matter which possesses the property of attracting iron.
MAGNETISM	:	The property or quality or condition of a magnetic field.

MAGNETISM	:	The property or quality or condition of a magnetic field.
MASS	:	Quantity of matter in a body. Becomes manifest due to a body's inertia and/or due to the property of being attracted by another mass in its environment (heaviness).
MELTING	:	Change of state from the solid to the liquid form.
MIXTURE	:	An aggregate of two or more substances which are not chemically united and exist in no fixed proportion and do not lose their individual characteristics.
MOLECULE	:	The smallest particle of any substance that has all its chemical properties. Atoms combine to form molecules.
MONOSACCHARIDE	:	A carbohydrate not decomposable by hydrolysis; simple sugar such as glucose, fructose, etc..
OSMOSIS	:	osmos – Greek: an impulse, a pushing The tendency of a fluid to pass through a semipermeable membrane into a solution of lower concentration, so as to equalize



concentration on both sides of the membrane.

OSMOTIC PRESSURE	:	The pressure caused by osmosis.
PARTICLE	:	Any body that is projected by some force and continues in motion by virtue of its own inertia.
PHLOEM	:	phloios – Greek: inner bark Bast-tissue; the soft bast of vascular bundles, consisting of sieve-tube tissue. Its purpose is to transport proteins and minerals.
PHOTOSYNTHESIS	:	phos – Greek/Latin: light synthesis – Greek: putting together Carbon assimilation, requiring the presence of chloroplasts and light, and consisting in synthesis of carbohydrates from carbon dioxide and water.
PHOTOTROPISM	:	phos – Greek/Latin: light tropein – Greek: to change A bending towards light.
POLYSACCHARIDE	:	polys – Greek: many saccharum – Latin: sugar

POLYSACCHARIDE	:	<p>polys – Greek: many  saccharum – Latin: sugar  Any of a group of carbohydrates that decomposes by hydrolysis into more than three molecules of monosaccharides. For instance cellulose, starch, etc..</p>
POWER	:	<p>Time rate of work:</p> $\text{power} = \frac{\text{work}}{\text{time}}$
PRESSURE	:	<p>Ratio of the amount of force per area over which that force is distributed.</p> $\text{pressure} = \frac{\text{force}}{\text{area}}$
PURE SUBSTANCE	:	<p>It is a substance which cannot be further separated on the basis of physical processes.</p>
RADIANT ENERGY	:	<p>Energy that travels in the form of electromagnetic waves through space without needing a medium. When it meets an absorber it is transformed into thermal energy. On the other hand, the thermal energy of a radiating body is transformed, at the instant of</p>

radiation, into voliant energy.

REFLECT	:	reflectare – Latin: to mirror
RODS	:	Cells which perceive light. About 6 milliosn are found in the retina of vertebrate animals. They serve to perceive light and the exact recognition of details.
SPEED	:	Distance traveled per time.
SPROUT	:	Usually the above ground part of a plant with the leaves, the buds, genital organs (e.g. blossoms).
STARCH	:	A polysaccharide which is insoluble in water. It consists of the two components amylose and amylopectin.
SURFACE TENSION	:	Tendency of the surface of a liquid to contract in area and thus behave similar a stretched rubber membrane.
SURFACE TENSION	:	Tendency of the surface of a liquid to contract in area and thus behave similar a stretched rubber membrane.

- THERMAL ENERGY : Internal energy a body possesses due to the random motion of its molecules. The faster the motion, the higher the thermal energy of the body.
- VASCULAR TISSUE : Specially modified plant-cells, usually consisting of either tracheid or sieve cells, for circulation of sap.
- VELOCITY : Speed of a body but with specification of its direction of motion.
- WORK : Product of the force extended and the distance through which the force acts.
- XYLEM : xylon – Greek: wood  
Lignified portion of vascular bundle, which is found all over the plant. Its purpose is to transport mineral salts and water sucked up over the roots.

**GTZ**

*Deutsche Gesellschaft für Technische Zusammenarbeit (GTZ) GmbH  
Dag-Hammarskjöld-Weg 1+2 · D6236 Eschborn 1 · Telefon (0 6196) 79-0 · Telex 407 501-0 gtz d*

The government-owned GTZ operates in the field of Technical Cooperation. Some 4,500 German experts are working together with partners from some 100 countries in Africa, Asia and Latin America in projects covering practically every sector of agriculture, forestry, economic development, social services and institutional and physical infrastructure. – The GTZ is commissioned to do this work by the Government of the Federal Republic of Germany and by other national and international organizations.

GTZ activities encompass:

- appraisal, technical planning, control and supervision of technical cooperation projects commissioned by the Government of the Federal Republic of Germany or by other authorities
- advisory services to other agencies implementing development projects
- the recruitment, selection, briefing and assignment of expert personnel and assuring their welfare and technical backstopping during their period of assignment
- provision of materials and equipment for projects, planning work, selection, purchasing and shipment to the developing countries
- management of all financial obligations to the partner country.



<http://cd3wd.com/dvd/> - filename: z\_science\_exp\_204 of 598





<http://cd3wd.com/dvd/> - filename: z\_science\_exp\_205 of 598

## **Source Book for Teaching, Learning and Enjoying Physics**

<http://cd3wd.com/dvd/> - filename: z\_science\_exp\_205 of 598

z\_science\_exp\_0205.jpg

<http://cd3wd.com/dvd/> - filename: z\_science\_exp\_206 of 598

<http://cd3wd.com/dvd/> - filename: z\_science\_exp\_206 of 598

z\_science\_exp\_0206.jpg

## Table of Contents

<b>Source Book for Teaching, Learning and Enjoying Physics</b> .....	<b>1</b>
<u>Foreword</u> .....	3
<u>Preface</u> .....	4
<u>How to Use This Book</u> .....	5
<u>1. What is Physics?</u> .....	6
<u>2. Laboratory Techniques</u> .....	12
<u>2.1 Collection of Data</u> .....	12
<u>3. Basic Mechanics</u> .....	22
<u>3.1 Rectilinear Motion</u> .....	23
<u>3.2 Forces</u> .....	24
<u>3.3 Weight and Mass</u> .....	28
<u>3.4 Centre of Gravity and Stability</u> .....	33
<u>3.5 The Force of Friction</u> .....	39
<u>3.6 Density</u> .....	43
<u>3.7 Pressure in Liquids and Gases</u> .....	45
<u>3.8 Archimedes' Principle and the Law of Floatation</u> .....	54
<u>3.9 Work, Energy and Power</u> .....	59
<u>3.10 Simple Machines</u> .....	65
<u>3.11 Astronomy – The Solar System</u> .....	70
<u>4. Matter</u> .....	74
<u>4.1 The Particle Model of Matter</u> .....	74
<u>4.2 States of Matter</u> .....	78
<u>4.3 Motion of Particles</u> .....	79
<u>4.4 Cohesion and Adhesion</u> .....	83
<u>4.5 Elasticity and Viscosity</u> .....	89
<u>5. Thermal Physics</u> .....	90
<u>5.1 Thermal Energy and Temperature</u> .....	90
<u>5.2 Thermal Expansion</u> .....	94
<u>5.3 Changes of State</u> .....	100
<u>5.4 Transfer of Thermal Energy</u> .....	106
<u>6. Wave Motion</u> .....	113

5.4 <u>Transfer of Thermal Energy</u> .....	106
6. <u>Wave Motion</u> .....	113
6.1. <u>Production of Waves</u> .....	114
6.2 <u>Propagation of Waves</u> .....	119
6.3 <u>Reflection of Waves</u> .....	122
6.4 <u>Music and Musical Instruments</u> .....	128
7. <u>Geometrical Optics</u> .....	132
7.1 <u>Nature and Propagation of Light</u> .....	132
7.2 <u>Reflection of Light</u> .....	140
7.3 <u>Refraction of Light</u> .....	146
7.4 <u>Lenses and Optical Instruments</u> .....	149
7.5 <u>Dispersion and Colours</u> .....	160
8. <u>Magnetism and Electricity</u> .....	163
8.1 <u>Magnetism</u> .....	164
8.2 <u>Electrostatics</u> .....	170
8.3 <u>Electric Current</u> .....	175
<u>Appendix</u> .....	186
<u>A Sootless Kerosene Burner</u> .....	186
<u>Test Tubes and Flasks</u> .....	187
<u>List of Materials</u> .....	188
<u>Questionnaire</u> .....	193
<u>Back cover</u> .....	194

<http://cd3wd.com/dvd/> - filename: z\_science\_exp\_208 of 598





# Source Book for Teaching, Learning and Enjoying Physics

## *SOURCE BOOK*

*IDEAS FOR TEACHING PHYSICS TO BEGINNERS WITH LOCALLY AVAILABLE MATERIALS*

*IDEAS FOR TEACHING, LEARNING AND ASSESSMENT BY DOING*



**MZUMBE BOOK PROJECT**  
**P.O. Box 19 MZUMBE,**  
**MOROGORO • TANZANIA**

This source book is the result of a workshop held at Morogoro Secondary School (Tanzania) from July 15th to 26th 1991. The workshop was organised by the Ministry of Education and Culture in cooperation with the Goethe-Institut (German Cultural Institute).

Workshop Administrative Coordinator:

Ignatius Sarikoki, Ministry of Education and Culture, Tanzania

Workshop Technical Coordinator:

Hans Schmidt, Darmstadt, Germany

Editing Coordinators:

Editing Coordinators:

J.B.A. Mihigo, Mzumbe Book/Project  
Manfred Schiess, Rastatt, Germany

This workshop project was sponsored by:

- Ministry of Education and Culture, Tanzania
- Ministry of Education and Culture, Hessen, Germany
- Goethe–Institut, Dar es Salaam

This low–priced edition for Tanzania is sponsored by:

- Canadian Organization For Development Through Education (CODE)
- Partnership Furtherance With the Third World (APDW), Karlsruhe, Germany

Editorial committee:

J.M. Waryoba, A.S. Mrutu, B.W. Faustine, M.J. Mbuji,  
J.M. Sekulu, J.B.A. Mihigo, G. Emmanuel, B. Enjiku,  
I. Tabaro, D. Pietz, M. Schiess

The editors thank Dr. W. Kemp, C. and G. Stieghorst for their valuable comments and help in proof–reading.

Special Technical assistance was sponsored by:

- German Didacta Association, Frankfurt, Germany (Deutscher Didacta Verband, e.V.)
- Merck Ltd., Darmstadt, Germany.

Type set by B.B. Sallim, Mrs. A. Mihigo

Graphic design by R. Kanyawana, C. Mdachi, P. Ndunguru

Darkroom technique: M. E. Mwano, Miss. E. Mwombeki

Production Supervisor: C. Mazunda

© Mzumbe Book Project 1991

ISBN 9987 552 11 0

Printed and Bound by

**Mzumbe Book Project**  
**P.O. Box 19 Mzumbe**  
**Morogoro – Tanzania**

List of Participants:

Alinanuswe W.P. Mwakabanje  
Loleza Secondary School

Daudi Mbungu  
Tambaza Secondary School

Busanji Wilson Faustine  
Kilakala Secondary School

Busanji Wilson Faustine  
Kilakala Secondary School

Charles Philemon  
Jangwani Secondary School

T.J. Msami  
Weruweru Secondary School

M.J. Mbuji  
Minaki Secondary School

U.S. Mohamed  
Usagara Secondary School

J.D.K. Bulemo  
Azania Secondary School

Pastory B. Rwamwasi  
Pugu Secondary School

Bonus P. Ndimbo  
Songea Boys Secondary School

Raphael R. Malisa  
Old Moshi Secondary School

H. Mgonja  
Same Secondary School

Samwel N.J. Mwakasonda  
Tabora Boys Secondary School

Mrs M. Muyenge  
Mzumbe Secondary School

George Emmanuel  
Morogoro Secondary School

Dettef Pietz  
Iyego Secondary School, Murang'a, Kenya

Jones M. Waryoba  
Institute of Curriculum Development, Tanzania

J.M. Sekulu  
Kleruu Teachers Training College

Dr. Manfred Spohr  
Dar es Salaam Teachers Training College

A.S. Mrutu  
Ministry of Education

D.D. Ben Enjiku  
Institute of Teacher Education – Uganda

Ignatius Tabaro–Sinaruhamagaye  
National Curriculum Development Centre – Uganda

## Foreword

Children come to school with rich knowledge about their environment. They gained this knowledge through observation and imitation. For example, they know how to construct toy cars by perfectly applying the physical laws. They also know how to carry a heavy load on the head and how to lift a heavy stone. They can do all this without studying Physics. Through such learning by doing they absorb easily the knowledge needed to solve everyday problems.

Science and Physics for that matter is borne in the nature around us. Scientists observe, explain and formulate the results into abstract laws for further investigation of other problems. We are all born with the ability to be investigators, however, we have to learn how to do it. This learning should start with phenomena the child is familiar with and not with abstract definitions what science is.

The rich practical knowledge of the students can be used as a springboard for teaching science not only to beginners by getting the pupils to have a critical look at and ask analytical questions about their environment. This requires a practical approach in teaching. By this approach students learn to be investigators by finding the applied principles in the things around them. Students should learn to see the daily environment with the eyes of an analytical scientist. This makes them also aware of the resources to be found in their country.

Physics as a natural science deals with the investigation of matter. However, the investigation of matter can be done by using a practical approach only.

Children are eager to talk or ask questions about things they are familiar with rather than about abstract theoretical knowledge taken from books.

Furthermore, the teaching of science with locally available materials makes learning by doing accessible, even when conditions for teaching are not conducive.

This is the message of this book. It shows that the most common materials are often sufficient for stimulating experimental lessons. Experimenting is a difficult job for a less experienced teacher. However it can also be

fun for him. Most of the experiments described in this book can be performed in a very short time and without long sessions of preparation.

The described experiments are not only for school purposes, but also for other people interested in this subject.

It is my sincere hope that this book will contribute to the building up of a broad line of people in our country who are interested in learning more about Physics.

LET US ENJOY PHYSICS BY DOING  
L.K. MSAKI  
Acting Commissioner for Education

## **Preface**

This source book is addressed to people who are concerned with teaching Science at the Junior Secondary School level. This includes Teachers, Teacher Training College Tutors and University Lecturers. Nevertheless, the book can be useful to Science Club Masters and Students who want to experiment on their own. The main audience are the teachers and tutors who work in inadequate teaching and learning conditions trying to encourage students to develop capabilities to master and use science in their daily life.

This source book contains therefore experiments and activities which can be performed in any classroom and in a very short time with a few low or even no cost materials. Moreover, these practicals do not require a long preparation time.

Such easy to carry out experiments for and through beginners have a long standing tradition in the history of teaching science. They are called *handy experiments* because they can be performed "by hands" only without any difficulties.

You will find in this source book ideas and suggestions which are not normally found in textbooks. We assume that the teachers know most of the traditional experiments which are found in the usual textbooks. Therefore

You will find in this source book ideas and suggestions which are not normally found in textbooks. We assume that the teachers know most of the traditional experiments which are found in the usual textbooks. Therefore there is no need to repeat them here. The reader will welcome the ideas on how to modernize his teaching since this book provides him not only with the "how to do it" but also with the "what to do" information.

Going through this book, the reader will find that many traditional experiments can be performed as handy experiments too. They are more illustrative and more appealing to students than "black box experiments" with sophisticated equipment. They encourage the students' creativity to invent other experiments and stimulate their natural curiosity to understand the physics behind the experiments.

The suggestions of this source book are stimulants to modern teaching and learning, i.e. *teaching and learning by doing*. They should be supplemented with the teachers' own ideas, students' ideas and ideas from other sources. This source book is a result of a workshop which drew participants from Uganda, Kenya, Germany and Tanzania.

We acknowledge with gratitude the professional, technical and financial assistance of all who have contributed to publish this source book particularly to the Ministry of Culture of the State of Hessen (Germany) and the Goethe-Institute for sponsoring the workshop.

Last but not least, we thank Morogoro Secondary School for hosting the workshop from which the source book resulted.

A.S. NDEKI  
Chairman of the Executive Committee  
Mzumbe Book Project



## How to Use This Book

This source book may be used in connection with the series of textbooks called "Enjoy Physics", volume I and II, produced by the same publishers, the MZUMBE BOOK PROJECT. These books have been written with great emphasis on the use of materials which can easily be obtained from our environment. However, this source book may be also used without these textbooks.

Many students think that Physics is a very tough subject and they actually fear it. If you as a Physics teacher use the approach suggested in this source book, you can be quite sure that your students will lose their fear. They will become interested and creative in Physics. They will like and even enjoy your Physics lessons. This way they will be able to develop those talents which are needed for real development to take place.

Being a Physics teacher, this book will help you to master the simple techniques described in order to be able to make simple apparatus, models and other teaching aids. After this you may want to transfer the skills to your pupils so that they may help you in making the required items.

The experiments described in this book are simple and can be carried out even in the absence of a Physics laboratory. The Physics kit described in the appendix is meant to be self-contained. However, first you may select only a few experiments from each section. Therefore, we have listed the materials needed for each single experiment in the appendix. Of course, each kit needs all the *materials* listed on p.111 and these were omitted in the list of materials of the various experiments (see p.112).

Perhaps your students might become interested to prepare the materials for further experiments described in this source book. Thus, after some time you might be able to carry out most of the experiments suggested.

For heating purposes an improved, sootless kerosene burner has been developed which any "fundi", who makes normal "vibatari", is able to produce, see p. 109.

Being a Student, this book may also help you in the designing and carrying out of physics projects. If you produce your own Physics kit, this will provide you with a kind of minilab at home.

Using it, you can train yourself on the practical and investigating aspects of Physics. Therefore, you will enjoy Physics and develop your talents in this subject. This way, Physics may contribute to self-sustained

Using it, you can train yourself on the practical and investigating aspects of Physics. Therefore, you will enjoy Physics and develop your talents in this subject. This way, Physics may contribute to self–substained development by improving the daily life of the people.

An experiment has several important phases which we have usually outlined in this source book. The symbols are as follows:

**P:** The *procedure*: what and how to perform the experiment and/or how to build the apparatus.

**Q:** *Questions* which the investigator may ask himself or a teacher may ask his students in order to guide them to the proper observations and explanations.

At this stage the dedicated investigator or student should stop reading and try to answer the questions himself after carrying out the experiment. If he/she has the self–discipline needed to do this, he/she will certainly gain a lot.

**O:** The *observations* are described here. So you may check *after* you have made your own observations if you did not miss an important point.

**E:** The *explanation* of the observations is outlined here. Physics always aims for explaining observations. Only if he can explain his observation, the scientist usually will be able to predict the outcome of other experiments. This leads to the knowledge of the laws of physics. Then he/she may also become creative enough to apply a certain physical law in a machine or an apparatus which he/she invents. This way development takes place.

**A:** Some *applications* of the phenomenon under investigation in the respective experiment may be given here. Thus, the interested student will easily recognise and appreciate the close relationship between Physics and Technology. The latter cannot exist without the former.

We warmly welcome your criticism, suggestions and opinions about this book. Please, fill in the questionnaire at the end of this volume and send it to us. Please write to us to improve future editions of this book:

Team of the source book and "Enjoy Physics"

Mzumbe Book Project  
P.O. Box 19,  
Mzumbe – Morogoro  
Tanzania.

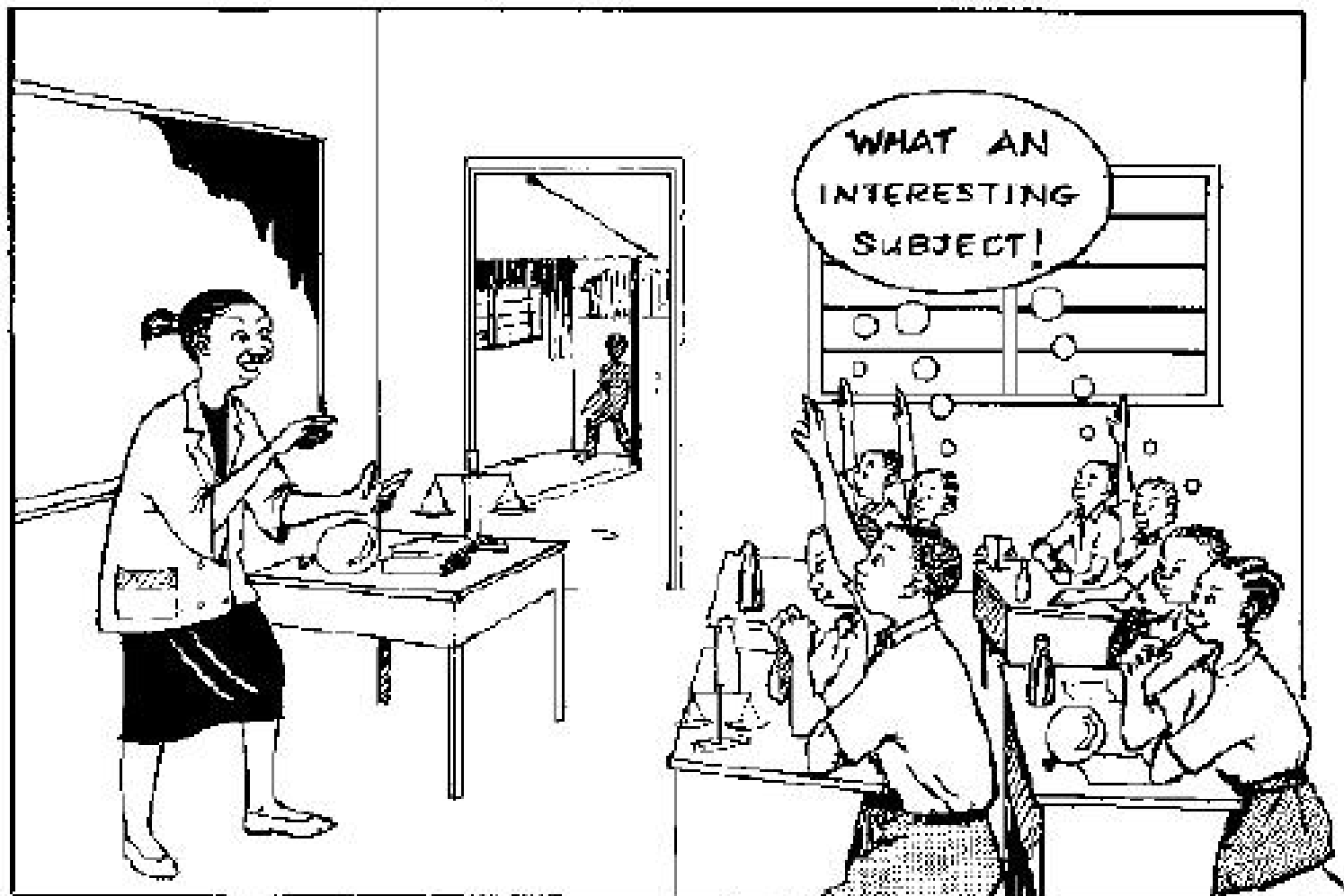

## 1. What is Physics?

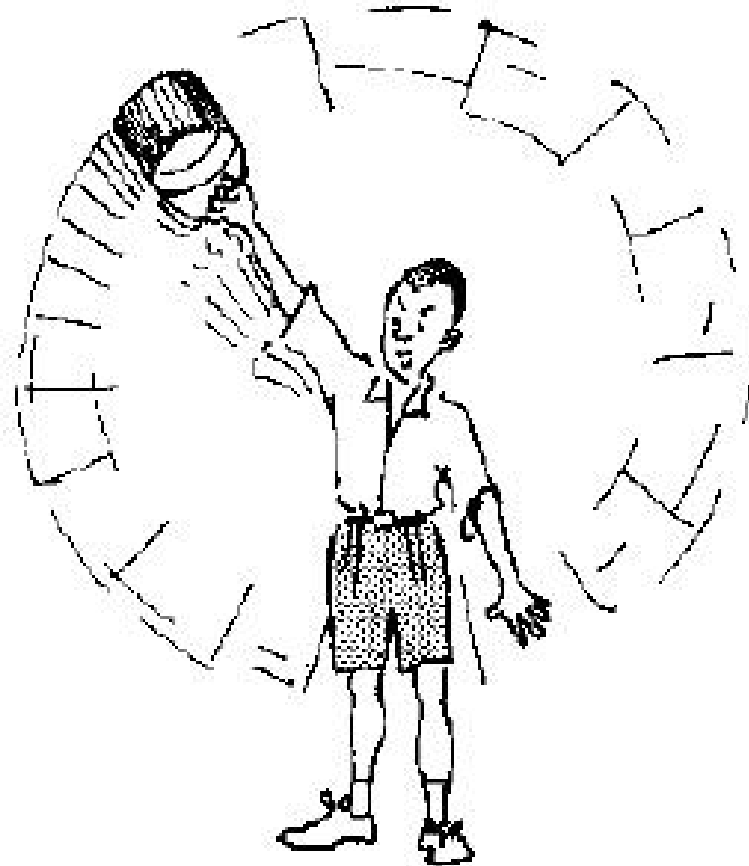

### 1.1 What is Physics?

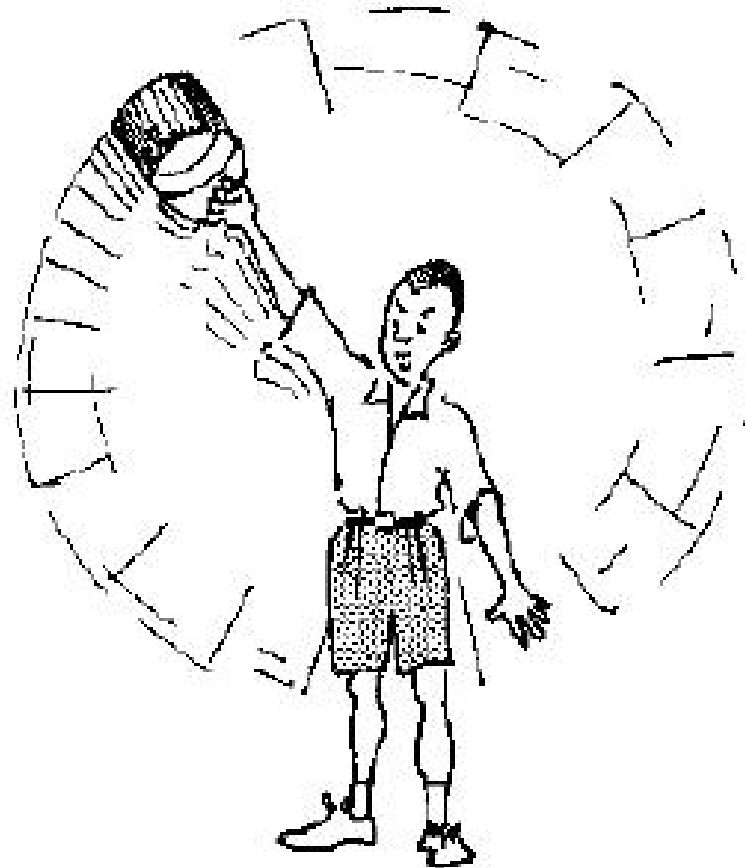

A bucket of water is sufficient to start investigating the effect of centripetal forces. Fill the bucket with various quantities of water and you will learn even more by doing. Increase the number of revolutions of the bucket.

Physics must not be a boring, tough subject, just good for exams and to be understood by a few "experts" only. Physics should not happen in books only. It is everywhere where things are. The teaching of science without experiments is just like a ngoma without dancers.

Pupils learn more and better by doing. Stimulate them to investigate their environment through easy to carry out experiments. Ask the pupils to make a list of physical phenomena which can be observed in their environment. Let the pupils enjoy physics. This sourcebook shows how this can be achieved.

## 1.2 Laboratory Techniques



Imagine you would buy different kinds and different quantities of meat. The butcher will have to weigh and then calculate the price for each kind of meat and produce the total bill. Thus, measuring and the collection of data happen nearly everyday in our life.

The tailor takes the measurements of his customer and of the material needed for a suit. The milkman measures the volume of the milk sold. The technician measures with a calliper the diameter of a screw and even at school the time of each period is measured. Especially in engineering precise measurements are

indispensable.

Therefore physics as a subject has to introduce even beginners to the principles of measuring and data collection. "I have no measuring instruments in my school," you may say. Really? Let the students enjoy physics starting with measurements which are easy to carry out and the construction of measuring instruments. For a lot of hints see chapter 2.

### 1.3 Basic Mechanics



Have you observed children balancing a plank like a seesaw? They know how a big and a small child can balance although they are of different weight.

Usually they do not know what a fulcrum, a load distance and a moment of force is. However, such basic mechanics dominate an essential part of our daily life. We encounter motion, friction, inertia, work and power almost every day. We also learn in a practical way about density, pressure of fluids or gases. Work, energy, power and other physical phenomena look very abstract in books but happen every day. Also the movement of earth, moon and the planets which determines the lengths of our days, months and years, has to do with basic mechanics such as motion, mass attraction and centripetal forces.

Ask the students to discuss where such basic mechanics phenomena can be observed. Discussing only? No! There are plenty of meaningful experiments. For these, see chapter 3.

There are plenty of meaningful experiments. For these, see chapter 3.

#### 1.4 Matter

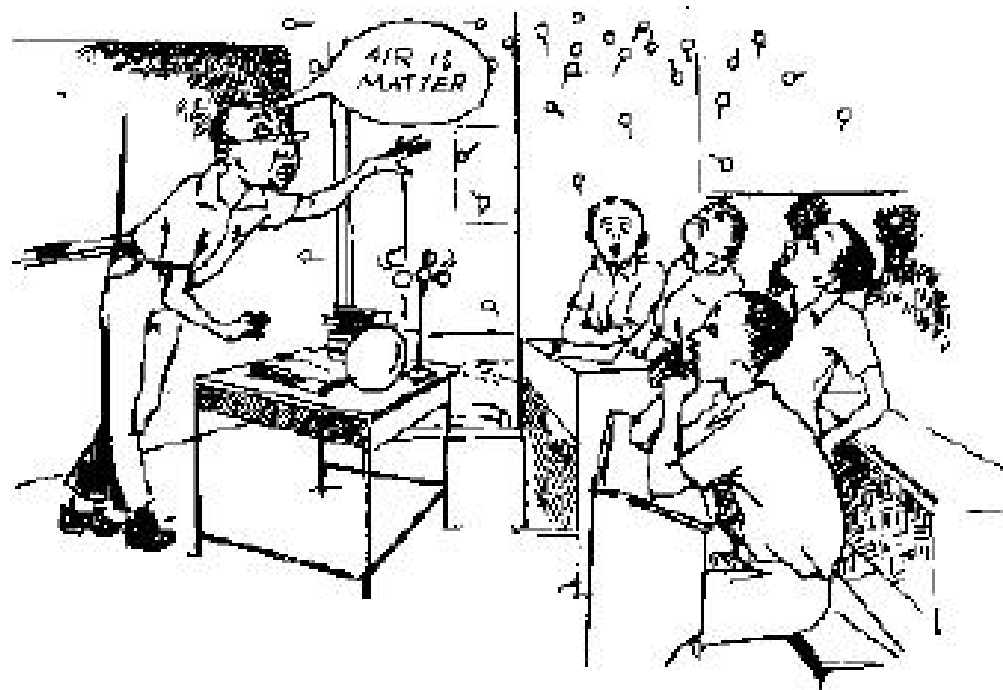

A chair can be touched. Water in a bucket also. But air? Can you imagine that while you are reading these lines your nose is punched more than 100 billion times by air molecules?

The environment around us, whether in solid, liquid or gaseous state is made up of billions of tiny particles which are either molecules or atoms. These particles which constitute air are so tiny, that we cannot see them even by a powerful microscope. However, the students can be given an idea of the particle structure of matter by indirect evidence.



Discuss with the students from which evidence we can conclude the existence of particles and ask them to write an essay about this. You may think, there are no experiments possible about states of matter, diffusion, molecular forces and other properties of matter? Failed! For details see chapter 4.

## 1.5 Thermal Physics

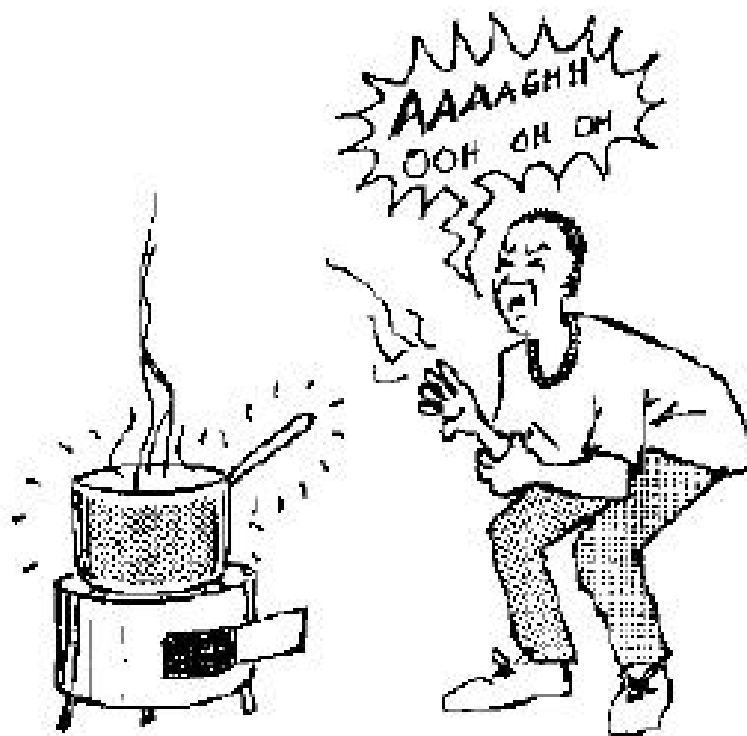

Would you ever touch the handle of a hot pan? Not me. Would you put margarine just aside of the pot? Not me. Would you hold your hand right above the hot water? Not me. This is because, we know a lot about thermal physics by daily experience. But we do not always relate this knowledge with what we learn at school about heat conduction, heat radiation or heat convection as is the case in the examples mentioned above.

Thermal physics has also to do with thermal energy and the measurement of temperatures, with calorimetry, change of states, expansion, etc. Ask the students to talk about everyday thermal phenomena and to write about these. Why should we teach this topic by talk and chalk only, if there are illustrative experiments which

change of states, expansion, etc. Ask the students to talk about everyday thermal phenomena and to write about these. Why should we teach this topic by talk and chalk only, if there are illustrative experiments which do not require a lot of equipment and which are not time consuming in their preparation and performance? See chapter 5.

## 1.6 Wave Motion

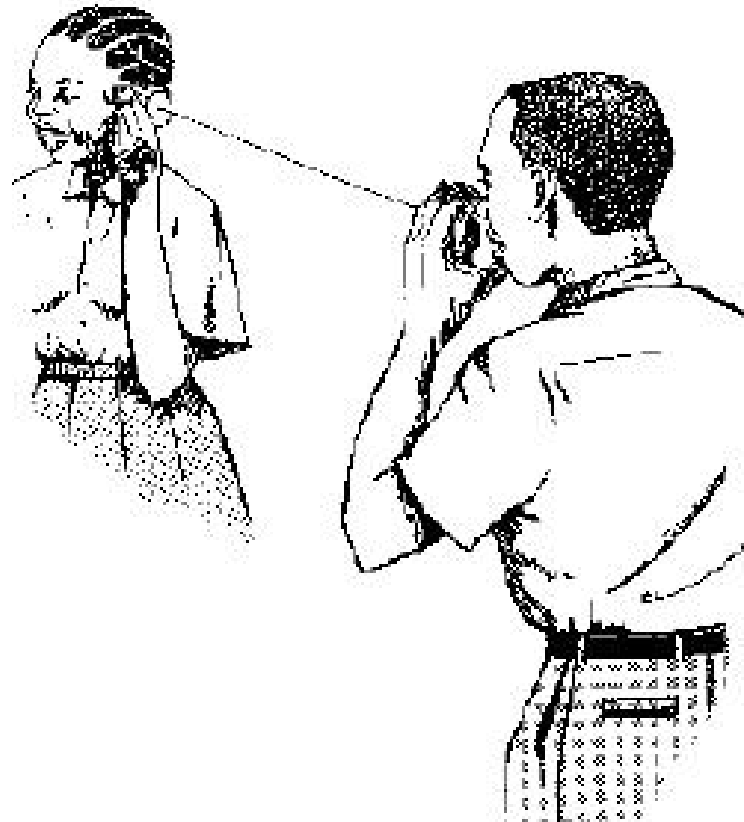

Communication through spoken words has to do with the transport of waves. Telephone and radio are well known. But do we think about waves when we hear a music band, when a crow is croaking or when children are playing with a string telephone?

However, children know how to construct a good string telephone. Two tin cans are needed, also a string which is tied with a knot in a hole at each can. The string should be stretched and not be slack. It should not be heavy. All this is everyday knowledge about the transport of sound waves.

But teaching about waves does not mean only sound waves. We already have mentioned electromagnetic waves. Water waves we notice in a water puddle as well as in a cup of tea.

Produce waves in physics not only by talking. Meaningful and simple experiments are possible on many themes of this topic. No time? Hand experiments are always brief, illustrative and can be carried out with everyday things. Get ideas by reading chapter 6.

### 1.7 Geometrical Optics





When we hear about optics, the optician, eye glasses and lenses come into our mind. But that is not all what optics is about. Optics is also about the reflection of an image in a mirror or in a water puddle. The water surface is like a mirror. The image to be seen is inverted and it seems to be as far behind the water surface as the object is in front of it. Perhaps there are no curved mirrors at your school to teach about concave and convex mirrors. No problem. Take a polished spherical spoon and you will be able to perform an interesting lesson. If you have no equipment for an introduction to the principles of how lenses work, this is no problem too. Take a fused and water filled transparent bulb and you can be sure about the admiration of your students about your creativity in teaching physics by doing. Certainly not all themes can be taught by simple qualitative hand experiments only. But you may be astonished to see how many there are for eye catching demonstrations. For details, see chapter 7.

## **1.8 Electricity and Magnetism**

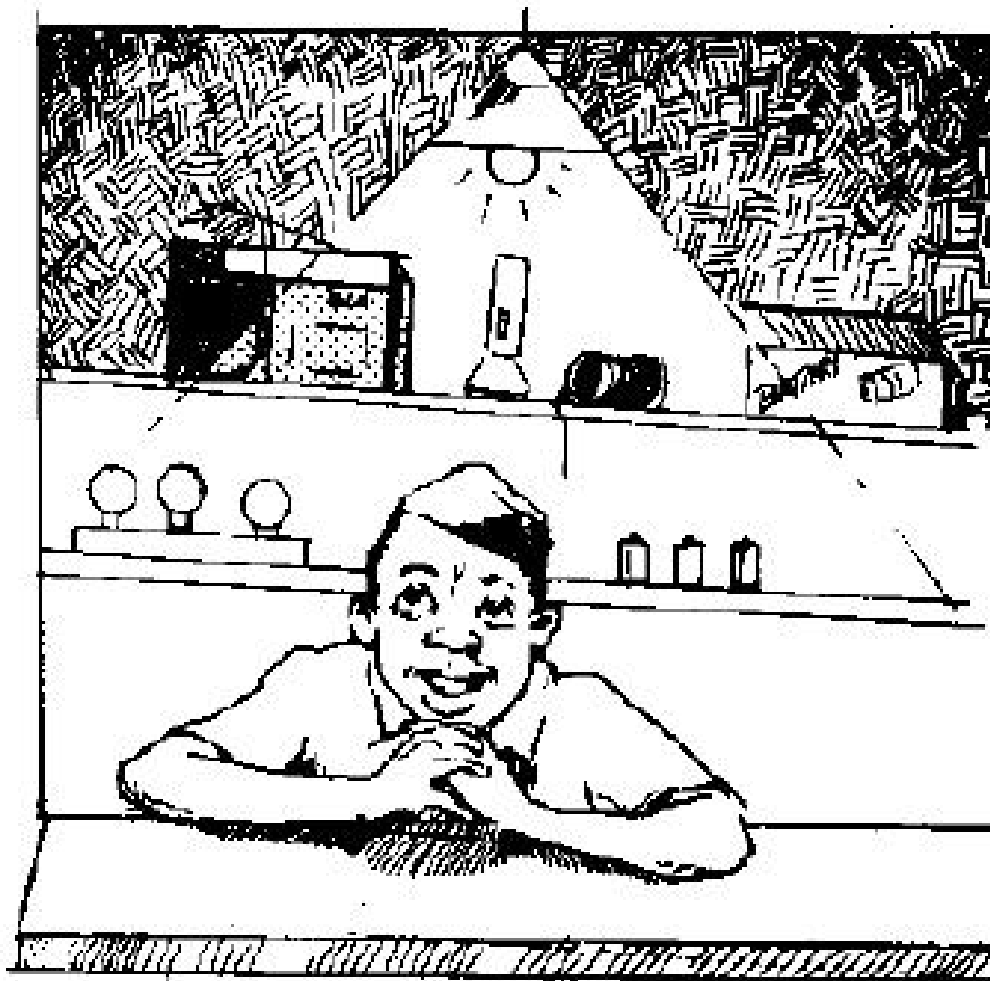

Effects of electricity can be observed nowadays nearly everywhere. A light bulb lights the room, a radio enchants our ears and a torch helps to find our way in the darkness and last but not least we do owe a cool soft drink to a refrigerator. The understanding on how electric apparatus work is essential nowadays.

But electricity does not only mean a current flows in a circuit. It means also static electricity or a lightning during a thunderstorm. The topic electricity is closely related to magnetism. Without magnets electric motors would not work. Loudspeakers work with magnets and even a simple bicycle dynamo has one. In harbours you can see how "attractive" magnets can be to lift heavy loads. Do you think that the teaching of electricity by doing is difficult, needs a lot of equipment and is even dangerous? Brief and attention attracting experiments

you can see how "attractive" magnets can be to lift heavy loads. Do you think that the teaching of electricity by doing is difficult, needs a lot of equipment and is even dangerous? Brief and attention attracting experiments wanted? Only look on chapter 8.



## 2. Laboratory Techniques

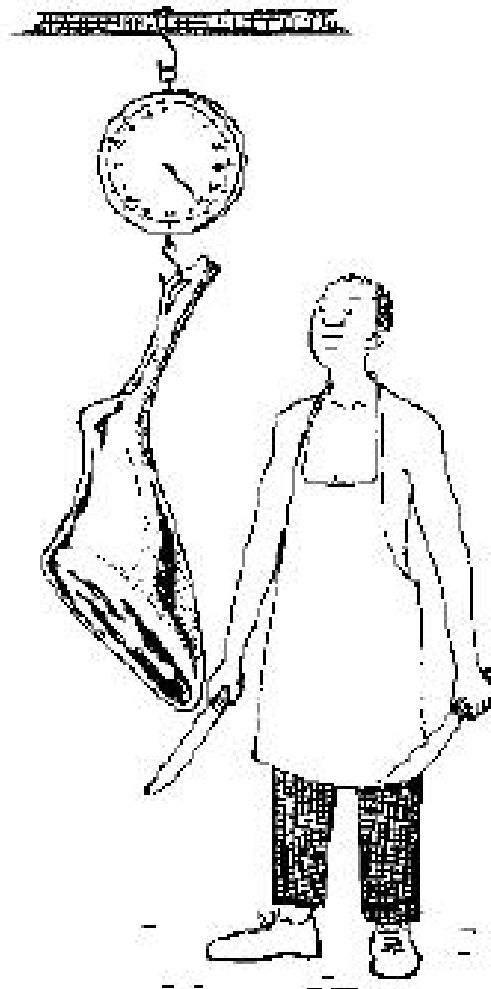

### 2.1 Collection of Data

Man's progress is due, in large part, to his ability to measure and hence collect data with greater and greater precision. Young pupils should learn, generally, about how to obtain data by carrying out simple experiments.

man's progress is due, in large part, to his ability to measure and hence collect data with greater and greater precision. Young pupils should learn, generally, about how to obtain data by carrying out simple experiments. They should be introduced to the basic measurements of mass, distance and time. They should be trained in recording and in graphical analysis of data.

### **2.1.1 Data on Weighing**



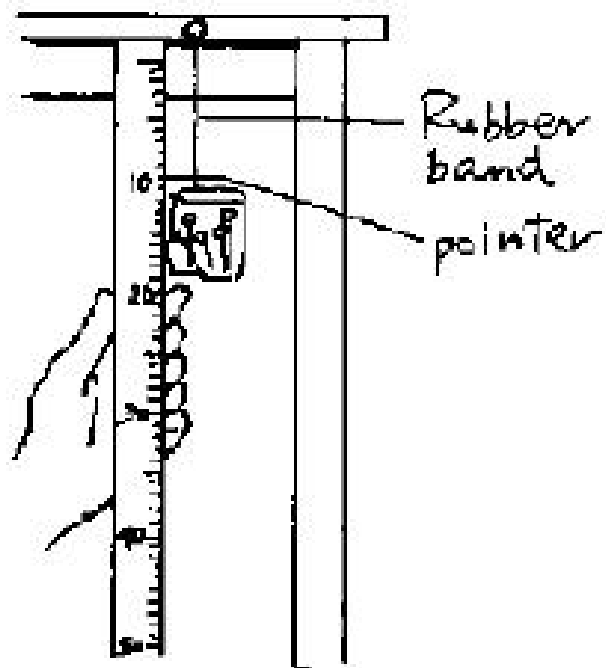

Number of nails	Extension in mm
1	
2	
3	
4	
5	
6	
7	
8	
9	
10	
11	
12	
13	
14	
15	
16	

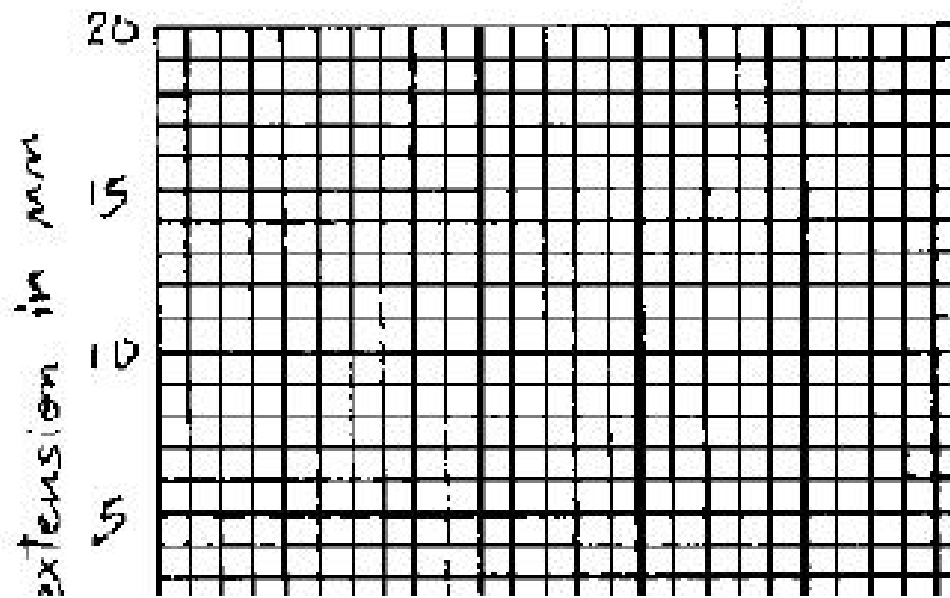

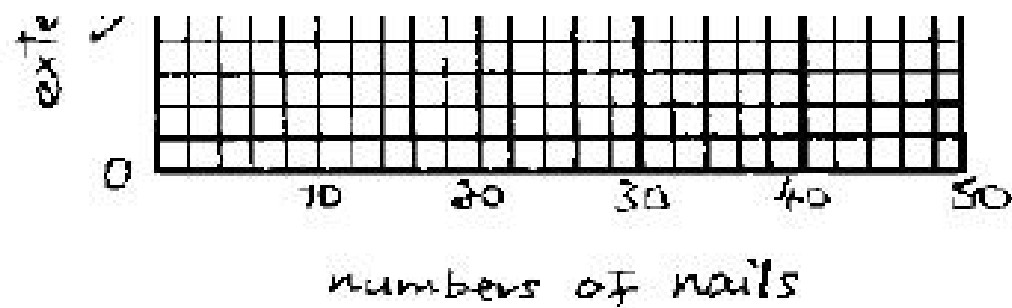

A rubber band is fixed at one end and is attached both to a wire hook at the other end (which serves as a pointer) and a small plastic bag (e.g. for wrapping groundnuts). Fill the bag with nails in successive small numbers (which you count) or other objects of similar weights. Let the pupils measure the extension of the rubber band, each time they add more nails, record the readings and ask them to draw a graph (see the figure).

### 2.1.2 Data on Distance



TURNS	DISTANCE

Make a mark on the tyre of a bicycle or a car at a point just next to the surface of the pavement. Turn the tyre to move straight forward along the pavement and measure and record the length of one turn. This is the distance covered when the mark is about to make contact with the pavement again. Let the pupils repeat the

to move straight forward along the pavement and measure and record the length of one turn. This is the distance covered when the mark is about to make contact with the pavement again. Let the pupils repeat the experiment several times in each case with the tyre allowed to roll a few more turns. The distance is calculated in each case and a graph is drawn.

### 2.1.3 Data on Time

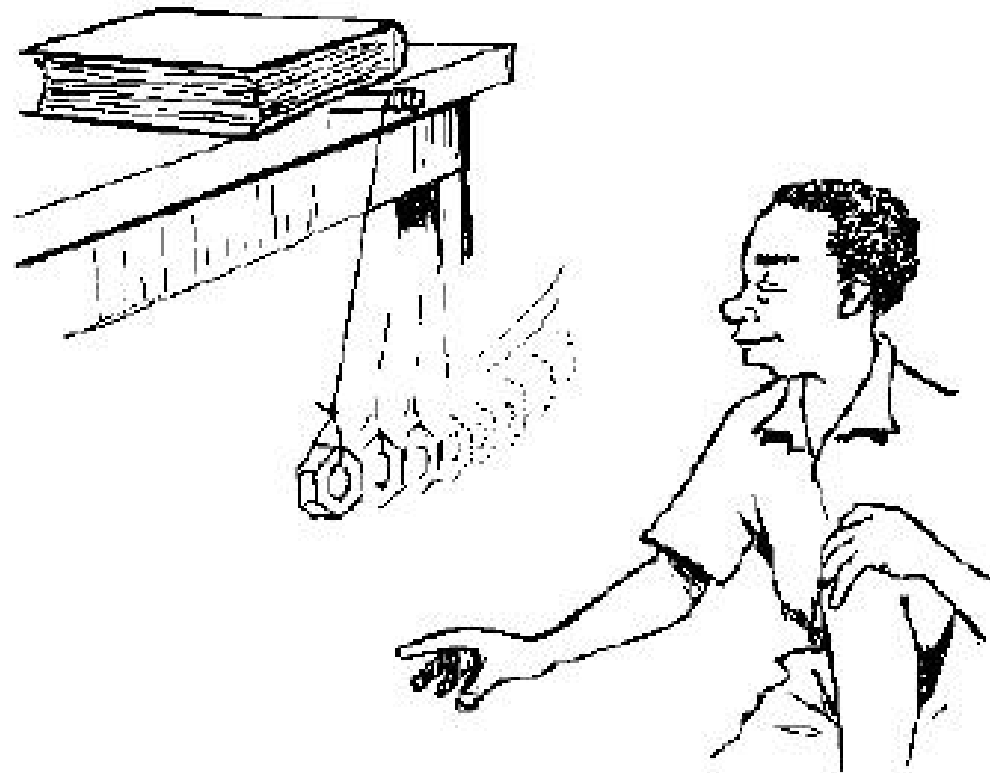

LENGTH OF PENDULUM	SWINGS		
	5 cm	10 cm	15 cm
50 cm			
75 cm			
100 cm			

Fix a thin thread somewhat off the edge of a table and hang e.g. a nut at a distance of 50 cm on it. You have made a pendulum. Hold the (nut) pendulum and pull it to one side, so that it is horizontally displaced by 5 cm. Start counting the number of oscillations (back and forth) that take place in one minute. Record your result as shown. Repeat the experiment by horizontally displacing the nut by 10 cm and 15 cm consecutively. Try to find out the length of a pendulum which happens to oscillate just 60 times in one minute.

shown. Repeat the experiment by horizontally displacing the nut by 10 cm and 15 cm consecutively. Try to find out the length of a pendulum which happens to oscillate just 60 times in one minute.

#### **2.1.4 Data on Velocity**



Mark a distance of 100 metres along a nearby road or playground. Note the time taken for a car, a bicycle or a sprinter to cover the distance as follows. One pupil waves down his hand as either the car, bicycle or sprinter crosses the 0 metres mark. Another pupil with a watch, starts timing at the same time. A third pupil at the 100 metre mark waves down his hand as the moving object crosses the 100 metre mark and at this instant the

crosses the 0 metres mark. Another pupil with a watch, starts timing at the same time. A third pupil at the 100 metre mark waves down his hand as the moving object crosses the 100 metre mark and at this instant the timekeeper stops his watch.

Pupils record the time taken for each case and figure out the respective velocities.

### 2.1.5 Simple Beam Balances

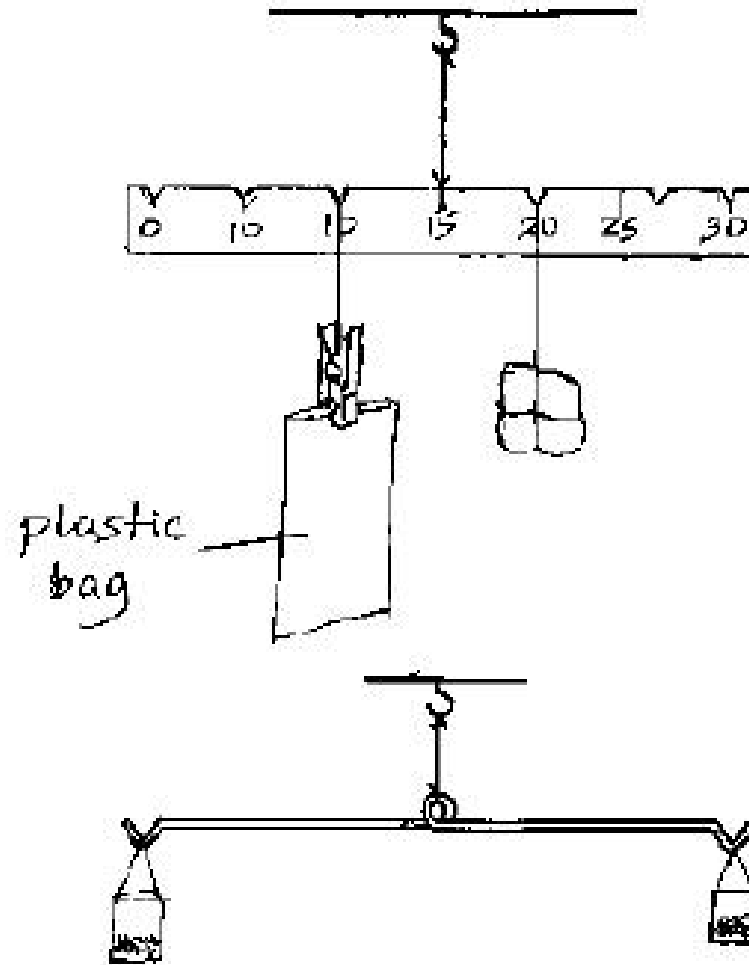



A balance for teaching moments and equilibrium can be made from a ruler or a thin wooden bar. A balance for introducing equilibrium consists of a wire with a loop for hanging in the centre and with two hooks at the ends.

### 2.1.6 Sensitive Laboratory Balance

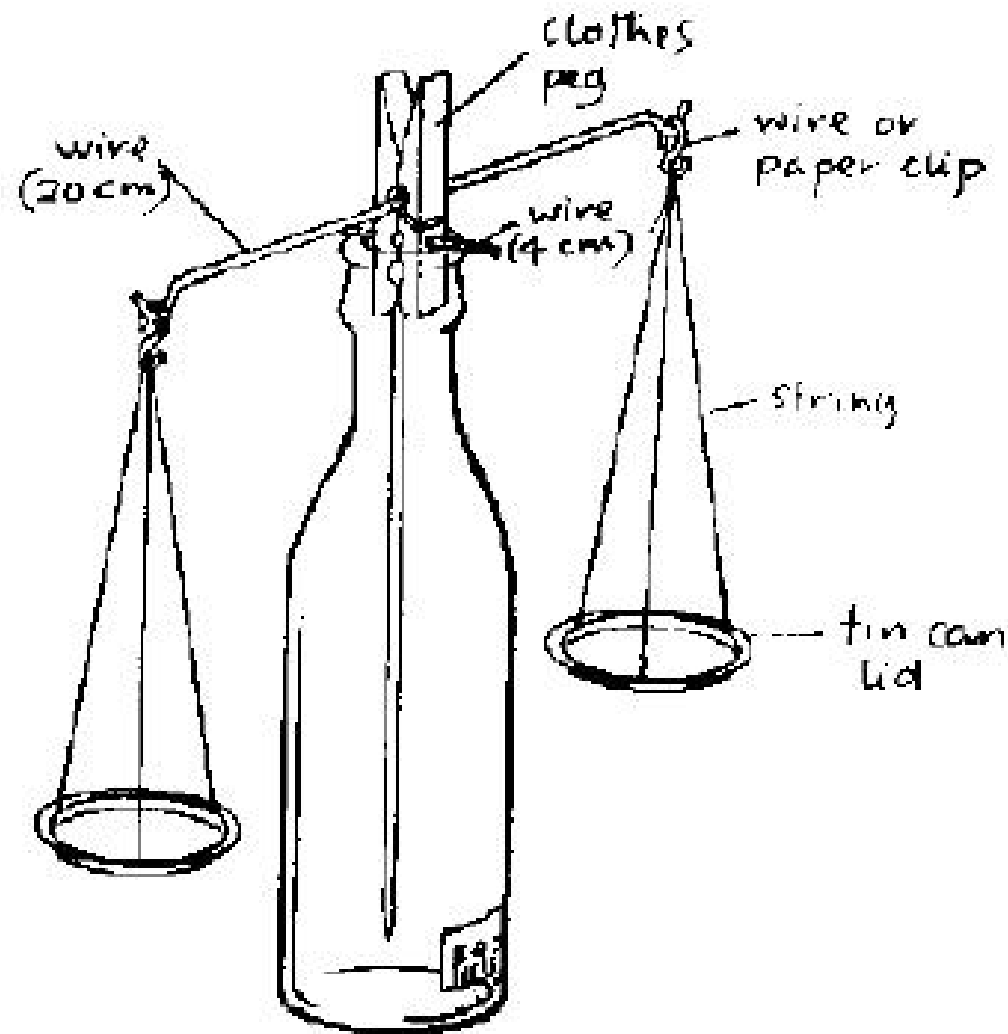

Drill a hole through a clothes peg below the spring for a wire or nail to pass through. Fix a wire right in the spring as a balance beam, and another one in the mouth of the peg as a pointer. (The shorter the pointer, the more sensitive the balance). Fit the arrangement in a wide-mouth glass bottle or a plastic bottle washed with a

Put a wire through a clothes peg below the spring for a wire or nail to pass through. Fix a wire right in the spring as a balance beam, and another one in the mouth of the peg as a pointer. (The shorter the pointer, the more sensitive the balance). Fit the arrangement in a wide mouth glass bottle or a plastic bottle marked with a scale.

### 2.1.7 Weights

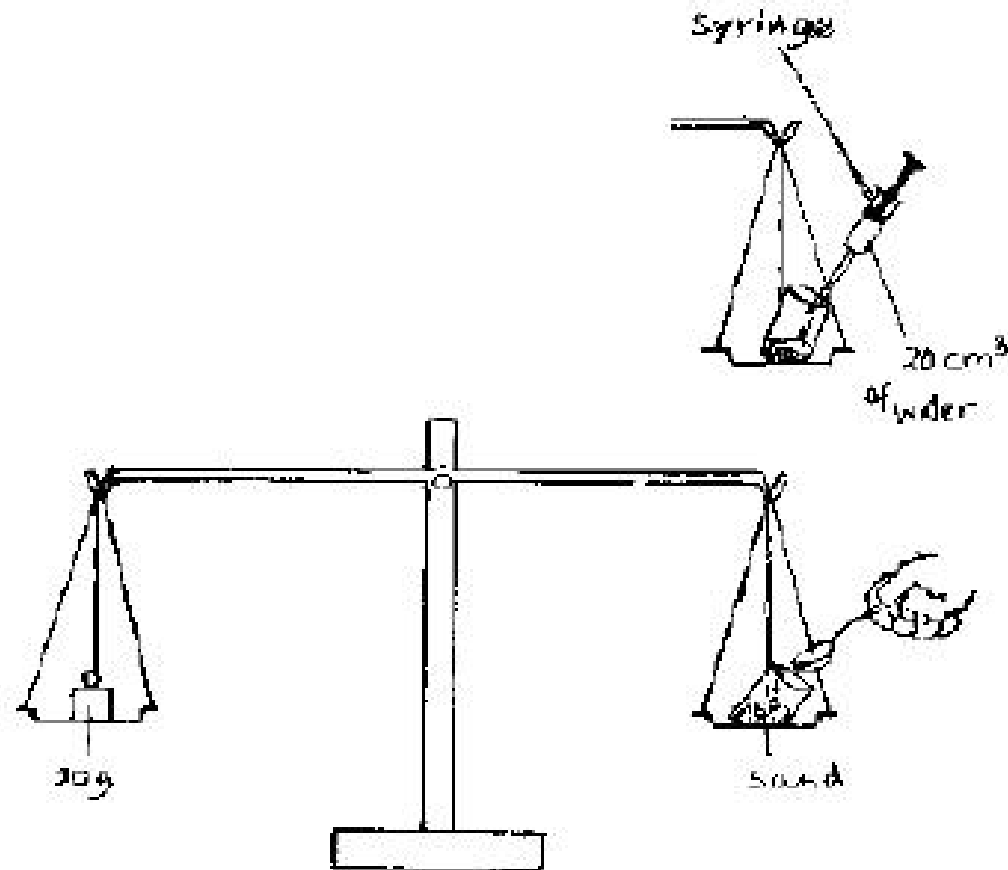

(a) Fill small plastic bags with sand or small stones and compare them with standard weights. Label and seal the bags with a small flame.

(b) Where there are no standard weights, use syringes or measuring cylinders to fill plastic bags with equal amounts of water. Use the fact that  $1 \text{ cm}^3$  of water has a mass of 1 gram.

### 2.1.8 Weighing Pans

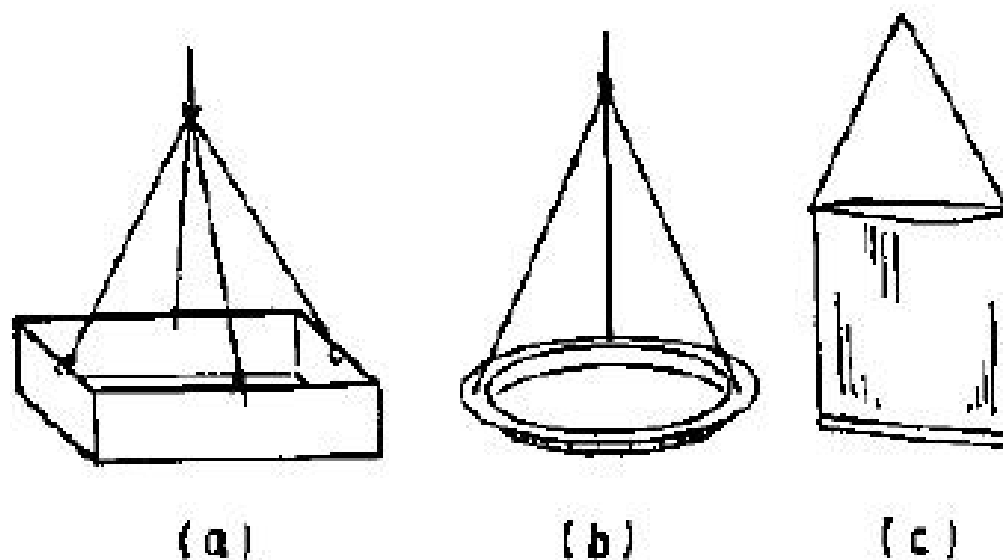

Weighing pans can be made from match boxes (a), plastic lids (b), or even small plastic bags (c) as used for wrapping ground nuts.

### 2.1.9 Measuring Liquids

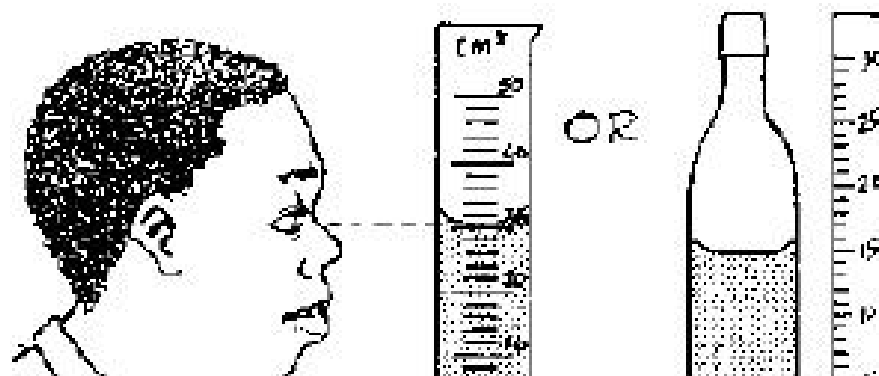

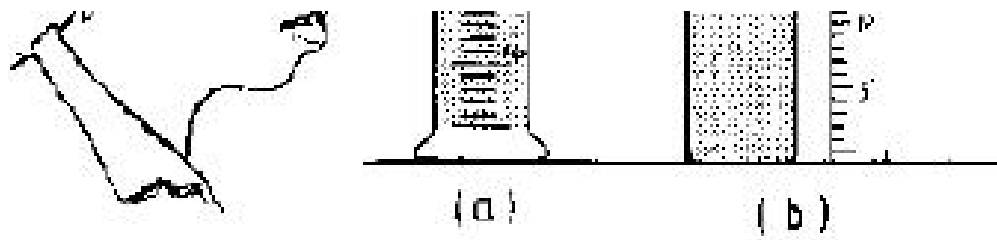

The volume of liquids can be measured by accurately reading the meniscus (a). The principle can be taught with a transparent bottle and a ruler (b).

### 2.1.10 Measuring Different Densities

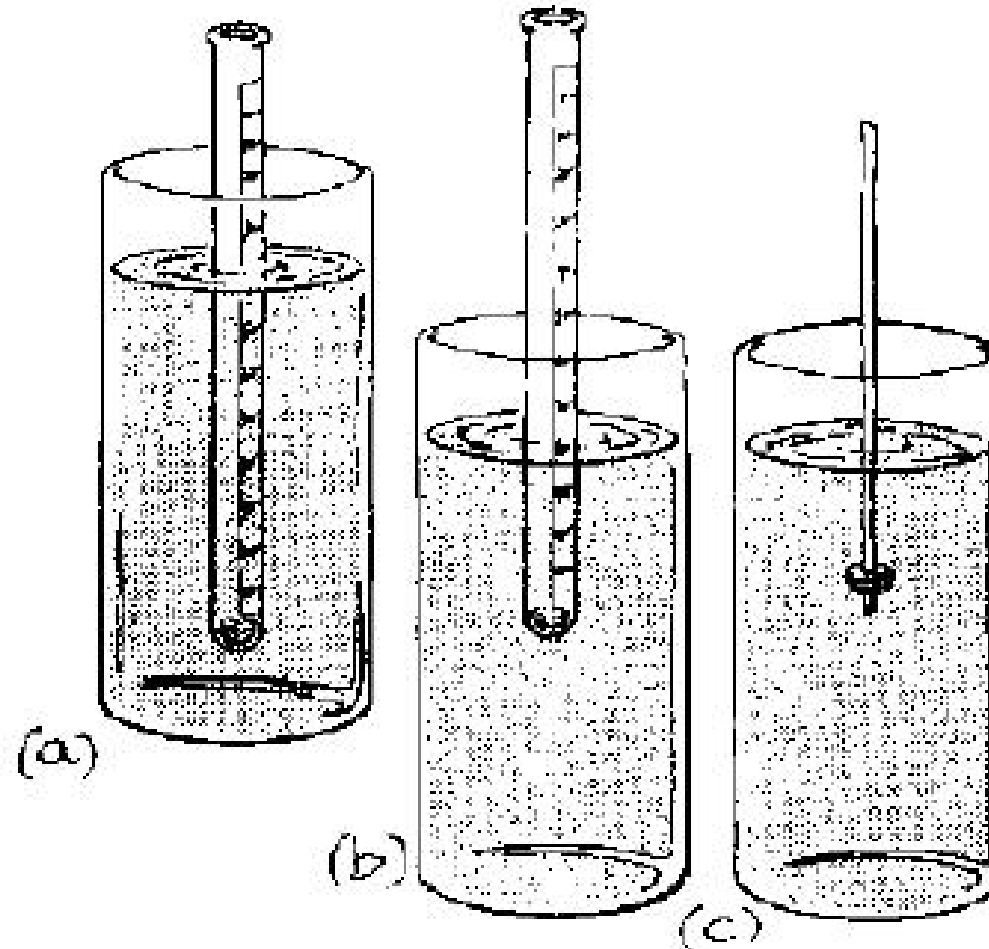

Fill a test tube with sand to keep it upright in water (b). Place a paper scale inside or fix a nut or a stone at one end of a wooden stick. Make regular marks (scale) along the wooden stick (a). Dip the tube or wooden stick in water (b), oil (a), (or kerosene, ethanol, etc.) and record in each case the extent to which the device sinks.

### 2.1.11 Measuring Irregular Bodies



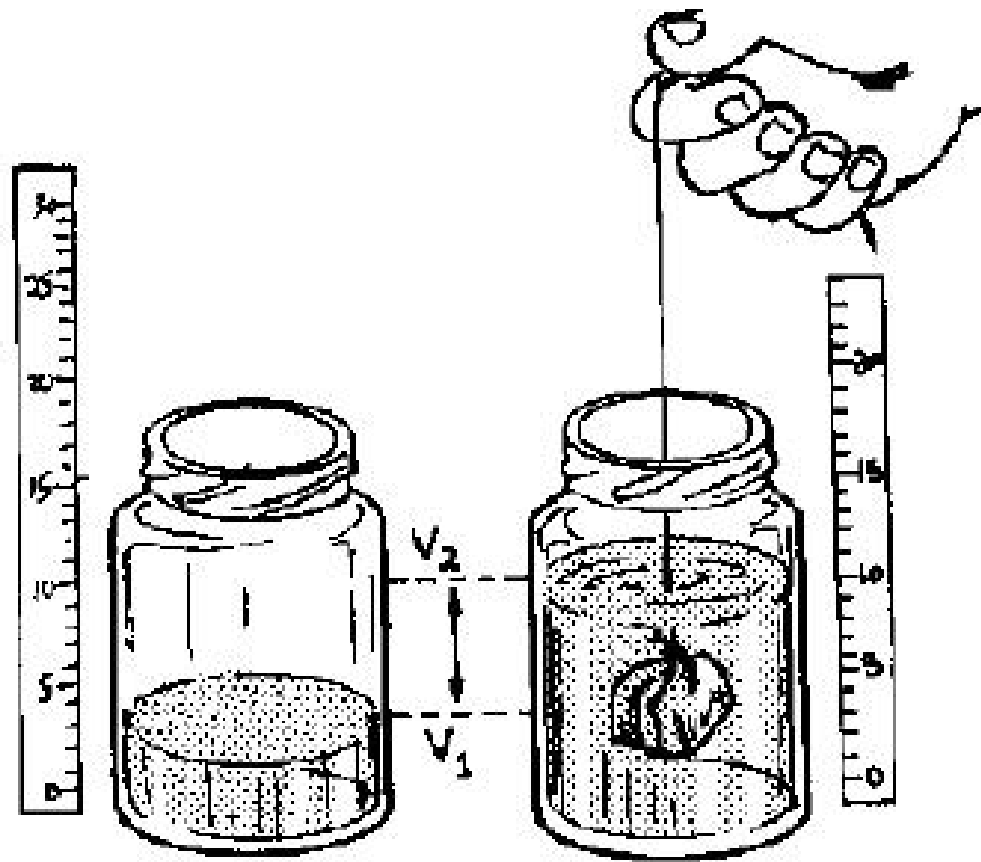

The volume of an irregular body (stone) can be measured by hanging it on a thin thread and dipping it completely in a measuring cylinder containing water. The difference in the volumes of the water read before and after completely submerging the irregular body is its volume. Only the principle is shown here.

### 2.1.12 Measuring Long Distances

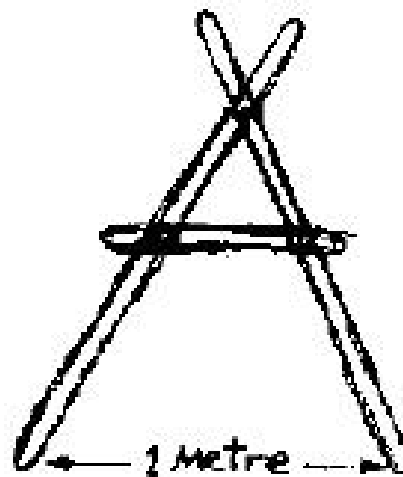

(c)

Measuring devices can be made from wooden sticks (a,c) or from strings by making knots at definite intervals (b). The sticks can be arranged closely together in succession to measure distances on uneven ground.

### 2.1.13 Wind Direction



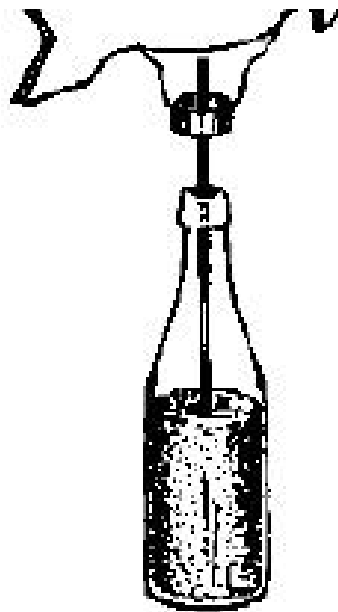

Take an opened fused bulb (for opening see appendix), place a piece of stiff wire so that the bulb turns with low friction on the tip of the wire. Fix two paper arrows folded around the bulb. Dip the wire in a sand filled bottle as a support. The device works excellently.

#### **2.1.14 Wind Speed**



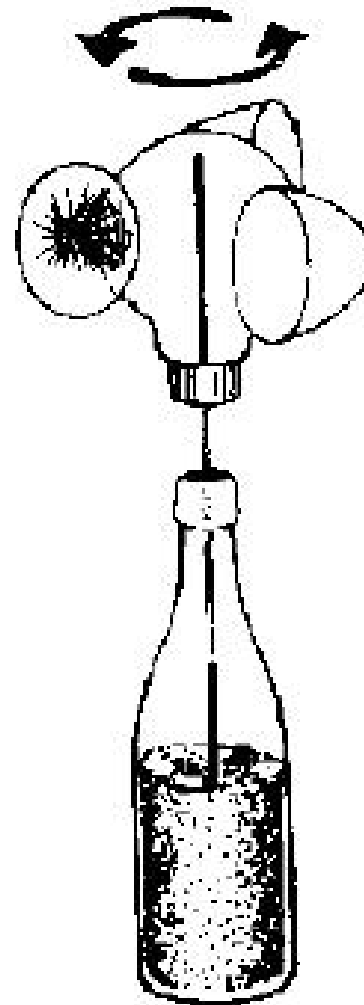

Fold 3 cones from round paper disks (preferably from cement bags or other resistant paper). One cone should be painted outside in a different colour for a better counting of the number of revolutions. Glue the cones to the bulb. Insert a piece of stiff wire which can be dipped in a sand filled bottle as a support (see experiment 2.1.13).

### 2.1.15 A Simple Current Indicator



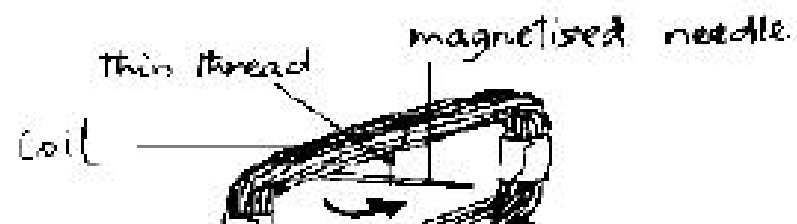
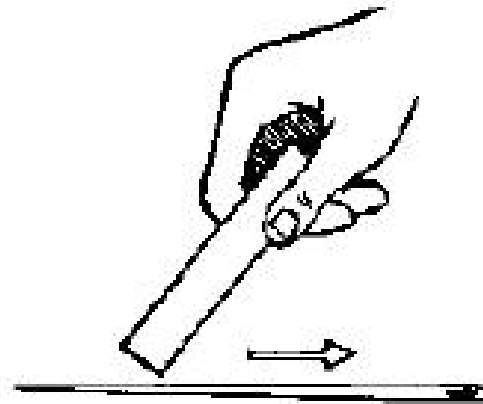
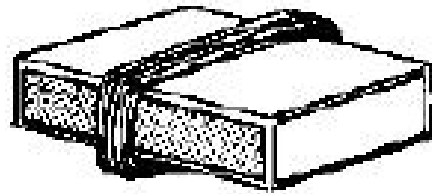

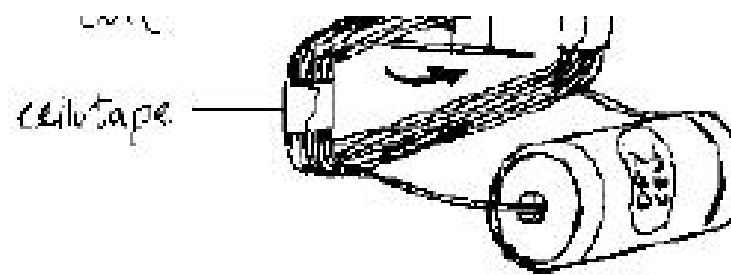

Wrap about 10 turns or more of insulated wire (from a used motor coil or as used for electric bells) round a match-box in order to get the required shape of the coil. Suspend a magnetised steel needle (or a magnetised piece of a bicycle spoke) with a thin thread inside the coil. You can magnetise the needle with a magnet (taken from the loudspeaker of an old radio) by moving it along for about 30 times always in the same direction. When a current flows through the coil, it deflects the needle. A change of the poles changes the deflection.

### 3. Basic Mechanics

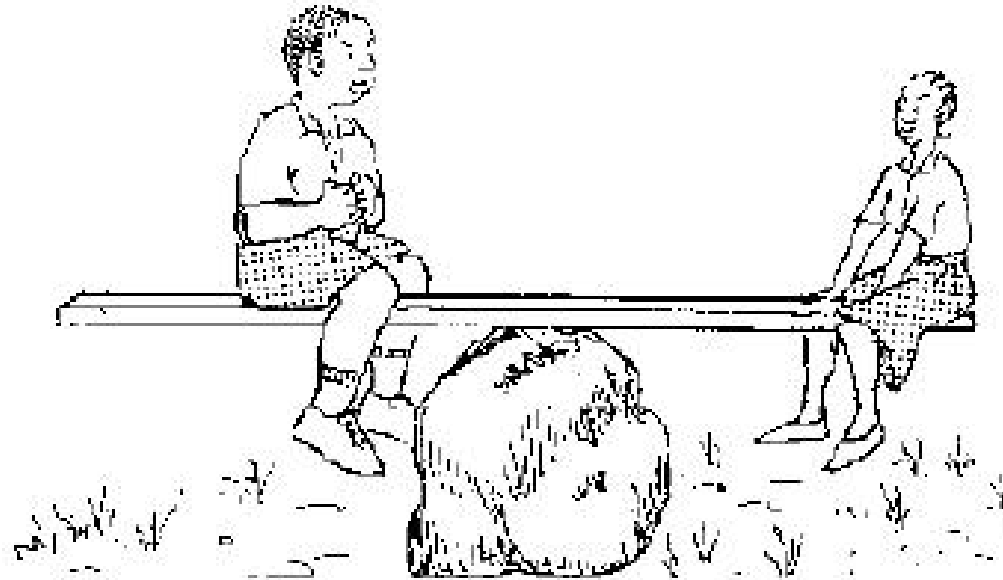

### 3.1 Rectilinear Motion

This section introduces the uniform and the accelerated rectilinear motions, i.e. those having constant velocity and constant acceleration.

Definitions:

Displacement = distance measured along a straight line

Velocity = displacement  $\div$  time taken

Acceleration = change in velocity  $\div$  time taken

Uniform and accelerated motions play an important role in the movement of cars, buses, trains, ships and aeroplanes.

#### 3.1.1 Uniform Motion

### 3.1.1 Uniform Motion

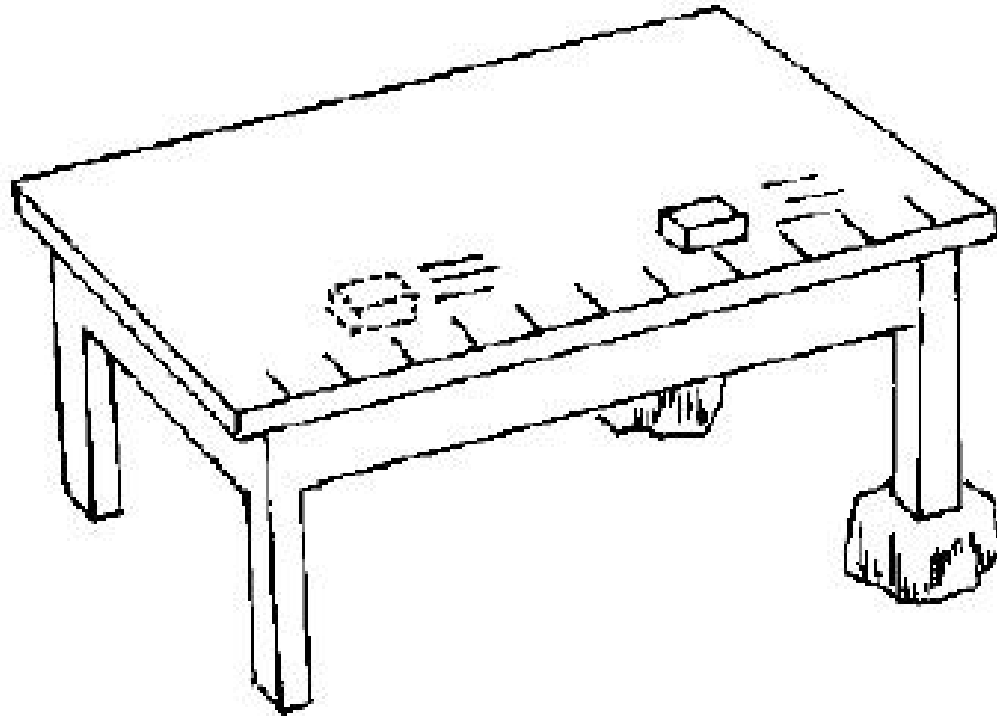

**P:** Place chalk marks along the long side of a smooth table or plank at an equal distance of 10 cm. Then tilt it so that a matchbox loaded with a stone will just not start to move. Then give the box a little push so that it will move.

**Q:** Does it need always the same time from one mark to the next?

**O:** If not, change the inclination of the table or plank until it does.

**E:** If so, this is a *uniform* rectilinear motion: the velocity is constant, there is no change in velocity, thus the acceleration is zero.

**A:** Where does this motion occur in daily life? – For example, a bus, a train or a boat going at constant speed on a straight line path.

### 3.1.2 Accelerated Motion

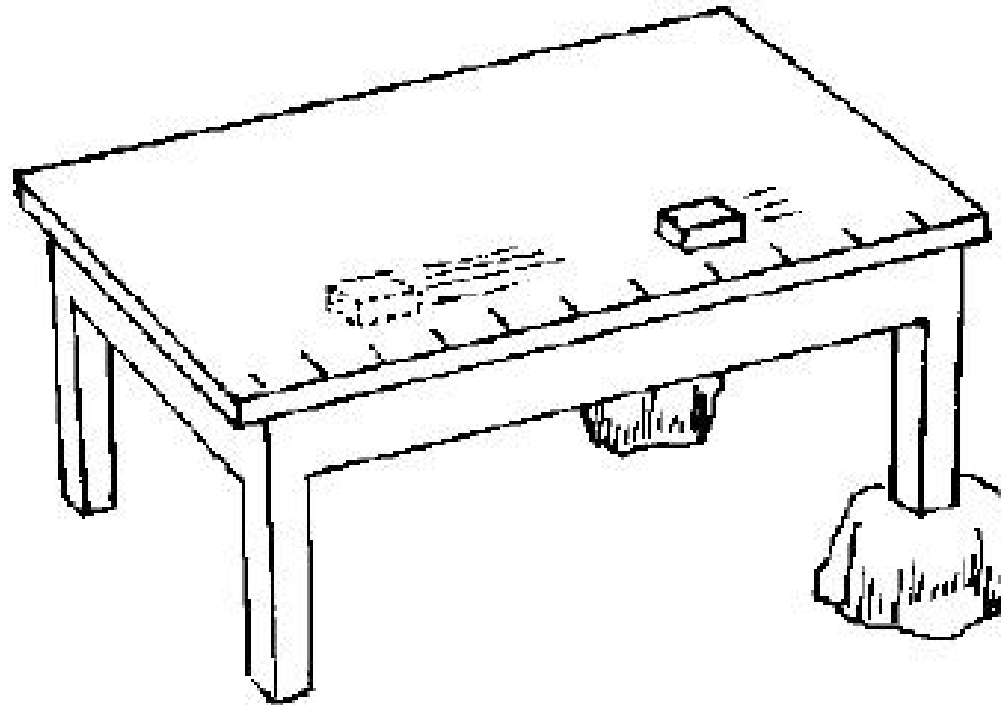

**P:** Tilt the smooth table or plank more than in experiment 3.1.1.

**Q:** How is the time which the matchbox needs to cover the distance between two marks? Is this time getting shorter when the box moves down?

**E:** If so, this is an *accelerated* motion. Its velocity changes as the box moves down. Its velocity *increases*. Thus, it is an accelerated rectilinear motion.

**A:** Where do such motions occur in daily life? – For example, a stone falling down; a bus accelerating after the stop; a bus braking before a stop.

**A:** where do such motions occur in daily life? – For example, a stone falling down, a bus accelerating after the stop; a bus braking before a stop.

## **3.2 Forces**

What is a force? *A force is a push or a pull on a body.* It can be recognised by its effects on a body which are:

Change in velocity of a body (accelerating, braking, changing the direction of the movement); Deformation of a body (changing its shape or size).

### **3.2.1 The Effects of Forces**



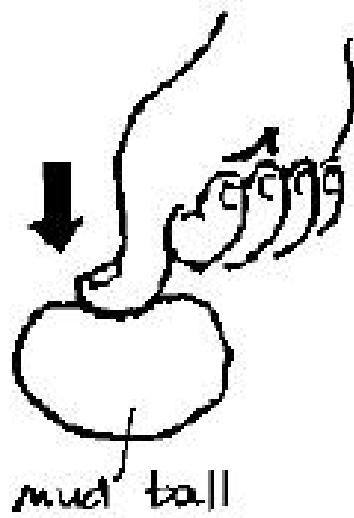

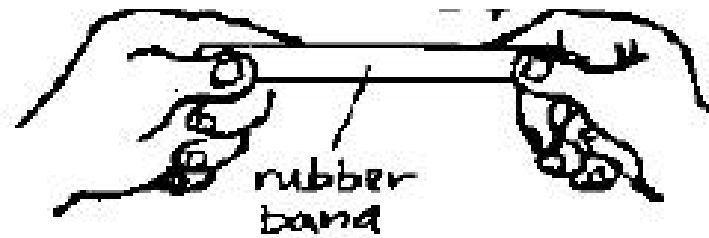

**P:** Show the effects of forces by pushing, pulling, lifting, turning a stone; by stretching a rubber band.

**Q:** How can you group these effects of force?

**E:** Pushing, pulling, lifting, turning *change the velocity of a body*. – Compressing and stretching *change the shape or size of a body*.

*A force changes the velocity or the shape of a body.*

### **3.2.2 Making a Newton Balance**

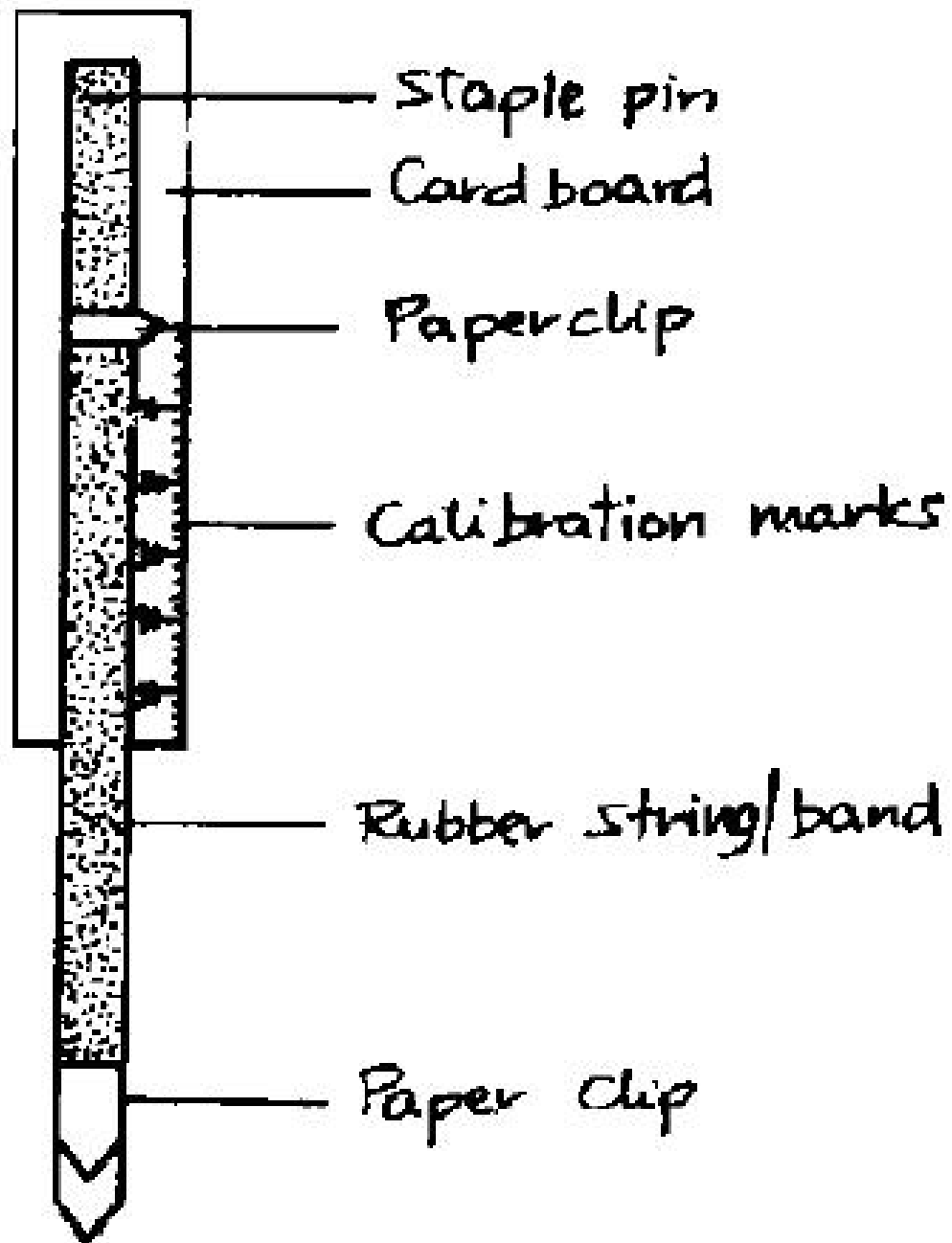

*Forces are measured with a Newton balance.*

*Forces are measured with a Newton balance.*

**P:** Take a strip of card board or a wooden lath. Using incisions or a nail fix a rubber band on it. (The stronger the rubber band, the larger the force you can measure.) Attach one paper clip as a pointer as shown in the figure. Then fix some paper clips as a hook at the bottom end of the rubber band.

Now *calibrate* the balance in *newtons* using either a standard set of weights (e.g. borrowed from the lab of a well equipped school) or another Newton balance: a weighing piece of 1 g mass has a weight of 0.01 N; one of 10 g mass has a weight of 0.1 N; one of 100 g mass has a weight of 1 N and so on. Draw marks accordingly on the scale of the balance.

**H:** Never apply such a big force that the pointer does not go back to the zero mark when the force ceases.

### **3.2.3 Direction of Forces**

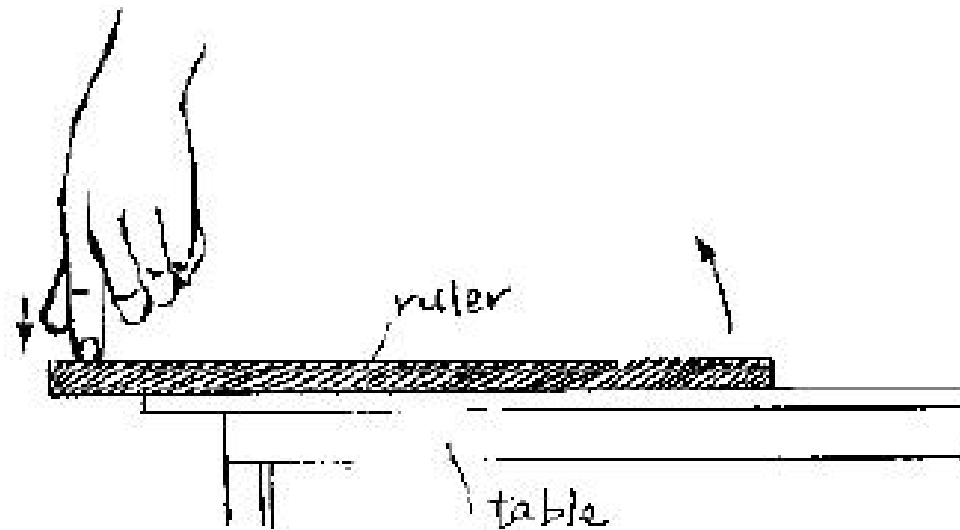
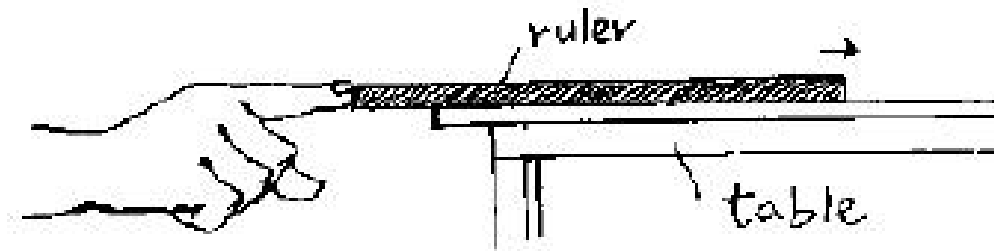

**P:** Show that the direction of a force is important for the effect of a force by applying a force on a stick in various directions, see the figure.

### 3.2.4 Forces as Vectors



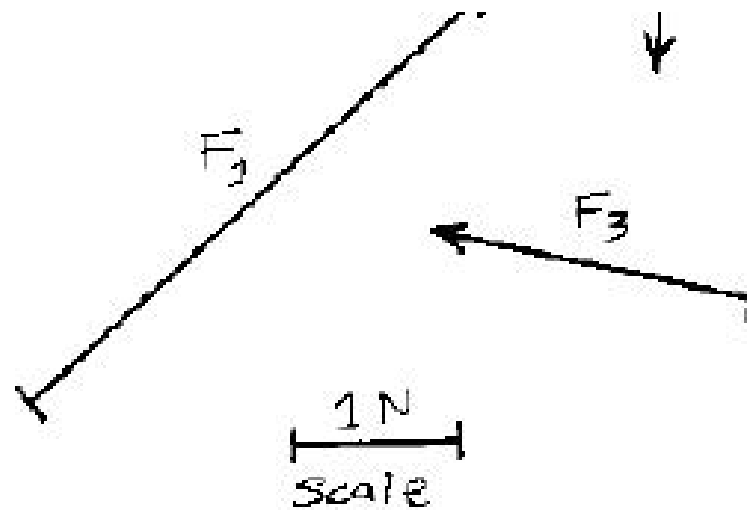

*Quantities which have both direction and magnitude are called vectors.*

Thus, for example, force, displacement, velocity and acceleration are vectors.

Vectors are drawn as arrows whose length gives the magnitude.

Draw some forces like those in the above figure and a scale on the blackboard and ask the students to give the direction and magnitude of these forces.

### **3.2.5 Measuring Forces**

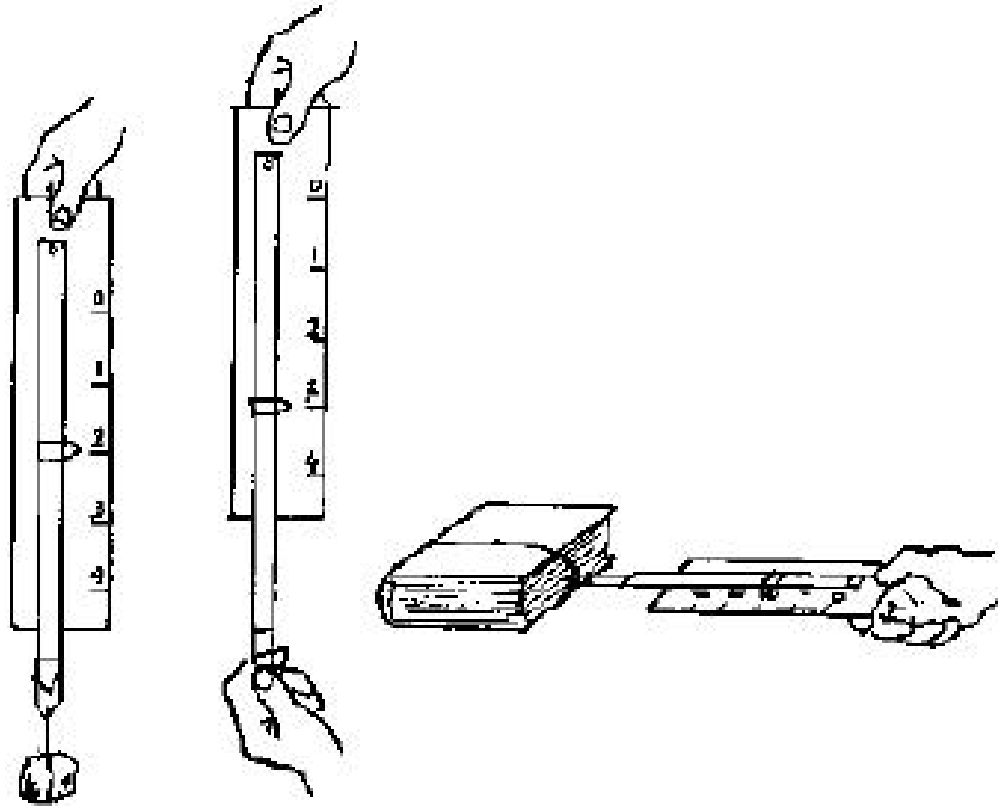

P: Using your Newton balance measure various forces like the force needed to lift different stones, the force needed to pull a book sliding over your desk, the force to stretch a spring, etc.

### 3.2.6 Drawing Forces

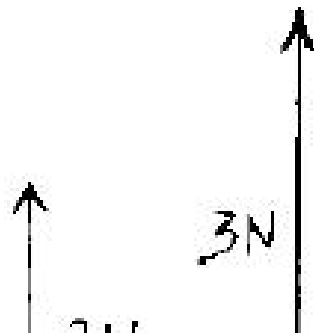

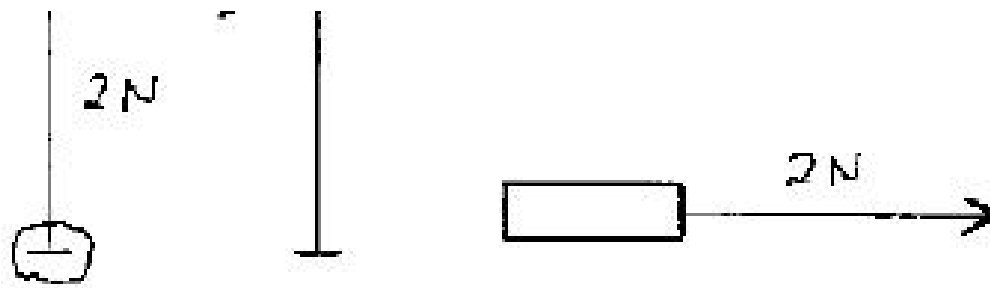

**P:** Ask the students to draw all the forces which you have measured in experiment 3.2.5 as vectors in their notebook.

### 3.3 Weight and Mass

The *weight* of a body is the pull of the earth on it. Thus, weight is a *force* measured in newtons. It is a *vector* directed to the centre of the earth. It is measured by the Newton (spring) balance.

The *mass* of a body is a measure for the quantity of matter in that body. Thus, it is a *scalar* which *stays everywhere the same* while the weight of body will decrease when its distance to the centre of the earth increases. It is measured by the beam balance.



### 3.3.1 Weight as the Pull of the Earth

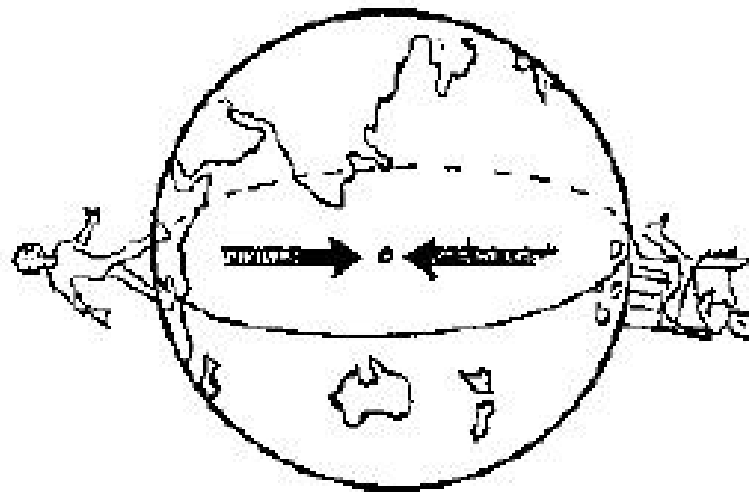

**P:** Hold a stone at the level of a table plate and release it.

**Q:** What do you observe?

**O:** It will fall down to the floor.

**E:** It changes its velocity, i.e. a *force* must act on it. This force is the pull of the earth on the stone. This pull is always directed to the centre of the earth. Thus, the weight has magnitude and direction. It is a *vector*.

Hence, as the figure shows, the weight of people in different regions of the world has different directions. However, it is *always directed to the centre of the earth*.

The *magnitude* of the weight of the same body is *not* everywhere the same. The further away from the centre of the earth the body will be, the less its weight will become.

### 3.3.2 Mass as the Quantity of Matter



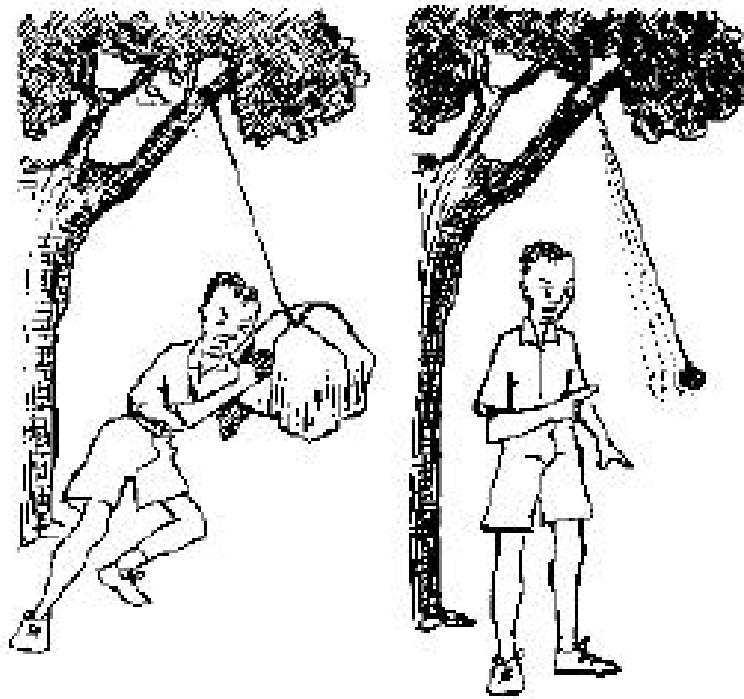

**P:** (a) Suspend a large and a small stone using long pieces of string (e.g. from a branch of a tree). Try to push the two stones. Then try to stop them.

**Q:** Which stone is harder to push? Which is harder to stop?

**P:** (b) Take a ball and a stone or brick of similar size. Throw both.

**Q:** Which is harder to throw?

**O:** (a) The larger stone is harder to push and to stop than the small stone.

(b) The stone or brick is harder to throw than the ball.

**E:** The greater the mass of a body, the more it resists to any change in its velocity. We say, the greater the mass of a body, the greater its *inertia*.

The quantity of matter of the same body, and hence its mass, is everywhere (e.g. on the earth, on the moon, etc) the same. Mass has no direction, thus it is a *scalar*.

### 3.3.3 Weight is Measured by the Newton (Spring) Balance

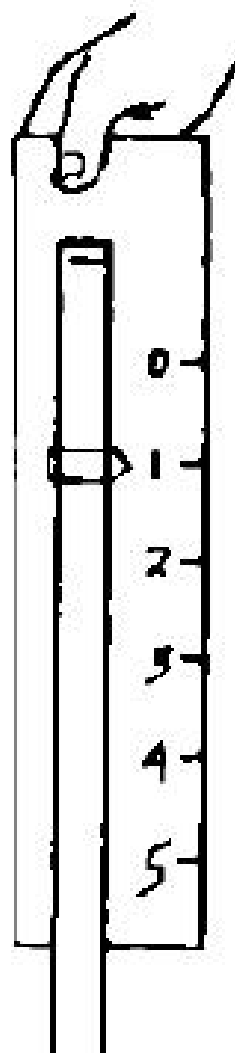

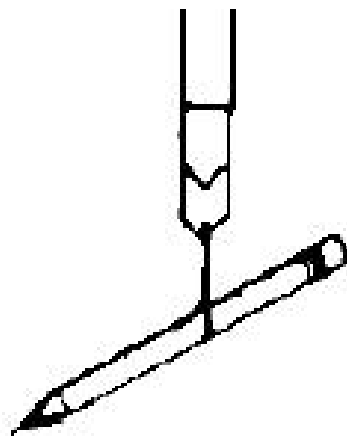

Since weight is a force, it is measured by the Newton (or spring) balance.

**P:** Take a Newton balance (see p. 15) and measure the weight of a pencil, a book, etc. in newtons.

### 3.3.4 Mass is Measured by the Beam Balance

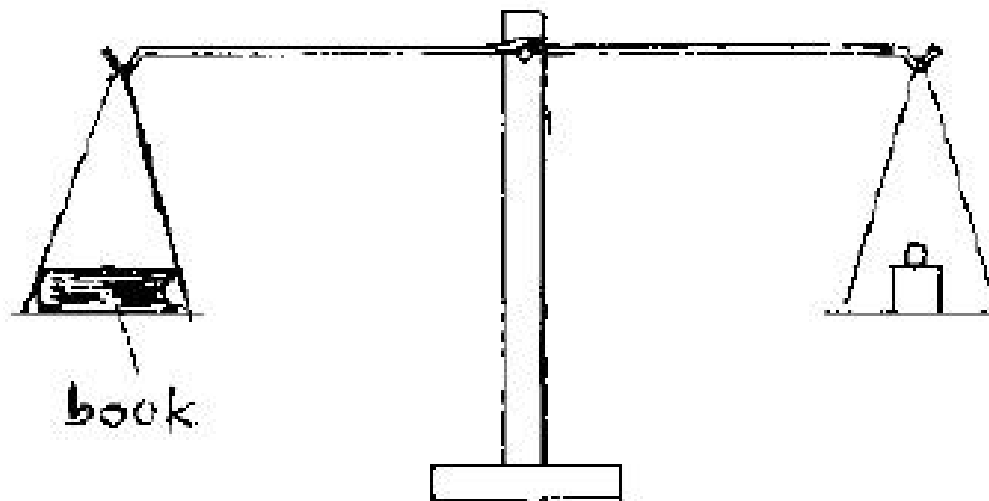

*The mass of a body is measured by the beam balance.*

**P:** Take a beam balance and a set of weighing pieces (see p. 10) and measure the mass of a pencil, a book, etc. in grams (g).

### 3.3.5 The Surprising Pencil

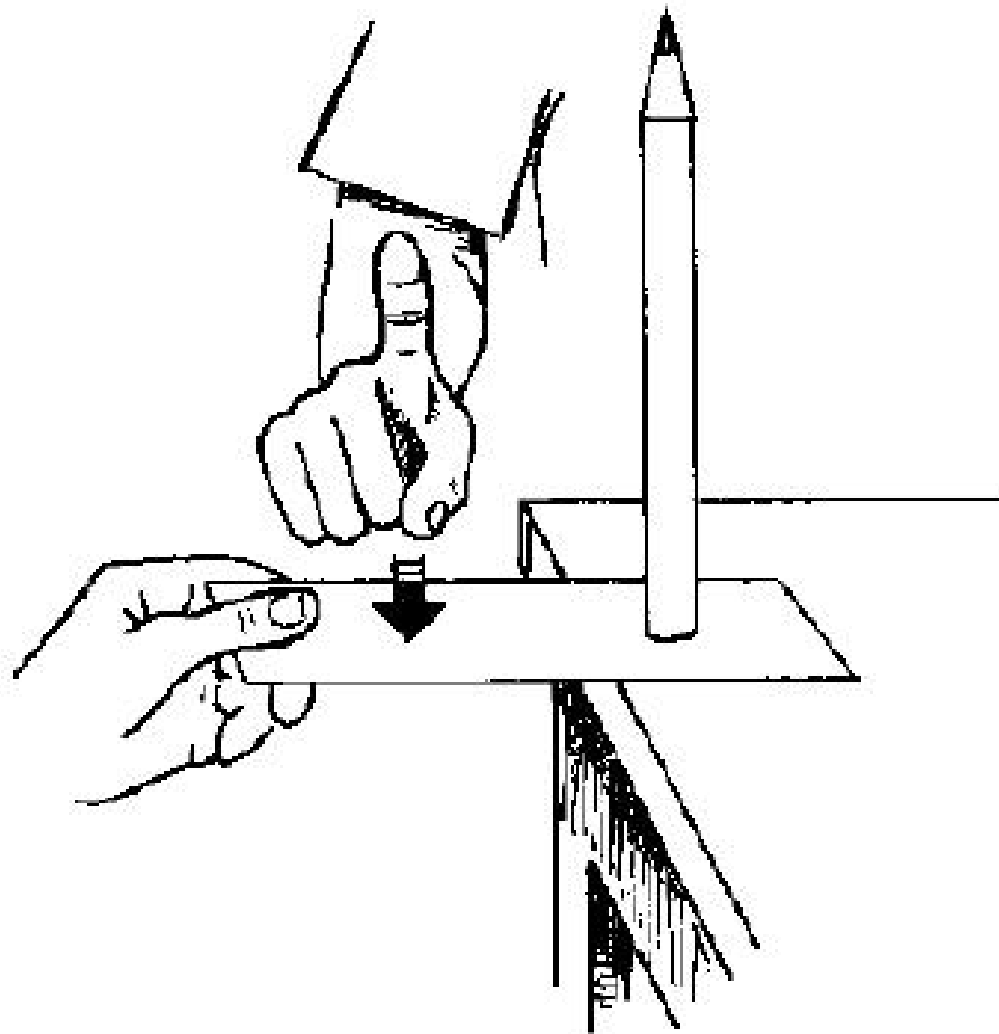

**D:** Place a pencil upright on a strip of paper near the edge of a table. At once hit the strip with your finger as

**P:** Stand a pencil upright on a strip of paper near the edge of a table. At once hit the strip with your finger so that it leaves the table, see the figure.

**Q:** What happens? How do you explain this?

### 3.3.6 The Standing Passenger in the Pick-up

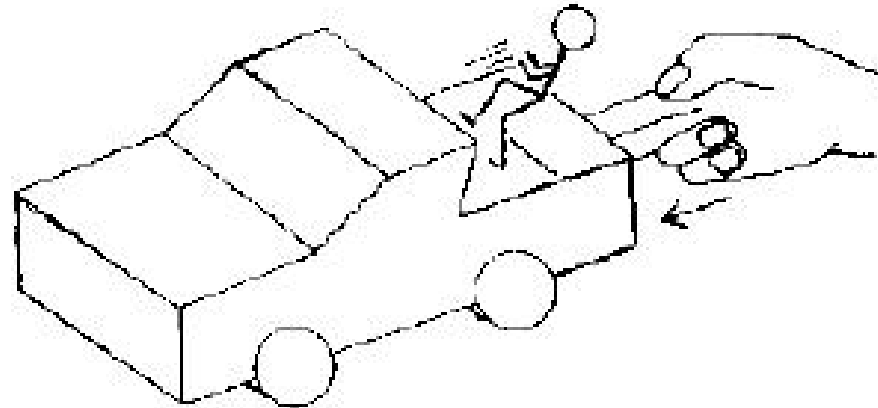

**P:** Take a toy pick-up or a box (representing a pick-up) and place a *freely standing* passenger (made of card or wood) in it. Strongly accelerate the pick-up. Make it turn a corner. Finally stop the pick-up suddenly.

**Q:** What happens to the standing passenger in each case? Why?

### 3.3.7 Kicking a Brick

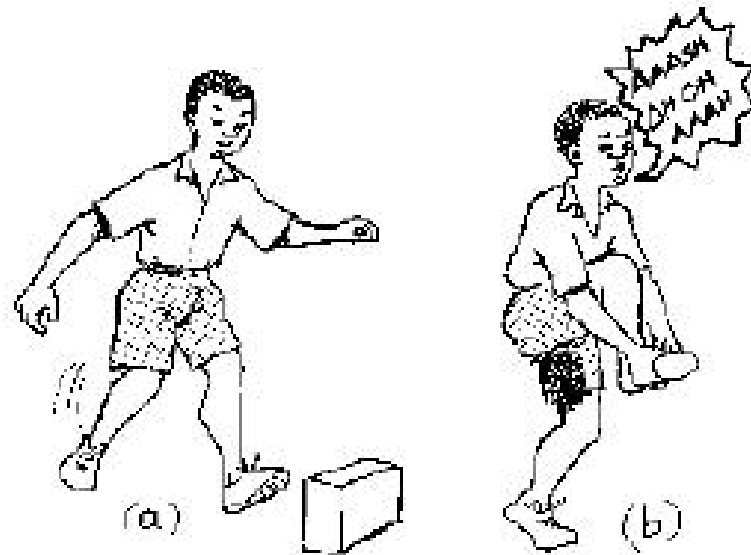

**P:** Ask students to draw the figure on a display chart.

**Q:** Why does the student feel great pain after he kicked the brick? Would the same happen, if he kicked the same brick on the moon?

**E:** He feels pain because the brick has a greater mass, and hence a greater inertia than a football. The same would happen at the moon, because the mass, and hence the inertia of the brick, is the same on the moon.

### 3.3.8 Car Crash



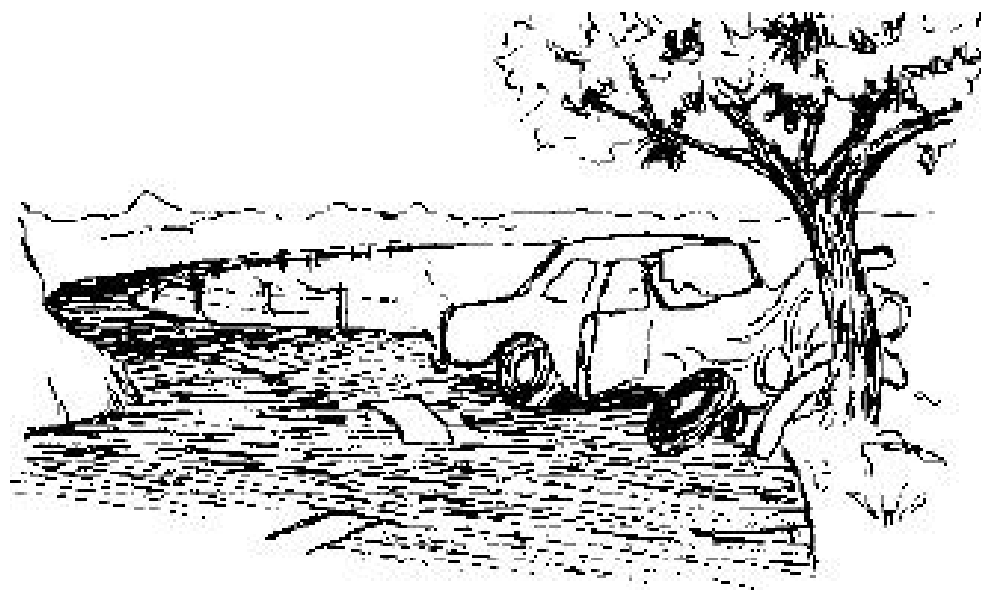

**P:** Make a display chart of the figure.

**Q:** Why did this car get so badly damaged?

**E:** The big mass of the car has great inertia. Thus, a great force exerted by the tree was needed to stop it suddenly. This force deformed the car.

### **3.3.9 The Weight Changes**



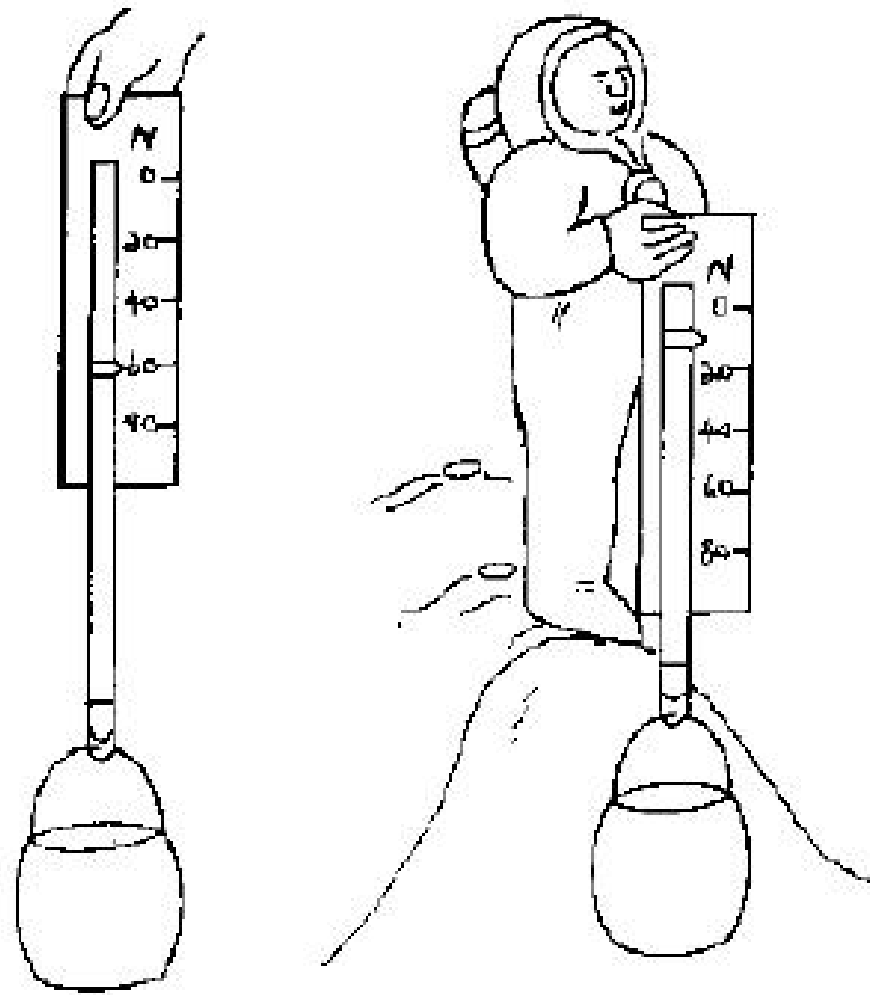

(a) On the earth

(b) On the moon

**P:** Make a display chart of the figure.

**Q:** Why is the weight of the same bucket of sand less on the moon than on the earth?

**E:** The weight of a body depends on the place where the body is. It is *not* everywhere the same.

### 3.3.10 The Mass Stays the Same

### 3.3.10 The Mass Stays the Same

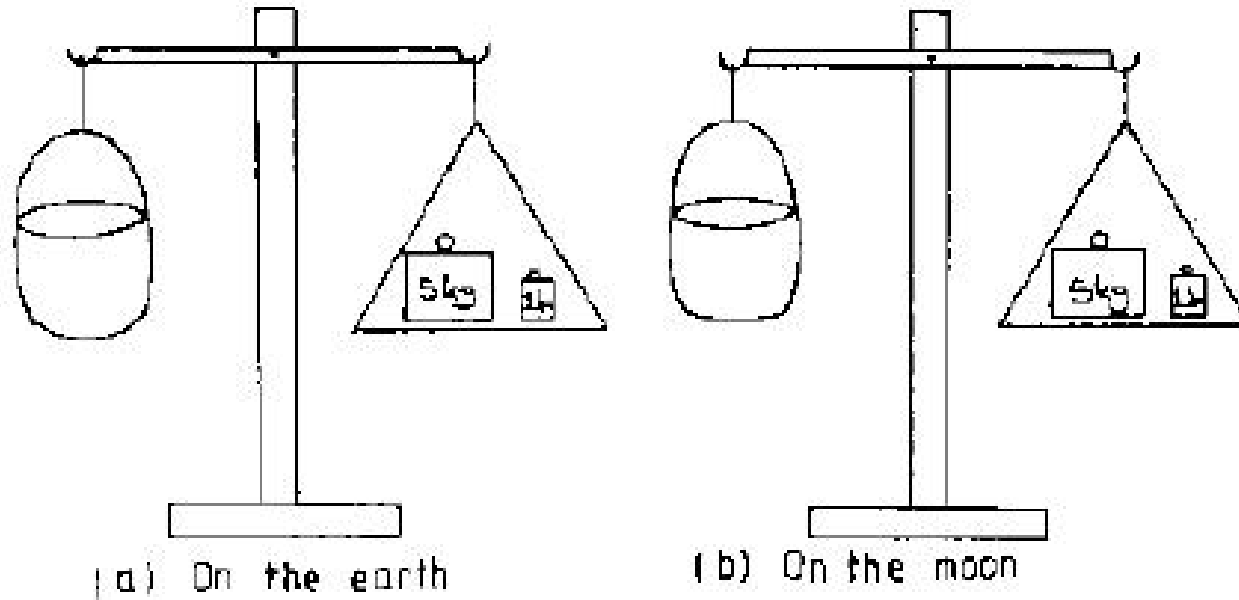

**P:** Make a display chart of the figure.

**Q:** Why is the mass of the bucket of sand the same on the earth and on the moon?

**E:** The quantity of matter of the bucket has not changed, hence its mass has not changed.

### 3.4 Centre of Gravity and Stability

This section deals with the moment of a force, the centre of gravity (centre of mass) and stability.

*Moment* of a force = force x perpendicular distance from the pivot

In equilibrium: total clockwise moment = total anti-clockwise moment

The *centre of gravity* (centre of mass) is the point in which the total weight of the body seems to act.

The stability of a body depends on the position of its centre of gravity (COG).

A body is in *stable* equilibrium if a small movement would rise its COG.

A body is in *unstable* equilibrium if a small movement would lower its COG.

A body is in *indifferent* equilibrium if a small movement would keep the COG at the same level.

### 3.4.1 Moment of a Force

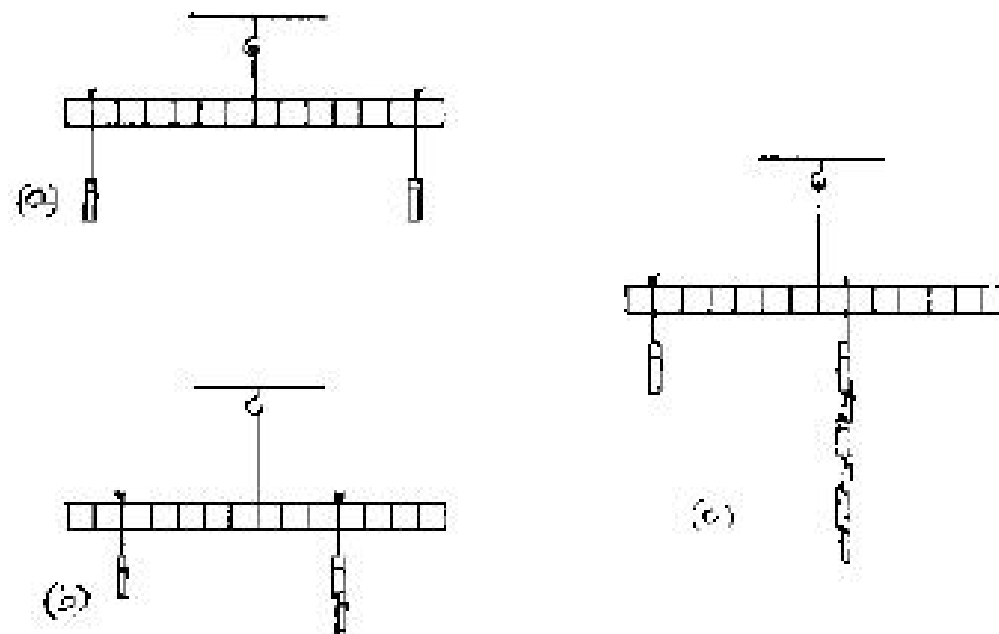

**P:** Cut a piece of cardboard 40 cm x 3 cm and attach a supporting string exactly at the middle of it in a hole

**P:** Cut a piece of cardboard 40 cm x 3 cm and attach a supporting string exactly at the middle of it in a hole near the top (see figure). Mark six 3 cm spaces on each side of this middle point (*fulcrum*). Suspend this balance e.g. from the back of a chair and balance it by cutting off a little from the heavier side. Tie pieces of thread of about 20 cm length into loops about 7 cm long to support the weights. Use e.g. *equal* clothes-pegs as weights and balance them in many ways (see fig.).

Multiply weight x distance (from the fulcrum) for each side of the balanced beam.

**Q:** Prepare a table for several weights and distances from the fulcrum.

**E:** A force acting at a distance from a fulcrum has a *turning* effect which is called *moment* or torque. It can be calculated:

Moment = force x perpendicular distance (from the force to the fulcrum)

Our table shows that *the clockwise moment must be equal to the anti-clockwise moment in order to achieve equilibrium.*

**A:** The beam balance (see p. 10), the roman steelyard and other levers (see section 3.10).

### 3.4.2 Centre of Gravity (COG)

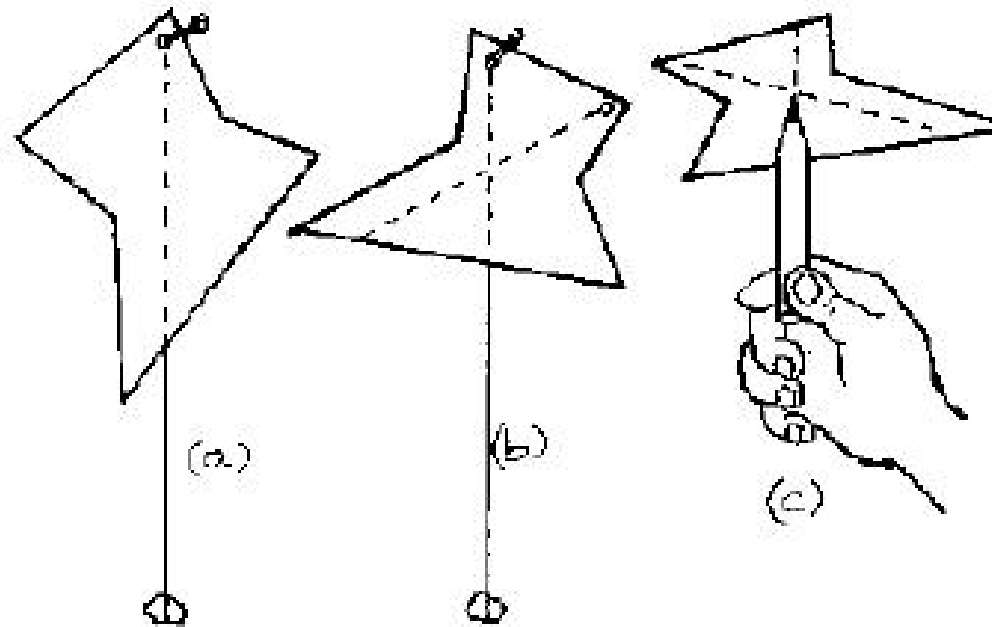

**P:** (a) Cut a piece of card into an odd shape (see fig.(a)). Suspend it from a nail and attach a string with a stone. Mark the position of the string using two crosses. Join these using a ruler to form a pencil line.

(b) Repeat (a) but fix the nail in another position on the card (see fig.(b)). Where the two pencil lines meet is the *centre of gravity* of the card.

(c) Now support the card with the tip of a pencil below the centre of gravity.

**Q:** What do you notice about the stability of the position of the card?

**E:** The position of the card remains stable as long as it is supported in the centre of gravity because now all the moments of the weights of all the mass particles of the card balance.

### 3.4.3 The Funny Jumper



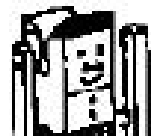
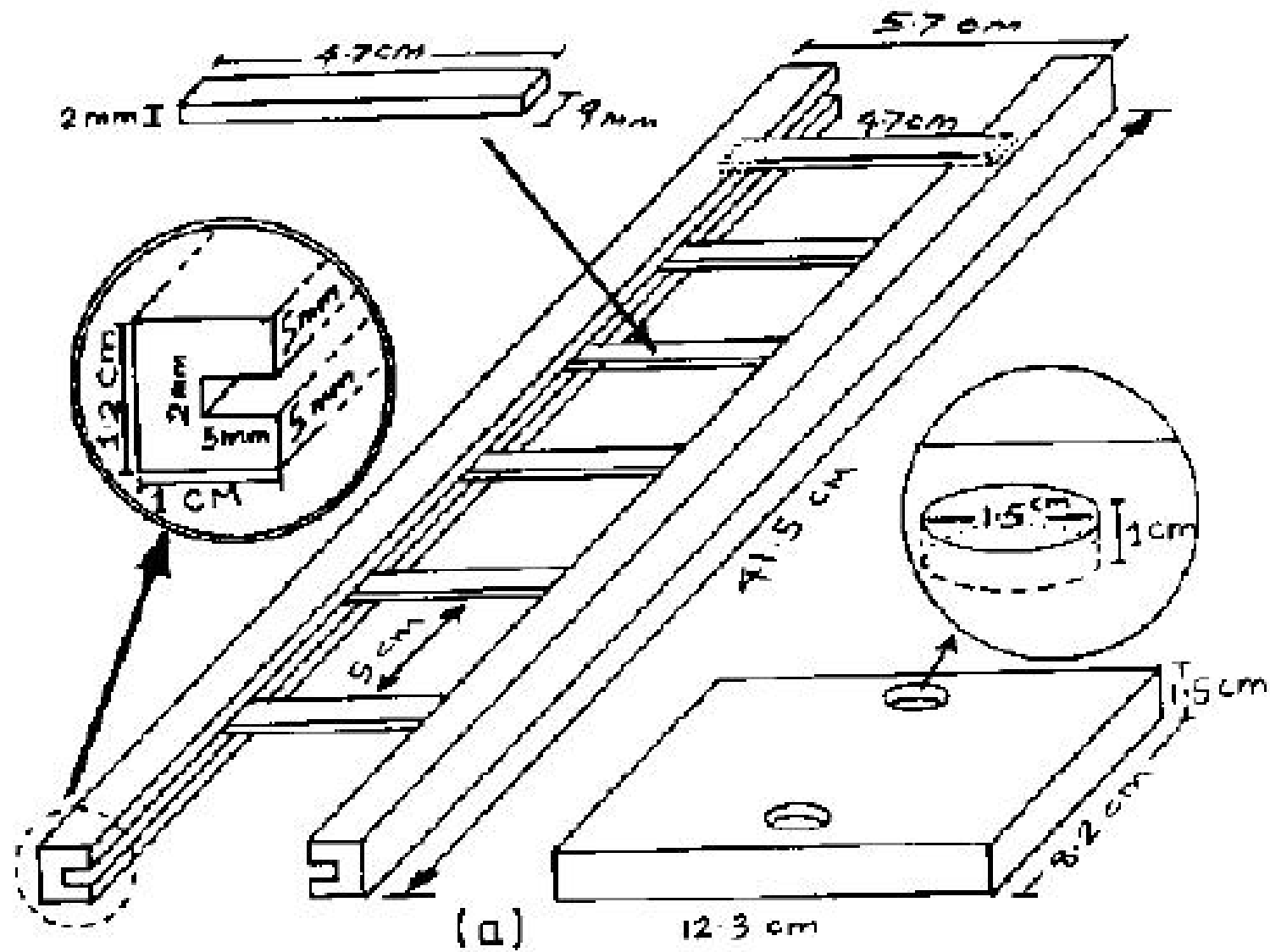

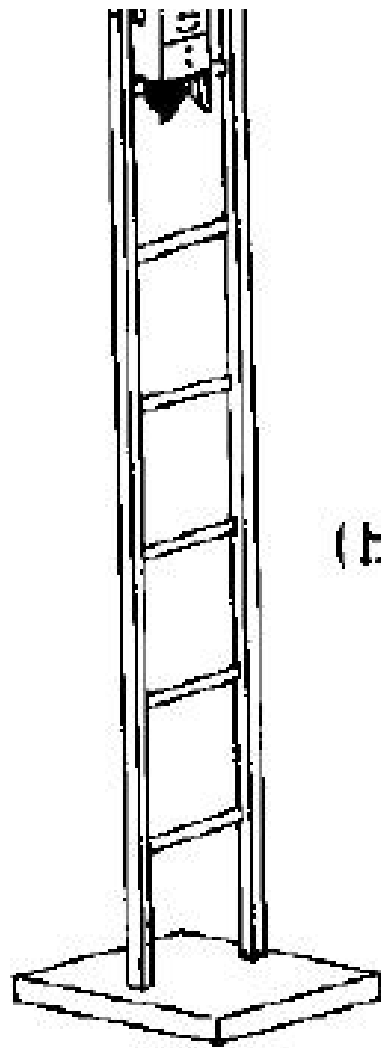

(b)

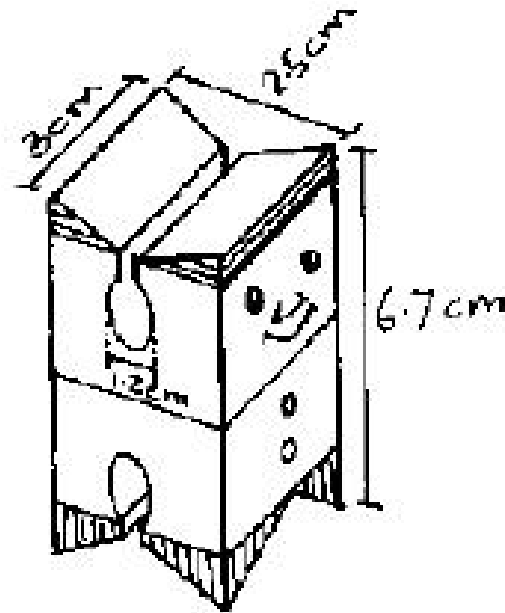

**P:** Ask a carpenter to make the funny jumper according to fig.(a) and (b). Place the jumper *feet down* on the uppermost step of the ladder.

**Q:** What happens? Why?



**O:** The jumper jumps from one step to the next down the whole ladder.

**E:** First the centre of gravity of the jumper is above a step of the ladder. This is an *unstable equilibrium* since the COG is lowered when the jumper turns round to hang on that step. However, due to the slot it has, it then falls down to be *above* the next step. Thus, the process is repeated until the jumper meets the ground level.

### 3.4.4 Balancing Nails

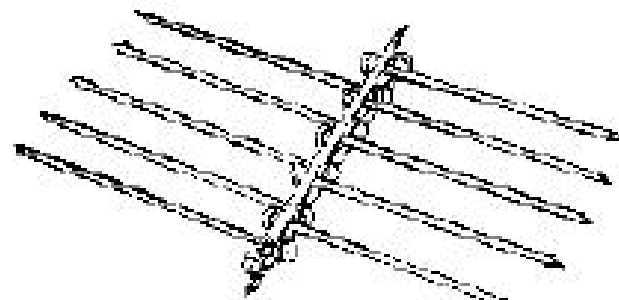
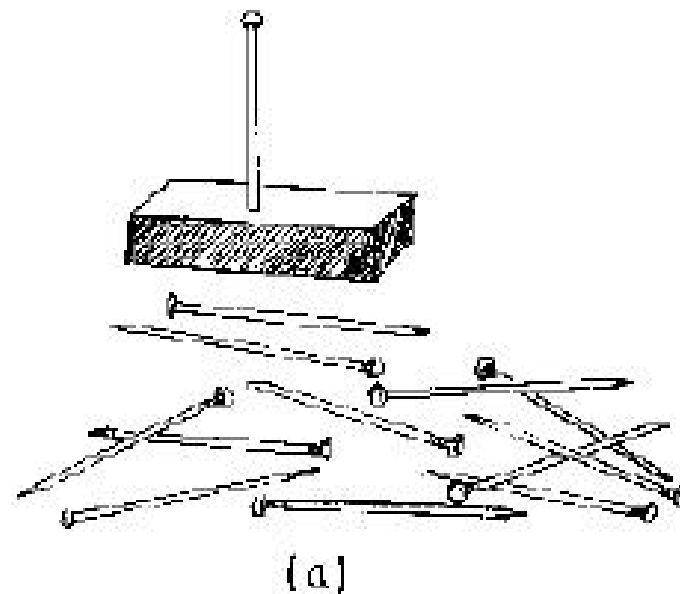

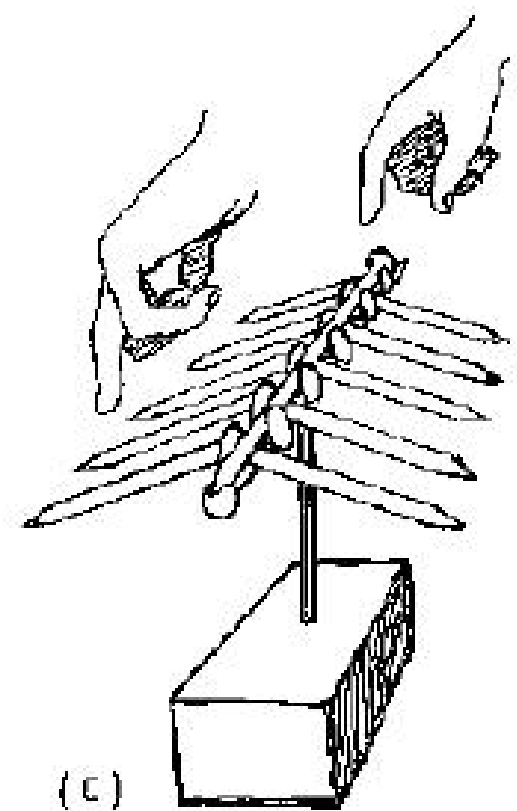

**P:** Give the students 2 inch nails (see fig.(a)) and ask them to balance them all on top of the nail which was fixed on the piece of wood. In doing this, the nails must neither be bent nor glued together etc.

This may be a challenging riddle for the students!

**E:** This riddle can be solved by arranging the nails according to fig.(b) when lying on the table. Then lift this arrangement carefully to the top of the first nail and balance it there. The COG is now lower than the

supporting head of the first nail. Thus, a *stable equilibrium* is reached.

### 3.4.5 The COG of a Ruler

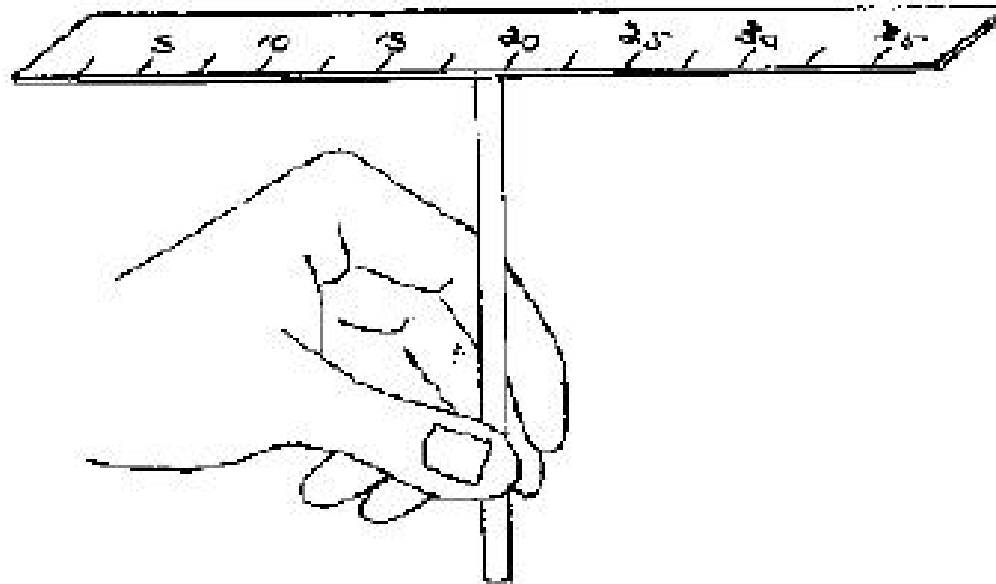

**P:** Find the centre of gravity of a ruler by balancing it on the tip of a pencil.

**Q:** Where does the COG of the ruler lie? Why?

### 3.4.6 Candle Balance

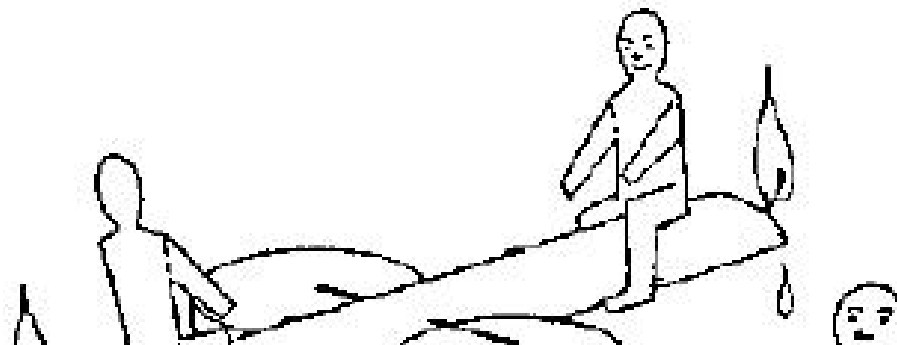

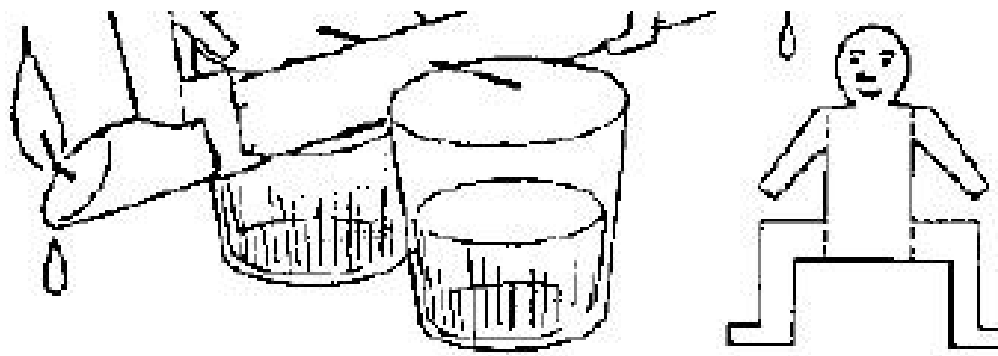

**P:** Construct a candle balance as shown in the figure.

**Q:** What happens? Why?

### 3.4.7 Balancing Coins

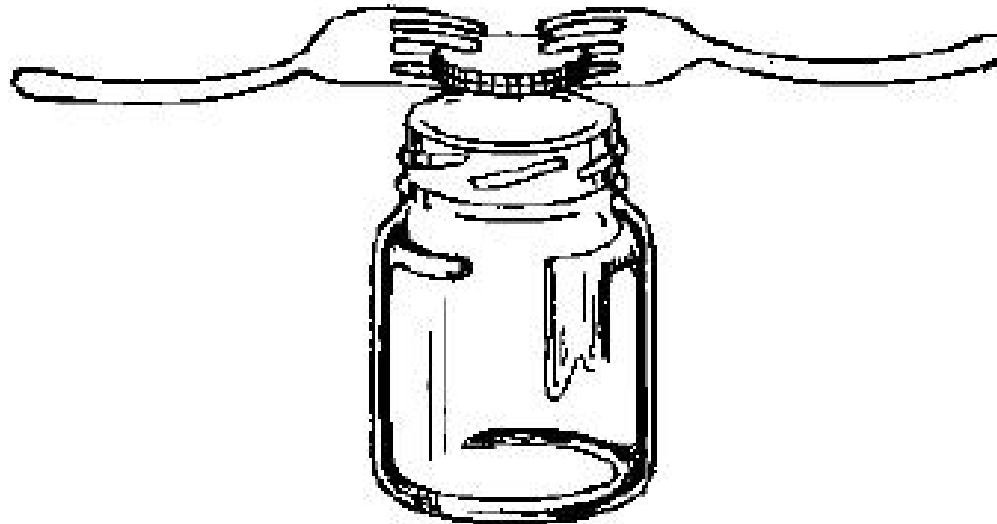

**P:** Take two coins and attach two forks to them as shown in the figure. Balance this arrangement on the rim of a jam glass.

Q: Why do the coins not fall down?

### 3.4.8 Riddles

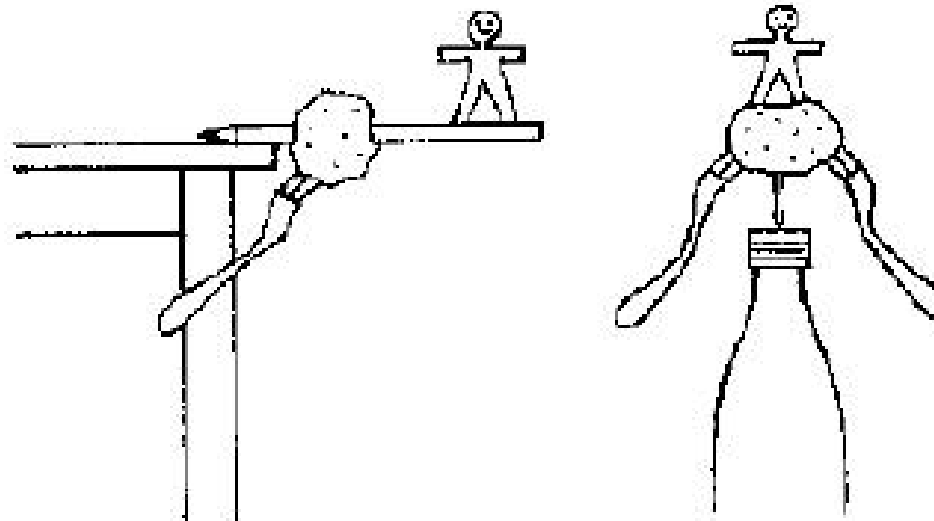
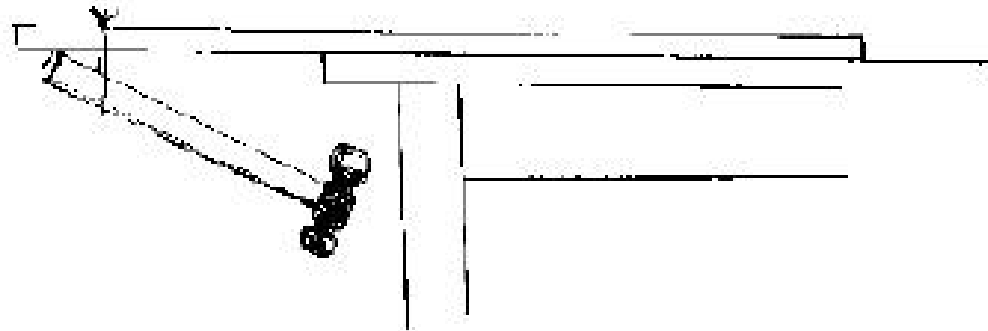

P: Produce the arrangements shown in the figures (a) and (b).

Q: Why do they not fall down?

### **3.5 The Force of Friction**

The force of friction always opposes motion. Friction may be reduced by lubrication. Rolling friction is less than sliding friction. The rougher a surface, the greater the force of friction.

Friction plays an important role in daily life. Without friction we would be unable to start walking.

Any woven material would decompose because it is held together by friction of the threads only. However, we have to reduce friction in the bearings of moving parts of vehicles and other machines in order to save fuel.

#### **3.5.1 Friction Produces Heat**



(a)

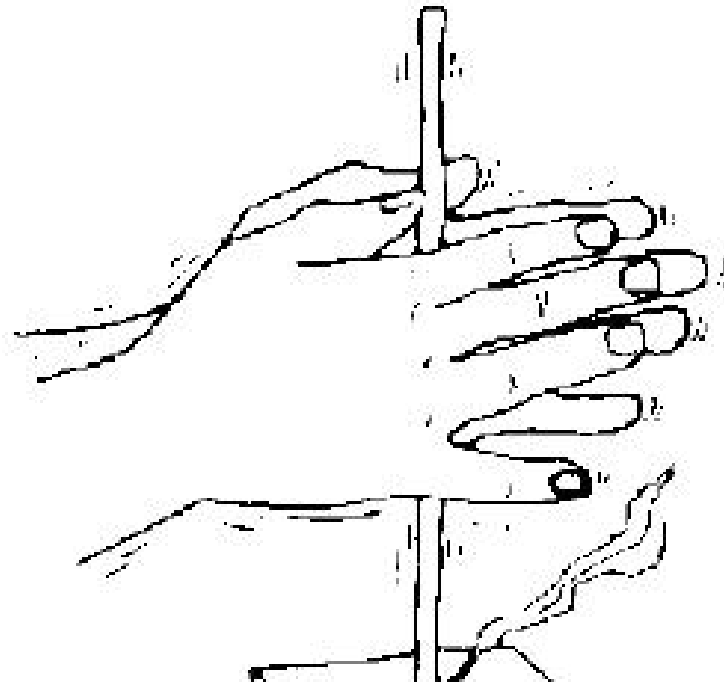

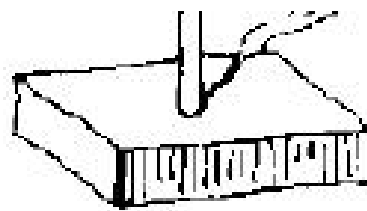

(b)

**P:** Rub your hands.

Turn a stick very quickly between your hands and press its tip onto a piece of wood.

**Q:** What do you feel on your hands?

What do you observe on the piece of wood?

How do you explain this?

**O:** The hands become warm, the piece of wood starts smoking and finally burning.

**E:** Friction produces heat which can light wood if great enough.

**A:** Lighting a fire without matches.

### **3.5.2 Friction and the Kind of Surface**



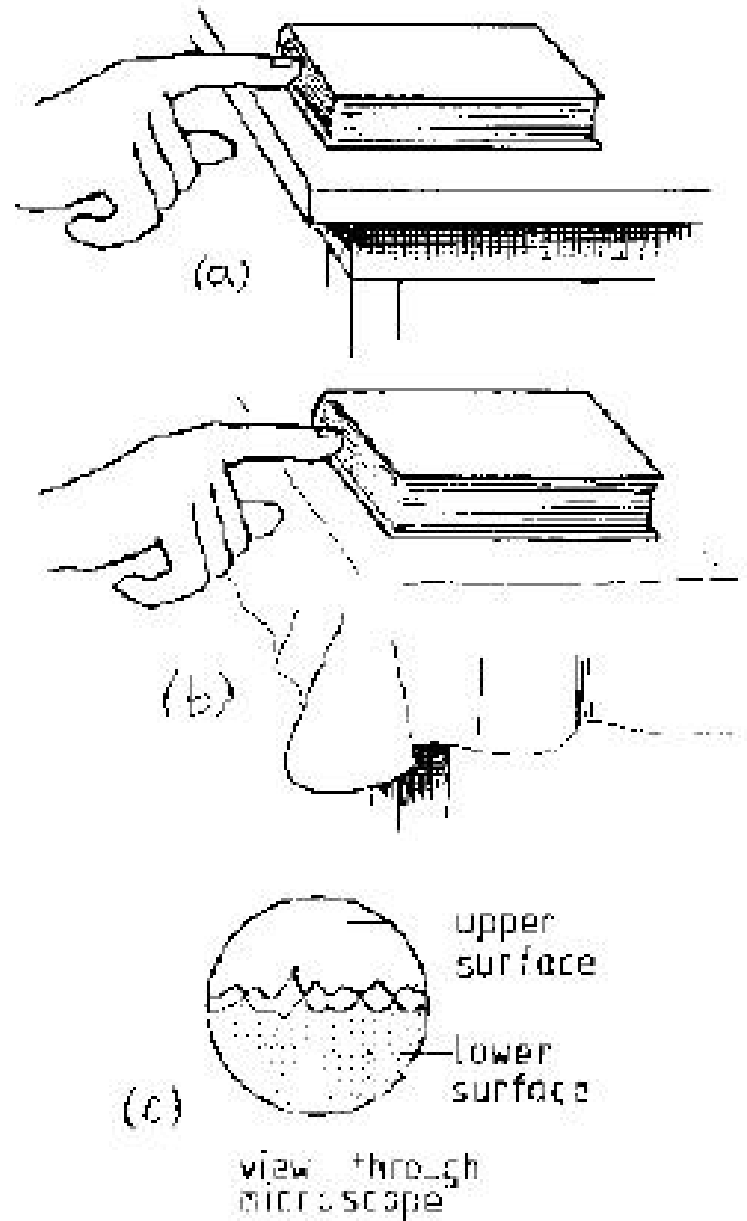

**P:** Pull a book on a bare table surface and then on a piece of cloth.

**Q:** On which surface is it harder to pull? How does the force of friction compare on the two surfaces? How can  
z\_science\_exp\_0249 (2).jpg

**Q:** On which surface is it harder to pull? How does the force of friction compare on the two surfaces? How can we explain friction?

**O:** It is harder to pull the book on the cloth than on the bare surface of the table.

**E:** The rougher the surfaces are which slide on each other, the greater the force of friction is. The "mountains" and "valleys" of the surfaces tooth and hence cause the force of friction, see figure (c).

### **3.5.3 Lubrication**

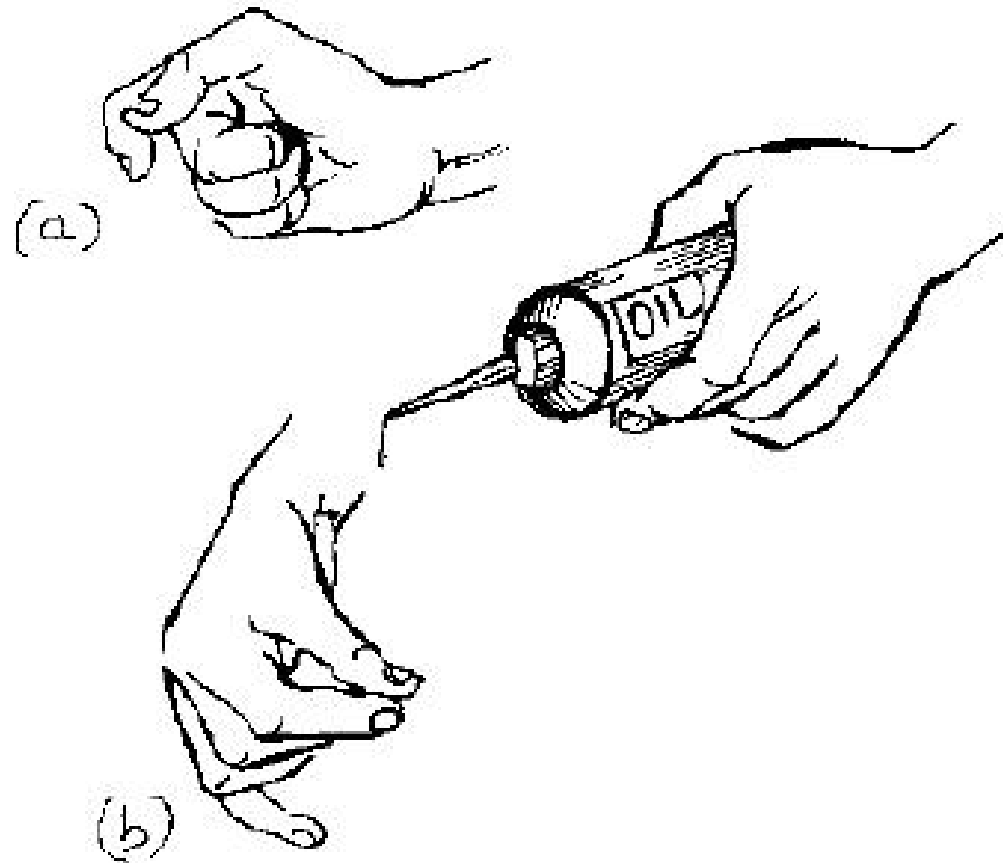

**P:** Rub your thumb and a finger together. Then place a drop of cooking oil or margarine on your thumb and repeat rubbing.

**Q:** How do the forces of friction (needed for the rubbing) compare in the two cases? Hence, what can be done to reduce friction?

**A:** Lubrication of bearings etc. to reduce friction.

#### 3.5.4 Rolling and Sliding Friction



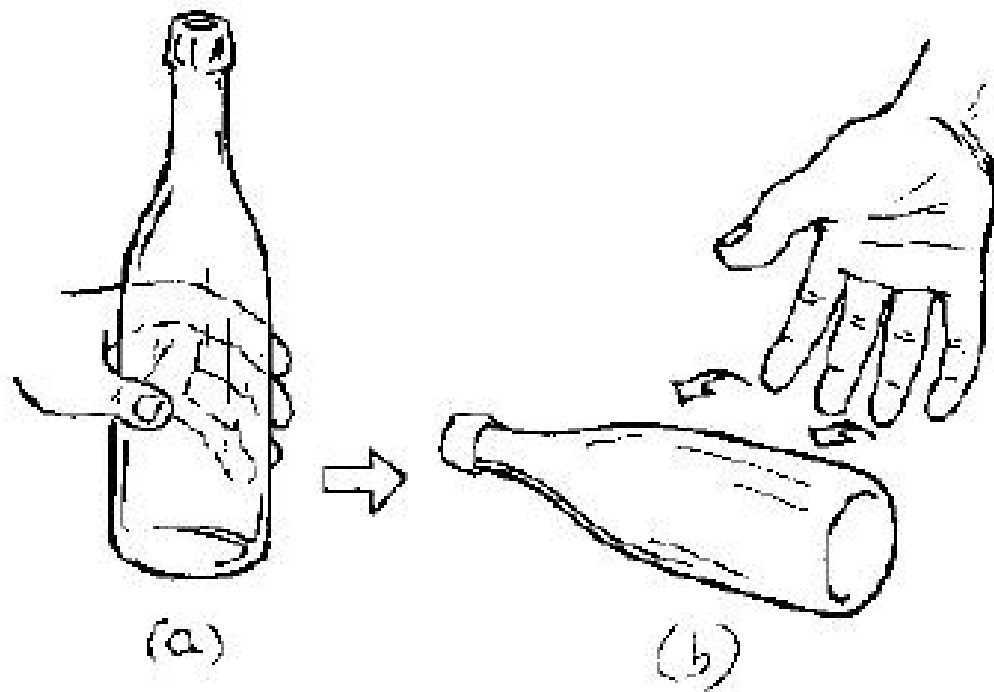

**P:** Slide a bottle or tin and roll it.

**Q:** How are the forces of friction in each case?

### 3.5.5 Rolling Friction

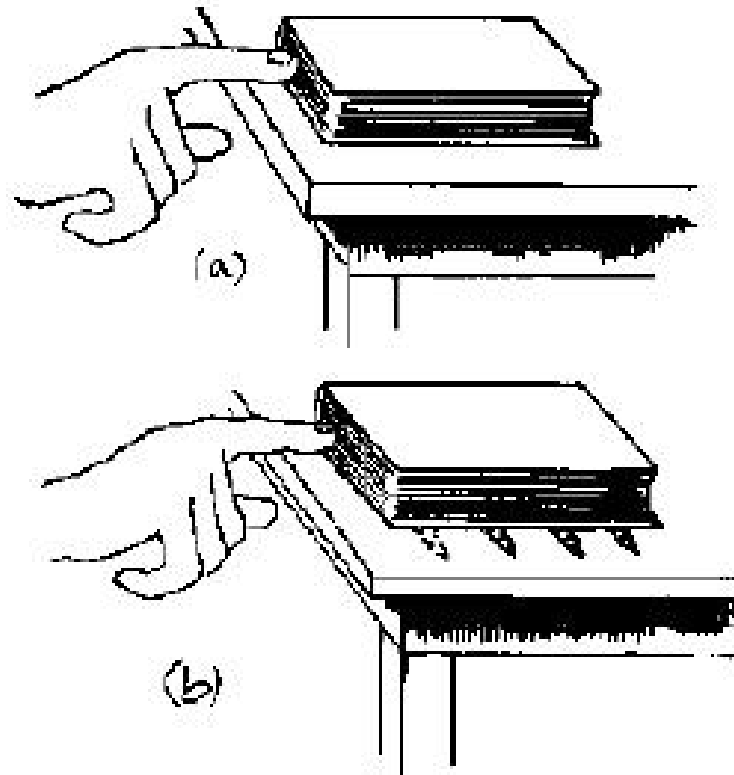

**P:** Pull a book over a table. Put some round pencils or drinking straws between the book and the table.

**Q:** How do the forces of friction compare now?

**A:** Roller bearings, ball bearings.

### 3.5.6 Where Friction is Needed





**P:** Ask students to draw the figure on a display chart.

**Q:** Why does the car *not* move even though the wheels turn?

**E:** There is not enough friction between the tyres and the road to get the car moving.

### 3.6 Density

The density of a substance tells us which mass the unit volume of that substance has got. Thus, it is defined as follows:

$$\text{Density} = \frac{\text{mass}}{\text{volume}}$$

For any pure substance the density is constant at constant temperature and pressure.

Hence, density may be used to identify substances.

#### 3.6.1 The Density of a Solid

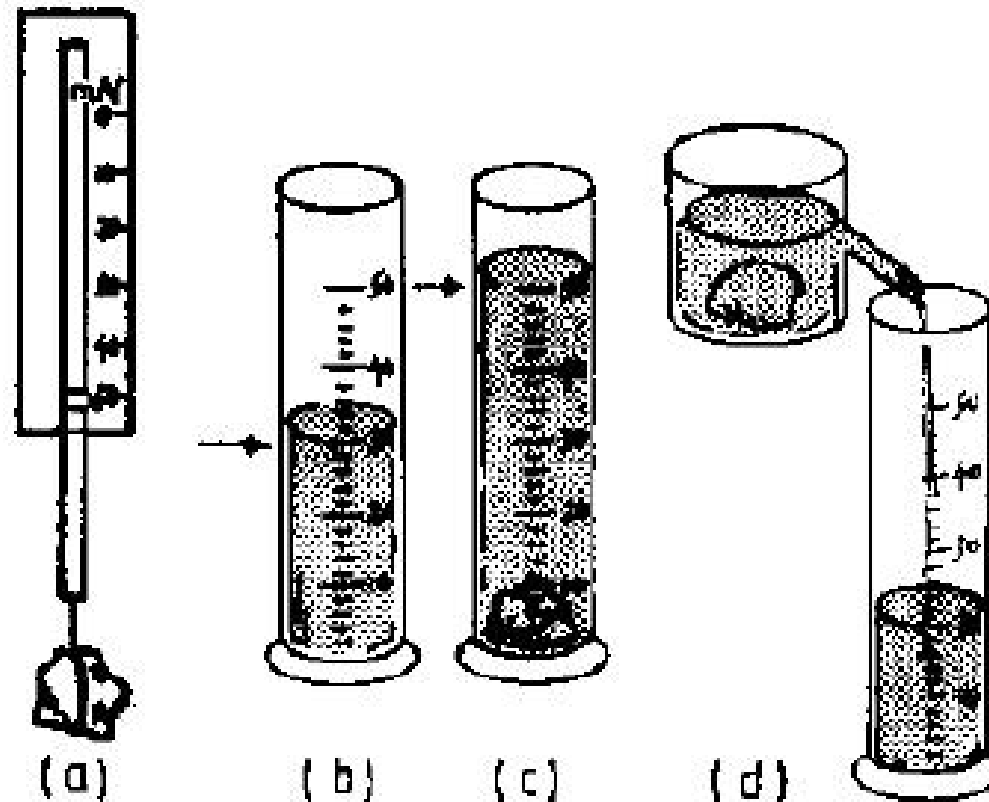

**P:** Attach a stone to a thread and determine the weight of the stone using a Newton balance, see fig.(a). Calculate the mass of the stone. Fill a measuring cylinder partly with water and record the volume, see fig.(b). Now immerse the stone fully in the water and record the new volume, see fig.(c). The difference in volume gives the volume of the stone. Alternatively, you can produce an overflow can from a tin using aluminium foil to make the overflow pipe, see fig.(d). Make the joint of pipe and tin water-tight using glue. Now calculate the density of the stone.

**E:** Assume that the stone has a weight of 0.5 N. Then its mass is

$$0.5 \text{ N} \div 10 \text{ N/kg} = 0.05 \text{ kg} = 50 \text{ g}$$

(Of course, the mass could be measured using a beam balance.)

(Of course, the mass could be measured using a beam balance.)

Assume that the volume of the water displaced by the stone is  $20 \text{ cm}^3$ . Then the density of the stone is

$$50 \text{ g} + 20 \text{ cm}^3 = 2.5 \text{ g/cm}^3$$

**A:** The determination of density can help to identify a certain substance, e.g. to answer the question: "Is a certain ring really made of gold?"

### 3.6.2 The Density of a Liquid

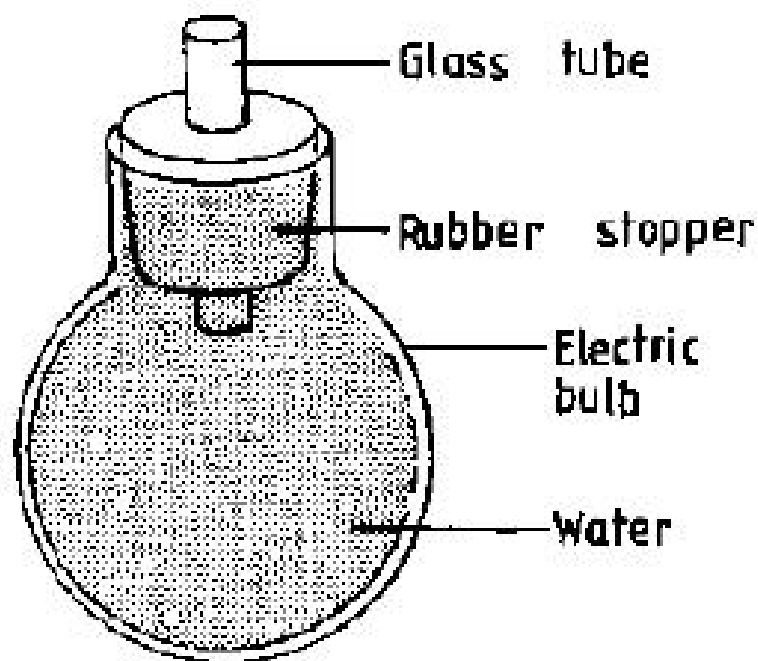

**P:** Prepare a density bottle from a worn out electric bulb fitted with a rubber stopper. Weigh the bulb with its stopper in air, then weigh it when filled with water and then when filled with liquid A, whose density is required. Determine the respective masses. You may use the beam balance described on p. 10.



**Q:** Determine the mass of the water and of the liquid. Calculate the volume of the density bottle and the density of liquid A.

**E:** E.g: Mass of empty density bottle = 15 g

Mass of density bottle with water = 68 g

Mass of density bottle with liquid A = 45 g

Then: Mass of the water = 68 g – 15 g = 53 g

Thus: Volume of density bottle = 53 cm<sup>3</sup>

Mass of liquid A = 45 g – 15 g = 30 g

Thus: Density of A = 30 g ÷ 53 cm<sup>3</sup> = 0.56 g/cm<sup>3</sup>

**H:** Be very careful when opening the worn out bulb, see appendix.

### 3.7 Pressure in Liquids and Gases

The pressure in liquids and gases is caused by their weight. It is defined as follows:

$$\text{Pressure} = \text{force} \div \text{area}$$

The laws of pressure govern many technical devices like barometers, manometers, pumps, etc.

#### 3.7.1 What is Pressure?



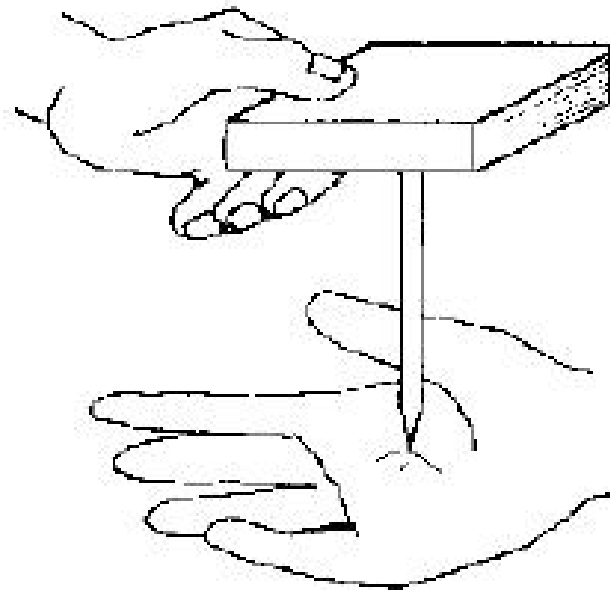
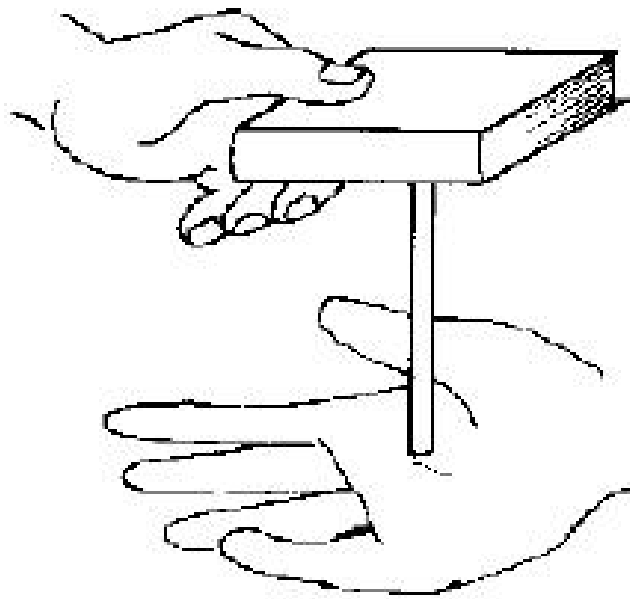

**P:** Ask a student to support a book as shown in figure (a). Then turn the pencil upside down as shown in figure (b).

**Q:** What will the student feel? Why?

**O:** In case (b) the student will feel pain on the hand supporting the pencil.

**E:** In case (b) the force with which the pencil acts on the hand is the same (equal to the weight of book plus pencil) as in case (a) but the pressure on the hand has increased very much since the area on which the pencil touches the hand has decreased so much. Hence, the students will understand that  $\text{pressure} = \frac{\text{force}}{\text{area}}$ .

**A:** Large area feet of elephants; wide tyres of tractors; wide chains of caterpillar machines.

### 3.7.2 Liquid Pressure Increases with Depth

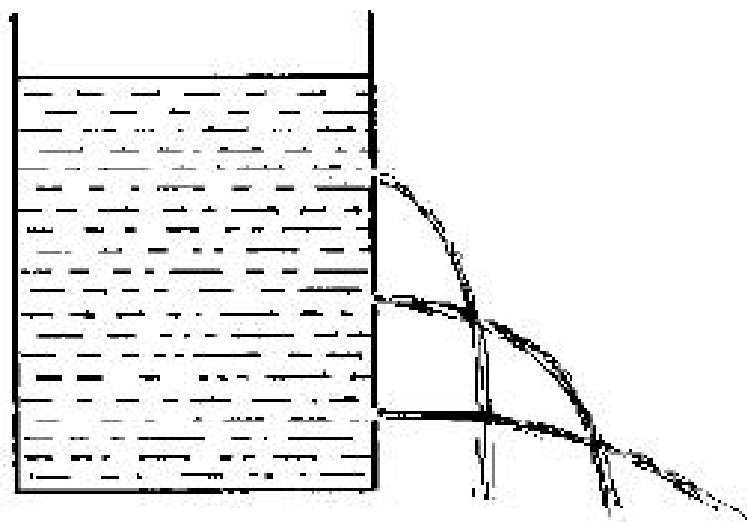

**P:** Pinch 3 holes into a tin according to the figure. Fill the tin with water up to its rim. What do you observe?

**Q:** How does the pressure change with the depth of the water? Why?

**Q:** How does the pressure change with the depth of the water? Why?

**O:** The water shoots the faster out of a hole, the greater the depth of that hole from the surface of the water in the tin.

**E:** The increasing speed of the water from the top to the bottom holes shows that the water pressure increases with the depth of the water. This is so because the weight of the water on top of a certain water particle acts on that particle causing pressure.

### **3.7.3 Carrying a Load on the Head**

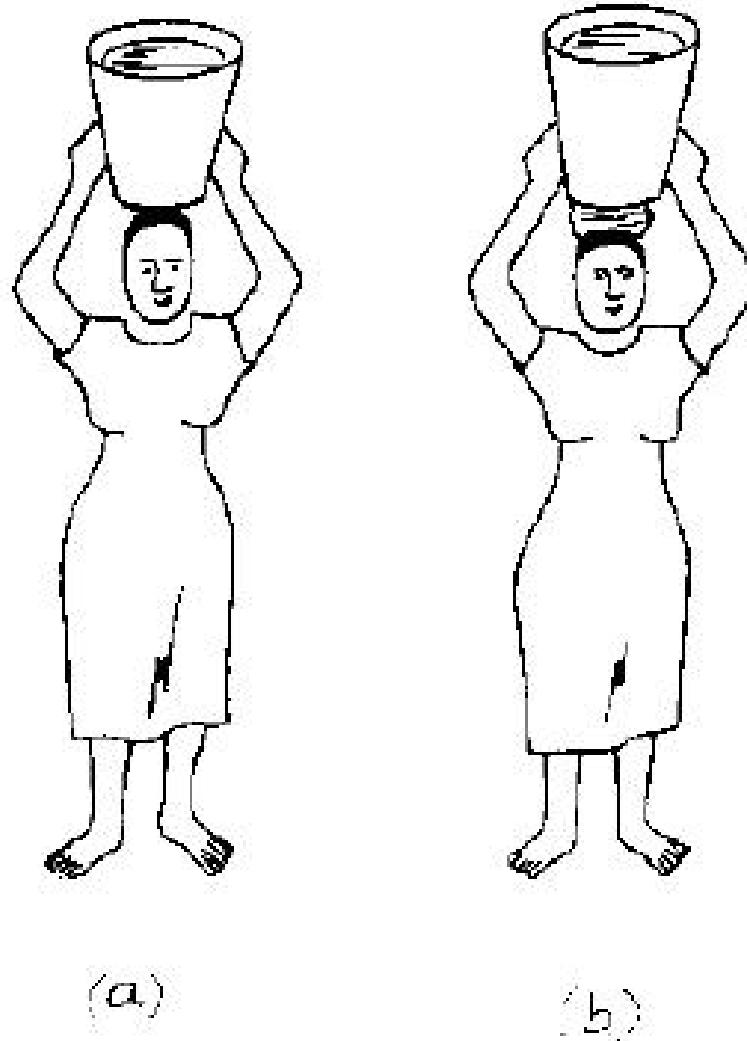

**P:** Carry a bucket of water on your head without (fig. a) and with a "ngata" (fig. b).

**Q:** What difference do you feel? Why?

### 3.7.4 Liquid Pressure Acts in All Directions



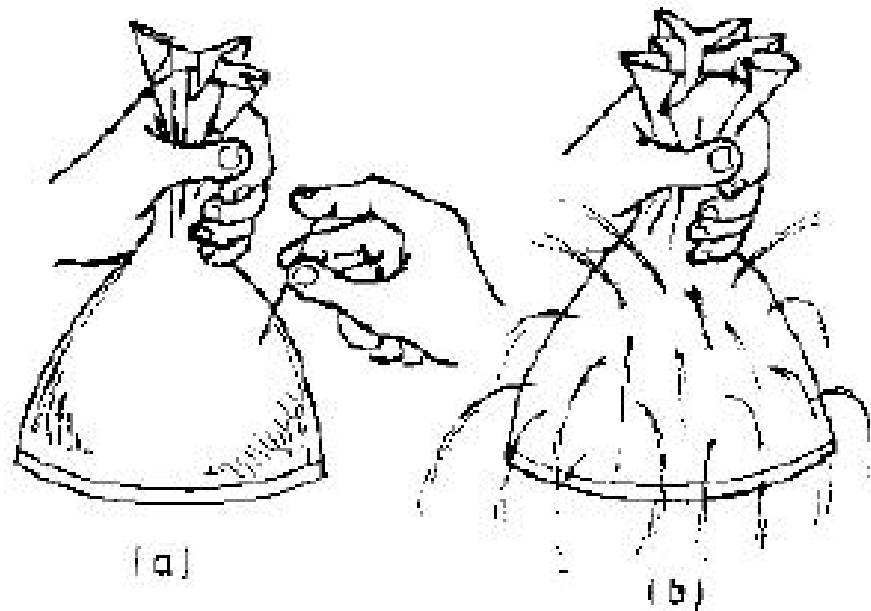

**P:** Pinch some small holes into a plastic bag using a needle. Fill it with water and squeeze the bag gently.

**Q:** In which directions does the pressure of the water act? Why?

**O:** The pressure acts in all directions.

**E:** The particles of a liquid can easily move behind each other while those of a solid are in fixed positions (see chapter 4.2).

### 3.7.5 Air Pressure: The Crashing Can

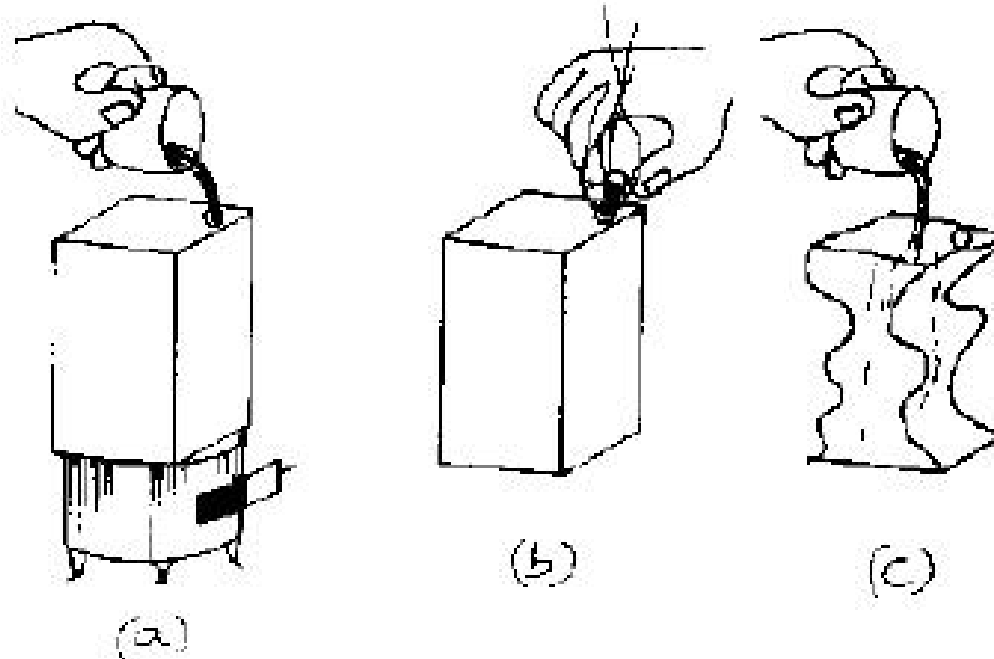

P: (a) Fill one cup of water into the large tin can. Then heat the *open* can to boiling.

(b) Remove the can from the fire and close it *immediately* air-tight.

(c) Now pour cold water on the can.

Q: What happens? Why?

### 3.7.6 Air Pressure

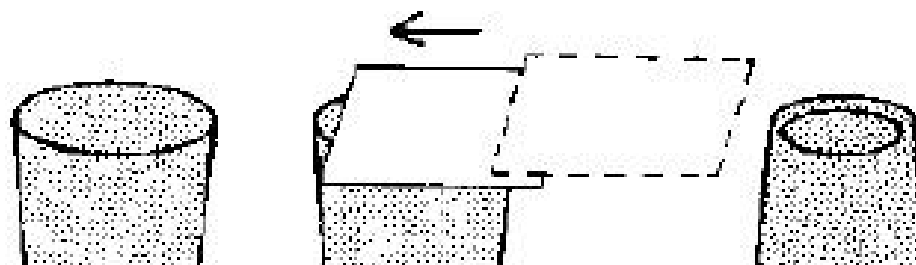

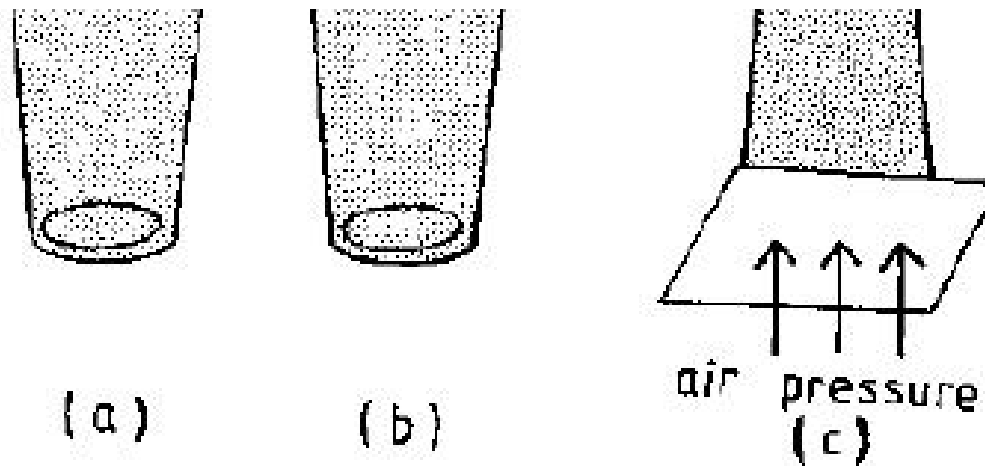

**P:** Fill a drinking glass up to the rim with water. Then push a smooth card or a sheet of smooth plastic from the side to close the glass so that no air bubbles are included. Then turn the glass upside down.

**Q:** Why will the card not fall off?

### 3.7.7 A Barometer



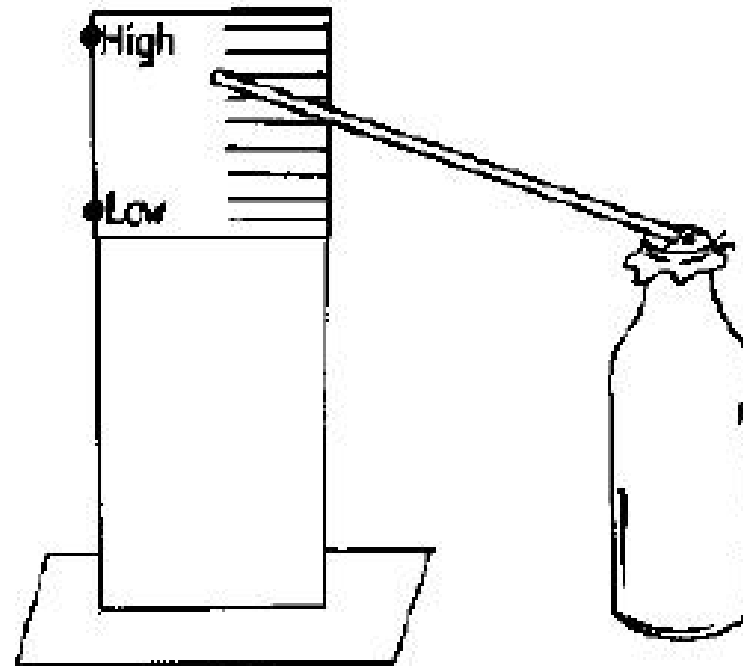

**P:** Assemble a barometer by closing a bottle *air-tight* by using a piece of plastic bag and a string. Glue the straw onto the middle of the piece of plastic and point the straw to a scale (see fig.)

**Q:** How does this barometer work, when the air pressure increases or decreases respectively?

### 3.7.8 A Manometer

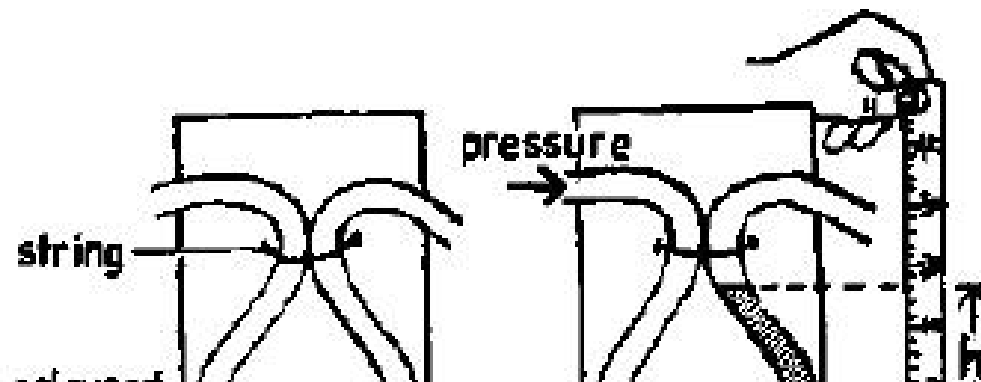

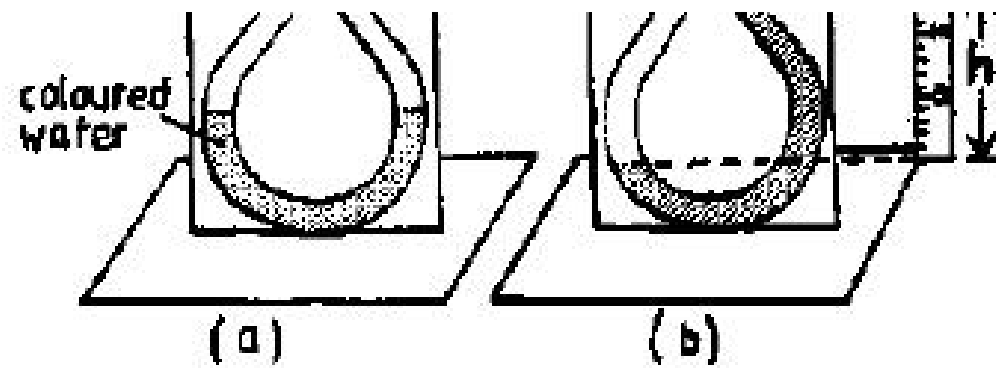

**P:** Make a manometer according to the figure. Use it to measure the water pressure at various depths of the tin of experiment 3.7.2, see p.26.

### 3.7.9 The Siphon

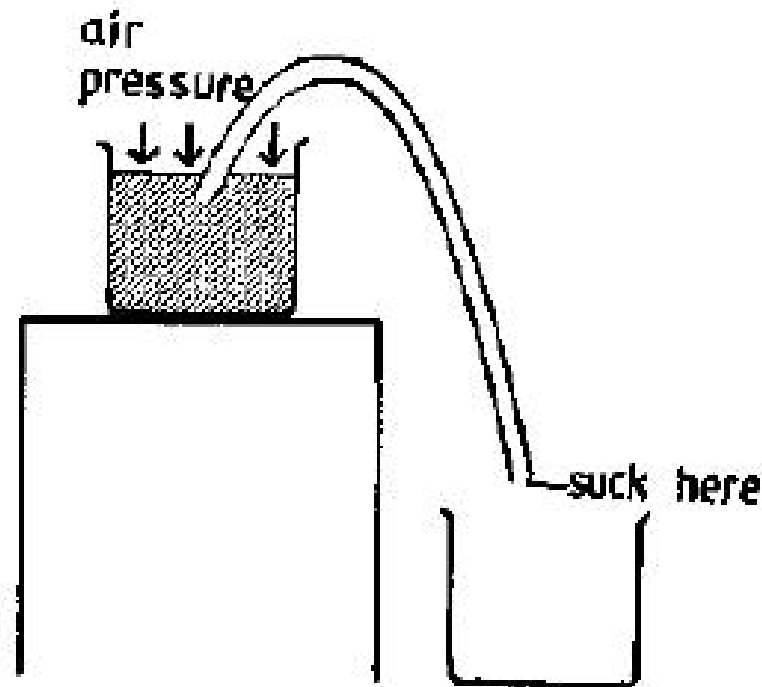

**P:** Arrange two glasses and a plastic or rubber tube as shown in the figure. Suck at the lower end of the tube.

**Q:** What happens? Why?

### 3.7.10 The Syringe

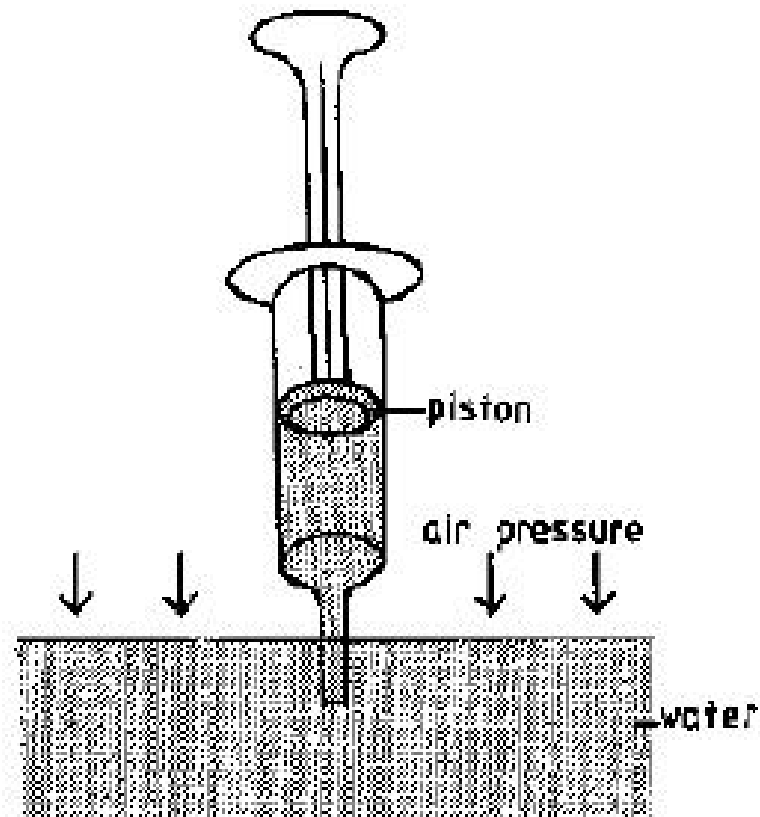

**P:** Obtain a one-way-syringe from a hospital. Suck water in as shown in the figure.

**Q:** Why does the water rise in the syringe?

### 3.7.11 The Bicycle Pump



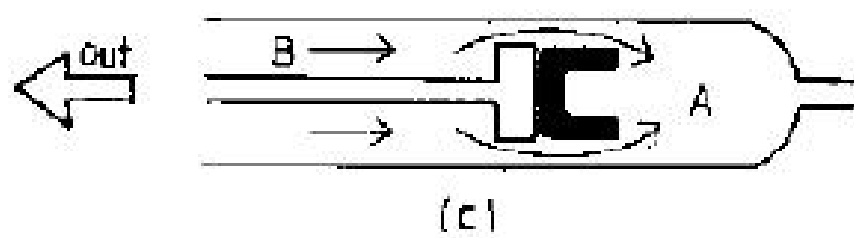
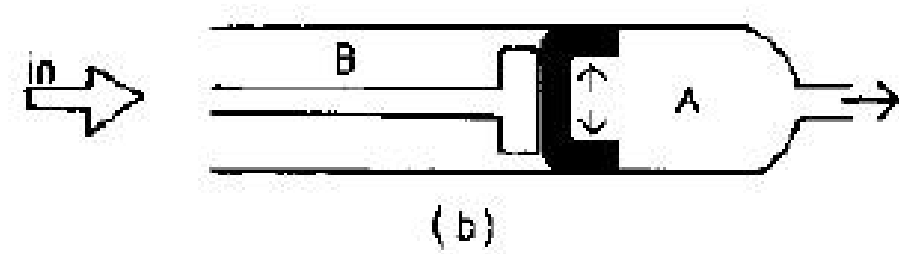
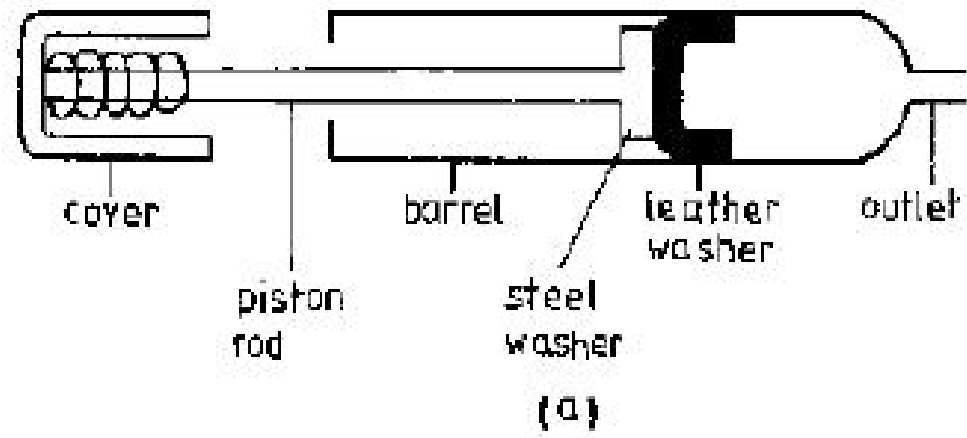

P: Using a bicycle pump, pump air into a bicycle tyre. Ask students to draw a display chart of the above figure.

**P:** Using a bicycle pump, pump air into a bicycle tyre. Ask students to draw a display chart of the above figure.

**Q:** Which stroke is easier, the inward or outward one? Why? Explain what happens in these strokes.

**O:** The outward stroke is easier than the inward.

**E:** *Inward stroke* (see fig. b): The air in region A will be compressed, and in turn it will press the leather washer against the barrel to make it air tight. Consequently air will be forced into the tube.

*Outward stroke* (see fig. c): The air in A decreases in pressure. Atmospheric air from B pushes the leather washer inwards and hence enters region A.

### 3.7.12 The Force Pump

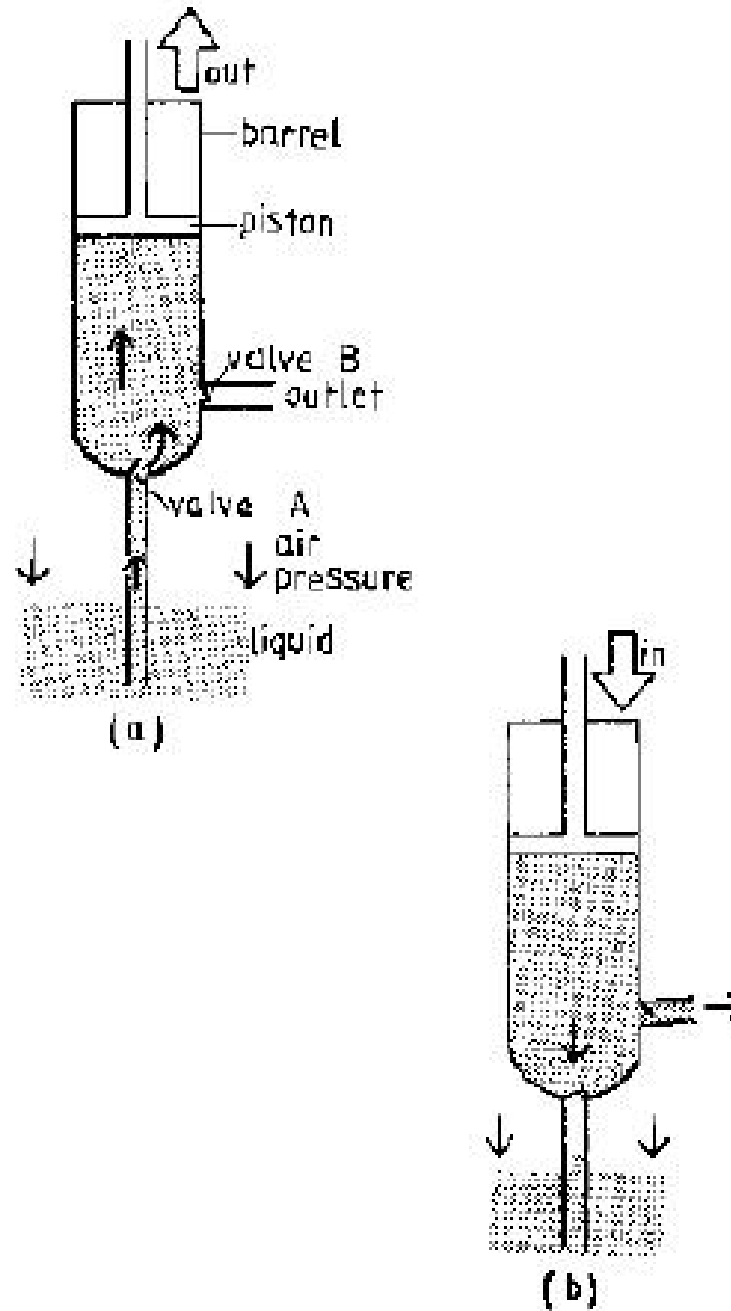

P: Ask students to draw a display chart of the force pump according to the above figure.

**P:** Ask students to draw a display chart of the force pump according to the above figure.

**Q:** Explain how the force pump works using the display chart.

**E:** *Outward stroke* (see fig. a). When the piston is raised, the liquid pressure in the barrel becomes less than the air pressure. Hence, the air pressure opens valve A and pushes the liquid up into the barrel. It closes valve B.

*Inward stroke* (see fig. b). When the piston is lowered, valve A closes and valve B opens because of the higher pressure of the liquid in the barrel. Consequently the liquid is forced through valve B to the outlet.

**A:** Force pumps are used to pump water from shallow wells in villages. Since the air pressure pushes the water up, the maximum depth from which the water can be lifted is less than 10 m

### **3.7.13 The Lift Pump**



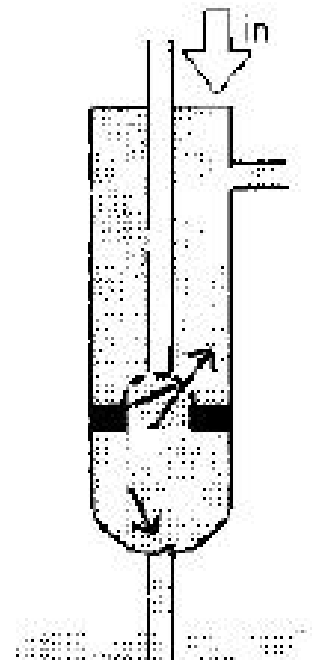
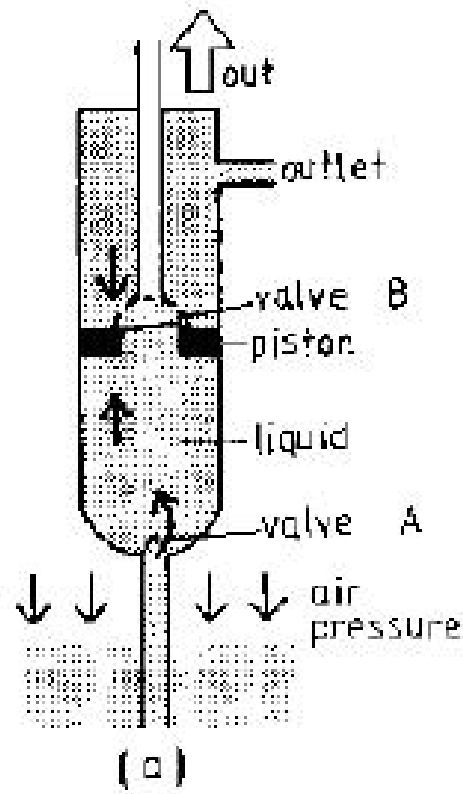

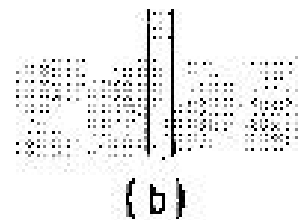

**P:** Ask the students to draw a display chart of the lift pump (see the above figure).

**Q:** Explain how the lift pump works using the display chart.

**E:** *Outward stroke* (see fig. a): The rising piston pushes the water on its upper side out of the outlet since valve B (on the piston) is closed. At the same time the air pressure pushes the water through the open valve A up the barrel.

*Inward stroke* (see fig. b): When the piston goes down, valve B opens and water flows from below to the top of the piston, while valve A is closed.

**A:** The lift pump is used to raise liquids from containers, e.g. tanks of kerosene etc.

### 3.7.14 The Hydraulic Press

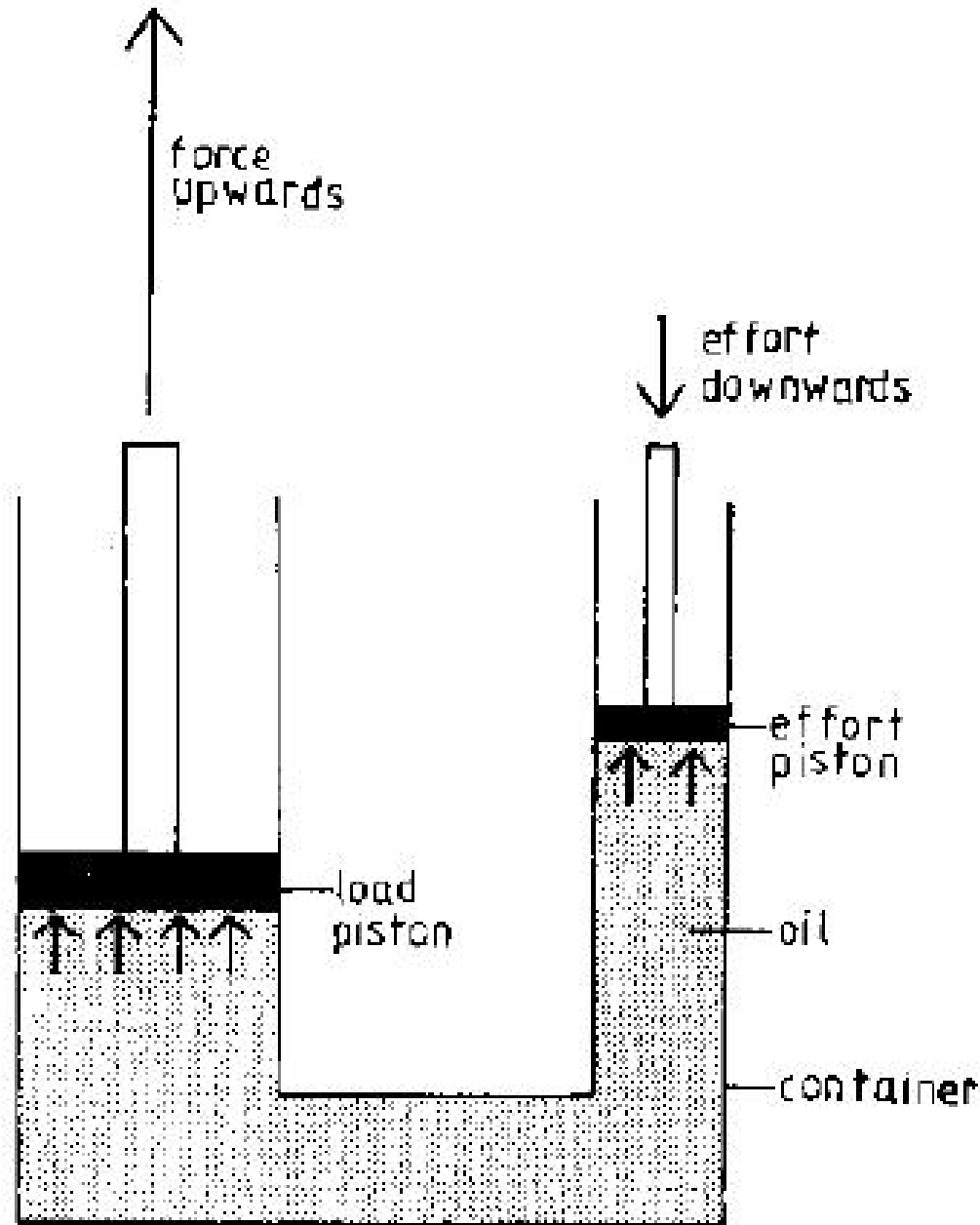

P: Ask the students to draw a display chart of the hydraulic press according to the above figure.

**P:** Ask the students to draw a display chart of the hydraulic press according to the above figure.

**Q:** Explain – using the display chart – how the hydraulic press works.

**E:** A hydraulic press consists of a container which has one end wider than the other. Load and effort pistons are fitted in its ends respectively. Note that the load piston has a larger surface area than the effort piston.

When the effort piston is forced downwards, the pressure of the liquid, e.g. oil, is transmitted equally in all directions in the whole liquid.

Therefore, the pressure at the load piston is the same as that one at the effort piston. Yet, since force = pressure  $\times$  area and the area of the load piston is greater than that of the effort piston, the force at the load piston is greater than that at the effort piston. Thus, *small effort will raise a big load*. However, the distance moved by the effort will be larger than that moved by the load.

**A:** Hydraulic systems are used in brakes, pressing bales of cotton, lifting heavy loads (e.g. vehicles in garages), etc.

### **3.8 Archimedes' Principle and the Law of Floatation**

Archimedes' principle states that the *upthrust* (buoyancy) of a body immersed in a liquid is *equal to the weight of the liquid displaced* by the body. When a body *floats* then *the weight of the liquid displaced is equal to the weight of the body* (Law of floatation).

#### **3.8.1 Upthrust**

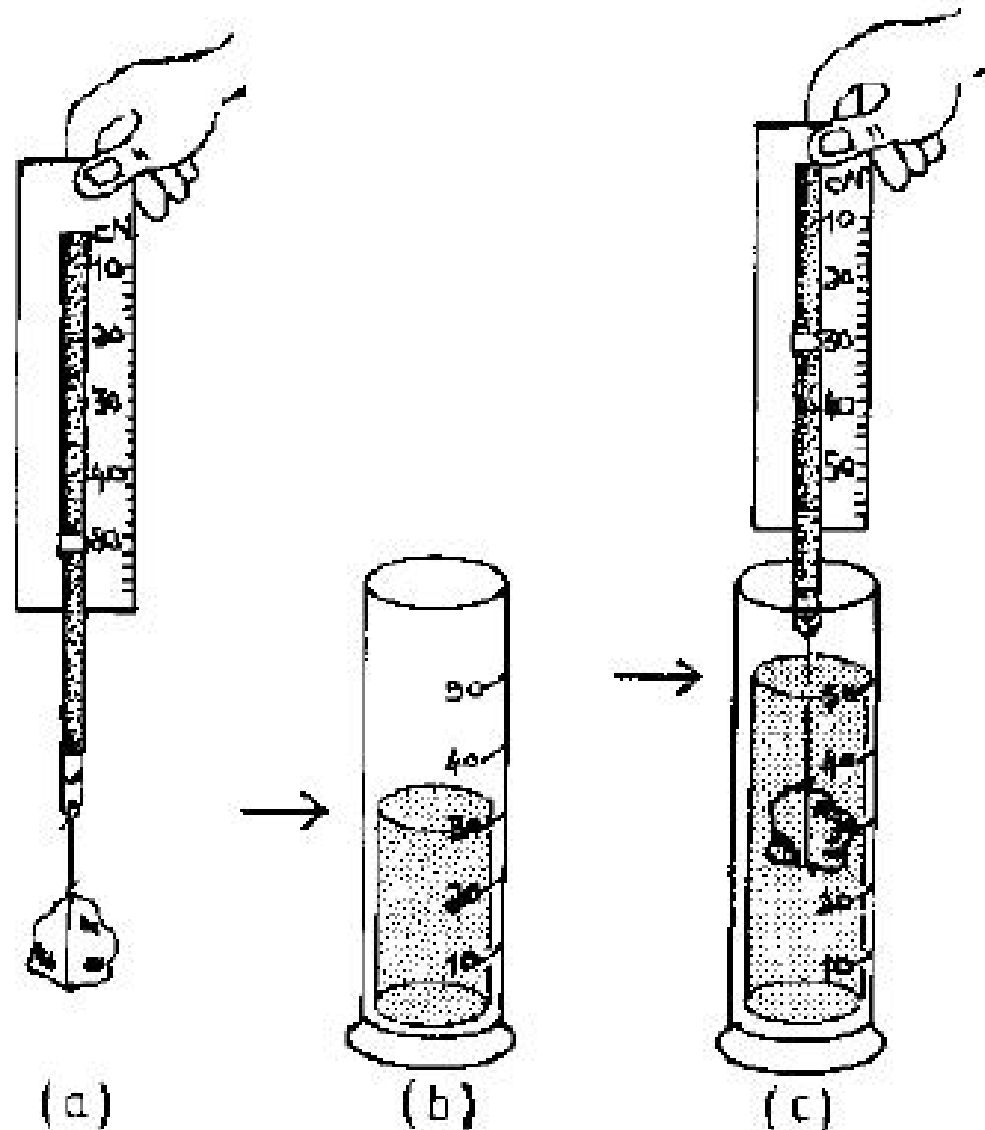

**P:** (a) Attach a stone to a thread, and fix it on a Newton balance (see p. 15). Note the weight of the stone.

(b) Fill a measuring cylinder partly with water and record the reading.

(c) Immerse the stone fully into the water (without touching the bottom of the cylinder) and record the reading

(c) Immerse the stone fully into the water (without touching the bottom of the cylinder) and record the reading of the spring balance. Record the reading of the water level too.

**Q:** How much is the volume of the stone? What is the weight of the water displaced, if  $1 \text{ cm}^3$  of water weighs  $0.01 \text{ N}$ ? By how much did the weight of the stone decrease when it was immersed in the water? What can you conclude about the upthrust?

**O:** For example, let the weight be  $0.2 \text{ N}$ . You observe that the decrease in weight when the stone is immersed is also  $0.2 \text{ N}$ , which is equal to the upthrust.

**E:** Thus, you have verified *Archimedes' principle*.

### 3.8.2 The Law of Floatation

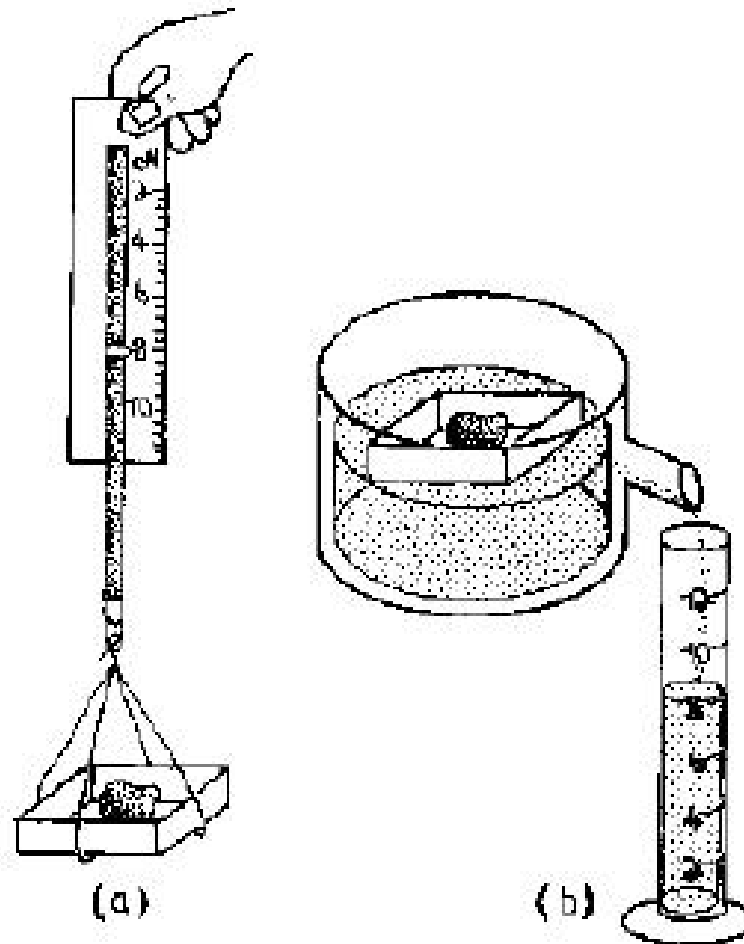

**P:** Load a matchbox with a small stone so that it still floats in water. Weigh the matchbox and stone using a Newton balance to obtain its weight (see p. 15).

Fill the overflow can (see p.25) with water and allow the matchbox with stone to float on it. Let the overflow run into a measuring cylinder. From the volume of the overflow find its weight.

**O:** For example, the weight of stone and matchbox be 0.08 N. Then you will observe that the weight of the overflow will also be 0.08 N.

**E:** Thus, you have verified the law of flotation.

E: Thus, you have verified the *law of floatation*.

### 3.8.3 The Cartesian Diver

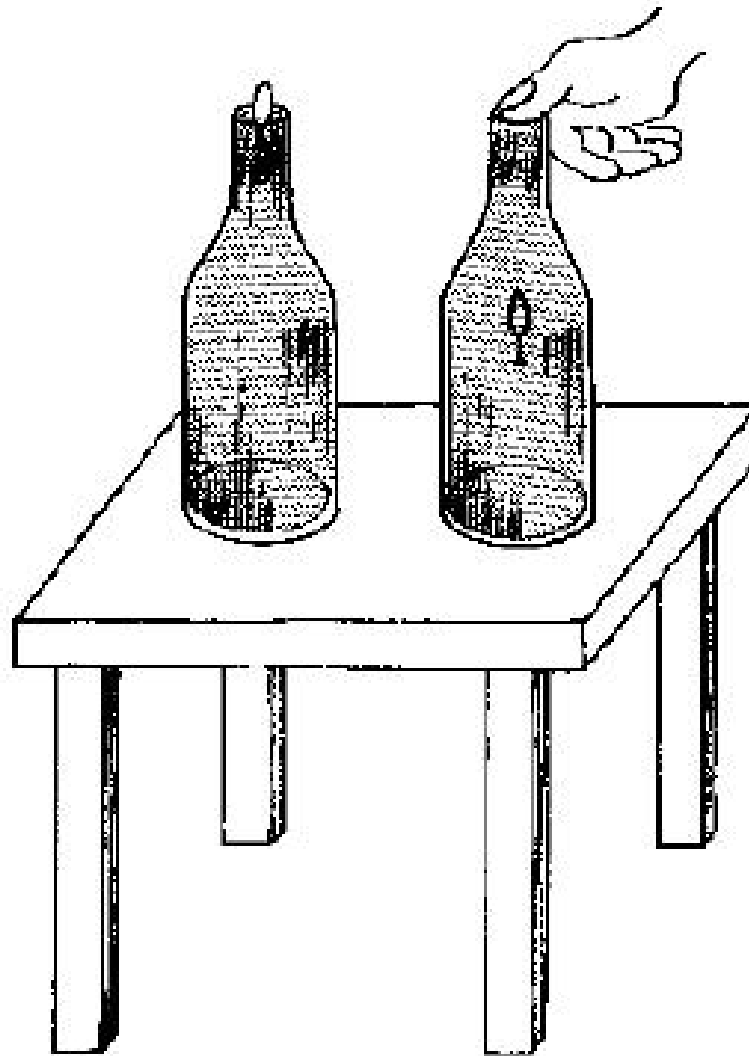



**P:** Fill a bottle to the rim with water. Load a small piece of styrofoam with a small nail so that it just floats in the bottle. This is the "diver". Close the bottle with your thumb airtight and apply pressure.

**Q:** What do you observe? Why?

**O:** According to the pressure exerted by your thumb, the diver will sink or rise.

**E:** Styrofoam has very many tiny pores which are full of air. Thus, when the pressure of the water increases, the air is compressed, its volume decreases, but its mass remains constant. Hence, its density increases, the diver sinks.

When the pressure is released, the air expands, its density decreases, the diver rises.

**H:** Do not allow the diver to stay for a long time in the water. Always remove it immediately from the water when your experiment is finished. Otherwise it will suck in water (since the styrofoam contains capillaries; see exp. 4.4.6, page 51) and sink even without the application of pressure.

### 3.8.4 The Hydrometer

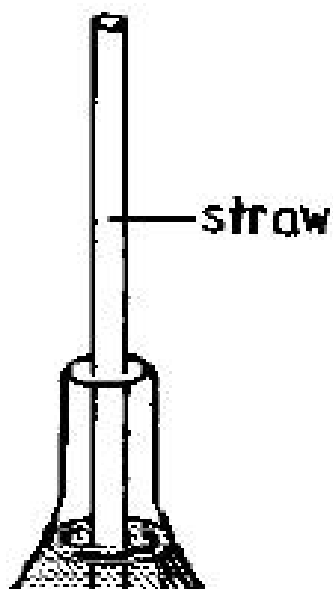

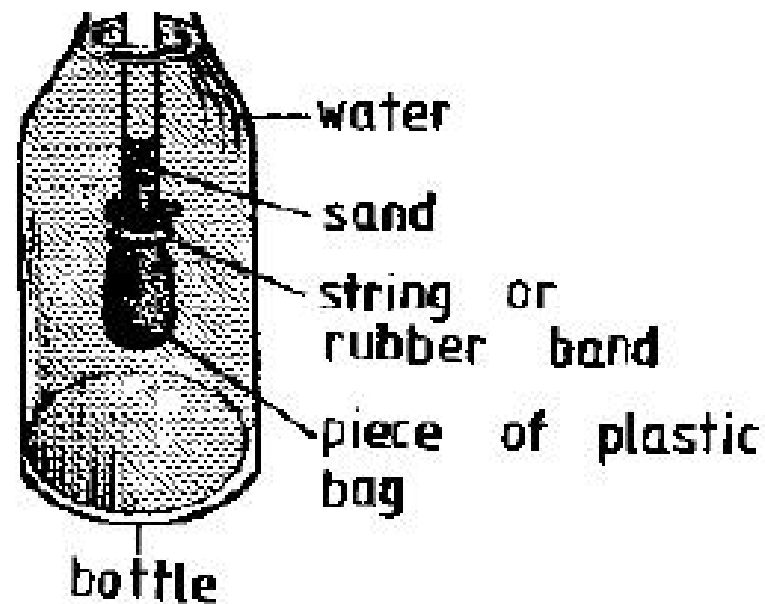

**P:** Prepare a hydrometer by using a drinking straw. Close one end of the straw by wrapping it with a piece of a plastic bag water-tight using a rubber band or a thread.

Fill clean sand into it until it floats in a vertical position in fresh water. Mark the water level on the straw. Label it 1.0 (since water has a density of  $1.0 \text{ g/cm}^3$ ). Take the distance of this mark from the bottom of the straw to be  $x \text{ cm}$ . Now you may put marks for liquids with other densities by calculating their distance 1 cm from the bottom of the straw by using the formula:

$$1 = x \div (\text{density of liquid})$$

For example, if  $x = 9.4 \text{ cm}$ , you calculate the position of the mark for a density of  $0.9 \text{ g/cm}^3$ :

$$1 = 9.4 \text{ cm} \div 0.9 = 10.4 \text{ cm}$$

i.e. you place the  $0.9 \text{ g/cm}^3$  mark at the distance of  $10.4 \text{ cm}$  from the bottom of the straw, and so on. Place marks from  $0.6$  to  $1.2 \text{ g/cm}^3$ .

**H:** You might have to compress the sand at the bottom of the straw using a stick (or put a nail inside) in order to make it float vertically.

**A:** Use the hydrometer to measure the density of e.g. kerosene, sea water and pure milk. Thus you can discover the wateringdown of milk by measuring its density using the hydrometer.

### 3.8.5 An Egg in Water

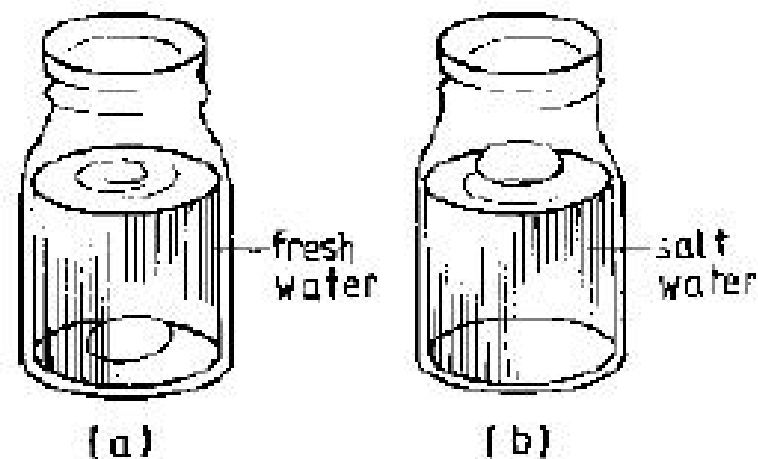

**P:** Place a fresh egg in water. Observe. Now dissolve salt in the water while stirring until the egg floats.

**Q:** Why does the egg float in the salt water?

**E:** The density of salt water is higher than that of fresh water. Thus, the weight of the displaced salt water becomes equal to the weight of the egg. Hence, the egg floats in salt water of a sufficient salt content.

### 3.8.6 The Floating Candle



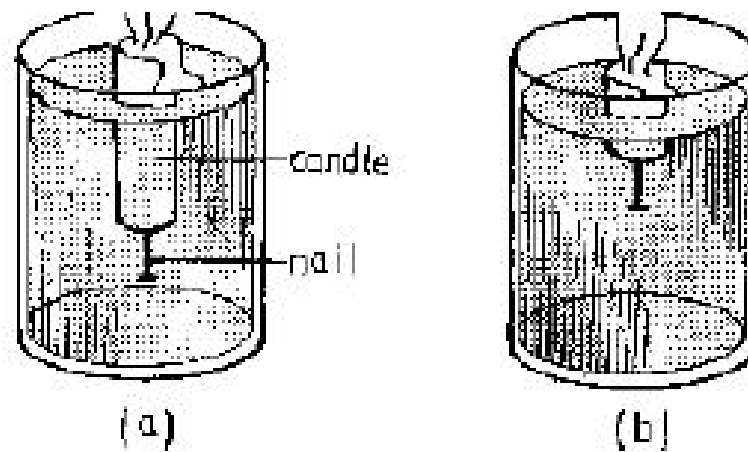

**P:** Put a nail into the bottom end of a candle so that the candle just floats with its top a bit above the surface of the water.

Light the candle and watch it as it burns up.

**Q:** Why does the candle continue to float even though it constantly loses weight as it burns up?

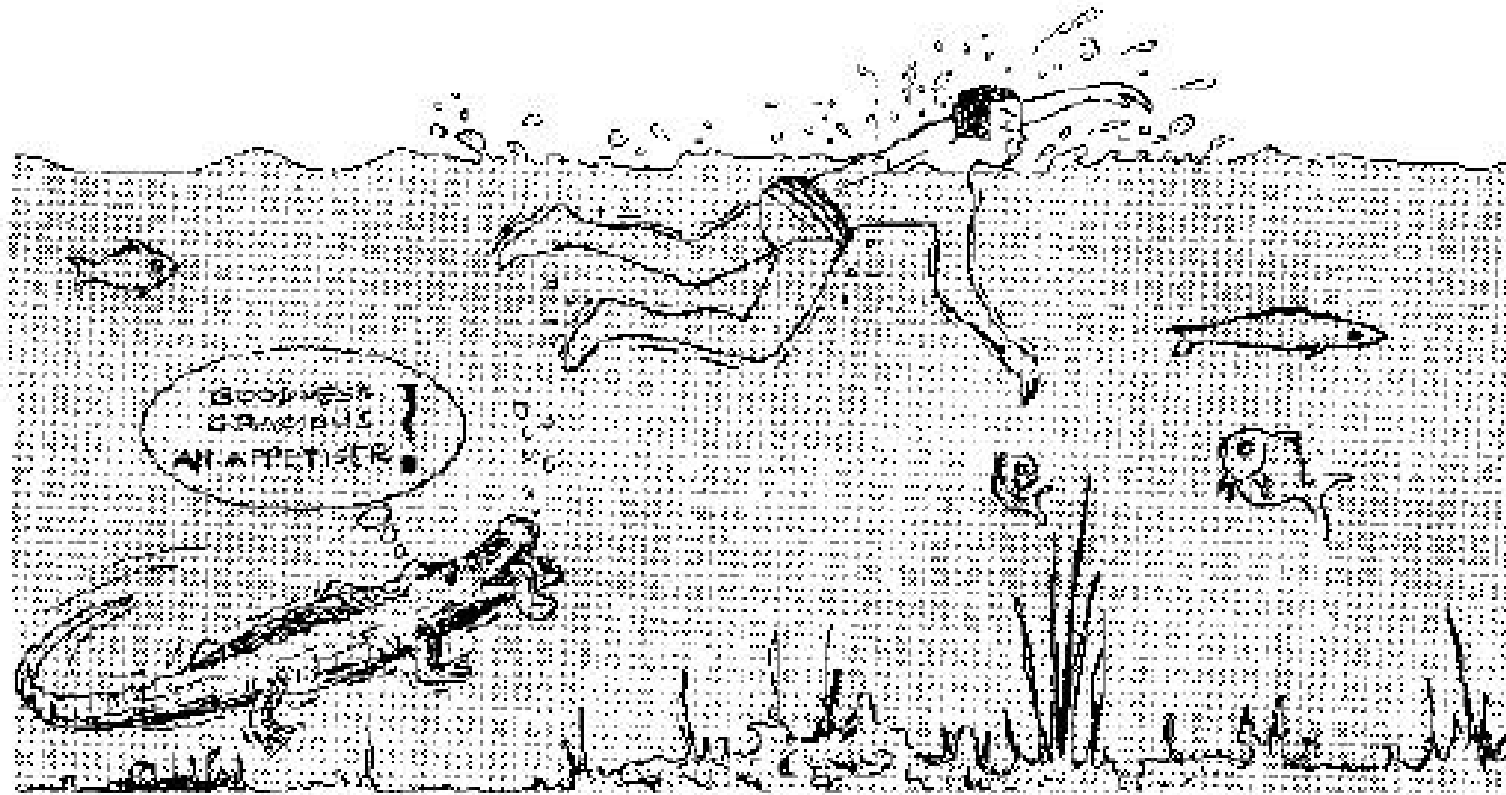

### 3.9 Work, Energy and Power

To pull a heavy cart is tiring work. In physics *work* is defined as follows:

Work done = force x distance moved in the direction of the force.

Unit:  $1 \text{ N} \times \text{m} = 1 \text{ J}$  (joule)

*Energy is the ability of doing work.* Hence, its unit is also 1J.

*Power is the rate of doing work, i.e. work per unit time.* Its unit is  $1 \text{ joule/second} = 1 \text{ watt}$  (1 W)

*Power is the rate of doing work, i.e. work per unit time. Its unit is 1 joule/second = 1 watt (1 W)*

### **3.9.1 Work Done by Lifting**

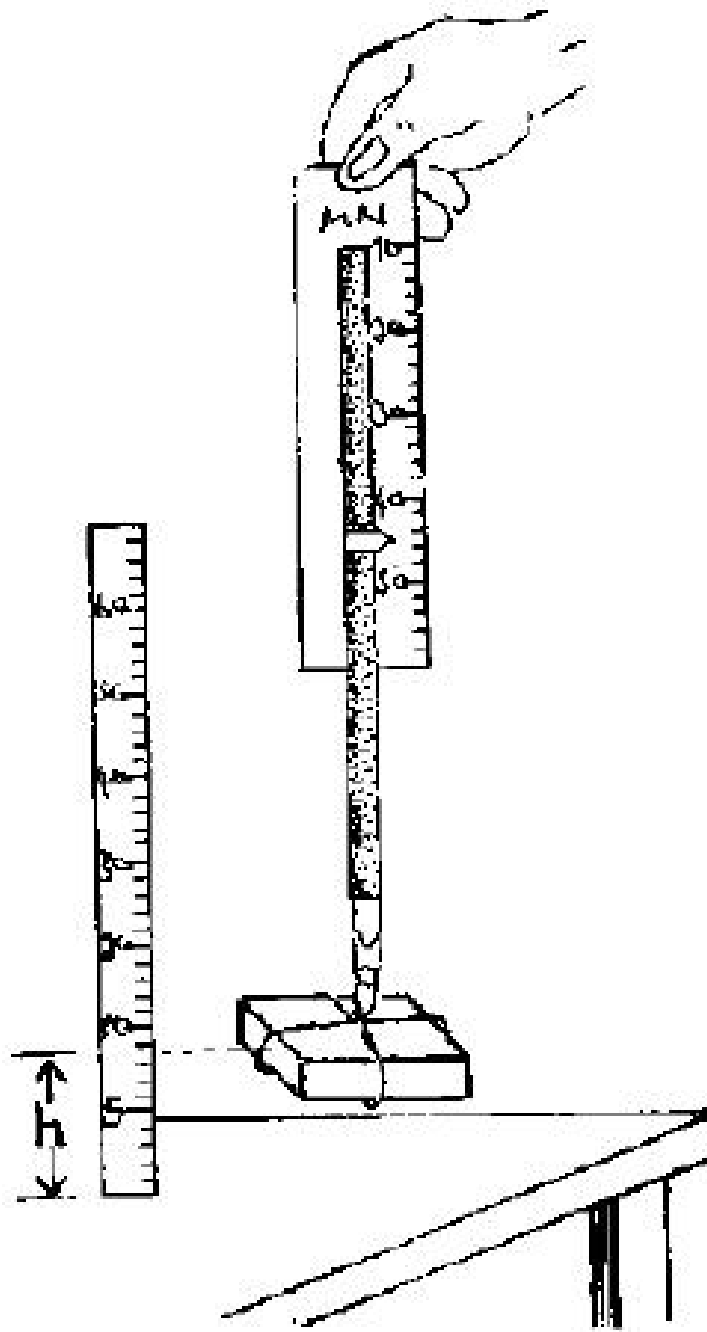

► Place a block of wood from the table using a Newton balance (see p. 15). Read the balance when you lift

**P:** Raise a block of wood from the table using a Newton balance (see p. 15). Read the balance when you lift the block at *constant* velocity, not when starting or stopping. Compare this force with the weight of the block. Measure the vertical distance the block is raised.

**Q:** Calculate the work done when the block was raised by the vertical distance  $h$ .

**E:** The force which lifts the block at constant velocity is equal to its weight in magnitude but has the opposite direction. Thus, the *work done by lifting* is

$$\text{Work done} = \text{weight} \times \text{vertical distance}$$

### 3.9.2 Work Done by Friction



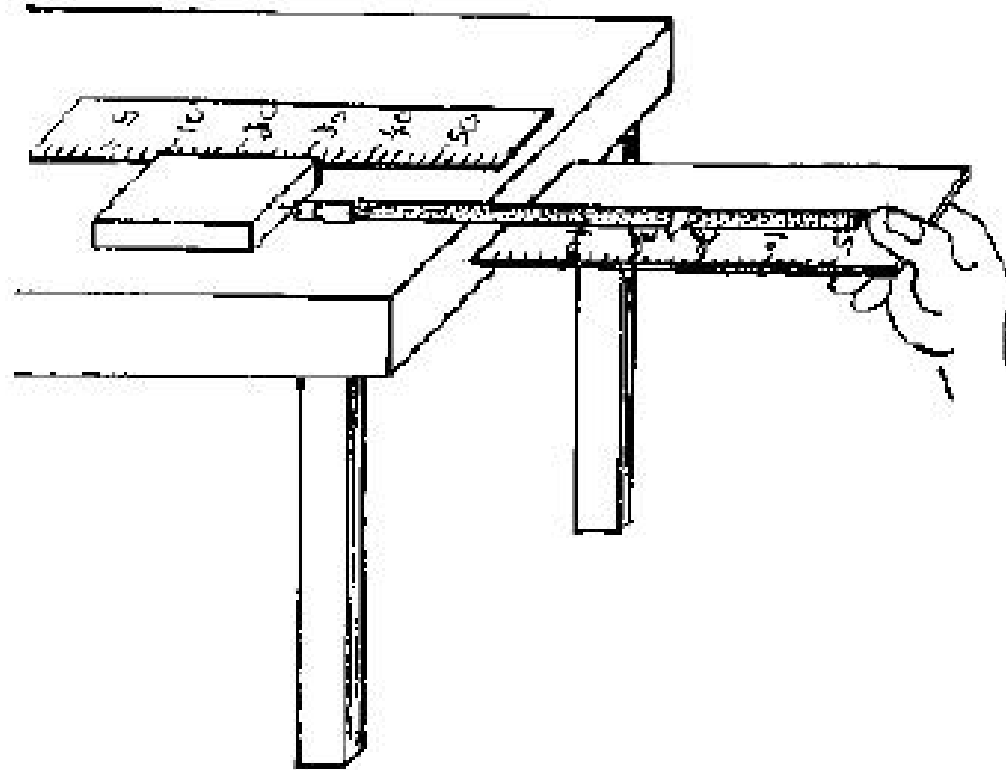

**P:** Place a block of wood on a table. Pull it with constant velocity using a Newton balance. Measure the distance moved by the block.

**Q:** Calculate the work done from the reading of the balance and the distance measured.

**E:** The force which pulls the block at constant velocity is equal to the force of friction in magnitude but has the opposite direction. Thus, the *work done by friction* is

$$\text{Work done} = \text{force of friction} \times \text{distance moved}$$

### 3.9.3 A Catapult



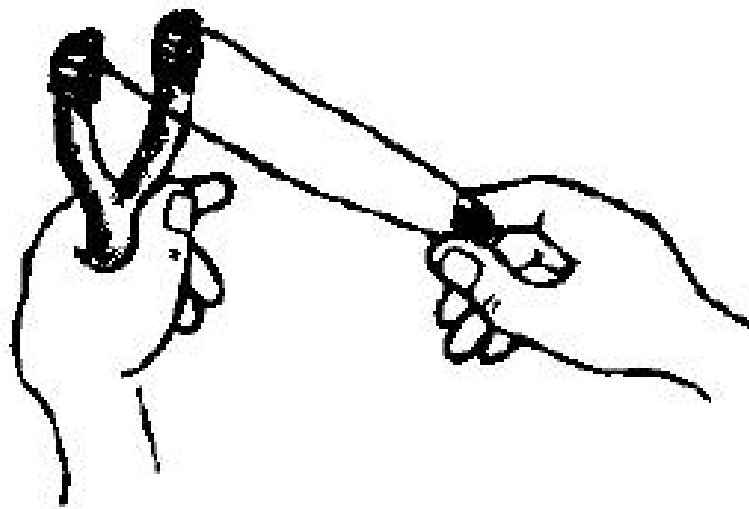

**P:** Tie a rubber band to the ends of a branched stick. Place a stone in the middle of the rubber band and stretch the band by pulling the stone towards you. Then release it.

**H:** Be very careful that nobody will be hit by the stone!

**Q:** What do you observe?

What kind of energy does the stretched rubber band, what the flying stone possess?

### **3.9.4 The Principle of a Steam Engine**

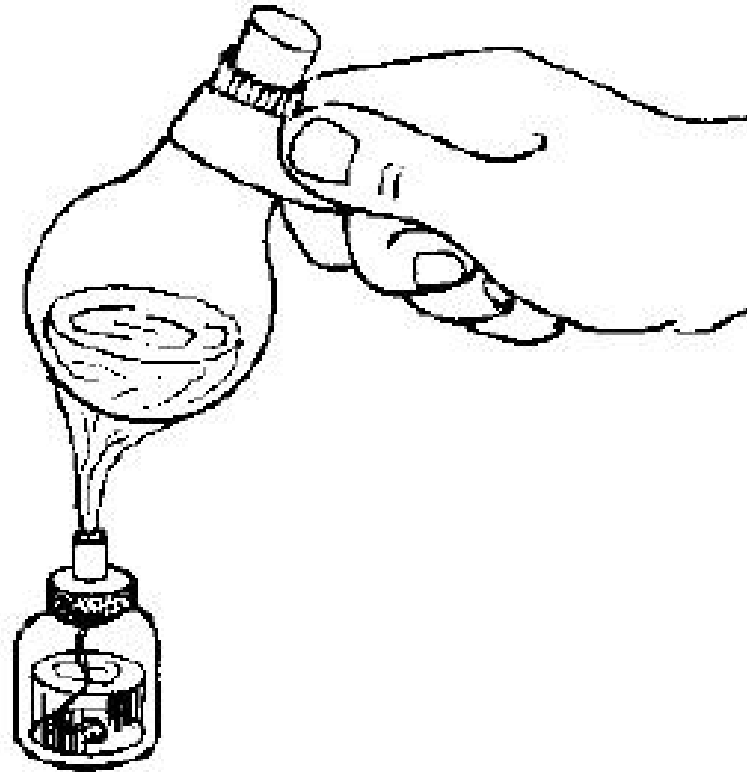

**P:** Fill some water into an opened electric bulb (see appendix) and close it *slightly* by a stopper. Then holding it with a strip of paper heat it using e.g. a kerosene burner until the water boils.

**Q:** What happens to the stopper? What energy changes take place?

### 3.9.5 A Pendulum

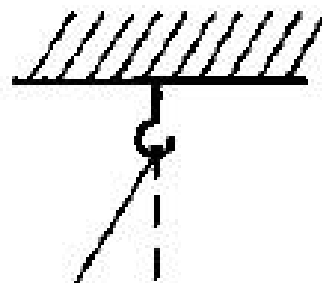

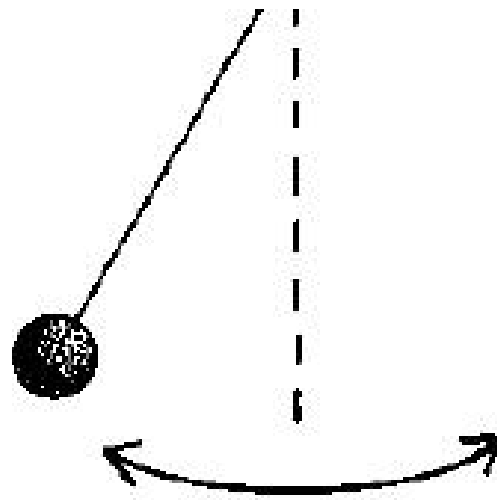

**P:** Suspend a stone on a long string. Displace it sideways.

**Q:** What do you observe? What changes in energy take place?

**E:** When the pendulum is displaced sideways by your hand, *chemical energy* of your food is changed into *potential energy* of the pendulum. When the pendulum swings back, it converts the latter into *kinetic energy* which is changed again into *potential energy* on the other side of the oscillation and so on.

### 3.9.6 Potential Energy in a Clothes-Peg

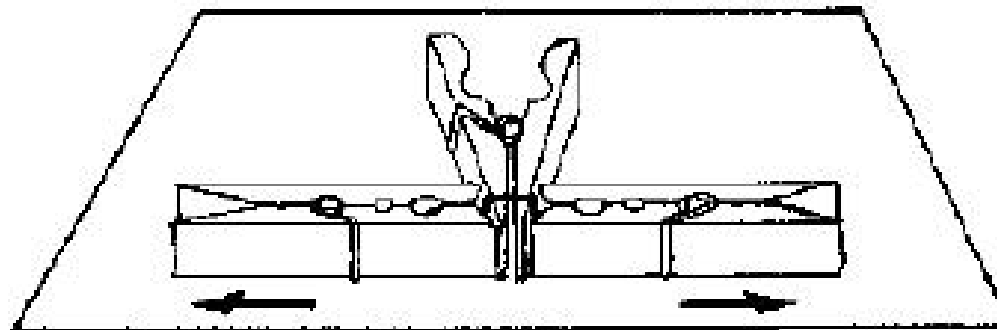

**P:** Tie the handles of a spring clothes-peg together with *one* loop of thread. Place this peg at the middle of a smooth table and place two other pegs beside it, one against each end of each handle. Burn the thread.

**Q:** What do you observe? What changes in energy take place?

### 3.9.7 Energy and the Funny Jumper

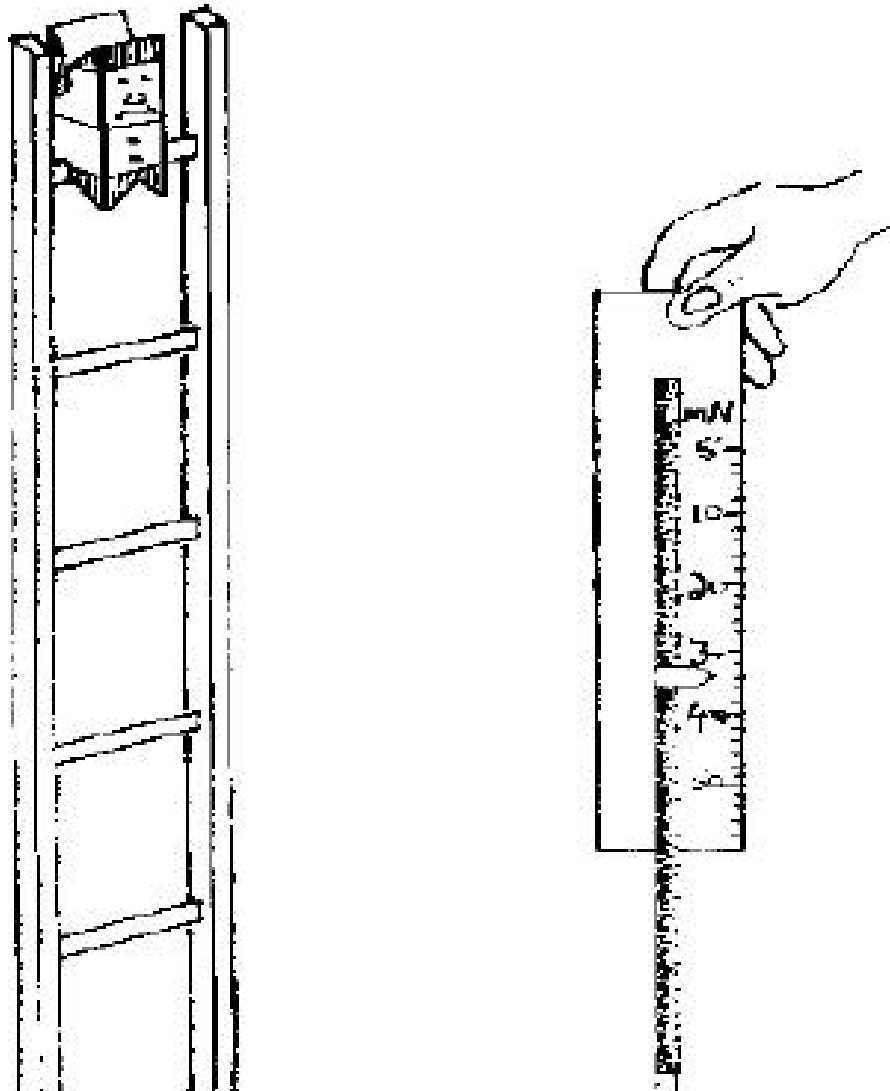

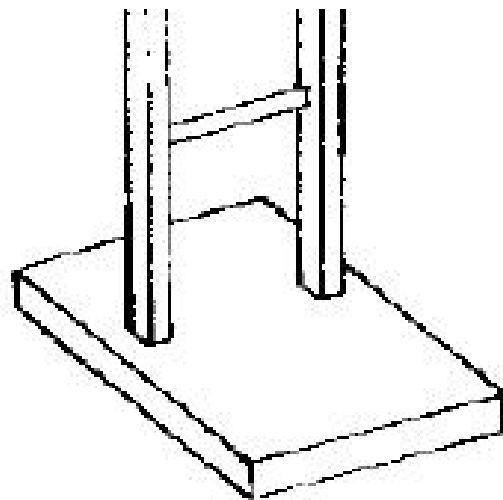

(a)



(b)

**P:** Set up the funny jumper (see p.21). Weigh the jumper using a Newton balance.

**Q:** Calculate the potential energy of the jumper when it is on the uppermost step of the ladder. Where does this energy go when it jumps down step by step?

**E:** The *potential energy* of the jumper is equal to its weight times the height of the uppermost step above ground. As the jumper jumps down, this energy is converted into *kinetic energy* (energy of motion) which in turn is converted into *heat* by friction.

### 3.9.8 Power

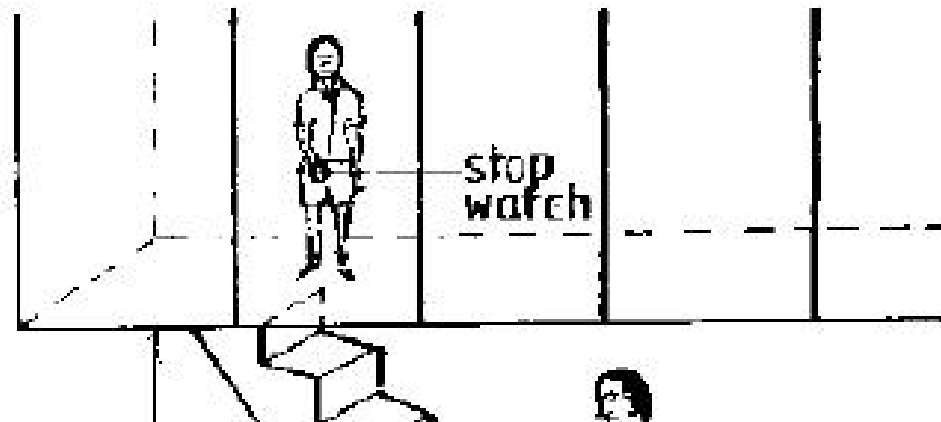
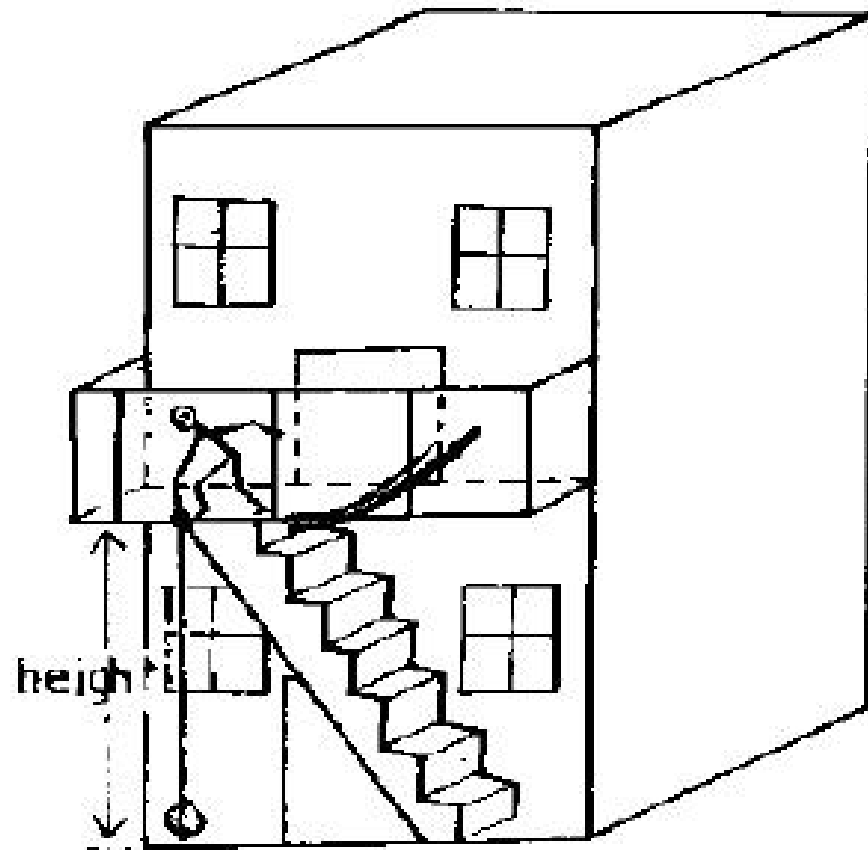

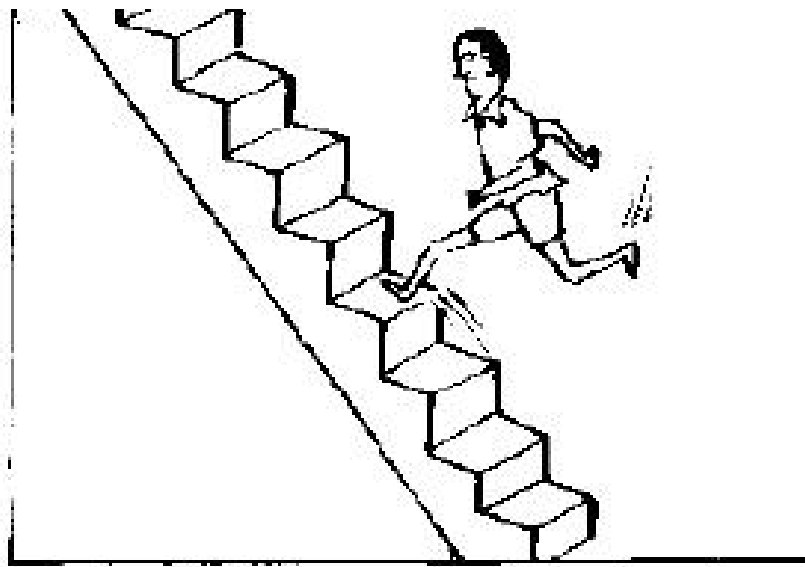

**P:** Measure the vertical height above ground of the first floor of a storey building. Run up to that floor as fast as you can while your friend times you with a watch. Take your weight (probably in a hospital).

**Q:** Calculate your maximum power.

**E:** Using your weight and the height of the first floor above ground, first calculate the potential energy (PE) of your body when it is on the first floor:

$$\text{PE} = \text{weight} \times \text{height}$$

This is the energy which you had to give out in order to raise your body to that height.

Now calculate your power by dividing that energy by the time (in seconds) you needed for running up.



### 3.10 Simple Machines

Simple machines use the principles of Physics to give us mechanical advantage, e.g. to *lift a heavy load using a small effort*. Examples are levers, wheel and axle, pulleys, the inclined plane etc.

Mechanical advantage (MA) = load  $\div$  effort. It depends on friction.

Velocity ratio (VR) = distance moved by effort  $\div$  distance moved by load. It does not depend on friction.

Efficiency = output  $\div$  input = work done on the load  $\div$  work done by the effort = MA  $\div$  VR. It depends on friction.

#### 3.10.1 Levers

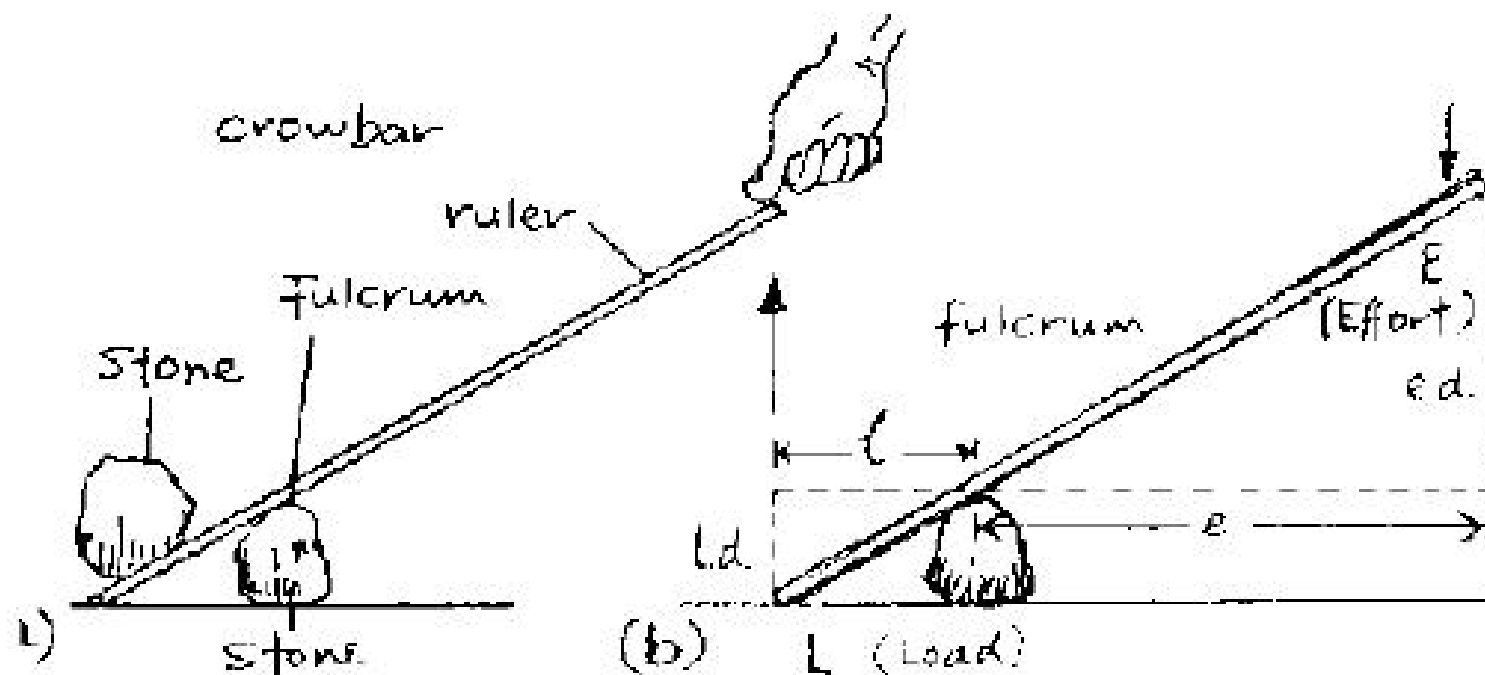

**P:** Make a lever using your ruler and a tipped stone. Use it to lift a heavy stone or brick.

**F:** Make a level using your ruler and a tipped stone. Use it to fill a heavy stone or brick.

**Q:** Do you feel the mechanical advantage? Derive a simple formula for MA (assuming there is no friction) using moments of forces (see p.20).

**O:** The effort is less than the load but the distance moved by the effort (d.e.) is longer than the distance moved by the load (d.l.).

**E:** Taking moments of forces (see fig. b) we obtain (neglecting friction):

$$L \times l = E \times e$$

**A:**

$$\frac{L}{E} = \frac{e}{l}$$



The seesaw, pliers, the wheelbarrow, tweezers, the bottle opener, the forearm, the roman steelyard, etc. are all levers.

### 3.10.2 The Roman Steelyard

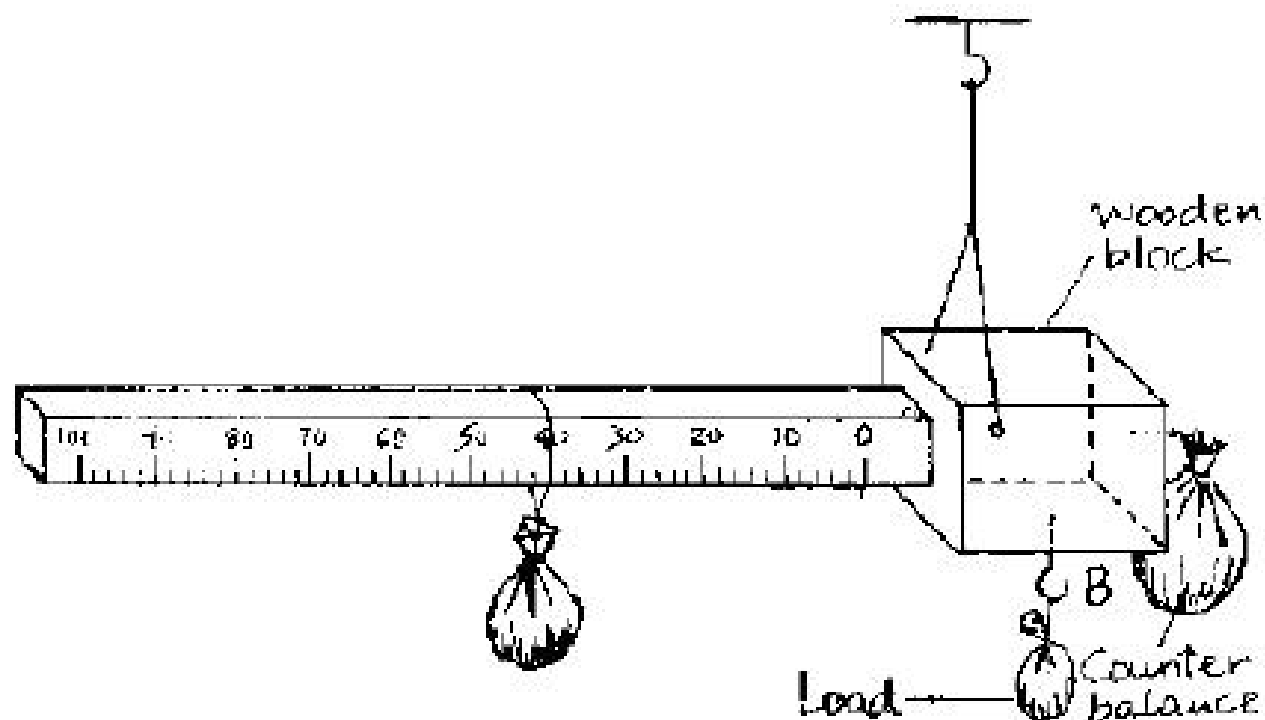

**P:** Make a roman steelyard according to the figure using wood.

*Calibration:* Suspend the roman steelyard in air. Then suspend e.g. a 100 g mass on the assumed zero mark. Hang a counterbalance mass on the other side (as shown) so that the whole system balances horizontally. Then hang a standard mass, e.g. 50 g on B and adjust the 100 g along the rod so that the whole system balances horizontally. Mark this point for the standard mass used (e.g. 50 g). Repeat this procedure for other masses (e.g. 100, 150, 200 g, ...).

*How to measure an unknown mass (load):* Suspend the load (whose mass you want to determine) from B. Then adjust the 100 g mass along the beam so that the whole system balances horizontally. Read and record

*How to measure an unknown mass (load):* Suspend the load (whose mass you want to determine) from B. Then adjust the 100 g mass along the beam so that the whole system balances horizontally. Read and record the mass of load.

**H:** The whole system should be suspended freely in air and it must be balanced *horizontally* in each step.

**A:** Used in weighing cotton, bags of coffee etc.

### **3.10.3 The Single Pulley**

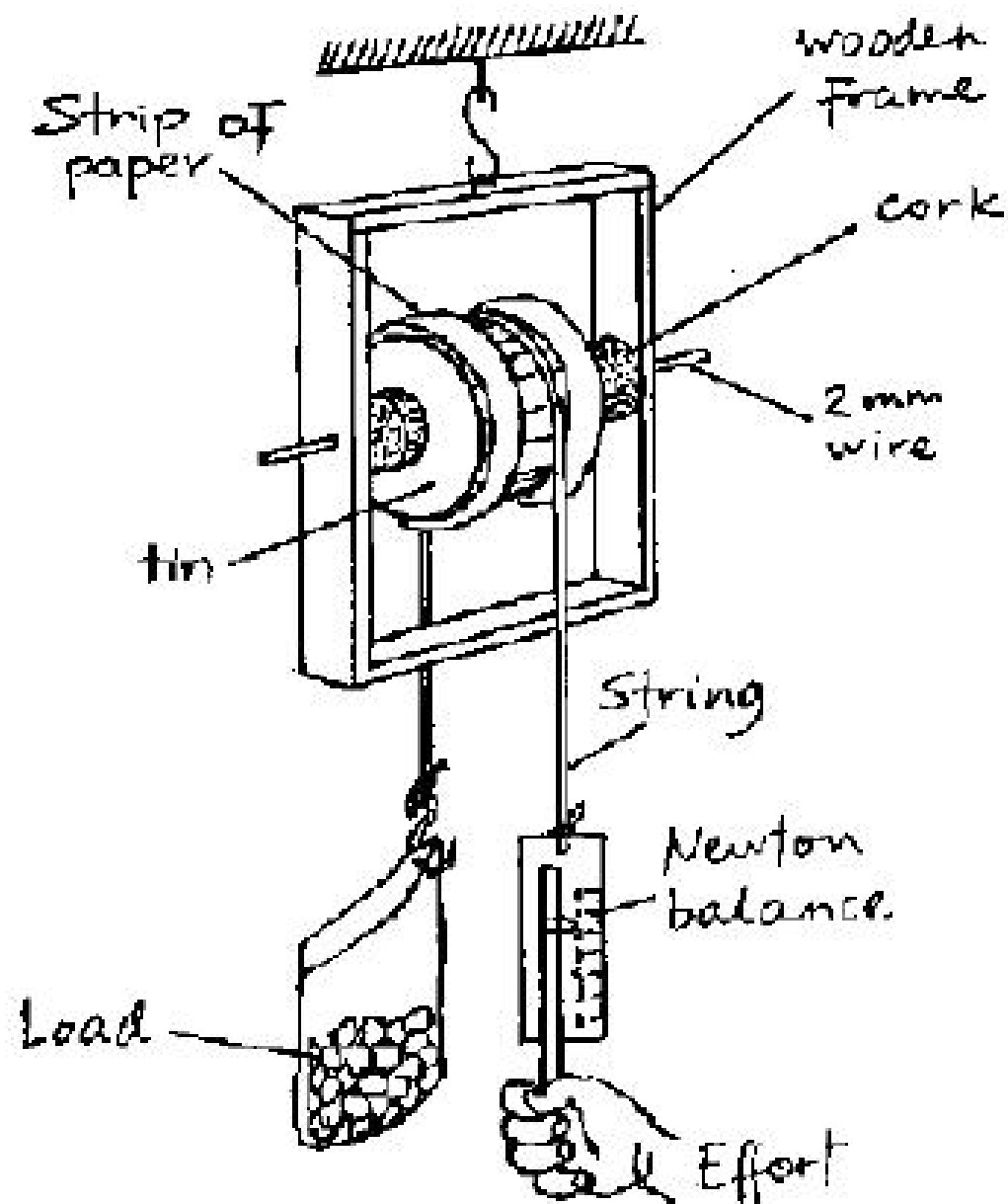

**P:** Produce a pulley by boring holes in the centre of the top and the bottom of a small tin. Take a wire of 2 mm diameter as an axle and fix it in a wooden frame as shown in the figure. Attach strings and use it to lift a load (which should be much heavier than the pulley). Use a Newton balance to measure load and effort.

diameter as an axle and fix it in a wooden frame as shown in the figure. Attach strings and use it to lift a load (which should be much heavier than the pulley). Use a Newton balance to measure load and effort.

**Q:** What is the MA of the simple pulley? What is the advantage of it?

**E:** A single pulley has an MA of 1, i.e. the effort is as big as the load is (including friction it is even bigger). Yet, the advantage is that the pulley *changes the direction* of the force. You can easier lift a heavy load by pulling downwards (assisted by your weight) than by pulling upwards.

### 3.10.4 The Two Pulley System

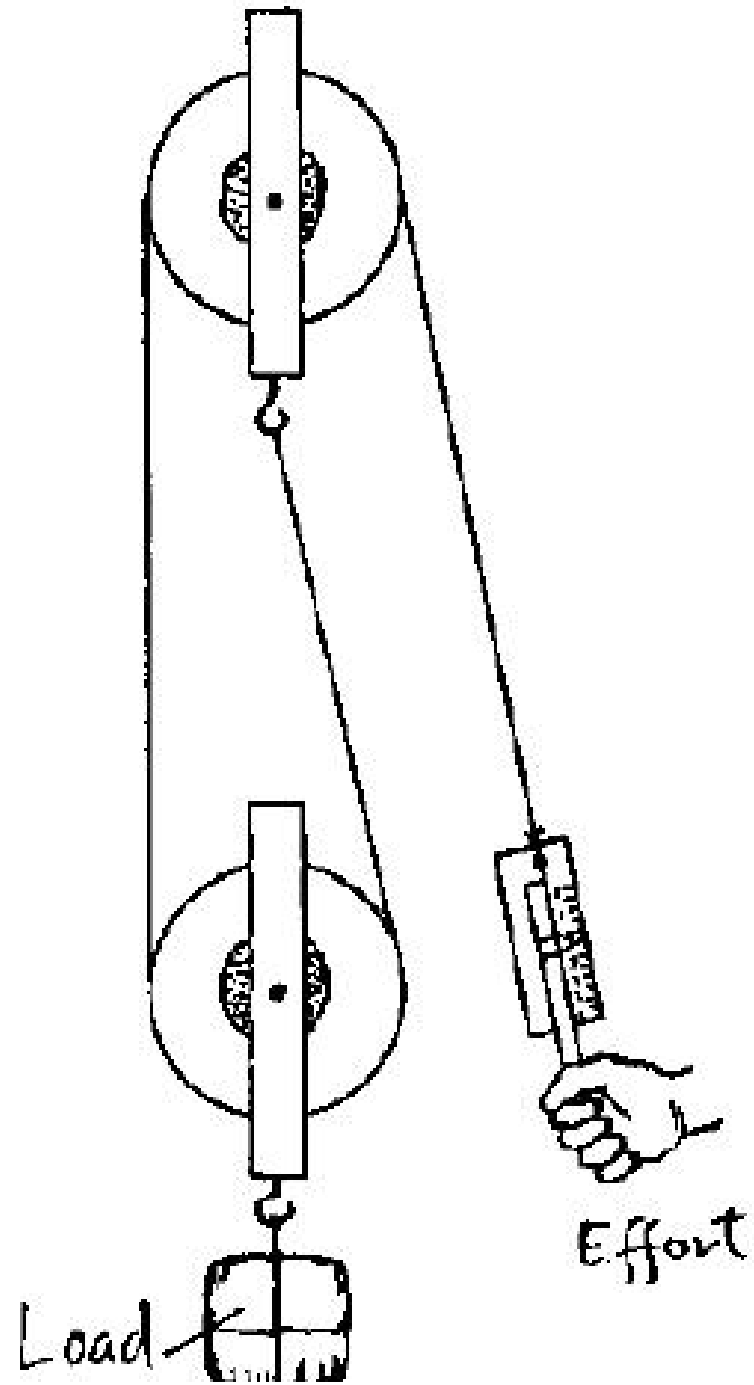

Load 

The two pulley system is the simplest *block and tackle* which gives a real MA when used to lift heavy loads.

**P:** Connect two single pulleys as shown in the above figure. Use this system to lift the same load as in experiment 3.10.3. Measure the effort using a Newton balance.

**Q:** What do you feel when lifting the load directly and when using this pulley system? How is the MA now (if you neglect friction and the weight of the lower pulley)? How far does the effort move, when the load moves, e.g. a distance of 20 cm?

**O:** It is easier to lift the load using this system: the effort is smaller.

**E:** Neglecting friction and the weight of the lower pulley, the MA will be 2, i.e. the load is twice the effort. However, in practice it is less due to the factors mentioned.

The effort moves 40 cm when the load moves 20 cm.

**A:** Cranes (e.g. in harbours) use (even more complex) pulley systems to lift very heavy loads.

### 3.10.5 A Riddle





**P:** Ask two strong boys and a girl to take two (broom) sticks and a rope and to arrange themselves as shown in the figure.

**Q:** Will the girl be able to pull the two strong boys together or can the boys resist the pull of the girl?

**O:** The girl wins. Why?

**E:** This is an arrangement of "broomstick pulleys". Thus, the girl needs much less effort to pull the heavy loads of the two boys! However, the girl will have to move farther than the boys do.

### 3.10.6 The Inclined Plane



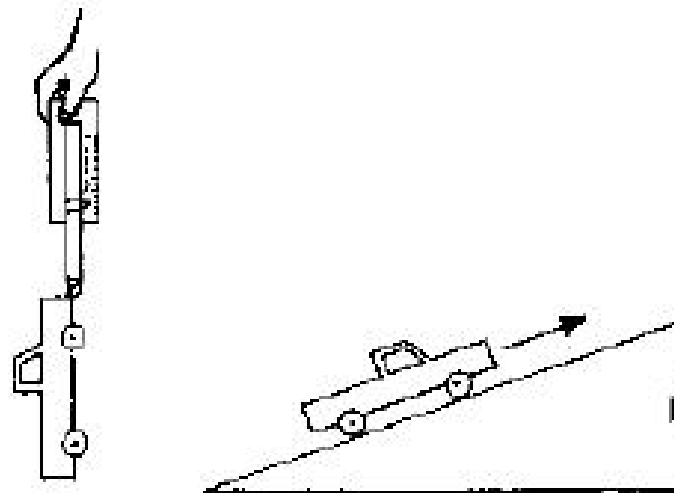
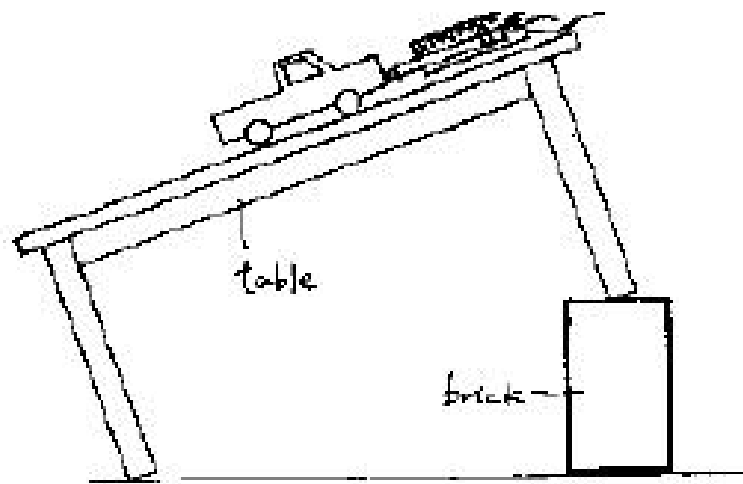

**P:** Tilt a smooth table by placing bricks underneath its legs on one end of the table (see fig. a). Ask students to bring their toy cars.

Weigh a toy car using a Newton balance. Now pull this toy car up the inclined plane of the table using a Newton balance to measure the effort.

**Q:** Is the effort smaller than the load (weight of the toy car)? How is the velocity ratio = (distance moved by effort along the slope) ÷ (distance moved by the load *vertically*)?

**E:** The effort is smaller than the load. The MA depends on the inclination of the plane as does the VR which is greater than 1.

**A:** Hills, slopes and ramps are examples of inclined planes, screws apply the same principle. The Egyptians used inclined planes to build their pyramids as people do sometimes nowadays to carry the building materials when building a two or three storey house.

### 3.11 Astronomy – The Solar System

Astronomy is the study of bodies in the universe and of their motion, e.g. the study of the solar system. The sun has nine planets going around it. The planets differ in size and relative distances from the sun. They are kept in their almost circular paths by the *gravitational force* of the sun which acts as *centripetal force*.

#### 3.11.1 Model of Sun–Earth–Moon

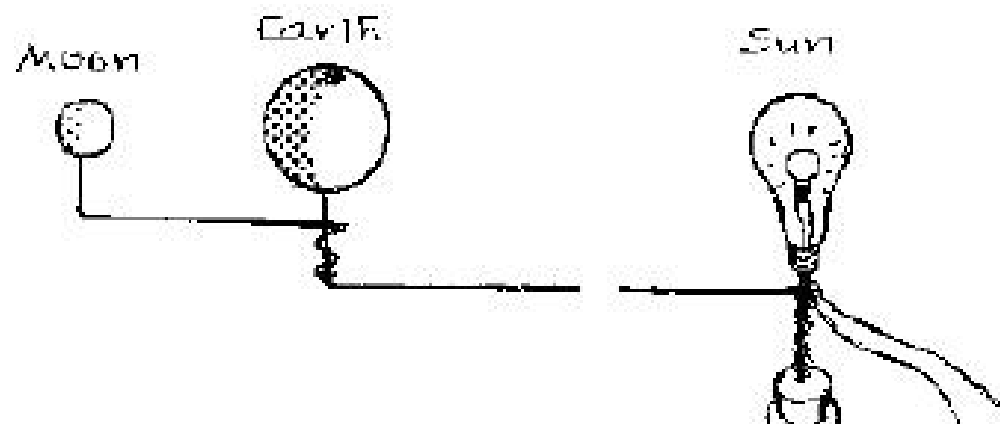

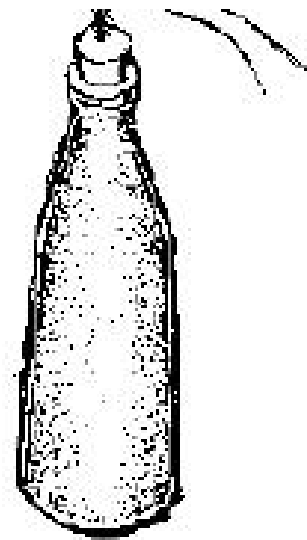

**P:** Pierce a seed and a small fruit with wires. Join an opened bulb (see appendix) to a bottle filled with sand using a wire. Join the three wires so that they allow rotation. The seed, fruit and bulb represent moon, earth and sun respectively. The bulb may be lit using a torch bulb and battery.

**E:** The model can be used to show the movement of the earth and the moon around the sun and earth respectively. It can also show the eclipse of the moon and the sun, when the earth shades the moon or the moon shades a part of the earth respectively.

### 3.11.2 Centripetal Force

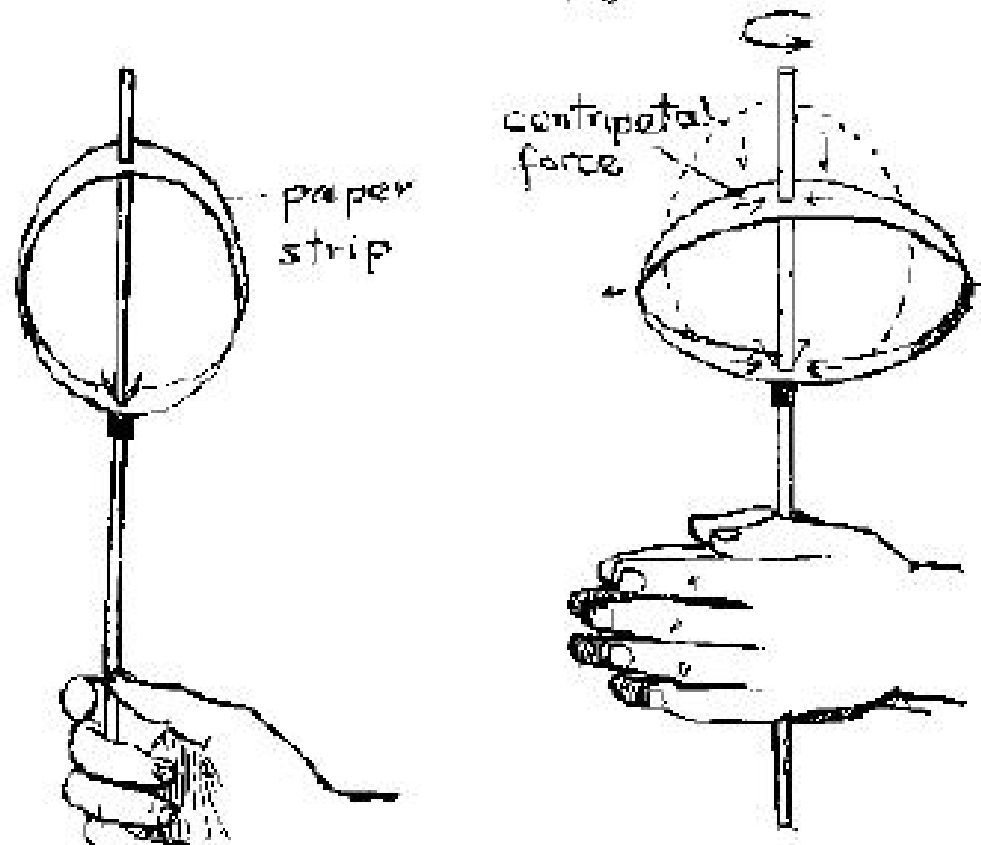
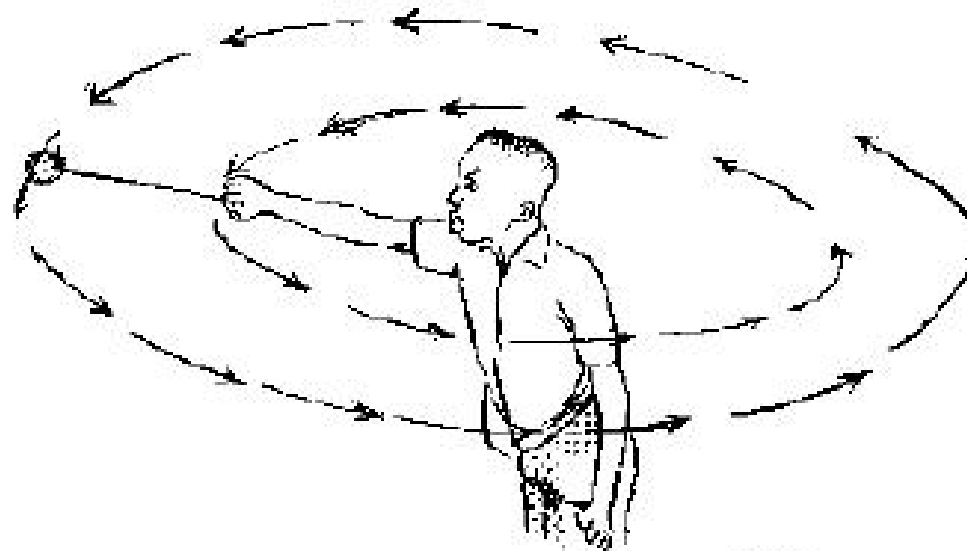



Due to its inertia a body will move along a straight line when *no* force acts on it. What force keeps the planets on their circular paths?

**P:** Tie a ball or stone to a thread and whirl it around as shown in the above figure.

**Q:** What force keeps the stone on its circular track?

**E:** There acts a force along the thread (which you feel in your hand) called the *centripetal force* which forces the stone to the circular path. Thus, a centripetal force must also act on each planet to keep it on its circular path.

### 3.11.3 Demonstrating the Solar System



**P:** Place a chair at the centre of the football field of your school to represent the sun. Now ask nine students to go around the chair in circles to represent the planets. The radius of each circle should correspond to the distance of the respective planet from the sun.

For example, if you use a scale of 1 cm representing a distance of 1 million km from the sun, then (see the table below) the radius of the mercury path must be 58 cm, that of the venus 107 cm, that of the earth 149 cm and so on. (Of course, in this scale, the sun would be a ball of 2 cm diameter, the earth only a grain of sand).

**Q:** What will be the radii of the paths of Jupiter, Uranus and Pluto respectively in this model?

**E:** They will be 7.8 m, 28.5 m and 58.7 m respectively.

E: They will be 7.8 m, 28.5 m and 58.7 m respectively.

Planet	Distance in millions of km from sun
Mercury	58
Venus	107
Earth	149
Mars	227
Jupiter	773
Saturn	1418
Uranus	2853
Neptune	4469
Pluto	5866

#### 3.11.4 Gravitational Force



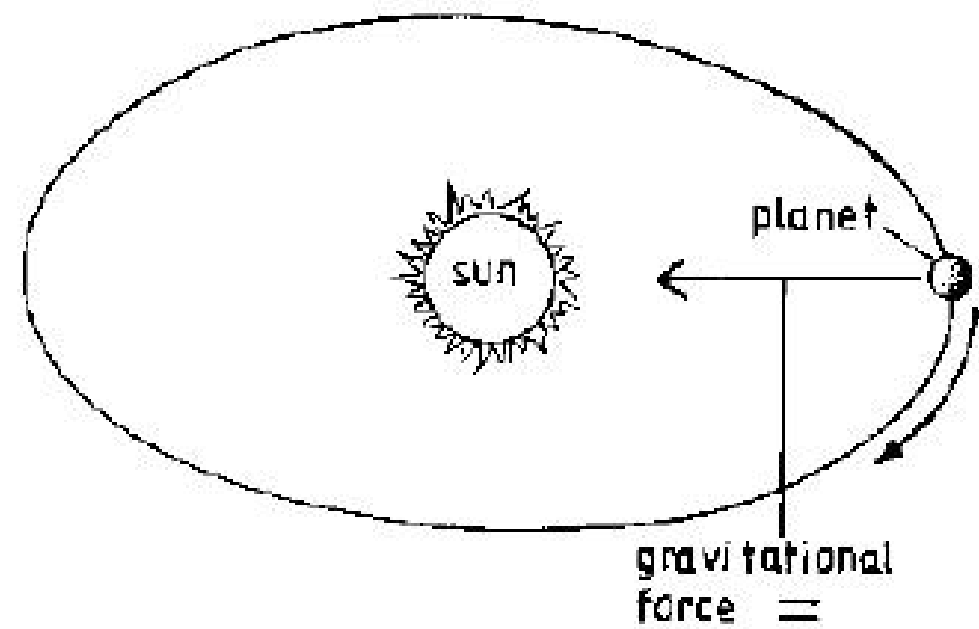
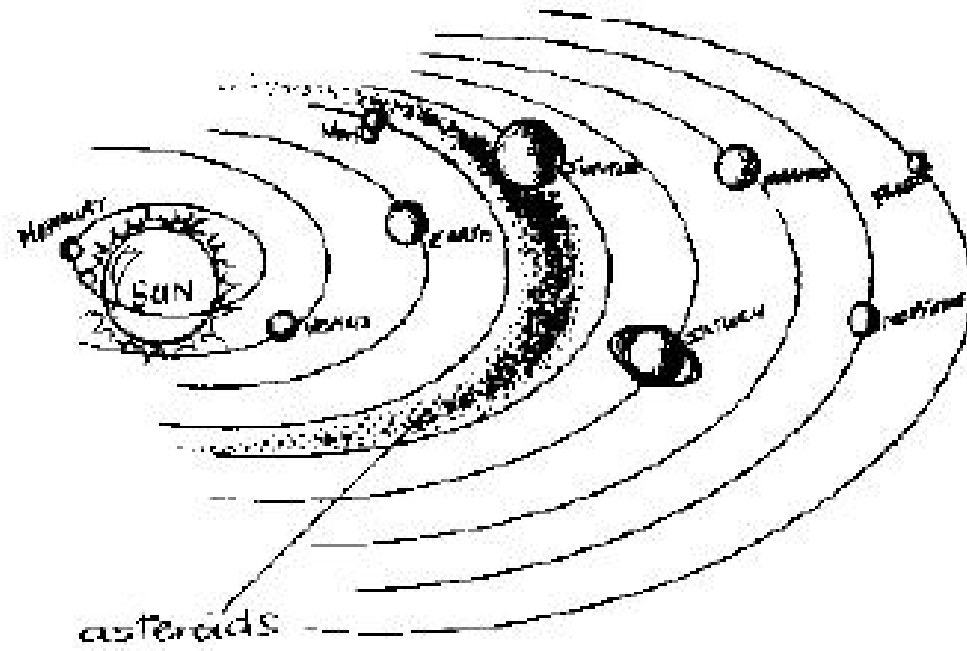

gravitational  
force =  
centripetal  
force

How do we call the force which acts as the centripetal force for the planets? Obviously, the planets are not tied to the sun by a string as the stone in experiment 3.11.2 is tied to your hand.

There must be a force acting through the empty space tying the planets to the sun. This force is the pull of the mass of the sun on the mass of the respective planet. It is a force of attraction between the two masses which we call *gravitational force*. Thus, the gravitational force between the sun and a planet acts as centripetal force (always directed towards the sun) to keep the planet in its circular path. (You can feel the gravitational force of the earth causing the *weight* of a body on the earth. Due to this gravitational pull of the earth, e.g. a stone falls down to the earth where released.)

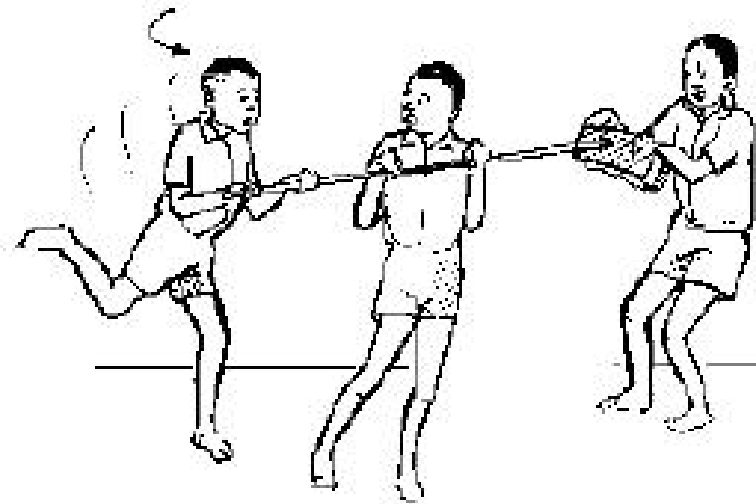

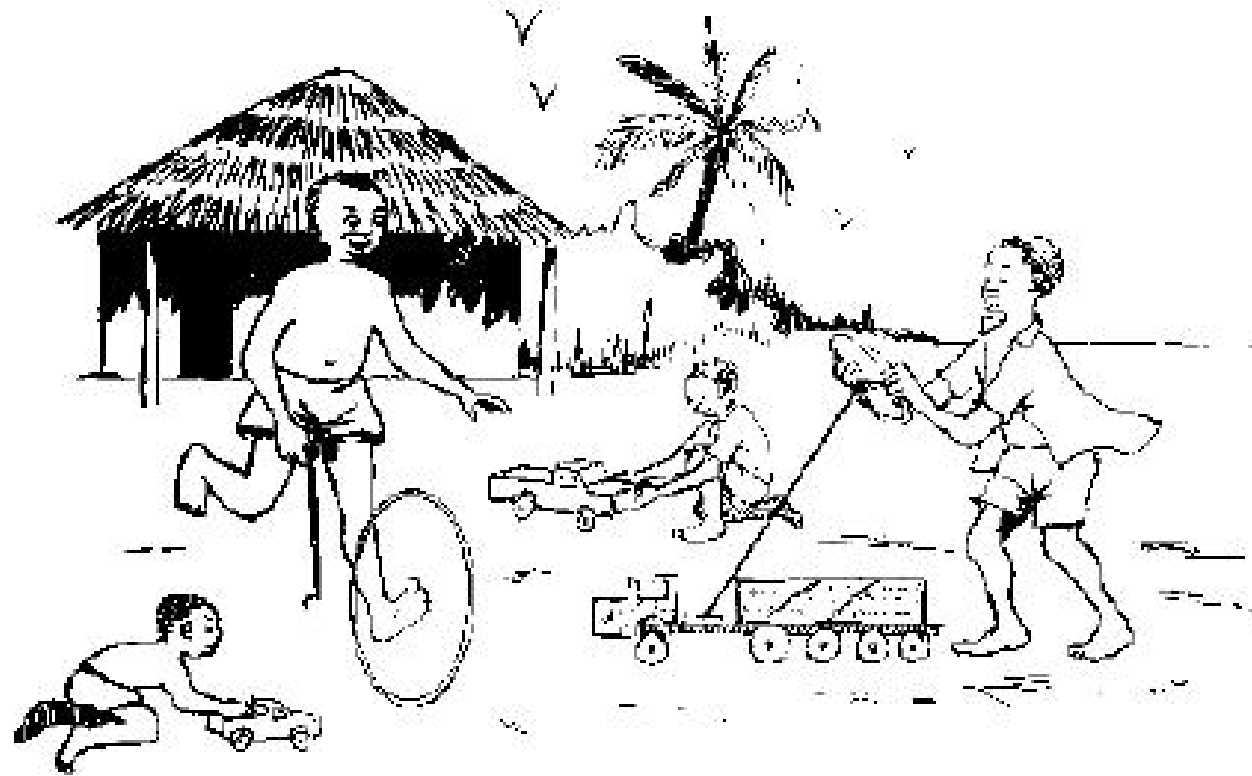

#### 4. Matter



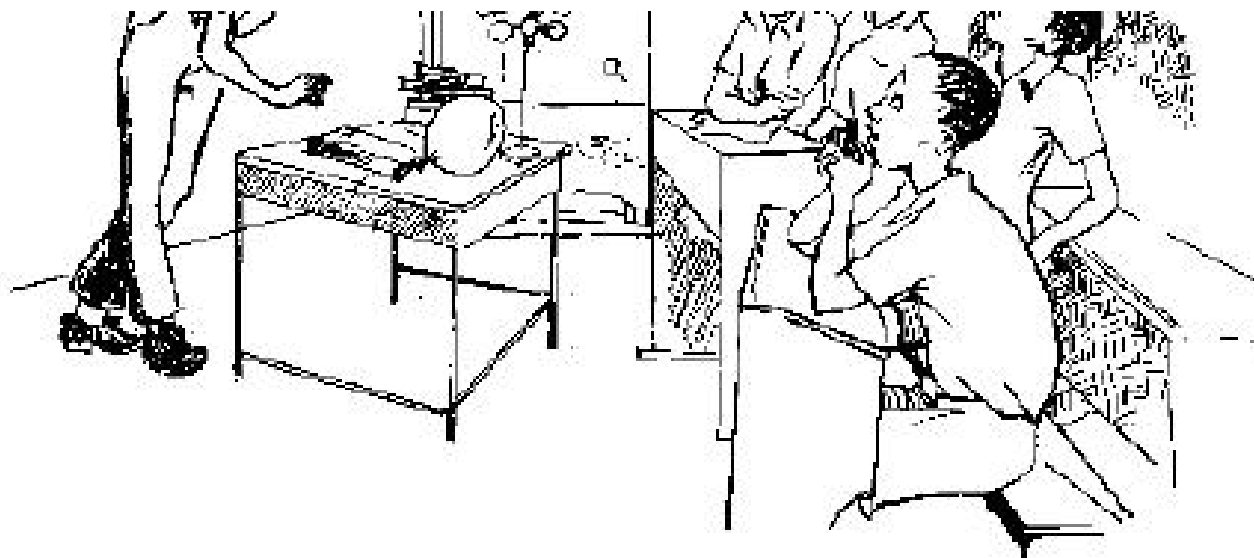

## 4.1 The Particle Model of Matter

*Matter* is anything which occupies space and has mass. It consists of very *small* particles called atoms or molecules which take part in chemical reactions. The particles possess kinetic energy. Therefore they are in constant vibration. The energy content increases with the increase in temperature. Hence, the motion of the particles increases with the temperature. Forces exist which hold the particles strongly together in *solids*, while they can easily move past each other in *liquids* and *gases*.

### 4.1.1 Salt is Made of Particles

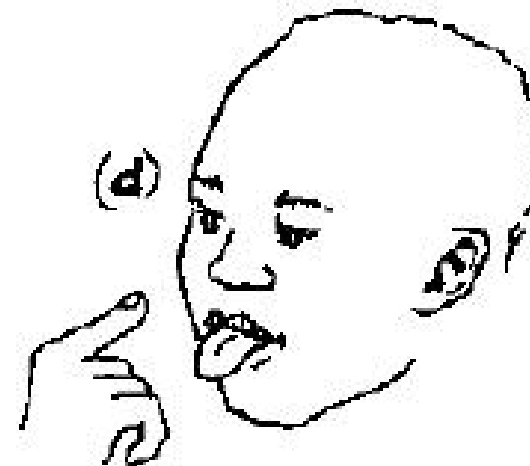

**P:** Take some salt (or sugar) crystals and roll them between your fingers in order to feel their hardness. Taste the crystals

**P:** Take some salt (or sugar) crystals and roll them between your fingers in order to feel their hardness. Taste the crystals.

Take a small amount of boiled water and taste it.

Put salt (or sugar) crystals into the water and shake. What happens? Taste again.

**Q:** Describe and explain your observations.

**O:** Salt crystals are often of cubical shape. They are quite hard.

The crystals dissolve in water. The solution tastes like salt (or sugar).

**E:** Sugar or salt in water exists as very tiny invisible particles that can be identified by tasting.

#### **4.1.2 Water is Made up of Particles**

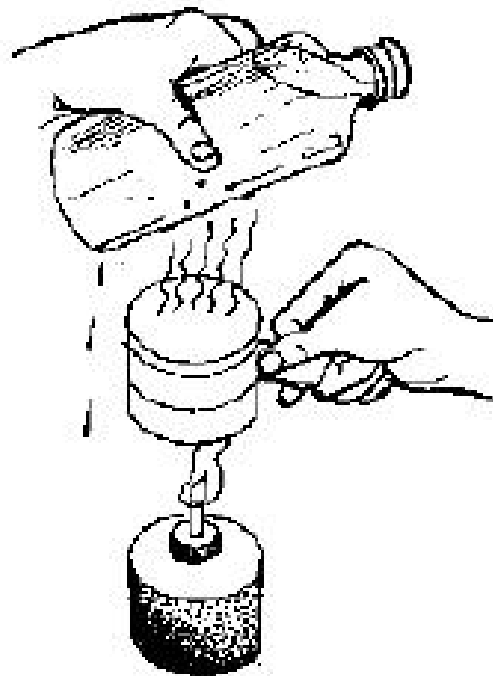

**P:** Pour a small amount of water into a tin can and heat it until it boils. Fill a bottle with cool water and hold it above the tin can.

**Q:** What do you observe?

**O:** Water drops form on the outside of the cool bottle wherever it is touched by the steam of the boiling water.

**E:** Water particles escape from the boiling water as vapour and condense on the lower surface of the bottle to form water droplets.

The formation of drops from vapour is an indirect evidence that water is made up of small particles.

#### 4.1.3 Size of Particles

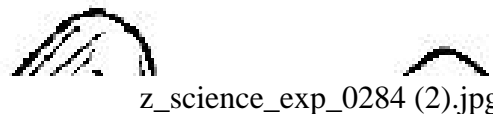

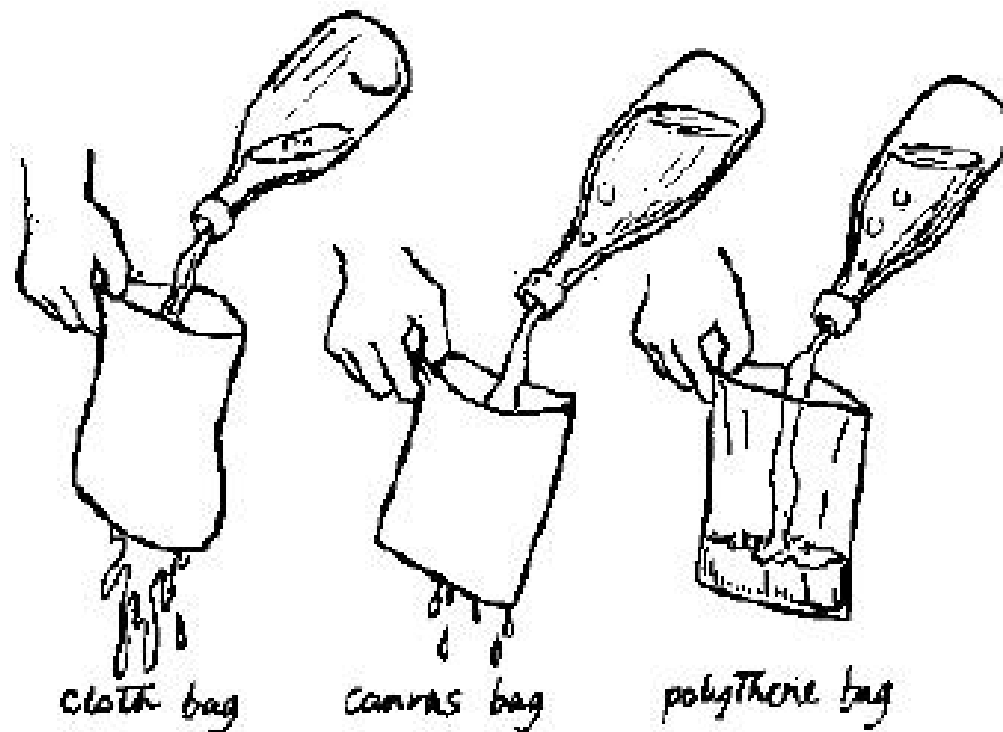

**P:** Make bags from cotton cloth, canvas cloth and polythene sheet. Fill water into the bags.

**Q:** What do you observe?

**E:** Water passes through cotton and canvas but not through polythene. This is because polythene has too small pores to allow water particles to pass through.

#### 4.1.4 Feeling Particles





**P:** A wind is blowing vigorously towards a student carrying an open umbrella.

**Q:** What will she feel?

**E:** The umbrella is forced down by the wind pressure. This is due to the current of air particles (wind).

#### 4.1.5 Smelling Particles

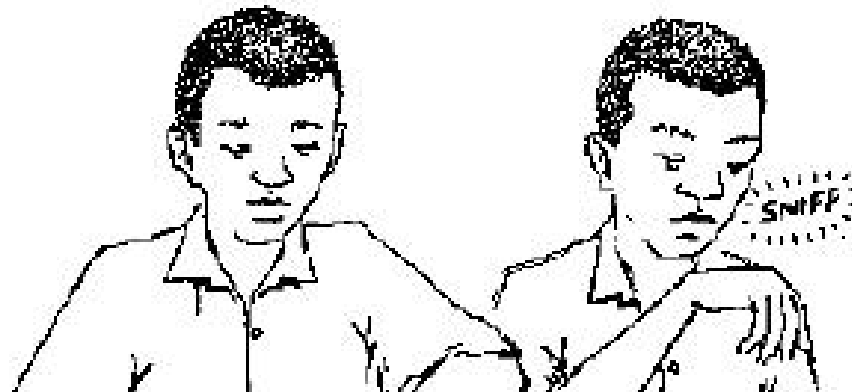

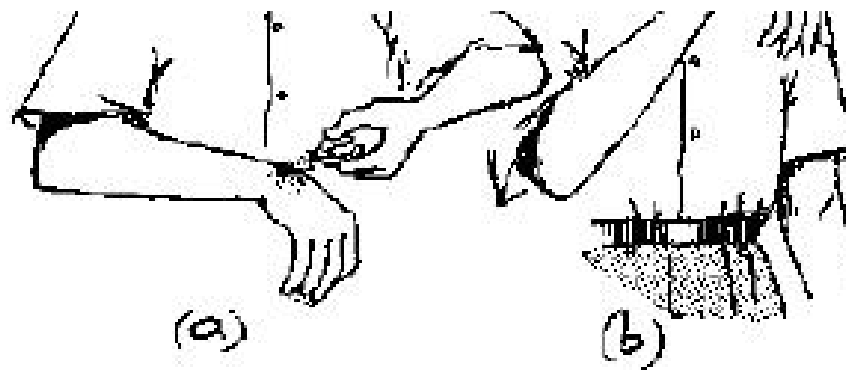

**P:** Let a student squeeze an orange peel.

**Q:** What can he sense?

**E:** He smells the orange, because invisibly tiny particles from the orange peel spread by diffusion to his nose.

#### **4.1.6 Weighing Particles**

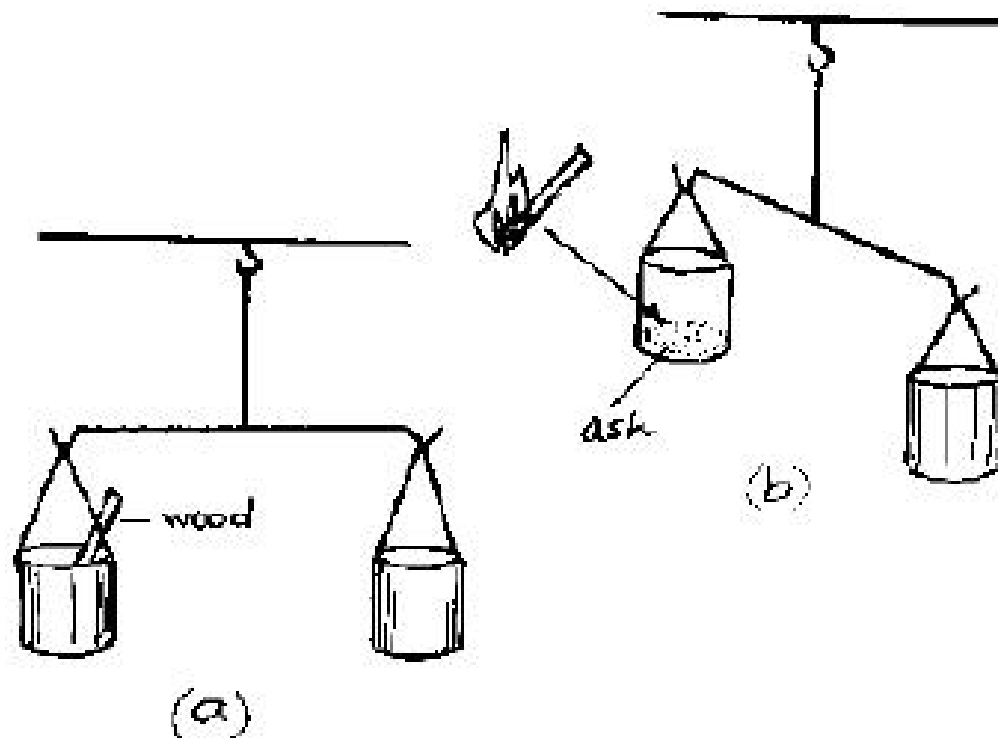

**P:** Ask students to weigh pieces of wood. Record the weight. Burn the pieces of wood and weigh the ash.

**Q:** Is there any difference between the weight of the wood and the ash?

**E:** The weight of ash is less than that of wood. The loss in weight is due to particles which escaped as soot and gas.

#### 4.2 States of Matter

Matter exists in three states namely: solid, liquid and gas. The three states can be converted into one another by heating and cooling. In *solids* the particles are very close together and have a definite order. In *liquids* the particles are slightly farther apart than in solids and can move past each other. In *gases* the particles are in fast random motion. The three states differ mainly in the thermal energy each contains and as a consequence

by heating and cooling. In solids the particles are very close together and have a definite order. In liquids the particles are slightly farther apart than in solids and can move past each other. In gases the particles are in fast random motion. The three states differ mainly in the thermal energy each contains and as a consequence in the volume which equal masses of the same substance occupy.

#### 4.2.1 Changes of State

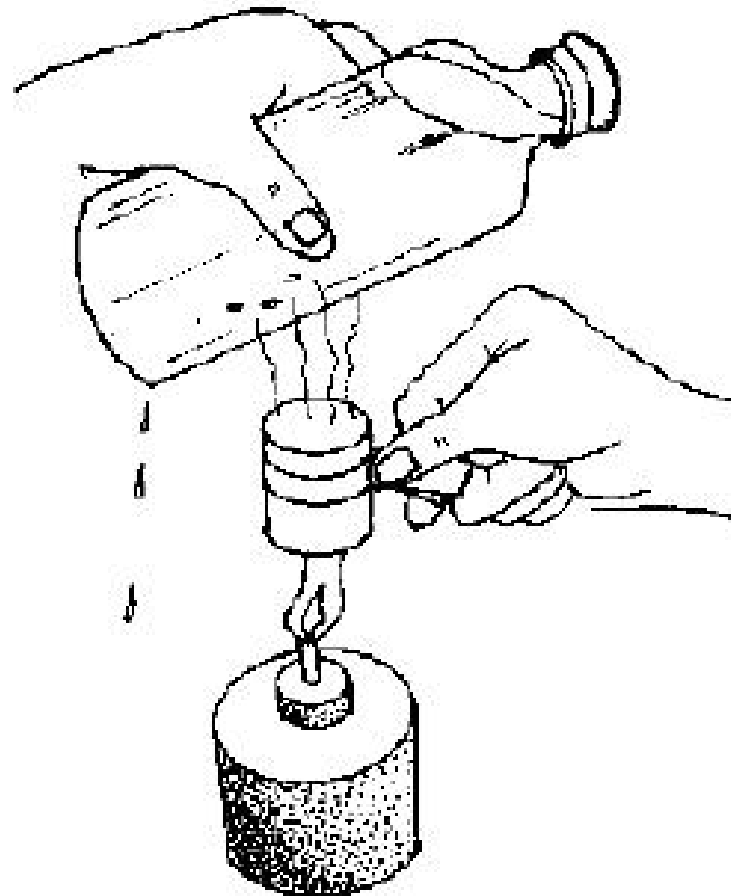

P: Heat pieces of candle wax carefully in a spoon or in a tin and hold a glass filled with cold water above it.

**Q:** What do you observe?

**O:** On heating, the solid melts to form a liquid and then by further heating the liquid evaporates as a vapour which is in gaseous state. The gas then condenses at the cold surface. This is similar to experiments performed with water (see 4.1.2, 5.3.1 and 5.3.2).

#### 4.2.2 Explaining the States of Matter



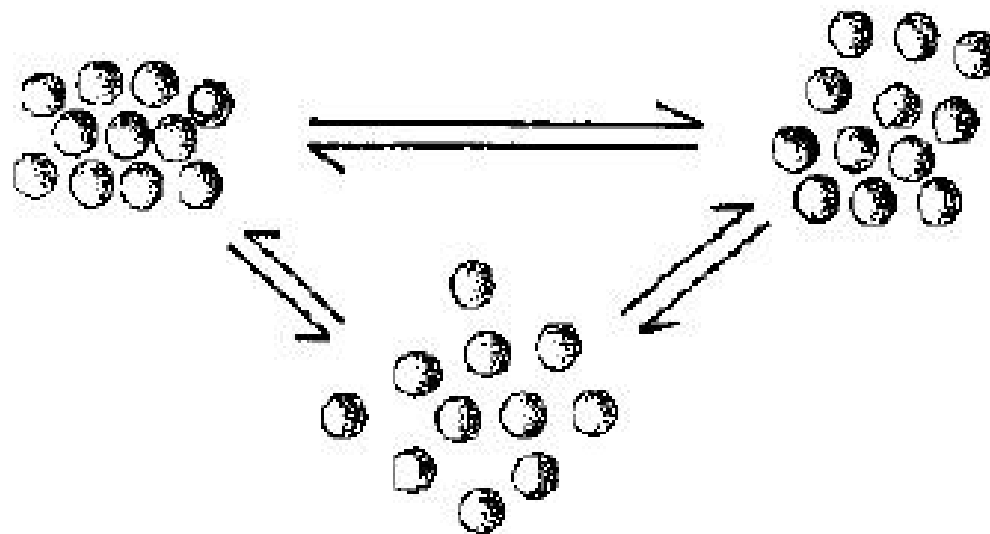

**P:** The three states of matter can be explained by simple models as shown in the figures above.

**Q:** What do the pictures represent?

**E:** Very close pupils or balls represent the particles in the *solid* state. Farther apart pupils or balls represent the particles in the *liquid* state. They move past each other. Fast and randomly moving pupils or balls represent the particles in the *gaseous* state.

#### 4.3 Motion of Particles

Particles are in random motion. However, they cannot be seen. How do we get to know about their motion? The existence of the molecular motion can be deduced by indirect evidence through observation of *diffusion*.

The movement of one kind of substance through a volume already occupied by another substance is known as diffusion. More direct evidence for molecular movement in gases or liquids comes from *Brownian movement*. Small visible particles can be seen in an irregular movement. From this we conclude that rapidly moving invisible gas molecules collide with them.

#### 4.3.1 Diffusion in Liquids

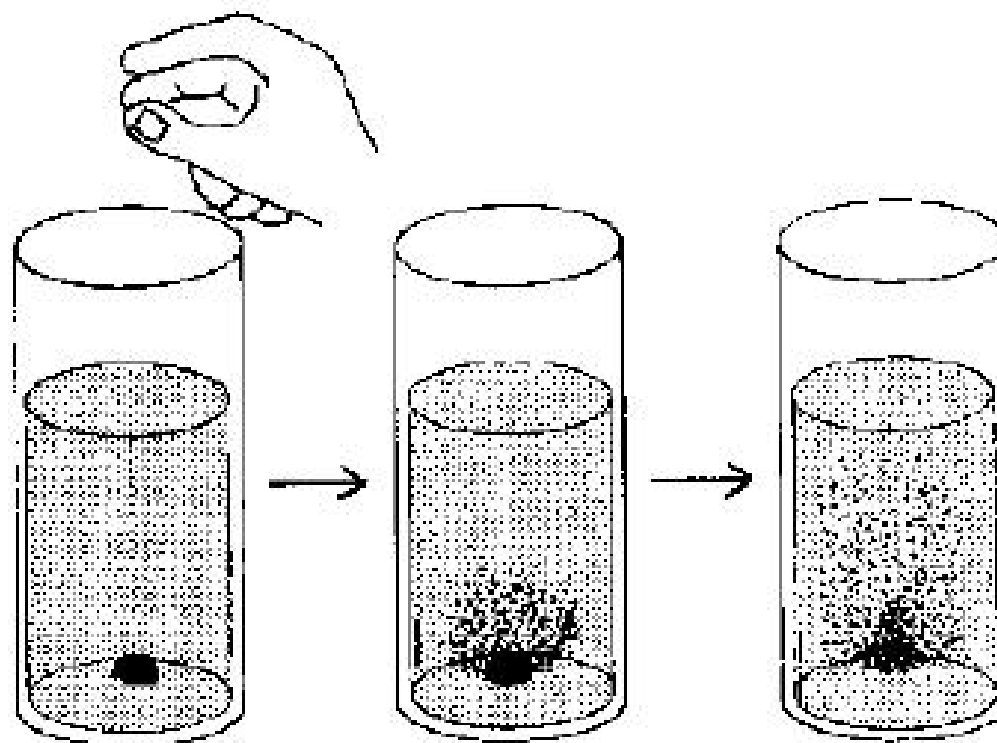

**P:** Put a crystal of potassium manganate (VII) (permanganate) into a jar containing water. Set the jar and observe.

**Q:** What do you observe?

**O:** The purple colour of potassium manganate(VII) (permanganate) will be found to spread gradually throughout the water.

**Q:** The purple colour of potassium manganate(VII) (permanganate) will be found to spread gradually throughout the water.

**E:** This spreading out is due to the motion of the particles of potassium manganate(VII).

This process is called *diffusion*.

**H:** This is a slow process. Therefore allow the jar to stand for some days.

#### **4.3.2 A Model on Motion**



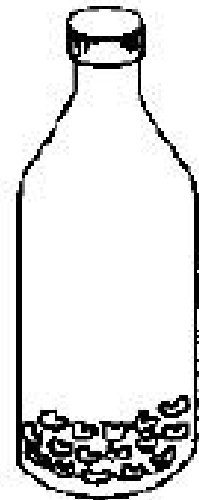

solid



liquid

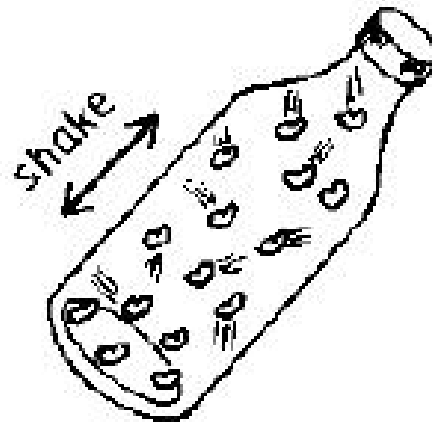

gas

Put some dry beans, rice or stones in a transparent bottle. Hold the bottle still (a), then turn it (b). Then

**P:** Put some dry beans, rice or stones in a transparent bottle. Hold the bottle still (a), then turn it (b). Then shake it vigorously (c).

**Q:** Which activity corresponds to which state of matter?

**E:** The movement of particles in *solids* is small and hence the particles are in a fixed order. In *liquids* the particles move past each other and have lost the stiff order. In *gases* the particles move very fast and randomly. They have now no order at all anymore. Hence, the observations in (a), (b) and (c) represent solid, liquid and gaseous state respectively.

### 4.3.3 Diffusion in Daily Life



P: Pass near a place where people are roasting meat or cooking.

Q: What do you smell? Why?

E: The smell is sensed even at a distance, because the particles which produce the smell spread by *diffusion*.

#### 4.3.4 Diffusion and Pollution



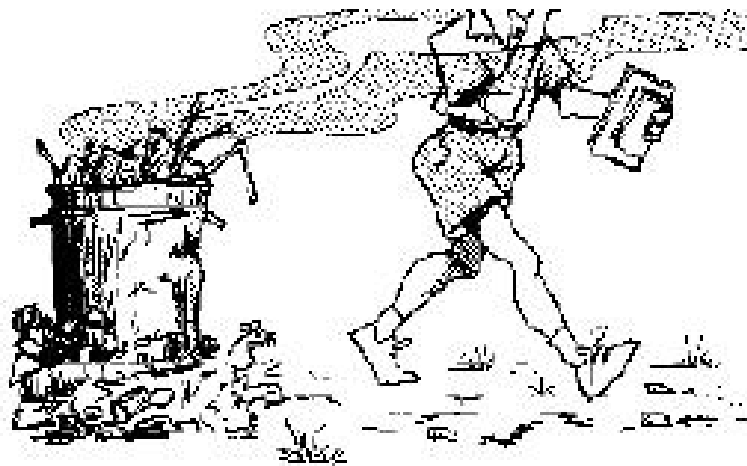

**P:** Pass near a polluted area (e.g. latrine, burning heaps of litter, a filling station).

**Q:** What do you smell?

**E:** Many hazardous substances spread to the environment by *diffusion*. (Hazardous substances in any state of matter in our environment mean *pollution*.)

#### **4.3.5 Brownian Motion**



**P:** Observe a beam of light through dust in a dark room.

**Q:** What do you observe? Why?

**E:** The dust particles can be seen moving randomly. This demonstrates *Brownian motion*. What is seen is the consequence of the bombardment of the dust particles by invisible air particles. This is an indirect evidence for the existence of particles in the air.

#### 4.3.6 Model on Brownian Movement



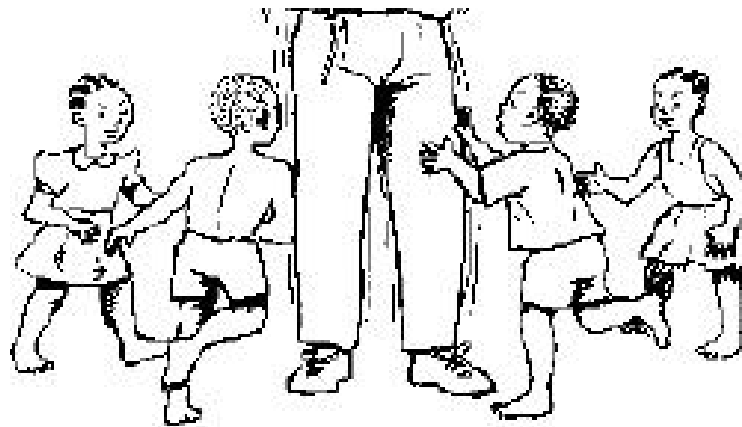

Imagine there would be standing a tall adult person around whom small children are in a continuous random movement. The tall person would be punched permanently by the children and hence would be jerkily moved.

#### 4.4 Cohesion and Adhesion

There are two types of *forces between particles*. Forces between particles of the same material are called *cohesive forces* while those between particles of different materials are called *adhesive forces*. Cohesive forces hold the molecules in a water drop together. Nevertheless they are weak, so that the molecules can be easily separated, for example, when we jump into water or when it is heated. Paints and all kinds of glues are based on the effects of adhesive forces.

##### 4.4.1 Exploring Cohesion and Adhesion

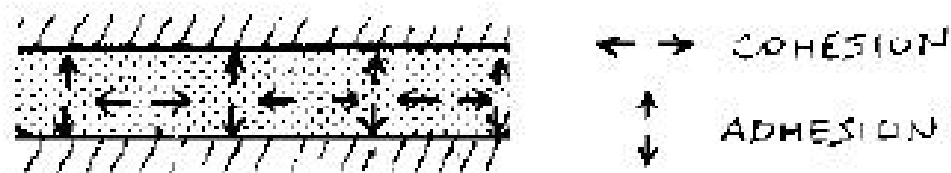
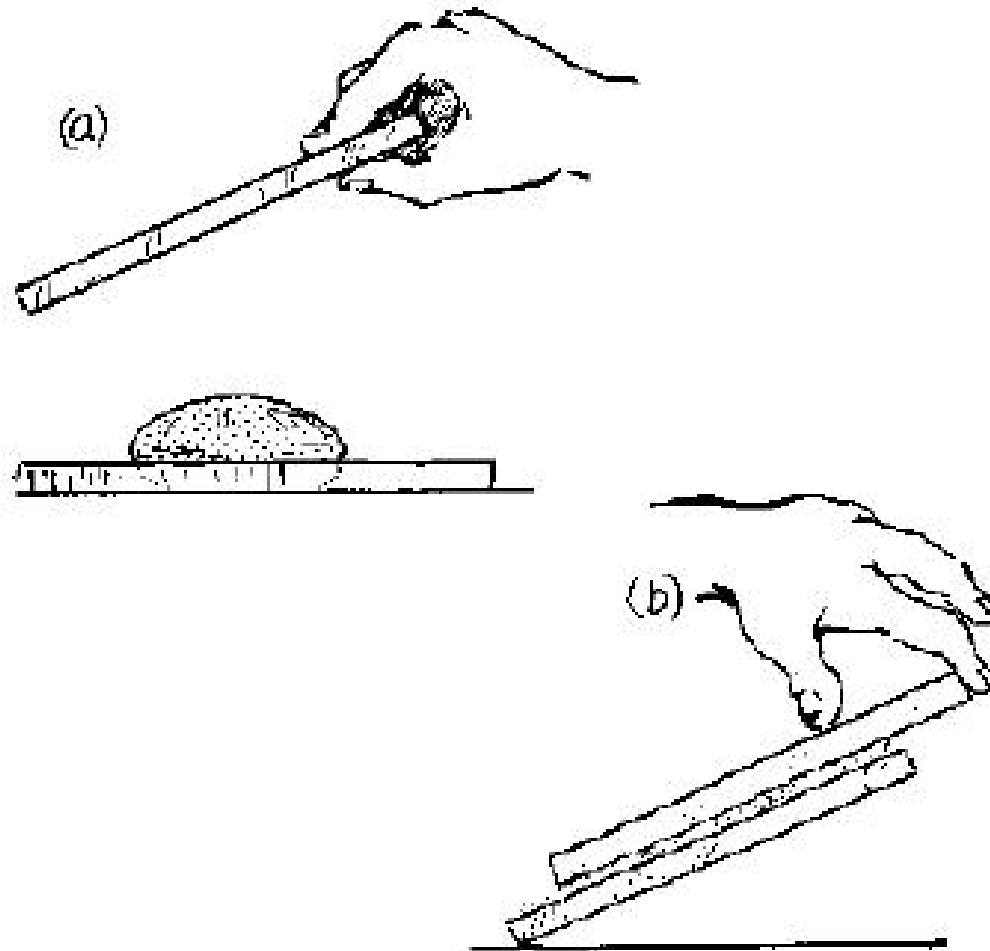

D. Dye water on a clean glass sheet (a)

P: Drip water on a clean glass sheet (a).

Q: What happens?

P: Place a second glass sheet on the wet first sheet and try to lift it, see fig.(b).

Q: What do you notice?

E: (a) Water spreads to form a patch on the first glass surface because *adhesive forces* attract water molecules to the glass surface.

(b) A strong force is applied to separate the two glass sheets because the adhesive forces between glass and water are large.

#### 4.4.2 Water Drops from the Tap



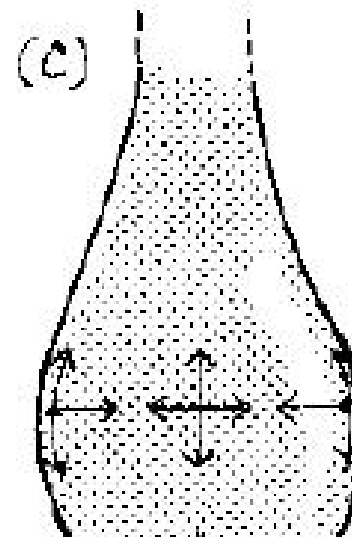
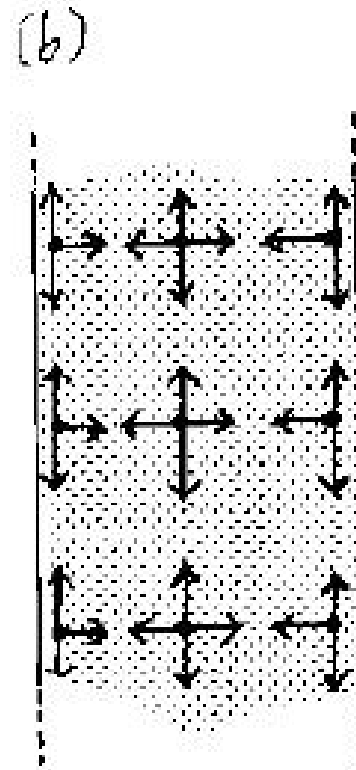

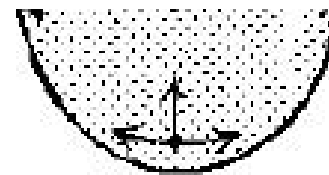

**P:** Let a thin stream of water flow from a water tap.

**Q:** What happens?

**O:** The water stream grows thinner and thinner as it moves further down and finally breaks to form drops.

**E:** Considerably strong *cohesive forces* exist as the stream starts to flow, but as the stream grows thinner the cohesive forces are overcome by the accelerating force of gravity and hence the stream is breaking down to drops. The molecules of the resulting drops are still held together by cohesive forces.

#### 4.4.3 Surface Forces

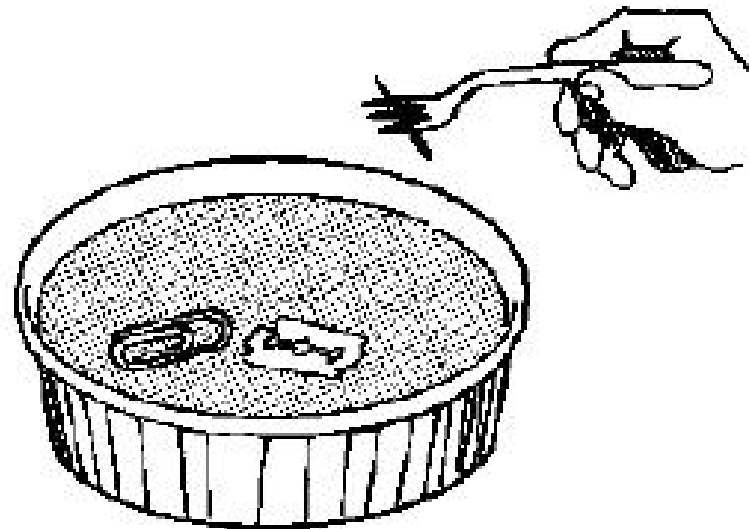

P: Carefully float a needle, a razor blade, a clip and a pin on a water surface as shown.

P: What do you observe?

E: The surface of water behaves like a thin elastic membrane. This is due to forces of cohesion called *surface tension*.

H: The pin can be easily floated with the help of a fork.

#### 4.4.4 More on Surface Forces

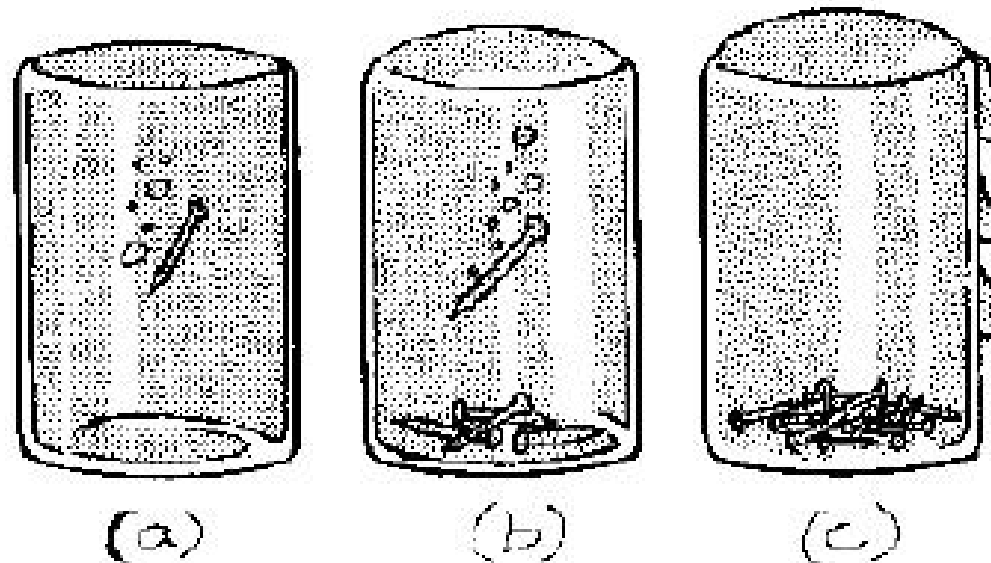

P: Carefully fill a transparent glass vessel with water to the rim. Add nails, one at a time, to the water and count the number of nails sunk just as water begins to spill over.

Q: Explain your observations.

E: The water surface bulges out but does not break immediately because of strong *cohesion forces* between the water particles.

the water particles.

#### 4.4.5 Affecting Surface Tension

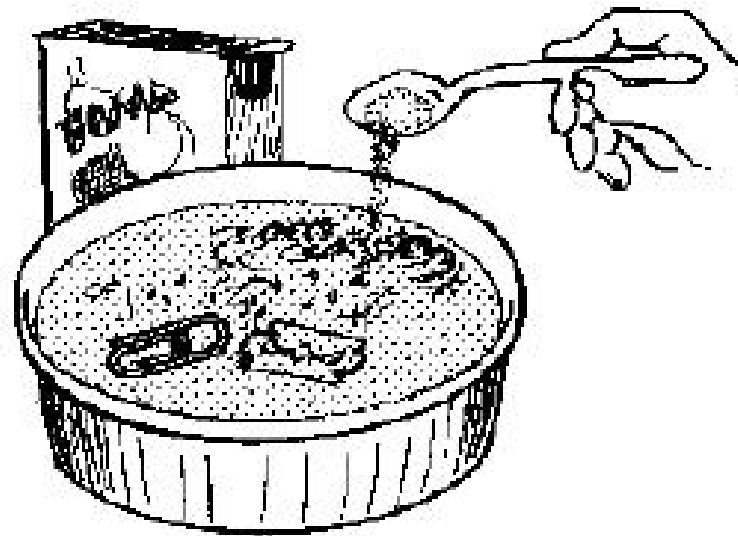

P: Repeat experiment 4.4.3 using detergent or soap solution instead of water.

Q: What do you observe?

E: Soap lowers the *surface tension* of water and therefore the bodies sink.

#### 4.4.6 Capillary Rise

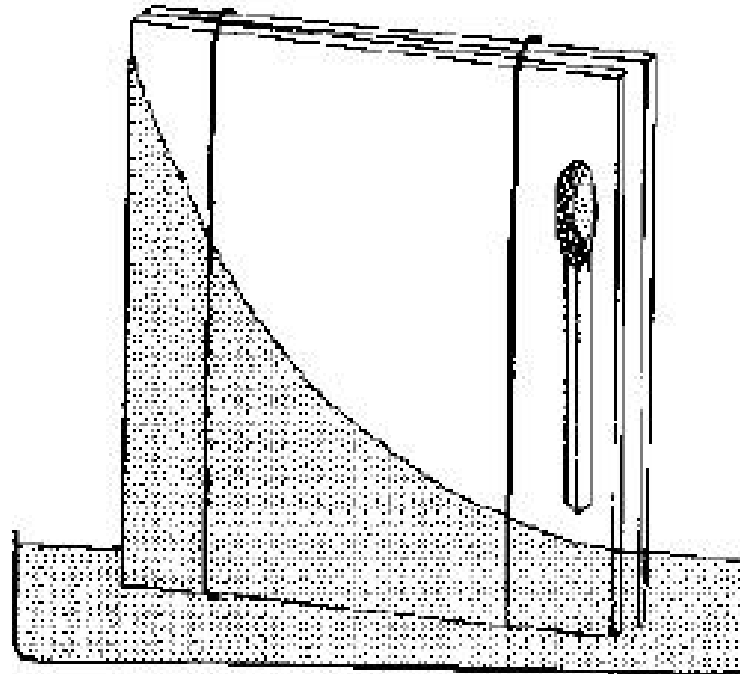

**P:** With the help of a rubber band and a matchstick, arrange two clean glass sheets as shown in the diagram. Place the arrangement in a plate containing some water.

**Q:** What do you observe?

**E:** Water rises to different heights along and between the glass sheets. This is *capillary action*. Water rises more where the glass sheets are closer together (see also 4.4.7).

#### 4.4.7 Measuring Capillary Rise



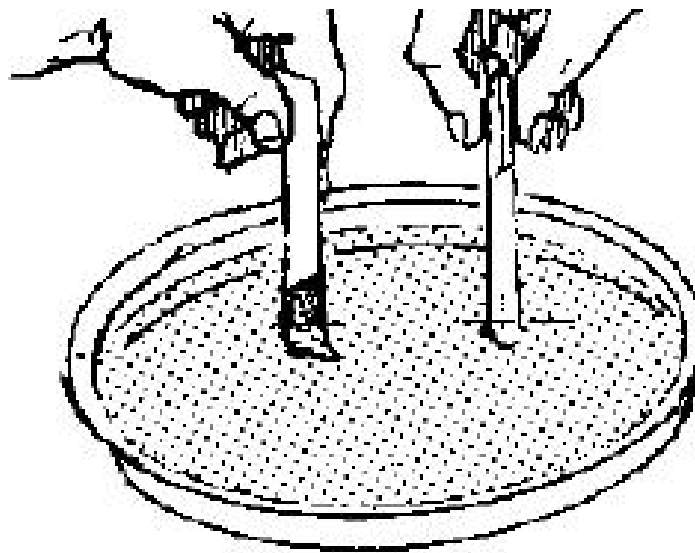

**P:** Hang a strip of newspaper and place a chalk-stick in a vessel containing water. Leave the arrangement for some time and measure the capillary rise in each with a ruler.

**Q:** Explain the causes of the differences in capillary rise.

**E:** Due to smaller capillaries water rises faster in the chalk-stick than in the paper.

**H:** Test other substances too.

#### **4.4.8 Automatic Irrigation**

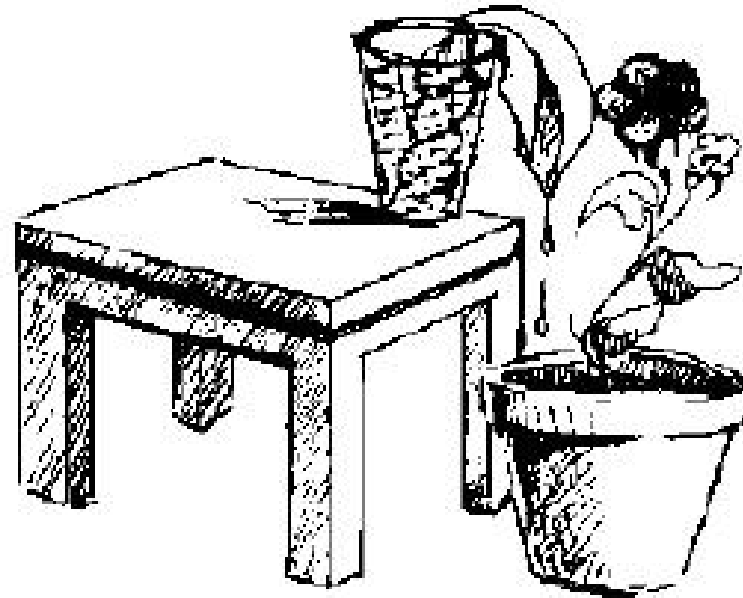

**P:** The knowledge of capillarity can be used to provide an automatic irrigation. Students can perform irrigation by dipping a porous material such as paper or cotton cloth in water.

#### 4.4.9 Inclined Water Transport

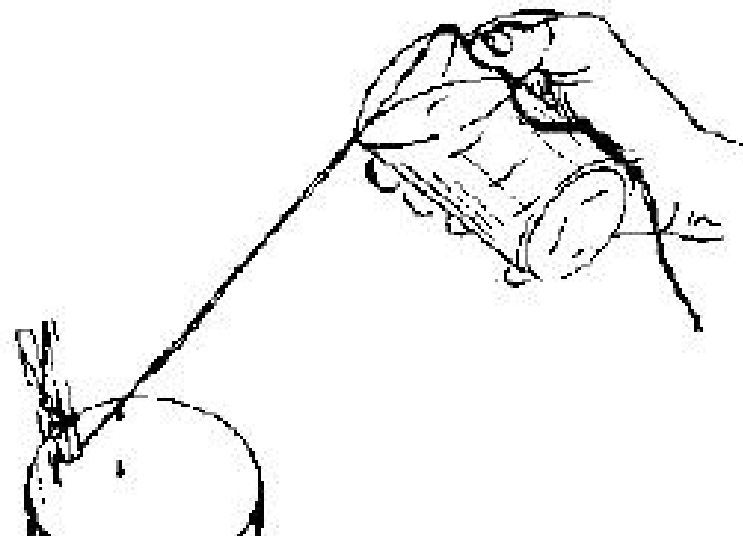

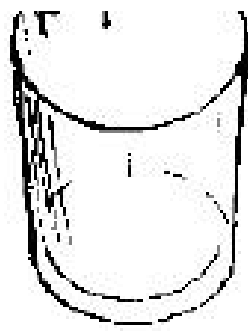

E: When *adhesive forces* are greater than *cohesive forces*, drops of water can be made to move down along an inclined thread.

#### 4.4.10 Weak Adhesion

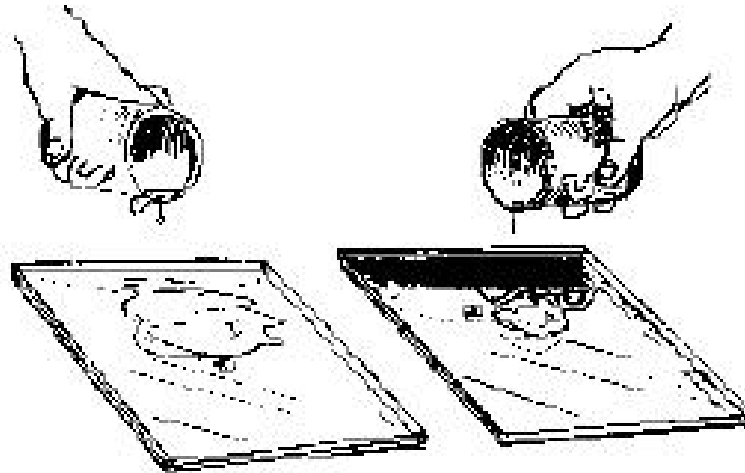

P: Put a few drops of water on a clear glass surface (a) and on a sooty or greasy surface (b).

Q: What do you observe?



**E:** The shiny surface gets wet because the *adhesive forces* between water and glass are very great. The sooty or greasy surface does not get wet because adhesive forces between water and these surfaces are very weak.

#### 4.5 Elasticity and Viscosity

*Elasticity* is the ability of a substance to recover its original shape after a distorting force is removed. *Hooke's law* on elasticity states that the extension of a spring is directly proportional to the load applied provided the elastic limit is not exceeded. Most materials are elastic. It is important to know the behaviour of a material when acted by forces before we can use it for a particular job.

*Viscosity* is the frictional force exerted by a fluid. The flow of liquids is influenced by this force. Where the frictional force is greater, the liquid flows less readily and is said to be more viscous and vice versa.

##### 4.5.1 Elasticity in Solids

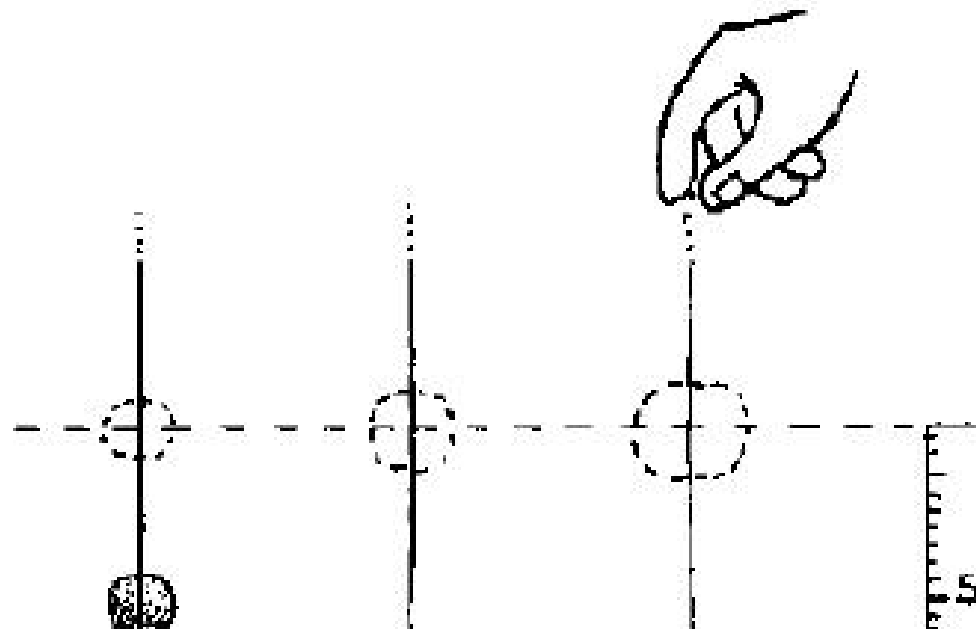

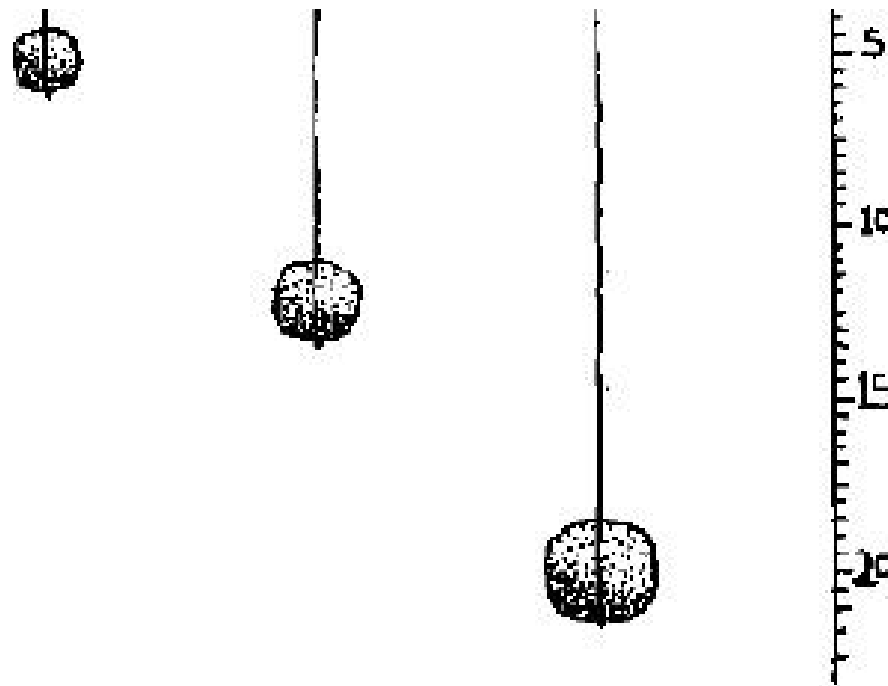

**P:** Attach various masses (e.g. 1 g, 2 g, 3 g) to a rubber band or a spring and measure the extension for each mass attached. Remove the masses in succession and record the corresponding readings.

**Q:** What happens when the masses are removed one after the other?

Plot a graph of extension (y-axis) against mass (x-axis).

**E:** The graph obtained shows that the extension is proportional to the mass which is *Hooke's Law*.

#### 4.5.2 Viscosity in Liquids

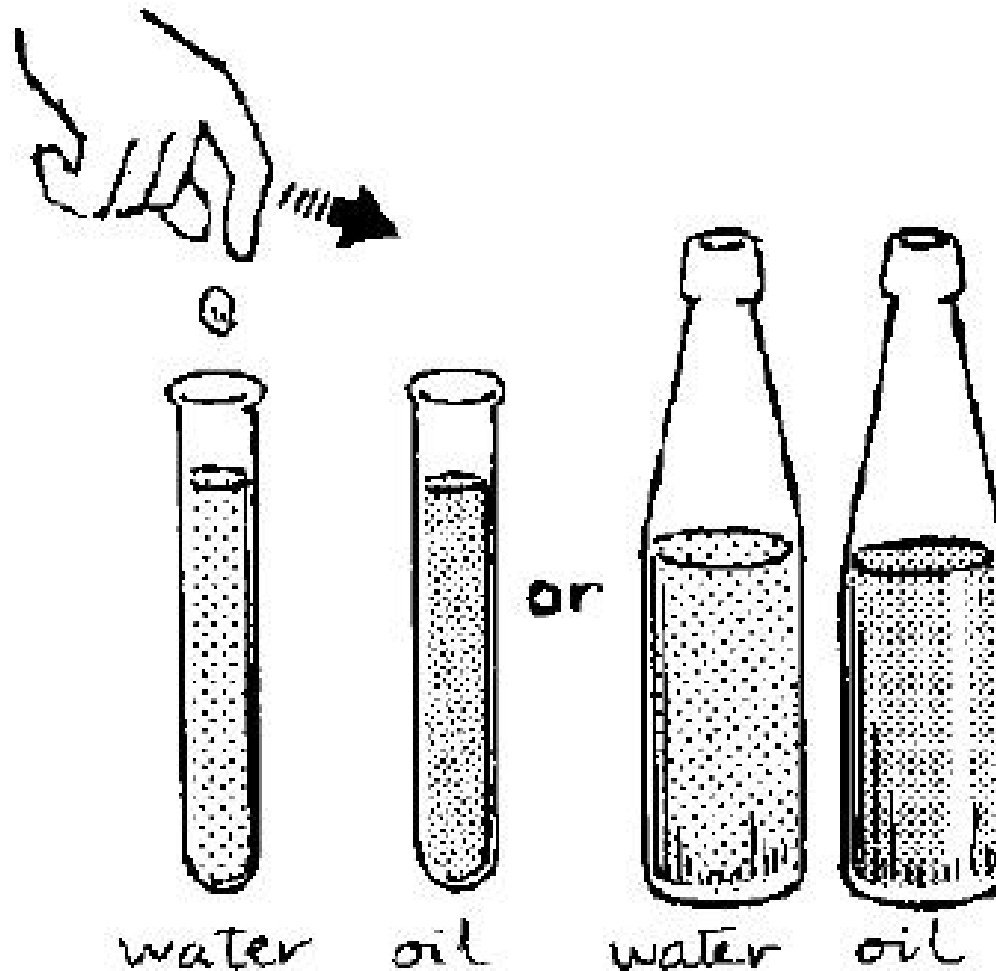

**P:** Fill one test-tube or a tall bottle with water and another with oil, both to the rim. Put a small stone into the water and record the time taken by the stone to reach the bottom. Repeat the experiment using oil.

**Q:** In which liquid does the stone take longer to reach the bottom?

**E:** The stone takes longer to reach the bottom in the vessel containing oil because oil has a higher *viscosity* than water.

## 5. Thermal Physics



### 5.1 Thermal Energy and Temperature

Thermal energy is a form of energy which can easily be produced by converting other forms of energy. Thermal energy is commonly called *heat*. The quantity of heat absorbed by a body generally causes an increase in its temperature. The *upper fixed point* of a thermometer is the temperature of the steam of pure

water boiling at standard atmospheric pressure. It is  $100^{\circ}\text{C}$ . The *lower fixed point* is the temperature of pure melting ice at standard atmospheric pressure. It is  $0^{\circ}\text{C}$ . *Absolute zero* is the coldest possible temperature which is  $-273^{\circ}\text{C}$ . This corresponds to the zero degree on the kelvin scale.

### 5.1.1 Sources of Thermal Energy

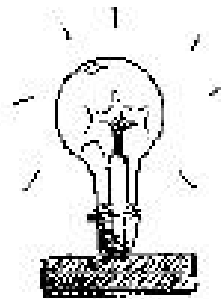

**P:** Ignite a match stick. Rub your hands very vigorously. Switch on an electric bulb. Run as fast as you can a certain distance or up a staircase.

**Q:** Which forms of energy are converted to thermal energy in each case?

**Q:** Which forms of energy are converted to thermal energy in each case?

**E:** (a) A match stick burns converting *chemical energy* into *thermal energy*.

(b) An electric bulb gets heated because *electric energy* is converted to *thermal energy*.

(c) The hands get hot, because *mechanical energy* is converted to thermal energy.

(d) We feel hot, because our body converts the *chemical energy* of the food partially to *thermal energy*.

### 5.1.2 Principle of a Thermometer

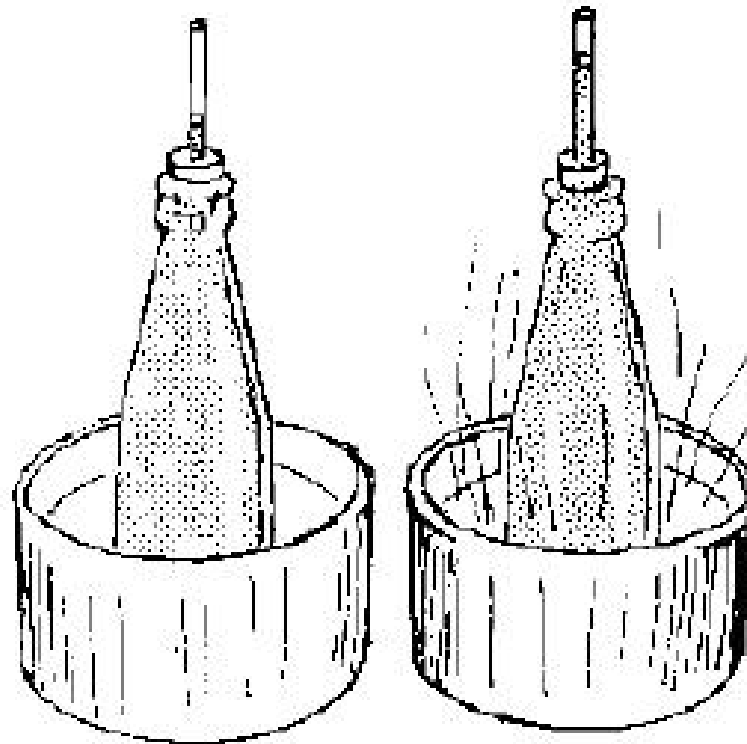

**P:** Fill a small bottle (about 0.5 litre) with coloured water up to the rim. Tightly fix a stopper which is carrying a narrow transparent tube (e.g. an empty ball pen tube) into the mouth of the bottle. The liquid level should be just visible above the stopper. Then put the bottle into hot water or heat it gently.

**Q:** What happens to the liquid level in the tube? Why?

**E:** The liquid level rises, because the liquid is expanding on being heated.

**A:** The principle of expansion of liquid is used in clinical thermometers. In the clinical thermometer the expansion of mercury is used to measure the body temperature. Obtain a clinical thermometer and discuss its scale. Ask the students to draw a diagram of the thermometer. Some out-door thermometers contain coloured alcohol instead of mercury. The expansion of alcohol is six times greater than that of mercury. Mercury is often used in thermometers for measuring higher temperatures than alcohol because it has a higher boiling point than alcohol.

### 5.1.3 Fixed Points

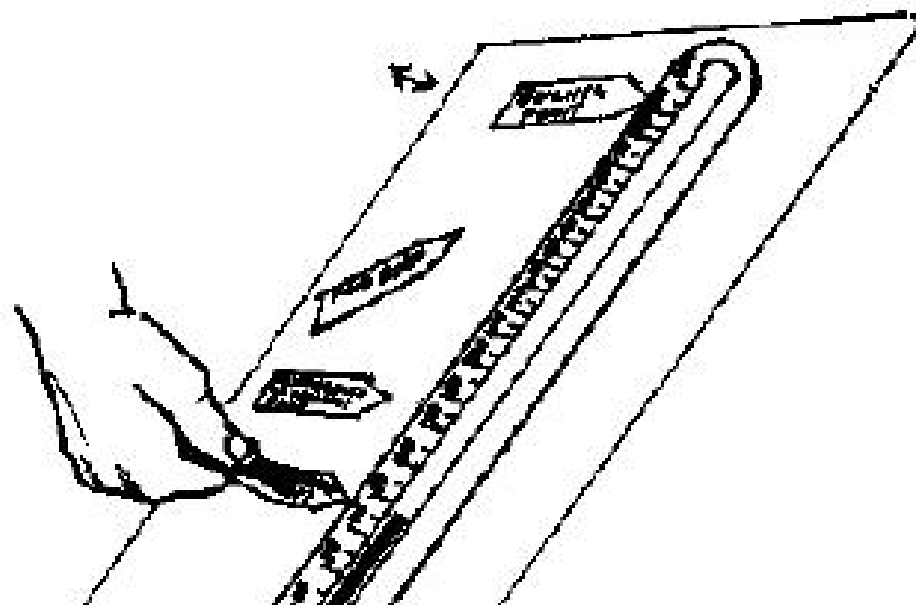

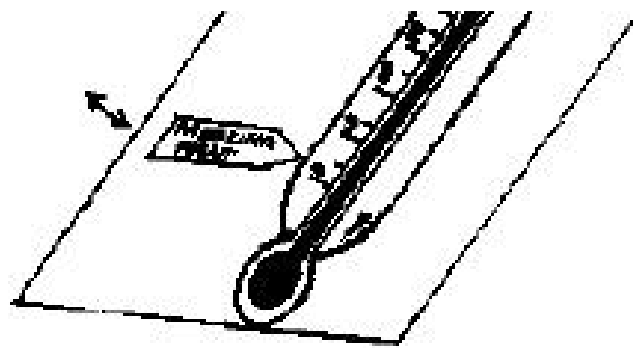

**P:** Draw a large diagram (a display chart) of a thermometer on a paper (paper from cement bags is suitable). Cut out paper arrows for indicating the characteristic fixed points for water and other substances. The pupils can be asked to indicate (using the arrows) the appropriate fixed points on the diagram.

#### 5.1.4 Specific Heat Capacity of Liquids

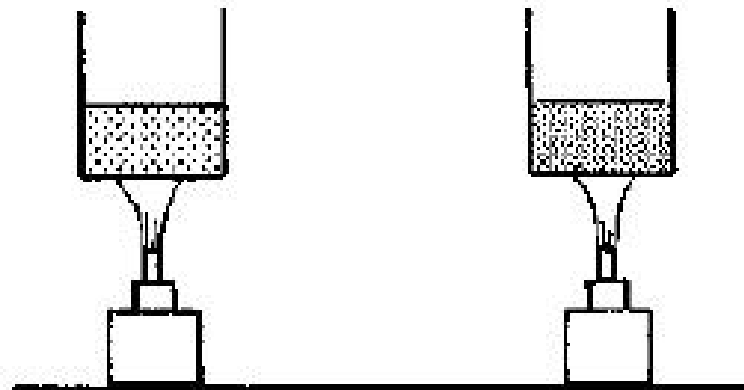

**P:** Heat equal masses of different liquids (e.g. water and oil) in two identical containers using a "kibatari" (kerosine lamp) for the same length of time.

**Q:** What difference in temperature can you feel with your finger?



**E:** The temperature of the oil is higher, because it needs less energy to raise the temperature of one gram of oil by  $1^{\circ}\text{C}$  than that of water. Thus, using the same amount of heat and mass, the temperature of oil must be higher.

**H:** Great care must be taken when heating oil, for it can catch fire (and you should not put your finger in it, if you have heated it for a long time).

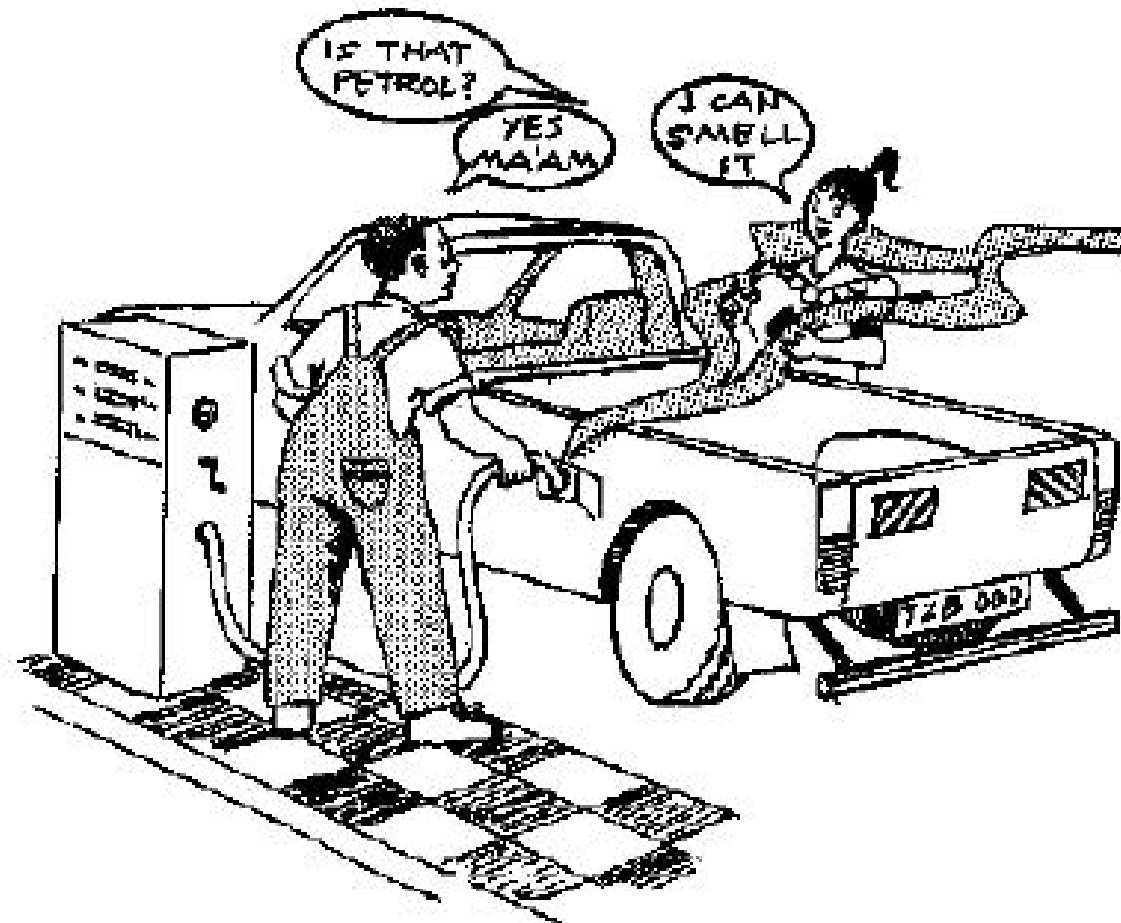

### 5.1.5 Thermal Energy

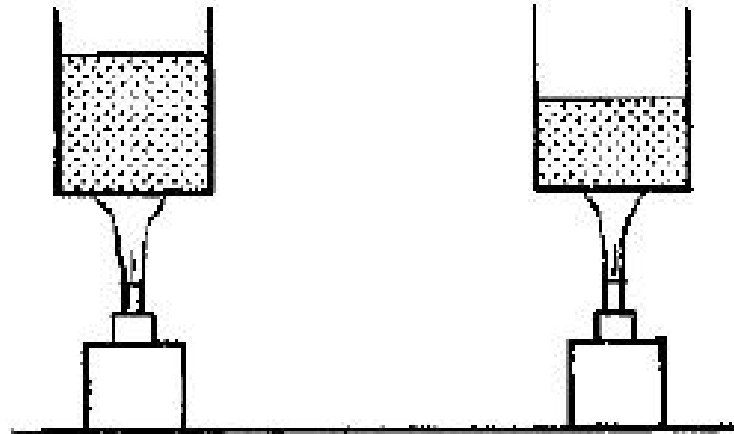

**P:** Heat different quantities of water using a "kibatari" (kerosine lamp) in two identical containers (e.g. tin cans) for the same length of time. Dip your finger into the two containers of water.

**Q:** What differences in temperature can you feel?

**E:** The temperature of the smaller quantity of water is higher, because it received more thermal energy per gram of its mass than the larger quantity. So for the same heat input the temperature rise of the smaller quantity of water will be greater.

### 5.1.6 Application of Specific Heat Capacity



**P:** Using your hand find out how fast a water puddle and a heap of sand warm up during the day. Find out again how fast they cool during the night.

**E:** A heap of sand heats up faster during the daytime and cools down faster during night, because sand has a lower specific heat capacity than water. (Specific heat capacity of water =  $4200 \text{ J/kg}^\circ\text{C}$ ; of sand =  $800 \text{ J/kg}^\circ\text{C}$ ).





## 5.2 Thermal Expansion

Solids, liquids and gases expand when heated and contract when cooled. Expansion and contraction occur in all directions. The kinetic theory explanation is, that the particles vibrate with large amplitudes when heated, forcing each other a little further apart. Cooling reduces the amplitude of vibration and brings the particles closer together. *Water* has an anomalous expansion. Its highest density is at 4°C. Therefore in cold regions water at this temperature always sinks to the bottom of lakes. This is why in cold regions the water at the bottom of the lakes does not freeze.

### 5.2.1 Expansion Apparatus

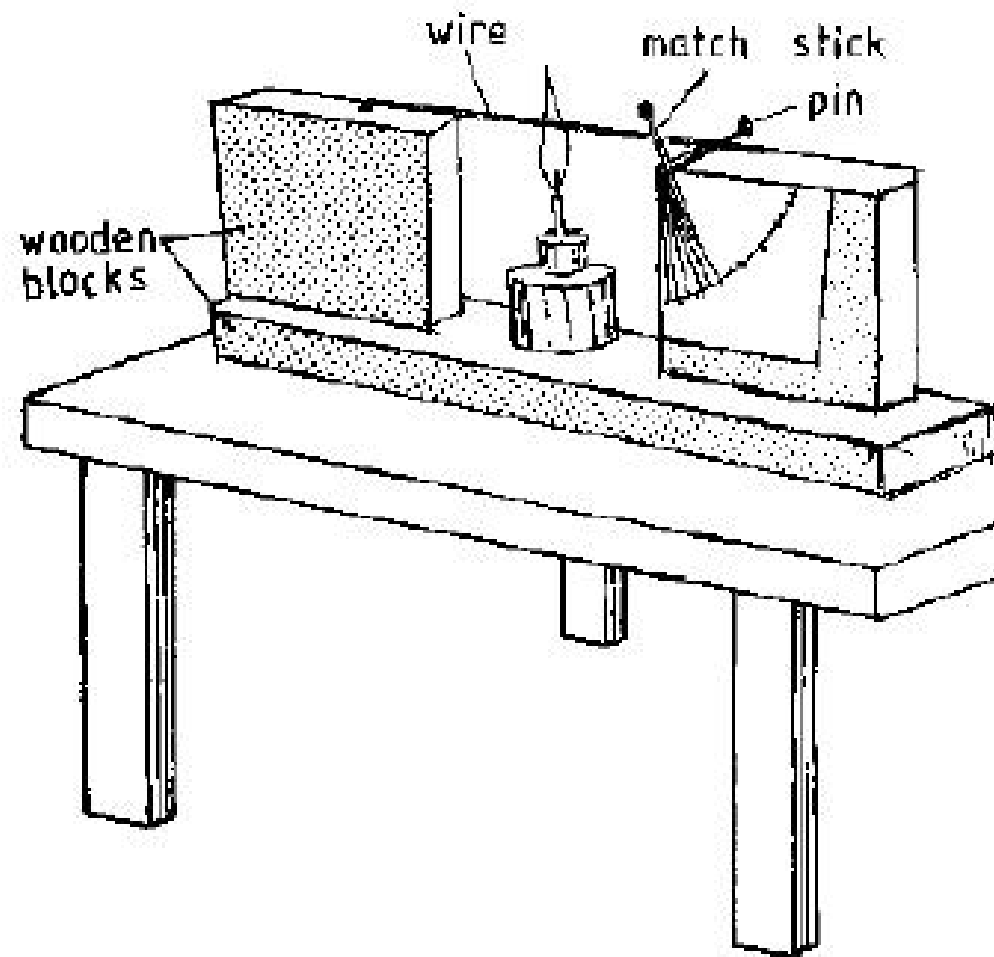

**P:** Place a metal rod horizontally with one end fixed firmly on a wooden block. Insert the pin through a match stick and place it under the rod as shown in the figure. Heat the rod from below with a candle or a "kibatari" (kerosine burner).

**Q:** What do you observe?

**E:** The match stick turns in the clockwise direction, because the rod expands causing the pin to roll forward and the match stick to turn.

**E:** The match stick turns in the clockwise direction, because the rod expands causing the pin to roll forward and the match stick to turn. **H:** For the best results the pin should lie on a smooth surface. A wire of 2 mm diameter or a bicycle spoke can be used for the metal rod.

### 5.2.2 A Simple Model for Explaining Expansion

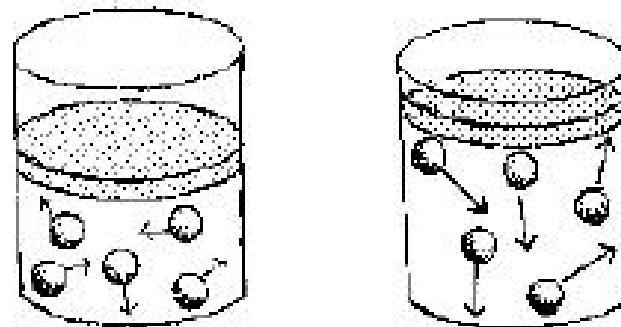

**P:** Expansion can be explained by a simple human model: When a group of pupils stands still, they are close together and they do not need much space. But if they start to dance or even to run about, each of them needs more space and the group as a whole takes more space. The particles in a body are like the pupils in the group, they only move far apart when they are heated and hence need more space.

### 5.2.3 Expansion of a Coin

### 5.2.3 Expansion of a Coin

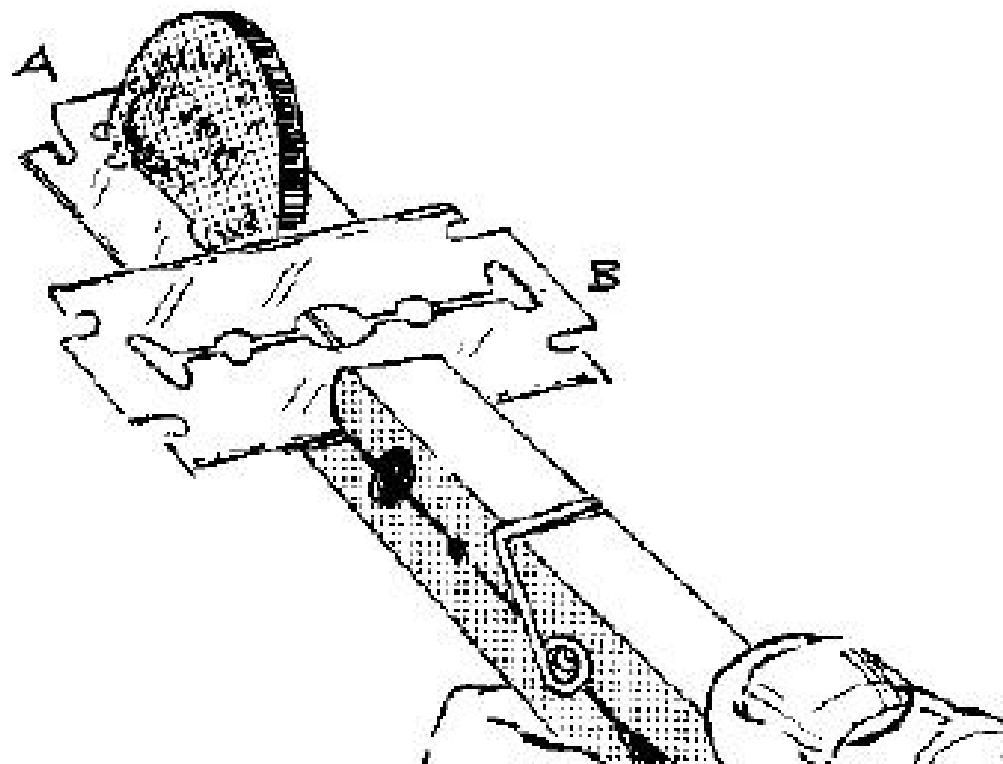

**P:** Place a coin into the slit of a razor blade A. Slide a second blade B so that the coin just passes through the slit. Firmly clamp the blades together with pegs or clips. Now remove the coin and heat it in a flame and try to pass it through the slit again.

**Q:** What happens?

**E:** The coin does not pass through, because it has expanded due to heating.



#### 5.2.4 Expansion of a Wire

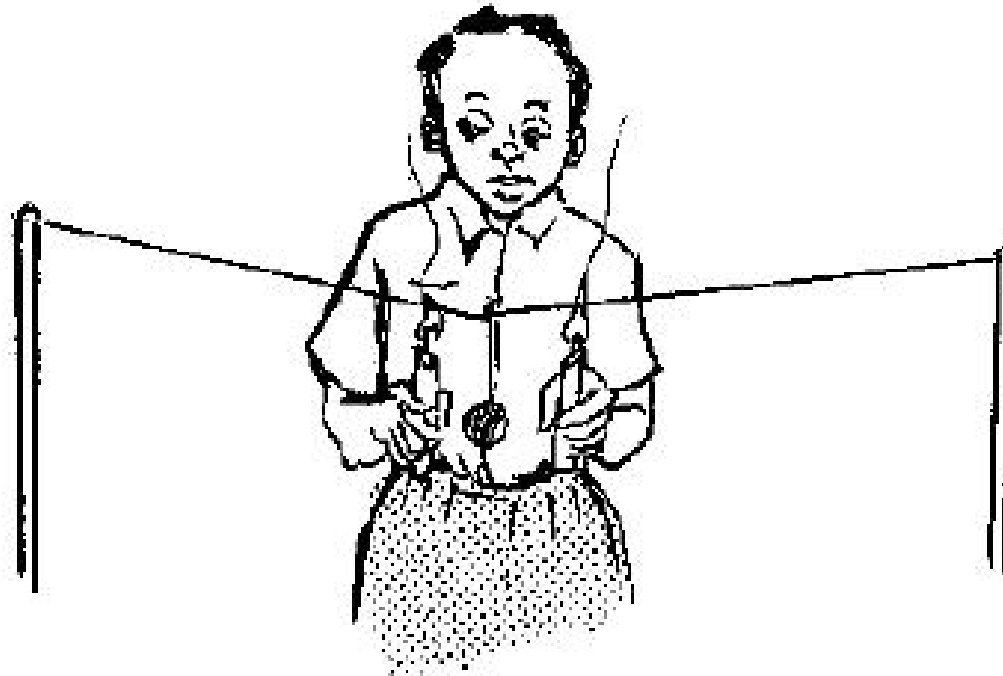

**P:** A thin copper wire is firmly fixed between two chairs and a weight is hung in the middle to stretch the wire. Then heat the wire along its length.

**Q:** What happens to the weight?

**E:** The weight sags further down, because the heated wire expands and hence increases in length.

#### 5.2.5 Applied Expansion



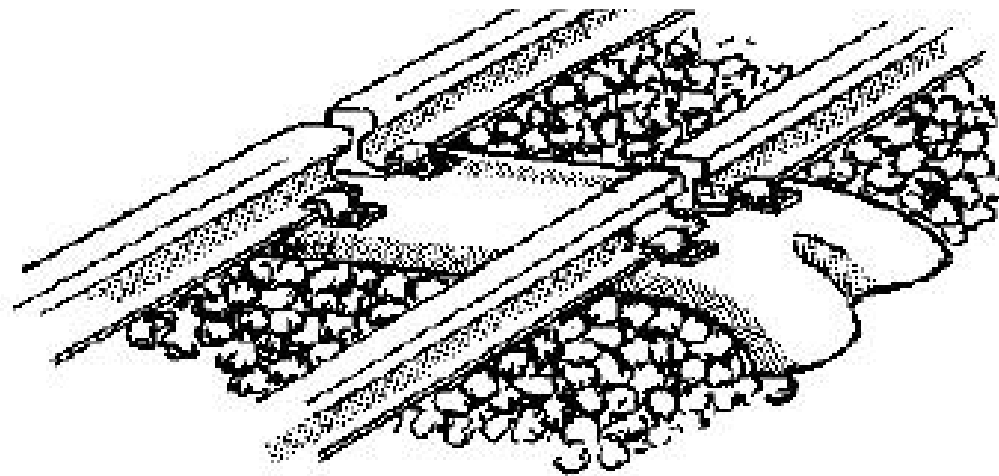

Steel railway lines have gaps at the end of each length of rail. Clicks can be heard as the wheels go over them.

**Q:** Why are the gaps necessary?

**E:** The gaps are needed to allow the rails to expand without bending during hot days. The gaps are called *expansion gaps*.

#### 5.2.6 Bimetal Principle

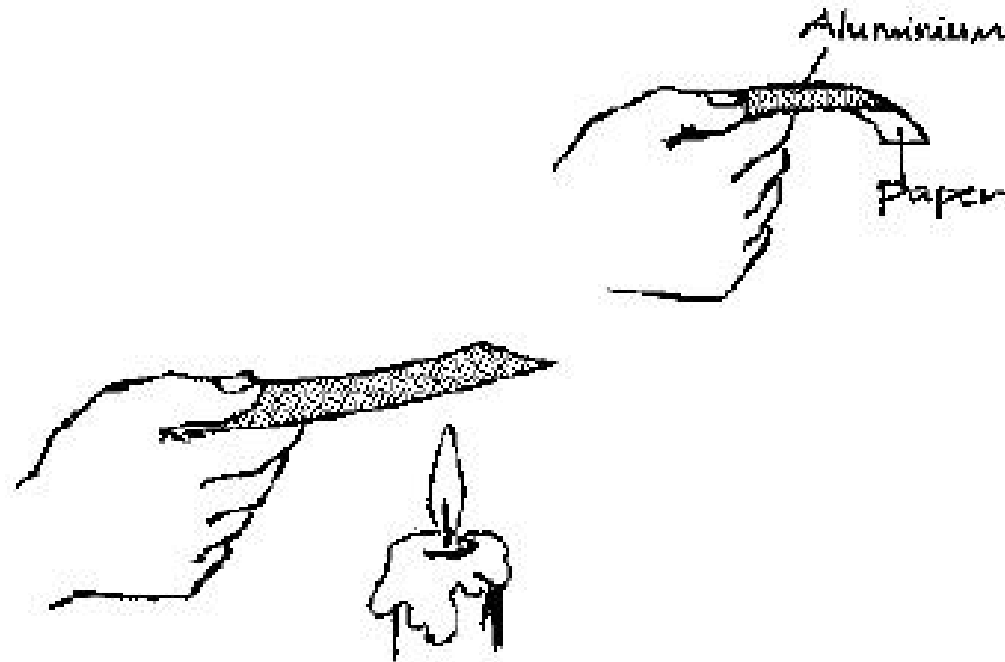

**P:** A bimetallic strip is made of two different metal strips like iron and brass or iron and aluminium joined together. To show the principle of a bimetallic strip, cut a one centimeter strip of aluminium paper from a cigarette packet and hold it close to a flame.

**Q:** What happens?

**E:** The strip bends towards the paper side, because aluminium expands more than paper.

### 5.2.7 Expansion of a Liquid



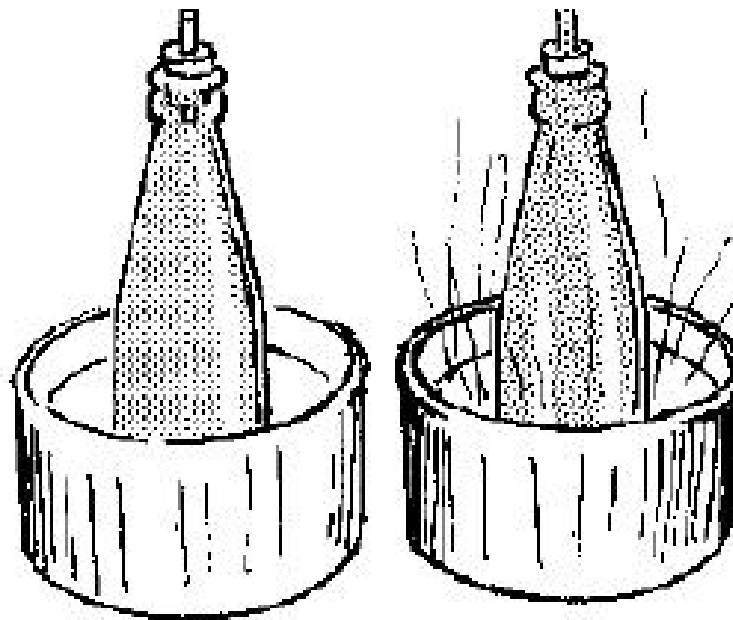

**P:** Fill a bottle up to the rim with coloured water. Tightly fix a cork bearing a transparent plastic tube (an empty ball point pen tube). Place the bottle into hot water.

**Q:** What happens?

**E:** The liquid rises along the tube, because it is heated by the hot water and expands along the tube.

### 5.2.8 Allowing for Liquid Expansion

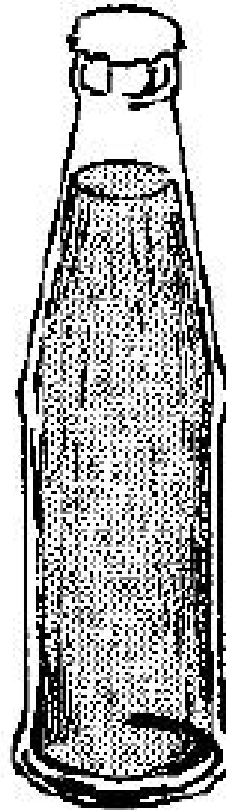

**P:** Observe the top of soda or beer in a corked bottle.

**Q:** Why does the bottle contain a small amount of gas trapped above the soda or beer?

**E:** The space is to allow the expansion of soda or beer when the bottle is stored in a warm place.

### 5.2.9 The Jumping Coin



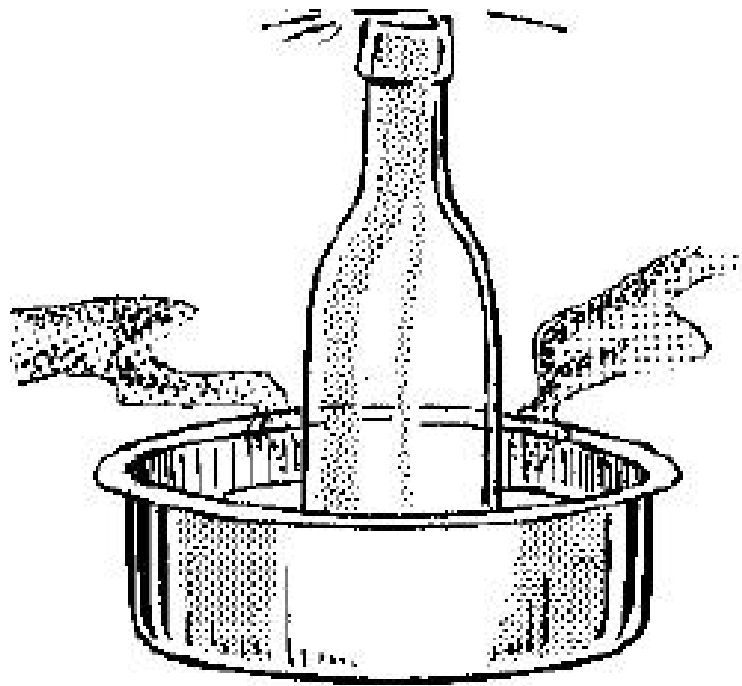

**P:** Wet the rim of a bottle with water and cover it with a coin (e.g. a shilling coin). Place the bottle into a hot water bath.

**Q:** What happens to the coin after a short time?

**E:** The coin vibrates opening and closing the bottle. This is because when the air inside the bottle expands, it pushes up the coin and when the air escapes, the pressure inside drops and the atmospheric pressure pushes down the coin.

### 5.2.10 Contraction of Air

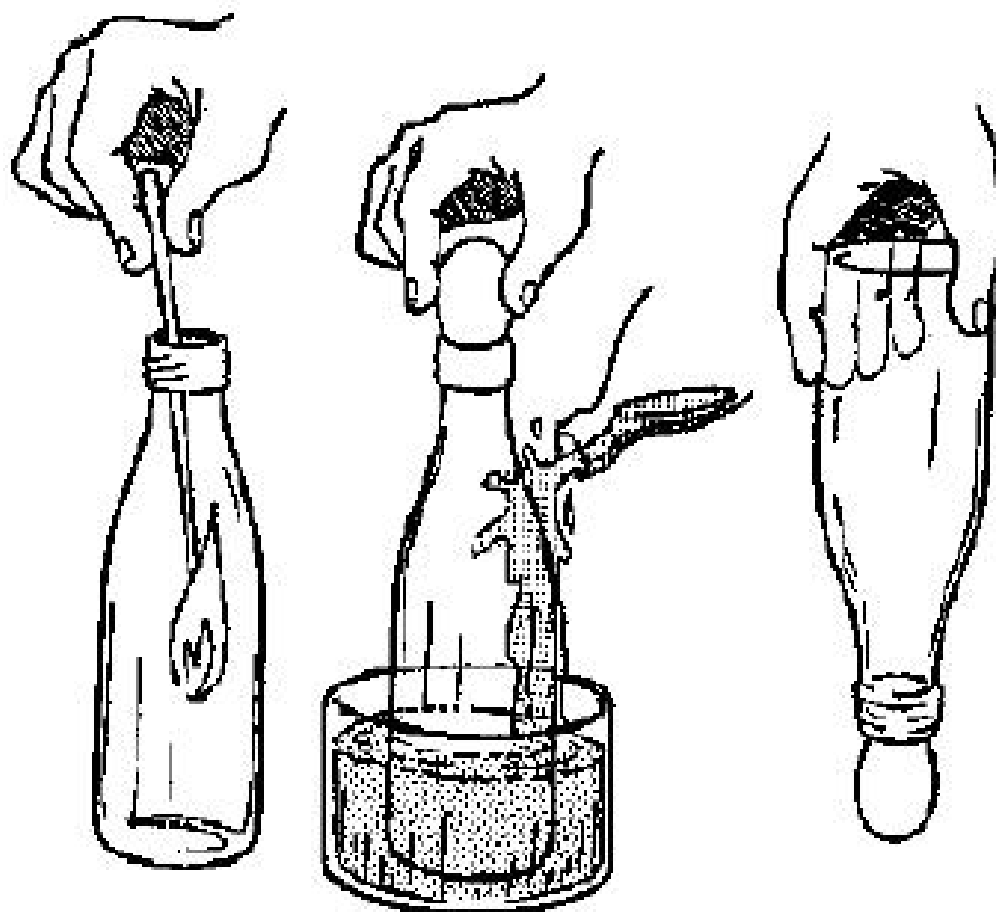

**P:** Place an "empty" bottle into a hot water bath or burn some paper or a wooden stick in it. After it has warmed up, close the bottle either with your thumb or a boiled and peeled egg. Now immerse the bottle in cold water.

**Q:** What do you observe?

**E:** The thumb or egg will be held by the bottle, because on cooling the bottle the air inside contracts and creates a lower air pressure inside.

creates a lower air pressure inside.

### 5.3 Changes of State

There are three states of matter, *solid*, *liquid* and *gas*. Matter can be converted from one state to another:

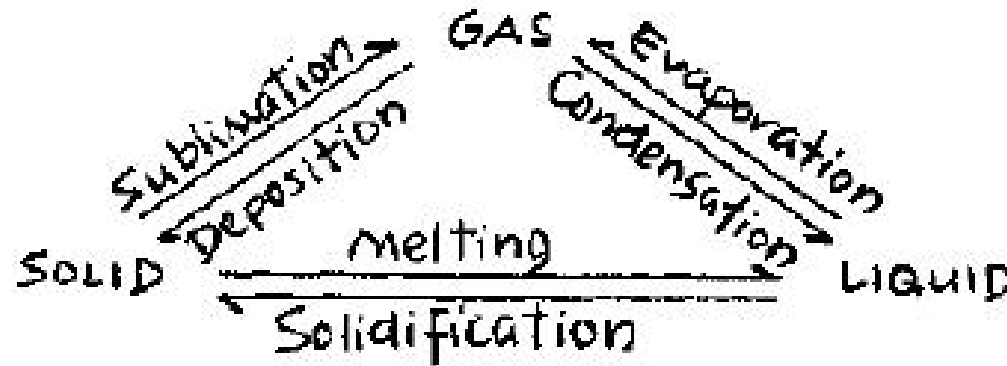

Every pure substance has *characteristic fixed points* at which one state changes into another one. That depends on the temperature. The water cycle in the atmosphere illustrates the change of state of water.

#### 5.3.1 Changes of State of Water



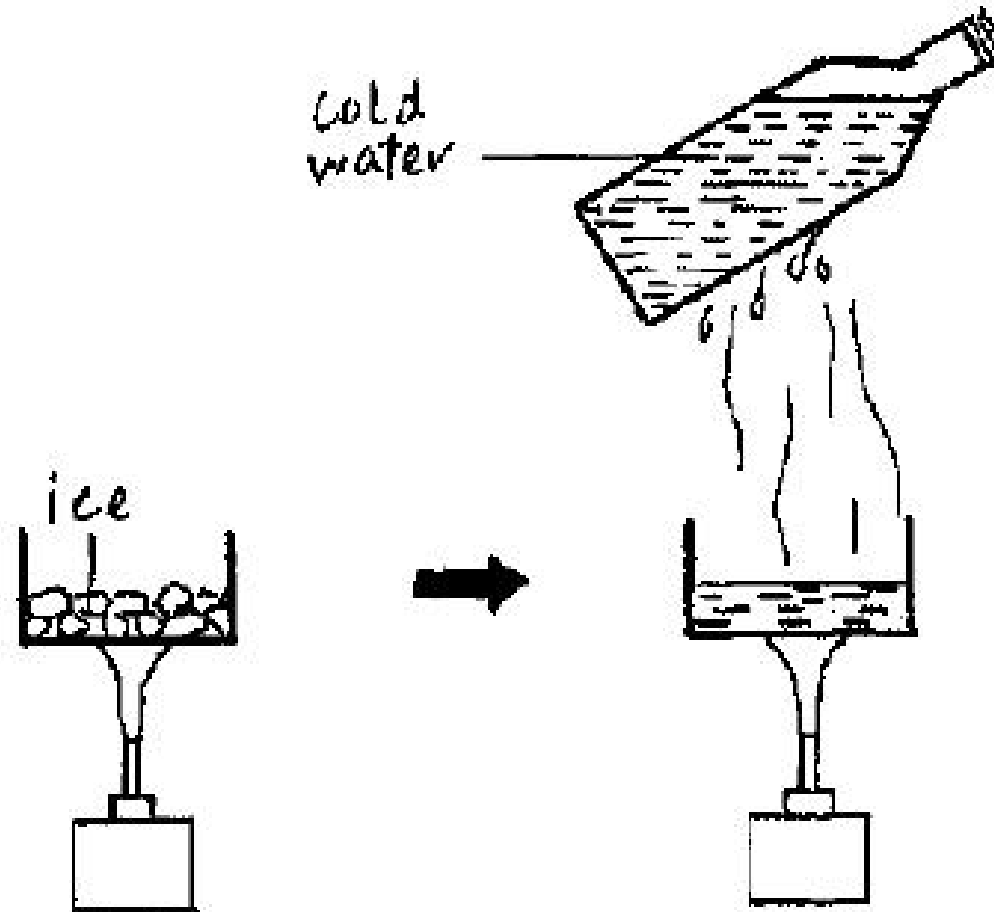

**P:** Heat ice in an open can for a few minutes and hold a glass bottle filled with cold water above the can.

**Q:** Which changes of state can you observe?

**E:** The ice changes from solid to liquid (*melting*) in the can. The liquid changes to gas (*boiling*) and the steam changes to liquid on the cold surface of the cold bottle (*condensation*).

### 5.3.2 Rain and Hailstone Formation

### 5.3.2 Rain and Hailstone Formation

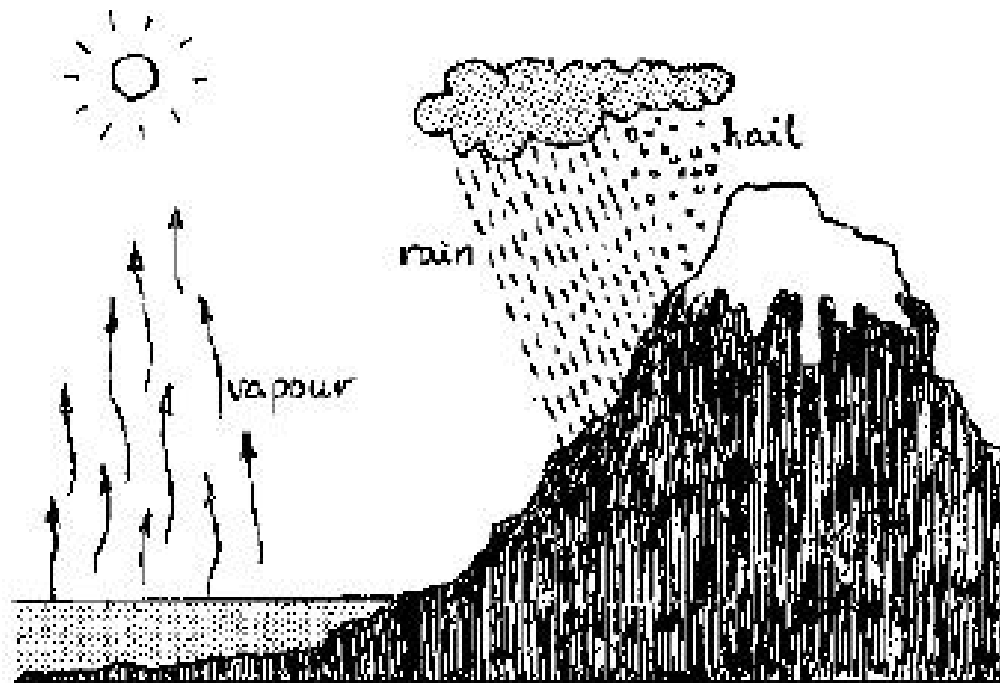

**P:** Rainfall is a common occurrence all over the country and sometimes the rain is accompanied by hailstones which destroy our crops.

**Q:** Can you explain how rain and hailstones are formed?

**E:** The sun heats the sea and lakes. The water evaporates and rises up in the air. The vapour cools and condenses into water droplets forming a part of the clouds. At higher altitudes where temperatures are very low, bigger drops of water are formed which fall as rain. At times bigger drops of water turn into ice (solid) and fall as hailstones.

### 5.3.3 Evaporation



**P:** Pour some spirit or petrol on the back of your hand.

**Q:** Explain what you feel as the spirit evaporates.

**E:** The back of the hand feels cold, because evaporation of the spirit needs energy which it absorbs from the skin.

### 5.3.4 Evaporation

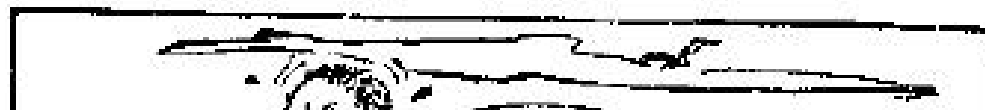



**P:** A boy plunges himself into a pool of water and then gets out.

**Q:** Explain the change of the temperature of his body.

**E:** He feels very cold (chilly) because the evaporation of water from his body absorbs heat from his skin making him feel cold. This explains why we feel very cold when we stand in a draught of air after sweating.

5.3.5 Cooling Water



**P:** Touch the blackboard with a wet hand.

**Q:** Observe the trace for some minutes.

**P:** In many houses water is kept in fired clay pots (*chungu*). Water pots have very tiny pores through which minute amounts of water ooze out.

**Q:** Explain how water is cooled in these clay pots.

**E:** Some water passes through the tiny pores and evaporates. The energy needed for the evaporation is taken from the pot and water and hence the water cools down.

#### 5.3.6 The Refrigerator

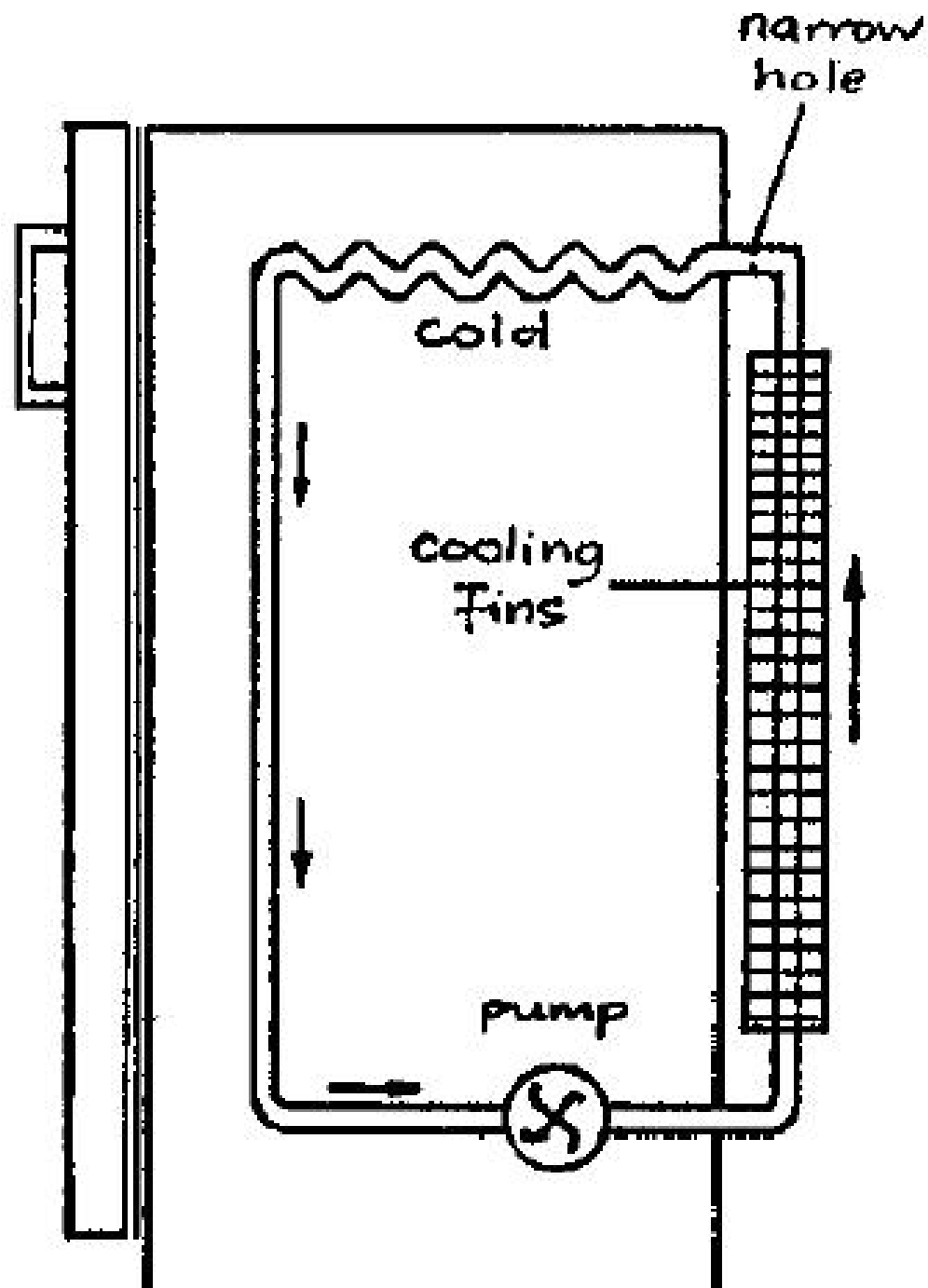



**E:** Some urban households have got refrigerators. In the refrigerator a special liquid is circulated through a pipe. In one portion of the pipe the liquid evaporates at a low pressure. The energy for the evaporation is taken from the pipe which cools the inner part of the refrigerator. In the pipe at the back the vapour condenses to a liquid under high pressure, thus giving out heat. Therefore cooling fins on the outside have to transmit this heat to the air.

### 5.3.7 Pressure and Melting Point



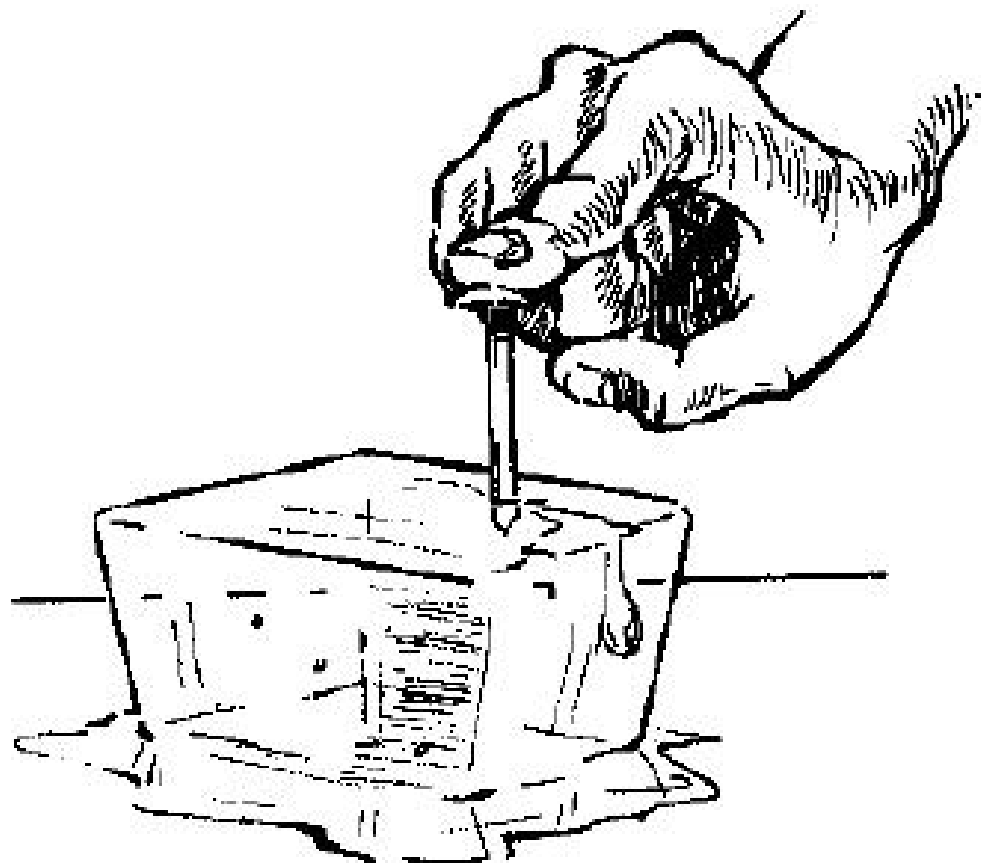

**P:** Steadily press a nail or a screw into a block of ice without heating it.

**Q:** What happens?

**E:** The nail penetrates into the ice because the pressure causes the ice at the tip of the nail to melt. (This is so, because water has less volume than the same mass of ice.) But when you release the pressure on the nail the water freezes again and "glues" the nail into the block of ice.

### 5.3.8 Impurities and Melting Point

### 5.3.8 Impurities and Melting Point

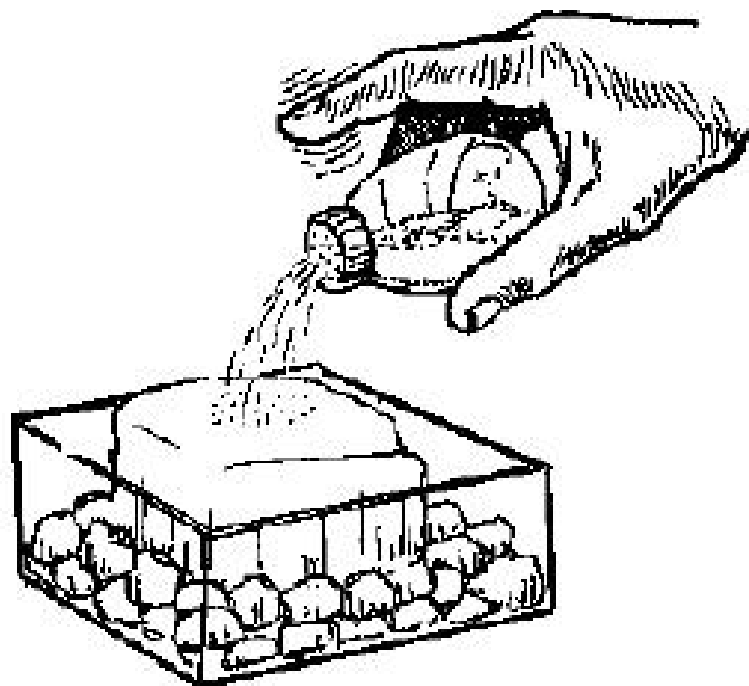

**P:** Place some pieces of ice in a glass container and sprinkle some salt on the ice. Stir the mixture and measure the temperature.

**Q:** What do you observe?

**E:** The ice pieces melt at a lower temperature than  $0^{\circ}\text{C}$ . *Impurities (e.g. salt) lower the melting point of ice.*

### 5.3.9 Pressure and Boiling Point



**P:** Some people who go for mountain climbing expeditions take pressure cookers with them for cooking on the peak of a mountain.

**Q:** Can you explain why?

**E:** The air pressure decreases with the altitude and water will boil at a lower temperature on the peak of a mountain. Generally, *the lower the pressure on the water, the lower its boiling point*. Thus, food would need a very long time to be cooked e.g. on the top of Mount Kilimanjaro. So for food to cook faster we need to use a pressure cooker so that the temperature inside increases to cook the food faster.

### 5.3.10 The Pressure Cooker



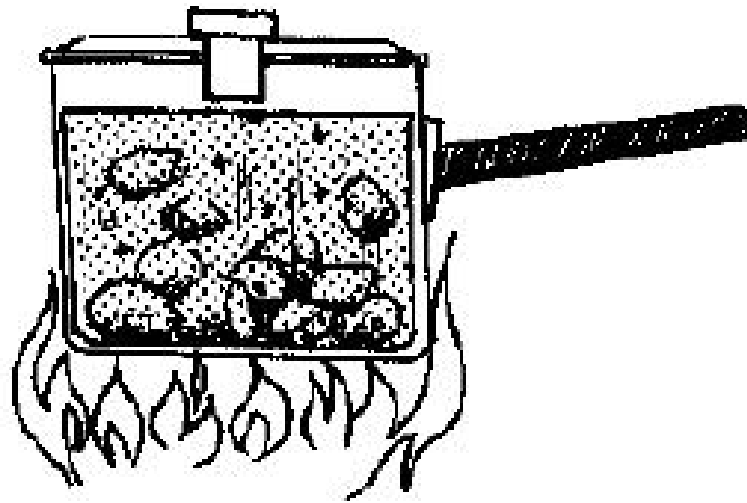

**P:** Demonstrate how a pressure cooker works.

**Q:** Explain how it helps to save energy costs.

**E:** Under the high pressure in such a pot the water boils at a higher temperature of about  $120^{\circ}\text{C}$ . At this temperature food like beans need only about one hour (instead of 3 hours in a normal pot) to cook and become soft. Therefore the pressure cooker uses less fuel to cook and hence saves fuel.

## 5.4 Transfer of Thermal Energy

Heat can be transferred in three ways:

*Conduction* of heat is the transfer of heat through a material from one point to another, whenever there is a temperature difference between the two points.

*Convection* of heat is the transfer of heat energy due to the movement of the material particles of the medium.

*Radiation* of heat is the transfer of heat energy from one place to another without the use of any material medium.

#### 5.4.1 The Football Model Of Thermal Energy

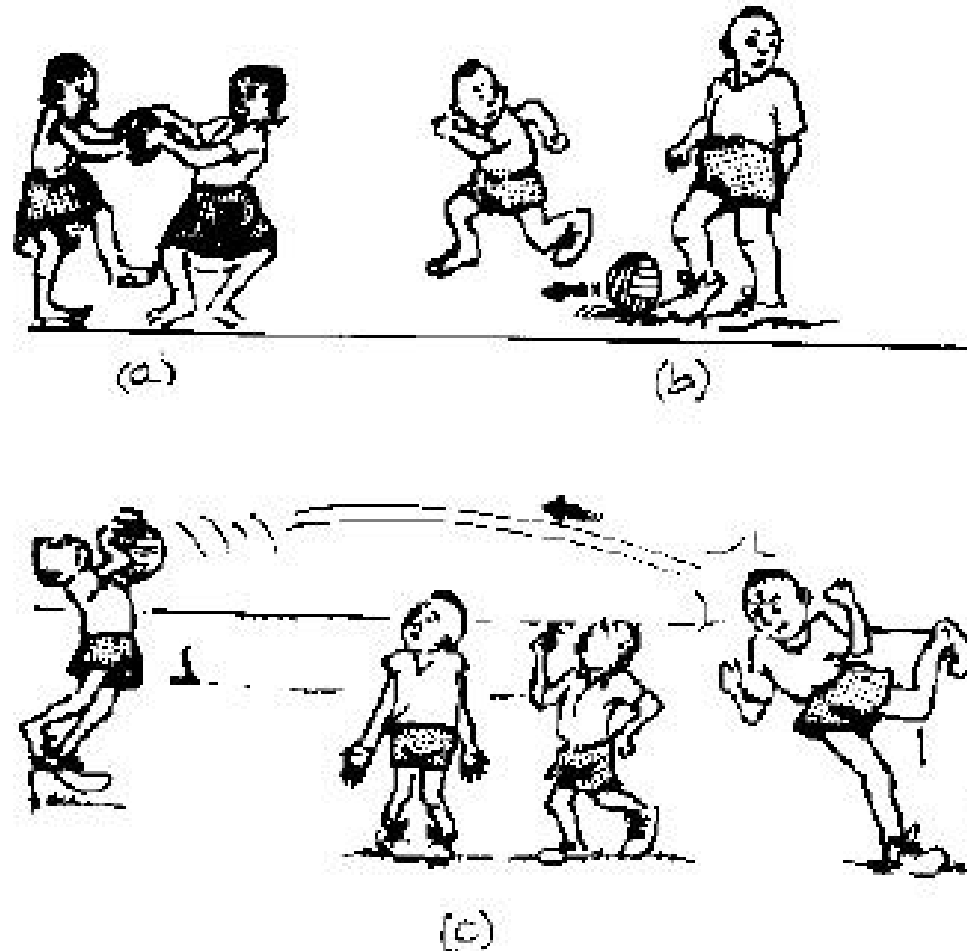

*Heat conduction* is likened to a football being passed from one player to another just as heat passes from one molecule to another in conduction of heat as shown in figure (a).

*Convection* is likened to a football being taken by one player from one point of the playground to another one just as heat in a gas or liquid is transported by a particle from one point to another in convection of heat as in figure (b).

*Radiation* is likened to a football being kicked by one player from one point at the playground to another one without the use of intervening players just as heat is transmitted from a hot object to another without any medium by radiation of heat as in figure (c).

#### **5.4.2 Candle Flame and Heat Transfer**

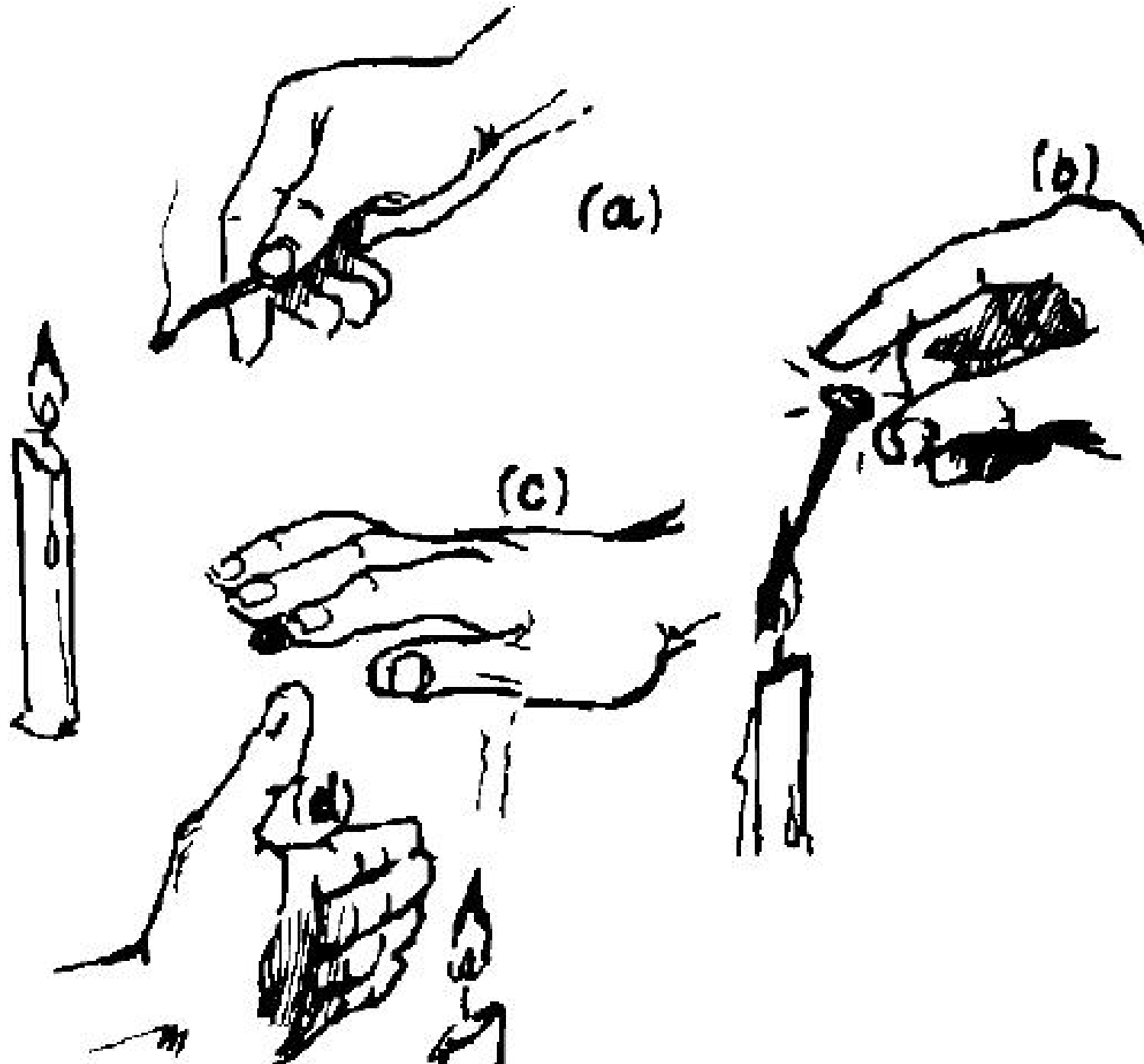



**P:** (a) Light a candle and demonstrate three ways of heat transfer by a simple hand experiment.

(b) *Conduction:* Stick one end of a nail into the flame.

**Q:** What do you feel?

(c) *Convection:* Place your hand at a distance above the flame.

**Q:** What do you feel?

(d) *Radiation:* Place your hand at the same distance on the side of the flame.

**Q:** What do you feel?

**O:** In each case heat is transmitted to your hand.

**P:** To check the *amount of heat transferred per unit time* by convection and radiation, hold a new match stick above and on the side of the flame and find out how long it takes to ignite the match stick in each case.

**H:** Any burner can be used instead of the candle. Non-luminous flames will produce the best results.

### 5.4.3 Solids as Conductors



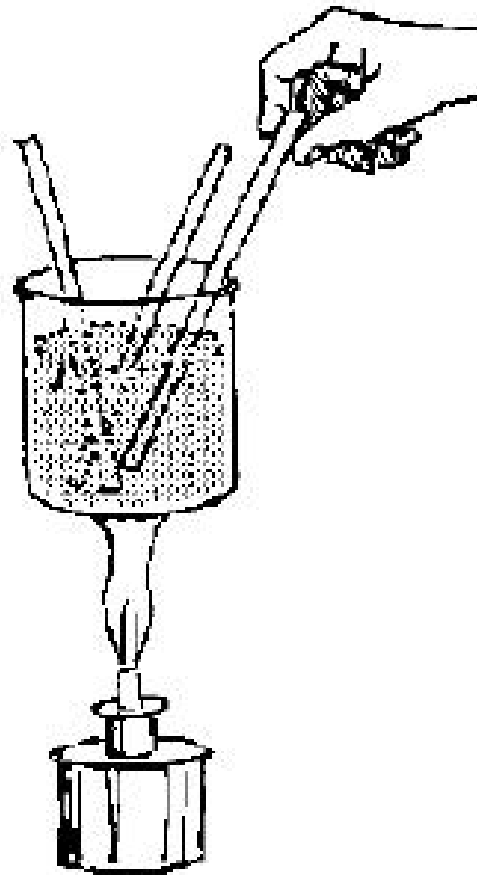

**P:** Heat water in a container until it is about to boil. Place metal, wooden and plastic rods of the same dimensions vertically into the water. Touch the exposed ends of the rods after 3, 4 and 5 minutes.

**Q:** What do you conclude about the conductivity of each rod?

**E:** The metal rod is a good conductor but the plastic and wood are bad conductors.

**A:** Plastics and wood are used as handles of saucepans; the saucepans and other cooking pots are best made of good conductors of heat e.g. metals.

#### 5.4.4 Conduction by a Metal Rod

#### 5.4.4 Conduction by a Metal Rod

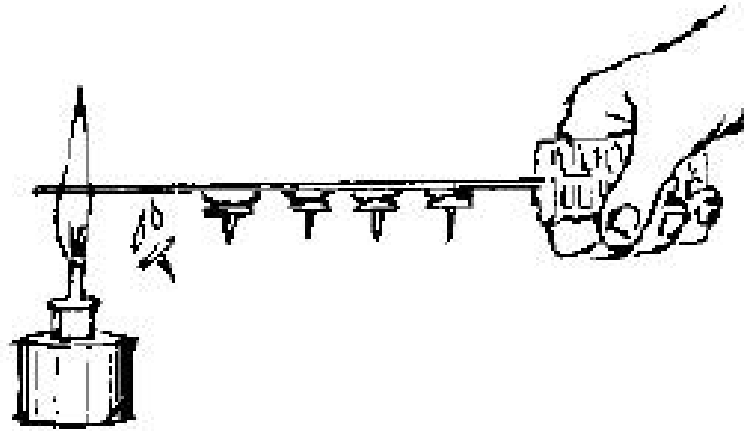

**P:** Fix several small stones with molten candle wax along a metal rod at a regular interval. Heat one end of the rod.

**Q:** What do you observe?

**E:** The stones will fall off one after another starting from the end being heated, because heat is conducted slowly along the rod from the heated end.

#### 5.4.5 Liquids as Conductors

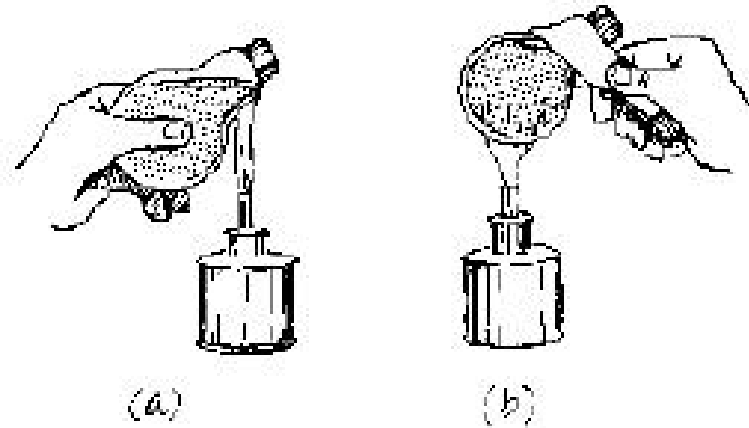

**P:** Fill a test tube or an opened bulb (see appendix) with water. Heat the water just below the top. Feel the bottom of the test tube with your hand, see figure (a).

**Q:** Explain what you feel.

**E:** The bottom of the test tube stays cold because water is a bad conductor and does not conduct the heat to the bottom.

**Q:** What would happen if you held the test tube at the top and heat it at the bottom? (see figure (b)).

#### 5.4.6 Convection of Heat

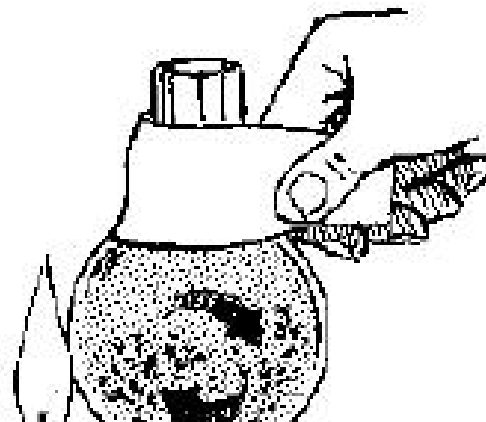

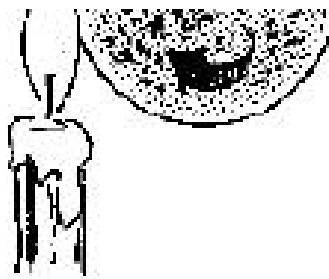

**P:** Fill a round flask or opened bulb (see appendix) up to the neck with water. Sprinkle a pinch of fine saw dust on the water. Heat one side of the flask only.

**Q:** What do you observe in the flask?

**E:** You will see a *convection current* being formed in the flask. The warm water rises and the cooler water sinks down to the bottom as seen by the movement of the saw dust.

#### **5.4.7 Breeze as a Convection Current**

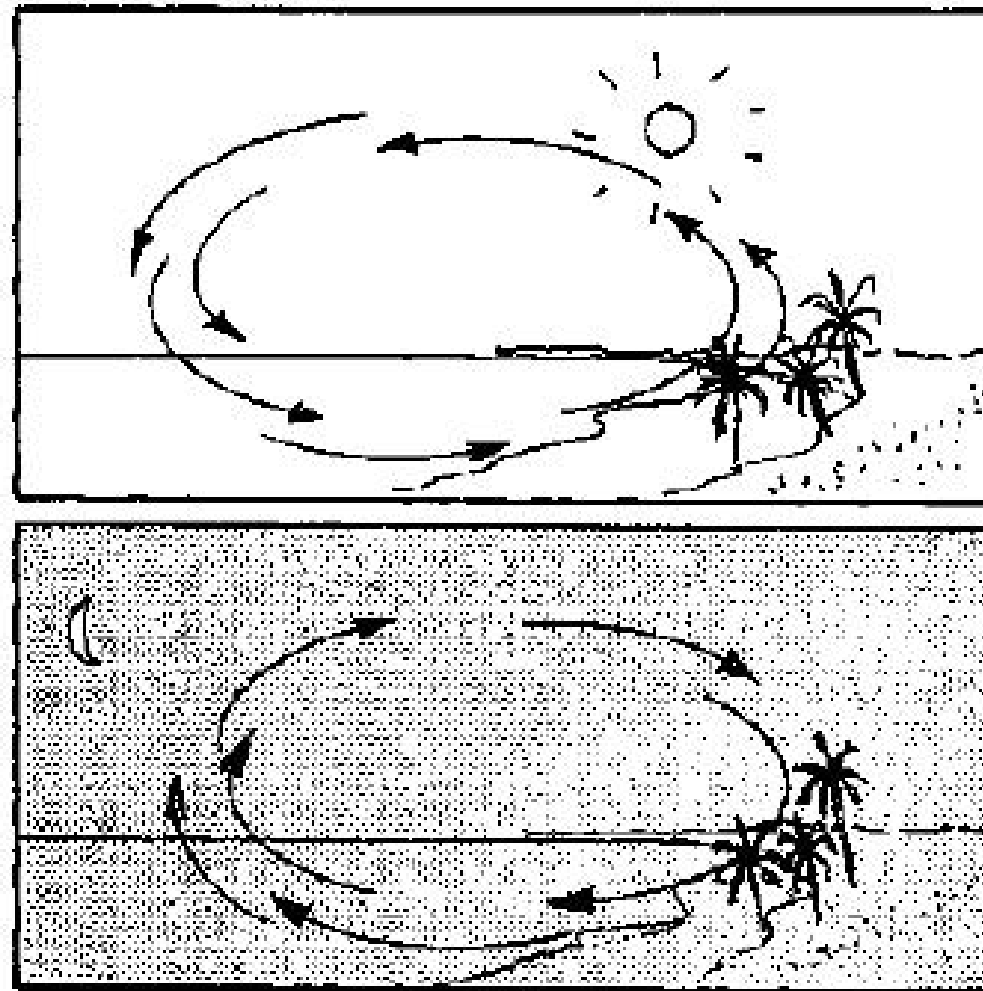

**O:** At the coast and on lake shores a gentle air stream (breeze) always blows. The direction of the breeze during the day is different from that at night.

**Q:** How can you explain this?

**E:** *During daytime* the land warms up faster than the sea. The warm air rises over the land and colder air from the sea flows to the land. This creates a breeze from the sea to the land. *During night*, the water stays warmer than the land, air over the water rises, colder air from the land flows to the sea. This creates a breeze from the

the sea flows to the land. This creates a breeze from the sea to the land. *During night*, the water stays warmer than the land, air over the water rises, colder air from the land flows to the sea. This creates a breeze from the land to the sea. The general effect is that the breeze from the sea keeps the daytime temperature on the land lower than expected from the hot sun, whereas the breeze from the land makes the night temperatures cooler than expected.

#### **5.4.8 Good and Bad Radiators**

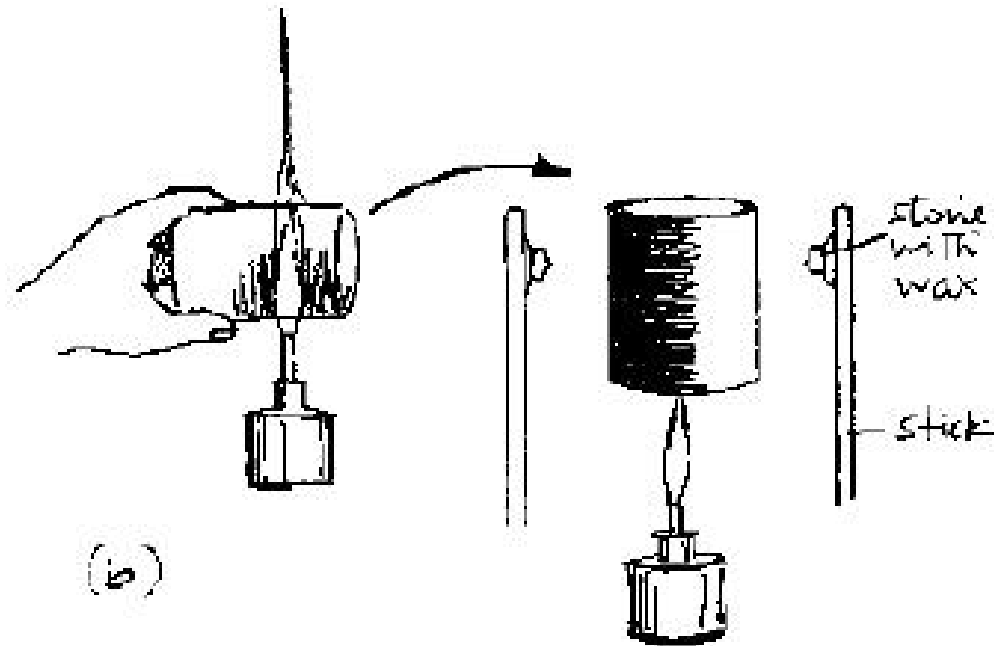
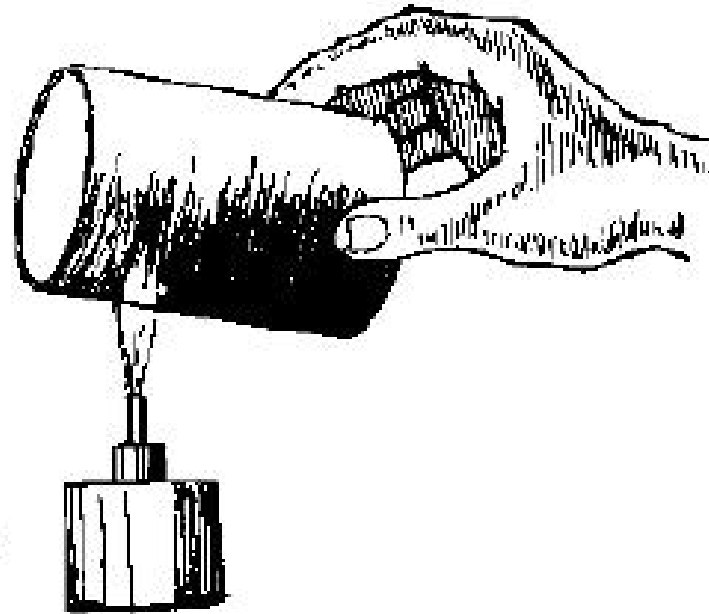



**P:** Paint one half of the outside of an open can black and leave the other half shiny (see figure (a)). Place a wooden stick near each side of the can. Stick a small stone with candle wax on each stick. Heat the bottom of the can.

**Q:** What do you observe?

**E:** The candle wax opposite the blackened surface begins to melt earlier than the wax opposite the shiny surface. This shows that *a black surface is a better radiator than a shiny surface.*

**H:** Soot and black shoe polish will do for the black paint.

#### 5.4.9 Good and Bad Heat Absorbers

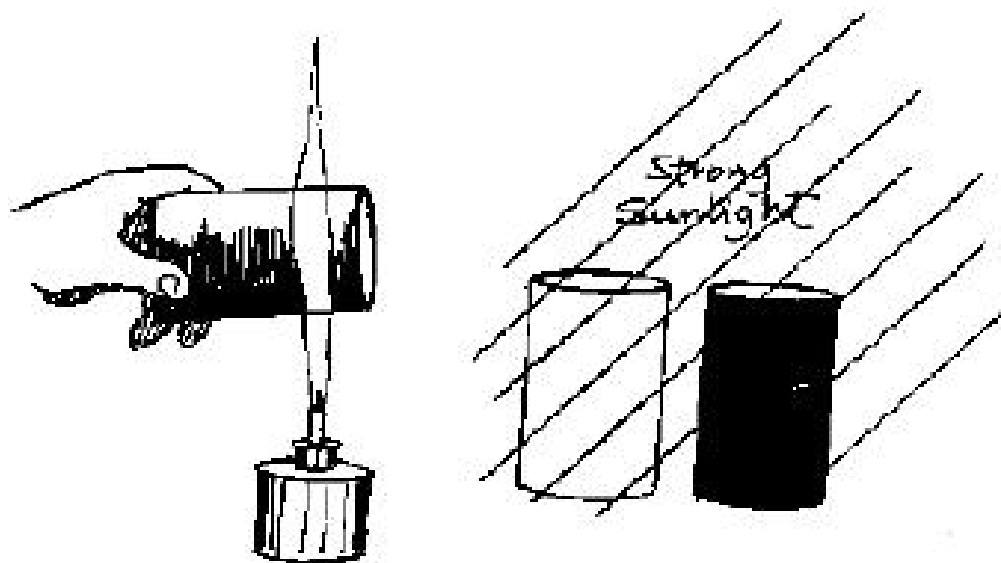



**P:** Take two shiny and identical cans and paint the outside of one black (soot can do). Place both of them in the sun or place them at equal distances from a fire for some time (about half an hour). Then find out how hot each can feels.

**Q:** Which can heats up more quickly?

**E:** The can with a *black surface* absorbs heat more quickly than the one with a *shiny surface*.

**A:** It is wiser for people in hot areas to wear bright clothes and paint their houses white – so that they absorb less heat. What colour should a petrol tank be painted? Give your reasons.

#### 5.4.10 The Thermos Flask

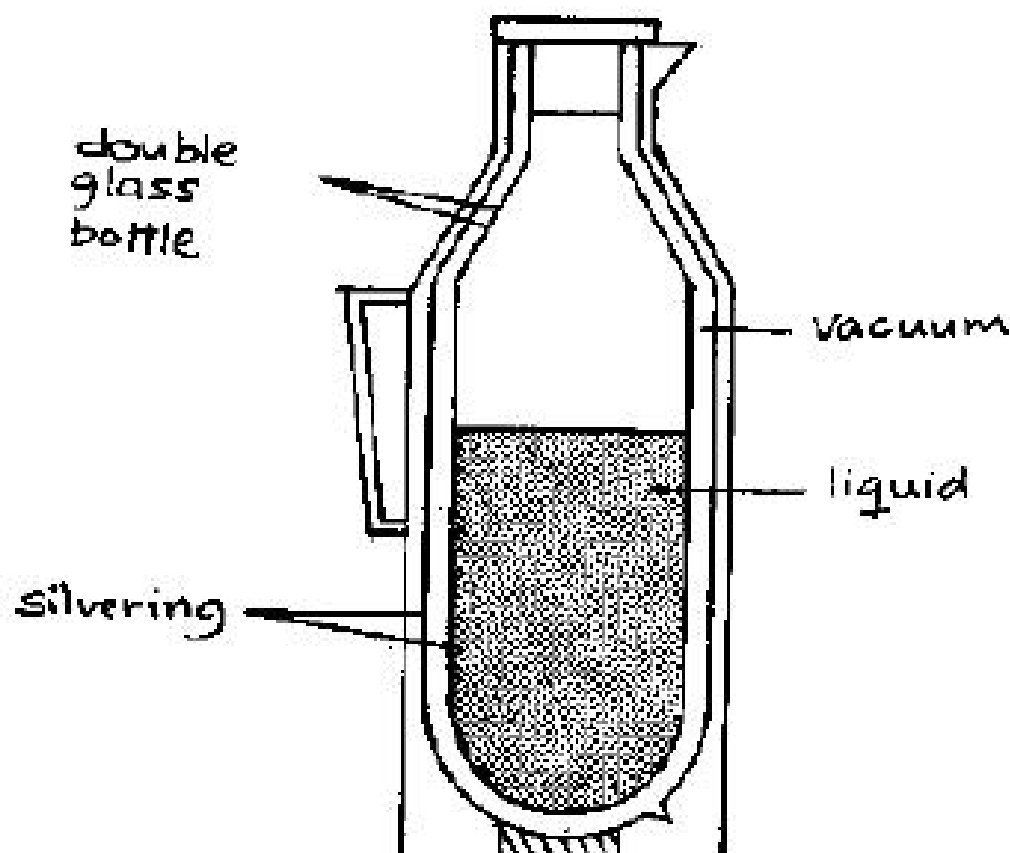

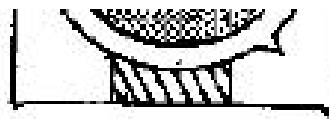

**P:** The thermos flask is a double walled glass bottle with a vacuum between the walls. Both the inner and outer surfaces of the walls are silvered so that they are shiny.

**Q:** How does the flask keep hot tea hot or cold water cold?

**E:** A vacuum is a bad conductor of heat and does not allow convection of heat. The vacuum prevents heat loss or gain by conduction and convection. The silvery walls reduce heat absorption and heat loss by radiation.

## 6. Wave Motion

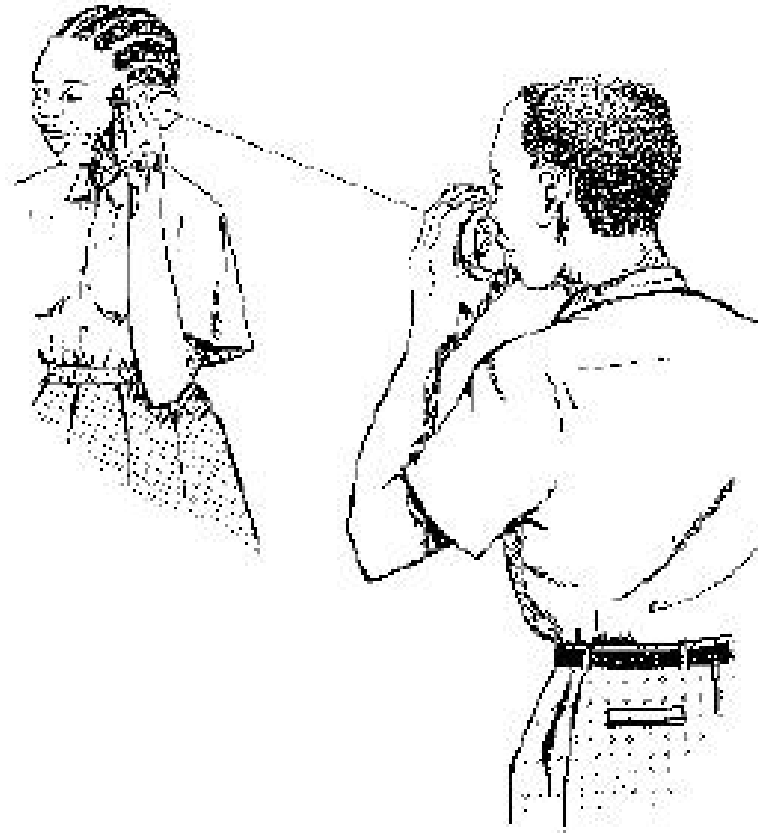

## 6.1. Production of Waves

If a stone is dropped in a still pool of water, concentric circles spread out from the point where the stone enters the water. These concentric circles are an example of a travelling disturbance. A travelling disturbance is called a *wave*.

In *transverse waves* (e.g. water waves) the vibration of the particles is *perpendicular* to the direction of the propagation of the waves. In *longitudinal waves* (e.g. sound waves) the vibration of the particles is *in the direction* of the propagation of the waves.

direction of the propagation of the waves.

Only *energy is transported by a wave*. The oscillating particles of the medium, which transmits the wave, do *not* travel with the wave.

The *frequency* gives the *number of oscillations per unit time*.

### 6.1.1 Transverse Wave Using a Rope

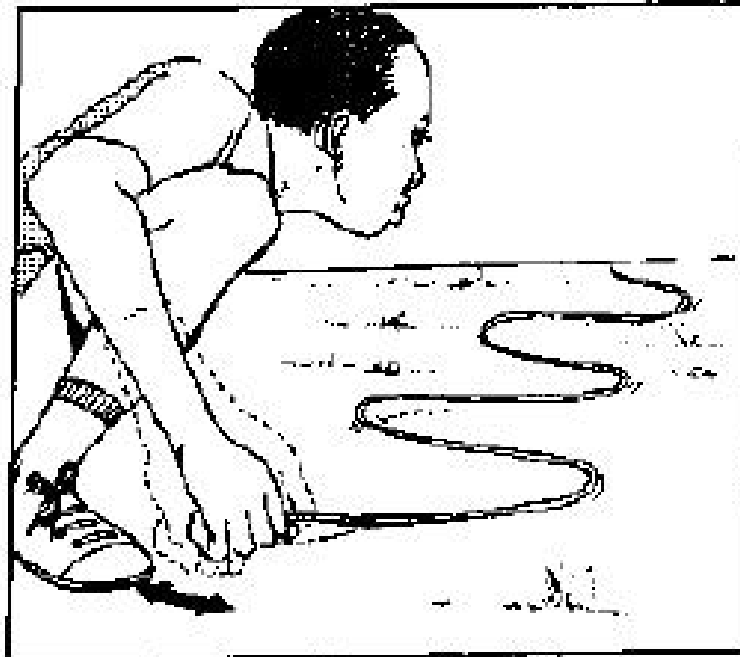

**P:** Take a piece of rope of about 6 m length. Hold it at one end and jerk it sideways.

**Q:** What do you observe? Draw a sketch.

**E:** The disturbance produced by jerking travels along the rope making *crests* and *troughs*. The jerking of the

rope acts as a source of disturbance which travels along the rope. The direction of motion of the wave is *perpendicular* to the direction of jerking. Thus is a *transverse wave*.

### 6.1.2 Tracing a Wave Using a Pendulum Container

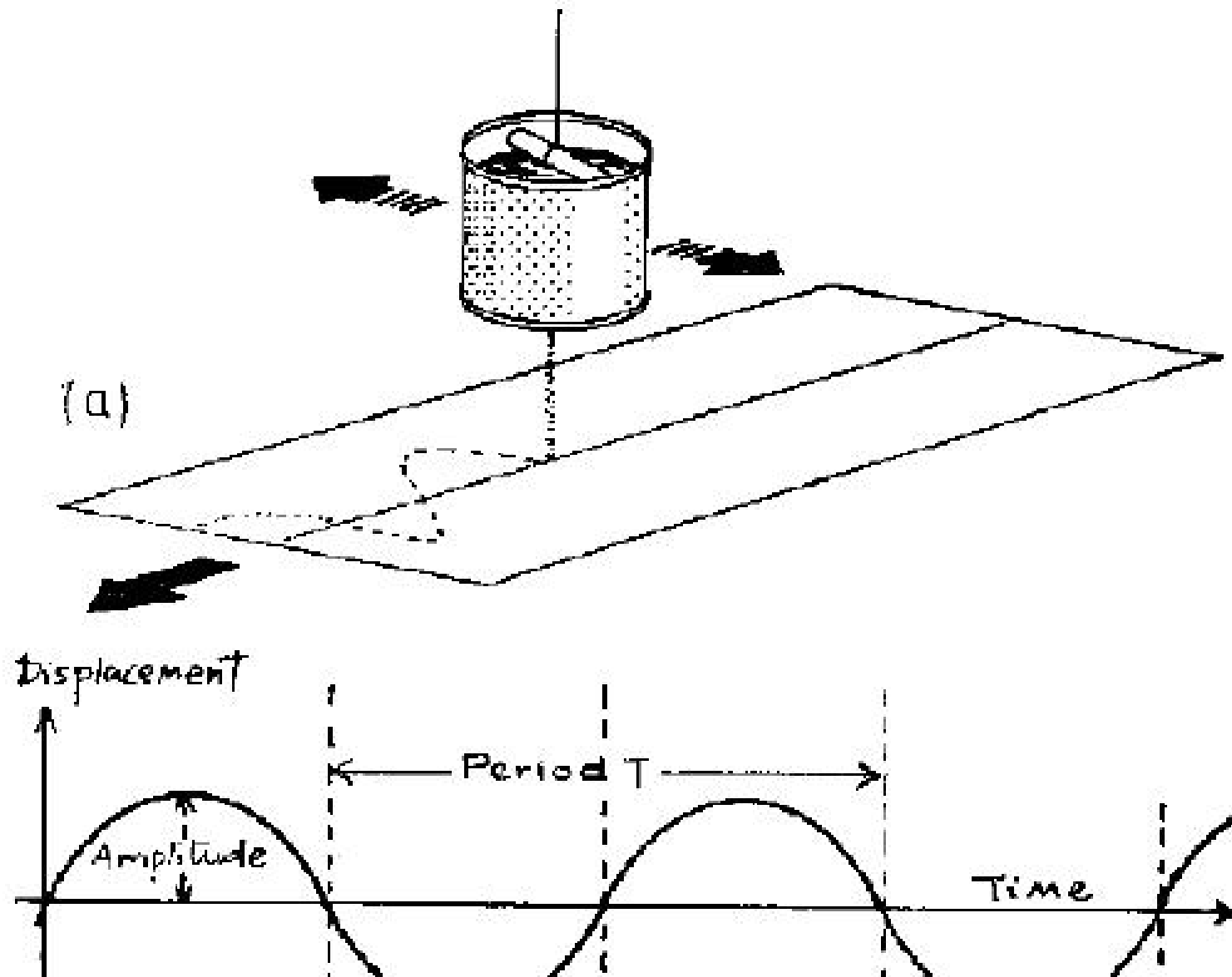

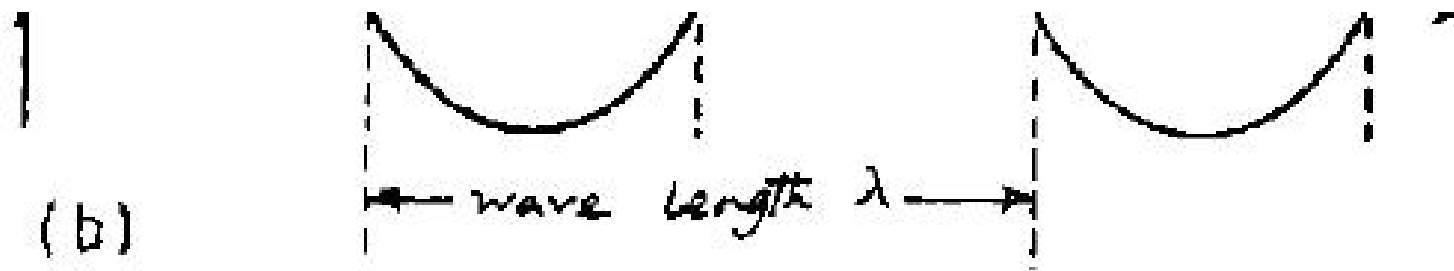

**P:** Take an empty tin opened at one end. Make a small hole at the other end using a sharp nail. Suspend it using a string so that the bored end faces downwards. By gluing or pinning prepare a 30 x 200 cm sheet of an old newspaper. Fill the suspended tin with coloured water (e.g. using ink) or fine sand (dry). Pull the tin to one side and leave it to oscillate freely. While it is oscillating steadily, pull the paper under the tin with *constant velocity*.

**Q:** What do you observe? Draw a sketch.

**E:** When the tin is pulled sideways, it tries to go back to the equilibrium position and overshoots. As it oscillates the jet from the tin draws a sinus trace on the paper passing underneath it. The resulting trace shows a *transverse wave*.

### 6.1.3 Sound from a Ruler

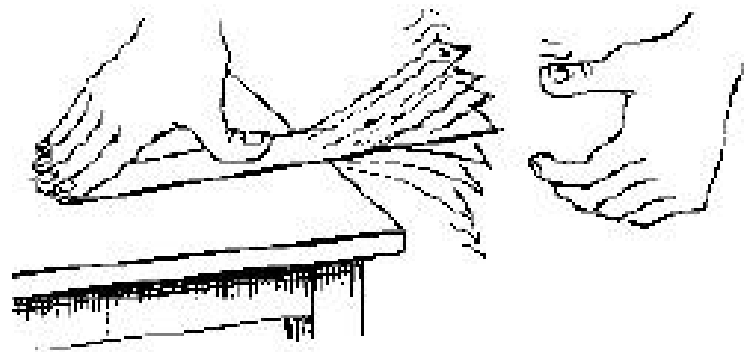

**P:** Clamp a ruler on a table with its free end protruding. Cause the free length to vibrate and listen to the sound. Repeat this for different protruding lengths of the ruler. Four different lengths are enough.

**Q:** How does the sound and vibration relate to the protruding length of the ruler?

**E:** When the vibrating length is reduced, a higher pitch sound is heard and the vibrations become faster and faster. When the vibrating length is increased, a lower pitch sound is heard and large masses of air are set into vibration with large amplitude. Consequently a loud sound is heard. Conversely, short lengths cause small masses of air to vibrate with small amplitudes producing a low sound.

#### 6.1.4 A Transverse Pendulum

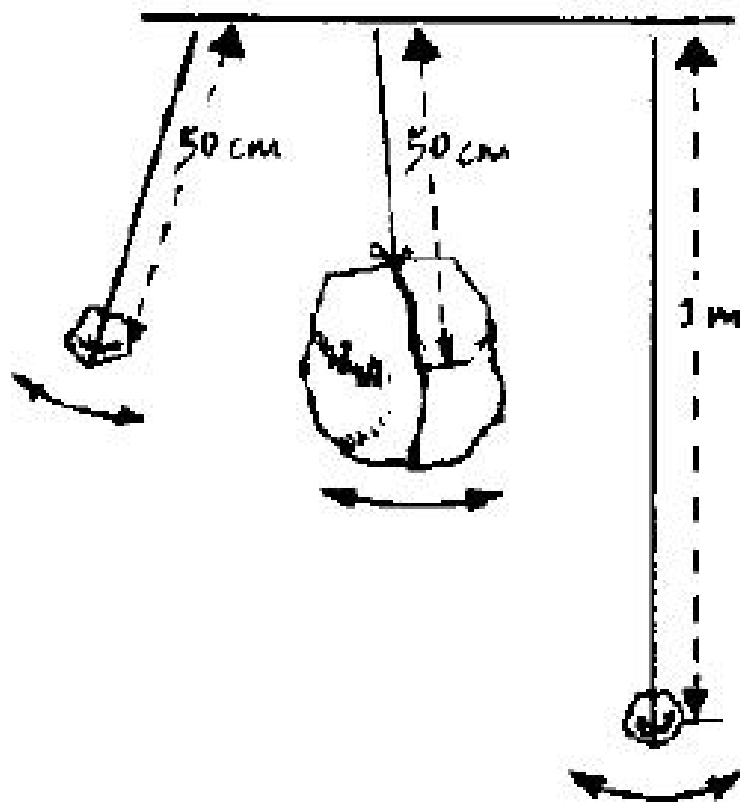

**P:** Tie a stone to one end of a thread of 50 cm length. Fix the other end of the thread and cause the pendulum

**P:** Tie a stone to one end of a thread of 50 cm length. Fix the other end of the thread and cause the pendulum to oscillate. Make sure that the displacement is not more than  $10^\circ$ . Record the time for 20 oscillations and find the frequency. (Frequency = number of oscillations  $\div$  time taken). Change the stone to a heavier one and repeat the procedure. Change the length of the thread to 100 cm and repeat the procedure.

**Q:** What do you find?

**E:** The frequency is independent of the mass, but depends on the length of the thread.

### 6.1.5 A Longitudinal Pendulum



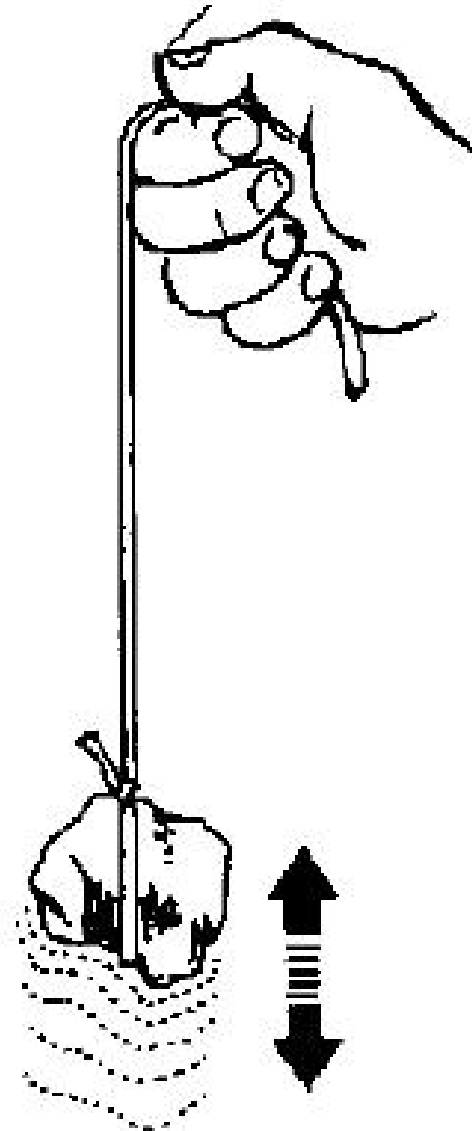

**P:** Tie a stone to one end of a rubber band and hold the other hand as shown above. Lift the stone up and release it so that it oscillates. Record the time for 20 oscillations. Find the frequency. Repeat the procedure by varying the length of the rubber band and the mass of the stone.

**Q:** What do you observe?

**Q:** What do you observe?

**E:** The frequency is independent of the mass but depends on the length.

### 6.1.6 Sound Vibrations



**P:** Cover one end of an open tin with a membrane (paper). Fasten it using a string. Spread fine dry sand on the membrane. Speak a soft and a loud sound from the bottom into the tin while your friend is watching the sand.

**Q:** What does he/she observe?

**O:** The louder the sound, the larger the amplitude of the vibrations.

**E:** The air underneath the membrane has been disturbed by the sound waves which in turn disturb the membrane and make it vibrate. This experiment shows that sound travels as a vibration.

### 6.1.7 Knocking a Water Tank

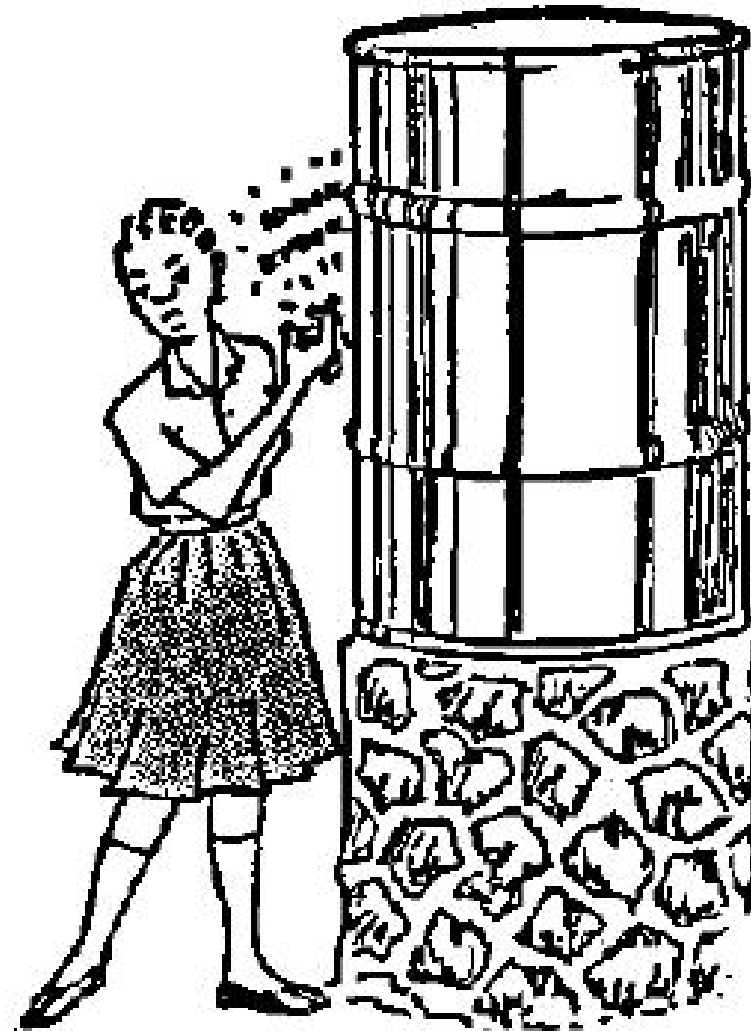

**P:** Gently knock the side of a wa(...)um from the top downwards to the bottom and listen to the tones (see the figure).

**Q:** What do you hear?

**O:** The knock causes the drum to vibrate. At the top, the knocking sets air inside the drum into vibrations giving a loud sound; at the bottom the knocking sets water inside the drum into vibrations giving a soft sound.

giving a loud sound; at the bottom the knocking sets water inside the drum into vibrations giving a soft sound.

**A:** This can be used to check the presence of liquids in tanks or larger containers.

### 6.1.8 Waves on a Water Surface

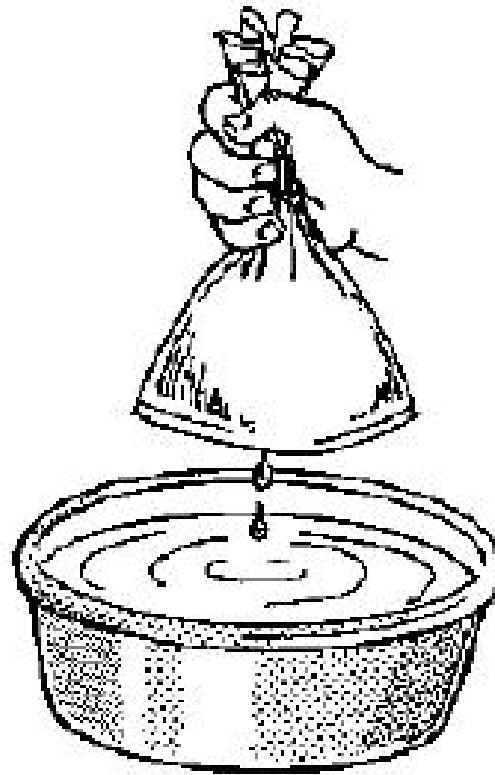

**P:** Allow the surface of coloured water in a bucket to come to rest. (Ink can be used to colour the water.) Fill a plastic bag with water and make a small hole at its bottom. Raise the bag so that drops of water fall on the surface of the coloured water.

**Q:** What do you observe?

**O:** You will see circular waves spreading out rapidly. The drops disturb the water. The disturbance spreads out in concentric circles from the centre. The concentric circles observed are water waves.

### 6.1.9 Transfer of Energy

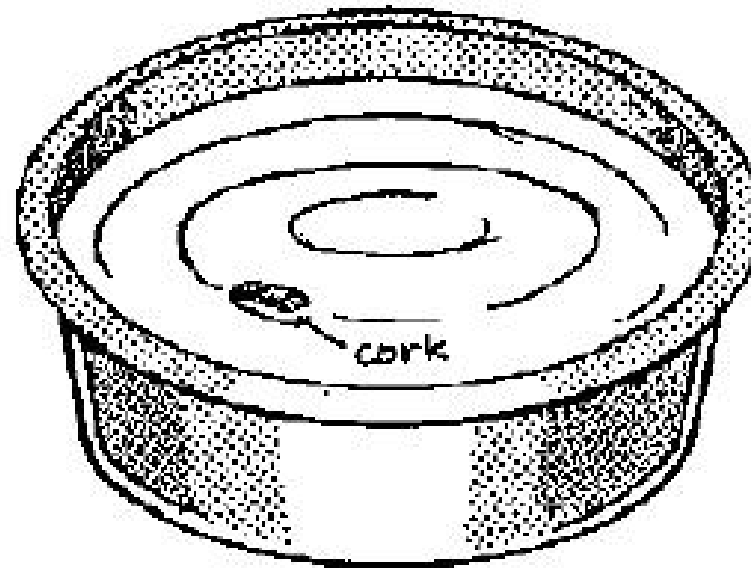

**P:** Put a small piece of light material (e.g. light wood, polystyrene) on the surface of water in a bowl. With a dropper (see 6.1.8) release a few drops of water onto the centre of the water surface. Avoid wind.

**Q:** What do you observe?

**O:** You will see water waves moving from the centre outwards but the pieces of light materia will not travel with the waves.

**E:** Energy travels with the wave. However, the particles of the wave-transmitting medium (e.g water) do *not* travel with the wave, they only oscillate up and down.

### 6.1.10 Transfer of Energy



**P:** Line up a group of students and ask each student to place his/her hands on the shoulder of the student in front with the elbows kept bent. Tell the last student to push forward.

**Q:** What do you observe when one after the other student pushes?

**O:** A longitudinal wave moves through the queue.

## 6.2 Propagation of Waves

Sound does not travel through a vacuum but it requires a *medium* for its propagation. Denser media are better transmitters of sound than less dense media.

Thus, sound travels faster and better in water, wood or strings of various materials than in air.

### 6.2.1 The String Telephone

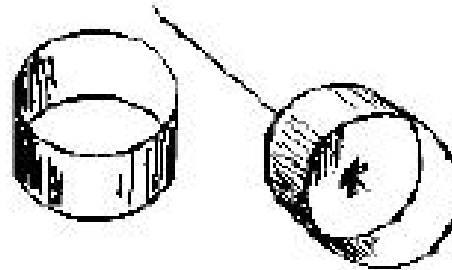

**P:** Punch a small hole at the centre of the bottom of each of the two empty cans. Connect the cans with a long string knotted inside each can. Hold the cans so that the string is stretched. Talk into one can while your friend is listening (he/she may close the other ear with a finger). Ask your friend to talk to you also and listen to him.

**Q:** What do you hear?

**O:** You will hear each other distinctly. Sound has travelled through the string (as a medium) from one can to the other.

### 6.2.2 Sound Waves in Air



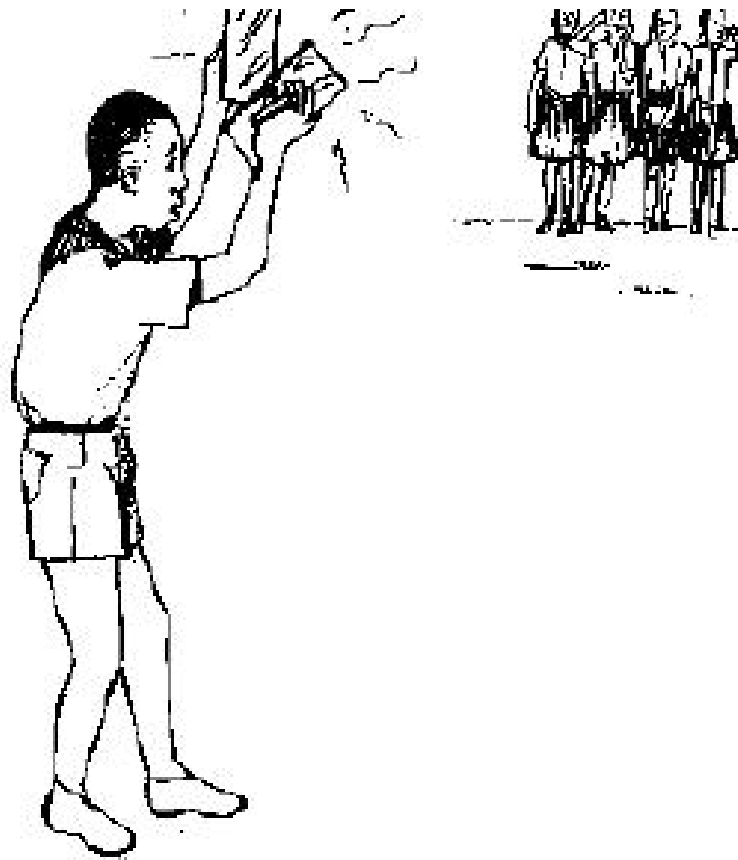

**P:** One student is standing about 100 m from the class and making sound by clapping two metal pieces (two lids) together.

**Q:** What do you hear?

**O:** You will hear a sound. The sound you hear has been transmitted from the source to you by air as a medium.

### 6.2.3 Sound in a String



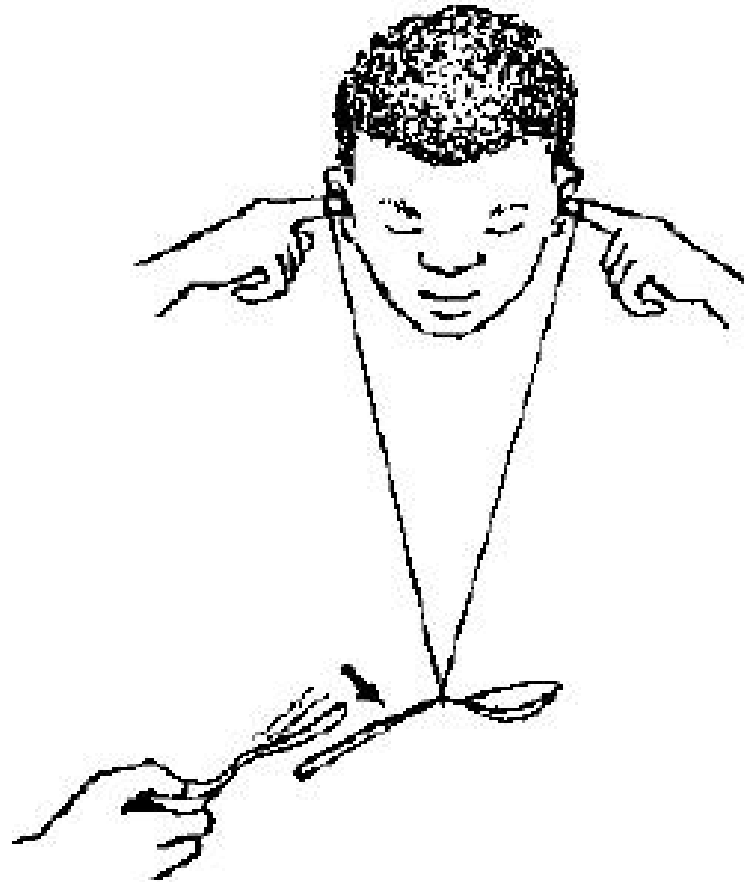

**P:** Tie a metallic teaspoon at the middle of a one metre long cotton thread. Wind each end of the thread around a fingertip (see figure). Press the fingertips into your ears. Bend down so that the string and the spoon hang freely. Let someone hit the spoon slightly with a nail or another spoon. Listen to the sound.

**O:** You will hear a chime sound like that of a church bell.

**E:** Sound travels through the string to your ears. Sound travels better in strings than in air.

#### 6.2.4 Sound in Wood



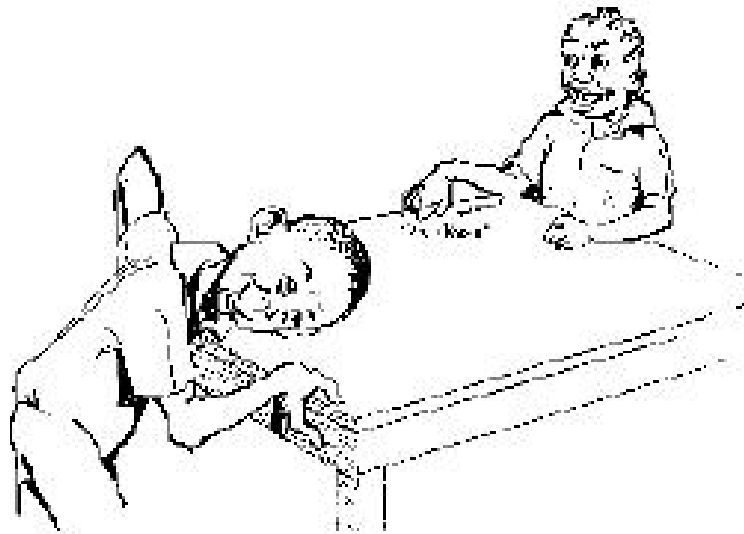

**P:** Place your ear against one edge of a table while your friend is knocking the opposite edge slightly. Repeat the experiment by scratching the table slightly. Listen to the sound through air and the sound through the table.

**Q:** Describe what you hear.

**O:** The sound travelling through the table is heard more distinctly than when heard through the air.

**E:** Hence sound travels better in wood than in air.

### **6.2.5 Sound in Metal**

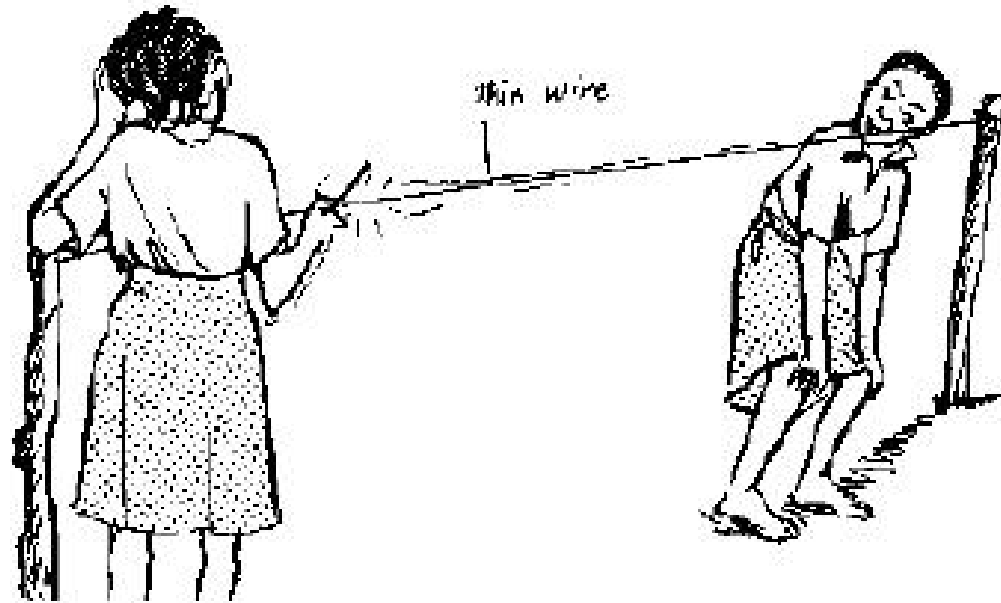

**P:** Take a long thin wire and fix it to two posts placed about 5 m apart. Tell your friend to be at one end. Then scratch the other end of the wire. Scratch the wire again while your friend has placed his/her ear against the wire on his/her side.

**Q:** Ask your friend what he/she hears.

**O:** Your friend will hear nothing unless he/she places his/her ear against the wire.

**E:** Sound travels better in metal than it does in air.

### 6.2.6 Sound in Water



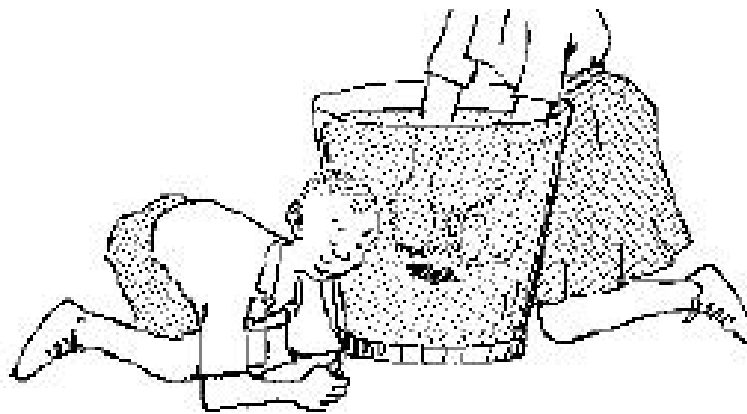

**P:** Fill a plastic bucket with water. Take two stones and knock them against each other *in the water*, while another person has put his/her ear close to the bucket.

**Q:** What does he/she hear?

**O:** He/she will hear the sound coming through the water more loudly.

**E:** Sound travels better in water than in air.

### 6.3 Reflection of Waves

When a travelling wave meets a smooth barrier it is reflected. When a wave is reflected, the angle of incidence is equal to *the angle of reflection*.

When a wave is constantly reflected the same way back as it comes to the obstacle (e.g. a wave reflected on the fixed end of a string), a *standing wave* is produced.

Reflected sound is called an *echo*. Ships use *echo-sounding* to determine the depth of the ocean.

### 6.3.1 Reflection of Water Waves

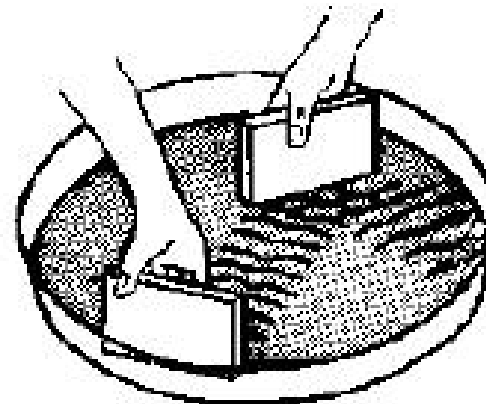
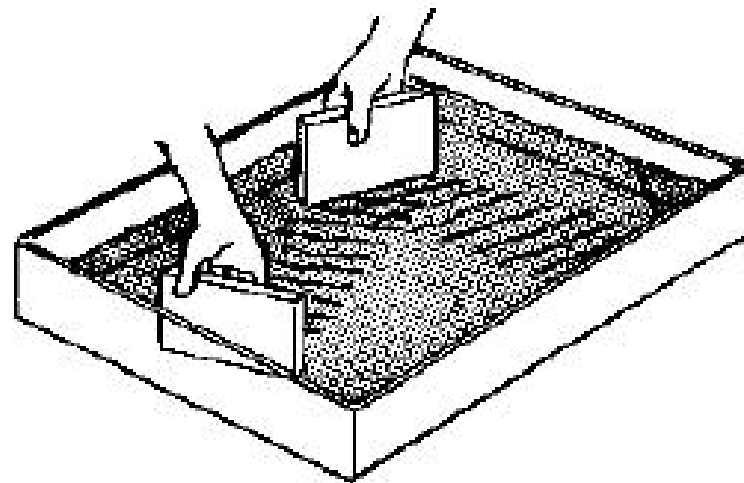

**P:** Place a straight metal or plastic barrier in the dish containing coloured water. Touch the surface of the water with a rectangular block of wood repeatedly in equal time intervals.

**Q:** What do you observe?

**O:** Parallel waves move across the dish and rebound from the barrier.

Q. Parallel waves move across the dish and rebound from the barrier.

E: This behaviour is known as *reflection of waves*. When the angle of inclination of the barrier is changed, the angle of reflection remains the same as the angle of incidence. The barrier is acting as a reflector just as a mirror is a reflector of light.

### 6.3.2 Reflection of Sound Waves

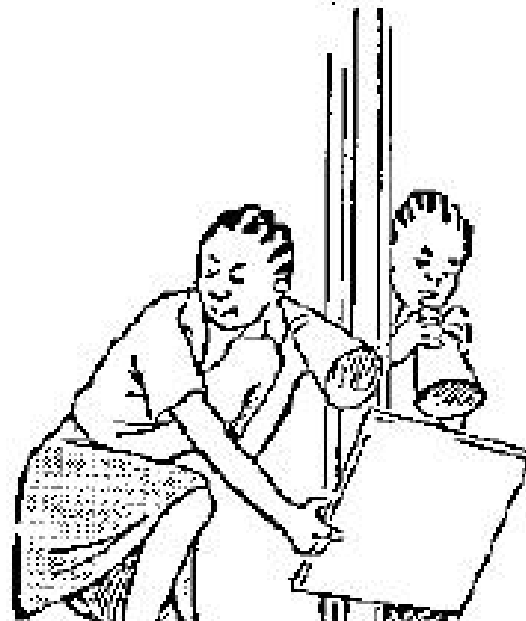



**P:** You and your friend should stand on both sides of a wall beside an opened door. Ask your friend to whisper into a cone and listen through the other cone, see figure (a).

**Q:** Do you hear anything?

**O:** No sound is heard.

**P:** Repeat the above procedure while holding a smooth cardboard as shown in figure (b). Change the position of the smooth cardboard.

**Q:** What do you hear?

**O:** Distinct sound is heard. This is because the whispered sound has been reflected by the smooth cardboard towards the listener.

### 6.3.3 Reflection in a Rope



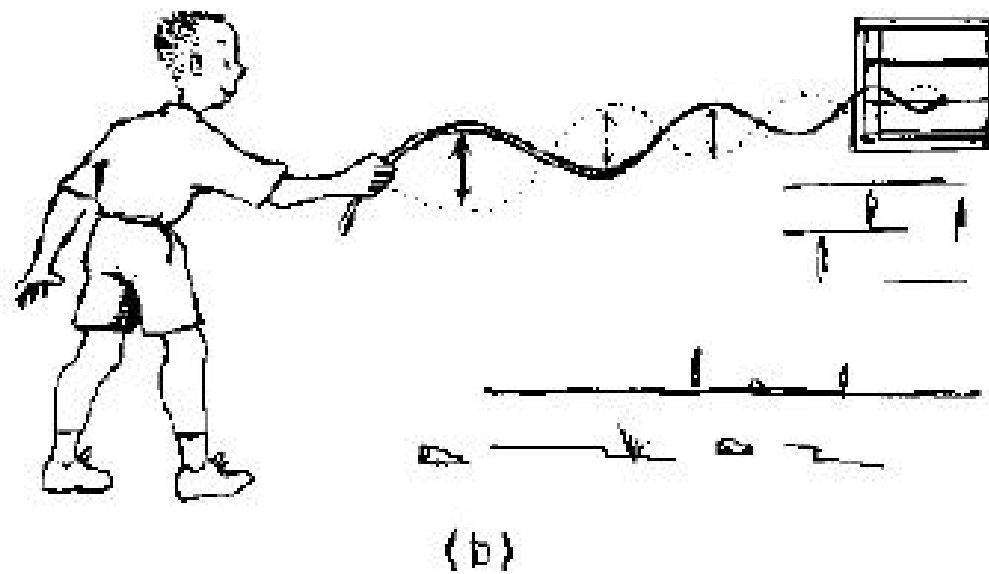
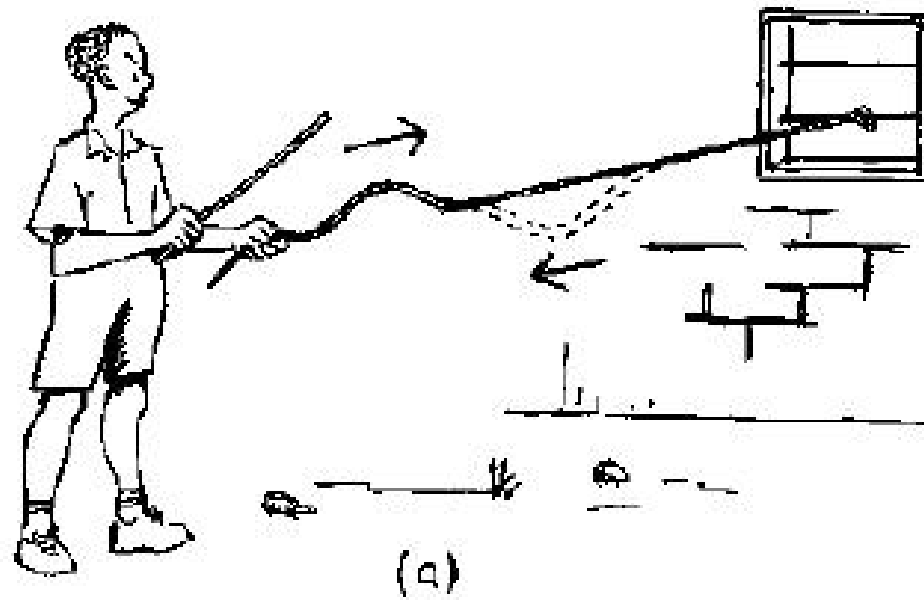

{ b }

**P:** Tie a rope of about 4 metres length on a fixed bar of a window as shown in the diagram. Hit the rope by a stick.

**Q:** What do you observe?

**P:** Repeat the procedure above by jerking the rope up and down.

**Q:** What do you observe now?

**O:** (a) An impulse travels along the rope and comes back.

**E:** When the impulse hits the fixed end of the rope, it bounces off and comes back again as shown by the dotted line in the diagram. The reflected impulse has the same shape as the incident impulse, but is inverted, see figure (a). ? Thus, when a wave is reflected on the fixed end of the rope, a *standing wave* is produced, see figure (b).

#### 6.3.4 Reflection in a Hose Pipe



**P:** Take a long piece of an empty garden hose pipe. Listen at one end of the pipe while your friend is whispering into the other end of the pipe.

**Q:** What do you hear?

**O:** The sound is heard more distinctly.

**E:** When your friend is whispering, he is sending sound waves into the pipe which are reflected on the walls of the hose pipe. These waves are directed to the other end of the hose pipe where they can be heard.

**A:** Similarly light can be reflected in a glass fibre. Thus, light pulses may be transmitted by glass fibres. This is used for telephone television etc.

### 6.3.5 Reflection of Sound Waves: Echoes



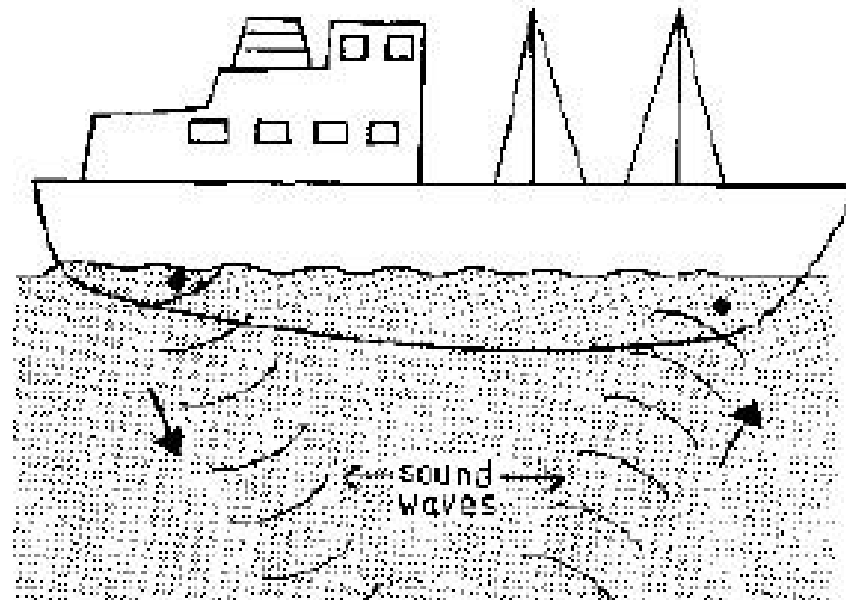
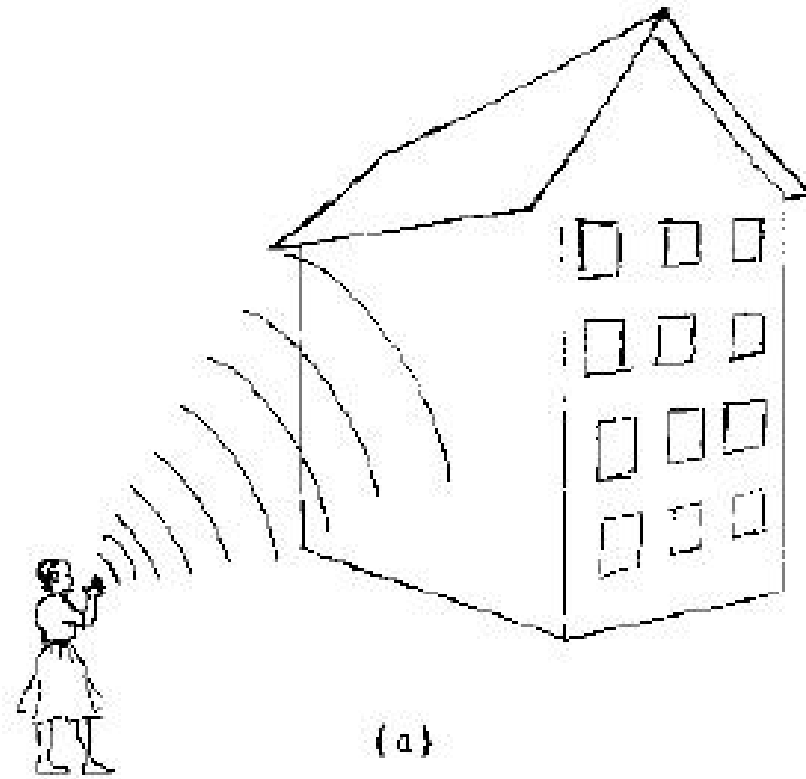

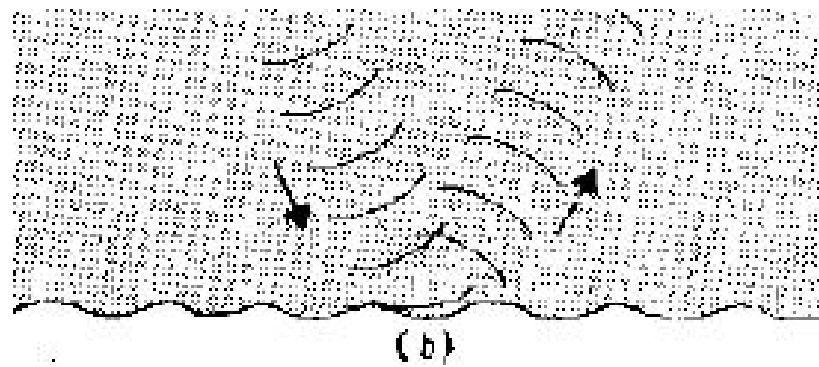

**P:** Stand near a tall building and call out loudly, see figure (a).

**Q:** What do you hear?

**O:** After a short time, the call is heard again.

**E:** The sound waves have been reflected from the wall of the building. The reflected sound which is heard is called an *echo*.

**A:** Echoes are used by bats in (ultra sound) navigation. Also echoes are used to determine shoals of fish and the depth of oceans, a phenomenon called *echo-sounding* see figure (b).

### 6.3.6 Reflection of Sound Waves

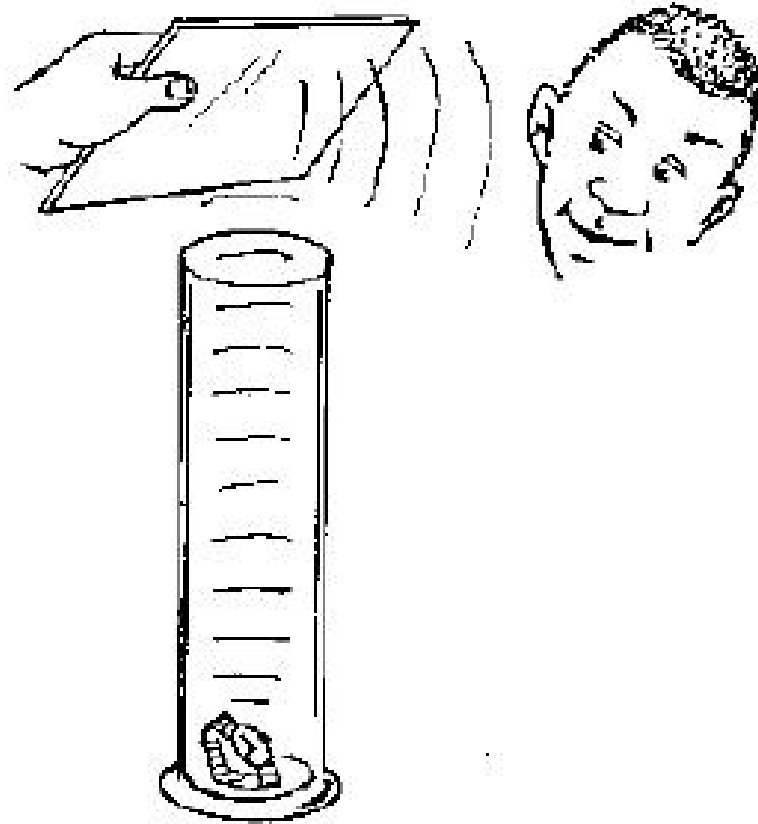

**P:** Take a tall cylindrical container and put a mechanical clock in it. Place your ear close to the side of the container. Listen to the sound from the clock. Then place a cardboard at slant position about 5 cm on top of the container and listen again (change the position of the board).

**Q:** What do you hear?

**O:** In the absence of the cardboard no sound is heard. But in the presence of the cardboard the tick-tack sound is heard.

**E:** This is because the sound from the clock travels vertically up and is reflected by the cardboard towards the observer.

## 6.4 Music and Musical Instruments

The human voice is produced by the vibration of the vocal cords. Changes in tension and length produce changes in pitch or tone of the voice. *The less the length and the higher the tension of a cord, the higher the pitch of the tone produced.* The same principle is used to produce music with a *guitar* or a *violin*. The *marimba* and the *xylophone* use sticks or bars of various length or thickness to produce tones of different pitch. The *flute*, the *bottle orchestra* and the *organ* use air columns of various length.

### 6.4.1 Sonometer (One – String Guitar)

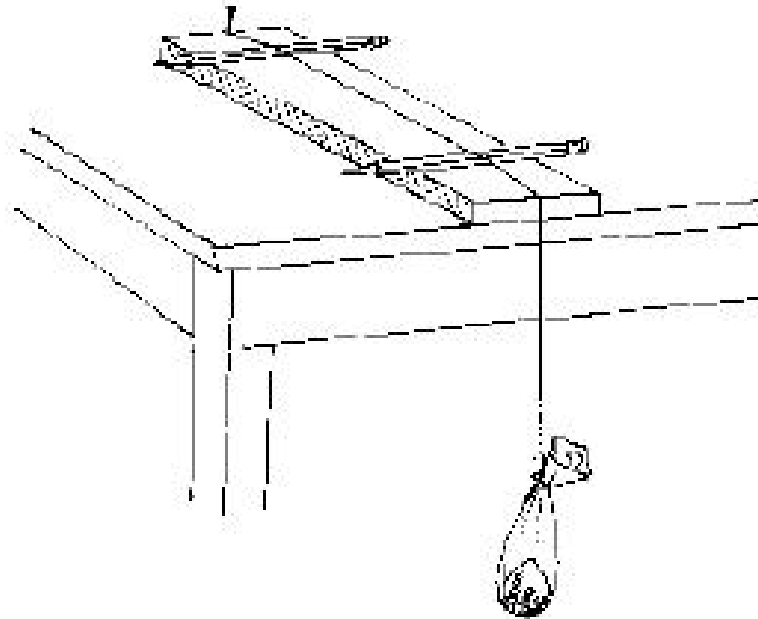

**P:** Place a soft board on a table. Fix a string with a nail to one end of the soft board. Tie the heavy mass of a stone to the other end of the thread so that the mass hangs below the edge of the table. Insert two pencils



under the thread so as to raise the thread off the board. Pluck the thread between the two pencils. Vary

- (a) the distance between the two pencils;
- (b) the mass hanging.

**Q:** What do you hear?

**O:** (a) A higher tone is produced if the distance between the two pencils is reduced.

(b) A higher tone is produced if the mass is increased.

**E:** The tone which is produced by the vibrating string depends on its vibrating length and the tension of the string.

#### 6.4.2 Bottle Orchestra





**P:** Take four equal bottles. Leave the first bottle empty. Fill the second bottle a quarter of its volume, the third a half, and the fourth three quarters of its volume with water and blow into the bottles one after another and listen to the tones produced.

**Q:** Do you notice any difference in sound?

**O:** The shorter the air column the higher the tones.

**A:** The organ (used in some churches); the flute.

#### 6.4.3 Marimba

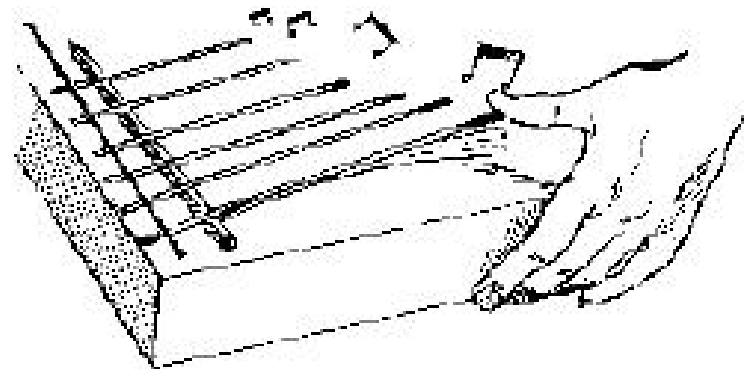

**P:** Cut bicycle spokes into different lengths. Arrange them on a piece of wood and fix them to it by putting another spoke across them as shown in the figure. Lift the fixed spokes by inserting a pencil under them to raise the free ends of the spokes off the wood. Pluck the free ends one after another and listen to the tones produced.

**Q:** What do you notice?

**O:** The plucking causes the spokes to vibrate and produce sound. The longer the spoke, the lower the tone.

**A:** Grand pianos produce lower notes than normal ones.

#### 6.4.4 Simple Flute (Bamboo Flute)



**P:** Take a straight bamboo tube of about 1.5 cm diameter and 30 cm length. Clean the knots inside. Dry it until its colour changes to yellowish–brown. Make a mouth–piece and a row of holes as shown in the figure. Blow air into the mouth–piece while closing some of the holes with your fingers.

**Q:** What do you hear?

**O:** Different tones are produced by the flute as you remove fingers from different holes.

**O:** Different tones are produced by the flute as you remove fingers from different holes.

The pitch of the tones depends on the distance of the first open hole from the mouthpiece, i.e. the closer the hole is to the mouth-piece, the higher the tone produced.

**E:** Thus, the tone produced is determined by the vibration of air in the column between the mouth-piece and the first uncovered hole.

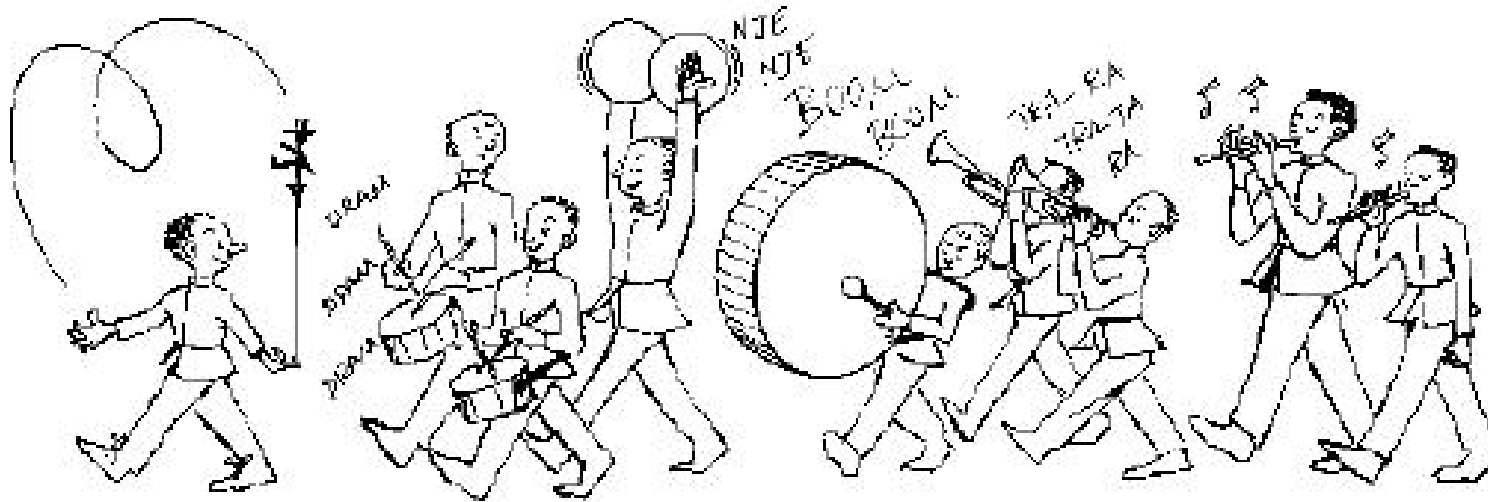

#### 6.4.5 The Violin



**P:** Make two holes diametrically opposite each other near the upper open end of a tin and then pass a flexible wooden stick through them so that it just protrudes from the can on one side. Bore a small hole at the centre of the bottom of the can. Fix one end of a string at the hole and tie the other end to the end of the stick which is bent into a bow as shown in the diagram. Make the string tight. Pluck the string repeatedly with a finger as if playing a guitar.

(a) Change the tension by further lightening the string.

(b) Change the length of the vibrating portion of the string by touching the upper end with your finger.

**Q:** What do you hear?

**O:** (a) The pitch of the tone produced increases with the tension of the string.

(b) The pitch of the tone produced increases with the decrease of the length of the string.

**H:** Knotting the string on a nail held horizontally in the bottom of the can helps to anchor the string.

#### 6.4.6 The Xylophone

## 6.4.6 The Xylophone



**P:** Make a wooden box with the bottom and the top side open. Take timber bars of different types and thickness. Drill four holes into each bar and pass two strings to hold all the bars together on the top of the open box. Beat the bars in turn by using two sticks.

**Q:** What do you hear?

O: Different sizes of bars give different tones and different types of materials of the same thickness give different tones.

## 7. Geometrical Optics



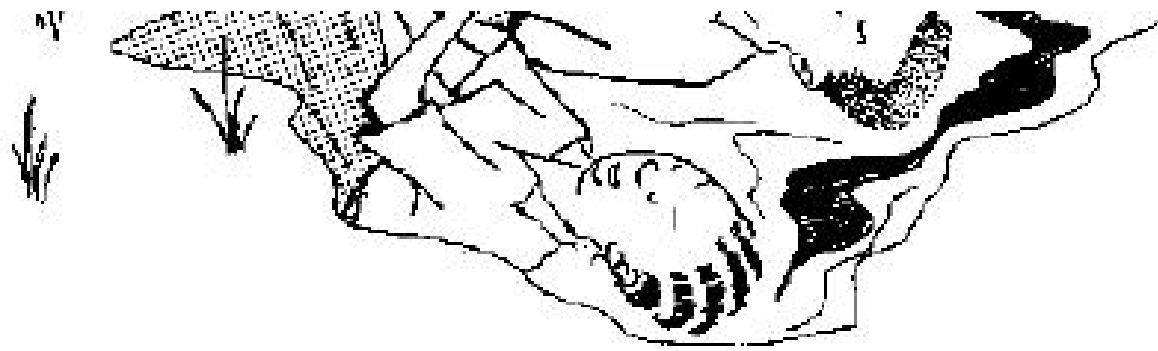

## 7.1 Nature and Propagation of Light

Light is the energy which is given off by very hot bodies in the form of electromagnetic waves and makes objects visible to our eyes. Light travels in straight lines. Thus, we may use *ray diagrams* in order to explain the *formation of the image in the pinhole camera* or the *formation of shadows* of an object.

### 7.1.1 Light Travels in Straight Lines



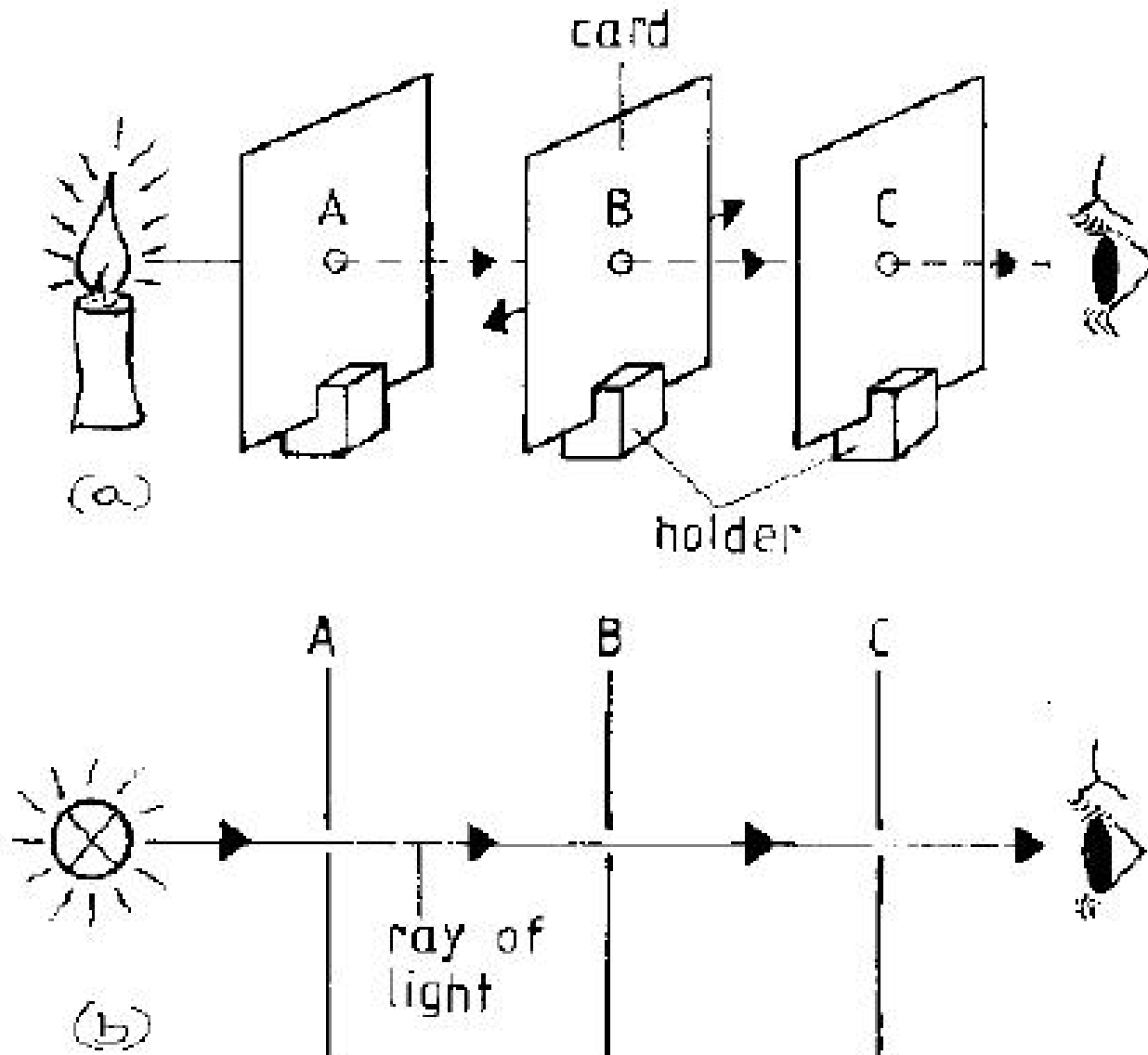

**P:** Make small holes on pieces of cardboard A, B and C. Place them in front of a source of light as shown. Pass a thread through the holes and pull it at both ends to make it taut. Adjust the cardboards so that all the three holes are in line. Remove the thread. Bring a candle near card A and look through the hole in card C. Record your observations.

Record your observations.

Displace anyone of the cards so that the holes are not in alignment.

**Q:** What do you observe? How can you explain this?

**E:** The light can be seen from end C only if all the three holes are in line. Displacing any of the cards obscures the ray of light and hence you cannot see the ray as you look from card C.

Hence *light travels in the straight lines*.

Figure (b) shows the same arrangement as figure (a) using symbols which are like the cross-section of the actual apparatus. We call such a figure a *ray diagram*.

### 7.1.2 The Pinhole Camera

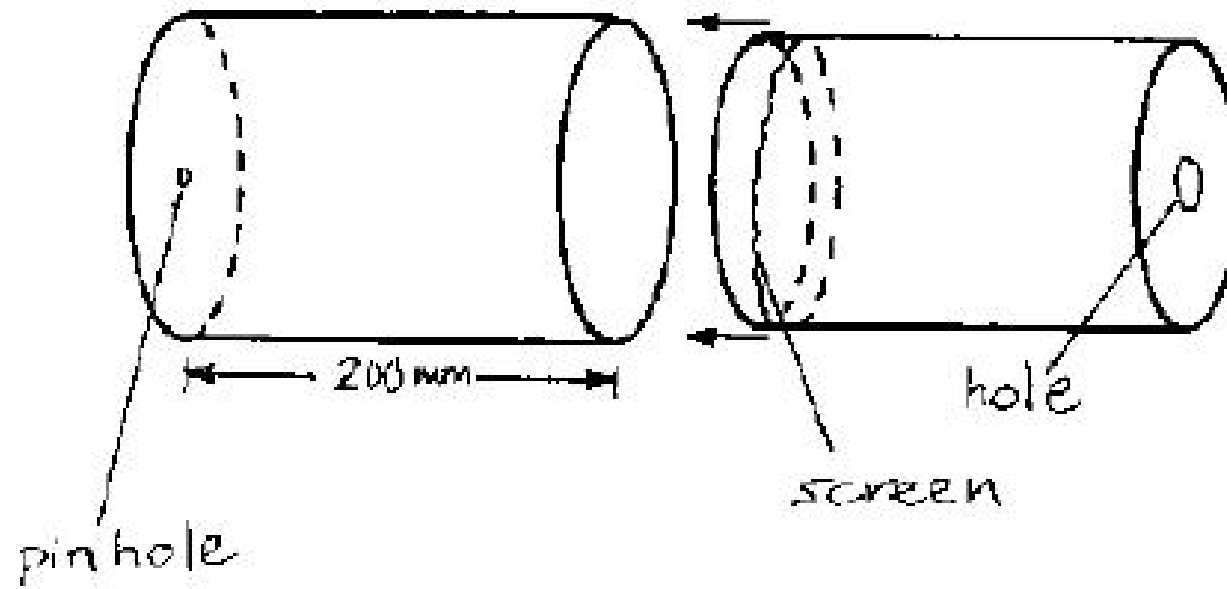

(a)

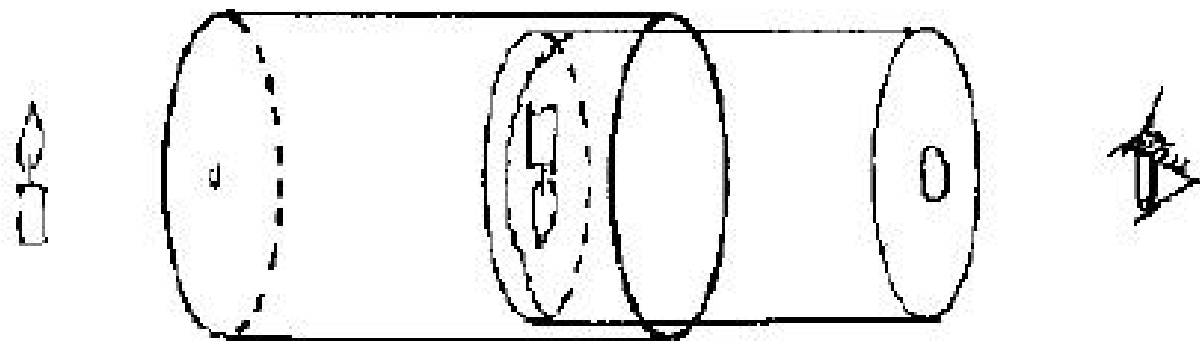

(b)

( b )

The pinhole camera is a camera made by using a tin or box with a pinhole at one end.

**P:** Roll a piece of manila card to make a cylinder. Glue a circular piece of card on one open end of the cylinder and puncture a hole at its centre using a pin. Make a second cylinder which fits tightly into the first cylinder. Cover one end of the second cylinder with a plain paper. The paper acts as a screen for the image which will be formed. Close the other end of this cylinder with a card. At the centre of the card produce a hole of about 2 cm diameter. Through this hole you will observe the image. The card prevents light to enter from this side because the image may be too dim to be seen, if light enters from the side of the observer.

### 7.1.3 Using a Pinhole Camera

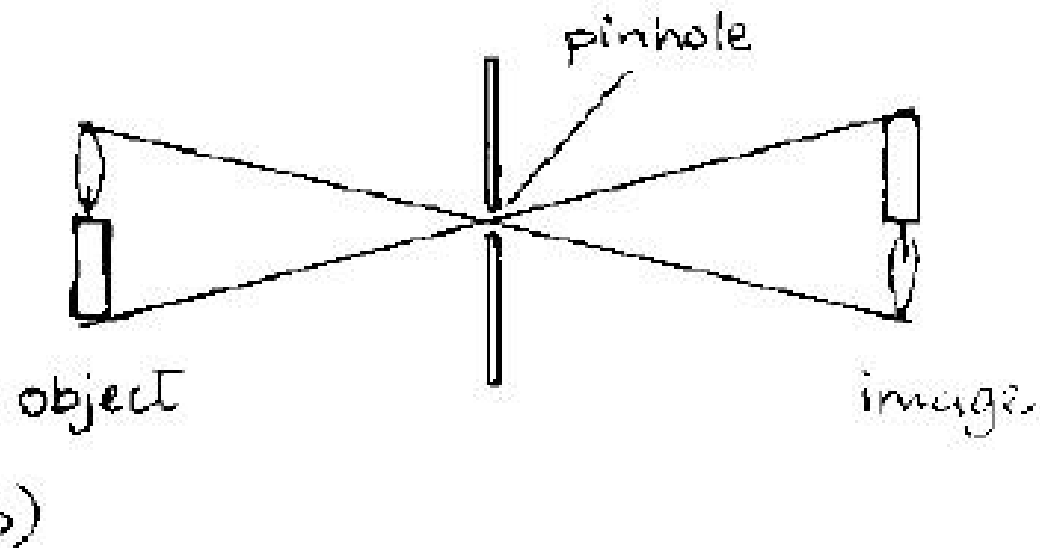
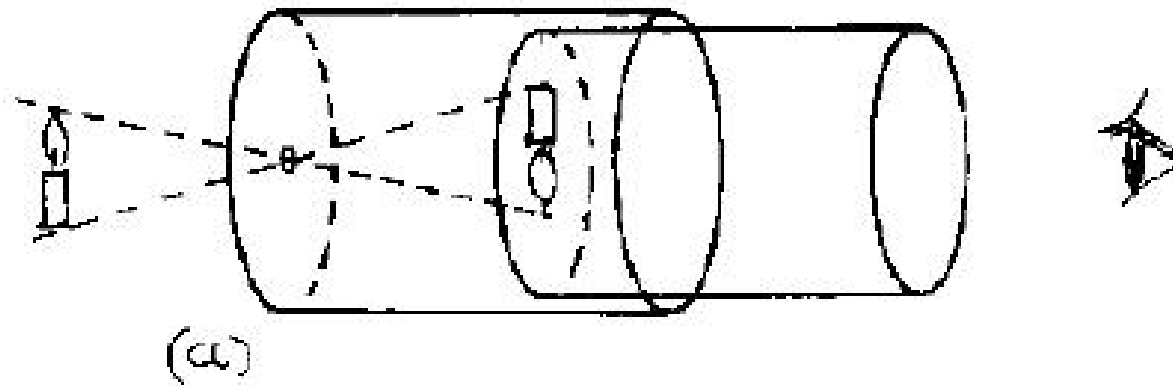

**P:** (a) Observe a burning candle using the pinhole camera. Adjust the pinhole–screen distance in order to get a clear, sharp image of the candle.

(b) Change the distance between the screen and the pinhole by steadily pulling the inner cylinder. Observe what happens to the image.

(c) Move the camera slowly away from the candle and observe what happens to the image.

(c) Move the camera slowly away from the candle, and observe what happens to the image.

(d) Make the hole wider. Observe the image.

**E:** (a) The cone of rays reaching the pinhole from the object (candle) decreases with the distance of the hole from the object. Thus, the image becomes smaller and less bright. It is always an *inversed and real image*. *An image is real if it can be caught by a screen, since the rays really meet in the various point of the image.*

(b) When the distance between screen and pinhole is increased the image on the screen becomes larger and more blurred.

(c) The image becomes larger and more blurred when the object is closer to the hole and becomes smaller and sharper when the object recedes.

(d) When the hole is made larger the image on the screen becomes larger and more blurred. Generally, *an optical image is sharp when all the rays, coming from one point of the object to the screen, meet at one point of the image*. If the rays, coming from one point of the object to the screen, hit several points of the screen, the image is blurred.

#### **7.1.4 Shadows Using one Light Source**

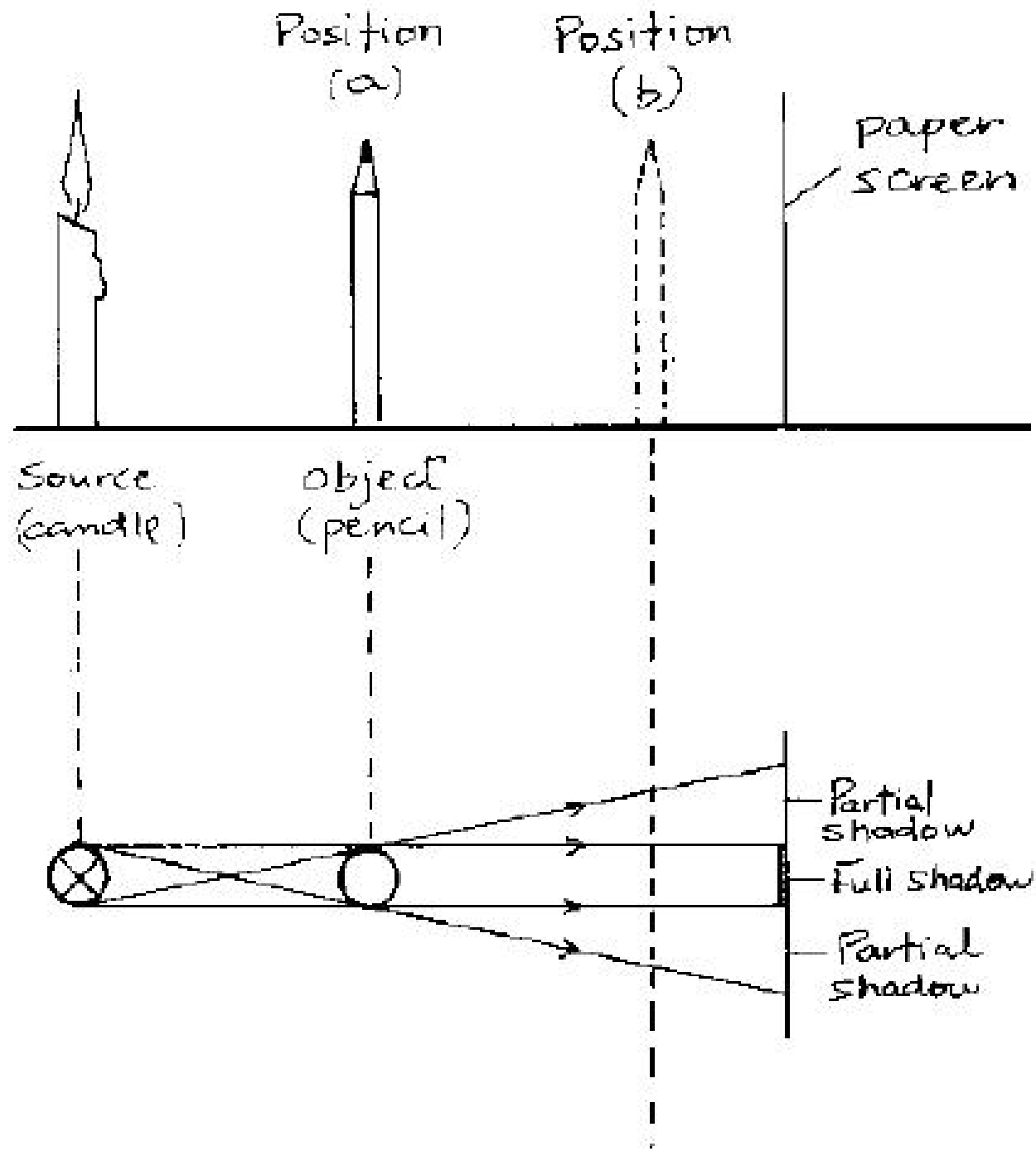

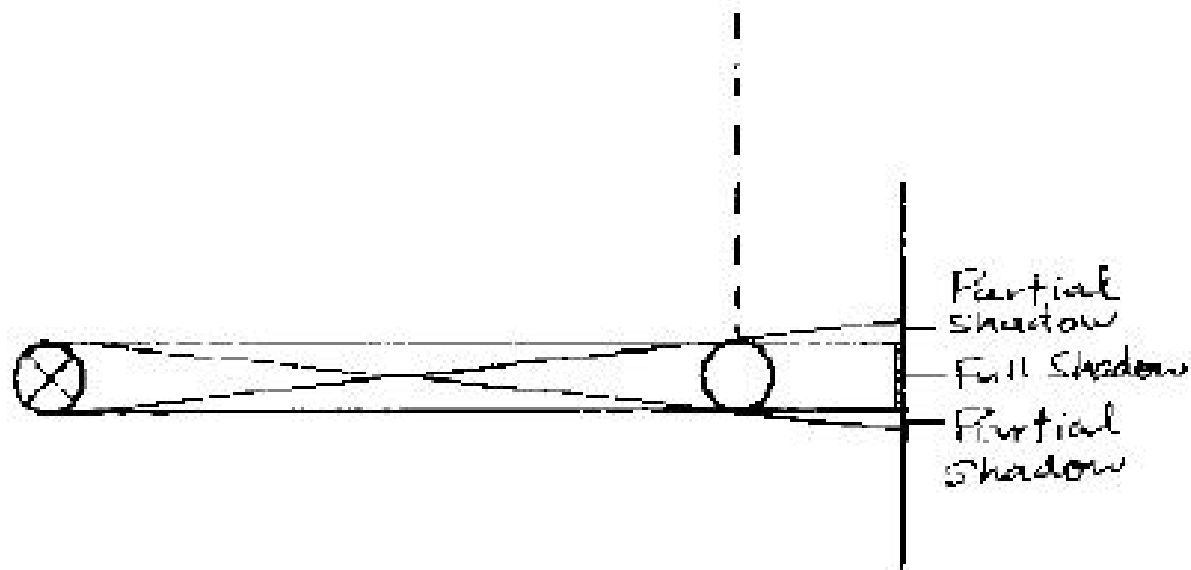

**P:** Hold a pencil between a source of light (e.g. candle) and a white paper. Observe the shadow formed on the paper (screen).

Gradually move the pencil closer to the screen and observe the change in the shadow.

**Q:** How does the shadow change?

Explain this with the use of ray diagrams.

**E:** The shadow becomes sharper as the obstacle (pencil) approaches the screen.

The figures show that *full shade* exists only on those points of the screen, which are *not hit at all by rays* coming from any light source. Wherever points of the screen receive rays from a *part* of the light source only (but *not* from the whole source), there is *partial shade*.

### 7.1.5 Shadows Using two Light Sources



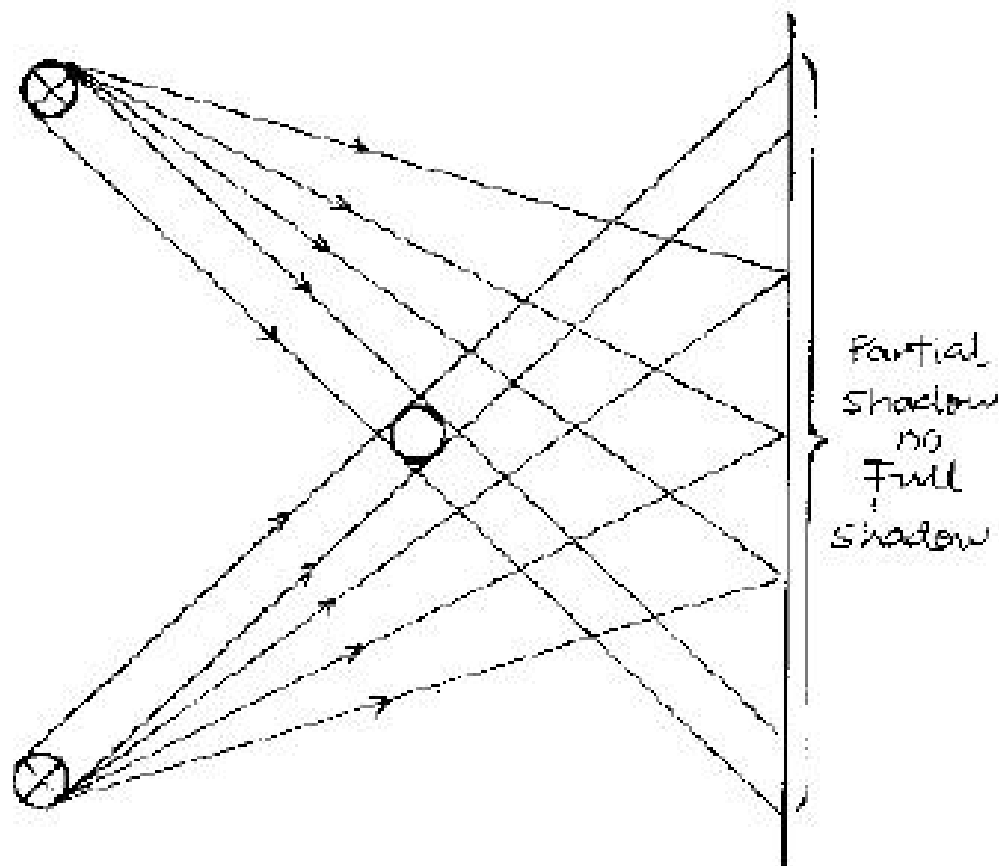

**P:** Repeat the above experiment using two candles and one pencil. Observe the shadows formed.

**Q:** Explain the results and discuss the formation of shadows by a point source and extended source of light.

**E:** The figure shows that all the points of the screen which do *not* receive rays from candle 1, *do* receive rays from candle 2 and vice versa. Thus, full shade does not exist in this experiment (except the object is brought very close to the screen).

### 7.1.6 Rays in the Smoke Box



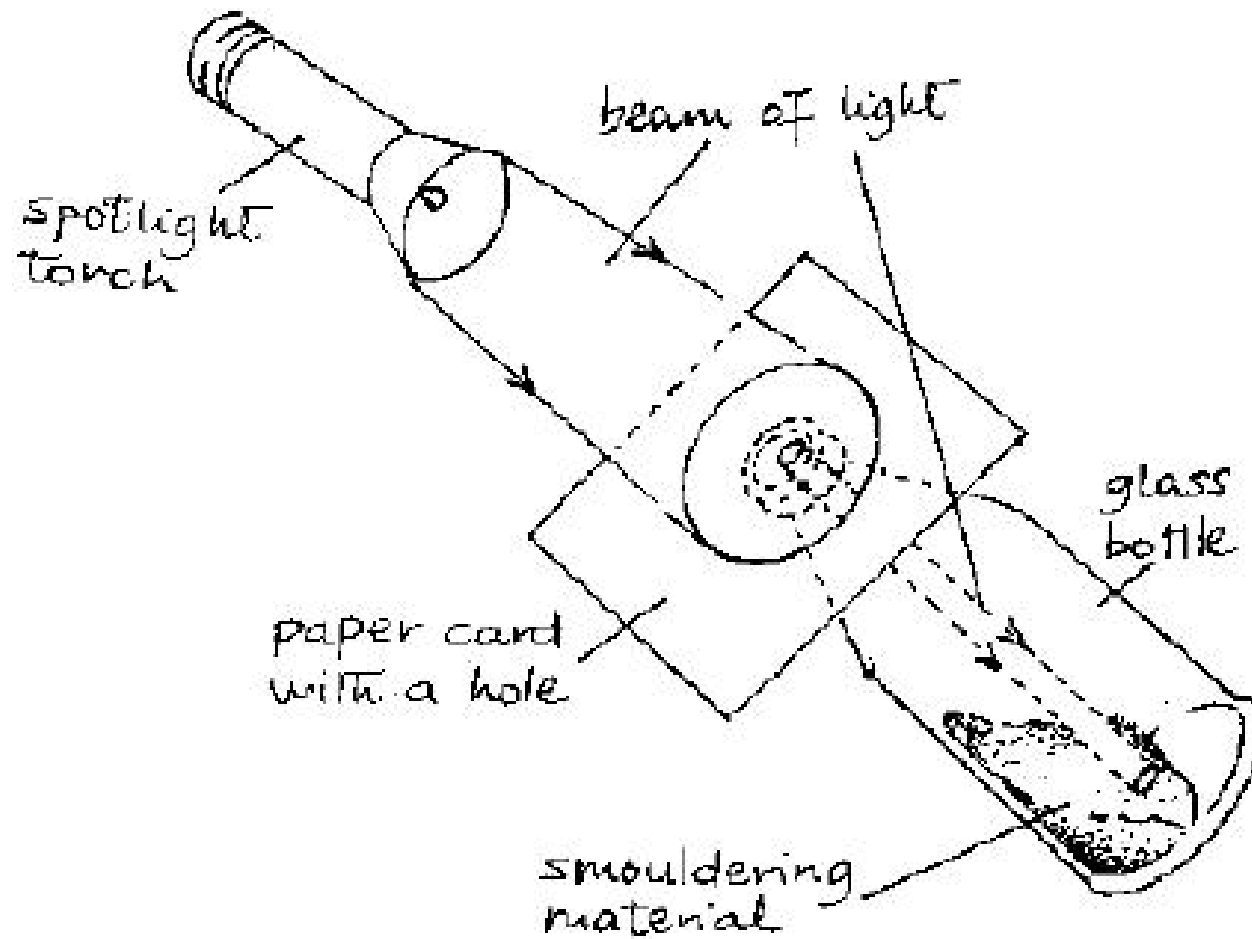

**P:** Make a smoke box using a glass bottle and some smouldering material e.g. damp paper, cotton wool etc., as shown in the figure.

Produce parallel and divergent beams of light by using small and larger holes in the papercard covering the mouth of the bottle. In a dusty room, parallel, convergent and divergent beams of light can be visible when the floor is swept.

Sunlight or torchlight may be used as a source of light.

**Q:** How is it possible for smoke or dust to make beams of light visible? Why are sunlight rays parallel?

**E:** The smoke particles reflect some of the light in all directions and hence make it visible.

Sunlight rays are parallel when they reach the earth, because the earth is 150 million km away from the sun.

### 7.1.7 Beams of Light

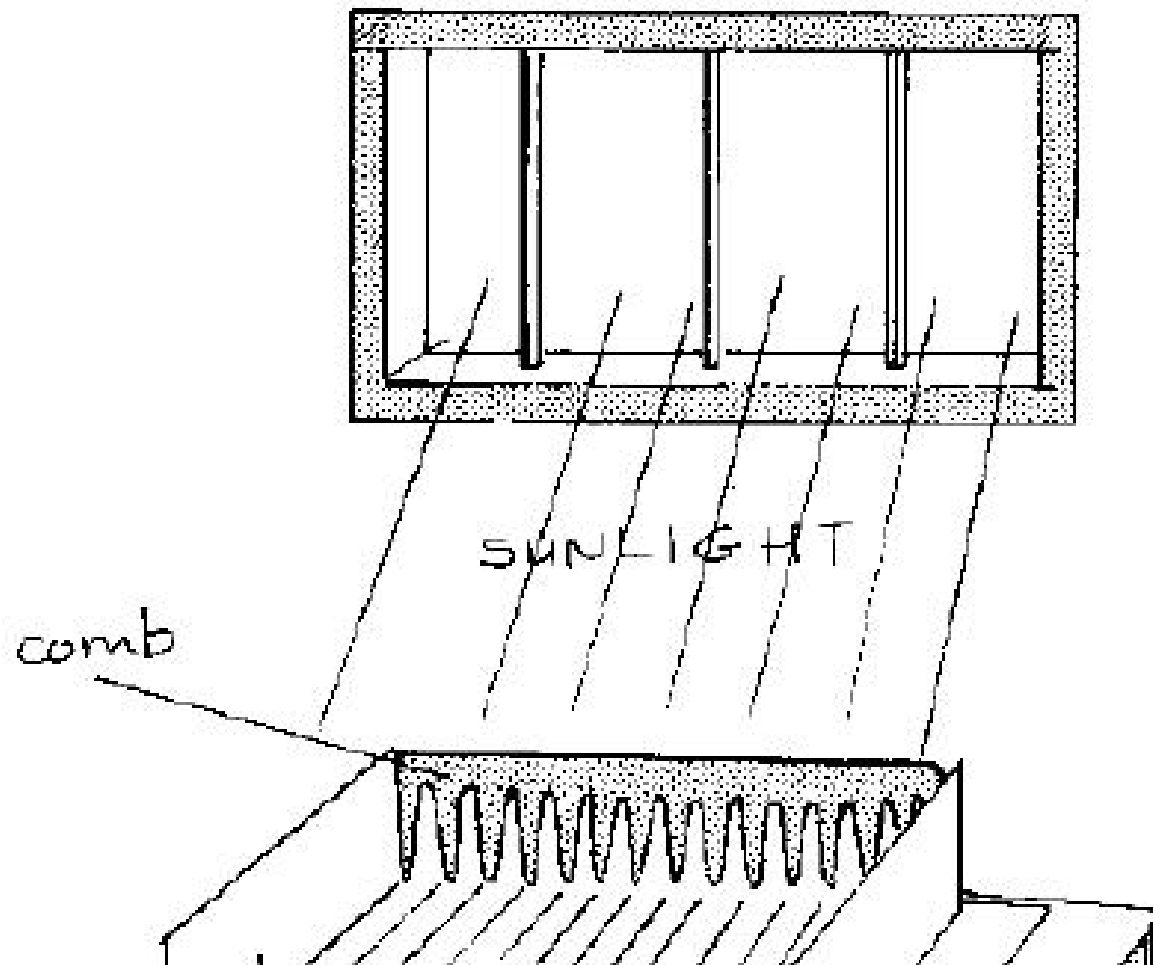

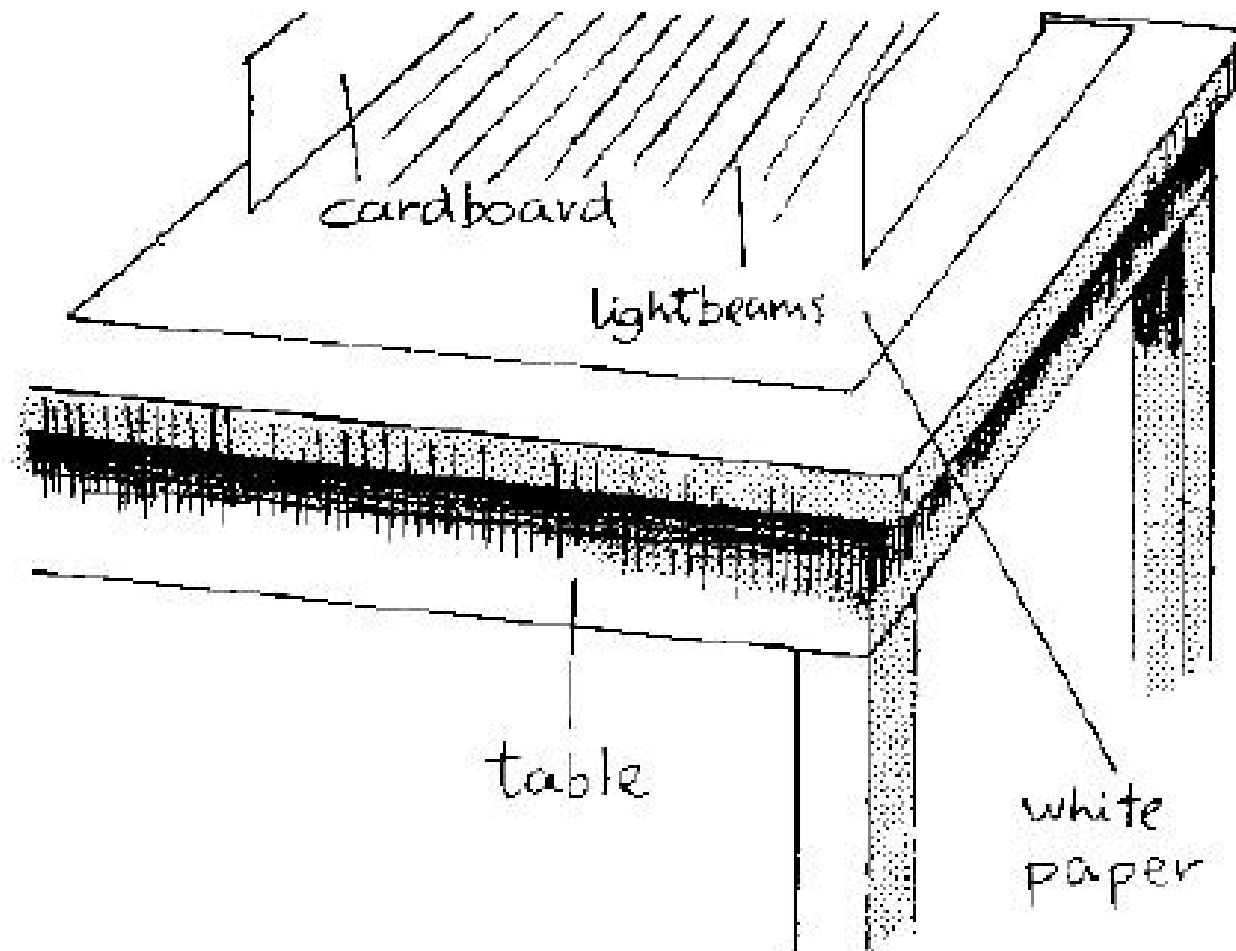

**P:** Hold a comb on a white paper placed on a table. Place pieces of cardboards by the sides of the comb (see diagram).

**Q:** What do you observe on this white paper? Explain.

Trace the beams of light which become visible on the white paper. Explain what is meant by the words "rays" and beam of light.

E: A ray is the direction of the path taken by light. A collection of rays forms a *beam*.

Since the sunlight consists of parallel rays, *parallel* beams of light will be observed on the white paper.

### 7.1.8 Shadow Formation by Point and Extended Sources of Light

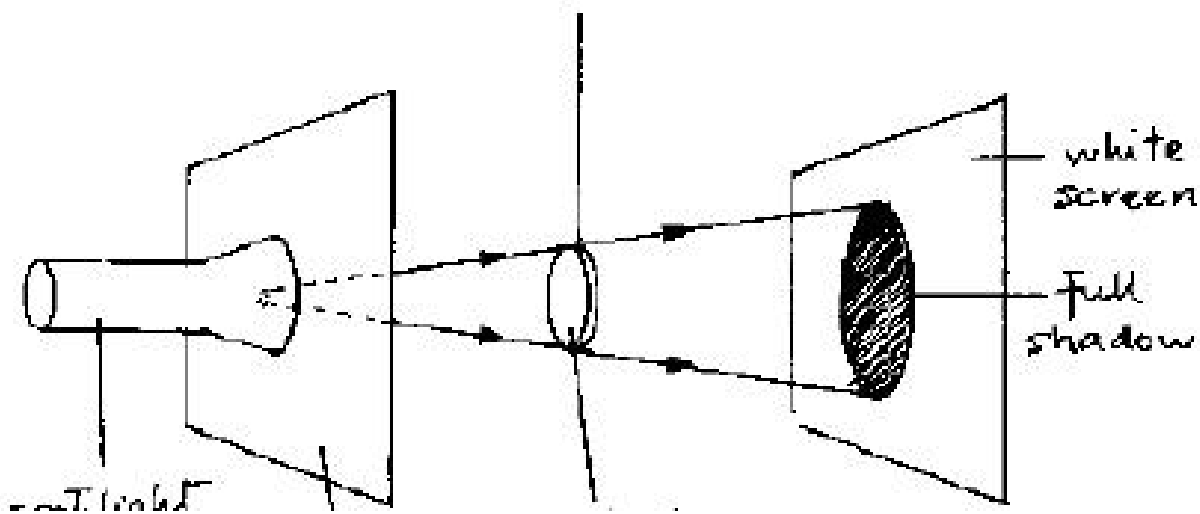
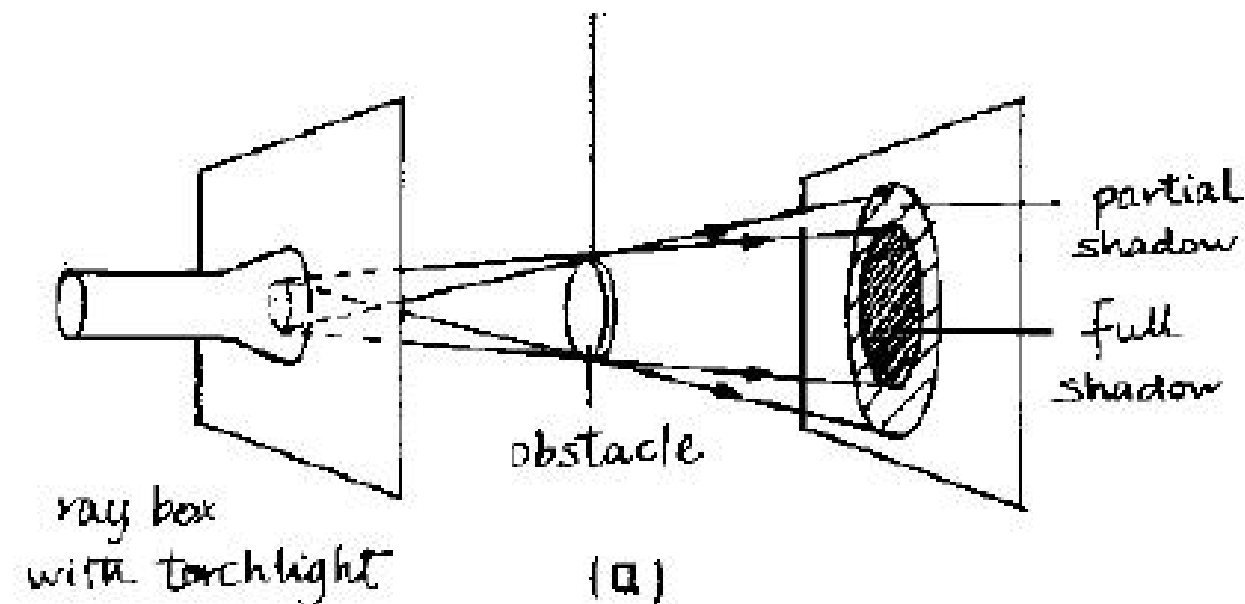

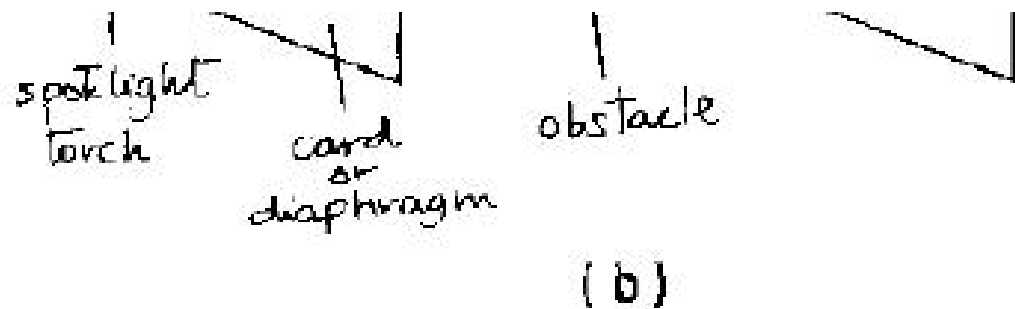

**P:** Place a torch light behind a cardboard with a hole in it. The assembly is called a *ray box*. Observe the shadow formed by an obstacle placed in the light from a ray box with a large hole (see fig. a).

Change the hole of the ray box to a very small size and note the shadow formed by the same obstacle on the same screen (see fig. b).

Repeat the above experiments with sunlight.

**Q:** In which case do you get

- (i) full and partial shadow?
- (ii) full shadow only?
- (iii) Sharper shadows?

Explain why the shadows formed by sunlight are not typical of your results in these experiments.

What do these experiments suggest about the way light travels?

**E:** All the experiments give evidence that light travels in straight lines.

Single *extended light sources* give partial and full shadows.

Single *point sources* give mainly full shadows. Sharper shadows are obtained when an obstacle intercepts parallel rays, i.e. rays from a distant source. Though the sun is an extended source, its rays reach the earth parallel and therefore produce sharp shadows.

## 7.2 Reflection of Light

When light strikes a surface separating two different media, part of it is thrown back to the original medium. This phenomenon is called *reflection*.

If the surface is smooth, reflection is regular, otherwise it is diffuse. The position of the object determines the position and attribute of the image.

The *law of reflection* states:

The *angle of incidence is always equal to the angle of reflection*. These angles are always measured *against the normal* of the reflecting surface.

This is sufficient to construct *ray diagrams* for plane mirrors. For *spherical mirrors* the following rules are helpful for the construction of ray diagrams:

- (i) *Rays parallel to the axis are always reflected through the principal focus F.*
- (ii) *Rays passing through C (the centre of curvature of the mirror) are reflected back along their own path.*
- (iii) *Rays passing through the principal focus F are reflected parallel.* (Reverse light path of (i).)

The distance of F from the mirror surface is called the *focal length*  $f$ . For spherical mirrors the *radius of curvature*  $r$  is always equal to  $2f$ :  $r = 2f$ .

The distance of F from the mirror surface is called the *focal length*  $f$ . For spherical mirrors the *radius of curvature*  $r$  is always equal to  $2f$ :  $r = 2f$ .

### 7.2.1 The Kaleidoscope (Inclined Mirrors)

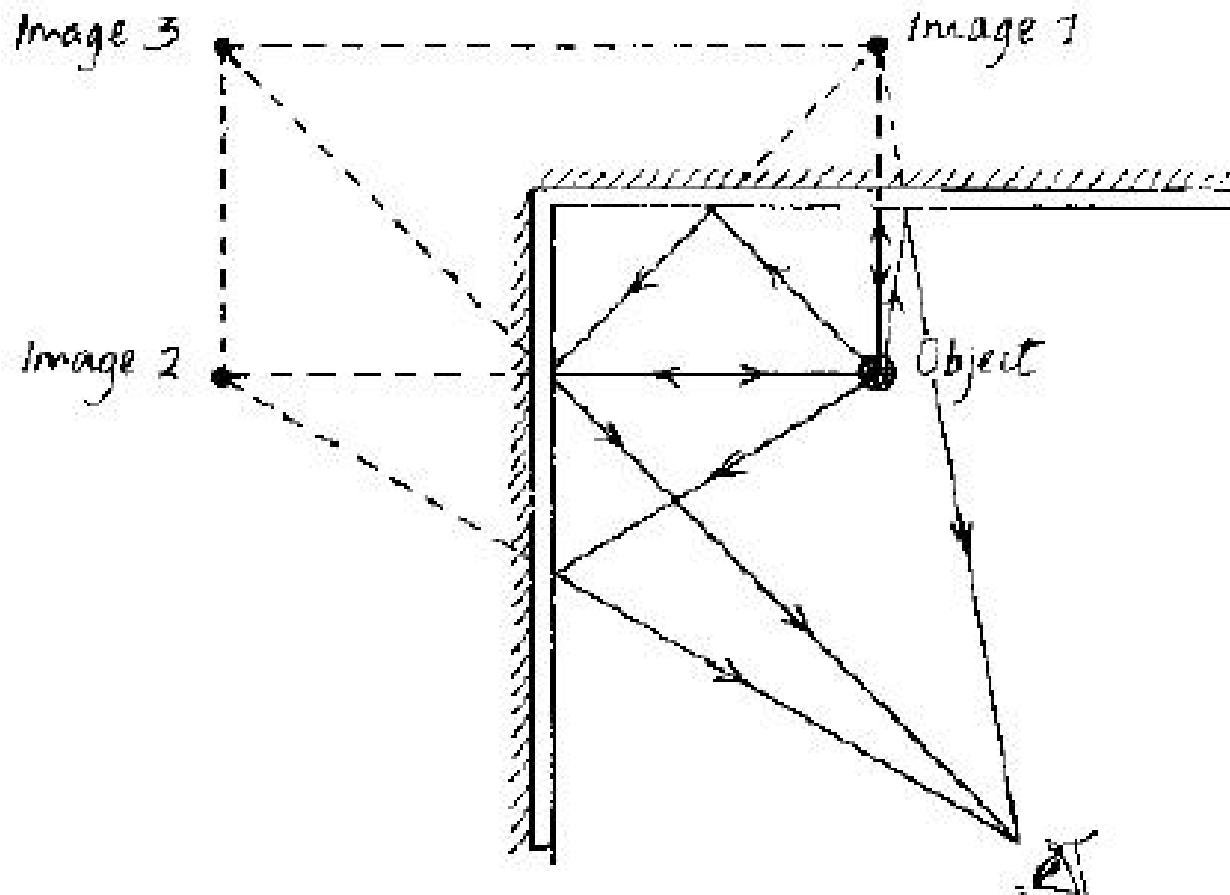

P: Arrange two plane mirrors to meet each other at right angles as shown. Confirm that three images of one object (candle) can be seen simultaneously. Refer to figure.



Repeat the experiment with mirrors at angles of  $60^\circ$  and  $30^\circ$  to each other.

**Q:** How many images can be seen in each case?

**O:** When mirrors are at  $60^\circ$  to each other, five images are seen, at  $30^\circ$  eleven images are observed. When the mirrors are parallel to each other, there is a large number of images.

**H:** Note that the number of images =  $(360^\circ \div \text{angle between the mirrors}) - 1$

**A:** The kaleidoscope arrangement is used in shops and pavillions to display items.

### 7.2.2 The Focus of a Concave Spherical Mirror

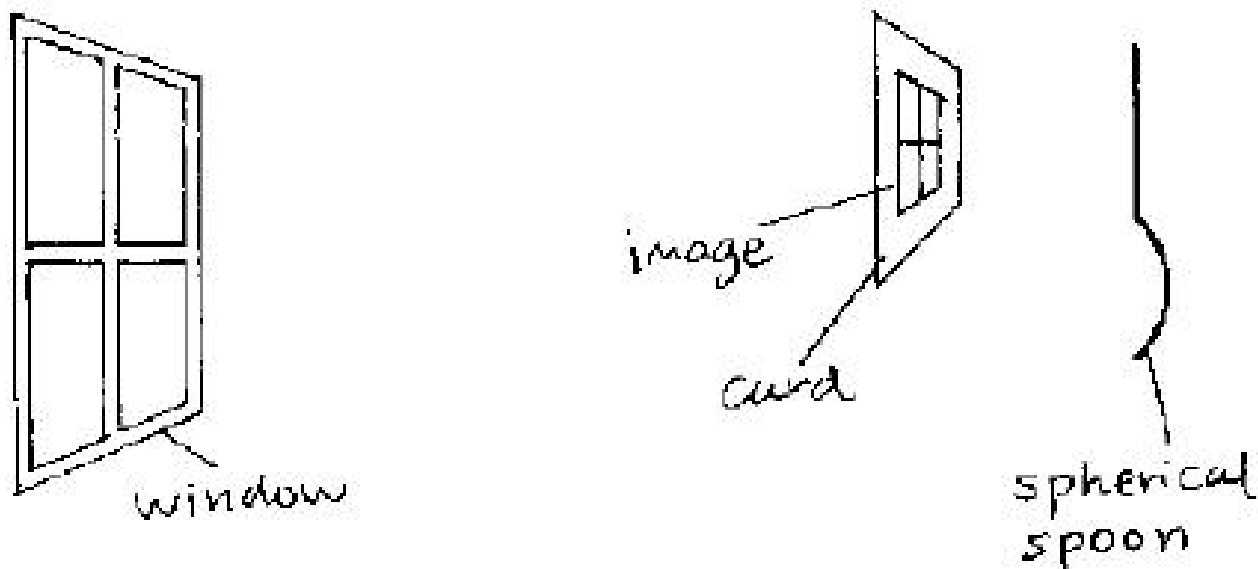

**P:** A simple concave mirror is the face of a shiny spherical spoon. Hold the curved mirror and a white card in front of the mirror as shown in the figure. Point it towards a distant window, so that it throws the image of the window on the white card. Move the mirror back and forth to find a position where it gives you a clear image on the white card. Note the image distance (the distance from the mirror to the card).

**Q:** Measure the distance for this experiment. Compare the same number from the distant window. What does the

on the white card. Note the image distance (the distance from the mirror to the card).

**Q:** Draw a ray diagram for this experiment. How are the rays coming from the distant window? What does the image distance give in this case?

**E:** Since the window is distant, its rays meet the mirror parallel. Hence, they are reflected through F. Thus, the image distance recorded give  $f$ , the focal length of the mirror.

### 7.2.3 The Radius of Curvature of a Concave Spherical Mirror

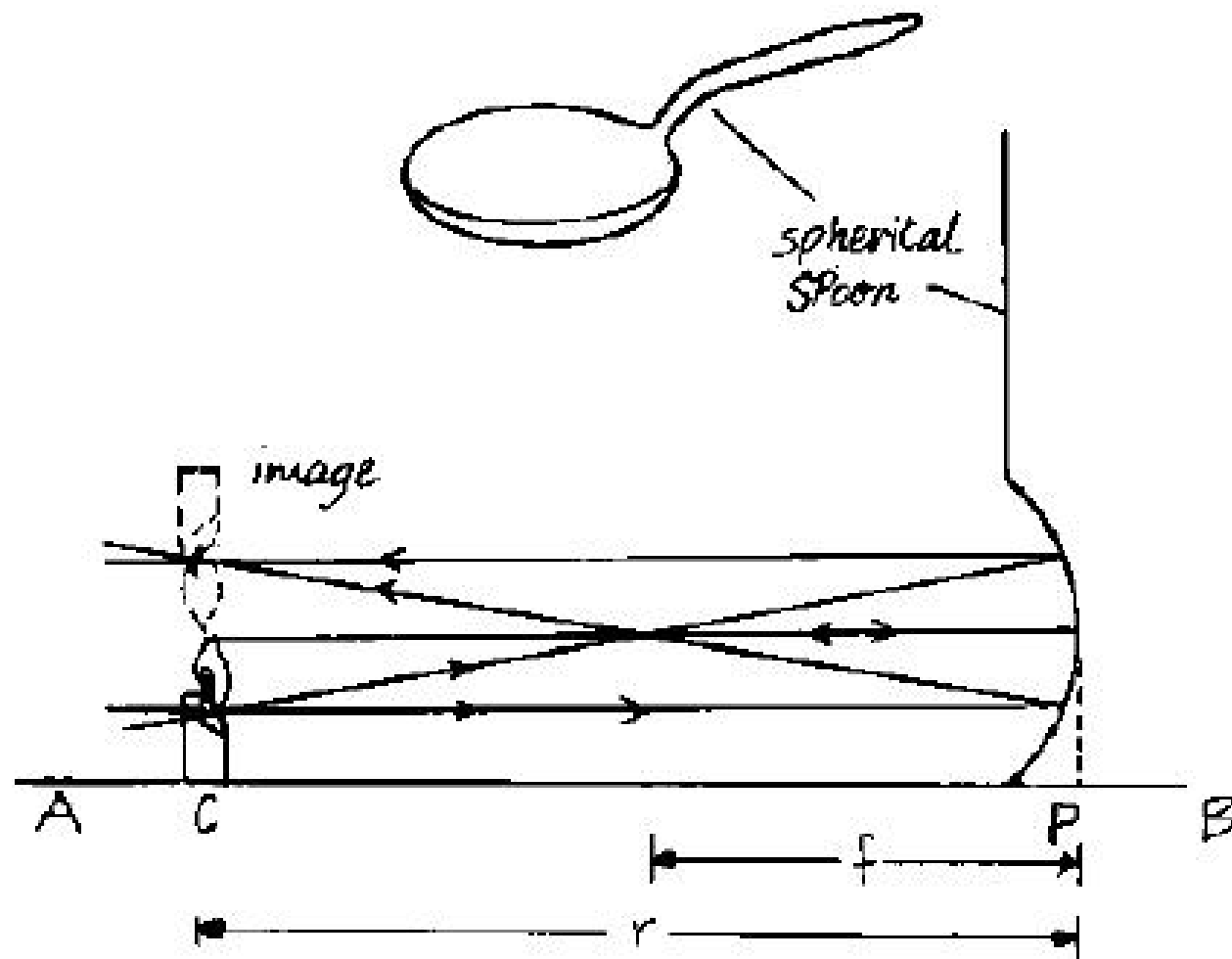

**P:** Draw a line AB on a white sheet of paper. Place a concave mirror on the paper with its centre vertical above point P. Light a candle and place it in front of the mirror on line AB, see in the figure.

Move the candle back and forth along line AB to get a point C on AB, where the inverted image of the candle coincides with the object candle. Point C is a *point of no parallax* because when you move your head slightly to the left or right, the object and image remain inseparable.

**Q:** Measure the radius of curvature  $CP = r$ . Compare your values of  $f$  and  $r$ . What do you find out?

**Q:** Measure the radius of curvature  $CP = r$ . Compare your values of  $f$  and  $r$ . What do you find out?

Draw ray diagrams to show how the mirror forms images of an object placed at different positions. How would the mirror work best as a shaving mirror?

**E:** The ray diagram shows that  $C$  is the centre of curvature and hence  $r = 2f$ .

Ray diagrams show that (i) the *concave mirror* produces a real, inverse and magnified image, if the object is farther away than  $F$  from the mirror.

(ii) If the object is nearer to the mirror than  $F$ , the image appears to be behind the mirror and is hence virtual. However, it is erect and magnified. In the latter case the mirror works best as a shaving mirror.

**A:** Shaving mirror, dentist's mirror, floodlight (case (ii)); if the object (bulb) distance =  $f$ : torch, car headlight.

#### 7.2.4 Convex Spherical Mirror

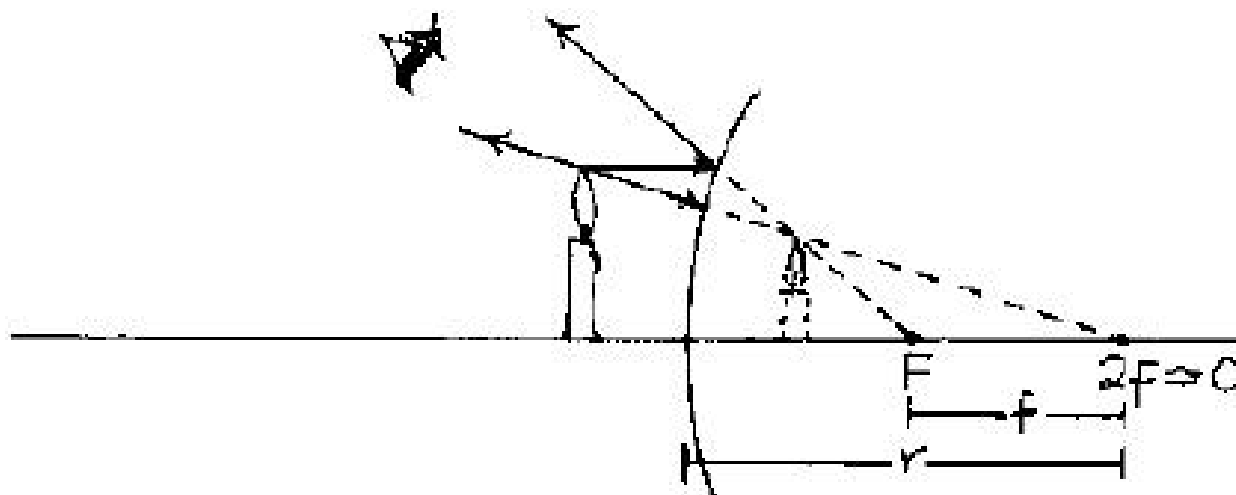

Arrange the back of a spherical spoon (a convex spherical mirror) and a lighted candle on a white sheet of paper. Locate the image formed by use of a needle or a lighted candle held behind the mirror. The image position is the point of no parallax (see 7.2.3) between the image and the locating needle or candle.

Mark the position of the object, the mirror and the image. Measure the object size, the object distance and the image distance.

Draw the ray diagram to show how the convex mirror forms an image (see the figure).

**E:** The image seen is always virtual, erect and reduced in size.

**A:** The convex spherical mirror is used as a rearview mirror in cars because it gives a broad field of view.

### 7.2.5 Candle in Water Experiment

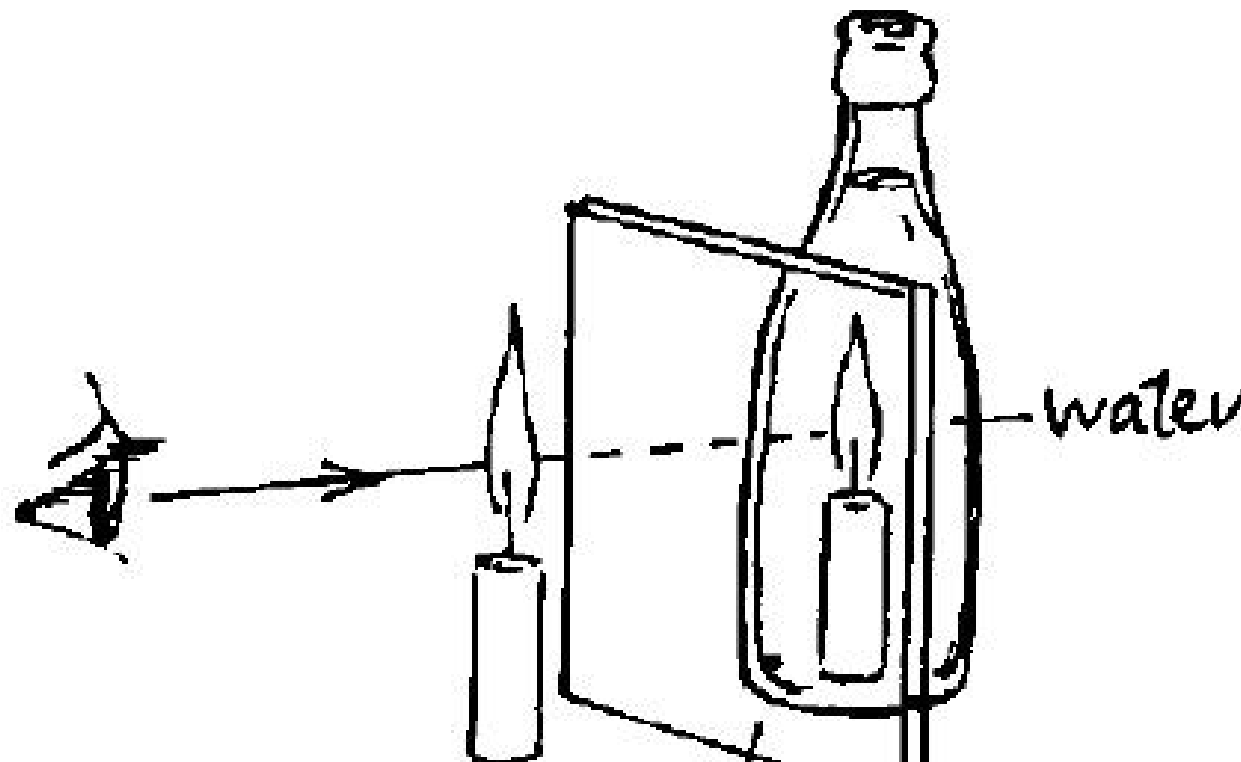



**P:** Place a transparent glass-pane mid-way between a lighted candle and bottle full of water. View the bottle through the glass-pane from the side of the candle.

**Q:** At what position do you see the image of the burning candle?

**O:** The candle appears to burn in the water in the bottle.

Explain this observation using a ray diagrams.

### 7.2.6 The Periscope

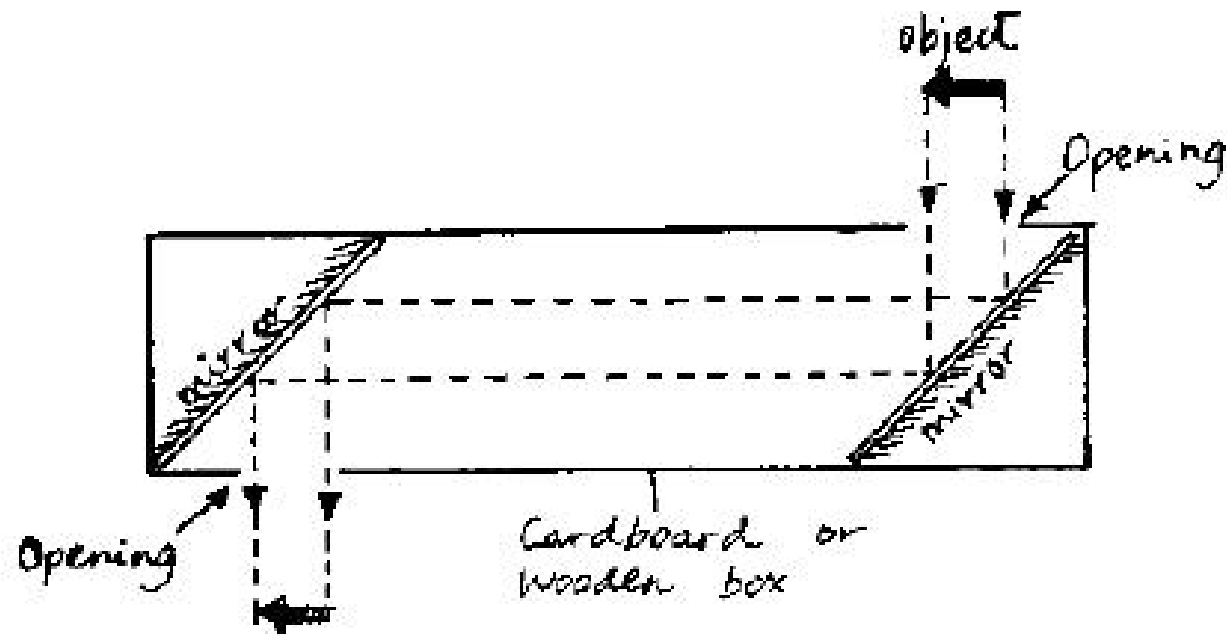

(a)

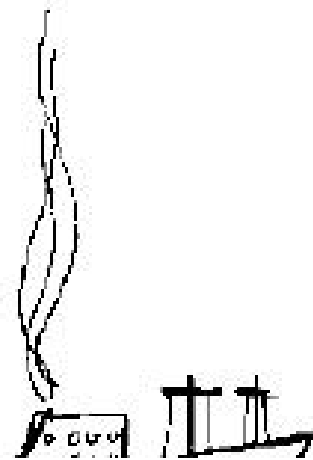

rays  
of light

Vertical  
Periscope.

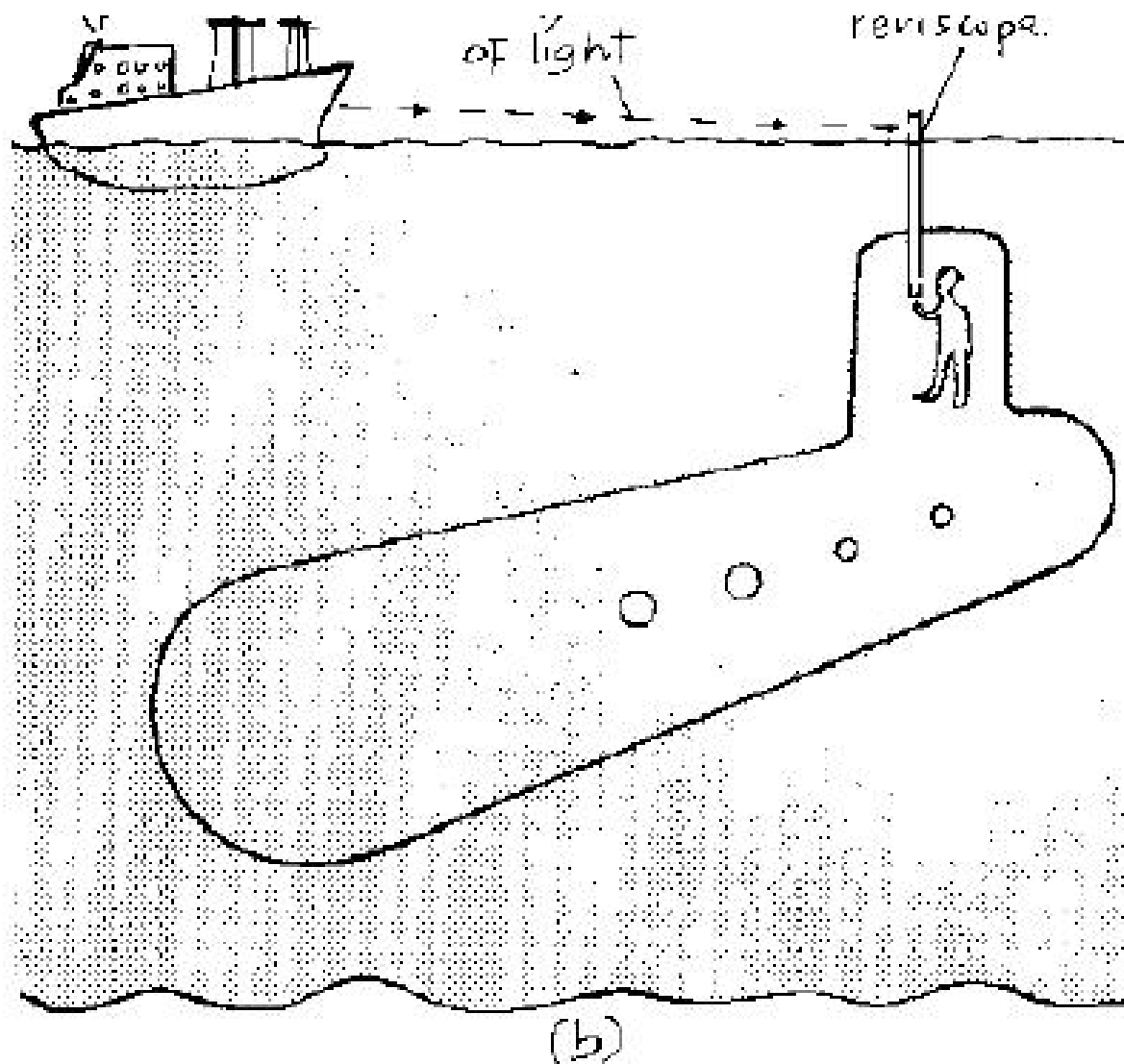

**P:** Arrange two mirrors in a rectangular box as shown in figure (a). This instrument is called a *periscope* and allows to observe objects behind corners.

**Q:** Observe objects placed behind obstacles.



How do they appear?

Write the word OPTICS on a paper and use it as an object. How does the image appear?

Compare your observations with experiment 7.2.7.

**A:** The periscope is used in dived submarines to see what is above the water surface, see figure (b).

### 7.2.7 Reversed Image

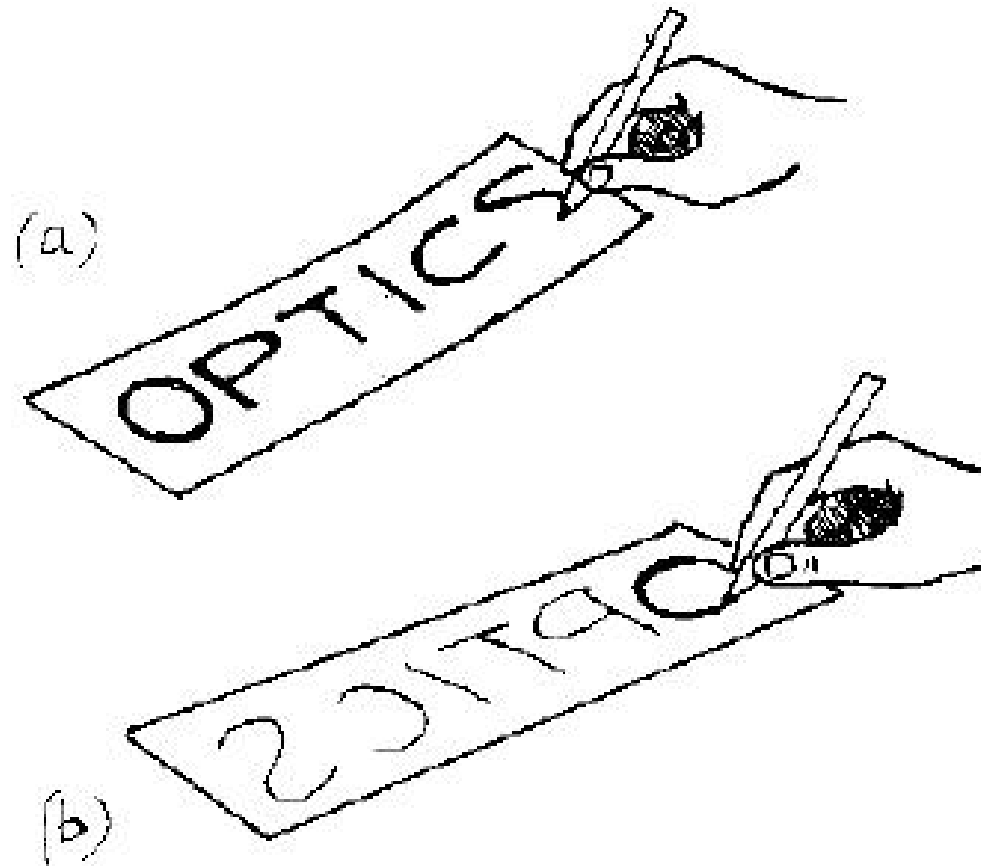

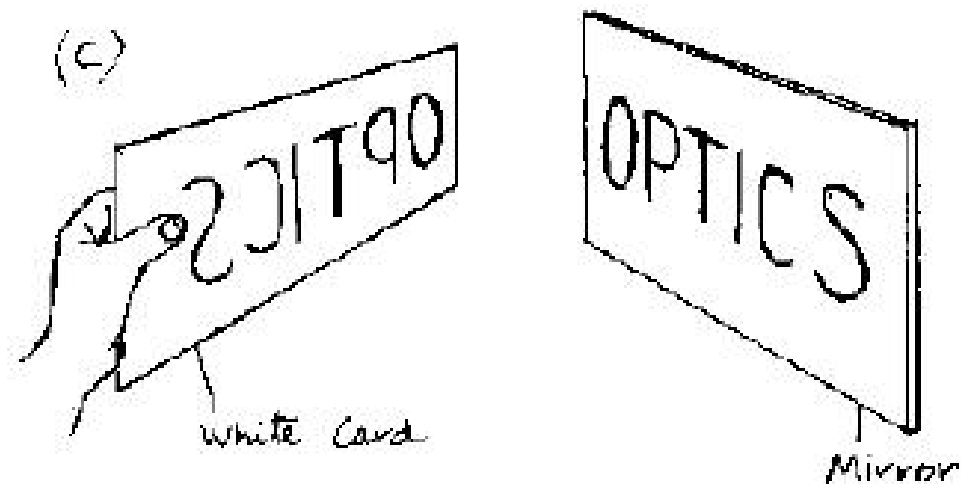

**P:** Write the word OPTICS on an ordinary piece of paper, see figure (a). Turn the piece of paper and retrace the faint word appearing on its back, see figure (b). You will obtain the *mirror-writing* of the word OPTICS. The latter is a reversed image of the former.

Place the piece of paper in front of a plane mirror (see figure (c)).

**Q:** What do you see? Repeat using the word at the back side of the paper. What do you see? Compare your

observations with those under section 7.2.6. What do you conclude about the mirror image?

E: Mirror images are reversed images, i.e. the left and right side of the object are interchanged.

### 7.3 Refraction of Light

*Refraction* is the change in direction of light as it passes from one medium into another of different density. Refraction is used in lenses to produce images in cameras, microscopes, telescopes, etc. *Total internal reflection* takes place on the boundary between an optically denser medium (e.g. glass) and an optically less dense medium (e.g. air), when the angle of incidence in the denser medium is greater than the *critical angle*.

#### 7.3.1 The Rising Coin

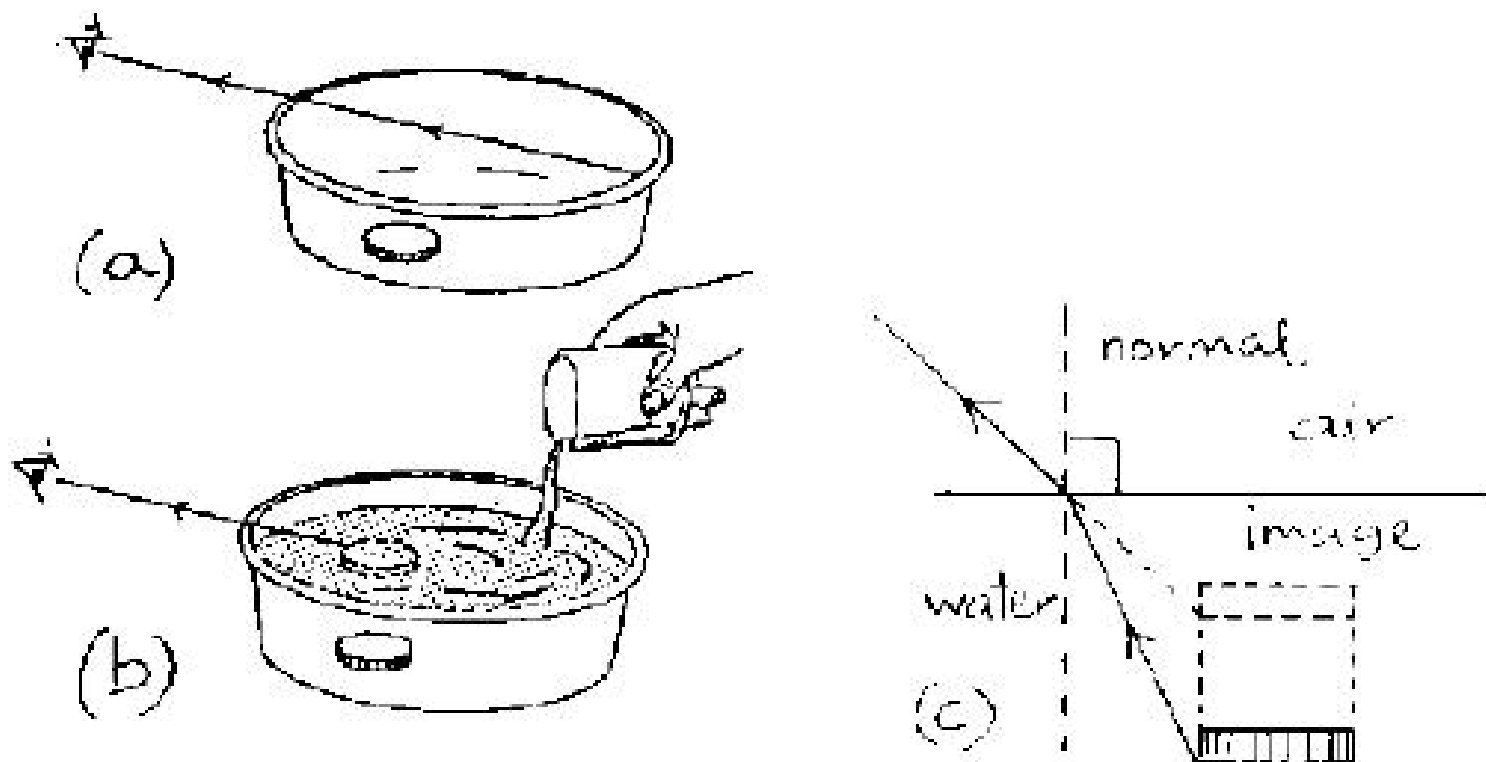



**P:** Put a coin in the lid of a jam jar.

Hold the lid up to almost level of your eye, until you just cannot see the coin in the bottom of the lid. Gently pour water in the lid to cover the coin completely. The coin will be visible to you again, see figures (a) and (b).

**Q:** Explain your observation with the use of a ray diagram.

**E:** The ray diagram of figure (c) shows that we can only see the coin because the light rays coming from it are deflected at the water surface away from the normal of the water surface.

**P:** Lower the lid and look at the water vertically from above

**Q:** Where does the coin appear now?

Explain the observation.

**O:** When viewed vertically from above the coin appears to be at the bottom of the lid. However, the bottom seems to have risen because of the refraction of those rays which reach the water surface under an angle of incidence different from  $0^\circ$ .

**P:** View the coin from different directions.

**Q:** How does its position seem to change?

**E:** When viewed at an angle from the vertical the coin appears to be raised above the bottom of the lid, therefore as the viewer changes position the coin's position also seems to change because of the refraction.

### 7.3.2 Total Internal Reflection

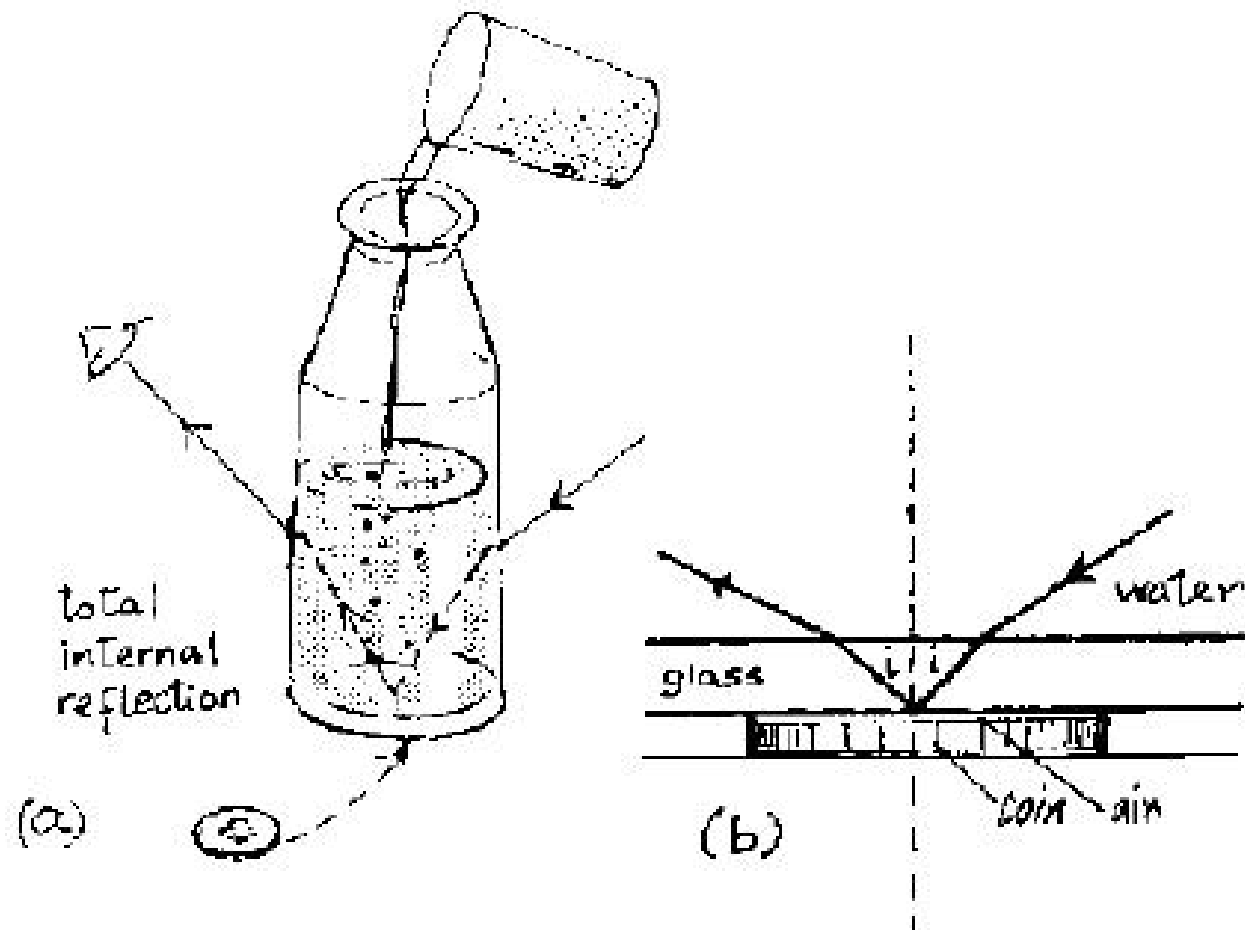

Place a transparent bottle on a coin and look at the coin from above at an angle from the normal. The coin can be seen. Pour water into the bottle slowly. There is a level at which, when you look at the coin, it disappears from sight, see figure (a).

This phenomenon is called *total internal reflection*. It is a special type of refraction. In our experiment, it takes place at the bottom of the bottle where the glass borders the air (above the coin). Total reflection only takes place on a boundary between an optically denser (e.g. glass) and an optically less dense medium (e.g. air) when the angle of incidence in the denser medium is greater than the *critical angle*. In our case the light rays

place on a boundary between an optically denser (e.g. glass) and an optically less dense medium (e.g. air) when the angle of incidence in the denser medium is greater than the *critical angle*. In our case the light rays coming from the right side into the glass of the bottom of the bottle are totally reflected and then coming to your eye, see figure (b). These rays are *not* refracted to the air outside the bottom of the bottle because their angle of incidence  $i$  is larger than the critical angle for a glass/air boundary which is  $42^\circ$ . These totally reflected rays are so strong that they completely cover the relatively weak rays coming from the coin. Hence, the coin cannot be seen any longer.

**A:** Prisms in binoculars, etc., see 7.3.6.

### 7.3.3 Bending a Pencil with Water

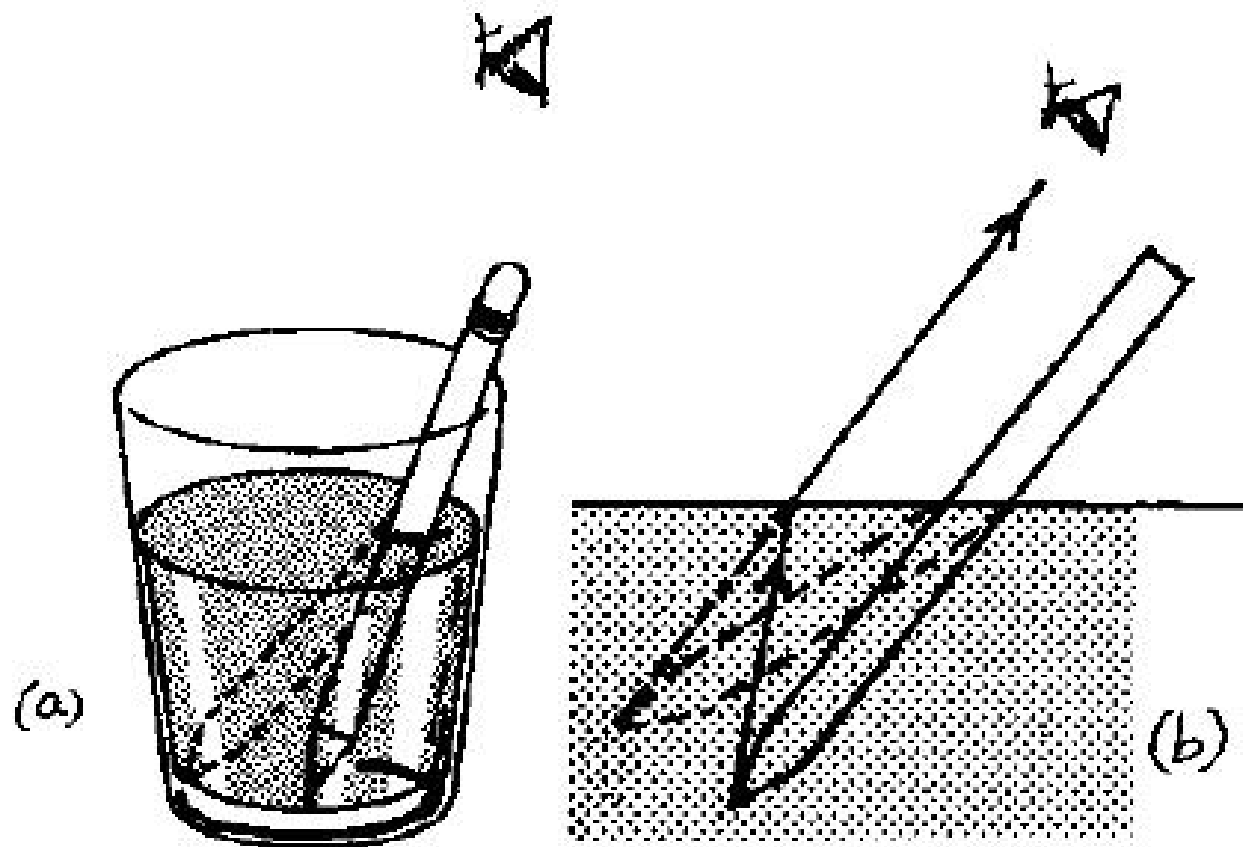

**P:** Pour water in a glass. Place a pencil in the water at a slant position, see figure (a). Look at the pencil through the surface of the water sidewise along its length and note what you see. Explain your observation by using a ray diagram.

**E:** Figure (b) gives the ray diagram which explains the observation that the pencil seems to be bent by refraction.

#### 7.3.4 The False Pin

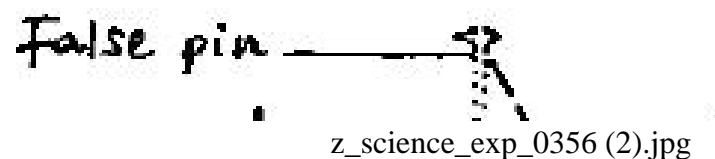

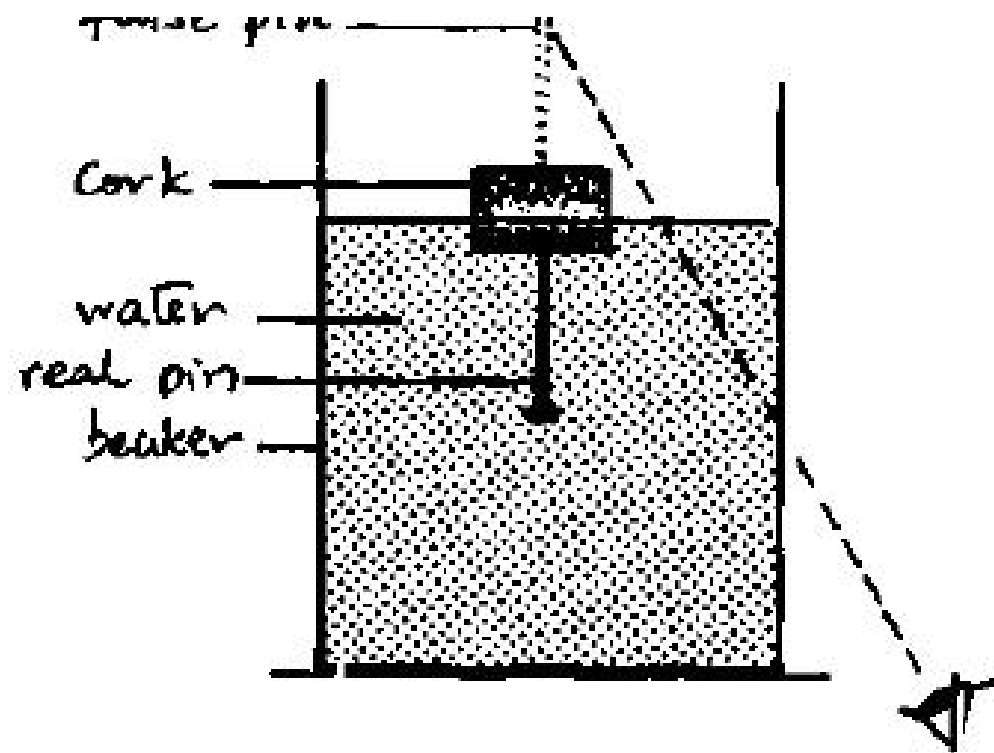

**P:** Stick a pin (office pin) into the underside of a small cork and allow it to float in a beaker full of water. Hold the beaker above your head and look up through the side of the beaker at an angle from the vertical.

**Q:** What do you see?

**O:** You will see the real pin below the cork and a fake pin above the cork.

### 7.3.5 Explaining the False Pin



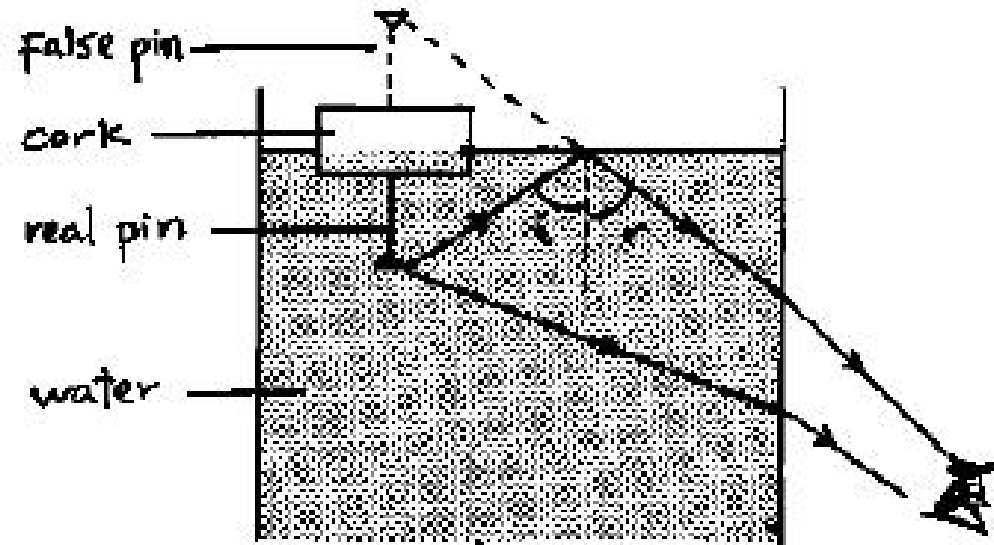

Draw a ray diagram and explain how the false pin appears on top of the cork.

**E:** Some rays from the pin towards the eye are refracted at the glass-air boundary making the pin visible to the eye.

Other rays from the pin undergo total internal reflection at the water-air boundary. The reflected rays are refracted at the glass-air boundary before they reach the eye. Hence the eye sees a virtual image of the pin on top of the cork as shown in the figure.

Hence both the real pin and the false pin can be seen by the observer.

### 7.3.6 Total Internal Reflection in Prisms

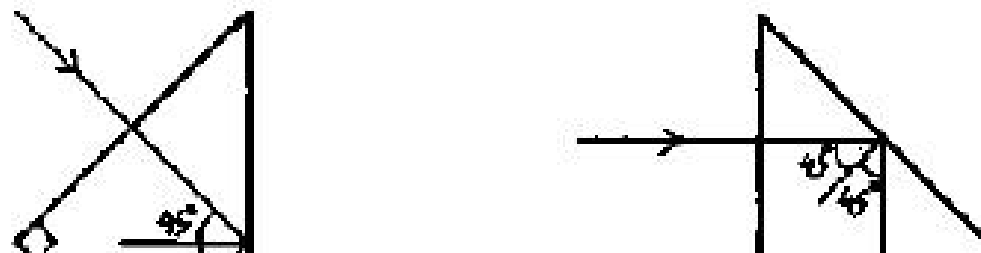

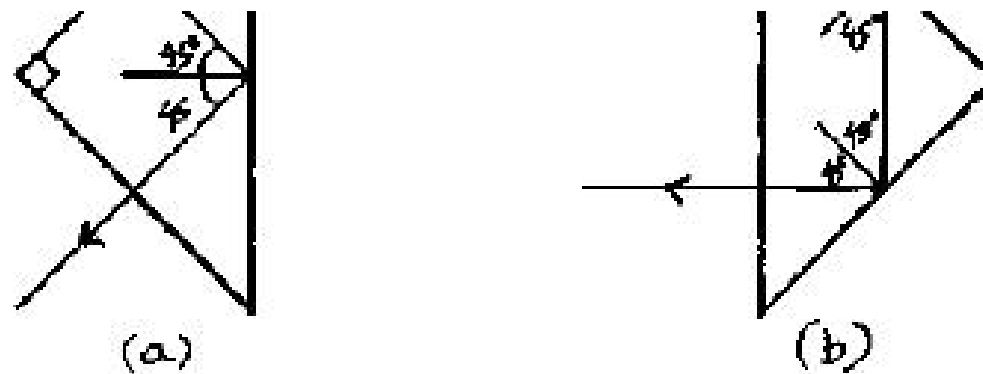

**P:** Total internal reflection occurs when light falls on a glass prism with angles of  $45^\circ$ ,  $45^\circ$  and  $90^\circ$ . This is because a ray falling normally on any face of such a prism hits the inside face at  $45^\circ$ , and this is greater than the critical angle of glass/air (about  $42^\circ$ ). In figure (a) the ray is turned through  $90^\circ$  and in figure (b) through  $180^\circ$ .

**A:** Totally reflecting prisms are used in periscopes (instead of mirrors) and in binoculars.

## 7.4 Lenses and Optical Instruments

Any transparent material bounded by at least one curved surface acts as a lens. Common examples of lenses are made of glass. By their action on rays of light lenses can be put into two groups: the converging and the diverging lenses. A *converging (convex) lens* is thickest at its centre whereas this is where the *diverging (concave) lens* is thinnest. The action of a lens is due to the refraction of the rays on its curved boundaries. For the construction of *ray diagrams* for *thin* lenses the following rules are helpful:

*For both types of lenses: rays passing through the centre of the lens travel straight on, see figure (a).*

For convex (converging) lenses: rays parallel to the axis are refracted through the principal focus F, see figure (b).

For concave (diverging) lenses: rays parallel to the axis are refracted away from the nearer principal focus F, see figure (c).

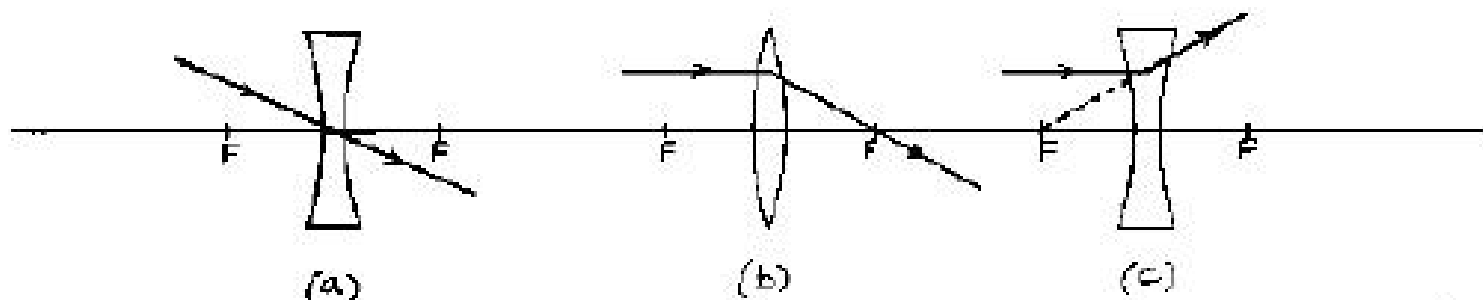

#### 7.4.1 Action of a Convex Lens on Parallel Rays

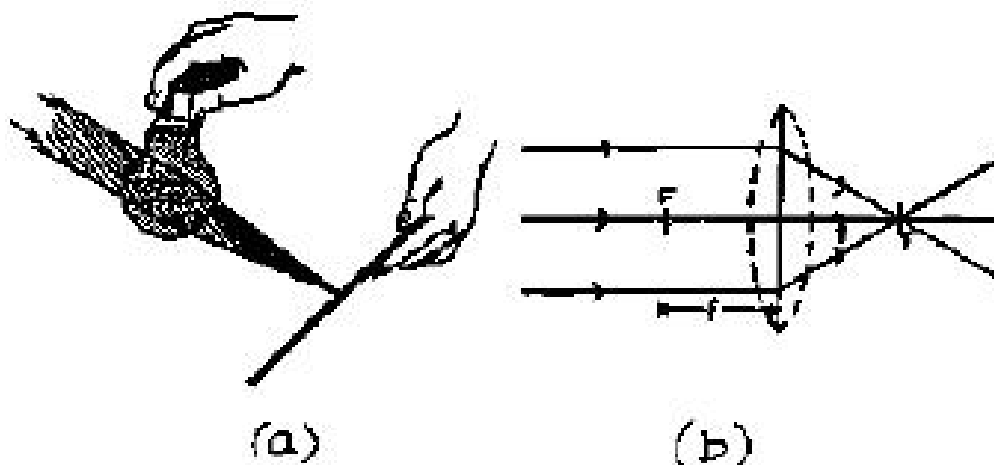

**P:** Hold a water filled opened bulb (see appendix) or a concave lens into the direct sunlight and focus the light on one spot of a paper.

**E:** The distance between the centre of the bulb or lens and that spot on the paper is called the *focal length*  $f$ . We can draw a ray diagram for this experiment, see figure (b). The focal points are denoted as F. The action

**E:** The distance between the centre of the bulb or lens and that spot on the paper is called the *focal length*  $f$ . We can draw a ray diagram for this experiment, see figure (b). The focal points are denoted as  $F$ . The action of the lens or bulb on the rays is explained by refraction of the rays on its curved surfaces.

**H:** The bulb is *not* a *thin* lens. Hence the focus is not as sharp as with a thin lens.

#### 7.4.2 Action of a Concave Lens on Parallel Rays

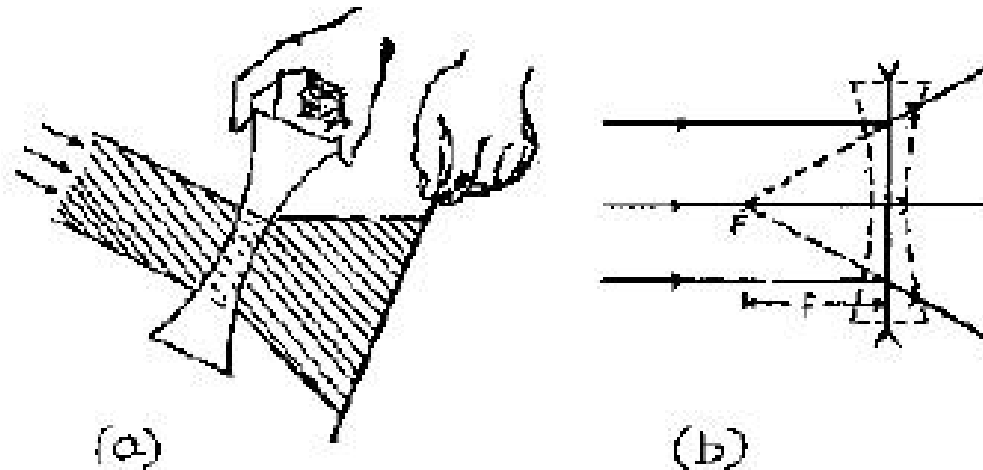

**P:** Try to repeat experiment 7.4.1 using a concave lens. If that is not available, the base of a soda bottle or a thin film of water on a wire loop also can serve as a concave lens.

**Q:** What do you observe? Do you find a focal point?

**O:** No focal point can be found.

**E:** This lens *diverges* the light and hence no real focus exists.

However, the ray diagram (see fig. b) shows that a *virtual* focal point can be found on the same side of the lens on which the light source is.

### 7.4.3 How to Construct a Simple Box Camera

(a)

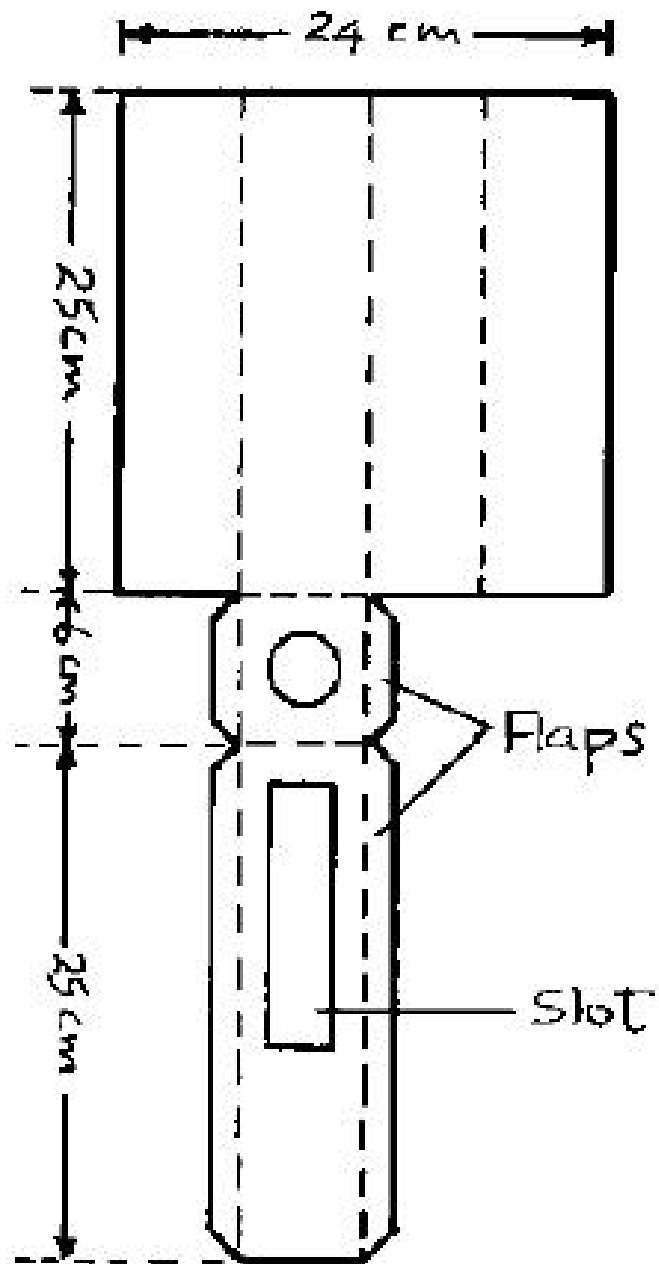

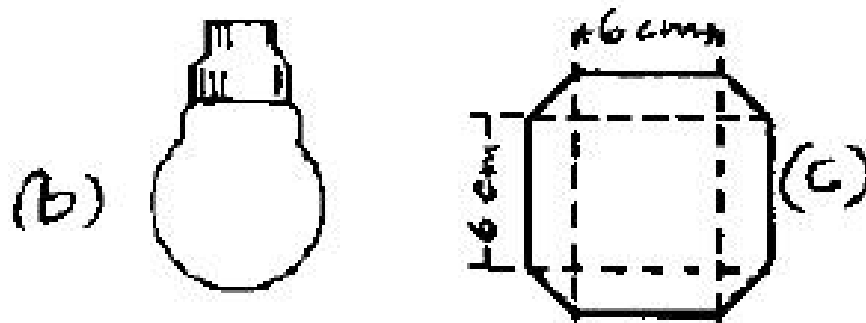

**P:** (i) Cut a piece of manila sheet according to the plan of a rectangular box in figure (a).

(ii) Open the bulb seal of a transparent used up electric bulb and remove the filament. Then fill it with water to make the water lens (see appendix).

(iii) Fold the manila sheet cutting (figure (a)) along the dotted lines. Fit the water lens on the slot and close the box by gluing the flaps.

(iv) Cover the open end with a piece of plain paper or (better) parchment paper as a screen using glue (see figure c).

(v) Close the slot using a sliding manila sheet cover, having dimensions of 6 cm by 30 cm with a hole to fit the bulb at its centre.

H: Make sure that the box is light-tight (light-proof).

#### 7.4.4 Using the Simple Box Camera

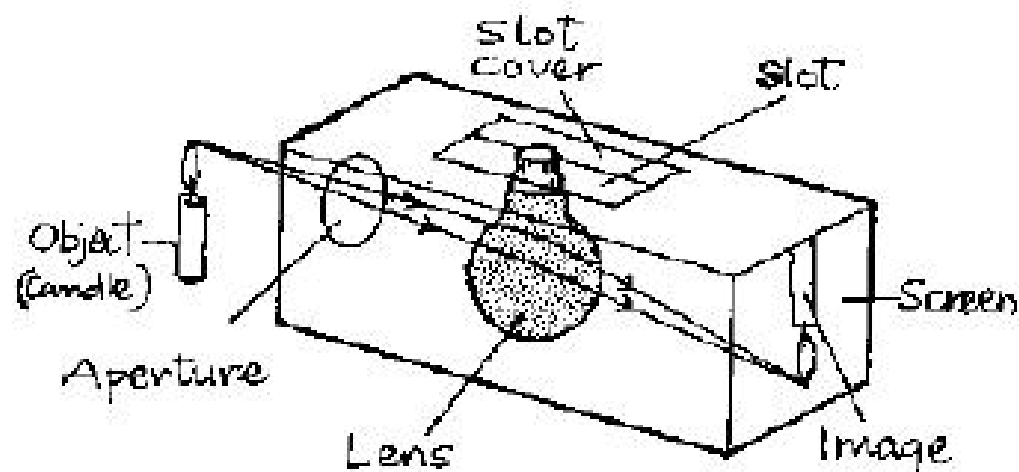

P: Use the simple box camera to produce images of illuminated objects like a candle, a window etc. Change the position of the lens (bulb) so that you obtain a sharp image on the screen.

(i) Find the focal length  $f$  of the lens (bulb) by focussing a distant object (e.g. a distant window) on the screen. Then the image distance  $v$  is equal to  $f$ . Measure the image distance  $v$  on top of the camera from the centre of the bulbs neck to the screen.

(ii) Choose a large object distance  $u$  of a lit candle (the distance between the centre of the lense (bulb neck) and the candle) and adjust the lens so that you obtain a sharp image on the screen.

(iii) Now decrease the object distance by moving the camera towards the object and adjust the image distance each time.

(iv) Note  $u$  and  $v$  at which the image size becomes larger than the object size.

Q: Why is  $v = f$  in case (i)? How is the image distance  $v$  in each case? How is the size of the image (e.g. of the candle flame) as compared with the size of the object in each case? What kind of image do you obtain?

**Q:** Why is  $v = f$  in case (i)? How is the image distance  $v$  in each case? How is the size of the image (e.g. of the candle flame) as compared with the size of the object in each case? What kind of image do you obtain?

**E:** (i)  $v = f$  because the rays coming from a distant object are parallel.

(ii), (iii) The size of the image grows larger as the object distance  $u$  decreases. First the image size is smaller than the object size. When  $u = 2f$ , then the image size is equal to the object size. All images are *real* because they appear on a *screen*.

(iv) When  $2f > u > f$ , then the image size is larger than the object size. When  $u < f$ , no *real* image can be observed.

**H:** The bulb is no thin lens hence the image will not be as sharp as with a thin lens which may be obtained from TAN OPTICS, P.O.B. 1929 Moshi, Tanzania.

**A:** (iii) Photographic cameras, (iv) projectors for movies and slides.

#### 7.4.5 Ray Diagrams for the Box Camera



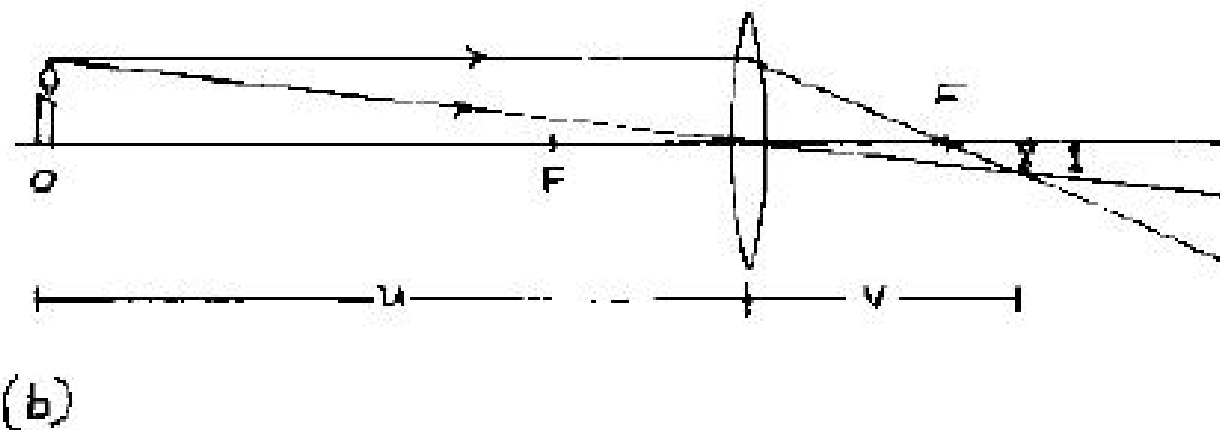
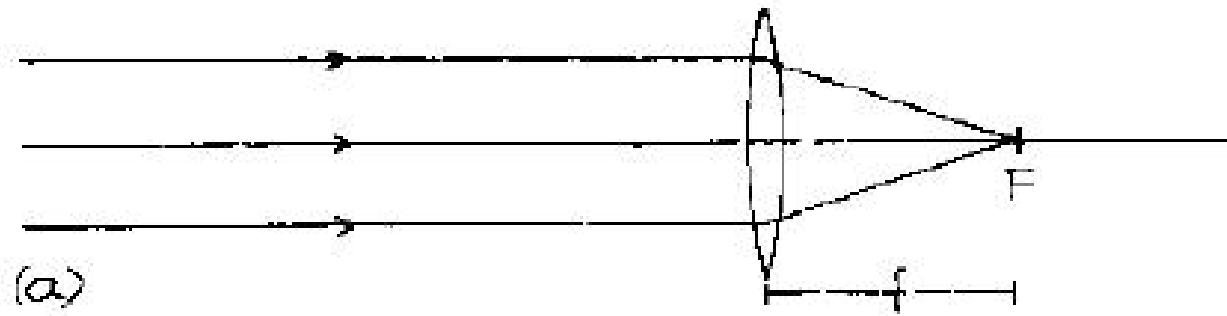

**P:** Ask the students to draw ray diagrams using thin converging (convex) lenses for the cases (i) to (iv) of experiment 7.4.4.

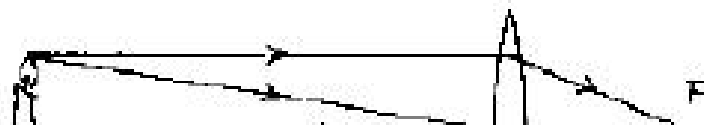

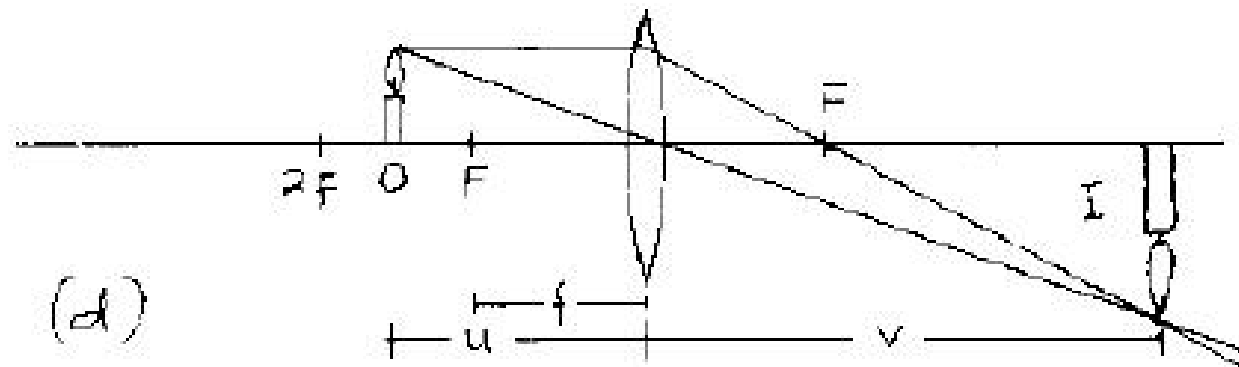
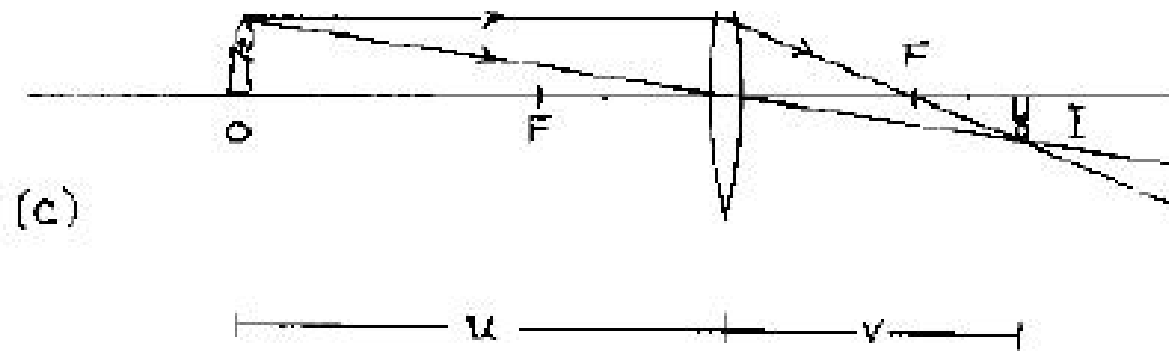

E: See figures (a) to (d) which correspond to the cases (i) to (iv) of experiment 7.4.4.

### 7.4.6 Magnification

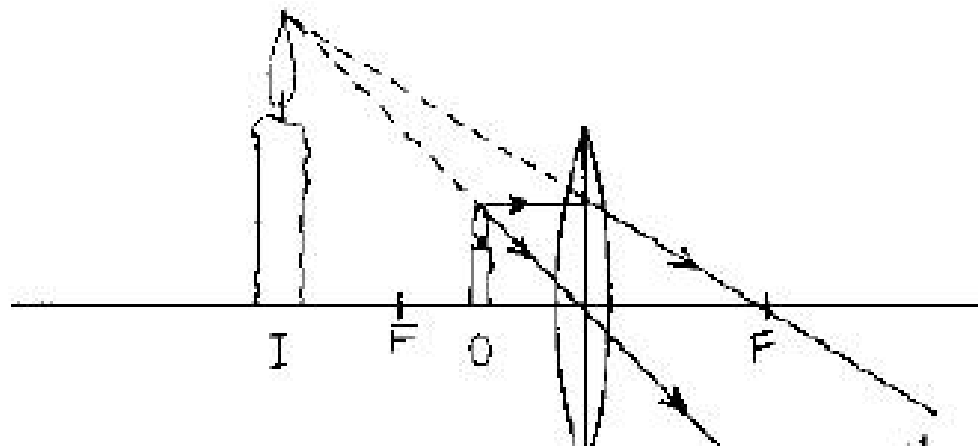
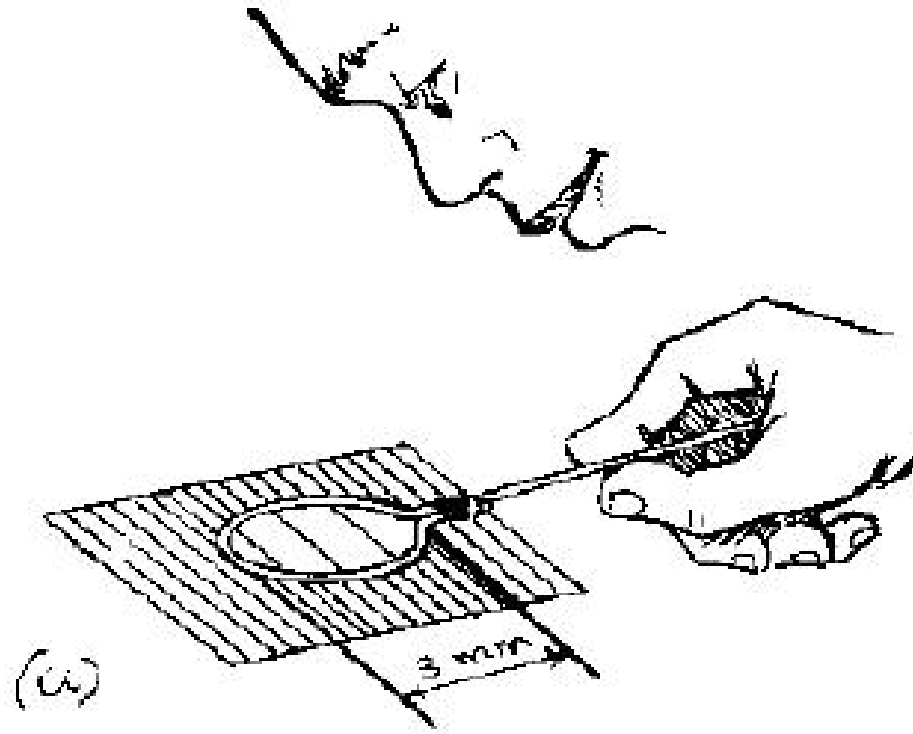

(b)

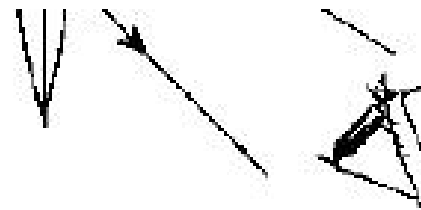

**P:** Produce a magnifying glass by making a loop as shown in figure (a) using paper clip wire (e.g. winding it around the tip of a ball point pen). Dip this loop in water and use it as a magnifying glass by observing letters in a book etc. Thus, this water drop lens acts as a convex lens.

**Q:** Explain the magnification by drawing a ray diagram. What kind of image is formed?

**E:** See fig. (b), the image is larger than the object. However, this image is *virtual* because it cannot be obtained on a screen. In a virtual image the light rays do not meet really in the image point. They only seem to meet there because the eye and brain of the observer are accustomed to assume that the light rays travel in straight lines only. Yet the real rays were refracted by the lens which causes the image to appear in the eye of the observer. The object distance  $u$  must be less than  $f$ :  $u < f$ .

**H:** A bulb filled with water can also be used.

**A:** Magnifying glass, eye lens of compound microscopes, telescopes etc.

#### 7.4.7 Simple Microscope

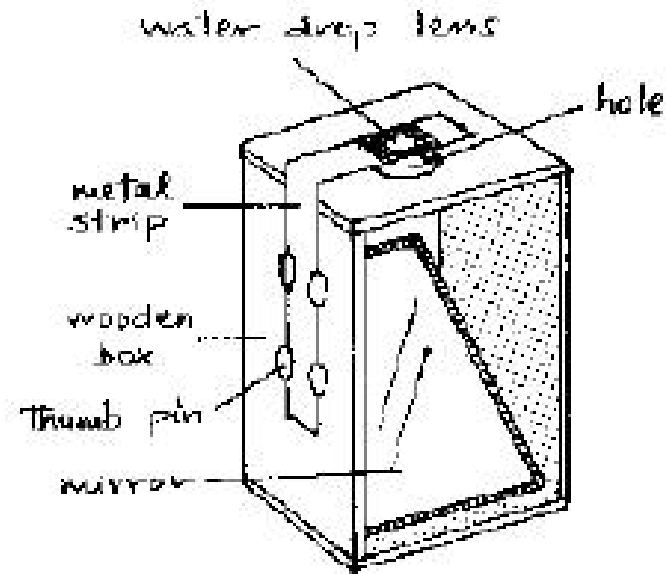

(a)

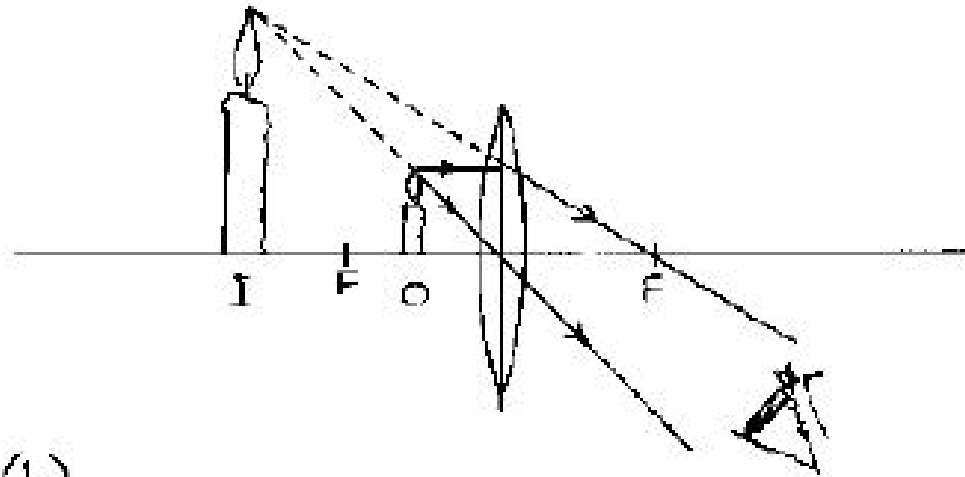

(b)

**P:** Produce a simple microscope according to the above figure. Adjust the mirror so that sun rays will be reflected to the hole below the lens. Place a transparent object (e.g. wire of a fish) on the hole and adjust the

**P:** Produce a simple microscope according to the above figure. Adjust the mirror so that sun rays will be reflected to the hole below the lens. Place a transparent object (e.g. wing of a fly) on the hole and adjust the metal strip so that the water drop lens has less distance from the object than its focal length.

**Q:** How does the lens act here? What happens when you bring it even nearer to the object? Draw a ray diagram.

**E:** The lens acts here as a magnifying glass. When the object distance decreases further, the magnification will increase. The ray diagram is the same as in the last experiment.

#### 7.4.8 Mirror Reflex Camera

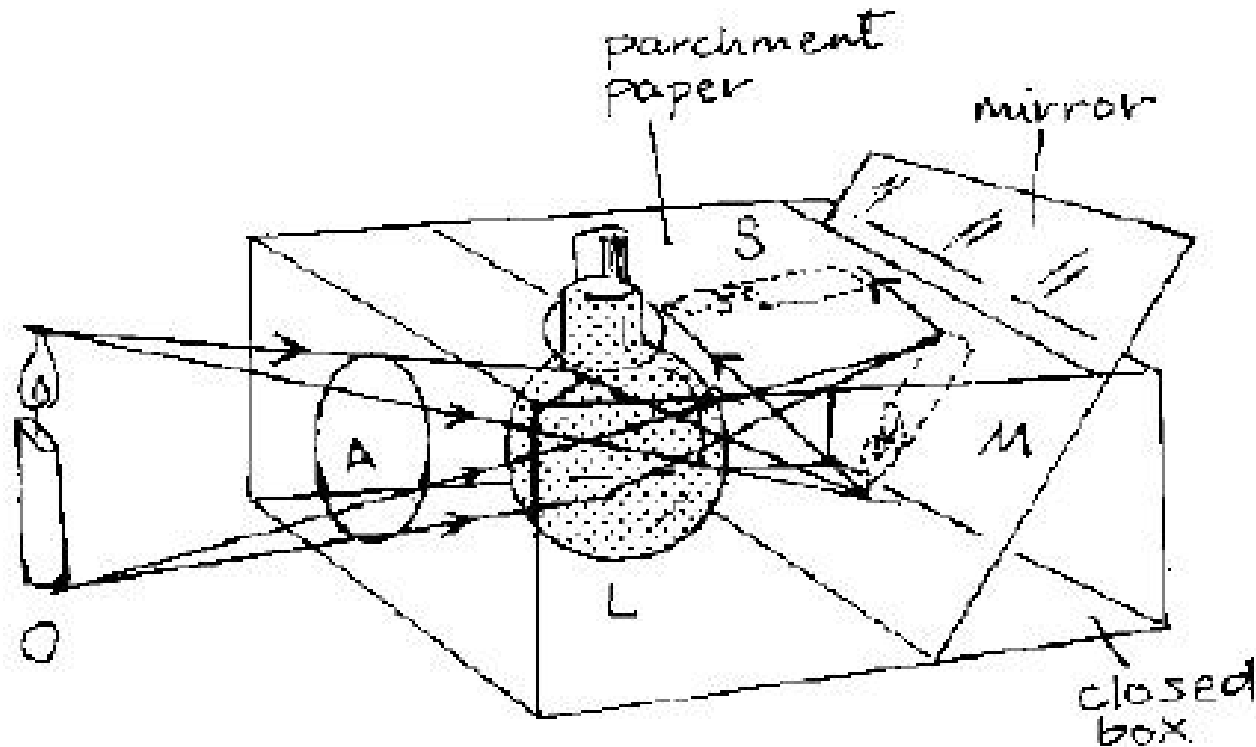

**P:** Modify the box camera (see p.90) according to the above figure using a mirror and another sheet of parchment paper to provide the top screen. Now this camera can serve as a model of a mirror reflex camera.

**Q:** Explain how a mirror reflex camera works.

**E:** In the mirror reflex camera the film is there where the screen is in the box camera (see p.90). The screen on top is just to view the same image (and to focus it) which will be produced on the film when the mirror has been removed. Thus, when taking a snap with the mirror reflex camera, the mirror is turned so that the image falls on the film instead on the top screen.

#### 7.4.9 Display Chart of the Eye

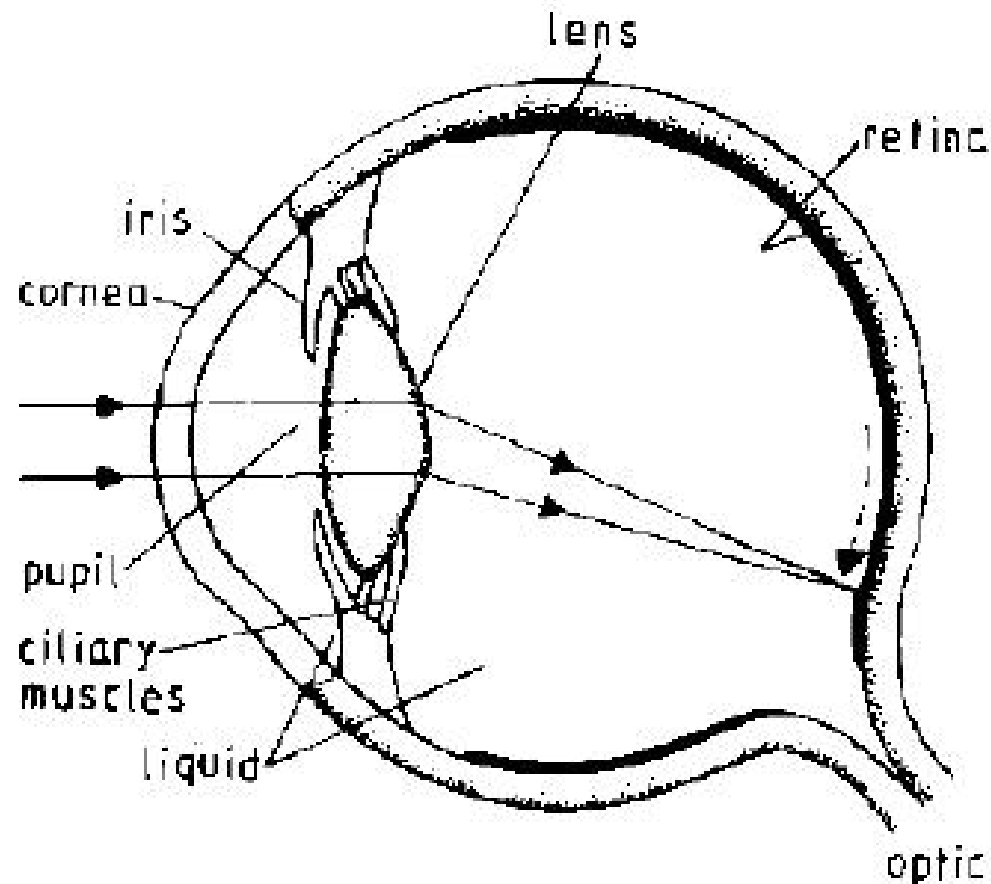

—  
x  
optic  
nerve

The eye possesses an convex lens which focusses the light on a sensitive membrane (called retina). In difference to the camera the eye lense changes its curvature and hence its focal length in order to focus the light from objects of different object distance. The focal length varies according to object distance while the image distance is kept constant and is roughly equal to the diameter of the eye, see the figure.

**P:** Draw a display chart of the above figure.

#### **7.4.10 The Long-Sighted Eye**



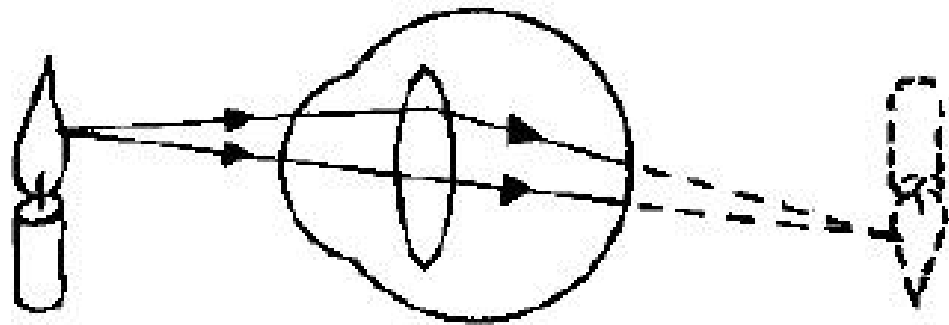
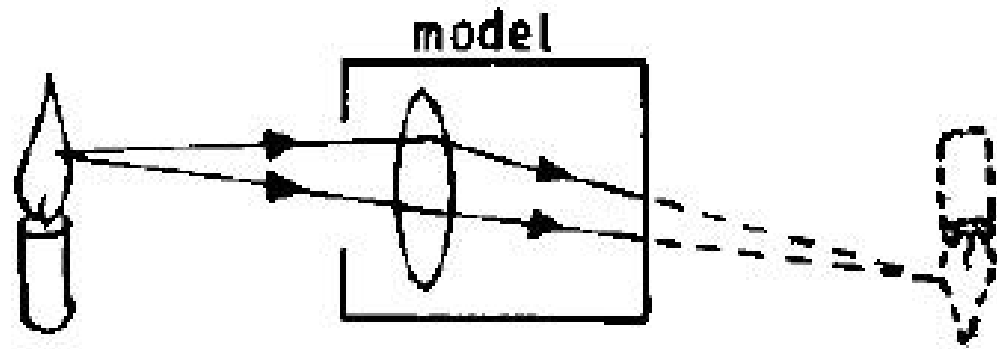

(a)

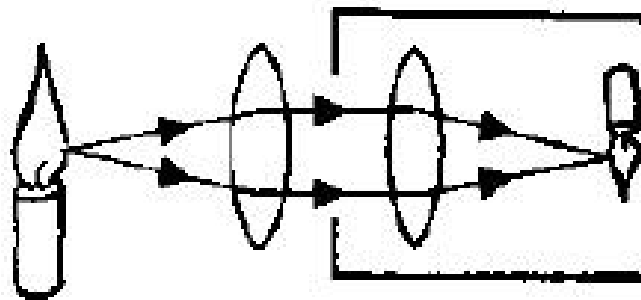

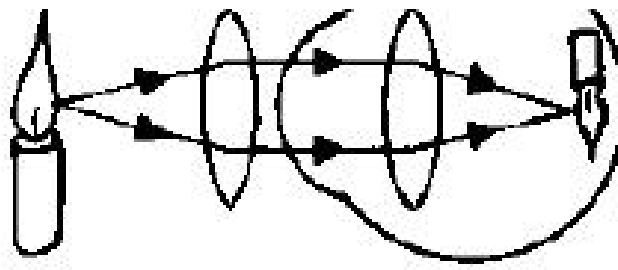

( b )

The long-sighted eye cannot focus near objects. The rays from a near object are focused *behind* the retina, see figure (a).

**P:** Make a *model of the long-sighted eye* by fixing the lens of the box camera (see p.90) so that it focusses a near candle *behind* the screen.

**Q:** How can you amend this sight defect in your model (without changing the image distance because that is *constant* in the eye)?

**E:** You need to place a convex lens of suitable focal length in front of the eye model in order to focus the near candle on the screen (retina), see figure (b). Thus, a long-sighted person needs spectacles having converging lenses.

#### 7.4.11 The Short-Sighted Eye

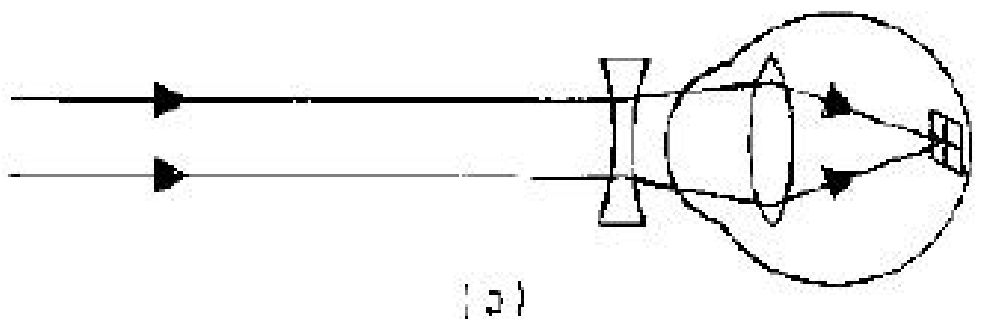
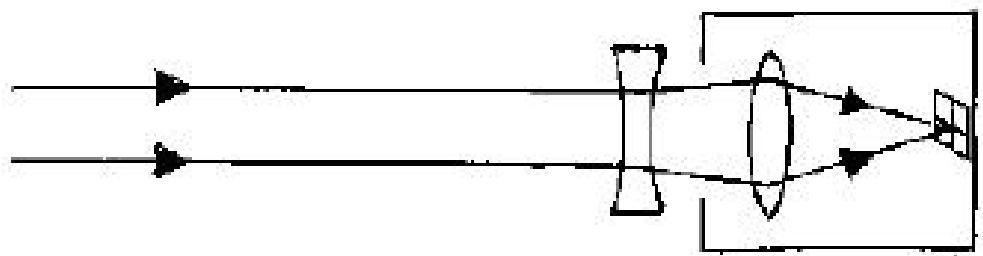
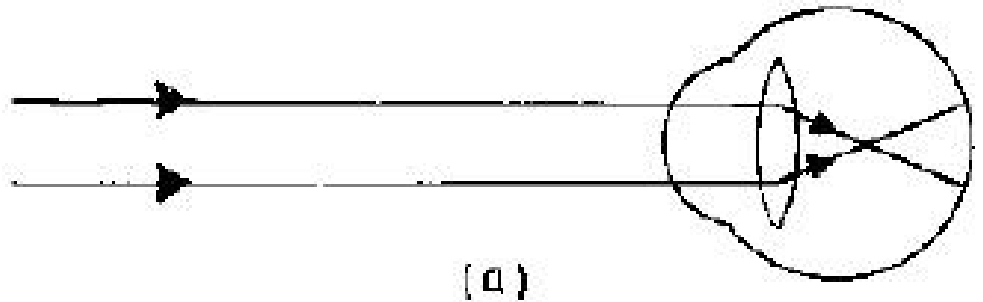

The short-sighted eye cannot focus distant objects. They are focussed *in front* of the retina, see figure (a).

**P:** Make a model of the short-sighted eye by fixing the lens of the box camera (see p.90) so that it focusses a distant candle *in front* of the screen.

**Q:** How can you amend this sight defect in your model (without changing the image distance because that is constant in the eye)?

**E:** You need to place a concave lens of suitable focal length in front of the eye model in order to focus the distant candle on the screen (retina), see figure (b). Thus, a shortsighted person needs spectacles having diverging lenses.

#### 7.4.12 Persistence of Vision

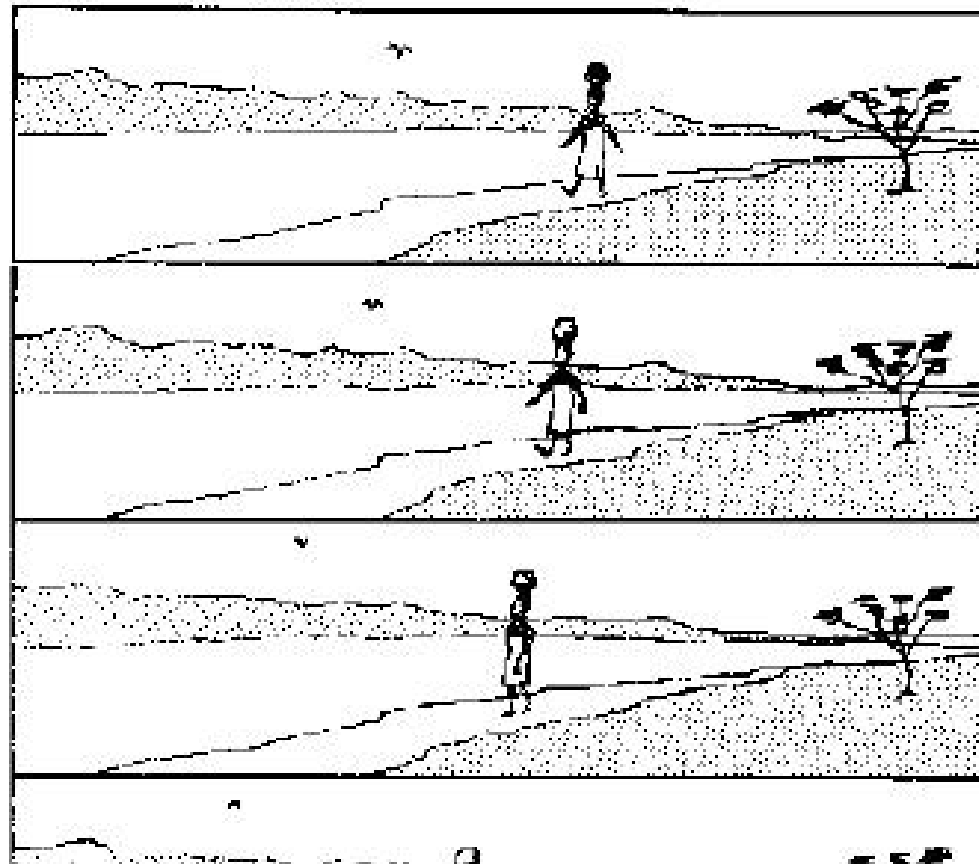
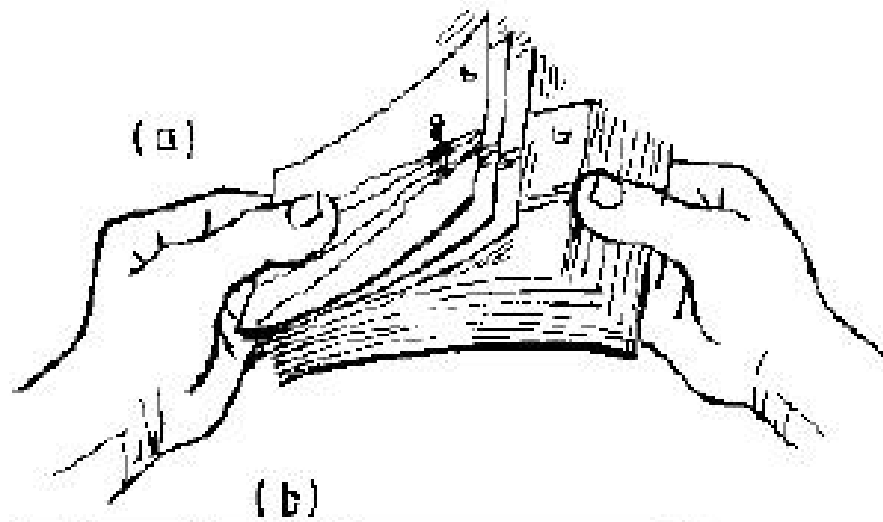

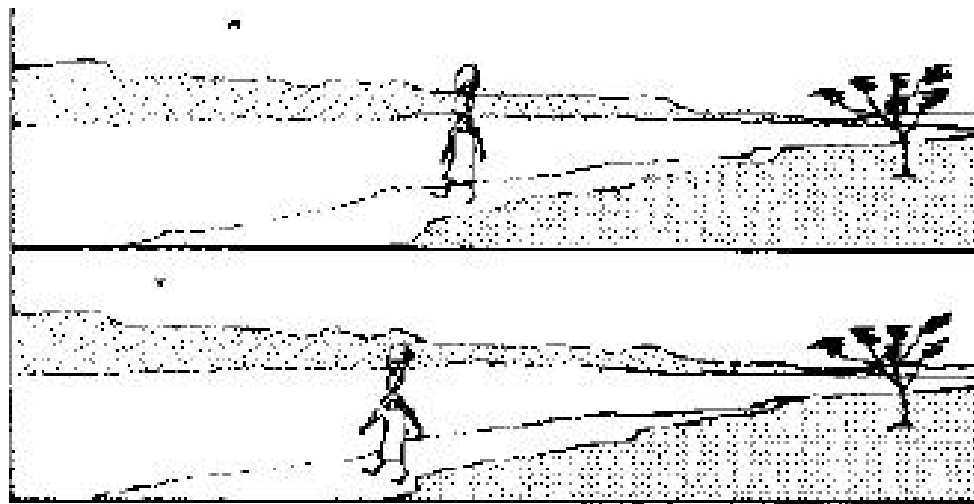

An image lasts on the retina for about one tenth of a second after the object has disappeared as can be shown by flipping cards having motion pictures as shown in figure (a).

**A:** The effect makes possible the production of motion pictures. 24 separate pictures each slightly different from the previous one, are projected on to the screen per second and give the impression of continuity.

**P:** Make eight motion pictures of a walking woman as shown in figure (b). Arrange them subsequently and hold them so that each picture comes to vision after the previous one within a short time.

**Q:** What do you observe?

**E:** The woman appears to walk.

**A:** Movies, television, videos.

## 7.5 Dispersion and Colours

The separation of white light into its component colours is called *dispersion*. Each colour has a particular value of refractive index. Hence by passing light through a glass prism, each colour is refracted through different angles.

### 7.5.1 Dispersion by a Glass Prism

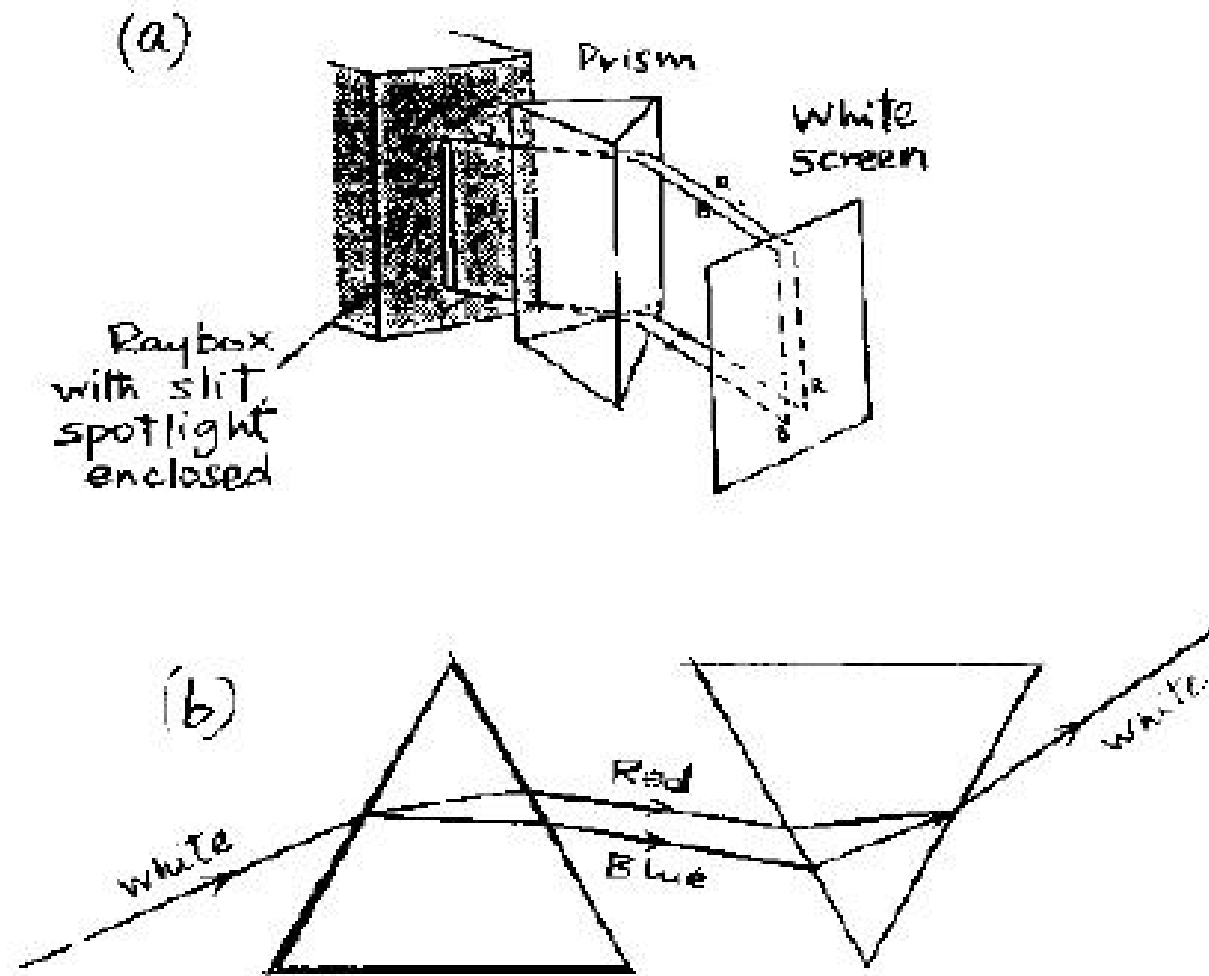

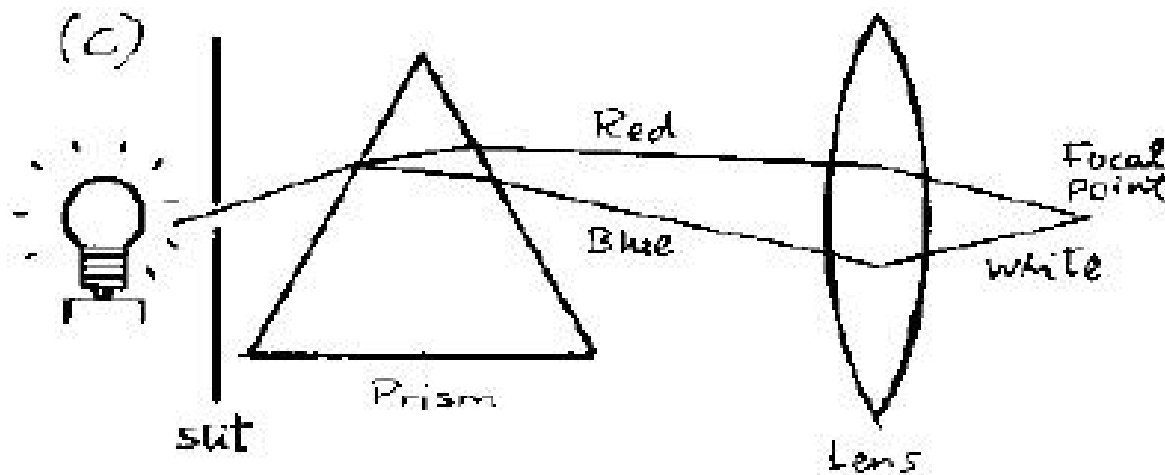

**P:** Arrange a glass prism, a narrow source of white light and a screen as shown in figure (a). Adjust the angle at which the ray hits the prism and the screen so that you catch the dispersion colours (*spectrum*)

**Q:** Which colour of light is most refracted by the prism? Which colour is least refracted by the prism?

**E:** The prism splits white light into its component colours. Blue light is refracted most and is observed nearest to the base of the prism. Red light is least refracted.

With the use of a second prism or a converging lens the separated light colours can be recombined to form white light, see figures (b) and (c).

### 7.5.2 Dispersion with a Mirror in Water



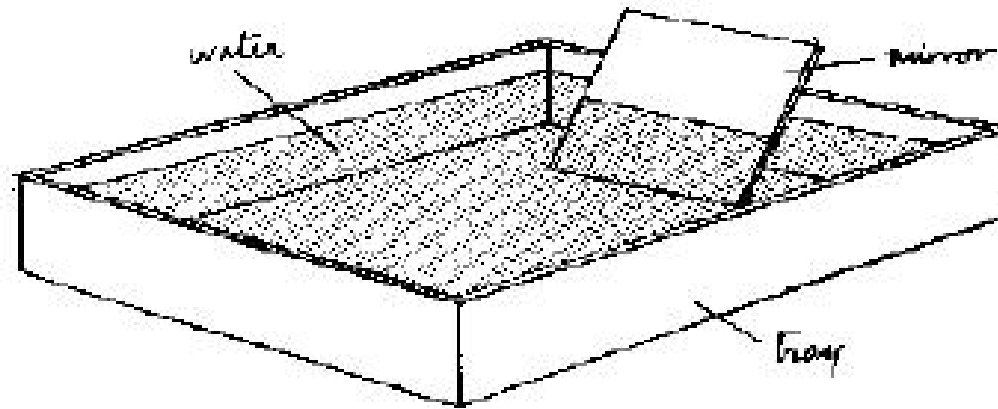

(a)

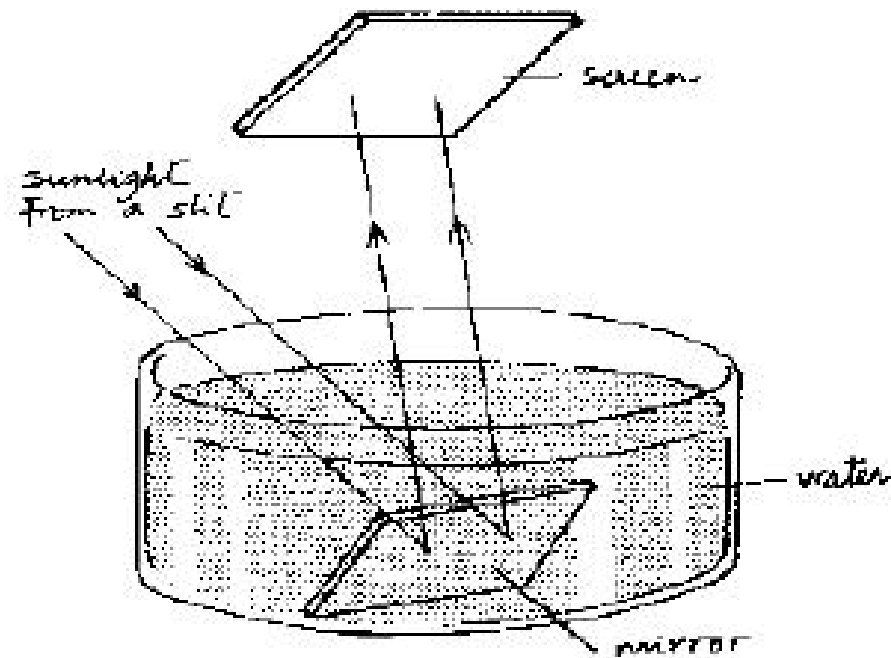

(b)

(b)

**P:** Place an inclined mirror in a container half full of water. Allow a light to strike at the slanted face of the mirror. Look through the submerged portion of the mirror, see figure (a).

**Q:** What do you observe?

**O:** The dispersion colours (spectrum).

**P:** Use the arrangement of figure (b) to obtain the spectrum on a screen.

**Q:** How do you explain the formation of this spectrum?

**E:** The refraction of the incident colours on the surface of the water and of the reflected rays again makes the water act as a "water prism".

### **7.5.3 Rainbow Colours from a Water Hose**





**P:** Early in the morning or late in the afternoon of a bright sunny day spray water from a hose pipe against a dark background of trees with your back towards the sun, see the figure.

**Q:** What do you see? How can it be explained?

**O:** You will observe the colours of the rainbow in the spray from the hose.

**E:** The rainbow is a result of the dispersion of light rays striking water droplets.

#### **7.5.4 Colour Mixing: Newton's Disk**

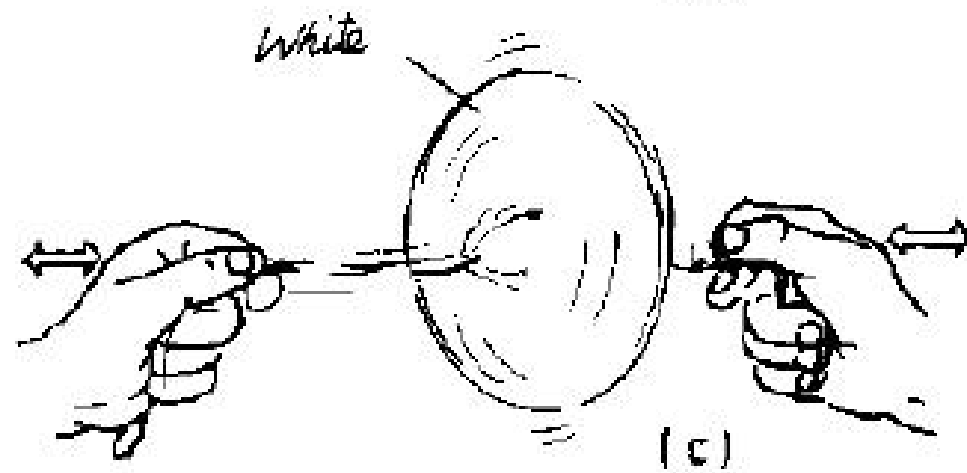
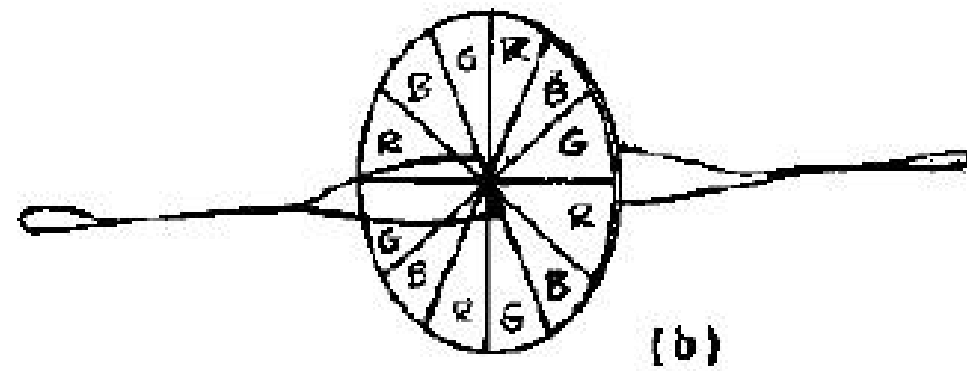
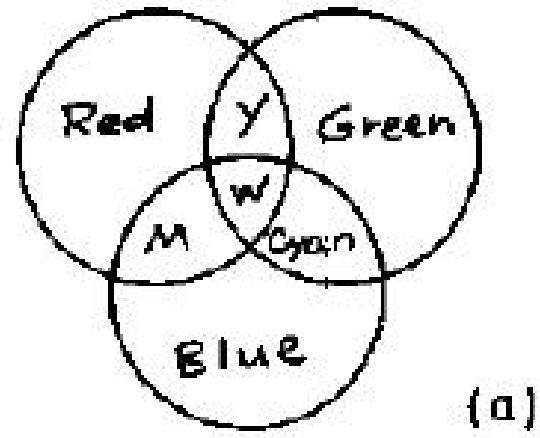

There are colours of light which when mixed in varying intensities will produce all other colours, but they themselves cannot be produced by mixing other colours. When mixed in appropriate intensities, they will also produce white light. These are the *primary colours* of light. The three primary colours of white light are *blue, green and red*. Hence BLUE + GREEN + RED = WHITE, see figure (a).

Y = yellow, M = Magenta and W = White.

*Secondary colours* are formed by adding two primary colours, e.g. Red + Green = Yellow.

So yellow is a secondary colour of red and green.

**P:** Paint twelve equal sectors of a disk made from white cardboard with red, green and blue colours arranged in that order, see figure (b). Tie a string through the two holes around the centre of disk. Swing and pull the string ends with both hands, see figure (c). The disk will start spinning to and forth.

**Q:** What do you observe on the disk?

**O:** The spinning disk appears whitish.

**E:** The colours of the light reaching the eye at short time intervals mix to white light due to the *persistence of vision*.

## 8. Magnetism and Electricity

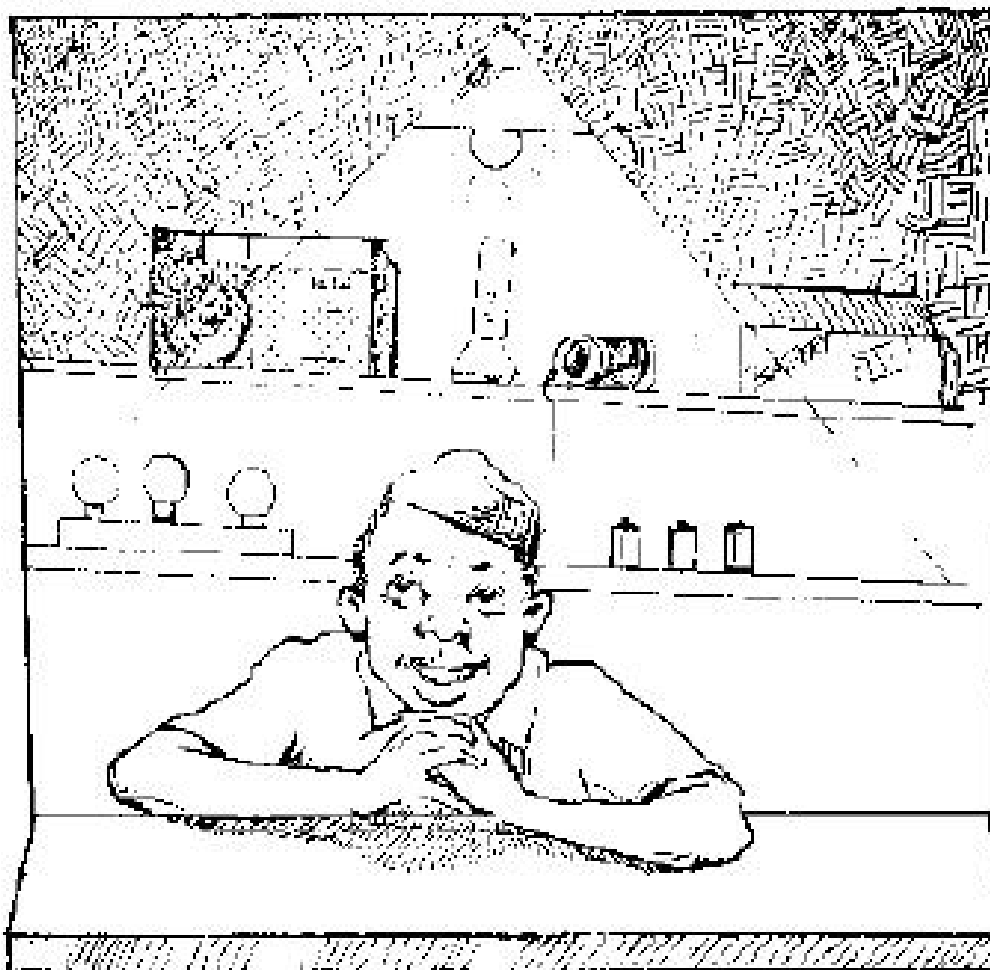

## 8.1 Magnetism

There are some materials which can attract iron. These kind of materials are said to have *magnetic properties*. The earth is a very weak magnet. Hence, a freely suspended magnet can be used as a *compass*. The end of a magnet pointing to the north is called the north (N-) pole, the end pointing to the south is called south (S-) pole. Thus, each magnet has a N-pole and a S-pole. Magnets can be found, for example, in loudspeakers and bicycle dynamos. Magnets are remarkable because they exert a force on iron or other

south (S-) pole. Thus, each magnet has a N-pole and a S-pole. Magnets can be found, for example, in loudspeakers and bicycle dynamos. Magnets are remarkable because they exert a force on iron or other magnets at a distance without any medium being in between. *Unlike poles attract each other, like poles repel each other.*

### 8.1.1 Distinction of Magnetic and Non-Magnetic Materials

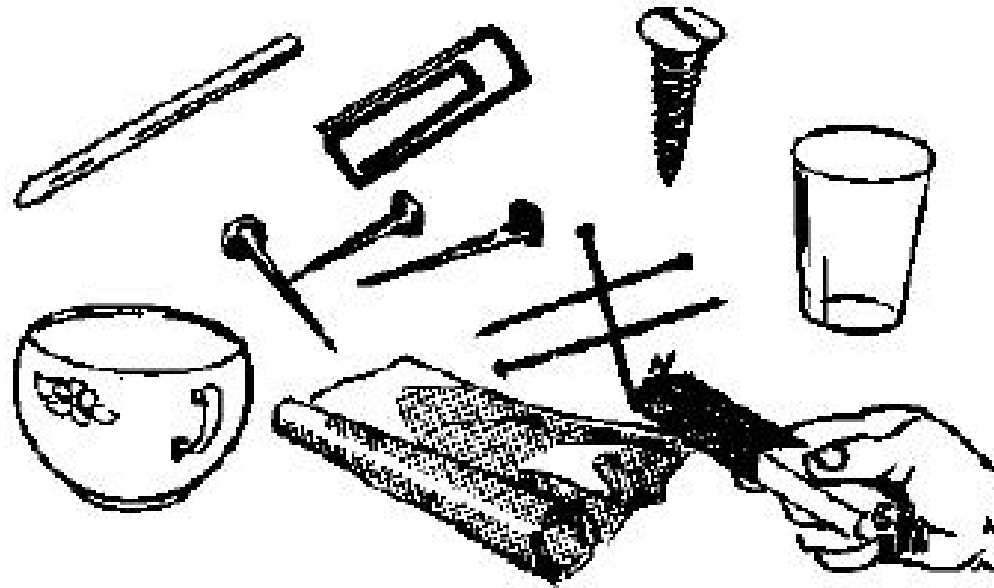

**P:** Arrange the materials shown in the diagram above on a table. Bring a magnet close to each material.

**Q:** What happens to each material?

**E:** Those materials which are attracted by a magnet are called magnetic substances. Those which are not attracted are called non-magnetic substances.

**A:** One can use a magnet to distinguish magnetic materials from non-magnetic materials. For example, you can find out if dry sand collected from outside contains magnetic materials by pushing a magnet through the



sand.

**H:** The materials used in this experiment should include copper, iron, aluminium, plastic, porcelain, wood, nickel etc. if ever possible.

### 8.1.2 Interaction between Magnets

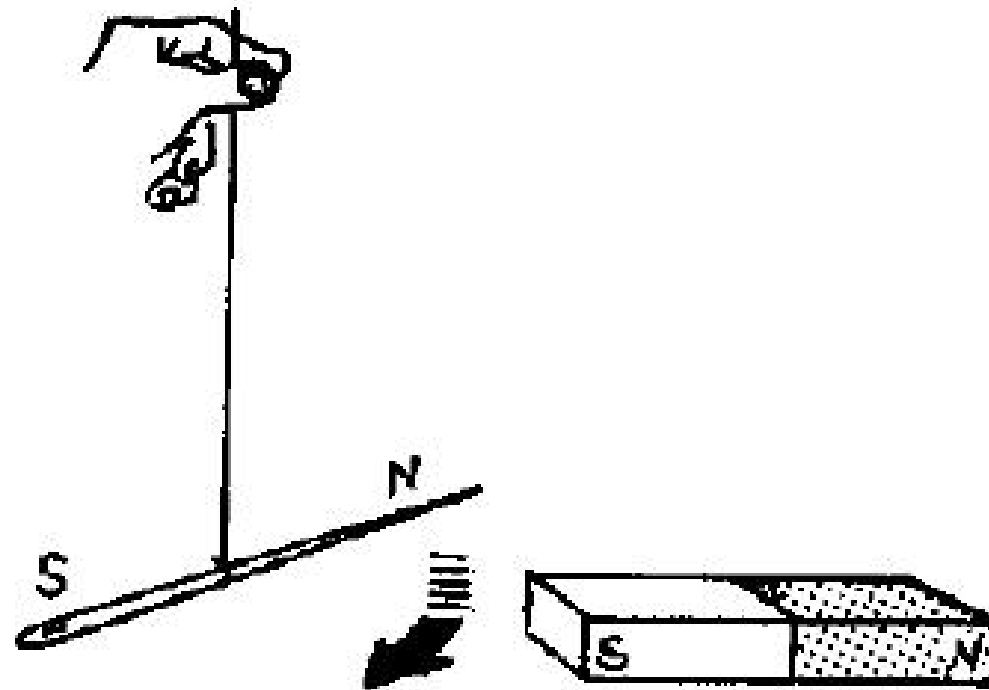

**P:** Suspend a magnetized steel needle (see experiment 8.1.3) and a bar magnet, one at a time. In each case mark the end pointing to the north as N-pole, and the end pointing to the south as S-pole.

Bring the N-pole of the magnet near the S-pole of the suspended needle.

Bring the S-pole of the magnet near the S-pole of the needle.

Now bring the N-pole of the magnet near the N-pole of the needle.

Now bring the N-pole of the magnet near the N-pole of the needle.

**Q:** What do you observe in each case?

**O:** You will observe that the N-pole of the magnet attracts the S-pole of the needle; the S-pole of the magnet repels the S-pole of the needle; and the N-pole of the magnet repels the N-pole of the needle. So we say *unlike poles of magnets attract each other and like poles repel each other.*

**H:** In case bar magnets are not available a magnetised piece of steel can be used instead of a bar magnet, see experiment 8.1.3.

### **8.1.3 Magnetisation by Single and Double Touch Method**

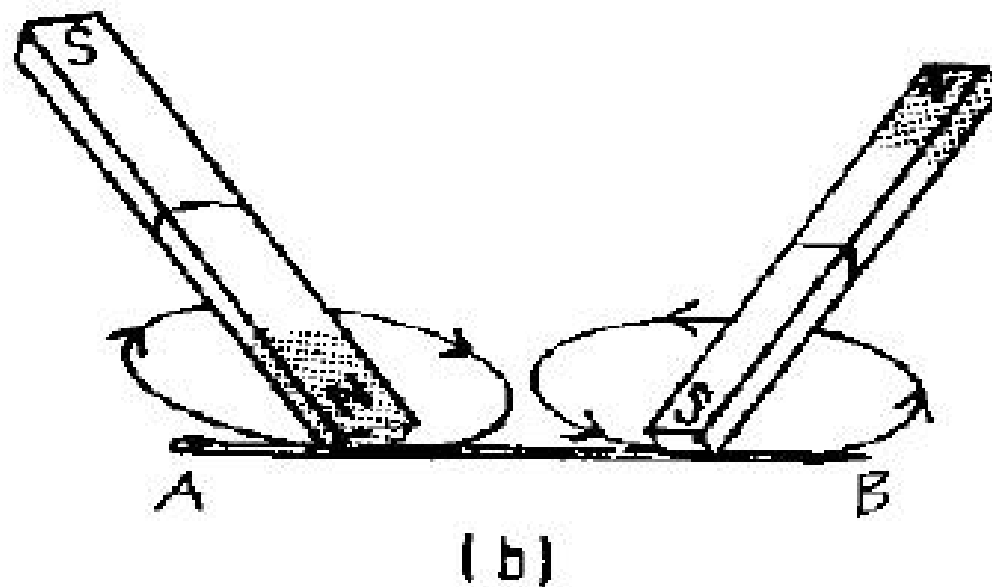
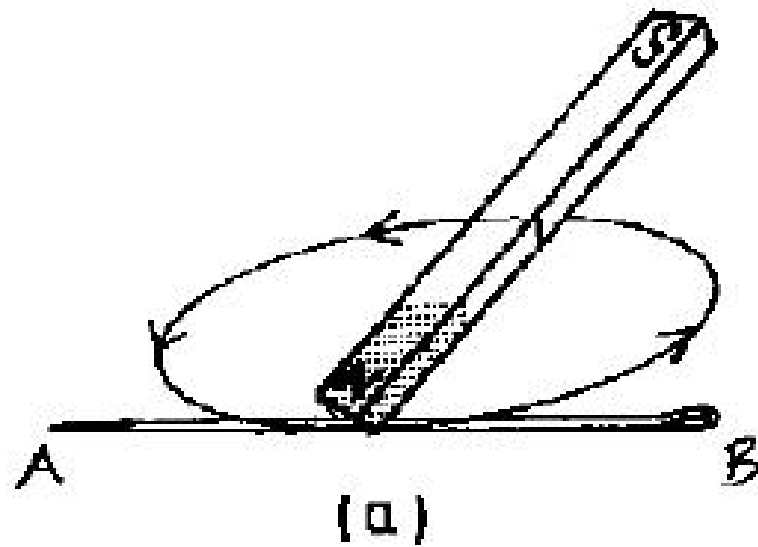

P: Move one pole of a bar magnet many times along the needle as shown in figure (a).

**P:** Move one pole of a bar magnet many times along the needle as shown in figure (a).

Now move the magnet along another needle as shown in figure (b). Do this several times, each time starting from the middle of the needle.

**Q:** Are the two needles magnetized? If so what are the poles of the needles?

**O:** Both needles are magnetised. The end A of the first needle is a N-pole and end B is a S-pole. The end A of the second needle is S-pole while end B is a N-pole.

**H:** The first needle has been magnetised by the single touch method and the second one has been magnetised by the double touch method.

#### 8.1.4 Magnetic Ducks

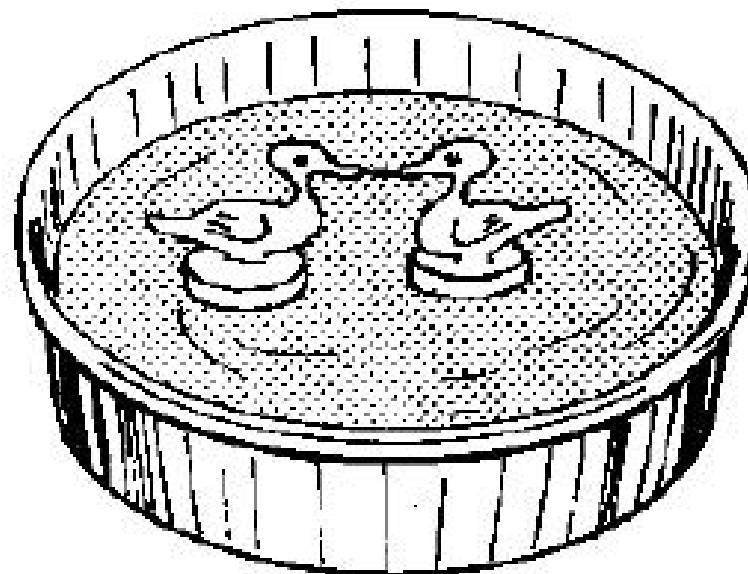

**P:** Magnetize one pin (or needle). Fix the pin or needle on the beak of one the paper ducks. Fix an unmagnetised pin on the beak of the second duck. Place the ducks to float in a bowl of water.

**Q:** What do you observe?

**O:** The beaks of the ducks come together as if they were kissing each other.

**E:** This is because the end of the magnetised pin in the beak of one duck attracts the end of the unmagnetized pin in the beak of the second duck.

**H:** To make the ducks, cut four pieces of paper in the shape of a duck and stick two of them together to make a duck. Fix each duck on a piece of wood so that it can float.

**P:** Magnetise both pins which are inserted into the beaks of the ducks and observe what happens.

### 8.1.5 Magnetisation by Electric Current

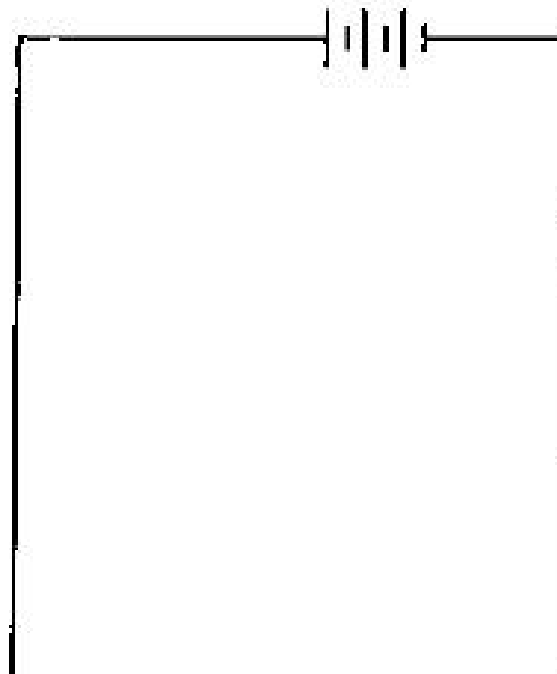

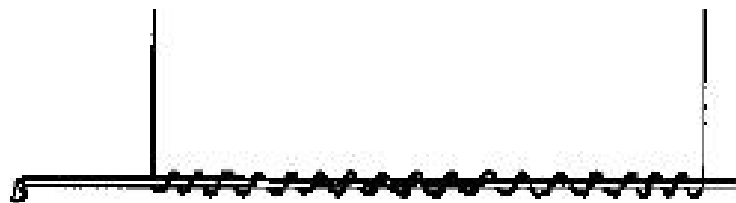

**P:** Make a coil by winding about fifty turns of isolated wire around a bicycle spoke. Connect the coil to two or three radio cells, see the figure. After a few minutes disconnect the battery and remove the spoke from the coil. Dip the spoke into iron filings.

**Q:** What do you observe?

**E:** The iron filings are attracted by the end of the spoke. The electric current in the coil has magnetized the spoke.

**H:** Steel can be magnetized by this method but soft iron *cannot*.

### 8.1.6 Demagnetisation of a Magnet

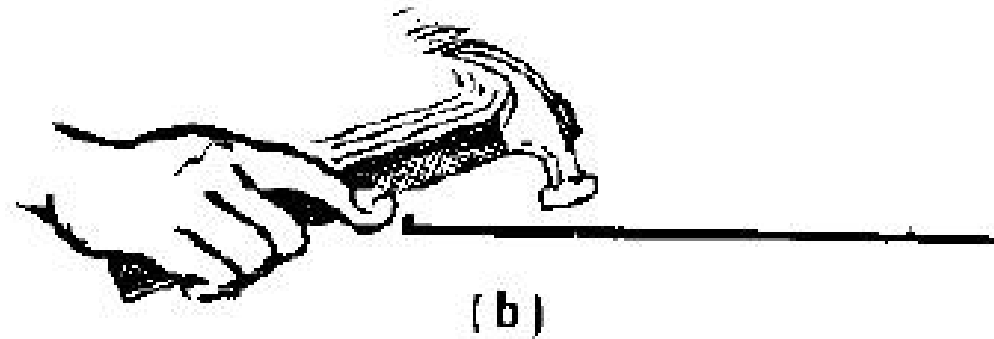
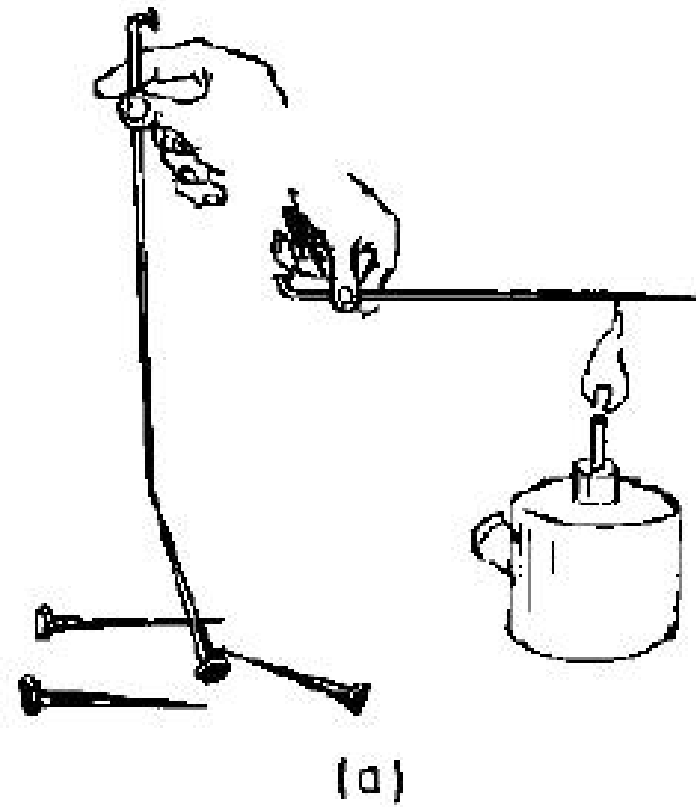

P• Magnetise a bicycle spoke and check if it attracts small nails or iron filings. Heat the spoke in a flame as in z\_science\_exp\_0376 (2).jpg

**P:** Magnetise a bicycle spoke and check if it attracts small nails or iron filings. Heat the spoke in a flame as in figure (a) and check again if it attracts the nails. Get another magnetised spoke and hammer it several times as shown in figure (b). Check if the spokes still retain their magnetism.

**Q:** What has happened to the spokes?

**E:** Heating and hammering of the spokes has destroyed the magnetism of the spokes.

**H:** Magnets should not be kept in hot places or dropped otherwise they may lose their magnetism.

### 8.1.7 Magnetic Field Pattern

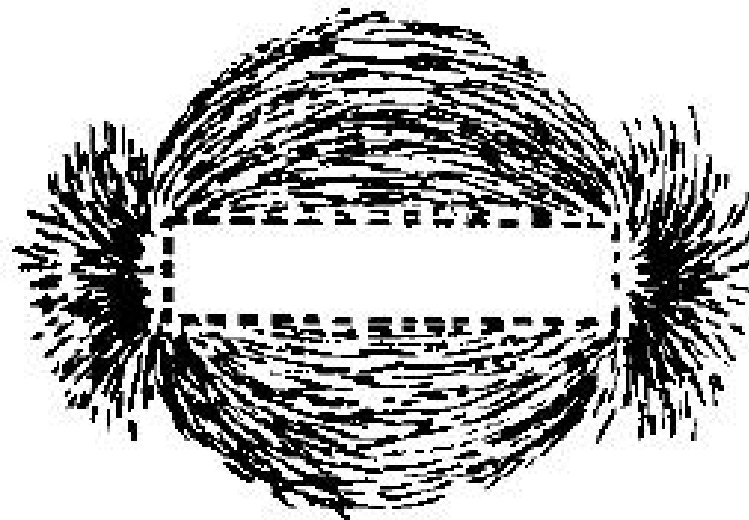

**P:** Place a cardboard on top of a permanent magnet. Sprinkle iron filings on the cardboard. Tap the cardboard gently several times.



**Q:** What pattern do you observe being formed by the iron filings? Draw a sketch diagram of the pattern formed.

**O:** The iron filings form a pattern as shown in the figure above. The iron filings are aligned along lines called *magnetic field lines* or lines of magnetic force.

**H:** Instead of iron filings small bits of iron wool may be used.

### 8.1.8 Making a Simple Compass Using a Knitting Needle

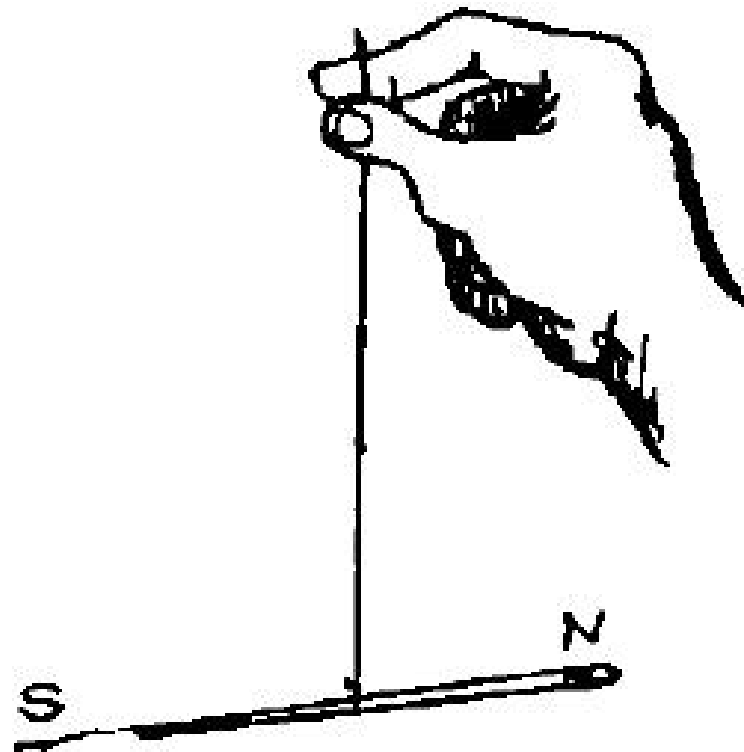

**P:** Suspend a magnetized knitting needle using a cotton thread. Allow the needle to settle and label the N-pole and S-pole of the needle.

Turn the suspended needle through various angles and release it.

Turn the suspended needle through various angles and release it.

**Q:** What do you observe?

**E:** You will notice that the needle will always return to settle in the N–S direction.

The suspended magnetised needle can act as a simple device to find the north–south direction.

**A:** Such a device which shows the N–S direction is called a *compass*.

### 8.1.9 Making a Simple Compass Using a Razor Blade

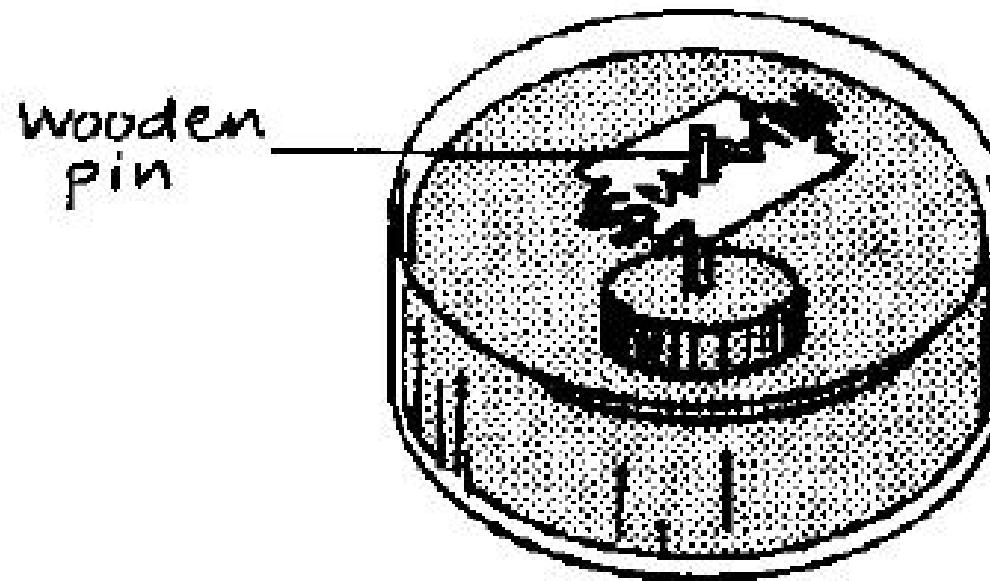

**P:** Fix a wooden pin vertically in a bowl of water. Slip a magnetised razor blade along the pin and carefully place it on the surface of the water so that it can rotate using the pin as an axle. Allow the blade to come to rest and mark its N–pole and S–pole.

First gently rotate the bowl. Then rotate the blade through any angle and leave it.

**Q:** What do you observe in each case?

**O:** In the first case the blade will continue to lie in the N–S direction. After the blade has been rotated, it returns to lie in the N–S direction.

**A:** This arrangement can be used as a simple compass.

### 8.1.10 Testing for Magnets

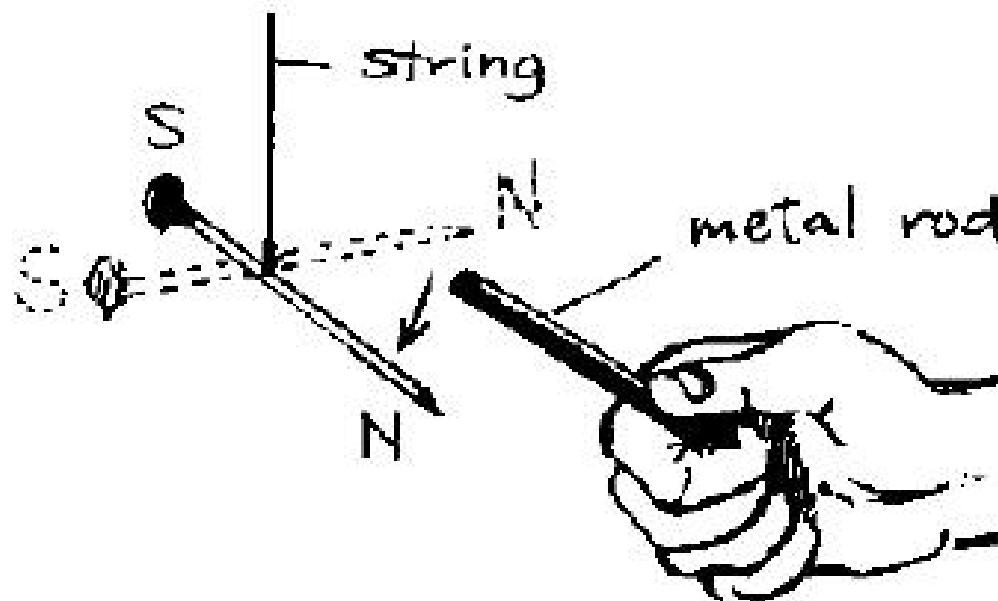

**P:** Bring the first end of a metal rod close to one pole of a suspended magnetized steel nail. Bring the second end of the metal rod close to the same pole of the suspended steel nail.

Repeat the above procedure with an iron rod which is magnetized.

**Q:** What do you observe with the magnetised and with the unmagnetised rod respectively?

**Q:** What do you observe with the magnetised and with the unmagnetised rod respectively?

**O:** With the unmagnetised rod both ends are attracted by the pole of the suspended magnet. With the magnetised iron rod, one of its ends will be repelled. This follows from the fact that like poles repel and unlike poles attract.

**A:** This is used to distinguish magnets from unmagnetised iron.

## 8.2 Electrostatics

When plastic materials, e.g. plastic pens, combs and rulers are rubbed with fur, woolen clothes, or hair, they acquire negative *electric charges*.

When materials made of glass are rubbed with silk or polyester clothes, they acquire positive charges.

The charges acquired are stationary (static). The study of stationary electric charges is known as *electrostatics*.

*Like electric charges repel each other, unlike charges attract each other.*

### 8.2.1 Charging by Rubbing (Friction)

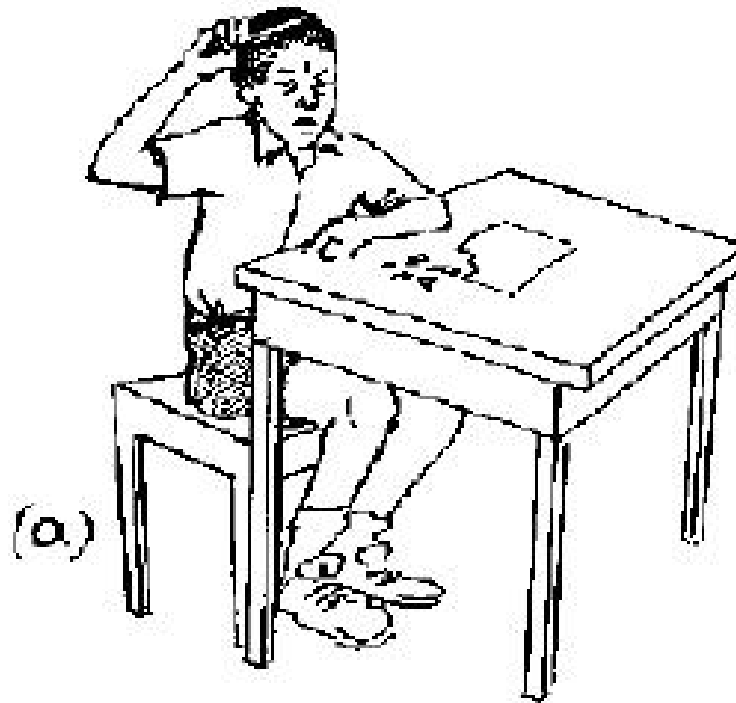

**P:** Rub a plastic pen on your hair, on woolen or synthetic clothes and bring it near small pieces of paper or pieces of thread.

Repeat the experiment by rubbing a glass bottle with a piece of "baibui" (made of silk) or polyester.

**Q:** What do you observe?

**Q:** What do you observe?

**O:** The plastic pen or glass bottle picks up small pieces of paper or thread.

**E:** The plastic pen becomes negatively charged and the bottle becomes positively charged. Thus they both attract pieces of paper.

**A:** The roller in a photocopying machine is charged positively. It attracts the paper which is being photocopied. Thus the paper sticks on the roller.

**H:** Charging by rubbing is more effective if you use dry materials during a dry day. Most of the time, electrostatic experiments won't work on a humid day.

### **8.2.2 Laws of Electrostatics**

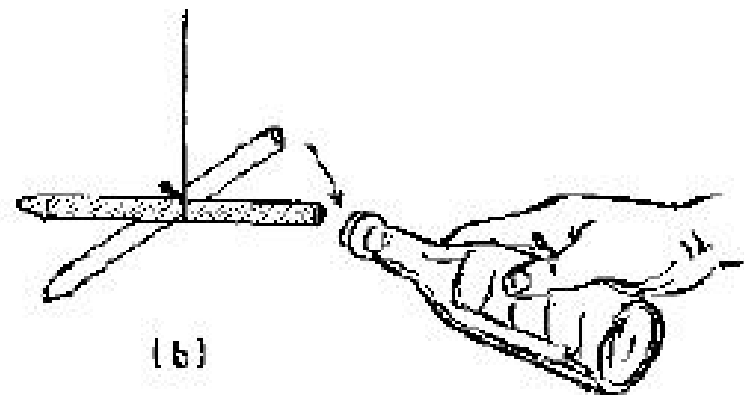
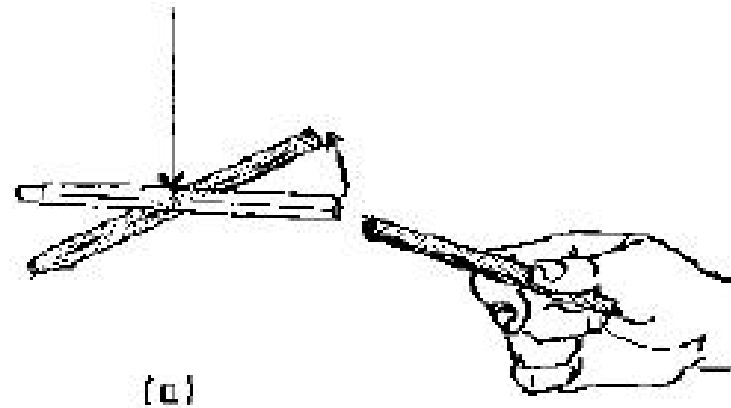

**P:** Rub a plastic pen on your hair or on a woolen or synthetic cloth and bring it near a suspended plastic pen (also charged by rubbing it on your hair).

Repeat the experiment by bringing a glass bottle charged by rubbing with silk or polyester material near the freely suspended *charged* plastic pen.

**Q:** What do you observe in both cases?

**O:** In the first experiment the two plastic pens repel each other, and in the second experiment, the plastic pen is attracted by the glass bottle.

is attracted by the glass bottle.

**E:** The existence of the same types of charges (negative) on the plastic pens causes repulsion. When the positively charged bottle (glass) is brought near the plastic pen, attraction occurs.

This experiment demonstrates the electrostatic law: *like charges repel and unlike charges attract each other.*

### **8.2.3 Simple Electroscope**



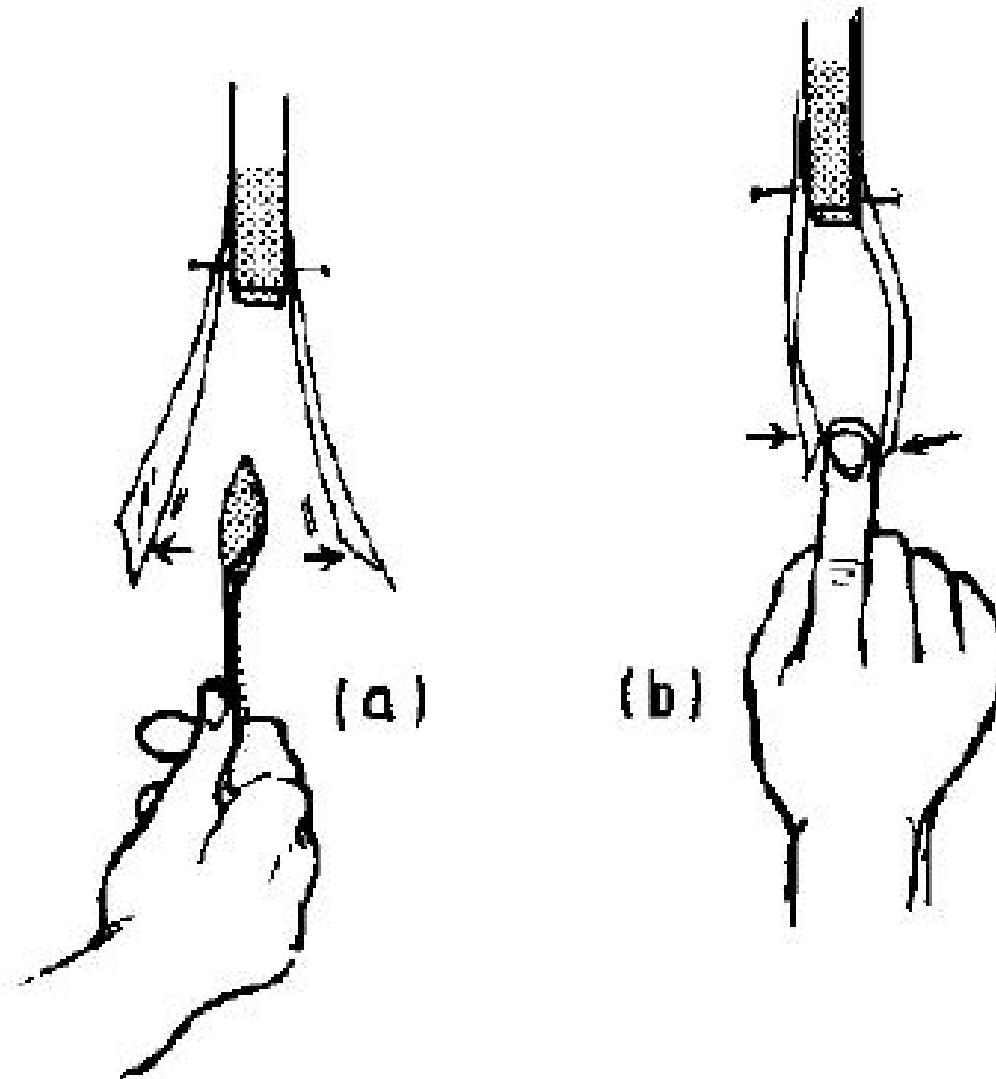

**P:** Cut two strips of polythene sheet. Fix the strips to a piece of wood as shown in the figure. Charge the strips by rubbing them with a clean duster.

(a) Introduce a charged plastic spoon between the charged strips.

(b) Introduce your finger between the charged strips.

(b) Introduce your finger between the charged strips.

**Q:** What happens to the strips?

**O:** The charged polythene strips repel each other.

(a) The strips are repelled further with the charged plastic spoon between them.

(b) The finger attracts the strips because the body is earthed. So it becomes positively charged relative to the two strips.

**H:** The polythene strips can be obtained from the transparent covering of a cigarette package.

**A:** The electroscope.

#### **8.2.4 Electrostatic Induction**

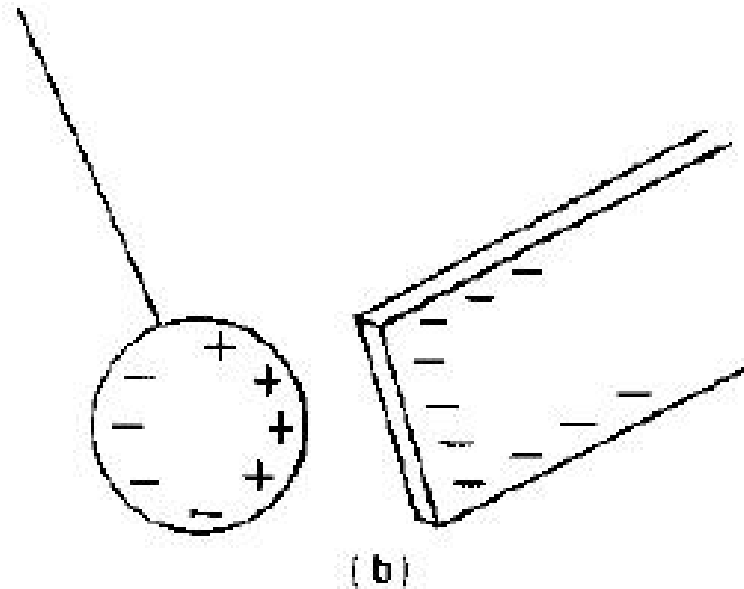
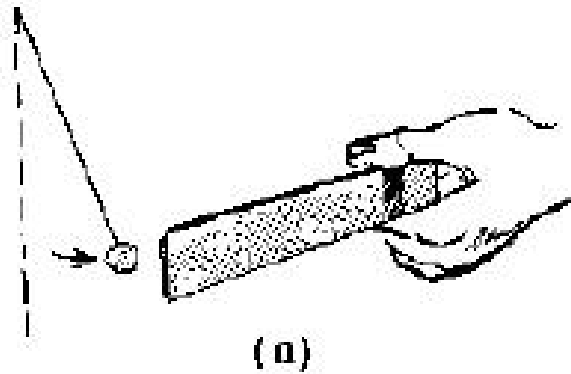

**P:** Make an aluminium ball (by using aluminium foil) and suspend it freely using a cotton thread. Bring a charged plastic ruler (negatively charged) near the aluminium ball without touching it.

**Q:** What do you observe?

**O:** The aluminium ball is attracted by the charged plastic ruler.

**E:** The force of attraction occurs due to the fact that the negative charges on the plastic ruler repels some of

or the aluminium ball is attracted by the charged plastic ruler.

**E:** The force of attraction occurs due to the fact that the negative charge on the plastic ruler repels some of the electrons in the aluminium ball away from the side of the spherical surface near the ruler. Therefore the surface near the ruler gets positive charges and so the aluminium ball is attracted by the plastic. The other side of the aluminium ball becomes negatively charged, see figure (b). The process taking place in the aluminium sphere is called *electrostatic induction*.

### 8.2.5 Attraction of a Thin Stream of Water by a Plastic Object

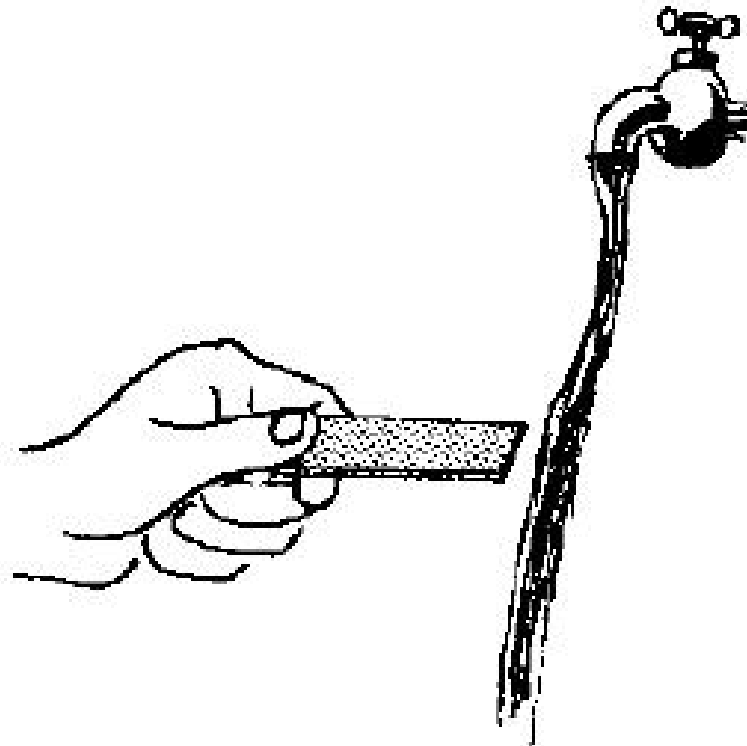

**P:** Charge a plastic object rubbing it on a woolen cloth. Then hold it near (but not touching) a thin stream of water from a tap.

**Q:** What happens?

**O:** The thin stream of water *is attracted by the plastic object*.

**E:** The negative charge on the plastic object causes the water stream to be attracted.

*(For teachers only: The water is not charged. This effect is due to the dipole nature of the water molecules. The pupils cannot understand this yet in form one or two. Since the water molecules are dipoles, they have a positively and negatively charged end, yet the total charge of the molecules is zero since the two charges balance. When the charged object comes near the water stream, the oppositely charged end of the water molecules is attracted, the other end repelled. Thus, the molecules turn so that the attracted end gets nearer to the charged object than the repelled end. Since the electrostatic forces become weaker with the increase in distance to the charged object, the attracted end of the water molecules is more attracted by the charged object than the other end is repelled. Hence, the water molecules are always attracted. It does not matter whether the object is positively or negatively charged).*

### 8.2.6 Charged Air Balloon

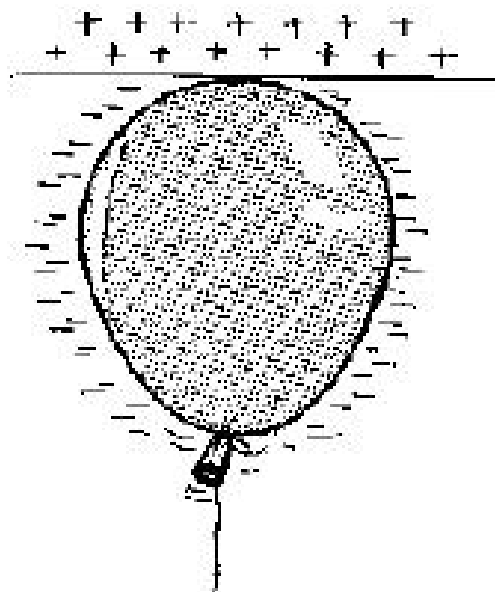

**P:** Rub a balloon on a woolen or synthetic cloth or hair and then place it against the ceiling.

**Q:** What do you observe?

**O:** The charged air balloon sticks to the ceiling.

**E:** This happens because the negative charge on the balloon repels some of the electrons in the ceiling away from the surface. This leaves the surface positively charged and so the negative balloon is attracted by the ceiling.

**H:** The experiment should be carried out during dry weather. Otherwise moisture in the air will neutralize the charges and the balloon will not stick to the ceiling. Holding the balloon with bare hands may also neutralize the charge. Try using dry paper.

**A:** Why do gramophone records tend to gather a lot of dust?

### **8.3 Electric Current**

When electrons flow through a conductor they may, for example, light a bulb, heat a wire and produce a magnetic field. The flow of electrons in such a conductor is called an *electric current*. Materials, which allow a current to pass, are called *conductors*. Materials which do not allow a current to pass, are called *insulators*.

Note: If your house or school has got electricity, *never use the mains for performing the following experiments. The voltage there is quite high and could easily kill you.*

#### **8.3.1 Conductors and Insulators**

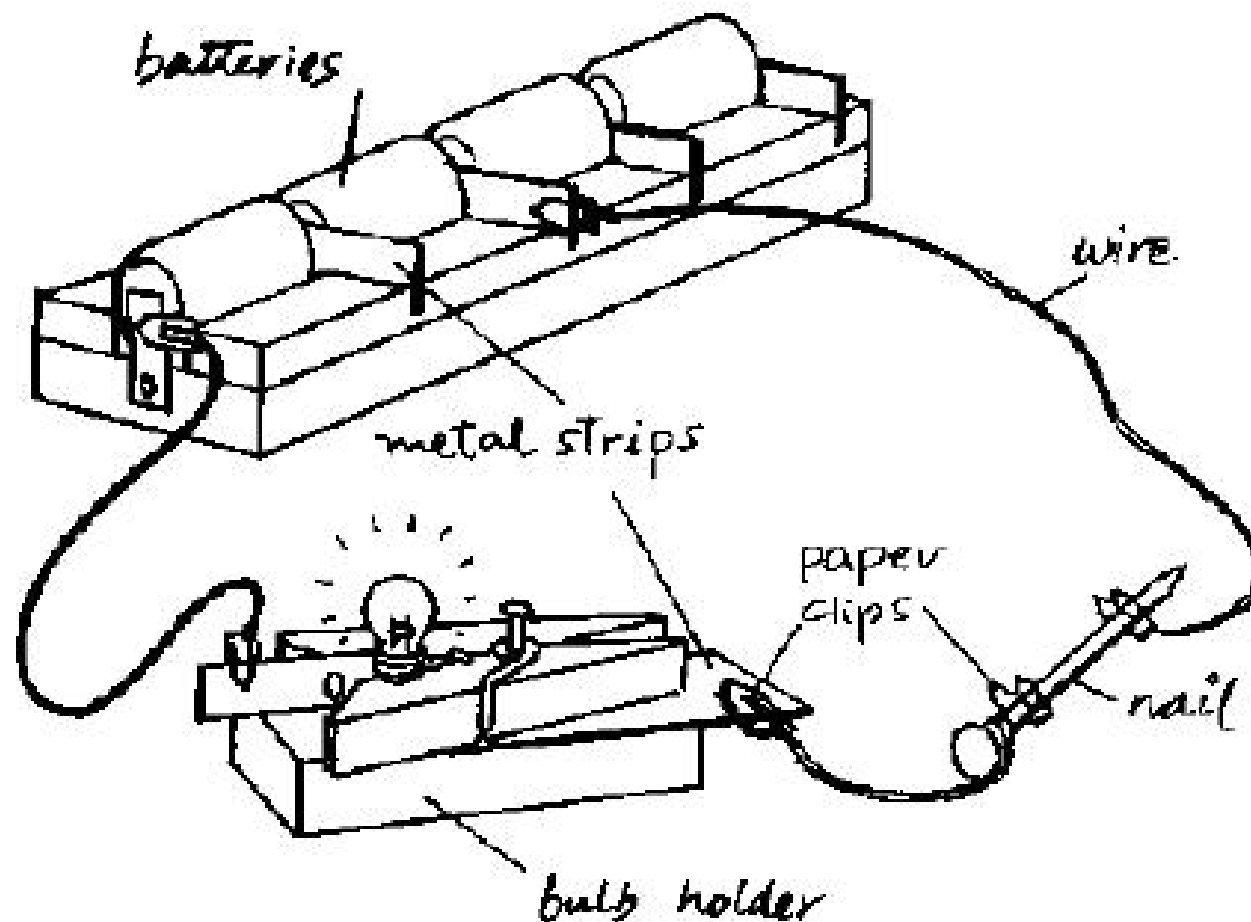

**P:** Connect a nail, a bulb and two cells with wires as shown in the figure. Successively replace the nail with cotton thread, a plastic spoon (or any plastic material), wood, aluminium foil (from a cigarette packet), paper and a piece of graphite from a pencil.

**Q:** What happens to the bulb in each case?

**O:** The bulb lights for some materials and does not light for others.

**E:** The bulb lights when current is allowed to flow through it and does not light when no current passes. The materials, which allow current to pass are called *good conductors* and those, which do not allow current to

**E:** The bulb lights when current is allowed to flow through it and does not light when no current passes. The materials, which allow current to pass are called *good conductors* and those, which do not allow current to pass, are called *poor conductors (insulators)*.

**H:** How to construct the bulb holder and the cell holder, refer to the figure. Note that metal plates are fixed at the end of the cells as a cell holder. For the lamp holder the metal plates are fixed on the side of the bulb and under the bulb.

Metals like copper, aluminium, iron etc. are used for connecting electric circuits. Plastics, wood, porcelain, etc. are used as insulators.

### **8.3.2 The Electric Circuit**



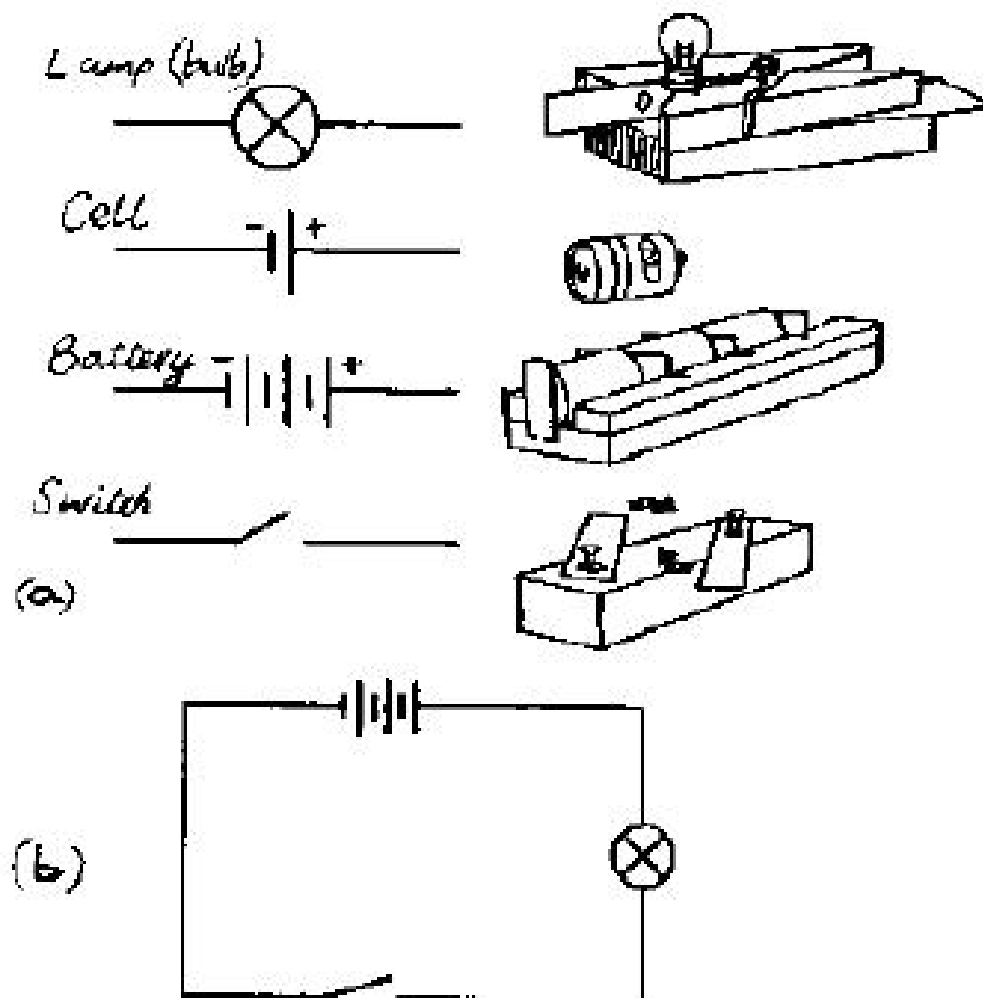

**P:** On the left side of diagram (a) we have placed the symbols used for a bulb, a cell, a battery of three cells, a switch. Connect a battery of three cells, a switch and a bulb with wires as shown in the circuit diagram (b). Close the switch.

**Q:** What do you observe at the bulb when the switch is closed?

**E:** When the switch is closed, the current flows through the bulb from the positive terminal of the battery to the negative terminal. Note, that this is *the conventional* current which flows from the positive to the negative

■: when the switch is closed, the current flows through the bulb from the positive terminal of the battery to the negative terminal. Note, that this is *the conventional* current which flows from the positive to the negative terminal. (Of course, actually *electrons* flow in the wires from the negative to the positive terminal.) The switch makes a continuous path possible and hence the current can flow. This continuous path is called an electric circuit. In an *electric circuit diagram* we always use symbols. Every component of the circuit has its own symbol.

### 8.3.3 Bulbs in Series and Parallel

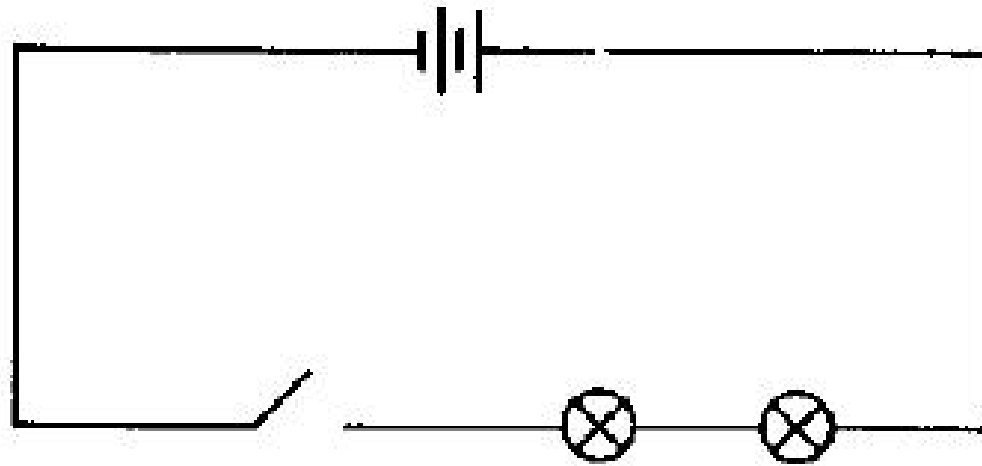

(a)

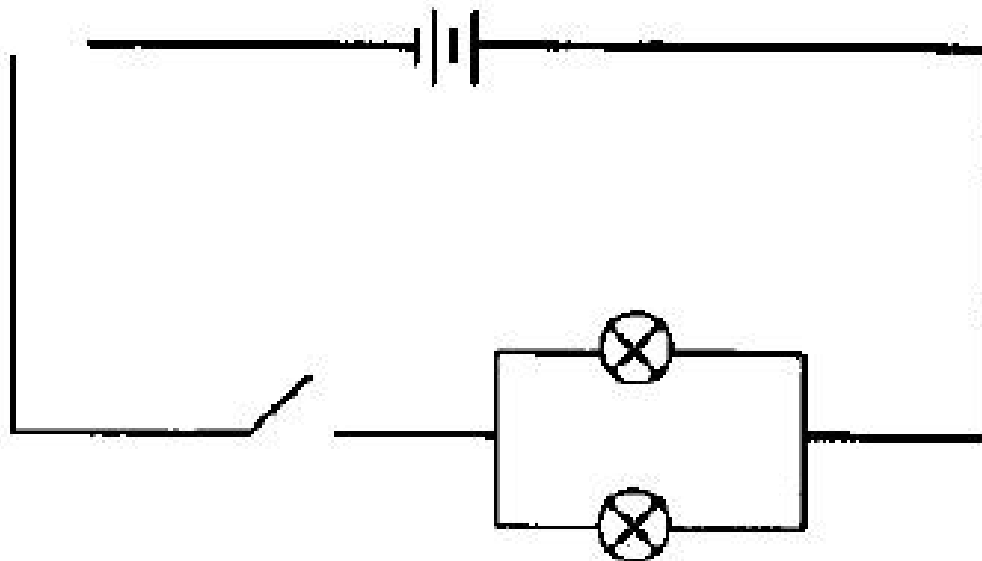



(b)

**P:** Connect two bulbs as shown in circuit diagram (a) so that they are in one line (series). Close the switch and observe the brightness of the bulbs. Now connect the bulbs side by side (parallel) as shown in circuit diagram (b). Close the switch and observe the brightness of the bulbs.

**Q:** What difference do you observe in the brightness of the bulbs when they are connected in series and when they are parallel? Explain your observations.

**O:** The bulbs are brighter when they are parallel than when they are in series.

**E:** More current passes through each bulb when they are parallel than when they are in series. The reason is that the full voltage of the battery lies on each bulb when the bulbs are connected parallel. When they are in series only half the voltage of the battery lies on each bulb.

**A:** In domestic wiring bulbs are connected parallel so that they obtain the right voltage.

#### **8.3.4 Cells In Series and Parallel**

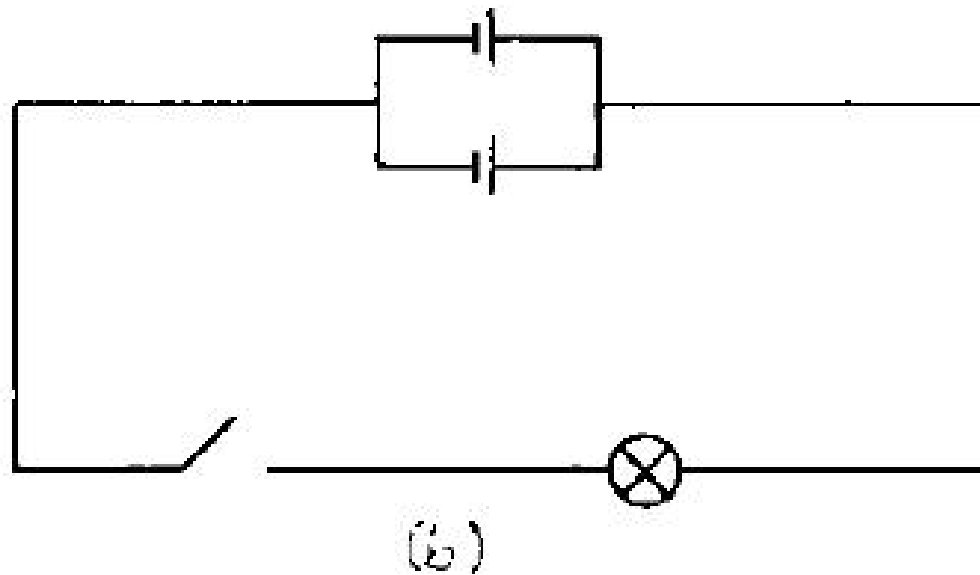
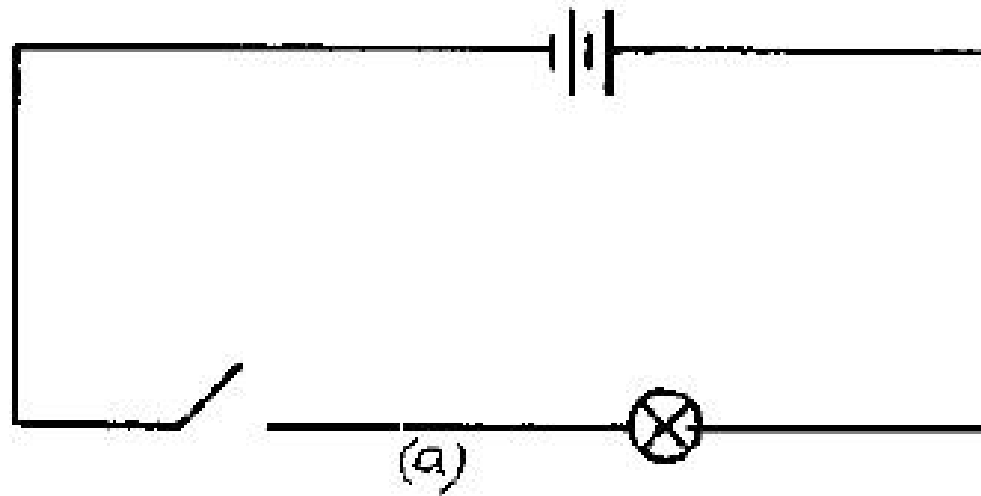

**P:** Connect two dry cells in series, that is the positive terminal of one to the negative terminal of the next as

**P:** Connect two dry cells in series, that is the positive terminal of one to the negative terminal of the next as shown in circuit diagram (a). Connect the two cells parallel, that is the positive terminal of one to the positive terminal of the other and the negative terminal of one to the negative terminal of the other as shown in circuit diagram (b).

**Q:** What difference do you observe in the brightness of the bulb when the cells are connected in series as in circuit (a) and when they are connected parallel as in circuit (b)? Explain your observations.

**O:** The bulb is brighter when the cells are connected in series than when they are connected parallel.

**E:** More current passes through the bulb when the cells are connected in series than when they are connected parallel. The reason is that the *voltage* of the two cells add when they are in series. When they are parallel, the voltage stays the same as that of one cell.

**A:** In torches and car batteries cells are connected in series to get the required voltage. In cars 12 volts are needed, thus 6 cells are connected in series since one car cell has only 2 volts.

### **8.3.5 Ohm's Law: Increasing the Resistance**

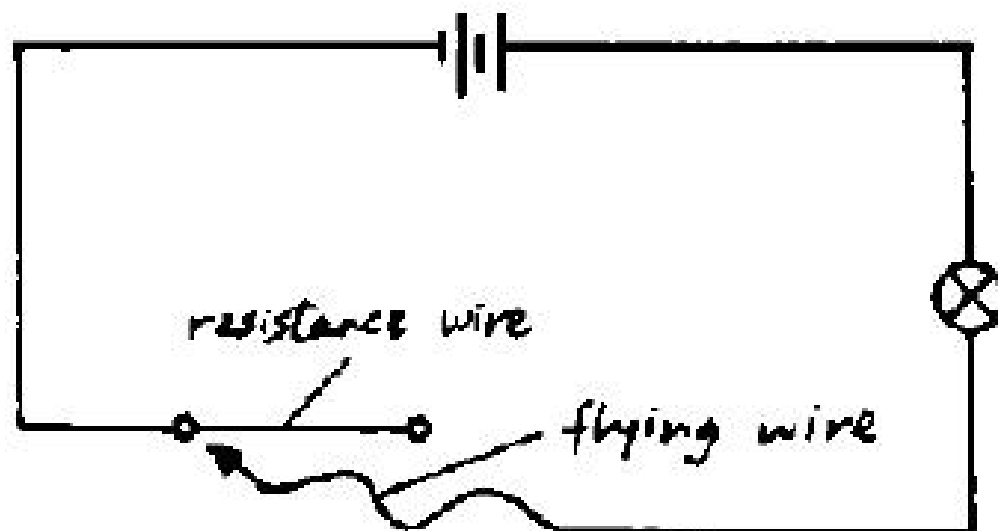

**P:** Connect the circuit as shown in the diagram. Slide the free end of the flying wire along the resistance wire.

**Q:** What happens to the brightness of the bulb?

**O:** The bulb becomes dim when the flying wire is placed at the free end of the resistance wire.

**E:** As the length of the resistance wire increases, the brightness of the bulb decreases. The current passing through the bulb decreases as the length of the wire increases, since the resistance of the wire increases.

**A:** Rheostats are long coiled wires used to vary the current in circuits.

**H:** For the resistance wire you can use a long steel wire from steel wool.

### 8.3.6 Ohm's Law: Increasing the Voltage

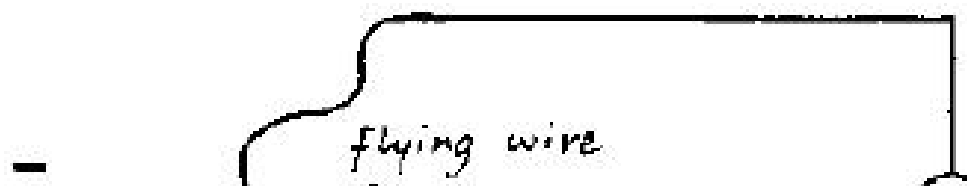

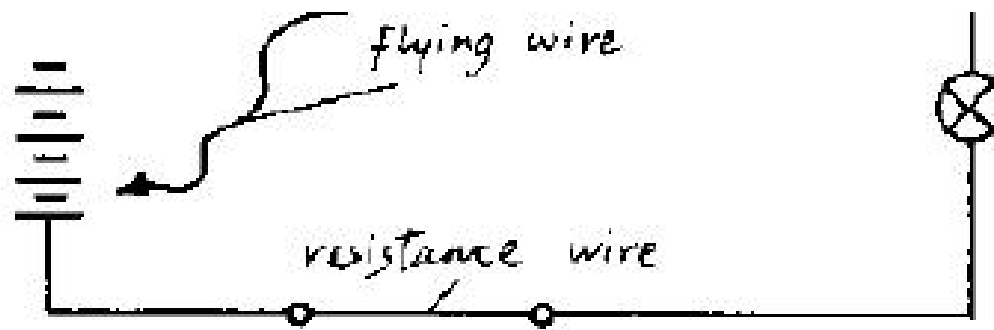

**P:** Connect the circuit above. Starting with the free end of the flying wire connected to one cell, successively increase the number of the cells.

**Q:** What difference in brightness of the bulb do you observe as the number of cells connected are increased?

**O:** The bulb becomes brighter when more cells are used than when one cell is used. The brightness increases with increase in the number of cells.

**E:** The current passing through a circuit increases with increase in the number of cells since the voltage increases accordingly.

### 8.3.7 Heating Effect of an Electric Current



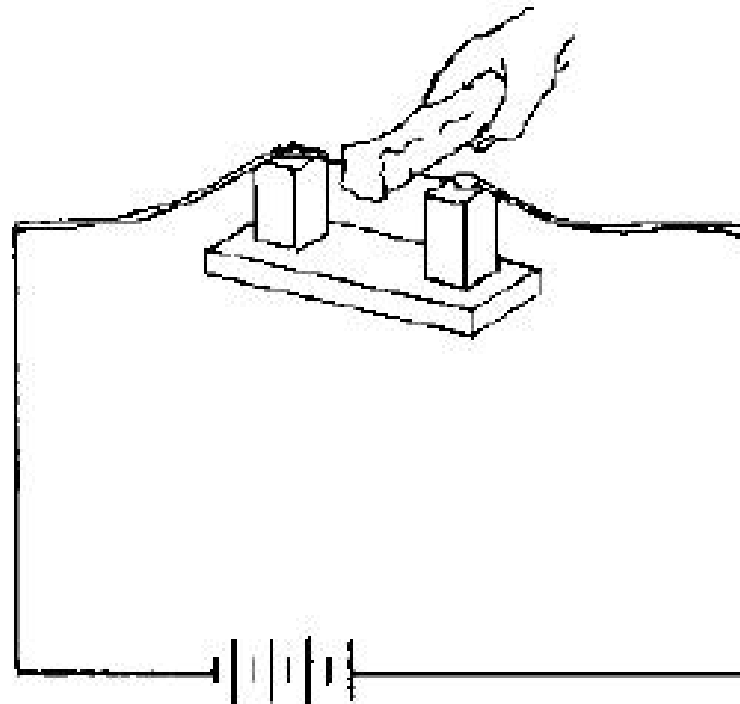

**P:** Set up the circuit as shown. Press a piece of styrofoam (polystyrene) gently across the steel wire.

**Q:** What happens to the styrofoam?

**O:** The styrofoam piece is easily cut.

**E:** The electrical energy has been converted to heat energy which melts the styrofoam.

**A:** Electric iron, electric kettle, electric cooker etc.

### 8.3.8 The Fuse

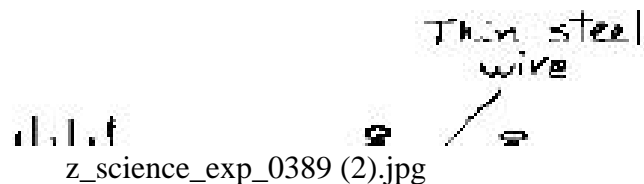

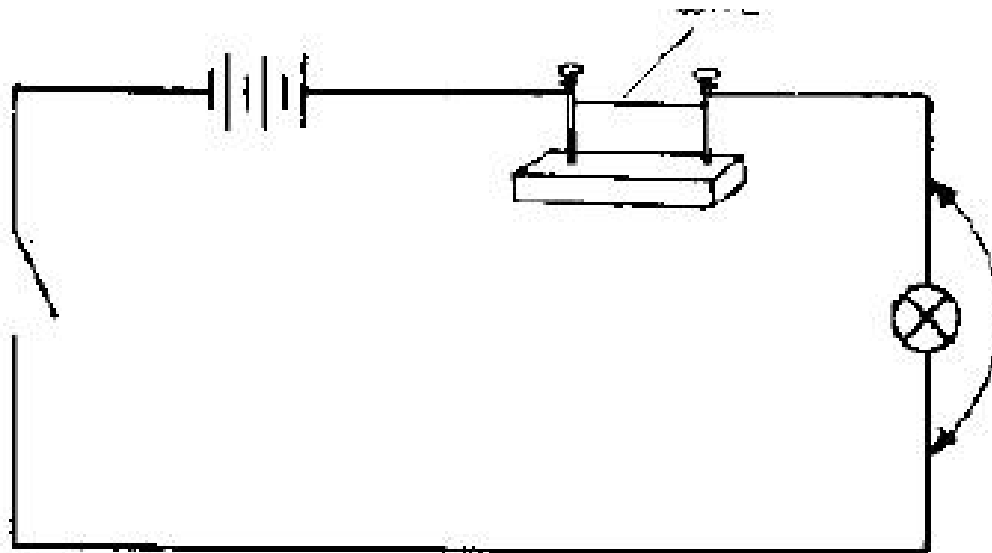

**P:** Connect the circuit as shown in the diagram. Close the switch. Make a short circuit by connecting a copper wire across the bulb.

**Q:** What happens to the thin steel wire connected across the nails?

**O:** The steel wire melts (fuses) and the bulb stops lighting. This is because a large current passes through the thin steel wire. The wire acts as a fuse.

**A:** A fuse is used in electrical appliances and domestic wiring to cut off large currents in electric circuits which could start fires.

### 8.3.9 Chemical Effect of an Electric Current

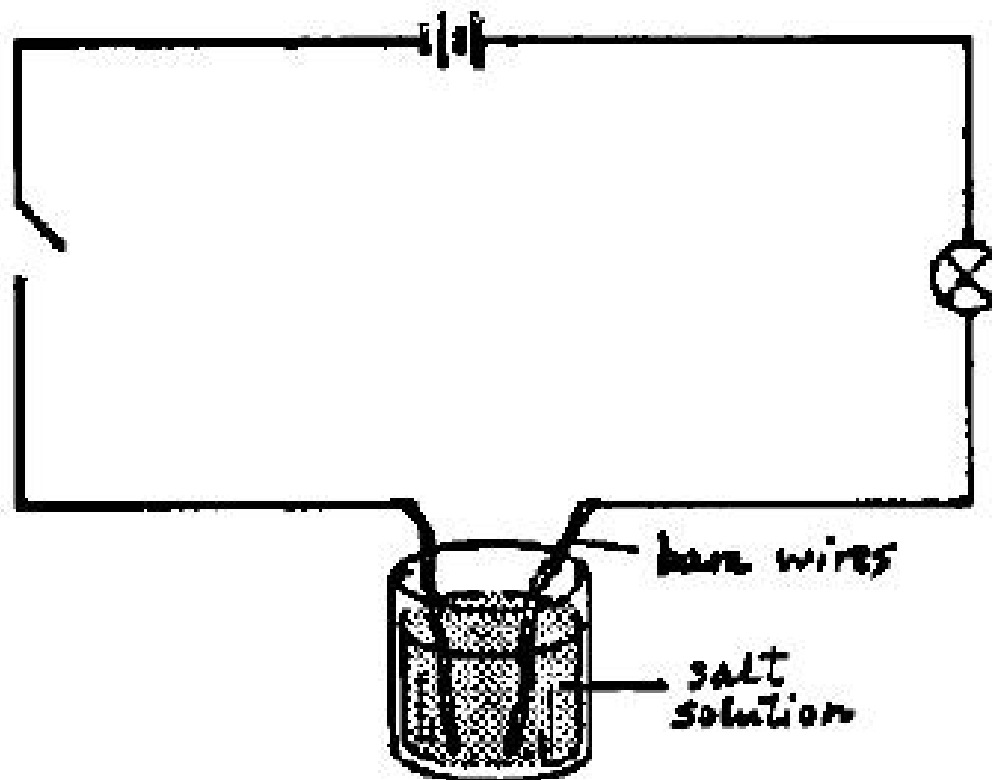

**P:** Connect the circuit shown in the diagram and close the switch so that an electric current passes through the salt solution.

**Q:** What do you observe in the salt solution?

**O:** Bubbles are produced on the bare wires in the salt solution.

**E:** When electricity is passed through a liquid like a salt solution, a chemical reaction takes place which gives off gas bubbles. This process is known as *electrolysis*.

**A:** Electrolysis is used in electroplating and coating of iron with different metals.

### 8.3.10 Magnetic Effect

### 8.3.10 Magnetic Effect

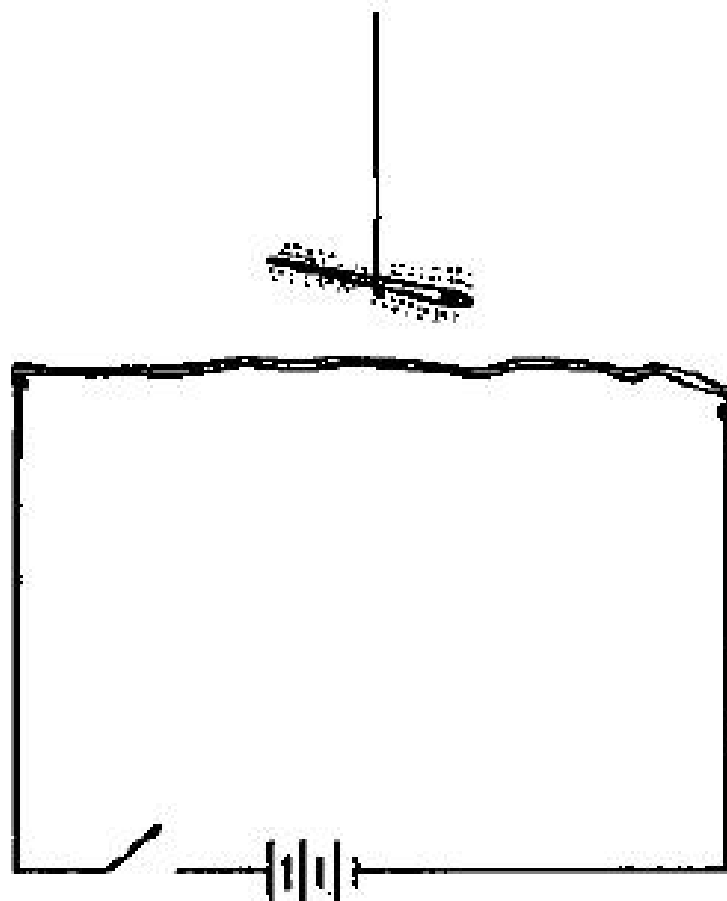

**P:** Connect the electric circuit as shown in the figure. Suspend a magnetized needle with a piece of cotton thread just above the wire. Close the switch *only for a very short time*.

**Q:** What happens to the magnetised needle?

**E:** The magnetised needle is deflected, because the wire has produced a magnetic field.

A: Electromagnets.

### 8.3.11 An Electromagnet

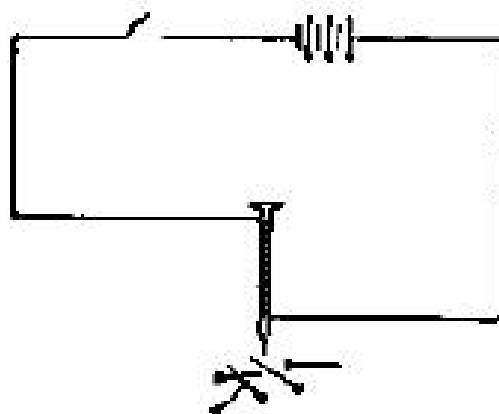

P: Wind about fifty turns of insulated wire around a nail. Connect the ends of the wire to the cells. Place one end of the nail close to office pins lying on the table and close the switch. After a while open the switch.

Q: What happens to the pins?

O: The pins are attracted to the nail, when the switch is closed, and fall off when the switch is opened.

E: When the switch is closed the current flows through the coil and magnetizes the nail. The magnet formed is known as *electromagnet*. The nail is made of soft iron. Thus it loses the magnetism when the current is switched off.

A: Used in harbours for lifting heavy loads with iron containers. In electric motors.

### 8.3.12 The Force on a Current in a Magnetic Field

magnet



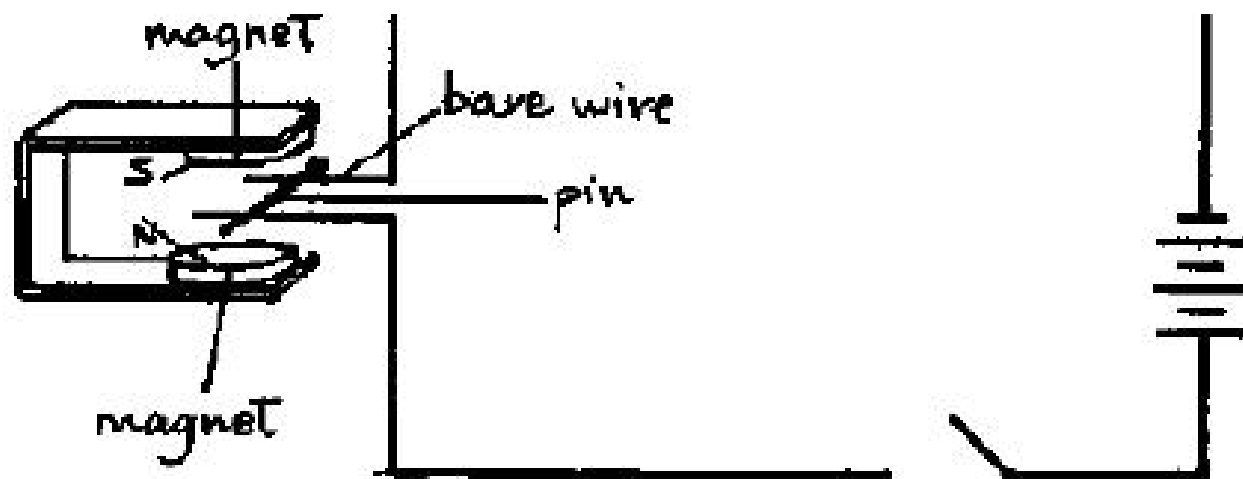

**P:** Connect the circuit as shown in the diagram. Place a nail across the straight bare wires between poles of the magnet and close the switch, *for a short time only*,

**Q:** What happens to the nail?

**O:** The nail rolls along the straight wires, because a force is produced on the current in the nail by the magnetic field.

**A:** Electric motors and loudspeakers.

### 8.3.13 Opening a Dry Cell

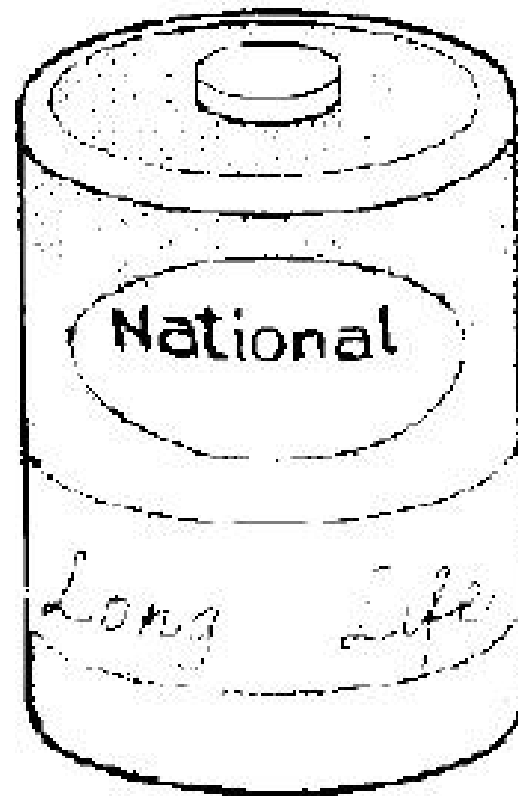

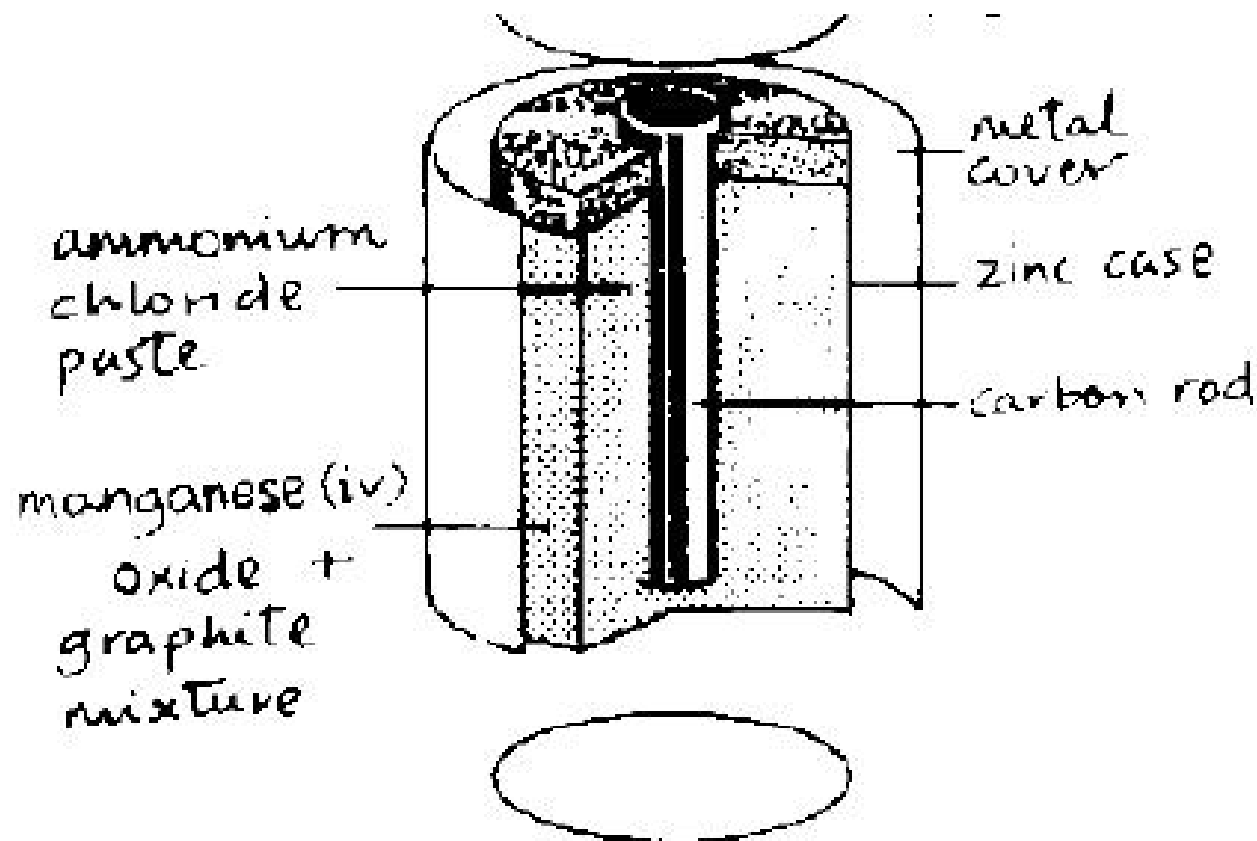

P: Open a dry cell. Examine it carefully.

Q: What do you see in the broken dry cell?

O: You will see a black rod at the centre of the cell surrounded by a black substance covered by eaten up zinc.

E: The black rod at the centre is a carbon rod (graphite). The black substance contains manganese(IV) oxide and ammonium chloride paste.



The electrical energy is produced by a chemical reaction between the zinc and the ammonium chloride paste.

### 8.3.14 The Bicycle Dynamo

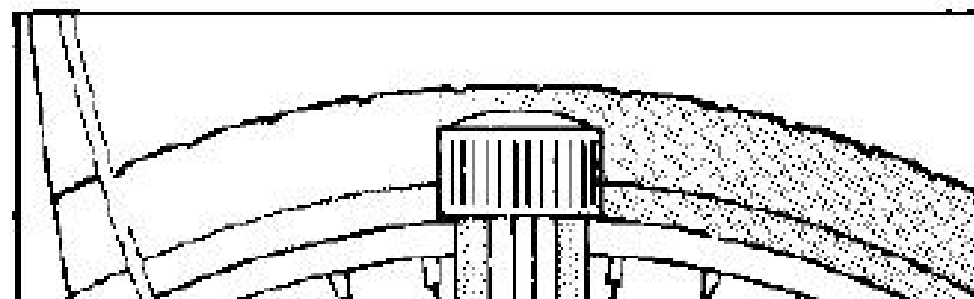
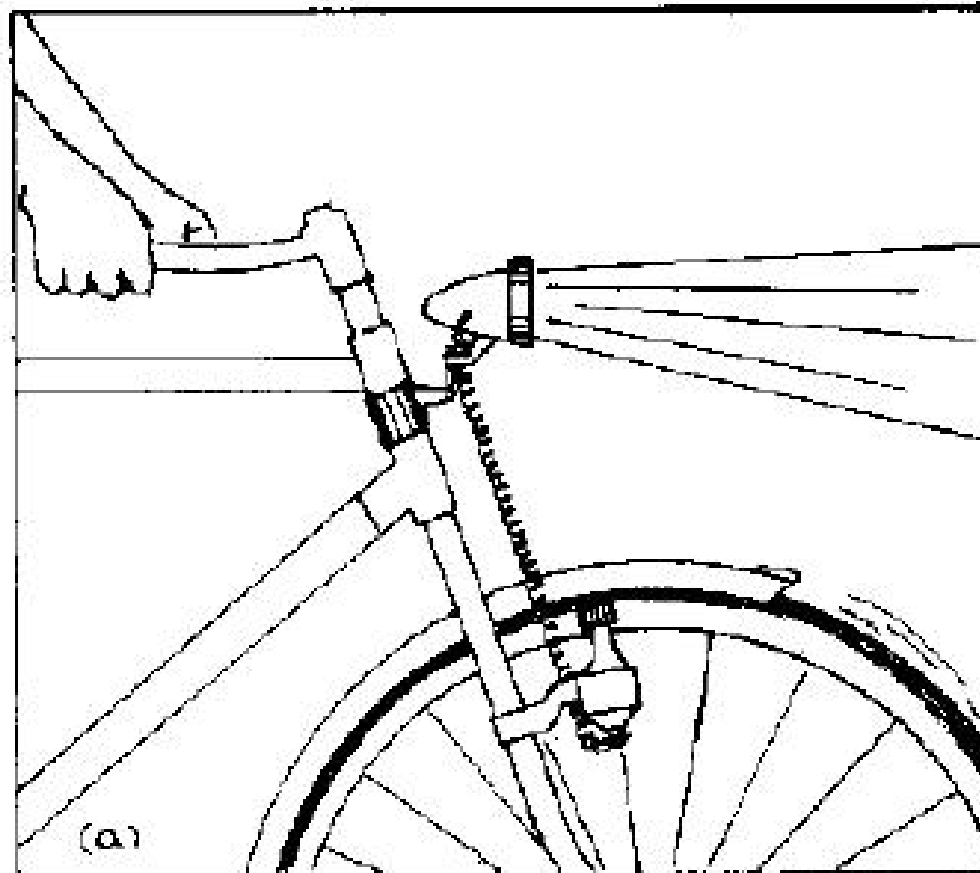

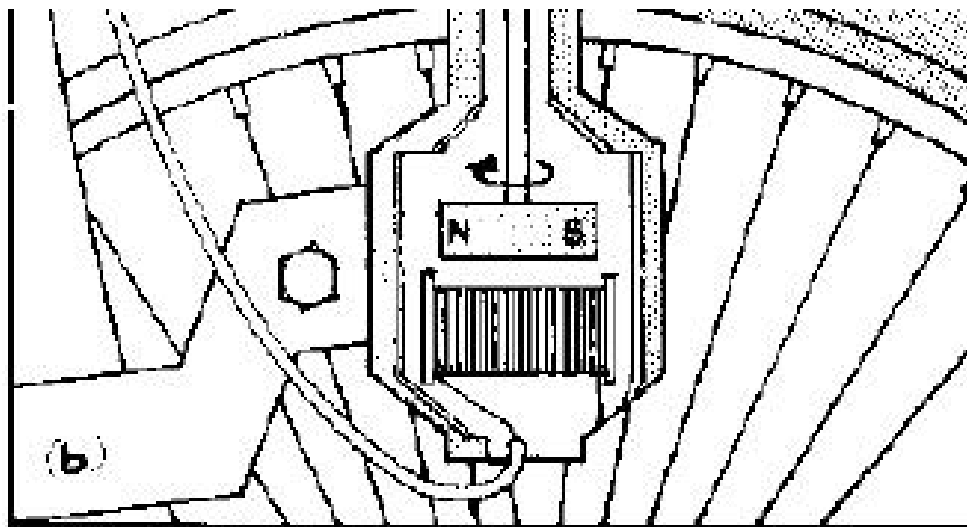

**P:** Connect a bulb to a bicycle dynamo by using connecting wires. Turn the wheel of the bicycle very fast and then slowly.

**Q:** What do you see when the wheel is turned very fast and when it is turned slowly?

**O:** When the wheel is turned very fast, the bulb gives a bright light, and when it is turned slowly, the bulb gives a dim light.

**E:** Inside a dynamo there is a magnet and a coil, see figure (b). When the wheel is turned, it makes the magnet rotate. The rotation of the magnet near the coil produces a current in the coil. The amount of current produced increases with the speed of rotation of the magnet.

**A:** Electric Generators.

## Appendix

### A Sootless Kerosene Burner

Spirit for burners is not always available, but kerosene can be purchased nearly everywhere. For the heating of tins or other things a sootless *kibatari* (kerosene burner) will do.

With a simple and cheap additional device which the same 'fundi' can make who produces the normal *kibatari*, you can get a nearly sootless flame. The principle behind is to improve the draft of the air stream in order to obtain a *more complete combustion* of the kerosene. The flame of the *kibatari* should burn in contact with a metal wall, which acts as a catalyst.

The basic device consists of 4 parts:

- (a) A *perforated inner chimney* is made from a tin which is about 1.3 cm wide and 7 cm long. If the diameter of this tube is too small, the flame will not burn; if it is too wide the effect will be small. The holes can be made with a nail and should have a diameter of 2 mm. There should be 3–4 holes per square centimetre.
- (b) An *outer chimney* which serves at the same time as a wind shield. The holes below are about 5 mm in diameter.
- (c) Both chimneys fit together in a *perforated soda bottle cap* as shown.
- (d) Ask the fundi to solder another soda bottle cap around the *wick holder (d)*. This holds the chimneys better.

The flame is optimized by adjusting the length and shape of the wick: it should have contact with the perforated tube. With this burner temperatures of about 650 °C can be achieved.

perforated tube. With this burner temperatures of about 650 °C can be achieved.

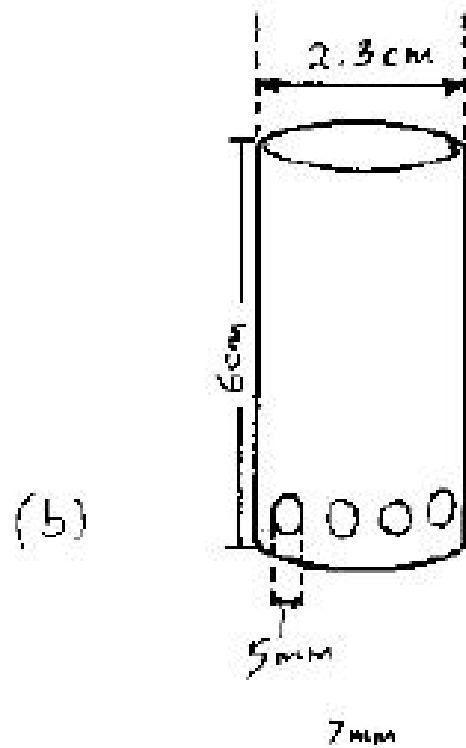
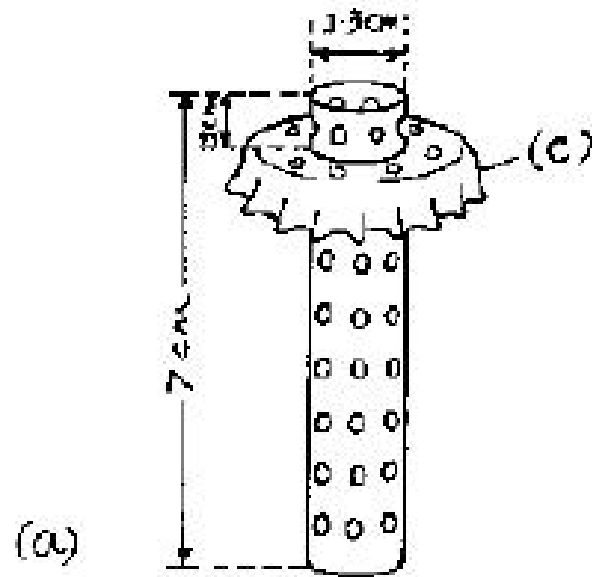

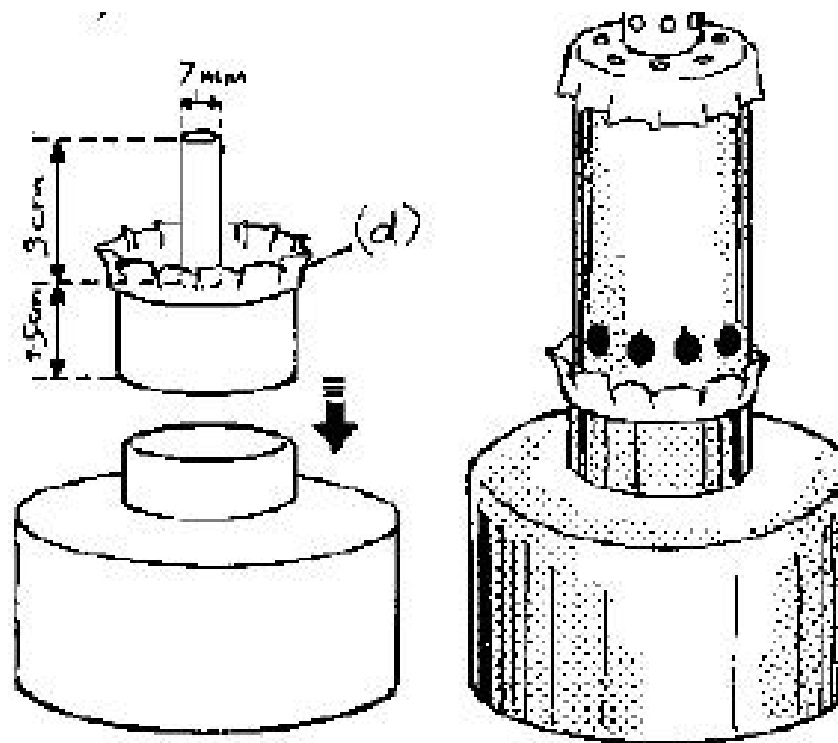

### Test Tubes and Flasks

A cheap substitute for expensive test tubes and reaction flasks are opened worn out electric bulbs. They resist the temperature of an alcohol or kerosene burner, but *not* the temperature of a bunsen burner. Heat the bulbs carefully and do *not* use them for aggressive substances like *concentrated* acids and hydroxides.

Bulbs can be opened with pliers and a round file or even with a pointed long nail. Wrap your hand with a piece of cloth. Never hold the bulb to be opened at its glass, hold it only at its socket, see figure (a).

Special clamps are not needed. Fold a sheet of paper and you have the cheapest test tube or bulb clamp, see figures (c).

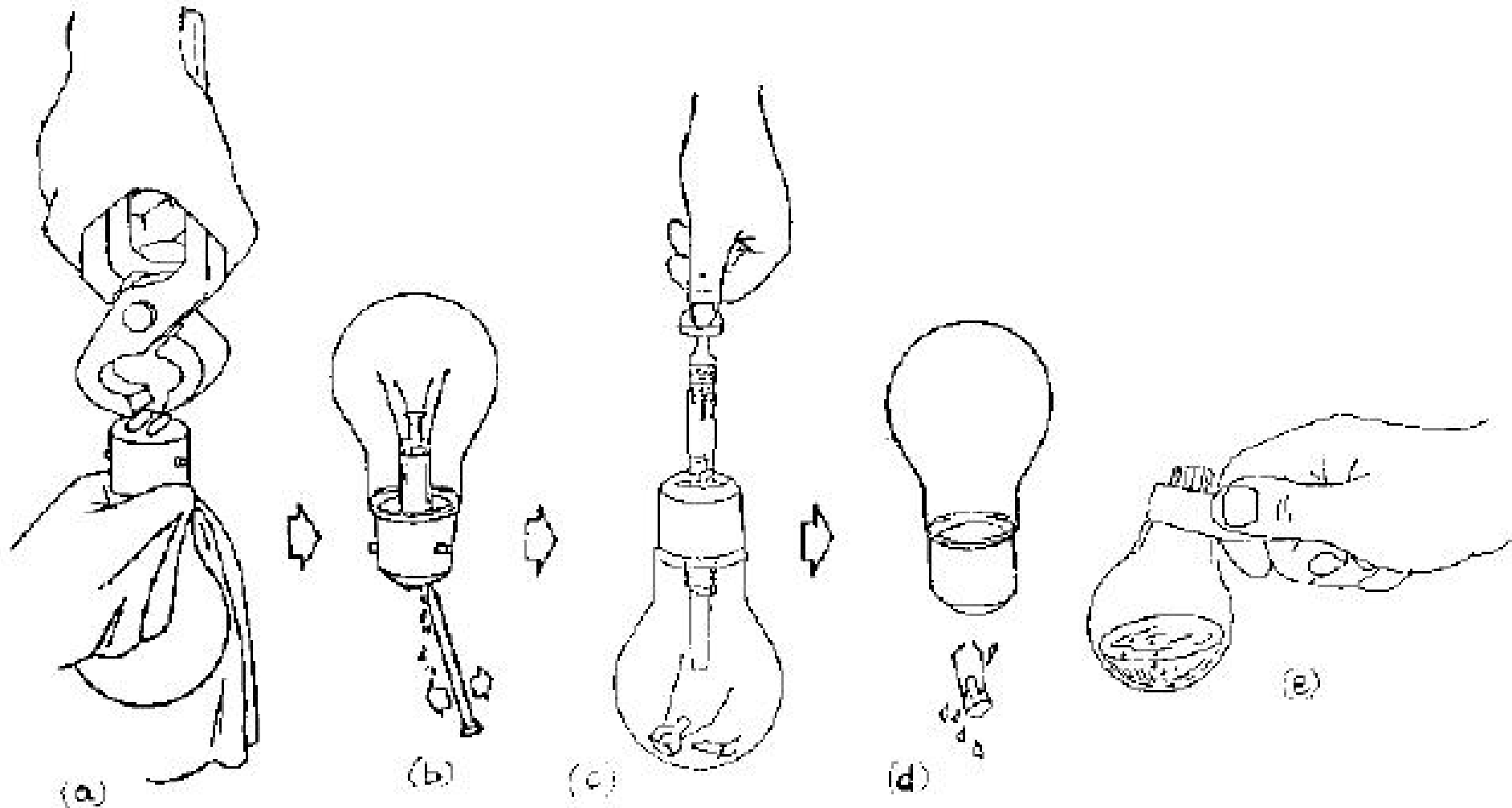

### List of Materials

This is the list of materials needed for a workshop on "Teaching Physics to Beginners with Locally Available

This is the list of materials needed for a workshop on "Teaching Physics to Beginners with Locally Available Materials."

It is assumed that the organisers will bring the materials which are needed for each kit and the tools listed below. These, therefore, are not mentioned especially under the numbered experiments below. Common materials like water, etc. are not mentioned.

The materials listed allow to produce the *Physics kit* with which the experiments described in this book can be performed. Each participant of a workshop should produce his/her own kit according to the experiments he/she selects.

### **Materials (needed for each kit)**

Matches

Wooden rulers

Opened (transparent) bulbs (and if possible some test tubes)

Some vibatari (kerosene lamps; if possible with chimneys for a sootless flame).

Cement bag or similar paper

Nails of different diameters

Thumb pins

Office pins

Paper clips

Small and medium size tins for heating

Some transparent bottles with smooth surface

Some transparent glass jars

2–3 candles

Glue

### **Tools etc. (needed only once)**



- 1 sharp knife
- 1 combination plier
- 1 hammer
- 1 set of weights
- 1 balance (see p. 10)
- 1 measuring cylinder
- 1 magnet (e.g. from a discarded loudspeaker)
- 1 drill borer for 2–3 mm holes
- 1 tin opener
- 1 pair of plate-shears
- 1 pair of scissors

**To be done by craftsmen:**

Chimney for sootless kibatari (see p. 109)

Funny jumper (see p.21)

Box with lid and handle for physics kit, see the figure below

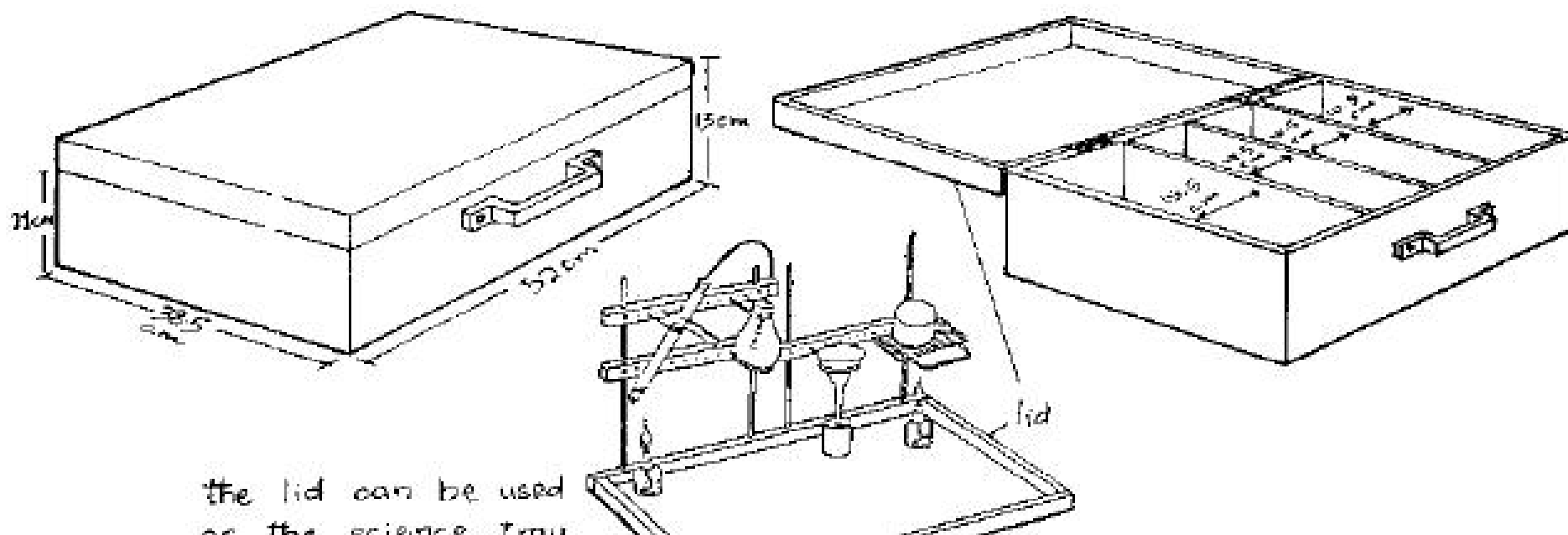

the lid can be used  
as the science stand

the lid can be used  
as the science tray,  
see Chemistry Source  
Book.



In addition to the materials listed above you need the following materials according to the experiments you choose:

- 2.1.1 Rubber band, thin wire, small plastic bags (groundnuts)
- 2.1.2 Bicycle, meter band
- 2.1.3 Thread, nut or small stone
- 2.1.4 Watch, meter band (better 10 m thread)
- 2.1.5 Thread, wooden ruler, small plastic bags, thin wire
- 2.1.6 Clothes-peg, wire (2 mm), thread
- 2.1.7 Plastic bags (groundnuts)
- 2.1.8 Small plastic bags (groundnuts)
- 2.1.9 –
- 2.1.10 Wooden stick, kerosene
- 2.1.11 –
- 2.1.12 5 m string
- 2.1.13 –
- 2.1.14 –
- 2.1.15 Sewing needle (or a piece of bicycle spoke), insulated wire, 1.5 V dry cell
- 3.1.1 Matchbox, smooth table or plank, some bricks, a small stone
- 3.1.2 The same as 3.1.1
- 3.2.1 A stone, a rubber band, a ball of mud
- 3.2.2 Card board or wooden lath, rubber band
- 3.2.3 –
- 3.2.4 –
- 3.2.5 Newton balance, see p. 15

- 3.2.6 –
- 3.3.1 Stone
- 3.3.2 A large and a small stone, string, ball
- 3.3.3 Newton balance, see p. 15
- 3.3.4 Beam balance, weights, see p. 10
- 3.3.5 A pencil, a strip of paper, (table)
- 3.3.6 A toy pick-up or an open box, some card
- 3.3.7 A large paper
- 3.3.8 A large paper
- 3.3.9 A large paper
- 3.3.10 A large paper
- 3.4.1 Sheet of cardboard, thread, 7 equal clothes-pegs
- 3.4.1 Sheet of cardboard, stone, string, pencil
- 3.4.3 –
- 3.4.4 14 nails of 2-inch length, piece of wood
- 3.4.5 Pencil
- 3.4.6 A candle, some card
- 3.4.7 A coin, 2 forks
- 3.4.8 A potato, 2 forks, pencil, bottle, some card, string
- 3.5.1 Wooden stick, a flat piece of wood
- 3.5.2 Book, table, piece of cloth
- 3.5.3 Oil or margarine
- 3.5.4 –
- 3.5.5 Book, about five round pencils or drinking straws
- 3.5.6 Large paper
- 3.6.1 Stone, thread, Newton balance (see p. 15), measuring cylinder
- 3.6.2 Rubber stopper, piece of glass or transparent plastic tubing, beam balance, (see p. 10)
- 3.7.1 Book, pencil
- 3.7.2 –
- 3.7.3 Bucket, a 'ngata'
- 3.7.4 Plastic bag
- 3.7.5 Large tin with air-tight lid, e.g. a charcoal stove, small tin or cup
- 3.7.6 Drinking glass or jam glass, smooth card or plastic sheet

- 3.7.5 Large tin with air-tight lid, e.g. a charcoal stove, small tin or cup
- 3.7.6 Drinking glass or jam glass, smooth card or plastic sheet
- 3.7.7 Bottle, plastic bag, string, straw
- 3.7.8 A piece of transparent plastic tubing, string
- 3.7.9 Plastic or rubber tube
- 3.7.10 One way syringe from a hospital
- 3.7.11 Bicycle pump, large paper
- 3.7.12 Large paper
- 3.7.13 Large paper
- 3.7.14 Large paper
- 3.8.1 Stone, thread, Newton balance, measuring cylinder
- 3.8.2 Matchbox, small stone, Newton balance, overflow can (see p.25), measuring cylinder
- 3.8.3 Bottle, small piece of styrofoam
- 3.8.4 Drinking straw, a piece from a plastic bag, thread, bottle or test tube
- 3.8.5 Salt, egg
- 3.8.6 Candle
- 3.9.1 Wooden block, Newton balance, thread
- 3.9.2 Like 3.9.1
- 3.9.3 Rubber band, stone, branched stick
- 3.9.4 Stopper, used bulb, paper, burner
- 3.9.5 Stone, string
- 3.9.6 3 clothes-pegs, thread, matches
- 3.9.7 Funny jumper (see p.21)
- 3.9.8 String (to measure height), stone, watch
- 3.10.1 Heavy stone, tipped stone
- 3.10.2 Wooden block and bar, some weights (see p. 10), string
- 3.10.3 Wooden lath, wire (diameter 2 mm), 1 cork, card, string
- 3.10.4 Two pulleys (see 3.10.3), string, Newton balance
- 3.10.5 Two broomsticks, rope of about 5 m length
- 3.10.6 Table or plank, some bricks, toy car, string, Newton balance
- 3.11.1 Wire (2 mm), thin wire, 1 seed, 1 small fruit, 1 bulb (1 torch bulb, battery, connecting wires), 1 bottle

- 3.11.2 Stone, string
- 3.11.3 Long string for measuring distances
- 3.11.4 –
- 4.1.1 Some salt
- 4.1.2 –
- 4.1.3 Pieces of cotton, canvas cloth, small polythene bag
- 4.2.4 Orange peels
- 4.2.5 Umbrella or big plastic sheet
- 4.1.6 Simple balance (see 2.1.5)
- 4.2.1 –
- 4.2.2 –
- 4.3.1 Some potassium manganate(VII) (permanganate; or other solid colouring agents)
- 4.3.2 –
- 4.3.3 –
- 4.3.4 –
- 4.3.5 –
- 4.3.6 –
- 4.4.1 2 clean glass pieces (of a broken window)
- 4.4.2 –
- 4.4.3 Razor blade, fork
- 4.4.4 –
- 4.4.5 Some detergent or soap
- 4.4.6 2 glass sheets of about 10 cm x 10 cm, rubber bands or string
- 4.4.7 Stick of chalk, plotting paper or newspaper
- 4.4.8 Piece of cloth
- 4.4.9 Thread
- 4.4.10 –
- 4.5.1 Rubber band, plastic bags (groundnuts)
- 4.5.2 2 tall small bottles (or test tubes)
- 5.1.1 –
- 5.1.2 Small bottle, cork stopper, empty ball point tube
- 5.1.3 Large sheet of paper, ruler, writing facilities
- 5.1.4 Some oil

- 5.1.3 Large sheet of paper, ruler, writing facilities
- 5.1.4 Some oil
- 5.1.5 –
- 5.1.6 –
- 5.2.1 2 Wooden blocks, 30 cm wire (about 2 mm diameter), pin needle
- 5.2.2 –
- 5.2.3 2 razor blades, 1 clothes-peg
- 5.2.4 Thin copper wire (from used motor coil)
- 5.2.5 –
- 5.2.6 Aluminium paper from cigarette packages
- 5.2.7 The same as 5.1.2
- 5.2.8 –
- 5.2.9 Soda or beer bottle
- 5.2.10 The same as 5.2.9, plus tin for a water bath
- 5.3.1 Some ice
- 5.3.2 –
- 5.3.3 Some spirit or petrol
- 5.3.4 –
- 5.3.5 –
- 5.3.6 –
- 5.3.7 Piece of ice
- 5.3.8 Some salt, piece of ice, plastic dish (or plate)
- 5.3.9 –
- 5.3.10 –
- 5.4.1 A ball (from children)
- 5.4.2 –
- 5.4.3 Wire, plastic rod, wooden rod (all of similar size)
- 5.4.4 30 cm wire (2 mm diameter)
- 5.4.5 –
- 5.4.6 Saw dust
- 5.4.7 –

- 5.4.8 Shiny tin, 2 wooden sticks
- 5.4.9 2 identical shiny tins
- 5.4.10 –
- 6.1.1 A rope of about 6 m length
- 6.1.2 Tin, string, some newspaper, glue, ink or fine sand
- 6.1.3 Table or chair
- 6.1.4 Thread, stones of different masses, watch
- 6.1.5 Rubber band, stones of different masses, watch
- 6.1.6 Tin, paper, string
- 6.1.7 Water tank, etc
- 6.1.8 Ink or potassium manganate(VII) (permanganate), a plate, plastic bag
- 6.1.9 Piece of cork, light wood or polystyrene, dropper (see 6.1.8), plate
- 6.1.10 –
- 6.2.1 2 empty tins, string
- 6.2.2 2 pieces of metal
- 6.2.3 2 spoons, string
- 6.2.4 Table
- 6.2.5 Some metres of a thin wire, two poles
- 6.2.6 Plastic bucket, 2 stones
- 6.3.1 Plate or tray, straight metal, plastic or wood barrier, rectangular block
- 6.3.2 Wall or door, 2 paper cones, a sheet of cardboard
- 6.3.3 A window with burglar bars, rope of about 5 m length, a stick
- 6.3.4 A garden hose pipe
- 6.3.5 Tall building or wall
- 6.3.6 Tall tin or jar, a clock, a sheet of cardboard
- 6.4.1 A soft board, thread, 2 pencils, various stones
- 6.4.2 4 equal soft drink bottles
- 6.4.3 A wooden block (better: a box), bicycle spokes
- 6.4.4 A bamboo tube (1.5 cm x 30 cm)
- 6.4.5 Empty tin with lid, wooden stick, string
- 6.4.6 Wooden box, timber bars of different wood and thickness, 2 sticks
- 7.1.1 Wooden blocks as stands, cardboard, candle
- 7.1.2 Manila sheet, string

- 7.1.1 Wooden blocks as stands, cardboard, candle
- 7.1.2 Manila sheet, string
- 7.1.3 Candle, pinhole camera (see 7.1.2)
- 7.1.4 Pencil, candle, white paper
- 7.1.5 2 candles, otherwise like 7.1.4
- 7.1.6 Glass bottle, damp paper etc., (torch), some cards
- 7.1.7 Comb, white paper, piece of cardboard
- 7.1.8 Torch, piece of card, piece of white card or paper as screen, pencil
- 7.2.1 2 plane mirrors, candle
- 7.2.2 Spherical spoon or concave mirror, white card, candle, sheet of white paper
- 7.2.3 Like 7.2.2 plus candle, sheet of white paper
- 7.2.4 Spherical spoon or convex mirror, candle, white paper, needle
- 7.2.5 Transparent glass-pane, candle, bottle
- 7.2.6 2 mirrors, rectangular box
- 7.2.7 Paper, plane mirror
- 7.3.1 Coin, lid of a jam jar
- 7.3.2 Transparent bottle, coin
- 7.3.3 Glass or jam jar, pencil
- 7.3.4 Pin or needle, cork, glass or jam jar
- 7.3.5 –
- 7.3.6 –
- 7.4.1 Convex lens or opened bulb (see p. 110), paper
- 7.4.2 Concave lens or soda bottle bottom or wire loop of 8–10 mm diameter
- 7.4.3 Manila sheet, opened bulb (see p. 110) or convex lens, parchment paper
- 7.4.4 Simple box camera (see 7.4.3), window or candle
- 7.4.5 –
- 7.4.6 Thin wire or opened bulb (see p. 110)
- 7.4.7 Wooden box, metal strip, plane mirror, thin wire loop of 3 mm diameter
- 7.4.8 Box camera (see p.90), plane mirror, parchment paper
- 7.4.9 Large sheet of paper
- 7.4.10 Box camera (see p.90), convex lens



- 7.4.11 Box camera (see p.90), concave lens
- 7.4.12 Some paper
- 7.5.1 Glass prism, white paper as screen, second glass prism or convex lens
- 7.5.2 Plane mirror, dish, white paper as screen
- 7.5.3 Hose pipe
- 7.5.4 White card, blue, green and red pencils or felt pens, string
- 8.1.1 Magnet (e.g. from discarded loudspeaker) plus materials listed on p.98
- 8.1.2 Magnet, magnetised steel needle (see 8.1.3), thread
- 8.1.3 Needle, magnet
- 8.1.4 Needle, magnetised pin or needle (see 8.1.3), paper, small pieces of wood or cork
- 8.1.5 Bicycle spoke, thin insulated copper wire (from old motor coil), 3 radio batteries, insulated wire, iron filings or bits of steel wool
- 8.1.6 The same as in 8.1.5 plus burner
- 8.1.7 Paper, bar magnet or magnetised steel needle, iron filings or bits of steel wool
- 8.1.8 Magnetised knitting needle (see 8.1.3), thread
- 8.1.9 Wooden pin, bowl, magnetised razor blade
- 8.1.10 Metal rod or needle, 2 magnetised needles or steel nails, thread
- 8.2.1 Plastic pen, piece of paper
- 8.2.2 2 plastic pens, thread, glass bottle, silk (e.g. baibui) or polyester material
- 8.2.3 Polythene sheets from transparent covering of a cigarette package or a plastic bag, piece of wood
- 8.2.4 Small piece of aluminium foil, cotton thread, plastic ruler or pen
- 8.2.5 Tap with water, plastic pen, woolen cloth
- 8.2.6 Balloon, wooden or synthetic cloth
- 8.3.1 2 radio cells, torch bulb, connecting wires, 2 metal strips, clothes-peg, plus materials listed on p. 104
- 8.3.2 Torch bulb, 8 metal strips, 3 radio cells, insulated wire for connecting
- 8.3.3 2 radio cells, 2 bulbs, 2 bulbholders (see 8.3.1), switch (see 8.3.2), insulated wire
- 8.3.4 2 radio cells, bulb holder (see 8.3.1), switch (see 8.3.2), insulated wire
- 8.3.5 2 radio cells, bulb, bulb holder, resistance wire or long wire from steel wool, insulated wire for connections
- 8.3.6 4 radio cells, insulated wire, torch bulb, cell holder, bulb holder
- 8.3.7 Styrofoam, 8 cm steel wire (from steel wool), insulated wires, 4 radio cells, some pieces of wood
- 8.3.8 3 radio cells, very thin steel wire (from steel wool), torch bulb, switch, insulated wire, piece of wood
- 8.3.9 2 radio cells, bulb, bare copper wire, insulated wire, switch, salt

- 8.3.8 3 radio cells, very thin steel wire (from steel wool), torch bulb, switch, insulated wire, piece of wood
- 8.3.9 2 radio cells, bulb, bare copper wire, insulated wire, switch, salt
- 8.3.10 3 radio cells, switch, 1–2 mm copper wire, insulated wire, needle, thread
- 8.3.11 3 radio cells, switch (see 8.3.2), insulated wire, thin insulated wire (e.g. from a motor coil)
- 8.3.12 4 radio cells, switch, insulated wire, 2 magnets or U-magnet, wooden stand for the magnets
- 8.3.13 Worn out radio cell
- 8.3.14 Bicycle with dynamo and headlight

## Questionnaire

### Questionnaire About "Sourcebook for Teaching Physics to Beginners with Locally Available Materials"

(Please tick the relevant answers)

Teacher  O'Level student

Other occupation .....

Male  Female  Domicile village  Town

Country .....

I have used the Sourcebook

for private studies	<input type="checkbox"/>
in my occupation	<input type="checkbox"/>

I like .....

.....

I dislike .....

.....

The book helped me .....

.....

I think the following parts should be omitted .....

.....

I would like to see the following topics added to the book when a new edition is made .....

.....

Further comments: .....

.....

Please send to: **Mzumbe Book Project,**  
**P.O. Box 19 Mzumbe,**  
**Morogoro – Tanzania.**

## **Back cover**

This book .....

- emphasizes learning Physics by doing without which no scientific development can take place.
- describes how to make a Physics Kit which is a minilab by itself. It can be used to equip schools which lack laboratory equipment for Physics with locally available materials.

laboratory equipment for Physics with locally available materials.

- Students can even make their own Physics Kit and use it as a home lab to promote their talents in Physics.
- promotes creativity and shows that creative Physics lessons can take place in any scientific development.
- tries to make teachers and students aware of the resources available in their environment which may be used for the teaching and learning of Physics and other science subjects.

ISBN 9987 552 11 0

Low priced edition

**Mzumbe Book Project**  
**P.O. Box 19 MZUMBE, MOROGORO – TANZANIA**



**Sponsored by:**  
**Canadian Organization for Development through Education**

## **Tailor-Made Textbooks – A Practical Guide for the Authors of Textbooks for Primary Schools in Developing Countries**

<http://cd3wd.com/dvd/> - filename: z\_science\_exp\_403 of 598

z\_science\_exp\_0403.jpg

<http://cd3wd.com/dvd/> - filename: z\_science\_exp\_404 of 598

<http://cd3wd.com/dvd/> - filename: z\_science\_exp\_404 of 598

z\_science\_exp\_0404.jpg



## Table of Contents

<b><u>Tailor-Made Textbooks – A Practical Guide for the Authors of Textbooks for Primary Schools in Developing Countries</u></b> .....	1
<u>Acknowledgements</u> .....	1
<u>Introduction</u> .....	2
<u>Using this Guide</u> .....	5
<u>Reference Material</u> .....	6
<u>Getting Down to Basics</u> .....	9
<u>1. A Textbook is Born</u> .....	9
<u>2. Those Responsible</u> .....	19
<u>3. Publishing Specialists</u> .....	22
<u>4. In Conclusion</u> .....	27
<u>The Authors</u> .....	29
<u>1. Profile</u> .....	30
<u>2. Tools of the Trade</u> .....	32
<u>3. In Conclusion</u> .....	34
<u>Preliminary Research</u> .....	35
<u>1. The Need for Research</u> .....	36
<u>2. General Overview</u> .....	37
<u>3. Taking Stock</u> .....	38
<u>4. Planning</u> .....	46
<u>5. Instruments</u> .....	48
<u>6. The Sample</u> .....	57
<u>7. Gathering Data</u> .....	59
<u>8. Results</u> .....	59
<u>9. In Conclusion</u> .....	60
<u>The Contents</u> .....	62
<u>1. Time Management</u> .....	63
<u>2. Methodological Approach</u> .....	66
<u>3. Defining Content Matter</u> .....	67
<u>4. Fine Tuning</u> .....	69
<u>5. Attainment Targets</u> .....	70

4. <u>Fine Tuning</u> .....	69
5. <u>Attainment Targets</u> .....	70
6. <u>Set of Materials</u> .....	70
7. <u>Arranging the Subject Matter</u> .....	73
8. <u>Contents of the Textbook</u> .....	76
9. <u>Contents of the Teachers' Guide</u> .....	79
10. <u>In Conclusion</u> .....	90
<u>The Form</u> .....	92
1. <u>Format</u> .....	93
2. <u>Number of Pages</u> .....	97
3. <u>Basic Visual Structure</u> .....	102
4. <u>The Artwork</u> .....	105
5. <u>Provisional Costing</u> .....	107
6. <u>Medium-Term Planning</u> .....	110
7. <u>In Conclusion</u> .....	112
<u>Writing the Text</u> .....	115
1. <u>Overview</u> .....	116
2. <u>Organising the Work</u> .....	116
3. <u>Texts Addressing Pupils</u> .....	121
4. <u>Exercises</u> .....	126
5. <u>External Checks</u> .....	133
6. <u>Writing the General Information Pages</u> .....	134
7. <u>In Conclusion</u> .....	135
<u>Preparatory Chain</u> .....	137
1. <u>Overview</u> .....	138
2. <u>Illustrations</u> .....	140
3. <u>Layout</u> .....	148
4. <u>Typography</u> .....	155
5. <u>Job Envelope</u> .....	160
6. <u>In Conclusion</u> .....	164
<u>By Way of Conclusion</u> .....	166

## Table of Contents

### Tailor-Made Textbooks – A Practical Guide for the Authors of Textbooks for Primary Schools in Developing Countries

<u>Annexe: Evaluation</u> .....	167
<u>1. Overview</u> .....	168
<u>2. Aspects of the Evaluation</u> .....	169
<u>3. Evaluation Indicators and Instruments</u> .....	170
<u>4. Planning the Activities</u> .....	170
<u>5. In Conclusion</u> .....	173
<u>Bibliography</u> .....	174
<u>Glossary</u> .....	178
<u>Back Cover</u> .....	190



# Tailor-Made Textbooks – A Practical Guide for the Authors of Textbooks for Primary Schools in Developing Countries

Marie Châtry-Komarek



CODE Europe  
Oxford  
1996

Published in Association with Deutsche Stiftung für internationale Entwicklung (DSE), Bonn

All rights reserved. No part of this publication may be reproduced or transmitted in any form or by any means (including photocopying and recording) without the written permission of the copyright holder except in accordance with the provisions of the Copyright, Designs and Patents Act 1988. The written permission of the copyright holder must also be obtained before any part of this publication is stored in a retrieval system of any nature. Applications for the copyright holder's written permission to reproduce, transmit or store in a retrieval system any part of this publication should be addressed to the publisher.

Originally published in 1994 as *Des Manuels Scolaires sur Mesures: Guide pratique à l'intention des auteurs de manuels scolaires pour le primaire dans les pays en développement*.

© French Edition – Edition l'Harmattan, 1994

© English Translation – Deutsche Stiftung für internationale Entwicklung (DSE), 1996

ISBN 0 9528651 0 6

A CIP catalogue record for this book is available from the British Library

A CIP catalogue record for this book is available from the British Library

Published by

CODE Europe  
The Jam Factory  
27 Park End Street  
Oxford OX1 1HU  
UK

Registered Charity No: 1021346

Illustrations: Vincent Randriantsoa  
English Translation: Lynne Jagau  
Design & Production Consultant: Adrian Bullock

Typeset, printed and bound in Great Britain by Alden Press, Oxford.

## **Acknowledgements**

I would like to thank everybody who helped me devise and write this guide, and produce the layout.

First of all I must thank Ramiandrasoa Rajhanson, who has helped me throughout, and provided many ideas which have helped to enrich this book in several ways.

My heartfelt thanks go equally to all my colleagues in the German–Malagasy TefBoky Project, the authors of the Malagasy reading and writing books *Garabola* and *Tongavola*, quoted time and time again in this guide, in particular Narison Andriamialijaona, Randimby Rafaralahy, Lucie Aimée Raharinorombola and Jules

Ranaivoarisoa; without their ideas and comments, and the dogged determination they displayed from 1986 to 1993, this guide would certainly never have been written.

I would also like to thank everybody who went to the trouble of reading the manuscript and making many valuable suggestions, in particular:

Guy Berger, University of Paris VIII

Herbert Bergmann, German Institute for International Pedagogical Research, Frankfurt am Main

Gustave Chené, Consultant to the World Bank's CRESED project in Madagascar

Rémi Clignet, Orstom

Marcel Crahay, University of Liege

Carmelle Denning, International Book Council, London

Sakhevar Diop, World Bank, Washington D.C.

Annick Dumont, Antananarivo

Gisela Frommer, GTZ, Eschborn

Utta von Gleich, Institut für Iberoamerika-Kunde, and the University of Hamburg

Waltraud Heidenreich, GTZ, Eschborn

Ingrid Jung, Ministry of Education, Lima

Claude Rabenoro, Editions Tsipika, Antananarivo

Claude Rabenoro, Editions Tsipika, Antananarivo

Roland Ramahatra, member of the Economic and Social Recovery Committee, Antananarivo

Aristide Velompanahy, former Minister of Education and member of the High Authority of State in Antananarivo and

Carol Warlop, Swiss Cooperation, Antananarivo.

Many, many more people have given me their support and assistance in one form or another; my warmest thanks go to all of them.

Marie Châtry-Komarek  
Antananarivo, April 1993

## **Introduction**

Producing textbooks has proved to be the best way to boost the effectiveness of education at primary level in many developing countries.<sup>1</sup>

Yet, the book situation has deteriorated steadily over the last fifteen years, to the point where today many pupils have no books at all. A recent study covering eight African countries<sup>2</sup> points to the situation in rural schools being the most serious: frequently only one or two copies of a book are available per class. The shortage of textbooks has become so severe that it is currently seen as the major obstacle to progress in primary education in sub-Saharan Africa<sup>3</sup>.

Naturally great efforts have been made to remedy the situation. Numerous governments have tried to obtain technical or financial assistance to enable them to provide their pupils with enough textbooks of a suitable



quality<sup>4</sup>. But the results have often been disappointing; most education projects implemented to this end have run into difficulties of scale, the most common being

- the almost total absence of any national textbook policy which could be used to identify the main shortcomings in the supply of school books in each country, and which would contain precise recommendations on how to remedy these;
- the major deficiencies in the education system; in particular the upstream and downstream services, i.e. curriculum design and pre- and in-service service teacher training;
- the frequent shortage of national authors with the skills required to devise books that are specifically tailored to the needs and the possibilities of the country;
- a general lack of the national structures and/or the publishing capacity needed to ensure a regular and general supply of books;
- the lack of an overview of the publishing chain: in some cases, there is no serious preliminary needs analysis, while in others the difficulties of distributing materials to rural areas have not been taken into consideration.

The first reasons advanced to explain the current lack of textbooks tend to be social, economic and political in nature. Our attention is drawn to the explosion in enrolment after universal primary education was introduced in the 1960s, to the austerity which forced many governments to cut non-salary costs in the education sector in the 1980s and to the fact that the education budget is considered to be of only secondary importance in many developing countries and by the international aid community<sup>5</sup>.

We should add that there are also technical reasons. It is extremely difficult to devise a strategy and the pertinent activities which would guarantee a regular supply of quality textbooks nationwide, and ensure that teachers and pupils put these to the best possible use. The efforts of international and bilateral aid organisations illustrate this difficulty to some extent: some fifteen years ago, attributing the shortages of textbooks to the lack of production capacity, they set up printing houses here and there, which rarely work at full capacity, at least partly because there are so few manuscripts worth printing. Today, these aid agencies

textbooks to the lack of production capacity, they set up printing houses here and there, which rarely work at full capacity, at least partly because there are so few manuscripts worth printing. Today, these aid agencies appear hesitant to decide between the two main priorities that face them: providing a short-term response to the urgent demand for textbooks by investing in existing human resources, primarily authors, or responding in the medium or long term by establishing a full publishing chain along the lines of the model which has proved its worth in industrialised countries, but which would often mean creating entirely new structures in developing countries.

The nature of available literature on textbooks in developing countries also reveals the complexity of the subject. We find analyses of the status quo, which are always instructive and unanimous in their conclusion that there is an urgent and massive demand for books, particularly in sub-Saharan Africa. We also find interesting proposals as to how to remedy the situation, but these tend to intimidate the reader with their inflated expectations. The people who actually work in the field are conspicuously silent in contrast, despite the wealth of experience they must have in the production of textbooks<sup>6</sup>: there is little material which describes innovative experiences vis à vis textbooks, and even less on the process of designing these books.

This is a regrettable state of affairs. Firstly, teams of authors are too often forced to gain the same experience time after time, repeating the errors of those that have gone before them – reinventing the wheel as it were; analyses alone, however important they may be in order to remedy the textbook problem in developing countries, are not enough. It is imperative that they be supplemented by data collected on the spot, in practical textbook development work.

This publication is first and foremost a testimony which we hope will go some way to help fill the gap. It reflects our experience gained in the course of more than fifteen years working in GTZ<sup>7</sup> education projects devoted to developing textbooks for primary schools. It lifts the curtain on two textbook workshops, the German-Peruvian Bilingual Education Project<sup>8</sup>, whose overall goal was to design didactic materials for all subjects and all classes at primary level for native Quechua and Aymara speakers (1977-1990) and the German-Malagasy TefBoky Project, which trained authors and devised textbooks in the national language for primary schools (1986-1994).

It should be noted that this book is not a case study. The specific experiences mentioned are used primarily to illustrate explanations which might otherwise be overly abstract. It is primarily a general interest publication for all those responsible for supplying high-quality textbooks to primary schools in developing countries. And above all it is a guide for authors of these books, all of whom should be able to find valuable information here, although it should be of most use to "apprentice authors" and those who have not had the benefit of an in-depth training in publishing. The points picked up in this book are those that in our experience constitute the commonest stumbling blocks. The contents can be broken down into two rough categories.

### **General Information**

The first two chapters are dedicated to general information. Chapter 1 looks at work relating to the production of textbooks in industrialised countries and at recommendations for developing countries, to enable authors to identify the nature of the textbook production system within which they operate, and the duties which will fall to them.

Chapter 2 looks at the skills and attitudes required by authors, and at the tools which will allow them to preserve group dynamics while enhancing the quality of the individual contributions.

This is background knowledge which we consider indispensable for all those involved in the development of textbooks. We should point out that the information contained in these chapters cannot be harnessed directly by authors in their day-to-day work, unlike the other chapters which do give detailed instructions that can be put into practice immediately.

### **Detailed, Step-by-Step Description of How to Produce a Textbook**

The rest of the guide covers the work involved in writing textbooks in developing countries, from the preliminary research to the preparation of a pilot version, ready to be printed.

What is unique about the approach taken here is that activities are described in chronological order. It is a sort of guide which takes authors through the process step by step, from forming a working group to submitting the final manuscript to the printer. In this we differ from other publications which look at this topic and then go on to analyse the various aspects of books, without aiming to follow every detail of the work of the authors<sup>9</sup>.

to analyse the various aspects of books, without aiming to follow every detail of the work of the authors<sup>9</sup>.

The topics tackled in the following chapters are numerous and sometimes complex. They should be relevant for the production of textbooks for primary level regardless of the subject or language in question, but authors of materials designed to teach reading and writing – particularly those working in a national language – will find information which specifically addresses them.

We would like to emphasise that, in spite of the number of points tackled, this work cannot be considered exhaustive, firstly because it is based on specific experience, which automatically makes it subjective and incomplete, secondly because it looks primarily at authors in developing countries and attempts to meet their particular needs<sup>10</sup>, and finally because the development of a textbook involves numerous different disciplines which cannot be dealt with extensively within the scope of any one publication. This work cannot thus be anything other than incomplete, and certain aspects have even been voluntarily omitted: we do not go into any details which refer too specifically to any one discipline, such as textbooks for a second language or foreign language, nor do we look at things which cannot under any circumstances be the duty of the authors, or those which cannot be considered a priority in the current crisis facing numerous developing countries. The voluntary omissions include

- 4-colour printing
- Planning and managing projects for the mass production of textbooks
- Distribution strategies
- Teacher training to enable teachers to put a new textbook to the best possible use.

It will probably not always be easy to read this guide. Some authors will be somewhat discouraged by the scope and complexity of the work described, others will begin to worry about the feasibility of the undertaking, while still others will be irritated by the inevitable gaps. We would like to encourage those feeling discouraged, doubtful or dissatisfied, and point out that this guide was written, edited and published in a developing country, using precisely the inputs generally at the disposal of textbook projects in developing countries<sup>11</sup>. It can thus be considered a real life demonstration that the work described between these covers is indeed feasible. In terms of the outer appearance, this book cannot claim to compete with the remarkable publications on the

same topic which have been published in industrialised countries. The contents, on the other hand, ought to be better adapted to the target group, even if they sometimes appear somewhat unorthodox to specialists from industrialised countries: the work described here is both necessary and sufficient to allow authors who do not yet have much experience to produce high-quality textbooks for and in developing countries.

This book cannot take the place of either practical experience or a long-term training course. We hope, nevertheless that the approach presented here, and the examples given will be instructive and useful. We equally hope that this testimony stimulates those working in the field, and encourages them to publish their own experience, which would be an invaluable contribution to the search for ways to overcome the current shortage of textbooks in developing countries.

### **Using this Guide**

We entitled this book "A Practical Guide" because we intended it to be a genuine tool to assist textbook authors. To ensure that it is used as such, here are a few pointers which should help you find your way around the book and locate the information you need with ease.

### ***Chapter Topics***

The basic structure of every chapter is identical, i.e.

- A summary which puts the work in context and underlines the essentials
- A description of the work involved in this particular phase, as precise as possible and in chronological order as far as possible
- Illustration of the main body of the text, generally in the form of boxes referring to experience gained in producing reading and writing books in Malagasy within the framework of the German–Malagasy Tef Boky Project already mentioned. For reasons of clarity we have decided to concentrate on *Garabola*, the first book to be produced in this series, which we will present in more detail below.

decided to concentrate on *Garabola*, the first book to be produced in this series, which we will present in more detail below.

- Notes at the end of the chapter
- Some suggestions for further reading which can be followed up by anyone interested in going into the subject in more depth
- A systematic resume of the ground covered in the chapter.

### ***Text Markers***

Apart from the first two chapters, you should read every chapter bearing in mind the order in which work should be performed; a number of text markers will help you find your place, i.e.

- The chapter title at the top of each left-hand page serves as a rough guideline.
- A running head at the top of each right-hand page gives you your bearings more exactly.
- A telegram-style summary of the most important points can be found in bold at various points in the text.
- An index at the back of the book allows you to look up individual points, check information or rapidly find precisely the information you need.

### ***How to Get the Most out of this Book***

This guide can be said to pursue a two-fold goal: the first two chapters aim to give textbook authors the basic information they need to start work, i.e. to train them all be it in a very rudimentary fashion; the second part is

designed as a guide for textbook production.

As a result of this dual goal – training and production – the guide comprises different sorts of texts. Firstly it presents general information which the reader should assimilate if possible. Secondly it gives detailed advice similar to a user's manual, which is far too compact to be memorised.

This explains why it is not advisable to try and read the book from cover to cover at one sitting. Neither, however should you merely dip into it from time to time. We recommend using the book as follows to ensure you get the most out of reading it:

- Read the first two chapters carefully, more than once if necessary, as an introduction to the problems of textbook production and to the layout of this guide.
- Read through chapters 3 to 7 rapidly. This is crucial to enable you to find the detailed information you need later.
- Consult the book throughout the process of producing a textbook as and when required to check information, or read in more detail about a specific point. You can only consult the book properly if you can put the specific information into the overall context.

These different approaches will help the reader extract a maximum of information from the book, and will help enhance the quality of the textbooks he or she is responsible for producing – and that is our aim.

## **Reference Material**

In this book we will make frequent reference to the didactic materials produced by the German–Malagasy TefBoky Education Project; particular importance is attached to the *Garabola* set of materials designed to teach reading and writing in Malagasy.

For reasons of clarity, we will outline the main features of the pilot version and the revised version below.

For reasons of clarity, we will outline the main features of the pilot version and the revised version below.

### ***Garabola, pilot version***

Published in 1988

Authors:

- Narison Andriamialijaona
- Randimby Rafaralahy
- Stefanoela Rakotodrainy
- Jules Ranaivoarisoa

### **The set**

- 3,000 copies of 1 reading book, printed in two colours, 80 pages, 240 x 170 mm, saddle stitched with two staples
- 3,000 copies of 1 writing book, printed in black, 240 x 170 mm, saddle stitched with two staples
- 100 copies of the teachers' guide, photocopied, 196 pages, 297 x 210 mm, spiral binding.

### **The reading book contains**

- Three lessons on the vowels, **o**, **i** and **a**



<http://cd3wd.com/dvd/> - filename: z\_science\_exp\_413 of 598

- 18 lessons on the 16 consonants and the vowels **e** and **y**; every four lessons two pages to read to consolidate what has been learned
- 16 pages of supplementary reading.

The book was printed in two colours to make it of a comparable standard to a book for learning French as a foreign language which had just been published in 4–colour, and which was being distributed nationwide at the time.

### **The writing book contains**

- 10 pages of preparations
- 3 pages of writing for each of the 21 letters of the alphabet, following the same order as the reading book
- 2 pages of revision, corresponding to the consolidation reading
- 3 times 2 pages of evaluation, which correspond to the Christmas, Easter and summer examinations.

### **The teachers' guide contains**

- 20 pages of general information on the subject "Malagasy" and the material
- A 12–page first part, which corresponds to the work of the first two weeks of the school year for the pupils in this class
- A 160–page second part, containing a real script for all elocution, reading and writing classes scheduled for the year

classes scheduled for the year

- One glossary of the principal technical terms used in the guide.

### ***Garabola, revised version***

Published in 1991

Authors:

- Narison Andriamialijaona
- Marie Châtry-Komarek
- Randimby Rafaralahy
- Jules Ranaivoarisoa

### **The set**

- 450,000 copies of 1 reading and writing book, printed in black, 96 pages, 240 x 170 mm, saddle stitched with two staples
- 17,000 copies of the teachers' guide, printed, 212 pages, 297 x 210 mm, spiral binding.

As regards the essential pupils' materials, the main difference between the pilot version and the revised version of *Garabola* is that the separate writing book was dispensed with.

The final version of the book is thus intended as a tool for both reading and writing.

With the exception of the first three lessons, which focus on learning the vowels, the presentation of all chapters is identical:

- 2 pages for reading
- 2 pages for writing.

Although the basic layout of the revised teachers' guide is the same as the pilot version, i.e. detailed instructions for each of the speaking and listening, reading and writing lessons scheduled for the year, fundamental changes were made as regards visual presentation.

### Notes

<sup>1</sup> Cf. Heyneman, S.P. et al *Textbooks and achievement. What we know*. Washington D.C.: World Bank, 1978.

<sup>2</sup> Cf. Buchan A. et al *Etudes sur le secteur du livre en Afrique*, p. 17. Washington D.C.: World Bank, 1991.

<sup>3</sup> Cf. World Bank *Education in Sub-Saharan Africa*, p. 42. Washington D.C., 1988.

<sup>4</sup> Between 1965 and 1983, for instance the World Bank helped finance 48 projects which tackled the preparation, supply and distribution of textbooks; the proportion of textbook projects, which accounted for 6% of all education projects in 1974, had risen to 43% of the total by 1983. Cf. Searle B. The provision of textbooks by the World Bank. In: Farrell, J.P. and Heyneman, S.P. *Textbooks in the Developing World*, p. 17. Washington D.C.: World Bank, 1989.

<sup>5</sup> In 1989 only 23% of international aid went to the social sector, and only 7% of the aid pledged to the education sector went to primary education. Cf. United nations Development Programme. *Human Development Report*, p. 8. New York, 1991.

This percentage is all the more surprising since the importance of primary education and textbooks is recognised. The need to invest in author training and in the production of textbooks specially tailored to the needs and abilities of those concerned should long have been accepted as a self-evident fact and been elevated to a priority of international aid.

needs and abilities of those concerned should long have been accepted as a self-evident fact and been elevated to a priority of international aid.

<sup>6</sup> In 1985 86 languages were recorded as being used in instruction in African primary schools. Cf. UNESCO. *Les langues communautaires africaines et leur utilisation dans l'enseignement et l'alphabétisation*. Dakar, 1985. In spite of the absence of any systematic documentation of the teaching materials produced in each of these languages it is safe to assume that a not inconsiderable number have been produced over the last twenty years.

<sup>7</sup> Deutsche Gesellschaft für Technische Zusammenarbeit (GTZ) GmbH (German Technical Cooperation).

<sup>8</sup> The experience gained in this project as regards the production of reading and writing books in Quechua has been presented in a Spanish publication. Cf. Châtry-Komarek M. *Libros de lectura para niños de lengua vernácula*. Eschborn: GTZ, 1987.

<sup>9</sup> At this point we should mention Richaudeau F. *Conception et production des manuels scolaires*. Paris: UNESCO, 1979 which we will refer to at several points in the course of this guide.

Although his method is not the same as ours, we would recommend this publication to all teams of authors of school materials in developing countries as one of the best works of reference currently available.

<sup>10</sup> It would be unthinkable in a book aimed at a European or North American audience not to dedicate a significant amount of space to colour printing, but we consider this too expensive for most developing countries, and thus of only secondary interest.

<sup>11</sup> We refer to the first French version published in Madagascar in 1993.

## Getting Down to Basics

Who decides to produce a new textbook? What steps must we take to produce it systematically? Who is responsible for preliminary research? Who produces the concept? How much time is needed from the finalisation of the concept until the finished book is distributed to schools? Who interfaces with the graphic artist? And with the printer?

These are a few of the questions facing first-time authors, and are probably the questions most likely to cause headaches for those of you who have already produced several books without having been specifically trained on the job. You may feel that you are unable to pinpoint the weaknesses of your own products, and thus improve them. To answer these questions, we will start by looking briefly at the various steps involved in producing a textbook, before going on to look at the respective responsibilities of the agencies and individuals involved in industrialised countries and in developing countries.

Why should we look at the various production systems, you may ask. Not to pronounce a value judgement, but to give you a framework of reference. Firstly we will look at the procedure adopted by major publishing houses to produce works that are competitive in terms of quality and price, and only then will we go on to identify the special nature of the production process in developing countries, and thus to deduce your responsibilities as authors.

This chapter, which contains general information and ideas, differs from the subsequent chapters which give precise descriptions of the steps involved in producing a textbook. We suggest nevertheless that you read it carefully since this will allow you to situate the various individual steps described later in the book within the context of the overall process.

**Try to become familiar with the various steps in the publishing chain, since this will allow you to identify the special features of the production system within which you operate, and to pinpoint your own role within that system**

**A private publishing house accompanies its “baby” every step of the way, until it is in the hands of the user**

## **1. A Textbook is Born**

We term the collection of operations leading from the idea to the production and distribution of a book – in the case in hand from the textbook publication project to the pupil – the “publishing chain”.

While it is true to a degree that the steps in the publishing chain are always identical (every book is planned, designed, produced and distributed in that order), as we will see below the procedure adopted does vary, and the differences are important.

### ***The Chain at Commercial Publishers***

In industrialised countries, textbooks are generally produced by private publishing houses, which are guided by the profit motive; the various steps making up this commercial production style are systematically organised. Since it is important for you to have a thorough understanding of the work involved, we will firstly explain this work, then illustrate it and finally summarise what you have learned.

### **Preliminary Research**

A market analysis is always conducted before work starts on a textbook. The publisher only decides to produce a book once he is certain that there is a demand for the product, i.e. once he has identified a shortage of textbooks in schools for a particular subject or when changes to a curriculum mean that new books will be required.

### **The Concept**

Having decided to go ahead and produce a textbook, the publisher moves on to the conceptual phase. He firstly defines his pedagogical, technical and financial criteria, and then decides on the sequence in which the content matter will be presented and on the physical and design features of the book (including the format,

number of pages, number of illustrations and their format, and the layout of the text and illustrations on the page).

At the end of this phase the publisher will generally have produced a preliminary plan or "design" of the future book, which serves as a guide for authors and illustrators, and can be used to draw up an initial quotation.

### **Producing Texts and Illustrations**

Authors and illustrators now enter the scene: the authors write their texts and devise exercises on the basis of findings identified during the conceptual phase; their work is subjected to various internal controls within the publishing house and sometimes to spot checks in one or more schools. The illustrators produce the graphics in line with the instructions they receive from the publisher and the authors. In general a final quotation can be drawn up at this stage.

### **Preparations for Printing**

All the elements to be printed must be prepared: the manuscript has to be typeset, i.e. composed into pages suitable for printing; illustrations must be prepared in a photoengraving workshop. Composition and photoengraving work is done on films for offset printing.

The text and illustrations are then arranged on each page: the design drawn up during the conceptual phase is finalised and a model or "layout" produced, which is used as a sort of template for the future textbook.

Following the instructions given in the layout, the films produced for the text and illustrations are arranged for every page, and the pages are "mounted", i.e. all the pages that are to be printed at the same time are stuck onto a transparent background.

This montage produces the forme which can then be used to print the book.

### **Printing and Finishing**

The textbook is now ready to be printed. Large-format sheets are placed in the printing press. Several pages of the future textbook will be printed at once, as they have been mounted.

The textbook is now ready to be printed. Large-format sheets are placed in the printing press. Several pages of the future textbook will be printed at once, as they have been mounted.

The sheets must then be put into the final form, which involves five steps: firstly they are folded in line with the number of pages printed per sheet and the type of folding planned, then they are put together to form the inside of the book; the book is then stitched, stapled or stuck together. All that then remains is to add the cover and trim the three open sides to give a neat finish – a new textbook is born.

### **Storage and Marketing**

The textbook is stored at a distribution centre. A promotion campaign is run to present it to those responsible for purchasing textbooks, primarily school teachers and head teachers. A distribution network then ensures that the textbook can be supplied to book shops or directly to the schools.

### **Follow-Up**

**In the field, the publishing house monitors the performance of “its” book, with a view to possible reprints**

The use of the textbook is more or less strictly monitored; the publisher thus gathers data which would be important for any reprints.

If you do not yet have much experience in this field, this initial description of the production process has probably confused you a little. You probably did not realise that so much went into producing a textbook.

The technical terms, specially those from the world of printing, are bound to be new to you, and you will have no clear idea about what certain operations really involve. But we have refrained from going into detail about the individual technical operations, and we have not even mentioned every essential step in the production of a textbook.



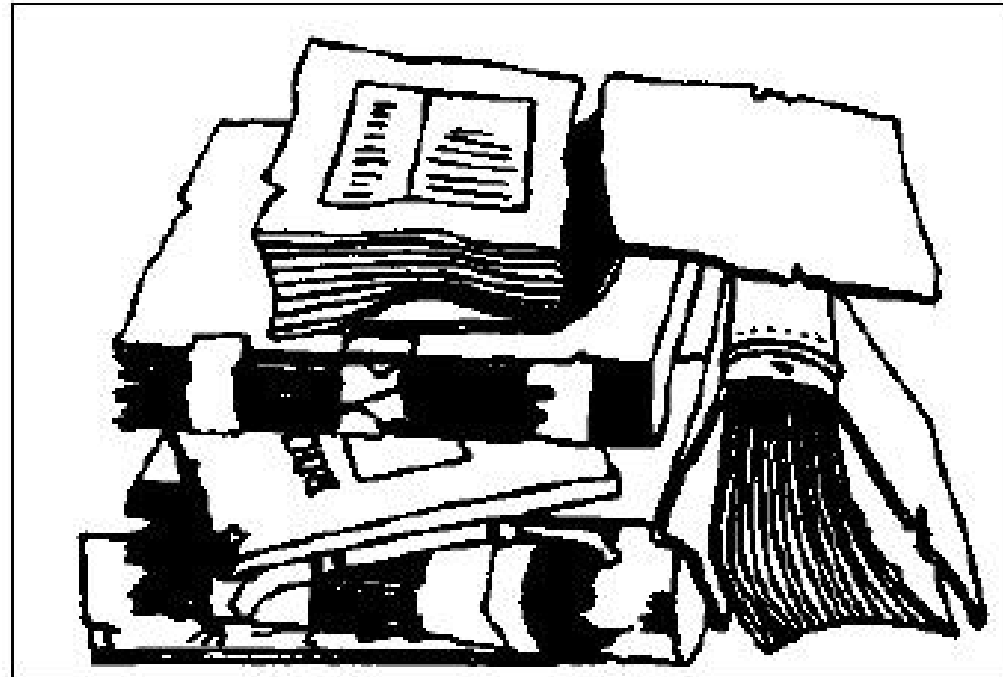

1. Preliminary Research: The most common reasons for publishers to produce new textbooks are that the old ones are tattered and worn, have become unusable or have become obsolete as a result of major changes in the official curricula.

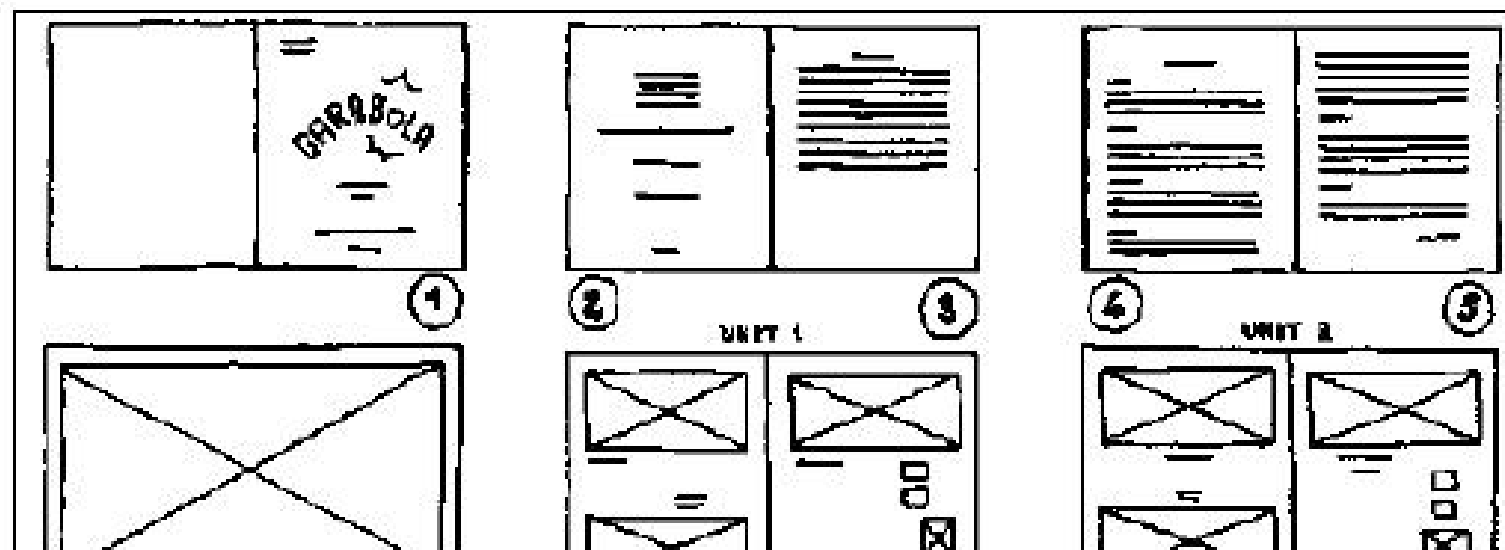

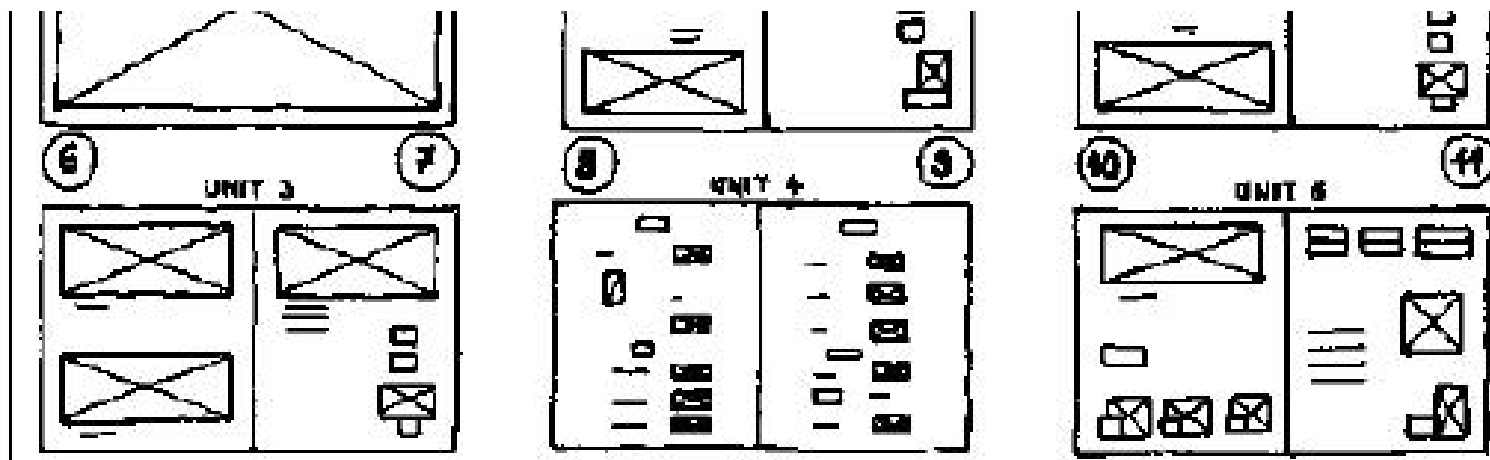

2. The Concept: Once the contents and the form of the textbook have been defined a design can be drawn up. Thereafter the approximate visual arrangement of the texts and illustrations can be undertaken, double page by double page; this draft is known as the layout plan. The illustration below shows the first few pages of Garabola at this stage.

There are three reasons for this: firstly, if you are interested in discovering more about certain production techniques you will have no difficulty in satisfying your curiosity; at the end of each chapter we list a number of publications which deal with these points and illustrate them well; secondly, you should focus your attention primarily on those parts of the process which directly concern you as authors – the analysis of the subject matter, for instance – rather than getting bogged down with technical details; finally this brief presentation will be taken up again and dealt with in more detail in chronological order in later chapters, which will give you additional information and broaden the scope of this first brief introduction.





3. Producing Texts and Illustrations: The authors devise texts and exercises, while the illustrators produce the graphics, both working on the basis of the layout plan.

What should be grasped at this stage is the principal stages that make up the publishing chain on one hand, and the basic principles of certain tasks involved in producing a textbook on the other. To allow you to better assimilate this information, we have summarised the essential points, and illustrated some of them.

**As authors you should become familiar with the various links in the publishing chain**

4. Preparations for Printing: You should be able to distinguish the various phases of work.

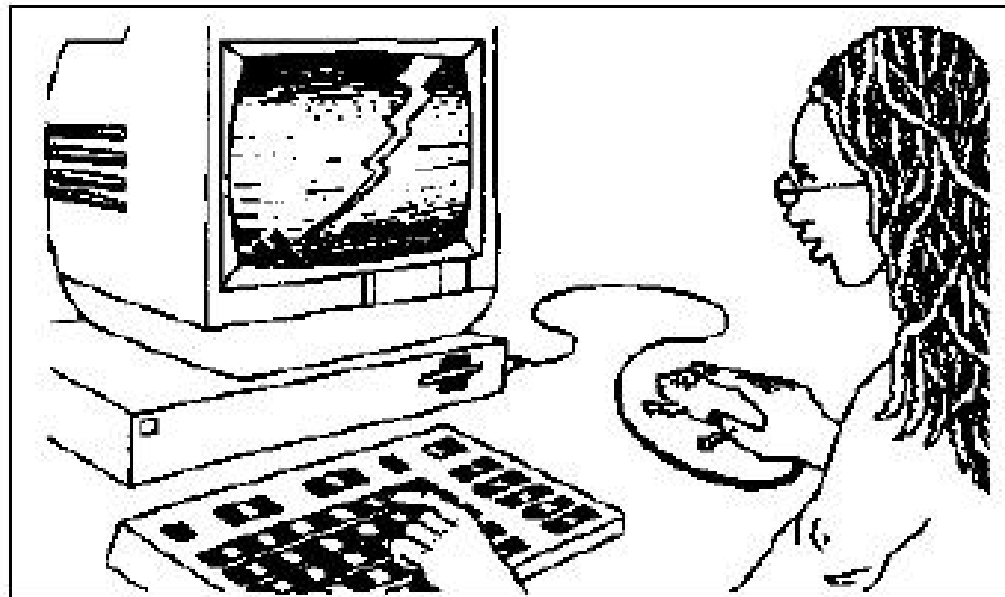

- The texts and exercises are typeset using a computer, the characters in the resultant copy are the correct

shape and size.

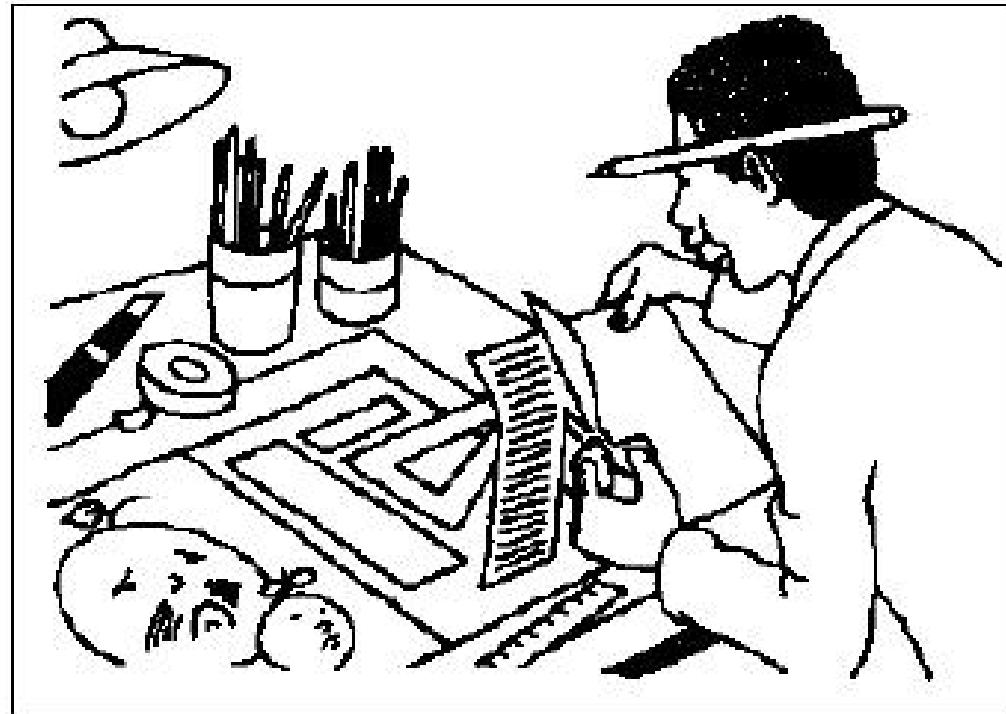

- The layout artist then makes a precise dummy make-up on paper, arranging texts and illustrations.

These explanations and the illustrations above will have helped you to familiarise yourself with the various steps that make up the chain, as practised by large publishing houses.

Given the fact that it is imperative for you to start to memorise the sequence of work involved, we will, however, come back to the production phases for a textbook one more time, summarising the main phases within the publishing chain and the results of each phase. Before you proceed to the next section, we would thus recommend that you look at Table 1.



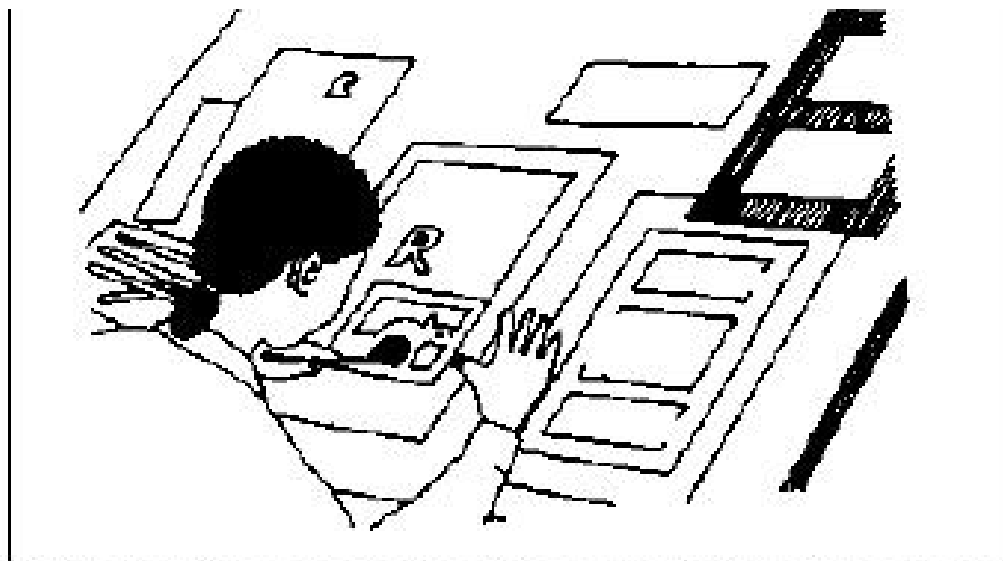

- On the basis of this, the films made for the texts and illustrations for each page are mounted.

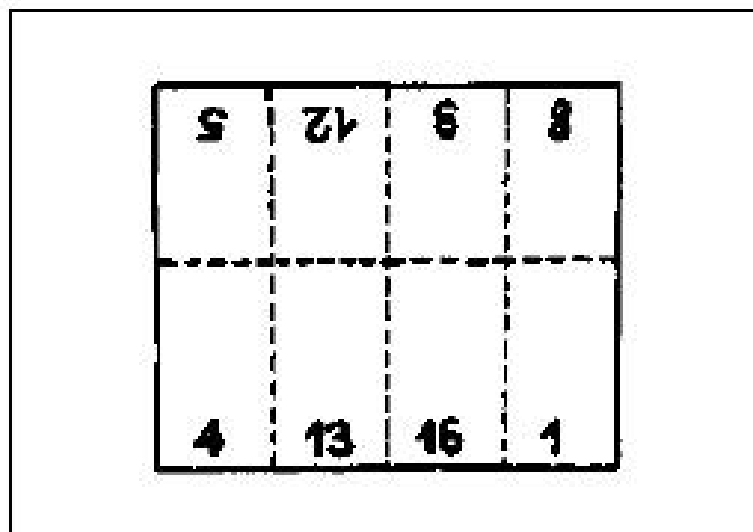

- Finally, the imposition is checked to ensure that the pages are arranged so that they will read consecutively when the printed sheet is folded. If eight pages are to be printed together, for instance, the layout would be as shown below.

### *Production Cycle in Developing Countries*

After this introduction to the steps involved in the commercial production of textbooks, let us now turn our attention to the procedure that should be adopted in developing countries.

5. Printing and Finishing Once again you must distinguish between various phases.

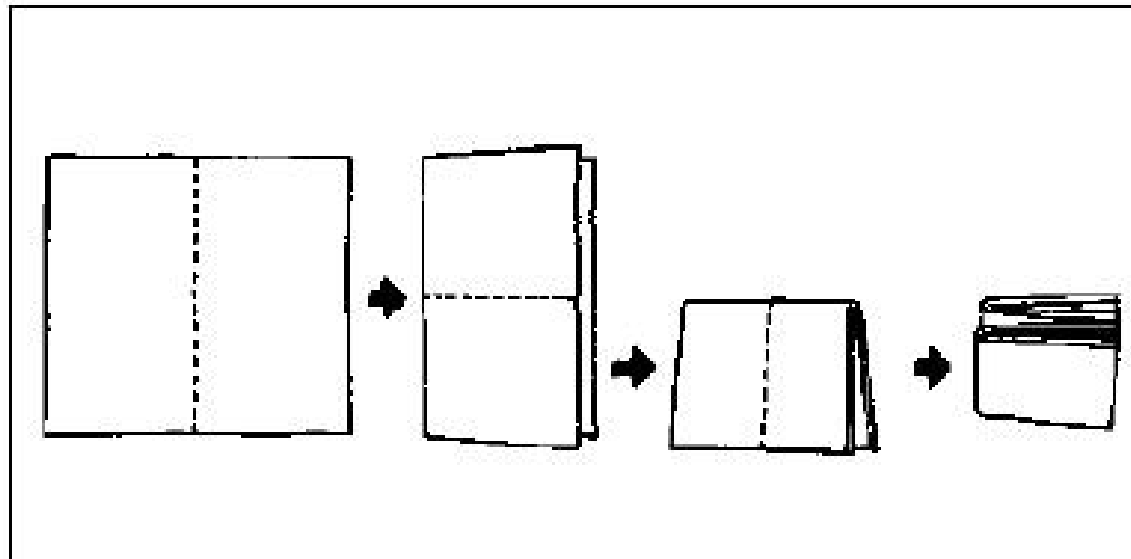

- Firstly the new textbook is printed on large sheets of paper which are folded several times to make what we call "signatures", so that the pages are in the correct order.

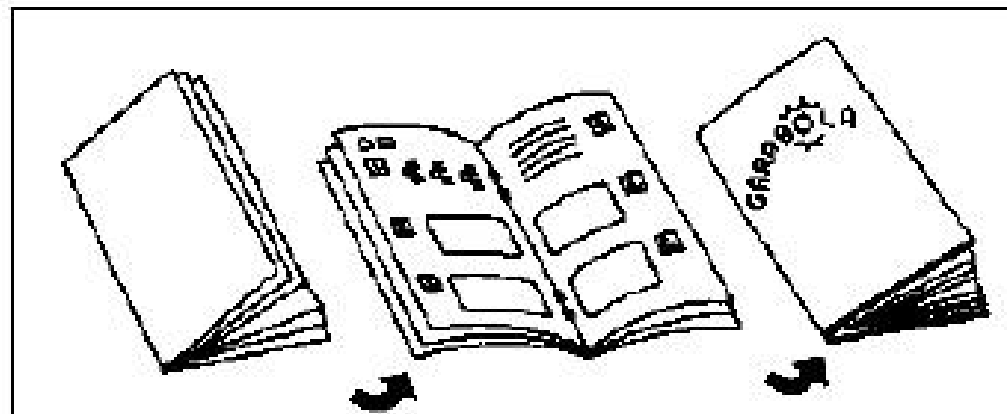

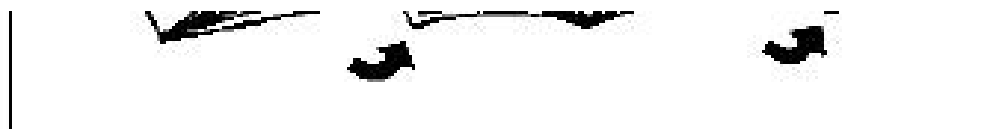

- Then the book is finished: the signatures are put together to form the inside of the book; they are sewn, stuck or stapled together, and finally the cover is added.

At first glance, the publishing chain is similar, since in both cases the preliminary research always precedes the concept, after which comes the writing, illustrating and production of the textbook. But, while industrialised countries have a long history of textbook production, as well as the resources to guarantee the quality of their work, the situation is very different in developing countries, where often even the most essential data is unavailable, as are expertise and resources. It is not unusual for there to be no official figures for the school-age population or the teacher to pupil ratio, and frequently it is not known what timetable the schools follow. This is why the production of high-quality textbooks, already an extremely complicated undertaking in industrialised countries, is all the more complex in developing countries.

<b>1. Main Stages in the Publishing Chain and Results</b>	
<b>Stages</b>	<b>Results</b>
<b>1. Preliminary analysis</b>	Market study
<b>2. The concept</b>	
Pedagogical considerations	Plan and organisation of contents
Physical considerations	Definition of format, number of pages, dummy
Graphic considerations	Decision on type of illustration and printing, layout
Financial considerations	Provisional quotation
<b>3. Producing texts and</b>	



<b>illustrations</b>	
Texts	Manuscript
Illustrations	Graphics dossier (photos, drawings)
<b>4. Preparations for printing</b>	
Typesetting the text	Galley proofs
Processing illustrations	Films
Paging on paper	Imposition scheme
Make-up and imposition	Film
Report	Blueprint
<b>5. Printing and Finishing</b>	
Printing	Printed sheets
Folding	Printed signatures
Assembly	Inside of book (unbound)
Binding	Inside of book (bound)
Attaching the cover	Book with irregular edges
Trimming	Finished product

We will look again at the steps in the publishing chain we identified above, and see where the procedure adopted in developing countries differs from the above scheme. Let us also point out that we will not go into the process of translating or adapting textbooks, however justified this may be under certain circumstances. What we describe here is how to produce an original textbook, what to do when one cannot adapt or translate existing books<sup>1</sup>.

existing books<sup>1</sup>.

**The publishing chain cannot be merely mechanically transferred to developing countries**

**The first unique feature of textbook production in developing countries: the feasibility study must look not only at the demand for textbooks, but also at the conditions under which they can be written and illustrated, manufactured and distributed**

### **Preparations for an Education Project**

Study of demand, available resources and conditions under which the books can be produced (1 year).

In industrialised countries, it is enough to identify a demand for a textbook, since the production and distribution techniques and facilities already exist. In developing countries on the other hand the production of a textbook depends on education policy, textbook policy, financial considerations, technical considerations such as the supply of paper and printing capacity, human resources, distribution and storage capacities, etc.<sup>2</sup> To ignore any one of these considerations may sometimes suffice to jeopardise the entire textbook project.

A period of several years may elapse before the textbook project can be launched, for, even with the support of an international or bilateral organisation, projects of this nature generally involve recruiting staff, finding premises and procuring the necessary materials.

### **Preliminary Research**

Analysis of the context within which the textbook is to be used (6 months–1 year).

Let us once again compare the situation in industrialised and developing countries. In the former case the publisher is already fairly familiar with the target group, since he usually specialises in one subject and one

specific level. In developing countries, however, the publisher often knows little about the target group, and the reference material available tends to be fairly unreliable and inadequate. It is thus crucial to conduct field studies to collect detailed data on teaching and learning conditions.

**The second unique feature: preliminary research must look at teaching and learning conditions**

**Pilot Textbook**

Devising, writing, illustrating, paging, printing and finishing the textbook (1 year).

The description and sequence of the tasks that make up this phase of the production work do not differ significantly from those undertaken in industrialised countries, even if textbook projects often lack the resources that a commercial publisher would have.

The result, however, is different in that it cannot be considered a final product. It can only be a pilot textbook.

**Testing and Evaluation**

Distribution of the textbook to selected schools and presentation to teachers at these schools, testing and evaluation (1 year).

In industrialised countries, given the degree of uniformity that exists from one school to another it is often enough to test one or two units of the new textbook at a few schools before moving on to produce a final version. In developing countries, given the lack of basic data, and given above all the great heterogeneity of teaching and learning conditions often found, the textbook must be tested in its entirety at a representative sample of schools for a minimum of one academic year before it is evaluated.

**Producing a Revised Version**

Revision of the pilot textbook, official check, printing the revised version (1–2 years).

Revision of the pilot textbook, official check, printing the revised version (1–2 years).

The results of the evaluation phase allow us to revise the book before printing a large run. The length of this phase can vary; it depends first and foremost on the scope of changes felt to be necessary and the willingness of the authors to modify a product with which they still identify closely; it will also depend on the authority and provisions of the official body responsible for approving the final version, and on the various factors involved in printing a large run of textbooks (size of the run, terms of financing, country where the books are to be printed, etc.).

### **Nationwide Introduction**

Devising and realising a distribution strategy for all schools concerned, in–service training and monitoring for teachers (2–4 years)

Let us once again compare the situation in industrialised countries with that in developing countries; in the former the new textbook is brought to the pupils without any major difficulty via book shops or schools, whereas in developing countries it is difficult to reach rural schools and rare to find an effective distribution network. Also, in industrialised countries teachers are in a position to use the new book without additional training, while in developing countries the new textbook must be systematically presented to ensure that it is put to the best possible use.

In developing countries the universal introduction phase thus demands skills, huge technical and financial resources and a great deal of time. However many schools must be served, and however many teachers must be trained, these two activities are always large–scale projects in their own right.

To sum up, then, the following tasks are needed in addition to the links of the commercial publishing chain to ensure that the textbooks produced in developing countries are suitably adapted to local needs:

- Preliminary feasibility study
- Field studies of the teaching and learning conditions

- Testing the new book at a representative sample of schools for a minimum of one academic year, and then evaluating the results
- Systematic revision of the pilot version of the textbook
- Development of a national distribution strategy
- Presentation of the new book to the teachers who will have to use it.

### ***Textbook Projects***

You will have realised by now that the systematic production of textbooks in developing countries would overtax any single department or unit. How, you may ask, can didactic material be devised and produced taking into account all the relevant aspects of the system? Who has the human, technical and financial resources to undertake a task of this scope?

Some developing countries can meet their textbook requirements using their own skills and funds – but these are the exceptions. More often projects, generally funded by international or bilateral technical or financial cooperation, are charged with the systematic production of textbooks.

We think that it is instructive for those of you who are still relative newcomers to the field of textbook production to realise that projects of this sort can generally manage to perform the work described above. By way of example we will describe below the main phases of production for the very first textbook devised, developed and produced within the scope of one such education project, the TefBoky Project<sup>3</sup>.

#### **2. A Textbook Emerges Step by Step**

At the end of 1986 an education project, the TefBoky Project, was launched in Madagascar. It aimed to train a group of authors and to develop textbooks in the national language for primary school pupils. To pursue the two-fold goal of training and production, the group of authors responsible for the subjects Malagasy and mathematics produced the materials step-by-step in a way which may be considered fairly exemplary. This table shows the chronology of *Garabo/a*, the first reading and writing book to be produced

Malagasy and mathematics produced the materials step-by-step in a way which may be considered fairly exemplary. This table shows the chronology of *Garabola*, the first reading and writing book to be produced in Malagasy.

### 1. Feasibility Study

In 1984 a study committee noted a general shortage of textbooks in Malagasy for primary school pupils. The committee recommended that authors be trained to fill this gap.

### 2. Preliminary Research

In 1986 the Tef'Boky Project was launched; in October, the authors responsible for Malagasy started work. They prepared and undertook preliminary research in the field, and at the end of 1987 presented the results in a document which served both as the principal frame of reference for the materials to be developed and as a report for the education authorities.

### 3. Producing a Version for Testing

In 1988 this working group devised and develop a set of learning materials for reading and writing Malagasy. 3,000 copies of *Garabola* were printed ready for the start of the academic year 1988–89.

### 4. Testing and Evaluation

The didactic material was tested for one academic year at forty schools and the level of attainment tested at the end of the year; the results were presented officially to the ministry.

### 5. Producing the Revised Version

In 1990, the material was revised on the basis of the results of the evaluation phase and was selected for nationwide use: thanks to a World Bank loan 450,000 copies of the new textbook and 17,000 copies of the teachers' guide were printed; slates introduced to replace exercise books were also financed.

## 6. Universal Introduction

The structure set up with the help of the World Bank<sup>4</sup> is currently in charge; it is responsible for working out the nationwide distribution plan. *Garabola* should be used throughout the country as from the academic year 1993–94. Some ten years have thus elapsed since the feasibility study.

### *Writing and Production*

**Test your book systematically and evaluate the results before printing a large run**  
**Plan the entire series of textbooks from the outset**

If you do not yet have experience in the field of textbook production, you may think that, once the appropriate funds have been approved, the revised version of a textbook can be rapidly distributed to all schools in a country. Nothing could be further from the truth, however. If you look carefully at Table 2, you will see that no less than three years elapsed before the textbook was finally distributed (in 1993), although the finished version was completed and the funds available in 1990.

It is important to know that the authors can only influence the rate of progress on the work for which they are directly responsible. Where your textbook is to be printed in large numbers you have no control over the printing or the distribution; your “product” slips completely out of your hands and there will be delays and break-down which you will almost inevitably feel are out of all proportion given the long, complex development work, particularly if you attacked your part of the work with great gusto.

Table 3 gives you an idea of the imbalances that can occur between the development phase and the production phase. This table follows the progress of *Garabola*, indicating a few crucial times in the printing and distribution of the 450,000 books.

### **3. Garabola is Born**

<b>Activities</b>	<b>84</b>	<b>85</b>	<b>86</b>	<b>87</b>	<b>88</b>	<b>89</b>	<b>90</b>	<b>91</b>	<b>92</b>	<b>93</b>
<b>Feasibility study</b>	■									
<b>Preliminary study</b>			■	■	■	■	■	■	■	■





Throughout the industrialised world, the production of textbooks follows a rigid scheme, spanning several years; in developing countries no other procedure should ever be adopted. Yet the planning is always most difficult in this part of the world, where the publishing chain is longer and more complex. When we aim to produce a series, we must coordinate the activities needed for several different textbooks at once; to put it more clearly, while the first textbook is being tested and revised, plans must be made for the development of the second, such that the books in the series are printed without "losing" any academic years, and without missing the start of the academic year.

To illustrate this, Table 4 shows the actual time schedule used in the TefBoky Project to produce the pilot and revised versions of the first two reading and writing books produced in Malagasy, *Garabola* and *Tongavola*<sup>6</sup>.

<b>4. Time-Frame for Work on Garabola and Tongavola</b>										
Work	84	85	86	87	88	89	90	91	92	93
<i>Garabola</i> (first version)										
Preliminary research			■	■	■					
Concept, development and production				■	■	■				
Testing and evaluation						■	■	■		
<i>Garabola</i> (revised version)										
Revision								■	■	
Printing									■	■
<i>Tongavola</i> (first version)										
Concept, development and production					■	■	■			
Testing and evaluation							■	■	■	
<i>Tongavola</i> (revised version)										
Revision									■	■
Printing										

## 2. Those Responsible

The duties described and illustrated above should have given you a basic understanding of how textbooks are produced.

This information is undoubtedly of capital importance to you, but it is still far from being adequate to allow you to start work, far less to plan your work. Indeed until you are aware of the many actors involved in the chain and their respective tasks, you will find it difficult to define your own. You should also note in this context that it is just as important for a new author to acquire an understanding of the technical side of production as to analyse and fully understand the production system within which he finds himself.

Bearing this in mind, we now propose to look at the duties of the various units and entities which are involved in producing textbooks.

Once again, we will firstly turn our attention to the system generally adopted in industrialised countries, to allow us to better gauge the special features of those used in developing countries.

**As authors you can only define your own task once you are familiar with those of all the other actors involved in the publishing chain**

**In the commercial publishing chain we find three entities each with its own well-defined role**

### *Private Contractors in Industrialised Countries*

In spite of certain differences it is true to say that there is only one real textbook production system in industrialised countries.

As a general rule, three entities are involved in the commercial publishing chain – the Ministry of Education<sup>7</sup>, a publishing house and a printer, the latter two always being private enterprises. The duties of each of the three have been clearly established for some time.

Each of these three can, naturally, sub-contract certain operations to another enterprise. It is, for instance, common practice for ministries to contract a research institute to modify curricula or to evaluate didactic materials; the publishing house may contract educational consultants to define the contents of the new textbook; and finally the printer does not as a rule perform every stage of the production work himself, and may well farm out the stitching or binding work.

In Table 5 we have only indicated which of the three entities is responsible for each task, regardless of whether they perform the work themselves or delegate it.

You will see that “evaluation”, so important in developing countries, is not even mentioned in the table. There are two main reasons for this.

- Firstly a rigorous external control is often conducted before a new textbook is granted the official authorisation, compulsory in some countries, where the publisher must have every book produced approved by the Ministry of Education. This procedure ensures that the products submitted by the publisher for approval are of a high quality.
- Secondly, where no official approval is required the publisher bases his decision on whether or not to order a reprint firstly on commercial considerations (sales figures), while head teachers, members of textbook examination committees and teachers play a not insignificant part in that they select the books, and thus help ensure certain quality.

<b>5. Principal Duties of Those Responsible for the Textbook</b>	
<b>Entity</b>	<b>Duty</b>
<b>Ministry</b>	

<b>Ministry</b>	
	Defines national education policy
	Develops or adapts curricula
	Officially approves textbooks <sup>a</sup>
	Evaluates levels of attainment
<b>Publishing House</b>	
	Decides whether or not to publish a textbook
	Defines the pedagogical considerations
	Identifies the physical and graphical form of the book
	Has a quotation drawn up
	Selects and contracts authors
	Selects and contracts illustrators/photographers
	Supervises and controls editorial work
	Organises the reviewing of texts
	Supervises and controls illustration work
	Designs the layout
	Performs / checks the typesetting
	Ensures that galley proofs are proofread

	Performs / checks photoengraving work
	Defines provisional layout in more detail
	Prepares the dummy make-up
	Prepares the file to submit to the ministry for the imprimatur
	Decides how to print and finish the book
	Selects a printer
	Has a final quotation drawn up for printing and finishing
	Selects and orders the desired paper from the printer
	Submits the job to the printer for printing
	Checks mounting work and gives the printer the go-ahead
	Pays for printing and finishing
	Is in charge of marketing the finished product
	Prepares and ensures the monitoring of the book in the field
<b>Printer</b>	
	Draws up the quotation for printing and finishing work
	Mounts text and illustrations
	Prepares the type forme
	Procures paper and other inputs
	Prints, finishes and delivers the textbook to the publisher as instructed

Prints, finishes and delivers the textbook to the publisher as instructed
---

In either case it is the private publishing house that is really in charge of the production of textbooks: as you will see from the Table 5, it decides whether or not to produce a book and has complete control over production, monitoring and management. It monitors the textbook right up to the reception it is given by pupils and observes the use of the book to make any preparations for reprinting as early as possible.

### ***Production Systems in Developing Countries***

In developing countries we find several production systems which differ to a greater or lesser degree from the model described above. The most commonly found types are described below.

#### **National Commercial Production**

This system has many similarities with that found in industrialised countries: the ministry stipulates the content matter and may define textbook requirements; then private publishers publish and market these. There is generally no preliminary testing, neither are the textbooks presented to teachers. Thus, as in industrialised countries, it is the market which decides when several different textbooks are available for the same target group.

This system can be found in varying degrees in countries which have managed to establish private publishing capacities, such as Kenya and Nigeria.

#### **State-Run Production**

The ministry is in sole charge of textbook production, defining the subject matter to be covered by the education system, identifying textbook requirements and meeting these requirements. Often the ministry entrusts the writing and publishing work to civil servants, while the production and distribution is delegated to parastatals.

In this system too, it is rare for the textbooks to be tested and systematically presented to teachers; they tend to be placed at the disposal of teachers or imposed from above. The textbooks produced in this way are generally cheap, but very often the quality is poor, especially in terms of the graphics (illustrations and layout).

This system has been used in Tanzania, Madagascar and other African states.

### **National and/or Foreign Commercial Production**

The ministry turns to other countries to provide the textbooks it needs to attain pre-determined objectives. There are two possible scenarios: either the publishers contacted produce the textbooks with national support; the manuscript is often produced by a team of local civil servants while the layout, illustrations and printing are executed outside the country; or the publisher simply imports its own textbooks and markets these. These are almost always attractive books, but they are also expensive, and the contents, particularly the graphics, are not always very well adapted to the country in question.

The large English and French publishers can thus be found to a greater or lesser degree in many African countries.

Several systems may co-exist: we may find private national production of text-books in European languages alongside state production of national-language books, where the financial rewards are not attractive enough for private publishers.

Each of these systems has its own shortcomings, but some specialists recommend moving towards the first of these; they claim that competition must be honed and the private sector encouraged to take part in the textbook sector, wherever possible<sup>9</sup>. It is true that the production of textbooks demands creativity, profitability and functionality which a civil service can rarely provide, but at the same time commercially produced textbooks, whether they are produced in the country or abroad, primarily address the well-off urban classes, with purchasing power and easily accessible without a complicated distribution network; poor pupils who represent the majority of the target group, or those living in rural areas which may be very isolated, are thus *de facto* discounted.

Let us for the moment just note that although authors naturally cannot modify the system within which they operate, it is imperative for them to understand the features of that system. This will allow them to understand

Let us for the moment just note that although authors naturally cannot modify the system within which they operate, it is imperative for them to understand the features of that system. This will allow them to understand the respective tasks of the entities involved in textbook production, and thus to define their own role.

### **3. Publishing Specialists**

Let us sum up what we have learned so far: we have analysed the technical steps involved in producing textbooks and the various production systems currently in use. Nevertheless, before they can identify their own role, authors must be familiar with the actors involved in the publishing chain. They must know who is responsible and who performs which work, who plans, directs and controls each stage and who performs the hands-on work.

So, let us then look at the role of publishing specialists, again making a distinction between common practice in large commercial publishing houses and in developing countries.

**A very few developing countries use the private sector to meet their national needs.  
Most of them rely on state or parastatal structures, or call on foreign assistance**

**The quality of textbooks in industrialised countries is first and foremost a reflection of  
the way publishing houses are organised**

#### ***Organisation of a Commercial Publishing House***

As you have seen it is the publisher who directs the writing and production of textbooks in industrialised countries. To meet his many-fold responsibilities, he needs managers who are responsible for various aspects of the process and technicians to perform the work required. Let us look in more detail at these two groups and their respective duties.



## Managers

The publisher firstly surrounds himself with a team of managers, the main duties of whom are listed in Table 6.

6. Main Duties of Managers within a Publishing House	
Manager	Duties
Publishing Manager	
	Identifies textbook production project
	Defines contents and how they are to be arranged
	Selects authors and contracts them
	Supervises and reviews authors' contributions
	Analyses the way the book is used in schools
Art Director	
	Decides on the graphics for the textbook
	Selects illustrators and photographers
	Supervises and reviews the illustrators' and photographers' contributions
	Designs and manages the layout
	Selects typographic characteristics
Production Manager	
	Defines physical features of the textbook

	Defines physical features of the textbook
	Estimates the production costs
	Plans and monitors production
	Obtains quotations from production companies
	Monitors typesetting and photoengraving work
	Monitors printing and finishing work
<b>Commercial Manager</b>	
	Performs market analysis
	Calculates approximate price of finished book
	Runs promotion campaigns
	Organises storage, distribution, marketing

### **Book Technicians**

When a publisher first decides to publish a book it is not only these four people who swing into action; to perform the necessary work, they mobilise a veritable army of specialists, both within and outside the publishing house.

One does not always find the same technicians in every publishing house of course, but in general it is fair to say that the four managers whose tasks we have just described delegate some of their work to specialists; the form this collaboration takes is illustrated in Table 7.

### **7. Main Duties of Technicians within a Publishing House**

<b>Technicians</b>	<b>Duties</b>
<b>Working with the Publishing Manager</b>	
Educational consultants	Help specify pedagogical features of textbook
Authors	Write and take stock of manuscript; run preliminary tests; read proofs
Proof readers	Correct manuscript; read proofs
Publisher's secretary	Prepares manuscript
<b>Working with the Art Director</b>	
Authors	Help with the graphic concept
Illustrators / photographers	Help design graphics, produce illustrations and check the quality of photoengraving
Documentation expert	Researches the necessary illustrated documents
Layout artist	Visualises the design, finalises layout; produces make-up
Graphic artist	Decides on typographic characteristics of text
<b>Working with the Production Manager</b>	
Publisher's secretary	Prepares elements to be printed, texts and illustrations
	Monitors ongoing activities (quotations, planning, contacts with type-setter, photoengraver and printer)
<b>Working with the Commercial Manager</b>	

<b>Working with the Commercial Manager</b>	
Promotion Manager	Designs and realises the promotion and marketing campaign for the textbook
Sales Manager	Ensures that the textbook is available to readers
Distribution Manager	Ships textbooks to points of sale

### ***Publishing Specialists in Developing Countries***

Let us now look at the situation in developing countries. The first difference is in the number of actors involved; generally textbook production teams are very much smaller in developing countries. Yet, if we leave aside the few countries with well developed private-sector publishing capacities, the main difference between the two systems is the absence of the publisher or the failure to appreciate the importance of his role, and the inevitable redistribution of the duties that would otherwise be assumed by the publisher among the other actors involved, in particular the authors and the printer: the former often do a great deal more than devising the concept and writing textbooks and the latter, whose role should be limited to the actual printing, is frequently forced to take on some of the publisher's duties too.

In some countries, it is fair to say that there is no national publishing capacity, in either the state or the private sector. In others private publishers address only that part of the population that constitutes a potentially interesting market, even if this is a tiny minority of the population: this was true in Peru, for instance, where, at the start of the 1980s private publishing houses were geared only to Spanish-language publications, and were not interested in local languages. In still other countries the role of the publisher is not understood or is not known: often the ministry is not properly informed about the role of the publisher, while authors do not readily accept him, seeing him as one more irritating control between them and the printer, which only swings into action once the manuscript is finished.

The lack of understanding of the publishing chain, the wariness of the authors vis à vis the publishing unit, the lack of technical know-how of insufficiently trained publishing managers and the difficulties of coordinating the work of different departments can thus lead to an astonishing redistribution of responsibility: as we will see,

the authors, and even the printer frequently see themselves forced to take on responsibility for considerably more than their traditional tasks.

### **Redefining the Traditional Role of Publishing Specialists**

In those countries where textbook production is in the hands of a public-sector publishing house or a publishing unit within the Ministry of Education, the roles and responsibilities of the various actors are not always clearly defined.

There are two common scenarios. In the first case the officials, often with no well-founded publishing skills, approach the printer directly with only a manuscript, i.e. a text rather than an imposition scheme including the final layout and illustrations – and expect him not only to print the textbook, but also to take on responsibility for publishing, or to contract this work out. The traditional publishing chain is thus reversed, since the publisher, rather than supervising work from the start, is only consulted at the end, if at all.

In the second scenario the officials entrust the authors with the overall responsibility; without realising the enormity of their demands, they expect the authors to produce a product which can be handed to the printer, and printed immediately. The authors have no choice but to assume some or all of the work of the publisher, without necessarily being up to the task.

To allow you to pinpoint the duties of the publisher, the author and the printer in industrialised countries and those characteristic of the production system within which you operate we have summed them up in visual form in Table 8. The illustration indicates how the traditional roles can be modified and the repercussions this has on the work of the various actors.

### **Rough Orientation of Textbook Projects**

It is interesting to see how donors who have specialised in textbook production react to a situation of this sort, or to put it more succinctly, how they organise their large-scale textbook projects. Their current efforts seem to pursue two objectives on different time-scales.

<b>8. Main Duties of Principal Actors in the Publishing Chain</b>
---

## 8. Main Duties of Principal Actors in the Publishing Chain

<p>In industrialised countries textbook authors are at hands-on level. Their duties are limited and well defined; they have no contact with the printer.</p>	<pre> graph TD     Publisher --&gt; PM[Publishing Manager]     Publisher --&gt; ProdM[Production Manager]     PM --&gt; Authors     ProdM --&gt; Printer         </pre>
<p>Where there is a publishing unit its duties are sometimes ill defined or little understood; in this set up the publisher, authors and printer may be in contact with one another without any clear definition of their respective duties.</p>	<pre> graph TD     PUBU[Publishing Back-Up Unit] --&gt; Authors     PUBU --&gt; Printer         </pre>
<p>In some developing countries which have no publishing capacity, the authors must assume some publishing responsibility and as such have direct contact to the printer, with whom they share responsibility for publishing.</p>	<pre> graph LR     Authors --- Printer         </pre>

**In developing countries the traditional roles of the publisher, the authors and the printer are re-allocated**

### **It is just as urgent to set up a publishing unit as to train authors**

Those who give precedence to a short-term strategy, aim firstly to respond to urgent needs, in some cases the total absence of textbooks in schools. To this end they focus first on the authors who they train in basic publishing techniques, wherever there is no publishing capacity in the country in question, to allow them to produce didactic materials against the odds. They generally manage, and the quality of the materials produced is acceptable, if not always excellent. We should, however, specify that when the projects come to an end, having trained authors and given the country the textbooks it needs, the authors cannot continue their work within a strong publishing structure and the know-how generally vanishes rapidly. When new textbooks are needed, generally about five years down the line, the whole process starts from scratch.

By contrast, those who accord priority to a medium- or long-term solution attempt to establish a sound publishing system, and there can be no doubt that this is what we ought to aim for; they focus on providing training for technicians and the various other book-related occupations, rather than on producing textbooks immediately. This formula too has its risks, of course, the two main ones being staff changes, with the result that individuals are given several years of training as technicians and then leave before they have ever worked productively, and the lack of competent authors on whom trained publishers can rely. In other words there is a risk of producing well trained publishers – who then have nothing to publish.

We would like to stress that, in view of the sheer scale of the demand for textbooks on the one hand, and the general lack of publishing skills on the other, these apparently divergent efforts should always be considered as complementary approaches, and pursued energetically without delay in many developing countries.

### **Responsibilities of Authors in Developing Countries**

**Your responsibilities as authors will depend on the production system within which you work**

Some of you may think that the previous section is more relevant for decision-makers at national level and international donors than for authors, in view of the fact that it is difficult if not impossible for the latter to modify the textbook production system. But you will not be able to define your own duties until you have a firm

international donors than for authors, in view of the fact that it is difficult if not impossible for the latter to modify the textbook production system. But you will not be able to define your own duties until you have a firm grasp of the stages involved in producing a textbook – and this is the *sine qua non* for you to commence and indeed one day finish your work.

The tasks of textbook authors in developing countries are not always identical in every country. In some cases you will be working within a structure which allows you to concentrate on writing a manuscript on the basis of a pre-defined concept; in others you will have to perform certain publishing work in addition to this, perhaps even all the publishing work. In other words your tasks will always be defined in terms of the publishing support at hand: the less efficient the publishing unit, the more you will have to do, to the point that in some cases you could justifiably be termed “publisher–authors”<sup>10</sup>.

Let us take stock at this point. Try to call to mind the various stages involved in the production of a textbook, and the entities and specialists needed to perform the relevant work. Then identify the support that you can expect in your work. In this way you can define what the officials implicitly expect of you most of the time, gauge the scope and complexity of the work, accept it and, in the ideal situation, optimise it.

### **Supervision and Training**

But how, you will ask, can we as authors or future authors of textbooks measure up to responsibilities of this magnitude? How can we become the “publisher–authors” that the country needs, when we are at best “apprentice authors”? If, as is generally the case, you are former teachers, pedagogical advisers or even school inspectors you will only be able to meet your commitments if you have technical supervision, or if you have had pertinent training.

We feel that several years of on–the–job experience, plus technical supervision, perhaps in conjunction with internships together make for the best training.

This was, in any case, our experience during the first few years of the Tef’Boky Project. To mitigate the shortages of textbooks the authors in the project learned their craft on the job, producing textbooks with the assistance of specialists; they were then able to systematise their knowledge with the help of short training



courses in Madagascar and overseas<sup>11</sup>.

#### **4. In Conclusion**

##### ***Beyond the Textbook***

Whatever the system within which they operate, i.e. whatever the tasks expected of them, groups of authors in developing countries always play a crucial part in ensuring a supply of high-quality textbooks, as we have seen in this chapter. But, however heavy this workload alone, their responsibility is rarely limited to producing textbooks; in fact it is generally the authors who must prepare the way so that their product is well received by teachers and parents.

Information and awareness measures must always be handled by a ministerial department specialised in this field, which will mean that it has the equipment it required. When the textbooks reflect curricular changes, for instance if a national language has replaced a European language as the language of instruction, these activities go well beyond the scope of a small group of authors who already have more work than they can handle. Nevertheless they are often left with the responsibility. The authors then find themselves faced with the choice of concentrating all their energy on writing and not preparing people for the launch of the new material, thus running the risk that the finished product will be rejected by insufficiently well informed users, or of adding one more string to their bow and running the risk of producing mediocre and superficial books<sup>12</sup>.

Before you start work on the textbook we thus suggest that you analyse the school situation and gauge the textbook's chances of being accepted without further action; this will enable you to make provision, if necessary, for information and awareness measures, without which your heavy workload as authors may be pointless.

**Make preparations for the launch of your textbook from the very start of the project**

#### **Notes**

## Notes

<sup>1</sup> See Seguin R. *L'élaboration des manuels scolaires*, p. 15–19. Paris: UNESCO, 1989 for information on the translation and adaptation of textbooks. It should be noted that textbooks for the primary level can rarely be translated, especially reading books in the national language; the rest of this guide should explain why.

<sup>2</sup> Cf. Read A. *A guide to textbook project design and preparation*. Washington D.C.: World Bank, 1986 for information on the preparation of textbook projects.

<sup>3</sup> “Tetik’asa famolavolana boky malagasy ho an’ny sekoly” (TefBoky) can be roughly translated as the “Malagasy Textbook Workshop”.

<sup>4</sup> The Unité d’Etude et de Recherche Pédagogique (UERP) (Pedagogical Research and Study Unit) within the Ministry of Education.

<sup>5</sup> “A minimum of six years is required to write a manuscript, print, publish and distribute the finished book, and it is reasonable to plan an overall period of some ten years, given the time required for preliminary studies, planning, recruitment and, in many cases, training”. In: Seguin R., op. cit. p. 6.

<sup>6</sup> The date of printing a large run of *Tongavola* is not indicated; it was delayed for several years again for reasons which are neither technical – the final version has been ready to print since 1991 – nor financial – the funds required have been pledged – in nature. This situation is unfortunately by no means exceptional. Even when technical and financial preconditions are met, there is no guarantee that the work will be published, far less than this will happen within the planned time–scale.

<sup>7</sup> We should specify that the Ministry of Education is not always responsible for the tasks described hereafter; in very decentralised systems, these may be delegated to a body at regional level, or to research institutes. To simplify the issue though, we will not take these cases into account here.

<sup>8</sup> The situation varies from one country to another. In Germany, for instance, publishers complain that they have to submit their textbooks to the relevant ministry for approval at regular intervals, in some cases every

two years (In: Institut für Bildungsmedien. *Die kleine Schulbuchschule*. Frankfurt am Main, 1989). In France on the other hand "there are no official textbooks any more than there are textbooks that are recommended or approved by the Ministry of Education" (A. Savary. In: Huot H. *Dans la jungle des manuels scolaires*, p. 145. Paris: Seuil, 1989).

<sup>9</sup> Buchan A. et al *Etudes sur le secteur du livre en Afrique*, op. cit. p. 13.

<sup>10</sup> As we noted at several points during the Tef'Boky Project this lack of transparency often worries authors, who find it difficult to pinpoint their own part within the system as a result of their poorly defined publishing responsibilities.

<sup>11</sup> A separate publication, scheduled to be printed in 1995, deals with the experience gained in the Tef Boky Project regarding training authors in developing countries who are responsible for producing textbooks for the primary level.

<sup>12</sup> The TefBoky Project managed to undertake some information and awareness measures (producing posters, calendars, supplementary reading materials and even a film), but this increased the workload of the authors, although they were only indirectly involved, such that they were pushed to the absolute limit.

### ***Recommended Reading***

#### **Textbook Production in Industrialised Countries**

BERTHELOT, J. *Petit guide à l'usage des auteurs débutants et de quelques autres*. Paris: Hachette, 1991

BERTHELOT, J. *Édition et techniques éditoriales*. Paris: Hachette Supérieur, 1992

FINELSC, G. AND SASSIER, D. *Un livre, des hommes. De l'auteur au lecteur*. Paris: Nathan, 1988

GREENFELD, H. *Bücher wachsen nicht auf Bäumen*. Munich: Ellerman, 1979

GRUPE DE LA CITE INTERNATIONALE *Le livre. Sa conception, sa réalisation. Documentation*. Paris, undated

GROUPE DE LA CITE INTERNACIONAL *Le livre. Sa conception, sa réalisation. Documentation.* Paris, undated

HUOT, H. *Dans la jungle des manuels scolaires.* Paris: Seuil, 1989

LAPOINTE, C. *Le livre du livre.* Paris: Gallimard, 1987

### **Textbook Production in Developing Countries**

ALTBACH, P.G. et al *Textbooks in the Third World. Policy, content and context.* New York: Garland, 1988

BUCHAN, A., DENNING, C. AND READ, T. *Etudes sur le secteur du livre en Afrique.* Washington D.C.: World Bank, 1991

CHATRY-KOMAREK, M. *Libros de lectura para niños de lengua vernácula. A partir de una experiencia en el Altiplano peruano.* Eschborn: GTZ Schriftenreihe No. 193, 1987

FARRELL, J.P. AND HEYNEMAN, S.P. (Ed.) *Textbooks in the Developing World.* Washington D.C.: World Bank, 1989

GUDSCHINSKY, S. *Manual de alfabetización para pueblos prealfabetas.* Mexico: SEP/ Setentas, 1984

RICHAUDEAU, F. *Conception et production des manuels scolaires. Guide pratique.* Paris: UNESCO, 1979

SEGUIN, R. *L'élaboration des manuels scolaires. Guide méthodologique.* Paris: UNESCO, 1989

### **To Sum Up**

In industrialised countries textbooks constitute an important market. Private-sector publishers write, produce and market them. The laws of the market force them to act professionally; the textbooks are produced by highly-qualified specialists who stick exactly to the various steps in the publishing chain. As a result the

purchaser can choose any one of a number of textbooks which are comparable in terms of quality and price.

In developing countries, the demand for textbooks is enormous, but textbook publishers are rarely able to produce enough books of a suitable quality as rapidly as needed. The central problem appears to be that we have not yet managed to adapt the publishing chain, which has proved so valuable in industrialised countries, to an environment which either fails to appreciate the importance of this chain, or lacks the human, financial and technical resources to put it properly into practice.

This guide addresses novice authors, who have been instructed to produce textbooks that are adapted to the teaching and learning conditions in their own country, at relatively short notice. We aim to strengthen their skills as authors, by giving them a basic understanding of the publishing process. The first chapter introduced the steps involved in systematic textbook production, to allow them to identify, by contrast, the steps needed to produce textbooks that are specially tailored to the needs and resources of their own country. We then looked at the organisation of large publishing houses and the responsibility of the professionals involved in textbook production, to help them pinpoint their own place within the system, and thus allow them to develop and react accordingly.

We believe that this is vital prior knowledge for all teams expected to produce textbooks in developing countries, if they are to bring their work to a successful conclusion.

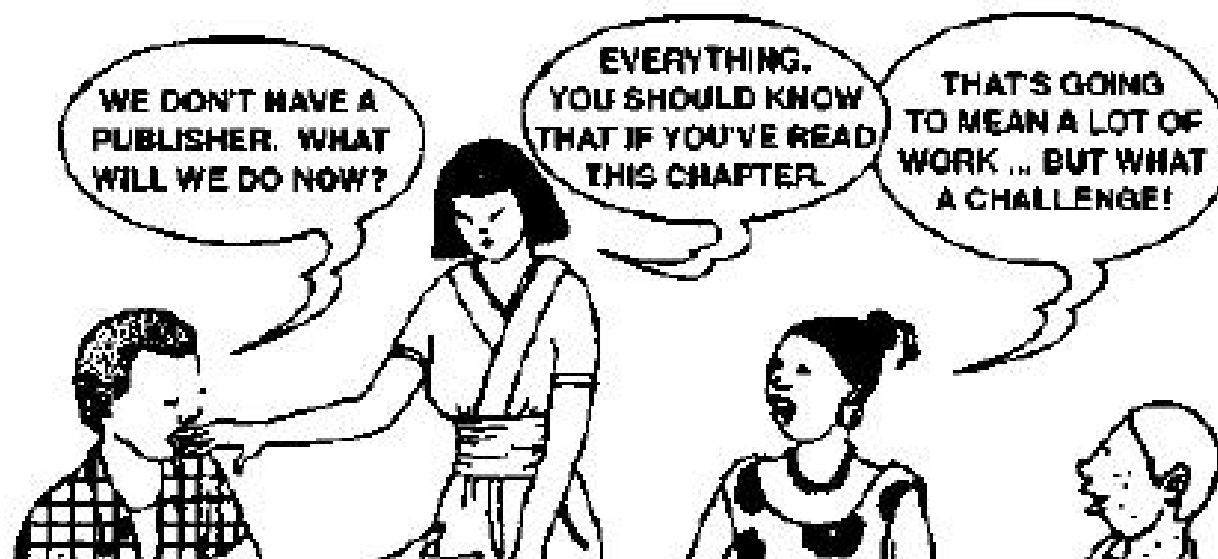

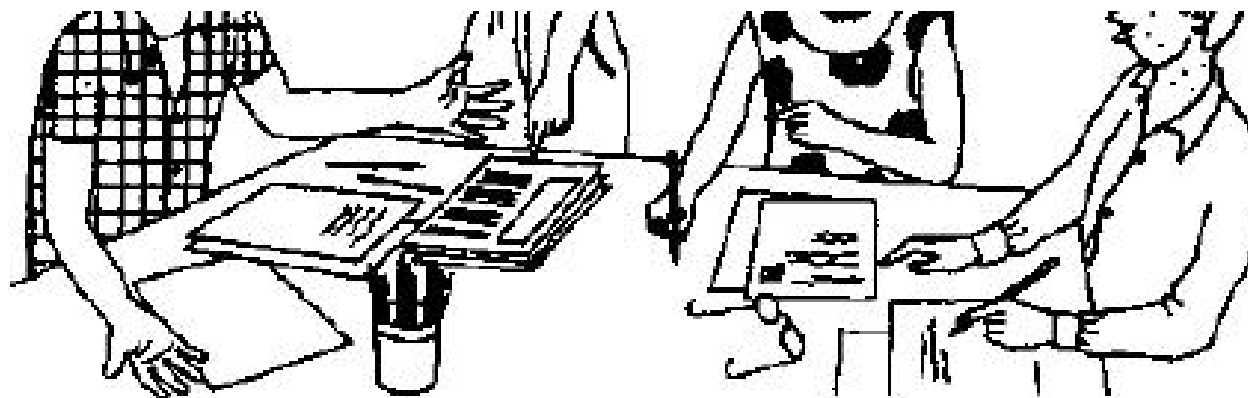

## The Authors

Once the feasibility study has been performed, work can start on producing the textbook; the first stage involves examining the context within which the book is to be used.

This field work marks the start of the work which, in most instances, will fall to you. You thus enter the scene and can expect to be there for a long time before the curtain falls. Given the length and importance of the work awaiting you, we feel that it is crucial to look at how you can best prepare yourself intellectually and in terms of materials, before going on to describe this work.

Please note that we will not be describing in detail the infrastructure you will need to do your work properly. Some of you will find a four-wheel-drive vehicle vital to undertake your preliminary research work, and later for the testing and evaluation of your material; it will be important for all of you to have a room where you can meet and access to a computer.

But, while recognising the importance of this infrastructure, we will not dwell on it, partly because the working conditions vary enormously from one team to another and your scope to influence your own working conditions is limited, and partly because the infrastructure alone is never responsible for the quality or

mediocrity of a textbook<sup>1</sup>. What is decisive is the profile of the authors and their working methods, two factors to which this short chapter is dedicated.

Another general information chapter with no immediate application, some of you will think, impatient to find the “recipes”. If this applies to you, try and force yourself to read this chapter nevertheless; as you will have realised after reading the first chapter, the responsibility that you will have to assume demands special preparations.

## **1. Profile**

Whether they write for primary or secondary level, textbook authors are not given specialised training, but those writing for primary level appear to be the least well prepared: they often have only the skills they have acquired on the job, in front of a class<sup>2</sup>.

Yet, as you will have realised after reading the first chapter, all authors have a great responsibility which ought to preclude any amateurism. Those whose duties go beyond writing and touch on publishing work in particular should never improvise. They must be professionals, well prepared for the unique nature of their work and fully aware of the skills and behaviour they will need to adopt if they are to perform their work satisfactorily.

Before looking at the preliminary research phase then, let us examine the profile of the textbook author, which will allow you to identify the skills and attitudes so essential in your situation.

### ***Basic Know–How***

The essential know–how for all textbook authors regardless of the level and the subject they write for, and the system within which they operate are as follows:

- Well–founded knowledge of their subject; this may be mathematics, science, linguistics or any other subject;
- Skills in adapting didactic material to suit the profile of future users;

- Skills in adapting didactic material to suit the profile of future users;
- The ability to write texts addressing both children and adults on a pre-defined topic within the space allocated;
- The ability to devise good exercises; exercises where the subject matter corresponds to both the attainment targets and to the demands of the layout;
- A basic understanding of the publishing chain; in particular as regards the essentials and possibilities open to various agents involved in the course of textbook production.

### ***Indispensable Attitudes and Behaviour***

Where there are recognised publishing facilities the above know-how will generally suffice to ensure that a textbook is produced: it will allow authors to prepare a manuscript of good enough quality to be published by the relevant unit, then printed and finished.

For authors without the back-up of a good publishing team, on the other hand, this know-how alone may well not be enough to allow them to meet all their commitments; if they are to take on the numerous and complex duties they will then be expected to perform, they will also have to acquire certain attitudes and behaviour, the most important of which are described below.

**Know-how and attitudes are more important for an author than a highly developed infrastructure**

**Step One – Learn to work in a group**

**Ability to Work in a Group**



It has become indispensable for everybody to learn to work in a group, since the trend is for more and more books to be written by a team of authors rather than by an individual.

But when the publishing unit is weak, and the authors bear most of the responsibility for the textbook, genuine team work is vital given the sheer scope of the work to be performed – and it is not easy to organise: agreement on even hotly contested points must be hammered out by the team, among equals as it were, without having recourse to a higher–level arbiter in the person of the publisher.

If you find yourself in this situation, where the responsibility of the publishing unit is limited to word processing, you must learn to create an atmosphere of tolerance and openness which will allow all team members to optimise their inputs. To this end, you will have to learn to formulate criticism or at least reservations, to argue a point, to listen to observations of others and take them into account, and finally to identify fully with the common decision.

Otherwise your work runs the risk of being slowed down or even paralysed well before the book ever goes to press.

### **Multi–Sectoral Attitude**

Decisions regarding didactic material always demand a cross–sectoral approach, whether they concern the publishing side or the domain of the authors.

If, for instance you wish to define the sort of materials needed to learn to write, you should look not only at the pedagogical and didactic factors (What is the best aid for learning to write? What is the best one for teaching writing? Exercise book or slate?), but also at the financial considerations (How much does an individual exercise book cost? And a slate? How many parents will be willing to pay this amount?), the logistics (Will it be possible to supply the schools with exercise books in time every year?), the working conditions (Are classrooms suitably furnished to allow pupils to write in exercise books? Would a slate which is rigid and can thus be used by pupils working without tables or desks, not be more practical?), the production considerations (Can slates be produced on the spot?), etc.

The less effective the publishing unit, the more you will have to take into account factors other than the purely pedagogical and didactic. If you were to refuse to look beyond the confines of your own subject–specific

The less effective the publishing unit, the more you will have to take into account factors other than the purely pedagogical and didactic. If you were to refuse to look beyond the confines of your own subject-specific knowledge you would be failing in your duties, and you would run the risk of either paralysing production or producing didactic materials that are poorly adapted to the actual environment in which they are to be used.

You should thus be prepared to look beyond your subject and become familiar with new fields, to look at a subject from several different aspects and compare these before taking an appropriate decision. You do not have to learn everything and know everything, but you should be attentive and well informed enough to react in time, and you should know who to turn to when you need assistance.

### **Step Two – Look beyond the narrow confines of your subject and examine the environment within which the book is to be used**

#### **Openness to Innovation**

The ability and willingness to innovate will be every bit as important for you as the skills laid out above.

If you intend to produce textbooks that are in line with the demands and the resources of the country you will often have to go your own way: you will not find many valuable discussion partners in large publishing houses which have different options and face their own problems; equally it will be difficult to find contacts in developing countries, where it is rare to find individuals who have sought out new paths and devised original solutions to specific problems. Indeed, authors of textbooks in developing countries tend to base their work more or less openly on foreign models<sup>3</sup>.

You must thus be open to new ideas: you should devise specially tailored answers to specific problems rather than looking for tried and tested recipes. You will have to fight against preconceived ideas, make your own hypotheses, and verify, check and analyse these. In fact you will have to become a researcher more than anything else. Otherwise what you produce will not be adapted to the needs of your country; it will be but a pale copy of existing materials.

**Be open to new ideas and look for appropriate solutions as a group**

### **Accepting the Constraints**

Finally, you will have to know how to accept major constraints and make the most of the leeway you have.

The single most important constraint will be the financial one; as textbook authors you must always distinguish between what is desirable and what is feasible for your country, and must decide on the didactic material without losing sight of the financial implications for those concerned.

If necessary, you must thus accept that your book be printed in two colours, or even in monochrome; or you must refuse to write a textbook if the country cannot finance it, concentrating instead on a teachers' guide, if this helps achieve pre-defined goals. There is no place in a group of authors in a developing country for anyone who refuses to accept constraints, or who imposes unreasonable financial burdens on others in the name of artistic freedom<sup>4</sup>.

If we have dwelt on the attitudes and behaviour demanded of textbook authors in developing countries it is because the importance of these factors is almost always underestimated, not only by education authorities, but also by those concerned. It is felt that a good teacher will automatically be a good author, for instance, ignoring the fact that the skills demanded of a teacher are quite different to those demanded of a writer or a publisher. We are astonished when otherwise brilliant specialists produce mediocre textbooks, poorly adapted to the target group, and when authors prove unable to properly identify the root cause of this mediocrity, which would allow them to remedy it.

These considerations aim to help you gear your work from the very start to the production system within which you operate. Do not let them discourage you, use them, even if they only help you to analyse the tensions which will inevitably arise in your group, and to remedy these more easily.

## **2. Tools of the Trade**

## 2. Tools of the Trade

The skills and knowledge described above are not always in themselves enough to allow authors to perform their work satisfactorily.

They will rapidly realise that it is not easy to work in a group, and that it becomes more and more cumbersome to consult the accumulated mountain of notes, references, decisions, texts and exercises when they need to. Paper and pencils are not enough: they need a high-performance tool, which will allow them to optimise the inputs and participation of each team member and to manage the data properly; an instrument which both enhances group dynamics and boosts the quality of the group's work.

Having practised it ourselves for several years, we recommend that you get used to a system of visualising your contributions. This is a working method which is inexpensive and easy to understand – if not always to use in practice. In our experience, displaying your work visually from the research phase to the preparation of the printer's copy is a much better guarantee of quality than any super de luxe electronic equipment.

Here are the tools you will need and the various steps involved in the procedure explained in a few words and several illustrations.

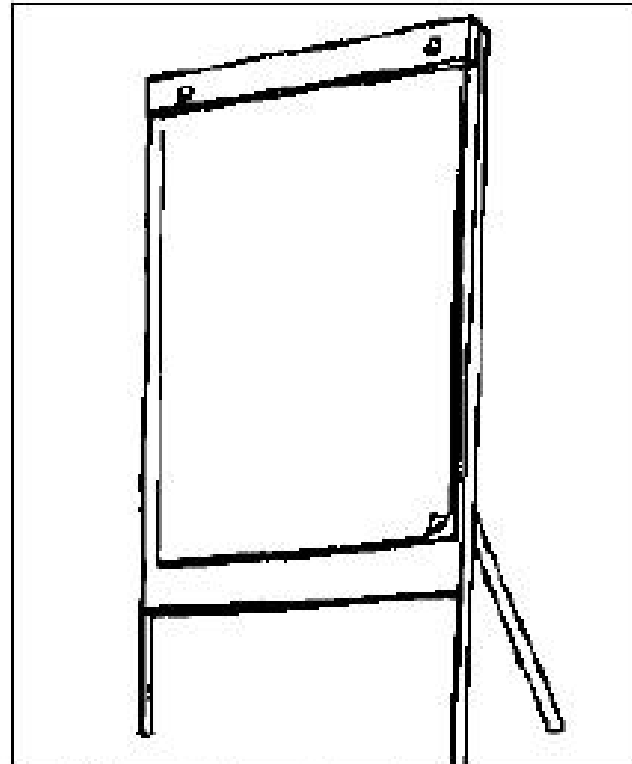

1. Preparing your tools: You should obtain a pin board made of porous material if possible, as well as several boxes of round-headed pins, a large number of cardboard strips or packing paper, the size of which will depend on the type of contributions. You will also need some marker pens and biros.





2. Identifying the topic: The topic you wish to work on should be defined verbally by the complete group. This way you avoid having to explain to those who have just arrived what has been decided on.

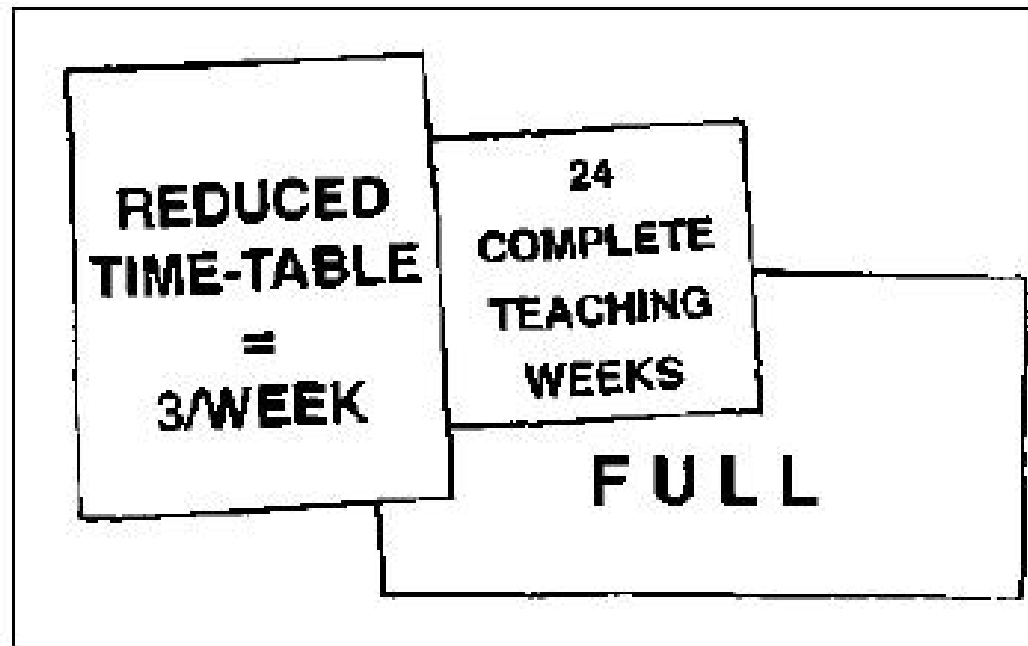

3. Initial brainstorming: Now you can start the written work. Allow about ten minutes for each participant to write cards without attempting to structure his or her contributions: contributions should be printed legibly, taking one card per idea and expressing it in a telegram style using no more than a dozen words.

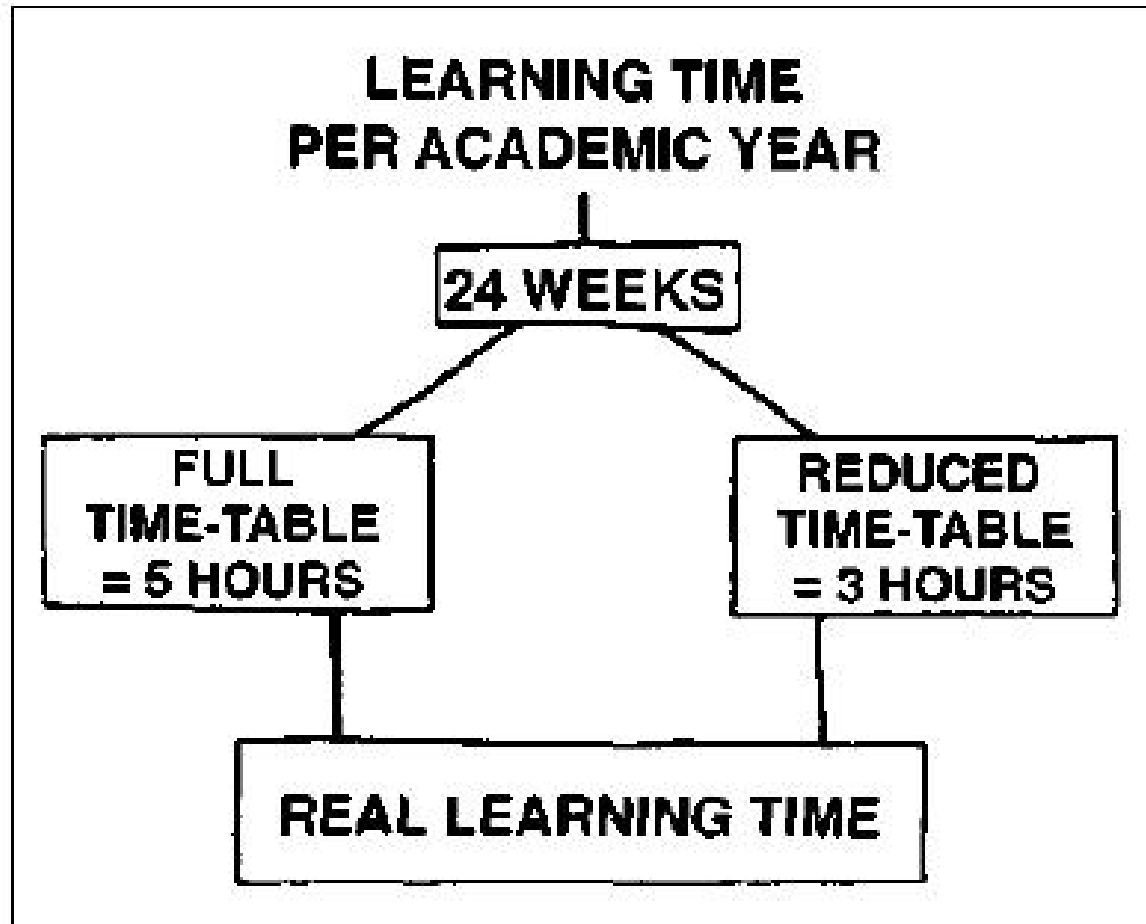

4. Pinning up provisional contributions: One participant gathers up all the cards one by one and reads them aloud. He pins them on the pinboard, arranging them in a provisional order. He does not comment on them at this stage, to allow all participants to re-read the cards for themselves. The cards are then taken one by one, corrected, and arranged definitively.

### 3. In Conclusion

### Notes

## Notes

<sup>1</sup> To convince yourself of the relative importance of the infrastructure for your work, look at books produced some thirty years ago; the quality of some is quite remarkable, and they were produced without much in the way of mechanical aids, and certainly without computers.

What authors at that time managed to do with paper, pencils, scissors, a ruler and some glue, you can manage today. Do not let yourself be discouraged by a lack of materials or tools. They are important, but not essential.

<sup>2</sup> This does not only apply to authors in developing countries, but also to some in industrialised countries; H. Huot notes that in France, the textbooks for lower secondary schools and primary schools, "are written by authors, most of whom have no specific qualifications in the subject for which they claim to speak, who are often not even aware of the most accessible specialised works, and who are incapable of gauging the risk or possible consequences of certain presentations or explanations." In: *Dans la jungle des manuels scolaires*, op cit. p. 60–61.

<sup>3</sup> Cf. Le Thanh Khoi: L'enseignement en Afrique et le modèle européen. In: Coquery-Vilroch C. and Forest A. (Ed). *Décolonisation et nouvelle dépendance*. Lille: Presses Universitaires de Lille.

<sup>4</sup> The vanity and desire of some authors to produce a splendid-looking book explain some wrong decisions, such as opting for extremely expensive 4-colour printing where there is no real reason for this, or the production of a pupils' book which is sometimes thought to offer greater prestige than a teachers' guide, although the latter would have served the pedagogical purpose and would have been considerably less expensive to produce.

Although these mistakes, which are easy to understand, are not fatal in a rich country, which can afford certain luxuries, they are dangerous in poorer countries, which cannot afford to make a mistake in this field, so every effort must be made to avoid them.

## ***Recommended Reading***



BERGER, G. AND BRUNSWIC, E. *L'éducateur et l'approche systémique*. Paris: UNESCO, 1984

CROZIER, M. AND FRIEDBERG, E. *L'acteur et le système*. Paris: Seuil, 1977

FERRY, G. *La pratique du travail en groupe*. Paris: Bordas, 1985

ZALTMAN, G., DUNCAN, R. AND HOLBEK, J. *Innovations and organizations*. New York: Wiley, 1973

### ***To Sum Up***

In industrialised countries the responsibilities of textbook authors are well-defined and relatively limited; in developing countries, they tend to be greater, even if they are not always well defined.

This is why authors in developing countries must prepare themselves particularly well for the work ahead.

Firstly it is, of course, vital for them to have certain basic know-how: there can be no question of planning to produce learning materials for mathematics, for instance, if the group cannot count on the support of a specialist in this subject.

Authors will also need certain attitudes, the most important being the ability to work in a group, a cross-sectoral attitude, an openness to new ideas and the ability to work within the given constraints. These are the attitudes which will enable authors to design, write and produce high-quality textbooks, that are genuinely adapted to the needs and resources of the country in question. They are all important, but we would like to stress the need for every textbook author in developing countries to be open to new ideas. In these countries a good textbook author cannot avoid being a researcher, looking for original answers to unique problems, where there are no cut and dried solutions.

Certain tools can be a great help to ensure the systematic development of textbooks; the methodical visual display of team members' contributions and of the main decisions made at the end of each session improves group dynamics and enhances the quality of the team's work.

**PLL JUST GO**

**IT'S THE GROUP**

**YES, WE NEED AN**



## Preliminary Research

Your first task if you have just been made responsible for producing textbooks is to conduct preliminary research. You will not be able to throw yourself into the conceptual phase without first identifying the actual needs and possibilities of the future users.

Preliminary research work must always be rigorous and meticulous, for the results will be of capital importance for the textbook in the making. If we compare our textbook to a building, the first phase is equivalent to the foundations; the data that you collect not only on the process of teaching and learning at classroom level and on the relevant subject matter, but also on the school environment as a whole ought to give you a solid base on which to build your book. The research work will almost invariably be complex and wide-ranging, and will generally require at least one year. It is thus quite impossible to describe this work

exhaustively here; we will give you only a few pointers which you can adapt to your own situation.

To avoid discouraging you in any way, we would like to point out from the outset that the research work described here is only possible with special technical and financial inputs: you should analyse the recommendations, use them as best you can, and continue to push forward, even if you are forced to admit that it is impossible to apply the model in the form presented here. You should also note that this work is only essential for the first book in a series: the data thus gathered are generally sufficient to allow you to produce the following books, verifying only individual points on the ground.

### **First task of the author – Analyse teaching and learning conditions**

**Get to know everybody involved in the textbook to ensure that the finished product will be appropriate**

## **1. The Need for Research**

Is it really essential to undertake preliminary research, some of you will ask. Does it have to be so complex and so wide-ranging in view of the urgent need for new textbooks?

Before you can conduct optimum research work, you must first be convinced that it is absolutely vital. You must understand that the textbook is part of a complex environment, that it affects groups which must be examined if the finished textbook is to be in line with their needs and possibilities.

To convince yourself of the need for preliminary research look firstly at the list of those involved in the main stages of the publishing chain in a state production system, for instance.

<b>9. The textbook and its environment</b>	
<b>Stages</b>	<b>Main individuals/groups involved</b>
<b>Decision to produce textbook</b>	

<b>Decision to produce textbook</b>	
	Education authorities
	Curriculum unit
	Publishing unit
<b>Writing and illustrating</b>	
	Authors
	Illustrators
	Publishing unit
<b>Production</b>	
	Printer
<b>Distribution</b>	
	Distribution unit
<b>Modalities of textbook utilisation</b>	
	Parents
	Education authorities
<b>Presentation to users</b>	
	Training unit
	Authors

<b>Utilisation of finished textbook</b>	
	Teachers
	Pupils
	Inspectors and educational advisers

**Field research work demands human resources, time and technical and financial inputs**

## **2. General Overview**

Highly developed planning and organisation are needed to gather data on the school environment. For a period of several months you will have to manage relatively extensive human, technical and financial resources.

Given the complexity and scope of this work, we will start with a general overview, which will enable you to evaluate the extent and nature of the research work and the ways and means of conducting it. This will give you a frame of reference to allow you to put the more detailed explanations which follow within the overall context.

To this end, we will summarise the approach taken in the TefBoky Project, the main phases of work and the duration of each phase. These are listed in Table 10.

### **10. Field Study in Madagascar**

In November 1986 the German–Malagasy TefBoky Project started the work that was to allow it to produce appropriate didactic material for reading and writing in Malagasy.

Given the dearth of information available on primary schools in Madagascar and the lack of any evaluation of the few existing textbooks in Malagasy that did previously exist, the project saw itself forced to prepare a

Given the dearth of information available on primary schools in Madagascar and the lack of any evaluation of the few existing textbooks in Malagasy that did previously exist, the project saw itself forced to prepare a field study, select a representative area in order to analyse conditions in the country's schools, develop the materials on this basis, and be able to test it at these schools at a later date. Here is a brief summary of the work involved and an outline of how it was performed.

#### **Listing factors to be examined (2 months)**

	The newly formed working group had to learn how to work as a group, become familiar with an alien form of visualisation and tackle a relatively new field of research all at once.
	By way of introduction, the apprentice authors identified the factors and criteria they felt were important to determine the quality of a textbook in general; this was a sort of introduction to the field of textbook production.
	Then they listed the factors that it was imperative to analyse in the Malagasy context to ensure that the new materials were in line with the needs and possibilities of the future users.

#### **Devising research instruments (2 months)**

	Among the factors to be analysed the team checked information already available and planned the analysis thereof.
	The team then devised and developed research instruments for missing data which would have to be gathered in the field, primarily in rural schools and villages: these mostly took the form of questionnaires and interview guides for adults (animateurs, teachers and parents), tests and guidelines for recording pupils' responses.
	These instruments were pre-tested at several schools in a peri-urban zone before being used in the field.

#### **Identifying a test zone (1 month)**

	Based on a number of criteria, the apprentice authors selected a representative sample of schools which fairly reflected teaching and learning conditions in the country.
	The sample involved 40 schools in one educational district. Preliminary research for the textbooks to be produced was conducted at these schools and the pilot version of the books was later tested and evaluated there.
<b>Gathering data (2 months)</b>	
	The entire team of apprentice authors and the three animateurs working in the test zone helped gather data in schools and villages. After one week of familiarising themselves with the research instruments, each member of the team was able to work independently examining one school per week.
<b>Processing and interpreting data (4 months)</b>	
	The data thus collected was processed, systematised and interpreted; the authors performed some of this work and delegated the rest to students and teachers (transcription of all recordings, counting the graphemes in the language, identifying words most frequently used by children, etc.).
<b>Publishing data (3 months)</b>	
	The authors prepared a fairly complete preliminary working paper to allow them to proceed with the conceptual phase without further delay.
	Parallel to the conceptual work, a final document was drawn up and submitted to the education authorities for their information.

### 3. Taking Stock

Having looked at this overview of what preliminary research can, and often does, entail within the scope of textbook production projects, let us return to the beginning. The first step must be to identify the factors that must be examined, evaluated or quantified before you can devise a systematic concept for new didactic

...textbook production projects, let us return to the beginning. The first step must be to identify the factors that must be examined, evaluated or quantified before you can devise a systematic concept for new didactic materials.

It is important that you adopt a methodical approach, to guarantee that the information you compile is as complete as possible. There are two reasons for this: firstly, this is the best way to ensure that you do not have to come back to this phase later, interrupting the conceptual phase which is long and complex enough without these irritations, and secondly any omissions and oversights you make at this stage may spawn serious errors in the concept, development and production of the textbook.

The factors to be analysed will not, logically, be the same in every case. To avoid major omissions, we suggest a two-stage approach. Firstly, identify the factors which are always important, i.e. factors related to the teaching and learning conditions. Secondly look at the supplementary factors, which are pertinent for the case in hand.

### ***Conditions in the Schools***

#### **Start by identifying the factors to be analysed**

Whatever the class and the subject for which the textbook is intended, the authors must examine in detail the conditions under which the teaching and learning process takes place.

This analysis must go beyond the narrow confines of the school itself, and look at the educational environment as a whole. We would recommend that you first collect data on the political and educational framework in the country, before looking at the way education is organised, i.e. the day-to-day life of teachers and pupils. Finally you should round off this information by analysing the various target groups affected by the new materials, which will include not only the educational authorities, (primarily inspectors and educational advisers) but also the teachers, pupils and parents.

Having seen ourselves how one automatically tends to devise voluminous instruments that are not sufficiently



well-targeted, we recommend that you systematically eliminate all factors that are not relevant for the material to be produced.

Table 11 shows the factors that should generally be examined before designing didactic material for primary level. To allow you to gauge the importance of these factors we have outlined the main reasons for including them in the analysis, and the repercussions they are likely to have on the new material.

<b>11. Main factors to analyse regarding conditions in schools</b>		
<b>Field</b>	<b>Factor</b>	<b>Relevance for new materials</b>
<b>Political and educational framework</b>		
	Educational legislation	General direction, e.g. language of instruction
	Curriculum <sup>1</sup>	Learning targets
	Official guidelines	Officially recommended learning methods
	Organisational set-up of ministry	Chances of having innovative material approved
<b>How education is organised</b>		
	Length of academic year	Volume of subject matter that can be covered
	Length of school week	Ditto
<b>Physical framework</b>		
	Storage space, furnishings	Quantity and type of materials available
	Lighting	Level of legibility required in textbook
	Blackboard	Blackboard-based learning activities
	Ratio of teachers-pupils	Group and individual learning activities

	Ratio of teachers–pupils	Group and individual learning activities
	No of pupils per class	Ditto
	No. of classes per teacher	Didactic pointers in the teachers' guide
	Teachers' working conditions	
	Administrative responsibilities	Adaptation of material to availability of teacher
	Didactic back–up materials	Preparing teachers to accept innovative ideas
	Pupils' working conditions	
	Location of school	Suitable format for pupil to carry to and from school
	Ratio tables–chairs to pupils	Format of material, composition of set
	No. of textbooks available	Pertinence of textbook production project
	Other teaching materials	Attitudes of parents to school
	Individual equipment	Identification of suitable writing tools
	<b>Target Groups</b>	
	Educational advisers	
	Professional training	Level of innovation of material to be defined
	Official duties	in terms of educational advisers' ability and
	Supplementary duties	capacity to train teachers
	Means of performing work (e.g. transport)	

	Teachers	
	Level of education	Degree of complexity innovation of material
	Professional training	Contents and presentation of teachers' guide
	Social background	Ditto
	Integration in community	Ditto
	Linguistic skills	Ditto
	Motivation	Degree of innovation of materials
	Pupils	
	Social background	Topics contained in pupils' material
	Focus of interest	Ditto
	Linguistic skills	Linguistic contents of book, instructions to teacher
	Previous knowledge, results in subject	Level and complexity of content matter
	Economic duties	Topic-related and pedagogical contents
	Parents	
	Socio-linguistic features	Language taught/language of instruction
	Level of education	Active support for children's education
	Economic resources	Cost of material
	Attitude to school	Planning information/awareness activities

**Textbook Projects**

## ***Textbook Projects***

Ideally in an educational project, the authors will be able to rely on a complete and reliable feasibility study; where this is the case they will be able to devise material appropriate for the needs and resources of the country on the basis of an examination of pre-defined factors. But authors may be called upon to produce a textbook on the basis of a less than perfect feasibility study, or where no real study has been conducted. In these cases they must also examine the project environment to avoid the pitfall of producing inappropriate material. Often this will not involve performing or repeating an entire feasibility study, but merely checking certain factors.

Table 12 lists some of the factors and aspects which we think are relevant in most cases, along with some essential questions which should be answered. Once again do not let this list discourage you; identify the factors that are important in your own specific case and, if you feel that a really exhaustive procedure is called for, consult the literature on the preparation of textbook projects that you will find listed at the end of this chapter.

**Take a methodical approach: you can use the results of research based on this table as the foundation of your textbook**

### ***Schools and National Languages***

As we mentioned above<sup>2</sup>, in 1985, 86 local languages were used as languages of instruction in sub-Saharan Africa. There are thus many textbook authors on the African continent working with a national language.

If this applies to you, it is vital that your preliminary analysis of the situation includes a linguistic component. You will have to find ways of solving the problems of using languages which are for the most part still little standardised in the classroom.

Again, the situation will vary from one case to another. Some languages, like Malagasy whose alphabet has existed in its present form for more than 150 years, have had an adequate system of transcription for many

years, while others use several different alphabets, none of which is really adapted to the needs of primary schools. Other still have not yet been written.

Let us look at the steps to take if one of these languages is to be the language of instruction and/or the language taught.

### **Fundamental linguistic analyses**

When we are dealing with a national language that has not yet been written, UNESCO<sup>3</sup> recommends that work be structured in Table 13 (page 52).

- Conduct a phonemic analysis which will be used as the basis for a scientific alphabet
- Conduct a grammatical analysis
- Prepare a preliminary lexicon.

<b>12. Factors regarding the environment of a textbook project</b>	
Factors	Aspects
<b>Writing Conditions</b>	
	Capacities of the curriculum unit
	Will the unit undertake any revision of the curriculum, or will you be officially charged with this

	you be officially charged with this work?
Capacities of the publishing unit	
	Can the publishing unit perform all the tasks expected of it? What is the quality of its services?
Responsibilities of the group of authors	
	Which of the many activities presented in the first chapter are to be entrusted to the authors? Are any other bodies involved in producing textbooks for primary level?
Legal aspects	
	How are royalties and copyright

	regulated?
<b>Production Conditions</b>	
	Identification of sources of funding
	Is the financing of the pilot version guaranteed? Is financing guaranteed or are there prospects of obtaining finance for the final version?
	Size of the market
	Are there reliable statistics on the number of schools and the number of pupils per class? Are there forecasts of the growth in school rolls? Has any research been performed on the financial status of parents?
	Definition of conditions of use

	Definition of conditions of use
	Do you plan to produce one textbook for two or three pupils, or one per pupil? Will the books be bought or borrowed? Do you intend to set up a revolving fund?
	Capacity and quality of preparations for printing
	Does the printer have the capacity for typesetting? Photoengraving?
	Capacity and quality of printing
	Is the printer's equipment suitable for textbook printing? Is it suitable for printing large runs while maintaining high



	quality? Are the technicians properly trained? Can the printer operate competitively?
Inputs	
	Are all inputs required available on the spot? What is the quality like? Must paper be imported? Ink? Printing plates? etc.
Finishing	
	Is the printer equipped to finish books? In particular, what type of binding can he produce? Can the printer cope with a large run? Can he pack the books properly?
<b>Distribution Conditions</b>	
	National statistics
	Does the unit in

National statistics	
	Does the unit in charge of distribution have reliable information on the school roll by school and region?
Precise information on transport routes	
	Are the precise itineraries known for the points to be served?
Organisational capacities	
	Does the unit have the ability to devise a distribution strategy? And to put it into practice?
Technical and financial resources	
	Does it have the means of transport to ensure

	distribution and/or the financial resources to have the materials distributed?
<b>Teacher Training</b>	
Capacities of the teacher training unit	
	Who is to plan the necessary training activities to accompany the introduction of the revised material? Who is to conduct the training?
Capacities of future trainers	
	What is the level of training, experience and motivation of those in charge of teacher training?
Technical and financial resources	
	What technical back-up resources and what budget

back-up resources and what budget does the teacher training unit have at its disposal?
--

For this work you will need qualified staff and a great deal of time; it can take up to five years to devise an alphabet<sup>4</sup>. That is why this work must never be part of a textbook project; it is an indispensable prerequisite for launching projects in this field.

### **Preliminary linguistic work**

Although it is out of the question for you as authors to transcribe a language, every time you use a local language you should examine the linguistic and socio-linguistic factors that are likely to have an impact on the teaching and learning process. On the following pages you will find a list of factors which you should pay attention to during this preliminary research phase, whatever the degree of standardisation of the local language you intend to use in your textbook<sup>5</sup>.

Once again, you should adapt our suggestions to the case in hand; try to identify the factors of vital importance which must be examined without delay and those which are neither really urgent nor so important. You should realise that at this stage of your work, it is less a question of making immediate decisions regarding writing or vocabulary than of gathering data which will allow you to make the relevant decisions at a later date, in particular during the writing phase when you will periodically come up against linguistic difficulties.

**No research work is an island: every issue will have immediately applicable consequences for your textbook**

**In the absence of a feasibility study, you must also examine the environment in which the textbook will be used**

Examine the writing, production and distribution conditions particularly closely

<b>13. Textbooks in a National Language</b>		
<b>Political Preconditions</b>		
	Language of instruction	
		Is the national language in question officially recognised as a/the language of instruction for native speakers?
	Languages taught	
		Which language or languages are taught? Will the national language be used purely as a medium of instruction, or will it also be one of the languages taught? Will primary school pupils also learn a world language? If so, as from which class and in what way?
	Making the alphabet official	
		Is the alphabet of the national language you intend to use officially recognised? Is it accepted as such by users of the language? Do other alphabets co-exist with this one, and are they also known and used?
	Promotion of the national language	
		Is there a clear political will to support work in the national language, and your work in particular? Are there any political activities to support national languages that go beyond mere declarations of intent?
<b>Scientific Factors</b>		
	Ensuring a pertinent and suitable alphabet	
		Does the alphabet selected for use in textbooks correspond to a scientific analysis of the

	Does the alphabet selected for use in textbooks correspond to a scientific analysis of the language?
Functionality of the alphabet	
	Is the method of writing selected suitable for school-level learning or is it more in line with the needs of researchers?
Respecting variants	
	Have dialect variants been identified? Can the alphabet respond satisfactorily to their special features? What line do you intend to take in textbooks destined for nationwide use?
Conformity to other alphabets	
	Does the alphabet used for the national language in question differ from those used for any other national languages without good reason? Does it differ from the world language used in the country?
Spelling	
	Are there conventions for hyphenation? For contractions? For spelling loan words taken from a world language?
Punctuation	
	Has any work been done on standardising punctuation? Do the punctuation rules differ from those used by the world language used in the country for no good reason?
<b>Institutional Factors</b>	
	Training teachers

		Does the training of primary school teachers include the study of the national language in question?
	On-the-job training for teachers	
		Are there in-service training programmes to prepare teachers to teach in the national language in question?
	Reference works	
		Is there a research institute responsible for producing reference books concerning the national language in question, in particular, grammar books and basic dictionaries?
	Terminology	
		Is a unit or a body responsible for enriching the language, and in particular, for creating the technical and scientific terms that are vital for consistent, diversified, precise instruction? Are efforts being made to standardise these new terms?
	Standardisation	
		Is a unit or a body responsible for standardising the national language, in particular, for proposing punctuation rules corresponding to the superstructure of the language?
<b>Practical aspects</b>		
	Characters	
		Can the characters used to write the national language in question be found on a standard keyboard?

#### 4. Planning

The preceding phase will have enabled you to identify those factors which will have to be examined before

The preceding phase will have enabled you to identify those factors which will have to be examined before you start writing your material.

You are thus now in a position to plan research activities; you should start by setting the deadlines, even if it is difficult to gauge the time that will be needed for certain activities, such as selecting a representative sample, and you may be forced to adjust your schedule at a later date.

To avoid getting bogged down in poorly prepared work or work that is not in line with your needs and your possibilities, you should concentrate on compiling as exact a schedule as possible, taking the following factors into account.

**If you work in a local language, analyse the linguistic environment of the textbook**

**Base planning on practical options rather than wishful thinking**

### ***Institutional Priorities***

The first textbook will require the greatest amount of research work, but it is also the book that will be most impatiently awaited. It is thus not unheard of for the institutions concerned, the Ministry of Education, and sometimes the donor to exert pressure on the authors to accelerate the preliminary research phase and complete the long awaited textbook rapidly.

It is not uncommon for an insufficiently standardised language to become the language of instruction, and for the scope of linguistic work to be underestimated by the education authorities – who nevertheless intend to meet their political commitments at any price.

You should of course plan your activities taking into account these pressures, but we have seen time and time again that ill-considered haste never pays off: the speed at which the work was performed is quickly forgotten, and all that remains are the shortcomings of the finished book. You should then consider carefully



to what extent and how you are prepared to take into account institutional pressure, to ensure that the quality of your research work is not jeopardised.

### ***Human Resources***

You must also take into account the people involved when you plan activities.

### **The Authors**

Field research will have to be performed by all the members of your team; even those who consider themselves well enough informed about the school situation must take part.

In this way you will ensure that all team members expand, deepen and update their knowledge, and that the group begins to come together, before going on to devise the material on the basis of a uniform level of information. If you do not harmonise points of view in the field you risk running into serious disagreements afterwards, particularly when you come to devise your material.

**All authors without exception should be involved in field research work**

### **Short-term consultants**

It is rare for a group of authors to have the necessary skills to perform all preliminary research work independently. You should thus identify the aspects requiring skills only available outside your team.

In line with your needs you should make provisions for the sporadic help of a linguist if you are going to have to write textbooks in a national language which has still not been sufficiently standardised, of a sociologist to prepare the field research work, of animateurs who are familiar with the test area where you aim to gather data or of a statistician who will help you to process and interpret certain results.

It is up to you to identify the areas where you will need occasional assistance from other professionals. You must then contact the latter and ensure that they will be available when required.

must then contact the latter and ensure that they will be available when required.

### ***Technical and Financial Resources***

The research work always demands a minimum of technical and financial resources. You should thus evaluate the costs of the operation and not start planning until you are sure that you have the resources you need. In most cases you will need office supplies, a four-wheel-drive vehicle, enough funds to cover the costs of the mission and the fees for short-term experts.

### ***Scope of Data to be Collected***

When the schedule is drawn up for your activities, you will see the scope. One often tends to underestimate the time needed to process the data collected in the field, particularly when recordings have to be transcribed.

If you have to work in a national language which is still not commonly written, and you intend to record information, plan the recordings with a view to the follow-up work, i.e.

### **Transcription**

Under these circumstances you had better calculate one hour to transcribe five minutes of recorded speech. If you delegate this work to individuals whose only qualification is verbal mastery of the language you must also think about approaching an experienced linguist to revise the transcriptions.

### **Analysis**

The recordings, thus transcribed, will then be analysed in various ways. If you aim to produce a reading book you will have to pinpoint the words most frequently used by children, classify these words by length, origin (from a dialect variant, loan words, etc.), among other things. If you are unable to do this by computer, you will have to perform the work manually which will take some time.

### **Data Processing**

All the data will have to be typed so that the authors can use it, before they start work on devising didactic material; this is a long and exacting secretarial task, the scope of which is often underestimated by authors.

You should bear in mind, when you draw up a schedule for your activities, that you will have to correct all the data that you collect. There is no point in conducting extensive research in the field if you cannot use the information you gather. You should thus always distinguish between what is possible, and what is desirable but unrealistic. Identify the research work which you cannot reasonably conduct and the work which can be postponed without any major impacts on your first didactic materials<sup>6</sup>.

At the end of this phase you will have two schedules, the first of which will be a short-term schedule for the research phase. It will indicate the main research activities, the deadlines, the persons responsible and the evaluation of costs.

The second, medium-term schedule will concern the actual writing and production of the materials.

It is important to gear your work from the outset to the start of a specific academic year. You should decide on the first year of introduction and make absolutely certain that you do not miss it, and perhaps the date of publication for any second set of materials. You should then inform the education authorities as soon as possible.

Refer back to the first chapter and look at Table 3 (the birth of the *Garabola* textbook) as a yardstick to help you gauge how much time you should allow.

## 5. Instruments

The objective of the current phase is to develop the research tools which will allow you to examine, quantify or verify the data required.

The approach taken in the field of social sciences to define an analytical model is discussed in several specialised publications; if concepts, hypotheses and indicators are completely new ground for you, it would certainly be a good idea to consult a sociologist or to refer to the literature on this subject listed at the end of

specialised publications; if concepts, hypotheses and indicators are completely new ground for you, it would certainly be a good idea to consult a sociologist or to refer to the literature on this subject listed at the end of this chapter.

But you should not forget that research in the field should never be an end in itself, it is merely a means to an end – which is the production of textbooks that are in line with the needs and resources of the country. You should thus attempt to surround yourselves with the skills which will prevent you as far as possible falling into the traps of wooliness or arbitrariness during your research, but do not lose sight of the fact that you are above all authors of textbooks. Your primary target group is the pupils who are waiting for their books, while university researchers must be relegated to second place if they appear at all on your list. Let us retain our pragmatic approach and again make the distinction between what is desirable – a piece of work which is scientifically unassailable and will require a lot of time and experienced staff – and what is possible under the given circumstances. It is up to you to make the best of the situation, even if your resources are minimal (e.g. novice researchers, or the fact that you are not given all the professional back-up you would like).

Within the scope of this guide, we will introduce you to a relatively simple way to identify research tools which you can use in most cases.

**Prepare functional and well-targeted tools**  
**Consult specialised books to find out about tools**

***Data to be Verified in the Office and in the Field***

You should start by differentiating between the data available in the office and those you will have to verify in the field, before going on to define the activities needed to analyse each of these.

<b>14. Initial Break-Down of Tasks to be Performed</b>
Data to be verified in the office – Activities
Education Policy

Analyse official guidelines <sup>7</sup>
1985 Official Curricula
Analyse the subject "Malagasy"
Analyse the targets for the first grade
Analyse the profile of the pupil at the end of primary education
Textbooks Used
Identify the main textbooks used
Define criteria to evaluate these
Analyse the most widely used in class
Pedagogical Directives
Inventorise, collect, exploit

Table 14 was drawn up to this end by the TefBoky Project. It could be useful to you for reference purposes.

### ***Hypotheses, Indicators and Instruments***

The above list still tells you nothing about how to study each element. You should proceed as follows to determine how to approach the matter, i.e. how to identify the sort of instrument you will need.

Firstly you should draw up your hypotheses; these are sort of provisional answers, formulated in a relatively summary fashion, which you propose for each element to be studied, and which will later have to be verified in the field.

Secondly, you should define the indicators which will allow you to verify these hypotheses; indicators should be factors which are easily observable, verifiable or quantifiable.

be factors which are easily observable, verifiable or quantifiable.

Thirdly, and lastly, you should select the instruments which will allow you to verify the indicators you have just identified.

Let us take an example to better illustrate the links between hypotheses, indicators and instruments. Let us assume that you are required to verify that the pupils achieve the attainment target for handwriting at the end of the first grade, i.e. that they are able to copy a sentence on the basis of a model in cursive style, forming the letters legibly and understanding the meaning of what they write. You could then devise the following table.

### ***Developing Instruments***

You have identified the research instruments you need – now you can develop these.

#### **Adapt the instruments for the case in hand**

<b>15. Identification of Instruments</b>	
Hypothesis: Pupils achieve the official attainment targets for handwriting at the end of their first year of schooling.	
<b>Indicators</b>	<b>Instruments</b>
<b>Time allocated for handwriting in the official time-table</b>	
	Analysis of official curriculum
<b>Importance attached to handwriting by teacher</b>	
	Examination of pupils' exercise books

	Questionnaires
	Interviews with teachers
	Classroom observations
<b>Importance attached to handwriting by parents</b>	
	Inventory of equipment purchased by parents and available in classroom
<b>Quality of handwriting</b>	
	Tests involving copying a text
<b>Spelling of certain common words</b>	
	Tests involving dictation of words
<b>Comprehension of texts copied by pupils</b>	
	Tests involving the comprehension of a text

If you have little experience in the subject we recommend that you seek the support of a specialist. It is not easy to prepare instruments that are both appropriate for the survey conditions and targeted so as to give you the information you require.

Within the scope of this publication we will limit ourselves to giving a few practical hints and some examples taken from the work of the TefBoky Project.

### **Research Conditions**

Instruments should firstly be designed with the investigators in mind. Sometimes you will have to involve teachers or educational advisers in your work, particularly as regards interviewing parents. You must thus design instruments on the assumption that however willing they are, they are novices when it comes to investigating, and will need tailor-made instruments, especially if you expect them to work relatively independently.

investigating, and will need tailor-made instruments, especially if you expect them to work relatively independently.

The instruments must, of course, also be tailored to the needs of those interviewed. It is up to you to identify instruments which will neither shock nor intimidate adults and children who are not familiar with investigations.

Finally you must take into account the conditions surrounding your research work, and take a pragmatic approach. If you have to be on the move for weeks on end, for instance, use only instruments that you can transport – no vast packages of tests and questionnaires. Sometimes you will not be able to use recordings because the logistics preclude this. To illustrate this, we have reproduced below a few pages taken from the investigation conducted in 1986–1987 by the Tef Boky Project. Examine them carefully and identify the precautions taken at that time to ensure a minimum of uniformity of investigation conditions and to guarantee precise results – and see how you can adapt these to suit your own circumstances<sup>9</sup>.

**Do not underestimate the importance of physical and logistical considerations**

**Nothing is too self-evident to ensure that the instruments are properly used**

### ***Preliminary Testing***

You now have research instruments, but no guarantee that they are precise enough or suitably tailored to your investigators and to the people investigated to give you the data you need.

For this reason you should organise a preliminary test run with the instruments, especially those aiming to evaluate school attainment levels. We recommend a test run in at least two schools offering teaching and learning conditions that can be considered representative for the country as a whole, which will usually mean moving away from urban areas.

To ensure that your instruments really work as intended, you may have to modify them, and then organise a second test run. This may prove impossible however. In our experience every expedition demands time,



human resources, funds and organisation, and it is rare for projects to have the free time and the resources for a second test run.

### Select a sample for your investigations

#### *The Final Instruments*

You are now ready for the final step in preparing your instruments. Modify them on the basis of the preliminary test runs and prepare a sufficient quantity for the number of villages and/or schools which you should now identify. It is generally a good idea to put together all the instruments to be used at any one location in one file; this will prevent the investigator misplacing documents or wasting time looking for them in front of those he wishes to interview – an embarrassing situation which can happen to even experienced investigators, and is bound to happen to novices unless you give them proper back-up.

**Take great care with attainment tests; the education authorities are always particularly interested in these results**

1. List instruments which will guide the investigator.

File No. 2	Instruments for Field Research Work
------------	-------------------------------------

Investigation conducted by.....

Period: from to.....

### List of Instruments

To give you an overview tick the relevant box after each instrument has been used

1. Instrument Group 1

Collecting data at  
CIRESB



- Collecting data at  
CIRESB
2. Instrument Group 2  
Collecting data from  
animateurs in the area
3. Identification sheet  
The village / the school
4. Instrument Group 3  
Target Group:  
Grade-one teachers
5. Instrument Group 4  
Target Group: All  
teachers
6. Instrument Group 5  
Target Group: Parents
7. Instrument Group 6  
Classroom observations  
(grade one)
8. Instrument Group 7  
Cultural features –  
inventory

- 9. Instrument Group 8  
Linguistic, cultural, etc., profile
- 10. Instrument Group 9  
Aptitude test
- 11. Instrument 10  
Test–decoding graphic representation
- 12. Instrument 11  
Reading test
- 13. Instrument 12  
Concerns and interests of pupils
- 14. Instrument 13  
Writing test
- 15. Instrument Group 14  
Physical working conditions at the school

2. Recall the hypotheses to be verified on each file

File No. 2	Instruments for Field Research Work
------------	-------------------------------------

INSTRUMENT GROUP 5  
Target Group: Parents  
Method: Interview based on questionnaire

QUESTIONNAIRE NO. 1

Objective:

Verify the hypothesis: Parents have low incomes.

Instructions:

1. Take one family per economic stratum (and one form per family)

rich  average  poor

2. Select families on the basis of information given by teachers, community workers and VIP

1. Family situation

	Number	Members of Family	Dependent Children	
			At School	Not at School
Sex				
Male				
Female				

Comments: .....

2. Income-generating activities

Importance	Activity	Agriculture	Animal Production	Crafts	Fishing	Commerce	Miscellaneous
Main activity							
Secondary							
Tertiary							

Comments: .....

3. Formulate questions precisely and give enough space for answers

File No. 2	Instruments for Field Research Work
------------	-------------------------------------

3.1.4. Course of lesson:

Did the teacher revise subject matter?

Yes  No

What did he take as the starting point?

Real-life experience

Text

Engraving

Short story

Observation

What phases did he

What phases did he then go through?

Expression

Exploitation

Application

3.1.5. Method

The teacher called on pupils' experience

The teacher guided pupils

The teacher developed the subject alone

A dialogue emerged between teacher and pupils

between pupils

3.1.6. Behaviour and attitude of pupils

Most pupils

participated

Some pupils participated

No pupils participated

Pupils reacted in the following ways

They wanted to speak come what may

They waited to be asked

They responded spontaneously

They responded hesitantly

They repeated what the teacher said

Comments: .....  
.....  
.....

4. Allow enough space for comments which do not apply to any of the individual questions

File No. 2	Instruments for Field Research Work
------------	-------------------------------------

SUPPLEMENTARY QUESTION No. 3

Ask the teacher how he goes about solving the major difficulties encountered by pupils learning to read.

Ask the teacher how he goes about solving the major difficulties encountered by pupils learning to read.

.....  
.....  
.....  
.....

IN THIS CONTEXT NOTE THE FEATURES THAT STRUCK YOU MOST IN THE COURSE OF THE READING LESSON, WHICH YOU CONSIDER INTERESTING BUT DID NOT FIT INTO ANY OF THE OTHER QUESTIONS

□

5. Give investigators written detailed instructions

File No. 2	Instruments for Field Research Work
INSTRUMENT No. 12 Target Group: First-grade pupils Type of Instrument: Test	

Objective:

Verification of the hypothesis:  
Children in rural areas have specific concerns and interests (2213)

Guide:



1. *Materials:*

Sheets of paper

Pencil

2. *Instructions:*

2.1. Separate children as far as possible to avoid copying

2.2. Hand out per pupil

1 sheet of paper

1 pencil

2.3. Ask the children to draw

• their favourite *person*:

WAIT 10 min.

• their favourite *animal*:

WAIT 10 min.

• their favourite *thing*:

WAIT 10 min.

2.4. At the end go and see *every* child

• Ask him/her to explain *each* drawing to you.

• Record the explanation on the sheet of paper (e.g. grand–father, pig, flower)

• Add the age of the pupil.

• Collect papers

6. Prepare forms as a record of documents

**RECORDING RECORD SHEET**

Label your cassettes!

List them in this record sheet and fill in the relevant information!!!

Place	Cassette No.	Date	Child Recorded			Subject
			Male	Female	Age	

## 16. Testing Attainment Levels

Among your instruments you are bound to have some tests to evaluate the attainment levels of schools. You will test the level of the class for which the new material is to be produced, to determine whether or not the pupils have achieved the official targets in the relevant subject so that the new textbook can be designed to bridge as many of the gaps thus identified as possible and/or to improve existing skills. Design these tests with care, and ensure that they are systematically applied and rigorously interpreted. Since evaluation tests are the focus of an expanding field of research, the suggestions below cannot be considered exhaustive. We will merely look at ten aspects concerning the contents, the mechanism and the interpretation thereof, which we feel are of particular importance.

### 1. Congruence with objectives

All tests taken together must allow us to determine whether or not the pupil has achieved the attainment targets, as laid down in the official curriculum for the subject and the class concerned.

### 2. Pertinence of tests

Each test should correspond to one specific, clearly formulated objective which will, in its turn, allow you

## **2. Formulation of tests**

Each test should correspond to one specific, clearly formulated objective which will, in its turn allow you to determine whether or not the general target has been achieved.

## **3. Reflecting the pupil's world**

The tests should only involve elements with which the pupils are familiar, or which are at least known to them.

You should thus naturally avoid tests concerning the arrangement of seats in an aircraft, or the keyboard of a computer, but also other objects which may still not be common in certain places, such as showers or calculators.

## **4. Interpreting illustrations**

Illustrations must be unequivocally understood by pupils. They must correspond to the cultural and psychological perception of the children. Pay special attention to the use of techniques such as movement or perspective which could be wrongly interpreted.

## **5. Duration**

The duration of the tests should take into account the pupils' concentration span.

For instance, 20 – 30 minutes should be allowed for all reading or writing tests in grade one of primary schools, interspersed with short breaks.

## **6. Preparing the investigators**

All investigators should conduct the tests in as similar a way as possible.

There are two ways of preparing investigators; call a meeting of all investigators before leaving to perform the field work, at which the procedure to be followed is repeated once again; and print the instructions on how to conduct each test at the top of each set of tests.

<b>7. Preparing the class</b>	
	The investigators must be able to create an atmosphere of trust which will allow the pupils to sit the tests in relatively satisfactory conditions.
	They must then be fluent in the pupils' native language, and be able to explain clearly to the teacher and then to the pupils what they are expected to do, and encourage them without putting an answer in their mouths; if so decided in advance, they will be able to instruct the teacher such that he can conduct the tests, while the investigators merely observe.
<b>8. Explaining the exercises</b>	
	Each type of exercise will be introduced on the blackboard, while every pupils should solve it in writing.
	To distinguish between understanding the mechanism and the knowledge or skills of the pupil, all exercises should be presented systematically on the blackboard, even where the mechanism appears to be self-evident. The investigators should always check to ensure that they do not present any particular comprehension difficulties.
<b>9. Pupil profile</b>	
	An individual information slip will give the information needed to interpret the results.
	Remember to note the age and sex of the pupil, whether he or she is repeating the year, attendance rate at the school, and if appropriate language skills.
<b>10. Systematic collation and interpretation</b>	
	To allow you to organise and interpret the results a points system should be drawn up, not when you come to process and interpret the results but when the tests themselves are devised. This system, and the interpretation of the results must be simple and clear enough for the education authorities, who do not necessarily have any statistical training, to understand them.

## 6. The Sample

## 6. The Sample

Now your instruments are ready, and you can identify a sample of schools in which to use them.

Why do you need a sample? Firstly, of course because it would not be feasible to gather information from every school in the country, and secondly to ensure that the information you obtain is representative for the country as a whole. Certain sample selection techniques will enable you to identify a zone where you can gather reliable data which will reflect the situation throughout the land. Finally, a sample will enable you to count on the long-term support of those concerned; you will need a representative group not only for the preliminary tests, but also to test the materials you produce one after the other. You can only create a good feed-back system if the sample selected does not change significantly over a period of several years.

We suggest that you select your sample in two stages, as follows.

### *Defining Selection Criteria*

**Select your sample with care; you will have to work there over a period of several years**

When you come to select zones and schools as part of your sample, you should firstly define your selection criteria. You must proceed with great care since this sample is going to be your laboratory not only for the research work at this stage, but also for testing the pilot textbooks at a later date.

Again, try to make the best possible use of our hints; look for feasibility, representativeness, sustainability, and the support of those concerned, each of which we will look at in more detail below, and decide which are the most important criteria for you.

**A good author is also a good organiser: what is the point in preparing good instruments if you don't know how to manage the application?**

## **Feasibility**

A good sample should not overtax the available resources and possibilities of the textbook production project.

Look at

- the geographical proximity of the test zone: the distance between the test zone and the project headquarters should be such that the authors, and perhaps also the animateurs and some teachers can easily commute between the two on a regular basis.
- the ease of access to all the schools selected: you should only select schools which you can reach in one day without major transport problems.
- the size of the sample: the number of schools selected must be limited to allow relatively regular monitoring of each one of them over a period of several years.

## **Representativeness**

A good sample must allow you to gain a global impression similar to that you would have obtained had you been able to look at every individual school in the country. Look at

- the teaching and learning conditions: the teacher to pupil ratio, the number of pupils per class and the number of classes per teacher, as well as the status of the schools (private or state for instance), must correspond to the national statistics, or where there are none, to the conditions observed in at least two other regions of the country.
- language and culture: the linguistic and cultural practices of the sample must reflect those found at national level. This may be a thorny issue if the global target population is spread over a large area which tends to encourage cultural and linguistic variations.
- the professional and economic profile: the professional occupations and income of those

- the professional and economic profile: the professional occupations and income of those observed within the sample must reflect those of the majority of parents throughout the country.
- experience of scientific work: if the test zone is a preferred area for research and testing, the inhabitants may have adopted certain mechanisms which do not reflect the situation of the population as a whole; if it was the test zone for a failed education project, it would be preferable to select another zone.

### **Sustainability**

To ensure that the sample remains representative over a period of several years you should try to guarantee:

- a sufficiently large initial sample: in the course of time, some villages or some schools will, for various reasons have to be dropped; in some cases the villagers will demand that they are dropped to avoid official visits, in others the sudden and prolonged absence of a teacher or the closure of a school will force you to take this step. To allow for these defections, it is imperative that the initial sample be relatively large.

### **Agreement and support**

Finally, to allow you to conduct your work, you must have the active support of teachers and parents, without which no cooperation is possible, or at least no good cooperation.

### ***Determining your Sample***

On the basis of your selection criteria, you should identify a few zones which could be taken as a sample.



You should make your final selection in the field, once you are certain that your choice is a good one and that you have the active support of the education authorities, teachers and parents.

From the outset, you should bear in mind the fact that you stand on the threshold of cooperation between your working group on the one hand and the village and its school on the other, which is likely to last several years. You must thus make an effort to create an appropriate climate of respect and trust.

## **7. Gathering Data**

The quality of your work in the field will naturally depend to a great extent on the quality of your instruments. But, if you ignore the logistical and material aspects of the mission, your instruments, however perfectly honed, may be ineffective.

We would thus suggest that you plan your field trip meticulously and that you evaluate it periodically, in the following way.

### **Preparing Materials and Logistics**

Think of your field research work as a project. To ensure success, the project must be prepared and implemented systematically; you must plan everything from the daily visit schedule for each investigator down to the last detail that every team member will need if they are to go and live and conduct investigations in a village for several days at a stretch. One oversight may cause serious delays in your already busy schedule.

### **Field Monitoring**

As far as possible you should organise regular visits to check that things are running smoothly for each investigator; they may be faced with surprises, a school may be closed or villagers may be hostile when confronted with an outsider, for instance, which may make it necessary for the investigator to leave the village rapidly.

### **Regular Comparing of Notes**

## **Regular Comparing of Notes**

Regular meetings should be held to discuss progress. A weekly report before returning to the field, for instance, allows the team members to swap the most important information and, if necessary, modify the way some instruments are applied, add more instruments or drop some.

## **8. Results**

You must now process and interpret the results of the data your team have collected in the field. This is a relatively long phase – it took some 4 months in the Tef'Boky Project – and must be conducted rigorously and meticulously if all the work to date is not to be nullified.

Some teams will call on the services of specialists to help them interpret the statistics, or guide them in their linguistic work, for instance. Be this as it may, you should think of the data you have collected as being at once extremely precious and far from complete.

### ***Major Indications***

The results that you will obtain will undoubtedly give you relevant information on the school situation. This makes them vitally important and you will find them useful not only for one textbook but for an entire textbook production project.

But you must not fall into the trap of thinking of them as complete and irrefutable. The situation will rarely allow you to do so. For example, let us assume that you have evaluated school attainment levels; your battery of tests may be appropriate and your results differentiated (girls/boys; school-age children/ significantly older pupils; pupils repeating the year/pupils enrolled for the first time; pupils who have lived in the area for some time / pupils who have recently moved to the area; pupils whose mother tongue is the language of the tests/ pupils who are learning the language, etc.) but the population tested will not necessarily remain the same

(different pupils sitting different tests, etc.), and neither will the school environment (prolonged absence of the teacher, school closed periodically, etc.).

Since the results you obtain will not give you an image which corresponds exactly with the reality, you will constantly be trying to enrich your data and make them more precise.

You should thus consider your research work in the field as the foundations for the new didactic material, but take care not to stem the flow of information.

During the conceptual phase and after the writing phase you should call on amateurs and some teachers who you will have identified during the field work, to confirm or refute certain results. Afterwards, when the material is tested, you should conduct classroom observation, talk to teachers about using the new material, and finally, of course evaluate the functionality of the material with the help of evaluation tests.

Thus, step by step, you will complete the mosaic of which the field research was the first piece.

**The results of the investigation must be complete and precise**

## 9. In Conclusion

### *A Reference Document*

The results of field research work are rarely published; so as not to waste time, the authors generally make do with a preliminary version, on which they base the conceptual work.

Yet, the results should always be documented in the form of a particularly carefully put together publication. Field research work often provides information which is new or which those in authority prefer to overlook in the capital, where major decisions are made. The findings may have repercussion for certain parts of the school system. For instance, the discovery that the actual learning time is half the official learning time could lead the authors to propose a revision of the official attainment targets, a decision which the education authorities would be reluctant to make.

lead the authors to propose a revision of the official attainment targets, a decision which the education authorities would be reluctant to make.

The report on field work here becomes a piece of evidence which the authors can use to explain, justify and even defend some of their proposals; it is a vital document which cannot be replaced by verbal explanations or the raw and uncollated results of research.

It is thus often a good idea to end this phase by publishing a document which should be accepted by the education authorities: having been prepared and implemented with care, the research work must be presented in this document with the necessary professionalism.

### Document your research

#### Notes

<sup>1</sup> According to Landsheere, "A curriculum is a collection of planned activities for instruction, comprising the definition of teaching targets, the content matter, the methods (including evaluation), materials (including textbooks) and the arrangements for suitable training of teaching staff. In *Dictionnaire de l'évaluation et de la recherche en éducation*, p. 65. Paris: PUF.

<sup>2</sup> Cf. Introduction.

<sup>3</sup> Cf. Sow, A.I. *Langues et politique de langues en Afrique Noire*, p. 46. Paris: Nubia/UNESCO, 1977.

<sup>4</sup> "Some five years are needed to fully describe all the sounds in a language that has never been written." *Langues et politique de langues en Afrique Noire*, op. cit. p. 39.

<sup>5</sup> In this context the work performed by the German–Peruvian Bilingual Education Project from 1979–1989 provides interesting practical information; cf. Châtry–Komarek M. *Linguistische Faktoren bei der Erstellung von Schulbüchern in Vernakularsprachen*, Osnabrück: Osnabrücker Beiträge zur Sprachtheorie 31, 1985 and Intentos de codificación del quechua en libros escolares. In: Lopez, L.E. and Moya, R. (Ed.) *Pueblos indios*,

*estados y educación*, Lima, 1989.

<sup>6</sup> In the German–Peruvian Project mentioned above, the authors of the reading books in Quechua would have liked to conduct research to identify punctuation responding to the supra–segmental characteristics of the language, which had not yet been sufficiently standardised. However, because of the lack of resources and time available, they were forced to write the textbooks for the first three grades of primary school without the assistance of this important research.

<sup>7</sup> The Charter of the Malagasy Socialist Revolution, published in 1975 in Madagascar, advocates democratisation, decentralisation and Malagasisation in education, for instance.

<sup>8</sup> These instruments prepared in 1986–87, were reproduced in their entirety in the third book of the *Garabola* series, entitled *Les Dossiers I*.

### ***Recommended Reading***

#### **Preliminary Work for Textbook Production**

AFOLAYAN, A. The Six–Year Primary Project in Nigeria. In: BAMGBOSE, A. *Mother tongue education*. London: Hodder and Stoughton and Paris: The UNESCO Press, 1976

FARREL, J.P. AND HEYNEMAN, S.P. (Ed.) *Textbooks in the Developing World*. Washington D.C.: The World Bank, EDI Seminar Series, 1989

KOMAREK, K. (Ed.) *Les dossiers I*. Eschborn, Antananarivo: GTZ, 1993 READ, A. *A guide to textbook project design and preparation*. Washington D.C.: The World Bank, 1986

RIEDMILLER et al *Diagnóstico sociolingüístico del área quechua del departamento de Puno*. Lima, Peru: Instituto Nacional de Investigación y Desarrollo de la Educación, 1979

#### **Linguistic Research**

CALVET, L.J. *La guerre des langues et les politiques linguistiques*. Paris: Payot, 1987

CALVET, L.J. *La guerre des langues et les politiques linguistiques*. Paris: Payot, 1987

COULMAS, F. *Linguistic minorities and literacy: language policy issues in developing countries*. Berlin: Mouton Publishers, 1984

COULMAS, F. *Sprache und Staat. Studien zur Sprachplanung*. Berlin: W. de Gruyter, 1985

RUBIN, J. Textbook writers and language planning. In: *Language planning*. Rubin J. et al (Ed.) The Hague: Mouton Publishers, 1977

SOW, A.I. *Langues et politique de langues en Afrique Noire*. UNESCO/Nubia, 1977

UNESCO *L'emploi des langues vernaculaires dans l'enseignement*. Paris, 1953

### **Research Instruments**

BOUDON, R. *Les méthodes en sociologie*. Paris: PUF, Coll. "Que sais-je?", 1969

GRAWITZ, M. *Méthode des sciences sociales*. Paris: Dalloz, 1984

QUIVY, R. AND CAMPENHOUDT, L.V. *Manuel de recherche en sciences sociales*. Paris: Bordas, 1988

### **Preparations for Investigative Work in the Field**

CHAMBERS, R. *Développement rural. La pauvreté cachée*. Paris: Karthala, 1990

### **To Sum Up**

When the education authorities of a developing country decide to produce a textbook for primary level, they turn to a group of individuals, generally inspectors and educational advisers, and often expect them to

produce a high-quality product within a few months.

Mission impossible. The team which has just been set up, is never able to start the conceptual work immediately. Indeed, this newly born entity will have to conduct a long and difficult mission, the need for which has not generally occurred to the education authorities, involving the following.

Firstly a genuine working group must be set up, without which no textbook, no matter how mediocre, will see the light of day; this presupposes that the authors identify the mechanisms which will allow every individual to contribute his and her best to the team throughout the several years of in-depth cooperation.

Then, although the authors are almost always recruited from the ranks of the teaching profession, they cannot have the in-depth, complete and systematic knowledge of the target group of the textbook that they will need. They will have to devise, plan and manage research on the lesser known aspects of day-to-day school life, collate these in a systematic form and interpret the results.

Finally, although no decision should ever be taken to produce a textbook before a serious feasibility study has been conducted, and before ensuring that certain preconditions are met – things often look different in practice. The feasibility study is not complete, sometimes no study has been conducted; it is the authors who often have to bridge these gaps.

In the best case scenario, the authors will need one full year to complete their research, the quality of which will largely determine the quality of the book produced, in particular the degree to which it is in line with the needs and possibilities of subsequent users. The sheer scope of this work explains why some teams of authors take only the unprocessed results and race on to the conceptual phase without further delay. But, the results of the research should be scrupulously documented and presented to the education authorities to enable them to understand the pedagogical choices reflected in the textbooks.





## The Contents

The conceptual phase is often welcomed as a deliverance by groups of textbook authors: after all these months of research, they believe that they can develop the materials relatively rapidly. More often than not they are disappointed, for months of hard work are needed to produce a textbook or a teachers' guide, as you will see in this chapter.

For didactic reasons, we will break down the conceptual phase into two parts and deal with each part in two separate chapters. The first will look at the contents, while the second focuses on the form, as though the two were not related. In fact the final form and contents of a book emerge from the very interaction between these two fields. Also for didactic reasons we have decided to present the work involved in a more or less logical sequence. Textbook teams generally take a "spiral" approach which allows them to lay down the rough structure of the material progressively. This approach involves taking one step back at regular intervals to



ensure that every important factor has been taken into account, to re-analyse these factors, weigh them up again and then make the appropriate decision.

You should read this chapter without losing sight of the fact that the order in which the work is presented will never be followed to the letter in practice.

**Take a “spiral” approach to determining the contents of your textbook, always going back to re-examine your decisions and ensure they were correct**

## **1. Time Management**

Time is the first aspect you should examine in the conceptual phase. The objective of this phase is to draw up a precise frame of reference for the time effectively allocated to the subject in hand.

Why, you may ask, should our first step be to analyse the time available rather than the contents of the materials we aim to produce? Firstly, because you will not generally have detailed data on the effective learning time dedicated to the subject for which you are producing new materials, and secondly because it would be imprudent to launch yourselves head over heels into an analysis of the contents of the material without first defining the general framework, and in particular the time available for the teaching of the subject in question per academic year and per week.

Consider the following aspects which will allow you to identify the time frame, step by step.

**The first element to look at when deciding on the contents of your book – the time factor**

### ***The Academic Year***

You should start by counting the number of teaching weeks available for the new material. To this end, consult the official curriculum which will probably state the official number of teaching weeks.

You should start by counting the number of teaching weeks available for the new material. To this end, consult the official curriculum which will probably state the official number of teaching weeks.

This figure is often more a recommendation than an absolute prescription, however. It may not take into account even official interruptions such as exams or once-a-term upgrading meetings for teachers.

To identify the effective length of the academic year you will also have to look at the statistics of the Ministry of Education regarding pupil attendance, and to analyse the data you gathered yourself in the field. There may be a wide discrepancy between the official number of teaching weeks and the number actually observed in the schools. You must then decide on the figure on which you wish to base your textbook.

At this stage you should be aware of the fact that any decision to base your work on the “shortened” school year may have serious repercussions: a reduction in the number of teaching weeks may entail a radical modification of the attainment targets for the entire primary cycle<sup>1</sup>.

You should also consider the “legality” of your decisions. Even if you are involved in a pilot project, which by its very nature needs a certain scope for action, you should check to what extent you are required to move within the confines of the official remit and to what extent the education authorities will allow you to work outside an official framework, even if it is considered outmoded or erroneous.

If you feel that you should introduce innovations, try to analyse the situation so that you can decide when to inform the education authorities of the changes introduced in your material: sometimes it may be prudent to keep them informed of your intentions, while under other circumstances new ideas may have a better chance of being accepted if you remain silent until the pilot material is presented. This is a vitally important consideration which applies not only to defining the time-frame, but to the entire conceptual phase of your work.

### ***Time-Table***

Having decided on the number of teaching weeks you wish to take into account in your new textbook, you should examine how schools manage this time at present.

In many industrialised countries all pupils follow the same officially prescribed time-table, which has not been substantially altered for several decades; textbook authors do not then generally have to worry much about the time aspect. The situation is often different in developing countries, where pupils do not necessarily all follow the same time-table, and where the official time-table or time-tables is or are not always observed in schools. In some countries, for instance, one group of pupils follows a so-called "full" time-table (5 hours a day), while another group follows the so-called "short" time-table (3 hours a day), and a third group follows an even more seriously slashed time-table with only one or two hours instruction a day<sup>2</sup>.

Sometimes this practice is officially sanctioned, but the existence of several different time-tables rarely has any impact on the level of attainment targets. To avoid any form of discrimination, the education authorities set the same targets for all groups.

### **Make the distinction between official guidelines and practice in the field**

This situation directly affects your work as textbook authors; you will be tacitly expected to produce materials which will allow different target groups to achieve the same targets at the same time.

At this stage you should concentrate on a thorough examination of the official guidelines and the general practice in schools to allow you to decide which timetable or time-tables you wish to take into account in your material. Do not take this decision lightly. If you discover that the majority of your target group follows a short time-table, and you wish to take this into account in the material you produce, you will be opting for a drop in the volume of knowledge to be acquired, which will in turn have repercussions at the level of the education authorities, the teachers, parents and pupils. Do not hesitate then to take one step backwards and check that your decisions are correct, if not legal, correcting them if necessary. You still have time.

### ***Breaking Down the Time-Table***

This is the third aspect you will need to bear in mind when determining the contents of your materials and the sequence in which you aim to present them.

Not all official curricula follow the same procedure here; some indicate only the overall time allocated to each subject, while others lay down the time allocated to every component of every sub-topic, i.e. for the subject

Not all official curricula follow the same procedure here; some indicate only the overall time allocated to each subject, while others lay down the time allocated to every component of every sub-topic, i.e. for the subject "mother tongue" the latter would not only stipulate the time to be allowed for reading, writing and speaking and listening, but would also break down the time reserved for writing into the time earmarked for handwriting, vocabulary, grammar, spelling, conjugation and creative writing. We recommend that you analyse the type of break-down found in your official curriculum.

Sometimes the break-down may surprise you, since it does not correspond to the methodological approach you had intended to take. Let us take an example. If you are to produce reading and writing materials for grade one, would you leave "handwriting" in the field of "art" as prescribed in some countries, or would you integrate it into your textbook, thus saving valuable time? You must of course specify the methodological approach you intend to take, but at this stage it is vital to know which subject "handwriting" is deemed to be part of before you can tackle the issue of the total time allocated for your subject.

These considerations may appear pointless to you if it is only a question of adding half an hour per week to the total time allocation for the subject; they may indeed be of secondary importance when the academic year comprises 35 weeks with a 27-hour school week, but they are anything but superfluous when the pupils spend no more than 15 hours a week at school and the school year is no longer than 24 weeks. Thus, again, take great care making your decision.

We should add that the approach you take must again be tailored to the circumstances. Sometimes you will have to consult with your colleagues who are responsible for producing textbooks for other subjects and/or with the curriculum development unit. Sometimes you will be unable to engage them in a real dialogue and your efforts to harmonise the procedure adopted for various subjects will be doomed to failure such that, to avoid paralysis, you may choose to confront the others with a *fait accompli*.

### ***Number and Length of Lessons***

Now you know the time-table to be respected and the overall time to be taken into account for your material. Would it then be appropriate at this stage to determine the exact number and length of lessons per week reserved for your subject, and to draw up a sort of time-table?

This sort of break-down is generally useful. If the subject in question is the "Mother tongue", which is traditionally made up of speaking and listening, reading and writing, which tend to overlap, it becomes indispensable. Before you can define the content matter to be learned in each of these sub-topics, you will need a detailed framework. If you are also addressing pupils following different time-tables you will not be able to progress in a coherent manner without determining the number of sessions within each of the time-tables to be taken into account.

Table 17 should help you better understand the importance of our recommendation. It shows how to break down two different time-tables so as to produce a single textbook for all pupils<sup>4</sup>.

### ***Official Teaching Time***

This is the last analysis you will have to perform regarding time management in schools<sup>5</sup>.

It is indispensable to know how the teacher officially breaks down his classroom teaching time. To calculate this you must know the number of pupils and classes he is in charge of, and if appropriate the amount of administrative work he has to perform. To this end you should once again consult the official statistics and compare them with your observations in the field.

**Check the legality of your decisions regarding the time to be taken into account for your textbook**

**Write a textbook that addresses all pupils in the grade whatever time-table they follow**

<b>17. One Textbook for Two Different Time-Tables</b>
In Madagascar, the official 1985 curricula refer to a short time-table of 3 hours a day and a full time-table of 5 hours a day. It follows that the length of time dedicated to

and a full time–table of 5 hours a day. It follows that the length of time dedicated to each subject depends on the working conditions: in grade two of primary schools 10 hours and 50 minutes a week are reserved in the full time–table for learning the mother tongue whereas only 5 are available for pupils following the short time–table.

When materials were devised for this grade the authors of the TefBoky Project decided to design a “common core” of texts to read, and speaking, listening and writing exercises for all pupils, with supplementary activities for those following the full time–table.

To this end they analysed the time officially allocated to speaking and listening, reading and writing in the two time–tables and drew up two plans so as to allow for at least one lesson of more or less identical length per day for each of these sub–topics, to be followed by all pupils. The temporal framework for the new materials to be produced was as follows:

Sub–topic	Full Time–Table	Short Time–Table
<b>Speaking and listening</b>	5 x 20 min. 5 x 10 min.	5 x 15 min.

<b>Reading</b>	10 x 25 min.	5 x 20 min.
<b>Writing</b>	10 x 25 min.	5 x 25 min.
On the basis of this table the team produced an initial break-down of the subject matter to be taught and learned, i.e.		
<ul style="list-style-type: none"><li>• in the textbook: for each of the 24 weekly modules, two pages for reading and two pages for writing, each corresponding to five 20-minute lessons, i.e. applicable for all pupils no matter what time-table they follow.</li><li>• in the teachers' guide: on the one hand the instructions for exercises common to all pupils, and on the other hand additional speaking and listening, reading and writing activities addressing primarily pupils following the full time-table.</li></ul>		

We should underline the fact that it is less the average class size which is important for your textbook than the average number of classes per teacher. Your approach will not change significantly whether there are 30 or 70 pupils in one classroom provided they belong to the same class. On the other hand, if the majority of teachers are in charge of more than one class at once, you must take into account the fact that they will have to teach these classes parallel to one another, which will mean eliminating or strictly limiting certain activities such as exercises or practical work out of doors. You will have to encourage more independent learning from the very start, and give the teachers very detailed instructions on how to manage the class in the teachers' guide. If one-teacher schools make up the majority of your target group this is the only way to take this fact into account.

By the end of this phase you will have identified the temporal framework within which your material will be used; we recommend that you record your results in the way suggested in the second chapter. This will allow

By the end of this phase you will have identified the temporal framework within which your material will be used; we recommend that you record your results in the way suggested in the second chapter. This will allow you to refer back to them at a glance.

### **Use the pinboard for all conceptual work**

## **2. Methodological Approach**

The aim of this phase is to identify the methodological approach which you intend to adopt.

Why, some of you will ask, should we once again delay looking at the content matter, and look first at the methodology. Before you can rationally decide on the contents, you must lay down the approach, for this can have major repercussions on the volume of knowledge to be acquired.

To illustrate this let us take the example of first-grade mathematics: you must decide whether to accord priority to calculating rather than counting, i.e. if your aim is to teach pupils to find solutions to problems rather than merely to count. This decision will have a direct impact on the subject matter, which you will define in the course of the following phase: in the latter case the child will have to learn to count to 100, while in the former he will probably only be able to count to 20, or 50 at the limit.

We will not go any deeper into subject-specific considerations here, but we will comment briefly on the points that you should analyse when selecting a methodological approach no matter which subject you are tackling.

### ***Practice in the Schools***

Your preliminary field research should have provided you with information about practice in the schools.

You should look at the preferences of teachers of the subject, any weaknesses in the methods generally employed and the principal difficulties encountered on the one hand; on the other you should analyse the level



of training of teacher trainers, educational advisers and amateurs and their working conditions, in particular as regards the budget and the material inputs allocated to them for training activities. As we will see later, this information will have a significant impact on your choice of an approach.

### ***Subject-Specific Research***

You should not be satisfied with merely adopting the methods currently advocated by teachers, and will thus have to undertake some research into the main trends in international research in the relevant subject. You should consult not only specialised literature, but also textbooks recently published in other countries if possible.

### ***Level of Innovation***

Analyse the level of innovation that is likely to be accepted by teachers as regards methodology – the level that they will accept and understand. To this end you will have to be able to bring the scientific findings for your subject into line with the current practices in the schools.

Sometimes you will have to opt for a relatively low level of innovation. If the teachers are poorly trained, and badly paid and if only limited funds have been budgeted for training, the approach you select must be familiar enough to teachers for the textbook to be accepted immediately, and used without a systematic introduction. Any complete break with current practices, which would require a great deal of additional effort on the part of the teachers, is unlikely to be accepted under these circumstances.

We cannot stress the importance of this enough; remember how reading books adopting an overly analytical method, or materials for maths using the theory of sets have failed when introduced to poorly trained teachers, largely as a result of the high level of innovation in terms of methodology.

**You should preferably select a traditional methodological approach with a limited level of innovation**

## **3. Defining Content Matter**

### 3. Defining Content Matter

Having defined the temporal framework and the methodological approach you can now go on to the next phase, which will aim to stipulate the volume of knowledge to be acquired for the subject and grade in question given the practical options and limitations of existing schools on the one hand, and the expectations of those involved on the other.

There are several different aspects which you will need to look at to help you identify the subject matter progressively.

#### *Current Curricula*

You should start by analysing the subject matter laid down in the current official curricula.

**Don't modify the contents of the official curriculum without first checking how much leeway you have**

In industrialised countries authors merely adopt the contents of these curricula without checking whether or not they are relevant. Indeed one of the first criteria applied when evaluating their products is the extent to which it corresponds to these official directions.

In developing countries, however, the situation is not always so clear. It is not unusual to find that the contents of official curricula do not tally with the actual learning conditions for a variety of reasons, such as the country's colonial past. The official learning time, for instance, may be at odds with the actual time available in practice. Where this is the case it is preferable to propose that the official curriculum be modified. Some specialists even recommend that textbook projects should be more or less systematically preceded by a full-scale overhaul of the national curriculum where needed, which can be expected to take some two years<sup>6</sup>.

As textbook authors you are not normally responsible for curricular revision; generally the ministry delegates this task to a special unit. But, experience shows that this is not always the case. Indeed relatively often in developing countries textbook authors find curricula that are hopelessly out of step with the reality of the education system in their country, and the curriculum unit declares itself unable to modify them<sup>7</sup>. Where this is the case, the authors themselves must revise the relevant curricula on a pilot basis to avoid producing textbooks that are inappropriate before they have even been published.

Be that as it may, analyse the situation thoroughly. It is now more important than ever before to gauge the leeway you have and, if you see yourself forced to reduce the volume of content matter covered gird your loins for major repercussions in the classrooms and negative reactions outside – as described below.

### ***Temporal Framework and Learning***

If the time effectively available is significantly less than that stipulated in the current curricula, you will doubtless intend to reduce the subject matter to be covered correspondingly. You should, however, bear in mind that a decision of this sort will have major repercussions on the teaching and learning process which we will now look at in more detail.

**Do you intend to opt for progression in step with pupils' progress, which is difficult to reconcile with a rigorous learning programme?**

The shorter the time effectively available for learning, the more rigorous your planning must be to guarantee that pupils acquire a minimum of knowledge, without which the school would not be meeting its commitments. This inevitable strict planning of learning time does have its advantages: it allows you to produce a detailed methodological guide for teachers, for instance, a sort of script which is bound to be a valuable aid to teachers who are often poorly trained.

This planning does, however, also have one major drawback: the teacher becomes a prisoner of the clock. He cannot take more time or repeat a lesson, without running the risk of jeopardising the entire course. He thus cannot adopt a "mastery" approach, according to which "generally a learning unit should be mastered before progressing to the next unit"<sup>8</sup>. This does not, naturally, mean that he should allow pupils to carry on learning without evaluating their progress. But, after the evaluation he is forced to carry on immediately with the next

progressing to the next unit<sup>8</sup>. This does not, naturally, mean that he should allow pupils to carry on learning without evaluating their progress. But, after the evaluation he is forced to carry on immediately with the next step, rather like traditional written examinations<sup>9</sup>.

In many developing countries, the rate of absence of pupils is high, primarily as a result of sickness, agricultural work and bad weather; inevitably pupils who have been absent drop behind and represent a real case of conscience for a teacher hemmed in by a tight schedule: either he proceeds according to the time-table so that the school is worthy of its name, or he deviates from it to focus on pupils who have missed a lot. And how can a teacher confronted by this dilemma be evaluated?

Before you lay down the learning contents, you should then re-examine the temporal frame that you have drawn up; remember that the less time available, the more the teacher is likely to be straight-jacketed by the materials you are going to produce, and act accordingly.

### ***Attitudes of Groups Concerned***

When determining the content matter for your textbook you should also take into account the attitudes of the education authorities, teachers and parents. It is not always easy to identify these; in our experience parents and even education authorities are often only able to express their wishes once they have the book in their hands. Nevertheless, if you intend to cut the volume of subject matter covered you can expect the following sorts of reactions:

#### **Education Authorities**

- A systematic refusal to accept any significant change to the volume of subject matter
- Spontaneous rejection of "bargain basement education" as compared to neighbouring countries and especially as compared to the curricula of the former colonial master
- Fear of incurring the wrath of parents.

### **Teachers**

- Vague fear of innovation which will inevitably mean curricular change
- Fear of having to deal with angry parents

### **Parents**

- Categorical refusal to accept mass education for their own children.

### ***Curricula in Other Countries***

To allow you to have all the information at your fingertips before you make a decision it might be a good idea to compare the content matter you plan to incorporate in your textbook with that found in foreign curricula in both developing countries and industrialised states.

Analysing these documents, looking in particular at the time–frame reserved for teaching and learning, you will often help you become more aware of your own position. Thus, if you are faced with the criticism that you are proposing “bargain basement education”, as you may be if you suggest cutting the volume of knowledge to be acquired, a reference to experience in other countries can help confirm that your decision is correct and help you argue your case in front of hesitant and poorly informed education authorities.

If you consider it vital to reduce the volume of material, you should proceed with caution, and agree to a compromise if necessary. Let us take an example: in grade one at primary school, the figure 100 is often considered a symbol of mathematical knowledge, held dear by teachers and parents alike. If this is the case, and you have limited the subject matter to be covered such that children are expected only to be able to count to 20, you can summarily present the figure 100 at the end of the year. A compromise of this sort may be enough to break down serious resistance to your textbook, resistance which will not always be technical in nature.

#### **4. Fine Tuning**

The relevance of a textbook production project should have been verified twice already, once by the feasibility study and once during your field research work.

If you wish to be absolutely certain that it is worthwhile continuing your work, check again at this stage that it is relevant. Some of you will consider this unrealistic in view of the advanced state of the work, but they should bear in mind that it is not necessarily the people who make the textbook who have performed the preliminary research, and they may still not have all the information they need. They should, however, have enough information to allow them to decide whether or not the decision taken by others to produce a textbook is genuinely justified.

If you are in this position, refer to the results of the preliminary investigation and re-examine the following options.

##### **Adoption of an Existing Textbook**

Check once more whether there is not already a textbook in your country or another country which has the features you have stipulated, i.e. which covers the relevant volume of material and adopts the methodological approach you have selected.

The production of new didactic material is always so expensive for a country, that you cannot justify starting work until you are absolutely certain that it is indispensable.

##### **Adaptation or Translation**

You should also check whether there are not already books which could be adapted or translated. If the negotiation of reproduction or translation rights is not a major problem, this can be a satisfactory compromise.

especially if the conditions for writing and producing new material are less than ideal.

If you conclude, having explored these options, that the production of new didactic material really is indispensable, you should pursue your work, laying down attainment targets in line with the volume of knowledge to be acquired, which you have already defined.

**Take your inspiration from curricula in other countries, but don't simply adopt these lock, stock and barrel**

## 5. Attainment Targets

During this phase of your work you will draw up the attainment targets for your new material, which will correspond to the contents you have already specified in functional terms.

You may encounter one of two situations here. Either you decide only to clarify and supplement the objectives laid down in the official curricula, without moving far from these, or you will see yourself forced to define objectives that are quite new in full or in part.

**Lay down clear attainment targets to allow you to define the contents of your textbook**

In either case you should consider that you will be touching on an area where you are probably not experts; if you can, you should thus call on the services of a specialist or at least consult the relevant literature, such as the books listed at the end of this chapter.

For our part we will merely illustrate, in Table 18, the difficulties that can arise when objectives are not properly formulated, and why it is important to remedy these.

## 6. Set of Materials

## 6. Set of Materials

You have now defined the content matter that is relevant for you and formulated it as targets. It is time for you to move on to identify the nature of the materials and the number of these materials you are going to produce.

### Decide on the composition of the set after careful consideration

You may find this superfluous, since you think you know the answer and will thus be tempted to start work immediately. Beware – the most obvious solution is not always the best one and the choice of the type of materials is always complex and has many consequences. If, for instance, you are attempting to produce reading and writing material for the first grade of the primary cycle, you should not necessarily produce a reading and writing book and a teachers' guide. It may be more appropriate to produce a writing exercise book or complementary pedagogical tools such as letter cards, word cards or pictures.

### 18. Vague and Incomplete Attainment Targets

In 1987, the authors of the TefBoky Project, who were responsible for devising didactic materials for learning to write in grade one of primary school analysed the existing curriculum, which made a distinction between handwriting and written expression. The target for handwriting in the first year was defined as "Knowledge of lower case letters", which was then further explained as:

"Knowledge of cursive lower case characters:

- Vowels, consonants, figures
- Letters and figures of different sizes".

During the analysis these directions proved to be so vague that it was not necessary to contravene them, but too imprecise to be translated into didactic materials without the authors making additional decisions. The main questions facing the authors were as follows.

The term "knowledge"



Firstly what exactly is to be achieved? Must pupils be able to form the characters as perfectly as the model? Or is it enough if their writing can be deciphered? What are the conditions needed to achieve this? Have pupils achieved the objective if they write without an example or need they only be able to copy an example they are given? If the latter is the case, is the model also in joined-up writing, or must the pupil be able to translate a printed model into cursive style?

#### **The term “letters”**

What exactly is to be achieved? Do we mean initially the 21 letters of the Malagasy alphabet or also the 13 complex graphemes in the language? Are pupils expected to write individual letters, or put them together to form words and sentences? A fundamental point, because the difficulty of joined-up writing is putting the letter together to make a word. In the latter case will pupils have achieved the target if they forget elements or add extra elements, i.e. if they make a spelling error? Or must they write without error? And so on.

To allow them to devise their material, the authors thus added the following details to the original targets: “By the end of grade one the pupils can copy simple, short sentences in Malagasy in joined-up letters on the basis of a model in either joined-up or printed characters; the sentences should be written in lower case characters only and involve only the letters of the alphabet. The pupils should write legibly without errors” (*Garabola teachers' guide*, 1988, p. 4)

Analyse the situation before deciding which materials would be most suitable. We suggest that you look in particular at the following aspects.

#### ***Pedagogical and Didactic Aspects***

You should first identify the materials that would be desirable to ensure high quality learning and teaching. The preliminary research should have given you precise information as to the level of training and experience of teachers, which will allow you to identify the tools that teachers will need to teach the subject in question as well as possible. This research should also enable you to pinpoint the materials that pupils need to raise the level of attainment significantly, given the conditions that you yourself observed in the field.

#### ***Financial Aspects***

## ***Financial Aspects***

Refer again to the results of your preliminary research, paying particular attention to the following points:

- the number of textbooks which each pupil in the class must purchase and the price of these books;
- the amount that parents are able and willing to pay for their children's school materials;
- the way individual school materials are bought or lent at present, or which are likely to be accepted;
- the way the teachers' materials are acquired;
- the way any large-scale reprints of the new materials will be funded.

You may reconsider your initial decisions in the light of these facts. You may, for instance decide to do without any expendable material, and to dispense with tools except the textbook and the teachers' guide.

We should point out that a textbook is, of course, still the best way to learn to read, but it is not imperative in other subjects. If you are producing materials for mathematics, for instance or, better still, science, you should explore the possibility of producing only a detailed teachers' guide, at least for the first two years of the primary cycle.

A teachers' guide is not, anyway necessarily a dull tome as many first-time authors seem to think; to convince you that it can be interesting look at the two examples below of teachers' guides for mathematics and science. They are designed for primary level, and were produced within the scope of the German-Peruvian Bilingual Education Project and the German-Malagasy Tef Boky Project respectively.

In some subjects a teachers' guide is more important than pupils' material  
Interchangeable, individual material is always a luxury

### Practical Aspects

Before you decide on the composition of your set of materials, look at the working conditions in schools as you observed them during your preliminary research. Even if it were possible to finance everything planned, it must be possible to use the material and store it in the schools. You should then consider the average number of pupils working at one table, the storage facilities and the existence of a desk where the teacher can open his guide, consulting it at his leisure during the lesson.

In our experience, the lack of storage facilities in the schools is a serious constraint to the production of pedagogical tools which would be very useful. If we take word cards, for instance, they should certainly not be produced as an integral part of learning to read if schools have no cupboard or safe, for they are almost bound to vanish rapidly.

7

**Material:** *Disponible, mais aussi, parfois, y compris les*  
**Equipement:** *Matériel et pour ceux qui disposent de lui, matériel, matériel et si vous le souhaitez à*  
*vous*

**¿Tú que quieres hacer después de esto?**  
*(Cada uno de ellos en el mismo tiempo)*

**Material**  
*Clases de teatro, música, danza, teatro, etc. etc. etc. teatro, teatro, teatro, etc.*

**Equipamiento**  
*1. Un pequeño grupo de teatro y danza en el aula.*

**2. ¿Disposiciones para el teatro y danza en el aula?  
*3. ¿Disposiciones para el teatro y danza en el aula?***

**3. ¿Disposiciones para el teatro y danza en el aula?  
*4. ¿Disposiciones para el teatro y danza en el aula?***



¿Qué sucede cuando se golpea un objeto con un martillo? ¿Qué sucede cuando se golpea un objeto con un mazo?

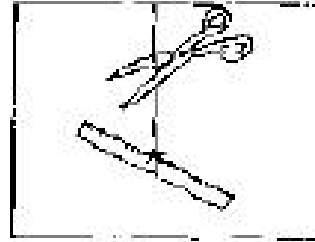

- Observación:**
1. Cuando golpeamos un objeto con un mazo o un martillo, ¿qué sucede? ¿Qué sucede cuando golpeamos un objeto con un mazo o un martillo? ¿Qué sucede cuando golpeamos un objeto con un mazo o un martillo?
  2. ¿Qué sucede cuando golpeamos un objeto con un mazo o un martillo? ¿Qué sucede cuando golpeamos un objeto con un mazo o un martillo? ¿Qué sucede cuando golpeamos un objeto con un mazo o un martillo?
  3. ¿Qué sucede cuando golpeamos un objeto con un mazo o un martillo? ¿Qué sucede cuando golpeamos un objeto con un mazo o un martillo? ¿Qué sucede cuando golpeamos un objeto con un mazo o un martillo?

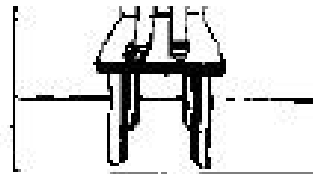

¿Qué sucede cuando se golpea un objeto con un mazo o un martillo? ¿Qué sucede cuando se golpea un objeto con un mazo o un martillo?

**Observación:**

¿Qué sucede cuando se golpea un objeto con un mazo o un martillo? ¿Qué sucede cuando se golpea un objeto con un mazo o un martillo?

¿Qué sucede cuando se golpea un objeto con un mazo o un martillo? ¿Qué sucede cuando se golpea un objeto con un mazo o un martillo? ¿Qué sucede cuando se golpea un objeto con un mazo o un martillo?

**Reflexión:**

¿Qué sucede cuando se golpea un objeto con un mazo o un martillo? ¿Qué sucede cuando se golpea un objeto con un mazo o un martillo? ¿Qué sucede cuando se golpea un objeto con un mazo o un martillo?

FIN ...

Kawsayninchis Fifth-Grade Science Lima-Puno, 1987



Even if you are preparing a limited number of pilot copies in the first instance, you should bear in mind the logistics of any subsequent large-scale distribution.

You should thus avoid materials that are difficult to pack, heavy or fragile. If you intend to produce expendable materials you must ascertain that they can be distributed to the schools in good time every year.

Ideally, the field work will have given you some indication as to the sort of material that is needed; in practice, however, this data may not be sufficient. You cannot foresee all the repercussions of the new material from the outset; mistakes can be made in spite of all the precautions taken by authors and they are always serious at this level. This is what happened in the TefBoky Project with a writing exercise book, written for beginners, which proved counter-productive. The failure of this exercise book seems to us to provide such a good example of what can go wrong that we have looked at the history of the book in detail in Table 19.

## **7. Arranging the Subject Matter**

Now that you have defined the content material to be covered in the subject and the grade in question, and have decided on the set of materials to be produced, you must determine how you wish to arrange the subject matter within the materials you plan to produce.

<b>19. Conceptual Error</b>
The research work performed in the field by the future textbook authors of the TefBoky group revealed that the level achieved in writing in the first grade of primary school was particularly low. The group then proceeded as follows to systematically identify the reasons for this low level, with a view to designing materials which would be best suited to remedy this serious problem.
<b>1. In the Official Curricula</b>

1.1. Writing is considered to be of secondary importance
1.2. Writing, classed as an artistic discipline, is seen merely as a manual skill, unrelated to speaking and listening or to reading
1.3. Attainment targets are vague
<b>2. Physical Conditions</b>
2.1. There is a lack of furniture (benches and tables).
2.2. There is a lack of working materials (slates, exercise books, pencils).
2.3. There is a lack of visual aids (pictures, exercise books, books) which would help pupils to memorise letters.
2.4. The blackboards, the only visual aids, are of poor quality.
2.5. The large classes preclude teachers checking the progress of individuals.
<b>3. Teacher's Activities</b>
3.1. Teachers are poorly trained; they do not know how to provide perfect models on the blackboard; they have not learned to introduce the writing of characters systematically; they do not put a stop to bad habits in time.
3.2. They have no time to prepare their lessons.
3.3. They have no reference books.
3.4. They do not know how to make the best use of the few documents that do exist.
<b>4. Pupils' Work</b>
4.1. Pupils have not systematically practised finer motor coordination (no official preschool education).
4.2. They see writing as only a senseless and boring copying exercise.

4.2. They see writing as only a senseless and boring copying exercise.

## 5. Role of Parents

5.1. The parents have never been told how important writing is, and thus do not worry about providing enough indispensable expendables such as, exercise books and pencils.

The best way of tackling so many problems appeared to be individual material for each pupil, with the following features:

A personal exercise book (cf. section 2.2.)

Involving fine motor coordination exercises (cf. section 4.1.)

Allowing pupils to learn to write systematically (cf. section 3.1.)

With writing models (cf. sections 2.3, 2.4., 3.1)

With various types of exercises, to reinforce reading lessons (cf. section 1.2)

With reminders and practical advice for the teacher (cf. sections 3.2, 3.3., 3.4)

Designed like a game (cf. section 4.2)

No more expensive than common exercise books (cf. section 5.1.)

Since the analysis indicated that parents were used to buying at least one writing exercise book and one pencil per year, the authors did not expect any negative reactions on their part. And indeed the exercise book was well received by everyone.

Yet, when the level of attainment was evaluated at the end of the year, the exercise book appeared to have had a counter-productive influence on handwriting: to the surprise of everyone concerned, the level achieved by pupils in the sample was lower than that achieved in the control group, who had learned to



write without any special materials! Interviews with the teachers and the analysis of the writing exercise books revealed the following:

The exercise book was an innovation in a context where printed materials are rare; teachers, parents and thus the pupils were reluctant to use such a pretty book as a learning tool. It was thus not used for the exercises, which might "sully" it, but only to verify what had been learned; it was only used when the pupils were sure that they could write well, but at the same time less time was spent practising on slates or in normal exercise books.

The teachers concentrated so fully on the exercise book that they forgot to introduce writing systematically and to monitor pupils' progress. They saw the book as a sort of "monitor" which allowed them to turn their attention to other sections while the first grade were learning to write. Thus pupils' progress was monitored only sporadically, and few notes were made, if any, as can be seen from the exercise books. During the revision phase the exercise book was thus abandoned. The new set of materials is made up of an individual slate, purchased with the help of a World Bank loan, a revised textbook comprising texts for reading and models and exercises for pupils to write, copy and solve on the same slate, and, of course, a teachers' guide.

This new set of materials was fairly well received, but in 1992, some parents who had followed their children learning to read with the help of the exercise book, continued to complain about its withdrawal...

The first step is of course to identify the contents of each component part of the set: if you have decided to produce a textbook and a teachers' guide what information will you put in each of these?

If all pupils follow the same time-table, you will distinguish primarily between the teaching and learning aspects, but if the materials address pupils following different time-tables, and if the majority of your target group are following a reduced time-table, it may be better to reproduce the supplementary exercises for pupils following the full time-table only in the teachers' guide. You should then proceed as follows.

### ***Reduced Time-Table***

You should refer to the plan you have already drawn up for the reduced timetable and note the number and length of lessons dedicated to the sub-topic in question.

length of lessons dedicated to the sub–topic in question.

### ***Stages of Learning***

Refer back to the attainment targets and identify the various stages that are indispensable if the targets are to be achieved. Thus, if first–grade pupils with no pre–school experience are learning to write, for instance, the major stages involved could be as follows:

- visual distinction and pre–writing exercises
- systematically learning to form the letters of the alphabet
- copying words and sentences
- composing and copying words
- composing and copying sentences.

### ***Contents and Learning Time***

Now you must ascertain that the learning targets can be achieved by all pupils. Those following a reduced time–table in particular must be able to systematically go through all the stages identified above as being indispensable.

#### **Divide up the contents and proceed step by step**

### ***Supplementary Subject Matter***

Finally you should define the content matter of supplementary activities for pupils following the full time–table.

If we assume that you are tackling the sub–topic “speaking and listening”, for instance, and the target for the week is aural recognition of the sound [o], all pupils must be able to recognise this sound. It is not difficult to imagine a few, simple exercises, such as asking all pupils to clap their hands when the teacher uses this sound in a list of words. For pupils who have more time, you could add supplementary exercises, like

guessing games involving words starting with o. The learning target remains unchanged. The exercises will merely reinforce the knowledge acquired by pupils following a full time-table.

Now you can distinguish between the contents that must appear in the textbook, including writing exercises that are crucial for achieving the target and which thus address all pupils, and the supplementary exercises which can easily be placed in the teachers' guide along with the teaching directions.

**An oversight when you decide on the composition of your set can be counter-productive**

**There is no universal formula for organising the contents of a guide**

## **8. Contents of the Textbook**

Having worked out the rough break-down of subject matter to be covered by each item of the set, you can go on to the next phase, which aims to organise the contents of the textbook.

This is a complex task, and the teams of authors which we have been able to observe have adopted various procedures. Some organise the contents little by little, feeling their way forward, rather like a jigsaw, while others make do with very rough plans, some of which can be very vague, which they firm up afterwards. Others again lay down in detail at the outset exactly how they plan to organise the content matter.

We do not believe that there is one correct way of organising the content matter, but we will take the liberty of outlining our own experience, in the hope that this will help you to adopt a more systematic approach.

### ***First Break-Down of Contents***

Whatever the subject and the grade in question, you should undertake a first rough break-down of the content matter, stipulating the relation between the time unit and the work unit. You may take a week, or a fortnight or a month as your time unit, while the work unit may be a letter, if the subject in question is reading, or a series of numbers in maths. This will give you the skeleton of the textbook as it were.

fortnight or a month as your time unit, while the work unit may be a letter, if the subject in question is reading, or a series of numbers in maths. This will give you the skeleton of the textbook as it were.

To illustrate this, the time unit adopted for *Garabola* was a week and the work unit a letter, as you can see from the illustration opposite.

### **Define the relation between time unit and learning unit**

#### ***Order of Presentation of Contents***

You now have the bare bones of your textbook. This overview is essential, but not in itself enough. Now you must organise the content matter to be learned, as defined by your group. Let us take the example of a reading book, again. If you have decided on the relation of time unit to work unit, you can decide in which order you wish to introduce the letters.

Depending on the material in question, you could select one of three approaches.

#### **A First Reading and Writing Book**

The first step is to determine how you intend to present the elements to be learned within the scope of reading lessons, in view of the fact that this will, in part, also determine the sequence for the writing lessons which will run parallel to reading.

The organisation of a first reading book always poses very specific problems. And again, there is no universal formula applicable in every situation and to every language.

Nevertheless we think that it is interesting to consider the approach taken by the TefBoky Project faced with the task of organising the schedule for learning the 21 letters of the Malagasy alphabet and the 13 complex graphemes in the language; this experience is illustrated in Table 20.

Fitaivjaram-potoana ao anatin'ny taona

Volana	Hari- nandro	Fotoam-palan- laseatra (F. p. t.) na hafa	Hinandro la- zana	Lesona
Oktobra	1	F4	★	★
	2	*	1	Fimanana ho a' sekoly
	3	*	2	Fimanana ho a' sekoly
	4	*	3	Fimanana ho a' sekoly
Novambra	1	*	4	o (vak = tak. 8-9)
	2	*	5	F (vak = tak. 10-11)
	3	*	6	a (vak = tak. 12-13)
	4	*	7	n (vak = tak. 14-15 ; sor = tak. 16-17)
Desambra	1	*	8	l (vak = tak. 18-19 ; sor = tak. 20-21)
	2	*	9	m (vak = tak. 22-23 ; sor = tak. 24-25)
	3	F. p. t. Nosit	★	★
	4	F. p. t. Nosit	★	★
Janvôry	1	F. p. t. Nosit	★	★
	2	F4	★	★
	3	*	10	v (vak = tak. 26-27 ; sor = tak. 28-29)
	4	*	11	y (vak = tak. 30-31 ; sor = tak. 32-33)
Febroary	1	*	12	e (vak = tak. 34-35 ; sor = tak. 36-37)
	2	*	13	r (vak = tak. 38-39 ; sor = tak. 40-41)
	3	*	14	l (vak = tak. 42-43 ; sor = tak. 44-45)
	4	*	15	s (vak = tak. 46-47 ; sor = tak. 48-49)
Martsa	1	Andron'ny Sekoly	★	★
	2	*	16	h (vak = tak. 50-51 ; sor = tak. 52-53)
	3	*	17	g (vak = tak. 54-55 ; sor = tak. 56-57)
	4	F. p. t. Paska	★	★
Aprily	1	F. p. t. Paska	★	★
	2	F4	★	★

April	1	E. p. 1. Paska	★	★
	2	F4	★	★
	3	*	18	d (vak. = lak. 58-59 ; sor. = lak. 60-61)
	4	*	19	j (vak. = lak. 62-63 ; sor. = lak. 64-65)
May	1	*	20	o (vak. = lak. 66-67 ; sor. = lak. 68-69)
	2	*	21	k (vak. = lak. 70-71 ; sor. = lak. 72-73)
	3	*	22	p (vak. = lak. 74-75 ; sor. = lak. 76-77)
	4	*	23	z (vak. = lak. 78-79 ; sor. = lak. 80-81)
June	1	■	24	r (vak. = lak. 82-83 ; sor. = lak. 84-85)
	2	Fansolinana	★	★
	3	Fansolinana	★	★
	4	Fansolinana	★	★

23

### Fitting together several sub-topics

Often the subject is subdivided; then you not only have to organise the sequence of learning one sub-topic, you must also ensure that the various sub-topics interlock as well as possible.

In first-grade maths, for instance, where priority is accorded to arithmetic, although geometrical concepts and measurement are also introduced, the subtopics cannot necessarily interlock on a repetitive basis, as is the case with reading and writing, described above. Indeed you must check in each instance which level of arithmetic is needed to progress in the other sub-topics.

The permanent interaction between the various sub-topics will, in this case, determine the structure of the textbook little by little, like a jigsaw. The best way to work systematically is to return to the pinboard.

**Base your arrangement of the subject matter to be learned on the interaction of the many sub-topics covered by your textbook**

## 20. Order of Graphemes in a First Reading Book

Malagasy has 21 simple graphemes and 13 complex graphemes, involving two or three elements. When the authors responsible for preparing learning materials for first-grade reading and writing lessons started work on *Garabola*, they stipulated the order in which the graphemes were to be presented in the textbook taking the following factors into account

### Frequency of the grapheme

The authors counted frequency on the basis of three texts of some 1000 words, the first of which was a newspaper article, the second a literary novel and the third a story told by a child. The frequency of punctuation such as apostrophes and hyphens was also counted. It emerged that the vowels, o, i and a had the highest frequency; with few exceptions, such as the "ts" used in negations "tsy" (not), simple consonant graphemes were found more frequently than the complex graphemes.

### Complexity of the form of each grapheme

Given the fact that pupils learn to write what they have learned to read, the authors then analysed the complexity of the form of graphemes, and modified the list based on frequency as follows:

- Numbers of elements making up the grapheme
- Single element graphemes (n, t, m, etc.) were put ahead of those made up of two elements (tr, dr, nk, etc.) or three elements (ntr, ndr); even ts, in spite of its high frequency, was relegated to a place behind the single element graphemes.

- Shape and complexity of the form of the letters
- Letters that are relatively simple to write (l, t, etc.) were given priority over more difficult forms (f, z, etc.)

### Aural distinction

Certain phonemes in Malagasy are relatively close to one another, and can cause interference in young children; the graphemes corresponding to these phonemes were presented separately; thus j and z were

Certain phonemes in Malagasy are relatively close to one another, and can cause interference in young children; the graphemes corresponding to these phonemes were presented separately; thus j and z were presented separately, as were tr and ts, etc.

### **Visual distinction**

Letters with vaguely similar forms, were separated from one another by at least one other letter whose form offers enough of a contrast, taking both printed and joined-up forms into account as far as possible. Thus n and m were separated by t, d and b by j and e and l by r.

### **Finding a common element**

Complex graphemes were sometimes tackled together where the authors felt that this would make it easier to learn them and would emphasise any common element; thus mb and mp followed on from one another as did nd and ng, etc.

### ***Writing Exercises***

The organisation of the contents of materials for writing becomes extremely complex as soon as the pupils start to study the language, i.e. often as from the third grade. The authors must then define and harmonise at least five sub-topics: handwriting, vocabulary, spelling, grammar and creative writing.

It is important to create a coherent approach within each of these sub-topics, and then ensure that the pupil's progress in each of them is harmonised: it is impossible, for instance to introduce the concept of sentences in grammar if the pupil has not yet learned to write upper case letters. The contents of the exercises will interlock more and more closely as time goes on thanks to the permanent interaction, until an intra and interdisciplinary coherence emerges. If you are in this situation, you can begin to familiarise yourself with the complexity of the subject by consulting the contents page of recently published books. If the book is well written, it should contain an overview of all subject matter presented in the book and the page make-up should make the links clear.

At the end of this phase you can draw up a list of the subject matter you wish to cover, and the order in which the material is to be presented. Be aware though that you may have to modify this provisional arrangement:



- when you begin to organise the subject matter page by page
- when you present the subject matter in the form of exercises, two phases that we will be looking at in the following chapters.

## 9. Contents of the Teachers' Guide

By the end of the conceptual phase you will have identified the subject matter you will wish to cover in your teachers' guide. Although this book deals more with the production of textbooks, we will spend a moment looking at the guide, given the vital importance of this publication in the hands of teachers who are often poorly trained.

**Take the vital role of the teacher into account and decide on the contents of the teachers' guide with great care.**

Many of you may ask if it is appropriate to write a sort of "user's manual" which would help the teacher day by day by giving detailed instructions, or if you should aim to write a "training manual" which would allow him to acquire the basic knowledge he needs to teach the subject in question, or again, if you should try to combine the two.

Given the fact that the didactic material you produce will stand or fail on the ability of the teacher to use it, you should attach great importance to the contents of the teachers' guide. We would suggest that you base your decision on an analysis of the needs and possibilities of teachers; to illustrate what we mean we have summed up the approach taken by the Tef Boky Project to define the contents of the *Garabola* teachers' guide in Table 21.

The main shortcomings of the existing teaching process were identified, enabling the authors of the revised version of the *Garabola* teachers' guide to decide on the subject matter that would best remedy these. The following list was drawn up:

- General information on the language

- General information on the language
- Presentation of the subject "Malagasy" and the sub-components reading, writing and speaking and listening

- Detailed information:

Sufficiently precise information for every lesson throughout the year in each of the three sub-topics, for the two time-tables – a sort of script;

Brief explanations on how to present an exercise involving a new mechanism;

Examples for some speaking and listening lessons

- Systematic visual presentation:

Reading and writing lessons in boxes  
The form of the letter in joined-up writing

- Teacher's texts:

Texts for reading, to read to the class, to answer an aspect of the speaking and listening target ("The pupil can listen to and understand messages read to him...")

Short weekly poems

- "Peripheral" information

Articles on the lexical enrichment of other languages;  
Articles on the history and creation of the Malagasy alphabet.

- Reminders

Interruptions to recapitulate the progress of work and look forward to the lessons to come;

Regular invitation to refer back to the beginning of the guide to read the general information.

## 21. Contents of the Garabola Teachers' Guide

When the authors revised the teachers' guide for teaching Malagasy in the first year of primary school, they defined the contents in a systematic form.

Firstly they identified the central problem regarding the use of the guide, basing their work primarily on the data collected during the preliminary research and on the results of testing the pilot version of *Garabola*. Then they looked for the reasons for these problems and the consequences thereof in day-to-day school practice.

### Central Problem

Teachers do not use the guide as they should

Reasons 2	Reasons 1	Consequences 1	Consequences 2
1.1. Having read the guide the	1. Teachers do not pay	1. Teachers are not	1.1. Teachers

1.1. Having read the guide the teachers change nothing in their practical work <sup>10</sup> 1.2. No sanctions on the part of the administration	1. Teachers do not pay enough attention to the guide	1. Teachers are not motivated	1.1. Teachers do not pay enough attention to their classes
2.1. Lack of training and/or willingness	2. They are not able to put the ideas in the guide into practice	2. Teaching remains superficial	2.1. The target is not achieved
3.1. Para-professional activities take priority	3. They only take time to read the guide during lessons	3. Teachers do not manage their classes	3.1. Pupils get bored
4.1. Teachers unaware of their own limitations	4. They believe that they know enough	4. Teachers, self-satisfied, give dogmatic lessons	4.1. Pupils are passive 4.2. Level of attainment is mediocre.
5.1. Shortage of well-written pedagogical documents	5. They do not have the benefit of a literate environment	5. Teachers see their work as a routine	
6.1. Inability to synthesise information and pinpoint the essentials 6.2. The guide lacks the recommendations needed for easy adaptation	6. They do not adapt the instructions properly to the actual classroom situation	6. They have no critical spirit. There is a lack of initiative and creativity	

7.1. Teachers doubtful about applying certain parts of the guide	7. They do not read what upsets them	7. Teachers are not rigorous enough in their lessons.	
8.1. Problems of readability, particularly because of the move from the verbal to the written mother tongue, terminology and communication difficulties	8. They are afraid of not understanding what they find in the guide	8. Too much time is wasted in class	

Garabola

To illustrate the points we have looked at in this chapter here are some typical pages taken from Garabola, which we have often quoted as an example.

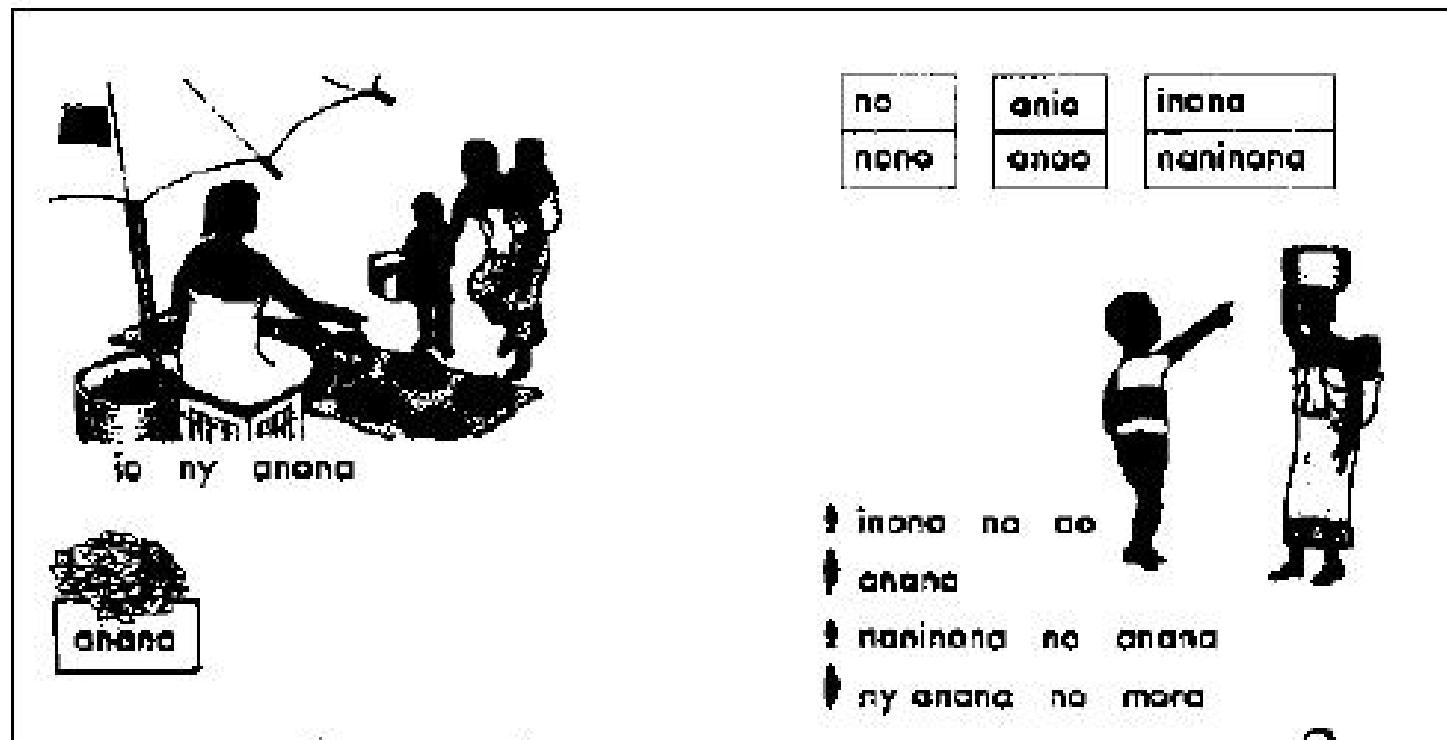

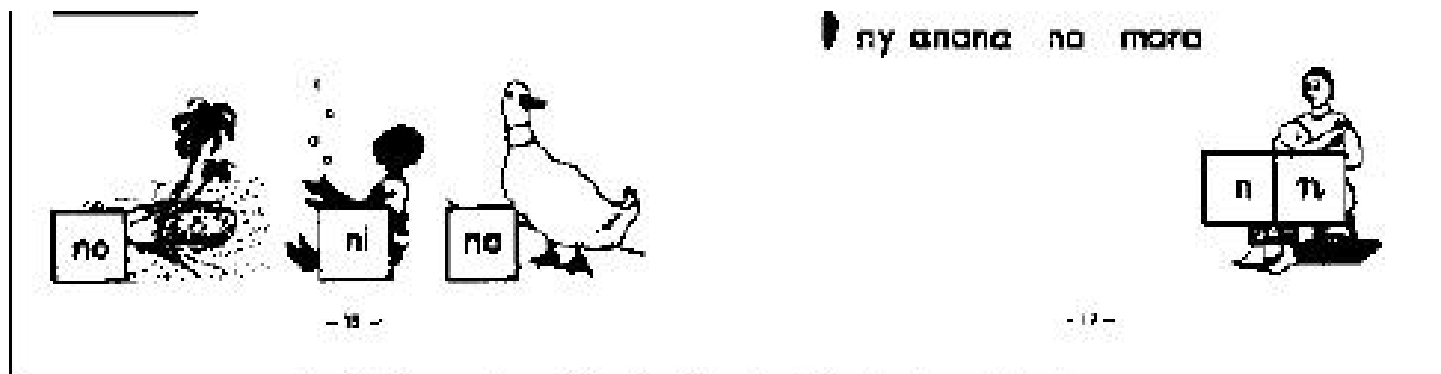

1. Pilot version of the textbook. A typical reading lesson

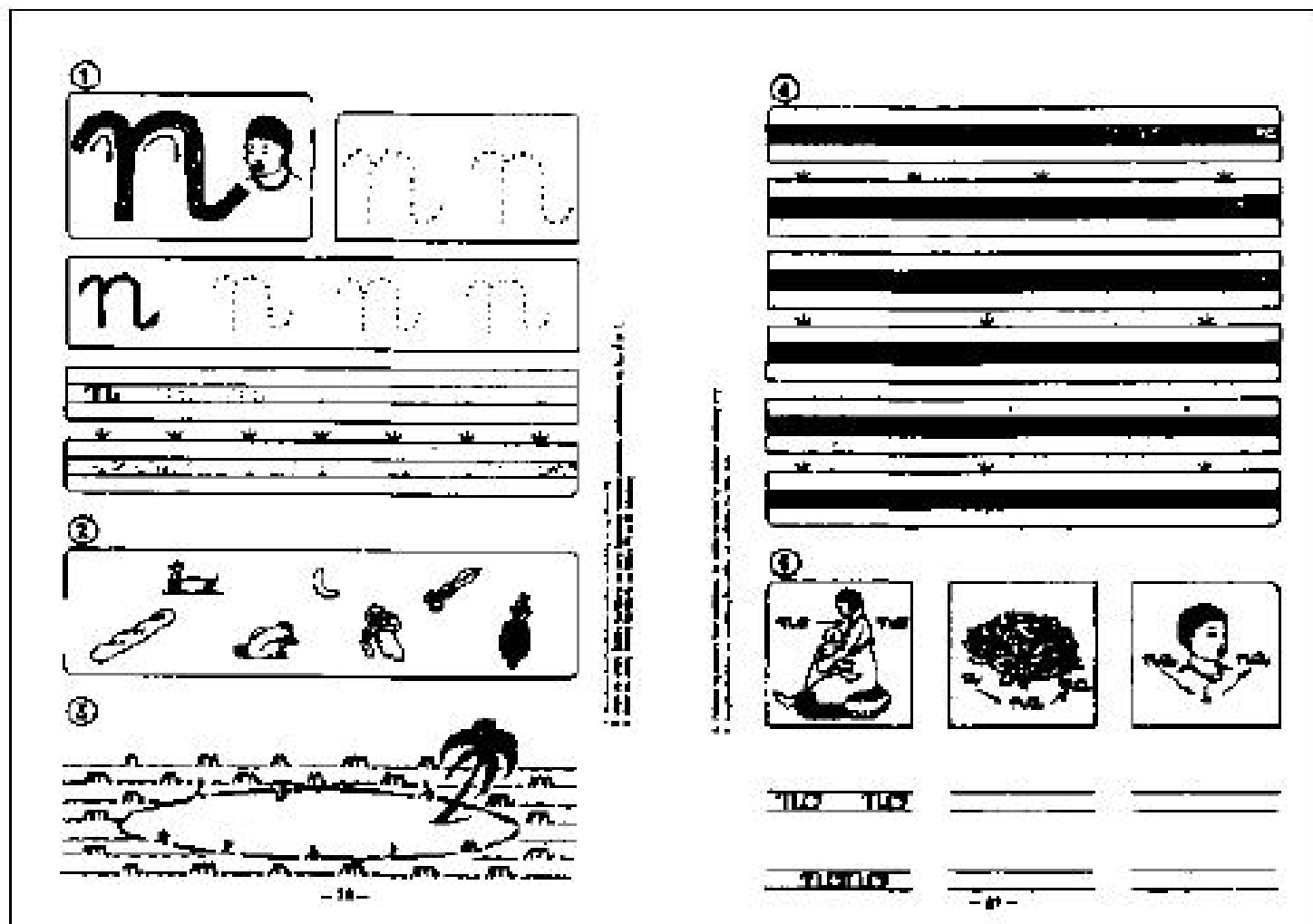

2. Pilot version of the exercise book: Two typical pages of writing.

Revised version of the textbook

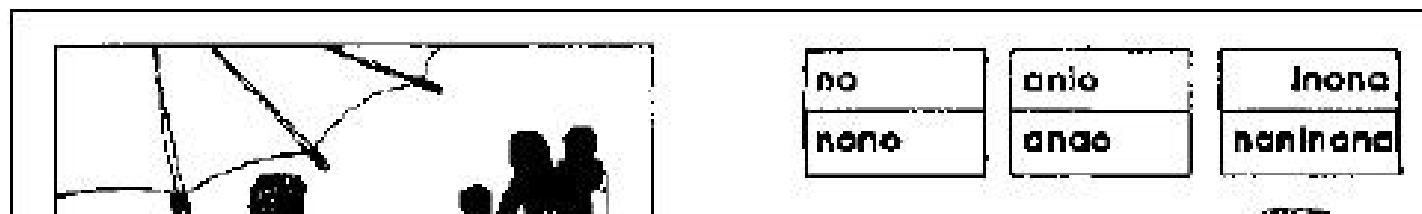



11



‡ Inona no ao  
 ‡ anana  
 ‡ naninona no anana  
 ‡ ny anana no mora



12

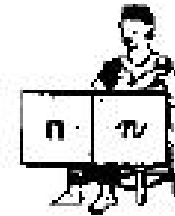

1. Typical reading lesson



**n** 



1. **Phonetic symbols**

e	na	e	ance	ance
e	na	na	anana	anana
i	na	na	inana	inana

2. **Phonetic symbols**

na	na	a	na
na	na	na	na



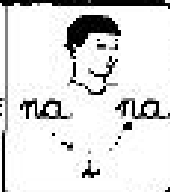



3. **Phonetic symbols**

		
--	--	---

4. **Writing of syllables**

- nana i nana
- nana i nana
- inana lo
- anana lo
- ance lo anana lo

5. **Phonetic symbols**

6. **Phonetic symbols**

anana lo

	_____ lo
---	----------

2. Typical writing lesson

Revised Version of the Teachers' Guide

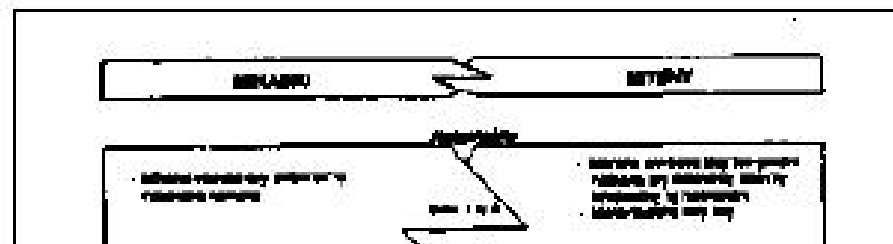

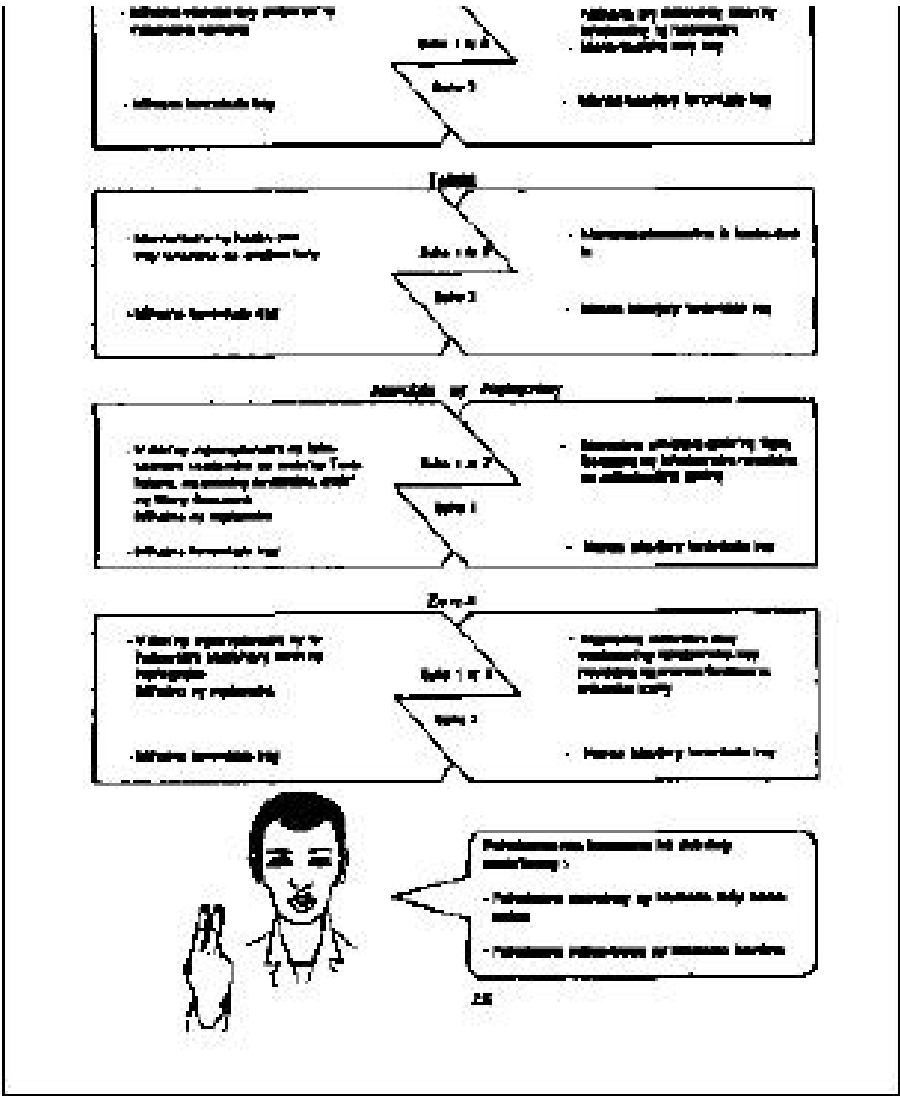

1. Use of graphics – the interlocking of reading











**MATHEMATICS**

Performance Objectives	Activities	Assessments
<p><b>1. Addition</b>                      Add whole numbers, including adding across tens boundaries, and adding within 100.</p> <p><b>Assessing:</b></p> <ul style="list-style-type: none"> <li>1. Identify by illustration the addition problems made by the students.</li> <li>2. Talk to representative students, including an example of a student across a tens boundary.</li> <li>3. Make a story, write or draw a story, or use a number line to solve an addition problem.</li> <li>4. Use a number line to solve an addition problem.</li> <li>5. Use a number line to solve an addition problem.</li> <li>6. Use a number line to solve an addition problem.</li> <li>7. Use a number line to solve an addition problem.</li> <li>8. Use a number line to solve an addition problem.</li> <li>9. Use a number line to solve an addition problem.</li> <li>10. Use a number line to solve an addition problem.</li> </ul>	<p><b>1. Addition</b>                      Add whole numbers, including adding across tens boundaries, and adding within 100.</p> <p><b>Assessing:</b></p> <ul style="list-style-type: none"> <li>1. Talk to representative students, including an example of a student across a tens boundary.</li> <li>2. Make a story, write or draw a story, or use a number line to solve an addition problem.</li> <li>3. Use a number line to solve an addition problem.</li> <li>4. Use a number line to solve an addition problem.</li> <li>5. Use a number line to solve an addition problem.</li> <li>6. Use a number line to solve an addition problem.</li> <li>7. Use a number line to solve an addition problem.</li> <li>8. Use a number line to solve an addition problem.</li> <li>9. Use a number line to solve an addition problem.</li> <li>10. Use a number line to solve an addition problem.</li> </ul>	<p><b>1. Addition</b>                      Add whole numbers, including adding across tens boundaries, and adding within 100.</p> <p><b>Assessing:</b></p> <ul style="list-style-type: none"> <li>1. Make a story, write or draw a story, or use a number line to solve an addition problem.</li> <li>2. Use a number line to solve an addition problem.</li> <li>3. Use a number line to solve an addition problem.</li> <li>4. Use a number line to solve an addition problem.</li> <li>5. Use a number line to solve an addition problem.</li> <li>6. Use a number line to solve an addition problem.</li> <li>7. Use a number line to solve an addition problem.</li> <li>8. Use a number line to solve an addition problem.</li> <li>9. Use a number line to solve an addition problem.</li> <li>10. Use a number line to solve an addition problem.</li> </ul>
<p><b>2. Subtraction</b>                      Subtract whole numbers, including subtracting across tens boundaries, and subtracting within 100.</p> <p><b>Assessing:</b></p> <ul style="list-style-type: none"> <li>1. Identify by illustration the subtraction problems made by the students.</li> <li>2. Talk to representative students, including an example of a student across a tens boundary.</li> <li>3. Make a story, write or draw a story, or use a number line to solve a subtraction problem.</li> <li>4. Use a number line to solve a subtraction problem.</li> <li>5. Use a number line to solve a subtraction problem.</li> <li>6. Use a number line to solve a subtraction problem.</li> <li>7. Use a number line to solve a subtraction problem.</li> <li>8. Use a number line to solve a subtraction problem.</li> <li>9. Use a number line to solve a subtraction problem.</li> <li>10. Use a number line to solve a subtraction problem.</li> </ul>	<p><b>2. Subtraction</b>                      Subtract whole numbers, including subtracting across tens boundaries, and subtracting within 100.</p> <p><b>Assessing:</b></p> <ul style="list-style-type: none"> <li>1. Talk to representative students, including an example of a student across a tens boundary.</li> <li>2. Make a story, write or draw a story, or use a number line to solve a subtraction problem.</li> <li>3. Use a number line to solve a subtraction problem.</li> <li>4. Use a number line to solve a subtraction problem.</li> <li>5. Use a number line to solve a subtraction problem.</li> <li>6. Use a number line to solve a subtraction problem.</li> <li>7. Use a number line to solve a subtraction problem.</li> <li>8. Use a number line to solve a subtraction problem.</li> <li>9. Use a number line to solve a subtraction problem.</li> <li>10. Use a number line to solve a subtraction problem.</li> </ul>	<p><b>2. Subtraction</b>                      Subtract whole numbers, including subtracting across tens boundaries, and subtracting within 100.</p> <p><b>Assessing:</b></p> <ul style="list-style-type: none"> <li>1. Make a story, write or draw a story, or use a number line to solve a subtraction problem.</li> <li>2. Use a number line to solve a subtraction problem.</li> <li>3. Use a number line to solve a subtraction problem.</li> <li>4. Use a number line to solve a subtraction problem.</li> <li>5. Use a number line to solve a subtraction problem.</li> <li>6. Use a number line to solve a subtraction problem.</li> <li>7. Use a number line to solve a subtraction problem.</li> <li>8. Use a number line to solve a subtraction problem.</li> <li>9. Use a number line to solve a subtraction problem.</li> <li>10. Use a number line to solve a subtraction problem.</li> </ul>

4. Presentation of attainment targets and corresponding activities for each week





Version :  
 Versiyonlar : 1.00000000  
 Versiyonlar : 1.00000000  
 Versiyonlar : 1.00000000

Tema-ler (Topic Areas) (MAGAZIN)	Faydali (Useful)	Faydali (Useful)
<p><b>Genetik (Genetics)</b></p> <p>By applying the skills :                      - identify the structure and function of DNA, RNA, and proteins.                      - identify the structure and function of the cell.                      - identify the structure and function of the organelles.                      - identify the structure and function of the tissues.</p>	<ul style="list-style-type: none"> <li>- Mendel's laws</li> <li>- Molecular Biology</li> <li>- Chromosomes and genes</li> <li>- Mendel's laws</li> <li>- Molecular Biology</li> <li>- Chromosomes and genes</li> <li>- Mendel's laws</li> <li>- Molecular Biology</li> <li>- Chromosomes and genes</li> </ul>	<ul style="list-style-type: none"> <li>- Mendel's laws</li> <li>- Molecular Biology</li> <li>- Chromosomes and genes</li> <li>- Mendel's laws</li> <li>- Molecular Biology</li> <li>- Chromosomes and genes</li> <li>- Mendel's laws</li> <li>- Molecular Biology</li> <li>- Chromosomes and genes</li> </ul>
<p><b>Genetik (Genetics)</b></p> <p>By applying the skills :                      - identify the structure and function of DNA, RNA, and proteins.                      - identify the structure and function of the cell.                      - identify the structure and function of the organelles.                      - identify the structure and function of the tissues.</p>	<ul style="list-style-type: none"> <li>- Mendel's laws</li> <li>- Molecular Biology</li> <li>- Chromosomes and genes</li> <li>- Mendel's laws</li> <li>- Molecular Biology</li> <li>- Chromosomes and genes</li> <li>- Mendel's laws</li> <li>- Molecular Biology</li> <li>- Chromosomes and genes</li> </ul>	<ul style="list-style-type: none"> <li>- Mendel's laws</li> <li>- Molecular Biology</li> <li>- Chromosomes and genes</li> <li>- Mendel's laws</li> <li>- Molecular Biology</li> <li>- Chromosomes and genes</li> <li>- Mendel's laws</li> <li>- Molecular Biology</li> <li>- Chromosomes and genes</li> </ul>
<p><b>Genetik (Genetics)</b></p> <p>By applying the skills :                      - identify the structure and function of DNA, RNA, and proteins.                      - identify the structure and function of the cell.                      - identify the structure and function of the organelles.                      - identify the structure and function of the tissues.</p>	<ul style="list-style-type: none"> <li>- Mendel's laws</li> <li>- Molecular Biology</li> <li>- Chromosomes and genes</li> <li>- Mendel's laws</li> <li>- Molecular Biology</li> <li>- Chromosomes and genes</li> <li>- Mendel's laws</li> <li>- Molecular Biology</li> <li>- Chromosomes and genes</li> </ul>	<ul style="list-style-type: none"> <li>- Mendel's laws</li> <li>- Molecular Biology</li> <li>- Chromosomes and genes</li> <li>- Mendel's laws</li> <li>- Molecular Biology</li> <li>- Chromosomes and genes</li> <li>- Mendel's laws</li> <li>- Molecular Biology</li> <li>- Chromosomes and genes</li> </ul>

20

5. Script for speaking and listening, reading and writing activities – one page a day



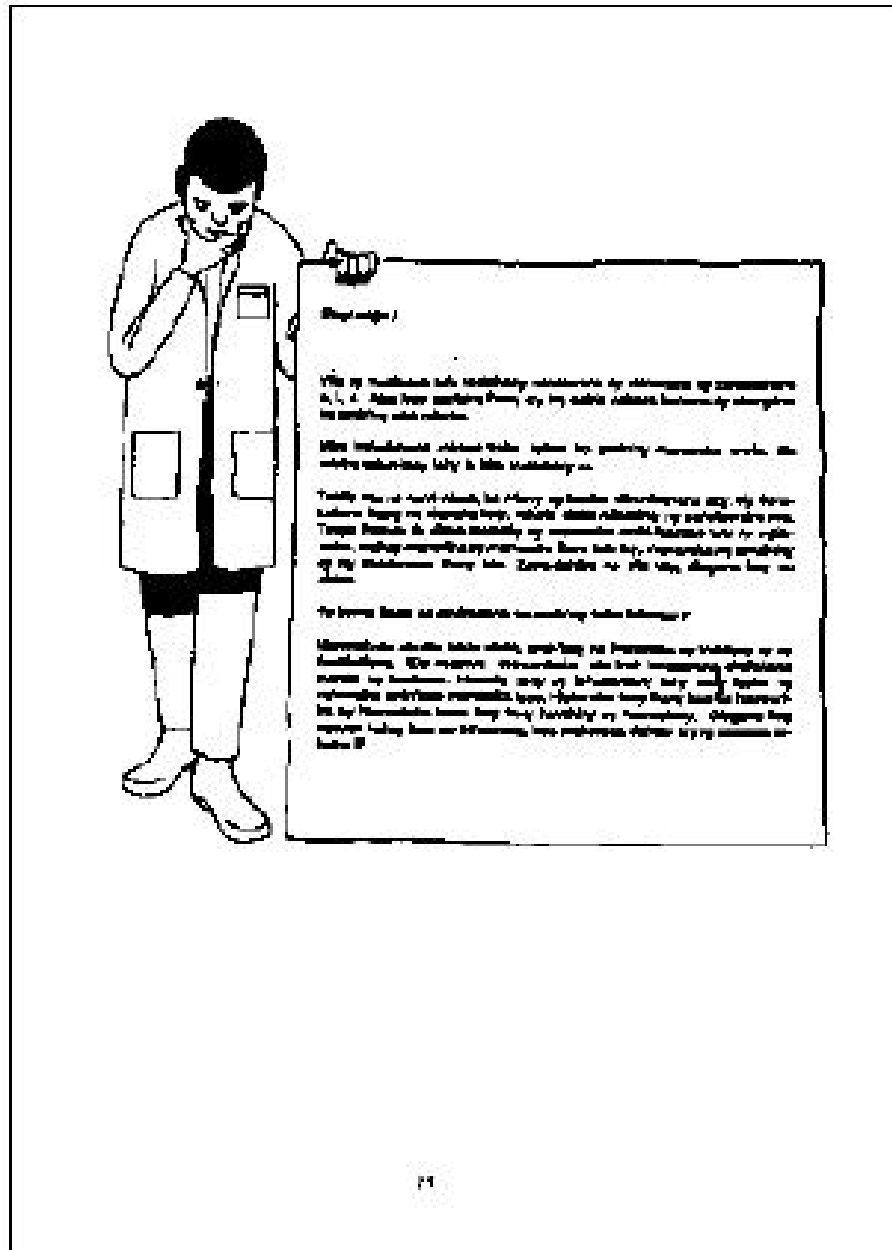

6. Periodic summaries of the work already done and the activities to come







Prerequisites	Topics	Exercises
	<p>1. <b>Understanding the structure of the atom:</b></p> <ul style="list-style-type: none"> <li>1.1. Discovery of electrons by cathode ray experiment</li> <li>1.2. Discovery of protons by Rutherford's alpha particle experiment</li> <li>1.3. Discovery of neutrons by Chadwick's experiment</li> </ul>	<p>1. <b>Structure of atoms:</b></p> <ul style="list-style-type: none"> <li>1.1. Bohr's model of atom</li> <li>1.2. Dual nature of matter</li> </ul>
<p>2. <b>Atomic structure:</b></p> <ul style="list-style-type: none"> <li>2.1. Atomic number and mass number</li> <li>2.2. Isotopes</li> <li>2.3. Electronic configuration of atoms</li> <li>2.4. Periodic table of elements</li> <li>2.5. Trends in physical and chemical properties of elements</li> </ul>	<p>2. <b>Atomic structure:</b></p> <ul style="list-style-type: none"> <li>2.1. Atomic number and mass number</li> <li>2.2. Isotopes</li> <li>2.3. Electronic configuration of atoms</li> <li>2.4. Periodic table of elements</li> <li>2.5. Trends in physical and chemical properties of elements</li> </ul>	



8. Caricatures to retain the attention of the teacher

## 10. In Conclusion

### *Where do we go from here?*

At the end of this phase you should have two lists of contents, one for the pupil's textbook and one for the teachers' guide.

It would obviously be preferable for you to write these two books in concert. The advice and instructions should at least be devised at the same time as the texts and exercises in the textbook, if not written in a final form.

However desirable this may be, though, it is not always possible. You will appreciate that each publication demands the closest attention of the authors over a period of several months, which generally precludes authors switching from one publication to another. You should not worry, then if you concentrate more and more of your energy on the textbook and end up gradually putting off work on the teachers' guide until later. Make do with noting the important points that you might otherwise forget and continue your work on the textbook – decide how to present the contents that you have now identified. The next chapter is devoted to the presentation work.

### **Notes**

<sup>1</sup> The repercussions of decisions relating to the temporal framework are numerous, e.g. the Tef Boky Project, noting that the time actually available in schools was significantly lower than the official allocation decided to spread the basic "Mother tongue" course over two years rather than one, thus drastically changing the attainment targets for this subject throughout the primary cycle.

<sup>2</sup> In Madagascar some isolated schools do not even manage to provide the reduced three-hour session and others are open for barely 20 weeks a year. When they devised their didactic materials, the textbook authors



of the Tef'Boky Project decided to discount schools that did not operate for a minimum of 24 weeks a year, considering that these establishments were not in a position to provide an education worthy of the name.

<sup>3</sup> In our experience the first version of some textbooks may well encounter major resistance on the part of the education authorities. But if this resistance is not based on well-founded technical or political criteria, and is merely a more or less deep-seated wariness of anything new, the revised version will carve out its own niche.

<sup>4</sup> This table indicates one of the major difficulties that the new materials will have to cope with: the full time-table dedicates twice as much time to reading and writing as the reduced time-table. This represents a major challenge for authors, and becomes more of a problem from year to year, if we take into account the fact that as from the third grade the study of the mother tongue involves grammar, vocabulary, conjugation, spelling and composition, whereas the reduced time-table remains the same.

<sup>5</sup> It is, of course, quite impossible to verify the actual teaching time left, once you have deducted everything which does not involve teaching, such as lines, time taken to hand out books and exercise books, or to wait for silence; although this information would be very useful, it would not have any direct impact on the concept of your material.

<sup>6</sup> Seguin, R. *L'élaboration des manuels scolaires*, op. cit., p. 5.

<sup>7</sup> This is often seen where a new education policy is approved. In Peru, for instance there had always been a department within the ministry responsible for producing the traditional curricula which were based on the assumption that Spanish was the mother tongue of all pupils. When "bicultural and bilingual education" was introduced in 1979 this department asked the German-Peruvian Bilingual Education Project, which has already been referred to several times, to develop curricula to match the didactic material produced in Quechua, Aymara and Spanish as a second language, since the textbook authors were felt to be better able to perform this work.

<sup>8</sup> More precisely, "the mastery theory is based on the finding that the vast majority of pupils in a normal class can master a given target if they are given enough time and the support they need to overcome their difficulties". In: Landsheere G. *Dictionnaire de l'évaluation et de la recherche en éducation*, op. cit., p. 197.

<sup>9</sup> In the curricula which the authors of the Tef'Boky Project proposed to the education authorities in

<sup>9</sup> In the curricula which the authors of the Tef'Boky Project proposed to the education authorities in Madagascar, it was stipulated that 70% of all pupils must achieve the attainment targets.

<sup>10</sup> This is the only problem that cannot be solved by the manual; the solution lies elsewhere – the promise of a career structure, reintroduction of inspectors' visits, etc.

### ***Recommended Reading***

#### **Curricula**

BABIN, N. AND Pierre, M. *Programmes, Instructions, Conseils pour l'école élémentaire*. Paris: Hachette Ecoles, 1986

BUDE, U. *Culture and environment in primary education. The demands of the curriculum and the practice in schools in sub-saharian Africa*, Bonn: German Foundation for International Development (DSE), 1991

HAMEYER, U. et al (Ed.) *Handbuch der Curriculumforschung*, Weinheim, Basle: Beltz, 1983

MAGER, R.F. *Comment définir des objectifs pédagogiques*. Paris: Bordas, 1977

SEGUIN, R. *Curriculum development and implementation of teaching programmes. Methodological guide*. Paris: UNESCO

#### **Innovation**

AREGGER, K. *Innovation in sozialen Systemen. 1. Einführung in die Innovationstheorie der Organisation*. Berne, Stuttgart: Paul Haupt, 1976

AREGGER, K. *Innovation in sozialen Systemen. 2. Ein integriertes Innovationsmodell am Beispiel der Schule*. Berne, Stuttgart: Paul Haupt, 1976

HAVELOCK, R.G. AND HUBERMAN, A.M. *Solving educational problems. The theory and reality of innovation in developing countries.* Paris: UNESCO, 1977

### ***To Sum Up***

Once authors are in possession of the main information regarding the production conditions and the circumstances in which their textbook will be used they can start work on the conceptual phase. Their first task must be to lay down the sequence of subject matter to be covered. To achieve this it is important to define each of the following:

- The actual learning time in the grade and subject in question, which is not always the same as the official learning time;
- The targets, in line with the teaching and learning conditions;
- The composition of the set of didactic materials which will allow pupils to achieve these targets, and which must be in line with the needs and possibilities of the target group;
- The break-down of the subject matter to be covered by the various types of material to be produced

Conceptual work is always complex in developing countries.

The official instructions often bear little resemblance to the reality in the schools, and the teams of authors must gauge how much leeway they have before deciding. Finally they must make a distinction between what is desirable (often the tacit wish of parents and the education authorities) and what is suitable for the given situation but often more difficult and almost always less attractive to both the authors and the various target groups. Every aspect of the new textbook must be examined on the basis of a number of criteria, including the material, psychological and social aspects, which it is often difficult to reconcile satisfactorily.

In spite of this complexity, however, or perhaps because of it, you must invest the necessary time and care in this conceptual phase if your textbook is not to be built on sand.

In spite of this complexity, however, or perhaps because of it, you must invest the necessary time and care in this conceptual phase if your textbook is not to be built on sand.



## The Form

The last chapter enabled you to identify the contents of the didactic material to be produced; in this chapter we will look at how to ensure that text and illustrations are of the quality required while staying within your budgetary constraints.

If you are still new to the profession of textbook writing, you may feel that you have spent so long on all the work to date that now it is time to close the conceptual phase. But, if you go on to write your textbook without a proper plan for the form, you will run the risk of writing texts that are too short or too long, producing exercises that are difficult or impossible to present visually, preparing artwork that is far too expensive or producing an unhappy mix of text and illustrations.

To avoid these eventualities, you should thus examine the physical and graphic aspects of your textbook before closing the conceptual chapter. Since the contents and the form are interdependent, you can create them in a two-pronged action, so that the texts and illustrations fit into a pre-established framework without major difficulties.

In large publishing houses, the work described in this chapter does not concern the authors directly<sup>1</sup>; if you are lucky enough to have good publishing back-up, you need only read through this chapter to understand the constraints that the publisher is bound to impose on you. If, however, you have to decide personally on the physical and graphic aspects of your book, you should read this chapter carefully, bear in mind that it is generally errors in the form which reveal the lack of professionalism of authors, and take appropriate precautions.

### **Contents and form must be devised in tandem**

**Don't leave the format to chance; analyse all possible consequences of your choice**

#### **1. Format**

To allow you to visualise the initial arrangement of the contents of your book on the page, we suggest that you first decide on the dimensions of the book.

If you look at textbooks designed for primary level, you will see that the basic form is rectangular<sup>2</sup>, but that the dimensions vary: some are scarcely larger than a standard paperback (200 x 130 mm), others are almost A4 size (297 x 210 mm) and most are somewhere between these two extremes (e.g. 240 x 170 mm).

size (297 x 210 mm) and most are somewhere between these two extremes (e.g. 240 x 170 mm).

The format of a textbook should never be a coincidence. The main elements that you should take into account to ensure that the dimensions are appropriate for the purpose intended, i.e. that they meet the needs of users and producers alike, are described below.

### ***Pedagogical and Didactic Considerations***

First and foremost you should identify the dimensions which guarantee optimum readability, in terms of both the structure and the text. Take the following points into consideration.

#### **Macro-legibility – the structure<sup>3</sup>**

The dimensions you choose must make the general structure of the textbook easily comprehensible. Other factors, including typographical aspects and layout considerations naturally play a contributory part, but it is the size of the pages more than any other single factor which will determine the macro-legibility of your book.

The format you choose must firstly reflect the structure of the lessons. If you are producing a first reading book, where it is important to respect certain stages of learning, the page should be big enough for the links to be quite clear. If you have chosen an analytical learning form, the reader should be able to recognise at first glance the progression from the sentence to the word, the syllable, and perhaps the letter.

Equally, the format must reflect the various functions of the text. Let us take an example to illustrate this: let us assume that you plan to print exercises along with brief instructions in your book. The page dimensions must then be such that each block (exercises and instructions) is easily recognisable at first glance.

The two illustrations below reveal how important this aspect is.

**First priority: the format must be large enough to ensure that the structure is easily recognisable**

### Micro-legibility – letters and words

The dimensions of your textbook must also be such that it can be easily and effectively read by users. This readability is governed by several factors, which you must bear in mind at the end when determining the layout of your book. At this stage we will look only at those factors that have a direct bearing on the format, i.e. the size of the characters used.

You should take your lead primarily from the research conducted in industrialised countries over a period of several years now into the readability of printed characters. M.A. Tinker, one of the best known experts in this field, concludes that the characters used in textbooks should be in indirect proportion to the level of education: the further down the educational ladder you go, the larger the characters should be<sup>4</sup>. The dimensions of the textbook must thus allow you to use the size of characters recommended for the grade in question.

This is always important, but it is vital for a first reading book. Since it is not recommended to hyphenate words at this level, and we would advise you not to spread sentences over more than one line in the first lessons, the textbook dimensions must enable you to write a sentence in one line using the size of characters recommended<sup>5</sup>; a paperback format would thus be inappropriate at this level.

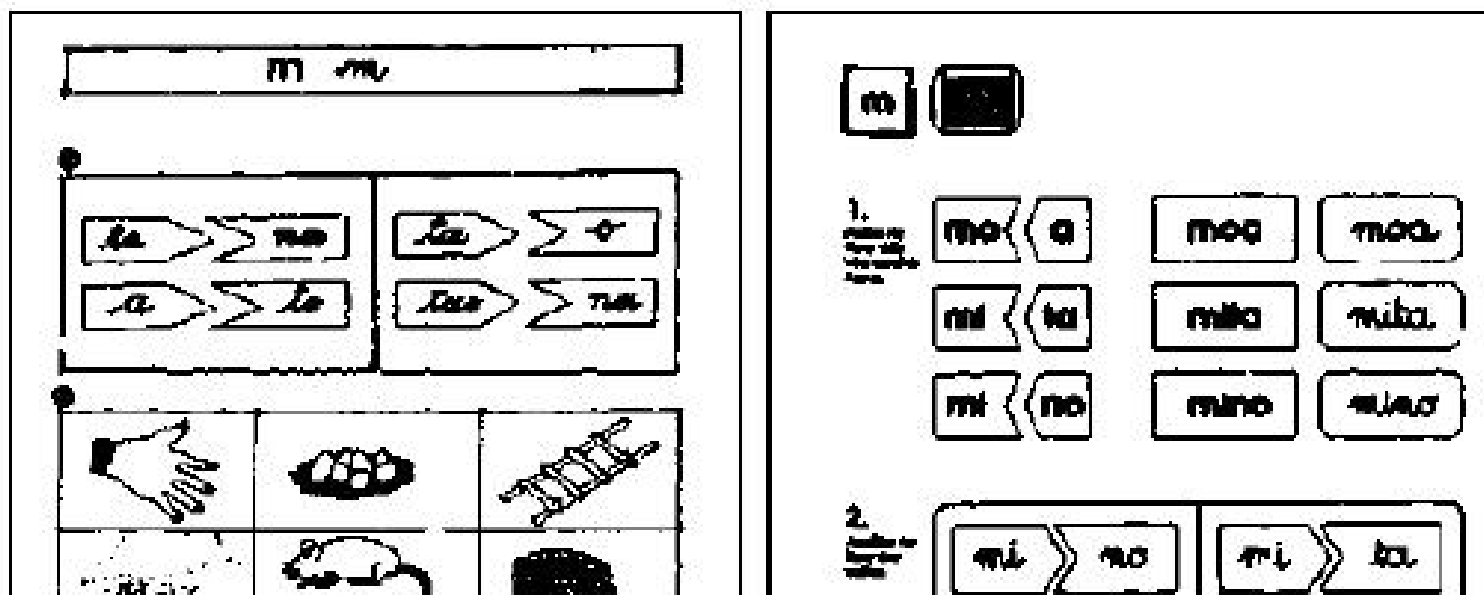

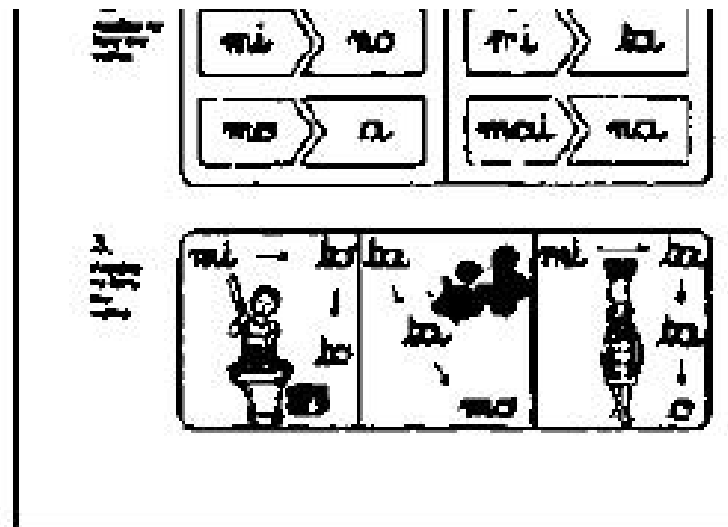
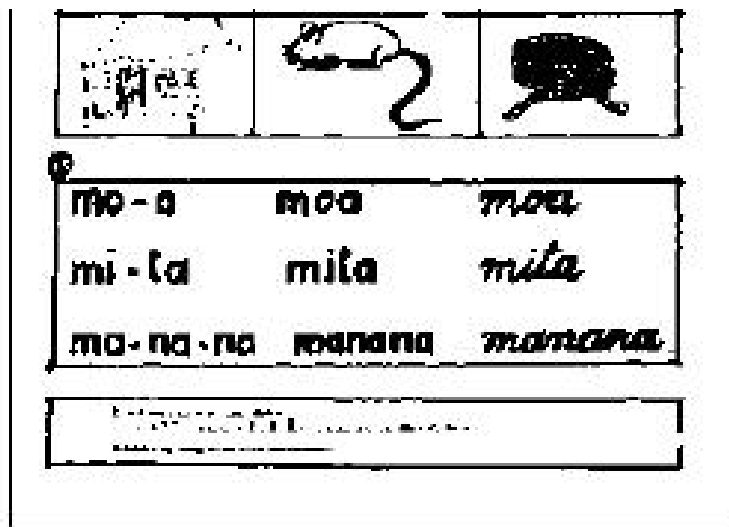

The left hand page shows a draft, the right hand page the final version of Garabola exercises. Look at the two, and see how important it is to arrange the exercises and instructions in a way that makes them easy to understand. Think about the consequences of the two versions: if the instructions are printed at the bottom of the page, the textbook must be long enough to separate them clearly from the exercises; if they are printed on one side of the page, on the other hand, the textbook must be wide enough for the exercises to be printed completely.

Secondly, you should bear in mind the learning conditions observed during field work: if the classrooms are poorly lit, if most pupils have not enjoyed preschool education, and if they have little contact with printed materials, you may have to raise the levels of readability determined for industrialised countries<sup>6</sup>, and use a larger format for the first grades at primary level.

### ***Practical Considerations***

This is the second important factor which will influence your decision on the appropriate format, and may force you to modify your original decisions. If you have, until this point, given priority to pedagogical and didactic considerations, you probably intend to use a relatively large format; but under the circumstances in which



textbooks are normally used in developing countries you may have to scale down your book.

Before deciding, consider the following factors.

### **Ease of Handling**

A book is always made to be visually attractive, as we have seen above, but it must also be easy to handle.

When you select the format, you should think firstly of the pupils of course: they must be able to hold the book closed with one hand without difficulty or open using both hands. You should also think of the teachers. Since some of them will be teaching several classes at once, and since they will almost always have to stand to better direct proceedings, you should choose a format which is small enough for the teacher to hold it in one hand during the reading lesson as they prefer to do.

Test your book for ease of handling by holding it in one hand as shown below.

**Large formats meet pedagogical needs best, while smaller formats respond to practical and financial considerations**

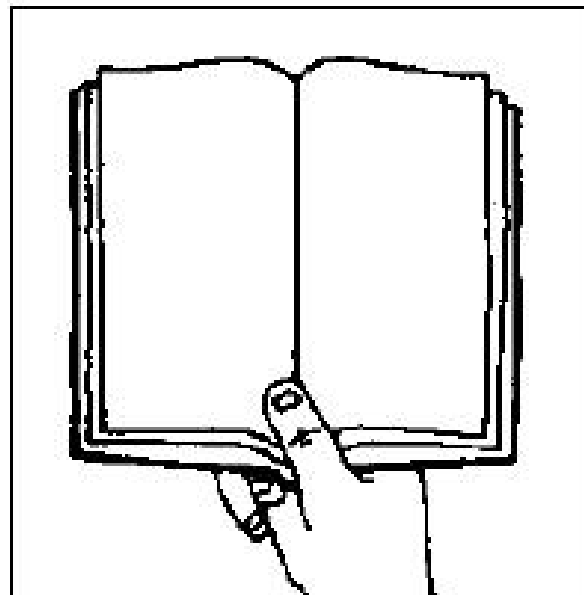



## **School Furniture**

The dimensions must also be appropriate for the school furniture available.

Return to the field study and determine how the schools are equipped in terms of tables and chairs; and more precisely look at the width of tables, the average seating space per class and the general state of repair of pupils' furniture. In some classes an unnecessarily large textbook can be a nuisance for pupils and will be rapidly destroyed.

## **Utilisation**

Finally, when deciding on the dimensions of a textbook you should bear in mind how it is going to be used, by one pupil or several.

If it is to be used by more than one pupil, the book will only be borrowed by pupils and will be kept in the school building. It can then be relatively large, especially if the system involves two or three pupils sharing a book. On the other hand, if parents are expected to buy the book, it will have to be carried back and forward to school in a small canvas or raffia bag; if this is the case you should come down on the side of a small, compact book, which will be easy to carry and won't be destroyed so quickly. Specialists reckon that textbooks for primary level in rural areas should have a maximum format of 220 x 140 mm to ensure a maximum service life<sup>7</sup>.

You should pay all the more attention to these considerations since the other factors which will help determine the service life of your textbook (paper used, material used for cover, binding) may not be of top quality.

### ***Economic Considerations***

By analysing users' needs you have worked out your first ideas as to the dimensions of your textbook. You should now check whether the desirable is financially feasible. The cost price of a book being closely linked to the price of the paper used<sup>9</sup> you should decide on an appropriate format in terms of the format of the paper and printing materials so as to avoid wastage, which can be very expensive.

We are now entering the technical domain with which authors are not, as a rule, familiar. Given the scope of this publication we will look only at the essentials. We recommend that you consult your printer who should be able to give you the additional information you need, and that you read the works listed at the end of this chapter.

### **Contact your printer at this stage**

#### **Format of Paper to be Used**

Paper is manufactured from pulp, which is in turn produced on the basis of certain raw materials (wood, but also plants and textile waste). Paper machines produce large rolls of paper which can then be cut into sheets.

The rolls of paper are sold by weight, whereas sheets are sold in reams (packs of 500). The format of rolls is determined by the width of the strip; reams of paper come in standard sizes<sup>9</sup>.

To avoid unnecessary wastage, make sure that the format of your textbook corresponds to the dimensions of the sheets of paper used in printing, folded once or more, as indicated briefly at the start of chapter one.

#### **Avoid paper wastage which will put an unnecessary strain on your budget**

You should thus contact your printer to find out whether or not he will have to import paper; if he can, you will have a certain leeway regarding the format, since large paper manufacturers can often produce paper to your specifications provided you order a large enough quantity and provided the order is not urgent. If, on the other hand, he is obliged to use locally-manufactured paper, or if you have been donated paper, as is relatively frequently the case with textbook projects, you should determine the format of the textbook on the basis of the

hand, he is obliged to use locally-manufactured paper, or if you have been donated paper, as is relatively frequently the case with textbook projects, you should determine the format of the textbook on the basis of the format of the available paper.

What you, as authors, must be aware of is that it is rare for a book to be printed one page at a time; for reasons of economy a maximum number of pages is set for each sheet printed. The forme thus obtained is slotted into the printing press, and the printed sheets are folded and then cut on three sides. You then have a "signature". The body of the book is made up of several signatures put together.

To print the maximum number of pages at a time on one press you should define the final format of the finished work with great care, on the basis of the paper format. If, for instance the paper available for printing is A1 format (594 x 841 mm), and you decide that your textbook should measure 250 x 190 mm, you can print 16 pages at once, as illustrated below, 8 right hand and 8 left hand pages; the blank edges will make it easy to trim the pages once they have been folded<sup>10</sup>.

### **Format of Printing Presses**

The format of your textbook must also correspond to the format of your printer's printing presses. To take the same example as before, if the dimensions of the printing press are 920 x 640 mm you should not select a finished format of 300 x 240 mm for your book; because of a few centimetres too many you would only be able to print eight pages at once rather than 16, the wastage would be high and the cost of the paper would almost double.

The paper wastage may appear to you to be negligible for a pilot run of a few hundred books, but if the prototype is approved for general nation-wide distribution with a run of say 50,000, the additional costs of your lack of foresight will be enormous.

<b>640 mm</b>	
<b>297 mm</b>	<b>297 mm</b> <b>210 mm</b>
	<b>210 mm</b>
	<b>210 mm</b>
	<b>210 mm</b>

You should, however, be very careful in this field. Although it is vital for you to understand the importance of the relation between the format of a book and of the paper used for printing, you must be aware that the information given here is far from complete. The printer, who has experience in this field, will often know how best to reconcile the financial considerations with the format you want. You should always consult your printer before making a decision which it will be difficult to change at a later date.

***Publishing Considerations***

### ***Publishing Considerations***

Finally, you should not forget that the dimensions you select for your textbook need not necessarily apply only to this one volume.

If you have been asked to produce a series, you should bear in mind that one feature of the set will be the identical format of all textbooks. Reconsider your decision in this light, and see if it is appropriate for the series as a whole.

### **2. Number of Pages**

The number of pages, which is closely linked to the format, and partly determined by it, should also be stipulated at this stage.

For most books, the number of pages can only be identified once the manuscript has been written: a system of counting, called "casting off", allows us to count the number of characters used and thus to calculate the space needed by the text once it is set. The complex structure of textbooks, however, precludes this approach. Indeed quite the reverse is true: before the authors start to write, the number of pages must be determined, and the text they write will be shaped by the exact number of pages and the relatively precise space allowed for text on each page.

We propose that you examine the following aspects and achieve as great a harmony as possible when deciding on the number of pages.

### ***Pedagogical and Didactic Considerations***

The number of pages must first correspond to the material to be covered, and the methodological approach that you have decided on in line with chapter 4. The following are the main aspects to be taken into account in

this phase.

### **Learning Pages**

Firstly you should count the number of pages that are to be dedicated to learning; this will give you an idea, and allow you to plan the number of printed signatures that will make up the finished textbook.

To this end you should look again at the draft contents for each learning unit – i.e. the lesson – and identify the number of pages required per unit or lesson. Take into account the format envisaged, and the learning stages or the major parts of each lesson. Then estimate the number of pages needed to present the subject matter in a systematic way – and multiply this figure by the number of units you intend to incorporate in the book.

If, for instance, you have planned 24 units for the year, your results will be as follows:

- For 2–page units      48 pages
- For 3–page units      72 pages
- For 4–page units      96 pages
- For 5–page units      120 pages
- For 6–page units      144 pages.

Some of you will probably wonder how you can go about identifying the space needed to present the contents satisfactorily on a page; if this applies to you, look briefly at section 3 of this chapter, which deals with this question, even if you have to come back to it in more detail later.

At this stage, of course, your results can only be provisional; as you will see, the total number of pages you have just calculated does not correspond to the total number of pages in the book. This exercise is only important to give you a first rough idea of size. Commit it to memory and put it up on the pinboard.

**The number of pages in a textbook is decided before the book is written**

**The number of pages in a textbook is decided before the book is written**

**The number of pages allocated for each lesson must allow for an effective layout of the contents**

### **Macro-legibility of the Book**

The number of pages must make for good macro-legibility. If you opt for an even number of pages per unit, the arrangement of the contents should be fairly transparent; the first page of every unit will either be a right-hand page, or a left-hand page.

If you chose an uneven number of pages for your units, you will not get any such clear structure; the first page in a unit will sometimes be a right-hand page and sometimes a left-hand page. If you intend to have units of 3 or 5 pages in length we would urge you to reconsider the wisdom of this before progressing.

To illustrate this point we have printed the arrangement of one unit of the pilot version of *Tongavola*, a reading and writing book for grade-two pupils in Malagasy. The authors saw no other option open to them but to opt for 6-page units; the first five units address all pupils, the last is made up of supplementary exercises for pupils following a full time-table.

Given the heterogeneity of the contents of certain pages, it was vital for the units to have an even number of pages, to give the reader a marker in the form of the first page, which is always on the same side. The figure below shows the first unit of *Tongavola* to illustrate this.



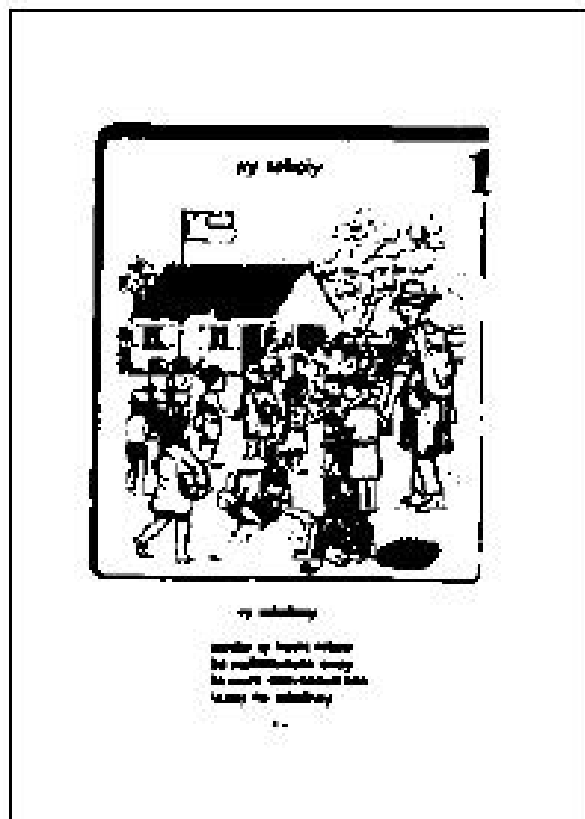

1. Visual introduction to the topic of the week, which is also used for speaking and listening lessons, followed by the poem of the week

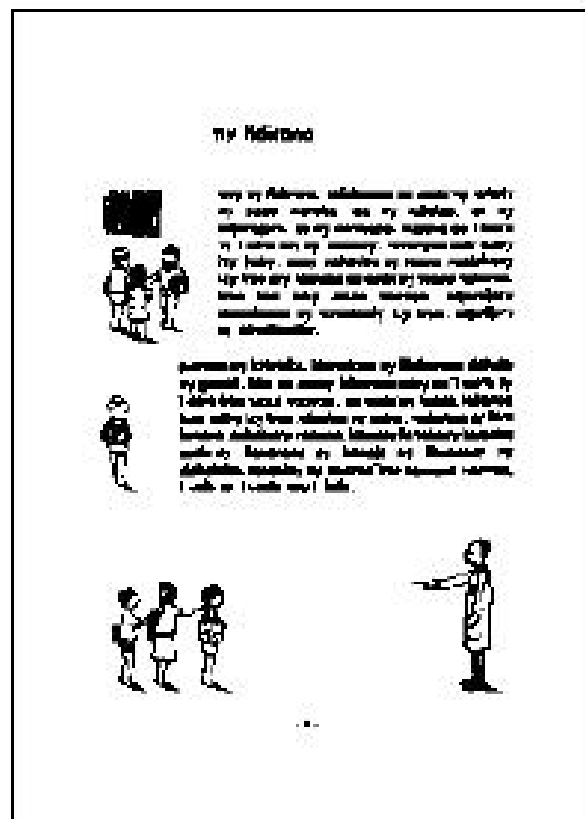

2. First reading text, descriptive in nature

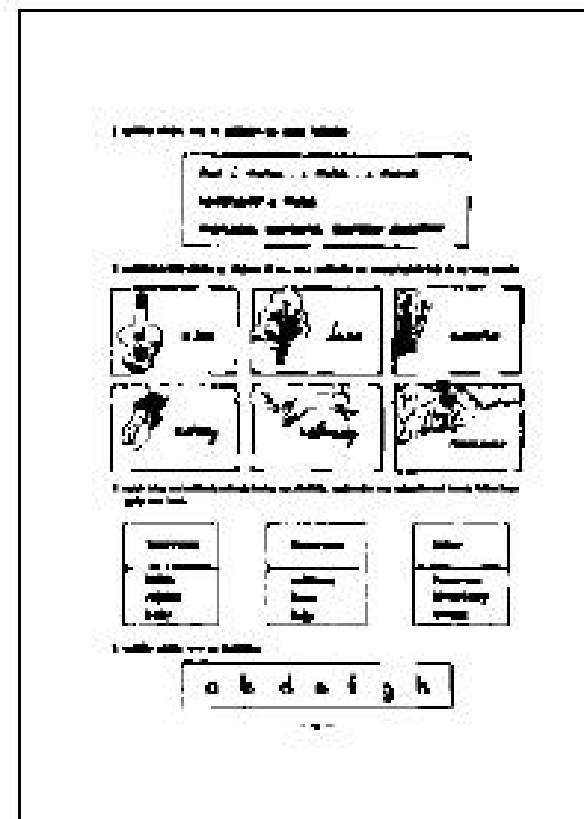

3. Writing practice: handwriting, spelling and vocabulary

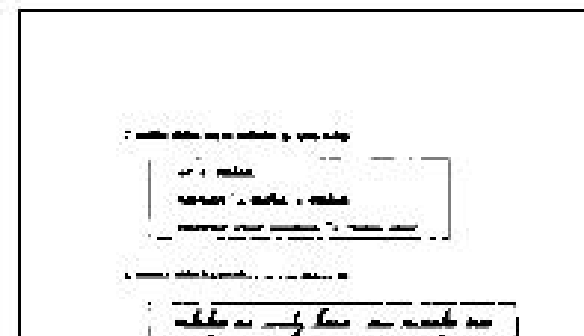
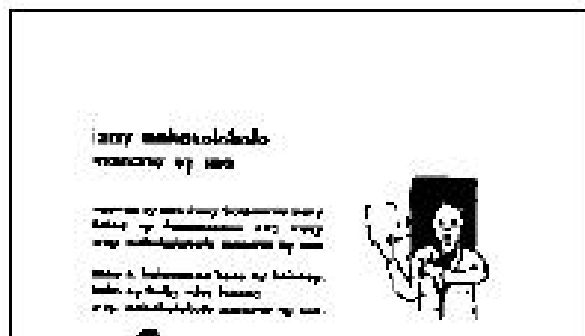

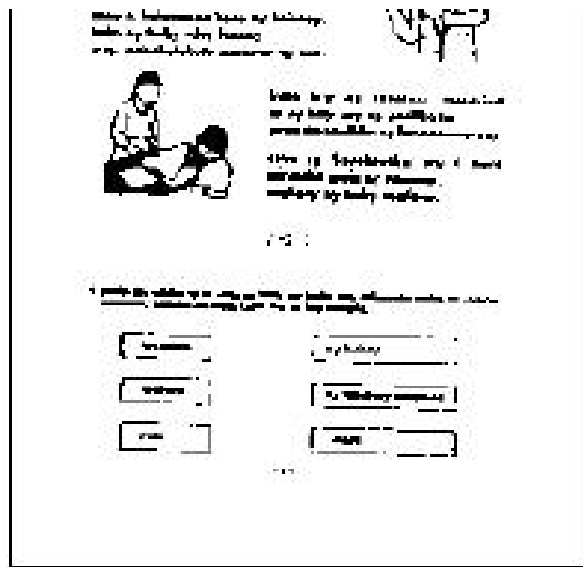

4. Second reading text, procedural in nature, followed by a grammar exercise

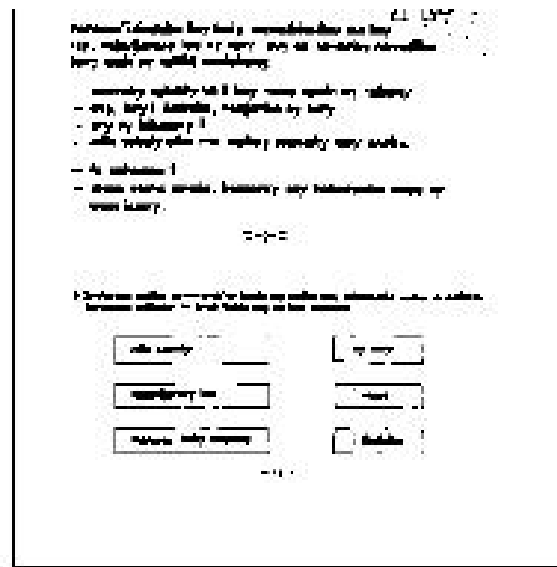

5. Third reading text, narrative in nature, followed by a composition exercise

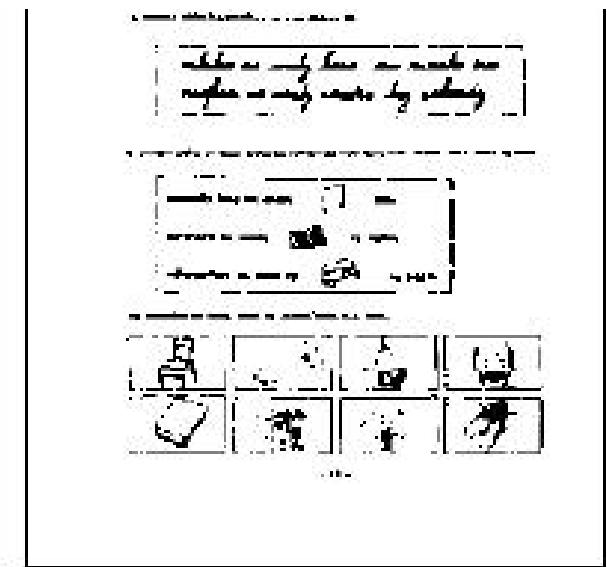

6. Additional text comprehension, spelling, grammar and vocabulary exercises

**To ensure that readers can find their way around the book easily, you should opt for an even number of pages for each lesson**

### ***Financial Considerations***

Beginners are often tempted to incorporate as much of their own knowledge as possible in their first book. Not only do they often overestimate the volume of work which teachers and pupils in developing countries can realistically get through, but they forget to gauge the financial implications of printing non-essential pages.

Paper is always expensive. Calculate for yourself the cost of an extra eight-page signature in a run of 100,000 or more.

So, keep to the number of pages you consider essential for each unit and modify this if necessary to keep costs within acceptable limits.

### ***Technical Considerations***

The figure you have calculated is still not the total number of pages of your textbook. It is merely a rough calculation, which you will be able to make more precise when you take the technical factors into account.

To this end you should go back to the format you plan to use, and the format of the sheets of paper to be used for printing, which will allow you to check how many pages can be printed at once. You will see that it is best to choose a multiple of 8 (16, 32, etc.) pages for your book. The difference between the number of pages reserved for learning and the total number printed will depend on what we will term “non–text information”, which we will look at in more detail below.

Let us assume that you consider 96 pages essential to present the subject matter, and you have to choose a multiple of 16 pages. To get a round number, you will have to use an entire signature for non–text information<sup>1</sup>.

### ***Bibliographical Conventions***

A book does not only contain information in the main body of the text, but also in the form of non–text information, which may be found on the title page, or at the start or end of the book. And in a book destined for true booklovers the first pages must be left blank.

It is acceptable for there to be no blank fly leaf in your book; but you must provide what we have chosen to term non–text information.

In an attempt to explain this briefly and as precisely as possible, we have printed the cover page and the first few pages of the revised version of *Garabola* opposite. Below each page we have described the information contained on that page and outlined the reasons for including this information.

### ***Publishing Constraints***

## ***Publishing Constraints***

This is the final point that you must take into account when deciding on the number of pages your book will have.

The books for each class should be at least as thick if not slightly thicker than the preceding volume. You should thus ensure that the grade one book does not take on the dimensions of a small encyclopaedia, which is bound to cause problems later in the series.

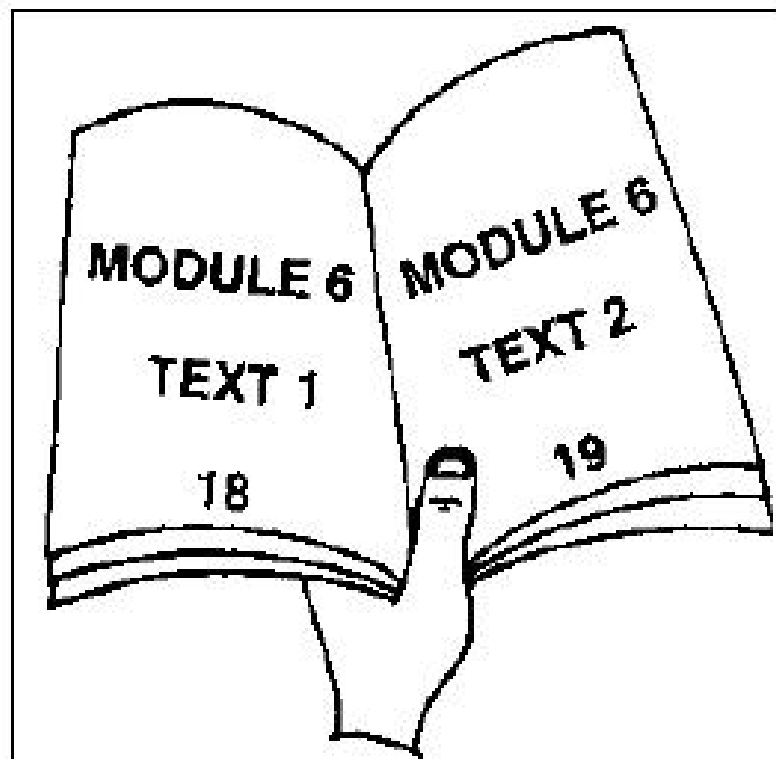

Run one last check at the end of this phase: if a page has remained blank due to an oversight it is easy to correct this oversight either at the start of the book (add a preface, spread the table of contents over two pages rather than one, for instance), or in the body of the text (in a reading book you could add an extra title

page before the supplementary texts, for instance). If, however, you have forgotten a page in your calculations, which can happen to even the most experienced authors, it will be difficult to add one at a later stage, and the later you discover your error the more difficult it will be: sometimes you will have to redesign the entire layout with all even pages becoming odd pages, etc.



Front Cover

Contents: Title of book:

Contents (subject and grade):  
Illustration

Reasons: Practical reasons: The potential purchaser must be attracted by the illustration, informed as to the contents of the

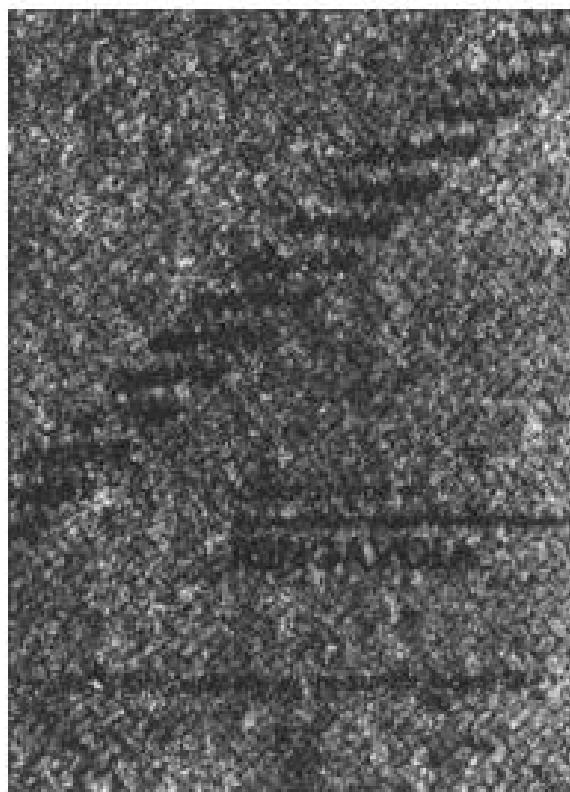

Back Cover

Contents: Announcement regarding the publishing of the textbook for the next grade:  
Reminder of contents: Printer's logo

Reasons: Practical reasons: The purchaser must be told whether or not the book is part of a series;

z\_science\_exp\_0507 (2).jpg

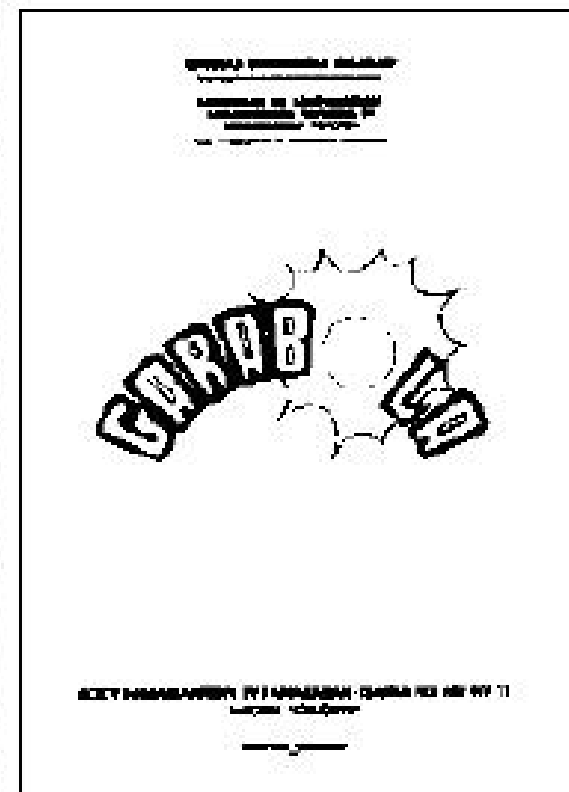

Full-Title Page

Contents: Name of ministry;  
Name of sponsor; Title of book;  
Contents (subject and grade);  
Version (pilot); Date and place published  
Reasons: Institutional reasons;  
Practical reasons: Even if the cover

attracted by the illustration, informed as to the contents of the book and told whether or not the book is officially approved.

purchaser must be told whether or not the book is part of a series; Legal and practical reasons; The printer must be specified.

Reasons: Institutional reasons; Practical reasons: Even if the cover is lost the full-title page gives the essential information

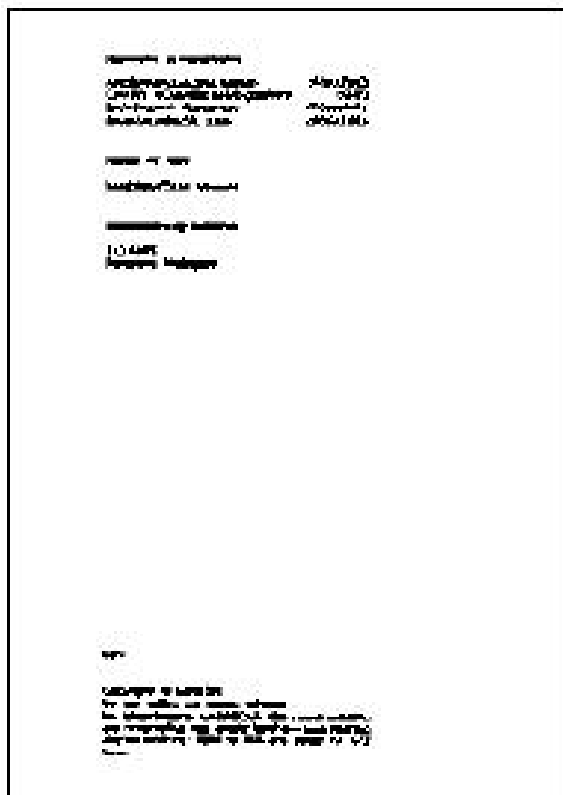

Copyright Page Contents: Authors' names; Illustrator's name; Publishing unit; Copyright Reasons: Legal reasons: Who holds the copyright; Recognition of the moral

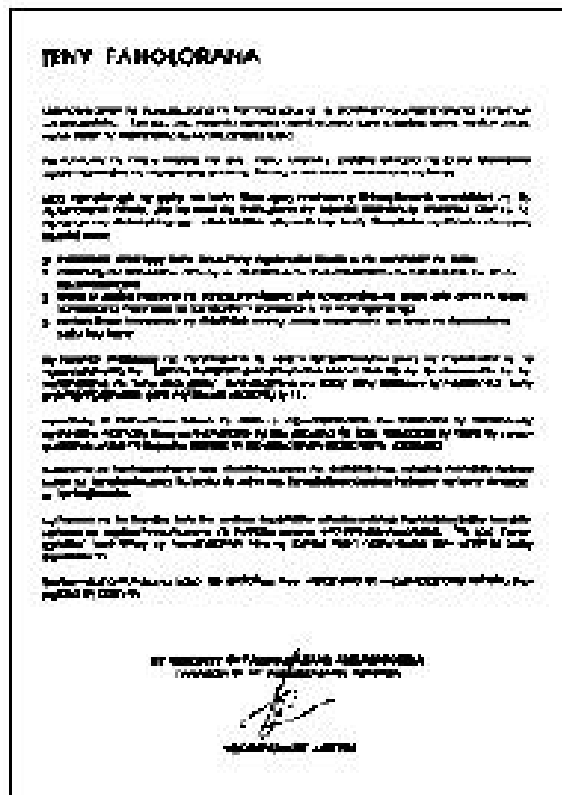

Preface Contents: General preface signed by the Minister of Education Reasons: Institutional reasons:

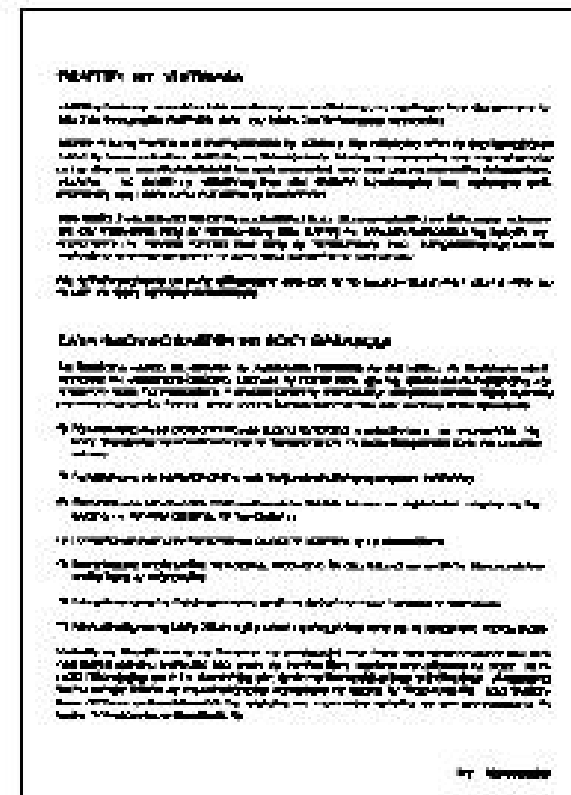

Introduction to the Book Contents: Text by the authors laying out the learning targets of the book and the different stages in its completion, including the evaluation phase

rights of authors, illustrators and the publishing unit

official seal of approval for the book and its contents

Reasons: Practical reasons; To enable teachers to use the book even without a teachers' guide; To boost the book's credibility with teachers: it has been tested and revised

To avoid this, make a mock-up of your book; write the unit number and the main contents on each page. You need not respect the finished format for your mock-up – a mini model is every bit as good.

**Ascertain that you have calculated the number of pages correctly before progressing to the next stage**

**The cover of a textbook is a very special place; take great care in selecting the information to be printed on it**

**You should always reserve a few pages at the start of your book for general information**

### 3. Basic Visual Structure

By laying down the format and the number of pages of your textbook you have defined the framework within which you must now insert the contents. The objective of the phase that you are now starting is to design an initial arrangement of the contents on the page, or to be more precise to put together texts and illustrations in an appropriate way on each page.

This is not the final layout. It is a draft, the first translation of your ideas into physical form. This overview will allow you to judge the general rate at which you aim to present the contents. The decisions you will make should be just precise enough to allow you to progress to the writing phase, gearing your work to a framework, which will probably have to be modified, adapted and specified in greater detail later.

framework, which will probably have to be modified, adapted and specified in greater detail later.

We are touching on a field which, in large publishers, would be the task of a professional layout person. When the authors themselves are in charge, they do not always appreciate the importance of this phase, or do not have the training they need. This is why, although we describe how to proceed, we also advise you to seek the advice of a professional and to train yourself systematically to evaluate the graphic aspects of books. Once again do not be discouraged: find out about the subject by examining the layout of other books and by reading specialised books, including those listed at the end of this chapter.

### ***Function of Visual Markers***

What is the point of identifying an underlying visual structure? – to make your book a good learning and teaching tool. If it is to be a valuable tool, it is not enough to have appropriate, well-organised contents; the presentation must facilitate the understanding of the content matter, and more precisely, you will need visual markers which will clear up doubts, prevent misunderstandings, visualise the progression and spotlight key information.

To this end you must put together the various elements which make up a page (texts, illustrations and blank space) in a form appropriate to the content matter. You will create the underlying structure, which will be repeated more or less identically in each unit. In this way you will give the book a uniformity and transparency which is vitally important for pupils and teachers who have little contact with the printed word.

### ***Organising a Learning Unit***

The basic structure will be determined at unit level, i.e. at the level of the chapter or lesson. You should thus design your unit step by step, using sketches and ideas, comparing these and modifying them one after another.

If we come back to the example of a reading and writing book, you could reflect on the following basic questions:



- Will the learning units or lessons be similar or will they be divided into easily distinguishable blocks with different structures?
- Will you present all the texts and exercises in the main units, or do you plan to distinguish between those that are indispensable for learning, and supplementary texts and exercises which could be put at the back of the book?
- Should the first page of each unit be on the same side of the book? On the right-hand side or the left-hand side?
- Will the reading texts and writing exercises be separated and printed on different pages or will they be printed on the same page?
- Will the reading and writing work be presented on a full double page or will one page of reading always alternate with one page of writing?
- What is the average length of texts for reading and the dimensions of accompanying pictures?
- Will some texts require a special layout?
- How much space approximately will each exercise need?

These considerations should result in a first draft or design of the contents of a unit. You should sketch your design in pencil without paying too much attention to precision or scale.

On the next page you will find the draft produced for four pages of a lesson in the revised version of *Garabola*.

**Outline the rough presentation of the contents of each lesson**

**You should identify the basic structure of your book little by little, scribbling down ideas, feeling your way forward, and changing your plan time and time again**

**ideas, feeling your way forward, and changing your plan time and time again**

### ***Double Pages***

Once you have decided how to arrange your unit, you should examine the resultant structure of the double pages; remember that the reader will always be confronted with a double page when he opens the book, and that your basic structure must build on this.

You may find certain shortcomings and feel that you should modify the arrangement of the unit. Let us assume, for instance that for a four–page unit comprising reading and writing you had decided to alternate one page reading and one page writing. You then discover that every double page throughout the book will follow an identical pattern, giving your book an apparent lack of structure.

One double page of reading followed by a double page of writing like *Garabola*, reproduced at the top of this page will give you greater transparency and dynamism.

### ***The Page***

If you are satisfied with the organisation of the double page, it is time to look more closely at the organisation of the individual pages. You must look at the size of all the elements which go to make up a page and make any necessary changes.

**By the end of this phase you should have a rough model of the contents of your book, page by page**

There are no universal prescriptions for a good page layout, but the following pointers are important. Avoid cramming the page too full and leaving it too empty; if you intend to put together an illustrated text and an exercise on one page, sketch the layout for each, and do not hesitate to revise your decision if you find that you don't have space to present the exercise properly at the bottom of the page. If you have a page of

exercises, remember that two exercises on an otherwise empty page may look silly, but that six or more may be too many, making it difficult for the reader to find his place and conveying an impression of a dauntingly packed page.

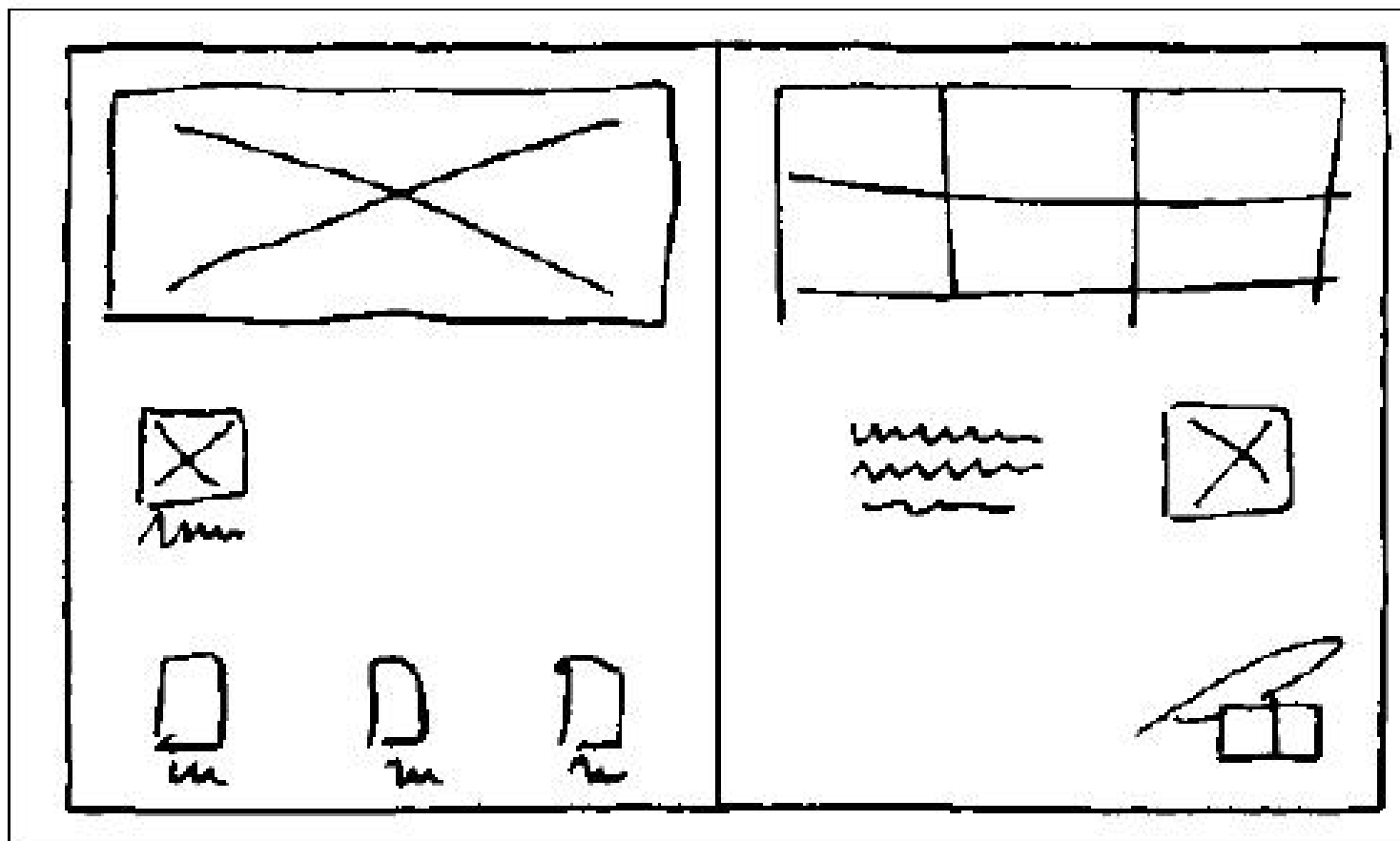

The two pages dedicated to reading consist of:

Left-hand side: A block to introduce the topic; A sentence using the new grapheme; The key word; The syllabic family.

Right-hand side: A table of new words; A text to reinforce what has been learned; A visual reminder of the new grapheme

Right-hand side; A table of new words; A text to reinforce what has been learned; A visual reminder of the new grapheme

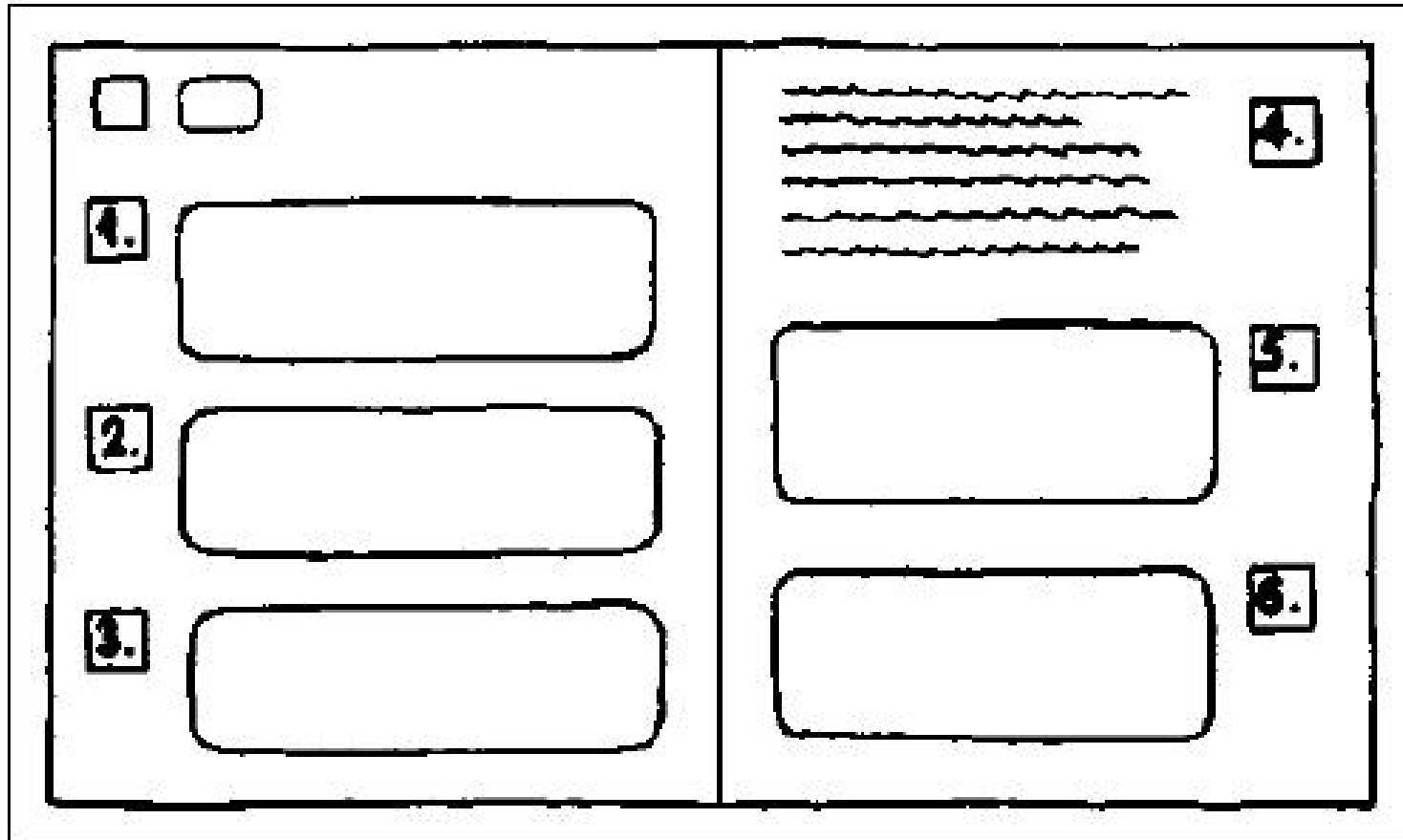

The two pages dedicated to writing consist of

Left-hand side: Words to read and copy in joined-up writing; Two-syllable words to write and copy; Ditto.

Right-hand side: A space for a text to reinforce the writing of syllables based on vignette;

A dictation of words on the basis of vignettes

### ***The Layout Plan***

Now you have your basic structure and can draw up a rough layout for the entire book. This model is known as the "layout plan".

Once again there is no need to respect the final format of the textbook, a smaller format will do just as well. If necessary refer to the layout plan for *Garabola*, which you will find at the start of chapter 1.

## **4. The Artwork**

You now have an overview of what your book will be like, but the conceptual phase is still not over.

You have still to decide on the artwork, which is crucial so that you can write the text and so that you can request a first estimate from the printer (this is a compulsory part of conceptual work).

Now is the time to decide what sort of illustrations you need (diagrams, photos, etc.) and how they are to be printed (in one or more colours). We suggest the following procedure to ensure that your decisions are well founded.

### ***Graphic Options Open to You***

Consider firstly the options open to you to illustrate a textbook; these can be summed up as follows

	Colours		
Type of Illustration	1	2	4
Photos			
Realistic drawings			

PHOTOS			
Realistic drawings			
Abstract drawings			

### ***Purpose of the Illustration***

Decide now what you want to achieve with the illustration; this will give you an initial idea as to which type would be best suited to your needs.

If, for instance, your primary aim is to impart information to the reader, you will find photographs (in history books for example) or abstract drawings (maps, diagrams, etc.) most suitable.

In a reading book, on the other hand, the illustration allows young readers to recognise visual elements from their own environment and thus to identify with the book at an emotional level. It facilitates the move towards the written word and helps young readers memorise certain written elements. The reader must thus be able to decipher the illustration with as little doubt and uncertainty as possible.

Realistic drawings, which allow the reader to select the relevant elements and discount any unnecessary information will often be more suitable than photos here.

### ***Financial Considerations***

The type or types of illustrations you have selected can be printed in three different ways: either in 4-colour, which will give you colours that are very close to natural shades, or in two colours, generally black and a light colour, or in one colour, which is usually black.

Sometimes the purpose of the illustration will force you to use colour; usually though your choice will be guided more by financial considerations, taking into account the following points in particular.

### **Image Processing**

Your illustrations must be prepared for printing; for monochrome printing you can choose line photoengraving if your illustrations involve only black lines. If, however, you want to lend some depth to your illustrations you will need shades of grey; this is called halftone gravure, and is more expensive.

When illustrations are to be printed in two colours, the preparation of the colour inks and the screen will often give you good value for money; this procedure is significantly cheaper than 4-colour printing, especially if the screens are produced manually, as is often the case in developing countries. The uninitiated often think of the result as a "colour" illustration, without making a distinction between this and 4-colour printing.

4-colour printing involves separating the colours, and producing three negative films with the positive images printed in magenta, cyan and process yellow, to which black is added to give depth. This procedure is complex and we will not go into details here because we do not consider this a priority for you, it always being an extremely costly operation.

We cannot urge you enough to keep a close watch on costs, and to accord financial considerations the importance they deserve. In our experience, authors, anxious to produce a really worthwhile book, often reject out of hand reasonably priced options, which they associate with mediocrity. Sometimes they produce entire books in colour, and then cannot find anybody to finance them. Sometimes, the authors simply refuse to listen to reason and insist on having at least one page in colour in the book; they consider this a modest and acceptable request without realising that it is not enough to produce the colour drawings, but that they must be processed and printed, and that this can be extremely expensive as we will see in the next section<sup>12</sup>.

**Sobriety should not necessarily be equated with mediocrity in the field of graphics  
Consult your printer again to ensure that your artwork decisions are well founded**

## Printing Costs

You should also look at the costs of printing per se.

In particular, you should be aware that for 4-colour printing each sheet must go through the presses four times with different elements being printed each time. That means that the printer must prepare his presses four times: the presses must be scrupulously well cleaned each time<sup>13</sup>, the new elements to be printed (films

times with different elements being printed each time. That means that the printer must prepare his presses four times: the presses must be scrupulously well cleaned each time<sup>13</sup>, the new elements to be printed (films or plates) fitted, the presses regulated, set, and of course the colours printed separately. For limited runs, the costs can be exorbitant<sup>14</sup>.

Two-colour printing, on the other hand, lightens a purely monochrome print, by using black (and the various shades thereof in grey tones) and orange (and the shades from a very bright orange to the palest hue). The result is sometimes perceived by an uninitiated reader as being a "colour print". Although the procedure is considerably more complex than monochrome printing it offers better value for money than 4-colour, especially in developing countries, where the screens are prepared by hand, making them fairly cheap.

### **Imposition**

You may not plan to use colours on every page. If only some illustrations are to be reproduced in colour, you must identify which illustrations and which pages are involved.

You should then ask the printer about his imposition, i.e. the way pages are arranged on the sheets of paper for printing. Try to put the illustrations to be printed in colour on one sheet of this sort, since this can make for major savings<sup>15</sup>.

### ***Paper and Printing***

If you are considering 4-colour printing, do not make a final decision until you are certain that the paper and the printing are of good quality.

**There is no point in 4-colour printing on poor quality paper or under mediocre printing conditions**

The paper must not look like blotting paper and must be sufficiently opaque for the printing not to shine through onto the other side; "bulky news" (the paper used to print newspapers), for instance, which is



transparent, browns rapidly and laps up ink is no good for 4-colour printing. The printer too, must have the skills and equipment required: for colour printing the printing presses must be extremely well regulated, and it is very, very difficult to set them with the precision required so that the blocks or plates match exactly. If they do not match exactly the reproductions of the various colours will be blurred and fuzzy.

If you cannot be sure that your printer can guarantee all these conditions it would be irresponsible to invest in expensive colour printing, the results of which will never justify the scale of the investment.

### **Don't focus on one single textbook. Take the entire series into account**

#### ***Long-Term Planning***

Finally, even if your budget today allows for four-colour printing, you must be sure that you will have the money tomorrow as well for reprints, which must then also be in colour.

This aspect is particularly important if you are preparing a pilot version. It may be easy enough to finance 3,000 colour books, even if the unit price is very high. In some cases, the need for 4-colour printing will only be seen during the testing phase<sup>16</sup>. In general, however, you should only use colour once you are certain that the revised version, which may involve a large run, can be financed. If you fail to look ahead at this stage you may end up having to redo all the artwork and remodel the original text; this is more than a revision, it really does involve rewriting the entire book<sup>17</sup>.

## **5. Provisional Costing**

Until now, you have worked in a state of splendid isolation, as if you were the entire publishing chain.

For the first time now you must leave the confines of your office and make contact with the body which charged you with producing the book and with the printer. You must make the preparations for the manufacturing phase, checking whether or not the physical and graphic features you have decided on are acceptable from a financial viewpoint. The aim of this next phase will be to request a provisional quotation and

manufacturing phase, checking whether or not the physical and graphic features you have decided on are acceptable from a financial viewpoint. The aim of this next phase will be to request a provisional quotation and ensure that it is within the limits of your budget.

To this end you will have to draw up your technical specifications, which will determine the costs of development and of manufacture.

### ***Development Costs***

In large publishing houses the publisher determines the costs of writing the manuscript and of the artwork. In other words this is the latest time to decide about the entitlements of the authors and the illustrator or photographer.

In general a distinction is made between the moral rights of authors and the royalties; the first entitles them to associate their name with the book that is considered to be their work, and the second could be considered remuneration for their work.

If you have worked on behalf of a private publisher, you will generally have to renounce the rights to your manuscript for a lump sum payment or a certain percentage of the sales price, in exchange for which the publisher will undertake to print your name in the finished work, among other things. If, on the other hand, you are a civil servant and produce textbooks within the scope of your normal duties, the ministry may not recognise your literary or artistic property, considering that this would make too great a distinction between your work and the work of your colleagues, which is just as important but much lower profile (e.g. in the field of teacher training). In this situation, certain international organisations specialised in this field, e.g. UNESCO, may be able to suggest a solution that is satisfactory to both sides.

It is a complex subject and the situation is changing all the time. Given the special profile of "publisher–authors" in some developing countries, certain international organisations are starting to re–examine the rights accorded to authors working within state structures, with a view to upgrading their work. Contact the body which has charged you with producing the book and settle this issue without any further delay.

### ***Manufacturing Costs***

These costs will always be calculated by the printer, who will base his quotation on the four following factors.

### **Composition**

This involves setting the text by computer, making the corrections required after proofreading and the composition and layout of these texts on the basis of detailed instructions.

By this stage you must know whether you will be submitting a typewritten manuscript to the printer and let him typeset it, or, whether, as is becoming increasingly common, you will write the text on a computer and submit the floppy disk to the printer. You must also decide whether or not you intend to set and compose the text yourself, and, if you are using monochrome illustrations without halftones, whether you will produce the imposition scheme or submit the text and illustration separately to the printer to allow him to assemble each page on the basis of your instructions.

The production of textbooks has changed drastically over the last few years, not only in industrialised countries, but also in the developing world. Whereas it was common practice in the 1980s to ignore computer-assisted printing, today it cannot be overlooked. Anyway large-scale textbook production projects all have computer equipment.

### **A computer only facilitates and enriches your work if you know how to use it properly**

If you are in this situation, you must be aware that computers cannot replace the creative process, neither as regards the concept nor as regards the writing and layout of your book. It can, however, facilitate your work, if used properly since it will help you transform your own manuscript into copy, and will allow you to visualise your layout very rapidly. But, if you do not have a good command of the programmes used and are quite unfamiliar with at least the basic principles of typography, you can easily fall into one of two traps – either you will magnify your already crushing workload as authors, or you will not be able to make good use of the many graphic options the computer offers you.

### **Printing**

## Printing

Under this heading the printer will look at three items: the inputs, such as ink, the costs of labour and materials needed to undertake the preparations for printing, (preparing films, process work or plates), and the labour costs of printing the book (the inside pages and the cover).

The printer must know what size the run is to be, i.e. how many copies are to be printed, before he can calculate his costs.

## Finishing

This heading includes all the costs of folding the signatures, putting them together to make the body of the book, and binding the finished book.

### **Educational materials need a firm binding**

You should pay particular attention to the binding of your book – it would be madness to jeopardise all the work you have already put into the development by choosing the wrong binding.

The world of binding is complex, but we can sum up what you need to know as follows (see illustrations on the following page):

- Saddle stitching with staples is cheap, but there is a danger that the pages may fall out if the staples are too short. It is not suitable for thick books, since, when you come to trim the book, you will have to trim the pages in the middle more than the outside pages; this is unaesthetic and can be dangerous if the margins are narrow, since you run the risk of trimming away some of the text. (Fig. 1)
- Signatures can be block stitched (i.e. stapled flat) and then stuck together to the covers. This is a firm binding, which is relatively cheap, but it has the disadvantage that it is difficult to

lay the book open on a table. (Fig. 2)

- Spiral binding is another option. It is the most expensive option, unless you are having a limited run printed and you have the equipment to allow you to insert the spiral binders manually; you could use this option for a pilot run of a few hundred copies. (Fig. 3)
- The pages can also be cut at the spine and then stuck. This is not too expensive and good quality adhesives are available today, but it is not recommended for school textbooks which are often handled roughly and may well start to lose pages rapidly. (Fig. 4)
- The signatures can be sewn with thread and then either sewn or stuck together. Stitching is expensive but it is the firmest option. (Fig. 5)

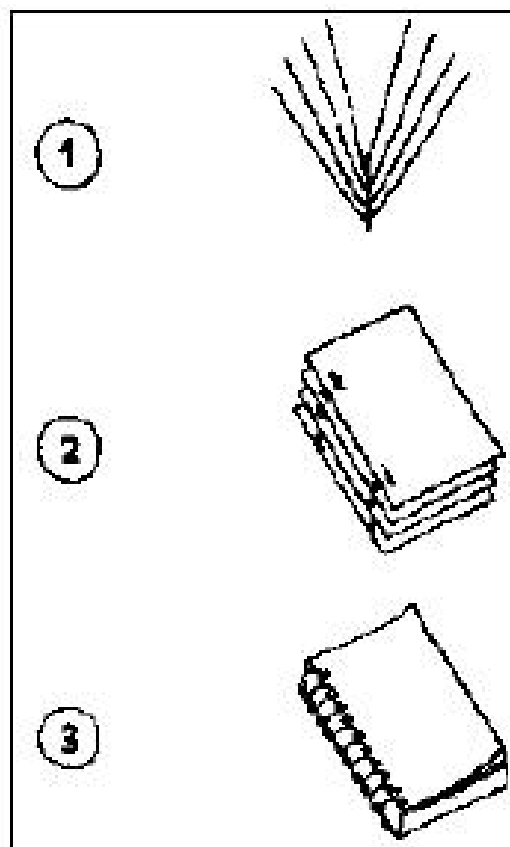

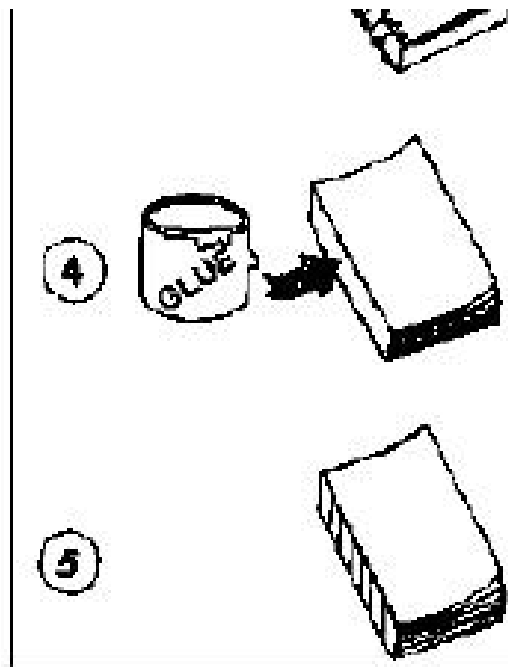

## Paper

This heading covers not only the price of the paper, but also the cardboard used for covers and any treatment required (e.g. reinforcing the cover with plastic).

Again, find out about the main features of the paper from your printer (whiteness, thickness, tearing strength, impermeability, smoothness, price). Ask him what quality of paper and cardboard he can procure.

The quotation you are given should be considered provisional; it is a guideline for you to help you ensure that your decisions are well-founded, and to allow you to make any necessary modifications.

The instructions you give the printer must, however, be as clear and complete as possible – as should his quotation. If you do not pay enough attention to this point you may have a nasty surprise later, and you may not be able to pay the additional unforeseen costs.

## **6. Medium–Term Planning**

You have made all the decisions regarding the physical and graphical aspects of your book – you may consider the conceptual phase over.

But, we would recommend that you draw up a medium–term work plan, i.e. up to the distribution of the books to schools, to ensure that the actual writing phase, which is about to start, runs smoothly without any major hiccups.

Make a list of the people who are going to be involved as from now in the development of the book and, finally, plan your activities as carefully as possible.

### ***Actors***

You should contact the individuals and bodies listed below at this stage, to ensure that they can provide their inputs on schedule.

### **Illustrators and/or photographers**

Ideally, these individuals should be part of the team of authors from the start, but in practice they are very often brought in once the first draft of the texts is finished at the earliest.

You must select the people you want now, to ensure that they will be free to work with you when needed. It may take some time to select them. If you are working on the first book in a series, you should perhaps run a competition and then check in the field that the style of the illustrator you have selected corresponds to the preferences of the target group. As you will see from the time schedule for the development of *Garabola* in Table 22, this can take a lot of time.

### **Resource Persons**

These individuals will review your manuscript and help improve it. They will include proof readers to eliminate

These individuals will review your manuscript and help improve it. They will include proof readers to eliminate typing and printing errors, educational advisers who will ensure that the book is appropriate for the teaching and learning conditions in rural areas, subject specialists who will focus on the contents, etc.

We recommend that you look for these individuals at as early a stage as possible and that you obtain their agreement in principle to work with you. We will look at the cooperation with them in more detail in the next chapter.



Work	1986		1987													
	09	10	11	12	01	02	03	04	05	06	07	08	09	10	11	12
Illustrators competition	■															
Presentation of illustrations in test schools			■													
Selection of an illustrator			■													
Development of texts and exercises	■															
Rough illustrations			■													
Writing parts of book not destined for pupils				■												
Manuscript read by amateurs working in test zone				■												
Presentation to official committee for approval				■												
Changes					■											
Final layout					■											
Final version of illustrations					■											
Preparation of imposition scheme							■									
Preparations for printing at printer; control								■								
Printing									■							
Finishing										■						
Definition of an evaluation strategy; preparing instruments												■				
Preparation for teacher training: 5-day courses														■		
Distribution of materials to test schools															■	

Work Schedule for Garabola

### **Publishing Unit**

If the publishing unit rather than the printer is to typeset your texts, you will have to ask it to do the following:

- firstly, once the first unit of the textbook has been written, the publishing unit will set it to give you an idea of the length of the texts and the provisional layout;
- once the entire manuscript is completed, it will set all texts, including those that do not address the pupils (introduction, table of contents, etc.);
- finally, once the proofs have been reread and corrected, it will make the changes you want and do the layout on the basis of your detailed instructions.

In view of the fact that this unit is bound to have other commitments, lay down the approximate date on which you intend to submit your manuscript now so that the publishing unit makes time for you.

### **The Printer**

Agree on the various things to be submitted to the printer, and the dates he can expect to receive them.

### ***Work Schedule***

By the end of the conceptual phase you should have drawn up a detailed work schedule, which will allow the textbook to be ready for the start of the academic year planned.

To give you an idea of the time needed, the table overleaf shows the planned schedule for the development and production of the pilot version of *Garabola*.

Don't take the contents of this table as a model, since working conditions vary from one country to another. Take them only as a frame of reference; in particular, look at the tasks listed and the time-scale reserved for each task and adapt these to bring them into line with your own situation.

**This is the time to organise the people who will read and correct your manuscript  
Allow at least one year for the development and production of a first textbook**

## 7. In Conclusion

### *Detailed Documentation*

You have now defined the contents and the form of your textbook, thanks to a systematic analysis of numerous factors.

To ensure that the quality of the development phase is as high as that of the conceptual phase, we recommend that you keep detailed records of every decision made. You can use two instruments to this end.

### **Logbook**

You can keep a note of the key ideas in your work on a day-to-day basis in a logbook; you might note the reasons why a certain decision was made, any disadvantages it may entail, the repercussions for the teachers' guide, steps to be taken to put it into practice smoothly, etc.

These notes may be useful when the conceptual work is over and you begin to forget the odd detail.

### **Pinboard**

If suitable for the way you work, you could prepare permanent pinboards to remind you at a glance of the framework for the texts and illustrations you are about to produce.

**Keep a careful record of all decisions made during the conceptual phase**

## Keep a careful record of all decisions made during the conceptual phase

### Notes

<sup>1</sup> Re-read the first point in the first chapter of this book to refresh your memory if necessary.

<sup>2</sup> The basic form of textbooks is always a rectangle, which creates a certain dynamism, rather than a square, which would neutralise tensions; for interesting ideas on this topic see Duplan, P. and Jauneau, R. *Maquette et mise en page*, p. 93–99. Paris: Usine Nouvelle, 1986.

<sup>3</sup> We have adopted the distinction made by F. Richaudeau between the “legibility corresponding to the integral reading of the lines of a text, or micro-legibility, (and) a second type of legibility, which corresponds to the image of the page as a whole, or macro-legibility.” In: *Manuel de typographie et de mise en page*, p. 9. Paris: Reitz, 1989.

<sup>4</sup> The limits of readability, as stipulated by M.A. Tinker for primary school children in the USA are as follows:

Grades	Bodies of letters
1	14–18
2	14–16
3–4	12–14

Cf. *Typography for children's books*. In: *Bases for effective reading*, p. 155. Minneapolis: University of Minnesota, 1965.

This means that the largest lower case letters without ascenders or descenders should be some 3 mm high (body 18), while the smallest characters should be some 2 mm (body 12).

<sup>5</sup> In chapter 7 where we will look at the basic concepts of layout, we shall come back to typographical options.

<sup>6</sup> For primary classes in developing countries C. McCullough and C. Chacko suggest significantly larger characters than those proposed by Tinker, i.e.

Grades	Bodies of letters
1	36
2	24
3	18
4	16
5	14

Developing materials for instruction. In: Staiger, R.C. *The teaching of reading*, p. 172. Paris: UNESCO and Lexington: Ginn and Company, 1973.

<sup>7</sup> Cf. Read, A. *A guide to textbook project design and preparation*, op. cit., p. 58.

<sup>8</sup> The paper costs as a percentage of the total production costs are put at the following

for 1,000 copies	28.5%
for 5,000 copies	47.6%
for 10,000 copies	53.5%

In: Smith, D.C. Jr. *Les problèmes économiques de l'édition des livres dans les pays en voie de développement*. Paris: UNESCO, 1977.

<sup>9</sup> The most common paper dimensions in the "A" series (in mm) are as follows:

A0: 841 x 1188

A1: 594 x 841

A2: 420 x 594

A3: 297 x 420

A4: 210 x 297

A5: 148 x 210

<sup>10</sup> There are, of course different ways of folding, cross folds, former folds, etc. It may be a good idea to use a combination, but the printer will have to plan for the necessary folding and inserting, and calculate the costs. Contact him and check that you have not made a mistake in either your choice or your calculation as to the number of pages.

<sup>11</sup> There are ways and means of not using a 16–page signature for non–text information; the printer is bound to suggest a half–signature (8 pages) for instance. If you are apprentice authors, we suggest that you do not go into this in any more detail, but that you consult the printer, and devote your own time and energy to tasks where you have no back–up.

<sup>12</sup> Beware of yourselves – authors who demand that their book be printed in 4–colour are always convinced that they are right and can easily fall into the trap of accusing anyone who disagrees of thinking small, and wanting to throw a spanner in the works. Our most recent experience in this regard was a group of authors who wanted four–colour printing in a first–grade maths book because of pictures of butterflies in some exercises.

<sup>13</sup> You must bear in mind that every additional step in the production, even apparently simple steps, can entail unforeseen complications. When fuel is sometimes rationed, for instance, the printer may be tempted to clean his machinery less scrupulously, since petrol is often used to clean printing machinery.

<sup>14</sup> “4–Colour printing is approximately eight times as expensive as a halftone”, In: Richaudeau, F. *Conception et production des manuels scolaires*, op. cit. p. 214. 1979.

<sup>15</sup> Imposition can be extremely complex, and must always be performed by a specialist. Do not be ashamed of consulting a printer to find out more, if you are only an amateur in this field. Ank make sure that the printer has the knowledge he needs, which is – unfortunately – not always the case.

<sup>16</sup> Colour may be considered unavoidable in a pilot book which aims to upgrade a local language in order to produce a book which will be as attractive to users as textbooks in European languages, which are almost always printed in 4–colour.

<sup>17</sup> In 1979 in the pilot version of a 4–colour Quechua reading book the authors from the German–Peruvian Bilingual Education Project already mentioned chose the key word “puka” (red) to introduce the letter p and illustrated it with a red box. Since the revised version could only be printed in monochrome, this word and the illustration had to be changed, triggering a chain of modifications throughout the book.

### ***Recommended Reading***

#### **Layout**

DUPLAN, P. AND JAUNEAU, R. *Maquette et mise en page*. Paris: Usine Nouvelle, 1986

GUERY, L. *Précis de mise en page*. Paris: CFPJ, 1988

RICHAUDEAU, F. *Manuel de typographie et de mise en page*. Paris: Retz, 1989

#### **Typographical Legibility**

TINKER, M.A. *Legibility of print*, Ames, Iowa: Iowa State University Press, 1963

TINKER, M.A. *Bases for effective reading*. Minneapolis: University of Minnesota, 1965

#### **Manufacturing Costs**

## **Manufacturing Costs**

DURCHON, P. *Photogravure et impression offset*. Paris: Usine Nouvelle, 1987

SMITH, D. *Les problèmes économiques de l'édition des livres dans les pays en développement*. Paris: UNESCO, 1977

## **Author's Rights**

ALTBACH, P.G. Copyright in the Developing World. In: FARRELL, J.P. AND HEYNEMAN, S.P. (Ed.) *Textbooks in the Developing World*. Washington D.C.: World Bank, 1989

COLOMBET, C. *Grands principes du droit d'auteur et des droits voisins dans le monde. Approche de droit comparé*. Paris: Litec, UNESCO, 1990

UNESCO *L'ABC du droit d'auteur*. Paris, 1982

## **To Sum Up**

Once the authors have defined the subject matter to be covered by the textbook they are still not ready to start writing: they still do not know how long the texts should be or how to fit them together with the artwork. To allow them to write well-founded texts and avoid the blunders that a poorly planned assembly of texts and illustration would entail, they should draw up a model of the book.

Before you design each page, it is important to define the main physical aspects of the book as a whole, in particular the format and the number of pages. It is equally important to think about the graphic aspects, i.e. to work out a provisional layout and decide on the nature of the illustrations. Much of this work demands specialised know-how, which is why publishers contract specialists who report to the production manager and the artistic manager.



Teams of authors working in developing countries rarely have the specialist know-how for this phase, but they are always left with the responsibility when the publishing back-up is not forthcoming. Given the fact that few authors will have any back-up from professionals, such as a layout man, most of you will have to acquire a working knowledge of layout and printing techniques and methods. You should consult specialists in your country, especially the printer, and try to put their experience within a systematic framework by reading specialised literature among other things.

The conceptual work should culminate in two documents:

- A detailed work schedule covering the work of the authors and the external inputs required during the writing and manufacturing phases;
- A quotation drawn up by the printer with a view to confirming the decisions made regarding the physical and graphical aspects of the textbook, or to calling into question these decisions.

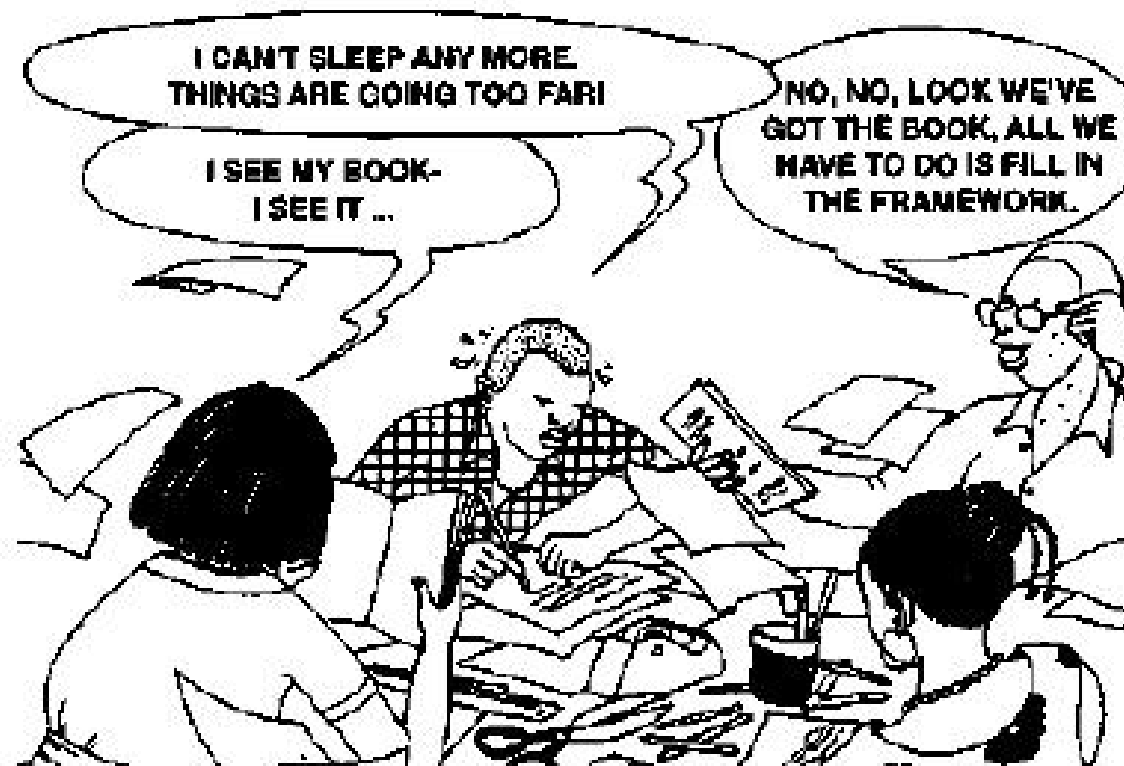



## Writing the Text

During the previous phase you decided on the contents of your textbook and on the artwork, which enabled you to define the sequence of the learning matter to be covered, and to lay down a basic visual structure for the book. The phase you are about to start will be a continuation of this work, culminating on one hand in finished texts and exercises, and on the other in the sketches or "roughs" for accompanying illustrations.

The literary and graphic work during this phase must go hand in hand. In large publishing houses the authors are responsible for the literary side only, while the artwork is entrusted to a layout man and/or a graphic artist. In developing countries, however, authors are almost invariably responsible for both sides. In this chapter we will first look at the preconditions for creating what Richaudeau terms the "text-image couple"<sup>1</sup>, before going on to look at the subsequent stages step by step.

Some of you will be sufficiently familiar with text-writing for it not to present any major difficulties. The visual presentation and illustration of texts and exercises on the other hand will be new ground for many of you, and difficult for all of you. You will have to understand the importance of bearing the visual aspect in mind as you write your texts. You will need to learn to do so by constantly weighing up the demands of the text and the presentation.

Even if you are no longer a novice where writing is concerned, we would urge you most strongly to read this chapter thoroughly, to ensure that you glean not only scattered pieces of information, but the entire systematic approach. Put yourself in the place of authors who have defined a detailed conceptual framework, and must now write, present and illustrate the contents of their textbook within a relatively short space of time; read the chapter from start to finish, point by point.

**You must do more than write a text – you must fit text and image together to create a harmonious whole**

**Plan your writing**

## **1. Overview**

The phase you are about to start will seem impossible to structure for some of you, who believe that the texts and exercises will simply come together with time.

However, if you aim to produce high quality material within a given time-scale we recommend that you do not merely wait for inspiration to strike. Forget the romantic image of the literary genius alone in his garret and plan this phase as strictly as possible. By way of reference, we will, as always, give you an overview of the work involved taking the example of the work on *Garabola*.

### ***Writing Garabola***

We have selected this textbook as an example because of one particularly interesting feature – since this was their first book, the authors chose to take a systematic approach, trying to avoid any unnecessary delays for the education authorities. The often contradictory goals of quality and keeping to schedule forced the authors to tackle the writing and illustration work in tandem.

We feel that this approach, which is described in detail in Table 23, should not necessarily be taken as a blueprint, but it is interesting and may be useful for teams of authors working under time pressure.

## **2. Organising the Work**

Once you have a general idea about the form your literary and artistic work should take, you can organise the writing work and decide what approach you wish to take.

Once you have a general idea about the form your literary and artistic work should take, you can organise the writing work and decide what approach you wish to take.

Why, you may ask, can't we get down to writing the texts at last after all the research and the conceptual work? Because you must firstly define the framework, without which your subsequent work will be subject to inopportune interruptions. You should thus accept a certain amount of "lost time" at the start of this phase in order to guarantee optimum writing conditions. Look in particular at the following points.

### **Start by deciding how much time you will need for the writing phase**

#### ***Rate of Working***

Take stock of the work ahead of you, before you do anything else. Recall the number of texts to be written: for a reading and writing book with 24 units, for instance you will have to write 24 texts if you plan to have a single text per unit, or 48 or 72 if you plan two or three texts respectively per unit.

Then recall the principal features of the contents and the presentation of these texts: to take the above example, once again, look at the sort of texts (adventure stories, fairy tales, historical texts, scientific texts, etc.), the approximate space available for each text on the page, and the average size of characters to be used. You should then turn your attention to the number of exercises to be devised: if you plan to devise two pages of exercises for each of 24 units or lessons with three exercises per page, you will need no less than 144 for the textbook as a whole. Finally, you should count the number of general information pages and look at the length of texts on these pages.

Now and only now can you set the markers which will allow you to lay down your time schedule. You should either lay down a daily or weekly quota for the writing work, or set deadlines for the individual parts of the book.

### **23. Developing the Garabola Reading and Writing Book**

<b>Planning and Organising Writing Work</b>	
	The authors started by defining the type of writing work to be performed and how they were to be fitted together. They set quotas in line with the work schedule drawn up at the end of the conceptual phase for the textbook as a whole. They also decided how they proposed to conduct the writing.
<b>Writing the First Version of the Reading Texts</b>	
	The authors settled down to write the textbook per se, starting with the reading texts. They adopted a systematic procedure, developing a list of criteria, identifying the topics to be tackled, deciding on the type of texts, writing and producing the artwork for a first unit which was then used as a model for the rest of the textbook, and then writing the other units. The authors then ran a series of checks on the texts produced.
<b>Organising and Supervising Illustration Work</b>	
	Since the illustrator had been selected and approached during the conceptual phase, the illustration work could start; he illustrated the reading texts while the authors devised the exercises. <sup>2</sup> Collaboration between authors and the illustrator took the following form: a contract was drawn up in line with the work to be performed, the contents of the illustrations were stipulated as was their layout on the page, drafts were produced and any changes made, the illustration techniques and instruments were stipulated. Once the layout had been finalised, the illustrator produced the final versions of the illustrations.
<b>Writing the Exercises</b>	
	While the illustrator was preparing sketches for the reading texts, the authors started work on the exercises. They established a list of criteria, identified attainment sub-targets, defined the space available for each exercise, selected the type of exercise, developed the exercises, devised the presentation, and ran an internal check. The illustrator produced sketches for the exercises once he had finished those for the reading texts, observing the same procedure.
<b>External Review</b>	
	Once the manuscript was completed, various people from outside the group of authors reviewed the texts

Once the manuscript was completed, various people from outside the group of authors reviewed the texts checking the linguistic aspects (pertinence of newly created technical terms, correctness, clarity, uniformity of style), subject-related aspects (coherence and exactness of contents), and pedagogical and didactic aspects (suitability for the given teaching and learning conditions). Others reviewed the illustrations from the pedagogical angle (clarity, exactness and pertinence of the scenes or objects represented), and from the cultural and political angle (respect of local customs, representation of scenes that are applicable for the country as a whole and not just certain regions).

### **Writing General Information Pages**

The authors wrote texts for the cover and general information pages at the front of the book, taking into account pedagogical aspects (the technical presentation of the textbook), legal requirements (credits and copyright), institutional factors (preface and mention of the ministry), and editorial conventions (on the covers and all pages in question).

### **Preparing a Copy of the Manuscript**

Having examined the internal suggestions and those of the external reviewers, the authors modified the initial manuscript and had a typewritten version prepared.

### **Preparations for Official Approval**

To obtain authorisation to print, the authors prepared a file for the education authorities, containing a list of information and a hand-crafted mock-up of the textbook, on the basis of the typewritten manuscript and photocopies of the sketches.

They were granted authorisation to print, the final layout was performed and the graphic work finished: the two files were then submitted to the printer to allow him to start work on the textbook.

Whatever you decide, try to avoid two common errors a) under-estimating the volume of work which is not directly related to writing, such as organising external checks; just when you think you have finished writing, you will often need several weeks more to complete the manuscript; b) with reading and writing books, under-estimating the level of complexity of the exercises, and not planning the development properly.

### **Writing and illustration work progress in tandem**

**If you do not have good editorial back-up, this phase will be a busy one**

#### ***Group and Individual Inputs***

You have drawn up your time-frame for the writing phase, and now you can go on to define how you intend to meet the deadlines you have set, defining the interaction of group and individual inputs.

While nobody would question the value of group work, some of you may ask when and how texts should be written by the group as a whole.

You can answer this question by identifying the type of writing demanded by the situation. Here are three possible options, which we have used in the past: analyse them, and decide which one best meets your needs.

#### **Group Writing**

Each text is written jointly; the authors formulate the text aloud in the group and then modify it, until they can agree on a version which is written down and considered definitive by everyone in the group.

This procedure has the advantage of preventing individuals from getting caught up in errors and allowing everyone to identify with the final version. On the other hand it may provoke tensions in the group, if you do not listen to those who are not good at formulating their ideas verbally, or who cannot defend them well.

Sometimes group writing will appear unavoidable. When, for instance, you are defining key words and writing key sentences for a first reading book the text is subject to such strict limitations that it is difficult to work individually. In our experience group work, where texts are formulated aloud, provides the best forum for applying pre-defined criteria to the words and texts to be developed.

If you are in this situation, have a look at Table 25, which outlines the criteria to observe when developing texts for a reading book. Read these and adapt them to your own particular situation.

texts for a reading book. Read these and adapt them to your own particular situation.

### Individual Writing and Correction

Here, the texts are written by individuals, revised at individual level and then, perhaps commented on by the group.

#### Individual writing can jeopardise the uniformity of the texts

24. Work for which authors are responsible		
To allow you to gauge the scope of the work for which authors are often responsible during this phase, we list below the tasks from the previous table which fell to the authors of <i>Garabola</i> . We have made a distinction between the work they had to perform themselves and the tasks they only had to organise or supervise.		
No.	Task	Organisation and Supervision
1	Overall plan of texts and artwork	
2	Devising and writing reading texts	
3	Internal revision of reading texts	
4		Preparation of illustrations for reading texts
5	Correcting sketches	
6	Devising and developing writing exercises	
7	Internal revision of exercises	



8		Preparation of illustrations for exercises
9	Correcting sketches	
10		Revision of entire manuscript by externals
11	Writing general information pages	
12	Final changes to the manuscript	
13		Preparation of a typewritten copy of the manuscript and production of hand-crafted mock-up
14	Drawing up specifications for textbook	
15	Organisation and moderation of official revision session	

This approach is often favoured by authors who are not used to working as part of a team, who see it as a fair compromise between the individual work they are accustomed to and the inevitable group work.

It does, however, have many disadvantages; the authors, themselves immersed in writing, do not always have the distance and the calm needed to judge the inputs of others fairly, and are reluctant to contradict their colleagues and criticise them. Some texts are thus accepted with reservations and the finished product displays a lack of cohesion and uniformity.

You should only adopt this approach if you have the back-up of a good publisher who has the skill, the distance and the necessary authority to suggest the necessary changes.

### **Individual Writing and Group Revision**

This approach involves every team member tackling the same text at the same time and handing it in without having time to perfect it; the individual inputs are then put up on the board and the group agrees on one text, or at least on a general direction, a basic text which can then be reworked to a greater or lesser degree.

or at least on a general direction, a basic text which can then be reworked to a greater or lesser degree.

<b>25. Identification of Key Words in the Group</b>	
In reading books graphemes are generally systematically introduced with the help of certain words known as "key words". Team work is needed to identify these words. It is the best way to harmonise criteria as demanding as those listed below. <sup>3</sup>	
<b>Productivity and interest for pupils</b>	
	The key words must trigger a strong emotive response in the pupil. If the basic vocabulary of the pupil has been studied, you should refer to the results of this study and select the most frequently occurring words.
<b>Pedagogical and didactic considerations</b>	
	Key words must reinforce the new element which the pupil is to learn in the course of the lesson. If it is a consonant, it should be at the start of the word, or at least at the start of the syllable.
<b>Simplicity of syllable structure</b>	
	Wherever possible, you should select key words made up of V (vowel) syllables or CV (consonant–vowel) syllables; try to avoid CVC syllables, which would be an obstacle later when you come to splitting words into their component syllables.
<b>Control of new elements</b>	
	The new element which is the object of the lesson should, if possible, be the only unknown element in the key word; you should thus avoid choosing key words with more than one consonant or vowel elements which has not already been presented systematically.
<b>Grammatical category</b>	

Most key words should be nouns.

For semantic and graphical reasons, only a few verbs (verbs of movement for instance) would be suitable. Adjectives of colour should be used with caution: you must be aware of the type of printing that will be used, not only for the pilot version, but also for the revised version. Avoid adjectives of colour if the textbook is to be printed in monochrome.

#### **Degree of visualisation**

Nouns that cannot be illustrated should be discarded. Then, of the nouns that can only be presented visually in a moderately satisfactory way, only the indispensable ones should be retained. Bear in mind that liquids in general are difficult to illustrate, and can lead to interpretation difficulties when you are dealing with young readers who have had little contact with printed materials.

#### **Unequivocal correlation between key word and its illustration**

The relation between the word and the illustration should be unequivocal if possible. In our experience images of people are difficult in this way, so key words such as "people", "man", "woman", "girl" "boy" etc. should be avoided, since the images are subject to more than one interpretation.

This procedure has several advantages. Firstly, the short time allowed for writing prevents each individual from identifying too closely with his own text. Secondly the fact of putting up all the inputs prevents new authors being so awe-stuck by the process of intellectual production that they are paralysed: the writing work unfolds step by step before their eyes in a certain anonymity, which robs it of its mystery. Finally the revision phase, which is often much more extensive than the writing phase, allows all group members to contribute to the final version and identify with it.

We should, however, point out one major disadvantage: if the authors want to retain a high quality they must identify the best texts irrespective of the originator, and the text, once selected, must be re-worked for as long as necessary, while taking care not to jeopardise the group dynamics. This is only possible if the group is made up of individuals who are not only of a high professional calibre, but who are also intellectually honest and extremely patient. In our experience all the charisma of an internal group leader is needed if the work is to run harmoniously over a longer period.

### ***Working Language***

If you are writing textbooks in a national language, it is conceivable that some members of your team may not speak this language. You will then have to agree on a common working language; this situation, common in projects which have received external technical or financial assistance is certainly not ideal, but it is sometimes unavoidable.

If, on the other hand, all the members of your group speak the national language in question, and this is accepted as the working language, other problems may arise to which you should be receptive. If the language in question does not have a long written tradition, it will often lack the technical terms you need, or these terms will not be precisely defined, lacking the background information which surrounds these terms in languages with a long written tradition. A certain laxity can result, which will prevent the national language from being an effective tool, consistent, diversified and precise.

Thus, if you are dealing with a teaching syllabus, will the language provide you with one word for "goal" and another for "finality"? Would you know how to say "sequence of numbers", "set of numbers", or "double-entry table", all terms which will be vital for first-grade maths? How can you express "key word", "word card" "word table" or "minimal pairs" so important for the development of reading materials?

#### **Agree on the language of communication Identify key words together**

If your work is too often interrupted by terminological considerations, you should analyse this handicap, and take appropriate steps, to allow you to complete your work. You can systematically record neologisms and put them on the board to force yourselves to use them; or draw up a definition of terms which you keep stumbling over. You can include these definitions in a glossary at the back of the teachers' guide.

#### **Write directly in the national language to follow the logic of the language**

### ***Language of Writing***

If you are producing a textbook in a language with no written tradition, it is common for only a few team members to be able to write it fluently. In this case, you should agree which language the inputs should be written in before you start to write.

This question is particularly relevant for texts which do not address the children, the technical presentation of the book for instance, and later for the teachers' guide. In the groups we have observed, we have noted two possible approaches to writing texts.

### **Translation**

The inputs are written in the European language common to the entire group, and then translated into the national language in question.

The advantages of this approach are clear: a highly specialised pedagogue can, for instance, write a text on learning to read in English, French or Spanish, which can then be translated into the national language by a colleague who is less well versed in the theory.

It is a procedure with a two-fold risk, however. Firstly, some authors, finding themselves downgraded to resource persons and translators may lose their motivation and give up on the group little by little. Secondly, internal leaders may emerge and introduce a vertical element within the group which will further limit the opportunity for dialogue.

### **Step by Step Writing in the National Language**

In this case, the texts are written step by step, as follows:

- common development of the criteria to be observed (in the European language)
- corresponding texts written (in the national language)
- verification firstly orally and then with the help of translation of certain passages into the European language, to check for congruence, followed by any corrections needed.

- verification firstly orally and then with the help of translation of certain passages into the European language, to check for congruence, followed by any corrections needed.

This approach too is less than perfect; in particular, if we take up the same example, the pedagogue is not always able to judge precisely whether or not his instructions concerning reading have been fully understood and correctly translated.

Yet, it is often more effective than translation. Firstly, it allows those in charge of writing texts in the national language to re-formulate technical information in their own language; they can move away from the initial wording and organise the information appropriately, following a chain of argument which will be better understood by readers, and especially by teachers<sup>4</sup> – the local writers are in a much better position to judge this than the external specialist.

This formula also allows all those concerned to see themselves as fully fledged authors and thus to identify with the product which really is the result of a joint effort.

### **3. Texts Addressing Pupils**

You have now organised writing and defined your framework. Your next objective is to produce a manuscript for all the reading texts, that has been revised by the group of authors.

To achieve this as methodically as possible, we suggest you take a step-by-step approach, as described below.

#### ***Criteria***

Whatever the discipline and the grade, you must always base your pupils' texts on precise criteria. Do not simply agree that these texts should be dictated primarily by pedagogical and didactic considerations; take it

upon yourself to conduct as exhaustive a study as possible and to draw up precise criteria.

To take stock of what your work at this level can involve, examine the list of criteria drawn up for reading texts in national languages, presented in Table 26. The list is long, but it is by no means exhaustive and may not be suitable for your particular situation.

### ***Topics***

You have identified the main features of the texts to be produced. To be one hundred percent operational, you must now draw up a list of the topics to be tackled.

In our experience, in primary school textbooks projects authors often start by producing a first reading book, in which the topics are defined by key words; this first book thus automatically reflects the everyday world of the pupils. In the textbooks for the following grades, these topics are repeated, for various reasons. Firstly the authors often see the texts as a way of achieving pre-defined language targets, primarily as a good basis for grammar and vocabulary exercises, and do not thus attach a great deal of importance to the selection of the topics. When national-language books are produced, the authors do not always manage to satisfy the contradictory demands of authenticity (as seen in the selection of topics related to the socio-cultural environment of the child) and openness to the outside world. They often opt for the endogenous to the detriment of the exogenous, and stay within the limits of the first book. Finally, most of them quite simply find it difficult to break out of the traditional topic framework of reading books for the primary level.

Two observations should, however, be made: in groups of authors, the selection of topics is rarely the result of systematic considerations, and the difficulty of the selection process is almost always underestimated. We again suggest a step-by-step procedure when you begin to select topics for the higher classes at primary level.

### **Select topics for reading books on the basis of precise criteria**

#### **Official Instructions**

First of all check how the curriculum defines the role of the school within society, and see if detailed topics are

First of all check how the curriculum defines the role of the school within society, and see if detailed topics are listed as is often the case. If this applies to you, check whether you are bound to remain within the official framework and tackle a certain number of topics.

### **Type of “reading book”**

At this stage you must decide what sort of reading book you want to produce. It may address solely native speakers learning their own language, in which case the aim will be to improve their reading skills, which will give you a lot of leeway to choose topics. However, when pupils have only a reading book and a maths book, you should consider whether a simple compilation of reading material is really the best option. You may choose to add texts which will introduce children to common scientific, historical and geographical knowledge for instance. This is a fundamental decision, which is bound to have repercussions on the choice of topics and on the curriculum.

### **Social Options**

The topics broached in a primary-level textbook will help form the adults that the pupils very soon become, especially those individuals who will read few other books in the course of their lives. It is up to you to organise an in-depth discussion to define the factors which you believe should be given priority, where the curriculum is vague.

### **Openness to Innovation**

Finally, bear in mind that it is difficult for authors of primary-level textbooks to find resource material: try not to fall back on your own experience and on the past. Read and re-read as much as you can, from legends to adventure stories, from extension manuals to foreign books, from cartoons to the best books written for children world-wide, to put you in a position to innovate as regards the content matter. Textbooks for the upper classes of primary level will always demand a lot of preparatory work here.

### ***Development of a Model Unit***



To sum up, you have laid down the approach you intend to take, drawn up a list of criteria and identified the topics for your reading texts. You can now start writing the texts.

<b>26. Criteria for Writing a First Reading Book in a National Language<sup>5</sup></b>	
<b>Texts corresponding to the general attainment target</b>	
	Texts must firstly be in line with the general targets set for reading in the grade in question. Thus, if the pupils are to learn to read and understand the literal sense of short, explicit messages, you should not produce texts that the pupil must complete to understand the meaning.
<b>Texts corresponding to the specific attainment target of the lesson</b>	
	Whenever the lesson has a specific reading target, the texts must meet these specific demands; thus if a new element is to be introduced, such as an upper case letter, the texts must allow for the systematic introduction of this element.
<b>Controlled use of words</b>	
	The words used must be in line with learning needs, i.e. a minimum of new words should be used at the start, and they should be repeated a number of times to imprint them on the memory of the pupil. <sup>6</sup> Elements which the pupil has not yet learned systematically should not be used. <sup>7</sup>
<b>Readability of words</b>	
	The words should not exceed the maximum linguistic readability for pupils; in languages used world-wide the authors can refer to research conducted since the 1940s. In most national languages, special features will determine the readability of words. <sup>8</sup>
<b>Readability of sentences</b>	
	The sentences too should not exceed a maximum level of readability: they should be short and have a simple morphological and syntactic structure. Here too you may find research done for world languages helpful, but in many national languages, the readability of sentences will depend on other criteria. Thus short sentences, used at the beginning of the learning procedure must make for maximum readability without being artificial or excessively simplified. A tall order for

	<p>more languages spoken, but in many national languages, the readability of sentences will depend on other criteria. Thus short sentences, used at the beginning of the learning procedure must make for maximum readability without being artificial or excessively simplified – a tall order for languages with a primarily oral tradition, which are not easy to dissect in this way.</p>
<p><b>Readability of texts</b></p>	
	<p>The texts must be clearly structured, with an introduction, however short, and an unambiguous conclusion; within the text the sentences should follow on one from another. If necessary the text will be divided into paragraphs, which will also follow on logically. Punctuation marks, which underline the structure of the text should be introduced gradually and with discretion.</p>
<p><b>Functional texts for teachers</b></p>	
	<p>Texts should be structured to make them easy to read in class. Thus, if a text is to be read at two sessions, it should be written accordingly, i.e. in two main sections, not counting the introduction and the conclusion.</p>
<p><b>Degree of visualisation</b></p>	
	<p>The words, sentences and texts must be selected to provide an appropriate degree of visual back-up so as to form a whole which meets both pedagogical and aesthetic demands.</p>
<p><b>Familiarity to pupils</b></p>	
	<p>The topics dealt with should be at least known to the pupil. In a first reading book, they will be dictated by the choice of key words and should preferably be taken from the pupils' immediate environment. Subsequent reading books should expand their scope gradually to take in the region, the nation and then other countries.</p>
<p><b>Variety of topics</b></p>	
	<p>The topics selected must be varied enough to hold the attention of pupils. This is a difficult criteria to meet in an entire series: authors frequently repeat themselves, with the</p>

result that the same topics are presented with increasing levels of difficulty in a spiral from the first to the last book in the series.

### **Idyllic past and glorified future**

The texts should reflect today's world, which is often a world in transition. They should avoid any nostalgic descriptions of times gone by – which were rarely idyllic – and should equally avoid glamorising a modern world which is likely to be unknown to the majority of pupils.

### **Games aspect and topics liable to provoke conflict**

The texts should firstly look at the universe of the child. It should focus on the happy side of childhood, but should not completely eclipse conflicts and the negative side – conflicts, problems and fears of childhood should be mentioned.

### **Respecting the environment**

Religious and political topics should only be broached with great care and social taboos should never be mentioned.

### **Texts for children and grown-ups**

The texts should be worthy of the child and the grown-up he will very soon become, because for many children in developing countries, given the rate of absenteeism, it is true to say that adult life begins after one or two years of schooling. In the books, anecdotes, recitations and games should thus alternate from an early stage with recipes and user's instructions, a literary genre with which they are most likely to come into contact in adult life<sup>9</sup>.

### **New fields of use**

The texts should pay enough attention to the traditional role of the national language (poems, legends, descriptions of daily life, etc.) but should also look at roles more often played by European languages (slogans, puzzles, recipes, posters, invitations, etc.). In other words the national language should emerge from the domestic ghetto to which it is often confined and should be upgraded by bringing it into the domain of modern life, traditionally the realm of the former colonial languages.

In other words the national language should emerge from the domestic grade to which it is then confined and should be upgraded by bringing it into the domain of modern life, traditionally the realm of the former colonial language.

Initially stick to the first unit, which will be a sort of test ground for you, and adopt a three-step procedure: refer to the basic structure and work out approximately where the texts and illustrations will be; write the texts in question and decide on the contents of the illustrations; prepare the text with the size of characters required for the level in question, which will allow you to see the average length of texts in the book, and prepare a sketch for the illustrations.

We would advise you to tailor your procedure to the subject and the grade concerned. Thus, if you are responsible for producing a series of books for pupils learning their native language at primary level, you should distinguish between the two types of book described in more detail below.

### **First Reading Book**

Given the primordial importance of the picture, which will take up a large part of the page and form a bridge between real-life and the new technology of reading, it is often preferable to work manually. You should thus draw up test pages in the correct format, and then write very short texts yourself, and make a rudimentary sketch of the illustration to accompany the text.

In view of the fact that this parallel approach to text and image often leaves a lot to be desired we have reproduced opposite the steps involved in the birth of one page of *Garabola*.

### **Books for Other Grades**

When the texts are more dense, it is more difficult to assess the length. If you are working on a book for a higher grade, submit the first unit to the publishing unit, which should typeset it in line with your instructions. You can then re-work the text to ensure that it is of the right length, and make a sketch of the drawings planned.

Bear in mind that whatever the level involved, the texts and illustrations should always be developed together, following the basic structure.

### ***Development of the Other Units***

Taking your lead from this first unit and your basic structure you will now be able to write the texts for the other units without any major difficulties.

**Revise your textbook, bearing in mind the needs and possibilities of users**  
**Keep a careful record of your reading texts**

We recommend that you compile the following, day by day.

### **Text File**

The texts selected by the group should be filed carefully, in a box file, for instance, and each of them accompanied by a sketch, however rough, of the scenes or items planned; a sketch is always better than instructions alone.

### **Logbook**

We also recommend that you continue to keep the logbook you started during the conceptual phase. Document your work; in particular keep a record of the instructions you plan for the teachers' guide, which you will otherwise forget before you come to produce this guide.

### ***Internal Revision and Changes***

The concentration needed during the writing phase is such that it is generally impossible to stand back from the texts and check their quality thoroughly. You should thus wait until all the pupils' texts are finished before conducting a series of internal controls.

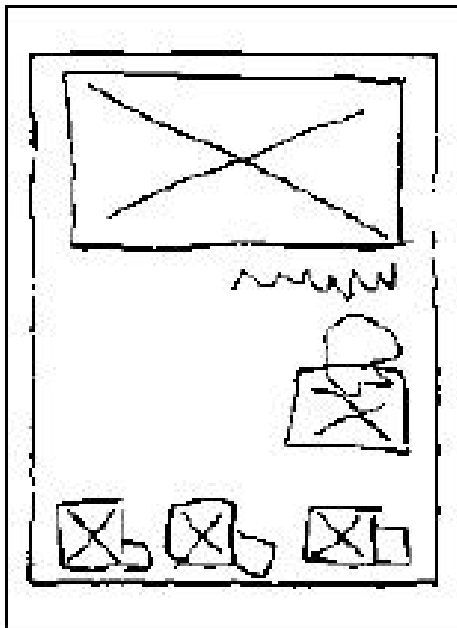

1. Conceptual phase – the contents and the form  
Contents are defined and a mock-up of the page completed.

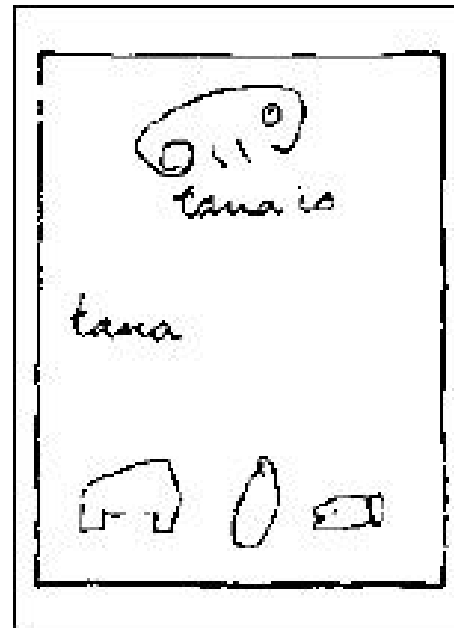

2. A text-image unit is created and the text written  
Texts and sketches of illustrations completed.

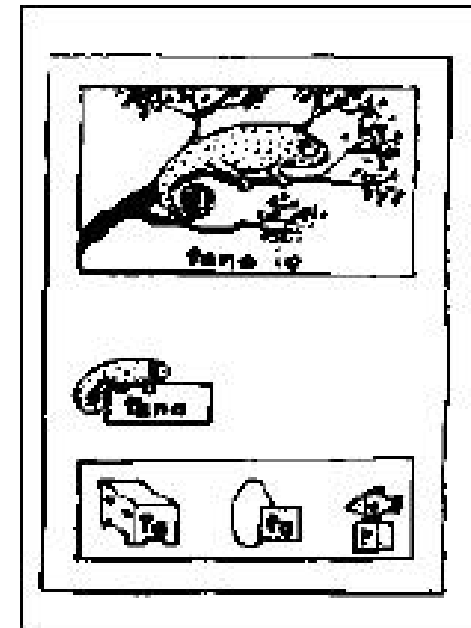

3. Layout and illustration  
Text typeset, layout finalised and illustrations done in ink.

Remember, you cannot postpone this work; it must be completed before the other external revisers start their work. We would suggest that you examine the following aspects in particular.

### Legal Aspects

Many of you will be well informed about the rights of reproduction and know that it is strictly prohibited to reproduce texts or illustrations without authorisation<sup>10</sup>.

Although authors do not generally infringe copyright, they may have absorbed existing texts to such a degree that they reproduce them, as they are, changing only details. Even if they are not aware of this, they will be

guilty of plagiarising. Check that this has not happened with your manuscript: copyright infringement can result in expensive legal action and plagiarism is not the best advertisement for a group of authors.

This point, which is scrupulously observed in industrialised countries, is often ignored in developing countries. We have seen groups of authors, who did not pay attention to this point being tripped up by harsh reality at a later stage. To ensure that what is often nothing more than ignorance does not become a time-bomb ticking away under your work, find out about the basic principles of reserved rights; the books listed at the end of the chapter may be useful.

### **Do not copy or plagiarise**

#### **Social Options**

You should also review the social options which you will automatically have selected as you wrote. Analyse the roles which you have attributed to the various protagonists: look at the number of times each of them appears in the texts and sketches, look at the occupations of mothers and fathers, of girls and boys, etc.

Then take a hard look at the social image reflected by the textbook: analyse the role of institutions, first and foremost the school, look at the angle you have taken on authority, be it parents, teachers or village elders; and look again at the way you have responded to certain crucial topics of today, the most important being the protection of the environment.

If you now, in retrospect, see serious imbalances or omissions in the texts, correct them – you still have time. You can either modify them or change graphic elements, which will sometimes be enough to redress the balance of the text-image unit. If, for instance, you wish to upgrade the role of women, and you note that there are fewer women than men in your textbook, you can redress this balance by making women figure more often in illustrations. Be careful in your choice of setting for these illustrations though. If you wish to upgrade the status of women do not show them performing only menial work.

#### **Linguistic Checks**

If you are producing a first reading book, you should pay particular importance to linguistic checks. First of all, count the words used in the book, and then look at the average length of these words, classifying them by

If you are producing a first reading book, you should pay particular importance to linguistic checks. First of all, count the words used in the book, and then look at the average length of these words, classifying them by number of syllables. List the words used only once and try to limit these. Look at the intervals at which words are repeated, etc. If you are producing a textbook for upper grades look again at the linguistic readability which you considered in advance, and see if you have respected your own criteria.

If, on the other hand, you are producing a book in a language with no written tradition, you should run specialised linguistic checks, for which it may be difficult to find back-up literature.

Given the importance and the complexity of the subject, we will take the liberty of dwelling on it a little in the table on the following page.

#### **4. Exercises**

The first version of the reading texts has now been completed. If your time schedule permits, you can put these on hold and concentrate on the rest of the book. If you are working under time pressure, as will often be the case, however, you should first finalise the artwork, adopting the procedure laid out earlier, so as to ensure that the illustration work can run parallel to your work on the exercises.

Writing exercises, unlike copying or traditional “fill-in-the-gap” exercises demand special skills. Since there is little specialised training available in this field, authors with the skills required to design good exercises are equally extremely rare ... and those who appreciate the degree of difficulty of this work are even rarer.

We see the results of this shortcoming everywhere: in some European textbooks the objective of the exercises is anything but clear, the mechanism used is sometimes overly complicated, the games aspect is often poorly represented and even errors are not unheard of<sup>11</sup>; textbooks produced in developing countries often dedicate a limited space to exercises, and reflect a certain disarray on the part of the authors.



We can only repeat that it is extremely difficult to design good exercises, much more difficult than to write texts for reading. The approach we suggest here will certainly not solve all your problems, but we hope that it will allow you to avoid the worst pitfalls and errors.

**Choose an easily understood mechanism and an appropriate form of presentation for your exercises**

***Drawing Up a List of Criteria***

As is the case with texts, you should never start designing exercises without first drawing up a list of criteria, which should be as precise as possible. The quality of the exercises in your books will depend firstly on the quality of these criteria. You should thus approach this first step with the rigour and the meticulousness it deserves.

Some criteria are general in nature, and can be applied to any subject and any grade: the exercises for instance must always reflect a clearly defined attainment target. Others, however, will be determined by the particular nature of the material you produce. If you have decided to present exercises in the textbook and have rejected the idea of producing expendable materials such as separate exercise books or cards, one criteria of your exercises will refer to the mechanism: you must reject out of hand all exercises requiring the children to stick things in, fill in gaps, join up, colour in or circle anything – a criteria which sometimes causes authors in developing countries enormous headaches as you will appreciate in the course of your work.

We look in more detail below at the general criteria that should be taken into account for primary-level textbooks in developing countries; as you will realise the list is by no means exhaustive and not all points will be relevant in every set of circumstances.

Examine them, adapt them as well as possible to suit the cultural, linguistic, pedagogical and didactic features which you must respect in your textbook, and supplement them as necessary.

<b>27. Linguistic Checklist for a Manuscript in a National Language</b>
---

In view of the fact that textbooks venture out into the world beyond the school yard, they can be
---

	<p>In view of the fact that textbooks venture out into the world beyond the school yard, they can be deemed to play a primordial role in the normalisation and standardisation of national languages. The authors must thus help create a coherent, homogeneous and dynamic linguistic environment.</p> <p>Some of you will be able to consult a language planning institute or the linguistics faculty of a university<sup>12</sup> while others will have to solve the problems they encounter alone. In either case you should pay particular attention to the following aspects.</p>
<p><b>Spelling</b></p>	
	<p>Without a solid spelling system there can be no proper readability: the human eye which can easily memorise the contours of words stumbles over words written in diverse fashions with no rhyme or reason, and the reader is unsettled, particularly if he is only a beginner. It is thus important to read and re-read your manuscript, and to have it read by others to ensure uniformity. You will always come up against awkward cases, which cannot be solved with the help of your reference tools (at best a dictionary and a grammar book) alone. Ensure that the two following aspects at least are standardised:</p>
	<p><b>Separation</b>  Check the criteria for separating elements, particularly in nouns and composite verbs, and ensure that you have used hyphens and apostrophes consistently throughout. If you intend using justified type, in columns, decide at this stage what criteria are to be applied to hyphenation and ensure that these are strictly applied.</p>
	<p><b>Borrowed words</b>  National languages always borrow words from the European language with which they come into contact. In general, there is no homogeneous rule for writing these words: uncertainty rules as to whether to take the original spelling or whether to adapt it more or less to fit the phonology and spelling system of the national language. Although it is not your profession to establish spelling standards, it is up to you to make the language first and foremost a valuable learning medium, by observing strict and consistent rules regarding the form of borrowed words, verifying that these</p>

are in line with official norms where any exist and that these forms are acceptable to the users of the national language, in particular to teachers.

### **Inventing Words**

National languages almost always have a vocabulary that is too limited to meet all cultural and technical requirements. You may thus be forced to invent some words, either resorting to borrowing the term from the former colonial language and adapting it, or neologising, i.e. creating a new term from the roots of the national language itself.

Although the process of creating technical terms is considered obligatory, positive and quite normal in strong languages, it often appears artificial in national languages. The readability of texts, particularly those which describe modern technologies (user's manuals, recipes, etc.) may suffer two weaknesses: newly created words may appear clumsy, and may not be accepted immediately by the reader, or the texts may be too liberally scattered with new, unfamiliar words. It is a good idea then to make a list of these words, to check that they do not already exist in another form, to check that they are correct by circulating the manuscript to have it read and to limit the number of these words used.

### **Official Language and Variants**

Most national languages exist in regional and local variations alongside the one variant that is recognised as more or less official. This situation has repercussions on textbooks since authors are torn between the need to normalise and standardise the language, which means making linguistic choices which will be binding for all users, and the needs of users who may reject the book if they cannot identify sufficiently with the language used.

This is an extremely delicate issue and we can only urge you to be vigilant; list words of limited usage, ask the people who re-read your manuscript for their opinion and be sensitive to the positive and negative feed-back.

### **Punctuation**

Punctuation is a relatively recent development, it is true, but it is now an integral part of written language. What we often forget, however, is that each language has its own punctuation rules. Few national languages have their own punctuation rules with the frequent result that authors

language. What we often forget, however, is that each language has its own punctuation rules. Few national languages have their own punctuation rules with the frequent result that authors apply the code of the former colonial language which they themselves learned at school; they only realise this at a later date when the punctuation rules that they know and that are appropriate for the European language in question causes dissonance in the national language. Before punctuation rules can be formulated in-depth linguistic studies are needed, which cannot be the task of textbook authors.

Once again, we can only urge you to be vigilant: firstly do not create rules which are unnecessarily at odds with those of the second language which the children will have to learn later; secondly bear in mind the fact that it is easier to create rules of usage than to modify them later, and thirdly beware of any uses which create vague feelings of unease; solve the problems as best you can and then apply the punctuation you have created uniformly since textbooks are a powerful force in standardising a language.

### **Spoken and Written Languages**

National languages tend to be primarily spoken languages. You should complete your linguistic checks by analysing the level of language of your manuscript. See in particular whether the circular logic which is characteristic of oral discourse has been satisfactorily replaced by the linear logic common to written language.

Once again, there is no simple solution, and no standard advice except to keep your ears and eyes open to the reactions of the individuals outside your group who re-read your manuscript.

### ***Attainment Sub-Targets***

The first criteria of an exercise is that it correspond to a precise attainment target. Even if you identified learning steps during the conceptual stage, you will now see that these are too vague to be directly translated into exercises.

To allow you to work properly, you will thus need to break down the general attainment target into a number of sub-targets. To this end you will bring together the basic structure, which stipulates how many exercises are planned per unit, and the sub-targets, which you should list by priority, thus ensuring that the most important

are tackled in the exercises.

Let us look at one example, to give you an idea of the practical significance of this recommendation. Let us assume that the general learning objective for writing has been defined in the following terms. "The pupil should be able to copy short texts legibly and correctly from a model in joined-up writing, and should understand the meaning." You should firstly identify the sub-targets regarding handwriting and those concerning written expression. For handwriting, you could identify the following sub-targets:

- Produce the round part of letters such as **a** or **g** with an anti-clockwise movement;
- Produce the ascenders in letters such as **b** or **h** and the descenders in **g** or **p** on the correct scale;
- Join up the letters within a word correctly
- Leave the space required between words and so on.

Having listed the sub-targets you should decide which ones are indispensable, and list those which could be considered part of the basic structure.

Identify the sub-targets for written comprehension in the same way.

### ***Mechanisms and Presentation***

The results of the last step should now allow you to begin devising the exercises. But, you may well ask, where do I start?

Your first task should be to identify a general direction for the first attainment sub-targets. If you already have some experience in this field you will be able to sketch these out fairly rapidly, and these will become exercises little by little. If, on the other hand, you are new to this work, and feel quite out of your depth we suggest that you look at the sort of exercises printed in recent textbooks. But be careful – you must not under any circumstances copy these exercises. Take them as a starting point by all means, add to them, change

suggest that you look at the sort of exercises printed in recent textbooks. But be careful – you must not under any circumstances copy these exercises. Take them as a starting point by all means, add to them, change them, make them more detailed, so that they fit the bill for your specific situation and the language you are working in.

In either case though, do not simply accept the first mechanism that comes to you. Try to improve on this and keep all your drafts. They may be useful later, especially when you do the layout.

### ***Devising Model Exercises***

The activities outlined above should allow you to go on to devise the exercises for your first unit, which will give you a frame of reference for the rest of the book.

As you saw when you came to write the texts, you should adopt a three-step approach here. Firstly check how much space has been allowed for each exercise in the basic structure. Secondly look at your draft exercises and select those which best correspond to the principal criteria we looked at earlier. Thirdly either prepare sample pages in the same format as the book, or give the exercises to the publishing unit and let it do this where the exercises are longer. Sketch in the illustrations. Either way, this first unit will allow you to judge the average length of the exercises.

**Step by step with the help of sketches, drafts and numerous new starts the exercises will begin to take shape**

**An exercise must meet a number of primarily pedagogical and didactic criteria**

**The exercises must also meet certain aesthetic criteria**

## **28. Criteria for Developing Writing Exercises**

<b>Exercises must correspond to a detailed attainment target</b>	
	This is the starting point for each exercise: every exercise must reflect a specific attainment target. An analysis of school textbooks shows how difficult it is to achieve this. The sole purpose of some exercises appears to be to balance a page aesthetically. Frequently they do not properly reflect the target set, and sometimes they tacitly reflect other targets.
<b>Coherent sequence</b>	
	Exercises must follow on, one from the other, in a logical sequence to allow a logical progression of new elements to be learned.
<b>Adaptation to working conditions</b>	
	The exercises must be in line with the working conditions found during the preliminary investigations, in particular as regards the time-table followed by the majority of the pupils, the average class size and the instruments available in most schools.
<b>Ensuring optimum impact</b>	
	Exercises should illustrate the phenomenon to be taught in an optimum way; it is thus important to identify not only the subject matter, but also the mechanism and the presentation best suited to enable pupils to achieve the target.
<b>Mechanism that is easily understood by the teacher</b>	
	The mechanism of the exercise should be immediately accessible to the teacher; explanations and information should not be needed to inform the teacher in detail about the mechanism, but merely to confirm what he has instinctively understood. This means that innovation must be kept within limits. If a book involves too many innovations there is a chance that teachers will not understand the exercise and will thus reject it, or that they will misunderstand it and use it incorrectly. <sup>13</sup>
<b>Mechanism that pupils can follow</b>	
	The exercises must be in line with the level of maturity and knowledge of the pupils: thus

	<p>The exercises must be in line with the level of maturity and knowledge of the pupils; thus exercises that are too easy or too complex must be rejected, as must those that would require too many explanations on the part of the teacher. Appropriate exercise types should be identified and repeated several times, perhaps with slight variations to avoid pupils wasting too much time and energy understanding the mechanism.</p>
<b>Games aspect</b>	
	<p>The exercises must meet the demands of the subject matter in question, and be tailored to the target group; if the latter is made up of young children, they will learn more rapidly and easily if the exercises have the appearance of a game.</p>
<b>Harmony of exercise–image entity</b>	
	<p>The presentation of the exercises and any illustrations must form a harmonious whole with the content matter; the form must not only meet aesthetic requirements, but should also help pupils to understand the contents and/or the mechanism of the exercise.</p>
<b>Harmony of the double page</b>	
	<p>Not only must the exercises follow a logical sequence, they must be placed in a harmonious fashion on each double page.</p> <p>For young pupils, for instance, care should be taken that the exercises which comprise only text alternate with text illustrations to make the pages “airy” enough.</p>
<b>Professional aspect</b>	
	<p>The presentation of exercises will implicitly convince readers of the professionalism of the team of authors. Sometimes we forget that certain graphic aspects of the book, including the presentation of exercises can be decisive for decision–makers who cannot necessarily judge other aspects of the book.</p> <p>Thus exercises that are too “home–made” in appearance should be abandoned and replaced</p>



with more sophisticated presentations.

<b>nd</b>	<b>nt</b>
a . . o pa . . a ke . . a te . . . a ma . . a	e . . ana ki . . ana vi . . ana fi . . ana ta . . ana

Example of function exercises

Transparency of mechanism: making and copying words (Tongavola p. 81)



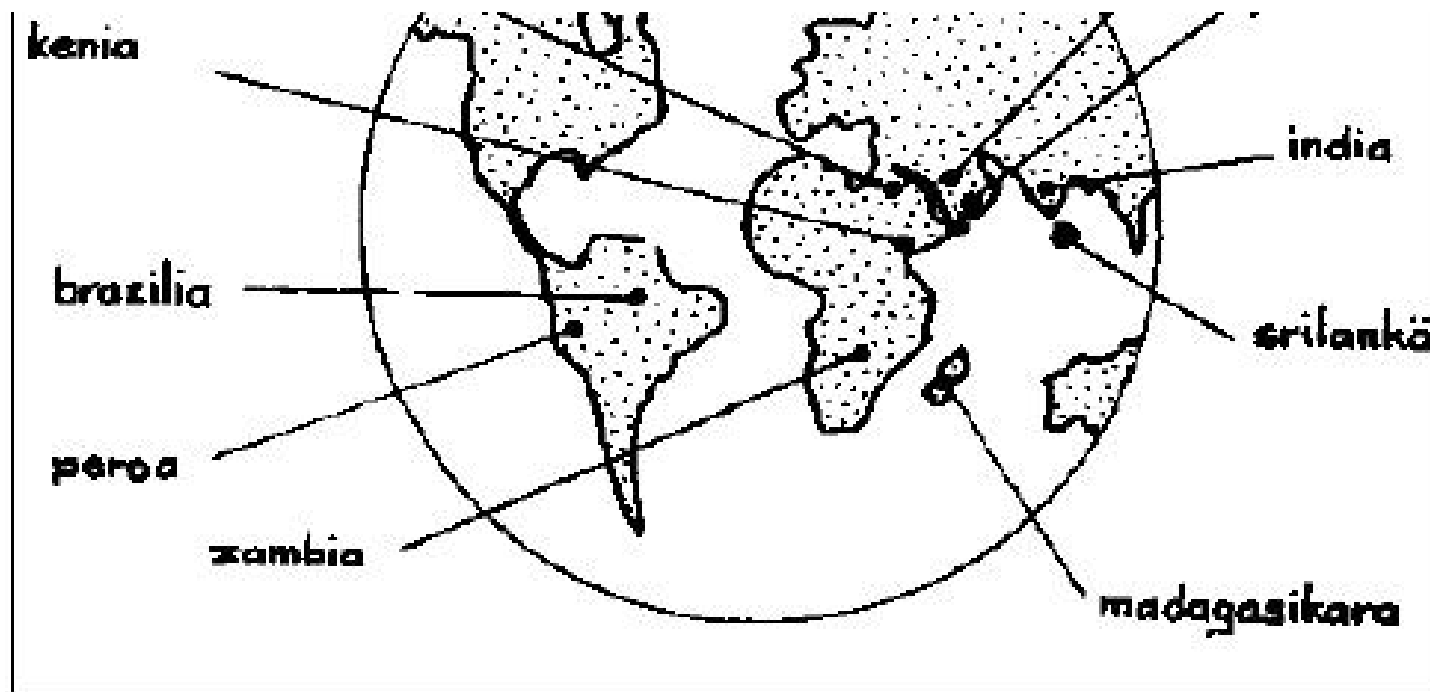

Example of presentation of content matter  
World map to illustrate the use of capitals (Rosovola, p. 78)

As you will have realised, once again the form and the content matter go hand in hand. Take care to select a form which is both functional and aesthetic; the form must allow you to present the mechanism of the exercise visually or to illustrate the content. Here is an example of two exercises where the form is a good illustration of the content matter.

### ***Designing the Other Exercises***

You should be able to design the other exercises without too many difficulties now, although this is not always the case. During this phase, authors often encounter obstacles in terms of the mechanism, the contents or the presentation, which force them to make modifications. Let us assume, for instance, that the planned

mechanism does not allow us to illustrate a phenomenon well: you will change it, of course, but this change may trigger a whole chain of repercussions.

You should not then be unduly surprised if you have to resume your work a hundred and one times before you have a final layout: this is more likely to be a sign of the quality of your work than a reflection of mediocrity.

### ***Internal Checks***

Designing exercises is almost always a long and extremely arduous task. Once you have completed your first version, try to stand back and run a series of internal checks. We suggest that you pay particular attention to the following aspects.

#### **Subject Matter Check**

Check that the exercises do not contain any errors! Force yourself to sit down and do them in their entirety, and if you intend to print the answers in the book or later in the teachers' guide make sure they are correct. These will be the errors that will leap out at every reader later, without their having to go through your product with a fine-tooth comb.

#### **Pedagogical and Didactic Check**

Check and see that the natural progression of learning has been respected; sometimes changes are made with the result that the exercises no longer correspond to the original sequence.

Once you have completed these internal checks, you can submit the manuscript to your external correctors. Prepare the manuscript and identify appropriate proof readers.

#### **Graphic Check**

Start by looking at the length of each exercise one at a time; make sure that the instructions are not longer than the shortest exercise. If necessary lengthen the exercise – three or four words do not count as a proper exercise! Thin out exercises where the sheer length is off-putting.

exercise! Thin out exercises where the sheer length is off-putting.

Ensure that there is a balance between the form and the content matter: modify exercises that take up too much space for a limited subject matter, for instance.

Secondly, look at the harmony of the individual page and the double page. In books for the first few grades, you should pay particular attention to alternating exercises with examples or special presentations (words in a box, or a circle, for instance). You should always ensure a balance between the exercises on facing pages.

**Undertake to excel in all aspects of the exercises, correct them, polish them, re-write them entirely if necessary until you are completely satisfied**

**No three-word exercises and no "essays" of instructions that are twice as long as the exercises**

### **Publishing Considerations**

At this level, you can record in detail the illustrations, writing and layout for the exercises.

Look first at the number, contents and dimensions of text illustrations or other illustrations to be produced by an illustrator. You should also plan the volume of text to be written in cursive style: if you do not have a computer programme which can reproduce italics, some of which are in any case unsatisfactory, and all of which are costly, you will have to have these parts written by hand. In some countries this is the work of professionals.

Finally, you should check the complexity of the presentation of exercises and ensure that the publishing unit can reproduce the layout you have planned.

## **5. External Checks**

You have produced the pages of text for the pupils, i.e. you have written the texts and sketched the illustrations, and you have produced the exercises, i.e. you have written them and decided on the presentation, and you are doubtless impatient to “see” the textbook, with the finished illustrations and the text printed on a word processor.

But let’s not jump the gun. After all the months of working in a vacuum, you no longer have the distance to your product to undertake the final revision, which is so vital. And you have been cut off from the outside world for too long. You can overcome this dual problem, however, by getting experts from outside the group to read your manuscript: this will allow you to check the quality one last time, and to inform the education authorities of the status of your work and start paving the way to ensure that your finished work is well received.

One way to do so is to follow the approach outlined below.

### ***Preparing the Manuscript***

Revise your manuscript once again, check that all your changes have been incorporated and that it can be read profitably and without any major difficulty by individuals without publishing experience. Remember that the unfinished nature of the manuscript may unsettle some readers who will then focus all their attention on shortcomings in terms of the form.

### ***Proof Readers***

Once your manuscript is ready, identify individuals whose skills and authority make them appropriate proof readers. Select proof readers who can make valuable comments now and can help ensure that your book is well received later; the following people would be suitable.

### **Subject Specialists**

Good specialists in the subject in question, from universities or the ministry will be able to give a well-founded assessment of your work, and identify any fundamental errors which other proof readers will probably not notice.

assessment of your work, and identify any fundamental errors which other proof readers will probably not notice.

### **Education Authorities**

Identify the education authorities whose support might be important when the book is introduced in schools and involve them in the production of the book by asking them to make their comments which can still be taken into account if they are pertinent.

### **Animateurs in Rural Areas**

Make a special effort to gain the support of animateurs in the test zone; given their excellent knowledge of the area and their training, they are often best placed to assess whether or not the material is appropriate for the normal teaching and learning conditions. If possible try to reserve several days to re-read the manuscript in their company.

You should also bear in mind that the same animateurs will be responsible for supervising teachers in the test schools during the test phase, and that as such they should be involved in the process of producing a book which they will have to explain and perhaps defend.

### **Teachers**

If you have produced a pilot book, you will plan to run a test in a sample of schools and then evaluate the results of this test phase. It is thus in your own interest to involve the teachers concerned in the production of the materials, by asking them for their opinion of the manuscript. Often it is not so much their comments per se which will be important, but the chance they are given to identify with the materials they will later be expected to use. This identification is crucial for the adoption of the material.

### **Parents**

If you have produced a textbook in a national language, especially if it is a reading book, we recommend that you submit a copy to parents; this will often involve reading them entire passages.

This will have two major advantages for you. Firstly, parents' comments may make for a greater richness and authenticity of the texts<sup>14</sup>, particularly if you have distanced yourself from your native tongue and no longer speak it with total ease. Secondly, these information and sensitisation activities will often assure you of the interest and even the support of parents for your activities.

### **Groups of Children**

It can be very interesting to have the manuscript read informally by children of the same age as the target group for which you have just produced the book. These children may be a source of important information, as regards in particular the complexity of the texts and their interests.

### ***Reading Documents***

To avoid generating too much confusion on the part of the proof readers who are not accustomed to re-reading manuscripts, you must inform them about your work and stipulate exactly what they are expected to do.

If you have time, you should then draw up two documents: specifications, identical for all proof readers which give a short presentation of the contents and the main physical and graphic features of the book, and an individual list of instructions, specifying the points you would like the individual readers to comment on, in the form of either a list of points to be examined carefully, or a series of detailed questions.

### ***Logistics***

If you wish all your efforts to bear fruit you cannot sit back yet. If possible contact your proof readers personally, ensure that they agree to help and define the terms of cooperation, in particular the time they have to read their copy of the manuscript and the date planned for pooling results. Stress that you are interested in constructive criticism rather than unfounded praise.

This phase, which in large publishing companies is the responsibility of the publisher, can mean a great deal

This phase, which in large publishing companies is the responsibility of the publisher, can mean a great deal of extra work for textbook authors in developing countries; sometimes you may have to undertake several trips into the field, organise trips to the main district towns, plan and chair meetings to pool results, etc.<sup>15</sup>. But, given what is at stake, we recommend that you plan and execute this work with the rigour which you have adopted throughout.

### **Think of organising proof readers as a mini-project in its own right**

## **6. Writing the General Information Pages**

After this phase of contact with the outside world you will have to return to your garret to finalise the manuscript.

You still have to write the general information parts, which generally make up the first few pages of the book and those found on the front and back cover. Pay attention to the following aspects.

### ***First Pages***

The first few pages contain the information which we looked at in more detail in the chapter on the concept of the physical and graphic aspects of the textbook.

### **Don't relax once the pupils' texts are finished – you still have to write the general parts of the book**

Write these parts carefully, because they will be a visiting card of sorts for the entire book. These are the parts that will be examined first by all adults interested in your book.



Try to avoid any errors, such as incorrect page numbers in the table of contents, or omissions which will irritate the reader: you should always give the date and place of publishing for instance. And you should exercise great care when you write these texts so that the official information (a foreword signed by the minister for instance) is every bit as convincing as the more technical parts (a presentation of the contents to allow readers to use the book without the teachers' guide if necessary).

And one last recommendation is surely important: do not underestimate the importance of the table of contents. It is not enough to list the units and give the page numbers; give a brief overview of the contents of each unit so that the table of contents is a genuine reference tool for the reader, and, when the layout is performed devote an appropriate length of time to this issue, to find a presentation worthy of your book.

### ***The Cover***

Take care also with the text which will be printed on the cover. The two outside cover pages address the purchaser, so give him the information he needs: print the ministry of education's name on the front cover, or at least the name of the publisher, the title, a description of the contents (e.g. reading book with exercises) and the grade for which it is designed. On the back cover you can, if appropriate list the other books in the series and announce the forthcoming titles. The two pages inside the cover should be left blank if possible. Think of the first as an invitation to the reader to concentrate, and the last as a visual curtain closing on the book, which makes white the most appropriate colour. If you are forced by financial constraints to use these pages, leave as much blank page as possible<sup>16</sup>.

## **7. In Conclusion**

### ***The End of the Writing Phase***

At the end of this phase, nothing is yet definitive. Your manuscript has undergone a first external check, but you can still modify it, add elements and remove others without losing time or entailing any extra costs.

If you need the authorisation of the education authorities to print your book, this is the time to submit the manuscript to them: you can still make any modifications at this stage. Later your choices will be more or less

If you need the authorisation of the education authorities to print your book, this is the time to submit the manuscript to them: you can still make any modifications at this stage. Later your choices will be more or less irreversible and any modifications that can still be made will be long, difficult and costly.

Check the procedures for printing your textbook at the end of this phase, and act accordingly before having the typesetting, layout and illustration work done.

## Notes

<sup>1</sup> In: *Conception et production des manuels scolaires*, op. cit, p. 88 (in inverted commas in original text.)

<sup>2</sup> We look at the illustrations in more detail in the next chapter; whenever the time schedule allows, it is preferable for the illustrator to start work when the precise format and place of the illustrations has been determined. It is up to you to decide whether or not you have time to proceed in this exemplary fashion.

<sup>3</sup> These criteria, which were initially drawn up to help identify key words in Quechua, can certainly be used as a reference for other languages. Cf. Châtry-Komarek, M. *Libros de lectura para niños de lengua vernácula*. Eschborn: GTZ, 1987.

<sup>4</sup> "You argue, and we attempt to convince", as one of the TefBoky authors summed up the difficulties of translating a French text with a linear structure into Malagasy for primary school teachers. Antananarivo, June 1990.

<sup>5</sup> These criteria were systematically applied to the reading books produced for the first two years of primary schools in Madagascar, *Garabola* and *Tongavola*.

<sup>6</sup> Many studies have been conducted on the controlled use of words in reading books for primary level: we would refer you, for instance, to McCullough, C. and Chacko, C. In: "Developing Materials for Instruction, In: Staiger, R.C. (Ed.) *The teaching of reading*. UNESCO/Ginn, Paris: Lexington, 1973.

<sup>7</sup> Here is one example, to demonstrate how important this is. In Malagasy, the negation “tsy” (“not”) does not figure in the first reading book, because it includes the complex grapheme **ts** which is incorporated in the systematic learning programme for the second year. This linguistic restriction proved to be the most irritating when the texts were being written for *Garabola*.

<sup>8</sup> This point is explained in more detail in this chapter in Table 27.

<sup>9</sup> Non-school education must be one of the considerations of authors of textbooks for the lower classes at primary level. See Hummel, C. *School textbooks and lifelong education: an analysis of schoolbooks from three countries*. Hamburg: UNESCO Institute for Education, 1988.

<sup>10</sup> A valuable book to read in this regard is Berthelot, J. *Petit guide a l'intention d'auteurs debutants et de quelques autres*, op. cit. pp. 59–69.

<sup>11</sup> Cf. Huot *Dans la jungle des manuels scolaires*, op. cit. p. 79.

<sup>12</sup> The modernisation of national languages is a long, complex process, which is rarely crowned with success; textbook authors, who may be the first to express an interest in this subject, are sometimes unaware even of the existence of a language planning agency. See also “Textbook writers and language planning”. In Rubins, J. (Ed.) *Language planning processes*. The Hague: Mouton Publishers, 1977.

<sup>13</sup> All innovations must be recognised as such, even where you consider the new methods obvious and incapable of being misunderstood. We will just recount the example of one teacher who was given an exercise book for writing for primary one – something completely new to hear; the letter to be taught was presented in dots to allow pupils to practice by joining up the dots. For several months she taught her pupils to write letters in dots.

<sup>14</sup> Textbook authors are often bilingual, but having undergone their education in a European language they have sometimes lost touch with their native tongue. If this applies to you do try to re-read your manuscript with groups of parents. They are an excellent source of lexical and syntactic information.

<sup>15</sup> When the author is responsible for organising the proofreading phase, this work is almost always a veritable mini project, whatever the type of publication in question. The organisation involved in having this book proof

<sup>15</sup> When the author is responsible for organising the proofreading phase, this work is almost always a veritable mini project, whatever the type of publication in question. The organisation involved in having this book proof read is a case in point; it was extremely time-consuming and took an enormous amount of energy.

<sup>16</sup> For instance print the colophon, indicating the month and year and the authorised supplier.

### ***Suggested Reading***

#### **Readability**

DE LANDSHEERE, G. *Le test de closure*. Paris: Nathan, 1973

FLESH, R. *How to test readability*. New York: Harper and Row, 1942

HENRY, G. *Comment mesurer la lisibilité*. Paris: Nathan, 1975

RICHAUDEAU, F. *Le langage efficace*. Paris: Retz, 1973

#### **Creating Technical Terms**

CALVET, L.J. *La guerre des langues et les politiques linguistiques*. Paris: Payot, 1987

CHATRY-KOMAREK, M. Intentos de codificación del quechua en libros escolares. In:

LOPEZ, L.E. AND MOYA, R. (Ed.) *Pueblos indios, estados y educación*. Lima, 1989

GLAS, A. *Guide de recherche en lexicographie et terminologie*. Paris: ACCT, 1985

RUBIN, J. et al *Language planning processes*. The Hague: Mouton, 1977

UNESCO *L'emploi des langues vernaculaires dans l'enseignement*. Paris, 1953

### ***To Sum Up***

The systematic concept drawn up for the contents and the physical and graphic aspects of the textbook allows the authors to move smoothly into the actual writing phase.

Among the many tasks of textbook authors, this is often the one they feel least apprehensive about, especially if they have been selected on the basis of their writing skills. This confidence is, however, often based on a misapprehension. Although the writing of texts and exercises is important, writing a textbook is not a purely literary pursuit; it must be accompanied by graphic considerations. It is important to deal with the form and the contents of each page together, such that the products of this phase are not merely texts and exercises, but an entity of words and images linked so coherently that we can speak of a "text-image unit".

We feel that three points are important to finish off this work, although the complexity of these tasks is often under-estimated. Firstly, a frame of reference and working conditions are needed which give free reign to the literary and artistic talents of authors. Secondly, certain procedures must become automatic, such as checking the position, length, presentation and accompanying illustrations for each piece written. Thirdly, a systematic approach should be taken to writing the texts and devising exercises, involving the following steps: drawing up a list of criteria, producing a model unit, doing the provisional layout, writing the other texts and exercises, performing an internal check, and identifying a group of external proof readers to re-read the manuscript one last time and make their comments.

At the end of this phase it is absolutely imperative that all authors' corrections be completed. This is why we recommend that all teams who must obtain the authorisation of the education authorities before printing their material submit their work at this stage, so that the latter has a chance of suggesting modifications which the authors can incorporate without entailing additional costs or losing time.





## Preparatory Chain

Until now you have focused on both the development of the contents and the development of the graphic design, which has allowed you to produce the texts and the sketches for accompanying illustrations. At this stage you must put them both into their final form.

In large publishing companies this work would be split among several people: illustrators and photographers would complete the illustrations on the basis of the sketches, or sometimes just on the basis of the author's instructions; then, ideally a graphic artist would decide which typeface should be used for the texts which will be typeset by computer; finally a layout man would produce the layout. All these tasks would be organised and supervised by the Art Director.

In developing countries, the authors themselves generally plan, define and supervise the illustration and layout work. In this chapter you will find a presentation of the work involved, which we hope will be interesting for all of you. You should, however, realise that if you have no training in graphic art, this chapter alone will not enable you to solve all the problems you are bound to encounter.

Try to get some professional back-up, and, whether or not you are successful, make an effort to become familiar with the basic principles of graphic art; read this chapter carefully, consult the books listed at the end and examine the illustrations and layout of recently published textbooks.

**A finished manuscript is still far from being a printed book  
It's an uphill struggle from the manuscript to the imposition scheme**

## 1. Overview

The preparatory chain involves all operations leading from the manuscript to giving the printer the go-ahead. This authorisation is noted on the final set of proofs, the blueprint, indicating that no more changes will be made and thus giving the printer the go-ahead.

This phase is long and complex, much more so than many authors realise, believing as they do that a completed manuscript is more or less a printed book. To give you an idea of the nature, scope and sequence of the tasks involved, we will proceed as always, starting with an overview. Once again we will take the example of the procedure followed in the TefBoky Project, which is laid out in Table 29.

The various tasks we describe here do not differ significantly from those found within large publishers, of course, but some of the steps taken by the project in an attempt to avoid the major pitfalls that beset the production of textbooks in developing countries may be instructive for teams without much publishing experience and for teams only able to ensure sporadic monitoring of the printing work.

<b>29. An Example of the Chain: Garabola</b>
--

<b>Illustration work</b>
--------------------------

### **Illustration work**

The illustration work, which commenced during the writing phase, continued parallel to the layout work. Little by little ink drawing replaced the sketches. The exercises which needed careful placing of text illustrations and text were illustrated once the layout was complete, and the letters, words and sentences to be written in cursive style were added last. Generally the illustration work was never finished until the job envelope is handed over to the printer.

### **Stipulating the final layout**

The format of the book and the basic visual structure had been clear for several months; it was time to decide on the final layout; firstly the stencil was defined, i.e. the precise frame within which the text and illustration blocks were to be arranged; secondly the typographic characteristics of the text were determined. The manuscript was coded to ensure that all instructions were clear to the photocompositor.

### **Typesetting the text and correcting proofs**

The texts and exercises in the manuscript still had to be typeset by computer. Given the shortness of the text and the complexity of the layout, no running text was produced; it was broken down immediately into its final form. The proofs thus obtained were examined by each of the authors. This was a time-consuming task: firstly the authors were not professional proof readers and had to learn to track down errors; and since the Malagasy language is still undergoing standardisation, they had to check that standard linguistic criteria had been applied throughout (regarding newly created words, spelling and punctuation in particular).

### **Preparation of a pasteup guide**

The authors prepared a pasteup guide to be used as a model for the assembler. This is a more detailed version of the layout plan, in which every page is prepared on the basis of a photocopy of the texts and the illustrations.

This model was extremely useful and made up to some extent for the absence of professional proof



readers and layout men. It revealed the more serious graphic errors, forced the authors to correct some pages or reconsider certain typographic decisions; it also allowed them to identify the odd punctuation or spelling error, and correct it.

### **Pinboards**

Gradually, as the pages of the pasteup guide were finished they were stuck up on a pin board, until the entire book including the cover pages had been pinned up, double page by double page. This method had the advantage of giving a permanent overview of progress; the authors could find the pages which had not yet been put into their final form and the illustrations that were missing, and were also able to pick up that one last mistake which had slipped through the individual checks, or something in the layout which had to be modified.

### **Shading**

For financial reasons the interior of the reading and writing books produced in the Tef Boky Project was printed in monochrome. The authors shaded the accompanying illustrations in three shades of grey; this gave depth to the pictures and marked the difference between reading and exercise pages, which have no shading. The authors themselves indicated how the shading was to be done on photocopies of the originals.

### **Preparing the job envelope**

The authors then prepared a job envelope for the printer. For every page of the textbook they prepared one large envelope containing four documents: the final version of the corrected text with layout, the corresponding original drawings, a photocopy of these drawings with shading instructions and the page layout, as a reference for the assembler. These precautions were felt to be necessary as a result of the poor communications with the printer, and because the authors were called away to other tasks almost as soon as the job envelope had been submitted to the printer.

### **Checking the blueprint**

In spite of the measures described above the authors asked the printer to prepare one last set of proofs, the blueprint. They checked these, ensuring not only that the montage was correct, but also that there

In spite of the measures described above the authors asked the printer to prepare one last set of proofs, the blueprint. They checked these, ensuring not only that the montage was correct, but also that there were no omissions<sup>1</sup> or changes<sup>2</sup>, before giving the printer the go-ahead for each page. Let us specify that after this the authors were only involved in very sporadic monitoring; even this, however, allowed them to pinpoint and remedy some errors which they never dreamt could happen.<sup>3</sup>

As you will see, the work is long and relatively complex, and, in most cases, it is your team which will be in charge.

To help you understand the sequence better, Table 30 lists the tasks for which Garabola authors were responsible, broken down into those which they performed themselves and those which they only had to organise and supervise. Take a good look at this table and see what you can expect.

<b>30. The Authors' Responsibility</b>		
<b>No.</b>	<b>Performed by Authors</b>	<b>Organised and Monitored by Authors</b>
1		Finishing illustration work
2	Final check of illustration work	
3	Putting together the stencil	
4	Identifying typeface	
5	Preparing the manuscript for typesetting	
6		Typesetting text on a computer
7	Proofreading	
8	Preparing a provisional layout plan for the printer's assembler	

9	Mounting the make-up on a board and checking texts and layout systematically	
10	Instructing the printer about shading	
11	Preparing the job envelope, with one envelope per page of the textbook, containing all the pertinent documents	
12	Instructing the printer, submitting the job envelope and set-off sheet	
13		Providing the printer with imported inputs
14		Monitoring the progress of work from assembly to printing
15	Checking assembly on the basis of the blueprints	
16		Checking printing quality
17		Checking quality of finishing

## 2. Illustrations

Now you have an idea of the various steps leading up to the printer receiving a go-ahead, let us go back to stage one.

**The illustrations will often be noticed first; make sure they are appropriate**

The objective is to have the illustrations that you devised and possibly sketched during the writing phase completed. These may be photographs or drawings, which will then be printed in one or more colours. Within the scope of this publication, for the reasons given in the introduction, we do not propose to go into the

the original artwork and illustrations may be created and possibly corrected during the printing process completed. These may be photographs or drawings, which will then be printed in one or more colours. Within the scope of this publication, for the reasons given in the introduction, we do not propose to go into the technicalities of 4-colour printing, focusing on representational drawings in one colour, with shading or without, and in two colours.

All teams of authors must work with the illustrator, but their specific tasks will not always be the same. In large publishing houses the authors will give the illustrator instructions as to the illustrations that are to accompany the text, and, for technical drawings they may compile a dossier of basic information. In developing countries on the other hand the authors are often in charge of all graphic work.

If you find yourself in this position, here are the steps you will generally have to take.

### ***Drawing up a Contract***

As we pointed out at the end of chapter 5 you should have sounded out the illustrator during the conceptual phase. You will have selected the artist whose skills and attitudes are best suited to the job in hand. When he reappears on the scene, which will not generally be before the texts have been completed, your first task will be to draw up a contract. Generally artists work as free-lancers, and prefer to be paid by the unit, depending on the type and dimensions of the illustrations to be produced.

Most of you will not have to deal with the legal and financial aspects of a contract of this sort, since it is unusual for the authors of a book to be responsible for the financial side<sup>4</sup>. But you will almost certainly be consulted to ensure that the contract reflects the services actually required; you should proceed as follows.

### **General Presentation of the Textbook**

Start by giving a thumbnail sketch of the textbook; inform the illustrator of which grade and subject it addresses, the format and the number of pages, the subject matter covered, the fundamental visual structure, etc.

### **Type and Number of Illustrations**

You should then list the main technical features of the illustrations.

First of all, stipulate what type of illustrations are required: perhaps realistic scenes from everyday life, to be drawn in ink with shading which will later be screened and printed in two colours, or text illustrations accompanying the exercises, or models for writing lessons, to be copied in pen. Go through the book page by page with the illustrator and make as detailed a list as possible of the number and format of the drawings to be produced. This will be used as a basis for determining the illustrator's fee.

**A carefully drawn up contract that is respected by both sides ensures good cooperation with the illustrator**

### **The Tasks of Those Concerned**

Stipulate the respective tasks of the authors and the illustrator at this stage.

At the outset it is essential that the illustrator appreciates that he must put his skills at the service of pedagogical and didactic criteria. He has not been contracted to "express himself" but to translate into images the more or less precise instructions you give him.

You should thus explain to him that together you will produce illustrations which best correspond to the visual decoding ability of the children in question. They must be in line with the average age of the children, with their degree of familiarity with printed materials and with the socio-cultural features of their immediate environment. It is up to you to decide, for example, if you feel it appropriate only to depict people in their entirety, to use unusual perspectives or to resort to caricatures – but the illustration work must always be based on an agreement in principle with the illustrator who is about to join your team. You are thus very much in charge of the illustration work, while the illustrator works within a pre-determined, limited framework and needs the transparency and complementarity of a genuine working group.

This has two important consequences: firstly you will have to determine all the features of the illustrations, and secondly the illustrator must agree to redo illustrations which do not correspond to your instructions. Make this

This has two important consequences: firstly you will have to determine all the features of the illustrations, and secondly the illustrator must agree to redo illustrations which do not correspond to your instructions. Make this point quite clear at the start to avoid working with artists who have not been properly informed about the working conditions and are too full of themselves or unable to knuckle down to the quality and time requirements found in the world of textbook production.

Finally, if you plan to print your textbook in two colours, you must decide who is going to be responsible for preparing the half-tones – you or the illustrator.

### **Many of you will be responsible for the entire preparatory chain**

#### **Methods and Steps**

Now you have established the general framework of collaboration you can move on to the details of your work with the illustrator.

Firstly, you should decide where he is to work. If conditions permit, put him in the same rooms where you meet; this is the best way to ensure smooth and rapid progress. Secondly, decide what tools he will require, which of these your organisation already has and which you will have to provide him with. Finally, determine the various steps to be undertaken from the first sketches to the final version of the illustrations: nothing is more demoralising for everybody concerned than having to redo or have someone else redo a drawing which has already been completed in ink because the original specifications were not clear.

To ensure that deadlines are respected, you too should make changes only to the drafts and agree at the outset on the number of finished drawing which can be revised without incurring any extra costs.

#### **Deadlines**

Set a deadline for the submission of all original drawings and draw up a contract which covers all the points we have touched on.

### **Graphic Criteria**

Once the illustrator has agreed to the terms and conditions, and has signed the contract you can start the illustration work per se, firstly drawing up a list of criteria to be respected.

Never under-estimate the power of the image. Remember that even if the texts in a book can capture the interest of an attentive reader, images do not need his attention or even his interest. They appeal directly to him, triggering an emotive response – attraction or rejection. Take great care then to draw up as precise as possible a list of criteria which will allow you to identify which elements should be given precedence and which should be ruled out to avoid the risk that the textbook will be rejected by readers.

In Table 31 you will find some of the general criteria which guided the illustration of the reading and writing books produced in the TefBoky Project. We have only listed the criteria we felt were most interesting for textbook authors in developing countries; read them carefully and see which ones apply in your case.

#### **Sometimes textbook illustrations must attempt to reconcile the irreconcilable**

#### **Do not wait passively for the illustrator to submit his drawings – you must guide him**

When the authors of the TefBoky Project began to draw up a list of criteria for the illustration of their textbooks, they differentiated between criteria which they felt were of universal validity, such as the concordance of text elements and drawings, and those which they felt were specific to developing countries. As you no doubt noted in the Table 31, the latter criteria are particularly difficult to respect since they are always somewhere between two extremes.

<b>31. Main Criteria Observed when Illustrating Garabola and Tongavola</b>	
<b>Realism vs. Idealisation</b>	
	The illustrations must reproduce actual everyday life, removing any element which could be construed as demeaning, i.e. the reality depicted should be idealised while remaining realistic enough for pupils to recognise it immediately and identify with it.

construed as demeaning, i.e. the reality depicted should be idealised while remaining realistic enough for pupils to recognise it immediately and identify with it.

### **Precision vs. Generalisation**

The illustrations must have a high level of precision and authenticity, allowing the reader to recognise beyond any shadow of a doubt everyday life on Madagascar (habitat, customs, countryside, dress, etc.). At the same time, however, they must abstract every element that is too closely linked to any one region, the objective being not that every pupil feels himself to be addressed directly, but that no pupils feel excluded by the life depicted. For Madagascar, for instance, no elements should be depicted which refer exclusively to either the coast or the high plateaux.

### **Traditional vs. Modern Elements**

The illustrations must do justice to traditional instruments and work that are still in use, while adequately documenting the progressive introduction of new technologies; plastic and the radio have a legitimate place alongside dugout canoes and oxen-drawn carts.

### **Diversity of Visual Techniques**

The visual techniques used must allow readers who have had little contact with printed materials to decode the illustrations without difficulty, but techniques should also be used which signal a certain leaning towards modernism and will familiarise pupils with graphic styles commonly used in industrialised countries. Thus, the perspective chosen should, for instance, be easy to decode, while making use of cartoon techniques to a certain extent (arbitrary cutting off of parts of the element shown, unusual perspectives, caricatures, etc.).

### **Humour and Criticism**

Efforts should not necessarily be made to renounce humour and criticism, but you should avoid using elements which, although they may be widespread and generally accepted elsewhere are liable not to be understood or to be considered shocking in the context in question – e.g. the



	personification of animals, where extra care is needed. Care should also be taken that the reader, unaccustomed to a critical view of his environment, is not unsettled or insulted.
--	--

<b>Childhood and Adulthood</b>	
--------------------------------	--

	Illustrations should be adapted to the children who the book addresses first and foremost; they should also be generally instructive and pertinent for children whose adult life often begins after barely two years schooling.
--	---

### ***Identifying Scenes***

Once the terms and conditions have been agreed on, and the criteria listed, you can go on to the next stage; starting to work in close cooperation with the illustrator.

To this end you should return to your texts and sketches, and examine them page by page. Start by arranging each drawing as exactly as possible on the page, and determining its dimensions. Then decide which elements must be depicted and which are at the heart of the text and must therefore be emphasised.

We recommend that you take seriously any reservations the illustrator may have. If he has major difficulties illustrating a particular text, look firstly for the reasons in your own work. See in particular if the text allows for an adequate degree of visualisation, and if it doesn't, rewrite it.

End this phase by ensuring that the illustrator has as precise a dossier of instructions as possible, in the form of notes or sketches, which will enable him to start work.

### **Correcting Drafts**

Although illustrators generally go off by themselves initially to produce their first sketches and familiarise themselves with the book, it is important for them to re-establish contact with you rapidly. During this phase you should intervene at least twice in the following way.

### **Initial Instructions**

To ensure that the illustrator is on the right lines, you must insist that he show you his first drafts. Examine

To ensure that the illustrator is on the right lines, you must insist that he show you his first drafts. Examine them and let him know whether he can finalise these or whether he must take an entirely different approach. React quickly to avoid the illustrator continuing under false apprehensions.

### **Revision of the Final Drafts**

The illustrator will often produce a series of drafts, which will become gradually more and more precise. The last of these drafts, which should be the more or less final version, must be examined in great detail: peruse them in the company of the illustrator to ensure that they are in line with pedagogical and didactic requirements and with the criteria you listed in advance. Specify any changes that will have to be made.

To give you a better understanding of your role as a supervisor of sorts during this phase look at the examples below; compare the pilot version with the corresponding pages of the revised version of *Garabola* and deduce the reasons for the modifications made in the interlude, indicated in the following figures by a circle.

**You will have to make some corrections to the graphic artist's work**

**Examine each drawing carefully and be precise and consistent in your comments**

**Correct illustrations on the basis of precise pedagogical and didactic criteria**

**The illustration should help create a "text-image unit"**

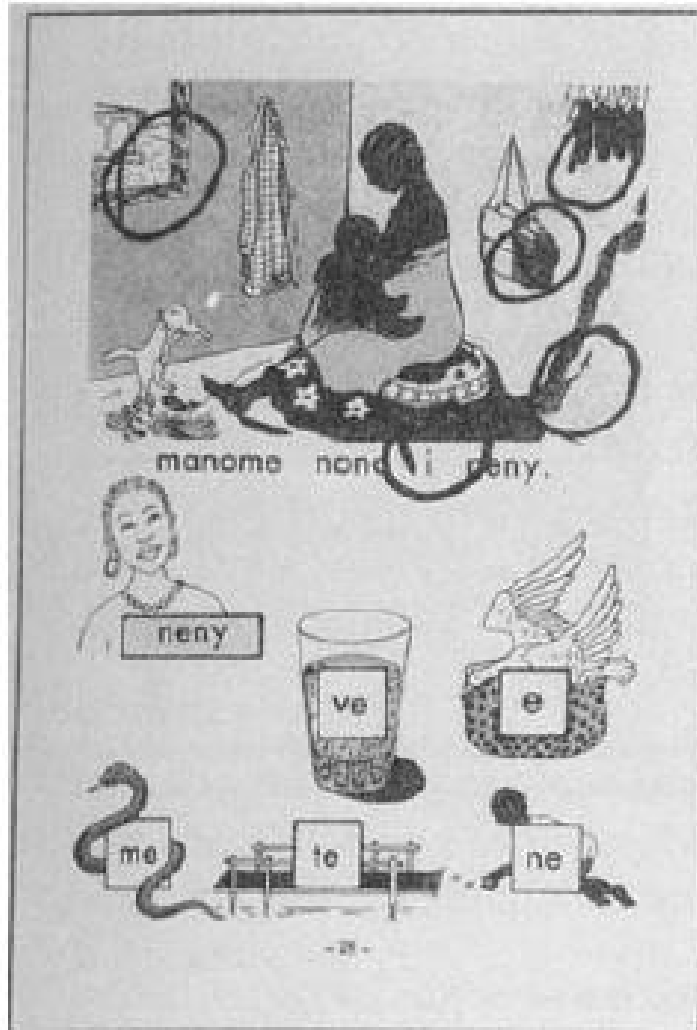

1. Remove secondary elements which obscure the relation between the text and the image.

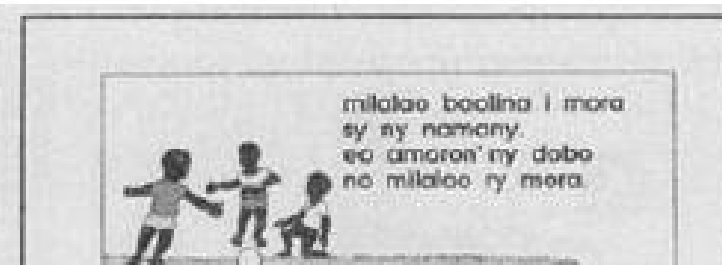



2. Remove any elements that are purely decorative.

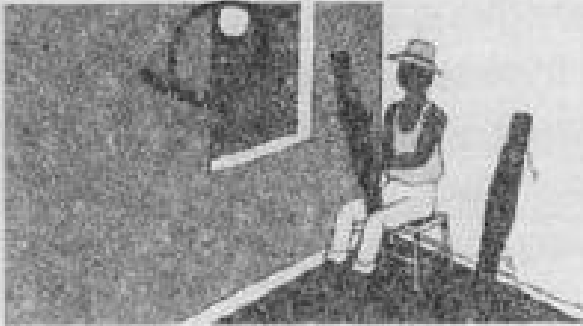

mitana valiha i dada.



dihy	dada
dimy	dodona

daholo	diavolana	redanina
adoladola	mianadahy	miredona

- 48 -

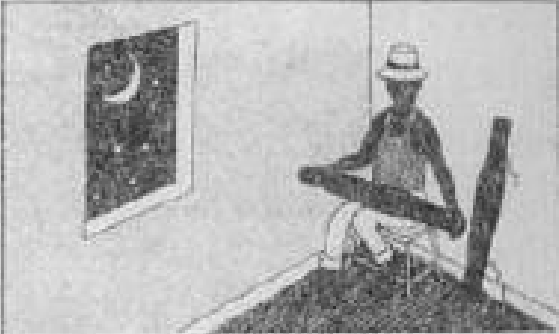

mitana valiha i dada.



da
----

de	do	di	dy
----	----	----	----

- 49 -

3. Select elements which make the object depicted as easily recognisable as possible.



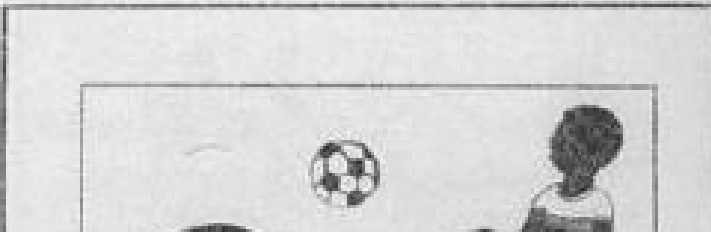



milalao baolina i mora.



baolina

dobo
daba

bararata
tabataba

iaba
jiaby

- 20 -



milalao baolina i mora.



baolina

dada
baba

dola
bola

dady
baby

didy
biby

44

4. Add any elements that are essential to allow the reader to identify the scene.

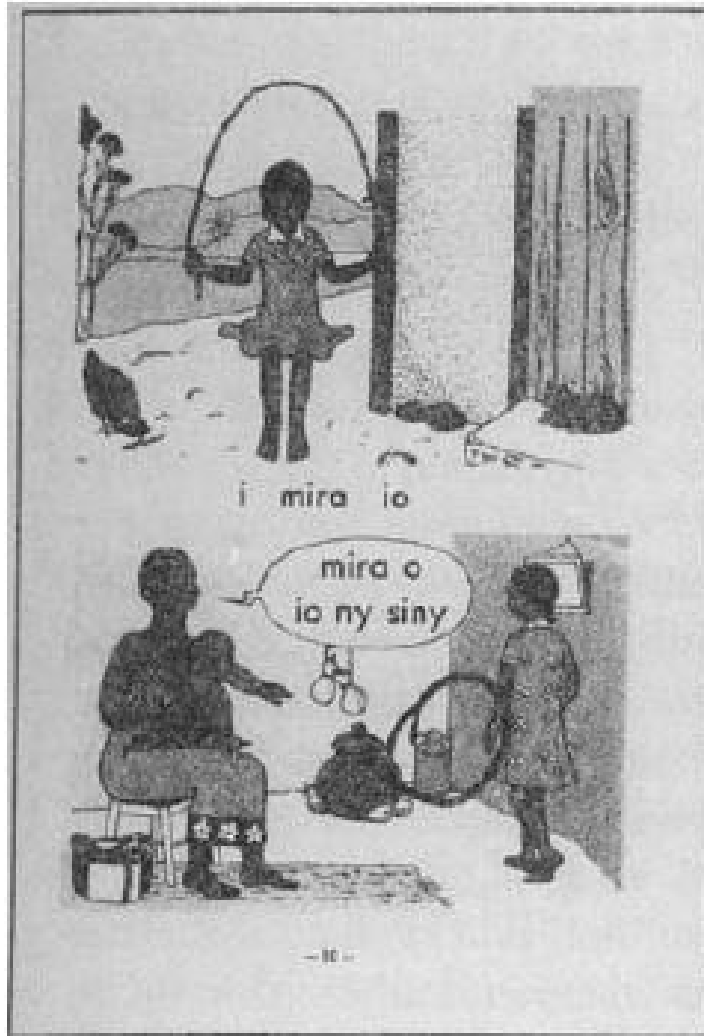

5. Outline elements that are central to the text.

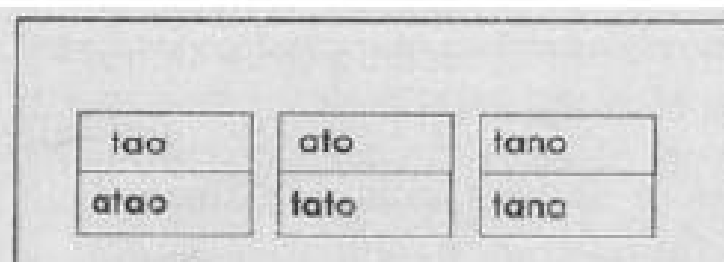
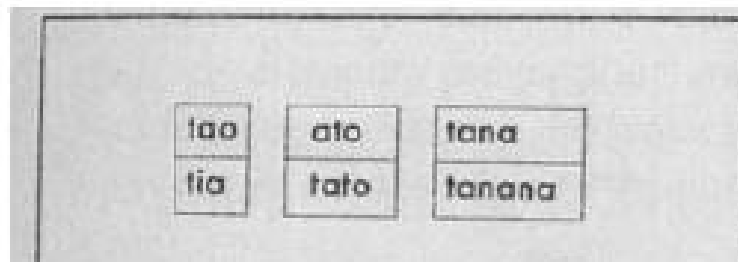

atao	tato	tano
------	------	------

† mora  
 † tana tana  
 † inona inona  
 † io tana  
 † tao anaty inona io tana io  
 † tato anaty anana



atao	tato	tano
------	------	------

† mora a  
 † inona inona  
 † tana tana  
 † atao inona tana  
 † tano io tana io



6. Use images to reflect the dynamism of the text.



ao anaty anana ny tana

tana

ti

ta

tana lo

tana

to

ti

7. Check the exactness of specific elements<sup>5</sup>

tao	ato	tana
tia	tato	tanana

tao	ato	tano
atao	tato	tana



8. Get rid of superfluous elements which distract the reader or get in the way of visual decoding.

### ***Final Versions of the Drawings***

To ensure that the arrangement of text and illustration is as perfect as possible, it is better not to start with the final versions of the drawings until the text has been typeset and the text layout finalised.

When the authors are responsible for supervising the illustrator they must not only examine the drafts and suggest any changes. They must also decide which tools the illustrator will need (Rotring pens, fountain pen, tweezers, etc.) and which materials are best suited to the printing procedures to be adopted (tracing paper,

canon, etc.).

All originals should be kept carefully; simply note the page on which the drawing is to be printed, and make a photocopy before filing the original. If it is not modified in any way, it should be submitted to the printer at a later date in this state.

### **3. Layout**

During the conceptual phase you will have laid down a fundamental visual structure for your book, which you will have developed in more and more detail during the various stages involved in writing and illustration. But the fruits of your labour are not yet ready to be published. If we can make a comparison with the world of haute couture you now have the fabric to make your dress and you have an idea what form the dress should take. But you still have to cut, sew and finish the garment.

During this phase you will "tailor" the page, deciding on the stencil, putting it together with the typeface you choose and finishing it by checking the arrangement of the elements on the page.

We cannot claim to present the fundamental principles of layout in a book like this; the field is much too wide. We will thus look only at what is essential for an author of textbooks, who alongside his many other roles finds himself responsible for the layout of his book, although he cannot claim to be a professional in this field. If you find yourself in this situation, proceed as follows.

#### ***Margins***

Your first concern must be to decide on the margins.

All printed materials have four margins, at the top, bottom, left and right hand edges of the page. Margins give a book its particular style, and you should aim to find the proportions which will give the best possible balance and coherence.

The size of the margins can be set professionally; layout artists today still set the margins on the basis of

The size of the margins can be set professionally; layout artists today still set the margins on the basis of calculations or diagrams, and many still refer to what has been done in the past<sup>6</sup>. You need not be so scientific in your approach, but you should respect three basic principles.

**A good layout person seeks excellence in every layout detail**  
**Leave wide enough margins**

Firstly, the outside margins on each page must be wide enough for you to hold the book in your hand without concealing the text. Secondly, convention dictates that the margins increase slightly from the interior of the page/towards the top called the “head” and from the outside of the page/towards the bottom, or “foot”: the most important thing to observe with margins is, however, that they present the text to its best advantage. A one-centimetre margin, for instance, is quite inadequate and will give your book a cramped look. Finally, once you have decided on the margins they must be respected throughout the book, from the first page to the last. In general nothing should be printed in the margins except the page numbers, or “folio” as they are known and any headers or footers, such as the ones at the top and bottom of the pages of this book. These elements are arranged outside the frame set by the margins, known as a grid. If it is absolutely essential for some elements to go beyond the frame thus set, for instance if you decide to incorporate bleed-off illustrations which cover the page in its entirety, you should ensure that they are positioned in such a way as to make the continuity of the grid easily recognisable for the reader.

***Arrangement of the Various Elements***

Having decided on the margin width you should turn your attention to the arrangement of the various elements on the page.

You have already decided on a basic structure which allowed you to produce texts of the required length, but now you must decide on the finer points, laying down the final arrangement of texts and illustrations. The aim is to find the positioning that best reflects your pedagogical objective, i.e. to find the layout that best captures the reader’s attention and facilitates the learning process.

If the contents of your book are relatively heterogeneous, as is the case in a reading and writing book, for instance, the layout is bound to be complex. Nevertheless you should not position the various elements instinctively. Arrange them as though they were on a sort of invisible grid. In view of the fact that the reader will be confronted by two pages of the book at a time, you should design your grid for even and uneven pages.

Start by familiarising yourself with the concept of a grid. Just look at the first page of your daily newspaper, and you will see that the text is divided into a certain number of columns, within which and across which the headlines and illustrations are spread; these columns are repeated on the following pages and give the newspaper its identity.

The grid for your textbook will never be as complicated as a newspaper grid, but you should have one to help you impose a certain discipline on your page and thus enhance the impact. The positioning of the various elements on this grid will not always be identical and rigorous; it will be a flexible distribution which may from time to time break with the basic structure without ever completely obscuring it and this will thus retain the attention of the reader without irritating him by introducing too many changes. On the opposite page you will find one example.



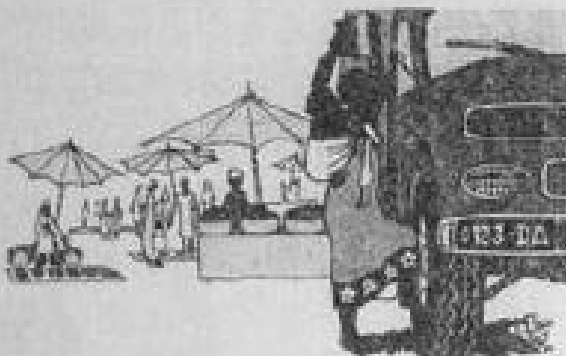

manatatao harona i neny.



hena	loha	lahilahy	harona
hanina	aloha	vehivavy	harena

- † iny any misy olona.
- † lahilahy sa vehivavy?
- † vehivavy i neny.
- † inona iny lalohaviny iny?
- † harona.
- † harena misy inona?
- † misy hanina.
- † hanina inona avy?
- † hena sy anana ary avy.

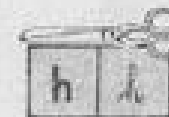

tana	lilany	sarena	manina
hena	lhany	harona	hanina

• iny any i neny.

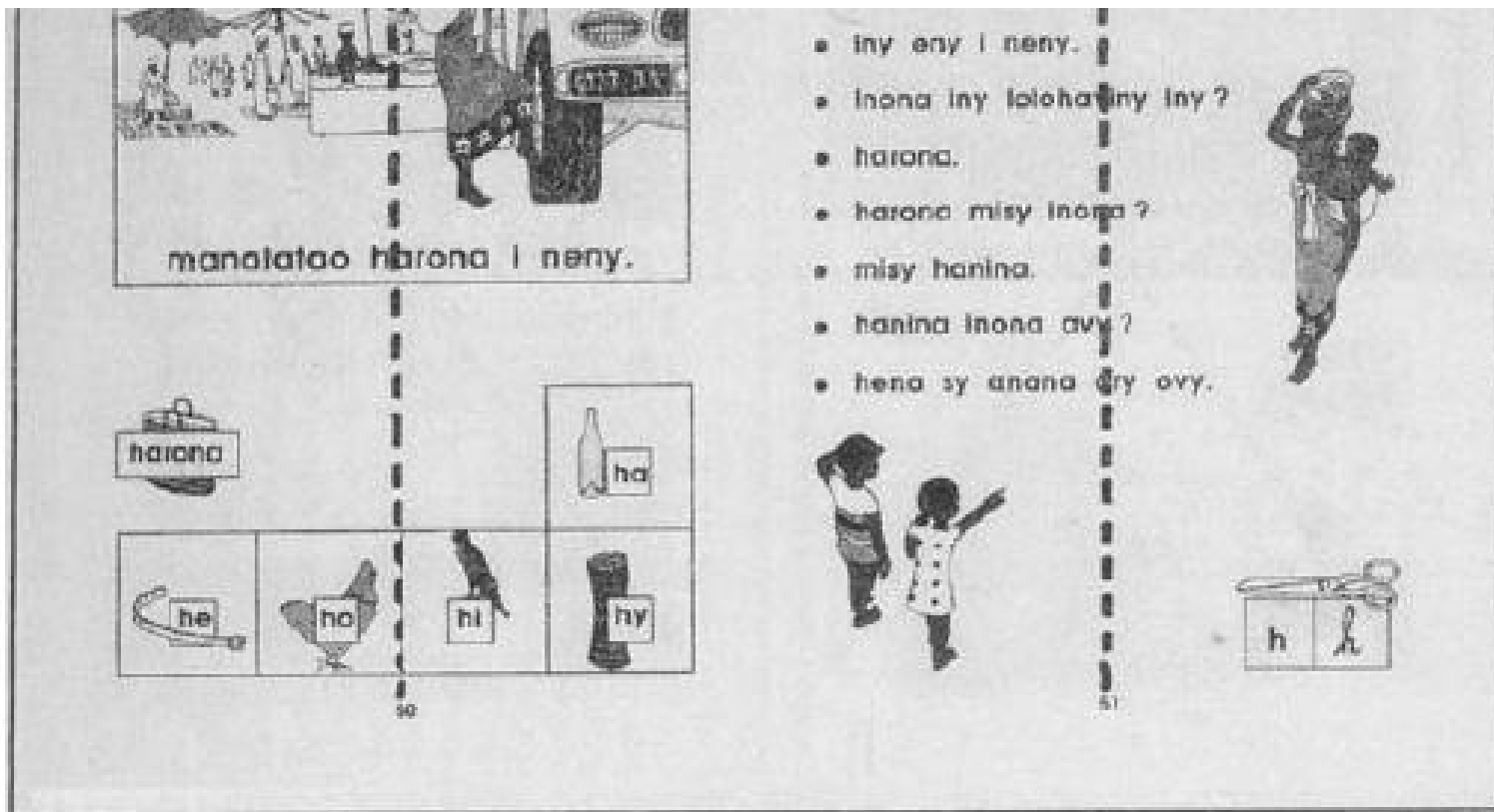

1. Decide on a basic structure for double pages; here we decided for two columns.



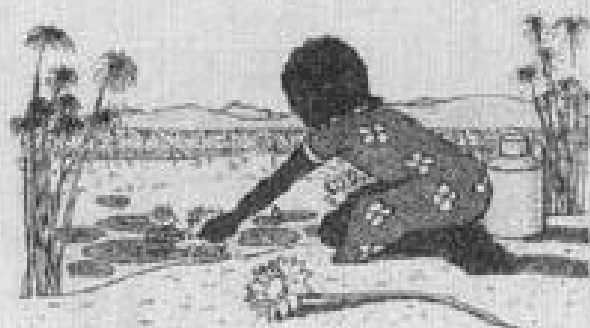

mioty tatamo i mira.



- 20 -

manana
maninona

manao
namanoo

mitoto
mitatao

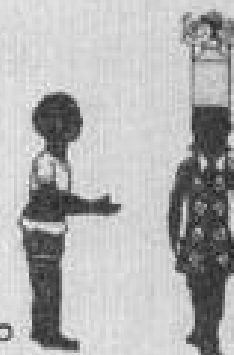

- † mira o
- maninona ianao
- ‡ mitatao siny
- † inona no ao anaty siny
- ‡ tatamo
- † omeo tatamo ny namanoo



- 21 -



manana
namana

maninona
mananona

mitoto
mitatao

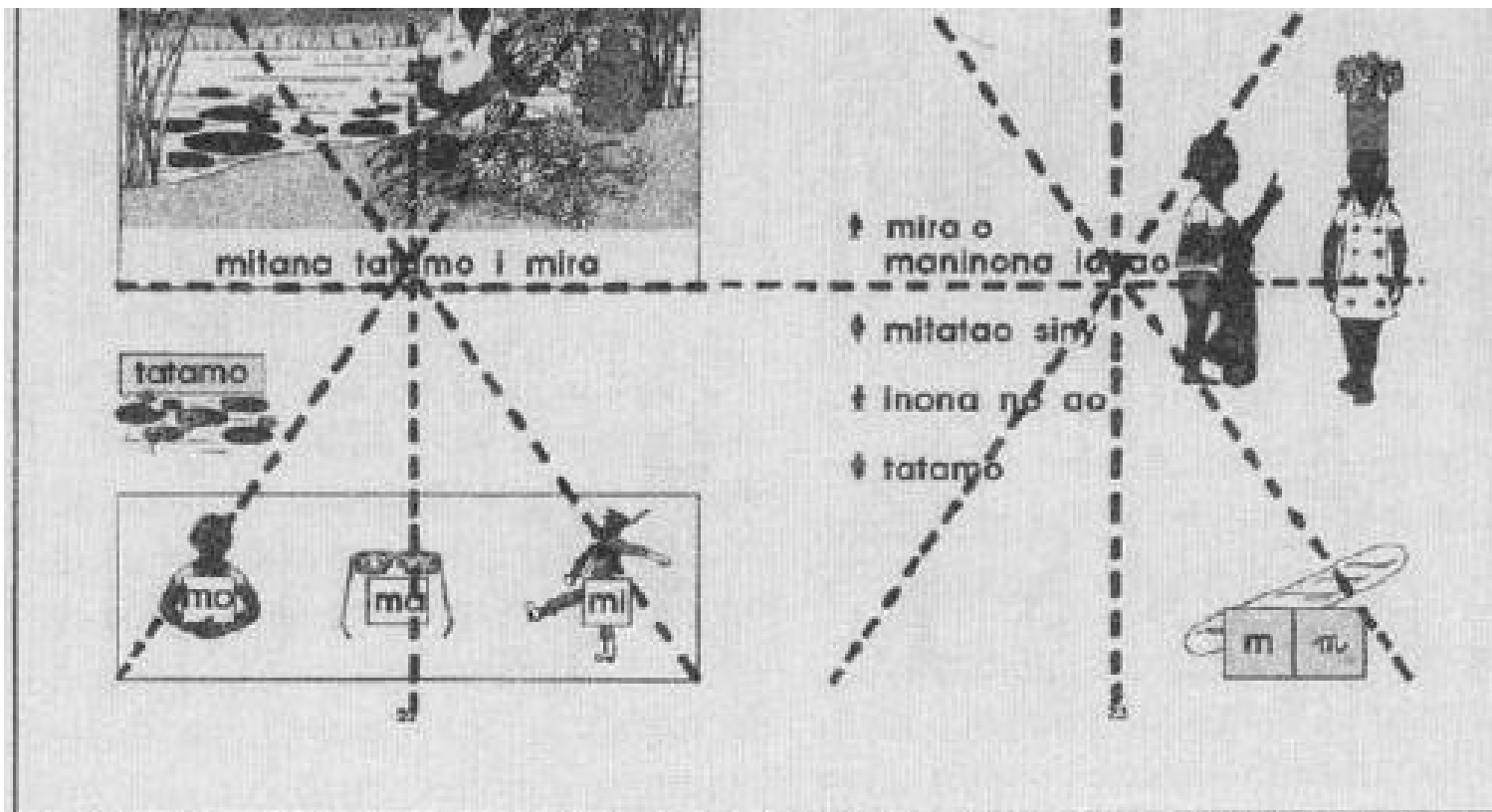

2. Position the various elements on your double page with the help of horizontal, vertical and diagonal lines of reference.

ry	ora	mira	vary
ery	orana	miramirana	varavarana





avy ny orana - maniry  
 ny vary, maniry ny avy,  
 lo amin'ny varavarana lo  
 i neny, miramirana ery  
 ny lavany.



- 25 -

eny	ava	avana	marina
ery	rava	orana	marina

- neny a.  
avy ny orana.
- marina ve ?
- avy ny orana.  
tavorava ve i neny ?
- eny.  
maniry ny vary.

26

3. Avoid monotony and break with the basic structure, but ensure that it is still identifiable as such.



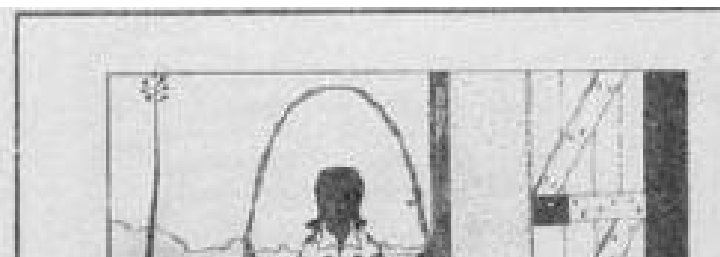
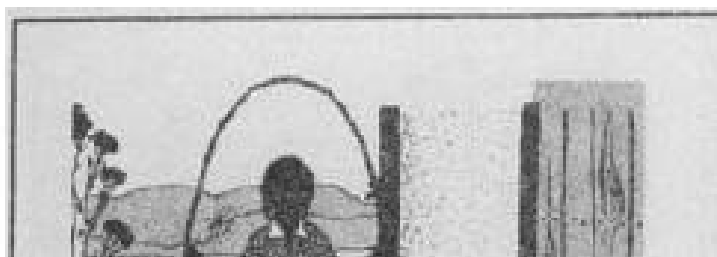



4. Make a clear optical distinction between the various elements on a page.



milalao baolina i mora sy ny namany.  
eo amonan'ny doba no taerana ilalaovana.



voadonan'ny lahan'i mora ny baolina ary lasa  
any anaty baranata.



avy laban'i mora sady mitereny hoe : iadida ny  
milalao ato. lalina anie ia doba ia e !



- 41 -

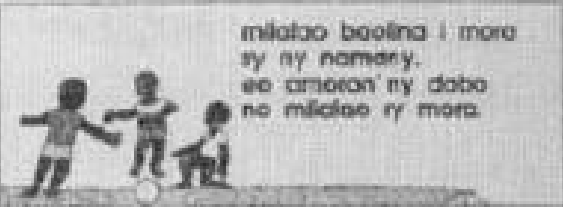

milalao baolina i mora  
sy ny namany.  
eo amonan'ny doba  
no milalao sy mora.

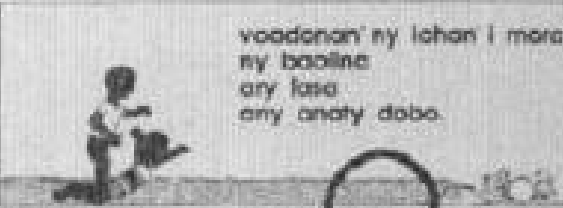

voadonan'ny lahan'i mora  
ny baolina  
ary lasa  
any anaty doba.

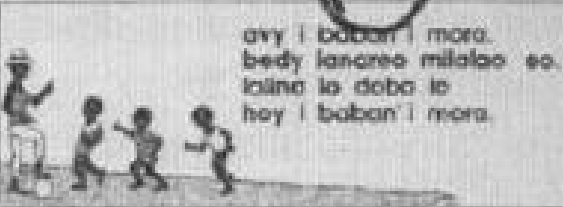

avy i baban'i mora.  
bady lanareo milalao eo.  
lalina ia doba ia  
hoay i baban'i mora.



42

5. Bring text and image close together while respecting the requirements of both.

tao	ato	tana
tia	tato	tanana



tao	ato	tana
atao	tato	tana



† mora  
 † tana tana  
 † inona inona  
 † io tana  
 † tao anaty inona io tana io  
 † tato anaty anana



† mora a  
 † inona inona  
 † tana tana  
 † atao inona tana  
 † tano io tana io



6. Respect the grid.



milalao baolina i mora sy ny namany.  
eo amaran'ny dobo no toerana ilalaovana.



vadonana'ny lohan'i mora ny baolina ary lasa  
ary anaty barerata.



avy laban'i mora sady mitseny hae : iadio ny  
milalao eto, lalina anie io dobo io a !



-51-

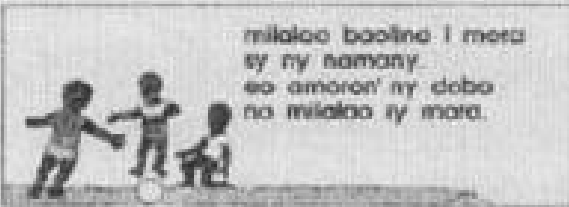

milalao baolina i mora  
sy ny namany.  
eo amaran'ny dobo  
no milalao sy mora.



vadonana ny lohan' i mora  
ny baolina  
ary lasa  
ary anaty dobo.



avy i baban' i mora.  
bady kamara milalao eo.  
lalina io dobo io  
hoay i baban' i mora.



52

7. Balance the dimensions of the various illustrations on a page.

1. maha sika, ary an'ny dobo an'ny hafa.

2. maha sika, ary an'ny dobo an'ny hafa.



1. maha sika, ary an'ny dobo an'ny hafa.







Compare the two and think about the principles behind the changes; they probably apply to your book too. Most changes are indicated by a circle.

**Arrange the elements on the page according to a grid, which need not be unduly complex – two columns are perfectly adequate**

**Practice identifying basic layout principles if you have no recourse to a professional layout man**

**There is no sure-fire recipe for good layout: rigour and imagination are equally necessary**

**Moderation is always called for in layout for primary school textbooks**

**The layout must bring out the essential elements**

**The layout concerns all the elements on a page; don't forget to examine the drawings, texts and blank spaces on each page**

#### **4. Typography**

By deciding on the precise margins and identifying the exact arrangement of the elements on a page, you have drawn up a plan for your book. You must now decide on the typographical features of the texts and exercises.

In a publishing house, this work would be performed by a professional graphic artist. If you are forced to make the typographical decisions you should firstly be aware that this is an extremely wide field, where research has been conducted for centuries, and about which more is being written today than ever before. It is a field that we cannot hope to do justice within the scope of this book any more than we could for the layout.

To avoid repeating information that you will find in any specialised literature, we have decided not to dwell on

To avoid repeating information that you will find in any specialised literature, we have decided not to dwell on any details that are not immediately relevant for textbook authors. For reasons of clarity we will equally take only a cursory look at those typographical features which will feel are important for a first reading book. Read the following pages in the knowledge that they are far from being complete, and try to adapt the recommendations to suit your own specific circumstances.

We would suggest that you adopt the following procedure to decide on the typographical features for a first reading book.

### ***Aspects to Take into Account***

First of all make a list of all the aspects to be taken into account, the most important of which will be:

#### **1. The characters**

- class
- type family
- fount
- category
- size of type body
- weight of type

#### **2. The texts**

- character spacing
- word spacing
- line spacing
- paragraphs
- line length and justification

- level and hierarchy of texts

### ***Decisions at Character Level***

Once you have drawn up your list, turn your attention firstly to six aspects concerning the characters you plan to use. The information below should help you make your decision.

#### **Class**

Today, you can print a multitude of different characters. They have been classified many times over<sup>a</sup>; one of the most widely used is Maximilian Vox's classification, which distinguishes eleven groups of characters<sup>a</sup>.

For a first reading book you should select the best class to help pupils learn to read and write. Straight-line characters are good for this and are found in most textbooks which address grade-one pupils. First of all the characters look like a simplified form of cursive style, and, unlike the characters used for other classes, they have no serifs (short lines drawn at right angles or obliquely across the ends of stems and arms of letters), which are not found in cursive style either. This means that the pupils need not discount any elements when they write most of these letters in cursive style. They simply have a shape to complete. These characters are also of more or less equal weight of type throughout, and since the days of the heavy down strokes and light up-strokes are over, they are thus more like the style of writing actually taught.

As of the second grade, the pupils should be able to read texts written in characters with and without serifs. In the books for second grade upwards you should thus select a different class of characters.

Lower case characters with serif

**garabola**

Lower case letters without serif

**garabola**

# garabola

## Type Family

Several families of characters are affiliated to each of the classes.

If you are producing a first reading book for which you have decided on a class without serif, you can now look at the form of the lower case characters of the different families that go to make up this class. For optimum readability, each letter should be immediately identifiable, without any chance of confusion, even when the letter stands alone. You should thus examine every individual character, one after another.

Check that the descender of the **j**, for example, finishes with a curve and does not only consist of a downward stroke. Likewise, the curve of the **r** must be clear enough, etc.

You should also pay particular attention to the form of two letters, the **a** and the **g**; to make it easier for the pupils to learn to read and write at the same time you should select a form which is as close as possible to the shape they will learn to write.

In the next books in the series you will have more leeway to chose the family of characters, once the pupil has been systematically introduced to the new forms of the **a** and **g**.

Look at the two examples below, before you decide on the form of **a** and **g** you wish to use.

garabola  
garabola

## Fount

Every family has three founts: roman characters, in which the axis is vertical, italics which are inclined and cursive style in which the letters are joined up as they are in handwriting<sup>10</sup>.

**There are no fewer than 12 aspects to be taken into account when deciding on the typography**

**Typography is important in all printed materials, but for a first reading book it is absolutely critical**

The first form is best suited for pupils who are learning to read, while the second is reminiscent of handwriting, but should not be taken as a model for the first graders.

### **Category**

Should you use upper or lower case letters?

In some languages, such as German, it is imperative that children learn both lower and upper case letters from the start, since upper case letters have a specific grammatical role, such as to denote nouns. In a first reading book you may, in some languages, be able to avoid using upper case letters. If you are forced to introduce both, use the same technique to introduce the upper case letters as you have already employed for the lower case – use characters with straight lines and no serif.

Here are two examples to illustrate this difference.

Upper case with serif

**GARABOLA**

Upper case without serif

**GARABOLA**

# GARABOLA

## Size of Type Body

If you look closely at this book you will note that not all the characters used are the same size. We say that the type body is of different sizes, and we define this size in points; to give you an idea of sizes, the main body of this text is printed in Palatino, 10 point.

At the start of a first reading book you could use 24 point and then go on to use 18 point. Before deciding, try out the different sizes; and for the moment look at the following models.

Avant-Garde, 24 point

Garabola

Avant-Garde 18 point

Garabola

## Weight

The weight, or thickness, of the characters used can vary; to convince you of this look once again at this book. You will find normal and bold characters: in photocompositors' catalogues you will find other options including the following:

Garabola (extra-light)  
Garabola (light)  
**Garabola (medium)**  
**Garabola (bold)**  
**Garabola (extra-bold)**

For a first reading book you should select normal characters for a continuous text and bold letters for headings as well as for free-standing letters, symbols and words.

### *Decisions at Text Level*

Once you have decided how to deal with the characters you can come to the text, and look at the following aspects.

### **Character Spacing**

The space left between letters within one word ought to be chosen for maximum readability, neither too large as can sometimes happen when texts are written in columns, nor too small.

This point is important when you are working on a reading book. If you have used straight-line characters, you will notice that the absence of serif makes it difficult for beginners to read certain combinations of letters; narrow letters, such as l, t and j are difficult to identify when they are followed by an i with automatic spacing.

To help solve this problem, you should widen the space between characters slightly. By way of illustration here is one word written with automatic spacing and one with slightly wider spacing.

**Garabola**  
**G a r a b o l a**

### **Word Spacing**

## Word Spacing

For maximum typographical readability, the space between words should equally not be too wide or too narrow.

But, for texts written in large characters, such as those found at the start of a first reading book, it may be advisable to use double word spacing. This will allow beginner readers to identify each word more easily as a unit. If you leave a double space between words, however, take care that the sentences do not appear disjointed.

Here is an example of single and double word spacing

**Garabola, school textbook**  
**Garabola, school textbook**

## Line Spacing

This is the space between two lines within the same paragraph.

You should be able to decide on a line spacing which will give your text optimum readability. If the line spacing is too large, each line will seem artificially isolated on the page, which will slow down the reader. On the other hand if the lines are too close together readability will also be poorer because the descenders of the letters on one line will become confused with the ascenders of the letters on the line below.

Computers insert automatic spacing; if you wish to modify this, try out different spacing.

The example below shows automatic, narrower and wider line spacing.



**Garabola is a reading and writing book for first-grade pupils in Madagascar's primary schools. It is written in Malagasy, printed in monochrome and stapled.**

**Garabola is a reading and writing book for first-grade pupils in Madagascar's primary schools. It is written in Malagasy, printed in monochrome and stapled.**

**Garabola is a reading and writing book for first-grade pupils in Madagascar's primary schools. It is written in Malagasy, printed in monochrome and stapled.**

### **Paragraphs**

In texts which address experienced readers, the start of a new paragraph is marked by different line spacing, by indentation of the first line of the paragraph or by a first line which starts further to the left than the body of the text.

In a first reading book the start of every new paragraph should be clearly indicated, if necessary by double line spacing.

Once again use this book to familiarise yourself with the possible ways of indicating the start of a new paragraph.

### **Line Length and Justification**

The length of the line again should ensure good readability; when the characters used are small, the line must not be too long so that the reader can find the start of the next line without difficulty.

It is possible to allocate spaces between words to make a line a predetermined length or width; then we say that the text is justified or aligned at the right and left-hand sides. This is not recommended for a first reading book where words would be stretched out to avoid hyphenating them, which in turn would not make for good readability.

For a first book, unjustified or ragged-right settings are generally preferred, i.e. the left hand edge of the text

For a first book, unjustified or ragged–right settings are generally preferred, i.e. the left hand edge of the text is aligned, but not the right hand edge. The gaps in the text at the right hand edge often correspond to natural breaks in the text, in line with the meaning units.

The right–hand edge of the text can also be justified as you can observe in the outside columns on each page of this book, or the text can be centred, with neither edge justified.

### **Use recently published textbooks to help you make your typographical decisions**

#### **Level and hierarchy of text**

The typography must make the text easy to read, by giving the reader a series of clear visual signs. When you decide on the layout of a book two things are important: firstly to distinguish between the text that addresses the pupils and the accompanying notes and instructions which are not necessarily meant for them, and secondly to show the hierarchy of the text, i.e. to identify the various headings and sub–headings.

You can guide the reader not only by separating the text blocks from the instructions, but also by using different typographical features, i.e. the judicious use of different sizes, founts and weights can indicate to the reader which parts of the text are headings, sub–headings, notes, etc. without your having to number them.

Let us add that this fact is extremely important to ensure linguistic and typographical readability in the teachers' guide. When you decide on the layout, you should thus re–read your manuscript and mark the various levels of text.

In our experience even if the plan is detailed and the points seem to follow on logically one from another, there are almost always imperfections. For instance we find a major heading, which we will call a level 1 heading, followed by a level 2 heading, and then we find that the text suddenly jumps to a level 4 heading, completely by–passing level 3.

There is no better way to avoid errors of this sort than to re-read the text, draw up a detailed table of contents and compare it with the body of the text as often as necessary.

### ***Additional Visual Aids***

In a school textbook the hierarchy of texts is sometimes such that it is not enough to alternate between characters of different sizes and weights; additional visual aids may be necessary.

These should be used to the extent appropriate and necessary; excessive or inappropriate use of additional aids will only confuse the reader. The aids we outline below have a place in a reading book.

### **Boxes and Lines**

To underline the separation of two distinct parts of a page, or to draw attention to one element or emphasise the unity of one exercise, you can use a box or a fine line.

You will see from this book how we have used these aids. You will find a certain number of boxes, most of which have only horizontal lines. We have used lines with circumspection, but you will find them, for instance separating pieces of information in tables or separating the body of the text from the running head on each page.

### **Shading**

To underline an element or to distinguish between different levels of text, a slight grey or coloured shading can be used. You should only attempt this if the assembly and printing conditions are good. Nothing looks worse than letters which are to be emphasised that are badly printed or badly shaded. Once again look at the use we have made of shading in this book.

### **Pictograms**

In a first reading book one is tempted to use symbols which it is felt will be easier for the children to decode. Thus slates are used to indicate a written exercise instead of a heading, while silhouettes are used to represent the speakers, dispensing with inverted commas. But again avoid overkill – keep the use of

Thus slates are used to indicate a written exercise instead of a heading, while silhouettes are used to represent the speakers, dispensing with inverted commas. But again avoid overkill – keep the use of pictograms to a minimum.

## **5. Job Envelope**

You have planned and defined the illustration and layout work. Generally you will then have delegated this work to the illustrator on the one hand and a keyboard operator on the other.

But, as this work is returned to you, you must check the quality before submitting it to the printer, and it is up to you to do this.

What you now have to compile is a copy of your book which is at least definitive if not complete; the printer must not have to add, remove or modify anything. And once he has received your job envelope and your written instructions regarding the printing, he should not have to consult you with any further questions. Once you have given him the final version of all the documents and the written instructions he should be able to print without delay – or to be more precise he should be able to put together the pages to make signatures, have you check that the imposition is correct by submitting the blueprints to you, prepare the printing plates, install these in the printing press, load up the paper and print and trim the book.

The quality of the printing will depend almost entirely on the quality of the preparatory work. To make sure that it is as good as possible, you should adopt a methodical procedure, as follows.

**This is the last part of your work as “publisher–authors” – take care not to nullify all your work to date**

### ***First Proofs***

You have submitted your manuscript to a keyboard operator. Before doing so you checked to make sure that there were no spelling errors in the manuscript, that no more corrections had to be made to the text, that the length of the text was in line with the layout requirements and that the punctuation had not been forgotten.

The first set of proofs you get back will surprise you; you will not always recognise the manuscript that you have slaved over for so many months... which is just as well, because it gives you a certain distance to the text and allows you to spot composition errors better.

In general the first set of proofs contains only the typewritten text in continuous form, without any concessions being made to the layout. Your corrections must thus meet the following criteria.

### **Clarity**

Use a red pen to append your corrections and write as legibly as possible.

This recommendation always applies, but it is all the more important when you have a manuscript in a national language which the keyboard operator does not necessarily speak or write well. Form every letter with great care if you want to avoid the keyboard operator making more errors as he or she corrects the first set, which will only add to the number of times you have to proofread.

The groups of authors which we have had the opportunity of observing have always corrected by hand, indicating in the margin when a letter or word must be changed, added or removed, a paragraph inserted or two syllables joined up. They either rewrote the entire word or gave detailed instructions as to the changes to be made, and these instructions were generally understood without difficulty by the keyboard operator. You too can adopt this procedure, but you must be careful that your instructions and corrections are always clear.

Official systems of proof correction marks do exist. They are used by professional proof readers and can be found in most books on layout and typography; you can refer to these works if you wish to upgrade your work – but check first that the keyboard operator is familiar with them, or far from enhancing the results you may face a disaster.

### **Precision**

## **Precision**

Read the proofs again and again and track down all the errors.

You must bear in mind that as from a certain stage the authors themselves become blind to the mistakes in their work; they can read and re-read their manuscript without picking up the errors. Thus, you should read and re-read the first proofs several times, but do not consider this work definitive. At a later stage you will have to read the second set of proofs, which you will receive once the layout has been done and the typographical choices translated into practice.

## **Pertinence**

If you are working in a language which still has few standards, you will be bound to have some doubts as to how to split a word for instance, the use of the apostrophe in a compound word, the use of capitals or how to write certain abbreviations. Do not correct these points before you have agreed on clear standards with your colleagues or checked if such rules already exist.

We must stress that when several groups of authors are working on didactic material in the same national language it is crucial – and extremely difficult – to ensure that the language used by all the groups is standardised. Care and discipline are vital to achieve this.

## **Functionality**

Do not make corrections just for the fun of it. As we said the last author corrections have been made. Remember that the text you submitted to the keyboard operator had already been read by numerous people, and unless you find a really serious error that none of them has found, do not make any more changes. If you really feel, in spite of everything, that you have to make more changes, consult your colleagues first.

**Re-read proofs with great care**

## ***Final Proofs***

161

<http://cd3wd.com/dvd/> - filename: z\_science\_exp\_567 of 598

The proofs that you have re-read and corrected should now be submitted once more to the keyboard operator, who will not only incorporate your corrections, but will then do the layout. He will follow your instructions as regards the characters and text features, and will then submit to you another set of proofs which you will once again have to re-read and correct. You must pay particular attention to the following aspects at this stage.

### **Spelling**

Re-read the proofs one last time. No effort can be too great to locate a missing point or a spelling error in a text designed for beginners. You will be held responsible for all mistakes – and this is the sort of mistake your readers will be quick to note.

### **Split Words**

Generally, when the text is arranged in columns some words will be split at the end of the line – check that this has been done correctly.

For languages in world-wide use you will find computer programmes which hyphenate words automatically. When you are working in a national language for which there is no such programme, pay particular attention to this point.

### **Hierarchy of Texts**

If you plan to use different characters, or different sizes and weights of characters check that your instructions have been properly followed, in particular that the hierarchy of texts has been properly respected. Paragraphs must be treated uniformly.

A heading in the same size of characters as the normal text, a word which has not been printed in bold print as planned, or one paragraph which is indented while all others are not – all these errors will make your book less readable and thus reduce the quality of the finished product.

### ***Graphics Dossier***

## ***Graphics Dossier***

Everything which has not been processed by the keyboard operator must be submitted separately to the printer. When your book is a reading and writing book for primary level, this dossier will generally include the original drawings and hand-written examples of writing. You should ensure that the dossier is complete and that it contains the following instructions.

### **Dimensions of the Illustrations**

Some drawings can be executed without difficulty in the size required, but for very small illustrations, such as text-illustrations for exercises, it would be better to have the illustrator produce larger drawings. In this case you must instruct the printer of the extent to which they must be scaled down, or "reduced".

### **Shadings**

If you decided to print your book in two colours, or to use one colour only but to add shades of grey in illustrations you must check that you have included a photocopy of the originals indicating exactly which colour or shade has to be printed where.

### **Assembly Instructions**

If the page contains several elements it is not enough merely to submit the text and the illustrations to the printer; you must also give him precise instructions as to the layout of each page.

The best way to do this is to prepare as complete a layout guide as possible for every page, using photocopies of the originals. The layout artist will base his work to the millimetre on this hand-made model: he generally has the instruments and the skills required.

### ***Final Checks***

Before you submit the job envelope to the printer ensure again that it is complete.



In our experience, many groups of authors are tempted not to finish their work in an attempt to accelerate the printing work. They submit an incomplete job envelope and think that they will complete it afterwards.

But, once the printer has the job envelope, those concerned with the development stage almost automatically consider their work over.

It is then very onerous to complete the work properly, because it is difficult to find every missing element: the illustrator appears to have vanished off the face of the earth, the photocompositor has other urgent work to finish or it is impossible to consult all the authors, since the group has been disbanded or sent elsewhere.

It is thus imperative to go through the job envelope one last time while all the actors are still present and correct. You should focus, in particular, on the two following aspects.

### **Complete Development**

All the many elements of the book should now have been duly prepared; you should not find the four cover pages are missing, or find that one page has vanished or that you are suddenly missing a text or graphic element on any of these pages.

For many years, we spread out the dossier on a desk, leafing through the pages one after another, which meant that we never had a complete vision of the dossier as a whole. Now, however, we believe that the best way to ensure that nothing is missing is to stick up a photocopy of your entire model on pinboards. This allows both authors and outsiders literally to take a stroll through the book. We have found that the physical distance this gives you allows you to note certain omissions and even to find (more!) typing or spelling errors which can still be corrected at the last minute.

We would thus urge you to adopt this procedure, and not to be content until every member of your team has examined the book page by page and signed each page on the pinboard.

### **Complete Job Envelope**

Secondly, check that all the original documents have been put together and all the necessary instructions given to allow the printer to produce the books without difficulty. You should then examine your textbook page

Secondly, check that all the original documents have been put together and all the necessary instructions given to allow the printer to produce the books without difficulty. You should then examine your textbook page by page, as it is pinned up on the board and make sure that everything is complete.

Here too we have modified the way we work over the years. For years and years we submitted a text dossier and an image dossier to the printer separately. Today we do things differently. For every page of the book, we prepare one large envelope on which we write the page number. The envelope contains all the pertinent elements for that page.

Thus for the revised version of *Garabola* each envelope contained

- The original copy of the texts
- The original copy of the illustrations
- A photocopy of the illustrations bearing the instructions for shading and, in some cases, for reducing the illustration
- The original copy of the hand-written examples in cursive style
- A montage using a photocopy of the texts and illustrations.

Once you hand this job envelope over to the printer, your work as authors is almost over. Afterwards, if you have prepared your dossier well, the printer will not have to contact you again before he submits the blueprints; these are the last proofs, printed on blue paper to allow you to check the assembly of the elements on the page, the imposition and perhaps also the shading. The blueprints will be submitted to you one signature at a time; you should check them, and if there are no errors you should give the printer the go-ahead, signing each one. The book is then out of your hands and you won't see it again until it is published.

We would just like to draw your attention to one last point: you should never make author corrections on the blueprint. Do not give in to the temptation to improve your text at this stage – it is too late. What can happen, of course, is that you spot another typing error, which you must, of course, correct. This is, however, the absolute exception, and if you have read this book attentively we will not have to explain why.

## **6. In Conclusion**

### ***Calculating the Sales Price of the Book***

The production of textbooks in developing countries is a long process and requires the attention of the authors throughout. Once the process is launched the authors rarely have time to stand back and evaluate the price of the operation.

There is, however, so much at stake that you must gauge the viability of the exercise. An examination of the costs should allow those concerned to better manage their work in future: authors and publishers thus have a good basis on which to determine the physical and graphic aspects of a series of books, and on the best way to produce them, or the final version, where you have been working on a pilot version.

This work should be performed by specialists who will take into account the following<sup>11</sup>.

### **Printing and production costs**

At the end of the conceptual phase you had a provisional quotation drawn up for the production of your book, based on approximate figures. You now have the precise figures, since the printer has been able to update and modify his prices. You can thus take the figures in his final quotation.

### **Development costs**

These costs include all costs incurred from the preliminary research phase until the job envelope is submitted to the printer, i.e. all the costs of preparing the manuscript, the graphics dossier and the layout work.

to the printer, i.e. all the costs of preparing the manuscript, the graphics dossier and the layout work.

### **Overheads**

These are costs which do not relate directly to any one task, such as general administrative services, rent or vehicle maintenance, so important for field work.

### **Costs of distribution and/or sale**

These costs cover the packing and transport of the books to the schools; in some cases they will also include the costs of advertising and promoting the book.

Throughout this book we have emphasised the huge responsibility borne by authors, the honesty they must bring to their work, the rigour and precision required. The costing exercise will convince you of the truth of this if nothing else has: authors of textbooks may not under any circumstances act negligently.

### **Notes**

<sup>1</sup> The blueprint does not always allow you to check the different shades of grey very exactly, but you can spot omissions in the shading, which may be printed white if not corrected.

<sup>2</sup> The blueprint allows authors to check changes made by the printer and remedy any errors. One example we encountered was the exercise on telling the time in an English book, where the printer had had the clock redrawn; it had certainly gained in aesthetic quality, but the time on the clock face no longer corresponded to the English sentence next to it, which the pupils were to learn.

<sup>3</sup> The monitoring showed them that even the highly improbable is possible and allowed them to correct some errors: thus we noted that the red Pantone ink which we had ordered overseas to print the cover had been wrongly delivered and that the cover was about to be printed in pale pink.

<sup>4</sup> If, however, you are forced to deal with the legal side of things look at the question of authors' rights and royalties, and be sure and consult the books recommended here.

<sup>5</sup> The pupils are expected to recognise not just any old fish but the "tilapia" which is well known in Madagascar, which is why the changes had to be made.

<sup>6</sup> Layout problems are not new: in the thirteenth century the French architect Villard de Honnecourt proposed a model which divided the page harmoniously; today research is still being conducted; some of the most interesting includes the work of J. Tschichold and R. Rosarivo, which you will find in the books on layout listed at the end of this chapter.

<sup>7</sup> Most of the changes to the illustrations and the layout of *Garabola* were made by Marina Dinkier, a professional graphic artist. These modifications significantly improved the final version. Cf. Dinkier, M. *Mise en page et préparation pour l'impression*. Internal paper, TefBoky Project, 1990.

<sup>8</sup> The major classifications are the work of Thibaudeau (1921), Vox (1952), Novarese (1964), Jacno (1978) and Alessandrini (1980). They are based on various perspectives (historical, aesthetic, geographical, etc.).

<sup>9</sup> In this classification the two last groups (Gothic and non-Latin characters) are not generally particularly relevant for textbook authors.

<sup>10</sup> If the textbook is to give examples of handwriting, you should bear in mind that computer programmes which can reproduce writing of this sort are expensive and rarely meet all your requirements. It is often a good idea to have examples illustrated by hand.

<sup>11</sup> We refer you to the costing grids proposed by F. Richaudeau in *Conception et production des manuels scolaires*, op. cit., pp. 215–239.

### ***Recommended Reading***

### **Preparation and Re-Reading Copy**

BAUDIN, F. La préparation de la copie. In: DREYFUS, J. AND RICHAUDEAU, F. *La chose imprimée*. Paris:

BAUDIN, F. La préparation de la copie. In: DREYFUS, J. AND RICHAUDEAU, F. *La chose imprimée*. Paris: Retz, 1977

GUERY, L. *Manuel de secrétariat de rédaction*. Paris: C.F.P.J., 1990

PRESSE ET FORMATION *Abrégé du code typographique à l'usage de la presse*. Paris: C.F.P.J., 1991

### **Layout**

DUPLAN, P. AND JAUNEAU, R. *Maquette et mise en page*. Paris: Usine Nouvelle, 1986

GUERY, L. *Précis de mise en page*. Paris: C.F.P.J., 1988

RICHAUDEAU, F. *Manuel de typographie et de mise en page*. Paris: Retz, 1989

### **Typography**

AICHER, O. *Typographie*. Lüdenscheid: Druckhaus Maack, 1989

DREYFUS, J. AND RICHAUDEAU, F. *La chose imprimée*. Paris: Retz, 1985

SALBERG-STEINHARDT, B. *Die Schrift: Geschichte, Gestaltung, Anwendung*. Cologne: DuMont Buchverlag, 1983

TSCHICHOLD, J. *Meisterbuch der Schrift*. Ravensburg: Otto Maier, 1965

ZAPF, H. *Variations typographiques*. Paris: Hermann, 1965

### **Illustration**

165

<http://cd3wd.com/dvd/> - filename: z\_science\_exp\_571 of 598

FUGELSANG, A. *About understanding. Ideas and observations on cross-cultural communication*. Dag Hammarskjöld Foundation Uppsala, 1982

WALKER, D.A. *Understanding pictures*. University of Massachussets, 1979

### **To Sum Up**

All the work we have described until now, has been geared to producing the raw material of the textbook. To make it publishable, you must now polish it and put it into its final form. To put it more plainly, you must have the illustration and the layout work done.

At this level everything is still open: a good manuscript can become a good book, but it can also be made into a monotonous, abstruse or obscure book. The illustrations and the layout of a book give the contents their contours, which will promote or block learning. You should thus illustrate the texts in a functional way. Do not decorate. Create references which will help the reader without trying his patience. Establish a rigorous and transparent structure for your book which will not bore readers.

This work demands unique expertise, an expertise which not all authors of textbooks in developing countries possess – sometimes they are not even aware of how important it is. Given the fact that few of them will have recourse to a professional and that there are few long-term training courses, they should try to train on the job, by

- demanding sporadic support from technicians on the spot, and in particular from the printer
- using specialised reference works on layout in particular
- acquiring certain mechanisms as they read, so that they register not only the contents but also the graphic features of printed materials.

This phase is over when the job envelope has been submitted to the printer. It should be so well prepared that contacts with the assembly man and the printer are kept to a minimum.

Even if the author's work is now finished, it is vital that the work performed be recapitulated and costed. Specialists should always calculate the price of the book, taking into account not only the development and

Even if the author's work is now finished, it is vital that the work performed be recapitulated and costed. Specialists should always calculate the price of the book, taking into account not only the development and production costs, but also the overheads and the costs of distributing the finished product to the schools. This is vital feed-back but it is all too seldom passed on to the authors in developing countries.

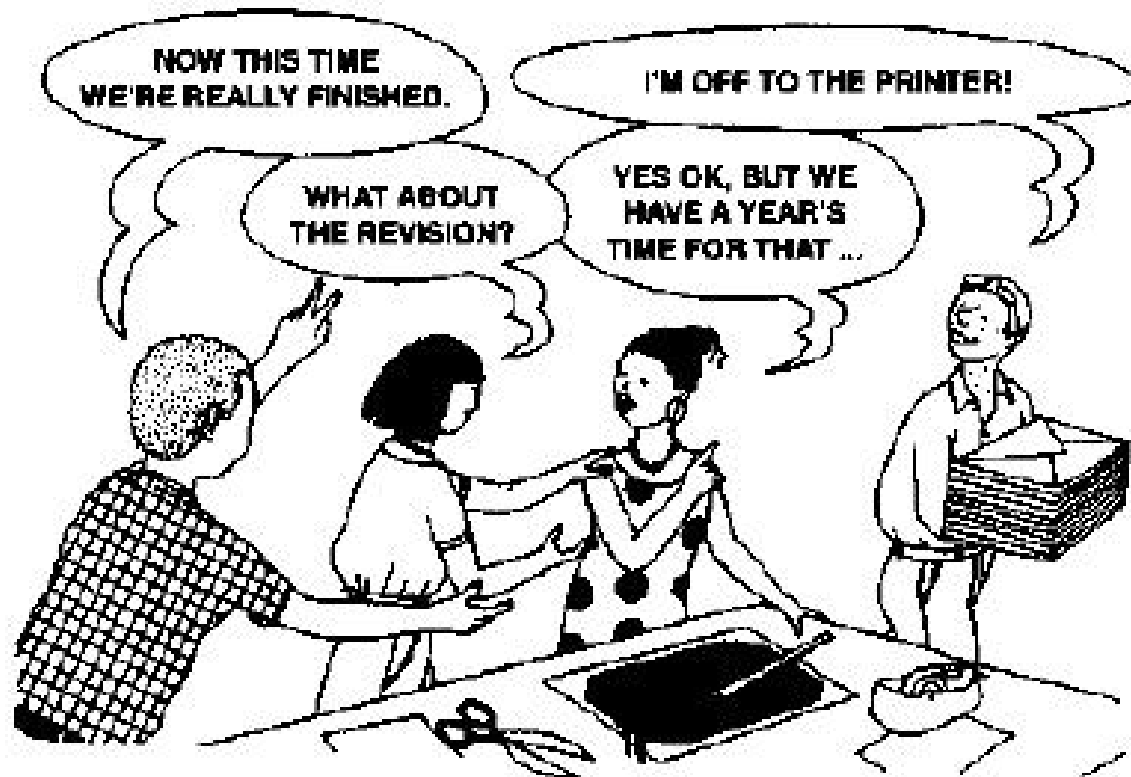

## By Way of Conclusion

You have now devoted several years to preparing a school textbook and you have just handed in the final version to the printer.



The fruit of so much work will now ripen rapidly as far as you are concerned, for the printer's deadline will bear no relation to the time you have spent up to now. The printing is generally the shortest step in the entire chain, assuming that the authors have made all the necessary preparations.

The joy and pride you will feel the first time you take your book in your hands and flick through it will almost inevitably be slightly dampened. You will be disappointed that the margins are so narrow and that you didn't notice before, that the grey of the shading is too dark or because at this stage you find a typing error in a prominent position, quite inexplicably in view of the care with which you compiled the manuscript and the model.

It is undoubtedly true that errors of this sort detract from the quality of the book, and may discourage authors, but they are minor details, even if people rush to point them out to you. The most important thing is that the book exists and that it is of an acceptable quality. By producing this book in such difficult circumstances you have blazed a trail for other publications of even better quality. In view of the urgent demand for textbooks in many developing countries, and the production conditions commonly encountered, minor shortcomings such as those mentioned above are relatively unimportant.

The publication of a book always marks the end of a long and intensive period of work. Given the book situation and the scarcity of experienced textbook authors, it is to be hoped that the skills thus acquired will be shared; that all those who toiled to make their contribution to a quality publication will continue in this line of work.

But, do not fall into the trap of thinking that your training is complete after the first book. You will never have learned everything there is to know, and the quality of your work will always depend on the diversity and solidity of your training. Every book you work on will be a challenge in its own way, and you will have to find individual, tailor-made solutions in each case. Your products will gradually improve the more experience you have and the more you learn. Keep in touch with professionals in the world of publishing, gather your own documentation, examine the contents and form of other printed materials, in particular textbooks, to try to help improve the efficiency of schools in your country.

## Annexe: Evaluation

Pupils have worked with the pilot version of your book over a period of one or several years. But your odyssey is not quite over yet; if you look back at the first chapter you will see that in developing countries the evaluation of pilot materials is an integral part of the chain. And, now that you have the chance to look at your book with a certain distance, you will be the last to stand in the way of a revised version: not only will you stumble over minor errors which you will find inexplicable after all the double, triple and quadruple checks, but certain doubts will also begin to sprout in your mind regarding the contents and the graphic features. An evaluation, followed by a revision of the pilot materials is thus called for in most cases.

How should you go about this? In some countries the ministry will assume responsibility for the evaluation. It will examine the books presented by private publishers and decide whether or not to accord the book official authorisation. It is not the actual performance of the book in schools that is evaluated here; the book is simply assessed according to a grid comparable to the grids you will find in the recommended reading at the end of this chapter. It is generally a sort of censorial work.

In our opinion grids of this sort are useful for authors performing internal checks as they write didactic materials, but they are quite unsuited to revising school publications. It is, in any case not sufficient to analyse new didactic material from your desk; it is imperative to look at how it actually works in schools.

For most of you, the evaluation work will constitute a new research project. You will have to carefully plan and execute numerous, complex activities and the work will sometimes involve managing significant human, technical and financial resources.

You should realise that this phase has much in common with the preliminary research phase, which is why we will only give you some general pointers, to help you understand how to make the preparations for the systematic revision of pilot materials; we will not repeat the information presented in chapter 3, but will simply refer you back to it whenever appropriate.

## 1. Overview

One of the main difficulties which you will face in your evaluation work is bound to be the logistics. In some cases, you will already be involved in other work, like drawing up your next book, and in others the education authorities will exert a lot of pressure on you to produce the final version as rapidly as possible<sup>1</sup>.

Whatever the specific constraints you will almost always be working under time pressure, which means that you must plan the evaluation activities meticulously to ensure that you achieve the quality required within the given time-frame.

Evaluation is a major task which will often take an entire year. To give you an idea of the scope and the complexity of this phase we will sum up the major steps taken in the Tef'Boky Project to evaluate the first version of *Garabola*.

### ***Evaluation Work for Garabola***

#### **Aspects, Strategy, Instruments**

*October 1988*

Once production work on the *Garabola* set (reading book, writing book and teachers' guide) was completed, the authors were quick to set up an evaluation system so that the evaluation could start at the beginning of the academic year. They drew up a list of the aspects to be examined, and then decided on a strategy and the research instruments that they would need to give them the information they required.

This was one of the most labour-intensive phases of the entire project, involving the following tasks in addition to the evaluation per se:

- designing and organising a system to distribute the *Garabola* materials to the schools in the test zone
- designing, organising, realising and evaluating the presentation of pilot materials to the 40 teachers concerned

- designing, organising, realising and evaluating the presentation of pilot materials to the 40 teachers concerned
- initiating the design work on *Tongavola*, reading and writing materials for the second year of primary school.

The authors could not do everything themselves, so they devised an evaluation strategy which only demanded their participation on a sporadic basis: they concentrated on devising evaluation instruments, taking part in classroom observations and interpreting the final results. The major logistic work, including gathering data and processing it systematically, was entrusted to a small team specially set up for this.

### **Daily Self-Evaluation Grid**

*October 1988*

The first evaluation instrument was a daily self-evaluation grid. This was the first priority of the authors so that it could be completed and distributed to 9 teachers in time for the start of the academic year. The nine were recommended by animateurs for their professional ethics; they undertook to fill in the grid every day.

### **First Test Series**

*December 1988*

The second instrument was a series of tests to be run at the end of the first term in all 40 test schools. This activity had a dual objective: to evaluate the very first results obtained with the new materials and to examine the level of receptiveness in the schools, which would enable the team to take remedial steps at an early stage if necessary.

### **Classroom Observations**

*January 1989*

The third instrument was a classroom observation grid, allowing the evaluators to look at the way *Garabola* was used over a one-week period; the authors themselves thus spent one week at the schools at the start of the second term.

### **Critical Examination of the Material**

*January 1989*

At the same time the *Garabola* set was sent to various individuals for a critical examination. It was accompanied by a form letter, inviting the recipients to make their comments and suggestions.

This action brought absolutely no results; not one single comment filtered back to the authors. It may be safe to assume that personalised questions would have had better results.

### **Second Test Series**

*March–June 1989*

The last evaluation instrument consisted of tests to gauge reading and writing progress. Preliminary tests were firstly run in two rural schools after which the instrument was modified. To give a comparative analysis of the year-end results the tests were run in 20 of the schools in the test zone and 20 control schools. The working conditions in this control group were comparable to those in the test schools, but they did not use *Garabola*. The evaluation team, duly instructed, ran the tests; the team members took advantage of this field visit to gather documents, first and foremost writing exercise books and gather information, such as the rate of attendance at the schools and the physical state of the books – all data which will help make for a complete evaluation.

### **Processing and Interpreting Results**

*July–August–September 1989*

*July–August–September 1989*

The team of evaluators was charged with processing the test results and the other information gathered. The authors then examined the data and interpreted it.

### **Development of an Evaluation Report**

*September–December 1989*

In view of the fact that the material broke with certain practices, notably significantly lowering the attainment targets laid down in the official curricula<sup>2</sup>, it was important to inform the education authorities of the results.

A reference document was thus produced by an educationalist, since the authors were too busy to take on this task as well, and the document widely circulated.

## **2. Aspects of the Evaluation**

Now that we have looked briefly at the possible evaluation activities for a pilot textbook, let us come back to the first stage, i.e. identifying precisely the aspects to be evaluated. Here is a short summary of the features that should usually be examined with care.

### ***Effectiveness in Terms of Attainment Targets***

You must prove that the materials actually do their job by analysing the results obtained using the new material as compared to the attainment targets.

The results of tests of this sort must, it is true, always be interpreted with care, but the results are of capital importance for you. If they are positive, general aspects of your material, in terms of the volume of subject matter presented, the learning method adopted and the composition of the materials can be considered

appropriate. If on the other hand they are clearly negative, you must examine these aspects in great detail and be ready to make far-reaching changes<sup>3</sup>.

And bear in mind that the education authorities are bound to attach great importance to the test results. Their first questions are unlikely to concern the aesthetic qualities, the suitability or even the solidity of the book, but whether or not it produces results.

### ***Shortcomings of the Content Matter and the Form***

The tests should give you an idea as to whether or not your material works; these general pointers will not, however, tell you what need not be changed and what should be modified on each page.

Before you can revise your material page by page with full knowledge of the facts you will need an instrument which will allow you to examine every aspect in detail.

Let us assume that you have been working on reading and writing materials: you should then look at the topics chosen, the linguistic and pedagogical aspects of the texts, the characteristics of the illustrations and the layout of the pupils' materials as well as the contents and presentation of the teachers' guide, rather than focusing only on the learning method used.

The results should enable you to revise your materials advisedly, on the basis of the reaction of users.

### ***Repercussions on Attitudes to School***

In many countries school rolls are dropping<sup>4</sup>, a development which is attributed to several different factors.

Although it is true that the rate of growth of school rolls in a country depends primarily on the household income, it is also linked to learning conditions. It can thus often be instructive to see if the introduction of the new material coincided with a drop in pupil absences or not.

### ***Robustness of the Book***

Although it is relatively unimportant if a pilot book loses pages or rips easily after one year of use, the revised

Although it is relatively unimportant if a pilot book loses pages or rips easily after one year of use, the revised version must be robust, particularly if a large run is to be printed and used nation-wide.

It is important to examine the material after it has been in use for a certain period, so that you can take the necessary technical and financial steps in time to ensure that the revised version of your materials enjoys a long service life.

### **3. Evaluation Indicators and Instruments**

Once you have decided which aspects you wish to evaluate, you must identify the instruments which will help you obtain the results required.

To this end you should take the same approach as you did during the preliminary research phase: firstly formulate indicators, i.e. easily observable, quantifiable or verifiable elements, and then determine which instruments will enable you to verify each of the indicators.

We suggest below a few indicators and instruments which can be used to examine the four aspects quoted above. Analyse them and adapt them as appropriate to your own circumstances.

### **4. Planning the Activities**

Ideally you would be able to use all the instruments you have listed, but this will not always be possible.

When you come to draw up a systematic plan for the evaluation phase you will be able to identify which ones you will actually be able to use. You should draw up your work schedule, taking the following elements into account.



<b>32. Identification of Evaluation Instruments</b>		
<b>Aspects–Indicators–Instruments</b>		
<b>Effectiveness of Material</b>		
	School results	
		Attainment tests
		Verification of the rate of learning (in teacher's lesson plan for instance)
		Daily self–evaluation grid
		Classroom observation
<b>Shortcomings of material</b>		
	Teaching process	
		Daily self–evaluation grid
		Classroom observation
		Voluntarily kept log–book
	Learning process	
		Daily self–evaluation grid
		Classroom observation
		Analysis of pupils' exercise books
<b>Repercussions of the materials</b>		
	Parents' attitude	

	Parents' attitude
	Talk with parents
	List of school attendance rates of their children
	Teachers' attitude
	Talk with teacher
	Verification of the frequency with which the material is being used, by checking its physical state
	Daily lesson plan
	Pupils' attitude
	Talk with pupils
<b>Physical aspects of the book</b>	
	Strength when handled frequently
	Examination of books
	Ease of handling
	Examination of books
	Classroom observations
	Talks with teacher

***Institutional Priorities***

In general, the existence of pilot materials in itself reassures the education authorities enough to stop them exerting undue pressure on authors to prepare a final version.

But if financial assistance has been pledged for printing and distribution, it is not unusual for time-limits to be set for the revision phase. In this case you will have to see how you can respect the deadlines without compromising the quality of materials which will then be used for several years in the schools of your country.

### ***Human, Physical and Financial Resources***

This is the second aspect to be examined when you come to plan your evaluation activities.

If you refer back to the experience in the TefBoky Project as presented earlier in this chapter, you will see that the authors delegated the responsibility for numerous tasks to a so-called evaluation group.

If you do not have this sort of back-up, and if your technical and financial resources are limited, plan your activities accordingly. Distinguish between what is desirable and what is possible, as you did during the preliminary research phase.

### ***Scope of the Work***

Time and special skills are always needed to develop instruments, but in developing countries, where research conditions are more complex than in industrialised countries, you will have to examine the entire evaluation phase, to avoid planning activities which are not feasible with the available resources.

In particular, no instruments should be used in the field without first undertaking a series of well-targeted preparatory measures.

It is, however, difficult to foresee all the work which instrument x or y will entail. To give you an idea of the scope of the work that lies ahead we list below the activities which we feel are indispensable to obtain significant results, if you opt for a comparative analysis of school results. Analyse these and draw your own conclusions for your specific circumstances.

### ***Work Involved in a Comparative Analysis***

### ***Work Involved in a Comparative Analysis***

The work involved in conducting a comparative study of school results is sporadic, it is true, but the tasks are many and varied, and are generally spread over an entire year. Here is a list of the principal tasks:

#### **Identification of Test Schools**

- Define a common profile for schools to be selected from the group of test schools and from outside this group (e.g. geographical location, teacher:pupil ratio, etc.)
- Undertake a first theoretical selection of schools having used the material to be evaluated
- Conduct a field visit to verify the data for the first set of schools
- Undertake a first theoretical selection of the control schools, followed by a field visit to check the selection
- Take the necessary administrative steps to allow you to operate outside the test zone.

#### **Development of Tests**

- Identify attainment targets to be evaluated
- Draw up a list of criteria referring to the contents, presentation, course of tests, marking scale and interpretation of results
- Develop the tests
- Illustration, layout and preparation of an adequate number of tests

- Select at least two schools, which correspond to the criteria laid down for the schools selected for the final test and administrative steps to allow you to run a preliminary test there
- Issue detailed instructions to those in charge of running the preliminary tests
- Conduct the preliminary tests
- Process results systematically and interpret these
- Make any modifications to the tests or the instructions given to those in charge
- Prepare a sufficient number of the final version of the tests.

### **Holding the Tests**

- Plan the tests (e.g. identify those responsible for running the tests, available transport, sources of financing; draw up a schedule for holding tests school by school)
- Take necessary administrative steps and inform each school in writing when the tests will be held and what they will involve
- Issue instructions to those responsible for running the tests
- Make effective preparations for the field visit
- Conduct evaluation work in the field
- File immediately and systematically the tests and all other documentation collected in the schools on this occasion.

### **Systematic Processing and Interpretation of Results**

## Systematic Processing and Interpretation of Results

- Issue instructions to those in charge of processing the data, regarding marking systems as agreed on earlier
- Examine and mark each test
- Draw up statistics
- Interpret the results
- Draw up a document presenting the procedures adopted and the results of the evaluation
- Distribute it to all interested parties.

## 5. In Conclusion

By way of conclusion we would just refer you to chapter 3 to refresh your memory about the follow–own work, in particular devising instruments, work in the field and data processing, and to some of the evaluation instruments which were used to evaluate *Garabola* and which may be useful to you, if not as a model, then at least for reference purposes<sup>5</sup>.

### Notes

<sup>1</sup> This always happens when the financing for a large run is available before the evaluation work is finished. The situation is not exceptional, but is always unpleasant for authors; time considerations often take precedence over the issue of quality.

<sup>2</sup> With *Garabola* first-grade pupils learn only 21 letters of the alphabet, whereas the current curriculum also provides for pupils learning 13 of the complex graphemes in Malagasy. It was thus particularly important to inform the education authorities about the results obtained in reading and writing.

<sup>3</sup> In the Tef'Boky Project the learning progress tests revealed that the writing exercise book was inappropriate given the current educational context in Madagascar. This led the authors to modify the make-up of the materials designed to teach writing in grade one of primary school. Cf. Chapter 4.

<sup>4</sup> "Although the rate of increase in enrolment declined at all levels of education, the drop was most pronounced at the first level, where it fell from 8.4 percent (approximately 2.9 million additional pupils each year) between 1970 and 1980 to 2.9 percent (approximately 1.4 million additional pupils each year) between 1980 and 1983." In: World Bank "Education in Sub-Saharan Africa" p. 28.

<sup>5</sup> The evaluation work is described in its entirety in KOMAREK K. *Dossiers II*, 1993.

### ***Recommended Reading***

ABERNOT, Y. *Les méthodes d'évaluation scolaire. Techniques actuelles et innovations*. Paris: Bordas, 1988

DE KETELE, J.M. *L'évaluation, approche descriptive ou prescriptive*. Brussels: De Boeck, 1987

DE LANDSHEERE, G. *Dictionnaire de l'évaluation et de la recherche en évaluation*. Paris: PUF, 1979

KOMAREK, K. (Ed.) *La Série Garabola. Dossiers II*. Antananarivo/ Eschborn: GTZ, 1993

MAGER, R.F. *Comment mesurer les résultats de l'enseignement*. Paris: Bordas, 1986

RICHAUDEAU, F. *Eléments pour un examen critique des manuels scolaires*. In: *Conception et production des manuels scolaires*, op. cit. pp. 267-281

### **Bibliography**

## Bibliography

- ABERNOT, Y. *Les méthodes d'évaluation scolaire. Techniques actuelles et innovations*. Paris: Bordas, 1988
- AICHER, O. *Typographic* Lüdenscheid: Druckhaus Maack, 1989
- ALTBACH, P.G. Problemas esenciales del libro escolar en el tercer mundo. In: *Perspectivas*, Vol. XIII, No. 47. Paris: UNESCO, 1983
- ALTBACH, P.G. Copyright in the Developing World. In: FARRELL, J.P. AND HEYNEMAN, S.P. (Ed.) *Textbooks in the Developing World*. Washington D.C.: World Bank, 1989
- ALTBACH, P.G. et al *Textbooks in the Third World. Policy, content and context*. New-York: Garland, 1988
- ARCIVAL, D. et al *Guide pratique des techniques de l'imprimerie*. Paris: AFNOR, 1983
- AREGGER, K. *Innovation in sozialen Systemen 1. Einführung in die Innovationstheorie der Organisation*. Berne, Stuttgart: Paul Haupt, 1976
- AREGGER, K. *Innovation in sozialen Systemen 2. Ein integriertes Innovationsmodell am Beispiel der Schule*. Berne, Stuttgart: Paul Haupt, 1976
- AVALOS, B. *L'enseignement aux enfants démunis. Une étude ethnographique en Amérique Latine*. Ottawa: Centre de recherches pour le développement international, 1986
- BERGER, G. AND BRUNSWIC, E. *L'éducateur et l'approche systématique*. Paris: UNESCO, 1984
- BERTHELOT, J. *Petit guide à l'usage des auteurs débutants et de quelques autres*. Paris: Hachette, 1991



BIJELJAC–BABIC, R. *L'utilisation des langues maternelles et nationales en tant qu'instruments d'enseignement, d'alphabétisation et de culture. Expériences dans les pays en développement d'Afrique et d'Asie*. Paris: UNESCO, 1985

BOUVAIST, J.M. *Pratiques et métiers de l'édition*. Paris: Promodis, 1986

BUCHAN, A. et al *Etudes sur le secteur du livre en Afrique. Rapport analytique*. Washington D.C.: World Bank, 1991

BUDE, U. *Culture and environment in primary education. The demands of the curriculum and the practice in schools in sub-Saharan Africa*. Bonn: German Foundation for International Development (DSE), 1991

CALVET, L.J. *Linguistique et colonialisme. Petit traité de glottophagie*. Paris: Payot, 1974

CALVET, L.J. *La guerre des langues et les politiques linguistiques*. Paris: Payot, 1987

CHAMBERS, R. *Développement rural. La pauvreté cachée*. Paris: Karthala, CTA, 1990

CHAMPION, J. *Langage et pédagogie en France et en Afrique*. Paris: Editions Anthropos, 1986

CHATRY–KOMAREK, M. Linguistische Faktoren bei der Erstellung von Schulbüchern in Vernakularsprachen. In: *Osnabrücker Beiträge zur Sprachtheorie*, No. 31. Osnabrück, 1985

CHATRY–KOMAREK, M. Consideraciones lingüísticas en torno a libros escolares en quechua puneño. In: *Revista Andina*, Año 4, No. 1. Cusco, 1986

CHATRY–KOMAREK, M. *Libros de lectura para niños de lengua vernácula. A partir de una experiencia interdisciplinaria en el Altiplano peruano*. Eschborn: GTZ Schriftenreihe No. 193, 1987

CHATRY–KOMAREK, M. Intentos de codificación del quechua en libros escolares. In: LOPEZ, L.E. AND MOYA, R. (Ed.) *Pueblos indios, estados y educación*. Lima, 1989

CLAS, A. *Guide de recherche en lexicographie et terminologie*. Paris: Agence de Coopération culturelle

CLAS, A. *Guide de recherche en lexicographie et terminologie*. Paris: Agence de Coopération culturelle technique, 1985

COLOMBET, C. *Grands principes du droit d'auteur et des droits voisins dans le monde. Approche de droit comparé*. Paris: Litec, UNESCO, 1990

CONFEMEN. *Promotion et intégration des langues nationales dans les systèmes éducatifs. Bilan et inventaire*. Paris: Editions Champion, 1986

COULMAS, F. *Linguistic minorities and literacy: language policy issues in developing countries*. Berlin: Mouton Publishers, 1984

COULMAS, F. *Sprache und Staat. Studien zur Sprachplanung*. Berlin: W. de Gruyter, 1985

CROZIER, M. AND FRIEDBERG, E. *L'acteur et le système*. Paris: Seuil, 1977

CUMMINGS, W.K. *L'enseignement primaire à coût modique. Mise en oeuvre d'une innovation dans six pays*. Ottawa: Centre de recherches pour le développement international, 1986

DE LANDSHEERE, G. *La recherche en éducation dans le monde*. Paris: PUF, 1986

DREYFUS, J. AND RICHAUDEAU, F. *La chose imprimée*. Paris: Retz, 1985

DUPLAN, P. AND JAUNEAU, R. *Maquette et mise en page*. Paris: Usine Nouvelle, 1986

DURCHON, P. *Photogravure et impression offset*. Paris: Usine Nouvelle, 1987

ESCARPIT. *L'Écrit et la communication*. Paris: PUF, 1973

FARRELL, J. AND HEYNEMAN, S. (Ed.) *Textbooks in the Developing World. Economic and educational choices*. Washington D.C.: World Bank, 1989

FERRY, G. *La pratique du travail en groupe*. Paris: Bordas, 1985

FINEL, G. AND SASSIER, D. *Un livre, des hommes. De l'auteur au lecteur*. Paris: Nathan, 1988

FISHMAN, J.A. Language modernization and planning in comparison with other types of national modernization and planning. In: *Advances in language planning*. The Hague, 1974

FISHMAN, J.A. Minority mother tongues in education. In: *Prospects, Quarterly review of education*. Vol. XIV, No. 1. Paris: UNESCO, 1984

FITOURI, C. *Biculturalisme, bilinguisme et éducation*. Neuchâtel, Paris: Delachaux et Niestlé, 1983

FRIEDMAN, M. *Libertés et responsabilités des journalistes et des auteurs*. Paris: Centre de formation et de perfectionnement des journalistes, 1988

GLEICH, U.V. *Latin American approaches to bilingual/bicultural primary education. Theory and practice*. Eschborn: GTZ, 1986

GLEICH, U.V., WOLFF, E. (Ed.) *Standardization of national languages*. Hamburg: UNESCO Institute for Education, 1991

GREENFELD, H. *Bücher wachsen nicht auf Bäumen*. Munich: Ellerman, 1979

GROUPE DE LA CITE INTERNATIONALE *Le livre. Sa conception, sa réalisation. Documentation*. Paris, undated

GUDSCHINSKY, S. *Manual de alfabetización para pueblos prealfabetas*. Mexico: SEP/ Setentas, 1974

GUERY, L. *Précis de mise en page*. Paris: Centre de formation et de perfectionnement des journalistes, 1988

GUERY, L. *Précis de mise en page*. Paris: Centre de formation et de perfectionnement des journalistes, 1988

HAMEYER, U. *Vier Gesichtspunkte zur Förderung von Innovationsprozessen im Bildungssektor*. Kiel: IPN-Kurzbericht 14, 1978

HAMEYER, U. et al (Ed.) *Handbuch der Curriculumforschung*, Weinheim, Basle: Beltz, 1983

HAVELOCK, R.G. AND HUBERMAN, A.M. *Solving educational problems. The theory and reality of innovation in developing countries*. Paris: UNESCO, 1977

HEYNEMAN, S. P. et al *Textbooks and achievement. What we know*. Washington D.C.: World Bank, 1978

HUMMEL, C. *School textbooks and life-long education: an analysis of schoolbooks from three countries*. Hamburg: UNESCO Institute for Education, 1991

HUOT, H. *Dans la jungle des manuels scolaires*. Paris: Seuil, 1989

HEALTH LEARNING MATERIALS PROJECT *Guidelines on how to produce a manual*. Kathmandu: WHO-UNDP, 1988

KOMAREK, K. (Ed.) *La série Garabola. Dossiers I et II*. Eschborn, Antananarivo: GTZ, 1993

LAPOINTE, C. *Le livre du livre*. Paris: Gallimard, 1987

LEINO, J. *Theoretical background and development of instructional materials*. Helsinki: Department of Education, University of Helsinki, 1989

LE THANH KHOI L'enseignement en Afrique et le modèle européen. In: COQUERY-VIDROVITCH, C. AND FOREST, A. (Ed.) *Décolonisation et nouvelle dépendance. Modèles et contremodèles idéologiques et culturels dans le Tiers Monde*. Lille: Presses Universitaires

LEVY-RANVOISY, F. *Manuel de dessin pour communiquer avec une population non alphabétisée. La perspective orthogonale*. Paris: ACCT-Karthala, 1987

LOCKHEED, M.E. *Improving primary education in developing countries*. Washington D.C.: World Bank, 1991

MACPHERSON, J. AND PEARCE, D. *Publishing educational materials in developing countries. A guide to policy and practice*. Ottawa: Canadian Organization for Development through Education. London: Harold Macmillan Trust, 1990

MAGER, R.F. *Comment définir des objectifs pédagogiques*. Paris: Bordas, 1977

MAGER, R.F. *Comment mesurer les résultats de l'enseignement*. Paris: Bordas, 1986

MENZEL, W. (Ed.) *Fibeln und Lesebücher für die Primarstufe*. Paderborn: Schöningh, 1975

NEUMANN, P.H. *Publishing for schools. Textbooks and the less developed countries*. Washington D.C.: World Bank, 1980

NYSTRÖM, A. *Manual for the selection, the production and the evaluation of textbooks*. Paris: UNESCO, 1975

OAKESHOTT, P. AND BRADLEY, C. *L'avenir du livre: l'impact des techniques nouvelles. Etudes sur le livre et la lecture*. Paris: UNESCO, 1982

PEARCE, D. La producción de libros escolares en los países en desarrollo. In: *Perspectivas*, Vol. XIII, No. 47. Paris: UNESCO, 1983

PEARCE, D. *A guide to planning and administering government school textbook projects. With special emphasis on cost-reduction factors*. Paris: UNESCO, 1988

READ, A. *A guide to textbook project design and preparation*. Discussion Paper. Washington D.C.: The World Bank, 1986

Bank, 1986

RICHAUDEAU, F. *Conception et production des manuels scolaires. Guide pratique*. Paris: UNESCO, 1979

RICHAUDEAU, F. *Recherches actuelles sur la lisibilité*. Paris: RETZ, 1984

RICHAUDEAU, F. *Manuel de typographie et de mise en page*. Paris: RETZ, 1989

RUBIN, J. Textbook writers and language planning. In: *Language planning*. Rubin J. et al (Ed.) The Hague: Mouton Publishers, 1977

ROGERS, E.M. AND SHOEMAKER, F.F. *Communication of Innovations. A cross-cultural approach*. Toronto: Collier-MacMillan, 1971

SALBERG-STEINHARDT, B. *Die Schrift: Geschichte, Gestaltung, Anwendung*. Cologne: DuMont, 1983

SEGUIN, R. *L'élaboration des manuels scolaires. Guide méthodologique*. Paris: UNESCO, 1989

SEGUIN, R. *Curriculum development and implementation of teaching programmes. Methodological guide*. Paris: UNESCO, undated

SMITH, D. *Les problèmes économiques de l'édition des livres dans les pays en voie de développement*. Paris: UNESCO, 1977

SOW, A.I. *Langues et politique de langues en Afrique Noire*. UNESCO/Nubia, 1977

STAIGER, R.C. *The teaching of reading*. Lexington: UNESCO/Ginn, 1973

UNDP *Education and training in the 1990s. Developing countries' needs and strategies*. New York: Education Development Center, 1989

UNESCO *L'emploi des langues vernaculaires dans l'enseignement*. Paris, 1953

UNESCO *Design, development and evaluation of low-cost educational materials*. Bangkok:

UNESCO Regional Office for Education in Asia and Oceania, 1978

UNESCO *Low-cost educational materials, how to make, how to use, how to adapt*. (Vol. 1). Bangkok:

UNESCO Regional Office for Education in Asia and Oceania, 1980

UNESCO *Educational development. A practical issue. Guide for the preparation, production and distribution of textbooks*. Paris, 1980

UNESCO *Expert meeting to review the worldwide position as refers to the results of activities relating to the use of the mother tongue as a medium of instruction*. Paris, 1982

UNESCO *L'ABC du droit d'auteur*. Paris, 1982

UNESCO *Production and distribution of textbooks. Report of a regional seminar on the production and distribution of textbooks and other related teaching/learning materials*. Bangkok: UNESCO Regional Office for Education in Asia and the Pacific, 1985

UNESCO *Les langues communautaires africaines et leur utilisation dans l'enseignement et l'alphabétisation. Une enquête régionale*. Dakar, 1985

UNESCO *Textbook and related teaching/learning materials for primary classes. A report of a sub-regional workshop on the development of systems and structures for producing textbooks and other related teaching/learning materials*. Bangkok: UNESCO Regional Office, 1985

UNESCO *Book production training course in Papua New Guinea*. Tokyo: Department of Education of Papua New Guinea, Asian Cultural Centre for UNESCO, 1987

UNESCO *Rapport mondial sur l'éducation 1991*. Paris, 1991

UNESCO *Rapport mondial sur l'éducation 1991*. Paris, 1991

UNICEF *Communicating pictures in Nepal*. Kathmandu: National Development Service, 1976

UNSEL, S. *L'auteur et son éditeur*. Paris: Gallimard, 1983

VARGAS VEGA, R. *Materiales educativos y post-alfabetización*. Mexico: UNESCO, 1982

VESSILIER-RESSI, M. *Le métier d'auteur*. Paris: Bordas, 1982

WORLD BANK *Education in Sub-Saharan Africa. Policies for Adjustment, Revitalization, and Expansion*. Washington D.C., 1988

WORLD BANK *World Development Report 1991*. Washington D.C.

ZALTMAN, G. et al *Innovations and organizations*. New York: Wiley, 1973

## **Glossary**

### **Attainment**

The total of results obtained at a certain level in a given subject. In general, the education authorities attach great importance to attainment in the initial evaluation of the impact of a new textbook. These figures should, however, merely be taken as a rough indication as to the effectiveness of the book, and must be examined in more detail.

The evaluation of attainment is not in itself enough of a basis on which to revise a pilot textbook.

### **Author of School Textbooks**



In the traditional publishing chain the author is responsible for providing texts.

In general these will be texts which address pupils (reading texts, exercises, captions for photographs or illustrations) and teachers (preface, presentation, table of contents, instructions and information on the cover of the textbook, as well as the entire teachers' guide and complementary didactic materials).

When the author does not have a good publishing structure behind him he may also have to assume certain editorial responsibilities, of a financial, technical, graphical and commercial nature.

### **Authorisation to Print**

Authorisation issued by the education authorities to the authors to go ahead and have a given textbook printed.

### **Body Size**

The size of a type character.

The size is expressed in points; by way of example the main body of the text of this book is printed in 10 point characters, while the chapter headings are printed in 22 point.

### **Character Count**

Calculation of the number of characters and spaces in a text manuscript which allows one to calculate the approximate length of the text after typesetting and the number of pages in the book.

### **Character Spacing**

The blank space between two characters within the same word.

The character spacing in a text may be normal, condensed or wide, and this choice has repercussions on the typographical readability of the text.

typographical readability of the text.

## **Copy**

Typed text with instructions for typesetting and layout.

The authors should bear in mind the fact that the copy contains the complete, definitive text of the book, and should refrain from making their own corrections at a later stage, which always entail delays and additional costs.

## **Creating Words**

Lexical additions to a language which can take the form of neologisms, or loan words from other languages.

In textbooks written in national languages which have not yet been adequately standardised, technical and scientific terms will have to be created; in the absence of an institute of applied linguistics, the authors will have to check themselves whether or not the technical terms they need already exist, and where none exist will need to create new words, and ensure that they can be disseminated so that they will be generally accepted and used.

## **Development**

Link in the publishing chain.

During this phase the textual and graphic elements that will make up a page are produced and combined.

The term development is sometimes preferred to simply "writing" since it underlines the fact that during this phase not only are texts written, but a text-image unit is created.

## **Devising the Contents**

Devising all texts to be included in a textbook.

For a reading book, this phase involves choosing and/or defining the attainment targets, identifying the subject matter to be covered, the mandatory steps to be respected and the arrangement of this subject matter within the book.

In developing countries the difficulties are increased by the fact that textbooks ought to correspond to the official curricula, while the work involved leads authors to examine or reconsider targets which deviate too much from the reality in the schools of the country, otherwise the product may be totally inappropriate before it is even printed.

During this phase it is important for authors to be able to judge how much leeway they have to move away from the official guidelines.

### **Devising the Form**

Devising the physical aspects (format, number of pages, binding) and graphic features (type, number and size of illustrations, rough layout, type of printing) of a book.

It is crucial that the form be devised before the writing and illustration phases so that the texts and exercises can be produced to fit a pre-defined framework. The importance of this work is, however, rarely appreciated by teams of publishers–authors, which accounts for the “home-made” appearance of some of their products, which is totally disproportionate to the high costs.

### **Distribution of Textbooks**

Important link in the publishing chain. In many developing countries the distribution of textbooks to rural areas where the majority of the school population live is difficult, and thus often constitutes an education project in its own right.

### **Documentation Specialist**

Person put in charge by the publisher of finding all the documents to accompany the texts of a book, and of

Person put in charge by the publisher of finding all the documents to accompany the texts of a book, and of checking them for pertinence and technical quality.

### **Double Page**

Visual unit made up of the left-hand page, which will bear an even number, and the right-hand page which will bear an odd number.

The double page is the basic layout unit.

The layout artist assembles the pages two by two, arranging text and illustrations on the basis of a framework known as the grid, which covers the two pages at once.

### **Evaluation of a Textbook**

All activities which aim to provide information about the way the textbook is used in classrooms.

When the evaluation phase is designed to provide information for the revision of the book in question it must not only determine the extent to which the attainment targets can be achieved with the help of the material in question, but must also give precise information as to what aspects of the contents, the physical form and the graphics must be revised.

### **Evaluation Grid**

A research instrument which makes it possible to examine the contents and form of a textbook.

Evaluation grids are useful and should be used systematically by authors running a final internal check on their own manuscript.

They are not, on their own, enough to allow you to revise a pilot textbook and must be supplemented by other instruments (classroom observation, attainment tests, etc.).

### **Exercise Book**

Didactic material considered appropriate or even indispensable for some subjects, such as learning to write. Exercise books are always expensive because they can only be used once.

Any decision based on the assumption that a set of materials must include an exercise book should be reviewed with great care by authors in developing countries.

### **Exercise–Image Unit**

The contents and the form of an exercise.

In a good exercise, the contents and form will complement one another; the form can be a text–illustration, or may present the underlying mechanism of an exercise.

It is always a major challenge for textbook authors to develop exercises which allow for a strict progression of learning, ensure an agreeable visual effect and make the underlying mechanism transparent for teachers and pupils alike.

### **Feasibility Study**

Study which precedes a textbook project and focuses not only on the demand for textbooks but also looks at the conditions in which the book is to be developed, produced and distributed.

No textbook project should be launched before a feasibility study has been conducted. Otherwise it is imperative for the preliminary research phase to include a study on the environment in which the books will be used.

### **Film**

**Film**

The reproduction of a document on a transparent film which will then be used to make plates.

**Finishing**

The step which transforms the printed sheets into a finished book.

Finishing work, which comprises mainly folding, gathering the signatures and binding, must be closely supervised by the publisher, or the authors, in order to ensure that all the work to date has not been in vain.

**Folio**

The page numbers in a book. The even numbers will be on the left hand page, while the odd numbers will be on the right hand page.

**Graphics Dossier/File**

All the graphics documents for a book to be printed.

For a textbook this will include not only drawings and photographs, but also hand-written models of writing in cursive style.

**Grid**

Document which lays down the margins and the basic structure of a book and which helps to typeset a manuscript precisely and to produce various models, and make-ups.

The stencil is an indispensable tool for books with a complicated layout, as textbooks generally are.

**Hierarchy of Text**

181

Order and classification of the different parts of a text.

When there is little publishing back-up the authors themselves will have to check the organisation of their texts, clearly indicating the level of titles and text blocks to ensure that the photocompositor can process them accordingly.

In a partly theoretical work, like a teachers' guide, the hierarchy of the texts is often particularly complicated to establish.

### **Imposition**

Setting out the pages of the book on the sheet so that once the sheet is folded the pages will appear in the correct order.

Careful imposition can keep cost down by putting pages with colour illustrations together on one or two sheets thus limiting the number of sheets to be printed in two or four colours.

### **Initial Quotation**

An estimate of the costs of printing and finishing a textbook, which the printer can draw up at the end of the conceptual phase. The initial quotation allows authors to compare the physical and graphic features they have planned with the budget available.

### **Innovation**

Intentional transformation of an education system with a view to achieving the existing objectives or defining new, more appropriate objectives.

In a textbook project innovation is at the centre of all action and it is not easy to have it accepted. It concerns first and foremost the education authorities: the conception and execution of a project demands expertise and attitudes which are not always encouraged within a bureaucracy.

Innovation involves all those who are indirectly affected by the book: the curriculum unit, teacher training unit,

Innovation involves all those who are indirectly affected by the book: the curriculum unit, teacher training unit, field supervisors, i.e. amateurs, educational advisers and inspectors, as well as parents.

Innovation is naturally geared to the teachers, whose resistance to change is often exaggerated, since their work in the field often makes them excellent change agents.

Finally innovation concerns the authors who often become the locomotive of change. Their status as civil servants, their professional training, their integration in the system and their aspirations are often barriers to a frame of mind that welcomes innovations, without which, however, no transformation worthy of the name is possible.

### **Instructions for Teachers**

Precise, practical instructions for teachers printed in the textbook itself or in the teachers' guide, to help them with every-day lessons.

Textbook authors who aim to provide teachers with an effective tool in this way, find themselves confronted by the problem of how to ensure immediate effectiveness without surrounding the teacher with repetitive and stupefying instructions, which will in the long run cramp his or her teaching style and prevent him or her from developing and being inventive.

The shorter the learning time available the more carefully planned lessons must be and the more acute this dilemma.

### **Job Envelope**

All the text and graphics documents to be submitted to the printer so that he can print the entire book.

Some of these documents are submitted in their final form, while others are accompanied by precise instructions as to how they are to be processed (enlargements or reductions of illustrations for instance).



### **Language of Instruction**

Language used as a medium of instruction.

Sometimes this is the mother tongue of the pupils, and sometimes it is another language of which they have a more or less good command.

During the feasibility phase of a textbook project it is absolutely crucial to determine which is the language of instruction.

### **Language Taught**

A language which the pupils must learn as a subject in its own right. In most developing countries, pupils must learn a European language in their first few years of school.

During the conceptual phase of the textbook the authors must determine the grade as from which pupils learn this language and the amount of time accorded to it, so that they can determine how much time is left to learn the mother tongue.

### **Layout**

Arrangement of the blocks of text and graphic elements on a page.

An examination of primary school text-books produced forty years ago shows that the layout is the one element which has evolved most in the course of time and which is thus the clearest sign of modernity. Today there can be no doubt that good layout is not a luxury but a necessity for a textbook. But it must play second fiddle to pedagogical and didactic demands, and it must stay within the limits of what is acceptable to the target group.

The layout of a textbook emerges little by little parallel to the content matter. It is still vague during the conceptual phase, becomes more definite during the writing phase and takes on its finished form just before the book is printed. It is up to the authors to ensure that it performs its primary task – to help learners.

the book is printed. It is up to the authors to ensure that it performs its primary task – to help learners.

### **Layout Grid**

A grid for arranging the elements on a page in line with vertical, horizontal and diagonal axes.

Newspapers and journals often need complex grids; in spite of the relative simplicity of the layout of a textbook the elements should not be arranged by chance, but in line with a few major axes.

### **Layout Plan**

Guide for the layout of the book being produced, double page by double page. The layout plan is prepared at the end of the conceptual phase and should show the contents of each page and the approximate layout of illustrations and text.

### **Letter Card**

Piece of card on which one letter is printed. Letter cards are commonly used by teachers to develop analysis and synthesis skills when pupils begin to learn to read. They are useful and inexpensive.

Letter cards are only suitable for use by individual pupils when good storage facilities are available in the classroom.

### **Line Length**

Length of lines of a typeset text, often expressed in millimetres.

A text is said to be justified when all lines are the same length; in a reading book for beginners the text is always justified at the left side only leaving the text unjustified right, which means that the lines are of different lengths. This avoids having to split words which would get in the way of the efforts of beginners to decode the text.

### **Loan**

The act of one language borrowing an element from another language.

By extension, a loan word is a word used in a given language that has been borrowed from another language.

### **Manuscript**

Hand-written document. By extension text written by authors and submitted to the publishing unit after typing.

### **National Language**

The mother tongue of a social group which is generally dominated socially or politically by another group, which speaks a different language.

Most national languages have a difficult and hotly contested entry into schools. While recognising that they allow pupils to better assimilate knowledge, their detractors point out that they are not properly normalised and standardised.

Authors working on textbooks in national languages where this is the case should check the congruence of the alphabet, see that spelling and punctuation rules are respected and enrich the language by creating the technical and scientific terms they need.

### **Nationwide Introduction**

Phase in the production of textbooks in developing countries.

In the typical production cycle, authors will produce a textbook which is then tested, evaluated and revised before a large run is printed and distributed to the various parts of the country for widespread introduction.

### **Non-Text Information or General Information**

Texts which accompany the contents of a book.

Texts which accompany the contents of a book.

These are texts which appear on the cover and the first and last pages of a book and give the reader general information.

In a textbook the authors must generally write these pages too. They must be written with particular care since they will be the visiting card of sorts of the book.

### **Official Approval**

The official authorisation of the education authorities to use a textbook or other materials freely in schools.

When official approval is mandatory, as is the case in the Federal Republic of Germany, the titles thus selected are presented in a catalogue on the basis of which the education authorities, ad hoc committees and teachers can make their choice.

In pilot projects to produce textbooks in national languages, the education authorities often insist on checking to ensure that the particular socio-linguistic and socio-cultural features of the target group have been respected, to verify that the attainment targets are pertinent (i.e. that they do not deviate significantly from the official targets), and to ensure that an appropriate methodological approach has been adopted.

### **One-Teacher Schools**

Schools where one teacher teaches all classes at primary level and also assumes the responsibilities of head teacher.

When the majority of the target group can be found in one-teacher schools the didactic materials produced must be geared as soon as possible to as independent a learning style as possible, which will allow the teacher to pay some attention to the other classes.

### **Pagination**

The sequence of page numbers of a printed book.

### **Paper Wastage**

Paper wasted due to a disharmony between the format of the book on the one hand and that of the sheets of paper and printing presses on the other.

Paper wastage should always be kept to an absolute minimum; in developing countries where the price of the paper may account for one-third or even half of the total costs of producing the book, this is all the more important.

### **Passed for Press**

Authorisation issued by the publisher or the publisher–authors to the printer to expose the plates and print.

The blueprints must be signed to confirm that the assembly and the imposition are correct and that the work is ready for engraving.

### **Pedagogical Specifications**

List of the most important pedagogical and didactic aspects to be taken into account in the materials to be produced.

In large publishing houses the Publishing Manager draws up the pedagogical specifications, which then constitute a detailed frame of reference for the authors.

In developing countries, this is rarely the case. It is almost always the authors themselves who draw up the pedagogical specifications on the basis of an in–depth analysis of the status quo.

### **Pilot Textbook**

## **Pilot Textbook**

Provisional version of a textbook which is tested in a number of schools so that it can be analysed, and revised as necessary. In a developing country this phase should always last at least one academic year.

## **Preliminary Research**

Important link in the publishing chain to produce textbooks in many developing countries.

Preliminary research is indispensable when the available data on the teaching and learning conditions are incomplete or unreliable.

Authors should carry out the lion's share of this work if not all of it, to ensure that they are in possession of all the facts, and to allow them to start work on the textbook on the basis of a common level of information. But, although they always bear the overall responsibility they will have to call on the services of specialists: a sociologist, a statistician, sometimes an anthropologist, an expert in teaching second languages if the project in question involves bilingual education and a linguist where textbooks are to be produced in a national language.

## **Preliminary Testing**

Preliminary testing of the evaluation instruments in a smaller number of schools which are nevertheless representative of the conditions in schools in the country as a whole, before using them on a wider scale.

The attainment tests should always undergo preliminary testing and then be revised. When the technical and financial framework permits, the authors should conduct a second preliminary test if major revisions proved necessary.

## **Printer**

The individual responsible for printing and finishing a book.

Each of the tasks performed by a printer to transform an imposition scheme into a finished product is either performed on the instructions of the publisher (e.g. purchase of paper, or choice of binding) or supervised by the latter (e.g. reading proofs before signing them ready for press, or checking the blueprints before marking them ready to engrave).

The printer should never be forced to take on tasks that are the responsibility of authors (correcting or completing texts) or of the illustrator (completing a page with illustrations), layout person or graphic artist (making typographical choices and deciding on layout).

### **Printing**

Major link in the publishing chain.

Printing is not the sole responsibility of the publisher or the authors. But, during the conceptual phase it is up to them to ensure that the printing conditions are such that the work they plan can be effected at a later date (no 4-colour printing if the machines are not sufficiently precise, for instance). During the printing phase they are also responsible for checking that the results correspond to the terms of the contract with the printer.

### **Proof Reader**

Individual whose skills and/or status is such that they can give textbook authors valuable suggestions or encouragement.

No publication should be printed until it has been screened by a number of proof readers. Time and energy are needed, however, to organise this phase, and textbook authors would do well to consider it a mini project in its own right.

### **Proofs**

Provisional print-out of a text that has been set and composed by computer. Proofs must be re-read and corrected.

### **Publisher**

## **Publisher**

Person who plans and directs the publication of a literary piece of work, and manages the promotion and marketing. In developing countries it is common for the publisher not to assume all the tasks within the editorial chain that would be the responsibility of a publisher in industrialised countries. This work is then distributed among the various other actors, and is often assumed by the authors alone.

## **Publisher–Author**

Neologism which refers to the many individuals in developing countries who are incorrectly termed “authors”.

In addition to the writing work, publisher–authors take on a greater or lesser part of the work that would traditionally be performed by the publisher.

## **Publishing Chain**

All operations involved in translating an idea into a book, and publicising this book.

In textbook production it refers specifically to all the operations taking place from the start of the publishing project until the pupils have the finished books in their hands.

## **Publishing Specialist**

Manager or specialist involved in the publishing chain.

Large publishing houses have many publishing specialists with well defined roles. In developing countries the responsibilities of the various individuals involved are often modified, and it is common for authors to have to assume some of the responsibilities generally borne by the publisher.



When textbooks are being produced in a national language, a few more specialists are required. Teams of authors must often call on the services of anthropologists, sociologists, statisticians, linguists and/or experts in the teaching of a second language.

### **Ream**

Package of 500 sheets of paper of the same format.

### **Recto**

The right-hand page of an open book where the book has an odd number of pages. It is the page that one tends to see flicking through a book. The title of a book should always start recto, as should the chapters as far as possible.

### **Research Institute**

Research or teaching centre which may be private or public.

In textbook projects for primary level it is a good idea to seek the support of universities and teacher training colleges, so that the workload of the authors can be lightened by delegating some research work and incorporating existing structures in a common project in this way.

In practice, however, the gulf that generally separates these bodies often makes cooperation an uncomfortable affair.

### **Resource Person**

Individual who gives the authors detailed information, generally of a socio-cultural or socio-linguistic nature.

The resource person cannot be considered an author; he provides the information, but plays no part in devising or developing the textbook.

### **Revised Textbook**

### **Revised Textbook**

Textbook which has been revised after having been tested at a number of schools.

Only a properly revised textbook should be considered for a large run.

### **School Enrolment**

The number of pupils attending school within one class, school or country.

### **Serif**

Small horizontal, vertical or oblique line across constituent parts of the type.

In this guide, the main body of the text is printed in *Palatino*, which displays serifs, while the tables are printed in *Univers* which does not.

### **Set of Didactic Materials**

All didactic materials devised and developed for one subject and grade.

The decision as to the composition of the set must always be well thought through and should depend not only on pedagogical and didactic considerations, but also take into account practical, logistic and financial considerations.

### **Sheet of Printing Paper**

A large sheet of paper on which several pages are printed at once.

The format and the number of pages of textbook must correspond to the dimensions of the sheet to be used.

## **Signature**

A collection of at least four pages, and more often 16 or 32 pages which are printed together on one large sheet of paper. The sheet is then folded several times so that the pages are in the correct order. A book is generally made up of several signatures.

## **Speaking and Listening**

Sub-discipline of the "mother tongue", in addition to reading and writing.

## **Survey Report**

Document presenting the main results of preliminary research regarding the development of textbooks.

The survey report is not indispensable for authors who are able to start the conceptual phase on the basis of the data they have gathered, but it is important for the education authorities.

To prepare the ground for the new textbook, authors are recommended to prepare a survey report, or have this done, and to present it to the relevant authorities.

## **Teachers' Guide**

Reference book for teachers.

The teachers' guide should always be part of a set of didactic materials; in some cases it can even replace the pupils' textbook.

The teachers' guide must offer teachers with a low level of professional training a supplement to their training and a sort of "script" with detailed instructions on how to conduct day-to-day lessons in a given subject.

The guide is the ideal vehicle for teaching innovations in developing countries, unlike industrialised countries, where innovation generally originates from research institutes and is circulated in specialised technical journals.

where innovation generally originates from research institutes and is circulated in specialised technical journals.

### **Technical Specifications**

List of the most important physical and graphic aspects of the materials to be produced.

The technical specifications are generally drawn up by the Art Director, the Commercial Manager and the Production Manager. They are vitally important since they allow those in charge to check the feasibility of the production project: the printer prepares his quotation for the costs of printing and finishing on the basis of the technical specifications.

### **Testing Textbooks**

Link in the publishing chain.

In developing countries the lack of reliable, complete data on conditions in schools and the heterogeneity of teaching and learning conditions make it vital to test the new textbook over a period of at least one academic year in a representative sample of schools.

### **Textbook Illustrator**

Graphic artist who uses his skills to illustrate textbooks, complying with pedagogical, didactic, aesthetic and perhaps financial considerations. A textbook illustrator must work closely with the authors who are generally in overall charge of the illustration work.

### **Textbook Projects**

Education project set up to supply text-books for a developing country.

Textbook projects involve either one phase in the publishing chain, such as large-scale production and distribution of existing books, or the entire chain from the feasibility study to testing, large-scale production, distribution and teacher training.

These projects demand human resources, technical inputs and funds and are often supported by bilateral or multilateral assistance.

### **Text Exercise**

Exercise consisting solely of text, with no concrete or abstract illustration (diagrams, frames, etc.).

### **Text-Illustration Exercise**

Exercise which is made up of a text and a graphics part.

In reading books for primary level these are useful to teach pupils to compose, complete or change words and sentences. There should always be at least one text-illustration exercise to lighten the extreme dullness of text exercises.

### **Text-Image Unit**

The contents and form of a text.

In textbooks which address the primary level, and particularly in reading books, authors must not only devise and write good texts. They must constantly be alert to ensure that their texts lend themselves to illustration.

The interaction of the form and the substance allows the authors to achieve this best.

### **Time-Table**

Official learning time.

Where several different time-tables exist side by side for pupils of the same grade, the authors' work is made

Where several different time-tables exist side by side for pupils of the same grade, the authors' work is made more complex by the fact that they must develop one set of materials for all pupils, which will enable the different target groups to achieve the same attainment targets within the same time.

### **Two-Colour Printing**

Generally black and a light colour, which may be printed in a solid block or screened to produce shading effects. The shades of colour thus obtained relieve the harshness of monochrome print, at a significantly lower cost than 4-colour (four-colour) printing.

### **Unformatted Typesetting**

The typeset text is justified at the left-hand side, but comprises no hyphenation or layout.

This text constitutes the first set of proofs which must be re-read and corrected, before a second set of proofs is obtained, which will take the hierarchy of the text into account. In practice authors often by-pass these two sets of proofs, especially when they have access to a computer.

### **Weight**

Thickness of the lines of a character.

A text may be printed in extra light, light, semi-light, medium, semi-bold, extra bold and ultra bold. Judicious use of these different weights can help underline the hierarchy of the text and enhance the typographical readability.

### **Width (of Characters)**

The visible width of type character. The width of characters can be modified, to make them more condensed or more expanded, which has repercussions on the typographical readability of the text.

### **Word Card**

Piece of card on which one word is printed. Word cards are commonly used by teachers to help pupils make up and change sentences. They are useful for pupils learning to read.

Word cards are only suitable for use by individual pupils when good storage facilities are available in the classroom.

### **Word Spacing**

Blank space left between two words in a sentence.

Word spacing may be normal, condensed or expanded and the choice will have an impact on the typographical readability and the aesthetic quality of a text.

### **Back Cover**



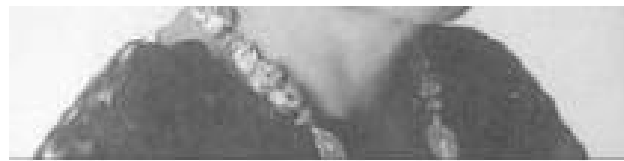

Marie Châtry-Komarek has worked for more than fifteen years in Africa and Latin America on the production of school textbooks in national languages. In this book, she describes the work carried out by a German–Malagasy project, supported by the German Agency for Cooperation (GTZ), the objective of which was to provide teachers and students with textbooks in Malagasy, adapted to their specific needs. She has previously written about the systematic development of texts in *quechua* and *aimara* in a book in Spanish: *Libros de lectura – para niños de lengua vernácula*. At present she is preparing a book on the training of author–publishers of textbooks in developing countries.



The German Foundation for International Development (DSE) is an institution for the initial and advanced training of specialists and executive personnel from developing countries. In addition, it prepares German experts for their assignments in a developing country, and maintains the Federal Republic of Germany's largest centre for documentation and information on development policy.

The DSE works in the areas "Education, Science and Documentation", "Economic and Social Development", "Public Administration", "Industrial Occupations Promotion", "Food and Agriculture" and "Health". Its objectives are an international exchange of experience and the qualification of specialists and executives from developing countries.

Dialogue and advanced training programmes (conferences, meetings, seminars, training courses, etc.,) support projects which serve economic and social development. The DSE thereby contributes to an effective, sustainable, and wide-ranging development process.



Since 1960 the DSE, in cooperation with national and international partner organizations, has given advanced professional training to more than 100,000 specialists and executive personnel from more than 140 countries. An increasing part of the programmes takes place in the developing countries, the rest in Germany.

The DSE makes its contribution to development cooperation on the basis of guidelines of the Federal government's development policy. The institutional contribution donor is the Federal Ministry for Economic Cooperation and Development (BMZ).

The DSE was founded by the Federal and Land governments in 1959 on the initiative of the political parties represented in the German Bundestag as a foundation under civil law. Its main seat is Berlin, and its other locations are Bonn, Bad Honnef, Mannheim, Feldafing, Zschortau, and Magdeburg.



Code Europe was established in Oxford as a UK charitable organization in May 1993 as part of the international CODE network which includes CODE affiliates in Canada, USA, and ten countries in Africa (Ethiopia, Ghana, Kenya, Mali, Malawi, Mozambique, Senegal, Tanzania, Zambia and Zimbabwe), and two in the Caribbean (Belize and Guyana). The overall CODE programme includes book distribution, library development, and support for indigenous publishing industries. As part of the worldwide CODE network, it represents the overall organization in Europe, and develops and manages projects in partnership with organizations in the developing countries. CODE Europe's *Partners in African Publishing Programme* aims to increase collaboration between publishers and organizations in Europe and Africa.

**ISBN 0 9528651 0 6**



<http://cd3wd.com/dvd/> - filename: z\_science\_exp\_598 of 598

