

THE ELECTRONIC ENGINEER

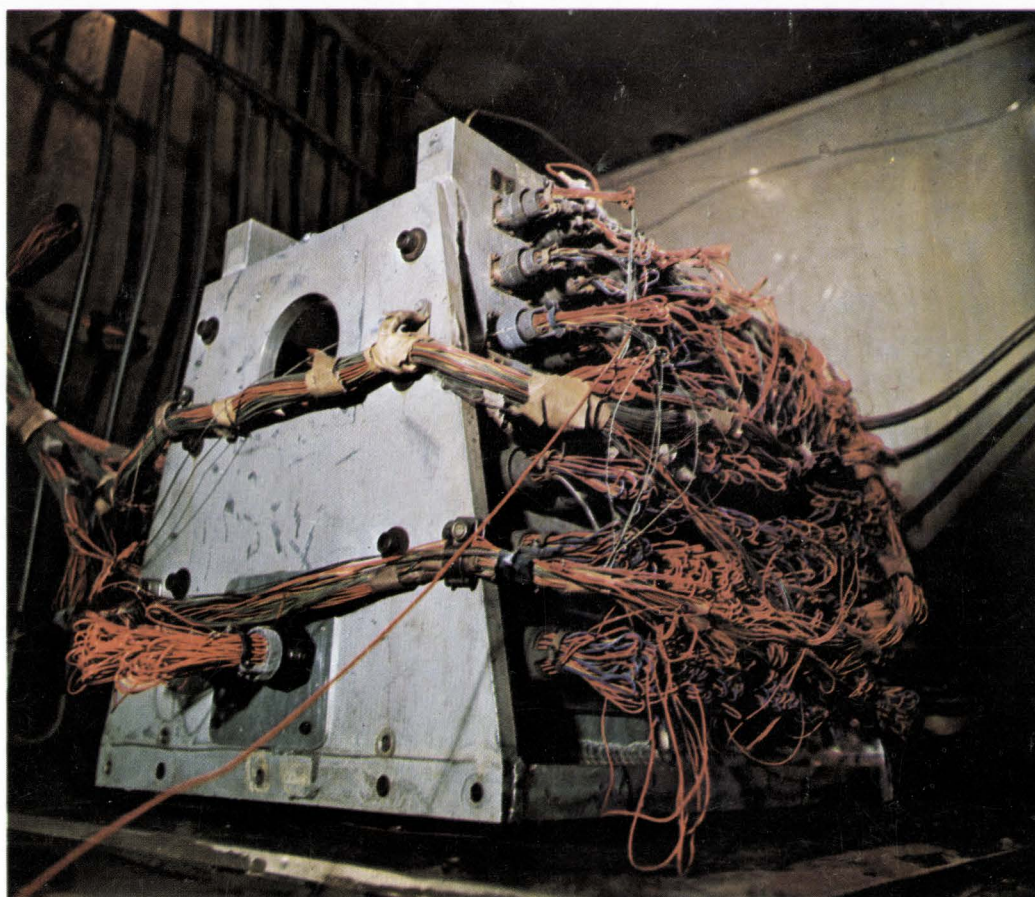

- Torture tests improve reliability p. 80**
Speed/power chart for digital ICs p. 48
IC op amp selection charts p. 61
Handling digital data without errors p. 74

Is the 901 counter-timer just too good to be true?



Shown with optional 1.3-GHz plug-in.

NO!

But we can't blame you if you think so.

Picture a state-of-the-art, 200-MHz, universal counter-timer selling for \$250 to \$1000 below the competition. Having trouble? Picture won't focus? Of course not. Cheap price tags usually mean cheap products.

Focus in again. This time, picture technological breakthroughs — new circuitry and new components that the competition hasn't caught up with yet. Now, see how easy it is to make a better product and sell it for less, too?

How much better is the CMC 901? Take a look. Range: 200 MHz (instead of 125 or 135) without prescaling or plug-ins. Gate times: $1\mu\text{sec}$ to 100 sec instead of to just 10 sec. TIM: built-in, with a resolution of 10 nsec instead of 100. Input sensitivity: 10 mV instead of the usual 50 or 100. Readout: 9 decades not just 8.

But specs aren't everything. How about the Model 901's "universality"? Besides counting to 200 MHz directly

(and 1.3 GHz or 3.3 GHz with optional plug-ins) the 901 also scales signals, measures time interval, period, and multiple-period average. It provides frequency and multiple-frequency ratios as well as total count; and, as an optional extra, it can be operated completely by remote control. The basic price tag? Just \$2475. So we can't blame you if you're skeptical, but would you be happy if you bought a lesser model and paid more?

For the full facts, circle the reader service card.

COMPUTER MEASUREMENTS COMPANY



A Division of Pacific Industries

12970 Bradley/San Fernando, Calif. 91342/(213) 367-2161/TWX 910-496-1487

Circle 1 on Inquiry Card

All the advantages of tantalum...at low cost!

Type 196D Dipped Solid-Electrolyte Tantalex[®] Capacitors

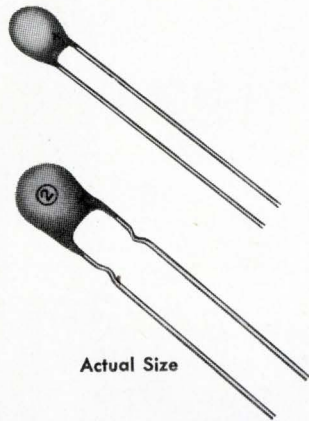

Actual Size

Circle 4 on Inquiry Card

Here's a capacitor design that admirably fills the need for low-cost yet dependable solid tantalum capacitors suitable for printed wiring boards. Straight leads as well as crimped leads are readily available to meet your manufacturing needs.

Covering a broad range of capacitance values from .1 μF to 330 μF , with voltage ratings from 4 to 50 VDC, Type 196D Capacitors are protected by a tough insulating coating which is highly resistant to moisture and mechanical damage.

450-9124

Tiny in size...Giants in volume efficiency!

Type 160D, 161D Solid-Electrolyte Tantalex[®] Capacitors for hearing aids and ultra-miniature circuits

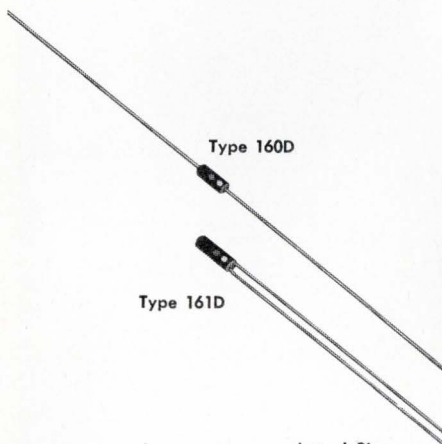

Type 160D

Type 161D

Actual Size

Circle 5 on Inquiry Card

Tiny Type 160D/161D Tantalex Capacitors are sealed within a polyester film tube with tightly-bonded epoxy fill, so the assembly is both electrically insulated and highly resistant to moisture. They are available with axial leads as well as in single-ended construction.

Offering extremely high capacitance per unit volume (for example: 0.25 μF @ 20 VDC in a case only .065" D. x .125" L.), Tantalex Hearing-aid Capacitors let you select from a broad range of ratings in five different case sizes.

450-9125

For complete technical data on Type 196D Capacitors, request Engineering Bulletin 3545A. For the full story on Type 160D/161D Capacitors, write for Engineering Bulletin 3515D. Address Technical Literature Service, Sprague Electric Co., 233 Marshall St., North Adams, Mass. 01247.



Sprague' and '®' are registered trademarks of the Sprague Electric Co.

THE BROAD-LINE PRODUCER OF ELECTRONIC PARTS

Semtech Silicon Rectifiers & Assemblies



"Cool Power"

Semtech Corporation manufactures a complete line of silicon rectifiers and devices. Offering unique packages — designed to solve old and new circuit problems efficiently, reliably and at low cost.

Semtech has a continuing research and development program, utilizing interrelated technologies, to guarantee state-of-the-art rectifiers and assemblies. The new "Metoxilite" rectifier is just such a device — the result of years of intensive materials research and testing. Fashioned from metal-oxides, this new device offers impermeable monolithic construction and advanced electrical characteristics.

Unique devices introduced by Semtech include:

- SEMPAC® (100 to 1000V) ■ MINISTAC (1 to 7kV) ■ COMPAC (50 to 3000V) ■ MINISTIC (10 to 40kV) ■ SLIMPAC® (2.5 to 45kV) ■ ALPAC® (50 to 600V) ■ STACPAC (500V to 25kV)
- "METOXILITE" (100 to 1000V) ■ A complete line of Multipliers (up to 50KV).

For complete information, contact your nearest representative and get your Free copy of Semtech's 1969 Silicon Rectifier Catalog. All products listed in our catalog are available for immediate delivery.

San Francisco—941 E. Charleston, Suite 10, Palo Alto, California 94303 / (415) 328-8025
Chicago—140 N. La Grange Road, La Grange, Illinois 60525 / (312) 352-3227 / TWX: 910-683-1896
Dallas—402 Irving Bank Tower, Irving, Texas 75060 (214) 253-7644
New York—116-55 Queens Blvd., Forest Hills, New York 11375 / (212) 263-3115 / TWX: 710-582-2959
European Sales—Bourne, A. G. Alpenstrasse 1, Zug, Switzerland / (042) 4 82 72/73

 **SEMTECH**
CORPORATION

652 Mitchell Road, Newbury Park, California 91320
(805) 498-2111, (213) 628-5392 / TWX: 910-336-1264

®SEMPAC, SLIMPAC and ALPAC are registered trademarks of the Semtech Corporation.



The Electronic Engineer

June 1969 Vol. 28 No. 6

Editorial	7
Up to date	10
Forefront	17
Speak up	28
Calendar	30
Careers	33
EES Get Ahead	42
Welcome	43
Seminars	44
Microworld	48
Books	59
Design Feature	74
Lab	80
IC Ideas	89
Abstracts	93
Product Application	97
New Products	104
System New Products	106
Microworld New Products	109
Lab Instruments	112
Elroy	120
Literature	126
Ad Index	138

Project management accomplishes "impossible" mission 33

The mission was to verify the structural integrity of the Apollo short stack—a task estimated to take at least a year—in four months. Project management techniques helped get the job done on time.

Speed/power chart for digital ICs 48

This 1969 specifying chart compares digital ICs by their two most important parameters—propagation delay and power dissipation.

Operational amplifiers application guide 51

You will find this multi-colored pullout wall chart a very useful design guide. The chart contains primary functions that can be performed by op amps. Remove your copy now, lest you forget.

Operational amplifier charts 61

Whether monolithic or hybrid, you'll find all commercial op amps here, classified by five important parameters.

Digital data: play it like it is 74

Distortion and noise in tape-playback amplifiers often give you false data. An improved peak detector for NRZI amps rejects both low- and high-level noise, and responds only to the true peak of the playback signal.

Torture tests improve equipment reliability 80

You can vibrate it, accelerate it, sand blast it, shock it, heat it, and chill it yourself, or you can send it out to be done, but the result will be the same—an improved product.

IC Ideas 89

- Fault monitor checks for circulating logic bit
- Shape pulses for RTL circuit use
- Counter counts to find faults

Jack-of-all-trades: monolithic i-f a universal subsystem 97

A single chip serves a multitude of transmission modes, and lets you switch economically from one to another, within a single receiver.

COVER

Environmental testing is the best known way, short of waiting years for equipment to fail, to learn how parts and equipment stand up to rugged environments. If properly planned and carried out, the environment tests will be tougher than any parts or equipment will ever see in normal operation. Smed Ruth has looked into the environmental test equipment field and presents some interesting and useful information for you. To typify today's rugged testing, our cover shows Amphenol connectors under test in an environmental chamber.

You say you want a

low-profile snap-in-mounting push button switch or matching indicator that is interchangeable with most 4-lamp displays... available in a full range of cap colors... with a choice of bezels with or without barriers in black, gray, dark gray or white.

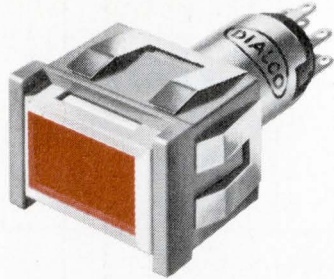

and a

legend presentation that's positive (like this one) or negative (like the one below) or just plain (like the one above)... one that's white when "off" and red, green, yellow (amber), blue or light yellow when "on"... or colored both "on" and "off."

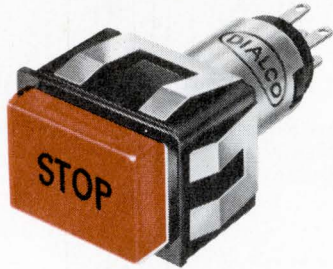

and a

highly reliable switch proven in thousands of installations... available in momentary or alternate action... N.O., N.C. or two circuit (one N.O., one N.C.)... that accommodates a T-1 1/4 bulb with midget flanged base, incandescent, in a range of voltages from 6-28V.

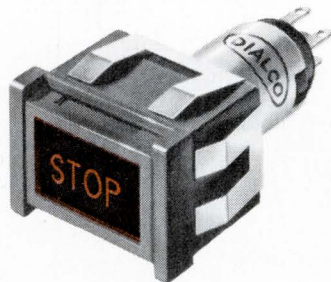

*etc.
etc.
etc.*

***Now, for the first time
Dialight gives you
custom panel designing
with a standard line of
push-button switches and
matching indicators***

Dialight offers a broader range of switch and indicator possibilities than you'll find anywhere in a standard single-lamp line.
Sizes: 3/4" x 1", 5/8" square and round.
Send today for our new full-color catalog L-209.

DIALIGHT

Dialight Corporation, 60 Stewart Ave., Brooklyn, N.Y. 11237

DT-125

EE

The Electronic Engineer

Vol. 28 No. 6

June 1969

Alberto Socolovsky, *Editor*

John E. Hickey, Jr., *Managing Editor*

Smedley B. Ruth, *Associate Editor*

Sheldon Edelman, *Associate Editor*

Stephen A. Thompson, *Western Editor*

Joan Segal *Assistant Editor*

Dr. O. M. Salati, *Consultant*

Anne Axe, *Editorial Assistant*

Dorothy Vondran, *Editorial Assistant*

Lynda Rothstein, *Editorial Assistant*

Mae Moyer, *Editorial Reader Service*

Andrew Mittelbrunn, *Chilton Art Director*

Phaue Featherson, *Art Assistant*

George Baker, *Washington News Bureau*
Neil Regeimbal,

K. Robert Brink, *Publisher*

Chilton   

Executive and Editorial Offices:

One Decker Square, Bala-Cynwyd, Pa. 19004
Tel. (215) SH 8-2000

Address Mail to: 56th & Chestnut Sts.
Philadelphia, Pa. 19139

Western Office: Stephen A. Thompson
1543 W. Olympic Blvd., Los Angeles, Calif. 90015
Tel. (213) DU 7-1271

New York Office:
100 E. 42nd St., New York, N.Y. 10017
Tel. (212) OX 7-3400

Chilton Officers & Directors: Chairman of the Board: G. C. Buzby; President: R. E. McKenna; Financial Vice-President: S. Appleby; Senior Vice-Presidents: J. Kofron, L. King; Vice-President: H. Barclay; Publishing Vice-Presidents: C. W. Hevner, W. A. Barbour, R. H. Groves, K. Robert Brink; Treasurer: James Miades; Secretary: J. A. Montgomery, Jr.; Other Directors: T. J. Casper, S. H. Collmann, R. Rimbach, Jr.; Asst. Secretary: I. C. Holloway.

Monthly publication of Chilton Company, Chestnut & 56th Sts., Phila., Pa. 19139. (Area Code 215) SHERWOOD 8-2000. Controlled circulation postage paid at Philadelphia, Pa. \$1 a copy. Subscription rates U. S. and U. S. Possessions: 1 yr. \$12.00; 2 yrs. \$20.00. Canada 1 year \$14.00; 2 yrs. \$25.00. All other countries 1 yr. \$20.00; 2 yrs. \$35.00. © Chilton Company 1969. Title Reg. U.S. Patent Office. Reproduction or reprinting prohibited except by written authorization.

"The Pill"

for price control

TELEDYNE



TO-5 Relay

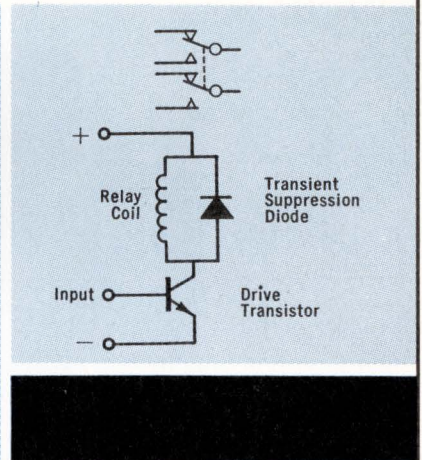
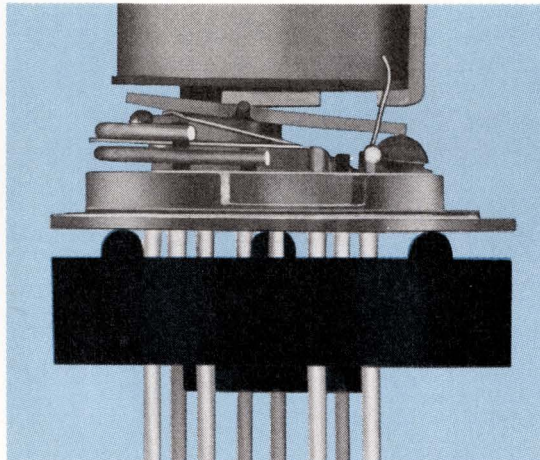

We keep our promises! Last month we promised a low-priced industrial application DPDT TO-5 case relay with an internal transistor driver. We call this new contraption "THE PILL." "THE PILL" contains a transistor driver and suppression diode, attaches externally to our DPDT industrial 712T relay to form the 712T . . . and does double duty as a transapad.

The 712T combines the advantages of relay operation, i.e., high isolation, low contact resistance, double throw contacts, high current and overload capability with the low signal drive requirement offered by the transistor front-end.

It's hermetically sealed; utilizes all welded construction; requires a turn on (trigger) power of only 200 microwatts or less depending on coil voltage; and may be driven directly from standard T¹L or similar logic. The relay coil is paralleled with a diode to suppress transients.

The entire package is only 0.405 high by 0.370 in diameter (including "THE PILL"), and is available from stock at your local Teledyne Relay distributor or from the factory at the following price schedule:

Quantity	100	1,000	10,000
Price	\$12.50	\$10.40	\$ 9.25

We call our first price control PILL the 712T . . . Look for an op-amp

PILL in July for DO-IT-YOURSELF time delays and level sensing applications.

No blue sky promises from us . . . just fast delivery for quick price relief.

Phone, wire or write for technical data.



TELEDYNE RELAYS
A TELEDYNE COMPANY

3155 West El Segundo Boulevard Hawthorne, California
90250 Telephone: (213) 679-2205

True to our tradition, we've got something great to tell you about this month.

Raytheon now has an op amp that draws less power than any other you can buy. Anywhere. It works within specifications with supplies as low as ± 3 volts. We call it the RM4132, and it's sitting on our distributors' shelves, right now, waiting for you to come and give it a home.

This graph plots power and current against supply voltage, and we guarantee that $150 \mu\text{W}$ figure at $\pm 3 \text{ V}$! Maximum input bias is 10 nA , max input offset current is 2 nA , with no more than $0.1 \text{ nA}/^\circ\text{C}$ drift.

It has typical unity-gain frequency response of 150 kHz . And small signal open loop gain is 94 dB minimum.

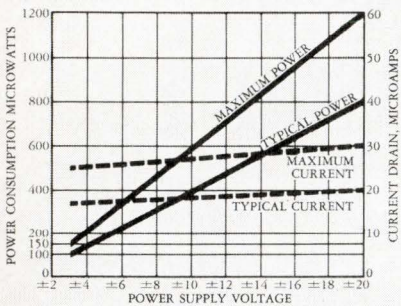

The RM4132 is internally frequency compensated. It's pin-for-pin compatible with the 709, 741, 107, 4131 and like that.

And the full military version costs only \$30 for 100-999.

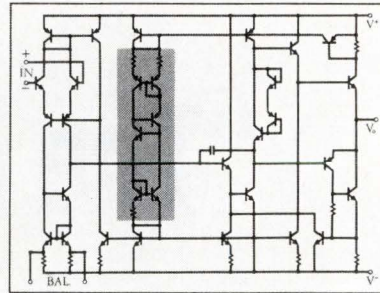

How do we do it? It's simple. This patent-pending little current regulator holds the amplifier quiescent current to $20 \mu\text{A}$ from ± 3 to ± 20 volts, and never

shows more than $\pm 10\%$ current variation across our whole -55 to $+125^\circ\text{C}$ temperature range. And those little bitty batteries seem to last forever. So immortalize your system with an RM4132 from the company that's getting the ideas and delivering the goods. Raytheon Semiconductor, Mountain View, California. (415) 968-9211.

Don't let your system run down.

Our new RM4132 microwatt op amp keeps your cells young and active.

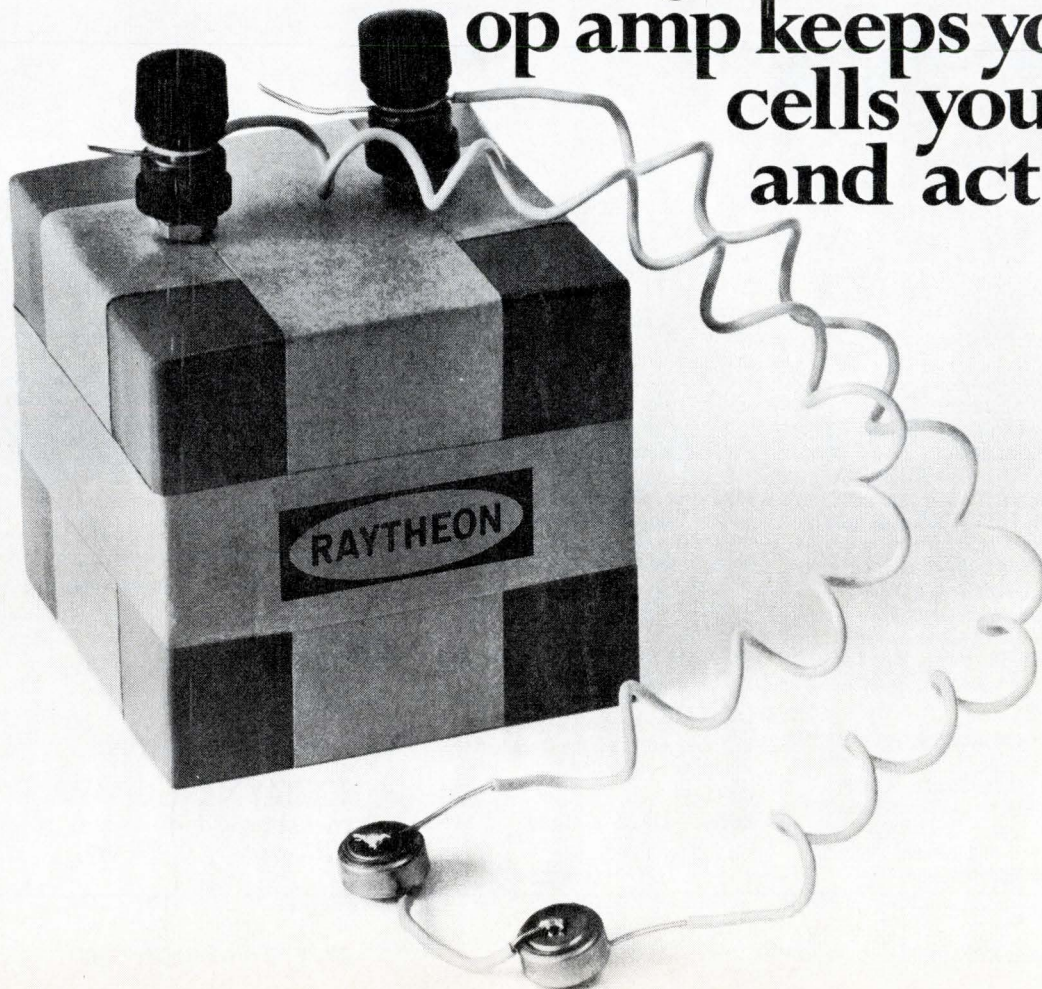

On heckling and doing

A pretty girl handed me a leaflet at the Spring Joint Computer Conference in Boston. It was a "statement of purpose" by the Computer Professionals for Peace, a group based in Brooklyn, N.Y. Together with unconditional withdrawal from Vietnam and cancellation of the ABM, the leaflet urged all computer professionals to seek employment in projects unrelated to war, and demanded that the two popular computer conferences (Spring and Fall JCC) cease to be a publicity forum for war contractors.

Fortunately, the Conference was ahead of this group. Most of the papers and the exhibits were devoted to computer applications that had nothing to do with war. And one of the paper sessions—"Computers and the underprivileged"—turned up the following examples of professional involvement in the causes the Brooklyn group claimed to espouse:

- The Urban Education Committee, a group formed by members of the Delaware Valley Chapter of the Association for Computer Machinery, provides free advice to the Philadelphia Board of Education on data processing curricula, consults for the Philadelphia Urban Coalition, and trains high school students as computer operators.
- Both faculty and students at MIT cooperate in a project* teaching computer programming to underprivileged people in Boston.
- Computer Personnel Development Association, Inc., of New York, procures jobs in the computer field for ghetto-dwellers.

In addition, the Conference featured sessions on subjects such as "Applications of computers in the urban environment," "Computer systems vs health systems," and "Urgent—Increased dialogue with society." Although it promised to be an interesting session and it was well attended, the latter one got nowhere thanks to the heckling by a group organized by CPP.

What the hecklers shouted for is already being implemented, for example, by the General Electric Valley Forge Space Center, which developed a mathematical model to study the pollution of the Delaware River, and by companies such as Philco-Ford, whose Education Operations group has contracts with the Department of Labor, with the Bureau of Indian Affairs, and with many community organizations to improve the lot and the education of the disadvantaged.

Perhaps the hecklers see themselves as the subject of the Socratic quote: "God put me upon your city as a gadfly on a noble horse, to bite him and keep him awake." We should be thankful for gadflies, but it's the quiet ones who do the constructive work.

Alberto Socolovsky
Editor

*This project at MIT also includes courses in modern technology for the "overprivileged." It trains well-educated people in subjects such as lasers and computer systems.

Fairchild announces the future. Available today.

Part No. MμL 4027

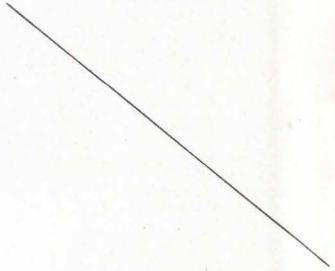

Bipolar



Random access



You're looking at the technology that's going to be used for the largest, least expensive bipolar and MOS memories. And it's here now to give you a fast start on economical high-performance scratchpad and buffer memories.

The product is the new Fairchild $M_{\mu}L4027$ Bipolar 128-Bit Read/Write Random Access Memory. Inside, we've used bipolar technology to give you read and write times of 35ns. And we've used face-down bonding and multi-layer ceramic to eliminate flying-wire leads and increase both performance and reliability. The 128 bits are organized as 64 2-bit words with uncommitted collectors that allow easy word or bit expansion. Addressing is through

eight X and eight Y coincident-select lines to simplify memory organization. All outputs are CCSL-compatible.

The completed memory comes in a 1" x 1" hermetic ceramic plug-in package that saves you weight and space. And it's yours for less than 52¢/bit (\$100, 1-24; \$80, 25-99; \$66, 100-999).

So write for the complete specs and application notes. Or pick up several units from your Fairchild distributor. The technology is for the future; the product is here today.

Fairchild Semiconductor / A Division of Fairchild Camera and Instrument Corporation
 Mountain View, California 94040
 (415) 962-5011/TWX: 910-379-6435

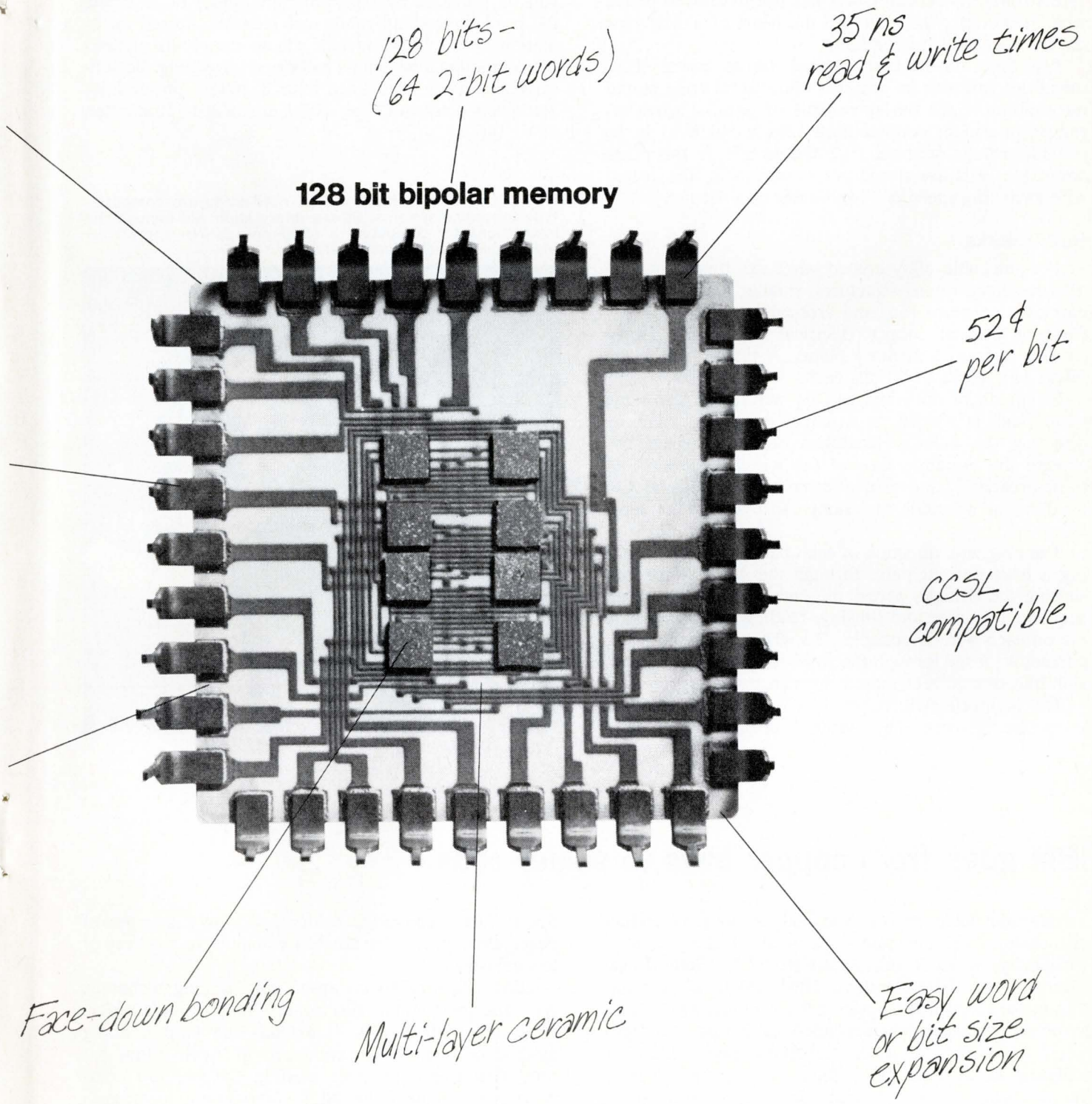

New entry in plated wire memories

The Stromberg-Carlson Corp. has just developed plated wire memories, which will be the heart of a new type data storage unit it is building.

Ten times faster than normal ferrite cores, these memories can also be reused without destroying stored information. Each device consists of parallel wires arranged in a plane configuration $12\frac{1}{2} \times 5\frac{1}{2} \times \frac{1}{2}$ in. to provide storage of about 10,240 data bits. In this plane about 800 bits are stored per square inch. The plated wire switching speed is 20 billionths of a second.

How it works

The magnetic alloy coated wires are placed in parallel insulated tunnel structures, smaller than the diameter of a common pin, and crossed at right angles by rows of printed copper electrical conductors (word straps) to form a memory plane. A plated wire plane offers 128 words of 80 bits each.

Hundreds of data bits can be written on the same wire. Each is written as a narrow magnetic band by directing the polarity clockwise or counter-clockwise around the circumference of the wire. Since each of these polarized bands is unaffected by the bands next to it, different magnetic directions can exist on the same wire.

The magnetic direction of each band is read by sending a brief current pulse through the word straps and sensing the voltages across the end of the wires. With sequential pulsing and sensing, reading more than one bit on each wire is possible. To write or change a bit, current is pulsed through the word straps, with a second, simultaneous current pulsed through the wire.

The memories will be used in future computer-type telephone systems. The systems' subscriber's services

will be provided by tape programs and will eliminate the need for making equipment changes. Stored information which would include all necessary instructions for computing a telephone call or for providing the subscriber's service is retained even if system power fails. Stromberg-Carlson Corp., 100 Carlson Rd., Rochester, N.Y. 14603.

New plated wire memory will be used in future computer-type telephone systems. Stored information will include the instructions for computing a telephone call or for providing a special subscriber's service.



IBM goes from copper balls to solder pads

In adapting solder pads as terminals for its semiconductor chips, IBM has joined the rest of the industry. Originally, when it introduced its SLT (Solid Logic Technology) hybrid system, IBM provided its semiconductor chips with copper ball terminals, which were criticized because they depended on a rather complicated metallurgical system involving two solders or different eutectic points: A high temperature solder to bond the ball to its chip, and a low temperature solder that was reflowed to bond the chip's ball to the circuit.

Other manufacturers such as Fairchild, Hughes and

Sperry have been using solder pads for a number of years already, and its use has extended to the rest of the industry.

IBM's "controlled collapse" chip joining technique was described at the Electronic Components Conference, April 30-May 2. It extends the chip bonding method of their SLT, announced in April 1964, for producing circuit modules used in System/360 computers. Originally, the SLT fabrication techniques bonded silicon transistor chips with three solder-coated

(continued on page 13)

new mil-performance square cermet trimmers from CTS

Now . . . with CTS Cermet Multi-Turn Square Trimmers you get Characteristic C Mil-spec performance for all military applications. All new series 165 (style RJ24) and series 175 (style RJ22) meet tough Characteristic C of Mil-R-22097C. These same environmental characteristics are available . . . at lower cost . . . for commercial and industrial applications.

Both small $\frac{3}{8}$ "-square series 165 and compact $\frac{1}{2}$ "-square series 175 trimmers assure infinite resolution over a 20 ohm to 2.5 megohm range . . . and power rating of $\frac{1}{2}$ watt @ 85°C. TC ± 150 ppm/°C for 2k ohms and above. -0 +175 ppm/°C from 50 ohms through 250 ohms and -0 +250 ppm/°C from 500 ohms through 1k ohm. All available at no extra cost.

Low cost*, proven quality, and top performance—combined with **fast distributor delivery**—make CTS your best industrial trimmer choice. Can't use one of our standard series? Ask how we can solve specific application problems. Call or write for complete details to CTS of Berne, Inc., Berne, Indiana 46711. Phone (219) 589-3111.

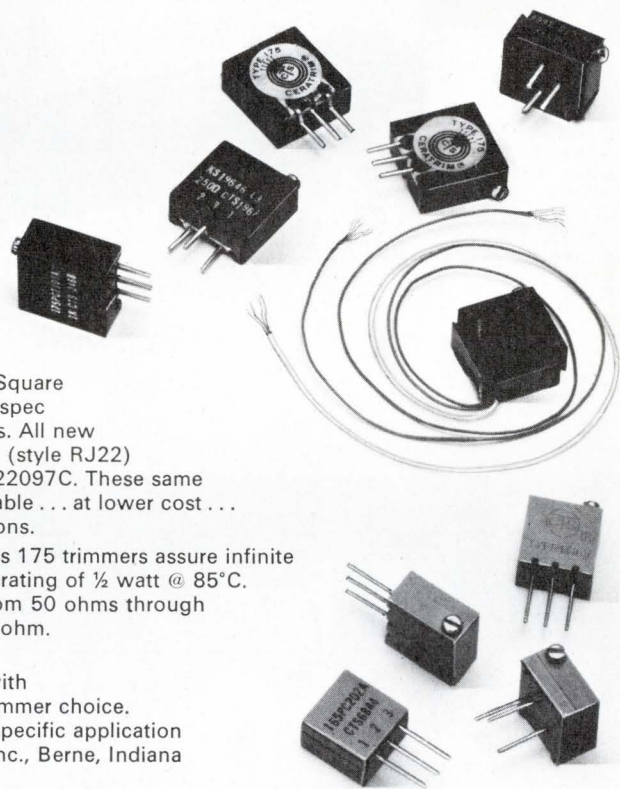







*Check these prices for 4-6 week production delivery. (Small quantities from stock)

	Series 165		Series 175	
Quantity	25-49 (each)	1000 (each)	25-49 (each)	1000 (each)
Commercial (=20% Tol.)	\$4.55	\$3.25	\$4.20	\$2.95
MIL-type (=10% Tol., Char. C)	5.30	3.80	5.10	3.65



CTS CORPORATION
Elkhart, Indiana

Other CTS Cermet Trimmers include:

						
Series 185 1- $\frac{1}{4}$ " x .290" x .364" multi-turn	Series 190 $\frac{3}{4}$ " x .160" x .310" multi-turn	Series 340 $\frac{1}{4}$ " x $\frac{1}{4}$ " square x .270" high—single-turn	Series 360 $\frac{7}{16}$ " x $\frac{1}{4}$ " x $\frac{25}{64}$ " single-turn	Series 385 $\frac{11}{32}$ " round x .225" high—single-turn	Series 660 $\frac{3}{8}$ " round x $\frac{1}{4}$ " high— single-turn	Series 630 $\frac{1}{2}$ " round x $\frac{13}{32}$ " high— single-turn

BUSS QUALITY

SMALL DIMENSION FUSES and FUSEHOLDERS

FOR THE PROTECTION OF ALL TYPES OF
ELECTRONIC & ELECTRICAL CIRCUITS & DEVICES

The complete BUSS line of fuses includes dual-element "slow-blowing," single-element "quick-acting" and signal or visual indicating types . . . in sizes from 1/500 amp. up—plus a companion line of fuse clips, blocks and holders.









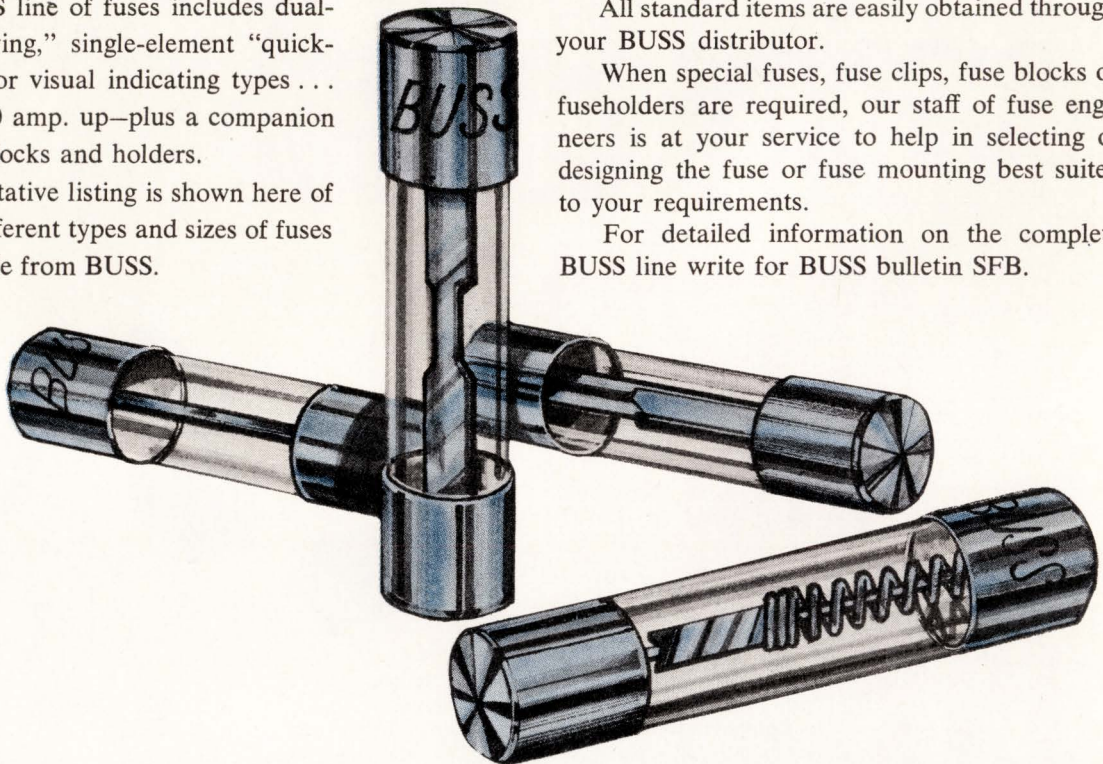







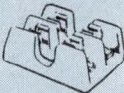







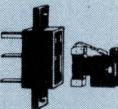

Only a representative listing is shown here of the thousands of different types and sizes of fuses and holders available from BUSS.

All standard items are easily obtained through your BUSS distributor.

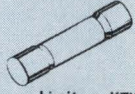
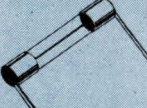
When special fuses, fuse clips, fuse blocks or fuseholders are required, our staff of fuse engineers is at your service to help in selecting or designing the fuse or fuse mounting best suited to your requirements.

For detailed information on the complete BUSS line write for BUSS bulletin SFB.

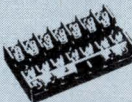
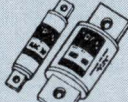

 Buss AGX Fast Acting Fuses	 Buss AGC and MTH Glass Tube Fuses	 Fusetron FNM Fibre Tube Fuses	 Fusetron FNA Indicating Fuses	 Buss In-the-Line or Panel Mounted Fuse/Holder	 Buss Panel Mounted Holders	 Buss Screw or Solder Terminal Fuse Blocks	 Buss Porcelain Base Fuse Blocks
 Buss AGC Glass Tube Fuses	 Buss Indicating Fuses	 Buss Sub-miniature Fuses and Holders	 Tron Sub-miniature Pigtail Fuses	 Buss HPC Holders	 Buss Lamp Indicating Holders	 Buss Silicon Rectifier Fuse Blocks	 Buss Indicating Aircraft Fuses
 Fusetron MDL Fuses	 Buss ABC Ceramic Tube Fuses	 Buss GMT Fuse and HLT Holder	 Buss High Voltage Fuses	 Buss Space Saver Holders	 Buss Shielded Holders	 Fusetron ACK Stud Mounted Fuses	 Limitron KTK High Interrupting Capacity Fuses
 Buss GJV Pigtail Fuses	 Buss SFE Standard Fuses	 Fusetron Type N Fuses and Holders	 Buss In-the-Line Holders	 Buss HLD Visual Indicating Holders	 Buss Signal Fuse Blocks	 Tron Rectifier Fuses	 Buss Miniature Glass Tube Fuses

BUSSMANN MFG. DIVISION, McGraw-Edison Co., ST. LOUIS, MO. 63107

IBM uses solder balls (continued)

copper balls to metallized substrates.

Now, malleable pads, consisting of vacuum-metallized lead/tin (95/5) solder, are constrained during the heating and bonding process, thus preventing solder from flowing to the edge of the semiconductor device and causing an electrical failure.

A key advantage of the technique is that the solder reflow characteristics compensate for minor variations in pad heights found in large monolithic semiconductor devices with many contacts. The ductility of the joint, which can absorb considerable stress during thermal cycling in normal operation, also provides more pliability to the bonded joint, thus improving its reliability.

IBM's "controlled collapse" method of joining a chip to its substrate uses solder balls instead of the original copper balls shown in the lower sketch. The copper ball method is being replaced with the solder method in IBM 360 computers. Several other companies have been using the solder ball method for quite a while, with success.

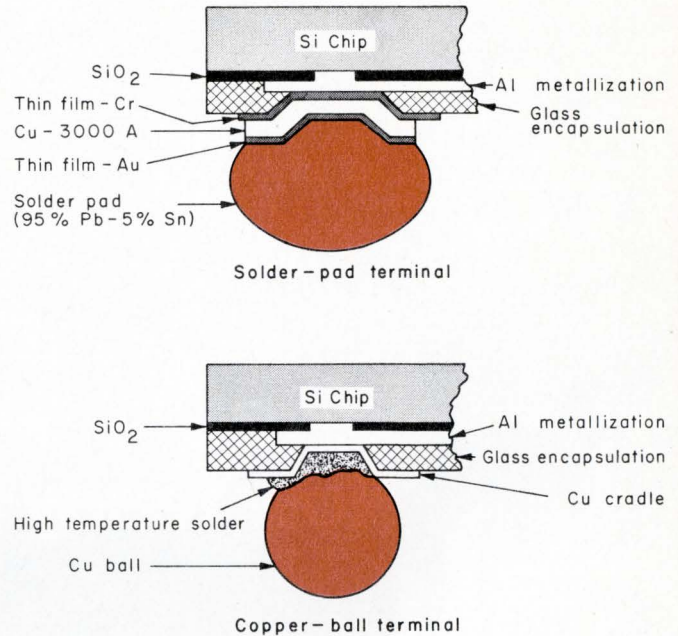

Desk calculator uses LSI/MOS

If you still have any doubts about the seriousness of large-scale integration (LSI) and the fact that it is here now, get rid of them. The SCM Corporation just showed a new desk-sized electronic calculator that uses LSI/MOS devices. And, the price of the unit, less than \$900, is competitive to that of other office type calculators.

The Marchant Cogito 414 has a total of eight LSI/MOS elements. Each MOS element is a chip consisting of from several hundred to over 1200 MOS transistors and 40 connecting leads, all mounted on a wafer thin ceramic base, equal to a 1 x 2 in. rectangle.

The chip containing the metal oxide silicon transistors is 120 mils square. These dimensions are significant

because a single MOS chip element or package performs the same calculator functions that previously required 600 discrete (large size) elements or 20 conventional ICs.

LSI made with MOS devices permits a drastic reduction in the total configuration of the calculator. If made with conventional integrated circuits, Cogito 414 would require 160 separate devices. The total of eight chip elements in the 414 are equivalent to 4800 discrete components.

The Cogito 414 has 14-digit capacity and is 10½ in long, 11½ in wide, 5½ in high, and weighs only 8 lb.

A new desk calculator uses large-scale integrated circuits made with MOS. The discrete board on the left, developed in 1964, was reduced to the IC board below in 1967, with this being replaced with the LSI unit held by the hand. The LSI units are made by American Micro-Systems, Inc., Santa Clara, Calif.

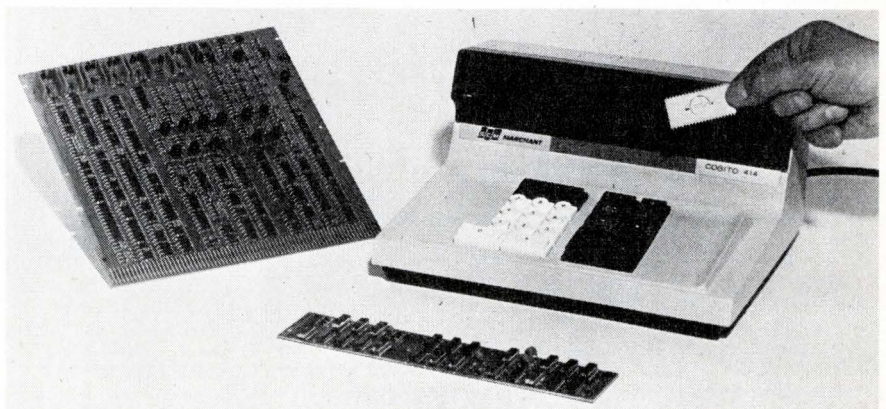



Now, ready for you in quantity.

The new Delco Radio DTS-701 and 702 NPN triple-diffused silicon high voltage transistors. They were designed for the tough requirements of off-line deflection in large screen TV.

However, they're built and tested for extra reliability in all high energy circuits. Proved by the surest peak energy capability rating in the business: Pulse Energy Testing.

And right now, they're available in both production and sample quantities.

Why will you want to use the Delco 701 or 702?

For the tough jobs—high inductive load switching or for circuits subject to transients or fault conditions.

For reduction of weight, size and component costs. Circuit complexity and number of components are reduced, so assembly costs go down, too. And fewer components mean higher reliability.

So now you know. The pioneer in high voltage silicon power has done it again.

For prices, samples or complete data, just call us or the nearest Delco Radio distributor listed below.

SEMICONDUCTOR DISTRIBUTORS: **EAST**—BALTIMORE, MD. 21201, Radio Electric Service Co., 5 North Howard St., (301)-539-3835 BINGHAMTON, N.Y. 13902, Federal Electronics, Inc., P. O. Box 1208, (607)-748-8211 CLIFTON, N.J. 07015, Eastern Radio Corporation, 312 Clifton Avenue, (201)-471-6600 NEWTON, MASS. 02195, The Greene Shaw Co., Inc., 341-347 Watertown St., (617)-969-8900 NEW YORK, NEW YORK 10036, Harvey Radio Co., Inc., 2 West 45th St., (212)-582-2590 PHILADELPHIA, PENN. 19114, Almo Electronics, Division of Sterling Electronics, Roosevelt Blvd. at Blue Grass Rd., Northeast Industrial Park, (215)-676-6000 PITTSBURGH, PENN. 15328, RPC Electronics, 620 Alpha Drive, RIDC Park, (412)-782-3770 WOODBURY, L.I., N.Y. 11797, Harvey Radio Company, Inc., 60 Crossways Park West, (516)-921-8700 **SOUTH**—BIRMINGHAM, ALA. 35233, Forbes Distributing Company, Inc., 1416 Fourth Ave., South, (205)-251-4104 MIAMI, FLORIDA 33142, Mountain Electronics, Division of Mountain National Co., 3730 Northwest 36th St., (305)-634-4556 RICHMOND, VA. 23220, Meridian Electronics, Inc., 1001 West Broad Street, (703)-353-6648 WEST PALM BEACH, FLA. 33402, Mountain Electronics, Division of Mountain National Co., 1000 N. Dixie Highway, (305)-833-5701 **MIDWEST**—CINCINNATI, OHIO 45237, United Radio, Inc., 7713 Reinhold Drive, (513)-761-4030 CLEVELAND, OHIO 44125, The W. M. Pattison Supply Co., Industrial Electronics Division, 4550 Willow Parkway, (216)-411-3000 DAYTON, OHIO 45414, F-J-R Ohio, Inc., 5212 North Dixie Dr., (513)-278-9411 INDIANAPOLIS, IND. 46204, Graham Electronics Supply, Inc., 133 S. Pennsylvania St., (317)-634-8486 KALAMAZOO, MICH. 49005, Electronic Supply Corp., P.O. Box 831, (616)-381-4626 KANSAS CITY, MO. 64111, Walters Radio Supply, Inc., 3635 Main Street, (816)-531-7015 MINNEAPOLIS, MINNESOTA 55401, Stark Electronics Supply Co., 112 3rd Ave., North, (612)-332-1325 ROSEMONT, ILL. 60018, F-J-R/Midwest, Inc., 9340 William St., (312)-678-8560 SKOKIE, ILL.



1200V - 3.0A
800V - 0.5A

DTS-701

Collector to emitter voltage (V_{CE0})	800V
Sustaining voltage ($V_{CE0(SUS)}$)	600V min.
Emitter to base voltage (V_{EB0})	5V
Collector current (I_C)	500mA
Base current (I_B)	100mA
Power dissipation (P_T)	25W

DTS-702

Collector to emitter voltage (V_{CEX})	1200V
Collector to emitter voltage (V_{CE0})	1000V
Sustaining voltage ($V_{CE0(SUS)}$)	750V min.
Emitter to base voltage (V_{EB0})	5V
Collector current (I_C)	3A
Base current (I_B)	1A
Power dissipation (P_T)	50W

Available in solid copper. JEDEC TO-3 package.

Kokomoan's Regional Headquarters

Union, New Jersey* 07083
Box 1018 Chestnut Station
(201) 687-3770

Chicago, Illinois* 60656
5151 N. Harlem Avenue
(312) 775-5411

Santa Monica, Calif.* 90401
726 Santa Monica Blvd.
(213) 870-8807

Detroit, Michigan 48202
57 Harper Avenue
(313) 873-6560

Kokomo, Ind. 46901
700 E. Firmin
(317) 459-2175 Home Office

*Office includes field lab
and resident engineer
for application assistance.



THE KOKOMOANS ARE IN POWER

DELCO RADIO

DIVISION OF GENERAL MOTORS

KOKOMO, INDIANA

60076, Merquip Electronics, Inc., 7701 N. Austin Ave., (312)-282-5400 ST. LOUIS, MISSOURI 63144, Electronic Components for Industry Co., 2605 South Hanley Road, (314)-647-5505 WEST—ALBUQUERQUE, N.M. 87108, Hyer Electronics Company, 130 Alvarado Drive, N.E., (505)-265-5767; 87106, Sterling Electronics Inc., 1712 Lomas Blvd., N.E., (505)-247-2486 COLORADO SPRINGS, COLO. 80902, L. B. Walker Radio Company, 9 E. Vermijo St., (303)-636-1661 DALLAS, TEXAS 75201, Adleta Electronics Company, 1907 McKinney Ave., (214)-742-8257 DENVER, COLO. 80219, L. B. Walker Radio Company, 300 Bryant Street, (303)-935-2406 ENGLEWOOD, COLORADO 80110, Hyer Electronics Company, 8101 E. Prentice Ave., (303)-771-5285 FORT WORTH, TEXAS 76102, Adleta Electronics Co., S. Expressway at E. Vickery, (817)-336-7446 HOUSTON, TEXAS 77001, Harrison Equipment Co., Inc., 1422 San Jacinto Street, (713)-224-9131 LOS ANGELES, CAL. 90015, Radio Products Sales, Inc., 1501 South Hill Street, (213)-748-1271 LOS ANGELES, CAL. 90022, Kierulff Electronics, Inc., 2585 Commerce Way, (213)-685-5511 OKLAHOMA CITY, OKLAHOMA 73102, Radio, Inc., 903 North Hudson, (405)-235-1551 PALO ALTO, CAL. 94303, Kierulff Electronics, Inc., 3969 East Bayshore Road, (415)-968-6292 PHOENIX, ARIZ. 85005, Sterling Electronics, Inc., 1930 North 22nd Ave., (602)-258-4531 SALT LAKE CITY, UTAH 84115, Hyer Electronics Company, 1425 South 2nd West, (801)-487-3681 SAN DIEGO, CAL. 92101, Milo of California, Inc., 2060 India Street, Box 2710, (714)-232-8951 SEATTLE, WASH. 98108, Kierulff Electronics, Inc., 5940 6th Ave., South, (206)-763-1550 TACOMA, WASH. 98402, C & G Electronics Co., 2502 Jefferson Ave., (206)-272-3181 TULSA, OKLA. 74119, Radio, Inc., 1000 South Main Street, (918)-587-9124 CANADA—SCARBOROUGH, ONTARIO, Lake Engineering Co., Ltd., 123 Manville Rd., (416)-751-5980

Be a sharp circuit shooter pack an AC switch

A line drawing of a hand holding a cylindrical component with two long, thin leads extending downwards. The component is shaded to show its three-dimensional form. The hand is simple, with a thumb and index finger gripping the component.

Pack our new SSPI PIC100 AC Switch. Lightning-fast gate trigger action . . . "inherent transient immunity" (dv/dt 50 volts/ μ sec.) that keeps it from turning on when the supply voltage suddenly changes. In action, it's the quickest AC Switch on-the-draw at high frequencies (up to 20,000 Hertz), and it's got that cool sure-fire dependability at low load currents (1.5 milliamps). It stops 400 volts cold at temperatures up to 150°C. Sighted for a "narrow range of gate control", providing the highest triggering reliability possible.

You can pack this beauty for use in Servo mechanisms, guidance and control, and process controls. So, if you want to marshal the best AC control, call or write Peter Jenner at:

SOLID STATE PRODUCTS 

DIVISION OF UNITRODE CORPORATION

1 Pingree Street, Salem, Massachusetts 01970
Tel: (617) 745-2900

The EE Forefront is a graphical representation of the practical state of the art. You will find here the most advanced components and instruments in their class, classified by the parameter in which they excel.

A word of caution

Keep in mind the tradeoffs, since any parameter can

be improved at the expense of others. If there is no figure-of-merit available, we either include other significant parameters of the same products, or we provide additional bar graphs for the same products.

Do not use these charts to specify. Get complete specifications first, directly from the manufacturers.

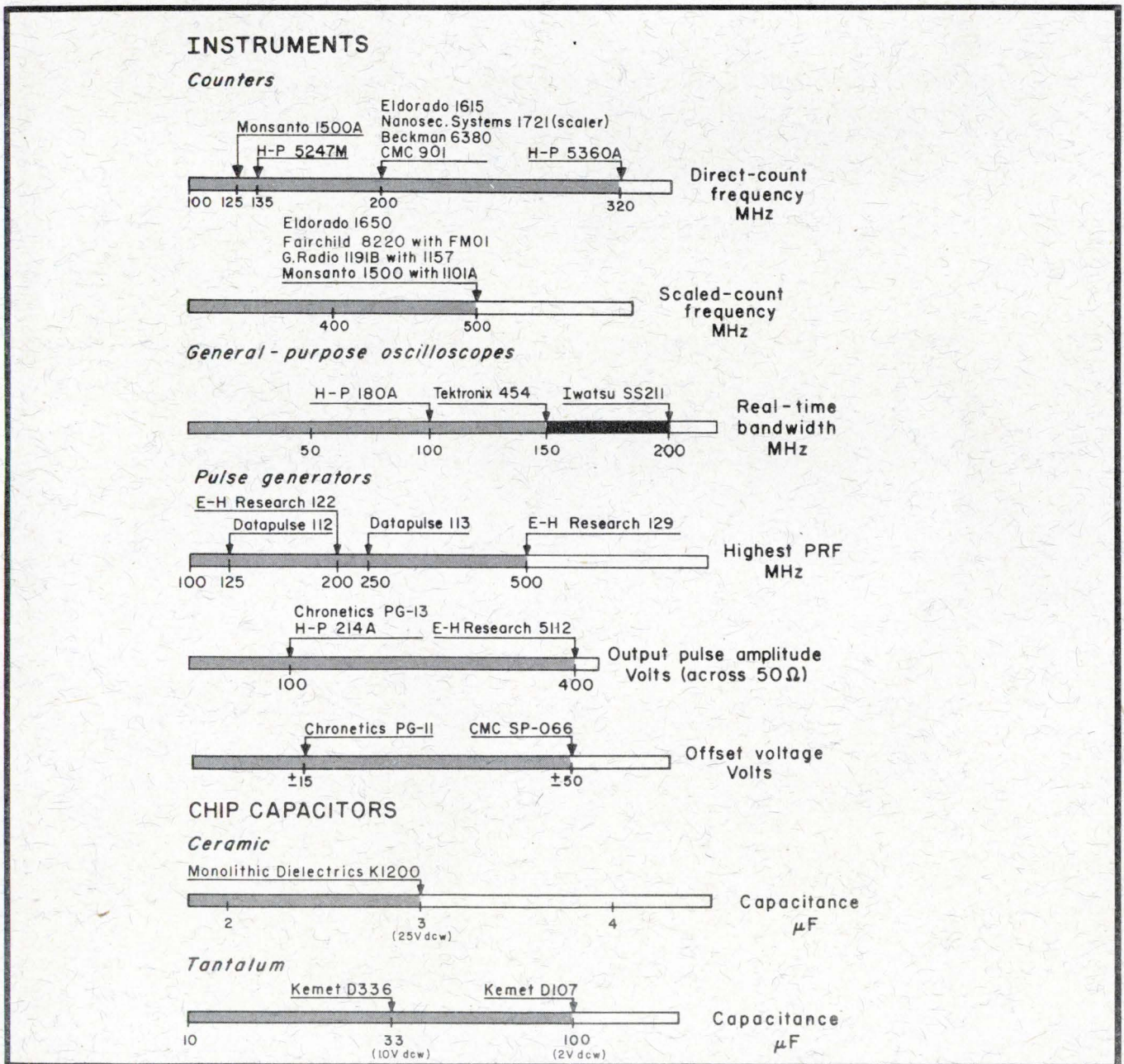

INTEGRATED CIRCUITS

Operational amplifiers

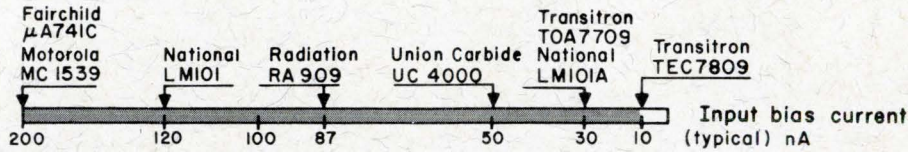

Voltage regulators

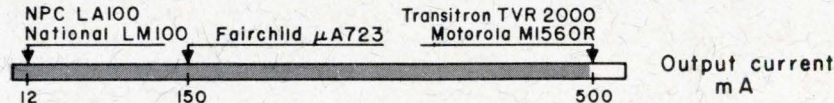

Power amplifiers

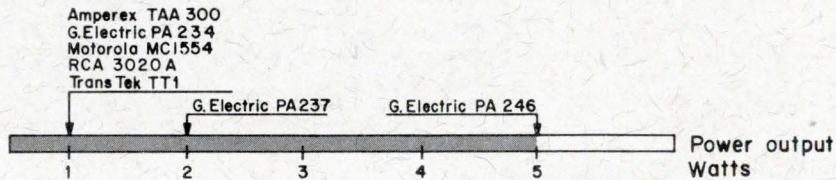

SEMICONDUCTORS

Silicon power transistors (npn)

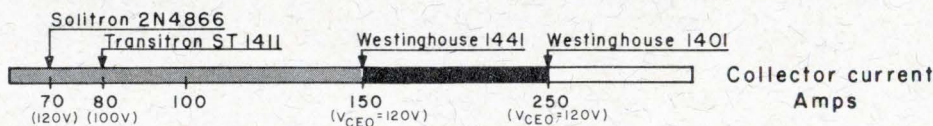
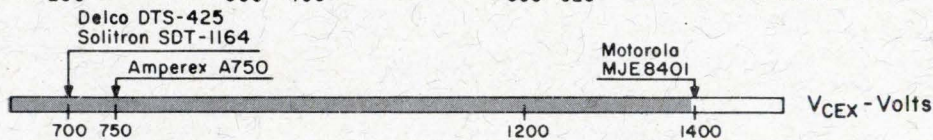
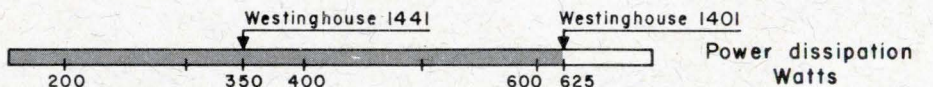

Dual bipolar transistors

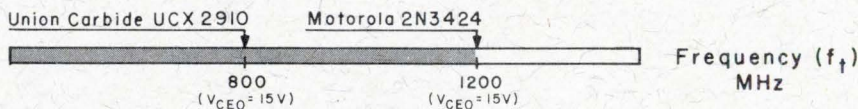

Microwave semiconductors (power)

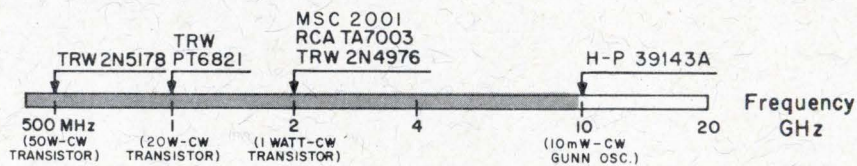

Junction FETs

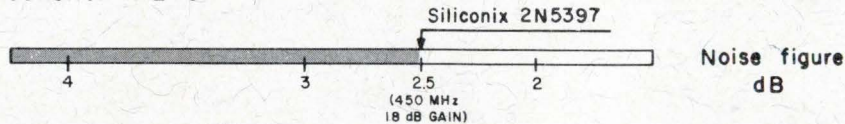

Zener diodes

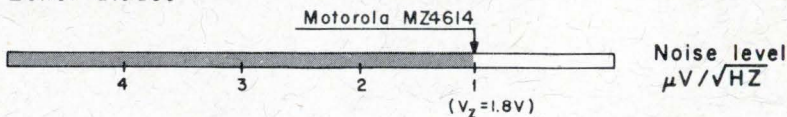



and now...
UNITRODE
 invents the 12 amp
UCR—
 the industry's first
 fused-in-glass SCR.

It has so many superior features it
 deserves to be called "something else".

- Ideal for pulse modulator applications
- Smallest medium-power SCR
- Efficient switching of high pulse currents
- Peak repetitive pulse current 150A in high frequency modulators
- Anode voltage 100 to 600V
- Low forward voltage drop
- Forward current 12A
- Peak gate current 100A
- 3.5°C/watt thermal impedance

TAKE A LOOK AT THE WAY IT'S BUILT

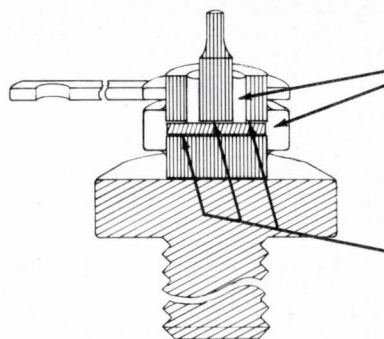

Two fused-in-glass seals melted, wetted and fused to both silicon and metal surfaces permanently protecting and stabilizing the SCR die in a voidless Unitrode package.

Thermal coefficients of glass, pins, and silicon are matched to withstand extremes in temperature shock and cycling.

True metallurgical bonds from terminal pins to the silicon provide rapid heat transfer and high current capability.

580 Pleasant Street, Watertown, Mass. 02172 (617) 926-0404

UNITRODE

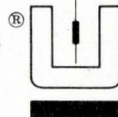

Check off the reply card now for a really comprehensive set of specs, charts, graphs, and curves. Or if you want really fast service, call John McCusker collect at (617) 926-0404.



THE G

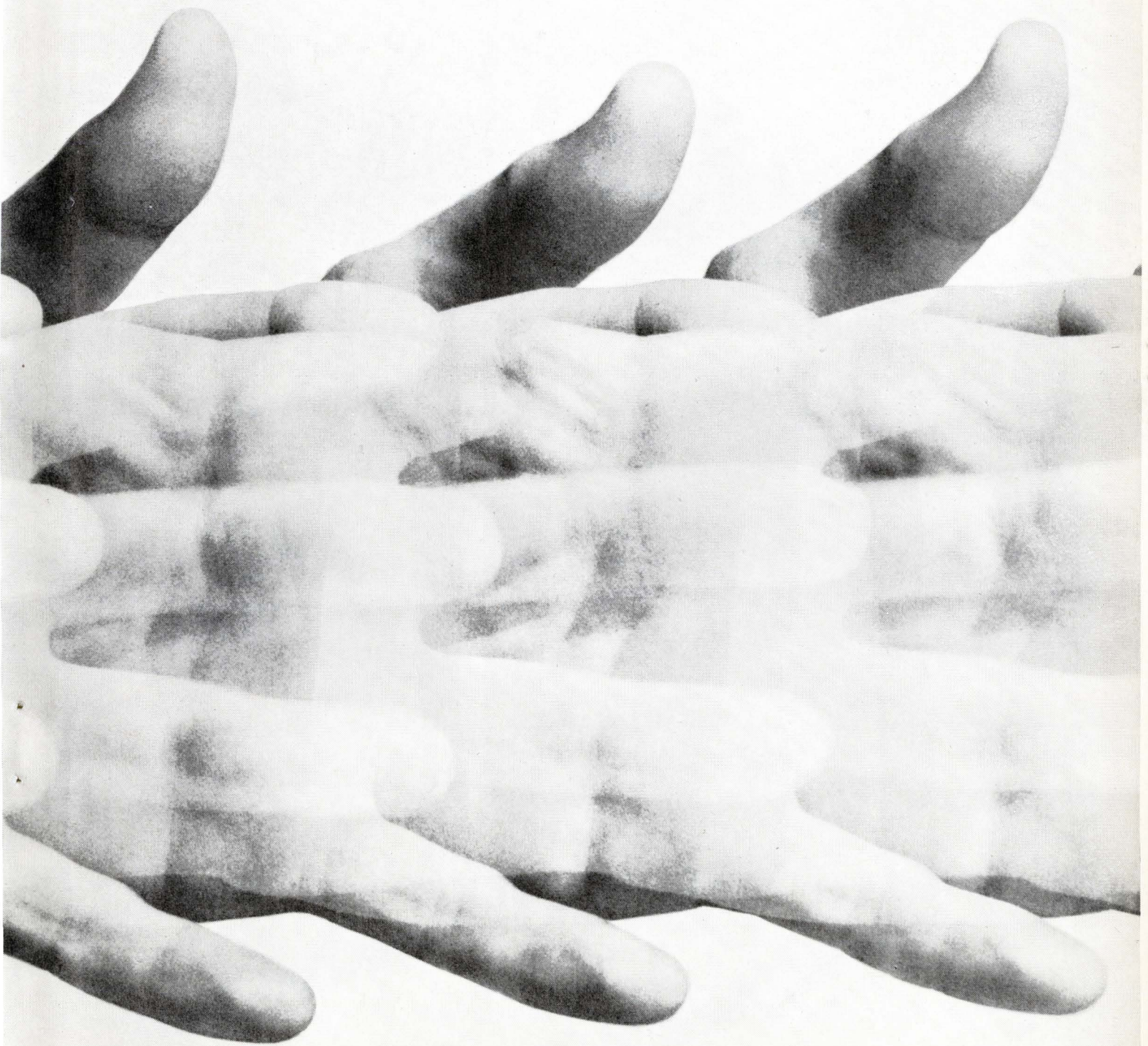

GREAT

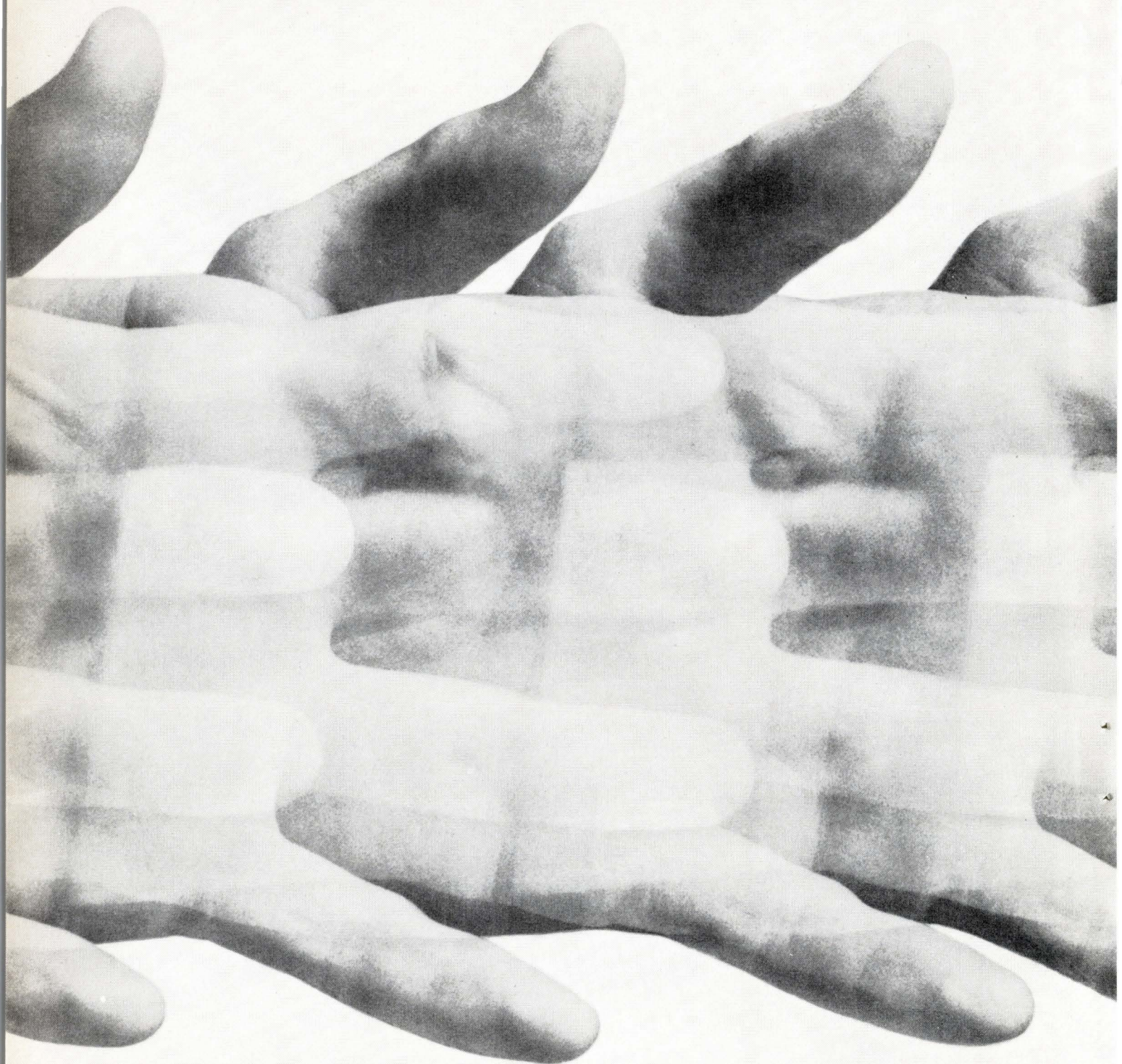

FAIRCH

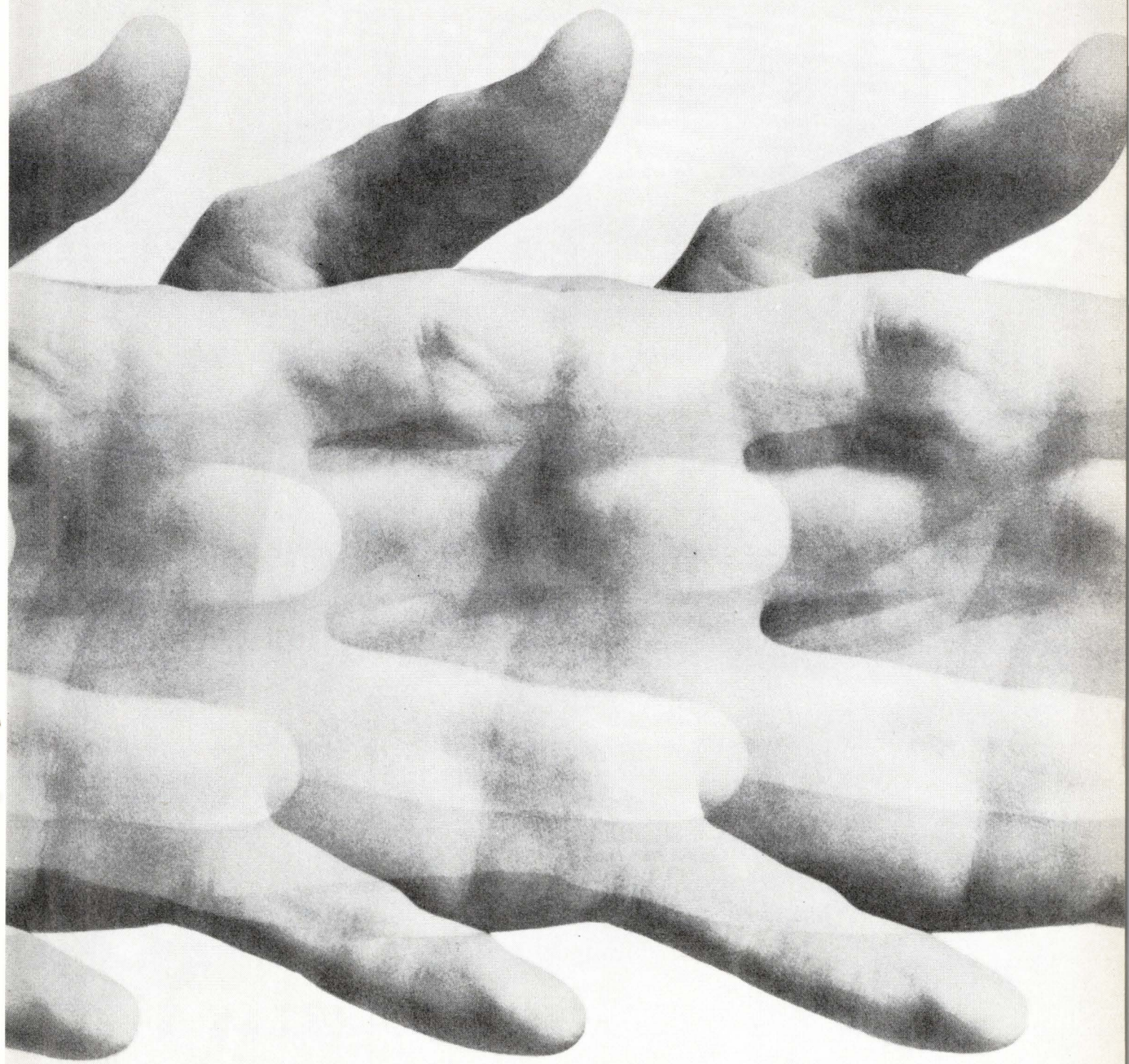

CHILD PO

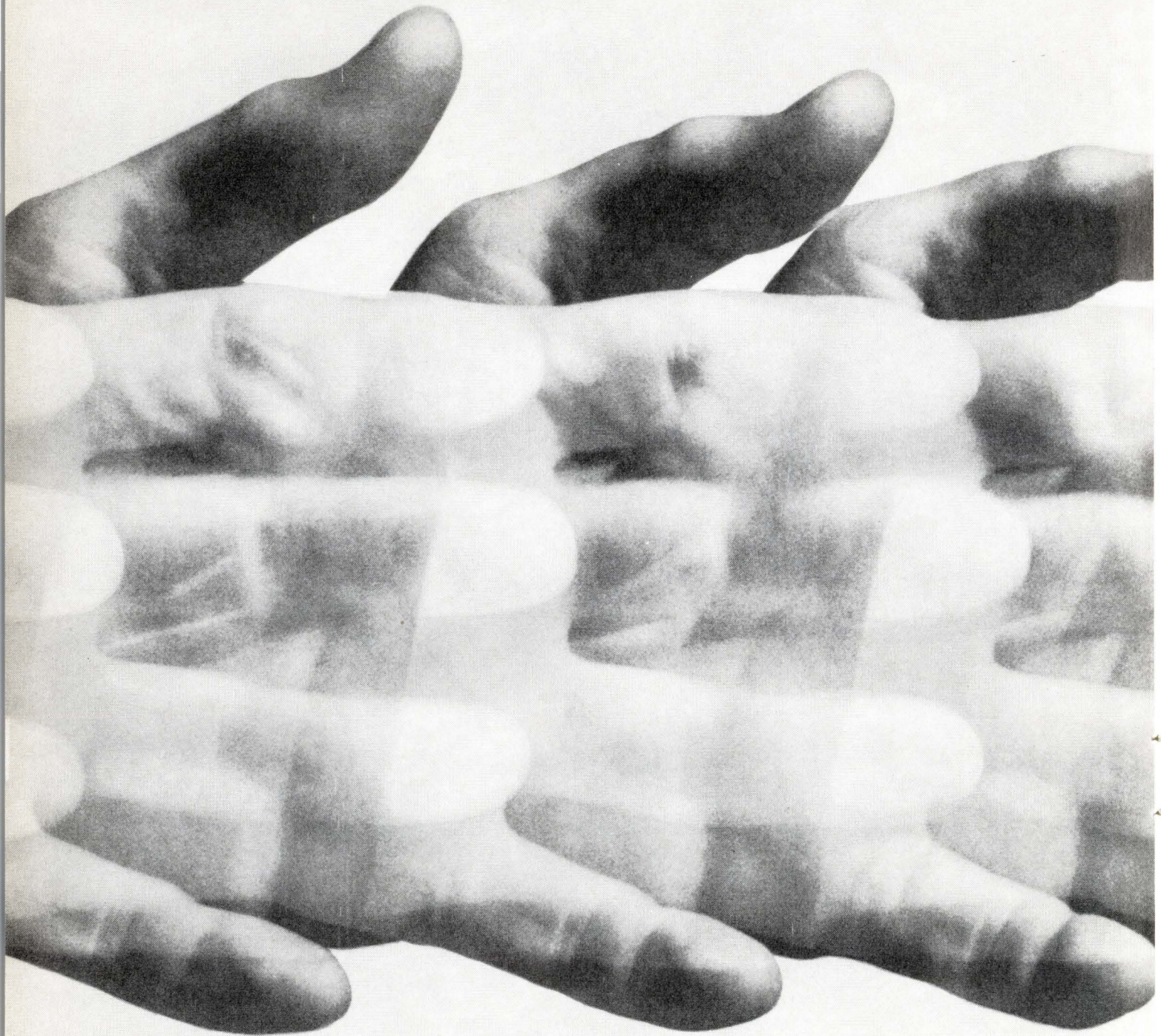

OWER O

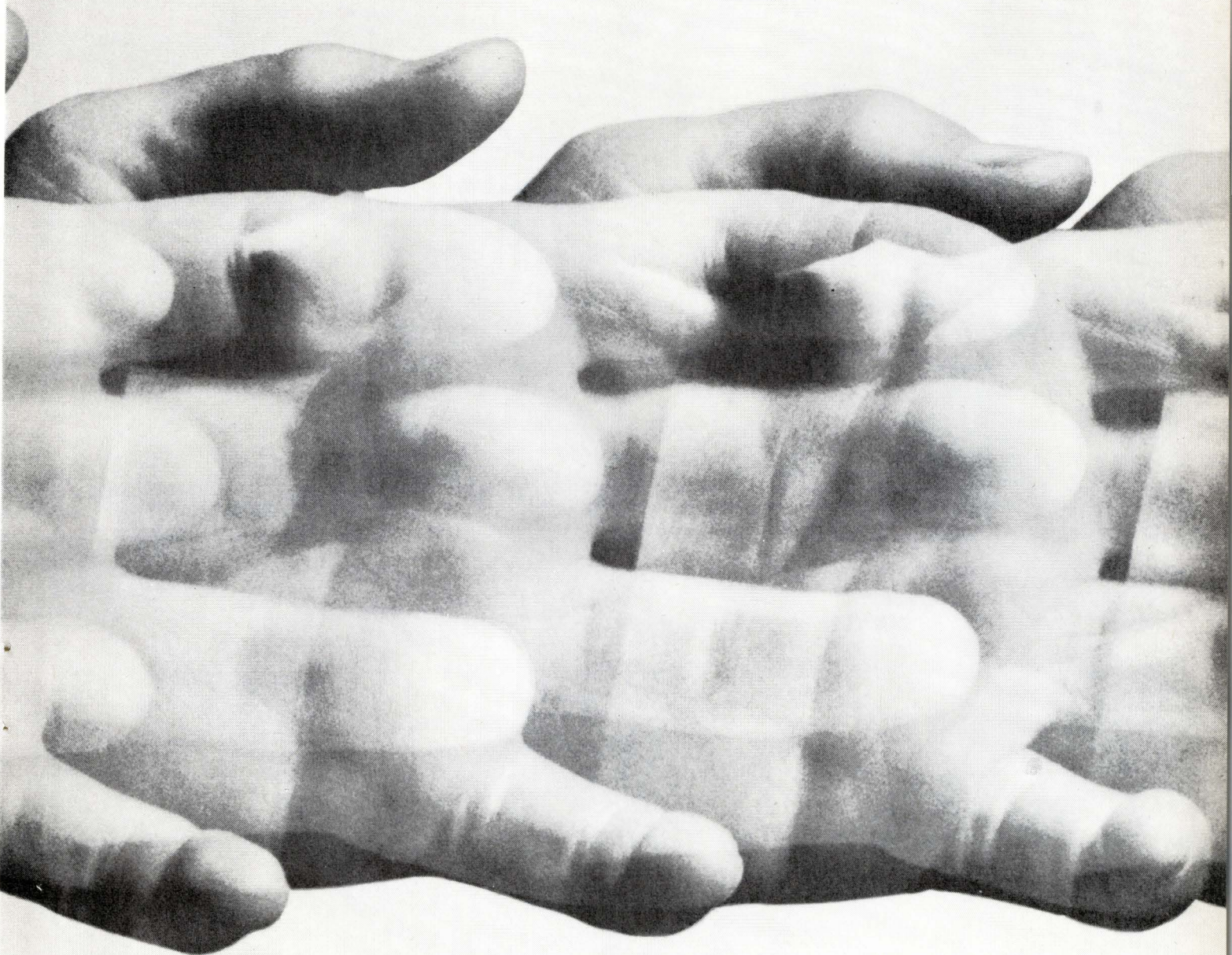

GRAB

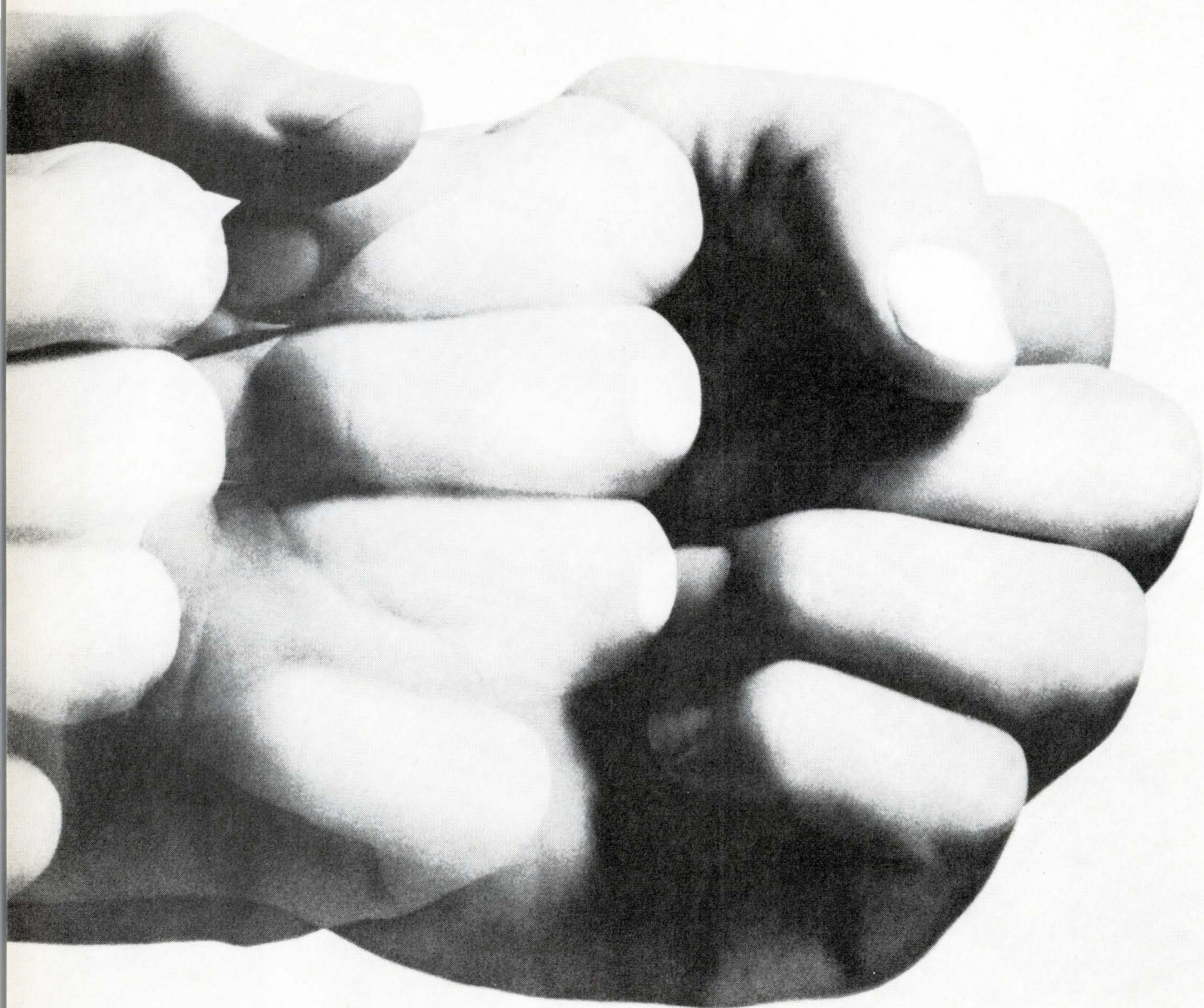

We're out to brute force the power business.
 Across the board: NPNs. PNPs. NPN/PNP
 complementary pairs.

High voltage devices. Devices no one else
 can make.

And second-source devices we can make
 better than anyone else.

Every month you'll see new power products.

Competitively priced. Available in volume,
 off distributor shelves.

All on the preannounced schedule below.
 To make a public announcement like this,
 you've got to be either superconfident or crazy.
 Crazy, we're not.

The Great Fairchild Power Grab is on.

JULY

NPN POWER SWITCHES AND AMPLIFIERS

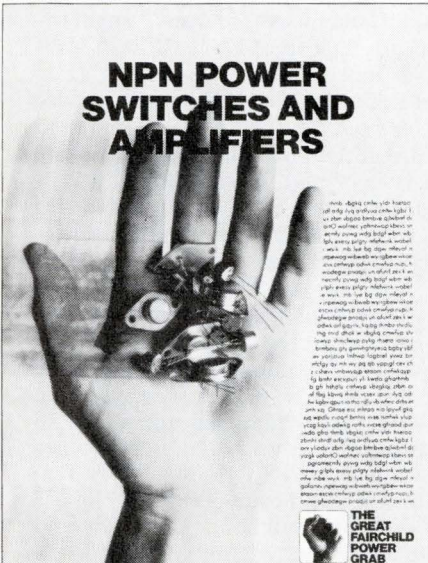

THE GREAT FAIRCHILD POWER GRAB

AUGUST

PNP COMPLEMENTARY POWER SWITCHES AND AMPLIFIERS



THE GREAT FAIRCHILD POWER GRAB

SEPTEMBER

NPN/PNP COMPLEMENTARY POWER SWITCHES



THE GREAT FAIRCHILD POWER GRAB

OCTOBER

TO-66/TO-3 PLASTIC POWER TRANSISTORS



THE GREAT FAIRCHILD POWER GRAB

NOVEMBER

HIGH VOLTAGE PLASTIC POWER AMPLIFIER TRANSISTORS



THE GREAT FAIRCHILD POWER GRAB

THE GREAT FAIRCHILD POWER GRAB



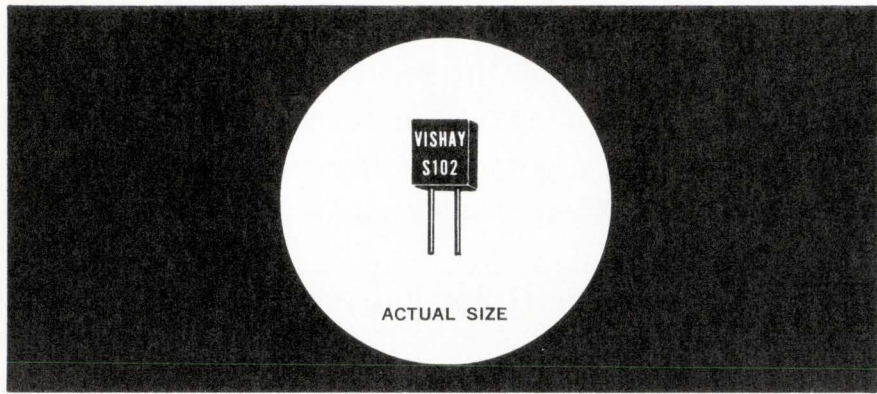

LET VISHAY PRECISION RESISTORS CHANGE YOUR IDEAS ABOUT . . .

1. WHAT RESISTOR PRECISION REALLY MEANS . . .

At Vishay, Precision in a resistor means more than just **absolute resistance tolerance** (we have a standard line of 0.005%). It also means **bedrock stability**, both **on the shelf** (standard is 25ppm per year) and **under load** (in a typical use situation—0.15 watt at 60°C. for 2000 hours—Vishay resistors shift an average of only 0.005%, even less under less load).

In use, too, Vishay offers the lowest TC of any production-use resistor—only $\pm 1\text{ppm}/^\circ\text{C}$. over the 0° to +60°C. range, $\pm 5\text{ppm}/^\circ\text{C}$. over the -55° to +125°C. range. It's a uniform, totally predictable TC that's the same for all Vishay resistors, **regardless of R value, ambient temperature, or frequency.**

You can use them at any frequency — to 100 Mhz. and beyond, because they're non-inductive (no ringing), are noiseless, and have a response time of less than 1 nanosecond.

And their size and shape meet your high density packaging requirements.

2. WHAT TRADE-OFFS YOU HAVE TO LIVE WITH . . .

With wirewounds, inductive and capacitive effects rule out use at high frequencies. With conven-

tional film, you can get the speed but can't approach Vishay's absolute tolerance or almost-zero TC.

The totally new Vishay design eliminates these trade-offs . . . **there just aren't any.**

3. WHAT SUCH COMPLETE PERFORMANCE MUST COST . . .

The best part is that Vishay Precision resistors are competitively priced with conventional units.

If you want or must have precision resistors, in your system or instruments, Vishay offers a precision package no other production resistor can come close to matching.

The simplest way to simplify your circuits and solve your problems is to get the "how", "why" and "where-to-use" data in this free 8-page Brochure. Write for your copy today. Check No. 21.

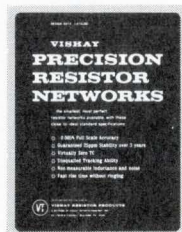
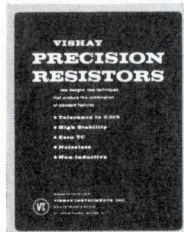

Working with NETWORKS? For unequalled performance (speed, tracking, stability), read these 16 pages. They're free, too. Check No. 22.

VISHAY RESISTOR PRODUCTS



a division of Vishay Intertechnology, Inc.
63 Lincoln Highway ■ Malvern, Pa. 19355

Engineers and society

Sir:

Concerning the two articles on engineers and society by R. F. Ficchi and R. A. Sears, it is correct that engineers are some kind of a silent part of our society. They are the ones who changed the face of our society (and still will do it in the future), they are the ones who improved our standard of living, and they are the ones who create our problems, pollution, and even crimes.

However, it won't change. Using our logic, just what made us successful in our profession? It seems that certain characters choose "engineering" as their profession (Ficchi calls them "loner"). This status will be again and again the same in the future (also no change). The engineer is some kind of a realistic character (in recognizing the laws of nature) and some are very realistic in making such money in this field or independently can reach a goal without depending on "favors" or "luck" of public opinion. This type of person feels frustrated and his time wasted when he joins the political fight of a community. Certainly there are always individuals who have some kind of a split-character, and ability to change from one profession to another first interested by one or another reasons. On the positive side, these are the ones who will be the preachers and links with the community. And the more engineers we have, the more we will have the opportunity to have this kind of "interpreter" between the engineers and the community.

The true engineer will be always a loner, silent, not a part of the political life, because it's his character. He does not accept the low efficiency of the present political life. He is the type of person "to be called to a certain job" and not, to gyrate a sales talk, to be elected.

F. A. Haschke
Data and Instrumentation
Test Facilities Engineering
General Electric, Cincinnati, Ohio

An apple isn't a pear

Sir:

You recently carried a new-product feature story on the Hewlett-Packard computing counter [THE ELECTRONIC ENGINEER, March 1969, p. 99]. We were surprised, and not too happy, to find a paragraph in the middle of that article dealing

with CMC's Model 901. We don't believe that one manufacturer's product should be used as an expendable buffer to promote another's, especially when you are comparing apples and pears. So let's set the record straight.

The mistake you made in your mentioning the 901 was to omit its price. It sells for only \$2475, as compared with H-P's \$6500 plus. Now, once that is established, it becomes clear that the H-P product should indeed have some performance advantages over any conventional counter selling for about a third of its price. (And you can be sure that for \$4000 on top of our base price, we would be prepared to offer Model 901 buyers a pot full of extras, too! Maybe we'd even throw in a computing module.)

We have no beef against H-P or the concept of a computing counter. But we believe you would have done your readers a greater service had you simply introduced the H-P model as a new, \$6500, special-purpose computing and measuring instrument, rather than billing it as some kind of a counter comparable with conventional counters in the medium- to low-price range.

Let us hope that your hapless reference to the CMC 901 has not confused your readers. The fact remains that at \$2475, the 901 still delivers the best performance-per-dollar of any comparable instrument available today. So perhaps those readers who aren't willing to spend \$6500 for special performance they may not need will want to refer back to that Hewlett-Packard article for CMC's telephone number.

Leslie B. Arnold
President and General Manager
Computer Measurements Co.
San Fernando, California.

EDITOR'S NOTE: The H-P instrument was billed as a counter because it is a counter, first and foremost. But a non-conventional design, plus some clever applications of side-benefits of that design, let you use the instrument as a computer also.

On the other hand, we must agree with Mr. Arnold's suggestion that it's unfair to compare the H-P item with a conventional counter, at least on a price basis. **And no such comparison was intended.** We brought in the CMC 901 simply as an example to show our readers what they could expect, in terms of direct-frequency count and resolution, from even such an outstanding example of a conventional counter as the 901.

The gentlemen at CMC will be delighted to discuss these points further, dear reader, if you'll call them at (213) 367-2161.



We'll tear your memory costs to bits.

Spec by spec. \$300 a unit.

Our low cost delay line memory system challenges any other memory system. Including any you are using now, or may be considering. You name the specifications.

This Digital Devices memory system is suited for buffering limited message keyboards, installation in peripheral equipment and more complex buffering units, interfacing with communications networks, incorporation in CRT displays and similar applications.

These versatile memory systems include the recirculation and control circuitry necessary for the complete memory function. They store up to 20,000 bits at 2.5 MHz. The systems hold storage indefinitely until cleared and can be loaded and unloaded at rates compatible with communications links or peripheral equipment.

Operating environment ranges from 0° to 70°C and atmospheres to 100% humidity. The compact units measure from as small as 6" x 7" x 3" to 12" x 12" x 2".

There are five basic models available – each adaptable quickly and reliably to your exact specifications. And best of all, each delivers more for less money. Some units cost as little as \$300.

Let us take on your memory requirements. Send us your specifications and we'll give you a quote. You can even send us your present memory costs and we'll see if we can beat them. Spec by spec. Digital Devices Division, Tyco Laboratories, Inc., 200 Michael Drive, Syosset, Long Island, New York 11791.

TYCO

condenser products
has capability,
reliability, versatility...

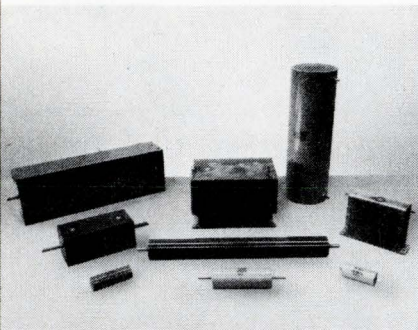

Special OEM designs to suit customer applications and space limitations. A wide range of voltages, capacities and constructional styles available to meet your specifications.

for all your high voltage
component needs.

DC FILTER CAPACITORS

Miniature glass — 1 to 50 KV standard; Rugged bakelite — 40 to 150 KV standard; CP70 type — 600 V to 50 KV standard.

TRANSMITTING CAPACITORS

Pulse or RF Series — 1 to 30 KV standard. Temperature ranges up to 210°C without derating.

LABORATORY AND INSTRUMENTATION CAPACITORS

Glass or CP70 containers to 60 KV at 0.1 mfd.

HIGH VOLTAGE POWER SUPPLIES

Modular compact and capacitor charging — output from 1 to 75 KV standard. OEM specials promptly quoted.

PULSE FORMING NETWORKS

Designed to your specifications and applications.

ULTRA LOW INDUCTANCE CAPACITORS

For laser, simulation and spark discharge technology.

Call or write for complete technical information. Special requirements tailored to your applications and specifications are promptly quoted.



**CONDENSER
PRODUCTS
CORPORATION**

Box 997, Brooksville, Florida
Phone: 904-796-3562
California: 213-391-1641
New York: 212-245-3866

EE CALENDAR

JUNE

8	9	10	11	12	13	14
15	16	17	18	19	20	21
22	23	24	25	26	27	28
29	30					

June 9-10: Chicago Spring Conf. on Broadcast & TV Receivers, Marriott Motor Hotel, Des Plaines, Ill. Addtl. Info.—Larry Maloney, Philco-Ford, 1820 Pheasant Trail, Mt. Prospect, Ill. 60634.

June 9-11: Int'l Communications Conf., Univ. of Colorado, Boulder, Colo. Addtl. Info. — A. J. Estlin, Radio Standards Eng'g Div., NBS, Boulder, Colo. 80302.

June 15-18: Consumer Electronics Show, Americana and New York Hilton Hotels, New York, N. Y. Addtl. Info. — Consumer Products Div., Electronic Industries Ass'n, 2001 Eye St., N.W., Washington, D. C. 20006.

June 17-19: Electromagnetic Compatibility Symp., Berkeley Cartaret Hotel, Asbury Park, N. J. Addtl. Info. — Harry Estelle, Honeywell Inc., 1162 Pinebrook Rd., Eatontown, N. J. 07724.

June 30-July 1: Conf. on Applications of Continuous System Simulation Languages, Sheraton-Palace Hotel, San Francisco, Calif. Addtl. Info.—Robert Brennan, IBM Scientific Ctr., 2670 Hanover St., Palo Alto, Calif. 94304.

JULY

		1	2	3	4	5
6	7	8	9	10	11	12
13	14	15	16	17	18	19
20	21	22	23	24	25	26
27	28	29	30	31		

July 7-11: Conf. on Nuclear & Space Radiation Effects, Penn State Univ., Univ. Park, Pa. Addtl. Info.—S. E. Harrison, Martin Marietta Corp., Baltimore, Md.

July 8-10: Sixth Symp. on Explosive Devices, St. Francis Hotel, San Francisco, Calif. Addtl. Info.—Gunther Cohn, Arrangements Chrmn., The Franklin Institute Research Labs, Philadelphia, Pa. 19103.

July 20-25: Eng'g in Medicine & Biology and Int'l Fed. for Medical & Biological Eng'g Conf., Palmer House, Chicago, Ill. Addtl. Info.—Box 1969, Evanston, Ill. 60204.

July 28-Aug. 1: '69 Research Conf. on Instrumentation Science, Hobart and William Smith College, Geneva, N. Y. Addtl. Info.—Thomas E. Tremellen, Mgr., Education & Research Services, Instrument Society of America, 530 William Penn Pl., Pittsburgh, Pa. 15219.

AUGUST

					1	2
3	4	5	6	7	8	9
10	11	12	13	14	15	16
17	18	19	20	21	22	23
24	25	26	27	28	29	30
31						

Aug. 19-22: Western Electronic Show & Conv. (WESCON), Cow Palace & San Francisco Hilton Hotel, San Francisco, Calif. Addtl. Info.—WESCON, 3600 Wilshire Blvd., Los Angeles, Calif. 90005.

Aug. 24-27: Electronic Materials Tech. Conf., Statler-Hilton Hotel, Boston, Mass. Addtl. Info.—D. P. Seraphim, IBM Components Div., Bldg. 300, Hopewell Junction, N. Y. 12533.

'69 Conference Highlights

WESCON—Western Electric Show and Conv., August 19-22; San Francisco, Calif.

NEREM — Northeast Electronics Research and Eng'g Meeting, Nov. 5-7; Boston, Mass.

Call for Papers

Sept. 24-26, 1969: Ultrasonics Symp., St. Louis, Mo. Submit abstracts before **July 15, 1969** to C. K. Jones, Westinghouse Research & Development Ctr., Beulah Rd., Churchill Borough, Pittsburgh, Pa. 15235.

Dec. 4-5, 1969: Vehicular Technology Conf., Columbus, Ohio. Submit a 50-word abstract and an 800-1000 word abridgement before **August 1, 1969** to Dr. Robert E. Fention, Dept. of Electrical Eng'g, Ohio State Univ., Columbus, Ohio 43210.



Electrical Engineers:

Join a small, hard-hitting logic design team at IBM.

Here's your chance to really get involved with designing the logic for sophisticated new systems for both military and commercial projects.

New Engineering Center

Here at IBM's new Communications and Engineering Sciences Center, near Washington, D.C., we work in small groups. This allows each member to dig into the project from the very beginning—from sitting down with the customers before we begin to conducting the maintenance training after we finish.

The entire group is involved with everything from hardware design to systems acceptance and program management.

You should have a degree in electrical engineering. Experience in logic design, digital systems or some other data processing area would be helpful.

Projects now underway

Several high-priority projects are already underway. They range from an advanced reservations system for commercial airlines to highly classified ground-based military systems.

We are also helping to develop greater mission capability for the post-Apollo period.

Why choose IBM?

Today's major growth industry is information handling and control. And IBM is a leader in that field. This growth environment can bring out the best of your talents and abilities, because in a growth company like IBM you can work constantly toward greater achievement. This means more opportunities to achieve distinction and personal recognition.

So if you're a problem-solver who wants a personal sense of achievement and recognition for your hard work in an exciting growth company, consider IBM.

Call or write

If you are an Electrical Engineer and want to join a small, hard-hitting team, call Jim Dunn at (301) 921-7724 collect any weekday between 9 and 4:30. Or, send a brief letter or resume to him at IBM Corporation, Federal Systems Division, Dept. CD1068, 18100 Frederick Pike, Gaithersburg, Maryland 20760.

An Equal Opportunity Employer

IBM®

Florida opportunities

for a special breed of communication engineer

If you're going to enjoy your job, you might as well enjoy where you're living! At Electronic Communications, Inc., you can have both: professional challenge and career opportunity plus the advantages of living in St. Petersburg on Florida's subtropical Gulf Coast.

We don't offer comfortable grooves where you can get lost . . . and your work overlooked. At ECI you'll work on projects that push the state-of-the-art in satellite communications, multiplexing, electronic switching and advanced radio communications to supply advanced systems and equipment for many of the nation's key military and space programs. You'll work on projects beginning with applied research and advance development through prototype and product design. In fact, two-thirds of all advanced development at ECI is done in regular engineering development areas.

CHECK THESE OPPORTUNITIES IN ENGINEERING AT ECI

RF Circuit Engineers
Systems Analysis Engineers
Systems Integration Engineers
Industrial Engineers
Digital Engineers
Reliability Engineers

CHALLENGE, GROWTH . . . AND LOCATION TOO!

If you'd like a challenging engineering position, growth instead of a groove, and stimulating, comfortable living in sunny St. Petersburg, send your resume — in confidence — to P. T. Jordan, Supervisor of Professional Placement, Electronic Communications, Inc., Box 12248, St. Petersburg, Florida 33733.

(An equal opportunity employer, M/F.)



ELECTRONIC COMMUNICATIONS, INC.
St. Petersburg Division a subsidiary of NCR



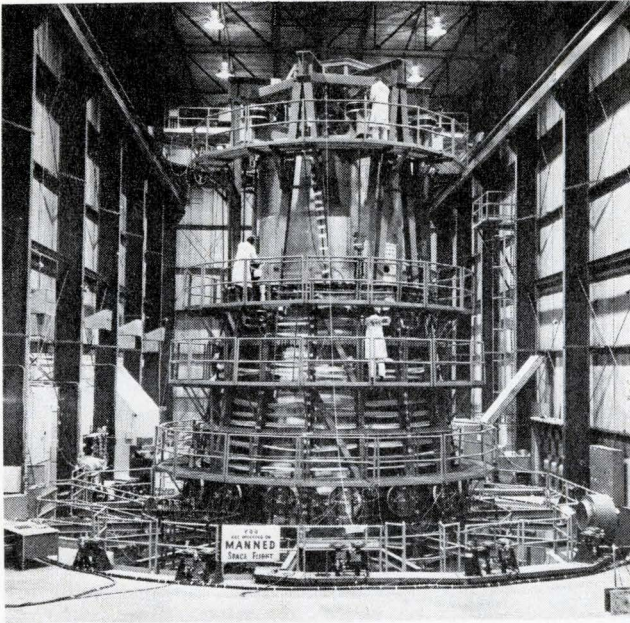

A case history

Project management accomplishes “impossible” mission

The mission was to verify the structural integrity of the Apollo short stack—a task estimated to take at least a year—in four months.

Project management techniques helped get the job done on time.

By **Joan Segal**, Assistant Editor

A project is usually defined as a “unique, well-defined effort to produce certain specified results at a particular point in time,” and by all terms of the definition the short stack testing program qualifies. It was an unprecedented testing effort (representing a significant advance in ground testing for space vehicles). It had a specific objective (to confirm that the short stack, as an assembly, was capable of withstanding the rigors of flight). And it certainly had a specified time span (four months).

To handle this complex project, with its very compressed and urgent schedule, Wyle top management immediately assigned a program manager with the full responsibility for administering the contract. It was his

responsibility to establish program objectives, budgets, and schedules, and to assure the performance of all services provided under the contract.

People power

When Wyle was awarded the short stack testing project, David R. Reese—who had managed the proposal effort—became the program manager. His first task was to assemble a project staff, and there was no time to waste because of the tremendous schedule requirements. What made his job easier was the company’s policy for staffing a project: When it commits itself to getting a job done, it gives the program manager the freedom to pick senior individuals for each of the identified tasks from virtually any of the cor-

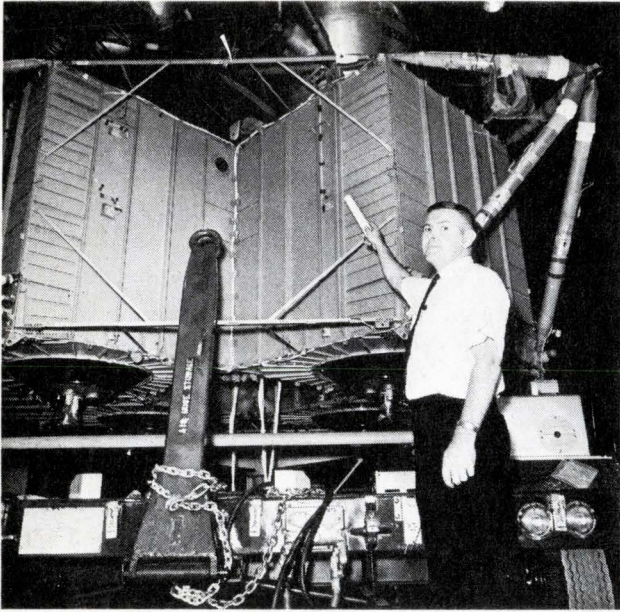

"Running a program like this is a continual evaluation of where you stand and where you have to put more strength, more engineering talent," quips Dave Reese, program manager for the short stack testing effort.

porate divisions—be it from the Norco or El Segundo, Calif., divisions, or from the Payne Division in Washington, D.C., or from the Hampton, Va., facility.

Dave Reese was able to identify who the key people were, and drew these people from each of the Wyle organizations virtually overnight. In all, 30 specialists—scientists, engineers, and technicians—were transferred to Huntsville from other Wyle facilities to work on the program.

Once the basic management team was formed, recruiters began long hours of daily interviewing and hiring which helped bring the entire program staff from zero to 300 persons in only 30 days.

The procurement panic

Because of the program deadline, one of Reese's most urgent tasks was to identify those items he knew he had to order immediately—or the whole schedule would blow up. But there was a more basic problem, and that was to bring together all the responsible parties from NASA, North American, Grumman, IBM, and McDonnell and get an agreement as to what the test parameters really were. Naturally, you need this kind of information before you can set the design of your test hardware, and thus before you can begin procuring needed materials and equipment. As the program manager recalls, "The original meetings to get this settled would involve some 65 to 70 people. The pains and agonies of getting enough of an agreement so that we could at least order long lead items was in itself a major undertaking."

In many cases, what he had to do was analyze the minimum-maximum requirements and try to order on this basis. For example, steel was a very tough item to get, but the exact requirements were not set immediately. Since he knew that the Saturn rocket during boost is in the range of 4 to 5 g, Reese felt that he would be safe in sizing the steel for the fixtures based upon a maximum of 5 g. As it turned out, the final test parameters were based on something a little over

4 g; but by estimating his needs rather than waiting for the exact parameters to be decided, he assured himself of obtaining the hard-to-get item—on time.

Another critical supply was wire. To connect the test set-up's 1300 strain gauges to the data system, a million feet of insulated wire was required. To fulfill this need, Wyle purchased nearly every foot of suitable wire available in the entire country.

In a normal program, the manager can allow a week or two for a shipment getting lost or for somebody in the receiving department "goofing up." But in this program a single day could be critical. Recognizing this, Reese and his staff sat down and, based upon their previous experience, tried to predict everything that could go wrong in the whole procurement cycle. Then, to make sure nothing did go wrong, they organized a purchasing staff to follow up every purchase order that was significant. And to do this, they had to put together a complex schedule that listed when you had to have what item to keep up to date.

To illustrate the enormity of this expediting job (which is usually only a minor problem for most major programs), in only 43 days purchase orders totaling \$1,300,000 had been placed and filled.

Making what you can't buy

The program's procurement problem went further than just selecting a supplier and watching over him to ensure that he delivered on time. In some cases, the needed item could not be purchased from any subcontractor within the allotted time span. For example, a major problem was how to apply the aerodynamic forces to the skin of the SLA (Spacecraft Lunar Module Adapter) and the SIV-B. The normal way for doing this is with a mechanical attachment, which affects the dynamic response of the structure. Since the short stack program involved dynamic tests, the forces had to be applied without affecting the dynamics. To do this, program engineers devised a method which called for the use of many specially formed air bags made from the same type of material that goes into the manufacture of a dirigible.

The big problem was finding a rubber company that could meet the delivery requirements for the nearly 200 air bags—ranging up to 20 ft long. Unfortunately, Reese discovered that although he could get the raw material, no plant would build these things in the allotted time. So, he lured an ex-Goodyear specialist out of retirement, had him set up a manufacturing area for air bags, hired platoons of vacationing college students, and got the job done.

As Reese summarizes, "Running a program like this is a continual evaluation of where you stand and where you have to put more strength, more engineering talent. We didn't particularly want to get into the manufacturing business but we had to—there were no two ways about it."

Coordinating the test effort

Aside from the technology involved, perhaps the most unique feature of the program was the smoothness with which Reese was able to get all the people from the various stage manufacturers and NASA to work together. After all, NASA, McDonnell Douglas, IBM, and Grumman had no real contractual relation-

New Miniature Power Supplies for Op-Amps and IC Logic Circuits

Now at new low prices

(Model 904)

$\pm 15V @ 50mA \dots \$39$

(Model 902)

$\pm 15V @ 100mA \dots \$49$

(Model 903)

$5V @ 500mA \dots \$49$

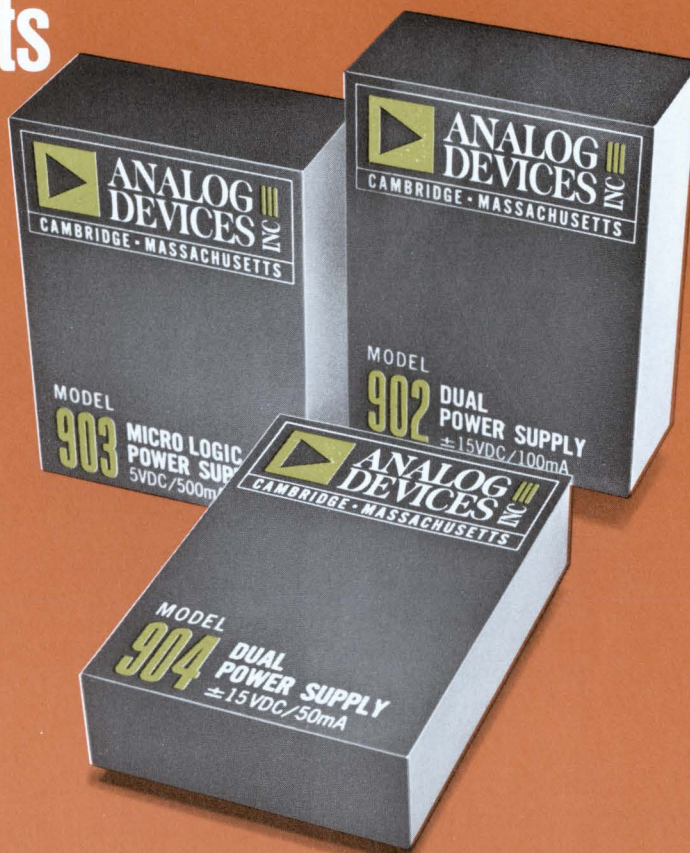

The circuit designer's best friend these days is the packaged circuit module. Engineers everywhere have discovered the convenience and economy of "plug-in" building blocks . . . op-amps, logic cards, miniature D/A converters, etc. Relatively new on the scene are power supply modules. The only problem, until now, has been the cost.

ANALOG DEVICES BREAKS THE PRICE BARRIER!

Special circuit design and high volume manufacturing techniques have led to dramatic cost savings . . . NOW YOU CAN BUY MINIATURE POWER SUPPLY MODULES, READY TO GO TO WORK FOR YOU, AT PRICES BELOW THE INTERNAL MANUFACTURING COST OF MOST OEM USERS! You get further cost savings (and reduced lead time) by eliminating engineering start-up and manufacturing lags. Just unpack and solder into your circuit board! (optional mating sockets are available for plug-in use). Meet your power supply requirements instantly, and with performance tested and guaranteed.

Designed by experts in op-amp and digital logic technology, these new supplies offer features (such as short-circuit and overvoltage protection) that you'd expect to find only in supplies of twice the size and cost. Ripple, noise and regulation are just right for almost all applications.

FREE TRIAL OFFER

We're so sure that once you see one of these great little supplies you won't want to part with it that we're prepared to send one to you for a free 30 day trial. At the end of the trial period you simply return the unit or send your purchase order. No risk to you and no obligation to buy, of course. USE THE INSTANT ACTION CARD.

**Instant
action card**

For detailed specs
Free trial offer
New catalog

BUSINESS REPLY MAIL
NO POSTAGE STAMP NECESSARY IF MAILED IN THE UNITED STATES

POSTAGE WILL BE PAID BY



221 FIFTH STREET • CAMBRIDGE • MASSACHUSETTS 02142

FIRST CLASS
Permit No. 39342
Cambridge, Mass.

SPECIFICATIONS (typical @ 25°C unless otherwise noted)

	MODEL 902 Op-Amp Supply	MODEL 904 Op-Amp Supply	MODEL 903 IC Logic Supply
INPUT VOLTAGE	105 to 125VAC ¹ 50 to 400Hz 17VA max	105 to 125VAC ¹ 50 to 400Hz 9VA max	105 to 125VAC ¹ 50 to 400Hz 17VA max
OUTPUT VOLTAGE (fixed)	±15V @ 0 to 100mA	±15V @ 0 to 50mA	±5V @ 0 to 500mA
ACCURACY	±(15.0 to 15.3)V -15V within ±1% of +15V	±(15.0 to 15.2)V -15V within ±¾% of +15V	Within ±1% of +5V
TEMP COEFFICIENT	0.015%/°C max	0.03%/°C max	0.02%/°C max
REGULATION Line (105 to 125VAC) Load (0 to 100%)	0.05% max 0.1% max	0.1% max 0.1% max	0.15% max 0.3% max
WARM UP DRIFT	±0.3% (45mV)	±0.25% (37mV)	±0.3% (15mV) no overshoot on turn-on
RIPPLE	0.5mV rms, 2mVp-p max	0.5mV rms, 2mVp-p max	1mV rms, max 5mVp-p max
OUTPUT IMPEDANCE	2 ohms @ 10kHz	0.2 ohms @ 10kHz	25 milliohms @ 10kHz
SHORT CIRCUIT PROTECTION	Either output to common indefinitely 0 to 71°C	Any combination of output pins indefinitely 0 to 71°C	Output to common indefinitely.
OVERVOLTAGE PROTECTION	_____	_____	6.5V max (internal fault) (Protected against reversed polarity)
OPERATING TEMPERATURE	0 to 71°C derate 5mA/°C above 60°C derate 1mA/°C	0 to 71°C derate 2mA/°C above 55°C derate 0.5mA/°C below 10°C	0 to 71°C derate 12mA/°C above 50°C derate 10mA/°C below 15°C
STORAGE TEMPERATURE	-25 to +85°C	-25 to +85°C	-25 to +85°C
SURFACE TEMPERATURE RISE	20°C above ambient @ full load	25°C above ambient @ full load	35°C above ambient @ full load
INPUT ISOLATION	50 Megohms	500 MΩ 100 pF	500 Megohms
WEIGHT	16 oz.	10 oz.	17 oz.
PRICE 1-9 10-24	\$49. \$47.	\$39. \$38.	\$49. \$47.

1. Input voltage of 205 to 240VAC available. Specify Model 90_ E.

Mating Socket AC1013 \$3.75

Power Supply Bench Mount Manifold

The Model 950 power supply manifold allows use of our modular power supplies on the design bench. In combination with either the model 904 or 902, it provides a safe, convenient, and inexpensive supply for breadboarding, testing, or general laboratory use.

The device incorporates a 3 wire power cord, line fuse, on-off toggle switch, and four universal terminals (+Vs, -Vs, output common, and power line ground). It is constructed in a rugged epoxy enclosure with four soft rubber feet. The power supply is simply plugged into mating receptacles and may be easily removed or replaced.

Price is just \$16. (1-9), \$15. (10-24)



OUTLINE DIMENSIONS



Height: Model 902-1.25"

Model 903-1.25" Model 904-.875"

221 FIFTH STREET • CAMBRIDGE • MASS. 02142 • (617) 492-6000 • TWX: (710) 320-0326

INSTANT ACTION REQUEST

Please send free catalog

My interest is for:

Immediate application

Anticipated application

Information only

Send OEM Quantity prices

Add my name to Mail List

Have salesman call

I am interested in model

904 Special

902 _____

903 _____

950 _____

FREE TRIAL OFFER

Please send the following unit(s) for 30 day free trial:

Model _____ Quantity _____

Model _____ Quantity _____

I understand that at the end of the 30 day trial period, I will send a purchase order (based on the prices published herein) for any units I decide to keep. I further understand that I may return these units at any time within 30 days with no obligation to buy.

Advance P.O. # _____

P.O. will follow after my approval

Date _____ Initials _____

Name _____

Title _____

Company _____

Dept./Mail Station _____

Address _____

Phone _____

City _____

State _____

Zip _____

FREE
NEW
CATALOG

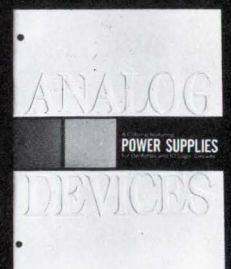

Analog Devices now offers an extremely broad line of op-amp, logic circuit, and special purpose power supplies. A free new 12 page catalog is now available with complete specifications, application data and prices. Get your copy now, use the instant action card.

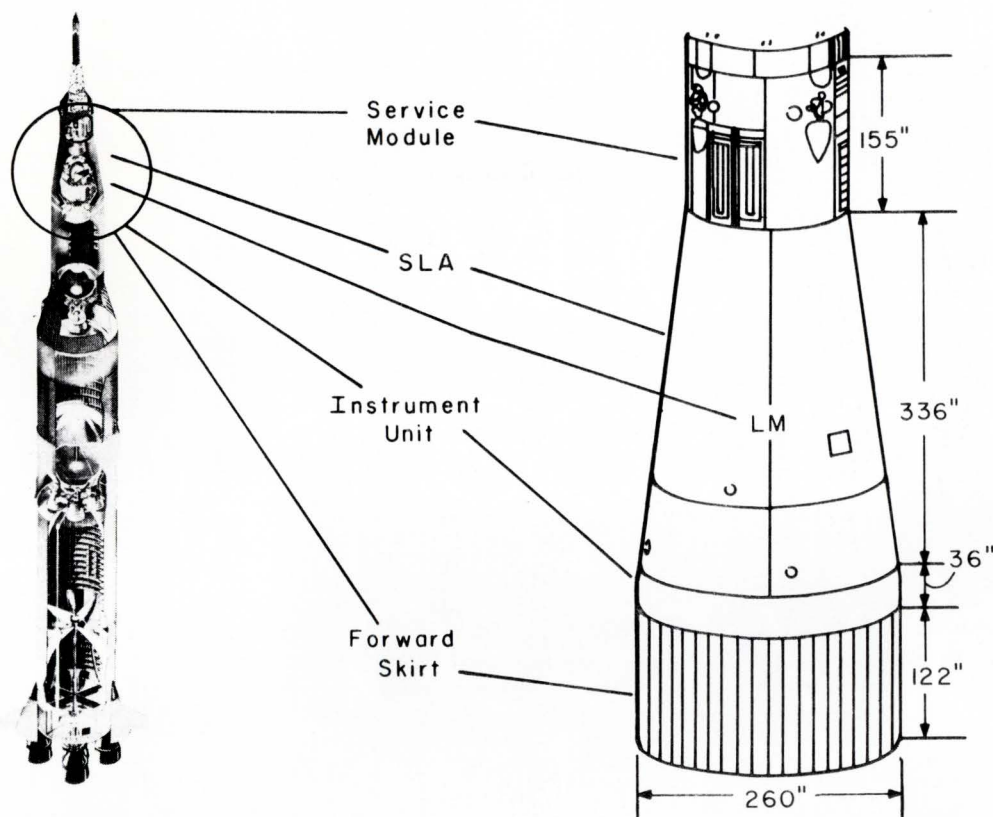

The Saturn V launch vehicle with illustration of the "short stack" Apollo spacecraft test configuration.

Problem and solution

Early in 1968 NASA's budget for space exploration was radically cut and the agency was thus forced to reduce the number of Saturn/Apollo test flights.

Then on April 5, 1968, Saturn/Apollo 6 preceding the manned Apollo 7 began to shed pieces of the Spacecraft Lunar Module Adapter (SLA) shortly after blastoff.

These two events presaged a long delay of the moon shot landing, a radical disruption of the United States space schedule, and a consequent problem for space contractors.

That June, NASA and the Space Division of North American Rockwell Corp., prime contractor, concluded a series of analyses with the decision that a multi-environmental test program was feasible—although the problem was compounded by the nearness of the next manned flight, scheduled for the fall of '68.

A contract was awarded to Wyle Laboratories, Huntsville, Ala. Wyle's task: to conduct an environmental testing program to simulate launch conditions of the Saturn/Apollo modified "short stack," an assembly which stands 60 ft high, is 22 ft in diameter at the base, and weighs close to 22 tons. It includes the Apollo Service Module and the

Spacecraft Lunar Module Adapter (North American), the Lunar Module (Grumman), the Saturn Instrument Unit (IBM), and the S-IVB (Saturn third stage) Forward Skirt (McDonnell Douglas).

At Wyle, the short stack was tested for its stamina under worst flight conditions—*Max Q Alpha* (that point in launch when the vehicle is subjected to the worst possible combination of static and dynamic loads), and *End of Boost* (that point in launch when the vehicle sees maximum acceleration and highest aerodynamic heating from air friction).

Although the program was initially estimated to take from ten to 14 months to complete, Wyle was contracted to finish testing in 20 weeks. Under further pressure from NASA and its contractors, the company accelerated the program and completed it in only 16 weeks. The result: the structural integrity of the short stack was confirmed and NASA was able to stay on its flight schedule.

As in most success stories, more than one "hero" is involved. But a major reason for Wyle's success can be discovered if you look at its project management system, and at the tools and techniques that it uses to implement this approach to managing large, complex, and critical programs.

You've
 never seen
 a dry reed
 relay
 like this
 new one
 from P&B

JDT Series Dry Reed Relay

An entirely new magnetic structure makes possible an exceptionally low seated height of only 0.275 inch for high density board packaging. Circuit boards employing JDT relays may be spaced on 0.5 inch centers.

This design minimizes magnetic flux dispersion, resulting in a very efficient magnetic circuit. This decreases coil power requirements and often permits direct operation of JDT relays in low-power semiconductor logic circuits. An interfacing amplifier may be eliminated in many applications.

Terminals are similar to those on IC packages, permitting spot testing on either side of a circuit board. The dual in-line terminals on 0.1 inch centers simplify circuit board design. The reed switches are rated at 10 watts maximum resistive (50V or 0.5A DC maximum) switching.

A solid state time delay circuit may be incorporated in this small package. Or a Darlington amplifier can be included to compensate for low current applications. However, the number of available poles for switching is reduced by the addition of either of these circuits.

The JDT is completely encapsulated in epoxy, giving protection against environmental contamination. The Series is presently available in many combinations of Forms of A, B and C.

Get full information today by calling your local P&B representative or call direct to Potter & Brumfield Division of American Machine & Foundry Company, Princeton, Indiana. 812-385-5251.

SPECIFICATIONS

Power:

JDT 4000 Series: 310mw nominal

JDT 8000 Series: 600mw nominal

Operate Time:

4 milliseconds maximum @ nominal voltage
 @ 25°C, including bounce

Temperature Range:

-50° to +85°C

Expected Life:

Approximately 20 million operations (resistive)

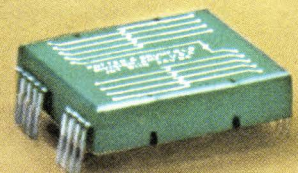
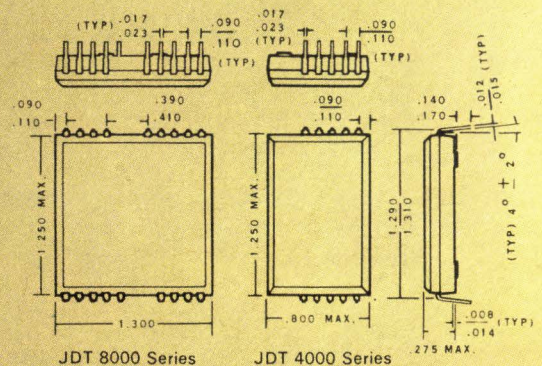

Introducing Potter & Brumfield's unique

dual thin-line dry reed relays

mounted height is only 0.275"
power requirements: only 75mw per pole
combinations of Forms A, B and C are available

Single lot prices are as low as \$7.65
for 4-pole version (JDT 4000 Series)
with 6 or 12-volt coils.
The 8-pole relays (JDT 8000 Series)
start at \$12.95. Quantity discounts
apply. Order sample quantities
today for evaluation in
your most sophisticated design.

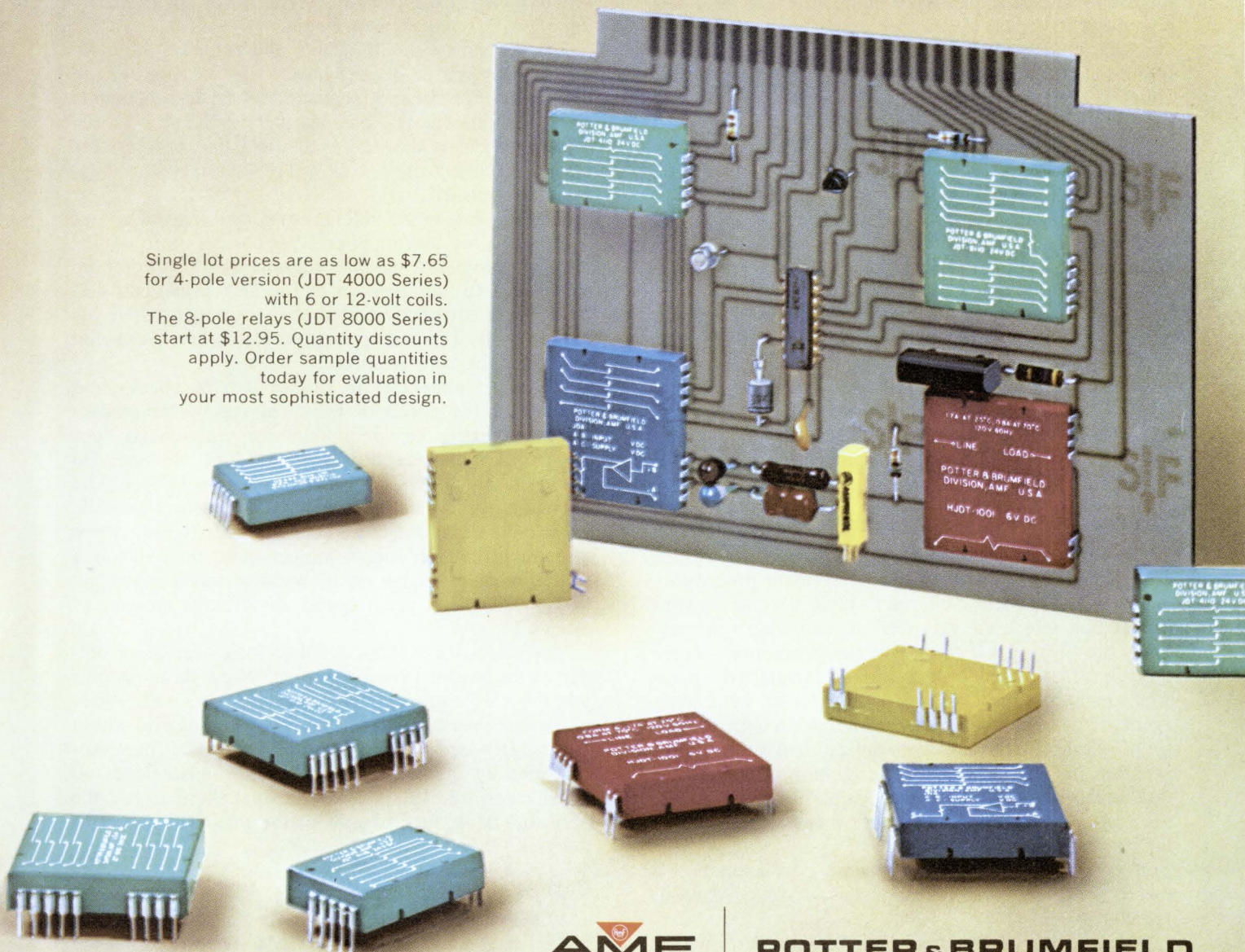

AMF

POTTER & BRUMFIELD

Circle 21 on Inquiry Card

ship with Wyle (North American was the sole customer).

From the very beginning, the program went on a 24-hour, seven-day-week schedule. And when testing finally began, the schedule was extremely rugged. There were many times when the team was continuously testing for periods exceeding 24 hours.

"The very critical thing was the complete cooperation of all the people involved in the testing effort," comments the program manager. "They, of course, had the motivation to get the job done, and to get it done properly, but sometimes we asked for cooperation beyond the call of duty . . . when you phoned everybody up at one or two in the morning and said, 'We're going to test in an hour . . .' It was a function to some extent of program management and planning and trying to make life easier every way we could, and having good meetings where everybody was fully informed."

Reese established a complete open-door communications policy, as well as very rigorous criteria for briefings. Originally, he had one of his assistants conduct weekly briefings; but then as all the hardware started to come in, daily briefings were held at 8:00 a.m. Everybody was invited and the "book was opened," so that everyone involved knew exactly what had happened in the past 24 hours. If there were any communications problems, personnel conflicts, or bottlenecks, these were solved right then. No problem was permitted to drift over into the next day. If something could not get resolved, Reese himself was called into the meeting to make the decision.

This "open-door" communications policy instilled in all the participants that sense of complete involvement. Moreover, it served to continually reinforce morale and helped keep everyone on schedule.

Indeed, Reese feels that as a program manager his main job is communication (see **The Electronic Engineer**, May 1968, page 24). "Ten years ago," he comments, "I used to get my hands dirty. Five years ago I used to at least draw something. But in the last two or three years, I cannot think of one thing I've done which has resulted in anything other than communication. . . . It came as a shock to me because, if you're in instrumentation or electronics as I started out, you like to be able to turn a knob and see something happening."

The check-and-balance organization

One reason Wyle was able to short-cycle the testing program is that it has built-in management procedures. When it is awarded a contract, Wyle uses its existing procedures, which are very flexible, and adapts the program the best way it can to fit the procedures. These procedures, outlined in a series of formalized operational memorandums, describe how you set up a management program. The memorandums define the responsibilities of three key organizational groups—the program manager, the contracts administrator, and the task supervisors (who are responsible for the performance of a specific increment of work)—and outlines the interfaces among them.

According to these memorandums, once a contract is received the responsibilities of the program manager are fourfold:

- to prepare a Program Plan for the performance

of work

- to issue work orders in accordance with the Program Plan
- to monitor the performance of all work including the technical approach, results, expenditures, and schedules
- to review and transmit all documentation, including progress, financial, and test reports, to the Contracts Administrator

In short, he is in charge of every aspect of the program.

In setting up his organization, the program manager follows a stylized procedure. He generally assigns three key people to work with him, the first being a **project engineer**. This man knows the technical aspects of the job. He is a good organizer. He is able to take all the engineering tasks and make sure that the right people are assigned to each task, that they interface properly, and that they know the objectives. The important thing is that the project engineer himself have both technical capabilities and capabilities for leading engineers.

On the other hand, he does *not* have to be a recognized technical expert in one specific line, and he does not have to be a genius at accounting. "We see him as a very straightforward organizer of our engineering effort," comments Mr. Reese.

The second key individual is the **program administrator**. Although he doesn't have to be an engineer, he has to talk engineering language and he has to understand the fundamental engineering problems. It is his job to make sure that the accounting and progress reports are accomplished, and that the contractual obligations are satisfied.

He also has to be able to spot problems. For example, let's say task number 22 is costing more money than was projected. It's the program administrator's job to call this to the attention of the task supervisor and the project engineer, so that they can focus their attention on it. The earlier such problems are discovered the easier they are to solve.

The third individual in this system of checks and balances is the purest of technical types—the **perfectionist engineer**. This individual (or individuals) does not care whether the program gets done on time. He does not care whether it gets done within budget. The only thing he is interested in is that the best possible job is done technically. "Of course," adds Reese, "there is nothing that can ruin a project more than to put a perfectionist in charge of it, because you'll never get the job done and you'll spend an ultimate amount of money."

The perfectionist is expected to look over the shoulder of the working level engineer. When he is given a job, this working level engineer is also made very aware of the fact that it has to be done on schedule and within the budget—and thus he sometimes is forced into compromises. In the event that his compromises lean too heavily towards schedule or budget limitations, the perfectionist is there to uphold the technical aspect of the task.

Conflict or balance?

With the three assigned individuals—project engineer, program administrator, and perfectionist—you

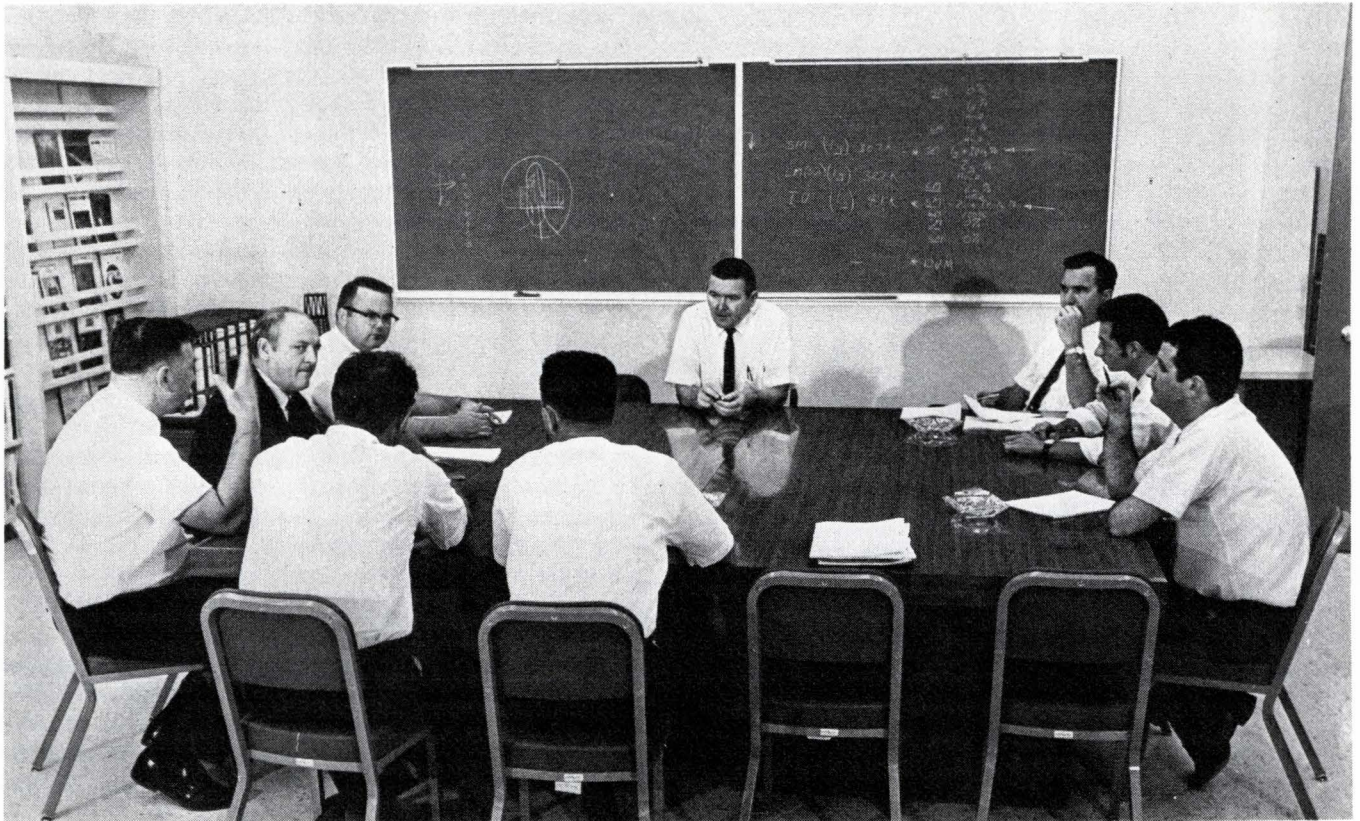

"Ten years ago I used to get my hands dirty. . . . But in the last two or three years, I can't think of a thing I've done which has resulted in anything other than communication."

get a balance between schedule, budget limitations, and technical competence. But inevitably a conflict will result. When it does, the program manager takes charge and makes sure that a decision is made. But the important thing is that if these individuals are competent, the conflict comes up early enough so that you can satisfy the technical requirements and still get the budget and schedule control that you need.

Planning and operating procedures

As stated previously, Wyle has its program procedures mapped out in what it calls "Operational Memorandums," and simply adapts the individual programs to fit the procedures. One of the program manager's first tasks is to develop a **Program Plan**, which divides the total program into a series of logical, identifiable tasks, and assigns budgets, schedules, and controls on the performance of the tasks. This includes determining the equipment, facility, and manpower requirements as well as establishing the requirements for technical, financial and progress reports.

For operating the program there is a system of time cards and charge numbers. These charge numbers are assigned to correspond with a logical breakdown of project tasks, or work breakdowns, which is part of the initial planning. Each person that works on the program uses the proper task number for the job he's working on, and the information is stuffed into the accounting system. The program manager can then get computer dumps daily or weekly—in almost any format he desires.

The computer (the CDC3300) is also "trained" to take this information and give x/y plots, which show projected expenditures versus actual. "In many cases," says Dave Reese, "the raw accounting numbers leave much to be desired, because most engineers are more apt to see a problem if the data is in the form of a plot."

Reports and more reports

Several other types of reports are required. PERT charts, however, are not one of them, although Wyle can handle PERT if the customer requests it. As Reese points out, "PERT is useful to a large company that is dealing with a program that has tremendously variable elements. If you're working with 20 different subcontractors, guidance equipment, ground support equipment, and so forth, PERT makes sense. But in most test programs it's not necessary."

For organizing and running the short stack program, Reese used *Milestone Charts*, an elaborate system of bars and symbols, arranged to give him total program visibility. These Milestone Charts have two main functions:

- to chronologically identify the tasks to be performed and emphasize critical events which may constrain completion of the program or another event
- to provide a means for clearly identifying work progress during the period of performance and to identify problem areas which may need special attention

INTRODUCING

THE DIP REED RELAY

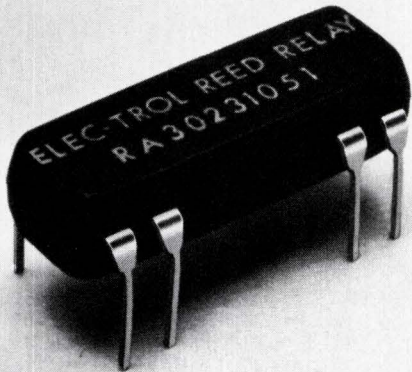

AN IC COMPATIBLE REED RELAY IN A DUAL INLINE PACKAGE

The DIP RELAY can be driven directly from your IC.

- draws 10 milliamps from 5 volt logic
- switches up to 10 watts, .5 amp. max., 100 VDC max.
- fits directly into a standard 14 pin DIP receptacle
- switches in less than 500 μ seconds
- tested to 500 million operations
- available with 1 form A contact and 5, 6, 12 and 24 VDC coils

This totally encapsulated relay meets military environmental specifications with a temperature range from -55°C to $+85^{\circ}\text{C}$.

Automated testing and production with 100% inspection from the individual contacts through the completed relay assures quality performance at low cost.

ELEC-TROL FILLS THE GAP...

Elec-Trol's Product Line is made up of 96 standard catalog Reed Relays as well as 3000 custom designs.

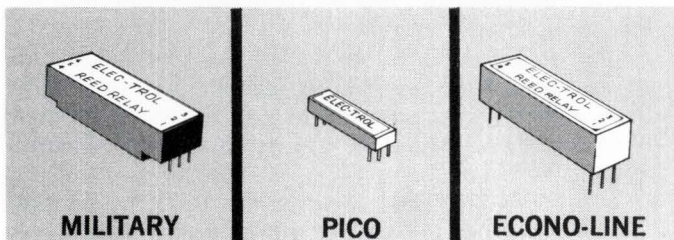

Phone, wire or write.

ELEC-TROL, INC.

21018 SOLEDAD CANYON ROAD/SAUGUS, CALIFORNIA 91350

PHONE: (805) 252-8330

eem File System Sec. 4500
electronic engineers master

Reshaping concepts in electronic components and systems!

The chronological events selected for display parallel the tasks identified in the Program Plan.

To control the finances, the Wyle program manager used what is called an *Expenditure Status and Forecast Report*, which is an elaborate method for projecting your expenses and then tracking them. Properly prepared and used, this report gives management financial visibility on complex programs.

As do most other projects, the short stack testing program also involved a progress report, which was published every two weeks. It essentially documented what had been performed; what, if any, bottlenecks had been uncovered; what was projected for the next two-week period; and where the project stood financially and against the previous schedules.

Another report was the "panic report"—any time Reese ran into something he felt was a tremendous constraint on the program, he was obligated to send a wire to the key people involved with the project and notify them of this.

Getting along with the functional organization

One of the main problems with program management is that a conflict often is created between the program and functional organizations. When a program is set up, you usually end up taking people from the functional organization to work on the new project, creating a burden on the functional group.

How do you keep peace in the family, then? Dave Reese gives the prescription: "When you undertake a program, and I can't really overemphasize it, you've got to have an agreement with corporate management that you are committing your resources. You get together with top management and say, 'This represents a tremendous undertaking. Are we willing to commit our total resources to this? What are the potential problems? What is the potential impact on other jobs, other contracts, other facilities?' You then can undertake the job or not undertake it. But once the company has agreed to proceed with a project, you've established the policy."

Who becomes the program manager?

Wyle has a firm procedure it follows when it comes to picking the program manager. In most cases the fellow who handles the proposal effort becomes the manager if a contract is awarded, since, as Reese points out, "it takes almost the same kind of engineering knowhow and management effort to write a proposal as it does to do the job."

But it goes further than that. The various groups expected to perform the engineering tasks in the event of a contract are the ones that write the sections of the proposal that involve them. They provide the budgetary cost estimates and establish the schedules—and when the job comes in they are forced to live up to these plans. "Of course," says Reese, "there is a lot of management review and a lot of changes. Obviously, if you know your people, there are certain engineers who always underestimate a task, and there are others that go the other way. It's part of your job as a project manager to know what these characteristics are."

INFORMATION RETRIEVAL
Careers, Project management

From Dale—the pots you don't ship back...

<1% customer rejection rate!

Less than 1% customer rejection for *all* causes. That's the record established by Dale T-Pots. Consider the savings this can bring you in time, paper work. Then consider the added efficiency of consolidating more of your buys at this versatile source. Almost 50% more models added in two years. Military (RT-10, 11, 12, 22, 24), Industrial, Commercial ... wirewound and film elements. All are very competitively priced. Check today and find out. We can deliver them quickly—and you won't have to send them back.

MILITARY GRADE T-POTS

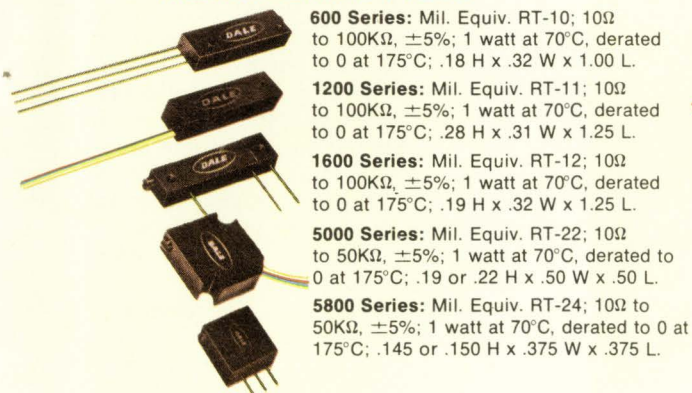

600 Series: Mil. Equiv. RT-10; 10Ω to 100KΩ, ±5%; 1 watt at 70°C, derated to 0 at 175°C; .18 H x .32 W x 1.00 L.

1200 Series: Mil. Equiv. RT-11; 10Ω to 100KΩ, ±5%; 1 watt at 70°C, derated to 0 at 175°C; .28 H x .31 W x 1.25 L.

1600 Series: Mil. Equiv. RT-12; 10Ω to 100KΩ, ±5%; 1 watt at 70°C, derated to 0 at 175°C; .19 H x .32 W x 1.25 L.

5000 Series: Mil. Equiv. RT-22; 10Ω to 50KΩ, ±5%; 1 watt at 70°C, derated to 0 at 175°C; .19 or .22 H x .50 W x .50 L.

5800 Series: Mil. Equiv. RT-24; 10Ω to 50KΩ, ±5%; 1 watt at 70°C, derated to 0 at 175°C; .145 or .150 H x .375 W x .375 L.

COMMERCIAL GRADE ECONO-TRIM T-POTS

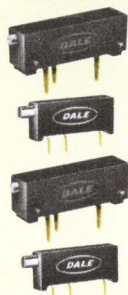

WIREWOUND ELEMENT

2300 Series: Sealed/Unsealed; 10Ω to 50KΩ, ±10%; 0.5 watt at 25°C, derated to 0 at 105°C; .36 H x .28 W x 1.00 L.

2400 Series: Sealed/Unsealed; 10Ω to 50KΩ, ±10%; 1 watt at 40°C, derated to 0 at 125°C; .31 H x .16 W x .75 L.

FILM ELEMENT

8300 Series: Sealed/Unsealed; 10Ω to 2 Meg., ±10% 100Ω thru 500K, ±20% all other values; .75 watt at 25°C, derated to 0 at 105°C; .36 H x .28 W x 1.00 L.

8400 Series: Sealed/Unsealed; 10Ω to 2 Meg., ±10% 100Ω thru 500K, ±20% all other values; .75 watt at 25°C, derated to 0 at 125°C; .31 H x .16 W x .75 L.

INDUSTRIAL GRADE T-POTS

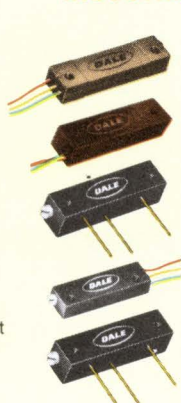

WIREWOUND ELEMENT

100, 200, 300 Series: 10Ω to 100KΩ.

100 Series: ±5%; 0.8 watt at 70°C, derated to 0 at 135°C.

200 Series: ±10%; 0.5 watt at 70°C, derated to 0 at 105°C.

300 Series: ±15%; .25 watt at 70°C, derated to 0 at 85°C.

Dimensions: .22 H x .31 W x 1.25 L (also 1.32 L for 100, 200).

1100 Series: 10Ω to 100KΩ, ±10%; 1 watt at 70°C, derated to 0 at 175°C; .28 H x .31 W x 1.25 L.

2100 Series: Industrial counterpart RT-11; 10Ω to 100KΩ, ±10%; 1 watt at 70°C, derated to 0 at 125°C; .28 H x .31 W x 1.25 L.

2200 Series: Industrial counterpart RT-10; 10Ω to 100KΩ, ±10%; 1 watt at 70°C, derated to 0 at 125°C; .18 H x .32 W x 1.00 L.

FILM ELEMENT

8100 Series: Industrial counterpart RJ-11; 10Ω to 2 Meg., ±10% 100Ω to 500K, ±20% other values; .75 watt at 70°C, derated to 0 at 125°C; .28 H x .31 W x 1.25 L.

Call 402-564-3131 for complete information or write for Catalog B



DALE ELECTRONICS, INC., 1304 28th Ave., Columbus, Nebraska 68601
In Canada, Dale Electronics Canada, Ltd. • A subsidiary of The Lionel Corporation



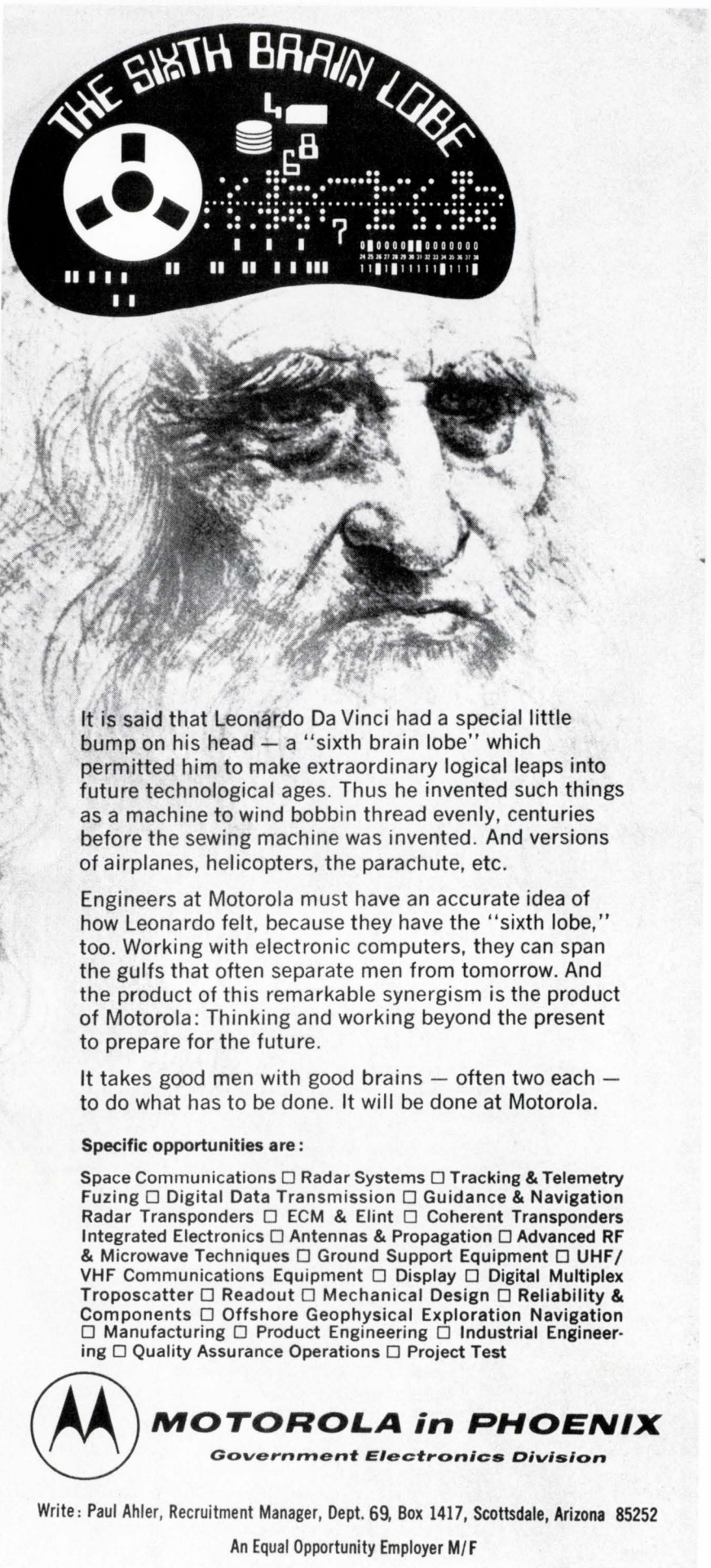

It is said that Leonardo Da Vinci had a special little bump on his head — a “sixth brain lobe” which permitted him to make extraordinary logical leaps into future technological ages. Thus he invented such things as a machine to wind bobbin thread evenly, centuries before the sewing machine was invented. And versions of airplanes, helicopters, the parachute, etc.

Engineers at Motorola must have an accurate idea of how Leonardo felt, because they have the “sixth lobe,” too. Working with electronic computers, they can span the gulfs that often separate men from tomorrow. And the product of this remarkable synergism is the product of Motorola: Thinking and working beyond the present to prepare for the future.

It takes good men with good brains — often two each — to do what has to be done. It will be done at Motorola.

Specific opportunities are:

- Space Communications Radar Systems Tracking & Telemetry Fuzing Digital Data Transmission Guidance & Navigation Radar Transponders ECM & Elint Coherent Transponders Integrated Electronics Antennas & Propagation Advanced RF & Microwave Techniques Ground Support Equipment UHF/VHF Communications Equipment Display Digital Multiplex Troposcatter Readout Mechanical Design Reliability & Components Offshore Geophysical Exploration Navigation Manufacturing Product Engineering Industrial Engineering Quality Assurance Operations Project Test



MOTOROLA in PHOENIX
Government Electronics Division

Write: Paul Ahler, Recruitment Manager, Dept. 69, Box 1417, Scottsdale, Arizona 85252

An Equal Opportunity Employer M/F

EES GET AHEAD

Brings digital inputs to process control



Nico H. Roos
Chief application engineer

Motorola Instrumentation and Control, known in the industry as an applications-conscious firm, has appointed Nico H. Roos as a chief application engineer for process systems.

In his new post, Roos will concentrate on applications research for the newly-developed Veritrak® performance optimizing controller, a device that contains many of the capabilities of a computer control system. He will also be involved with the entire line of Veritrak process control instrumentation.

Prior to this responsibility, Mr. Roos was a senior systems engineer in digital computer products at the Foxboro Co., where he worked on control systems. At Motorola he will put increased emphasis on digital methods for process control instruments.

His background—a mix of process control, analytical concepts, solid-state equipment, and logic systems—should enable him to accelerate application projects where the performance optimizing controller and Motorola's new MDP-1000 data processor will be major elements.

Nico Roos feels that a prime function of any applications engineer is trying to determine what the customer really needs, as opposed to what he says he needs. “My background in science and math has helped me tremendously in being able to solve this dilemma,” he says. “It's necessary to read between the lines, solve the problem, and communicate the solution to the user. There are pitfalls,” he adds. “But with the proper approach, communication with the customer does not become insurmountable.”

Mr. Roos holds an honors degree in physics from Michigan State and has done graduate work in physics and math at Massachusetts Institute of Technology.

Here we welcome new companies or divisions in the electronics industry. For more details, circle the appropriate numbers on the reader service card.

Communications: From black box to systems. Nardcom Corp., a new subsidiary of Narda Microwave Corp., is entering the microwave communications subsystems and satellite ground station field, and will be introducing three products this year.

The first is a unique up and down frequency conversion system whose special feature is its dual-conversion design. The up converter (Model UC-5000) can be used to convert any message or video carrier at the 70-MHz intermediate frequency to an rf carrier in the 5925- to 6425-MHz range. The down converter (Model DC-5000) can convert any rf message or video carrier in the 3700- to 4200-MHz range to an intermediate frequency of 70 MHz without signal returning. Both converters are now available.

The firm's second product, to be available around September, is a threshold extension demodulator for use in communications systems where a very sensitive receiver is needed. The third product line—high-power amplifiers (3-kW output klystron amplifiers)—will be introduced by year's end.

Although Nardcom is now only building the boxes, it eventually plans to integrate them into one system. And "on a long term basis," says Fred Kornberg, the vice-president and general manager, "we are interested in producing microwave data transmission terminals." Located in Plainview, N. Y., Nardcom is not an internal Narda development, but rather was formed separately and staffed by outside engineers.

Circle 399 on Inquiry Card

A partner for Sprague. Pirgo Electronics, Inc., located in Farmingdale, N.Y., is a corporation in its own right and a partner of Sprague as well. When Sprague consulted with New Business Resources, a company formed last year by Richard Hanschen and Dr. Richard Petritz (formerly of Texas Instruments), the result was the union of the two firms to form Pirgo.

As a manufacturer of power semiconductors, including transistors and thyristors, Pirgo hopes to attract computer, power supply, and industrial control houses, as well as the military.

Circle 400 on Inquiry Card

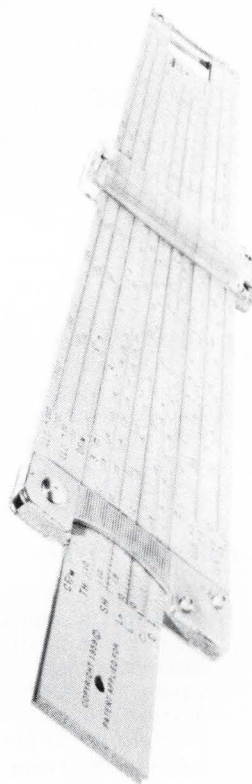

Do you measure up?

If you are an **Electronic** and/or **Simulation Specialist**, you're invited to "measure" your talents against our needs...

**Aerodynamics • Circuit design
Reliability engineering • Components
engineering • Systems engineering
Scientific Programming
Manufacturing engineering
Contract administration
Math modeling**

Send us your resume today.
Write Mr. L. Schneider, Professional
Employment, Condustron Corporation,
P.O. Box 426, St. Charles (near
St. Louis), Mo. 63301.

**CONDUCTRON
CORPORATION**



An equal opportunity
employer

san fernando
electric manufacturing company

Electronic components
of proven reliability

**Aluminum Electrolytic
Capacitors**

The rugged CAPACITORS by West-Cap that have built-in reliability and durability. Because of their all-welded construction they will withstand more vibration and shock. The elements are made from 99.99% pure etched aluminum foil sealed in high grade aluminum cases.

SERIES WHC Computer Grade Electrolytic.

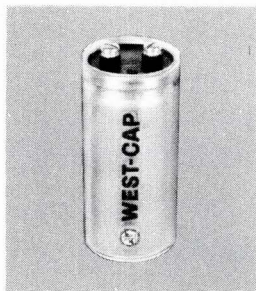

A superior line of energy storage and filter electrolytics which meet all the specifications set by MIL-C-62. In addition, this series will meet all the standard telephone quality standards set by the telephone industry. This electrolytic will meet the most exacting ripple standards.

**Ratings: 200 mfd to 100,000 mfd
from 5 VDC to 150 VDC
Voltages in excess of 150 VDC
to 500 VDC on special order**

SERIES MAC Axial Lead Electrolytic.

They are available in miniature size with 1/4" x 5/8" case and larger.

**Ratings: 2 mfd to 70,000 mfd
from 3 VDC to 150 VDC**

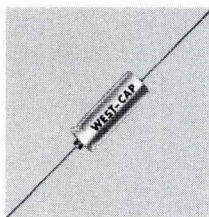

The manufacturing process is completely quality-controlled in West-Cap's modern new facility in the Tucson International Airport Industrial Park. This facility was designed and equipped primarily for the manufacture of high quality electrolytic capacitors at competitive prices.

Call your representative of West-Cap high reliability components, or contact West-Cap Arizona, where service and quality count.

WEST-CAP ARIZONA

SUBSIDIARY OF SAN FERNANDO ELECTRIC MANUFACTURING CO.
2201 EAST ELVIRA ROAD, TUCSON, ARIZONA 85706

This new column lists product seminars that electronic companies offer to users of their products. For more details, circle the appropriate reader service number on the inquiry card.

21-110 Mass Spectrometer: June 16-20, Monrovia, Calif., \$225. Intended for those responsible for operation and maintenance of a CEC Type 21-110B or 21-110C gas ion source mass spectrometer. Coordinator of Training and Technical Publications, Bell & Howell, 1500 S. Shamrock Ave., Monrovia, Calif. 91106.

Circle 401 on Inquiry Card

Resistance Welding and Reflow Soldering: Aug. 5, Monrovia, Calif., \$5. AC and dc resistance welding fundamentals, metallurgical considerations, welding techniques, weld schedule development, soldering, packaging techniques. E. F. Koshinz, Unitek/Weldmatic Div., 1820 S. Myrtle Ave., Monrovia, Calif. 91016.

Circle 402 on Inquiry Card

Hybrid Microelectronic Bonding & Packaging: Aug. 12, Monrovia, Calif., \$5. Bonding fundamentals, metallurgical considerations, theory and fabrication of the semiconductor chip, bonding techniques, hybrid packaging. E. F. Koshinz, Unitek/Weldmatic Div., 1820 S. Myrtle Ave., Monrovia, Calif. 91016.

Circle 403 on Inquiry Card

RGA Spectra Interpretation: Aug. 18-20, Monrovia, Calif., \$150. Emphasis is on the spectra of materials found in vacuum systems; for users of residual gas analyzers. Coordinator of Training and Technical Publications, Bell & Howell, 1500 S. Shamrock Ave., Monrovia, Calif. 91106.

Circle 404 on Inquiry Card

Operation & Maintenance 1912 Visicorder: Aug. 18-22, Denver, \$180. Fundamentals of oscillographic recording, operating procedures, circuit analysis, calibration, options to the 1912. C. F. Creswell, Training Center Services, Honeywell Inc., Test Instruments Div., 4800 E. Dry Creek Rd., Denver, Colo. 80217.

Circle 405 on Inquiry Card

Process Automation: Sept. 8-19, Phoenix, tuition-free. Theory, application, and operation of automated process control systems. Motorola Instrumentation and Control Inc., Box 5409, Phoenix, Ariz. 85010.

Circle 406 on Inquiry Card

Get sine, square and triangle functions—and positive and negative going pulses, positive and negative going ramps—in the new HP 3310A. And there's more! You'll have these seven functions over a decade of decades—0.0005 Hz to 5 MHz.

All this capability is packed into a package only 7¾" wide, 4½" high, 8" deep! With the 3310A Function Generator performing many of the functions of the pulse generator, ramp

generator, bias box and amplifier on your bench—think about the clutter you eliminate...the instant access you'll have to all these signals.

With the dc offset capability of the 3310A, you can put any of the functions where you want them—easily and without biasing. And, with the choice of high or low level output, you can get clean low level signals without an external attenuator. You get a maximum of 15 V peak-to-peak into 50 Ω—and that's plenty of power to eliminate most needs for external amplification.

Add to this the external frequency control capability which allows you to sweep over a 50 to 1 range or tie the 3310A into a system—the price

of only \$575—solid-state reliability—and you know the HP 3310A is more than a function generator!

Order your HP 3310A today from your nearest HP Sales Office. For full specifications, write to Hewlett-Packard, Palo Alto, California 94304. Europe: 1217 Meyrin-Geneva, Switzerland.

HEWLETT *hp* PACKARD
S I G N A L S O U R C E S

099/9

This One Is More Than A Function Generator!



lev-er-wheel™

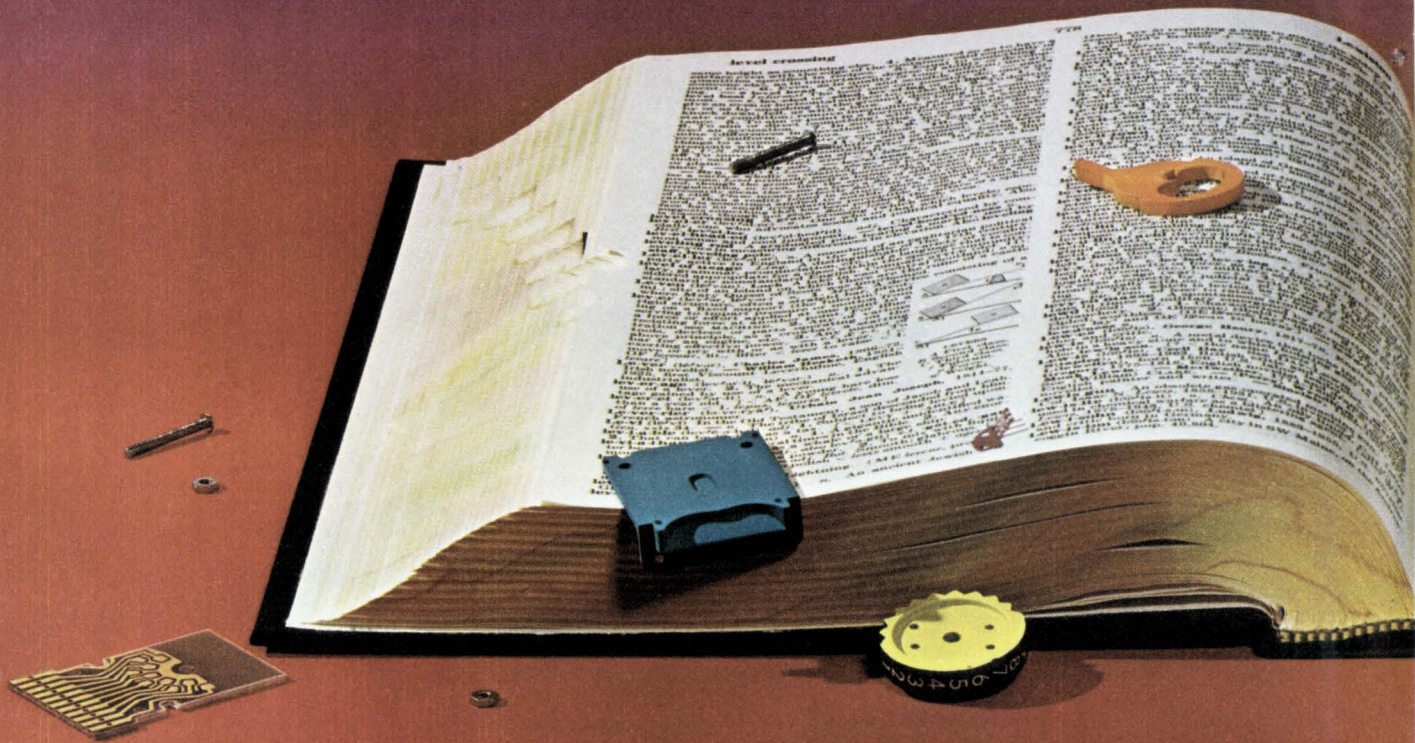

LEVERWHEEL SWITCH a brand new concept...

Since when does Cherry make rotary thumbwheel switches? Since we figured out how to make them *better*. Which is right now with the new Cherry "Leverwheel" Thumbwheel Lever-Action switches that set in half the time of conventional thumbwheels.

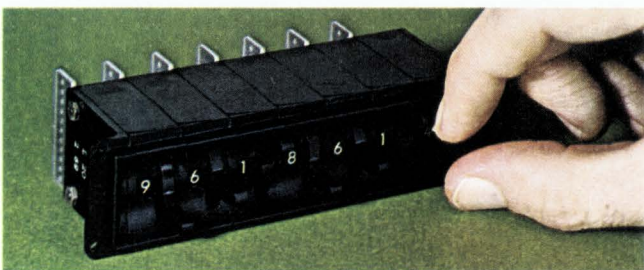

THE SLOW PLUNK VS. THE FAST SET

A single movement of the Leverwheel lever through its 60° arc is all that's necessary for a complete 10-position cycle. (Compare *that* to plunking through the 360° rotation on conventional thumbwheels!)



EVERYTHING'S COMING UP ZERO

There's instant reset at no extra cost. A simple sweep with the hand and all levers return to home position with every switch in the bank returned to "zero".

LEVERWHEEL
TM

From the makers of famous, dependable precision Snap-Action Switches...

CHERRY 

so new you can't look it up
in your Funk & Wagnalls

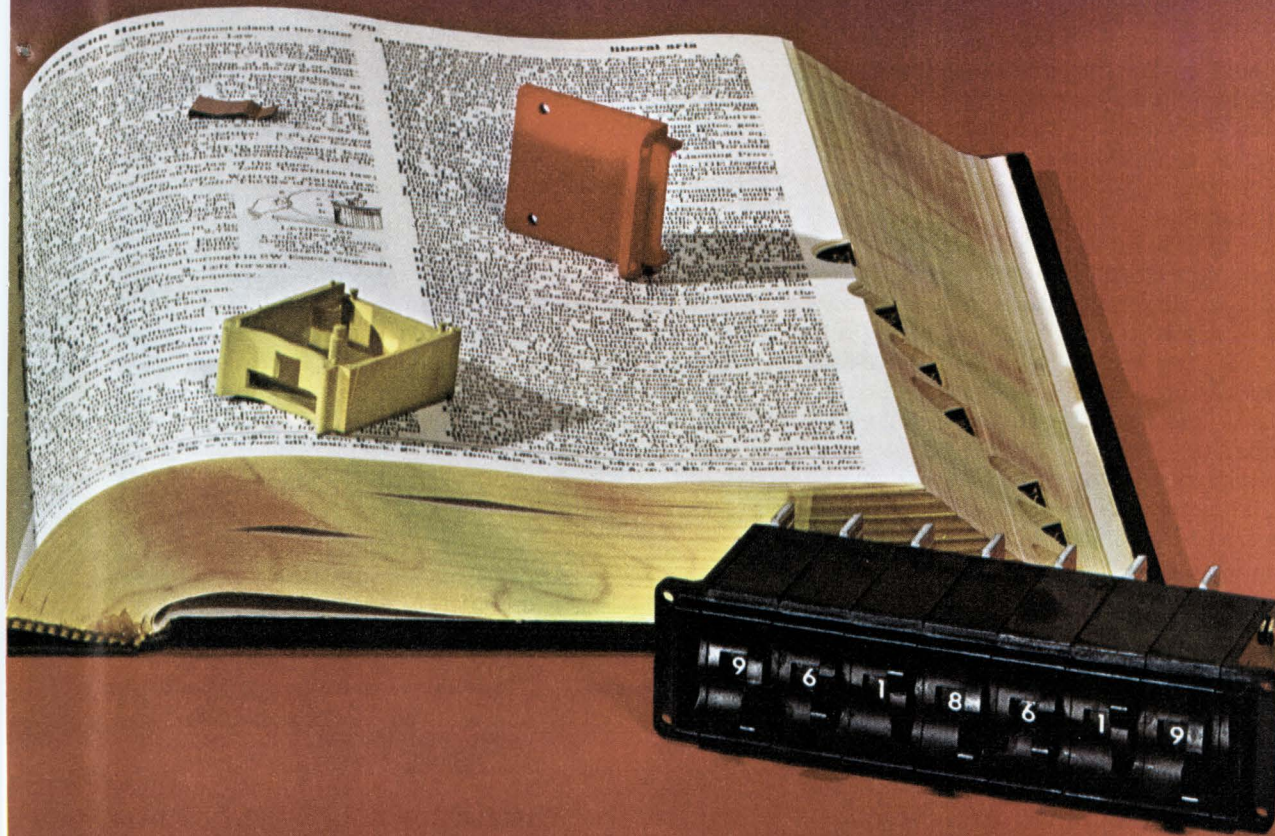

...Thumbwheel Lever-Action by CHERRY...

SEND TODAY for a free copy of the new eight-page brochure describing the complete line of Cherry Leverwheel and Thumbwheel Switches. For immediate action phone: 312|831-5024

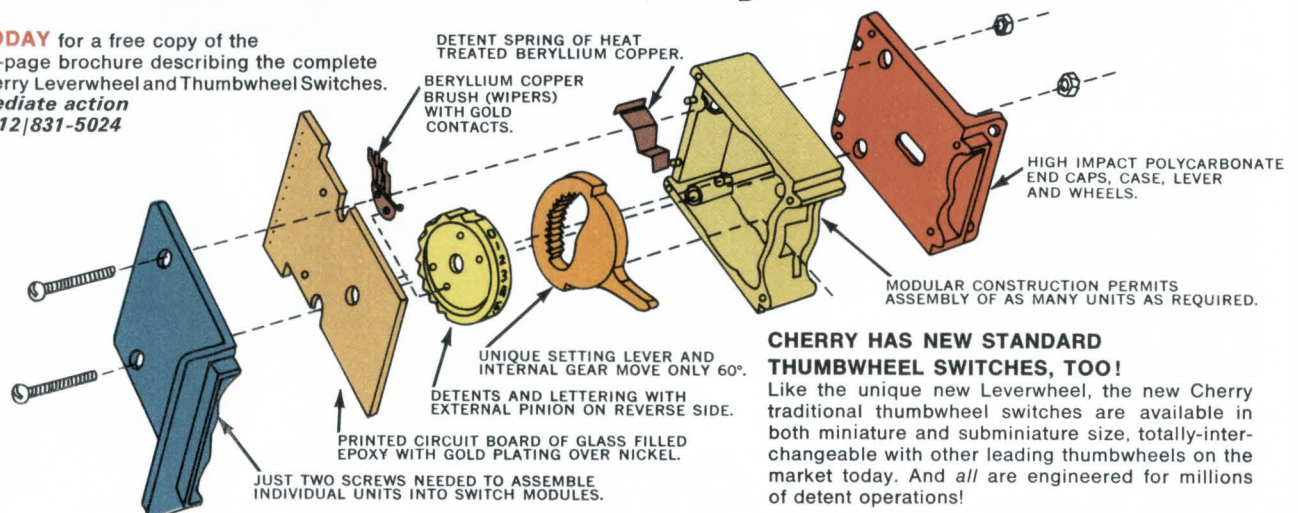

CHERRY ELECTRICAL PRODUCTS CORP. 1655 Old Deerfield Road, Highland Park, Illinois 60035

Circle 28 on Inquiry Card

Speed/power chart for digital ICs

This 1969 specifying chart compares digital ICs by their two most important parameters—propagation delay and power dissipation.

Compiled by the staff of **The Electronic Engineer**
The specifying chart on the facing page is a new edition of the speed/power chart that we have been publishing for the past two years. It allows you to make a ballpark selection of those digital integrated circuits that are best suited to your application.

The chart shows typical propagation delay in nano-seconds plotted against average power dissipation (usually for a 50% duty cycle) in milliwatts per gate. Over 100 catalogued commercial ICs are listed, including all generic forms as well as some specials. These circuits are all silicon monolithics—MOS and hybrid devices have been excluded—and represent about 70 different circuit configurations.

Each circuit configuration is indicated on the chart by a color dot. The larger dots indicate those popular circuits, made by several manufacturers, that have the same or nearly the same speed/power parameters.

If you compare the 1969 chart to that of 1968 or 1967, you can note some interesting changes in the

digital IC market. The DTL circuits, previously the most common type made, have lost their popularity rating to the faster TTL circuits. And while RTL has made no advances, ECL is definitely finding wider use. Of all circuit configurations shown, those made by most manufacturers are the TTL 54/74 variety (12 sources), and the DTL 930 (nine sources).

The following list represents the individual ICs shown on the chart. The number next to the manufacturer corresponds to the number of a circuit configuration shown on the chart. Also shown below is a list of circuit type names and their acronyms, including most of the better known types.

INFORMATION RETRIEVAL
Integrated circuits, Digital design, Charts and nomographs

For a copy of this article circle #419 on Inquiry Card.

DIGITAL LOGIC CHART

- | | | |
|---|---|--|
| <p>DTL</p> <ol style="list-style-type: none"> 1 Amperex FCJ 111, 201 2 Amperex FCJ 121, 131, 191, 211 3 Amperex FCJ 221 4 Amelco HN1L 300 5 Fairchild LPDTL 9040 6 Amperex FCJ 101 7 Amperex FCH 231 8 Radiation 930 hardened circuits 9 Amperex FCH 101, 121, 141, 151, 181, 201 10 Texas Instruments MOD-DTL 53 and 73 11 Amperex FCH 111, 131, 161, 171, 191, 211 12 Fairchild DTμL 930 13 Motorola MDTL MC930/830 14 Philco-Ford DTL-10-MHz PL9930 15 RCA CD2300 16 Raytheon 200 and 930 17 Siliconix S1830 and 930 18 Stewart-Warner SW930 19 Texas Instruments 15930, 15830 20 Raytheon 200 Series with collector resistors 21 Signetics SP600A 22 Hughes HSM 930J (typical) 23 Siliconix A01, A41 24 Radiation 200, 300, 500 <p>RTL</p> <ol style="list-style-type: none"> 1 Texas Instruments 17,900L and 17,800L 2 Fairchild LPRTμL 9910 3 Philco-Ford MWμL-8-MHz PL9908 4 Motorola mW MRTL MC908 5 Motorola mW MRTL MC808/708 6 Motorola mW MRTL MC800P/700P 7 Amelco 100 8 Philco-Ford μL-20-MHz PL9900 9 Fairchild RTμL 900, 9990 10 Motorola MRTL MC900/800 11 Motorola MRTL MC700, MC800P/700P 12 Philco-Ford MW111-15-MHz PL9975 13 Philco-Ford Super RTL-35-MHz PL9600 <p>TTL</p> <ol style="list-style-type: none"> 1 Amelco 500-509 2 Amelco 530-548 3 Amelco 510-513 4 Philco-Ford MEL-5-MHz PL9600 | <ol style="list-style-type: none"> 5 National 54L 6 Texas Instruments 54L/74L 7 Amperex FJH 231, 251 8 Amperex FJJ 111, 121, 191 9 Signetics NE/SE400J 10 Amelco 570-587 11 Signetics S/N 8400 12 Amperex FJJ 131 13 Amperex FJJ 101 14 Amperex FHJ 101A, 101B 15 Amperex FHJ 121A, 121B 16 Amperex FJH 151, 161, 171, 181, 221 17 Siemens 100 18 Amperex FJH 101, 111, 121, 131, 241 19 Hughes HSM5400 (typical) 20 ITT 5400/7400 21 Motorola MTL MC5400/7400 22 National DM7000 and 8000 (54/74) 23 Nucleonic Products 7400 24 Philco-Ford 7400 25 Raytheon Ray I 26 Signetics S/N 8800, S5400, N7400 27 Sprague 54/74 28 Texas Instruments SN-7400 and 54/74 29 Transistron 54/74 30 Amperex FJH 141 31 Amperex FJJ 181 32 Motorola MTL I MC500/400 33 Sylvania SUHL I 34 Transistron TTL Series I 35 Hughes HSG40 (typical) 36 Fairchild 9000 37 ITT 9000 38 RCA CD2400 39 Raytheon Ray II 40 Transistron TTL Series II 41 United Aircraft 200 42 Philco-Ford 9620 43 Amperex FHH 101A, 101, 121A, 121B, 141A, 141B, 161A, 161B, 181A, 181B 44 Motorola MTL II MC2100/2000; MTL III MC3000 45 Sprague 54H/74H 46 Sylvania SUHL II 47 Texas Instruments 54H/74H 48 Transistron 54H/74H 49 Fairchild 9300 (MSI 4-bit shift register) 50 Raytheon Ray III <p>ECL</p> <ol style="list-style-type: none"> 1 Motorola MECL MC300/350 2 Stewart-Warner SW300 and 350 Series ECL I 3 RCA CD2100 4 Motorola MECL II MC1200/1000 | <ol style="list-style-type: none"> 4 Stewart-Warner SW1000 and 1200 Series ECL II 5 RCA CD2150 6 Fairchild CML 1228, 1229, 1230, 1231 7 Texas Instruments 2500 8 Amperex FKH 111 9 Motorola MECL III MC1660 <p>SPECIAL</p> <ol style="list-style-type: none"> 1 Texas Instruments RCTL 51 and 51R (130 ns @ 3 V) 2 Motorola MHTL MC660 3 Signetics LU300K, SU300G/K 4 Signetics LU and SP300A 5 Fairchild CTL 9950 |
|---|---|--|

Types of Logic Circuits and Their Acronyms

- | |
|--|
| <p>CCSL Compatible Current-Sinking Logic</p> <p>CL Counting Logic</p> <p>CML Current-Mode Logic</p> <p>CTL Complimentary Transistor Logic</p> <p>DCTL Direct-Coupled Transistor Logic</p> <p>DTL Diode-Transistor Logic</p> <p>DTμL Diode-Transistor Micrologic</p> <p>ECCSL (EC²SL) Emitter-Coupled Current-Steered Logic</p> <p>ECL Emitter-Coupled Logic</p> <p>EECL (E²CL) Emitter Emitter-Coupled Logic</p> <p>HLTTL (HLT²L) High-Level Transistor-Transistor Logic</p> <p>HNIL High Noise Immunity Logic</p> <p>LPDTL Low-Power Diode-Transistor Logic</p> <p>LPDTμL Low-Power Diode-Transistor Micrologic</p> <p>LPRTL Low-Power Resistor-Transistor Logic</p> <p>LPRTμL Low-Power Resistor-Transistor Micrologic</p> <p>MCML Motorola Current Mode Logic</p> <p>MDTL Motorola Diode-Transistor Logic</p> <p>MECL Motorola Emitter-Coupled Logic</p> <p>MEL Micro Energy Logic</p> <p>MHTL Motorola High-Threshold Logic</p> <p>MRTL Motorola Resistor-Transistor Logic</p> <p>MTTL Motorola Transistor-Transistor Logic</p> <p>MVTL Motorola Variable-Threshold Logic</p> <p>mWμL Milliwatt Micrologic</p> <p>mWMRTL Milliwatt Motorola Resistor-Transistor Logic</p> <p>OMIC Optimized Microcircuits</p> <p>RCTL Resistor-Capacitor-Transistor Logic</p> <p>RTL Resistor-Transistor Logic</p> <p>RTμL Resistor-Transistor Micrologic</p> <p>SUHL Sylvania Universal High-Level Logic</p> <p>TTL (T²L) Transistor-Transistor Logic</p> <p>VHL Variable-Threshold Logic</p> <p>Utilogic Utility Logic (with features of DTL, RTL, TTL)</p> |
|--|

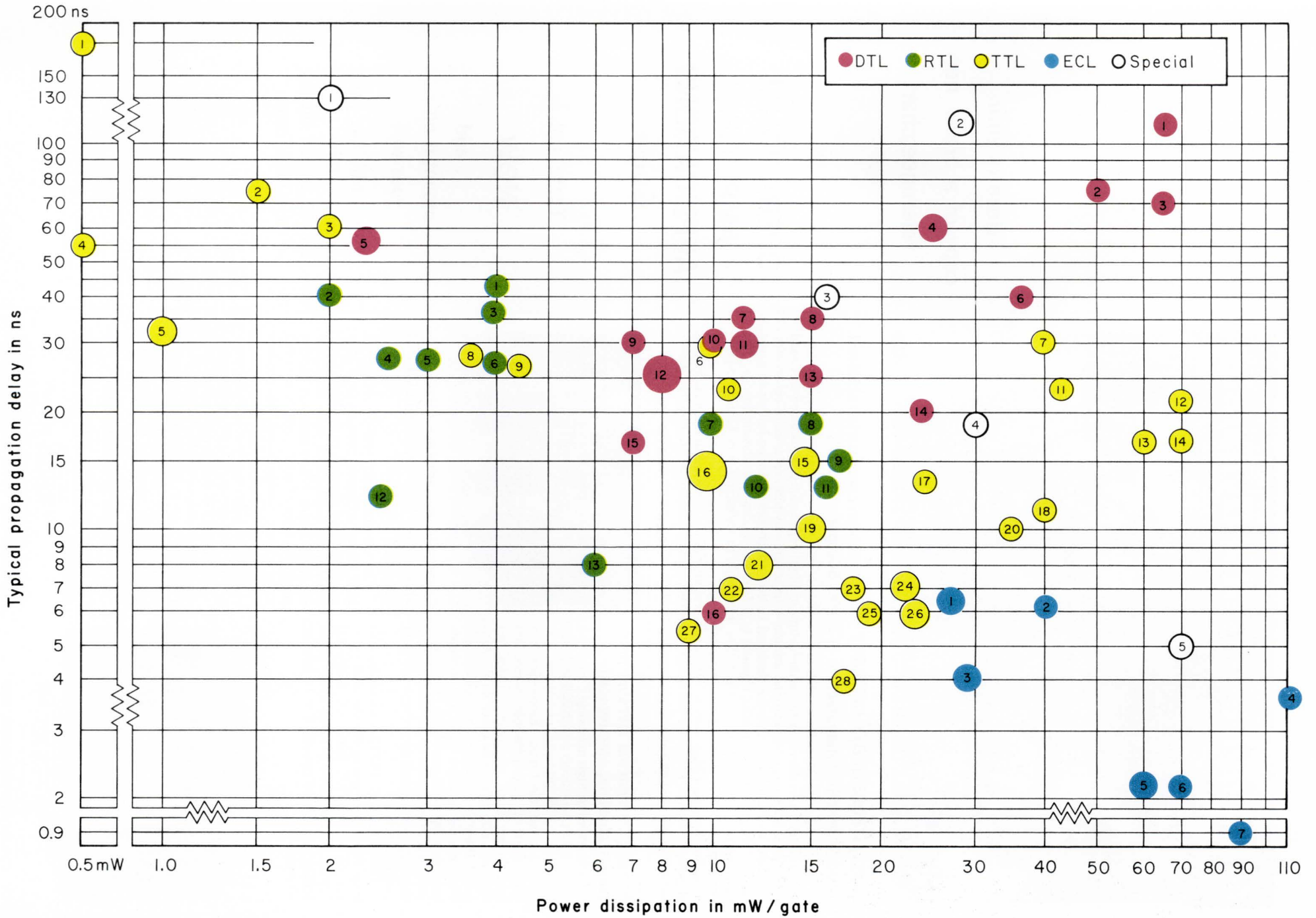

MB Environmental Dynamics

Analysis Instruments · Signal Conditioning · Electrohydraulics · Pressure Measurement · Vibration Systems

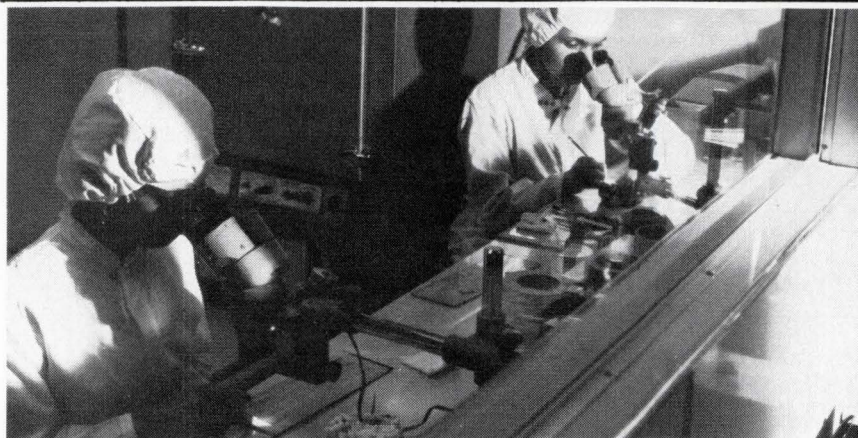

A view through the window of the "white room" where MB pressure cells are assembled.

Cost/Pressure/Accuracy Optimum combination achieved through precision manufacture in Series 500 pressure cells

Low cost Series 500 pressure cells are an outgrowth of many years of work in developing production facilities for the manufacture of highly specialized transducers intended for applications requiring extreme accuracy, or severe environments, as in cryogenics.

These 5-volt output cells were designed to take advantage of Alinco foil strain gages bonded directly to the sensing element in a four-active arm Wheatstone Bridge. The inherent ruggedness of the design makes it possible to withstand very high over-pressures—up to 400%—without mechanical damage.

Selling for under \$200, Series 500 transducers are finding wide use in dynamic testing of pressure valves, hydraulic test stands, pump controls, gas transmission monitoring and, in undersea technology, for depth measurement.

Reader Service No. 101

Series 500 systems measure pressure accurately, electronically

Incorporating high accuracy ($\pm 0.5\%$) Series 500 transducers and N928 or N929 indicators, MB pressure measuring systems are all electronic. Employing the bonded strain gage principle, Series 500 transducers have no moving parts, no linkages, no silicones or other fluids. As a result there is no wear, no maintenance. The systems measure static and dynamic pressures—without snubbers. They have proved ideal for pressure measurements in the laboratory as well as in OEM and field applications.

The N928 and N929 have built-in solid state transducer power supplies and operate on normal AC lines. An additional feature of the N929 is a high/low alarm setting which also permits it to be used as a controller.



Reader Service No. 103



Cryogenic transducers offer operable range to -452° , 30,000 PSI overload capability

The integral body and diaphragm of MB/Alinco cryogenic pressure cells offer an exceptional order of ruggedness. Combined with bonded foil strain gage construction, Series 172 transducers yield a combined error of only $\pm 0.35\%$ over full scale. Their compensated temperature range is -320°F to $+77^\circ\text{F}$ and can, for example, be fully immersed in liquid nitrogen or other extremely cold environments.

The Series 172 cells are offered in three reference pressures—PSIG, PSIA and PSIS. There are four standard models covering twenty different pressure ranges. Special models can be prepared to meet specific applications.

Reader Service No. 102

MB ELECTRONICS

A **textron** COMPANY

P.O. BOX 1825, NEW HAVEN, CONNECTICUT 06508
Tel. (203) 389-1511 Twx 710 465-3283 Telex 0963-437

Here is your
copy of a brand new
reference chart



OPERATIONAL AMPLIFIER APPLICATIONS Guide

Tear it out, 

NOW

... and
mount it on
your wall

If the chart has been removed, Circle Number 40 on the Inquiry Card for a copy.

EE READ THESE BOOKS

Analysis and Synthesis of Linear Active Networks

By S. K. Metra. Published 1969 by John Wiley & Sons, Inc., 605 Third Ave., New York, N. Y. 10016. Price \$15.95. 565 pages.

This book provides a comprehensive introduction to the important branch of network theory indicated by the title. It satisfies a twofold purpose: to provide a text for a first year graduate level course in active networks, and, to provide the practicing engineer with a reference book or a text for self instruction.

To fully appreciate this book, the reader should have a knowledge of complex variables and matrix algebra. As well, he should be familiar with passive one-port and two-port network analysis and synthesis.

To increase the usefulness of the book, extensive lists of references are supplied at the end of each chapter. Mathematical rigor has been kept to a minimum, while examples are given extensively. A complete set of problems augments the text, but unfortunately no solutions are included.

Control Engineering

By N. M. Morris. Published 1969 by McGraw-Hill Book Co., 330 West 42nd St., New York, N. Y. 10036. Price \$7.95. 194 pages.

Here is a book for both the practicing engineer or one who is new to the field of control systems. This volume is both practical and comprehensive, and includes the latest information on techniques used in day-to-day control systems installation.

Since this is not a mathematically sophisticated text, it is particularly suited for those who are primarily concerned with installation of equipment. Its academic level is equivalent to the final year of a technicians course. Basic material on feedback amplifier theory and closed-loop systems are presented, but the major emphasis is on modern applications and physical operation. Thermionic, gas-, and vapor-filled tubes and semiconductor devices are treated throughout.

Principles of Linear Circuits

By E. A. Faulkner. Published 1966 by Barnes & Noble, Inc., 105 Fifth Ave., New York, N. Y. 10003. Price \$4.50. 116 pages.

Analysis and Simulation of Multiport Systems

By Dean Karnopp and Ronald C. Rosenberg. Published 1968 by The MIT Press, 50 Ames St., Cambridge, Mass. 02142. Price \$10.00. 221 pages.

CATV System Engineering, Second Edition

By William A. Rheinfelder. Published 1967 by Tab Books, Blue Ridge Summit, Pa. 17214. Price \$12.95. 256 pages.

Theory and Design of Active RC Circuits

By L. P. Huelsman. Published 1968 by McGraw-Hill Book Co., 330 West 42nd St., New York, N. Y. 10036. Price \$14.50. 297 pages.

RCA Power Circuits Manual

Published 1969 by RCA Electronics Components, Harrison, N. J. 07029. Price \$2.00. 448 pages.

NEW IDEAS

FROM TITCHENER

No. 8 of a series

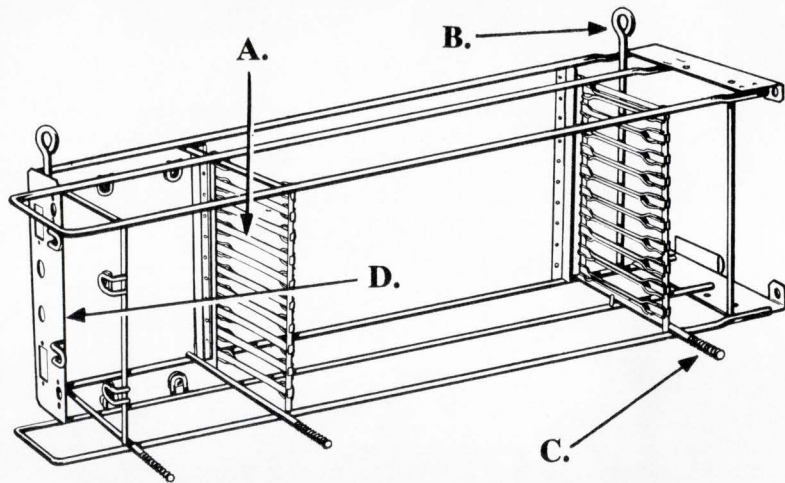

THESE DESIGN TIPS HELP KEEP COSTS DOWN WHEN YOU'RE DESIGNING CB RACKS AND CHASSIS.

A. This combination of guide wires and a flat spring holds circuit boards gently, yet firmly . . . grips from all directions — eliminating stress on connectors.

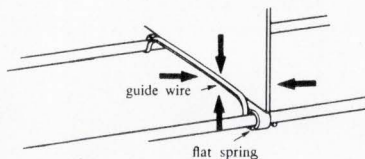

B. Simple eyes formed at wire ends provide inexpensive mounting holes. If fastener is too small for the smallest eye that can be turned in the wire itself, weld a washer to the eye.

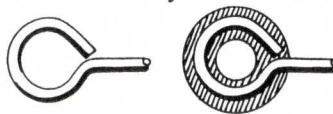

C. Rolled threads at the ends of chassis or CB racks act as mounting bolts. Use cut threads if necessary, though roll threading provides a stronger part at lower cost.

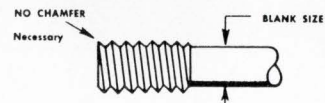

D. Inexpensive standard weldments — threaded nuts, threaded studs, washers and many other shapes can be welded to CB racks and chassis for mounting components in either fixed or adjustable configurations.

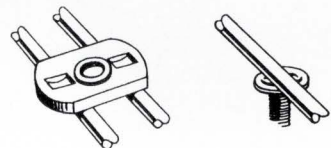

Want more helpful design tips? Send today for "How Titchener Wire Construction Improves Electronic Product Design."



E.H. TITCHENER
AND COMPANY
Working Wonders with Wire
2 Titchener Place, Binghamton, New York

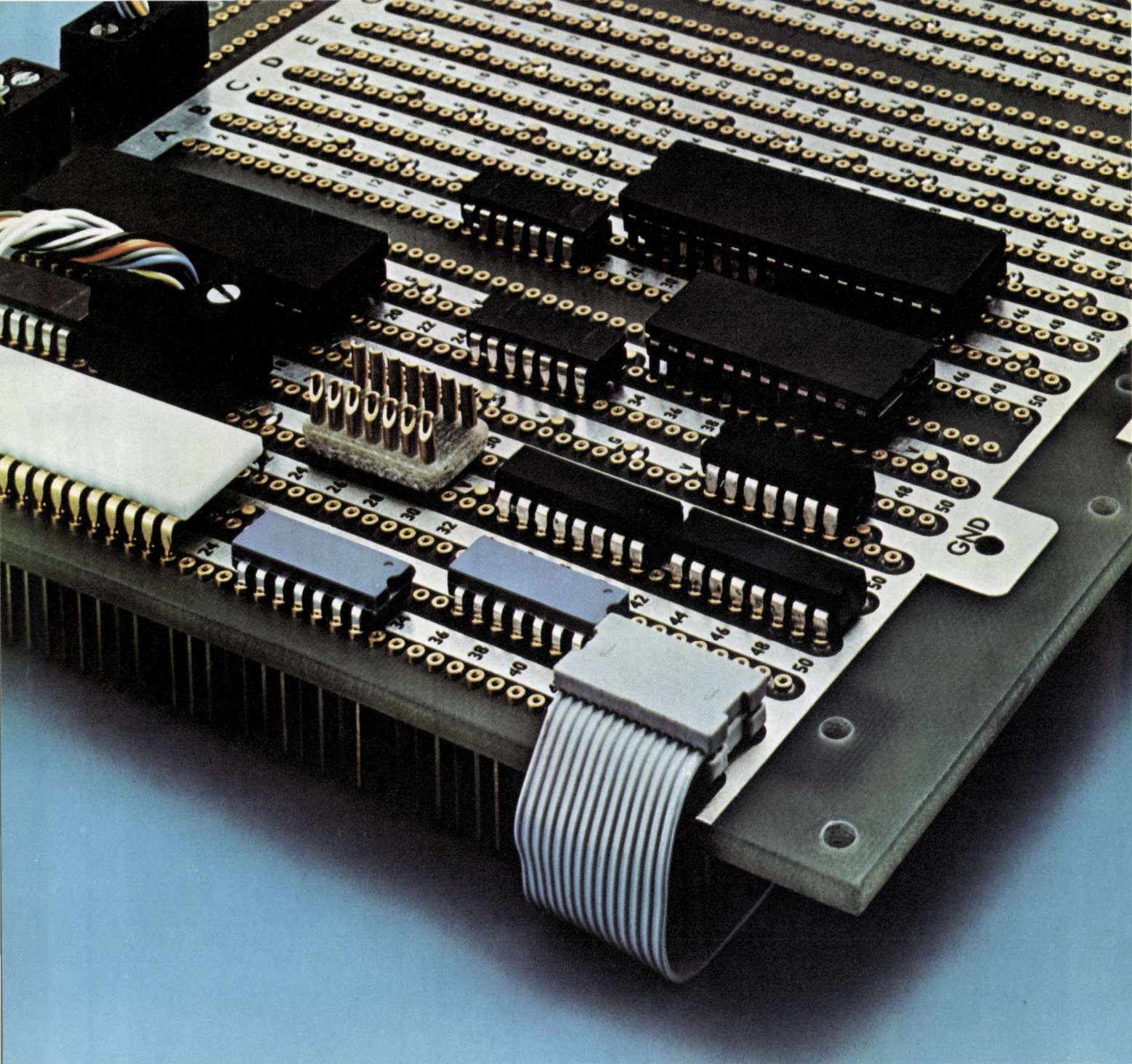

Plug in anything

Let Augat's new universal board provide complete flexibility in IC packaging and prototyping.

You can plug in any dual-in-line IC including popular 14, 16, 24 or 36 packages. The rows of contacts also accommodate our adaptor plugs for interposing discrete components and plugs for I-O connections and interfacing. Board also accepts Augat's new 14-pin, flat cable plug with unique patented design permitting fast assembly without stripping the wire. Plugs directly into IC socket pattern.

Universal board is available in modules of 9 rows with 50 contacts to a row up to 6 modules. Additional pins

tied in to power and ground planes are strategically located . . . easily accessible. No interference with IC patterns. Like all Augat panels, board is available automatically wrapped to your specifications.

Why be restricted in your packaging and prototyping? Let Augat open the door to greater flexibility.

Call us, (617) 222-2202, or write for our complete IC folder. Augat Inc.
30 Perry Ave. Attleboro, Mass. 02703.

AUGAT
INC.

IC Op Amp Selection Charts

Whether monolithic or hybrid, you'll find all commercial op amps here, classified by five important parameters.

Compiled by the staff of **The Electronic Engineer**

On the next five pages you'll find a new set of charts that graphically illustrate the relation between price and the five most important parameters used in specifying op amps. The five charts are:

1. Differential voltage amplification vs Price
2. Input bias current vs Price
3. Bandwidth (at rated load) vs Price
4. Slew rate vs Price
5. Input offset voltage temp. sensitivity vs Price

In all, 227 different devices are represented with a complete listing, shown on the following page, which is divided into two categories—hybrid and monolithic. Each device listed has a number next to it, and is represented by this device number on all five graphs. This listing also shows the price per unit to simplify the job of finding a particular device on the charts.

To help you better understand these charts, a set of definitions of the five op amp parameters is listed below. These agree with the op amp parameter definitions being drawn up by the EIA Industry Committee MED-20 under the chairmanship of Richard Lindner of Bell Labs.

Since these charts are a first for us as well as for you, we look forward to hearing your reactions and suggestions.

Op amp parameter definitions

The op amp parameters used on the charts and their definitions given below are the most recent available. A few of these parameters are known by simpler (if less accurate) names, which will be indicated for those of you who still call kilohertz by kilocycles.

Differential voltage amplification (A_{VD} or A_{vd}), previously called **open-loop gain**.

The ratio of the change in output voltage to change in differential input voltage in the linear range. For amplifiers with only one output terminal, it is the ratio of the change in output voltage with respect to ground to the change in differential input voltage.

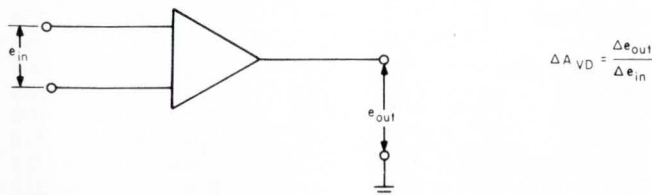

It should be noted that the symbol A_{VD} is used to indicate small-signal quantities.

Input bias current (I_{IB})

One-half the sum of the separate bias currents entering into the two-input terminals of a balanced amplifier, or, the bias current entering the input terminal of a single-ended amplifier.

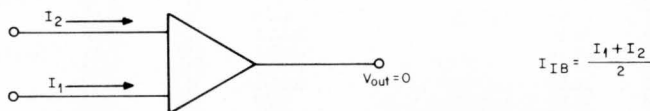

Bandwidth (small signal) (BW)

The range of frequencies within which the small-signal voltage (or current) amplification of the amplifier is more than $1/\sqrt{2}$ the value of the midband amplification.

This parameter was sometimes called the **3 dB bandwidth** to differentiate it from the **0 dB** or **unity-gain bandwidth**. Despite the newly accepted definitions, our chart shows the unity-gain bandwidth (or frequency) of the open-loop amplifier when operating into its rated load. All this causes a lot of confusion which we are the first to admit. However, we feel that the information presented is still valuable within the constraints imposed by the definitions.

Slew rate (SR)

The time rate of change of the closed-loop amplifier output voltage for a maximum-step signal input (a maximum-step signal input is the largest input voltage step for which the amplifier performance remains linear).

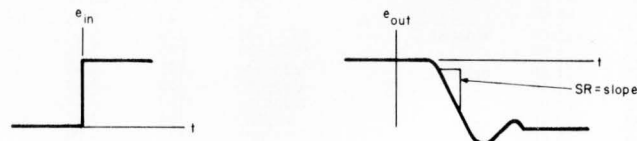

Since the value of closed-loop amplification is not specified in the definition, we have taken the value of slew rate at unity amplification.

Input offset voltage temperature sensitivity (no symbol specified at this time)

The ratio of the change in input offset voltage (V_{i0}) to the change of circuit temperature for a constant output voltage.

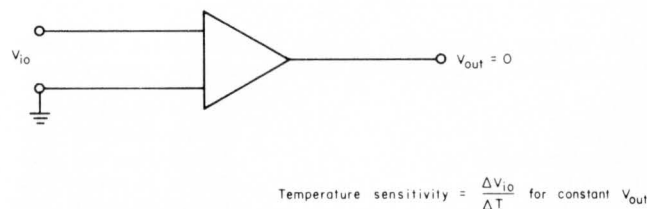

The use of the terms **drift** or **coefficient** have been replaced by the term **sensitivity**.

For a copy of this article circle #420 on Inquiry Card.

Chart Guide to Manufacturers and Devices

Hybrid op amps

1	\$ 15.00	Amelco	2809CG	84	40.50	1404/01	170	4.80	CA3015	
2	17.00		2709CG	85	52.00	1407/01	171	4.80	CA3038	
3	25.00		2809BG	86	63.75	1402/01/02	172	5.10	CA3010A	
4	30.00		2709BG	87	137.00	Q85AH	173	5.10	CA3037A	
5	58.50		2404BG	88	153.00	Q25AH	174	5.95	CA3033A	
6	58.50		2405BG	89			175	6.30	CA3015A	
7	17.00	Amperex	ATF401	90	22.00	Zeltex	176	6.30	CA3038A	
8	20.00		ATF404	91	28.00		177	7.90	CA3008	
9	26.00	Analog Devices	P501A	92	44.00		178	8.10	CA3016	
10	31.00		P501B	93	45.00		179	8.40	CA3008A	
11	42.00		P501C	94	56.00		180	9.00	CA3016A	
12	3.00	Burr-Brown	3058/01	95	61.00		181	15.95	Radiation	RA2909
13	5.95		3057/01	96	64.00		182	18.15		RA909
14	7.50		3053/01	97	165.00		183	33.00		RA2909A
15	9.90		3227/03			Monolithic op amps	184	36.30		RA909A
16	9.95		3057A/01	101	3.95	Amelco	185	43.50		RA238
17	10.40		3056/01	102	7.95		186	65.30		RA240
18	11.50		3053A/01	103	8.75		187	1.90	Raytheon	RC709
19	14.25		3056A/01	104	15.00		188	3.25		RC741
20	14.80		3226/03	105	15.00		189	3.45		RC101A
21	17.25		3055/01	106	15.00		190	3.90		RM709
22	18.75		3052/01	107	16.00		191	3.95		RC4101A
23	21.00		3054/01	108	27.80		192	5.00		RC4709
24	21.75		3052A/01	109	27.80		193	5.00		RC4131
25	29.25		3051/01	110	28.00		194	7.00		RC4741
26	33.00		3050/01	111	45.00		195	7.00		RC4132
27	14.70	Data Device	007C	112	9.75	Analog Devices	196	7.50		RC101
28	16.50		008C-2	113	13.00		197	7.50		RC4101
29	16.50		108C-2	114	15.00		198	9.35		RM709A
30	18.00		108C-1	115	1.90	Fairchild	199	15.00		RM741
31	18.00		008C-1	116	3.25		200	15.00		RM101
32	18.60		007D	117	3.25		201	15.00		RM4101
33	23.60		007A	118	3.90		202	17.00		RM4709
34	26.30		008B-3	119	5.95		203	20.00		RM4131
35	26.30		108B-3	120	9.95		204	30.00		RM4741
36	29.40		008B-2	121	4.20	ITT	205	30.00		RM101A
37	29.40		108B-2	122	8.60		206	30.00		RM4132
38	31.60		007A-4	123	13.50		207	33.00		RM4101A
39	31.60		008B-1	124	6.50	Motorola	208	3.75	Signetics	SS709
40	31.60		108B-1	125	7.50		209	15.00		SE530K
41	47.00		008A-2	126	7.50		210	35.00		SE516K
42	47.00		108A-2	127	8.50		211	7.50	Siliconix	LM201
43	52.50		007A-3	128	8.50		212	15.00		LM101
44	64.50		008A-1	129	8.50		213	15.00		LH101
45	64.50		108A-1	130	8.50		214	15.00		LM102
46	68.00		007A-2	131	8.50		215	45.50		L174
47	75.00		007A-1	132	15.00		216	1.60	Texas Instrument	SN52709BN
48	81.00		207C	133	1.95	National	217	1.75		SN52702BN
49	85.00		207A/B	134	3.00		218	2.00		SN52709N
50	92.00		208	135	3.45		219	2.20		SN52702N
51	42.00	General Instrument	NC210	136	3.95		220	2.80		SN52709AN
52	42.00		NC212	137	6.00		221	3.10		SN52702AN
53	48.20		PC210	138	7.50		222	11.60		SN524AL
54	48.20		PC212	139	7.50		223	3.80	Transitron	TOA1709V
55	80.00	Keithley	302	140	8.50		224	9.00		TOA4709V
56	160.00		300	141	12.00		225	12.80		TOA7709A
57	160.00		301	142	13.00		226	14.75		TOA7809V
58	185.00		50200	143	15.00		227	14.75		TOA1741V
59	26.00	Melcor	1810	144	15.00		228	14.75		TOA1741WV
60	45.00		1841	145	15.00		229	19.50		TOA7741V
61	56.00		1842	146	30.00		230	19.50		TOA7741WV
62	66.00		1843	147	33.00					
63	12.00	Motorola	MCH1439	148	1.95	Nucleonic	LA709C			
64	15.00		MCH1539	149	3.00		LA302			
65	11.60	National	NH0002C	150	3.45		LA301A			
66	11.70		NH0005C	151	3.95		LA307			
67	17.00		NH0001C	152	6.00		LA202			
68	17.40		NH0005	153	7.50		LA201			
69	20.00		NH0002	154	7.50		LA201H			
70	20.00		NH0004C	155	8.50		LA709			
71	27.00		NH0003C	156	12.00		LA201A			
72	40.00		NH0005A	157	13.00		LA207			
73	45.00		NH0003	158	15.00		LA101			
74	48.00		NH0001	159	15.00		LA101H			
75	60.00		NH0004	160	15.00		LA102			
76	4.50	Philbrick-Nexus	1301	161	30.00		LA101A			
77	4.50		1303	162	33.00		LA107			
78	6.50		T-52	163	2.60	Philco-Ford	7709C			
79	7.65		1300	164	10.00		7709A			
80	11.50		T82AH	165	12.80		7709			
81	16.00		CIA-2	166	3.60	RCA	CA3010			
82	21.50		1406	167	3.60		CA3037			
83	25.00		1408/01/02	168	3.60		CA3031/702A			
				169	4.75		CA3033			

Prices not available

Union Carbide	H2000BL
Hybrids	H2030BL
	H6000
	H7000
	H9000A
	H6010
	H6020
	H9010A
	H9020A
	H9030A
	H7010A
	H7020A
	H7030A
	H7050G
	H8010C
Monolithics	UC709
	UC7200
	UC4000/C
	UC4001/C
	UC4002/C
	UC4100CM
	UC4200/C/CM

For further information on the manufacturers and their products, circle the following numbers on the Inquiry Card.

Amelco	Circle Number 291
Amperex	Circle Number 292
Analog Devices	Circle Number 293
Burr-Brown	Circle Number 294
Data Device Corp.	Circle Number 295
Fairchild	Circle Number 296
General Instrument	Circle Number 297
ITT	Circle Number 298
Keithley	Circle Number 299
Melcor	Circle Number 300
Motorola	Circle Number 301
National Semiconductor	Circle Number 302
Nucleonic Products	Circle Number 303
Philbrick-Nexus	Circle Number 304

Philco-Ford	Circle Number 305
RCA	Circle Number 306
Radiation, Inc.	Circle Number 307
Raytheon	Circle Number 308
Signetics	Circle Number 309
Siliconix	Circle Number 310
Texas Instruments	Circle Number 311
Transitron	Circle Number 312
Union Carbide	Circle Number 313
Zeltex	Circle Number 314

INFORMATION RETRIEVAL:
Integrated circuits, Circuit design,
Semiconductors, Charts and nomographs,
Amplifiers

Differential Voltage Amplification vs Price

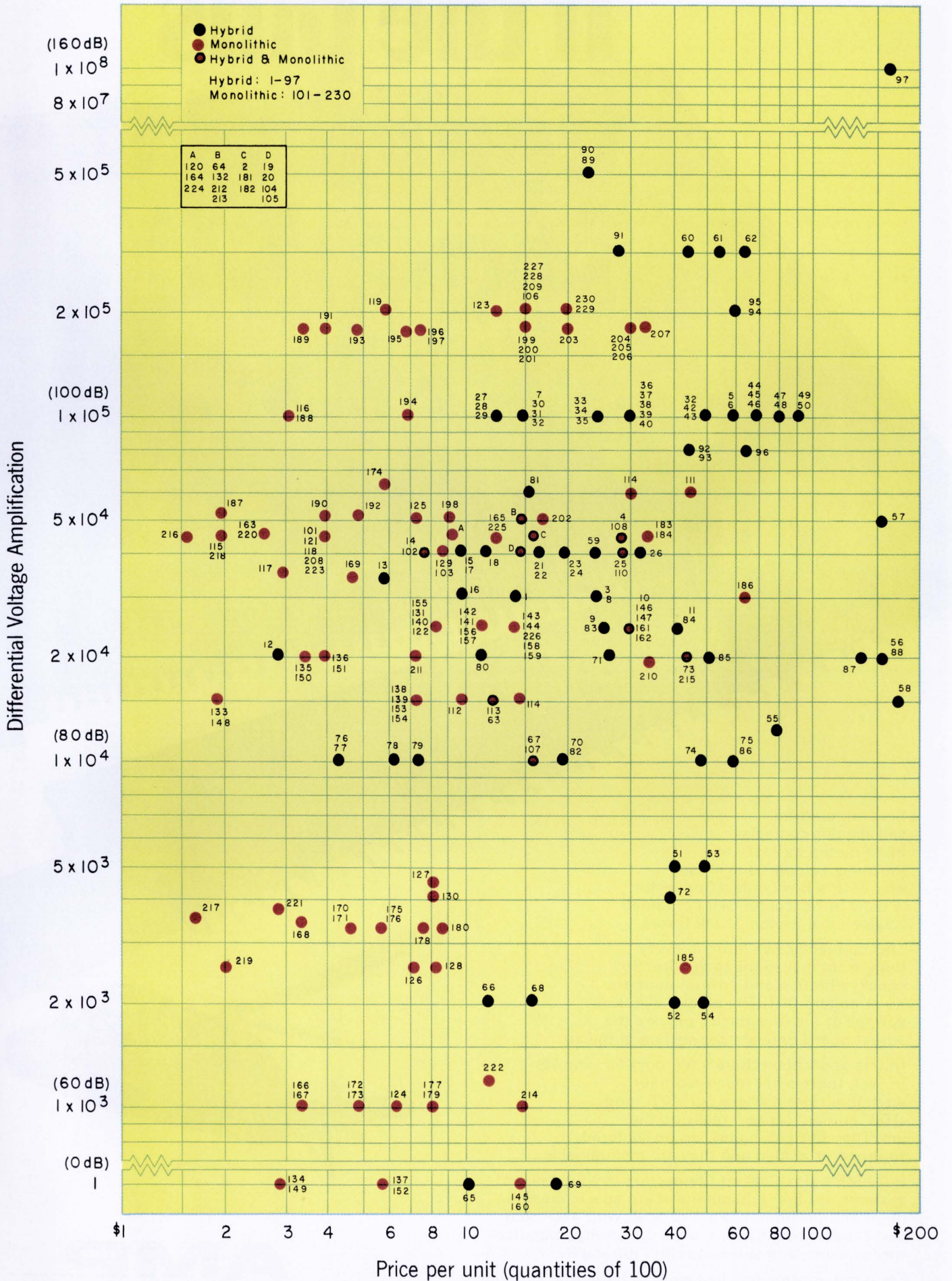

If the pins don't find the sockets, the sockets will find the pins.

Several hundred self aligning contacts hand mated as easily as meshing a zipper: one reason why AMP's Box Contact Connector is used in Helicopter Self Contained Navigational System Black Boxes.

This connector has flown in everything from monsoons to gunfire. So shock, vibration and environment are no strangers to it. The unique elliptical springs of the receptacles provide the surest board-to-board connection in the air.

In this application there's no room for almosts. In fact, there's not much room for anything. Here's where our .075" and .100" contact centers really do the job. They fit right in and can be soldered, wrapped or welded and they are maintainable.

Put AMP's Box Contact Connectors in your Avionic systems or other equipment where space, environment and performance are critical. With AMP, you can expect complete product engineering, manufacturing, sales, and service around the world.

For more information, just write to **Industrial Division, AMP Incorporated, Harrisburg, Pa. 17105.**

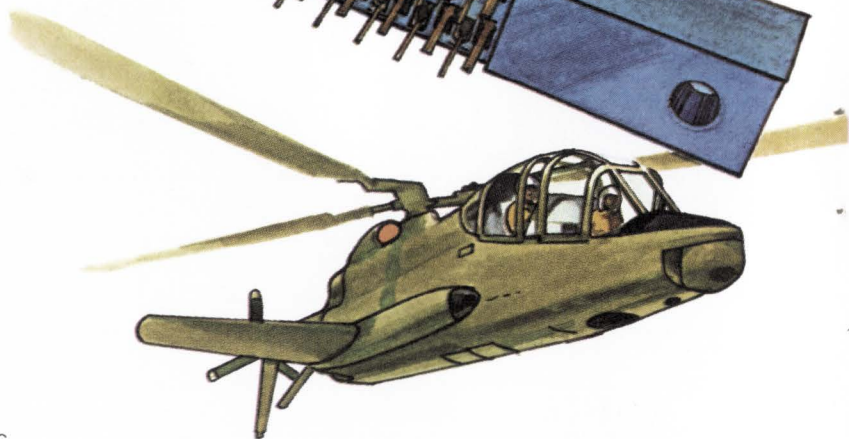

AMP
INCORPORATED

Circle 31 on Inquiry Card

Input Bias Current vs Price

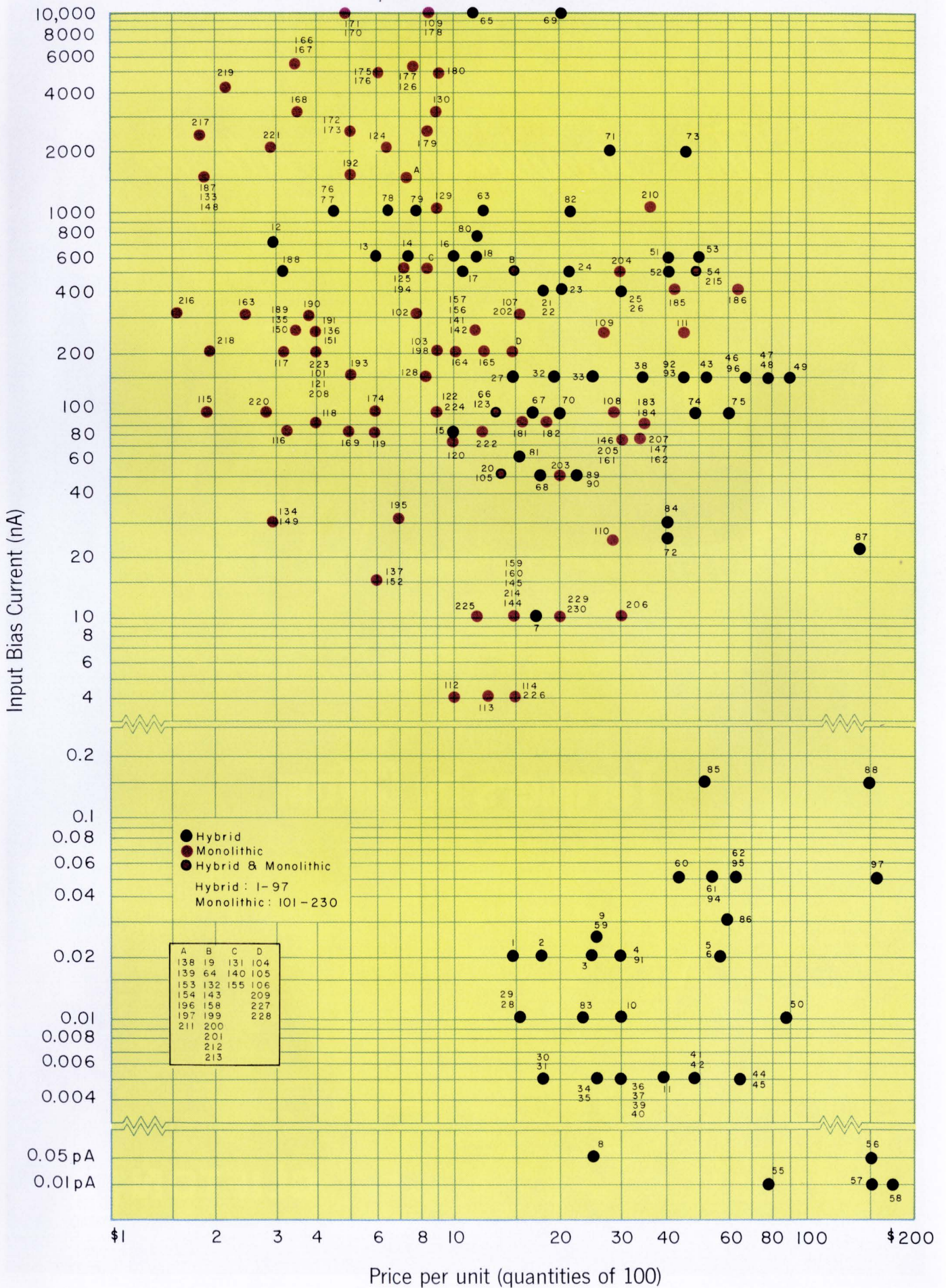

The Standard of Excellence

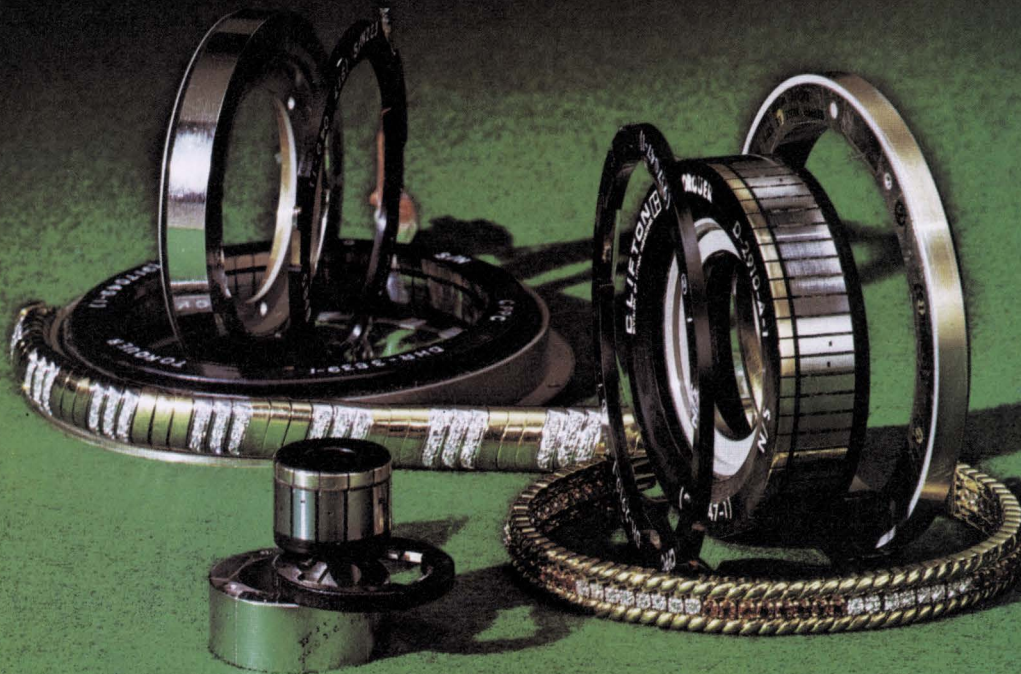

Torquers by Clifton

What makes Clifton torquers inherently excellent? We feel it's materials technology.

Of course, quality fabrication and electrical design are extremely important too. But Clifton long ago mastered the hollow shaft "pancake" configuration and the designing of optimum performance rotating components. It's our materials engineers who have provided our designers with the space-age materials and techniques which enable us to set a very high standard in torquers.

Consider the following characteristics.

□ **DOUBLE INSULATED HI TEMP (200°C) MAGNET WIRE** minimizes leakage current, gives superior insulation characteristics.

□ **MOLDED BRUSH BLOCK ASSEMBLY.** Brush blocks are completely interchangeable. Brush position on commutator is optimized.

□ **BRUSHES MECHANICALLY FASTENED TO BRUSH SPRING IN ADDITION TO SOLDERING** assures optimum brush alignment during soldering operation and a good mechanical and electrical bond between spring and brush.

□ **STABLE HI TEMP MOLDING MATERIAL** minimizes the movement of the windings under temperature variations. Material will not crack, thereby eliminating voids, exposed windings, dirt or humidity traps.

□ **SOLID GOLD ALLOY COMMUTATOR** insures consistent

low brush contact resistance over the life of the unit. Problems encountered in plating, such as gold migration and corrosive salts are eliminated.

□ **SPECIAL MAGNETIC MATERIAL ALLOY** permits higher torque per unit of volume, higher torque to inertia ratio, and will not corrode under high humidity.

Clifton's torquers are operational now in many of our nation's critical defense programs. Why not get Clifton excellence in your program too! Call your Local Clifton Sales Office or 215 622-1000.

CLIFTON 
DIVISION OF LITTON INDUSTRIES

Bracelets by J. E. Caldwell Co., Philadelphia—\$5600.

Bandwidth (unity gain at rated load) vs Price

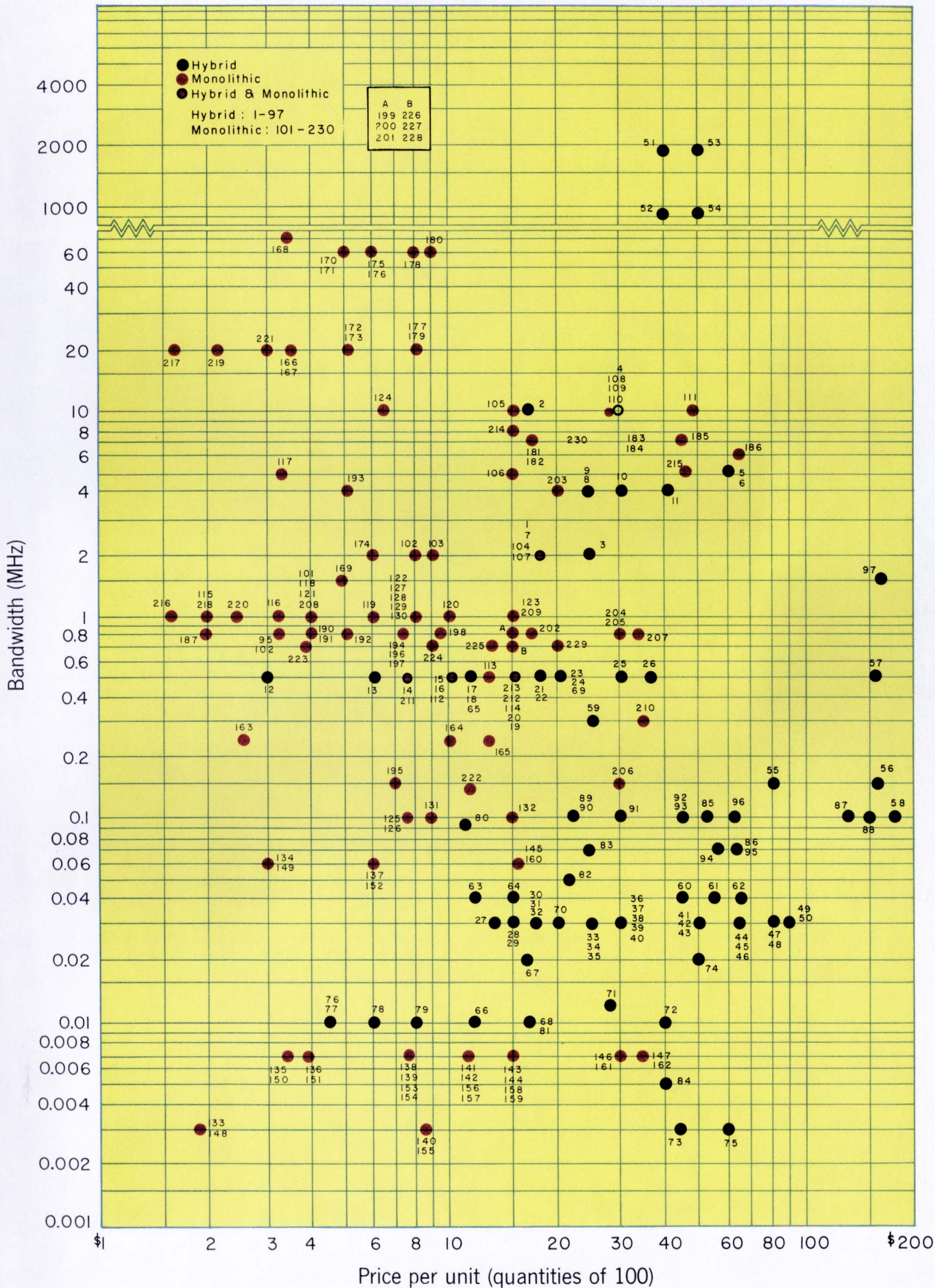

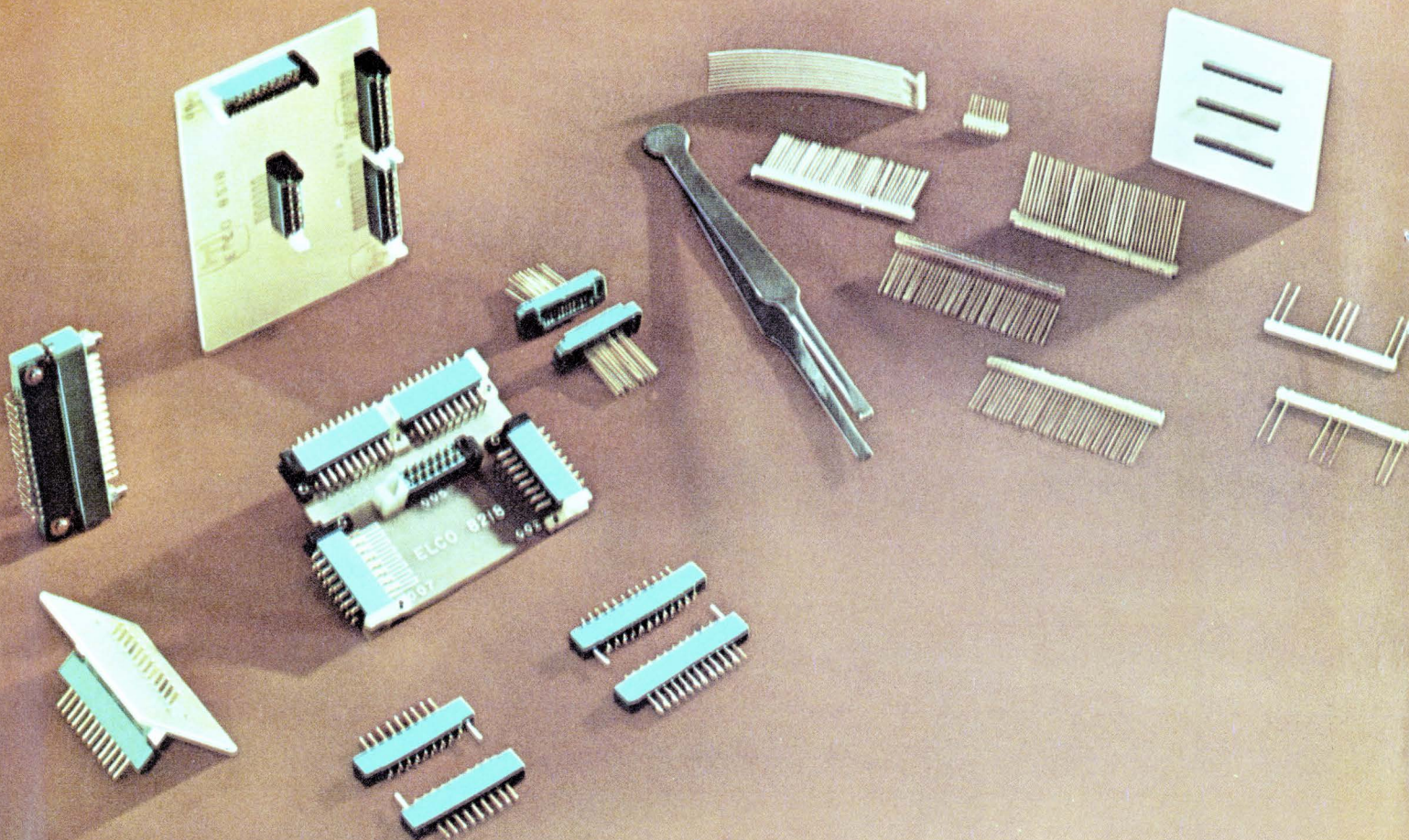

Miniature, subminiature connectors, yes.

Miniature, subminiature contacts, no.

Microelectronics can give you a pain in the tweezers. You have to be perfect. And you have to be perfect in places so small that a flea would have trouble scratching his back.

Actually, the electronics part isn't too hard, what with piezoelectric this's and thin-film that's to work with.

But, inevitably, there comes the day when all the this's and that's have to be put together. It's a problem. Mechanically. Electrically.

You don't want to put a big fat plug on a skinny little mini-circuit.

So you need miniature or subminiature connectors. Those we have. By the catalogfull.

But you sure don't need undernourished contacts. You need all the strength you can get, all the contact area you can get, all the hang-togetherness you can get.

Those we give you. Every miniature in our catalog is made with our patented Varicon™ contacts (you probably already know about them). Our newer subminiatures are made with Bi/Con™ contacts (which

is sketched at the left).

See the four mating surfaces?

Four mating surfaces, coined so that they're exceptionally hard and smooth.

Four mating surfaces, held together snugly by the spring-like action of the design. And by the innate characteristics of the phosphor-bronze.

Four mating surfaces, strengthened by a reinforcing web.

Four mating surfaces, on a contact that floats in its insulator to make sure that the four mating surfaces mate.

No comparably sized contact can match the Bi/Con's dimensional, electrical, and mechanical characteristics.

And no subminiature contact can match the Bi/Con's incredibly low price, either.

For more information, write, wire, call or TWX us for our Microelectronics catalog.

Elco Corporation, Willow Grove, Pa. 19090.
(215) 659-7000. TWX 510-665-5573.

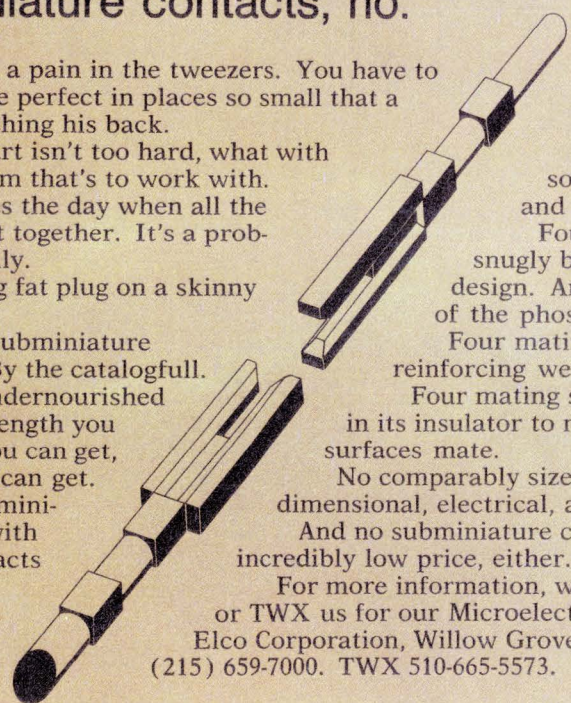

ELCO Varicon® miniatures
Bi/Con® subminiatures

Slew Rate vs Price

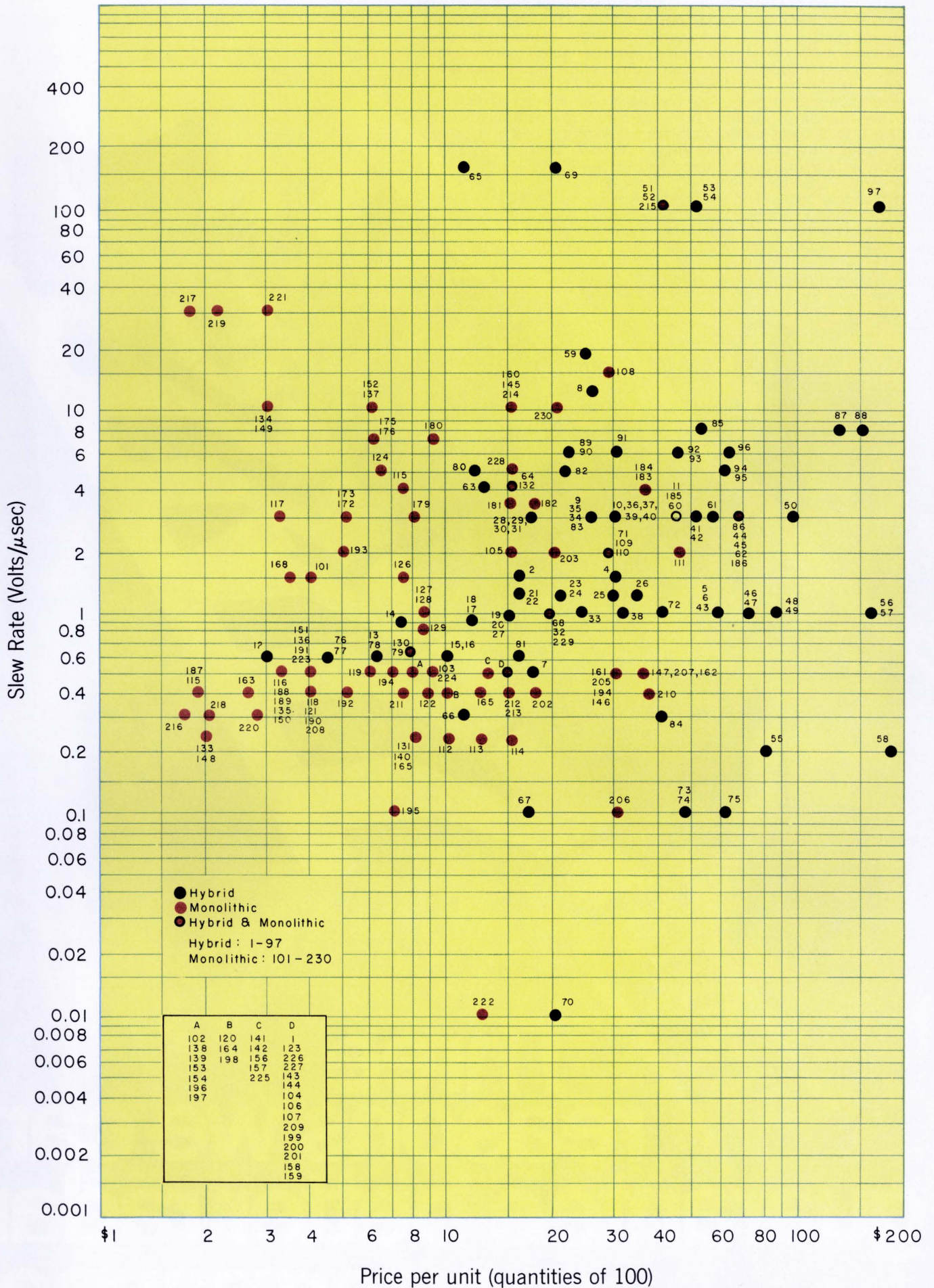

For the first time, Varian has combined three Pulse-TWT improvements, illustrated in this cutaway photo, which greatly improve duty cycles and provide better pulse radar performance: (1) Latest focusing techniques decrease size and weight. (2) State-of-the-art fabrication provides better heat dissipation, more reliable environmental service. (3) Advanced slow wave structures allow higher gain and efficiency in shorter tubes, with outstanding stability.

Here are some examples of our line, each with at least 50 dB gain. One standard L-band TWT puts out 5 kW at 5% duty. An 8 lb S-band model delivers 3 kW at 10%, a 5 lb C-band tube at 6% duty gives 1½ kW. This capability extends through X-band and Ku-band, where we have an off-the-shelf 1 kW model with a 1% duty cycle. And each tube in our line is broadband enough to cover an entire radar band. So get what your pulse radar really needs from any of our more than 30 Electron Tube and Device Group Sales Offices throughout the world, or from our TWT Division, 611 Hansen Way, Palo Alto, California 94303.



varian
twt division

1. Lightweight focusing
2. Improved heat conduction
3. Ultra-stable high gain circuits

Three reasons we can guarantee better radar performance.

Input Offset Voltage Temperature Sensitivity vs Price

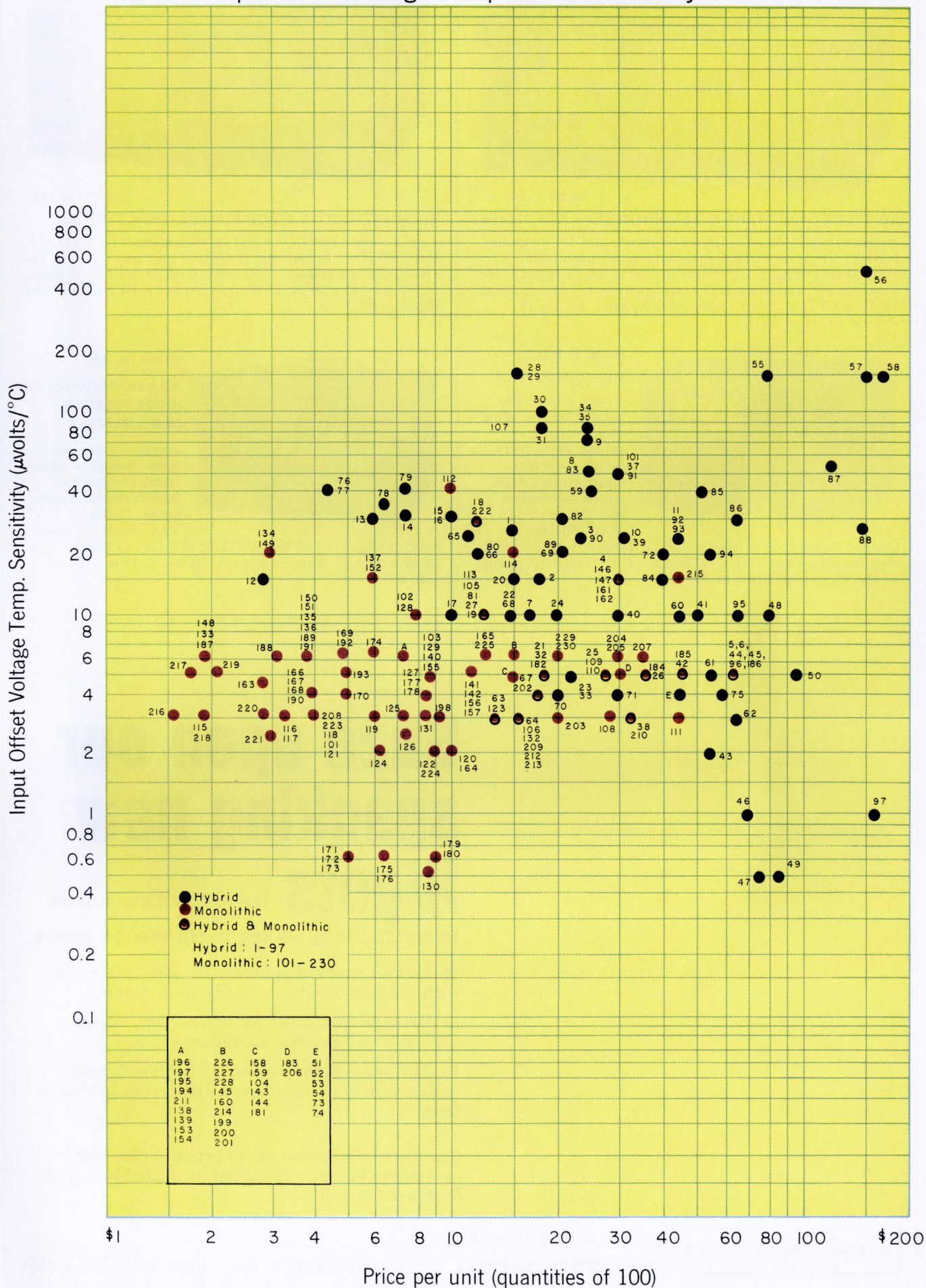



Model H 306 E

AC/DC HIPOT TESTERS & MEGOHMMETERS (300 SERIES)

Applications: For AC hipot, DC hipot, and DC megohm testing; IR tests to 1000 megohms ("A" units) and 100,000 megohms ("B" units) at 500 volts. *Input:* 115 VAC, 60 Hz, 1 amp max. *Output current:* 5 ma. *Size:* 21"W x 19"D x 10"H. *Weight:* Approx. 50 lbs. *Prices:* Start at \$415.

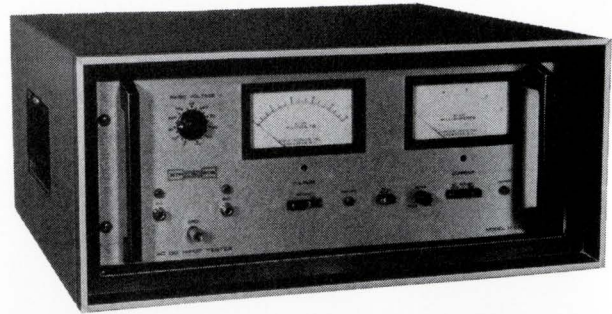

Model H 115

NON-DESTRUCTIVE HIPOT & INSULATION TESTERS

Applications: For AC or DC hipot testing. *Input:* 115 VAC, 60 Hz, 5 amps max. *Output current:* 5 ma, AC or DC. *Output voltage:* 0-10 KV AC; 0-25 KV DC. *Size:* 21"W x 19"D x 10"H. *Weight:* Approx. 60 lbs. *Prices:* Start at \$270.



Model H M3AS
MEGOHMMETERS

Applications: For production or laboratory testing of cables, capacitors, printed circuits, transformers, electronic assemblies, etc. *Input:* 115 VAC, 60 Hz.

Output voltage: 50 to 1000 volts. *Ranges:* to 20,000,000 megohms *Size:* 7"H x 12"W x 8"D. *Weight:* Approx. 20 lbs. *Prices:* Start at \$170.

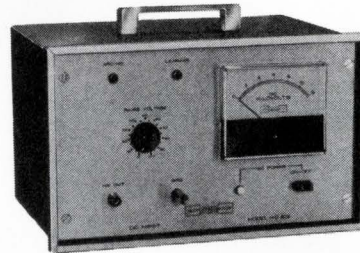

Model HD B12
AC & DC PRODUCTION HIPOT TESTERS (A & B SERIES)

Applications: For mass testing of electrical components, transformers, appliances. *Input:* 115 VAC, 60 Hz, 3 amps

max. *Output:* 3-10 KV AC; 4-12 KV DC. *Size:* 7"H x 12"W x 8"D. *Weight:* Approx. 20 lbs. *Prices:* Start at \$145.

Gaze upon our spanking new Hipots

We restyled the outside to match the sparkling performance inside.

- Human engineered for *simple, easy operation* — with functional controls, easily read meters.
- Package engineered for *lightweight, compact design* — with brushed aluminum finish.
- And yet — *priced reasonably, competitively* — with a variety of highly accurate models to choose from.

Complete information on all types, series, and models can be made immediately available to you. Just write or call:



High-Potential Electronics

HIPOTRONICS, INC. BREWSTER, N.Y. 10509, (914) BR 9-8091



Centralab's substrates in 95% and 99.6% alumina, provide unexcelled surface finish and reliability for hybrid microcircuits

Available in sizes and shapes to meet any design requirement, these materials are available as fired, glazed or metallized. (Glazed units are available only in 99.6% alumina.) They have high mechanical strength and good dimensional tolerance control.

Bodies	Surface Finish (μ. in.)		Glazed
	As Fired	Ground	
95% Alumina	40	10*	(not available in 95% Al.)
99.6% Alumina	10-20	2-5*	1 max.

*Lapped, diamond polished.

Exclusive processing

These precision substrate materials are produced by an exclusive thin sheet process in specialized alumina kilns. They meet demanding design criteria of thick-film and thin-film hybrid circuit manufacturers and have been used in all types of circuit deposition: brushing, screening, dipping, spraying, vapor deposition, evaporation, tapes, decalomania, solution metallizing and printing.

Glazed substrates have a 1½ mil maximum glaze thickness. Edge meniscus is negligible. Metallized units are available with up to 200 or more terminals, and can be brazed with kovar, nickel, copper or brass hardware.

All in all, for performance, variety and application, your design is in for smooth sailing when you specify substrates and ScoreStrates™ from Centralab.

TM-Scored substrates for multiple processing



CENTRALAB

Electronics Division
GLOBE-UNION INC.

5757 NORTH GREEN BAY AVENUE
MILWAUKEE, WISCONSIN 53201

M-6902

For more information and/or design assistance on substrates and ScoreStrates, contact Centralab Application Engineering.

Digital data: play it like it is

Distortion and noise in tape-playback amplifiers often give you false data. An improved peak detector for NRZI amps rejects both low- and high-level noise, and responds only to the true peak of the playback signal.

By **Frank C. Marino**, Sr. Dev. Engr.
Digitronics Corp., Albertson, N. Y.

In high density NRZI (**nonreturn-to-zero inverted**) data recording systems, playback signal amplitude variations of 20 to 30 dB are not uncommon. Thus, the peak detector in the playback amplifier of such systems must respond to full-wave rectified signals that range from a few tenths to several volts peak amplitude.

The sensitivity of such a detector poses two problems. One is that at low levels, you must prevent noise signals from reaching the detector. You usually do this by mixing a dc voltage with the rectified input, so that only signals exceeding this threshold-voltage level reach the peak detector.

The second problem is that of high-level noise signals, which the detector must also reject. Most peak detectors consist of a differentiator followed by a non-linear amplifier. Now, a differentiator is a high-pass network. So unwanted high-frequency noise that exceeds the dc voltage level mixed with the rectified input signal will be passed along by the peak detector.

To prevent this, first remember that most unwanted high-frequency noise—which may be larger in amplitude than wanted low-level signals—is narrower in width than the desired signals. This fact tells you that if you place a pulse-width discriminator after the peak-detector stage, you can get high-level noise rejection. The pulse-width discriminator usually takes the form of an integrator at the input of a shaper amplifier such as a Schmitt-trigger.

Signal distortions

A peak detector made of a differentiator followed by an amplifier is, basically, a zero-slope detector. Such a detector will work properly only for good NRZI playback signals as shown in Fig. 1a, where the signal

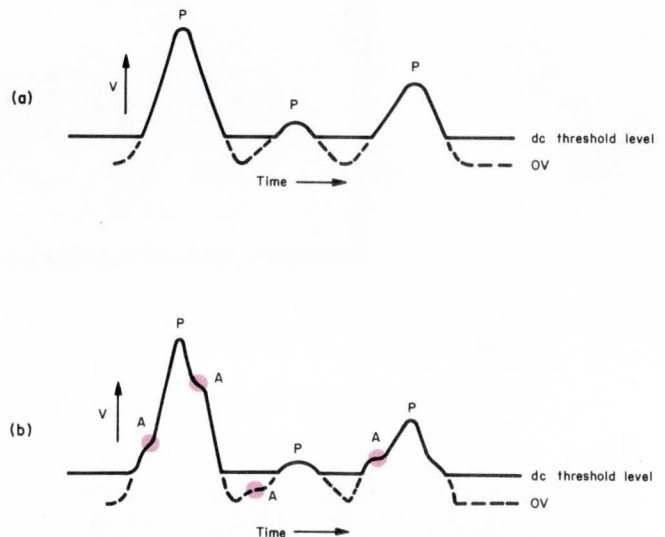

Fig. 1. The upper waveform, (a), is a good NRZI playback signal, after rectification. Note that zero-slope points, P, occur only at the true peak of the waveform. Waveform (b), on the other hand, shows spurious zero-slope points, A, from vibration, crosstalk, and dropouts. These cause unwanted outputs from conventional peak detectors.

peaks, P, are the only points at which $dv/dt=0$. The detector will have difficulty with the distorted waveforms of Fig. 1b. Here, a distorted signal shows additional points of zero-slope, or near zero-slope, at points A of the waveform.

At unconventional tape speeds (under 3 ips), mechanical vibrations caused by vacuum motors, rotating pulleys, idlers, and so forth, become significant. They move along the tape to the playback head and help produce the distortions shown in the figure. Such

Digital data and magnetic tape

There are several formats for recording digital data on magnetic tape. And a feature common to all such recording modes is that the recording head produces sufficient flux to saturate the tape's magnetic oxide. The direction of magnetization depends upon the direction of the write current, and the length (on the tape) of a particular magnetized section is a function of the tape speed and the write-current time.

Because the tape's oxide is saturated, the play-

and transport mechanism; and accidental polarity reversals do not affect the accuracy of the data (because the flux direction is of no significance: a 1 is represented by a transition in either direction).

To recover the recorded data, you must linearly amplify the playback signal, full-wave rectify it (because in the NRZI mode, binary ones are bipolar), and peak-detect it. Peak detection is desirable because the peak of the playback signal is least affected by pulse crowding and dropout on the tape.

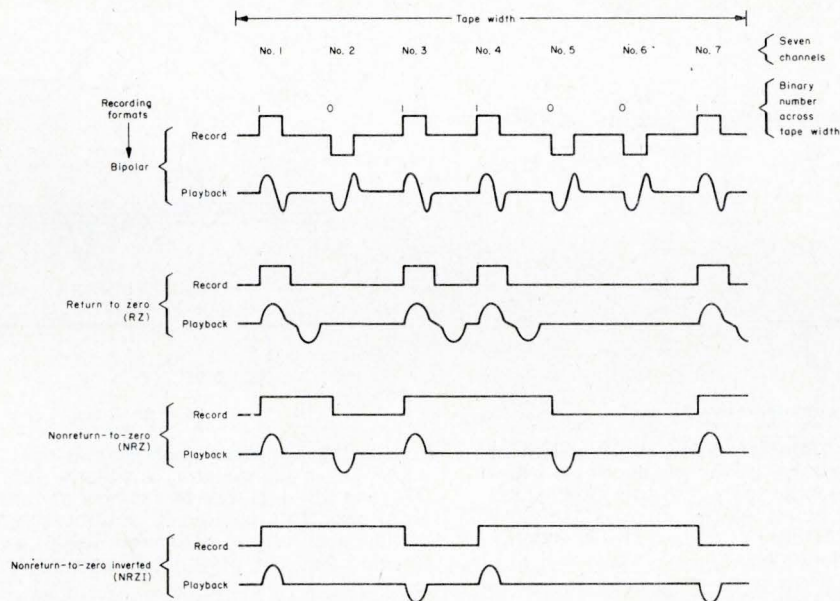

back head gives you an output only at those times that the tape magnetization changes direction.

The various recording modes use the playback head's output pulses to represent the one's and zeroes of digital data. Some common recording formats are shown.

The *nonreturn-to-zero inverted* (NRZI) mode is one of the most common formats. It has a high packing density (you can put lots of data in a small length of tape): it is the least demanding format with respect to the frequency response of the tape

Obviously, proper operation of the peak detector is important to the accuracy of the recovered data. One vital aspect of detector performance is its ability to generate an output that corresponds in time to the true peak of the rectified playback signal. Another is the detector's ability to accurately peak-detect signals in the presence of noise and large input-amplitude variations.

If you satisfy these criteria, you'll have a good detection system. This article describes one way of doing it.

distortions are also common with relatively inexpensive IBM-compatible read/write heads, where write-to-read and read-to-read crosstalk levels are greater than 3%.

The effects of crosstalk are especially noticeable at the base of the waveforms, where signal-to-noise ratios are low. But because it is desirable to use dc threshold voltage levels much less than 15% during playback (to recover extreme dropout signals), the peak detector must tolerate the type of waveform distortion shown

in Fig. 1b.

A close look at these waveforms shows you that the peak-points, P, are distinguished from the distortion points, A, by the first derivative of the waveforms. The derivative changes polarity only at the points P, the desired peaks of the waveform. An improved peak detector, therefore, is one which is responsive only to a *change in the polarity of the first derivative* of the playback signal. Such a peak detector consists of a differentiator, followed by a bistable amplifier.

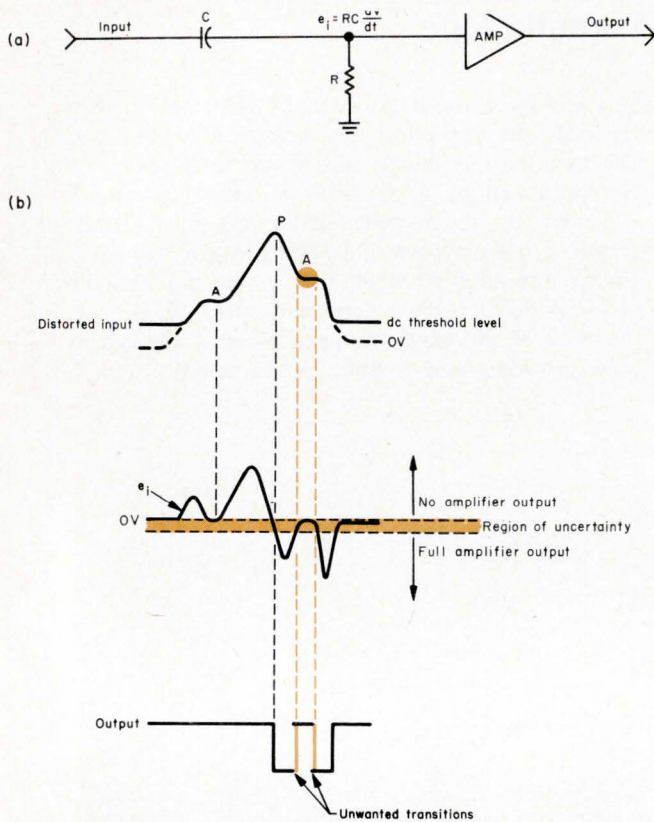

Fig. 2. A conventional peak detector, as in (a), consists of a differentiator, RC , followed by an amplifier. False zero-slope points, A , cause unwanted output transitions which are equivalent to erroneous binary ones. There is a limited dynamic range, and the amplifier's region of uncertainty causes spurious output transitions.

An op amp to the rescue

Figure 2b shows you how a conventional peak detector fails when presented with a distorted waveform. Another type of failure, not shown, is that of an oscillatory or unstable amplifier output that occurs at the point of distortion which approaches zero-slope. This happens because the resulting input-voltage to the amplifier, $RCdv/dt$, may be in the region of uncertainty common to all amplifiers because of their inherent lack of hysteresis.

The combination of any bistable amplifier preceded by an ordinary RC differentiator gives you improved peak-detection. That is, the circuit will respond only to a change in the polarity of the first derivative of the input waveform. But the improved detector of Fig. 3 goes one step further. Its bistable amplifier is a Fairchild $\mu A702C$ op amp arranged in the form of a comparator with pre-determined hysteresis.

In Fig. 3a, the total differentiator resistance R includes the non-linear resistance of the two diodes. These diodes protect the comparator from the excessive input voltages of signals with large peak amplitudes (say, 5 V), and with sharp rising and decaying slopes. Conversely, for very weak input signals (100 mV) most of the differentiated voltage appears across the now relatively-large diode resistances. Consequently, the peak detector operates accurately with input signal

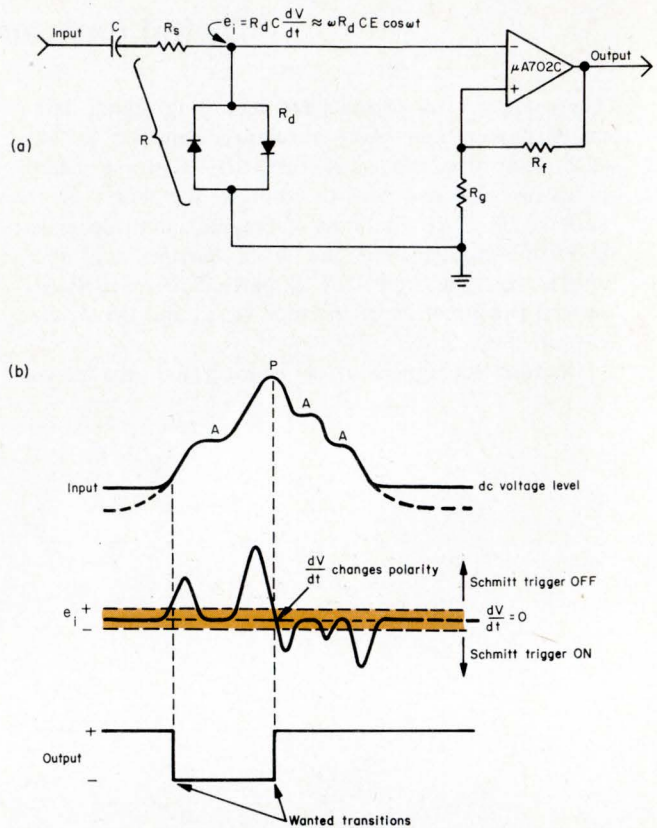

Fig. 3. The improved peak detector (a) is an op amp connected as a comparator. A clearly defined region between OFF and ON replaces the region of uncertainty in ordinary amplifiers. This eliminates spurious triggering, even in the presence of severe distortion. Diodes protect the comparator, and give the detector a large dynamic range.

variations greater than 30 dB.

Some analysis

If you assume the rectified input signal approximates a sine wave, you can write this first-order differential equation for the differentiator:

$$RC \frac{dv}{dt} + V = E \sin \omega t \quad (1)$$

The general solution for the voltage V developed across the capacitor is:

$$V = \epsilon^{-\frac{t}{RC}} \left[\frac{E}{RC} \int \epsilon^{\frac{t}{RC}} \sin \omega t dt + K \right] \quad (2)$$

From which,

$$V = \epsilon^{\frac{t}{RC}} \left[\frac{E \epsilon^{\frac{t}{RC}} (\sin \omega t - \omega RC \cos \omega t)}{(\omega RC)^2 + 1} + K \right] \quad (3)$$

$$\text{Since } V = 0 \text{ at } t = 0, K = \frac{\omega RCE}{(\omega RC)^2 + 1}$$

and the particular solution of eq. (1) is:

$$V = \frac{E \left[\sin \omega t + \omega RC (\epsilon^{-\frac{t}{RC}} - \cos \omega t) \right]}{(\omega RC)^2 + 1} \quad (4)$$

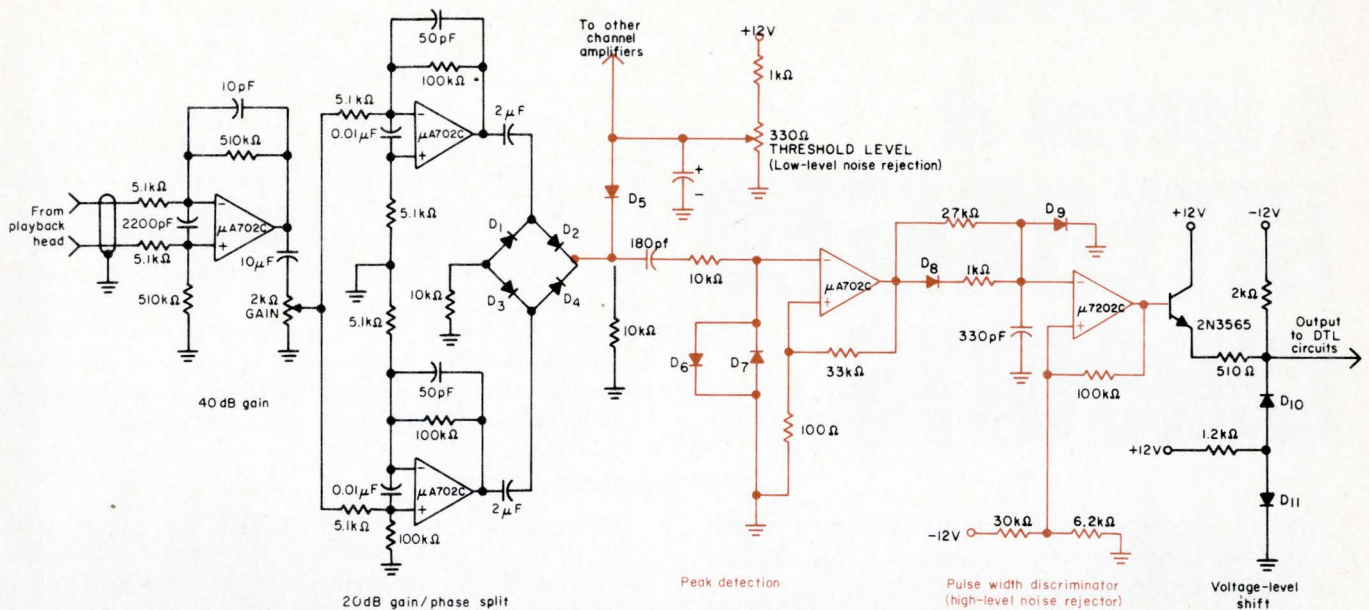

Fig. 4. The complete NRZI amplifier. It features the improved peak detector, with low- and high-level noise rejection. Fairchild $\mu A702C$ op amps are used throughout, and the output signal will drive DTL logic circuits.

Since $Cdv/dt = e_i/R_d$, you can rewrite eq. 1 as

$$V = E \sin \omega t - \frac{e_i}{R_d} R, \text{ where } R = R_s + R_d. \quad (5)$$

Now combine eqs. (4) and (5):

$$\frac{e_i}{R_d} = \frac{\omega CE}{(\omega RC)^2 + 1} \left[\omega RC \sin \omega t + \cos \omega t - e^{-\frac{t}{RC}} \right] \quad (6)$$

You must solve equation (6) graphically for values of capacitance as a function of the fundamental frequency of the input signal. In the final analysis, you must apply a single value of the ratio e_i/R_d to the graphical results, to find the optimum values of capacitance for given values of the fundamental frequency.

If you differentiate eq. (5) with respect to time, assuming $\left(\frac{e_i}{R_d}\right)R$ is constant at a specific point on the input waveform, you can evaluate the resulting equation at that point:

$$\left[\frac{\partial v}{\partial t} \right] \frac{e_i R}{R_d} = \omega E \cos \omega t \quad (7)$$

$$\text{Then, } \frac{\partial v}{\partial t} C = \frac{e_i}{R_d} \approx \omega CE \cos \omega t \quad (8)$$

$$\text{from which } C = \frac{e_i}{\omega R_d E \cos \omega t} \quad (9)$$

The forward diode-resistance, R_d , is a non-linear function of the voltage, e_i , developed across it. To ensure that a minimum input-signal peak amplitude of $E = 100$ mV will exceed the hysteresis level of 30 mV needed to switch the bistable amplifier, choose $e_i = 50$ mV. The germanium diodes used in the circuit have an R_d of 50 k Ω at this signal level.

A practical point at which to use these results is at $1/8$ cycle. Thus, $\omega t = \pi/4$ and $\cos \omega t = 0.707$. Putting

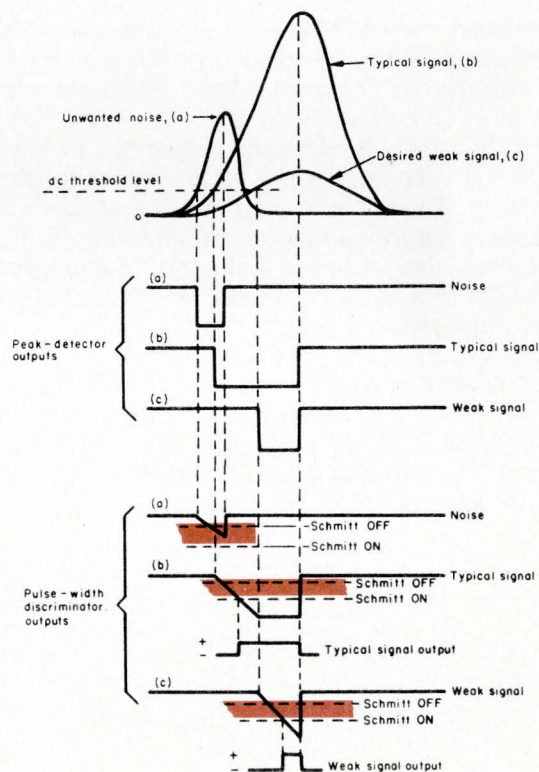

Fig. 5. High-level noise rejection in the improved peak detector. An op amp arranged as a comparator has predetermined hysteresis levels. Note that even though the unwanted noise signal is initially peak detected, the Schmitt trigger does not allow an output to occur.

ANNOUNCING...

A Course in INTEGRATED CIRCUITS

And an important opportunity for all design, equipment and systems engineers to stay ahead of the evolution in integrated circuits.

There is now available a practical and authoritative course in Integrated Circuits. This 10 part course appeared originally in *The Electronic Engineer* and is now being reprinted by popular demand. The course is designed for engineers who are buying or using, or who plan to use the whole range of integrated circuits—Silicon monolithic, thin-film, MOS, and hybrids. The course describes the function and use of integrated circuits in clear and complete form.

You achieve new skills—This course gives you the required background to properly communicate with device designers. The course will also sharpen your capability to make the right decisions about the selection and use of ICs. In addition, the course traces the history of integrated circuits so you can evaluate new developments and anticipate those now on the drawing board. The course also includes a study of manufacturing details to keep you abreast of the complexities in this area.

The complete 10 part course costs \$2.00. To get yours, just fill out the coupon below and send it today. Send your order to *The Electronic Engineer*, Chestnut and 56th Streets, Philadelphia, Pennsylvania 19139.

Yes, I accept your offer. Send me ___ complete course(s) in Integrated Circuits at a cost of \$2.00 each. My check, cash or money order is enclosed. Send as soon as possible to:

Name _____

Address _____ Company _____

City _____ State _____ Zip _____

Send me special quantity prices

these values into eq. (9), you can approximate the capacitance as a function of frequency:

$$C_{pF} \approx \frac{2250}{f_{kHz}}$$

For example, at 800 bpi and a tape speed of 40 ips, $f \approx (1/2) (800) (40) = 16 \text{ kHz}$, and $C = 2250/16 \approx 140 \text{ pF}$. At 556 bpi and the same tape speed, $C = 203 \text{ pF}$. Because it is impractical to change the value of this capacitor to compensate for a change between these two popular packing densities (556 and 800 bpi), you can choose 180 pF as a compromise value for the tape speed. You should pick a value for R_s that is relatively small compared to R_d for weak input signals, but large enough to avoid dynamic overloading of the driving stage during nominal strength input signals.

A complete amplifier

Figure 4 shows a playback amplifier for tape speeds from 10 to 40 ips and packing densities of 556 and 800 bpi. At 40 ips, the best value of the peak detector's differentiator capacitor is 180 pF. At 10 ips, you should increase its value by the factor of 40/10, to about 750 pF.

The first-stage linear amplifier has a balanced input for common-mode rejection, and a closed-loop gain of 40 dB. The second-stage linear amplifier gives you the needed phase-splitting function, and an additional gain of about 20 dB. A full-wave, balanced bridge rectifies the playback signals. The overall frequency response of the linear portions of the amplifier is flat to about 33 kHz, and rolls-off at 12 dB/oct. from this point. Note that the dc voltage that sets the low-level noise is added at the bridge, through D_5 .

Following the improved peak-detector circuit are the integrator and Schmitt-trigger stages. These two circuits comprise a pulse-width discriminator for high-level noise rejection. Figure 5 shows how it works. The Schmitt-trigger is, again, an op amp arranged as a comparator with pre-determined hysteresis threshold levels.

You can apply the general amplifier configuration of Fig. 4 to high-density NRZI tape systems with tape speeds from one to more than 100 ips. But at speeds below 10 ips, you must add linear gain. At speeds above 40 ips, you must appropriately extend the upper-corner frequencies by lowering the capacitor values of the various lag networks. And you must also modify the RC time constant in the integrator, as a function of the tape speed.

During read-only operations, you can safely use low-level noise-threshold voltages as low as 3%. This is due mainly to the improved peak detector circuit. And the added use of pulse-width discrimination following the detector eliminates high-frequency noise that exceeds this low threshold-level. Further, the improved detector lets this amplifier perform reliably with less expensive IBM-compatible read/write heads, because it can tolerate increased levels of write-to-read and read-to-read crosstalk.

INFORMATION RETRIEVAL:

Amplifiers, Digital design,
Data acquisition and processing

New GAF "A" film: better radiographs twice as fast.

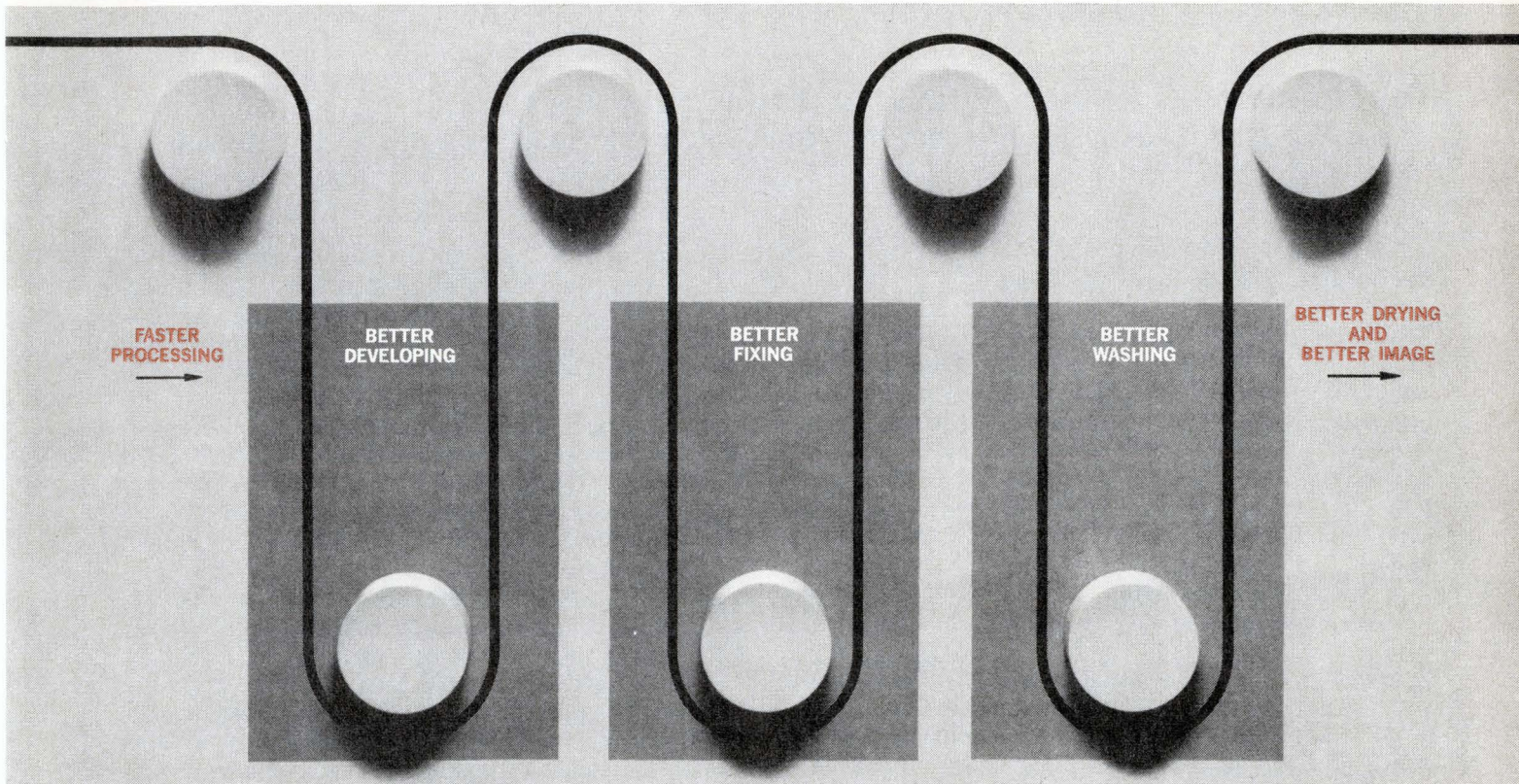

Introducing new GAF Industrial "A" Polyrapid™ X-Ray film on a tough polyester base. It's especially designed for short-cycle processing.

Circle 37 on Inquiry Card

Now you don't have to trade time for image quality. In fact, you can get better contrast and definition in your radiographs than you're getting now... in half the time.

How? With new GAF Industrial "A" Polyrapid™ X-Ray film. Tests show that our new film produces better, cleaner radiographic images on 5 to 6½ minute dry-to-dry processing cycles than any other Class II film. These tests further show that Industrial "A" Polyrapid film is equal to or better than any competitive film in sensitometric properties, and penetrameter sensitivity. What is more, our film has significant processing advantages over the other films in fixing, washing and drying, whether processed manually or in conventional automatic processing systems. These advantages were maintained over processing times vary-

ing from 5 to 13 minutes.

Suggestion: If you've been thinking about buying a second processor to beat the "waiting game," why not call in a GAF representative. He'll be glad to assist you to step up your present processor to double time or any time you choose and demonstrate the fast processing speed and superior radiographic properties of Industrial "A" Polyrapid film. If you're not satisfied, he'll set your processor back for you. Just fill in the coupon.



136-0450

GAF Corporation
Dept. 204-669 140 West 51 Street, New York, New York 10020

Gentlemen:
Convince me!

Please have a GAF representative call for an appointment to demonstrate the advantages of GAF Industrial "A" Polyrapid X-Ray film.

Please send me additional information on this film.

Name _____ Title _____
Company _____
Address _____
City _____ State _____ Zip _____



Torture tests improve equipment reliability

You can vibrate it, accelerate it, shock it, heat it, and chill it yourself, or you can send it out to be done, but the result will be the same—an improved product.

By Smedley B. Ruth, Associate Editor

The current testing philosophy is to simulate, as closely as possible, the environment which the equipment will see in actual use, or in transit. To perform this simulation you will need environmental test equipment. Since ordering and using this equipment is not always as easy as it may seem, particularly if you are new to the game, let's discuss some general guidelines you can follow when purchasing and using environmental test equipment:

- Study your needs before you call the manufacturer. At least know the characteristics of the equipment you will be testing.
- Plan several years ahead if possible. Don't purchase equipment that will meet today's need and then have to upgrade it to meet tomorrow's need.
- Know the vender. Make certain he is reputable. Visit his plant if possible.
- Don't overspecify. Don't ask for a lot of extras that you will seldom, if ever use. If you specify too much you may be tying the manufacturer's hand and raising the price unnecessarily.
- Make certain that you have a knowledgeable operator. Poorly run tests give poor results.
- Be sure that your test apparatus is accurate—have it checked periodically.
- Compare the costs of buying and testing with your own equipment or sending the items out to a commercial test lab. A general rule of thumb is that if you can amortize the cost of the equipment over 2-4 years you should buy. (But keep in mind the other considerations such as maintenance costs, convenience and so forth.)

Now, let's discuss the various types of tests and the equipment needed to perform them.

Vibration

Technically, the vehicle that does the vibration is called a vibration exciter, but it's generally referred to as a *vibrator*, *head*, *shaker*, or just plain *exciter*, and these terms are interchangeable.

The four main types of shakers are classified according to the source of vibration producing energy—electromechanical, electrohydraulic, mechanical, and pneumatic. Which type you select depends upon its intended use.

Electrohydraulic and electrodynamic (electromechanical) exciters are the ones most commonly used to test electronic equipment. However, electrodynamic types tend to be used for vibration tests while electrohydraulic shakers tend to be used for fatigue tests—although both can be performed on either shaker.

The electrohydraulic exciter is basically a simple hydraulic cylinder where the crucial element is a servo valve, which regulates the flow of pressurized fluid.

The electrodynamic system consists of basically three components: an oscillator, which acts as a signal source, an amplifier, and an exciter. A wide range of input signals (sinusoidal, complex, random, and tape recording) can be converted to mechanical vibration.

When do you use an electrodynamic and when an electrohydraulic shaker? For testing lightweight components at high frequencies, the electrodynamic type is best. For testing heavy components at low frequencies, on the other hand, you are probably going to want the electrohydraulic type. You will seldom see anything less

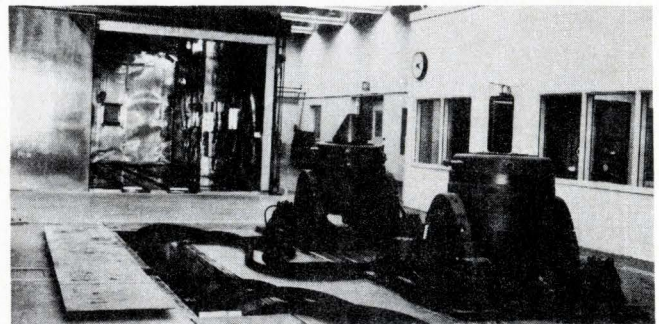

Large walk-in chambers such as this one at the U.S. Naval Weapons Development Lab in Forest Park, Ill. are one method of conducting combined environmental tests. The two vibration exciters can be used outside the chamber or can be tracked inside it for a combined test. The shakers can be used singly or simultaneously to give you more flexibility. (MB Electronics)

than a 100-lb payload on an electrohydraulic shaker because of the economics involved.

Where the breakpoint is depends on frequency, force levels, and so forth. Electrodynamic types have hf capability that electrohydraulic types don't have, and electrohydraulic types have a long stroke capability (probably 80% have 5-10 in. of stroke) that the electrodynamic (great majority are for only 1 in. of stroke) don't have. Fortunately, the requirements tend to go together. That is, in general, with heavy payloads you are mainly interested in the lower frequencies, and with light items you are mainly interested in the higher frequencies. You won't hurt a small electronic component with 5 Hz—it just doesn't react to it. And, there is no reason to put 1000 Hz to a large heavy console, because by the time the vibration gets a few inches off the base, it has been absorbed.

For most electronic applications, therefore, electrodynamic shakers will usually be specified. These range from a 25 force lb unit to a 35,000 force lb unit.

Force rating of the exciter doesn't change as the weight of the test specimen changes; rather, it is the amount of acceleration you can get that changes. The equation $F = Wg$ is used to calculate how much you can accelerate different loads. The force capability of the exciter is defined by $F = BIL$, a physical equation for an air gap where B = flux density of the air gap, I is the current through the conductor, and L is the length of the conductor in the gap. Thus the force capability depends upon the construction of the exciter and not upon the weight of the test specimen.

The equation $F = Wg$ tells you how much you can get out of the exciter for a given payload.

Take, for example, a 1200 force lb exciter. It can take a 102 lb payload to 10 g acceleration (the reason payload weight is not more is that you must also consider the weight of the moving element in the exciter). For a 20 g acceleration test, the 102-lb payload would have to be derated to about 42 lb. So you are limited by the 1200 force, which is the fixed factor. Weight and acceleration are the variables, but you can trade them off, one for the other; the higher the rate, the higher the acceleration and vice versa.

To get the system best suited to your requirements, you should be able to tell the manufacturer as much of the following as possible:

- type, size and weight of the package to be tested
- intended use in the actual environment
- acceleration level needed
- vibration levels that must be reproduced
- operating frequency range
- in which axis the motion is to be produced (horizontal, vertical, etc.)
- actuator stroke required
- number of exciters needed (it can be a single or a multi-head system)
- fixture weight
- how test is to be controlled (Will the input signal be sinusoidal, random or complex?)
- instrumentation required

Any background information or Mil Specs that you will be testing to would also be helpful.

Many people who purchase the smaller systems don't need a signal source—they probably already have one of their own (an oscillator) that can do the job. The

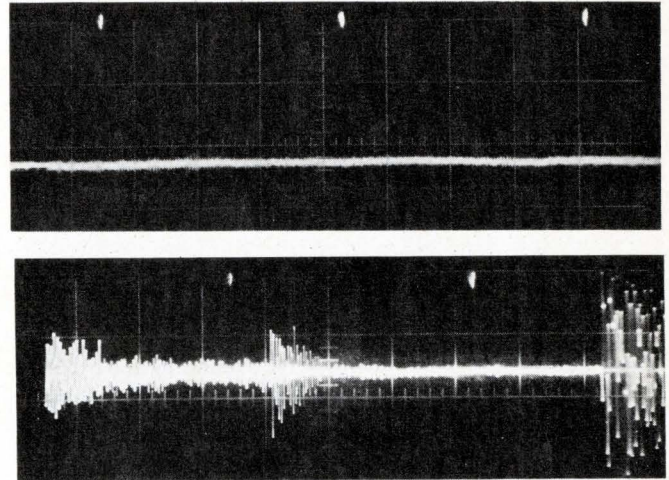

Besides their normal testing function, vibration exciters can be used to detect loose particles inside sealed electronic components. Scope trace (a) indicates no particles present, while trace (b) indicates particle noise, telling the operator that the sealed unit he is checking has loose particles bouncing around inside it. Sweep time for both traces is 1 ms/cm. Vertical deflection for trace (a) is 5 mV/cm while for trace (b) it is 50 mV/cm. (G.E. Space Systems Organization, Valley Forge, Pa.)

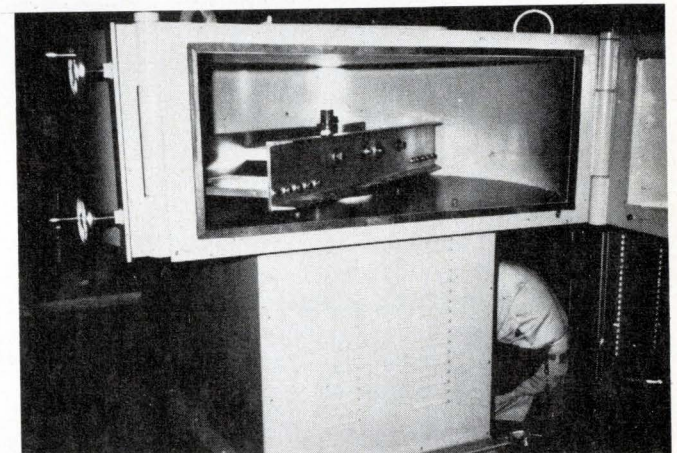

This rotary accelerator is rated at 10,000 g-pounds. Speed of the dc motor drive is controlled by tachometer generator feedback. Fifteen slip rings provide electrical connections between the rotating items being tested and the external instrumentation. Schaevitz Engineering's G-4-A centrifuge will handle a 12-in.³ test package.

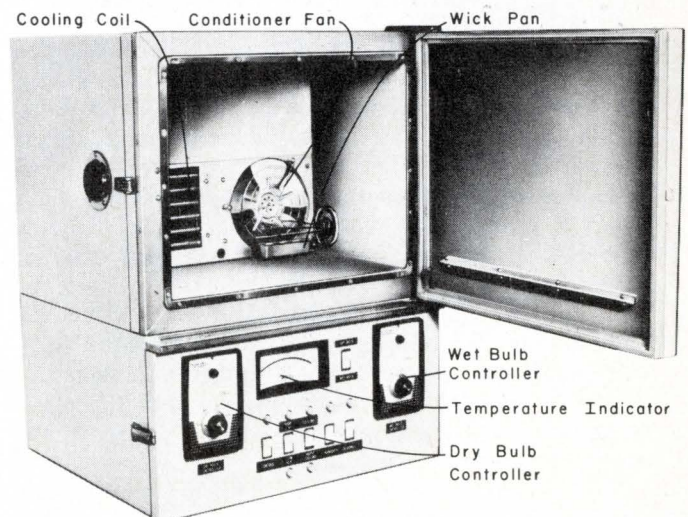

Small bench-top temperature-humidity chamber. (Tenney Engineering Inc.)

higher force rating exciters will also include a cooling package (amplifier output tubes are water-cooled and the exciter is usually either water- or oil-cooled). This will probably be included in the system price, but accelerometers and other instrumentation won't be included. Instrumentation is a subject that should definitely be discussed with the manufacturer. He is the one to advise you on what is needed and how it should be used.

Fixturing is a critical step in vibration testing. It's really an art because every test object requires its own peculiar fixture—it's almost a cut and try process. Without proper fixturing and instrumentation placement the test won't truly represent the specimen's performance under the specified environment. In placing the accelerometer you must know the purpose of the test and what you are trying to simulate—you then place the instrumentation at the points that will most closely duplicate it. Also, tests are repeatable only if they are performed in the same way with the same fixturing and drive source, and only if the instrumentation is placed at the same points.

Another factor you will have to discuss with the manufacturer is the possible need to isolate the exciter. Most exciters have some sort of built-in isolation system that is adequate, but occasionally you will need an auxiliary system.

You can upgrade your exciter to some extent as new amplifiers become available, but when you select a system, try to look ahead—what will your needs be next year, or five years from now?

Portions of a shaker such as suspension and other parts associated with the moving element will wear out. But, even with the larger shakers almost all such parts can be replaced in a day assuming they are "available."

And finally, you might consider using a multi-shaker setup. Systems with up to eight shakers have been built. The advantage is flexibility—you can apply the vibration in more than one place.

Acceleration

Acceleration tests are performed on components that will be subjected to this condition during their lifetime. But they also serve another function—to spot weak points in a component. For example, let's consider the effects acceleration might have on the IC. A potential weak spot is the gold bond on the lead. Acceleration checks the bonding procedures. If an IC is overbonded or underbonded, if the pressure applied on the bond is not exactly right, or if the loop that the lead has is too much or not enough, the stress put on it when accelerated will make it pull out.

Another point is that since the chip sits on a glass substrate, it has to be flat. If it isn't flat, you'll get a lever effect. The acceleration force will then crack it and you will actually destroy the chip.

Acceleration may also damage the glass-to-metal seal that exists on the package, if it is not a reliable seal. And finally, the external leads will have a tendency to pull away or break the seal they have with the glass. Temperature cycling or thermal shock does much the same, but to a lesser degree.

To simulate acceleration environments you need a rotary accelerator, which can take small components to levels over 250,000 g. The basic unit is a centrifuge that generally has a variable speed drive, operator controls,

a rotating arm for mounting test specimens, and slip rings for connecting power and instruments to the test objects.

You may often want to subject a test object to a controlled environment while it is being accelerated, since certain failures will occur under a combination of environments but not under one or the other alone. For such tests, you can either mount an environmental chamber at the end of the accelerator's rotating arm or enclose the entire centrifuge chamber with insulation and provide means for high and low temperature, vacuum, humidity, and so forth.

If you decide to buy a rotary accelerator, you should know the following before contacting a manufacturer.

- the amount of g ($1g = 32.2 \text{ ft/s}^2$ needed)
- physical dimensions (l, w, h) of the test package and fixture (6 in. cube, 8 in. cube, etc.)
- location of the package's center of gravity
- package weight
- how closely you want the acceleration controlled
- accessory equipment needed
- type of speed indication—tachometer (2% acc.) or counter (0.01% acc.)
- acceleration gradient
- speed regulation and acceleration accuracy needed

It's important to remember that acceleration is proportional to the distance from nominal radius. For example, if the g rating for a 2³ in. package at a 10 in. radius is 100, then at 9 in. it will be 90 and at 11 in. it will be 110 g (g gradient is then $\pm 10\%$). Thus, the farther out on the arm you have the package mounted, the higher the rating.

This could affect your test considerably. Let's say that you have a package that must be tested to 100 g at the center. Somewhere in that package is a component that is marginal at, say 110 g, and you have a 25% g gradient—giving you 125 g at the outside. If, when you mount the package, that component is on the outside (away from the center of the centrifuge), you will be subjecting it to 125 g and it may well fail. However, if you mount the package such that the component is on the inside (toward the center of the centrifuge), it will be subjected to only 75 g's and will not fail.

Many specs will state just how the package is to be oriented so you needn't be concerned, but if they don't, be careful. In general, the greater the g gradient, the cheaper the machine.

One way to eliminate g gradient entirely is to mount two smaller centrifuges on a larger one. If these satellite tables are locked to ground (or are motor-driven), you can have the main table going one way and the satellite tables going the opposite way at exactly the same speed. At any point on the satellite table you have the same acceleration. Thus, if a test requires that the test object have the same acceleration all across it (even if it were only an inch), you could use this setup. Another feature of the satellite setup is that you can apply sinusoidal changes in acceleration at very low frequencies. By controlling the satellites, you can make the sine wave anything you want.

Another factor is the center of gravity of the test object. The cg of the test object and the counterbalance (or another test object) must be dynamically balanced. Generally, in something like a centrifuge where the horizontal distance to each package is great and the cg's are

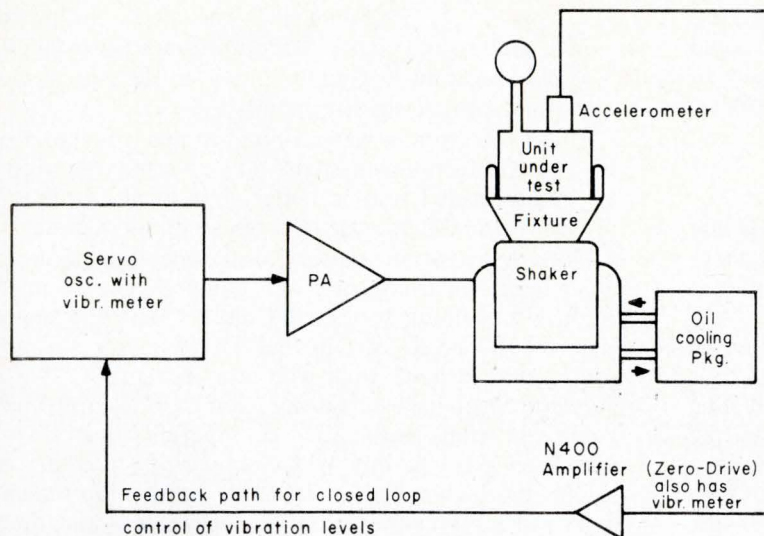

Typical setup for a vibration test. For sophisticated control you can insert a multi-level programmer, a highest/lowest selector or an averager in the feedback path. The N400 shown is part of a "Zero Drive" signal conditioning technique. It is a method of signal acquisition from high impedance transducers such as accelerometers, hydrophones, force gages and pressure cells. With it, you can drive long cables up to several miles in length. (MB Electronics.)

Selecting a vibration exciter.*

Basic physical formula (Newton's Law) is

$$F = ma$$

Related to vibration testing it is

$$F \text{ (in pounds force)} = (W \text{ wgt. in lb}) \times (\text{acceleration level in } g \text{ units})$$

or $F = W_T g$ where,

F = force rating of exciter

W_T = total dynamic wgt

$$= W_{ME} + W_F + W_S$$

↑ moving element wgt

↑ fixed wgt

↑ specimen wgt

g = acceleration level of test
(1 $g = 32.2 \text{ ft/s}^2$)

Let's take a hypothetical case:

Let specimen wgt = 175 lb

(say it's a guidance control) and

$g = 20$

The fixture designer requires 238 lb of aluminum to construct a suitable fixture.

Attachment bolts and hardware = 8 lb.

Problem: What size should the exciter be, or what is the proper system rating?

$$W_T = W_{ME} + 246 + 175$$

$$= W_{ME} + 421$$

$$F = (W_{ME} + 421) (20)$$

Since we now have two unknowns, let's

try a shaker rated @ 9000 lb ($W/ME = 40 \text{ lb}$)

$$9000 \gtrsim (461) (20)$$

$$9000 \gtrsim 9220$$

Since this doesn't work, let's try

a shaker rated at 17,500 lb ($W/ME = 100 \text{ lb}$)

$$17,500 \gtrsim (521) (20)$$

$$\gtrsim 10,420$$

This one is acceptable.

*Courtesy Bob Morse, MB Electronics.

Acceleration*

To order a centrifuge you must know the centrifugal capacity and acceleration gradient that you will need. Here's how to calculate them:

Centrifugal capacity = package wt. + fixture wt. × acceleration level.

For example, 200 lb. (pkg. wt. + fix. wt.) × 100 g (acceleration test level) = 20,000 g·lb.

Thus you would need a centrifuge with a capacity of at least 20,000 g·lb.

Acceleration gradient

If a gradient is specified, will greater acceleration load beyond the nominal radius adversely affect the chances of meeting the spec?

*Courtesy John Magdziak, Schaevitz Engineering.

Example: A $\pm 10\%$ g gradient is specified.

We know $g \propto \text{radius}$

$$R_{\text{nominal required}} = \frac{\frac{1}{2} \text{ pkg length}}{\text{decimal equivalent of specified } g \text{ gradient}}$$

Pkg. is 10 in long.

$$R_{\text{nominal required}} = \frac{\frac{1}{2} (10)}{0.1 \pm 10\% \text{ grad.}} = \frac{5}{0.1} = 50 \text{ in}$$

At 45 in. $g = 90$
At 55 in. $g = 110$ > $\pm 10\%$ gradient

The g gradient will then determine the approximate nominal radius.

close to the same plane, if they are in static balance, they will be in reasonable dynamic balance.

The center of gravity relative to the instrument base could also affect radius. Other conditions that could well affect radius are distance from mounting base to center of spindle, dihedral angle of the mounting base, variations in eccentricity, and temperature.

Temperature-humidity-altitude

One of the main problems with these chambers is that users tend to overspecify. It's easy to do because there are so many types and combinations available, but it can be avoided.

Let's take a typical example of what happens when an engineer overspecifies. If he has a Mil Spec that calls for testing to -65°F , he will specify -100°F feeling that it will guarantee that he will get -65°F . What he doesn't realize is that reputable manufacturers take a safety factor and bottom it out to -110° or -115°F . Thus, the safety factors have been compounded—the fellow that wrote the spec took one and the customer took one, and the manufacturer also took one to compensate for wear factors and so forth. The manufacturer suggests taking the worst condition you'll find in your Mil Specs, and this should be sufficient.

This is particularly true with the lower temperatures. Cooling costs money (compressors, coils, refrigerants, instruments, and maintenance), while heat is relatively inexpensive. Even with heat, however, overspecifying can be costly—there is a breakpoint in cost.

Heater elements are cheap—up to about 300°C , but above that you start to complicate chamber construction. Your common gasket materials such as neoprene don't work much above 300°F . Another problem is that you have to use the more exotic sealing materials—silicone rubber, Teflon and so forth. The refrigeration coils also present a problem (most chambers combine high and low temperatures). Copper above about 400°F begins to oxidize, so you may need stainless steel coils, and SS is expensive.

Let's consider some of the factors you must consider before you decide on a chamber:

- Do you need combination or separate chambers?
- How high do you want to go in temperature and how quickly do you want to get there from ambient?
- How cold do you want to go in temperature and how quickly do you want to get there from ambient?
- What control tolerance do you need? (Not more than you need—it's costly.)
- What is your specimen? Does it radiate heat, and if so, how much? (When you have a test package that is operating while in the chamber, remember that it will generate heat. If you don't take this into consideration, you'll soon find that the chamber isn't operating up to capacity.)
- What is the size and weight of the specimen and how is it going to be distributed in the chamber? (Rule of thumb is that a test specimen must not occupy more than 50% of the chamber volume. However, it's best if it doesn't occupy more than 25%.)
- What is the rate of heatup and rate of pulldown?
- What humidity range do you want and over what

range do you want to control?

- What power is available—single or three-phase? This is very important as it can affect the instrumentation and control circuitry to a great extent.
- Do you want a window and if so do you want a wiper (for a humidity chamber)?
- Do you want a water or air-cooled condenser in the refrigeration system? (For very large rigs a water-cooled unit is better, but local regulations may prohibit the use of large amounts of water.)

Note that instrumentation wasn't mentioned above. As in other environmental test equipment, instrumentation is something you should discuss with the manufacturer. But, make certain that what you get will give you a true idea of what you are measuring. If you purchase cheap instrumentation, you'll get cheap results.

Do you want combination or separate chambers? It sometimes pays to buy two chambers instead of one combination chamber—that is, if your requirements don't call for a combination. It doesn't cost that much more to buy two and it increases your flexibility. For example, humidity is typically a long run test, possibly weeks or a month, and while it is running, it is tying up the chamber.

If you have a temperature-altitude chamber and operate it at high or low temperature, you have to derate it as you go to higher altitudes—the gradients get very high because there is no longer any air to pump around. You can minimize these effects somewhat with a two-speed fan, or maybe even with an infinitely variable fan that you can run very fast at high altitudes to minimize the gradient. Or, possibly you can request an air-operated switch that will cut the heaters back at high altitude and can even cut them off above 100,000 ft. You may run into a similar problem with refrigeration—you begin to get blackbody radiation from the coils, although not below 50,000 ft.

Specifying very rapid pulldown rate can be costly. It means that you are specifying a big compressor and coil—in other words a big refrigeration system, which doesn't give you a lower temperature capability. Some people order a chamber with very low temperature capability because they want to pull down very fast from ambient to zero, but this doesn't hold true. A single stage made to do the job will pull down a lot faster than a cascade system made to keep going down. What they should have ordered was a chamber that will pull down from ambient to zero in, say, 10 minutes, and then let the manufacturer decide how to do it.

The advantage of a cascade system is that it can go to a lower temperature (increases the temperature range). It's common to go down to -40°F with a single stage, down to -120°F and even lower with a cascaded system. Three-stage cascade systems have gone to -200°F and below in the lab, I'm told. Most electronic testing is not below -100°F .

The mechanical refrigeration system is the most common, but you may want to use CO_2 or LN_2 systems to get to a lower temperature very quickly. They are also useful if you need cold for only a short time or if you test only occasionally, but they aren't economical for prolonged use. They can be used to supplement mechanical refrigeration too. Thus, to get down to temperature fast you can inject CO_2 or LN_2 to help reach the desired temperature and then shut them off.

Do you really need that window? They are nice to have but you probably don't need to see what is happening (your instrumentation will tell you). Glass viewing ports are a potential source of air and heat leakage, and glass is transparent to radiant heat. (This brings up another point—make certain that your heat sensing element is never optically exposed to the heating element—it will pick up radiant heat.)

One last point. It's a good idea to make a thermal survey of the equipment when you receive it. Set up a dummy load or simulated test specimen in the chamber. Then try various heating and cooling powers to determine heat-up and pull-down rates as well as required holding power. The data you obtain will help you to set your controls for later tests.

Thermal shock

Thermal shock chambers allow you to test the effect that sudden, severe temperature changes will have on components. Generally, the thermal shock is created by transferring the test specimen between a hot and cold chamber, but it is occasionally done by heating and cooling the item in one chamber. The transfer between chambers can be automated. The top chamber is heated and the bottom one is cooled.

Another type of chamber has three compartments. Here, a third or ambient-temperature, station is placed between the other two chambers so that the test item can be exposed to an ambient temperature for a specified length of time during the transfer between hot and cold stations.

Each chamber automatically seals tightly after the basket carrying the test specimen enters or leaves. Transfer is usually via a pneumatically operated "dumb waiter".

Shock

With shock machines you can accurately reproduce shock parameters found in the equipments' actual use. It may require specially designed setups but you can duplicate the exact pulse shape, acceleration, and duration needed.

However, the most common pulses called for are $\frac{1}{2}$ sine, sawtooth, and square wave. Various shaping devices are used to obtain these pulses. For example, to get the $\frac{1}{2}$ sine pulse, drop an anvil on a rubber pad of known thickness and hardness. To duplicate the sawtooth drop the anvil on a conically-shaped lead pellet or use a hydraulic self-recovering programmer. Varying the pellet's form factor will enable you to obtain various pulse amplitudes and widths. The lead pellets, which are expendable, can be made in molds by the user.

The three most common types of shock machines used are—pendulum, pneumatic and drop or gravity types. The latter two are frequently used for testing smaller items while the pendulum machine is generally used to produce very large and powerful pulses.

The pneumatic, or compressed air operated, machines have capacities in the hundreds or thousands of pounds, and need much less drop height than is needed by the gravity machines.

Gravity machines, which have load capacities into the hundreds of pounds, have carriages that are raised to a pre-selected height and then fall on a decelerating device chosen to produce a shock pulse of specific wave

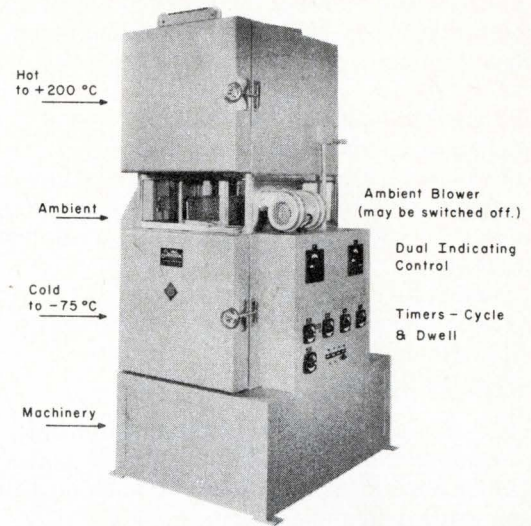

Thermal shock chamber. The load passes from hot, to ambient, to cold, or vice versa. The basket may be stopped at ambient and both chambers used as steady state chambers. Refrigeration may be mechanical (air or water cooled) or LN_2 or CO_2 . (Standard Cabinet Co.)

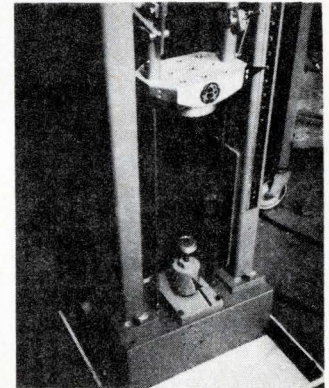
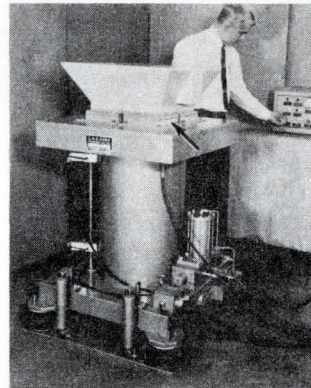

Two types of shock machines are shown here. The manually-operated drop type at the left can be used for loads up to 4 pounds. Note the liquid spring decelerator for $\frac{1}{2}$ sine waveform (arrow). The pneumatic model on the right takes loads up to 2000 pounds. Carriage is shown on elastomer $\frac{1}{2}$ sine pads (arrow). It has automatic recycling or single pulse operation. (L.A.B. Corp.)

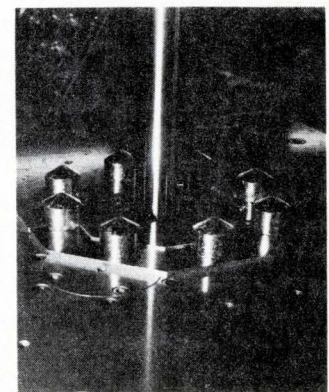
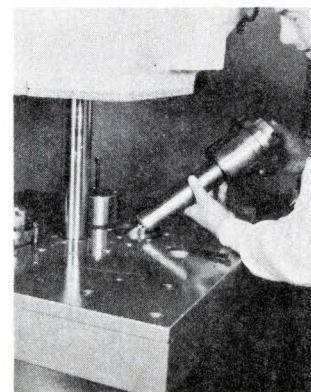

Various methods of obtaining pulses: (a) Installing hydraulic sawtooth programmers. This type is self recovering and re-useable. (b) Lead cones in place for terminal peak sawtooth pulse. Pellets deform and must be replaced after each shock. Carriage is in the "up" position ready to be driven down onto the pad. (L.A.B. Corp.)

shape, acceleration, and duration. They can be recycled automatically or operated for single shock pulses.

Before you contact the manufacturer, you'll want to know:

- size and weight of your load
- height of cg above mounting surface
- percentage of load supported on shock mounts
- direction in which shock pulse must be produced
- axes of specimen through which shock must be applied
- shock pulse characteristics (waveshape, peak acceleration, pulse duration, load, and drop height)
- applicable specs
- repeatability desired

You should also advise the manufacturer of any possible installation problems such as ceiling clearance, whether or not shocks must be isolated from the building, and construction of the floor.

You can use the following formulas to find the free fall distance or velocity needed to produce a given shock pulse.

For $\frac{1}{2}$ sine pulses

$$S = 19.6 g^2 t^2$$

$$V = 123 gt$$

For terminal peak sawtooth

$$S = 48.3 g^2 t^2$$

$$V = 192 ft$$

Square wave (non rebound)

$$S = 192 g^2 t^2$$

$$V = 386 gt$$

where

S = Equivalent free fall height in in.

V = Velocity at impact in in./s

g = Peak pulse acceleration in multiples of acceleration due to gravity.

t = Time in seconds.

Where S is known and you must find velocity use:

$$V = \sqrt{2gS}$$

To do it yourself or to send it out . . . ?

The commercial test lab will help you to prepare technical proposals or detailed test procedures. They will perform all phases of your test programs, including simulation and measurement of environmental conditions and measurement of equipment performance parameters. They will supply you with detailed test reports and analysis of results.

These labs can be particularly valuable to those of you who have never done any environmental testing, and to the occasional tester. All you need to know is the spec and the paragraph number that you must test to. However, if you plan to use a commercial lab it will pay to contact them before you bid on a contract so that they can suggest methods whereby the test program can be made easier and less expensive.

If you can't contact them before you make your bid, they suggest that you let them write the test procedure for complex programs because they know their equipment and it will make the program go much smoother. They would, of course, test to your spec.

Occasionally they will have the test equipment needed, but not the instrumentation. Here they will conduct the test and the customer will operate the instruments and equipment.

If you are considering setting up your own environmental test lab you might call one of the commercial labs and ask to see their facility—they tell me they would be glad to discuss it with you. Why the beneficent attitude? Because they feel that even if you set up your own lab you will always have overflow or scheduling problems, and hence you will come to them.

Even companies with good in-house capabilities go out to test labs on occasion for several reasons. One, is that they may have to schedule a test on fairly short notice and their own lab is "booked solid". Although the commercial labs would like at least two or three days notice, they can often handle a request immediately. (Some tests require more notice.) It's interesting to note that when they have a slack period, many of these company labs will "go commercial" and perform tests for others—it helps pay the overhead.

And another advantage to the commercial lab is the "third man theme". A report from an independent testing lab has much more impact on a prospective customer than does an in-house report, since the independent lab is unbiased and has no axe to grind.

On the "con" side

There are four common reasons given for not using a test lab—cost, availability, convenience and control.

Cost can be fairly high for certain tests, but you pay for what you get—experience, wear and tear on equipment, and so forth. Also, even though the basic test may be inexpensive, the related equipment (recorders, instrumentation) you insist must be used, will run up the cost.

Availability may be a valid reason for not using the commercial lab if your company has a large enough facility and enough equipment to insure that it won't become overloaded. Keep in mind that whereas your lab may have, say, one or two chambers or exciters, the commercial lab may have tens or hundreds of them.

Convenience could also be a valid reason—it's easier to carry your equipment down the hall than it is to ship it off to a lab. However, convenience is contingent upon availability.

The final reason is *control*, but if this is a concern you can always send an engineer to the commercial lab to monitor the tests.

Maintenance: What the users say

Maintenance of any equipment is very important, and this is particularly true of equipment that uses pumps, refrigeration lines and so forth. Without proper preventive maintenance and careful servicing the equipment would see little use. And this points out a serious complaint I have heard from users; that chambers and other equipment are not designed for service—that parts which must be serviced are difficult if not impossible to reach.

For example, I've heard of cases where a part that required periodic servicing was positioned behind a structural member. Since this member was welded in place, the manufacturer had to send workmen to the customer's plant to modify the equipment.

The point here is that service should be a serious consideration. If possible, check the equipment before it

leaves the manufacturer's plant. If this isn't possible, then do a thorough checkout or dry run in your plant before putting the unit in operation.

Even the manufacturers will admit that equipment, and especially chambers, are sometimes a "little" difficult to service. But they argue that a great deal of plumbing and controls must, of necessity, be placed in a chamber, and that they try to make these accessible. Also, many of these chambers are either custom or standard units that have been "customized" so there is always the possibility that the manufacturer has made a mistake. However, if he knows his business and is reputable, he will be happy to rectify the error.

Thus, the old cliché "choose a reputable supplier" is particularly appropriate when choosing environmental test equipment. Make certain that he is knowledgeable and has experience in the field. He doesn't necessarily have to be a large manufacturer (there are many relatively small ones in this field), but he should be experienced. A look at his plant will help—see how he operates.

Some users claim that their equipment is down or inoperative 50% of the time. This figure includes both periodic maintenance time and time down due to breakdowns.

What the makers say

To be fair to the manufacturers we must give them "equal time." They say that some users are careless about their maintenance programs, and when the unit fails, they wonder why. Those who have a regular program of preventive maintenance have little trouble with the equipment. The majority of breakdowns are due to neglect or misuse.

Users take a chamber and place it in a confined space where the condenser (which is air cooled) doesn't receive any fresh air—then they wonder why it fails or why its efficiency is affected. They also let dust and dirt accumulate around the condenser coil, which affects efficiency.

Lightweight power lines or extension cords are other sources of inefficiency. Also, customers will operate a combination chamber at a low temperature, shut it down for the night, and then the next morning wonder why there is condensation present. With a little forethought they would have heated the chamber to at least room temperature before shutdown, preventing this condition.

Another point—don't expect to get an instruction manual with a chamber comparable to that of electronic equipment. Most are really inadequate because there are few standard units. Even many of the off-the-shelf units are very different because of the many options.

Ingenuity sometimes pays off

Another point raised by users is that they can't always get equipment that will meet their requirements, or that it is sometimes too costly. Some have solved it by improvising and/or building their own units. Some are very professional and some are disasters.

I know of one enterprising company where packages were tested for contaminants in a fish tank. And some attempt to use a deep freeze to perform their temperature tests. I've also seen a bell jar placed in an in-

expensive temperature chamber to simulate a temperature altitude test; and the product qualified. Rotary accelerators and shock machines are other "home brews" I have seen. But even the people who have made them don't usually recommend them, particularly if you are not very experienced. Some tests with these units are useful in design and to the maker as self-proof that his design works, but they can't be used for qualification testing.

Another factor to consider when building the equipment yourself is "How much will it cost to properly instrument the unit?" This can be a significant amount.

Acknowledgements

I'd like to thank those people who took time from their busy schedules to see me. I'd particularly like to thank Thomas Freedom, AMP Incorporated; John Latour and Richard Hassett, Associated Testing Laboratories; H. L. Banton, Richard Sipple, and Bruce Thompson, EMR Div. of Weston Instruments; Michael Maher, General Testing Laboratories; Fred Mohr and Jack Dennis, Harowe Servo Controls, Inc.; Robert Morse and John Zamparo, MB Electronics; John Magdziak, Schaevitz Engineering; Robert Norton, Standard Cabinet Co.; George Butler, Jim Quigley, and Al Silverman, Tele-Dynamics Div. of AMBAC Industries Inc.; and Conrad Miller, Tenney Engineering.

INFORMATION RETRIEVAL
Instruments and measurements, reliability

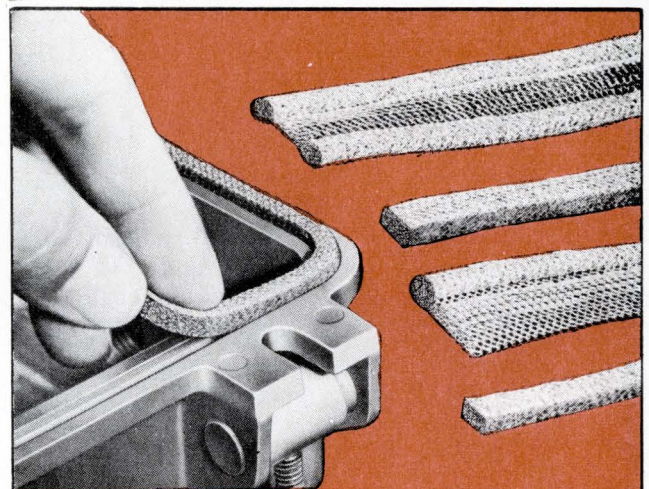

EMI/RFI SHIELDING GASKET CONDUCTIVE/RESILIENT STRIP

TECKNIT STRIP ■ Total Shielding Effectiveness up to 120 dB ■ Available in Tin Coated Copper Clad Steel, Monel, Aluminum, Silver Plated Brass ■ Variety of cross sections: square, round, rectangular, single fin, double core ■ Write for data #200, and FREE sample.

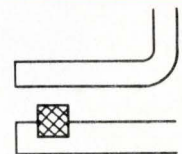

Easy groove mounting method shields flange to cover.



TECKNIT® TECHNICAL WIRE PRODUCTS, INC.

East Division • 129 Dermody St., Cranford, N. J. 07016 (201) 272-5500
West Division • 427 Olive St., Santa Barbara, Calif. 93101 (805) 963-1867

**What this country
needs is a good
nickel cigar...
and a $\frac{3}{8}$ square
industrial
cermet
trimmer.**

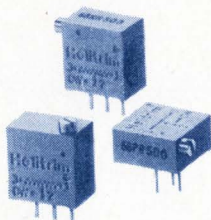

★
Helipot has the trimmer for \$3.50 list...
now available in local stock.

(But you'll have to find the cigar.)

Beckman®

INSTRUMENTS, INC.

HELIPOT DIVISION

FULLERTON, CALIFORNIA • 92634

INTERNATIONAL SUBSIDIARIES: AMSTERDAM; CAPE TOWN; GENEVA; GLENROTHES,
SCOTLAND; LONDON; MEXICO CITY; MUNICH; PARIS; STOCKHOLM; TOKYO; VIENNA

Fault monitor checks for circulating logic bit	920
Shape pulses for RTL circuit use	921
Counter counts to find faults	922

Vote for the one you like best.

Write the number of the Idea you like best in the box on the Inquiry Card, and send to us.

Send us practical, reproducible ideas that are original with you and have been implemented with linear or digital ICs.

- If we publish your idea you win a check for \$25.00.
- If our readers vote yours the best of the issue in which it appears, you have your choice of a Simpson 270 or a Triplet 600 multimeter.
- After 12 issues our readers will vote on the best

idea for all 12 issues. The winner gets his choice of either a Hewlett-Packard 1206A or a Tektronix 310A oscilloscope.

Submit your IC Ideas to:
Alberto Socolovsky
Editor
THE ELECTRONIC ENGINEER
Chestnut & 56th Sts.
Philadelphia, Pa. 19139

Here's how you voted

The winning Idea for the January 1969 issue is, "Digital filter replaces bulky components."

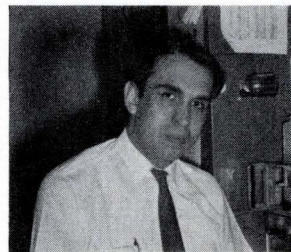

Mario Humberto Acuña, our prizewinning author, is a Supervisor in the Engineering Research and Development section of Fairchild Hiller, in Riverdale, Md. Mr. Acuña chose the Simpson 270 tester.

920 Fault monitor checks for circulating logic bit

Robert Serody
Raytheon, Bedford, Mass.

This circuit monitors the operation of a ring counter to determine that only one bit is circulating. When this condition does not occur, the monitor sends a reset pulse to correct the counter and register a fault condition.

Previously, you had to use separate test/monitoring circuits to sense the presence of the circulating logic bit. A typical way would be to sum every state of the counter with a summing amplifier, and compare that output with two comparators that define the acceptable voltage range. If the counter states fall outside this range, the monitor resets the counter. Such a method needs a circuit with precision components, usually mounted on a separate module, with several power supplies necessary to operate it.

The new ring counter/fault monitor combines the counter and monitor into one circuit that checks periodically for proper operation. This is possible because the monitor checks for the presence of only one state of the ring counter.

As an example, consider the 3-state counter/monitor shown here. A NAND gate, HY-1, monitors the first state. (One input to HY-1 is a Q output; the other inputs are \bar{Q} .) The absence of this state shows that either all outputs of the counter are 0, or that more than one logic 1 is circulating. In either case, the output of HY-1 stays HIGH, and C_1 charges to the supply voltage via HY-2's pull-up resistor.

When the voltage across C_1

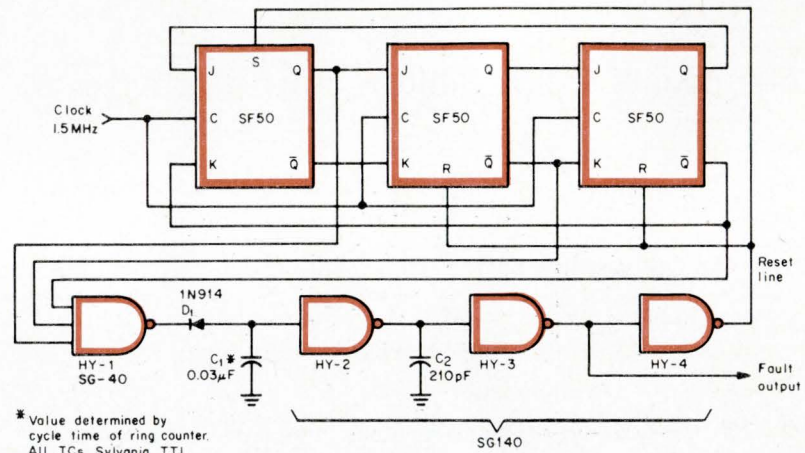

* Value determined by cycle time of ring counter. All ICs Sylvania TTL.

reaches the logic threshold level, HY-2 sends a logic 0 through HY-3 and HY-4 to reset the counter. This, in turn, forces HY-1's output to drop to a 0 and discharge C_1 through D_1 . The input to HY-2 thus drops below threshold, removing the reset pulse.

A time lag set by C_2 ensures that the reset pulse does not disappear before the flip-flops can reset. Gates HY-3 and HY-4 decrease the transition times of the reset pulse. Diode D_1 isolates C_1 from HY-1 during the recharge interval.

The circuit doesn't need precision components because the time constant set by C_1 and the pull-up resistor in HY-2 need be only long enough to prevent C_1 from reaching the threshold voltage between discharge times. The time between

each discharge is the period of the ring counter. The fault monitor will reset the counter at turn-on, or when any extra bits are generated by noise spikes, or when the counter becomes defective.

You can use the monitor in a timing system by connecting the fault output of HY-3 to a register which is reset periodically. Connecting the register to trigger an alarm warns you if too many faults occur in a given time.

The ring counter may have any number of states. But the fault monitor always retains its basic simplicity of design because it need monitor only one of the states. In general, you can use the monitor to check the operation of many other circuits which involve a change of state in their operation.

921 Shape pulses for RTL circuit use

Charles Erwin Cohn
Argonne National Laboratory,
Argonne, Ill.

This circuit accepts either positive or negative pulses with amplitudes of 1 V or more, and shapes them to a form suitable for use with RTL logic.

In the quiescent state, the 2N-3904 transistor is OFF, and the inverter following it is ON. But when a pulse appears, the transistor receives base drive and starts to conduct. As the inverter comes out of saturation, the transistor receives more drive. Such regenerative action rapidly turns the transistor ON and the inverter OFF. When the input pulse terminates the inverse action occurs.

The output has sharp transi-

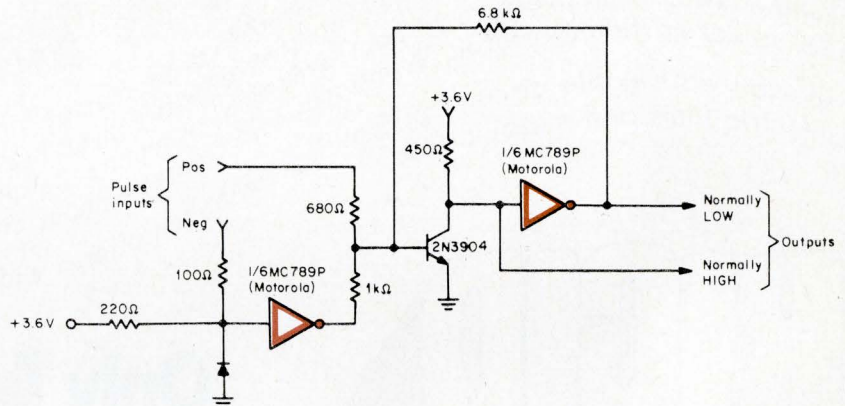

tions even if the input pulse has very long rise and fall times be-

cause of hysteresis in the regenerative loop.

922 Counter counts to find faults

J. J. Hoefler
Bendix, Kansas City, Mo.

Suppose you must monitor a large number of remotely-located, low impedance loads connected in parallel (a bank of squib switches, for example). For such situations, this circuit tells you if a load is open-circuited, and if so, which one.

The circuit uses a 6.3-V filament transformer at each load station. The low-voltage winding, wired in series with the load, applies an oscillator signal to the load during test. Thus, the presence of ac in the transformer secondary shows that the load is not open-circuited.

After detection, the signal from the secondary is applied to one input of the first gate. Now, if there is also an output at point A from the preceding stage, the first gate

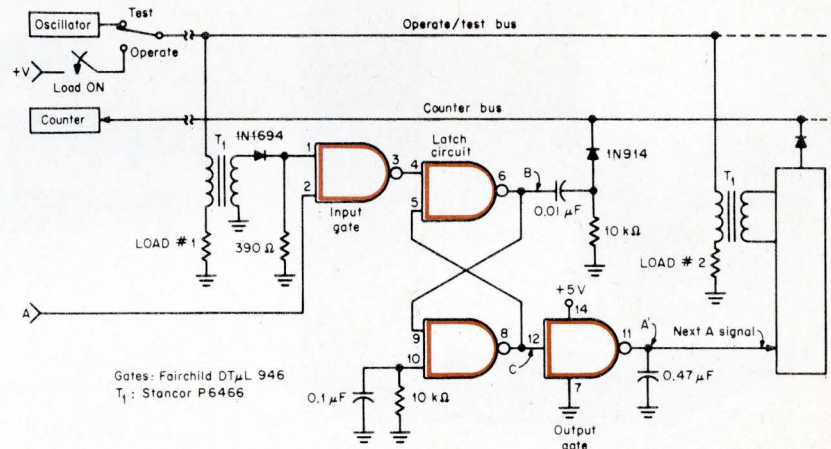

sets the latch circuit output (point B) to a 1 state, putting a pulse on the counter bus.

The other side of the latch circuit (point C) drives the output gate. A 0.47-μF capacitor delays

this signal (A'), and thus determines the pulse separation time.

The counter runs until it detects the first open load (a missing pulse), or until it counts all the loads.

FLEXIBLE

Taylor is your only source for Riegel Monotherm® copper clad polyimide film. It offers unmatched reliability and ease of fabrication. Basic properties of the film and a high temperature thermoset adhesive permit the use of high pressure without "swimming" or rupture. Retains dimensional stability and resists normal soldering temperatures. Withstands 180° creases without cracking or separating.

For specialized flexible circuit applications, Taylor can offer a wide range of dielectric films and metallic foils.

RIGID

Taylorclad FIREBAN 1011E is a premium glass-epoxy copper clad for critical circuit needs. It combines all of the basic properties of NEMA G-10, G-11, FR-4, and FR-5 grades. Heat resistant, flame retardant, it meets MIL-P-13949 and takes precision drilling, punching and shearing.

Taylor also has three other glass epoxy grades of copper clad, plus Teflon glass to meet your circuit needs.

Only Taylor offers total service for all your copper clad needs

All Taylor copper clad laminates are trouble-free for faster, easier processing.

Help you meet MIL-P-55110.

Write for data, prices and samples.

ULTRATHIN

Composites of copper foil glass epoxy laminates that save space and weight. Thicknesses range from .003 through .031 inches. GEC 550 meets NEMA G-10. FIREBAN 650 is flame retardant—meets NEMA FR-4. Both can be readily processed with standard equipment and solutions.

Taylor's controlled flow prepreg systems have low gel time—30-second range—resulting in minimal circuit displacement during the pressing cycle.



synthane·taylor

Valley Forge, Pa. 19481 (215) 666-0300
An Alco Standard Co.



Feature article abstracts

Published information is vital to your job.

To save time in finding this information,
we have abstracted the important technical features
from eight electronic engineering publications.

Should any of these articles interest you, contact the magazine—
names and addresses are listed below.

Reprints of articles with an asterisk are available free.

Save this section for future reference.

Amplifiers

Digital data: play it like it is, Frank C. Marino, Digitronics, "The Electronic Engineer," Vol. 28, No. 6, June 1969, pp. 74-78. Data processing by computer is not limited to scientific or military uses; it is already part of our personal activities (monthly bank statements, charge account billings, and so forth). How is more and more data handled with fewer and fewer errors? By constant improvement of each element in the processing chain. One such element is the "play-back amplifiers," in which the raw digital information is shaped to perform electronic functions. This article tells of an improvement in the signal-shaping mechanism of such an amplifier, one that further reduces the possibility of error in the digital data stream.

Stabilize your op amp experimentally, Karl Huehne, Motorola Semiconductor, "Electronic Design," Vol. 17, No. 9, April 26, 1969, pp. 50-56. A quick way to calculate the correct values for amplifier compensation capacitors is described. This method uses five simple scope measurements taken under actual operating conditions.

***Operational amplifier charts**, Staff Report, "The Electronic Engineer," Vol. 28, No. 6, June 1969, pp. 61-71. Manufacturers of both monolithic and hybrid operational amplifiers offer a complete line of products at prices that make it uneconomical for most designers to calculate and build their own op amps. To simplify the reader's job, the Electronic Engineer has classified 200 commercial operational amplifiers (split about evenly between monolithic and hybrids) by their six most important parameters, one of them being the all-important price. This group of five charts, published for the first time, will constitute the most useful specifying reference that the user has ever had available to him.

High-frequency characteristics of wide-band inverter op-amps, Heinrich Krabbe, Zeltex, "EEE," Vol. 17, No. 4, April 1969, pp. 74-78. Both theoretically and graphically, the author explains the significance of, and how to calculate and how to improve frequency response, settling time, slew rate, and loop gain.

Circuit Design

Specify your trap filter the easy way, Jerome H. Howitz, Bunker-Ramo, "Electronic Design," Vol. 17, No. 9, April 26, 1969, pp. 58-64. Computer tables are provided for quickly establishing the Q, notch depth, and group delay of trap filters once the desired attenuation and center frequency are specified.

Cut differential-amplifier design time, Sidney A. Friedman, Cardion Electronics, "Electronic Design," Vol. 17, No. 10, May 10, 1969, pp. 114-117. Reference tables of equations are given that enable differential-amplifiers to be designed quickly if they fall into one of several commonly used configurations.

Active filters: part 9, Applying nonlinear elements, Velio A. Marsocci, State Univ. of New York, "Electronics," Vol. 42, No. 8, April 14, 1969, pp. 116-121. Hall-effect and magnetoresistive devices can solve problems where high temperatures or radiation effect normal semiconductors or ICs. These two types of devices will do as good a job as linear amplifiers in converters or gyrators.

Design and match rf amplifiers, Gunnar Richwell, Reflectone Electronics, "Electronic Design," Vol. 17, No. 10, May 10, 1969, pp. 106-111. Two Quktran programs are provided for device analysis and matching network selection. Inputs to the first are the stability factor and y-parameters of a two port device. The outputs are admittances, transducer and unilateralized gain, stability, sensitivity and input and output impedances. The second program uses source and load impedances, frequency, and Q to determine the components of 28 possible matching networks.

Communications

Frequency-spectrum dilemma—crisis or opportunity? James E. Kluge, Sr. Ed., "EDN," Vol. 14, No. 9, May 1, 1969, pp. 33-45. Radio spectrum congestion is very bad between 25 and 890 MHz. FM and TV bands occupy 60% of this region, and land-mobile services (railroads, utilities, police and fire departments, etc.) less than 5%. Crowding of the land-mobile services spectrum already endangers public safety. A similar congestion is building in the microwave spectrum, where data and video transmissions are increasing. Sharing parts of the uhf-TV band with the land-mobile services, and extending the useable spectrum to the millimeter and optical ranges seem to be possible solutions. A detailed analysis of the land-mobile services problem, **Something's got to give**, by Wm. H. Detweiler of Radio Specialists Co., pp. 46-52, immediately follows Mr. Kluge's article.

Design bias circuits with nomographs, M. G. Golden, 3M Research Center, "Electronic Design," Vol. 17, No. 9, April 26, 1969, pp. 66-71. A series of nomographs is provided for rapid design of transistor bias circuits once the operating point is defined in terms of V_{CE} and I_B .

Magazine publishers and their addresses

EDN

Cahners Publishing Company
3375 S. Bannock Street
Englewood, Colo. 80110

EEE

Mactier Publishing Co.
820 Second Avenue
New York, N. Y. 10017

Electronic Design

Hayden Publishing Co.
850 Third Avenue
New York, N. Y. 10022

Electronic Products

United Technical Publications
645 Stewart Avenue
Garden City, N. Y. 11530

Electronics

McGraw-Hill, Inc.
330 W. 42nd Street
New York, N. Y. 10036

Electro-Technology

Industrial Research Inc.
Industrial Research Bldg.
Beverly Shores, Ind. 46301

IEEE Spectrum

Institute of Electrical & Electronics Engineers
345 East 47th Street
New York, N. Y. 10017

The Electronic Engineer

Chilton Company
56th & Chestnut Streets
Philadelphia, Pa. 19139

Reprints available free. Request them on your company letterhead.

Data communication: The medium and the message. Michael J. Riezenman, Technical Editor, "Electronic Design," Vol. 17, No. 9, April 26, 1969, pp. C3-C21. This is a three-part article on digital transmission. Part 1 advances the theory that digital transmission is the best choice for sending analog or digital information in the future. Part 2 compares analog and digital data transmission, concluding in favor of digital. Part 3 outlines the problems of sending the desired digital form over existing systems originally developed for analog transmission.

Components

Picking and working with a hybrid job shop. Jon Van Hise, Bell & Howell, "Electronic Products," Vol. 11, No. 13, April 1969, pp. 12-16, 170-175. This guide will help you to decide whether or not to use the custom hybrid approach in your circuit construction. Prime factors in such a decision are quality, size, cost, and reliability. Should you decide on a custom hybrid, the article also tells you how to select a job shop.

Digital panel meters. Bill Segallis, Western Ed., "Electronic Products," Vol. 11, No. 13, April 1969, pp. 60-75. More than a hundred models of DPMs are now available, proving their wide acceptance in spite of their price. The article describes DPMs in general, and gives pointers on picking one to satisfy your needs. There is a two-page buying guide.

Computers and Peripherals

Sonic film unit is a sound bet. Rabah Shahbender, RCA, "Electronics," Vol. 42, No. 8, April 14, 1969, pp. 90-94. The sonic film memory operates with strain waves moving along a substrate and interacting with magnetic films on the substrate. This memory, which is still experimental, features a non-destructive readout, is non-volatile, and has no mechanical linkages.

Digital Design

Applying off-the-shelf MOS logic to digital systems. J. J. Kubinec, National Semiconductor, "Electronic Products," Vol. 11, No. 13, April 1969, pp. 44-51. The author writes that mating MOS and bipolar IC technologies makes sense, if you use the bipolar for fast logic and the MOS for memories. He shows you how to economically interface MOS and bipolar circuitry, how MOS logic eliminates interfaces, and the advantages of MOS circuits.

The crystal resonator—a digital transducer. Donald L. Hammond and Albert Benjaminson, Hewlett-Packard Labs, "IEEE Spectrum," Vol. 6, No. 4, April 1969, pp. 53-58. Temperature and pressure transducers are not digital devices in the purest sense. However, these devices, using quartz-crystal sensors, can convert information from analog physical parameters into the analog parameter of frequency, which in turn is measured by the techniques of digital counters.

Integrated Circuits

Jack-of-all-trades: monolithic i-f is a universal subsystem. Robert A. Hirschfeld, National Semiconductor, "The Electronic Engineer," Vol. 28, No. 6, June 1969, pp. 97-102. Each class of two-way broadcast radio service (land, mobile, marine, and so forth) has its own standard mode of transmission (am, fm, ssb, and so forth). This diversity has discouraged wide use of IC i-f subsystems, since each such subsystem is peculiar to its own transmission mode. The article describes a new IC that serves nearly all radio service users, because the user himself can change the microcircuit's functions. He does this by rearranging the order of the circuits on the chip, and using only those which he needs—through external pin connections. The result is a universal subsystem that lets its user switch from one mode to another, even within the same receiver.

Phase locking: integrated tuned circuits made easy. Hans R. Comenzind and A. B. Grebene, Signetics, "Electronics," Vol. 42, No. 9, April 28, 1969, pp. 94-98. The phase-locked loop permits precisely tuned ICs for fm radios as well as for telemetry receivers. And, this is done without any expensive precision components. This old method is a simple way to get resonant frequencies accurately.

Designing with diff-amp and op-amp ICs. Ralph Seymour and Leonard Brown, Signetics, "EEE," Vol. 17, No. 4, April 1969, pp. 59-61. This article describes four applications, two using the Signetics 516 differential amplifier, and two for the Signetics 5709 operational amplifier. The first two are a one-shot multivibrator with a long time constant, to provide ramps with slow build-up (0.1 to 1 seconds), and a triggerable ramp generator. The two op-amp applications are an audio pre-amp with both tape and phono equalizing compensations that can be switched in, and another audio amplifier with bass-treble controls.

Speed/power chart for digital ICs. Staff Report, "The Electronic Engineer," Vol. 28, No. 6, June 1969, pp. 48-49. This chart allows the reader to make a "ballpark" selection of those digital integrated circuits that are best suited for his application. Organized by the two most important parameters—power dissipation and propagation delay—the chart shows, in a graph form easily grasped by the engineer, the relative positions of more than 100 commercially available digital integrated circuits.

MOS integrated circuit directory. Raymond D. Speer, Microelectronics Ed., "Electronic Design," Vol. 17, No. 10, May 10, 1969, pp. 75-103. Twenty-seven pages of standard MOS products are tabulated. Manufacturers, characteristics, and availability of data sheets, application notes, and price lists are included.

Single building block proves logical choice for custom ICs. Donald K. Lauffer, National Cash Register, "Electronics," Vol. 42, No. 9, April 28, 1969, pp. 88-93. For special purpose systems, a multipurpose circuit can usually give you more stability against transients, variations in power supply voltage, and temperature extremes than can stock devices. While the price may seem high for these custom circuits, volume usage will offset most of the added cost.

Microwaves and Microwave Products

Designing lumped elements into microwave amplifiers. Martin Caulton and Walter E. Poole, RCA, "Electronics," Vol. 42, No. 8, April 14, 1969, pp. 100-110. Because thin-film inductors, capacitors, and resistors can be made so small, lumped passive elements can be used in microwave ICs without distributed reactive effects. The hybrid microwave units are potentially cheaper and much smaller than those made with microstrip techniques. Manufacturing methods are based on the photo-resist methods developed for transistors.

Reliability

Torture tests improve equipment reliability. Smedley B. Ruth, Associate Editor, "The Electronic Engineer," Vol. 28, No. 6, June 1969, pp. 80-87. The current testing philosophy is to simulate, as closely as possible, the actual environment that the equipment will see in use or in transit. To perform this simulation requires environmental test equipment, and since many engineers are not too familiar with this equipment, they find ordering and using somewhat perplexing. This article is designed to alleviate these problems. Guidelines for ordering and using environmental equipment are set up and discussed. Also discussed by users, manufacturers, and commercial test labs is the question: "Should you build, buy, or send it out to be tested?"

Semiconductors

Forum on power transistors. Michael Perugini, Contr. Ed., and George Flynn, Sr. Assoc. Ed., "Electronic Products," Vol. 11, No. 13, April 1969, pp. 18-38. Today's activity centers on new packages, improved devices, and some old problems. Manufacturers and users here discuss the impact of such activity on the devices you will be buying.

Zeta—a proposed regulation factor for zener diodes. John L. Haynes, Endevco Labs., "EDN," Vol. 14, No. 9, May 1, 1969, pp. 55-59. The author defines a new variable easily calculated from common spec-sheet information. Zeta connotes the diode's ability to regulate against bias current variations. It is a useful criterion for zener selection, because it allows an unambiguous comparison of regulating capabilities.

Unijunction transistor: the offbeat semiconductor. "Electronic Products," Vol. 11, No. 14, May 1969, Part 1, pp. 96-98. **UJT's: what they are, what they do.** Sidney C. Silver, Assoc. Ed., describes construction, defines parameters, and tells why UJT's are useful. Part 2, pp. 99-102. **UJT applications: right and wrong.** by William H. Sahm, of General Electric, gives several examples of careless design that show the major traps, their cures and prevention.

Systems

Special report on multiplexers. "Electronic Products," Vol. 11, No. 14, May 1969, Part 1, pp. 28-31. **Multiplex systems.** by Michael English of Fairchild Semiconductor, describes time-division multiplexing in short discussions of throughput rate, MOS multiplex switches and their bandwidth, crosstalk, output settling time, and signal levels. Part 2, pp. 32-34. **Digital multiplexing.** by Bob Burlingame of Motorola Semiconductor, briefly describes data distributors and selectors for digital transmission lines. Part 3, pp. 35-38. **Multiplexing with junction FETs.** by Roger Schuttenhelm of Amelco, tells why J-FETs are well-suited to multiplexing analog signals, and how to do it. Part 4, pp. 37-38. **Multiplexing in the jumbo jets.** by Herb Evander of Hughes Aircraft, describes the passenger entertainment and service systems for the new jetliners. The system for the DC-10 uses about 2000 MSI MOSFET chips.

Test and Measurement

PRBS can fool the system. A. J. Martin, Solartron, "Electronics," Vol. 42, No. 9, April 28, 1969, pp. 82-87. Pseudo-random binary sequences are periodic and can be precisely generated. Hence, they can be very good test inputs for a system's response to random inputs. From these signals an engineer can learn how a system will function under random noise conditions.

How to extend sampling-oscilloscope versatility. H. Allen Zimmerman, Tektronix, "IEEE Spectrum," Vol. 6, No. 4, April 1969, pp. 79-85. Many measurement problems, some of which have been causing difficulties for several years, can be solved by a recently-developed sampling-oscilloscope system. This system consists of some 20 different kinds of units, including plug-ins and self-contained instruments, which can be used together in a wide variety of functional configurations. Rather than giving a detailed description of these units, the author discusses five specific applications in which the sampling-oscilloscope system offers a particular advantage.

Ultrasonic instrumentation in industry. Erwin H. Sherry, Asst. Ed., "Electronic Products," Vol. 11, No. 13, April 1969, pp. 108-113. New techniques, improved transducers, and so forth, have inspired an increase in the number of ultrasonic instruments being marketed. Here's a brief description of such equipment for non-destructive testing, materials evaluation, fault detection, and so forth, which predicts more sophisticated future uses.

Miscellaneous

Convolution revisited. Timothy J. Healy, Univ. of Santa Clara, "IEEE Spectrum," Vol. 6, No. 4, April 1969, pp. 87-93. There are few mathematical operations more important to engineers than convolution and transform analysis. This article first describes the mathematical operations involved in discrete convolution, continuous convolution, and transform analysis. An intuitive explanation then provides the key to why convolution and transform analysis techniques lead to the same solution.

What is a "systems" approach? It's just the name of the game. Raphael Kestenbaum, Associate Editor, "Electronics," Vol. 42, No. 9, April 28, 1969, pp. 68-75. The systems approach can mean many things to many engineers. But, regardless of what is thought, it has become the way that a program must be done when jobs are complex. Emphasis is on total and continuous planning throughout the project. This is what this article discusses with different views presented.

Looking for a summer study session? Richard Turmoil, Management and Careers Ed., "Electronic Design," Vol. 17, No. 10, May 10, 1969, pp. 120-125. Over 200 summer courses, locations, dates and costs are tabulated. Courses are for Design Engineers and Engineering Managers.

Do you know what regulation to expect from your brute force regulator design?

Figure it with ease using your free nomograph from Semcor.

This is the first of a series of application nomographs to be offered by Semcor in the coming months to help you solve your design problems quicker and easier. Circle our number and we'll send yours today.

Excellence begins with Capability



3540 W. OSBORN ROAD / PHOENIX, ARIZONA 85019
PHONE 602-272-7671 / TWX 910-951-1381

Preamp temperature compensation isn't a circuit problem.

If you've been using preamps for signal conditioning, instrumentation or analog computation, you've been paying for circuit solutions to temperature stability problems. Paying in dollars and paying in space, weight and design time. The new Fairchild $\mu A727$ Temperature-Controlled Differential Preamp solves the problem on the chip. No more FETs, choppers or ovens. Offset voltage drift is $0.6\mu V/^{\circ}C$, offset current drift is $2pA/^{\circ}C$, while long term drift is $5\mu V$ per week. All specifications apply over the full military, temperature range from $-55^{\circ}C$ to $+125^{\circ}C$.

Our Second Generation Linear technology gives you this premium performance with no premium on the price. The $\mu A727$ has a built-in temperature regulating circuit that ensures accurate operation whatever your needs. Besides the low drifts, it has an input impedance of $300M\Omega$,

a common mode rejection ratio of 100 dB and a low frequency noise output of only $3\mu V$ rms. Here are three ways to use it. Our data sheets and application notes list a few more.

To order the $\mu A727$, ask your Fairchild distributor for:

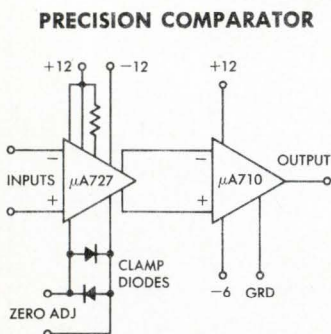

Input Resistance: $300M\Omega$
 Differential Input Voltage: $\pm 10V$
 Input Voltage Range: $\pm 8V$

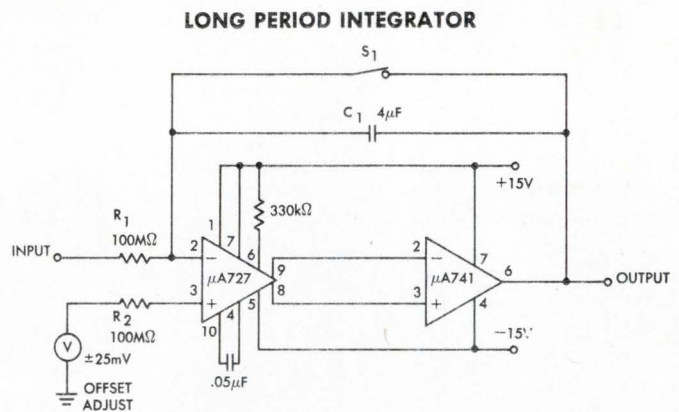

LONG PERIOD INTEGRATOR
 Error accumulation rate: 0.05%/minute

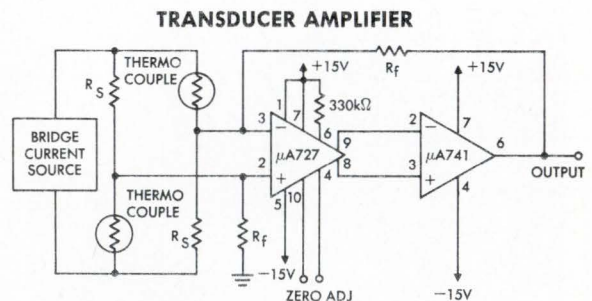

Accuracy: 0.01%
 Input impedance: $300M\Omega$
 Open-loop gain: 140dB

PART NUMBER	PACKAGE	TEMPERATURE RANGE	PRICES		
			1-24	25-99	100-999
U5J7727312	TO-5	$-55^{\circ}C$ to $+125^{\circ}C$	\$50.00	\$40.00	\$34.00
U5J7727333	TO-5	$-20^{\circ}C$ to $+85^{\circ}C$	22.50	18.00	15.00

FAIRCHILD
 SEMICONDUCTOR

Jack-of-all-trades: monolithic i-f is a universal subsystem

A single chip serves a multitude of transmission modes, and lets you switch economically from one to another, within a single receiver.

By Robert A. Hirschfeld, Applications Engineering, National Semiconductor Corp., Santa Clara, Calif.

Because of differing user needs, each class of broadcast and two-way radio service¹ has evolved its own standard mode of transmission (a-m, fm, nbfm, cw, ssb, and so forth). This diversity has heretofore discouraged widespread use of IC i-f subsystems. But now a single microcircuit can serve nearly all radio users. National Semiconductor's LM373 incorporates those subsystem functions which may be changed, by a few external connections, from the duties required of one mode to those of another.

The 373 is for a-m, fm, and ssb i-f applications, and for broadband video amplification as well—even though the reception of these modes requires contradictory performance parameters. For example, a-m and ssb receivers must have linear amplitude-response, and agc (automatic gain control) to help maintain that linearity. On the other hand, fm reception is basically nonlinear: you need limiters to remove all amplitude variations from the signal. And fm detection systems differ radically from those needed in a-m or ssb systems.

An a-m i-f strip

Figure 1 (top) shows a block diagram of an a-m i-f strip. A high-performance agc stage (80-dB range) is preceded by one gain stage and followed by another. The gain stages isolate input and output circuitry from y-parameter shifts as agc-stage gain varies.

Balanced construction on the chip gives you a dc output voltage that is constant with varying gain. This means that you can have a fast attack or pulsed agc and not induce ringing in high-Q tuned-interstages. Output

from the second gain stage couples externally to the third-stage input via a lumped bandpass filter (or a single capacitor, for broadband applications).

Putting the selectivity in the middle of the strip's total gain reduces the noise bandwidth of signals reaching the detector, as compared to strips in which selectivity precedes all gain. Similarly, placing the agc section after the first-stage gain gives less fixed gain between agc and

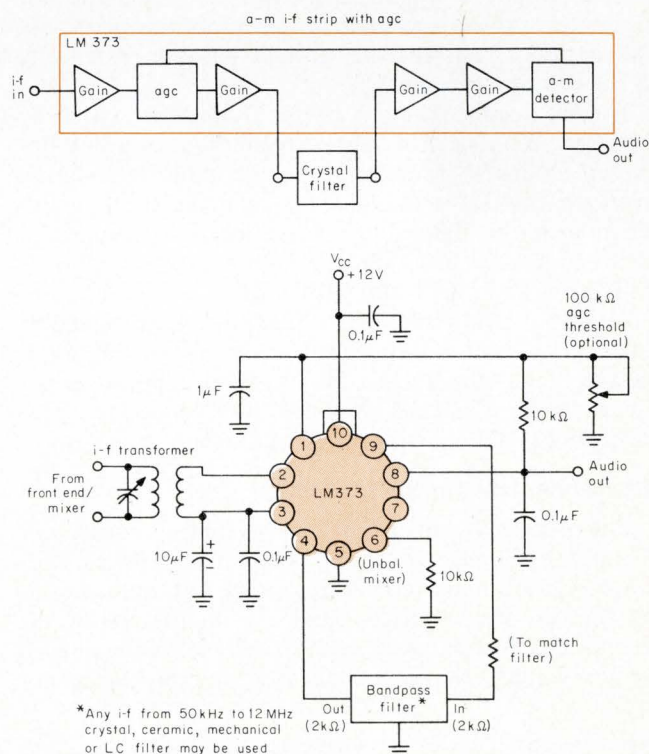

Fig. 1. The LM373 connected as an a-m i-f strip with agc.

¹For a detailed listing of frequency allocations in the U. S., see ITT's *Reference Data for Radio Engineers*, 5th Ed., 1968, pp. 1-8 to 1-14, Howard W. Sams & Co., Indianapolis, Ind. Also see the "Electromagnetic Spectrum Chart," *The Electronic Engineer*, Vol. 28, No. 1, Jan. 1969.

detector, and thus less output noise at higher input signal levels than when agc precedes all gain.

An active detector follows a total of four gain stages. It not only detects, but also gives you some audio gain and an agc output. The agc voltage is externally filtered and fed back to the agc-stage control input.

Each gain stage is an emitter-coupled limiter which, for a-m, operates in its linear region. Because such stages limit without saturating, large impulse-noise spikes superimposed on a constant-carrier a-m signal cause the first and second stages to limit momentarily. This action reduces both spike amplitude and ringing in any high-Q, lumped, bandpass filter that may follow stage two. Limiting in the last gain stage reduces the effect of spikes upon the active detector, allowing fast recovery.

The bottom sketch in Fig. 1 shows a circuit realization of the block diagram. It is useable in a-m receivers at all standard intermediate frequencies up to 12 MHz. Because the output impedance at pin 9 is about 70 Ω , you need a series resistor for any high-Q filters whose shape factor deteriorates when driven from other than the manufacturer's recommended source impedance.

Only a small amount of unbalance in the balanced mixer gives you maximum gain in the fourth stage. The 10-k Ω resistor from pin 6 to ground does this, because it acts as a voltage divider with the internal 3-k Ω biasing resistance at that pin. Do not ground pin 6 directly, since this will forward-bias the junction capacitor (used only for fm), and the strip will draw excessive supply current.

A 0.1- μ F capacitor at pin 8 smooths the active-detector output. An RC network consisting of a 10-k Ω resistor to pin 1 bypassed by a 1- μ F capacitor (or larger, for slower agc action), operates the agc loop. The optional resistance to ground lets you externally adjust the agc threshold.

The dc feedback loop at pin 3 must be carefully bypassed. You need a large capacitor to prevent unwanted feedback from distorting the audio modulation envelope, and a small rf bypass to make the loop ineffective at the desired i-f. Lead length is important, since inductance in either pin 3 or 5 makes bypassing ineffective, and may cause oscillation.

At 455 kHz, assuming a bandpass with negligible loss at the center frequency, the strip's useful input-voltage range (pin 2) is from 50 μ V to 200 mV rms—an agc range of 72 dB. Signals 100%-modulated produce about 700 mV pk-pk of audio output.

Meanwhile, back in the fm section . . .

The block diagram of Fig. 2 shows an fm i-f strip. For this purpose, the agc is defeated and each emitter-coupled gain stage becomes a symmetrical, non-saturating limiter. An external bandpass filter between the second and third stages provides nearly all of the needed receiver selectivity. The balanced quadrature-detector

needs only a single external phase-shift element; this may be a parallel-LC filter for wideband fm or a quartz crystal for narrowband applications.

A crystal quadrature-detector is attractive for vhf fm receivers because it allows single conversion to a high i-f, where images aren't a problem, while giving large audio-outputs for very small deviations. Present nbfm vhf receivers must use double conversion to retrieve audio at a low i-f, where the ratio of deviation to center frequency is larger. The crystal quadrature-detector eliminates many components in such systems, and gives a detector with a center frequency as stable as the crystal itself.

Except for bandwidth differences, the input and bandpass circuitry of the fm i-f is similar to that of the a-m and ssb (Fig. 3) strips, with the same requirements of dc biasing, impedance matching, and quality of bypass elements. Grounding pin 1 simultaneously defeats the agc and closes the internal switch to the junction quadrature capacitor on the chip. Thus, a 90° phase-shifted signal appears at the quadrature input, pin 6.

The wideband quadrature-element shown in the figure is a conventional parallel-LC network, with dc decoupling from pin 6. The narrowband element is a fundamental-mode quartz crystal.

Bypassing pin 7 removes i-f components from the audio output, and another bypass stabilizes pin 8.

At 10.7 MHz, with a bandpass filter of negligible loss, the strip begins to limit at 600 μ V rms; first-stage overload occurs above 500 mV. With the narrowband quadrature element, you get 300 mV pk-pk audio for ± 3 kHz deviations. The wideband element produces the same output for ± 75 kHz deviations.

Because its gain stages are broadbanded, the LM-373's limiting and a-m rejection characteristics cannot equal those of a tuned emitter-coupled strip made of an equal number of single-stage amplifiers. For fm, limiting must occur not only in the fourth gain stage, but also in the third, since the third-stage output drives the quadrature port of the balanced mixer.

Practical receivers, therefore, may require more limiting gain ahead of the 373. If another 373 precedes the fm i-f strip of Fig. 2, it may be either a limiter/amplifier, with output (not bypassed) from its pin 7, or an fm agc amplifier. This latter scheme has merit in its ability to hold a constant drive level to the limiting amplifier's input, resulting in constant bandpass-filter phase and shape factors for varying signals: Certain crystal filters exhibit variations in these parameters as a function of drive level.

The configuration of the fm agc amplifier is that of the a-m strip of Fig. 1, with output taken from pin 7 to drive the limiting amplifier, while the agc loop operates exactly as it would for an a-m signal. Thus, in a-m/fm equipment, you can use the first (agc) strip for a-m and both strips for fm with relatively little component switching when you change modes.

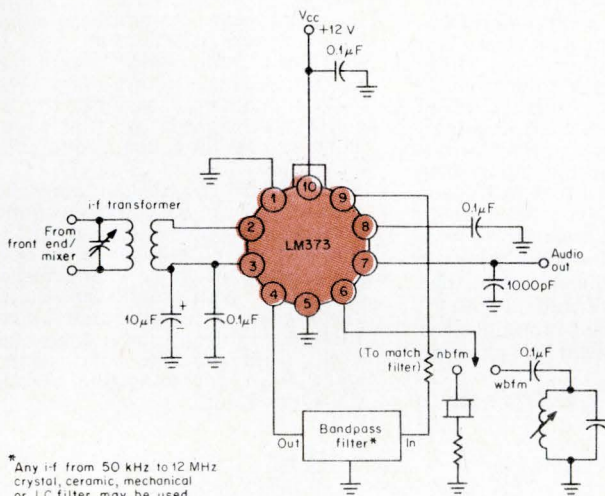
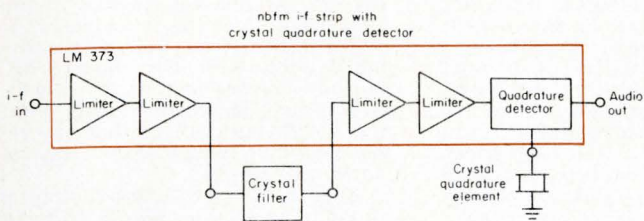

Fig. 2. An nbfm i-f strip with crystal quadrature-detector.

For cw/ssb buffs

Connected for single- or double-sideband (suppressed carrier) operation as in Fig. 3, the first stages operate linearly, as for a-m, and use the same agc and band-pass-shaping arrangement. A doubly-balanced product detector follows the gain stages, and gives an audio output proportional to the product of the received signal with an externally-injected local oscillator.

Because the product detector is balanced with respect to both input and local oscillator signals, only a small amount of these signals appears at the audio output (pin 7), where such rf is bypassed with a small capacitor.

Since there is no carrier present, you create agc action by peak detecting the audio output of the i-f strip. With appropriate external capacitance, this produces an agc with fast attack and slow release. Gain is maximum up to about 2.1 Vdc at pin 1, and full attenuation is reached at about 2.4 V. You use the same system to receive cw signals, where you also need local oscillator (beat-frequency oscillator, or BFO) injection to produce an audible beat note. For cw rf gain control, you can use a manually-controlled dc agc voltage at pin 1. The agc system has a large audio-smoothing capacitor at pin 8 and an rf bypass at pin 1 to prevent instability.

The residual rf voltage at pin 7 is, ideally, the sum of the local oscillator and incoming signal frequencies

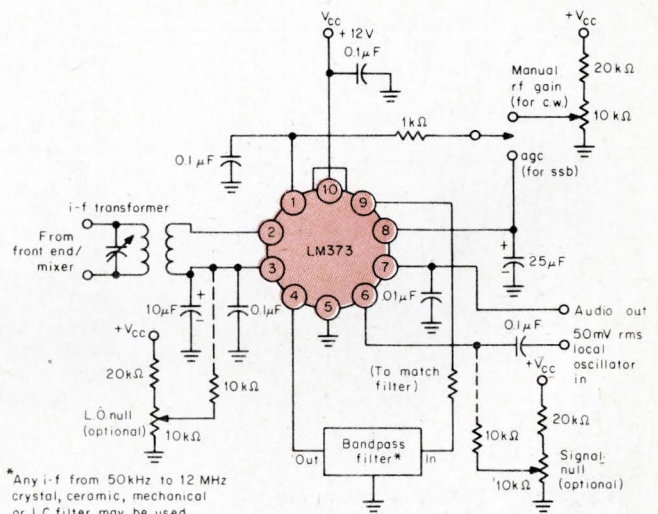
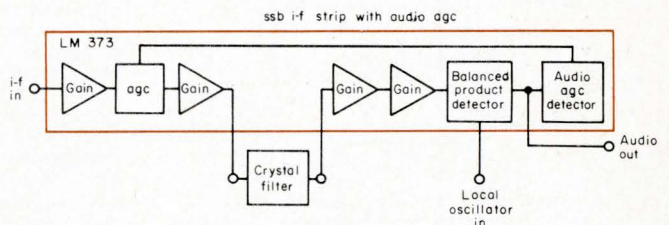

Fig. 3. A ssb/cw i-f strip with audio agc for ssb use.

(assuming that the audio is the difference). Practically, however, a slight unbalance in the mixer could allow the signal, the local oscillator, or both to leak through. If only the signal leaked through, it would help in operating the agc detector. But if the constant, large-amplitude LO predominated, the agc would act as if too large an audio signal were present, and reduce the system gain to an unwarranted low level. Bypassing at pin 7 is effective in solving this problem; however, you must be careful in using very low i-f's, which must be distinguished from audio by the bypass capacitor.

Some applications may require precisely-nulled mixing. Figure 3 shows how you can inject (or draw) nulling currents into (or from) either pin 6 to balance the signal, or pin 3 to balance the local oscillator port. The injection at pin 3 is an error signal that drives the dc feedback loop in one direction or the other, letting you critically balance the collector currents in differential gain-stage four. Injection at pin 6 places a dc offset voltage across the LO port, nulling incidental dc offsets that may arise from unit to unit.

Because the mixer has conversion gain, the ssb system can operate with inputs somewhat below those possible for a-m. At 10.7 MHz, 40- to 50-µV signals operate the agc loop, while max. input level, limited by the linear input range of gain-stage one, is still about 200 mV rms.

The whole is the sum of its parts

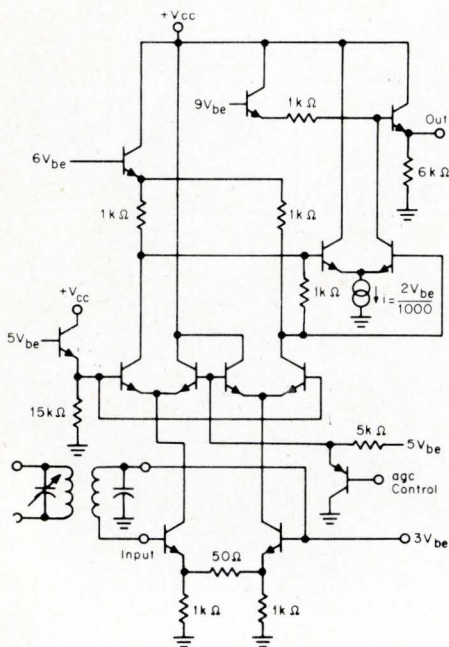

This balanced mixer serves as a quadrature detector for fm and a product detector for ssb reception. It is a cross-coupled version of the agc circuit. If all parts of the circuit are in dc balance, a differential signal from the collectors of stage four cancels at the output, as does a differential signal across the local oscillator or quadrature inputs. When balanced, the only output is proportional to the algebraic product of the two input signals.

For a-m operation, you unbalance the mixer by a dc voltage at the LO input. More than 200 mV of unbalancing voltage turns one group of CB stages completely OFF, leaving only one side of differential gain-stage four connected to the load resistance. If you unbalance the mixer in the opposite direction, the phase of signals reaching the load will reverse.

To get quadrature detection for fm, drive one port of the balanced mixer with amplitude-limited fm signals, and drive the other port (the quadrature terminal) with the same signal, phase-shifted 90° at the center frequency. The phase shifter is an RC network made up of 3 kΩ in parallel with the real part of the quadrature impedance (externally connected to the quadrature input), and a small junction capacitor, part of the LM373 chip. Stage three's output drives the capacitor when a switching arrangement, internally connected to the agc control pin, senses that agc has been defeated for fm operation. Otherwise, the internal quadrature capacitor is disconnected.

An output pulse train appears as a result of the 90° phase shift.

The circuitry between pins 2 and 9 of the pin connection diagram consists of the first-gain, agc, and second-gain stages, as shown here. A low dc impedance, such as a transformer secondary or a small shunt resistor, drives the differential input-stage single-ended, so that the rf input is dc-biased at the same voltage as that of the fixed input. The 50-Ω degeneration resistance that separates the differential emitters extends the 373's agc range: it lets larger input signals be handled linearly in a-m and ssb applications.

Each side of the input differential-pair is the common-emitter first stage of a cascode amplifier. These stages drive the two common-base stages of the agc section which have their emitters tied together. One CB stage of each half drives a 1 k-Ω resistor, but the other does not. Now, the transistors with loads are biased from 4V_{be}. Thus when the other two, which are driven from the agc CONTROL input, are held OFF by a control voltage more than 200 mV below 3V_{be} (about 1.9 V), signal current flows through the loads and gives maximum first-stage gain, about 13 dB.

When the control voltage rises to

Ideally, it is a 50% duty-cycle square wave, and its dc value is halfway between its positive and negative peak voltages. A resonant circuit attached to the quadrature input gives a 90° phase difference between the input and quadrature ports, at the tuned circuit's resonant frequency. On one side of resonance, quadrature phase lags the input phase; on the other side, it leads. This gives the variations in output duty cycle shown in the figure.

Integration of these pulses gives an audio output proportional to duty cycle, and hence also to frequency deviation. Because the pulse train's amplitude is constant, the maximum peak-to-peak output is the same for any quadrature element. Positive and negative peaks occur at the element's 3-dB points, and are the peaks of the fm detector S-curve.

You can see that the detector's sensitivity to deviation, for a given tuned circuit, is adjustable by resistive loading of the quadrature terminal. This decreases Q and increases separation of the 3-dB points. Because of its very high Q a quartz crystal causes a large phase shift for very small deviations.

SSB operation also requires that you operate the mixer at its balance point. Since agc is operating, the built-in junction capacitor is automatically disconnected, and you inject the local oscillator, via a capacitor, into the same terminal used for fm quadrature elements. Mixing action is linear for small local-oscillator injection levels. Since the LO and signal frequencies are generally high, and since they cancel, only

3V_{be}, it biases the common-base stages equally, and half of the signal current (as well as half of the dc current from the input stage) is shunted away from the signal-carrying devices. Gain falls about 6 dB. Further increase in the control voltage diverts all current away from the amplifying pair, so that any remaining gain arises from stray-capacitance coupling.

This circuit has a gain control range of more than 80 dB, and can handle large signals with little distortion. The dc current through the amplifying common-base stages goes to zero at minimum gain, so that the common-mode output voltage at their collectors rises. With good monolithic matching, the circuit stays balanced, so that a gain change does not cause a differential dc voltage.

The 20-dB second gain stage has differential inputs, and responds only to a differential signal. Its single-ended output has a dc operating point which is unaffected by agc. The emitter-follower output stage gives a 70-Ω source impedance for driving interstage networks, and prevents load capacitance from degrading the second-stage bandwidth.

sum and difference frequencies appear at the output. Generally, one of the two will be nearly twice the signal frequency, while the other is audio, so that a simple bypass capacitor at the output completes the product detection process.

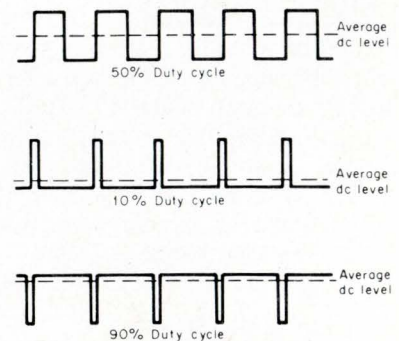
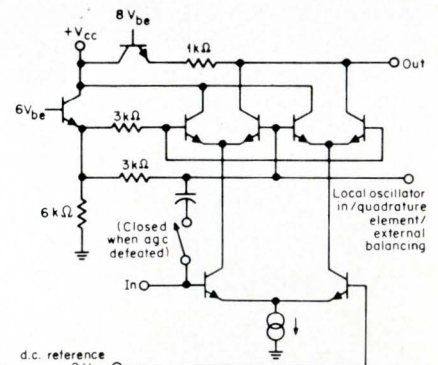

The third and fourth gain-stages, shown at the right, are conventional emitter-coupled amplifiers, each with 20 dB of gain. An emitter-follower between them reduces third-stage loading. A dc feedback loop, derived from several common-base stages in the balanced mixer following gain-stage four, sets the base voltage of

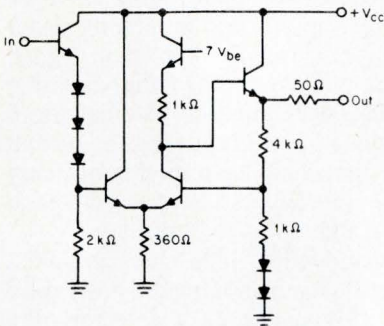

one side of stage three to $2V_{be}$ (1.4 V). The input of stage three is already biased at $2V_{be}$, so the dc feedback loop automatically balances stages three, four, and the balanced mixer. The regulated feedback voltage simultaneously provides base bias for stage one.

The last section of the LM373 is the peak detector, an op amp type feedback circuit. For a-m, its external output smoothing capacitor bypasses rf, but passes audio. As an audio detector, to provide agc voltage in ssb use it needs a larger capacitor, one that can't follow rapid audio variations. Using an emitter-follower to charge the larger capacitor gives true peak detection; that is, a rapid charge on peaks, and a

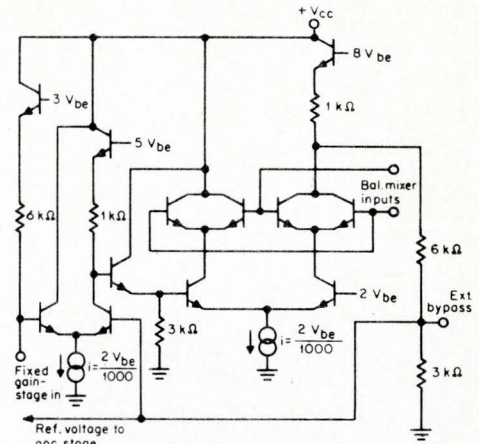

relatively slow discharge between peaks, so that the audio detector constitutes a fast-attack, slow-release system for ssb.

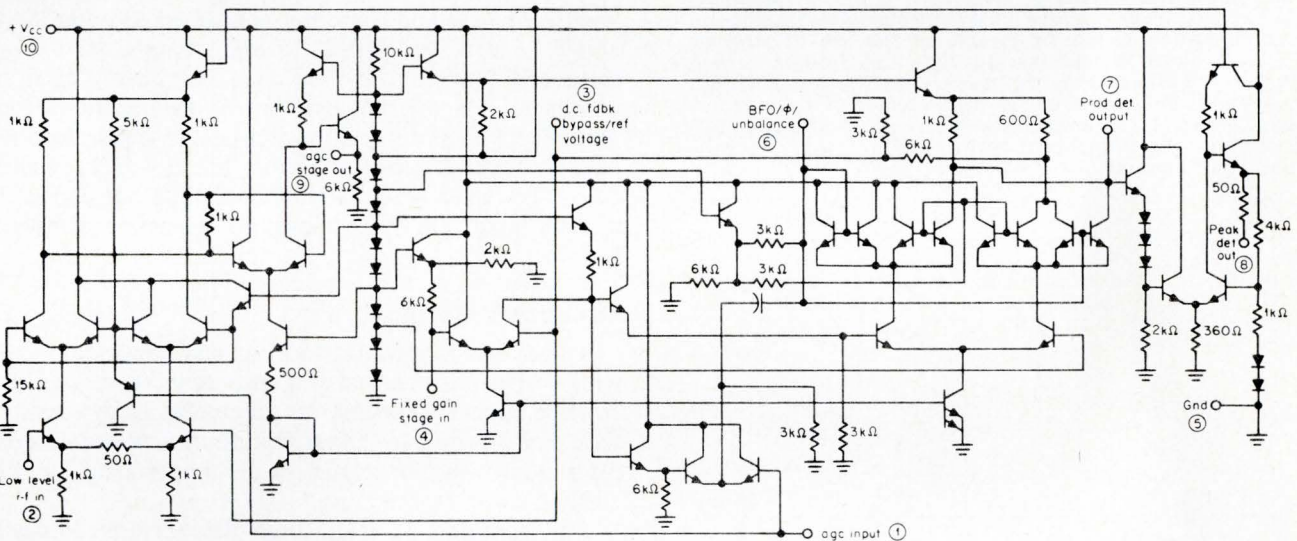

The complete schematic of the LM373 shows the techniques used to hold the total number of pins to only ten. Pins 2, 4, 5, 9, and 10 serve the single functions shown. But all other pins perform multiple functions. For example, pin 3 connects a large external capacitor that makes the feedback loop ineffective at high frequencies. But it also provides dc bias for pin 2, and you can use it to inject an external dc current to manually trim the mixer balance.

Pin 1 is an agc control input; it also controls the internal switch that connects the quadrature capacitor in the fm mode.

Pin 6 can be used for LO/BFO input for ssb and cw reception, for connection of the fm quadrature element, as a terminal for the deliberate unbalancing of the mixer in

the a-m mode, and for injection of an external dc current to balance manually the upper part of the mixer.

Pin 7 serves for audio output in the fm and ssb modes. You can also shunt it with an external parallel-tuned circuit for added selectivity on a-m, or use it as a video or rf output in either broadband or first i-f applications.

Pin 8 is the audio output for a-m, and also provides the agc voltage in both a-m and ssb modes.

A string of reference diodes and emitter-followers provide power-supply decoupling and dc bias, so that you need only one power-supply pin for the entire i-f strip. You don't need individual stage decoupling capacitors; and each stage operates essentially from a regulated supply, reducing performance variations as the main supply voltage changes.

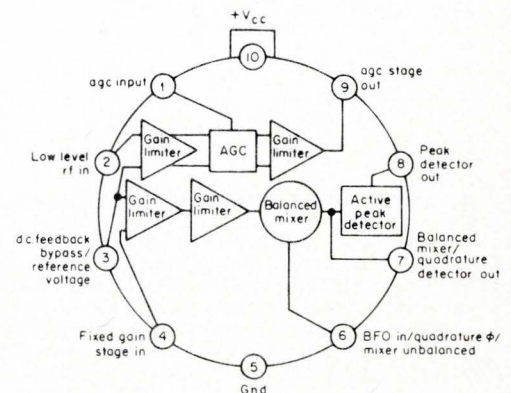

LM173/273/373 Top view pin connections

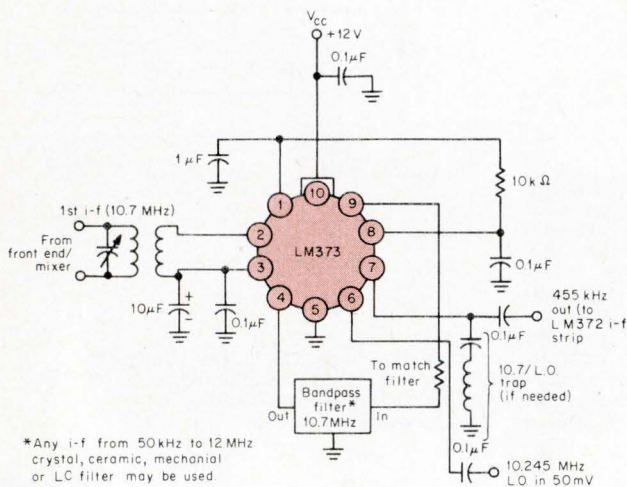

Fig. 4. Here's the LM373 connected as a first i-f amplifier and a second mixer, for use in double-conversion systems. The configuration is similar to that of the ssb i-f strip of Fig. 3, with these exceptions: agc operates from a carrier (in this example); output isn't audio, but the lower i-f agc may, instead, be controlled by the detector of the second i-f strip (when, for example, you need ssb audio-operated agc). System requirements may make it necessary to trap out the small amount of LO leakage at pin 7.

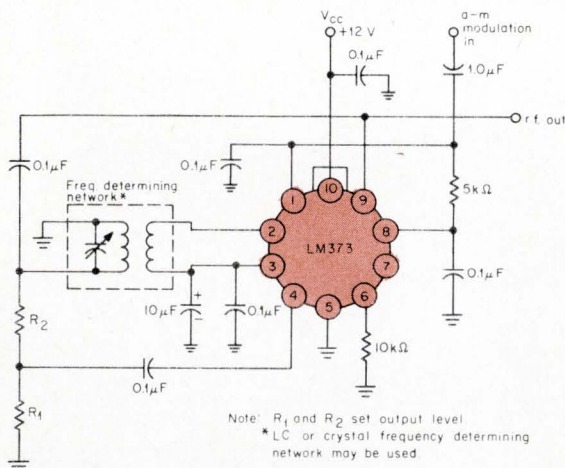

Fig. 5. Constant-amplitude/amplitude-modulated oscillator. Use the agc section of the 373 as an oscillator, and sense the rf output level with the fixed-gain/detector portion. This reduces the open-loop gain of the agc section to the minimum value to sustain oscillation at a fixed amplitude. You can use many types of frequency-determining networks in the oscillator feedback loop. Output is stabilized at that level where there is about 0.7 V pk-pk at pin 7. Since such an a-m agc circuit constitutes a closed-loop feedback system, you can inject an error voltage that disturbs the output amplitude by a proportional amount. The audio modulating voltage does just this; the result is an amplitude-modulated oscillator with closed-loop system a-m characteristics, and with distortion set by that of the 373's peak detector.

TV, too

With broadband, RC interstage components, the LM-373 can handle video signals with bandwidths up to 12 MHz. Peak detection gives an agc determined by either the positive or negative peak value of the input signal, depending on stage four phasing. (Stage four is either inverting or non-inverting, depending on whether pin 6 is unbalanced by injecting or withdrawing a current from it.) You can gate the signal by applying ordinary 5-V logic levels to pin 1, or you can use a dc voltage at the same pin for remote, manual gain control.

Medium level, wide bandwidth video may be picked up at pins 9 or 4, while the agc is operated by the third and fourth gain stages, driving the peak detector. Pin 7 gives a higher gain, lower bandwidth output.

You can use the first, second, and agc stages as an amplifier with about 32 dB gain and a 57-MHz bandwidth, if pins 9 and 4 are not connected together. With about 36 dB gain and a 15-MHz bandwidth, stages three and four can be used as a completely separate amplifier. If agc is not used in the first section, don't ground pin 1, as this will switch-in the quadrature capacitor. Instead, bias pin 1 from about 1.8 V, slightly below the region where attenuation starts but above the turn-on point of the quadrature capacitor switching section.

Tomorrow's systems

The 373 is a powerful tool for communications systems designers—one that will help convert existing discrete-component systems to microcircuit systems. It should also stimulate the realization of new system concepts which would otherwise be impractical or too costly.

And speaking of cost, these devices are modestly priced. The LM373, which operates from 0° to 70°C, sells for \$4.73 each in quantities of 1-24, \$3.73 ea. for 25-99, and \$2.73 ea. for 100-999. The LM273, an industrial version for -25° to 75°C, and the LM173, a military version for -55° to 125°C, are somewhat higher in price. All versions will be in distributor stock by late summer.

References

- Hirschfeld, R., "Linear Integrated Circuits in Communications Systems," *WESCON 1968, Paper 1/3*; also, *IEEE Spectrum*, Nov. 1968.
- Hirschfeld, R., "A Complete Monolithic IF Strip for AM/AGC Applications," *National Semiconductor Corp. An-15*, Aug. 1968.
- Davis, W. R., and J. E. Solomon, "A High Performance Monolithic IF Amplifier Incorporating Electronic Gain Control," *ISSCC, Paper FAM 11.3*, Feb. 1968.
- Bilotti, A., and R. S. Pepper, "A Monolithic Limiter and Balanced Discriminator for FM and TV Receivers," *Proceedings of NEC*, Oct. 1967.

INFORMATION RETRIEVAL:
Integrated circuits, Amplifiers, Oscillators,
Circuit design, Communications



BETTER QUALITY AND RELIABILITY THROUGH CONTROL

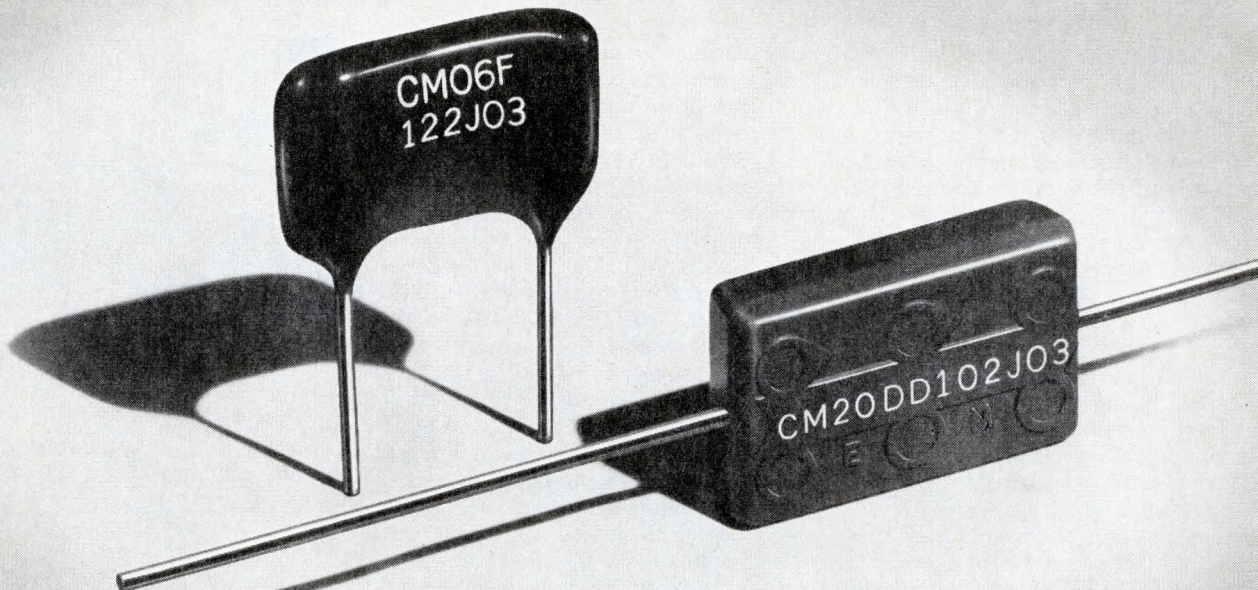

Shown 2½ x Actual Size

Capacitor Problems That Require A Lot Of Self-Control...Chemically Speaking

Problem 1: How to make sure the silver paste composition used for electrodes provides the best results for each electrical parameter in a given capacitor design?

Problem 2: How to improve the recognized moisture reliability of our dipped mica capacitors without adversely affecting life reliability?

Problem 3: How to upgrade the reliability of molded mica capacitors to equal that of dipped mica capacitors so designers can take advantage of body uniformity and axial lead design?

Solution: Chemical self-control! To do this we operate our own chemical manufacturing plant where we formulate silver pastes, phenolic dipping compounds, and epoxy molding compounds — all under strict controls.

Result: Dipped mica capacitors and molded mica capacitors of equally high reliability that operate up to 150°C. Send for technical literature and always insist on El-Menco brand capacitors . . . your assurance of better quality and reliability through control.

THE ELECTRO MOTIVE MFG. CO., INC.

WILLIMANTIC, CONNECTICUT 06226

Dipped Mica • Molded Mica • Silvered Mica Films • Mica Trimmers & Padders
Mylar-Paper Dipped • Paper Dipped • Mylar Dipped • Tubular Paper

West Coast Manufacturers contact: COLLINS & HYDE CO., 900 N. San Antonio Rd., Los Altos, California 94022
5380 Whittier Blvd., Los Angeles, California 90022

ALSO SOLD NATIONALLY THROUGH ELECTRONIC PARTS DISTRIBUTORS

New material makes a better relay

In a standard reed relay, if you apply enough coil current the reed will close. Any additional current increases the magnetic force but doesn't influence the contact. If you decrease the current, the force is reduced and the reed will drop out at some point below the initial closure point.

To obtain a bi-stable or latching reed, you can put a small permanent magnet near the reed capsule. This magnet provides enough force to keep the switch closed after it has been operated by an external field. Much less coil current is needed than for the non-latching version.

The magnet force keeps the reed closed even if the coil current is decreased, because of the increased flux through the closed contacts. To release the relay, you reduce the permanent magnetic force below the levels needed to hold the switch closed. This is done by causing an opposing magnetic field which will subtract from the permanent's field.

Unfortunately, with this method, variations in reed configurations and in placement of the permanent magnet within the reed cluster create manufacturing problems.

In the new Hystereed, a saturable core material replaces the biasing magnets. This material's hysteresis characteristic is such that it can be

magnetized by the current applied to the operate coil. Thus, when you apply current to the operate winding the reed closes and at the same time a magnetic field builds in the core. If the current is increased no further than point A of the illustration, the magnetic material will not be saturated, and reducing the coil current will drop the magnetic force back towards zero and the reed switch will drop out. Thus far, Hystereed operation is identical to that of a standard non-latching reed relay. However, if you increase coil current beyond point A, the core will saturate and when you reduce or remove coil current, the resultant residual magnetic force will keep the reed latched. As shown, this field is much greater than the force needed to keep the reed switch closed and any number of reeds can be added to the assembly without jeopardizing the dropout point of the individual switches.

You can unlatch the Hystereed by reversing current in the operate coil and demagnetizing the core material, or by using a second winding to produce the demagnetizing effect. When you apply current to such a release coil, and limit the excursion to point B, the magnetic force generated destroys the residual magnetic force. However, the coil current is enough

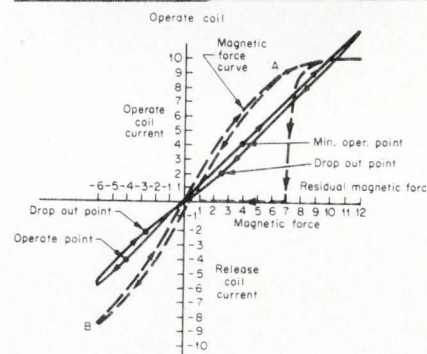
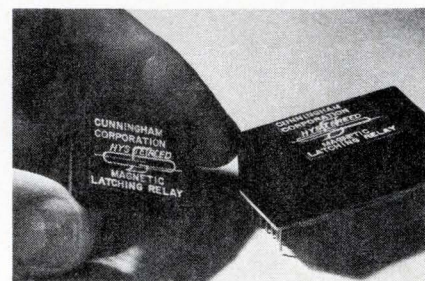

to keep the reed closed until the release current decreases below the dropout point of the reed switch. The magnetic force now present in the core material is virtually zero and with continued operation of the release coil, the relay will behave as a standard relay.

The Hystereed can be operated as a non-latching relay on either the operate or release windings by limiting

Op amp likes the military life

Protected by its hermetically-sealed metal case, and with its long-term performance assured by thin-film construction, this op amp stands ready to work for you in a wide range of environmental conditions.

The ADO-101B has terminal connections identical to those of the popular μ A741 monolithic op amp, except for pin 2. The 101B's designers have wired its pin 2 to the metal case. This connection turns the case into an electrostatic shield which you may either ground or drive as a guard to enhance the amplifier's noise performance. The case, by the way, is a metal version of the 14-pin, dual in-line package; it's 0.875-in. long, 0.55-in. wide (that's about 0.5 in.² of board area), and 0.17-in. high.

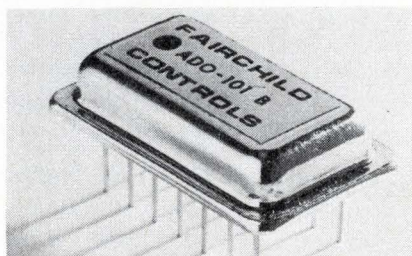

The 101B's performance guarantees satisfaction over the military temperature range, with operating and storage temperatures from -55° to 125°C . Offset voltage drift is $\pm 25 \mu\text{V}/^{\circ}\text{C}$ max. over the full temperature range, $\pm 40 \mu\text{V}/\text{V}$ max. for power supply variations, and has a $\pm 10 \mu\text{V}/\text{day}$ typ. change. Initial equivalent

offset voltage is $\pm 3 \text{ mV}$ max. (A 10-k Ω balance pot in your circuit takes this down to zero.) The input bias current is $\pm 40 \text{ pA}$ max.

You can use power supply voltages between ± 10 and $\pm 18 \text{ V}$. Rated voltage is $\pm 15 \text{ V}$, which gives an 8-mA max. quiescent current. Short-circuit protection is built into the device.

The ADO-101B has an 800-kHz typ. (400-kHz min.) gain-bandwidth product with a straight-from-the-shoulders 6-dB/oct. gain roll-off, and a 0.6-V/ μs min. slew rate. Open-loop dc voltage gain into a 2-k Ω load is 112 dB min. The common-mode rejection competes for attention with a very high 88 dB min. and a $10^{11}\text{-}\Omega$ min. cm input impedance. Differential input impedance is the same value, while

the current. Under these conditions, it will behave like a standard reed relay whenever there is current in the coil. By increasing the current in the operate coil, the reed can be made to latch; it remains closed after coil current is decreased to zero.

The new relay has been built with up to six form A reed capsules within a single package. In addition to form A contacts, form C and combinations of form A and form C have been packaged and operated successfully.

Because of the pre-biasing condition of the magnet in the ordinary latching reed relay, it takes very little coil current to close the reed switch. Result is a sensitive system where as little as a 1 V pulse causes closure in a nominally rated 24 V relay.

As the new relay doesn't have the permanent magnet pre-bias it takes a voltage of over half the nominal operating voltage to latch the reed switch. Once latched, it takes a 150 g shock to unlatch the relay. Shock, vibration or electrical transients can't close and latch the switch.

The relay can be pulsed and latched with a minimum of a 1½ ms pulse at nominal voltage. Cunningham Corp. Subs. of Gleason Works, Honeoye Falls, N.Y. 14472. (716) 624-2000.

Circle 252 on Inquiry Card

the 20-Hz, open-loop, output impedance is about 500 Ω. Into a 2-kΩ load, the output current can swing ±5 mA min.

Let's not forget that the 101B sports a FET input stage. This contributes not only to the input impedance specs, but also to the amp's noise performance. From 0.1 to 10 Hz, the equivalent input noise with a 50-Ω source is 3 μV pk-pk max., while from 10 Hz to 1 kHz the figure is 3 μV rms max. Typical numbers run half as large.

You can buy the ADO-101B for \$95 apiece in 1-24 pc. quantities. It's made by Fairchild Controls, 423 National Ave., Mountain View, Calif. 94040. (415) 962-3833.

Circle 253 on Inquiry Card



MONOLITHIC CRYSTAL FILTER FEVER

Spreading fast! It's understandable, when you consider the advantages brought to you by monolithic crystal filters.

MTBF computed to be improved 600% over conventional filters. Filter sizes reduced considerably. One instead of several different temperature coefficients. Greatly improved shock-and-vibration resistance.

THE CURE

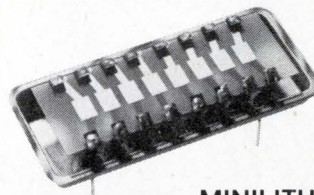

MINILITH®

Break that fever!

... with the practical cure, Reeves-Hoffman's Minilith crystal filter. Reeves-Hoffman is unsurpassed in engineering background and in actual monolithic crystal filter production performance:

Frequencies 4 to 30 MHz
Bandwidths 0.01% to 0.4%
Attenuation to 80 dB
Shape factors as steep as 2:1
Spurious suppression to 50 dB

Reeves-Hoffman has been awarded the only Army Signal Corps production engineering measure for crystal filters employing the principles of coupled resonance.

Call, TWX, or write your requirements today.

craft-masters in crystal controls

REEVES-HOFFMAN

DIVISION, DYNAMICS CORPORATION OF AMERICA

400 WEST NORTH ST., CARLISLE, PENNSYLVANIA 17013 • 717/243-5929 • TWX: 510-650-3510



WHAT?

1. MF.

INA CK06 TO
MIL-C-11015/19

with $\pm 15\%$ stability

MUCON[®]
MU-CAPS[®]
SUB-MINIATURE CERAMIC
MOLDED
CAPACITORS

... ALSO .1 MF.
INA CK05 TO
MIL-C-11015/18

50 WVDC

.1 MF in CK05	1. MF in CK06
------------------	------------------

100 WVDC

.01 MF in CK05	.1 MF in CK06
-------------------	------------------

200 WVDC

.001 MF in CK05	.01 MF in CK06
--------------------	-------------------

Republic Electronics makes a broad line of Mucon Subminiature Ceramic Capacitors to meet any requirement. Write for Catalog

REPUBLIC ELECTRONICS CORP.
176 E. 7th St. PATERSON, N. J. 07524
201-279-0300 TWX 710-988-5908

Circle 46 on Inquiry Card

EE SYSTEMS EQUIPMENT

SWITCHING MATRIX

Complete guarding.

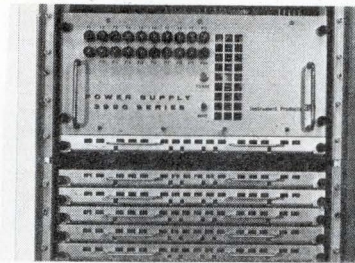

The 3990 is a high-speed, computer-programmed, random-access, 2-D reed relay matrix. It has program input storage registers for direct interface to TTL positive or negative logic levels. Complete guarding permits high CMR in system uses. Instrument Products, 3M Co., 300 S. Lewis Rd., Camarillo, Calif. 93010. (805) 482-1911.

Circle 201 on Inquiry Card

BUFFER MEMORY SYSTEM

Access time is 600 ns.

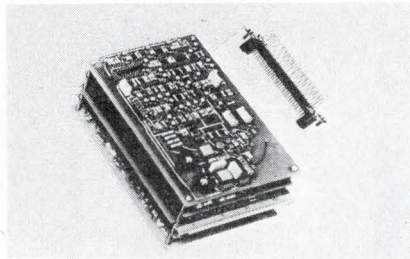

This 1024 word by 8 bit/word ferrite core system is built on five interconnected circuit cards. The 4 μ s random access system (FI-2) contains all decoding, drive, data and timing circuits. All I/O lines are terminated at a single connector. Ferroxcube Systems Div., Englewood, Colo. 80110. (303) 771-2000.

Circle 202 on Inquiry Card

DISPLAY TERMINAL

To replace keyboard/printers.



This self-contained, alphanumeric display comes in formats of 480, 512, 960 or 1,024 ASCII characters, displaying the complete set of 96 char., including upper and lower case alphabets. The Uniscope 100 can operate as either a data entry or display device. Sperry Rand Corp., Univac Div., Box 8100, Philadelphia, Pa. 19101

Circle 203 on Inquiry Card

SURVEILLANCE RECEIVER

Has a 40 MHz panoramic display.



WR-550 receiver covers from 3 kHz to 100 GHz in a single 1.2 ft.³ assembly. It has demodulation for AM, FM, CW, and FM/FM signals. It will also demodulate SSB and other narrowband signals. A feature is an automatic search and track capability. Micro-Tel Corp., 1406 Shoemaker Rd., Baltimore, Md. 21209. (301) 823-6227.

Circle 204 on Inquiry Card

TONE CALLING TERMINAL

Expands touch calling system use.

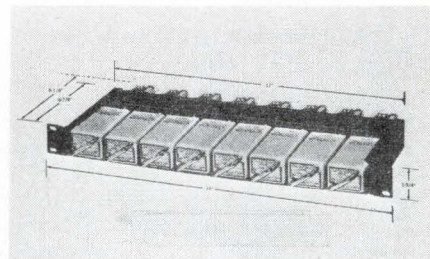

Dataton RTCT (Receiver Tone Calling Terminal), lets any tone-button telephone location be used for control or computer input functions over any commercial or private communications link. No special line matching equipment is needed. Trepac Corp. of America, 30 W. Hamilton Ave., Englewood, N.J. 07631.

Circle 205 on Inquiry Card

DATAREED MATRIX

Has 100 crosspoints.

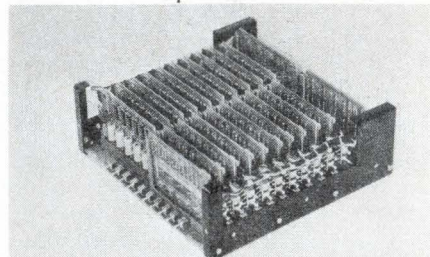

This high speed signal routing instrument is capable of sequential operation at 250 ns intervals without waiting for actual contact closure. It has computer compatible logic levels to allow remote programming. Analog Digital Data Systems, Inc., 830 Linden Ave., Rochester, N.Y. 14625. (716) 381-2370.

Circle 206 on Inquiry Card

SIDEBAND RECEIVER

For general purpose use.

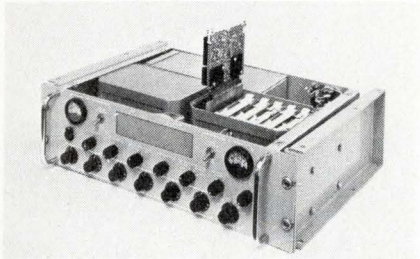

The RF-505 is a freq. synthesized, digitally tuned, two independent sideband receiver, operating from 1.6000 to 29.9999 MHz. Tuning is in 100 Hz increments. Continuous tuning is available in the 1 kHz tuning control. Frequency stab. is ± 1.0 ppm. R F Communications Inc., 1680 University Ave., Rochester, N.Y. 14610.

Circle 207 on Inquiry Card

TELEPRINTER

Is a compact 4.5 x 8.63 x 4 in.

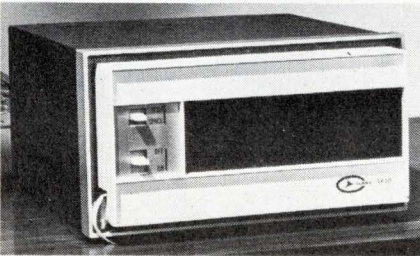

Lightweight "Informer" Model SP-20 accepts data input at std. DT μ L logic levels in 6-line, parallel binary (ASCII) code, or serial entry. It prints alphanumeric data (full 64 char.) on pressure-sensitive paper at up to 1200 char./min. Clary Corp., 320 W. Clary Ave., San Gabriel, Calif. 91776. (213) 287-6111

Circle 208 on Inquiry Card

DATA LOGGER

Has 10 to 100 information channels.

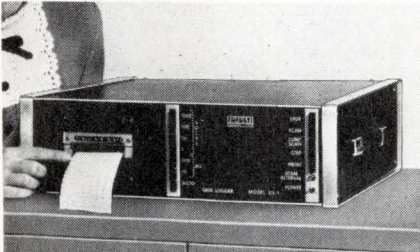

Multi-channel logger Model DL-2 is for automatic and precise measuring and recording. Monitoring speed is normally one signal/s and intervals between scans can be adjusted up to 5 min. duration. Signals are printed to four figure accuracy. P/P/M, Inc., 7016 Euclid Ave., Cleveland, Ohio 44103.

Circle 209 on Inquiry Card

take
the mess
out of
breadboarding
with
elite 1

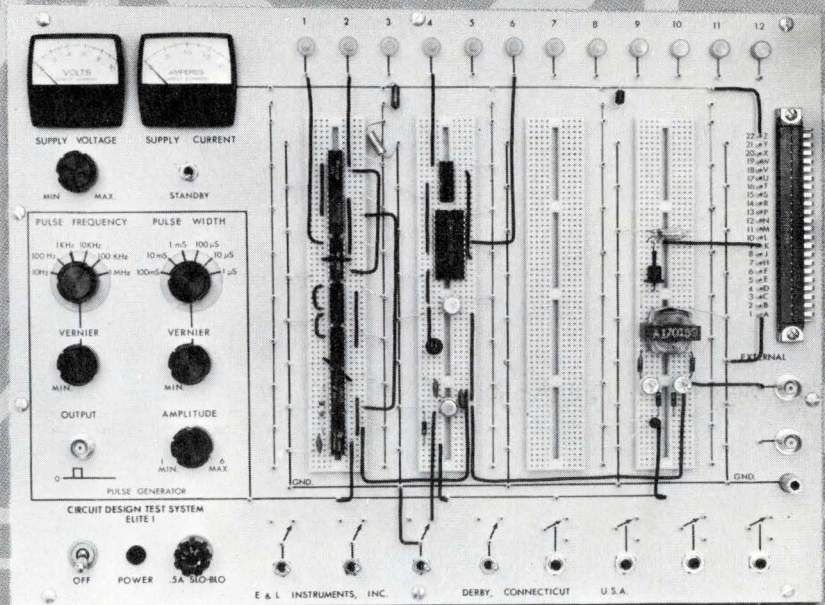

This unique instrument takes all the scavenging and soldering out of design, while conveniently accommodating any combination of IC's and Discrete Components.

BUILT-IN FEATURES:

- Precision Pulse Generator, Variable-Freq., Ampl. and Width.
- Variable Power Supply.
- Neon Lamp Display with Drivers.

ADVANTAGES:

- Total breadboarding without soldering.
- Complete breadboard interconnections with solid #22 wire.
- Breadboarding with any combination of IC's and Discrete's.
- Convenient desk-top operation.

AS A UNIVERSAL INTERFACE

... use the elite 1 for all DESIGNING, TESTING, and BURN-IN; and reduce your breadboarding to merely — inserting components, interconnecting with #22 wire and monitoring circuit responses via built-in display.

\$650.00 complete



EL Instruments Incorporated

61 First Street, Derby, Connecticut 06418 Telephone 203-735-8774



Camera Shy?

Don't be. Here's a truly compact CCTV camera (2⁷/₈" head) that delivers over 1,200-line horizontal resolution.

The Fairchild TCS-950B

It's ideal for those who have shied away from high resolution cameras because of their large sizes and price tags. Fairchild's new TCS-950B gives the sharpness and clarity of over 1,200-line horizontal resolution and 700-line vertical resolution. With the smallest head on the market and exceptionally compact design, the TCS-950B is perfect for data transmission, microscopic component inspection, flight simulation, photo interpretation, medical observation and a multitude of other applications.

For specifications and performance data, contact:

If your CCTV needs are varied and sometimes unusual, you should also consider the versatility available with the TCS-950B:

- Switchable scan rates (either or both scan directions).
- Interlaced or sequential frame scan.
- Video polarity reversal.
- Scan polarity reversal.
- Militarized construction.

Reliability of the TCS-950B is ensured by Fairchild's solid-state Micrologic® circuitry. For its size and high resolution performance, it's one of the lowest priced cameras on the market.

New: The TC-177. You'll get remarkably stable, crisp, high-contrast video signals from this self-contained camera. Features Micrologic® circuitry, 800-line resolution (standard); 2:1 interlace, EIA sync remote control, high resolution (over 900-line), video polarity reversal and other options available.

FAIRCHILD

SPACE AND DEFENSE SYSTEMS

A DIVISION OF FAIRCHILD CAMERA AND INSTRUMENT CORPORATION
30 PARK PLACE, PARAMUS, NEW JERSEY 07652
TEL. 201-262-7000 / TWX 710-990-6610



FOUR-QUADRANT ANALOG MULTIPLIER

High sensitivity for low-level applications.

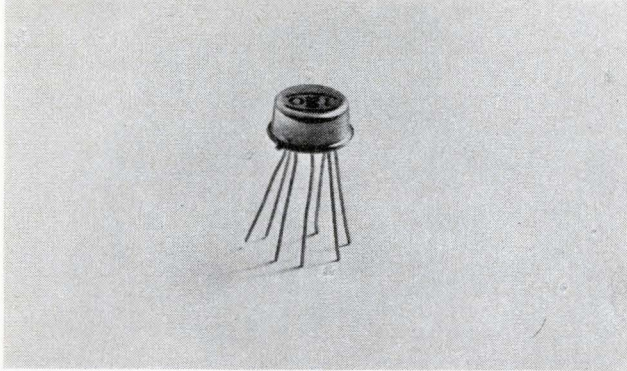

Use this single-chip monolithic device with an op amp to multiply, divide, square, square-root, frequency double, and so forth. Input sensitivity is 10 mV max., and the input impedance is 4 kΩ. Linearity is ±0.8% typ., ±2% max. Frequency for 3° x-y shift is 2 MHz typ.; -3 dB point is 3 MHz min. Output impedance, 50 kΩ min. Operating temperature range, -55° to 125°C, with a 0.1% f.s./°C temperature coefficient on the output. You can use power supplies between 3 V and 20 V. \$25 ea., 1-9 pcs. Optical Electronics, Inc., P. O. Box 11140, Tucson, Ariz. 85706. (602) 624-8358.

Circle 254 on Inquiry Card

LADDER NETWORK

One-fourth the price of comparable MIL-spec units.

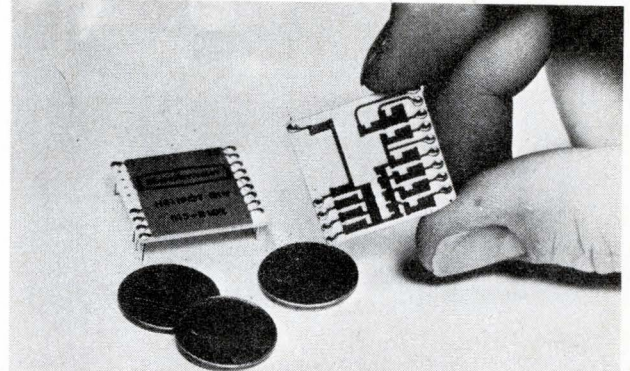

A cermet, monolithic, 8-bit binary ladder, the Model 815 meets applicable environmental requirements of MIL-STD-883. Standard resistance value is 10 kΩ. Maximum output voltage ratio error is 1952 ppm over an operating temperature range of -55° to 125°C. Output voltage is within 0.1% of final value in less than 100 ns after application of the input step. Size-compatible with DIP and flat-pack ICs, the 815 costs \$5.56 ea. in 100-pc. lots. Technical Info. Section, Helipot Div., Beckman Instruments, Inc., 2500 Harbor Blvd., Fullerton, Calif. 92634. (714) 871-4848.

Circle 256 on Inquiry Card

OP AMP

Hybrid, with FET input.

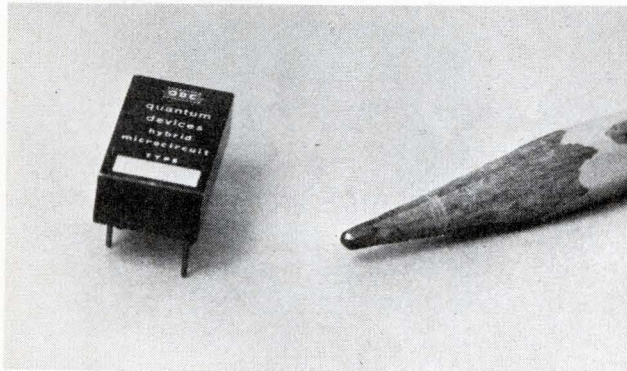

This hybrid op amp features a 5-μV/°C offset voltage drift. The OA104 has a FET input, and is housed in a dual in-line package. According to the maker, the latest techniques of hybrid technology, together with optimal selection of thin-film resistor networks and active devices, produced this stable, balanced circuit. The OA104's initial offset voltage is internally trimmed to better than 1 mV. The device is internally frequency compensated and short-circuit proofed. \$50 ea., 100-pc. lots. Quantum Devices Corp., 15 W. Main St., Box 294, Bergenfield, N. J. 07621. (201) 385-9600.

Circle 255 on Inquiry Card

VARIABLE LENGTH SHIFT REGISTERS

Electronically adjustable.

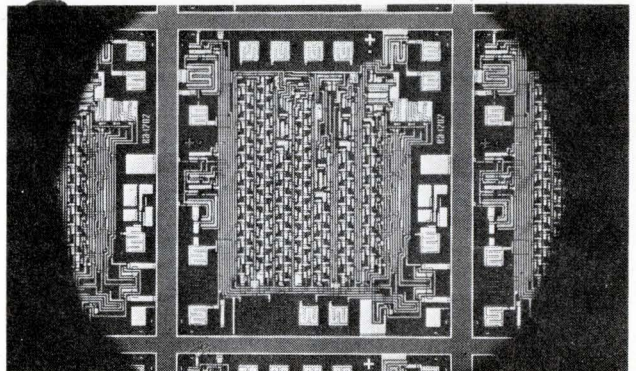

You can either fix or vary the length of these MOS dynamic registers between one and 64 bits, by the logic state of six register-length control inputs. Data input and output leads remain fixed. The EA 1203 operates to 1 MHz with a single-phase 9-V clock; the EA 1202 goes to 3 MHz with a two-phase 24-V clock. Faster units on special order. You can bias a low-impedance output buffer to drive DTL/TTL circuits directly. Operates -55° to 85°C. Hermetic, 14-lead DIP. \$16 ea., 100-999 pcs. Electronic Arrays, Inc., 501 Ellis St., Mountain View, Calif. 94040. (415) 964-4321.

Circle 257 on Inquiry Card

EE NEW MICROWORLD PRODUCTS

COMPUTER-INTERFACE LINEAR IC SERIES

Core memory drivers.

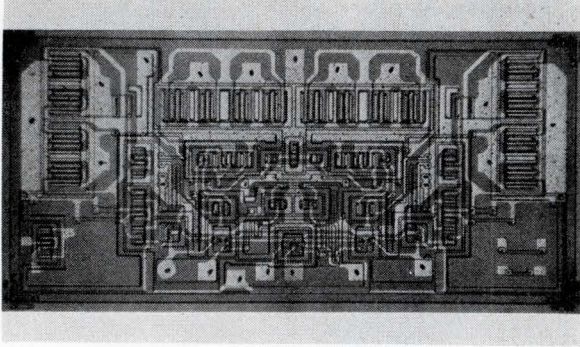

The SN75324 is the first monolithic 400-mA core memory driver with logic and decode in the same package. (Subsequent series additions will be 150- and 500-mA core drivers.) It eliminates transformer coupling and is TTL-compatible. Output saturation voltage is 0.65 V (typ.); output current, 400 mA; avg. prop. delay, 60 ns; operating temperatures, 0° to 70°C. Short-circuit protected. In 100-999 pc. lots, the SN75324 costs \$13.70 ea. for flatpacks, or \$12.25 ea. for plastic DIPs. Texas Instruments, Inquiry Answering Service, P. O. Box 5012—MS/308, Dallas, Tex. 75222. (214) 238-3741.

Circle 258 on Inquiry Card

AUTOMATIC PROBE

For LSI wafers.

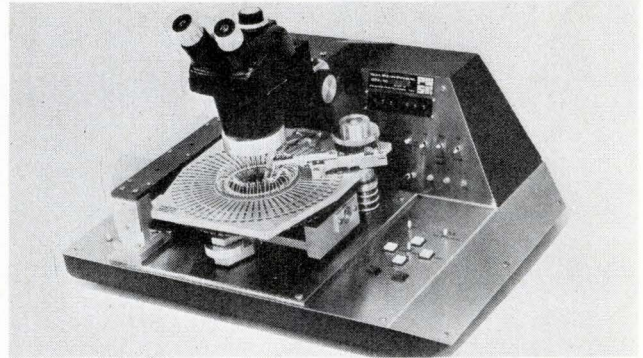

According to the manufacturer, this is the industry's first fully operational probe machine. An automatic system, it represents nearly two years of on-line testing. The 64 adjustable probes have less than 1-pF point to point capacitance. A probe head with a 7-ms inker mounts on a Model CE high-speed automatic probe machine. Drive and logic sections mount in a pull-out rear drawer. The machine can test 3-in. wafers, and may be had with 5-pitch, 10-pitch, or metric lead screws. Pacific Western Systems, Inc., 855 W. Maude Ave., Mountain View, Calif. 94040. (415) 961-8855.

Circle 260 on Inquiry Card

MECHANICAL DIE BONDER

Reduces chip waste, speeds bonding.

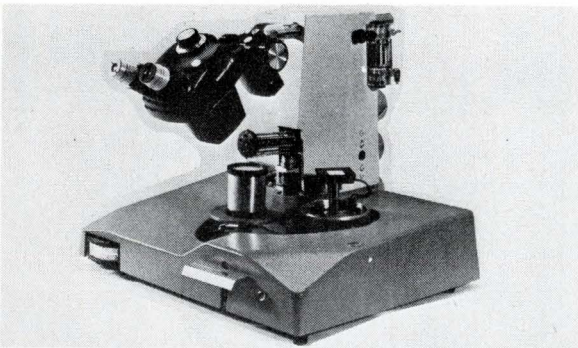

Instead of manually bonding chips to substrates by hand with the usual tweezer methods, you can use this new bonder to do the entire job mechanically. It picks the die from a mirrored dish and places it, precisely oriented, onto the workpiece. The bonder then applies a low-frequency scrub for a firm, void-free bond. You can vary the scrub force as needed. Model 642 has a multiple-collet head that picks up six different-size dice and places them onto the workpiece. Single-collet or ultrasonic heads available. Kulicke and Soffa Industries, Inc., Fort Washington, Pa. 19034. (215) 646-5800.

Circle 259 on Inquiry Card

COPPER-BASED CONDUCTIVE INK

For thick-film circuits.

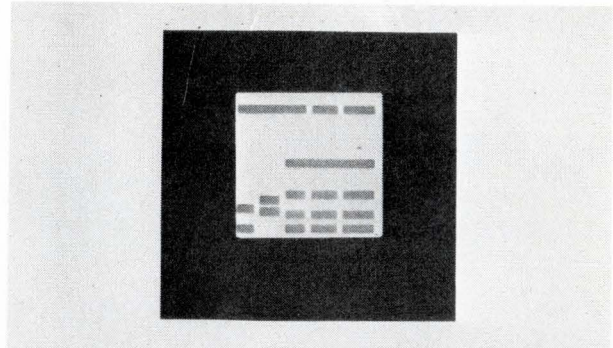

This ink costs 30 to 40% less than silver based inks, and, according to its maker, has excellent printing qualities. Patterns dry in about five minutes at 80°C. The ink's resistance range is from 15 to 40 milliohms per square mil. Adherence to alumina is excellent, and solderability is good. The ink's frit melts at 750°C. Firing should be in a protective nitrogen (or other inert gas) atmosphere with an oxygen content of 0.01% or less so that the copper doesn't oxidize. General Electric Co., Lamp Metals and Components Dept., 21800 Tungsten Rd., Cleveland, Ohio 44117. (216) 266-2451.

Circle 261 on Inquiry Card

Suffering from Pot Core tolerance pain?

(Take a powder and control it all the way).

Ferroxcube pot cores offer the magnetics designer extra performance and value because every step from powder formulation to final machining is under strait-jacket-tight control. And there are a lot of steps to be controlled: particle size, uniformity of properties, pressing, firing, grinding, testing. It takes precision all the way to give you pot cores with electrical tolerances that are the tightest in

the business. That's why our pot cores are the choice of hard-nosed design engineers.

Ferroxcube pioneered ferrite materials. Out of this experience have come some proprietary contributions to the art of mass producing pot cores. These are reflected both in a wide variety of pot core sizes and a range of bobins and hardware accessories. All with prices you can live with.

Ferroxcube pot cores are stocked by distributors in your area. If you haven't yet designed around them and would like to experiment a bit before you buy, write for Bulletin 220-D. A quick scan will tell you which free sample pot core to ask us for.

Ferroxcube 
Saugerties, New York

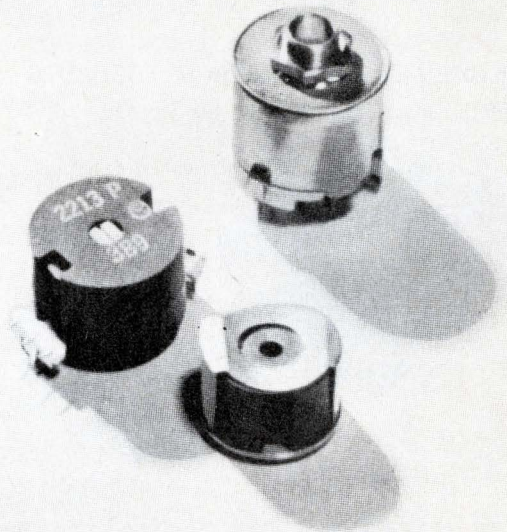
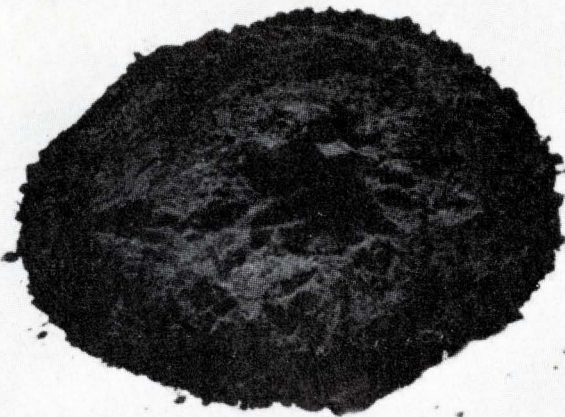

Atlanta—Cartwright & Bean, (404) 237-2273; Baltimore—Eastern Components, (301) 322-1412; *Burbank, Cal.—(213) 849-6631; Columbus, Ohio—Mulligan & Mathias, (614) 486-2976; *Dallas—Gillett Industries, (214) 363-0107; Fayetteville, N.Y.—R. P. Kennedy Co., (315) 637-9531; Huntsville, Ala.—Cartwright & Bean, (205) 852-7670; Hyde Park, N.Y.—R. P. Kennedy Co., (914) 229-2269; Littleton, Col.—Wm. J. Purdy Agents, (303) 794-4283; Minneapolis—(612) 920-1830; *New York—Kahgan Sales, (516) 538-2300; *Northlake, Ill.—(312) 261-7880; No. Miami Beach—Cartwright & Bean, (305) 945-2962; Orlando—Cartwright & Bean, (305) 425-8284; Ormond Beach, Fla.—Cartwright & Bean, (904) 677-3480; *Philadelphia—Eastern Components, (215) 927-6262; Phoenix—(602) 264-3129; Rochester, N.Y.—R. P. Kennedy Co., (716) 271-6322; *San Francisco—Wm. J. Purdy Agents, (415) 347-7701; Saugerties, N.Y.—(914) 246-2811; Union, N.J.—(201) 964-1844; *Waltham, Mass.—(617) 899-3110; Winston Salem—(919) 725-6306; *Woodstock, N.Y.—Elna Ferrite Labs, (914) 679-2497; *Toronto, Ont.—Philips Electron Devices, Ltd. (416) 425-5161. *Denotes stocking distributor.

EE NEW LAB INSTRUMENTS

PORTABLE INSTRUMENTATION RECORDER

Four channels, three speeds, very low flutter.



A crystal-controlled, phaselock servo drive gives a tape-limited speed accuracy of $\pm 0.2\%$ and minimum flutter. Model 3960A uses any four-channel combination of fm or direct record/reproduce electronics. FM mode signal-to-noise ratio is 46 dB min. at 15/16 ips, 48 dB min. at higher speeds (3¼ and 15 ips). At 15 ips, direct recording response goes to 60 kHz, fm to 5 kHz. The recorder uses ¼-in. tape on standard 7-in. reels, and has built-in calibration circuitry for the fm mode. With four fm channels, the 3960A costs \$4285. Inquiries Mgr., Hewlett-Packard Co., 1501 Page Mill Rd., Palo Alto, Calif. 94304. (415) 326-7000.

Circle 262 on Inquiry Card

PUNCHED-CARD RESISTANCE DECADES

Digitally programmed with a hand punch.

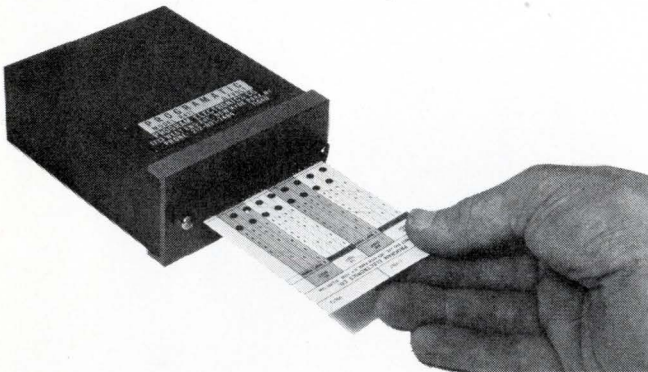

Use this panel-mounted card reader to automate resistively-controlled equipment. It translates a punched digital number to an equivalent analog resistance function. Available in accuracies from $\pm 0.1\%$ to $\pm 0.01\%$, the programmed-resistance repeatability is $\pm 0.0025\%$. Operating temperature range is 10° to 40°C , with a TC of 25 ppm/ $^\circ\text{C}$. Needs 2 x 4.25 in. on panel, 6 in. behind panel. Model P413, $\pm 0.1\%$ accurate, six cards and a punch, \$99. Model P413M, militarized for -55° to 125°C , \$137.25. Program Electronics Co., 1733 West End Ave., New Hyde Park, N. Y. 11040. (212) 991-7484.

Circle 263 on Inquiry Card

PORTABLE SPECTRUM ANALYZER

Battery/ac powered; bright display; 10 Hz to 50 kHz.



Calibrated functions include: scan width, 10 Hz/cm to 5 kHz/cm; i-f bandwidth, 10 Hz and 100 Hz; sweep time, 3 ms/cm to 10 s/cm; vertical display, 30 nV/cm to 3 V/cm linear, 10 dB/cm (60 dB on screen) log. Sensitivity as a low-noise receiver is better than -140 dBm. Switch-selectable 50- Ω to 1-M Ω input impedances. Recording outputs and controls; 4-digit digital frequency readout. Called the 710/800, it consists of a Model 710 display unit and a Model 800 analyzer module. \$2495. Microwave Div., Systron-Donner Corp., 14844 Oxnard St., Van Nuys, Calif. 91409. (213) 786-1760.

Circle 264 on Inquiry Card

LOW-FREQUENCY COUNTERS

Tachometry, crystal checking, production testing, etc.

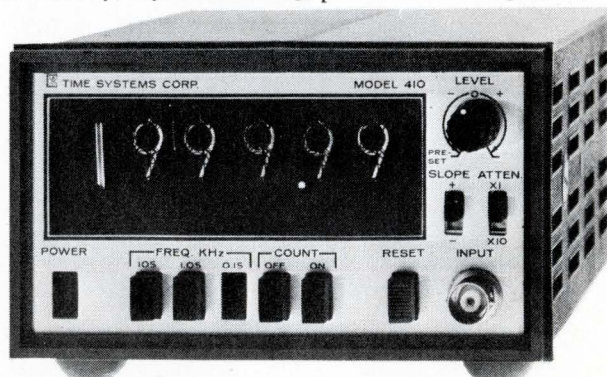

These counters offer a useful combination of features for the low-cost, low-frequency market. There is a full set of input conditioning controls; a 10-s time base position for resolution and accuracy to 0.1 Hz; BCD output; remote programming of all functions; and push-button operation. Input conditioning controls include a trigger level control, switch-selectable slope, and a two-position attenuator. You can use the counters for most waveforms. Three units can fit side by side in a 19-in. panel. Time Systems Corp., 265 Whisman Rd., Mountain View, Calif. 94040. (415) 961-9321.

Circle 265 on Inquiry Card

Hi-Reliability from Weston is no put on.

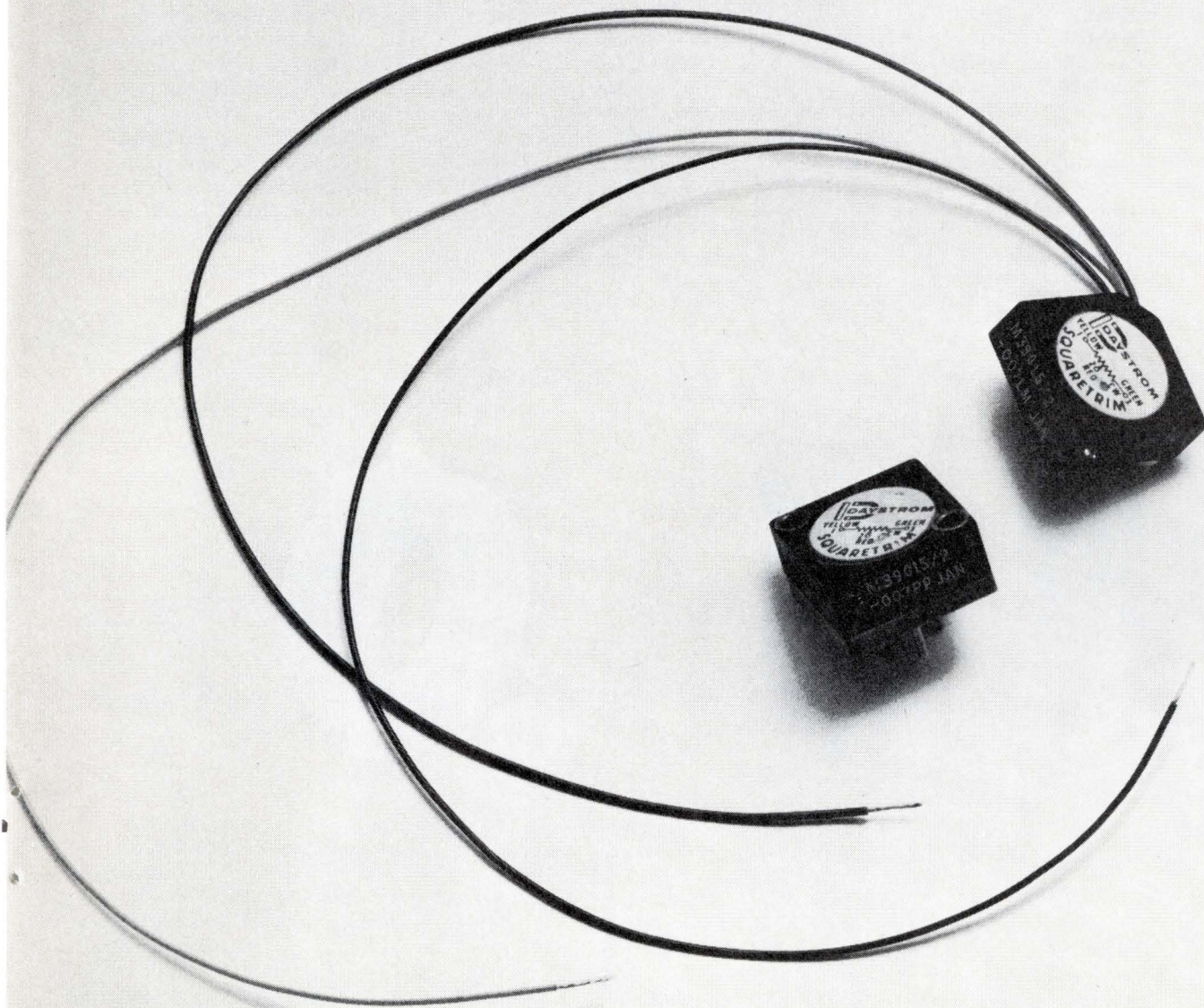

When we say Hi-Reliability, we mean it! Weston offers units designed, manufactured and tested in complete conformance with MIL-R-39015. You'll find a designator stamped on every Weston Squaretrim® Hi-Rel pot in the 200 ohm to 20K range. This number verifies its failure rate and confidence level at full ¼ watt operating power. Design, materials

and workmanship must be tops. Not to mention Weston's 45 to 1 adjustment ratio, patented wire-in-the-groove construction, and slip clutch mechanical protection which are standard features of these pedigreed models. Insist on the genuine item—Squaretrim Hi-Rel Model 313-160HS with flexible leads or 318-160HS with pins—in all critical applica-

tions. Contact the factory about other Hi-Rel values available, or see your local distributor. Daystrom potentiometers are another product of WESTON COMPONENTS DIVISION, Archbald, Pa. 18403, Weston Instruments, Inc. a Schlumberger company

WESTON®

EE NEW LAB INSTRUMENTS

DUAL CONVERSION UP-CONVERTER

Covers communications satellite band without retuning.

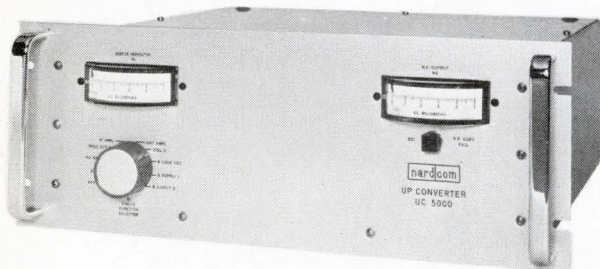

This unit converts any 70-MHz i-f carrier to an rf signal between 5925 and 6425 MHz. Simply change the frequency of the local oscillator signal to the second up-conversion mixer, to change the converter's output frequency. Output level is -20 dBm (0 dBm, optional); 70-MHz input level, -10 to 0 dBm. Frequency repeatability, better than 5 ppm over a 5-yr. period; stability better than 2 ppm/month. Less than -125 dBW rf noise in any 4-kHz band. Model UC-5000 meets CCIR and ICSC requirements. Nardcom Corp., 75 Commercial St., Plainview, N. Y. 11803. (516) 433-9000.

Circle 266 on Inquiry Card

HIGH-SPEED MINIVERTERS™

Throughput rates to 180 kHz; 12-bit format.

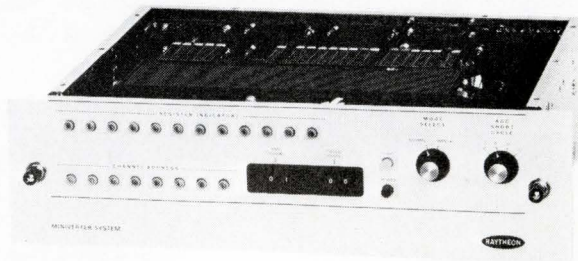

Three instruments each combine a multiplexer, sample-and-hold amplifier, and A-to-D converter for throughput rates of 90, 135, and 180 kHz. A short-cycle mode gives higher rates at fewer bits resolution. Capable of sequential and random address operation, the units handle up to 64 input channels in 8-channel plug-in increments. Input range, ± 10 V. Sample-and-hold amplifier aperture time, 50 ns max. Overall accuracy of multiplexed units, 0.065% ± 1 LSB. Optional control and indicator panel. \$5800 to \$8200 ea. Raytheon Computer, 2700 S. Fairview St., Santa Ana, Calif. 92704. (714) 546-7160.

Circle 268 on Inquiry Card

AUTO-RANGING DIGITAL MULTIMETER

Reads to 10 μ V and 10 pA; teleprinter/recorder outputs.



Push-button select a basic measuring range, and this instrument automatically selects one of three sub-ranges to display a best-resolution reading. The PM-2421 reads 10 μ V to 1000 Vdc; to 500 Vac max. rms; dc/ac currents from 10 pA to 1.4 A; resistances from 0.01 Ω to 1400 M Ω . Maximum resolution is 10 pA in the 14-nA range, 0.01 Ω in the 14- Ω range, and 10 μ V in the 14-mVdc range. DC voltage readings are accurate to 0.1% ± 1 digit. \$1125. Digital output module and rf probe (2 mV-140 V, 700 MHz) options. Philips Electronics Instr., 750 S. Fulton Ave., Mt. Vernon, N. Y. 10550. (914) 664-4500.

Circle 267 on Inquiry Card

RF CURRENT PROBES

For measurements of conducted interference in cables.



Model 94430 accepts cables to $\frac{3}{4}$ -in. dia. Standard connector is BNC; TNC on request, but miniature connectors must be special-ordered. Operates 20 Hz to 250 MHz with your specified transfer impedance of 0.05, 0.1, 1.0, or 7.0 Ω . Rated output load is 50 Ω . Model 94456 accepts 4-in. cables, has type-N connector, operates from 10 Hz to 100 MHz. Transfer impedances are 0.06, 0.1, 1.0, or 5.0 Ω . Output load, 50 Ω . Probes hinge open, clamp shut, and are available with other transfer impedances. Stoddart Electro Systems, 2045 W. Rosecrans Ave., Gardena, Calif. 90249. (213) 770-0270.

Circle 269 on Inquiry Card

At last...a practical enclosure styling system with unlimited versatility.

Amco takes the sting out of styling with 33 new styling approaches that can be quickly and inexpensively applied to Amco stock modular enclosures.

Here's how the Amco INTERFACE-33 styling system works:

There are at least 33 different combinations of horizontal and vertical trim that can be added to Amco Custom & Semi-custom frames. In certain cases, these frames can also be interfaced with Amco Heavy-Duty Aluminum frames. The trim style works as well for one enclosure as it does for multiple-bay consoles. Different basic enclosure systems may be combined to take advantage of their particular features while still maintaining a unitized, custom appearance for the entire system.

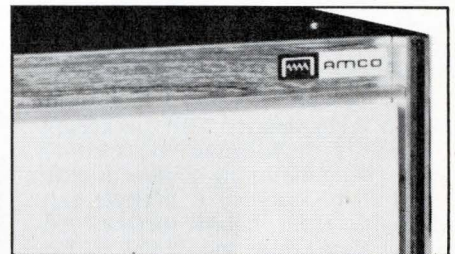
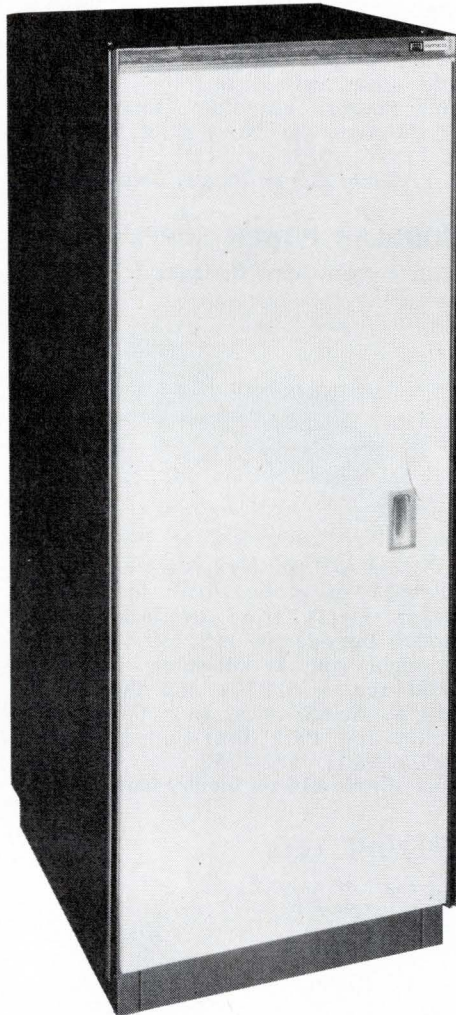

A wood grain effect on the horizontal trim was also specified to enhance the styling effect.

You're not limited to the standard INTERFACE-33 styling combinations. Many different styling effects can be achieved through the use of various colors or vinyls on the enclosure panels or trim. Amco styling engineers will gladly assist in selecting your own protected styling approach.

The complete versatility of the Amco INTERFACE-33 system makes protected styling feasible.

INTERFACE-33 is versatile . . .

- 33 distinctly different styling combinations.
- 3 structurally different console systems . . . 2 in steel . . . 1 in aluminum.
- 10 different textured and semi-gloss finishes in two-tone combinations with high scuff and chemical resistance epoxy finishes.

- 12 different colors, including two neutral metallic finishes.
- 3 different pressure sensitive adhesive vinyl trims.

INTERFACE-33 is easy to use . . .

It looks different and it looks like it belongs. For example, the enclosure shown utilizes INTERFACE-33 style approach #14 which consists of horizontal trim and vertical trim:



AMCO ENGINEERING CO.

7333 West Ainslie St., Chicago, Illinois 60656

CONTROLLED INDICATOR

IC compatible.

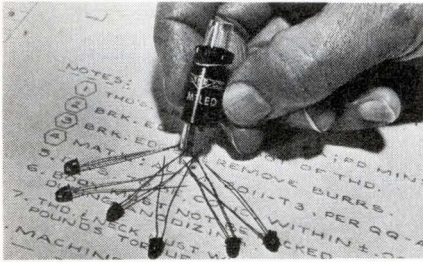

This MTLED series indicator consists of a light emitting diode (L.E.D.) controlled by integral SS logic. It interfaces directly with RTL, DTL and TTL and operates from +5.0 V supply. The light source is a GaAs phosphide diode. Transistor Electronics Corp., Box 6191, Minneapolis, Minn. 55424.

Circle 210 on Inquiry Card

FLAT PACK SOCKETS

Provide low profile.

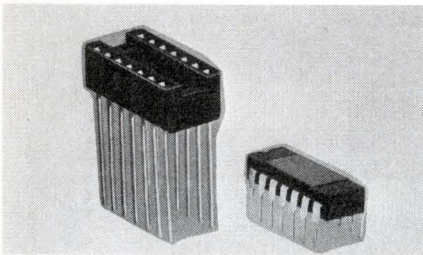

New 14 and 16 contact receptacles provide high density DIP packaging. Connectors are soldered into a circuit board giving mounting centers as close as 0.400 in. Installed it projects only 0.255 in. from board surface. Advanced Packaging, Inc., 1357 E. Edinger Ave., Santa Ana, Calif. 92707. (714) 547-3935.

Circle 211 on Inquiry Card

BALUN TRANSFORMERS

Reduce noise in memory circuits.

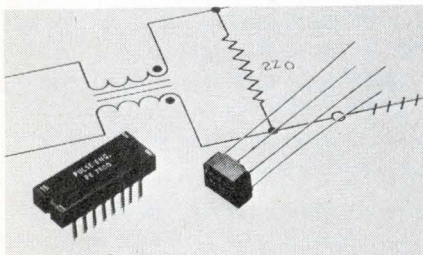

The balun transformer series comes in a four transformer module compatible with ICs as well as in discrete miniature cases. They feature ratios of primary ind. to leakage ind. as high as 6600:1. Balun transformers with primary ind. of 20 μ H to 2000 μ H are available. Pulse Engineering Inc., 560 Robert Ave., Santa Clara, Calif. 95050. (408) 248-6040.

Circle 212 on Inquiry Card

PHOTOVOLTAIC CELLS

Fast response time.

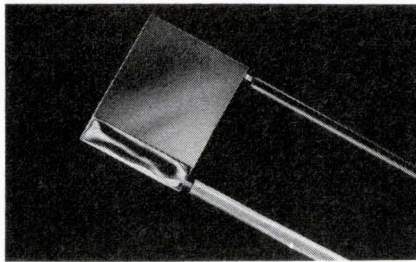

These silicon cells (Ultra-Cells) feature typical leakage of 2 μ A -5.0 Vdc and 25°C. Typically an Ultra-Cell is two to three times faster than normal sensors with higher values possible under certain operating conditions. Sensor Technology, Inc., 7118 Gerald Ave., Van Nuys, Calif. 91406. (213) 873-1533.

Circle 213 on Inquiry Card

MODULAR POWER SUPPLY

With current limit foldback.

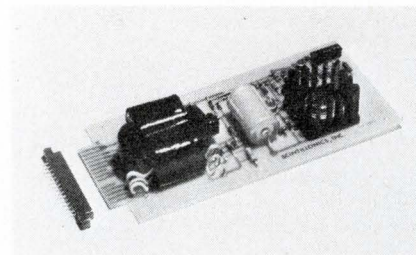

Model ACF supply has current limit foldback to protect both load and power supply from overloads. All models provide for 115/230 V input. Nominal volt. is adjustable \pm 10%. Load reg. is 0.03% and line reg. 0.01%. Scintillonics, Inc., 600 Fort Collins Ind. Park, Fort Collins, Colo. 80521. (303) 482-4752.

Circle 214 on Inquiry Card

VHF/UHF FETS

Have a low noise figure.

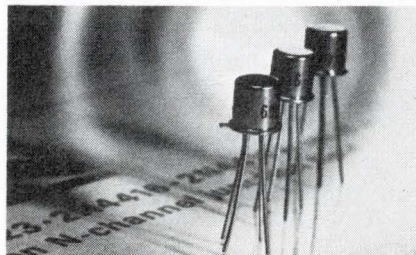

These devices (2N3823, 2N4416 and 2N4416A) provide 18 dB pwr. gain at 100 MHz or 10 dB gain at 400 MHz. Noise fig. is 2.0 dB at 100 MHz or 4.0 dB at 400 MHz. They also have low capacitance (0.8 pF) and high gain (4500 μ mhos). National Semiconductor Corp., 2950 San Ysidro Way, Santa Clara, Calif. 95051. (408) 245-4320.

Circle 215 on Inquiry Card

SI BRIDGE RECTIFIERS

For PC boards.

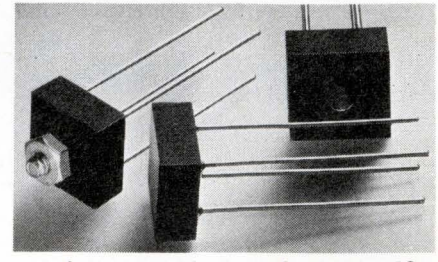

Miniature, single phase rectifier units in this series will accept inputs to 700 V rms and withstand PIVs to 1000 V. Maximum dc current is 2 A in amb. temps. to 30°C. However, the rectifiers are capable of reduced output current up to 130°C. Sarkes Tarzian Semiconductor Div., 415 N. College Ave., Bloomington, Ind. 47401.

Circle 216 on Inquiry Card

DECODER/DISPLAY

Decoding done with readout head.

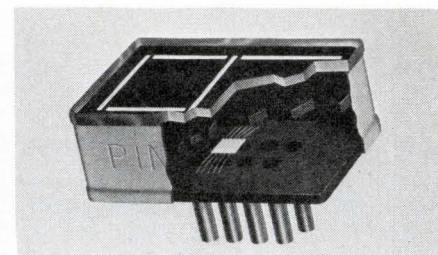

With the Midgi-Coder-Lite, Model M6-IC, you don't need a separate decoder package to translate from 8-4-2-1 BCD code to seven segment displays. It is done within the readout head; with a total combined depth of only 3/16 in. Pinlites Inc., 1275 Bloomfield Ave., Fairfield, N.J. 07006. (201) 226-7724.

Circle 217 on Inquiry Card

CIRCUIT PROTECTOR

Senses and deflects transients.



Transtector™ Circuit Protector can sense and deflect damaging transient voltages and currents in < 50 ns. It will then return the transient to nominal line voltage in < 500 ns. It also protects against sudden losses of voltage below acceptable operating levels. Transtector Systems of M & T Chemicals Inc., 3025 W. Mission Rd., Alhambra, Calif. 91803.

Circle 218 on Inquiry Card

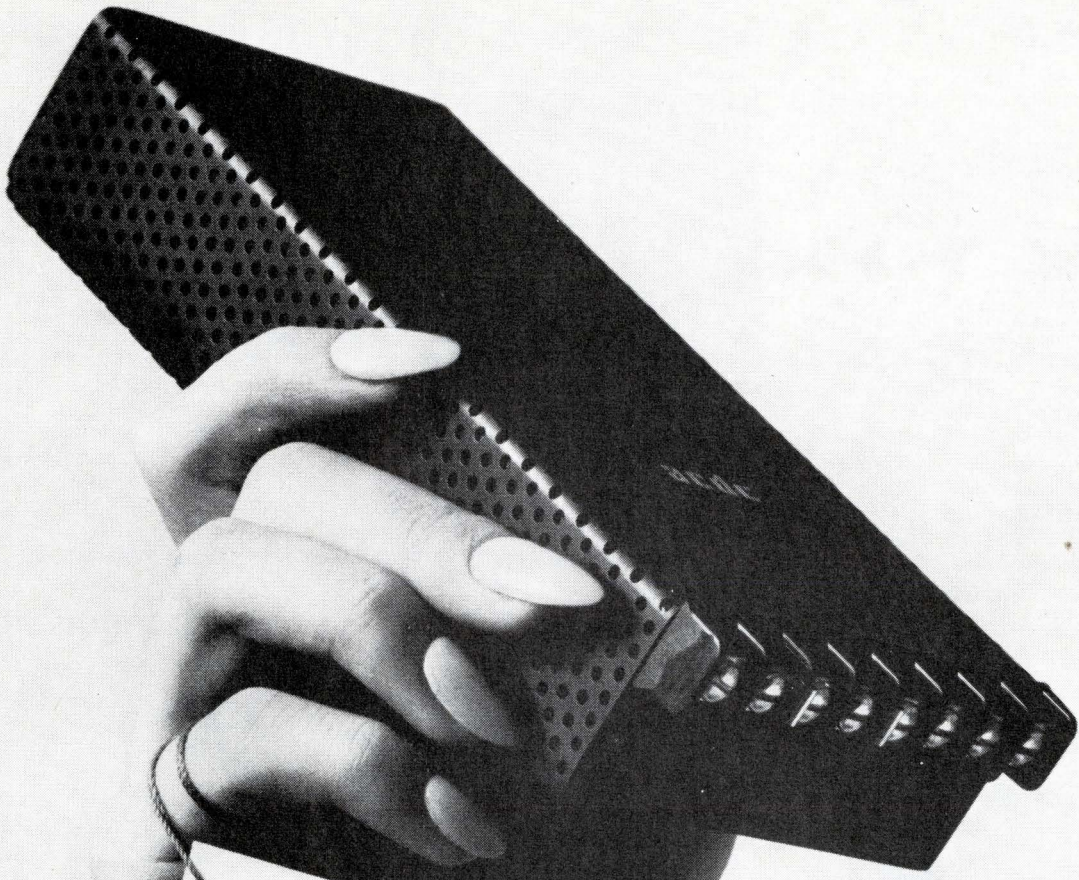

**New tiny
product.**

**Old giant
guarantee.**

DC Power Supply Modules
**GUARANTEED
FOREVER**
acdc electronics inc.

Meet JR.
The world's first
Guaranteed Forever
miniaturized power supply.
Five times smaller. 50%
better efficiency.
Competitively priced.
Write for complete catalog.
acdc electronics, inc.
2979 North Ontario St.,
Burbank, Calif. 91504.

EE NEW PRODUCTS

CRYSTAL FILTER

Center freq. is 40 MHz.



New 40 MHz crystal filter (Model P4012 AA) has a 3 dB bandwidth of 10 Hz, 20 Hz, 30 Hz, 40 Hz and 200 Hz. The 60 dB to 3 dB bandwidth ratio is 2.0 with a spurious rejection of 60 dB for narrow bands and 50 dB for wide bands. Microsonics, 60 Winter St., Weymouth, Mass. 02188.

Circle 219 on Inquiry Card

PLASTIC SOLDER

Can be cured at room temp.

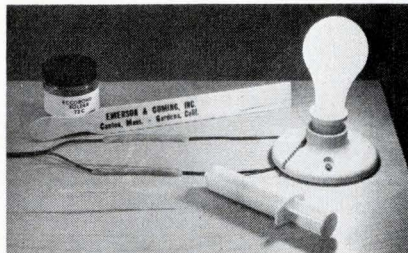

Eccobond 72-C is a two component electrically conductive adhesive that effectively replaces hot solders. Its price is one-fourth that of silver filled plastic solders, while the vol. res. is five times (0.01Ω cm). Emerson & Cuming, Inc., Canton, Mass. 02021. (617) 828-3300.

Circle 222 on Inquiry Card

FLATPACK LEAD CUTTER

Trims individual leads.

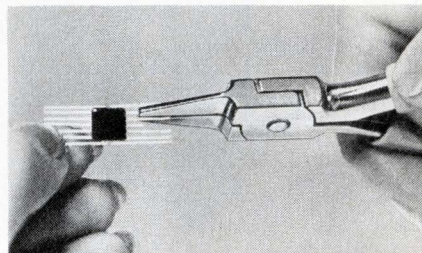

The Model 1018 narrow end cutter has a tip width of 0.062 in., allowing adequate clearance of adjacent leads. Stop screw in shank prevents possible overpressure. Rated for cutting capacity of 0.006 x 0.020 in. maximum lead dimensions. ETM Corp., Monrovia, Calif. 91016.

Circle 225 on Inquiry Card

RF SWITCHES

For transient-free switching.



These rf switches cover from 0.2 to 500 MHz. High freq. components of the switching signal are suppressed 30 dB or greater. Schottky barrier diodes permit fast switching speeds. Less than 1 ns switching speeds and "on-off" ratios > 80 dB are specified. Relcom, 2329 Charleston Rd., Mountain View, Calif. 94040. (415) 961-6265.

Circle 220 on Inquiry Card

DESOLDER TOOL

For PCs and microcircuits.

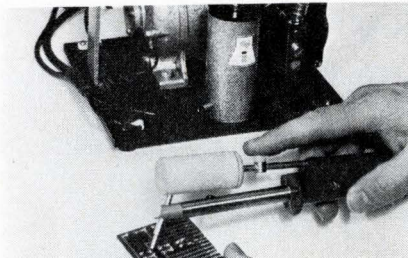

Model 67-1 De-soldermaster draws unwanted solder into an asbestos trap by using a precision built continuous duty diaphragm pump. It allows the operator to desolder multi-contacts without damaging adjacent components. Scientific Industries, Inc., 55 Madison Ave., Hempstead, N.Y. 11550.

Circle 223 on Inquiry Card

NPN DUAL TRANSISTORS

Low noise figure.

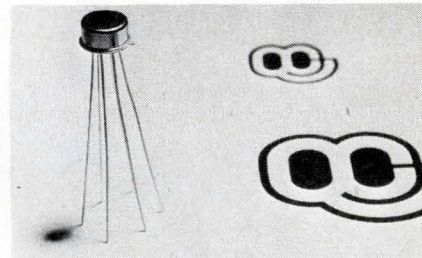

Series 2N2913-20 transistors have a NF of 3.0 dB max. at 1.0 kHz, breakdown voltages as high as 60 V, V_{BE} matching of ± 3.0 mV max., and V_{BE} tracking accuracy of $10 \mu V/^\circ C$ at $100 \mu A$. A high current gain of 150 min. is provided at $10 \mu A$. Qualidyne Corp., 3699 Tahoe Way, Santa Clara, Calif. 95051. (408) 738-0120.

Circle 226 on Inquiry Card

OP AMP

Minimum output is 5.5 mA at ± 11 V.

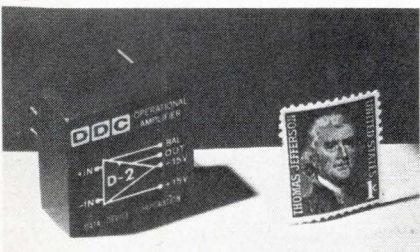

These low cost D-2 series devices feature input overvoltage and output short-circuit protection. Typical stability is $10 \mu V/^\circ C$ voltage and 0.2 nA/ $^\circ C$ current drift. DC open loop gain at rated load is 90 dB and freq. for full output is 50 kHz. Frequency for unit gain is 1.5 MHz. Data Device Corp., 100 Tec St., Hicksville, N.Y. 11801. (516) 433-5330.

Circle 221 on Inquiry Card

COAXIAL SWITCH

In a subminiature package.

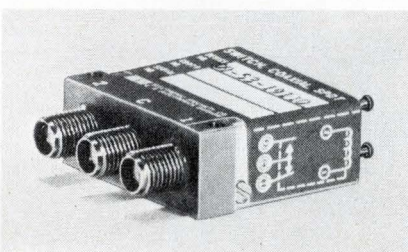

New SPDT switch combines good rf performance with broad bandwidth. Series 09-53 switches have excellent vswr (e.g. at 12.4 GHz it = 1.25:1), and high inter-channel isolation to 18 GHz (e.g., 60 dB min. at 11 GHz and 55 dB to 18 GHz). Electronic Specialty Co., 4561 Colorado Blvd., Los Angeles, Calif. 90030. (213) 246-6761.

Circle 224 on Inquiry Card

DIGITAL READOUT

Meets Mil Specs.

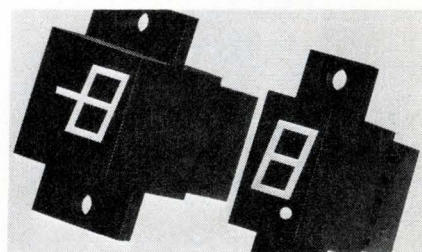

Series 30 Digator® modules have a character size of about 0.3 x 0.2 in. Maximum current per lamp is 20 mA max. at 5 Vdc. Rated life is 50,000 hrs. Light output is from 10 to 200 FL with standard lamps, and up to 1000 FL with higher current lamps. Discon Corp., 1150 Northwest 70th St., Ft. Lauderdale, Fla., 33309 (305) 933-4551.

Circle 227 on Inquiry Card

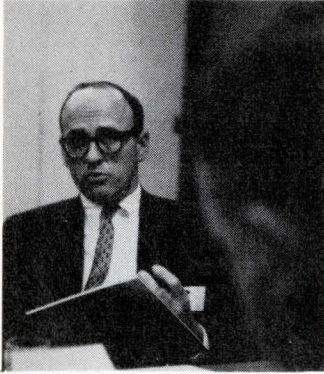

SWITCH CRAFT FORUM

order, stock, assemble and test the cable assemblies you're now using. Compare your total costs with the price we'll

I've been itching for a FORUM on molded cable assemblies. I say you can't beat the solder or screw connected assemblies when it comes to fast repairs in the field.

How about less repairs to begin with? Failure incident rates have proven to be less with molded cable assemblies. Pull tests show why molded assemblies are 50%-100% stronger than soldered plugs. Solder types, like the one shown in fig. 1 (bottom) broke at forces as low as 24 lbs. In fact, in the tests we've run, the cable itself broke before it would pull out of the molded plug.

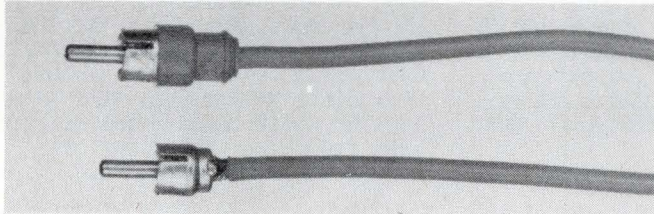

But when it does break, you're finished. That could mean expensive equipment down-time unless it can be quickly repaired.

Let's say the molded assembly does break. If you clip off the damaged plug and replace it, you're still better off than with solder or screw type connectors. You want better aspirin; we say, eliminate the headache in the first place.

Repair costs can be expensive, too. Especially, if the connection is poorly soldered and shows up as an intermittent defect. Add this to the possibility of non-molded plug handles coming loose from vibration, poor shielding from moisture and contaminants, or excessive strain due to plug and cable size mis-matches and you've got yourself a potential profit-killer.

O.K., I'll have to concede your point as far as the cable-plug connection is concerned. But, you'll have to admit that when the molding holds the plug parts together, plastic cold flow can loosen the plug tip and kill reliability.

You're right. That's why Switchcraft doesn't mold the plug components together.

Fig. 2. shows how we start with a one-piece tip rod, connector and insulators, with the rod solidly staked into the tip terminal. After soldering the center conductor, a bridge sleeve is crimped around the cable and connector flange prior to molding. No tip loosening, no cable strain.

I'm almost convinced. Now give me the bad news about the cost of molded cable assemblies vs. solder or screw types.

Brace yourself. Think of what it costs your company to

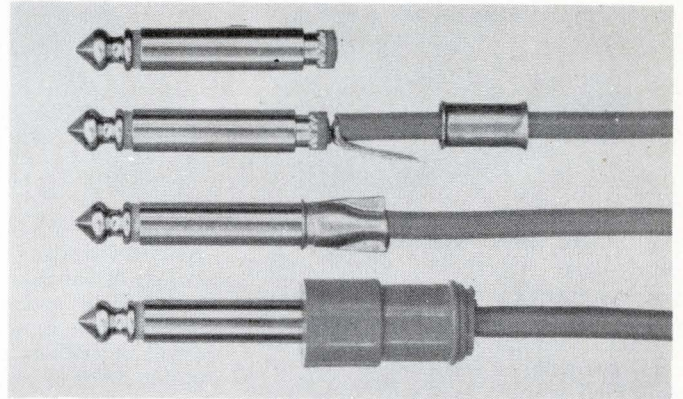

quote for a comparable molded cable assembly, and you'll be money ahead. And that doesn't even include the cost-savings you'll get from the added reliability of our molded cable assemblies.

That's great for phone and phono plugs, but we often get into some pretty oddball applications where we need a different type of connection.

You name it, we can produce it. Most of the time, one of our standard straight or right angle phone or phono plugs, microphone connectors or extension jacks will do the job. If not, Switchcraft has the know-how and high production machinery to run an economical, custom-molded unit to your specs. *Just circle the reader service number for more info on these standard and custom made molded cable assemblies.*

Sounds good, but how can my staff get further technical details on specific applications that back up what you've just told me?

Simple. Have them join the FORUM by writing their questions or comments on your company letterhead. We'll send

our "Forumfacts on Molded Cable Assemblies" handbook, and also add their name to our TECH-TOPICS mailing list. Every other month, they'll receive this engineering application magazine that we're sure will be useful and interesting to them. 10,000 design engineers can't be wrong!!



SWITCHCRAFT
INC.

5529 North Elston Avenue
Chicago, Illinois 60630

PARAMETRIC AMPLIFIER

For dc to 1 kHz ranges.

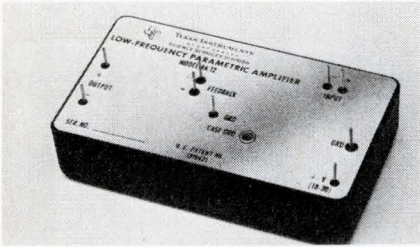

Model RA-12 If amplifier is for use where min. system noise, indiscernible input noise current, high input impedance and high common mode rejection are desired. Gain, adjustable through ext. feedback resistors, normally is from 60 to 100 dB. Amplifier input is fully differential and floating and is completely separated from the feedback circuitry, preventing the possibility of any ground loops between sensor elements and recording equipment. Texas Instruments Incorporated, Box 5621, M.S. 938, Dallas, Tex. 75222.

Circle 228 on Inquiry Card

VARIABLE ATTENUATOR

Weighs less than 6 oz.

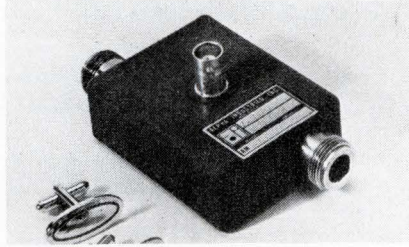

Voltage variable attenuator Model AM7000A can also be used as a switch or modulator in systems where low VSWR and system accuracy are critical requirements. This device is available with standard PIN diodes or optional PN types for greater switching speed. Specs. include: Freq. range: 1-4 GHz; insertion loss (0 mA): 2 dB max.; dynamic range (50 mA): 40 dB min. from 1-2 GHz, 50 dB min from 2-4 GHz and VSWR: 2.0 max. Alpha Industries, Inc., 381 Elliot St., Newton Upper Falls, Mass. 02164 (617) 969-6480.

Circle 229 on Inquiry Card

COAXIAL CONNECTOR

Solderless SMA type.

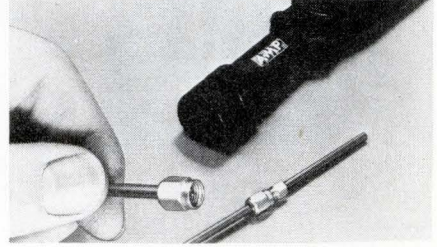

Until now, all Mil-C-39012 Type SMA connectors have been the solder type. However, these new connectors are mechanically terminated to the cable, avoiding any possibility of heat damage to cable dielectric during assembly. They can be salvaged for re-application to another cable if necessary, and are interchangeable with existing Type SMA connectors. This 50Ω subminiature unit is usable up to 12 GHz with a vswr < 1.02 + 0.0067 (f in GHz). Rf leakage is -78 dB at 2.5 GHz. AMP Incorporated, Harrisburg, Pa. 17105. (717) 564-0101.

Circle 230 on Inquiry Card

New from IGC: sintered form of the industry's best alnico 8.

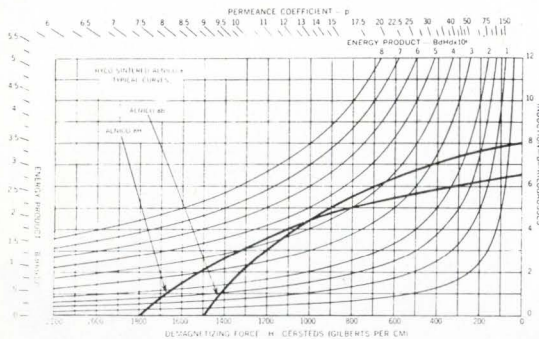

You might be able to get sintered alnico 8 somewhere else —but not like this. Our HyCo 8 has the greatest coercive force of all sintered alnicos. Typically, 1500 oersted for HyCo 8B, and 1800 oersted for 8H.

Sintered alnico 8 is well suited for miniaturized applications requiring a high coercive force. Typical uses include motors, TWTs, polarized relays, reed switches, pick-up cartridges, core meters, and holding and torque transmitting devices. And sintered has it all over cast alnicos when it comes to smoother surfaces, closer tolerances, physical strength, and flexibility of shapes.

For the complete characteristics and further details on sintered HyCo Alnico 8B and 8H, write Mr. C. H. Repenn, Manager of Sales, Indiana General Corporation, Magnet Division, Valparaiso, Indiana.

INDIANA GENERAL

We make it easy for the design engineer.

Circle 54 on Inquiry Card

ELROY

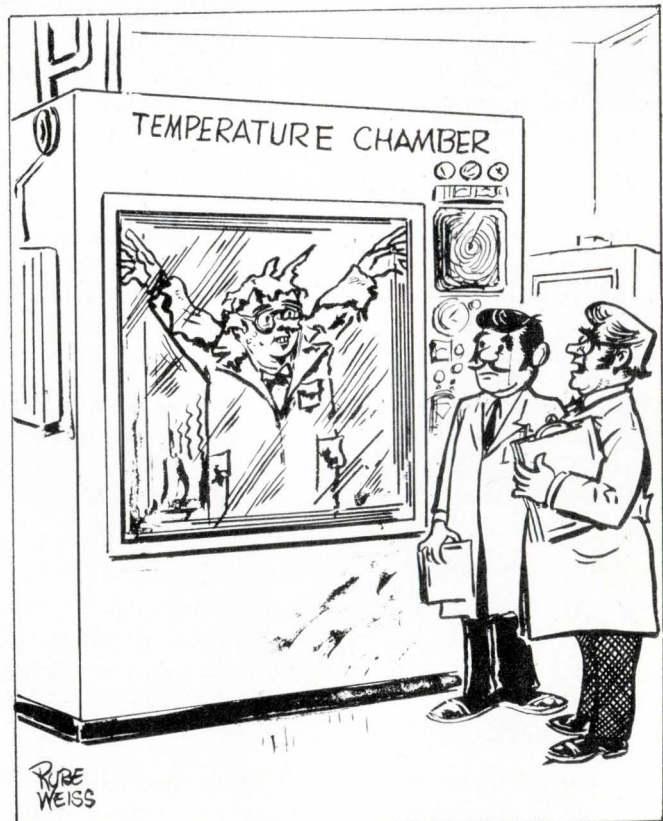

"Who cares who lowered the temperature . . . What's he doing in there in the first place?"

increase ic yield

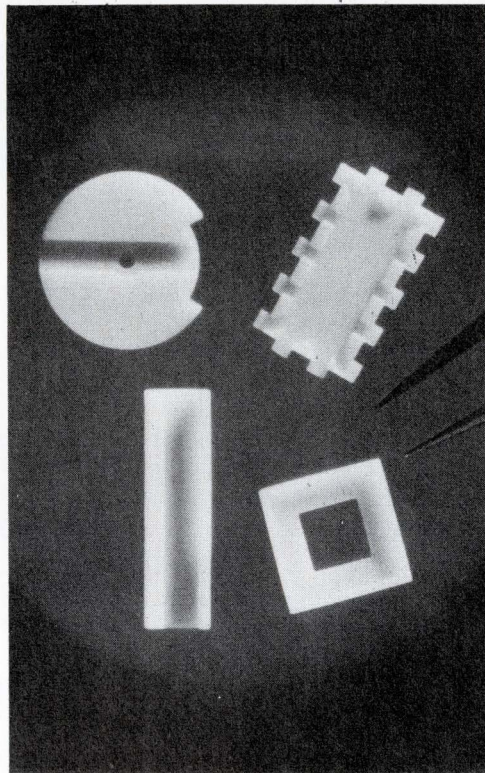

With Coors microceramics. Parts and complete packages. Of alumina and beryllia. Strong, chemically inert, dimensionally stable. Unaffected by age or environment. Part-to-part uniformity from 1st to nth. Precision-ground or as-fired surfaces. Easy to metallize, by you, by us. Most any size, any shape. Fast delivery. Prototype quantities, millions, or anything in between. Get higher yield, more profit. Start with the most reliable circuit packaging. Coors microceramics. Send for data pack.

Coors Porcelain Company
Golden, Colorado 80401

Coors/CERAMICS

EE NEW PRODUCTS

REED RELAY

Only 0.43 in. long by 0.2 in. dia.



This microminiature relay has a 0.1 A contact current, 150 mW sensitivity, up to 28 Vdc coils, -65°C to $+130^{\circ}\text{C}$, shock 50 g/11 ms, vibration 30 g up to 300 Hz, approximate weight 0.7 grams (0.02 oz.) type SM. Amec, c/o Nortec, Box 246, Thomaston, Conn. 06787.

Circle 231 on Inquiry Card

VHF/UHF PREAMP

Frequency range is 150 kHz-1 GHz.

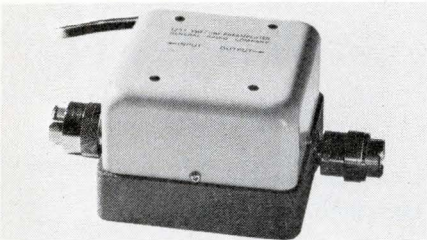

Type 1237 is a low-noise, low-level, transistorized amplifier for use as a general-purpose amp., preamp., and isolator. It consists of a 3-stage amp., a 30 MHz stop-band filter, and an ac power supply. General Radio Co., 300 Baker Ave., West Concord, Mass. 01781. (617) 369-4400.

Circle 232 on Inquiry Card

MODULAR PC CONNECTOR

For array-mounting on motherboard.

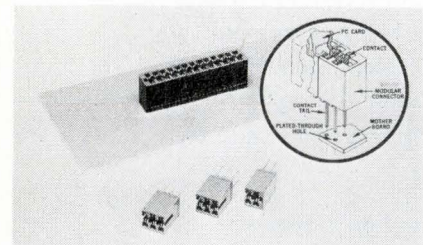

Mojo™ card-edge receptacle has a completely new contact that eliminates soldering when contact tails are press-fitted into plated-through holes in the board. Two module sizes are available: connector and modules use 4 dual-readout contacts (two 0.150 in.—center card positions) and one molded-in card guide. Center modules use six contacts (3 card positions) and are open-ended. Elco Corp., Willow Grove, Pa. 19090. (215) 659-7000.

Circle 233 on Inquiry Card

CIRCULATOR/ISOLATOR

Operates from 1 GHz to 2 GHz.

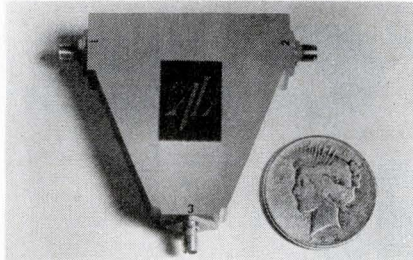

Miniature junction circulator can be used as an isolator by terminating one of its ports with a 50Ω load. It has 19 dB isolation, 0.5 dB insertion loss and 1.3:1 VSWR. Addington Laboratories, Inc., 1043 DeGiulio Ave., Santa Clara, Calif. 95050. (408) 248-5511.

Circle 234 on Inquiry Card

CHIP THERMISTORS

TC at 25°C is $-4.4\%/^{\circ}\text{C}$.

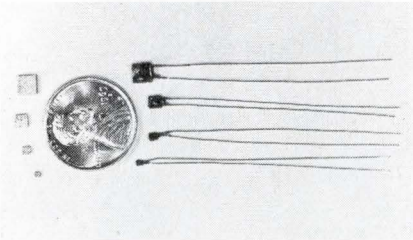

These inexpensive thermistors come in sizes ranging from 0.04 to 0.15 in.² with thicknesses from 0.012 to 0.035 in. They have values of 1200 to 20,000 Ω . Max. op. temp. is 130°C . Standard res. tol. $\pm 10\%$. National Lead Co., TAM Div., Hyde Park Blvd., Niagara Falls, N.Y. 14305.

Circle 235 on Inquiry Card

SUBCARRIER VCO

Uses hybrid ICs.

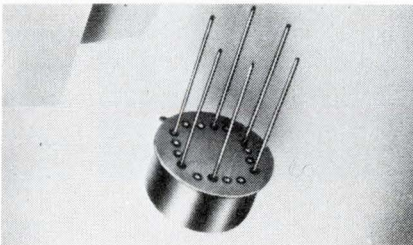

Model 870, microminiature VCO offers freq. stab. to within $\pm 1\%$ of the $\pm 7.5\%$ deviation band (1-18) or $\pm 0.5\%$ of the $\pm 15\%$ deviation band (A-E) and linearity better than $\pm 0.1\%$ (BSL) of the deviation band. Individual units cover bands 1-18 and A-E and are compatible with IRIG telemetry stds. Multitech Microelectronics, 583 Monterey Pass Rd., Monterey Park, Calif. 91754. (213) 282-3161.

Circle 236 on Inquiry Card

SWITCH BANKS

Only $\frac{3}{4}$ in. high

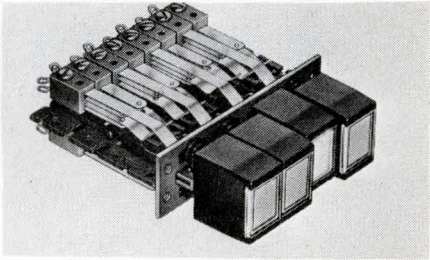

Available non-illuminated or illuminated with color coding. Switches are on $\frac{5}{8}$ in. centers. Up to 12 stations in multiples of two. Contacts are rated at both $1\frac{1}{2}$ and 10 A at 115 Vac resistive. Up to 4PDT/station. Guardian Electric Mfg. Co., 1550 W. Carroll Ave., Chicago, Ill. 60607.

Circle 237 on Inquiry Card

THUMBWHEEL SWITCH

It's only $\frac{5}{16}$ in. wide.

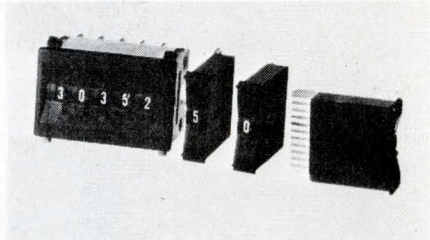

These binary and decimal-coded Model M switches are rated from 0.5 to 50 Vac or dc. They will handle a 0.1 A res. load at rated voltage. Current carrying capacity is 1 A. Contact res., including printed circuitry, is 0.07Ω . Interswitch, 770 Airport Blvd., Burlingame, Calif. 94010.

Circle 238 on Inquiry Card

VIBRATION EXCITER

Rated a 1200 force pounds.

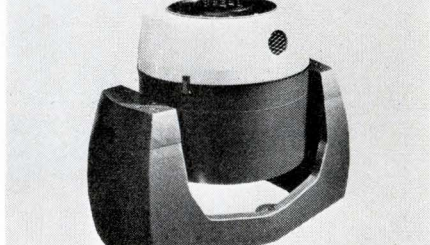

High "g" vibration exciter, Model VP-120 meets vibration test requirements on components and sub-systems specified in Mil. Stds. 202, 810, 883, 750. It uses the company's "Link Arm" suspension system for increased reliability. It has a wide freq. range—1.5 to 5000 Hz; large mounting surface—7 in. dia.; low distortion and transverse motion. AGAC-Deritron Inc., Box 358, Alexandria, Va. 22313. (703) 836-4641.

Circle 239 on Inquiry Card

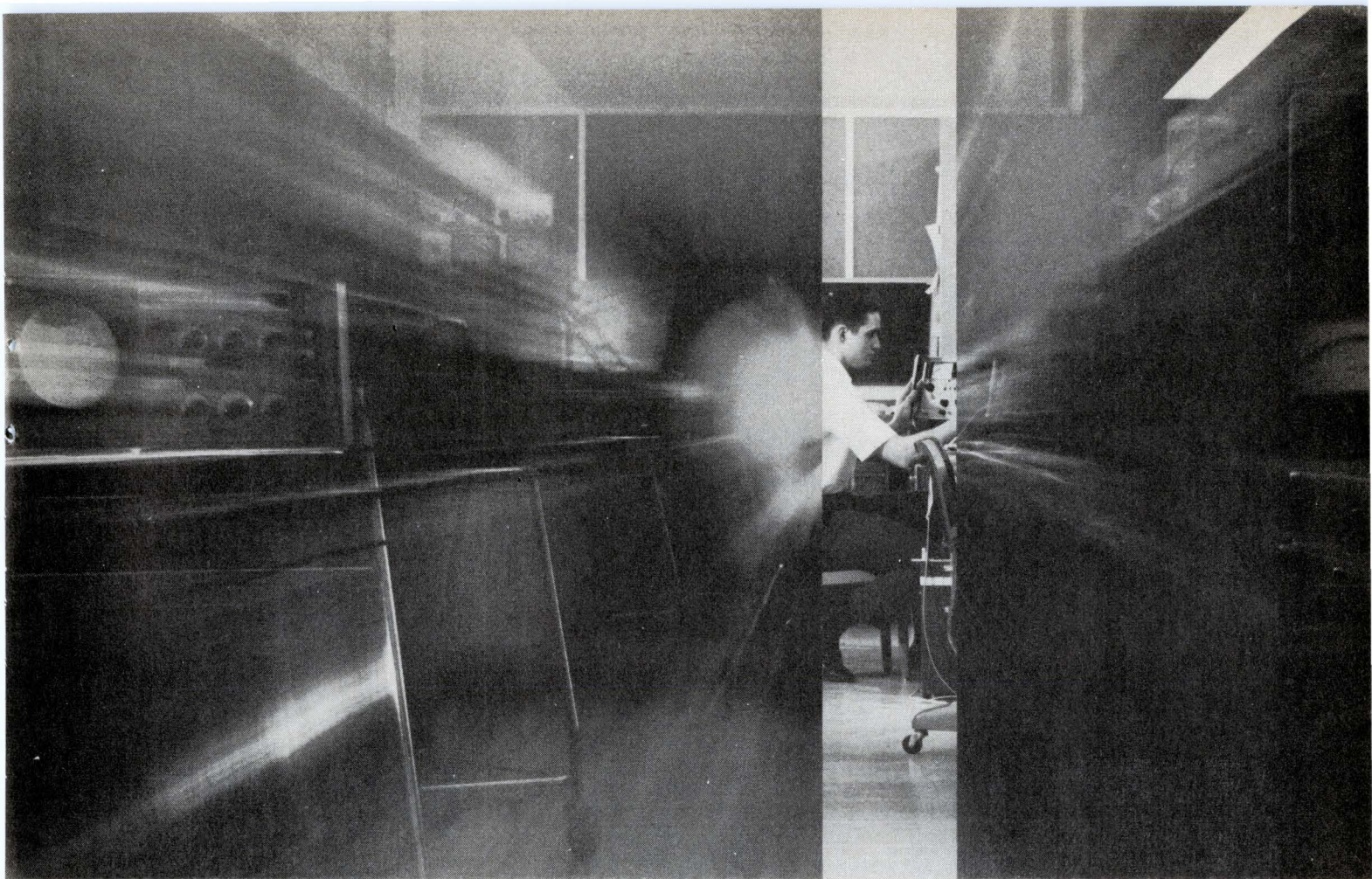

The Narrow Point-Of-View for Broad-Minded Engineers

When someone keeps telling you to be broad-minded and to get the "big-picture," aren't you often tempted to reply that sometimes a narrow point-of-view can be even more valuable? For example, one of the greatest race horses that ever lived, parlayed a narrow point-of-view into a fortune. By placing blinders on this horse, all extraneous objects were eliminated and he could concentrate on the immediate problem — the finish line and getting there first.

Hewlett-Packard has their own set of "blinders" for engineers who want to take a "narrow look" at individual signals over a wide range of frequencies. We call them wave analyzers.

Let's start with the HP 302A. When a very narrow point-of-view is required, a special 1 Hz bandpass is available. This bandpass, combined with a sensitivity of 3 μ V to 300 V,

is ideal for differentiating closely spaced signals with wide variations in amplitude. This wave analyzer can be battery operated and covers the frequency range of 20 Hz to 50 kHz. The price, \$1900.

Next in line is the HP 310A, a highly selective wave analyzer for the 1 kHz to 1.5 MHz range, 1 μ V to 100 V. With selectable bandwidths of 200, 1000 and 3000 Hz, it is well suited for tape transport harmonic measurements, or frequency response and level measurements on carrier and radio systems up to 300 channels. Get direct readouts in volts or dB. All this capability for \$2500.

And finally, the HP 3590A — the most automated wave analyzer you can get today. Covering a frequency range of 20 Hz to 620 kHz with built-in autoranging and electronic sweeping, the HP 3590A almost operates

itself. With 85 dB dynamic range and 4 selectable bandwidths of 10, 100, 1000 and 3100 Hz you can separate closely spaced signals, characterize distortion, or analyze a frequency spectrum. With its plug-ins the HP 3590A runs from \$3280 to \$4800.

When a balanced input and selectable impedances are required, just add \$150 to the price of a 3590A and get the HP 3591A.

So, if the "big-picture" has become a big pain then it's time to quit "horsing-around" and call your local HP field engineer for more information. Or, write to Hewlett-Packard, Palo Alto, California 94304. Europe: 1217 Meyrin-Geneva, Switzerland.

HEWLETT  PACKARD
SIGNAL ANALYZERS

Circle 56 on Inquiry Card

EE NEW PRODUCTS

LOG PERIODIC ANTENNA

Reduced profile.

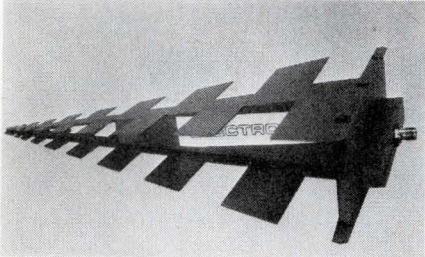

AN112F broadband antenna covers 1-12.5 GHz freq. range. Its small profile offers easier storage and handling for portable RFI/EMC surveillance uses. Outline dimensions are 8 x 6½ x 1¾ in., and it weighs under 1 lb. Electro/Data, Inc., 3121 Benton St., Garland, Tex. 75040. (214) 276-6167.

Circle 240 on Inquiry Card

DECADE POTENTIOMETER

Terminal linearity is 50 ppm.

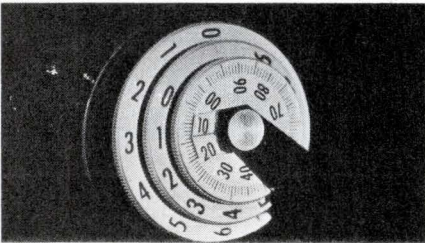

DP 310 Dekapot, newest in a series of stacked-decade, coaxial-dial voltage dividers, minimizes space while providing easy in-line readout. It has high resolution (0.0035%) and constant input impedance. Input resis. is 1, 10 and 100 kΩ. Electro Scientific Industries, Inc., 13900 N.W. Science Park Dr., Portland, Ore. 97229. (503) 646-4141.

Circle 241 on Inquiry Card

WIRE MESH

For EMI gaskets.

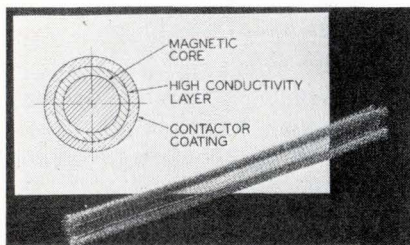

Higher frequency and magnetic field attenuation is possible with this tri-metallic, narrow wire mesh. It's good for use as the conductive element in EMI gaskets. It consists of a magnetic, ferrous alloy core; a mid-section of high conductivity metal, and an outer, contactor coating. Metex Corp., 970 New Durham Rd., Edison, N.J. 08817. (201) 287-0800.

Circle 242 on Inquiry Card

HV SILICON RECTIFIERS

Working ratings from 1 kV to 20 kV.

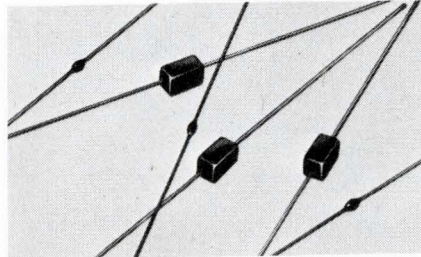

Miniature rectifiers in either glass envelopes or molded packages achieve a high power to volume ratio with low leakage currents. For miniature displays, photo-multiplier circuits and many industrial applications. Erie Technological Products, Inc., 644 W. 12th St., Erie, Pa. 16512. (814) 456-8592.

Circle 243 on Inquiry Card

WIDEBAND DC OP AMP

Guaranteed 500 V/μs slew rate.

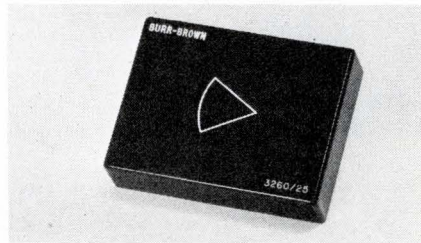

Model 3260/25 is for D/A conversion, high-speed integration, fast pulse amp., fast sampling, peak detection, and broadband amp. It settles to 1% of final value in 100 ns (0.1% in 1-2 μs). It has an FET input stage with low bias current. Burr-Brown Research Corp., Internat'l Airport Industrial Park, Tucson, Ariz. 85706. (602) 294-1431.

Circle 244 on Inquiry Card

RADIAL LEAD WIREWOUNDS

Cut production time.

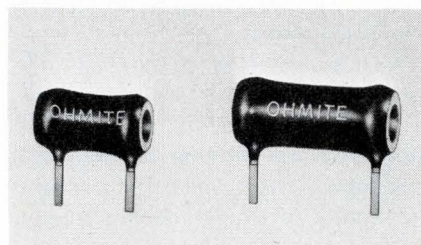

These resistors come in 3, 5, and 8 W sizes. Designated PC-58, they are for use where axial lead resistors are manually inserted in PC boards. When mounted in the PC board they reduce the overall length needed as compared to axial lead resistors. Standard range is 0.51 to 7000Ω. Ohmite Mfg. Co., 3601 W. Howard St., Skokie, Ill. 60076.

Circle 245 on Inquiry Card

DIL SOCKET

For PC board or chassis mounting.

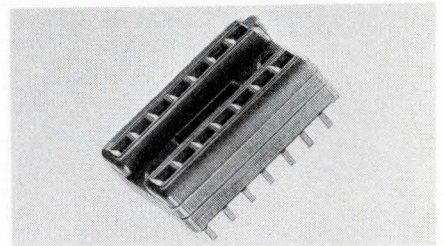

This socket is available for 14 and 16 lead DILs with leads on 0.1 in. centers in row and 0.3 in. between rows. Accepts any package with round, square or rectangular leads with a cross section of 0.008 to 0.023 and 0.090 in. min. lead length. Robinson-Nugent, Inc., 800 E. 8th St., Albany, Ind. 47150.

Circle 246 on Inquiry Card

FLAT CABLE PLUG

For 14 conductor cable.

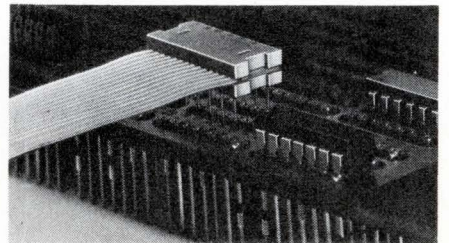

This plug (2P14-1) is for 28 gauge stranded 14 conductor flat cable. It comes unassembled, but it can be installed either at cable ends or at any desired bussing location. Designed for use with the company's 8136 series packaging panels, it plugs into IC pattern without soldering. Augat, Inc., 33 Perry Ave., Attleboro, Mass. 02703. (617) 222-2202.

Circle 247 on Inquiry Card

DECIMAL DISPLAY

Features IC logic.

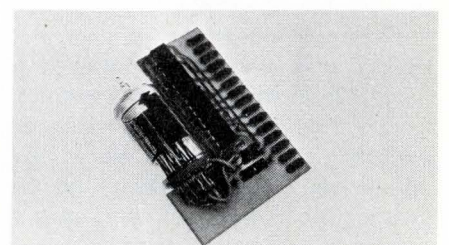

DM500 series displays are self-contained plug-in units. The DM519 includes a decade counter with BCD outputs available to the connector as well as the decoder/driver circuit. The DM529 accepts BCD inputs for decoding and display. Computer Products, Inc., 2801 E. Oakland Park Blvd., Ft. Lauderdale, Fla. 33306. (305) 565-9565.

Circle 248 on Inquiry Card

HYBRID DRIVER CIRCUIT

Increases current sinking capacity.

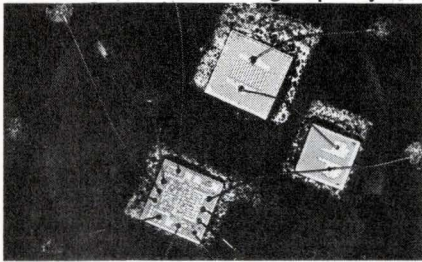

High performance lamp and relay driver has a 50 V output and a sinking current of 500 mA at 6 V. The SH2200 provides a combination of four input NAND gates and an inhibit (NOR) input. It can interface with all other current sinking logic circuits. The driver will also serve in display systems, tape readouts, go-no-go testers, and readouts of computer peripheral equipment. Other applications are in solenoid driving and memory and clock driving. Fairchild Semiconductor, 313 Fairchild Dr., Mountain View, Calif. (415) 962-3563.

Circle 249 on Inquiry Card

WIREWOUND POT

It's only 0.50 x 0.50 x 0.18 in.

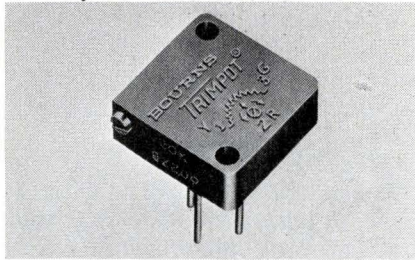

Model 3255 Trimpot® is a sub-miniature 25-turn screwdriver adjustment pot. Specifications are:

Std. res. range: 10Ω to 50 kΩ.

Res. Tol.: ±5% std.

Op. Temp. range: -65 to +150°C

Temp. coeff.: 70 ppm/°C

Absolute min. res.: 0.5Ω

Power rating: 1 W at 50°C

Mech. life: 200 cycles without discontinuity.

Load life: 1000 hrs at rated power.

In addition, Model 3255 is rated at 30 g vibration and 100 g shock. Bourns Inc., 1200 Columbia Ave., Riverside, Calif. 92507. (714) 684-1700.

Circle 250 on Inquiry Card

NPN POWER TRANSISTORS

Operate at frequencies to 5 MHz.

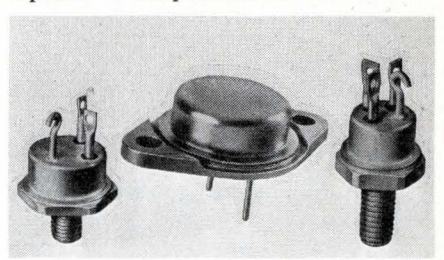

This family of transistors features If capability (f_t is rated up to 40 MHz min.), fast switching speeds (typ. storage times from 400 ns at 2 A to 330 ns at 60 A), and HV capability ($V_{CE0(sus)}$ is rated to 200 V). They span a power range from 20 to 150 W and have peak collector current ratings from 10 through 75 A. Double epitaxial mesa process provides good gain linearity and low sat. voltages (typ. $V_{CE(sat)}$ ranges from 0.30 V at 2 A to 1.25 V at 60 A), insuring min. losses and increased operating eff. Westinghouse Semiconductor Div., Youngwood, Pa. 15697. (412) 255-3693.

Circle 251 on Inquiry Card

VARGLAS ACRYLIC SLEEVING

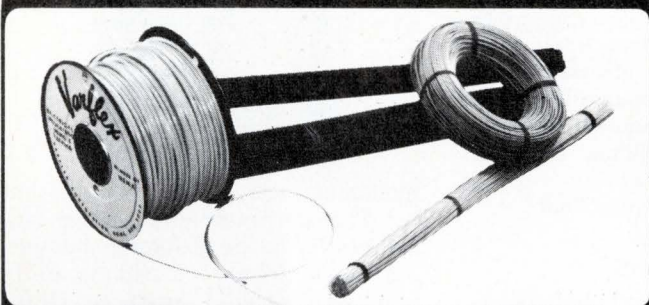

FOR CLASS F APPLICATIONS

Varglas Acrylic Sleeving by Varflex will not soften, flow or blister — even at 155°C, for as long as 15,000 hours. In fact, it passes the thermal endurance test under MIL-1-3190 (latest revision).

Made of modified acrylic resin on Fiberglas braid, it is compatible with polyester, epoxy, phenolic or formvar coatings and is made to exceed military, IEEE and NEMA standards. Varglas resists acids, solvents, oils, alkalis, fungus and moisture.

Select from a wide range of sizes and coding colors. Immediate off-the-shelf shipment or one week for special production.

Send for free sample of this and 24 other sleeveings.
VARFLEX CORPORATION
506 W. Court Street
Rome, New York 13440

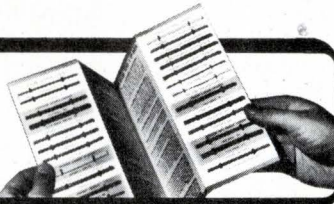

Circle 57 on Inquiry Card

NEW LOW COST PROBE

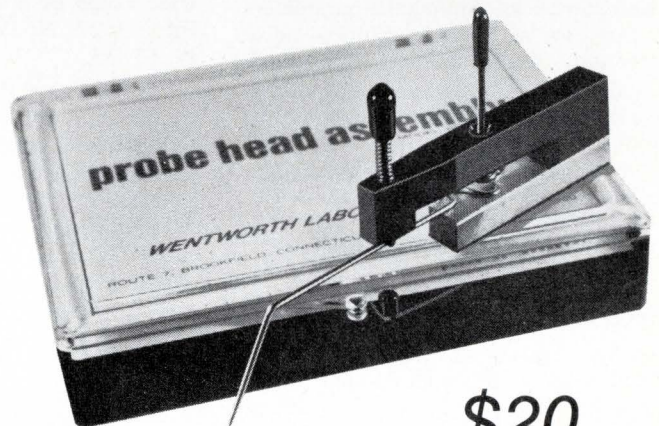

\$20 ea.

Wentworth Laboratories' Model PR-0100 Probe Assembly was designed specifically for thick and thin film applications. Features "snap-in" probe point, magnetic base, a 6-1 ratio joystick for fine positioning plus height and pressure adjustment.

Probe points available unwired or with one or two wires.

Send for Bulletin 1068.

WENTWORTH LABORATORIES  INC.
ROUTE 7, BROOKFIELD, CONN. 06804 — (203) 775-1750

Circle 58 on Inquiry Card

Logic modules

This 416-page guide should be a useful reference for those who specify, design, manufacture, or apply solid-state logic. Presented in paperback form, the 1969 Logic Handbook covers logic modules and hardware.

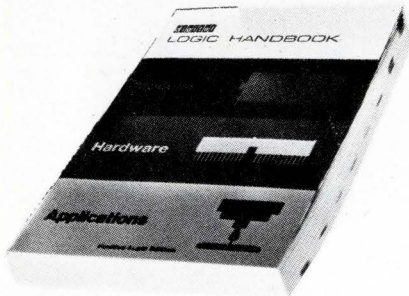

Featured are the M series TTL integrated circuit modules and the K series low-speed noise-immune logic. A highlight of the book is its 75-page section of application notes. Digital Equipment Corp., Dept. P, Maynard, Mass. 01754.

Circle 321 on Inquiry Card

Digital voltmeters

This 40-page brochure features a discussion on the meaning of digital voltmeter specs. Among the parameters covered are accuracy, resolution, noise rejection, and measurement speed. Catalog DL-930 also contains a listing of 33 models and 300 configurations of digital voltmeters available from the manufacturer. Dana Laboratories, Inc., 2401 Campus Dr., Irvine, Calif. 92664.

Circle 322 on Inquiry Card

Producing fastener holes

"An Engineering Statement on the Economics of Fastener Holes," an 8-page brochure, evaluates the various methods for producing fastener holes: punching, drilling, piercing, molding, and burning. These methods are explained with appropriate cost estimates for each. Technical Report No. 81 then describes a self-drilling fastener which eliminates the need for separate hole-making, and thus eliminates the related hole preparation costs. Shakeproof Div., Illinois Tool Works Inc., St. Charles Rd., Elgin, Ill. 60120.

Circle 323 on Inquiry Card

RF power instruments

You will find 60 pages of data on a line of instruments for rf power measurement in this product catalog. The company's new rf standard Thru-line® peak wattmeter is one of the many items covered. Bird Electronic Corp., 30303 Aurora Rd., Cleveland (Solon), Ohio 44139.

Circle 324 on Inquiry Card

Noise testing

Application Note, No. 101 deals with the subject of transient noise susceptibility testing. Suggested electronic equipment is covered and typical test set ups and specific testing data are given in the 6-pager. Velonex Marketing Dept., 560 Robert Ave., Santa Clara, Calif. 95050.

Circle 325 on Inquiry Card

Electronic controls

A 36-page photoelectric catalog lists 284 pre-engineered photo controls, photo sensors, light sources, electronic timers, impact controls, and other products. Illustrations, specs, and prices are given. Also included in the 1969 catalog are diagrams showing a wide range of applications. Autotron, Inc., 3627 N. Vermilion, Danville, Ill. 61832.

Circle 326 on Inquiry Card

Operational amplifiers

This 32-page handbook, intended as a selection guide for op amps, provides application data and detailed specs for some 100 devices. Of spe-

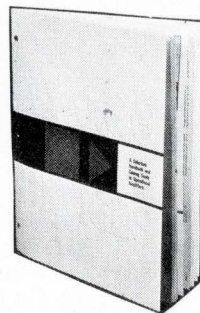

cial interest to EEs who select or specify op amps are two sections which discuss how to select op amps and the meaning of the more important op-amp specs. Analog Devices, Inc., 221 Fifth St., Cambridge, Mass. 02142.

Circle 327 on Inquiry Card

Microwave products

This 140-page catalog lists a wide range of microwave products, including standard coaxial, waveguide, and millimeter devices. Catalog 20 also contains sections on attenuators, high sensitivity detectors, directional couplers, high power loads, filters, preselectors, and diplexers. Covered too is a complete line of miniature components. Microlab/FXR, 10 Microlab Rd., Livingston, N.J. 07039.

Circle 328 on Inquiry Card

Hybrid microcircuits

Applications for hybrid microcircuits in lightweight and compact packaging designs are the subject of a 24-page guide. The reference explains how hybrid technology can achieve design functions not possible using

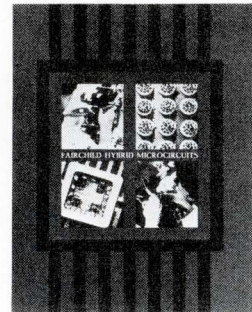

monolithic ics. It also explains the hybrid manufacture step by step, and outlines layout procedures for designing custom products. Listed too are 16 off-the-shelf hybrid products. Distribution Services, Fairchild Semiconductor, 313 Fairchild Dr., Mountain View, Calif. 94040.

Circle 329 on Inquiry Card

Interface circuits

"Monolithic Interfacing in Computers," a 10-page application report, discusses three types of computer interfacing. It then describes new integrated circuits to serve these three interface areas—line circuits, memory drivers, and sense circuits. Other topics in Bulletin CA-122 are history, trade-offs between system advantages and problems, and general application examples. Texas Instruments Incorporated, Inquiry Answering Service, Box 5012, MS/308, Dallas, Tex. 75222.

Circle 330 on Inquiry Card

This is the world's smallest all-pluggable DPM.



Weston Model 1290
\$204

Then there's our less expensive model.



Weston Model 1260
\$99.50

We brought out our 3½-digit compact DPM* just last March. It's the one that plugs into a panel slot only seven inches square, and pulls out for servicing or replacement. If you need the accuracy of 3½ digits, Model 1290 is still your best buy. But if you can settle for a digit less, you can have our new Model 1260 at less than half the price. Don't be fooled by the price tag, though... there's nothing "cheap"

about this 2½-digit version. Housed in the very same plug-in case and fully compatible with its more sophisticated brother, Weston Model 1260 offers 0.5% ±1 digit accuracy—with far greater resolution capability than mechanical movements provide. Full scale reading is 199, with 25% over and under-range capability, remote command signal and Weston's usual high rejection characteris-

tics. In addition to the convenience of front panel pluggability and circularly polarized viewing, we've included front panel calibration as a built-in bonus feature on the 1260. Write to the originators of the DPM. WESTON INSTRUMENTS DIVISION, Weston Instruments, Inc., Newark, N.J. 01774.

a Schlumberger company
WESTON®

Prices for Models 1290 and 1260 based on quantities of 25.

*U.S. Pat. 3,051,939 and patents pending.

Operational-amplifier chart

This handy foldout chart lists key parameters for a line of integrated circuit op amps, including both military and commercial types. Product type numbers, physical characteristics, frequency compensation requirements, and specific advantages are included in the op amp guide. National Semiconductor, 2975 San Ysidro Way, Santa Clara, Calif. 95050.

Circle 331 on Inquiry Card

Video-detector nomogram

A laminated nomogram provides a convenient method for computing tangential sensitivity of video detectors. It allows solving for any one of four unknowns—noise figure (ratio), bandwidth, diode figure of merit, or tangential sensitivity — given the other three. The copyrighted nomogram is available from Microphase Corp., Greenwich, Conn. 06830.

Circle 332 on Inquiry Card

Custom Wound Bobbins ■ In 10 Days

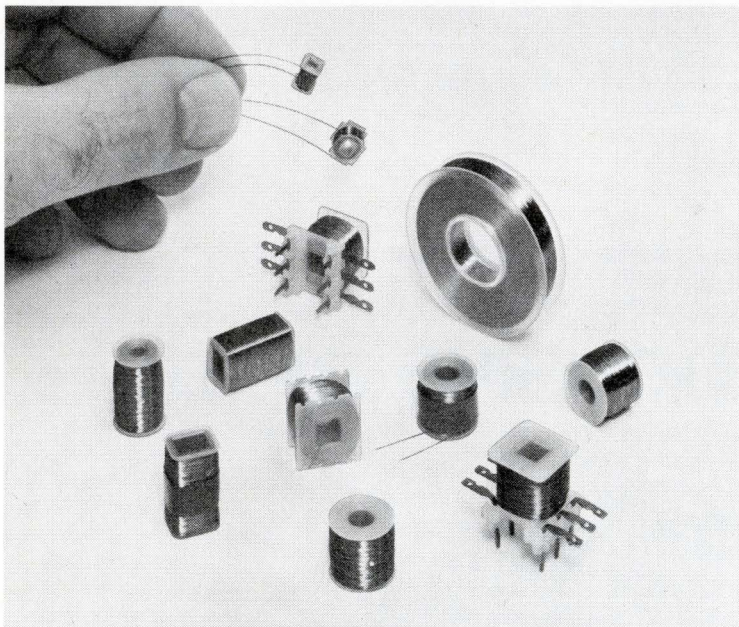

Custom wound bobbin samples are available in ten days; production shipments start within three weeks after sample approval.



Special 16 Pi/30 KV windings for oil-filled high voltage transformers . . . special coils also are furnished on 10-day sample/3-week production delivery cycle.

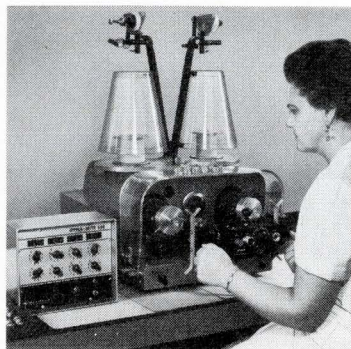

Bobbins furnished in wide range of inductance and current ratings. If desired, Miller engineers will make recommendations for optimum performance.



J.W. MILLER COMPANY

P.O. BOX 5825 ■ COMPTON, CALIFORNIA 90224

Write for your copy of the latest full line catalog

Memory systems

"Taking the Mystery Out of the Memory" is the title of an 8-page technical note, which provides basic

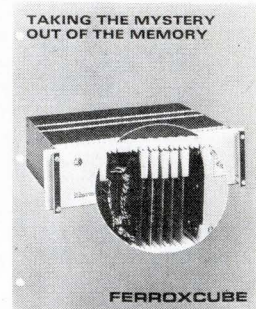

information on electronic memory system interface. Definitions of terms are given and common memory and digital binary math are discussed. Ferroxcube Corp., Saugerties, N.Y. 12477.

Circle 333 on Inquiry Card

Special purpose tapes

A short-form catalog covers a line of special purpose tapes for a variety of applications. Chemical resistant, electroplating, insulation, and temperature resistant tapes are a few of the types shown. Mystik Tape, Borden, Inc., 1700 Winnetka Ave., Northfield, Ill. 60093.

Circle 334 on Inquiry Card

Electronic stroboscope

A 12-page pocket-size booklet explains the basic concepts of stroboscopy. Topics include how the stroboscope works and how you use it to measure speed. Accessories and applications are also covered in the primer. General Radio Co., 300 Baker Ave., West Concord, Mass. 01781.

Circle 335 on Inquiry Card

Acceleration transducers

A brochure features five different acceleration transducers for aerospace and oceanographic applications. They are available either as single- or multiple-axis sensors, with ranges as low as 0.25 g and as high as 200 g. Humphrey Inc., 2805 Canon St., San Diego, Calif. 92106.

Circle 336 on Inquiry Card

Telemetry components

Listed in this 12-page brochure is a line of L- and S-band telemetry components. Amplifiers, multicouplers, filters, converters, and multipliers are among the products covered. Applied Research Inc., 76 S. Bayles Ave., Port Washington, N.Y. 11050.

Circle 337 on Inquiry Card

Magnetic shields

"Helpful Information for Designing a Magnetic Shield" is the title and subject of an informative 23-page article. The text is supported by tables of measured shielding ratios. Included too is a list of magnetic shields for CRTs, as well as a list of various brands and types of multiplier tubes and corresponding magnetic shield types. James Millen Mfg. Co., Inc., 150 Exchange St., Malden, Mass. 02148.

Circle 338 on Inquiry Card

Power supplies

This catalog supplement contains 32 pages of data on the company's new products. Among these are integrated circuit power supplies, standard power supply assembly systems, and so forth. A handy selection guide is included. Lambda Electronics Corp., 515 Broad Hollow Rd., Melville, N.Y. 11746.

Circle 339 on Inquiry Card

Tube caps

A wall guide for a standard tube cap line is intended to help you solve connecting problems. The chart lists integrally molded cap connectors — available in polyethylene, nylon, CTFE, silicone, or phenolic—for high temperature, high voltage, high reliability applications. Insulation, contact, lead, and resistor data is included. Alden Products Co., 117 N. Main St., Brockton, Mass. 02403.

Circle 340 on Inquiry Card

Switches

A 6-page selection guide, No. 2007d, contains data on lighted push-button switches, word indicators, fuse holders, and circuit breakers. Un-

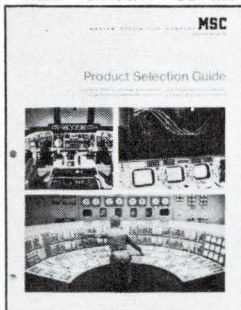

lighted switch assemblies and audio and visual warning and display systems are also covered. Descriptions, characteristics, and application data are given. Master Specialties Co., 1640 Monrovia, Costa Mesa, Calif. 92627.

Circle 341 on Inquiry Card

ASK MATHESON... why 1 + 1 > 2



Matheson's understanding of gas technology combined with inherent advantages of gas phase processing make conversion to gas systems pay *added* dividends.

Consider the considerable advantages of gas phase processing

Contamination is minimized. For one thing, source limiting of impurities significantly reduces diffusion tube contamination. And there are no trace "heavy impurities." Troublesome vaporization processes are also eliminated.

Convenience is maximized. Introduction of vapors in high temperature processes is simplified to merely opening and adjusting a gas flow line. And gas systems are readily and conveniently adapted to automated control.

Matheson gas systems are designed with you in mind

For example, U. H. P. Ammonia for vapor deposition of silicon nitride. This grade of Ammonia has been specifically developed for use by the semiconductor industry. It affords greater reproducibility in dielectric constant of grown layers . . . a degree not normally obtainable with standard Ammonia.

Matheson can also help you with Ammonia systems. For example, High Purity, Stainless Steel Regulators for vacuum or purge systems. Or low cost Stainless Steel Gas Proportioners for blending the desired vapor concentrations in Ammonia systems.

This is just one way Matheson serves the electronics industry. Experienced, confidential, technical service is also offered. And don't worry — we'll help you with the installation.

Ask Matheson now — for our new catalog "Gases and Systems for the Electronics Industry". It contains extensive technical data on epitaxial and doping gases. Address: P. O. Box 85, East Rutherford, N. J. 07073.



MATHESON GAS PRODUCTS

A Division of Will Ross, Inc., East Rutherford, N. J.;
Cucamonga, Calif.; Gloucester, Mass.; Joliet, Ill.; LaPorte, Texas;
Morrow, Ga.; Newark, Calif.; Whitby, Ont.

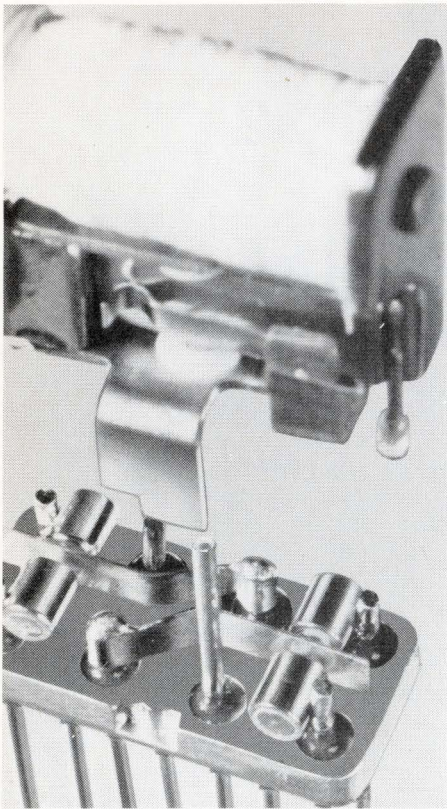

mite-size relays with macro-size contacts

Couch 2X relays are true $\frac{1}{2}$ -size, yet the contacts are as large or larger than many full and half-size crystal can units. Couch 2X relays meet MIL-R-5757D/19 and /30 specs in $\frac{1}{25}$ th of a cu. in. Design simplicity and oversize contacts assure the ultimate in performance. Each relay is fully tested. Ideal for missile and aerospace switching applications or wherever reliability in small space is of prime importance. Available in many terminal styles and a wide choice of mountings.



Write for Data Sheets No. 9 and No. 10 today.

	2X (DPDT)	1X (SPDT)
Size	0.2" x 0.4" x 0.5"	same
Weight	0.1 oz. max.	same
Coil		
Operating Power	100 mw or 150 mw	70 mw or 100 mw
Coil		
Resistance	60 to 4000 ohms	125 to 4000 ohms
Temperature	-65°C to 125°C	same
Vibration	20G	same
Shock	75G	same

RUGGED ROTARY RELAYS  Dynamically and Statically Balanced



S. H. COUCH DIVISION

ESB INCORPORATED

3 Arlington St., North Quincy, Mass. 02171

Circle 62 on Inquiry Card

EE LITERATURE

Audio amplifier IC

A 6-page condensed catalog highlights a new 1-W audio amplifier integrated circuit. Other products covered are 1.5- and 10-W zener regulators (6.8 to 200 V); 1-, 1.5-, and 3-A silicon single junction rectifiers; and 1.6-A full-wave bridge rectifiers. Trans-Tek, South Plainfield, N.J. 07080.

Circle 342 on Inquiry Card

Quartz crystals

A line of quartz crystals for control of frequency response is described in a 16-page brochure. Product applications, crystal specs, design considerations, and Mil reference tables are included. Also covered is a line of temperature control ovens. Erie Technological Products, Inc., 644 W. 12th St., Erie, Pa. 16512.

Circle 343 on Inquiry Card

Trimmer pots

An expanded trimmer potentiometer line is listed in a 32-page catalog. "Catalog B" describes six new recti-

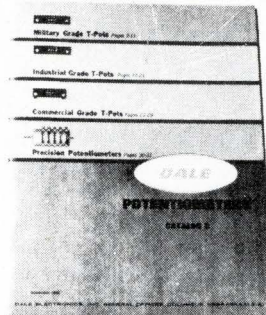

linear and square series film element trimmers, and also contains data on the company's single turn, wire-wound precision pots. Dale Electronics, Inc., Box 609, Columbus, Neb. 68601.

Circle 344 on Inquiry Card

High current SCRs

A line of high current silicon controlled rectifiers covering the range from 55 to 275 A rms are listed in an 8-page catalog. Operating characteristics are given in chart form. KSC Semiconductor Corp., KSC Way (Katrina Rd.), Chelmsford, Mass.

Circle 345 on Inquiry Card

CLASSIFIED ADVERTISING

GROWTH POSITIONS \$12,000-\$25,000

MANAGEMENT — ENGINEERING — SALES
RESEARCH — MANUFACTURING
Nationwide Coverage

Fees company paid. Include present salary, minimum salary requirement and location flexibility with resume. Longberry Employment Service, Inc., 910 Niles Bank Bldg., Niles, Ohio 44446. (216) 652-5871.

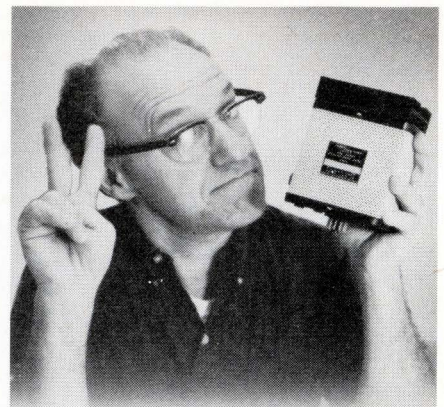

ACOPIAN DUALS...

2

POWER SUPPLIES IN THE SPACE OF

1

Where your equipment or system requires more than one regulated DC output, consider Acopian duals. They consist of two independent regulated power supplies housed in a single module. You can select two like outputs (such as for op amps) or any of 80,000 combinations of different outputs.

Acopian duals cut mounting space requirements roughly in half, cost less than two individual modules and, like all Acopian power supplies save you time because they're shipped three days after receipt of your order.

For information on the complete line of 82,000 different Acopian power supplies, including singles and duals, regulated and unregulated, and rack mounted assemblies, ask for our new catalog. Write Acopian Corp., Easton, Pa. 18042 call (215) 258-5441.



Circle 63 on Inquiry Card

Transistors and microcircuits

A 12-page condensed catalog contains product data on a line of silicon transistors and microcircuits. Listed are single and dual n-channel junction FETs, p-channel single and dual MOSFETs, dielectric isolated

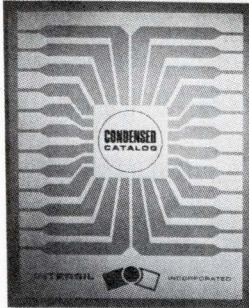

monolithic npn's, and dual npn and pnp transistors. MOS shift registers, MOS micropower counters, MOS voltage comparators, FET analog gates, and flip chips are also covered. Intersil Incorporated, 10900 N. Tantau Ave., Cupertino, Calif. 95014.

Circle 346 on Inquiry Card

Voltage regulator

A 25-page brochure discusses the design and application of a monolithic voltage regulator with foldback current limiting. A high-performance, short-circuit-proof regulator with high current capacity is described. Tables of physical and mechanical specs, and schematics that outline the various applications, are included. Transistron Electronic Corp., Wakefield, Mass. 01880.

Circle 347 on Inquiry Card

Circular electro adapters

Electro adapters (or backshells) for circular connectors are the subject of a 40-page publication. Catalog EA-2-69 covers four basic product styles: environmental, non-environmental, EMI/RFI shielded, and unshielded. Helpful design, selection, and assembly data are presented. Electro Adapter, Inc., 8217 N. Lankershim Blvd., North Hollywood, Calif. 91605.

Circle 348 on Inquiry Card

Switches

Catalog 50e contains about 90 pages of data on precision electrical switches. The source is conveniently arranged in eight product sections: limit switches, enclosed switches, explosion-proof switches, proximity switches,

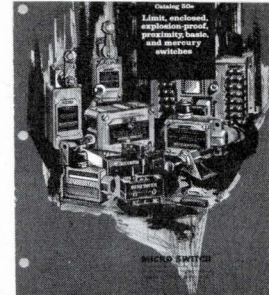

basic switches, small basic switches, mercury switches, and other switches. Also included is a glossary of switch terms, as well as a variety of design and ordering data. Micro Switch, a division of Honeywell, Freeport, Ill. 61032.

Circle 349 on Inquiry Card

Designing an Electromagnetic Shield?

Let Magnetic Metals help
WITH THIS

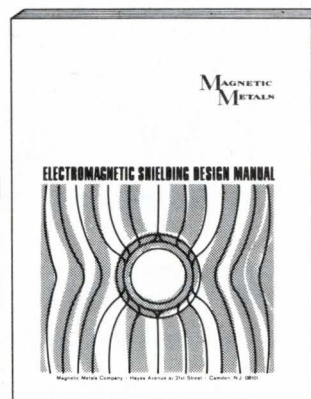

A complete reference book for the design, specification and purchase of drawn and fabricated electromagnetic shields. Data is given for both electrical and mechanical design considerations. Custom-made shields as well as standard shields are discussed in detail. Everything you need to know about Electromagnetic Shield Design is presented in clear, precise language. A valuable addition to the design engineer's technical library. Available **FREE FROM MAGNETIC METALS.**

Magnetic Metals Company
Hayes Ave. at 21st Street
Camden, New Jersey
(609) 964-7842 Ext. 321

TRYGON HAS THE POWER

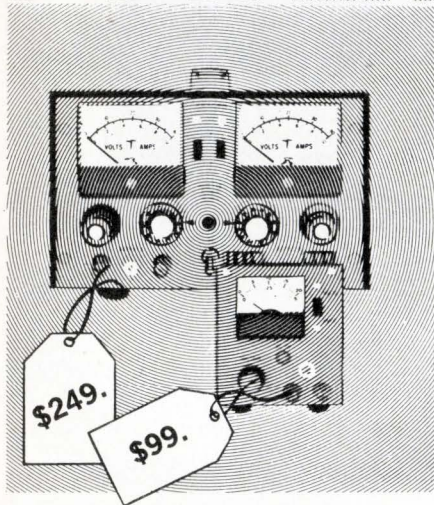

to deliver these great laboratory power supplies immediately.

Trygon's economy EAL and precision DL-series laboratory power supplies are available—right now—from 36 sales offices, nationwide. So when we say you'll have them, you can depend on it. You can also depend on them.

The versatile DL Series gives you two independent dual-range supplies (0-20V @ 1 amp or 0-40V @ 0.5 amps) in one half-rack package.

The compact EAL fits in a corner of your bench and your budget (only \$99) and comes in the four most commonly used laboratory voltage ranges.

TRYGON POWER SUPPLIES
 111 Pleasant Ave., Roosevelt, L.I., N.Y. 11575*
 I need the following unit(s).

Qty.	Model	Rating
....	EAL 10-1	0-10 VDC @ 1.0 Amp
....	EAL 20-500	0-20-VDC @ 500 ma
....	EAL 32-300	0-32 VDC @ 300 ma
....	EAL 50-250	0-50 VDC @ 250 ma
....	DL 40-1	2x0-40 VDC @ 1.0 Amp

Name/Title _____
 Firm _____
 Address _____
 City _____ State _____ Zip _____

Purchase Order Attached.
 Contact us for Purchase Order.
 Please send Trygon Power Supply Handbook.

*PRICES SLIGHTLY HIGHER IN EUROPE.
 TRYGON GMBH, 8 MUNCHEN 60, HAIDELWEG 20, GERMANY.

Circle 65 on Inquiry Card

EE LITERATURE

Rectifier modules

A revised 20-page application note (N-130B) describes how to replace high-voltage, high-current rectifier tubes with stackable Doorbell® rectifier modules. These modules permit



direct, plug-in replacement. Data on over 120 rectifier tubes, including maximum ratings and recommended module-type replacements, are given in table form. Unitrode Corp., 580 Pleasant St., Watertown, Mass. 02172.

Circle 350 on Inquiry Card

Heat-shrinkable polyolefins

A short-form catalog (6 pages) provides information on Insultite®—a family of heat shrinkable irradiated polyolefins. From the mil-spec variety to the new commercial-grade type, these polyolefins are designed to help you wrap up electrical insulation or encapsulation problems. Electronized Chemicals Corp., Burlington, Mass. 01803.

Circle 351 on Inquiry Card

Monolithic linear multiplier

The MC15959, a monolithic, linear four-quadrant multiplier, is designed for applications where the output voltage is a linear product of two input voltages. Features, typical applications, electrical characteristics, and circuit schematics are presented in a 4-page data sheet. Technical Information Center, Motorola Semiconductor Products, Inc., Box 20924, Phoenix, Ariz. 85036.

Circle 352 on Inquiry Card

steatite, alumina, ceramic & lava insulators

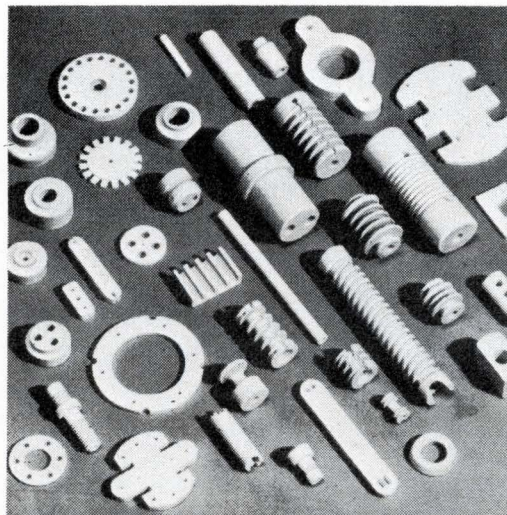

for electrical and electronic applications

Custom-molded, extruded or machined to close tolerances to meet your exact specifications. Prompt delivery at low cost on large or small orders. Over half a century of service is your guarantee of complete satisfaction.

FIND OUT TODAY. Illustrated bulletin with complete technical data will be sent on request.

SUPERIOR STEATITE & CERAMIC CORP.

100 West Forest Avenue, Englewood, N. J. • 'phone: (201) 568-4555

West Coast Representative:

Yarbrough Sales Co., 1608 Orange Street, Alhambra, California • 'phone: (213) 283-0668

Circle 66 on Inquiry Card

Microwave components

You will find 132 pages of product data on microwave components and packages in this new catalog. Each major product section is preceded by a technical guide on applications and available engineering op-



tions. About 200 new products are listed, including miniature designs in mixers, couplers, hybrids, attenuators, terminations, and video detectors. Sage Laboratories, Inc., 3 Huron Dr., Natick, Mass. 01760.

Circle 353 on Inquiry Card

Magnetic synchronous drives

In this 8-page guide you'll find instructions on how to design ceramic magnet axial gap synchronous drives for transmitting rotary motion through an air gap. Included are 13 sets of design curves relating torque to air gap. Also given is an example which solves an actual coupling design problem using the torque-gap curves. Indiana General Corp., Magnet Div., 405 Elm St., Valparaiso, Ind. 46383.

Circle 354 on Inquiry Card

Relays

A line of power, rf, and signal relays available in over 40 basic types is described in a 36-page design handbook and catalog. Besides product data, the publication contains contact code data for determining relay size, material, and resistive rating, and a relay parameter selection guide. Hart/Advance Relay Div., Oak Electro/Netics Corp., Crystal Lake, Ill. 60014.

Circle 355 on Inquiry Card

Monolithic integrated circuit

Application Report No. S-138 discusses the use of the TAA 300 as a complete audio amplifier. It provides a circuit description of this monolithic device, a discussion of its various

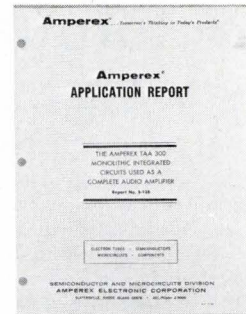

properties, application notes, and schematics and graphs. Precautions to take when you use this IC are also listed in the 21-page report. Amperex Electronic Corp., Semiconductor and Microcircuits Div., Slatersville, R.I. 02876.

Circle 356 on Inquiry Card

You can imitate a Digiswitch but you can't duplicate it.

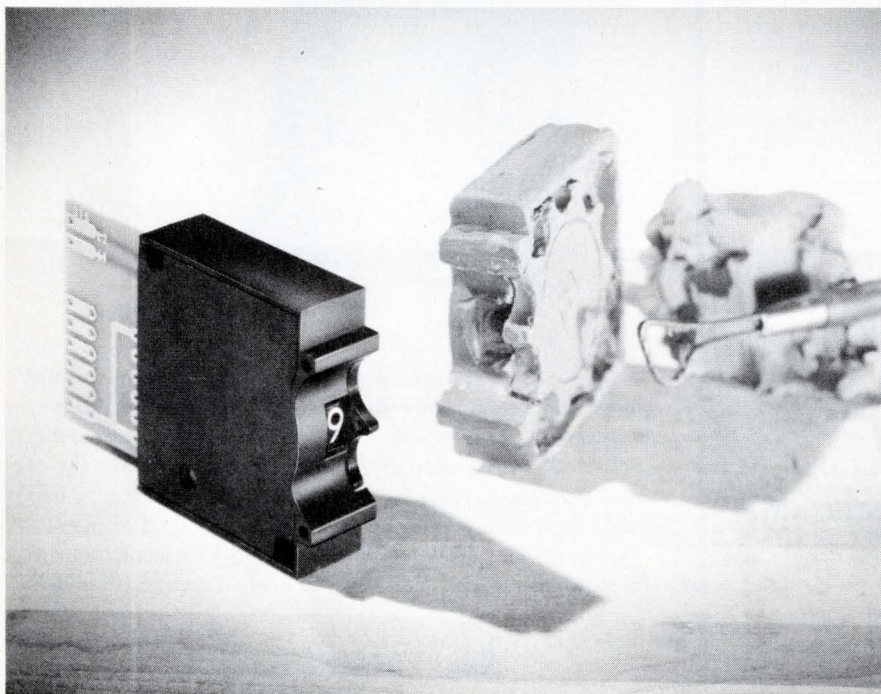

You can't duplicate a Digiswitch® any more than you could duplicate a sculpture by Rodin.

Make a fair copy? Sure, but the knowledge, experience and skill that went into the original would be missing.

Digitran pioneered thumbwheel switches, and years of experience and improvement have established Digiswitch as the industry standard. And, nobody comes close to duplicating our service organization, application library or scope of product.

Insist on an original. Digiswitch. The switch you can count on. More information about the original is yours for the asking.

THE DIGITRAN COMPANY

Subsidiary of Becton, Dickinson and Company 
855 S. Arroyo Pkwy./Pasadena, Cal. 91105
Tel: (213) 449-3110/TWX 910-588-3794

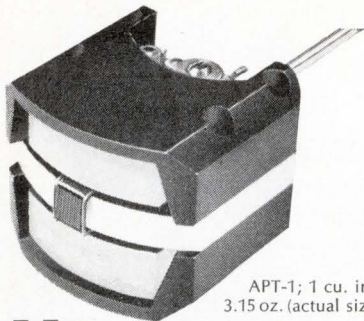

APT-1; 1 cu. in., 3.15 oz. (actual size)

More torque, Less weight in moving coil mechanism

Highly stable, linear and accurate mechanism for indicating, control or recording systems. 18-0-18° linearity is 1%. Coil design with over 75% of winding "working" in high energy, uniform field air gap assures greater accuracy. Coil system weighs 0.85 gm, develops 26.4 mmg of torque; 31:1 T/W. Mechanism offers negligible vibration pivots and jewels — custom damping — wide range of sensitivities.

AMMON

AMMON INSTRUMENTS, INC.
345 Kelley St., Manchester, N.H. 03105

Circle 68 on Inquiry Card

EE LITERATURE

Packaged switches

Major reasons why engineers specify hermetically sealed switches are discussed in this 22-pager. Basic control circuits with schematics showing how to apply them are also described. In

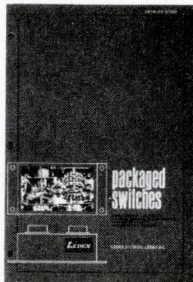

addition, Catalog B-3252 lists both off-the-shelf stock models and pre-engineered models of hermetically sealed switches, and shows some packaging solutions to complex control problems. Ledex Inc., 123 Webster St., Dayton, Ohio 45402.

Circle 357 on Inquiry Card

Molded inductors

A large product line, including a shielded inductor series, a molded inductor series, variable inductors, and custom devices, is covered in a 32-page booklet. Brochure No. 103068 also includes a handy cross reference list, as well as inductor color code data. San Fernando Electric Mfg. Co., 1501 First St., San Fernando, Calif. 91341.

Circle 358 on Inquiry Card

Numeric instruments

Mechanical, electrical, and electronic instruments and accessories are covered in an 8-page brochure (Form No. 1865). A listing of specs, features, and applications is included for counting, recording, and controlling devices and standard input devices. Veeder-Root, 70 Sargeant St., Hartford, Conn. 06102.

Circle 359 on Inquiry Card

STANPAT GIVES SHARP, CRISP REPRODUCTION EVERY TIME!

STANPATs are made specifically for use on drawings. Inferior imitations create endless problems. STANPAT will preprint your own repetitive items for instant drafting. Every sheet is guaranteed to meet your exact requirements. Adhesion is instant . . . reproduction is always perfect.

Unbelievable? Send today for free samples — judge for yourself. Be sure to enclose a sample of your own repetitive details and we'll send you a quote. Use quick-reply coupon below.

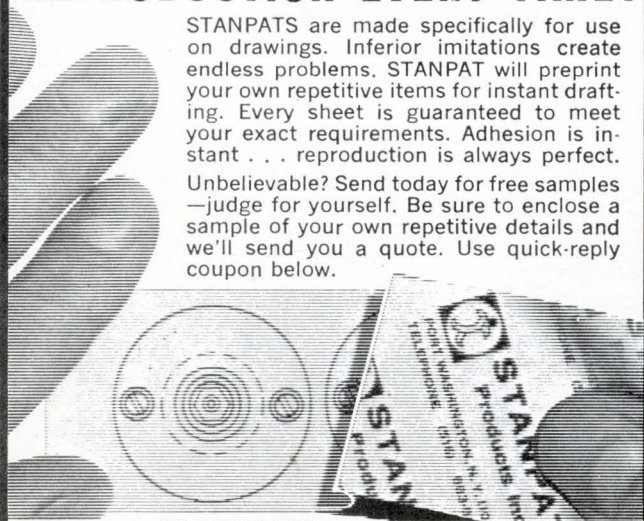

Tel: 516 883-8400

faithfully serving the architect and engineer for over 25 years



STANPAT PRODUCTS INC.

Dept. C 6, 366 Main St., Port Washington, N.Y. 11050

Send free samples and literature. Quote on my attached art.

Name _____ Title _____

Company _____

Address _____

City, State, Zip Code _____

FREE



Model S1301A

Get technical literature on the only *totally* portable, solid state oscilloscope. Operates from optional internal battery or from 110/220 vac, 50 to 400 Hz line voltage. Features include: 20 MHz bandwidth; 17 nsec rise time; 18 ranges of calibrated sweep speeds; internal voltage calibrator; and triggering stability in excess of 30 MHz.

Write for Bulletin TIC 3316 to Motorola Communications & Electronics Inc., 4501 W. Augusta Blvd., Chicago, Ill. 60651



MOTOROLA
Precision Instrument Products

Specify KEYSTONE BATTERY HOLDERS

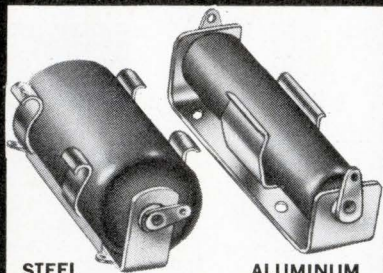

STEEL

ALUMINUM

A complete standard line of battery holders for use with all type batteries. Available for immediate shipment from stock, single or multiple holders.

- LOW COST
- STURDILY CONSTRUCTED
- LIGHTWEIGHT

Free engineering service for your special custom built holders.

A holder for every application. Also a complete line of Standardized Components or Modification of our Standard Line.

- TERMINAL BOARDS
- TERMINALS
- PLUG-IN HOUSING
- STAKING TOOLS
- PRE-PUNCHED BOARDS
- BUSHINGS

NEW FREE CATALOG ON REQUEST

KEYSTONE ELECTRONICS CORP.

49 Bleecker St., New York, N.Y. 10012

Circle 74 on Inquiry Card

EE LITERATURE

Sweep lock synchronizers

"Maintaining a Fixed Frequency Separation Between Two Microwave Sources," an 8-page applications guide, covers methods for phase-locking two sources a fixed increment apart. It describes techniques using sweep-lock synchronizers as well as techniques using conventional discrete frequency synchronizers for sweep locking. Sage Laboratories, Inc., Instrument Div., 14 Huron Dr., Natick, Mass. 01760.

Circle 363 on Inquiry Card

Antennas and accessories

Catalog No. 6970 describes coaxial, ground-plane, and co-linear antennas covering the range from 25 to 470 MHz. Also shown is a broadband discone antenna with a VSWR below 2 to 1 from 225 to 1800 MHz. Herb Kreckman Co., Cresco, Pa. 18326.

Circle 364 on Inquiry Card

Electroplating

"Precision Electroplating" is the title of a 10-page brochure which discusses the design and use of NobleCoat electrodes. Typical applications, electrode mechanics, and advantages are covered. Technical Service Dept., Engelhard Minerals & Chemicals Corp., 113 Astor St., Newark, N.J. 07114.

Circle 365 on Inquiry Card

Ceramic capacitors

This 12-page catalog, (E-1) contains a rundown of the company's subminiature ceramic capacitors. Capacitor types include: molded square, molded tubular, temperature compensating, ribbon lead, general purpose, uhf standoff, and high capacitance monolithic devices, among others. Republic Electronics Corp., 176 E. 7th St., Paterson, N.J. 07524.

Circle 366 on Inquiry Card



THE MARK PRESCORED LINE OF ELECTRONIC EYELETS HAS ELEVEN DISTINCT ADVANTAGES

- | | |
|---|--|
| 1 ELIMINATES PRESOLDERING | 6 CAUSES NO SEPARATION OF PADS FROM SUBSTRATE |
| 2 EASILY FED AND STAKED WITH EXISTING EQUIPMENT | 7 ELIMINATES FLUX ENTRAPMENT |
| 3 NO COMPLEX, EXPENSIVE TOOLING | 8 ASSURES UNIFORM SOLDERING |
| 4 FLARES WITH ONLY 7 LBS. PRESSURE | 9 SPEEDS PRODUCTION; ELIMINATES HAND SOLDERING |
| 5 ELIMINATES P.C. BOARD DAMAGE | 10 PROVIDES FOR THERMAL SHOCK |

11 OFFERED AT THE SAME PRICES AS CONVENTIONAL EYELETS AND THEY ARE AVAILABLE FROM STOCK.



COMPLETE DETAILS ON REQUEST



MARK

EYELET & STAMPING, INC.
173 WAKELEE ROAD, WOLCOTT, CONN. 06716

PANDUIT CABLING TOOLS SPEED HARNESSING



Two cabling tools cover complete line of Panduit STA-STRAP® Cable Ties. GS2B Tool ties 11 smaller sizes of Ties, Clamps, and Markers; GS4H Tool ties 10 larger sizes.

- Both meet MIL SPEC MIL-T-81306 (AS), MS90387-1 & -2.
- Automatically tighten cable ties to uniform preset tension, cut flush and eject cut-off portion.
- Save time and money.
- No sharp edges. No twisting.
- Lightweight and easy to use.
- One tool model handles most harnessing requirements.
- In stock at your local Panduit Distributor.

PANDUIT CORP.

Tinley Park, Ill. 60477 • Phone: 312-532-1800 • Telex 25-4560

FROM THE MANUFACTURERS OF PANDUCT® PLASTIC WIRING DUCT



VISIT PANDUIT AT NEP/CON EAST SHOW, BOOTH 714

Switches and accessories

Catalog 89 will give you detailed specs for a line of switches, which include snap-action, push-button, rocker-actuated, and toggle types. Glossaries

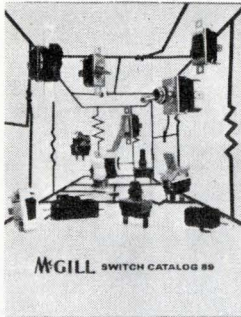

of general switch terms and snap-action switch terms, along with a table of circuitry abbreviations, are provided. McGill Manufacturing Co., Inc., Electrical Div., Valparaiso, Ind. 46383.

Circle 367 on Inquiry Card

Diode test instruments

The D-200 series is a family of automatic test instruments for go/no-go testing, evaluation, and classification of low- to medium-power diodes and rectifiers. A 12-page brochure gives details on these high-speed units, which are for use on production lines and at incoming inspection. Teradyne, Inc., 183 Essex St., Boston, Mass. 02111.

Circle 368 on Inquiry Card

Microwave components

Microwave coaxial devices for operation through 18 GHz are the subject of a 12-page brochure. Among the components shown are electro-mechanical switches, solid state switches, filters, and a variety of directional couplers. Subsystems and assemblies are also covered. Automatic Metal Products Corp., 315 Berry St., Brooklyn, N.Y. 11211.

Circle 369 on Inquiry Card

NEW High-Voltage Corona-Free J-Series Connectors

New J-Series Rowe Connectors for economical use in lasers, power supplies, display systems, etc.

- Unmated flash-over value 12KV DC
- Mated 20 KV DC, unmated 10 KV DC
- Corona inception in excess of 5 KV at 75,000 feet
- Operating temperature range -55°C to 125°C
- Current 2 amps DC
- Quick-disconnect

Also available in complete cable assembly form.

J-Series Connectors are adaptable to standard coaxial cables RG-58, -59, -54, etc. with reduced ratings.

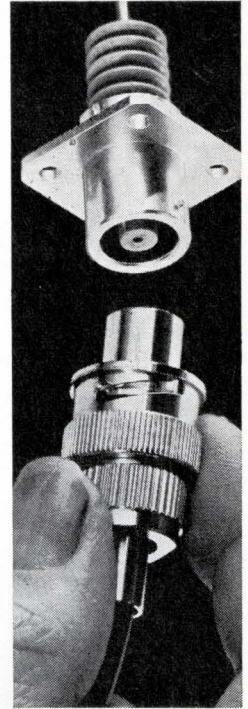

Phone or write today.

ROWE INDUSTRIES, INC.

1702 Airport Highway,
Toledo, Ohio 43609
Phone: 419-382-5666,
TWX: 810-442-1734

Circle 77 on Inquiry Card

NATVAR FLOTUBE

FLUIDIC CABLE

- Easy to install
- Self-contained harness
- Permits fast assembly
- Variety of colors for coding

Now you can get Natvar Flotube fluidic tubing in cable design of 7, 14, 21 and special configurations. Perfect for fast assembly and color coding of fluidic circuits. You get tight, leakproof connections that won't kink even on small radii. Available in all sizes for commonly used devices. Select combination of sizes needed and color combinations from 10 colors and clear. Send for technical data and Free samples.

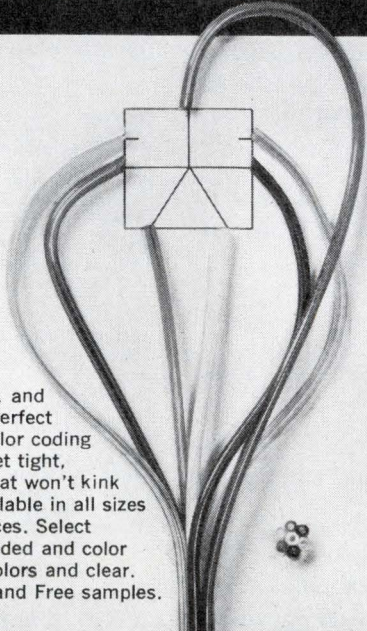

NATVAR CORPORATION
P. O. BOX 67 • RAHWAY, N. J. 07065

Circle 78 on Inquiry Card

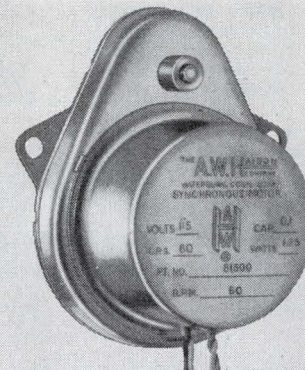

New! High-Torque Reversible Synchronous Motor

Here's a newly-developed, low-cost synchronous motor you can use in your timing or drive applications where high torque, reversibility, or low power input are required. You can obtain .75 oz. in. at 300 rpm directly from the rotor, at an input of only 1.5 watts. The motor will operate efficiently with an input as low as 0.2 watt!

You can choose from four standard gearing systems if you need higher torque or lower speed — torque up to 100 oz. in., and speed as slow as one revolution per day. You can use either a single-phase or two-phase supply, and single-phase reversibility is obtained by merely changing one connection. Special models are also available. Send for technical data now.

NORTH AMERICAN PHILIPS
COMPANY

AWHAYDON
THE COMPANY

232 North Elm Street
Waterbury, Conn. 06720

See EEM for local
Representatives in U. S.

In Europe: s.a. Polymotor • 29 Av. Paul Henri Spaak • Brussels 7 • Tel. 23.40.83
Timing & Stepper Motors • Electromechanical & Electronic Timing Devices & Systems

Circle 79 on Inquiry Card



Advertisers—June 1969

This index is published as a convenience.
No liability is assumed for errors or omissions.

DISTRICT SALES MANAGERS

EDWARD G. SHAUD

PHILADELPHIA 19139—56th & Chestnut Sts.
(Area Code 215) SHERWOOD 8-2000

JOSEPH DRUCKER

NEW YORK 10017—100 East 42nd St.
(Area Code 212) OXFORD 7-3400

JOHN UPHUES

THOMAS A. MORIE
CHICAGO 60606—120 S. Riverside Plaza
(Area Code 312) 782-1400

G. T. ALFANO

NEEDHAM HEIGHTS, MASS. 02194—570 Hillside Ave.
(Area Code 617) 444-0010

TERRENCE D. BUCKLEY

LOS ANGELES 90015—1543 W. Olympic Blvd.
(Area Code 213) DUNKIRK 7-1271

RALPH PETERSEN

SAN FRANCISCO—839 Mitten Rd.
BURLINGAME 94010
(Area Code 415) 697-8703

LEONARD PREYSS

CLEVELAND 44114—601 Rockwell Ave.
(Area Code 216) SUPERIOR 1-2860

FRANK A. SMITH

HOLLYWOOD, FLA. 33020—2419 Hollywood Blvd.
(Area Code 305) 927-7829

NEWTON COLLINSON

ATLANTA 30309—1776 Peachtree St. N.W.
(Area Code 404) 872-4723

HAROLD E. MOTT

DALLAS 75206—Meadows Bldg. Expressway at Milton
(Area Code 214) EMERSON 3-6426

JOHN F. WALLACE

HOUSTON 77027—West Loop Bldg. Rm. #209, 4848 Guiton
(Area Code 713) 621-3428

European Sales Offices

MAX F. HOLSINGER

LONDON, S.W. (1)—67/68 Jermyn St. St. James
Tel: TRafalgar 6318/9
4 DUSSELDORF—RATH, Germany
United International Industrial Press
Eitelstrasse 32
Tel: Dusseldorf 632031

STEPHEN BROWN-JOUSSARD

PARIS 8e, France
70 Rue de Ponthieu
Tel: ELYsees 65-77

Far East Sales Office

CLARENCE T. SAKAGUCHI

TOKYO, MARUNOUCHI, Japan
C.P.O. Box #1572, Room 814
Tel: 211-3506-3509
Togin Bldg.

BUSINESS STAFF

K. ROBERT BRINK

Publisher

STEPHEN A. FARKAS

Marketing Services Manager

BERNARD GITTELMAN

Directories Manager

DENNIS J. PERKINS

Promotion Manager

PAT PIEHL

Advertising Production

WILLIAM M. COFFEY

Circulation Director

JAMES F. NAGY

Circulation Manager

JOSEPH P. BABCOCK

Reader Service Manager

ACDC ELECTRONICS	117
Chiat/Day Inc.	
ACOPIAN CORPORATION	130
Mori Barish Assoc., Inc.	
AMCO ENGINEERING CO.	115
Buti-Roberts Adv.	
AMERICAN MACHINE & FOUNDRY CO., POTTER & BRUMFIELD DIV.	36, 37
Grant, Wright & Baker, Inc.	
AMMON INSTRUMENTS, INC.	134
Culver Adv., Inc.	
AMP INC.	64
Garceau, Hallahan & McCullough, Inc.	
ANALOG DEVICES, INC.	Ins. Fol. P. 34
Adastra Inc.	
AUGAT, INC.	60
Horton, Church & Goff, Inc.	

BECKMAN INSTRUMENTS, INC., HELIPOT DIV.	88
N. W. Ayer/Jorgensen/MacDonald, Inc.	
BUCKEYE STAMPING Co.	135
Wheeler, Knight & Gainey, Inc.	
BUSSMANN MFG. DIV.	12
Henderson Adv. Co.	

CENTRALAB DIVISION	73
The Brady Company	
CHERRY ELECTRICAL PRODUCTS CORP.	46, 47
K & A Inc.	
CLIFTON DIV. OF LITTON INDUSTRIES ...	66
Ivey Adv., Inc.	
COMPONENTS INC.-SEMCOR DIV.	95
Marketing & Corporate Communications	
COMPUTER MEASUREMENTS CO.	Ins Fr. Cov.
Jones, Maher Roberts Inc.	
CONDENSER PRODUCTS CORPORATION ..	30
Bill Reed & Assoc., Inc.	
CONDUCTRON CORPORATION	43
J. Walter Thompson Co.	
COORS PORCELAIN Co.	121
Tallant/Yates Adv., Inc.	
COUCH ORDNANCE, INC.	130
Culver Adv., Inc.	
CTS CORPORATION	11
Reinke, Meyer & Finn, Inc.	

DALE ELECTRONICS, INC.	41
Swanson, Sinkey, Ellis, Inc.	
DELCO RADIO DIVISION, GENERAL MOTORS CORPORATION	14, 15
Campbell-Ewald Co.	
DIALIGHT CORPORATION	4
Michel-Cather, Inc.	
DIGITRAN COMPANY, THE	133
Precise Ink Adv. Services	

EL INSTRUMENTS INC	107
L. Froehlich Adv. Services	
ELCO CORPORATION	68
Schaefer Adv., Inc.	
ELECTROL	40
S. Michelson Adv.	
ELECTRO MOTIVE MFG. CO.	103
Reynolds & Foster, Inc.	
ELECTRONIC COMMUNICATIONS, INC. .	32
Neals & Hickok, Inc.	

FAIRCHILD SEMICONDUCTOR	8-9, 20-27, 96
Chiat/Day Inc.	
FAIRCHILD SPACE AND DEFENSE SYSTEMS	108
Keyes, Martin & Co.	
FERROXCUBE CORP.	111
W. H. Schneider, Inc.	

GAF CORPORATION	79
Michel-Cather, Inc.	
GRIES REPRODUCER COMPANY	135
Harold Marshall Adv. Co., Inc.	

A. W. HAYDON CO., THE	137
J. B. Rundle, Inc.	
HEWLETT-PACKARD, LOVELAND DIV.	45, 123
Tallant/Yates Adv., Inc.	
HIPOTRONICS INC.	72
Caroe Marketing, Inc.	

INDIANA GENERAL CORPORATION	120
The Griswold & Eshleman Co.	
INTERNATIONAL BUSINESS MACHINES ..	31
Ogilvy & Mather, Inc.	

KEYSTONE ELECTRONICS CORPORATION. 136	
Lawrence Nelson Adv.	

MAGNETIC METALS	131
Robert H. Kiefreider Assoc.	
MARK EYELET & STAMPING, INC.	136
Basil W. Schwarz Assoc.	
MATHESON GAS PRODUCTS, A DIV. OF WILL ROSS, INC.	129
Cooper, Strock & Scannell, Inc.	
MB ELECTRONICS, A TEXTRON CO.	50
Codella Savage Peck Inc.	
J. W. MILLER COMPANY	128
Schaeper Industrial Adv.	
MOTOROLA COMMUNICATIONS & ELECTRONICS INC.	134
The Griswold & Eshleman Co.	
MOTOROLA GOVERNMENT ELECTRONICS DIV.	42
Jennings & Thompson	

NATVAR CORPORATION	137
Sanger-Funnell Inc.	

PANDUIT CORPORATION	136
Donald L. Arends, Inc.	
PHILBRICK/NEXUS RESEARCH....	Ins. Fol. P. 50
Renaccio Adv., Inc.	
POTTER & BRUMFIELD DIV., AMERICAN MACHINE & FOUNDRY CO.	36, 37
Grant, Wright & Baker, Inc.	
POWER DESIGNS, INC.	Ins. Back Cover
Lescarboura Adv., Inc.	
PYLON CO., INC.	135
American Line-A-Graph Corp.	

RCA, INTEGRATED CIRCUITS DIV....	Back Cover
Al Paul Lefton Co., Inc.	
RAYTHEON SEMICONDUCTOR	6
Botsford, Constantine & McCarty, Inc.	
REEVES-HOFFMAN DIV., D.C.A.	105
Adams Assoc., Inc.	
REPUBLIC ELECTRONICS CORP.	106
Kardonne Adv. Agency	
ROWE INDUSTRIES	137
John I. Carr Assoc., Inc.	

SAN FERNANDO ELEC. MFG. CO.	44
West-Ad Communications	
SEMTECH CORPORATION	2
burruss/advertising	
SOLID STATE PRODUCTS, DIV. OF UNITRODE CORP.	16
Van Christo Assoc., Inc.	
SPRAGUE ELECTRIC CO.-CAPACITOR DIV... 1	
The Harry P. Bridge Co.	
STANPAT PRODUCTS INC.	134
Morton Adv., Inc.	
SUPERIOR STEATITE AND CERAMIC CORP. 132	
Harold Marshall Adv., Co. Inc.	
SWITCHCRAFT, INC.	119
Buti-Roberts Adv.	
SYNTHANE-TAYLOR CORPORATION	92
Arndt, Preston, Chapin, Lamb & Keen, Inc.	

TECKNIT	87
Douglas Brush Adv.	
TELEDYNE RELAYS	5
S. Michelson Advertising	
E. H. TITCHENER & CO.	59
Conklin, Labs & Bebee Inc.	
TRYGON POWER SUPPLIES	132
Kameny Assoc., Inc.	
TYCO, DIGITAL DEVICE DIV.	29
Kenyon & Eckhardt Inc.	

UNITRODE CORPORATION	19
Silton Brothers, Inc.	

VARFLEX CORPORATION	125
Barlow/Johnson Inc.	
VARIAN ASSOC.-TRAVELING WAVE TUBE DIVISION	70
Botsford, Constantine & McCarty, Inc.	
VISHAY RESISTOR PRODUCTS	28
Alpern Communications	

WENTWORTH LABORATORIES, INC.	125
William Bridgman Assoc.	
WESTON INSTRUMENTS, INC., ARCHBALD DIV.	113
Arndt, Preston, Chapin, Lamb & Keen, Inc.	
WESTON INSTRUMENTS, INC., NEWARK DIV.	127
Arndt, Preston, Chapin, Lamb & Keen, Inc.	

The heart of your display



Model 1579/1584 family of High Voltage Sources provides ultra-stable, noise-free output up to 30 KV and 5 MA in a compact, environmentally-independent package with unique features not available in any other equipment.

FEATURES

- Stability 100 ppm/24 hrs
- Repeatability 100 ppm
- Ripple & Noise 250 mv peak-to-peak
- Temperature Coefficient 50 ppm/°C
- Regulation 25 ppm
- Calibration Accuracy 0.25%
- Overload & Short Circuit Protection
- Supplied with 50 KV Output Connector

Options: Remote Voltage or Resistance Programming; Adjustable Overvoltage Protection and Polarity Reversal.

Write For Technical Data

POWER DESIGNS PACIFIC, INC.
MIRANDA AVE., PALO ALTO, CALIFORNIA 34304



POWER DESIGNS, INC.
1700 SHAMES DRIVE • WESTBURY, N. Y. 11590

4 Amplifier High Gain "Building Block" Array

Here you are—four identical linear amplifiers built on a single IC chip and mounted in the new 16-lead dual-in-line plastic package ready to plug into your design plans. Use them as AF feedback amplifiers; equalizers; in 2- or 4-channel audio applications. Figure them into linear signal mixer designs; as oscillators; as low frequency high gain amplifiers and as multivibrators.

The "matched set" of four is the RCA-CA3048. It provides 57 dB (typ.) voltage gain per amplifier or 114 dB (typ.) when two amplifiers are cascaded. Each amplifier features a Noise Figure of 2 dB (typ.)

at 1 kHz, -3 dB bandwidth of 300 kHz, and an input resistance of 90 k Ω (typ.).

Ask your local RCA Representative or your RCA Distributor for full details. Or write for technical data to RCA Electronic Components, Commercial Engineering, Section ICJ-6, Harrison, N. J. 07029.

If you need an array with greater bandwidth—check: **RCA-CA3035**—Three individual general-purpose amplifiers with gain-bandwidth externally adjustable. \$1.50 (1,000 units)

RCA-CA3048 in 16-lead dual-in-line plastic package, \$2.45 (1,000 units)

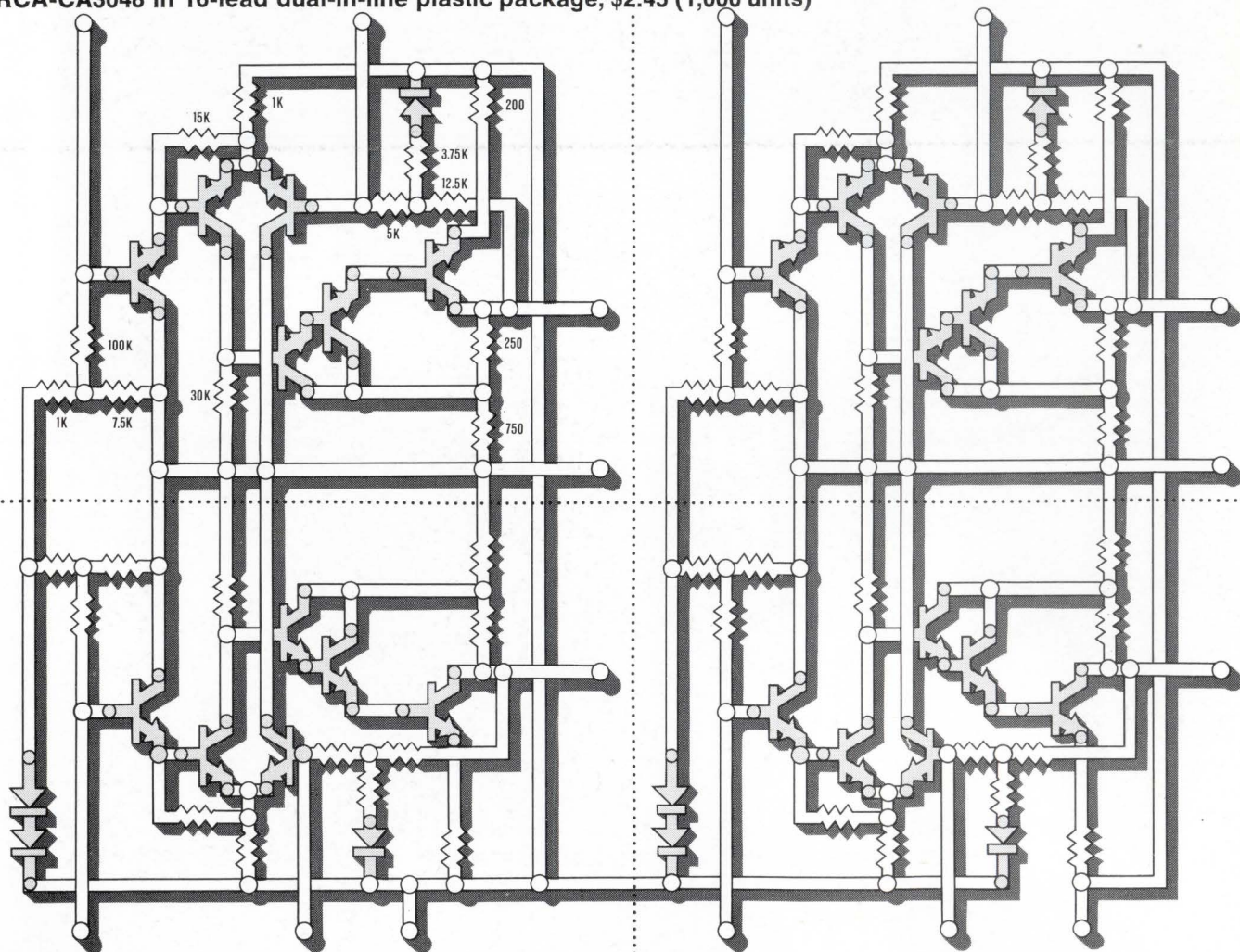

RCA Integrated
Circuits