

COMPUTER DESIGN

THE DESIGN AND APPLICATION
OF DIGITAL CIRCUITS,
EQUIPMENT & SYSTEMS

JUNE 1965



in this issue

A Fluid-Logic
Digital
Computer

BOEING
SEATTLE WASH 98107

22275
460650
0502
B23690



Over 300 Circuits 2.5X Actual Size

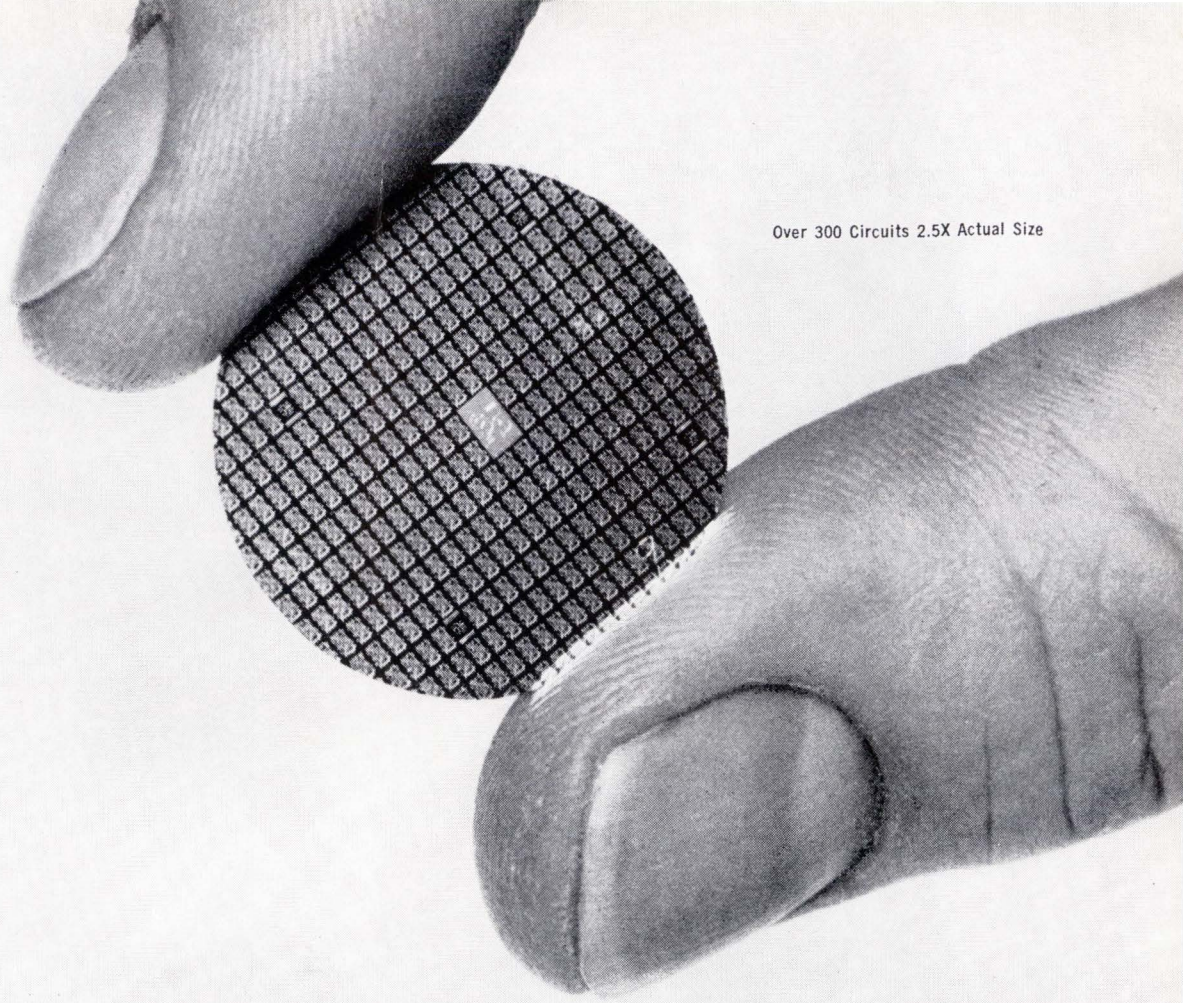

1st Microcircuit GP Computer

DDP-124 NEW SIZE, PRICE, AND PERFORMANCE

24-bit word DDP-124 features monolithic integrated circuit μ -PACtm construction throughout; fast, reliable, and flexible logic configuration — binary, parallel, sign/magnitude, single address with indexing, powerful command structure. Over 285,000 computations per second. **MEMORY:** 4096 words (expandable to 32,768) directly addressable; cycle time 1.75 μ secs. **INPUT-OUTPUT:** Typewriter, paper tape reader and punch. (Strong optional I/O capability and broad range of peripheral equipment.) **SOFTWARE:** FORTRAN IV, assembler, executive, utility and service routines. Fully program compatible with DDP-24 and DDP-224 general purpose computers. Write for complete specifications.

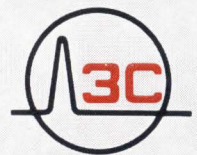

3C SALES OFFICES: NEEDHAM, MASS.; SYRACUSE, N.Y.;
COMMACK, L.I., N.Y.; LEVITTOWN, PA.; CLEVELAND,
OHIO; CENTERVILLE, OHIO; SILVER SPRING, MD.; DES
PLAINES, ILL.; ORLANDO, FLORIDA; ALBUQUERQUE,
N.M.; PALO ALTO, CALIF.; LOS ANGELES, CALIF.;
KENT, WASH.; HOUSTON, TEXAS; HUNTSVILLE, ALA.

COMPUTER CONTROL COMPANY, INC.
OLD CONNECTICUT PATH • FRAMINGHAM, MASSACHUSETTS

CIRCLE NO. 1 ON INQUIRY CARD

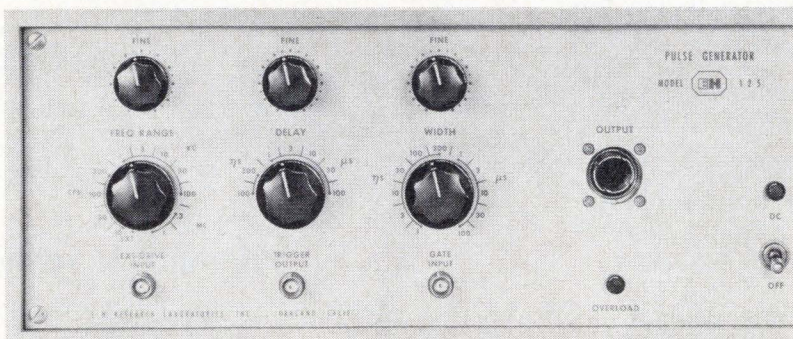
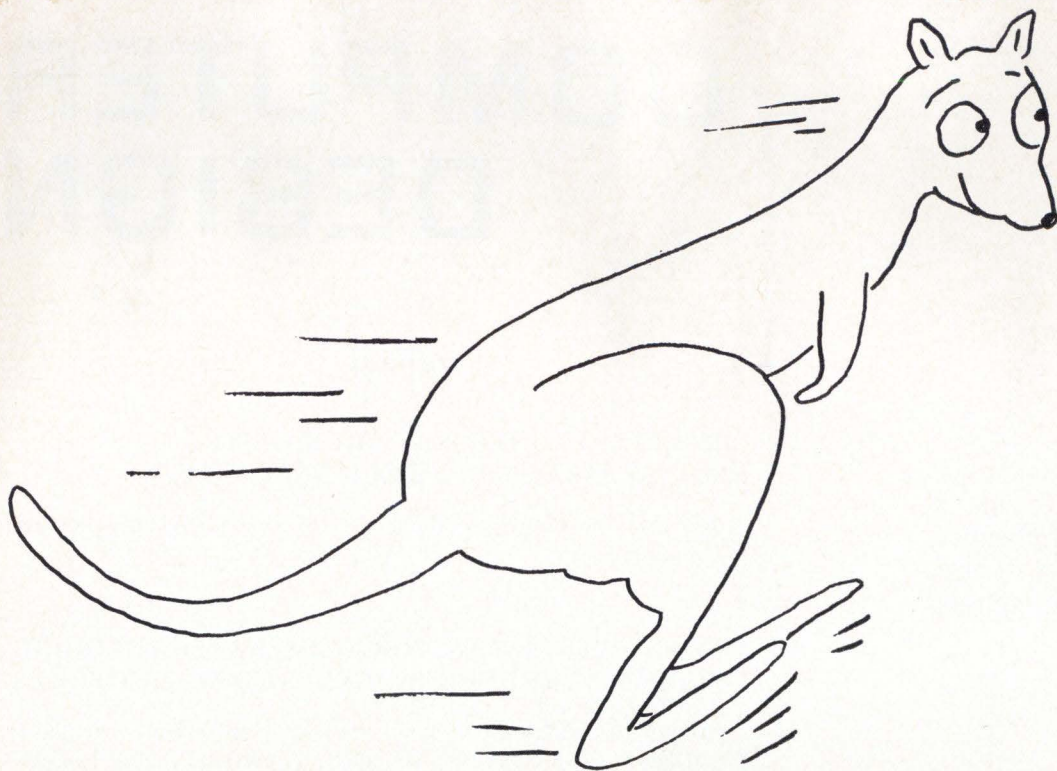

New E-H 125 pulser makes big jump in rise time to 200 picoseconds

with 10 volts into 50 ohms. Once more E-H sets the pace in pulser development, with a new pulser featuring pulse rise time of 200 picoseconds. Output pulse amplitude is 10 volts in 50 ohms with pulse top distortion of less than 5% p-p from ideal waveform. Pulse width is continuously variable from less than 1 ns to 100 μ s. A fine control and 1/3/10 coarse selector provide continuous pulse width coverage. Width jitter less than 0.1%. Rep rates from 10 cps to 1 MC, continuously variable. Synchronous gating and trigger output features. Here are all the advanced specs you want, backed by the E-H reputation for reliability. For a demonstration call your E-H representative now. **\$2275**

NEW FROM E-H: Programmable core drivers, ultra-linear ramp current and voltage generators, featuring rise times of less than 10 ns, 50 volts into 50 ohms, short-circuit proof outputs and high rep rates.

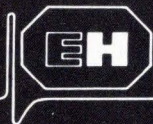

E-H RESEARCH LABORATORIES, INC.

163 ADELIN STREET • OAKLAND, CALIFORNIA 94607 • TEMPLEBAR 4-3030 • TWX-415-891-9651

IN EUROPE: E-H Research Laboratories, AG; P. O. Box 293, 6301 Zug, Switzerland

CIRCLE NO. 2 ON INQUIRY CARD

COMPUTER DESIGN

FEATURES

FOR ENGINEERING PERSONNEL RESPONSIBLE FOR THE DESIGN & APPLICATION OF DIGITAL CIRCUITS, EQUIPMENT, AND SYSTEMS IN COMPUTING, DATA PROCESSING, CONTROL AND COMMUNICATIONS.

ROBERT BROTHERSTON, Publisher
S. HENRY SACKS, Editor

Editorial Advisory Board

HAROLD H. SEWARD
JOSEPH D. SABO
EDWARD M. COPPS, JR.
DANIEL J. LICKLY

Contributing Editors

RICHARD AHRONS
A. S. BUCHMAN
H. S. MILLER
W. A. GANNON
DAN M. BOWERS
WALTER A. LEVY

JAMES FLORA Art Director
THERESA SACKS Production Manager
SANDRA M. MARTIN Adv. Prod.
JANET RICH Circulation Mgr.

LINDSAY H. CALDWELL
Vice Pres.-Sales

Editorial & Executive Offices Professional Bldg.

Baker Ave. • W. Concord, Mass.
Tel. 369-6660

Computer Design is published monthly. Copyright 1965 by Computer Design Publishing Corporation. Accepted as controlled circulation publication at Post Office at Boston, Massachusetts. No material may be reprinted without permission. Postmaster: CHANGE OF ADDRESS — FORM 3579 to be sent to Computer Design, Circulation Dept., P. O. Box B, Arlington, Mass. 02174. Subscription rate to non-qualified subscribers is \$15.00 per year; \$1.50 per issue. Subscription rate to all foreign subscribers is \$25.00 per year; \$2.50 per copy.



Circulation
over 24,000

14 "BEAM-LEAD" INTEGRATED CIRCUITS REDUCE PARASITIC CAPACITANCE

Strong leads are built into the integrated circuit structure providing many advantages.

18 ORGANIZATION of AND/OR ELEMENTS for ENCODING, DECODING, and PATTERN GENERATING NETWORKS

The normal minimizing techniques are sometimes difficult to apply to the design of multi-input logic structures. A practical matrix approach is described in this article.

26 A FLUID-LOGIC DIGITAL COMPUTER

Explaining the basic operating principles of fluid-logic devices and evaluating their advantages and disadvantages, this article describes the overall logical design of a working experimental "air" computer.

38 DIGITAL HYDRAULIC VALVE-ACTUATOR

Open-loop "ON-OFF" positioning device offers several advantages over conventional techniques.

40 NEW MASS CORE MEMORY

Ferrite system claims to be economically competitive with discs and drums.

DEPARTMENTS

4 NEW BOOKS

6 INDUSTRY NEWS

46 NEW PRODUCTS

- Circuit Components • Circuit Packaging • Input-Output Equipment
- Console Equipment • Power Supplies • Memories • Test Equipment
- Systems • Circuit Modules

61 LITERATURE

64 ADVERTISERS' INDEX

Reader subscription cards opposite page 9
Reader inquiry cards opposite page 56

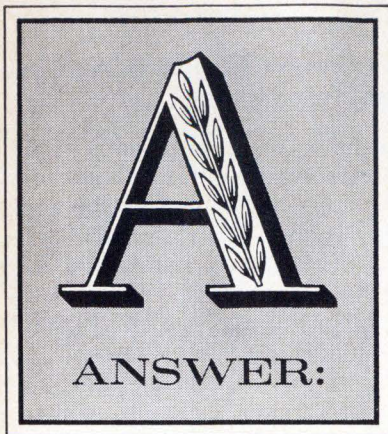

- Input noise immunity of **2.5v** at frequencies of 1mc to 5mc.
- True 1mc speed through the use of parallel logic.
- Parallel operation of **120** binary counter stages at **1mc clock rate** . . . with all outputs settling within 150 nanoseconds after count pulse.
- Number of allowable stages of amplified logic between two flip-flops is a **minimum of 8** at 1mc clock rate.
- No external clamp supply required—Zener clamp supply on **every** card to cut power supply and wiring costs.
- Rise and fall time maximum of 100 nanoseconds.
- Complete ground shielding and ringing clamps to cut backplane "debugging" expense.

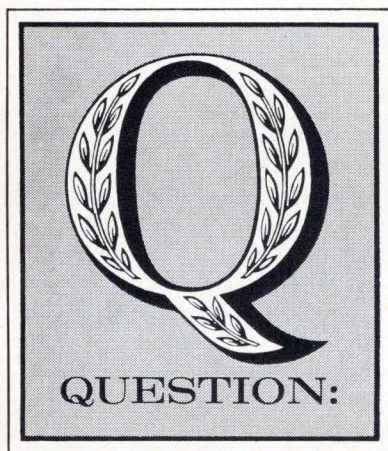

COULD YOUR DIGITAL MODULE SPECS BE MORE DEMANDING THAN THESE?

Probably not, but they illustrate the effective performance of NAVCOR's new 1mc modules under worst case conditions . . . and the wide latitude of design flexibility that these new modules offer you.

When you add to the above specifications: "System Function" versatility (one NAVCOR module can perform the functions of up to ten conventional cards); the most stringent quality control check in the industry (heat cycling equivalent to nine months use); instant check-out neon indicators; and one of the industry's most competitive pricing schedules . . . you'll quickly realize that you should know more about NAVCOR's new 1mc modules. Send in the quick-action coupon for full technical data.

NAVCOR

Where Advanced State of the Art is Expected

NAVIGATION COMPUTER CORPORATION

Dept. CD-65 Valley Forge Industrial Park, Norristown, Pa. • 215-GL 2-6531

NAVCOR Valley Forge Industrial Park, Norristown, Pa.

YES! Please send me full technical information on NAVCOR'S new "System Function" compatible 1mc and 5mc modules.

NAME _____ TITLE _____

COMPANY _____

ADDRESS _____

DEPT. CD-65

CD NEW BOOKS

ELECTRONIC ANALOG AND HYBRID COMPUTERS

Author: Granion A. Korn, Ph.D., Professor of E.E., University of Arizona and Theresa M. Korn, M.S.

This 564 page book presents authentic, up-to-date design information on hybrid analog-digital computing devices and systems, including circuits for instrumentation, control, and data processing as well as for general-purpose problem solving. The authors introduce improved computing techniques made possible by ultra-fast hybrid analog-digital computers, and they present new successful applications of electronic analog/hybrid computers. Chapters 1 and 2, comprising Part I of the book, introduce classical electronic analog computation and tried programming and scaling procedures. The second part of the book deals with the actual design of modern analog computing elements. Part III covers the design of complete analog and hybrid analog-digital computing systems, and Part IV introduces the novel mathematical techniques opened up by the new iterative differential analyzers. The discussion links practical design (with many actual circuit examples) to computing techniques and applications by mathematical error analysis wherever possible. Price: \$17.50. Order from:

McGraw-Hill, 327 West 41 Street, New York, N.Y. 10036.

SEMICONDUCTOR BOOKLETS

Two new booklets have been published by the Semiconductor Division of Hoffman Electronics Corp. They are "Semiconductor Circuit Handbook" and "Theory and Operational Functions of Silicon Tunnel Diodes." The "Semiconductor Circuit Handbook", priced at 50 cents, contains 48 pages, 4 x 6 inches in size, divided into six sections. Each section explores the performance characteristics and operational range of different categories of semiconductors and circuits. The sections are devoted to rectifiers, limiters, and ZENER functions, logic circuits, switching and control circuits, oscillators and signal generators, solar application guide, and miscellaneous circuits.

"Theory and Operational Functions of Silicon Tunnel Diodes", priced at \$1.50 is a 16-page 8½ x 11 inch booklet. It describes quantum mechanical tunneling with diagrams, the Hoffman tunnel diode product and its applications, the important 0/1 ratio parameter, use of the silicon tunnel diode as a bistable preliminary stage to convert an analog signal into digital information for auxiliary devices, tunnel diode biasing, photovoltaic readouts, the Uni-Tunnel diode, and an explanation of the quick-recovery characteristic of the tunnel diode. Order from:

Hoffman Electronics Corp., El Monte, Cal.

MILITARY INFORMATION SYSTEMS

Edited by Edward Bennett, James Degan, and Joseph Spiegel, Mitre Corp.

This book explores some of the major aspects of information-system technology and discusses the possible designs of computer-aided military information systems. The editors have compiled nine essays on the following subjects: the relation of military information systems to the conduct of strategic war; the role of communication in military information handling; and the various technical approaches possible in system design, including the evaluation of information systems, the role of the user in system design. Price: \$5.00. Order from publisher:

Frederick A. Praeger, 111 Fourth Ave., New York, N.Y. 10003

DIGITAL LOGIC HANDBOOK

New 80-page handbook contains design and circuit application information relative to a compatible family of digital logic plug-in circuits. Subjects covered include an explanation of company's logic techniques, Boolean algebra, waveform techniques, level-shifting at no cost, zero-cost gating, logic counters, thin-film memories, analog-digital conversion, least-cost high-speed memories, and various system techniques. Detail circuits are shown for counters and divide-by-N techniques and unit-load concept is explained. Specific examples are used to show how the use of company's logic cards saves dollars and increases reliability. The handbook may be obtained by sending \$1.25 to cover shipping, to:

Computer Logic Corp., 11800 Olympic Blvd., Los Angeles, Cal. 90064.

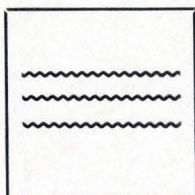

**"CAUSES AND CURES
OF NOISE
IN DIGITAL SYSTEMS"**



SEE PAGE 60

**"TELETYPEWRITER
FUNDAMENTALS"**

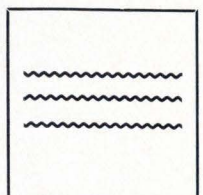

SEE PAGE 9

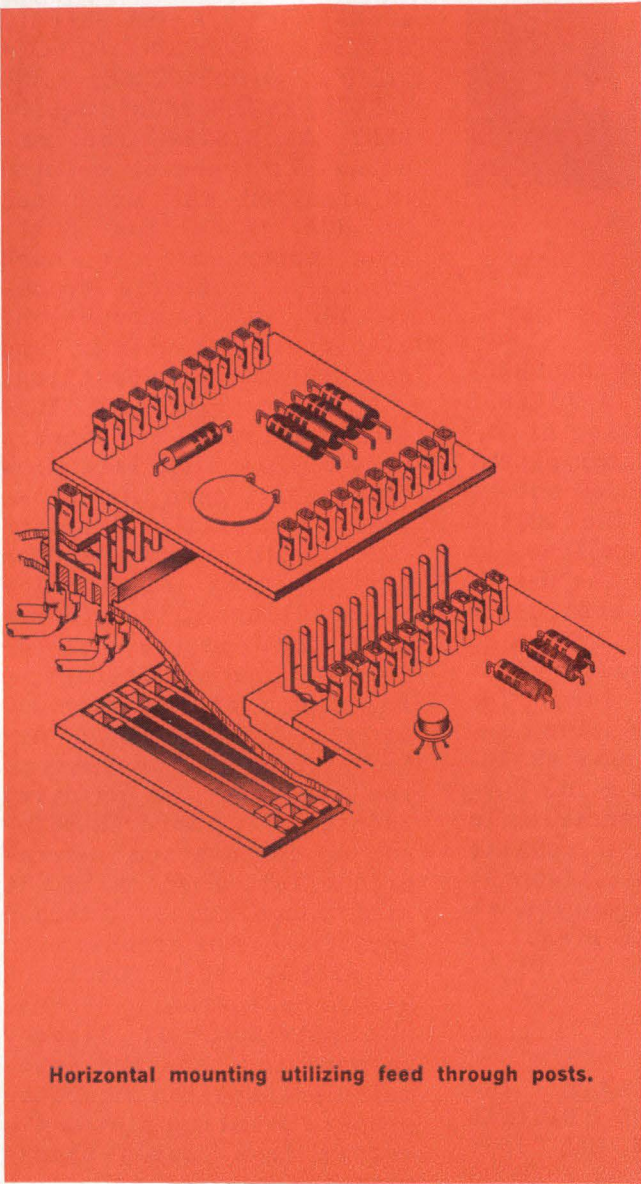

Horizontal mounting utilizing feed through posts.

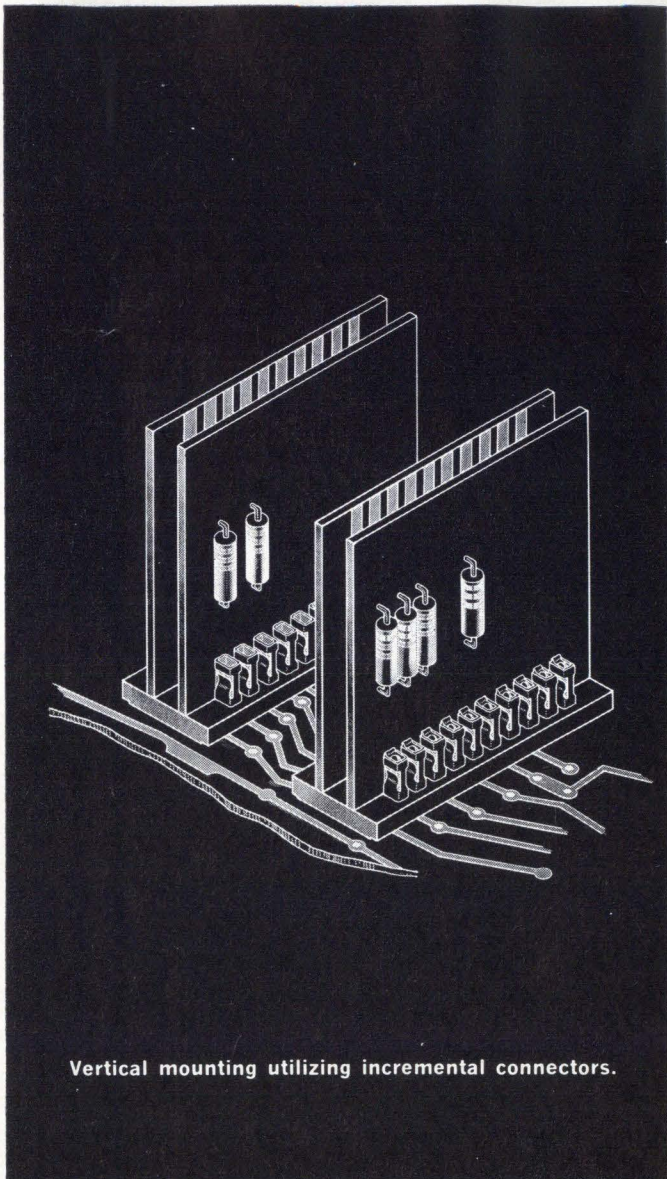

Vertical mounting utilizing incremental connectors.

Flexibility across the board

Here's a two-piece connector that offers unlimited design potential in printed circuit and modular applications. Plan the layout any way you want—horizontal, vertical, end-to-end. The AMPMODU[★] Interconnection System not only gives you *reliable* interconnections, but its sound contact design and adaptability to automated assembly techniques reduce installed costs in the bargain.

Male contacts are available as incremental connectors or as feed-through posts to accept TERMI-POINT[★] clip applications and other automated wire terminations. Female contacts come in strip form for automatic staking to printed circuit boards. They are designed to overcome mating misalignments, can be mounted with center-to-center densities up to .100 inch.

Reliability is increased by the contact design which features redundant cantilever beams with built-in anti-overstress protection. In addition, modular circuits can be conveniently job-lot assembled on a true production line basis . . . no need to solder or test until they're all assembled.

Before you start working on that new design, check these features:

- Lowest per line cost
- Compatible with TERMI-POINT Terminals and tools
- Automatic staking of contacts to board
- Reliability—simple spring contact and built-in anti-overstress
- Versatility—for boards $\frac{1}{32}$, $\frac{1}{16}$, $\frac{3}{32}$ -inch thick
- Flexibility—contacts mounted vertically or horizontally

Why not design it with the AMPMODU Interconnection System and get all these benefits at the lowest installed cost? Write today for complete details.

★Trademark of AMP INCORPORATED



A-MP[★] products and engineering assistance are available through subsidiary companies in: Australia • Canada • England • France • Holland • Italy • Japan • Mexico • West Germany

CIRCLE NO. 4 ON INQUIRY CARD



A \$1.3 MILLION CONTRACT FROM NASA'S MARSHALL SPACE FLIGHT CENTER, FOR THREE DEE-6 DIGITAL EVENTS EVALUATORS was announced by Scientific Data Systems. The DEE-6s will be used at Huntsville and at Cape Kennedy to perform automatic checkouts on Saturn rocket stages. During Saturn checkout, each DEE-6 will automatically monitor the status of 3,000 information lines every two thousandths of a second and report on the status of the space vehicle and ground support equipment. The DEE-6 is built around an SDS 930 general purpose computer and can also perform a variety of other data reduction and correlation tasks.

COMPUTERS INTO WHICH HAVE BEEN FED MINIMAL AMOUNTS OF ADVANCE INFORMATION MAY LEARN TO DO BETTER THAN MEN AT FINDING UNSEEN ENEMY SUBMARINES OR INVISIBLE POOLS OF MINERAL OIL, according to two Purdue University engineers. The statement was made as an aside to a paper presented before the IEEE's convention in the New York Hilton Hotel. The report explains that the computers learned to separate and identify random patterns presented to them "cold" from two sources after preliminary minimal briefing. Data and graphs showed that almost-clean-slate computers, not overburdened with information from fallible humans, can learn to recognize and identify unknown complex patterns which men cannot.

GULTON INDUSTRIES ANNOUNCED THE GRANTING OF A LICENSE to Radio Corporation of America under a Gulton patent relating to a random access memory module. The Gulton patent, which expires in 1979, applies to the use of modules made of continuous thin sheets of laminated ferrite with conductor wires printed on both sides. The lines of the conducting material are as close as 40-thousandths of an inch. Payment to Gulton Industries is provided for on a royalty basis under the license, which is not exclusive to Radio Corp. of America.

A CONTRACT FOR ANALOG INSTRUMENTATION AND A DIGITAL COMPUTER SYSTEM HAS JUST BEEN AWARDED TO THE FOXBORO CO., Foxboro, Mass., by the Associated Electric Cooperative of Springfield, Mo. The instrumentation system, to be installed in the summer of 1966, will serve a 150 MW steam electric generating station. The contract specifies pneumatic analog instrumentation, valves, and panels covering all phases of combustion control and includes a Foxboro Model 97400A Computer System described as a low-cost process computer system employing miniaturized integrated-type silicon circuitry. The computer system, capable of monitoring 500 inputs, will provide automatic alarming and data logging and will later be used for performance calculations and control functions.

FORMATION OF A NEW GRAPHIC SYSTEMS DIVISION TO DEVELOP, MANUFACTURE, AND MARKET NEW ELECTRONIC EQUIPMENT AND SYSTEMS for handling all types of printed information was announced by RCA. Recalling RCA's long experience in such areas as facsimile transmission and reproduction, electronic printing, and computerized typesetting, RCA President Elmer W. Engstrom said, "The new Graphic Systems Division will draw extensively upon this background and will at the same time explore new methods for applying electronics to handling all information that is to be recorded in permanent form — in print, pictures, or code. It will relate these new techniques and systems to the needs of the printing industry for improved methods of composition and reproduction. Eventually, it will range across a broad spectrum of the graphic arts to embrace such functions as the electronic storage and retrieval of library information, and the automatic preparation of photographic printing plates directly from images transmitted electronically over long distances."

A JOINT DEVELOPMENT PROJECT FOR DIRECT CONTROL OF PETROLEUM REFINERIES BY DIGITAL COMPUTER was announced today by Esso Research and Engineering Company and IBM Corp. This direct digital control (DDC) project will physically explore new techniques for automatically controlling refinery operations and other processes. The pilot application of DDC in the new development project is scheduled to start operation this spring in the United Kingdom at the Fawley Refinery of Esso Petroleum Co., Ltd.

SDS doesn't talk about Integrated Circuits

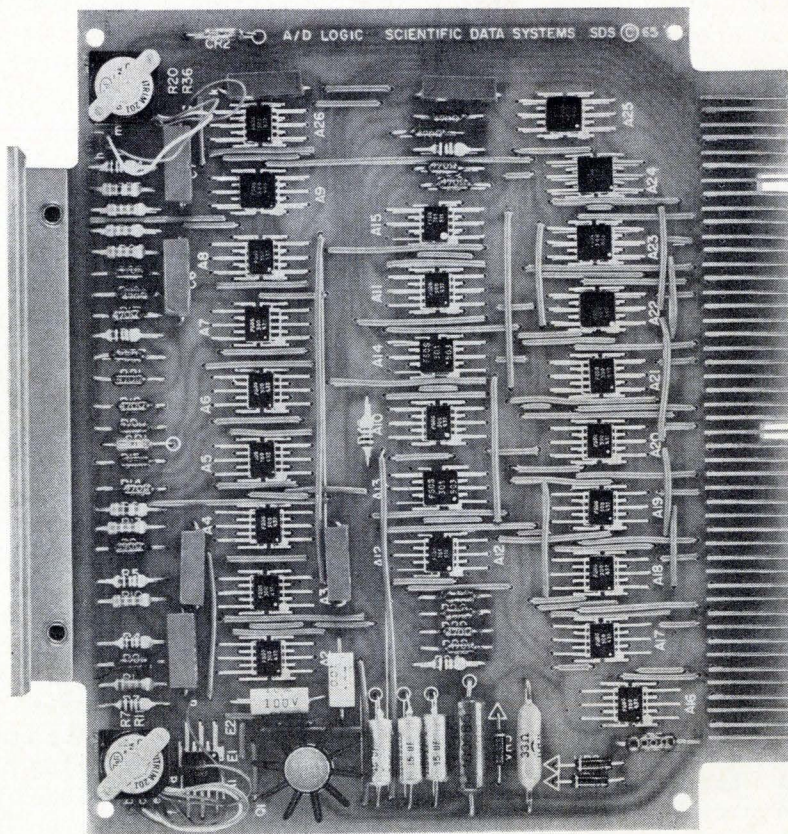

...we use them.

Our new A to D Converters, for instance:

We are now shipping two new all-silicon A to D converter models. One of them makes 33,000 15-bit conversions per second. The other makes 54,000 12-bit conversions per second. Accuracy is 0.01%. And in both of these new converters, all logic circuitry is integrated.

We also have options. For slight increases in cost, we can make it possible for you to: 1. Make positive detection and indication of out-of-scale inputs. 2. Perform go / no-go limit tests at rates above 330,000 per second. 3. Have a self-contained D to A converter that operates independ-

ently of the rest of the primary A to D converter module.

If you'll use the reader service number on the left, below, we'll send along complete specifications on our two new A to D's. We'll also include data on our other five A to D converters. If you'll use the right hand reader service number below, we'll send you a complete SDS logic module catalog. You're bound to need one or the other.

SDS SCIENTIFIC DATA SYSTEMS
1649 Seventeenth Street, Santa Monica, Calif.

Sales offices in: Santa Monica, New York City, Boston, Washington, D.C., Philadelphia, Pittsburgh, Wilmington, Houston, Huntsville, Cocoa Beach, Dallas, Chicago, Detroit, Albuquerque, Denver, San Francisco, San Diego, Seattle, Anaheim, Minneapolis, St. Louis, Phoenix. Foreign representatives: CECIS, Paris, France; Geneva, Switzerland; Kanematsu, Tokyo, Japan; RACAL, Sydney, Australia; Instronics, Ltd., Stittsville, Ontario, Canada.

CIRCLE NO. 5 ON INQUIRY CARD

CIRCLE NO. 6 ON INQUIRY CARD

A NEW 24-BIT WORD COMPUTER CONSTRUCTED WITH MONOLITHIC INTEGRATED CIRCUITS has been announced by Computer Control Company, Inc. of Frammingham, Mass. The micro-circuit computer, the DDP-124, employs 3C's new module line of integrated circuit packages (μ -Pacs). In announcing the new general purpose digital computer, 3C president Benjamin Kessel pointed to a broad range of control and simulation markets as areas of prime potential for the DDP-124 which will sell in the \$65,000 range and be available after the first of the year. The DDP-124, fully parallel, may be applied to a variety of on-line, real-time systems uses, as well as general purpose open shop computation. It is capable of 285,000 computations per second, has a basic memory cycle of 1.75 microseconds with 0.8 microsecond access time, and multiplies in 14 microseconds. The new computer includes 4096 words of core memory optionally expandable to 32,768 words and is program compatible with 3C's DDP-24 and DDP-224.

AN EXPERIMENT CONDUCTED BETWEEN BUENOS AIRES, ARGENTINA, AND CAMBRIDGE, MASS., has shown that a large, complex computer can be operated by a distant user via a radio teletype link. Civil engineers from the Massachusetts Institute of Technology and from the University of Buenos Aires carried out the unique experiment, using commercial radio

teletype facilities from Buenos Aires to RCA Communications, Inc., in New York City. There, the channel was patched into the Western Union Co.'s commercial Telex system to put the researchers in Buenos Aires into direct contact with a time-shared IBM 7094 computer at M.I.T. in Cambridge. At the same time, some 20 other persons also were using the computer from consoles located at remote stations around Cambridge and linked to the central machine through telephone lines.

Previous experiments have been conducted in which the time-shared computer has been used from as far away as Edinburgh, Scotland, and Oslo, Norway. But in those experiments, connections were through commercial wire and cable systems. The Buenos Aires experiment was the first in which a radio link was used.

THE FIRST IBM COMPUTER TO RENT FOR LESS THAN \$1,000 A MONTH WAS INTRODUCED RECENTLY. Monthly rental of the new IBM 1130 computing system begins at \$695. The desk-size 1130 is designed for individual use by engineers, scientists and mathematicians. But with its range of peripheral units, the 1130 also will be used in such fields as publishing, construction, finance, manufacturing and distribution. For ease of use by many individuals, an advanced storage technique is available with the 1130 computer. Data and instructions for computer processing are recorded on a magnetic disk. Disks are protected by a plastic cartridge. Each IBM 2315 disk cartridge can hold the equivalent of more than one million characters of in-

formation. The cartridge enables an engineer, for example, to store information about his own work on his own disk. When he wishes to use the computer, he simply slides the disk with its plastic jacket into a slot on the 1130 console. Information from the disk is transferred into the 1130's high-speed core memory for processing. The computer has a memory capacity equivalent to more than 16,000 characters of information.

SPERRY RAND CORP. DISCLOSED THAT IT HAS COMPLETED ARRANGEMENTS WITH FAIRCHILD SEMICONDUCTOR for purchase of nearly a half-million monolithic microcircuits, an amount equal to 20 percent of the entire semiconductor industry's microcircuit output last year. The order is believed to be the largest placed for integrated circuits. Under terms of the new agreement, Sperry orders will be worth approximately \$2 million. The units ordered by Sperry will be employed in a number of major programs including the SGN-10 Inertial, Loran-C, Loran-D, Padloc, HAPDAR, Apollo Ship Computer, systems. Half the microcircuits ordered were custom-designed in a joint Sperry-Fairchild project and half are Fairchild standard integrated circuits.

FULLY-MILITARIZED CARD PUNCH MACHINE FOR USES IN SHIPBOARD COMPUTER SYSTEMS will be developed by Sylvania Electric under a \$307,000 Navy contract. The unit, a service test model, will be capable of performing its card punching operations even after exposure to shock levels more than 100 times the force of gravity.

now available

TELETYPEWRITER FUNDAMENTALS HANDBOOK

By Wm. D. Rexroad

... IN HANDY POCKET-SIZE BOOKLET FORM PUBLISHED
BY COMPUTER DESIGN PUBLISHING CORPORATION

The Handbook is based on an article that appeared in the November issue of COMPUTER DESIGN. The demand for reprints of the article was so overwhelming that it has now been expanded, giving more details on some of the topics previously-covered, **and** adding up-to-date information on 8-level codes, the standard code adopted by the ASCII, frequency shift keying systems, radio teletypewriter techniques, and descriptions of the latest in teletypewriter machinery.

IDEAL FOR: REFERENCE BOOK • TRAINING PROGRAMS • SALES AIDS
FOR SWITCHING COMPUTER MFGRS. • LIBRARIES • EMPLOYEE
EDUCATION • CUSTOMER INDOCTRINATION

MAJOR TOPICS: BASIC PRINCIPLES OF TELETYPEWRITERS

HOW THEY OPERATE • Signal Generation & Reception • Baudot
Code & Eight Level Codes • Teletypewriter Distortion

HOW THEY ARE USED • Simplex, Half-Duplex, Full Duplex •
Neutral & Polar Circuits • FSK & RTTY

GLOSSARY OF TELETYPEWRITER TERMINOLOGY

DESCRIPTIONS & PHOTOS OF TELETYPEWRITER MACHINES

PRICE: only \$1.50 per copy

Quantity prices available on request

To order your copy, simply fill out coupon below, enclose
\$1.50 per copy, and mail to: COMPUTER DESIGN PUBLISHING
CORPORATION, BAKER AVE., W. CONCORD, MASS.
01781



.....
COMPUTER DESIGN PUBLISHING CORP.
BAKER AVE., W. CONCORD, MASS. 01781

GENTLEMEN:

Enclosed is \$..... for copy(ies) of
TELETYPEWRITER FUNDAMENTALS HANDBOOK.

SEND HANDBOOK(S) TO:

NAME

COMPANY

ADDRESS

CITY STATE



Thin, flat, odd-shaped precision parts have you up a tree???

use the

theory of probability

to solve your problems

This is where experience counts! Chances are Photoforming by Hamilton will get you quickly from the drawing board stage to prototype production of thin, odd-shaped precision parts. No dies . . . no burrs . . . no bent edges . . . no stresses . . . no delays when parts are produced by the Hamilton process called Photoforming. Another plus, Photoformed parts can be heat-treated, plated, or formed according to your specifications. □ What can you lose? Invest a postage stamp and discover greater flexibility and freedom of design. Write for the facts—no obligation or high-pressure sales talk—just useful data on Hamilton's Photoforming and other facilities.

 **HAMILTON**
WATCH COMPANY
INDUSTRIAL AND MILITARY PRODUCTS DIVISION • LANCASTER, PA.

CIRCLE NO. 7 ON INQUIRY CARD

INDUSTRY NEWS

A MACHINE DEEMED CAPABLE OF CREATING A NEW BILLION DOLLAR A YEAR MARKET for the computer and data processing industry, has been leased by Philco, to New Era Data Systems, Inc. of New York. Capable of scanning up to 2000 characters a second of most type faces, and converting what it "reads" directly onto magnetic tape, this new general-purpose print reader is considered a major breakthrough in the paperwork bottleneck which, up to now, has prevented full use of modern computer systems. According to Edwin M. Bederson, chairman of the board of New Era Data Systems, Inc., his firm has leased approximately 11,000 square feet of space in the American Management Association

Building, 135 West 50th Street, New York City, to house the Philco Reader and New Era's related computer and data processing equipment. The new headquarters office will be open and the Philco Reader installed and operating by early spring. A product of 17 years of data recognition research and development by Philco Corporation, the Reader represents a new generation in "reading machines". According to reports, the machine's speed and ability to read most commercially-used type faces, even on documents that have been subject to wear-and-tear of daily handling, will markedly increase the utilization of EDP systems by many organizations who have been seeking fast and accurate ways to convert their everyday business records to computer input. New Era's new offices will be operated on a 7-day-a-week, 24-hour-per-day basis.

THE FIRST TIME-SHARED COMPUTER SYSTEM TO BE USED FOR R&D IN THE OPTICAL FIELD has been ordered by the Perkin-Elmer Corp. The \$616,000 time-sharing system includes an SDS 9300 computer and related peripheral equipment. It will be used in a multiple station laboratory so that up to fifteen scientists or engineers at remote, individual consoles can send problems to the computer simultaneously. Scientists at the Perkin-Elmer Electro-Optical Division Laboratories will use the SDS 9300 for research problems in gas and solid-state lasers, atmospheric turbulence and other problems in physical optics. Computation of problems on the SDS 9300 will occur on a real-time basis so that immediate results may be obtained by researchers while their experiments are underway. Results from this research activity will be applied in the design of advanced lens systems, optical tracking and guidance systems, and space telescopes.

THE PUBLIC SERVICE BOARD OF NEW SOUTH WALES, AUSTRALIA, HAS PURCHASED A LARGE-SCALE HONEYWELL 800-III DATA PROCESSING SYSTEM valued in excess of \$1.4 million. The computer joins two smaller Honeywell 400 computers now installed at the Public Service Board, and makes that state government's computer center the largest in Australia, according to J. M. Sterling, director of Honeywell EDP International. The H-800-III system combines a large Honeywell 800 computer in an on-line link with a smaller Honeywell 200 computer. When installed in June, the system will process New South Wales' school certificate program and handle all rental accounting for the N.S.W. Housing Commission.



SALES OFFICES

BOSTON

Lindsay H. Caldwell
Professional Bldg.
Baker Ave.
W. Concord, Mass.
phone: (617) 369-6660

CHICAGO

Phil Holmes
410 N. Michigan Avenue
Chicago 11, Illinois
phone: (312) 467-6240

DETROIT

Robert T. Barrett
424 Lafayette Building
Detroit 26, Michigan
phone: (313) WO 1-0278

LOS ANGELES

David Barton
672 So. Lafayette Park Pl.
Los Angeles 57, California
phone: (213) 382-1121

NEW YORK

Robert J. Bandini
1 Rockefeller Center
New York 20, N. Y.
phone: (212) CI 6-4712

SAN FRANCISCO

David Barton
672 So. Lafayette Park Pl.
Los Angeles 57, California
phone: (213) 382-1121

**What kind of
memory systems
let you add on
memory capacity—
as it is needed?**

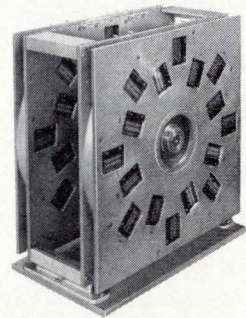

Very simple.

The answer to the question is **simple** and so is the **advanced design** of the new L-400 Magnetic-Disc Memory Systems developed by Librascope Group of General Precision, Inc. This simplified design provides strength, light weight, and dependability at low cost where rapid-access memory is required in data storage and transfer for computer systems and peripheral equipment. An important saving of capital expenditure is made possible with the L-400 series memory files because you can install only the memory capacity presently needed, allowing for later expansion or "add on" memory capability as required. Librascope's series L-400 consists of two models: the L-414, a 14-inch disc memory file with a storage capacity of up to 8,388,608 bits, and the 24-inch disc L-424 with a capacity of up to 27,033,600 bits. Field expansion of a 14-inch or 24-inch memory is accomplished by adding "head bars" of 16 read-write heads to the

basic single disc system. Further expansion is possible by adding the 16-head modules to the opposite side of the disc. For maximum capacity, a second disc is added with head bars on both sides. These memories provide outstanding magnetic performance under all operating conditions. They can be used as the main storage, buffer storage, or to supplement other memories. Reliable and inexpensive, they are available now. If necessary, they can be tailored by Librascope to fill your need. For complete technical details, write for Bulletin L-400.

**GP GENERAL
PRECISION INC.**

LIBRASCOPE GROUP

610 Rodier Drive, Glendale, California

CHALLENGING POSITIONS for COMPUTER ENGINEERS

Interstate Electronics has several outstanding positions in the DIGITAL DATA HANDLING SYSTEMS field for Computer Engineers at the Senior level. The work is rewarding, both financially and in realistic growth opportunity. Interstate is one of the top electronics firms in So. California (Orange County) and there is ample opportunity for advancement.

PRELIMINARY DESIGN:

In support of development and new business programs, to accomplish preliminary design of ground-based digital data handling systems comprising interfaces with data-source transducers and systems; data-signal conditioners; multiplexers; analog-to-digital converters; digital formatting and coding logic; data displays; and magnetic-tape recorders. Must possess demonstrable capability to obtain correct definition of potential customers' problems in operational terms to formulate creative and saleable solutions at the functional-block-diagram level, to manage the preparation of technical and cost proposals, and to make effective technical presentations to customer personnel. Mature understanding of DOD-NASA needs, plans, and programs; and of technical trends in at least one segment of the data-handling systems field is essential. Professional history should show a successful growth from detailed hardware design to the design of complete systems, including several years of supervisory experience at the program-management level. BSEE or Physics required, MS preferred, and 8-10 years' applicable experience. This is not a sales or marketing position.

COMPUTER DESIGN:

To accomplish the functional-block design of computers for use in ground-based digital data-handling systems. Ability to devise small-machine organizations for minimum equipment cost is essential. Hardware orientation preferred, but a strong "minor" in programming is mandatory. Familiarity with the interface problems connected with integrating A/D converters, quick-look displays, printers and digital tape-output recorders into computer-oriented systems is required. Must have gained significant experience through the planning, design and test phases of a recognized computer-development program. Requires BSEE or Physics, MS preferred, and 8-10 years of computer-oriented experience.

RELATED OPPORTUNITIES:

Principal, Staff and Senior level positions are also available to qualified applicants in the following areas:

- Computer Circuit Design
- Logic Design
- Programming
- Systems Analysis
- Memory Electronics
- Peripheral Controls
- Input/Output Equipment

Please submit resume to Personnel Department indicating Code S-1

Interstate ELECTRONICS CORP.

A SUBSIDIARY OF
INTERSTATE ENGINEERING CORP.
600 E. VERMONT
ANAHEIM, CALIFORNIA

U. S. CITIZENSHIP REQUIRED
AN EQUAL OPPORTUNITY EMPLOYER

CIRCLE NO. 900 ON INQUIRY CARD

DIODE MATRIX IN INTEGRATED CIRCUIT FORM

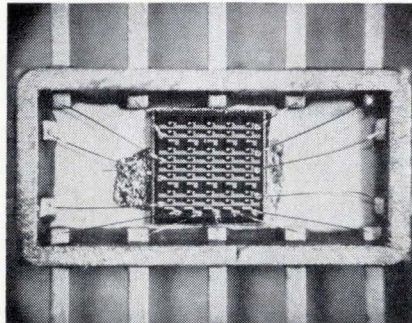

Radiation's RS-104 monolithic diode matrix in a $\frac{1}{4}$ " x $\frac{1}{8}$ " flat pack.

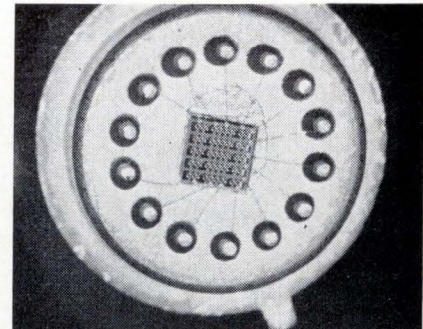

Radiation's RS-104-1 monolithic diode matrix in a low silhouette standard TO-5 package.

Radiation Inc., of Melbourne, Florida, recently developed a monolithic diode matrix said to be the first integrated circuit device of its kind available. It is expected to find wide applications in logic, decoding, addressing, and steering functions. The new device was made possible by the development and application of Radiation's "Waffle Wafer" isolation process first announced last April; a new interconnect "blow-out" process; and special process developments resulting in extremely low buss resistance within the bulk semiconductor material.

According to Ury S. Davidsohn, director of engineering for Radiation's Physical Electronics Division, the new methods provide necessary columnar electrical isolation for virtually any custom capability, essentially eliminate the parasitic coupling associated with P-N junction isolation, and reduce capacitance coupling by more than an order of magnitude over a normal P-N junction. In the new diode matrix, up to 67 interconnects have been eliminated over a conventional component 5 x 8 matrix.

In the Radiation-designed monolithic structure, diodes are arranged in rows and columns. The diodes in the columns have their commons within the isolated silicon regions. The diodes in the rows have their

commons inter-connected with the deposited metallization. Isolation breakdown between columns is typically 1000 volts. Typical isolation leakage at 50 volts is less than 0.1 na. Diode breakdown of 100 volts is typical.

Using a proprietary process for determining the particular interconnect of a matrix, Radiation processes the matrix with all diodes inter-connected. These are then tested on programmed automatic test equipment which provides a punched card output. This card is then used when customizing the interconnect pattern. Unwanted diodes are eliminated from the circuit to achieve the desired configuration. The process of elimination is basically that of burning out a fuse. This procedure allows the construction of many different diode matrix circuits out of one basic element.

The monolithic diode matrix can be packaged in a variety of configurations. A standard $\frac{1}{4}$ " x $\frac{1}{8}$ " flat pack will accommodate up to a 100 diode matrix using any configuration with 14 leads. A wide range of diode characteristics is available from 10 ma to 100 ma I_F , 50 to 100 volts BV_R , and a diode recovery time down to 10 nsec. Diodes are epitaxial, planar passivated silicon.

Circle No. 113 on Inquiry Card

DATA COMMUNICATIONS

equipment for on-line,
real-time processing

the shift-less keyboard that isn't!

Shifting between letters and numbers is no longer necessary as a result of the new 4-row keyboard on Teletype Models 33 and 35 page printers and automatic send-receive sets. However, when used in real-time data communications, these machines are anything but shiftless on the job.

"COMPUTER" SPOKEN HERE
Operating on the same permutation code approved by the American Standards Association for information interchange, this Teletype equipment can communicate with most business machines and computers. It is being used as input/output terminal gear in such applications as communications between branch offices and a centralized computer, making a data processing center available to all company offices.

				0	0	0	1	1	1	1
b ₇				0	0	1	1	0	0	1
b ₆				0	1	0	1	0	1	0
b ₅				0	1	0	1	0	1	0
b ₄										
b ₃										
b ₂										
b ₁										
	0	0	0	0	0	0	0	0	0	0
	0	0	0	1	1	1	1	1	1	1
	0	0	1	SOM	DC ₁	!	!	A	Q	
	0	0	1	EOA	DC ₂	"	2	B	R	
	0	0	1	EOM	DC ₃	#	3	C	S	
	0	1	0	EOT	DC ₄	\$	4	D	T	
	0	1	0	WRU	ERR	%	5	E	U	N
	0	1	0	RU	SYNC	&	6	F	V	A
	0	1	1	BELL	LEM	(APPOS)	7	G	W	S
	1	0	0	FE ₂	S ₂	(8	H	X	G
	1	0	0	HF ₁ SK	S ₁)	9	I	Y	E
	1	0	1	LF	S ₂	*	:	J	Z	E
	1	0	1	V _{TAB}	S ₃	+	:	K		D
	1	1	0	FF	S ₄	(COMMA)	<	L	\	ACK
	1	1	0	CR	S ₅	-	=	M		⓪
	1	1	1	SO	S ₆	.	>	N	↑	ESC
	1	1	1	SI	S ₇	/	?	O	←	DEL

The American Standard Code is composed of eight columns of 16 characters each. Control characters, found in the first two columns, include those required for the control of terminal devices, input and output devices, format, or transmission and switching operations. Common punctuation symbols are found in the third column, numbers in the fourth, and the alphabet in the fifth and sixth columns. The final columns are reserved for future standardizations. Teletype Models 33 and 35 sets generate an even parity in the eighth level.

PRINTS ON BUSINESS FORMS
Any business form, such as invoices, payroll checks, sales orders, freight records, and reservations, can be typed on these Teletype sets and transmitted directly to various departments. This minimizes recopying errors. The 4-row keyboard further reduces the possibility of errors, be-

cause it isn't necessary to shift when typing numbers. Notice the similarity to a regular typewriter keyboard, which is why any typist can easily learn to use these new machines.

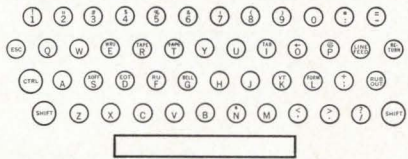

VERSATILITY PLUS
Added to the versatility of the 4-row keyboard is the complete reliability and economy of Teletype equipment. It's built to last, with pneumatic shock absorbers, nylon pulleys and gears, and all-steel clutches that keep maintenance down to a bare minimum. And, these sets are surprisingly low in cost.

That's why Teletype Models 33 and 35 page printers and automatic send-receive sets are made for the Bell System and others who insist on the most reliable communications equipment at the lowest possible cost. For more details on the capabilities of the Teletype 4-row keyboard in real-time data communications, write to: Teletype Corporation, Dept. 71F, 5555 Touhy Avenue, Skokie, Illinois 60078.

machines that make data move



CIRCLE NO. 9 ON INQUIRY CARD

"BEAM-LEAD" INTEGRATED CIRCUITS REDUCE PARASITIC CAPACITANCE

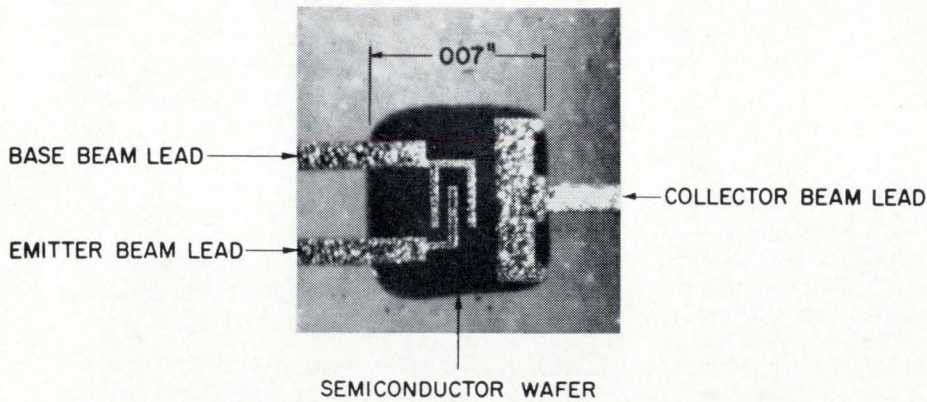
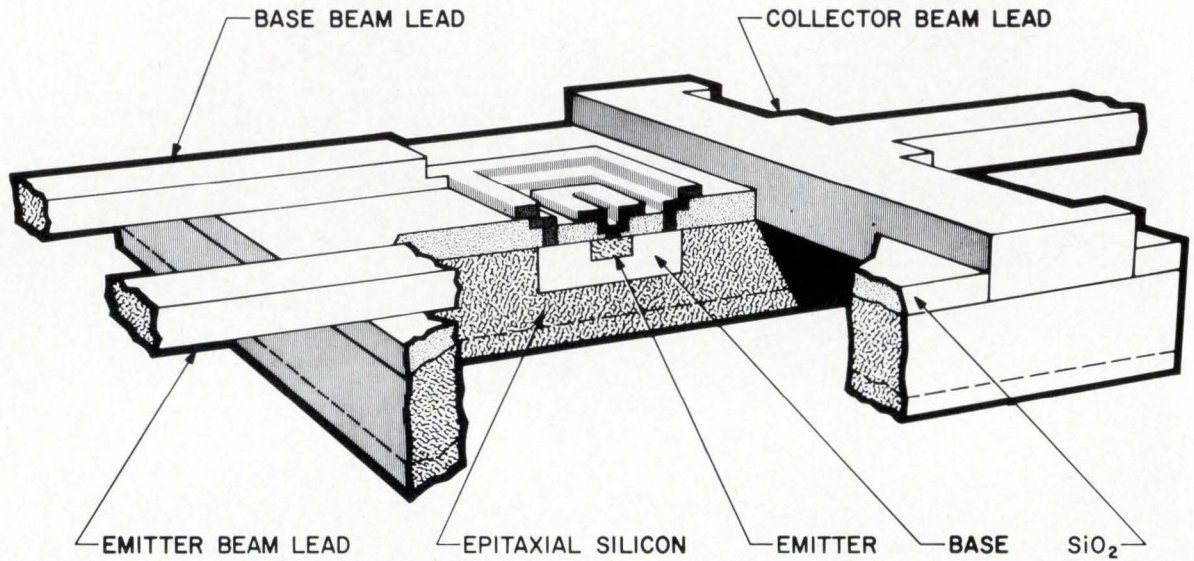

The top drawing is a cross-sectional view of a silicon "beam-lead" transistor. A photomicrograph of an actual transistor is shown below the drawing. Conventional planar techniques are used to form the transistor active regions. Strong electrical leads — called beam leads — are then deposited over the silicon oxide to connect to the base, emitter, and collector. Excess silicon is removed to complete the transistor and leave the beam leads extending out from the structure like cantilevers. The transistor can now be bonded directly to a header or circuit by its beam leads.

A new type of structure for semiconductor devices and integrated circuits, devised at Bell Telephone Laboratories, is expected to simplify fabrication and assembly procedures. The development was described at the last IEEE Electron Devices Meeting, in two Bell Laboratories papers: "Beam-Lead Devices," by M. P. Lepselter and R. W. MacDonald, and "Beam-Leaded and Intraconnected Integrated Circuits," by M. P. Lepselter, H. A. Waggener, and R. E. Davis.

Beam leads are integral parts of devices and circuits and extend out from the structure like cantilever beams to form both the electrical and mechanical connection to a header or substrate. For integrated circuits, they also form the electrical intraconnections between components. The beam leads are made of gold and are approximately 10 microns or 4/10,000 of an inch thick.

One of the main features of beam-lead integrated circuits is the simple way in which electrical isolation of components is accomplished: all unwanted material between com-

DATA COMMUNICATIONS

equipment for on-line,
real-time processing

put punch in your communications...with paper tape

The continuous evolution of data processing systems has brought new uses for punched paper tape. In fact, paper tape has become an important communications link, and is still the most inexpensive and reliable continuous recording medium available.

Paper tape is easy to handle and accommodates data of any length. In addition, Teletype paper tape units can transmit most recognized codes, including the permutation code approved by the American Standards Association for information interchange. This makes Teletype sets capable of communicating directly with business machines and computers.

COLLECTION AGENT

Teletype punched paper tape units are versatile, flexible, and capable of collecting and distributing data from a large number of machines and transmitting to computers at high speeds. There is a paper tape unit for every need—from 60 to 2000 wpm.

Many business operations have been improved through the use of Teletype punched paper tape equipment with integrated data processing systems. This list includes: order entry, shipping, and invoicing for the accounts receivable procedure; production control; payroll computation; banking operations, insurance processes, etc. An important advantage of punched paper tape is that it can store fixed information, such as customers' names and addresses, which can be used over and over again to save re-typing.

INDEPENDENT OPERATOR

On the Teletype Model 35 ASR (automatic send-receive) set, the tape punch and reader can operate independently of the page printer. Thus, messages can be received by the page printer, while the operator is preparing a tape for later transmission. This independent operation also means the keyboard can be used to prepare one tape, while the tape reader transmits the message of another tape.

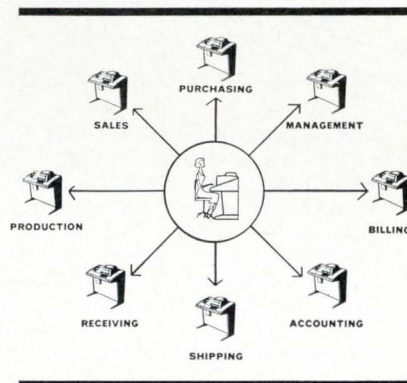

VOICE OF A COMPUTER

Applications of Teletype equipment as input/output terminals for com-

puters and other business machines are numerous. For example: a national insurance company has demonstrated a system that will link a large multi-processing computer with more than 900 district offices. Teletype Model 33 ASR sets will be used in this system to print out premium information from the district offices, and as tape output equipment for a centralized computer in order to update all premium transactions.



This is another indication why these Teletype paper tape units and automatic send-receive sets are made for the Bell System and others who insist on the most reliable communications equipment at the lowest possible cost. To find out more on how they can be an important part in your data processing systems, write to: Teletype Corporation, Dept. 71F, 5555 Touhy Avenue, Skokie, Illinois 60078.

machines that make data move



CIRCLE NO. 10 ON INQUIRY CARD

When it comes to space, UNIVAC systems are way out there.

Our Data Buffer Memory System in Mariner is now on its 350 million mile journey to Mars. This sophisticated little package weighs only 21 ounces. It contains two memories with 1320 data bits of storage per memory. Its job is to record and store what is "seen" by Mariner's TV cameras and make it available for subsequent radio transmission back to earth.

This system is just one example of UNIVAC-St. Paul's systems engineering and production proficiency in space and defense work. We are, in fact, more involved in this area than any other computer company.

For our staff—and for our computer logic designers in particular—this means constantly working with new techniques and devices on the edge of today's technological revolution spurred by the conquest of space. Our lab work right now is deeply involved with new connections and packaging techniques that go a long way to solve the systems problems of nanosecond logic circuits...new evaporated circuitry operating on low drive currents...techniques in overcoming radiation effects in space computer systems...real time data links...ground support and test recording devices.

Opportunities are open to logic designers whose pioneering spirit and technical knowledge matches our own. Assignments require a BS or MS degree to perform logical design of high speed digital equipment using solid state circuitry and the logical design of systems taking into account the interfaces between the central computer and its input-output equipment.

If you qualify, send a resume to Mr. R. K. Patterson, Employment Manager, Dept. F-9, UNIVAC Division of Sperry Rand Corp., Univac Park, St. Paul, Minn. 55116. An equal opportunity employer.

UNIVAC
DIVISION OF SPERRY RAND CORPORATION

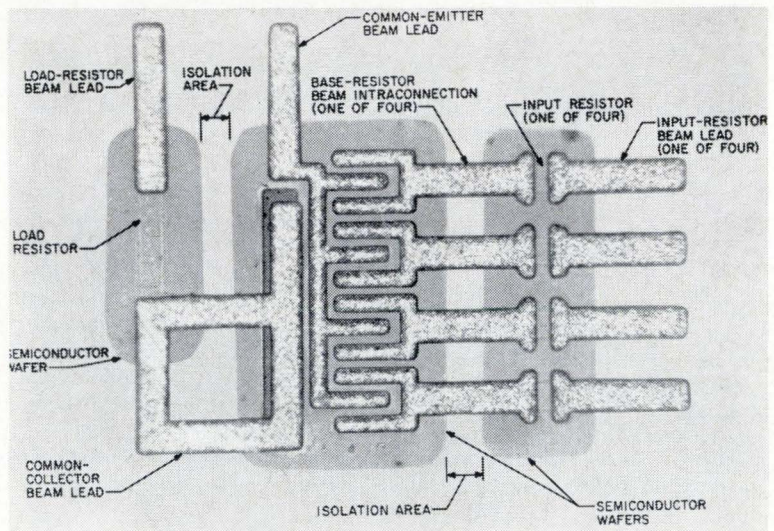
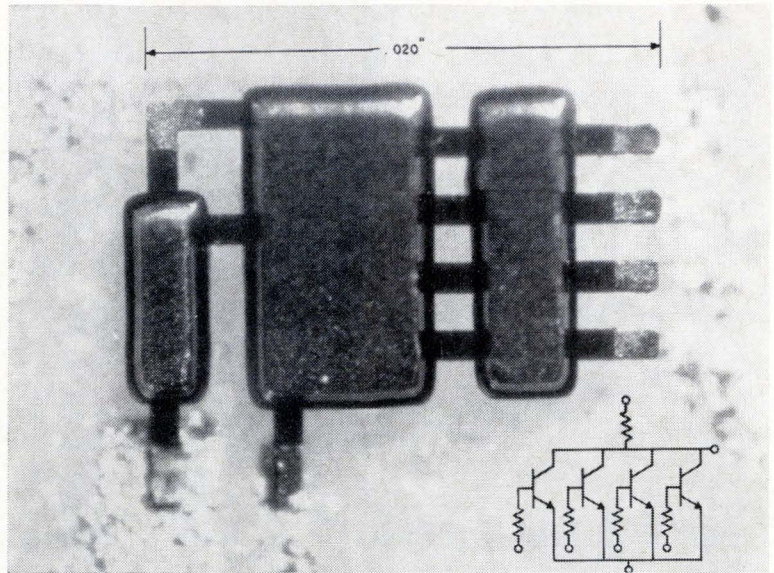

Two different views of an ultra high-speed logic circuit made by the new beam-lead structure devised at Bell Telephone Laboratories. The structure uses strong electrical leads — called beam leads — to provide mechanical support and to make electrical connections for semi-conductor devices and circuits. The top photo shows the logic circuit connected in a header. The bottom photo shows the underside of the same circuit with the various elements identified. Conventional planar techniques are used to form the transistor and resistor regions. Electrical isolation is accomplished by removing all unwanted material between components. The beam leads then remain to support and intracconnect the isolated components.

ponents is removed at the same time that individual circuits are being separated. The beam-lead intracconnections are then left to support and electrically connect the components. Unlike other techniques in use today, according to the reports, no additional diffusion or processing steps are required to isolate components; the beam-lead structure provides isolation as a bonus. Parasitic capacitance between components is negligible, making beam-lead integrated circuits suitable for ultra high-speed switching applications. Another feature of the

beam-lead structure is that semiconductor wafers or chips — which may contain either single devices or entire circuits — can be connected directly to headers by beam-leads.

Diodes, moderate- and ultra high-speed transistors, and ultra high-speed logic circuits have been built and tested at Bell Laboratories. These beam-lead devices and circuits have indicated their physical ruggedness by successfully passing tests which include thermal aging in 360C steam and centrifuging to greater than 100,000 times the force of gravity. END

DATA COMMUNICATIONS

equipment for on-line,
real-time processing

stunt box*..your communication's girl friday

An important component of all Teletype Model 35 page printers and automatic send-receive sets is the stunt box. This is an automatic switching device which performs remote control functions usually expected only of larger, costlier, and more complex equipment.

The stunt box handles anything that can be electrically controlled—ranging from performing such non-typing functions as automatic carriage return and horizontal tabulation . . . to activating remote apparatus, including tape punches and readers, business machines, and computers.

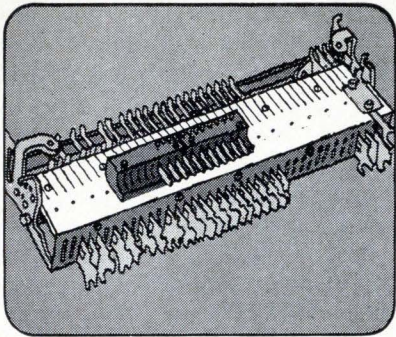

Basically, the stunt box does three things—mechanically initiates internal functions, electrically controls internal functions, and electrically controls external equipment.

STATION CALLER

Remote stations can be selectively called through the stunt box. Thus, one station can call others simultaneously, individually, or in predetermined groups. In this way, specific information can be selectively directed only to the stations specifically concerned with the information being transmitted. For example: an operator types out a sales order on a Teletype Model 35 page printer. Such information as the order number is received by all departments, while cost information is directed by the stunt box only to accounting, billing, and management departments.

AUTOMATIC BACK TALK

Teletype Model 35 sets can be equipped with an answer-back drum, which stores up to 20 characters. In on-line uses, the stunt box at a remote unattended station can trigger the answer-back mechanism so that the station automatically returns its identification call letters to the sending station.

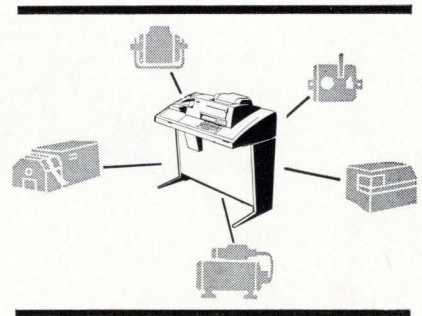

The stunt box can activate the mechanism that automatically feeds the information needed to program a computer so that it can accept the input data which follows.

The versatility that the stunt box gives to Teletype Model 35 page printers and automatic send-receive sets is another reason why they are made for the Bell System and others who require the most reliable communications equipment at the lowest possible cost. For more detailed information on the real-time uses of Teletype equipment, write to: Teletype Corporation, Dept. 71F, 5555 Touhy Avenue, Skokie, Illinois 60078.

*This device is used in Teletype machines to perform non-printing functions such as carriage return, line feed, etc.

machines that make data move

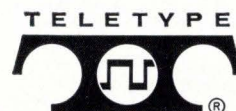

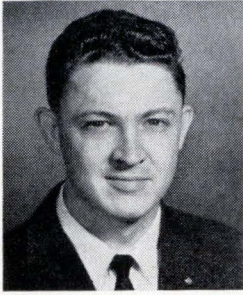

As a computer engineer with G. E.'s Computer Dept., David L. Sansbury's work includes the planning and development of electronic logic for computers and related equipment. Joining G. E. in 1962, after graduating from Ohio State University with a B. S. E. E., he participated in the design of the Compatibles/400 family of medium-to-large scale computers and associated common peripheral subsystems. Mr. Sansbury served for nine years in his spare time as a technician with the Ohio Air National Guard. He is a member of the IEEE.

DAVID L. SANSBURY,
*Computer Engineer, Computer Dept.,
General Electric Co., Phoenix, Ariz.*

ORGANIZATION OF For Encoding, Decoding, and

In the design of logic structures that contain a large number of input variables, the normal minimizing techniques become difficult to use and apply. Encoding, decoding, and pattern generating networks are often characterized by this problem. An excellent practical solution for these structures is presented here.

In digital equipment, an encoding, decoding, or pattern generating network may produce from one to n output signals of some prescribed combination in response to from one to m input signals. Generally, the number of output variables are not related to the number of input variables. Thus, a single input can cause a response from one to n output variables, even though only 21 unique combinations of the output variables exist. This type of network performs a few-to-many translation of signals and is referred to as a decoding or pattern generating network, depending on the transfer function. In the same manner, m input variables can cause a response from a single variable. This is essentially a many-to-few translation of signals and is referred to as encoding.

Although some work has been done to develop design techniques for multiple output networks, the most common design practice is to treat multiple output networks as

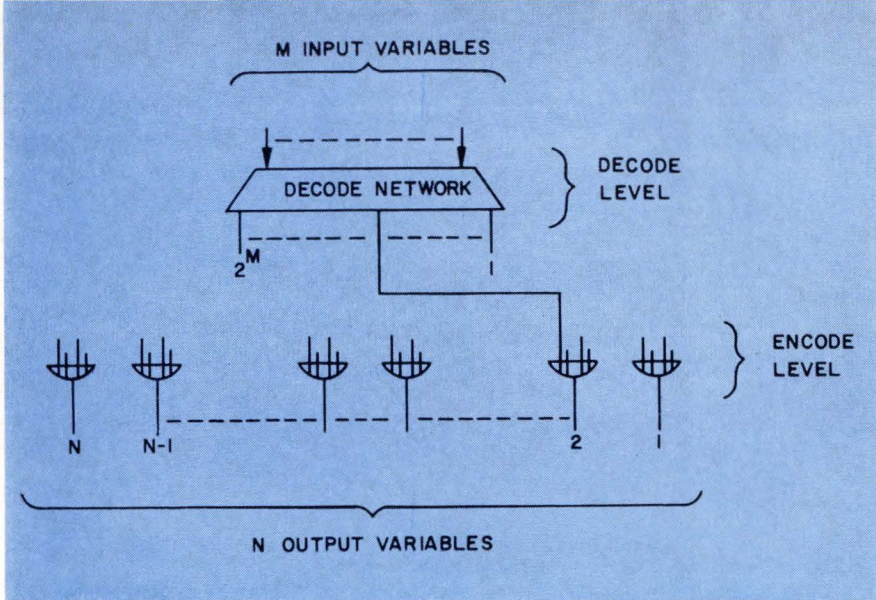

Fig. 1 General structure of the overall network between input and output may be divided into two levels: the decode level and the encode level.

AND/OR ELEMENTS

Pattern Generating Networks

compound problems, i.e., a combination of separate encoding type problems. In this approach, a transfer function is formulated for each output variable in terms of the input variables. Either graphical or numerical minimizing techniques are then used to simplify each transfer function. Because input variables for all transfer functions are the same, it is sometimes possible to realize a savings in implementation by sharing the common terms among the output networks. In general however, no statements can be made about the efficiency of the over-all network implementation.

It is evident that in the preceding design procedure, increasing the number of output variables increases the number of sub-problems. Increasing the number of input variables has the effect of increasing the complexity of each sub-problem. When the number of input variables becomes large, the minimizing techniques become cum-

bersome and difficult to use. Graphical minimizing techniques such as the Karnaugh maps or Vietch diagrams are particularly less effective than algebraic techniques such as McCluskey's or Quine-McCluskey's methods for problems of many input variables. Not only does the number of combinations of the input variables become large, but the number of possible solutions in the minimization process also increase.

While the majority of problems are easily solved by the above procedures, many important problems become overly complex with these techniques. The aim of this article is to suggest a straightforward implementation which is practical and expedient for the latter class of problems rather than being concerned with minimal solutions. The approach, which was considered during the development of General Electric's Compatibles/400 family of computers, will be to formulate the problem in such a

manner that it is readily adapted to a matrix structure which is physically compact and adaptable to the designer's particular application.

Basic Design Approach

The procedure used is first to decode the m input variables into 2^m unique signals and then, for each output, to OR together those signals which are to cause a true output. This is shown in Fig. 1. Selected connections are made between the 2^m decoded signals and the output OR elements to satisfy the particular problem.

Obviously this approach can result in poor utility of the logic elements, particularly when m is large and n is small. On the other hand, it offers a single uniform means for treating any encoding, decoding, or pattern generating problem by generating any number of independent outputs concurrently. In addition, the connections

Fig. 2 The decode level of the overall network is implemented with two decoding levels. The input variables are divided into two groups and decoded completely on the first level. The two groups are then combined on the second decode level with two input AND gates.

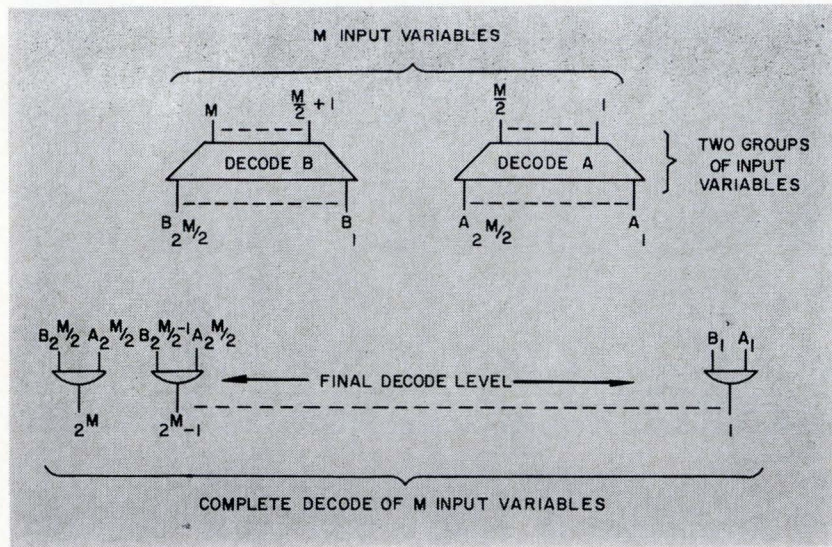
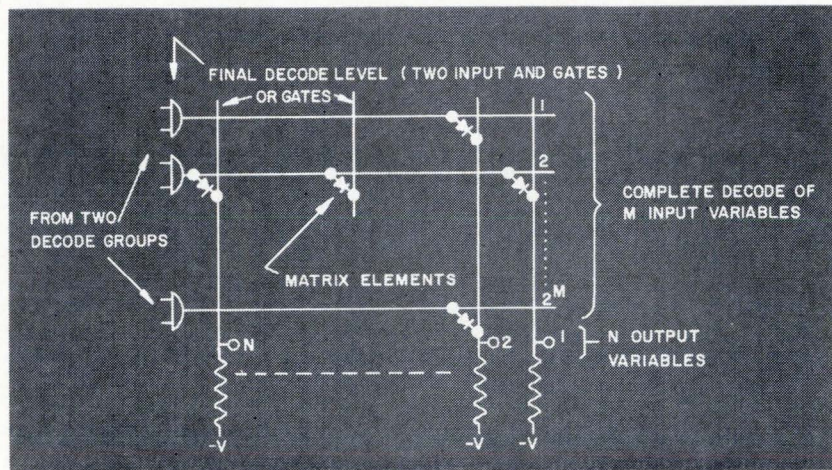

Fig. 3 The encode level of the overall network is composed of OR gates which have a variable number of inputs. The OR gates may be distributed over the vertical line, with the presence of a diode representing one input. The OR diode therefore becomes the matrix element.



to be made at the OR level are easily specified by the designer. The result is a single logic structure which is easily applied and serves a wide variety of problems.

Decoding Input Variables

The particular logic structure used to decode the m input variables into 2^m unique signals can have a variety of forms differing in depth and width of logic levels. The classical decode tree requires the minimum number of diodes but for m input variables it has $m-1$ logic levels. The number of diodes required for the decode tree is given by the expression:

$$N_{DT} = \sum_{j=3}^{j=m+1} 2^j$$

for $m > 1$, where $m =$ number of inputs. The minimum number of logic levels necessary to perform the decode function is one. A single level decode, however, requires the greatest number of diodes. The number of diodes required for single level decoding can be found from the expression:

$$N_{DS} = m \cdot 2^m$$

Though diode counts may frequently be useful in predicting the complexity of a logic structure, practical aspects such as speed and cost often take precedence in selecting one design over another. Few practical circuits have more than two levels of diode logic before re-referencing is required due to signal degeneration. Since re-referencing circuits ordinarily con-

stitute a major portion of the cost for a logic element, the decode tree with many logic levels is seldom used. On the other hand, the input loading is greatest for the single level decoding structure where the number of re-referencing circuits is a minimum. Normally then, the designer will choose some intermediate decoding structure based on the applications and the elements available. If a structure is to be useful, the logic designer should retain as much freedom as possible to make his selections.

For purposes of this discussion, the final level of decoding logic should consist entirely of two input AND gates. The input variables are divided into two equal groups; each group is decoded completely, and the outputs combined on the

Some of this light has something to say:

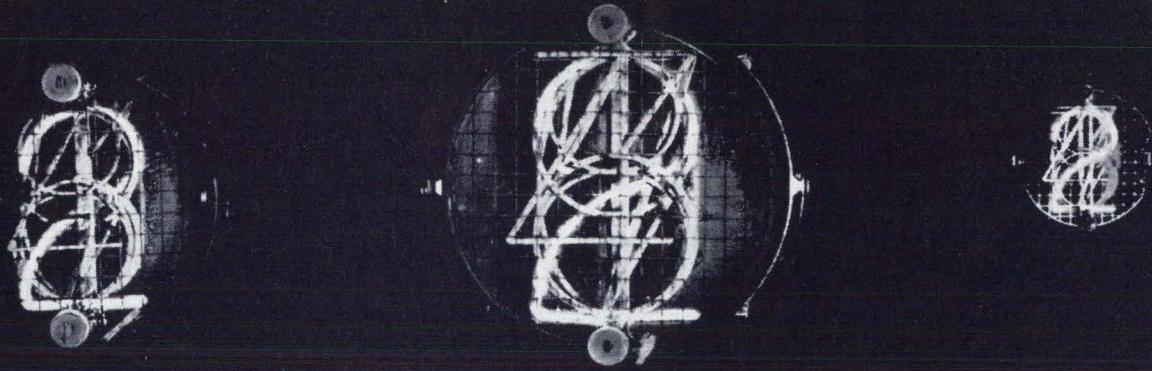

we've got a way to cut out all the rest.



Polaroid circular polarizers let you see only what you want to see. They kill glare and reflections by polarizing light (not just absorbing it like ordinary neutral density filters). They're the most effective way to increase contrast and will let you read a readout loud and clear from any angle—even in a room that's all lit up. Contrast is as much as 600% better with a Polaroid circular polarizer than it is with a comparable neutral density filter.

Many major instrument manufacturers are now using circular polarizers in digital indicators, radar screens, oscilloscopes, and television equipment. If you'd like in-

formation on complete custom-designed filter systems, fill in this coupon and send it on to us. We'll shed some wanted light on the subject. **Polaroid Circular Polarizers**

Polarizer Division, Department C-6
Polaroid Corp.

Cambridge, Mass. 02139

I want to know more.

Name _____

Position _____

Company _____

Address _____

City _____

State _____

Zip _____

©POLAROID®

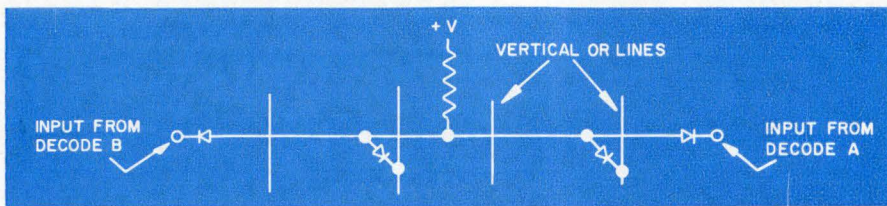

Fig. 4 All gates on the final decode level have two inputs. These gates may be arranged as shown in order to facilitate a matrix structure.

final decode level as shown in Fig. 2. The designer retains complete freedom in specifying the decoding structures referred to as A and B in Fig. 2.

Output Connection

As noted, one OR gate is required per output signal. To satisfy particular applications, the designer must specify the connection of the decoded lines to the OR gates. Because the absence of an OR diode is equivalent to the absence of a wire connection, the connection specification becomes the specification of required diodes.

It is of interest that no more than $2^m/2$ or 2^{m-1} diodes are required for any single OR gate if an inverter can be supplied at the output of the OR. In this case the decoded signals connected to the OR gate are those which do not cause a true response.

Matrix Structure

The principal difference between a logic structure and a matrix is the physical organization of the components. The matrix is compact and useful where a general structure is required which can serve many applications by specifying the matrix elements present. This is precisely the requirement for the logic structure discussed thus far, where the presence or absence of the OR diode is specified for the particular application. Fig. 3 diagrams the organization to be used.

Suggested Implementations

Two limitations have been suggested for the decoding structure. The first is that the final level of the decoding structure consist en-

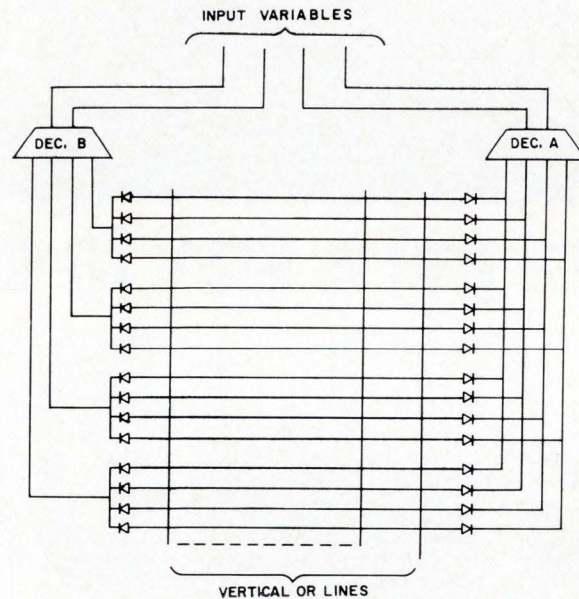

Fig. 5 The two input AND gates of the final decode level may be arranged in a regular pattern as shown. The four input variables are fully decoded into sixteen horizontal lines independent of the number of outputs required.

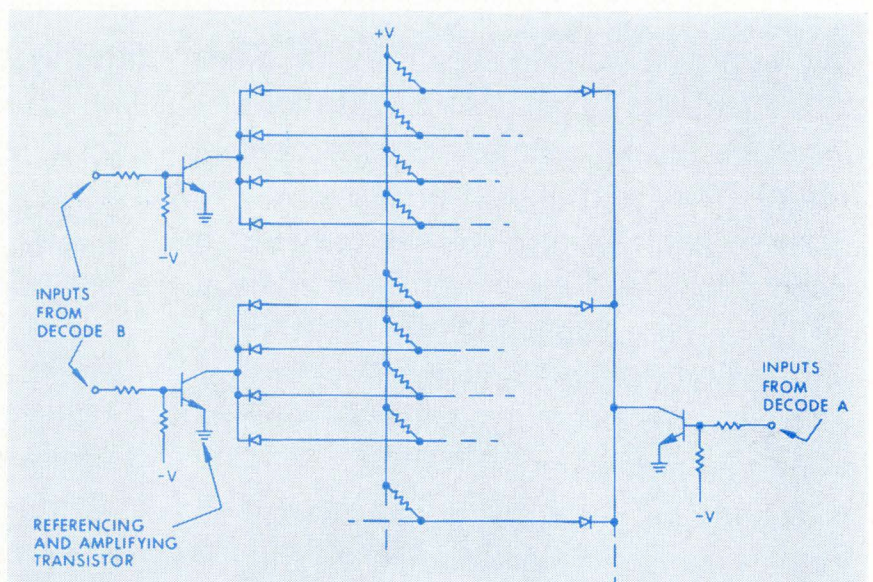

Fig. 6 The horizontal AND lines are readily grouped so that a single transistor may be used to re-reference and drive a group of AND inputs. When the groups become too large, they may be divided or multiple transistors used.

On May 31st 90% of all regulated power supplies used in D.P. equipment became obsolete.

The reason: Omnimod!!

A brash statement, but the facts support it.
FOR EXAMPLE:

A single OMNIMOD power controller module can supply any voltage between 2 and 60v dc at 0-7 amperes **without modification or adjustment.**

High efficiency. Cuts input power needed to supply a given piece of equipment up to 40%, thus reducing overall cooling system requirements.

Want to change the size of your system? Add or take away a module.

All modules are interchangeable . . . no maintenance problems with the OMNIMOD.

Overtoltage protection? Remote sensing? Turn on/Turn off sequencing? Of course! And much more!

Let us plug one in and show what OMNIMOD can do.

Write, or call collect, and we'll have the full story to you within 48 hours.

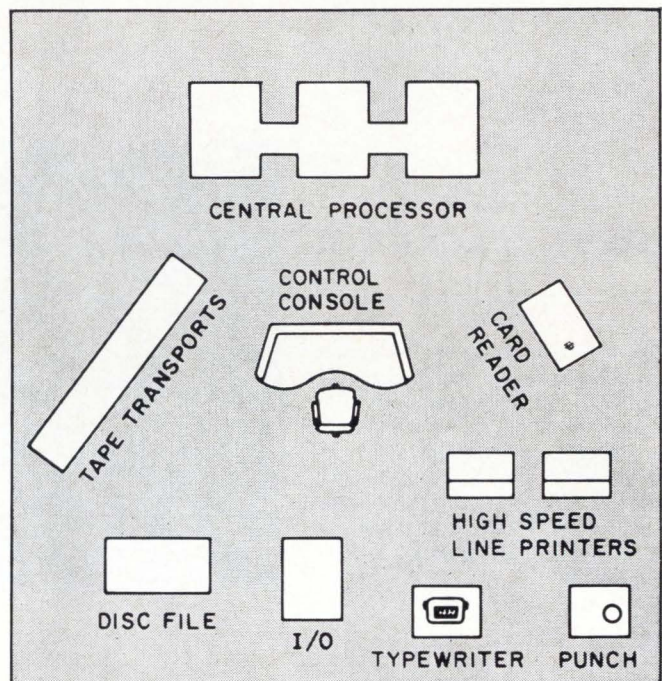

Every voltage in every element of this typical data processing system can be supplied with interchangeable OMNIMOD power supply modules.



CONTEMPORARY ELECTRONICS

128 North Jackson, Hopkins, Minn. 55343 Telephone 935-8481—Area Code 612

EXTRA SERVICE TO THE DATA PROCESSING INDUSTRY

CIRCLE NO. 13 ON INQUIRY CARD

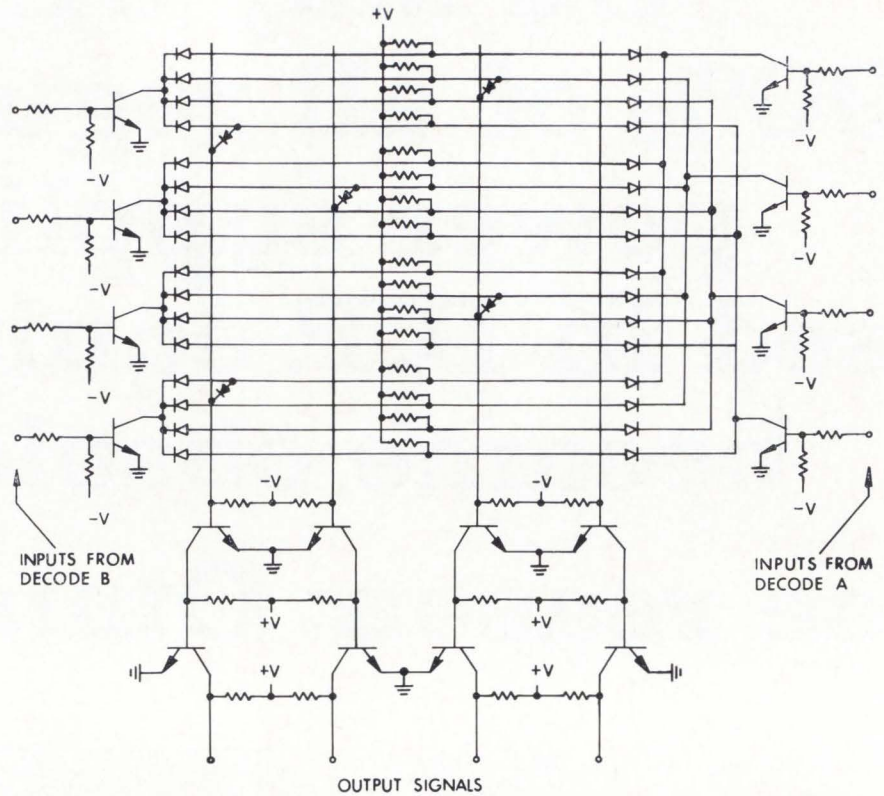

Fig. 7 A 16 x 4 matrix example showing input and output transistors. The number of outputs can be expanded freely within the electrical limitations of the drive circuits. Four input variables dictate the sixteen AND lines shown.

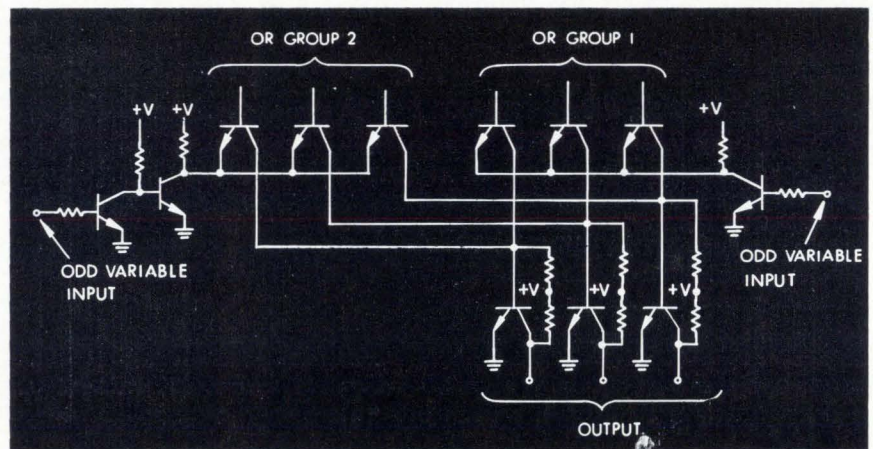

Fig. 8 A variation in the output circuit allows an odd number of inputs to be accommodated. The input variables are divided into two equal groups and decoded as before. The odd input variable is then used in the output as shown. Note that twice as many vertical OR lines as outputs are required.

tirely of two input AND gates. This would permit the organization of the final decoding level and the OR gates into a matrix. The AND gates that drive the horizontal matrix line in Fig. 3 can be distributed with one AND diode at either end of the horizontal line. This is shown in Fig. 4.

The second limitation suggested for the decoding structure is that the input variables be divided into two equal groups and each group

decoded completely. The decoded signals from each group are then combined on the final decoding level to form the complete decode for all input signals. If this is accomplished, then the output of each group is common to a number of AND gates equal to the number of outputs from each group. The connection of these common signals can be made by permanently tying the AND diodes together as shown in Fig. 5. Further, because the

two groups have equal numbers of decoded signals, the signals of one group drive AND diodes on one side of the matrix; the remaining group of signals drive the AND diodes of the other side of the matrix. Fig. 5 shows the organization for a simple case of four input variables. The input signals of Fig. 5 are well-grouped so that amplifying or re-referencing circuits may be readily located. Fig. 6 shows a single transistor driving each set of

common diodes for the AND gates.

In Fig. 6, the complete selection of a horizontal line (both inputs to AND gate are true) is accomplished when one transistor from each side is turned off. It is therefore necessary that the outputs of the decode network A and B be negated. One method to achieve this negation would be to employ a single level NAND logic for decode structures A and B.

Finally, a transistor can be added to the vertical OR lines for re-referencing and amplification. If a grounded emitter transistor is used as shown in Fig. 7, a second inverting transistor is required to achieve a positive output.

Fig. 7 shows a complete 16 x 4 matrix with amplifier and re-referencing transistors. The matrix is easily expanded to any practical size to meet the application of a particular problem. Within electrical constraints, the number of vertical OR lines is independent of the number of horizontal AND lines, which satisfies a basic requirement of the encoding, decoding, or pattern generating network.

Variations

One problem of immediate concern is that the number of input variables may be odd and cannot be divided into even groups as required by the circuitry suggested thus far. This problem can be circumvented by using the odd variable of the input variables to select one of two output groups. This selection can be accomplished by using the first transistor of the vertical OR lines in an AND function. Fig. 8 shows how this is done for three outputs.

In Fig. 8, pairs of collectors are tied together to form an OR function. The odd variable then selects one group of OR outputs by providing a sink for the emitter currents of the selected group. This procedure then can be extended to the condition where only one output signal is required. In this case, all of the first OR transistors would have the collectors tied together and the emitters of each would receive an output signal. The net result is an extremely versatile configuration which may be applied to the few-to-many, as well as the many-to-few translation problems. END

MODULES DRUM MEMORIES SYSTEMS

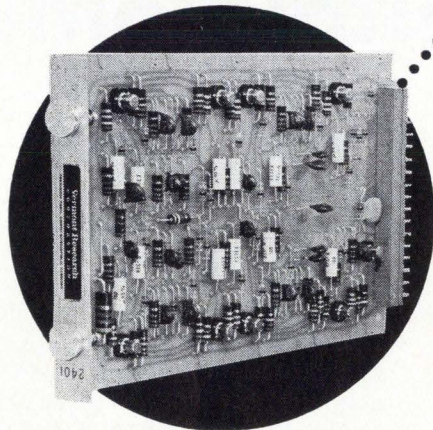

Electronic Modules, designed with optimum drum performance in mind, provide reliable recording/retrieval rates as high as 2.5 megacycles with standard VRC Drum Memories.

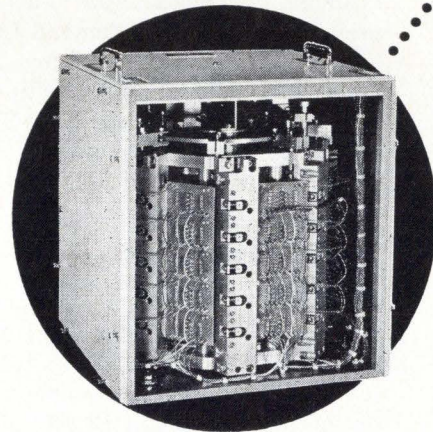

Drum Memories with aerodynamic bearing support for read/record heads yield storage capacities to 50 million bits. Cost? Less than 0.1¢ per bit.

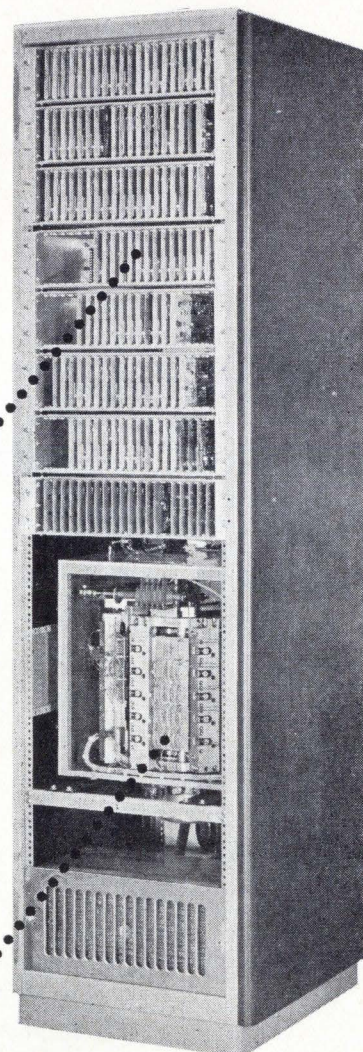

SYSTEMS

A Drum Memory System by Vermont Research Corporation is your most economical and versatile means of mass information storage, delivering true random access times as low as 8.3 milliseconds.

FREE BROCHURE

Complete basic specifications of VRC Drum Memories and Modules, plus general design data and descriptions of special Systems.

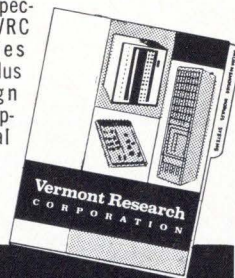

Vermont Research CORPORATION

Box 20 A Precision Park North Springfield, Vermont

CIRCLE NO. 14 ON INQUIRY CARD

A Fluid-Logic Digital Computer

R. S. GLUSKIN,
M. JACOBY,
T. D. READER,

*Sperry Rand Corp.,
Univac Div.
Blue Bell, Pa.*

The use of fluids (both liquids and gases) for the transmission and amplification of power has been common for over a century. This power has been controlled by valves, pistons, and other mechanical parts. Within the past decade considerable attention has been given, both in this country and in Russia,¹ to the use of fluids for control and logic functions, and until recently these systems also employed mechanical moving parts. In 1960, the Diamond Ordnance Fuze Laboratory (now the Harry Diamond Laboratories) of the U.S. Army announced a fluid amplifier with no moving parts² — a discovery which seems likely to revolutionize the whole field of fluid logic and control.

Fundamental Mechanisms

There are two fundamental mechanisms involved in pure fluid amplification: one is momentum transfer, and the other is wall effect. A jet of fluid having a density ρ , a velocity V , and a cross sectional area A has a momentum $M_1 = \rho V^2 A$. Consider now a smaller jet, of momentum M_2 , which we shall call the control jet, impinging at right angles on the larger jet, of momentum M_1 , which we shall call the power jet, as is shown in Fig. 1. From conservation of momentum principles it can be seen that the power jet will be deflected through an angle $\theta = \tan^{-1} \frac{M_2}{M_1}$. If a re-

ceiver or catcher is placed as shown in Fig. 1, all the energy of the power jet can, in principle at least, be recaptured if there is zero control jet flow. But as the control jet flow is increased, the power jet will be deflected, and less and less energy will enter the receiver.

The wall effect is shown in Fig. 2. If a wall is placed close to a jet it is found that the jet appears to be attracted to the wall and will often attach itself to the wall quite strongly. The reason for this is that as the jet moves, it entrains fluid from the surrounding medium. This entrained fluid must be made up by fluid from afar. If a wall is placed close to one side of a jet, the flow of replacement fluid is impeded, resulting in a slightly lower pressure on the side of the jet closer to the wall than on the other side where there is no impediment. Consequently, the jet will bend toward the wall, making it even harder for replacement fluid to flow into the low-pressure region, and eventually lock onto the wall altogether, forming what is called a low-pressure bubble upstream from the point of attachment. This wall effect is sometimes called the Coanda effect.³ Both wall effect and momentum transfer are usually involved in most fluid amplifiers.

Fluid Logic Devices

The Harry Diamond Laboratories' amplifier, shown in Fig. 3, consists

Editor's Note: Based on a paper published in the proceedings of the 1964 Fall Joint Computer Conference, this article briefly explains the basic operating principles of fluid logic devices, discusses their advantages and disadvantages, and describes the overall logical design of a working fluid digital computer.

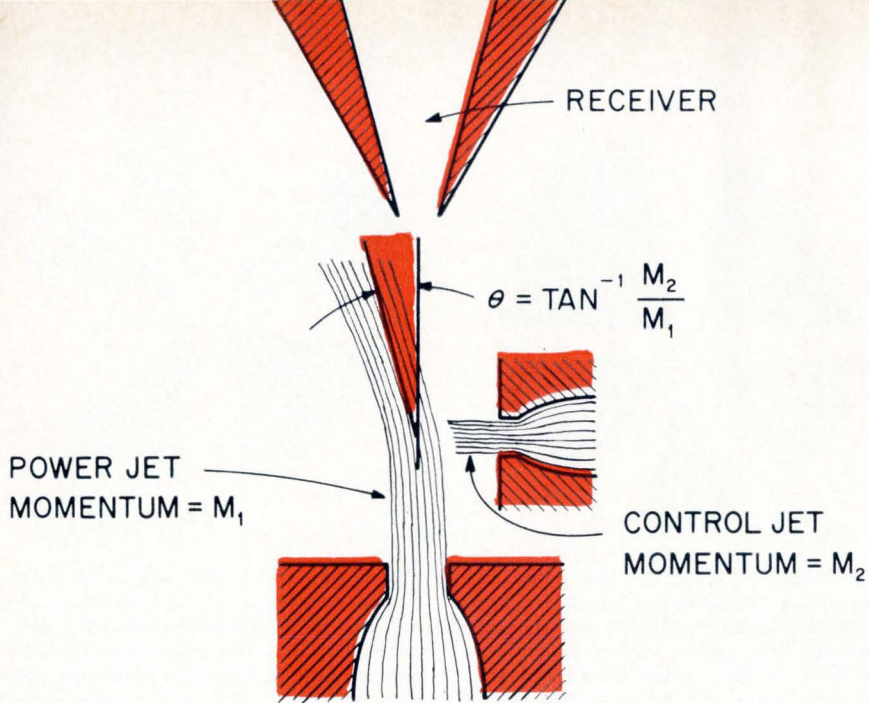

Fig. 1 Momentum exchange.

of a power jet, A, an interaction region, B, two control jets, C and D, and two output passages, E and F. The amplifier may be made to operate either proportionally or in a digital fashion, depending on slight differences in geometry. In the proportional device, fluid issuing from jet A will divide almost equally between output passages E and F in the absence of any control signals at C or D; but if a small amount of fluid is blown into the device through control port C, the main jet will be deflected to the right, and more of it will exit from passage F than from passage E. For small signals, the output variation can be made fairly linear with respect to the input, and furthermore, the output variation will be larger than the input variation, thus producing gain or amplification.

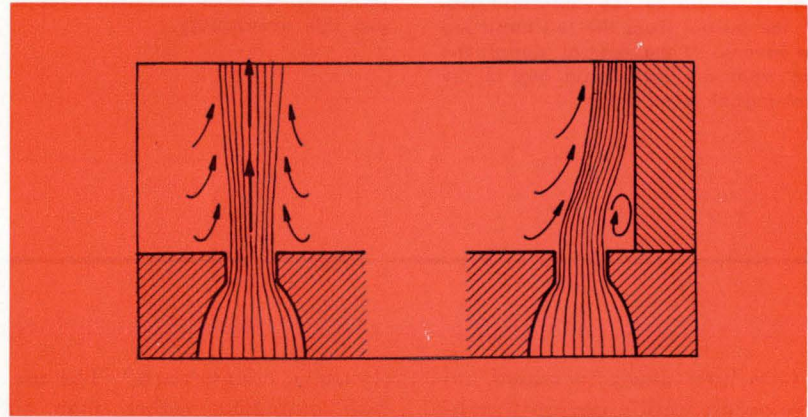

Fig. 2 Wall effect.

If certain changes are made in the geometry of the proportional amplifier, namely, if the divider tip G is moved further down-stream and if the walls HH and JJ are moved closer to the centerline of symmetry, the amplifier becomes bistable or digital. That is, the power jet bends by itself and attaches to one or the other of the sidewalls so that even in the absence of any control signal, substantially all the flow is from a single output passage, for example, passage E.

Assuming an output from passage E, if the pressure at control

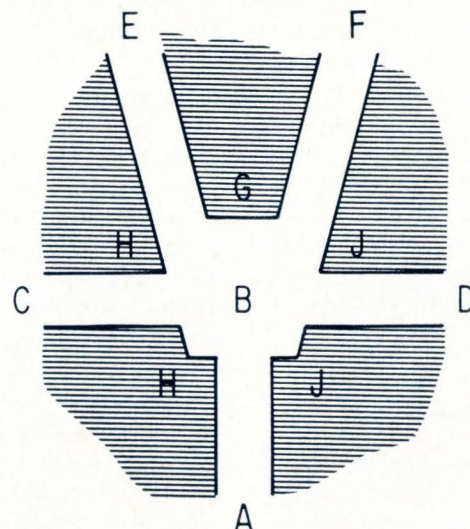

Fig. 3 Fluid amplifier developed at the Harry Diamond Laboratories.

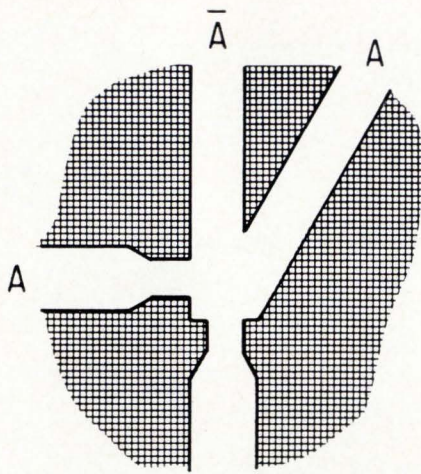

Fig. 4 A pure fluid inverter is purposely made very asymmetrical so that in the absence of a control signal the fluid flows essentially in a straight line and exits from the left-hand leg. Only when a control signal of sufficient strength is present will the jet be blown over to the right-hand leg. When the control signal disappears the output will immediately return to the left-hand leg. Thus, the output from the left-hand leg is the inverse of the control signal; the output from the right-hand leg is the control signal amplified.

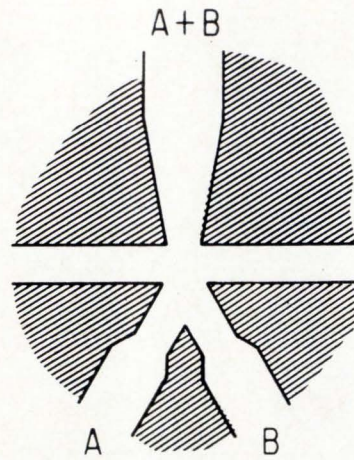

Fig. 5 An OR gate is constructed by converting the pressure energy in two or more signals to velocity energy and directing this into a common receiver. Because of the vector quality of the two jets, there will be very little leakage of signal from one input backward through the other unless the output is substantially blocked. The two side passages provide for fluid escape in just this eventuality.

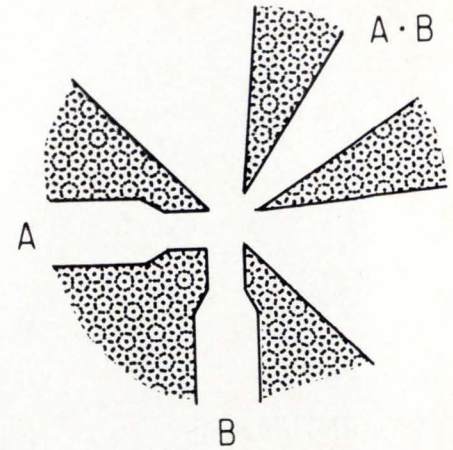

Fig. 6 As in the OR construction, the vector properties of high-velocity jets are also made use of in this AND gate. If the signal A is present alone it will pass straight through the AND gate and vent to atmosphere, and similarly for B alone. If signals A and B are present simultaneously, however, and have approximately equal amplitudes, then the resulting jet will make an angle of 45° to the original jets and will be caught in the receiver placed at this position. With proper design of the receiver, exact balance of the two signals is not necessary; ratios of 2:1 are easily accommodated.

port C is now slowly increased, no change occurs until a certain threshold value is reached, at which point the power jet suddenly switches to the other side and exits from output passage F. If the control signal is returned to zero, the power jet remains locked to wall JJ and continues to issue from output passage F. Thus, the device has memory capability and is the logical equivalent of the electronic flip-flop.

All the other fundamental switching and logic functions which are now performed electronically can also be implemented by pure fluid devices as shown in Figs. 4 through 8.

Why Fluid Amplifiers?

Granting the feasibility of constructing complex digital systems from fluid amplifiers, what is the motivation for doing so? What advantages, if any, do fluid amplifiers have over their well-established

electronic counterparts? The use of fluid amplifiers rather than their electronic counterparts may be justified on the basis of four significant advantages: reliability, environmental immunity, low cost, and absence of r-f radiation. Each of these advantages is briefly discussed below:

Reliability: Pure fluid amplifiers have no moving parts except the fluid itself. There is nothing to wear out, nothing to age, nothing to burn out. With the proper selection of structural material and fluid, there are no potential chemical or solid-state reactions. There need be no delicate structures. In short, the life of a fluid amplifier should be practically infinite, whether in use or quiescent. About the only conceivable cause of deterioration would be dirt in the fluid, and this can be controlled easily by filtration and the use of closed-cycle systems.

The fluid amplifier art is still

too young for masses of statistical data on reliability to have been compiled. However, the nature and operation of these devices are such that extremely favorable comparisons with electronic and other types of devices can be expected.⁴

Environmental Immunity: Fluid amplifiers can be made of almost any solid material, for example, plastics, metals, glass, or ceramics. If the right materials are selected, operation is possible under environmental conditions which preclude the use of electronic devices. For example, ceramic fluid amplifiers could operate at white heat. Metal fluid amplifiers should be operable in intense radiation fields. With the proper materials and assembly procedures, shocks, or accelerations, of thousands of G's should present no problem.

Low Cost: Fluid amplifiers consist basically of rectangular channels in a suitable material. They can be fabricated by any one of a number of extremely low-cost methods, such

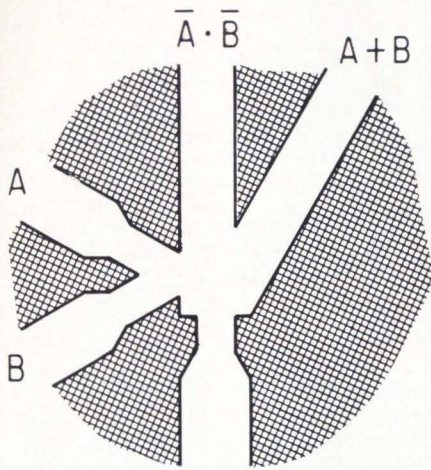

Fig. 7 The combination of the OR gate and the inverter gives this extremely powerful NOR element. The right-hand output is the amplified OR function of the inputs while simultaneously the left-hand output gives the amplified NOR function. This principle has been extended to achieve a NOR gate with a fan-in and fan-out of four.

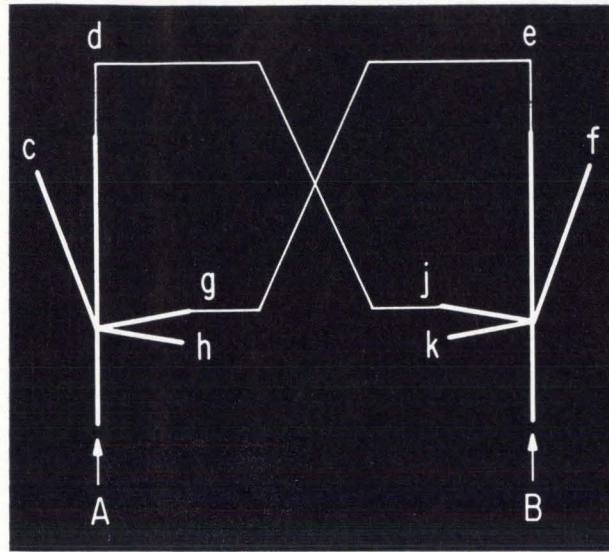

Fig. 8 A flip-flop is made by interconnecting two NOR elements. In this flip-flop configuration, one element is in the 1 state, and its output is used to switch the other element into the 0 state. The elements remain stable in their respective states until an outside signal changes the state of the flip-flop. Assume that element A is in the 1 state, that is, its output signal is in leg d. This signal is sent to element B through input j which switches the element into the 0 state, that is, the jet is diverted to output f. There is no signal in leg e of element B; therefore, element A is not affected by element B. The flip-flop will remain stable in this state until an outside signal is applied to element A by way of input h. When the signal appears, A will be switched to the 0 state, and the jet will be diverted from leg d to leg c. The signal to input j of B will go off, and the element will switch from the 0 state to the 1 state, that is, the jet will switch from leg f to leg e. The signal from B will then be applied to A through input g. When the outside signal through h is removed, the signal through g will keep A in the 0 state. The flip-flop has been switched, and it will remain stable in this state until another outside signal is applied to input k of element B.

as casting, injection molding, stamping, or etching. Entire circuits of fluid amplifiers, including the interconnecting passageways, can be formed by such methods in one low-cost operation. Planes could be stacked one on top of another with holes in the planes at the proper locations for the necessary interconnections. With techniques such as these, which are already being developed, it is estimated that the cost of fluid amplifier circuits may be as much as 100 times less than the cost of comparable electronic circuits.

R-f Radiation: Fluid devices neither emit nor are affected by radiation; consequently, a very common and often serious problem associated with electronic logic, namely, r-f radiation, is eliminated.

Operational Speed

Fluid amplifiers have one significant disadvantage: their operational speed is relatively slow. Switching

times are of the order of a millisecond, and signal propagation time is of the order of a millisecond per foot. Fluid amplifiers, at present, are only approaching kilocycle rates of operation as opposed to the megacycle and higher rates common in electronic systems. Speeds can be expected to improve, of course, but nanosecond switching times are not foreseeable today. Because of this speed limitation, there are many applications for which fluid amplifiers will probably never be suitable.

It should be noted that the inherent speed limitation can be offset by taking advantage of the low cost and high reliability of fluid amplifiers, which make it economical to compensate for much of the speed deficit by making extensive

use of parallel and polymorphic operation.

Univac Fluid Computer

Every general-purpose digital computer must have means for accomplishing four basic functions — memory, arithmetic, control, and input/output — consequently, it was necessary to provide these functions if we were to fully meet the goal of demonstrating a generalized fluid computer, even though on a very small scale. All four functions are fully and formally developed in the computer.

The problems of memory size, word size, and instruction set are all interrelated. The objective was to build a very small airpowered general-purpose digital computer

which could be programmed to do a few elementary problems. At least three instructions seemed necessary to prove generality: an Arithmetic instruction, a Data Transfer instruction, and a Conditional Jump instruction. Since two bits are needed to specify three instructions, a fourth instruction becomes possible without any increase in word size. It was decided to make this a Halt instruction. The four instructions used then are:

Instruction Code	Explanation
Transfer Tm 10	(A) → m
Add Am 11	(m) + (A) → A
Jump Jn 01	Go to instruction in memory location n if (A) ≠ 0; otherwise continue with the next instruction in the memory.
Halt H 00	Stop the computer.

After a few trials it was found that a reasonable program could be written using all four instructions with a memory of only *four words*. This program, which is the basic test program for the computer, will be discussed later.

A four-word memory implies two bits for addressing, and this, with the two bit operation code, fixes the word length at four bits. The first two bits of a word are the operation code and the last two the address. Alternately, a word may consist of numerical data only.

To recapitulate, the UNIVAC Fluid Computer has four instructions and four words of memory; each word is four bits long. To compensate as much as possible for the speed disadvantage of fluid elements, operation is bit parallel.

Logical Design

Fig. 9 shows the overall block diagram of the fluid computer. Each instruction is processed in four steps by the step counter which is driven from the master clock. The control counter contains the address of the next instruction to be executed and, except during the fulfillment of the Conditional Jump instruction, is augmented by one at the end of

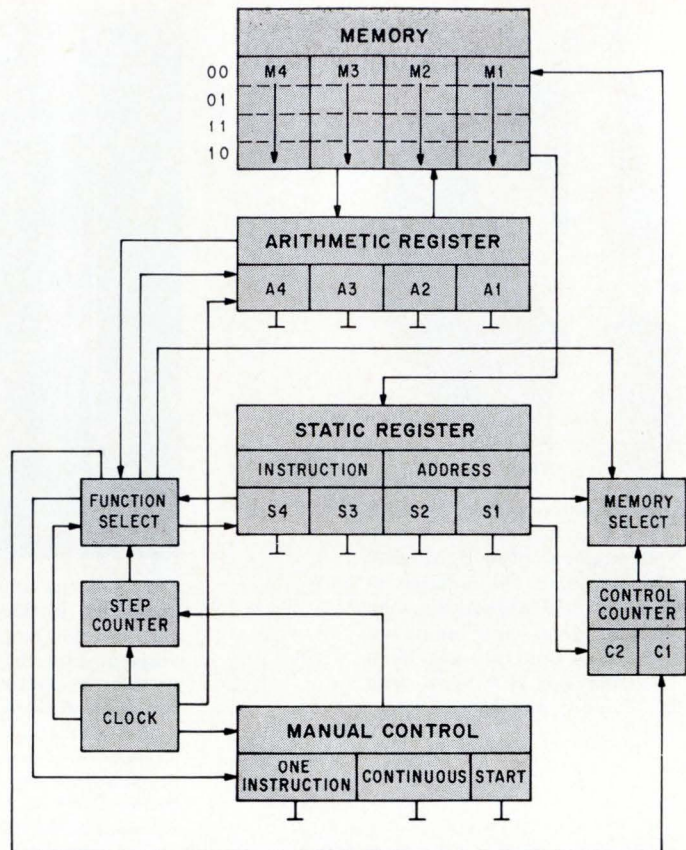

Fig. 9 Block diagram of Univac's experimental fluid computer.

each instruction cycle. During step 1 the control counter operates the memory select circuits, and by the end of step 1 the specified memory word, which contains the next instruction, is read into the static register. The two left-hand bits (the operations code) are decoded and this information is sent to the function select circuits, where, in conjunction with step counter and clock signals, the necessary gating pulses for all instructions are generated. The two right-hand bits, specifying the operand address, are sent to the memory select circuits, permitting the required data word to be read out. All this takes place during step 1. The actual instruction execution is carried out during some or all of the last three steps.

The Add instruction is carried out in two stages. The first stage is completed during step 3 and consists of adding the word in the memory to the word in the arithmetic register without regard to carry. This portion of the Add instruction changes a bit in the arithmetic register from a 1 to 0 or vice

versa, whenever there is a 1 in the corresponding position of the word to be added. The second stage of the addition process starts at the beginning of step 4 and causes a carry pulse to be sent to the next more significant bit position whenever the sum bit is presently a zero and the addend bit was a one. Means are provided to rapidly transmit the carries to subsequent stages if the original carry pulse would in turn produce another carry at the next higher bit position. This carry generation and propagation proceeds asynchronously and could continue during steps 4 and 1, if necessary. It is actually completed by the end of step 4.

Memory Design

The memory is a two-dimensional matrix array using flip-flops as the storage elements. In order to understand the operation of the memory, a very important technique, known as pulsed power jet operation or "pre-steering," should first be described. When the power jet

now! anyone can afford a new "off-line" tape converter

(so why waste the time and cost of using a computer?)

Free your computer. Convert or duplicate magnetic and paper tapes and punched cards faster and more economically, "off line," with one of these new high-speed Versa-Verter* tape converters. Select the bi-directional versatility of the SC-332A unit or the uni-directional economy of a new B, C or D model. Each has a universal code converter with programmable plug board and a standard density magnetic tape transport. Ideal for data translation needs for numerically controlled machine tools, invoice and inventory data control, and business machine tape conversions. Select the one designed for your requirements and write or call for information. Phone (716) 342-8000 or write: Product Mgr., Data Equipment, General Dynamics|Electronics, 1400 N. Goodman St., Rochester, N. Y.

*Trademark applied for

shop here

SC-332A VERSA-VERTER MAGNETIC to PAPER TAPE / PAPER to MAGNETIC TAPE / PAPER to PAPER TAPE

Features up to a 2,048-character buffer, 1000-char/sec. PT reader, 300-char/sec. punch. Operates with standard 5, 6, 7 or 8 level paper tape. Post-punch verification also available.

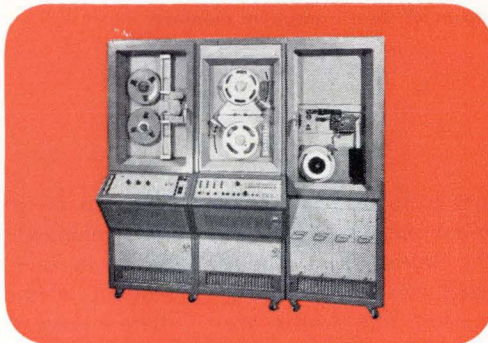

SC-332C VERSA-VERTER MAGNETIC to PAPER TAPE

A uni-directional unit with up to 2,048-char. buffer and a 300-char/sec. PT punch that operates with either 5-level 11/16" tape or 6, 7 and 8 level 1" paper tape. Post-punch verification available.

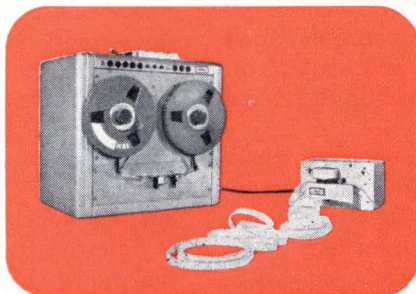
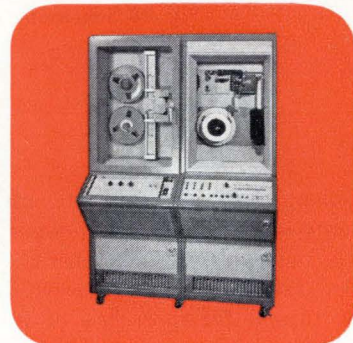

SC-332B VERSA-VERTER PAPER to MAGNETIC TAPE

A uni-directional unit with a 100-char/sec. PT reader that operates with standard 5, 6, 7 or 8 level paper tape.

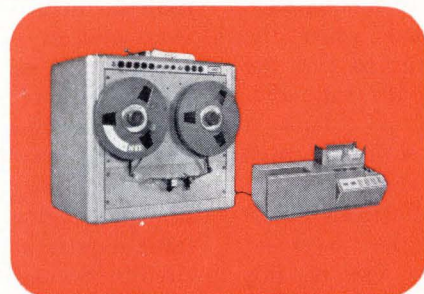

SC-332D VERSA-VERTER PUNCHED CARD to MAGNETIC TAPE

A uni-directional unit with a 100-card/min. reader that accepts standard 80-column punched cards.

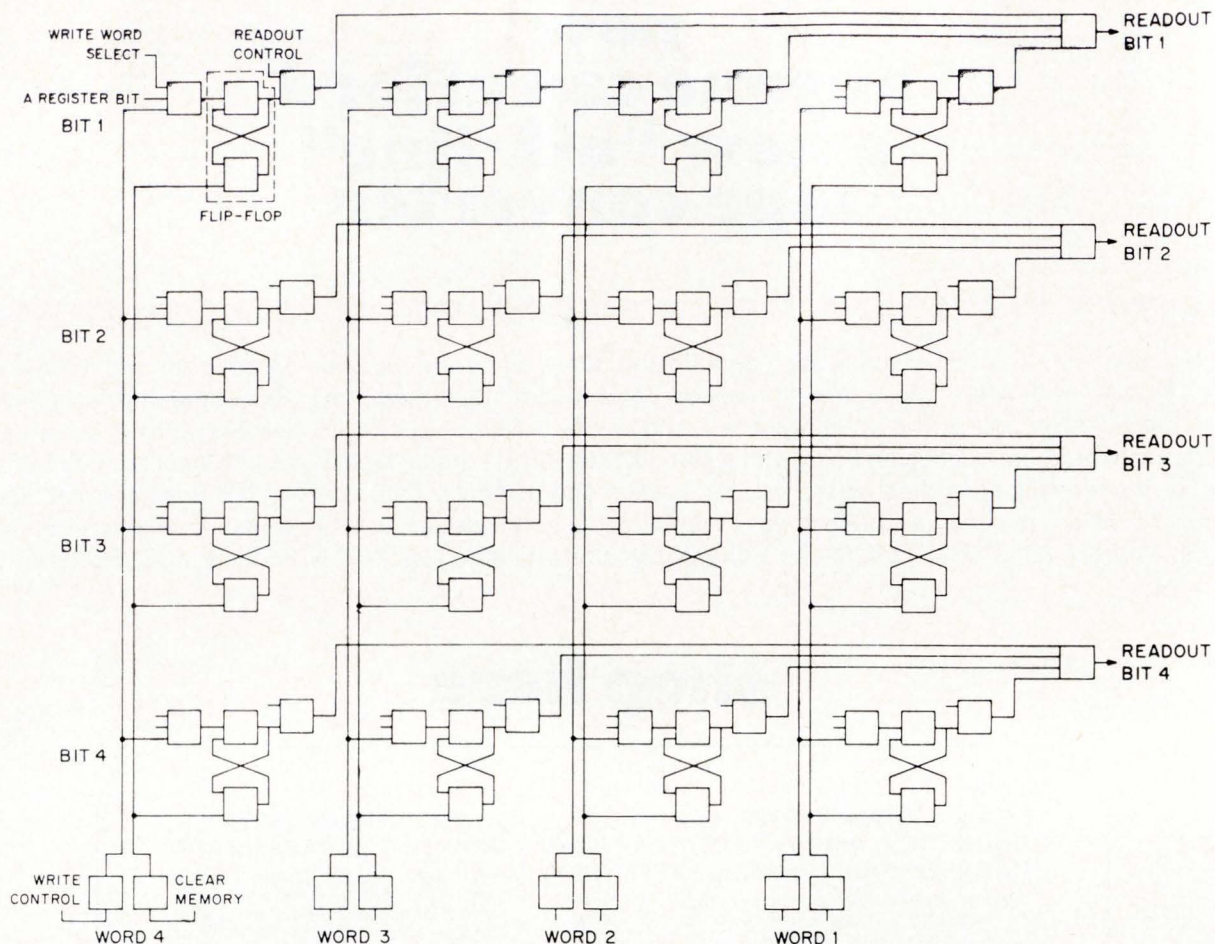

Fig. 10 Schematic diagram of fluid computer memory.

is ON in a fluid flip-flop, a considerable amount of energy is required at the control jet to switch from one state to the other. However, if the power jet is first turned OFF, then a very small flow at either control jet will provide enough "pre-steering" so that when the power jet is again turned ON the flip-flop will assume the state dictated by the control jet. Thus, a control signal which is far too small to switch a flip-flop when the power jet is ON can very effectively determine its state when the power jet is turned OFF. By use of this principle, it has been found that the effective gains of these devices can be enhanced by a factor of ten or more.

Fig. 10 is a schematic of the fluid computer memory. Each block represents a NOR element with four inputs and four outputs. Lines into the left side and bottom of the blocks indicate inputs to the ele-

ments, and lines from the right side and top represent outputs from the elements. The memory contains four words, each consisting of four bits of information. The words are located in vertical columns, the right column being the first or 00 word address. The horizontal rows contain the same information bit for all four words, the top row being the least significant bit.

Writing into memory is a three-step operation. First, the memory storage location is selected by the static register and the memory select circuits. Second, a clear memory signal from the function select erases any information already in that word location by resetting all flip-flops to zero. Third, the word in the accumulator is gated into the memory location by another function select signal. The write operation utilizes three counts of the step counter cycle.

A simple nondestructive readout is employed. Each of the 16 memory

flip-flops feeds into an intermediate NOR element which in turn sends a signal to one of the four memory readout elements. These intermediate elements are controlled by the memory select circuits. When a particular address is chosen for readout, the memory select turns off the intermediate elements of the other three words, thus prohibiting any output signals from these words. Parallel operation is used. Therefore, all bits of a word are written into and read out simultaneously.

Referring back to the overall block diagram of Fig. 9, it is seen that a manual control unit is provided which makes possible two modes of operation: *continuous* and *one instruction*. To enter information into the memory, the computer is placed in the *one instruction* mode. A word is then set up manually in the A register, and a Transfer instruction specifying the desired memory location of the word is set up in the static

digital



There's five million dollars' worth of digital circuit thinking in this catalog.

You can have it free.

This catalog is different.

It's been called the standard reference work on digital logic for the industry.

It has information as basic as a description of simple number systems.

It includes sections on Boolean algebra, binary coded decimal codes, definitions, symbols and useful tables.

It leads to clear and well-defined descriptions of the most sophisticated of circuits.

In short it's a valuable manual on circuit design that can help your people design better circuits faster.

As well as a complete catalog of FLIP CHIP™ modules.

The one thing you won't find in this book is jargon.

On the contrary, the writing is clear, direct and supple. Even elegant.

And for good reason.

We wanted the quality of our catalog to reflect the quality of our FLIP CHIP modules—in clarity, in directness and in ease of application.

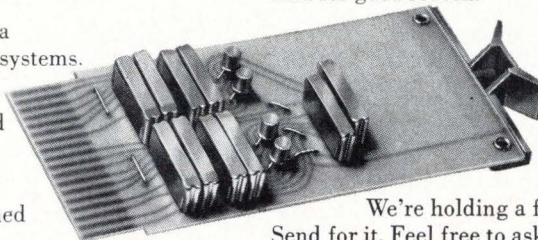

We're holding a free copy for you right now. Send for it. Feel free to ask for two, even.

They have a way of disappearing.

For your copy, just call any Digital Equipment office. Or the main office: DIGITAL EQUIPMENT CORPORATION, Maynard, Massachusetts 01754. Telephone: 617 897-8821.

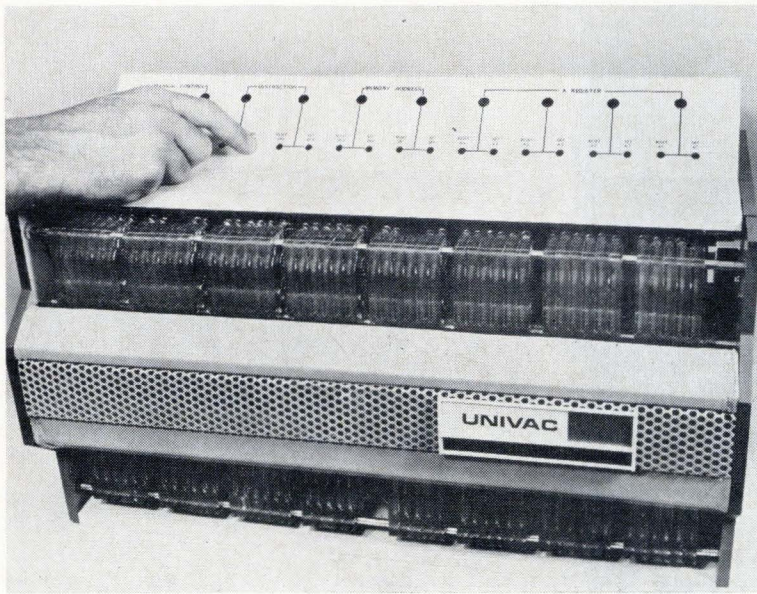

Fig. 11 Programs and operating instructions are fed into the Univac fluid computer by covering appropriate openings on the panel board. This results in pressure changes in elements adjacent to the openings. Read-out is provided by larger openings along top of panel board. A register indicator (extreme right, top) counts up to sixteen in binary.

register. When the START switch, also located in the manual control unit, is activated, the word in the A register will be transferred into the memory. This process is repeated for each word to be loaded. The act of setting a switch consists merely in putting one's finger lightly over a bleed hole on the control console (Fig. 11). The resulting back pressure will then set a flip-flop or generate a fluid pulse, as the case may be. It is difficult to imagine a simpler form of keyboard. The contents of the A register and static register are displayed by using bi-positional visual indicators. The indicators consist of a colored ball in a glass tube. The balls are lifted into view by a pressure signal when the flip-flops are in the 1 state.

Construction and Test

The NOR elements used in the UNIVAC Fluid Computer were made by injection-molding a thermoplastic material into a metal negative master.

The physical size of the fluid devices is a function of the width of the power input nozzles. The

widths of the nozzles used on the computer elements were either 0.016" or 0.020". These widths are chosen because they allowed the use of standard laboratory fabrication techniques and equipment and afforded accessible tolerances. Increased dimensional accuracy was obtained by machining the master from a large template five times normal size and reducing by means of a pantomill.

Reducing the size of the elements with the above fabrication method is limited by the size of the cutting tool used in making the master. A nozzle width of 0.005" might be attainable, but present photoetching processes are able to produce still smaller and more accurate models.

Because of dimensional variations occurring during fabrication, the characteristics of the elements sometimes differed. It was necessary, therefore, to set up a testing procedure to check all elements before using them in the computer circuits. Two testing criteria were chosen. The first was that the pressure recovery be at least a set minimum value. Pressure recovery

is the ratio, expressed in percentage, of the output pressure to the input supply pressure. At the present state-of-the-art, the NOR elements have a rather low pressure recovery factor. The computer elements averaged about 30 percent, although other experimental models have reached almost 50 percent. Acceptability for the fluid computer required a pressure recovery of at least 28 percent.

The second test for the elements was gain. This is the ratio of the element output to the input signal required to switch the element. A figure of 1.6 was chosen as the criterion here. The supply pressure for the elements in the fluid computer was 20" of water (0.8 of a pound per square inch). This means that the output pressure would have to be at least five inches of water and that the elements would have to switch with less than three inches of water input signal pressure. Elements not meeting these specifications were rejected. All tests were made with the device loaded with the equivalent load of four other elements.

To simplify construction and testing, the computer was divided into two parts. Each half consists of a power supply manifold and three rows of NOR elements. There is a total of 280 elements in the computer. The existing circuitry requires only 250 NOR elements but the extra elements were added in case replacements had to be made or for possible changes or extensions to the logic. The NOR element power inputs are plugged directly into the manifold. Interconnection of the elements is done by simply connecting one of the four outputs of an element to one of the four inputs of the next logical element in the circuit. These connections were made with plastic tubing.

One side of the computer contains the clock, step counter, instruction portion of the static register, function table, and A register circuits; the other side contains the control counter, address portion of

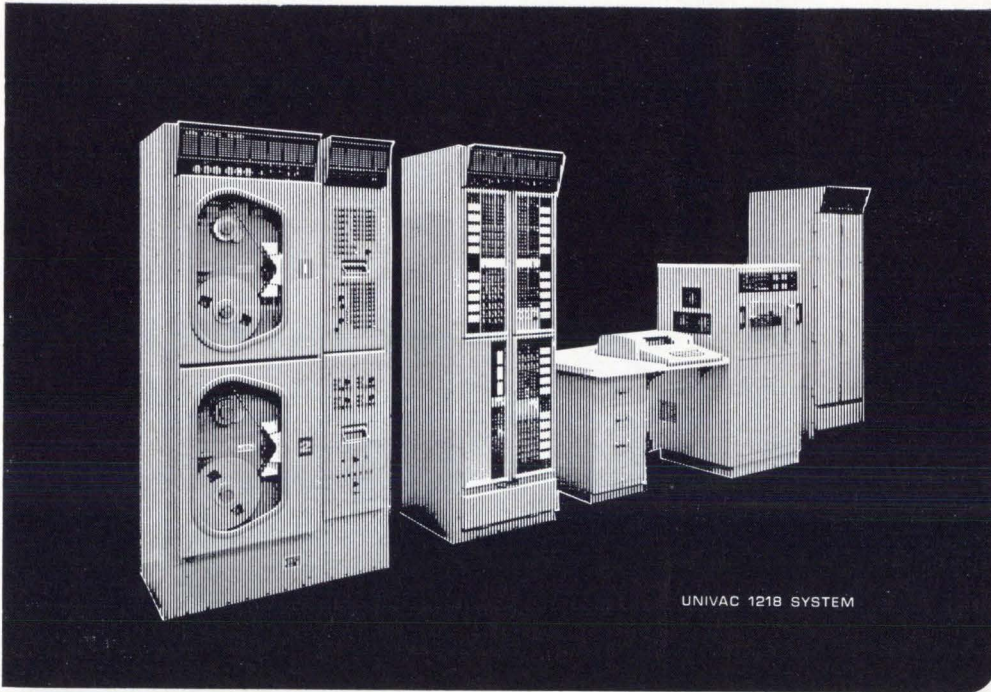

UNIVAC 1218 SYSTEM

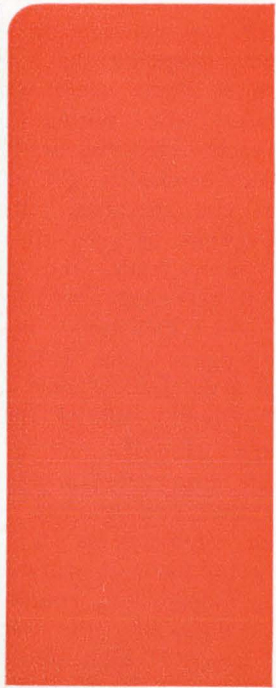

UNIVAC*
uses **CTC memory**
test systems

to test
memory modules
for
military
computers

...those who build the
most reliable digital systems
standardize on
CTC test equipment

*UNIVAC DIVISION OF SPERRY RAND CORPORATION

COMPUTER TEST CORPORATION
CHERRY HILL, N.J.



static register, memory select, and memory circuits.

The two halves were wired and tested independently. Simulated pressure signals were used where necessary when testing the circuits on each side. When both were working separately, the entire computer was assembled, all the cross connections between the two sections were made, and appropriate outputs were connected to the control panel indicators. To facilitate maintenance, the computer was constructed so that one side hinges out, exposing all of the internal circuitry (Fig. 12).

The entire system was then tested, and after straightening out a few minor problems in the circuitry, the computer was working reliably as an independent, coordinated system. Physically, the computer is 14" deep, 14" high, and 21" wide.

Summary

The individual reliability test given to each component NOR element greatly reduced the probability of encountering any serious problems during the final checkout of the system. A few minor logic and performance problems did show up, but these were easily traced and corrected. The UNIVAC Fluid Computer was operating reliably only a few weeks after construction was begun.

The nominal clock rate of the computer is ten cycles per second. This was chosen to avoid wave propagation and reflection problems which are potential dangers at not very much higher frequencies because of the long lead lengths involved and the lack of attention given to exact impedance matching. It should be pointed out that the speed of fluid signal propagation in air is almost one million times slower than the speed of signal propagation in electric wires. Thus, from the point of view of signal wavelength, a frequency of ten cycles per second using air as the working medium is analogous to a frequency of ten megacycles in electronics. Simpler circuits built with elements identical with those in the computer, but compactly packaged, have operated with clock frequencies as high as 250 cycles per second.

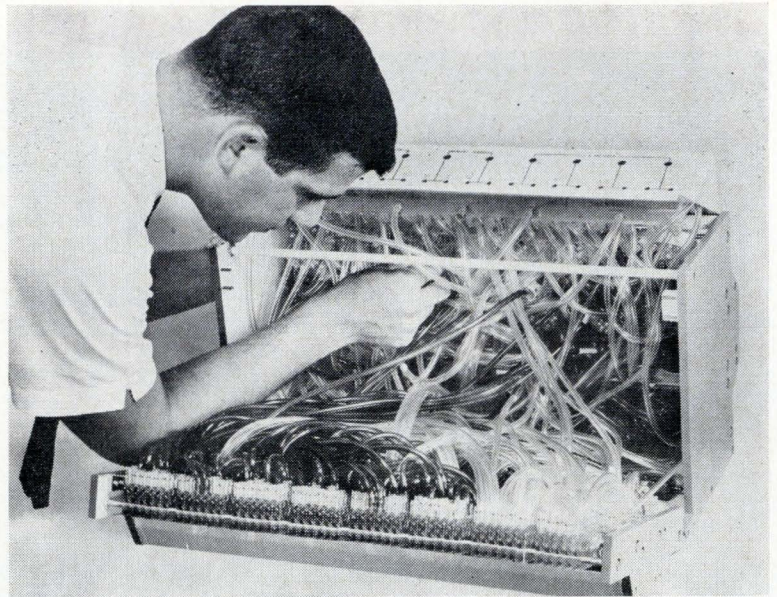

Fig. 12 Plastic tubing is attached to one of the switching elements in the Univac fluid computer by R. S. Gluskin. This experimental, general-purpose digital computer operates entirely by air flowing through plastic channels and elements.

The UNIVAC Fluid Computer has amply demonstrated that a pure fluid general-purpose digital computer is indeed feasible. The question remains: Is such a computer desirable? There are many areas in which fluid logic cannot hope to compete with electronic logic simply because of the speed limitations inherent in fluid systems even if the utmost advantage is taken of parallel and polymorphic operation.

Conversely, however, there are areas involving extreme environments, such as very high radiation levels or very high temperatures, where present-day electronics cannot hope to compete with fluids, and here fluid logic may supply the only means of solving many pressing military and space science problems. Between these two extremes there is a vast area where fluid logic does appear to be competitive with electronics and where the advantages and disadvantages of both approaches will have to be carefully studied. This area includes such devices as adding machines, desk calculators, tabulating machines, process control computers, and such peripherals as keyboards and punched card and paper tape readers. Here, timing rates are frequently below a kilocycle, and the speed disadvantage of fluid amplifiers disappears. Here too, the tremendous cost advantage plus

the postulated reliability advantage makes fluid logic look very attractive indeed. It may further develop that, given sufficient cost and reliability advantages, the marketplace may well learn to live with slower computing speeds for small general-purpose computers.

The authors believe that there is a vast role to be played by fluid technology in the computer field, and this view is shared by their company. The Univac Fluid Computer is the precursor of what we hope will be long series of useful pure fluid systems of increasing complexity and decreasing cost. END

REFERENCES:

1. Auger, Raymond N., "Pneumatic Computer Research in the USSR", *AUTOMATIC CONTROL*, Vol. 13, No. 6 (December 1960), pp. 43-48.
2. Refer to parts A through F of the Diamond Ordnance Fuze Laboratories, "News Release" for March 2, 1960.
3. Coanda, H., "Precede et Dispositif Pour Faire Devier, Une Veine Fluide Penetrant Autre Fluids", Patent No. 788,140 (France), 217, 1934.
4. Fox, H. L., "A Comparison of the Reliability of Electronic Components and Pure Fluid Amplifiers", Proceedings of the Fluid Amplification Symposium, October 1962, Diamond Ordnance Fuze Laboratories, Washington 25, D.C.

SUPERCONDUCTIVITY DISCOVERED IN GRAPHITIC COMPOUNDS

Superconductivity has been discovered in compounds of graphite and alkali metals by scientists at Bell Telephone Laboratories. This is the first time that carbon structures, rather than interstitial carbon atoms, have been directly involved in superconductivity.

The superconducting compounds consist of layers of either potassium, rubidium, or cesium atoms interleaved with layers of carbon. For these compounds, the critical magnetic field — the field required to destroy superconductivity — depends on its direction through the material. Fields in the plane of the carbon layers must be stronger to quench superconductivity than fields cutting across the layers. This dependence of the critical field's orientation with respect

to the structure is greater in graphite compounds than in any other superconductor. The temperatures at which the compounds were found to become superconductive range from 0.020 to 0.55 degrees Kelvin.

The experiments were performed by N. B. Hannay, T. H. Geballe, B. T. Matthias, K. Andres, P. Schmidt, and D. MacNair. These scientists believe that the strikingly large orientation dependence of the critical magnetic field results from the layer structure of the compounds. Graphite consists of closely-packed layers of carbon that are loosely stacked on top of each other. Its well-known mechanical properties stem directly from this structure. Chemists have known for decades how to prepare compounds consisting of eight atoms of

carbon with one of either potassium, rubidium, or cesium. The discovery that superconductivity can exist in these systems now opens the way to the study of superconductivity in new circumstances.

The strong orientation dependence of the critical magnetic field is of fundamental importance and bears on the basic nature of superconductivity. Further experiments in progress are designed to exploit this feature. It is important, for example, to answer the question of whether or not it is possible for these unusual materials to support supercurrent flow in only two dimensions. The nature of graphite itself, which is composed of carbon — one of man's most important elements — may be better understood as a result of these experiments.

No Memory Failures?

...Well, we haven't heard of any from VersaLOGIC Core Memory users

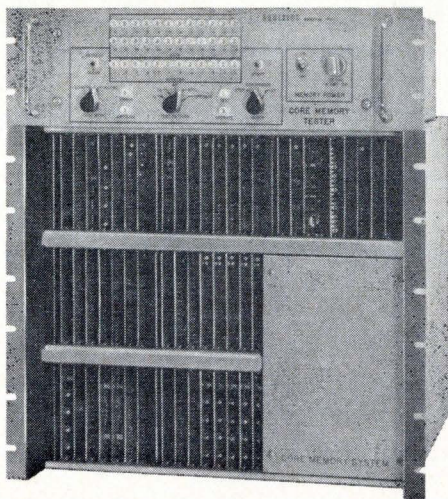

And we haven't sold a single replacement module for a memory in the field. Some in continuous service for over two years. Surprising? At Decision Control it's the way we design them—for MTBF's of 15,000 to 20,000 hours.

We would like to tell you more about our VersaLOGIC Memory design, our exacting quality control and manufacturing procedures. We will also tell you how easy it is to design a VersaLOGIC Core Memory into your computer system or input/output equipment.

- No operational adjustments
- 2 μ sec. or 5 μ sec. operation
- Full or half cycle operation
- 0° to 50°C. temperature range without a heated stack
- High noise rejection, 4.5 v. at "1", 1v. at "0"
- All interface signals buffered

And that's not all. Our "Memory Application Brochure" will give you the full story. Write for one, or call us.



DECISION CONTROL, INC.

1590 Monrovia Avenue, Newport Beach, Calif. 92660
Tel. (714) 646-9371 • TWX (714) 642-1364

DIGITAL HYDRAULIC VALVE-ACTUATOR

Open-Loop "On-Off" Positioning Device Offers Several Advantages Over Conventional Analog Techniques

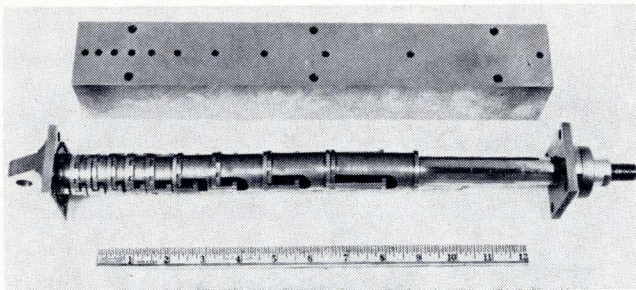

Digital actuator with piston assembly.

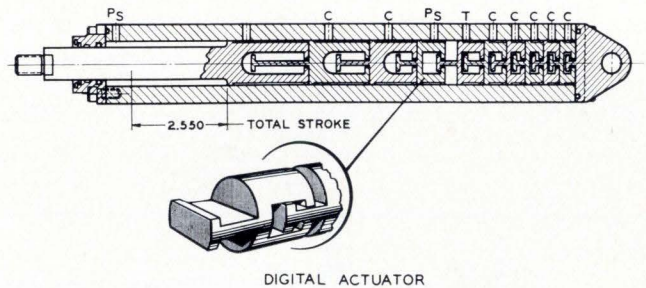

Cross-section view of binary piston assembly.

Vickers Division of Sperry Rand Corporation has developed a versatile and unusual hydraulic digital valve-actuator that can be used in any application where a position signal is available in digital form. This valve-actuator positioning device accepts straight binary-coded, parallel input signals and converts them to discrete actuator positions. The actuator can be used in position systems with or without external feedback. Typical applications include rocket engine gimbaling, radar antenna positioning, and flight control surface positioning.

The digital actuator is basically an open-loop positioning device consisting of a series of pistons with binary-weighted displacements. Each piston is pressurized and depressurized by a 3-way, 2-position "on-off" valve. The magnitude of the individual displacements is determined by mechanical motion stops that are set at the time of machining.

According to Vickers, the open-loop "on-off" design of the hydraulic digital actuator yields the following advantages over positioning by conventional analog techniques:

- Eliminates digital-to-analog conversion

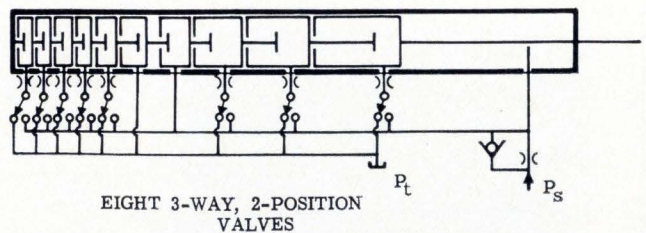

Schematic diagram of valve-actuator hydraulic circuit.

- Maintains high signal integrity of digital information throughout the system
- Eliminates need for servo-amplifiers and feedback transducers
- Is less susceptible to contamination
- Has improved load stiffness characteristics
- Operates independently of fluid characteristics.

Vickers has designed and fabricated special valves for use with the hydraulic digital actuator. These are minia-

ture, high response, 3-way, 2-position valves capable of 4.5 gpm at 3000 psi. They feature a two-stage construction with a spool-type first stage which requires hydraulic power only when the valves change state. At steady state there is essentially zero leakage. The electrical input requirements are low: 50 ma to 70 ma at 10 volts. Response time of the valve, from energization of input voltage to full open of valve ports, is 8 msec.

Actuator Operation

The digital actuator illustrated here is 18.625 in. long by 2 in. by 2 in. and weighs 15 lbs., not including valves or manifold plate. It consists of a series of eight binary-weighted pistons with a least significant bit size of 0.010 in. and a total stroke of 2.550 in. However, the size, length of stroke, number of actuator sections, and least significant displacement varies according to the application. The number of possible positions is dependent on the number of pistons used since, in the binary code, the number of positions equals 2^n , where n is the number of pistons. Thus, this prototype actuator, having eight pistons, is capable of 256 positions or 2^8 , but if one more piston was added, the total number of output positions would be doubled.

Actuator output is produced by fluid pressure on the series of linked pistons in a cylinder. Precise positioning is accomplished by mechanical stops which determine the distance between adjacent pistons. Fluid pressure

applied between a pair of pistons forces them apart to the limit of their mechanical stops. Eight of the ten pistons are active pistons that determine the steady-state position of the actuator. The remaining two are passive pistons: one is always vented to tank and allows 0.32 in. overshoot of the final position on forward strokes; the other is always pressurized and allows 0.32 in. overshoot on reverse strokes. This prevents deformation of the piston during full extension or full contraction of the actuator with resultant dissipation of load energy and severe limitation on load capability.

These same design principles may be applied to actuators which operate on ternary-coded information. While the number of valves would be decreased, the number of pistons would be increased. The valves would need to be of the 4-way, 3-position type. For example, 242 positions could be obtained with 5 valves and 10 pistons.

In controlling high-inertia loads, the accuracy of Vickers hydraulic digital actuator runs from 0.16% for the largest increments to 2.6% for the smallest; repeatability is within 0.0003 in. Since a wide range of either compressible or incompressible fluids can be used, the actuator will operate in nuclear atmospheres or with hot gas bled from rocket chambers. Because pistons are preloaded at full operating pressure in all positions, operation is unaffected by accelerations, vibration, or thermal transients.

Circle No. 107 on Inquiry Card

GOVERNMENT REPORTS ★ ★

PHASE II REPORT ON CRYOTRON MEMORY PROGRAM

This report indicates that a 1 billion-bit cryoelectric memory can be fabricated since further advances in theoretical understanding of memory operation have clearly delineated the requirements. Tests of many samples made during the year have established that matching of memory planes with necessary cryotron trees is practical.

Order from Clearinghouse, U. S. Dept. of Commerce, Springfield, Va. 22151. Order No: AD 609 469N. Price \$6.00.

MANUAL ON THE PROGRAMMING LANGUAGE LISP

This report describes LISP's use in processing data consisting of lists of symbols. It has been used for symbolic calculations in differential and integral calculus, electrical circuit theory, mathematical logic, games, and other fields requiring specialized handling of symbols.

Order from Clearinghouse, U. S. Dept. of Commerce, Springfield, Va. 22151. Order No: AD 603 482N. Price: \$7.05.

CALL FOR PAPERS

1965 UAIDE ANNUAL MEETING

Users of Automatic Information Display Equipment

The 1965 UAIDE Annual Meeting will be held at the Holiday Inn, 57th Street, New York City, October 11 through 14. This meeting will present the latest advances in programs, applications and techniques regarding the use of cathode-ray tube-type digital display devices. Papers are encouraged in the areas of system organization, display hardware, applications and programming. A one-paragraph abstract should be submitted to:

C. L. BANNISTER, PROGRAM CHAIRMAN, 1965 UAIDE ANNUAL MEETING; R-COMP-RRL, NASA/MARSHALL SPACE FLIGHT CENTER, HUNTSVILLE, ALABAMA 35812.

Abstracts of papers should arrive as soon as possible, but no later than July 15, 1965. Final papers should be submitted by Oct. 1, 1965.

what is the shape of the european computer market?

A comprehensive survey of the European computer market is available now. Prepared by Computer Consultants Limited of Great Britain, **EUROPEAN COMPUTER SURVEY, 1965** has comprehensive information for each of the following countries:

Austria	Germany	Norway
Belgium	Great Britain	Portugal
Denmark	Greece	Spain
Finland	Holland	Sweden
France	Irish Republic	Switzerland
	Italy	

Listed individually for each country is:

1. Economic information.
2. List of computer installations by name of user up to December 1964.
3. Table of installations up to December 1964 by user categories and price group.
4. Table of estimate of new installations for 1965 by user categories and price group.
5. Estimate of new installations for 1966 by user categories and price group.
6. Estimate of future installations by user categories and price group from 1967 to 1970 inclusive.

Also included are:

- Grand summary of installations, showing number installed, home built and import value; number on order, home built and import value; total population, working population and number of people capable of being helped by a computer.
- Tables of value of computers installed and on order showing home built and import value.
- Table of individual countries export of computers.
- Notes on the computers currently installed in European countries.
- Names and addresses of the manufacturers of the computers installed in Europe.
- European manufacturing locations, if any, of the computers installed in Europe.

Is this the data you need to understand and benefit from the rapidly expanding European Computer Market?

To order your copy of the **European Computer Survey, 1965** send your check or purchase order to the International Data Corporation, P.O. Box 1, Newtonville, Mass. 02160. Price is \$285. Additional copies for the same organization may be ordered for \$95 each.

The International Data Corporation is the exclusive North American distributor for the **European Computer Survey, 1965**.

IDC

International Data Corporation
P.O. Box 1
Newtonville, Massachusetts 02160

NEW MASS CORE MEMORY

A new low-cost mass core memory has been announced by the Ferroxcube Corp. of Saugerties, New York. The selling price of this new system is said to be well under two cents per bit. The new memories, dubbed "Megabit," are offered in modules of five million core capacities. Available in a 65K (76 bit) configuration, the Megabit 53.12 is priced at $1\frac{1}{2}\text{¢}$ to 2¢ per bit, or an average of \$87,500 per system. This 5-million-bit size can be expanded whenever desired by adding on additional 5 million bit modules. For current systems, according to Ferroxcube, Megabit 53.12 can cut sorting and merging time by one third thereby releasing vital computation time and extending system efficiency. Ferroxcube designed the 53.12 stack as a word address system. To employ as few selection switches as possible, selection takes place through a switch core matrix (previously described in the August 1964 issue of **COMPUTER DESIGN**). The switch cores, in turn, are coincident-current selected. To maintain simple design within the stack itself, the same wire is used for both sense and inhibit. This minimum configuration contains 256 x 256 words, each word driven by one switch core.

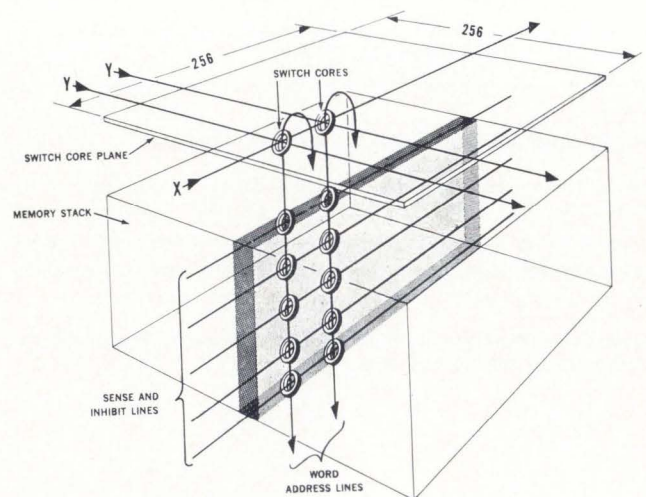

Switch cores in the new "Megabit" memory select the proper word line in a word-address stack array. The diagram illustrates how one wire can be utilized for both sense and inhibit functions. This is said to be one of the key low-cost features of the system.

Ferrite System Claims

to be Economically Competitive

With Discs and Drums

Therefore, there are an equal number of switch cores — one on each intersection of 256 "X" drive wires and 256 "Y" drive wires. All switch cores are threaded by a third wire carrying a bias current. Finally, each switch core is threaded by a fourth wire which couples the switch core to the 76 memory cores of one word. One switch core, and thereby one word, is isolated by selecting one out of the 256 "X" wires and one out of the 256 "Y" wires.

To reduce the number of selection switches, group selection principles are used. The 256 drive wires of one coordinate are connected in 16 groups, each group terminating in a selection switch. The same technique is used on the opposite side of the stack array, again terminating in a selection switch. The current generator is connected between the selection switches on both sides of the stack.

Employing one wire for both sense and inhibit places tight design requirements on the read amplifier. This amplifier must recover from the inhibit noise quickly enough to detect a ZERO or ONE output micro-seconds later. This recovery time, not only in the read amplifier

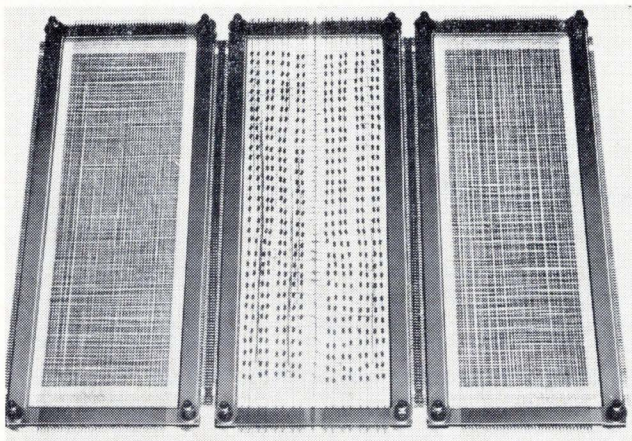

Memory plane used in the "Megabit" system. The switch cores mounted in the center are surrounded by standard 30 mil memory cores.

opinionated

Two months before Spectra 70 announcement!

September 28, 1964

RCA SETS TO
ANNOUNCE NEW
COMPUTER SERIES
DESIGNED TO BE
PROGRAM COMPATIBLE
WITH SYSTEM/360

EDIP
**INDUSTRY AND
MARKET REPORT**

A SEMI-MONTHLY NEWSLETTER FOR EXECUTIVES
IN THE ELECTRONIC DATA PROCESSING INDUSTRY,
AND THE FINANCIAL COMMUNITY.

First report on this important large-scale computer order!

July 15, 1964

GENERAL ELECTRIC
OBTAINS ADVANCED
POSITION IN
COMPUTER TIME-
SHARING FIELD
BY WINNING MIT
PROJECT MAC AWARD

EDIP
**INDUSTRY AND
MARKET REPORT**

A SEMI-MONTHLY NEWSLETTER FOR EXECUTIVES
IN THE ELECTRONIC DATA PROCESSING INDUSTRY,
AND THE FINANCIAL COMMUNITY.

Over six months before Model 20 announcement!

April 30, 1964

IBM PONDER'S
INTRODUCTION OF
MODEL 20
PROCESSOR; 7000
SERIES PROGRAM
CONVERSION

EDIP
**INDUSTRY AND
MARKET REPORT**

A SEMI-MONTHLY NEWSLETTER FOR EXECUTIVES
IN THE ELECTRONIC DATA PROCESSING INDUSTRY,
AND THE FINANCIAL COMMUNITY.

EDP INDUSTRY AND MARKET REPORT is a semi-monthly newsletter that gives an unclouded view of the developments in the fast-moving computer industry. Unbiased reporting. Timely analysis. Straight-from-the-shoulder opinion. The **REPORT** is management information for the EDP industry executive and the advanced computer user.

EDP INDUSTRY AND MARKET REPORT is industrial intelligence at its best. Well—researched. To the point. How is the EDP market changing? What new equipment will be significant? From which companies are these products coming? Who is merging with whom? And what do the answers to these questions mean for EDP companies and for the industry?

The **EDP INDUSTRY AND MARKET REPORT** is edited by a staff of computer industry experts who bring more than a dozen years of computer industry editorial experience to the job. Editorial contributions are gathered from the top industry authorities. The **REPORT** is backed by the full research facilities of the International Data Corporation whose research studies include an installation by installation analysis of over 80% of all computers installed and on order in the U.S.

EDP INDUSTRY AND MARKET REPORT subscriptions are \$49. per year; \$29. for six months. To enter a subscription or request a sample copy write to International Data Corporation, P.O. Box 1, Newtonville, Mass. 02160.

I | D | C

International Data Corporation
P.O. Box 1
Newtonville, Massachusetts 02160



We make this airmover unit,

Vaneaxial gas bearing fan, ultra-high reliability, used in *Minuteman*. Only IMC produces it.



and this unit,

The *Boxer*®, standard sized, distributor-stocked. Rugged metal frame, our own impeller and motor, moves air economically and reliably.



and this unit,

Tubeaxial, the IMCool is distributor stocked in 10 types, inputs of 60, 400, and 1000 cps, air delivery from 18 to 108 cfm.

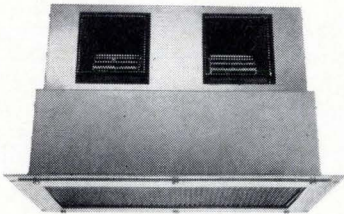

and this unit,

Rackmounted double blower. This one installed right in the broadcast area, delivers 500 quiet cfm to a high-power broadcast transmitter.

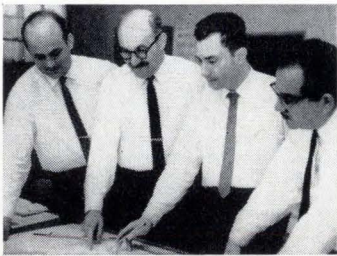

but this unit

will design and build an airmover to fit your specifications.

IMC is the single-source specialist for airmovers. We design and build the entire system—motor, blade, bearing, housing—and can assume full responsibility in meeting your needs. For quick response, contact Sales Dept., Eastern Division, Telephone (516) 334-7070, or TWX 516 333-3319.

Plants: Westbury, N. Y.; Maywood, Calif.; Rochester, N.H.; and Tempe, Ariz. Products: Airmovers; induction, hysteresis, synchronous, torque, servo, and stepper motors; synchros; solenoids; pressure switches; hydraulic and pneumatic valves; and fuel atomizers. For more data, write:



IMC Magnetics Corp. Marketing Division, 570 Main Street, Westbury, N.Y. 11591.

CIRCLE NO. 20 ON INQUIRY CARD

but also in the stack allows for decaying transients and is one of the main parameters governing cycle time.

To avoid extreme over-drive of the read amplifier, Ferroxcube designers intersect the bit wire in four identical parts. These four sections are then connected in a bridge circuit which is driven by the inhibit source across one diagonal and sensed by the read amplifier across the other diagonal. To accomplish this in the actual unit, the memory array is constructed of four independent modules. Each module contains one fourth the 65K and 76 capacity. The common sense and inhibit wire from each module is connected to the four respective corners of the balanced bridge.

According to Ferroxcube, this development will allow four to ten times the amount of core storage previously employed. The result will be a two or three times improvement in the utilization of computer systems and a reduction in programming costs. Also, the company expects that thousands of applications in industrial processing and business control will be made economical by the new development. Immediate impact, they say, is likely to be felt in the highly-competitive computer industry. "For example," according to the report from Ferroxcube, "the 360 Series of computers, recently announced by IBM utilize large core memories. The prices of these memories were thought until now to be unapproachable by smaller competitors with lower production volumes. The new Ferroxcube system with its low core costs and the substitution of inexpensive ferrite switch cores, in place of thousands of expensive semiconductors, will be a much needed tool to keep IBM's competitors in the game. Using normal mark-ups on peripheral equipment, computer manufacturers can buy 'Megabit' modules and resell them at competitive prices. Besides the price advantage, manufacturers will have use of a modular approach and a size smaller than the minimum unit offered by IBM."

In addition to extending the processing capability of present day EDP systems, Ferroxcube believes that the size and speed of memories such as "Megabit" will permit much more ambitious computer applications in the field of real-time control. The Megabit 53.12 System is contained in a cabinet size of 25" x 26" x 70" high, which includes power supply, standard memory exerciser, and memory retention unit. Cycle time is 12 microseconds; access time is 2 microseconds or less. Production on the new systems started this Spring with first deliveries being made soon after mid-year.

Circle No. 105 on Inquiry Card

GOVERNMENT REPORTS ★★

THE DOVE DATA STORAGE AND RETRIEVAL SYSTEM

Described is a system that provides high-speed and high-density storage and retrieval of digital information on recording media such as thin metallic foils or semiconductor films. The heart of the system is an electron beam tube which produces a spot the size of five microns at the recording surface by magnetically focusing the beam. Electrostatic deflection is employed to position the beam wherever required.

Order from Clearinghouse, U. S. Dept. of Commerce, Springfield, Va. 22151. Order No: AD 608 923N. Price: \$1.00.

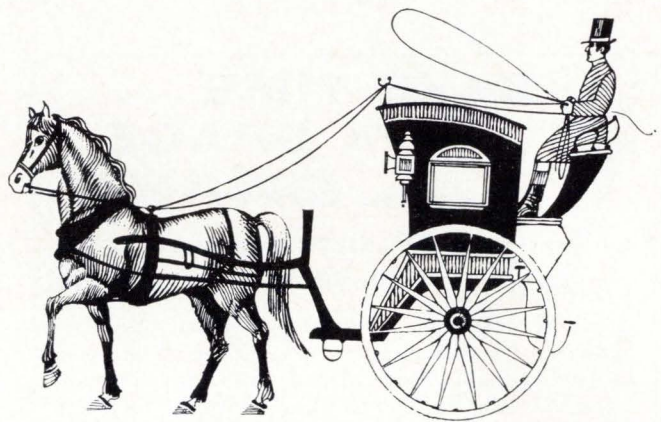

IS YOUR TAPE CONVERSION STILL WORKING AT HORSE AND BUGGY SPEEDS?

THINK AHEAD...THE NEW KLEINSCHMIDT 321 ADS CONVERTS TAPE TO HARD COPY AT 400 WORDS PER MINUTE!...TODAY



Think of tape conversion four times faster than you may be getting now. Think of less tape backup. Think of the Kleinschmidt™ 321™ ADS. Whether it's used "on line" or "off line," the 321 ADS gives you complete and reliable facilities for tape preparation, tape duplication and hard-copy print-out. For further information on the

efficiency of the 321 ADS and other Kleinschmidt Electronic Data Communications equipment, write: KLEINSCHMIDT, Division of SCM Corporation, Lake Cook Road, Deerfield, Illinois.

THINK AHEAD
... THINK SCM



CIRCLE NO. 21 ON INQUIRY CARD

POWER LOSSES AT EDP INSTALLATION OVERCOME BY LINE-VOLTAGE REGULATOR

The necessity for line-voltage regulation in electronic data processing systems has been re-emphasized with the installation of regulators at a southwestern U.S. Air Force Base. The EDP section of the base had been experiencing voltage fluctuations large enough to cause a complete power shutdown on several or all computer components. When magnetic tape trunks or data disc files were operating at the time of voltage fluctuation, complete power shutdowns could — and did — cause from \$200 to \$400 of testing or re-sorting time. According to Sola Electric Co., the installation of their regulators has considerably reduced the number of such failures.

Base EDP personnel have pointed

out that the regulation, being the difference between voltage fluctuation and complete power shutdown, has saved about 120 hours of computer testing or re-sorting time. Based on a 200-hour-per-month prime shift contract, the time saved is worth about \$8160 of the taxpayers' money.

This particular Air Force base always experiences severe weather conditions during the months from April through June. In 1964, for example, a tornado damaged power stations and lines supplying power to the computer. Temporary power was restored within 36 hours, and processing resumed. Severe voltage fluctuations were experienced in buildings immediately adjacent to the computer site, but the computer operations

remained normal. During the three-week period when temporary power was supplied, many instances of voltage fluctuations, exceeding the input rating of the line-voltage regulator, were experienced. However, electricians informed EDP personnel that nevertheless, the input voltage to the computer was 190 volts minimum. Normally, the regulator maintains an output voltage of 208 volts $\pm 1\%$ when input voltage does exceed its input rating. The electricians indicated that installation of the regulator units permitted normal operation during this three-week period.

The Sola Electric regulator is a fast-response electronic-magnetic device which will produce 90% correction in less than 5 cycles and complete correction in 10 cycles for 20% line-voltage changes or load variations of 0 to 100%. At 10 KVA and above, it is said to be the only regulator available with this response time.

Circle No. 111 on Inquiry Card



**SAVE TIME ...
SAVE SPACE...
with new DRAKE**

**Bi-Pin Cartridge ★ Lamps ★
Lampholders ★ Assemblies**

A whole new line — designed especially to *slice direct cost and assembly time alike* — gives you unusually wide choice of 5 neon, 5 incandescent lamp varieties — 4 useful filter styles in 5 colors.

All fit in any Bi-Pin Lampholders, as well as in two special aluminum body DRAKE styles, which feature small size, sturdy construction, insulated contacts, various optional built-in resistors for neon. Replacement? The easiest!

EXCLUSIVE: *Indexed* Readout Filters — 1 to 3 letters or figures — always position upright — saves expensive assembly time because body is keyed to hole. And — The *only* neon types you can get with flush or short cylindrical filters!



DRAKE

**MINIATURE
LIGHTING
SPECIALISTS**

4624 N. OLCOTT AVENUE • CHICAGO 31, ILLINOIS

CIRCLE NO. 22 ON INQUIRY CARD

"PERFORATED TAPE READERS"

A 20-Page Reprint Now Available

The industry-wide survey of perforated tape readers that appeared as the Product Reference File feature in the January 1965 issue of COMPUTER DESIGN is now available as a 20-page reprint.

Providing a comprehensive analysis of the design and performance characteristics of commercially-available perforated tape reading equipment, this survey article serves as an excellent reference for evaluating and selecting a tape reader for a particular application.

**Order Your Copy Now!
Only 50 cents per copy.**

**Enclose check or money order payable to:
Computer Design Publishing Corp.**

**And mail to: Computer Design
Baker Ave.
W. Concord, Mass. 01781**

Now! Abacus adds the F-Series integrated circuit modules for complete design freedom

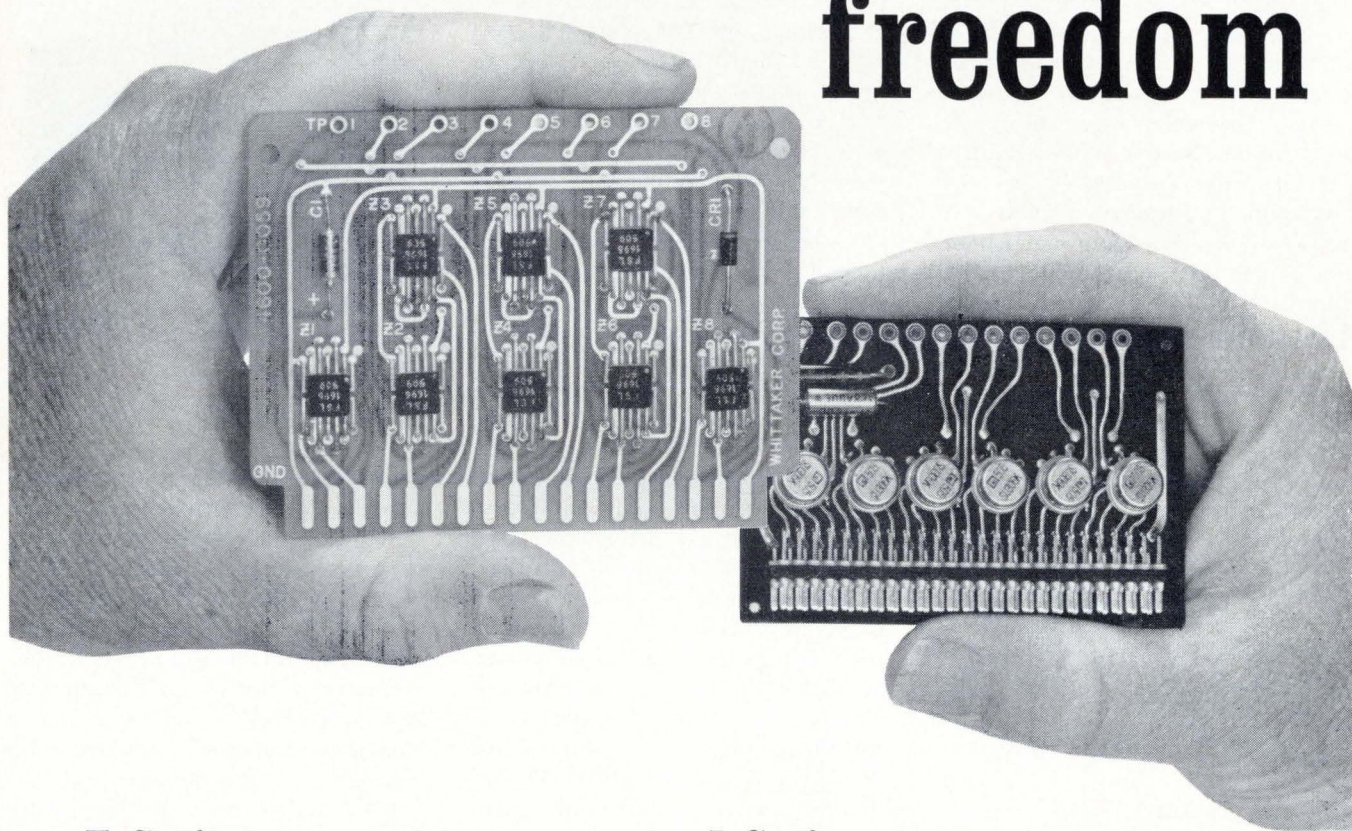

F-Series FUNCTIONAL: Many common functions are prewired on module PACKING DENSITY: 500 to 1000 flip-flops in 3½" drawer FAN-OUT: 8 NANDS or flip-flops and 40 pf at 5 mc.

Auxiliary circuits, interfaces, and standard hardware and power supplies available for both series. Complete application and wiring documentation provided upon request.

48 HOUR DELIVERY

I-Series GENERAL PURPOSE: All inputs & outputs available at pins PACKING DENSITY: Over 1000 flip-flops in 3½" drawer FAN-OUT: 12 NANDS and 10 ff and 200 pf at 5 mc.

Whittaker
CORPORATION
Abacus DIVISION

12838 Saticoy St. — No. Hollywood, Calif. 91605
(213) 765-8160

CIRCLE NO. 23 ON INQUIRY CARD



NEW PRODUCTS

SHAFT ENCODERS

A new shaft encoder called the Model D "Digitizer", is an absolute digital output device for use with closed-loop positioning and position display systems. It is said to feature a standard servo mount, lower driving torque, and fail-safe design. High level output, 30ma at 24vdc, is achieved without amplifiers. Dual brush technique, wherein each increment of shaft rotation determines a single, specific arrangement of contact closures, assures 100% accuracy. Higher order decades up to 5000 rpm can be monitored with two LSD's disengaged. Continuous monitoring of seven decades up to 100 rpm is possible. Coleman Electronic Systems, Santa Ana, Cal.

Circle No. 124 on Inquiry Card

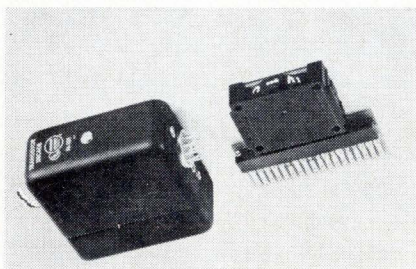

DECADE SWITCHES

A new packaging concept in decade switches utilizes integrated circuits to provide a size reduction of 20 to 1 as compared to the earlier switches. A true output (+5 volts) is provided when the decade count reaches a number preselected by the switch. The encapsulated decade operates with the 1-2-3-8 BCD code. Engineered Electronics Co., Santa Ana, Calif.

Circle No. 197 on Inquiry Card

MULTI-FUNCTION IC FLIP-FLOPS

Multi-function economies in integrated circuits have now been applied to flip-flops with the development of two dual J-K flip-flops which are additions to a line of medium speed digital monolithic circuits. The "multi-function" approach to integrated circuits consists of packing several circuit functions into a single monolithic bar of silicon. Since the additional circuits can be fabricated simultaneously with only a nominal increase in cost over that required to build one circuit, the cost-per-circuit-function can be reduced drastically. Although multi-function gates have been produced for some time, with as many as four and six circuit functions per network bar, it is claimed that this is the first time that multi-function IC flip-flops have been available. Each bar contains 85 component elements, including 32 npn and 8 pnp transistors with 200 picofarads of capacitance and 92,000 ohms of resistance. This component capability is equivalent to 8 to 12 gates in a single monolithic bar. The dual J-K flip-flop, the SN5302 version has independent clocks, inputs, outputs, and presets for each circuit. It is designed for ripple-counter, shift-register, storage-flip-flop, asynchronous-counter, and control-flip-flop applications. The SN5304 version is a dual J-K flip-flop with preset and clear, featuring independent inputs and outputs, independent presets, with a common clock and common clears. Its capability encompasses synchronous counters and the full range of shift-register functions, including parallel input. Both of the new single-phase flip-flops have a fan-out of 10. Texas Instruments, Dallas, Texas.

Circle No. 149 on Inquiry Card

INDICATOR LIGHTS

Said to have been designed in conjunction with leading industrial designers, a new indicator light features a $\frac{3}{4}$ " square lens, mounts in a $\frac{7}{16}$ " diameter hole, and is $1\frac{11}{32}$ " in length. The two-terminal indicator light is designed for replacement of lamp from the front, "Push" to install the lens, "Pull" to remove lens. The Sloan Co., Sun Valley, Cal.

Circle No. 158 on Inquiry Card

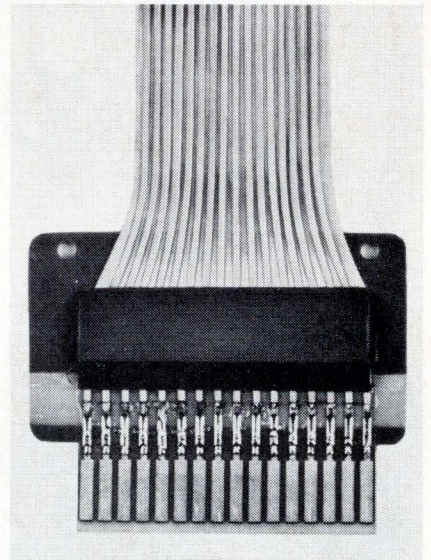

FLAT CONDUCTOR CONNECTIONS

Flat conductor cable systems can be produced with very narrow cable with extremely small conductor center-to-center dimensions, called "Micro-pitch", which can then be spread (called "Spread Pitch") to match the pitch of PC boards or other interconnections hardware. The pitch of the conductors in the cable is one dimension and then spread, without etching, to be compatible with the pitch requirements of the PC board. Considerable savings in weight and size are said to be accomplished without loss of strength, flexibility, or current carrying ability. Retractable roll-ups (expandable rack and panel systems), accordions, or other preformed shapes with "Spread-Pitch" and "Micro-Pitch" even further enhance the inherent features of flexibility for continuous or frequent bending or moving of cable. ACI Div., Kent Corp., Princeton, N. J.

Circle No. 165 on Inquiry Card

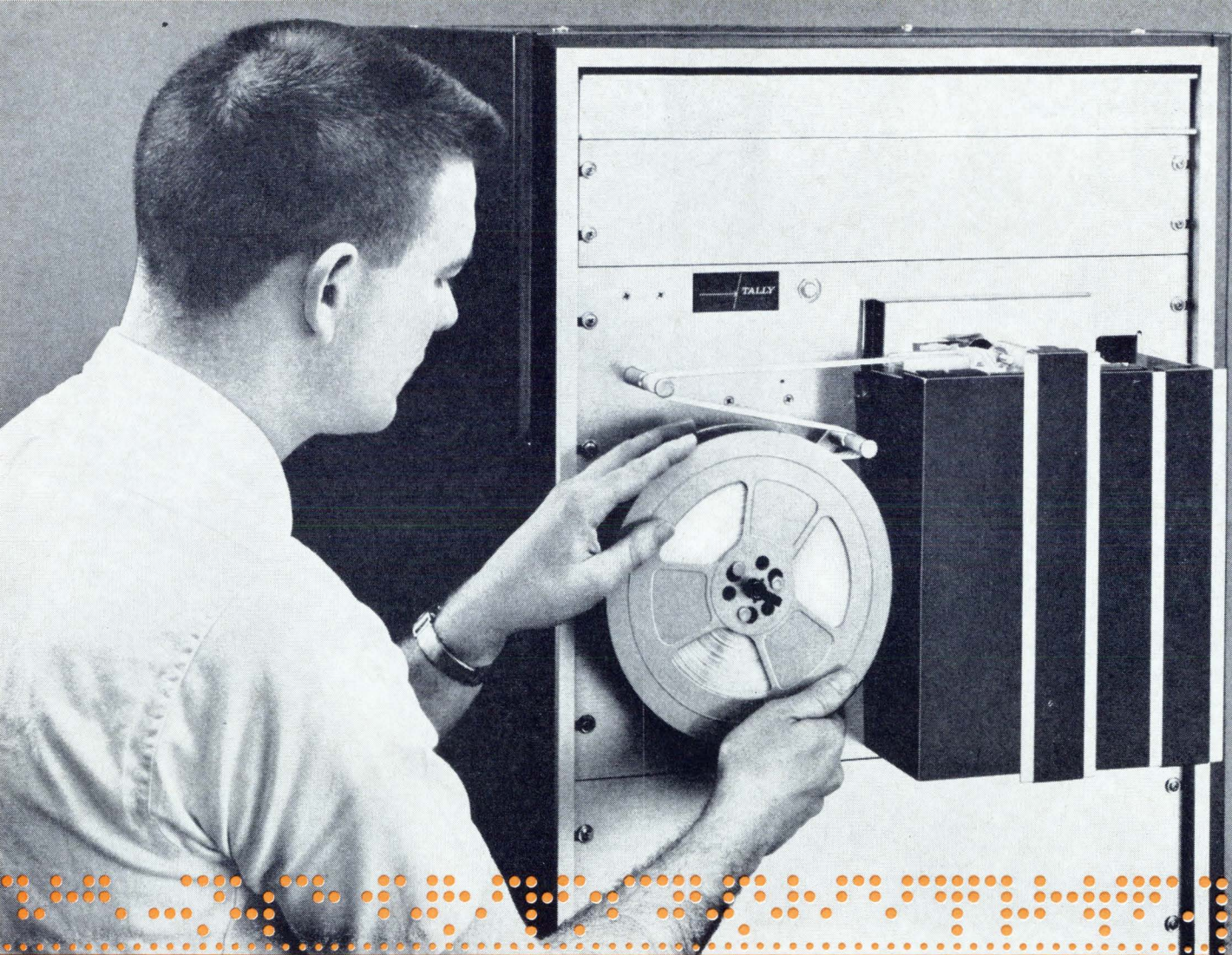

NEW P-120 PERFORATOR...

... puts down data at 120 char/sec,
catches errors,
and prices out at \$975 in quantity

Once in a while, a new product comes along which fits the functional needs of a market to a "T". Tally's new P-120 Perforator is just such a device. The P-120 embodies more useful features and better performance specifications than any perforator ever offered at this price (or even several times the price).

This compact, panel-mounted perforator features integral tape supply and take-up reeling.

The P-120 is designed for quick, easy, front tape loading. Using a limited number of moving parts in a highly accessible frame gives exceptional reliability and speeds maintenance. Operation is asynchronous. Error control and remote tape backup options are offered at modest extra cost. Error checking is accomplished by contacts which

sense the mechanical motion of each punch pin. If an error is sensed, a delete code can be punched **before** the tape advances.

A new bulletin, yours for the asking, tells all. Write our Mr. Ken Crawford, Tally Corporation, 1310 Mercer Street, Seattle, Washington 98109. In the U.K. and Europe, address our man in London, H. Ulijohn, Tally Europe Ltd., Radnor House, 1272 London Road, Norbury, S.W. 16, Surrey, England.



CIRCLE NO. 24 ON INQUIRY CARD

NEW PRODUCTS

X-Y SWITCHING SYSTEM

A new X-Y relay system operates in a random access mode. Economic switching in low level data acquisition measurement applications is said to be possible due to superior electrical performance and ruggedness of unit's design. Performance characteristics include a 60 channel per second scanning rate; low thermal EMF; current carrying capacity to 10 amps; current switching capacity of 250 milliamperes; and a contact resistance of 2 milliohms max. McKee Automation Corp., No. Hollywood, Cal.

Circle No. 145 on Inquiry Card

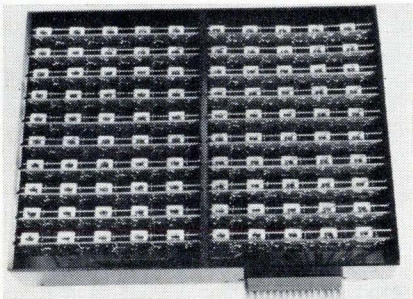

REED RELAY SWITCHING MATRIX

A reed relay matrix has been designed specifically for the routing of high-speed pulsed data from one input channel to one or more of many output channels. The switched path has very low distributed capacitance and inductance, and for high-frequency signals this gives the properties of high characteristic impedance transmission with minimum distortion and deterioration of pulse rise time. The system, called the datareed matrix, also is said to offer a unique method of cross-point selection using solid-state silicon circuitry for latching and unlatching individual cross-points from low level logic inputs. A.D. Data Systems, E. Rochester, N.Y.

Circle No. 157 on Inquiry Card

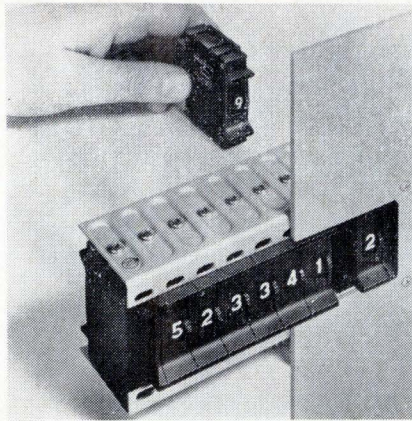

THUMBWHEEL SWITCHES

New interchangeable thumbwheel switch assemblies directly replace other similar style switches without need for change in panel cutout or mounting dimensions. Unique advantages are single switch replaceability without removing the whole assembly, plus metal-to-metal mounting of hardware assembly to panel — which does not rely on plastic parts to hold the assembly in place. The assemblies convert dial setting to a wide variety of electrical output codes eliminating or simplifying conversion from man to machine. Units meet or exceed MIL-S-22710. Majority of switches range in price between \$5.00 and \$14.00 in single unit quantity. Engineered Electronics Co., Santa Ana, Cal.

Circle No. 139 on Inquiry Card

MICROMINIATURE INDICATOR LIGHT

Transistor-driven, microminiature indicator light features a subminiature "relampable" bulb and a silicon epitaxial transistor. It is said to be smaller than a kernel of corn. Designed for use with computer logic boards and high density control panels, the light mounts without hardware by press-fitting into a 0.191 inch diameter panel hole and extends less than $\frac{5}{8}$ " behind the front of the panel. It is designed for use with T-1 subminiature lamps with voltage ratings between 1.5 and 28 volts and current ratings up to 125 milliamperes. Cal-Glo Co., El Segundo, Cal.

Circle No. 174 on Inquiry Card

PC BUSSING CONNECTOR

Nine-contact bussing connector for mounting on printed circuit boards is expected to find applications in communications, data acquisition, and transmission equipment. It mounts on any printed circuit board up to $\frac{3}{32}$ " thick; mounting is through standard 0.051 diameter holes. The connector is suitable for dip or wave soldering. Jumper bars are available for bussing between any pair of contacts. The contacts are formed of beryllium copper, electro-tinned. Insulation material is glass-filled diallyl phthalate. The connector measures $\frac{2-3}{8}$ " long x 0.340" wide x $\frac{7}{16}$ " high, not including terminals. Price is 75 cents each in production quantities. Methode Electronics, Inc. Chicago, Ill.

Circle No. 188 on Inquiry Card

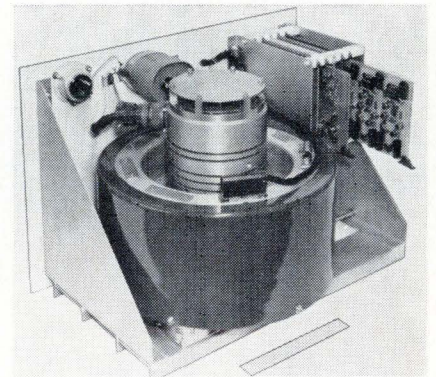

DISC MEMORY

New disc memory system was designed to meet high quality industrial applications requiring a $\frac{1}{2}$ million bit capacity. The model DM220 features a standard model with 1 clock track, 1 origin track, 1 recirculating track, and 15 data tracks which can be expanded to 64 data tracks. Ferranti recording techniques are employed with 8000 bits per track. The three output clocks are basic clock CL0, phase 1 clock CL1, and phase 2 clock CL2. Phase 1 and 2 clocks are delayed from phase 0 for maximum signal during reading and are 180° out of phase. During read mode, the output is provided by a flip-flop at CL1 time. Physical size is $12\frac{1}{4}$ " high by $17\frac{1}{2}$ " wide by $12\frac{1}{2}$ " deep. Data-metrics Corp., No. Hollywood, Cal.

Circle No. 133 on Inquiry Card

A 20-million-bit mass core memory can be economical, reliable, and fast! Here's how:

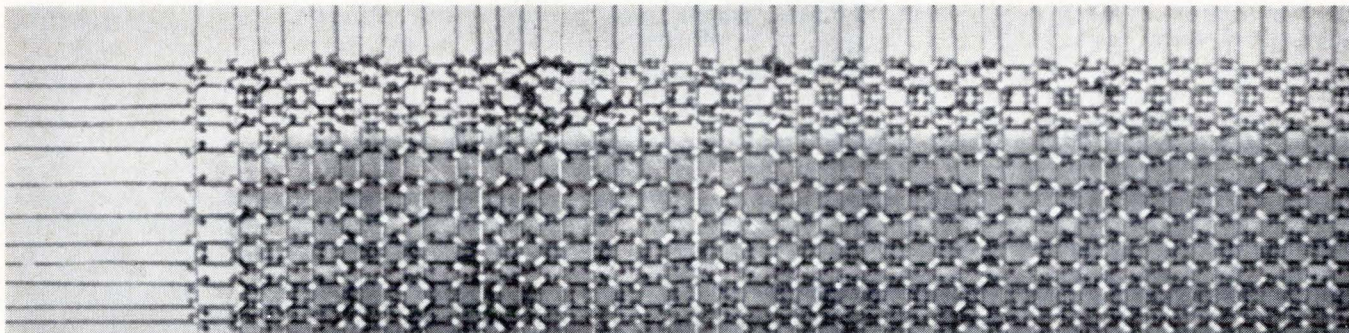

Coincident-current versatility with only two wires!

(Cross-section of Fabri-Tek's simple and reliable orthogonal mass core memory plane.)

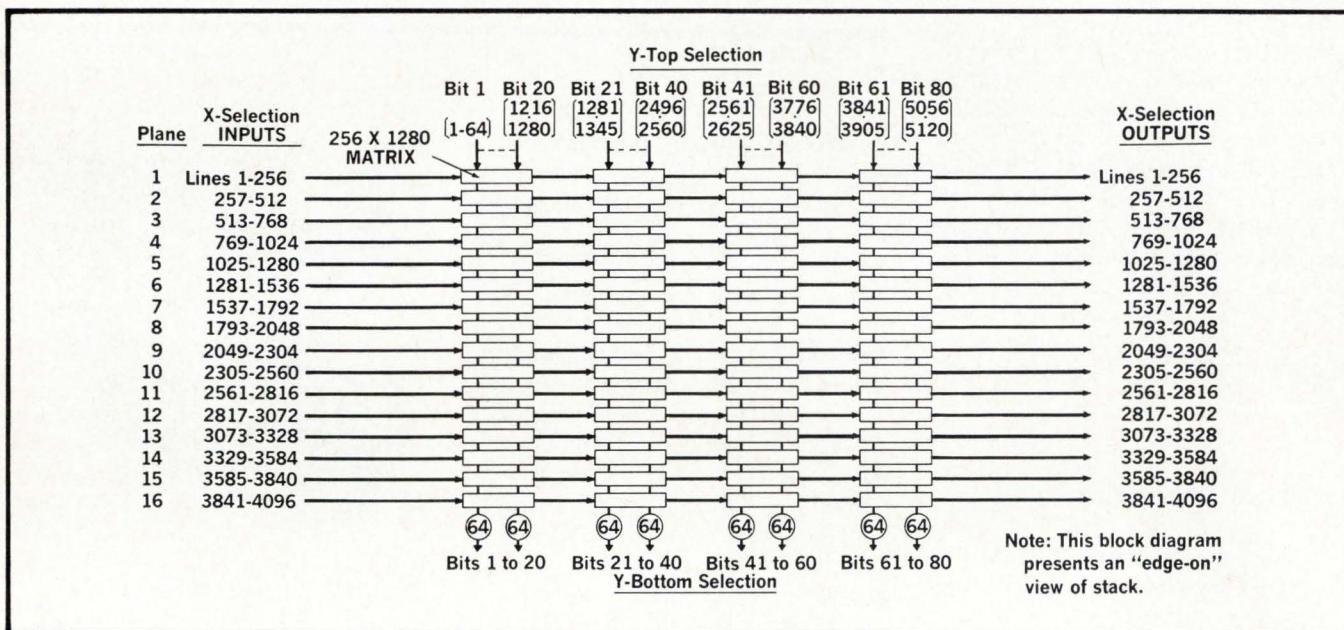

Here is the road-map to reliability!

(Core-selection block diagram for Fabri-Tek's mass core memory stack.)

In extremely large capacity core memory systems such as Fabri-Tek's new Series MT mass core memory, the stack and core selection circuit costs become the major system cost consideration. The illustrations above show the key factors which make the Series MT a truly practical mass core memory.

A simple and reliable orthogonal array uses only X and Y wires to reduce the stack stringing cost and to reduce X and Y drive line soldered connections by a ratio of more than 4:1.

The core-selection block diagram shows how a 20-million-bit array is divided into 4,096 X lines and 5,120 Y lines. A total of 327,680 cores is wired into each frame.

If conventional 128 X 128 matrices were used, a total of 1,280 frames would be required instead of 64. This would mean a total of 655,360 X and Y-line to frame connections compared to the 196,608 connections used in this Fabri-Tek memory.

Special Fabri-Tek circuit techniques, using all-silicon semi-conductors, give reliable memory speeds of 4 to 8 microseconds. Interface is compatible with discrete or integrated circuitry.

If you'd like more interesting facts about the Fabri-Tek mass core memory, write, call, or wire Fabri-Tek Incorporated, Amery, Wisconsin. Phone: 715-268-7155. TWX: 510-376-1710.



FABRI-TEK
INCORPORATED

CIRCLE NO. 25 ON INQUIRY CARD

NEW PRODUCTS

MODULE RACK ADAPTERS

Group of rack accessories can be used for multiple mounting of modular power supplies. These relay rack adapters are available in several basic types which permit any combination of modules to be adapted for standard relay and panel mounting. While primarily designed for the company's modular power supplies, these adapters are also applicable to other types of modular units as well. In addition to giving a maximum stacking factor, the adapters provide for efficient heat sinking or convection cooling for minimum heat rise. Facilities available with these adapters include interwiring of units, rear or front termination, metering, front panel controls, monitoring terminals or other special custom requirements. Prices start at \$35.00 per adapter for the simpler single tier type. Electronic Research Associates, Inc., Cedar Grove, N. J.

Circle No. 161 on Inquiry Card

COMPACT FAN FILTERS

Described as the most compact fan filter ever designed for "Boxer" and similar size fans, a new filter is said to save from 16 to 49 cubic inches of enclosure space. Only $\frac{1}{8}$ in thickness, the new filter is said to eliminate both the need to recess filter fans and the use of brackets for filter fan mounting. The filter ensures easier, quicker maintenance and more efficient filtering because material filtered out is readily detectable on the screen face and easily removed. The one-piece filter can be mounted directly to a cabinet panel. It also can be mounted directly on the fan, and the entire assembly, in turn, mounted on the outside of the cabinet — saving an additional 33 cubic inches of space within the enclosure. Filter is available for \$1.50 each in small quantities. IMC Magnetics Corp. Westbury, N.Y.

Circle No. 152 on Inquiry Card

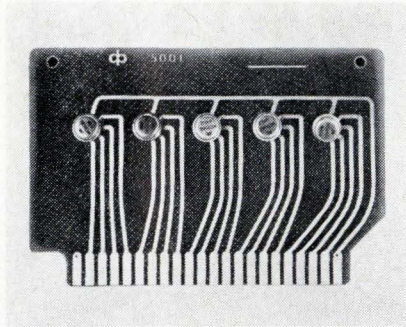

INTEGRATED LOGIC MODULES

Series of integrated logic modules has been developed as an economical and flexible means of utilizing highly reliable emitter-coupled integrated circuits in the design and

REMOTE-CONTROL SYSTEM

Standardized remote-control system, the Conitel 10 (Control, Digital, Electronic), has the capability of remotely-controlling and supervising up to 24 devices which operate such field equipment as circuit breakers, valves, and pumps. It can operate over virtually any communications media, including wire line, telegraph, voice facility, microwave, or power-line carrier. In an application involving 10 devices, the system can perform a supervisory function in one second and a control and supervisory operation in about two seconds. A wide variety of options and features are included so the system can accommodate many diverse applications. A single dispatcher at a master station controls and operates the system through a control and display panel that can be mounted either in the door of the equipment cabinet or in a desk-top turret. Basic components in the Conitel 10 system are "Correeds", glass-encapsulated contacts which switch circuits at split-second speed. The Conitel 10 is a so-called quiescent system in that it is inactive unless a change of status is detected at a remote station or a control is initiated by the dispatcher. Automatic Electric, Northlake, Ill.

Circle No. 156 on Inquiry Card

implementation of digital systems and instruments. Eleven basic circuit configurations encompass all standard logic functions. The modules, each containing five integrated circuits, are arranged so that all logic connections are available at the module connector, with power supply connections pre-wired to each integrated circuit. A wide variety of standard configurations are available off-the-shelf, with special configurations available on short delivery times. Compatible hardware and power supplies are also available. Digital Products, San Pedro, Cal.

Circle No. 184 on Inquiry Card

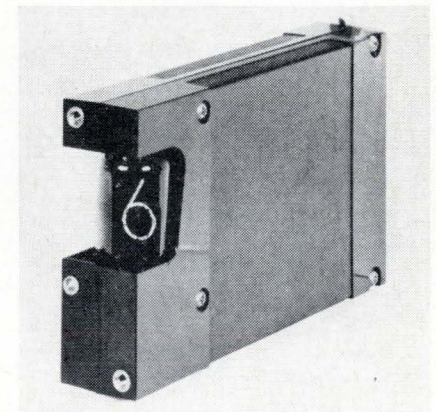

DECADE COUNTER/DISPLAY

All-silicon high speed counter with in-line Display counts at rates from 0 to 50 mc and displays the accumulated decimal count. The display includes all decimal digits and the decimal point. "Output Carry" and "Output BCD Levels" are provided. Since the circuit uses a common, rather than a ground, the drive signal may have an arbitrary reference level that matches the requirements of a wide variety of standard and non-standard logic control levels. The model B-100-50 comes in a conveniently mounted, rugged case that measures 3" x 5" x 1". It sells for the unit price of \$142.50 in quantities of 55-99. Janus Control Corp., Newton, Mass.

Circle No. 193 on Inquiry Card

If we don't show our age it's because our ideas keep us looking young. Like the one we patented back in 1948 for the first ferrite memory core. It actually gave the memory business its start. Now, many large computer manufacturers use our patents. Yet, we're still making more of these cores than any of them. Ten million a week. Every one of them fully tested. All at a good price.

We're known for other ideas, too. Like the Microstack®, the first miniaturized and ruggedized memory module. And for our basic research with core materials, multi-aperture devices, and circuitry.

While it's true we're the old man of the memory business, you'll find that Indiana General is still young at the core. Look to us for new ideas backed

by experience. The kind you can use. Experience that's yours for the asking. It's all in our technical literature packet on memory products. Write the Indiana General Corporation, Electronics Division/Memory Products, Keasbey, New Jersey.

INDIANA GENERAL 

Indiana General. The old man of the memory business.

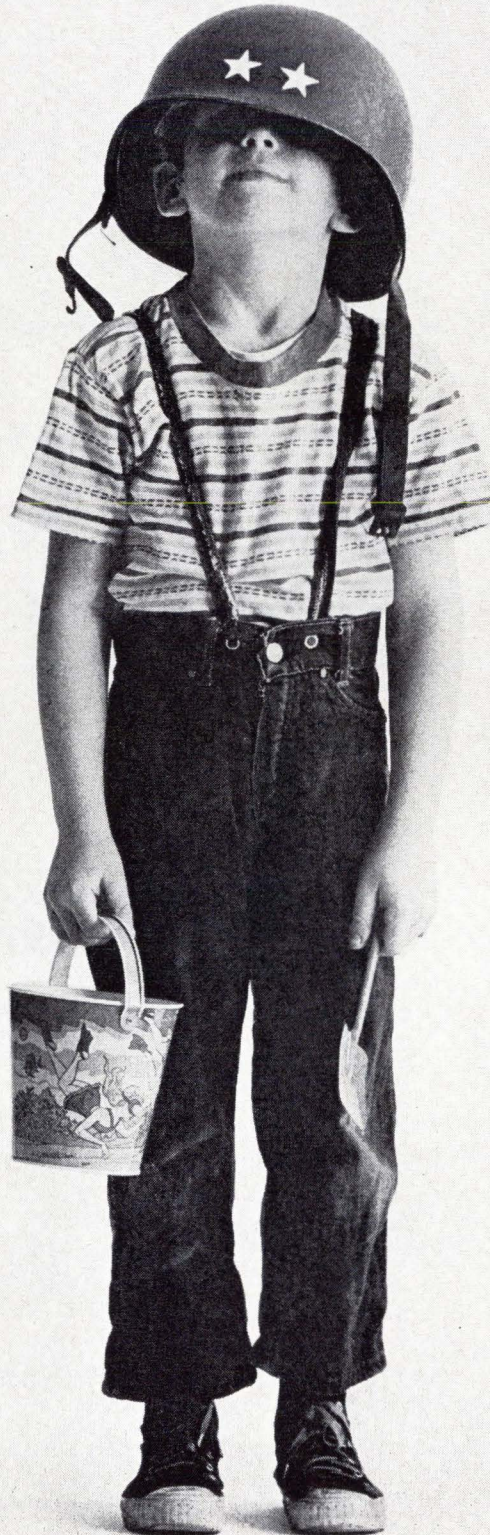

DIGITAL ENCODER

New electromechanical digital encoder, called the Memomark is adaptable to any data transmission system where analog (electrical or mechanical) signals are to be converted into digital values. The new encoder is said to be particularly suited to on-line computer systems, process control systems, and complex correlated-data systems requiring transmission of many variables which must be stopped in time for proper correlation. All models feature non-ambiguous entry to memory and buffer storage of input signal to prevent loss of information during memory update. Even if power fails, the last update data is retained. Depending upon requirements, the Memomark is designed to convert signals into straight binary code or BCD. Other Memomark features include parallel memory output allowing instantaneous readout or scanning; accuracy of 1 part in 10,000 over full range; and compatibility with most telemetering systems. Leupold & Stevens Instruments, Inc., Portland, Oregon.

Circle No. 126 on Inquiry Card

CORE MEMORY SYSTEMS

New line of current, core memory systems includes three models. The Model CC100 has a read/write cycle time of one microsecond, word size to 16,384 words and bit length of 4 to 60 bits. Model CC200 with a read/write cycle time of two microseconds comes in word sizes to 16,384 words and bit lengths from 4 to 60 bits. Model CC500 has a read/write cycle time of 4.8 to 10 microseconds, a word size to 16,384 words, and a bit length 4 to 36 bits. These systems are available for commercial use or to military specifications. Addressing can be random access, sequential non-interlaced or sequential interlaced. Other special optional features are available, such as indicator lights, parity check, and counters. Memory Devices Dept., Lockheed Electronics Co., Los Angeles, Cal.

Circle No. 160 on Inquiry Card

SILICON CONTROLLED SWITCH

New silicon controlled switch is essentially an NPN and PNP transistor pair designed in a positive feedback configuration. All four terminals are available on one side through a glassivated hermetic-seal. The fabrication process allows batch manufacturing, batch glassivation, batch fabrication of interconnect pads, and batch testing. The batch fabrication of interconnect pads is made by metallurgical bonding of all devices simultaneously while they are still on the wafer. This permits final test probing of raised contact pads on the wafer. No header is required, and individual bonding of wires from device pads to header posts, duplicate test procedures and additional encapsulation are eliminated. The device is available as

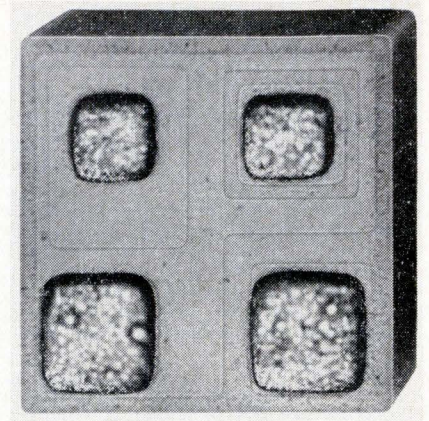

a component part of hybrid integrated circuits including a latch circuit, a decimal readout driver, a binary-to-decimal converter with memory, and a counter. Burroughs Corp., Plainfield, N.J.

Circle No. 183 on Inquiry Card

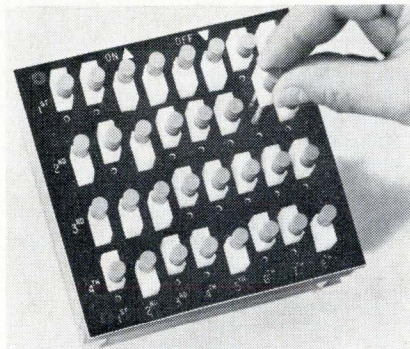

PROGRAMMING BOARDS

New cordless programming board, providing a SPDT switching function, features a pivoting, captive shorting pin which can be rotated through 360 degrees. Contacts are located on two decks of the program board at both 0 degrees and 180 degrees. These two contacts are normally open until the pin is inserted. Electrical connection to each contact is brought out independently to the rear panel of the program board. This new unit also features "Klip-on" electrical terminations, and color coded pins for program identification from a distance. The board is said to be more economical than a comparable array of toggle switches for many applications. Seaelectro Corp., Mamaroneck, N.Y.

Circle No. 153 on Inquiry Card

HIGH-SPEED PERFORATOR

Tape perforator, the Model P-120, is capable of operating at up to 120 characters per second. A synchronous operation eliminates the need for synchronizing the associated system with the cyclical rate of the perforator. Therefore, the Model P-120 is said to be an excellent device for use in computer input/output equipment, tape preparation systems such as those found in photocomposing, linecasting, other programming applications, data logging, and data communications. The panel-mounted perforator features integral tape supply and take-up reeling. Compact packaging significantly reduces the amount of radio frequency interference caused by the P-120. Error control option allows the motion of each punch pin to be mechanically sensed as the character is being punched; odd or even parity can be checked. If an error has occurred, the tape advance pulse can be inhibited and the erroneous character overpunched with a delete code. Basic unit is priced at \$1300 with substantial quantity discounts available. Tally Corp., Seattle, Wash.

Circle No. 155 on Inquiry Card

UNIVERSAL BUFFER

A new "Universal Buffer" derives its name from its ability to handle up to 100 telegraph data lines, or other data channels' simultaneously. In addition to its basic functions of message assembly and disassembly, the buffer also performs the tasks of code and format conversion, line identification, input-output timing, and communication line monitoring. Built-in system reliability is said to be assured through error detection and retransmission of messages in error. In the event of communication line failure, the buffer will transfer a "Line Fault" message to the computer for diagnostic print out. Data Trends, Parsippany, N. J.

Circle No. 138 on Inquiry Card

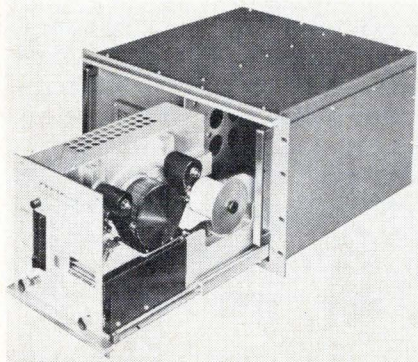

DIGITAL PRINTER

New digital printer uses a six-font print drum to provide for the mechanically changing from one four-line binary code to another. To change the input character code, the print drum is simply indexed so that the desired font vs. character code coincides with a key-way on the print-drum shaft. Thus, circuit changes are not required to accommodate a change of coding. Each font has its characters in a sequence that matches the particular code with which it is to be used. The three selectable codes are 8421, 4221, and 2421. It is priced in the \$1500 range (\$1250 to \$2000, depending on quantity and columns); any number of columns may be specified from 1 to 12. Printing rate is 20 lines per second. Price includes rack/table cabinet. Franklin Electronics, Inc. Bridgeport, Pa.

Circle No. 154 on Inquiry Card

SWITCH AND PROGRAM **fast simple**

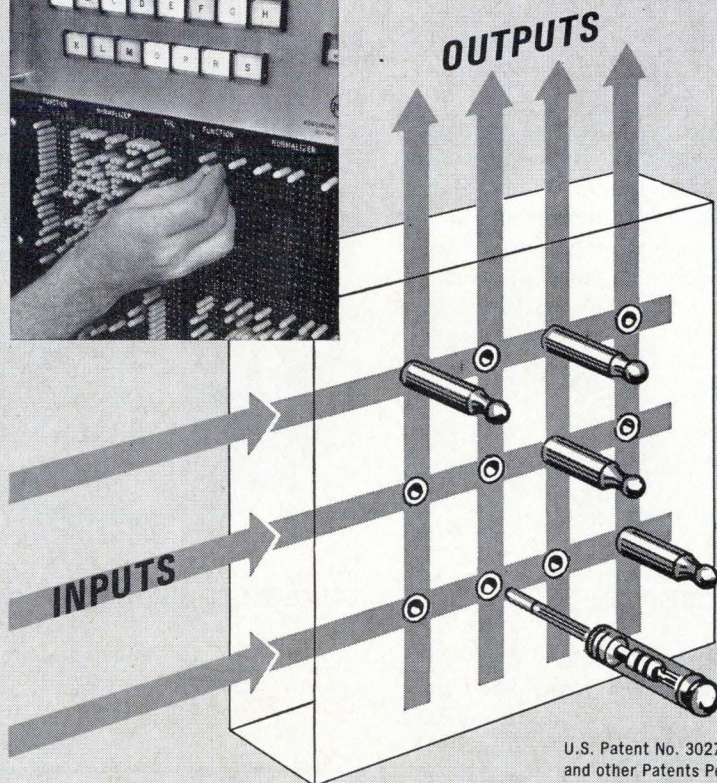

U.S. Patent No. 3027534
and other Patents Pending.

SEALECTOBOARD[®]

End patch-board clutter and confusion . . . "Sealectoboard" programming and switching provides complete ease and simplicity of operation with drastic reductions in hardware and space. Complete programming or multi-switching operations are provided in a mechanically simple, ruggedly constructed "Sealectoboard." A single pin completes switching or component insertion in a circuit . . . move the pin to a new location and you have a new program function. Sealectoboard is made in 2, 3, and 4 deck versions. Modular or custom designs available for any application. Patented* component holders for interpositioning diodes or other components, skip pins and shorting pins are available in colors for color coding. Send for your free copy of our latest catalog of engineering information and application data . . .



PROGRAMMING DEVICES DIVISION

SEALECTRO CORPORATION

HOYT STREET • MAMARONECK • NEW YORK
PHONE: 914 698-5600 TWX: 914-3180

Sealectro Ltd., Walton-on-Thames, Surrey, England

* Sealectoplug U.S. Patent No. 3145329

CIRCLE NO. 27 ON INQUIRY CARD

NEW PRODUCTS

DIGITAL MOTOR/CONTROLLERS

New product line of digital motors and controllers for industrial control systems, data processing, and computer interface applications was developed to meet, according to the company, a wide range of torque, speed, and accuracy requirements at exceptionally low prices. The digital servomotors with matching controllers feature controlled variable speed, immediate reversal, no mechanical detents or brushes, no drift, minimum overshoot, and require no compensation networks or feedback. The motors are bidirectional, magnetically-detented, pulse-operated units with matching plug-in, printed circuit controller that enables 15°, 45°, and 90° stepping increments. Automation Development Co., Monterey Park, Cal.

Circle No. 146 on Inquiry Card

DATA ACQUISITION

Data acquisition, handling and processing system was designed for a wide range of applications, including performance analysis, process monitoring, automatic checkout, on-line quality control, engine testing and other checkout functions. The unit is said to represent a new concept in flexible, modular, computer-controlled data acquisition and analysis. It can acquire digital and analog data under stored program control; data is edited and formatted on location for immediate analysis and action. The system eliminates the need for collecting large quantities of meaningless data, and the delays associated with central computation facilities. The basic system includes a scanner, A/D converter, control and buffer unit, a digital computer with 1028 words of memory, input keyboard, typewriter and reader/punch. Several options are available. Basic unit is priced under \$45,000. Electronic Associates, Inc., Long Branch, N.J.

Circle No. 121 on Inquiry Card

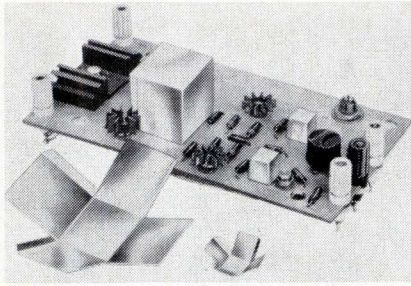

MAGNETIC SHIELDS

Higher density packaging can now be achieved by enclosing magnetically sensitive components of any size or shape in "Netic" and/or "Co-Netic" foil alloys. The shields minimize magnetic interaction and effects of external magnetic disturbances. Accordingly, commonly used reac-

tive components or devices radiating magnetic fields can now be positioned in very close proximity to each other. Where quantities warrant, Netic and Co-Netic pre-fabricated conformal can enclosures should be considered instead of foil alloys. Permanently pre-annealed Netic and Co-Netic magnetic shields are shock insensitive and have minimum retentivity. Photo shows possibilities of proximity positioning of reactive components. In the foreground are simple outline patterns cut with ordinary scissors and folded to generate functional shields. Magnetic Shield Div., Perfection Mica Co., Chicago, Ill.

Circle No. 159 on Inquiry Card

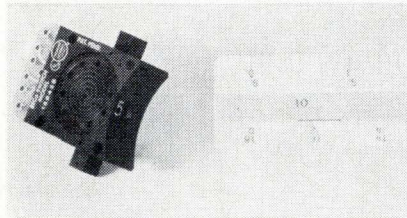

THUMBWHEEL SWITCHES

Subminiature thumbwheel switch is said to provide ideal applications

for pre-set ring counters and search/control systems. The switch features ready to use, prewired circuitry which provides a 10 position, 2 pole, biquinary code with two isolated commons. Unit measures 1 inch high and 1/2 inch wide and occupies 1.02 cubic inches behind-the-panel. Prices start at \$8.50 in quantities of 1 to 9. Engineered Electronics Co., Santa Ana, Cal.

Circle No. 172 on Inquiry Card

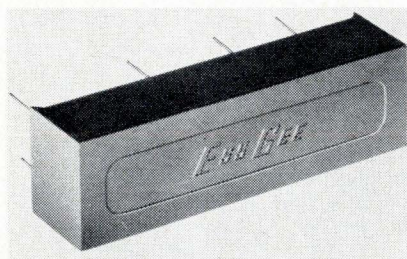

LOGIC MODULES

New silicon logic modules are potted in an epoxy to provide high degree of reliability under extreme environmental conditions, and to avoid dip soldering "hot spots." The series, designed for optimum noise immunity and worst-case tolerance conditions, includes bistable, inverters, a driver and a gate, each measuring 2 1/2 x 37/64 x 47/64 inch. All the modules in this series can be inte-

grated for multiple logic functions. Any output may be shorted to ground without damage to any component. A J-K bistable, which has a single transistorized J-K type flip-flop circuit, operates at frequencies up to 2mc in T, RS and RST modes. It is capable of driving 8 unit-loads (4ma to +13 volts) of 4 ma each and may be driven with external OR gates for applications such as shift registers, adders, preset binary or decimal counters, ring counters and frequency dividers. An RS bistable, operating at frequencies up to 2mc, may be used as a switching element in shift registers, adders, counters and frequency dividers. Ess Gee, Inc., White Plains, N.Y.

Circle No. 185 on Inquiry Card

FIRST SIZE 11 NEO-MAGNETIC NON-CONTACT ENCODER PACKAGES SIZE 18 CAPACITY INTO 1/6 THE SPACE AND 1/4 THE WEIGHT

Litton's new size 11 shaft-to-digital encoder offers a significant size reduction over a standard size 18 magnetic unit of like capacity. It's 84% smaller and 75% lighter. The reductions were effected through a new proprietary technique representing a distinct departure from the conventional "magnetic spot" approach in which ferrite discs are permanently magnetized to create code-symbolizing flux patterns. Now under patent application, Litton's neo-magnetic approach offers complete immunity from external conditions capable of degrading accuracy by altering magnetic patterns or nullifying operation through demagnetization. **■ ■ ■** Output of the new size 11 encoder is 7 through 19 bits natural binary, either decoded or undecoded for time-shared V-scan decoding logic. Resolution is 8

bits per turn. Operating speed ranges from zero to 1,500 rpm with slew rate to 4,000 rpm maximum. Electronics MTBF is conservatively rated at 15,000 hours. Mechanical life exceeds 200,000,000 revolutions. The electronics, available in discrete or microelectronic form and integrally or separately packaged, can be configured to multiplex a number of encoders. **■ ■** Litton's neo-magnetic, non-contact technique also permits other code patterns to be packaged into cases substantially smaller than previously possible. For details, write: 7942 Woodley Avenue, Van Nuys, California. Telephone 213-781-2111. New York: 212-524-4727. Chicago: 312-775-6697. **■ ■ ■ ■**

**LITTON INDUSTRIES
ENCODER DIVISION**

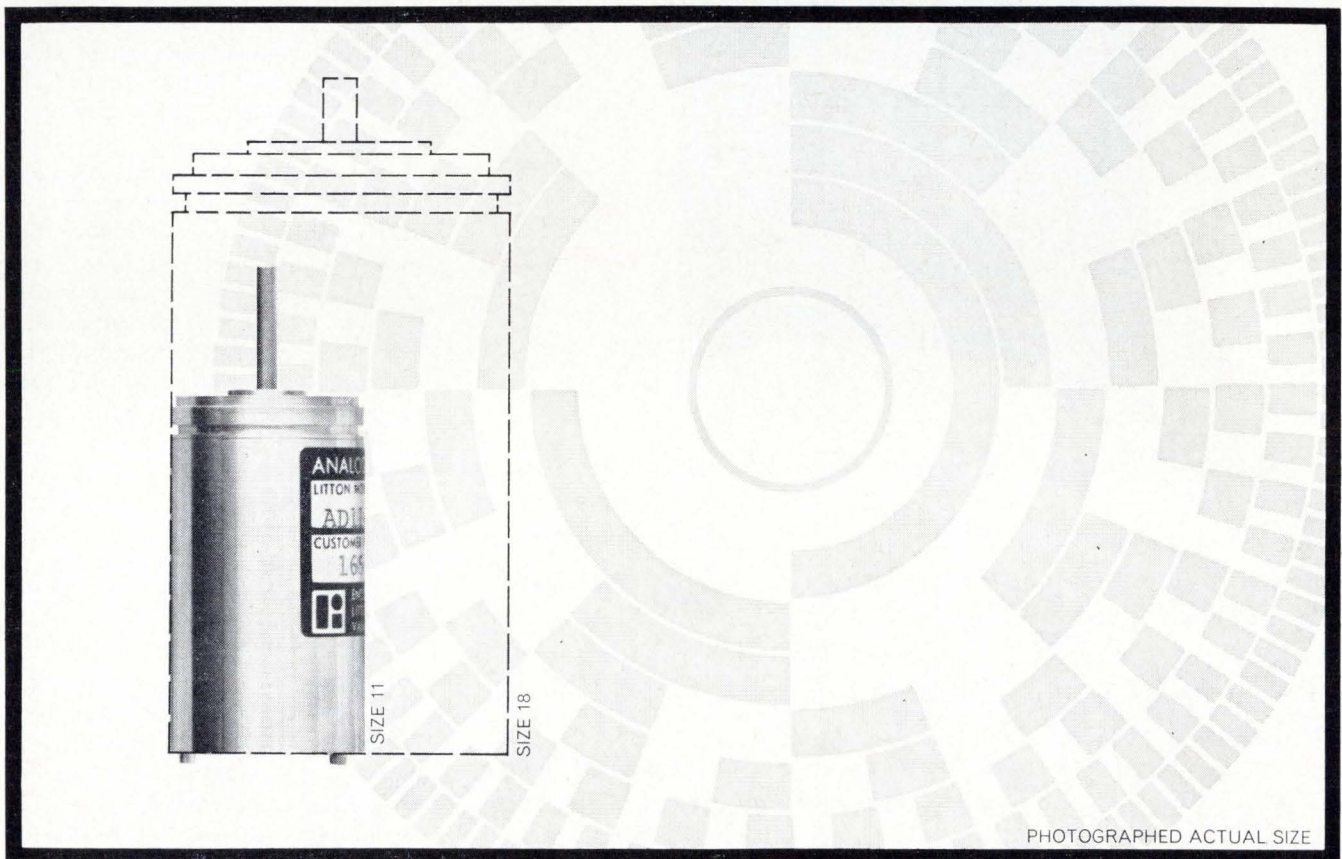

Specifications for Typical 13-Bit, Size 11 Neo-Magnetic Encoder

Resolution	2° per turn	Diameter	1.062 in.
Output Voltage, nominal	13 ma @ 4 v; higher if required	Length	1.825 in.
Interrogation/output cycle time	4.5 usec for parallel decoded word	Starting torque	0.05 oz-in max.
		Power consumption	700 mw

Optical **■ ■ ■ ■ ■** Solid-State Optical **■ ■ ■ ■ ■** Magnetic **■ ■ ■ ■ ■** Contact

CIRCLE NO. 28 ON INQUIRY CARD

Memory designers, read and store:

Raytheon Computer has reduced prices up to 20% on 2MC BIAx® memory systems, arrays and elements.

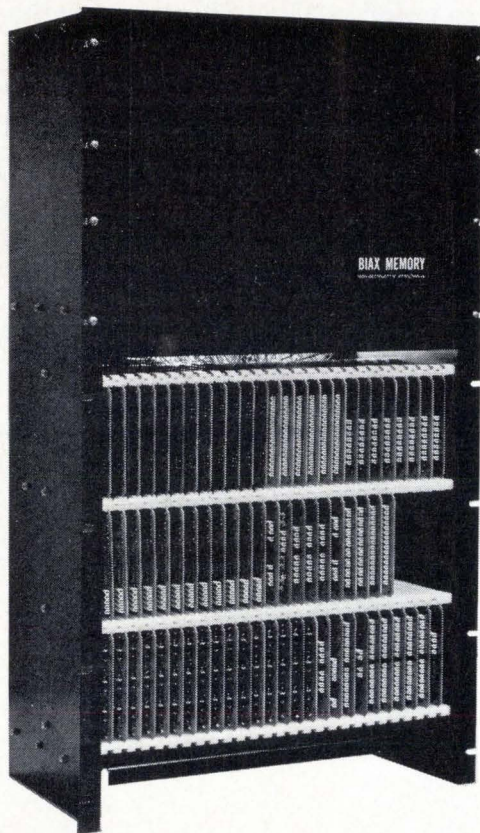

Now you can hike computer and data systems performance with BIAx 2 MC non-destructive readout memories at prices lower than those of coincident-current destructive readout systems for capacities up to 1024 words. For example, the 1024 word x 48 bit BIAx memory shown above can be delivered complete for only \$34,050 within thirty days. Other sizes from 128 to 1024 words are also available on short delivery cycle.

We've been delivering BIAx memory systems since 1961 with readout rates of 1 MC and faster for ground, airborne and spaceborne applications.

The price is right and we're eager to help you with your memory design programs. Call us direct at (714) 546-7160, Ext. 402, for engineering consultation. If you'd like technical literature, write for Data File B-109B. Raytheon Computer, 2700 S. Fairview Street, Santa Ana, California 92704.

CIRCLE NO. 29 ON INQUIRY CARD



NEW PRODUCTS

PLUG-IN DISPLAY

Plug-in display in a 9 pin throw-away encapsulated package features miniature size and low cost. It has a seven segment, in-plane incandescent numerical display with optional decimal point. Bright $\frac{3}{4}$ " high numbers are readable to over 20 feet. Specs include 1" mounting centers; 5 volts at 50 ma. per segment; and 1 ounce weight. Price: \$12.50. United Computer Co., Phoenix, Ariz.

Circle No. 144 on Inquiry Card

DATA GENERATOR

Model 206M data generator provides six channels of serially programmed pulse outputs in NRZ or RZ (variable width) format with 72 bits per channel and independent delay, width and amplitude for each channel. Auxiliary sync pulses, clock pulses, and command functions available permit test and evaluation of a wide range of high speed tape and memory devices, and other multi-channel pulse equipment. Internal clock rate is continuously variable from 2 cps to 2mc. Provision is made to slave the unit to an external signal source, and a single clock may be generated for each operation of a front panel pushbutton. Six channels of serial data are available with one independently variable output provided for each. The I/O content of each bit in each channel, up to 72 bits, may be independently toggle switch programmed. Serial word length is selectable from 1 to 100 serial bits. Serial words may be repeated continuously, or recycled manually by panel pushbutton, or by initiation of external command signals. Data format is independently selectable for each channel as NRZ or Variable Width. Data delay is independently controllable for each channel as zero, or continuously variable from less than 50 nanosec to 5 mil-licsec. Datapulse Inc., Inglewood, Cal.

Circle No. 128 on Inquiry Card

KEYBOARD TAPE CARD PUNCH

A 28 bank keyboard to tape or card punch unit can be used for data preparation whenever further processing of that data is required. In the standard unit, one or two entry columns can be used to set up supervision circuits so that pre-programmed fields must be filled with data before punching will occur. Lights are lit over the columns where data must be entered and go out when data is entered. Automatic characters can be pre-programmed and punched at the beginning and end of each block of tape. Price is \$2195.00. Digital Electronics, Kansas City, Mo.

Circle No. 134 on Inquiry Card

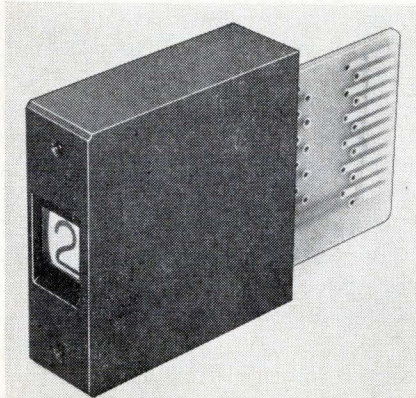
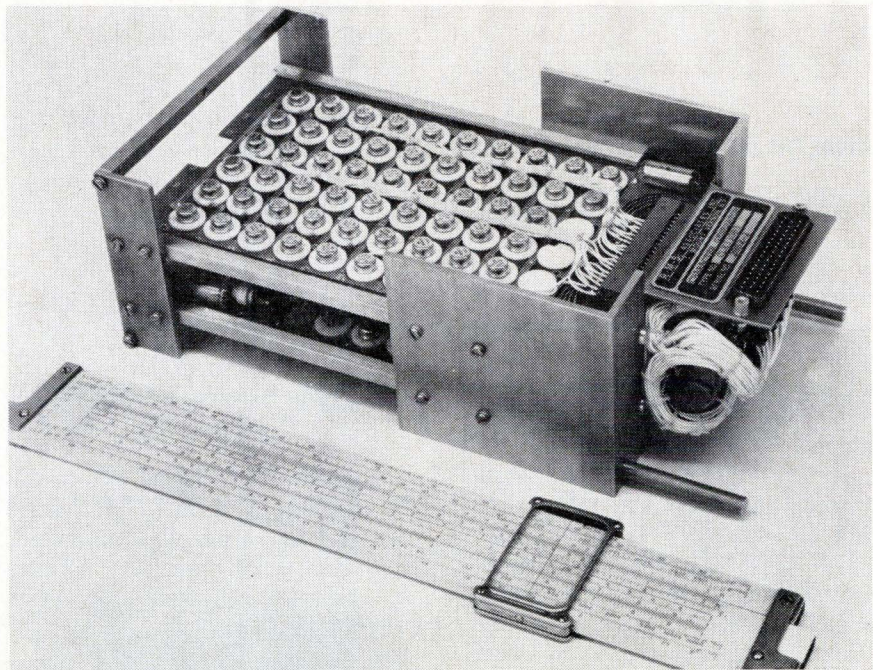

PULSE-DRIVEN DISPLAY

Electrically-pulsed display indicates numerals from 0 to 9 with a fast response time of 450 ms. Called the Logicator, it has only one moving part, the indicator wheel. The module is actuated by an 11 wire input through a printed circuit card in the rear of the display. Female connectors are furnished and solid state drivers are available for various computer interfaces. All numeral positions are magnetically-detented eliminating the need for electrical power between drive pulses. The Logicators can be stacked to provide any number of figures when parallel-driven. Total response time for any system will not exceed 450 ms. Actuating voltage requirement is 24 volts dc, 2 watts per module during the actuating period only. Bowmar Instrument Corp., Fort Wayne, Ind.

Circle No. 196 on Inquiry Card

IC CHARACTER GENERATOR

Packaged on only two 8" high x 4 $\frac{3}{4}$ " wide plug-in circuit boards, a new character generator is believed to be the smallest alphanumeric character generator and the first commercially-available generator built with integrated circuits. Stroke writing is used for character generation in the IC generator. The unit operates essentially the same as company's standard character generator, except that only two formats are used and rounding is not available at present in this integrated circuit unit. Capable of generating all digits, all letters (except the Q and Z), and four special symbols, the integrated circuit

unit operates at rates up to 50,000 characters per second. One interesting feature of the generator is that its crystal control clock allows the unit to be used as a clock source for other equipment in addition to performing the nominal function of character generation. Approximately 80 integrated circuits, 6 transistors, and several other discrete components are used in the IC generator, while the standard generator uses approximately 90 transistors, 250 diodes, 200 resistors, and 80 capacitors. Temperature range of the integrated circuit unit is -25C to +85C. Information Displays, Inc., Mt. Vernon, N.Y.

Circle No. 130 on Inquiry Card

AIRBORNE MEMORY

New magnetic core memory system is said to incorporate packaging and wiring techniques which afford great savings in both size and cost. One model, a 1024 word, 14 bit per word, random access memory is housed in a physical package of 4 $\frac{3}{4}$ " high x 10" wide x 12" deep. The power supply is in a separate box only 4 $\frac{3}{4}$ " high x 6" wide x 12" deep. This unit interfaces with micrologic circuits, operating with

logic levels of 0V and +3V. The new memory systems are available in sizes up to 4096 words and 36 bits per word. Conservative worst-case design techniques, combined with a circuit approach which minimizes the number of active elements, are said to provide high reliability at low cost. The memories will operate in temperatures from 0°C to 50°C. Rese Engineering, Inc., Philadelphia, Pa.

Circle No. 163 on Inquiry Card

NEW PRODUCTS

ANALOG PLOT DIGITIZER

A Model 300 Digitizer converts analog graphical information into codes on magnetic tape for digital computer analysis. It generates incremental coordinate data without potentiometers or analog-to-digital voltage converters. As the analog plot is traced with a carriage-mounted stylus, each 0.01-inch movement of the stylus and/or the carriage generates a pulse. Each incremental pulse is automatically (without a manual input instruction for each character) recorded in a single character on magnetic tape. When each character is recorded, the lateral odd parity bit is also derived and recorded. When an "inter-record gap" button is depressed, the IRG and longitudinal parity bits are automatically generated and recorded. "End-of-file" gaps are also generated automatically when the appropriate button is depressed. The task of summing the increments to obtain whole value coordinates is performed by the computer which finally uses the taped data. This new approach records 1" of analog plot on every 1/2" tape. Calma Co., Los Gatos, Cal.

Circle No. 141 on Inquiry Card

MAGNETIC CODE CONVERTER

Magnetic code converter utilizes magnetic tape-wound cores and silicon circuitry to provide readouts of arbitrary binary functions. The unit accepts a parallel 8-bit "argument" as an input and produces a parallel 8-bit "function" as an output. The 256 binary function numbers are completely arbitrary — they are specified by the user and permanently wired into a 32-bit core matrix. Two commands are required to control this Model 4043 converter: a Load command reads the parallel input code to the magnetic cores, and a Readout command reads the parallel output code to the output lines. Unit features are said to include low power consumption, small size, and excellent

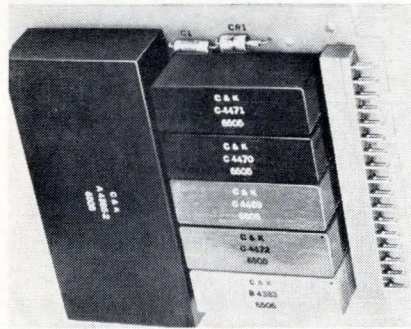

operating characteristics under shock, vibration, and other extreme environmental conditions. Maximum continuous conversion rate of the unit is 10kc. C & K Components, Inc., Newton, Mass.

Circle No. 169 on Inquiry Card

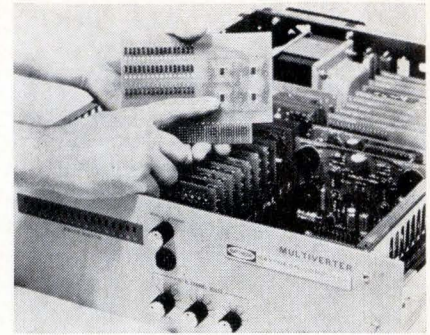

IC MULTIPLEXER

New multiplexer and a new multiverter, which combines a multiplexer/analog-to-digital converter/sample and hold amplifier system into a single unit, take full advantage of the cost and size reduction benefits of integrated circuitry by providing, according to the company, up to four times the data handling capacity for about half the cost of existing discrete component units. The integrated circuit multiplexer provides up to 256 data channels per standard 5 1/4" x 19" case. A basic unit can be expanded to 1024 channels, occupying four 5 1/4" cases. It samples data with a 4 microsecond settling time to 0.01% accuracy. A typical full-expanded multiverter can provide 50kc data throughout with 96 multiplex channels, a high-speed sample and hold amplifier, and a 12-bit analog-to-digital converter in the one compact drawer. Raytheon Computer, Santa Ana, Cal.

Circle No. 162 on Inquiry Card

NETWORK TESTING SYSTEM

Designed for testing wiring networks in multi-layer boards, back panels, electronic assemblies and cables, a new system called the Programmed Network Testing System TE 602, enables testing wiring networks at speeds compatible with high-volume testing required in many commercial and military operations. Testing such networks prior to assembly — that is, at in-plant receiving and inspection stations, or at vendors' final inspection — enables the TE 602 to closely monitor reliability and

quality control levels before networks are incorporated into electronic assemblies. The TE 602 can test an extensive range of complex wiring networks currently in wide use. In addition, the system design provides the required flexibility to enable testing the newest and most advanced types of interconnections — such as in multi-layer boards — and other future types. The basic TE 602 can perform this broad spectrum of tests without any modification of the basic system. The system operates under the control of either an IBM computer or a magnetic tape reader. The TE 602 is used to apply shorts

and continuity checks to wiring networks in circuits and assemblies ranging from 864 to 20,736 terminal points. Various tests are performed to determine that continuity exists in defined networks; any two points of a network will carry a specified amount of high current; a high-voltage pulse does not cause a short between networks; or that no extra wires or circuit paths exist. The TE 602 requires one operator to perform the entire range of these tests. IBM Industrial Products Div., White Plains, N. Y.

Circle No. 136 on Inquiry Card

SOLID TANTALUM CAPACITORS

Polarized dry solid tantalum capacitors are said to be priced competitively for commercial and industrial electronic equipment such as computers and business machines. Major features of the capacitors are: small size with 0.020 inch diameter and tinned nickel leads suitable for automatic insertion. The new capacitor is available in 29 standard ratings. The smallest of the three case sizes is 0.240 inches long by 0.090 inch diameter, available in ratings from 0.068 mfd at 20 WVDC to 10 mfd at 2 WVDC. The largest case size is 0.345 inch long by 0.180 inch diameter, available in ratings from 6.8 mfd at 20 WVDC to 68 mfd at 2 WVDC. The 1000 price for a 1.0 mfd, 20 WVDC unit is \$0.22. Components, Inc., Biddeford, Maine.

Circle No. 129 on Inquiry Card

INTEGRATED CIRCUIT CARRIER

An integrated circuit "Flat-pak" carrier is said to be the most versatile holder available for either $\frac{1}{8} \times \frac{1}{4}$ or $\frac{1}{4} \times \frac{1}{4}$ microcircuits. The circuits may be resistance welded, planar welded, or soldered to the gold plated, 0.019 diameter pins after positioning the circuit in a recessed cavity provided on the carrier. The 0.450 x 0.750 body of the carrier is compression-molded diallyl phthalate and features "Finger Lifts" for plug-in extraction, polarizing mark, and pad suitable for printing circuit identification. The carrier pins have been located on a polarized 0.05 x 0.10 pattern, and were selected to mate with an economical pin socket which may be soldered into a printed circuit board. Thus, the carrier may be a true plug-in device, or may be permanently soldered into either the pin sockets or a mother printed circuit board. The pin spacing provided on the carrier permits most integrated circuit interconnections to be made on simple 2-sided printed circuit boards. The carrier is said to solve many handling, testing, and mounting problems normally associated with the diminutive flat-packs. Walkirt Co., Los Angeles, Cal.

Circle No. 170 on Inquiry Card

PUSHBUTTON SWITCHES

Series of pushbuttons composed of easily assembled and interchangeable components — switch modules and actuators — can provide up to 90 different configurations to suit nearly every switch application. Options include momentary (push on, release off) and alternate (push on, push off) action switches; magnetic hold-in (using coil-equipped switch modules) operating on 6—,

28— and 48 volt dc; and wide power-handling capacities ranging from dry-circuit versions (measured in milliamperes) up to a full 2-horsepower (at 250 volts ac) rating. Contact arrangements available are 1-, 2-, 3- or 4-pole double-throw and 2 circuit double-break. Switch options range from husky basic snap-action switches down to subminiature models. Micro Switch, Freeport, Ill.

Circle No. 164 on Inquiry Card

DIGITAL DISPLAY UNITS

Digital display units, developed for CBS News election coverage, are now available for commercial and industrial use. As no lamps are used for illumination of this electromechanical 12-position readout, periodic replacement of "burnouts" has been eliminated. This is particularly important when a display is located in out-of-reach locations. Even in bright sunlight, the $1\frac{1}{2}'' \times \frac{1}{16}''$ characters on a vertical split-flap "back page" mechanism are completely visible, even if the angle of view is extended to 145°. The unit operates from any 110 volts ac outlet in conjunction with positioning switching, and requires only 2.7

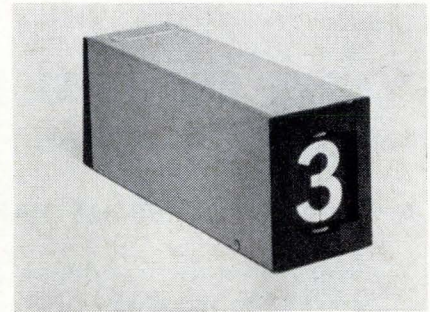

watts of power during postings — no power once the character is "found." Turning off power will not hold this position indefinitely — a useful feature in many applications. CBS Labs, Stamford, Conn.

Circle No. 125 on Inquiry Card

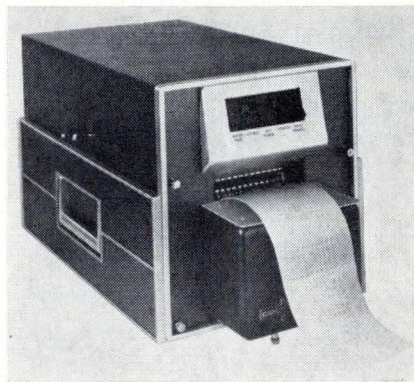

DIGITAL PRINTER

Digital instrumentation printer is said to offer at least twice the operating speed of any competitively-priced machine. The new instrument can print more than 10 lines

per second and also offers eight-digit column printing, with up to four additional columns optionally available. Designated the 410A, it is designed for digital printing of BCD information received from digital measuring instruments or computers. Unlike earlier printers, the 410A prints seven-segmented digits that are controlled by electromagnetically-triggered locking levers, and uses an all-electronic logic conversion. Once the segments are positioned, no power is required to hold the data. With a positioning time of 35 milliseconds, input data needs to be available for only one-third of the print cycle. CMC, San Fernando, Cal.

Circle No. 199 on Inquiry Card

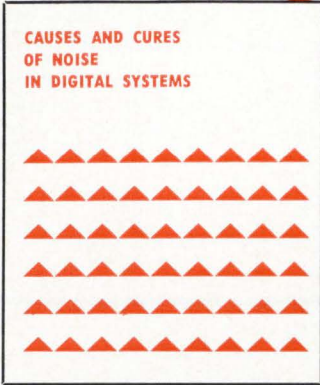
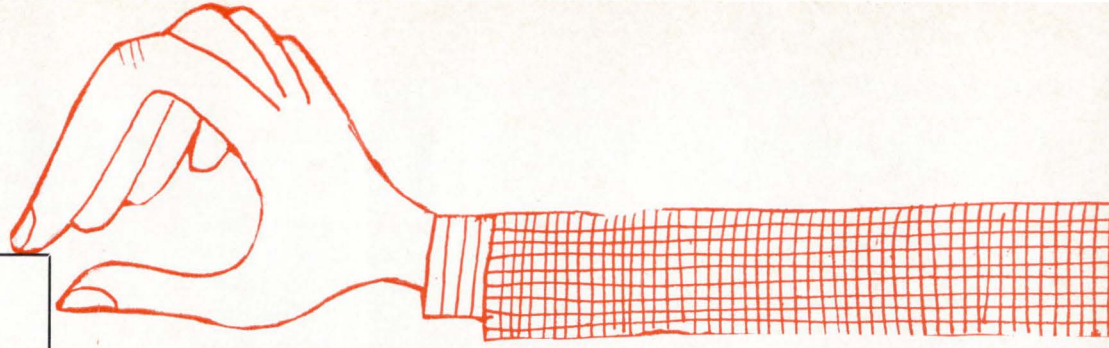

NOW AVAILABLE

A DESIGN REFERENCE GUIDE
FOR ALL DIGITAL DESIGN ENGINEERS

"CAUSES AND CURES OF NOISE IN DIGITAL SYSTEMS"

By J. Paul Jones, Jr.

A 56-PAGE POCKET-SIZE HANDBOOK

The material in this handbook originally appeared in a 3-part series of articles in the 1964 Fall issues of **COMPUTER DESIGN**. The large number of requests for copies prompted the printing of this handbook.

Excellent design tips and basic guideline rules for eliminating or minimizing noise in digital systems are given. Here is just a partial listing of topics:

- Electrostatic Interference in Backplane Wiring • Worst-Case Cabling of Wires • Inductive Noise in Systems Backplanes • Routing of Circuit Grounds • Use of Output Clamps • Test Points • Driving Diode Matrices • Output Filters • RFI-Proofing • AC Power Line Noise • Power Supplies for Very High Noise Locations

PRICE: \$1.75 per copy

Bulk quantity prices available on request.

To order your copy, simply fill out coupon below, enclose check or money order, for \$1.75 per copy, payable to Computer Design Publishing Corp. Shipment will be made immediately upon receipt of order.

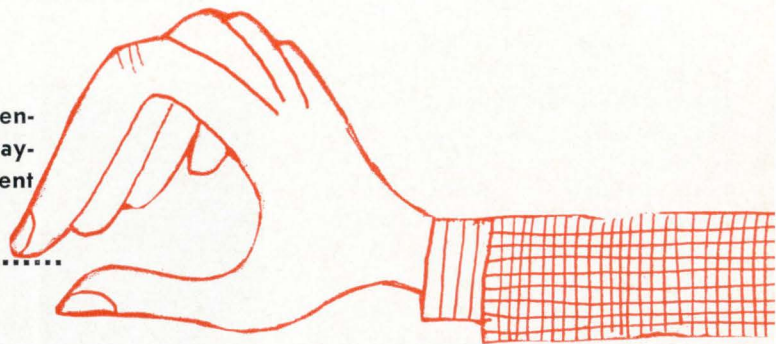

COMPUTER DESIGN PUBLISHING CORP.
BAKER AVE., W. CONCORD, MASS. 01781

GENTLEMEN:

Enclosed is \$..... for copy(ies) of 56-page Handbook — "CAUSES AND CURES OF NOISE IN DIGITAL SYSTEMS".

SHIP HANDBOOK(S) TO:

NAME

COMPANY

ADDRESS

CITY STATE

SPECIAL DISCOUNT OFFER

SAVE 25 CENTS

If you also fill out and enclose coupon from Navigation Computer Corp.'s ad on page 3, handbook is yours for \$1.50. Navigation Computer Corp. will pay the additional 25 cents.



Drum Memories

Major feature of a new 10-page brochure is a 3-page foldout chart that presents complete basic specifications of drum memories and modules. The reference chart covers mechanical, electro-mechanical, magnetic, packaging and performance specs of 15 modules of drum memories in three series. It also describes standard diode boards, matrix drivers, read amplifiers and write amplifiers. Vermont Research Corp., North Springfield, Vt.

Circle No. 203 on Inquiry Card

Memory Cores

Bulletin contains a complete summary of square-loop, ferrite core specifications for an entire company line. These cores include 10, 30, 50 and 80 mil units for memory applications and 120, 150, and 250 mil units for switching and magnetic logic applications. Summary sheet covers most pertinent design parameters including core switching times and outputs. Ferroxcube Corp. of America, Saugerties, N. Y.

Circle No. 210 on Inquiry Card

Readout Devices

A 2-page engineering data sheet describes a rear-projection readout device that is capable of displaying characters which are up to 2" in height and may be read from over 50 feet. The data sheet provides engineering details, mounting dimensions, lamp specifications and a chart of standard displays that are available. Industrial Electronic Engineers, Inc., Van Nuys, Cal.

Circle No. 204 on Inquiry Card

Cable Specifying Guide

New cable specifying guide includes drawings and descriptions of various cable configurations, a glossary of wire and cable terminology, and an ordering guide for wire, cable, and harnesses. Phalo Corp., Shrewsbury, Mass.

Circle No. 201 on Inquiry Card

Indicators/Displays

Line of visual indicators and display systems is described in a 4 page brochure. Comparative table lists five standard indicators and their specifications, characteristics, applications, and relative costs. Bloomingdale Instruments, Inc. El Segundo, Cal.

Circle No. 211 on Inquiry Card

Semiconductor Devices

A 12-page guide lists a wide range of semiconductor products by type number with information on their pertinent electrical characteristics and case type. Typical circuit applications are illustrated. Bendix Semiconductor Div., Holmdel, N. J.

Circle No. 206 on Inquiry Card

Heat Dissipators

An 8-page engineering catalog covers a line of standard heat dissipators. Included in the various configurations available is the serrated fin patented unit allowing 5° to 10°C cooler operating temperatures. Special Operations, Inc., Glendora, Cal.

Circle No. 202 on Inquiry Card

Voltage Stabilizer

The causes of voltage variation in an apparently normal power service is concisely explained in a new catalog. In addition to covering the common problem of voltage drop by transmission, this catalog also points out the frequently occurring faults that result in excessive voltage surges which are often more damaging to equipment than undervoltage operation. The discussion is helpful in understanding the effect of load and power factor on output voltage level and the effect of frequency variation and operating temperature on output voltage levels. Catalog also illustrates the range of designs available in company's voltage stabilizer line together with full operating characteristics. Acme Electric Corp., Cuba, N. Y.

Circle No. 217 on Inquiry Card

Digital Printer

Bulletin on digital strip printers contains a description of operating principles, complete with a simplified schematic and a graphic presentation of the timing cycle. Specifications give a detailed price breakdown, as well as the usual electrical and mechanical data. Franklin Electronics, Inc., Bridgeport, Pa.

Circle No. 221 on Inquiry Card

Tantalum Capacitors

Eighteen new case sizes of plug-in type tantalum foil capacitors, distinguished by extra-high capacitances up to 14,000 microfarads, are described in a newly revised engineering bulletin. The twelve-page bulletin includes data on both polar and nonpolar ratings and shows complete characteristic curves for both types. Dimensional tables list sizes in decimals, fractions, and millimeters. Tansitor Electronics, Inc., Bennington, Vt.

Circle No. 212 on Inquiry Card

Zener Selection Chart

Wall chart lists in detail military and commercial Zener diodes, voltage references, multi-current references, certified and industrial references. The chart describes ranges and representative specifications for each. Transistron Electronic Corp., Wakefield, Mass.

Circle No. 200 on Inquiry Card

Heat Sinks

New 12-page distributor catalog covers all heat sinks and accessories that are stocked by the company. Complete technical data is provided, so that purchases can be made directly from the catalog. Included are photos, dimensions on line drawings, specifications and weights. Mounting accommodations and insulator requirements also are given. Wakefield Engineering, Inc., Wakefield, Mass.

Circle No. 216 on Inquiry Card

X-Y Recorders

A 4-page brochure describes two new X-Y recorders with built-in null detectors to permit plotting of data in sequential form. User may optionally elect to point plot, character print, or to plot curves in colors with fast drying inks. Houston Instrument Corp., Bellaire, Texas.

Circle No. 213 on Inquiry Card

Switch Specifications

Complete line of precision snap-action switches are described in 28 pages of technical data covering operating characteristics, engineering drawings, and specifications. Cherry Electrical Products Corp., Highland Park, Ill.

Circle No. 207 on Inquiry Card

Coaxial Cable

A 16-page short form catalog describes a line of coaxial cable, transmission lines, and connectors. The subjects of matching connectors, special cable assemblies, and coaxial cable accessories are also covered. Coaxial cable delay lines are dealt with in detail and a section of the catalog is devoted to the company's capability in testing and measuring techniques. Phelps Dodge Electronic Products Corp., North Haven, Conn.

Circle No. 214 on Inquiry Card

Multiplexers

High-speed, solid-state multiplexers are described in an 8-page booklet containing diagrams, configurations, specifications, and ordering information. Features of the multiplexers include sequential and addressable operation; a dc to 100 kc sampling rate which is not a function of the number of channels; single ended and/or differential inputs; and constant input impedance that minimizes dynamic problems due to source impedance. Scientific Data Systems, Santa Monica, Cal.

Circle No. 219 on Inquiry Card

Four-Layer Diode Memories

Engineering application bulletin on the use of miniature glass four-layer diodes in memory circuits features practical circuits with explanations as to how they operate, suggested circuit values for maximum performance and special design considerations for very high speed switching. The high speed switching phenomena, known as "Rate Effect," is described and methods for reducing it are introduced. ITT Semiconductors, National Transistor Div., Lawrence, Mass.

Circle No. 205 on Inquiry Card

Step-Servomotors

Two-page bulletin contains a detailed description of a new two-phase, two-pole, permanent-magnet stepping servo-motor which has a variety of applications in digital control systems. The technical data sheet describes how a programmed input voltage will provide discrete 90-degree angular steps with a stall torque of 1.8 oz.-in., as well as giving a no-load response rate of 150 pulses/second while slewing at up to 200 pulses/second. Total power input to the 7-ounce stepping servomotor is only 16 watts, total, at 28 volts dc, while theoretical acceleration at stall is 40,000 radians/second.² There is no ambiguity in initial position of the rotor and final shaft position is the integral of the input signal. Diehl Div., The Singer Co., Somerville, N. J.

Circle No. 218 on Inquiry Card

Reed Relay Evaluation

A 2-page bulletin describes a life test to evaluate the reliability and contact resistance of reed relays. Relay contacts were subjected to more than 1.35 billion current pulses, the equivalent of 20,000 8-hour days of operating in a typical memory tester switching application. They showed no signs of welding and negligible increases in contact resistance. Digital Equipment Corp., Maynard, Mass.

Circle No. 222 on Inquiry Card

Resistor-Capacitor Modules

A 2-page data sheet gives complete technical data on a new space-saving passive circuit network module that combines the stability and reliability of "Cermet" resistors and capacitors with the heat dissipation characteristics of a thick alumina substrate. Included are mechanical and electrical features and specifications. CTS Corp., Elkhart, Ind.

Circle No. 208 on Inquiry Card

No matter what we start discussing at Xerox... sooner or later we're talking about more new jobs

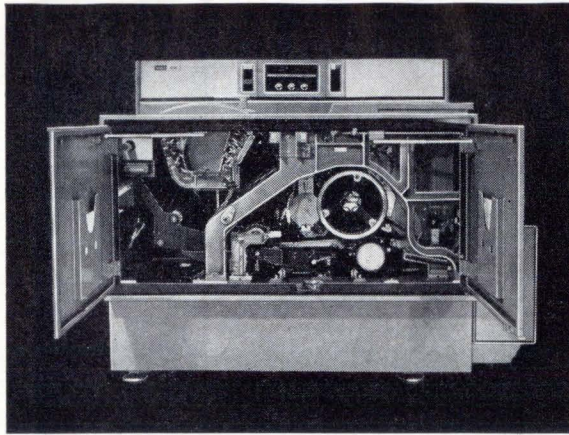

Have you seen the new Xerox 2400? Our scientists and engineers started developing it in 1959, the same year we introduced the now world-famous 914 Copier. At that time, the 813 desk-top copier was well along in development. The 813 hit the marketplace in 1963 (ahead of schedule). Then, in October 1964, the 2400 was unveiled. If the 914 revolutionized office copying, the 2400 seems well on its way to starting a revolution of its own — in high speed copying. Why? Because this machine can produce copies on ordinary paper directly from an original document at the rate of

ELECTRO-MECHANICAL DEVELOPMENT ENGINEERS

EE or ME for configuration study, design, and prototyping of precision electro-opto-mechanical products. Experience in photographic systems, graphic arts, business machines, mechanisms, and/or control circuits.

INFORMATION SYSTEMS ENGINEERS

EE, ME, or Physics for system configuration study and synthesis leading to detailed specification of Information Storage and Retrieval equipments, Computer Peripheral equipments, and Data System Terminals. Experience in digital information processing display, communications, and/or microfilm systems.

ELECTRONIC DEVELOPMENT ENGINEERS

EE for experimental design, fabrication and testing of advanced CRT

display, character generation, and control equipment. Experience in electronic circuit design, solid state logic, display, communications, and/or packaging.

2,400 per hour. An operator need only dial the number of copies wanted and press a button. If you sense that it took some highly sophisticated research and development engineering to create this electro/optical/chemical/mechanical device, you ought to meet some of the men who helped create it.

The openings outlined below are abstracts from our current list of immediate vacancies. In most cases they are new, expansion-created spots. In others, the man has been promoted. Isn't this the best way to come on board in any organization?

display, character generation, and control equipment. Experience in electronic circuit design, solid state logic, display, communications, and/or packaging.

INFORMATION SYSTEM ANALYSTS

EE, IE, Mathematics, or Business Administration for applications analysis, simulation, and testing of new information system values, parameters, and human interactions. Experience in commercial or military information systems analysis, operations research, commercial office procedures analysis, scientific programming and/or software development. Straightforward user application programming is not adequate.

Positions are in Rochester, N.Y. Send resume, including salary history to Mr. R. E. Conboy, Xerox Corporation, Dept. CD-6, P.O. Box 1540, Rochester, N.Y. 14603

XEROX

An Equal Opportunity Employer

XEROX, 813, 914 AND 2400 ARE TRADEMARKS OF XEROX CORPORATION

LITERATURE

Delay Line Memories

High data rate serial memory completely packaged on a 7½" by 4¼" printed circuit card is described in a 2-page bulletin. Plug-in connection to card racks is accomplished through a 35-pin connector. Maximum bit rate is 10 mc/sec. RZ of NRZ with total capacity up to 20,000 bits, depending on bit rate and delay. Delay lines up to 1000 microseconds are board-mounted; longer lines may be mounted on a common plate or separated by as much as 3 feet. Andersen Laboratories, Inc., West Hartford, Conn.

Circle No. 220 on Inquiry Card

Tantalum Capacitors

Three 4-page catalogs cover miniature and cordwood solid tantalum capacitors. Each 4-page catalog has complete engineering drawings, all pertinent dimensions, construction and electrical features, performance graphs, a listing by case size with all electrical ratings and color codes. There is also a quick "rating availability chart" for each separate catalog. Components, Inc. Biddeford, Maine.

Circle No. 215 on Inquiry Card

Integrated Logic Circuits

Integrated circuits with a new temperature range of -20°C to +85°C especially suited to military GSE and severe environment industrial applications are described in 22-page brochure. Data on the seven circuit family of ANDs, NORs, and a J-K binary element includes typical characteristics and subsystem applications. Signetics Corp., Sunnyvale, Cal.

Circle No. 223 on Inquiry Card

ADVERTISERS' INDEX

AMP, INC.	5
COMPUTER CONTROL CO.	Cover 2
COMPUTER TEST CORP.	35
CONTEMPORARY ELECTRONICS	23
DECISION CONTROL, INC.	37
DIGITAL EQUIPMENT CORP.	33
DRAKE MFG. CO.	44
E-H RESEARCH LABORATORIES, INC.	1
FABRI-TEK, INC.	49
FAIRCHILD SEMICONDUCTOR	Cover 4
GENERAL DYNAMICS, INC.	31
GENERAL PRECISION, INC. Librascope Group	11
HAMILTON WATCH. CO. Electronic Div.	10
HONEYWELL EDP	Cover 3
IMC MAGNETICS CORP.	42
INDIANA GENERAL CORP.	51
INTERNATIONAL DATA CORP.	40, 41
INTERSTATE ELECTRONICS CORP.	12
LITTON INDUSTRIES	55
NAVIGATION COMPUTER CORP.	3
POLAROID CORP.	21
RAYTHEON COMPUTER	56
SCIENTIFIC DATA SYSTEMS, INC.	7
SEAELECTRO CORP.	53
SCM Kleinschmidt Div.	43
TALLY CORP.	47
TELETYPE CORP.	13, 15, 17
UNIVAC Div. of Sperry Rand	16
VERMONT RESEARCH CORP.	25
WHITTAKER CORP. Abacus Div.	45
XEROX CORP.	63

do you
catch
yourself
browsing
through...

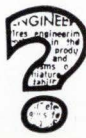

You're not alone. Most engineers and other professionals make it a habit to leaf through help-wanted ads taking note of which company is working on what space project, staffing a new facility, or just offering "challenging opportunities" in some Eldorado.

In your own browsing, you may have noticed advertisements from Honeywell Electronic Data Processing.

What's our story?

No space vehicles, that's another division.

No Eldorados either, although the EDP Engineering and Research Center is located in one of Boston's more Eldorado-like communities. As to "challenging opportunities" — to that, we plead guilty.

Professional assignments exist in all major areas of advanced computer technology, with present emphasis in the following areas:

**Logic Design • Memory Development • Circuit Design
• Applied Research • Mechanical Engineering • Advanced Development.**

If you're interested in doing more than just browsing, and your experience falls within any of the above areas, forward a resumé to us for prompt consideration.

Mr. Frederick S. Bartlett
Personnel Manager
Technical Divisions

Honeywell

ELECTRONIC DATA PROCESSING

151 Needham Street Dept. 7890
NEWTON, MASSACHUSETTS 02161

Opportunities exist at other Honeywell Divisions. Send resumé to F. E. Laing, Honeywell, Minneapolis 8, Minnesota. An equal opportunity employer.

56 Integrated Circuits!

FAIRCHILD MICROLOGIC™ — WIDEST LINE IN THE INDUSTRY

MICROLOGIC INTEGRATED CIRCUITS	HIGH SPEED μL MICROLOGIC -55°C to +125°C	INDUSTRIAL $F\mu\text{L}$ MICROLOGIC +15°C to +55°C	MILLIWATT $\text{MW}\mu\text{L}$ MICROLOGIC -55°C to +125°C	TRANSISTOR/TRANSISTOR $\text{TT}\mu\text{L}$ MICROLOGIC -55°C to +125°C	DIODE/TRANSISTOR $\text{DT}\mu\text{L}$ MICROLOGIC -55°C to +125°C	COMPLEMENTARY TRANSISTOR $\text{CT}\mu\text{L}$ MICROLOGIC +15°C to +55°C	COUNTING $\text{C}\mu\text{L}$ MICROLOGIC 0°C to +75°C
GATES	NAND/NOR 903 3-input 907 4-input 914 Dual 2-input 915 Dual 3-input	NAND/NOR 903, 915 3-input 907 4-input 910, 911 (see $\text{MW}\mu\text{L}$) 914 Dual 2-input Epoxy	NAND/NOR 910 Dual 2-input 911 4-input	103 Dual 4-input 104 8-input	930 Dual 4-input 946 Quad 2-input 962 Triple 3-input	NOR 952 Dual 2-input inverter AND 953 2-2-3-input 954 Dual 4-input 955 8-input	
ADDERS	904 AND/OR 2-level Half Adder	904 AND/OR 2-level Half Adder 908, 912 (see $\text{MW}\mu\text{L}$)	908 EXCLUSIVE OR 912 AND/OR 2-level Half Adder				
BUFFERS	900 Low Impedance	900 Low Impedance Epoxy 909 2-input inverting	909 2-input		932 Dual 4-input 944 Dual 4-input	956 Dual 2-input	
STORAGE ELEMENTS (Flip-Flops)	902 RS 905 GATED RS with inverter 906 GATED RS 926 J-K	923 Epoxy J-K 905 GATED RS with inverter 913 TYPE D 926 J-K	913 TYPE D		931 CLOCKED 945 CLOCKED Low Impedance 948 CLOCKED Low Impedance 950 A.C. Coupled R.S.	957 DUAL RANK	958 DECADE COUNTER CASCADING 959 BUFFER/STORAGE (coming 2nd qtr. '65) 960 DECODER/DISPLAY DRIVER (coming 2nd qtr. '65)
OTHER	901 Counter Adapter	921 EXTENDER Dual 2-input	921 EXTENDER Dual 2-input		933 EXTENDER Dual 4-input 951 MONOSTABLE MULTIVIBRATOR		
PERFORMANCE (Logic form, speed, power, noise immunity, packaging)	RTL; 12 nsec; 15 mW/node; 300 mV; TO-5; Cerpack 1/4" x 1/4" flat	RTL; 12 nsec; 2-15 mW/node; 300 mV; TO-5; Metal or Epoxy	RTL; 40 nsec; 2 mW/node; 300 mV; TO-5; Cerpack 1/4" x 1/4" flat	TTL; 25 nsec; 22 mW/gate; 450 mV; Cerpack 1/4" x 1/4" flat	DTL; 25 nsec; 5 mW/gate; 1.0V; TO-5; Cerpack 1/4" x 1/4" flat	CTL; 5 nsec; 35 mW/gate; 600 mV; Dual In-Line Industrial type	RTL; TO-5, Dual In-Line Industrial

New circuits in red

Micrologic—Fairchild's brand name for digital integrated circuits.

Micrologic, DT μL , MW μL , TT μL , CT μL , F μL , C μL , μL and μA are Fairchild trademarks.

PLUS—NEW MONOLITHIC LINEAR CIRCUITS

1. High Gain, Wideband D.C. Amplifier— $\mu\text{A}702\text{A}$
Precision instrumentation amplifier for high speed analog systems. Offset voltage: 2mV. Voltage gain: 2800.

2. High Speed Differential Comparator— $\mu\text{A}710$

Variable-threshold Schmitt trigger. Pulse height discriminator. Memory sense amplifier. Compatibility with all integrated logic forms. Offset voltage: 3mV. Response time: 50nsec.

FAIRCHILD
SEMICONDUCTOR

EASTERN ALABAMA Huntsville: Schweber Electronics, 539-2756. **CONNECTICUT** Hamden: Cramer Electronics, 288-7771. **FLORIDA** Orlando: Crescent Electronics Sales, 423-8586; Hall Mark Electronics Corp., 855-4020. **MARYLAND** Baltimore: Valley Electronics, NO 8-4900/D. C. Area: Powell Electronics, 474-1030. **MASSACHUSETTS** Newton: Cramer Electronics, WO 9-7700/Watertown: L. L. Schley Co., WA 6-0235. **NEW JERSEY** Cherry Hill: Valley Electronics, NO 2-9337. **NEW YORK** Baldwin, L.I.: Taylor Electronics Corp., 223-8000/Buffalo: Dart Sales, 684-6250; Summit Distributors, 884-3450/Syracuse: Dart Sales, GL 4-9257; Eastern Semiconductor Sales, Inc., 455-6641/Westbury, L.I.: Schweber Electronics, ED 4-7474. **PENNSYLVANIA** Philadelphia: Powell Electronics, 724-1900. **CENTRAL ILLINOIS** Chicago: Avnet Electronics, 678-8160; Semiconductor Specialists, 622-8860. **MICHIGAN** Detroit: Semiconductor Specialists, LU 4-5901. **MINNESOTA** Minneapolis: E. C. Electronics Sales, 888-4626; Semiconductor Specialists, UN 6-3435. **MISSOURI** St. Louis: Durbin-Hamilton Electro Corp., 966-3003. **OHIO** Cincinnati: Sheridan Sales Co., 761-5432. **TEXAS** Dallas: Norvell Associates, FL 7-6451/Houston: Norvell Associates, MO 5-0558. **WESTERN ARIZONA** Phoenix: Hamilton Electro, 272-2601; G. S. Marshall Co., 946-4276. **CALIFORNIA** Los Angeles: Hamilton Electro, 870-3300/Palo Alto: Hamilton Electro, 321-7541/Redwood City: G. S. Marshall Co., 365-2000/San Diego: Denny-Hamilton Electronics, 279-2421; G. S. Marshall Co., 278-6350/San Marino: G. S. Marshall Co., MU 1-3292. **COLORADO** Denver: Hyer Electronics, 771-5285. **NEW MEXICO** Albuquerque: Hyer Electronics, 268-6744. **WASHINGTON** Seattle: Hamilton Electro, 282-3886. **CANADA** Toronto, Ontario: Avnet, 789-2621; Montreal, Quebec: 697-1993.

FAIRCHILD SEMICONDUCTOR SALES OFFICES

EASTERN ALABAMA Huntsville 536-4428. **FLORIDA** Orlando CH 1-2596. **MARYLAND** College Park 779-6868. **MASSACHUSETTS** Bedford 275-8450. **NEW YORK** Endwell 754-2600; Long Island ED 4-8500; Poughkeepsie 454-7320; Syracuse GR 2-3391. **PENNSYLVANIA** Jenkintown TU 6-6623. **CENTRAL ILLINOIS** Elmwood Park 456-4200. **OHIO** Dayton 228-1111. **MINNESOTA** Minneapolis UN 6-3301. **TEXAS** Dallas FI 2-9523. **WESTERN ARIZONA** Phoenix 946-6583. **CALIFORNIA** Los Angeles HO 6-8393; Palo Alto 321-8780. **WASHINGTON** Seattle AT 2-5344. **CANADA OFFICE:** Ontario, Toronto 782-9230.

FAIRCHILD SEMICONDUCTOR/A DIVISION OF FAIRCHILD CAMERA AND INSTRUMENT CORPORATION/313 FAIRCHILD DR., MOUNTAIN VIEW, CALIF./962-5011/TWX: 910-379-6435

CIRCLE NO. 30 ON INQUIRY CARD