

Sampler Spectra (8B)

-
-

Copyright (c) 2012 Young W. Lim.

Permission is granted to copy, distribute and/or modify this document under the terms of the GNU Free Documentation License, Version 1.2 or any later version published by the Free Software Foundation; with no Invariant Sections, no Front-Cover Texts, and no Back-Cover Texts. A copy of the license is included in the section entitled "GNU Free Documentation License".

Please send corrections (or suggestions) to youngwlim@hotmail.com.

This document was produced by using OpenOffice and Octave.

Sampler

Ideal Sampling

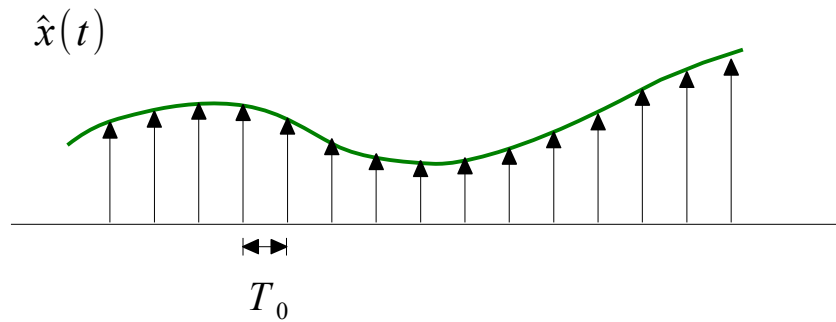

$$\hat{x}(t) = \sum_{n=-\infty}^{+\infty} x(nT_0) \delta(t - nT_0)$$

↓ CTFT



Practical Sampling

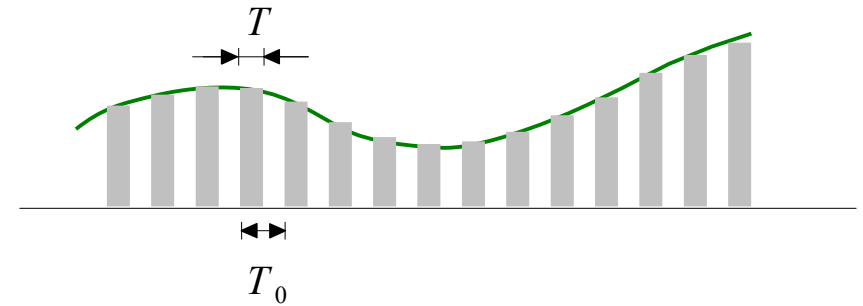

$$\hat{x}(t) \approx \sum_{n=-\infty}^{+\infty} x(nT_0) p(t - nT_0)$$

↓ CTFT



Zero Order Hold (ZOH)

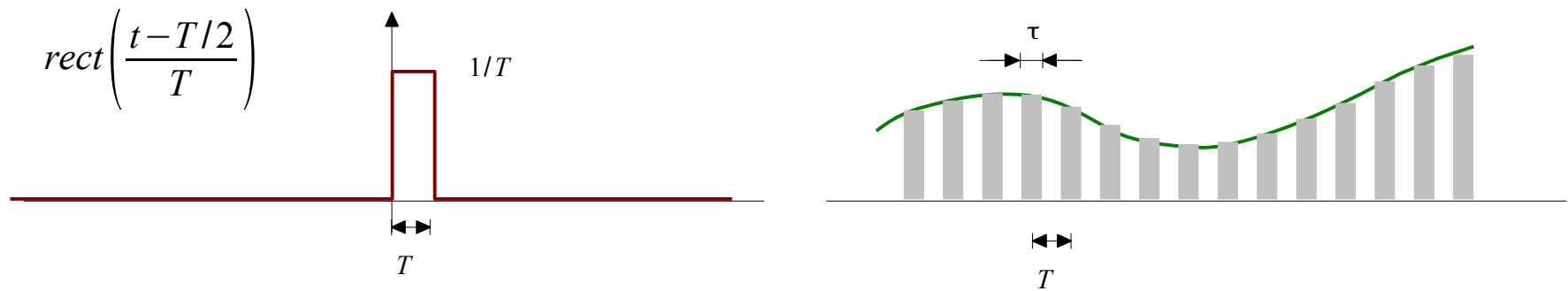

$$x_{ZOH}(t) = \sum_{n=-\infty}^{+\infty} x[n] \cdot rect\left(\frac{t-T/2-nT}{T}\right)$$

Square Wave CTFS (1)

Continuous Time Fourier Series

$$C_k = \frac{1}{T} \int_0^T x(t) e^{-jk\omega_0 t} dt \quad \longleftrightarrow \quad x(t) = \sum_{n=0}^{\infty} C_k e^{+jk\omega_0 t}$$

$$C_k = \frac{1}{T_0} \int_{-T_0/2}^{+T_0/2} x_{T_0}(t) e^{-jk\omega_0 t} dt$$

$$C_k T_0 = \int_{-T_0/2}^{+T_0/2} x_{T_0}(t) e^{-jk\omega_0 t} dt$$

$$= \int_{-T_0/2}^{+T_0/2} e^{-jk\omega_0 t} dt = \left[\frac{-1}{jk\omega_0} e^{-jk\omega_0 t} \right]_{-T_0/2}^{+T_0/2}$$

$$= -\frac{e^{-jk\omega_0 T_0/2} - e^{+jk\omega_0 T_0/2}}{jk\omega_0} = \frac{\sin(k\omega_0 T_0/2)}{k\omega_0/2}$$

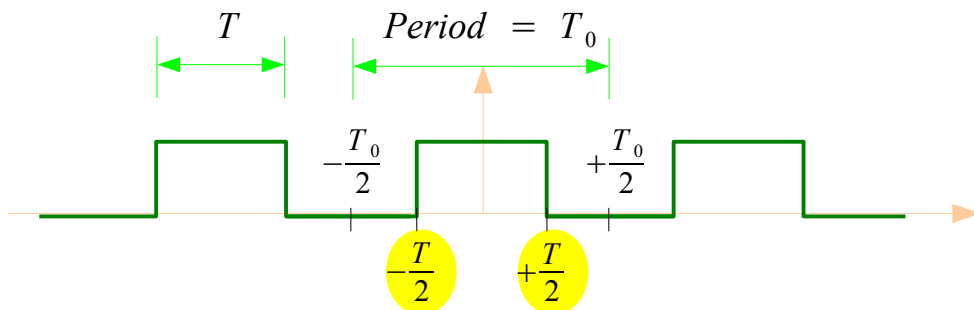

Fundamental Frequency

$$\omega_0 = \frac{2\pi}{T_0} \quad \omega_0 T_0 = 2\pi \quad \leftarrow \quad \frac{T_0}{T} = \frac{2}{1}$$

$$\omega_0 T = \pi$$

$$\omega_0 T = 2\pi \frac{T}{T_0}$$

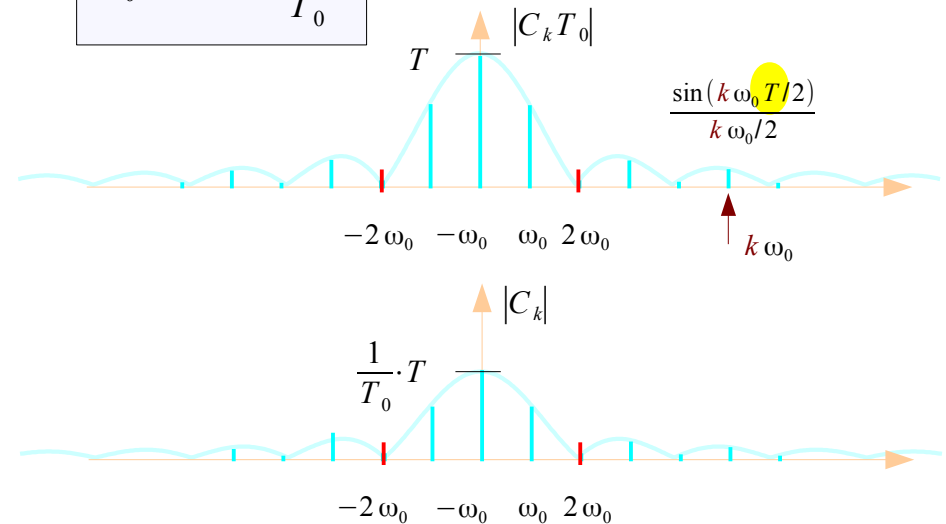

Square Wave CTFS (2)

$$C_k = \frac{1}{T_0} \cdot \frac{\sin(k \omega_0 T/2)}{k \omega_0/2} = \frac{1}{T_0} \cdot \frac{\sin(T k \omega_0/2)}{k \omega_0/2}$$

$$C_k = 0 \quad \rightarrow \quad \sin(k \omega_0 T/2) = 0$$

$$\sin\left(k \frac{2\pi T}{T_0} \frac{T}{2}\right) = 0 \quad \rightarrow \quad \sin(\pm n \pi) = 0$$

$$k = \pm n \frac{T_0}{T} \quad \rightarrow \quad \omega = \pm n \frac{T_0}{T} \omega_0$$

$$C_0 = \lim_{k \rightarrow 0} \frac{1}{T_0} \cdot \frac{\sin(T k \omega_0/2)}{k \omega_0/2}$$

$$C_0 = \lim_{k \rightarrow 0} \frac{1}{T_0} \cdot \frac{(T \omega_0/2) \cos(T k \omega_0/2)}{\omega_0/2} = \frac{T}{T_0}$$

$$\omega_0 = \frac{2\pi}{T_0}$$

$$\omega_0 \frac{T_0}{T} = \frac{2\pi}{T}$$

$$\omega_0 T = 2\pi \frac{T}{T_0}$$

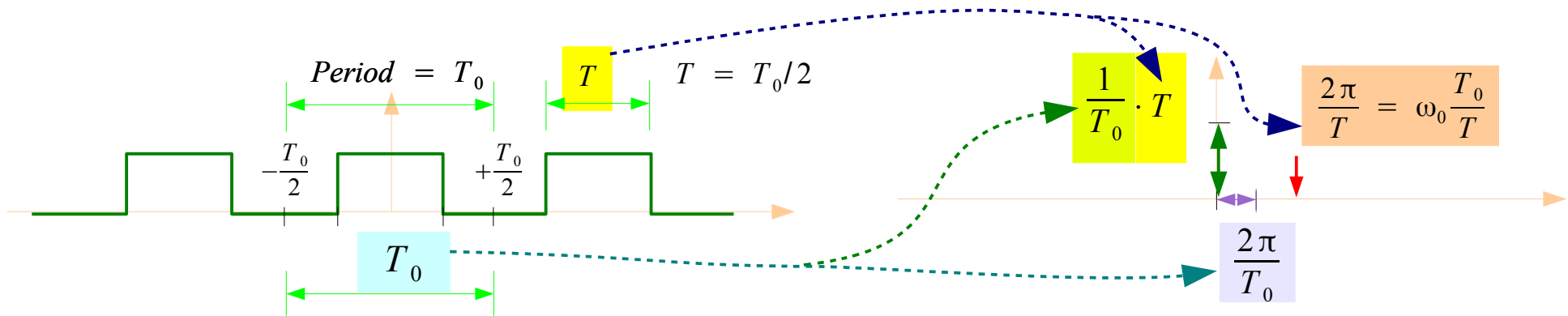
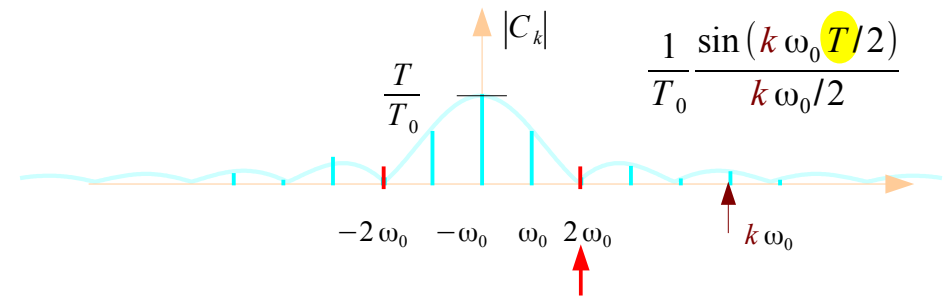

Square Wave CTFS (3)

Continuous Time Fourier Series

$$C_k = \frac{1}{T} \int_0^T x(t) e^{-jk\omega_0 t} dt \quad \longleftrightarrow \quad x(t) = \sum_{n=0}^{\infty} C_k e^{+jk\omega_0 t}$$

$$C_k = \frac{1}{T_0} \int_0^{+T_0} x_{T_0}(t) e^{-jk\omega_0 t} dt$$

$$C_k T_0 = \int_0^{+T_0} x_{T_0}(t) e^{-jk\omega_0 t} dt$$

$$\begin{aligned} &= \int_0^{+T} e^{-jk\omega_0 t} dt = \left[\frac{-1}{jk\omega_0} e^{-jk\omega_0 t} \right]_0^{+T} \\ &= -\frac{e^{-jk\omega_0 T} - e^0}{jk\omega_0} = \frac{1 - e^{-jk\omega_0 T}}{jk\omega_0} = \frac{1 - e^{-jk2\pi T/T_0}}{jk2\pi/T_0} \end{aligned}$$

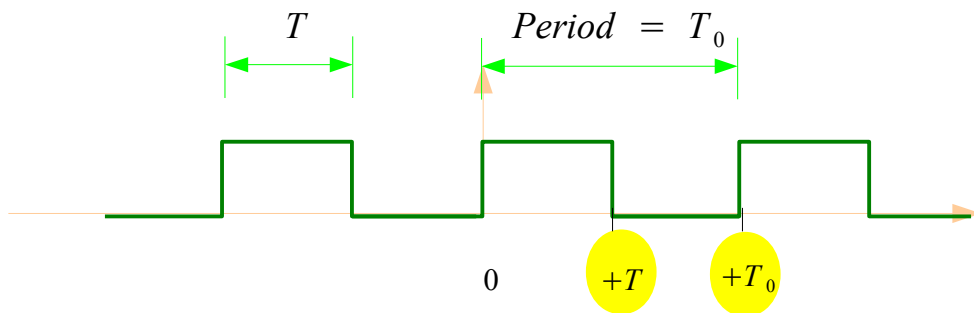

Fundamental Frequency

$$\omega_0 = \frac{2\pi}{T_0} \quad \omega_0 T_0 = 2\pi \quad \leftarrow \quad \frac{T_0}{T} = \frac{2}{1}$$

$$\omega_0 T = \pi$$

$$\omega_0 T = 2\pi \frac{T}{T_0}$$

$$C_k T_0 = \frac{1 - e^{-jk\pi}}{jk2\pi/T_0} \quad \rightarrow \quad C_k = \frac{1 - (-1)^k}{j2\pi k}$$

$$C_0 T_0 = \int_0^{+T} e^{-j0\omega_0 t} dt = T \quad \rightarrow \quad C_0 = \frac{1}{2}$$

Square Wave CTFS (4)

$$C_k = \frac{1}{T_0} \int_0^{+T_0} x_{T_0}(t) e^{-jk\omega_0 t} dt$$

$$C_k T_0 = \int_0^{+T_0} x_{T_0}(t) e^{-jk\omega_0 t} dt$$

$$= \int_0^{+T} e^{-jk\omega_0 t} dt = \left[\frac{-1}{jk\omega_0} e^{-jk\omega_0 t} \right]_0^{+T}$$

$$= -\frac{e^{-jk\omega_0 T} - e^0}{jk\omega_0} = \frac{1 - e^{-jk\omega_0 T}}{jk\omega_0} = \frac{1 - e^{-jk2\pi T/T_0}}{jk2\pi/T_0}$$

Fundamental Frequency

$$\omega_0 = \frac{2\pi}{T_0} \quad \omega_0 T_0 = 2\pi \quad \frac{T_0}{T} = \frac{2}{1}$$

$$\omega_0 T = 2\pi \frac{T}{T_0}$$

$$C_k T_0 = \frac{1 - e^{-jk\pi}}{jk2\pi/T_0} \Rightarrow C_k = \frac{1 - (-1)^k}{j2\pi k}$$

$$C_0 T_0 = \int_0^{+T} e^{-j0\omega_0 t} dt = T \Rightarrow C_0 = \frac{1}{2}$$

C_{-4}	C_{-3}	C_{-2}	C_{-1}	C_0	C_1	C_2	C_3	C_4
0	$\frac{-1}{j3\pi}$	0	$\frac{-1}{j\pi}$	$\frac{1}{2}$	$\frac{1}{j\pi}$	0	$\frac{1}{j3\pi}$	0

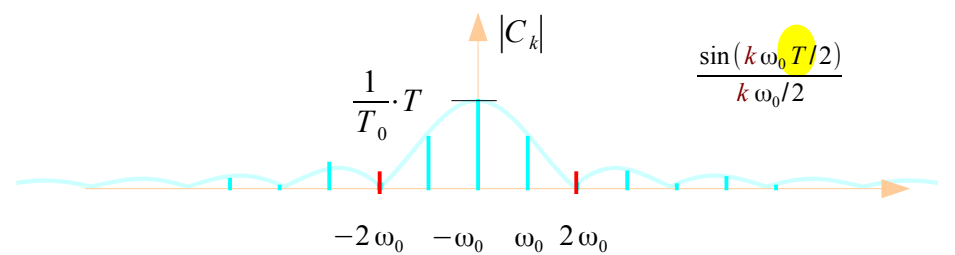
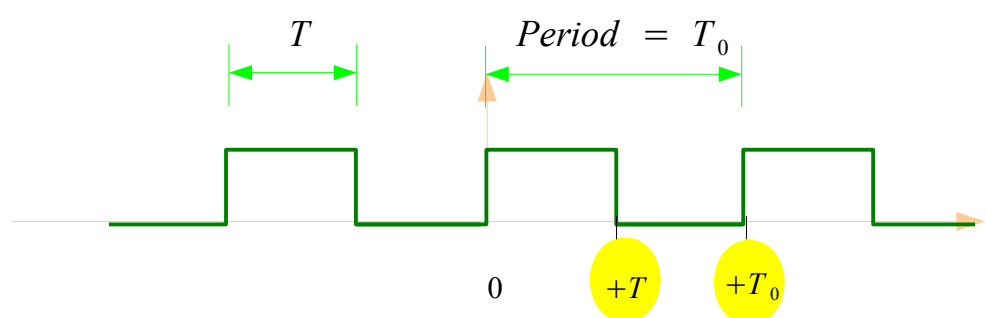

CTFT of a Rect(t/T) function (1)

Continuous Time Fourier Transform

Aperiodic Continuous Time Signal

$$X(j\omega) = \int_{-\infty}^{+\infty} x(t) e^{-j\omega t} dt \quad \longleftrightarrow \quad x(t) = \frac{1}{2\pi} \int_{-\infty}^{+\infty} X(j\omega) e^{+j\omega t} d\omega$$

$$\begin{aligned} X(j\omega) &= \int_{-T/2}^{+T/2} e^{-j\omega t} dt \\ &= \left[\frac{-1}{j\omega} e^{-j\omega t} \right]_{-T/2}^{+T/2} = -\frac{e^{-j\omega T/2} - e^{+j\omega T/2}}{j\omega} \\ &= \frac{\sin(\omega T/2)}{\omega/2} \end{aligned}$$

$$X(j0) = \lim_{\omega \rightarrow 0} \frac{\sin(\omega T/2)}{\omega/2} = \lim_{\omega \rightarrow 0} \frac{T \cos(\omega T/2)}{2 \cdot 1/2} = T$$

$$\sin(\omega T/2) = 0 \quad \rightarrow \quad \omega T/2 = \pi n$$

$$\rightarrow \quad \omega = \frac{2\pi}{T} n$$

$$\rightarrow \quad \omega = \pm \frac{2\pi}{T}, \pm \frac{4\pi}{T}, \pm \frac{6\pi}{T}, \dots$$

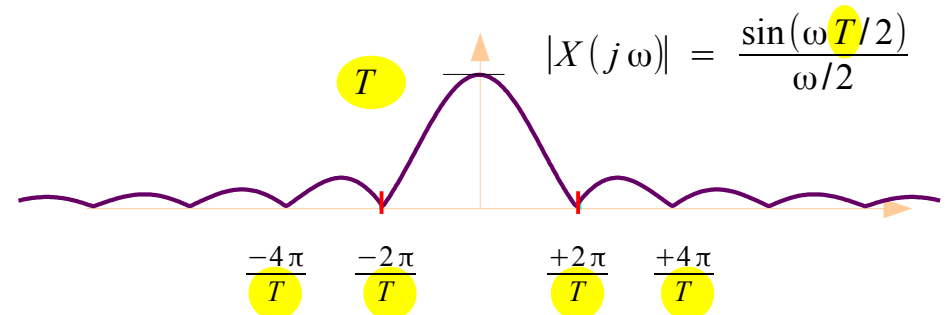
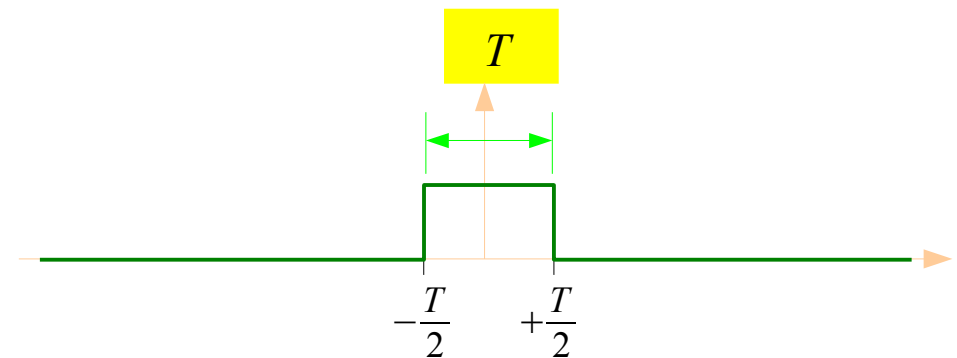

CTFT of a Rect(t/T) function (2)

Continuous Time Fourier Transform

Aperiodic Continuous Time Signal

$$X(j\omega) = \int_{-\infty}^{+\infty} x(t) e^{-j\omega t} dt \quad \longleftrightarrow \quad x(t) = \frac{1}{2\pi} \int_{-\infty}^{+\infty} X(j\omega) e^{+j\omega t} d\omega$$

$$X(j\omega) = \int_{-T/2}^{+T/2} e^{-j\omega t} dt = \frac{\sin(\omega T/2)}{\omega/2}$$

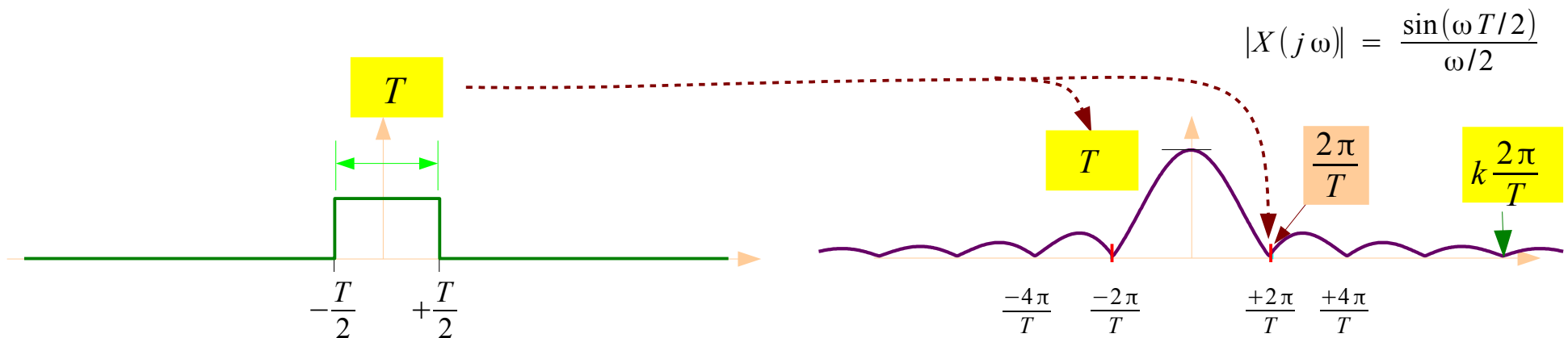

CTFT and CTFS

Continuous Time Fourier Transform

Aperiodic Continuous Time Signal

$$X(j\omega) = \int_{-\infty}^{+\infty} x(t) e^{-j\omega t} dt \quad \longleftrightarrow \quad x(t) = \frac{1}{2\pi} \int_{-\infty}^{+\infty} X(j\omega) e^{+j\omega t} d\omega$$

$$X(j\omega) = \frac{\sin(\omega T/2)}{\omega/2}$$

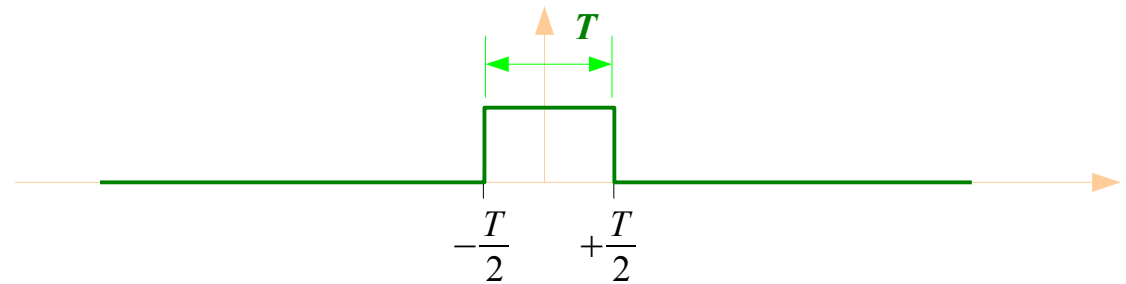

Continuous Time Fourier Series

Periodic Continuous Time Signal

$$C_k = \frac{1}{T} \int_0^T x(t) e^{-jk\omega_0 t} dt \quad \longleftrightarrow \quad x(t) = \sum_{n=-\infty}^{\infty} C_k e^{+jk\omega_0 t}$$

$$C_k = \frac{1}{T_0} \frac{\sin(k\omega_0 T/2)}{k\omega_0/2}$$

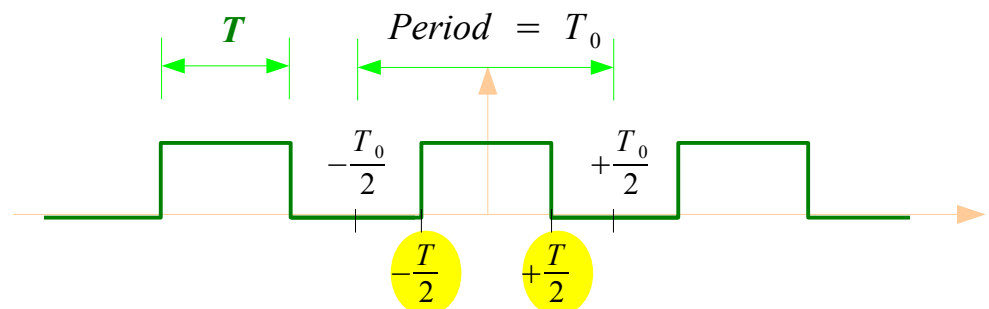

CTFT ← CTFS

Aperiodic Continuous Time Signal Continuous Time Fourier Transform

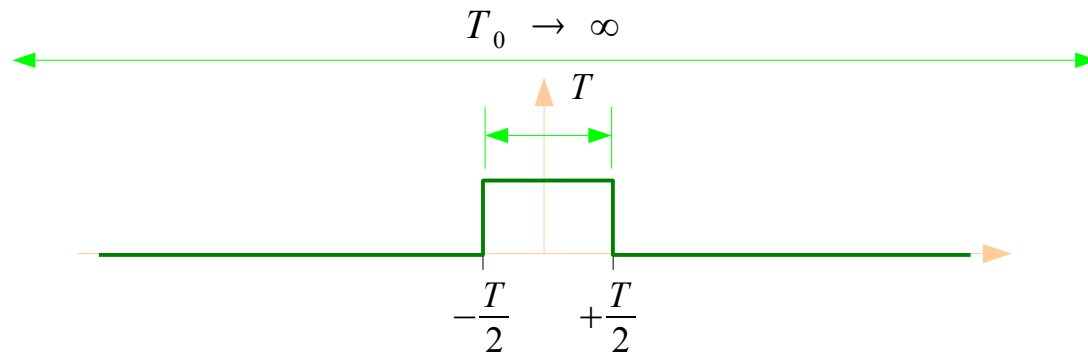

Periodic Continuous Time Signal Continuous Time Fourier Series

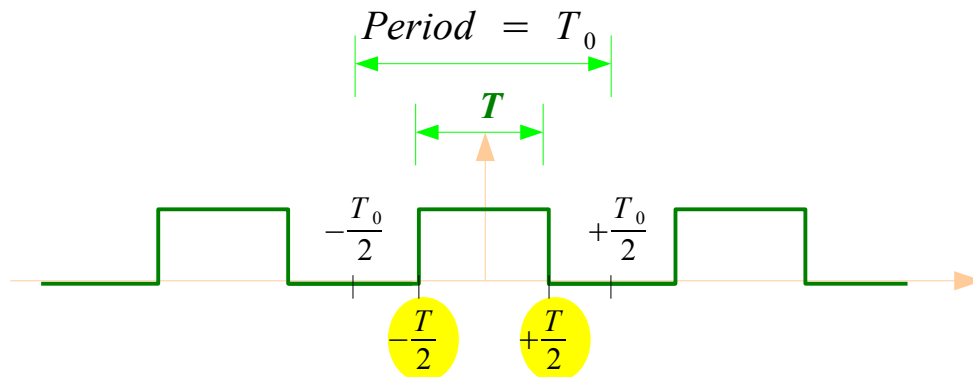

$$x(t)$$

$$\text{As } T_0 \rightarrow \infty, \\ x_{T_0}(t) \rightarrow x(t)$$

$$\omega_0 = \frac{2\pi}{T_0} \rightarrow 0$$

$$x_{T_0}(t) = \sum_{n=-\infty}^{+\infty} x(t - nT_0)$$

CTFT and CTFS as $T_0 \rightarrow \infty$ (1)

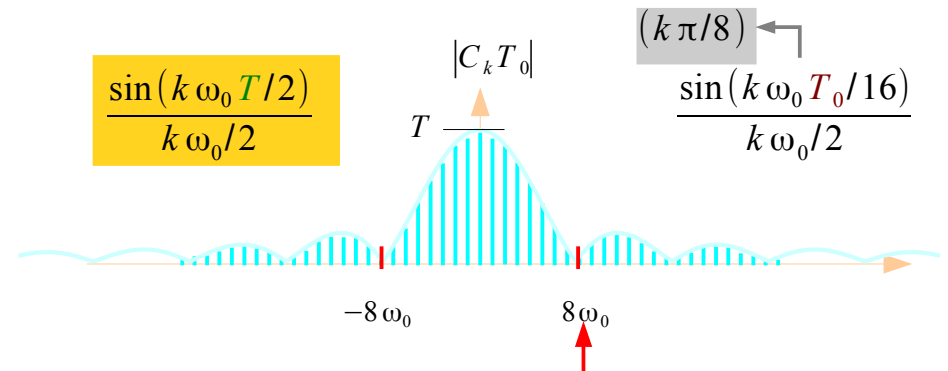
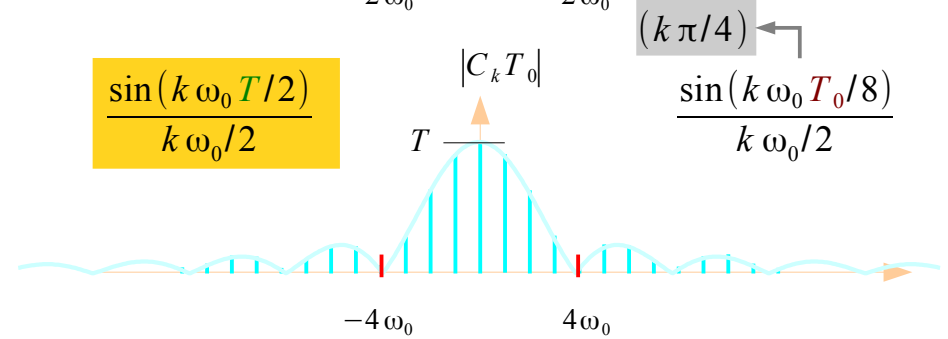
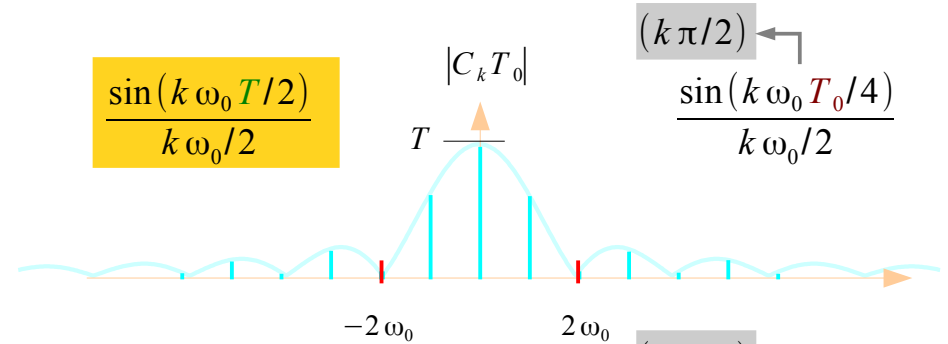
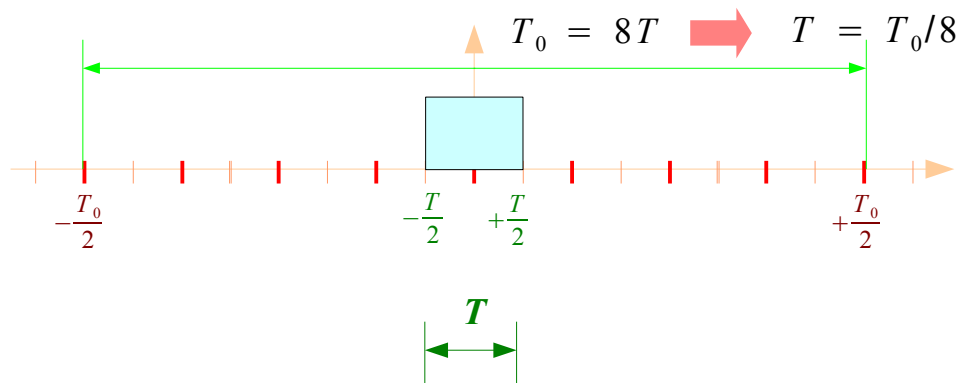
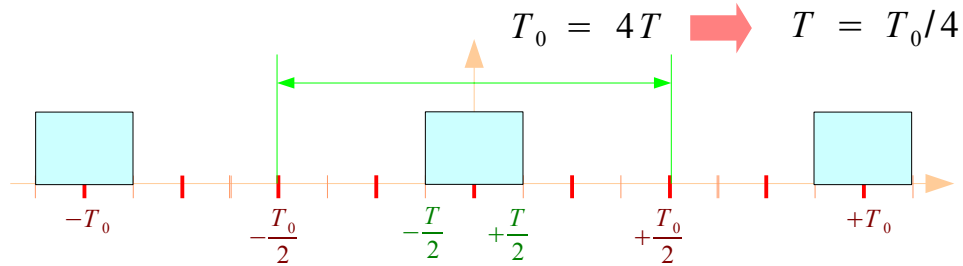
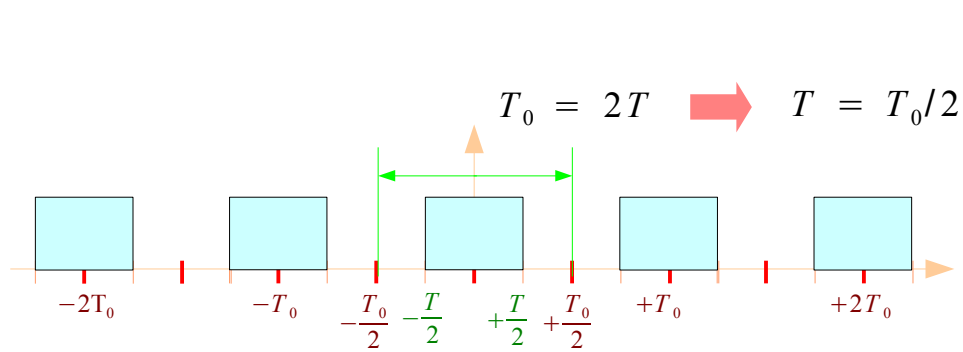

$$\omega_0 = \frac{2\pi}{T_0} = \frac{2\pi}{8T} \rightarrow \frac{T_0}{T} \omega_0 = \frac{2\pi}{T}$$

CTFT and CTFS as $T_0 \rightarrow \infty$ (2)

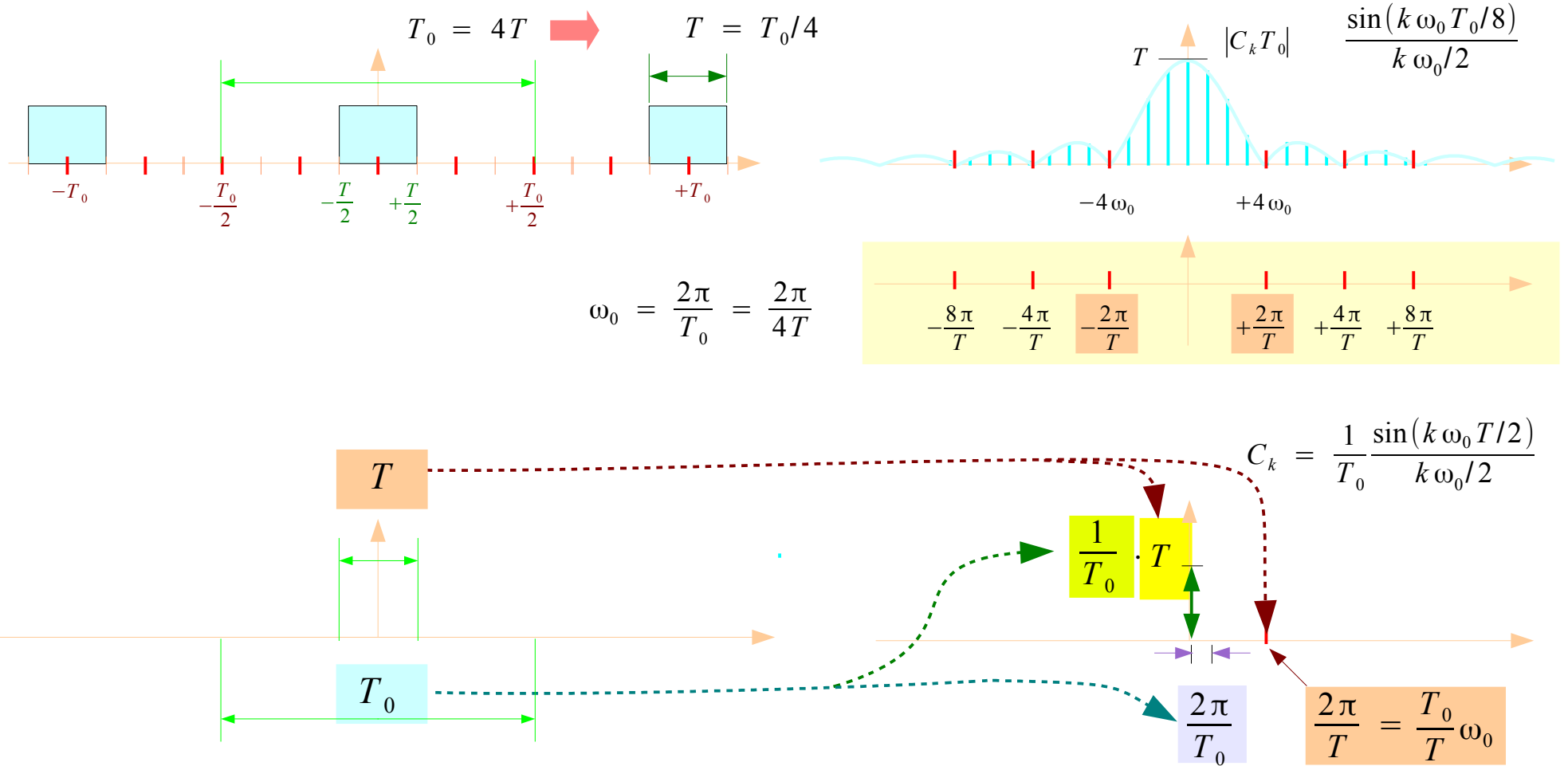

CTFT of a Rect(t/T) function (3)

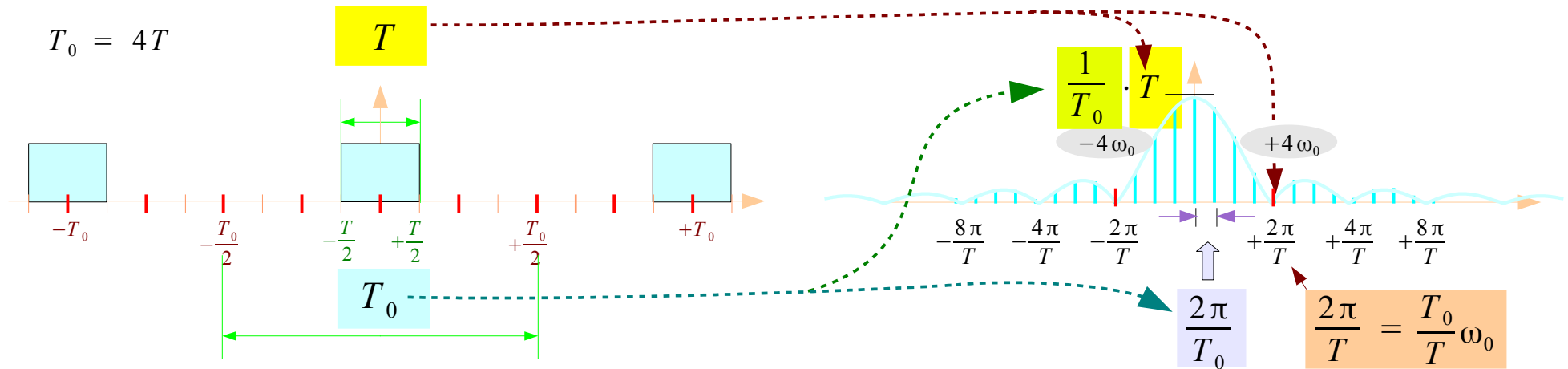

$$C_k T_0 = \frac{\sin(k \omega_0 T/2)}{k \omega_0/2}$$

$$C_k = \frac{1}{T_0} \frac{\sin(k \omega_0 T/2)}{k \omega_0/2}$$

$$X(j\omega) = \lim_{k \omega_0 \rightarrow \omega} \frac{\sin(k \omega_0 T/2)}{k \omega_0/2} = \frac{\sin(\omega T/2)}{\omega/2}$$

$$X(j\omega) = \frac{\sin(\omega T/2)}{\omega/2}$$

$$X(j\omega) = \frac{\sin(\omega T/2)}{\omega/2}$$

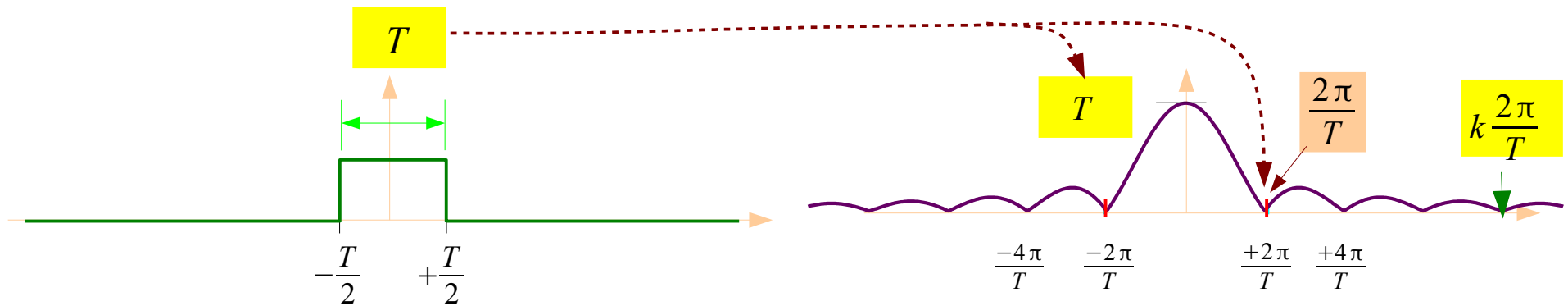

Sampling (1)

Ideal Sampling

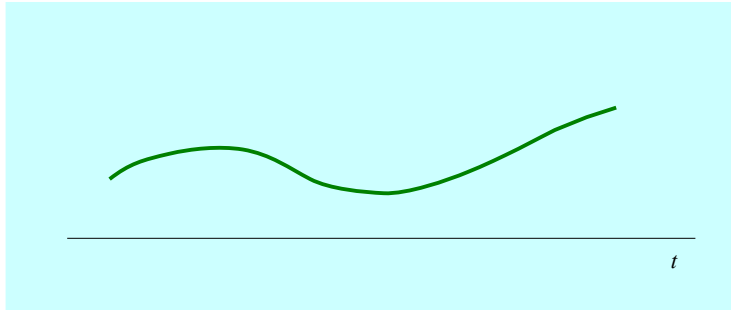

X

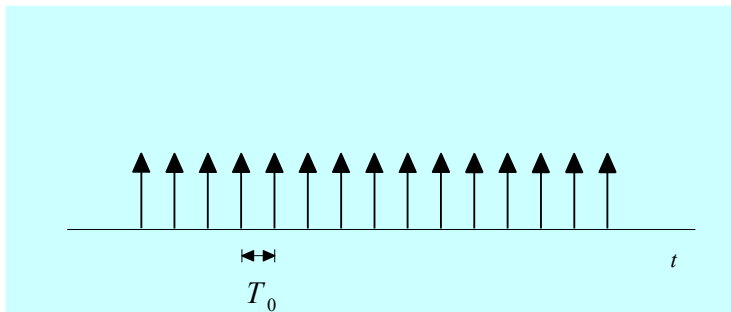

||

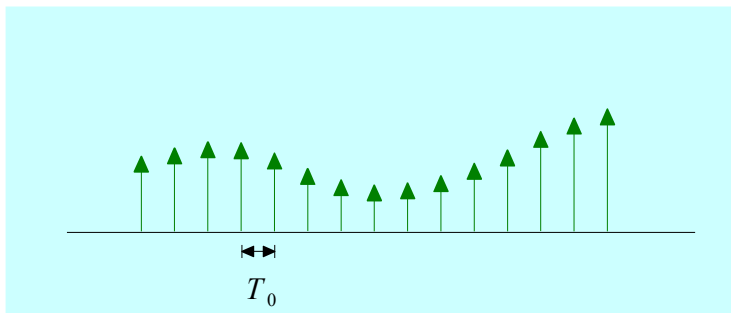

Practical Sampling

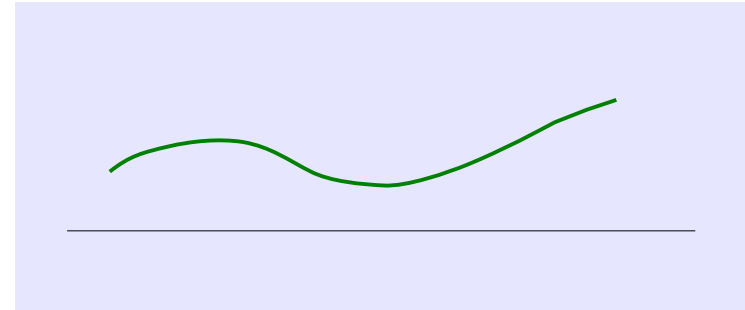

X

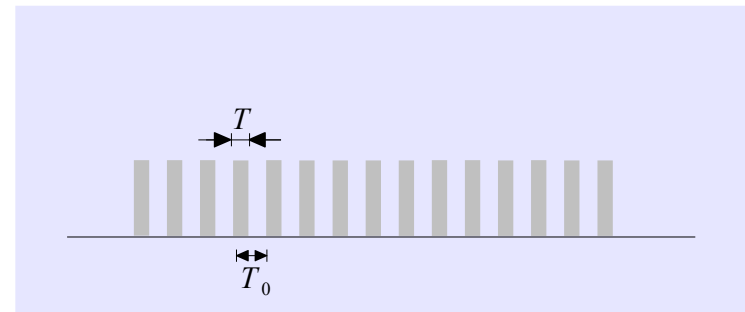

||

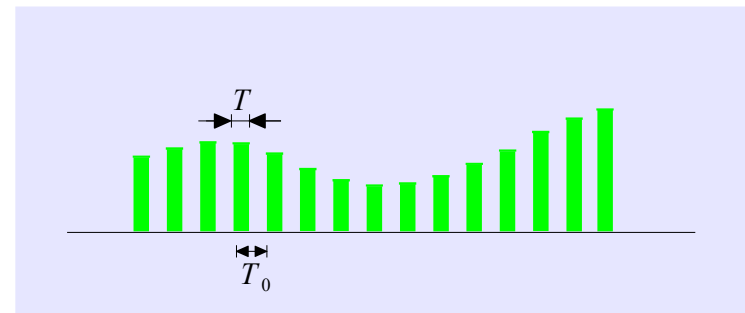

Sampling (2)

Ideal Sampling

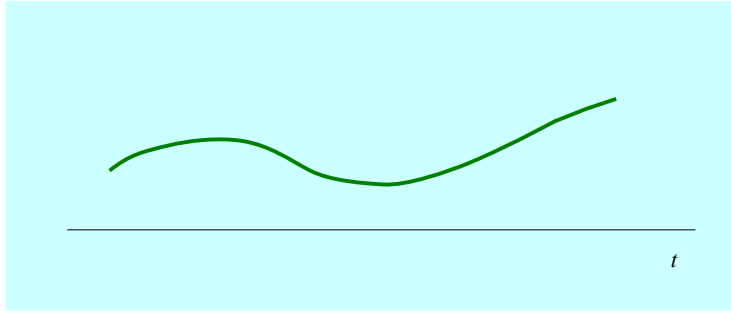

CTFT



Frequency Domain

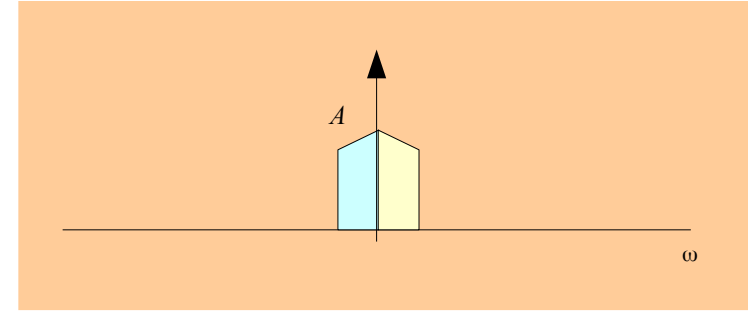

X

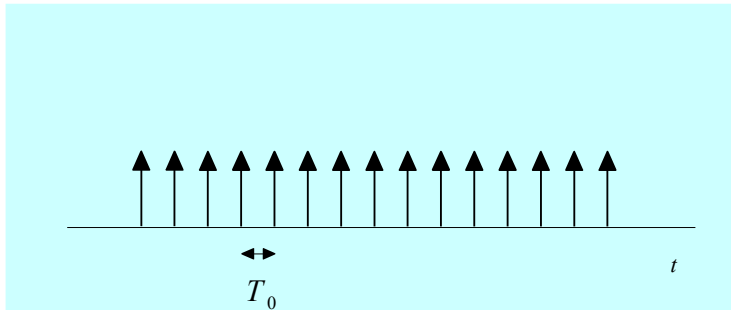

CTFT

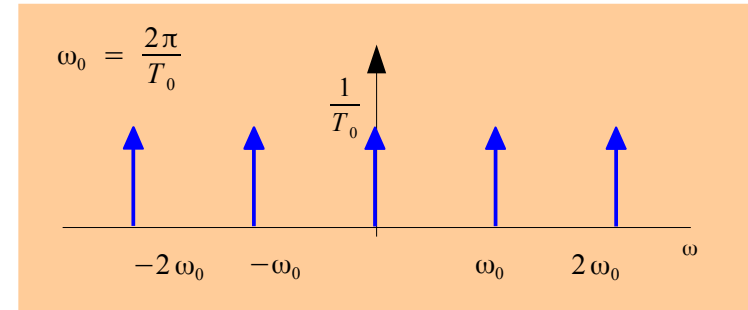

*

||

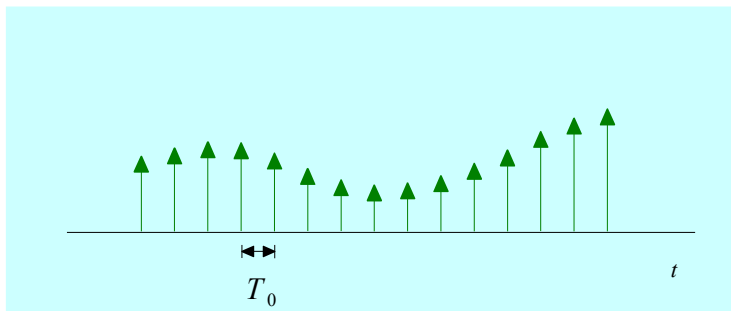

CTFT

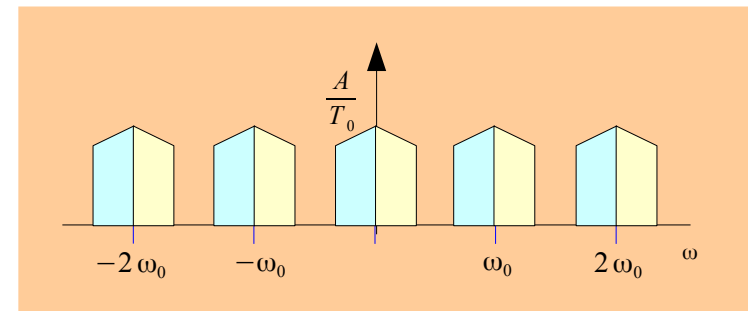

||

Sampling (3)

Practical Sampling

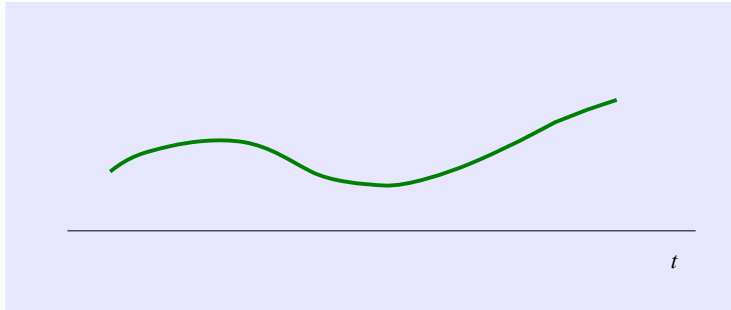

CTFT



Frequency Domain

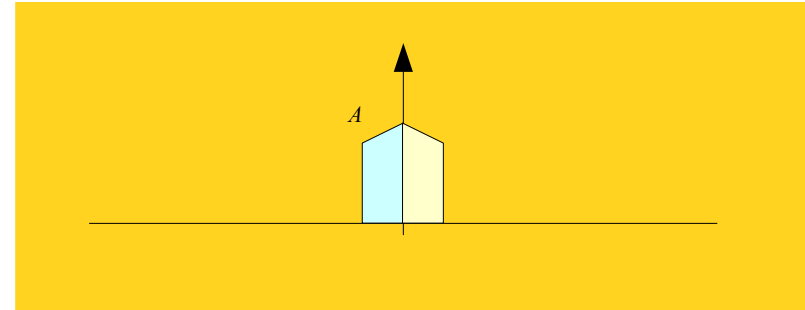

X

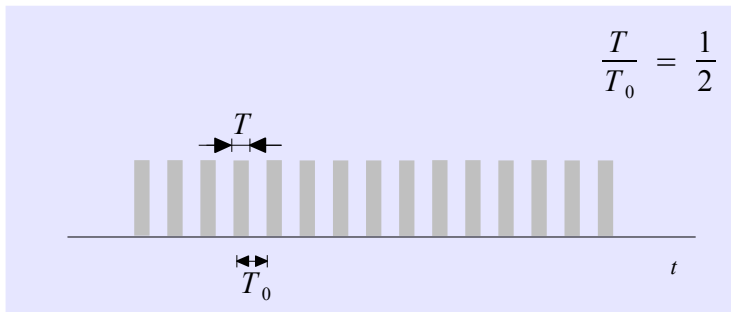

CTFT

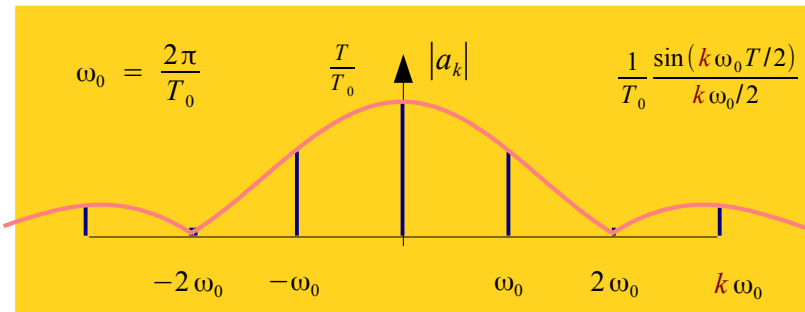

*

||

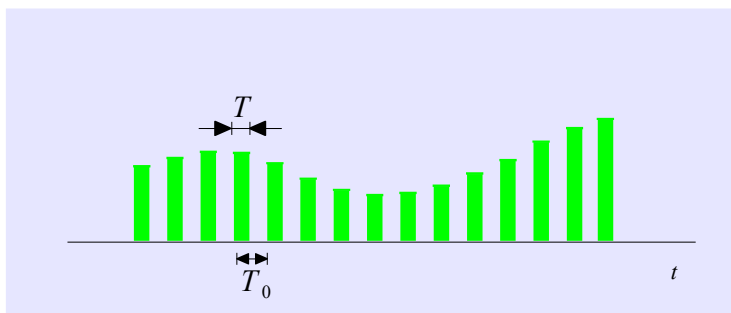

CTFT

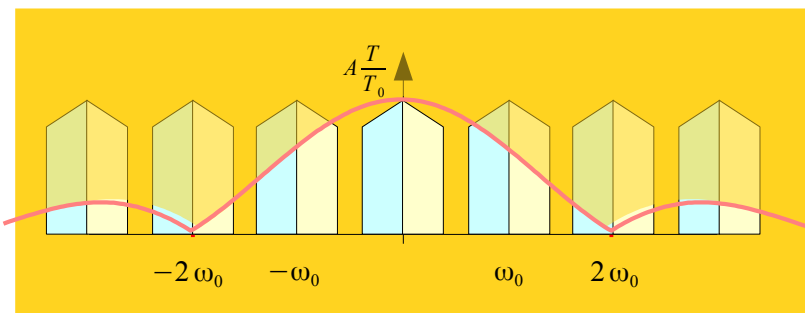

||

Sampling CTFT

Ideal Sampling

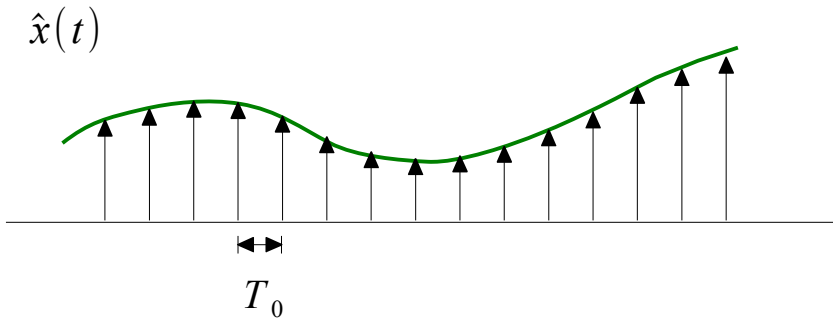

$$\hat{x}(t) = \sum_{n=-\infty}^{+\infty} x(nT_0) \delta(t-nT_0)$$

↓ CTFT

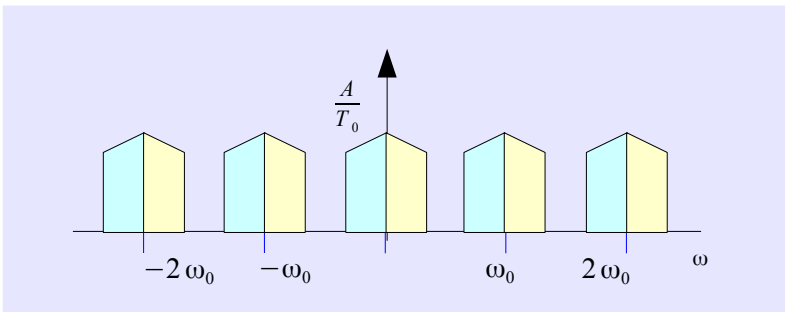

Practical Sampling

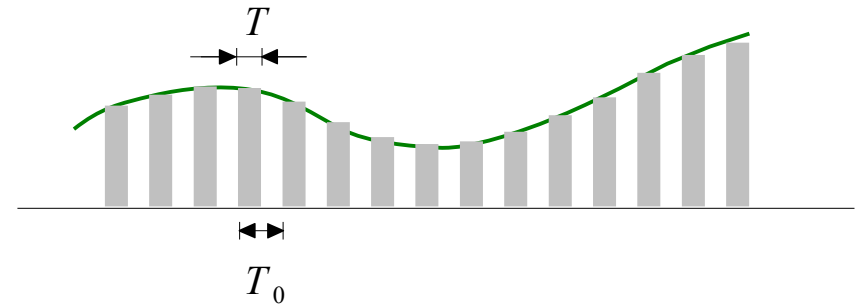

$$\hat{x}(t) \approx \sum_{n=-\infty}^{+\infty} x(nT_0) p(t-nT_0)$$

↓ CTFT

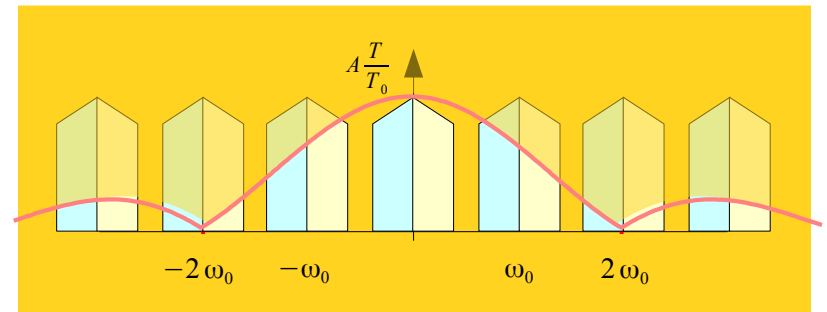

Convolution with Impulse Train

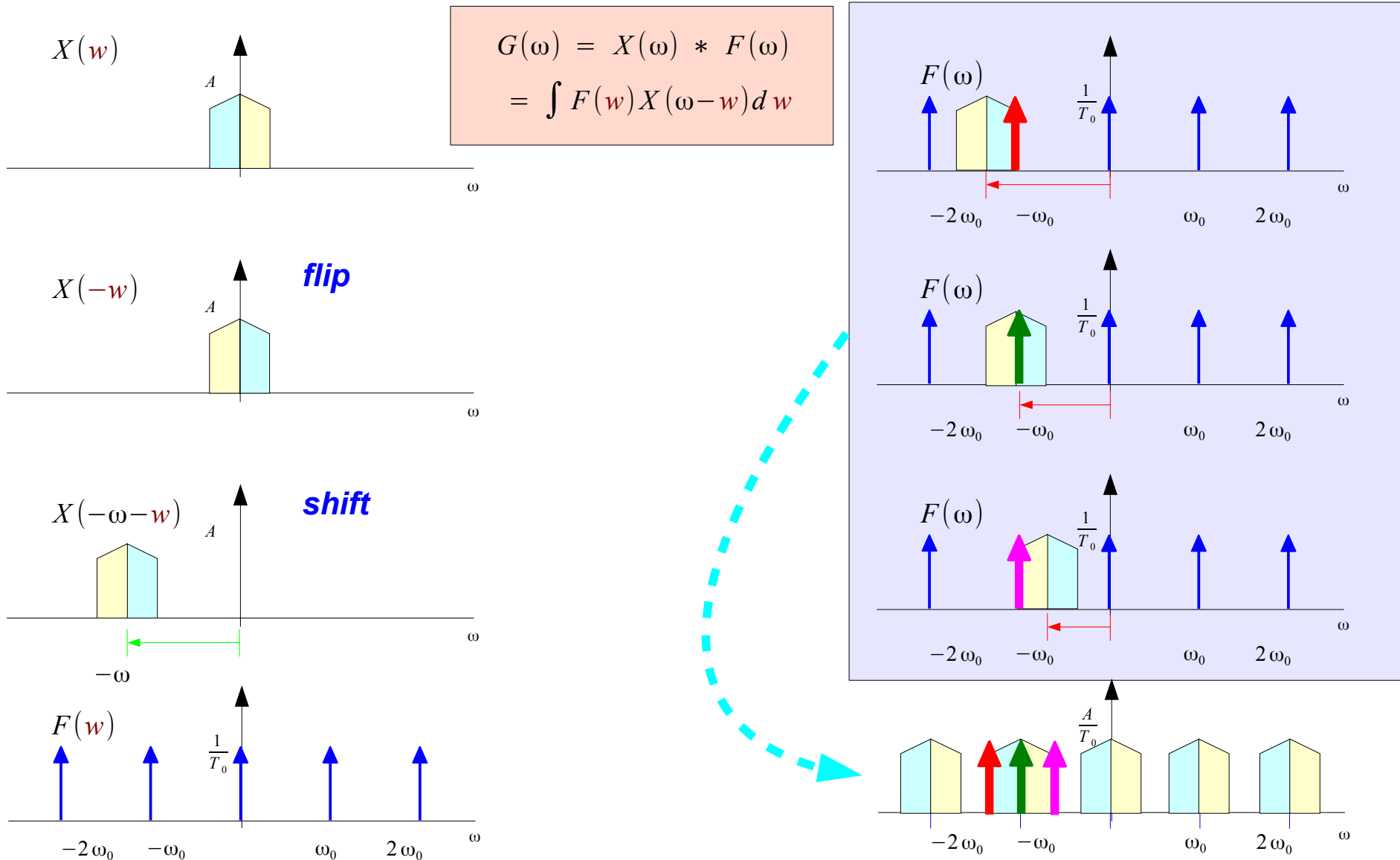

Convolution with Sinc Impulse Train

$X(\omega)$

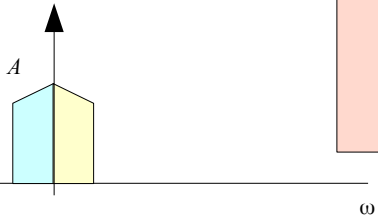

$$G(\omega) = X(\omega) * F(\omega) = \int F(\omega') X(\omega - \omega') d\omega'$$

$X(-\omega)$

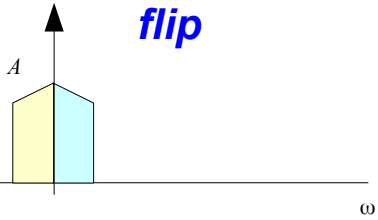

$X(-\omega - \omega')$

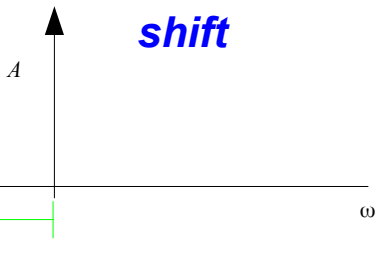

$F(\omega)$

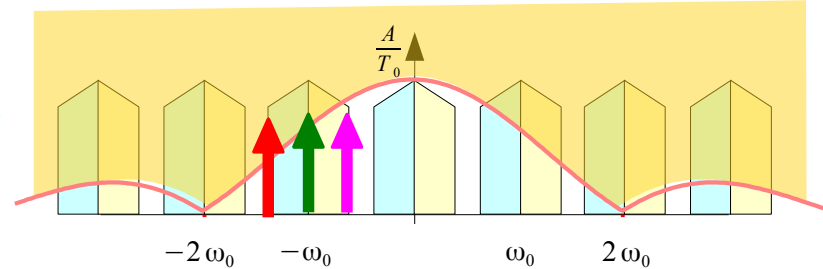
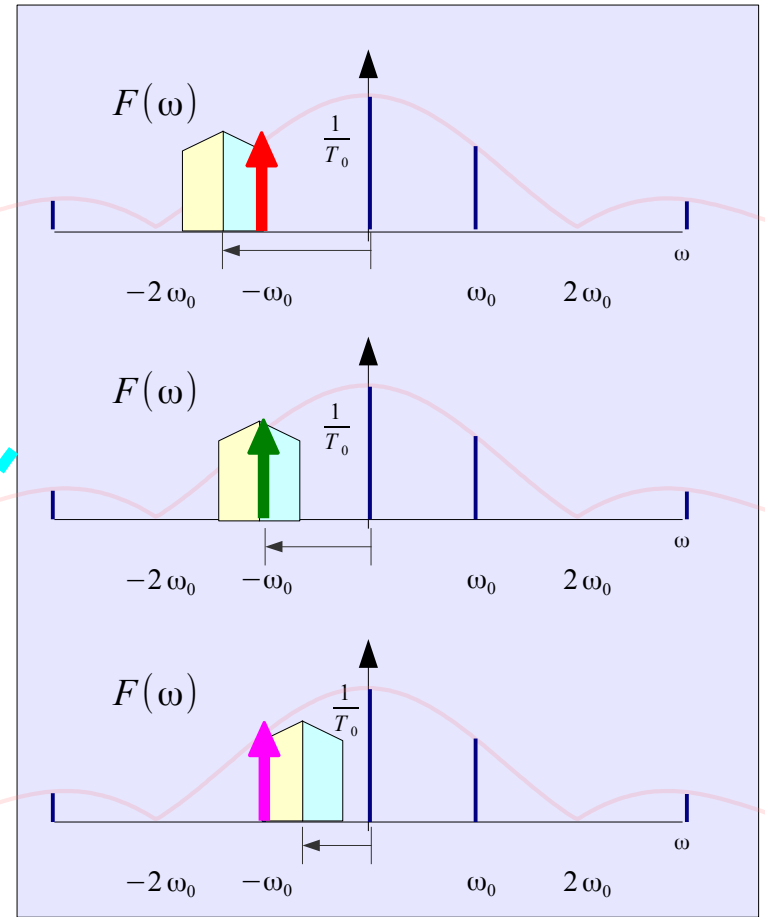
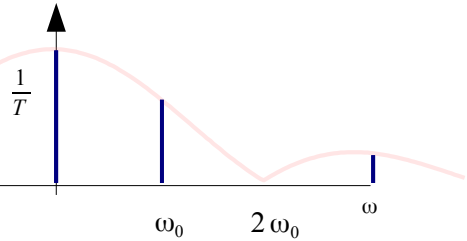

CTFT of Sampled Signal

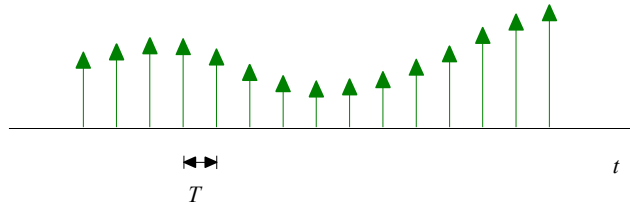

$$\hat{x}(t) = \sum_{n=-\infty}^{+\infty} x(nT) \delta(t-nT)$$

CTFT

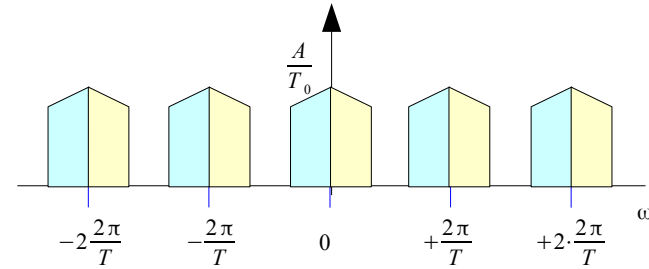

$$\begin{aligned} \hat{X}(f) &= \int_{-\infty}^{+\infty} \hat{x}(t) e^{-j2\pi f t} dt \\ &= \int_{-\infty}^{+\infty} \sum_{n=-\infty}^{+\infty} x(nT) \delta(t-nT) e^{-j2\pi f t} dt \\ &= \sum_{n=-\infty}^{+\infty} x(nT) e^{-j2\pi f T n} \end{aligned}$$

$$\hat{x}(t) = \sum_{n=-\infty}^{+\infty} x(nT) \delta(t-nT)$$

CTFT



$$\hat{X}(f) = \sum_{n=-\infty}^{+\infty} x(nT) e^{-j2\pi f T n}$$

Periodicity in Frequency

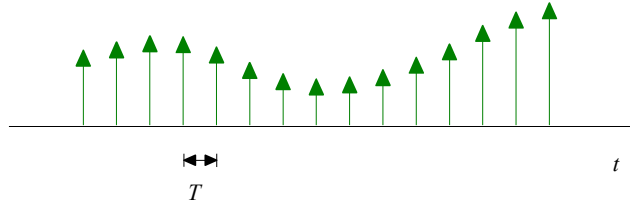

$$f_s = \frac{1}{T} \quad 2\pi f_s = \frac{2\pi}{T} = \omega_0$$

$$\hat{x}(t) = \sum_{n=-\infty}^{+\infty} x(nT) \delta(t-nT)$$

CTFT

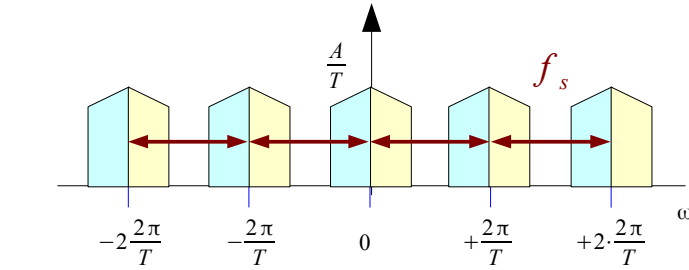

$$2\pi f = \omega$$

$$\hat{X}(f) = \sum_{n=-\infty}^{+\infty} x(nT) e^{-j2\pi f T n}$$

$$e^{-j2\pi(f+f_s)Tn} = e^{-j2\pi(f)Tn} \quad \leftarrow f_s T = 1$$

Period = Sampling Frequency f_s

$$\hat{X}(f) = \hat{X}(f + f_s)$$

Time Sequence

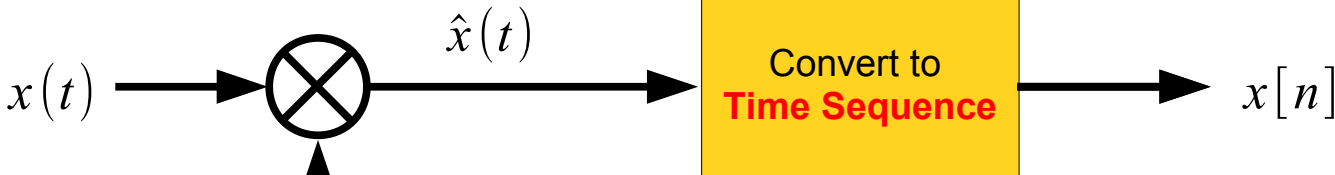
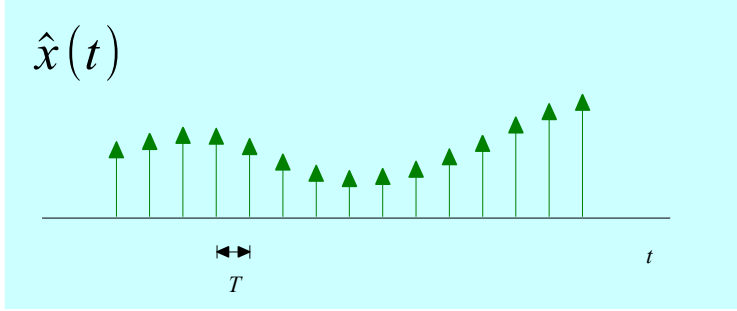
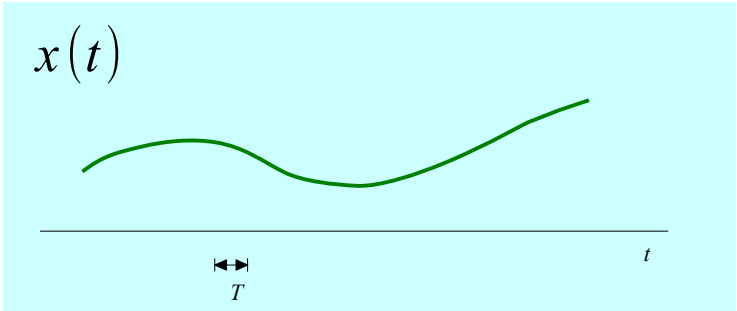

Ideal Sampling

$$p(t) = \sum_{n=-\infty}^{+\infty} \delta(t - nT)$$

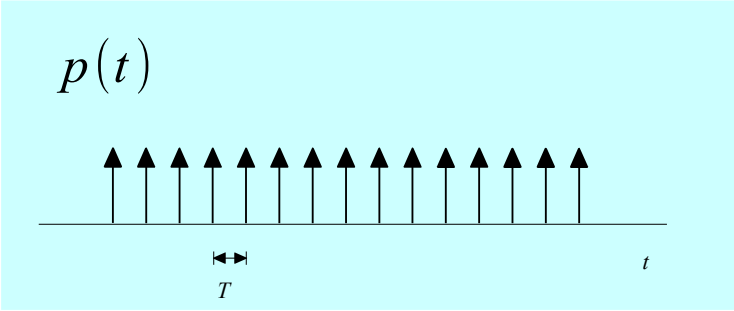

T Sampling Period

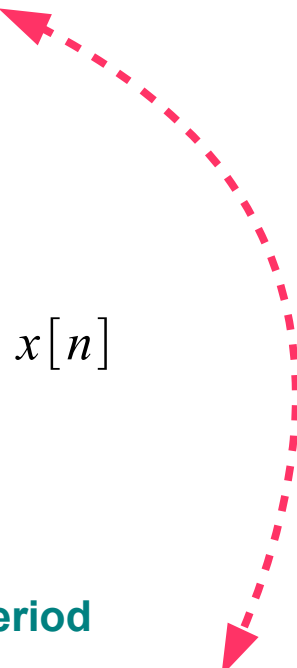
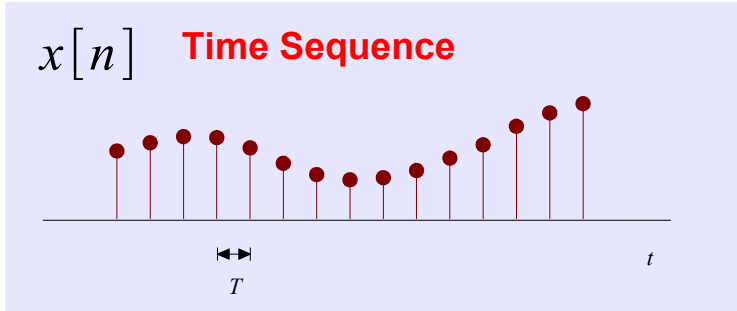

DTFT of a Time Sequence

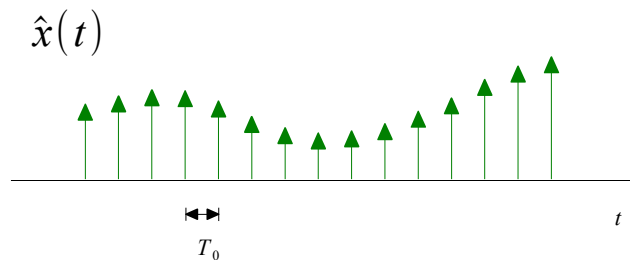

$$\hat{x}(t) = \sum_{n=-\infty}^{+\infty} x(nT_0) \delta(t-nT_0)$$

CTFT

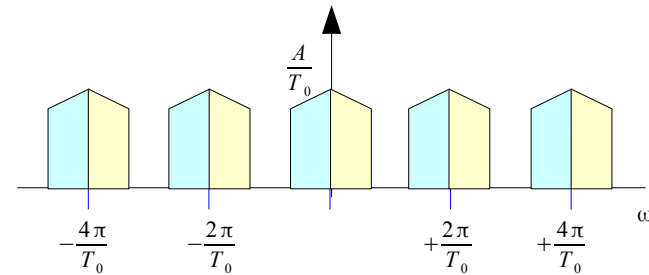

$$\hat{X}(f) = \sum_{n=-\infty}^{+\infty} x(nT_0) e^{-j2\pi f T_0 n}$$

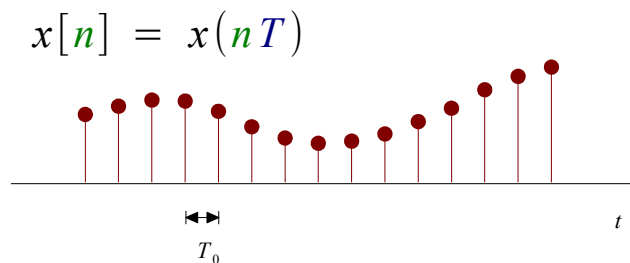

$$x[n], \text{ Sampling Period } T_0$$

DTFT

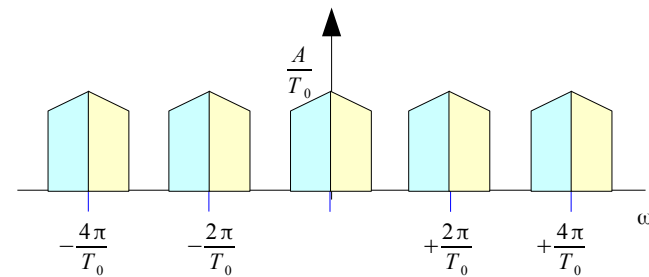

$$X(f) = \sum_{n=-\infty}^{+\infty} x[n] e^{-j2\pi f T_0 n}$$

Here, $X(f)$ does not denote the CTFT of $x(t)$

Discrete Time Fourier Transform (1)

$$x[n] = x(nT)$$

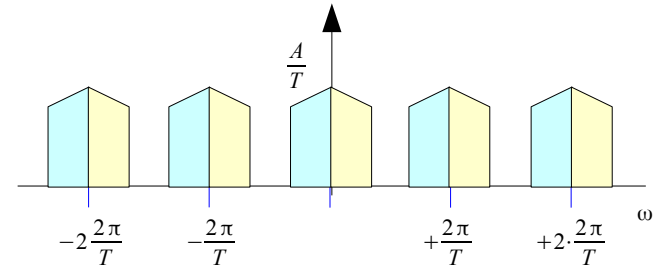
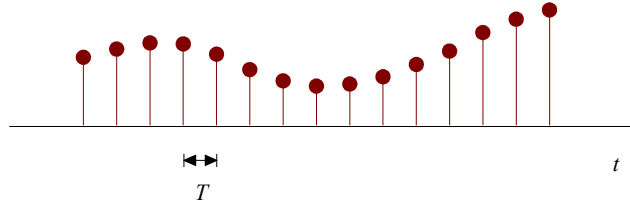

$x[n]$, Sampling Period T

DTFT



$$X(f) = \sum_{n=-\infty}^{+\infty} x[n] e^{-j2\pi f T n}$$

Normalized Angular Frequency

$$2\pi f T = \frac{2\pi f}{1/T} = 2\pi \frac{f}{f_s} = \hat{\omega}$$

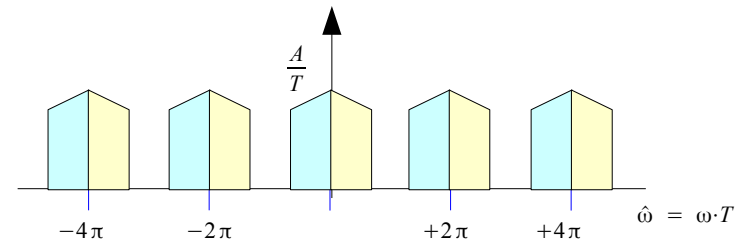

$x[n]$, Sampling Period T

DTFT



$$X(e^{j\hat{\omega}}) = \sum_{n=-\infty}^{+\infty} x[n] e^{-j\hat{\omega} n}$$

Discrete Time Fourier Transform (2)

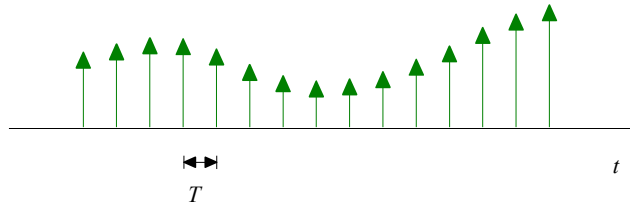

$$f_s = \frac{1}{T} \quad 2\pi f_s = \frac{2\pi}{T} = \omega_0$$

$$X(f) = \sum_{n=-\infty}^{+\infty} x[n] e^{-j2\pi f T n}$$

Normalized Angular Frequency

$$2\pi f T = \frac{2\pi f}{1/T} = 2\pi \frac{f}{f_s} = \hat{\omega}$$

$$X(e^{j\hat{\omega}}) = \sum_{n=-\infty}^{+\infty} x[n] e^{-j\hat{\omega} n}$$

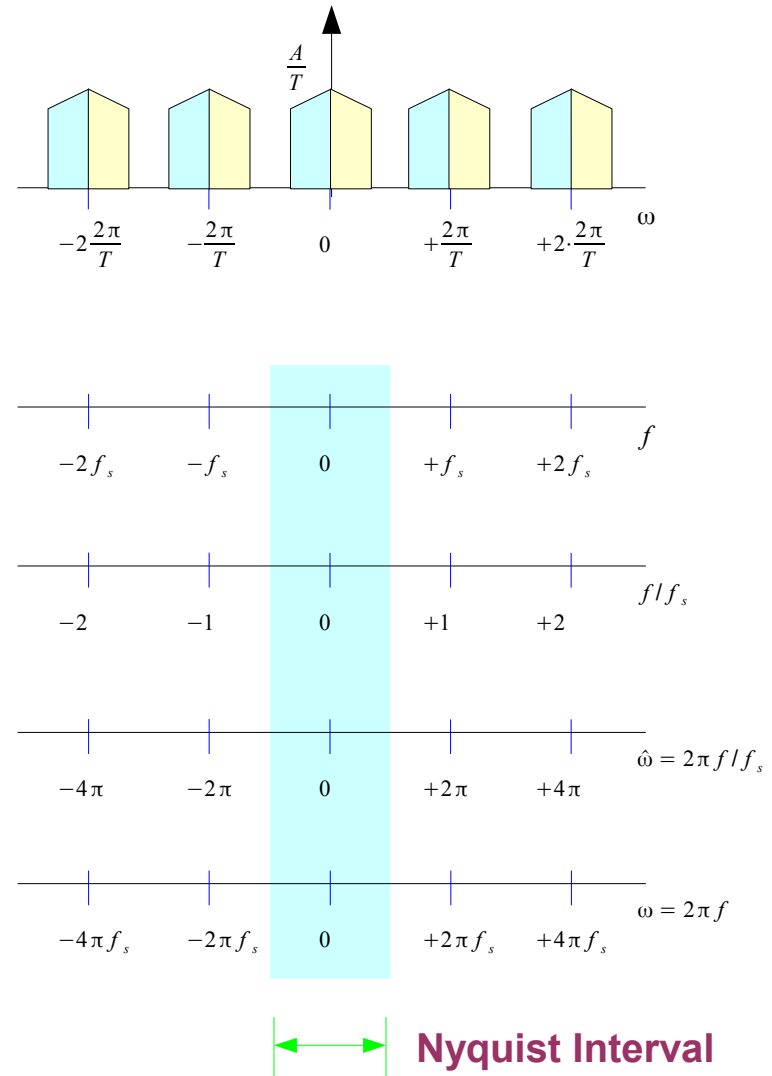

Discrete Time Fourier Transform (3)

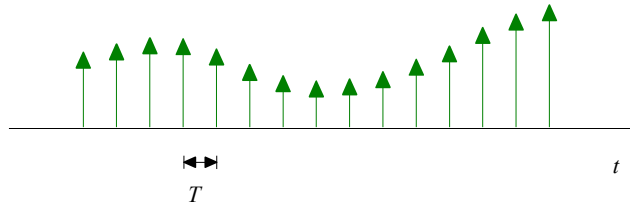

$$f_s = \frac{1}{T} \quad 2\pi f_s = \frac{2\pi}{T} = \omega_0$$

$$X(f) = \sum_{n=-\infty}^{+\infty} x[n] e^{-j2\pi f T n}$$

Normalized Angular Frequency

$$2\pi f T = \frac{2\pi f}{1/T} = 2\pi \frac{f}{f_s} = \hat{\omega}$$

$$X(e^{j\hat{\omega}}) = \sum_{n=-\infty}^{+\infty} x[n] e^{-j\hat{\omega} n}$$

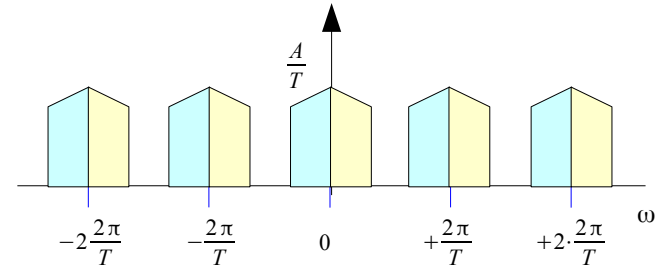

$\hat{X}(f)$ Absolute Frequency



$\hat{X}(e^{j\hat{\omega}})$ Normalized Angular Frequency
unit circle →
emphasize the periodic nature



Fourier Series Interpretation

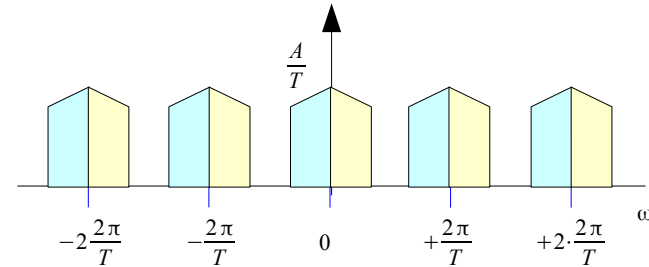
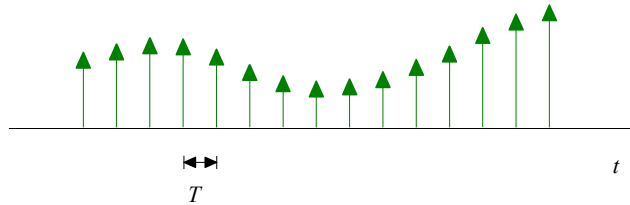

$$\hat{x}(t) = \sum_{n=-\infty}^{+\infty} x(nT) \delta(t-nT)$$

CTFT



$$\hat{X}(f) = \sum_{n=-\infty}^{+\infty} x(nT) e^{-j2\pi fTn}$$

$$x(nT) = \frac{1}{f_s} \int_{+f_s/2}^{-f_s/2} \hat{X}(f) e^{+j2\pi fTn} df$$

CTFS



$$\hat{X}(f) = \sum_{n=-\infty}^{+\infty} x(nT) e^{-j2\pi fTn}$$

$$= \int_{-\pi}^{+\pi} \hat{X}(\omega) e^{+j\omega n} \frac{d\omega}{2\pi}$$

$$\omega = 2\pi f / f_s \quad \frac{df}{f_s} = \frac{d\omega}{2\pi}$$

Fourier Series Coefficients $x(nT)$

$\hat{X}(f)$ **Continuous Periodic Function**

View as a Fourier Series Expansion

Numerical Approximation

$$X(f) = \lim_{T \rightarrow 0} T \hat{X}(f)$$

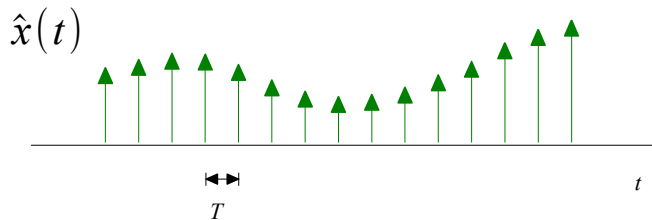
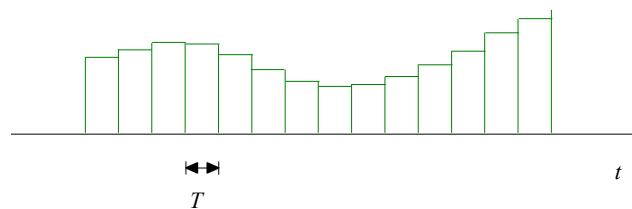
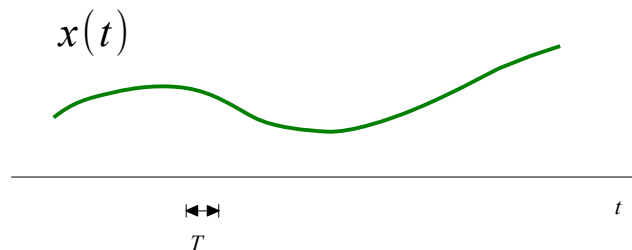

$$\hat{x}(t) = \sum_{n=-\infty}^{+\infty} x(nT) \delta(t-nT)$$

CTFT

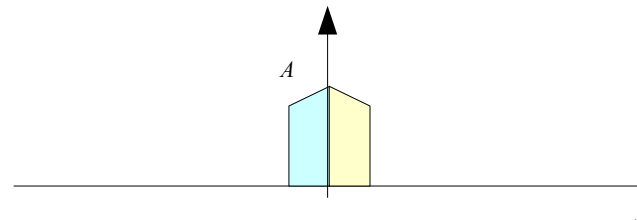

$$X(f) = \int_{-\infty}^{+\infty} x(t) e^{+j2\pi f t} dt$$

$$\approx \sum_{n=-\infty}^{+\infty} x(nT) e^{-j2\pi f T n} \cdot T$$

$$X(f) \approx T \hat{X}(f)$$

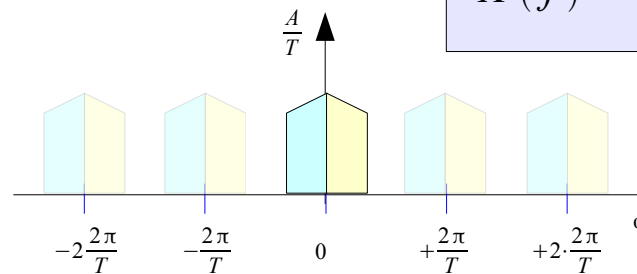

CTFT



$$\hat{X}(f) = \sum_{n=-\infty}^{+\infty} x(nT) e^{-j2\pi f T n}$$

Spectrum Replication (1)

Ideal Sampling

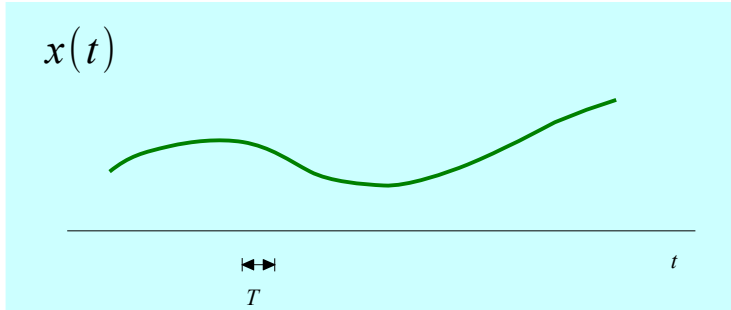

X

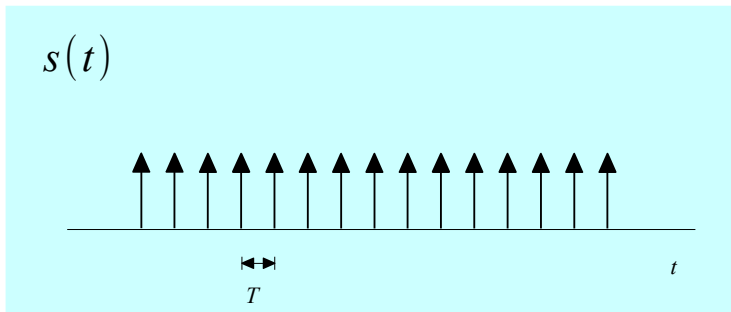

||

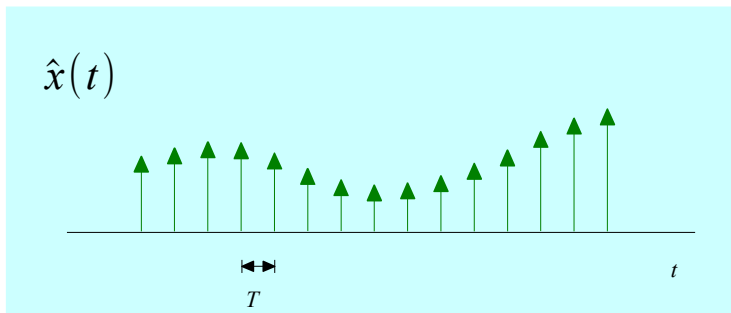

$$\hat{x}(t) = \sum_{n=-\infty}^{+\infty} x(nT) \delta(t-nT)$$

$$\begin{aligned} s(t) &= \sum_{n=-\infty}^{+\infty} \delta(t-nT) \\ &= \frac{1}{T} \sum_{m=-\infty}^{+\infty} e^{+j2\pi m f_s t} \end{aligned}$$

$$\hat{x}(t) = \frac{1}{T} \sum_{n=-\infty}^{+\infty} x(t) e^{+j2\pi m f_s t}$$

Shift Property



$$\hat{X}(f) = \frac{1}{T} \sum_{n=-\infty}^{+\infty} X(f - m f_s)$$

Spectrum Replication (2)

$$S(f) = \frac{1}{T} \sum_{m=-\infty}^{+\infty} \delta(f - m f_s)$$

Convolution in Frequency

$$\hat{X}(f) = X(f) * S(f)$$

$$= \int_{-\infty}^{+\infty} X(f - f') S(f') d f'$$

$$= \frac{1}{T} \sum_{m=-\infty}^{+\infty} \int_{-\infty}^{+\infty} X(f - f') \delta(f' - m f_s) d f'$$

$$\hat{X}(f) = \frac{1}{T} \sum_{n=-\infty}^{+\infty} X(f - m f_s)$$

Frequency Domain

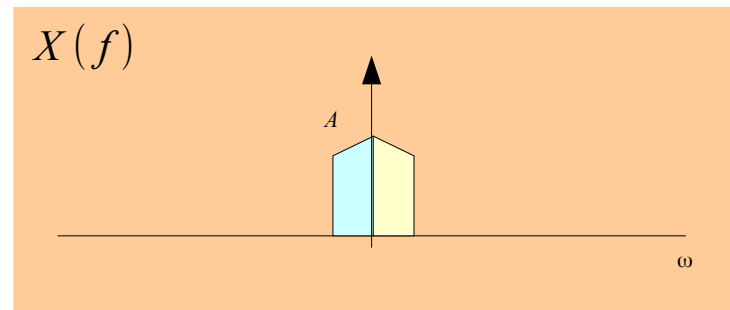

*

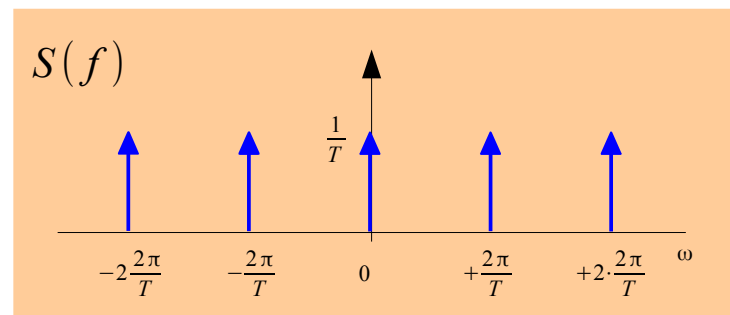

||

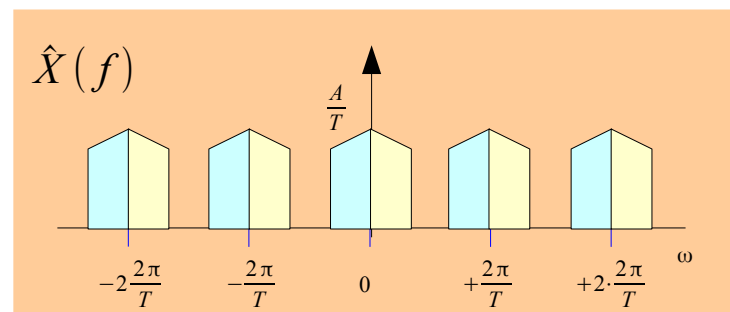

References

- [1] <http://en.wikipedia.org/>
- [2] J.H. McClellan, et al., Signal Processing First, Pearson Prentice Hall, 2003
- [3] A “graphical interpretation” of the DFT and FFT, by Steve Mann
- [4] R. G. Lyons, Understanding Digital Signal Processing, 1997
- [5] AVR121: Enhancing ADC resolution by oversampling
- [6] S.J. Orfanidis, Introduction to Signal Processing
www.ece.rutgers.edu/~orfanidi/intro2sp