

Control (1A)

Copyright (c) 2010, 2011 Young W. Lim.

Permission is granted to copy, distribute and/or modify this document under the terms of the GNU Free Documentation License, Version 1.2 or any later version published by the Free Software Foundation; with no Invariant Sections, no Front-Cover Texts, and no Back-Cover Texts. A copy of the license is included in the section entitled "GNU Free Documentation License".

Please send corrections (or suggestions) to youngwlim@hotmail.com.

This document was produced by using OpenOffice.

If Statement

```
if ( A ) B;  
else   C;
```

```
if ( A ) B;
```

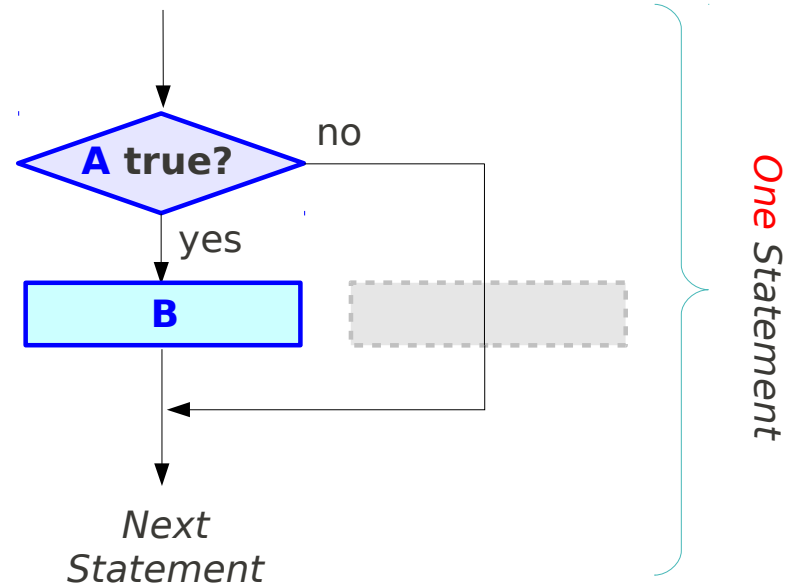
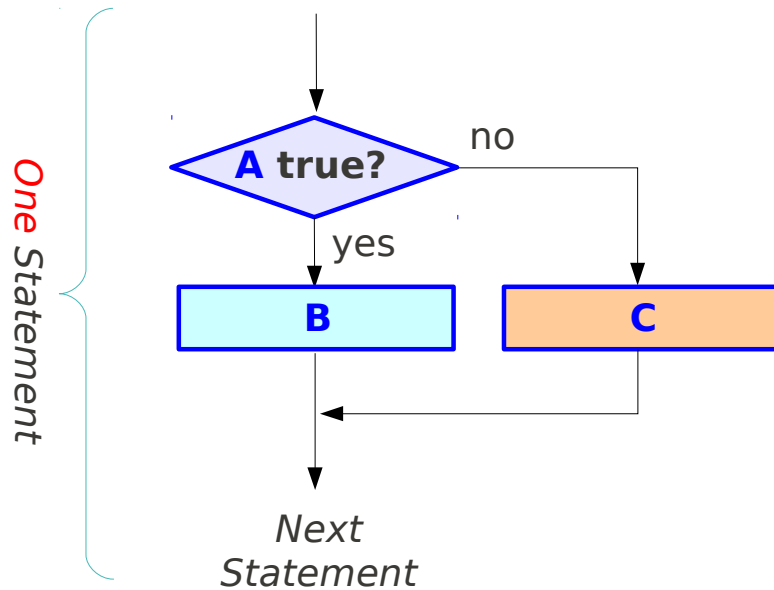

If Compound Statement

```
if ( A ) { B1; B2; B3; }  
else     { C1; C2; }
```

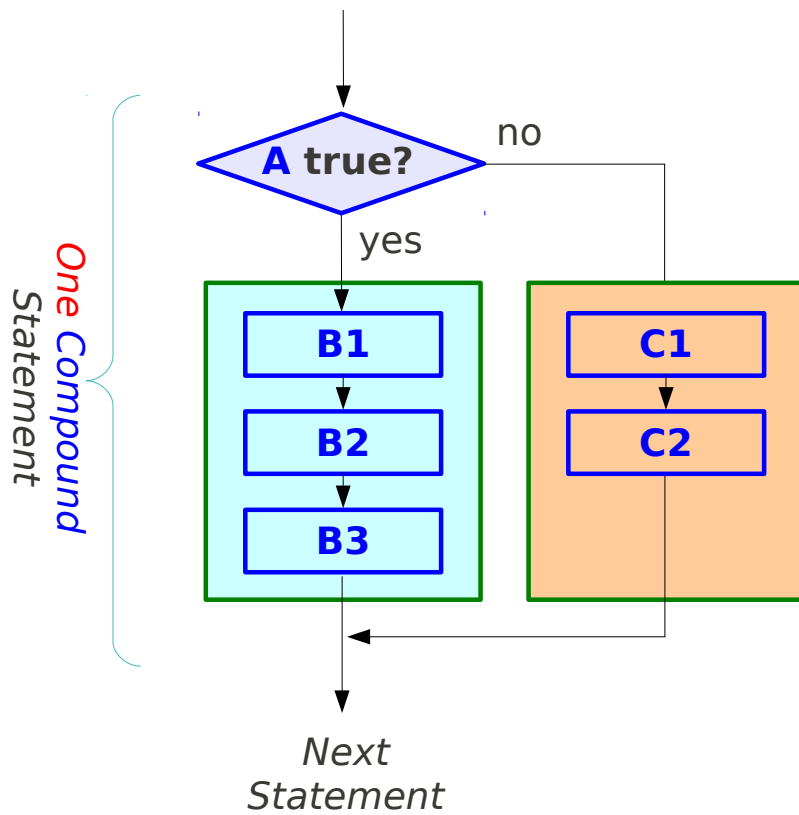

```
if ( A ) { B1; B2; B3; }
```

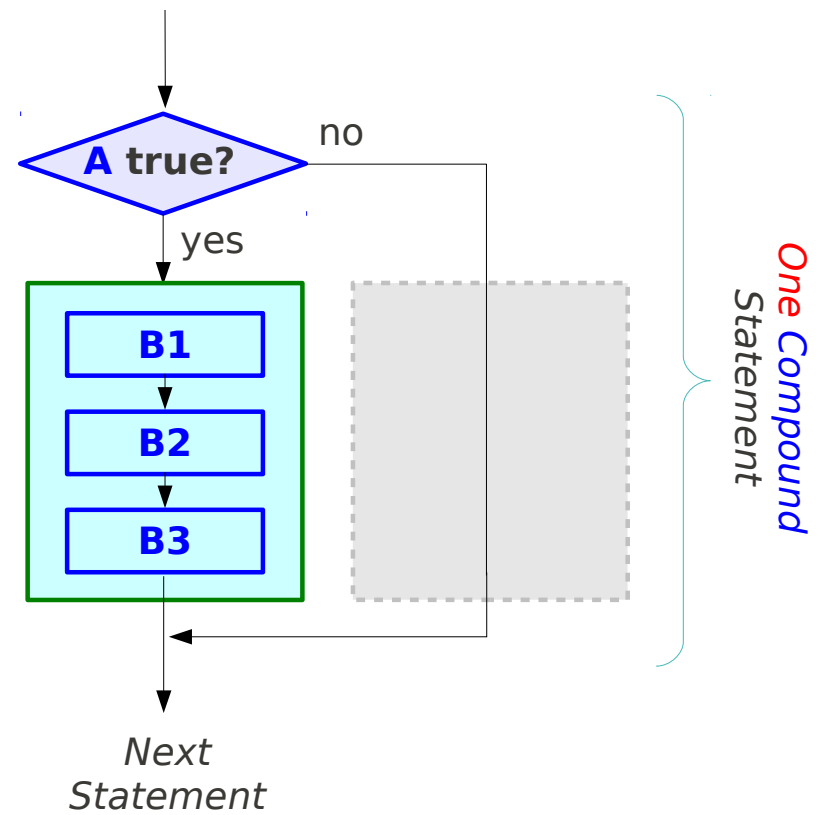

Cases of **if-else** Statements (1)

Each of these if statements are treated as a single statement.

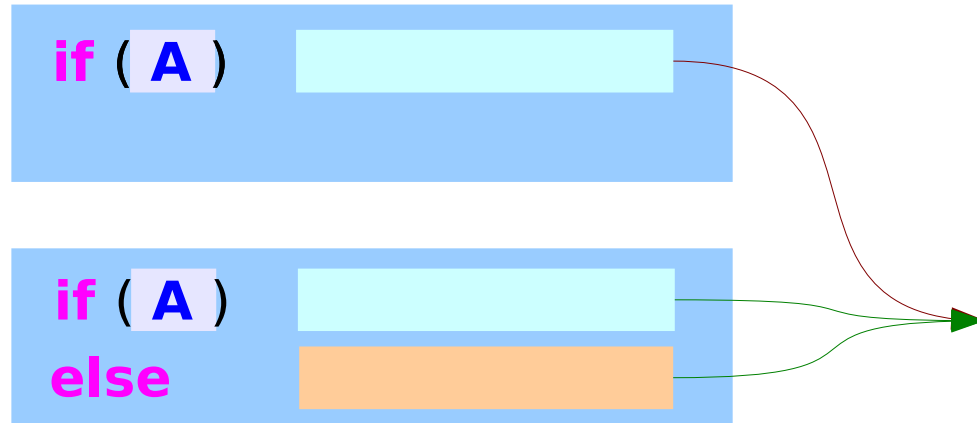

If clause and else clause can be

1) a single statement

St1;

2) a compound statement

{ St1; St2; St3; }

3) a nested if statement

if (B) [light blue box]

4) a nested if-else statement

if (B) [light blue box]

else [orange box]

Cases of **if-else** Statements (2)

if clause

single *if* clause

```
if ( A ) B1;
```

compound *if* clause

```
if ( A ) { B1; B2 }
```

if-else clause

single *if* - single *else* clause

```
if ( A ) B1;  
else C1;
```

single *if* - compound *else* clause

```
if ( A ) B1;  
else { C1; C2; }
```

compound *if* - single *else* clause

```
if ( A ) { B1; B2 }  
else C1;
```

compound *if* - compound *else* clause

```
if ( A ) { B1; B2 }  
else { C1; C2; }
```

Pairing **if** and **else**

An **else** clause is matched with the **closest if** clause

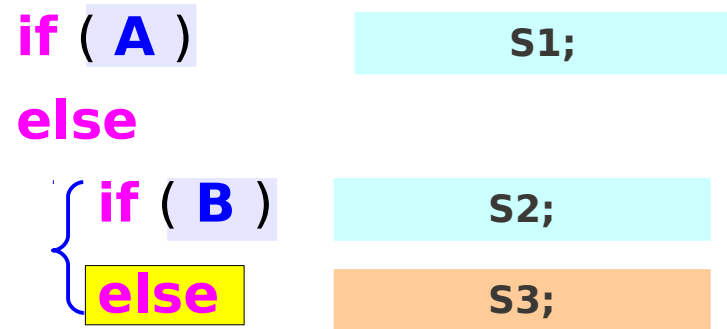
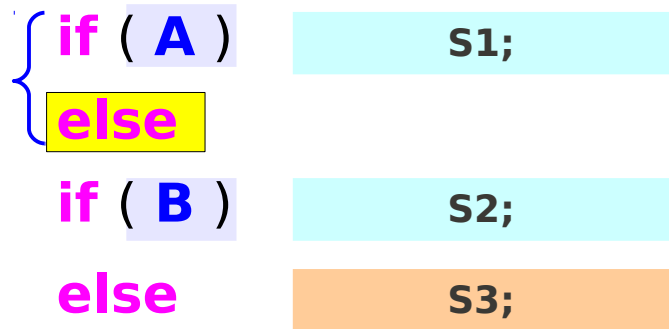
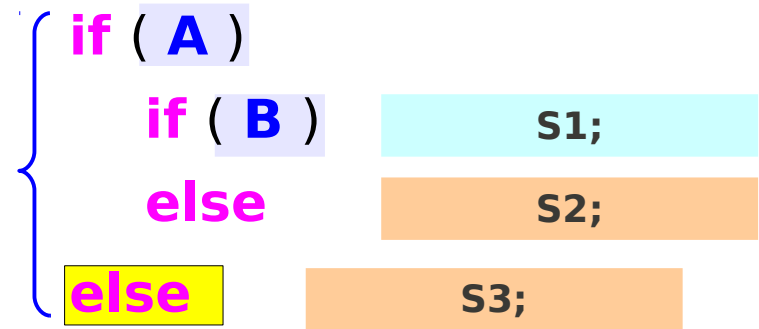
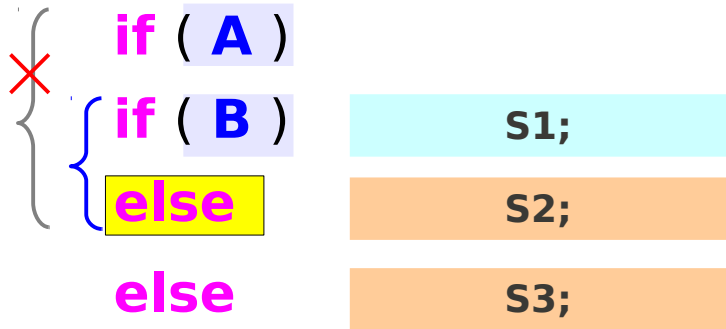

Nested If Statement (1)

```
if ( A1 )  
  if ( A2 ) B2;  
  else C2;  
else C1
```



```
if ( A1 )  
  if ( A2 ) B2;  
  else C2;  
else C1;
```

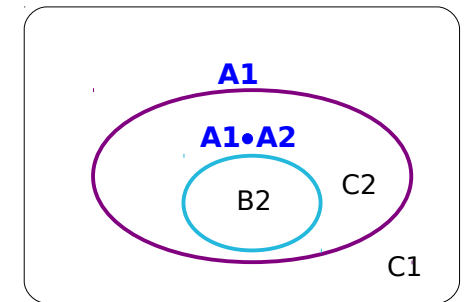
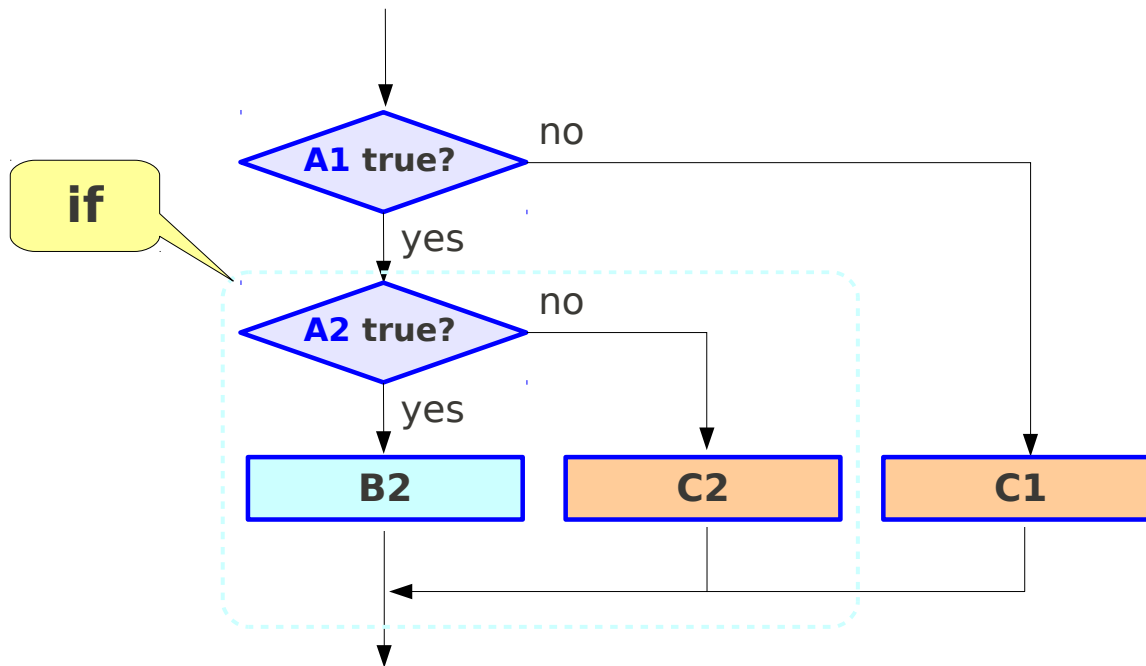

Nested If Statement (2)

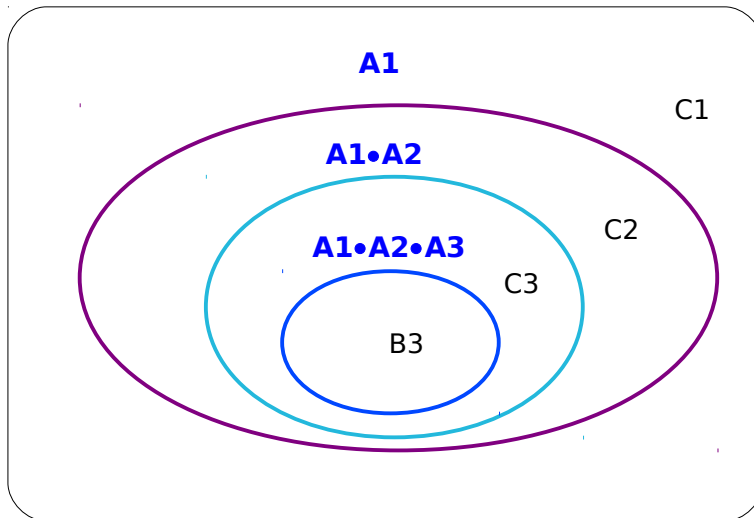
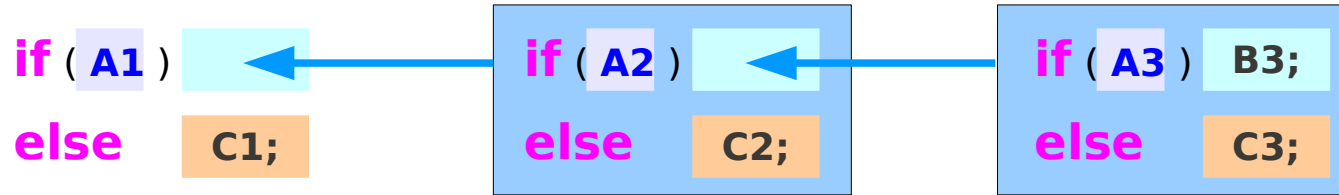

```
if (A1)  
  if (A2)  
    if (A3) B3;  
    else C3;  
  else C2;  
else C1;
```

Nested If Statement (3)

```
if ( A1 ) B1;  
else  
if ( A2 ) B2;  
else C2;
```



```
if ( A1 ) B1;  
else if ( A2 ) B2;  
else C2;
```

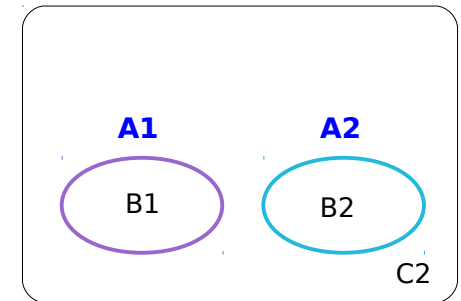
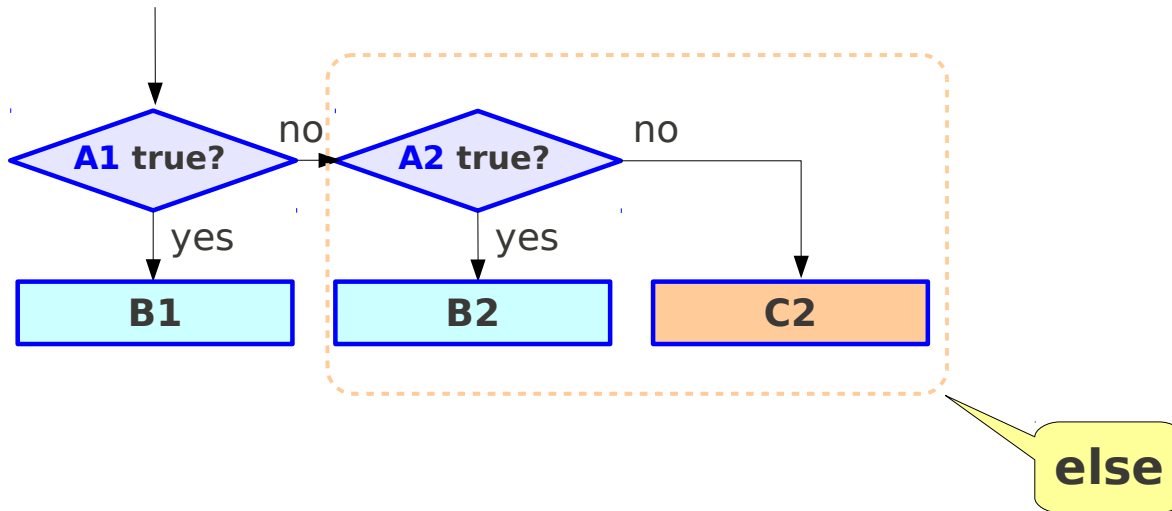

Nested **if** Statement (4)

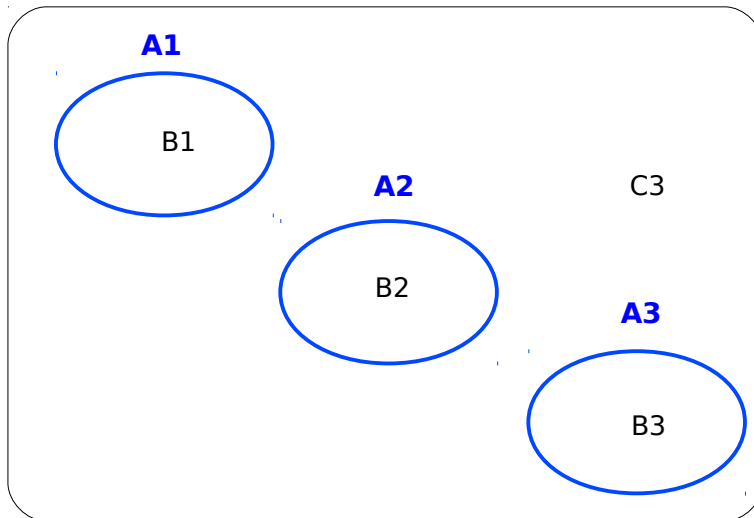
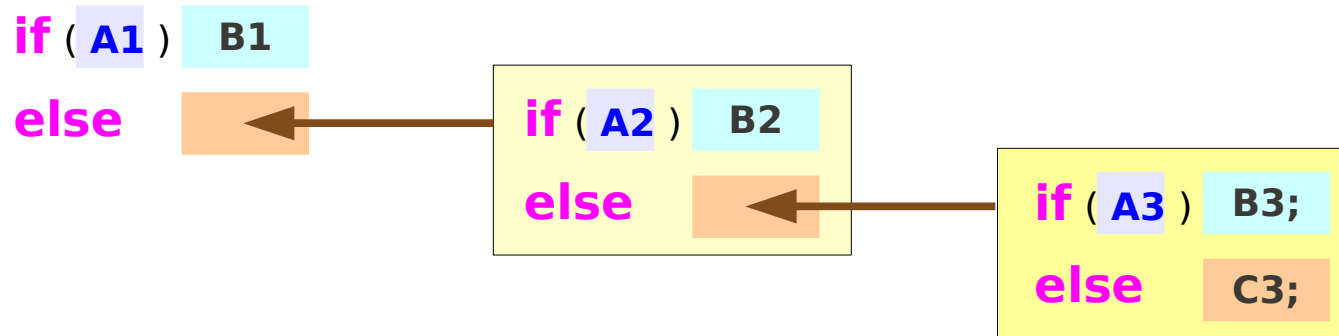

```
if (A1) B1;  
else if (A2) B2;  
else if (A3) B3;  
else C3;
```

Switch Statement (1)

```
switch ( A ) {  
  case A1: S1;  
            break;  
  case A2: S2;  
            break;  
  default : S3;  
            break;  
}
```

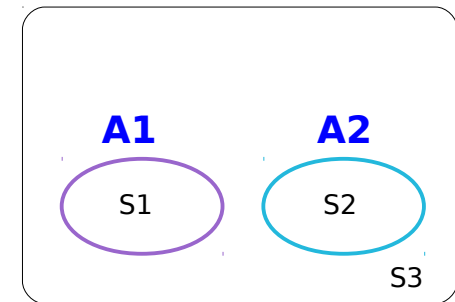
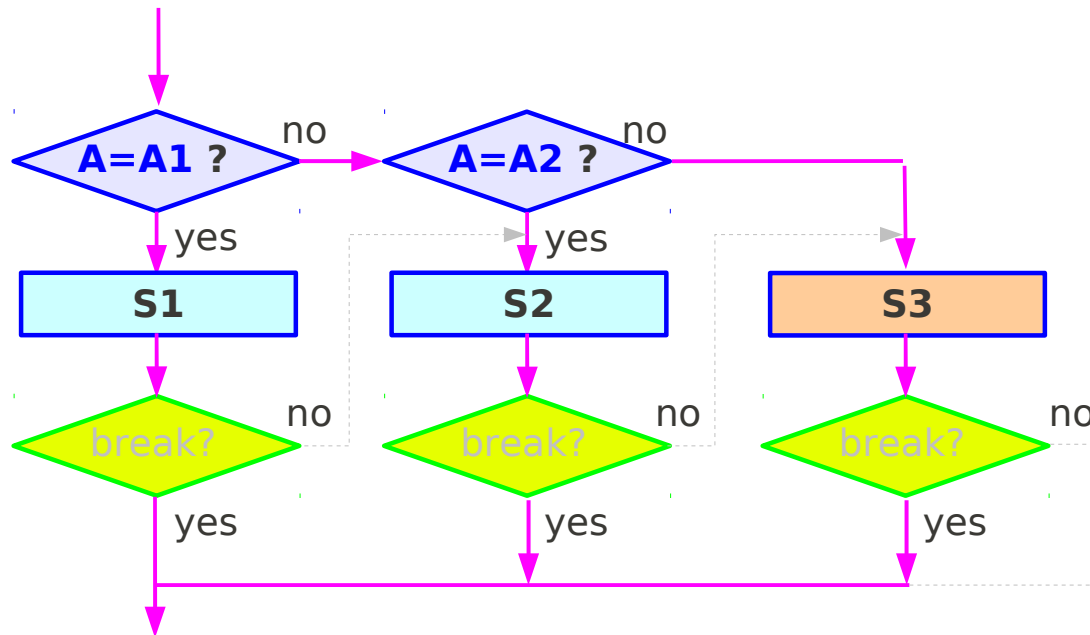

Switch Statement (2)

```
switch ( A ) {  
  case A1: S1;  
  case A2: S2;  
           break;  
  default : S3;  
           break;  
}
```

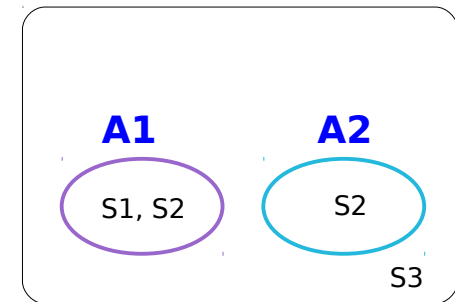
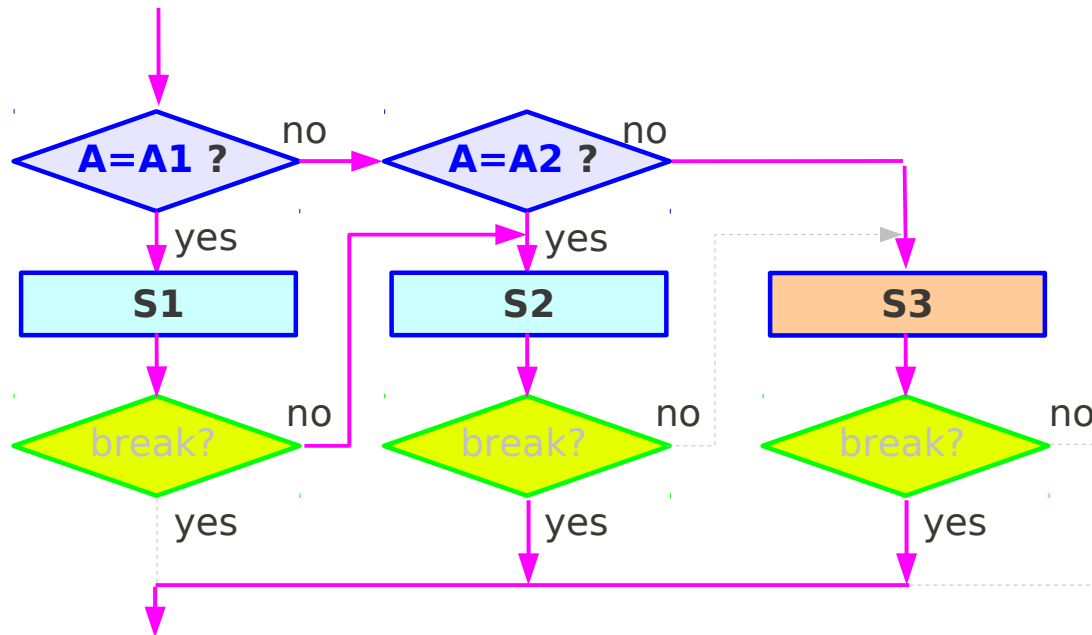

Switch Statement (3)

```
switch ( A ) {  
  case A1:  
  case A2: S2;  
           break;  
  default : S3;  
           break;  
}
```

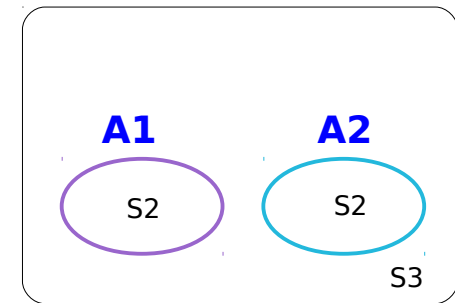
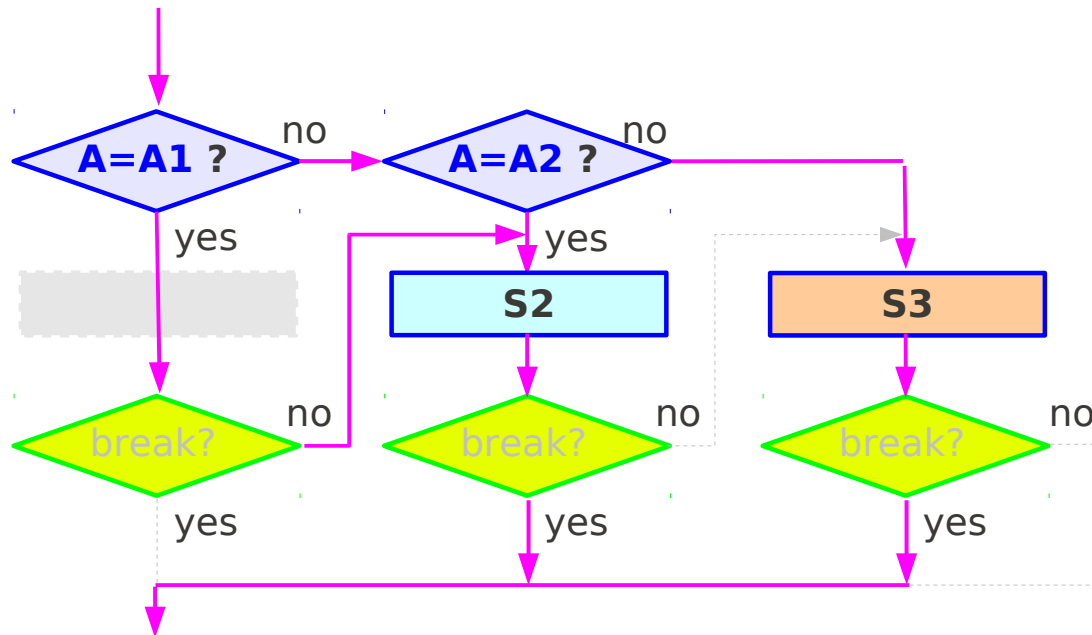

2-d Array

References

- [1] Essential C, Nick Parlante
- [2] Efficient C Programming, Mark A. Weiss
- [3] C A Reference Manual, Samuel P. Harbison & Guy L. Steele Jr.
- [4] C Language Express, I. K. Chun