

that no Clock-maker that doth not understand how to apply the force of a spring to the motion of a Clock.

A New Engin to make Linen-Cloth without the help of an Artificer, presented to the Royal Academy, by Monsieur de Gennes, an Officer belonging to the Sea. Extracted out of the Journal de Scavans

THis Engin is no other than a Mill, to which are apply'd all the parts of a Weavers ordinary Loom-

This Mill is composed of four principal parts, that is to say, the Serpent *A A*, two Footsteps or Treddles *B B*, one Clapper *C*, and two Arms *DDDD*.

The Serpent or Iron Barr *A A* has two Elbows *E E*, where-to the ends of the Ropes are fix'd that raise and put down the Foot steps *B B*. *F F* are two fourths of a Circle, that successively rest upon two Arches or Bows of Iron *G G*, which are above the Clapper *C*. to raise it. *H H* are two Teeth of Iron, added to the Serpent making an Angle of 25 degrees with *F F* and *K K*, which serve to put down a *Bascule* or *Sweep* which is in the Arm that carries the Shuttle. The Footsteps or Treddles differ in nothing from those which are usually made use of, only the Cords that hold them pendent from the ground are fixed in the Elbows of the Serpent, which in turning raises and puts them down by the help of two little pullies, upon which the Ropes turn.

The Clapper is supported between two Pillars with a Rope double twisted, which makes it to make a kind of a Spring, and causes it naturally to give forwards to beat the Cloth.

L M is one of the Arms which pass freely into the Canal or Pipe *N N*, supported by four Pillars of Wood *O O O O*. The Motion of it proceeds from the following Parts. *P Q* is a *Bascule* which, though unequally divided by its supporter *R*, is yet in *Equilibrio*, the end *P R* being made to weigh exactly as much as *R Q*.

At the Extremity of this *Bascule* is ty'd a Cord which passes through the Pully *S*, and terminates at the Extremity of the Arm, where it is fastned to a little *Bowle M*. At the other Extremity of the same Arm that is to say towards *L*, is

6 Q also

also fastned underneath a Cord, which passeth through the Pulley *T*, and which carries the weights *V*.

At the same end of the Arm is added a little *Niche Z*, about the bigness of half the Shuttle : then over a little Barr *X Y*, which passeth athwart the Arm, there are two other little peices of Wood having at the end of them two teeth, which enter into the *Niche Z* through two holes which are there of the one side and t'other.

To the ends of these little peices of Wood there is a little bow of whale-bone or Steel, which keeps the two ends asunder, and forces the teeth, which are at the other end, to enter into the *Niche*, before the said peices can themselves. At the Points *r r.* are two Ropes, that pass through the pulleys *22.* fastned to the Pillars *o. 3. o. 4.* and have each of them a little weight at the end big enough to keep it from passing through a little *Bowl* which is under each Pulley.

This Arm thus disposed goes and comes in the hole *NN* in the following manner. One Tooth of the Serpent already described, strikes upon the Extremity of the *Bascule P Q*, and so causes the end *Q* to rise up, which drawing the Cord fastned to the Point *P M*, makes the Arm *L M* to advance forward. But when afterwards the tooth of the Serpent is come forth again, then the Weight *V* ty'd to the other end of the same Arm by a Cord, that passeth through the Pulley *T*, forces the said Arm by its own Weight to return again.

When the Arm *L M* is in its ordinary place, the 2 little pieces of Wood, into which enters the Bar *X Y*, enclose the Shuttle by means of the Whale bone Spring. But when the said Arm approaches the other opposite Arm, then the cords ty'd to the point *r r.* being a little too short, and the Weight which is at the end of them not being able to pass through, the Spring gives way a little, and so the Shuttle is no longer enclosed by the Arm which carries it, but is wholly received and grasped by the other; which likewise in its turn delivers it back again, in the same manner.

The Motion of the whole Machine is made at the rate as you move the handle of the Serpent, for then the Arms cause the threads to open, and immediately one of the Arms begins to slide in towards the opposite Arm, to which it carries

carries the Shuttle and retires, immediately. At the same time one of the Quarters of a Circle, which held the Clapper elevated, forsakes it, and leaves it to flap, and then the opposite Quarter of a Circle elevating it self, the other Elbow changes the threads, and the other Arm retires, and so successively.

The advantages that may be drawn from this Engin above the ordinary Looms to make Linen Cloth are these; 1. that one Mill alone will set 10. or 12. of these Looms at work. The Author has also a way to stop one, for the tying a knot in any thread, while the rest go. 2. You may make the Cloth of what breadth you please, or at least much broader than any which hath been hitherto made, in regard the Arms will play to what extent you desire. 3. There will be fewer Knots in the Cloth, since the threads will not break so fast as in other Looms, because the Shuttle, that breaks the greatest part, can never touch them. In short, the Work will be carried on quicker and at less charge, in regard that instead of several work-folks, which are required in making of very large Clothes, one boy will serve to tie the threads of several Looms as fast as they break, and to order the Quills about the Shuttle,

The Author hath also an easy way so to order it, that the Cloth shall give way of it self, as fast as it is made.

A Relation of a Worm Voided by Urine; Communicated by Mr.

Ent: to whom it was sent by Mr. Matthew Milford.

THE Worm when I voyded it, which was at the second Urine, was then alive. It was Snake-headed, of indifferent substance in the middle, and small at the tail. In length above half a yard. I was very ill before it came from me, and have ever since urin'd a kind of blood.

This Relation is here set down in the Patients own words. 'Tis most probable he had had a Suppression of Urine for some time, at the first making whereof the Worm was Voided from one of the Kidneys (wherein it was bred) into the Bladder; and at the second, from thence into the Por.

The Worm being dead and dry, was of a dull red colour, and in thickness about the 12th. of an Inch.

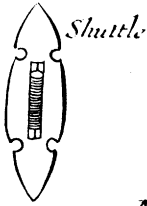

Shuttle

The arm. carrying the Shuttle

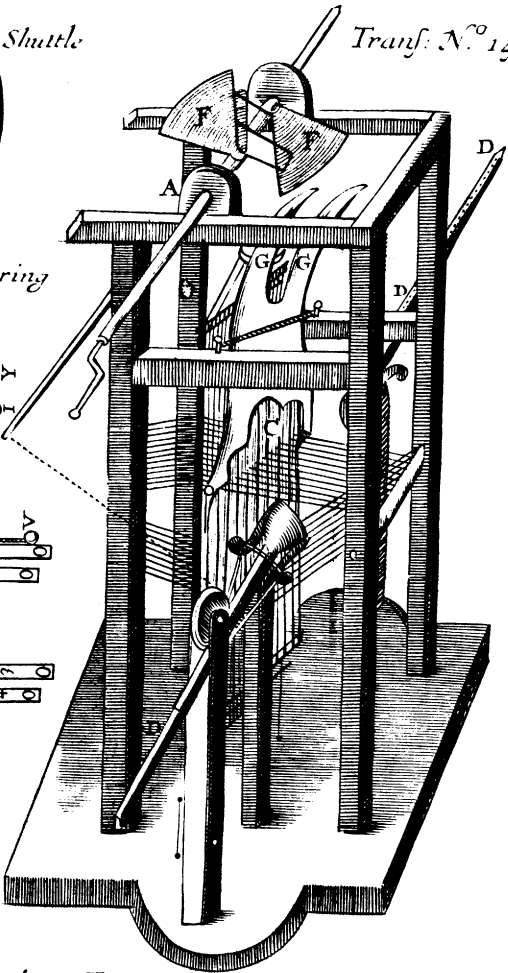
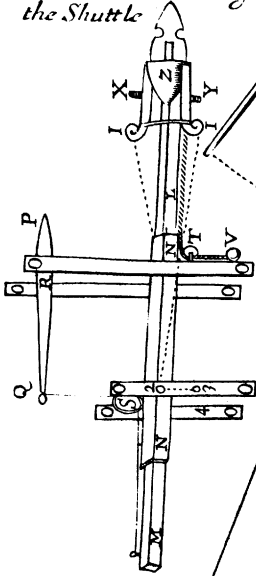

Serpent

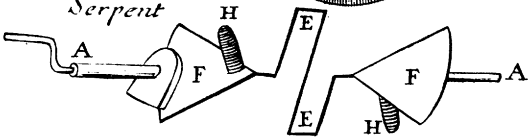

Shuttle

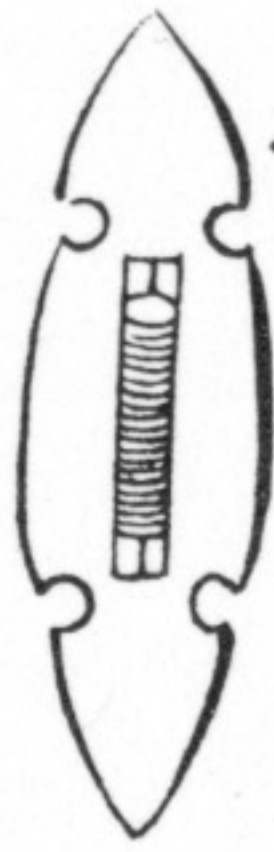

The arm carrying the Shuttle

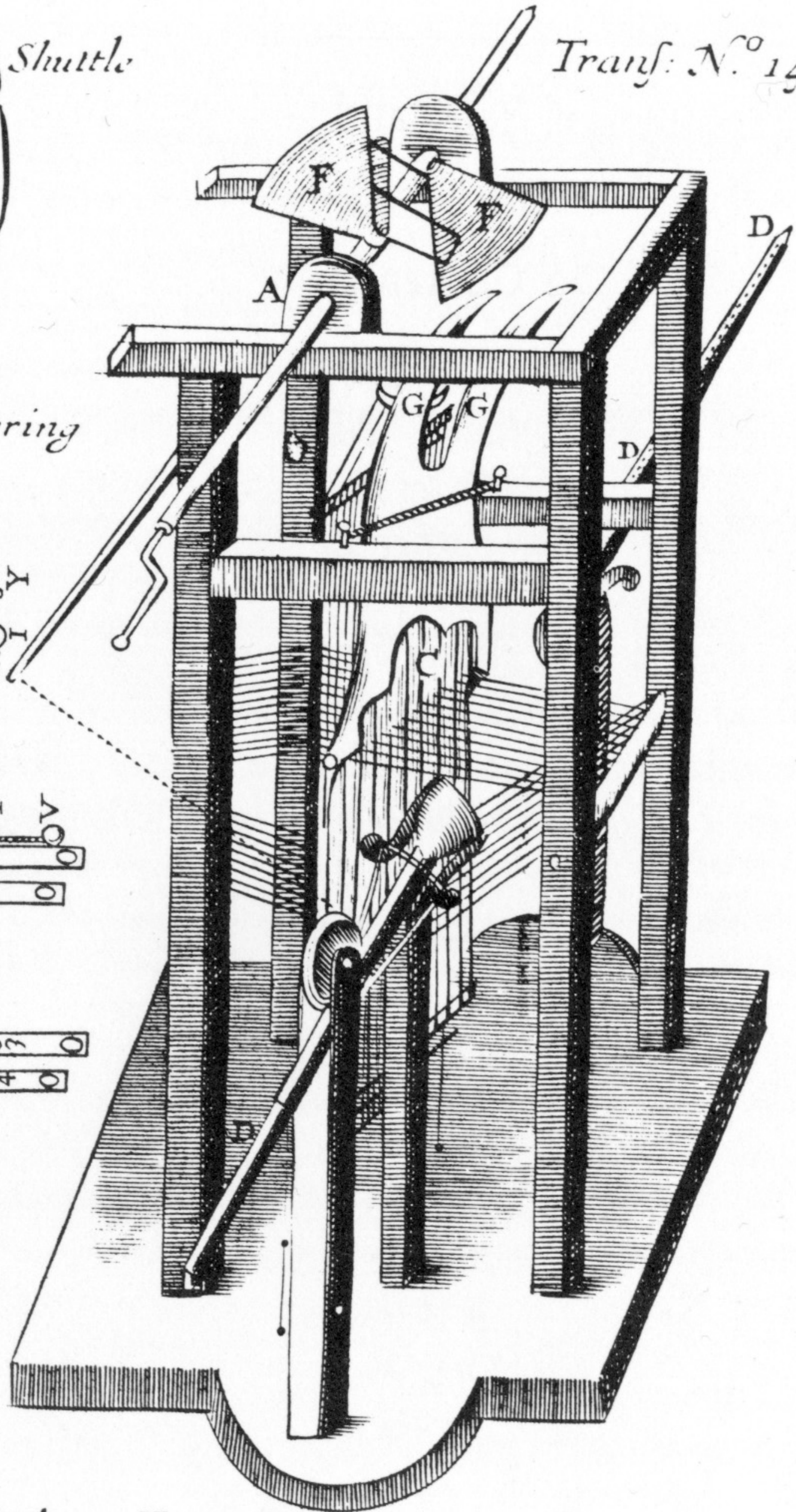
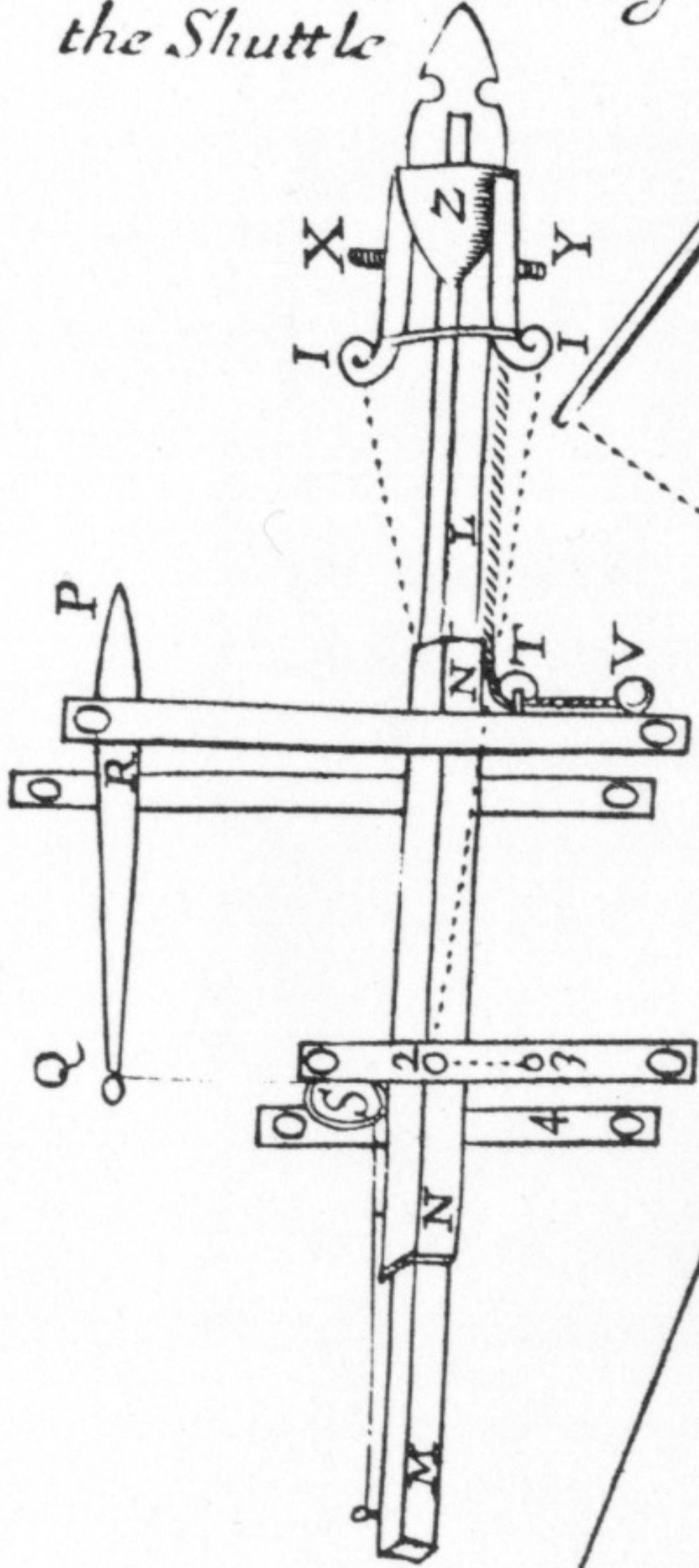

Serpent

