



[REDACTED]

DEPARTMENT OF THE ARMY  
87<sup>TH</sup> MILITARY POLICE DETACHMENT (AIRBORNE)(FORWARD)  
DIVISION SUPPORT ELEMENT (CID)  
AR RAMADI, IRAQ APO AE 09384

7 Dec 05

MEMORANDUM FOR SEE DISTRIBUTION

SUBJECT: CID REPORT OF INVESTIGATION - FINAL(C)/JOINT-SSI-0027-03-  
CID679-64999-5H1M/5C1L/5M3/5Y2D2/5X5/9G1/9G2F

DRAFTER : SA [REDACTED]

RELEASER: SA [REDACTED]

CLASSIFIED - SECRET//NOFORN

1. DATES/TIMES/LOCATIONS OF OCCURRENCES:

(FOUO) 1. 26 NOV 2003/0920 - 26 NOV 2003/0950; BLACKSMITH HOTEL,  
NEAR FORWARD OPERATING BASE (FOB) TIGER, IRAQ [GRID [REDACTED]]

(FOUO) 2. 24 NOV 2003/0001 - 24 NOV 2003/2359; BLACKSMITH HOTEL,  
NEAR FOB TIGER, IRAQ [GRID [REDACTED]]

(FOUO) 3. 19 JAN 2004/1200 - 19 JAN 2004/1320; FOB TIGER, IRAQ.

(FOUO) 4. 27 APR 2004/1040 - 27 APR 2004/1522; BATTALION CLASSROOM,  
1<sup>ST</sup> BN, 5<sup>TH</sup> SFG (A), FORT CAMPBELL, KY 42223.

[REDACTED] 5. 20 MAY 04/0915 - 23 MAY 04/1112; [REDACTED]  
[REDACTED]

(FOUO) 6. 8 JUL 2004/0902 - 8 JUL 2004/1200; BATTALION CLASSROOM, 1<sup>ST</sup>  
BN, 5<sup>TH</sup> SFG (A), FORT CAMPBELL, KY 42223.

(FOUO) 2. DATE/TIME REPORTED: 26 Nov 2003, 1350

DERIVED FROM:

[REDACTED]

DECLASIFY ON:

6 December 2030

000002

[REDACTED]

b1, b3, b6, 7C

[REDACTED]

0027-03-CID679-64999

(FOUO) 3. INVESTIGATED BY: SA [REDACTED]; SA [REDACTED]  
[REDACTED] SA [REDACTED]

4. SUBJECT: [REDACTED]  
[REDACTED] [AGGRAVATED ASSAULT (UNFOUNDED)],  
[FALSE OFFICIAL STATEMENT (UNFOUNDED)]

(FOUO) 2. [REDACTED] CW2; [REDACTED]  
[REDACTED] M; WHITE; 66TH MILITARY INTELLIGENCE  
COMPANY, FOB TIGER, IRAQ; CT; [MURDER], [DERELICTION OF DUTY]

(FOUO) 3. [REDACTED]; CW3; [REDACTED]  
[REDACTED] M; WHITE; 66<sup>TH</sup> MILITARY INTELLIGENCE  
COMPANY, FOB TIGER, IRAQ; CT; [MURDER], [DERELICTION OF DUTY],  
[OBSTRUCTION OF JUSTICE]

(FOUO) 4. [REDACTED] SFC; [REDACTED];  
[REDACTED] M; WHITE; 66<sup>TH</sup> MILITARY INTELLIGENCE COMPANY, FOB  
TIGER IRAQ; CT; [MURDER], [DERELICTION OF DUTY]

(FOUO) 5. [REDACTED]; SPC; [REDACTED] WHITE;  
AVIATION MAINTENANCE TROOP, SUPPORT SQUADRON, 3<sup>RD</sup> ARMORED  
CALVARY REGIMENT, RIFLES BASE, IRAQ (FORT CARSON, CO); CT;  
[MURDER], [DERELICTION OF DUTY]

[REDACTED]  
[REDACTED]  
[AGGRAVATED ASSAULT (UNFOUNDED)], [FALSE OFFICIAL STATEMENT  
(UNFOUNDED)]

[REDACTED]  
[REDACTED]  
[AGGRAVATED ASSAULT (UNFOUNDED)], [FALSE OFFICIAL  
STATEMENT (UNFOUNDED)]

(FOUO) 8. [REDACTED] CW2; [REDACTED];  
[REDACTED] M; WHITE; ODA 531, 1<sup>ST</sup> BATTALION, 5<sup>TH</sup> SPECIAL FORCES  
GROUP (A), FORT CAMPBELL, KY 42223; DJ; [AGGRAVATED ASSAULT],  
[FALSE OFFICIAL STATEMENT]

(FOUO) 9. HOLLEYMAN, AARON NATHANIEL; (DECEASED);  
SSG; [REDACTED] 26 NOV 1977; FLOWOOD, MS; M; WHITE; ODA 531, 1<sup>ST</sup>  
BATTALION, 5<sup>TH</sup> SPECIAL FORCES GROUP (A), FORT CAMPBELL, KY 42223;  
DJ; [AGGRAVATED ASSAULT], [FALSE OFFICIAL STATEMENT]

[REDACTED]

b1, b3, b2, b4, 7C

000003

(FOUO) 10. [REDACTED] SSG; [REDACTED] M; BLACK; ODA 515, 1<sup>ST</sup> BATTALION, 5<sup>TH</sup> SPECIAL FORCES GROUP (A), FORT CAMPBELL, KY 42223; DJ; [FALSE OFFICIAL STATEMENT]

(FOUO) [REDACTED]  
[REDACTED]  
[FALSE OFFICIAL STATEMENT]

[REDACTED]  
[FALSE OFFICIAL STATEMENT]

(FOUO) [REDACTED]  
[REDACTED] OTHER; [REDACTED] [FALSE OFFICIAL STATEMENT]

5. VICTIM: (FOUO) 1. MOWHOUSH, ABED HAMED (DECEASED); FORMER MAJOR GENERAL; IRAQI ARMY; CAPTURE TAG #076; 1947; M; OTHER; IZ; [NFI] [MURDER], [AGGRAVATED ASSAULT].

(FOUO) 2. U.S. GOVERNMENT [DERELICTION OF DUTY], [FALSE OFFICIAL STATEMENT]

(FOUO) 6. INVESTIGATIVE SUMMARY:

(FOUO) THIS IS AN OPERATION IRAQI FREEDOM INVESTIGATION.

(FOUO) This investigation was initiated upon notification from MAJ [REDACTED] [REDACTED] Provost Marshal, 82D Airborne Division, Champion Base, Iraq, of the death of a detainee who was in U.S. custody in the vicinity of Al Qaim, Iraq.

[REDACTED] Investigation did not develop sufficient evidence to prove [REDACTED] committed the offense of aggravated assault or false official statement as [REDACTED] denied the allegation himself and though multiple witness interviews it was unclear if [REDACTED] struck MG MOWHOUSH with a length of black hose during an interrogation.

(FOUO) Investigation established probable cause to believe CW2 [REDACTED] committed the offense of murder when, on 26 Nov 03, he participated in binding MG MOWHOUSH in a sleeping bag during an interrogation as a means of eliciting cooperation. While bound in the sleeping bag, MG MOWHOUSH died of asphyxiation. Investigation established probable cause to believe CW2 [REDACTED] committed the offense of dereliction of duty when, on 24 Nov 03, he participated in the use of an unauthorized interrogation technique during an interrogation of MG MOWHOUSH.

[REDACTED]  
b1, b3, b6, 7C

(FOUO) Investigation established probable cause to believe CW3 [REDACTED] committed the offense of murder when, on 26 Nov 03, he participated in binding MG MOWHOUSH in a sleeping bag during an interrogation as a means of eliciting cooperation. While bound in the sleeping bag, MG MOWHOUSH died of asphyxiation. Investigation established probable cause to believe CW3 [REDACTED] committed the offense of dereliction of duty when, on 24 Nov 03, he participated in the use of an unauthorized interrogation technique during an interrogation of MG MOWHOUSH. Further investigation established probable cause to believe CW3 [REDACTED] committed the offense of obstruction of justice after he instructed a subordinate to not reveal evidence to CID.

(FOUO) Investigation established probable cause to believe SFC [REDACTED] committed the offense of murder when, on 26 Nov 03, he participated in binding MG MOWHOUSH in a sleeping bag during an interrogation as a means of eliciting cooperation. While bound in the sleeping bag, MG MOWHOUSH died of asphyxiation. Investigation established probable cause to believe SFC [REDACTED] committed the offense of dereliction of duty when, on 24 Nov 03, he participated in the use of an unauthorized interrogation technique during an interrogation of MG MOWHOUSH.

(FOUO) Investigation established probable cause to believe SPC [REDACTED] committed the offense of murder when, on 26 Nov 03, he participated in binding MG MOWHOUSH in a sleeping bag during an interrogation as a means of eliciting cooperation. While bound in the sleeping bag, MG MOWHOUSH died of asphyxiation. Investigation established probable cause to believe SPC [REDACTED] committed the offense of dereliction of duty when, on 24 Nov 03, he participated in the use of an unauthorized interrogation technique during an interrogation of MG MOWHOUSH.

[REDACTED] Investigation did not develop sufficient evidence to prove [REDACTED] committed the offense of aggravated assault or false official statement as [REDACTED] denied the allegation himself and though multiple witness interviews it was unclear if [REDACTED] repeatedly struck MG MOWHOUSH during an interrogation.

[REDACTED] Investigation did not develop sufficient evidence to prove [REDACTED] committed the offense of aggravated assault or false official statement as [REDACTED] denied the allegation himself and though multiple witness interviews it was unclear if [REDACTED] repeatedly struck MG MOWHOUSH during an interrogation.

(FOUO) Investigation established probable cause to believe CW2 [REDACTED] committed the offense of aggravated assault when, on 24 Nov 03, he repeatedly struck MG MOWHOUSH during an interrogation. Investigation established probable cause to believe CW2 [REDACTED] committed the offense of false official statement when, on 12 Jul 04, he admitted all of his previous statements to CID and his chain of command regarding MG MOWHOUSH were false.

[REDACTED]

b1, b3 b6, 7c

0027-03-CID679-64999

(FOUO) Investigation established probable cause to believe SSG HOLLEYMAN committed the offense of aggravated assault when, on 24 Nov 03, he repeatedly struck MG MOWHOUSH during an interrogation. Investigation established probable cause to believe SSG HOLLEYMAN committed the offense of false official statement when, on 9 Jul 04, he admitted all of his previous statements to CID and his chain of command regarding MG MOWHOUSH were false.

(FOUO) Investigation established probable cause to believe SSG [REDACTED] committed the offense of false official statement when, on 10 Jul 04, he admitted all of his previous statements to CID and his chain of command regarding MG MOWHOUSH were false.

(FOUO) Investigation established probable cause to believe [REDACTED] committed the offense of false official statement when, on 11 Aug 04, he rendered a verbal statement regarding his actions on 24 Nov 03, he knew to be false.

[REDACTED] Investigation established probable cause to believe [REDACTED] committed the offense of false official statement when he provided multiple statements to the CIA-OIG he knew to be false.

(FOUO) Investigation established probable cause to believe [REDACTED] committed the offense of false official statement when, on 28 Nov 03, [REDACTED] rendered a verbal statement [REDACTED] knew to be false.

#### STATUTES:

Article 118, UCMJ: Murder  
 Article 128, UCMJ: Aggravated Assault  
 Article 107, UCMJ: False Official Statement  
 Article 92, UCMJ: Dereliction of Duty  
 Article 134, UCMJ: Obstruction of Justice  
 Title 18, Sec 1001: False Statement  
 Title 18, Sec 113: Assault

#### EXHIBITS/SUBSTANTIATION:

Attached:

(FOUO) 1. Agent's Investigation Report (AIR) of SA [REDACTED] 10 Jan 04, detailing the Basis for Investigation, coordination with the 82<sup>nd</sup> Airborne Division, coordination with 3<sup>rd</sup> Armored Cavalry Regiment, preliminary examination of MG MOWHOUSH's remains, crime scene examination, suspect interviews, witness interviews, review of the capture file pertaining to MG MOWHOUSH, canvass interviews and preliminary autopsy results.

(FOUO) 2. Photographic packet comprised of 119 photographs.

000006

b1, b3, b6, 7c

[REDACTED]

(FOUO) 3. Compact disc 030027.679, containing original images of Exhibit 2.  
(USACRC copy only)

(FOUO) 4. Crime Scene Sketch, 28 Nov 03, prepared by SA [REDACTED]

(FOUO) 5. Chronological Record of Medical Care, 26 Nov 03, detailing the treatment provided to MG MOWHOUSH.

(FOUO) 6. Non Waiver Certificate pertaining to CW3 [REDACTED], 28 Nov 03.

(FOUO) 7. Waiver Certificate and Sworn Statement of CW2 [REDACTED] 28 Nov 03, wherein he detailed the events surrounding MG MOWHOUSH's death.

(FOUO) 8. Sworn Statement of SFC [REDACTED] 28 Nov 03, wherein he detailed the events surrounding MG MOWHOUSH's death.

(FOUO) 9. Waiver Certificate and Sworn Statement of SPC [REDACTED] 28 Nov 03, wherein he detailed the events surrounding MG MOWHOUSH's death.

(FOUO) 10. Canvass Interview Worksheets, 28 Nov 03, documenting canvass interviews of detention facility personnel.

(FOUO) 11. Armed Forces Institute of Pathology Preliminary Autopsy Report ME03-571, 2 Dec 03.

(FOUO) 12. Sworn Statement of SFC [REDACTED] 30 Dec 03, wherein he detailed the events surrounding MG MOWHOUSH's death.

(FOUO) 13. AIR of SA [REDACTED] 17 Feb 04, detailing the review of applicable regulations, coordination with 5<sup>th</sup> Special Forces Group, witness interviews, coordination with the CIA-OIG, final autopsy results and coordination with 3<sup>rd</sup> Armored Cavalry Regiment.

(FOUO) 14. Operational Detachment B 530, Report of Text of Statements, 27 Nov 03, pertaining to MSG [REDACTED], CW2 [REDACTED], SSG [REDACTED], SSG HOLLEYMAN, CW3 [REDACTED] and [REDACTED]

(S-NF) 15. Sworn Statement of CPT [REDACTED] 5 Feb 04, wherein he related witnessing [REDACTED] beating a detainee.

(FOUO) 16. Armed Forces Institute of Pathology Autopsy Examination Report, ME03-571, 18 Dec 03, including compact disc containing autopsy photographs.

(FOUO) 17. AIR of SA [REDACTED] 9 Feb 04, detailing the interview of MSG [REDACTED]

[REDACTED]

[REDACTED] 8. Sworn Statement of MSG [REDACTED] 9 Feb 04, wherein he related witnessing [REDACTED] assault MG MOWHOUSH during an interrogation on 24 Nov 03.

(FOUO) 19. Sketch of Blacksmith Hotel, prepared by MSG [REDACTED] 9 Feb 04.

(FOUO) 20. AIR of SA [REDACTED] 13 May 04, detailing coordination with 3<sup>rd</sup> Armored Cavalry Regiment, the re-interview of CW3 [REDACTED] the re-interview of CW2 [REDACTED] the re-interview of SFC [REDACTED], the re-interview of SPC [REDACTED] the re-interview of SFC [REDACTED], the re-interview of SPC [REDACTED], the re-interview of CPT [REDACTED] the interview of SPC [REDACTED] coordination with 5<sup>th</sup> Special Forces Group, the re-interview of CW2 [REDACTED] the re-interview of SSG HOLLEYMAN, the interview of SSG [REDACTED] and the review of the CIA-OIG file.

[REDACTED]

(FOUO) 22. AIR of SA [REDACTED] 16 Jun 04, detailing the review of CIA-OIG reports, the interview of [REDACTED] and the interview of SFC [REDACTED]

(FOUO) 23. AIR of SA [REDACTED] 12 Jul 04, detailing the re-interview of CW2 [REDACTED] the re-interview SSG [REDACTED] and the re-interview of SSG HOLLEYMAN.

(FOUO) 24. Waiver Certificate of CW2 [REDACTED] 8 Jul 04.

(FOUO) 25. Waiver Certificate of SSG [REDACTED], 8 Jul 04.

(FOUO) 26. Waiver Certificate of SSG HOLLEYMAN, 8 Jul 04.

[REDACTED] 27. Waiver Certificate and Sworn Statement of SSG HOLLEYMAN, 9 Jul 04, wherein he admitted he and [REDACTED] assaulted MG MOWHOUSH on 24 Nov 03, during an interrogation.

[REDACTED] 28. Waiver Certificate and Sworn Statement of SSG [REDACTED], 10 Jul 04, wherein he admitted being present when [REDACTED] assaulted MG MOWHOUSH.

[REDACTED] 29. Waiver Certificate and Sworn Statement of CW2 [REDACTED] 12 Jul 04, wherein he admitted he assaulted MG MOWHOUSH with [REDACTED] on 24 Nov 03, during an interrogation.

(FOUO) 30. AIR of SA [REDACTED] 22 Sep 04, detailing the re-interview of MSG [REDACTED] coordination with AFIP, the interview of [REDACTED] the re-interview of SFC [REDACTED] and coordination with 3<sup>rd</sup> Armored Cavalry Regiment.

[REDACTED]

b1, b3, b6, 7C



[REDACTED]

(FOUO) 31. Polygraph Examination Report, 12 Jul 04, pertaining to CW2 [REDACTED]

(FOUO) 32. Polygraph Examination Report, 10 Jul 04, pertaining to SSG [REDACTED]

(FOUO) 33. Polygraph Examination Report, 9 Jul 04, pertaining to SSG HOLLEYMAN.

[REDACTED]

[REDACTED]

[REDACTED]

(FOUO) 35. Rebuttal to General Letter of Reprimand, 11 Feb 04, submitted to Commander, 82<sup>nd</sup> Airborne Division.

[REDACTED] 36. AIR of SA [REDACTED], 12 Aug 04, detailing the discovery of an email in which CW3 [REDACTED] advocated the use of physical contact (open handed and back handed slapping) in interrogations.

[REDACTED] 37. Email message suspected to be authored by CW3 [REDACTED] 14 Aug 03, in which he advocated the use of open handed slaps during interrogations.

(FOUO) 38. AIR of SA [REDACTED], 9 Feb 05, detailing the interviews of SSG [REDACTED], SSG [REDACTED], SFC [REDACTED] MAJ [REDACTED], and SFC [REDACTED] and coordination with the Defense Computer Forensics Laboratory.

(FOUO) 39. Waiver Certificate pertaining to MAJ [REDACTED] 18 Nov 04.

[REDACTED]

[REDACTED]

[REDACTED]

(FOUO) 41. AIR of SA [REDACTED] 24 Nov 04, detailing coordination with the 3<sup>rd</sup> Armored Cavalry Regiment.

(FOUO) 42. CID Form 87-R-E, Consent to Search, 24 Nov 04, authorizing the search of three servers collected as evidence from 3<sup>rd</sup> Armored Cavalry Regiment.

(FOUO) 43. AIR of SA [REDACTED], 19 Aug 05, detailing coordination with the 3<sup>rd</sup> Armored Cavalry Regiment.

(FOUO) 44. AIR of SA [REDACTED] 2 Nov 05, detailing coordination with DCFL, the receipt of compact discs (CD) containing copies four CID Report of Investigations (ROI) and Staff Judge Advocate coordination's.

[REDACTED]

[REDACTED]

(FOUO) 46. AIR of SA [REDACTED] 31 Aug 05, documenting the attempt to locate the remains of MG MOWOUSH.

[REDACTED] 47. AIR of SA [REDACTED] 5 Dec 05, detailing the receipt of DCFL report.

[REDACTED]

(FOUO) 49. DA Form 4137, Evidence/Property Custody Document, voucher numbers 168-04 and 393-04. (USACIDC and file copies only)

(FOUO) 50. DA Form 4137, Evidence/Property Custody Document, voucher number 471-05. (USACIDC and file copies only)

(FOUO) 51. CID Form 118-E-R, Disclosure Accounting Record (USACRC and file copies only).

Not Attached:

Retained in the evidence depository, 48<sup>th</sup> MP Detachment (CID), Fort Carson, CO:

(FOUO) 52. Sleeping Bag, Item 1, Voucher # 168-04.

(FOUO) 53. Electrical wire, Item 2, Voucher # 168-04.

(FOUO) 54. Compaq Blade Server, Item 1, Voucher # 393-04.

(FOUO) 55. Compaq Blade Server, Item 2, Voucher # 393-04.

(FOUO) 56. Domain Server, Item 3, Voucher # 393-04.

Retained in the files of the U.S. Army Crime Records Center, Fort Belvoir, VA:

(FOUO) 57. Polygraph Authorization ([REDACTED]) 12 Jul 04.

(FOUO) 58. Polygraph Examination Statement of Consent ([REDACTED]), 12 Jul 04.

(FOUO) 59. Polygraph Authorization ([REDACTED]), 9 Jul 04.

(FOUO) 60. Polygraph Statement of Consent ([REDACTED]) 10 Jul 04.

[REDACTED]

bl.7c

000010

[REDACTED]

(FOUO) 61. Four Polygraph Charts [REDACTED] 10 Jul 04.

(FOUO) 62. Polygraph Authorization (HOLLEYMAN), 9 Jul 04.

(FOUO) 63. Polygraph Statement of Consent (HOLLEYMAN), 9 Jul 04.

Retained in the Evidence Depository, this office:

[REDACTED] 64. External Hard Drive, Item 1, Voucher # 471-05.

[REDACTED] 65. External Hard Drive, Item 2, Voucher # 471-05.

(FOUO) The originals of Exhibits 1, 3 - 10, 12, 13, 15, 17 - 30, 36, 38, 39, 40 - 48, and 51 are attached to the USACRC copy of this report. The originals of Exhibits 11 and 16 are retained in the files of the Office of the Armed Forces Institute of Pathology, 1413 Research Blvd, Bldg 102, Rockville, MD 20850. The original of Exhibit 14 is retained in the files of 1<sup>st</sup> Battalion, 5<sup>th</sup> Special Forces Group, Fort Campbell, KY. The originals of Exhibits 31-33 are retained in the files of the Polygraph Division, U.S. Army Crime Records Center, Fort Belvoir, VA. The originals of Exhibits 34 and 37 are retained in the files of the Headquarters 3<sup>rd</sup> Armored Cavalry Regiment, Fort Carson, CO. The original of Exhibit 35 is retained in the files of Headquarter, 82<sup>nd</sup> Airborne Division, Fort Bragg, NC 28310. The original of Exhibit 49 is retained in the files of the evidence depository, 48<sup>th</sup> Military Police Detachment, (CID), Fort Carson, CO. The original of Exhibit 50 is retained in the files of the evidence depository, this office.

(FOUO) STATUS: This is a Final (C) Report. This investigation is being terminated IAW paragraph 4-17a(4), CIDR 195-1 in that the supported SJA or prosecutor is of the opinion that sufficient evidence is available to prosecute the perpetrators for the offense(s), that additional investigation would produce only cumulative and unneeded evidence, and that the identification of additional offenders or offenses is unlikely. Leads remaining include the full ID and witness interviews of SFC [REDACTED] (NFI), CPT [REDACTED] and individuals attached to email traffic.

On 6 Oct 05, the Special Assistant to the US Attorney declined to prosecute [REDACTED]  
[REDACTED] On 14 Oct 05, LTC [REDACTED], SJA, 5<sup>th</sup> Special Forces Group, Ft Campbell, KY reported SSG HOLLEYMAN, SSG [REDACTED] and CW2 [REDACTED] received non-judicial punishment amounting to a letter of reprimand, further SSG HOLLEYMAN was killed in action in Aug 04. Commander's Report of Disciplinary Action taken (DA Form 4833) is pending.

[REDACTED]

000011

b1, b3, b6, 7c

0027-03-CID679-64999

Report Prepared By:

Report Approved By:

[REDACTED]  
Special Agent, [REDACTED]

[REDACTED]  
Special Agent in Charge

DISTRIBUTION:

1 - DIR, USACRC, Fort Belvoir, VA 22060

1 - THRU:

CDR, 10<sup>TH</sup> MP BN (CID)(ABN), Fort Bragg, NC 28310

CDR, 3rd MP Group, USACIDC, Fort Gillem, GA

TO: CDR, USACIDC (ATTN: CIOP-CO), Fort Belvoir, VA

1 - SJA (ATTN: MAJ [REDACTED]), Fort Carson, CO 80913

1 - File

[REDACTED]  
000012

b2, b6, 7C

[REDACTED]

87<sup>TH</sup> MILITARY POLICE DETACHMENT (CID) (ABN), 3D MILITARY POLICE GROUP (CID), USACIDC, FORT BRAGG, NC 28310

AGENT'S INVESTIGATION REPORT

0027-03-CID679-64999

10 JAN 2004

DETAILS:

(FOUO) BASIS FOR INVESTIGATION: At 1350, 26 Nov 03 this office was notified by the PMO, 82<sup>nd</sup> ABN DIV, [REDACTED] Iraq of the death of Major General Abed Hamed MOWHOUSH, AL-MOHALOWI tribe, a high profile detainee, while in US Custody. The initial report from the unit that was detaining the General related he died of natural causes while being interrogated.

(FOUO) About 1407, 26 Nov 03, SA [REDACTED] and SA [REDACTED], this office, attended a G-3, 82<sup>nd</sup> ABN DIV briefing pertaining to MG MOWHOUSH's death.

(FOUO) About 1500, 26 Nov 03, SA [REDACTED] coordinated with LTC [REDACTED], SJA, 82<sup>nd</sup> ABN DIV, and LTC [REDACTED], G-3, 82<sup>nd</sup> ABN DIV, and informed them CID would be conducting an investigation of MG MOWHOUSH's death.

(FOUO) About 0050, 27 Nov 03, SA [REDACTED] coordinated with LTC [REDACTED] G-3, 82<sup>nd</sup> ABN DIV, Champion Base, Iraq who provided copies of digital photographs taken of MG MOWHOUSH's remains. The photographs depicted several bruises on MG MOWHOUSH's torso and lower extremities. (See compact disc for details)

(FOUO) About 0058, 27 Nov 03, SA [REDACTED] coordinated with LTC [REDACTED] SJA, 82<sup>nd</sup> ABN DIV, Champion Base, Iraq who provided a copy of the initial press release photo of MG MOWHOUSH. It was believed the photo was taken at the time the MG turned himself in to US forces. (see compact disc for details)

(FOUO) About 0115, 27 Nov 03, SA [REDACTED] briefed SA [REDACTED] Forensic Science Officer, 10<sup>th</sup> MP Bn (CID) (ABN) (FWD), Baghdad International Airport (BIAP), Iraq, on the details of this investigation.

(FOUO) About 1445, 27 Nov 03, SA [REDACTED], SA [REDACTED] and SA [REDACTED] examined MG MOWHOUSH's remains. He was a Caucasian male. He had dark hair with some graying. He had a mustache. He was grossly overweight. It appeared that rigor mortis had passed. Lividity

[REDACTED]

DERIVED FROM:

[REDACTED]

SPECIAL AGENT, [REDACTED]

Page 1 of 12

DECLASIFY ON:

15 JAN 2029

[REDACTED]

EXHIBIT 1

000013

b1, b3, b2, b4, 7C

[REDACTED]

87<sup>TH</sup> MILITARY POLICE DETACHMENT (CID) (ABN), 3D MILITARY POLICE GROUP  
(CID), USACIDC, FORT BRAGG, NC 28310

AGENT'S INVESTIGATION REPORT  
0027-03-CID679-64999  
10 JAN 2004

DETAILS:

was present and fixed in the lower arms and lower back. Congestion appeared to be present in the arms. The examination revealed numerous contusions on MG MOWHOUSH's abdomen, legs, buttocks, chest, back and arms. Several abrasions were found on the back, arms and legs. Some of the contusions appeared to be made by a long straight edged object. Other contusions appeared to be made by an object similar to the butt of a rifle. The contusions varied in color from red to dark purple. Zipties were present on each wrist, but were not connected. An identification band bearing the writing "3 ACR, 03-76" was found on the right wrist. Body fluids were being purged through the nasal cavity. There were no obvious signs of petechial hemorrhages present in the eyes or mouth. There were pinpoint abrasions present slightly above the right knee on the medial side. There was an abrasion present over the sternum. SA [REDACTED] exposed digital photographs of the injuries using a Fuji Finepix Camera. (See Photographic Log and CD ROM for details)

(FOUO) AGENT'S COMMENT: SA [REDACTED] coordinated with SSG [REDACTED] NCOIC, Mortuary Affairs, 54<sup>th</sup> QM Co, Fort Lee, VA, Al Asad, Iraq during the examination. SSG [REDACTED] related MG MOWHOUSH's remains were photographed about 2030, 26 Nov 03 by CPT [REDACTED] (NFI). No one else examined the remains. SSG [REDACTED] related he received the body from CPT [REDACTED] RS-3, 3<sup>rd</sup> Armored Cavalry Regiment (ACR), Fort Carson, CO (FCCO), at 1700, 26 Nov 03.

(FOUO) About 1555, SA [REDACTED], SA [REDACTED] and SA [REDACTED] briefed CPT [REDACTED], SJA, CPT [REDACTED] Battle Captain, and LTC [REDACTED] Deputy Regimental Commander, 3<sup>rd</sup> ACR, on the results of the examination of MG MOWHOUSH's remains.

[REDACTED] About 2030, 27 Nov 03, SA [REDACTED], SA [REDACTED] and SA [REDACTED] briefed COL [REDACTED] Commander 3<sup>rd</sup> ACR, FCCO, on the results of the examination of MG MOWHOUSH's remains. COL [REDACTED] related MG MOWHOUSH was interviewed by MI assets assigned to 3<sup>rd</sup> ACR, a Special Forces A team and the Central Intelligence Agency (CIA). COL [REDACTED] stated both the Special Forces [REDACTED]

[REDACTED]

SPECIAL AGENT, [REDACTED]  
Page 2 of 12

[REDACTED]

EXHIBIT 1

b1, b3, b2, b4, 7C 000014

87<sup>TH</sup> MILITARY POLICE DETACHMENT (CID) (ABN), 3D MILITARY POLICE GROUP (CID), USACIDC, FORT BRAGG, NC 28310

AGENT'S INVESTIGATION REPORT

0027-03-CID679-64999

10 JAN 2004

DETAILS:

Central Command. COL [REDACTED] related all information pertaining to MG MOWHOUSH and the personnel that interrogated him was classified Top Secret.

AGENT'S COMMENT: The correct classification level was determined to be Secret. [REDACTED] not CENTCOM.

(FOUO) About 0750, 28 Nov 03, SA [REDACTED] SA [REDACTED] and SA [REDACTED] met with CW3 [REDACTED] 66<sup>th</sup> MI Co, 3<sup>rd</sup> Squadron, 3<sup>rd</sup> ACR, FCCO. CW3 [REDACTED] began a tour of the facility. He identified interview room 6 as the site of MG MOWHOUSH's death. He then made the comment that he was interrogating MG MOWHOUSH at the time of his death, and had been advised by counsel not to answer questions. At that time, SA [REDACTED] advised CW3 [REDACTED] someone else should be our point of contact, as he had sought legal counsel.

(FOUO) AGENT'S COMMENT: At the time CW3 [REDACTED] began the tour of the detention facility, CID was not aware of his role as the interrogator of MG MOWHOUSH at the time of his death.

(FOUO) About 0800, 28 Nov 03, 1LT [REDACTED] 66<sup>th</sup> MI Co (NFI), provided SA [REDACTED] SA [REDACTED] and SA [REDACTED] with a walk through of the detention facility.

(FOUO) About 0825, 28 Nov 03, SA [REDACTED] and SA [REDACTED] conducted a crime scene examination of Interrogation Room 6, Building 3A, [REDACTED] Iraq.

(FOUO) Characteristics of the Scene: The [REDACTED] was a Detention Facility operated by 3<sup>rd</sup> ACR, vicinity of Grid [REDACTED]. Building 3A was a one story, brick building containing several interrogation rooms and the 66<sup>th</sup> MI Co TOC. Room 6 was located in the approximate center of the west side of building 3A. The room was 9'8" wide by 9'11" deep. The ceiling was 9'2" high. The exterior entranceway to the room was located in the southwest

[REDACTED]  
SPECIAL AGENT [REDACTED]

Page 3 of 12

[REDACTED]  
EXHIBIT 1

000015

b1, b3, b2, b6, 7c

[REDACTED]

87<sup>TH</sup> MILITARY POLICE DETACHMENT (CID) (ABN), 3D MILITARY POLICE GROUP  
(CID), USACIDC, FORT BRAGG, NC 28310

AGENT'S INVESTIGATION REPORT  
0027-03-CID679-64999  
10 JAN 2004

DETAILS:

corner of the west wall. There was no door present. The room had a tile floor, and the walls were tiled about two thirds up from the floor. There was window in the east wall that was covered with plywood. There was an entranceway in the north wall that was covered with plywood. There was a U shaped green bar attached to the north wall three feet above the floor. The bar was approximately one inch in diameter, and approximately three feet long.

(FOUO) Condition of the Scene: There was a halogen work light in the northwest corner of the room. There was an old style green sleeping bag on the floor at the base of the light. The outside of the sleeping bag was covered with mud. Underneath the sleeping bag, was a length of white electrical wire. There were two MRE boxes present in the room that appeared to have been used as seats. There was one unfired 7.62mm rifle round on the floor, near the door.

(FOUO) Scene Documentation: SA [REDACTED] prepared a Crime Scene Sketch of Room 6. SA [REDACTED] exposed digital photographs of Room 6 utilizing a Nikon Coolpix 995 Digital Card Camera. (See Sketch, Photographic Log and CD ROM for details)

(FOUO) Collection of Crime Scene Evidence: SA [REDACTED] collected the sleeping bag and the electrical wire as documented on DA Form 4137, Evidence/Property Custody Document (EPCD), document number 521-03. The unfired round was not collected, as unfired small arms ammunition was frequently seen on the ground in the area, and there was no evidence of gunshot injuries on MOWHOUSH's remains.

(FOUO) About 0820, 28 Nov 03, SA [REDACTED] interviewed SSG [REDACTED], Medical Troop, Spt Sqd, 3<sup>rd</sup> ACR, Fort Carson, Al Asad, Iraq. SSG [REDACTED] stated just after 0900, 26 Nov 03, he was notified that a prisoner was unconscious and unresponsive. When he arrived at Room 6, SGT [REDACTED], CPT [REDACTED] and CPT [REDACTED] all assigned to Medical Troop, Spt Sqd, 3<sup>rd</sup> ACR, were present. Two other soldiers, SSG [REDACTED] did not know, were also present. SSG [REDACTED] observed a detainee lying on his back with his head towards the door. CPT [REDACTED] and CPT [REDACTED] were attempting to revive the detainee. SSG [REDACTED] saw a

[REDACTED]  
SPECIAL AGENT, [REDACTED]  
Page 4 of 12

[REDACTED]

EXHIBIT 1

000016

b2, b6, 7c



87<sup>TH</sup> MILITARY POLICE DETACHMENT (CID) (ABN), 3D MILITARY POLICE GROUP  
(CID), USACIDC, FORT BRAGG, NC 28310

AGENT'S INVESTIGATION REPORT

0027-03-CID679-64999

10 JAN 2004

DETAILS:

light set in the room. The lights were on. SSG [REDACTED] did not assist in the efforts to revive the detainee.

(FOUO) About 0830, 28 Nov 03, SA [REDACTED] interviewed SGT [REDACTED] SGT [REDACTED] related about 0910, 26 Nov 03, he was in the holding pens area with CPT [REDACTED], when SFC [REDACTED] 66<sup>th</sup> MI Co, attached to 3<sup>rd</sup> ACR, briefed them that he was interrogating a prisoner that stated he was not feeling well. The prisoner had lost control of his bodily functions and was unresponsive. SGT [REDACTED] and CPT [REDACTED] went to interrogation room 6. They arrived about 0920, and found the patient lying on his back, with his head near the door and his feet near the far wall. The patient was unresponsive, was not breathing and did not have a pulse. The detainee's eyes were open. The pupils were dilated and fixed. There were no weapons in the room. There was a large light in the corner. SGT [REDACTED] did not know who the detainee was. None of the personnel in the room mentioned any details about the interrogation. CPT [REDACTED] and CPT [REDACTED] started CPR while SGT [REDACTED] went to retrieve additional medical equipment. When SGT [REDACTED] returned to the room, he continued CPR with the assistance of PFC [REDACTED] SFC [REDACTED] CPT [REDACTED] and CPT [REDACTED]. During CPR they used a bag valve with maximum setting for the oxygen, exhausting two tanks. They attempted to insert an intravenous line in the femoral and anacubical arteries, but were unsuccessful. A medevac helicopter was called, but did not arrive. CPT [REDACTED] pronounced the patient dead at 0950, 28 Nov 03. The patient was wearing a shirt, a t-shirt and a man dress. The dress was pulled up during CPR. SGT [REDACTED] observed old sores on the patient's ankles, but did notice any other external injuries. A J-tube and an intubation tube were left on the body. He had not received any reports of unruly prisoners or injuries to prisoners during his time at the detention facility.

(FOUO) About 0842, 28 Nov 03, SA [REDACTED] interviewed CPT [REDACTED], who stated SFC [REDACTED] notified her that a detainee was unconscious and unresponsive in interrogation room 6. She arrived at room 6 at 0911. When she arrived, the detainee was on his back, with his head toward the door. CW3 [REDACTED] was performing chest compressions on the detainee. CW3 [REDACTED] told CPT [REDACTED] the detainee had been unconscious for five or six

[REDACTED]  
SPECIAL AGENT, [REDACTED]

Page 5 of 12

[REDACTED]  
EXHIBIT   1  

b2, b6, 7c

000017

87<sup>TH</sup> MILITARY POLICE DETACHMENT (CID) (ABN), 3D MILITARY POLICE GROUP  
(CID), USACIDC, FORT BRAGG, NC 28310

AGENT'S INVESTIGATION REPORT

0027-03-CID679-64999

10 JAN 2004

DETAILS:

minutes. He also told her that prior to passing out, the detainee lost bladder control. CPT [REDACTED] stated the detainee did not have a pulse, and was not breathing. At 0918, the patient was intubated by CPT [REDACTED] on the second attempt, and was given oxygen with a bag valve mask. Multiple attempts to insert an IV into the right anacubical artery and the right femoral artery were unsuccessful. At 0950, a reassessment revealed no spontaneous breathing, no pulse, no corneal reflex and no gag reflex. CPT [REDACTED] pronounced the detainee dead at that time. While attempting to insert the IV into the femoral artery, CPT [REDACTED] noticed several contusions on the detainee's legs. CPT [REDACTED] stated there were no furnishings in the room. There was a set of lights in the room that was on. She did not notice any weapons in the room. CPT [REDACTED] stated the detainee had not received any prior medical treatment from her staff. MOWHOUSH's in-processing medical screening did not reveal any preexisting medical conditions or medication use. CPT [REDACTED] stated the detainee was wearing a gray man dress and undergarment. CPT [REDACTED] provided SA [REDACTED] with a SF 600, Chronological Record of Medical Care, pertaining to the detainee. (see SF 600)

(FOUO) About 0900, 28 Nov 03, SA [REDACTED] interviewed CPT [REDACTED]. CPT [REDACTED] stated about 0906, 26 Nov 03, SFC [REDACTED] informed her that someone had collapsed. She told him to go set CPT [REDACTED]. She arrived on scene, at room 6, about 0911. The detainee was lying on his back with his head toward the door. CPT [REDACTED], CW3 [REDACTED] and SGT [REDACTED] were present in the room. CW3 [REDACTED] was conducting chest compressions. The detainee was being given rescue breathing with a mask. She intubated the detainee on the second attempt. Several attempts to insert an IV into the right femoral and right anacubical arteries were unsuccessful. After 30 minutes of resuscitative efforts, CPT [REDACTED] pronounced the detainee dead at 0950. CPT [REDACTED] stated the patient was an obese Caucasian male, who did not reveal any preexisting medical conditions or use of medication during the in processing medical screening. CPT [REDACTED] noticed contusions on the detainee's legs during attempts to insert the IV. CPT [REDACTED] stated there was a set of lights in the room, and maybe a box. She did not see any chairs in the room.

[REDACTED]  
SPECIAL AGENT, [REDACTED]

Page 6 of 12

[REDACTED]  
EXHIBIT 1

b2, b4, 7C

000018

87<sup>TH</sup> MILITARY POLICE DETACHMENT (CID) (ABN), 3D MILITARY POLICE GROUP  
(CID), USACIDC, FORT BRAGG, NC 28310

AGENT'S INVESTIGATION REPORT

0027-03-CID679-64999

10 JAN 2004

DETAILS:

(FOUO) About 0910, 28 Nov 03, SA [REDACTED] advised CW3 [REDACTED] of his rights. CW3 [REDACTED] invoked his right to counsel. (See Non-waiver Certificate for details)

[REDACTED] About 0922, 28 Nov 03, SA [REDACTED] advised CW2 [REDACTED] 66<sup>th</sup> MI Company, 3<sup>rd</sup> ACR, Al Asad, Iraq, of his rights. CW2 [REDACTED] waived his rights, and rendered a sworn statement. CW2 [REDACTED] was part of the interrogation team that interrogated MG MOWHOUSH on 26 Nov 03. While CW2 [REDACTED] was in the interrogation, CW3 [REDACTED] placed MG MOWHOUSH in a sleeping bag and then laid him on the floor. While being questioned MG MOWHOUSH became unresponsive and medical personnel were summoned. When questioned about who else had interviewed MG MOWHOUSH, CW2 [REDACTED] stated between 24 and 48 hours prior to the interview mentioned above, members of a Special Forces [REDACTED] interviewed MG MOWHOUSH. [REDACTED]

[REDACTED] were present with the Special Forces Team. CW2 [REDACTED] was present when MG MOWHOUSH was brought from the cage and released to Special Forces [REDACTED]

[REDACTED] CW2 [REDACTED] stated MG MOWHOUSH recognized [REDACTED]

[REDACTED] CW2 [REDACTED] said MG MOWHOUSH was visibly fearful [REDACTED] Special Forces [REDACTED] [REDACTED] took MG MOWHOUSH to an interrogation room, and he heard screams MG MOWHOUSH screaming, and what he thought were the sounds of a person being struck with a hard object. (See Rights Waiver Certificate and Sworn Statement for details)

(FOUO) About 0928, 28 Nov 03, SA [REDACTED] interviewed SFC [REDACTED] who stated he was [REDACTED] assigned to the interrogation team that interviewed MG MOWHOUSH on 26 Nov 03. During the interrogation, CW3 [REDACTED] placed MG MOWHOUSH in a sleeping bag, and then laid him on the floor. While in the sleeping bag, MG MOWHOUSH became unresponsive, at which time medical personnel were summoned. (See Sworn Statement for details)

[REDACTED]  
SPECIAL AGENT, [REDACTED]

Page 7 of 12

[REDACTED]  
EXHIBIT 1

000019

b1, b3, b2, b4, 7C

[REDACTED]

87<sup>TH</sup> MILITARY POLICE DETACHMENT (CID) (ABN), 3D MILITARY POLICE GROUP  
(CID), USACIDC, FORT BRAGG, NC 28310

AGENT'S INVESTIGATION REPORT  
0027-03-CID679-64999  
10 JAN 2004

DETAILS:

AGENT'S COMMENT: SFC [REDACTED] was not advised of his legal rights, as he was not suspected of any criminal wrongdoing at the time of the interview.

(FOUO) About 1013, 28 Nov 03, SA [REDACTED] interviewed SPC [REDACTED] Aviation Maintenance (AVIM) Trp, Spt Sqd, 3<sup>rd</sup> ACR, Al Asad, Iraq. SPC [REDACTED] stated he was the guard that escorted MG MOWHOUSH to interrogation room 6 on 26 Nov 03. SPC [REDACTED] stated he was present for the interrogation and assisted in placing MG MOWHOUSH in the sleeping bag under the direction of CW3 [REDACTED]

(FOUO) About 1032, 28 Nov 03, SA [REDACTED] coordinated with SFC [REDACTED] who provided the 66<sup>th</sup> MI Company Interrogation Log, which was used to document when detainees were interrogated, where they were interrogated and by whom. A review of the documents showed MG MOWHOUSH was signed out only one time since his capture to CW3 [REDACTED] at 0815, 26 Nov 03. The time was crossed out and changed to 0715 by SFC [REDACTED] who stated that was the correct time. There were no comments or return date listed on the log, and the recommendation was to hold the detainee. SFC [REDACTED] stated the sign out time indicated the detainee's capture file was signed out, not the time the interrogation was started. The log was returned to SFC [REDACTED]

(FOUO) Agent's Comment: There was no way to copy the log and the detention facility needed the log for their records. All pertinent information was noted by SA [REDACTED] at the time of the log review.

(FOUO) About 1055, 28 Nov 03, SA [REDACTED] coordinated with 1LT [REDACTED] SJA, 3<sup>rd</sup> ACR, Al Asad, Iraq, and briefed him on the results of the interview of SPC [REDACTED]. 1LT [REDACTED] advised SA [REDACTED] to advise SPC [REDACTED] of his legal rights and obtain a sworn statement if a waiver was given.

[REDACTED] About 1107, 28 Nov 03, SA [REDACTED] advised SPC [REDACTED] of his rights, which he waived and rendered a sworn statement. SPC [REDACTED] stated he was present during the interview of MG [REDACTED]

[REDACTED]  
SPECIAL AGENT, [REDACTED]  
Page 8 of 12

[REDACTED]

EXHIBIT 1

000020

b2, b6, 7c

[REDACTED]

87<sup>TH</sup> MILITARY POLICE DETACHMENT (CID) (ABN), 3D MILITARY POLICE GROUP  
(CID), USACIDC, FORT BRAGG, NC 28310

AGENT'S INVESTIGATION REPORT

0027-03-CID679-64999

10 JAN 2004

DETAILS:

MOWHOUSH on 26 Nov 03, and assisted in placing MG MOWHOUSH in the sleeping bag and lying him down. SPC [REDACTED] stated CW3 [REDACTED] sat on MG MOWHOUSH's chest, and began asking him questions. When CW3 [REDACTED] stood up, SPC [REDACTED] noticed MG MOWHOUSH was not breathing. After a few seconds, MG MOWHOUSH took a deep breath. At that point MG MOWHOUSH was rolled over, and CW3 [REDACTED] sat on MG MOWHOUSH's back. At that point, SPC [REDACTED] left the room. When he came back, medical personnel were present at the room. When questioned about others who had interviewed MG MOWHOUSH, SPC [REDACTED] stated 24 to 48 hours prior to the interrogation on 26 Nov 03, MG MOWHOUSH was interrogated by Special Forces. SPC [REDACTED] was the guard that escorted MG MOWHOUSH to the interrogation. While waiting to escort MG MOWHOUSH back to the cage, SPC [REDACTED] heard MG MOWHOUSH screaming and the sounds of a person being struck with a hard object coming from the room MG MOWHOUSH was being interrogated in. SPC [REDACTED] stated the sounds lasted for approximately 10 to 15 minutes. (See Sworn Statement for details)

(FOUO) About 1120, 28 Nov 03, SA [REDACTED] reviewed the Capture File pertaining to MG MOWHOUSH. The file included a very limited data sheet, which contained only his name, tribe and year of birth. The file contained two Sworn Statements pertaining to the capture of MG MOWHOUSH. The first statement was written by CPT [REDACTED], HHT, 1<sup>st</sup> Sqd, 3<sup>RD</sup> ACR. It stated MG MOWHOUSH came to FOB Tiger to attempt to secure the release of [REDACTED] on 10 Nov 03. MG MOWHOUSH was detained as a suspected leader of anti-coalition efforts in Al Qaim. The second statement was written by CPT [REDACTED], HHT, 1<sup>st</sup> Sqd, 3<sup>rd</sup> ACR. It also stated MG MOWHOUSH came to FOB Tiger in an attempt to secure the release of [REDACTED] on 10 Nov 03. He was detained as a suspected leader of anti-coalition forces in Al Qaim, and had been on the 3<sup>rd</sup> ACR Black List since Aug 03.

(FOUO) About 1150, 28 Nov 03, SA [REDACTED] interviewed SGT [REDACTED] 56<sup>th</sup> MI Co, 3<sup>rd</sup> ACR, [REDACTED] who stated his only contact with MG MOWHOUSH was shortly after his capture. SGT [REDACTED] assisted CW3 [REDACTED] during an interrogation at [REDACTED]. The interrogation lasted less than one hour, and MG MOWHOUSH did not

[REDACTED]  
SPECIAL AGENT, [REDACTED]  
Page 9 of 12

[REDACTED]

EXHIBIT   L  

b2, b6, 7c

000021

87<sup>TH</sup> MILITARY POLICE DETACHMENT (CID) (ABN), 3D MILITARY POLICE GROUP  
(CID), USACIDC, FORT BRAGG, NC 28310

AGENT'S INVESTIGATION REPORT

0027-03-CID679-64999

10 JAN 2004

DETAILS:

display any visible signs of distress or injury. MG MOWHOUSH displayed a cocky smile during the interrogation. He stated during the interview MG MOWHOUSH was made to kneel and not allowed to rest his buttocks on his lower legs. The only physical contact between CW3 [REDACTED] and MG MOWHOUSH was when CW3 [REDACTED] was trying to make a point and poked MG MOWHOUSH in the chest several times. The only other person present during the interrogation was [REDACTED]

(FOUO) About 1210, 28 Nov 03, SA [REDACTED] interviewed SPC [REDACTED] Aviation Maintenance Troop, 3<sup>rd</sup> ACR, who stated he was the night guard for Pen 8, the pen MG MOWHOUSH was kept in. He described MG MOWHOUSH as quiet. The last two days MG MOWHOUSH was there, he complained that he was very, very sick. SPC [REDACTED] asked MG MOWHOUSH if he wanted medical attention, but he did not respond. The medical staff made rounds every morning, but MG MOWHOUSH never asked for them. MG MOWHOUSH was kept on sleep deprivation and was never allowed to sleep at the direction of the interrogators.

(FOUO) About 1350, 28 Nov 03, SA [REDACTED] interviewed SPC [REDACTED] Aviation Maintenance Troop, 3<sup>rd</sup> ACR, who stated he helped MG MOWHOUSH back to his pen after an interview between 1300-1600, 24 Nov 03. MG MOWHOUSH could not walk on his own and looked very tired. SPC [REDACTED] did not hear MG MOWHOUSH being hit at any time.

(FOUO) Between 1218 and 1340, 28 Nov 03, SA [REDACTED] conducted canvass interviews of the guards on both the day and night shifts. MG MOWHOUSH was a quiet prisoner who did not cause any problems. None of the guards ever had to restrain him and none of the guards ever hit MG MOWHOUSH. MG MOWHOUSH always seemed tired and could not do physical training. Most of the guards knew MG MOWHOUSH was on sleep deprivation. (See canvass interview sheets for details.)

[REDACTED]  
SPECIAL AGENT, [REDACTED]

Page 10 of 12

[REDACTED]  
EXHIBIT 1

000022

b1, b3, b2, b6, 7C

[REDACTED]

87<sup>TH</sup> MILITARY POLICE DETACHMENT (CID) (ABN), 3D MILITARY POLICE GROUP  
(CID), USACIDC, FORT BRAGG, NC 28310

AGENT'S INVESTIGATION REPORT  
0027-03-CID679-64999  
10 JAN 2004

DETAILS:

(FOUO) About 1240, 28 Nov 03, SA [REDACTED] canvass interviewed personnel from the 223<sup>rd</sup> MI, Mobile Interrogation team who stated they had no contact with MG MOWHOUSH. (See canvass interview sheets for details.)

(FOUO) About 1252, 28 Nov 03, SA [REDACTED] interviewed SFC [REDACTED] 66<sup>th</sup> MI Co, Al Asad, Iraq, who stated he stepped into the interrogation of MG MOWHOUSH on 26 Nov 03. When SFC [REDACTED] stepped into the room, MG MOWHOUSH was lying on the floor in the sleeping bag. SFC [REDACTED] heard SFC [REDACTED] tell MG MOWHOUSH to get up, but he did not comply. CW3 [REDACTED] and CW2 [REDACTED] were also in the room. SFC [REDACTED] stated he was in the room for 10 to 15 seconds and left. Ten to 15 minutes later SFC [REDACTED] observed medical personnel heading to the room MG MOWHOUSH was in, and heard someone say MG MOWHOUSH might be dead.

[REDACTED] About 1305, 28 Nov 03, SA [REDACTED] interviewed [REDACTED] who stated [REDACTED] was involved in interviews with MG MOWHOUSH on two occasions. [REDACTED] stated the first time was shortly after his capture at [REDACTED] [REDACTED] stated CW3 [REDACTED] was the interrogator both times. [REDACTED] stated the other time was after MG MOWHOUSH was transferred to [REDACTED] [REDACTED] stated there was no physical contact between the interrogation team and MG MOWHOUSH, nor was there any physical stressors placed on MG MOWHOUSH during either interview [REDACTED] was involved with. [REDACTED] stated in both interviews there were other personnel present but [REDACTED] did not remember whom. [REDACTED] stated during an interview of MG MOWHOUSH by [REDACTED] ODA, on 24 or 25 Nov 03, [REDACTED] heard MG MOWHOUSH being slapped.

(FOUO) About 1355, 28 Nov 03, SA [REDACTED] re-interviewed CW2 [REDACTED], who clarified several issues from his earlier sworn statement. SFC [REDACTED] had a better vantage point and could see the interview better than he could. CW2 [REDACTED] was positioned at MG MOWHOUSH's feet to keep him from kicking CW3 [REDACTED]. CW3 [REDACTED] was straddling MG MOWHOUSH, but CW2 [REDACTED] was unsure if CW3 [REDACTED] had his weight on the prisoner's chest. At several points during the interview the guard may have been

[REDACTED]  
SPECIAL AGENT, [REDACTED]  
Page 11 of 12

[REDACTED]

EXHIBIT 1

b1, b3, b2, b6, 7C

000023

[REDACTED]

87<sup>TH</sup> MILITARY POLICE DETACHMENT (CID) (ABN), 3D MILITARY POLICE GROUP  
(CID), USACIDC, FORT BRAGG, NC 28310

AGENT'S INVESTIGATION REPORT

0027-03-CID679-64999

10 JAN 2004

DETAILS:

in the room, but the guard was not in the room at the time MG MOWHOUSH became unresponsive. CW2 [REDACTED] was unsure who tied the cord around MG MOWHOUSH. CW2 [REDACTED] stated that he did not remember MG MOWHOUSH taking a dramatic last breath, but he did remember that when they realized the prisoner was not breathing, they took the sleeping bag off of him. CW2 [REDACTED] did not see anyone kick MG MOWHOUSH and at no time did he kick MG MOWHOUSH. CW2 [REDACTED] did not remember SFC [REDACTED] entering the room.

(FOUO) About 0900, 4 Dec 03, SA [REDACTED] received a copy of the Preliminary Autopsy Report pertaining to MG MOWHOUSH. A review of the report revealed determination of the cause and manner of death are pending the results of histology, toxicology and this investigation.

[REDACTED] About 1300, 30 Dec 03, SA [REDACTED] interviewed SFC [REDACTED] 141<sup>st</sup> Military Intelligence Company, Utah Army National Guard, who rendered a sworn statement, wherein he related he had seen CW3 [REDACTED] and CW2 [REDACTED] strike MOWHOUSH. (See Sworn Statement for details)

(FOUO) At 1350, 10 Jan 04, SA [REDACTED] briefed LTC [REDACTED] and CPT [REDACTED] on the information to date. LTC [REDACTED] stated he would review the information and provide his legal opinion pertaining to the assaults committed by CW2 [REDACTED] and CW3 [REDACTED]

[REDACTED] //LAST ENTRY//

[REDACTED]  
SPECIAL AGENT [REDACTED]

Page 12 of 12

[REDACTED]

EXHIBIT     

b2, b6, 7C

000024



## Exhibit 2

Page(s) 25-32 withheld

Third Party Information  
Not Reasonably Segregable

Exemptions (b)2), (b)(6), (b)(7)(C) and  
(b)(7)(E)

ROUGH SKETCH DEPICTING CRIME SCENE

0027-03-CID679-64999

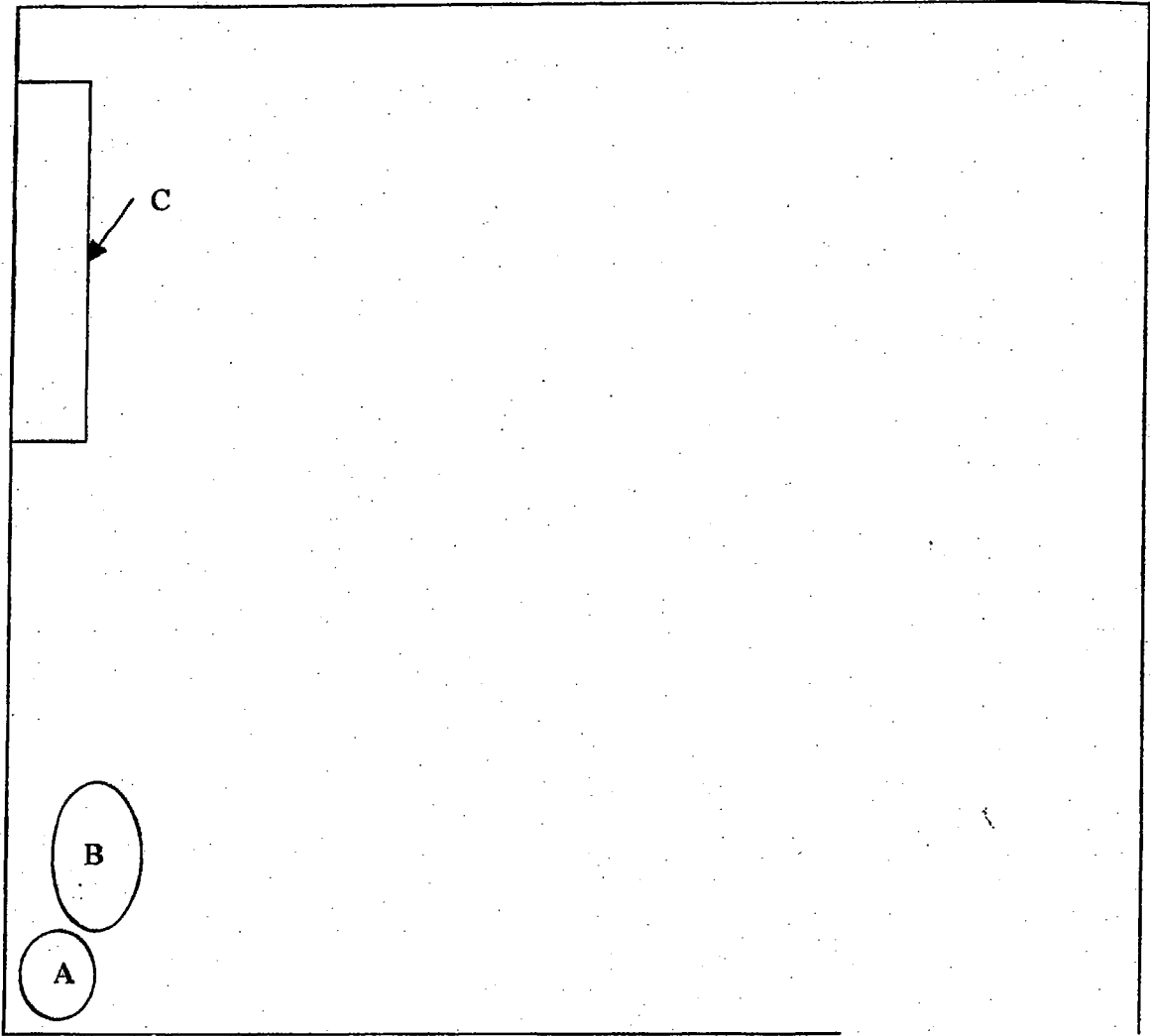

LEGEND:

- A. Light Set
- B. Sleeping Bag
- C. Green Railing



NOT TO SCALE

TITLE BLOCK:

SEQ: 0027-03-CID679-64999  
 OFFENSE: Undetermined Death  
 DEPICTING: Interrogation Room 6  
 LOCATION: Blacksmith Hotel, vic 37S FT  
 VICTIM: Abed Hamed MOWHOUSH  
 STARTED: 0825, 28 Nov 03  
 SKETCHED BY: SA [REDACTED]  
 VERIFIED: SA [REDACTED]

FOR OFFICIAL USE ONLY

EXHIBIT

4

000033

b6.7c

Exhibit(s) 5

Page(s) 34 referred to:

CDR USAMEDCOM  
ATTN: FOIA Office, STOP 76  
1216 Stanley RD 2D FL  
FT. Sam Houston, TX 78234-5049

**RIGHTS WARNING PROCEDURE/WAIVER CERTIFICATE**

For use of this form, see AR 190-30; the proponent agency is ODCSOPS

**DATA REQUIRED BY THE PRIVACY ACT**

**AUTHORITY:**  
**PRINCIPAL PURPOSE:**  
**ROUTINE USES:**  
**DISCLOSURE:**

Title 10, United States Code, Section 3012(g)  
To provide commanders and law enforcement officials with means by which information may be accurately identified.  
Your Social Security Number is used as an additional/alternate means of identification to facilitate filing and retrieval.  
Disclosure of your Social Security Number is voluntary.

1. LOCATION <u>Iraq</u>	2. DATE <u>28 Nov 03</u>	3. TIME <u>0917</u>	4. FILE NUMBER <u>0027-03-CID 679</u> <u>64998-9</u>
5. Name (Last, first, middle) [REDACTED]	8. ORGANIZATION OR ADDRESS <u>66th MI Co</u> <u>1113 ACT</u> <u>Fort Carson, CO</u>		
6. SSN [REDACTED]	7. GRADE/STATUS <u>CW3</u>		

**PART I - RIGHTS WAIVER/NON-WAIVER CERTIFICATE**

**SECTION A. Rights**

The investigator whose name appears below told me that he/she is with the United States Army Criminal Investigation Command and wanted to question me about the following offense(s) of which I am suspected/accused: Murder 111

Before he/she asked me any questions about the offense(s), however, he/she made it clear to me that I have the following rights:

1. I do not have to answer any questions or say anything.
2. Anything I say or do can be used as evidence against me in a criminal trial.
3. (For personnel subject to the UCMJ) I have the right to talk privately to a lawyer before, during, and after questioning and to have a lawyer present with me during questioning. This lawyer can be a civilian lawyer I arrange for at no expense to the Government or a military lawyer detailed for me at no expense to me or both.

-or-

(For civilians not subject to the UCMJ) I have the right to talk privately to a lawyer before, during, and after questioning and to have a lawyer present with me during questioning. I understand that this lawyer can be one that I arrange for at my own expense, or if I cannot afford a lawyer and want one, a lawyer will be appointed for me before any questioning begins.

4. If I am now willing to discuss the offense(s) under investigation, with or without a lawyer present, I have the right to stop answering questions at any time, or speak privately with a lawyer before answering further, even if I sign the waiver below.

5. COMMENTS (Continue on reverse side)

**SECTION B. Waiver**

I understand my rights as stated above. I am now willing to discuss the offense(s) under investigation and make a statement without talking to a lawyer first and without having a lawyer present with me.

WITNESSES (if available)		3. SIGNATURE OF INTERVIEWEE
1a. NAME (Type or Print)		
b. ORGANIZATION OR ADDRESS AND PHONE		4. SIGNATURE OF SUPERVISOR
		[REDACTED]
2a. NAME (Type or Print)		5. NAME OF INVESTIGATOR
		[REDACTED]
b. ORGANIZATION OR ADDRESS AND PHONE		6. ORGANIZATION OF INVESTIGATOR
		<u>87th MP Det (CID)</u> <u>Fort Bragg, NC</u>

**SECTION C. Non-waiver**

1. I do not want to give up my rights  
 I want a lawyer  
 I do not want to be questioned or say anything

2. SIGNATURE OF INTERVIEWEE  
[REDACTED]

ATTACH THIS WAIVER CERTIFICATE TO THE STATEMENT (DA FORM 2823) SUBSEQUENTLY EXECUTED BY THE SUSPECT/ACCUSED

DA FORM 3881, NOV 89 (AUTOMATED)

EDITION OF NOV 84 IS OBSOLETE

FOR OFFICIAL USE ONLY

EXHIBIT

000035

bl.7C

**RIGHTS WARNING PROCEDURE/WAIVER CERTIFICATE**

For use of this form, see AR 190-30; the proponent agency is ODCSOPS

**DATA REQUIRED BY THE PRIVACY ACT**

**AUTHORITY:**  
**PRINCIPAL PURPOSE:**  
**ROUTINE USES:**  
**DISCLOSURE:**

Title 10, United States Code, Section 3012(g)  
To provide commanders and law enforcement officials with means by which information may be accurately identified.  
Your Social Security Number is used as an additional/alternate means of identification to facilitate filing and retrieval.  
Disclosure of your Social Security Number is voluntary.

1. LOCATION <i>Confine man facility Al Qaim, IRAQ</i>	2. DATE <i>28 NOV 03</i>	3. TIME <i>0922</i>	4. FILE NUMBER <i>0027-03-012629</i> <i>649987</i>
5. Name (Last First MI) [REDACTED]	8. ORGANIZATION OR ADDRESS <i>66 ME CO 3 ACR</i> <i>AL ASAD IRAQ</i> <i>APO AE 09146</i>		
6. SSN [REDACTED]	GRADE/STATUS <i>CW2</i>		

**PART I - RIGHTS WAIVER/NON-WAIVER CERTIFICATE**

**SECTION A. Rights**

The investigator whose name appears below told me that he/she is with the United States Army Criminal Investigation Command suspected/accused murder and wanted to question me about the following offense(s) of which I am

Before he/she asked me any questions about the offense(s), however, he/she made it clear to me that I have the following rights:

1. I do not have to answer any questions or say anything.
2. Anything I say or do can be used as evidence against me in a criminal trial.
3. (For personnel subject to the UCMJ) I have the right to talk privately to a lawyer before, during, and after questioning and to have a lawyer present with me during questioning. This lawyer can be a civilian lawyer I arrange for at no expense to the Government or a military lawyer detailed for me at no expense to me or both.

-or-

(For civilians not subject to the UCMJ) I have the right to talk privately to a lawyer before, during, and after questioning and to have a lawyer present with me during questioning. I understand that this lawyer can be one that I arrange for at my own expense, or if I cannot afford a lawyer and want one, a lawyer will be appointed for me before any questioning begins.

4. If I am now willing to discuss the offense(s) under investigation, with or without a lawyer present, I have the right to stop answering questions at any time, or speak privately with a lawyer before answering further, even if I sign the waiver below.

5. COMMENTS (Continue on reverse side) Q: Have you been advised of your legal rights and requested a lawyer within the last 30 days? A: NO

**SECTION B. Waiver**

I understand my rights as stated above. I am now willing to discuss the offense(s) under investigation and make a statement without talking to a lawyer first and without having a lawyer present with me.

WITNESSES (if available)		3. SIGNATURE OF INTERVIEWER
1a. NAME (Type or Print)	[REDACTED]	[REDACTED]
b. ORGANIZATION OR ADDRESS AND PHONE	[REDACTED]	[REDACTED]
2a. NAME (Type or Print)	[REDACTED]	[REDACTED]
b. ORGANIZATION OR ADDRESS AND PHONE	[REDACTED]	[REDACTED]
		6. ORGANIZATION OF INVESTIGATOR <i>USA Army CID 10th MP BN (CID)</i> <i>APO AE 09335</i>

**SECTION C. Non-waiver**

1. I do not want to give up my rights  
 I want a lawyer  I do not want to be questioned or say anything
2. SIGNATURE OF INTERVIEWEE

ATTACH THIS WAIVER CERTIFICATE TO ANY SWORN STATEMENT (DA FORM 2823) SUBSEQUENTLY EXECUTED BY THE SUSPECT/ACCUSED  
DA FORM 3881, NOV 89 (AUTOMATED) EDITION OF NOV 84 IS OBSOLETE

**LAW ENFORCEMENT SENSITIVE  
FOR OFFICIAL USE ONLY**

**EXHIBIT 7**

000036

*bl.7c*

SWORN STATEMENT

For use of this form; see AR 190-45; the proponent agency is ODCSOPS

PRIVACY ACT STATEMENT

AUTHORITY: Title 10 USC Section 301; Title 5 USC Section 2951; E.O. 9397 dated November 22, 1943 (SSN).
PRINCIPAL PURPOSE: To provide commanders and law enforcement officials with means by which information may be accurately
ROUTINE USES: Your social security number is used as an additional/alternate means of identification to facilitate filing and retrieval.
DISCLOSURE: Disclosure of your social security number is voluntary.

1. LOCATION: Vicinity Al Qaim, Iraq
2. DATE (YYYYMMDD): 2003 11 28
3. TIME: 10:37
4. FILE NUMBER: 2003-03-CID-697
5. LAST NAME, FIRST NAME, MIDDLE NAME: [Redacted]
6. SSN: [Redacted]
7. GRADE/STATUS: CW2
8. ORGANIZATION OR ADDRESS: 66 MI Company 3 ACR Al ASAO APOAE 09146

I, [Redacted], WANT TO MAKE THE FOLLOWING STATEMENT UNDER OATH:

On 26 Nov 03 0830 I joined the interrogation of Abid. The interrogation started about 0840 and Abid did not want to answer the questions being asked. He was put in the sleeping bag and laid on the ground. He was talking to the interrogator when he became unresponsive. We called for the medics and they attempted to save his life for about 30 min. Some time around 0950 the Doctor stopped life saving measures and pronounced the death.

Q: SA [Redacted]

A: CW2 [Redacted]

Q: Who was interviewing ABID Mahoush?

A: CW3 [Redacted] and SFC [Redacted] They had been interviewing him prior to my arrival but I only joined the interview at 0840 [Redacted]

Q: What do you mean when you say he was put into a sleeping bag?

A: He was standing up. The sleeping bag was placed over his head and around his body. a cord was wrapped around his body to keep the bag on. His head was covered. He was then laid down on the floor and rolled from his stomach to his back and asked questions. This was not the first time this technique had been used on him. ABID was talking and answering questions while in the bag. Then he became unresponsive, we knew something was wrong when we took him out of the bag. we immediately called for the medics [Redacted]

10. EXHIBIT
11. INITIALS OF PERSON MAKING STATEMENT: [Redacted]
PAGE 1 OF 4 PAGES

ADDITIONAL PAGES MUST CONTAIN THE HEADING "STATEMENT" TAKEN AT DATED

THE BOTTOM OF EACH ADDITIONAL PAGE MUST BEAR THE INITIALS OF THE PERSON MAKING THE STATEMENT, AND PAGE NUMBER MUST BE INDICATED.

LAW ENFORCEMENT SENSITIVE

66,70

000037

USE THIS PAGE IF NEEDED. IF THIS PAGE IS NOT NEEDED, PLEASE PROCEED TO FINAL PAGE OF THIS FORM.

STATEMENT OF [REDACTED] TAKEN AT vic Al Qaim 12 DATED 28 NOV 03

9. STATEMENT (Continued)

Q: IS that a standard MI technique?

A: I do not know. I am not an interrogator. But I have seen the sleeping bag used before. [REDACTED]

Q: Did anyone hit ABID in your presence?

A: No. [REDACTED]

Q: Did ABID say he was hurt or not feeling well?

A: He did not say he was hurt. I had asked him how he was doing and he said "not so good". It was a standard response from him. [REDACTED]

Q: Did you notice any injuries on him?

A: no. [REDACTED]

Q: How hard was he placed on the ground?

A: very gently [REDACTED]

Q: Did he complain about not being able to breathe in the bag?

A: I do not know, but he did not say that in English and [REDACTED] SFC [REDACTED] did not say that. [REDACTED]

Q: How long <sup>was it</sup> between going unresponsive and the arrival of the medics?

A: 5-10 minutes. [REDACTED]

Q: Did you or anyone else do CPR before the medics arrived?

A: We rolled him over on his side and pushed on his back, ~~but~~ CW3 [REDACTED] may have done chest compressions. No one did rescue breathing. [REDACTED]

Q: Did you take him fully out of the sleeping bag?

A: Yes. [REDACTED]

Q: Do you know of any other people who interviewed ABID?

A: Yes. [REDACTED] on 24 or 25 NOV 03 I know he was interviewed by people who knew him from other areas other than here. He was scared of these people. I was under the impression that ABID was beaten during this interview. I did not see it but I heard it. ABID was frightened and intimidated by these people and was scared they would come back to re-interview him. That was the impression I got from him. [REDACTED]

INITIALS OF PERSON MAKING STATEMENT [REDACTED]

PAGE 2 OF 4 PAGES

b1, b3, b6, 7c

USE THIS PAGE IF NEEDED. IF THIS PAGE IS NOT NEEDED, PLEASE PROCEED TO THE NEXT PAGE OF THIS FORM.

STATEMENT OF [REDACTED] TAKEN AT Vic McQuinn II DATED 28 NOV 03

9. STATEMENT (Continued)

Q: [REDACTED]  
A: [REDACTED]

Q: Do you know them by name?

A: NO

Q: What type of weapons did they have?

A: M-4's MP 5's and AK 47 type weapons.

Q: How long did the interview last?

A: I do not know.

Q: How long did the beatings last?

A: I do not know I was only in the building for a few minutes.

Q: Did you see any injuries on ABID?

A: No. He was wearing a long gown, or man dress.

Q: Did he complain of injuries or seem sore?

A: He was a very overweight man and always looked uncomfortable. After that interview he did seem a little more tender and/or tired. Nothing remarkable though. He was out of shape and was always struggling to even walk or stand unassisted.

Q: Do you know why this team beat ABID?

A: I did not see it so no I do not even know if it happened. I simply heard what sounded like ABID being hit.

Q: Do you know of any other stressors being put on ABID?

A: He was being sleep deprived. He was woken up every 20 to 30 minutes for one or two nights. It was meant to soften him up. He was also only 3 MRE's a day, which judging by his weight was less than he normally gets.

Q: Is there anything else you would like to add to this statement?

A: NO. ~~THE END OF STATEMENT~~

Q: Did you ever hit ABID, ~~was~~?

A: NO. ~~THE END OF STATEMENT~~

INITIALS OF PERSON MAKING STATEMENT [REDACTED]

PAGE 3 OF 4 PAGES

b1, b3, b6, 7c

000039



STATEMENT OF [REDACTED] TAKEN AT 28 NOV 03 DATED 11 Qain, IZ

9. STATEMENT (Continued)

NOT used [REDACTED]

AFFIDAVIT

I, [REDACTED], HAVE READ OR HAVE HAD READ TO ME THIS STATEMENT WHICH BEGINS ON PAGE 1, AND ENDS ON PAGE 4. I FULLY UNDERSTAND THE CONTENTS OF THE ENTIRE STATEMENT MADE BY ME. THE STATEMENT IS TRUE. I HAVE INITIALED ALL CORRECTIONS AND HAVE INITIALED THE BOTTOM OF EACH PAGE CONTAINING THE STATEMENT. I HAVE MADE THIS STATEMENT FREELY WITHOUT HOPE OF BENEFIT OR REWARD, WITHOUT THREAT OF PUNISHMENT, AND WITHOUT COERCION, UNLAWFUL INFLUENCE

[REDACTED]

(Signature of Person Making Statement)

WITNESSES:

Subscribed and sworn to before me, a person authorized by law to administer oaths, this 28 day of NOV, 2003 at 11 Qain IZ

\_\_\_\_\_  
\_\_\_\_\_  
\_\_\_\_\_  
\_\_\_\_\_  
\_\_\_\_\_  
\_\_\_\_\_  
\_\_\_\_\_  
\_\_\_\_\_  
\_\_\_\_\_  
\_\_\_\_\_

ORGANIZATION OR ADDRESS

[REDACTED]

(Administering Oath)

SA [REDACTED]

(Typed Name of Person Administering Oath)

ARI 136 (B)(4) UCMJ

(Authority To Administer Oaths)

ORGANIZATION OR ADDRESS

INITIALS OF PERSON MAKING STATEMENT [REDACTED]

PAGE 4 OF 4 PAGES

b6,7c

000040

SWORN STATEMENT

For use of this form, see AR 190-45; the proponent agency is ODCSOPS

PRIVACY ACT STATEMENT

AUTHORITY: Title 10 USC Section 301; Title 5 USC Section 2951; E.O. 9397 dated November 22, 1943 (SSN).  
PRINCIPAL PURPOSE: To provide commanders and law enforcement officials with means by which information may be accurately  
ROUTINE USES: Your social security number is used as an additional/alternate means of identification to facilitate filing and retrieval.  
DISCLOSURE: Disclosure of your social security number is voluntary.

1. LOCATION FO3 [REDACTED]	2. DATE (YYYYMMDD) 01 MAR 2003 11 28	3. TIME 11:15L	4. FILE NUMBER
5. LAST NAME, FIRST NAME, MIDDLE NAME [REDACTED]	6. SSN [REDACTED]	7. GRADE/STATUS SFC	
8. ORGANIZATION OR ADDRESS 66th MI Co, FT CARSON, CO, AL ASAD, IRAQ			

[REDACTED], WANT TO MAKE THE FOLLOWING STATEMENT UNDER OATH:

That I was the interpreter present on 26 November 2003 for the interrogation of of Abed NAMED MACHASH, former General in the Iraqi Army. I was called into room 6 by CW2 [REDACTED] because he needed a [REDACTED]. The General was already present in the room along with CW3 [REDACTED], CW2 [REDACTED] and myself. I translated and assisted in questioning the General for approximately 15 minutes. During the interrogation the detainee was placed in the bag. An old green sleeping bag which provided air flow but is restrictive and very uncomfortable. I personally verified that the General's airflow was not restricted by the bag before beginning and translated interrogations. At no time was the General beaten or any devices used to injure him or cause any bodily harm. The [REDACTED] CW3 [REDACTED] asked the General if he was the "Snakes Head" numerous times. He then said that the General was the "Snakes head" and asked the General if that was true. He asked the General if [REDACTED] should be interrogated. Then CW3 [REDACTED] said that Republican Guards are strong. CW2 [REDACTED] said the Republican Guards should be strong; strong from the inside. I [REDACTED]. The detainee was rolled over onto his chest and CW2 [REDACTED] said that the General had shit himself (lose bowel control). We noticed that he was unresponsive so I checked for chest movement and a pulse. There was none. (continued)

10. EXHIBIT 9	11. INITIALS OF PERSON MAKING STATEMENT [REDACTED]	PAGE 1 OF 4 PAGES
------------------	---	-------------------

ADDITIONAL PAGES MUST CONTAIN THE HEADING "STATEMENT [REDACTED] TAKEN AT [REDACTED] DATED [REDACTED]"

THE BOTTOM OF EACH ADDITIONAL PAGE MUST BEAR THE INITIALS OF THE PERSON MAKING THE STATEMENT, AND PAGE NUMBER MUST BE BE INDICATED.

Ex 8  
b6,7c  
000041

USE THIS PAGE IF NEEDED. IF THIS PAGE IS NOT NEEDED, PLEASE PROCEED TO FINAL PAGE OF THIS FORM.

STATEMENT OF [REDACTED] TAKEN AT [REDACTED] DATED 2003/1/28

9. STATEMENT (Continued)

CW3 [REDACTED] sent me to go get the Doctor. I ran to the aid station and was told that the Doctor was down in the inprocessing tent. I ran there and she followed me to Room 6. When I arrived CW3 [REDACTED] was doing CPR. I assisted the medical team with CPR and when one of the medics attempted to start an IV. When we lifted the detainees clothing to expose his legs I noticed that he had signs of physical/blunt trauma on his legs. The only other item that I noted was that the detainee, in death, was smiling. This face really upset me.

Q: [REDACTED]

A: [REDACTED]

Q: Did any one during the interrogation physically touch or "control" MG Mowthorst?

A: Yes, CW3 [REDACTED] sat on the detainees chest and put his hand over the detainees eyes and mouth. He did not cover his nose. This was an effort in my opinion to show the detainee that the interrogator was in total control of the situation and to enhance physical discomfort. I did not feel that this was meant to endanger the detainees life.

Q: Have you been involved in any other interviews with the MG?

A: No.

Q: Why do you think the MG died?

A: I think that emotionally he gave up his will to live and then died of a heart attack.

INITIALS OF PERSON MAKING STATEMENT

PAGE 2 OF 4 PAGES

bb.7c

000042

USE THIS PAGE IF NEEDED. THIS PAGE IS NOT NEEDED. PLEASE PROCESS THE FINAL PAGE OF THIS FORM.

STATEMENT OF [REDACTED] TAKEN AT Blacksmith Hotel DATED 20031128

9. STATEMENT (Continued)

Q: Do you know how many times he was interviewed while in custody?  
A: I believe that he was interviewed once or twice a day since his arrival in order to gain critical tactical intelligence related to anti-coalition activities.

Q: Who conducted those interviews?

A: CW 3 [REDACTED]

Q: Have you seen the MG after he was interviewed by any of the [REDACTED]

A: Only once as he was headed back to the detention cage. I noticed that the detainee was having severe difficulty getting back to his cage so I ran down to assist. I and four guards and one officer helped to move the General back to his living area. The entire time I spoke with and encouraged him. At one point he fell to the ground and said, "I can't, I can't, I die!" I told him that he was going to be alright and helped him to his area. I ensured that he had his blanket wrapped around him and that he was alright. This was approximately the 24th of November at around 1900 hrs.

Q: Do you have anything else to add to your statement?

A: No. III END OF STATEMENT // [REDACTED]

INITIALS OF PERSON MAKING STATEMENT

LAW ENFORCEMENT SENSITIVE  
FOR OFFICIAL USE ONLY

PAGE 3 OF 4 PAGES

USAPA V1.00

EXHIBIT 8

b1, b3, b6, 7C

000043

STATEMENT OF [REDACTED]

TAKEN AT Bledisworth Hotel

DATED 2003 11 28

9. STATEMENT (Continued)

[REDACTED]

AFFIDAVIT

I, [REDACTED], HAVE READ OR HAVE HAD READ TO ME THIS STATEMENT WHICH BEGINS ON PAGE 1, AND ENDS ON PAGE 4. I FULLY UNDERSTAND THE CONTENTS OF THE ENTIRE STATEMENT MADE BY ME. THE STATEMENT IS TRUE. I HAVE INITIALED ALL CORRECTIONS AND HAVE INITIALED THE BOTTOM OF EACH PAGE CONTAINING THE STATEMENT. I HAVE MADE THIS STATEMENT FREELY WITHOUT HOPE OF BENEFIT OR REWARD, WITHOUT THREAT OF PUNISHMENT, AND WITHOUT COERCION, UNLAWFUL INFLUENCE, OR UNLAWFUL INDUCEMENT.

[REDACTED]  
[REDACTED] (Making Statement)

WITNESSES:

Subscribed and sworn to before me, a person authorized by law to administer oaths, this 28 day of November, 2003 at Bledisworth Hotel, Fort Tuler, DRAG

ORGANIZATION OR ADDRESS

[REDACTED]

(Signature of Person Administering Oath)

ORGANIZATION OR ADDRESS

(Typed Name of Person Administering Oath)

ART 136 (b) (4) USMJ

(Authority To Administer Oaths)

INITIALS OF PERSON MAKING STATEMENT

[REDACTED]

LAW ENFORCEMENT SENSITIVE

PAGE 4 OF 4 PAGES

FOR OFFICIAL USE ONLY

EXHIBIT 8

000044

b6,7C

**WARNING PROCEDURE/WAIVER CERTIFICATE**

For use of this form, see AR 190-30; the proponent agency is ODCSOPS

**DATA REQUIRED BY THE PRIVACY ACT**

**AUTHORITY:** Title 10, United States Code, Section 3012(g)  
**PRINCIPAL PURPOSE:** To provide commanders and law enforcement officials with means by which information may be accurately identified.  
**ROUTINE USES:** Your Social Security Number is used as an additional/alternate means of identification to facilitate filing and retrieval.  
**DISCLOSURE:** Disclosure of your Social Security Number is voluntary.

1. LOCATION <i>Iraq</i>	2. DATE <i>28 Nov 85</i>	3. TIME <i>1107</i>	FILE NO. <i>0020-03-00679</i> <i>649977</i>
5. NAME (Last, First, MI) [REDACTED]	8. ORGANIZATION OR ADDRESS <i>Avim Top, spt Sed</i> <i>3ACR, Fort Carson, CO</i>		
6. SSN [REDACTED]	7. GRADE/STATUS <i>SPC1A0</i>		

**PART I - RIGHTS WAIVER/NON-WAIVER CERTIFICATE**

**Section A. Rights**

The investigator whose name appears below told me that he/she is with the United States Army *Criminal Investigation Command* and wanted to question me about the following offense(s) of which I am suspected/accused: *Murder/111*

- Before he/she asked me any questions about the offense(s), however, he/she made it clear to me that I have the following rights:
- I do not have to answer any question or say anything.
  - Anything I say or do can be used as evidence against me in a criminal trial.
  - (For personnel subject to the UCMJ) I have the right to talk privately to a lawyer before, during, and after questioning and to have a lawyer present with me during questioning. This lawyer can be a civilian lawyer I arrange for at no expense to the Government or a military lawyer detailed for me at no expense to me, or both.

- or -

(For civilians not subject to the UCMJ) I have the right to talk privately to a lawyer before, during, and after questioning and to have a lawyer present with me during questioning. I understand that this lawyer can be one that I arrange for at my own expense, or if I cannot afford a lawyer and want one, a lawyer will be appointed for me before any questioning begins.

- If I am now willing to discuss the offense(s) under investigation, with or without a lawyer present, I have a right to stop answering questions at any time, or speak privately with a lawyer before answering further, even if I sign the waiver below.

5. COMMENTS (Continue on reverse side)

**Section B. Waiver**

I understand my rights as stated above. I am now willing to discuss the offense(s) under investigation and make a statement without talking to a lawyer first and without having a lawyer present with me.

**WITNESSES (If available)**

1a. NAME (Type or Print)	3. SIGNATURE OF INTERVIEWEE [REDACTED]
b. ORGANIZATION OR ADDRESS AND PHONE	
2a. NAME (Type or Print)	5. TYPED NAME OF INVESTIGATOR [REDACTED]
b. ORGANIZATION OR ADDRESS AND PHONE	
6. ORGANIZATION OF INVESTIGATOR <i>8715 MP Det (CID)</i> <i>Fort Bragg, NC</i>	

**Section C. Non-waiver**

- I do not want to give up my rights  
 I want a lawyer  
 I do not want to be questioned or say anything

2. SIGNATURE OF INTERVIEWEE

ATTACH THIS WAIVER CERTIFICATE TO ANY SWORN STATEMENT (DA FORM 2823) SUBSEQUENTLY EXECUTED BY THE SUSPECT/ACCUSED

DA FORM 3881, NOV 89

**LAW ENFORCEMENT SENSITIVE**

FOR OFFICIAL USE ONLY **EXHIBIT**

USAPA 2.01

*b6,7c*

000045

SWORN STATEMENT

For use of this form, see AR 190-45; the proponent agency is ODCSOPS

PRIVACY ACT STATEMENT

AUTHORITY: Title 10 USC Section 301; Title 5 USC Section 2951; E.O. 9397 dated November 22, 1943 (SSN).
PRINCIPAL PURPOSE: To provide commanders and law enforcement officials with means by which information may be accurately
ROUTINE USES: Your social security number is used as an additional/alternate means of identification to facilitate filing and retrieval.
DISCLOSURE: Disclosure of your social security number is voluntary.

1. LOCATION: Iraq vic of FOB Tiger
2. DATE: 20031128
3. TIME: 1243
4. FILE NUMBER: 0027-03-010679-6492
5. LAST NAME, FIRST NAME, MIDDLE NAME: [REDACTED]
6. SSN: [REDACTED]
7. GRADE/STATUS: SPC/AD
8. ORGANIZATION OR ADDRESS: Avium Trp Spt Sgd, 3rd ACR, Fort Carson, CO

I, [REDACTED], WANT TO MAKE THE FOLLOWING STATEMENT UNDER OATH:

2 days ago I was called on the radio to escort number 76 (the General) to go to interrogation room number 6. I proceeded to pm 28 to get the General. About 50 to 75 feet from the cage I said "General. Let's go General." in a very friendly way. Just like I do to all the EPWs. By time I got there he still wasn't standing. I had to physically help him up. On the way to the interrogation room I had to help him walk the whole way. Very slowly I might add. He was breathing short & heavy with a little bit of wheezing and a tired/bull moan at the exhale of every breath. I had to carry a lot of his weight on me while walking with him with his hands and arms over mine. When I got up to the "Bat cave" (the interrogation rooms) Chief [REDACTED] was waiting and told me to take him to room six. I took him there and waited out-side the room against the wall. After standing there awhile I was told by [REDACTED] to come inside and make sure he doesn't sit down. [REDACTED] left for approximately 15 minutes and came back. Before [REDACTED] came back [REDACTED] came into the room just talking to the General. Taking him "How was your cookie I gave you?" The General said it was good and that's all he had to eat in the last few days. [REDACTED] was telling him how he was his friend and that he liked him and some other stuff I don't really remember. About that time [REDACTED] and the interpreter, [REDACTED] came in the room. [REDACTED] asked him a few questions and the General responded all same, "I don't know". At this time [REDACTED] should step out and he slightly shake his head no. [REDACTED] told the General that if he didn't tell [REDACTED] what he wanted to know then he's not going to like what's coming. [REDACTED] asked

10. EXHIBIT: 10
11. INITIALS OF PERSON MAKING STATEMENT: [REDACTED]
PAGE 1 OF 4 PAGES

ADDITIONAL PAGES MUST CONTAIN THE HEADING "STATEMENT TAKEN AT [REDACTED] DATED [REDACTED]"

THE BOTTOM OF EACH ADDITIONAL PAGE MUST BEAR THE INITIALS OF THE PERSON MAKING THE STATEMENT, AND PAGE NUMBER MUST BE INDICATED.

Handwritten: b6,7c, Ex 9, 000046

-03- CID697-649987

USE THIS PAGE IF NEEDED. IF THIS PAGE IS NOT NEEDED, PLEASE PROCEED TO FINAL PAGE OF THIS FORM.

STATEMENT OF [REDACTED] TAKEN AT Vic of [REDACTED] DATED 2003/12/8  
Trog

## 9. STATEMENT (Continued)

a few more questions. The same thing "I don't know." [REDACTED] picked up the sleeping bag and wrapped it around the General and I tied it up with electrical cord. [REDACTED] told me to make sure that it was tight. So I did. I was still wrapping the chord around his thighs and I asked [REDACTED] how low do you want me to go. He replied "A little lower." So I did. After that [REDACTED] asked me if it was tight, and I said ~~yes~~ yes. We had ~~tried~~ tried to turn him around a couple of times but he was too big to turn. Me, [REDACTED], and [REDACTED] all layed the General down on his back. After laying him down [REDACTED] sat on his both chest and stomach. [REDACTED] asked him a few question and he same thing. "I don't know." [REDACTED] put his hand over the face of the General and held it there for a few seconds and then released. I asked him a few more questions and the same answer. [REDACTED] took both his hands and pushed down on the sleeping bag on both sides and held it there. Meanwhile me and [REDACTED] are standing and the sides of the sleeping bag to hold down the General's legs to keep them from kicking or kneeling. [REDACTED] asked a few more questions and there was no answers. [REDACTED] stood up and was watching the guy. I saw that at first the general wasn't breathing, but after about 15 to 20 seconds he took a big, deep breath. [REDACTED] then said "Thank God, I was worried that he stopped breathing." [REDACTED] then told us to roll him over. Before we rolled him over he started to shake for about 2 seconds. We all really thought nothing of it. We rolled him over and [REDACTED] sat on his back. After a few seconds I saw the General's whole body just clench. His body clenched about 3 or 4 times, maybe more. At this time [REDACTED] walks in the room stands there for a minute or so and she tells me to step out of the room. After I walked out of the room about 2 minutes later a battle buddy of mine walked by and I talked to him for no more than 5 minutes. When I came back to the room a Sgt ran out of the room yelling "Where's the Doc?! Where's the Doc!?" At that time I was wondering what the hell was going on. A few minutes later the DOC

INITIALS OF PERSON MAKING STATEMENT [REDACTED]

PAGE 2 OF 4 PAGES

bl.7c



USE THIS PAGE IF NEEDED. IF THIS PAGE IS NOT NEEDED, PLEASE PROCESS THE FINAL PAGE OF THIS FORM.

STATEMENT OF [REDACTED] TAKEN AT Vic of [REDACTED] DATED 20031128 Iraq

9. STATEMENT (Continued)

runs over and starts doing her thing.

2 days before that I was told to escort # 076 to the Bat cave. I did and the General was taken from me by some of the SF personnel. They kept him for about an hour to an hour and a half. When the General came back out it took 4 or five of us to practically carry him back to the cage he was in. The General had no energy. No breath. It was almost almost as if he was about to die. Excuse the pun.

Q: Describe [REDACTED]

A: He is [REDACTED] and works at the Al Asad EPW site.

Q: Describe [REDACTED]

A: He is [REDACTED] I think he has [REDACTED]

Q: Describe [REDACTED]

A: [REDACTED] He was [REDACTED] and [REDACTED] He is a [REDACTED]

Q: Describe [REDACTED]

A: [REDACTED] He [REDACTED]

Q: Were there any weapons in Room 6 on 26 Nov 05?

A: My guard stick was in the corner of the room.

Q: Did you see anyone hit the general on 26 Nov 05?

A: No.

Q: Did you ever hit the general?

A: No

Q: Did you ever see anyone hit the general.

INITIALS OF PERSON MAKING STATEMENT [REDACTED]

PAGE 3 OF 4 PAGES

b6,7c

STATEMENT OF [REDACTED] TAKEN AT Vic of [REDACTED] DATED 2003/12/8  
Irag

9. STATEMENT (Continued)

A: I never saw it, but I did hear someone hit him.  
 Q: Describe what happened when you heard the general being hit  
 A: The day I escorted the general to SF I waited about 40 feet from the door to the room he was in. I heard smacking sounds and the general screaming. It sounded like the general was being hit with an object. I think the sounds lasted five to ten minutes. That was the day we had to carry the general back to the cage.  
 Q: Are you sure it was the general you heard screaming?  
 A: Yes  
 Q: Do you know who was in the room with the general?  
 A: No. They were all wearing masks.  
 Q: Did the general ever ask to see a doctor?  
 A: No.  
 Q: Did the general ever complain about anything?  
 A: Sometimes he would complain when we made him get up. He was like that from when he first got here.  
 End of Statement

AFFIDAVIT

I, [REDACTED], HAVE READ OR HAVE HAD READ TO ME THIS STATEMENT WHICH BEGINS ON PAGE 1, AND ENDS ON PAGE 4. I FULLY UNDERSTAND THE CONTENTS OF THE ENTIRE STATEMENT MADE BY ME. THE STATEMENT IS TRUE. I HAVE INITIALED ALL CORRECTIONS AND HAVE INITIALED THE BOTTOM OF EACH PAGE CONTAINING THE STATEMENT. I HAVE MADE THIS STATEMENT FREELY WITHOUT HOPE OF BENEFIT OR REWARD, WITHOUT THREAT OF PUNISHMENT, AND WITHOUT COERCION, UNLAWFUL INFLUENCE, OR UNLAWFUL INDUCEMENT.

[REDACTED] Making Statement

Subscribed and sworn to before me, a person authorized by law to administer oaths, this 28<sup>th</sup> day of November, 2003 at Vic of FOB Tiser, Irag

[REDACTED] (Signature of Person Administering Oath)

SA [REDACTED] (Typed Name of Person Administering Oath)

Art 136 (b)(4) (ACM) (Authority To Administer Oaths)

WITNESSES:

\_\_\_\_\_  
 ORGANIZATION OR ADDRESS

\_\_\_\_\_  
 ORGANIZATION OR ADDRESS

INITIALS OF PERSON MAKING STATEMENT

PAGE 4 OF 4 PAGES

9000049

bl, 7c

Night Shift

CASE # 0027-03-CID697-6492802

CANVASS INTERVIEW WORKSHEET

TIME AND DATE BEGAN: 28 Nov 03 1218

NAME & SSN	UNIT AND/OR ADDRESS	PHONE NUMBER
Sgt [REDACTED]	Maint Troop 3 ACR	
PFC [REDACTED]	Maint Troop 3 ACR	
CPL [REDACTED]	" "	
SSG [REDACTED]	" "	
PFC [REDACTED]	" "	UCOIC
SPC [REDACTED]	2-5 BCo Troop 212 Field Artillery BDE Fort Sill OK	
PFC [REDACTED]	SMT Troop 3 ACR	
PFC [REDACTED]	AVIM Troop 3 AC	Steep deprivation
SPC [REDACTED]	B Co 16th Sig BN 3 Sg BDE	Just sat there

FOR OFFICIAL USE ONLY

EXHIBIT: 10

000050

b6,7c

DAY Shift

CANVASS INTERVIEW WORKSHEET

CASE # 0027-03-CD697-64998-02

TIME AND DATE BEGAN: 1250 28 NOV 03

NAME & SSN

UNIT AND/OR ADDRESS

PHONE NUMBER

SG6	[REDACTED]	Maint Troop 3ACR	one day rolled 15 min sleep dep NCOIC
SGT	[REDACTED]	Avim Troop 3/ACR	Ran a little - was tired rolled around in front of others
PFC	[REDACTED]	Avim Troop 3ACR	
SGT	[REDACTED]	Avim Troop 3ACR	
PFC	[REDACTED]	86016th Sig Bn 35ig BDE	DID PT - moaned Never dealt with
SGT	[REDACTED]	HHT 3ACR	ON sleep dep couldn't do PT
SGT	[REDACTED]	Maint Troop	1st night not complaining A bout 23,000
PFC	[REDACTED]	HHT SPT Sq 3ACR	Sleep dep wanted to lay down
PFC	[REDACTED]	B Co 16 Sig 35ig BDE	
SPC	[REDACTED]	B Co 16th Sig	
SGT	[REDACTED]	C Co 16th Sig	
SPC	[REDACTED]	Avim Troop 3ACR	
SPC	[REDACTED]	Avim Troop 3ACR	
SPC	[REDACTED]	Avim Troop 3ACR	

EXHIBIT: 10

FOR OFFICIAL USE ONLY

PAGE 2 OF 3 PAGES

bk. 7C

000051

Exhibit(s) 11

Page(s) 52, 53 referred to:

CDR USAMEDCOM  
ATTN: FOIA Office, STOP 76  
1216 Stanley RD 2D FL  
FT. Sam Houston, TX 78234-5049

For use of this form, see AR [redacted] The proponent agency is Office of The Deputy Chief of Staff for Personnel.

LOCATION CAMP Doha, Kuwait	DATE 30 Dec 03	TIME 1423	FILE NUMBER 0027-03-G1D679-64999
LAST NAME, FIRST NAME, MIDDLE NAME [redacted]	SOCIAL SECURITY NUMBER [redacted]	GRADE/STATUS SFC/E7	
ORGANIZATION OR ADDRESS 141ST Military Intelligence Company, CT, NG			

WANT TO MAKE THE FOLLOWING STATEMENT UNDER OATH.

On or near the date of 17 November 2003, I began [redacted] arrived at FOB Tiger to begin an operation which was to work at a temporary holding facility at [redacted] a few days after I arrived at [redacted] CW3 [redacted] told me that I would be the interrogation NCOIC. To date I have never conducted an interrogation therefore I assumed the position as much as I knew how, seeing to it that interrogations went as smoothly as possible.

General Mahawish was already at the [redacted] detention facility when I arrived as far as I know. I only had personal knowledge of very few of the times that the [redacted] General Mahawish was being interrogated and that was because I stumbled onto his interrogations. During one of the interrogations, which CW3 [redacted] was conducting with someone else, I don't remember who, I accidentally turned the light off. On another incident, I saw CW3 [redacted] CW2 [redacted] and others I don't recall interrogating the General, CW2 [redacted] would throw a full box of M&S at the General if he didn't like the answers that the General gave. Another time that I only heard about was that [redacted] (NFI) and [redacted] were on the roof beating the [redacted] General up. I did not investigate further or ask any other questions. I don't remember any dates involved with when the General was interrogated.

The night of 25 November 2003, the General was told by CW3 [redacted] that if he wanted to see [redacted], he had 10 seconds to get up and go see him. The General's condition was so bad that he couldn't get up on his own. It took the General about 30 minutes to get 150m from the cage to the interrogation room to see [redacted] I walked the general to see [redacted] and he needed a great deal of help walking because he was in so much pain. I do not know if his pain was a result of his beating or

EXHIBIT 13	INITIALS OF PERSON MAKING STATEMENT [redacted]	PAGE 1 OF 4 PAGES
ADDITIONAL PAGES MUST CONTAIN THE HEADING "STATEMENT OF [redacted] TAKEN AT [redacted] DATED [redacted] CONTINUED." THE BOTTOM OF EACH ADDITIONAL PAGE MUST BE INITIALED AS "PAGE [redacted] OF [redacted] PAGES [redacted] UTILIZED, THE BACK OF PAGE 1 WILL BE LINED OUT, AND THE STATEMENT WILL BE [redacted] OF ANOTHER COPY OF THIS FORM.		

b1, b3, b6, 7c

FO00054

USE THIS PAGE IF NEEDED. IF T

ED TO FINAL PAGE OF THIS FORM

0027-03-CID0679-64999

STATEMENT OF

SFC

TAKEN AT

Usulut

DATED

30 Dec 03

9. STATEMENT (Continued)

From the rigorous PT/Sleep dep they had him on.

The morning of 26 November 2003, SFC [redacted] came out to the cage where I was to inform me that the General was dead. SFC [redacted] told me at that time that he just fell over dead. Later that day, I asked SFC [redacted] why he would just die and SFC [redacted] told me he was in the sleeping bag when he died.

CW3 [redacted] told me on 27 November that CID would be interested in the sticks that I carried for defense because [redacted] was using them to beat the General with.

On the night prior to the General's death, I witnessed CW3 [redacted] on the [redacted] sitting on the chest of [redacted] (VFD) while [redacted] (a detainee) was being interrogated. When [redacted] didn't answer CW3 [redacted] questions, Chief would bang him up and down on the floor. When [redacted] still didn't confess, Chief [redacted] poured water over the sleeping bag over where [redacted] mouth and nose were, so that [redacted] couldn't breathe.

I have no personal knowledge of what extent the General was subjected to sleep deprivation nor PT, except to say that [redacted] I saw them occasionally doing it to him. As much as I was in the cage, I only saw the General doing PT once. I cannot say about sleep dep, only that it happened. It was the individual interrogator that was responsible for coordinating PT/sleep dep with the guards.

I had difficulty getting CW3 [redacted] to properly sign out prisoners on the paper work nor would CW3 [redacted] properly sign out rooms. I confronted him about this and he said "Chief does what Chief wants to do". I never questioned him again regarding signing rooms nor prisoners.

Q: [redacted]

A: [redacted]

Q: How often was the sleeping bag treatment used?

A: If the prisoner did not cooperate, and it was handy, the sleeping bag was used. at least daily, depending on need by CW3 [redacted]

INITIALS OF PERSON MAKING STATEMENT

[redacted]

PAGE 2 OF 4 PAGES

EXHIBIT

USAPA V1.00

b1, b3, b6, 7c

000055

0027-03-CID679-64999

SFC [REDACTED]  
STATEMENT OF

[REDACTED] Ussat  
TAKEN AT

FILE NUMBER:  
30DEC03  
DATED

CONTINUED

Q: How did the use of the sleeping bag come about?

A: SGT [REDACTED] said that his brother used to put him in a sleeping bag when they were kids and that's when he and chief [REDACTED] started using it. I don't know when.

Q: Did you ever personally see CW3 [REDACTED] hit the MG or another detainee?

A: I have never seen CW3 [REDACTED] hit General Mahawish. I saw CW2 [REDACTED] throw a full box of M&S at the general during an interrogation at which CW3 [REDACTED] was conducting. I have seen CW3 [REDACTED] slap and punch several detainees. I have seen CW3 [REDACTED] beat detainees on the ground while in the sleeping bag.

Q: Did you see the MG being beat by the [REDACTED] people?

A: I have never seen [REDACTED] beat the general but interrogators that worked for me told me that they did see the beatings.

Q: Was CW3 [REDACTED] on the roof during the interview of the MG and [REDACTED]?

A: Chief [REDACTED] was very protective of whom he allowed to interrogate the General. He was very interested in what he told interrogators. It is not likely that CW3 [REDACTED] was not in any of the General's interrogations. It is highly likely that he was at all interrogations, including the one on the roof but I did not see it, so I don't know for sure.

Q: Did the MG ever say anything to you about his treatment?

A: The general did not tell me that he was being mistreated. CW3 [REDACTED] told me after the General died that the General asked him to kill him to put him out of his misery and the mistreatment to stop.

Q: Do you have anything else to add to your statement?

A: No at this time. // END OF STATEMENT // [REDACTED]

[REDACTED]

EXHIBIT 12

INITIALS OF PERSON MAKING STATEMENT [REDACTED]

PAGE 3 OF 4 PAGES

000056

b1, b3,

bl.7c



SFC

Warrant 30 Dec 03

STATEMENT OF

TAKEN AT

FILE NUMBER:

DATED

CONTINUED:

STATEMENT (Continued)

0027 - 03 - CID 679 - 64999

*(This section is crossed out with a large diagonal line)*

AFFIDAVIT

I, [REDACTED], HAVE READ OR HAVE HAD READ TO ME THIS STATEMENT WHICH BEGINS ON PAGE 1 AND ENDS ON PAGE 4. I FULLY UNDERSTAND THE CONTENTS OF THE ENTIRE STATEMENT MADE BY ME. THE STATEMENT IS TRUE. I HAVE INITIALED ALL CORRECTIONS AND HAVE INITIALED THE BOTTOM OF EACH PAGE CONTAINING THE STATEMENT. I HAVE MADE THIS STATEMENT FREELY WITHOUT HOPE OF BENEFIT OR REWARD, WITHOUT THREAT OF PUNISHMENT, AND WITHOUT COERCION, UNLAWFUL INFLUENCE, OR UNLAWFUL INDUCEMENT.

WITNESSES:

[REDACTED] (Signature of Person Making Statement)

Subscribed and sworn to before me, a person authorized by law to administer oaths, this 30 day of December, 20 03 at Camp Doha, Kuwait

ORGANIZATION OR ADDRESS

[REDACTED] (Signature of Person Administering Oath)

ORGANIZATION OR ADDRESS

SA [REDACTED] (Typed Name of Person Administering Oath)

ART 136 (b)(4) (Authority To Administer Oaths)

INITIALS OF PERSON MAKING STATEMENT

PAGE 4 OF 4 PAGES

EXHIBIT 12000057

b6.7c

87<sup>TH</sup> MILITARY POLICE DETACHMENT (CID) (ABN), 3D MILITARY POLICE GROUP (CID), USACIDC, FORT BRAGG, NC 28310

AGENT'S INVESTIGATION REPORT

0027-03-CID679-64999

17 Feb 04

DETAILS:

(FOUO) About 1420, 13 Jan 04, SA [REDACTED] reviewed AR 190-8, Enemy Prisoners of War, Retained Personnel, Civilian Internees and Other Detainees. The review revealed three citations pertinent to this investigation. They appear in their entirety below.

(FOUO) Paragraph 1-5.a(4): The inhumane treatment of EPW, CI, RP is prohibited and is not justified by the stress of combat or with deep provocation. Inhumane treatment is a serious and punishable violation under international law and the Uniform Code of Military Justice (UCMJ).

(FOUO) Paragraph 2-1.a(1)(d): Prisoners may be interrogated in the combat zone. The use of physical or mental torture or any coercion to compel prisoners to provide information is prohibited. Prisoners may voluntarily cooperate with PSYOP personnel in the development, evaluation, or dissemination of PSYOP messages or products. Prisoners may not be threatened, insulted, or exposed to unpleasant or disparate treatment of any kind because of their refusal to answer questions. Interrogations will normally be performed by intelligence or counterintelligence personnel.

(FOUO) Paragraph 3-7.e(3): No EPW or RP will be handcuffed or tied, except to ensure safe custody or when prescribed by a responsible medical officer as needed to control a medical case requiring restraint.

(FOUO) About 1120, 19 Jan 04, SA [REDACTED] coordinated with CPT [REDACTED] Det Cdr, ODA 531, 1<sup>st</sup> Bn, 5<sup>th</sup> SFG(A), Fort Campbell, KY (FOB Tiger, Iraq), and briefed him on this investigation. CPT [REDACTED] related personnel from ODA 531 had very limited interaction with MG MOWHOUSH. He further stated a few of his soldiers provided written statements to the chain of command after the incident, and that the statements were likely in the possession of MAJ [REDACTED] the Company Commander.

(S-NF) About 1200, 19 Jan 04, SA [REDACTED] interviewed CW2 [REDACTED] Assistant Det Cdr, [REDACTED] 1<sup>st</sup> Bn, 5<sup>th</sup> SFG(A), Fort Campbell, KY (FOB Tiger, Iraq), who

[REDACTED]

DERIVED FROM:

[REDACTED]

SPECIAL AGENT, [REDACTED]

Page 1 of 5

DECLASIFY ON:

17 FEBRUARY 2029

[REDACTED]

EXHIBIT 19

000058

b1, b3, b2, b6, 7C

87<sup>TH</sup> MILITARY POLICE DETACHMENT (CID) (ABN), 3D MILITARY POLICE GROUP (CID), USACIDC, FORT BRAGG, NC 28310

AGENT'S INVESTIGATION REPORT

0027-03-CID679-64999

17 Feb 04

DETAILS:

related he did have contact with MG MOWHOUSH about three or four days prior to his death. CW2 [redacted] related he was at the forward detention facility conducting an interview of another detainee (NFI) when he noticed MG MOWHOUSH was being interviewed by someone else. He could not remember if it was MI [redacted]. During a group conversation outside of the interrogation room, it was decided to send [redacted] to continue the interrogation. CW2 [redacted] went into the interrogation room with [redacted] MG MOWHOUSH was in the room squatting in a corner. When CW2 [redacted] entered the room, MG MOWHOUSH laid on his side. [redacted] asked one or two questions. At that point, MG MOWHOUSH reached out with legs and put [redacted] who was leading the interrogation in a scissor type leg lock around [redacted] ankles. CW2 [redacted] stated a couple of guys held MG MOWHOUSH down while [redacted] in the scissor lock broke the scissor lock by kneeling and pulling away. CW2 [redacted] stated the interrogation was terminated at that point and MG MOWHOUSH was returned to the holding cage. CW2 [redacted] could not remember the exact date of the incident, but stated it occurred one to two days prior to MG MOWHOUSH's son being transferred to the forward detention facility. CW2 [redacted] related there were [redacted] operating in the area at the time of MG MOWHOUSH's death. He knew each of them by first name only. [redacted]

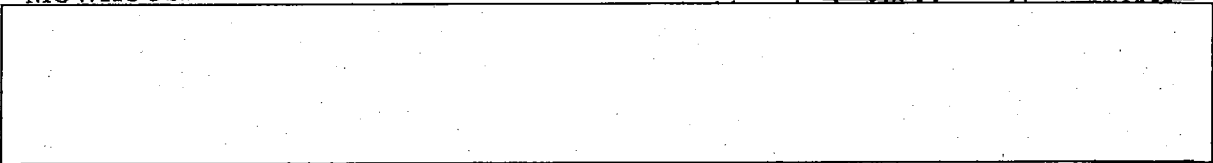

(FOUO) About 1305, 19 Jan 04, SA [redacted] interviewed SSG Aaron N. HOLLEYMAN, [redacted] 1<sup>st</sup> Bn, 5<sup>th</sup> SFG(A), Fort Campbell, KY (FOB Tiger, Iraq), who relate he had contact with MG MOWHOUSH on two occasions while he was in custody. SSG HOLLEYMAN escorted MG MOWHOUSH to the detention facility on FOB Tiger the day MG MOWHOUSH was detained. SSG HOLLEYMAN described MG MOWHOUSH as docile and willing to cooperate. The second time SSG HOLLEYMAN saw MG MOWHOUSH was at the forward detention facility during Operation Rifles Blitz. SSG HOLLEYMAN stated MG

SPECIAL AGENT, [redacted]

Page 2 of 5



EXHIBIT 13

b1, b3, b2, b4, 7C 000059

87<sup>TH</sup> MILITARY POLICE DETACHMENT (CID) (ABN), 3D MILITARY POLICE GROUP  
(CID), USACIDC, FORT BRAGG, NC 28310

AGENT'S INVESTIGATION REPORT  
0027-03-CID679-64999  
17 Feb 04

DETAILS:

MOWHOUSH was being interrogated by [redacted] an older guy in glasses (probably SFC [redacted]) and the chief (CW3 [redacted]). SSG HOLLEYMAN was in the room for approximately five minutes and could not remember what was being discussed. He did not see any weapons or a sleeping bag in the room. While he was in the room, MG MOWHOUSH was seated on an MRE box.

(FOUO) About 1320, 19 Jan 04, SA [redacted] interviewed SSG [redacted], [redacted], 1<sup>st</sup> Bn, 5<sup>th</sup> SFG(A), Fort Campbell, KY ([redacted] Iraq), who related he did not have any contact with MG MOWHOUSH. He further related he had not observed any interrogations conducted by 3<sup>rd</sup> ACR personnel.

(FOUO) About 1615, 19 Jan 04, SA [redacted] coordinated with MAJ [redacted] Commander, [redacted] 1<sup>st</sup> Bn, 5<sup>th</sup> SFG(A), [redacted] Iraq, who provided the text of written statements made by members of his unit in regards to their contact with MG MOWHOUSH. The statements were made by MSG [redacted], CW2 [redacted], SSG [redacted], SSG Aaron N. HOLLEYMAN and CW3 [redacted], each assigned to 5<sup>th</sup> SFG(A). (See attached text of statements for details)

AGENT'S COMMENT: MAJ [redacted] related the original copies of the statements had been destroyed, but the text in transcripts was exact transcription, to include grammar and spelling errors.

(FOUO) About 1730, 19 Jan 04, SA [redacted] interviewed CW3 [redacted], [redacted] C Co, 1<sup>st</sup> Bn, 5<sup>th</sup> SFG(A), [redacted] Iraq. CW3 [redacted] stated he had no personal contact with MG MOWHOUSH and was not present for any interrogations of MG MOWHOUSH.

[redacted] About 1000, 30 Jan 04, SA [redacted] received an email message from [redacted] Office of the Inspector General (OIG), Central Intelligence Agency (CIA).

[redacted]  
SPECIAL AGENT, [redacted]  
Page 3 of 5

[redacted]  
bl, b3, b2b67c

EXHIBIT 13

000060

87<sup>TH</sup> MILITARY POLICE DETACHMENT (CID) (ABN), 3D MILITARY POLICE GROUP (CID), USACIDC, FORT BRAGG, NC 28310

AGENT'S INVESTIGATION REPORT

0027-03-CID679-64999

17 Feb 04

DETAILS:

[redacted] who related MSG [redacted] and CPT [redacted] [redacted] Detachment Commander, [redacted] 1<sup>st</sup> Bn, 5<sup>th</sup> SFG(A), [redacted], Iraq, walked in on the interrogation and put a stop to it.

[redacted] About 1400, 30 Jan 04, SA [redacted] and SA [redacted] interviewed CPT [redacted], who related he was present at the 3<sup>rd</sup> ACR Detention Facility on 24 Nov 03. CPT [redacted] stated [redacted] with him at the detention facility.

[redacted] individual whose name he could not remember. [redacted]  
[redacted]  
[redacted]  
[redacted]

[redacted] were also present at the detention facility. CPT [redacted] described an incident where he walked into an interrogation that was being conducted by [redacted] CPT [redacted] stated when he walked into the room he observed [redacted] striking a detainee (NFI) with fists, a short wooden club and a length of black rubber hose. [redacted] was present in the room. CPT [redacted] did not remember seeing [redacted] strike the detainee. CPT [redacted] stated he quickly assessed the situation as being "out of control." CPT [redacted] terminated the interrogation and pulled the [redacted] out of the interrogation room. CPT [redacted] believed this incident occurred prior to the incident described by MSG [redacted], which involved MG MOWHOUSH, but he is not sure. CPT [redacted] did not witness members of [redacted] interrogate MG MOWHOUSH. CPT [redacted] described [redacted] [redacted] stated [redacted] CPT [redacted] stated there might have been some other soldiers from [redacted] in the room, but he was not sure.

[redacted]  
SPECIAL AGENT, [redacted]  
Page 4 of 5

[redacted]

EXHIBIT 13

b1, b3, b6, 7C

000061

87<sup>TH</sup> MILITARY POLICE DETACHMENT (CID) (ABN), 3D MILITARY POLICE GROUP (CID), USACIDC, FORT BRAGG, NC 28310

AGENT'S INVESTIGATION REPORT  
0027-03-CID679-64999  
17 Feb 04

DETAILS:

[redacted] About 2015, 5 Feb 04, SA [redacted] re-interviewed CPT [redacted], who rendered a sworn statement, detailing how he witnessed the beating of a detainee (NFI) by [redacted] (See Sworn Statement for details)

(FOUO) About 1100, 12 Feb 04, SA [redacted] received a copy of the Final Autopsy Report pertaining to this investigation. A review of the report revealed the cause of death was determined to be Asphyxia due to smothering and chest compression. The manner of death was determined to be homicide. (See Autopsy Report for details.)

[redacted] About 1300, 12 Feb 04, SA [redacted] received the results of the interview of MSG [redacted] conducted at Fort Campbell, KY. A review of the report revealed MSG [redacted] identified [redacted] as a witness to the beating of MG MOWHOUSH [redacted] (See AIR of SA [redacted] Sworn Statement of MSG [redacted] and Sketch for details.)

(FOUO) About 1820, 12 Feb 04, SA [redacted] coordinated with SFC [redacted], Interpreter Coordinator, 3 ACR. SFC [redacted] did not recall [redacted] working for 3<sup>rd</sup> ACR at any time.

(FOUO) About 1450, 17 Feb 04, SA [redacted] coordinated with MAJ [redacted], who related his unit [redacted] while at Al Qa'im. [redacted] returned to the states [redacted] MAJ [redacted] could not recall [redacted] //LAST ENTRY//

[redacted]  
SPECIAL AGENT, [redacted]  
Page 5 of 5

b1, b3, b2b67c

EXHIBIT 13

000062

# EXHIBIT 14

Page(s) 43-64 referred to:

FOIA Office  
Fort Campbell, KY

For use of this form, see AR 190-45; the proponent agency is ODCSOPS

PRIVACY ACT STATEMENT 027-03-C10679-64999

AUTHORITY: Title 10 USC Section 301; Title 5 USC Section 2951; E.O. 9397 dated November 22, 1943 (SSN).  
PRINCIPAL PURPOSE: To provide commanders and law enforcement officials with means by which information may be accurately  
ROUTINE USES: Your social security number is used as an additional/alternate means of identification to facilitate filing and retrieval.  
DISCLOSURE: Disclosure of your social security number is voluntary.

1. LOCATION FOB Rifles Base, Al Asad, Iraq	2. DATE (YYYYMMDD) 2004/02/05	3. TIME 2122 C	4. FILE NUMBER 0027-03-C10679-64999
5. LAST NAME, FIRST NAME, MIDDLE NAME [REDACTED]	6. SSN [REDACTED]	7. GRADE/STATUS CPT/AD	

8. ORGANIZATION OR ADDRESS  
ODA 525, 1st Bn, 5th SFG(A), Fort Campbell, KY [REDACTED] Iraq)

9. I, [REDACTED], WANT TO MAKE THE FOLLOWING STATEMENT UNDER OATH:

On 24 Nov 03, I was at the temporary detention facility that was established for [REDACTED] It was near the city [REDACTED] Iraq's the closest city to where we were located. I arrived at the detention facility about 1030. [REDACTED] were already there with other members of my team. There names are [REDACTED] shortly after I arrived, I walked in on an interrogation [REDACTED] were conducting with [REDACTED] there was also an interpreter in the room. I don't know who he is. I observed [REDACTED] strike the detainee that was being interrogated. The detainee was slapped. [REDACTED] had a wooden club he used to hit the detainee. Another [REDACTED] had a length of black rubber hose he used to hit the detainee. I determined the situation was out of control. I rounded up [REDACTED] who were attached to me at the time, and put an end to the interrogation.

Q: What started the beating?  
A: The detainee was sitting in a chair. He screamed an answer to a question and jumped up from the chair. [REDACTED] pushed the detainee into a corner of the room, and started to hit him.

Q: Did the detainee hit any of the interrogators first?  
A: He might have.

Q: Did the beating go beyond simply bringing the detainee back under control?  
A: Yes. It lasted less than one minute, but it seemed to go beyond just restraining the detainee. He continued to talk, but he was not putting up any physical resistance.

Q: Did [REDACTED] strike the detainee?  
A: Yes.

Q: How did [REDACTED] strike the detainee?  
A: He slapped. It was maybe two or three times.

Q: Do you know who the detainee was?  
A: No. I do know it was not MOWHOUSH.

Q: Did [REDACTED] make any effort to restrain the [REDACTED] who were striking the detainee?  
A: Not that I saw.

Q: Did all [REDACTED] strike the detainee?  
A: They were all around him. I don't think all of them struck him.

Q: Do you know which [REDACTED] had the rubber hose?  
A: No.

Q: Do you remember which [REDACTED] had the club?  
A: No.

Q: Did [REDACTED] use either of the objects to strike the detainee?  
A: He may have. I did not see. [REDACTED] were in a tight ring around the detainee in the corner and it was hard to tell who was doing what.

Q: Were any other [REDACTED] present at the detention facility that day?  
A: A guy named [REDACTED] No one else.

Q: Did you witness the interrogation of MOWHOUSH that took place on 24 Nov 03?  
A: No.

Q: [REDACTED]  
A: [REDACTED]

Q: What do you mean by odd ball?  
A: He seems to be immature. He doesn't think things through and he is not a good decision maker.

10. EXHIBIT 16	11. INITIALS [REDACTED]	MAKING STATEMENT	PAGE 1 OF 3 PAGES
-------------------	----------------------------	------------------	-------------------

ADDITIONAL PAGES MUST CONTAIN THE HEADING "STATEMENT \_\_\_\_\_ TAKEN AT \_\_\_\_\_ DATED \_\_\_\_\_"  
THE BOTTOM OF EACH ADDITIONAL PAGE MUST BEAR THE INITIALS OF THE PERSON MAKING THE STATEMENT, AND PAGE NUMBER MUST BE BE INDICATED.



USE THIS PAGE IF NEEDED. IF THIS IS THE

FINAL PAGE OF THIS FORM.

0027-03-CID679-64995

STATEMENT OF

TAKEN AT

DATED 2004/02/05

0027-03-CID679-64999

9. STATEMENT (Continued)

Q: What is your basis for the characterization of [redacted]

A: The conversations I had with him. He was out with us a couple of times prior to this, and I didn't think he represented himself well in his actions or speech. When he first got in country we went to [redacted]. There was an Army female truck driver there. He made an inappropriate comment to her. I remember thinking I was going to have to watch him closely.

Q:  
A:  
Q:  
A:  
Q:  
A:  
Q:  
A:  
Q:  
A:

Q: Did [redacted] say anything to you about this incident after you cleared everyone out of the room?

A: No.

Q: Did you discuss this with anyone [redacted]

A: That night I approached [redacted] I told him about the incident with [redacted] I told [redacted] I thought the incident had gotten out of control. [redacted] agreed with me. [redacted] told me he was not going to allow [redacted] to deal with detainees any more as a result of this incident.

Q: Describe the wooden club you saw used to strike the detainee.

A: It was about 18" long and about the diameter of a broom handle. It reminded me on a police night stick.

Q: Describe the rubber hose.

A: It was probably two to three feet long. It was black. I don't really remember anything else about because I didn't get a close look at it.

Q: Was anyone else in the interrogation room besides [redacted] the detainee and yourself?

A: There was an interpreter. [redacted] I don't know who he was. There were some other guys in the room standing back a little. I am not sure who they were.

Q: Is there anything you would like to add to this statement?

A: There was a stand type light that was directed at the detainee and the TV was on in the room. I don't remember what was on the TV.

Q: Is there anything else you would like to add to this statement?

A: No.//END OF STATEMENT [redacted]

[redacted]

INITIALS OF PERSON MAKING STATEMENT [redacted]

PAGE 2 OF 3 PAGES

EXHIBIT

15  
000036

b1, b3

b6, 7c

STATEMENT OF [REDACTED] TAKEN AT [REDACTED] DATED 2004/02/05

9. STATEMENT (Continued)

[REDACTED]

AFFIDAVIT

I, [REDACTED], HAVE READ OR HAVE HAD READ TO ME THIS STATEMENT WHICH BEGINS ON PAGE 1, AND ENDS ON PAGE 3. I FULLY UNDERSTAND THE CONTENTS OF THE ENTIRE STATEMENT MADE BY ME. THE STATEMENT IS TRUE. I HAVE INITIALED ALL CORRECTIONS AND HAVE INITIALED THE BOTTOM OF EACH PAGE CONTAINING THE STATEMENT. I HAVE MADE THIS STATEMENT FREELY WITHOUT HOPE OF BENEFIT OR REWARD, WITHOUT THREAT OF PUNISHMENT, AND WITHOUT COERCION, UNLAWFUL INFLUENCE, OR UNLAWFUL INDUCEMENT.

[REDACTED]  
(Signature of Person Making Statement)

WITNESSES:

Subscribed and sworn to before me, a person authorized by law to administer oaths, this 5th day of February, 2004 at [REDACTED] Al Asad, Iraq

ORGANIZATION OR ADDRESS

[REDACTED]  
(Typed Name of Person Administering Oath)

ORGANIZATION OR ADDRESS

SA [REDACTED]  
(Typed Name of Person Administering Oath)  
ART 136(b)4, UCMJ  
(Authority To Administer Oaths)

INITIALS OF PERSON MAKING STATEMENT [REDACTED]

PAGE 3 OF 3 PAGES

b67c

EXHIBIT 15  
000087

Exhibit(s) 16

Page(s) 68-76 referred to:

CDR USAMEDCOM  
ATTN: FOIA Office, STOP 76  
1216 Stanley RD 2D FL  
FT. Sam Houston, TX 78234-5049

CID Regulation 195-1

PAGE 1 OF 1 PAGES

About 1400, 9 Feb 04, SA [REDACTED] this office, and

[REDACTED] Office of Inspector General, Central Intelligence Agency, Langley, VA 22101 interviewed MSG [REDACTED] 1<sup>st</sup> Battalion (BN), 5<sup>th</sup> Special Forces Group (Airborne) (SFG(A)), Fort Campbell, Kentucky (FCKY) 42223, pertaining to his knowledge of the death of Major General (MG) MOWHOUSH, Iraqi National Detainee. MSG [REDACTED] provided a Sworn Statement detailing his knowledge of events prior MG MOWHOUSH' death and provided a sketch of the 3<sup>rd</sup> Armor Cavalry Regiment Detainee Facility. (See Sworn Statement and Sketch for Details)///LAST ENTRY///

EXHIBIT 17

TYPED AGENT'S NAME AND SEQUENCE NUMBER

SA, [REDACTED]

ORGANIZATION

31<sup>st</sup> MP DET (CID)  
Ft Campbell, KY 42223

Signature: [REDACTED]

Date: 9 Feb 04 Exhibit: P

CID Form 94  
1 FEB 77

FOR OFFICIAL USE ONLY

ENCL 1

b1, b3

b2, b6, 7C

000077

For use

217 ODCS 08 - CID 679 - 64999

LOCATION Fort Campbell, KY 42223	DATE 9 Feb 04	TIME 1955	FILE NUMBER 0059-04-010083
LAST NAME, FIRST NAME, MIDDLE NAME [REDACTED]	SOCIAL SECURITY NUMBER [REDACTED]	RANK/STATUS MSG / AD	
ADDRESS/ORGANIZATION Headquarters and Support Company 1 <sup>st</sup> Battalion 5 <sup>th</sup> Special Forces Group (Airborne) (SFG(A)), Fort Campbell, KY 42223			

I, [REDACTED], WANT TO MAKE THE FOLLOWING STATEMENT UNDER OATH:  
 I have been the S2 NCOIC for 1<sup>st</sup> BN, 5<sup>th</sup> SFG(A) since August 2002. I volunteered to deploy with A Company 1/5<sup>th</sup> SFG(A) to Al Qaim, Iraq in September 03. The unit arrived in arrived in the Al Qaim, Iraq area sometime during the third week of Oct 03. About the 0900 hrs, 24 November 2003, myself along with a split team from [REDACTED], and [REDACTED] departed our base in Al Qaim. We arrived at the 3<sup>rd</sup> Armored Calvary Regiment (ACR) detention facility for [REDACTED] at about 0930. From 0930 until about 1530 hrs, I conducted field interrogations of Iraqi detainees. About 1530 hrs, our group started to get ready to depart the facility when I walked by one of the interrogation rooms. In the interrogation room I saw General (Gen) MOWHOUSH being interrogated by several 3<sup>rd</sup> ACR interrogators. From the interrogators, I got the sense the the interrogation of Gen MOWHOUSH was not going well, the General was not being cooperative. At some point [REDACTED] entered the room and started to interrogate the General. [REDACTED] started to use a hostile interrogation method on the General. From my translator I was told that [REDACTED] interrogators knew a great deal about the background of the General. However the General still denied any of the facts given by the interrogators. I was not told what was the information the General was confronted with. After two to three minutes of interrogation, [REDACTED] started to hit the General. The hits were open hand slaps and punches to the upper part of the body. The general was also struck about three to four times with a soft piece of rubber, approximately 36 inches long and approximately one inch wide. The punching lasted about 1 to 1 1/2 minutes, afterward [REDACTED] stopped and the General was led away to the detainee holding facility. The last thing I heard was that the General was going to be made to do exercise in order to make him cooperate. I left with the same personnel I arrived right after the incident. The next time I saw the General was one to two days later. While working at the detention facility on 25 Nov 03, I observed the General doing light exercise inside the detainee holding area. That was last time I saw Gen MOWHOUSH.

Q: SA [REDACTED]  
 A: MSC [REDACTED]  
 Q: Who were the people from [REDACTED] that were with you at the 3<sup>rd</sup> ACR detention facility on 24 Nov 03?  
 A: CW2 [REDACTED] SFC [REDACTED] and SPC [REDACTED] were with me.  
 Q: Who were the people [REDACTED] that were with at the 3<sup>rd</sup> ACR detention facility on 24 Nov 03?  
 A: [REDACTED] don't know there last names.  
 Q: Were there any other people that were with you at the 3<sup>rd</sup> ACR detention facility on 24 Nov 03?  
 A: Yes the translators assigned to our unit [REDACTED] were there.  
 Q: The two men you saw slapping and hitting Gen MOWHOUSH, can you describe them?  
 A: Yes, [REDACTED]

Q: Do you know either of their names?  
 A: No.  
 Q: Can you describe what clothes they were wearing?  
 A: [REDACTED]

Q: The people from 3<sup>rd</sup> ACR that had been interrrogating Gen MOWHOUSH prior to [REDACTED] do you know who they were?  
 A: There was a Warrant Officer, I think his name was [REDACTED] a translator, and two of the guards. The guards had [REDACTED]

EXHIBIT 19	INITIALS OF PERSON MAKING STATEMENT [REDACTED]	PAGE 1 OF 3 PAGES
---------------	---	-------------------

ADDITIONAL PAGES MUST CONTAIN THE HEADING "STATEMENT TAKEN AT [REDACTED] DATED [REDACTED] CONTINUED."  
 THE BOTTOM OF EACH ADDITIONAL PAGE MUST BEAR THE INITIALS OF THE PERSON MAKING THE STATEMENT AND BE INITIALED AS "PAGE [REDACTED] OF [REDACTED] PAGES." WHEN ADDITIONAL PAGES ARE UTILIZED, THE BACK OF PAGE 1 WILL BE LINED OUT AND THE STATEMENT WILL BE CONCLUDED ON THE REVERSE SIDE OF ANOTHER COPY OF THIS FORM.

b1, b3, b67C [REDACTED]

Ex 18  
 ENCL 2

0059-04-010083

their name tapes covered, and I don't know the translator's name.  
Q: Where were the [REDACTED] slapping the General?  
A: They were slapping him from the chest up, to include his head.  
Q: Where were the [REDACTED] hitting (Closed Hand) the General?  
A: From the neck down to his waist.  
Q: Where was General MOWHOUSH hit with the piece of rubber?  
A: Over both shoulders and down his back, the strikes were coming from over top of him.  
Q: What was the General wearing?  
A: It was called a Dishdasha, a mans dress and shoes.  
Q: How was the General positioned in the room?  
A: He was standing.  
Q: Who was in the interrogation room when the [REDACTED] were punching, slapping, and hitting Gen MOWHOUSH with the piece of rubber?  
A: I think the Chief and several others from 3<sup>rd</sup> ACR were there, [REDACTED] and myself were there.  
Q: Did anyone try to stop the [REDACTED]  
A: No, everything seemed to be under control, it appeared there was a method to what they were doing.  
Q: How long did all of this take?  
A: About 5 minutes at the most.  
Q: The [REDACTED] were they assigned to any unit that you were aware of?  
A: They were [REDACTED]  
Q: Were you ever informed of the Rules of Engagement when dealing with detainees?  
A: No, the only guidelines we were aware of were the time limits we could detain an individual before they were to be sent to a detention facility, and the priorities for classifying a detainee.  
Q: After 24 Nov 03, did you hear anyone talking about more interviews or interrogations taking place with Gen MOWHOUSH?  
A: No.  
Q: The day you saw Gen MOWHOUSH in the detainee holding area, 25 Nov 03, did he appear to be injured in anyway?  
A: No.  
Q: To the best of your knowledge did [REDACTED] ever interrogate Gen MOWHOUSH after 24 Nov 03?  
A: No, none of [REDACTED] or myself interrogated Gen MOWHOUSH after 24 Nov 03?  
Q: How did you learn the General had died?  
A: I was told by someone in the 3<sup>rd</sup> ACR detention facility, I don't remember the name, on 26 Nov 03, when I arrived that day to conduct more interrogations. I was told he had collapsed in one of interrogation rooms while during an interrogation. The body had already been moved by the time I arrived there.  
Q: Were you told who was conducting the interrogation?  
A: No.  
Q: Did you ever learn who was conducting the interrogation?  
A: No.  
Q: Is this statement in your own words and typed by SA [REDACTED]  
A: Yes.  
Q: How have you been treated here today?  
A: Fine.  
Q: Is this statement honest and truthful to the best of your knowledge?  
A: Yes.  
Q: Do you have anything else you [REDACTED] ke to add to this statement at this time?  
A: No.///END OF STATEMENT///[REDACTED]

[REDACTED]

EXHIBIT 18

Initials of Person Making Statement [REDACTED]

Page 2 of 3 pages

FOR OFFICIAL USE ONLY

ENCL 2

b1, b3, b6, 7C

000000

STATEMENT (Continued)

0027 - 03 - CID679 - 64999

AFFIDAVIT

I, [REDACTED] HAVE READ OR HAD READ TO ME THIS STATEMENT WHICH BEGINS ON PAGE 1 AND ENDS ON PAGE 3. I FULLY UNDERSTAND THE CONTENTS OF THE ENTIRE STATEMENT MADE BY ME. THE STATEMENT IS TRUE. I HAVE INITIALED ALL CORRECTIONS AND HAVE INITIALED THE BOTTOM OF EACH PAGE CONTAINING THE STATEMENT. I HAVE MADE THIS STATEMENT FREELY WITHOUT HOPE OR BENEFIT OR REWARD, WITHOUT THREAT OF PUNISHMENT, AND WITHOUT COERCION, UNLAWFUL INFLUENCE, OR UNLAWFUL INDUCEMENT.

[REDACTED]  
(Signature of Person Making Statement)

WITNESSES:

Subscribed and sworn to before me, a person authorized by Law to administer oaths, this Ninth day of February, 2004 at Bldg 2745, Ft Campbell, KY 42223

[REDACTED]

ORGANIZATION OR ADDRESS

SA [REDACTED]

(Typed Name of Person Administering Oath)  
Article 136, UCMJ

ORGANIZATION OR ADDRESS

(Article 136, UCMJ Administer Oaths)  
**EXHIBIT**

INITIALS OF PERSON MAKING STATEMENT

[REDACTED]

PAGE 3 OF 3 PAGES

b2b67C

ENCL 2

000080

0059-04-033

0027 - C3 - CID 679 - 64999

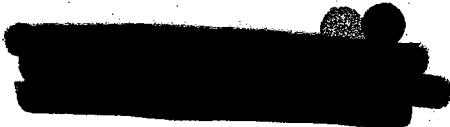

Case # 0059-04-CID033  
Victim:  
Scene Description: Detaining Center 3rd PCR  
Location: Area outside Al Qaima, Iraq  
Sketched by MSG [redacted]  
Certified by SA [redacted]  
Time/Date prepared: 15 35, 9 Feb 04

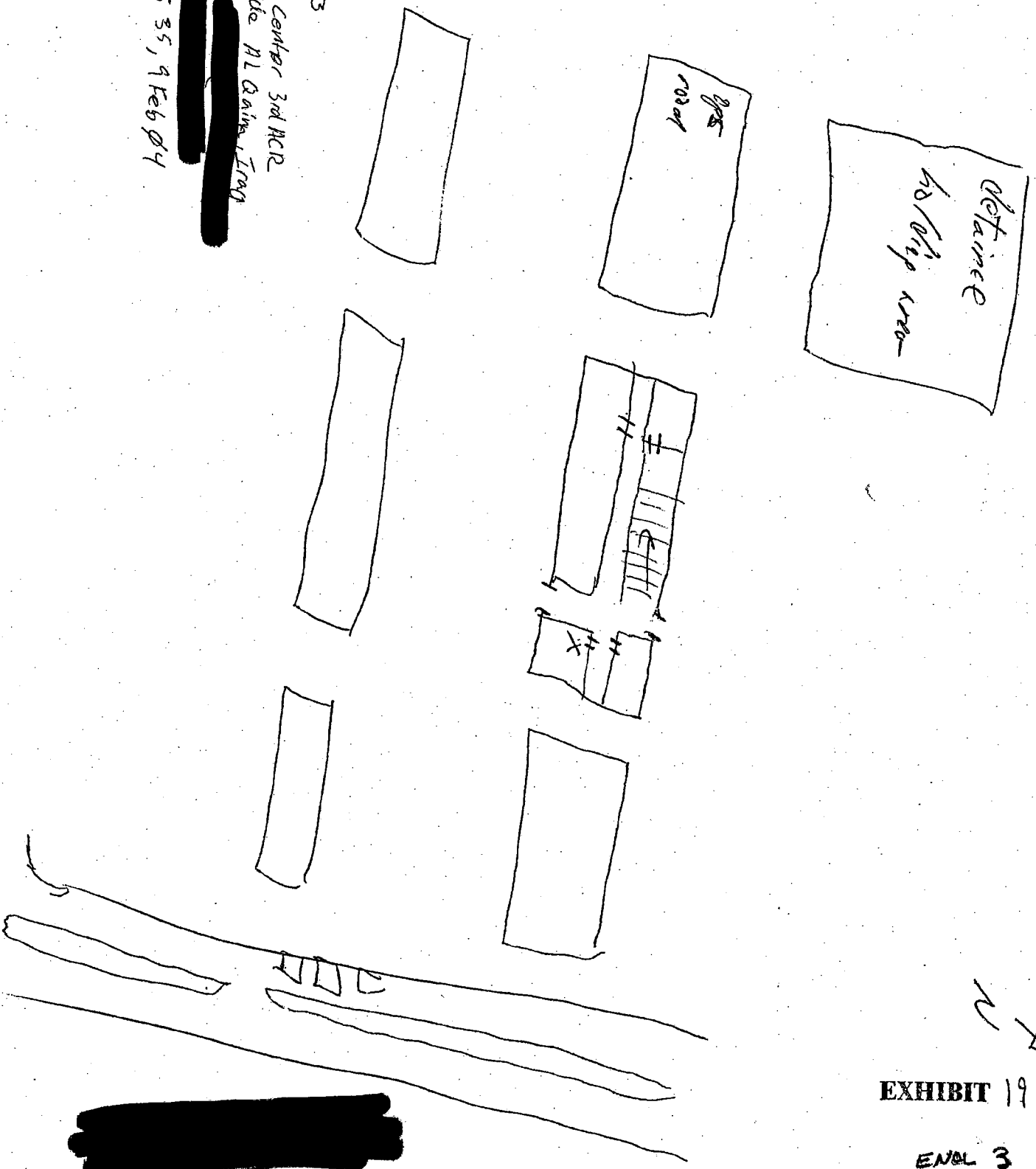

N  
A

EXHIBIT 19

ENCL 3

180000

bl, 7C

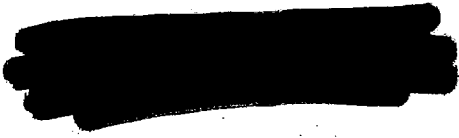



87<sup>TH</sup> MILITARY POLICE DETACHMENT (CID) (ABN), 3D MILITARY POLICE GROUP  
(CID), USACIDC, FORT BRAGG, NC 28310

AGENT'S INVESTIGATION REPORT  
0027-03-CID679-64999  
13 May 04

DETAILS:

(FOUO) About 0900, 13 Apr 04, SA [redacted] met with LTC [redacted] and LTC [redacted] Executive Officer, 3<sup>rd</sup> ACR, FCCO, and briefed them on the status of this investigation.

(S-NF) About 1030, 13 Apr 04, SA [redacted] interviewed CW3 [redacted]. CW3 [redacted] initiated the contact saying he wanted to make a verbal statement concerning incidents he witnessed on 24 Nov 03. He stated he fully understood his legal rights and did not want to discuss or answer questions about his own actions of the events of 26 Nov 03. He specifically wanted to make a statement concerning contact between [redacted] employees and MG MOWHOUSH. CW3 [redacted] stated he was in an interrogation with MG MOWHOUSH about 0900, 24 Nov 03. [redacted] was interpreting for him. After five or ten minutes of interrogation, [redacted]

[redacted] Shortly after that, [redacted] and three Special Forces soldiers filtered into the room. CW3 [redacted] knew one of the Special Forces soldiers as [redacted]. A guy who spoke Arabic told CW3 [redacted] to move his people out of the room. CW3 [redacted] stayed in the room to compare any information provided by MG MOWHOUSH with information he had previously provided. CW3 [redacted] stated [redacted] began to question MG MOWHOUSH in Arabic. CW3 [redacted] stated he followed the interrogation from translation by a SF soldier who spoke Arabic. CW3 [redacted] stated

[redacted]

During the interrogation, MG MOWHOUSH was standing up with his hands zip-tied in front. About 45 minutes into the interrogation, [redacted] started beating MG MOWHOUSH. CW3 [redacted] stated two pieces of black rubber hose were used to beat MG MOWHOUSH. One was a long thin rubber hose. The other was like a section of radiator hose. CW3 [redacted]

[redacted]

DERIVED FROM:

[redacted]

SPECIAL AGENT, [redacted]  
Page 1 of 8

DECLASIFY ON:  
13 MAY 2029

b1, b3, **62667C**

EXHIBIT 20

000032

87<sup>TH</sup> MILITARY POLICE DETACHMENT (CID) (ABN), 3D MILITARY POLICE GROUP (CID), USACIDC, FORT BRAGG, NC 28310

AGENT'S INVESTIGATION REPORT

0027-03-CID679-64999

13 May 04

DETAILS:

██████████ stated the long thin hose was stiffened with a piece of mosquito net pole that had been placed inside. CW3 ██████████ stated the beating lasted about five minutes and consisted of blows to the legs, feet and torso. CW3 ██████████ stated MG MOWHOUSH was also kicked during the beating. During the beating, MG MOWHOUSH fell to the floor and was trying to roll away. CW3 ██████████ stated the beating only stopped when word arrived in the interrogation room that the 3<sup>rd</sup> ACR Commander, COL ██████████, had arrived at the detention facility. Immediately after, ██████████ SF soldiers left the detention facility. CW3 ██████████ stated MG MOWHOUSH was able to walk back to the holding area under his own power, and he did not see any blood or open injuries caused by the beating. He said MG MOWHOUSH had been feigning some ailments during his captivity, but did not think they were anything serious. CW3 ██████████ stated 24 Nov 03 was the only time ██████████ interrogated MG MOWHOUSH.

(S-NF) About 1220, 13 Apr 04, SA ██████████ interviewed CW2 ██████████. CW2 ██████████ stated he witnessed part of the interrogation of MG MOWHOUSH conducted by ██████████ on 24 Nov 03. He saw ██████████ punch and slap MG. He stated he heard a helicopter approaching and went to see who was arriving. He returned to the interrogation room and stood outside. While outside of the interrogation room CW2 ██████████ heard questions being screamed at MG MOWHOUSH in Arabic. He also heard what he thought was the sound of some being beaten and he heard MG MOWHOUSH screaming in pain. He thought the beating and screaming lasted for 15 to 20 minutes. Thirty minutes to one hour later he witnessed four soldiers carrying MG MOWHOUSH back to the holding area.

(S-NF) About 1405, SA ██████████ interviewed SFC ██████████. SFC ██████████ stated he witnessed ██████████ use the "sleeping bag" technique of interrogation on detainees, but he could not recall specific details or which detainees were involved. He reiterated the information he previously provided pertaining to MOWHOUSH.

██████████  
SPECIAL AGENT, ██████████

Page 2 of 8

██████████  
EXHIBIT 20

b1, b3, b2, b6, 7C

000083

[REDACTED]

87<sup>TH</sup> MILITARY POLICE DETACHMENT (CID) (ABN), 3D MILITARY POLICE GROUP  
(CID), USACIDC, FORT BRAGG, NC 28310

AGENT'S INVESTIGATION REPORT  
0027-03-CID679-64999  
13 May 04

DETAILS:

[REDACTED] About 0800, 14 Apr 04, SA [REDACTED] interviewed SPC [REDACTED]. SPC [REDACTED] stated his duties at the detention facility included overseeing the holding area occupied by MG MOWHOUSH. He stated MG MOWHOUSH ate sparingly, complained of being ill and had difficulty walking. He had heard of sleeping bags being used during interrogation, but had not witnessed their use. He also stated he heard of some instances of MRE boxes being thrown at detainees. He could not remember the names of the detainees or who told him about the incidents. SPC [REDACTED] was not aware [REDACTED] at the detention facility. He observed what he called mental changes in MG MOWHOUSH about three days prior to his death. MG MOWHOUSH stopped getting up in the morning. He did not notice any injuries on MG MOWHOUSH, but did state that MG MOWHOUSH's hands were always swollen from the presence of the zip-ties.

[REDACTED] About 1010, 14 Apr 04, SA [REDACTED] interviewed SFC [REDACTED]. SFC [REDACTED] was at the forward detention facility from 21 Nov to 2 Dec 03. He stated he knew [REDACTED] interviewed MG MOWHOUSH. He witnessed [REDACTED] in the interrogation room with MG MOWHOUSH. He could not remember the date, but knew the interrogation took place during daylight hours. He did not see anyone strike MG MOWHOUSH. SFC [REDACTED] stated he saw two or three detainees that were taken outside of the detention facility by [REDACTED] come back with black eyes, but he was unable to provide more specific information.

(FOUO) About 1055, 14 Apr 04, SA [REDACTED] interviewed SPC [REDACTED]. SPC [REDACTED] stated about two to three days prior to his death; he helped three other soldiers carry MG MOWHOUSH back to the holding area after an interrogation. He did not observe any injuries on MG MOWHOUSH and stated he thought MG MOWHOUSH was tired. He was sure SPC [REDACTED] was one of the soldiers, but he did not remember who the other two soldiers were.

(FOUO) About 1530, 14 Apr 04, SA [REDACTED] briefed COL [REDACTED] on the status of this investigation.

[REDACTED]  
SPECIAL AGENT, [REDACTED]

Page 3 of 8

b1, b3,

[REDACTED]  
b2b67c

EXHIBIT 20

000084

[REDACTED]

87<sup>TH</sup> MILITARY POLICE DETACHMENT (CID) (ABN), 3D MILITARY POLICE GROUP  
(CID), USACIDC, FORT BRAGG, NC 28310

AGENT'S INVESTIGATION REPORT  
0027-03-CID679-64999  
13 May 04

DETAILS:

[REDACTED] About 0930, 26 Apr 04, SA [REDACTED] interviewed CPT [REDACTED] who provided additional information to clarify his written statement. CPT [REDACTED] confirmed that [REDACTED] told him [REDACTED] operated under the same rules as [REDACTED] and [REDACTED] in handling detainees. [REDACTED] were not authorized to use any hands on techniques in the interrogation of detainees. CPT [REDACTED] was never told that [REDACTED] were not authorized for use in interrogations. He remembered briefing [REDACTED] on the rules pertaining to the use of force, specifically that they should only use the level of force necessary to control a given situation. CPT [REDACTED] was able to identify [REDACTED] involved in the incident on 24 Nov 03 (described in his statement) from photographs provided by [REDACTED]. CPT [REDACTED] identified a member of his team who was not previously known. The individual was a reserve or national guard First Sergeant named [REDACTED] (NFI). CPT [REDACTED] stated 1SG [REDACTED] and he thought 1SG [REDACTED] had been demobilized. CPT [REDACTED] explained that 1SG [REDACTED] was sliced on to his team for Operation Rifles Blitz because of his Arabic language skills. CPT [REDACTED] further explained how [REDACTED] were utilized the day they had contact with MG MOWHOUSH. About 0800, 24 Nov 03, while he remained at the 3<sup>rd</sup> ACR Headquarters, SFC [REDACTED] traveled to the detention facility with the remainder of CPT [REDACTED]'s team [REDACTED]. About 1000, 24 Nov 03, CPT [REDACTED] arrived at the detention facility and saw SFC [REDACTED]. SFC [REDACTED] told CPT [REDACTED] [REDACTED] took control of [REDACTED] earlier in the day. CPT [REDACTED] began to look for [REDACTED] assigned to his team. He overheard a commotion coming from an interrogation room. When he went into the room he observed the events described in his previous written statement. CPT [REDACTED] stated he was sure [REDACTED] was in the room. CPT [REDACTED] also provided further information about his actions after leaving the detention facility. Upon his return to base, he had a conversation with [REDACTED] and told him what had happened at the detention facility. [REDACTED] reiterated to him that [REDACTED] were bound by the same rules that governed [REDACTED]. After speaking with [REDACTED] CPT [REDACTED] through 1SG [REDACTED] had a discussion with [REDACTED] about the incident at the detention facility. [REDACTED] explained to him that they were only doing what they

[REDACTED]  
SPECIAL AGENT, [REDACTED]  
Page 4 of 8

[REDACTED]

EXHIBIT 20

b1, b3, b2, b6, 7C

000085

[REDACTED]

87<sup>TH</sup> MILITARY POLICE DETACHMENT (CID) (ABN), 3D MILITARY POLICE GROUP  
(CID), USACIDC, FORT BRAGG, NC 28310

AGENT'S INVESTIGATION REPORT  
0027-03-CID679-64999  
13 May 04

DETAILS:

had seen others do during interrogations. CPT [REDACTED] heard that some of [REDACTED] were involved with an interrogation of MG MOWHOUSH on 24 Nov 03 and that CW3 [REDACTED] was present during the interrogation. He did not know which [REDACTED] were involved in the interrogation. Someone in 3<sup>rd</sup> ACR informed him that [REDACTED] were involved with a rough interrogation of MG MOWHOUSH, but he was unable to provide further details. CPT [REDACTED] had heard the "sleeping bag" technique was in use at the detention facility and had seen the sleeping bag in the facility, but had not seen it used during an interrogation.

(FOUO) About 1600, 26 Apr 04, SA [REDACTED] interviewed SPC [REDACTED] C Co, 1-5<sup>th</sup> SFG(A), Fort Campbell, KY 42223. SPC [REDACTED] stated he did not witness any interrogations of MG MOWHOUSH.

[REDACTED] About 0945, 27 Apr 04, SA [REDACTED] interviewed MAJ [REDACTED]. MAJ [REDACTED] remembered hearing [REDACTED] were involved in an interrogation of MG MOWHOUSH during which [REDACTED] struck MG MOWHOUSH. The incident occurred two days prior to the death of MG MOWHOUSH. He had a meeting with his commanders (CPT [REDACTED] and CPT [REDACTED]) to make sure they understood that a similar incident should not happen in the future. MAJ [REDACTED] stated it was his understanding that personnel from 3<sup>rd</sup> ACR asked that [REDACTED] be brought into the interrogation of MG MOWHOUSH because he was resisting the techniques being used by 3<sup>rd</sup> ACR. [REDACTED] were involved in the incident. He could not provide further details. MAJ [REDACTED] later heard MG MOWHOUSH died of a heart attack, and he was concerned people might attempt to pin the death on [REDACTED] because they were easy targets.

[REDACTED] About 1040, 27 Apr 04, SA [REDACTED] interviewed CW2 [REDACTED]. CW2 [REDACTED] provided further details concerning the incident described in his statement to the chain of command and his previous statement to this office. By his current recollection, he believed the incident occurred about four or five days prior to MG

[REDACTED]  
SPECIAL AGENT, [REDACTED]

Page 5 of 8

b1, b3, b2b67c

EXHIBIT 20

000086

[REDACTED]

87<sup>TH</sup> MILITARY POLICE DETACHMENT (CID) (ABN), 3D MILITARY POLICE GROUP  
(CID), USACIDC, FORT BRAGG, NC 28310

AGENT'S INVESTIGATION REPORT

0027-03-CID679-64999

13 May 04

DETAILS:

MOWHOUSH's death. He stated he was at the detention facility when CW3 [REDACTED] approached him. CW3 [REDACTED] told him MG MOWHOUSH had clammed up. They decided to put a bunch of people in the room, including [REDACTED] who were close by, and see if they could shake MG MOWHOUSH up. CW2 [REDACTED] stated [REDACTED] also went into the room. MG MOWHOUSH was in one corner of the room, standing, with his hands zip-tied in front. CW2 [REDACTED] stated MG MOWHOUSH slid to the floor when the questioning began. People started to crowd around MG MOWHOUSH when he (MOWHOUSH) shot his legs out and locked them at the ankle around one of [REDACTED] legs. CW2 [REDACTED] stated the people in the room used their hands to force MG MOWHOUSH's legs apart. MG MOWHOUSH was then taken back to the holding area. On the way out, MG MOWHOUSH walked past COL [REDACTED] who was at the facility. MG MOWHOUSH was walking under his own power. CW2 [REDACTED] next saw MG MOWHOUSH on the day of his death. He stated MG MOWHOUSH looked fatigued, but was walking under his own power.

(FOUO) About 1400, 27 Apr 04, SA [REDACTED] interviewed SSG HOLLEYMAN. SSG HOLLEYMAN could not provide any further information beyond what he previously stated to this office.

(S-NF) About 1522, 27 Apr 04, SA [REDACTED] interviewed CPT [REDACTED]. CPT [REDACTED] stated he did not have any specific information regarding the death of MG MOWHOUSH. He heard that three or four days prior to this death several people had been called into one of the interrogations of MG MOWHOUSH to act as witnesses. He did not know the details surrounding that event or who specifically was involved. The only other thing CPT [REDACTED] knew about MG MOWHOUSH was the initial guidance from [REDACTED] was to treat him well.

(S-NF) About 0900, 28 Apr 04, SA [REDACTED] interviewed SSG [REDACTED], A Co, 1-5<sup>th</sup> SFG(A), Fort Campbell, KY 42223. SSG [REDACTED] described the one incident of his having contact with MG MOWHOUSH. He stated he walking down the

[REDACTED]  
SPECIAL AGENT, [REDACTED]

Page 6 of 8

[REDACTED]

EXHIBIT 20

b1, b3, b2, b6, 7C

000037

[REDACTED]

87<sup>TH</sup> MILITARY POLICE DETACHMENT (CID) (ABN), 3D MILITARY POLICE GROUP  
(CID), USACIDC, FORT BRAGG, NC 28310

AGENT'S INVESTIGATION REPORT  
0027-03-CID679-64999  
13 May 04

DETAILS:

hallway with [REDACTED] when he passed a room in which MG MOWHOUSH was being interrogated. He stated there were [REDACTED] in the room with three or four regular army soldiers. There were others in the room as well, but he was not sure how many or where they were from. He stated [REDACTED] tried to get MG MOWHOUSH away from where he was standing against the wall. Some soldiers from 3<sup>rd</sup> ACR grabbed MG MOWHOUSH by the arms and attempted to lead him toward a chair. MG MOWHOUSH resisted by falling to the floor. [REDACTED] moved forward to pick MG MOWHOUSH up. When they were close enough, MG MOWHOUSH tried to kick them. SSG [REDACTED] stated MG MOWHOUSH was trying to kick anyone within his reach. At least one person was kicked hard because SSG [REDACTED] remembered someone yelling out. The people in the room got control of MG MOWHOUSH, and he was led back to the holding area. SSG [REDACTED] stated he was in the room with MOWHOUSH for 10-15 minutes and that no one hit MOWHOUSH while he was present. SSG [REDACTED] remembered there was a piece of black hose at the detention facility. He said it was used by some people (NFI) for intimidation. He stated the foam was something that was found at the detention facility. He described it as the insulation used on water pipes. He did not remember seeing a piece of the foam that had been stiffened with a stick. SSG [REDACTED] rode to the detention facility that day with CW2 [REDACTED] SSG HOLLEYMAN, [REDACTED] SSG [REDACTED] speculated MG MOWHOUSH was beaten up by other detainees, but did not have any direct information to support his theory.

[REDACTED] On 13 May 04, SA [REDACTED] reviewed CIA IG file [REDACTED] which documented the investigative efforts of the CIA IG to that date. The review of the file revealed the following information pertinent to this investigation. On 28 Nov 03, [REDACTED]

[REDACTED] describes a conversation he had with CPT [REDACTED] wherein CPT [REDACTED] told him [REDACTED] participated in an interrogation of MG MOWHOUSH on 24 Nov 03. The description of the contact between [REDACTED] and MG MOWHOUSH is consistent with what CPT [REDACTED] described in his written statement. However, in his written statement, CPT [REDACTED] asserts that he observed [REDACTED] strike a different detainee. In

[REDACTED]  
SPECIAL AGENT, [REDACTED]

Page 7 of 8

b1, b3, [REDACTED]  
b2b67c

EXHIBIT

20

000033

[REDACTED]

87<sup>TH</sup> MILITARY POLICE DETACHMENT (CID) (ABN), 3D MILITARY POLICE GROUP  
(CID), USACIDC, FORT BRAGG, NC 28310

AGENT'S INVESTIGATION REPORT  
0027-03-CID679-64999  
13 May 04

DETAILS:

the [REDACTED] it clearly states that CPT [REDACTED] told [REDACTED] were involved in a 10-15 minute physical confrontation with MG MOWHOUSH. The incident [REDACTED] consistent with the incident described by [REDACTED] with the exception of the involvement of MG MOWHOUSH. The [REDACTED] emphasizes that this was the only occasion on which [REDACTED] participated in an interrogation of MG MOWHOUSH, and it was sent with the qualifier from [REDACTED] that it was difficult to articulate what exactly happened because he was not there.

[REDACTED] AGENT'S COMMENT: [REDACTED]  
[REDACTED]  
[REDACTED]  
[REDACTED] //LAST ENTRY//

[REDACTED]  
SPECIAL AGENT, [REDACTED]  
Page 8 of 8

[REDACTED]  
EXHIBIT 20

000089

b1, b3, b2, b6, 7c



87<sup>TH</sup> MILITARY POLICE DETACHMENT (CID) (ABN), 3D MILITARY POLICE GROUP  
(CID), USACIDC, FORT BRAGG, NC 28310

AGENT'S INVESTIGATION REPORT  
0027-03-CID679-64999  
23 May 04

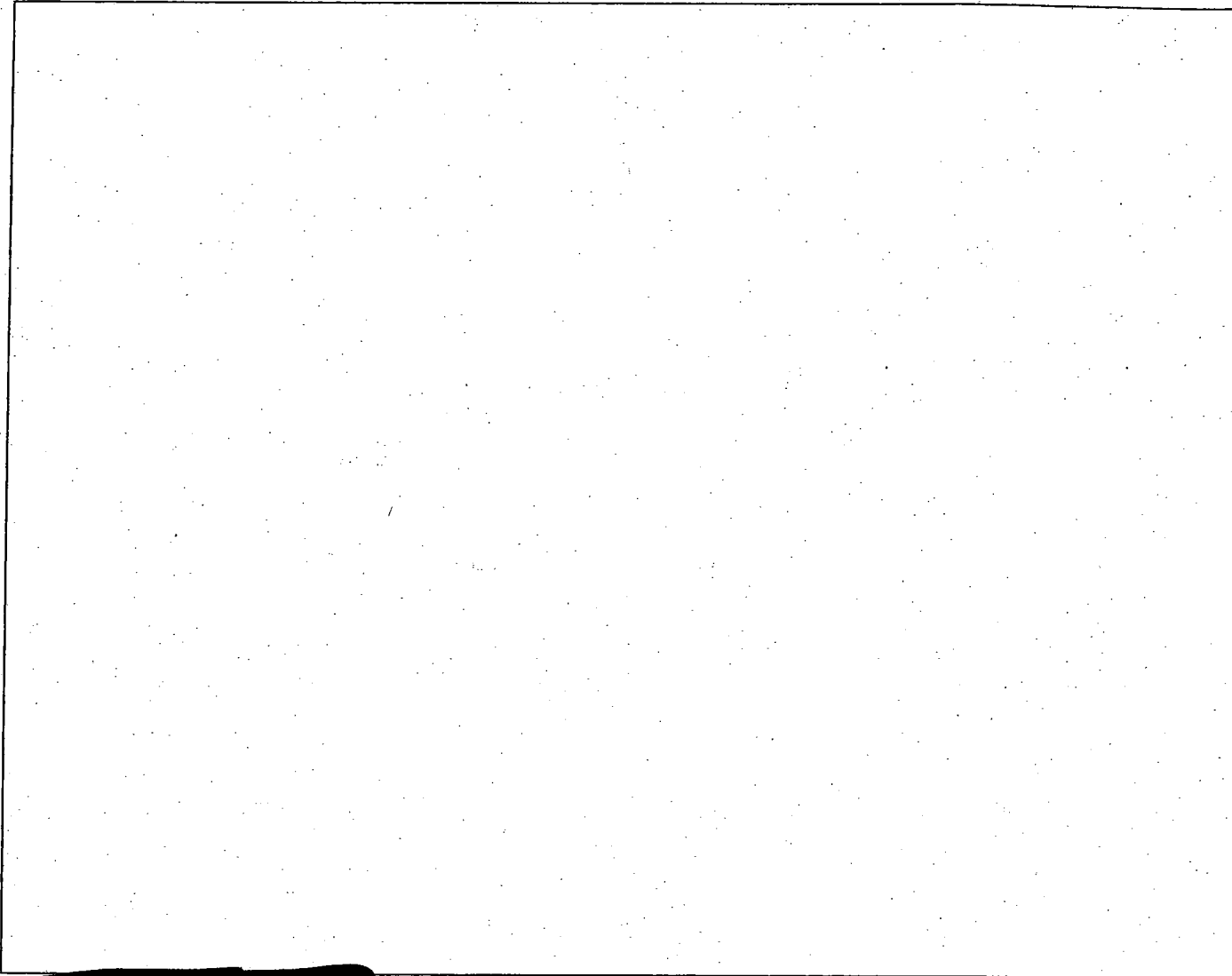

SPECIAL AGENT, [REDACTED]  
Page 1 of 5

DERIVED FROM:

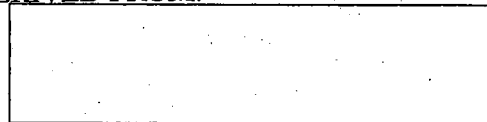

DECLASIFY ON:  
23 MAY 2029

b1, b3, b2b67c

EXHIBIT 21

000090

[REDACTED]

87<sup>TH</sup> MILITARY POLICE DETACHMENT (CID) (ABN), 3D MILITARY POLICE GROUP  
(CID), USACIDC, FORT BRAGG, NC 28310

AGENT'S INVESTIGATION REPORT  
0027-03-CID679-64999  
23 May 04

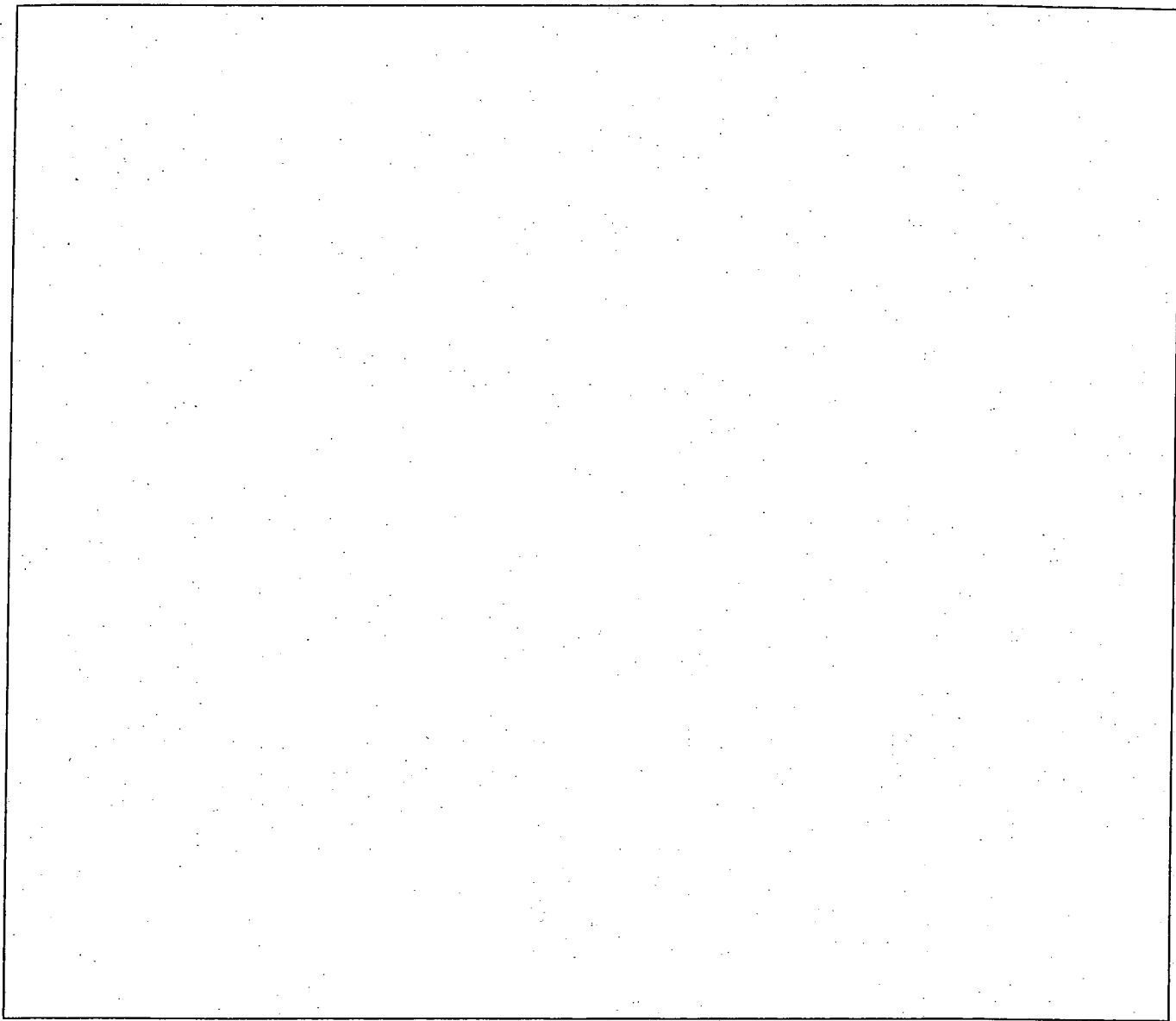

[REDACTED]  
SPECIAL AGENT, [REDACTED]  
Page 2 of 5

[REDACTED]

EXHIBIT 2h

b1, b3, b2, b4, 7C

000091

87<sup>TH</sup> MILITARY POLICE DETACHMENT (CID) (ABN), 3D MILITARY POLICE GROUP  
(CID), USACIDC, FORT BRAGG, NC 28310

AGENT'S INVESTIGATION REPORT  
0027-03-CID679-64999  
23 May 04

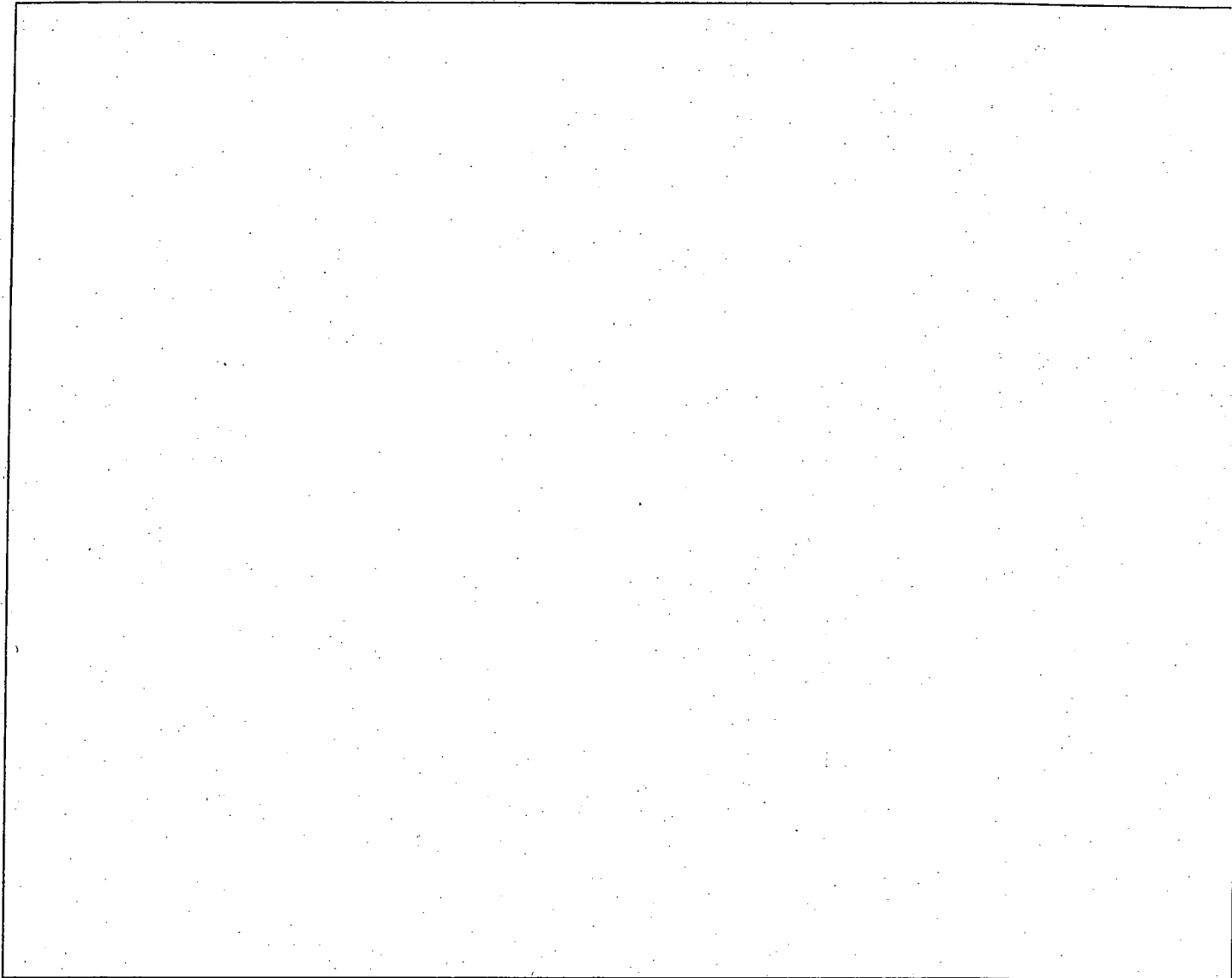

SPECIAL AGENT, [REDACTED]

Page 3 of 5

[REDACTED]  
b1, b3, b2b67C

EXHIBIT 21

000092

[REDACTED]

87<sup>TH</sup> MILITARY POLICE DETACHMENT (CID) (ABN), 3D MILITARY POLICE GROUP  
(CID), USACIDC, FORT BRAGG, NC 28310

AGENT'S INVESTIGATION REPORT  
0027-03-CID679-64999  
23 May 04

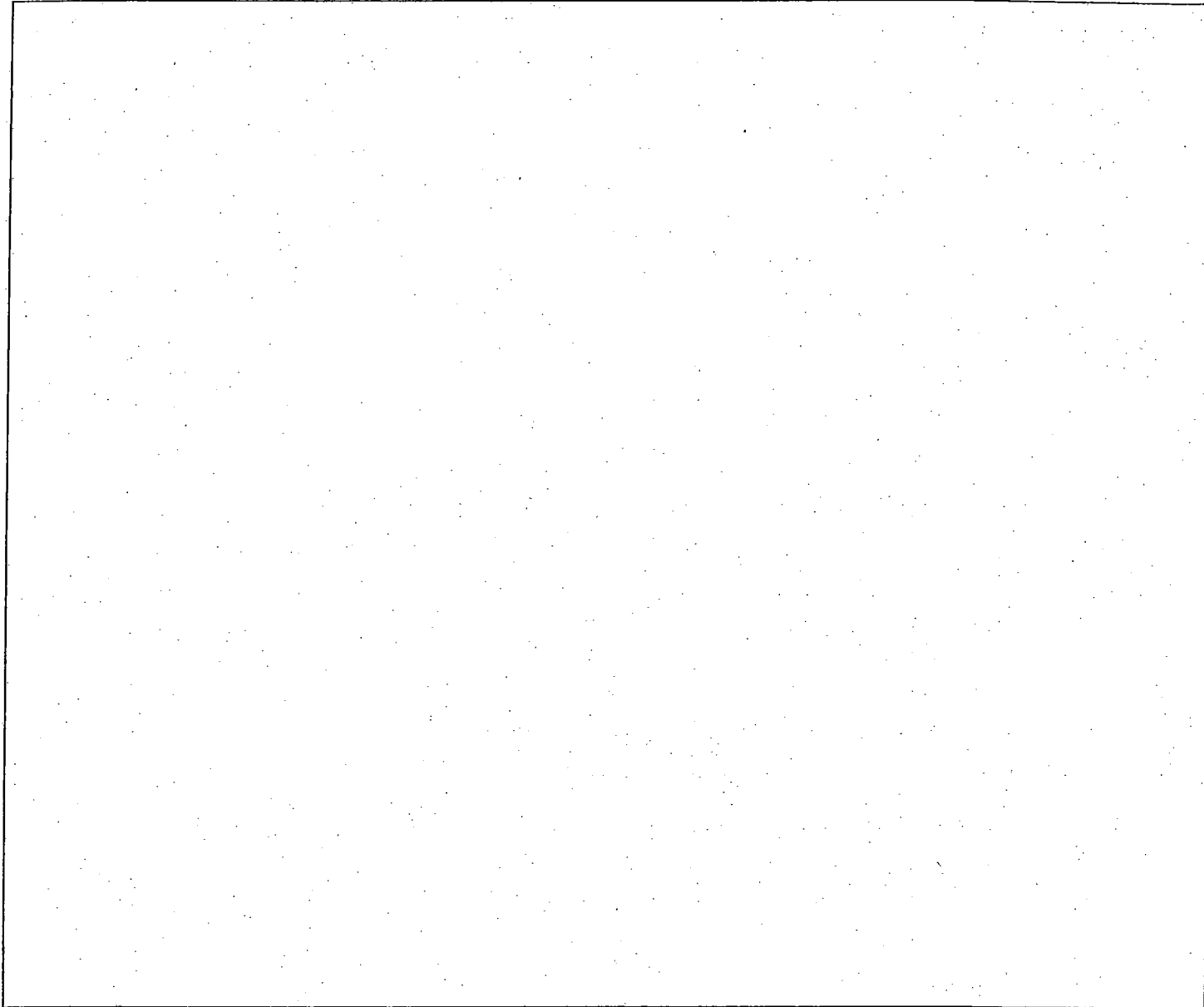

[REDACTED]  
SPECIAL AGENT, [REDACTED]  
Page 4 of 5

[REDACTED]

EXHIBIT 21

b1, b3, b2, b6, 7C

000093

[REDACTED]

87<sup>TH</sup> MILITARY POLICE DETACHMENT (CID) (ABN), 3D MILITARY POLICE GROUP  
(CID), USACIDC, FORT BRAGG, NC 28310

AGENT'S INVESTIGATION REPORT  
0027-03-CID679-64999  
23 May 04

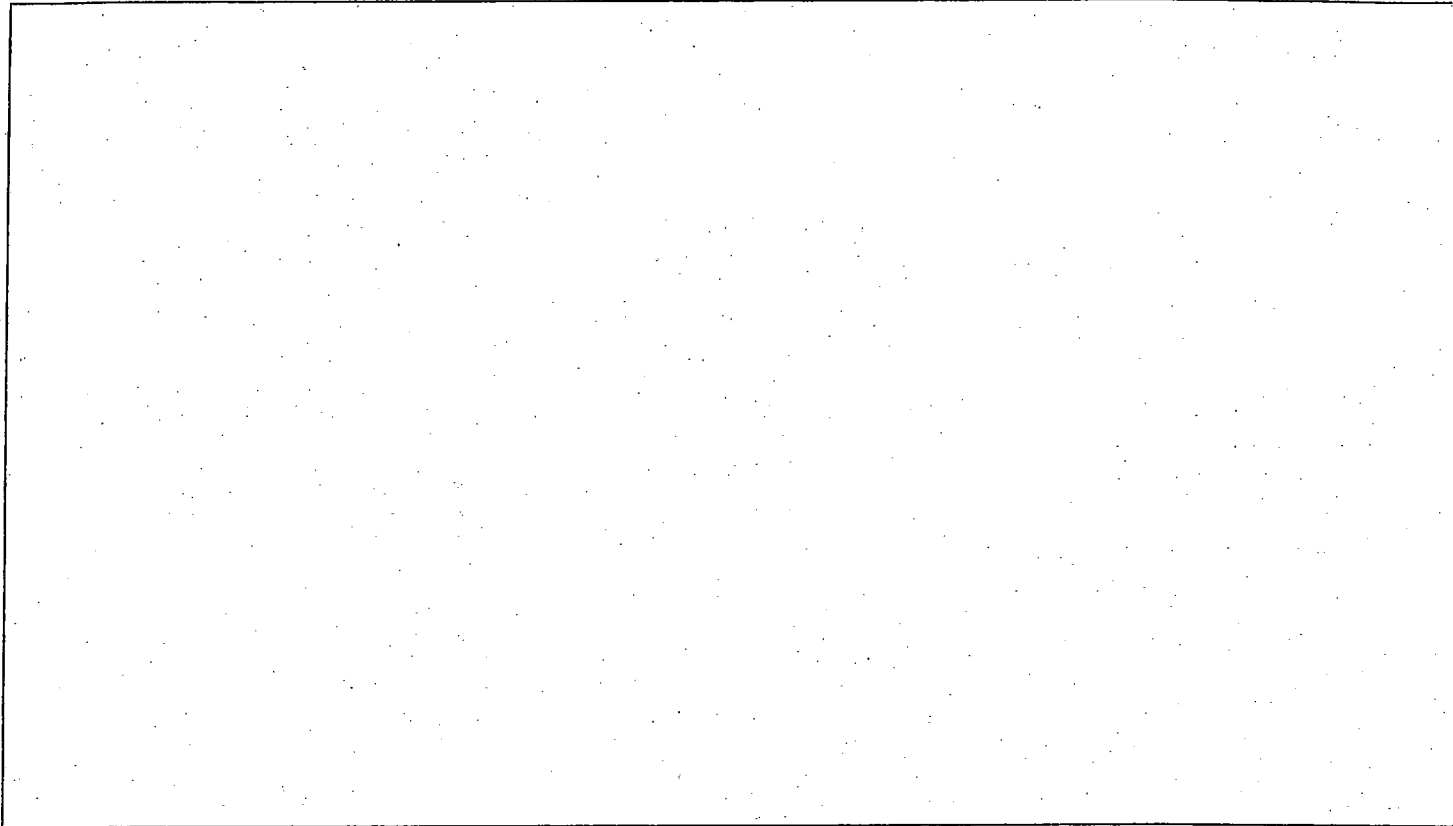

[REDACTED]  
SPECIAL AGENT [REDACTED]  
Page 5 of 5

[REDACTED]

b1, b3, b2b67C

EXHIBIT 21

000094

[REDACTED]

87<sup>TH</sup> MILITARY POLICE DETACHMENT (CID) (ABN), 3D MILITARY POLICE GROUP  
(CID), USACIDC, FORT BRAGG, NC 28310

AGENT'S INVESTIGATION REPORT  
0027-03-CID679-64999  
16 Jun 04

DETAILS:

[REDACTED] About 0950, 14 Jun 04, SA [REDACTED] reviewed [REDACTED] pertaining to  
the interview of [REDACTED]  
[REDACTED] The review revealed [REDACTED]

[REDACTED]

DERIVED FROM:

[REDACTED]

[REDACTED]

SPECIAL AGENT [REDACTED]  
Page 1 of 5

DECLASIFY ON:  
16 JUNE 2029

[REDACTED]

EXHIBIT 22

b1, b3, b2, b4, 7C

000095

87<sup>TH</sup> MILITARY POLICE DETACHMENT (CID) (ABN), 3D MILITARY POLICE GROUP  
(CID), USACIDC, FORT BRAGG, NC 28310

AGENT'S INVESTIGATION REPORT  
0027-03-CID679-64999  
16 Jun 04

DETAILS:

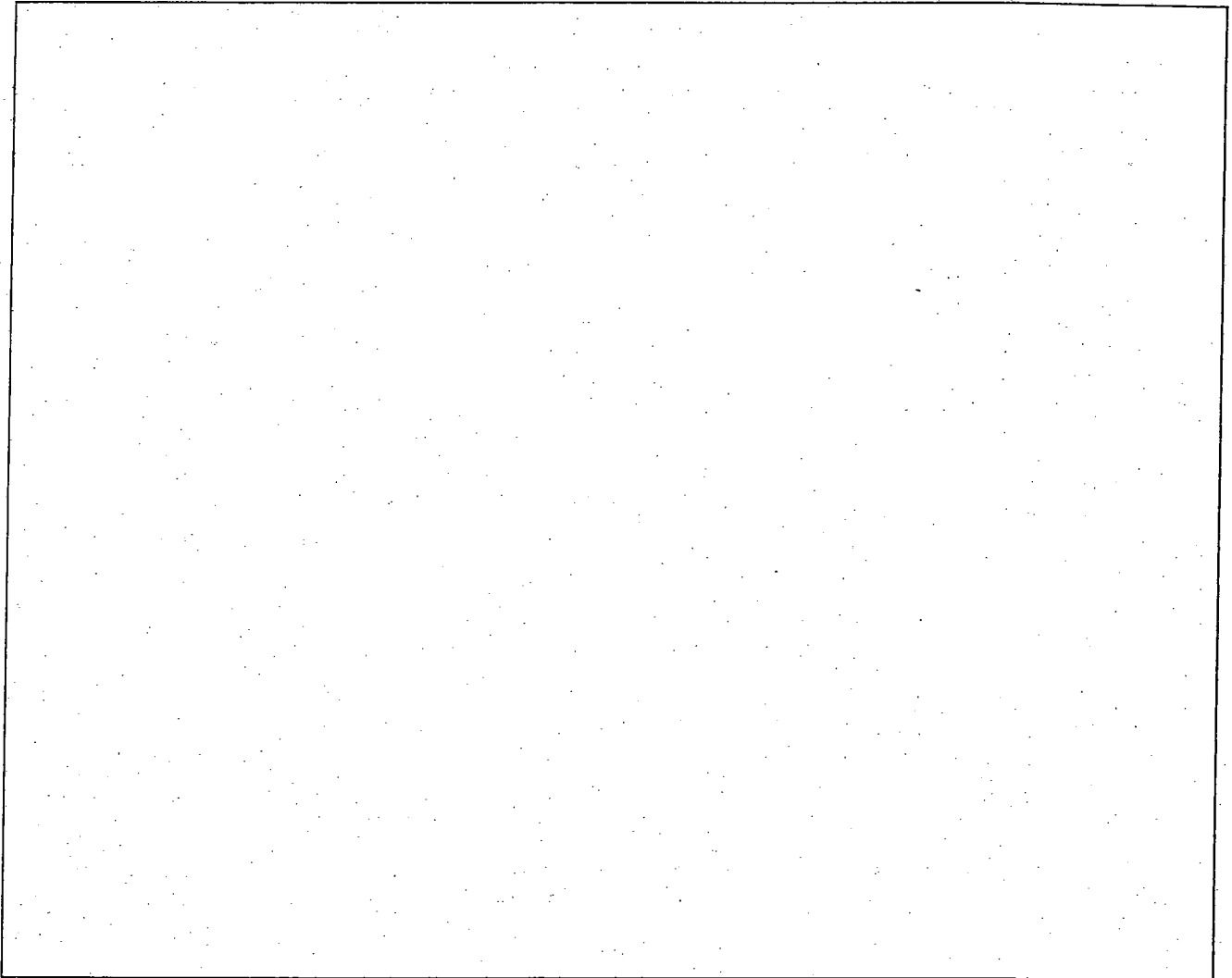

SPECIAL AGENT, [REDACTED]  
Page 2 of 5

[REDACTED]  
bl, b3, b2b67C

EXHIBIT 22

000096

[REDACTED]

87<sup>TH</sup> MILITARY POLICE DETACHMENT (CID) (ABN), 3D MILITARY POLICE GROUP  
(CID), USACIDC, FORT BRAGG, NC 28310

AGENT'S INVESTIGATION REPORT

0027-03-CID679-64999

16 Jun 04

DETAILS:

[REDACTED]

[REDACTED] About 1420, 15 Jun 04, SA [REDACTED] interviewed SFC [REDACTED] C Co, 323<sup>rd</sup> MI Bn, Fort Meade, MD 20755. SFC [REDACTED] related he was deployed to Iraq in support of 3<sup>rd</sup> Squadron, 3<sup>rd</sup> ACR from May 03 to Feb 04. SFC [REDACTED] first started working with [REDACTED] in Sep 03. [REDACTED] as a linguist working for CPT [REDACTED]. His primary responsibility was to aid CPT [REDACTED] in directing the actions of [REDACTED]. SFC [REDACTED] traveled to the forward detention facility between two and four times during [REDACTED]. After the incident between [REDACTED] and MOWHOUSH, [REDACTED] stayed away from the detention facility. One or two days prior to MOWHOUSH's death, SFC [REDACTED] was at the forward detention facility with CPT [REDACTED]. The other [REDACTED] gone to the forward detention facility earlier in the day. When he arrived at the forward detention facility with CPT [REDACTED] they went looking for the other [REDACTED] which contained [REDACTED]. SFC [REDACTED] and CPT [REDACTED] walked into an interrogation room and saw [REDACTED] hitting a detainee. SFC [REDACTED] did not know who the detainee was, but was sure it was not MOWHOUSH. SFC [REDACTED] thought MOWHOUSH was being interrogated in a different interrogation room at that time. SFC [REDACTED] also saw [REDACTED]. SFC [REDACTED] said there were other Special Forces soldiers in the room that were not members of [REDACTED]. No soldiers from 3 ACR were in the room. SFC [REDACTED] witnessed [REDACTED] punch and kick the detainee. The detainee was described as an [REDACTED]. He was [REDACTED]. When SFC [REDACTED] first walked in the room, the detainee was being questioned while seated on an MRE box. SFC [REDACTED] stated several times the detainee was knocked from the MRE box by blows. The detainee would then be hit a few times

[REDACTED]  
SPECIAL AGENT, [REDACTED]

Page 3 of 5

[REDACTED]  
EXHIBIT 22

b1, b3, b2, b6, 7c

000097



87<sup>TH</sup> MILITARY POLICE DETACHMENT (CID) (ABN), 3D MILITARY POLICE GROUP (CID), USACIDC, FORT BRAGG, NC 28310

AGENT'S INVESTIGATION REPORT  
0027-03-CID679-64999  
16 Jun 04

DETAILS:

while on the floor then placed back on the MRE box in a seated position. SFC [redacted] stated [redacted] was hitting the detainee with a long black object. He thought the object was hollow, like something you would put around electrical wire or pipe. He stated [redacted] was swinging the object with two hands, like someone splitting logs with an axe. [redacted] was hitting the detainee with a tan object about 12 inches long by 3 inches wide. SFC [redacted] thought [redacted] hit the detainee between 15 and 20 times. He described the beating as a brawl and said it was difficult to tell who else was doing what hitting and how much they were hitting. SFC [redacted] stated the interrogators were using the good cop, bad cop technique on the detainee. During this time [redacted] was sitting near the door of the room. After three or four minutes, CPT [redacted] stopped the interrogation, rounded up all members of [redacted] and the attached [redacted] and left the forward detention facility. Prior to CPT [redacted] no one made any attempt to stop the interrogation. That night, CPT [redacted] instructed SFC [redacted] to talk to [redacted] and tell them to never strike a detainee again during an interrogation. [redacted] told SFC [redacted] they were instructed to use physical force in the interrogation by US personnel. They were not able to identify the person that gave them the instructions. He described [redacted] as being "scared shitless." SFC [redacted] was sure [redacted] would not have used physical force in an interrogation without being instructed to do so. SFC [redacted] thought MOWHOUSH died the next day or two days after this incident. SFC [redacted] did not see [redacted] interrogate MOWHOUSH, but heard they were involved in one or two interrogations. He thought they interrogated MOWHOUSH on the same day as the incident he described, and that [redacted] may have been involved in the interrogation of MOWHOUSH. CPT [redacted] told SFC [redacted] he voiced concerns over what they saw to [redacted] SFC [redacted] related he was the person who gave [redacted] [redacted] SFC [redacted] heard of a sleeping bag being used in interrogations, but he never witnessed an interrogation where the sleeping bag was used.

[redacted] About 1430, 16 Jun 04, SFC [redacted] reviewed photographs of [redacted] [redacted] He positively identified [redacted] from their photographs. He reviewed photographs of [redacted] and [redacted]

[redacted]  
SPECIAL AGENT, [redacted]  
Page 4 of 5

b1, b3, b2b67C

EXHIBIT 22

000038

[REDACTED]

87<sup>TH</sup> MILITARY POLICE DETACHMENT (CID) (ABN), 3D MILITARY POLICE GROUP  
(CID), USACIDC, FORT BRAGG, NC 28310

AGENT'S INVESTIGATION REPORT  
0027-03-CID679-64999  
16 Jun 04

DETAILS:

identified [REDACTED] He stated they were [REDACTED]  
involved in striking the detainee in the incident he witnessed.

AGENT'S COMMENT: The [REDACTED] are contained in the CIA OIG file related to this  
investigation.///LAST ENTRY///

[REDACTED]  
SPECIAL AGENT, [REDACTED]  
Page 5 of 5

[REDACTED]

EXHIBIT 22

b1, b3, b2, b4, 7C

000099

87<sup>TH</sup> MILITARY POLICE DETACHMENT (CID) (ABN), 3D MILITARY POLICE GROUP (CID), USACIDC, FORT BRAGG, NC 28310

AGENT'S INVESTIGATION REPORT  
0027-03-CID679-64999  
12 Jul 04

DETAILS:

(FOUO) About 0902, 8 Jul 04, SA [REDACTED] advised CW2 [REDACTED] of his rights, which he waived in writing. CW2 [REDACTED] maintained the truthfulness of his previous statements, and denied he ever witnessed anyone strike MOWHOUSH as a means of eliciting information. (See Rights Waiver Certificate for details)

(FOUO) About 1026, 8 Jul 04, SA [REDACTED] advised SSG [REDACTED] of his rights, which he waived in writing. SSG [REDACTED] maintained the truthfulness of his previous statements, and denied he ever witnessed anyone strike MOWHOUSH as a means of eliciting information. (See Rights Waiver Certificate for details)

(FOUO) About 1059, 8 Jul 04, SA [REDACTED] advised SSG HOLLEYMAN of his rights, which he waived. SSG HOLLEYMAN maintained the truthfulness of his previous statements, and denied he ever witnessed anyone strike MOWHOUSH as a means of eliciting information. (See Rights Waiver certificate for details)

[REDACTED] About 1018, 9 Jul 04, SA [REDACTED] 1000<sup>th</sup> MP Bn (CID), advised SSG HOLLEYMAN of his rights. SSG HOLLEYMAN waived his rights in writing and rendered a sworn statement. SSG HOLLEYMAN admitted his previous statements were false. He further stated he was present when [REDACTED] struck MOWHOUSH during an interrogation as a means of eliciting information. During that interrogation, MOWHOUSH kicked at an interrogator, at which SSG HOLLEYMAN, and the other personnel present, converged on MOWHOUSH. SSG HOLLEYMAN stated he punched MOWHOUSH in the midsection between two and six times while MOWHOUSH was on the floor of the interrogation room. (See Rights Waiver Certificate and Sworn Statement for details)

[REDACTED] About 1330, 10 Jul 04, SA [REDACTED] advised SSG [REDACTED] of his rights. SSG [REDACTED] waived his rights in writing and rendered a sworn statement. SSG [REDACTED] admitted his previous statements were false. He further stated he was present when [REDACTED] used physical force in an interrogation of MOWHOUSH as a means of eliciting

[REDACTED]

DERIVED FROM:

[REDACTED]

SPECIAL AGENT,  
Page 1 of 2

DECLASIFY ON:  
12 JULY 2029

b1, b3, b2b67c

EXHIBIT 23

000100

[REDACTED]

87<sup>TH</sup> MILITARY POLICE DETACHMENT (CID) (ABN), 3D MILITARY POLICE GROUP  
(CID), USACIDC, FORT BRAGG, NC 28310

AGENT'S INVESTIGATION REPORT  
0027-03-CID679-64999  
12 Jul 04

DETAILS:

information. SSG [REDACTED] described how MOWHOUSH kicked at an interrogator during this interrogation causing the personnel in the room to converge on MOWHOUSH. SSG [REDACTED] stated MOWHOUSH was struck repeatedly at this time, but denied he hit MOWHOUSH. SSG [REDACTED] stated he was not able to reach MOWHOUSH because of the number of people already around and on top of him. (See Rights Waiver Certificate and Sworn Statement for details)

[REDACTED] About 0900, 12 Jul 04, SA [REDACTED] advised CW2 [REDACTED] of his rights. CW2 [REDACTED] waived his rights in writing and rendered a sworn statement. CW2 [REDACTED] admitted his previous statements were false. He further stated he was present when [REDACTED] used physical force as a means of eliciting information during an interrogation of MOWHOUSH. During that interrogation, MOWHOUSH kicked at an interrogator. CW2 [REDACTED] reacted by moving toward MOWHOUSH and pushing him to the floor. CW2 [REDACTED] held MOWHOUSH on the floor as other people in the room converged. He stated he punched MOWHOUSH with his closed fist and hit MOWHOUSH with the heel of his hand, but was not sure how many times. (See Rights Waiver Certificate and Sworn Statement for details)//LAST ENTRY//

[REDACTED]  
SPECIAL AGENT, [REDACTED]  
Page 2 of 2

[REDACTED]  
EXHIBIT 28

b1, b3, b2, b6, 7C

000101

**RIGHTS WARNING PROCEDURE/WAIVER CERTIFICATE**

For use of this form, see AR 190-30; the proponent agency is ODCSOPS **0027-03-C10679-64999**

**DATA REQUIRED BY THE PRIVACY ACT**

**AUTHORITY:** Title 10, United States Code, Section 3012(g)  
**PRINCIPAL PURPOSE:** To provide commanders and law enforcement officials with means by which information may be accurately identified.  
**ROUTINE USES:** Your Social Security Number is used as an additional/alternate means of identification to facilitate filing and retrieval.  
**DISCLOSURE:** Disclosure of your Social Security Number is voluntary.

1. LOCATION <b>Fort Campbell, KY</b>	2. DATE <b>8 Jul 09</b>	3. TIME <b>0900</b>	4. FILE NO.
5. NAME (Last, First MI) [REDACTED]	8. ORGANIZATION OR ADDRESS <b>ODA 531 1-5<sup>th</sup> SFG Fort Campbell, KY 42223</b>		
6. SSN [REDACTED]	7. GRADE/STATUS <b>CW2/AO</b>		

**PART I - RIGHTS WAIVER/NON-WAIVER CERTIFICATE**

**Section A. Rights**

The investigator whose name appears below told me that he/she is with the United States Army **Criminal Investigation Command** and wanted to question me about the following offense(s) of which I am suspected/accused: **False Statements and Mistreating Detainees**

Before he/she asked me any questions about the offense(s), however, he/she made it clear to me that I have the following rights:

- I do not have to answer any questions or say anything.
- Anything I say or do can be used as evidence against me in a criminal trial.
- (For personnel subject to the UCMJ) I have the right to talk privately to a lawyer before, during, and after questioning and to have a lawyer present with me during questioning. This lawyer can be a civilian lawyer I arrange for at no expense to the Government or a military lawyer detailed for me at no expense to me, or both.

- or -

(For civilians not subject to the UCMJ) I have the right to talk privately to a lawyer before, during, and after questioning and to have a lawyer present with me during questioning. I understand that this lawyer can be one that I arrange for at my own expense, or if I cannot afford a lawyer and want one, a lawyer will be appointed for me before any questioning begins.

- If I am now willing to discuss the offense(s) under investigation, with or without a lawyer present, I have a right to stop answering questions at any time, or speak privately with a lawyer before answering further, even if I sign the waiver below.

5. COMMENTS (Continue on reverse side)

**Section B. Waiver**

I understand my rights as stated above. I am now willing to discuss the offense(s) under investigation and make a statement without talking to a lawyer first and without having a lawyer present with me.

WITNESSES (If available)

b. ORGANIZATION OR ADDRESS AND PHONE

**OIG, CIA  
Langley, VA**

2a. NAME (Type or Print)

5. TYPED NAME OF INVESTIGATOR

**SA [REDACTED]**

b. ORGANIZATION OR ADDRESS AND PHONE

6. ORGANIZATION OF INVESTIGATOR

**87<sup>th</sup> MP Det (Civ)  
Fort Bragg, NC 28310**

**Section C. Non-waiver**

- I do not want to give up my rights:  
 I want a lawyer.  I do not want to be questioned or say anything.

2. SIGNATURE OF INTERVIEWEE

**LAW ENFORCEMENT SENSITIVE**

ATTACH THIS WAIVER CERTIFICATE TO ANY SWORN STATEMENT FOR (201-482) 9-9350 ONLY EXECUTED BY THE SUSPECT/ACCUSED.

**b6,7C**

## THE WARNING

1. **WARNING** - Inform the suspect/accused of:
  - a. Your official position.
  - b. Nature of offense(s).
  - c. The fact that he/she is a suspect/accused.
2. **RIGHTS** - Advise the suspect/accused of his/her rights as follows:
 

"Before I ask you any questions, you must understand your rights."

  - a. "You do not have to answer my questions or say anything."
  - b. "Anything you say or do can be used as evidence against you in a criminal trial."
  - c. (For personnel subject to the UCMJ) "You have the right to talk privately to a lawyer before, during, and after questioning and to have a lawyer present with you during questioning. This lawyer

can be a civilian you arrange for at no expense to the Government or a military lawyer detailed for you at no expense to you, or both."

- or -

(For civilians not subject to the UCMJ) You have the right to talk privately to a lawyer before, during, and after questioning and to have a lawyer present with you during questioning. This lawyer can be one you arrange for at your own expense, or if you cannot afford a lawyer and want one, a lawyer will be appointed for you before any questioning begins."

- d. "If you are now willing to discuss the offense(s) under investigation, with or without a lawyer present, you have a right to stop answering questions at any time, or speak privately with a lawyer before answering further, even if you sign a waiver certificate."

Make certain the suspect/accused fully understands his/her rights.

## THE WAIVER

"Do you understand your rights?"

(If the suspect/accused says "no," determine what is not understood, and if necessary repeat the appropriate rights advisement. If the suspect/accused says "yes," ask the following question.)

"Have you ever requested a lawyer after being read your rights?"

(If the suspect/accused says "yes," find out when and where. If the request was recent (i.e., fewer than 30 days ago), obtain legal advice on whether to continue the interrogation. If the suspect/accused says "no," or if the prior request was not recent, ask him/her the following question.)

"Do you want a lawyer at this time?"

(If the suspect/accused says "yes," stop the questioning until he/she has a lawyer. If the suspect/accused says "no," ask him/her the following question.)

"At this time, are you willing to discuss the offense(s) under investigation and make a statement without talking to a lawyer and without having a lawyer present with you?" (If the suspect/accused says "no," stop the interview and have him/her read and sign the non-waiver section of the waiver certificate on the other side of this form. If the suspect/accused says "yes," have him/her read and sign the waiver section of the waiver certificate on the other side of this form.)

## SPECIAL INSTRUCTIONS

**WHEN SUSPECT/ACCUSED REFUSES TO SIGN WAIVER CERTIFICATE:** If the suspect/accused orally waives his/her rights but refuses to sign the waiver certificate, you may proceed with the questioning. Make notations on the waiver certificate to the effect that he/she has stated that he/she understands his/her rights, does not want a lawyer, wants to discuss the offense(s) under investigation, and refuses to sign the waiver certificate.

**IF WAIVER CERTIFICATE CANNOT BE COMPLETED IMMEDIATELY:** In all cases the waiver certificate must be completed as soon as possible. Every effort should be made to complete the waiver certificate before any questioning begins. If the waiver certificate cannot be completed at once, as in the case of street interrogation, completion may be temporarily postponed. Notes should be kept on the circumstances.

**PRIOR INCRIMINATING STATEMENTS:**

1. If the suspect/accused has made spontaneous incriminating statements before being properly advised of his/her rights he/she should be told that such statements do not obligate him/her to answer further questions.

2. If the suspect/accused was questioned as such either without being advised of his/her rights or some question exists as to the propriety of the first statement, the accused must be so advised. The office of the serving Staff Judge Advocate should be contacted for assistance in drafting the proper rights advisal.

**NOTE:** If 1 or 2 applies, the fact that the suspect/accused was advised accordingly should be noted in the comment section on the waiver certificate and initialed by the suspect/accused.

**WHEN SUSPECT/ACCUSED DISPLAYS INDECISION ON EXERCISING HIS OR HER RIGHTS DURING THE INTERROGATION PROCESS:** If during the interrogation, the suspect displays indecision about requesting counsel (for example, "Maybe I should get a lawyer."), further questioning must cease immediately. At that point, you may question the suspect/accused only concerning whether he or she desires to waive counsel. The questioning may not be utilized to discourage a suspect/accused from exercising his/her rights. (For example, do not make such comments as "If you didn't do anything wrong, you shouldn't need an attorney.")

**COMMENTS (Continued)**

**LAW ENFORCEMENT SENSITIVE  
FOR OFFICIAL USE ONLY**

**EXHIBIT 25**

### RIGHTS WARNING PROCEDURE/WAIVER CERTIFICATE

For use of this form, see AR 190-30; the proponent agency is ODCSOPS 002703-C10679-64997

#### DATA REQUIRED BY THE PRIVACY ACT

**AUTHORITY:** Title 10, United States Code, Section 3012(g)  
**PRINCIPAL PURPOSE:** To provide commanders and law enforcement officials with means by which information may be accurately identified.  
**ROUTINE USES:** Your Social Security Number is used as an additional/alternate means of identification to facilitate filing and retrieval.  
**DISCLOSURE:** Disclosure of your Social Security Number is voluntary.

1. LOCATION Fort Campbell, KY	2. DATE 8 Jul 04	3. TIME 1026	4. FILE NO.
5. NAME (Last, First, MI) [REDACTED]	8. ORGANIZATION OR ADDRESS ODA 515, 1-5E SFG(A) Fort Campbell, KY 42223		
6. SSN [REDACTED]	GRADE/STATUS SSG/AD		

#### PART I - RIGHTS WAIVER/NON-WAIVER CERTIFICATE

##### Section A. Rights

The investigator whose name appears below told me that he/she is with the United States Army Criminal Investigation Command and wanted to question me about the following offense(s) of which I am suspected/accused: False statements and mistreating detainees

- Before he/she asked me any questions about the offense(s), however, he/she made it clear to me that I have the following rights:
- I do not have to answer any questions or say anything.
  - Anything I say or do can be used as evidence against me in a criminal trial.
  - (For personnel subject to the UCMJ) I have the right to talk privately to a lawyer before, during, and after questioning and to have a lawyer present with me during questioning. This lawyer can be a civilian lawyer I arrange for at no expense to the Government or a military lawyer detailed for me at no expense to me, or both.

- or -  
 (For civilians not subject to the UCMJ) I have the right to talk privately to a lawyer before, during, and after questioning and to have a lawyer present with me during questioning. I understand that this lawyer can be one that I arrange for at my own expense, or if I cannot afford a lawyer and want one, a lawyer will be appointed for me before any questioning begins.

- If I am now willing to discuss the offense(s) under investigation, with or without a lawyer present, I have a right to stop answering questions at any time, or speak privately with a lawyer before answering further, even if I sign the waiver below.

5. COMMENTS (Continue on reverse side)

##### Section B. Waiver

I understand my rights as stated above. I am now willing to discuss the offense(s) under investigation and make a statement without talking to a lawyer first and without having a lawyer present with me.

WITNESSES (if available)

b. ORGANIZATION OR ADDRESS AND PHONE OIG, CIA Langley, VA	3. SIGNATURE OF WITNESS [REDACTED]
2a. NAME (Type or Print)	4. SIGNATURE OF SUSPECT/ACCUSED [REDACTED]
b. ORGANIZATION OR ADDRESS AND PHONE	5. TYPED NAME OF INVESTIGATOR SA [REDACTED]
	6. ORGANIZATION OF INVESTIGATOR 87E MP Det (CID) Fort Bragg, NC 28310

##### Section C. Non-waiver

- I do not want to give up my rights:
  - I want a lawyer.
  - I do not want to be questioned or say anything.

2. SIGNATURE OF INTERVIEWEE

LAW ENFORCEMENT SENSITIVE

ATTACH THIS WAIVER CERTIFICATE TO ANY SWORN STATEMENT OF FORM 2831 SUBSEQUENTLY EXECUTED BY THE SUSPECT/ACCUSED.

b67c

## THE WARNING

1. **WARNING** - Inform the suspect/accused of:
  - a. Your official position.
  - b. Nature of offense(s).
  - c. The fact that he/she is a suspect/accused.
2. **RIGHTS** - Advise the suspect/accused of his/her rights as follows:
 

"Before I ask you any questions, you must understand your rights."

  - a. "You do not have to answer my questions or say anything."
  - b. "Anything you say or do can be used as evidence against you in a criminal trial."
  - c. (For personnel subject to the UCMJ) "You have the right to talk privately to a lawyer before, during, and after questioning and to have a lawyer present with you during questioning. This lawyer

can be a civilian you arrange for at no expense to the Government or a military lawyer detailed for you at no expense to you, or both."

- or -

(For civilians not subject to the UCMJ) You have the right to talk privately to a lawyer before, during, and after questioning and to have a lawyer present with you during questioning. This lawyer can be one you arrange for at your own expense, or if you cannot afford a lawyer and want one, a lawyer will be appointed for you before any questioning begins."

- d. "If you are now willing to discuss the offense(s) under investigation, with or without a lawyer present, you have a right to stop answering questions at any time, or speak privately with a lawyer before answering further, even if you sign a waiver certificate."

Make certain the suspect/accused fully understands his/her rights.

## THE WAIVER

"Do you understand your rights?"

(If the suspect/accused says "no," determine what is not understood, and if necessary repeat the appropriate rights advisement. If the suspect/accused says "yes," ask the following question.)

"Have you ever requested a lawyer after being read your rights?"

(If the suspect/accused says "yes," find out when and where. If the request was recent (i.e., fewer than 30 days ago), obtain legal advice on whether to continue the interrogation. If the suspect/accused says "no," or if the prior request was not recent, ask him/her the following question.)

"Do you want a lawyer at this time?"

(If the suspect/accused says "yes," stop the questioning until he/she has a lawyer. If the suspect/accused says "no," ask him/her the following question.)

"At this time, are you willing to discuss the offense(s) under investigation and make a statement without talking to a lawyer and without having a lawyer present with you?" (If the suspect/accused says "no," stop the interview and have him/her read and sign the non-waiver section of the waiver certificate on the other side of this form. If the suspect/accused says "yes," have him/her read and sign the waiver section of the waiver certificate on the other side of this form.)

## SPECIAL INSTRUCTIONS

**WHEN SUSPECT/ACCUSED REFUSES TO SIGN WAIVER CERTIFICATE:** If the suspect/accused orally waives his/her rights but refuses to sign the waiver certificate, you may proceed with the questioning. Make notations on the waiver certificate to the effect that he/she has stated that he/she understands his/her rights, does not want a lawyer, wants to discuss the offense(s) under investigation, and refuses to sign the waiver certificate.

**IF WAIVER CERTIFICATE CANNOT BE COMPLETED IMMEDIATELY:** In all cases the waiver certificate must be completed as soon as possible. Every effort should be made to complete the waiver certificate before any questioning begins. If the waiver certificate cannot be completed at once, as in the case of street interrogation, completion may be temporarily postponed. Notes should be kept on the circumstances.

**PRIOR INCRIMINATING STATEMENTS:**

1. If the suspect/accused has made spontaneous incriminating statements before being properly advised of his/her rights he/she should be told that such statements do not obligate him/her to answer further questions.

2. If the suspect/accused was questioned as such either without being advised of his/her rights or some question exists as to the propriety of the first statement, the accused must be so advised. The office of the serving Staff Judge Advocate should be contacted for assistance in drafting the proper rights advisal.

**NOTE:** If 1 or 2 applies, the fact that the suspect/accused was advised accordingly should be noted in the comment section on the waiver certificate and initialed by the suspect/accused.

**WHEN SUSPECT/ACCUSED DISPLAYS INDECISION ON EXERCISING HIS OR HER RIGHTS DURING THE INTERROGATION PROCESS:** If during the interrogation, the suspect displays indecision about requesting counsel (for example, "Maybe I should get a lawyer."), further questioning must cease immediately. At that point, you may question the suspect/accused only concerning whether he or she desires to waive counsel. The questioning may not be utilized to discourage a suspect/accused from exercising his/her rights. (For example, do not make such comments as "If you didn't do anything wrong, you shouldn't need an attorney.")

COMMENTS (Continued)

**LAW ENFORCEMENT SENSITIVE  
FOR OFFICIAL USE ONLY**

**EXHIBIT** 26



**RIGHTS WARNING PROCEDURE/WAIVER CERTIFICATE**

For use of this form, see AR 190-30; the proponent agency is ODCSOPS

**DATA REQUIRED BY THE PRIVACY ACT**

0027-03-C10679-64999

**AUTHORITY:** Title 10, United States Code, Section 3012(g)  
**PRINCIPAL PURPOSE:** To provide commanders and law enforcement officials with means by which information may be accurately identified.  
**ROUTINE USES:** Your Social Security Number is used as an additional/alternate means of identification to facilitate filing and retrieval.  
**DISCLOSURE:** Disclosure of your Social Security Number is voluntary.

1. LOCATION Fort Campbell, KY	2. DATE 8 Jul 04	3. TIME 1059	4. FILE NO.
5. NAME (Last, First, MI) Holleyman Aaron N.	8. ORGANIZATION OR ADDRESS ODA 531, 1-5th SFG Fort Campbell KY 42223		
6. SSN [REDACTED]	7. GRADE/STATUS SSG/AD		

**PART I - RIGHTS WAIVER/NON-WAIVER CERTIFICATE**

**Section A. Rights**

The Investigator whose name appears below told me that he/she is with the United States Army Criminal Investigation Command and wanted to question me about the following offense(s) of which I am suspected/accused: False Statements and Mistreating Detainees  
 Before he/she asked me any questions about the offense(s), however, he/she made it clear to me that I have the following rights:

- I do not have to answer any questions or say anything.
- Anything I say or do can be used as evidence against me in a criminal trial.
- (For personnel subject to the UCMJ) I have the right to talk privately to a lawyer before, during, and after questioning and to have a lawyer present with me during questioning. This lawyer can be a civilian lawyer I arrange for at no expense to the Government or a military lawyer detailed for me at no expense to me, or both.

- OF -

(For civilians not subject to the UCMJ) I have the right to talk privately to a lawyer before, during, and after questioning and to have a lawyer present with me during questioning. I understand that this lawyer can be one that I arrange for at my own expense, or if I cannot afford a lawyer and want one, a lawyer will be appointed for me before any questioning begins.

- If I am now willing to discuss the offense(s) under investigation, with or without a lawyer present, I have a right to stop answering questions at any time, or speak privately with a lawyer before answering further, even if I sign the waiver below.

5. COMMENTS (Continue on reverse side)

**Section B. Waiver**

I understand my rights as stated above. I am now willing to discuss the offense(s) under investigation and make a statement without talking to a lawyer first and without having a lawyer present with me.

WITNESSES (If available)		3. SIGNATURE OF INTERVIEWEE 
1a. NAME (Type or Print)		4. SIGNATURE OF INVESTIGATOR 
b. ORGANIZATION OR ADDRESS AND PHONE		5. TYPED NAME OF INVESTIGATOR SA [REDACTED]
2a. NAME (Type or Print)		6. ORGANIZATION OF INVESTIGATOR 87th MP Det (C10) Fort Brass, NC 28310
b. ORGANIZATION OR ADDRESS AND PHONE		

**Section C. Non-waiver**

- I do not want to give up my rights:  
 I want a lawyer.  I do not want to be questioned or say anything.
- SIGNATURE OF INTERVIEWEE

ATTACH THIS WAIVER CERTIFICATE TO ANY SWORN STATEMENT (DA FORM 2829) SUBSEQUENTLY EXECUTED BY THE SUSPECT/ACCUSED.

DA FORM 3881, NOV 89

FOR OFFICIAL USE ONLY

EXHIBIT 26

**bl.7c**

000106

## THE WARNING

1. WARNING - Inform the suspect/accused of:
  - a. Your official position.
  - b. Nature of offense(s).
  - c. The fact that he/she is a suspect/accused.
2. RIGHTS - Advise the suspect/accused of his/her rights as follows:
 

"Before I ask you any questions, you must understand your rights."

  - a. "You do not have to answer my questions or say anything."
  - b. "Anything you say or do can be used as evidence against you in a criminal trial."
  - c. (For personnel subject to the UCMJ) "You have the right to talk privately to a lawyer before, during, and after questioning and to have a lawyer present with you during questioning. This lawyer

can be a civilian you arrange for at no expense to the Government or a military lawyer detailed for you at no expense to you, or both."

- or -

(For civilians not subject to the UCMJ) You have the right to talk privately to a lawyer before, during, and after questioning and to have a lawyer present with you during questioning. This lawyer can be one you arrange for at your own expense, or if you cannot afford a lawyer and want one, a lawyer will be appointed for you before any questioning begins."

- d. "If you are now willing to discuss the offense(s) under investigation, with or without a lawyer present, you have a right to stop answering questions at any time, or speak privately with a lawyer before answering further, even if you sign a waiver certificate."

Make certain the suspect/accused fully understands his/her rights.

## THE WAIVER

"Do you understand your rights?"

(If the suspect/accused says "no," determine what is not understood, and if necessary repeat the appropriate rights advisement. If the suspect/accused says "yes," ask the following question.)

"Have you ever requested a lawyer after being read your rights?"

(If the suspect/accused says "yes," find out when and where. If the request was recent (i.e., fewer than 30 days ago), obtain legal advice on whether to continue the interrogation. If the suspect/accused says "no," or if the prior request was not recent, ask him/her the following question.)

"Do you want a lawyer at this time?"

(If the suspect/accused says "yes," stop the questioning until he/she has a lawyer. If the suspect/accused says "no," ask him/her the following question.)

"At this time, are you willing to discuss the offense(s) under investigation and make a statement without talking to a lawyer and without having a lawyer present with you?" (If the suspect/accused says "no," stop the interview and have him/her read and sign the non-waiver section of the waiver certificate on the other side of this form. If the suspect/accused says "yes," have him/her read and sign the waiver section of the waiver certificate on the other side of this form.)

## SPECIAL INSTRUCTIONS

**WHEN SUSPECT/ACCUSED REFUSES TO SIGN WAIVER CERTIFICATE:** If the suspect/accused orally waives his/her rights but refuses to sign the waiver certificate, you may proceed with the questioning. Make notations on the waiver certificate to the effect that he/she has stated that he/she understands his/her rights, does not want a lawyer, wants to discuss the offense(s) under investigation, and refuses to sign the waiver certificate.

**IF WAIVER CERTIFICATE CANNOT BE COMPLETED IMMEDIATELY:** In all cases the waiver certificate must be completed as soon as possible. Every effort should be made to complete the waiver certificate before any questioning begins. If the waiver certificate cannot be completed at once, as in the case of street interrogation, completion may be temporarily postponed. Notes should be kept on the circumstances.

**PRIOR INCRIMINATING STATEMENTS:**

1. If the suspect/accused has made spontaneous incriminating statements before being properly advised of his/her rights he/she should be told that such statements do not obligate him/her to answer further questions.

2. If the suspect/accused was questioned as such either without being advised of his/her rights or some question exists as to the propriety of the first statement, the accused must be so advised. The office of the serving Staff Judge Advocate should be contacted for assistance in drafting the proper rights advisal.

**NOTE:** If 1 or 2 applies, the fact that the suspect/accused was advised accordingly should be noted in the comment section on the waiver certificate and initialed by the suspect/accused.

**WHEN SUSPECT/ACCUSED DISPLAYS INDECISION ON EXERCISING HIS OR HER RIGHTS DURING THE INTERROGATION PROCESS:** If during the interrogation, the suspect displays indecision about requesting counsel (for example, "Maybe I should get a lawyer."), further questioning must cease immediately. At that point, you may question the suspect/accused only concerning whether he or she desires to waive counsel. The questioning may not be utilized to discourage a suspect/accused from exercising his/her rights. (For example, do not make such comments as "If you didn't do anything wrong, you shouldn't need an attorney.")

COMMENTS (Continued)

**LAW ENFORCEMENT SENSITIVE  
FOR OFFICIAL USE ONLY EXHIBIT 27**

**RIGHTS WARN [REDACTED] CERTIFICATE**

7-03-CID679-64999

**AUTHORITY:** Title 10, United States Code, Section 3012(g)  
**PRINCIPLE PURPOSE:** To provide commanders and law enforcement officials with means by which information may be accurately identified.  
**ROUTINE USES:** Your Social Security is used as an additional/alternative means of identification to facilitate filing and retrieval.  
**DISCLOSURE:** Disclosure of your Social Security Number is voluntary.

**LOCATION:** Fort Campbell, KY 42223 **DATE:** 9 July 04 **TIME:** 1018  
**FILE NUMBER:** 00027-03-CID679-64999-5H1  
**NAME (Last, First MI):** HOLLEYMAN, Aaron Nathaniel SSN: [REDACTED] **GRADE/STATUS:** E6/Active  
**ORGANIZATION OR ADDRESS:** Operations Detachment Alpha (ODA) 531, 5<sup>th</sup> Special Forces Group, Fort Campbell, KY 42223

**RIGHTS WAIVER/NON-WAIVER CERTIFICATE**

The investigator whose name appears below told me that he/she is with the United States Army Criminal Investigation Command as a Special Agent and wanted to question me about the following offense(s) of which I am suspected/accused: Aggravated Assault; Conspiracy; Misprision of a Serious Offense; False Official Statement; False Swearing

Before he/she asked me any questions about the offense(s), however, he/she made it clear to me that I have the following rights:

- 1. I do not have to answer questions or say anything.
- 2. Anything I say or do can be used as evidence against me in a criminal trial.
- 3. (For personnel subject to the UCMJ) I have the right to talk privately to a lawyer before, during, and after questioning and to have a lawyer present with me during questioning. This lawyer can be a civilian lawyer I arrange for at no expense to the Government or a military lawyer detailed for me at no expense to me, or both.

- or -

(For ~~persons~~ not subject to the UCMJ) I have the right to talk privately to a lawyer before, during, and after questioning and to have a lawyer present with me during questioning. I understand that this lawyer can be one that I arrange for at my own expense, or if I cannot afford a lawyer and want one, a lawyer will be appointed for me before any questioning begins.

- 4. If I am now willing to discuss the offense(s) under investigation, with, or without a lawyer present, I have the right to stop answering questions at any time or speak privately with a lawyer before answering further, even if I sign the waiver below.
- 5. **COMMENTS:** Have you ever been advised of your legal rights and requested legal counsel? No

I understand my rights as stated above. I am now willing to discuss the offense(s) under investigation and make a statement without talking to a lawyer first and without having a lawyer present with me.

Signature of Witness  
SA [REDACTED]  
87<sup>th</sup> MP Det (CID)  
Witness# 2  
Signature of Witness

Signature of Interviewee  
[REDACTED]  
Signature  
SA [REDACTED]  
1000<sup>th</sup> MP BN (CID)  
FORT CAMPBELL, KY 42223

**NON-WAIVER CERTIFICATE**

I do not want to give up my rights: I want a lawyer:  I do not want to be questioned or say anything:

Signature of Interviewee: \_\_\_\_\_

[REDACTED]  
b2b67c

EXHIBIT 27

000108

SWORN STATEMENT

For use of this form, see AR 190-45; the proponent agency is ODCSOPS

LOCATION FT. CAMPBELL, Ky 42223	DATE 9 July 04	TIME 1301-1826	FILE NUMBER
LAST NAME, FIRST NAME, MIDDLE NAME Holleyman, Aaron Nathaniel	SOCIAL SECURITY NUMBER.	GRADE/STATUS E-6/566	
ORGANIZATION OR ADDRESS C/1/5 SFG(A) ODA 531 FT. CAMPBELL, Ky 42223			

I, Aaron Holleyman, WANT TO MAKE THE FOLLOWING STATEMENT UNDER OATH

ON 31 OCT 03 I RECEIVED WORD THAT WOUNDED WAS ON THE WAY TO OUR COMPOUND AT ABOUT 1730. THAT WAS THE ONLY INFORMATION THAT I WAS GIVEN. ABOUT 5 MINUTES LATER A GMV PULLED UP AT THE STOPS OF THE LANDING DOCK AND I WITNESSED SFC [REDACTED] STEP OUT OF THE PASSENGER SEAT COVERED WITH BLOOD, MISSING HIS RIGHT ARM AND HIS LEFT ARM HANGING LIMPLY AT HIS SIDE. I WENT TO HIM AND HELPED HIM WALK TO MY AIR-STATION. ONCE INSIDE I STARTED TREATING HIS INJURIES. ONCE HE WAS STABILIZED I FLOW WITH HIM TO AL ASAD WHERE HE UNDERWENT THE FIRST SURGERY AND I STAYED WITH HIM UNTIL HE WAS FLOWN TO BAHADAD THE NEXT DAY. I LINKED BACK UP WITH MY TEAM A COUPLE OF DAYS LATER AND RESUMED OPERATIONS.

ON 21 ~~NOV~~ NOV 03 WE WERE LEAVING HUSAYBATH HEADINK BACK TO OUR COMPOUND WHEN MY GMV WAS ANNIHILATED WITH A 62MM CHINESE ROCKET. THE ROCKET STRUCK THE REAR PASSENGER SIDE DOOR AND DESTROYED. WHEN THE SMOKE CLEARED OUR CONVOY CONTINUED THROUGH TOWN UNTIL WE COULD FIND A SUITABLE SPOT FOR US TO TREAT THE WOUNDED. MY TEAM SERGEANT RICH [REDACTED] HAD BEEN INJURED SEVERELY IN HIS RIGHT ARM AND FACE. ONCE I STABILIZED HIS INJURIES HE WAS FLOWN TO THOR BASE WHERE I MET HIM TO UNDERGO SURGERY AND THEN FLOWN TO BAHADAD. WE AS A TEAM RESUMED MISSION THE NEXT DAY.

ON 24 OR 25 NOV 03 I WAS TASKED TO GO TO THE DETENTION FACILITY ALONG WITH CW2 [REDACTED] AND SSG [REDACTED] CONDUCT RESTRAINED INTERVIEWS. SOMETIME DURING THAT DAY WE WERE ASKED TO STAND IN ON AIC [REDACTED] INTERVIEW. NO

EXHIBIT	INITIALS OF PERSON MAKING STATEMENT AS	PAGE 1 OF 10 PAGES
---------	---	--------------------

ADDITIONAL PAGES MUST CONTAIN THE HEADING "STATEMENT OF [REDACTED] TAKEN AT [REDACTED] DATED [REDACTED] CONTINUED." THE BOTTOM OF EACH ADDITIONAL PAGE MUST BEAR THE INITIALS OF THE PERSON MAKING THE STATEMENT AND BE INITIALED AS "PAGE [REDACTED] OF [REDACTED] PAGES." WHEN ADDITIONAL PAGES ARE UTILIZED, THE BACK OF PAGE 1 WILL BE LINED OUT, AND THE STATEMENT WILL BE CONCLUDED ON THE REVERSE SIDE OF ANOTHER COPY OF THIS FORM.

NOT USED

AFFIDAVIT

I, \_\_\_\_\_ HAVE READ OR HAVE HAD READ TO ME THIS STATEMENT WHICH BEGINS ON PAGE 1 AND ENDS ON PAGE \_\_\_\_\_. I FULLY UNDERSTAND THE CONTENTS OF THE ENTIRE STATEMENT MADE BY ME. THE STATEMENT IS TRUE. I HAVE INITIALED ALL CORRECTIONS AND HAVE INITIALED THE BOTTOM OF EACH PAGE CONTAINING THE STATEMENT. I HAVE MADE THIS STATEMENT FREELY WITHOUT HOPE OF BENEFIT OR REWARD, WITHOUT THREAT OF PUNISHMENT, AND WITHOUT COERCION, UNLAWFUL INFLUENCE, OR UNLAWFUL INDUCEMENT.

WITNESSES:

ORGANIZATION OR ADDRESS

ORGANIZATION OR ADDRESS

INITIALS OF PERSON MAKING STATEMENT

(Signature of Person Making Statement)

Subscribed and sworn to before me, a person authorized by law to administer oaths, this \_\_\_\_\_ day of \_\_\_\_\_, 19\_\_\_\_ at \_\_\_\_\_

(Signature of Person Administering Oath)

(Typed Name of Person Administering Oath)

(Authority To Administer Oaths)

PAGE OF PAGES

000110

STATEMENT OF:

HOLLEYMAN, AARON

dated: 9 JUL 04

0027-03-CID679-64999

When we walked in there was about 10-15 people in the room to include 3<sup>rd</sup> ACR, [redacted] The General was standing in the corner with [redacted] around him asking questions along with the 3<sup>rd</sup> ACR interpreter. When [redacted] asked the General a question he would not answer. They would then take a rubber hose and strike the wall. They would ask again then strike the floor. They would then strike the General if he still would not answer. After this a white guy in [redacted] stopped in front of the General. The General attempted to kick him. When this happened the white room converted on the General to subdue him. While [redacted] subdue the General was struck with the rubber hose and punched. I punched the General while he was being subdued. Once he was restrained the decision was made to end the interview and continue later. At this time I left the room with CW2 [redacted] and ISK [redacted] to complete our interviews. [redacted] were being directed by [redacted] who got the questions from those in the room.

Q: [redacted]

A: HOLLEYMAN.

Q: How many times did you punch GENERAL MOWHOUSH?

A: At least 2 but nowhere than 6 times

Q: Where did you punch GENERAL MOWHOUSH?

A: MID SECTION

Q: DID YOU STRIKE GENERAL MOWHOUSH WITH AN OBJECT?

A: NO

EXHIBIT 27

NO

b1, b3,

b67C

Page 2 of 10<sup>KS</sup>

000111

STATEMENT OF:

ITOLLEY, [REDACTED]

DATE: 9 JUL 04

0027 - [REDACTED] - 64999

Q: DID YOU WITNESS SSG [REDACTED] STRIKE GENERAL MOWHOUSH?

A: NO, I WAS FOCUSED ON RESTRAINING AND SUBDUING THE GENERAL.

Q: DID YOU WITNESS SSG [REDACTED] RESTRAIN THE GENERAL IN ANYWAY?

A: WHEN THE ROOM CONVERGED ON THE GENERAL HE WAS IN THE GROUP BUT I DID NOT WITNESS WHAT HIS ACTIONS WERE.

Q: DID YOU WITNESS CW2 [REDACTED] STRIKE GEN. MOWHOUSH?

A: WHEN THE ROOM CONVERGED ON THE GENERAL HE WAS IN THE GROUP BUT I DID NOT WITNESS HIS ACTIONS.

Q: WAS MSG [REDACTED] IN THE INTERROGATION ROOM?

A: I AM NOT SURE IF HE WAS BUT HE WENT OUT THERE THAT DAY, BUT I CAN'T SAY WHETHER HE WAS PRESENT AT THE TIME I WAS THERE.

Q: WHO DIRECTED YOU FOR YOUR TEAM TO ENTER THE INTERROGATION ROOM?

A: I BELIEVE MR. [REDACTED] ASKED US TO BE PRESENT AS WE WERE LEAVING OUR OWN INTERVIEW UNRELATED TO THE GENERAL.

Q: WHY DID YOU PUNCH GENERAL MOWHOUSH?

A: I WAS ANGRY FOR WHAT HAD HAPPENED TO SFC [REDACTED] AND MSG [REDACTED] OVER THE PAST 3 WEEKS AND WHEN I SAW HIM (THE GENERAL) ATTEMPT TO ATTACK AN AMERICAN I GOT CARRIED AWAY WITH MY EMOTIONS.

Q: DID YOU WRONGFULLY STRIKE GENERAL MOWHOUSH?

A: AT THE TIME I DID NOT BECAUSE HE WAS ATTEMPTING TO ATTACK SOMEONE BUT LOOKING BACK IT WAS BECAUSE THERE WERE ALREADY PEOPLE ATTEMPTING TO RESTRAIN HIM.

Q: DESCRIBE GEN. MOWHOUSH'S REACTION?

A: DURING THE QUESTIONING WHEN HE WAS STRUCK HE WOULD YELL OUT ~~NO~~

EXHIBIT 27

PAGE 3 OF 10

b6,7c

000112

Land by in pain. That continued until he was restrained after attempting to attack and quit resisting.

0027 [redacted] 079-64999

Q: YOU MENTIONED YOU OBSERVED PERSON(S) USING PHYSICAL FORCES ON GENERAL MOWHOUSE AS A METHOD OF INTERROGATION, IS THAT CORRECT?

A: YES, [redacted] WOULD HIT HIM IN THE LEGS AND MID SECTION WITH THE RUBBER HOSES WHEN HE WOULD NOT ANSWER THEM.

Q: PRIOR TO GENERAL MOWHOUSE KICKING AT THE INTERROGATORS, HOW MANY (APPROXIMATE) TIMES WAS HE STRUCK WITH AN INSTRUMENT?

A: IN THE FIRST 2-3 MIN (WAS IN THERE HE WAS STRUCK BETWEEN 15-25 TIMES.

Q: DID SSG [redacted] & CWZ [redacted] OBSERVE INTERROGATORS STRIKE GEN. MOWHOUSE W/ AN INSTRUMENT?

A: YES

Q: DID YOU NOTICE ANY INJURIES ON GENERAL MOWHOUSE?

A: NO, HE WAS WEARING HIS DISH DASHA AND I NEVER <sup>PERFORMED</sup> ~~PERFORMED~~ A MEDICAL SCREENING ON HIM.

Q: WHAT IS YOUR MOS?

A: 18D, SPECIAL FORCES MEDICAL SERGEANT

Q: DESCRIBE ANY INSTRUMENT(S) THAT WERE USED AS A METHOD OF INTERROGATION?

EXHIBIT 27

A: HEAVY BLACK RUBBER HOSE APPROXIMATELY 3 FT LONG AND 1-1/2" THICK, 8" WOODEN CLUB. THE HOSE WAS HARD RUBBER NOT FOAMY AND NOT HAD APPROXIMATELY 2 1/2 LBS. IT WAS SOMEWHAT FLEXIBLE BUT NOT FLIMSY. ~~TO~~

[redacted]

b1, b3, b6, b7C



STATEMENT of: [REDACTED]

HOLLEYMAN, AARON [REDACTED]

DATED 9 JULY 0027-03-CID679-64999

Q: DURING THIS INTERVIEW DID YOU DRAW A LAYOUT OF THE INTERROGATION ROOM?

A: yes

Q: [REDACTED]

A: Holleyman

Q: How many [REDACTED] were involved in the interrogation?

A: [REDACTED]

Q: What other [REDACTED] personnel were present?

A: [REDACTED]

Q: Describe [REDACTED]

A: [REDACTED]

Q: what were [REDACTED] names/nicknames?

A: I don't know.

Q: Describe [REDACTED]

A: [REDACTED]

Q: which [REDACTED] was striking Mowhoush with the black hose?

A: [REDACTED]

Q: who was translating the interrogation for the English speakers in the room?

A: [REDACTED]

Q: who translated questions from the English speakers in to Arabic for [REDACTED]?

A: [REDACTED]

EXHIBIT 27

~~NO~~  
b1, b3, b6, 7c

Pages of 10  
000114

Statement of: [redacted] Holleyman, Aaron

Dated 9 Jul 04

0027-03-CID679-64999

Q: Do you remember anything [redacted] told you about what was being said?

A: He said that ~~the~~ the General was responsible [redacted]

Q: Was there any one person that was controlling [redacted] actions?

A: No, [redacted] would take questions and have [redacted] ask the General.

Q: Describe [redacted].

A: Approximately [redacted]

Q: How long did it take to subdue Mowhoush once ~~at~~ everyone conversed on him?

A: 30-45 secs.

Q: Was Mowhoush flex cuffed during the interrogation?

A: Yes

Q: How often did you travel to the [redacted] detention facility?

A: Every other day

Q: What is your understanding of why your team was brought in to the interrogation room with Mowhoush?

A: As to show of force.

Q: What happened once Mowhoush was subdued?

A: We backed off of the General. He moaned and sat himself up in a corner. It was decided that the interview was over so we left.

Q: Was there anyone in the room that did not converse on Mowhoush when he lashed out?

A: [redacted]

EXHIBIT 27

Q: Did you or any of your Team members conspire to withhold information about what happened to Mowhoush?

A: No, not to my knowledge. ~~to~~

b1, b3, **667C**

Statement of:

Holleyman, Aaron

Dated  
9 Jul 04

Q: Did you observe any other interrogations during which detainees were struck?

A: yes.

0027-03-CID679-64999

Q: who did you observe striking detainees?

A: [redacted]

Q: Describe [redacted]

A: [redacted]

A: [redacted]

Q: How many times did you see [redacted] <sup>but would work with us when we needed him.</sup> strike a detainee during interrogation?

A: I only saw him do it during [redacted] and only at the detention center. During [redacted] I was out at the detention center every other day for 2 weeks. I could not have seen him more than 2 or 3 times but of those times I would say it was more than half.

Q: How many times did you see [redacted] strike a detainee during interrogation?

A: During the same period mentioned above and approximately the same number of times.

Q: Describe how [redacted] would strike detainees?

A: He would use a 8" (approx) wood club and his hands. He would use the club and tap their head to intimidate them, he would also use it to strike the shoulders and hands. He would also slap and punch them.

Q: Describe the reactions of the detainees you saw [redacted] strike.

EXHIBIT 27

A: when he would strike with the club on a bony prominence it was hard enough to make them grimace and sometimes scream.

Q: Describe how [redacted]

Q: who was in the room with [redacted] when you saw him striking detainees?

[redacted] Page 7 of 10

b1, b3, b6, b7C

000116

A: Sometimes He was by himself other times He would have [redacted]

Q: Describe how [redacted] would strike detainees during interrogation

A: He would punch, slap or kick them.

0027-r3-CID679-64999

Q: Do you know which detainees struck?

[redacted]

A: no

Q: Who was in the room with [redacted] when he was striking detainees?

A: [redacted] only

Q: Why was [redacted] striking the detainees?

A: It appeared that he was frustrated because the detainees would not talk.

Q: Why was [redacted] striking the detainees?

A: The same reason as [redacted]

Q: Did you tell anyone about [redacted] striking detainees?

A: The team brought it to [redacted] attention, after it was brought up at a team meeting, the command went to the [redacted] with our concerns.

Q: Who from your team observed [redacted] striking detainees?

A: Based on our conversations at the meeting stated above, I feel as though everyone on the team had witnessed it at some time.

Q: Was the fact that [redacted] was striking detainees ever addressed to the unit leadership?

A: The interpreters were told that if they had done it in the past that they were not to do it anymore. They were told, if they had struck anyone before to stop because it would not be tolerated. I'm not sure who told them but it was conveyed to them.

Q: Did [redacted] continue to strike detainees after the unit leadership addressed his behavior to [redacted]?

A: The day we had the meeting was the day that I wrote my statement. The [redacted] personnel were soon rotated out and I did not see [redacted] strike anyone after that.

EXHIBIT 21

Q: Where any photographs taken of any of the incidents you have described?

A: No

[redacted]

Statement of [REDACTED] Holleyman, Aaron Dated  
9 Jul 04

Q: Why were you not entirely honest in your previous statements about the incident with Mowhoush?

A: I know that I was wrong for striking him and I was worried about what might have happened to me. I was covering myself.

Q: How would you characterize the way you have been treated during your interview?

A: I have been treated with respect and honesty.

Q: Have you been offered the chance to eat, use the latrine and smoke?

A: yes

Q: Is there anything you would like to add to this statement?

A: NO!!! END OF STATEMENT!!!

0027-03-C1D679-64999

[REDACTED]  
EXHIBIT 27

To  
Page 9 of 10

b6,7C

000118

**SWORN STATEMENT**

For use of this form, see AR 190-45; the proponent agency is ODCSOPS

LOCATION	DATE	TIME	FILE NUMBER
LAST NAME, FIRST NAME, MIDDLE NAME	SOCIAL SECURITY NUMBER		GRADE/STATUS
ORGANIZATION OR ADDRESS			

I, \_\_\_\_\_, WANT TO MAKE THE FOLLOWING STATEMENT UNDER OATH

*NOT USED*

EXHIBIT	INITIALS OF PERSON MAKING STATEMENT	PAGE 1 OF _____ PAGES
---------	-------------------------------------	-----------------------

ADDITIONAL PAGES MUST CONTAIN THE HEADING "STATEMENT OF \_\_\_\_\_ TAKEN AT \_\_\_\_\_ DATED \_\_\_\_\_ CONTINUED." THE BOTTOM OF EACH ADDITIONAL PAGE MUST BEAR THE INITIALS OF THE PERSON MAKING THE STATEMENT AND BE INITIALED AS "PAGE \_\_\_\_\_ OF \_\_\_\_\_ PAGES." WHEN ADDITIONAL PAGES ARE UTILIZED, THE BACK OF PAGE 1 WILL BE LINED OUT, AND THE STATEMENT WILL BE CONCLUDED ON THE REVERSE SIDE OF ANOTHER COPY OF THIS FORM.

DA FORM 2823  
JUL 72

SUPERSEDES DA FORM 2823, 1 JAN 69, WHICH WILL BE USED

000119

STATEMENT (Continued)

0027-03-CID679-64999

~~AS~~ NOT USED

~~AS~~

AFFIDAVIT

Mr. Aaron Holloman HAVE READ OR HAVE HAD READ TO ME THIS STATEMENT WHICH BEGINS ON PAGE 1 AND ENDS ON PAGE 10. I FULLY UNDERSTAND THE CONTENTS OF THE ENTIRE STATEMENT MADE BY ME. THE STATEMENT IS TRUE. I HAVE INITIALED ALL CORRECTIONS AND HAVE INITIALED THE BOTTOM OF EACH PAGE CONTAINING THE STATEMENT. I HAVE MADE THIS STATEMENT FREELY WITHOUT HOPE OF BENEFIT OR REWARD, WITHOUT THREAT OF PUNISHMENT, AND WITHOUT COERCION, UNLAWFUL INFLUENCE, OR UNLAWFUL INDUCEMENT.

*[Signature]*  
(Signature of Person Making Statement)

WITNESSES:

SA [Redacted]  
B7E MP Det (C/O), Fort Bragg, NC

Subscribed and sworn to before me, a person authorized by law to administer oaths, this 9<sup>th</sup> day of July, 2008 at FORT CAMPBELL, KY 42223

[Redacted] SA  
(Signature of Person Administering Oath)

[Redacted]  
(Typed Name of Person Administering Oath)  
ARTICLE 136 (b) (4)  
(Authority To Administer Oaths)

ORGANIZATION OR ADDRESS

INITIALS OF PERSON MAKING STATEMENT

PAGE 10 OF 10 PAGES

EXHIBIT 27.

b6.7c

000120

Door

0021-03-CIN679-64999

GENERAL

CIV

CIV

CIV

Holleyman

CONFERENCE POINT

CLASSIFIED

CIV

9 July 04 1600

Arson Holleyman

Hose in trunk

EXHIBIT 27

20' X 30'

b2b67C

000121

SA

SA



**RIGHTS WARN[REDACTED] CERTIFICATE**

**AUTHORITY:** Title 10, United States Code, Section 3012(g)  
**PRINCIPLE PURPOSE:** To provide commanders and law enforcement officials with means by which information may be accurately identified.  
**ROUTINE USES:** Your Social Security is used as an additional/alternative means of identification to facilitate filing and retrieval.  
**DISCLOSURE:** Disclosure of your Social Security Number is voluntary.

**LOCATION:** Fort Campbell, KY 42223 **DATE:** 10 Jul 04 **TIME:** 1330  
**FILE NUMBER:** 00027-03-CID679-64999-5H1  
**NAME (Last, First MI):** [REDACTED] **SSN:** [REDACTED] **GRADE/STATUS:** E6/Active  
**ORGANIZATION OR ADDRESS:** Operations Detachment Alpha (ODA) [REDACTED] Special Forces Group, Fort Campbell, KY 42223

**RIGHTS WAIVER/NON-WAIVER CERTIFICATE**

The investigator whose name appears below told me that he/she is with the United States Army Criminal Investigation Command as a Special Agent and wanted to question me about the following offense(s) of which I am suspected: Aggravated Assault; Conspiracy; Misprision of a Serious Offense; False Official Statement; False Swearing//

Before he/she asked me any questions about the offense(s), however, he/she made it clear to me that I have the following rights:

1. I do not have to answer questions or say anything.
2. Anything I say or do can be used as evidence against me in a criminal trial.
3. (For personnel subject to the UCMJ) I have the right to talk privately to a lawyer before, during, and after questioning and to have a lawyer present with me during questioning. This lawyer can be a civilian lawyer I arrange for at no expense to the Government or a military lawyer detailed for me at no expense to me, or both.

- or -

(For ~~civilians~~ not subject to the UCMJ) I have the right to talk privately to a lawyer before, during, and after questioning and to have a lawyer present with me during questioning. I understand that this lawyer can be one that I arrange for at my own expense, or if I cannot afford a lawyer and want one, a lawyer will be appointed for me before any questioning begins.

4. If I am now willing to discuss the offense(s) under investigation, with, or without a lawyer present, I have the right to stop answering questions at any time or speak privately with a lawyer before answering further, even if I sign the waiver below.

5. **COMMENTS:** Have you ever been advised of your legal rights and requested legal counsel? <sup>NO</sup> N/A [REDACTED]

I understand my rights as stated above. I am now willing to discuss the offense(s) under investigation and make a statement without talking to a lawyer first and without having a lawyer present with me.

Signature of Witness  
SIA [REDACTED]  
87th MP Det (CID)  
Witness# 2  
Signature of Witness  
[REDACTED]

Signature of Investigator/Special Agent  
SA [REDACTED]  
1000<sup>TH</sup> MP BN (CID)  
FORT CAMPBELL, KY 42223

**NON-WAIVER CERTIFICATE**

I do not want to give up my rights: I want a lawyer:  I do not want to be questioned or say anything:

Signature of Interviewee: \_\_\_\_\_

DA Form 3881-E

[REDACTED] Y

**EXHIBIT 28**

bl, 7C

000122

SWORN STATEMENT 027-03-CID679-64999

For use of this form, see AR 190-45; the proponent agency is GDSOPS

LOCATION FORT CAMPBELL, KY 42223	DATE 10/11/04	TIME 2235	FILE NUMBER
LAST NAME, FIRST NAME, MIDDLE NAME [REDACTED]	SOCIAL SECURITY NUMBER [REDACTED]	GRADE/STATUS E6/ACTIVE	
ORGANIZATION OR ADDRESS OPERATIONS DETACHMENT ALPHA (DDA), 515/5 <sup>th</sup> SPECIAL FORCES GROUP (SFG)			

I, [REDACTED], WANT TO MAKE THE FOLLOWING STATEMENT UNDER OATH.

I WAS ATTACHED TO ODA 531 AFTER HEARING A RADIO MSG THAT MY FRIEND SFC [REDACTED] HAD BEEN SERIOUSLY WOUNDED IN ACTION. ON APPROX. 3 DAYS BEFORE THE DEATH OF GEN MAHOWISH MYSELF AND SSG AARON HOLLERMAN HAD TO RETURN TO THE TRAIN STATION TO PICK UP SOME EQUIPMENT ON THE WAY BACK TO THE DETENTION FACILITY WE WERE INTERCEPTED BY TO [REDACTED] WHICH DESPITE OUR RECOGNITION SYMBOLS BEING DISPLAYED [REDACTED] THE DETENTION FACILITY. AT THIS TIME I ASSISTED IN A COUPLE OF INTERVIEWS. AT THE END OF THE LAST INTERVIEW MYSELF AND [REDACTED] WALK DOWN THE HALL TO SEE IF THERE WERE ANY OTHER INTERVIEWS GOING ON AT WHICH TIME WE WALKED IN ON GEN. MAHOWISH BEING INTERVIEWED IN ONE OF THE LAUL [REDACTED] ROOMS. THIS ROOM WAS FILLED WITH PEOPLE THE GEN AT THIS TIME WAS STANDING AGAINST A WALL AND WAS BEING ASKED QUESTIONS BY [REDACTED] WHO WERE HITTING HIM IN THE FACE AND MIDSECTION AND ALSO IN THE THIGHS THE [REDACTED] HAD A RUBBER HOSE IN HIS HAND, THEY CONTINUED TO ASK QUESTIONS AND SLAP THE GEN IN THE FACE AND STRIKE IN THE MIDSECTION. SOME ONE THEN SAID FOR THEM TO SIT HIM DOWN AT WHICH TIME THE GEN TOOK APPROX 4 STEPS AND THEN DROPPED TO THE GROUND WHEN THEY TRIED TO HELP HIM TO HIS FEET HE KICKED IN AN ATTEMPT TO HIT SOMEONE AT WHICH TIME HE GOT RUSHED BY EVERYONE AND WAS ALSO STRUCK BY THE HOSE THE HE WAS TAKEN BACK OUT TO HIS PEN.

Q: [REDACTED]

A: [REDACTED]

Q: Did you strike Gen Mowhoush?

A: NO

Q: Describe [REDACTED] you saw hitting Mowhoush [REDACTED]

EXHIBIT 29	INITIALS OF PERSON MAKING STATEMENT	PAGE 1 OF 6 PAGES
---------------	-------------------------------------	-------------------

ADDITIONAL PAGES MUST CONTAIN THE HEADING "STATEMENT OF [REDACTED] TAKEN AT [REDACTED] DATED [REDACTED] CONTINUED." THE BOTTOM OF EACH ADDITIONAL PAGE MUST BEAR THE INITIALS OF THE PERSON MAKING THE STATEMENT AND BE INITIALED AS "PAGE [REDACTED] OF [REDACTED] PAGES." WHEN ADDITIONAL PAGES ARE UTILIZED, THE BACK OF PAGE 1 WILL BE LINED OUT, AND THE STATEMENT WILL BE CONCLUDED ON THE REVERSE SIDE OF ANOTHER COPY OF THIS FORM.

DA FORM 2823 JUL 72

SUPERSEDES DA FORM 2823 JUL 72

b1 b3 b67c

Ex 28

000123

STATEMENT (Continued)

NOT USED

AFFIDAVIT

I, \_\_\_\_\_ HAVE READ OR HAVE HAD READ TO ME THIS STATEMENT WHICH BEGINS ON PAGE 1 AND ENDS ON PAGE \_\_\_\_\_. I FULLY UNDERSTAND THE CONTENTS OF THE ENTIRE STATEMENT MADE BY ME. THE STATEMENT IS TRUE. I HAVE INITIALED ALL CORRECTIONS AND HAVE INITIALED THE BOTTOM OF EACH PAGE CONTAINING THE STATEMENT. I HAVE MADE THIS STATEMENT FREELY WITHOUT HOPE OF BENEFIT OR REWARD, WITHOUT THREAT OF PUNISHMENT, AND WITHOUT COERCION, UNLAWFUL INFLUENCE, OR UNLAWFUL INDUCEMENT.

WITNESSES:

\_\_\_\_\_  
\_\_\_\_\_  
\_\_\_\_\_

ORGANIZATION OR ADDRESS

\_\_\_\_\_  
\_\_\_\_\_  
\_\_\_\_\_

ORGANIZATION OR ADDRESS

INITIALS OF PERSON MAKING STATEMENT

(Signature of Person Making Statement)

Subscribed and sworn to before me, a person authorized by law to administer oaths, this \_\_\_\_\_ day of \_\_\_\_\_, 19 \_\_\_\_\_ at \_\_\_\_\_

(Signature of Person Administering Oath)

(Typed Name of Person Administering Oath)

(Authority To Administer Oaths)

PAGE OF PAGES

66,7C

000124

A: [REDACTED]

Q: Why was Mowhoush being struck?

A: FROM WHAT I SAW BECAUSE HE WAS GIVING THEM THE WRONG ANSWERS  
Q: Were they hitting him as part of the interrogation?

A: FROM WHAT I COULD TELL, YES

Q: How were [REDACTED] hitting Mowhoush?

A: OPEN HAND SLAP TO FACE, CLOSED FIST TO MIDSECTION, KNEES TO THE THIGH AREA

Q: How many times did they hit Mowhoush?

A: AT LEAST A DOZEN IN ABOUT 5-10 MIN

Q: Did each [REDACTED] hit Mowhoush about the same number of times?

A: YES

Q: Was anyone giving [REDACTED] instructions?

A: NO

Q: Did anyone else strike Mowhoush as part of interrogation?

A: NO

Q: Who was in the room with you?

A: CW2 [REDACTED] GEN. MAHOWISH

Q: How many people were in the room?

A: AT LEAST 15

Q: What happened when Mowhoush kicked out?

A: EVERYONE WHO WAS IN THE ROOM RAN OVER TO GET HIM

Q: Who did you see go over to get the General?

A: COULDN'T SEE IT WAS A BIG CROWD AND ALL I SAW WERE BACKS

Q: What types of blows did Mowhoush receive while he was being subdued?

A: I SAW THE HOSE SO I KNOW HE WAS HIT WITH THAT AND HE GOT KICKED BUT I COULD NOT TELL WHO WAS DOING WHAT BECAUSE OF ALL THE PEOPLE

Q: How long did it take to subdue Mowhoush?

A: LESS THAN A MIN.

Q: What happened immediately after that?

EXHIBIT 28

b67C

b1 b3

000125

STATEMENT OF [REDACTED]

DATED

10 JULY

03-C1D679-64999

A: MYSELF AND OTHERS HELPED HIM TO HIS FEET AND THE GUARDS LED HIM OUT TO HIS PEN

Q: Was Mowhoush yelling in pain when [REDACTED] were hitting him?

A: DON'T REMEMBER  
Q: How hard were [REDACTED] hitting Mowhoush?

A: MODERATE, HARD ENOUGH TO GET A RESPONSE BUT NOT HARD ENOUGH TO KNOW <sup>OUT</sup>

Q: why didn't you hit Mowhoush?

A: BECAUSE EVERYONE BEAT ME TO IT

Q: why were you not entirely honest in your previous statements?

A: OPSEC, I WASN'T SURE WHAT COULD BE SAID ABOUT [REDACTED]

Q: Did you see [REDACTED] or Holleyman hit Mowhoush?

A: NO

Q: Did you kick Mowhoush?

A: NO

Q: Did you grab Mowhoush?

A: YES, TO HELP HIM UP

Q: Did Holleyman tell you he hit Mowhoush?

A: NO, BUT HE TOLD ME HE WAS IN THE ROOM SO I GATHERED HE DID

Q: Did you discuss what to say in your previous statements with Holleyman?

A: YES, ABOUT SPELLING THE GEN. NAME AND ABOUT [REDACTED] SAYING ANYTHING ABOUT [REDACTED]

Q: Did someone tell you he hit Mowhoush?

A: NO

Q: Did you discuss what to say in your previous statements with [REDACTED]?

A: NO

Q: Did you ever hit a detainee during an interrogation?

A: YES, IN RESPONSE TO AN AGGRESSIVE ACT TOWARD ME.

Q: Who was that detainee?

A: I DO NOT REMEMBER [REDACTED]

EXHIBIT 28

Page 3 of 6

b1, b3, b6, 7C

000126

STATEMENT OF [REDACTED]

DATED 10 JUL 04

Q: Describe further the detainee's aggressive act and your response.

0027-03-CID679-64999

A: DURING THE INTERROGATION THE DETAINEE AGGRESSIVELY ROSE UP AND APPROACHED ME IN A THREATENING MANNER AT WHICH TIME I STRUCK HIM IN THE MIDSECTION TO BANK HIM UP. I STRUCK HIM WITH MY CLOSED FIST.

Q: Would you characterize your use of force as appropriate?

A: YES

Q: Did you see anyone strike Mowhoush outside of the incident you have already described?

A: A GARDIAN GUARD HAD AN ASP AND HAD MAHWISH GOING UP AND DOWN THE STAIRS AND STRUCK HIM A COUPLE OF TIMES IN THE BUTTOCKS AND BACK OF HIS THIGHS WITH THE ASP

Q: Describe the guard you saw hitting Mowhoush?

A: A WHITE MALE IN DCUs

Q: How hard did he hit Mowhoush?

A: MODERATE POP TO GET HIM TO GO UP THE STAIRS

Q: Did you see [REDACTED] strike other detainees during interrogation?

A: YES, AT 4-5 DETAINEES

Q: Describe what you saw.

A: ONE DETAINEE WAS FOR AT LEAST 45 MIN AND HIT HIM IN THE FACE AND BODY WITH THIR HANDS, FISTS, KNEES AND A RUBBER HOSE. THE OTHERS WERE JUST WITH HANDS, FISTS, AND KNEES.

Q: On any of these occasions were US personnel participating in the interrogations?

A: YES, I WAS IN AND OUT OF THE INTERVIEW ROOM AND [REDACTED] WERE INTERVIEWING A DETAINEE [REDACTED] WAS WRITING NOTES AS THE INTERVIEW WENT ON [REDACTED] WOULD SLAP THE DETAINEE A COUPLE TIMES AND [REDACTED] HIT HIM WITH THE HOSE [REDACTED] STOPPED THEM

Q: Did you see any other US personnel in interrogations with [REDACTED] when [REDACTED] hit a detainee?

A: YES, [REDACTED]

Q: Who does [REDACTED] work for?

A: HE TOLD ME HE WAS A [REDACTED]

EXHIBIT 28

b1, b3, b6, b7C

STATEMENT OF: [REDACTED]

DATED

0027-03-C/D 10 JUL 04  
D679-64999  
use physical

Q: Did you ever see any US personnel use force as an interrogation technique?

A: [REDACTED] AARON HOLLERMAN TOLD ME [REDACTED] HAD USED FORCE DURING AN INTERROGATION. NO I HAVEN'T SEEN ANY US PERSONNEL USE FORCE DURING AN INTERROGATION.

Q: What did Hollerman tell you [REDACTED] did?

A: HE BROKE A DETAINEES ARM

Q: Do you know where this happened?

A: NO

Q: Did you draw a sketch of the interrogation of Mowhoush during this interview?

A: YES

Q: How many [REDACTED] were located in Al Qaim?

A: I ~~KENB~~ REMEMBER [REDACTED] BUT MAY HAVE BEEN MORE

Q: Were all [REDACTED] involved in hands on interrogations?

A: I SAW THE [REDACTED] THAT WERE WITH MAHOWISH MORE THAN ONCE AND [REDACTED] ONE ONLY ONCE

Q: Describe the [REDACTED]?

A: [REDACTED]

Q: How have you been treated during this interview?

A: VERY WELL

Q: Have you been offered food and the opportunity to use the latrine?

A: YES

Q: Is there anything you would like to add to this statement?

A: NO // END OF STATEMENT [REDACTED]

EXHIBIT 28

STATEMENT (Continued)

0027 - 03 - CID 679 - 64999

NOT USED

AFFIDAVIT

HAVE READ OR HAVE HAD READ TO ME THIS STATEMENT WHICH BEGINS ON PAGE 1 AND ENDS ON PAGE 6. I FULLY UNDERSTAND THE CONTENTS OF THE ENTIRE STATEMENT MADE BY ME. THE STATEMENT IS TRUE. I HAVE INITIALED ALL CORRECTIONS AND HAVE INITIALED THE BOTTOM OF EACH PAGE CONTAINING THE STATEMENT. I HAVE MADE THIS STATEMENT FREELY WITHOUT HOPE OF BENEFIT OR REWARD, WITHOUT THREAT OF PUNISHMENT, AND WITHOUT COERCION, UNLAWFUL INFLUENCE, OR UNLAWFUL INDUCEMENT.

WITNESSES:

BTIS MP Det (CID), Fort Bragg, NC  
ORGANIZATION OR ADDRESS

ORGANIZATION OR ADDRESS

INITIALS OF PERSON MAKING STATEMENT

(Signature of Person Making Statement)  
Subscribed and sworn to before me, a person authorized by law to administer oaths, this 10<sup>th</sup> day of July, 2004 at FORT CAMPBELL, KY 42223  
(Typed Name of Person Administering Oath)  
ARTICLE 136 (b) (4)  
(Authority To Administer Oaths)

PAGE 6 OF 6 PAGES

EXHIBIT 28

000129

b2b67c



**SWORN STATEMENT**

For use of this form, see AR 190-45; the proponent agency is ODCSOPS

LOCATION	DATE	TIME	FILE NUMBER
LAST NAME, FIRST NAME, MIDDLE NAME		SOCIAL SECURITY NUMBER	GRADE/STATUS
ORGANIZATION OR ADDRESS			

I, \_\_\_\_\_, WANT TO MAKE THE FOLLOWING STATEMENT UNDER OATH:

*[The main body of the form is mostly blank, with a diagonal line drawn across it from the bottom left to the top right. Two large black redaction marks are present: one in the lower-left quadrant and one in the upper-right quadrant. The text "NOT USED" is written diagonally across the center of the page.]*

EXHIBIT	INITIALS OF PERSON MAKING STATEMENT	PAGE 1 OF _____ PAGES
---------	-------------------------------------	-----------------------

**ADDITIONAL PAGES MUST CONTAIN THE HEADING "STATEMENT OF \_\_\_\_\_ TAKEN AT \_\_\_\_\_ DATED \_\_\_\_\_ CONTINUED." THE BOTTOM OF EACH ADDITIONAL PAGE MUST BEAR THE INITIALS OF THE PERSON MAKING THE STATEMENT AND BE INITIALED AS "PAGE \_\_\_\_\_ OF \_\_\_\_\_ PAGES." WHEN ADDITIONAL PAGES ARE UTILIZED, THE BACK OF PAGE 1 WILL BE LINED OUT, AND THE STATEMENT WILL BE CONCLUDED ON THE REVERSE SIDE OF ANOTHER COPY OF THIS FORM.**

DA FORM 2823 JUL 72

SUPERSEDES DA FORM 2823, 1 JAN 68, WHICH WILL BE USED

*bb.7c*

000130

HOSE IN HAND  
3/4" RUBBER BLACK  
2 1/2" WIDE  
FLEXIBLE

FORM DDD-147013

10 JULY 84

0027-03-CID679-64999

DON'T MOVE

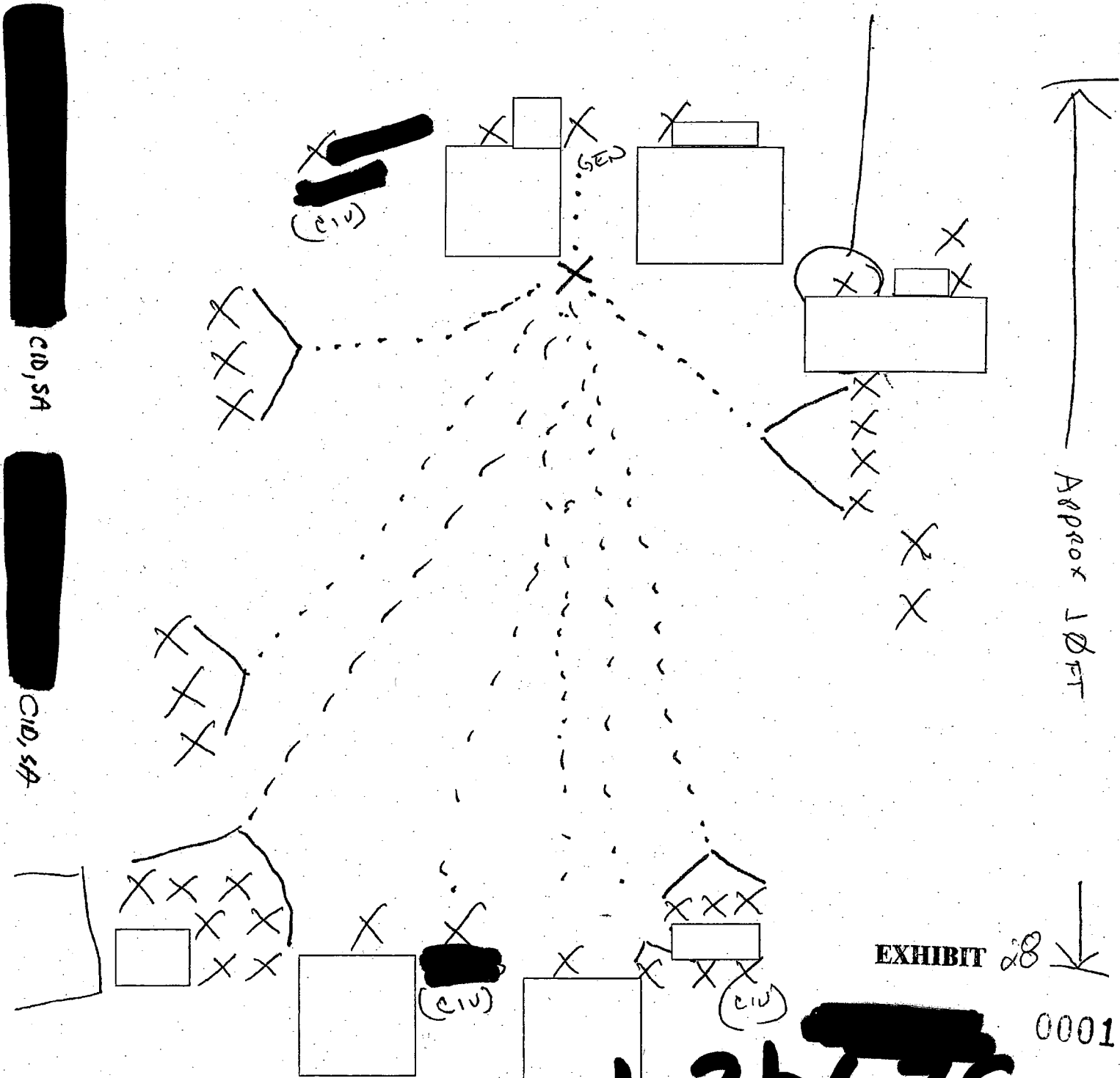

[Redacted]  
CID, SA

[Redacted]  
CID, SA

EXHIBIT 28

00013

b1 b3

b2b67C

**RIGHTS WARNING [REDACTED] CERTIFICATE**

**AUTHORITY:** Title 10, United States Code, Section 3012(g)  
**PRINCIPLE PURPOSE:** To provide commanders and law enforcement officials with means by which information may be accurately identified.  
**ROUTINE USES:** Your Social Security is used as an additional/alternative means of identification to facilitate filing and retrieval.  
**DISCLOSURE:** Disclosure of your Social Security Number is voluntary.

**LOCATION:** Fort Campbell, KY 42223 **DATE:** 12 JULY 04 **TIME:** 0900, [REDACTED]  
**FILE NUMBER:** 00027-03-CID679-64999-5H1  
**NAME (Last, First MI):** [REDACTED] **SSN:** [REDACTED] **GRADE/STATUS:** W2/Active  
**ORGANIZATION OR ADDRESS:** Operations Detachment Alpha (ODA) 531, 5<sup>th</sup> Special Forces Group, Fort Campbell, KY 42223

**RIGHTS WAIVER/NON-WAIVER CERTIFICATE**

The investigator whose name appears below told me that he/she is with the United States Army Criminal Investigation Command as a Special Agent and wanted to question me about the following offense(s) of which I am suspected: Aggravated Assault; Conspiracy; Misprision of a Serious Offense; False Official Statement; False Swearing// [REDACTED]

Before he/she asked me any questions about the offense(s), however, he/she made it clear to me that I have the following rights:

1. I do not have to answer questions or say anything.
2. Anything I say or do can be used as evidence against me in a criminal trial.
3. (For personnel subject to the UCMJ) I have the right to talk privately to a lawyer before, during, and after questioning and to have a lawyer present with me during questioning. This lawyer can be a civilian lawyer I arrange for at no expense to the Government or a military lawyer detailed for me at no expense to me, or both.

- or -

(For civilians not subject to the UCMJ) I have the right to talk privately to a lawyer before, during, and after questioning and to have a lawyer present with me during questioning. I understand that this lawyer can be one that I arrange for at my own expense, or if I cannot afford a lawyer and want one, a lawyer will be appointed for me before any questioning begins.

4. If I am now willing to discuss the offense(s) under investigation, with, or without a lawyer present, I have the right to stop answering questions at any time or speak privately with a lawyer before answering further, even if I sign the waiver below.

5. **COMMENTS:** Have you ever been advised of your legal rights and requested legal counsel? *NO*, [REDACTED]

I understand my rights as stated above. I am now willing to discuss the offense(s) under investigation and make a statement without talking to a lawyer first and without having a lawyer present with me.

Witness# 1: [REDACTED]  
Witness# 2: [REDACTED] SJA, [REDACTED]  
87<sup>th</sup> MP Det (CID), Fort Brass, WC

Signature of Witness

Signature of Investigator/Special Agent  
SA [REDACTED]  
1006<sup>th</sup> MP BN (CID)  
FORT CAMPBELL, KY 42223

**NON-WAIVER CERTIFICATE**

I do not want to give up my rights: I want a lawyer:  I do not want to be questioned or say anything:

Signature of Interviewee: \_\_\_\_\_

DA Form 3881-E

**EXHIBIT** 29)

b2, b6, 7C

000132

SWORN STATEMENT 27-03-CID679-64999

For use of this form, see AR 190-45; the proponent agency is ODCSOPS

PRIVACY ACT STATEMENT

AUTHORITY: Title 10 USC Section 301; Title 5 USC Section 2951; E.O. 9397 dated November 22, 1943 (SSN).
PRINCIPAL PURPOSE: To provide commanders and law enforcement officials with means by which information may be accurately identified.
ROUTINE USES: Your social security number is used as an additional/alternate means of identification to facilitate filing and retrieval.
DISCLOSURE: Disclosure of your social security number is voluntary.

1. LOCATION: FORT CAMPBELL, KY 42223
2. DATE (YYYYMMDD): 20040712
3. TIME: 1435
4. FILE NUMBER:
5. LAST NAME, FIRST NAME, MIDDLE NAME:
6. SSN:
7. GRADE/STATUS: W2/ACTIVE
8. ORGANIZATION OR ADDRESS: ODA 531, 5th SFG, FORT CAMPBELL, KY 42223

9. I, [redacted], WANT TO MAKE THE FOLLOWING STATEMENT UNDER OATH:
I was involved in a interrogation of a detainee in an adjoining room. After I was finished I talked to [redacted] in the hallway about General Mahowish. We came up with the tactic to place a large number of people in the room and to use [redacted] due to [redacted] 12-15 persons entered the room and began asking questions. General Mahowish stood up at this time. [redacted] began yelling at him. General Mahowish was also being slapped and hit after the yelling began. General Mahowish fell to the floor shortly after the yelling and hitting began. When General Mahowish went down his legs were around the legs of [redacted] I went forward with the intent to hold the General down & still. I placed my hands on his head and waist. If I felt [redacted]

10. EXHIBIT: 30
STATEMENT DATED:
PAGE 1 OF 6 PAGES

ADDITIONAL PAGES MUST CONTAIN THE HEADLINE AND BE DATED

THE BOTTOM OF EACH ADDITIONAL PAGE MUST BEAR THE INITIALS OF THE PERSON MAKING THE STATEMENT, AND PAGE NUMBER MUST BE INDICATED.

[redacted] b1 b3 b67C Ex 29 000133

STATEMENT OF \_\_\_\_\_ TAKEN AT \_\_\_\_\_ DATED \_\_\_\_\_

9. STATEMENT (Continued)

[Redacted area]

NOT USED

AFFIDAVIT

I, \_\_\_\_\_, HAVE READ OR HAVE HAD READ TO ME THIS STATEMENT WHICH BEGINS ON PAGE 1, AND ENDS ON PAGE \_\_\_\_\_. I FULLY UNDERSTAND THE CONTENTS OF THE ENTIRE STATEMENT MADE BY ME. THE STATEMENT IS TRUE. I HAVE INITIALED ALL CORRECTIONS AND HAVE INITIALED THE BOTTOM OF EACH PAGE CONTAINING THE STATEMENT. I HAVE MADE THIS STATEMENT FREELY WITHOUT HOPE OF BENEFIT OR REWARD, WITHOUT THREAT OF PUNISHMENT, AND WITHOUT COERCION, UNLAWFUL INFLUENCE, OR UNLAWFUL INDUCEMENT.

WITNESSES:

\_\_\_\_\_  
\_\_\_\_\_  
ORGANIZATION OR ADDRESS  
\_\_\_\_\_  
\_\_\_\_\_  
ORGANIZATION OR ADDRESS

\_\_\_\_\_  
(Signature of Person Making Statement)  
Subscribed and sworn to before me, a person authorized by law to administer oaths, this \_\_\_\_\_ day of \_\_\_\_\_, \_\_\_\_\_ at \_\_\_\_\_  
\_\_\_\_\_  
(Signature of Person Administering Oath)  
\_\_\_\_\_  
(Typed Name of Person Administering Oath)  
\_\_\_\_\_  
(Authority To Administer Oaths)

INITIALS OF PERSON MAKING STATEMENT PAGE OF PAGES

bb,7c

000134

STATEMENT OF: [REDACTED]

DATED

12 JUL 04

0027-03-CID 679-64999

resistance or movement from him I would hit or exert more force to his mid section. As soon as I saw [REDACTED] leg free. I stood up and pushed away from the General.

While I was down, there was a flurry of motion around me. I was hit and pushed in the back as others came forward to subdue the General. During these moments the General was hit and pressure was [REDACTED] placed. I do not know how long this scuffle took.

After I stood up I looked at Luc and we both shook our heads. The interrogation was over at this time. Two guards escorted General Mahowish back to the holding area, 200 meters away. General Mahowish and his two escorts walked past 3 ACR Commander and a camera man with a large T.V. camera.

There were foam pipe insulation present in the room. I am sure that these were used during the scuffle. [REDACTED]

EXHIBIT JF

Page 2 of 6

b1 b3 b67c

000135

STATEMENT OF: [REDACTED]

DATED

12 JUL 04

0027-03-CID679-64999

I cannot place a name to the person holding these foamies. I believe the entire incident lasted 10-15 minutes.

Q: Did you hit Mahowash during the interrogation?

A: No

Q: How many [REDACTED] were in the room?

A: [REDACTED]

Q: Did you see anyone hit Mahowash with the black foamie during interrogation?

A: No

Q: Describe [REDACTED] that were in the room.

A: [REDACTED]

Q: Were all [REDACTED] hitting Mahowash?

A: yes

Q: Did any [REDACTED] hit Mahowash during interrogation?

A: NO.

Q: How long did the physical part of the interrogation last?

A: 5 to 6 minutes.

Q: Who else was present in the room?

A: Lue, myself, Aaron, [REDACTED] The following were in the hallway and asked to come in. I do not know their exact placement. [REDACTED], [REDACTED], 2 SACR guards.

Q: Did you draw a sketch depicting the approximate locations of the personnel involved in the Mahowash interrogation during this interview?

A: yes. [REDACTED]

EXHIBIT 20

STATEMENT OF:

(DATED)

27-03-CID 679-64999  
12 JUL 01

Q: Prior to Mowhoush kicking, was he being assaulted

A: The General was being hit by the persons around him with open and closed hands. [redacted] was yelling questions to him. The General was not responding to any of the questions.

Q: Where was Mowhoush being hit?

A: Above the waistline.

Q: Was Mowhoush being hit as a means of obtaining information?

A: yes.

Q: who told [redacted] what to ask Mowhoush?

A: [redacted] The conversation was between Lue and myself. Once the decision was made I would have told Lue to give the questions to [redacted] because [redacted]

Q: Did you tell [redacted] it was okay to hit Mowhoush to obtain information?

A: No.

Q: why didn't you stop [redacted] when they were hitting Mowhoush for information?

A: I did not feel that it was out of hand at that time. I questioned the hitting, however did not stop it earlier during the interrogation.

Q: when do you think Mowhoush sustained the most injury?

A: After he went to the floor.

Q: Did you ever see anyone else strike [redacted] detainee as a means of obtaining information?

A: No, I had slapped a detainee to show that I knew when they were being honest.

EXHIBIT A

b1, b3, b6, 7C



STATEMENT OF [REDACTED]

DATE

12 JUL 04

0027-03-CID679-64999

This was an open palm hand slap, not forceful.

This happened on three different occasions.

Q: Describe the black linear object that was used to hit Mowhoush after he kicked?

A: It was 1 1/2" DIA foam rubber used to insulate a 1/2" DIA water pipe. "sold at Lowes"

Q: Did any of your team members strike Mowhoush at any time?

A: No. not prior to the General going down. After he went down

Arron ~~assisted~~ helped hold him down, to my right. Q: why is this statement different than your previous statements?

A: I do not want information to be added to or made to be worse than stated. It has been my experience that words can be twisted and the true meaning lost.

Q: How have you been treated during this interview?

A: as a soldier.

Q: Have you been offered the opportunity to eat and use the latrine?

A: yes.

Q: Is there anything you would like to add to this statement?

A: No. /// END OF STATEMENT ///

EXHIBIT 29

Page 5 of 6

b6.7c

000138

STATEMENT (Continued)

0027-03-C1D679-64999

NOT USED

AFFIDAVIT

I HAVE READ OR HAVE HAD READ TO ME THIS STATEMENT WHICH BEGINS ON PAGE 1 AND ENDS ON PAGE 6. I FULLY UNDERSTAND THE CONTENTS OF THE ENTIRE STATEMENT MADE BY ME. THE STATEMENT IS TRUE. I HAVE INITIAED ALL CORRECTIONS AND HAVE INITIAED THE BOTTOM OF EACH PAGE CONTAINING THE STATEMENT. I HAVE MADE THIS STATEMENT FREELY WITHOUT HOPE OF BENEFIT OR REWARD, WITHOUT THREAT OF PUNISHMENT, AND WITHOUT COERCION, UNLAWFUL INFLUENCE, OR INTimidation.

WITNESSES:

SA [redacted]  
[redacted]  
ORGANIZATION OR ADDRESS

Subscribed and sworn to before me, a person authorized by Law to administer oaths, this 12<sup>th</sup> day of July, 2004 at FORT CAMPBELL, KY 42223

[redacted] (Oath) SA [redacted]  
[redacted] (Typed Name of Person Administering Oath)

ORGANIZATION OR ADDRESS

ARTICLE 136 (b) (4)  
(Authority to Administer Oaths)

INITIALS OF PERSON MAKING STATEMENT

PAGE 6 OF 6 PAGES

B2667C

EXHIBIT 29

000139

**SWORN STATEMENT**

For use of this form, see AR 190-45; the proponent agency is ODCSOPS

LOCATION	DATE	TIME	FILE NUMBER
LAST NAME, FIRST NAME, MIDDLE NAME	SOCIAL SECURITY NUMBER		GRADE/STATUS
ORGANIZATION OR ADDRESS			

I, \_\_\_\_\_, WANT TO MAKE THE FOLLOWING STATEMENT UNDER OATH:

*NOT USED*

EXHIBIT	INITIALS OF PERSON MAKING STATEMENT	PAGE 1 OF _____ PAGES
---------	-------------------------------------	-----------------------

ADDITIONAL PAGES MUST CONTAIN THE HEADING "STATEMENT OF \_\_\_ TAKEN AT \_\_\_ DATED \_\_\_ CONTINUED."  
THE BOTTOM OF EACH ADDITIONAL PAGE MUST BEAR THE INITIALS OF THE PERSON MAKING THE STATEMENT AND BE INITIALED AS "PAGE \_\_\_ OF \_\_\_ PAGES." WHEN ADDITIONAL PAGES ARE UTILIZED, THE BACK OF PAGE 1 WILL BE LINED OUT AND THE STATEMENT WILL BE CONCLUDED ON THE REVERSE SIDE OF ANOTHER COPY OF THIS FORM.

**b6.7C**

000140

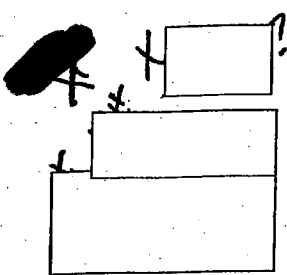

X [redacted]  
" [redacted]"

x Arrow  
~~EPH~~  
Holleyman  
"CIVIS"?

0027-03-010629  
64999 12 JUL 04

[redacted]  
CID - SA - [redacted]  
12 Jul 04  
[redacted]

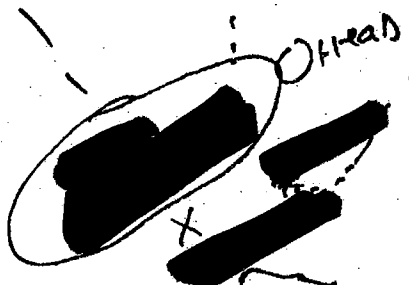

110  
one past

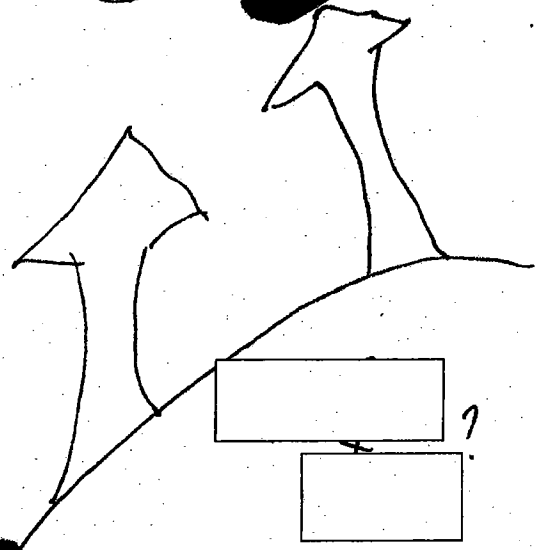

+?

+?

+?

+?

+?

+?



are one of  
these unknown  
people

EXHIBIT 29

12:34  
12 JULY 04

ACR  
Guard

X coveralls

b1 b3

b67c

000141

3-28-03  
C-2016

87<sup>TH</sup> MILITARY POLICE DETACHMENT (CID) (ABN), 3D MILITARY POLICE GROUP  
(CID), USACIDC, FORT BRAGG, NC 28310

AGENT'S INVESTIGATION REPORT  
0027-03-CID679-64999  
22 SEP 04

0027-03-CID679-64999

DETAILS:

██████████ About 1100, 4 Aug 04, SA ██████████, SA ██████████ ██████████ re-interviewed MSG (RET) ██████████ who elaborated on his previous statement. MASG (RET) ██████████ stated he was walking out of one of the interrogation buildings, when he stuck his head in one of the interrogation rooms and saw MOWHOUSH. He thought it was two or three days before MOWHOUSH died. CW3 ██████████ and ██████████ were in the room with MOWHOUSH. There were two or three other people in the room. ██████████ MSG (RET) ██████████ stepped in to the room. Shortly after, many other people came in to the room. At that point ██████████ assumed the interrogation. ██████████ were interrogating MOWHOUSH using the good cop/bad cop technique. The technique involved the good cop asking questions, and the bad cop hitting MOWHOUSH. MSG (RET) ██████████ stated the bad cop slapped MOWHOUSH with an open hand and punched him with a fist. The bad cop also hit MOWHOUSH with black hose. MSG (RET) ██████████ described the hose as having the consistency and flexibility of rubber trim used around car windows. He estimated the bad cop hit MOWHOUSH multiple times over a period of about two minutes. At one point, the people on MSG (RET) ██████████'s left started moving toward MOWHOUSH. MSG (RET) ██████████ also converged on MOWHOUSH. He stated he moved toward MOWHOUSH's feet, and held his legs. MSG (RET) ██████████ stated he might have held punched MOWHOUSH. He said he did not remember if he did, but he would not be able to refute it if someone else said they saw him hit MOWHOUSH. MSG (RET) ██████████ used the word melee to describe what happened in the room. He did not know what stopped the incident, but described it as being over "in the blink of an eye." MSG (RET) ██████████ remembered ██████████ was present, but could not remember if SSG ██████████ was there. He also stated he knew ██████████ CW2 ██████████ and Tim (NFI) were at the detention facility that day. MSG (RET) ██████████ described Tim as a bald, stocky member of one of the Special Forces teams. He estimated he was in the room with MOWHOUSH on 24 Nov 03 for about eight to ten minutes. During that time ██████████ interrogated MOWHOUSH for five to six minutes, and were hitting MOWHOUSH for about two minutes. On previous occasions MSG (RET) ██████████ observed ██████████ striking detainees with a six to eight inch long piece of wood. He thought the wood might have been from a hammer handle. ██████████ used the stick to hit detainees on the fingers, toes

DERIVED FROM:

██

SPECIAL AGENT, ██████████  
Page 1 of 8

DECLASIFY ON:  
22 SEP 2029

EXHIBIT 30

b1 b3 b2.b6.7C

000142

87<sup>TH</sup> MILITARY POLICE DETACHMENT (CID) (ABN), 3D MILITARY POLICE GROUP (CID), USACIDC, FORT BRAGG, NC 28310

AGENT'S INVESTIGATION REPORT

0027-03-CID679-64999

22 SEP 04

0027-03-CID679-64999

DETAILS:

and head. He did not know how many different detainees [redacted] hit. [redacted] [redacted] On one occasion [redacted] drew blood from a detainee's toe when he hit the detainee with the stick. MSG (RET) [redacted] had not heard of any of the medics working at the detention facility having to treat detainees with broken bones. MSG (RET) [redacted] stated he and all members of [redacted] were using interrogation methods consistent with the techniques they were subjected to during [redacted] and [redacted]. The techniques included slapping the face and head with an open hand and the use of stress positions. He could not say how often the techniques were used, but described their use as commonplace. He described the level of force used as light to moderate. MSG (RET) [redacted] witnessed [redacted] using the good cop/bad cop method to interrogate detainees a handful of times. He only observed the use of the hose to hit a detainee during the MWOHOUSH interrogation on 24 Nov 03. MSG (RET) [redacted] never saw [redacted] alone in a room with a detainee. [redacted]

[redacted] MSG (RET) [redacted] witnessed the sleeping bag being used to interrogate a detainee on one occasion at [redacted]. He observed an interrogator from 3<sup>rd</sup> ACR (NFI) interrogating a detainee who was completely enclosed in an OD green Army sleeping bag. The interrogator was squatting on the detainee's chest with his feet on either side of the detainee flat on the floor.

(FOUO) About 0940, 5 Aug 04, SA [redacted] SA [redacted] and [redacted] coordinated with Dr. [redacted]. Dr. [redacted] stated there were multiple blunt force injuries to MOWHOUSH noted during the autopsy. However, the blunt force injuries were not the cause of death. He did describe the blunt force trauma as significant, and stated it was consistent with a person being beaten. Some of the blunt force injuries appeared to have been inflicted by a long, thin object. Dr. [redacted] stated the blunt force injuries were consistent with the events of 24 Nov 03 as described by witnesses. Dr. [redacted] further stated the use of the sleeping bag on 26 Nov 03, as

SPECIAL AGENT, [redacted]

Page 2 of 8

EXHIBIT 30

b1 b3

b2b67c

000143

87<sup>TH</sup> MILITARY POLICE DETACHMENT (CID) (ABN), 3D MILITARY POLICE GROUP  
(CID), USACIDC, FORT BRAGG, NC 28310

## AGENT'S INVESTIGATION REPORT

0027-03-CID679-64999

22 SEP 04

0027-03-CID679-64999

## DETAILS:

described by witnesses, would have caused MOWHOUSH to die regardless of the 24 Nov 03 beating. The broken ribs noted at autopsy were not consistent with CPR and could have occurred on either 24 or 26 Nov 03. Dr. [REDACTED] stated MOWHOUSH did have an enlarged heart, but that was not the cause of death. Dr. [REDACTED] stated the history combined with lack of other lethal injuries were the significant findings of the autopsy that he used to conclude the death was the result of asphyxiation caused by the sleeping bag.

(S-NF) About 0945, 11 Aug 04, SA [REDACTED] and [REDACTED] interviewed [REDACTED] at his residence. [REDACTED] stated he was present at the forward detention facility on 24 Nov 03. He was there interrogating a detainee named [REDACTED] who was part of the former regime's Special Security Forces. He left that interrogation, and on his way out of the building he looked in on another interrogation and recognized MOWHOUSH. He stated [REDACTED] was asking MOWHOUSH questions in Arabic. [REDACTED] Someone in the room, he could not remember who, asked him to come and ask MOWHOUSH some questions. He thought someone also asked [REDACTED] to leave the room. [REDACTED] asked a couple of questions. He did not remember what they were or what MOWHOUSH's responses were. Shortly after he started asking questions [REDACTED] came in the room. One was hitting the floor and the wall with a hose. [REDACTED] then started screaming questions at MOWHOUSH. [REDACTED] stated he knew his role in the interrogation was finished so he decided to go outside and smoke a cigarette. He stated the way [REDACTED] were screaming was normal behavior for [REDACTED] He thought CW2 [REDACTED] and MSG (RET) [REDACTED] were in the room, and stayed, when he left, but he was not sure. While he was outside, he heard yelling and screaming coming from the room and the sound of the hose hitting the wall and the floor. He said the screaming was not the sound of someone crying out in pain. At one point MSG (RET) [REDACTED] came out of the room, and he and [REDACTED] talked about the interrogation. [REDACTED] SSG [REDACTED] and SSG HOLLEYMAN were present with him at the detention facility that day, but he was not sure if they were in the room with MOWHOUSH. He thought there were about 20 people in the room when he left. He said [REDACTED] were in the room. He heard [REDACTED] say to MOWHOUSH, "Come on tell us. We are not Sadaam Hussein. We know you hurt a lot of

[REDACTED]  
SPECIAL AGENT, [REDACTED]

Page 3 of 8

EXHIBIT 30

000144

b1 b3 b2, b6, 7c

87<sup>TH</sup> MILITARY POLICE DETACHMENT (CID) (ABN), 3D MILITARY POLICE GROUP  
(CID), USACIDC, FORT BRAGG, NC 28310

AGENT'S INVESTIGATION REPORT

0027-03-CID679-64999

22 SEP 04

DETAILS:

people." [redacted] stated no one hit MOWHOUSH while he was in the room. When [redacted] walked out MOWHOUSH's wrists were secured with zip ties. On a previous day [redacted] saw MOWHOUSH being made to walk up and down a flight of stairs as physical training. [redacted] stated he primarily worked with MSG (RET) [redacted] and [redacted] while he was in [redacted]. He had also worked with CW2 [redacted] but claimed [redacted] preferred [redacted]. [redacted] did not know how many [redacted] were in [redacted]. He could tell [redacted]. [redacted] He did not know if any [redacted] [redacted] with MOWHOUSH. [redacted] he saw with the hose in the room with MOWHOUSH was the tallest of the group. [redacted] were present the day MOWHOUSH died. He never saw anyone [redacted] or 3<sup>rd</sup> ACR hurt anyone. He described them as being professional and respectful. [redacted] described the hose the tall [redacted] was using to hit the floor as being about 1 meter long and black in color. He did not know if there was something inside the hose. [redacted] carried a small wooden stick outside of the detention facility, but he never saw [redacted] hit anyone with it. [redacted] stated he thought [redacted] was responsible for security. He did not know if [redacted] had a role in interrogation. [redacted] never saw [redacted] conducting an interrogation with [redacted] [redacted] last spoke to [redacted] one month prior to this interview. [redacted] stated he never saw anyone [redacted] hit a detainee. The only time he had seen anyone hit a detainee was when one of the guards hit a detainee who was trying to escape. [redacted]

(FOUO) About 1700, 13 Aug 04, SA [redacted] coordinated with SA [redacted] Detainee Assessment Task Force, who related he had discovered an email message from CW3 [redacted] to CW2 [redacted] A Company, 519<sup>th</sup> MI Bn, Fort Bragg, NC 28310. In the email, [redacted] advocated the use hands on techniques during interrogation. SA [redacted] stated he would provide this office with a copy of the email and a report explaining its origins.

[redacted]  
SPECIAL AGENT, [redacted]

Page 4 of 8

EXHIBIT 30

b1 b3

b2b67C

000145



[REDACTED]

87<sup>TH</sup> MILITARY POLICE DETACHMENT (CID) (ABN), 3D MILITARY POLICE GROUP  
(CID), USACIDC, FORT BRAGG, NC 28310

AGENT'S INVESTIGATION REPORT  
0027-03-CID679-64999  
22 SEP 04

DETAILS:

(FOUO) About 0900, 18 Aug 04, SA [REDACTED] received the Polygraph Examination Reports pertaining to CW2 [REDACTED], SSG [REDACTED] and SSG HOLLEYMAN. (See Polygraph Examination Reports for details)

(FOUO) About 0900, 22 Aug 04, SA [REDACTED] received SA [REDACTED] received the AIR of SA [REDACTED] 12 Aug 04, detailing the discovery of the email message pertaining to CW3 [REDACTED]. SA [REDACTED] also received a copy of the email message. A review of the message revealed CW3 [REDACTED] in response to an email stating, "the gloves are coming off," stated he advocated the use of punching and slapping in interrogations. He also advocated the use of close confinement quarters; sleep deprivation, white noise and the fear of dogs and snakes. He closed the email by stating, "I firmly agree that the gloves need to come off." The email was dated 14 Aug 03. (See AIR of SA [REDACTED] and email message dated 14 Aug 03 for details)

(S-NF) About 0905, 31 Aug 04, SA [REDACTED] and [REDACTED] interviewed SFC [REDACTED] at his residence. SFC [REDACTED] identified SPC [REDACTED] and SGT [REDACTED] both members of the Utah National Guard, as potential witnesses in this investigation. SFC [REDACTED] stated on 24 Nov 03, he was present when CW3 [REDACTED] interviewed a detainee named [REDACTED]. SFC [REDACTED] was also present for the interrogation. The interrogation was conducted at the forward detention facility known as [REDACTED]. During the interrogation, CW3 [REDACTED] put [REDACTED] in an OD green Army sleeping bag. CW3 [REDACTED] then wrapped the sleeping bag with a length of electrical cord. [REDACTED] was standing while he was being placed in the sleeping bag. After [REDACTED] was secured in the sleeping bag, CW3 [REDACTED] picked [REDACTED] up and threw him on the floor. After [REDACTED] landed on the floor, CW3 [REDACTED] jumped in the air and landed on [REDACTED] in a seated position. CW3 [REDACTED] then began to interrogate [REDACTED]. During the interrogation, CW3 [REDACTED] punched and slapped [REDACTED] through the sleeping bag. He also poured water on the area of the sleeping bag that was over [REDACTED] face. At one point during the interrogation, [REDACTED] pinched [REDACTED] leg, through the sleeping bag, hard enough to make [REDACTED] cry out in pain. Because of this he was nicknamed [REDACTED] the [REDACTED]. At that point [REDACTED] was taken out of

[REDACTED]  
SPECIAL AGENT, [REDACTED]  
Page 5 of 8

[REDACTED]

EXHIBIT 30

b1 b3 b2.b6.7c

000146

87<sup>TH</sup> MILITARY POLICE DETACHMENT (CID) (ABN), 3D MILITARY POLICE GROUP  
(CID), USACIDC, FORT BRAGG, NC 28310

AGENT'S INVESTIGATION REPORT

0027-03-CID679-64999

22 SEP 04

DETAILS:

the sleeping bag, doused with water by [REDACTED] and sent to the detention pens. SFC [REDACTED] also stated he witnesses SGT [REDACTED] hit detainees during interrogation. SFC [REDACTED] witnessed SGT [REDACTED] strike a detainee with a karate chop. He also witnessed SGT [REDACTED] punch the same detainee in the stomach. CW3 [REDACTED] told SFC [REDACTED] used his stick, a mosquito net pole, to beat up MOWHOUSH on 24 Nov 03. CW3 [REDACTED] told SFC [REDACTED] to not let CID see the stick. SFC [REDACTED] said CW3 [REDACTED] took the stick and he never saw it again. SFC [REDACTED] stated he saw several Special Forces soldiers hit detainees during interrogation. He did not know the names of the soldiers. SFC [REDACTED] stated CW2 [REDACTED] never hit a detainee during interrogation. On 18 Nov 03, SFC [REDACTED] witnessed [REDACTED] interrogating five detainees who he thought were Saudi Arabian. During the interrogations [REDACTED] hit the detainees with a hammer handle he carried around. [REDACTED] would hit the detainees on the fingers, knuckles and head with the hammer handle. SFC [REDACTED] said [REDACTED] beat the first four detainees to get the fifth to talk. During the interrogation, [REDACTED] told SFC [REDACTED] "Once you get them to this point they will confess to killing Kennedy." SFC [REDACTED] said Special Forces soldiers were also present, but he did not say if they hit the detainees. CW2 [REDACTED] told SFC [REDACTED] "I can understand why they need to hit people." SFC [REDACTED] related [REDACTED] were at the detention facility the day after CID agents had come to the detention facility to investigate the death of MOWHOUSH. [REDACTED] knew certain details of the investigation, and also knew CID suspected [REDACTED] of beating MOWHOUSH with a rifle butt. [REDACTED] told [REDACTED] he did not hit MOWHOUSH with a rifle butt. [REDACTED] said he hit MOWHOUSH with the hammer handle he carried with him. SFC [REDACTED] stated every time he saw [REDACTED] conduct an interrogation [REDACTED] would hit the detainee he was interrogating. He stated he was afraid [REDACTED] and called him a "psycho." SFC [REDACTED] stated Special Forces soldiers and [REDACTED] were routinely present when [REDACTED] hit detainees during interrogation. SFC [REDACTED] said after CID collected the sleeping bag CW3 [REDACTED] used to interrogate MOWHOUSH as evidence, CW3 [REDACTED] instructed him to find another sleeping bag to replace it. SFC [REDACTED] stated both the sleeping bag and the electrically cord were replaced, but he did not witness any subsequent use of the sleeping bag during interrogation. After the CID investigation began, CW3 [REDACTED] became more secretive

[REDACTED]  
SPECIAL AGENT, [REDACTED]

Page 6 of 8

EXHIBIT 30

b1 b3

b2 b6 7c

000147

87<sup>TH</sup> MILITARY POLICE DETACHMENT (CID) (ABN), 3D MILITARY POLICE GROUP (CID), USACIDC, FORT BRAGG, NC 28310

AGENT'S INVESTIGATION REPORT  
0027-03-CID679-64999  
22 SEP 04

DETAILS:

about interrogation. SFC [redacted] stated CW3 [redacted] would only interrogate with his trusted circle. Both SFC [redacted] and SGT [redacted] were part of the trusted circle. Special Forces soldiers began to conduct their interrogations outside of the detention facility. At one point, prior to MOWHOUSH's death, CW3 [redacted] got the interrogators together and told them to discontinue the use of the sleeping bag. SFC [redacted] said this happened because a prisoner at Al Asad had lost consciousness while [redacted] was interrogating the detainee in the sleeping bag. During the meeting CW3 [redacted] stated no one was supposed to use the sleeping bag except for SGT [redacted] and himself. On one occasion [redacted] told SFC [redacted] he thought he broke his hand when he hit a detainee. [redacted] said, "I think I broke my hand on that fat mother fucker." SFC [redacted] was not sure, but thought [redacted] was referring to MOWHOUSH. SFC [redacted] described CW2 [redacted] as sadistic and stated there was no reason for [redacted] to be in interrogations. SFC [redacted] also believed there was no way the chain of command did not know how CW3 [redacted] was conducting interrogations.

(FOUO) About 0900, 1 Sep 04, SA [redacted] and [redacted] met with MAJ [redacted] MAJ [redacted] and CPT [redacted] Office of the Staff Judge Advocate, Fort Carson, CO 80913, and briefed them on this investigation.

(FOUO) About 0900, 2 Sep 04, SA [redacted] and [redacted] attempted to interview SGT [redacted] SGT [redacted] stated he had retained legal counsel and did not wish to answer any questions.

(FOUO) About 1030, 2 Sep 04, SA [redacted] and [redacted] attempted to interview CPT [redacted] Commander, 66<sup>th</sup> MI Co, Fort Carson, CO 80913, regarding his knowledge of interrogations conducted at [redacted] CPT [redacted] stated he did not wish to answer any questions.

[redacted] About 1400, 22 Sep 04, SA [redacted] coordinated with [redacted] related 3<sup>rd</sup> ACR briefing slides had been found among the records maintained by [redacted] at Al

[redacted]  
SPECIAL AGENT, [redacted]  
Page 7 of 8

EXHIBIT 30

000148

b1 b3 b2, b6, 7C

[REDACTED]  
87<sup>TH</sup> MILITARY POLICE DETACHMENT (CID) (ABN), 3D MILITARY POLICE GROUP (CID), USACIDC, FORT BRAGG, NC 28310

AGENT'S INVESTIGATION REPORT  
0027-03-CID679-64999  
22 SEP 04

DETAILS:

Qaim. There was a total of six slides dated 18 Nov 03. The fourth slide was written in the first person and dealt with MOWHOUSH (spelled MAHAUSH on the slide). The slide described who MOWHOUSH was and what his role in the Al Qaim region was believed to be. The last paragraph on the slide dealt with interrogation. The slide states, "The interrogation session lasted several hours and I took the gloves off because Abid refused to play ball." [REDACTED] provided SA [REDACTED] with a copy of the slide via secure facsimile. (See briefing slides for details) */// LAST ENTRY ///* [REDACTED]

[REDACTED]  
SPECIAL AGENT, [REDACTED]  
Page 8 of 8

b1 b3

[REDACTED]  
**b2b67C**

EXHIBIT 30

000149

Exhibit 34

Pages 150 – 155 referred to

DIRECTORATE OF INFORMATION MANAGEMENT  
ATTN: FOIA OFFICER  
6151 SPECKER AVE  
FORT CARSON, CO 80913

Exhibit 35

Pages 156 – 158 referred to

COMMANDER  
U.S. ARMY INTELLIGENCE AND SECURITY  
COMMAND (INSCOM)  
FREEDOM OF INFORMATION/PRIVACY OFFICE  
ATTN: IAMG-CIC-FOIA/PO  
4552 PIKE ROAD  
FORT GEORGE G. MEADE, MD 20755-5995

# AGENT'S INVESTIGATION REPORT

CID Regulation 195-1

ROI NUMBER

0027-03-CID679-64999

Page 1 of 2 Pages

## DETAILS

On 31 Mar 04, LTG [REDACTED] Commander, [REDACTED] appointed MG [REDACTED] as an AR 381-10 Procedure 15 Investigating Officer (IO), to conduct an investigation in accordance with AR 15-6 into all the relevant facts and circumstances surrounding the alleged misconduct by personnel assigned or attached to the 205<sup>th</sup> MI Brigade (BDE), to include civilian interrogators and interpreters, from 15 Aug 03 – 1 Feb 04, at the Abu Ghraib Detention Facility, Baghdad, Iraq.

On 5 Jun 04, CW2 [REDACTED] A Company, 519<sup>th</sup> MI BN, Fort Bragg, NC, voluntarily provided a copy of several e-mail messages that he felt were relevant to the Procedure 15 investigation to Mr. [REDACTED] [REDACTED] 902d MI Group, Fort Meade, Maryland, a member of the Procedure 15 investigation team.

AGENT'S COMMENT: CW2 [REDACTED] was previously deployed to Iraq and performed duties at the Joint Interrogation and Debriefing Center (JIDC) at Abu Ghraib during the time period under investigation.

The Detainee Assessment Task Force, US Army Criminal Investigation Command, Fort Belvoir, VA 22060, conducted a review of the e-mail messages, which revealed on or about 14 Aug 03, CW2 [REDACTED] received an e-mail message from CW3 [REDACTED] 66<sup>th</sup> MI CO, which was a reply to a previously forwarded e-mail message from CPT [REDACTED] Battle Captain, CJTF-7 J2X. The message from CPT [REDACTED] concluded with, "The gloves are coming off gentlemen regarding these detainees, Col [REDACTED] has made it clear that we want these individuals broken. Casualties are mounting and we need to start gathering info to help protect our fellow soldiers from any further attacks. I thank you for your hard work and your dedication." CPT [REDACTED] sent his original email to three addressees - [REDACTED] [REDACTED] and [REDACTED] CPT [REDACTED]. The recipient at [REDACTED] forwarded CPT [REDACTED] e-mail message to the following addressees:

- a. SPC [REDACTED]
- b. MAJ [REDACTED]
- c. [REDACTED] (CW2 [REDACTED])
- d. [REDACTED] CPT [REDACTED]
- e. [REDACTED] (SGT [REDACTED])
- f. [REDACTED]
- g. [REDACTED]
- h. [REDACTED]
- i. [REDACTED]
- j. [REDACTED] CW4
- k. [REDACTED] MAJ (1AD 501<sup>st</sup> MI S3)
- l. [REDACTED] MSG (1AD 501<sup>st</sup> MI BN HOC)
- m. [REDACTED]

TYPED AGENT'S NAME AND SEQUENCE NUMBER SA [REDACTED]		ORGANIZATION Detainee Assessment Task Force, USACIDC Fort Belvoir, VA 22060	
SIGNATURE [REDACTED]	DATE 12 Aug 04	EXHIBIT 36	

b2b67C

# AGENT'S INVESTIGATION REPORT

CID Regulation 195-1

ROI NUMBER

0027-03-CID679-64999

Page 2 of 2 Pages

## DETAILS

- n. [REDACTED]@us.army.smil.mil
- o. [REDACTED]@us.army.smil.mil
- p. [REDACTED]
- q. [REDACTED]
- r. [REDACTED]
- s. [REDACTED]
- t. [REDACTED]
- u. [REDACTED]
- v. [REDACTED]

In CW3 [REDACTED] reply to the previously described e-mail message he stated, "I spent several months in Afghanistan interrogating the Taliban and al Qaeda. Restrictions on interrogations techniques had a negative impact on our ability to gather intelligence. Our interrogation doctrine is based on former Cold War and (sic) WWII enemies. Today's (sic) enemy, particularly those in SWA, understand force, not psychological mind games or incentives. I would propose a baseline interrogation technique that at a minimum allows for physical contact resembling that used by SERE instructors. This allows open handed facial slaps from a distance of no more than about two feet and back handed blows to the midsection from a distance of about 18 inches. Again, this is open handed. I will not comment on the effectiveness of these techniques as both a control measure and an ability to send a clear message. I also believe that this should be the minimum baseline. Other techniques would include close confinement quarters, sleep deprivation, white noise, and a litany (sic) of harsher fear-up approaches...fear of dogs and snakes appear to work nicely. I firmly agree that the gloves need to come off." [REDACTED] sent his reply e-mail message to all of the addressees who received the forwarded email, and added one addressee - [REDACTED]@us.army.smil.mil. ///LAST ENTRY///

TYPED AGENT'S NAME AND SEQUENCE NUMBER

SA [REDACTED]

ORGANIZATION

Detainee Assessment Task Force, USACIDC  
Fort Belvoir, VA 22060

SIGNATURE

[REDACTED]

DATE

12 Aug 04

EXHIBIT

36

CID FORM 101 FOR OFFICIAL USE ONLY - Law Enforcement Sensitive

(Automated)

000160

b2.b67c



Exhibit 37

Pages 161 – 163 referred to

COMMANDER  
U.S. ARMY INTELLIGENCE AND SECURITY  
COMMAND (INSCOM)  
FREEDOM OF INFORMATION/PRIVACY OFFICE  
ATTN: IAMG-CIC-FOIA/PO  
4552 PIKE ROAD  
FORT GEORGE G. MEADE, MD 20755-5995

AGENT'S INVESTIGATION REPORT

0027-03-CID679-64999

9 Feb 05

DETAILS:

(FOUO) Around 1745, 15 Nov 04, SA [REDACTED] interviewed SSG [REDACTED] [REDACTED] A Co, 141<sup>st</sup> Military Intelligence (MI) Battalion, 300<sup>th</sup> MI Brigade, Utah National Guard (NG), Utah, 84118, who provided a verbal statement. SSG [REDACTED] stated he deployed to Iraq in March of 2003, and during his tour his primary mission was an interrogator, assigned to a Mobile interrogation Team (MIT) based out of [REDACTED]. SSG [REDACTED] stated he was tasked to support the [REDACTED] in Nov 2003, which incorporated a temporary detention area named [REDACTED] which was near [REDACTED] Iraq. SSG [REDACTED] stated he was never involved in an interrogation of MG MOWHOUSH, but he was at the temporary detention area the day he died, and was canvassed interviewed by CID. He stated he believed the only person to interrogate MG MOWHOUSH was CW3 [REDACTED] the Officer in Charge (OIC) for the detention area. Further SSG [REDACTED] stated he was aware of the Sleeping Bag being used as an interrogation technique, but had never used it himself. He stated the only person he knew using it was CW3 [REDACTED]. SSG [REDACTED] stated after the death of MG MOWHOUSH, CW3 [REDACTED] told everyone of the death, and stated that MG MOWHOUSH died under stress, but did not go into any further detail. SSG [REDACTED] went on to say that CW3 [REDACTED] held a meeting in which he put out that he would do what he did because he had the experience, and if you (other interrogators) didn't feel comfortable then don't do it. SSG [REDACTED] stated CW3 [REDACTED] was referring to stress positions used in interrogations but could not remember which stress position he was referring to. SSG [REDACTED] stated he never worked with or participated in any interrogations with personnel from [REDACTED] or Special Forces (SF). SSG [REDACTED] stated he knew of no abusive techniques used while interrogating detainees

(FOUO) Around 1000, 16 Nov 04, SA [REDACTED] interviewed SSG [REDACTED] [REDACTED] C Company, 141<sup>st</sup> MI BN, 300<sup>th</sup> MI Brigade, Utah NG, Utah, 84118, who provided a verbal statement. SSG [REDACTED] stated he was assigned as an Interrogator within a MIT from July 2003, on based out of [REDACTED] Iraq. SSG [REDACTED] stated he was tasked to support the [REDACTED] in Nov 2003, which incorporated a temporary detention area named [REDACTED] which was near [REDACTED] Iraq. SSG [REDACTED] stated he never participated with any interrogations with MG MOWHOUSH, and that he believed CW3 [REDACTED] was the only person interrogating MG MOWHOUSH. SSG [REDACTED] stated the only contact he did have with MG MOWHOUSH was assisting in loading his body into a [REDACTED]

SPECIAL AGENT, [REDACTED]

Page 1 of 3

FOR OFFICIAL USE ONLY/LAW ENFORCEMENT SENSITIVE

b1 b3 b2 b6 b7c

EXHIBIT 38

000164

AGENT'S INVESTIGATION REPORT  
0027-03-CID679-64999  
9 Feb 05

DETAILS:

transport truck. He stated after the death, CW3 [REDACTED] held a meeting with all the interrogators and informed them of the death and that MG MOWHOUSH died while being interrogated in the sleeping bag. SSG [REDACTED] stated he never worked with SF or [REDACTED]. He also stated the only other person he ever seen use the sleeping bag technique was SGT [REDACTED]. SSG [REDACTED] stated he knew of no abusive techniques used while interrogating detainees.

(FOUO) Around 1200, 17 Nov 04, SA [REDACTED] interviewed SFC [REDACTED] who provided a verbal statement wherein he stated he attended a meeting between the interrogators and CW3 [REDACTED] wherein CW3 [REDACTED] put out that no interrogators besides SGT [REDACTED] or himself were allowed to use the sleeping bag technique for interrogations. SFC [REDACTED] stated the meeting was called after two interrogators (NFI) placed a detainee in the sleeping bag, and then pretended to chamber a round in a pistol in order to get the detainee to talk. SFC [REDACTED] stated this meeting took place only a couple of days prior to MG MOWHOUSH's death. SFC [REDACTED] could give no other details pertaining to the two unidentified interrogators other than he believed they were NG or Reserve soldiers, maybe under the command of 1LT [REDACTED] (NFI). SFC [REDACTED] also provided his journal, which was contained in a bound notebook. SFC [REDACTED] stated he kept the journal during his time deployed. He stated the journal contained mostly personal information but did contain information regarding events, which he was either involved in or had first hand knowledge of.

Agents Note: The journal was reviewed for any pertinent information, which met with negative results. The journal was then provided to Maj [REDACTED] Staff Judge Advocates Office, Ft Carson, 80913, for review.

(FOUO) Around 1014, 18 Nov 04, SA [REDACTED] advised MAJ [REDACTED] HHD 201<sup>ST</sup> MI Brigade, Fort Lewis, WA 98513 (Former Cdr of 66<sup>th</sup> MI) of her legal rights, which she waived and rendered a verbal statement. MAJ [REDACTED] stated CW3 [REDACTED] informed her of the death of MG MOWHOUSH. She stated when CW3 [REDACTED] told her on the phone of MG MOWHOUSH's death he (CW3 [REDACTED]) said "the son of a bitch died on me", he then asked to speak to a lawyer before giving any further details of the death.

[REDACTED]  
SPECIAL AGENT, [REDACTED]

Page 2 of 3

FOR OFFICIAL USE ONLY/LAW ENFORCEMENT SENSITIVE

EXHIBIT 38

000165

b1 b3 b2, b6, 7c

AGENT'S INVESTIGATION REPORT  
0027-03-CID679-64999  
9 Feb 05

DETAILS:

MAJ [REDACTED] stated she saw MG MOWHOUSH the day prior to his death at the temporary detention area and he appeared to be fine, she stated she even spoke with him. MAJ [REDACTED] stated in regards to the sleeping bag interrogation technique, CW3 [REDACTED] told her of the technique in Aug 2003, but she stated she wished to confer with a defense lawyer prior to answering further question regarding the sleeping bag. MAJ [REDACTED] also stated she wished to confer with a defense lawyer prior to answering questions concerning knowledge of detainee abuse by [REDACTED] SF or MI personnel. MAJ [REDACTED] was shown a copy of the briefing slides which mention MG MOWHOUSH interrogations and back ground, she stated the briefing appeared to have been generated and given at the Tiger Squadron, 3 ACR, level; however, she was unable to determine who presented the briefing, and she did not recall if she had attended the briefing. MAJ [REDACTED] stated during the [REDACTED] she visited the temporary detention facility several times. MAJ [REDACTED] change of command was on 17 Jun 04. (See Waiver Certificate for details)

(FOUO) Around 1400, 7 Feb 05, SA [REDACTED] received the Defense Computer Forensics Laboratory (DCFL) report, 24 Jan 04, DCFL# 2004-I004327, detailing the examination of the four 3<sup>rd</sup> ACR servers. The report contained four DVD's, one for each server examined, containing over 500,000 hits pertaining to the search words and phrases. (See DCFL report for details)

(FOUO) Around 1020, 9 Feb 05, SA [REDACTED] and [REDACTED] interviewed SFC [REDACTED] [REDACTED] G Company, 1st BN, 1st Special Warfare Training Center, FBNC 28310, who provided a verbal statement, in which he stated he never had contact with MG MOWOUSH, nor did he ever see any interrogations conducted on him. SFC [REDACTED] stated he did not recall any information concerning MG MOWOUSH. SFC [REDACTED] also stated he did not recall observing any abuse by Army or [REDACTED]

//////////////////////////////////////LAST ITEM//////////////////////////////////////

[REDACTED]

SPECIAL AGENT,  
Page 3 of 3

FOR OFFICIAL USE ONLY/LAW ENFORCEMENT SENSITIVE

b1 b3 **b2b67c**

EXHIBIT 38

000166

**RIGHTS WARNING PROCEDURE/WAIVER CERTIFICATE**

For use of this form, see AR 190-30; the proponent agency is ODCSOPS

**DATA REQUIRED BY THE PRIVACY ACT**

**AUTHORITY:**  
**PRINCIPAL PURPOSE:**  
**ROUTINE USES:**  
**DISCLOSURE:**

Title 10, United States Code, Section 3012(g)  
To provide commanders and law enforcement officials with means by which information may be accurately identified.  
Your Social Security Number is used as an additional/alternate means of identification to facilitate filing and retrieval.  
Disclosure of your Social Security Number is voluntary.

0027-03-CID679-64999

1. LOCATION <i>FORT LEWES, WA</i>	2. DATE <i>18 NOV 04</i>	3. TIME <i>1014</i>	FILE NO.
5. NAME (Last, First, MI) [REDACTED]	8. ORGANIZATION OR ADDRESS <i>HHD 200<sup>th</sup> ME BRIGADE FT LEWIS, WA</i>		
6. SSN [REDACTED]	7. GRADE/STATUS <i>MAJ</i>		

**PART I - RIGHTS WAIVER/NON-WAIVER CERTIFICATE**

**Section A. Rights**

The investigator whose name appears below told me that he/she is with the United States Army

*Criminal Investigation Command*

and wanted to question me about the following offense(s) of which I am

suspected/accused *dereliction of duty III*

Before he/she asked me any questions about the offense(s), however, he/she made it clear to me that I have the following rights:

- I do not have to answer any question or say anything.
  - Anything I say or do can be used as evidence against me in a criminal trial.
  - (For personnel subject to the UCMJ)* I have the right to talk privately to a lawyer before, during, and after questioning and to have a lawyer present with me during questioning. This lawyer can be a civilian lawyer I arrange for at no expense to the Government or a military lawyer detailed for me at no expense to me, or both.
- or -
- (For civilians not subject to the UCMJ)* I have the right to talk privately to a lawyer before, during, and after questioning and to have a lawyer present with me during questioning. I understand that this lawyer can be one that I arrange for at my own expense, or if I cannot afford a lawyer and want one, a lawyer will be appointed for me before any questioning begins.
- If I am now willing to discuss the offense(s) under investigation, with or without a lawyer present, I have a right to stop answering questions at any time, or speak privately with a lawyer before answering further, even if I sign the waiver below.

5. COMMENTS (Continue on reverse side)

**Section B. Waiver**

I understand my rights as stated above. I am now willing to discuss the offense(s) under investigation and make a statement without talking to a lawyer first and without having a lawyer present with me.

WITNESSES (If available)		3.
1a. NAME (Type or Print)	[REDACTED]	[REDACTED]
b. ORGANIZATION OR ADDRESS AND PHONE	[REDACTED]	[REDACTED]
2a. NAME (Type or Print)	5. TYPED NAME OF INVESTIGATOR	[REDACTED]
b. ORGANIZATION OR ADDRESS AND PHONE	6. ORGANIZATION OF INVESTIGATOR	<i>87<sup>th</sup> MP Det CIA FT BRAGG, NC 28310</i>

**Section C. Non-waiver**

- I do not want to give up my rights  
 I want a lawyer  
 I do not want to be questioned or say anything

2. SIGNATURE OF INTERVIEWEE

ATTACH THIS WAIVER CERTIFICATE TO ANY SWORN STATEMENT (DA FORM 2823) SUBSEQUENTLY EXECUTED BY THE SUSPECT/ACCUSED

*EX 39*

*b6.7C*

000167

PART II - RIGHTS WARNING PROCEDURE

THE WARNING

1. **WARNING - Inform the suspect/accused of:**
  - a. Your official position.
  - b. Nature of offense(s).
  - c. The fact that he/she is a suspect/accused.
2. **RIGHTS - Advise the suspect/accused of his/her rights as follows:**  
 "Before I ask you any questions, you must understand your rights."  
  - a. "You do not have to answer my questions or say anything."
  - b. "Anything you say or do can be used as evidence against you in a criminal trial."  
 (For personnel subject to the UCMJ) "You have the right to talk privately to a lawyer before, during, and after questioning and to have a lawyer present with you during questioning. This lawyer
  - c.

can be a civilian you arrange for at no expense to the Government or a military lawyer detailed for you at no expense to you, or both."

(For civilians not subject to the UCMJ) You have the right to talk privately to a lawyer before, during, and after questioning and to have a lawyer present with you during questioning. This lawyer can be one you arrange for at your own expense, or if you cannot afford a lawyer and want one, a lawyer will be appointed for you before any questioning begins."

- d. "If you are now willing to discuss the offense(s) under investigation, with or without a lawyer present, you have a right to stop answering questions at any time, or speak privately with a lawyer before answering further, even if you sign a waiver certificate."

Make certain the suspect/accused fully understands his/her rights.

THE WAIVER

"Do you understand your rights?"

(If the suspect/accused says "no," determine what is not understood, and if necessary repeat the appropriate rights advisement. If the suspect/accused says "yes," ask the following question.)

"Have you ever requested a lawyer after being read your rights?"

(If the suspect/accused says "yes," find out when and where. If the request was recent (i.e., fewer than 30 days ago), obtain legal advice whether to continue the interrogation. If the suspect/accused says "no," or if the prior request was not recent, ask him/her the following question.)

"Do you want a lawyer at this time?"

(If the suspect/accused says "yes," stop the questioning until he/she has a lawyer. If the suspect/accused says "no," ask him/her the following question.)

"At this time, are you willing to discuss the offense(s) under investigation and make a statement without talking to a lawyer and without having a lawyer present with you?" (If the suspect/accused says "no," stop the interview and have him/her read and sign the non-waiver section of the waiver certificate on the other side of this form. If the suspect/accused says "yes," have him/her read and sign the waiver section of the waiver certificate on the other side of this form.)

SPECIAL INSTRUCTIONS

**WHEN SUSPECT/ACCUSED REFUSES TO SIGN WAIVER CERTIFICATE:** If the suspect/accused orally waives his/her rights but refuses to sign the waiver certificate, you may proceed with the questioning. Make notations on the waiver certificate to the effect that he/she has stated that he/she understands his/her rights, does not want a lawyer, wants to discuss the offense(s) under investigation, and refuses to sign the waiver certificate.

**IF WAIVER CERTIFICATE CANNOT BE COMPLETED IMMEDIATELY:** In all cases the waiver certificate must be completed as soon as possible. Every effort should be made to complete the waiver certificate before any questioning begins. If the waiver certificate cannot be completed at once, as in the case of street interrogation, completion may be temporarily postponed. Notes should be kept on the circumstances.

**PRIOR INCRIMINATING STATEMENTS:**

1. If the suspect/accused has made spontaneous incriminating statements before being properly advised of his/her rights he/she should be told that such statements do not obligate him/her to answer further questions.

2. If the suspect/accused was questioned as such either without being advised of his/her rights or some question exists as to the propriety of the first statement, the accused must be so advised. The office of the serving Staff Judge Advocate should be contacted for assistance in drafting the proper rights advisal.

**NOTE:** If 1 or 2 applies, the fact that the suspect/accused was advised accordingly should be noted in the comment section on the waiver certificate and initialed by the suspect/accused.

**WHEN SUSPECT/ACCUSED DISPLAYS INDECISION ON EXERCISING HIS OR HER RIGHTS DURING THE INTERROGATION PROCESS:** If during the interrogation, the suspect displays indecision about requesting counsel (for example, "Maybe I should get a lawyer."), further questioning must cease immediately. At that point, you may question the suspect/accused only concerning whether he or she desires to waive counsel. The questioning may not be utilized to discourage a suspect/accused from exercising his/her rights. (For example, do not make such comments as "If you didn't do anything wrong, you shouldn't need an attorney.")

COMMENTS (Continued)

**UNITED STATES  
DEPARTMENT OF DEFENSE**

**COMPUTER FORENSICS LABORATORY**

0027-03-CID679-64999

**Digital  
Evidence  
Forensic  
Analysis  
Report**



AUTHORIZED ACCESS ONLY



DCFL Form 4, May 99

FOR OFFICIAL USE ONLY

**b67c**

Ex 40

000139



**DEPARTMENT OF DEFENSE  
COMPUTER FORENSICS LABORATORY (DCFL)  
911 Elkridge Landing Road, Suite 300  
Linthicum, MD 21090**

24 January 05

0027-03-CID679-64999

**MEMORANDUM FOR SPECIAL AGENT IN CHARGE 87<sup>th</sup> MP Det, DSE**  
Third MP Group (CID)  
Fort Bragg, NC 28307

**SUBJECT:** Digital Evidence Forensic Analysis Report – DCFL 2004-I004327

**1. Support Requested:** Special Agent (SA) [REDACTED] 87<sup>th</sup> MP Det., DSE submitted a request to search all supplied media for any files, electronic data or significant email message traffic, along with other documentation that could be considered evidence in this murder investigation. The search authority was provided by CAPT. [REDACTED] RHHT, 3<sup>rd</sup> Armor Cavalry, Fort Carson, CO 80913. The request consisted of:

- Search for files, emails, or any other digital documentation from the keywords and phrases provided
- Any other tests deemed necessary

**2. Summary of Findings:** From 1 December 2004 to 24 January 2005, computer forensic examiner [REDACTED] with the assistance of forensic examiners [REDACTED] and SrA [REDACTED] and forensic technicians SrA [REDACTED] and [REDACTED] conducted an examination of the media provided. A basic search was conducted on each hard drives for files and free space using the search terms that were provided. The search provided no relevant data to support the allegation. The following shows the number of hits for each tag number provided to SA [REDACTED]

Label	Hit Count
Tag393-04_Item1_HD001&HD002	427,844 hits
Tag393-04_Item2_HD001&HD002	193,435 hits
Tag393-04_Item3_HD001&HD002	13,810 hits
Tag393-04_Item3_HD003&HD004	132,197 hits

**SPECIAL HANDLING REQUIRED**

This document is subject to a claim of privilege under military law. Handle in accordance with Title 10, United States Code (U.S.C.) Section 8013.

NOTICE - The DoD Computer Forensic Laboratory (DCFL) prepared this report at the specific request of your agency. Your agency is the record custodian. You may make release of the report or the information it contains without prior DCFL approval under the Freedom of Information Act (5 U.S.C., Section 552) or the Privacy Act (5 U.S.C., Section 552a).

**FOR OFFICIAL USE ONLY**  
"WHERE TECHNOLOGY MEETS INTEGRITY"

**b67c**

000170



0027-03-CID679-64999

**3. Items Analyzed:****Item**

Compaq Blade Server, S/N 6J31JNT180EJ  
Compaq Blade Server, S/N 6J31JNT1801Y  
BSI Domain Server, S/N BSI1024983

**Labeled As**

Tag393-04\_Item1\_HD001 & HD002  
Tag393-04\_Item2\_HD001 & HD002  
Tag393-04\_Item3\_HD001, HD002, HD003 & HD004

**4. Items Provided:**

- One (1) Findings CD, labeled SECRET, titled "Findings CD" containing a list of the files found on the ASCII and UNICODE searches from Tag393-04\_Item3\_HD001 & HD002.
- One (1) Findings CD labeled SECRET, titled "DCFL-2004-I004327 Findings CD, dated 21-January-2005" containing a list of the files found on the ASCII and UNICODE searches from Tag393-04\_Item 2\_HD001 & HD002 and also Tag393-04\_Item3\_HD003 & HD004.
- One (1) Findings CD labeled SECRET, titled "DCFL Form 42 Dated 24-January-2005" containing a list of the files found on the ASCII and UNICODE searches from Tag393-04\_Item1\_HD001 & HD002.

[REDACTED] CIV, DCFL  
Computer Forensic Examiner

Released by: [REDACTED]

**Attachments:**

- (1) Form 42 titled Findings CD
- (1) Form 42 titled DCFL-2004-I004327 Findings CD, dated 21-January 2005
- (1) Form 42 titled DCFL Form 42 Dated 24-January-2005

**FOR OFFICIAL USE ONLY**

2 of 2

**667C**

000171

Exhibit 40

Pages 172 - 178 referred to

Department of Defense  
Computer Forensics Laboratory (DCFL)  
911 Elkridge Landing Road  
Suite 300  
Linthicum, MD 21090



**UNITED STATES  
DEPARTMENT OF DEFENSE**

**COMPUTER FORENSICS LAB**

0027-03-CID679-64999

**Examiner Notes**

**Date: 21 January 2005**

**DCFL-2004-I004327  
USACIL-2004-CID131-2130**

**FOR OFFICIAL USE ONLY**

**b67c**

Ex 42

000179

**Examiner Notes**

<p>1-Dec-04</p>	<p>Received case jacket from Team Lead [REDACTED]</p> <p><b>Case Information:</b> DCFL-2004-1004327 USACIL Case Number: 2004-CID131-2130      0027-03-CID679-64999 Submitter Case Number: 0027-03-CID679-64999</p> <p><b>CASE AGENT:</b> SA [REDACTED] Special Agent in Charge 87<sup>th</sup> MP DET, DSE Third MP Group (CID) Fort Bragg, NC 28307 COM: 910.396.6429/4311/8806 FAX Extensions: 8595/8607 Email: [REDACTED]@bragg.army.mil</p> <p><b>SUBJECT :</b> Unknown</p> <p><b>SYNOPSIS OF THE CASE:</b> Murder. This is a SECRET case.</p> <p><b>EVIDENCE SUBMITTED:</b> Exhibit 1 – One (1) Blade Server, serial number 6J31JNT180EJ Exhibit 2 – One (1) Blade Server, serial number 6J31JNT1801Y Exhibit 3 – One (1) Domain Server, serial number BSI 1024983</p> <p><b>SUPPORT REQUESTED:</b> Search of the aforementioned computer equipment, to include any internal hardware or storage media for any files, electronic data or significant email message traffic, along with other documentation that could be considered evidence. Using the keyword list provided search for files, emails, or any other digital documentation.</p>												
<p>2-Dec-04</p>	<p>A case acknowledgement letter sent to SA [REDACTED]</p>												
<p>13-Dec-04</p>	<p>Received two (2) hard drives from Forensic Technician SrA [REDACTED]</p> <table border="1" data-bbox="324 1207 1063 1428"><tr><td><b>Image Drive 1 – Tag393-04_Item1_HD001 &amp; HD002 Images</b></td></tr><tr><td>Western Digital Model WD1600BB</td></tr><tr><td>S/N: WMACK1264754</td></tr><tr><td>DCFL #: MB13472</td></tr><tr><td>Size: 160GB</td></tr><tr><td>Marked: Secret</td></tr></table> <table border="1" data-bbox="324 1459 1063 1680"><tr><td><b>Image Drive 2 – Tag393-04_Item2_HD001 &amp; HD002 Images</b></td></tr><tr><td>Western Digital – WD2000BB</td></tr><tr><td>S/N: WMACK1412998</td></tr><tr><td>DCFL #: MB13693</td></tr><tr><td>Size: 200GB</td></tr><tr><td>Marked: Secret</td></tr></table>	<b>Image Drive 1 – Tag393-04_Item1_HD001 &amp; HD002 Images</b>	Western Digital Model WD1600BB	S/N: WMACK1264754	DCFL #: MB13472	Size: 160GB	Marked: Secret	<b>Image Drive 2 – Tag393-04_Item2_HD001 &amp; HD002 Images</b>	Western Digital – WD2000BB	S/N: WMACK1412998	DCFL #: MB13693	Size: 200GB	Marked: Secret
<b>Image Drive 1 – Tag393-04_Item1_HD001 &amp; HD002 Images</b>													
Western Digital Model WD1600BB													
S/N: WMACK1264754													
DCFL #: MB13472													
Size: 160GB													
Marked: Secret													
<b>Image Drive 2 – Tag393-04_Item2_HD001 &amp; HD002 Images</b>													
Western Digital – WD2000BB													
S/N: WMACK1412998													
DCFL #: MB13693													
Size: 200GB													
Marked: Secret													
<p>13-Dec-04</p>	<p>Connected to the Examiner LAN and downloaded all program updates. The Cleaner has been updated to version 3713, Symantec Antivirus signature file was updated to 17-Nov-04. Also downloaded current FBI and NCME hash sets.</p>												

b67c

000180

**Examiner Notes**

0027-03-CID679-64999

13-Dec-04	Received the following working drives from SrA [REDACTED] <table border="1" data-bbox="342 268 1101 489"> <tr><td><b>Operating System Hard Drive - C: &amp; D:</b></td></tr> <tr><td>Seagate Model ST340810A</td></tr> <tr><td>S/N: 5FB73794</td></tr> <tr><td>DCFL #: MB14022</td></tr> <tr><td>Size: 40GB</td></tr> <tr><td>Labeled: DCFL Fred 2.8 OS XP Pro/Linux (Secret)</td></tr> </table> <table border="1" data-bbox="342 516 1101 730"> <tr><td><b>Findings Hard Drive - L:</b></td></tr> <tr><td>Western Digital Model WD2500JB</td></tr> <tr><td>S/N: WMAEP1435826</td></tr> <tr><td>DCFL #: MB15478</td></tr> <tr><td>Size: 250GB</td></tr> <tr><td>Marked: Secret</td></tr> </table>	<b>Operating System Hard Drive - C: &amp; D:</b>	Seagate Model ST340810A	S/N: 5FB73794	DCFL #: MB14022	Size: 40GB	Labeled: DCFL Fred 2.8 OS XP Pro/Linux (Secret)	<b>Findings Hard Drive - L:</b>	Western Digital Model WD2500JB	S/N: WMAEP1435826	DCFL #: MB15478	Size: 250GB	Marked: Secret
<b>Operating System Hard Drive - C: &amp; D:</b>													
Seagate Model ST340810A													
S/N: 5FB73794													
DCFL #: MB14022													
Size: 40GB													
Labeled: DCFL Fred 2.8 OS XP Pro/Linux (Secret)													
<b>Findings Hard Drive - L:</b>													
Western Digital Model WD2500JB													
S/N: WMAEP1435826													
DCFL #: MB15478													
Size: 250GB													
Marked: Secret													
20-Dec-04	The 2800mhz FRED computer system (MB15012) configuration will be used to Analyze the media - three (3) hard drives. Documentation of the Machine and Hardware was placed into the Notes. The following are the specifics that will be used in this request.												
20-Dec-04	Booted up FRED system into Windows XP. Opened ILOOK v8.0.3 to analyze image sets.												
20-Dec-04	Using Western Digital Hard Drive MB13693 containing Tag393-04_Item 2_HD001 & HD002 images. Added evidence to case in ILOOK. Traversed and mapped image sets. A hash was conducted on the drive contents after images loaded.												
20-Dec-04	A salvage of drive free space was conducted on Tag393-04_Item2_HD001, salvaged for the following file types: ARJ, ZIP, Database, email boxes, spreadsheets web, word-processing documents.												
27-Dec-04	1/14/2005 10:59:43 AM Completed salvage for Evidential Media item (DCFL-2004-1004327 => Tag393-04_Item2_HD_001 (2) => Tag393-04_Item2_HD_001 (3)) stats follow. 1/14/2005 10:59:43 AM Salvaged (113) file(s) for definition (Enhanced Meta File). 1/14/2005 10:59:43 AM Salvaged (0) file(s) for definition (Word Perfect). 1/14/2005 10:59:43 AM Salvaged (962) file(s) for definition (MS Word 4-5). 1/14/2005 10:59:43 AM Salvaged (1283) file(s) for definition (MS Word 1). 1/14/2005 10:59:43 AM Salvaged (1264) file(s) for definition (MS Word 2). 1/14/2005 10:59:43 AM Salvaged (457) file(s) for definition (MS Word or MS Excel). 1/14/2005 10:59:43 AM Salvaged (3) file(s) for definition (Rich Text File). 1/14/2005 10:59:43 AM Salvaged (0) file(s) for definition (Windows Write). 1/14/2005 10:59:43 AM Salvaged (0) file(s) for definition (Lotus123 (1)). 1/14/2005 10:59:43 AM Salvaged (0) file(s) for definition (Lotus123 (2)). 1/14/2005 10:59:43 AM Salvaged (3) file(s) for definition (Lotus123 (3)). 1/14/2005 10:59:43 AM Salvaged (0) file(s) for definition (MS Works). 1/14/2005 10:59:43 AM Salvaged (0) file(s) for definition (MS Excel 3-4). 1/14/2005 10:59:43 AM Salvaged (0) file(s) for definition (Data Interchange Format). 1/14/2005 10:59:43 AM Salvaged (457) file(s) for definition (MS Excel or MS Word). 1/14/2005 10:59:43 AM Salvaged (461) file(s) for definition (MS Office Catch-All). 1/14/2005 10:59:43 AM Salvaged (6) file(s) for definition (MS Access Db). 1/14/2005 10:59:43 AM Salvaged (0) file(s) for definition (Outlook Mail). 1/14/2005 10:59:43 AM Salvaged (1) file(s) for definition (Outlook Express Mail Dump). 1/14/2005 10:59:43 AM Salvaged (0) file(s) for definition (Outlook Express Mail Index). 1/14/2005 10:59:43 AM Salvaged (0) file(s) for definition (Outlook Express Mail Box). 1/14/2005 10:59:43 AM Salvaged (0) file(s) for definition (Outlook Offline Storage). 1/14/2005 10:59:43 AM Salvaged (0) file(s) for definition (AOL MailBox). 1/14/2005 10:59:43 AM Salvaged (46) file(s) for definition (ZIP Files). 1/14/2005 10:59:43 AM Salvaged (1102) file(s) for definition (ARJ Files).												

**b67C**

**Examiner Notes**

	1/14/2005 10:59:43 AM Salvaged (17) file(s) for definition (HTML (1)). 1/14/2005 10:59:43 AM Salvaged (1304) file(s) for definition (HTML (2)). 1/14/2005 10:59:43 AM Salvaged (247) file(s) for definition (HTML (3)).
22-Dec-04	A salvage of drive free space was conducted on Tag393-04_Item2_HD002, salvaged for the following file types: ARJ, ZIP, Database, email boxes, spreadsheets web, word-processing documents.
27-Dec-04	1/15/2005 12:43:49 PM Completed salvage for Evidential Media item (DCFL-2004-1004327 => Tag393-04_Item2_HD_002 (4) => Tag393-04_Item2_HD_002 (5)) stats follow. 1/15/2005 12:43:50 PM Salvaged (91) file(s) for definition (Enhanced Meta File). 1/15/2005 12:43:50 PM Salvaged (0) file(s) for definition (Word Perfect). 1/15/2005 12:43:50 PM Salvaged (997) file(s) for definition (MS Word 4-5). 1/15/2005 12:43:50 PM Salvaged (1334) file(s) for definition (MS Word 1). 1/15/2005 12:43:50 PM Salvaged (1209) file(s) for definition (MS Word 2). 1/15/2005 12:43:50 PM Salvaged (466) file(s) for definition (MS Word or MS Excel). 1/15/2005 12:43:50 PM Salvaged (7) file(s) for definition (Rich Text File). 1/15/2005 12:43:50 PM Salvaged (0) file(s) for definition (Windows Write). 1/15/2005 12:43:50 PM Salvaged (0) file(s) for definition (Lotus123 (1)). 1/15/2005 12:43:50 PM Salvaged (0) file(s) for definition (Lotus123 (2)). 1/15/2005 12:43:50 PM Salvaged (0) file(s) for definition (Lotus123 (3)). 1/15/2005 12:43:50 PM Salvaged (0) file(s) for definition (MS Works). 1/15/2005 12:43:50 PM Salvaged (0) file(s) for definition (MS Excel 3-4). 1/15/2005 12:43:50 PM Salvaged (0) file(s) for definition (Data Interchange Format). 1/15/2005 12:43:50 PM Salvaged (466) file(s) for definition (MS Excel or MS Word). 1/15/2005 12:43:50 PM Salvaged (468) file(s) for definition (MS Office Catch-All). 1/15/2005 12:43:50 PM Salvaged (3) file(s) for definition (MS Access Db). 1/15/2005 12:43:50 PM Salvaged (0) file(s) for definition (Outlook Mail). 1/15/2005 12:43:50 PM Salvaged (0) file(s) for definition (Outlook Express Mail Dump). 1/15/2005 12:43:50 PM Salvaged (0) file(s) for definition (Outlook Express Mail Index). 1/15/2005 12:43:50 PM Salvaged (0) file(s) for definition (Outlook Express Mail Box). 1/15/2005 12:43:50 PM Salvaged (0) file(s) for definition (Outlook Offline Storage). 1/15/2005 12:43:50 PM Salvaged (0) file(s) for definition (AOL MailBox). 1/15/2005 12:43:50 PM Salvaged (39) file(s) for definition (ZIP Files). 1/15/2005 12:43:50 PM Salvaged (1050) file(s) for definition (ARJ Files). 1/15/2005 12:43:50 PM Salvaged (21) file(s) for definition (HTML (1)). 1/15/2005 12:43:50 PM Salvaged (1295) file(s) for definition (HTML (2)). 1/15/2005 12:43:50 PM Salvaged (262) file(s) for definition (HTML (3)).
27-Dec-04	Contacted case agent and verified his email address. The address on paperwork was wrong. Correct email address is [redacted]@braqq.army.mil, resent case acknowledgement letter to him.
27-Dec-04	Started basic search of salvaged files on Tag393-04_Item2_HD001, using the search terms provided by Agent.
27-Dec-04	1/14/2005 11:05:20 AM Started basic search of file objects for Evidential Media item (DCFL-2004-1004327 => Tag393-04_Item2_HD_001 (2) => Tag393-04_Item2_HD_001 (3)). 1/14/2005 11:05:20 AM Completed ASCII basic search of file objects for Evidential Media => 0 hit(s) found in 0 objects. 1/14/2005 11:05:20 AM Completed Unicode basic search of file objects for Evidential Media => 0 hit(s) found in 0 objects. 1/14/2005 11:05:20 AM Started basic search of file slack for Evidential Media item (DCFL-2004-1004327 => Tag393-04_Item2_HD_001 (2) => Tag393-04_Item2_HD_001 (3)). 1/14/2005 11:05:20 AM Completed ASCII basic search of file slack for Evidential Media => 0 hit(s) found. 1/14/2005 11:05:20 AM Completed Unicode basic search of file slack for Evidential Media => 0 hit(s) found. 1/14/2005 11:05:20 AM Started basic search of salvage for Evidential Media item (DCFL-2004-1004327 => Tag393-04_Item2_HD_001 (2) => Tag393-04_Item2_HD_001 (3)). 1/14/2005 12:11:31 PM Completed ASCII basic search of salvage for Evidential Media => 2761 hit(s) found in 1085 objects. 1/14/2005 12:11:33 PM Completed Unicode basic search of salvage for Evidential Media => 681 hit(s)

0027-03-CID679-64999

b67c

000182

Examiner [redacted]

Examiner Notes 03-CID679-64999

	<p>found in 269 objects. 1/14/2005 12:11:33 PM Started basic search of free space for Evidential Media item (DCFL-2004-1004327 =&gt; Tag393-04_Item2_HD_001 (2) =&gt; Tag393-04_Item2_HD_001 (3)). 1/14/2005 12:11:48 PM Completed ASCII basic search of free space for Evidential Media =&gt; 1 hit(s) found. 1/14/2005 12:11:48 PM Completed Unicode basic search of free space for Evidential Media =&gt; 0 hit(s) found. 1/14/2005 12:11:48 PM Started basic search of unused space for Evidential Media item (DCFL-2004-1004327 =&gt; Tag393-04_Item2_HD_001 (2) =&gt; Tag393-04_Item2_HD_001 (3)). 1/15/2005 10:50:46 AM Completed ASCII basic search of unused space for Evidential Media =&gt; 104985 hit(s) found. 1/15/2005 10:50:47 AM Completed Unicode basic search of unused space for Evidential Media =&gt; 17068 hit(s) found.</p>						
27-Dec-04	<p>Started basic search of salvaged files on Tag393-04_Item2_HD002, using the search terms provided by Agent.</p>						
	<p>1/17/2005 8:35:09 AM Started basic search of file objects for Evidential Media item (DCFL-2004-1004327 =&gt; Tag393-04_Item2_HD_002 (4) =&gt; Tag393-04_Item2_HD_002 (5)). 1/17/2005 8:35:09 AM Completed ASCII basic search of file objects for Evidential Media =&gt; 0 hit(s) found in 0 objects. 1/17/2005 8:35:09 AM Completed Unicode basic search of file objects for Evidential Media =&gt; 0 hit(s) found in 0 objects. 1/17/2005 8:35:09 AM Started basic search of file slack for Evidential Media item (DCFL-2004-1004327 =&gt; Tag393-04_Item2_HD_002 (4) =&gt; Tag393-04_Item2_HD_002 (5)). 1/17/2005 8:35:09 AM Completed ASCII basic search of file slack for Evidential Media =&gt; 0 hit(s) found. 1/17/2005 8:35:09 AM Completed Unicode basic search of file slack for Evidential Media =&gt; 0 hit(s) found. 1/17/2005 8:35:09 AM Started basic search of salvage for Evidential Media item (DCFL-2004-1004327 =&gt; Tag393-04_Item2_HD_002 (4) =&gt; Tag393-04_Item2_HD_002 (5)). 1/17/2005 10:21:21 AM Completed ASCII basic search of salvage for Evidential Media =&gt; 5949 hit(s) found in 2152 objects. 1/17/2005 10:21:21 AM Completed Unicode basic search of salvage for Evidential Media =&gt; 972 hit(s) found in 523 objects. 1/17/2005 10:21:21 AM Started basic search of free space for Evidential Media item (DCFL-2004-1004327 =&gt; Tag393-04_Item2_HD_002 (4) =&gt; Tag393-04_Item2_HD_002 (5)). 1/17/2005 10:21:34 AM Completed ASCII basic search of free space for Evidential Media =&gt; 0 hit(s) found. 1/17/2005 10:21:34 AM Completed Unicode basic search of free space for Evidential Media =&gt; 0 hit(s) found. 1/17/2005 10:21:34 AM Started basic search of unused space for Evidential Media item (DCFL-2004-1004327 =&gt; Tag393-04_Item2_HD_002 (4) =&gt; Tag393-04_Item2_HD_002 (5)). 1/18/2005 9:04:00 AM Completed ASCII basic search of unused space for Evidential Media =&gt; 105156 hit(s) found. 1/18/2005 9:04:01 AM Completed Unicode basic search of unused space for Evidential Media =&gt; 17426 hit(s) found.</p>						
27-Dec-04	<p>Received the following additional completed drives from Image &amp; Extraction technician [redacted]</p> <table border="1" data-bbox="365 1564 1136 1816"><tr><td><b>Image Drive 3 - Tag393-04_Item3_HD003 &amp; HD004 Images</b></td></tr><tr><td>Western Digital Model WD1600BB</td></tr><tr><td>S/N: WMACK1343832</td></tr><tr><td>DCFL #: MB13742</td></tr><tr><td>Size: 160GB</td></tr><tr><td>Marked: Secret</td></tr></table>	<b>Image Drive 3 - Tag393-04_Item3_HD003 &amp; HD004 Images</b>	Western Digital Model WD1600BB	S/N: WMACK1343832	DCFL #: MB13742	Size: 160GB	Marked: Secret
<b>Image Drive 3 - Tag393-04_Item3_HD003 &amp; HD004 Images</b>							
Western Digital Model WD1600BB							
S/N: WMACK1343832							
DCFL #: MB13742							
Size: 160GB							
Marked: Secret							

b67c

000183

Examiner

Examiner Notes

<b>Image Drive 2 – Tag393-04_Item3_HD001 &amp; HD002 Images</b>
Western Digital – Model WD2000
S/N: WMACK1305673
DCFL #: MB13730
Size: 200GB
Marked: Secret

0027-03-CID679-64999

<p>28-Dec-04</p>	<p>Received the rest of the media from [REDACTED], forensic technician. The following is an inventory of what I received:</p> <ol style="list-style-type: none"> <li>1) Seagate Barracuda ATA IV, Model ST380021A, 80GB, S/N: 3HVOVH6F, MB13109, labeled: 'Restore Item2_HD_002 4327'</li> <li>2) IBM Deskstar, Model DTLA-307075, 76.8GB, S/N: YSG52336, MB12483, labeled: 'Tag393-04-Item2_HD_001 Copy (Good)'</li> <li>3) IBM Deskstar, Model DTLA-307075, 76.8GB, S/N: YSG5K123, MB11790, labeled: 'Tag393-04-Item2_HD_002 Copy (Good)'</li> <li>4) Seagate Barracuda ATA IV, Model ST380021A, 80GB, S/N: 3HVOVH6N, MB13107, labeled: 'Tag393-04_Item 3_HD_001 Copy'</li> <li>5) Seagate Barracuda ATA IV, Model ST380021A, 80GB, S/N: 3HV3ZJTN, MB13316, labeled: 'Tag393-04_Item 3_HD_002 Copy (Failed)'</li> <li>6) Maxtor, Model D740X-6L, 80GB, S/N: 664207718861, MB14864, labeled: 'Tag393-04_Item 3_HD_003 Copy (Failed)'</li> <li>7) Seagate Barracuda ATA IV, Model ST380021A, 80GB, S/N: 3HV49AS1, MB13770, labeled: 'Tag393-04_Item 3_HD_004 Copy'</li> <li>8) Hitachi-Deskstar, Model HDS722580VLAT20, 82.3GB, S/N: C2TPO5MM, MB15529, labeled: '4327 Item 3_HD_002 Restore'</li> <li>9) IBM Deskstar, Model DTZA-307075, 76.8GB, S/N: YSG5A402, MB12412, labeled: '4327 Item 3_HD_004 Restore'</li> <li>10) IBM Deskstar, Model IC35L080AVVA07-0, 82.3GB, S/N: A4H5V27G, MB13582, labeled: '4327 Item 3_HD_003 Restore'</li> <li>11) Seagate Barracuda ATA IV, Model ST380021A, 80GB, S/N: 3HVOVH3Y, MB13077, labeled: '4327 Item 3_HD_001 Restore'</li> <li>12) Seagate Barracuda ATA IV, Model ST380021A, 80GB, S/N: 3HV3G5PN, MB13334, labeled: '4327 Item 1_HD_002 Restore'</li> <li>13) IBM Deskstar, Model DTLA-307075, 76.8GB, S/N: VSG5N320, MB12441, labeled: '4327 Item 1_HD_002 Copy (Good)'</li> <li>14) IBM Deskstar, Model DTLA-307075, 76.8GB, S/N: VSFQR910, MB11762, labeled: 'None'</li> <li>15) Maxtor, Model 98196H8, 81.9GB, S/N: V80M8Q4C, MB12380, labeled: 'Restore Item 2_HD_001 4327'</li> <li>16) Seagate, Model 340810A, 40GB, S/N: 5FB7373C, MB13151, labeled: '4327 16202 OS' DCFL FRED 2.8 OS XP Pro/Linux'</li> </ol>
<p>29-Dec-04</p>	<p>A salvage of drive free space was conducted on Tag393-04_Item3_HD003, salvaged for the following file types: ARJ, ZIP, Database, email boxes, spreadsheets web, word-processing documents.</p>
	<p>1/12/2005 9:20:51 AM Started salvage for Evidential Media item (DCFL-2004-I004327 =&gt; Tag393-04_Item3_HD_003 (8) =&gt; Tag393-04_Item3_HD_003 (9)).</p> <p>1/12/2005 11:45:10 AM Completed salvage for Evidential Media item (DCFL-2004-I004327 =&gt; Tag393-04_Item3_HD_003 (8) =&gt; Tag393-04_Item3_HD_003 (9)) stats follow.</p> <p>1/12/2005 11:45:11 AM Salvaged (101) file(s) for definition (Enhanced Meta File).</p> <p>1/12/2005 11:45:11 AM Salvaged (42) file(s) for definition (Word Perfect).</p> <p>1/12/2005 11:45:11 AM Salvaged (1084) file(s) for definition (MS Word 4-5).</p> <p>1/12/2005 11:45:11 AM Salvaged (1259) file(s) for definition (MS Word 1).</p> <p>1/12/2005 11:45:11 AM Salvaged (1202) file(s) for definition (MS Word 2).</p> <p>1/12/2005 11:45:11 AM Salvaged (13614) file(s) for definition (MS Word or MS Excel).</p> <p>1/12/2005 11:45:11 AM Salvaged (157) file(s) for definition (Rich Text File).</p> <p>1/12/2005 11:45:11 AM Salvaged (1) file(s) for definition (Windows Write).</p>

b67c

000184



Examiner

**Examiner Notes**

0027-03-CID679-64999

	<p>1/12/2005 11:45:11 AM Salvaged (0) file(s) for definition (Lotus123 (1)). 1/12/2005 11:45:11 AM Salvaged (0) file(s) for definition (Lotus123 (2)). 1/12/2005 11:45:11 AM Salvaged (0) file(s) for definition (Lotus123 (3)). 1/12/2005 11:45:11 AM Salvaged (0) file(s) for definition (MS Works). 1/12/2005 11:45:11 AM Salvaged (0) file(s) for definition (MS Excel 3-4). 1/12/2005 11:45:11 AM Salvaged (0) file(s) for definition (Data Interchange Format). 1/12/2005 11:45:11 AM Salvaged (13614) file(s) for definition (MS Excel or MS Word). 1/12/2005 11:45:11 AM Salvaged (13712) file(s) for definition (MS Office Catch-All). 1/12/2005 11:45:11 AM Salvaged (182) file(s) for definition (MS Access Db). 1/12/2005 11:45:11 AM Salvaged (7) file(s) for definition (Outlook Mail). 1/12/2005 11:45:11 AM Salvaged (0) file(s) for definition (Outlook Express Mail Dump). 1/12/2005 11:45:12 AM Salvaged (0) file(s) for definition (Outlook Express Mail Index). 1/12/2005 11:45:12 AM Salvaged (1) file(s) for definition (Outlook Express Mail Box). 1/12/2005 11:45:12 AM Salvaged (7) file(s) for definition (Outlook Offline Storage). 1/12/2005 11:45:12 AM Salvaged (0) file(s) for definition (AOL MailBox). 1/12/2005 11:45:12 AM Salvaged (109) file(s) for definition (ZIP Files). 1/12/2005 11:45:12 AM Salvaged (1243) file(s) for definition (ARJ Files). 1/12/2005 11:45:12 AM Salvaged (172) file(s) for definition (HTML (1)). 1/12/2005 11:45:12 AM Salvaged (517) file(s) for definition (HTML (2)). 1/12/2005 11:45:12 AM Salvaged (115) file(s) for definition (HTML (3)).</p>
3-Jan-05	<p>Received from SrA [redacted] forensic technician the rest of the media. The following is an inventory of what I received:</p> <ol style="list-style-type: none"><li>1) Seagate, Model ST340810A, 40GB, S/N: 5FB73FT4, MB13135, labeled: 'DCFL FRED 2.8 OS XP Pro/Linux'</li><li>2) Western Digital, Model WD2000-BB, 200GB, S/N: WMACK1449719, MB13697, labeled: 'Images (2) Item 3_HD_001 &amp; HD_002'</li><li>3) Western Digital, Model WD2000-BB, 200GB, S/N: WMAEH2309085, MB15633, labeled: 'Item 3_HD_003 &amp; HD_004 Images (2)'</li><li>4) Western Digital, Model WD2000-BB, 200GB, S/N: WMAEH2298177, MB15622, labeled: 'Tag393-04_Item 1 HD_001 HD_002 Images (2)'</li><li>5) Western Digital, Model WD2000-BB, 200GB, S/N: WMACK1437086, MB13712, labeled: 'Tag393-04_Item 2 HD_001 &amp; HD_002 Images (2)'</li></ol>
12-Jan-05	<p>Started basic search of salvaged files on Tag393-04_Item3_HD003, using the search terms provided by Agent.</p> <p>1/17/2005 8:41:57 AM Started basic search of file objects for Evidential Media item (DCFL-2004-1004327 =&gt; Tag393-04_Item3_HD_003 (8) =&gt; Tag393-04_Item3_HD_003 (9)). 1/17/2005 8:41:57 AM Completed ASCII basic search of file objects for Evidential Media =&gt; 0 hit(s) found in 0 objects. 1/17/2005 8:41:57 AM Completed Unicode basic search of file objects for Evidential Media =&gt; 0 hit(s) found in 0 objects. 1/17/2005 8:41:57 AM Started basic search of file slack for Evidential Media item (DCFL-2004-1004327 =&gt; Tag393-04_Item3_HD_003 (8) =&gt; Tag393-04_Item3_HD_003 (9)). 1/17/2005 8:41:57 AM Completed ASCII basic search of file slack for Evidential Media =&gt; 0 hit(s) found. 1/17/2005 8:41:57 AM Completed Unicode basic search of file slack for Evidential Media =&gt; 0 hit(s) found. 1/17/2005 8:41:57 AM Started basic search of salvage for Evidential Media item (DCFL-2004-1004327 =&gt; Tag393-04_Item3_HD_003 (8) =&gt; Tag393-04_Item3_HD_003 (9)). 1/17/2005 7:13:05 PM Completed ASCII basic search of salvage for Evidential Media item =&gt; 48066 hit(s) found in 12565 objects. 1/17/2005 7:13:05 PM Completed Unicode basic search of salvage for Evidential Media =&gt; 1751 hit(s) found in 728 objects. 1/17/2005 7:13:05 PM Started basic search of free space for Evidential Media item (DCFL-2004-1004327 =&gt; Tag393-04_Item3_HD_003 (8) =&gt; Tag393-04_Item3_HD_003 (9)). 1/17/2005 7:33:56 PM Completed ASCII basic search of free space for Evidential Media =&gt; 0 hit(s) found. 1/17/2005 7:33:56 PM Completed Unicode basic search of free space for Evidential Media =&gt; 22 hit(s)</p>

b67c

000185

0027-03-CID679-64999  
Examiner Notes

	<p>found. 1/17/2005 7:33:56 PM Started basic search of unused space for Evidential Media item (DCFL-2004-1004327 =&gt; Tag393-04_Item3_HD_003 (8) =&gt; Tag393-04_Item3_HD_003 (9)).</p>
12-Jan-05	<p>A salvage of drive free space was conducted on Tag393-04_Item3_HD004, salvaged for the following file types: ARJ, ZIP, Database, email boxes, spreadsheets web, word-processing documents.</p>
12-Jan-05	<p>1/12/2005 2:14:47 PM Completed salvage for Evidential Media item (DCFL-2004-1004327 =&gt; Tag393-04_Item3_HD_004 (10) =&gt; Tag393-04_Item3_HD_004 (11)) stats follow. 1/12/2005 2:14:48 PM Salvaged (114) file(s) for definition (Enhanced Meta File). 1/12/2005 2:14:48 PM Salvaged (37) file(s) for definition (Word Perfect). 1/12/2005 2:14:48 PM Salvaged (1088) file(s) for definition (MS Word 4-5). 1/12/2005 2:14:48 PM Salvaged (1174) file(s) for definition (MS Word 1). 1/12/2005 2:14:48 PM Salvaged (1229) file(s) for definition (MS Word 2). 1/12/2005 2:14:48 PM Salvaged (13610) file(s) for definition (MS Word or MS Excel). 1/12/2005 2:14:48 PM Salvaged (150) file(s) for definition (Rich Text File). 1/12/2005 2:14:48 PM Salvaged (0) file(s) for definition (Windows Write). 1/12/2005 2:14:49 PM Salvaged (0) file(s) for definition (Lotus123 (1)). 1/12/2005 2:14:49 PM Salvaged (0) file(s) for definition (Lotus123 (2)). 1/12/2005 2:14:49 PM Salvaged (0) file(s) for definition (Lotus123 (3)). 1/12/2005 2:14:49 PM Salvaged (0) file(s) for definition (MS Works). 1/12/2005 2:14:49 PM Salvaged (0) file(s) for definition (MS Excel 3-4). 1/12/2005 2:14:49 PM Salvaged (0) file(s) for definition (Data Interchange Format). 1/12/2005 2:14:49 PM Salvaged (13610) file(s) for definition (MS Excel or MS Word). 1/12/2005 2:14:49 PM Salvaged (13708) file(s) for definition (MS Office Catch-All). 1/12/2005 2:14:49 PM Salvaged (199) file(s) for definition (MS Access Db). 1/12/2005 2:14:49 PM Salvaged (20) file(s) for definition (Outlook Mail). 1/12/2005 2:14:49 PM Salvaged (0) file(s) for definition (Outlook Express Mail Dump). 1/12/2005 2:14:49 PM Salvaged (0) file(s) for definition (Outlook Express Mail Index). 1/12/2005 2:14:49 PM Salvaged (1) file(s) for definition (Outlook Express Mail Box). 1/12/2005 2:14:49 PM Salvaged (20) file(s) for definition (Outlook Offline Storage). 1/12/2005 2:14:49 PM Salvaged (0) file(s) for definition (AOL MailBox). 1/12/2005 2:14:49 PM Salvaged (112) file(s) for definition (ZIP Files). 1/12/2005 2:14:49 PM Salvaged (1248) file(s) for definition (ARJ Files). 1/12/2005 2:14:49 PM Salvaged (137) file(s) for definition (HTML (1)). 1/12/2005 2:14:50 PM Salvaged (546) file(s) for definition (HTML (2)). 1/12/2005 2:14:50 PM Salvaged (103) file(s) for definition (HTML (3)).</p>
12-Jan-05	<p>Started basic search of salvaged files on Tag393-04_Item3_HD004, using the search terms provided by Agent.</p>
	<p>1/12/2005 2:30:52 PM Started basic search of file objects for Evidential Media item (DCFL-2004-1004327 =&gt; Tag393-04_Item3_HD_004 (10) =&gt; Tag393-04_Item3_HD_004 (11)). 1/12/2005 2:30:52 PM Completed ASCII basic search of file objects for Evidential Media item (DCFL-2004-1004327 =&gt; Tag393-04_Item3_HD_004 (10) =&gt; Tag393-04_Item3_HD_004 (11)). 0 hit(s) found in 0 objects. 1/12/2005 2:30:52 PM Completed Unicode basic search of file objects for Evidential Media item (DCFL-2004-1004327 =&gt; Tag393-04_Item3_HD_004 (10) =&gt; Tag393-04_Item3_HD_004 (11)). 0 hit(s) found in 0 objects. 1/12/2005 2:30:52 PM Started basic search of file slack for Evidential Media item (DCFL-2004-1004327 =&gt; Tag393-04_Item3_HD_004 (10) =&gt; Tag393-04_Item3_HD_004 (11)). 1/12/2005 2:30:52 PM Completed ASCII basic search of file slack for Evidential Media item (DCFL-2004-1004327 =&gt; Tag393-04_Item3_HD_004 (10) =&gt; Tag393-04_Item3_HD_004 (11)). 0 hit(s) found. 1/12/2005 2:30:52 PM Completed Unicode basic search of file slack for Evidential Media item (DCFL-2004-1004327 =&gt; Tag393-04_Item3_HD_004 (10) =&gt; Tag393-04_Item3_HD_004 (11)). 0 hit(s) found. 1/12/2005 2:30:52 PM Started basic search of salvage for Evidential Media item (DCFL-2004-1004327 =&gt; Tag393-04_Item3_HD_004 (10) =&gt; Tag393-04_Item3_HD_004 (11)). 1/13/2005 8:11:28 AM Completed ASCII basic search of salvage for Evidential Media item (DCFL-2004-1004327 =&gt; Tag393-04_Item3_HD_004 (10) =&gt; Tag393-04_Item3_HD_004 (11)). Renewed counts - 791884 hit(s) found in 86624 objects.</p>

000186



### DEVIATION FROM STANDARD CONFIGURATION

PART 1 - REQUEST

REQUESTER [REDACTED]	DATE 30 December 2004
DCFL TRACKING NUM DCFL-2004-I004327	CONFIGURATION ITEM NUMBER (Being Deviated From) CI-20 v1.2

REASON FOR DEVIATION REQUEST (Describe the Problem to be Solved)  
Need to rip and/or deconstruct emails for case.

0027-0000-000 0:999

PROPOSED ALTERNATIVE (Describe How to Solve the Problem)

Add the FTK application and use the deconstruct capability.

PART 2 - APPROVAL

ACTION <input type="checkbox"/> APPROVE	SIGNATURE BLOCK SECTION CHIEF	PRINTED NAME AND SIGNATURE [REDACTED]	DATE
--	----------------------------------	--	------

PART 3 - COMMENTS AND RESULTS

COMMENTS AND RESULTS (Describe Restrictions or Outcome of Deviation)

PART 4 - COORDINATION

<input type="checkbox"/> OPERATIONS	<input type="checkbox"/> TECHNICAL DIRECTOR	<input type="checkbox"/> RDT&E	<input type="checkbox"/>
-------------------------------------	---	--------------------------------	--------------------------

b67c

000103

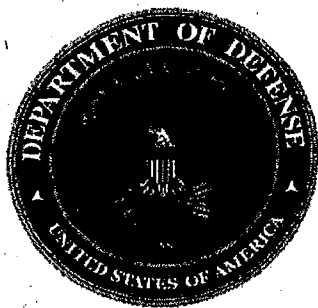

**UNITED STATES  
DEPARTMENT OF DEFENSE**

**COMPUTER FORENSICS LAB**

0027-03-CID679-64999

**Technician Notes**

[REDACTED]

**Date: 3 January 2005**

**DCFL 2004-1004327  
USACIL-2004-CID131-2130**

**FOR OFFICIAL USE ONLY**

**b67C**

[REDACTED]  
3

Ex 46  
000189



**Department of Defense Computer Forensics Lab,  
Technician Notes**  
DCFL Request # - DCFL-2004-1004327

0027-03-CID679-64999

Page 2 of 2

<p>Taj 393-04 Item 3 contained 4 HD's. Opened front of case to remove HD's. Case overall was in bad shape. There were scratches all over the case outside and there was dust in all 3 of the machines that was pretty heavy. The <span style="background-color: black; color: black;">[REDACTED]</span> of the 4 HD's two were hooked up to the SCSI cable. Server (Item 3) was in pretty bad cosmetic shape. Extremely dirty inside: out. Lots of scratches on all sides.</p>	
<p>HD-001 : HD-004 were the only two hooked up. HD-002 : HD-003 were just lying in the machine not even screwed in. Removed all 4 HD's : labeled them w/ initials <span style="background-color: black; color: black;">[REDACTED]</span>, date 29NOV 2004 : File names 4327-Taj 393-04-Item 3-HD-001 - HD-004</p>	
<p>HD-001 Specs</p> <p>S/N: 3H20LH36</p> <p>M/N: ST373307LC</p> <p>Sagate chetah ULTRA 320 SCSI WIDE 73.466</p>	<p>Server Specs</p> <p>BSE</p> <p>S/N: 1624983</p> <p>M/N: N/A</p>
<p>HD-002 Specs</p> <p>S/N: 3H20Q756</p> <p>M/N: ST373307LC</p> <p>Sagate chetah ULTRA 320 SCSI WIDE 73.466</p>	
<p>HD-003 Specs</p> <p>S/N: 3H20JAAF</p> <p>M/N: ST373307LC</p> <p>Sagate chetah ULTRA 320 SCSI WIDE 73.466</p>	
<p>HD-004 Specs</p> <p>S/N: 3H20PT66</p> <p>M/N: ST373307LC</p> <p>Sagate chetah ULTRA 320 SCSI WIDE 73.466</p>	
<p>FINAL ENTRY ON THIS PAGE</p>	

Technician: [REDACTED] Initials: [REDACTED]

FOR OFFICIAL USE ONLY

**b67c**

000191

**Department of Defense Computer Forensics Lab,  
Technician Notes**  
DCFL Request # - DCFL-2004-100 4327

0027-03-CID679-64999 Page 1 of 2

30 NOV 04	Hooked the 4 drives from Tag 393-04-Item 3 up to Solo 2 Forensics Image masters; 1 Solo 2 Professional Image master. All drives were hooked up through the PCMECA port on the image masters. Began copy of drives to IDE drives Tag 393-04-Item 3-HD-001 was copied to Mb 13107 Tag 393-04-Item 3-HD-002 " " " Mb 13316 " " HD-003 " " " Mb 14864 " " HD-004 " " " Mb 13770
	Began copying. HD-002; HD-003 copies dropped to 0 Mb/min after about 5% completion. Both copies were aborted after about 3 hours of processing at 0 Mb/min.
	Placed the HD's from Tag 393-04-Item 2 onto the image masters that the 2 drives that failed were on and replaced the copy drives with Mb 12483; Mb 11790 Tag 393-04-Item 2-HD-001 was copied to Mb 12483 Tag 393-04-Item 2-HD-002 was copied to Mb 11790
1 Dec 04	HD-001; HD-004 for Tag 393-04-Item 3 dropped to 0 Mb/min. Copy was restarted.
2 Dec 04	Tag 393-04-Item 2-HD-001 copy finished successfully for 142264000 sectors Tag 393-04-Item 2-HD-002 copy finished successfully " " " Removed Item 2 HD's from Solomaster. Hooked up HD-001 from Item 2 to 2.8 GHz FRED machine Mb 14927 JAW CE 1.8 v1.0 - Mb 12483 Booted to Linux OS Mb 13135 JAW CE 03 v2.3 to begin imaging. Partitioned; formatted images drive Mb 13693; mounted hdd1 to /mnt/images Shutdown machine. Placed Mb 12483 on a nicetech forensic combodock Mb 16091-1 to begin imaging. Booted into Linux; ran "fdisk -l" Mb 12483 showed up as SDB Ran "fdisk -l  dn/sdb > HD-001-orig.fdisk" from newly created Tag 393-04-Item 2-HD-001 directory Ran "dcfdd conv=sync,noerror if=/dn/sdb hashwindow=256k hashlog=HD-001-orig count=142264000; split -b 1900m - hd-001 -" Imaging completed w/ no errors 142264000+0 records in; out Shutdown machine; removed Mb 12483

Technician: \_\_\_\_\_ Initials: \_\_\_\_\_

**FOR OFFICIAL USE ONLY**

**b67c**





Department of Defense Computer Forensics Lab,  
Technician Notes  
DCFL Request # - DCFL-2004-100 4327

0027-03-CID679-64999

Page 1 of 1

02 Dec 04	<p>Booted FRED 2.8GHz machine Mb16202 w/ Linux OS inserted <sup>as HDA</sup> Mb13751 ; images drive Mb13730 inserted as HDD.</p> <p>Ran "fdisk /dev/hdd" Ran "mke2fs -F 32 /dev/hdd1"</p> <p>Ran "mount -t vfat /dev/hdd1 /mnt/images"</p> <p>Shutdown machine. Inserted evidence Tag 343-04-Item3-HD-001. Placed evidence on a FireBox <del>SSD</del> write blocker.</p> <p>Booted FRED into Linux.</p> <p>Ran "fdisk -l"</p> <p>Evidence showed up as sdb. Ran "fdisk -l /dev/sdb &gt; HD-001-orig.fdisk"</p> <p>Ran "defldd conv=sync,noerror if=/dev/sdb hashwindow=256k hashlog=HD-001-orig.md5   split -b 1900m - hd-001-"</p>
6 Dec 2004	<p>Imaging completed w/ no errors 143374744 +0 records in ; out.</p> <p>Shutdown machine ; replaced Item3-HD-001 w/ Item3-HD-002</p> <p>Ran same commands for HD-002 as I did for HD-001</p> <p>Imaging completed w/ no errors 143374744 +0 records in ; out</p> <p>Replaced Item3-HD-002 w/ Item1-HD-001 and replaced images drive Mb13730 w/ images drive Mb13472 to begin imaging of Item1.</p> <p>Booted into Linux ; ran same previous commands. Evidence drive did not show up under Linux. After several attempts to get the evidence to show up using the Black Bay Fire Box Both HD's from Item1 were placed on Solo 2 Forensics machines to copy <sup>to</sup> the IDE HD's</p> <p>Item1-HD-001 was copied to MB11762. Item2-HD-002 copied to</p> <p>Item1-HD-002 was copied to MB12441 Item1-HD-002 copied successfully for 14264000 records</p>
NOTE =>	<p>Item1-HD-001 would not show up on the Solo 2 Forensics machine.</p> <p>Placed images HD for Item3-HD-001 ; Item3-HD-002 into FRED machine Mb16202 to verify images for both HD's. Booted into Linux. Ran "cd /mnt/images" file.mv.pl" from Tag 343-04-Item3-HD-001 directory. Command was run to rename all image files to conform to Eltek naming conventions.</p> <p>Ran "cat hd-001.0x   defldd conv=sync,noerror of=/dev/null hashwindow=256k hashlog=HD-001-img.md5"</p> <p>command completed w/ no errors 143374744 +0 records in ; out. md5sums matched</p> <p>Ran same commands for HD-002. verification completed w/ no errors 143374744 +0 records in ; out. md5sums matched. shutdown machine</p> <p>FINAL ENTRY ON THIS PAGE</p>

Technician: [REDACTED]

Initials: [REDACTED]

FOR OFFICIAL USE ONLY

b67c

000194

**Department of Defense Computer Forensics Lab,**  
**Technician Notes**  
 DCFL Request # - DCFL-2004-1004327

0027-08-CID679-64999

7 Dec 2004	Booted FROD machine MB 14927 to Linux to begin verification of Item2-HD-001 ; Item2-HD-002 image files. Mounted HDD1 to /mnt/images Ran "cat hd-001.*   dd if=/dev/zero conv=sync,noerror of=/dev/null hashwindow=256k hashlog=HD-001-Img.md5" Command was run from the Tag393-04-Item2-HD-001 directory command completed w/ no errors 142264000 to records in ; out. Ran "tail -1 HD-001-*.md5" Both md5sums matched Ran "cd .." Ran "cd Tag393-04-Item2-HD-002" Ran same verification command as for HD-001 changing the filename to reflect HD-002. <del>HD-001 would not show up on the solo 2 Forensics image master.</del> Command completed w/ no errors 142264000 to records in ; out. All md5sums matched. Shutdown machine ; placed MB13742 into machine as HDD. MB13742 contains the image files for Item3-HD-003 ; Item3-HD-004 Booted into Linux to verify the images for both Hard Drives. <del>HD-003 verification</del> Ran "cat hd-003.*   dd if=/dev/zero conv=sync,noerror of=/dev/null hashwindow=256k hashlog=HD-003-Img.md5" Ran command from the Tag393-04-Item3-HD-003 directory. Command completed w/ no errors 143374744 to records in ; out. Ran "tail -1 HD-003-*.md5" all md5sums matched. Ran same commands for HD-004 from the Tag393-04-Item3-HD-004 directory verification completed w/ no errors 143374744 to records in ; out. md5sums matched. shutdown machine. Inserted MB13730 images for Item3-HD-001 ; HD-002 to begin archive to DCT IV tape. Booted into Linux. Ran "ntfs (default) status" Ran "ntfs (default) full" Ran "tar -cvzpf (default) * -b 128" from /mnt/images Archive completed w/ no errors over 4 tapes. Shutdown machine. Removed images drive from machine. Inserted images drive MB13472 as HDD ; <del>placed</del> <sup>placed</sup> Solomonster copy of Item1-HD-002 on a Winstat Forensic Combook MB 16107 to image. Booted into Linux.
8 Dec 2004	Archive completed w/ no errors over 4 tapes. Shutdown machine. Removed images drive from machine. Inserted images drive MB13472 as HDD ; <del>placed</del> <sup>placed</sup> Solomonster copy of Item1-HD-002 on a Winstat Forensic Combook MB 16107 to image. Booted into Linux.

Technician: [redacted] Initials: [redacted]

FOR OFFICIAL USE ONLY

b67c

## Department of Defense Computer Forensics Lab,

## Technician Notes

DCFL Request # - DCFL-2004-1004327

0027-03-CID679-64999

Page 2 of 4

	mounted HDD to /mnt/images, changed into /mnt/images/Taf393-04-Item1-HD-002 directory.
	Ran "fdisk -l" evidence showed up as Sdb
	Ran "fdisk -l /dev/sdb > HD-002-org.fdisk"
	Ran "dd if=/dev/sdb conv=sync,noerror iflag=dirsync,hashwindow=256k hashlog=HD-002-org.mds count=142264000; split -b 1900m - hd-002 -"
	imaging completed w/ no errors 142264000 + 0 records in; out
	Ran "file-mv.pl" to rename images to conform to Etoole naming conventions
	Ran "cat hd-002.0*"; dd if=/dev/null conv=sync,noerror of=/dev/null hashwindow=256k hashlog=HD-002-img.mds"
9 Dec 2004	verification completed w/ no errors 142264000 + 0 records in; out
	Ran "tail -l HD-002-*.md5"
	Both md5sums matched.
	Shutdown machine.
	Inserted MB13742, Item3-HD-003; HD-004 images drive, to begin archive to tape.
	Booted into Linux. Mounted HDD to /mnt/images. From /mnt/images I ran
	"nt -f /dev/inst0 status"
	Ran "nt -f /dev/inst0 kill"
	Ran "tar -cvMhpf /dev/inst0 * -b 128"
	Archive completed w/ no errors
	Shutdown machine.
	Removed HDD and replaced it with Images (2) drive MB13712 for Item2-HD-001; HD-002. Inserted tape of the archive also to begin extraction from tape.
	Booted into Linux. Mounted HDD1 to /mnt/images.
	Ran "nt -f /dev/inst0 status"
	Ran "nt -f /dev/inst0 kill"
	From /mnt/images I ran "tar -xvMhpf /dev/inst0 +b 128"
10 Dec 2004	Extraction completed w/ no errors.
	Shutdown machine & inserted MB13690 as HD B to restore the images to. Booted into Linux; mounted HDD1 to /mnt/images
	From /mnt/images I ran "cat From /mnt/images/Taf393-04-Item2-HD-001 I ran command "cat hd-001.0*"; dd if=/dev/hdb conv=sync,noerror of=/dev/hdb"
	Sent e-mail to Examiner John Brannock requesting him to come and get the images HD for Item2-HD-001; HD-002 MB13693. Drive will

Technician: [REDACTED]

Initials: [REDACTED]

FOR OFFICIAL USE ONLY

b67c

000196

## Department of Defense Computer Forensics Lab,

## Technician Notes

DCFL Request # - DCFL-2004-100 4327

0027-03-CID679-64999

Page 3 of 4

	checked out first thing Monday morning.
14 Dec 2004	Restore completed w/ no errors 142264000+0 records in ; out. Ran "defldd conv=sync, noerror if=/dev/hdb of=/dev/null hashwindow=256k hashlog=HD-001-res.md5 count=142264000" Restore verification completed w/ no errors 142264000+0 records in ; out. Ran "tail -1 HD-001-*.md5" All md5sums matched. Shutdown machine Removed restore drive for Item2-HD-001 and replaced it with MB13109, restore drive for Item2-HD-002. Booted into Linux. Ran same commands as for HD-001 changing the filenames to reflect HD-002 Restore completed w/ no errors 142264000+0 records in ; out. Restore verification completed w/ no errors 142264000+0 records in ; out All md5sums matched Shut down machine
15 Dec 2004	Replaced Restore drive for Item2-HD-002 w/ restore drive MB13334 for Item1-HD- 002 and replaced images (2) drive MB1562 with images (2) drive from Item1. Booted into Linux - mounted HD01 to /mnt/images. From /mnt/images/Tape9301.Item1-HD-002 I ran "cat hd-001.0#"; defldd conv=sync, noerror of=/dev/hdb Restore completed w/ no errors 142264000+0 records in ; out
16 Dec 2004	Ran command "defldd conv=sync, noerror if=/dev/hdb of=/dev/null hashwindow= 256k hashlog=HD-002-res.md5 count=142264000" Restore verification completed w/ no errors 142264000+0 records in ; out. Ran "tail -1 HD-002-*.md5" All md5sums matched Shutdown machine; removed HD01; HD03 from machine. Replaced HD01 with MB13697, images (2) for Item3-HD-001; HD-002 and replaced HD03 with MB13077 Restore for Item3-HD-001. Booted into Linux

Technician: \_\_\_\_\_

Initials: \_\_\_\_\_

FOR OFFICIAL USE ONLY

**b67c**

000197



Department of Defense Computer Forensics Lab,  
Technician Notes

DCFL Request # - DCFL-2004-1004327

0027-03-CID679-64999

Page 1 of 3

7 Dec 2004	Inserted images drive from Tag 397-04-Item 2-HD-001 & HD-002 into F800 2.8 GHz machine MB1622 to begin archive to DLT & tape.
	Booted machine into Linux. Mounted HD01 to /mnt/images. From /mnt/images I ran command "tar -xvmjpf /dev/nst0 -b 128" to begin archive
9 Dec 2004	Archive completed w/ no errors.
	Shutdown machine. Removed Item 2-HD-001 & HD-002 images drive.
	Inserted images drive MB1342 for Item 1-HD-001 & HD-002 into machine to begin archiving to DLT tape.
	Booted into Linux. Mounted HD01 to /mnt/images. From /mnt/images I ran command "tar -xvmjpf /dev/nst0 -b 128"
10 Dec 2004	Archive completed w/ no errors
	Shutdown machine; removed tape and HD01. Write-protected tapes and inserted MB15622 images(2) drive into machine as HD0. Inserted 1 <sup>st</sup> tape in sequence for Item 1 and booted into Linux.
	Partitioned & formatted HD0 to receive images.
	Mounted HD01 to /mnt/images. From /mnt/images I ran commands
	"mt -f /dev/nst0 status"
	"mt -f /dev/nst0 tell"
	"tar -xvmjpf /dev/nst0 -b 128"
	Extraction completed w/ no errors.
	Shutdown machine & removed the tape. Inserted MB1230 to restore the Item 1-HD-002 images to. Booted into Linux
13 Dec 2004	Extraction completed w/ no errors.
	Shutdown machine & removed MB15622
	Inserted MB15633 Images(2) drive for Item 3-HD-001 & HD-002
	Booted into Linux.
	Ran Partitioned & formatted HD0 to receive images from extraction from tape.
	Mounted HD01 to /mnt/images & inserted tape 1 from Item 3-HD-001 & HD-002
	Ran "mt -f /dev/nst0 status"
	Ran "mt -f /dev/nst0 tell"
	From /mnt/images I ran "tar -xvmjpf /dev/nst0 -b 128"
15 Dec 2004	Extraction completed w/ no errors
	Shutdown machine & removed HD0.
	Replaced MB15622 with MB15633, images(2) drive for Item 3-HD-003 & HD-004

Technician: \_\_\_\_\_

Initials: \_\_\_\_\_

FOR OFFICIAL USE ONLY

**b67c**

000199

Department of Defense Computer Forensics Lab,  
Technician Notes  
DCFL Request # - DCFL-2004-100 4327

Page 2 of 3

0027-03-CID679-64999

15 Dec 2004	Booted into linux. Partitioned: formatted HD01 to receive images from tape. Mounted HD01 to /mnt/images Ran "cat f (dir/instp status)" ran "cat f dir/instp hll" FROM /mnt/images I ran "tar -xvMhpf (dir/instp sb128)"
NOTE =>	Extraction errored between tapes 1:2. <sup>Extraction archive</sup> Archive is going to have to be redone. Shutdown machine; removed images (1) drive and replaced it with the (2) images drive to restart archive. ERROR STATED TAPE WAS OUT OF SEQUENCE. INSERTED TAPE I had labeled as "volume 3 of 3" and got some out of sequence error.
	Rebooted into linux. Ran some archive commands as before.
17 Dec 2004	Archive completed w/ no errors. Shutdown machine; removed HD01 and replaced it with Mb15633 images (2) drive for Item3-HD-003; HD-004. Ran some extraction commands as for the previous time.
20 Dec 2004	Power was shutdown Saturday 18 Dec 2004 and extraction of Item3-HD-003 & HD-004 was stopped. Process was restarted this morning.
	Extraction completed w/ no errors Shutdown machine.
	Inserted Mb13582 to begin restore of Item3-HD-003. Booted into linux mounted HD01 to /mnt/images Changed directories to Tq3923-04-Item3-HD-003
	Ran command "cat hd-003.04; dcfldd conv=sync,noerror of=/dev/hdb"
22 Dec 2004	Restore completed w/ no errors 143374744 to records in: out.
	Ran "dcfldd conv=sync,noerror if=/dev/hdb of=/dev/null hashwindow=256k hashlog: HD-003-res.mds Count=143374744" Command completed w/ no errors 143374744 to records in: out

Technician: [REDACTED]

Initials: [REDACTED]

FOR OFFICIAL USE ONLY

b67c

000200





Exhibit 40

Pages 202 - 206 referred to

Department of Defense  
Computer Forensics Laboratory (DCFL)  
911 Elkridge Landing Road  
Suite 300  
Linthicum, MD 21090



**00027**  
**UNITED STATES 03-CID679-64999**  
**DEPARTMENT OF DEFENSE**

**COMPUTER FORENSICS LAB**

**Examiner Notes**

**SrA [REDACTED]**

**Date: 19 January 2005**

**DCFL-2004-I004327**  
**USACIL-2004-CID131-2130**

**FOR OFFICIAL USE ONLY**

**667C**

*Ex 4a*

000207

**Department of Defense Computer Forensics Laboratory**

Date \_\_\_\_\_

Page 1 of 4

**Event Log 0027-03-CID679-64999**

<p>12 Jan 05</p>	<ul style="list-style-type: none"> <li>• Loaded images provided by [REDACTED] into look v. 8.0.3</li> <li>• Filesystem map revealed two separate image sets (two different hard drives were imaged onto same large capacity image drive)</li> <li>• Partition Traverse was run and revealed the following:             <ul style="list-style-type: none"> <li>○ HD_1 contained two NTFS partitions with intact logical filesystems that appeared to be identical; first partition was hashed to create a hash list; that hash list was used to negative hash the second partition; all files from second partition were eliminated—confirming that second partition was exact copy of first partition</li> <li>○ HD_2 contained no logical filesystem, and appeared to contain only unallocated space</li> </ul> </li> <li>• look identified HD_1 as being 68.4 GB in size, with 27.2 GB of free space</li> <li>• look identified HD_2 as being 205 GB in size, with 205 GB of free space</li> </ul>
<p>13 Jan</p>	<ul style="list-style-type: none"> <li>• Performed search on HD_1 using search terms provided by case agent; results as follows:             <ul style="list-style-type: none"> <li>○ 1/13/2005 3:17:57 PM Failed to search object (50676) named (\\WINNT\\$\NtServicePackUninstall\$\ldapsvcx.dll) for Evidential Media item (4327 =&gt; 4327 =&gt; Blade Server HD_1 (3)).</li> <li>○ 1/13/2005 4:38:41 PM Completed ASCII basic search of file objects for Evidential Media item (4327 =&gt; 4327 =&gt; Blade Server HD_1 (3)). 16996 hit(s) found in 3624 objects.</li> <li>○ 1/13/2005 4:38:41 PM Completed Unicode basic search of file objects for Evidential Media item (4327 =&gt; 4327 =&gt; Blade Server HD_1 (3)). 1391 hit(s) found in 369 objects.</li> <li>○ 1/13/2005 4:38:41 PM Started basic search of file slack for Evidential Media item (4327 =&gt; 4327 =&gt; Blade Server HD_1 (3)).</li> <li>○ 1/13/2005 4:41:16 PM Failed to search file slack of object (9200) named (\\\$Extend\\$\UsnJrnl) for Evidential Media item (4327 =&gt; 4327 =&gt; Blade Server HD_1 (3)).</li> <li>○ 1/13/2005 4:57:17 PM Completed ASCII basic search of file slack for Evidential Media item (4327 =&gt; 4327 =&gt; Blade Server HD_1 (3)). 129 hit(s) found.</li> <li>○ 1/13/2005 4:57:17 PM Completed Unicode basic search of file slack for Evidential Media item (4327 =&gt; 4327 =&gt; Blade Server HD_1 (3)). 22 hit(s) found.</li> <li>○ 1/13/2005 4:57:17 PM Started basic search of archives for Evidential Media item (4327 =&gt; 4327 =&gt; Blade Server HD_1 (3)).</li> <li>○ 1/13/2005 5:06:48 PM Completed ASCII basic search of archives for Evidential Media item (4327 =&gt; 4327 =&gt; Blade Server HD_1 (3)). Renewed counts - 17476 hit(s) found in 3680 objects.</li> <li>○ 1/13/2005 5:06:48 PM Completed Unicode basic search of archives for Evidential Media item (4327 =&gt; 4327 =&gt; Blade Server HD_1 (3)). Renewed counts - 1432 hit(s) found in 378 objects.</li> <li>○ 1/13/2005 5:06:48 PM Started basic search of deconstructions for</li> </ul> </li> </ul>

Case Number - DCFL-2004-1004327  
0027-03-CID679-64999

[REDACTED] SrA, USAF

**667C**

000208

## Department of Defense Computer Forensics Laboratory

Date \_\_\_\_\_

0027-03-CID679-64999

Page 2 of 4

	<p>Evidential Media item (4327 =&gt; 4327 =&gt; Blade Server HD_1 (3)).</p> <ul style="list-style-type: none"> <li>o 1/13/2005 5:06:48 PM Completed ASCII basic search of deconstructions for Evidential Media item (4327 =&gt; 4327 =&gt; Blade Server HD_1 (3)). Renewed counts - 17476 hit(s) found in 3680 objects.</li> <li>o 1/13/2005 5:06:48 PM Completed Unicode basic search of deconstructions for Evidential Media item (4327 =&gt; 4327 =&gt; Blade Server HD_1 (3)). Renewed counts - 1432 hit(s) found in 378 objects.</li> </ul>
14 Jan	<ul style="list-style-type: none"> <li>• Performed physical level carve on HD_2 to try and recover any HTML, MS Office, or E-mail files; results as follows: <ul style="list-style-type: none"> <li>o 1/15/2005 1:17:20 AM Salvaged (47) file(s) for definition (Word Perfect).</li> <li>o 1/15/2005 1:17:20 AM Salvaged (1080) file(s) for definition (MS Word 4-5).</li> <li>o 1/15/2005 1:17:20 AM Salvaged (1284) file(s) for definition (MS Word 1).</li> <li>o 1/15/2005 1:17:20 AM Salvaged (1187) file(s) for definition (MS Word 2).</li> <li>o 1/15/2005 1:17:20 AM Salvaged (13546) file(s) for definition (MS Word or MS Excel).</li> <li>o 1/15/2005 1:17:20 AM Salvaged (170) file(s) for definition (Rich Text File).</li> <li>o 1/15/2005 1:17:20 AM Salvaged (0) file(s) for definition (MS Works).</li> <li>o 1/15/2005 1:17:20 AM Salvaged (0) file(s) for definition (MS Excel 3-4).</li> <li>o 1/15/2005 1:17:20 AM Salvaged (13546) file(s) for definition (MS Excel or MS Word).</li> <li>o 1/15/2005 1:17:20 AM Salvaged (13662) file(s) for definition (MS Office Catch-All).</li> <li>o 1/15/2005 1:17:20 AM Salvaged (169) file(s) for definition (MS Access Db).</li> <li>o 1/15/2005 1:17:20 AM Salvaged (14) file(s) for definition (Outlook Mail).</li> <li>o 1/15/2005 1:17:20 AM Salvaged (0) file(s) for definition (Outlook Express Mail Dump).</li> <li>o 1/15/2005 1:17:20 AM Salvaged (0) file(s) for definition (Outlook Express Mail Index).</li> <li>o 1/15/2005 1:17:20 AM Salvaged (0) file(s) for definition (Outlook Express Mail Box).</li> <li>o 1/15/2005 1:17:20 AM Salvaged (14) file(s) for definition (Outlook Offline Storage).</li> <li>o 1/15/2005 1:17:21 AM Salvaged (0) file(s) for definition (AOL MailBox).</li> <li>o 1/15/2005 1:17:21 AM Salvaged (149) file(s) for definition (HTML (1)).</li> <li>o 1/15/2005 1:17:21 AM Salvaged (539) file(s) for definition (HTML (2)).</li> <li>o 1/15/2005 1:17:21 AM Salvaged (89) file(s) for definition (HTML (3)).</li> <li>o 1/15/2005 1:17:21 AM Salvaged (169) file(s) for definition (Microsoft Access file).</li> <li>o 1/15/2005 1:17:21 AM Salvaged (8) file(s) for definition (MS Excel v2).</li> <li>o 1/15/2005 1:17:21 AM Salvaged (1) file(s) for definition (MS Excel v4 File).</li> <li>o 1/15/2005 1:17:21 AM Salvaged (0) file(s) for definition (MS Word 6.0 File).</li> </ul> </li> </ul>

Case Number -DCFL-2004-1004327  
0027-03-CID679-64999

██████████ SrA, USAF ██████████

b67c

000209

**Department of Defense Computer Forensics Laboratory**

Date \_\_\_\_\_

Page 344

~~0027-03-CID679-64999~~

	<ul style="list-style-type: none"> <li>o 1/15/2005 1:17:21 AM Salvaged (14) file(s) for definition (Outlook 97 File).</li> <li>o 1/15/2005 1:17:21 AM Salvaged (1639) file(s) for definition (PDF-1.2).</li> <li>o 1/15/2005 1:17:21 AM Salvaged (0) file(s) for definition (MS Word for DOS v6 File).</li> <li>o 1/15/2005 1:17:21 AM Salvaged (541) file(s) for definition (HyperText Markup Language 3 File).</li> <li>o 1/15/2005 1:17:21 AM Salvaged (120) file(s) for definition (MS Excel XML Document).</li> <li>o 1/15/2005 1:17:21 AM Salvaged (89) file(s) for definition (HyperText Markup Language 2 File).</li> <li>o 1/15/2005 1:17:21 AM Salvaged (149) file(s) for definition (HyperText Markup Language 1 File).</li> <li>o 1/15/2005 1:17:21 AM Salvaged (29) file(s) for definition (Outlook Express Email Message).</li> <li>o 1/15/2005 1:17:21 AM Salvaged (170) file(s) for definition (Rich Text Format).</li> <li>o 1/15/2005 1:17:21 AM Salvaged (0) file(s) for definition (MS Word File).</li> <li>o 1/15/2005 1:17:21 AM Salvaged (0) file(s) for definition (Microsoft Excel Workbook).</li> <li>o 1/15/2005 1:17:21 AM Salvaged (0) file(s) for definition (Outlook Express Email Storage File).</li> <li>o 1/15/2005 1:17:21 AM Salvaged (47) file(s) for definition (WordPerfect v5 or v6).</li> <li>o 1/15/2005 1:17:21 AM Salvaged (0) file(s) for definition (MS Excel Document).</li> </ul>
<p>18 Jan</p>	<ul style="list-style-type: none"> <li>• Performed search of carve results using terms provided by case agent; results as follows:             <ul style="list-style-type: none"> <li>o 1/18/2005 1:08:11 PM Started basic search of salvage for Evidential Media item (4327 =&gt; 4327 =&gt; Blade Server HD_2 (4)).</li> <li>o 1/18/2005 11:26:48 PM Completed ASCII basic search of salvage for Evidential Media item (4327 =&gt; 4327 =&gt; Blade Server HD_2 (4)). Renewed counts - 38511 hit(s) found in 8591 objects.</li> <li>o 1/18/2005 11:26:48 PM Completed Unicode basic search of salvage for Evidential Media item (4327 =&gt; 4327 =&gt; Blade Server HD_2 (4)). Renewed counts - 5182 hit(s) found in 1161 objects.</li> <li>o 1/18/2005 11:26:48 PM Control file (L:\4327 Control\SearchResults\Sdb_0_0.x) copied to backup file (L:\4327 Control\SearchResults\Sdb_0_0.x18012005232647.bak).</li> <li>o 1/18/2005 11:26:48 PM Saving control file (L:\4327 Control\SearchResults\Sdb_0_0.x).</li> <li>o 1/18/2005 11:26:48 PM Saved Search Db data to file (L:\4327 Control\SearchResults\Sdb_0_0.x).</li> <li>o 1/18/2005 11:26:48 PM Completed basic search for Evidential Media item (4327 =&gt; 4327 =&gt; Blade Server HD_2 (4)) using search set (Basic ASCII filesystem search of containers (0)).</li> </ul> </li> </ul>

Case Number - DCFL-2004-1004327  
0027-03-CID679-64999

██████████ SrA, USAF ██████████

**b67c**

000210

Department of Defense Computer Forensics Laboratory

Date \_\_\_\_\_

Page 4 of 4

19 Jan	• Examination complete; writing Form 42
<b>LAST ENTRY ON THIS PAGE</b>	

0027-03-CID679-64999

Case Number -DCFL-2004-1004327  
 0027-03-CID679-64999  
 \_\_\_\_\_ SrA, USAF \_\_\_\_\_

**bb7C**

# DoD COMPUTER FORENSICS LABORATORY

0027-03-CID679-64999

## COMPUTER SYSTEM WORKSHEET

DCFL# <b>04-2004327</b>	TAG/ITEM#: <b>393-04-Item 3</b>
MAKE: <b>BSE</b>	MODEL: <b>N/A</b>
SERIAL #: <b>66180TA076</b>	BIOS (NAME AND VERSION): <b>N/A</b>
SYSTEM TIME: <b>N/A</b>	SYSTEM DATE: <b>N/A</b>
CURRENT TIME: <b>11:22:30</b>	CURRENT DATE: <b>12-23-2004</b>

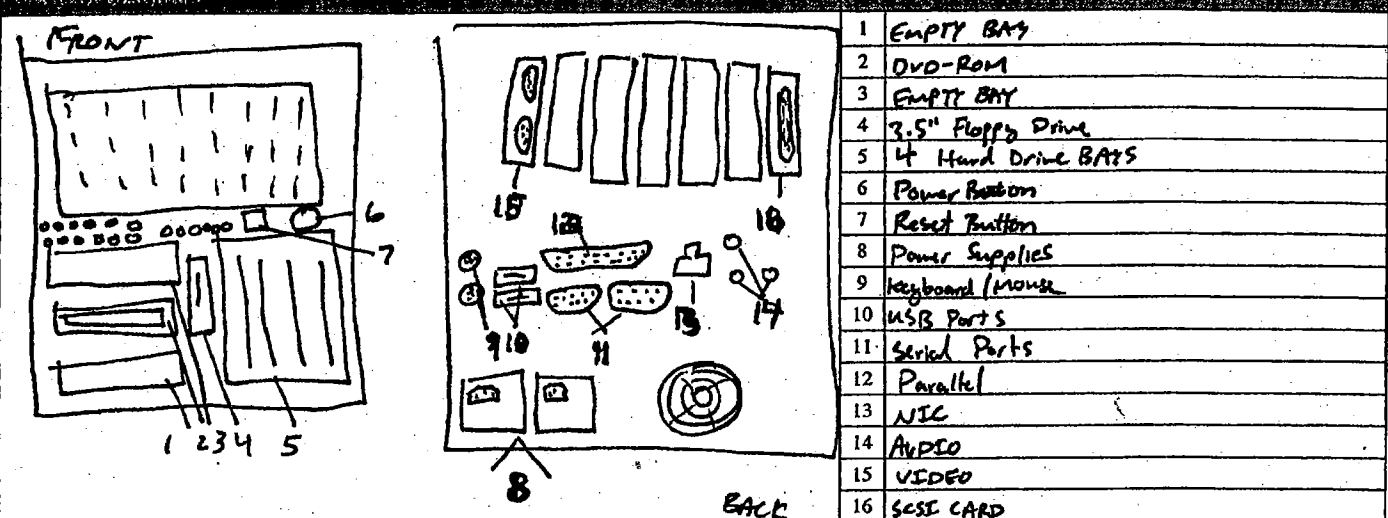

**INTEGRATED COMPONENTS LEGEND:**  
 K - Keyboard    M - Mouse    P - Power Supply    S - Serial Port    R - Parallel Port    F - Firewire Port    U - USB Port  
 D - Modem    N - NIC    A - Audio    J - Joystick    V - Video    C - SCSI

DEVICE	BRAND	MODEL #	SERIAL #	SIZE
Hard Disk	Seagate	ST373307LC	3H2QLH3G	73.3
Hard Disk	Seagate	ST373307LC	3H2Q756	73.3
Hard Disk	Seagate	ST373307LC	3H2Q7AAE	73.3
Hard Disk	Seagate	ST373307LC	3H2QPTP6	73.3

Couldn't get any video from machine. FAN LED was blinking. Removed fans in case and retested them but still didn't get any video. BIOS information could not be obtained.

ANALYST NAME (Print) <b>[REDACTED]</b>	DATE <b>12-23-2004</b>	SIGNATURE <b>[REDACTED]</b>
---	---------------------------	--------------------------------

b67c

000212



# DoD COMPUTER FORENSICS LABORATORY

0027-03-CID 679-64999

## COMPUTER SYSTEM WORKSHEET

DCFL # <b>4-2004327</b>	TAG/ITEM #: <b>T41393-01-Item1</b>
MAKE: <b>Compaq</b>	MODEL: <b>Proliant DL36062</b>
SERIAL #: <b>6J31JNT100ET</b>	BIOS (NAME AND VERSION): <b>N/A</b>
SYSTEM TIME: <b>N/A</b>	SYSTEM DATE: <b>N/A</b>
CURRENT TIME: <b>10:30:43</b>	CURRENT DATE: <b>12-23-2004</b>

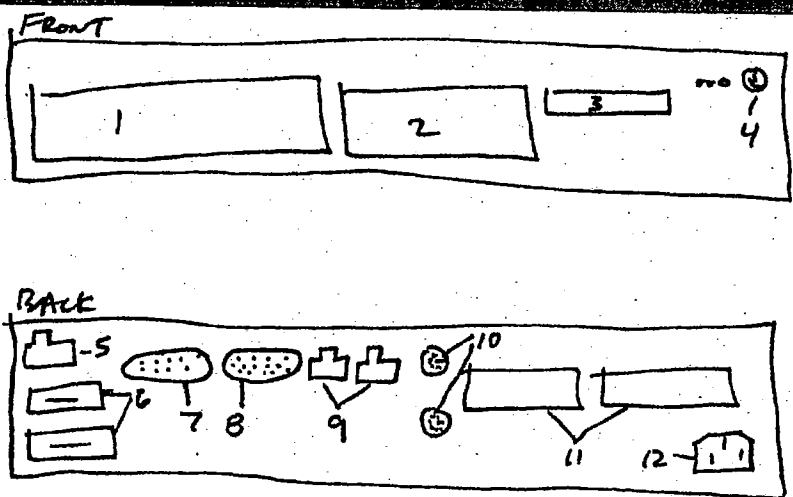

- |    |                   |
|----|-------------------|
| 1  | Hard Drive BAY    |
| 2  | Hard Drive BAY    |
| 3  | 3.5" Floppy drive |
| 4  | Power Button      |
| 5  | NIC               |
| 6  | USB Ports         |
| 7  | Serial Port       |
| 8  | Video             |
| 9  | NIC 1 & NIC 2     |
| 10 | Keyboard/Mouse    |
| 11 | EMPTY BAYS Slots  |
| 12 | Power             |
| 13 |                   |
| 14 |                   |
| 15 |                   |
| 16 |                   |

**INTEGRATED COMPONENTS LEGEND:**

K - Keyboard    M - Mouse    P - Power Supply    S - Serial Port    R - Parallel Port    F - Firewire Port    U - USB Port  
 D - Modem        N - NIC            A - Audio            J - Joystick        V - Video            C - SCSI

DEVICE	BRAND	MODEL #	SERIAL #	SIZE
Hard Disk	HP INVENT	B3D07205A25	3H30DJ4Z	72.8Gb
Hard Disk	HP INVENT	B3D07205A25	3H30DJ4Z	72.8Gb

Machine wouldn't power up so BIOS information could not be obtained.

ANALYST NAME (Print)	DATE	SIGNATURE
[REDACTED]	12-23-2004	[REDACTED]

b67c

000213

# DoD COMPUTER FORENSICS LABORATORY

0027 03-C 15679 64999

## COMPUTER SYSTEM WORKSHEET

DCFL # 04-1004327	TAG/ITEM #: T0393-01-Item2-
MAKE: COMPAQ	MODEL: Proliant DL360 G2
SERIAL #: GJ31JNT180EY	BIOS (NAME AND VERSION): P26
SYSTEM TIME: 10:00:34	SYSTEM DATE: 12-23-2004
CURRENT TIME: 10:30:34	CURRENT DATE: 12-23-2004

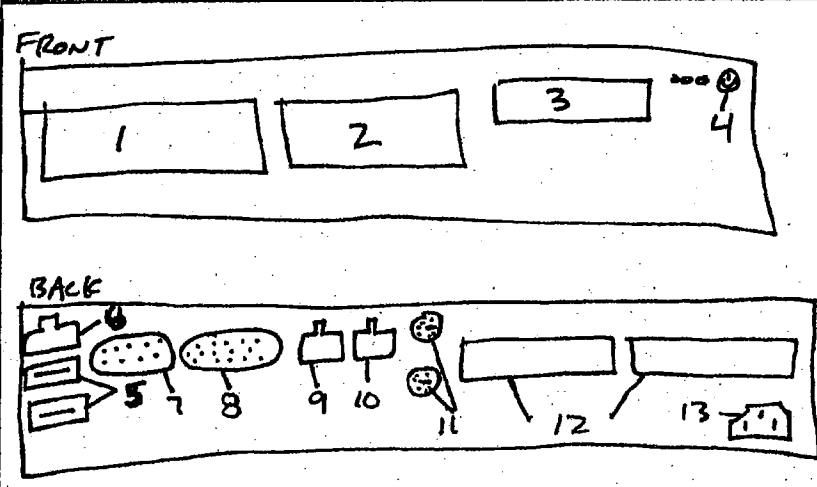

- |    |                                      |
|----|--------------------------------------|
| 1  | Hard Drive Bay                       |
| 2  | Hard Drive Bay                       |
| 3  | 3.5" Floppy drive                    |
| 4  | Power Button                         |
| 5  | USB Ports                            |
| 6  | NIC                                  |
| 7  | <del>Parallel Port</del> Serial Port |
| 8  | Video                                |
| 9  | NIC 2                                |
| 10 | NIC 1                                |
| 11 | Keyboard/Mouse                       |
| 12 | EMPTY slots                          |
| 13 | Empty slot Power                     |
| 14 |                                      |
| 15 |                                      |
| 16 |                                      |

**INTEGRATED COMPONENTS LEGEND:**  
 K - Keyboard    M - Mouse    P - Power Supply    S - Serial Port    R - Parallel Port    F - Firewire Port    U - USB Port  
 D - Modem    N - NIC    A - Audio    J - Joystick    V - Video    C - SCSI





DEVICE	BRAND	MODEL #	SERIAL #	SIZE
Hard Disk	HP Invent	BD07205A25	3H30ES8H	72.8 Gb
Hard Disk	HP Invent	BD07205A25	3H30E89V	72.80b

ANALYST NAME (Print)	DATE	SIGNATURE
[REDACTED]	23 Dec 2004	[REDACTED]

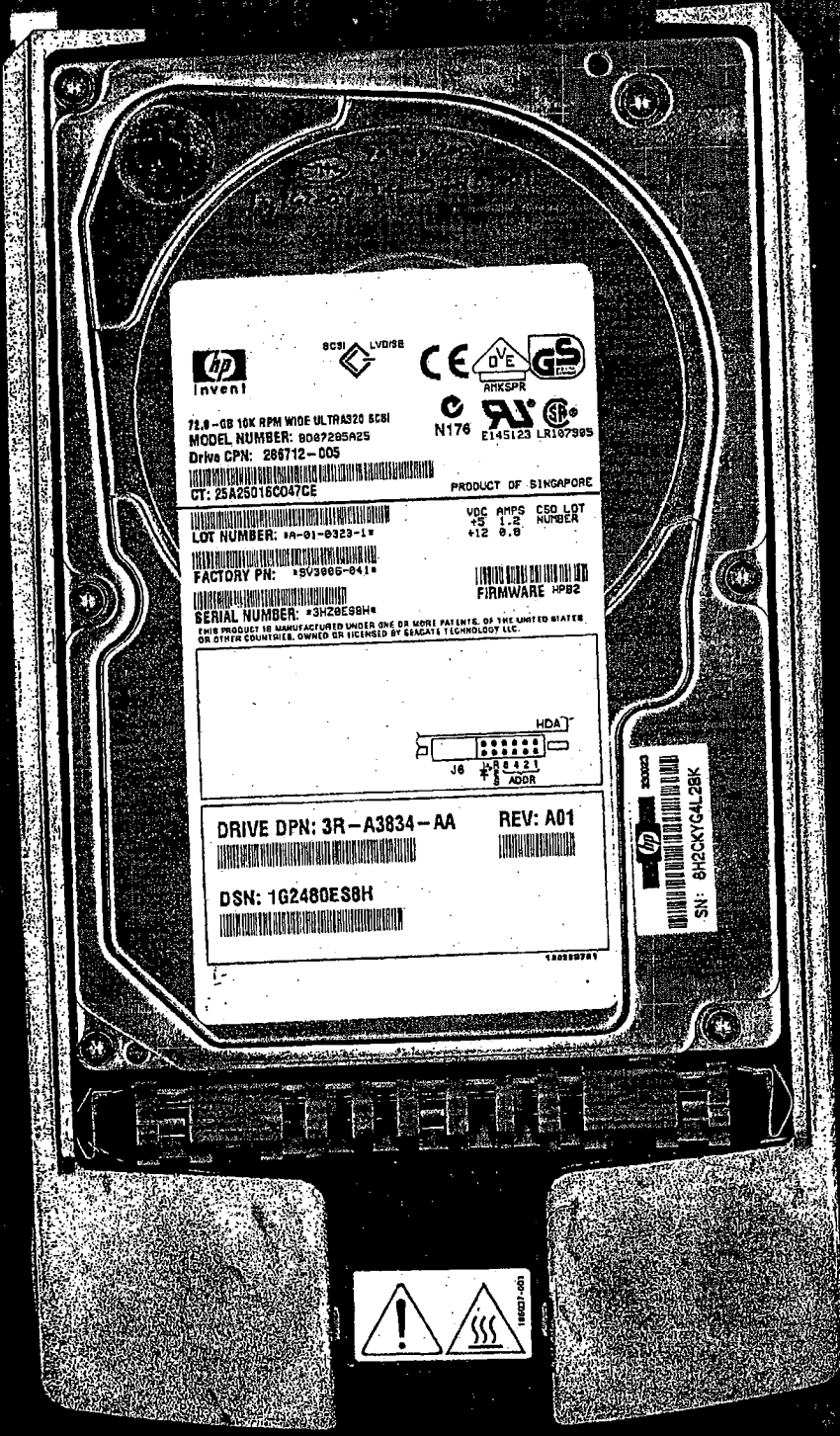
b67c

000214



**72.8-GB 10K RPM WIDE ULTRA320 SCSI**  
**MODEL NUMBER: 8087285A25**  
**Drive CPN: 288712-005**  
 CT: 25A25016C047CE

**PRODUCT OF SINGAPORE**

VDC	AMPS	CSD LOT
+5	1.2	NUMBER
+12	0.8	

**LOT NUMBER: \*A-01-0323-1\***  
**FACTORY PN: \*9V3865-041\***  
**SERIAL NUMBER: \*3F24E88H\***

FIRMWARE: HPB2

THIS PRODUCT IS MANUFACTURED UNDER ONE OR MORE PATENTS OF THE UNITED STATES OR OTHER COUNTRIES, OWNED OR LICENSED BY SEAGATE TECHNOLOGY LLC.

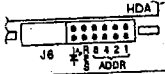

**DRIVE DPN: 3R-A3834-AA**      **REV: A01**  
**DSN: 1G2480E58H**

SN: 8H2CKYCAL2BK



000215

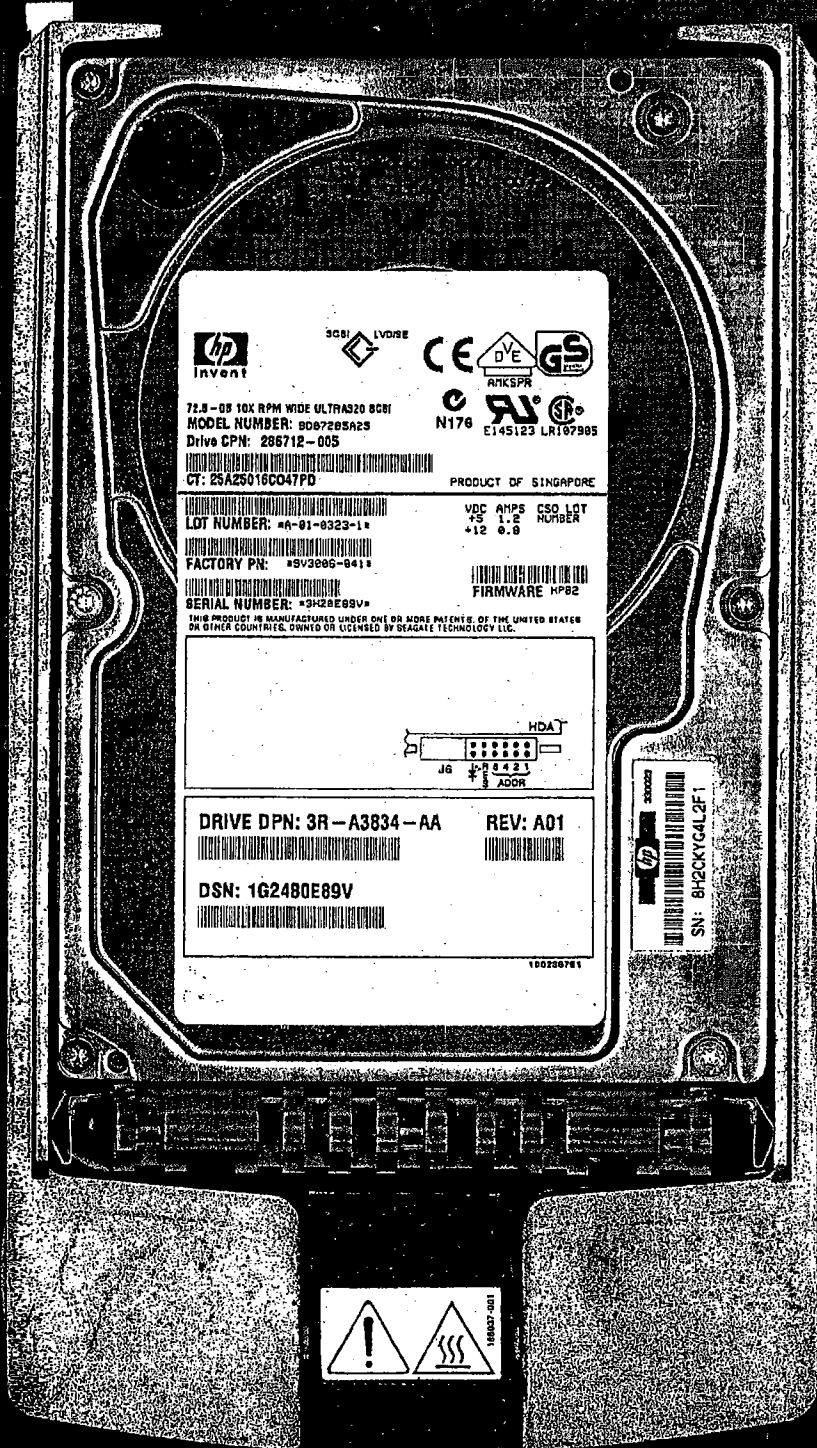

72.5 - 08 10K RPM WIDE ULTRAS20 8001  
 MODEL NUMBER: 8087205A25  
 Drive CPN: 286712 - 005  
 CT: 85A25016C047PD



AMKSPR  
 N176 E145123 LRI07985

PRODUCT OF SINGAPORE

LOT NUMBER: \*A-01-0323-1\*  
 FACTORY PN: \*8V3095-041\*  
 SERIAL NUMBER: \*3H20E89V\*

VDC AMPS CSO LOT  
 \*5 1.2 AC78ER  
 \*12 0.8  
 FIRMWARE MP82

THIS PRODUCT IS MANUFACTURED UNDER ONE OR MORE PATENTS OF THE UNITED STATES  
 OR OTHER COUNTRIES, OWNED OR LICENSED BY SEAGATE TECHNOLOGY LLC.

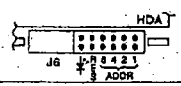

DRIVE DPN: 3R - A3834 - AA      REV: A01

DSN: 1G2480E89V



000216

<b>Department of Defense Computer Forensics Laboratory (DCFL)</b>		
<b>Configuration Item</b>	<b>Title: Windows XP Software Build</b>	
<b>CI Number: CI-20</b>	<b>Revision: 1.0</b>	<b>Effective Date: 14 May 2004</b>
<b>Approved (Director):</b> [REDACTED]		

0027-03-CID679-64999

**1. PURPOSE**

The purpose of this Configuration Item is to identify the list of software tools, installed in a Windows XP Professional workstation, that are authorized to perform forensic examinations in the Defense Computer Forensics Laboratory (DCFL).

**2. SCOPE**

The Software list, policies and procedures contained herein are to be followed by all Computer Forensic Examiners when performing forensic examinations in the DCFL.

**3. POLICIES**

The Laboratory Director is the only person that can approve standard configurations of hardware, firmware or software tools for performing forensic examinations in the DCFL. In the event that additional software from the Accessory Software List (CI-7), is required for performing forensic examinations, Forensic Examiners shall request approval from their Section Chief using DCFL Form 13, Deviation From Standard Configuration. All Form 13 documents are to be routed to the DCFL Operations Director, DCFL Technical Director and DCCI Engineering Director.

**4. REFERENCES**

N/A

**5. RESPONSIBILITY**

- 5.1. DIRECTOR, DCFL: The Director of DCFL is responsible for the approval of standard hardware, firmware and software tools used to perform forensic examinations in the DCFL.
- 5.2. Director of Operations: The Director of Operations is responsible for ensuring Forensic Examiners comply with this procedure.
- 5.3. Section Chief: Section Chiefs are also responsible for enforcing this procedure.
- 5.4. Forensic Examiners: Forensic Examiners are responsible for complying with this procedure.

**6. SUMMARY OF PROCEDURES**

This document defines the software operating system, tools and utilities used in the Windows XP Professional software build to perform forensic examinations.

**7. SAFETY**

b67c

CI-20 V1-0  
Page 1 of 3Ex 40  
000217

Department of Defense Computer Forensics Laboratory (DCFL)		
Configuration Item	Title: Windows XP Software Build	
CI Number: CI-20	Revision: 1.0	Effective Date: 14 May 2004
Approved (Director): [REDACTED]		

All personnel using electronic equipment should be aware of safety precautions and procedures while using electronic equipment in accordance with laboratory safety policy.

## 8. EQUIPMENT AND MATERIAL

0027-03-CID679-64999

Windows Professional Operating System	XP
Windows XP Service Pack	1a
MS Office 2000 Professional	SR1 with SP 3
Internet Explorer	6.0.2800.1106
ACDSee	6
iLook	8.0.0
Quickview +	7.0.0
Norton Utilities 2002	6.00.20g
Norton Antivirus Corporate Edition	7.01
The Cleaner	4
MS Media Player	9
Acrobat Reader with Search	5.0.5
IE History Viewer	1.4.2.6
DIVX Codec	5.1.1
Nero CD Burner	5.5.10.42
WinZip	8.1
Winhex 64bit	10.54
Macromedia Flash Player	6
SMT Archive for Outlook	2.5
CD-R Inspector	1.2.4
DBXtractor	3.7
MBXtractor	2.11
RealOne player	6.0.10.864
DatView	2.1
AOLSupp	36683
Net Analysis	1.X
WNTIPCFG.EXE	1.00.0.1
MS Publisher	SR1
MS Office 2000 Multi-language Pack	SR1
MS Photo Editor	3.01
DbbView	2.1
DCCeye	1.0
AVI Codec for Windows Media Player	1.1.0.4
MS Office Metadata Script	1.0

b67c

Department of Defense Computer Forensics Laboratory (DCFL)		
Configuration Item	Title: Windows XP Software Build	
CI Number: CI-20	Revision: 1.0	Effective Date: 14 May 2004
Approved (Director): [REDACTED]		

KaZaLyser	1.X
Tcopy	1.0
Perl	5.8
Snapview	1.50.002
Registry Browser	2.02a
WinDVD	5.0
Windows Media Codec	MPG-4

## 9. PROCEDURES

- 9.1. Install Windows XP Operating System using an NTFS format. Use appropriate XP boot floppies as necessary.
- 9.2. Install the full package of Windows XP with all regional settings (languages and fonts).
- 9.3. Install Windows XP Service Pack 1a. SP must be installed prior to step 9.4.

**N.B. Service Pack 1a does not install Microsoft VM. SP1 did.**

- 9.4. Enable 48-bit support in Windows Registry as outlined in Microsoft Knowledge Base Article – 303013. This enables use of ATAPI HD drives over 137GB capacity and eliminates corruption of HDDs over 137GB from being in Hibernation mode.  
Insure that the Atapi.sys file is version 5.1.2600.1135 or later. If the system has an earlier version of this file, see article 331958 in the Microsoft Knowledge Base to download the HotFix Q331958\_WXP\_SP2\_x86\_ENU.exe
- 9.5. Copy Windows Office CD's to hard drive and install from hard drive.
- 9.6. Set CD autostart to off.
- 9.7. Set Windows Explorer view to all files.
- 9.8. Set Internet Explorer homepage to "blank".
- 9.9. When the drive has all programs, updates and fixes applied, use Sysprep from Windows XP CD-ROM to setup a mini-install of the drive for multiple System ID (SID) assignments.

## 10. REVISION HISTORY

None.

**B67C**

<b>Department of Defense Computer Forensics Laboratory (DCFL)</b>		
<b>Configuration Item</b>	<b>Title: 2800Mhz (FRED) Computer System Configuration</b>	
<b>CI Number: CI-18</b>	<b>Revision: 1.0</b>	<b>Effective Date: 13 JAN 04</b>
<b>Approved (Director):</b> [REDACTED]		

**1 PURPOSE**

0027-03-CID679-64999

The purpose of this Configuration Item is to identify the parts and configuration of the 2800 MHz computer systems that are authorized to perform forensic examinations in the Defense Computer Forensics Laboratory (DCFL).

**2 SCOPE**

The hardware configuration, policies and procedures contained herein are to be followed by all Computer Forensic Examiners when performing examinations in the DCFL.

**3 POLICIES**

The Laboratory Director is the only person that can approve standard configurations of hardware, firmware or software tools for performing forensic examination in the DCFL. In the event that additional software is required for performing forensic examinations, Examiners shall request approval from their Section Chief using DCFL Form 13, Deviation From Standard Configuration. All Form 13 documents are to be routed to the DCFL Operations Director, DCFL Technical Director and DCCI Engineering Director.

**4 REFERENCES**

N/A

**5 RESPONSIBILITY**

- 5.1 DIRECTOR, DCFL: The Director of DCFL is responsible for the approval of standard hardware, firmware and software tools used to perform forensic examinations in the DCFL.
- 5.1 Director of Operations: The Director of Operations is responsible for ensuring Forensic Examiners comply with this procedure.
- 5.2 Section Chief: Section Chiefs are also responsible for enforcing this procedure.
- 5.3 Examiners and Forensic Personnel: Forensic Examiners are responsible for complying with this procedure.

**6 SUMMARY OF PROCEDURES**

This document defines the 2800 MHz computer system used to perform forensic examinations.

**7 SAFETY**

All personnel using electronic equipment should be aware of safety precautions and procedures while using electronic equipment in accordance with laboratory safety policy.

b67c



<b>Department of Defense Computer Forensics Laboratory (DCFL)</b>		
<b>Configuration Item</b>	<b>Title: 2800Mhz (FRED) Computer System Configuration</b>	
<b>CI Number: CI-18</b>	<b>Revision: 1.0</b>	<b>Effective Date:</b>
<b>Approved (Director):</b>		

**8. EQUIPMENT AND MATERIAL**Parts list

0027-03-CID679-64999

<b>Case:</b>	Standard ATX Full Tower Case (6) 5.25" drive bays (8) 3.05" drive bays [No memory on board]
<b>Motherboard:</b>	Gigabyte GA-8KNXP ATX Motherboard Pentium 4 400 MHz FSB
<b>BIOS:</b>	Manufacturer: Phoenix BIOS Version: 6.0PG (Non-Volatile)
<b>Internal Motherboard I/O Ports:</b>	
<b>F_PANEL</b>	Front panel connectors: Power On/Off, Reset Switch, Speaker
<b>IDE1</b>	Primary IDE Connector
<b>IDE2</b>	Secondary IDE Connector
<b>IDE3</b>	Third IDE Connector
<b>IDE4</b>	Forth IDE Connector
<b>FDD</b>	Floppy Controller Connector
<b>SOCKET</b>	FCPGA2 478 Pentium 4 Processor- Socket
<b>SATA0_SB</b>	Serial ATA Connector
<b>SATA1_SB</b>	Serial ATA Connector
<b>SATA0_SII</b>	Serial ATA Connector
<b>SATA1_SII</b>	Serial ATA Connector

**b67c**

**Department of Defense Computer Forensics Laboratory  
(DCFL)**

<b>Configuration Item</b>	<b>Title: 2800Mhz (FRED) Computer System Configuration</b>	
<b>CI Number: CI-18</b>	<b>Revision: 1.0</b>	<b>Effective Date:</b>
<b>Approved (Director):</b> [REDACTED]		

CHAFAN1	Rear Chassis Fan Connection
CHAFAN2	Front Chassis Fan Connection
CPUFAN	CPU Fan Connection
DIMM1	Dual In-Line Memory Module Port 1
DIMM2	Dual In-Line Memory Module Port 2
DIMM3	Dual In-Line Memory Module Port 3
DIMM4	Dual In-Line Memory Module Port 4
DIMM5	Dual In-Line Memory Module Port 5
DIMM6	Dual In-Line Memory Module Port 6
PCI#1	Peripheral Component Interconnect 1
PCI#2	Peripheral Component Interconnect 2
PCI#3	Peripheral Component Interconnect 3
PCI#4	Peripheral Component Interconnect 4
PCI#5	Peripheral Component Interconnect 5
AGP	4X/8X Accelerated Graphics Port

0027-03-CI D679-64!

0027-03-CI D679-64999

**External Motherboard I/O Ports:**

PS/2	Keyboard Port
PS/2	Mouse Port
PRT	Standard printer port
COMA	Standard serial port
COMB	Standard serial port
USB1	Universal serial port
USB2	Universal serial port
USB3	Universal serial port
USB4	Universal serial port
AOUT	Audio Out Port
AIN	Audio In Port
AMIC	Microphone Port
NIC	Network Interface Port

**b67c**

**Department of Defense Computer Forensics Laboratory  
(DCFL)**

<b>Configuration Item</b>	<b>Title: 2800Mhz (FRED) Computer System Configuration</b>	
<b>CI Number: CI-18</b>	<b>Revision: 1.0</b>	<b>Effective Date:</b>
<b>Approved (Director):</b> [REDACTED]		

<b>Video Card:</b>	<b>Manufacturer: Asus Model: V9560 Video Suite GeForce FX 5600 (128Mb) AGP 8X Dual-DVI</b>
<b>Processor:</b>	<b>Manufacturer: Intel Model: Pentium 4, 2.8GHz</b>
<b>Memory: (Volatile)</b>	<b>512KB L2 Cache Memory</b>
<b>Power Supply:</b>	<b>Standard 400 Watt, 12 Volt ATX Power Supply [No memory on board]</b>
<b>Ram Memory: (Volatile)</b>	<b>Manufacturer: ValueRAM DDR400 SDRAM DIMM Memory Module 512MB, 168 pin (x2)</b>
<b>CPU Fan:</b>	<b>Intel Pentium 4 based cooling fan with heat sink</b>
<b>SCSI Card: Memory</b>	<b>Manufacturer: Adaptec Model: 29160 (Ultra 160) Non-Volatile Memory</b>
<b>Network Card:</b>	<b>Manufacturer: Intel, Model: 82547EI 10/100/1000 Ethernet Network Adapter Non-Volatile Memory</b>
<b>Drive Frames:</b>	<b>IDE Dataport 40 Pin ATA/133mb Frame and Carrier (x3) [No memory on board]</b>  <b>SCSI Dataport 68 Pin SCSI Frame (x1) [No memory on board]</b>
<b>Floppy Drive:</b>	<b>3.5" Standard Floppy Drive 1.44 MB [No memory on board]</b>
<b>CD-ROM Drive:</b>	<b>Manufacturer: Sony Model: DRU-510A IDE DVD+R/+RW/-R/-RW, CDRW CD-Rom (32X read) 8Mb Volatile Cache Memory</b>

0027 FRED CI 1379-64099

b67c

<b>Department of Defense Computer Forensics Laboratory (DCFL)</b>		
<b>Configuration Item</b>	<b>Title: 2800Mhz (FRED) Computer System Configuration</b>	
<b>CI Number: CI-18</b>	<b>Revision: 1.0</b>	<b>Effective Date:</b>
<b>Approved (Director):</b> 		

Internal:

0027-03-010675-64999

**PCI Bus Configuration**

PCI Slot #1 – Empty  
 PCI Slot #2 – Adaptec Model: 29160 (Ultra 160)  
 PCI Slot #3 – Empty  
 PCI Slot #4 – Empty  
 PCI Slot #5 – Empty

**AGP Configuration**

ASUS V9560 Video Suite GeForce FX 5600

**Memory Configuration**

DIMM 1 – 512MB DDR333 SDRAM Memory Module  
 DIMM 2 – Empty  
 DIMM 3 – Empty  
 DIMM 4 – 512MB DDR400 SDRAM Memory Module  
 DIMM 5 – Empty  
 DIMM 6 – Empty

**Floppy Cable Connection**

Standard 34 Pin cable from FDD1 (red stripe to pin 1) to 34 Pin connection on rear of floppy drive (red stripe to pin 1).

**IDE Cable Connection**

Important: All connections must have red stripe to pin 1

IDE1 – Connect 40-pin, 80-wire conductor cable. Connect end connection to rear of IDE Frame 1 and center connection to DVD-ROM drive. Connect other end to motherboard IDE port channel 1.

IDE2 – Connect 40-pin, 80-wire conductor cable. Connect end connection to rear of IDE Frame 2 and center connection to IDE Frame 3. Connect other end to motherboard IDE port channel 2.

b67c

<b>Department of Defense Computer Forensics Laboratory (DCFL)</b>		
<b>Configuration Item</b>	<b>Title: 2800Mhz (FRED) Computer System Configuration</b>	
<b>CI Number: CI-18</b>	<b>Revision: 1.0</b>	<b>Effective Date:</b>
<b>Approved (Director):</b> [REDACTED]		

0027-68-11-00 (7.0.0.0)

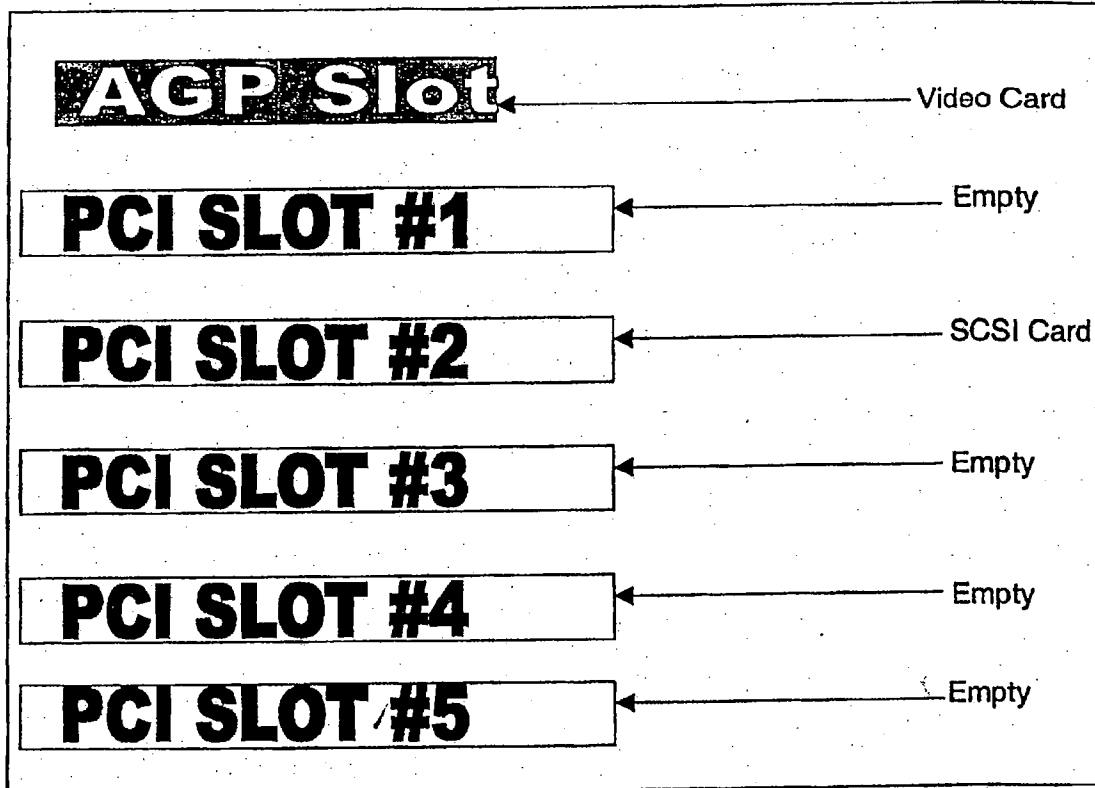

**9. PROCEDURES**

9.1 None.

**10. REVISION HISTORY**

10.1 None.

**b67c**

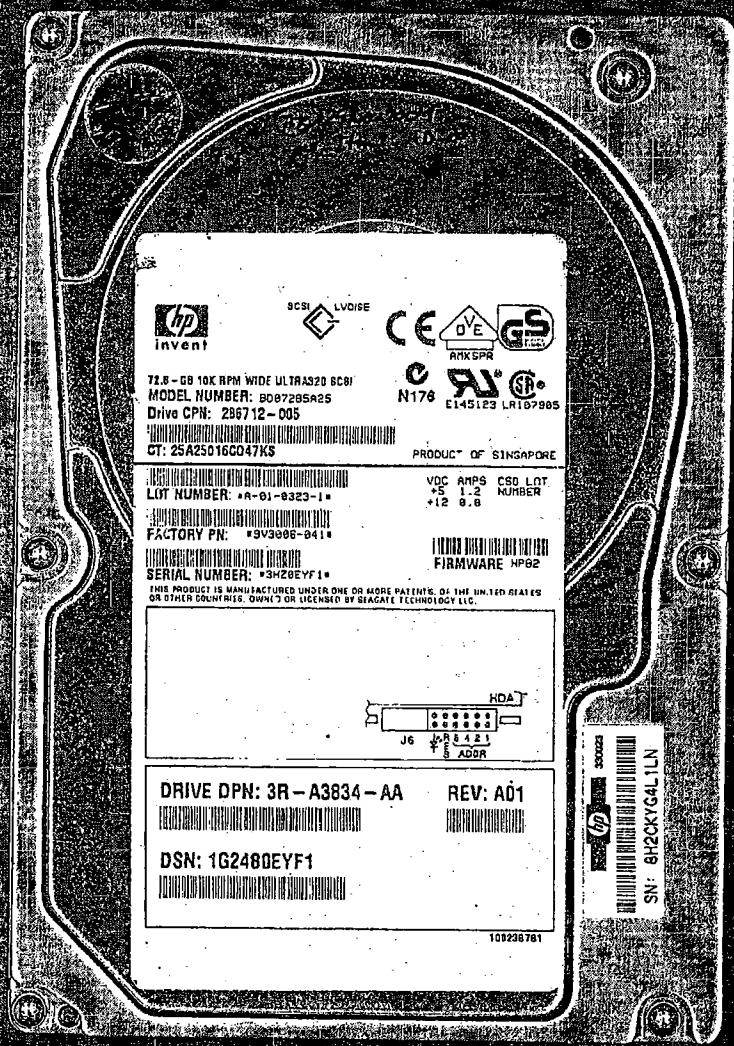

 **invent**      SCSI LVDISE  
 72.8 - GB 10K RPM WIDE ULTRAS320 SCSI  
 MODEL NUMBER: B097295A25  
 Drive CPN: 2B6712-005  
 CT: 25A25016C047KS      PRODUCT OF SINGAPORE  
 LOT NUMBER: \*R-01-8323-1\*      VDC AMPS CSD LOT  
 \*5 1.2 NUMBER  
 \*12 9.8  
 FACTORY PN: \*9V3086-041\*      FIRMWARE HP02  
 SERIAL NUMBER: \*3H20EYF1\*  
THIS PRODUCT IS MANUFACTURED UNDER ONE OR MORE PATENTS OF THE U.S. AND OTHER COUNTRIES. OWNED OR LICENSED BY SEAGATE TECHNOLOGY LLC.

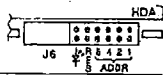
  
 HDA  
 J6      1 2 3 4 5  
          6 7 8 9 10  
          11 12 13 14 15  
          16 17 18 19 20  
          21 22 23 24 25  
          26 27 28 29 30  
          31 32 33 34 35  
          36 37 38 39 40  
          41 42 43 44 45  
          46 47 48 49 50  
          51 52 53 54 55  
          56 57 58 59 60  
          61 62 63 64 65  
          66 67 68 69 70  
          71 72 73 74 75  
          76 77 78 79 80  
          81 82 83 84 85  
          86 87 88 89 90  
          91 92 93 94 95  
          96 97 98 99 100  
          101 102 103 104 105  
          106 107 108 109 110  
          111 112 113 114 115  
          116 117 118 119 120  
          121 122 123 124 125  
          126 127 128 129 130  
          131 132 133 134 135  
          136 137 138 139 140  
          141 142 143 144 145  
          146 147 148 149 150  
          151 152 153 154 155  
          156 157 158 159 160  
          161 162 163 164 165  
          166 167 168 169 170  
          171 172 173 174 175  
          176 177 178 179 180  
          181 182 183 184 185  
          186 187 188 189 190  
          191 192 193 194 195  
          196 197 198 199 200  
          201 202 203 204 205  
          206 207 208 209 210  
          211 212 213 214 215  
          216 217 218 219 220  
          221 222 223 224 225  
          226 227 228 229 230  
          231 232 233 234 235  
          236 237 238 239 240  
          241 242 243 244 245  
          246 247 248 249 250  
          251 252 253 254 255  
          256 257 258 259 260  
          261 262 263 264 265  
          266 267 268 269 270  
          271 272 273 274 275  
          276 277 278 279 280  
          281 282 283 284 285  
          286 287 288 289 290  
          291 292 293 294 295  
          296 297 298 299 300  
          301 302 303 304 305  
          306 307 308 309 310  
          311 312 313 314 315  
          316 317 318 319 320  
          321 322 323 324 325  
          326 327 328 329 330  
          331 332 333 334 335  
          336 337 338 339 340  
          341 342 343 344 345  
          346 347 348 349 350  
          351 352 353 354 355  
          356 357 358 359 360  
          361 362 363 364 365  
          366 367 368 369 370  
          371 372 373 374 375  
          376 377 378 379 380  
          381 382 383 384 385  
          386 387 388 389 390  
          391 392 393 394 395  
          396 397 398 399 400  
          401 402 403 404 405  
          406 407 408 409 410  
          411 412 413 414 415  
          416 417 418 419 420  
          421 422 423 424 425  
          426 427 428 429 430  
          431 432 433 434 435  
          436 437 438 439 440  
          441 442 443 444 445  
          446 447 448 449 450  
          451 452 453 454 455  
          456 457 458 459 460  
          461 462 463 464 465  
          466 467 468 469 470  
          471 472 473 474 475  
          476 477 478 479 480  
          481 482 483 484 485  
          486 487 488 489 490  
          491 492 493 494 495  
          496 497 498 499 500  
          501 502 503 504 505  
          506 507 508 509 510  
          511 512 513 514 515  
          516 517 518 519 520  
          521 522 523 524 525  
          526 527 528 529 530  
          531 532 533 534 535  
          536 537 538 539 540  
          541 542 543 544 545  
          546 547 548 549 550  
          551 552 553 554 555  
          556 557 558 559 560  
          561 562 563 564 565  
          566 567 568 569 570  
          571 572 573 574 575  
          576 577 578 579 580  
          581 582 583 584 585  
          586 587 588 589 590  
          591 592 593 594 595  
          596 597 598 599 600  
          601 602 603 604 605  
          606 607 608 609 610  
          611 612 613 614 615  
          616 617 618 619 620  
          621 622 623 624 625  
          626 627 628 629 630  
          631 632 633 634 635  
          636 637 638 639 640  
          641 642 643 644 645  
          646 647 648 649 650  
          651 652 653 654 655  
          656 657 658 659 660  
          661 662 663 664 665  
          666 667 668 669 670  
          671 672 673 674 675  
          676 677 678 679 680  
          681 682 683 684 685  
          686 687 688 689 690  
          691 692 693 694 695  
          696 697 698 699 700  
          701 702 703 704 705  
          706 707 708 709 710  
          711 712 713 714 715  
          716 717 718 719 720  
          721 722 723 724 725  
          726 727 728 729 730  
          731 732 733 734 735  
          736 737 738 739 740  
          741 742 743 744 745  
          746 747 748 749 750  
          751 752 753 754 755  
          756 757 758 759 760  
          761 762 763 764 765  
          766 767 768 769 770  
          771 772 773 774 775  
          776 777 778 779 780  
          781 782 783 784 785  
          786 787 788 789 790  
          791 792 793 794 795  
          796 797 798 799 800  
          801 802 803 804 805  
          806 807 808 809 810  
          811 812 813 814 815  
          816 817 818 819 820  
          821 822 823 824 825  
          826 827 828 829 830  
          831 832 833 834 835  
          836 837 838 839 840  
          841 842 843 844 845  
          846 847 848 849 850  
          851 852 853 854 855  
          856 857 858 859 860  
          861 862 863 864 865  
          866 867 868 869 870  
          871 872 873 874 875  
          876 877 878 879 880  
          881 882 883 884 885  
          886 887 888 889 890  
          891 892 893 894 895  
          896 897 898 899 900  
          901 902 903 904 905  
          906 907 908 909 910  
          911 912 913 914 915  
          916 917 918 919 920  
          921 922 923 924 925  
          926 927 928 929 930  
          931 932 933 934 935  
          936 937 938 939 940  
          941 942 943 944 945  
          946 947 948 949 950  
          951 952 953 954 955  
          956 957 958 959 960  
          961 962 963 964 965  
          966 967 968 969 970  
          971 972 973 974 975  
          976 977 978 979 980  
          981 982 983 984 985  
          986 987 988 989 990  
          991 992 993 994 995  
          996 997 998 999 1000

DRIVE DPN: 3R - A3834 - AA      REV: A01  
 DSN: 1G2480EYF1  
 SN: 6H2CKY64L1LN  
 109226701

002

hp invent

SCSI LVOISE

CE DE GS

RIKSPR

N176 E145123 LR107505

72.8 - GB 10K RPM WIDE ULTRAS20 SCSI  
 MODEL NUMBER: 8067205A25  
 Drive CPN: 286712-005

PRODUCT OF SINGAPORE

CT: 25A25016C048HD

LOT NUMBER: \*A-01-8323-1\*

VDC AMPS CSQ LOT  
 \*5 1.2 NUMBER  
 \*12 0.8

FACTORY PN: \*3V3006-041\*

FIRMWARE HPB2

SERIAL NUMBER: \*3200J4Z\*

THIS PRODUCT IS MANUFACTURED UNDER ONE OR MORE PATENTS OF THE UNITED STATES  
 OR OTHER COUNTRIES, OWNED OR LICENSED BY BRAGAZZ TECHNOLOGY LLC.

HDA

J6 4 5 6 7 8 9 10 11 12 13 14 15 16

ADP

DRIVE DPN: 3R - A3834 - AA REV: A01

DSN: 1G2480J4Z

SN: 8HCKYGL1MR

100238701

000227

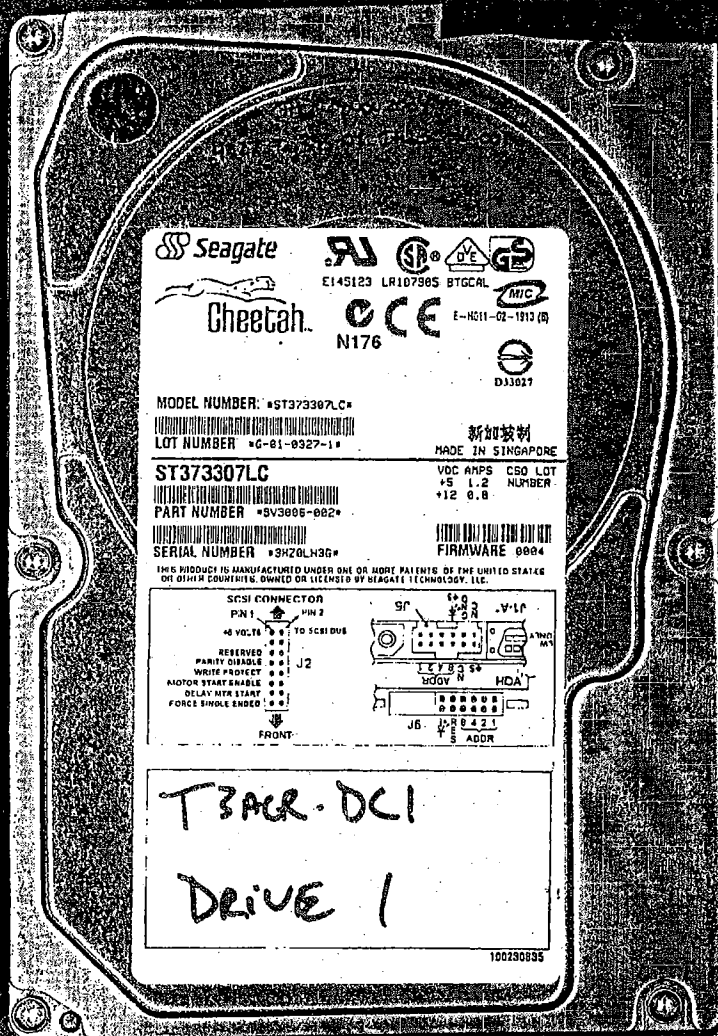



<b>Department of Defense Computer Forensics Laboratory (DCFL)</b>		
<b>Configuration Item</b>	<b>Title: 2800Mhz (FRED) Computer System Configuration</b>	
<b>CI Number: CI-18</b>	<b>Revision: 1.0</b>	<b>Effective Date:</b>
<b>Approved (Director):</b> [REDACTED]		

Configuration External: Case Front

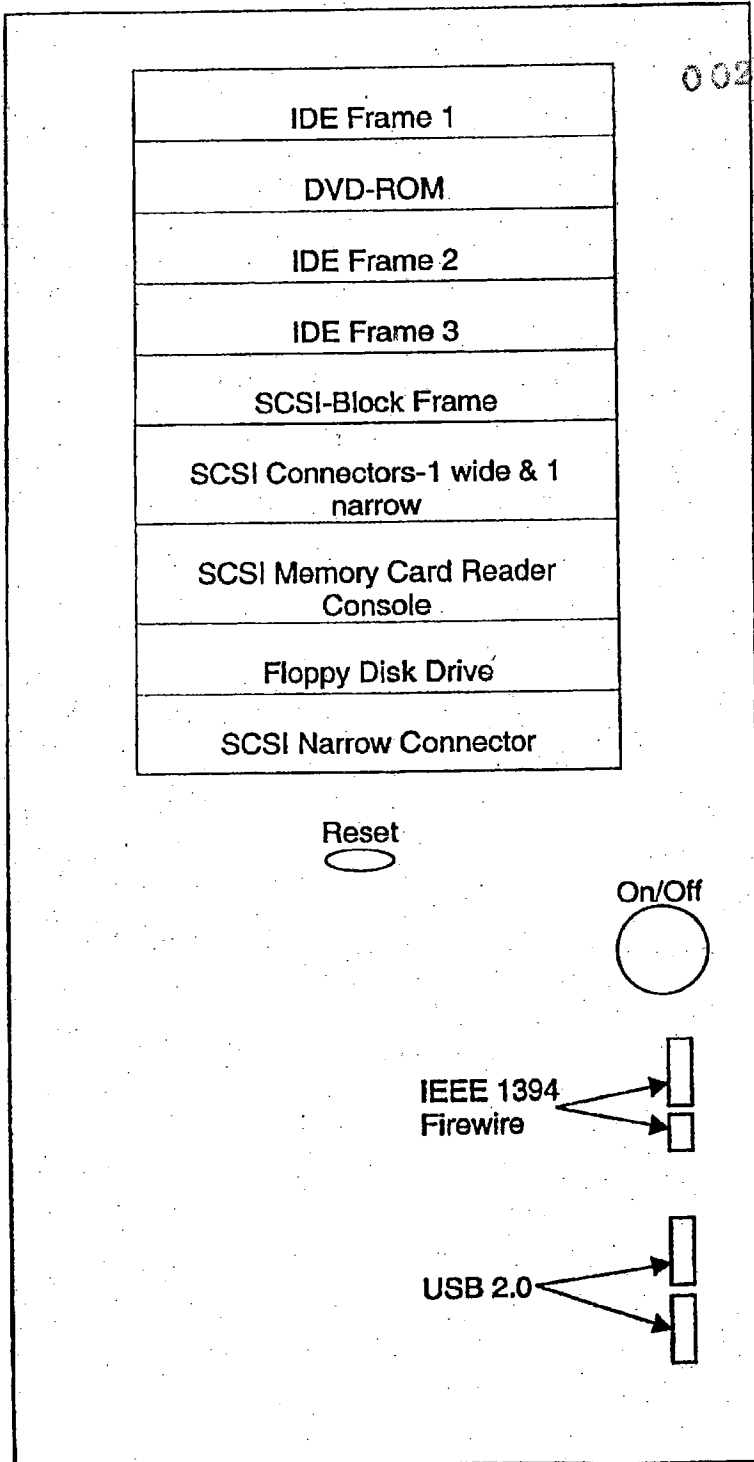

**b67c**

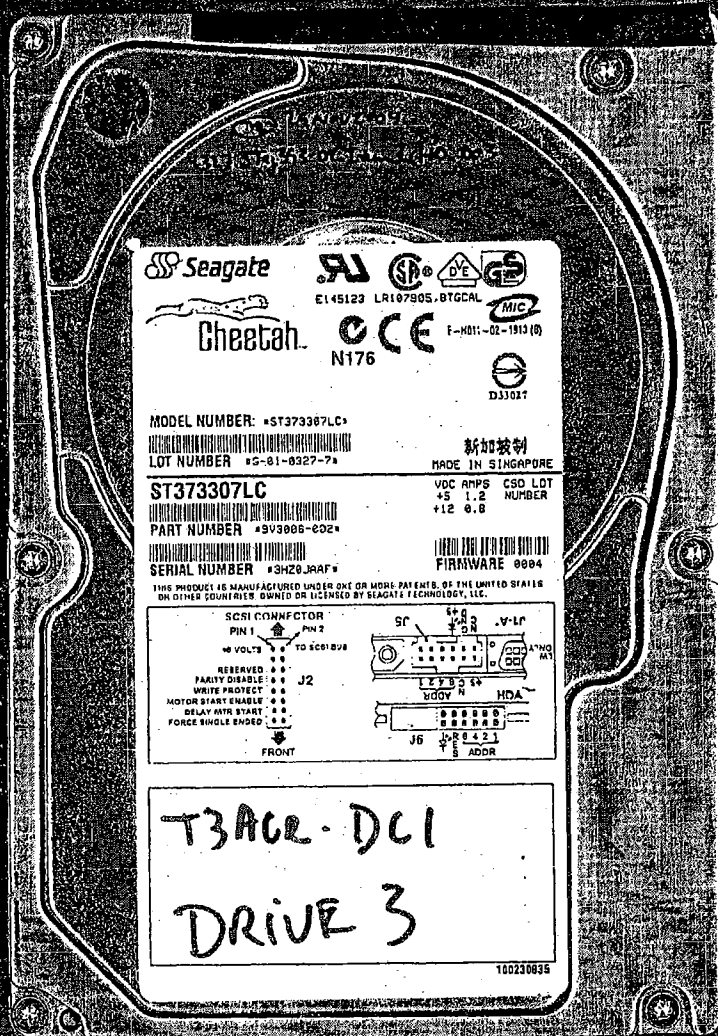

Seagate  
Cheetah N176  
E145123 LRI07905.0TGCAL  
CE E-M01-02-1913 (R)  
D33037



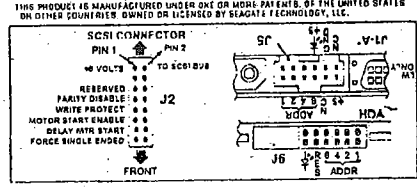

MODEL NUMBER: \*ST373307LC\*  
LOT NUMBER #5-81-8327-7A  
新加坡制  
MADE IN SINGAPORE

ST373307LC  
VDC AMPS CSO LOT  
#5 1.2 NUMBER  
+12 0.8  
PART NUMBER #313005-602  
SERIAL NUMBER #3H20JAAF  
FIRMWARE 0004

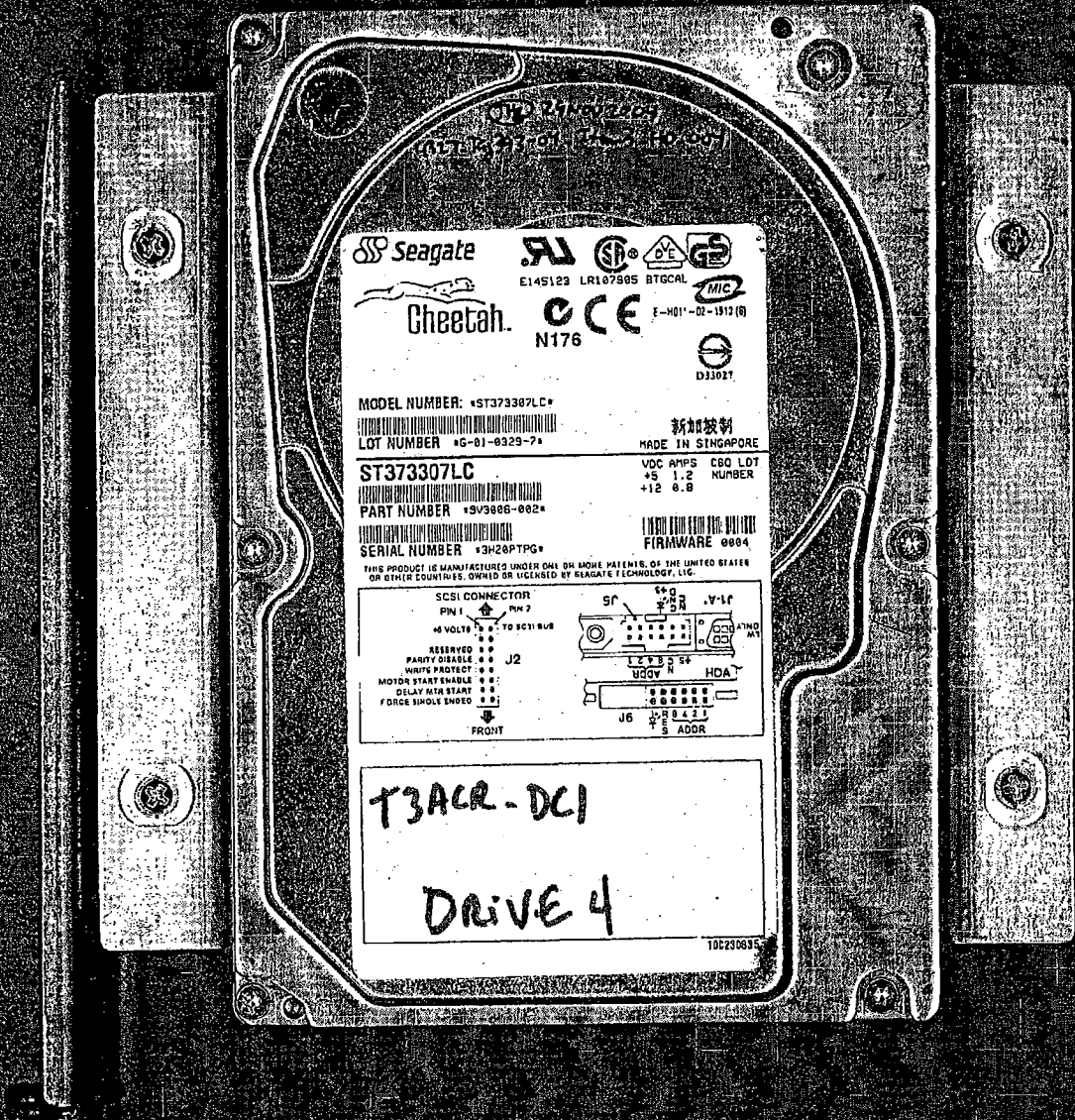



T3ACR-DCI  
DRIVE 3  
100230835



Seagate     

E145123 LR107985 BT0CAL

Cheetah.   F-H01-D2-1312 (R)

N176

MODEL NUMBER: \*ST373307LC\*

LOT NUMBER \*G-01-0329-7\*

ST373307LC

PART NUMBER \*3V3806-002\*

SERIAL NUMBER \*3H20PTPG\*

MADE IN SINGAPORE

VDC AMPS CBO LOT  
+5 1.2 NUMBER  
+12 0.8

FIRMWARE 0004

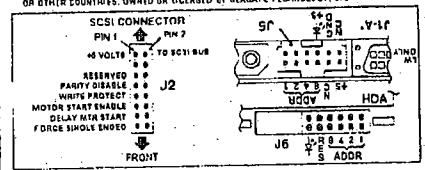





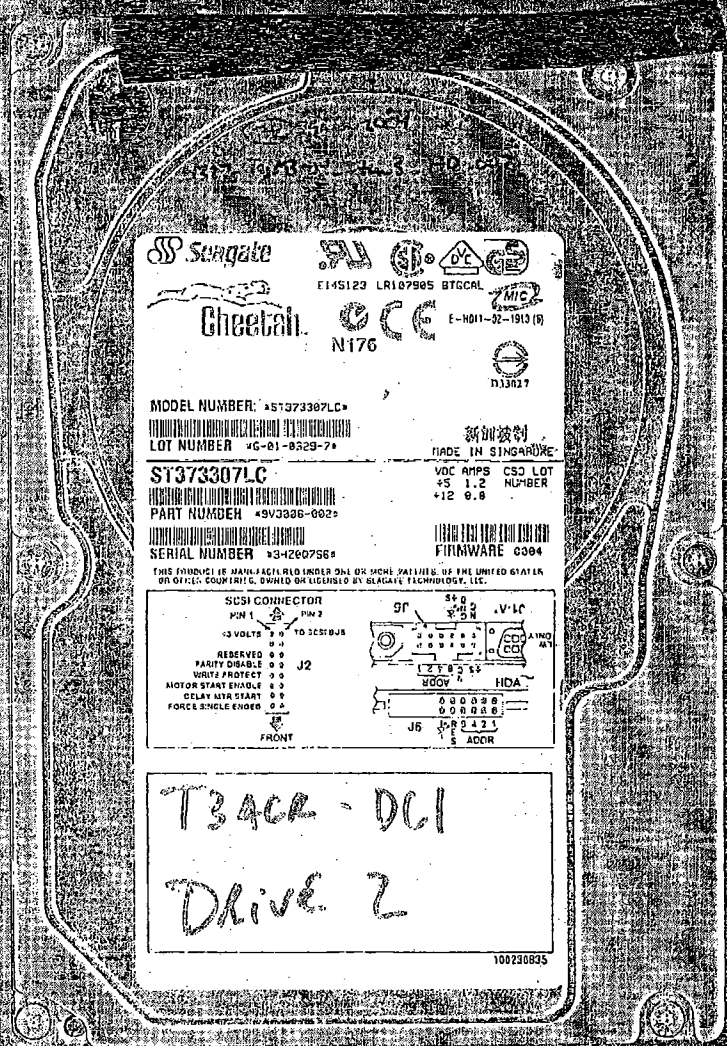

T3ACR-DCI

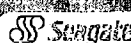
DRIVE 4

10C20083E









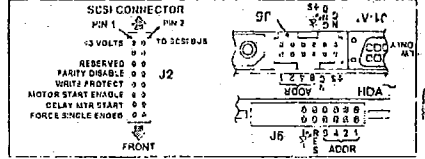

MODEL NUMBER: \*ST373307LC\*  
 LOT NUMBER \*G-01-8529-7\*  
**ST373307LC**  
 PART NUMBER \*9V3886-002\*  
 SERIAL NUMBER \*34260756\*

MADE IN SINGAPORE  
 VDC AMPS CSD LOT  
 \*5 1.2 NUMBER  
 \*12 9.8

FIRMWARE C004

THIS PRODUCT IS MANUFACTURED UNDER ONE OR MORE PATENTS OF THE UNITED STATES OR OF OTHER COUNTRIES, OWNED OR LICENSED BY SANYO TECHNOLOGY, INC.



T34CR - DCI  
Drive 2

100230835

Overview Models Introduction Service and Support, HP Care Pack, and Warranty Information  
 Ultra320 Hot Plug Hard Disk Drives Ultra320 Non-Hot Plug Hard Disk Drive

Overview

0027-03-010579-64999

HP SCSI Ultra320 Hard Drive Option Kits (Servers)

A wide variety of rigorously tested, HP-qualified, SMART capable, Ultra320 Hard Drives offering data integrity and availability in hot pluggable and non-pluggable models. HP 15,000 rpm Hard Drives provide up to 26 percent better performance than standard 10,000 rpm drives. Actual performance increases will vary depending upon application and configuration.

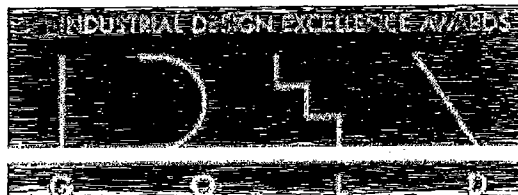
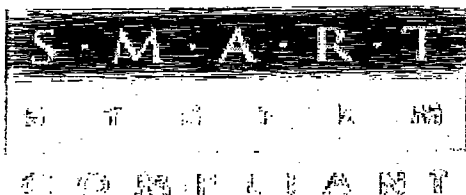

All HP hard drives pass a rigorous qualification process, which ensures that every HP drive is proven to perform in your critical server or workstation. Before final certification, all HP hard drives are provided with HP-unique firmware specifically designed to optimize compatibility and functionality, including support of SMART and Insight Manager. HP received the 1999 Gold Idea Award for design excellence for the innovative design of the Hot Pluggable Universal carrier. The carrier is praised for both its ergonomics and aesthetics, as well as its many functional enhancements such as the compact design, improved cooling properties and more secure drive mounting for reduced vibration.

What's New

- New 146.8-GB Non-hot plug Ultra320 SCSI 10,000 rpm Universal Hard Drive (1")

Overview Models Introduction Service and Support, HP Care Pack, and Warranty Information  
 Ultra320 Hot Plug Hard Disk Drives Ultra320 Non-Hot Plug Hard Disk Drive

Models

Hot Plug Drives:

72.8-GB Pluggable Ultra320 SCSI 15,000 rpm Universal Hard Drive (1")	2867
	3H-A3
36.4-GB Pluggable Ultra320 SCSI 15,000 rpm Universal Hard Drive (1")	2867
	3H-A2
300-GB Pluggable Ultra320 SCSI 10,000 rpm Universal Hard Drive (1")	3508
	3H-A4
146.8-GB Pluggable Ultra320 SCSI 10,000 rpm Universal Hard Drive (1")	2867
	3H-A3
72.8-GB Pluggable Ultra320 SCSI 10,000 rpm Universal Hard Drive (1")	2867
	3R-A3

Non-Hot Plug Drives:

36.4-GB Ultra320 SCSI 15,000 rpm Universal Hard Drive (1")	3570
72.8-GB Ultra320 SCSI 10,000 rpm Universal Hard Drive (1")	3327
146.8-GB Ultra320 SCSI 10,000 rpm Universal Hard Drive (1")	3568

*blot*

Overview Models Introduction Service and Support, HP Care Pack, and Warranty Information  
 Ultra320 Hot Plug Hard Disk Drives Ultra320 Non-Hot Plug Hard Disk Drive

## Introduction

0027-168-010679-64998

### Drive Quality

Today's distributed enterprise is seeing larger, more complex applications, an increase of critical data moving to the server, increasing demand for transaction processing and critical consolidation. In this environment, storage has become a critical component of the information system, significantly defining both the system's reliability and performance. This is why HP undergo an intense qualification process that eliminates data integrity problems, firmware incompatibilities and other causes of data corruption or premature failure. All drive firmware is specific to our drives and is designed to maximize both functionality and compatibility. All drives are proven to perform in the HP systems for which they were designed.

### Performance

Only those drives whose performance is suitable for an enterprise environment are selected through the HP qualification process and are labeled "best-in-class." All our drives are proven to be reliable and tuned for optimum performance in the HP equipment for which they were designed.

### Pre-Failure Warranty

When used in conjunction with a SMART Array Controller and Insight Manager, the SMART capable firmware in HP hard drives enables extensive fault prediction capabilities. If potential problems develop in one of the drives, the SMART Array Controller, Insight Manager and/or SMART hard disk drive lets you know in advance so you can have the drive replaced, before failure, under the HP Pre-Failure Warranty.

**NOTE:** All drives are protected by a Pre-Failure Warranty when used with a HP array controller (SMART or SMART-2) and Insight Manager, allowing hard drives to be replaced before failure free of charge. In addition, all drives are covered by a one to three-year limited on-site warranty or the remaining warranty of the HP CPU in which it is installed (up to three years).

### Integration

Many issues customers have with third party drives are "simple" integration issues. When taken from another supplier, there is no guarantee that a drive has been correctly set for proper operation with ProLiant servers and storage systems. These incompatibilities can create problems in configuration, can rob your system of performance, or at their worst, can cause you to lose data. HP hard drives are specifically designed and tested for flawless operation in your HP equipment. The integration of hard drives in HP systems means that cables, SCSI ID settings, termination, hot plug drive trays and firmware are right for your ProLiant server or storage system.

### Ultra320 SCSI Hard Drives

HP's Ultra320, Ultra3 and Ultra2 hard drives increase the maximum transfer rate of the SCSI bus to 320 MB/s (Ultra320), 160 MB/s (Ultra3) or 80 MB/s (Ultra2). By reducing the opportunity for SCSI bus saturation, this increased data rate allows all SCSI devices to perform at optimum levels. Ultra320, Ultra3 and Ultra2 hard drives are being offered in an improved hot plug drive carrier and can be used interchangeably in HP Ultra2, Ultra3 or Ultra320 capable systems. In addition to improved drive performance and increased storage density, the new carrier will help prevent the inadvertent insertion of single-ended SCSI drives into Low Voltage Differential SCSI capable equipment (avoiding inadvertent performance degradation of LVD-capable systems). To achieve the maximum (320 MB/s) transfer rates of Ultra320, the hard drive and array controller (or SCSI host bus adapter) must both be Ultra320 capable.

### Ultra320 SCSI Universal Hard Drives

HP Ultra320 SCSI Universal hard drives provide storage commonality across the enterprise. Ultra320 Universal drives add the feature of hot plug compatibility between any Ultra320, Ultra3, Ultra2 capable ProLiant Servers, ProLiant Storage Systems, AlphaServers, and Modular Array enclosures by HP. These hot plug drives are offered in multiple capacities and spindle speeds. Storage commonality across these platforms provides many benefits including reduced cost.

**DOTC**

ownership, reduced storage complexity, and a minimized hard drive spares inventory.

<a href="#">Overview</a>	<a href="#">Models</a>	<a href="#">Introduction</a>	<a href="#">Service and Support, HP Care Pack, and Warranty Information</a>
<a href="#">Ultra320 Hot Plug Hard Disk Drives</a>	<a href="#">Ultra320 Non-Hot Plug Hard Disk Drive</a>		

0027-03-CID679-64999

## Service and Support, HP Care Pack, and Warranty Information

### Support Services

Care Pack services provide a range of life cycle support options that let you choose the service levels that meet your business requirements, from basic to mission-critical.

A full range of HP Care Pack hardware and software services are available including:

- Installation and start up
- Education courses
- Extended onsite hardware coverage hours from same business day 13 hours, 5 day 24 hours, 7 days call window with options including 4-hour response or 6-hour Call-To-Action
- Comprehensive range of software technical support for Microsoft, Linux, ProLiant Essentials, and VMWare-based IT solutions helping to deliver high level of application availability. Response times ranging from 30 minutes for critical problems to 2 hours
- System Management, Performance Services and Mission Critical Support Solution

**NOTE:** For more information on HP Care Pack services, contact any of our sales offices or resellers or visit our Web site on the internet at: <http://www.hp.com/hps/carepack>

**NOTE:** For more complete information on HP Services offerings, customers and resellers, visit us at: <http://www.hp.com/hps>

**NOTE:** Additional information regarding worldwide limited warranty and technical support is available at: <http://h18004.www1.hp.com/products/servers/platforms/warranty/index.html>

<a href="#">Overview</a>	<a href="#">Models</a>	<a href="#">Introduction</a>	<a href="#">Service and Support, HP Care Pack, and Warranty Information</a>
<a href="#">Ultra320 Hot Plug Hard Disk Drives</a>	<a href="#">Ultra320 Non-Hot Plug Hard Disk Drive</a>		

## Ultra320 Hot Plug Hard Disk Drives

(For ease of deployment it is recommended that RAID sets not contain a combination of Ultra320/2/3 drives and previous generation SCSI drives. Mixed RAID sets may be used if desired, however some combinations may require reconfiguring RAID array.)

### Application Information

HP Ultra320 SCSI hard drives provide a maximum data transfer rate of 320 MB/s - twice the rate of Ultra3 systems. These Universal Hard Disk Drives provide the ability to hot plug between various HP Ultra320, Ultra3 and Ultra2 SCSI platforms. All HP Hard Disk Drives are required to meet our rigorous standards for reliability and performance. These drives are intended for use in today's demanding, data-critical enterprise environments. Universal kits are configured and pre-mounted in the appropriate hot plug tray for immediate installation into your ProLiant server or storage system.

<b>72.8-GB Pluggable Ultra320 SCSI 15,000 rpm Universal Hard Drive (1")</b> 286778-B22 3R-A3851-AA	<b>72.8 GB 15K</b>	<b>Capacity</b>	72837.2 MB	
		<b>Height</b>	1.0 in (2.54 cm)	
		<b>Width</b>	4.0 in (10.16 cm)	
		<b>Interface</b>	Ultra320 SCSI	
		<b>Transfer Rate Synchronous (Maximum)</b>	320 MB/s	
		<b>Seek Time</b>	Single Track	0.4 ms
		(typical reads, including	Average	3.8 ms

**h67c**

0027-03-C1D679-64999

settling)	Full-Stroke	8.0 ms
	Rotational Speed	15,000 rpm
<b>Physical Configuration</b>	Bytes/Sector	512
	Logical Blocks	142,264,000
<b>Operating Temperature</b>	50° to 95° F (10° to 35° C)	

**36.4-GB Pluggable Ultra320 SCSI 15,000 rpm Universal Hard Drive (1")**  
 286776-B22  
 3R-A3849-AA

**36.4 GB 15K**

<b>Capacity</b>	369419.2 MB	
<b>Height</b>	1.0 in (2.54 cm)	
<b>Width</b>	4.0 in (10.16 cm)	
<b>Interface</b>	Ultra320 SCSI	
<b>Transfer Rate Synchronous (Maximum)</b>	320 MB/s	
<b>Seek Time (typical reads, including settling)</b>	Single Track	0.4 ms
	Average	3.8 ms
	Full-Stroke	8.0 ms
	Rotational Speed	15,000 rpm
<b>Physical Configuration</b>	Bytes/Sector	512
	Logical Blocks	71,132,000
<b>Operating Temperature</b>	50° to 95° F (10° to 35° C)	

**300-GB Pluggable Ultra320 SCSI 10,000 rpm Hard Drive (1")**  
 350964-B22  
 3R-A4952-AA

**300 GB 10K**

<b>Capacity</b>	300000 MB	
<b>Height</b>	1.0 in (2.54 cm)	
<b>Width</b>	4.0 in (10.16 cm)	
<b>Interface</b>	Ultra320 SCSI	
<b>Transfer Rate Synchronous (Maximum)</b>	320 MB/s	
<b>Seek Time (typical reads, including settling)</b>	Single Track	0.55 ms
	Average	4.9 ms
	Full-Stroke	10.0 ms
	Rotational Speed	10,000 rpm
<b>Physical Configuration</b>	Bytes/Sector	512
	Logical Blocks	585,937,500
<b>Operating Temperature</b>	50° to 95° F (10° to 35° C)	

**146.8-GB Pluggable Ultra320 SCSI 10,000 rpm Hard Drive (1")**  
 286716-B22  
 3R-A3841-AA

**146.8 GB 10K**

<b>Capacity</b>	146815.74 MB	
<b>Height</b>	1.0 in (2.54 cm)	
<b>Width</b>	4.0 in (10.16 cm)	
<b>Interface</b>	Ultra320 SCSI	
<b>Transfer Rate Synchronous (Maximum)</b>	320 MB/s	
<b>Seek Time (typical reads, including settling)</b>	Single Track	0.55 ms
	Average	4.9 ms
	Full-Stroke	10.0 ms
	Rotational Speed	10,000 rpm
<b>Physical Configuration</b>	Bytes/Sector	512
	Logical Blocks	286,749,488
<b>Operating Temperature</b>	50° to 95° F (10° to 35° C)	

**h67c**



0027-03-C1D679-64999

**72.8-GB Pluggable  
Ultra320 SCSI  
10,000 rpm Hard Drive  
(1")  
286714-B22  
3R-A3839-AA**

**72.8 GB 10K**

<b>Capacity</b>	72837.2 MB	
<b>Height</b>	1.0 in (2.54 cm)	
<b>Width</b>	4.0 in (10.16 cm)	
<b>Interface</b>	Ultra320 SCSI	
<b>Transfer Rate</b>	320 MB/s	
<b>Synchronous (Maximum)</b>	<b>Seek Time</b>	Single Track 0.55 ms
	(typical reads, including settling)	Average 4.9 ms
		Full-Stroke 10.0 ms
		Rotational Speed 10,000 rpm
<b>Physical Configuration</b>	Bytes/Sector	512
	Logical Blocks	142,264,000
<b>Operating Temperature</b>	50° to 95° F (10° to 35° C)	

<a href="#">Contents</a>	<a href="#">Overview</a>	<a href="#">Models</a>	<a href="#">Introduction</a>	<a href="#">Service and Support, HP Care Pack, and Warranty Information</a>
	<a href="#">Ultra320 Hot Plug Hard Disk Drives</a>	<a href="#">Ultra320 Non-Hot Plug Hard Disk Drive</a>		

## Ultra320 Non-Hot Plug Hard Disk Drive

(For ease of deployment it is recommended that RAID sets not contain a combination of Ultra2/3 drives and previous SCSI drives. Mixed RAID sets may be used if desired, however some combinations may require reconfiguring the RAID array)

### Application Information

HP non-hot plug hard disk drives provide an economical, reliable, fully HP supported prime storage solution. These drives provide functionality and features to satisfy our business professional users. All non-hot plug hard disk drive kits provide mounting hardware for both 1-inch and 5.25-inch bays and include detailed instructions for mounting and configuring new hard disk drive in your ProLiant server or workstation.

**36.4-GB Ultra320 SCSI  
15,000 rpm Hard Drive  
(1")  
357012-B21**

**36.4 GB 15K**

<b>Capacity</b>	36419.2 MB	
<b>Height</b>	1.0 in (2.54 cm)	
<b>Width</b>	4.0 in (10.16 cm)	
<b>Interface</b>	Ultra320 SCSI	
<b>Transfer Rate</b>	320 MB/s	
<b>Synchronous (Maximum)</b>	<b>Seek Time</b>	Single Track 0.4 ms
	(typical reads, including settling)	Average 3.8 ms
		Full-Stroke 8 ms
		Rotational Speed 15,000 rpm
<b>Physical Configuration</b>	Bytes/Sector	512
	Logical Blocks	71,132,000
<b>Operating Temperature</b>	50° to 95° F (10° to 35° C)	

**72.8-GB Ultra320 SCSI  
10,000 rpm Hard Drive  
(1")  
332751-B21**

**72.8 GB 10K**

<b>Capacity</b>	72837.2 MB	
<b>Height</b>	1.0 in (2.54 cm)	
<b>Width</b>	4.0 in (10.16 cm)	
<b>Interface</b>	Ultra320 SCSI	

b67c

<b>Transfer Rate Synchronous (Maximum)</b>	320 MB/s	
<b>Seek Time</b> (typical reads, including settling)	Single Track	0.55 ms
	Average	4.9 ms
	Full-Stroke	10ms
	Rotational Speed	10,000 rpm
<b>Physical Configuration</b>	Bytes/Sector	512
	Logical Blocks	142,264,000
<b>Operating Temperature</b>	50° to 95° F (10° to 35° C)	

**146.8-GB Ultra320 SCSI 146.8 GB 10K  
10,000 rpm Hard Drive  
(1")  
356990-B21**

<b>Capacity</b>	146815.74 MB	
<b>Height</b>	1.0 in (2.54 cm)	
<b>Width</b>	4.0 in (10.16 cm)	
<b>Interface</b>	Ultra320 SCSI	
<b>Transfer Rate Synchronous (Maximum)</b>	320 MB/s	
<b>Seek Time</b> (typical reads, including settling)	Single Track	0.4 ms
	Average	3.8 ms
	Full-Stroke	8.0 ms
	Rotational Speed	10,000 rpm
<b>Physical Configuration</b>	Bytes/Sector	512
	Logical Blocks	286,749,488
<b>Operating Temperature</b>	50° to 95° F (10° to 35° C)	

© Copyright 2004 Hewlett-Packard Development Company, L.P.  
 The information contained herein is subject to change without notice.  
 Microsoft and Windows NT are US registered trademarks of Microsoft Corporation. Intel is a US registered trademark Corporation.  
 The only warranties for HP products and services are set forth in the express warranty statements accompanying such products and services. Nothing herein should be construed as constituting an additional warranty. HP shall not be liable for technical or editorial errors or omissions contained herein.

DA-11531 - U.S. - Version 7 - November 1, 2004

**b67c**

0027-03-C1D679-64999

seagate.com

investor relations | about Seagate

Seagate  Support

home products support partners news + info jobs where to buy contact us

Enter keyword(s)  
Advanced search

Home > Support > Disc

### ST373307LC Configuration and Specifications

#### Related Links

- > Installation Software
- > Diagnostic Software
- > U320 Time-Out Firmware Upgrade
- > Graphic Page

#### Cheetah 10K.6

Capacity: 73.4 GB  
 Speed: 10000 rpm  
 Average Seek Time: 4.7 ms

0027-03-CID679-64999

#### Did this page help?

- Yes  
 No  
 Maybe
- 

Installation Guide | Product Manual

Odd characters? [Click here for help.](#)

SEAGATE TECHNOLOGY LLC  
 1-800-SEAGATE  
<http://www.seagate.com>  
 (C)opyright 2002

#### Email this page to a friend

#### Disc Drive Encyclopedia

- > by Model Number
- > by Interface
- > by Product Family
- > Interpreting Model Numbers

#### Glossary Index of all terms

ST-373307LW Ultra320 SCSI Wide (Cheetah 10K.6, LVD)

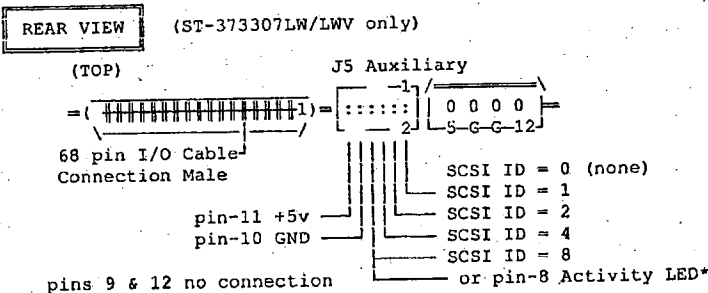

\* These pins are driven low for 250ms after PWR ON and RESET to allow jumper selectable SCSI ID as shown above.

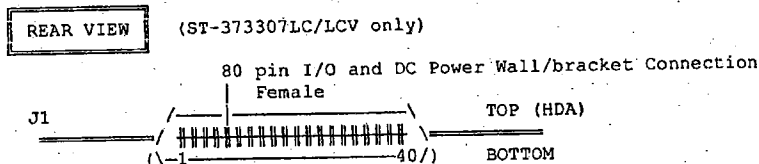

Notes on 80 pin I/O connector:

pins 1 - 4 = +12v	41 - 44 = 12v GND
34 - 36 = +5v	74 - 76 = 5v GND
37 = SYNC	77 = LEDC
38 = MTRON	78 = DLYDST
39 = SCSI1A0	79 = SCSI1A1

**b67c**  
 11/30/2004  
 000239

40 = SCSI2

80 = SCSI3

Mating connector: AMP US p/n: 2-557103-1 straight-in, Male 80-pin  
2-557101-1 right angle to PCB

**SIDE VIEW**

(ST-373307LW only)

0027-03-CID 679-6499c

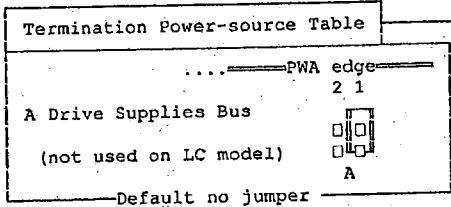
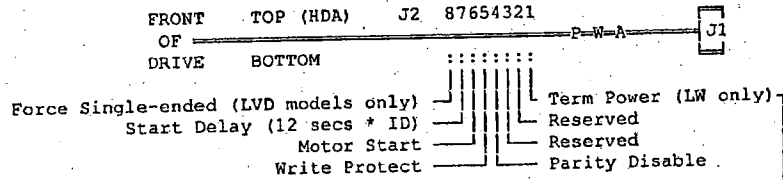

Note: LW and LC drives do not have internal terminators or any other way of adding internal terminators to the drive; use external active termination if required. Use active (ANSI SCSI-2 Alternative 2) terminators when terminating the bus. Use active negation terminators when terminating a SCSI Ultra2 bus operating in Low Voltage Differential (LVD) mode.

**FRONT VIEW**

(ST-373307LW/LC)

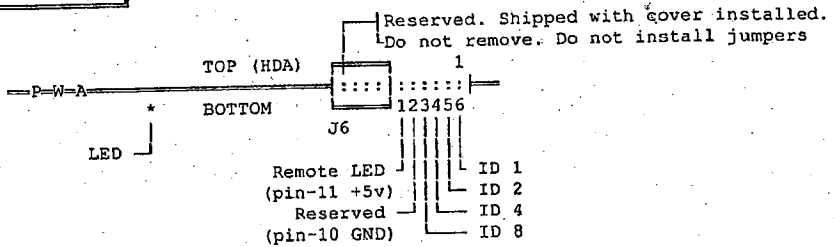

ST-373307LW

UNFORMATTED CAPACITY (GB)	94.8
FORMATTED CAPACITY (GB)	73.4
AVERAGE SECTORS PER TRACK	718 rounded down
ACTUATOR TYPE	ROTARY VOICE COIL
TRACKS	199,420
CYLINDERS	49,855 user
HEADS	4
DISCS (2.5 in)	2
MEDIA TYPE	THIN FILM/GMR
RECORDING METHOD	PRML
INTERNAL TRANSFER RATE (mbits/sec)	475 to 841
INTERNAL FORMATTED TRANSFER RATE (MB/sec)	59 to 105
EXTERNAL TRANSFER RATE (mbyte/sec)	40 Sync
Low Voltage Differential(LVD)	80/320 Sync
SPINDLE SPEED (RPM)	10,008
AVERAGE LATENCY (mSEC)	2.99
BUFFER	8MB
Read Look-Ahead, Adaptive, Multi-Segmented Cache	
INTERFACE	Ultra-SCSI Wide

Low Voltage Differential	Ultra3-SCSI Wide
ASA II, SCAM level 2 (1 default)	
BYTES PER TRACK	368K avg
SECTORS PER DRIVE	143,374,744
TPI (TRACKS PER INCH)	64,000
BPI (PEAK KBITS PER INCH)	570
AVERAGE ACCESS (ms read/write)	4.7/5.3
Drive level without controller overhead	
SINGLE TRACK SEEK (ms read/write)	0.35/0.55
MAX FULL SEEK (ms read/write)	9.0/9.5
MTBF (power-on hours)	1,200,000
SHOCK (G's, 11/2/.5 ms):	
operating (Read/Write)	15
abnormal	40
nonoperating	75/225/120
ACOUSTICS (Bels typical, sound power)	3.6
POWER DISSIPATION (watts/BTUs)	
Active	/
Idle	8.7/29.7
POWER REQUIREMENTS: +12V START-UP (amps)	
+12V TYPICAL (amps)	1.21
+5V START-UP (amps)	0.34 idle
+5V TYPICAL (amps)	0.93
IDLE (watts)	0.78 idle
LANDING ZONE (cyl)	AUTO PARK
IBM AT DRIVE TYPE	0 or NONE

## Physical:

Height (inches/mm):	1.0/25.4
Width (inches/mm):	4.00/101.6
Depth (inches/mm):	5.75/146
Weight (lbs/kg):	1.61/0.731

Already low-level formatted at the factory with x spare sectors at the end of each x cylinder region.

ZBR = Zone Bit Recording = Variable sectors per track

Seagate reserves the right to change, without notice, product offerings or specifications. (09/12/2002)

0027-09-01D679-64999

**b67c**

Department of Defense Computer Forensics Lab,  
Technician Notes

DCFL Request # - \_\_\_\_\_ DCFL2004-1004327

0027-03-CID679-64999 Page 1 of 1

	<p>27 Dec 04 On December 27<sup>th</sup> I was tasked by the I.P.E. supervisor to pick up the remaining requirement to "Archive only" the images &amp; harddrive that were created by [REDACTED]. The 4 image &amp; drives were identified as DCFL MB 13697, MB 15633, MB 13712 and MB 15622. I performed the Archiving using DCFL FRED 2.805 XP Pro/LINUX DCFL MB 13135 (I-20<sup>18</sup> v1.0. I performed the Archive on Fred 2.86Hz System MB 16202. I performed the Archive using procedures and guidance for Archiving.</p> <p>On Images &amp; harddrive MB 13697 (200 GB) I mounted this into the Fred 2.86Hz jumped to slave and attached to the secondary IDE position. I installed the OS drive (Linux) jumped to master in the primary IDE position. I booted successfully and logged in as root. I mounted the images &amp; using the following command:</p> <pre>mount -t vfat /dev/hdd1 /mnt/images</pre> <p>I placed a new DLT tape into the tape drive attached to the 2.86Hz Fred workstation. I performed the 3 following commands:</p> <ol style="list-style-type: none"> <li>(1) mt -f /dev/nst0 rewind</li> <li>(2) " " " " " status</li> <li>(3) " " " " " tell</li> </ol> <p>I ensured the tape was a Tape Block 0</p> <p>I then changed to the images directory by performing the following</p> <pre>" cd /mnt/images</pre> <p>I then performed the archive command:</p> <pre>tar -cvmhp /dev/nst0 * -b 128</pre> <p>This resulted in the successful completion of 4 DLT tapes</p> <p>I performed the exact same process on hard drive(s) Images &amp;</p> <p>29 Dec 04 MB 15633 resulting in 4 completed tapes (begin 29 Dec - to 30 Dec 04)</p> <p>30 Dec 04 MB 13712 resulting in 3 completed tapes (begin 30 Dec<sup>04</sup> - to JAN 05)</p> <p>3 JAN 05 MB 15622 resulting in 2 completed tapes (begin JAN 03, 05 to JAN 05)</p> <p>All 4 harddrive (Images &amp;) succeeded with no errors</p> <p>LAST item on this page</p>
--	---

Technician: [REDACTED]

Initials: [REDACTED]

FOR OFFICIAL USE ONLY

b67c

000242



For Official Use Only

# DCFL - Imaging Request

0027-03-CID679-64999  
**Media**

DCFL# DCFL2004-1004327  
Request# 0  
Requestor ----  
Received 11/29/2004

Tag/Item	Media Code	Qty	Total Size in GB
393/1	HD	1	0
393/2	HD	1	0
393/3	HD	1	0

## Standard Processes

Image  Restore  Archive

**Media Classified**

**Expedited Service**

SECRET - CAT 1

**Special Request**

COMPAQ blade servers.  
Make duplicate archive tapes for USACIL

### Additional Information

USACIL - 2004-CID131-2130

### Other issues with media

*Handwritten scribble*

Exhibit 40

Pages 244 - 247 referred to

Department of Defense  
Computer Forensics Laboratory (DCFL)  
911 Elkridge Landing Road  
Suite 300  
Linthicum, MD 21090



0027-03-CID679-64999

AGENT'S INVESTIGATION REPORT

CID Regulation 195-1

ROI NUMBER

0419-04-CID056

PAGE 1 OF 1 PAGES

DETAILS

At 1807, 23 Nov 04, this office received an additional Request for Assistance (RFA) from Special Agent [REDACTED] 87<sup>th</sup> Military Police Detachment (CID), Fort Bragg, NC 28310, requesting this office conduct additional activity under this RFA. SA [REDACTED] requested this office obtain a Consent to Search from the Commander, RHHT, 3<sup>rd</sup> Armor Cavalry Regiment (ACR), Fort Carson, CO (FCC) 80913, authorizing the forensic examination of the three computer servers collected as evidence under this RFA on 5 Oct 04. Further, SA [REDACTED] requested the Consent to Search be forwarded to the Department of Defense Computer Forensic Laboratory, point of contact Ms. [REDACTED] (NFI).

At 0940, 24 Nov 04, SA [REDACTED] this office, coordinated with CPT [REDACTED] Commander, RHHT, 3<sup>rd</sup> ACR, who provided a Consent to Search pertaining to the three computer servers collected under DA Form 4137, Evidence/Property Custody Document (VO) 0167-04, on 5 Oct 04. The Consent to Search authorized the forensic examination of two Compaq brand blade servers, serial numbers 6J31NT180EJ and 6J31JNT1801Y, and one BSI brand server, serial number 1024983. (See Consent to Search for details)

At 0955, 24 Nov 04, a facsimile copy of the Consent to Search was forwarded to Ms. [REDACTED] at the DOD Computer Forensic Laboratory.

Agent's Comment: As no additional activity is requested by SA [REDACTED] this file is closed in the files of this office.

///Last Entry///

TYPED AGENT'S NAME AND SEQUENCE NUMBER SA [REDACTED]		ORGANIZATION 48 <sup>th</sup> Military Police Detachment (CID) Fort Carson, CO 80913	
SIGNATURE [REDACTED]		DATE 24 Nov 04	EXHIBIT 41

1 FEB 77

000343

62667C

Date

24 Nov 2004

**LAW ENFORCEMENT SENSITIVE**  
**CONSENT TO SEARCH**

(USACIDC SUPPLEMENT 1 TO AR 190-22)

Time

0940

1. Name of person consenting to search

CPT [REDACTED]

2. Organization and location

RHHT, 3rd Armor Cavalry, Fort Carson, CO 80913

3. I have been informed by the undersigned USACIDC Special Agent that an inquiry is being conducted in connection with the following possible violation(s) of law:

Murder

0027-03-CID679-64999

4. I have been requested by the undersigned USACIDC Special Agent to give my consent to a search of my person, premises, or property as indicated below. I have been advised of my right to refuse a search of my person, premises, or property. (If you do not give your consent, do not sign this form.)

I hereby authorize the undersigned USACIDC Special Agent and/or other Authorized Law Enforcement Officials assisting the undersigned USACIDC Special Agent to conduct a search of: (Initial and sign applicable blocks)

a.	My Person	Initials	Signature
b.	My Quarters	Initials	Signature

Located At:

c.	My Vehicle	Initials	Signature
----	------------	----------	-----------

Located At:

Described As:

d.	Other	Initials	[REDACTED]
----	-------	----------	------------

Located At: US Army Criminal Investigative [REDACTED]

Described As: Two Compaq brand Blade Servers, and one BSI Brand domain server.

5. I am authorizing the above search(s) for the following general types of property which may be removed by the authorized law enforcement personnel and retained as evidence under the provisions of Army Regulation 195-5, or other applicable laws or regulations:

A search of the aforementioned computer equipment, to include any internal hardware or storage media for any files, electronic data or significant email message traffic, along with other documentation that could be considered evidence. Equipment to be searched is described as Compaq blade service, serial number 6J31JNT180EJ, Compaq blade service, serial number 6J31JNT1801Y, and BSI Domain server, serial number 1024983.

6. This written permission is given to the undersigned USACIDC Special Agent freely, voluntarily, and without threats or promises of any kind.

[REDACTED]

CPT, AR  
[Signature]

Person Granting Consent

Signature of Witness (if available)

EX 42

000249

**b67c**

AGENT'S INVESTIGATION

CID Regulation 195-1

PAGE 1 OF 1 PAGES

DETAILS:

BASIS FOR INVESTIGATION: On 18 Aug 05, this office received a Request For Assistance (RFA) from the 48<sup>th</sup> Military Police Detachment (MP DET), Camp Victory, Baghdad, Iraq to inquire about the location of and possibly obtain the original detainee capture file pertaining to MG Abed Hamed MOWHOUSH, Capture Tag 076.

At 0945, 19 Aug 05, SA [redacted] coordinated with MAJ [redacted] S-2, 3<sup>rd</sup> Armored Cavalry Regiment (ACR), [redacted] Iraq. MAJ [redacted] related he was the S-2 with the 3<sup>rd</sup> ACR during the initial incident involving MG MOWHOUSH. MAJ [redacted] stated he believed the original capture file was a part of the investigation packet in 2003 and that his office did not have it. MAJ [redacted] stated LTC [redacted] Regimental Staff Judge Advocate, 3<sup>rd</sup> ACR, FOB SYKES may know the location of the detainee packet. MAJ [redacted] stated CW3 [redacted] 66<sup>th</sup> Military Intelligence Company (MI CO), Fort Carson, CO didn't prepare intelligence briefs for him. MAJ [redacted] related 1LT [redacted] Rear Detachment, S-2, 66<sup>th</sup> MI CO may have knowledge of this information and could have a copy of the detainee file. MAJ [redacted] also stated CW3 [redacted] probably briefed his commander, MAJ [redacted] (Ft Lewis, WA) (NFI) on all intelligence issues.

At 1005, 19 Aug 05, SA [redacted] coordinated with LTC [redacted] who related her office did not have the original or a copy of the detainee file pertaining to MG MOWHOUSH. LTC [redacted] stated she believed it was forwarded with MG MOWHOUSH when he died but she was not certain of its exact whereabouts. LTC [redacted] also stated her office never received it when she got back to the rear after the incident originally happened.

STATUS: This RFA is closed in the files of this office as no further investigative activity is anticipated.///LAST ENTRY///

TYPED AGENT'S NAME AND SEQUENCE NUMBER

SA [redacted]

ORGANIZATION

37<sup>th</sup> Military Police Det (CID)(-)  
3d Military Police Group (CID)  
LSA Diamondback, Iraq

S [redacted]

DATE

19 AUG 05

EXHIBIT

CID Form 94

FOR OFFICIAL USE ONLY

[redacted]

Ex 43

b2b67C

000250

AGENT'S INVESTIGATION REPORT

0027-03-CID679-64999

6 Oct 05

DETAILS:

(FOUO) Around 1040, 20 Jul 05, SA [REDACTED] coordinated with SA [REDACTED] 48<sup>th</sup> MP DET (FWD), Camp Victory, Iraq. SA [REDACTED] related he had two open actions and three or four closed actions in which CW3 [REDACTED] 66<sup>th</sup> Military Intelligence Company, Fort Carson, CO (FCCO) 80913 was a potential suspect of detainee abuse. SA [REDACTED] stated he would collect the information and forward it to this office.

(FOUO) Around 1120, 20 Jul 05, SA [REDACTED] coordinated with CPT (Retired) [REDACTED]. He related the last time he saw any external hard drives relating to the 3<sup>rd</sup> Armored Cavalry Regiment (ACR), FCCO recent deployment to Iraq, they were in the 3ACR Headquarters vault. CPT [REDACTED] stated they may contain intelligence summaries (INSUMS) prepared during Operation Iraqi Freedom (OIF) 1.

(FOUO) Around 1125, 20 Jul 05, SA [REDACTED] S and SA [REDACTED] this office, coordinated with 1LT [REDACTED] Rear Detachment, S-2, 3ACR, FCCO who stated she could not locate the external hard drives mentioned by CPT [REDACTED] and that the Regimental Headquarters had moved. She stated she believed all information pertaining to the last deployment was sent with the 3ACR for their current deployment.

(FOUO) Around 1400, 20 Jul 05, SA [REDACTED] coordinated with Mr. [REDACTED] Defense Computer Forensics Laboratory (DCFL), Linthicum, MD requesting his office expand / re-examine the 3ACR servers for any and all INSUM reports pertaining to CW3 [REDACTED]

(FOUO) Around 0900, 6 Sep 05, SA [REDACTED] received final DCFL report, 2005-I005250, 1 Sep 05, which reflected the results of the search for INSUMS and emails related to CW3 [REDACTED] (See DCFL report for details)

(FOUO) Around 0721, 13 Sep 05, SA [REDACTED] received email from SA [REDACTED] Special Agent in Charge (SAC), 48<sup>th</sup> MP Det (CID), [REDACTED] Iraq, which fully identified the one detainee who is still under U.S. control identified in the four ROI's

[REDACTED]  
SPECIAL AGENT, [REDACTED]

Page 1 of 3

FOR OFFICIAL USE ONLY/LAW ENFORCEMENT SENSITIVE

EXHIBIT 44

b2. b6. 7C

000251

AGENT'S INVESTIGATION REPORT  
0027-03-CID679-64999  
2 Nov 05

DETAILS:

involving CW3 [REDACTED]. The detainee was Mr. [REDACTED] National  
Identification number [REDACTED] dossier number [REDACTED]  
[REDACTED] his ISN number was [REDACTED]. Mr. [REDACTED] was currently incarcerated at the  
Abu Gharib prison, Iraq.

[REDACTED] Around 1400, 20 Sep 05, SA [REDACTED] received four compact discs (CD's)  
containing copies of ROI's from the 48<sup>th</sup> MP Det (CID), [REDACTED] Iraq. The ROI's are  
investigations which list CW3 [REDACTED] as a suspect on detainee related investigations,  
to include a statement by detainee Mr. [REDACTED] who states he was placed in a sleeping bag  
similar to the MG Abed Hamed MOWOUSH, former Major General, Iraqi Army, Iraq,  
[REDACTED] (NFI) incident. (See CD's for details)

(FOUO) Around 1530, 5 Oct 05, SA [REDACTED] coordinated with MAJ [REDACTED]  
Staff Judge Advocates Office, FCCO, who stated probable cause existed to believe CW2  
[REDACTED] 66<sup>th</sup> MI Co, FCCO and CW3 [REDACTED]  
committed the offenses of murder and dereliction of duty, further he stated probable cause  
existed to believe SPC [REDACTED] Aviation Maintenance Troop, Support  
Squadron, 3ACR, FCCO and SFC [REDACTED] 66<sup>th</sup> MI Co, FCCO  
committed the offense dereliction of duty. MAJ [REDACTED] stated there was sufficient evidence  
available to prosecute all subject for the listed offenses. MAJ [REDACTED] stated the  
commander's intent for CW2 [REDACTED] and CW3 [REDACTED] was to bring them to  
courts martial and that SPC [REDACTED] and SFC [REDACTED] commanders were undecided as  
to which course of action they would take.

(FOUO) Around 1000, 6 Oct 05, SA [REDACTED] coordinated with MAJ [REDACTED]  
Special Assistant to the U.S. Attorney, FBNC who stated probable cause existed to believe  
[REDACTED]  
[REDACTED] committed the offense of False Official Statement.  
MAJ [REDACTED] stated there was sufficient evidence to prosecute; however, her office would  
not seek prosecution.

[REDACTED]  
SPECIAL AGENT,  
Page 2 of 3

FOR OFFICIAL USE ONLY/LAW ENFORCEMENT SENSITIVE

[REDACTED] T 44  
b1, b3, b2, b6, 7C

000252

87<sup>TH</sup> MILITARY POLICE DETACHMENT (CID) (ABN), 1<sup>ST</sup> MILITARY POLICE GROUP (CID), USACIDC, FORT BRAGG, NC 28310

AGENT'S INVESTIGATION REPORT  
0027-03-CID679-64999  
2 Nov 05

DETAILS:

(FOUO) Around 0900, 14 Oct 05, SA [REDACTED] coordinated with LTC [REDACTED] Staff Judge Advocate, 5<sup>th</sup> Special Forces Group, Fort Campbell, KY stated probable cause existed to believe SSG [REDACTED], SSG Aaron N. HOLLEYMAN, [REDACTED] and CW2 [REDACTED] all of 1<sup>st</sup> BN, 5<sup>th</sup> Special Forces Group, Fort Campbell, KY committed the listed offenses and that there was sufficient evidence available to prosecute; however, both had already received letters of reprimand for the listed offenses, also SSG HOLLEYMAN was killed in action in Aug 04. LTC [REDACTED] stated SSG [REDACTED] and CW2 [REDACTED] would be testifying in the Courts Martial against CW3 [REDACTED]

(FOUO) Around 0900, 2 Nov 05, SA [REDACTED] S coordinated with MAJ [REDACTED] who opined there was not probable cause to believe [REDACTED]  
[REDACTED] committed the offenses of Aggravated Assault and False Official Statement.

(FOUO) A review of the National Crime Information Center, Computerized Criminal History File, and the files of the Defense Clearance and Investigations Index, US Army Crime Records Center, Fort Belvoir, VA 22060, revealed no derogatory information pertaining to; [REDACTED] SSG HOLLEYMAN, SSG [REDACTED] SFC [REDACTED], SPC [REDACTED] and CW2 [REDACTED] CW3 [REDACTED] was a victim of a closed case number [REDACTED] offense occurred on post at Schofield Barracks, HI, no disposition was available. CW2 [REDACTED] was the subject of a closed investigation, case number [REDACTED], offense was failure to [REDACTED] or [REDACTED]  
//////////////////////////////////////LAST ITEM//////////////////////////////////////

[REDACTED]  
SPECIAL AGENT, [REDACTED]  
Page 3 of 3

FOR OFFICIAL USE ONLY/LAW ENFORCEMENT SENSITIVE

EXHIBIT 44

b1, b3, b2, b6, 7c

000253

[REDACTED]  
0027-03-CID679-64999



**UNITED STATES  
DEPARTMENT OF DEFENSE**

---

**COMPUTER FORENSICS LAB**

**0027-03-CID679-64999**  
**DCFL-2005-1005250**

**REQUESTER'S DOCUMENTATION**

Mr. [REDACTED]  
DATE: 1 SEPTEMBER 2005

[REDACTED]  
**b67C**

45 [REDACTED]  
000254

0027-03-CID679-64999



Department of Defense Computer Forensics Laboratory Request Form 1

1. Administrative Information

In the table below, enter all contact information.

	Investigator	Alternate Point-of Contact	Requestor
Name	SA [REDACTED]	SA [REDACTED]	SA [REDACTED]
Commercial telephone number	910-396-19125	317-510-5669	910-396-1912
Street address (include city, state, and zip code)	Bldg 8-1221, Randolph Street, Fort Bragg, NC 28310	8899 East 56 <sup>th</sup> Street, Column 218-C, Indianapolis, IN 46249	
DSN number	236-8777	N/A	236-8777
Fax number	910-396-8595	317-510-5519	910-396-8595
Email address	[REDACTED]@bragg.army.mil	[REDACTED]@us.army.mil	
Cellular number	[REDACTED]	[REDACTED]	
Pager number	N/A	N/A	

2. Case Identification Information

2.1 Requesting agency's case number: 0027-03-CID679-64999

2.2 Name of SUBJECT: [REDACTED]

2.3 Classification level: Secret

2.4 Enter a description of the situation and background surrounding the investigation (executive summary):

CW3 [REDACTED] smothered a detainee (MOWHOUSH) during an interrogation, which led to the death of the detainee.

2.5 The work requested is an  initial submission or a  follow-on submission.

If follow-up submission was chosen, enter the dates of the previous case: 21Jan05 and the previous case number: DCFL-2004-1004327.

3. Support Requested

3.1 All media associated with the case is being submitted to DCFL?  Yes  No  
If "No", what agency is performing the other part of the examination?

3.2 Has the evidence been previously analyzed by a forensic examiner or agent?  Yes  No

3.3 Enter a detailed description of the services for DCFL to perform.

Search submitted evidence for documents, emails, files pertaining to CW3 [REDACTED] and MOWHOUSH. In particular Intelligence / Interrogation Summaries (INSUMS) written by [REDACTED]

4. Attachments

4.1 Search authority attached?  Yes  No (We cannot begin exam without search authority)

4.2 If 3.2 was answered "Yes" we require a copy of the original exam. Copy attached?  Yes  No

4.3 Evidence list attached?  Yes  No

5. Signature

Name:	Date:	Sig:
[REDACTED]	July 20, 2005	[REDACTED]

DCFL - 2005 - 1005250

FOR OFFICIAL USE ONLY

PAGE 1 OF 13

b67C

000255



0027-03-CID679-64999

DCFL - 2005 - 1005250

FOR OFFICIAL USE ONLY 6027-03-CID679-64999

PAGE 2 OF 13

000256

bl, b3

b67C



FOR OFFICIAL USE ONLY - LAW ENFORCEMENT SENSITIVE

DEPARTMENT OF THE ARMY  
US ARMY CRIMINAL INVESTIGATION LABORATORY  
4553 N 2ND STREET  
FOREST PARK, GA 30287-5122

0027-03-CID679-64999

CILA-EP

19 November 2004

MEMORANDUM FOR DEPARTMENT OF DEFENSE COMPUTER FORENSIC LABORATORY (DCFL), 911 ELKRIDGE LANDING ROAD, SUITE 300, LINTHICUM, MARYLAND 21090

SUBJECT: Case Transfer/Request for Forensic Media Analysis  
USACIL Case Number 2004-CID131-2130  
Submitter Case Number 0027-03-CID679-64999

1. Reference telephone agreement on 19 Nov 04 between SA [REDACTED] [REDACTED] Imaging and Technical Support Division, USACIL, and Mr [REDACTED], Director of Operations, DCFL.
2. On 19 November 2004, the USACIL received evidence from Fort Bragg, NC requesting forensic media analysis of evidence. Upon review of the request by SA [REDACTED] it was determined that the case met the requirements for forwarding to the DCFL for examination.
3. Request your office process the evidence submitted and forward the report of findings and the evidence directly to the submitting agency. IAW regulatory guidelines, request all chain of custody documents be appropriately annotated, the evidence packaged IAW with regulatory guidelines and returned to the submitter via Registered Mail, Federal Express etc.. If there are any questions regarding the examinations requested, or if evidence discrepancies are noted, please contact the investigative agency, SPECIAL AGENT IN CHARGE, 87TH MILITARY POLICE DETACHMENT, THIRD MILITARY POLICE GROUP, USACIDC, BLDG 8-1221 RANDOLPH STREET, FORT BRAGG NC 28310-5000.
4. It is also requested that a copy of the report of findings, the forensic duplicate of the data on the submitted evidence, and the lab/examiner's notes be forwarded to the USACIL. The field elements are not equipped for long-term storage.



AN ASCLD/LAB ACCREDITED LABORATORY (SINCE 1985)

FOR OFFICIAL USE ONLY - LAW ENFORCEMENT SENSITIVE 1 of 2

5  
DCFL - 2005 - 1005250

PAGE 3 OF 13

000257

COPY

0027-03-CTD679 64399

FOR OFFICIAL USE ONLY - LAW ENFORCEMENT SENSITIVE

USACIL CASE WORKSHEET 2004 -CID131- 2130

INCOMING/OUTGOING TIME/DATE 1315 22 Nov 04

SUBMITTER AGENCY Brea

SUBMITTER CASE NUMBER 0027-03-CID 679-64999

SUBMITTER REPRESENTATIVE SA [REDACTED]

SUBMITTER TELEPHONE # DSN: FAX # DSN

CML: 910-396-8777 FAX # CML

REG/CERT MAIL/FED EX NUMBER(S) RR426-001-888 / FE 8372 61703520

DATE FWD TO LAB DATE RCVD 19 Nov 04

EVID CONT # 11-24D & 11-252B REPORT REQUESTED YES/NO

PURPOSE: STATUS CHECK FINDINGS BRIEFING

EXPEDITE EVIDENCE DISCREPANCY (MEMO REQ)

ROUTING CHANGE: ADD DELETE

CASE CANCELLATION ACTION CANCELLATION

VERIFIED BY/DATE:

OTHER

EXPEDITE JUSTIFICATION/REASON FOR CANCELLATION/REMARKS:

Previously spoke to MS [REDACTED] re Search Authorization. SA [REDACTED] said that we will be receiving a copy of Search Authorization from SAC @ St Carson. POC is [REDACTED] 719-492-3846. via fax hard copy forthcoming.

PREPARED BY [REDACTED]

CF: EP TE SD DC FD LP FA IT CASE FILE

FOR OFFICIAL USE ONLY - LAW ENFORCEMENT SENSITIVE

DCFL - 2005 - 1005250

PAGE 5 OF 13

000350

b6.7c

0027-03-CID679-64999

Page 260 withheld.

Exemptions b1, b3, b6,7C

Not reasonably segregable

DO NOT PROCESS, STORE, OR TRANSMIT CLASSIFIED INFORMATION ON NON-SECURE TELECOMMUNICATIONS SYSTEMS. FACSIMILE MACHINES ARE SUBJECT TO MONITORING FOR TELECOMMUNICATIONS SECURITY PURPOSES AT ALL TIMES. USE OF DOD TELECOMMUNICATIONS SYSTEMS CONSTITUTES CONSENT TO TELECOMMUNICATIONS SECURITY MONITORING.

FOR OFFICIAL USE ONLY - LAW ENFORCEMENT SENSITIVE

US ARMY CRIMINAL INVESTIGATION LABORATORY  
4553 N 2ND  
FOREST PARK GA 30297-5122

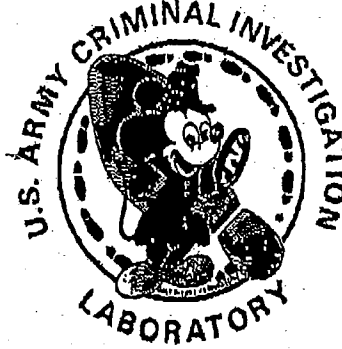

DATE: 28 NOV 04

TIME: 8:24

TO: [REDACTED]

Phone: DSN 622-2595

DCFL  
LINTHICUM, MD

FAX: 410-981-0183

FROM: [REDACTED]  
USACIL

PHONE: 404-469-7110  
FAX: DSN 797-7112

REF: USACIL CASE# 2004-CID131-210  
SUBMITTER CASE# 0027-04-CID679-64999

US Army Criminal Investigation Laboratory  
EVIDENCE PROCESSING  
4553 N 2<sup>nd</sup>, Forest Park, GA 30297-5122  
EMAIL:

CC: [REDACTED] Number of pages including cover sheet (3)

Consent to Search.

[REDACTED]  
Lab Ops Assistant

000261

FOR OFFICIAL USE ONLY - LAW ENFORCEMENT SENSITIVE

DCFL - 2005 - 1005250

b6,7c

0027-03-CID679-64999

Date 24 Nov 2004  
**CONSENT TO SEARCH**  
(USACIDC SUPPLEMENT 1 TO AR 190-22)

1. Name of person consenting to search  
CPT [REDACTED]

2. Organization and location  
RHHT, 3rd Armor Cavalry, Fort Carson, CO 80913

3. I have been informed by the undersigned USACIDC Special Agent that an inquiry is being conducted in connection with the following possible violation(s) of law:  
Murder

4. I have been requested by the undersigned USACIDC Special Agent to give my consent to a search of my person, premises, or property as indicated below. I have been advised of my right to refuse a search of my person, premises, or property. (If you do not give your consent, do not sign this form.)  
I hereby authorize the undersigned USACIDC Special Agent and/or other Authorized Law Enforcement Officials assisting the undersigned USACIDC Special Agent to conduct a search of: (Initial and sign applicable blocks)

a.	My Person	Initials	Signature
b.	My Quarters	Initials	Signature

Located At:

c.	My Vehicle	Initials	Signature
----	------------	----------	-----------

Located At:

Described As:

d.	Other	[REDACTED]	[REDACTED]
----	-------	------------	------------

Located At: US Army Criminal Investigation [REDACTED]

Described As: Two Compaq brand Blade Servers, and one BSI Brand domain server.

5. I am authorizing the above search(es) for the following general types of property which may be removed by the authorized law enforcement personnel and retained as evidence under the provisions of Army Regulation 195-5, or other applicable laws or regulations:  
A search of the aforementioned computer equipment, to include any internal hardware or storage media for any files, electronic data or significant email message traffic, along with other documentation that could be considered evidence. Equipment to be searched is described as Compaq blade service, serial number 6J31JNT180EJ, Compaq blade service, serial number 6J31JNT1801Y, and BSI Domain server, serial number 1024983.

6. This written permission is given to the undersigned USACIDC Special Agent freely, voluntarily, and without threats or promises of any kind.

[REDACTED SIGNATURE] *CPT [REDACTED]*  
Granting Consent

000262

Signature of Witness (if available)

0027-03-CID679-64999



**Fort Carson Resident Agency**  
**48<sup>th</sup> MP DET (CID)**  
**6<sup>th</sup> MP Group CID**  
**FORT CARSON, CO 80913**  
**"THE MOUNTAIN POST"**

FAX COVER SHEET

Do not process, store, or transmit classified information on nonsecure telecommunications systems, including FAX machines. All telecommunications are subject to monitoring for security purposes at all times. Use of Department of Defense telecommunications systems constitutes consent to monitoring.

TO: DDP Computer Forensics Lab FROM: SA [REDACTED]  
ATTN: [REDACTED] DATE: 24 November 2004  
FAX #: 8 797-7112 PAGES: 2  
(Includes cover)

The voice call back number for this office is (719) 526-3991 or DSN 691-3991.  
The FAX number is (719) 526-4258 or DSN 691-4258.

REMARKS: POC for SA [REDACTED] is 719-526-2564  
DSN 691-0564

000263

0027-03-CID679-64999

**66.7C**

**CRIME LABORATORY INFORMATION REQUEST**

For use of this form see AR 195-5, the proponent agency is USACIDC

SE ONLY

Referral Number

TO: Laboratory  
USACIL-CONUS  
4553 North 2<sup>nd</sup>  
Forest Park, GA  
30297-5122  
  
ATTN: Imaging & Technical

FROM: Special Agent in Charge  
87<sup>th</sup> MP Det, DSE  
Third MP Group (CID)  
Fort Bragg, NC 28307  
(910)-396-6429/4311/8806  
Fax Extension: 8595/8607  
Email: [mail023@cid023](mailto:mail023@cid023)  
  
ATTN: Evidence Custodian

Received	Returned

*Case Number*  
0027-03-CID679-64999

*Investigator*  
SA [REDACTED]

*AVN/Phone #:*  
236-4311/8777  
[REDACTED]@bragg.army.mil

*Suspect(s):*  
Multiple

*Victim(s):*  
[REDACTED] former Major General, Iraqi Army

*Offense(s):*  
Murder

*Copy of Evidence receipt enclosed:*  
Yes

*Other evidence previously submitted:*  
None

*If other evidence was previously submitted, list other subjects and the case and lab referral number(s):*

EXHIBIT	ITEM DESCRIPTION
1	Blade Server, serial number 6J31JNT180EJ, (Item 1, VO # 393-04)
2	Blade Server, serial number 6J31JNT1801Y, (Item 2, VO # 393-04)
3	Domain Server, serial number BSI 1024983, (Item 3, VO # 393-04)

000261





**EXAMINATION(S) REQUESTED:**

**Imaging & Technical Division:**

Please search Exhibits 1 through 3 for files, emails, or any other digital documentation for the following key words and phrases.

SEE ATTACHED:

PLEASE CONDUCT ANY OTHER TEST YOU DEEM NECESSARY.

Evidence has not been examined by another expert in the same field.

Typed/ Printed Name of Requestor

Signature

Date

SA [REDACTED]

15 Nov 04

000285

b6,7c



0027-03-C-679-64999

Recipient's Copy

**FedEx** US Airbill  
Express

1 From: This section can be removed for Recipient's records.  
 Date: 23 NOV 04  
 FedEx Tracking Number: 846842985863  
 Sender's Name: Lab Director  
 Phone: 404-469-7107  
 Company: US ARMY CRIME LAB  
 USAFICL # 2004-2130  
 Address: 4553 N 2ND ST BLDG 213B  
 City: FOREST PARK State: GA ZIP: 30297-5122  
 Dept./Post/Box/Room:  
 2 Your Internal Billing Reference: 4328-7701  
 3 To: Recipient's Name: 410 981-0100  
 Phone:

DEPARTMENT OF DEFENSE  
 COMPUTER FORENSIC LABORATORY  
 911 ELKRIDGE LANDING ROAD STE 300  
 LINTHICUM MD 21090

**FedEx** PRIORITY OVERNIGHT WED  
 emp: 409064 23NOV04  
 Deliver By: 24NOV04  
 TRK# 8468 4298 5863 FORM 0215  
 21090 -MD-US NK BWIA  
 BWI 281064965

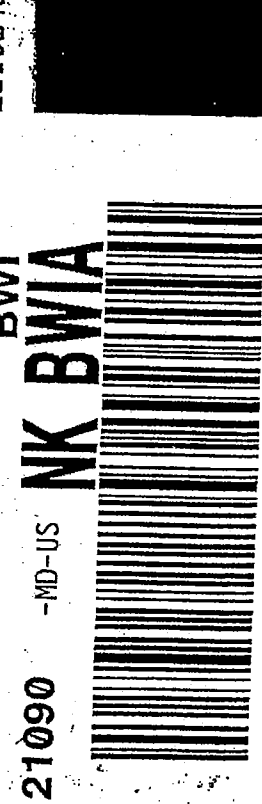

4a Express Package Service

FedEx Priority Overnight  
 FedEx Standard Overnight  
 FedEx Express Saver  
 FedEx 2Day  
 FedEx 2Day Freight  
 Express Freight Service

4b Express Freight Service

FedEx 1Day Freight  
 FedEx 2Day Freight  
 FedEx 3Day Freight  
 FedEx 4Day Freight  
 FedEx 5Day Freight  
 FedEx 7Day Freight  
 FedEx 9Day Freight  
 FedEx 12Day Freight  
 FedEx 15Day Freight  
 FedEx 30Day Freight  
 FedEx 45Day Freight  
 FedEx 60Day Freight  
 FedEx 90Day Freight  
 FedEx 120Day Freight

5 Packaging

FedEx Envelope  
 FedEx Pak  
 FedEx Box  
 FedEx Tube  
 FedEx Mailer  
 FedEx Mailbox

6 Special Handling

Saturday Delivery  
 Hold at FedEx Location  
 Hold at Recipient Location  
 Signature Required  
 Signature Restricted  
 Signature Adult Only  
 Signature Restricted Adult Only  
 Signature Restricted Adult Only (No Signature)

7 Payment Method

Sender  
 Recipient  
 Third Party  
 Cash/Check  
 Credit Card  
 Money Order  
 Personal Check  
 Business Check  
 Government Check  
 International Money Order  
 International Personal Check  
 International Business Check  
 International Government Check  
 International Money Order  
 International Personal Check  
 International Business Check  
 International Government Check  
 International Money Order

8 Sign to Authorize Delivery Without a Signature

Sign to Authorize Delivery Without a Signature  
 Do Not Sign to Authorize Delivery Without a Signature

DCFL - 2005 - 1005250

FOR OFFICIAL USE ONLY 0027-03-CID679-64999

PAGE 12 OF 13

66.7c

000.200

FOR OFFICIAL USE ONLY

**FedEx** Express **US Airbill** Tracking Number 8468 4298 5852

1 From This portion can be removed for Recipient's records.  
 Date **23 Nov 04** FedEx Tracking Number  
 Sender's Name **Lab Director** Phone **444 469-7167**  
 Company **US ARMY CRIME LAB** USACIL # **2004-2130**  
 Address **4553 N 2ND ST BLDG 213B**  
 City **FOREST PARK** State **GA** ZIP **30297-5122**

2 Your Internal Billing Reference **4338-7700**  
 3 To Recipient's Name  
 Phone **410 981-0100**

DEPARTMENT OF DEFENSE  
 COMPUTER FORENSIC LABORATORY  
 911 ELKRIDGE LANDING ROAD STE 300  
 LINTHICUM MD 21090

**FedEx** **PRIORITY OVERNIGHT** **WEB**  
 Emp: 409004 23NOV04  
 Deliver By **24NOV04**  
 Form **8468 4298 5852** FORM 0215  
**21090** -MD-US

**NK BWIA**  
**BWI**

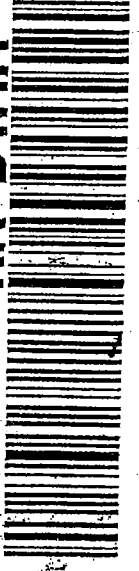

Recipient's Copy

4a Express Package Service  
 FedEx Priority Overnight  
 FedEx Standard Overnight  
 FedEx First Overnight  
 FedEx 2Day  
 FedEx Express Saver  
 FedEx 1Day Freight\*  
 Express Freight Service

4b Express Freight Service  
 FedEx 1Day Freight\*  
 FedEx 2Day Freight  
 FedEx 3Day Freight  
 FedEx 4Day Freight  
 FedEx 5Day Freight  
 FedEx 7Day Freight  
 Other

5 Packaging  
 FedEx Envelope\*  
 FedEx Pak\*  
 FedEx Tube  
 FedEx Box  
 Other

6 Special Handling  
 SATURDAY Delivery  
 HOLD Weekday at FedEx Location  
 HOLD Saturday at FedEx Location  
 Fragile  
 Dry Ice  
 Signature Required  
 Signature Restricted  
 Signature Adult Only  
 Signature Restricted Adult Only  
 Signature Restricted Adult Only (Cash/Check)

7 Payment: Bill Me  
 Recipient  
 Third Party  
 Credit Card  
 Cash/Check

Total Packages **1**  
 Total Weight **82 LBS**  
 Total Charges  
 Credit Card Aut. **466**

8 Sign to Authorize Delivery Without a Signature  
 By signing you authorize us to deliver this shipment without obtaining a signature and agree to indemnify and hold us harmless from any resulting claims.  
 Signature: **466**

b6.7c

000267

**DEFENSE CYBER CRIME CENTER**

**DEFENSE COMPUTER FORENSICS LABORATORY**

**Digital  
Evidence  
Forensic  
Analysis  
Report**

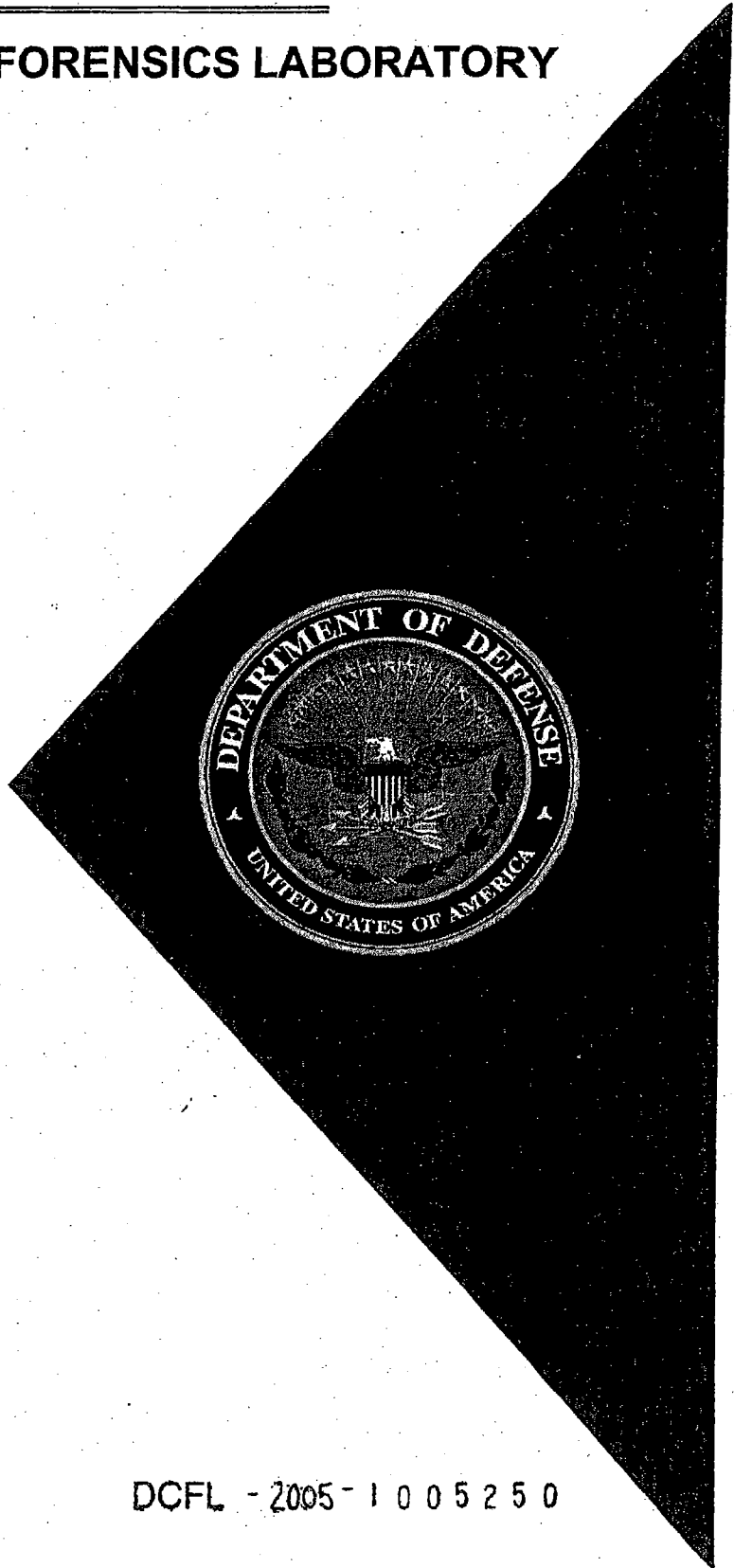

AUTHORIZED ACCESS ONLY

DCFL - 2005 - 1 0 0 5 2 5 0

**FOR OFFICIAL USE ONLY**

DCFL Form 4 Sep 2004

2 [Redacted]

**DL, 7C**

000268

0027-03 CID679 64999

**DEFENSE COMPUTER FORENSICS LABORATORY**  
911 Elkridge Landing Road, Suite 300  
Linthicum, MD 21090



1 September 2005

**MEMORANDUM FOR SPECIAL AGENT IN CHARGE**  
87<sup>th</sup> Military Police Detachment (CID)  
Bldg 8-1221  
Randolph Street  
Fort Bragg, NC 28310

**SUBJECT:** Digital Evidence Forensic Analysis Report - DCFL-2005-I005250 (0027-03-CID679-64999;  
CW3 [REDACTED])

1. **Background:** SA [REDACTED] 87<sup>th</sup> MP Det., DSE, submitted a request dated 20 July 2005, to search all previously submitted evidence for any documents, emails and other files pertaining to CW3 [REDACTED] and a detainee MOWHOUSH. This request is a follow-on to original DCFL case #DCFL-2005-I004327. SA [REDACTED] requested that the hard drives be searched for any documents, emails, and any files pertaining to CW3 [REDACTED] and a detainee MOWHOUSH, in particular Intelligence/Interrogation Summaries (INSUMS) written by SUBJECT. Search authority was provided by CAPT. [REDACTED] HHT, 3<sup>rd</sup> Armor Cavalry, Fort Carson, CO 80913.

2. **Summary of Findings:** From 22 July – 1 September 2005, Computer Forensic Examiner [REDACTED] with the assistance of Computer Forensic Examiners [REDACTED] and [REDACTED], conducted an examination of the media provided. A salvage was conducted on all hard drive partitions for all documents, graphics, email, and HTML files. A keyword search was conducted using the terms [REDACTED] MOWHOUSH, [REDACTED] Interrogation, Intelligence, and Summaries). An examination of the search results identified nine hundred and ten (910) documents that appear to be written by CW3 [REDACTED] thirty-seven (37) email messages that appear to pertain to CW3 [REDACTED] and twenty-three (23) possible graphic files of the detainee MOWHOUSH.

3. **Items Analyzed:**

**TAG NUMBER:**

393-04\_Item1\_HD001 & HD002  
393-04\_Item2\_HD001 & HD002  
393-04\_Item3\_HD001, HD002, HD003 & HD004

**ITEM DESCRIPTION:**

Compaq Blade Server, S/N 6J31JNT180EJ  
Compaq Blade Server, S/N 6J31JNT1801Y  
BSI Domain Server, S/N BSI1024983

**SPECIAL HANDLING REQUIRED**

This document is subject to a claim of privilege under military law. Handle in accordance with AFI 71-101, Vol. 1.

NOTICE - The Defense Computers Forensics Laboratory (DCFL) prepared this report at the specific request of your agency. Your agency is the record custodian. You may make release of the report or the information it contains without prior DCFL approval under the Freedom of Information Act (5 U.S.C., Section 552) or the Privacy Act (5 U.S.C., Section 552a).

*"Where Technology Meets Integrity"*  
**FOR OFFICIAL USE ONLY**

Page 1 of 2

PAGE 1 OF 9

Initial [REDACTED]

bb.7c

000269

4. **Items Provided:** In addition to this hard copy report and attachments, a Findings CD labeled "Digital Evidence Forensic Analysis Report dated 1 September 2005" was provided containing an electronic copy of this report and it's attachments.



Computer Forensic Examiner

Released by:

Attachments:

- 1. DCFL Form 42, Examination of DCFL-2005-I005250 Tag393-04\_Item 1\_HD001 and HD002, dated 1 September 2005, 2 pages
- 2. DCFL Form 42, Examination of Tag393-4\_Item 2\_HD\_001 & HD\_002, dated 1 September 2005, 2 pages
- 3. DCFL Form 42, Examination of Tag393-04\_Item3\_HD001, HD002, HD003 & HD004, dated 1 September 2005, 3 pages

FOR OFFICIAL USE ONLY

Page 2 of 2

Initial

PAGE 2 OF 9

b6,7C

000270

0027 - 0 C 379 64999

**DEFENSE COMPUTER FORENSICS LABORATORY  
REPORT OF EXAMINATION**

1. DATE OF REPORT 1 September 2005	2. REQUESTOR'S CASE CONTROL NUMBER 0027-03-CID679-64999	3. DCFL FILE NUMBER DCFL-2005-I005250
---------------------------------------	--	--

## 4. EXAMINATION

**DCFL-2005-I005250 Tag393-04 Item 1 HD 001 and HD 002**

**CAUTION:** The Findings CD provided with this report should be viewed on a stand-alone computer (not connected to any network) because the CD may contain disturbing information or contraband (e.g., child pornography); dangerous software (e.g., viruses or Trojans, etc.); or may try to connect to outside computers (e.g., contain hyperlinks to web pages or other servers).

1. Special Agent (SA) [REDACTED] 87<sup>th</sup> MP Detachment, DSE, submitted a requested for digital media analysis dated 20 July 2005, for Tag393-04\_Item1, (One (1) Western Digital, model # WD2000BB-00WA0, serial # WMAEH2298177, MB15622, 200GB hard drive. The 200GB hard drive contained two directory folders -- Tag393-04\_Item1\_HD\_001 and Tag393-04\_Item1\_HD\_002. This request was follow-on to the DCFL request number DCFL-2005-I004327. SA [REDACTED] requested the hard drives be examined for any evidence of documents, emails, or files pertaining to CW3 [REDACTED] and detainee MOWHOUSH. In particular, search for all Intelligence/Interrogation Summaries (INSUMS) written by CW3 [REDACTED]

## 2. DETAILS:

a. Tag393-04\_Item1\_HD\_001 was damaged and deemed to be irreparable. Please refer to DCFL Form 42 dated 24 January 2005 for more information on this drive.

b. Tag393-04\_Item1\_HD\_002 was damaged, however the hardware technician was able to image the drive. Approximately 20,000 sectors were reported as damaged. Due to the 20,000 sectors being damaged the partition and file system structure was compromised.

(1) Fifteen (15)-document files that appeared to be written by CW3 [REDACTED] were recovered from unallocated areas of the media. These files were transferred to the Findings CD in "DCFL05-5250\DOC (WP) salvage files" directory.

(2) A keyword search was conducted using the terms ([REDACTED] Mowhoush, intelligence, INSUMS, interrogation, and summaries) provided by SA [REDACTED]. An examination of the search results identified three (3) emails that appeared to pertain to CW3 [REDACTED] and eighty-one (81) document files that appeared to be written by CW3 [REDACTED]. These files were transferred to the Findings CD in "DCFL05-5250\ Search Results for HD02" directory.

## 3. GLOSSARY:

**Unallocated Space:** Data storage area of the media that is currently not assigned to any particular file but may have been at one time, thereby still containing residual information.

**Image:** A verified copy of a hard drive residing on another hard drive as a file or group of files.

## 5. CONDUCTED BY

[REDACTED] GS-13, DAFC  
Counter Intelligence/Counter Terrorism Section

## 6.

[REDACTED]

## 7. RELEASED

[REDACTED]

## SPECIAL HANDLING REQUIRED

This document is subject to a claim of privilege under military law. Handle in accordance with AFI 71-101, Vol. 1.

NOTICE - The Defense Computer Forensics Laboratory (DCFL) prepared this report at the specific request of your agency. Your agency is the record custodian. You may make release of the report or the information it contains without prior DCFL approval under the Freedom of Information Act (5 U.S.C., Section 552) or the Privacy Act (5 U.S.C., Section 552a).

1. DATE OF REPORT 1 September 2005	2. REQUESTOR'S CASE CONTROL NUMBER 002-3-CID679-64999	3. DCFL FILE NUMBER DCFL-2005-I005250
---------------------------------------	--	--

4. EXAMINATION *Continued*

0027-03-CID679-64999

4. ITEMS PROVIDED: In addition to this hard copy report, a Findings CD labeled 'Findings CD for DCFL-2005-I005250 Tag393-04 Item1 HD 001 and HD 002 contains DCFL Form 42 dated 1 September 2005' was provided which contains an electronic copy of this report with hyperlinks to all above-mentioned files.

PAGE 4 OF 9

bl,TK

000272



0027-03 CID 679 64999

DEFENSE COMPUTER FORENSICS LABORATORY  
REPORT OF EXAMINATION

1. DATE OF REPORT  
1 September 2005

2. REQUESTOR'S CASE CONTROL NUMBER  
0027-03-CID679-64999

3. DCFL FILE NUMBER  
DCFL-2005-I005250

4. EXAMINATION

Examination of Tag393-4\_Item2\_HD\_001 & HD\_002

**CAUTION:** The Findings CD provided with this report should be viewed on a stand-alone computer (not connected to any network) because the CD may contain disturbing information or contraband (e.g., child pornography); dangerous software (e.g., viruses or Trojan horses, etc.); or may try to connect to outside computers (e.g., contain hyperlinks to web pages or other servers).

**NOTE:** Each evidence item containing pertinent findings has a corresponding directory on the Findings CD. Notable files were copied to these directories in the same directory structure that was found on the original media.

1. Special Agent (SA) [REDACTED] MP, DET, DSE, Fort Bragg, NC requested Tag393-4\_Item2\_HD\_001 & Tag393-4\_Item2\_HD002 be analyzed for documents, emails, and any other files pertaining to SUBJECT and Interrogation activities involving detainee MOWHOUSH. Search authority was provided by Capt [REDACTED] RHHT, 3<sup>rd</sup> Armor Cavalry, Fort Carson, CO.

2. Items Analyzed:

TAG NUMBER:

Tag393-4\_Item2\_HD\_001

Tag393-4\_Item2\_HD\_002

ITEM DESCRIPTION:

One (1) HP Invent 72.8 GB Hard drive, Model # BD07285A25, Serial # 3HZ0ES8H

One (1) HP Invent 72.8 GB Hard drive, Model # BD07285A25, Serial # 3HZ0E89V

3. Details:

- a. The HP Invent 72.8 GB hard drive Model number BD07285A25, Serial # 3HZ0ES8H removed from Tag393-4\_Item2 contained two (2) FAT12 partitions. Neither of these partitions contained an operating system.
- b. The HP Invent 72.8 GB hard drive Model # BD07285A25, Serial # 3HZ0E89V removed from Tag393-4\_Item2 contained three (3) partitions. One (1) FAT12 partition, one (1) FAT32 partition, and one (1) NTFS partition. The NTFS partition had at one time contained a \WINNT operating system, however, it had been deleted.
- c. Recovered all picture files, text files, document files, spreadsheet files, movies, email files, Internet history files, and other possibly relevant files to the investigation. Actions performed to obtain these results include: Sector carve, keyword search, and drive structure analysis.

5. CONDUCTED BY

[REDACTED]  
GS-13, Forensic Examiner [REDACTED]

7. RELEASED

**SPECIAL HANDLING REQUIRED**

This document is subject to a claim of privilege under military law. Handle in accordance with AFI 71-101, Vol. 1.

**NOTICE** - The Defense Computer Forensics Laboratory (DCFL) prepared this report at the specific request of your agency. Your agency is the record custodian. You may make release of the report or the information it contains without prior DCFL approval under the Freedom of Information Act (5 U.S.C., Section 552) or the Privacy Act (5 U.S.C., Section 552a).

PAGE 5 OF 9

b6.7C

000273

0027-03 CID679-64999

1. DATE OF REPORT 1 September 2005	2. REQUESTOR'S CASE CONTROL NUMBER 0027-03-CID679-64999	3. DCFL FILE NUMBER DCFL-2005-1005250
<p>4. EXAMINATION <i>Continued</i></p> <p>d. A full file-listing database of Tag393-4_Item2_HD_001 can be located under \Reports\HD_001.</p> <p>e. A full file-listing database of Tag393-4_Item2_HD_002 can be located under \Reports\HD_002.</p> <p>f. A sector carve was executed against Tag393-4_Item2_HD_001 and resulted in fourteen thousand three hundred twenty-eight (14,328) files. After analysis, twenty (20) possibly relevant files to this investigation were placed under \HD_001.</p> <p>g. A keyword search was executed against Tag393-4_Item2_HD_001 utilizing the terms [REDACTED] <i>mowhoush, insums, interrogations, intelligence, summaries, ISUM, [REDACTED] Mouhowsh, Mohowsh, [REDACTED], [REDACTED], terror, Mowhoush, and ISUM</i>'. This search resulted in three hundred twenty (320) files. After analysis, no relevant files were recovered.</p> <p>h. A sector carve was executed against Tag393-4_Item2_HD_002 and resulted in twelve thousand eight hundred eighty-one (12,881) files. After analysis, nine (9) possibly relevant files to this investigation were placed under \HD_002.</p> <p>i. A keyword search was executed against Tag393-4_Item2_HD_002 utilizing the terms [REDACTED] <i>mowhoush, insums, interrogations, intelligence, summaries, ISUM, [REDACTED] Mouhowsh, Mohowsh, [REDACTED], [REDACTED], terror, Mowhoush, and ISUM</i>'. This search resulted in three thousand four hundred twelve (3,412) files. After analysis, no relevant files were recovered.</p> <p>4. Definitions:</p> <p>a. <u>Sector Carve</u>: The process of recovering files by searching for a known file signature.</p> <p>b. <u>Hash value</u>: A value generated by running a file through a mathematical algorithm resulting in a 32-character (128 bit) a unique alphanumeric value or "fingerprint".</p> <p>c. <u>Hash Set</u>: A group of hash values assembled for a purpose. Used to compare hash values of a group of unknown files in an effort to identify those known files hidden among them.</p> <p>5. Provided with this DCFL Form 42 is a Findings CD labeled "Tag393-4_Item2_HD_001 and Tag 393-4_Item2_HD_002 Form 42 and Notes, dated 1 September 2005, which contains an electronic copy of this Form 42, all relevant files, and all additional attachments.</p>		

DEFENSE COMPUTER FORENSICS LABORATORY  
REPORT OF EXAMINATION

1. DATE OF REPORT 1 September 2005	2. REQUESTOR'S CASE CONTROL NUMBER 0027-03-CID679-64999	3. DCFL FILE NUMBER DCFL-2005-I005250
---------------------------------------	--	--

## 4. EXAMINATION

**Examination of Tag393-04 Item3 HD001, HD002, HD003 & HD004**

**CAUTION:** The findings media provided with this report should be viewed on a stand-alone computer (not connected to any network) because the media may contain disturbing information or contraband (e.g., child pornography); dangerous software (e.g., viruses or Trojans, etc.); or may try to connect to outside computers (e.g., contain hyperlinks to web pages or other servers).

1. Special Agent (SA) [REDACTED] 87<sup>th</sup> MP DET, DSE, submitted a request for digital media analysis dated 20 July 2005, of a computer (One (1) BSI Blade server S/N: BSI1024983), containing Four (4) Seagate 73.3 GB hard drives. This request is a follow-on to original DCFL case #DCFL-2005-I004327. SA [REDACTED] requested the hard drives be examined for any evidence of documents, emails, or files pertaining to CW3 [REDACTED] and a detainee (MOWHOUSH).

## 2. ITEM ANALYZED:

LOG NUMBER:

Tag393-04\_Item3\_HD001  
Tag393-04\_Item3\_HD002  
Tag393-04\_Item3\_HD003  
Tag393-04\_Item3\_HD004

ITEM DESCRIPTION:

One (1) Seagate 73.3 GB Hard Drive Model # ST373307LC, S/N: 3HZ0LH3G  
One (1) Seagate 73.3 GB Hard Drive Model #ST373307LC, S/N: 3HZ0Q7S6  
One (1) Seagate 73.3 GB Hard Drive Model #ST373307LC, S/N: 3HZ0JAAF  
One (1) Seagate 73.3 GB Hard Drive Model #ST373307LC, S/N: 3HZ0PTPG

## 3. DETAILS:

- a. Tag393-04\_Item3\_HD001, a Seagate 73.3GB hard drive, model #ST373307LC, serial # 3HZ0LH3G, taken from a BSI Blade server, serial #BSI1024983, contained two (2) 68.354 GB NTFS partitions (Partition 0 & 1). The system was running Windows 2000. Additional system information can be found in the Registry Report on the findings media at "5250 Findings\5250 Reports\Registry Report.rtf". A database listing all active recovered and deleted files from Tag393-04\_item3\_HD001 can be found on the findings media at "5250 Findings\5250 Reports\BSI Server Drive1.mdb".

- (1) A salvage was run against Tag393-04\_Item3\_HD001 searching for all graphic, document, email, and other files resulting in one hundred ninety five thousand five hundred ninety-seven (195,597) files.
- (2) A keyword search was conducted using the terms ([REDACTED], Mowhoush, intelligence, insums, interrogation, and summaries) provided by SA [REDACTED]. An examination of the search results identified four hundred thirty (430) document files that appeared to be written by CW3 [REDACTED], eighteen (18) email files were identified that appear to pertain to CW3 [REDACTED] and eight (8) picture files possibly of detainee MOWHOUSH. These

5. CONDUCTED BY

[REDACTED] CIV, DCFL

Computer Forensic Examiner

6. SIGNATURE

7. RELEASED

SPECIAL HANDLING REQUIRED

This document is subject to a claim of privilege under military law. Handle in accordance with AFI 71-101, Vol. 1.

NOTICE - The Defense Computer Forensics Laboratory (DCFL) prepared this report at the specific request of your agency. Your agency is the record custodian. You may make release of the report or the information it contains without prior DCFL approval under the Freedom of Information Act (5 U.S.C., Section 552) or the Privacy Act (5 U.S.C., Section 552a).

DCFL FORM 42 SEP 2004

FOR OFFICIAL USE ONLY

Page 1 of 3

PAGE 7 OF 9

b6,7c

000275

1. DATE OF REPORT 1 September 2005	2. REQUESTOR'S CASE CONTROL NUMBER 0027-03-CID679-64999	3. DCFL FILE NUMBER DCFL-2005-I005250
---------------------------------------	--	--

4. EXAMINATION *Continued*

files can be found at "5250 Findings\Tag393-04\_Item3 results\Hard Drive 001" on the findings media.

b. Tag393-04\_Item3\_HD002, a Seagate 73.3GB hard drive, model #ST373307LC, serial # 3HZ0Q7S6, taken from the BSI Blade server, contained two (2) 68.366 GB NTFS partitions (Partition 0 & 1). No logical partition was present on the drive. A database listing all active recovered and deleted files from Tag393-04\_item3\_HD002 can be found on the findings media at "5250 Findings\5250 Reports\BSI Server Drive2.mdb".

- (1) A salvage was run against Tag393-04\_Item3\_HD002 searching for all graphic, document, email, and other files resulting in eighty seven thousand eight hundred twenty six (87,826) files.
- (2) A keyword search was conducted using the terms from paragraph a2. An examination of the search results identified three hundred sixty-four (364) document files that appeared to be written by CW3 [REDACTED]. These files can be found at "5250 Findings\Tag393-04\_Item3 results\Hard Drive 002" on the findings media.

c. Tag393-04\_Item3\_HD003, a Seagate 73.3GB hard drive, model #ST373307LC, serial # 3HZ0JAAF, taken from the BSI Blade server, contained two (2) 68.366 GB NTFS partitions (Partition 0 & 1). No logical partition was present on the drive.

- (1) A salvage was run against Tag393-04\_Item3\_HD003 searching for graphics, documents, email, and other files resulting in eighty nine thousand sixty seven (89,067) files.
- (2) A keyword search was conducted using the terms from paragraph a2. An examination of the search results identified five (5) document files that appeared to be written by CW3 [REDACTED] and two (2) emails that appear to pertain to CW3 [REDACTED]. These files can be found at "5250 Findings\Tag393-04\_Item3 results\Hard Drive 003" on the findings media.

d. Tag393-04\_Item3\_HD004, a Seagate 73.3GB hard drive, [REDACTED] taken from the BSI Blade server, contained two (2) 68.366 GB NTFS partitions (Partition 0 & 1). No logical partition was present on the drive.

- (1) A salvage was run against Tag393-04\_Item3\_HD004 searching for graphics, documents, email, and other files resulting in eighty nine thousand sixty seven (89,067) files.
- (2) A keyword search was conducted using the terms from paragraph a2. An examination of the search results identified fifteen (15) document files that appeared to be written by CW3 [REDACTED]. These files can be found at "5250 Findings\Tag393-04\_Item3 results\Hard Drive 004" on the findings media.

4. GLOSSARY:

Salvage: Also known as Data carving, locates every possible instance of a specific type of file from unallocated space or within other files.

1. DATE OF REPORT	2. REQUESTOR'S CASE CONTROL NUMBER	3. DCFL FILE NUMBER
1 September 2005	0027-03-CID679-64999	DCFL-2005-I005250

4. EXAMINATION *Continued*

Unallocated Space: All the clusters in a partition that are not currently assigned to a file. Also called free space. Some of these clusters may still contain data from files that were deleted but have not yet been overwritten by other files.

- 5. ITEMS PROVIDED: In addition to this hard copy report, a Findings DVD labeled "DCFL Form 42 Examination of Tag393-04\_Item3\_HD dated 1 September 2005" was provided which contains an electronic copy of this report with hyperlinks to the above-mentioned files.

PAGE 9 OF 9

bb.7c

000277

0027-03-C, L679-64999



**UNITED STATES  
DEPARTMENT OF DEFENSE**

---

---

**COMPUTER FORENSICS LAB**

**0027-03-CID679-64999**  
**DCFL-2005-I005250**

**EXAMINER NOTES**

Mr. [REDACTED]

DATE: 1 SEPTEMBER 2005

FOR OFFICIAL USE ONLY

*bb.7c*

③  
[REDACTED]  
000278

**Department of Defense Computer Forensic Laboratory**

**Examiner/Technician Notes**

Examiner/Technician Name [REDACTED]	Requester Case Number 0027-03-CID679-64999	DCFL Case Number DCFL-2005-1005250
--	---	---------------------------------------

**22-July-05** Received case jacket from [REDACTED], Team Lead.  
**Case Information:**  
 DCFL-2005-1005250  
 Submitter Case Number: 0027-03-CID679-64999

**CASE AGENT:**  
 SA [REDACTED]  
 Special Agent in Charge  
 87<sup>th</sup> MP DET, DSE  
 Third MP Group (CID)  
 Fort Bragg, NC 28307  
 COM: 910.396.6429/4311/8806  
 FAX Extensions: 8595/8607  
 Email: [REDACTED]@bragg.army.mil

**SUBJECT :**  
 CW3 [REDACTED]

**SYNOPSIS OF THE CASE:** SUBJECT smothered a detainee (MOWHOUSH) during an interrogation, which led to the death of the detainee. This is a follow on case to DCFL-2005-1004327.

**EVIDENCE SUBMITTED:**  
 Exhibit 1 – One (1) Compaq Blade Server, S/N 6J31JNT180EJ Two (2) 72GB Hard Drives  
 Exhibit 2 – One (1) Compaq Blade Server, S/N 6J31JNT1801Y Two (2) 72GB Hard Drives  
 Exhibit 3 – One (1) BSI Domain Server, S/N BSI 1024983 Four (4) 73GB Hard Drives

**SUPPORT REQUESTED:** Search submitted evidence for documents, emails, files pertaining to CW3 [REDACTED] and MOWHOUSH. In particular Intelligence/Interrogation Summaries (INSUMS) written by [REDACTED]

**22-July-05** A case acknowledgement letter was sent to SA [REDACTED] advising him that the case was assigned to me.

**25-July-05** Received (3) Hard Drives from [REDACTED] (Image & Extraction).

<b>DCFL FRED 2.8 OS Win2K/Linux Labeled: SECRET</b>
Seagate Model ST340810A
S/N: 5FB7373C
DCFL #: MB13151
Size: 40GB

<b>DCFL FRED 2.8 OS Win2K/Linux Labeled: SECRET</b>
Seagate Model ST340810A
S/N: 5FB737L3
DCFL #: MB13930
Size: 40GB

<b>DCFL FRED 2.8 OS Win2K/Linux Labeled: SECRET</b>
Seagate Model ST340810A
S/N: 5FBNA3BYE
DCFL #: MB13287
Size: 40GB

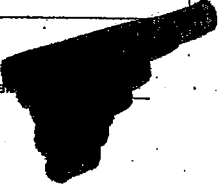

*bb, TC*

000279

Department of Defense Computer Forensic Laboratory

Examiner/Technician Notes

Examiner/Technician Name [REDACTED]	Requester Case Number 0027-03-CID679-64999	DCFL Case Number DCFL-2005-1005250
--	---	---------------------------------------

Received (3) three drives from [REDACTED], Forensic Technician, to be utilized as findings drives.

<b>Findings Drive Labeled: SECRET</b>
Western Digital Model WD2000BB-00DAA0
S/N: WMACK1462421
DCFL #: MB13698
Size: 200GB

<b>Findings Drive Labeled: SECRET</b>
Western Digital Model WD1600BB-00DAA0
S/N: WMACK1300998
DCFL #: MB13532
Size: 160GB

<b>Findings Drive Labeled: SECRET</b>
Western Digital Model WD2500JB-00FUA0
S/N: WMAEP1378499
DCFL #: MB15481
Size: 250GB

25-July-05

Received four (4) hard drives from Forensic Technician, [REDACTED]. These drives contain the images.

<b>4327 Item3 HD_003 &amp; HD_004 Images 2 Labeled - SECRET</b>
Western Digital Model WD2000BB-00DWA0
S/N: WMAEH2309085
DCFL #: MB15633
Size: 200GB

<b>4327 Item3 HD_001 &amp; HD_002 Images 2 Labeled - SECRET</b>
Western Digital Model WD2000BB-00DAA0
S/N: WMACK1449719
DCFL #: MB13697
Size: 200GB

<b>4327 Item2 HD_001 &amp; HD_002 Images 2 Labeled - SECRET</b>
Western Digital Model WD2000BB-00DAA0
S/N: WMACK1437086
DCFL #: MB13712
Size: 200GB

<b>4327 Item1 HD_001 &amp; HD_002 Images 2 Labeled - SECRET</b>
Western Digital Model WD2000BB-00DAA0
S/N: WMACK1462421
DCFL #: MB13698
Size: 200GB

25-July-05

Reviewed 6 part case folder and all documents including the search authority (Authorization for Search and Seizure - CID Form 87-R-E, signed by Captain [REDACTED] dated 24 November 2004). This was provided with original DCFL case number DCFL-2004-1004327.



b6.7c

000280



## Department of Defense Computer Forensic Laboratory

## Examiner/Technician Notes

Examiner/Technician Name

Requester Case Number

DCFL Case Number

0027-03-CID679-64999

DCFL-2005-1005250

26-July-05	Inserted ASCLD Control Boot disk into FRED (MB15012) to conduct POST and calibration test. The MD5 (f3700f01948bfed485be224f137292b9) values matched.
26-July-05	Inserted ASCLD Control Boot disk into FRED (MB15400) to conduct POST and calibration test. The MD5 (f3700f01948bfed485be224f137292b9) values matched.
26-July-05	The 2800mhz FRED computer system (MB15012) configuration will be used to Analyze the media – one (1) hard drive. Documentation of the hardware and software configuration and revision used to conduct the examination was placed into the Notes.
26-July-05	The 2800mhz FRED computer system (MB15400) configuration will be used to Analyze the media – two (2) hard drives. Documentation of the hardware and software configuration and revision used to conduct the examination was placed into the Notes.
26-July-05	DCFL Form 13 Deviation from Standard Configuration was completed to deviate from the normal (SOP) examination as some of these required steps were accomplished on the original request DCFL-2004-1004327.
26-July-05	Placed hard drive (MB15633) containing the image files from (4327 Item3_HD_003 & HD_004). Tag 393-04_Item3_HD003 (hd_001.001 thru hd_001.037) and Tag 393-04_Item3_HD004 (hd_001.001 thru hd_001.037), were placed into FRED (MB15012) and booted into Linux OS v9.0 to begin verifying the md5 hash values of the image files on the drive.
26-July-05	The following commands were used at the command prompt to verify the MD5 hash values: Fdisk -l (drive identified as hda1) Mount -t vfat /dev/sda1 /mnt/images (to mount drive) cd /mnt/images ls cd tag393-04_Item3_HD_003 tail -1 HD*.md5 (showed previous saved hash values) cat hd_001.*  dcfldd  md5sum; tail -1 HD*.md5 The command completed with no errors. The md5 hash value a8a00dd51907f5af755e91f92196d5ca matched.  Opened second terminal window and ran: ls cd tag393-04_Item3_HD_004 tail -1 HD*.md5 (showed previous saved hash values) cat hd_001.*  dcfldd  md5sum; tail -1 HD*.md5 The command completed with no errors. The md5 hash value f8addacd4871ec0fa24e7e052155c53 matched. 143374592 blocks written (70045MB) 143374744+0 records in 143374744+0 records out
26-July-05	End of the workday.

27-July-05

Started llook version 8.0.9 and loaded images for Tag 393-04\_Item3\_HD-003. Automated scripting enabled a standard partition transverse and mapping of image files. llook reported the following partition information:

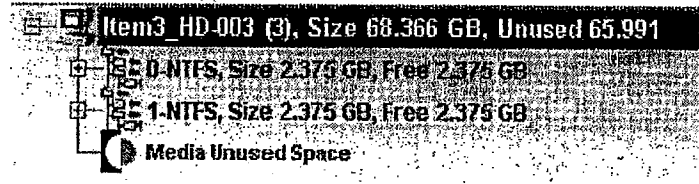

Saved all mapping data.

b6,7c

000281

# Department of Defense Computer Forensic Laboratory

## Examiner/Technician Notes

Examiner/Technician Name [REDACTED]	Requester Case Number 0027-03-CID679-64999	DCFL Case Number DCFL-2005-1005250
--	---	---------------------------------------

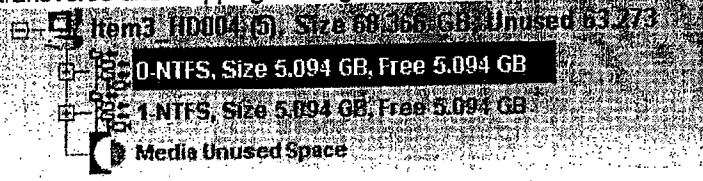
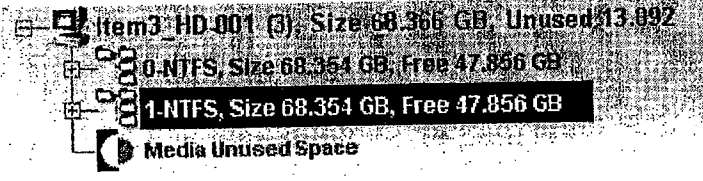
27-July-05	<p>Loaded images for Tag 393-04_Item3_HD-004. Automated scripting enabled a standard partition transverse and mapping of image files. Ilook reported the following partition information:</p>  <p>Saved all mapping data</p>
27-July-05	<p>Placed hard drive (MB13697) labeled (Images (2) Item3_HD_001 &amp; HD_002) containing the image files, Tag 393-04_Item3_HD001 (hd_001.001 thru hd_001.037) and Tag 393-04_Item3_HD002 (hd_001.001 thru hd_001.037), were placed into FRED (MB15400) and booted into Linux OS v9.0 to begin verifying the md5 hash values of the image files on the drive.</p>
27-July-05	<p>The following commands were used at the command prompt to verify the MD5 hash values:</p> <pre>Fdisk -l (drive identified as hda1) Mount -t vfat /dev/sda1 /mnt/images (to mount drive) cd /mnt/images ls cd tag393-04_Item3_HD_001 tail -1 HD*.md5 (showed previous saved hash values) cat hd_001.*  dcfldd  md5sum; tail -1 HD*.md5 The command completed with no errors. The md5 hash value 0f56d31d539e6b95991ce247bcf6664d matched.</pre> <p>Opened second terminal window and ran:</p> <pre>ls cd tag393-04_Item3_HD_002 tail -1 HD*.md5 (showed previous saved hash values) cat hd_001.*  dcfldd  md5sum; tail -1 HD*.md5 The command completed with no errors. The md5 hash value 6ba03242d854a97bc8221d0ec84d44c7 matched. 143374592 blocks written (70045MB) 143374744+0 records in 143374744+0 records out</pre>
27-July-05	<p>Started Ilook version 8.0.9 and loaded images for Tag 393-04_Item3_HD-001. Automated scripting enabled a standard partition transverse and mapping of image files. Ilook reported the following partition information:</p>  <p>Saved all mapping data</p>
27-July-05	<p>Loaded images for Tag 393-04_Item3_HD-004. Automated scripting enabled a standard partition transverse and mapping of image files. Ilook reported the following partition information:</p>



bb, TC

000282

Department of Defense Computer Forensic Laboratory

Examiner/Technician Notes

Examiner/Technician Name [REDACTED]	Requester Case Number 0027-03-CID679-64999	DCFL Case Number DCFL-2005-I005250
--	---	---------------------------------------

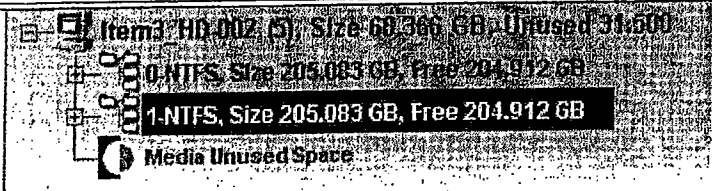

Saved all mapping data.

27-July-05	Computer Forensic Examiner [REDACTED] will be assisting on the examination of the hard drives. Hard drive (MB15622) titled "393-04_Item1_HD001 & 002". This drive is the image files from Exhibit 1 - One (1) Compaq Blade Server, S/N 6J31JNT180EJ Two (2) 72GB Hard Drives.
27-July-05	Computer Forensic Examiner [REDACTED] will be assisting on the examination of the hard drives. Hard drive (MB13712) titled "393-04_Item2_HD001 & 002". This drive is the image files from Exhibit 1 - One (1) Compaq Blade Server, S/N 6J31JNT1801Y Two (2) 72GB Hard Drives.
27-July-05	A complete full file listing from the hard drives was created and saved to the findings drive (L:) titled "BSI server drive 1 file list.dbx, and BSI server drive 2 file list.dbx".
27-July-05	A file salvage was conducted on Tag393-04_Item3-HD-003, for all graphic, word (doc, txt, rtf files), spreadsheet files and all email files with FRED (MB15012). The following results were returned from the salvage. Salvaged (1) file(s) for definition (AOL Graphic File3). Salvaged (80) file(s) for definition (Graphics Interchange File (1)). Salvaged (978) file(s) for definition (Graphics Interchange File (2)). Salvaged (110) file(s) for definition (Portable Network Graphic). Salvaged (70) file(s) for definition (Tif Graphic). Salvaged (1000) file(s) for definition (Jpeg Graphic File (2)). Salvaged (489) file(s) for definition (Windows Meta File (2)). Salvaged (3757) file(s) for definition (Bitmap (Catch-All)). Salvaged (888) file(s) for definition (Jpeg Graphic File (3)). Salvaged (101) file(s) for definition (Enhanced Meta File). Salvaged (42) file(s) for definition (Word Perfect). Salvaged (1084) file(s) for definition (MS Word 4-5). Salvaged (1259) file(s) for definition (MS Word 1). Salvaged (1202) file(s) for definition (MS Word 2). Salvaged (13614) file(s) for definition (MS Word or MS Excel). Salvaged (157) file(s) for definition (Rich Text File). Salvaged (1) file(s) for definition (Windows Write). Salvaged (13614) file(s) for definition (MS Excel or MS Word). Salvaged (13712) file(s) for definition (MS Office Catch-All). Salvaged (7) file(s) for definition (Outlook Mail). Salvaged (1) file(s) for definition (Outlook Express Mail Box). Salvaged (7) file(s) for definition (Outlook Offline Storage). Salvaged (109) file(s) for definition (ZIP Files). Salvaged (1243) file(s) for definition (ARJ Files). Salvaged (4) file(s) for definition (Google GZIP). Salvaged (12) file(s) for definition (MPG). Salvaged (30477) file(s) for definition (MPEG). Salvaged (15) file(s) for definition (Windows Media File). Salvaged (652) file(s) for definition (AVI or WAV). Salvaged (2752) file(s) for definition (Adobe Acrobat Reader). Salvaged (1629) file(s) for definition (PDF-1.2).
27-July-05	A file salvage was conducted on Tag393-04_Item3-HD-004, for all graphic, word (doc, txt, rtf files), spreadsheet files, and all email type files with FRED (MB15012). The following results were returned from the salvage.

b6,7c

000233

Department of Defense Computer Forensic Laboratory

Examiner/Technician Notes

Examiner/Technician Name [REDACTED]	Requester Case Number 0027-03-CID679-64999	DCFL Case Number DCFL-2005-1005250
--	---	---------------------------------------

Salvaged (1) file(s) for definition (AOL Graphic File3).  
 Salvaged (80) file(s) for definition (Graphics Interchange File (1)).  
 Salvaged (978) file(s) for definition (Graphics Interchange File (2)).  
 Salvaged (110) file(s) for definition (Portable Network Graphic).  
 Salvaged (70) file(s) for definition (Tif Graphic).  
 Salvaged (1000) file(s) for definition (Jpeg Graphic File (2)).  
 Salvaged (489) file(s) for definition (Windows Meta File (2)).  
 Salvaged (3757) file(s) for definition (Bitmap (Catch-All)).  
 Salvaged (888) file(s) for definition (Jpeg Graphic File (3)).  
 Salvaged (101) file(s) for definition (Enhanced Meta File).  
 Salvaged (42) file(s) for definition (Word Perfect).  
 Salvaged (1084) file(s) for definition (MS Word 4-5).  
 Salvaged (1259) file(s) for definition (MS Word 1).  
 Salvaged (1202) file(s) for definition (MS Word 2).  
 Salvaged (13614) file(s) for definition (MS Word or MS Excel).  
 Salvaged (157) file(s) for definition (Rich Text File).  
 Salvaged (1) file(s) for definition (Windows Write).  
 Salvaged (13614) file(s) for definition (MS Excel or MS Word).  
 Salvaged (13712) file(s) for definition (MS Office Catch-All).  
 Salvaged (7) file(s) for definition (Outlook Mail).  
 Salvaged (1) file(s) for definition (Outlook Express Mail Box).  
 Salvaged (7) file(s) for definition (Outlook Offline Storage).  
 Salvaged (109) file(s) for definition (ZIP Files).  
 Salvaged (1243) file(s) for definition (ARJ Files).  
 Salvaged (4) file(s) for definition (Google GZIP).  
 Salvaged (12) file(s) for definition (MPG).  
 Salvaged (30477) file(s) for definition (MPEG).  
 Salvaged (15) file(s) for definition (Windows Media File).  
 Salvaged (652) file(s) for definition (AVI or WAV).  
 Salvaged (2752) file(s) for definition (Adobe Acrobat Reader).  
 Salvaged (1629) file(s) for definition (PDF-1.2).

27-July-05 End of Workday.

27-July-05 A file salvage was conducted on Tag393-04\_Item3-HD-001, for all graphic, word (doc, txt, rtf files), spreadsheet files, and all email type files with FRED (MB15400). The following results were returned from the salvage.  
 Salvaged (1) file(s) for definition (AOL Graphic File3).  
 Salvaged (352) file(s) for definition (Graphics Interchange File (1)).  
 Salvaged (4229) file(s) for definition (Graphics Interchange File (2)).  
 Salvaged (688) file(s) for definition (Portable Network Graphic).  
 Salvaged (94) file(s) for definition (Tif Graphic).  
 Salvaged (1177) file(s) for definition (Jpeg Graphic File (2)).  
 Salvaged (1273) file(s) for definition (Windows Meta File (2)).  
 Salvaged (5259) file(s) for definition (Bitmap (Catch-All)).  
 Salvaged (3765) file(s) for definition (Jpeg Graphic File (3)).  
 Salvaged (76) file(s) for definition (Enhanced Meta File).  
 Salvaged (48) file(s) for definition (Word Perfect).  
 Salvaged (1013) file(s) for definition (MS Word 4-5).  
 Salvaged (1146) file(s) for definition (MS Word 1).  
 Salvaged (1183) file(s) for definition (MS Word 2).  
 Salvaged (30443) file(s) for definition (MS Word or MS Excel).  
 Salvaged (271) file(s) for definition (Rich Text File).  
 Salvaged (3) file(s) for definition (Lotus123 (3)).  
 Salvaged (30443) file(s) for definition (MS Excel or MS Word).

bb, 7C

000284

Department of Defense Computer Forensic Laboratory

Examiner/Technician Notes

Examiner/Technician Name [REDACTED]	Requester Case Number 0027-03-CID679-64999	DCFL Case Number DCFL-2005-I005250
--	---	---------------------------------------

	<p>Salvaged (30484) file(s) for definition (MS Office Catch-All).          Salvaged (133) file(s) for definition (MS Access Db).          Salvaged (17) file(s) for definition (Outlook Mail).          Salvaged (2) file(s) for definition (Outlook Express Mail Dump).          Salvaged (17) file(s) for definition (Outlook Offline Storage).          Salvaged (351) file(s) for definition (ZIP Files).          Salvaged (1146) file(s) for definition (ARJ Files).          Salvaged (3) file(s) for definition (Yahoo GZIP).          Salvaged (32) file(s) for definition (Google GZIP).          Salvaged (25) file(s) for definition (MPG).          Salvaged (75017) file(s) for definition (MPEG).          Salvaged (4) file(s) for definition (Windows Media File).          Salvaged (688) file(s) for definition (AVI or WAV).          Salvaged (6214) file(s) for definition (Adobe Acrobat Reader).</p>
28-July-05	<p>A file salvage was conducted on Tag393-04_Item3-HD-002, for all graphic, word (doc, txt, rtf files), spreadsheet files, and all email type files with FRED (MB15400). The following results were returned from the salvage.</p> <p>Salvaged (1) file(s) for definition (AOL Graphic File4).          Salvaged (87) file(s) for definition (Graphics Interchange File (1)).          Salvaged (958) file(s) for definition (Graphics Interchange File (2)).          Salvaged (75) file(s) for definition (Portable Network Graphic).          Salvaged (70) file(s) for definition (Tif Graphic).          Salvaged (1038) file(s) for definition (Jpeg Graphic File (2)).          Salvaged (468) file(s) for definition (Windows Meta File (2)).          Salvaged (4032) file(s) for definition (Bitmap (Catch-All)).          Salvaged (959) file(s) for definition (Jpeg Graphic File (3)).          Salvaged (94) file(s) for definition (Enhanced Meta File).          Salvaged (47) file(s) for definition (Word Perfect).          Salvaged (1080) file(s) for definition (MS Word 4-5).          Salvaged (1284) file(s) for definition (MS Word 1).          Salvaged (1187) file(s) for definition (MS Word 2).          Salvaged (13546) file(s) for definition (MS Word or MS Excel).          Salvaged (170) file(s) for definition (Rich Text File).          Salvaged (13546) file(s) for definition (MS Excel or MS Word).          Salvaged (13662) file(s) for definition (MS Office Catch-All).          Salvaged (169) file(s) for definition (MS Access Db).          Salvaged (14) file(s) for definition (Outlook Mail).          Salvaged (14) file(s) for definition (Outlook Offline Storage).          Salvaged (116) file(s) for definition (ZIP Files).          Salvaged (1261) file(s) for definition (ARJ Files).          Salvaged (2) file(s) for definition (Google GZIP).          Salvaged (22) file(s) for definition (MPG).          Salvaged (30412) file(s) for definition (MPEG).          Salvaged (17) file(s) for definition (Windows Media File).          Salvaged (1) file(s) for definition (Real Player).          Salvaged (653) file(s) for definition (AVI or WAV).          Salvaged (2841) file(s) for definition (Adobe Acrobat Reader).</p>
28-July-05	<p>Started basic search of Tag393-04_Item3-HD-004 using search terms provided by case agent [REDACTED] ([REDACTED], Mowhoush, INSUMS, Interrogation, Intelligence, Summaries). The following results from the search were found.</p> <p>Started basic search of file objects for Evidential Media item Tag393-04_Item3-HD-004.          Completed UTF8 basic search of file objects for Evidential Media item Tag393-04_Item3-HD-004. 0 hit(s) found in 0 objects.</p>

000285

b6,7c

Department of Defense Computer Forensic Laboratory

Examiner/Technician Notes

Examiner/Technician Name [REDACTED]	Requester Case Number 0027-03-CID679-64999	DCFL Case Number DCFL-2005-1005250
--	---	---------------------------------------

Completed ASCII basic search of file objects for Evidential Media item Tag393-04\_Item3-HD-004. 0 hit(s) found in 0 objects.  
 Completed Unicode basic search of file objects for Evidential Media item Tag393-04\_Item3-HD-004. 0 hit(s) found in 0 objects.

Started basic search of file slack for Evidential Media item Tag393-04\_Item3-HD-004.  
 Completed UTF8 basic search of file slack for Evidential Media item Tag393-04\_Item3-HD-004. 0 hit(s) found.  
 Completed ASCII basic search of file slack for Evidential Media item Tag393-04\_Item3-HD-004. 0 hit(s) found.  
 Completed Unicode basic search of file slack for Evidential Media item Tag393-04\_Item3-HD-004. 0 hit(s) found.

Started basic search of salvage for Evidential Media item Tag393-04\_Item3-HD-004.  
 Completed UTF8 basic search of salvage for Evidential Media item Tag393-04\_Item3-HD-004. Renewed counts - 179648 hit(s) found in 25060 objects.  
 Completed ASCII basic search of salvage for Evidential Media item Tag393-04\_Item3-HD-004. Renewed counts - 179648 hit(s) found in 25060 objects.  
 Completed Unicode basic search of salvage for Evidential Media item Tag393-04\_Item3-HD-004. Renewed counts - 5952 hit(s) found in 2476 objects.  
 Started basic search of free space for Evidential Media item Tag393-04\_Item3-HD-004.  
 Completed UTF8 basic search of free space for Evidential Media item Tag393-04\_Item3-HD-004. 20 hit(s) found.  
 Completed ASCII basic search of free space for Evidential Media item Tag393-04\_Item3-HD-004. 20 hit(s) found.  
 Completed Unicode basic search of free space for Evidential Media item Tag393-04\_Item3-HD-004. 74 hit(s) found.

**28-July-05**  
 Started basic search of Tag393-04\_Item3-HD-003 using search terms provided by case agent [REDACTED]s ([REDACTED], Mowhoush, INSUMS, Interrogation, Intelligence, Summaries). The following results from the search were found.  
 Started basic search of file objects for Evidential Media item Tag393-04\_Item3-HD-003.  
 Completed UTF8 basic search of file objects for Evidential Media item Tag393-04\_Item3-HD-003. 0 hit(s) found in 0 objects.  
 Completed ASCII basic search of file objects for Evidential Media item Tag393-04\_Item3-HD-003. 0 hit(s) found in 0 objects.  
 Completed Unicode basic search of file objects for Evidential Media item Tag393-04\_Item3-HD-003. 0 hit(s) found in 0 objects.

Started basic search of file slack for Evidential Media item Tag393-04\_Item3-HD-003.  
 Completed UTF8 basic search of file slack for Evidential Media item Tag393-04\_Item3-HD-003. 0 hit(s) found.  
 Completed ASCII basic search of file slack for Evidential Media item Tag393-04\_Item3-HD-003. 0 hit(s) found.  
 Completed Unicode basic search of file slack for Evidential Media item Tag393-04\_Item3-HD-003. 0 hit(s) found.

Started basic search of salvage for Evidential Media item Tag393-04\_Item3-HD-003.  
 Completed UTF8 basic search of salvage for Evidential Media item Tag393-04\_Item3-HD-003. Renewed counts - 99332 hit(s) found in 14387 objects.  
 Completed ASCII basic search of salvage for Evidential Media item Tag393-04\_Item3-HD-003. Renewed counts - 100575 hit(s) found in 14764 objects.  
 Completed Unicode basic search of salvage for Evidential Media item Tag393-04\_Item3-HD-003. Renewed counts - 6668 hit(s) found in 1461 objects.

bb.7c

000286

Department of Defense Computer Forensic Laboratory

Examiner/Technician Notes

Examiner/Technician Name [REDACTED]	Requester Case Number 0027-03-CID679-64999	DCFL Case Number DCFL-2005-1005250
	<p>Started basic search of free space for Evidential Media item Tag393-04_Item3-HD-003.                  Completed UTF8 basic search of free space for Evidential Media item Tag393-04_Item3-HD-003. 6 hit(s) found.                  Completed ASCII basic search of free space for Evidential Media item Tag393-04_Item3-HD-003. 6 hit(s) found.                  Completed Unicode basic search of free space for Evidential Media item Tag393-04_Item3-HD-003. 100 hit(s) found.</p>	
28-July-05	End of workday.	
29-July-05	<p>Started basic search of Tag393-04_Item3-HD-001 using search terms provided by case agent [REDACTED] (Mowhoush, INSUMS, Interrogation, Intelligence, Summaries). The following results from the search were found.                  Started basic search of file objects for Evidential Media item Tag393-04_Item3_HD-001.                  Completed UTF8 basic search of file objects for Evidential Media item Tag393-04_Item3_HD-001. 107045 hit(s) found in 9246 objects.                  Completed ASCII basic search of file objects for Evidential Media item Tag393-04_Item3_HD-001. 107643 hit(s) found in 9568 objects.                  Completed Unicode basic search of file objects for Evidential Media item Tag393-04_Item3_HD-001. 20635 hit(s) found in 1298 objects.</p> <p>Started basic search of file slack for Evidential Media item Tag393-04_Item3_HD-001.                  Completed UTF8 basic search of file slack for Evidential Media item Tag393-04_Item3_HD-001. 3516 hit(s) found.                  Completed ASCII basic search of file slack for Evidential Media item Tag393-04_Item3_HD-001. 3514 hit(s) found.                  Completed Unicode basic search of file slack for Evidential Media item Tag393-04_Item3_HD-001. 18 hit(s) found.</p> <p>Started basic search of salvage for Evidential Media item Tag393-04_Item3_HD-001.                  Completed UTF8 basic search of salvage for Evidential Media item Tag393-04_Item3_HD-001. Renewed counts - 448019 hit(s) found in 56401 objects.                  Completed ASCII basic search of salvage for Evidential Media item Tag393-04_Item3_HD-001. Renewed counts - 448915 hit(s) found in 56802 objects.                  Completed Unicode basic search of salvage for Evidential Media item Tag393-04_Item3_HD-001. Renewed counts - 158056 hit(s) found in 12592 objects.</p>	
29-July-05	Using QuickView Plus.version 7.0.0.3 began reviewing the documents from search results.	
29-July-05	End of workday.	
30-July-05	Weekend (no Work)	
31-July-05	Weekend (no work)	
1-Aug-05	Personal Day Off.	
2-Aug-05	Continued reviewing documents from search results. (4 hours personal time off)	
2-Aug-05	Spoke with Special Agent [REDACTED] updating him on the results found thus far. Also alternate spellings of victim's name.	
2-Aug-05	End of workday.	
3-Aug-05	<p>Started basic search of Tag393-04_Item3-HD-002 using search terms provided by case agent [REDACTED] (Mowhoush, INSUMS, Interrogation, Intelligence, Summaries). The following results from the search were found.                  Started basic search of file objects for Evidential Media item Tag393-04_Item3_HD-002.                  Completed UTF8 basic search of file objects for Evidential Media item Tag393-04_Item3_HD-002. 18 hit(s) found in 2 objects.                  Completed ASCII basic search of file objects for Evidential Media item Tag393-04_Item3_HD-002. 18 hit(s) found in 2 objects.</p>	

000204

# Department of Defense Computer Forensic Laboratory

## Examiner/Technician Notes

Examiner/Technician Name [REDACTED]	Requester Case Number 0027-03-CID679-64999	DCFL Case Number DCFL-2005-1005250
--	---	---------------------------------------

	<p>Completed Unicode basic search of file objects for Evidential Media item Tag393-04_Item3_HD-002. 74 hit(s) found in 2 objects.</p> <p>Started basic search of file slack for Evidential Media item Tag393-04_Item3_HD-002. Completed UTF8 basic search of file slack for Evidential Media item Tag393-04_Item3_HD-002. 80 hit(s) found. Completed ASCII basic search of file slack for Evidential Media item Tag393-04_Item3_HD-002. 82 hit(s) found. Completed Unicode basic search of file slack for Evidential Media item Tag393-04_Item3_HD-002. 8 hit(s) found.</p> <p>Started basic search of salvage for Evidential Media item Tag393-04_Item3_HD-002. Completed UTF8 basic search of salvage for Evidential Media item Tag393-04_Item3_HD-002. Renewed counts - 392335 hit(s) found in 54114 objects. Completed ASCII basic search of salvage for Evidential Media item Tag393-04_Item3_HD-002. Renewed counts - 395414 hit(s) found in 55357 objects. Completed Unicode basic search of salvage for Evidential Media item Tag393-04_Item3_HD-002. Renewed counts - 54413 hit(s) found in 9207 objects.</p>
3-Aug-05	Continued reviewing documents from search results.
3-Aug-05	End of workday.
4-Aug-05	Continued reviewing documents from search results.
4-Aug-05	End of workday.
5-Aug-05	Continued reviewing documents from search results.
5-Aug-05	End of workday.
6-Aug-05	Weekend (no Work)
7-Aug-05	Weekend (no Work)
8-Aug-05	Continued reviewing documents from search results.
8-Aug-05	End of workday.
9-Aug-05	Continued reviewing documents from search results.
9-Aug-05	End of workday.
10-Aug-05	Continued reviewing documents from search results.
10-Aug-05	End of workday.
11-Aug-05	Continued reviewing documents from search results.
11-Aug-05	End of workday.
12-Aug-05	Spoke with Special Agent William Hughes updating him on what has been discovered thus far.
12-Aug-05	Continued reviewing documents from search results.
12-Aug-05	End of workday.
13-Aug-05	Weekend (no Work)
14-Aug-05	Weekend (no Work)
15-Aug-05	Continued reviewing documents from search results.
15-Aug-05	End of workday.
16-Aug-05	Continued reviewing documents from search results. (3 hours personal time off)
16-Aug-05	End of workday.
17-Aug-05	Continued reviewing documents from search results.
17-Aug-05	End of workday.
18-Aug-05	Continued reviewing documents from search results.
18-Aug-05	End of workday.
19-Aug-05	Continued reviewing documents from search results.
19-Aug-05	End of workday.
20-Aug-05	Weekend (no Work)
21-Aug-05	Weekend (no Work)
22-Aug-05	Continued reviewing documents from search results.

Initials [REDACTED]

bl. TC

Ono



## Department of Defense Computer Forensic Laboratory

### Examiner/Technician Notes

Examiner/Technician Name	Requester Case Number	DCFL Case Number
[REDACTED]	0027-03-CID679-64999	DCFL-2005-I005250
22-Aug-05	End of workday.	
23-Aug-05	Continued reviewing documents from search results.	
23-Aug-05	End of workday.	
24-Aug-05	Continued reviewing documents from search results.	
24-Aug-05	End of workday.	
25-Aug-05	Continued reviewing documents from search results.	
25-Aug-05	End of workday.	
26-Aug-05	Continued reviewing documents from search results.	
26-Aug-05	End of workday.	
27-Aug-05	Weekend (no Work)	
28-Aug-05	Weekend (no Work)	
29-Aug-05	Continued reviewing last of documents from the search results. Reviewed all 3912 jpg files that were salvaged from the hard drives. Eight (8) jpg files of interest were discovered. Utilizing WinHex version 10.54 was able to extract the pictures and bring them into a more readable image. These 8 files were copied out to the findings drive.	
29-Aug-05	End of the workday.	
30-Aug-05	Began writing from 42 for Tag 393-04_Item 3_HD001, 002, 003 and 004. Finished reviewing all documents. All relevant files have been copied to the findings drive.	
30-Aug-05	End of workday.	
31-Aug-05	Received voice mail from SA [REDACTED] looking for an update. Call was returned this morning. SA [REDACTED] was brought up to date on the progress. He asked if it was possible to send a copy of the findings directly to the prosecutor Maj. [REDACTED]. After discussing the pictures that were salvaged with SA [REDACTED] it looks like these are pictures of MG Mowhoush.	
31-Aug-05	Talked to SA [REDACTED] and got Major [REDACTED] phone number. Contacted Major [REDACTED] in regards to getting his mailing address to send copy of findings media to. His address is: Office of Staff Judge Advocate 7086 Albanese Loop, Bldg 6285 Fort Carson, CO 80913-4303 Attn : Major [REDACTED]	
31-Aug-05	End of workday.	
1-Sept-05	Received completed Form 42 from Computer Forensic examiner [REDACTED] for Tag393-04_Item1_HD001 & HD002.	
1-Sept-05	Received completed Form 42 from Computer Forensic examiner [REDACTED] for Tag393-04_Item2_HD001 & HD002.	
1-Sept-05	A hash was conducted on the drives contents after the analysis was conducted. The following hash values were obtained: HD001 The md5 hash value 0f56d31d539e6b95991ce247bcf6664d matched. HD002 The md5 hash value 6ba03242d854a97bc8221d0ec84d44c7 matched. HD003 The md5 hash value a8a0dd51907f5af755e91f92196d5ca matched. HD004 The md5 hash value f8addacd4871ec0fa24e7e052155c53 matched.	
1-Sept-05	Inserted ASCLD Control Boot disk into FRED (MB15012) to conduct POST and calibration test. The MD5 (f3700f01948bfded485be224f137292b9) values matched.	
1-Sept-05	Inserted ASCLD Control Boot disk into FRED (MB15012) to conduct POST and calibration test. The MD5 (f3700f01948bfded485be224f137292b9) values matched.	
1-Sept-05	End of the workday.	
1-Sept-05	These notes are closed.	
	-----Nothing Follows-----	

[REDACTED]

b6.7c 000289



0027-03 MORI DocID: 1476019 9-64999

**UNITED STATES  
DEPARTMENT OF DEFENSE**

---

**COMPUTER FORENSICS LAB**

**Examiner Notes**

Ms. [REDACTED]

**Date: 1 September 2005**

**DCFL-2005-I005250  
0027-03-CID679-64999**

**FOR OFFICIAL USE ONLY**

*bl, 7C*

000290



Department of Defense Computer Forensic Laboratory

Examiner/Technician Notes

Examiner/Technician Name

Requester Case Number

DCFL Case Number

[Redacted]

0027-03-CID679-64999

DCFL-2005-I005250

25 Jul 05

[Redacted] Computer Forensic Examiner, requested my help with examining media received in DCFL-2005-I005250.

SUPPORT REQUESTED:

A keyword search for any documents and email files pertaining to CW3 [Redacted] and Mowhoush. Search for any reference to Intelligence/Interrogation Summaries (INSUMS) written by SUBJECT [Redacted]

END OF DAY

26 Jul 05

The 2800mhz FRED computer system (MB15404) configuration will be used to analyze the image sets.

Items Analyzed

One (1) Western Digital, model # WD2000BB-00WA0, serial # WMAEH2298177, MB15622, 200GB hard drive. The hard drive contained two directory folders -- Tag393-04\_Item1\_HD\_001 and Tag393-04\_Item1\_HD\_002.

Tag393-04\_Item1\_HD\_001 did not contain any image sets. After talking with Mr [Redacted] he mentioned that Tag393-04\_Item1\_HD\_001 was sent to hard drive repair and they could not repair the drive.

Tag393-04\_Item1\_HD\_002 (HD\_002) contained 3 hash value files, one fdisk file, and 37 image sets the following was what was found in the folder:

- hd\_002.001 thru hd\_002.037
- HD\_002\_img.md5
- HD\_002\_org.fdisk
- HD\_002\_org.md5
- HD\_002\_res.md5

The following are the specs on the drives that will be used in this request.

FORENSIC DRIVE - C: & F:

Manufacturer	Seagate
Model	ST340810A
Serial Number	5FB72X9C
LAB ID Number	MB13158
Capacity	40GB
Type	ATA - Primary/Master
File System	NTFS
Software Configuration:	DCFL/WinXP Pro and Red Hat OS

FINDINGS DRIVE - E:

Manufacturer	Western Digital
Model	WD2000BB-00DAAO
Serial Number	WMACK1462421
LAB ID Number	MB13698
Capacity	200GB
Type	ATA - Primary/Master
File System	FAT 32

[Redacted]

b6,7c

000291

# Department of Defense Computer Forensic Laboratory

## Examiner/Technician Notes

Examiner/Technician Name

Requester Case Number

DCFL Case Number

0027-03-CID679-64999

DCFL-2005-1005250

26 Jul 05

### IMAGE DRIVE - D:

Manufacturer Western Digital  
 Model WD2000BB-00WA0  
 Serial Number WMAEH2298177  
 LAB ID Number MB15622  
 Capacity 200GB  
 File System FAT 32

Post/MD5 calibration was OK and the hash values matched the disk label.  
 END OF DAY

28 Jul 05

Ilook v8.0.9 will be used to examine the image sets on the hard drive.

Verified the hash value for the image set of Tag393-04\_Item1\_HD\_002.  
 Used the following commands in Linux to verify the image set:  
 Mounted the device (mount /dev/hdd1 /mnt/images -t vfat)  
 Change directories into Tag393-04\_Item1\_HD\_002  
 Ran the command to verify (cat hd\_001.\* | dcfldd | md5sum; tail -1 HD\*.md5)  
 VERIFIED -- 681c1819e13cf5a1b4a703c35214836a

Used Ilook v8.0.9 to run a Partition Traverse and mapped the file system for Tag393-04\_Item1\_HD\_002 (HD\_002) the following was what was found:

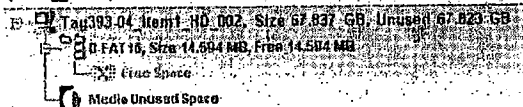

This didn't work as expected will try to run a probe on the partition.  
 END OF DAY

29 Jul 05

Used Ilook v8.0.9 to run a Probe and mapped the file system for HD\_002 and the following was what was found:

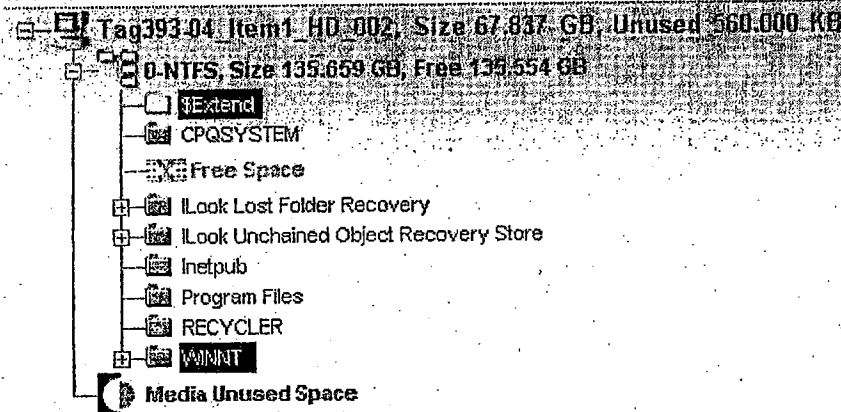

Ran a keyword search for the following words:  
 [REDACTED] Mowhoush, INSUMS, Interrogation, Intelligence, Summaries, and 'ISUM'  
 Have not yet reviewed the keyword search results.  
 END OF DAY

3 Aug 05

Ran a salvage against HD 002 with the following 11 file extensions:

bl, TC

000292

## Department of Defense Computer Forensic Laboratory

## Examiner/Technician Notes

Examiner/Technician Name [REDACTED]	Requester Case Number 0027-03-CID679-64999	DCFL Case Number DCFL-2005-1005250
--	---	---------------------------------------

3 Aug 05

Adobe Acrobat Reader (.PDF)
MS Access DB (.MDB)
MS Word file (.DOC)
PDF-1.2 (.PDF)
MS Excel or MS Word (.XLS)
MS Works (.WKS)
Rich text files (.RTF)
MS Word 1, 2, and 4-5 (.DOC)

The following are the Salvage results:

Documents 16 files all are (.PDF's)
MS Access 9 files all are (.MDB)
Spreadsheet 804 files all are (.XLS)
Word Processing 3757 files: 7 files are (.RTF) 3750 files are (.DOC)

Searched through the results of the salvage.

Started to review the word processing .DOC documents and have only found FRAGO documents.

END OF DAY

4 Aug 05	Copied out the .DOC files to the Findings drive (E:). Searched through the word processing documents salvaged from the hard drive and have only found FRAGO documents. END OF DAY
5 Aug 05	Searched through the word processing documents salvaged from the hard drive and have only found FRAGO documents. END OF DAY
8 Aug 05	Searched through the documents (16 files .PDF) and found nothing of evidentiary value.  Searched through the MS Access files (9 files .MDB) and found nothing of evidentiary value.  Copied out the Spreadsheet files (804 files .XLS) to the Findings drive (E:). Searched through the 804 .XLS files and found nothing of evidentiary value.  Searched through the word processing documents salvaged from the hard drive and have only found FRAGO documents. END OF DAY
9 Aug 05	Searched through the word processing documents salvaged from the hard drive and have only found FRAGO documents. END OF DAY
10 Aug 05	Searched through the word processing documents salvaged from the hard drive and have only found FRAGO documents. END OF DAY
11 Aug 05	Searched through the word processing documents salvaged from the hard drive and have only found FRAGO documents. END OF DAY
12 Aug 05	Searched through the word processing documents salvaged from the hard drive and have only found FRAGO documents.

b6,7c

000293

Department of Defense Computer Forensic Laboratory

Examiner/Technician Notes

Examiner/Technician Name [REDACTED]	Requester Case Number 0027-03-CID679-64999	DCFL Case Number DCFL-2005-1005250
--	---	---------------------------------------

	END OF DAY
15 Aug 05	Searched through the word processing documents salvaged from the hard drive and have found FRAGO documents. Found four interrogation reports written by CW3 [REDACTED] all the files didn't contain the victim's name. The following files were intact: '31349072.doc' '32597368.doc' and '32598656.doc' The following file appeared to be fragmented '31349024.doc' END OF DAY
16 Aug 05	Searched through the word processing documents salvaged from the hard drive and have only found FRAGO documents. END OF DAY
17 Aug 05	Started basic search for Tag393-04_Item1_HD_002 hd_002 using search set (Basic ASCII file system search of containers (0)). Keyword Search expression ([REDACTED], Mowhoush, insums, interrogation, intelligence, summaries, Isum).  Started basic search of file objects for Tag393-04_Item1_HD_002 hd_002. <ul style="list-style-type: none"> <li>Completed ASCII basic search of file objects for Tag393-04_Item1_HD_002 hd_002. 248 hit(s) found in 1 object.</li> <li>Completed Unicode basic search of file objects for Tag393-04_Item1_HD_002 hd_002. 4 hit(s) found in 1 object.</li> </ul> END OF DAY
18 Aug 05	Started searching through files (ASCII 248hits) and (Unicode 4hits). Found 21 dumped files dealing with the SUBJECT. END OF DAY
19 Aug 05	Searching through files (ASCII 248hits) and (Unicode 4hits). Found 4 dumped files dealing with the SUBJECT. END OF DAY
22 Aug 05	Searching through files (ASCII 248hits) and (Unicode 4hits). Found 4 dumped files dealing with the SUBJECT. END OF DAY
23 Aug 05	Searching through files (ASCII 248hits) and (Unicode 4hits). END OF DAY
24 Aug 05	Searching through files (ASCII 248hits) and (Unicode 4hits). Found 4 dumped files dealing with the SUBJECT. END OF DAY
26 Aug 05	Searching through files (ASCII 248hits) and (Unicode 4hits). END OF DAY
29 Aug 05	Searched through the word processing documents salvaged from the hard drive. Found 15 interrogation reports written by CW3 [REDACTED] all the files beside one has the contained the victim's name. The following are the 15 interrogation reports: '30140424 .doc' '31349024.doc' '31349072.doc' '32597368.doc' '32598656.doc' '34770389.doc' '42968828.doc' '127969929.doc' '130009226.doc' '130279662.doc' 'ILook1039_30140424.doc' 'ILook1043_31349024.doc' 'ILook1044_31349072.doc' 'ILook1045_32597368.doc' 'ILook1048_32598656.doc' NOTE: Of the fifteen (15) interrogation reports 10 are originals 5 are duplicate files of the originals.

b6,7c

000294

**Department of Defense Computer Forensic Laboratory**

**Examiner/Technician Notes**

Examiner/Technician Name [REDACTED]	Requester Case Number 0027-03-CID679-64999	DCFL Case Number DCFL-2005-1005250
29 Aug 05	Searching through files (ASCII 248hits) and (Unicode 4hits). END OF DAY	
30 Aug 05	Searching through files (ASCII 248hits) and (Unicode 4hits). END OF DAY	
31 Aug 05	Searching through files (ASCII 248hits) and (Unicode 4hits). The following was recovered from the search results: <ul style="list-style-type: none"> <li>• Eighty-one (81) documents files that appeared to be written by CW3 [REDACTED]</li> <li>• Three (3) emails that appeared to pertain to CW3 [REDACTED]</li> </ul> END OF DAY	
1 Sep 05	Verified the hash value for the image set of Tag393-04_Item1_HD_002. Used Linux to verify the image set and it VERIFIED -- 681c1819e13cf5a1b4a703c35214836a Post/MD5 calibration was OK and the hash values matched the disk label. Started to write a DCFL Form 42.	
-----FINAL ENTRY ON THIS PAGE-----		

**06,7C**

**000295**



UNITED STATES 0027-03  
DEPARTMENT OF DEFENSE

679-64999

COMPUTER FORENSICS LAB

CASE # 0027-03-CID679-64999  
DCFL-2005-I005250

EXAMINER NOTES

[REDACTED]  
DATE: 1 September 2005

FOR OFFICIAL USE ONLY



bl.7c

000296



Department of Defense Computer Forensic Laboratory

Examiner/Technician Notes

0027-03-C

679 64999

Examiner/Technician Name [REDACTED]	Requester Case Number 0027-03-CID679-64999	DCFL Case Number DCFL-2005-1005250
--	---	---------------------------------------

9 August 2005

Received drives for Tag393-4\_Item2\_HD\_001 and Tag393-4\_Item2\_HD\_002 from Mr. [REDACTED]

Case Agent: Special Agent (SA) [REDACTED]  
87th DET, DSE  
Bldg 8 -1221  
Randolph Street  
Fort Bragg, NC

SUBJECT: [REDACTED] CW3

Support Request: This is a follow-on request to original DCFL case # DCFL-2005-1004327 dated 20 July 2005 to analyze media for documents, emails, and any other files pertaining to SUBJECT and Interrogation activities involving detainee MOWHOUSH. Search authority was provided by Capt [REDACTED] RHHT, 3<sup>rd</sup> Armor Cavalry, Fort Carson, CO.

Evidence submitted:

One (1) Compaq Blade Server, SN# 6J311JNT1801Y; containing one (1) HP Invent 72.8 GB Hard drive, Model # BD07285A25, Serial # 3HZ0ES8H (Identified as Tag393-4\_Item2\_HD\_001) and one (1) HP Invent 72.8 GB Hard drive, Model # BD07285A25, Serial # 3HZ0E89V (Identified as Tag393-4\_Item2\_HD\_002).

10 August

Using Analysis Machine 2800 mhz CPU #12B and Forensic OS (MB13184), booted up with ASCLD Control Boot Disk to verify system post and MD5 hash for integrity of forensic machine. MD5 correctly matched MD5 values. Continued to boot up into Windows XP. Partitioned and formatted Findings Drive (MB13712) with NTFS. Assigned drive letter as Q: with volume name of 'Findings'. Shut down system to add Images drives. Rebooted with added Images drive (MB13520). Assigned drive letter is K:

Setup OS for Analysis

- Did not need to download or install Norton Antivirus v9.0.1.1000 update 20050706-008-x86.exe or the current cleaner files (Cleaner.cbd), dated 7 July 2005, database v.3541 because of the follow on status of the request. Virus and Trojan check had been executed on DCFL-2005-1004327.
- Copied the Hashkeeper database files to Findings drive Q:.

Using Ilook v8.0.9, loaded Tag393-4\_Item2\_HD\_001 image files from Images drive K:. Automatic scripting attempted to execute a standard partition transverse to map dd image files. No partition information was recovered. Executed a File Partition Probe. Ilook reported the following partition information:

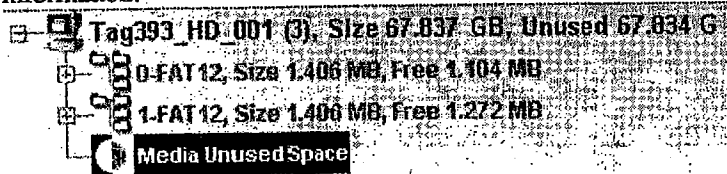

Saved mapping data.

FOR OFFICIAL USE ONLY

Int [REDACTED]

1 of 4

W. J. C.

000297

## Department of Defense Computer Forensic Laboratory

## Examiner/Technician Notes

Examiner/Technician Name [REDACTED]	Requester Case Number 0027-03-CID879-64999	DCFL Case Number DCFL-2005-1005250
--	---	---------------------------------------

10 August

Data appears to be deleted on the drive. No operating system was recovered.

Using Ilook v8.0.9, loaded Tag393-4 Item2 HD\_002 image files from Images drive K:. Automatic scripting attempted to execute a standard partition transverse to map dd image files. No partition information was recovered. Executed a File Partition Probe. Ilook reported the following partition information:

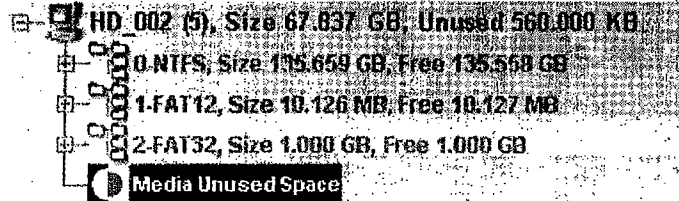

Saved mapping data.

Hashed all files for HD\_001. Created a database of all files for each partition. Placed these database reports in the \Reports\HD\_001 folder. The file names are as follows: \Reports\HD\_001 Full File Listing P(0) and \Reports\HD\_001 Full File Listing P(1).

Created a database of all files for each partition. There were no files in Partition (1) or Partition (2). Hashed all files in Partition (0). Created a database report for Partition (0) and placed in the \Reports\HD\_002 folder. The file names are as follows: \Reports\HD\_002 Full File Listing P(0).

11 August

Reviewed all files. All data appears to have been deleted. Copied out undeleted /WINNT operating system to Findings drive Q: Executed Registry Browser v 2.0.2 and pointed it at the copied out /WINNT folder. Error message stating that there is no registry information could be gathered.

Office function in the late morning and all afternoon. No additional work was done for the day.

12 August

Executed a carve on HD\_001 & HD\_002 for all picture files, document files, and email files.

Copied out all results to temporary folders under \HD\_001 and \HD\_002.

Executed a string search on each tag for the terms [REDACTED] *mowhoush, insums, interrogations, intelligence, summaries, ISUM,* [REDACTED] *Mohowsh,* [REDACTED] *i,* and [REDACTED]

Copied all results to temporary folders on the Findings drive.

15 August

Began reviewing all recovered files.

The results were as follows:

HD\_001

- .dbx - One (1) file - After analysis, nothing of relevancy was recovered.
- .eml - Five hundred sixty-two (562) files - After analysis, fourteen (14) files possibly relevant to the investigation were recovered and placed in the HD\_001 folder.
- .jpg / .jpeg - One thousand, one hundred nine (1,109) - After analysis, six (6) files possibly relevant to the investigation were recovered and placed in the HD\_001 folder.

Init [REDACTED]

FOR OFFICIAL USE ONLY

Page 4 of 4 [REDACTED]

bb.7c

000298

## Department of Defense Computer Forensic Laboratory

## Examiner/Technician Notes

Examiner/Technician Name [REDACTED]	Requester Case Number 0027-03-CID679-64999	DCFL Case Number DCFL-2005-1005250
--	---	---------------------------------------

15 August

- .bmp - Four thousand one hundred twenty-four (4,124) files - After analysis, nothing of relevancy was recovered.
- .gif - Two thousand nine hundred seven (2,907) files - After analysis, nothing of relevancy was recovered.
- .zip - Forty-nine (49) files - After analysis, nothing of relevancy was recovered.
- .png - One hundred seventy-six (176) files - After analysis, nothing of relevancy was recovered.
- .mdb - Six (6) files - After analysis, nothing of relevancy was recovered.
- .xls - Six hundred sixty-nine (669) files - After analysis, nothing of relevancy was recovered.
- .htm / .html - Three thousand one hundred thirty-nine (3,139) files - After analysis, nothing of relevancy was recovered.
- .doc - One thousand five hundred eighty-six (1,586) files - After analysis, nothing of relevancy was recovered.

HD\_002

- .avi - Sixty (60) files - After analysis, nothing of relevancy was recovered.
- .mov - One (1) file - After analysis, nothing of relevancy was recovered.
- .mpg / .mpeg - Two hundred sixty-two (262) files - After analysis, nothing of relevancy was recovered.
- .bmp - Four thousand one hundred twenty-three (4,123) files - After analysis, nothing of relevancy was recovered.
- .doc - Four thousand two hundred two (4,202) files - After analysis, nothing of relevancy was recovered.
- .rtf - Seven (7) files - After analysis, nothing of relevancy was recovered.
- .eml - Five hundred seventy-four (574) files - After analysis, nothing of relevancy was recovered.
- .xls - Seven hundred thirty-eight (738) files - After analysis, nothing of relevancy was recovered.
- .zip - Thirty-nine (39) files - After analysis, nothing of relevancy was recovered.
- .mdb - Three (3) files - After analysis, nothing of relevancy was recovered.
- .png - One hundred seventy-five (175) files - After analysis, nothing of relevancy was recovered.
- .htm / .html - One thousand five hundred seventy-eight (1,578) files - After analysis, nothing of relevancy was recovered.
- .jpg / .jpeg - One thousand one hundred nineteen (1,119) files - After analysis, nine (9) files possibly relevant to the investigation were recovered and placed in the HD\_002 folder.

16 August

Other case priority stopped work on this case for the rest of the day.

17 August

Out of office - sick

18 August

Other casework suspense date priority took precedence for the entirety of the day.

19 - 28  
August

Out of office - vacation

29 August

Executed an additional search on the terms 'terror, Mowhoush, ISUM, [REDACTED] and [REDACTED] Copied all results out to temporary folders on the Findings drive.

Initials [REDACTED]

FOR OFFICIAL USE ONLY

bb, 7C

000299

Department of Defense Computer Forensic Laboratory

Examiner/Technician Notes

Examiner/Technician Name [REDACTED]	Requester Case Number 0027-03-CID679-64999	DCFL Case Number DCFL-2005-1005250
--	---	---------------------------------------

30 August

Began review of all search term result files.

Continued with analysis of search term result files. The results are as follows:

HD 001 Search

- .bmp – Eighteen (18) files – After analysis, nothing of relevancy was recovered.
- .gif – Forty (40) files – After analysis, nothing of relevancy was recovered.
- .png – Four (4) files – After analysis, nothing of relevancy was recovered.
- .tif – One (1) file – After analysis, nothing of relevancy was recovered.
- .avi – Six (6) files – After analysis, nothing of relevancy was recovered.
- .jpg / .jpeg – Ten (10) files – After analysis, nothing of relevancy was recovered.
- .mdb – One (1) file – After analysis, nothing of relevancy was recovered.
- .xls – Twenty-eight (28) files – After analysis, nothing of relevancy was recovered.
- .mpg / .mpeg – Five (5) files – After analysis, nothing of relevancy was recovered.
- .htm / .html – Sixty-one (61) files – After analysis, nothing of relevancy was recovered.
- .doc – One hundred thirty-one (131) files – After analysis, nothing of relevancy was recovered.
- .eml – Fifteen (15) files – After analysis, nothing of relevancy was recovered.

HD 002 Search

- .bmp – Three hundred twenty-two (322) files – After analysis, nothing of relevancy was recovered.
- .gif – Two hundred fifty-six (256) files – After analysis, nothing of relevancy was recovered.
- .png – Twenty-eight (28) files – After analysis, nothing of relevancy was recovered.
- .tif – Three (3) files – After analysis, nothing of relevancy was recovered.
- .avi – Eighty-eight (88) files – After analysis, nothing of relevancy was recovered.
- .jpg / .jpeg – Seventy-two (72) files – After analysis, nothing of relevancy were recovered.
- .xls – Three hundred forty-seven (347) files – After analysis, nothing of relevancy was recovered.
- .mpg / .mpeg – Forty-seven (47) files – After analysis, nothing of relevancy was recovered.
- .htm / .html – One thousand two hundred thirty-four (1,234) files – After analysis, nothing of relevancy was recovered.
- .doc – Eight hundred forty-eight (848) files – After analysis, nothing of relevancy was recovered.
- .eml – One hundred forty-five (145) files – After analysis, nothing of relevancy was recovered.
- .rtf – Two (2) files – After analysis, nothing of relevancy was recovered.
- .zip – Twenty (20) files – After analysis, nothing of relevancy was recovered.

31 August

Completed the analysis of recovered files from secondary search. No files of relevancy were recovered.

Shut system down and rebooted with ASCLD Control Boot Disk to verify system post and MD5 hash for integrity of forensic machine. MD5 correctly matched MD5 values.

Executed a MD5 Hash value on evidence media Tag301 and evidence media Tag302. Hash values from both tags matched initial hash values provided by I&E on DCFL Form 42 Forensic Imaging report.

1 September

Analysis completed. Last entry for this report.

Initials [REDACTED]

FOR OFFICIAL USE ONLY

[REDACTED]

bl. TC

000300

0027-03-CID679-64999

0027-03-CID679-64999

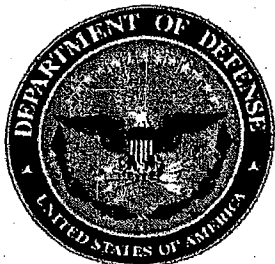

**UNITED STATES  
DEPARTMENT OF DEFENSE**

**COMPUTER FORENSICS LAB**

**0027-03-CID679-64999**

**DCFL-2005-I005250**

**EXAMINER CORRESPONDENCE**

Mr. [REDACTED]

DATE: 1 SEPTEMBER 2005

FOR OFFICIAL USE ONLY

(6) [REDACTED]

bb.7c

000301

0027-03-CID679-64999

[Redacted]

From: [Redacted] SA [Redacted]@us.army.mil]  
Sent: Wednesday, August 03, 2005 4:30 PM  
To: [Redacted]  
Subject: need additional info

0027-03-CID679-64999

[Redacted]

Maj [Redacted] the SJA out at Ft Carson is requesting you expand your search to include any and all email traffic from [Redacted]

Sorry for the constant changes, I'm feeling it to.

Thanks

[Redacted]

**FOR OFFICIAL USE ONLY**

DCFL - 2005 - 1005250  
8/4/2005

PAGE 1 OF 3

0027-03-CID679-64999

[Redacted]

*bb, TC*

000002

0027-03-CID679-64999

From: [redacted]  
Sent: Friday, July 22, 2005 2:15 PM  
To: [redacted]@brago.army.mil  
Cc: [redacted]  
Subject: DCFL Case Receipt Acknowledgement 0027-03-CID679-64999 DCFL-2005-I005205

DCFL Case Receipt Acknowledgement - 22 July 2005

The Defense Computer Forensics Laboratory (DCFL) has received your request for forensic media analysis on your case number: 0027-03-CID679-64999

It has been re-assigned to me in the Counter Intelligence/Counter Terrorism (CI/CT) Section and will retain DCFL number: DCFL-2005-I005250

Base on the complexity of this case, the volume of data, and my current caseload, we have estimated the following completion date: 1 September 2005

During analysis of this case I will provide you weekly informal status reports. If I find significant information, this will be reported to you as soon as I find it via our DCFL Form 42. After I complete the entire forensic analysis of your case, I will provide you a formal report and complete findings on CD.

Your agency's Computer Crime Ops Chief has also requested a "cc" copy of all of your agency's case submissions.

Please provide contact information, such as telephone (commercial), fax, pager number; and e-mail addresses for you or anyone else who would be an alternate contact for this case. Please indicate how you would prefer to be contacted.

If you have any questions you may contact me at any time at the addresses below.

[redacted]  
Tel: 410.981.1008  
Fax: 410.981.0181  
DSN: 312.622.2595  
E-mail: [redacted]@ogn.af.mil or [redacted]@dcfl.gov

If you have trouble contacting me, you may contact the:

Section Chief, SA [redacted]  
Tel: 410.981.0117  
Fax: 410.981-0181  
DSN: 312.622.2595  
E-mail: [redacted]@ogn.af.mil or [redacted]@dcfl.gov;  
or the

Director of Operations, SA [redacted]  
Tel: 410.981.1121  
Fax: 410.981.0181  
DSN: 312.622.2595, or  
Email: [redacted]@ogn.af.mil or [redacted]@dcfl.gov

FOR OFFICIAL USE ONLY

0027-03-CID679-64999

Thank you  
DCFL - 2005 - 1005250

PAGE 2 OF 3

bb, TC

000

[Redacted]

Computer Forensic Examiner  
Defense Computer Forensics Lab

0027-03-CID679-64999

cc: Section Chief, DO, DCIO rep

**FOR OFFICIAL USE ONLY**

PAGE 3 OF 3  
2

0027-03-CID679-64999

DCFL - 2005 - 1005250

**bb.7c**

000304



Exhibit 40

Page 305 referred to

Department of Defense  
Computer Forensics Laboratory (DCFL)  
911 Elkridge Landing Road  
Suite 300  
Linthicum, MD 21090

000308 CID 679-64999

FOR OFFICIAL USE ONLY - LAW ENFORCEMENT SENSITIVE

# AGENT'S INVESTIGATION REPORT

CID Regulation 195-1

ROI NUMBER

0205-05-CID259

PAGE 1 OF 2 PAGES

**DETAILS**

**BASIS FOR INVESTIGATION:** About 0945, 17 Aug 05, this office received a Request For Assistance (RFA) from the 87<sup>th</sup> Military Police (MP) Detachment (DET) (CID), Fort Bragg, NC 28310, which requested this office coordinate with the S-2, 3<sup>rd</sup> Armored Cavalry Regiment (ACR), Mosul, Iraq (IZ), and obtain the original capture file of MG Abed Hamed MOWHOUSH, Capture Tag #076. It was further requested this office inquire as to the disposition of the file if it could not be produced. This office was also requested to inquire as to whom CW3 [REDACTED], 66<sup>th</sup> Military Intelligence (MI) Company (Co), Fort Carson, CO, prepared his intelligence briefs for; coordinate with the Red Crescent Organization regarding the disposition/location of MG MOWHOUSH's remains; and if possible, obtain contact information of family members for possible exhumation of MG MOWHOUSH's body.

**Agent's Comment:** The portion of the RFA concerning the original capture file of MG MOWHOUSH was forwarded to Mosul, Iraq (IZ), since 3<sup>rd</sup> ACR was located in their Area of Responsibility.

About 1050, 19 Aug 05, SA [REDACTED] this office, coordinated with [REDACTED] Red Cross, who provided an e-mail address for the Red Crescent Organization, [bagdad.bag@icrc.org](mailto:bagdad.bag@icrc.org), and a phone number of 964 1 88 6291. SA [REDACTED] subsequently sent an email to the above mentioned address requesting information about the disposition/location of MG MOWHOUSH's remains and contact information of his family members.

About 1115, 19 Aug 05, SA [REDACTED] located the Iraq Red Crescent Organization Home page (<http://www.ifrc.org/address/iq.asp>). Same phone number listed. Web page date of last update was 06.08.2003. Attempted to contact listed telephone numbers; however, efforts met with negative results.

Between 19-23 Aug 05, SA [REDACTED] coordinated with personnel from the 86<sup>th</sup> Combat Support Hospital, International Zone, Baghdad, IZ and 44<sup>th</sup> MEDCOM, Camp Victory, Baghdad, IZ APO AE 09342, requesting information about the disposition/location of MG MOWHOUSH's remains and contact information of his family members. SA [REDACTED] was provided the following telephone

TYPED AGENT'S NAME AND SEQUENCE NUMBER		ORGANIZATION	
SA [REDACTED]		48 <sup>th</sup> MP DET (CID) (FWD)	
SIGNATURE [REDACTED]		Camp Slayer, Iraq APO AE 09342	
		DATE	EXHIBIT
		31 Aug 05	46

CID 1 FEB 7

FOR OFFICIAL USE ONLY - LAW ENFORCEMENT SENSITIVE

b2, b6, 7C

000308

0027-03-629-6499

FOR OFFICIAL USE ONLY - LAW ENFORCEMENT SENSITIVE

## AGENT'S INVESTIGATION REPORT

ROI NUMBER

0205-05-CID259

CID Regulation 195-1

PAGE 2 OF 2 PAGES

## DETAILS

numbers for the Iraq Red Crescent Organization: 914-360-9499 and IRAQNA cell 015376641.

About 1545, 23 Aug 05, SA [REDACTED] sent an email to the above mentioned address requesting information about the disposition/location of MG MOWHOUSH's remains and contact information of his family members.

Between 1450-1520, 25 Aug 05, SA [REDACTED] attempted to call the numbers provided for the Red Crescent Organization (914-360-9499 and IRAQNA cell 015376641). SA [REDACTED] attempted to contact the first number (914-360-9499) several times; however, efforts met with negative results. SA [REDACTED] called the IRAQNA number (015376641) with the assistance of Mr. [REDACTED] this office, and was told the number was for a generator repair business and not the Iraq Red Crescent Organization.

About 1545, 25 Aug 05, SA [REDACTED] coordinated with CPT [REDACTED] (NFI), [REDACTED], Surgeon's Cell, Multi National Corps-Iraq (MNC-I), Camp Victory, Baghdad, IZ APO AE 09342, who advised his office only coordinated with the Red Cross, not the Red Crescent Organization.

About 2100, 28 Aug 05, SA [REDACTED] received e-mail from [REDACTED] Detention Coordinator, ICRC Iraq ([REDACTED]@icrc.org), who provided a point of contact for coordinating the request for information about detainees who have died in US Custody was MAJ [REDACTED], Office of the Staff Judge Advocate (SJA), Camp Victory, Baghdad, IZ APO AE 09342 ([REDACTED]@iraq.centcom.mil). SA [REDACTED] subsequently sent an email to the above mentioned address requesting information about the disposition/location of MG MOWHOUSH's remains and contact information of his family members.

About 1800, 31 Aug 05, SA [REDACTED] received an email from MAJ [REDACTED] who related he had contacted the ICRC and was informed they could not locate any information on MG MOWHOUSH.

After coordination with the requesting office, no further activity is anticipated by this office. This case is closed in the files of this office. ///LAST ENTRY///

TYPED AGENT'S NAME AND SEQUENCE NUMBER		ORGANIZATION	
SA [REDACTED]		48 <sup>th</sup> MP DET (CID) (FWD)	
SIGNATURE [REDACTED]		Camp Slayer, Iraq APO AE 09342	
		DATE	EXHIBIT
		31 Aug 05	146

CID

FOR OFFICIAL USE ONLY - LAW ENFORCEMENT SENSITIVE

b2.b6.7c

000307

87<sup>TH</sup> MILITARY POLICE DETACHMENT (CID) (ABN), 3D MILITARY POLICE GROUP (CID), USACIDC, FORT BRAGG, NC 28310

AGENT'S INVESTIGATION REPORT

0027-03-CID679-64999

5 Dec 05

DETAILS:

[REDACTED] At 1400, 5 Dec 05, SA [REDACTED] received DCFL Report #2005-I005538, 17 Nov 05, consisting of a Digital Evidence Forensic Analysis Report of the two external hard drives; the work request for the examination of the hard drives; the Examiner/Technician Notes, dated 17 Nov 05; the Examiner/Technician Notes, dated 7 Nov 05; email correspondence, dated 17 Nov 05; one CD containing the digital copies of the report; one CD containing the digital copies of Report of Examination pertaining to external hard drive identified as Tag 471\_Item 1; and one DVD containing all documents and images recovered from the hard drive. (see DCFL report for details)

//////////////////////////////////////LAST ITEM//////////////////////////////////////

[REDACTED]

SPECIAL AGENT, [REDACTED]  
Page 1 of 1

FOR OFFICIAL USE ONLY/LAW ENFORCEMENT SENSITIVE

EXHIBIT 47

b2, b4, 7C

000308

**DEFENSE CYBER CRIME CENTER**

**DEFENSE COMPUTER FORENSICS LABORATORY**

**Digital  
Evidence  
Forensic  
Analysis  
Report**



**AUTHORIZED ACCESS ONLY**



*AN ASCLD/LAB DIGITAL EVIDENCE ACCREDITED LABORATORY*

**FOR OFFICIAL USE ONLY**

DCFL Form 4 - Oct 2005

DCFL-2005-1005538

**b67c**

2

48  
000309



0027 03 - CID679 - 64999  
**DEFENSE COMPUTER FORENSICS LABORATORY**  
 911 Elkridge Landing Road, Suite 300  
 Linthicum, MD 21090

17 November 2005

**MEMORANDUM FOR SPECIAL AGENT IN CHARGE**  
 87<sup>th</sup> Military Police Detachment (CID)  
 Bldg 8-1221  
 Randolph Street  
 Fort Bragg, NC 28310

**SUBJECT:** Digital Evidence Forensic Analysis Report - DCFL-2005-I005538 (0027-03-CID679-64999;  
 CW3 [REDACTED])

1. **Background:** SA [REDACTED] 87<sup>th</sup> MP Det., DSE, submitted a request dated 5 October 2005, to search submitted evidence to determine if evidence was previously submitted and if not to search for any documents, emails and other files pertaining to CW3 [REDACTED] and a detainee MOWHOUSH. This request is a follow-on to original DCFL case #DCFL-2005-I004327. SA [REDACTED] requested that the hard drives be searched for any documents, emails, and any files pertaining to CW3 [REDACTED] and a detainee MOWHOUSH, in particular Intelligence/Interrogation Summaries (INSUMS) written by SUBJECT. Search authority was provided by CAPT. [REDACTED] RHHT, 3<sup>rd</sup> Armor Cavalry, Fort Carson, CO 80913.

2. **Summary of Findings:** From 13 October – 17 November 2005, Computer Forensic Examiner [REDACTED] and Computer Forensic Technicians [REDACTED] and [REDACTED] conducted an examination of the media provided. A salvage was conducted on all hard drive partitions for all documents, graphics, email, and HTML files. A keyword search was conducted using the terms ([REDACTED] MOWHOUSH, INSUMS, Interrogation, Intelligence, and Summaries). An examination of the search results identified nine hundred eighty one (981) documents that appear to be written by CW3 [REDACTED] two hundred twenty (220) graphic files that appear to match personnel named in the documents.

3. **Items Analyzed:**

**TAG NUMBER:**

**ITEM DESCRIPTION:**

471\_Item1

Maxtor hard drive, 250 GB, S/N: A8062XFE

471\_Item2

Maxtor hard drive, 250 GB, S/N: Y63V3RRE

**SPECIAL HANDLING REQUIRED**

This document is subject to a claim of privilege under military law. Handle in accordance with AFI 71-101, Vol. 1.

NOTICE - Handle this report with utmost care to protect the reputations of persons named here who were juveniles when the matter disclosed occurred.

NOTICE - The Defense Computer Forensics Laboratory (DCFL) prepared this report at the specific request of your agency. Your agency is the record custodian. You may make release of the report or the information it contains without prior DCFL approval under the Freedom of Information Act (5 U.S.C., Section 552) or the Privacy Act (5 U.S.C., Section 552a).



AN ASCLD/LAB DIGITAL EVIDENCE ACCREDITED LABORATORY

"Where Technology Meets Integrity"

**FOR OFFICIAL USE ONLY**

Page 1 of 2

Initial [REDACTED]

**b67c** PAGE 1 OF 7

000310

0027-03-CID679-64999

DCFL-2005-I005538

0027-03-CID679-64999

4. **Items Provided:** In addition to this hard copy report and attachments, a Findings CD labeled "Digital Evidence Forensic Analysis Report dated 17 November 2005" was provided containing an electronic copy of this report and it's attachments.

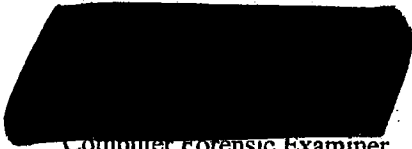

Computer Forensic Examiner

Released by: 

Attachments:

- 1. DCFL Form 42, DCFL Form 42 Examination of Tag471\_Item 1, dated 17 November 2005, 2 pages
- 2. DCFL Form 42, DCFL Form 42 Examination of Tag471\_Item 2, dated 17 November 2005, 2 pages
- 3. DCFL Form 42, Forensic Imaging, dated 31 October 2005, 1 page

**b67c**

FOR OFFICIAL USE ONLY

Page 2 of 2

PAGE 2 OF 7

Initials: 

000311

DEFENSE COMPUTER FORENSICS LABORATORY  
REPORT OF EXAMINATION

1. DATE OF REPORT 17 November 2005	2. REQUESTOR'S CASE CONTROL NUMBER 0027-03-CID679-64999	3. DCFL FILE NUMBER DCFL-2005-I005538
---------------------------------------	--	--

4. EXAMINATION

Examination of Tag471\_Item1

**CAUTION:** The findings media provided with this report should be viewed on a stand-alone computer (not connected to any network) because the media may contain disturbing information or contraband (e.g., child pornography); dangerous software (e.g., viruses or Trojans, etc.); or may try to connect to outside computers (e.g., contain hyperlinks to web pages or other servers).

1. Special Agent (SA) [REDACTED] 87<sup>th</sup> MP DET, DSE, submitted a request for digital media analysis dated 5 October 2005, of a external hard drive (One (1) Maxtor external hard drive model 5000XT, containing one (1) Maxtor hard drive, 250 GB, S/N: A8062XFE, labeled "Falcon View". Classified SECRET. This request is a follow-on to original DCFL case #DCFL-2005-I004327. SA [REDACTED] requested the hard drives be examined for any evidence of documents, emails, or files pertaining to CW3 [REDACTED] and a detainee (MOWHOUSH).

2. ITEM ANALYZED:

LOG NUMBER:  
Tag471\_Item1

ITEM DESCRIPTION:  
One (1) Maxtor external hard drive model 5000XT, containing one (1) Maxtor hard drive, 250 GB, S/N: A8062XFE, labeled "Falcon View". Classified SECRET

3. DETAILS:

Tag471\_Item1, a Maxtor external hard drive model 5000XT, containing one (1) Maxtor hard drive, 250 GB, S/N: A8062XFE, labeled "Falcon View", contained one (1) NTFS partition. The NTFS partition appears to have been re-formatted. The drive is Classified SECRET.

- (1) A salvage was run against Tag471\_Item1 searching for all graphic, document, email, and other files resulting in twenty two thousand nine hundred sixty-one (22,961) files. A review of the salvaged files revealed no files relevant to the request.
- (2) A keyword search was conducted using the terms ([REDACTED] Mowhoush, [REDACTED] ntelligence, insums, interrogation, and summaries) provided by SA [REDACTED]. No files relevant to the request were found.

5. CONDUCTED BY [REDACTED] CIV, DCFL Computer Forensic Examiner	[REDACTED]	7. RELEASED [REDACTED]
---	------------	---------------------------

SPECIAL HANDLING REQUIRED

This document is subject to a claim of privilege under military law. Handle in accordance with AFI 71-101, Vol. 1.

NOTICE - The Defense Computer Forensics Laboratory (DCFL) prepared this report at the specific request of your agency. Your agency is the record custodian. You may make release of the report or the information it contains without prior DCFL approval under the Freedom of Information Act (5 U.S.C., Section 552) or the Privacy Act (5 U.S.C., Section 552a).

**b67c**

PAGE 3 of 7

000312



0027-03-CID679-64999

1. DATE OF REPORT 17 November 2005	2. REQUESTOR'S CASE CONTROL NUMBER 0027-03-CID679-64999	3. DCFL FILE NUMBER DCFL-2005-I005538
---------------------------------------	--	--

4. EXAMINATION *Continued*

4. GLOSSARY:

**Salvage:** Also known as Data carving, locates every possible instance of a specific type of file from unallocated space or within other files.

**Unallocated Space:** All the clusters in a partition that are not currently assigned to a file. Also called free space. Some of these clusters may still contain data from files that were deleted but have not yet been overwritten by other files.

5. **ITEMS PROVIDED:** In addition to this hard copy report, a Findings CD labeled "DCFL Form 42 Examination of Tag471\_Item1 dated 17 November 2005" was provided which contains an electronic copy of this report with hyperlinks to the above-mentioned files.

**b67c**

PAGE 4 OF 7

000000

DEFENSE COMPUTER FORENSICS LABORATORY  
REPORT OF EXAMINATION

1. DATE OF REPORT 17 November 2005	2. REQUESTOR'S CASE CONTROL NUMBER 0027-03-CID679-64999	3. DCFL FILE NUMBER DCFL-2005-I005538
---------------------------------------	--	--

## 4. EXAMINATION

Examination of Tag471 Item2

**CAUTION:** The findings media provided with this report should be viewed on a stand-alone computer (not connected to any network) because the media may contain disturbing information or contraband (e.g., child pornography); dangerous software (e.g., viruses or Trojans, etc.); or may try to connect to outside computers (e.g., contain hyperlinks to web pages or other servers).

1. Special Agent (SA) [REDACTED] 87<sup>th</sup> MP DET, DSE, submitted a request for digital media analysis dated 5 October 2005, of a external hard drive One (1) Maxtor external hard drive model One Touch, containing one (1) Maxtor hard drive, 250 GB, S/N: Y63V3RRE. Classified SECRET. This request is a follow-on to original DCFL case #DCFL-2005-I004327. SA [REDACTED] requested the hard drives be examined for any evidence of documents, emails, or files pertaining to CW3 [REDACTED] and a detainee (MOWHOUSH).

## 2. ITEM ANALYZED:

LOG NUMBER:

Tag471\_Item2

ITEM DESCRIPTION:

One (1) Maxtor external hard drive model One Touch, containing one (1) Maxtor hard drive, 250 GB, S/N: Y63V3RRE. Classified SECRET

## 3. DETAILS:

Tag471\_Item2, a Maxtor external hard drive model One Touch, containing one (1) Maxtor hard drive, 250 GB, S/N: Y63V3RRE, contained one (1) FAT32 partition. Partition 0 is 233.757 GB in size and was formatted with FAT 32. Partition 0 had at one time contained a \WINNT operating system, however, it had been deleted. The drive is Classified SECRET.

- (1) A database listing all active recovered and deleted files can be found on the findings media at \5538 Findings\5538 Reports\Full File List.mdb.
- (2) A salvage was run against Tag471\_Item2 searching for all graphic, document, email, and other files resulting in twenty six thousand nine hundred twenty-three (26,923) files. A review of the salvaged files revealed five hundred fifty-eight (558) possible relevant document files were found and placed in the \5538 Findings\salvaged documents directory on the Findings media.
- (3) A keyword search was conducted using the terms [REDACTED] Mowhoush, [REDACTED] intelligence, insums, interrogation, and summaries) provided by SA [REDACTED]. This search resulted in fourteen thousand three hundred seventy nine (14,379) files. After analysis, four hundred twenty three (423) possibly relevant files to this investigation were placed in the \5538 Findings\search results directory on the Findings media.

## 5. CONDUCTED BY

[REDACTED] CIV, DCFL  
Computer Forensic Examiner

## 7. RELEASED

[REDACTED]

SPECIAL HANDLING REQUIRED

This document is subject to a claim of privilege under military law. Handle in accordance with AFI 71-101, Vol. 1.

NOTICE - The Defense Computer Forensics Laboratory (DCFL) prepared this report at the specific request of your agency. Your agency is the record custodian. You may make release of the report or the information it contains without prior DCFL approval under the Freedom of Information Act (5 U.S.C., Section 552) or the Privacy Act (5 U.S.C., Section 552a).

b67c

PAGE 5 OF 7

000314

1. DATE OF REPORT 17 November 2005	2. REQUESTOR'S CASE CONTROL NUMBER 0027-03-CID679-64999	3. DCFL FILE NUMBER DCFL-2005-I005538
---------------------------------------	--	--

4. EXAMINATION *Continued*

(4) A review was conducted on the four thousand five hundred seven (4,507) graphic files. Two hundred twenty (220) possibly relevant files to this investigation were placed in the \5538 Findings\Pictures directory on the Findings media.

4. GLOSSARY:

**Salvage:** Also known as Data carving, locates every possible instance of a specific type of file from unallocated space or within other files.

**Unallocated Space:** All the clusters in a partition that are not currently assigned to a file. Also called free space. Some of these clusters may still contain data from files that were deleted but have not yet been overwritten by other files.

5. ITEMS PROVIDED: In addition to this hard copy report, a Findings <sup>DVD</sup> CD labeled "DCFL Form 42 Examination of Tag471\_Item2 dated 17 November 2005" was provided which contains an electronic copy of this report with hyperlinks to the above-mentioned files.

**b67c**

Continued

PAGE 6 OF 7

DEFENSE COMPUTER FORENSICS LABORATORY  
REPORT OF EXAMINATION

1. DATE OF REPORT 31 Oct 2005	2. REQUESTOR'S CASE CONTROL NUMBER 0027-03-CID679-64999	3. DCFL FILE NUMBER DCFL-2005-I005538
----------------------------------	--	--

4. EXAMINATION

**FORENSIC IMAGING**

From 13 Oct - 31 Oct 2005 computer forensic technician [REDACTED] imaged, archived, and restored the digital evidence provided. The items that were processed are as follows:

Tag/Item	Quantity	Make/Model	Serial #	Size
471/1	1	Maxtor/4A250J0080211	A8062XFE	250GB
471/2	1	Maxtor/7Y250P00628J4	Y63V3RRE	250GB

The results from processing are as follows:

Tag/Item	Records In/Out	MD5 Hash--original/image	Images Match	Restore Match
471/1	490047822+185010/ 490232832+0	879e9ae0ef489bd35e3138f4fb14b8c9 770b82ab641edb8f0e6178b8b36aa447	No	Yes
471/2	490232832+0	e465a85a63816892f76eb4829a590882	Yes	Yes

Soft copies of all electronic documents are saved on OS (MB14859) FAT32 partition - "Notes" folder.

**FINAL ENTRY ON THIS PAGE**

5. CONDUCTED BY [REDACTED] Computer Forensic Technician	6. [REDACTED]	7. RELEASED [REDACTED]
---	---------------	---------------------------

**SPECIAL HANDLING REQUIRED**

This document is subject to a claim of privilege under military law. Handle in accordance with AFI 71-101, Vol. 1.

NOTICE - Handle this report with utmost care to protect the reputations of persons named here who were juveniles when the matter disclosed occurred.

NOTICE - The Defense Computer Forensics Laboratory (DCFL) prepared this report at the specific request of your agency. Your agency is the record custodian. You may make release of the report or the information it contains without prior DCFL approval under the Freedom of Information Act (5 U.S.C., Section 552) or the Privacy Act (5 U.S.C., Section 552a).

**b67c**

0027-03-CID679-64999



**UNITED STATES  
DEPARTMENT OF DEFENSE**

**COMPUTER FORENSICS LAB**

**0027-03-CID679-64999**  
**DCFL-2005-1005538**

**REQUESTER'S DOCUMENTATION**

Mr. [REDACTED]  
DATE: 17 NOVEMBER 2005

*work  
request  
+  
consent*

**FOR OFFICIAL USE ONLY**

**b67c**

① [REDACTED]  
48

000317



Department of Defense Computer Forensics Laboratory Request Form 1

**1. Administrative Information**

In the table below, enter all contact information.

	Investigator	Alternate Point-of Contact	Requestor
Name	SA [REDACTED]	SA [REDACTED]	SA [REDACTED]
Commercial telephone number	910-396-1912	317-510-5669	910-396-1912
Street address (include city, state, and zip code)	Bldg 8-1221, Randolph Street, Fort Bragg, NC 28310	8899 East 56 <sup>th</sup> Street, Column 218-C, Indianapolis, IN 46249	
DSN number	239-8777	N/A	236-8777
Fax number	910-396-8595	317-510-5519	910-396-8595
Email address	[REDACTED]@bragg.army.mil	[REDACTED]@us.army.mil	
Cellular number	[REDACTED]	[REDACTED]	
Pager number	N/A	N/A	

**2. Case Identification Information**

2.1 Requesting agency's case number: 0027-03-CID679-64999

2.2 Name of SUBJECT: [REDACTED]

2.3 Classification level: *Secret*

2.4 Enter a description of the situation and background surrounding the investigation (executive summary):

CW3 [REDACTED] mothered a detainee (MOWHOUSH) during an interrogation, which led to the death of the detainee.

2.5 The work requested is an  initial submission or a  follow-on submission.

If follow-up submission was chosen, enter the dates of the previous case: 21 Jan 05 and the previous case number: DCFL-2004-1004327, DCFL-2005-1005250.

**3. Support Requested**

3.1 All media associated with the case is being submitted to DCFL?  Yes  No

If "No", what agency is performing the other part of the examination?

3.2 Has the evidence been previously analyzed by a forensic examiner or agent?  Yes  No

3.3 Enter a detailed description of the services for DCFL to perform.

Determine if submitted evidence is copy of previous submitted evidence, if not a copy please search for documents, emails, files pertaining to CW3 [REDACTED] and MG MOWHOUSH. In particular Intelligence / Interrogation Summaries (INSUMS) written by CW3 [REDACTED]

**4. Attachments**

4.1 Search authority attached?  Yes  No (We cannot begin exam without search authority)

4.2 If 3.2 was answered "Yes" we require a copy of the original exam. Copy attached?  Yes  No

4.3 Evidence list attached?  Yes  No

**5. Signature**

Name: [REDACTED]	Date: October 5, 2005	Signature: [REDACTED]
------------------	-----------------------	-----------------------

PAGE 1 of 2

ORIGINAL

DCFL-2005-1005538

FOR OFFICIAL USE ONLY

667C

000318

Date 24 Nov 2004		<b>CONSENT TO SEARCH</b> (USACIDC SUPPLEMENT 1 TO AR 190-22)		0940
1. Name of person consenting to search CPT [REDACTED]		2. Organization and location RHHT, 3rd Armor Cavalry, Fort Carson, CO 80913		
3. I have been informed by the undersigned USACIDC Special Agent that an inquiry is being conducted in connection with the following possible violation(s) of law: Murder				
4. I have been requested by the undersigned USACIDC Special Agent to give my consent to a search of my person, premises, or property as indicated below. I have been advised of my right to refuse a search of my person, premises, or property. (If you do not give your consent, do not sign this form.) I hereby authorize the undersigned USACIDC Special Agent and/or other Authorized Law Enforcement Officials assisting the undersigned USACIDC Special Agent to conduct a search of: (Initial and sign applicable blocks)				
a.	My Person	Initials	Signature	
b.	My Quarters	Initials	Signature	
Located At:				
c.	My Vehicle	Initials	Signature	
Located At:				
Described As:				
d.	Other	Initials	[REDACTED]	
Located At: US Army Criminal Investigation Laboratory, Forest Park, GA				
Described As: Two Compaq brand Blade Servers, and one BSI Brand domain server.				
5. I am authorizing the above search for the following general types of property which may be removed by the authorized law enforcement personnel and retained as evidence under the provisions of Army Regulation 195-5, or other applicable laws or regulations: A search of the aforementioned computer equipment, to include any internal hardware or storage media for any files, electronic data or significant email message traffic, along with other documentation that could be considered evidence. Equipment to be searched is described as Compaq blade service, serial number 6J31JNT180EJ, Compaq blade service, serial number 6J31JNT1801Y, and BSI Domain server, serial number 1024983.				
6. This written permission is given to the undersigned USACIDC Special Agent freely, voluntarily, and without threats or promises of any kind.				
[REDACTED]				Granting Consent
				Signature of Witness (if available)

0027-03-CID679-64999



UNITED STATES  
DEPARTMENT OF DEFENSE

COMPUTER FORENSICS LAB

0027-03-CID679-64999

DCFL-2005-1005538

EXAMINER NOTES

Mr. [REDACTED]

DATE: 17 NOVEMBER 2005

*work  
log*

FOR OFFICIAL USE ONLY

**b67c**

3

48

000320



Department of Defense Computer Forensic Laboratory

Examiner/Technician Notes

Examiner/Technician Name [REDACTED]	Requester Case Number 0027-03-CID679-64999	DCFL Case Number DCFL-2005-I005538
--	---	---------------------------------------

**13-Oct-05** Received case jacket from [REDACTED] Team Lead.  
**Case Information:**  
 DCFL-2005-I005538  
 Submitter Case Number: 0027-03-CID679-64999  
 Follow on for DCFL-2005-I005025 and DCFL-2004-I004327

**CASE AGENT:**  
 SA [REDACTED]  
 Special Agent in Charge  
 87<sup>th</sup> MP DET, DSE  
 Third MP Group (CID)  
 Fort Bragg, NC 28307  
 COM: 910.396.6429/4311/8806  
 FAX Extensions: 8595/8607  
 Email: [REDACTED]@us.army.mil

**SUBJECT :**  
 CW3 [REDACTED]

**SYNOPSIS OF THE CASE:** SUBJECT smothered a detainee (MOWHOUSH) during an interrogation, which led to the death of the detainee. This is a follow on for DCFL-2004-I004327/DCFL-2005-I005250.

**EVIDENCE SUBMITTED:**  
 Item 1: One (1) Maxtor external hard drive model 5000XT, containing one (1) Maxtor hard drive, 250 GB, S/N: A8062XFÉ, labeled "Falcon View". Classified SECRET  
 Item 2: One (1) Maxtor external hard drive model One Touch, containing one (1) Maxtor hard drive, 250 GB, S/N: Y63V3RRE. Classified SECRET

**SUPPORT REQUESTED:** Search submitted evidence for documents, emails, files pertaining to CW3 [REDACTED] and MOWHOUSH. In particular Intelligence/Interrogation Summaries (INSUMS) written by [REDACTED]

**13-Oct-05** Received (4) Hard Drives from Hardware Technician [REDACTED] (Image & Extraction).

<b>DCFL FRED 2.8 OS Win2K/Linux (C &amp; D) Labeled: SECRET</b>
Seagate Model ST340810A
S/N: 5FB1KFR8
DCFL #: MB16786
Size: 40GB

<b>FINDINGS DRIVE (L): Labeled: SECRET</b>
Western Digital Model WD2500JB-00FUA0
S/N: WMAEP1378499
DCFL #: MB15481
Size: 250GB

<b>EVIDENCE IMAGE (K): 5538_Item2 images Labeled: SECRET</b>
Seagate Barracuda Model: ST3400832A
S/N: 3NF09CTK
DCFL #: MB16575
Size: 400GB

b67c

000321

Department of Defense Computer Forensic Laboratory

Examiner/Technician Notes

Examiner/Technician Name [REDACTED]	Requester Case Number 0027-03-CID679-64999	DCFL Case Number DCFL-2005-I005538
--	---	---------------------------------------

<b>EVIDENCE IMAGE: 5538 Item 2 Restore Labeled: SECRET</b>
Maxtor DiamondMax 10. Model: 6B300R0060803
S/N: B60MQM1H
DCFL #: MB16603
Size: 300GB

13-Oct-05	A case acknowledgement letter was sent to SA [REDACTED] advising him that the case was assigned to me.					
13-Oct-05	Reviewed 6 part case folder and all documents including the search authority (Authorization for Search and Seizure - CID Form 87-R-E, signed by Captain [REDACTED] dated 24 November 2004). This was provided with original DCFL case number DCFL-2004-I004327.					
13-Oct-05	End of Workday.					
14-Oct-05	No work done on case awaiting drive to be imaged by the Image and Extraction section.					
15-Oct-05	Weekend no work conducted.					
16-Oct-05	Weekend no work conducted.					
17-Oct-05	No work done on case awaiting drive to be imaged by the Image and Extraction section.					
18-Oct-05	No work done on case awaiting drive to be imaged by the Image and Extraction section.					
19-Oct-05	Still waiting for drives to be imaged.					
20-Oct-05	Received two (2) drives titled (5538_Item2 images & 5538_Item2 Restore) from [REDACTED]					
20-Oct-05	End of workday.					
21-Oct-05	Attempted to load image drive (MB16575) Tag 471 Item2 HD002 and was unable to view/load images. Drive given to Forensic Technician [REDACTED] to extract images into a viewable format.					
21-Oct-05	End of workday.					
22-Oct-05	Weekend no work conducted.					
23-Oct-05	Weekend no work conducted.					
24-Oct-05	Received successfully extracted image set from [REDACTED]					
	<table border="1"> <tr> <td><b>EVIDENCE IMAGE (K): 5538_Item2 images Labeled: SECRET</b></td> </tr> <tr> <td>Seagate Barracuda Model: ST3400832A</td> </tr> <tr> <td>S/N: 3NF09CTK</td> </tr> <tr> <td>DCFL #: MB16575</td> </tr> <tr> <td>Size: 400GB</td> </tr> </table>	<b>EVIDENCE IMAGE (K): 5538_Item2 images Labeled: SECRET</b>	Seagate Barracuda Model: ST3400832A	S/N: 3NF09CTK	DCFL #: MB16575	Size: 400GB
<b>EVIDENCE IMAGE (K): 5538_Item2 images Labeled: SECRET</b>						
Seagate Barracuda Model: ST3400832A						
S/N: 3NF09CTK						
DCFL #: MB16575						
Size: 400GB						
24-Oct-05	Using Analysis Machine 2800 mhz CPU #12B and Forensic OS (MB15400) booted up with ASCLD Control Boot Disk to verify system post and MD5 hash for integrity of forensic machine. The MD5 (f3700f01948bfd485be224f137292b9) values matched. Continued to boot up into Windows XP. Partitioned and formatted Findings Drive (MB15481) with NTFS and assigned it the drive letter L: with volume name of 'Findings'. Powered down system to add Image drives. Images drive has been assigned drive letter K: with the volume label 'EVIDENCE'.					
24-Oct-05	Received from Forensic Examiner [REDACTED] all program updates (The Cleaner, Symantec Antivirus, and hashkeeper database). The cleaner has been updated to version 3857, dated 11-Oct-05, Symantec Antivirus signature file was updated to 11-Oct-05. The current Hashkeeper database was released May 2004.					
24-Oct-05	The Cleaner 3.5.4 build 3857 was run to check for the presence of malicious logic (such as viruses, Trojans, worms, etc.) against the validated restored hard drive and no malicious logic was found on the					

**b67c**

000322

# Department of Defense Computer Forensic Laboratory

## Examiner/Technician Notes

Examiner/Technician Name [REDACTED]	Requester Case Number 0027-03-CID679-64999	DCFL Case Number DCFL-2005-1005538
--	---	---------------------------------------

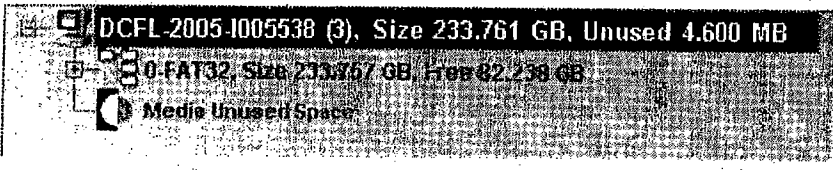
	drive.					
24-Oct-05	Symantec Antivirus with signature file 11-Oct-05 was run against all drives, no viruses were found.					
24-Oct-05	Placed hard drive (MB16981) containing the image files (5538_Tag471_Item2 hd_001.001 to 5538_Tag471_Item2 hd_001.126 into FRED (MB15400) and booted up system into Windows XP operating system.					
24-Oct-05	Started ILook version 8.0.9 and loaded images for Tag61_00. Automated scripting enabled a standard partition traverse and mapping of image files. ILook reported the following partition information.   Saved all mapping data					
24-Oct-05	End of workday.					
25-Oct-05	Generated a MD5 Hash value of the image set to verify against the Imaging notes.  MD5 Value correctly matched for 5538_Tag471_Item2 (E465A85A63816892F76EB4829A590882)					
25-Oct-05	Attempted to run a hash on the (636,434) files, program hung up and failed to complete the hash of all of the files.					
25-Oct-05	The hard drive from this image contains one (1) FAT 32 partition 233.757 GB in size with 82.238 GB of free space.					
25-Oct-05	End of workday					
26-Oct-05	Rebooted FRED system, and began to hash the files on the hard drive. Took drive all day to hash files.					
26-Oct-05	The hash of all files completed successfully. End of workday.					
27-Oct-05	Created a full file listing for the FAT 32 partition and saved it to the Findings Drive "IReports\5538_Tag471_Item2 file listing.mdb".					
27-Oct-05	Attempted to contact SA [REDACTED] for an update on the case, left voice message for him to call me.					
27-Oct-05	Imported the hashkeeper database into Ilook and a negative hash was run against the hashed drive to eliminate known /common system files. The current hashkeeper database (hb_ke.mdb) dated 5/16/04 was used.					
27-Oct-05	End of workday.					
28-Oct-05	Copied 26,791 word documents (.doc, .txt, .rtf, .wp) to a directory labeled documents on the Findings drive. Began reviewing documents.					
28-Oct-05	End of workday.					
29-Oct-05	Weekend no work scheduled.					
30-Oct-05	Weekend no work scheduled.					
31-Oct-05	Continued reviewing all documents for any documents containing SUBJECT's name or MOWHOUSH.					
31-Oct-05	Received rest of drives from [REDACTED] for this case Tag471_2_HD001 DEL.  <table border="1" data-bbox="316 1606 1144 1764"> <tr><td>DCFL FRED 2.8 OS Win2K/Linux (C &amp; D) Labeled: SECRET</td></tr> <tr><td>Seagate Model ST340810A</td></tr> <tr><td>S/N: 5FB73751</td></tr> <tr><td>DCFL #: MB14859</td></tr> <tr><td>Size: 40GB</td></tr> </table>	DCFL FRED 2.8 OS Win2K/Linux (C & D) Labeled: SECRET	Seagate Model ST340810A	S/N: 5FB73751	DCFL #: MB14859	Size: 40GB
DCFL FRED 2.8 OS Win2K/Linux (C & D) Labeled: SECRET						
Seagate Model ST340810A						
S/N: 5FB73751						
DCFL #: MB14859						
Size: 40GB						

**b67c**

000323

# Department of Defense Computer Forensic Laboratory

## Examiner/Technician Notes

Examiner/Technician Name [REDACTED]	Requester Case Number 0027-03-CID679-64999	DCFL Case Number DCFL-2005-1005538
--	---	---------------------------------------

<b>EVIDENCE IMAGES: 5538 Item1 Images Labeled: SECRET</b>
Seagate Barracuda Model: ST3400832A
S/N: 3NF08383
DCFL #: MB16548
Size: 400GB

<b>EVIDENCE IMAGE: 5538 Item1 images2 Labeled: SECRET</b>
Western Digital Model: WD2000BBH-00DWA0
S/N: WMAEH2298177
DCFL #: MB15622
Size: 200GB

<b>EVIDENCE IMAGE: Labeled: SECRET</b>
Maxtor Maxline PlusII Model: 7Y250M00660RA
S/N: Y63DCX2E
DCFL #: MB15675
Size: 250GB

<b>EVIDENCE IMAGE: 5538 Item 1 images2 Labeled: SECRET</b>
Western Digital Model: WD1600BB-00DAA0
S/N: WMACK1339060
DCFL #: MB13527
Size: 160GB

<b>EVIDENCE IMAGE: Labeled: SECRET</b>
Western Digital Model: WD2000BB-00DWA0
S/N: WMAEH2309085
DCFL #: MB15633
Size: 200GB

<b>EVIDENCE IMAGE: Labeled: SECRET</b>
Western Digital Model: WD2000BB-00DAA0
S/N: WMACK144719
DCFL #: MB13697
Size: 200GB

<b>DCFL FRED 2.8 OS Win2K/Linux (C &amp; D) Labeled: SECRET</b>
Seagate Model ST340810A
S/N: 5FB736J0
DCFL #: MB14837
Size: 40GB

31-Oct-05	End of workday.
1-Nov-05	Continued reviewing the 26,791 document files.
1-Nov-05	End of workday.
2-Nov-05	Finished reviewing document files and reviewed jpg files. 220 jpg files pulled out and saved to the directory titled Matching pictures. Pictures are of personnel matching interrogation reports pulled out earlier.

# 667C

000324

Department of Defense Computer Forensic Laboratory

Examiner/Technician Notes

Examiner/Technician Name [REDACTED]	Requester Case Number 0027-03-CID679-64999	DCFL Case Number DCFL-2005-1005538
--	---	---------------------------------------

2-Nov-05	End of workday.					
3-Nov-05	Completed reviewing picture files matching to documents. Began salvage of evidence drive.					
3-Nov-05	End of workday. Salvage running.					
4-Nov-05	Completed salvage for Evidential Media when arrived for work. Stats follow: Salvaged (326) file(s) for definition (Enhanced Meta File). Salvaged (6) file(s) for definition (Word Perfect). Salvaged (2159) file(s) for definition (MS Word 4-5). Salvaged (6780) file(s) for definition (MS Word 1). Salvaged (2505) file(s) for definition (MS Word 2). Salvaged (13752) file(s) for definition (MS Word or MS Excel). Salvaged (8179) file(s) for definition (Rich Text File). Salvaged (6) file(s) for definition (Windows Write). Salvaged (13752) file(s) for definition (MS Excel or MS Word). Salvaged (13859) file(s) for definition (MS Office Catch-All). Began reviewing documents from salvage.					
4-Nov-05	Began a basic search of drive (Tag471_Item2) for keywords [REDACTED] MOWHOUSH, [REDACTED] supplied from previous cases. Allowing to the search to run over the weekend.  Attempted to load Tag471_1 (MB15675) into FRED MB15012 and load into Ilook. Unable to mount or read hard drive. Image drives given to Forensic Technician [REDACTED] to copy to another drive as readable images, utilizing SAMBA to do this procedure.					
5-Nov-05	Weekend no work scheduled.					
6-Nov-05	Weekend no work scheduled.					
7-Nov-05	Drive (Tag471_Item2) completed search with the following results:  Completed UTF8 basic search of file objects for Evidential Media item 23393 hit(s) found in 5703 objects. Completed ASCII basic search of file objects for Evidential Media item 23603 hit(s) found in 5920 objects. Completed Unicode basic search of file objects for Evidential Media item 8666 hit(s) found in 1804 objects.					
7-Nov-05	Started analyzing the hit results of the basic search.					
7-Nov-05	Received drive that was extracted to readable images from Forensic Technician Steve Shuck.  <table border="1"> <tr><td>EVIDENCE IMAGE: Labeled: SECRET</td></tr> <tr><td>Seagate Barracuda Model: ST3400832A</td></tr> <tr><td>S/N: 3NF0E9ZP</td></tr> <tr><td>DCFL #: MB17076</td></tr> <tr><td>Size: 400GB</td></tr> </table>	EVIDENCE IMAGE: Labeled: SECRET	Seagate Barracuda Model: ST3400832A	S/N: 3NF0E9ZP	DCFL #: MB17076	Size: 400GB
EVIDENCE IMAGE: Labeled: SECRET						
Seagate Barracuda Model: ST3400832A						
S/N: 3NF0E9ZP						
DCFL #: MB17076						
Size: 400GB						
7-Nov-05	Using Analysis Machine 2800 mhz CPU #12B and Forensic OS (MB15012) booted up with ASCLD Control Boot Disk to verify system post and MD5 hash for integrity of forensic machine. The MD5 (f3700f01948bfed485be224f137292b9) values matched. Continued to boot up into Windows XP. Partitioned and formatted Findings Drive (MB15481) with NTFS and assigned it the drive letter L: with volume name of 'Findings'. Powered down system to add Image drives. Images drive has been assigned drive letter K: with the volume label 'EVIDENCE'.					
7-Nov-05	Placed hard drive (MB16981) containing the image files (5538_Tag471_Item1 hd_001.001 to 5538_Tag471_Item1 hd_001.126 into FRED (MB15012) and booted up system into Windows XP operating system.					
7-Nov-05	End of workday.					
8-Nov-05	Started ILook version 8.0.9 and loaded images for Tag471_1. Automated scripting enabled a standard partition traverse and mapping of image files. ILook reported the following partition information.					

b67c

000325

Department of Defense Computer Forensic Laboratory

Examiner/Technician Notes

Examiner/Technician Name [REDACTED]	Requester Case Number 0027-03-CID679-64999	DCFL Case Number DCFL-2005-1005538
--	---	---------------------------------------

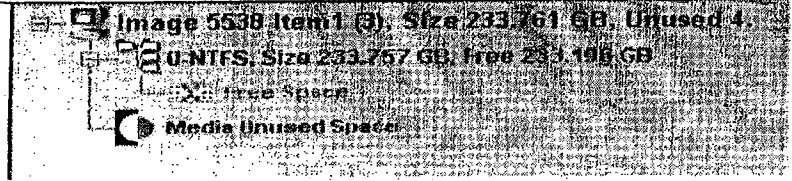

Saved all mapping data

8-Nov-05	Salvage started on evidence drive (Tag471_Item1).
8-Nov-05	Completed salvage for Evidential Media item (Tag471_Item1) stats follow: Salvaged (15) file(s) for definition (Graphics Interchange File (2)). Salvaged (375) file(s) for definition (Portable Network Graphic). Salvaged (49) file(s) for definition (Tif Graphic). Salvaged (28) file(s) for definition (Jpeg Graphic File (2)). Salvaged (7919) file(s) for definition (Bitmap (Catch-All)). Salvaged (233) file(s) for definition (Jpeg Graphic File (3)). Salvaged (16) file(s) for definition (Enhanced Meta File). Salvaged (2347) file(s) for definition (MS Word 4-5). Salvaged (6710) file(s) for definition (MS Word 1). Salvaged (2713) file(s) for definition (MS Word 2). Salvaged (531) file(s) for definition (MS Word or MS Excel). Salvaged (9) file(s) for definition (Rich Text File). Salvaged (531) file(s) for definition (MS Excel or MS Word). Salvaged (531) file(s) for definition (MS Office Catch-All). Salvaged (2) file(s) for definition (Outlook Express Mail Index). Salvaged (2) file(s) for definition (Outlook Express Mail Box). Salvaged (66) file(s) for definition (MPG). Salvaged (868) file(s) for definition (MPEG). Salvaged (1) file(s) for definition (Windows Media File). Salvaged (15) file(s) for definition (AVI or WAV).
8-Nov-05	End of Workday.
9-Nov-05	Began reviewing all the documents that were salvaged from Tag471_Item1. Drive appears to have been formatted, no files appear on the logical partition. All files reviewed were salvaged.
9-Nov-05	Finished reviewing all documents, pictures, and spreadsheets that were salvaged. No files relevant to the case were found.
9-Nov-05	End of Workday.
10-Nov-05	No work today personal day.
11-Nov-05	No work today holiday.
12-Nov-05	No work weekend.
13-Nov-05	No work weekend.
14-Nov-05	Began a basic search of drive (Tag471_Item1) for keywords [REDACTED] MOWHOUSH, [REDACTED] supplied from previous cases. Allowing to the search to run over the weekend.
14-Nov-05	Drive (Tag471_Item1) completed search no hits were found on the keywords.
14-Nov-05	Began writing Form 42 for Tag471_Item1. No relevant files were found on this drive.
14-Nov-05	End of Workday.
15-Nov-05	Began writing Form 42 for Tag471_2 Organized and ensuring all files are in their proper directory.
15-Nov-05	End of Workday.
16-Nov-05	No work done on case personal day off.
17-Nov-05	Verified the MD5 Hash value of the image set and verify it against earlier notes entry. MD5 Value correctly matched for Tag471_2 (E465A85A63816892F76EB4829A590882)
17-Nov-05	Powered down FRED (MB15400), removed hard drives.
17-Nov-05	Booted up with ASCLD Control Boot Disk to verify system post and MD5 hash for integrity of forensic

b67c



000326

### Department of Defense Computer Forensic Laboratory

### Examiner/Technician Notes

Examiner/Technician Name



Requester Case Number

0027-03-CID679-64999

DCFL Case Number

DCFL-2005-1005538

- 17-Nov-05 machine (MB15400). The MD5 (f3700f01948bfed485be224f137292b9) values matched.
- 17-Nov-05 Form 42 has been completed and peer reviewed. Verified all hyperlinks worked on the Findings Media.
- 17-Nov-05 Powered down FRED system (MB15012), removed hard drives.
- 17-Nov-05 Booted up with ASCLD Control Boot Disk to verify system post and MD5 hash for integrity of forensic machine (MB15012). The MD5 (f3700f01948bfed485be224f137292b9) values matched.
- 17-Nov-05 Form 42 has been completed and peer reviewed.
- 17-Nov-05 These Notes are closed.

-----Nothing Follows-----



# b67c

000327

0027-03-CID679-64999



**UNITED STATES  
DEPARTMENT OF DEFENSE**

**COMPUTER FORENSICS LAB**

**0027-03-CID679-64999**  
**DCFL-2005-I005538**

**TECHNICIAN NOTES**

Mr. [REDACTED]

Mr. [REDACTED]

DATE: 7 NOVEMBER 2005

*Examiner  
notes*

FOR OFFICIAL USE ONLY

**b67c**

(4) [REDACTED]

000328 <sup>4/8</sup>



# DCFL - Imaging Request

DCFL # : DCFL-2005-1005538

Organization : USACIL

Request # : 0

Case # : 0027-03-CID679-64999

Requestor : -----

Received : 10/12/2005

## Media

Tag # / Item	Media	Qty	Total Size (GB)
471	HD	2	500

## Standard Processes

Image  Archive  Restore

Media Classified

Expedited Service

Special Request

### Additional Information

Evidence drives are classified  
\*\*\*SECRET\*\*\*

### Other issues with media

Item 1 250 GB

Item 2 250 GB

**b67c**

Department of Defense Computer Forensic Laboratory

Examiner/Technician Notes

Examiner/Technician Name [REDACTED]	Requester Case Number 0027-03-CID679-64999	DCFL Case Number DCFL-2005-I005538
--	---	---------------------------------------

13 Oct 2005	Received request to image, archive, and restore Evidence Property Tag 471-05 (referred to as Tag471). Description of evidence is as follows: One (1) Maxtor external hard drive, model 5000XT, SN A8062XFE--medium contains a "SECRET" classification sticker with "Falcon View" written in ink (on the sticker); containing one (1) Maxtor 250GB hard drive, model 4A250J0080211, SN A8062XFE, marked with 5538_Tag471_Item1_HD_001 DEL". And, one (1) Maxtor external hard drive, model One Touch, SN Y63V3RRE--medium contains a "SECRET" classification sticker; containing one (1) Maxtor 250GB hard drive, model 7Y250P00628J4, SN Y63V3RRE, marked with 5538_Tag471_Item2_HD_001 DEL".
	LBA listed on drive label was suspect, connected each evidence item to solomasster (MB12750) and results from each drive reported an LBA of 490232832 .
	Computer (MB14940, CI-18 v1.0) booted using DCFL ASCLD Boot Disk; md5sum matched. Processing using Linux OS (MB14837, CI-03 v3) on 2.8GHz CPU (MB14940, CI-18 v1.0); Connected Images drive (MB16548) to hdd and mounted Images drive (hdd1) to /mnt/images. Evidence, marked with "5538_Tag471_Item1_HD_001 DEL", connected using WiebeTECH Forensic Combodock (MB16778) as sdb.
	Computer (MB14906, CI-18 v1.0) booted using DCFL ASCLD Boot Disk; md5sum matched. Processing using Linux OS (MB14859), CI-03 v3) on 2.8GHz CPU (MB14906, CI-18 v1.0); Connected Images drive (MB16575) to hdd and mounted Images drive (hdd1) to /mnt/images. Evidence, marked with "5538_Tag471_Item2_HD_001 DEL", connected using WiebeTECH Forensic Combodock (MB16778) as [REDACTED]
14 Oct 2005	Ran the following commands from within 5538_Tag471_Item1 and 5538_Tag471_Item2 directories: "fdisk -ul /dev/sdb > HD_001_org.fdisk" "dcfldd conv=sync,noerror if=/dev/[REDACTED] hashwindow=256k hashlog=HD_001_org.md5   split -b 1900m - hd_001_"  - Powered off WiebeTECH Forensic Combodock and removed each evidence from [REDACTED] - Renamed image files for 5538_Tag471_Item1 and 5538_Tag471_Item2 to conform to ILook naming conventions--"file_mv.pl"  "cat hd_001.*   dcfldd of=/dev/null hashwindow=256k hashlog=HD_001_img.md5; tail -1 *.md5"
Note →	5538_Tag471_Item1 reported 490047822+185010 records in and 490232832+0 records out; image and original md5sums do not match. 5538_Tag471_Item2 reported 490232832+0 records in and out; md5sums matched.
Note →	5538_Tag471_Item1 is imaging with errors. Imaging completed 21 Oct 2005
	<b>5538_Tag471_Item2:</b> Ran " tar cvMhpf /dev/nst0 * -b 128" from /mnt/images/5538_Tag471_Item2; command completed with no errors.
	Shut down machine (MB14906), removed Images drive (MB16575), connected Images2 drives (MB13697--200GB) to hdd and (MB13527--160GB) to hdb. Establishing a Linear RAID due to lack of adequate size (Secret) drives. Created raiddev /dev/md0, and mounted /dev/md0 to /mnt/images.

b67c

000330

Department of Defense Computer Forensics Laboratory

Examiner/Technician Notes

Examiner/Technician Name	Requester Case Number	DCFL Case Number
[REDACTED]	0027-03-CID679-64999	DCFL-2005-I005538
	Ran "tar xvMhpf /dev/nst0 -b 128" from /mnt/images/5538_Tag471_Item2 directory; command completed with no errors.	
	Ran " cat hd_001.*   dcfldd   md5sum; tail -1 *.md5" from /mnt/images/5538_Tag471_Item2 directory; command completed with no errors, reporting 490232832+0 records in and out; md5sums matched.	
17 Oct 2005 NOTE →	Images2 drives used in Linear RAID will also have to be used for Item 1 tape extraction. Shut down machine (MB14906) and removed Images2 drives (MB13697--200GB) and (MB13527--160GB). Will use 5538_Tag471_Item2 Images drive (MB16575) to create Restore. Connected Images drive to hdd and Restore drive (MB16603) to hdb. Booted to Linux, and mounted Images drive (hdd1) to /mnt/images.	
	Ran "cat hd_001.*   dcfldd of=/dev/hdb; dcfldd if=/dev/hdb of=/dev/null hashwindow=256k hashlog=HD_001_res.md5 count=490232832; tail -1 *.md5" from 5538_Tag471_Item2 directory, command completed with our errors, reporting 490232832+0 records in and out; md5sums matched. Computer (MB14906, CI-18 v1.0) booted using DCFL ASCLD Boot Disk; md5sum matched.	
21 Oct 2005	<b>5538_Tag471_Item1:</b> Ran " tar cvMhpf /dev/nst0 * -b 128" from /mnt/images/5538_Tag471_Item1 directory; command completed with no errors.	
	Shut down machine (MB14940), removed OS (MB14837) and Images drive (MB16548); connected OS (MB14859) and Images2 drives (MB13697--200GB) to hdd and (MB13527--160GB) to [REDACTED] Establishing a Linear RAID due to lack of adequate size (Secret) drives. "raiddev /dev/md0" previously created on this OS; and mounted /dev/md0 to /mnt/images.	
	Ran "tar xvMhpf /dev/nst0 -b 128" from /mnt/images/5538_Tag471_Item1 directory; command completed with no errors.	
24 Oct 2005	Ran " cat hd_001.*   dcfldd   md5sum; tail -1 *.md5" from /mnt/images/5538_Tag471_Item1 directory; command completed with no errors, reporting 490232832+0 records in and out; md5sums matched.	
Note →	Shut down machine (MB14906) and removed Images2 drives (MB13697--200GB) and (MB13527--160GB). Will use 5538_Tag471_Item1 Images drive (MB16548) to create Restore. Connected Images drive to hdd and Restore drive (MB16477) to hdb. Booted to Linux, and mounted Images drive (hdd1) to /mnt/images.	
	Ran "cat hd_001.*   dcfldd conv=sync,noerror of=/dev/hdb; dcfldd conv=sync,noerror if=/dev/hdb of=/dev/null hashwindow=256k hashlog=HD_001_res.md5 count=490232832; tail -1 *.md5" from 5538_Tag471_Item1 directory; command failed--stated target drive ran out of space. Ran "fdisk -l" and Linux reported only 131GB, not 250GB as indicated on drive label.	
25 Oct 2005	Shut down system and removed Restore drive. Wiped Restore drive using Solomasster (MB13664). Drive info still being reported as 131GB. Marking this drive as damaged.	
NOTE →	Due to lack of available drives, using 250GB SATA drive for restore.	
	Connected Restore Drive (MB15675) to Serial ATA connector on back of machine. Booted to Linux, and mounted Images (hdd1) drive to /mnt/images.	

**b67c**

000331

Department of Defense Computer Forensics Laboratory

Examiner/Technician Notes

Examiner/Technician Name [REDACTED]	Requester Case Number 0027-03-CID679-64999	DCFL Case Number DCFL-2005-I005538
	Ran "cat hd_001.*   dcfldd conv=sync,noerror of=/dev/hde" from 5538_Tag471_Item1 directory; command completed with out errors, reporting 490232832+0 records in and out.	
28 Oct 2005	Ran "dcfldd conv=sync,noerror if=/dev/hde of=/dev/null hashwindow=256k hashlog=HD_001_res.md5 count=490232832; tail -1 *.md5" from 5538_Tag471_Item1 directory; command completed with out errors, reporting 490232832+0 records in and out; image and restore md5sums matched--original did not match but that was to be expected due to errors during imaging.	
31 Oct 2005	Computer (MB14940, CI-18 v1.0) booted using DCFL ASCLD Boot Disk; md5sum matched. FINAL ENTRY ON THIS PAGE	

667C

000332

0027-03-CID679-64999

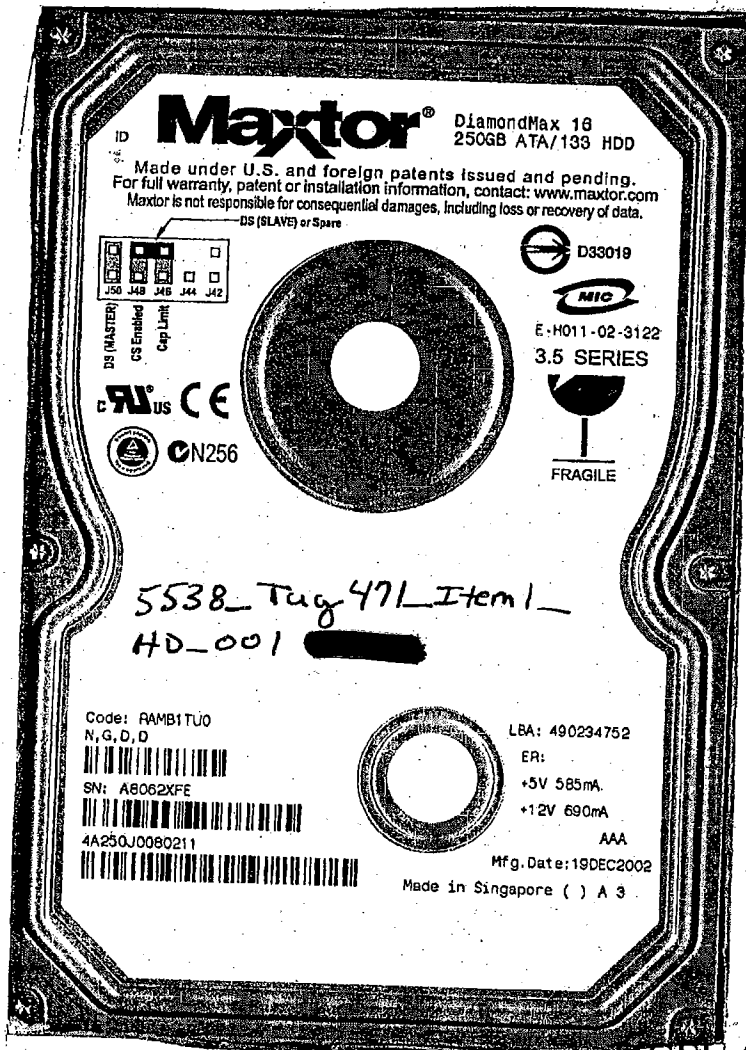

0027-03-CID679-64999

DCFL-2005-I005538

13 Oct 2005

FOR OFFICIAL USE ONLY

Page 5 of 8 Initials

PAGE 5 OF 8

b67c

000333

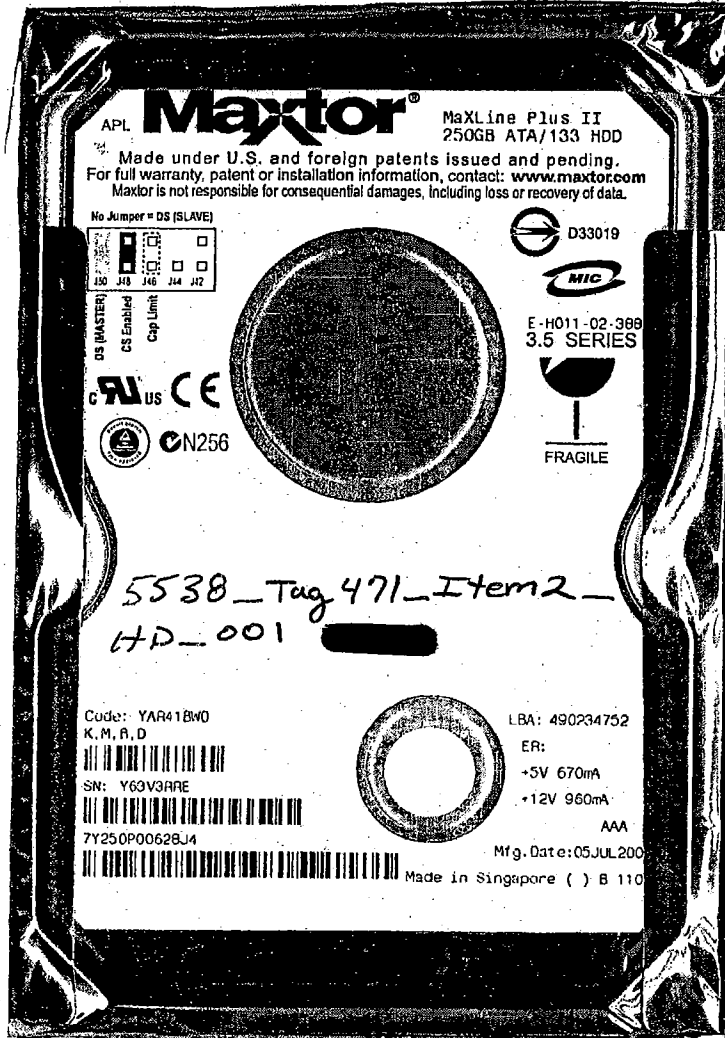

DCFL-2005-I005538

13 Oct 2005

0027-03-CID679-64999

Page 6 of 8 Initials [REDACTED]

FOR OFFICIAL USE ONLY

PAGE 6 OF 8

b67c

000334

## Department of Defense Computer Forensic Laboratory

## Examiner/Technician Notes

Examiner/Technician Name [REDACTED]	Requester Case Number 0027-03-CID679-64999	DCFL Case Number DCFL-2005-1005538
21 OCT 05	Received Images drive (MB16575) for DCFL 2005-1005538 Tag 471 Item2 HD 001 from examiner [REDACTED]. Examiner is not able to view/load images to Ilook. He requested that I extract images to a viewable format.	
	Created a network with (2) FRED computers and will use Samba share to extract the image set from the images drive (MB16575) to a wiped drive (MB16981) formatted NTFS.	
	Booted to the DCFL ASCLD Control Boot Floppy to run the POST test and MD5 hash verification on the FRED forensic machine (MB14937) and FRED forensic machine (MB14910). Results POST good, MD5 hash matched.	
	Booted FRED computer (1) (MB14937) to a Helix boot CD/Linux OS with the image set for 5538_Tag471_Item2_HD_001 (MB16575) in the write protected bay. Set computer IP Address to 192.168.11.1	
	Booted FRED computer (2) (MB14910) to Windows XP OS (MB16786) with the wiped drive (MB16981) as slave hdb. Partitioned and formatted the wiped drive with one (1) 400 GB NTFS partition. To be used as the extraction drive. Shared drive and gave drive share name "Z". Set computer IP address to 192.168.11.2	
	On the FRED computer (1) (MB14937) mounted the NTFS drive (MB16981) from the FRED (2) computer to: mount -t smbfs -o username=Administrator,password= //192.168.11.2/Z/ /mnt/dump	
	On the FRED computer (1) (MB14937) mounted the image set drive (MB16575) to: mount /dev/sda1 /mnt/images	
	On the FRED computer (1) (MB14937) changed directory to /mnt/images	
	Ran the copy command: cp -pvr * /mnt/dump	
24 OCT 05	Copy completed. Powered off both FRED computers. Removed all drives and gave to examiner [REDACTED]	
	Booted to the DCFL ASCLD Control Boot Floppy to run the POST test and MD5 hash verification on the FRED forensic machine (MB14937) and FRED forensic machine (MB14910). Results POST good, MD5 hash matched.	
	Notes are located on the Windows XP OS drive (MB16786) in the FAT32 (D:).	
	FINAL ENTRY ON THIS PAGE.	

Department of Defense Computer Forensic Laboratory

Examiner/Technician Notes

Examiner/Technician Name [REDACTED]	Requester Case Number 0027-03-CID679-64999	DCFL Case Number DCFL-2005-I005538
--	---	---------------------------------------

3 NOV 05	Received Images drive (MB16548) for DCFL 2005-I005538 Tag 471 Item1 HD 001 from examiner [REDACTED]. Examiner is not able to view/load images to Ilook. He requested that I extract images to a viewable format.
4 NOV 05	Created a network with (2) FRED computers and will use Samba share to extract the image set from the images drive (MB16548) to a wiped drive (MB17076) formatted NTFS.
	Booted to the DCFL ASCLD Control Boot Floppy to run the POST test and MD5 hash verification on the FRED forensic machine (MB14937) and FRED forensic machine (MB14910). Results POST good, MD5 hash matched.
	Booted FRED computer (1) (MB14937) to a Helix boot CD/Linux OS with the image set for 5538_Tag471_Item1_HD_001 (MB16548) in the write protected bay. Set computer IP Address to 192.168.11.1
	Booted FRED computer (2) (MB14910) to Windows XP OS (MB14837) with the wiped drive (MB17076) as slave hdb. Partitioned and formatted the wiped drive with one (1) 400 GB NTFS partition. To be used as the extraction drive. Shared drive and gave drive share name "Z". Set computer IP address to 192.168.11.2
	On the FRED computer (1) (MB14937) mounted the NTFS drive (MB17076) from the FRED (2) computer to: mount -t smbfs -o username=Administrator,password= //192.168.11.2/Z/ /mnt/dump
	On the FRED computer (1) (MB14937) mounted the image set drive (MB16548) to: mount /dev/sda1 /mnt/images
	On the FRED computer (1) (MB14937) changed directory to /mnt/images
	Ran the copy command: cp -pvr * /mnt/dump
7 NOV 05	Copy completed. Powered off both FRED computers. Removed all drives and gave to examiner [REDACTED]
	Booted to the DCFL ASCLD Control Boot Floppy to run the POST test and MD5 hash verification on the FRED forensic machine (MB14937) and FRED forensic machine (MB14910). Results POST good, MD5 hash matched.
	Notes are located on the Windows XP OS drive (MB14837) in the FAT32 partition.
FINAL ENTRY ON THIS PAGE.	

PAGE 8 OF 8

b67c

000336



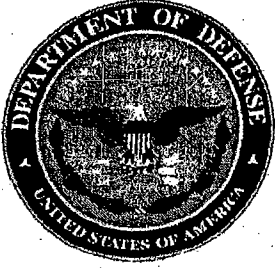

**UNITED STATES  
DEPARTMENT OF DEFENSE**

---

**COMPUTER FORENSICS LAB**

**0027-03-CID679-64999**  
**DCFL-2005-1005538**

**EXAMINER CORRESPONDENCE**

Mr. [REDACTED]  
DATE: 17 NOVEMBER 2005

*Email  
correspondence*

FOR OFFICIAL USE ONLY

**b67c**

(5) [REDACTED]  
48

000337

0027-03-CID679-64999

[Redacted]

From: [Redacted]  
Sent: Thursday, October 13, 2005 10:57 AM  
To: [Redacted]@us.army.mil  
Subject: FW: DCFL Case Receipt Acknowledgement 0027-03-CID679-64999 DCFL-2005-I005538

Sorry had the wrong email address.

[Redacted]

From: [Redacted]  
Sent: Thursday, October 13, 2005 10:56 AM  
To: [Redacted]@bragg.army.mil  
Cc: [Redacted]  
Subject: DCFL Case Receipt Acknowledgement 0027-03-CID679-64999 DCFL-2005-I005538

DCFL Case Receipt Acknowledgement - 13 October 2005

The Defense Computer Forensics Laboratory (DCFL) has received your request for forensic media analysis on your case number: 0027-03-CID679-64999

It has been re-assigned to me in the Counter Intelligence/Counter Terrorism (CI/CT) Section and will retain DCFL number: DCFL-2005-I005538

Base on the complexity of this case, the volume of data, and my current caseload, we have estimated the following completion date: 1 December 2005

During analysis of this case I will provide you weekly informal status reports. If I find significant information, this will be reported to you as soon as I find it via our DCFL Form 42. After I complete the entire forensic analysis of your case, I will provide you a formal report and complete findings on CD.

Your agency's Computer Crime Ops Chief has also requested a "cc" copy of all of your agency's case submissions.

Please provide contact information, such as telephone (commercial), fax, pager number; and e-mail addresses for you or anyone else who would be an alternate contact for this case. Please indicate how you would prefer to be contacted.

If you have any questions you may contact me at any time at the addresses below.

[Redacted]

Tel: 410.981.1008  
Fax: 410.981.0181  
DSN: 312.622.2595  
E-mail: [Redacted]@dc3.mil

If you have trouble contacting me, you may contact the:

[Redacted]

0027-03-CID679-64999 FOR OFFICIAL USE ONLY DCFL-2005-I005538

PAGE 1 OF 12

10/21/2005

b6,7C

000338

0027-03-CID679-64999

Section Chief, SA [redacted]  
Tel: 410.981.0117  
Fax: 410.981-0181  
DSN: 312.622.2595  
E-mail: [redacted]@dc3.mil

Director of Operations, SA [redacted]  
Tel: 410.981.1121  
Fax: 410.981.0181  
DSN: 312.622.2595, or  
Email: [redacted]@dc3.mil

Thank you

[redacted]  
General Dynamics  
DOD Computer Forensics Laboratory (DCFL)  
Linthicum, MD 21090  
Phone: 410-981-1008  
Pager E-Mail: [redacted]@dc3.mil

cc: Section Chief, DO, DCIO rep

DCFL-2005-1005538

0027-03-CID679-64999

**FOR OFFICIAL USE ONLY**

PAGE 2 OF 12

10/21/2005

**bl.7c**

000339

0027-03-CID679-64999

**From:** [redacted] SA [redacted]@us.army.mil  
**Sent:** Thursday, October 13, 2005 12:11 PM  
**To:** [redacted]  
**Subject:** RE: DCFL Case Receipt Acknowledgement 0027-03-CID679-64999 DCFL-2005-I005538

thanks

**From:** [redacted] [mailto:[redacted]@dc3.mil]  
**Sent:** Thursday, October 13, 2005 11:01 AM  
**To:** [redacted] SA  
**Subject:** RE: DCFL Case Receipt Acknowledgement 0027-03-CID679-64999 DCFL-2005-I005538

Hey [redacted]  
No problem, we definitely haven't checked them with the original request. Will do the same with those two.

**From:** [redacted] SA [mailto:[redacted]@us.army.mil]  
**Sent:** Thursday, October 13, 2005 11:00 AM  
**To:** [redacted]  
**Subject:** RE: DCFL Case Receipt Acknowledgement 0027-03-CID679-64999 DCFL-2005-I005538

Hi [redacted]  
Sorry for the additional work, the unit just dropped those two external hard drives off at Maj [redacted] door. Not sure what is on them, but looking for the same stuff.

Thanks  
[redacted]

**From:** [redacted] [mailto:[redacted]@dc3.mil]  
**Sent:** Thursday, October 13, 2005 10:57 AM  
**To:** [redacted] SA  
**Subject:** FW: DCFL Case Receipt Acknowledgement 0027-03-CID679-64999 DCFL-2005-I005538

Sorry had the wrong email address.  
[redacted]

**From:** [redacted]  
**Sent:** Thursday, October 13, 2005 10:56 AM  
**To:** [redacted]@bragg.army.mil  
**Subject:** DCFL Case Receipt Acknowledgement 0027-03-CID679-64999 DCFL-2005-I005538

DCFL Case Receipt Acknowledgement - 13 October 2005

The Defense Computer Forensics Laboratory (DCFL) has received your request for forensic media analysis on your case number: 0027-03-CID679-64999

0027-03-CID679-64999 **FOR OFFICIAL USE ONLY** DCFL-2005-I005538

11/17/2005

PAGE 3 OF 12

bb.7C

000340

0027-03-CID679-64999

It has been re-assigned to me in the Counter Intelligence/Counter Terrorism (CI/CT) Section and will retain DCFL number: DCFL-2005-I005538

Base on the complexity of this case, the volume of data, and my current caseload, we have estimated the following completion date: 1 December 2005

During analysis of this case I will provide you weekly informal status reports. If I find significant information, this will be reported to you as soon as I find it via our DCFL Form 42. After I complete the entire forensic analysis of your case, I will provide you a formal report and complete findings on CD.

Your agency's Computer Crime Ops Chief has also requested a "cc" copy of all of your agency's case submissions.

Please provide contact information, such as telephone (commercial), fax, pager number; and e-mail addresses for you or anyone else who would be an alternate contact for this case. Please indicate how you would prefer to be contacted.

If you have any questions you may contact me at any time at the addresses below.

[REDACTED]

Tel: 410.981.1008  
 Fax: 410.981.0181  
 DSN: 312.622.2595  
 E-mail: [REDACTED]@dc3.mil

If you have trouble contacting me, you may contact the:

Section Chief, SA [REDACTED]  
 Tel: 410.981.0117  
 Fax: 410.981-0181  
 DSN: 312.622.2595  
 E-mail: [REDACTED]@dc3.mil

Director of Operations, SA [REDACTED]  
 Tel: 410.981.1121  
 Fax: 410.981.0181  
 DSN: 312.622.2595, or  
 Email: [REDACTED]@dc3.mil

Thank you

[REDACTED]  
 General Dynamics  
 DOD Computer Forensics Laboratory (DCFL)  
 Linthicum, MD 21090  
 Phone: 410-981-1008  
 Pager E-Mail: [REDACTED]@dc3.mil

cc: Section Chief, DO, DCIO rep

0027-03-CID679-64999

FOR OFFICIAL USE ONLY DCFL-2005-I005538

11/17/2005

PAGE 4 OF 12

bl.7C

000341

0027-03-CID679-64999

\*\*\*\*\*

This email and any files transmitted with it are confidential and intended solely for the use of the individual or entity to whom they are addressed. If you have received this email in error please notify the system manager.

This footnote also confirms that this email message has been swept by MIMESwecper for the presence of computer viruses.

[www.mimesweeper.com](http://www.mimesweeper.com)

\*\*\*\*\*

0027-03-CID679-64999

FOR OFFICIAL USE ONLY

DCFL-2005-I005538

11/17/2005

PAGE 5 OF 12

b6.7c

000342

0027-03-CID679-64999

[REDACTED]

---

**From:** [REDACTED]  
**Sent:** Thursday, October 13, 2005 11:01 AM  
**To:** [REDACTED] SA  
**Subject:** RE: DCFL Case Receipt Acknowledgement 0027-03-CID679-64999 DCFL-2005-I005538

Hey [REDACTED]  
 No problem, we definitely haven't checked them with the original request. Will do the same with those two.

[REDACTED]

---

**From:** [REDACTED] SA [mailto:[REDACTED]@us.army.mil]  
**Sent:** Thursday, October 13, 2005 11:00 AM  
**To:** [REDACTED]  
**Subject:** RE: DCFL Case Receipt Acknowledgement 0027-03-CID679-64999 DCFL-2005-I005538

Hi [REDACTED]  
 Sorry for the additional work, the unit just dropped those two external hard drives off at Maj [REDACTED] door. Not sure what is on them, but looking for the same stuff.

Thanks  
 [REDACTED]

---

**From:** [REDACTED] [mailto:[REDACTED]@dc3.mil]  
**Sent:** Thursday, October 13, 2005 10:57 AM  
**To:** [REDACTED] SA  
**Subject:** FW: DCFL Case Receipt Acknowledgement 0027-03-CID679-64999 DCFL-2005-I005538

Sorry had the wrong email address.

[REDACTED]

---

**From:** [REDACTED]  
**Sent:** Thursday, October 13, 2005 10:56 AM  
**To:** [REDACTED]@bragg.army.mil  
**Cc:** [REDACTED]  
**Subject:** DCFL Case Receipt Acknowledgement 0027-03-CID679-64999 DCFL-2005-I005538

DCFL Case Receipt Acknowledgement

13 October 2005

The Defense Computer Forensics Laboratory (DCFL) has received your request for forensic media analysis on your case number: 0027-03-CID679-64999

It has been re-assigned to me in the Counter Intelligence/Counter Terrorism (CI/CT) Section and will retain DCFL number: DCFL-2005-I005538

Base on the complexity of this case, the volume of data, and my current caseload, we have estimated the following completion date: 1 December 2005

During analysis of this case I will provide you weekly informal status

0027-03-CID679-64999

FOR OFFICIAL USE ONLY DCFL-2005-I005538

11/17/2005

PAGE 6 OF 12

000343

b6.7c

reports. If I find significant information, this will be reported to you as soon as I find it via our DCFL Form 42. After I complete the entire forensic analysis of your case, I will provide you a formal report and complete findings on CD.

Your agency's Computer Crime Ops Chief has also requested a "cc" copy of all of your agency's case submissions.

Please provide contact information, such as telephone (commercial), fax, pager number; and e-mail addresses for you or anyone else who would be an alternate contact for this case. Please indicate how you would prefer to be contacted.

If you have any questions you may contact me at any time at the addresses below.

[Redacted]

Tel: 410.981.1008  
Fax: 410.981.0181  
DSN: 312.622.2595  
E-mail: [Redacted]ctr@dc3.mil

If you have trouble contacting me, you may contact the:

Section Chief, SA [Redacted]

Tel: 410.981.0117  
Fax: 410.981-0181  
DSN: 312.622.2595  
E-mail: [Redacted]dc3.mil

Director of Operations, SA [Redacted]

Tel: 410.981.1121  
Fax: 410.981.0181  
DSN: 312.622.2595, or  
Email: [Redacted]dc3.mil

Thank you

[Redacted]

General Dynamics  
DOD Computer Forensics Laboratory (DCFL)  
Linthicum, MD 21090  
Phone: 410-981-1008  
Pager E-Mail: john.brannock.pager@dc3.mil

cc: Section Chief; DO, DCIO rep

\*\*\*\*\*

This email and any files transmitted with it are confidential and intended solely for the use of the individual or entity to whom they are addressed. If you have received this email in error please notify the system manager.



0027-03-CID679-64999

FOR OFFICIAL USE ONLY DCFL-2005-I005558

PAGE 17 OF 12

11/17/2005

bb.7c

000344



0027-03-CID679-64999

This footnote also confirms that this email message has been swept by MIMESweeper for the presence of computer viruses.

www.mimesweeper.com

\*\*\*\*\*

0027-03-CID679-64999

FOR OFFICIAL USE ONLY

DCFL2005-I005538

11/17/2005

PAGE 8 OF 12

b6.7c

000345

0027-03-CID679-64999

From: [redacted] SA [redacted]@us.army.mil  
Sent: Thursday, October 13, 2005 11:00 AM  
To: [redacted]  
Subject: RE: DCFL Case Receipt Acknowledgement 0027-03-CID679-64999 DCFL-2005-I005538

Hi [redacted]

Sorry for the additional work, the unit just dropped those two external hard drives off at Maj [redacted] door. Not sure what is on them, but looking for the same stuff.

Thanks  
[redacted]

From: [redacted] [mailto:[redacted]@dc3.mil]  
Sent: Thursday, October 13, 2005 10:57 AM  
To: [redacted] SA  
Subject: FW: DCFL Case Receipt Acknowledgement 0027-03-CID679-64999 DCFL-2005-I005538

Sorry had the wrong email address.  
[redacted]

From: [redacted]  
Sent: Thursday, October 13, 2005 10:56 AM  
To: [redacted]@bragg.army.mil  
Cc: [redacted]  
Subject: DCFL Case Receipt Acknowledgement 0027-03-CID679-64999 DCFL-2005-I005538

DCFL Case Receipt Acknowledgement - 13 October 2005

The Defense Computer Forensics Laboratory (DCFL) has received your request for forensic media analysis on your case number: 0027-03-CID679-64999

It has been re-assigned to me in the Counter Intelligence/Counter Terrorism (CI/CT) Section and will retain DCFL number: DCFL-2005-I005538

Base on the complexity of this case, the volume of data, and my current caseload, we have estimated the following completion date: 1 December 2005

During analysis of this case I will provide you weekly informal status reports. If I find significant information, this will be reported to you as soon as I find it via our DCFL Form 42. After I complete the entire forensic analysis of your case, I will provide you a formal report and complete findings on CD.

Your agency's Computer Crime Ops Chief has also requested a "cc" copy of all of your agency's case submissions.

Please provide contact information, such as telephone (commercial), fax, pager number; and e-mail addresses for you or anyone else who would be an alternate contact for this case. Please indicate how you would prefer to be contacted.

0027-03-CID679-64999

FOR OFFICIAL USE ONLY DCFL-2005-I005538

PAGE 9 OF 12

11/17/2005

b6,7c

000346

0027-03-CID679-64999

If you have any questions you may contact me at any time at the addresses below.

Tel: 410.981.1008  
Fax: 410.981.0181  
DSN: 312.622.2595  
E-mail: [redacted]ctr@dc3.mil

If you have trouble contacting me, you may contact the:

Section Chief, SA [redacted]  
Tel: 410.981.0117  
Fax: 410.981-0181  
DSN: 312.622.2595  
E-mail: [redacted]@dc3.mil

Director of Operations, SA [redacted]  
Tel: 410.981.1121  
Fax: 410.981.0181  
DSN: 312.622.2595, or  
Email: [redacted]dc3.mil

Thank you

[redacted]  
General Dynamics  
DOD Computer Forensics Laboratory (DCFL)  
Linthicum, MD 21090  
Phone: 410-981-1008  
Pager E-Mail: [redacted]@dc3.mil

cc: Section Chief, DO, DCIO rep

\*\*\*\*\*  
This email and any files transmitted with it are confidential and intended solely for the use of the individual or entity to whom they are addressed. If you have received this email in error please notify the system manager.

This footnote also confirms that this email message has been swept by MIMESweeper for the presence of computer viruses.

www.mimesweeper.com

\*\*\*\*\*



0027-03-CID679-64999

FOR OFFICIAL USE ONLY

DCFL-005-1005538

PAGE 10 OF 12

11/17/2005

b6,7C

000347

0027-03-CID679-64999

[Redacted]

From: [Redacted]  
Sent: Thursday, October 13, 2005 10:57 AM  
To: [Redacted]@us.army.mil  
Subject: FW: DCFL Case Receipt Acknowledgement 0027-03-CID679-64999 DCFL-2005-I005538

Sorry had the wrong email address.

[Redacted]

From: [Redacted]  
Sent: Thursday, October 13, 2005 10:56 AM  
To: [Redacted]@bragg.army.mil  
Cc: [Redacted]  
Subject: DCFL Case Receipt Acknowledgement 0027-03-CID679-64999 DCFL-2005-I005538

DCFL Case Receipt Acknowledgement - 13 October 2005

The Defense Computer Forensics Laboratory (DCFL) has received your request for forensic media analysis on your case number: 0027-03-CID679-64999

It has been re-assigned to me in the Counter Intelligence/Counter Terrorism (CI/CT) Section and will retain DCFL number: DCFL-2005-I005538

Base on the complexity of this case, the volume of data, and my current caseload, we have estimated the following completion date: 1 December 2005

During analysis of this case I will provide you weekly informal status reports. If I find significant information, this will be reported to you as soon as I find it via our DCFL Form 42. After I complete the entire forensic analysis of your case, I will provide you a formal report and complete findings on CD.

Your agency's Computer Crime Ops Chief has also requested a "cc" copy of all of your agency's case submissions.

Please provide contact information, such as telephone (commercial), fax, pager number; and e-mail addresses for you or anyone else who would be an alternate contact for this case. Please indicate how you would prefer to be contacted!

If you have any questions you may contact me at any time at the addresses below.

[Redacted]

Tel: 410.981.1008  
Fax: 410.981.0181  
DSN: 312.622.2595  
E-mail: [Redacted]ctr@dc3.mil

If you have trouble contacting me, you may contact the:

0027-03-CID679-64999

FOR OFFICIAL USE ONLY DCFL-2005-I005538

PAGE 11 OF 12

11/17/2005

b6,7C

000348

0027-03-CID679-64999

Section Chief, SA [redacted]  
Tel: 410.981.0117  
Fax: 410.981-0181  
DSN: 312.622.2595  
E-mail: [redacted]@dc3.mil

Director of Operations, SA [redacted]  
Tel: 410.981.1121  
Fax: 410.981.0181  
DSN: 312.622.2595, or  
Email: [redacted]@dc3.mil

Thank you

[redacted]  
General Dynamics  
DOD Computer Forensics Laboratory (DCFL)  
Linthicum, MD 21090  
Phone: 410-981-1008  
Pager E-Mail: [redacted]@dc3.mil

cc: Section Chief, DO, DCIO rep

0027-03-CID679-64999

FOR OFFICIAL USE ONLY

DCFL 2005-I005538

PAGE 12 OF 12

11/17/2005

bb7c

000349

CASE FILE DOCUMENTS INDEX (REV 12/01)

NAME OF CONTRIBUTOR

DCFL-CI/ET

ADDRESS OF CONTRIBUTOR

911 ELKRIDGE LANDING RD - SUITE 300  
LINTHicum, MD 21090

RECEIVED BY

DATE

DESCRIPTION

- 2 CDs
- (1) CD Labeled "DIGITAL EVIDENCE FORENSIC ANALYSIS REPORT, dated 17 November 2005"
  - (1) CD Labeled "DCFL Form 42- Examination of TAG 471 - Item 1, dated 17 November 2005"
  - (1) CD Labeled "DCFL Form 42 Examination of TAG 471 - Item 2, dated 17 November 2005."

0027-03-CID679-64999

FILE NUMBER

DCFL-2005-IO 05538

CONTENTS NUMBER

(6)

AF FORM 3987, SEP 96 (Replaces AFOSI Form 39a which is obsolete)

**FOR OFFICIAL USE ONLY**



b67C

AGENT COPY

000350

EVIDENCE/PROPERTY CUSTODY DOCUMENT

MPR/CID SEQUENCE NUMBER

0027-03-CID679

For use of this form see AR 190-45 and AR 195-5; the proponent agency is US Army. Criminal Investigation Command.

CID REPORT/CID ROI NUMBER

64995

RECEIVING ACTIVITY  
B7E MP Det (CID) (FWD)

LOCATION  
Champion Base, Iraq

NAME, GRADE AND TITLE OF PERSON FROM WHOM RECEIVED

ADDRESS (Include Zip Code)

OWNER  
 OTHER Crime Scene

N/A

LOCATION FROM WHERE OBTAINED From Interrogation Room 6, Blacksmith Hotel of FOB Tiger Grid [redacted] Iraq

REASON OBTAINED

Evidence

TIME/DATE OBTAINED

1303 - 1307  
28 Nov 03

ITEM NO.	QUANTITY	DESCRIPTION OF ARTICLES (Include model, serial number, condition and unusual marks or scratches)
1	1	sleeping bag, green in color, fabric construction. The sleeping bag is worn, heavily soiled on the exterior and torn at the feet. MFID with 1303, 28 Nov 03, [redacted] (Floor)
2	1	Electrical wire, white color, approximately 20 feet long and 1/2" in diameter. MFID with 1307, 28 Nov 03, [redacted] (Floor)
Last Item		

CHAIN OF CUSTODY

ITEM NO.	DATE	RELEASED BY SIGNATURE NAME, GRADE OR TITLE	RECEIVED BY SIGNATURE NAME, GRADE OR TITLE	PURPOSE OF CHANGE OF CUSTODY
1 and 2	28 Nov 03	N/A Crime Scene	[redacted] SA	Evidence
1 and 2	1 Dec 03	[redacted] SA	[redacted] SA	Released for Transport to Evidence Custodian
1 and 2	10 Dec 03	[redacted] SA	[redacted] SA	RECEIVED BY EVIDENCE CUSTODIAN SCRCNI
1-2	21 FEB 04	[redacted] SA	[redacted] SA	CHANGE OF EVIDENCE CUSTODIAN SCRCNI
1-2	6 MAY 2004	[redacted] SA	[redacted] SA RC 025209537 us	SCRCNI FORWARD TO CONTROLLING OFFICE REGISTERED MAIL

DA FORM 4137 1 JUL 78

Replaces DA FORM 4137, 1 Aug 74 and DA FORM 4137-R Privacy Act Statement 26 Sep 75 Which are Obsolete.

LOCATION

136

DOCUMENT NUMBER

521-03  
158-04

bb,7C

000351

REGISTERED MAIL  
 CHAIN OF CUSTODY (Continued)

ITEM NO.	DATE	RELEASED BY	RECEIVED BY	PURPOSE OF CHANGE OF CUSTODY
1-2	19 MAY 2004	SIGNATURE: [Redacted] NAME, GRADE OR TITLE: REGISTERED MAIL	SIGNATURE: [Redacted] NAME, GRADE OR TITLE: REGISTERED MAIL	US ARMY CID EVIDENCE CUSTODIAN FT BRAGG, NC
1	30 NOV 2004	SIGNATURE: [Redacted] NAME, GRADE OR TITLE: INVESTIGATIVE OPS - CID	SIGNATURE: [Redacted] NAME, GRADE OR TITLE: REGISTERED MAIL	RELEASED TO CONTROLLING CID OFFICE
2	30 NOV 2004	SIGNATURE: [Redacted] NAME, GRADE OR TITLE: INVESTIGATIVE OPS - CID	SIGNATURE: [Redacted] NAME, GRADE OR TITLE: REGISTERED MAIL	RELEASED TO CONTROLLING CID OFFICE
		SIGNATURE: [Redacted] NAME, GRADE OR TITLE:	SIGNATURE: [Redacted] NAME, GRADE OR TITLE:	
		SIGNATURE: [Redacted] NAME, GRADE OR TITLE:	SIGNATURE: [Redacted] NAME, GRADE OR TITLE:	
		SIGNATURE: [Redacted] NAME, GRADE OR TITLE:	SIGNATURE: [Redacted] NAME, GRADE OR TITLE:	
		SIGNATURE: [Redacted] NAME, GRADE OR TITLE:	SIGNATURE: [Redacted] NAME, GRADE OR TITLE:	
		SIGNATURE: [Redacted] NAME, GRADE OR TITLE:	SIGNATURE: [Redacted] NAME, GRADE OR TITLE:	

FINAL DISPOSAL ACTION

RELEASE TO OWNER OR OTHER (Name/Unit)

DESTROY

OTHER (Specify)

FINAL DISPOSAL AUTHORITY

ITEM(S) \_\_\_\_\_ ON THIS DOCUMENT, PERTAINING TO THE INVESTIGATION INVOLVING \_\_\_\_\_ (Grade)

(Name)

(Organization)

(IS) (ARE) NO LONGER

REQUIRED AS EVIDENCE AND MAY BE DISPOSED OF AS INDICATED ABOVE. (If article(s) must be retained, do not sign, but explain in separate correspondence.)

(Typed/Printed Name, Grade, Title)

(Signature)

(Date)

WITNESS TO DESTRUCTION OF EVIDENCE

THE ARTICLE(S) LISTED AT ITEM NUMBER(S) \_\_\_\_\_ (WAS) (WERE) DESTROYED BY THE EVIDENCE CUSTODIAN, IN MY PRESENCE, ON THE DATE INDICATED ABOVE.

(Typed/Printed Name, Organization)

(Signature)

bl,TK 000352



EVIDENCE/PROPERTY CUSTODY DOCUMENT

For use of this form see AR 190-45 and AR 195-5; the proponent agency is US Army Criminal Investigation Command

8-04-C10023  
MPR/CID SEQUENCE NUMBER

0419-04-C10056  
CRD REPORT/CID ROI NUMBER  
0027-03-C10679-64999

RECEIVING ACTIVITY  
48th MP DET (CID) 0027-03-C10679-64

LOCATION  
Fort Carson, CO 80913 0358-04-C10023

NAME, GRADE AND TITLE OF PERSON FROM WHOM RECEIVED  
 OWNER SFC [REDACTED]  
 OTHER Network NCOIC

ADDRESS (Include Zip Code)  
RHHT, 3 ACR  
Building 2352  
Fort Carson, CO 80913

LOCATION FROM WHERE OBTAINED  
From SFC [REDACTED] while at Room 107, Building 2352, Fort Carson, CO 80913

REASON OBTAINED  
Evidence

TIME/DATE OBTAINED  
1611, 5 Oct 04

ITEM NO.	QUANTITY	DESCRIPTION OF ARTICLES <i>(Include model, serial number, condition and unusual marks or scratches)</i>
1	1	Blade Server, brand name Compag, serial number [REDACTED] with one power cable. Items were marked for ID 1611, 5 Oct 04. (Mail server)
2	1	Blade Server, brand name Compag, serial number [REDACTED] with one power cable. Items were marked for ID 1611, 5 Oct 04. (Mail server)
3	1	Domain Server, brand name BSI, serial number BSI [REDACTED] with one power cable. Items were marked for ID 1611, 5 Oct 04. (Web page server, "D Drive backup files")
//////////////////////LAST ITEM//////////////////////////////////////		

ITEM NO.	DATE	CHAIN OF CUSTODY		
		RELEASED BY	RECEIVED BY	PURPOSE OF CHANGE OF CUSTODY
1 thru 3	5 Oct 04	[REDACTED]	[REDACTED]	Evaluation as Evidence. Received by Evidence Custodian.
1 thru 3	5 Oct 04	[REDACTED]	SA [REDACTED] SIGNATURE FEDEx	Fwd to Contracting Office
1 thru 3	06 OCT 2004	[REDACTED]	SA [REDACTED] SIGNATURE 791949054915	RECEIVED BY US ARMY CID EVIDENCE CUSTODIAN FT BRAGG, NC
1 AND 2	16 NOV 2004	[REDACTED]	[REDACTED] INVESTIGATIVE OPS - CID 1 888	SHIPPED TO US ARMY CRIMINAL INVESTIGATION LABORATORY
3	16 NOV 2004	[REDACTED]	[REDACTED] INVESTIGATIVE OPS - CID REGISTERED MAIL SIGNATURE 426001 891 NAME, GRADE OR TITLE REGISTERED MAIL	SHIPPED TO US ARMY CRIMINAL INVESTIGATION LABORATORY

DA FORM 4137, 1 JUL 74

Replaces DA FORM 4137, 1 Aug 74 and DA FORM 4137-R Privacy Act Statement 26 Sep 75 Which are Obsolete

ORIGINAL

FILE COPY

LOCATION FLOOR

DOCUMENT NUMBER 167-04

393-04

b6,7c

000353

49

EVIDENCE/PROPERTY CUSTODY DOCUMENT

For use of this form see AR 190-45 and AR 195-5: the proponent agency is US Army Criminal Investigation Command

MPR/CID SEQUENCE NUMBER

0027-03-CID 679  
64999

RECEIVING ACTIVITY <b>87<sup>th</sup> MP Det (CID)</b>	LOCATION <b>FT BRAGG, NC</b>
NAME, GRADE AND TITLE OF PERSON FROM WHOM RECEIVED <input type="checkbox"/> OWNER <input checked="" type="checkbox"/> OTHER <b>FedEx</b>	ADDRESS (Include Zip Code) <b>N/A</b>
LOCATION FROM WHERE OBTAINED <b>Received through FedEx channels with a tracking number of 675199374404</b>	REASON OBTAINED <b>Evidence</b>
	TIME/DATE OBTAINED <b>1000, 5 OCT 05</b>

ITEM NO.	QUANTITY	DESCRIPTION OF ARTICLES <small>(Include model, serial number, condition and unusual marks or scratches)</small>
1	1	External HARD DRIVE, brand name "MAXTOR" 250 GB, serial number, A8062XFE, marked for ID w/ 1000, 5 OCT 05, [REDACTED]
2	1	External HARD Drive, Brand name "MAXTOR", 250 GB, serial number 463V3RRE, marked for ID w/ 1000, 5 OCT 05, [REDACTED]
		LAST ITEM

ITEM NO.	DATE	CHAIN OF CUSTODY		
		RELEASED BY	RECEIVED BY	PURPOSE OF CHANGE OF CUSTODY
1/2	5 OCT 05	SIGNATURE <b>FedEx</b> NAME, GRADE OR TITLE <b>675199374404</b>	[REDACTED]	<b>Evidence</b>
1/2	05 OCT 2005	[REDACTED]	[REDACTED]	RECEIVED BY US ARMY CID EVIDENCE CUSTODIAN FT BRAGG, NC
1 AND 2	05 OCT 2005	[REDACTED]	426 700	SHIPPED TO US ARMY CRIMINAL INVESTIGATION LABORATORY
1/2	11 OCT 2005	SIGNATURE <b>Reg McNeil II</b> NAME, GRADE OR TITLE <b>RR: 426 007 700 US</b>	[REDACTED]	<b>To MD</b> <b>Storage</b> <b>DEF condition u/c</b>
1/2	1 Oct 2005	[REDACTED]	[REDACTED]	<b>To Lab</b> <b>condition u/c</b>

DA FORM 4137  
1 JUL 79

Replaces DA FORM 4137, 1 Aug 74 and DA FORM 4137-R Privacy Act Statement 28 Sep 75 Which are Obsolete.

LOCATION \_\_\_\_\_

DOCUMENT NUMBER **471-05**

**b6,7c**

50  
00035

DISCLOSURE ACCOUNTING RECORD

RECORD SYSTEM NAME AND TYPE  
AO195-2b Criminal Investigation Case File

INDIVIDUAL'S NAME	REQUESTER'S NAME AND ADDRESS	NATURE AND PURPOSE OF DISCLOSURE	INDIVIDUAL'S CONSENT (M)		DATE OF DISCLOSURE
			YES	NO NOT REQUIRED	
MSC [REDACTED]	[REDACTED]	Criminal Investigation		X	9 Feb 04

CIDF 118-ER  
1 MAR 97

The Prescribing Directive is CIDR 195-1

FOR OFFICIAL USE ONLY

ENCLOSURE

bb, 7C 000005