

## Surface Water Drainage for Low-Income Communities

ISBN 92 4 154416 3



**Published by the  
World Health Organization  
In collaboration with the  
United Nations Environment Programme**

The World Health Organization is a specialized agency of the United Nations with primary responsibility for international health matters and public health. Through this organization, which was created in 1948, the health professions of some 165 countries exchange their knowledge and experience with the aim of making possible the attainment by all citizens of the world by the year 2000 of a level of health that will permit them to lead a socially and economically productive life.

By means of direct technical cooperation with its Member States, and by stimulating such cooperation among them, WHO promotes the development of comprehensive

health services, the prevention and control of diseases, the improvement of environmental conditions, the development of health manpower, the coordination and development of biomedical and health services research, and the planning and implementation of health programmes.

These broad fields of endeavour encompass a wide variety of activities, such as developing systems of primary health care that reach the whole population of Member countries; promoting the health of mothers and children; combating malnutrition; controlling malaria and other communicable diseases including tuberculosis and leprosy; having achieved the eradication of smallpox, promoting mass immunization against a number of other preventable diseases; improving mental health; providing safe water supplies; and training health personnel of all categories.

Progress towards better health throughout the world also demands international cooperation in such matters as establishing international standards for biological substances, pesticides and pharmaceuticals; formulating environmental health criteria; recommending international nonproprietary names for drugs; administering the International Health Regulations; revising the International Classification of Diseases, Injuries, and Causes of Death; and collecting and disseminating health statistical information.

Further information on many aspects of WHO'S work is presented in the Organization's publications.

World Health Organization  
Geneva 1991

WHO Library Cataloguing in Publication Data

Surface water drainage for low-income communities.

1. Drainage, Sanitary 2. City planning 3. Consumer participation 4. Developing countries

ISBN 92 4 154416 3 (NLM Classification: WA 671)

© WORLD HEALTH ORGANIZATION 1991

Publications of the World Health Organization enjoy copyright protection in accordance with the provisions of Protocol 2 of the Universal Copyright Convention. For rights of reproduction or translation of WHO publications, in part or *in toto*, application should be made to the Office of Publications, World Health Organization, Geneva, Switzerland. The World Health Organization welcomes such applications.

The designations employed and the presentation of the material in this publication do not imply the expression of any opinion whatsoever on the part of the Secretariat of the World Health Organization concerning the legal status of any country, territory, city or area or of its authorities, or concerning the delimitation of its frontiers or boundaries.

The mention of specific companies or of certain manufacturers' products does not imply that they are endorsed or recommended by the World Health Organization in preference

to others of a similar nature that are not mentioned. Errors and omissions excepted, the names of proprietary products are distinguished by initial capital letters.

TYPESET IN INDIA  
PRINTED IN ENGLAND

90/8386-Macmillan/Clays-6500

## **Ordering information**

### **Surface Water Drainage for Low-income Communities**

1991, v + 88 pages [E, F, S]

ISBN 92 4 154416 3

Sw.fr. 16.-/US \$14.40; in developing countries: Sw.fr. 11.20

Order no. 1150352

## **Acknowledgements**

The United Nations Environment Programme and the World Health Organization wish to thank all those who have taken part in the preparation of this publication, in particular the two principal authors: Dr S. Cairncross of the London School of Hygiene and Tropical Medicine, and Dr E. A. R. Ouano, consulting engineer, Manila, Philippines. The authors drew heavily on a training module prepared by the United Nations Centre for Human Settlements (Habitat), whose cooperation in providing this material is gratefully acknowledged. Finally, thanks are due to GTZ (Agency for Technical Cooperation, Federal Republic of Germany) for its generous financial assistance, which made possible the publication of this book.

## **1. Surface water drainage in urban areas**

### **1.1 The problem**

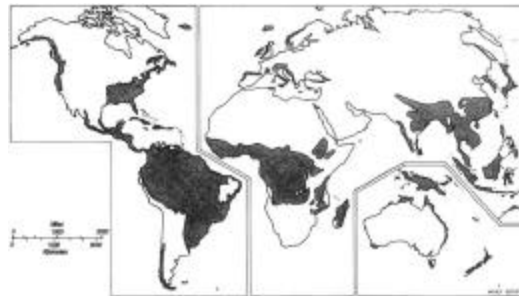
Many low-income communities in developing countries consider stormwater drainage to be their most urgent need as far as urban infrastructure is concerned. This is partly because their houses are often built on unsuitable land. In areas sufficiently close to the city centre for the journey to work to be affordable, land prices tend to be beyond their means. The only land they can afford, or on which the owners will allow them to stay as squatters, is land that is unsuitable for other purposes. This is often on steep hillsides subject to erosion and landslides, or it is low-lying, marshy land often subject to flooding.

Historically, most of the major cities of the developing world arose along the coast as ports, often on the estuaries of rivers which served as commercial arteries for the transport of goods to and from the hinterland. It is the coastal regions of the world that have the highest average rainfall (Fig. 1), but the flat estuarine terrain and often impermeable alluvial soils make drainage difficult.

Even in the arid areas where average rainfall is low, tropical rainfall - when it comes - is more intense than in temperate climates, and the lack of vegetation and of adequate drainage means that torrents of water can form in minutes, causing damage to homes and property which will take years to repair. Rainwater is not the only problem. Leaking

water mains, wastewater from washing and bathing, and the sewage from overflowing septic tanks and blocked sewers constitute health hazards, damage buildings, and can cause flooding if an adequate drainage system does not exist.

The lack of drainage is especially serious where the ground is either steeply sloping or very flat. On very steep sites, as in parts of Luanda, Rio de Janeiro and Hong Kong, stormwater flows fast and violently, damaging buildings, eroding the land and sometimes causing landslides. Soil eroded from a hillside is usually deposited at the foot of the slope; the soil eroded in a single rainstorm has been known to bury houses completely in this way. In other cases the land is flat; in cities such as Bangkok, Calcutta, Colombo, Dar es Salaam, Jakarta, Guayaquil, Lagos, Manila and Recife, many neighbourhoods are flooded at least once or twice a year, and people have to learn to cope with water inside their dwellings. Sometimes people build their houses on stilts and connect them by elevated pathways. However, their construction is rickety, and it is very easy to lose one's balance and fall into the muddy, polluted water underneath.

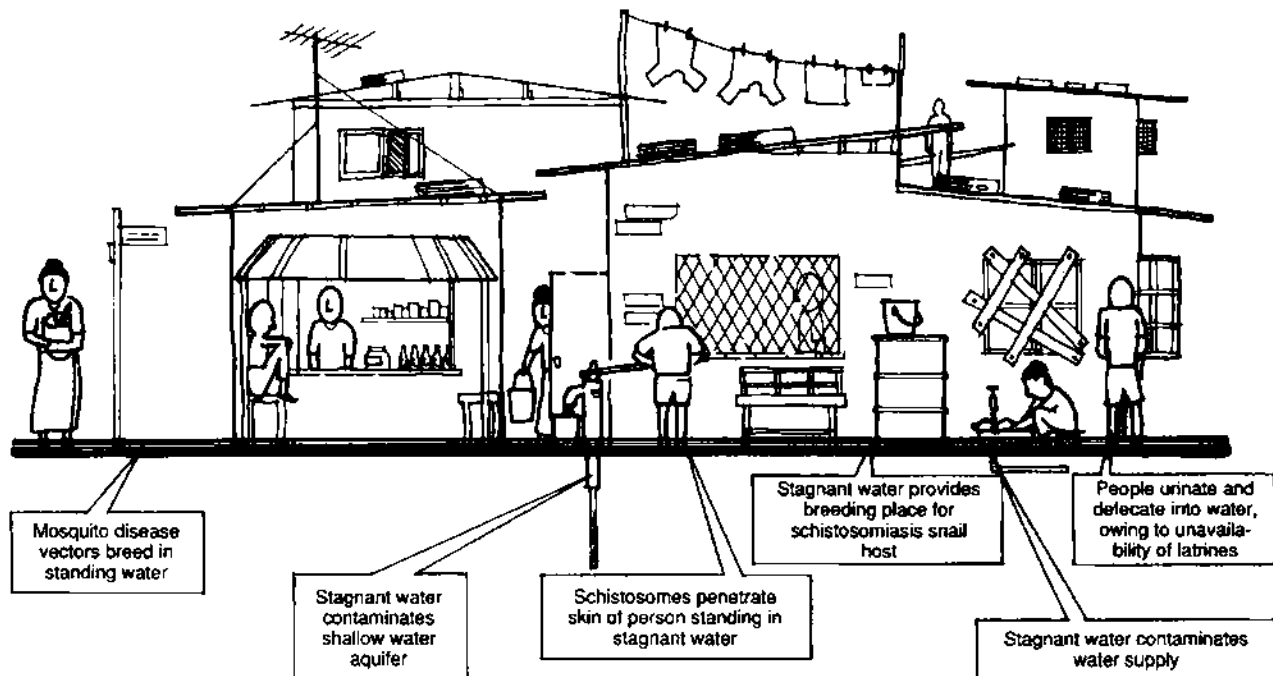


**Fig. 1. Areas of the world with more than 1.5 m average annual rainfall**

## **1.2 Health consequences**

Deaths due to drowning in floods or burial beneath landslides or collapsing homes are perhaps the most dramatic signs of the suffering that drainage can help to alleviate. Less noticeable to an outsider, but of greater impact on the residents' lives in a poor community, is the steady toll of disease, disability and death taken by standing water.

First in public health importance are the many "faecal-oral" infections acquired by consumption of contaminated food and drink. The microscopic pathogens that cause them are found in the excreta of infected people or animals. Surface water becomes contaminated with these pathogens from sources such as blocked sewers and overflowing septic tanks, and often from defecation in the open by livestock and by people who have no toilet. This contaminated surface water can then infect people in many ways. It can contaminate their hands, their utensils or their drinking-water supply (Fig. 2). Children are particularly exposed to infection when playing or bathing in surface water.



**Fig. 2. Stagnant water and disease transmission - the health consequences of poor drainage**

The faecal-oral diseases include the well known water-related diseases that are often fatal, such as cholera and typhoid fever, but also the many common diarrhoeal diseases that particularly affect young children in developing countries, contributing to malnutrition and death. In fact, these diarrhoeal diseases are often responsible for more child mortality than any other cause of death. Important measures for their control are an improved water supply and better sanitation, but these are almost impossible to install in areas subject to frequent flooding.

In countries where schistosomiasis is endemic, poorly drained urban areas present ample opportunities for transmission of the disease (Fig. 2). Contamination of standing water with the faeces of infected persons (or, for one form of the disease, with their urine) enables the schistosomes, the microscopic parasites that cause this infection, to reach the small aquatic snails in whose bodies they multiply. From every infected snail, thousands of schistosomes emerge and swim in the water. Local residents become infected when they enter the water and the schistosomes penetrate their skin.

Schistosomiasis may sometimes be thought of as a rural disease, but it is often no less prevalent in urban areas where drainage is lacking. Some of the species of snail host thrive and breed rapidly in the heavily polluted stagnant water which often accumulates there. Moreover, a single infected person in an urban area can cause sufficient contamination to infect very large numbers of the people living in his or her crowded neighbourhood, because even a small number of snails, once infected, can produce many thousands of schistosomes over a long period of time.



**A public water tap in a poorly drained low-income community in Pondicherry, India. Sanitary services such as water supply and excreta disposal cannot function hygienically without adequate surface water drainage.**

**Photo: S. Cairncross**

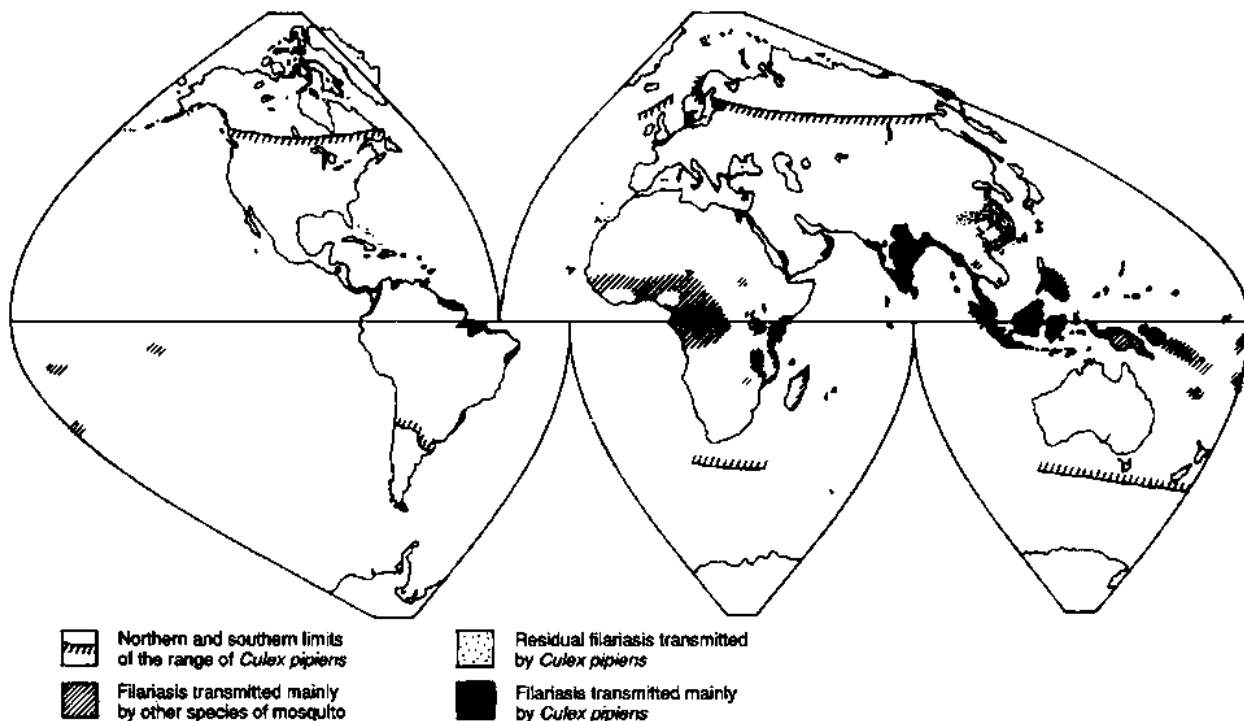
Another important group of diseases related to poor drainage is transmitted by mosquitos. Different diseases are transmitted by different species of mosquito, and each chooses different bodies of water in which to breed. Some prefer water that is heavily polluted, some prefer it clean; some breed in flooded areas, some in the drains themselves if they are blocked by rubbish or vegetation or are laid unevenly so that there is standing water in them.

Malaria is the best known of the mosquito-borne infections, and is transmitted by *Anopheles* species, many of which bite animals as well as humans. Transmission can be particularly intense in urban areas where there are relatively few animals to divert the vector species of mosquitos from human blood meals. Anopheline mosquitos do not usually breed in heavily polluted water, but can multiply in swamps, pools, puddles, and also in streams and stormwater canals in which there is standing water. Anopheline mosquitos breeding in poorly drained areas can transmit malaria to adjacent parts of town. A particular danger in a city is the significant amount of international travel to and from it, which increases the risk of importation of new and possibly drug-resistant strains of the malaria parasite.

Another family of mosquitos, the *Aedes* species, can transmit several viruses, such as those that cause dengue and yellow fever. Urban epidemics may result. In recent years, a more virulent form of dengue has been observed, known as dengue haemorrhagic fever (DHF). Both DHF and yellow fever are often fatal. *Aedes* mosquitos usually breed in clear water, for instance in domestic storage vessels, but they have also been found to multiply in swampy and flooded areas, and in open drains and stormwater canals.

Finally, there is the particularly urban problem of bancroftian filariasis, which can cause elephantiasis (irreversible swelling of the legs) as well as other disabling symptoms. Although transmitted in rural areas by *Anopheles* species, which appear to be the original vectors of the disease, it seems to have adapted to transmission in urban areas by the *Culex pipiens* group (Fig. 3), which generally multiply in heavily polluted bodies

of water. Transmission of the disease is a relatively inefficient process, so that many years of exposure to intense night-time mosquito biting are needed for the average case to develop. Nevertheless, more than 80 million people in the developing world are infected. In many countries, such as India, it is especially prevalent in urban areas. Filariasis transmission by *Culex pipiens* mosquitos is now common in Asia, is occurring in cities on the eastern coasts of Africa and South America, and may soon begin in the large poorly drained urban areas of West Africa where both the disease and the vector mosquito already exist.



**Fig. 3. Geographical distribution of *Culex pipiens* mosquitos and bancroftian filariasis** (from: Curtis, C. F. & Feachem, R. G. Sanitation and *Culex pipiens* mosquitoes: a brief review. *Journal of tropical medicine and hygiene*, **84**: 17-25 (1981)).

Drainage construction is an effective mosquito control measure. It is cheaper than application of insecticides and does not have to be repeated regularly; in many cases, it costs less than a year's supply of insecticide. Unlike insecticides, it can have no detrimental effect on the environment; on the contrary, it constitutes an environmental improvement. Moreover, the danger of mosquitos' developing resistance, as they have been known to do to insecticides, does not apply.

### 1.3 Implications for town planning

The urban poor may often build on land with drainage problems, but good urban planning can help to avoid making those problems worse.

One of the simplest planning measures is to set out regular plots before house building starts in an area, leaving space for well-aligned roads. Adequate road width and alignment will make it much easier to build drains when they are needed later. Site-

and-service schemes are expensive and take a long time to plan and implement, but such a "site only" scheme should be within the means of any municipality. Once the overall layout of a neighbourhood has been planned, residents (or future residents) can be shown how to set out individual rectangular plots with nothing more sophisticated than a tape measure, or even a piece of string with knots at regular intervals. Some degree of discipline over house building is necessary, to ensure that plot boundaries are observed, and to prevent houses from obstructing existing drainage paths or from occupying land needed for future drainage works. The residents themselves are in the best position to enforce this discipline.

The development of residential areas can increase drainage problems in other ways. As vegetation is removed, the capacity of the ground to retain water and resist erosion is reduced. The increasing area covered by roofs and road surfaces diminishes the area of ground into which water can infiltrate, leaving a greater volume of water to be removed by drainage. Low-lying areas subject to flooding play a role in storing the water from sudden rainstorms until it can drain away gradually; when these are filled in for housing, the result may be flooding in other areas.

Roads must be built above the flood level, and the resulting embankments can obstruct natural lines of drainage, or can channel water alongside them causing erosion. In some cases, as in parts of Bangkok, roads have been built by filling in existing channels, causing serious flooding. Where the natural drainage channels are not filled in or obstructed by buildings, they often become blocked by domestic refuse.

On the other hand, drainage improvements in one area are closely linked with drainage problems elsewhere, and are best planned in the context of the city as a whole, or at least of a whole catchment area. Better drainage in one neighbourhood means that surface water flows away faster, imposing a greater burden on the capacity of the system downstream. At the same time, drainage improvements at a local level may be of little use if water still backs up because the downstream capacity is insufficient. This has been a serious problem in Jakarta, where improved local drains were often submerged by water held back by constrictions in the city's major canals.

Of course, it is possible for a community to make local improvements, even without the full involvement of the city planning authorities, but at least some consideration should be given to the body of water into which a new drainage system will discharge. Whether this is a main sewer, river, lake or sea, the maximum level to which it floods will normally set the minimum level for the drainage system. The discharge of drainage water also affects the quality of the "receiving water" into which it flows, especially when sewage or septic tank effluent is released into the drains. In Bangalore, for example, the discharge of sewage into several dams in the city led to intense breeding of mosquitos until measures were taken to breach or bypass them.

#### **1.4 The need for collaboration**

Drainage improvements are not only a job for a drainage engineer. They involve several professions and need the cooperation of several sectors if they are to succeed. Drainage is of great concern to town planners and, if some houses have to be relocated to make room for new drains, architects and builders may also be involved. Drains are usually built beside roads, and the roads department will have an interest because good drainage is essential to protect the road surface.



Maintenance of the drainage system depends on an efficient service for collection of solid waste, as without one the drains will soon fill with rubbish. Moreover, the street-cleaning and solid-waste collection service will often be the most suitable municipal department to clean the drains regularly, as it will have the necessary vehicles to remove the solid materials such as silt, vegetation and refuse that will accumulate in them. The health department will be concerned to ensure that the cleaning is done well and regularly, and that the drains are not built in such a way as to make this difficult or to promote disease transmission. This in turn involves several specialities, such as medical entomology.

The community has a key role to play. Whether or not local residents participate in construction, their cooperation is needed in obtaining the necessary land. Some people may have to sacrifice part of their premises, or agree to relocate their houses, to make room for the new drains. Whether or not the community takes responsibility for maintaining the system, a responsible attitude on their part will be a great help towards its upkeep, reducing the amount of rubbish thrown into the drains, and damage done to them by vehicles, building work or vandalism. A single uncooperative resident who blocks the water flow, or neglects to clean his or her section of the drainage line, can harm the interests of the whole community. Proper drainage therefore calls for the close cooperation of the community and its leaders, and also of those who work with the community, such as educators and health workers.

A cooperative attitude is not enough, however. Effective collaboration between municipal departments and involvement of the community have institutional implications. At the level of local government, the most fundamental consideration is that some department at least must have the primary responsibility for urban drainage. In many cities there is no clear definition of who is responsible for cleaning and maintaining the natural and man-made drainage system, and in some it is not even clear who is to build it, or which national government department is to finance major drainage works. An example of the absurd situations that can arise in such cases is for one department to remove rubbish from the drains, for the solid-waste collection service to refuse to collect the rubbish from where it is dumped on the adjoining roads, and for the roads department to sweep it back into the drains again!

Ideally, the regular cleaning of urban drains should be the job of the street-cleaning and solid-waste collection service. However, other sectors will usually be responsible for drainage construction and repairs, so that several sectors are inevitably involved. Some arrangement for regular liaison meetings should therefore be set up, and a single department should be responsible for convening them. The health department should be represented.

Some institutional arrangements are also needed in the community, to mobilize and coordinate the community's contribution and to ensure that it is not undermined by the antisocial behaviour of a minority. If possible, it is best to build on existing community institutions, although these may already be fully occupied with other day-to-day tasks. In many cases, a useful initial step will be to form a drainage committee to organize the community's contribution to planning, implementation and maintenance of drainage improvements. Community institutions are discussed further in section 4.

## **1.5 Development of a drainage programme**

A typical neighbourhood drainage improvement programme passes through four principal phases:

- initiation,
- planning,
- construction, and
- maintenance.

The first two of these are fundamental, as they determine all that follows.

*Initiation* of a programme may arise from the community's own realization of the need for better drainage, possibly after experiencing a particularly serious flood or seeing drainage improvements in other neighbourhoods. In many cases, however, it is catalysed by some external agency, such as the municipality, a political party or nongovernmental organization, or by a concerned individual such as a teacher or health worker. This phase involves identification of the need for drainage, formation of a consensus regarding the scope of the problem and the desired solution, and establishment of a drainage committee, at least on an interim basis. Where the initiative comes from outside, it is also likely to include a certain amount of work in the community to develop awareness of the problem and mobilize support for a drainage programme.

*Planning* is the most important phase of all, as it involves the most fundamental decisions. The more decisions that can be taken at the planning stage, the better it is for the future of the programme.

The most basic decision for the community is whether to implement the drainage programme on a formal basis through the local authorities, or to attempt a "do-it-yourself" project on its own. Formal drainage projects tend to be expensive, so that the first task of the drainage committee is to lobby and persuade the local authority to agree to support the programme (unless of course the authority itself initiated the scheme). The authority will usually have to obtain finance from some other agency, which is likely to require a feasibility study and design by a consulting engineer before a contractor is given the job of building the new drainage system. All this takes time - typically three to ten years - and members of the community may prefer to carry out some "do-it-yourself" interim measures themselves, while they wait (Fig. 4).

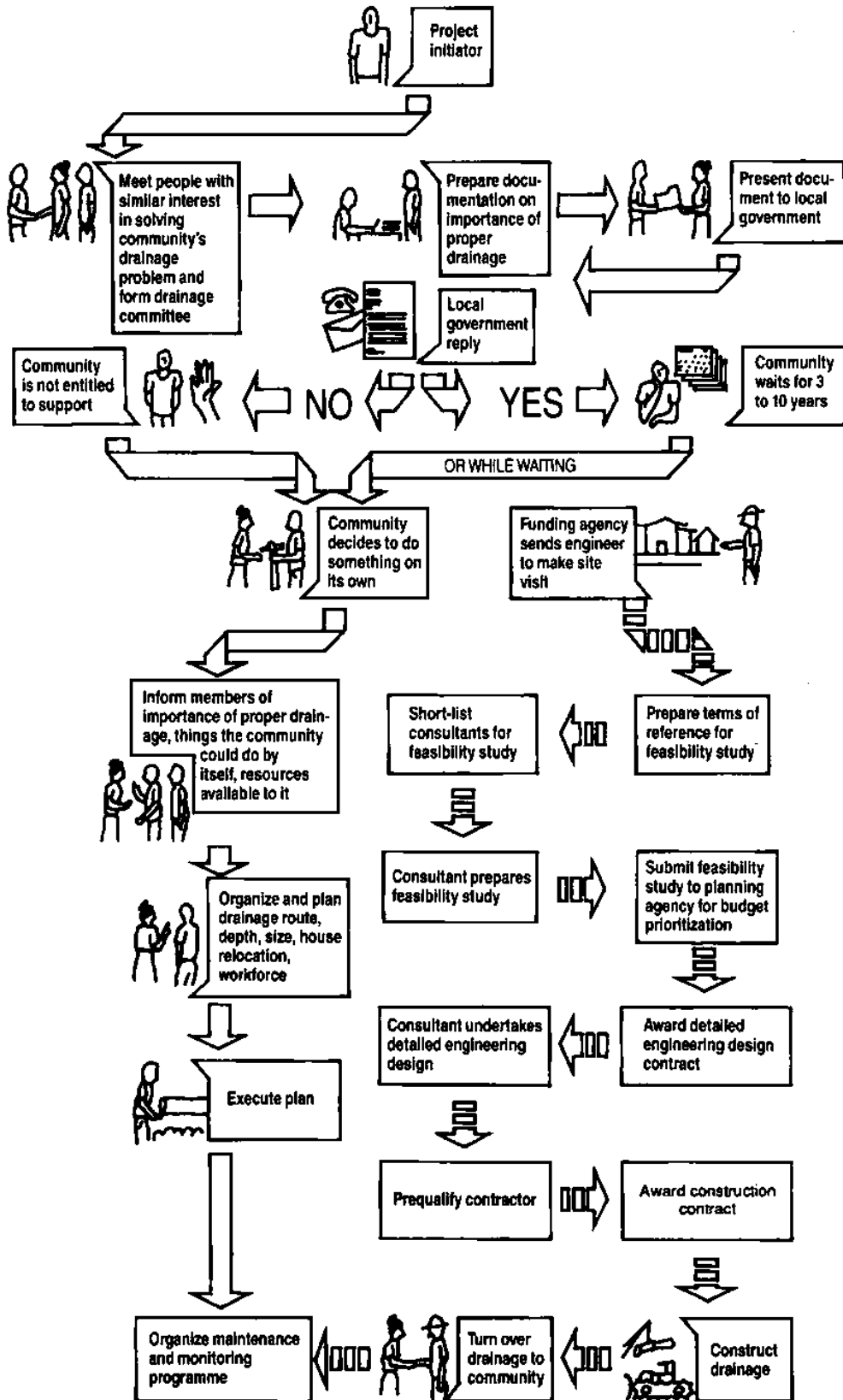


Fig. 4. Possible sequences of events in solving local drainage problems

Whichever approach is followed, it is important to define not only the layout and design of the new drainage system but also the community's role in the construction and maintenance phases, and how its contribution is to be organized.

*Construction and maintenance* are discussed in detail in the remainder of this book. The following description of how the sections are arranged may help to guide the reader.

The technical aspects of drainage design and construction are considered in section 2. Much of this information will also be of interest to nontechnical readers. Sections 2.1 and 2.2 are especially important as they explain basic concepts in lay language. Section 2.9 describes how a community can plan its own drainage improvements without external support, and will also be of interest to an engineer making a first approach to a local drainage problem.

Section 3 discusses rehabilitation and maintenance. Most of the chapter is technical, but lay readers will not find it difficult to follow. Institutional aspects of maintenance are discussed in section 3.4.

Section 4 considers participation by the community in drainage schemes, a subject whose importance tends to be underrated. The reader should at least look at section 4.1 before deciding whether to read the rest!

A glossary of terms is provided in Annex 1, and other annexes cover design calculations, terms of reference for consultants, and resources for the orientation of the drainage committee.

## **1.6 Selected reading**

CAIRNCROSS, S. Urban drainage in developing countries. *Parasitology today*, 2 (7): 200-202 (1986).

CAIRNCROSS, S. & FEACHEM, R. G. *Environmental health engineering in the tropics: an introductory text*. Chichester, John Wiley & Sons, 1983.

CURTIS, C. F. & FEACHEM, R. G. Sanitation and *Culex pipiens* mosquitoes: a brief review. *Journal of tropical medicine and hygiene*, **84**: 17-25 (1981).

DAVIDSON, F. & PAYNE, G. *Urban projects manual: a guide to upgrading and new development projects accessible to low income groups*. Liverpool, Liverpool University Press, 1983.

HARPHAM, T., ed. *In the shadow of the city: health care and the urban poor*. Oxford, Oxford University Press, 1988.

MCAUSLAN, P. *Urban land and shelter for the poor*. London, International Institute for Environment and Development, 1985.

TABIBZADEH, I. et al. *Spotlight on the cities. Improving urban health in developing countries*. Geneva, World Health Organization, 1989.

*Urbanization and its implications for child health. Potential for action.* Geneva, World Health Organization, 1988.

## **2. Drainage options**

### **2.1 The drainage hierarchy**

The drainage problems of an individual neighbourhood are part of a hierarchy of problems related to the drainage network of the whole city and corresponding with the hierarchy of drains which compose it. These drains range from the major canals or large sewers which collect water from large areas of the city down to the small ditches or drainpipes that run along the roadside or serve individual properties.

At the most basic position in the hierarchy is the *receiving water body* into which the system discharges. This may be the sea, a lake or a river. The water level in the receiving water body fixes the minimum level of the drainage channels, because the pumping of storm-water is not feasible for any but the wealthiest communities. Even if it were possible to afford pumps large enough to handle the amounts of water involved, they would not be practical because of the many difficulties of maintenance and the extent of the damage that would result from malfunction or breakdown of the pumps. The water level in the receiving water body comes very close to ground level in many flat low-income areas, which means the drains cannot be made very deep.

Next in the hierarchy is the *primary drainage system*, composed of main drains, sometimes called interceptor drains. These serve large areas of a city or the city as a whole, and often follow the line of natural drainage channels such as rivers or streams. The design, construction and maintenance of a city's primary drains require extensive engineering skills and a large financial base, and are well beyond the means of an individual community. These drains are not considered here.

Finally there is the *secondary drainage system*, a network of small drains within each neighbourhood. These are sometimes known as micro-drainage or laterals, and each serves a small catchment area, ranging from a single property to several blocks of houses. This publication deals principally with the secondary level of the drainage system. At this level, improvements can be made with modest investments, and low-cost solutions are often appropriate.

### **2.2 Factors affecting stormwater flows**

Not all the water falling as rain needs to be removed by the drainage system. Some of it will infiltrate into the ground, while some may stand in puddles and other depressions and eventually evaporate. The proportion that runs away over the ground surface and has to be carried in the drainage system is known as the runoff coefficient. In practice, there is little chance for evaporation during a rainstorm, so that the runoff coefficient to use when calculating the size of the drains required is based on the infiltration capacity of the ground. This depends mainly on soil conditions, the slope of the terrain, and on land use:

*Soil conditions.* Water seeps more readily into sandy soil than into clay or rocky ground.

*Terrain.* Water flows more rapidly down a steep slope, leaving it less time to infiltrate than when it stands or moves slowly in a flat area.

*Land use.* Vegetation traps much of the water and also loosens the soil, thus making infiltration easier. Roofs and paved surfaces, on the other hand, prevent infiltration.

Runoff coefficients are therefore higher in areas of clay soil or rock, on steep slopes and in densely built-up areas with little vegetation. As an example of this, the quantity of water to be drained from a high-density housing area may be 5-6 times greater than it was when the area was undeveloped and covered with vegetation.

The rate at which water enters the drainage system depends on the runoff coefficient, but also on the rate of rainfall. Of course this can vary, from a heavy downpour to a light shower, and it is hard to estimate the maximum intensity of rainfall that will occur in a given year, because of the unpredictability of the weather. However, by analysing past rainfall records, it is possible to make an estimate of the probability of any particular rate occurring. The more severe the rainstorm (i.e., the higher the rate of rainfall), the lower the probability of its occurring.

This probability is usually expressed as a "return period". A rainstorm with a probability of 1 in 20 of happening in any particular year is said to have a return period of 20 years, and is called a 20-year storm. This does not mean, of course, that it happens exactly every 20 years, but that on average it will happen that often - an average of five times a century.

If a drainage system is designed for an unusually severe rainstorm with a 100-year return period, it may never be fully used within its lifetime. The money spent in constructing a system with such a large capacity might have been better spent on building smaller drains in areas that have none. Choosing the optimal return period for the design of an urban drainage system is a difficult judgement based on weighing the risk of the drains overflowing, and the damage this might cause, against the cost of building larger drains to prevent it.

A return period of five years is widely used to design primary drainage systems in tropical cities, but shorter periods (three years or less) are more suitable for micro-drainage within residential areas, where an occasional overflow is less likely to cause serious damage. In a low-income area, where the value of property liable to damage is relatively small, and only limited funds are available for drainage, the appropriate return period may be shorter still. In Mombasa, for example, a one-year return period has been adopted for all but the largest drains. In Calcutta some drains have been designed for a return period of only two months. A few inches of flooding several times each year may be a great improvement on waist-deep water for weeks on end.

The damage that can be done to roads by stormwater is often the major justification for drainage in low-income areas. On steep slopes, a single heavy rainstorm that makes the drains overflow can cause enormous damage by erosion, so that a longer return period may be justified than in flat areas.

Annex 2 gives further details of how to estimate stormwater flows and use them to calculate the size of drains for design purposes.

### **2.3 Problems of steep slopes**

Sloping land easily suffers from erosion when the vegetation cover is damaged and when intensive land use bares the soil. It is therefore important to prevent water from rushing down in uncontrolled flows that may undermine houses and turn paths and streets into impassable gulleys. As a rule of thumb, slopes of more than 5% can be considered steep slopes.

On steep terrain, the only way to keep water in the soil is through terracing so as to reduce the slope. Various methods exist and are used to control erosion on agricultural land. However, these can be applied in an urban area only if the neighbourhood has not already been fully built up.

When the water is concentrated in a natural or artificial line of drainage running down a steep slope, it can flow at great speed and thus cause considerable damage. Various methods can be used to lead the water down gradually and in manageable quantities:

(a) Diverting the water horizontally by a bank built along the contour or by turnout drains (Fig. 5), thus reducing the speed of water flow and avoiding the accumulation of all the water from the whole slope in a single drain.

(b) Leading the water in a controlled zigzag through baffles built into the drain to slow down the flow (Fig. 6(a)).

(c) Building steps into the drain (Fig. 6(b)). The area on to which the water falls from each step is built to resist the force of the falling water. Step drains are practical if the slope exceeds 30%, but otherwise they become too expensive.

(d) Checkwalls (Fig. 6(c)) are a less expensive solution to the problem, and can be used in unlined drains. The water deposits silt behind each checkwall, gradually building up a stepped drain. The checkwalls should be set well into the ground on each side and beneath them, to ensure that the water does not cut a way past them. In particular, the foundation of each wall should not be higher than the crest of the next one downstream.

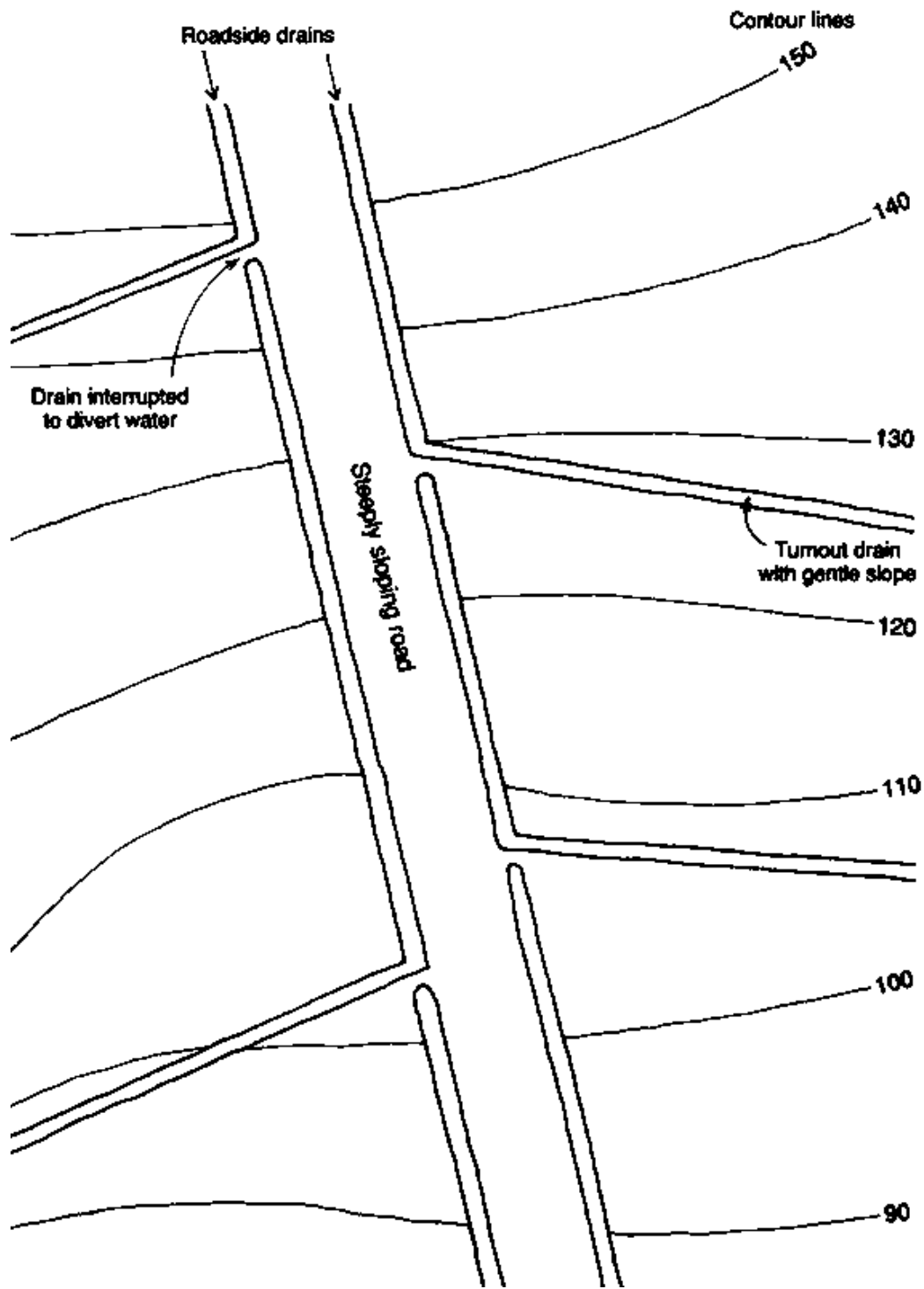
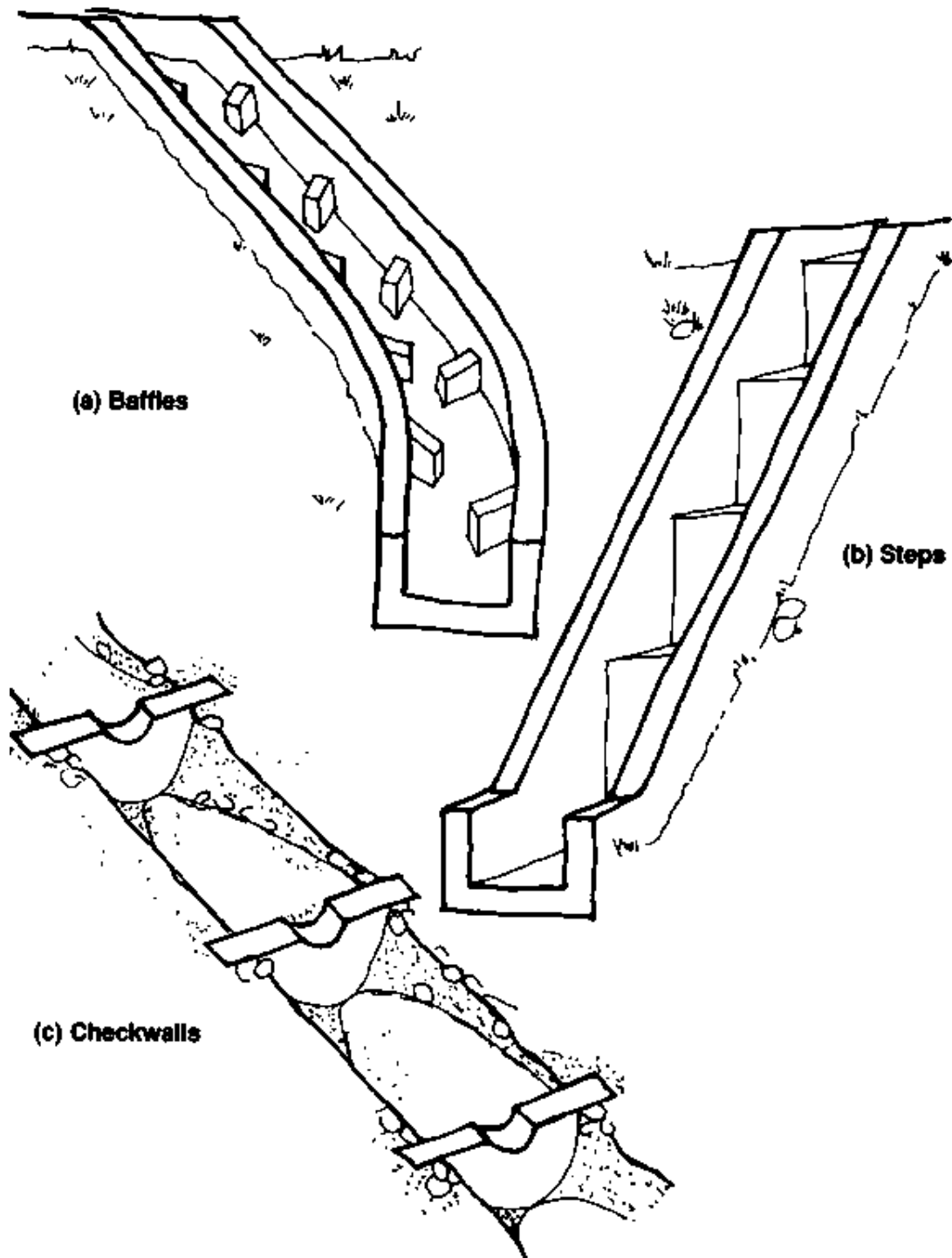


Fig. 5. Turnout drains to divert water from a steep slope

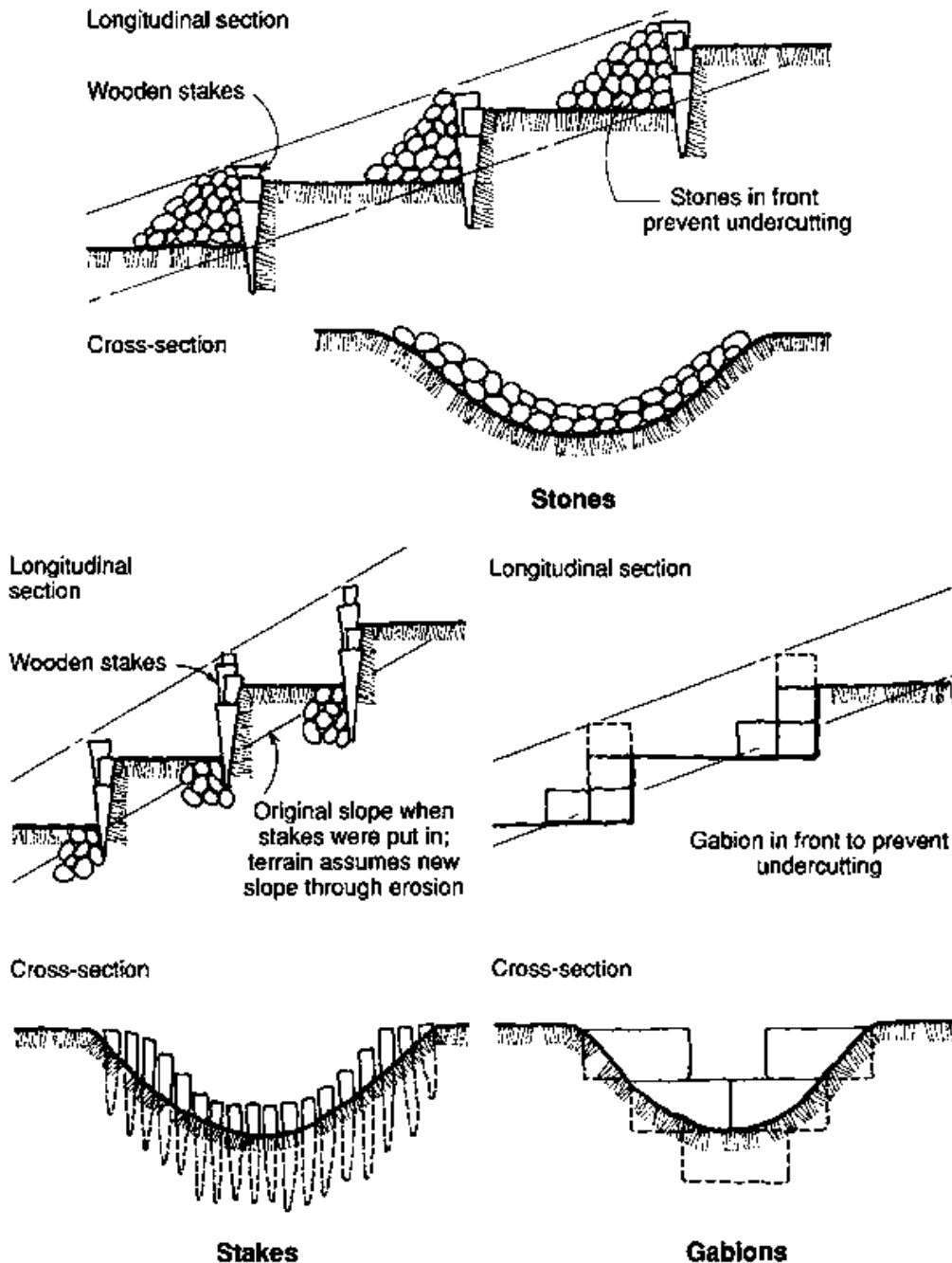




**Fig. 6. Types of construction for step drains**

Checkwalls can be built of various materials besides concrete or masonry (Fig. 7). Piles of large stones help to dissipate the energy of the water as it flows through the tortuous spaces between the stones. The stones must be large enough to resist being carried downstream by the water.

In areas where rocks of sufficient size are not available, smaller rocks may be tied together in a large bundle or bale known as a gabion. A gabion is made by filling a large basket of galvanized wire mesh with stones, to make a large rectangular bundle of about 0.5-1.0 m<sup>3</sup>. These can be built up into a wall; however, it is advisable to fill them only after putting them in position. Bamboo strips may be used as a substitute for wire, although they will rot away in a few years. As the bamboo deteriorates, weak cement can be applied sparingly to the exterior of the gabion, taking care not to block completely the spaces between the rocks. When a gabion is newly placed, the rocks have to settle down; a weak concrete would easily crack whereas wire and bamboo are flexible.



**Stakes** **Gabions**  
**Fig. 7. Types of checkwall or dissipator**

In areas with a moderate ground slope of about 4-10%, drainage channels may be lined with concrete, masonry or vegetation to prevent scouring of the channel bottom. Channel linings are discussed in section 2.6.

## **2.4 Problems of flat areas**

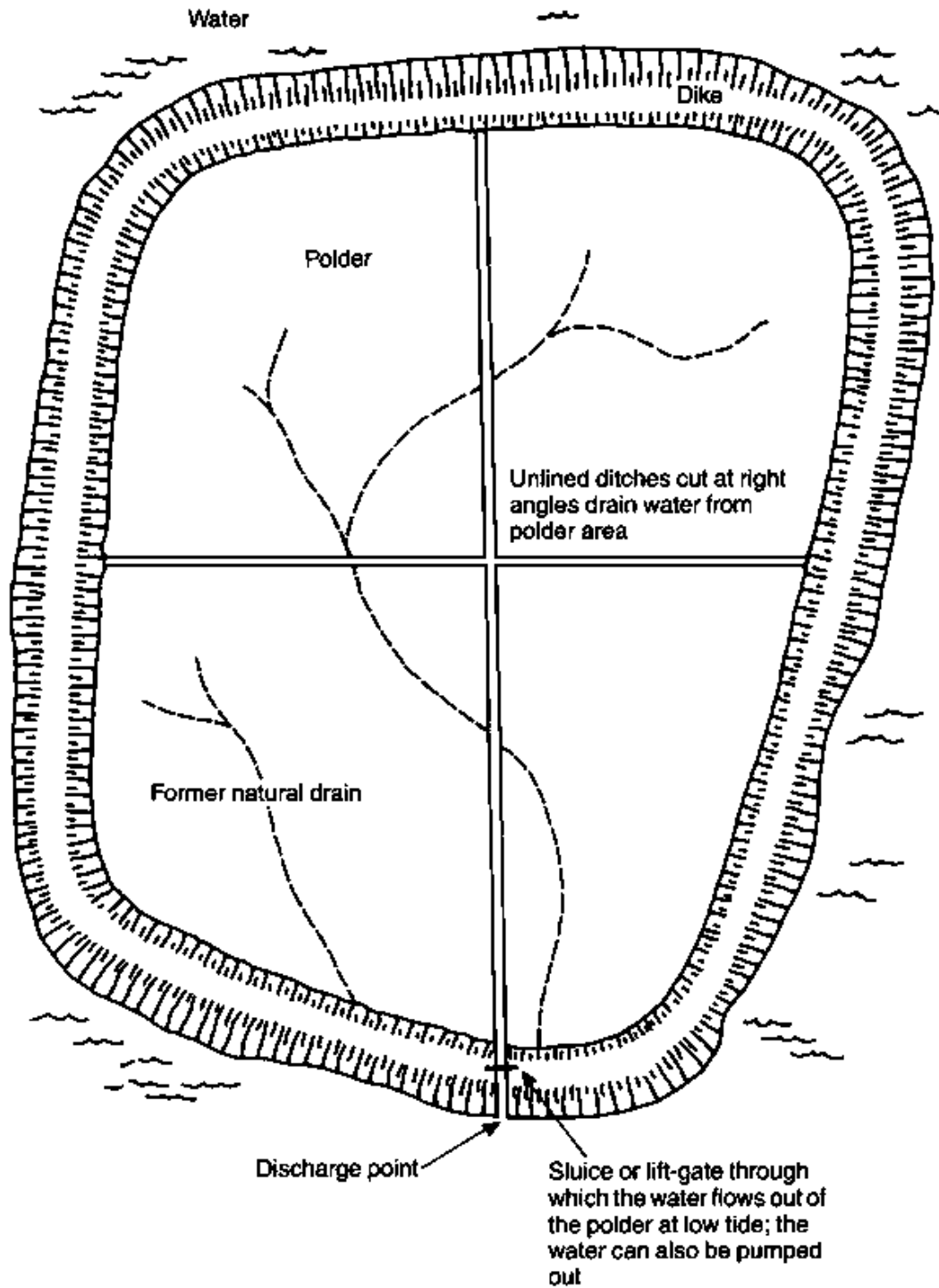
In flat low-lying areas subject to flooding, a major problem often results from the relatively high level of the receiving water body. This limits the slope to which drains can be laid, so that water flows along them quite slowly. Together with the difficulty of digging deep drainage channels where the groundwater level is high, this means that drains have to be relatively wide in order to have sufficient capacity.

Sometimes there is no alternative to using landfill to raise the level of the ground in all or part of the neighbourhood. Landfill limited to the streets will cause increased flooding of people's plots and houses, so that adequate quantities should be provided, sufficiently close to people's houses for them to cart it away and spread it on their premises. They should be helped to judge how to place it by marks painted in advance on each house showing the level to which the ground should be raised by the landfill.

The idea of people placing rubble and soil inside their houses to raise the floor level may seem strange to some, but there are low-income urban areas whose residents have been glad of up to 50 cm of landfill placed in this way. Their houses will eventually need modification or rebuilding as a result, but the impact of landfill can so transform an area that residents often wish to build a new house more appropriate for the improved surroundings, once they are convinced that it will be safe from flood damage.

The water level in the receiving water body often fluctuates, owing to tidal effects or the flow of water into it from other catchment areas. These variations in level can be analysed in terms of their return period when a decision is made as to the depth of landfill required.

Alternatively, tidal variations in level can be turned to advantage by installing a sluice gate at the outlet from the drainage system which is opened at low tide and closed when the level rises. The need for landfill can also be avoided by building a large embankment or dike along the bank of a river liable to flood, or right around the residential area creating a "polder" (Fig. 8). Of course, some installation such as a sluice gate is needed to allow a way out for water drained from the area. However, no such arrangement should be considered without very thorough study by an engineer and a guarantee of reliable operation and maintenance. A dike that overflows or a sluice gate that fails to function could do enormous damage.



**Fig. 8. The polder system**

Another difficulty in the drainage of flat areas is the deposition of sediment in the drains, owing to the slow speed of flow of the water. Where possible, drainage systems should be designed to produce a minimum "self-cleansing" speed of flow, at least when the drains are running full, so that water will carry the sediment along with it. In a drainage channel with a rectangular cross-section, the water will flow slowly in a thin layer on the bottom after light or moderate rain. Moreover, any irregularities in the flat

bottom will create puddles in which mosquitos can breed. Building a drainage channel with sloping sides and a narrow bottom helps to maintain a steady flow speed whatever the water level in the channel. A refinement of this principle is to build a channel with a composite section (Fig. 9). The central channel with a narrow bottom is to carry the flow in dry weather and moderate rain, while the outer channel is for the occasional heavy flood flow. The outer channel floor should preferably slope gently down to the central channel or "cunette".

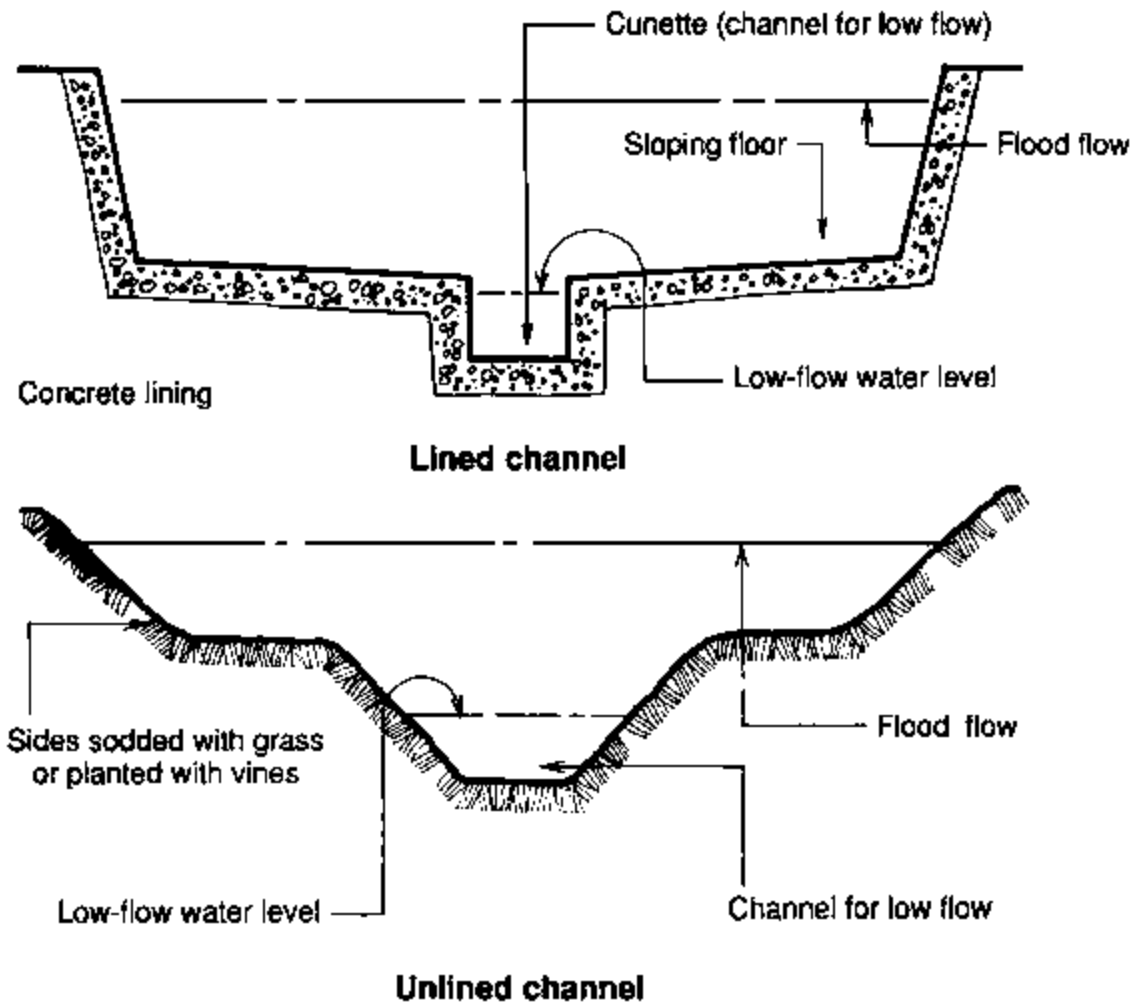


Fig. 9. Cross-sections of typical composite drainage channels

A self-cleansing speed of flow also requires a minimum slope, which is greater for small drains than for large ones. Roughly speaking, a channel 10-15 cm wide will need a minimum slope of about 1 % to achieve a self-cleansing speed of flow. A channel twice the size needs roughly half the slope. Such minimum slopes are not always achievable, though, as there may not be a sufficient drop in level from the street to the receiving water body. However well the system is designed, some sediment is bound to be deposited, so that regular cleaning is essential to keep the drains working.

## 2.5 Open or closed drains

Engineers and administrators often have a preference for closed drains rather than open channels, probably because they are more accustomed to them. Yet closed drains have several disadvantages:

(a) They cost more to build, because they require deeper excavation, must withstand heavy loads on the street overhead, and also require expensive additional works such as manholes and inlets.

(b) Construction defects, deterioration and accumulation of debris or sediment are more difficult to monitor than in an open drain.

(c) The design, construction and maintenance of closed drains require more sophisticated engineering techniques.

(d) Since closed drains are laid beneath the ground, a smaller drop in level to the receiving water body is available to obtain a sufficient minimum slope to ensure self-cleaning flow speeds.

(e) Mosquito breeding in closed drains is more difficult to control.

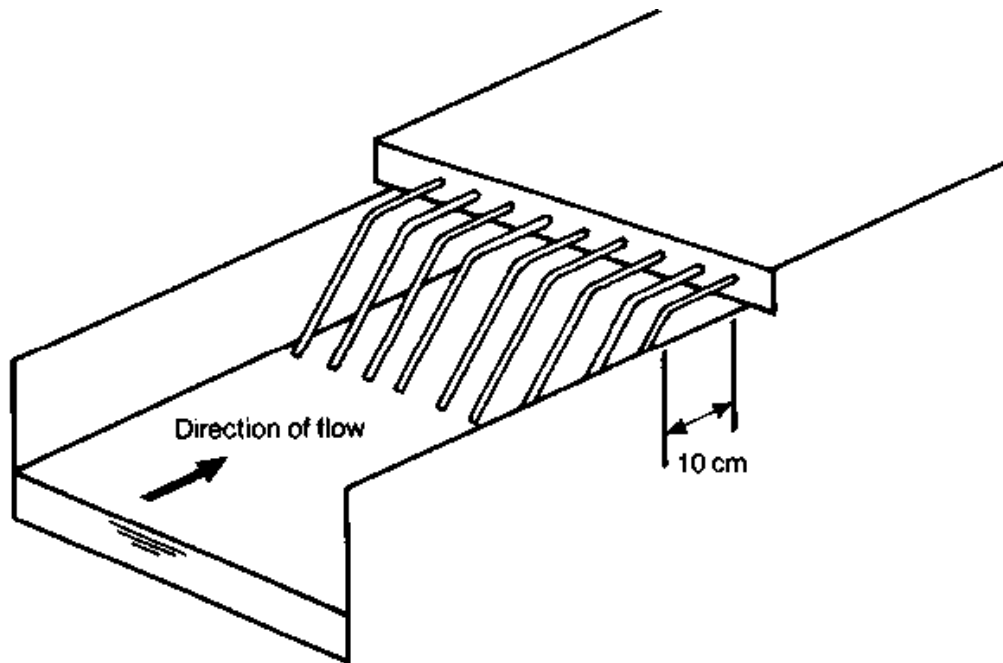
(f) Slowly-moving sewage produces gases that can attack cement and concrete in a closed drain if it is not well ventilated.

The main advantage of closed drains is that they do not take up surface space. They also reduce the risk of children playing in or falling into polluted water, and the possibility of vehicles damaging the drains or falling into them. It is nevertheless a fact that open drainage channels are used and maintained in good hygienic and aesthetic conditions in sophisticated cities such as Amsterdam and Singapore. Closed drains should be built in low-income tropical areas only after very careful consideration of the other options.

If open channels are built, careful thought should be given to the question of access bridges across them to adjoining properties, for people and vehicles. Without such provision, residents are likely to place stepping stones in the drains, fill them with earth or obstruct them in other ways. The worst option is a drainage system that is partly open and partly closed, so that rubbish thrown into the open section blocks the closed sections, where it is harder to remove. Water dammed up behind the blockage provides a shady stretch of polluted standing water in which mosquitos can breed prolifically.

Some short covered sections are almost inevitable, however, at road crossings and under access bridges. An iron grille should be placed at the upstream end of each such section to keep out solids. If these are made as shown in Fig. 10, then it will be easier to remove the accumulated debris by pulling it up the bars with a rake.

The bottom level of a covered section should not be any lower than the bottom of the channel downstream of it. Otherwise water will stand in it, enabling mosquitos to breed, and it will also be likely to become blocked with silt. If the pipe is of large diameter and if protecting it from damage by traffic would entail burying it at a level lower than that of the channel downstream, then an alternative is needed, such as a wide, shallow culvert (e.g., a reinforced pipe) protected with a concrete slab cover.



**Fig. 10. A type of grille which can be cleaned easily with a rake**

It is sometimes a conventional practice to build a small basin, called a silt trap, at the entrance to a closed section. However, in most low-income areas these fill very quickly with sand or rubbish, so that they are of little use in practice. Because they are also breeding sites for mosquitos, they should be avoided.

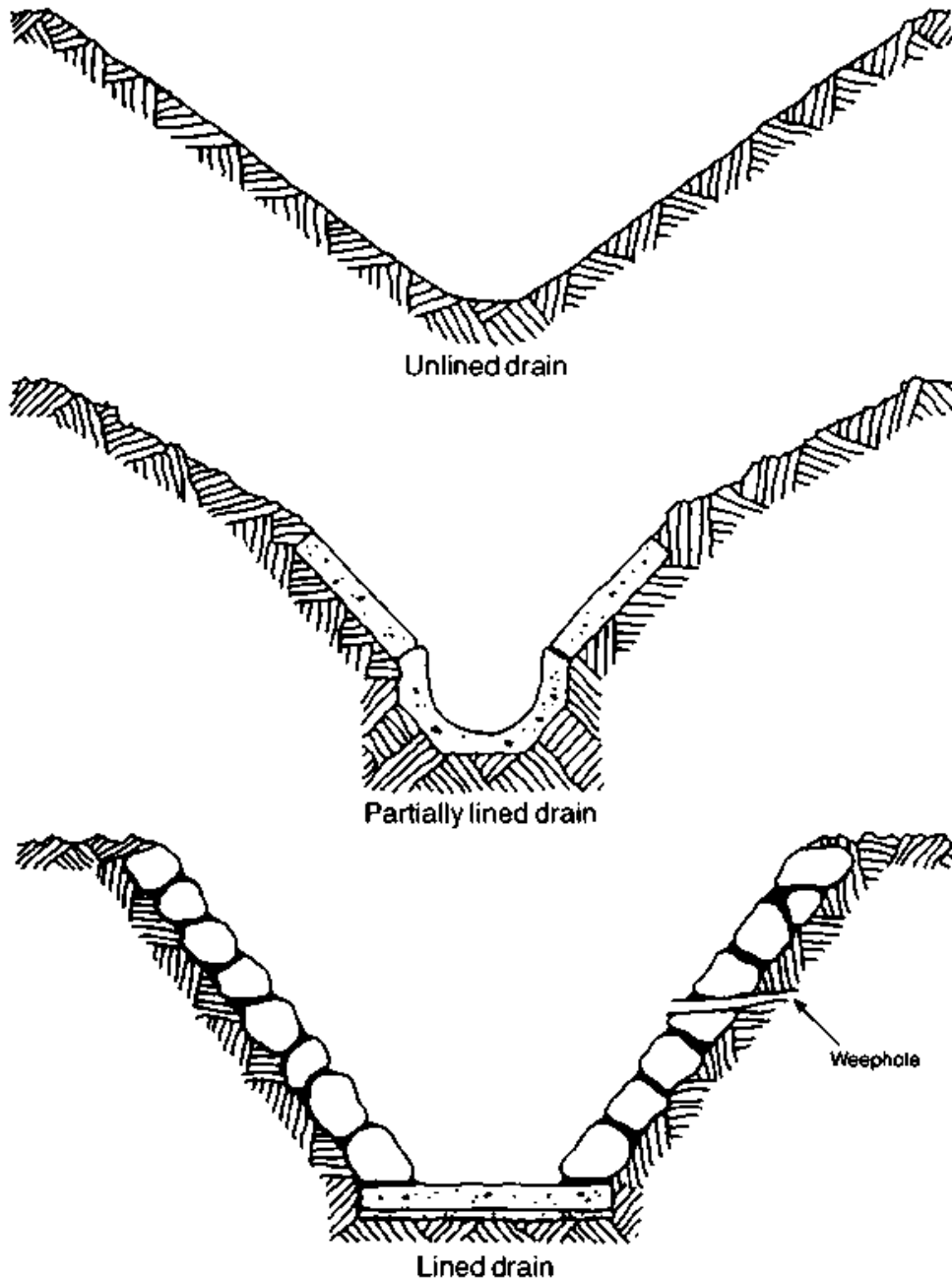
## **2.6 Channel design and construction**

The cheapest drains of all are unlined channels, which can be cut along the roadside with a road grader. The sides of an unlined drain should not slope by more than 1 in 2 to ensure that they will be stable. If the slope along the drain is greater than about 1%, the drain may be damaged by scouring, and some lining will usually be required to protect the channel bottom from the fast-flowing water. For slopes of 1-5%, partial lining is likely to be sufficient and will cost less than complete lining (Fig. 11). In a partially lined drain, special protection is needed at the most vulnerable points, such as culverts, drain junctions, sharp bends, and steep sections.

Another cheap measure, especially suitable for the upper part of a partially lined channel, is to lay turf or sow grass, whose roots will help to hold the soil in place. The most satisfactory grasses are those that spread sideways and cover the surface of the soil. Their rapid growth can be encouraged with fertilizer, by laying topsoil, and by building temporary checkwalls to cause silt to be deposited.

For relatively gentle slopes, the lining does not have to be of solid concrete or masonry. Compacted gravel or stone will be sufficient. Various types of permanent and temporary lining are shown in Fig. 12. Drains with vertical sides always need a lining to support the sides. As this type of channel is used only when space is in short supply and when the drains have to pass close to houses, the lining must be strong enough to protect adjacent house foundations.

Lined drainage channels often fail because the lining does not allow water to enter from the ground at either side. Either this causes water pressure to build up and overturn the linings, or the water runs alongside the drain, cutting a parallel channel. The solution is to provide weepholes, about 10 mm in diameter, in the lining at the sides. This can be done with short lengths of pipe running horizontally through the masonry and embedded in the mortar, spaced at intervals of not more than 1 m.

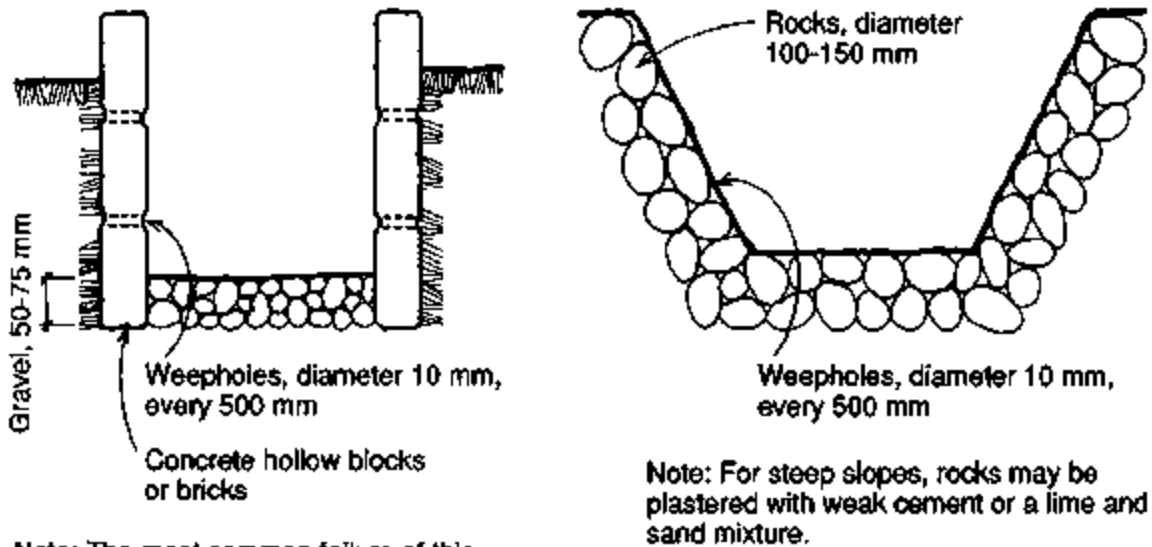


**Fig. 11. Cross-sections of typical unlined, partially lined and lined drains**

In very narrow streets where heavy vehicles do not pass and space is at a premium, the road itself may be designed to function as a drain (Fig. 13). This is possible only if the slope is less than 5% and if the road has a surface such as compacted gravel or

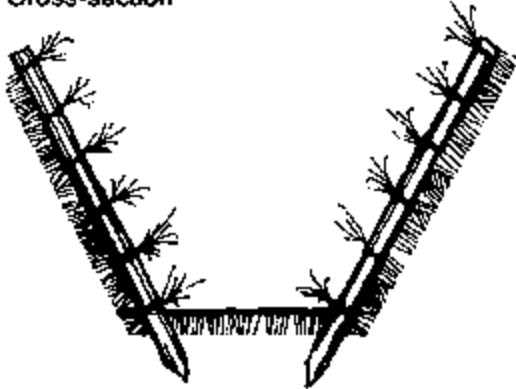


stone to protect it from erosion. Alternatively, drainage channels may be provided with removable covers (Fig. 13), which should have holes or notches in them to enable water to enter and make it easier to remove them to clean the drain beneath. The latter approach can also be used on very steep sections, with a series of prefabricated channel elements laid as a stepped drain beneath a pedestrian stairway. Fig. 14 shows a design of this kind used in the city of Salvador, Brazil.



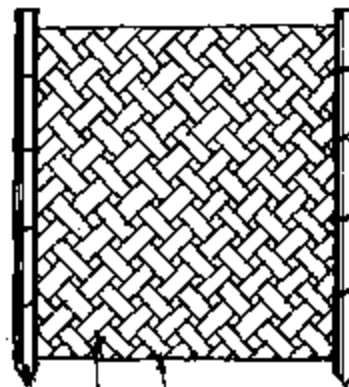
Note: The most common failure of this type of lining is due to the omission of weepholes.

Cross-section



Note: Temporary lining to hold newly excavated soil; plant with grass or place over turf sods to improve soil stability.

Side view



Wood or bamboo lattice, soaked in oil to minimize rotting

Grass planted through holes

Bamboo stakes, diameter 25-75 mm, spaced at intervals of 1 m

Fig. 12. Types of drainage channel lining

The smallest channels, less than 300 mm deep, do not need weepholes, and can conveniently be lined with brick or with precast concrete elements (Fig. 15). Elements

should weigh less than 50 kg, so that they can be carried and laid in place by two persons without machinery. Precast channels should preferably be laid on a bed of compacted sand, 50 mm thick. A single channel size can be adapted for larger flows by laying it deeper and building up the sides with masonry.

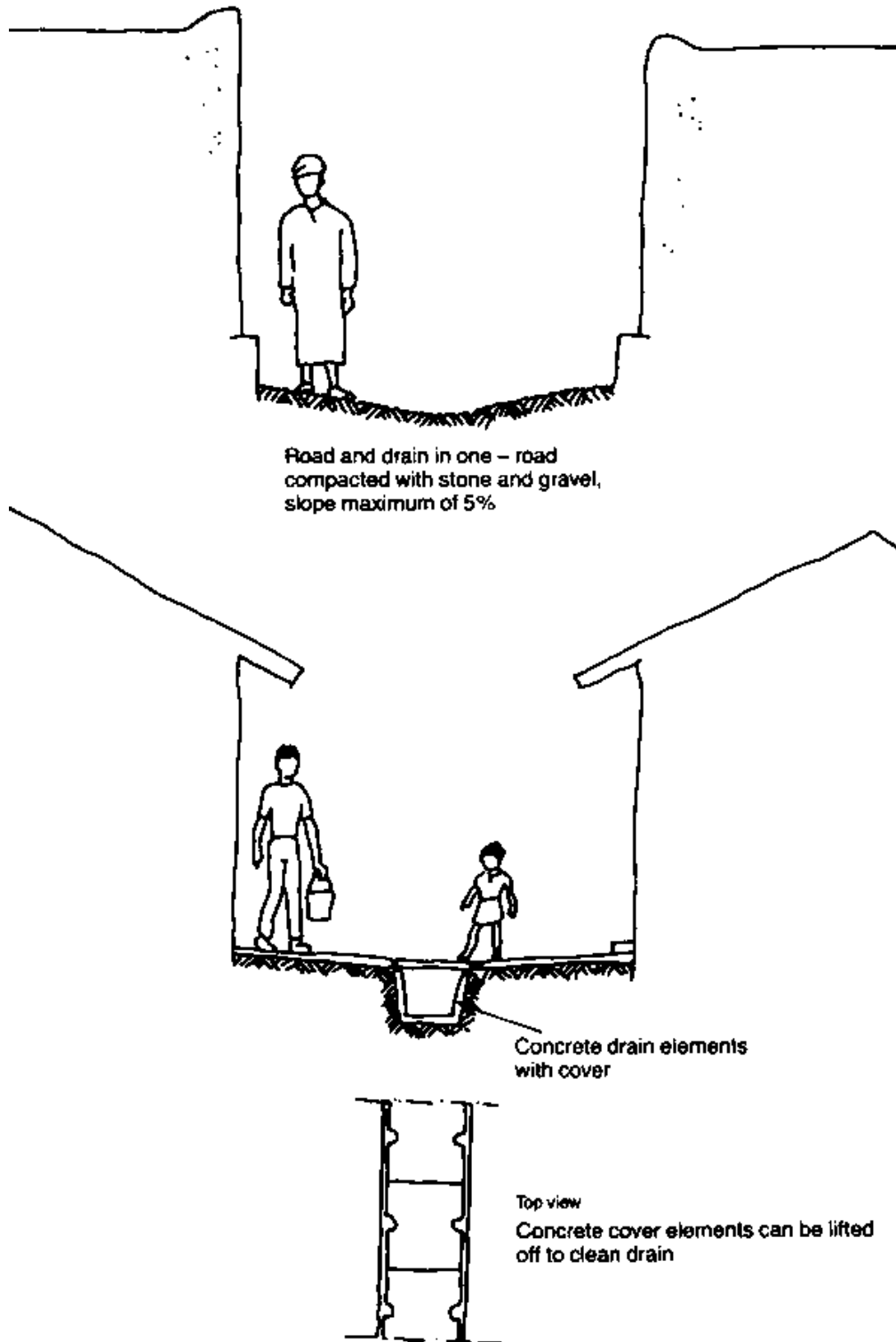
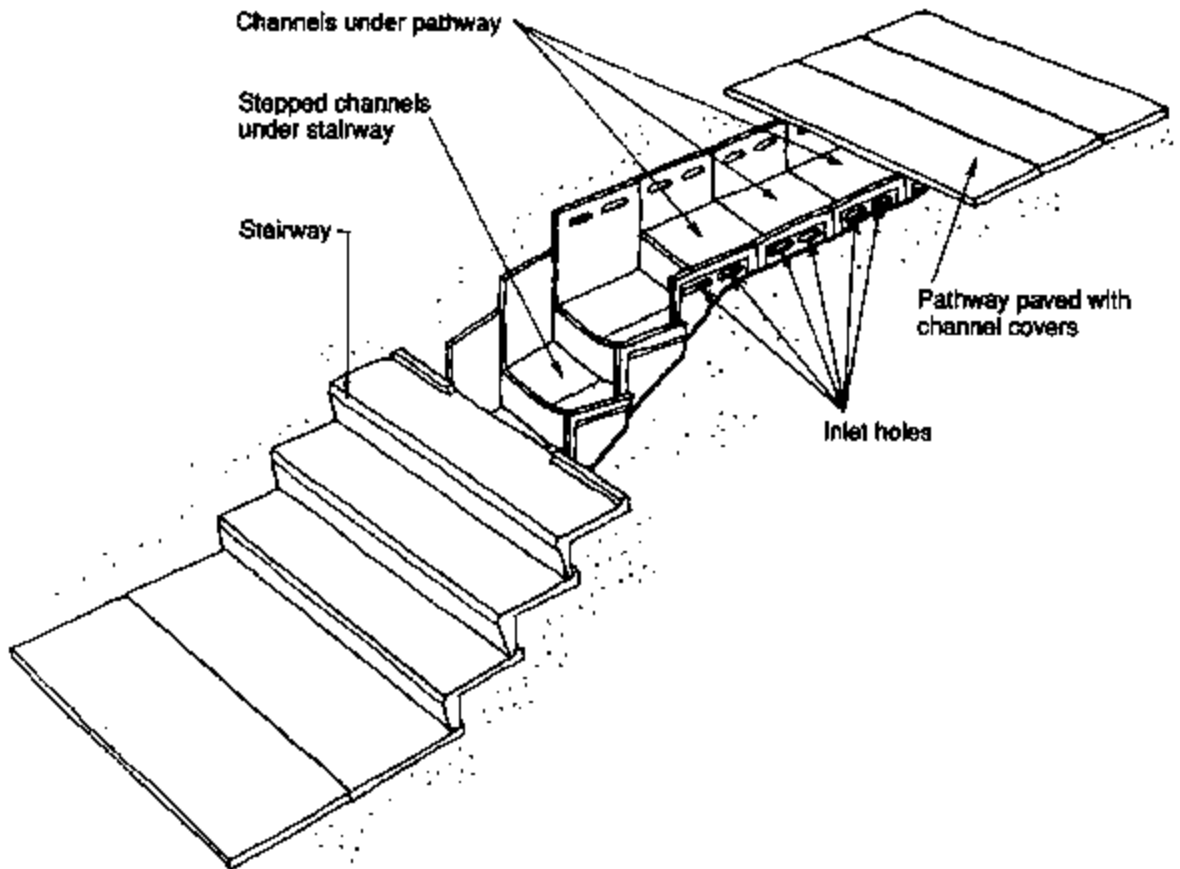


Fig. 13. Combined drains and pathways

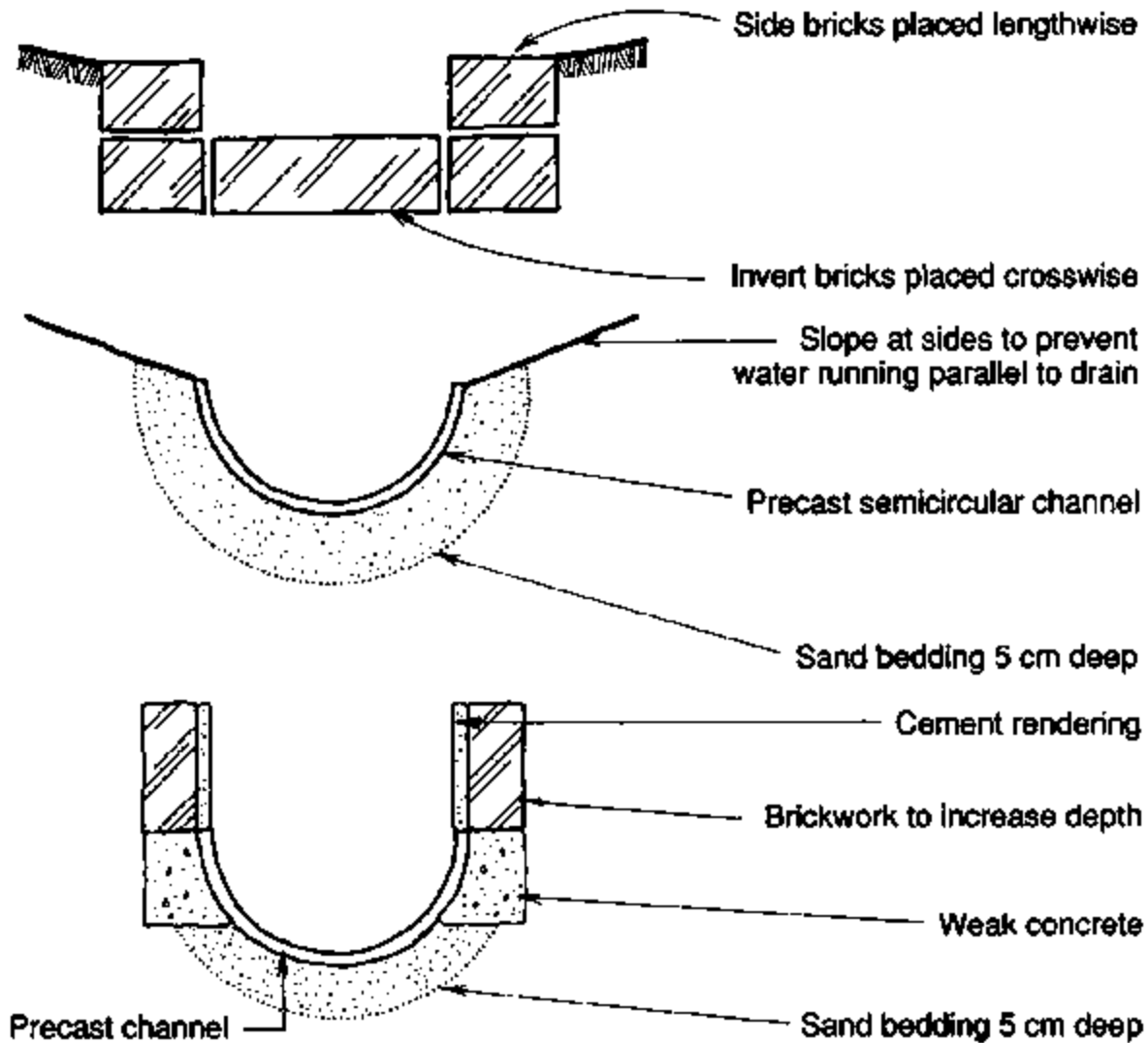
Prefabricated elements have the advantage over masonry or *in situ* concrete linings in that they can be laid relatively quickly. Masonry drains take a long time to build, and concrete poured in place requires several days to set. Meanwhile, local traffic is disrupted, and the fresh masonry or concrete can be ruined by a sudden downpour of rain. If the drains are built in the dry season to avoid an unexpected rainstorm, there may be a shortage of water to cure the concrete in place. In a covered workshop, elements are protected from the sun and rain, water for curing can be made available, and quality control is easier and better than in conventional construction work.



**Fig. 14. Combined footpath and drain made of prefabricated elements, as used in Salvador, Brazil**

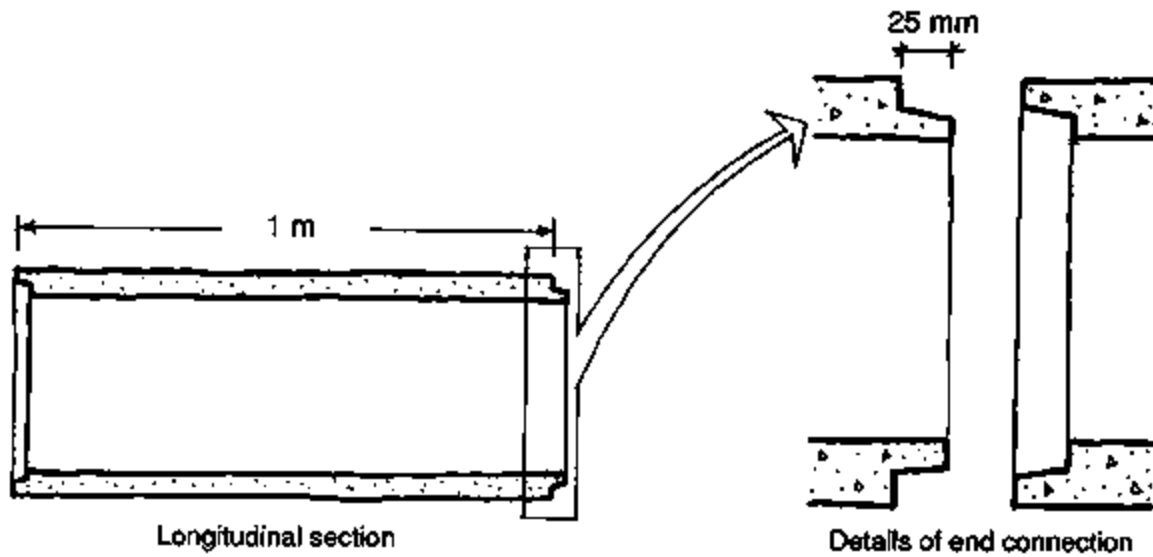
## 2.7 Closed drains

A common type of closed drain is constructed from prefabricated sections of cement pipe, typically 1 m long and 50 mm in diameter. A tongue on the end of each section fits into the next, ensuring that they are properly aligned (Fig. 16(a)). If closed drains are used to convey sewage as well as rainwater the drainage system is known as a combined sewer system, and another kind of pipe connection is normally used to prevent the sewage from leaking out and contaminating the groundwater (Fig. 16(b)).

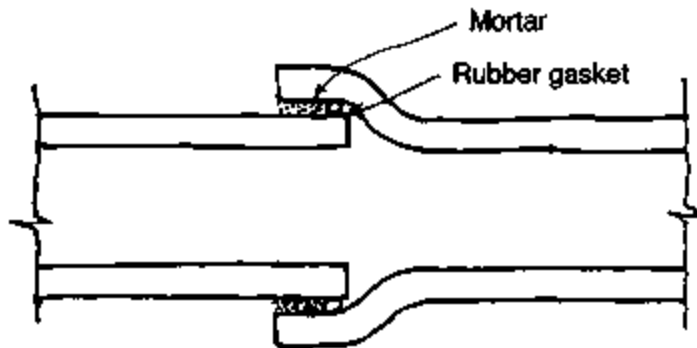


**Fig. 15. Cross-sections of three types of small open drain**

The trenches in which pipes are laid are normally dug at least 0.5 m wider than the pipe diameter, and deep enough for the top of the pipes to be covered with at least 1 m of soil. Before the pipe is laid, a 50-mm thick bed of sand is placed in the trench, compacted and carefully levelled to give an even slope. The pipes are laid over the sand and a spirit level is placed on each pipe to check the evenness of the slope. Then more sand is added and compacted beneath and around each pipe until it is half buried. Finally the excavated soil is replaced in layers 150 mm thick, each of which is compacted carefully. The purpose of the sand bedding and the minimum depth of 1 m is to protect the pipes from damage by heavy vehicles passing over them. In areas with only very light vehicular traffic the sand bed can be omitted and the pipes laid at shallower depth.



**(a) Normal reinforced cement pipe for drainage**



**(b) Bell and spigot arrangement for reinforced concrete pipe in combined sewers**

**Fig. 16. Jointing of reinforced concrete pipes**

A closed drainage system must be provided with inlets for the water to reach it from the road surface. These should be covered with a grille to prevent leaves and other coarse solids from entering and blocking the system. One inlet is usually provided every 30-50 m along the road, depending on the slope and rainfall intensity. For the same reason that silt traps are not recommended (see section 2.5 above), gully pots should not be provided at drain inlets.

To facilitate cleaning and maintenance, manholes should be provided at intervals of 120-150 m for pipes of more than 0.6 m in diameter, and 70-100 m for smaller pipes. They are also required wherever the pipes change in diameter or direction, and at intersections. Further details on the design and construction of closed drains are given in standard works on sewerage.

## 2.8 Construction

Building a drainage system requires skilled supervision, but many tasks can be done by the community. They include:

- excavation work (digging);
- transport of soil, water, sand and cement;
- compacting of soil or sand in the drain foundation;
- prefabrication of drain elements;
- watering and curing of drain elements;
- transport and storage of drain elements;
- accounting for drain elements and guarding them;
- finishing and planting of embankments;
- providing food for volunteer workers.

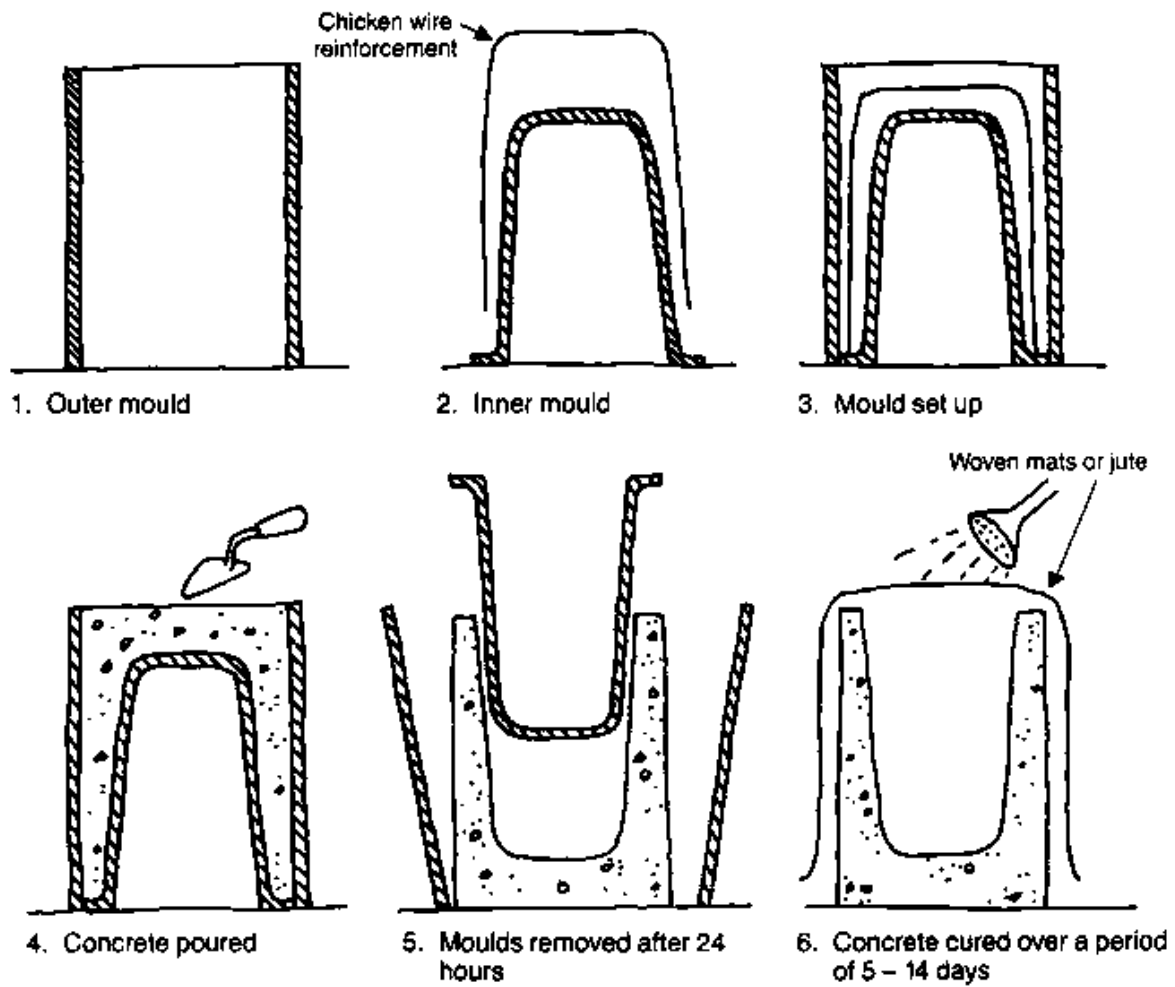
Most of these tasks require little special skill and can be done after an hour of instruction. The only task requiring real training is the production of prefabricated drain elements.

The prefabrication of drain elements can easily be learnt by semiskilled community members, for whom it may also prove to be an attractive method of income generation. In many cities there is a ready market for prefabricated elements of this type.

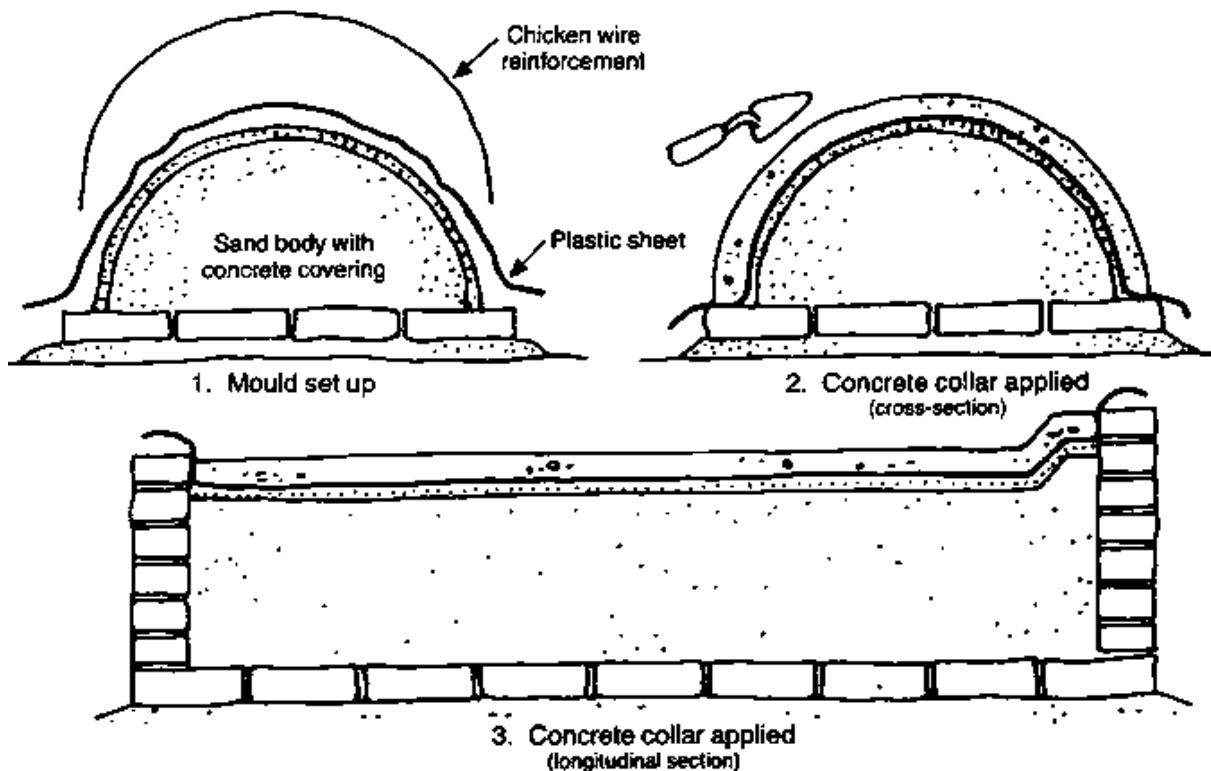
Two simple prefabrication methods are shown in Fig. 17. The first was developed by the National Housing Authority of Thailand and offered to small contractors. The other type of element was designed by the Roorkee Research Centre in India and was intended to form the bottom part of shallow, partially lined drains, although it can be used as a small drain on its own, as shown in Fig. 15. The mould is covered by plastic sheeting or oiled newspapers before the reinforcement and cement mortar are placed on it. A wooden board with a semicircle cut out of it is moved along the channel to ensure that the mortar has the correct thickness.

The purpose of the reinforcement is to prevent breakage during transport of the elements, so that if they are not to be taken long distances the chicken wire can be replaced with cheaper alternatives such as sisal or coconut fibre. This makes the element very flexible while the mortar is still wet, so that a third casting method can be used. The mortar is placed on a plastic sheet while it lies on a flat surface. A rectangular wooden frame lying on the sheet is used to give the layer of mortar the right length and width. The vegetable fibres are spread on the mortar when it has been placed to half the final thickness. When all the mortar is in place, a straightedge is used across the frame to ensure that it has an even thickness - the depth of the wooden frame. Finally, the frame is removed and the plastic sheet is lifted up by two wooden battens previously fixed along the sides, and draped over a semicircular concrete channel used as a concave mould.<sup>1</sup>

<sup>1</sup> HILLMAN. E. Pre-fabricated fibre-reinforced cement irrigation channels, *Waterlines*, 4 (4): 22-25 (1986).



(a) The Bangkok drain element



(b) The Roorkee drain element

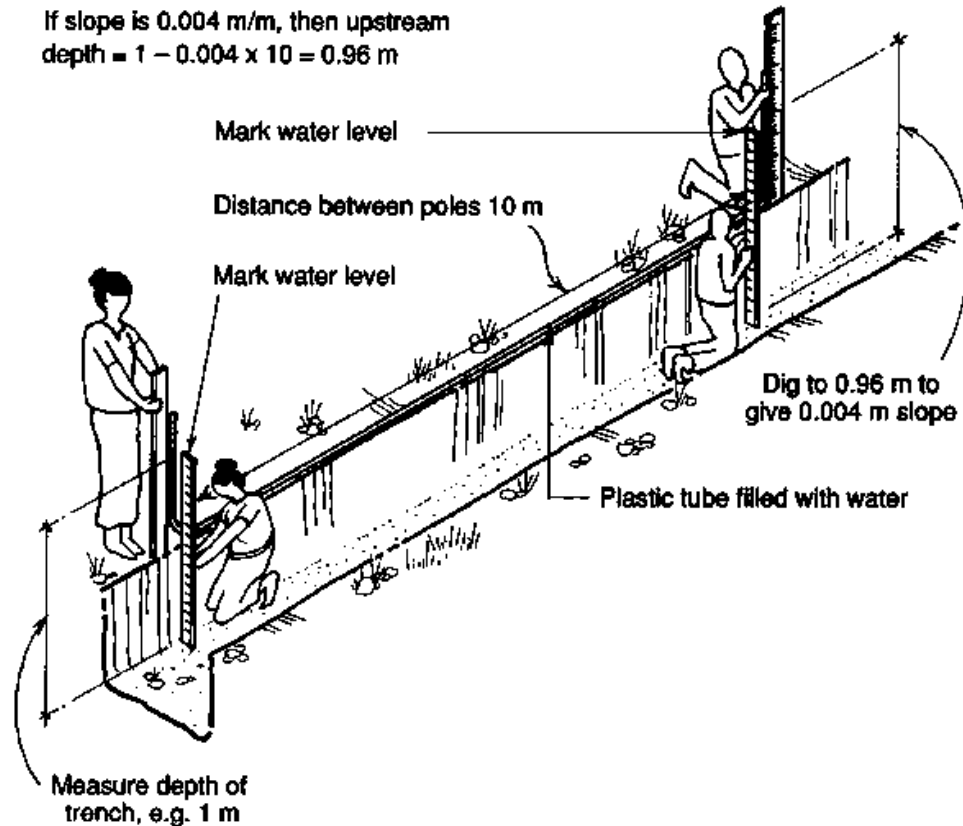
### **Fig. 17. Methods of casting prefabricated drainage channel elements**

After two days of setting, the elements are removed from their moulds and cured for 5-14 days so as to strengthen the concrete. As the objective of curing is to prevent rapid evaporation of water from the surface, curing is best done by placing the elements in a tank filled with water. However, it is also acceptable to cover the elements with mats or fabric which are then sprayed every evening with water, or otherwise kept wet, for at least five days.

Construction should always start from the downstream end. This keeps the working area dry and makes it easier to check the slope. Checking the slope by eye is risky. Simply checking that water flows away down the newly-laid drain will ensure that it slopes the right way, but in flat areas it may lead to the drain being laid at too steep a slope, making it impossible to maintain an adequate slope further upstream.

If surveying equipment is not available, a simple alternative is a long plastic hose filled with water (Fig. 18). Make sure there are no bubbles in it, and lift up both ends. The water level at each end of the hose will be the same. If a slope of, for instance, 0.4% (0.004 m/m) is desired, this means a difference in level along a 10-m length of drain of  $0.004 \times 10 = 0.04$  m. If the hose is held so as to keep the water level 1.00 m above the bottom of the trench at the downstream end, the bottom should therefore be 0.96 m (1.00 - 0.04) beneath the water level at a point 10 m upstream. The same method can be used to check the level of the drain elements when they are laid, using a piece of string to check their horizontal alignment. A spirit level should be used to check the slope of individual elements.





**Fig. 18. Laying drains to an even slope using a water hose level**

It is not advisable to use such simple methods when laying closed drains. A trained surveyor with proper surveying equipment is required.

The community's role in drainage construction can be considerable (Fig. 19), but municipal authorities cannot rely on such community participation to work smoothly in all cases, especially if unpaid work is involved. If a contractor has been engaged for the construction work, he or she may prefer to use his or her own staff so as to maintain control of the construction schedule. If the contractor has to wait for the community to get organized, the municipality may be charged for overheads and staff salaries incurred during the delay. It is often preferable to write into the contract an obligation to give priority to hiring local people and to training a local maintenance team.

If the community is to participate in construction, substantial effort must be devoted beforehand to mobilizing community members and organizing their contribution, and their advice and agreement must be sought from the beginning of the planning stage.

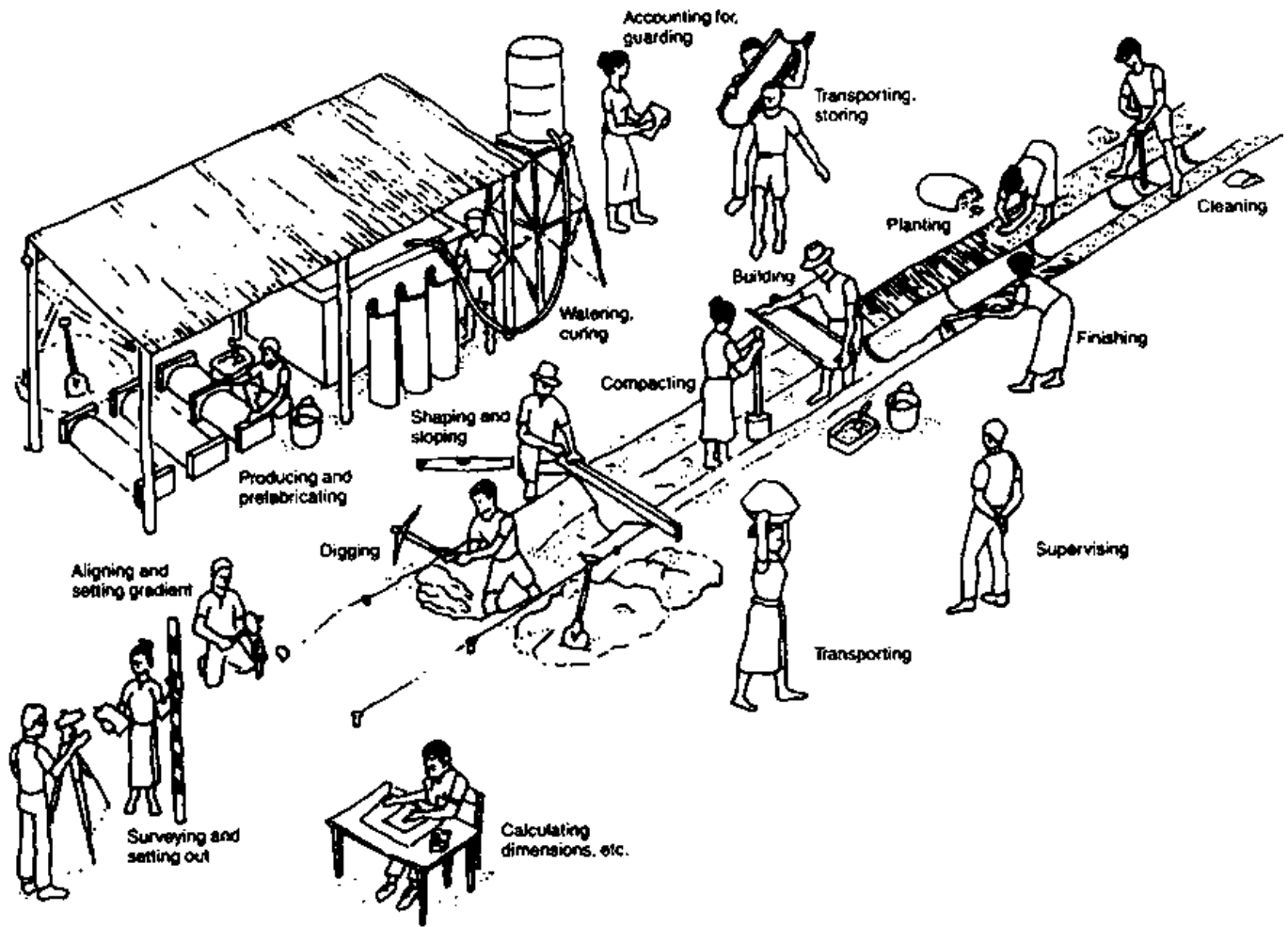


Fig. 19. Tasks in drainage construction

A drainage scheme which is not accepted by the community is sure to fail. Community participation is discussed in further detail in section 4.

## 2.9 "Do-it-yourself" drainage

Ideally, a community drainage scheme should be developed with a local authority or other body which has the capacity to provide engineering expertise. However, some communities may wish to undertake some improvements if they prove unable to obtain such technical assistance, or while waiting for it to materialize. This section suggests how they might do so, taking advantage of the residents' ability to monitor the results of their work and make progressive modifications in subsequent years.

The following initial steps (a)-(g) are recommended to any group or individual wishing to plan a drainage scheme. No specialized training is needed to carry them out. Engineers carrying out initial studies may also find them useful as suggestions. For steps (h)-(m), it is desirable to have the help of an engineer.

(a) Before you start your survey, it will be wise to obtain a map of the area. Maps are usually obtainable from the city planning department, the land registry or the national

survey department. If no up-to-date map is available, you can use aerial photographs, or a tracing made from an original photograph. Quite suitable photographs for this purpose can be taken with an ordinary camera from a small aeroplane, flying at a height of about 600 m. At this low altitude, survey flights can be done under any reasonable weather conditions. The shadows cast by clouds will not interfere with interpretation of the photographs. As a last resort a sketch map can be made; the section on plane table methods in a book on surveying will describe how this can be done without sophisticated equipment.

The map should be of a convenient scale, preferably at least 1:5000. A scale of 1:1000 is best. A map that is of too small a scale can be expanded with a pantograph, or by dividing it into squares and copying it on to larger squares. You can then sketch in details, visiting the area to see if any features are missing or need to be changed.

(b) Walk around the area. Ask the residents about the probable causes of recent flooding or landslides. Residents may not have a technical background, but they can usually identify the source of the water that caused the problem. Long-standing residents may even be able to relate flood or landslide problems to particular events in the past, especially to major civil works carried out in the vicinity, such as the building of road or railway embankments or cuttings, or the filling in of depressions.

(c) Try to establish the water levels reached during a specific flood. Residents can describe the depth in terms of their anatomy (ankles, knees, waist) or by pointing to parts of their fence or house. Marks from a flood may still be visible on walls. Use a tape measure to express this as a depth in centimetres, and write each measurement on your map of the area at the appropriate point. Since water finds its own level, these measurements will give you a good idea of the topography of the area; the greatest depths will be in the lowest-lying areas.

(d) Note the natural direction of flow of wastewater from houses, and of surface water from rainstorms. Mark existing lines of drainage on the map, including both natural streams and man-made channels, noting problems such as stretches of channel blocked by garbage, eroded sections, areas of standing water, and landslides. Make a note of structures built along the waterways which could obstruct drainage or prevent future widening.

(e) Note the discharge point and the water level in the receiving stream, river or sea. Ask the residents about water level fluctuations in the receiving water body, particularly the maximum water levels reached in the last few years and, if possible, the dates on which they occurred. If the receiving water body is a river, the water resources or hydrology department may be able to help, particularly by giving you the dates and probable return periods of major floods, which you can then compare with witnesses' accounts of which areas were flooded on those occasions. If the receiving water is the sea, the local port authority can provide tidal tables. The highest tides normally occur in March/April and September/October.

(f) Prepare a sketch of the drainage improvements most urgently needed, showing where expansion of existing channels is required, where new drains will have to be dug, and where protection against erosion is to be provided in steep areas. Drains should as far as possible follow existing or planned road and path alignments. Nevertheless, some existing structures may have to be moved, and these should be marked on the sketch map. Fig. 20 shows the result of steps (a)-(f) in a particular community.

(g) Call a meeting of the residents and present the proposed scheme to them for their suggestions and approval. Their intimate knowledge of the area puts them in a good position to offer practical advice.

(h) Design the initial improvements. In the absence of the information or technical assistance needed to make detailed design calculations, it is best to start with unlined channels for flood control and boulder checkwalls (or dissipators) to control erosion.

Unlined channels 0.3 m wide are a useful size for the small branches along individual streets and alleys; if they prove to be too narrow, they can be widened at a later date. A close look at existing lines of drainage, including natural channels and especially constrictions which cause water to back up behind them during storms, will give a good idea of the best size for the major drains. If in doubt, channels 1 m wide would be a convenient size to start with.

For steep areas, large boulders, preferably at least 30 cm in diameter, can be used to build dissipator checkwalls held in place by wooden stakes (see Fig. 7, page 18). If the boulders are washed away, it may be possible to collect them and pack them in gabions. The spaces between the stones should not be blocked with mortar, as this will only deflect the direction of the water flow, causing erosion at another point. It is better for the water to flow between the stones, dissipating its energy as it does so.

(i) Excavate the channels, starting from the downstream end and working upstream. To drain flat areas, fix the downstream end of the system at the lowest level possible without its becoming submerged by a typical flood of the receiving water body, even if this means water may flow some distance up the channels at high tide. The slope should be carefully controlled using a water hose (see section 2.8). As a start, a rise of 0.2 m for every 100 m would be a reasonable minimum slope for a channel that is 1 m wide, and 0.5 m for every 100 m in a channel 0.3 m wide. If the slope of the ground allows it, a greater slope is better. If the slope is greater than 5 m in every 100 m, place checkwalls as soon as possible after excavating the channel, one for every 1-m drop in level.

(j) Once the channel has been excavated, visit after rain has fallen and note which sections contain standing water. These are low points. Either raise the bottom level by backfilling with gravel or soil, or deepen the bottom downstream so that the water can flow away. Look also for early signs of future erosion, such as water bypassing the checkwalls or running parallel to the channel.

(k) Add a temporary lining if desired, such as the wood or bamboo lining shown in Fig. 12, page 26. Temporary screens to hold back rubbish can be installed across the smaller channels using wood or bamboo stakes, with gaps of 20-50 mm between them. Allocate responsibilities for weekly cleaning of each screen and organize a monthly work party to clear the major channels.

(l) Monitor the system's functioning during at least one wet season, noting areas of scouring, overflow, stagnant water, silt deposition, or other problems. Water will tend to erode and deepen a channel if it is too narrow and steep, and to deposit silt if it is too wide and the slope is insufficient. Fig. 21 shows some of the changes that can occur in a typical unlined channel, and how they can be used to diagnose the need for suitable measures.

(m) After one or two years, the channel sizes and slopes should be more or less established. The community may now decide to line the channels, build permanent bar screens, road crossings, checkwalls, etc.

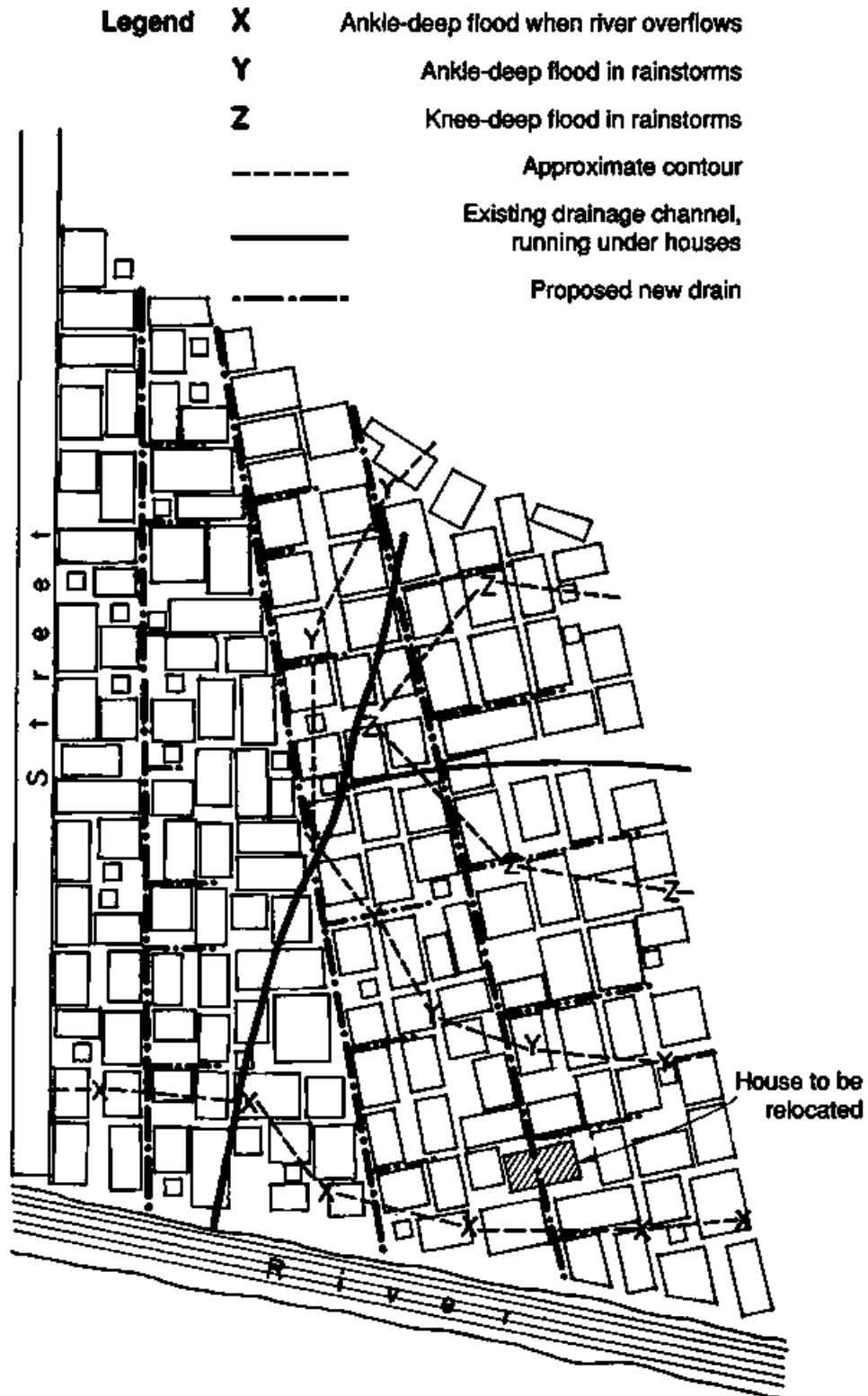


Fig. 20. Sketch for planning a drainage system

**Cross-section after one year**



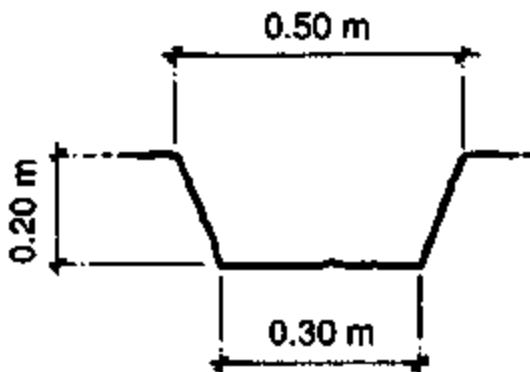
**Cause:** Canal cross-sectional area too big;  
slope too steep

**Action:** Add dissipator if too steep, otherwise  
adding gravel, rocks, or a weak  
cement bottom will do



**Cause:** Canal cross-sectional area too small;  
slope too small

**Action:** Maintain regularly to remove silt; line  
sides; or enlarge channel



**Cross-section of original unlined canal**



**Cause:** Canal cross-sectional area too small;  
slope too steep

**Action:** Line or enlarge channel



**Cause:** Canal cross-sectional area too big;  
slope too small

**Action:** Remove silt and decrease cross-  
sectional area if necessary

Fig. 21. Troubleshooting - diagnosing problems in an unlined drainage canal

## 2.10 Selected reading

CHATTERJEE, S. & BHUNIA, A. K. Drainage problem of metropolitan Calcutta and its solution. *Journal of the Institution of Civil Engineers (India)*, **50** (10, part PH3): 83-92 (1970).

HILLMAN, F. Pre-fabricated fibre-reinforced cement irrigation channels. *Waterlines*, **4** (4): 22-25 (1986).

MANOHARN, S. Application of ferrocement drainage flume in slum upgrading. *Journal of ferrocement*, **12** (4): 373-383 (1982).

OKUN, D. A. & PONGHIS, G. *Community wastewater collection and disposal*. Geneva, World Health Organization, 1975.

SHARMA, P. C. & KUMAR, A. Ferrocement channels for small-scale irrigation. *Appropriate technology*, **9** (3): 7-8 (1982).

WATKINS, L. H. & FIDDES, D. *Highway and urban hydrology in the tropics*. London, Pentech Press, 1984.

## 3. Rehabilitation and maintenance

### 3.1 Causes of drainage failure

Some communities suffer from drainage problems not because they have no drains, but because the existing drainage system has collapsed, become blocked, or is otherwise in need of repair and rehabilitation. Many more will find that the nearest convenient point of discharge for a new drainage system is an existing primary drainage pipe or canal that needs attention if it is to function properly.

Collapse and blockage are the principal types of drainage failure. Each of these can have several causes. Collapse of drains can occur through:

- erosion of the bottom and sides of the drain (scouring);
- excessive pressure of water in the ground beneath and beside the drain lining;
- vehicles passing over or too close beside the drains;
- root growth, especially from nearby trees;
- crown corrosion in closed drains containing sewage.

The causes of blockage can be:

- accumulation of refuse, leaves and earth in the drain;
- structures such as houses or bridge piers erected in the drain and obstructing the flow;
- excessive vegetation growing in drainage channels;
- silt deposited in low sections owing to misalignment or where the slope is insufficient and cleaning is not regular enough.

If rehabilitation of a failed system is to have a good chance of success, diagnosis and elimination of the original causes of failure are required as well as treatment of the immediate symptoms. Each possible cause of collapse has its cure.

(a) *Erosion* in an unlined channel is illustrated in Fig. 21 (page 39) along with the appropriate remedies. In a lined drain, erosion can mean the lining itself is not robust enough, and a more resistant lining is needed. A common weak point is at the joints between channel or pipe elements, which should be sealed with cement mortar. Where the slope is greater than 10%, baffles or steps of some kind are needed (see Fig. 6, page 17). Scouring on the outside of a channel lining can mean that water is not entering the drain but running parallel to it. If the lining rises above ground level, it needs notches in the sides so that the water can flow in. Small earth banks running diagonally across the road will also help to divert water to the drain at the side. Alternatively, scouring beside the drain can mean that it overflows during storms, indicating that more frequent cleaning, a larger drain, or more frequent turnouts are required (see Fig. 5, page 16). In closed drains that are overloaded, water can escape into the ground through the joints owing to the pressure inside the pipe. When the pressure drops, the water runs back into the drain, carrying soil with it and excavating a cavity over the drain which will eventually collapse. The solution is to seal the joints with cement grout or, preferably, to build a larger drain.

(b) *Water pressure* from the outside or pressure resulting from the swelling of clay can be controlled by using a sand bedding (see Fig. 15, page 29) and providing weepholes in the lining (see Fig. 11, page 25).

(c) *Vehicles* can easily damage open drains. If vehicle damage recurs frequently, the drains should be protected by some form of barrier such as a rail or a kerbstone. If the damage is due to vehicles attempting to cross the drain, then an adequate vehicle crossing should be built over it. Vehicle damage to covered drains indicates that they should either be laid deeper or be protected by concrete.

(d) *Roots* from nearby trees will tend to grow into drains, especially if they contain standing water and the linings are not impermeable. The most effective protection, if the problem persists, is to remove all trees within 5 m of the drain.

(e) *Crown corrosion* occurs in closed drains containing sewage, where gases from the sewage can attack and weaken cement, particularly over the crown or cover of the drain.

The cures for most of the causes of blockage are fairly easy to see: collection of refuse, removal of structures, and clearing of vegetation. If the drains have an even and adequate slope, it should not be necessary to remove silt; clearing the vegetation, whose roots hold the silt in place, should enable the next heavy flow in the drain to wash it away.

However, the slope is not always even. The drain may have been badly laid, the sand bedding beneath some sections may have been eroded causing them to sink, or the lack of weepholes or a sand bedding may have caused the lining to be lifted by the pressure of water from the surrounding ground. Uneven settlement of the ground is common in flat areas of clay soil, and is another cause of uneven slope. Damage by vehicles and earthquakes can also cause distortion, or even misalignment of sections of drainage channel or pipe, resulting in blockage by sediment or other solids. In such



cases, the drains should be rebuilt to an even slope, although slight irregularities can be corrected by filling in the depressions with cement mortar.

Finally, the drain itself may be in good condition, but may fail to function correctly owing to insufficient capacity. Even a drain that was large enough when built may prove to be too small for the increases in runoff flow which accompany increased building development in the catchment area.

### **3.2 Rehabilitation of existing systems**

There are many drainage systems in urban areas that are functioning imperfectly or not at all owing to one or more of the causes of failure listed in the previous section. Before a new system is envisaged, the first step is to ascertain whether a drainage system already exists and whether it can be rehabilitated. Local residents will normally know if one exists in their area, but they may not be aware of existing main drains, especially closed drains, which are outside their neighbourhood, and into which a future local micro-drainage system could discharge.

Municipal records, including old drainage master plans, should be consulted for details of any previous drainage construction in the vicinity, and the area should be visited on foot to check their accuracy and to look for tell-tale signs such as old manholes, or pieces of pipe or concrete exposed by erosion, especially along major streets and downstream of the area where better drainage is needed.

Remove cover slabs from drainage channels, taking care that there is no risk of pedestrians' or vehicles' falling into them accidentally. Starting at the downstream end, remove silt and solids. Special tools for cleaning channels are described in section 3.3. After clearing, flush the drainage line with water. The fire services may be able to help with this.

#### ***Inspection of closed drains***

The inspection of closed drains is more difficult and dangerous, and should be carried out under expert supervision. The first step is to draw a sketch map of the system, if record drawings are not available. The map should show all existing manholes, inlets and other drainage structures. If the gap between any two manholes is very long compared to that between most others, it is likely that one or two other manholes have been buried or destroyed between them. From the regular manhole spacing, it should be possible to calculate the most likely location of a missing manhole. Local residents, who may know of buried manholes, should also be consulted. The probable sites of missing manholes should be excavated, to uncover them.

No one should enter any manhole until it has been adequately ventilated. As a precaution, the manholes upstream and downstream of the section to be inspected should be opened at least two hours beforehand. To save time, a number of manholes can be opened simultaneously. Further ventilation can be achieved by introducing the air hose from a compressor, if one is available. Inspection should start as far downstream as possible, and work upstream. Water in flooded manholes should be pumped out to the next manhole downstream using a sump pump, of the type used by construction firms for excavations. Alternatively, the water could be baled out with buckets or removed with a siphon, but this is likely to take a very long time.

Once the manhole has been ventilated, a further safety check is necessary to ensure that it is safe to enter. A lighted candle or a miner's safety lamp is lowered into the manhole. If the flame dies, it means that there is insufficient oxygen inside and that anyone entering the manhole could be suffocated by the gases produced by sewage and sediment. However, no naked light should be used until the manhole has been ventilated, as it could cause those gases to explode.

A final safety precaution, no less necessary, is that no one should enter a manhole without a lifeline. A spare lifeline should be ready for use if necessary. Access steps in an old manhole are liable to be seriously corroded and much less secure than they appear. They are often slippery. At least two people should remain above ground to pull out the third member of the party in case of emergency. They should *never* follow the third member into the manhole, even in an emergency, as they could all be killed. Even if the manhole is properly vented, the person inspecting it should disturb the settled sludge and silt as little as possible. These sometimes contain poisonous gases, which could be released when the sediment is agitated. If a drain is completely blocked so that it cannot be inspected, material should be removed only from the upstream end. These safety precautions are illustrated in Fig. 22.

The alignment of a closed drain can be checked by two people in consecutive manholes using a flashlight and a mirror, as shown in Fig. 23. First the flashlight and the mirror are held within 5-10 cm of the bottom of the pipe (known as the invert), and then they are both raised to just below the crown. If there is any irregularity in the vertical alignment of the drain pipe, it will be detected in one of these positions, since it will obscure the flashlight beam. This procedure will also make minor defects and obstructions visible.

The most likely place to find cracks and misalignment is immediately adjacent to the manhole, owing to uneven settlement of the ground after pipe-laying (Fig. 24). Another problem to look for is crown corrosion, which can easily be discovered by attempting to dig into the pipe material at the sides and top with a penknife or a large nail.

Drainage pipes of less than 1 m in diameter cannot be entered safely, and great care should be taken in entering larger drains. The dangers include poisonous gas, cave-ins, sudden rushes of water from clogged sections or from storms, and even wild animals. Naked lights such as matches or candles should not be used in a closed sewer or within 3 m of any open manhole. A miner's safety lamp is preferable to a flashlight, to avoid the risk of explosions.

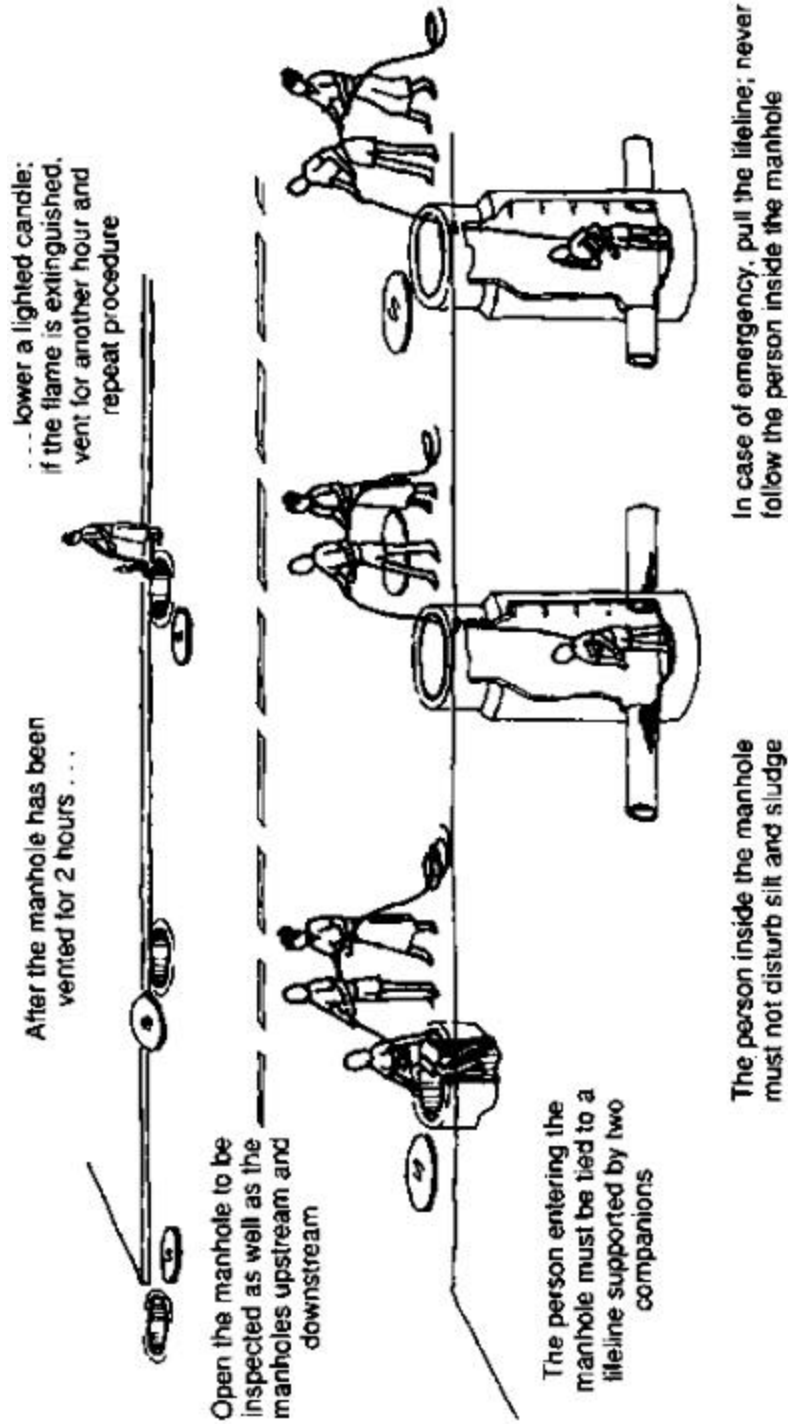
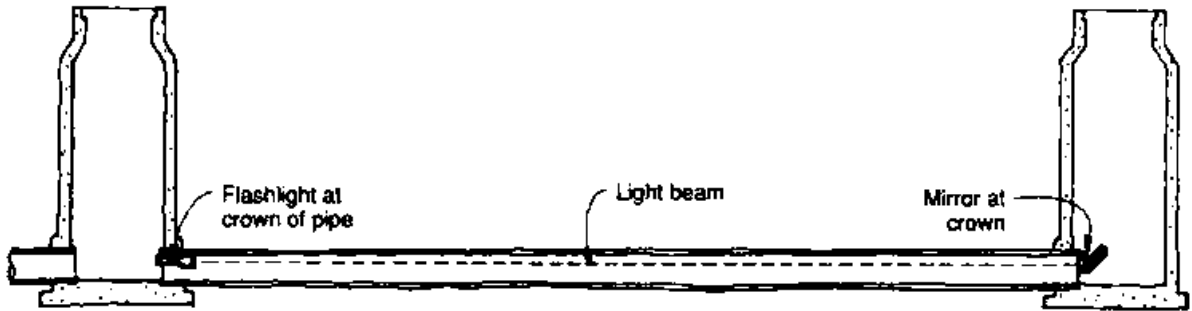
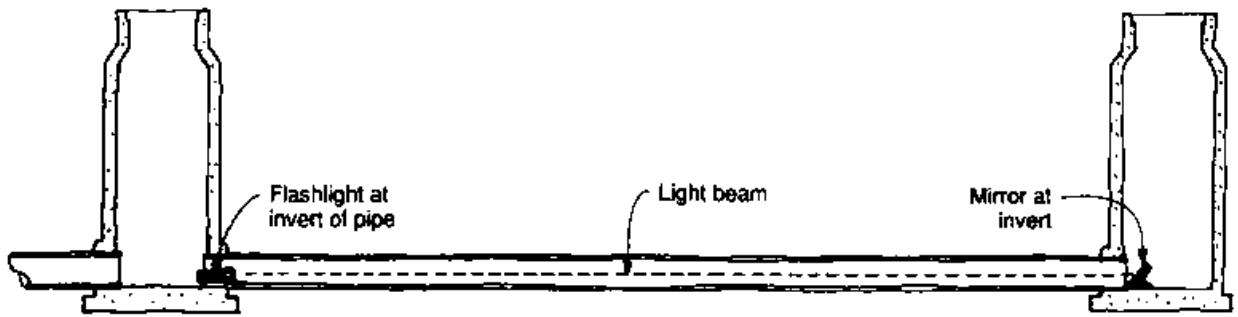
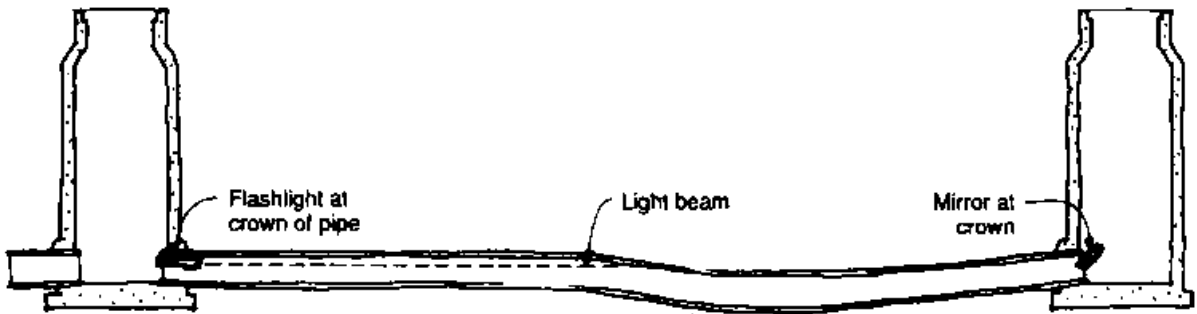


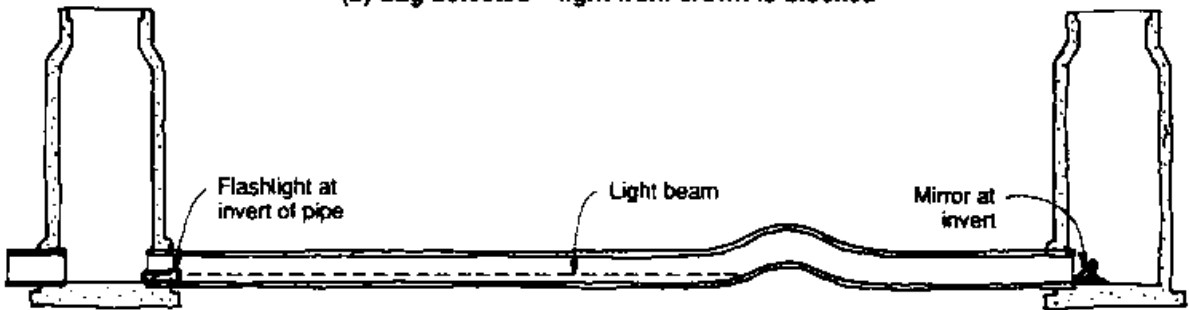
Fig. 22. Safety in entering closed drains



(a) Light is well aligned – light at one end is reflected by the mirror when placed at crown and invert



(b) Sag detected – light from crown is blocked

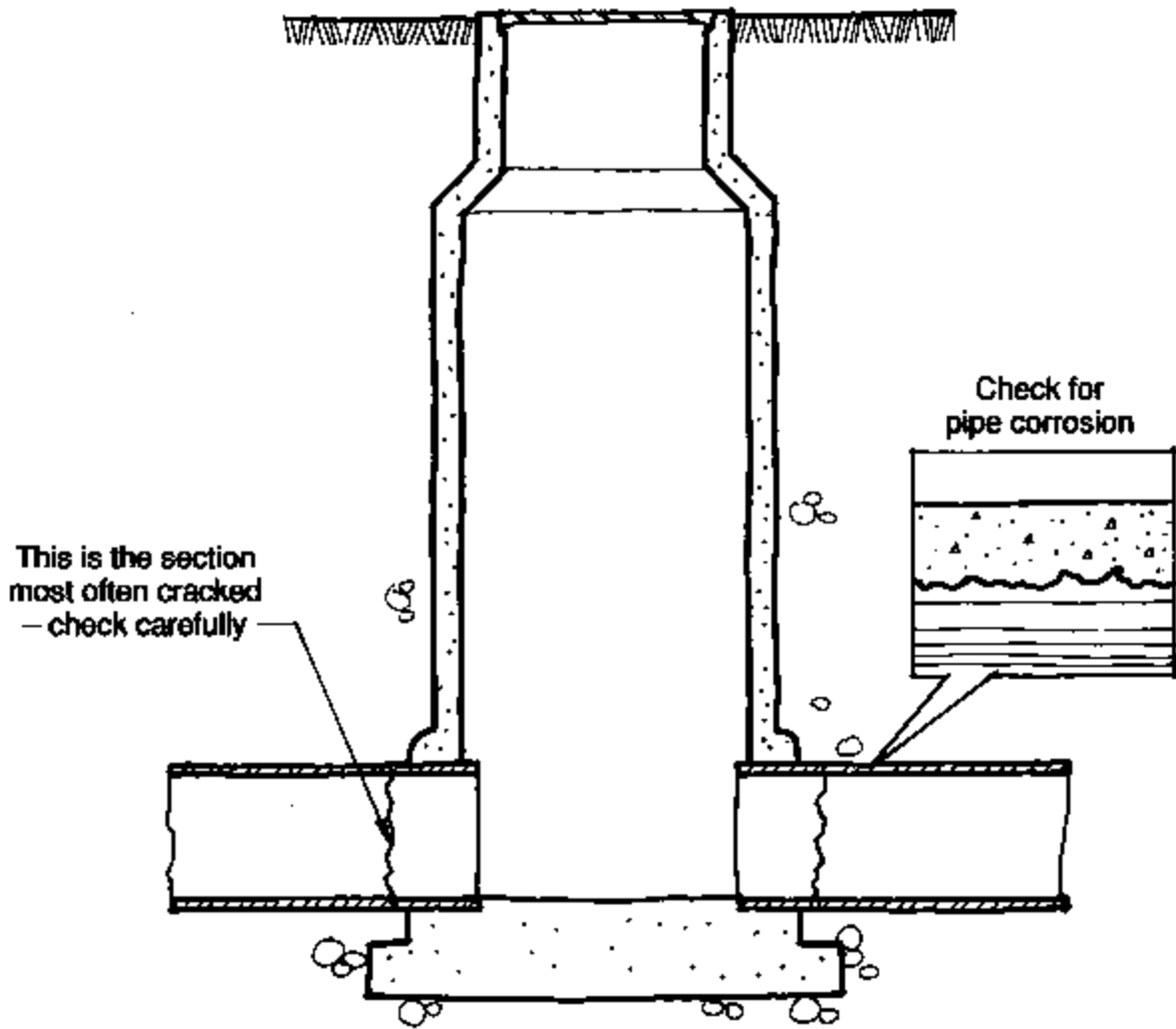


(c) Uplifted pipe detected – light from invert is blocked

Fig. 23. Checking the alignment of closed drains

*Rehabilitation*

Some sections may require complete rebuilding, but others may only need to be cleared of obstructions and flushed with water. Deteriorated or cracked concrete or masonry should be made good, care being taken to avoid major irregularities, especially at joints, which may hold back solid objects and cause blockage. The surface to be repaired should be roughened by hitting it with a sledge hammer, and then plastered with good quality cement mortar. If plastering is needed on the bottom of the drain, first divert the water flow away from the working area by building a small dam of earth or sandbags and digging a temporary parallel channel or by pumping.



**Fig. 24. Common failure sites in closed drains**

Some fittings may be damaged or have disappeared, especially metallic ones such as manhole covers, inlet screens and grilles, which may have been stolen and sold as scrap metal. The community may decide to replace these with concrete equivalents, or to fix metal screens into concrete. This makes drain maintenance a little less easy, but minimizes theft if it is a problem. If closed sections are frequently blocked by refuse, additional screens should be installed at the upstream end to keep the refuse out (see section 2.5). Existing covers and inlets should be cleaned, and repaired or replaced if necessary, and steel fittings painted with two coats of tar or primer paint.

If the drainage system has sluice gates (Fig. 25), the handle, plates and guide channels in the frame should be checked. Rust and old paint should be removed with a steel brush. Any holes should be patched by welding a steel plate over them. The gate and frame should be painted with three or four coats of an epoxy or other equally durable type of paint. The stem and guide plates should be well greased.

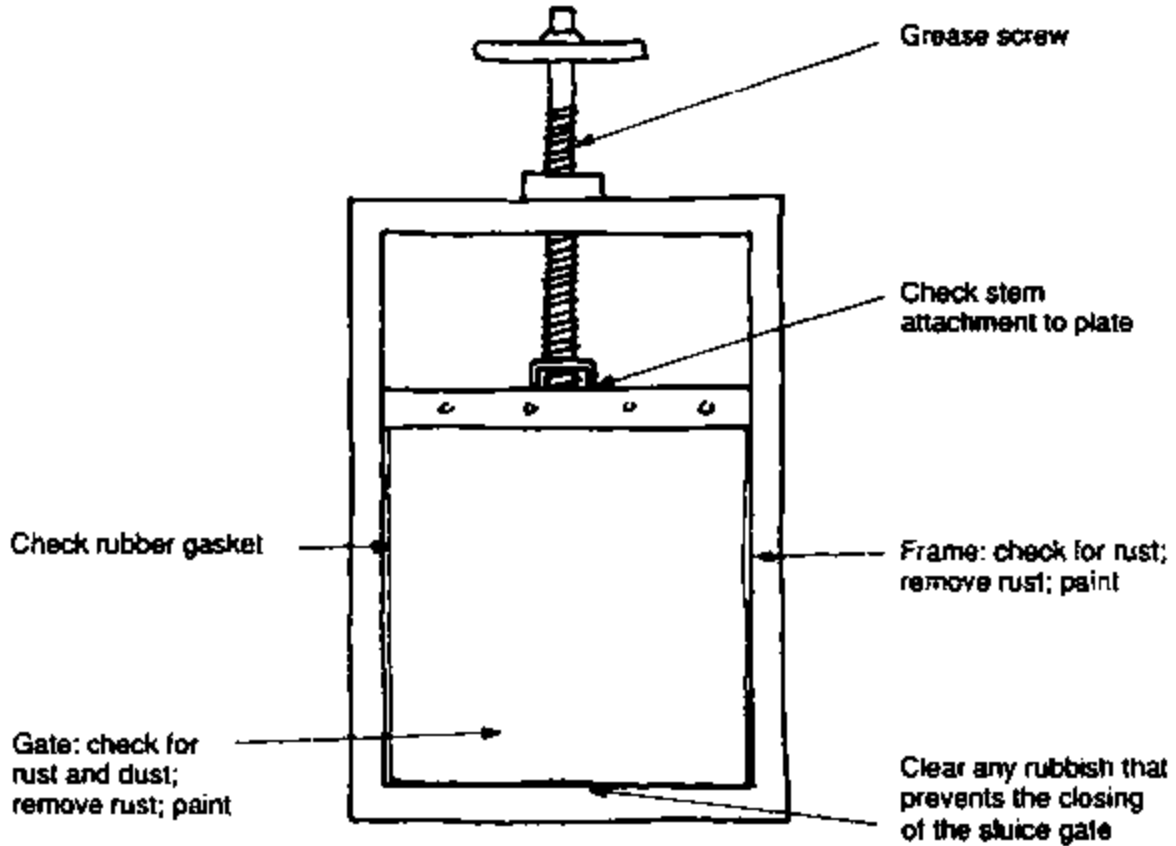


Fig. 25. Requirements for maintenance of sluice gates

### 3.3 Maintenance - technical aspects

The most important maintenance task is to remove refuse, silt and other solid material from the drains. All drains should be cleaned at least twice a year, preferably at the start and end of the rainy season. Some drains, especially the secondary drains and house connections, will need to be cleared more frequently. Small open channels in flat areas are likely to require cleaning on a weekly basis. Unlined channels need to be regularly cleared of vegetation.

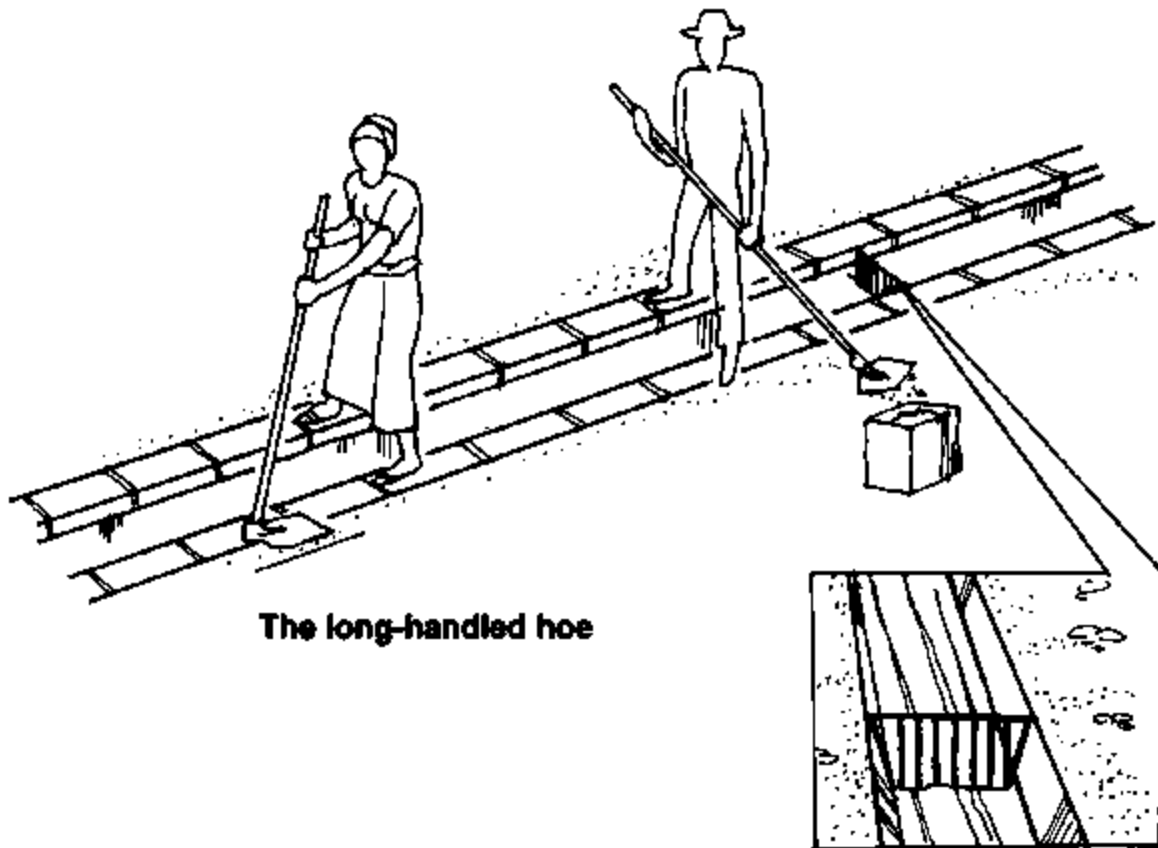
It is important to establish the cleaning of drains as a routine activity at regular intervals, and not wait until the system fails as a result of blockage. Repairing the damage done when the system fails, including damage to the drains themselves, can cost far more than regular preventive maintenance.

Drain clearing must be coordinated with the collection and disposal of solid waste, so that solid material removed from the drains will not be left where rain can wash it back or where it can be a nuisance and a health hazard, encouraging the breeding of rats and flies.

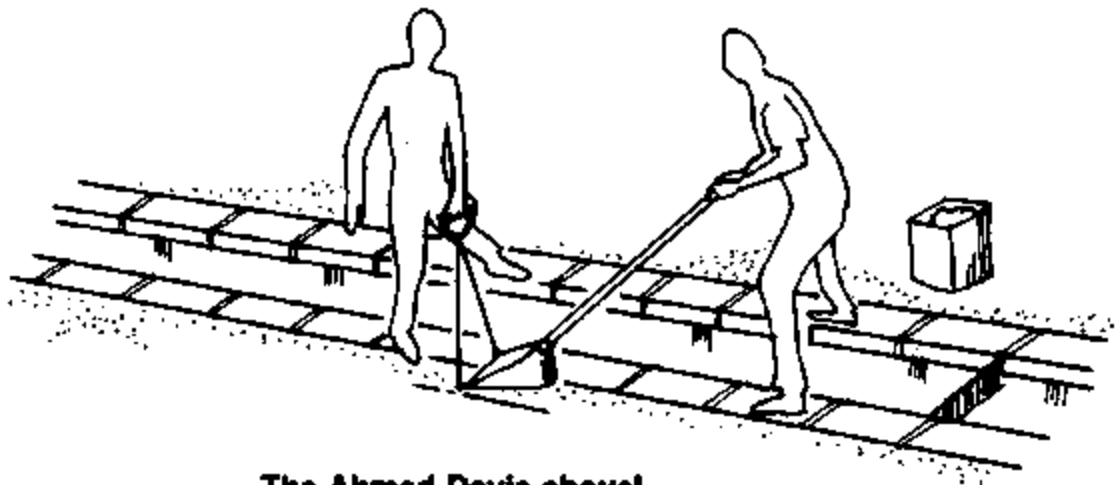
### ***Open channels***

Cleaning of open channels is usually done manually, with the help of spades, hoes, shovels and scoops. It can be disagreeable and strenuous work if it is done with the wrong tools, especially if the drains are deep. It is worthwhile having some special tools that can clean the drains over their whole length, such as shovels that just fit into the drain.

One tool that has proved to be useful for cleaning deep and narrow drains is an agricultural hoe with an extra-long handle (Fig. 26).



**The long-handled hoe**



**The Ahmed-Davis shovel**

**Fig. 26. Tools for cleaning drains**

Another tool, also shown in Fig. 26, is the Ahmed-Davis shovel. This was developed in Tunisia, where it was found to reduce cleaning time by 30%. One person pushes the shovel deep into the drain using the handle, and then the other pulls it forward and upward using the steel wires attached to the front end. The size and shape of the shovel are determined by the size and shape of the drains. It may help to pierce several small holes in the bottom of the shovel so that water in the solids from the drain can run out when the shovel is lifted.



The responsibility for maintenance of a system of drainage channels is often divided between several residents, neighbourhoods or work teams, each responsible for a particular section. If so, it is advisable to install grilles across the channels at the downstream end of each section. This ensures that solids are not carried along to the next section, imposing an excessive burden on that section's team.



**A grille in a small drainage channel. Grilles such as this retain rubbish near the point where it enters the channel, so that the responsibility for cleaning each section can be fairly divided.**

**Photo: S. Cairncross**

### ***Closed drains***

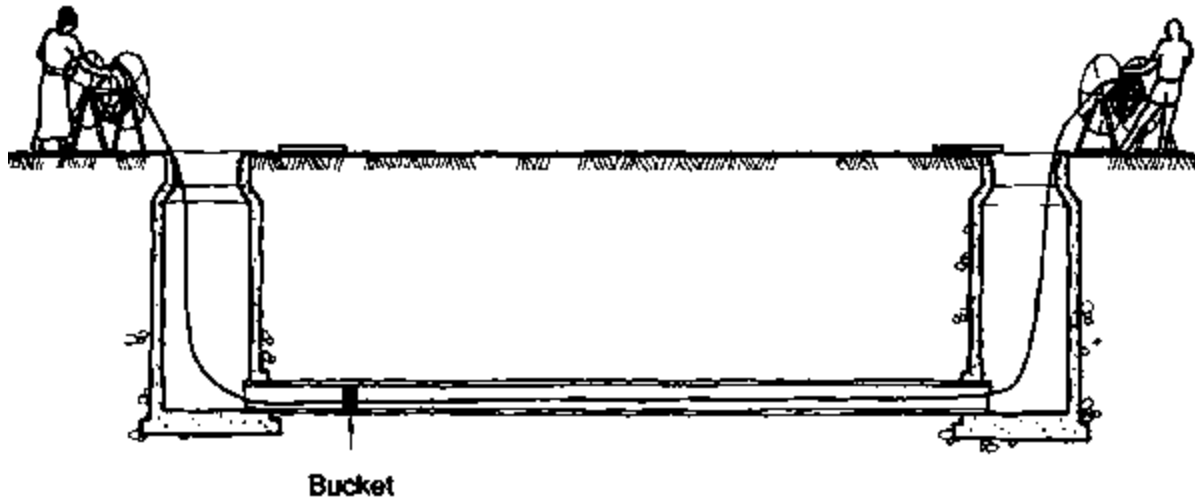
In the cleaning of closed drains, all the safety precautions described in section 3.2 should be scrupulously observed.

The most common tool used in removing silt and solids is a bucket tied in the middle of a steel cable (Fig. 27). The cable should be at least twice as long as the longest distance between manholes. One end is threaded into the drainage line with the bucket facing downstream, and wound on to a windlass on the ground beside the next manhole. As the bucket is pulled down the line, it scoops the solids and silt. The bucket diameter must be at least 5 cm smaller than the internal diameter of the drainage pipe to allow excess solids to pass around it, and ensure that the bucket does not become jammed against obstructions.

Excessive force should not be used to pull the bucket if it sticks, as this may compress the solids, making them still more difficult to remove. Instead, it should be winched back and a smaller bucket or an auger (described below) used for the first pass. When the bucket reaches the downstream manhole, it should be removed with the solids and detached from the cable. The cable is wound back and the bucket reattached. The procedure is repeated until the drain is cleaned.

If the drainage line is blocked, or the solids are too stiff to be removed using the bucket, the line can be cleared by an auger (Fig. 28). The auger is like a large drill bit, and is rotated by means of a lever inserted into one of a chain of connected driving rods. The rods are normally 10-15 mm in diameter and made of stainless steel. Water

trapped upstream of the blockage does not have to be removed. When the auger penetrates the solids obstructing the line, this water will help to flush the solids away.



**Fig. 27. Cleaning of closed drains using a bucket**

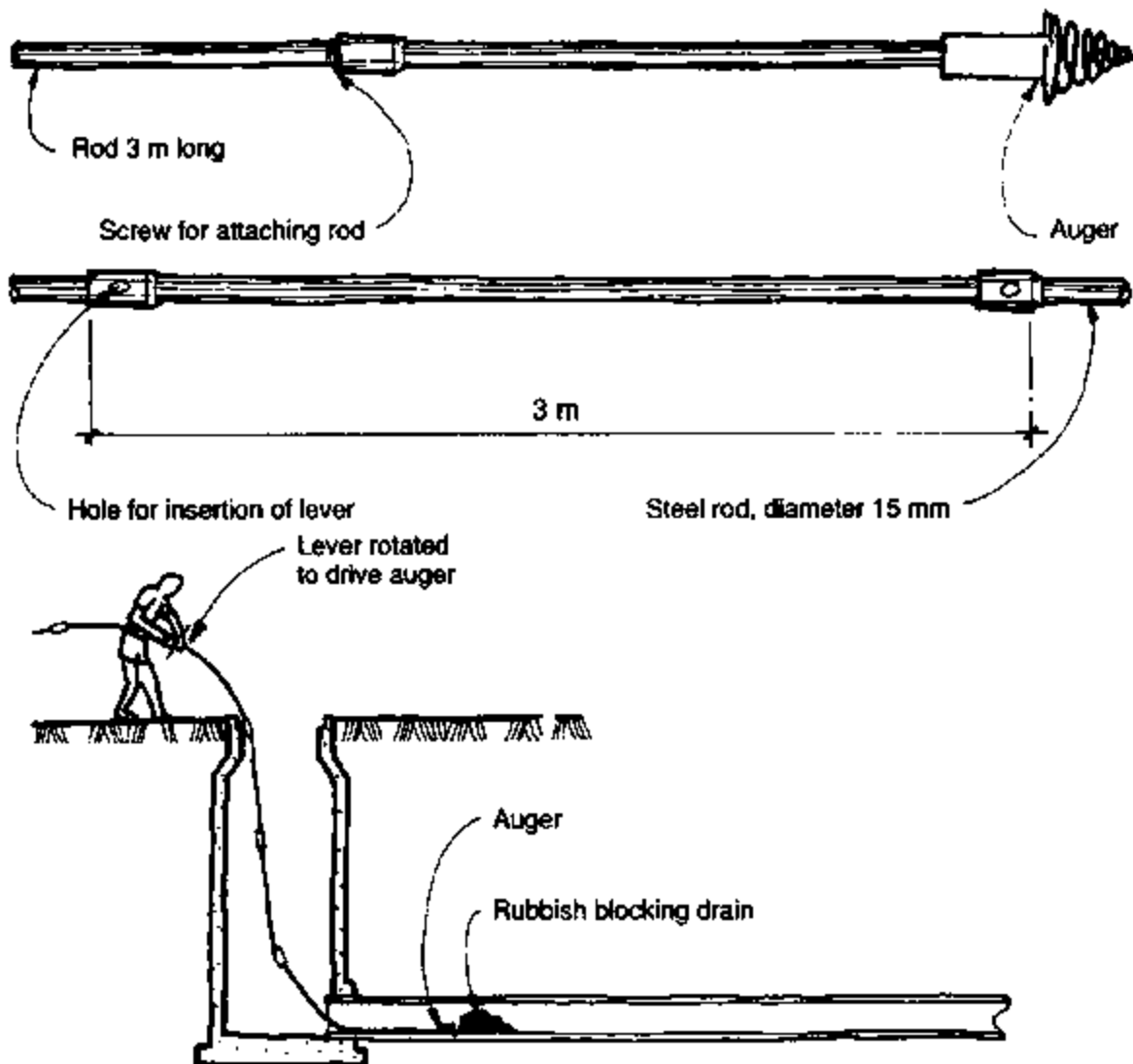


Fig. 28. Cleaning of closed drains using an auger

### 3.4 Maintenance - institutional aspects

The need to coordinate drainage maintenance with solid waste disposal has already been mentioned. Coordination is necessary for two reasons. First, the solids removed from the drain must be adequately disposed of. Second, the drains cannot be kept clear without effective solid waste disposal. If solid wastes are not collected regularly, residents will have little choice but to throw their rubbish into the drainage channels, or to dump it in the streets and open spaces where it will be dispersed by stormwater, wind and animals, much of it eventually reaching the drains. The most effective way to ensure good coordination between drainage maintenance and refuse disposal is for both these activities to be the responsibility of the same municipal department or neighbourhood committee.

Maintenance, including the inspection, cleaning and repair of the drainage system, must be institutionalized if it is to be kept up throughout the life of the system. For this reason, the ultimate responsibility should preferably be with the municipality, which has paid staff who can carry out the work. It is much more difficult to mobilize a community

on a voluntary basis to carry out a routine task, year after year, than to win their active participation for the limited period required for construction. Nevertheless, there is ample scope for participation by the community in drainage maintenance. Section 4 describes how this can be organized.

### **3.5 Selected reading**

*Safety in sewers and at sewage works.* London, Institution of Civil Engineers, 1967.

FLINTOFF, F. *Management of solid wastes in developing countries.* New Delhi, WHO Regional Office for South-East Asia, 1984 (WHO Regional Publications, South-East Asia Series No. 1).

## **4. Community participation**

### **4.1 The need for participation**

#### ***Participation in planning***

A drainage system, like any other item of infrastructure, is part of the built environment of a community, and residents may find it inappropriate and unacceptable if they have not participated in the key planning decisions. Traditionally, the planning and design of urban surface water drainage systems have been carried out by governmental or municipal agencies, without the involvement of the local residents and with limited, if any, consultation with them. However, the technical and planning staff of such agencies do not normally live in low-income communities and can easily be mistaken about local needs, customs and aspirations unless the community is given a chance to state its views.

Open drains take up a certain amount of land, a scarce commodity in many low-income urban communities and one that residents may be unwilling to sacrifice unless they are convinced that it is for their benefit. Houses may have to be relocated and rebuilt to make way for new drains, and residents must be dissuaded from erecting new structures that would obstruct the drainage system. The position is complicated by the problems of land tenure which beset many urban slums and shanty towns. For example, the conventional procedures used by a municipality for compulsory purchase of land are clearly inapplicable in a community of squatters with no legal title to the land on which they have built. The land requirement of a drainage system can make it a burning issue and can give rise to great bitterness unless the community has participated in planning the system.

A drainage system is very vulnerable to abuse, even by a single member of the community. A resident can effectively block a drainage line by dumping a moderate amount of rubbish in it, and thus render useless the whole system upstream. Deliberate blockage and other forms of sabotage are not unknown, but apathy and neglect can have equally serious consequences in the long term. Community participation in planning is the most effective means of generating the interest and involvement of local residents, and is essential for the success of a drainage project.

Residents can also contribute much to the design of a drainage system because of their detailed knowledge of the area. For example, the shortage of accurate hydrological data

for urban areas can easily lead to unnecessarily expensive drainage systems being designed, unless witnesses' recollections of past floods are taken into account. Many other types of information can be collected by residents on a voluntary basis, avoiding the need for expensive surveys.

### ***Participation in construction***

Community participation in construction is not essential, but has several advantages. Voluntary labour can permit significant savings in cost, an important consideration for most municipalities in developing countries, which have only very limited funds to invest in infrastructure. It can also help to develop a sense of ownership and a climate of cooperation which will facilitate the responsible use and satisfactory maintenance of the system. Community participation in construction, whether paid or unpaid, will ensure that residents acquire a knowledge of the drainage system and many skills which will help them to participate in maintaining it. Lastly, construction by the community may be the only possible solution when municipal authorities are not able, for whatever reasons, to provide a drainage system for the neighbourhood.

### ***Participation in maintenance***

There is no need to argue the case for community participation in drainage maintenance. Too often, low-income communities are expected to maintain their drainage systems with minimal assistance, either as a result of wishful thinking on the part of municipal authorities or by default, because the municipality simply does not have the resources or capacity to maintain the system it has installed. Rather, what the community needs is support to enable it to carry out its part of the work more effectively. This includes not only technical and material support, particularly in the form of training and the provision of specialized equipment where necessary, but also support for the development of community institutions and procedures to organize the task.

## **4.2 Community institutions**

Community participation is not a spontaneous, automatic process. It requires an initiative to launch it, and management to organize it. In practice, communities can participate only through community institutions. On the other hand, these institutions do not need to be created out of nothing. A low-income urban community is not the unorganized mass it may seem to outsiders. Usually, a variety of institutions are already in existence, some of them with a high degree of organization and considerable power to influence people's attitudes and behaviour. They are of many different kinds, such as the following:

- residents' associations and amenity groups,
- women's organizations,
- political parties,
- labour unions,
- religious bodies,
- cultural associations,
- ethnic or "home-boy" associations,
- rotating credit associations,
- burial societies,

- schools, parent-teacher associations,
- health posts, health committees, community health workers.

Some of them may be formally recognized and affiliated to regional or national bodies. Others may have developed informally in response to specific local needs. Their activities and influence often range much wider than the purposes for which they were originally established. They are often far more active and influential in low-income communities than the corresponding institutions in wealthier neighbourhoods. In addition, some individuals may be recognized informally as leaders in the community owing to their education, wealth, age or experience.

The initiative to start discussion of the possibility of drainage improvements will often come from an individual who already plays a prominent role in one of these organizations, such as the school-teacher, religious leader or party secretary. When the initiative comes from an outside body such as the municipality, these institutions are valuable "entry points" through which a first approach to the community can be made. Indeed, many residents may feel slighted if the approach is not made through the existing community institutions.

### ***The drainage committee***

It will normally be necessary to establish a drainage committee to organize the community's contribution to a drainage project. This is most likely to succeed if it is not a completely new structure, but is built on to existing community institutions whose authority is generally accepted. The drainage committee will enjoy the established authority of the community's leaders if it is answerable to them.

The committee should be representative of the community. Its task will be easier if it includes women and members from the principal ethnic and religious groups in the community, and from various parts of the neighbourhood. On the other hand, it should not be too large as this can make it harder to reach consensus decisions and to ensure that all the members play an active role. It is preferable to have fewer than 10 members. The active participation of the committee members can be encouraged by allocating specific roles among them, such as Chairperson, Secretary and Treasurer, with other members responsible for technical aspects, liaison with the municipality, public relations, organization of voluntary labour, relocation of affected houses, and so on. Some of these may have deputies if the number of members is sufficient.

In many cases, the members of the committee will be willing to work on a voluntary basis, but there are circumstances in which some remuneration for the work done on a drainage committee can be justified. This is especially the case when the work of the drainage committee permits significant cost savings to the municipality.

One of the first steps for the committee is to approach the local municipality to seek its help, either directly or through local leaders. Even if the municipal authority cannot afford to provide material resources, it may be able to offer other kinds of assistance, such as technical guidance, advice regarding possible sources of funds, and liaison with other relevant bodies, including other communities which have successfully undertaken drainage improvements. In addition, the municipality can help to avoid conflict with the police. While community meetings and participation are encouraged in most countries, there are some cases where a group of people meeting regularly in a low-income high-density housing area could be suspected of subversive activity.

If the municipal authority is willing to help, every effort should be made to ensure close collaboration between it and the committee. The drainage committee, for its part, should brief municipal officials on its decisions and send them minutes of meetings or, better, invite representatives of relevant departments to attend. It could also offer to assist with data collection and other tasks. The municipality, on the other hand, should consult the committee about planning and design decisions, allowing it time to consult the community before replying. It can arrange regular briefings for committee members on the progress of the project.

Some resources that would be useful for the orientation of a drainage committee are described in Annex 4.

### **4.3 Creating awareness**

A prerequisite for a community's active and willing participation in a drainage scheme is an awareness of the need for it, of its feasibility, and of the benefits it can bestow. In many low-income communities there is no lack of awareness of the problem, drainage often figures first on the list of felt needs for community infrastructure. However, the drainage committee (or anyone wishing to set one up) will need to develop public awareness that the community itself can and should do something to improve the situation. A further requirement is to generate a climate of responsibility for the drainage system once it has been built.

A range of methods can be used to give publicity to the drainage committee and its objectives, including public meetings, posters and door-to-door canvassing. Schoolchildren are a particularly valuable resource. They are usually more ready to accept new ideas, they have time and energy which can be mobilized for various activities, and they can influence their families at home.

However, people's attitudes and behaviour are not easily influenced by a one-way flow of information and exhortations to participate. A far more effective strategy is to stimulate discussion in such a way that residents come to see for themselves the advantages of contributing towards a drainage scheme and the importance of a responsible attitude towards it.

Four principal incentives can help motivate people to participate in a drainage project:

- comfort and safety,
- financial gain,
- status,
- group pressure.



**A low-income community in Recife, Brazil, a few years after construction of a drainage system. Many of the residents have already built new houses.**

**Photo: S. Cairncross**

### ***Comfort and safety***

An effective argument for drainage is the prospect of no longer having to walk through pools of stagnant water and sewage, or of having no more collapsing houses and landslides. These improvements make it worthwhile for residents to undertake improvements to their houses, and open the way for other aspects of infrastructure such as water supply and sanitation. Improved drainage makes access easier for vehicles; even if few residents own a motor car, many will be keen to ensure easy access for emergency vehicles such as ambulances and fire engines. The prospect of reduced mosquito nuisance is a further inducement, once people have been shown that mosquitos breed in stagnant water. The health benefits of drainage have been described in section 1, and should be explained to the community.

### ***Financial gain***

Drainage improvements can increase property values, making houses more profitable to sell or to let. If convincing facts and figures can be provided to demonstrate that a drainage project is affordable to the community and gives economic returns, the prospect of financial gain can be effective motivation.

### ***Status***

Whether or not residents wish to sell or let their houses, better drainage can give their neighbourhood the appeal of wealthier districts and confer status on the community and its members. Additional status may attach to those most actively involved in the project.

### ***Group pressure***

Group pressure can be one of the most powerful incentives for participating in a community effort, once a consensus has been achieved. Every community exerts considerable internal pressure on its members to comply with its norms and decisions;

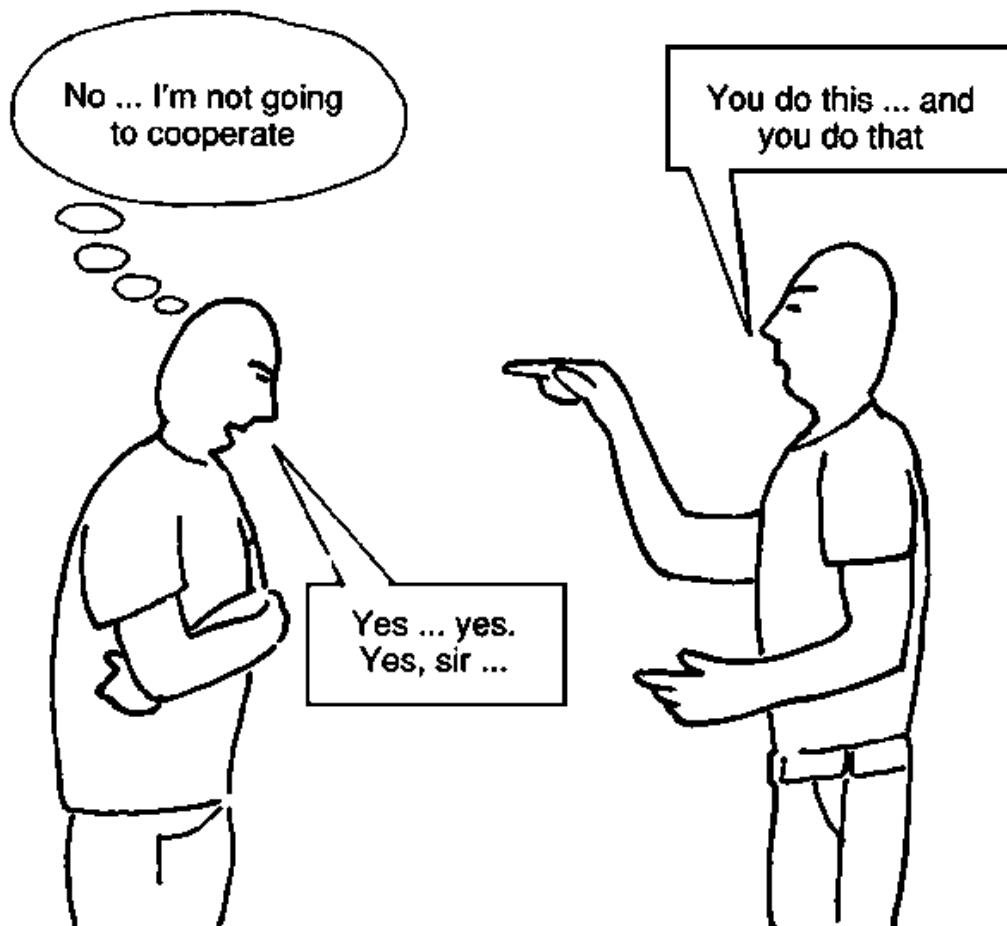


those who deviate may be shunned, ridiculed or humiliated, but for most the example of the majority is sufficient to persuade them to join in. However, this can be effective only when the majority has already been motivated to participate by reaching a consensus through discussion.

Two effective means to encourage discussion, while helping to focus it, are pictures and questions. Pictorial material may be in the form of cartoons, felt boards on which adhesive figures can be placed and moved around, or slides, films or videos showing drainage problems and areas where drainage has been improved. Residents can be asked to comment on this material, rearrange it or tell imaginary stories about it. Other visual aids can be improvised from local materials: for example, a glass jar containing mosquito larvae, or two models of the local topography, one with small drainage channels cut into it, to be watered with a watering can to simulate rain.

Carefully chosen questions can also serve to start up a discussion. The following are some examples:

- "Why does flooding occur in neighbourhoods like ours, but never in the centre of town?"
- "Why are there so many mosquitos in our area?"
- "If a drainage scheme were built here, how would that affect the value of our houses?"



**Fig. 29. Community participation in planning is essential for success**

**Community members may say “yes” to all questions and requests. But if the project is imposed on them, deep down they will resent it and refuse to cooperate. If the project is to succeed, it must be planned with the community.**

The process takes time, and can lead in unexpected directions. There are no short cuts, however. A low-income community that is simply told what it should do may appear to react positively during meetings and surveys, but may withhold its cooperation when the time comes for action. It is advisable not to rush any decisions, but to give the community time to discuss the problem and reach a consensus.

#### **4.4 A programme of action**

Once the drainage committee has been formed and the community has agreed to support its efforts, it is time to plan a programme for the implementation of the drainage project. This planning is not the same as the technical design of the scheme. It is not necessary to have the completed design in order to make the main planning decisions, although it is an advantage to have some idea of the principal technical options. The committee may find it helpful to start with steps (a)-(f) in section 2.9 to give them some idea of the likely scope of the project.

In order to develop the programme of action, the implementation of the project should be divided into separate phases and activities, such as the following.

##### *Planning and design*

- Collection of data
- Outlining technical solutions
- Selection of the best alternative
- Detailed design
- Cost calculations
- Fund-raising

##### *Construction*

- Acquisition of land
- Relocation of buildings
- Preparation of storage facilities, casting yard, etc.
- Purchase of materials and equipment
- Skilled construction work and supervision
- Unskilled construction work
- Provision of water for construction
- Storing, guarding and accounting for materials and equipment
- Providing food for voluntary workers

##### *Maintenance*

- Routine drain cleaning
- Reporting of defects and blockages
- Twice-yearly inspection
- Repair
- Payment for maintenance

- Passing of by-laws regarding the use of drains
- Enforcement of by-laws.

For each activity, a decision is needed as to which individuals are to carry it out, when they will do so, how they will be organized and to whom they will be responsible. This means that during the planning stage, decisions must be taken about what the community will do in the future. The more decisions that can be taken during this planning stage, the better it is for the future of the project.

It is not necessary or even advisable for the drainage committee to take these decisions alone. Some of them will be determined in practice by what the municipality can offer, but many of the activities will have to be performed by the community or by those whom it hires for the purpose, and the final decision about these is best left to a meeting of the community or its representatives. Nevertheless, the committee should first consider the alternatives available to it, so that it can advise such a meeting of the advantages and disadvantages of each alternative.

It is easier for the community to discuss a proposed programme of action if there is some estimate of the timing of each activity. Municipal staff may be able to advise on the time likely to be required for each task.

The programme should be presented to one or more meetings of the community for discussion, possible modification and final approval. Public meetings are especially useful in the early stages, as they help to ensure that:

- residents have a clear idea of what is being decided, and do not rely on rumours and second-hand accounts, which may be incorrect;
- the community feels it has some control over the decision-making and can therefore identify with the conclusions;
- maximum use is made of local knowledge, to reach the most cost-effective solution.

Each meeting should begin with a presentation of the options under consideration. It is preferable to seek comments and suggestions from the participants first, before the committee's recommended solution to each problem is presented. In this way, the meeting can take the form of a "brainstorming" session, which is a very creative process. Ideas are suggested by the participants and written up on a blackboard. The secret of successful brainstorming is to observe four basic rules:

- (1) Do not criticize suggestions.
- (2) Do not alter or edit the ideas, but take them just as they come.
- (3) Encourage even far-fetched ideas, as they may trigger more practical ones.
- (4) The more ideas the better; do not stop as soon as there is a pause in the discussion.

Once a list of suggestions has been compiled in this way, the meeting can be asked to comment on them, and the drainage committee asked to give more detailed consideration to the best ones.

On this basis, a more detailed programme can be developed and presented to another meeting. The whole process may take one to two months, and should culminate in the drawing up of written agreements between the parties concerned, setting out responsibilities for design, for construction, and for use and maintenance. If engineering consultants or contractors are to be engaged, specialist help should be sought in drafting suitable contracts and terms of reference. The agreements and contracts should include provision for further consultation with the community, particularly during the design stage. Annex 3 lists some of the points to check in drawing up terms of reference for a feasibility study of a community drainage system.

Before construction can begin, there should be a reasonable degree of certainty that sufficient funds will be available. Where necessary, fund-raising within the community, and efforts to obtain funds from external sources, can start while the programme of action is still being developed.

There are many tasks the community can perform in the construction of a drainage system (see section 2.8), but their participation must be carefully planned. Most importantly, the plans must specify which people will be responsible for each task and who will supervise them. Certain tasks may be organized by street or block, residents of a given street may work on the drainage of their own street, or may work on a particular day, on a rota system. Some light tasks could be the responsibility of schoolchildren, or of the elderly.

Plans should be made in advance for dealing with people who fail to participate. Some community members may prefer to contribute cash or materials rather than their labour to the projects. The drainage committee should consider what forms of pressure it will bring to bear on those who contribute nothing. Sanctions will be much easier to apply if they have been agreed upon beforehand by the community.

The drainage committee will wish to call another meeting when the drainage system is completed. This can take the form of a celebration, but it is also appropriate to consider the maintenance of the new system, either under the same drainage committee or a reconstituted one.

#### **4.5 Participation in maintenance**

As mentioned in section 3.4, the maintenance of a drainage system requires specific institutional arrangements, preferably with a municipal department assuming the ultimate responsibility for this task.

Whether or not a municipal department assumes the responsibility for maintenance, a neighbourhood drainage committee can at least monitor the functioning of the system and report defects and deficiencies to the officials responsible. In many cases, the community can also carry out much of the routine maintenance work. There must then be good coordination and a clear division of responsibilities. Residents must know to whom they should report any problems such as damage or blockages. It is certainly advisable that the community should appoint a drainage committee to plan and supervise the maintenance work. This committee should liaise with the municipality to ensure the prompt collection of solids removed from the drains and the unhindered discharge of stormwater into the primary drainage system linking their neighbourhood with the receiving water body.



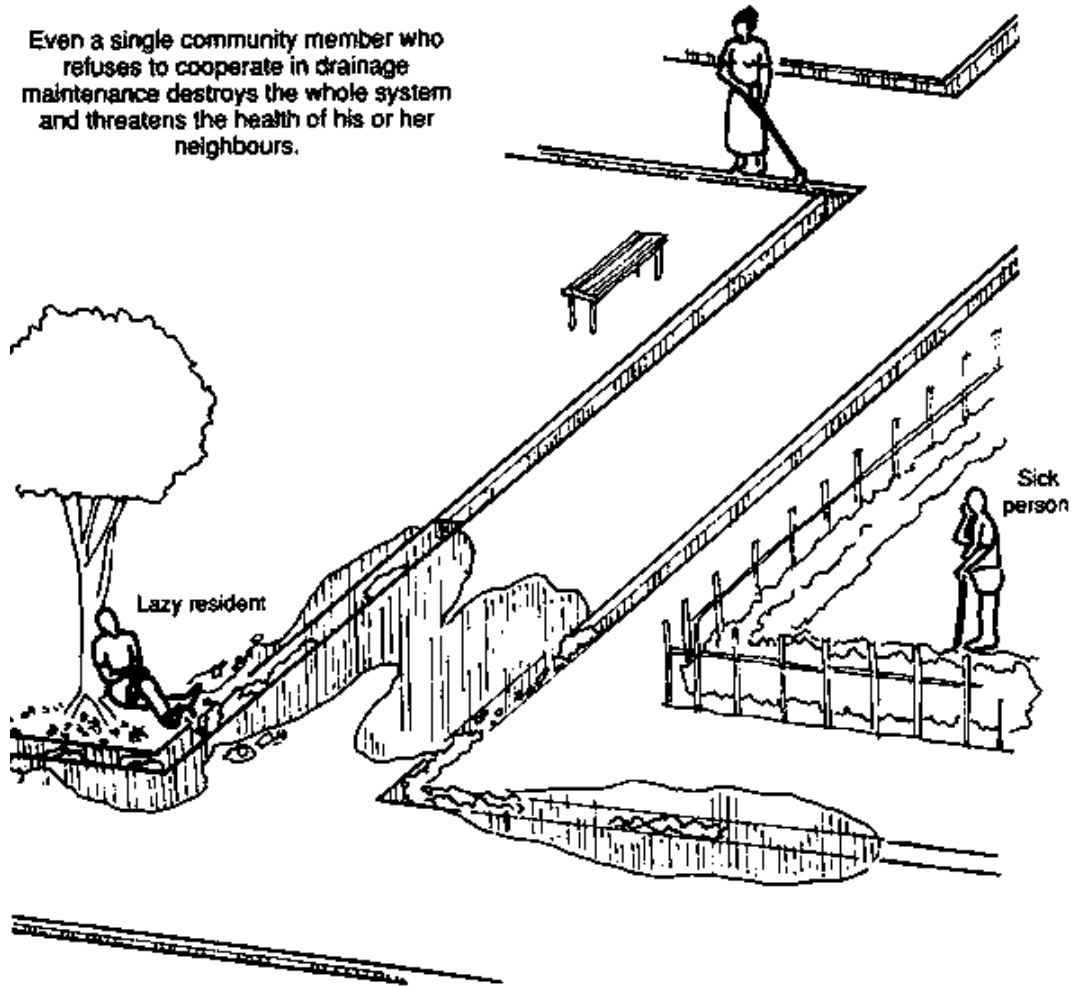
**A surface water drain in Colombo, Sri Lanka. Although the area is crowded, the drain is kept reasonably clear as it passes through the front yards of the houses.**

**Photo: R. Reed**

One possibility is for each household to take responsibility for the section of drain passing through or in front of its plot. However, if this is to work successfully, it has two prerequisites: (1) the arrangement must be accepted by the community at large; and (2) some additional procedure is needed to monitor and bring pressure to bear on those who neglect their responsibility (Fig. 30). The process is illustrated by the example of one self-help upgrading scheme in Bandung, Indonesia, where houseowners agreed to be responsible for the daily cleaning of the drains in front of their houses. A neighbourhood coordinator inspected the drains twice a week and recorded his findings. The response to the friendly inspections was very good, and the inspector assisted in the manufacture of simple scoops and scrapers to facilitate the cleaning of the small culverts under the house entrances. Soon, it became a daily routine performed by every self-respecting householder.

The other approach is for a specific group of residents to clean the whole system. This has the advantage that they can be supplied with any special equipment needed, such as shovels and handcarts or wheelbarrows. The composition of the group could change regularly on a rotating basis so that everyone takes a turn, under the supervision of the standing drainage committee. Alternatively, they could be a fixed section of the community, such as the members of a youth organization. Whether the membership of the group is fixed or rotating, they must have some incentive to carry out the work, or be subject to some sanction if they fail to do so.

Even a single community member who refuses to cooperate in drainage maintenance destroys the whole system and threatens the health of his or her neighbours.



**Fig. 30. Everybody must cooperate in drainage maintenance**

Poor drainage maintenance does not always give rise to problems immediately. The accumulation of sediment or rubbish in the drains and the deterioration of the system can occur progressively over a period of time, unnoticed until a major effort is needed to restore the system to good working order. In addition to organizing routine maintenance, the drainage committee would be well advised to establish one day each year when the community is mobilized to give the whole system a thorough cleaning and overhaul. It would be most convenient to fix this day near the end of the dry season, when there is little water in the drains so that cleaning and repair can be carried out easily.

Clearly, community participation in maintenance needs proper planning and organization. However, if the municipality neglects its responsibility for maintaining the primary drainage system, water from the neighbourhood and adjoining areas may back up and cause flooding, causing residents to lose heart. A community has the best chance of achieving successful maintenance when it works in partnership with the municipality.

#### **4.6 Selected reading**

APPLETON, B. & CAIRNCROSS, S. *Minimum evaluation procedure (MEP) for water supply and sanitation projects*. Unpublished WHO document, May 1985 (International Drinking Water Supply and Sanitation Decade, CWS Series, No. 6). Available on request from: Division of Environmental Health, World Health Organization, 1211 Geneva 27, Switzerland.

CHAUHAN, S. K. *Who puts the water in the taps? Community participation in Third World drinking water, sanitation and health*. London, International Institute for Environment and Development, 1983.

MUIR, J. Rural health in northern Pakistan. *Waterlines*, 5 (2): 10-14 (1986).

WHYTE, A. *Community participation in water supply and sanitation, concepts, strategies and methods*. The Hague, International Reference Centre for Community Water Supply and Sanitation, 1981 (Technical Paper No. 17).

WHYTE, A. *Guidelines for planning community participation activities in water supply and sanitation projects*. Geneva, World Health Organization, 1986 (Offset Publication No. 96).

VAN WIJK-SIJBESMA, C. *Participation of women in water supply and sanitation, roles and realities*. The Hague, International Reference Centre for Community Water Supply and Sanitation, 1985 (Technical Paper No. 22).

## Annex 1. Glossary<sup>1</sup>

<sup>1</sup> The definitions given here are for use solely with this publication and may not be applicable in other contexts. Terms in italics in the definitions are also defined in this glossary.

<b>alluvial</b>	Deposited by a river, normally on a flood plain near the river's mouth
<b>baffle</b>	Slab or board partly closing a drainage channel to divert or slow down the flow of water
<b>bedding</b>	Sand or gravel placed beneath a drainage pipe or channel <i>element</i> to support it evenly
<b>by-laws</b>	Laws made at local level
<b>catchment area</b>	Area of ground from which rainwater will flow to a single point
<b>checkwall</b>	Wall placed across a drainage channel to prevent <i>scouring</i>
<b>concentration time</b>	Time required for rainwater from all over a <i>catchment area</i> to flow to a single point
<b>crown</b>	The highest point in the cross-section of a pipe
<b>culvert</b>	Drain for carrying water underneath a road or pathway
<b>curing</b>	Treatment of concrete by keeping its surface damp for the first seven days after placing, to ensure it develops its full strength
<b>dissipator</b>	<i>Checkwall</i> built of loose boulders which allows water to pass through the boulders but slows it down, dissipating its energy
<b>element</b>	Precast section of drainage channel lining or pipe
<b>erosion</b>	Removal of soil by the action of water
<b>gabion</b>	Bundle or bale of stones bound in wire or other mesh

<b>grader</b>	Machine used for road construction and maintenance, with a blade fixed between its front and rear wheels
<b>groundwater</b>	Water located beneath the ground surface
<b>gully pot</b>	Basin incorporated into the inlets of some closed drainage systems to collect sediment, which must be removed from it regularly
<b>impermeable</b>	Describes a material through which water cannot pass
<b><i>in situ</i> concrete</b>	Concrete placed and allowed to set in the position where it will remain
<b>infiltrate</b>	(of a fluid) To pass into the pores or small spaces in a solid, e.g., soil
<b>infrastructure</b>	Permanent facilities for the common use of a community
<b>invert</b>	The lowest point in the cross-section of a pipe
<b>landfill</b>	Earth or rubble spread over the ground to raise the level
<b>manhole</b>	Underground chamber of brick or concrete, permitting entry to closed drains and sewers
<b>masonry</b>	Construction of brick or stones held together with mortar
<b>mortar</b>	Mixture of cement, sand and water
<b>municipality</b>	Organ of local government in a city or urban district
<b>parasite</b>	An organism that lives on or in another living organism and draws nourishment from it
<b>pantograph</b>	Instrument for mechanical copying of drawings or plans on the same or a different scale
<b>planimeter</b>	Instrument for measuring areas on paper
<b>polder</b>	Low-lying area of land protected from flooding by an embankment
<b>primary drainage system</b>	System of large drains, each serving a wide area of a city
<b>receiving water body</b>	Body of water into which water flows from a drainage system
<b>refuse</b>	Rubbish, garbage
<b>return period</b>	Average interval between storms or floods of a given severity
<b>runoff</b>	Water from rainfall, flowing over the ground and into drains and streams
<b>runoff coefficient</b>	Proportion of rainwater that flows over the ground and is thus likely to enter a drainage system
<b>scouring</b>	Washing away of soil ( <i>erosion</i> ) around, beneath or in the bed of a drain
<b>secondary drainage system</b>	Network of small drains within a neighbourhood serving a small catchment area and discharging into the <i>primary drainage system</i>
<b>self-cleansing speed of flow</b>	Speed of flow in a drain or sewer sufficient to prevent the accumulation of sediment
<b>sewage</b>	Human excreta and wastewater, flushed along a <i>sewer</i>
<b>sewer</b>	A pipe containing wastewater or <i>sewage</i>
<b>slope</b>	Gradient; inclination to the horizontal



<b>sludge</b>	Mixture of solids and water deposited on the bottom of drains, septic tanks, etc.
<b>sluice gate</b>	Structure that can be opened or closed to control the passage of water
<b>stormwater</b>	Water from rainfall flowing in a drain or sewer
<b>topography</b>	Shape of the ground surface, including the position of natural and manmade features
<b>trapezoidal</b>	Describes a drainage channel with sloping sides and a flat bottom
<b>turnout</b>	Drain taking water away from the side of a road
<b>weephole</b>	Small hole in a drainage channel lining through which water can flow, to relieve groundwater pressure

## **Annex 2. Design calculations**

### **Basic concepts**

The basic concepts of return period and runoff coefficient are explained in section 2.2. Two other important concepts are involved in drainage design calculations: rainfall intensity and concentration time.

Rainfall is normally measured in millimetres; 1 mm of rainfall on a flat area of land, with no infiltration into the ground, evaporation into the air, or runoff to drainage, would flood the area to a depth of 1 mm. Rainfall intensity is a measure of the rate at which rain is falling, and is usually expressed in mm/hour.

The intensity of rainfall varies during each storm, reaching a peak value much greater than the average for the whole storm. Very high rates of rainfall can come in bursts lasting a few minutes, but not long enough to cause flooding or serious erosion. An important question therefore is the period of time over which rainfall is to be calculated. For a duration of a few minutes, very high intensities would be reached, a drain designed on this basis would be unnecessarily large and expensive. However, if the rainfall intensity is taken as the average for the entire duration of the storm, this would give too low a figure, and drains designed using it would be overloaded for much of the time. The way in which rainfall intensity is related to duration and return period is illustrated by Fig. A2.1, which is based on records for the city of Cebu, Philippines. (Note: the curves in Fig. A2.1 cannot be used in other cities, because rainfall conditions vary greatly in different parts of the world.)

The correct duration to use in designing a drain is the “concentration time” of the catchment area which it serves. That is, the amount of time required for water falling on the most far-flung point in the catchment area to run over the ground, into the drainage system, and downstream to the drain that is to be designed. Smaller catchment areas have shorter concentration times. Water flows faster down relatively steep slopes, so that concentration times are also shorter in hilly areas.

However, very short bursts of rainfall lasting less than 15 minutes are unlikely to do serious damage. Thus, a reasonable rule of thumb for small catchment areas (less than 5 ha) is to use a concentration time of 15 minutes. Where average land slopes are greater than 0.5%, this time can be used for areas up to 20 ha. In flatter areas, slightly

longer concentration times can be used for areas over 4 ha. A reasonable approximation would be to add one minute for each extra hectare up to 20 ha. For larger catchment areas, it is advisable to consult an engineer.

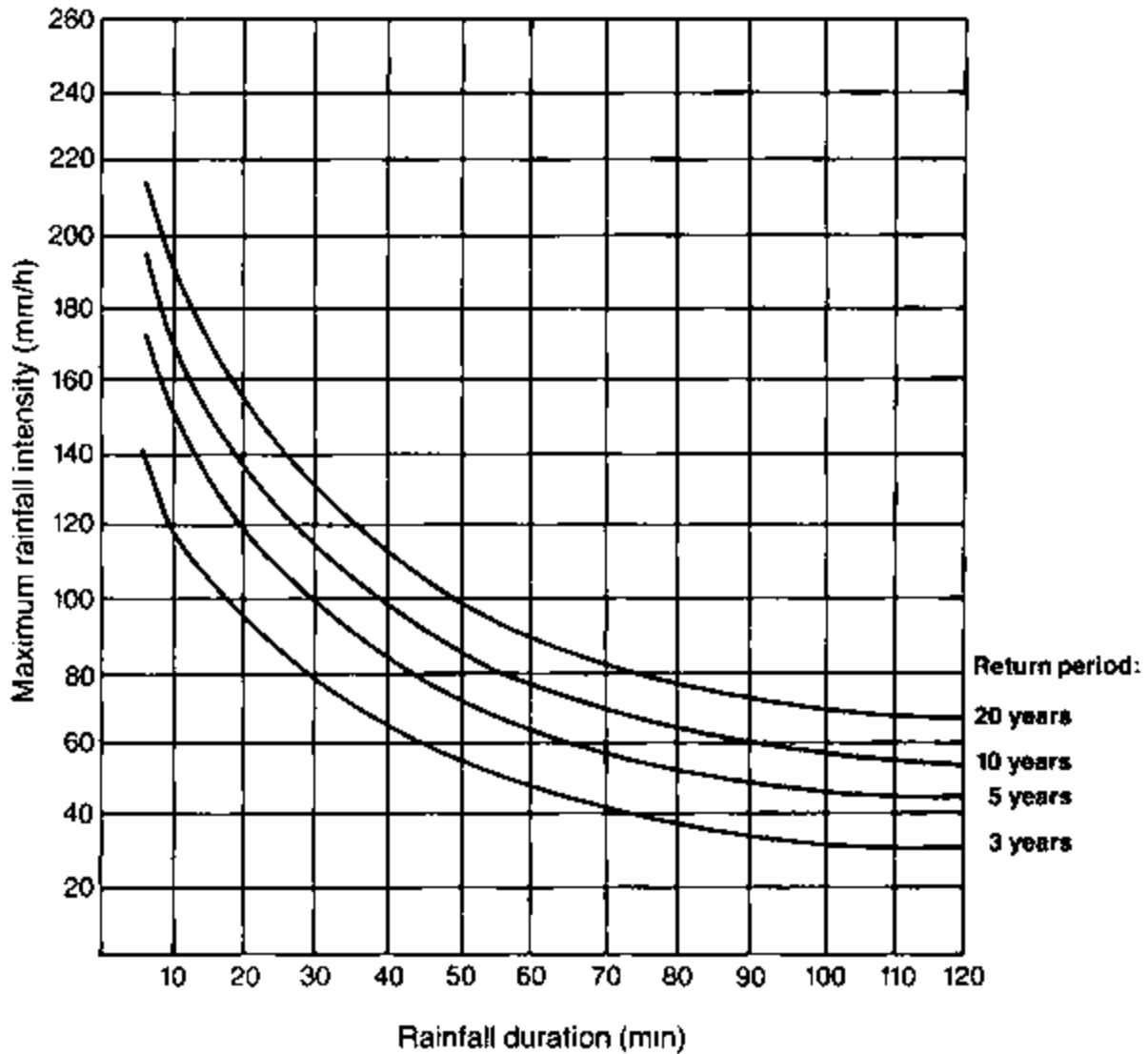


Fig. A2.1. Rainfall intensity-duration graph for Cebu, Philippines

### Calculating stormwater flow

In order to design a drain it is first necessary to calculate the maximum stormwater flow that it will be required to carry. This involves the following steps.

- (a) Decide on the appropriate return period and concentration time.
- (b) Find the maximum rainfall intensity for those conditions ( $I$  mm/h).
- (c) Calculate the catchment area served by the drain ( $A$  ha).
- (d) Estimate the runoff coefficient for that catchment ( $C$ ).
- (e) From  $I$ ,  $A$  and  $C$ , calculate the peak flow - the maximum quantity of water to be drained per second.

These steps are discussed below.

(a) *Return period and concentration time.* The choice of these is described in section 2.2 and on pages 73-74, respectively.

(b) *Rainfall intensity.* Ideally, this should be found from an intensity-duration graph of the same form as Fig. A2.1. However, a graph compiled for one city should not be used for another city without professional advice.

Rainfall data can be obtained from the department of hydrology or water resources. If intensity-duration data are not available, an estimate can be made using the maximum daily rainfall for the appropriate return period. In each climatic zone, maximum rainfall in 15 minutes is a fairly constant percentage of the maximum daily total - typically between 10% and 40%.

(c) *Catchment area.* This is most conveniently estimated from a map. First the edges of the catchment area are drawn. Some investigation in the field may be needed to ascertain the full extent of the area from which surface water will run to the drain being designed. The area on the map can then be measured with a planimeter, or estimated by dividing it into squares. Squares whose sides are equivalent to 100 m on the map will each have an area of 1 ha. For smaller areas, smaller squares can be used. Each 10 × 10 m square will have an area of 0.01 ha.

(d) *Runoff coefficient.* As indicated previously, the runoff coefficient depends on soil conditions, terrain and land use. The first step is to determine the runoff coefficient ( $C_u$ ) for the uncovered areas, that is, for the areas which are not paved or covered by buildings. Values of  $C_u$  are given in Table A2.1. Then an estimate must be made of the percentage ( $P$ ) of the total catchment area that is covered by impermeable pavements or the roofs of buildings. This could be done from an aerial photograph, but the process is very laborious. A reasonable estimate can be made from the population density using Table A2.2. Then the overall runoff coefficient for the catchment area ( $C$ ) can be derived using Fig. A2.2.

(e) *Peak flow.* For small catchments, this is best calculated using the "rational method", expressed by the formula:

$$Q = 2.78 CIA$$

where

$Q$  = flow (l/s)

$C$  = runoff coefficient

$I$  = rainfall intensity (mm/h)

$A$  = catchment area (ha).

**Table A2.1. Values of  $C_u$ , the runoff coefficient for areas not paved or covered with buildings<sup>a,b</sup>**

### **I. Humid regions**

Average ground	Soil permeability
----------------	-------------------

slope				
	very low (rock and clay)	low (clay loam)	medium (sandy loam)	high (sand and gravel)
Flat: 0-1%	0.55	0.40	0.20	0.05
Gentle: 1-4%	0.75	0.55	0.35	0.20
Medium: 4-10%	0.85	0.65	0.45	0.30
Steep: > 10%	0.95	0.75	0.55	0.40

## II. Semi-arid regions

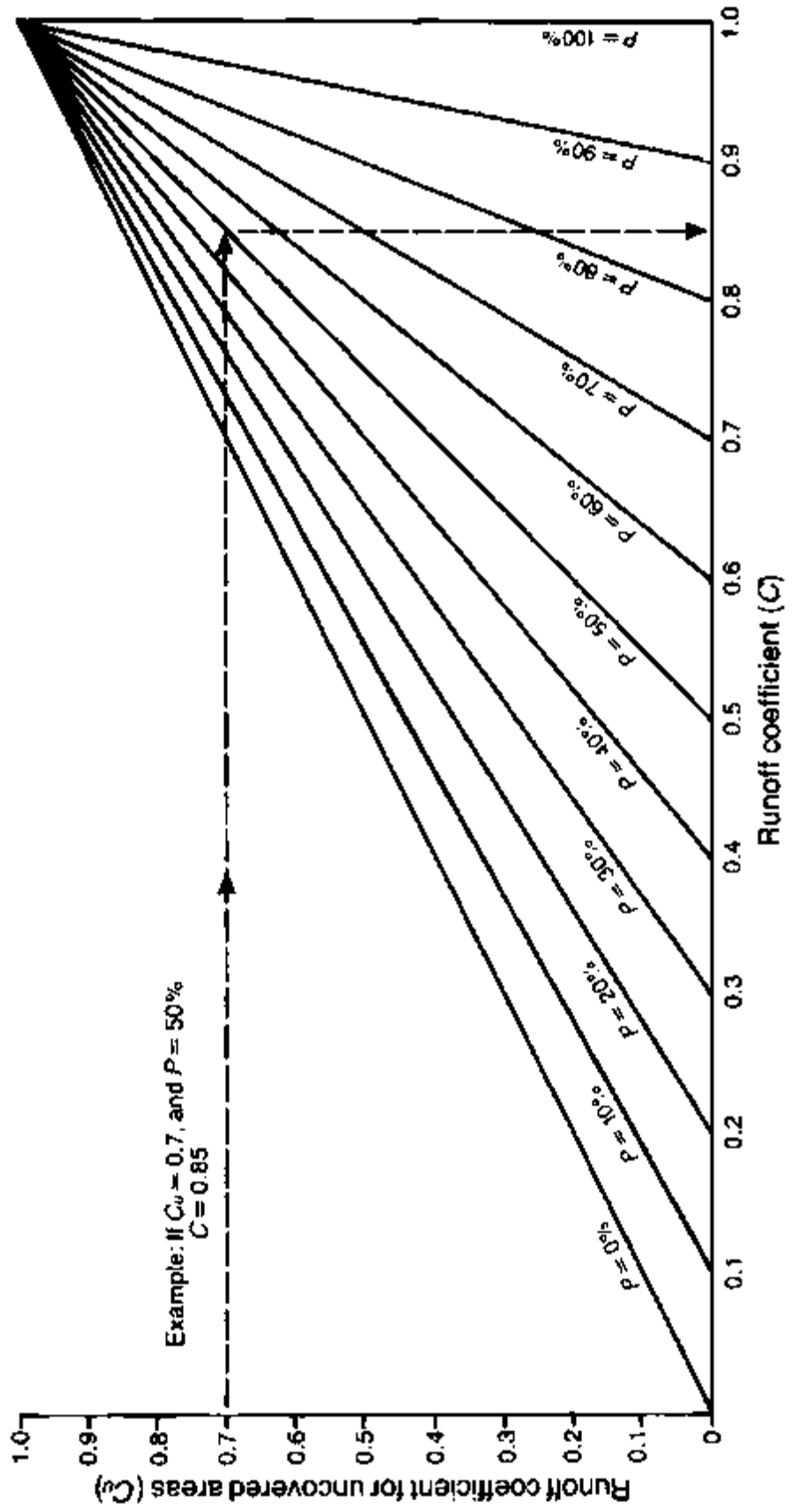
Average ground slope	Soil permeability			
	very low (rock and clay)	low (clay loam)	medium (sandy loam)	high (sand and gravel)
Flat: 0-1%	0.75	0.40	0.05	0.0
Gentle: 1-4%	0.85	0.55	0.20	0.0
Medium: 4-10%	0.95	0.70	0.30	0.0
Steep: > 10%	1.00	0.80	0.50	0.05

<sup>a</sup> From WATKINS, L. H. & FIDDES, D. *Highway and urban hydrology in the tropics*. London, Pentech Press, 1984.

<sup>b</sup> In case of doubt, part I can be used for those regions of the world shaded black in Fig. I, and part II for the remainder.

**Table A2.2. Typical values of the percentage of impermeable paved and covered areas in low-income urban settlements (*P*)**

Population density (residents/ha)	<i>P</i> (%)
0-50	0-12
100	25
200	50
300	75
> 400	100



Example: If  $C_u = 0.7$ , and  $P = 50\%$   
 $C = 0.85$

**Fig. A2.2. Diagram for deriving the runoff coefficient (C) from the coefficient for the unpaved area (C<sub>u</sub>) and the percentage of paved area (P)**

For catchment areas larger than about 5 ha, other calculation methods are more accurate, but they tend to be rather more complex.

**Example**

Calculate the flow capacity needed for a drain in a flat part of Cebu, Philippines, with a clay soil. The drain serves a catchment area of 3 ha inhabited by 600 people.

(a) The area is flat, so there is no danger of erosion. A relatively short return period (say, 3 years) is therefore suitable. The area is less than 4 ha, so concentration time can be taken as 15 min.

(b) Using Fig. A2.1, for a return period of 3 years and a duration of 15 min, the rainfall intensity  $I = 107$  mm/ha.

(c) Catchment area  $A = 3$  ha.

(d) The Philippines is in a humid region. Using Table A2.1, for a flat, clay terrain,  $C_u = 0.55$ .

Population density =

$$\frac{600}{3} = 200 \text{ residents/ha.}$$

Using Table A2.2, percentage paved area  $P = 50$ .

Hence using Fig. A2.2, the runoff coefficient  $C = 0.77$ .

(e) Finally, to calculate the flow:

$$\begin{aligned} Q &= 2.78 CIA \\ &= 2.78 \times 0.77 \times 107 \times 3 \\ &= 687 \text{ l/s} \end{aligned}$$

**Calculating drain size**

Once the flow has been determined, it is possible to derive the required dimensions of the drain cross-section. Engineers often do this using the Manning formula:

$$Q = \frac{AR^{\frac{2}{3}}S^{\frac{1}{2}}}{n}$$

where

$Q$  = flow in the drain ( $\text{m}^3/\text{s}$ )

$A$  = area of the channel cross-section ( $\text{m}^2$ )

$R$  = the "hydraulic radius" of the drain cross-section (m); to calculate this, divide the cross-sectional area by the "wetted perimeter", that is, the length of the perimeter of the channel cross-section which is in contact with the water, not counting the water surface

$S$  = slope of the drain; for a 1% slope,  $S = 0.01$

$n$  = a constant that depends on the roughness of the channel lining; typical values of  $n$  are:

$n = 0.015$  for a smooth concrete or plastered brick masonry;

$n = 0.025$  for straight unlined channels free of vegetation;

$n = 0.035$  for unlined channels with short grass and few weeds.

However, many readers will find it simpler to use Fig. A2.3. This is a design chart for a channel with the trapezoidal cross-section shown in the inset, which has no lining or vegetation ( $n = 0.025$ ). The channel depth  $D$  obtained from Fig. A2.3 can be used to derive the dimensions of channels and pipes with other shapes and other types of lining. The procedure then is as follows:

(a) Find the maximum flow in l/s, as described on pages 74-78.

(b) Find the slope of the section to be designed in % (1% means a vertical drop of 1 m in every 100 m of drain).

(c) Use Fig. A2.3 to find the value of  $D$  for this slope and flow.

(d) If the drain is not a trapezoidal channel, multiply  $D$  by the factor given in Fig. A2.4 to derive the dimensions for the appropriate shape of cross-section. If the drain cross-section does not correspond exactly to any of the shapes shown in Fig. A2.4, choose the nearest equivalent and follow the method to find the size required for the standard cross-section. Then plan for the dimensions of the drain to have the same cross-sectional area as the standard cross-section design.

(e) If the drain is to have a smooth lining, or if the sides and bottom will be covered with short grass, the dimensions will need further adjustment:

- for smooth concrete or plastered brick masonry lining, multiply the dimensions by 0.83 (i.e., reduce by 17%),

- for unlined channels with short grass and few weeds, multiply the dimensions by 1.13 (i.e., increase by 13%);

- for a smooth earth or unplastered masonry lining, no adjustment is needed.

(f) Finally, calculate the average speed of flow of the water when the drain is running full. If the flow is so rapid that it would cause erosion of an unlined channel, the

channel should be lined, or at least stabilized with grass. Step (e) above should then be repeated for a lined or grassed channel.

On the other hand, too low a speed will fail to achieve self-cleansing and so allow sediment to accumulate. If possible, a speed of at least 0.5 m/s should be achieved in all drains when flowing full. A speed of 1.0 m/s would be better still.

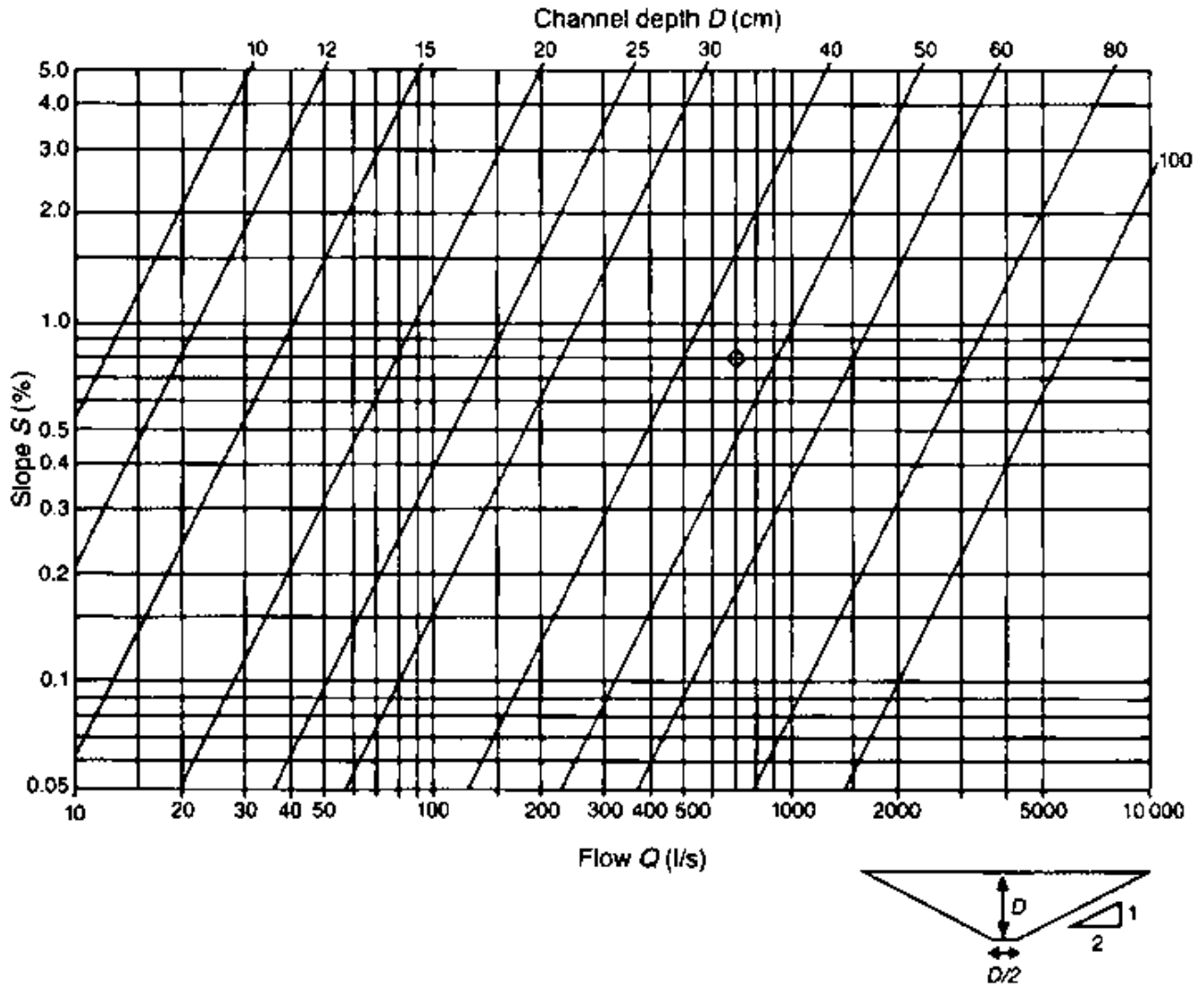
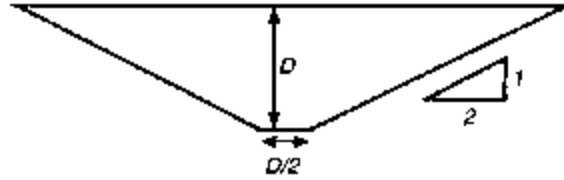


Fig. A2.3. Design chart for small drains with a trapezoidal cross-section and no lining or vegetation

Fig. A2.4. Calculating the dimensions of various types of drain, using values of channel depth ( $D$ ) from Fig. A2.3





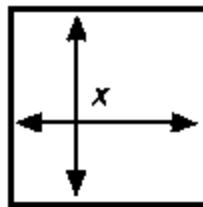
(a) Trapezoidal channel

Base width =  $\frac{D}{2}$   
 Side slope = 1 in 2  
 Find  $D$  from Fig. A2.3.



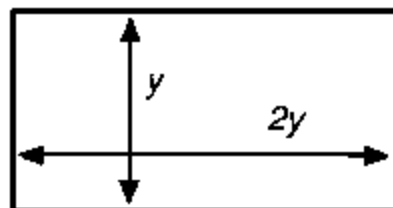
(b) Semicircular channel

Radius  $r = 1.2 D$   
 Find  $D$  from Fig. A2.3.  
 Then multiply by 1.2 (i.e., add 20%)  
 to find  $r$ .



(c) Square channel

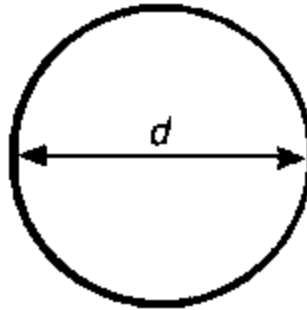
Side  $x = 1.56 D$   
 Find  $D$  from Fig. A2.3.  
 Then multiply by 1.56 (i.e., add 56%)  
 to find  $x$ .



(d) Rectangular channel

Depth  $y$ , width  $2y$   
 $y = 1.1 D$   
 Find  $D$  from Fig. A2.3.

Then multiply by 1.1 (i.e., add 10%)  
to find  $y$ .



(e) Closed circular pipe, flowing full

Diameter  $d = 1.34 D$   
Find  $D$  from Fig. A2.3.  
Then multiply by 1.34 (i.e., add 34%)  
to find  $d$ .

### Checking the speed of flow

Once the dimensions of a drain have been chosen, the cross-sectional area can be calculated from them. The average speed of flow can be found from the formula:

$$V = \frac{10Q}{A}$$

where

$V$  = flow speed in m/s  
 $Q$  = flow in l/s  
 $A$  = cross-sectional area in  $\text{cm}^2$ .

If this speed is found to be greater than the corresponding value in Table A2.3, there is a danger of serious erosion unless the drain is lined or provided with checkwalls (see section 2.3). Table A2.3 also gives maximum permissible speeds of flow in channels whose sides and base are stabilized by a firm cover of grass.

**Table A2.3. Permissible flow speeds to prevent erosion in unlined drainage channels<sup>a</sup>**

Type of soil	Typical particle size (mm)	Permissible speed (m/s)
Fine sand	0.05	0.4
Sandy loam	-	0.7
Medium sand	1.0	0.8
Silty loam	-	0.8
Ordinary firm loam	-	1.0

Volcanic ash	-	1.0
Coarse sand	2.5	1.0
Stiff clay	-	1.5
Alluvial silt	-	1.5
Shales and hardpans	-	1.8
Fine gravel	5	1.5
Coarse gravel	10	1.8
Cobbles and shingles	40	2.4
Grass cover, erodible soils	-	1.2
Grass cover, stable soils	-	1.8

<sup>a</sup> From: CHOW, V. T. *Open-channel hydraulics*. New York, McGraw-Hill, 1959; and WATKINS, L. H. & FIDDES, D. *Highway and urban hydrology in the tropics*, London, Pentech Press, 1984.

### Example

Design a square concrete channel to drain a peak flow of 687 l/s. The channel bed level falls 40 cm along a 50 m length.

(a) Flow  $Q=687$  l/s

(b)

$$\text{Slope} = \frac{0.4 \times 100}{50} = 0.8\%$$

(c) On the left side of the design chart (Fig. A2.3), find the 0.8% slope, and on the bottom of the chart find the approximate point corresponding to 687 l/s (very slightly to the left of the 700 l/s point). Find where the corresponding horizontal and vertical lines cross; the point is marked in Fig. A2.3.

This point is roughly half-way between the two sloping lines for  $D = 40$  cm and  $D = 50$  cm respectively. By interpolation, take  $D = 45$  cm.

(d) Using Fig. A2.4(c), it can be seen that this value must be increased by 56% to give the width of a square channel:

$$45 \times 1.56 = 70 \text{ cm}$$

(e) Since the lining is of concrete, the width can be adjusted to allow for the reduced friction from the smooth channel sides. The dimensions can be reduced by 17%:

$$70 \times 0.83 = 58 \text{ cm}$$

Rounding up the result to a convenient value, the drain can be 60 cm deep and 60 cm wide.

(f) This channel will have a cross-sectional area of  $3600 \text{ cm}^2$ . The speed of flow  $V$  will therefore be

$$V = \frac{10 \times 687}{3600} = 1.9 \text{ m/s}$$

This speed of flow would cause erosion in almost any unlined drain, but not in a well-built concrete channel. A speed of 1.9 m/s is more than enough for self-cleansing; silt deposition will not be a problem in this drain.

### **Annex 3. Terms of reference for consultants**

Many drainage schemes are designed by consulting engineers. However, these are not usually for low-income communities. There is therefore a danger that consulting engineers may design drainage systems for low-income areas which are inappropriate or unaffordable unless the terms of reference for their work are drafted to make it very clear what sort of solution is desired. A municipality that has already obtained funds for the construction of a drainage system will generally have a fairly clear idea of its requirements, and will usually find that consultants' work is most satisfactory when they are contracted to perform clearly specified design tasks within the framework of those needs.

However, national and international funding agencies often require that, before they agree to pay for the construction of a drainage system, it should be the subject of a feasibility study by a reputable firm of consulting engineers. In such a case the funding agency will have its own requirements and will wish to participate in drafting the terms of reference for the feasibility study. Nevertheless, the municipality or the community's representatives can suggest clauses in the terms of reference to ensure that:

- the full benefits of the proposed drainage scheme are demonstrated;
- the study is conducted in such a way as to arrive at the most cost-effective solution;
- an accurate assessment is made as early as possible of the resources that will be required for maintenance of the system;
- construction of the most urgently needed parts of the system is not delayed any more than necessary by the lengthy process of project preparation, approval and design; and
- the community is involved in key decisions.

These factors are discussed in turn.

#### **Benefits**

The health consequences of inadequate drainage, described in section 1.2, indicate the health benefits which improved drainage can bestow. These can be further documented by the consultants, using existing health statistics or the results of any community health surveys that have been carried out.

In addition to the health benefits, the most significant economic benefits will stem from the prevention of damage by flood or erosion to:

- public infrastructure, particularly roads,
- private property, especially houses,
- domestic furniture and other movable property.

A money value can be put on these benefits. Private property in a low-income community can be valued at a given percentage of the minimum wage.

Other benefits can include:

- enhancement of land value,
- reduced traffic delays,
- reduced losses of income, rent, sales and production,
- reduced clean-up and maintenance costs,
- reduced emergency relief costs,
- greater sense of security,
- improved aesthetic environment, and
- more opportunities for recreation.

### **Cost-effectiveness**

The technical options outlined in section 2 indicate that drainage systems need not be expensive. The design criteria explained there can be varied to give options with different costs and benefits, and the best option chosen. This applies particularly to the following choices:

- return period (section 2.2),
- open or closed drains (section 2.5),
- channel lining (section 2.6).

The terms of reference for a feasibility study should require an analysis of the costs and benefits of the possible options, so that these decisions are not taken arbitrarily.

It is difficult to calculate exactly how the many benefits of drainage will be altered by changes in design criteria to allow occasional shallow flooding. The problem can be simplified by assuming that the damage caused by a flood is proportional to a "damage index"  $D$ :

$$D = F \times Q \times T$$

where

$F$  = frequency of occurrence of the flood (say, number of times in a 10-year period)

$Q$  = quantity of water that cannot be drained away immediately (mm of rainfall)

$T$  = time for which the flood lasts (hours).

The estimated cost  $C$  of each option can be compared with the value of  $D$  to find the option with the highest ratio of  $C : D$ .

### **Maintenance requirements**

These are discussed in section 3. A typical value for the annual cost of maintenance would be about 8% of the construction cost of the system. The feasibility study should make a more accurate estimate, including an assessment of the human resources and equipment that will be needed.

### **Urgent construction**

The terms of reference can authorize the consultants to proceed with detailed design of the most urgently needed components of the system (say, to a value of 10% or 20% of the total estimated value of the system) once the choice of solution has been agreed, but without the need for a new contract or new approval by the funding agency.

### **Community involvement**

It is conventional in any consultancy agreement to stipulate stages at which the client's opinion or approval is to be sought. The client in this case will usually be the municipality. There is no reason why the community should not be involved in this process. As far as the terms of reference are concerned, responsibility for ensuring that the community participates in decision-making could be assigned to the client or the consultant. The latter could either follow lines laid down by the client or be asked to propose a procedure for community participation when bidding for the contract.

### **Annex 4. Resources for the orientation of the drainage committee**

Section 4, on community participation, provides guidance on the establishment and functions of the drainage committee. Where such a committee is established the members should gather to exchange information about the local drainage situation. They should also attempt to assimilate general information about common methods and materials for solving drainage problems. This will facilitate agreement on what needs to be done and in what sequence. The books and documents listed below are useful sources of general information about drainage and community participation that are likely to be readily available from libraries or other sources of United Nations publications. Drainage committees may also request such information from national and/or local public works or health authorities. The unpublished WHO documents listed here can be obtained from Division of Environmental Health, World Health Organization 1211 Geneva 27, Switzerland; unpublished Habitat documents are available from the United Nations Centre for Human Settlements, Nairobi, Kenya.

#### **Useful books and documents**

CAIRNCROSS, S. & FEACHEM, R. G. *Environmental health engineering in the tropics: an introductory text*. Chichester, John Wiley & Sons, 1983.

OKUN, D. A. & PONGHIS, G. *Community wastewater collection and disposal*. Geneva, World Health Organization, 1975.

WHYTE, A. *Guidelines for planning community participation activities in water supply and sanitation projects*. Geneva, World Health Organization, 1986 (WHO Offset Publication No. 96).

*Improving environmental health conditions in low-income settlements: a community-based approach to identifying needs and priorities.* Geneva, World Health Organization, 1987 (Offset Publication No. 100).

*Catalogue of external support*, 3rd ed. Unpublished WHO document, December 1985 (International Drinking Water Supply and Sanitation Decade, CWS Series, No. 7).

*Water supply and sanitation for developing countries. An international source list of audiovisual materials.* Unpublished WHO document, April 1987 (International Drinking Water Supply and Sanitation Decade, CWS Series, No. 8).

*Environmental aspects of water management in metropolitan areas of developing countries.* Unpublished document, United Nations Centre for Human Settlements (Habitat), Nairobi, 1984.

*Delivery of basic infrastructure to low-income settlements: issues and options.* Unpublished document, United Nations Centre for Human Settlements (Habitat), Nairobi, 1986.

*Community participation in low-cost sanitation. Training module.* Unpublished document, United Nations Centre for Human Settlements (Habitat), Nairobi, 1986.

*Community participation and low-cost drainage. Training module.* Unpublished document, United Nations Centre for Human Settlements (Habitat), Nairobi, 1986.

### **Selected WHO publications of related interest**

	Price* (Sw. fr.)
<b>Technology for water supply and sanitation in developing countries:</b> report of a WHO Study Group. WHO Technical Report Series, No. 742, 1987 (38 pages)	7.- (4.90)
<b>Improving environmental health conditions in low-income settlements. A community-based approach to identifying needs and priorities.</b> WHO Offset Publication, No. 100, 1987 (68 pages)	12.- (8.40)
Oakley, P. <b>Community involvement in health development. An examination of the critical issues.</b> 1989 (81 pages)	16.- (11.20)
Whyte, A. <b>Guidelines for planning community participation in water supply and sanitation projects.</b> WHO Offset Publication, No. 96, 1986 (53 pages)	10.- (7.-)
<b>Health principles of housing.</b> 1989 (86 pages)	11.- (7.70)
<b>Urbanization and its implications for child health. Potential for action.</b> 1988 (86 pages)	16.- (11.20)
Tabibzadeh, I. et al. <b>Spotlight on the cities. Improving urban health in developing countries.</b> 1989 (179 pages)	30.- (21.-)

Further information on these and other World Health Organization publications can be obtained from Distribution and Sales, World Health Organization, 1211 Geneva 27, Switzerland.

\* Prices in parentheses apply in developing countries.

### **Back cover**

For many low-income communities, lack of an adequate drainage system for surface water is a serious problem, leading to frequent flooding, land erosion, and increased transmission of a number of diseases. This publication describes how such communities can take action themselves to construct a simple, effective, low-cost drainage system or to rehabilitate an existing system that has fallen into disrepair. It gives practical guidance on the design and construction of drainage channels, and on ways of coping with specific problem areas such as steep slopes and low-lying flat terrain. Throughout the book, emphasis is placed on the importance of community participation at all stages of the project, from planning through implementation, and particularly in maintaining the system once it is built. Written in nontechnical language and copiously illustrated, this book will be invaluable to local authorities and community groups, as well as planners and public works officials in developing countries.

Price: Sw. fr. 16.-

ISBN 92 4 154416 3

Price in developing countries: Sw. fr. 11.20