

ምግብ
FOOD

ጥገታ
pasta

ባለአትክልት ጠፍጣፋ ጥካርኒ
spinach noodles

ጠፍጣፋ ጥካርኒ
noodles

ጥጥጥ ጥካርኒ
twisted macaroni

ላሳጎ
lasagna

spinach lasagna

ደረጃግ ላሳጎ
curly lasagna

mafalde

non-skid spaghetti

mafaldine

vermicelli

thin macaroni

fedelini

ቀጭን ስፓጌቲ
thin spaghetti

mezzani

ስፓጌቲ
spaghetti

ታሊያቲሊ
ziti

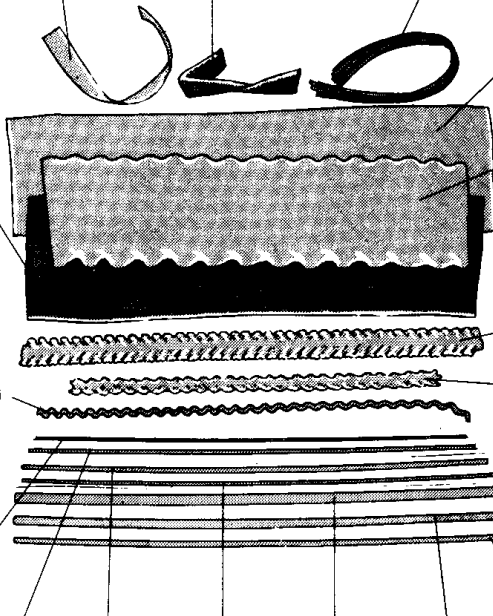

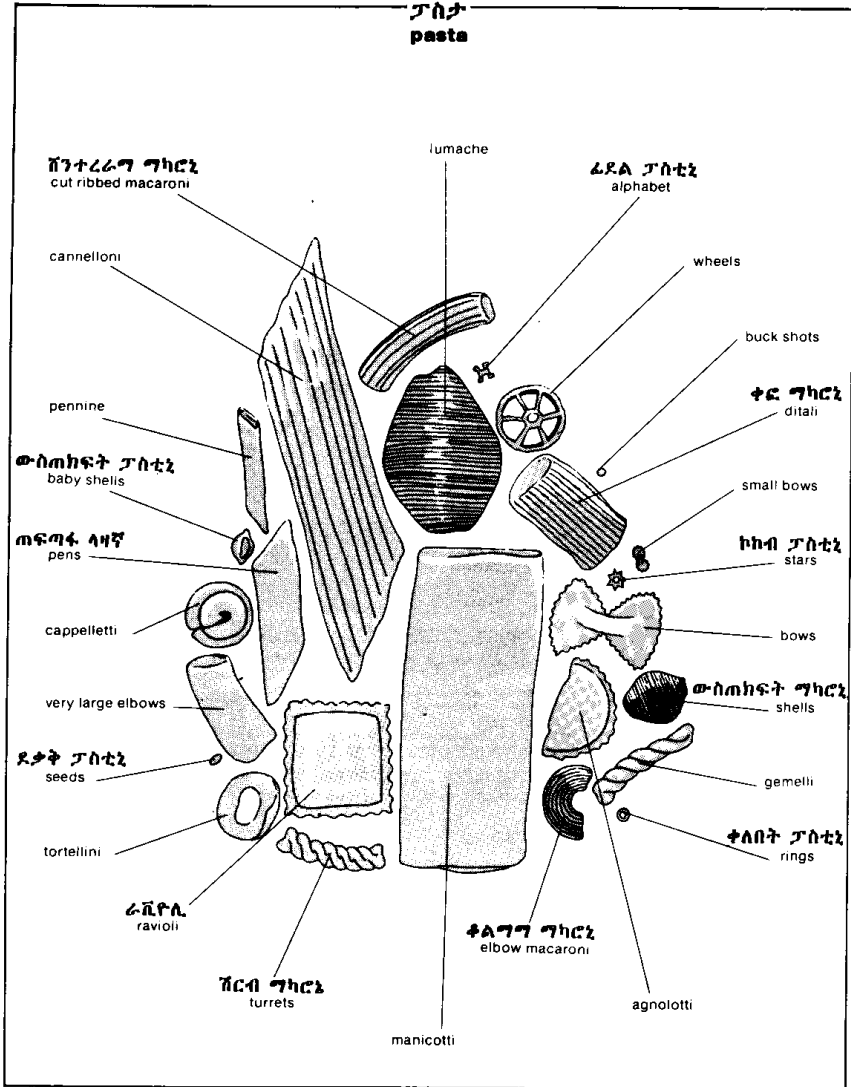

የበግ ብልት

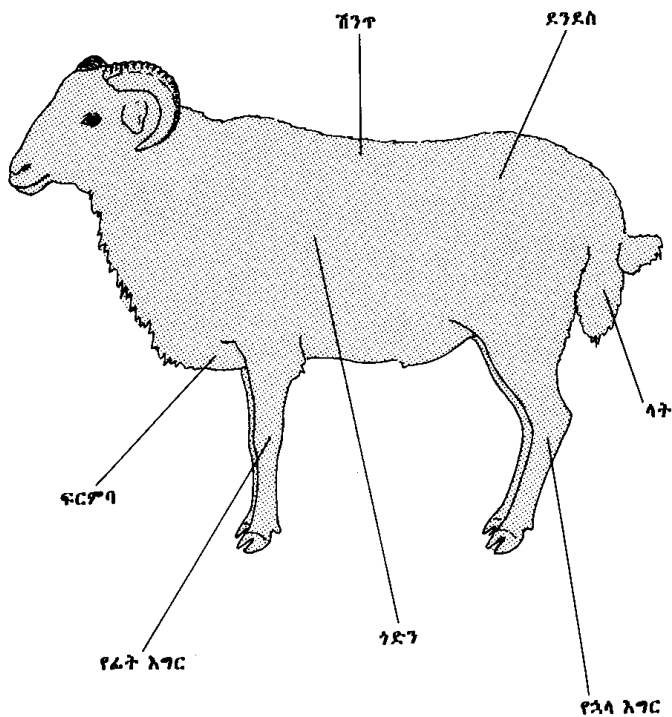

የቦራ ብልት

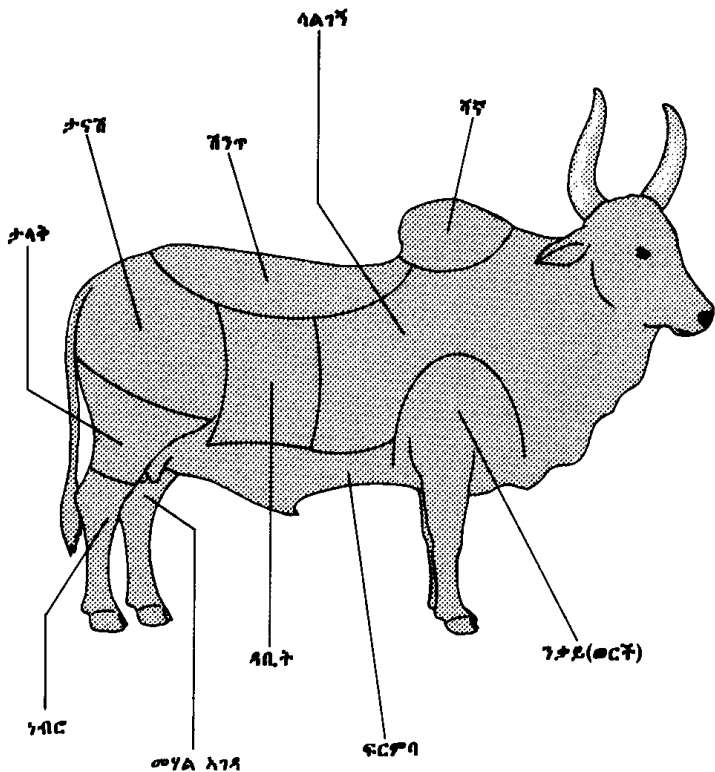

የጾር ብልት አወጣጥ

አጭረ

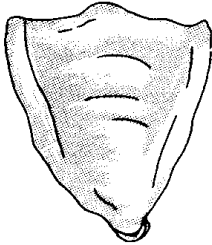

ጠባባጭ

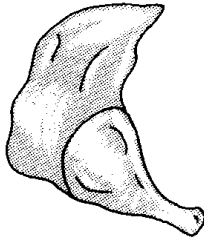

አገር

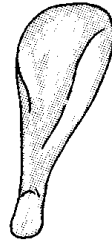

ፈረሰኛ

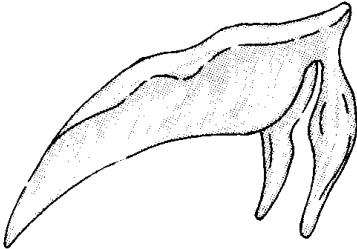

ባንባላቃረ

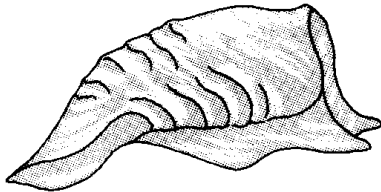

ከገፍ

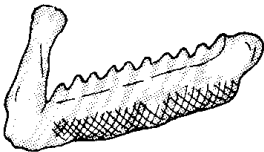

ጠጽጽኛ

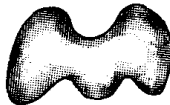

ጉርር

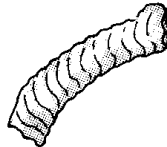

ጥገታ
desserts

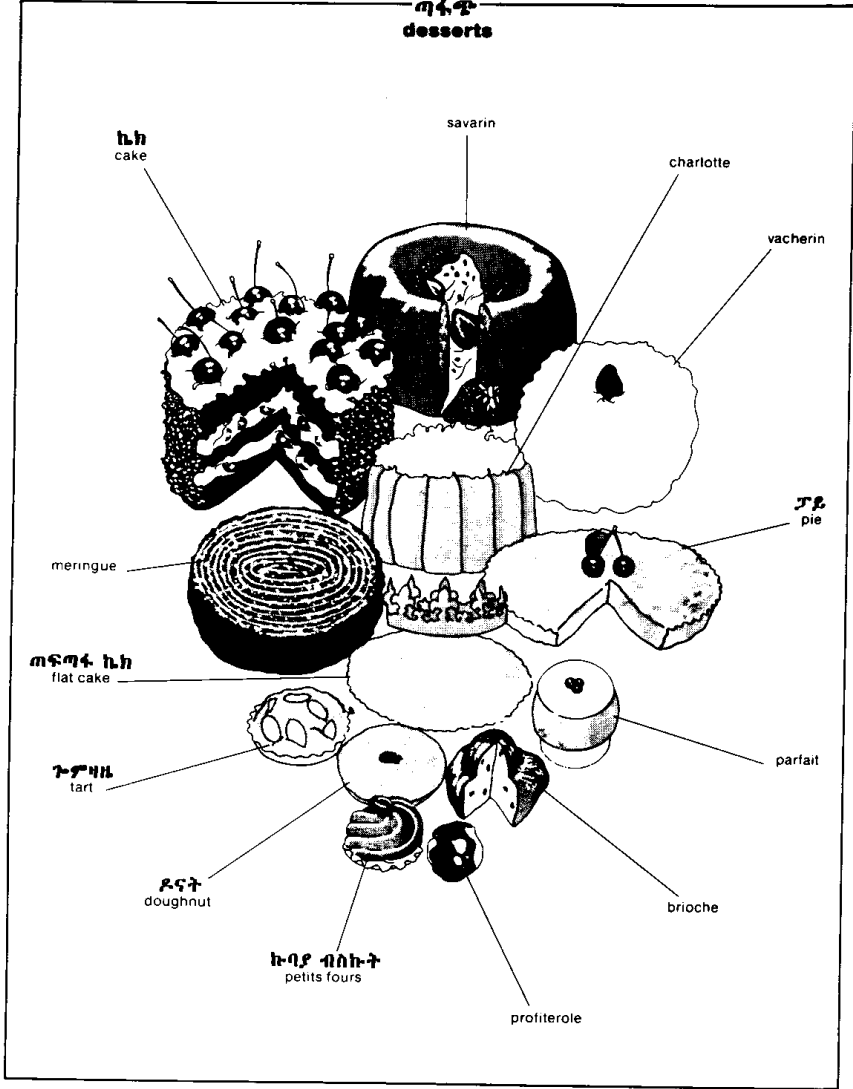

ጣፋጥ
desserts

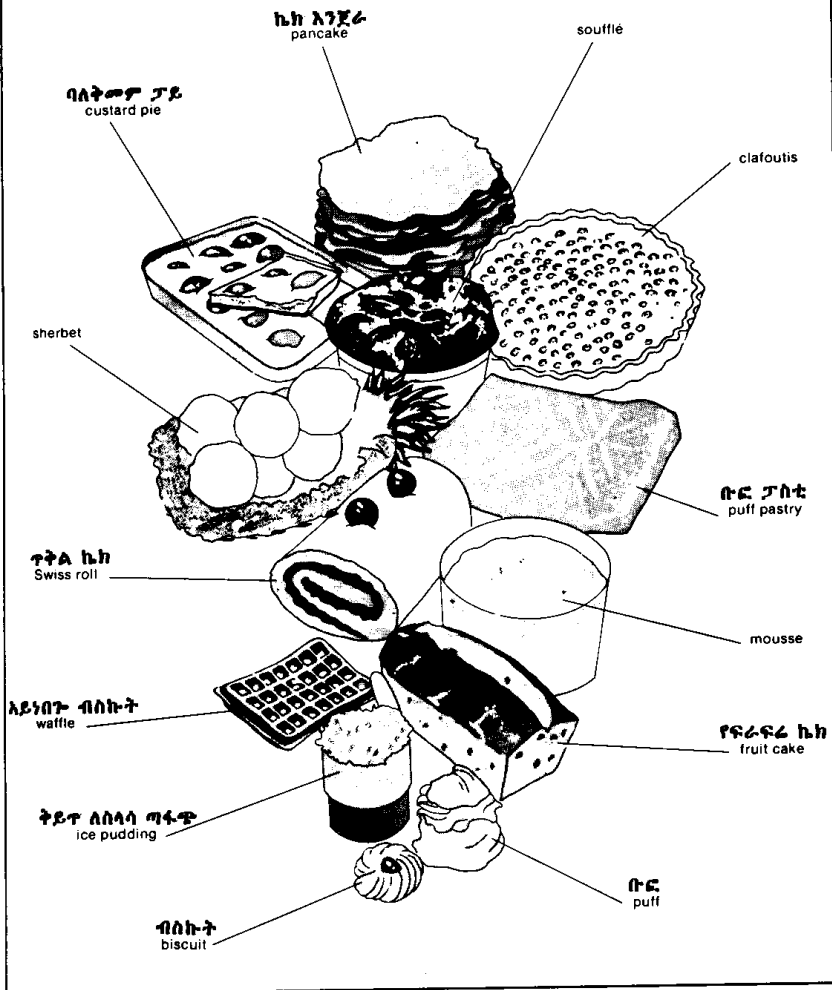

ኬክ ለንጀራ
pancake

soufflé

ባለትጦጥ ፓይ
custard pie

clafoutis

sherbet

ቡፎ ፓስቲ
puff pastry

ፕታላ ኬክ
Swiss roll

mousse

አይነቡት ብስኩት
waffle

ፕሩፍሩ ኬክ
fruit cake

ትይጥ ለሰላላ ጣፋጥ
ice pudding

ቡፎ
puff

ብስኩት
biscuit

እርሻ
FARM

ሀገራዊ
buildings

የገብርና ተቆ
open housing

ያደረ መራት
fallow

ወተት ቤት
milk room

ጽጌ ግለገለጊያ
vertical silo

ገመሽ መስክ
pasture

ዶሮ ቤት
poultry house

በቀሎ መኖ
fodder corn

እሌክትሪክ አጥር
electrified fence

ኅተራ
barn

ወርዳዎ ግለገለጊያ
bunker silo

ተር
beehive

የአትክልት ወጀድ
vegetable garden

እርሻጊ
farmyard

አሳግ ቤት
pigsty

ጋራሽ
hangar

ገበሬ ቤት
farmhouse

የበግ ጉርኖ
sheep shelter

ላዎበረት
cowshed

ውሃ ጉርግድ
well

ቤት ሃመላግላ
greenhouse

የፍራፍራ እርሻ
orchard

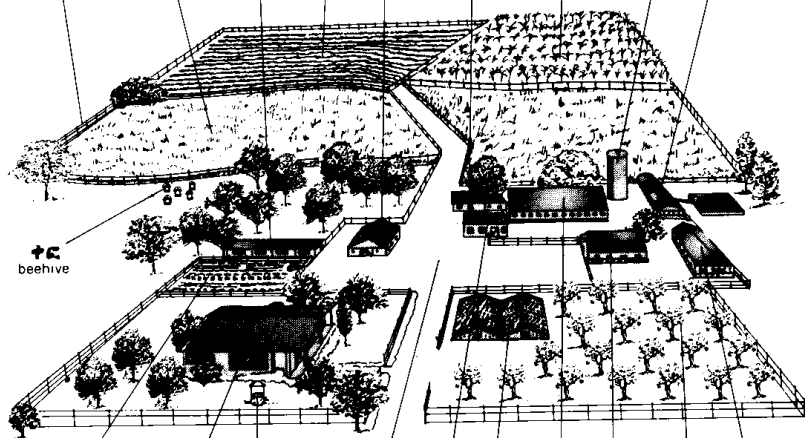

የእርሻ መሳሪያዎች
agricultural machinery

ሳር አሳሪ
pickup automatic baler

ትራክተር
tractor

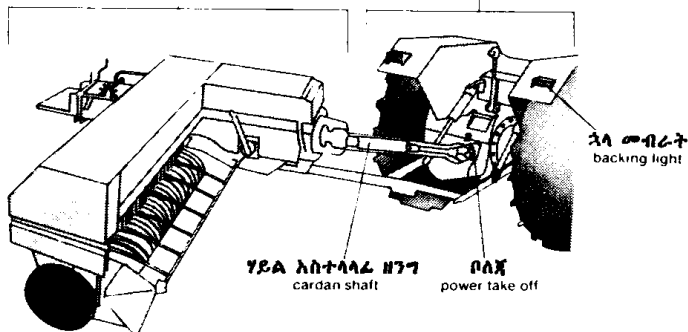

ተላላፊ ግጭድ
reciprocating knife mower

አንስተ ጫኛ
pickup loader

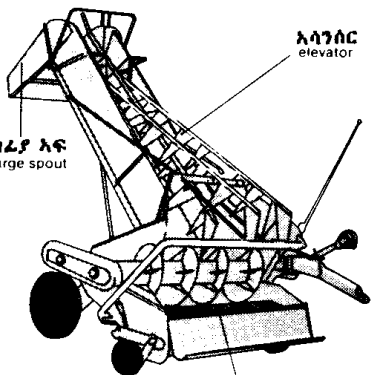
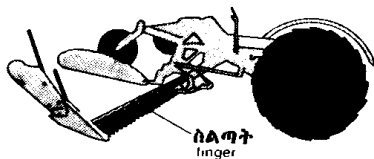

መከሰካኝ
harrow

መሪዘንግ
steering track rod

ግራገሊያ አፍ
discharge spout

መደጠጫ
spike-tooth

ግጥር
loam

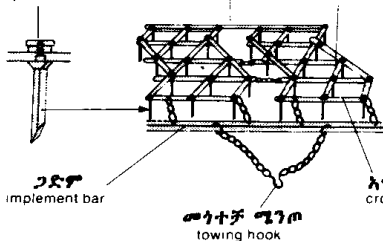

አግዳሚ ዘንግ
crossbar

የእርሻ መሳሪያዎች
agricultural machinery

ተሽከርካሪ መጎተቻ
rotary hoe

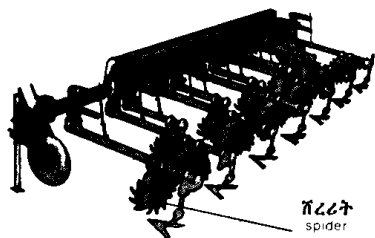

ፍጥጥላረሻ
manure spreader

ጥጥረሻ ተሽከርካሪ
spreading rotor

ፍጥቋት
manure spreader box

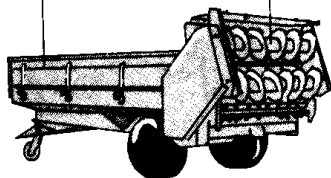

ጎድጎዮሽ ግረሻ
ribbing plow

አገዳሚ
beam

እግር
leg

ቢጋር
frame

መራትጊ
landside

ግርጊ
heel

ፍሮግ
frog

መጋፊያ
skimmer

መቀርደሻ
coultter

ግረሻ
share

ገልባጭ
moldboard

ግርጊ
bottom

መናኦጫጅ
silage harvester

ግራገሬያ አፍ
discharge spout

መኮትኮት
cultivator

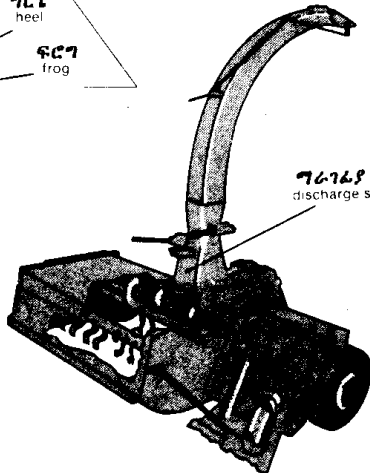
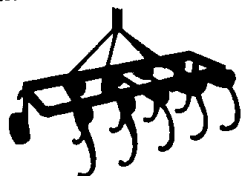

የእርሻ መሳሪያዎች
agricultural machinery

ትሪት መበተኛ
field heap spreader

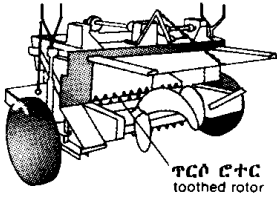

ፕሮሶ ፎተር
toothed rotor

ተካይ
seed drill

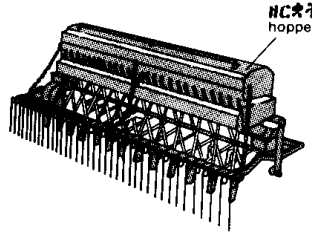

ዘርጃት
hopper

ግዳረቂያ
fingerwheel

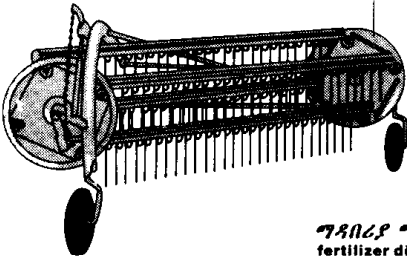

ግጦንጦኛ
reel

መስረግረጊያ
subsoil plow

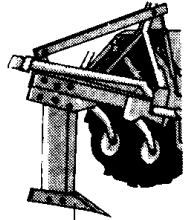

ፕሮሶ
tooth

ድንች መትከያ
potato planter

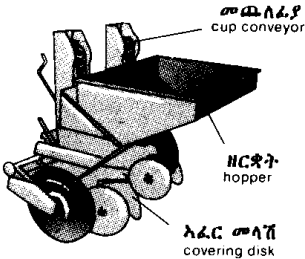

መጨለፊያ
cup conveyor

ዘርጃት
hopper

አፈር መላሽ
covering disk

ግዳበሪያ ግሰራጫ
fertilizer distributor



ባለምጣድ መከሰከሻ
tandem disk harrow

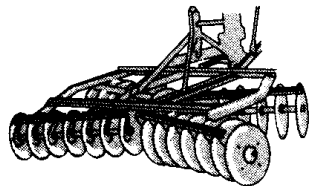

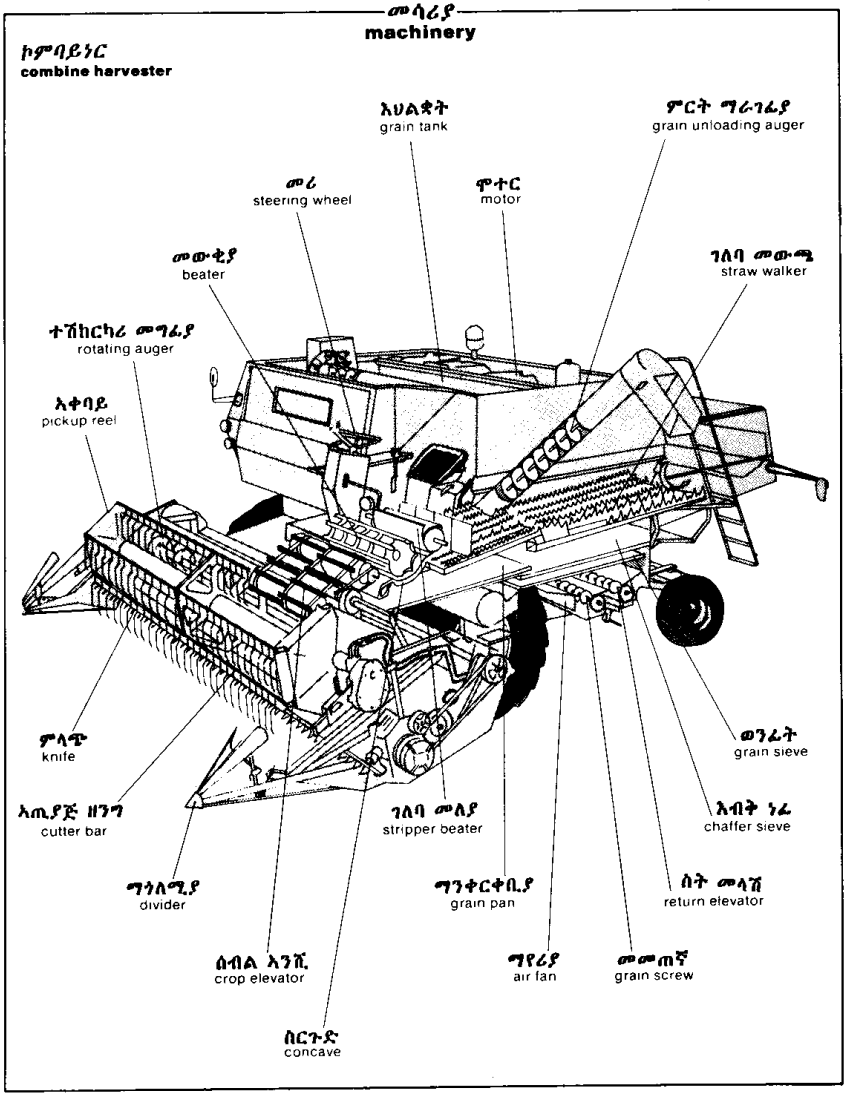

ባህላዊ የእህል መያዥ ያና ግዝግቻ

ባልቻ

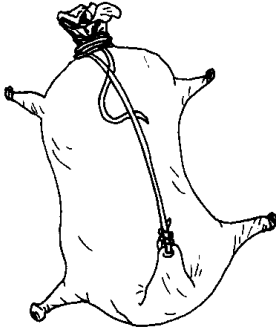

ጎተራ (ያተኛሻለ)



ኢብኝት

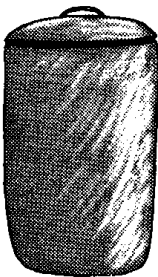

የተኛሻለ ጎተራ



እዚጥ የግዝግቻ ለግር

ባህላዊ የገብርና መሳሪያ

ደንጎራ

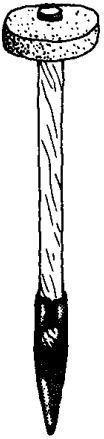

ገሰ

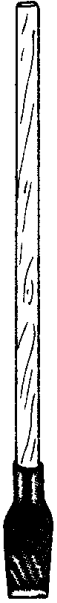

ወኒቶ



መኮትኮቻ

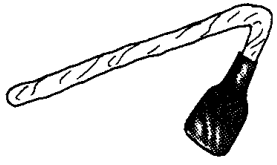

አካቶ

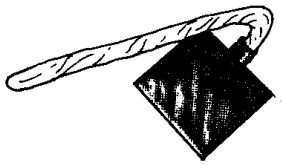

ገሰ

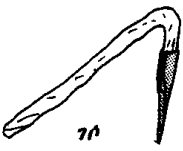

ባገጋ

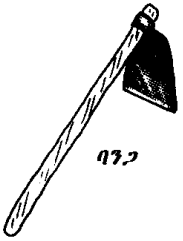

አገካሌ



ባለሁለት ጣት መኮትኮቻ



ባህላዊ የግብርና መሳሪያ

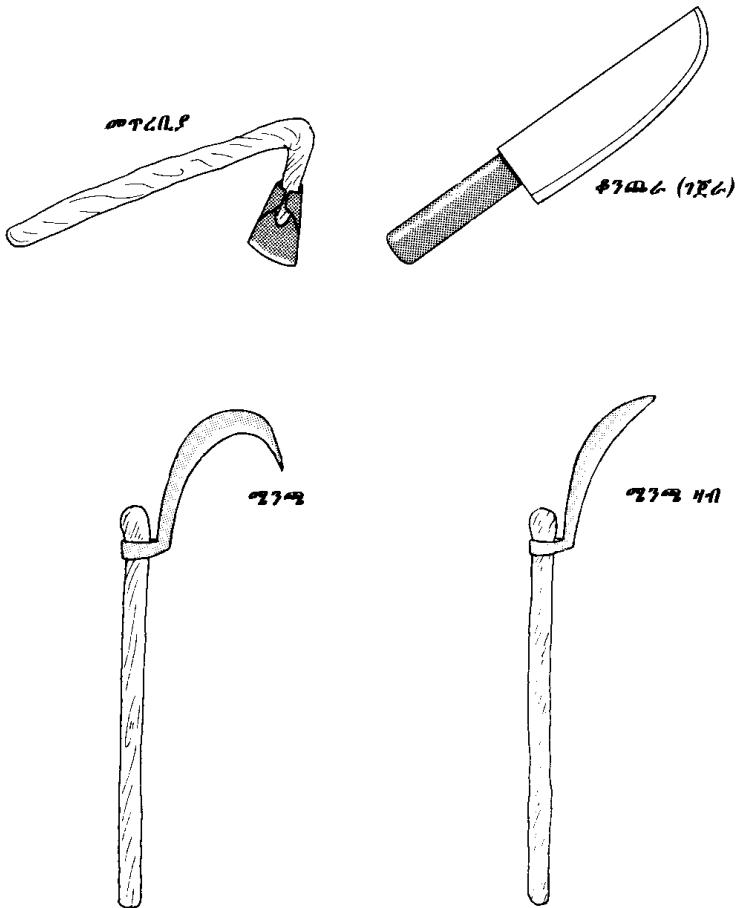

ባህላዊ የግብርና መሳሪያ

ኖራርና ቀንበር

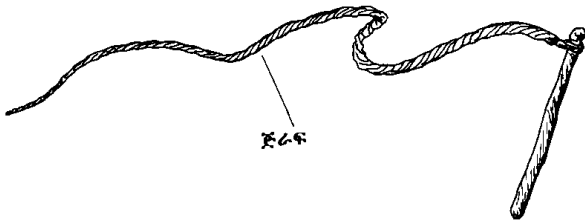
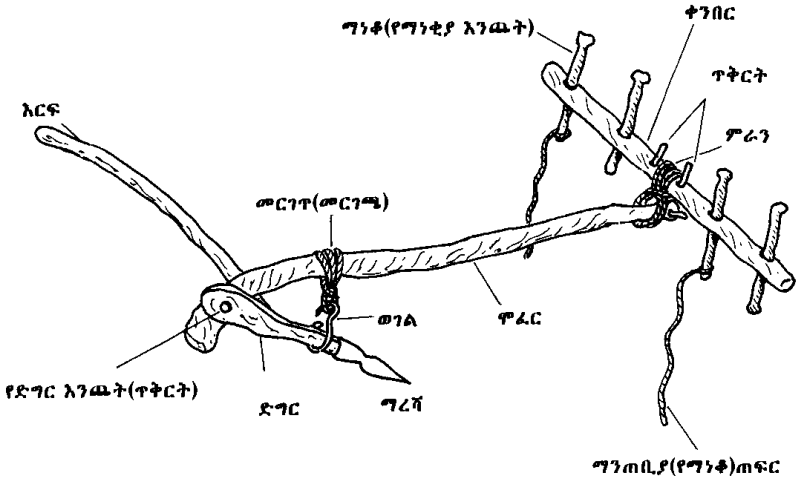

የአውድግ ሊቃ

የግሽላ መውረያ



የጤፍ መውረያ (መጭ) (አገደዮ)

የአገጣጥ መንሽ



የጤፍ ወንጊት

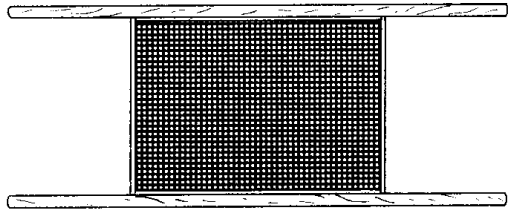

ላይዳ

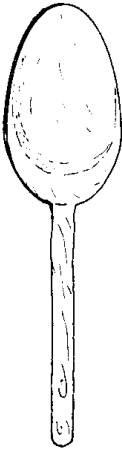

ቀርቆቦ

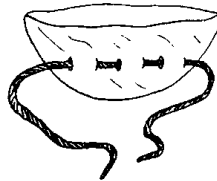

የጤፍ ግራገቢያ

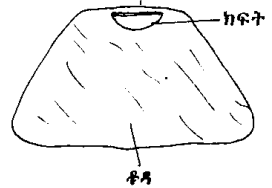

የከብት እርባታ መሳሪያ

መገቀያ

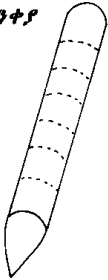

ቀንድ መፈገቀያ

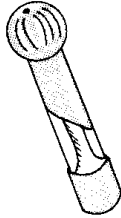

ቀንድ መፈገቀያ

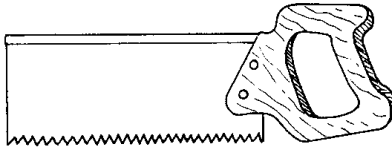
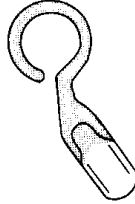

መጋዝ

ግኮላሻ ሰንጢ

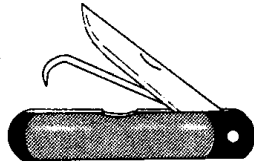

ቡርዲዞ

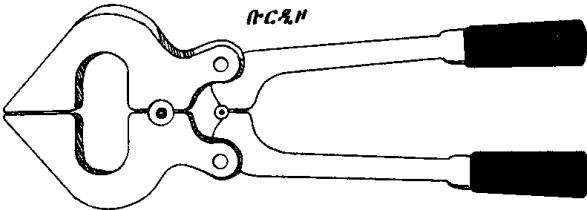

የክብት እርባታ መሳሪያ

ገለቢያ

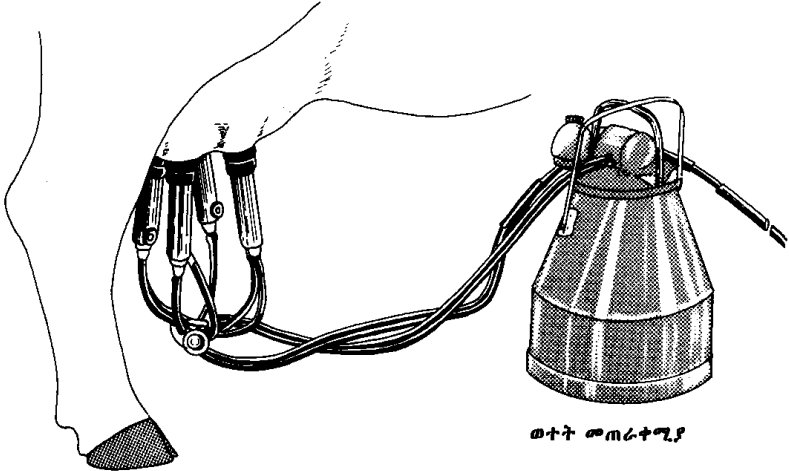

ወተት መጠራቀሚያ

የወተት ለቃ

ወተት ግጣሪያ

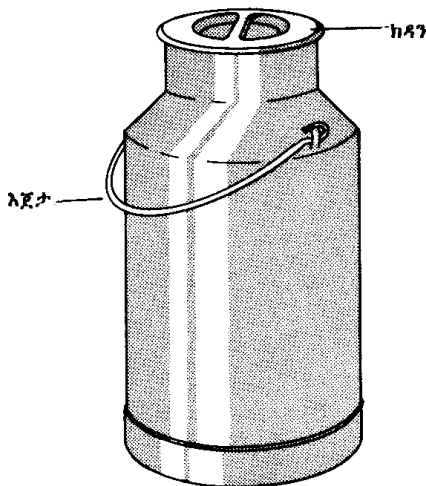
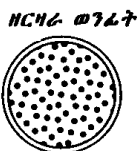
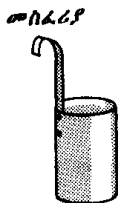
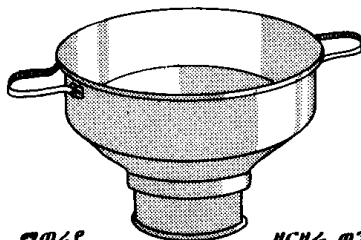

የወተት መለያ መሳሪያ

የወተት ጥራት መቆጣጠሪያ



ቅባት መለያ

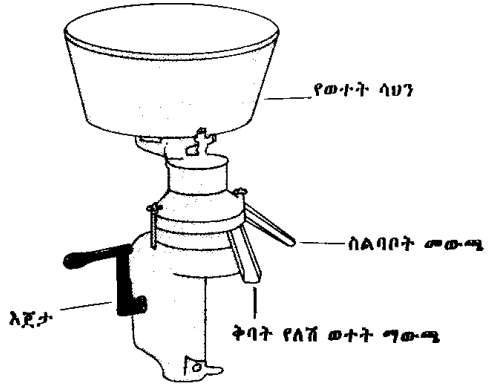

መኖሚያ

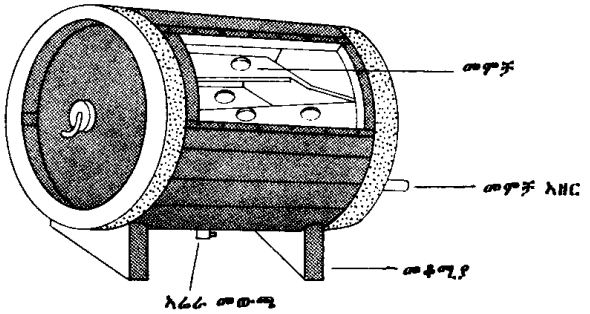

የዶሮ እርባታ እቃ

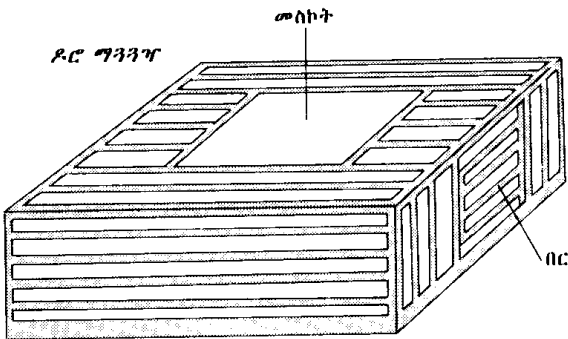
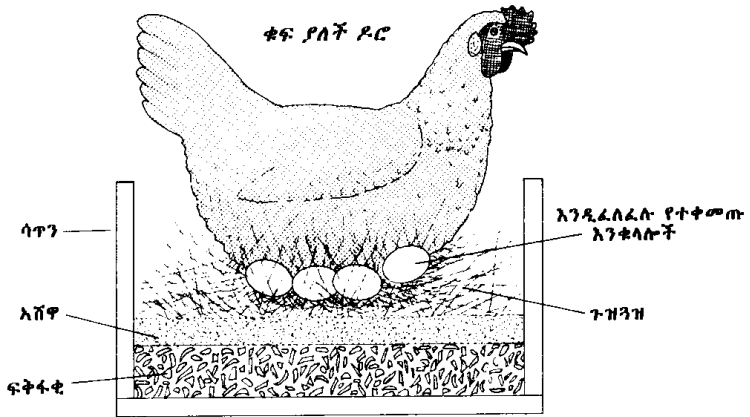

ሰው ሰራሽ ግብረልፊያ

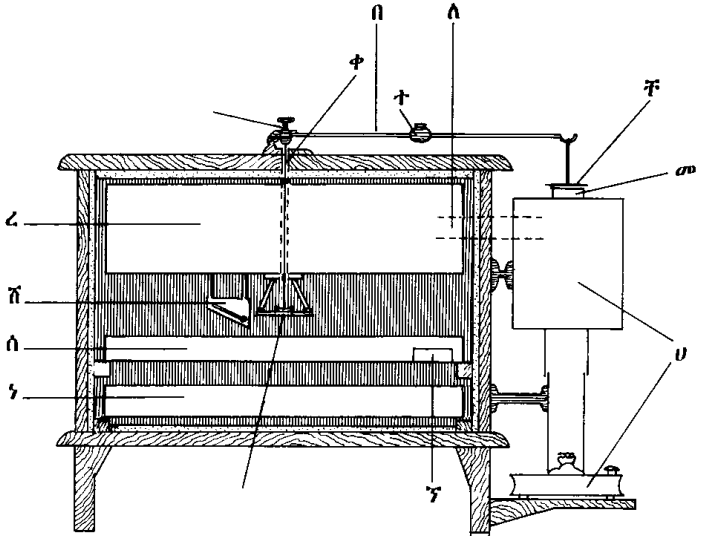

ሆ - ግሞቂያ (በዘይት)

ለ - የሙቀት መግቢያ

መ - የሙቀት መተንፈሻ

ረ - ሙቀት ቤት

ሰ - የእንቁላል ትሪ

ሸ - ቴርሞሜትር

ቀ - ዘንግ

በ - ተንቀሳቃሽ እጅታ

ተ - ክብደት መጠበቂያ

ሸ - መክደኛ

ኘ - የሜሎት ትሪ

ኘ - የውሃ እቃ

ስነህንጻ
ARCHITECTURE

ብሔራዊ ቤተሰብ
traditional houses

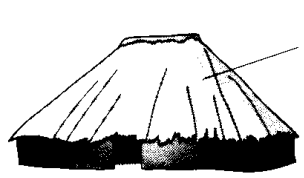

ኅጽ
hut

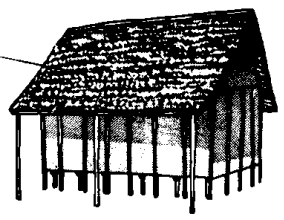

የሀንድ ኅጽ
wigwam

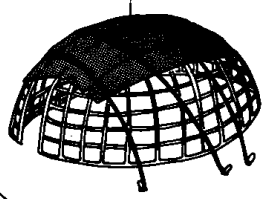

ኅጽ
hut

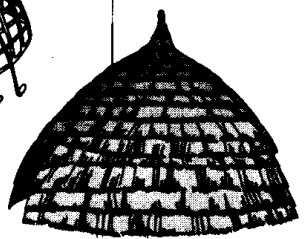

የስኪሞ ኅጽ
igloo

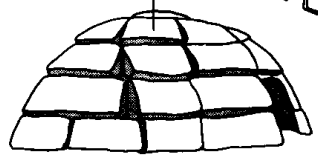

yurt

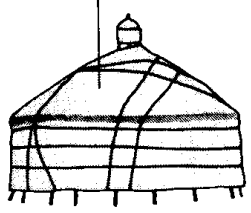

tepee

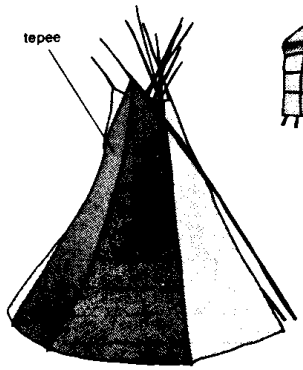

isba

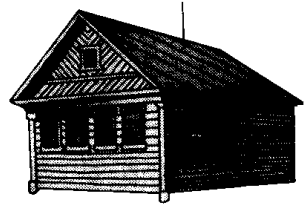

ቅስቀሻ
arches

ግግሽ ክብ ቅስቀሻ
semicircular arch

ሽብልቄ
voussoir

ቅስቀሻ ዙሪያ
spandrel

ላይ ቅስቀሻ መነሻ
springer

ተሸካሚ
pier

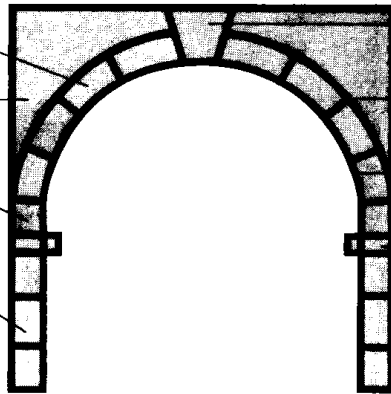

ሽብልቅ ድንጋይ
keystone

ውጫዊ ቅርፅ
extrados

ውስጣዊ ቅርፅ
intrados

ቅስቀሻ መነሻ
impost

የቅስቀሻ አይነቶች
types of arches

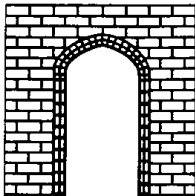

ቱዶር
Tudor

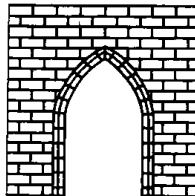

ኅን እኩል
equilateral

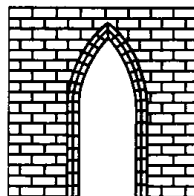

ቅርፅ ምላስ
lancet

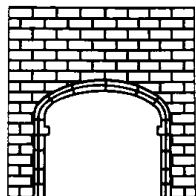

ቅርፅት እጀታ ቅርፅ
basket-handle

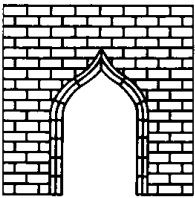

ቅርፅ ኀጀ
ogee

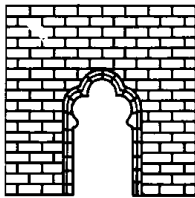

ቅርፅ እበባ
trefoil

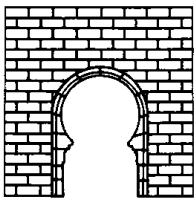

ፈረስ ኮቲ
horseshoe

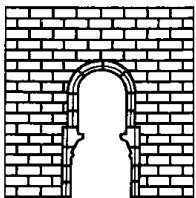

ቅርፅ "በ"
stilted

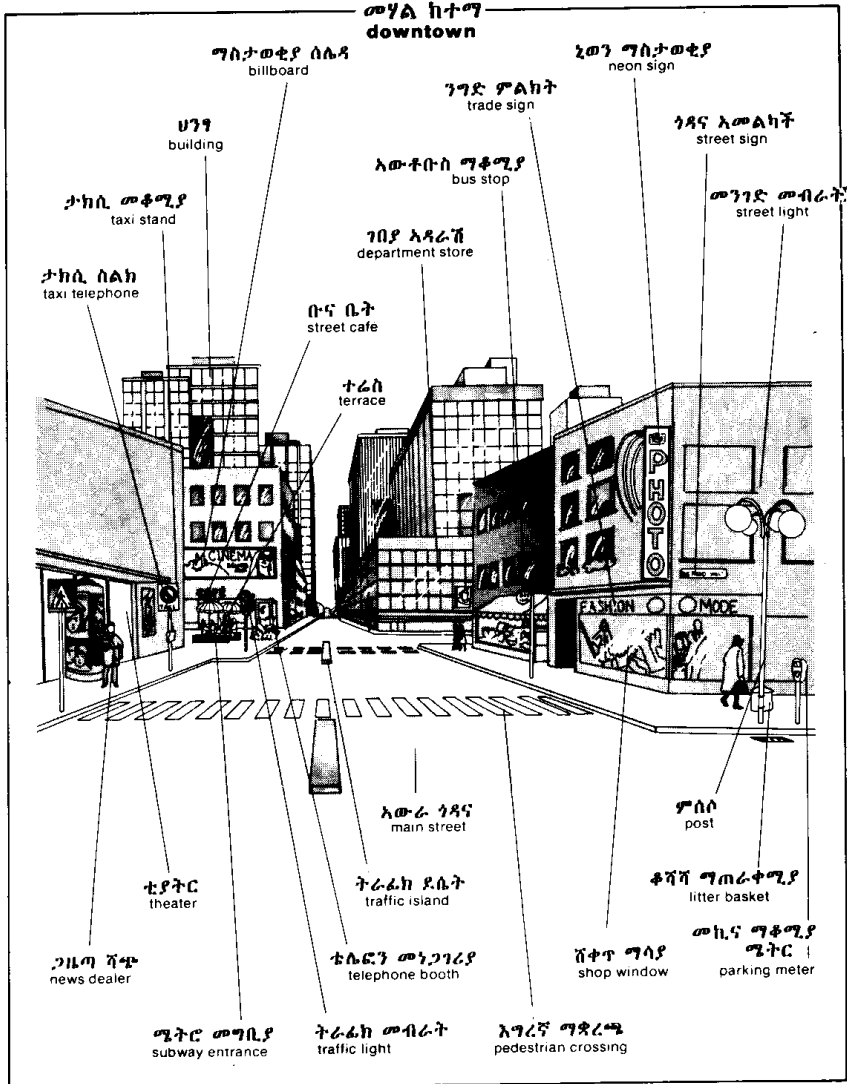

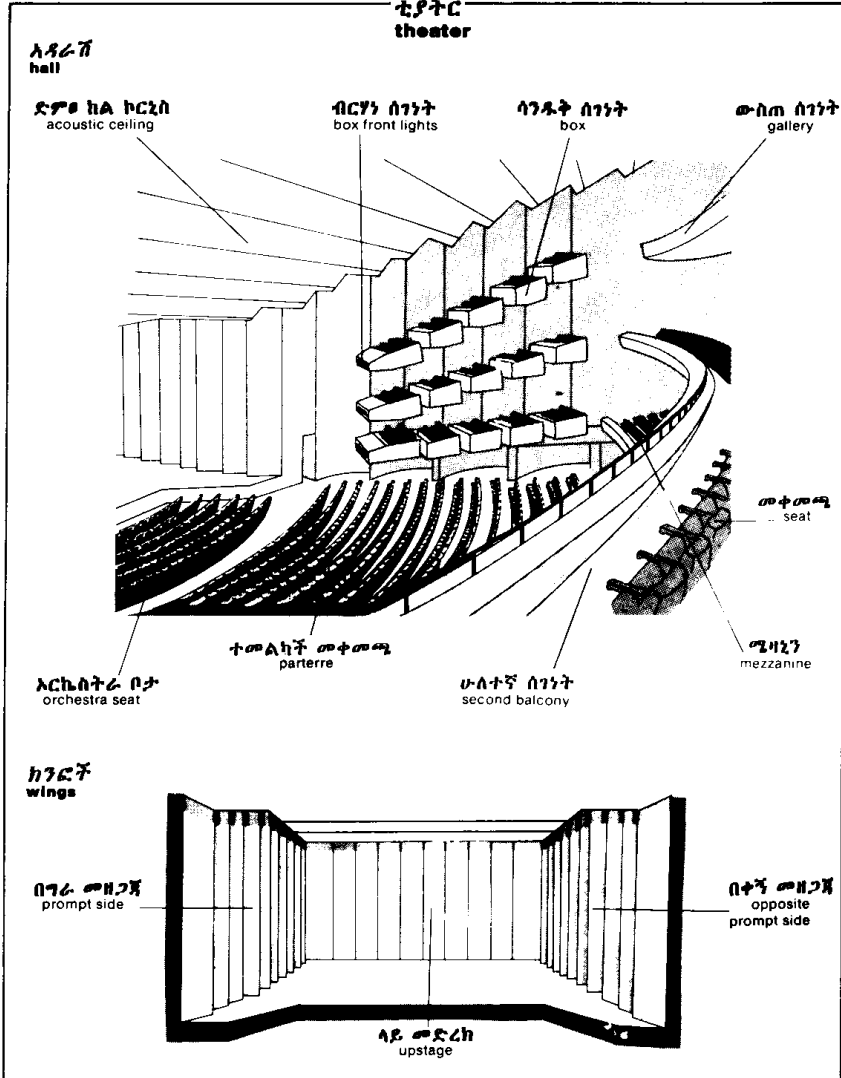

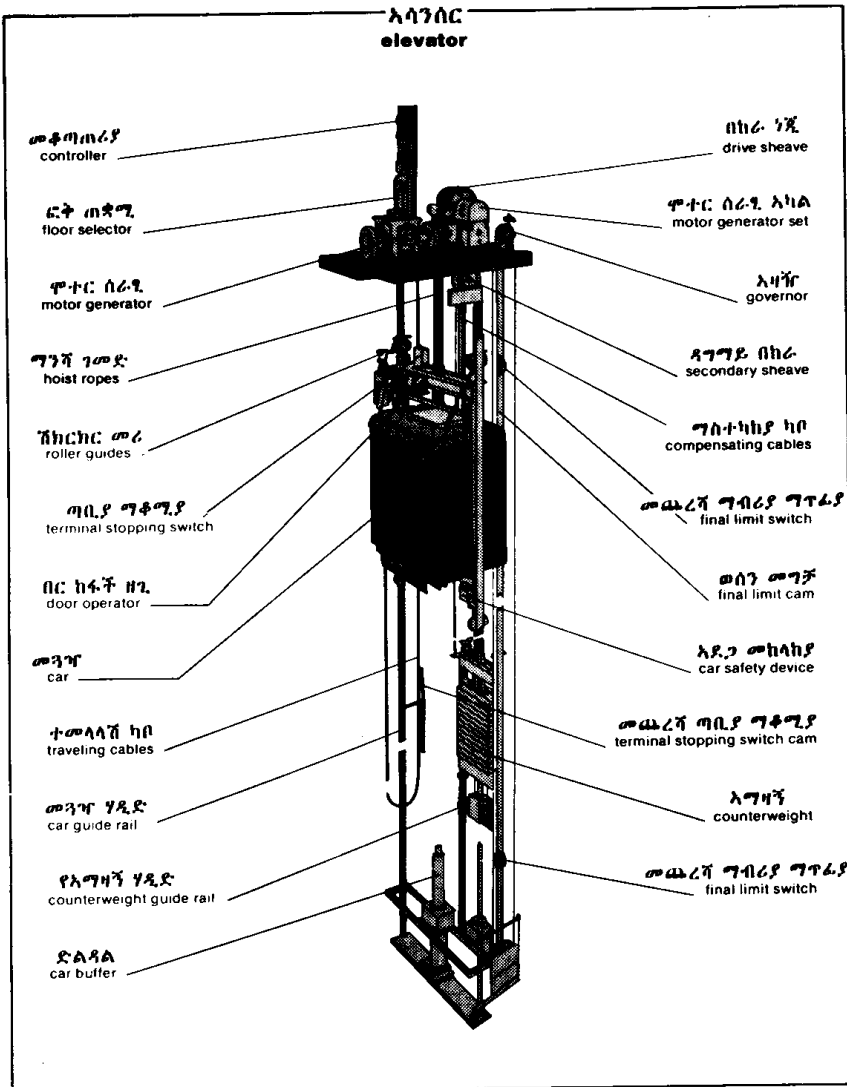

ተሽከርካሪ ደረጃ
escalator

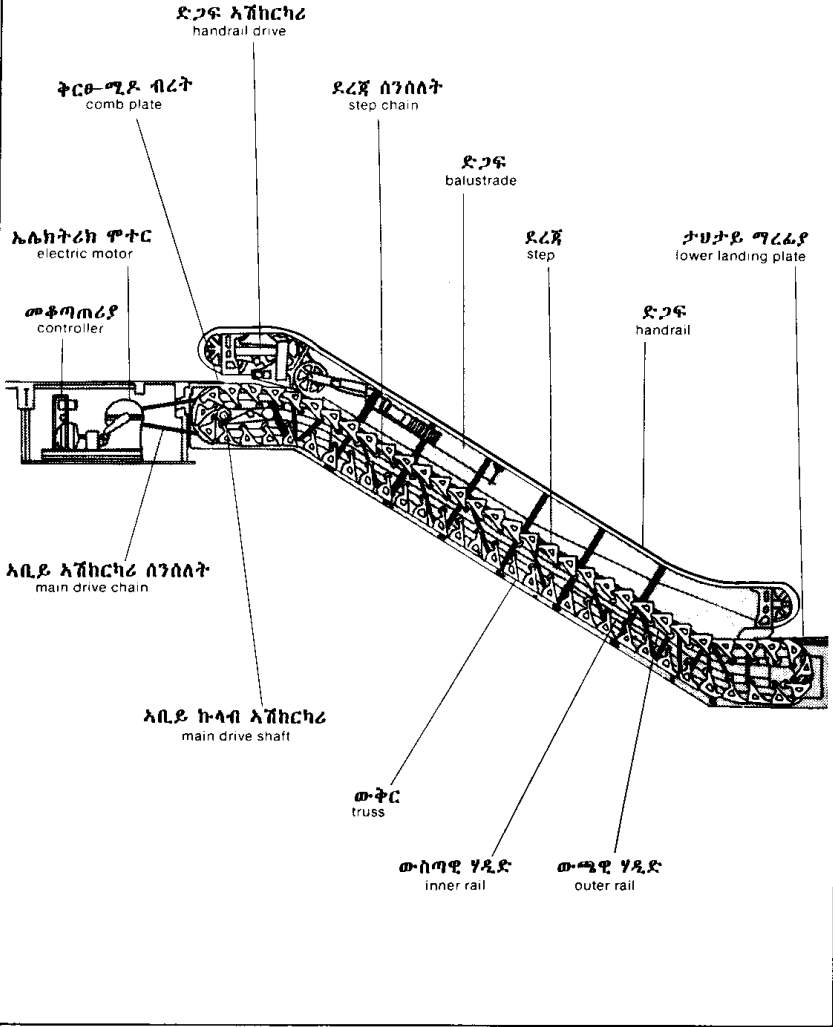

ከተማ ቤቶች
city houses

ባንጋሎ
bungalow



ገጫስ ገጠም ኃጅ
semi-detached cottage



ጥንድ አፓርተማ
duplex

ባለሶስት አፓርተማ
triplex

ባለአራት አፓርተማ
quadriplex

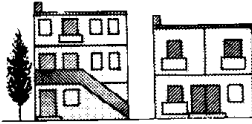
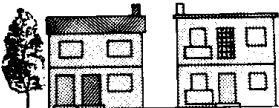

ገጫስ-ገጠም ባለሶስት አፓርተማ
semi-detached triplex

መለስተኛ ከተማ ቤቶች
town house

ኃጅ
cottage

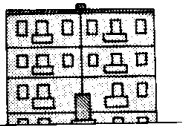

ሰማይ ጠቀስ አፓርተማ
high-rise apartment

ግል አፓርተማ
condominium

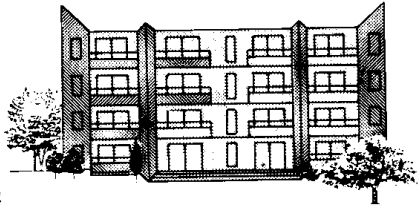
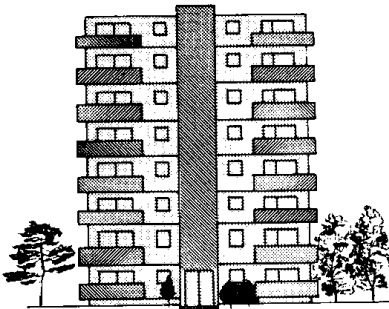

ባህላዊ የቤት አሰራር

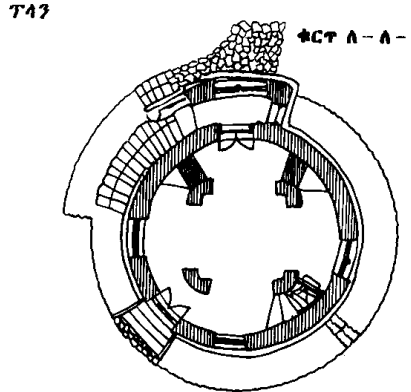
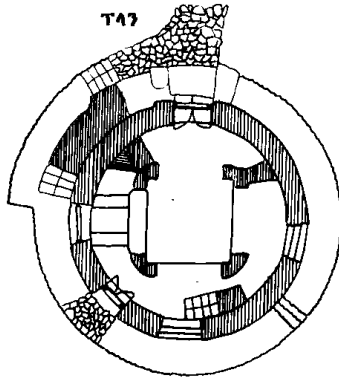

የትግራይ ቤት

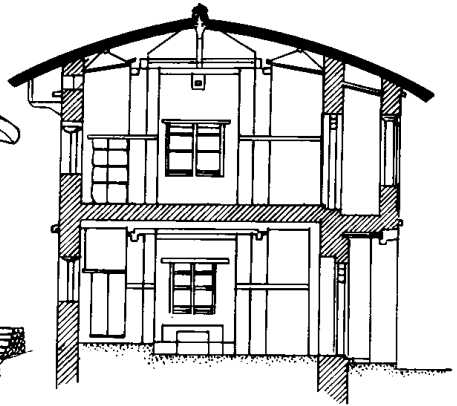
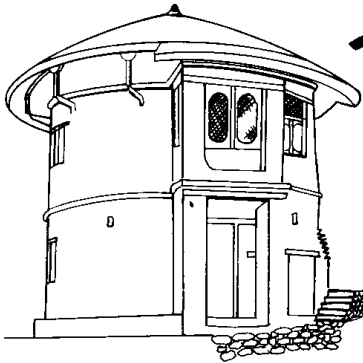

ባህላዊ የቤት አሰራር

የጉራጊ ቤት

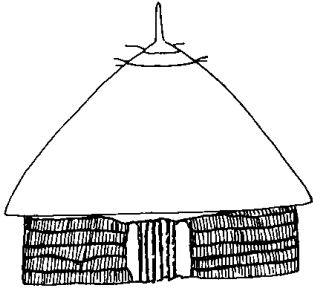

ፊትለፊት ገፅታ

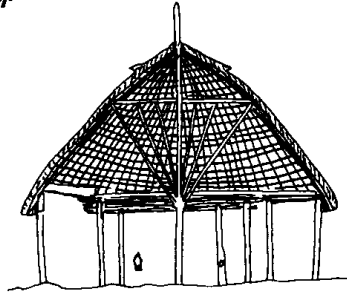

ቁርጥ

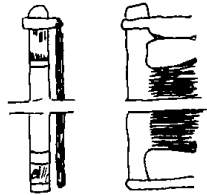

የቦር አሰራር

ዝርዝር አሰራር

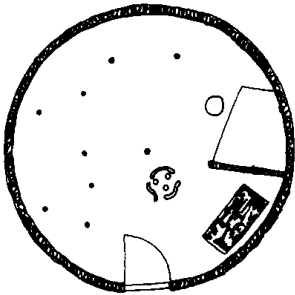
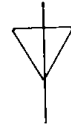

ፕላን

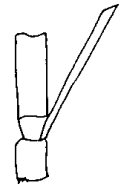

ባህላዊ የቤት አሰራር

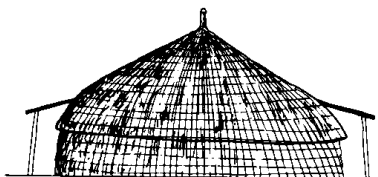

ጎን ገበታ



ዝርዝር አሰራር አገድ

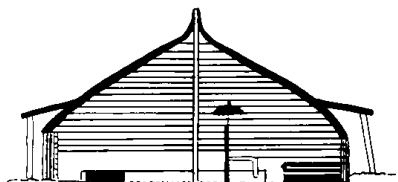

ቁርጥ ሀ - ሀ -

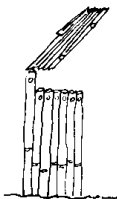

ዝርዝር አሰራር ሁለት

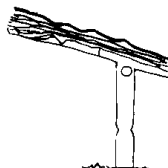

ዝርዝር አሰራር ሦስት

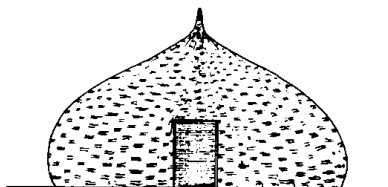

ፊትለፊት ገበታ

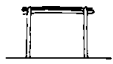

ቀርቀሃ አልጋ



ጃንጥላ

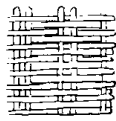

የቦር አሰራር

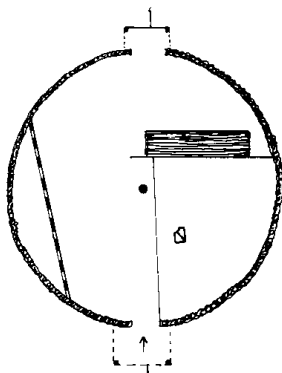

ጥላን ሚዛን

ባህላዊ የቤት አሰራር

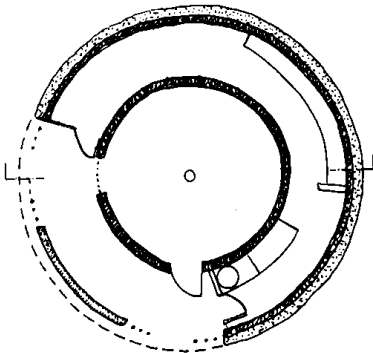

ፕላን

የወለይታ ጎጆ

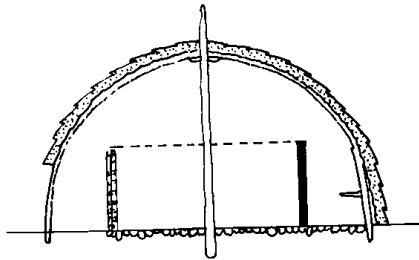

ቁርጥ ሀ-ሀ-

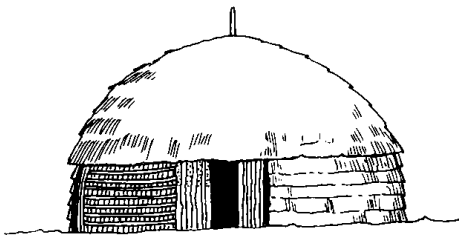

ገፅታ