

ከባድ መሳሪያ
HEAVY MACHINERY

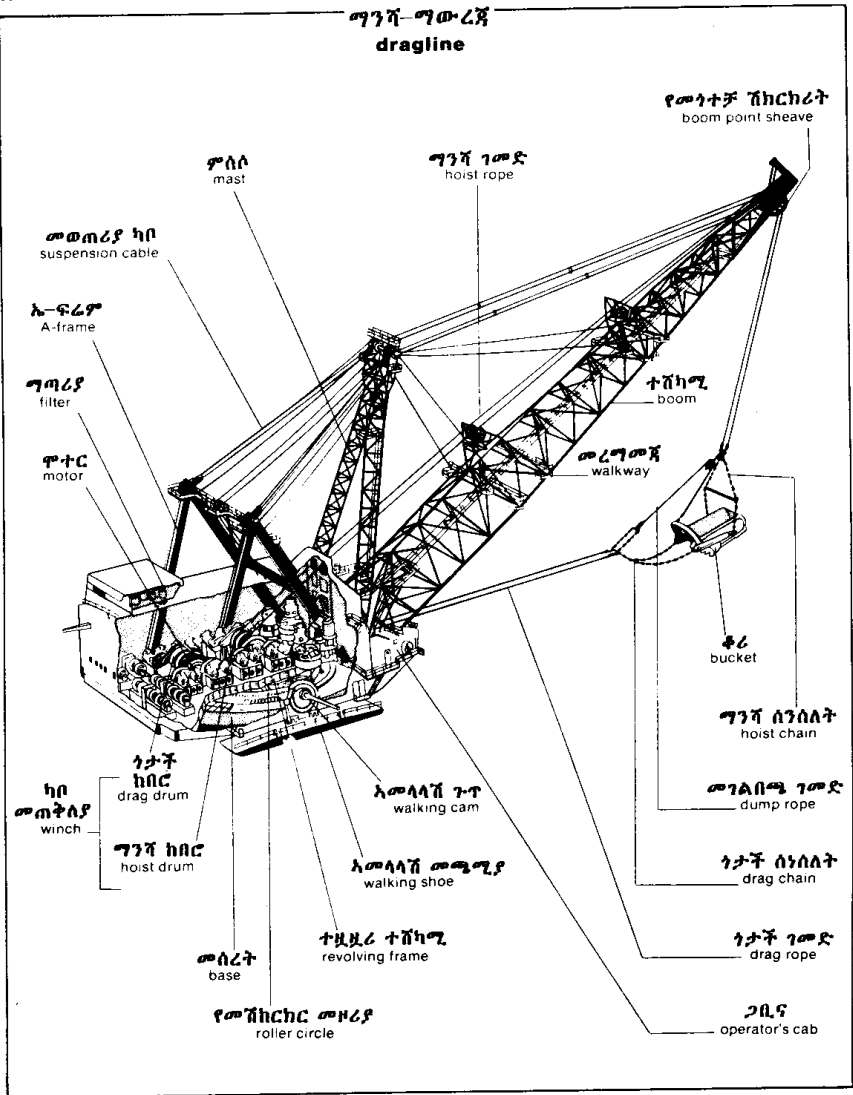

እሳት አደጋ
fire engine

ባለመሰላል መኪና
aerial ladder truck

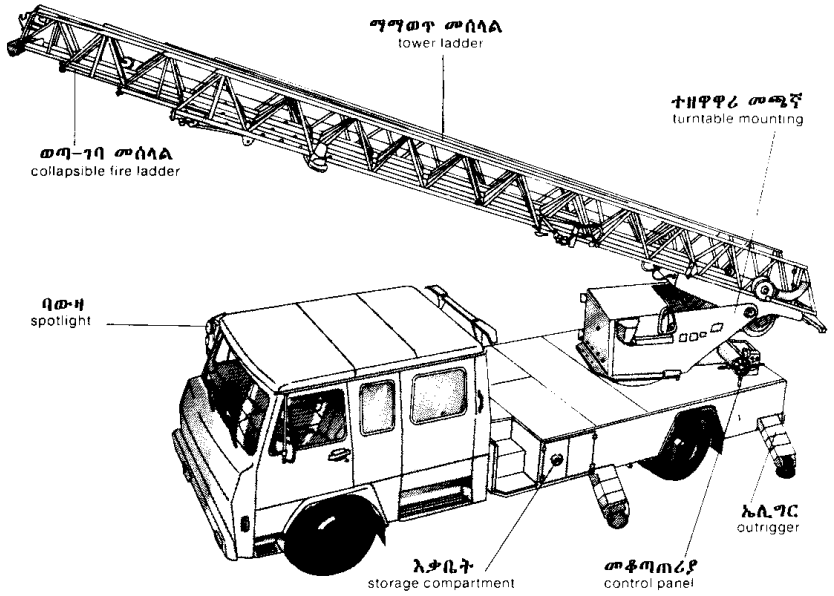

- ወጣ-ገባ መሰላል
collapsible fire ladder
- የሳት አደጋ መሰላል
lower ladder
- ተዘዋዋሪ መጫኛ
turntable mounting
- ባውዛ
spotlight
- እቃቤት
storage compartment
- መቆጣጠሪያ
control panel
- ኤሊግር
outrigger

መተንፈሻ
breathing apparatus



አየር ማመቂያ ቦርሜሎ
compressed-air cylinder

እሳት ማጥፊያ ቱቦ
fire hose

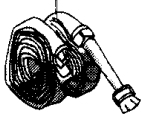

(የ)እጅ ባትሪ
hand lamp



መርጫፍ
nozzle

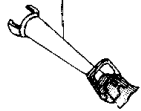

መጥረቢያ
fireman's hatchet



የእጅ ባትከል
portable fire extinguisher



ማከፋፈያ
dividing breeching



እሳት አደጋ
fire engine

ገፍትሬ
pumper

ጥፋንባ
horn

ናገዊ ቱቦ
deluge gun

ባውዛ
spotlight

ግርሳዊ ብርሃን
mars light

ግለሚያ
control wheel

መምጠሚ ውኃኛጥም
suction hose

ባውዛ
spotlight

መርጫፍ
nozzle

መቅጠያ
fitting

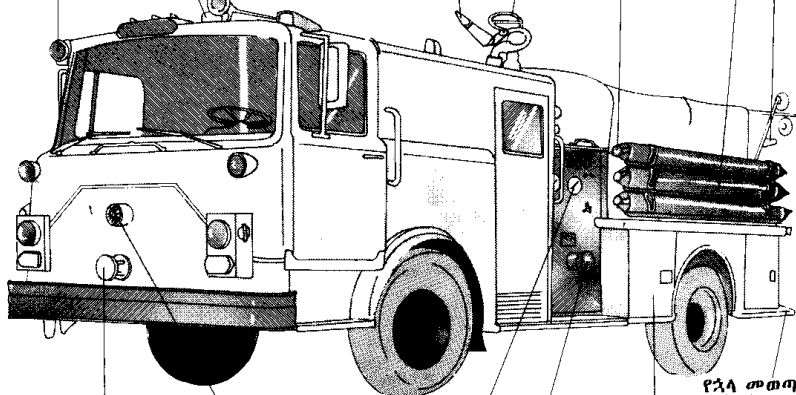

ውሃ መምጠሚ
hydrant intake

ድምፅ ግጉያ
loudspeaker

ግሬት ዘጋቢ
water pressure gauge

የእሳ መውጣሚ
backstep

አቃቤት
storage compartment

ውሃ መምጠሚ
hydrant intake

ሚንጦግ መሰለል
hook ladder

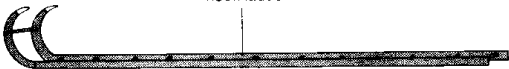

መፈንቅያ
pike pole

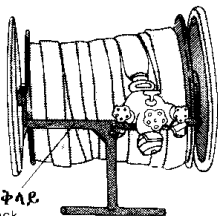

ውኃኛጥም ጠቅላይ
hose truck

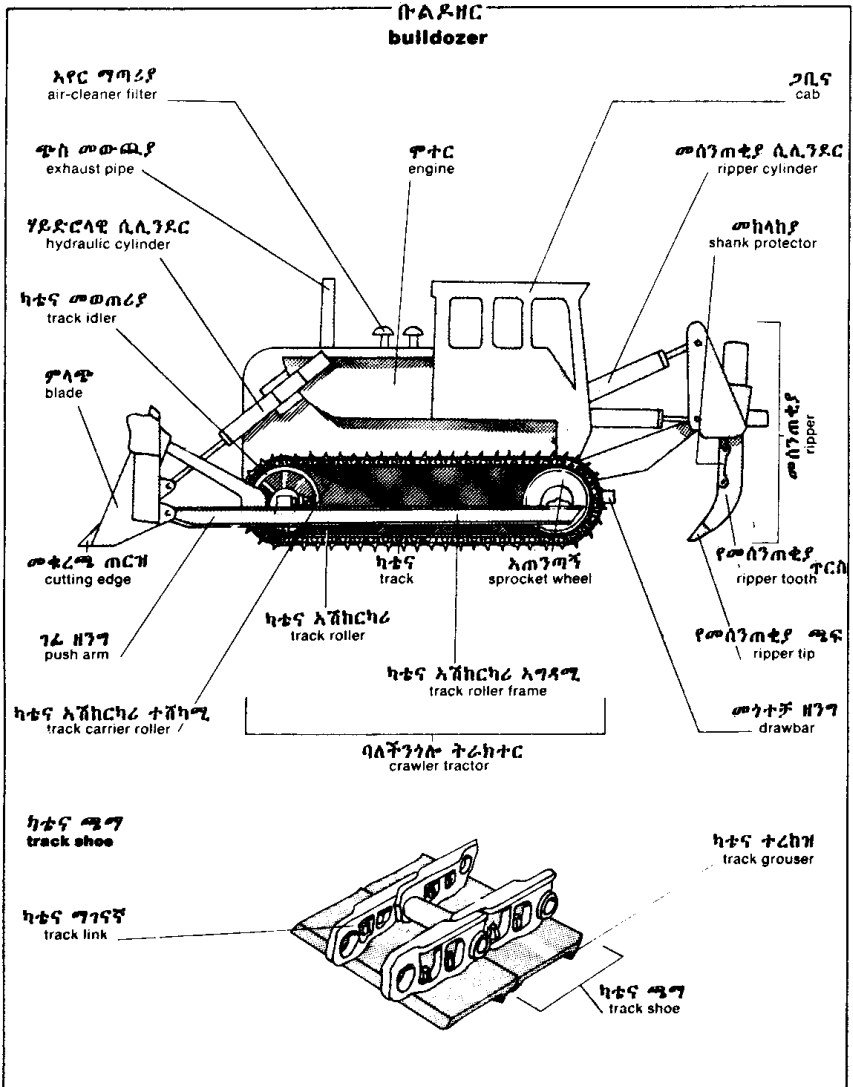

ጎሳ ቆፋሪ መጫኛ
backhoe loader

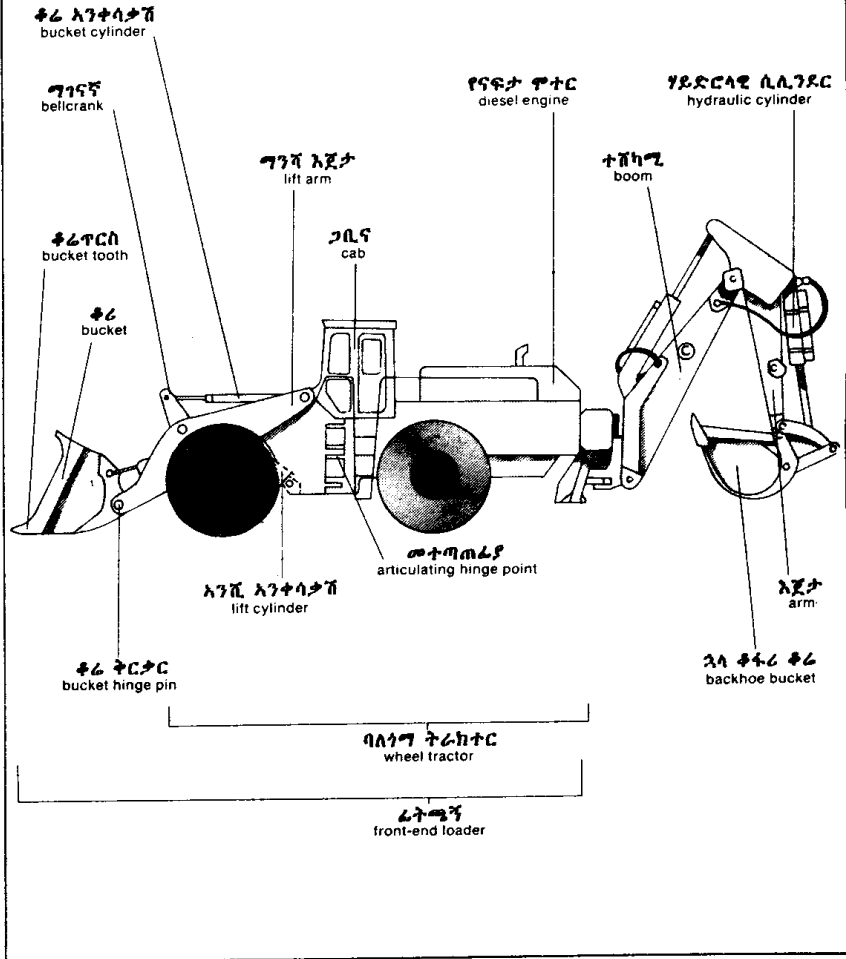

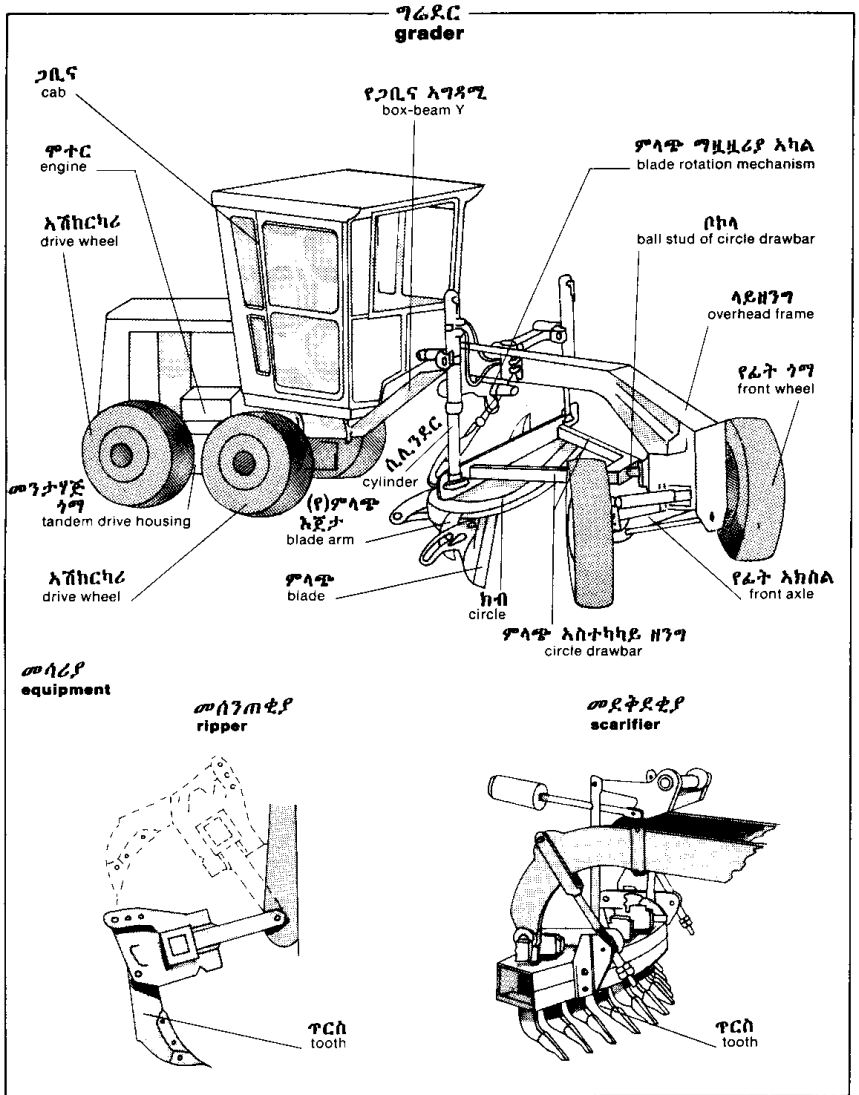

ሃይድራሊክ አካፋ
hydraulic shovel

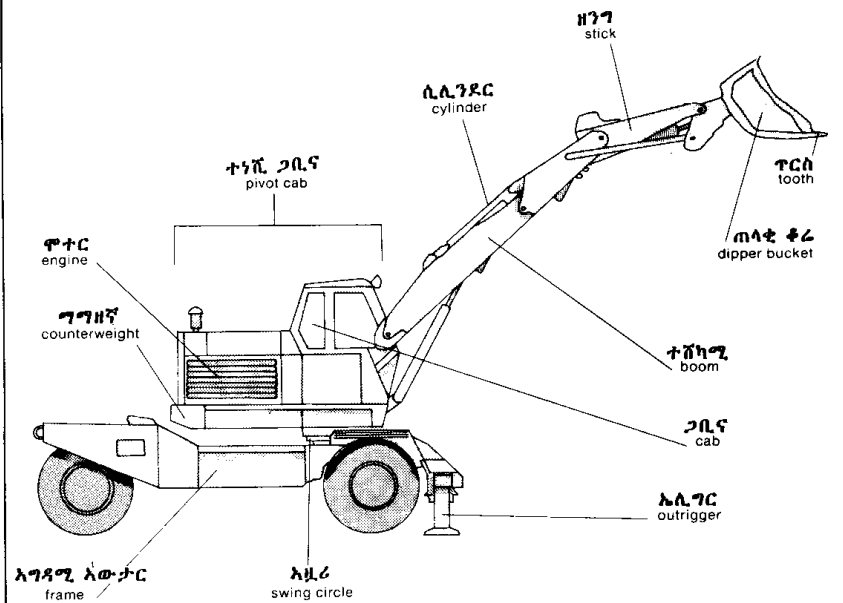

ተከፋኝ ቆራ
clamshell bucket

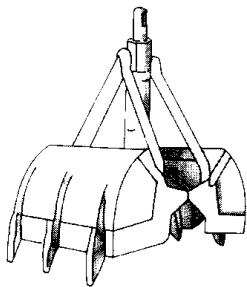

ግጉርጥ
grapple

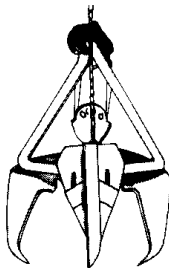

መጋፊያ
scraper

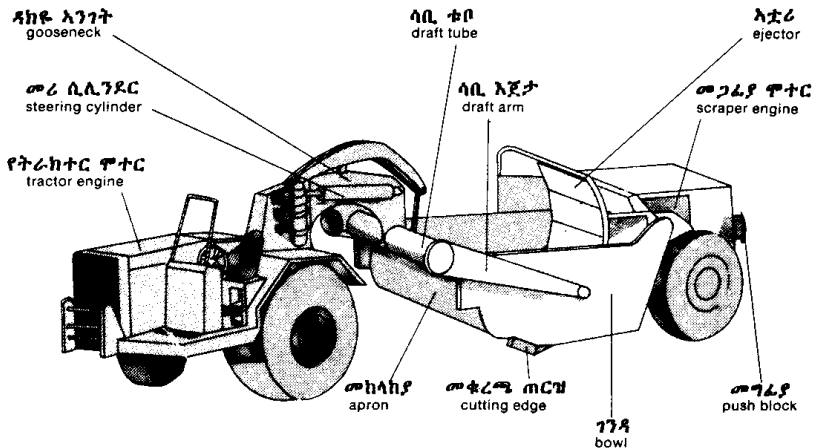

ገልባጭ
dump truck

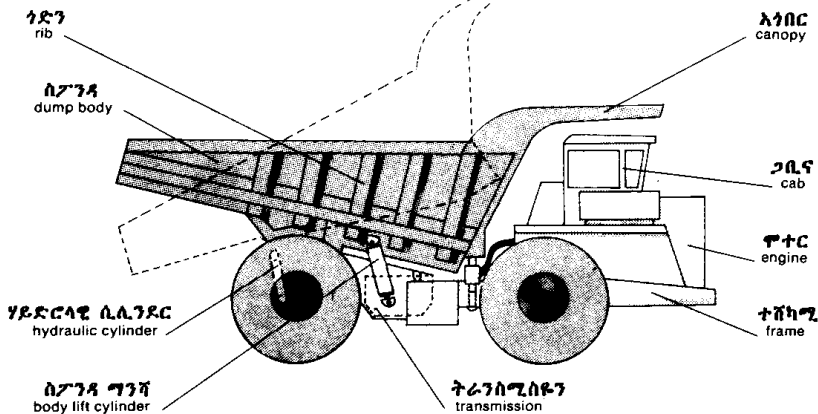

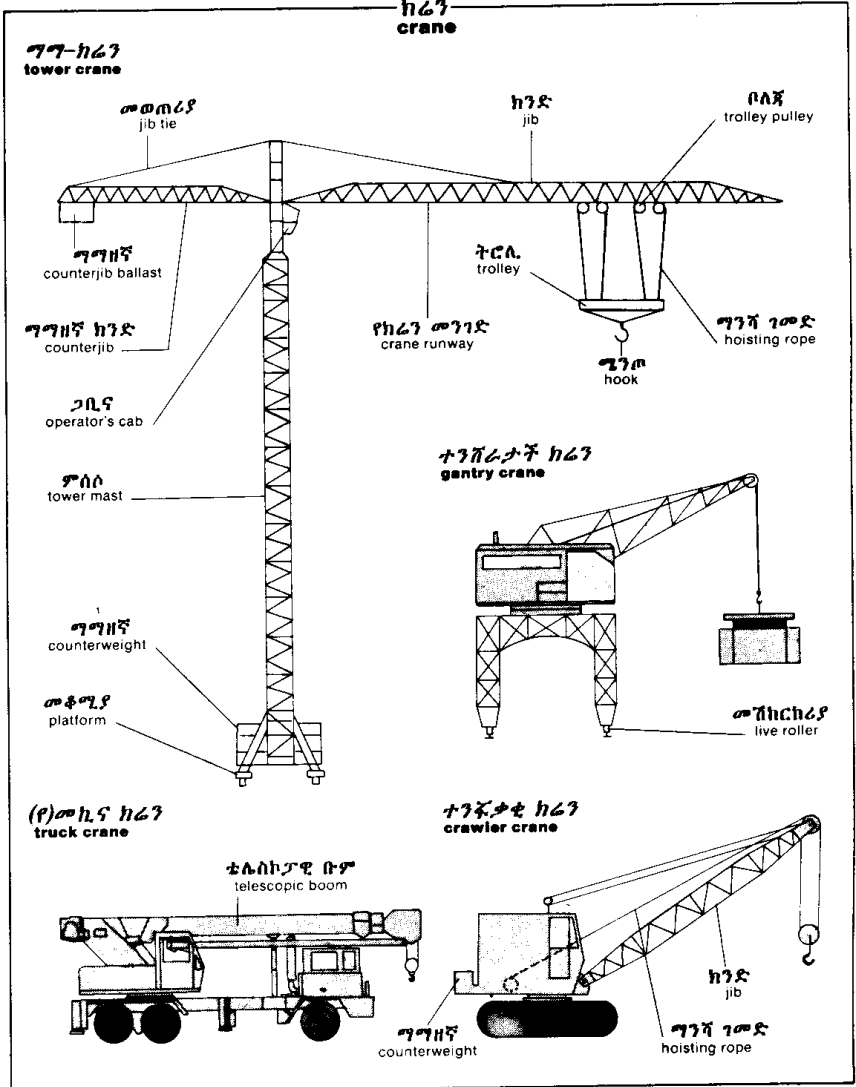

አንሺ-የጎይል መኪና
power lift truck

እቃ ግንቻ መኪና
forklift truck

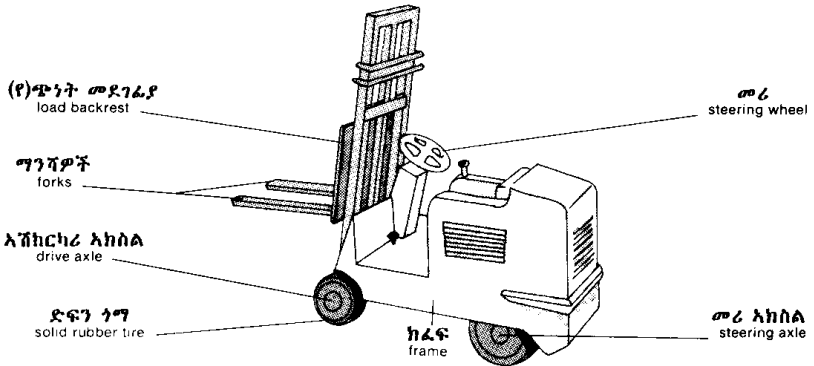

ጫኛ መኪና
forklift reach truck

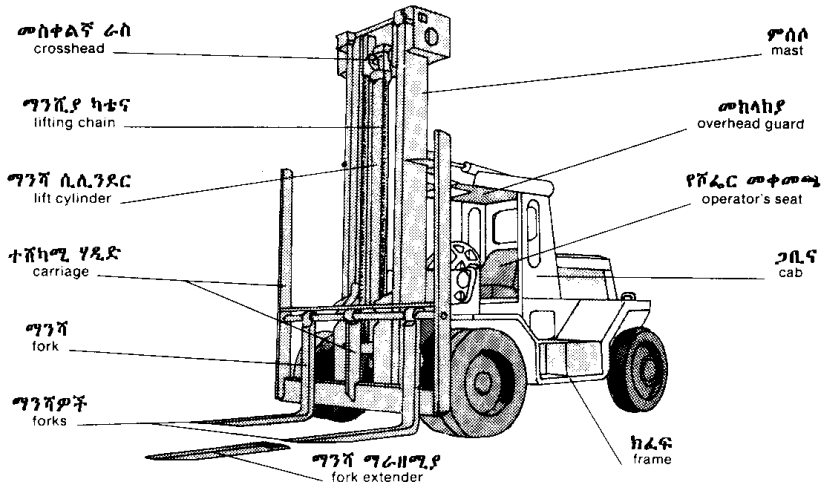

እቃ ማጓጓዣ መሳሪያዎች
handling engines

የእጅ ጋሪ
hand truck

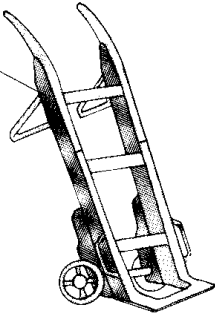

ባለወለል ጋሪ
platform truck

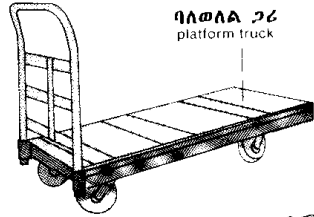

ተጎታች ጋሪ
manual lift truck

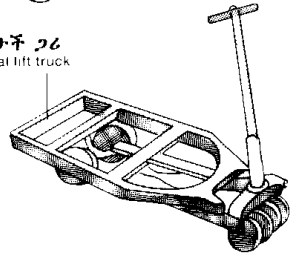

የእጅ ጋሪ
hand pallet truck

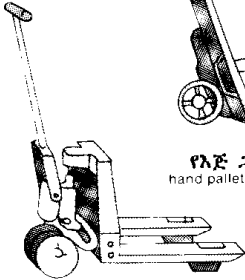

እቃ መጫኛዎች
pallets

ባለሁለት እርከን መጫኛ
double-decked pallet

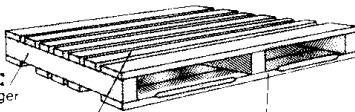

ባለአንድ እርከን መጫኛ
single-decked pallet

የላይ ደርብ ርብራብ
top deckboard

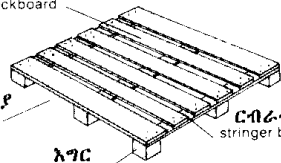

ማገር
stringer

የላይ ደርብ ርብራብ
top deckboard

የታች ደርብ ርብራብ
bottom deckboard

ማስገቢያ
entry

አግር
block

ርብራብ
stringer board

ባለክንፍ መጫኛ
wing pallet

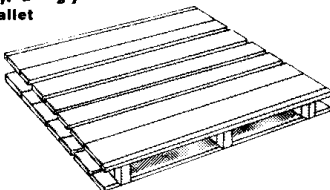

ባለሳጥን መጫኛ
box pallet

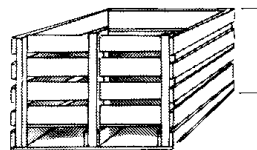

ንጎ
side

የጦር መሳሪያዎች

WEAPONS

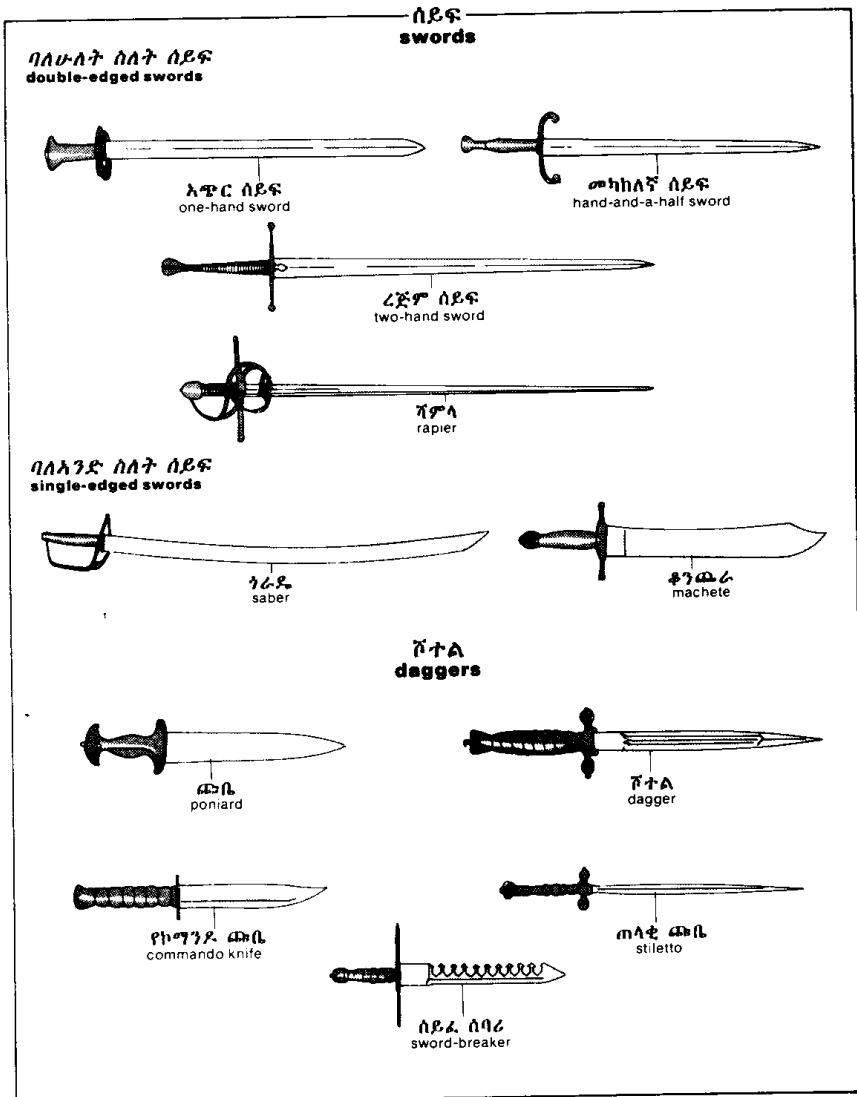

ሳንጃ
bayonets

ዋና ዋና የሳንጃ አይነቶች
major types of bayonets

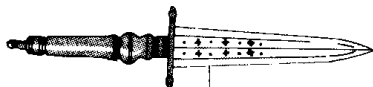

ተወታሪ ሳንጃ
plug bayonet



ተሰኪ ሳንጃ
socket bayonet



ተለጣፊ ሳንጃ
integral bayonet

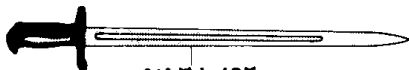

ባለአጀታ ሳንጃ
hilted bayonet

የባለ አጀታ ሳንጃ ልዩ ልዩ ክፍሎች
parts of a hilted bayonet

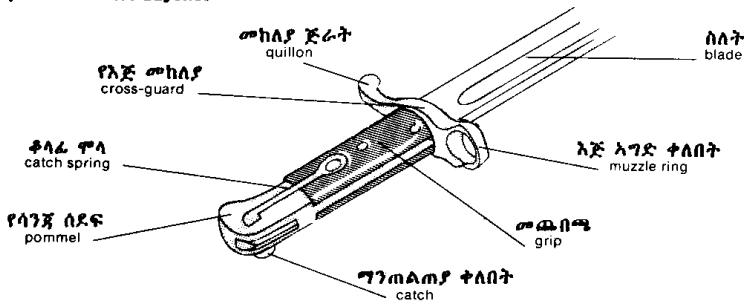

arquebus



flintlock

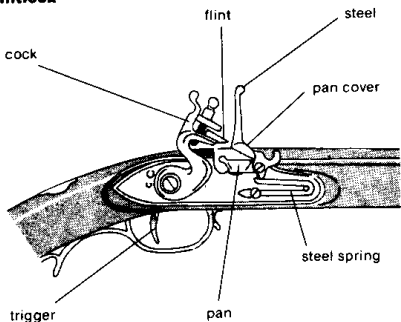

loading

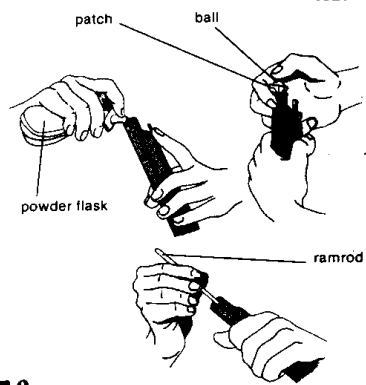

የእጅ በምብ hand grenade

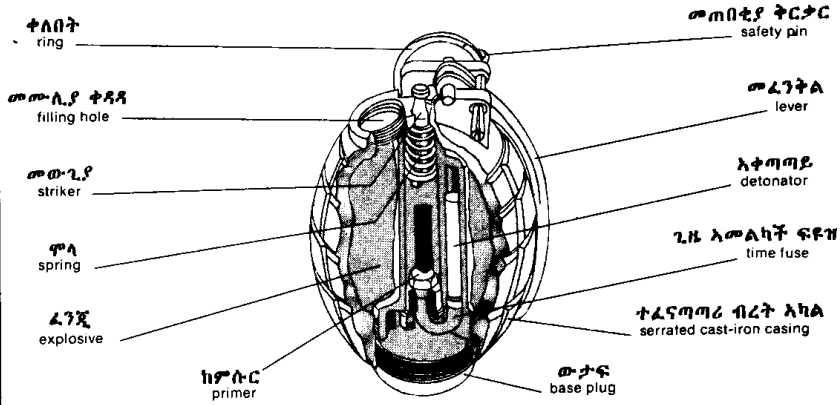

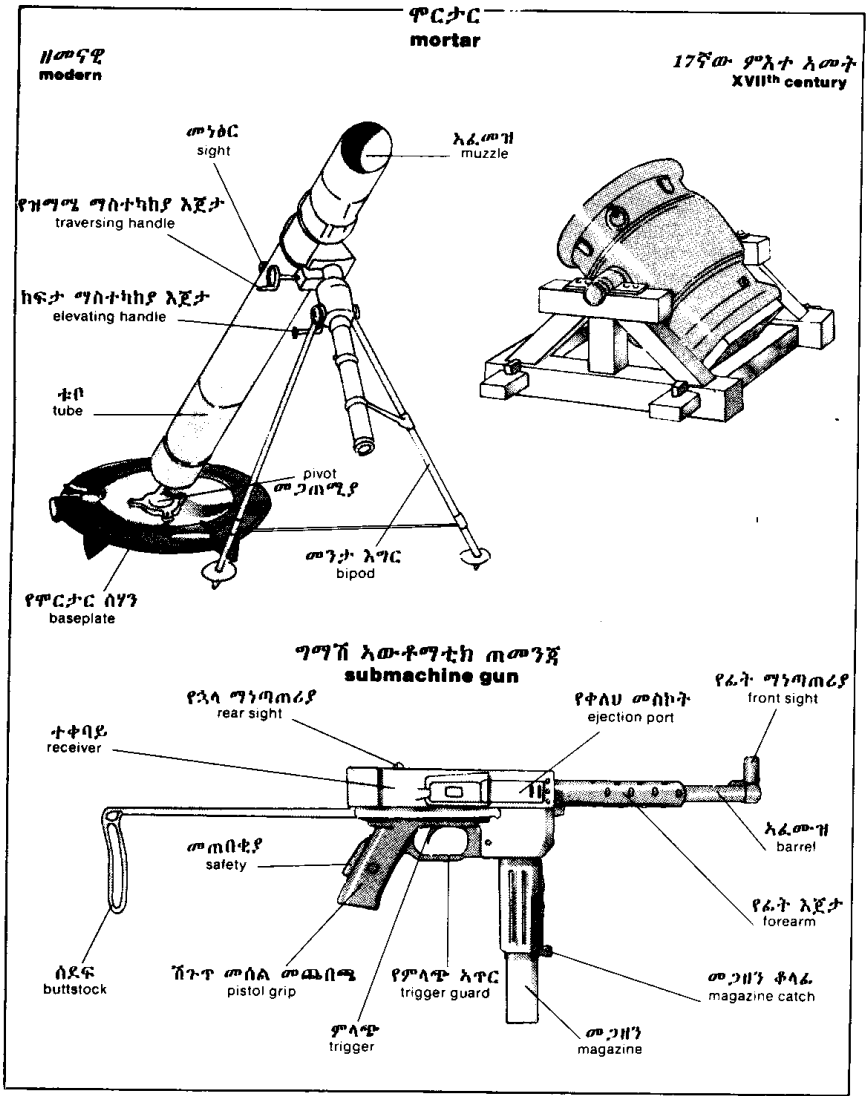

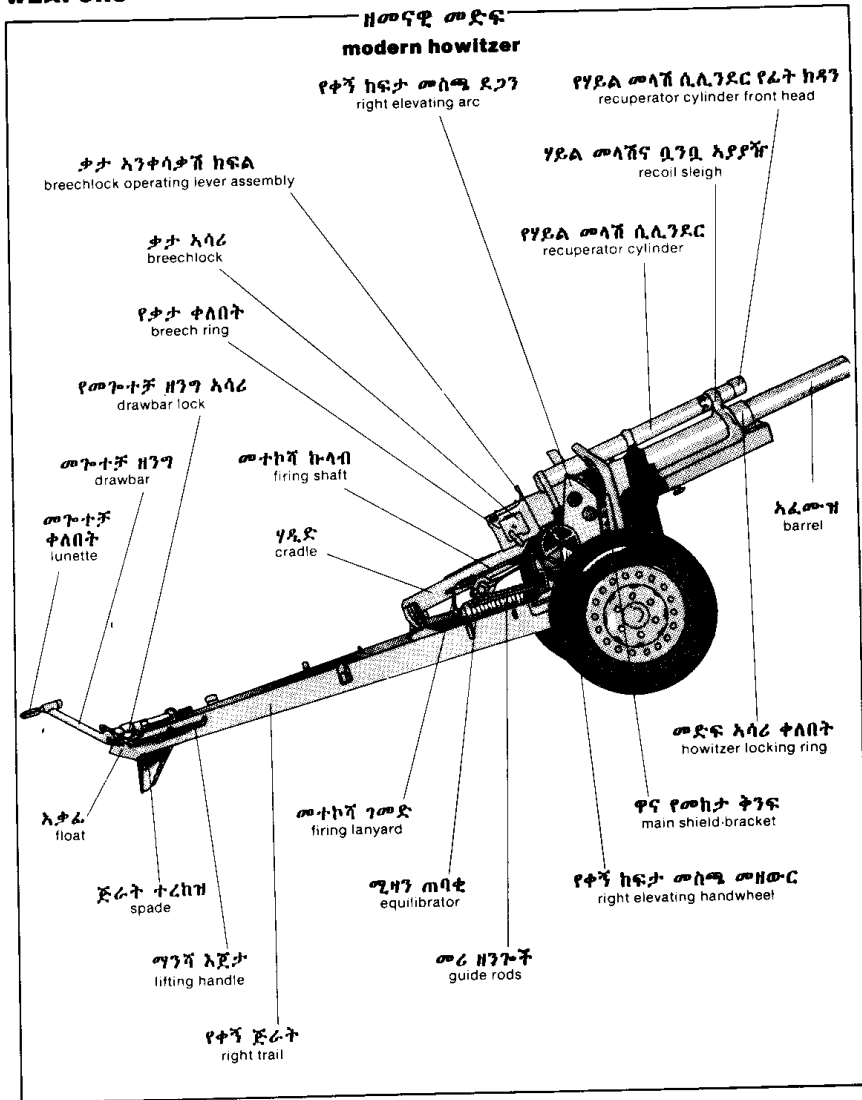

አውቶግቲክ ጠመንጃ
automatic rifle

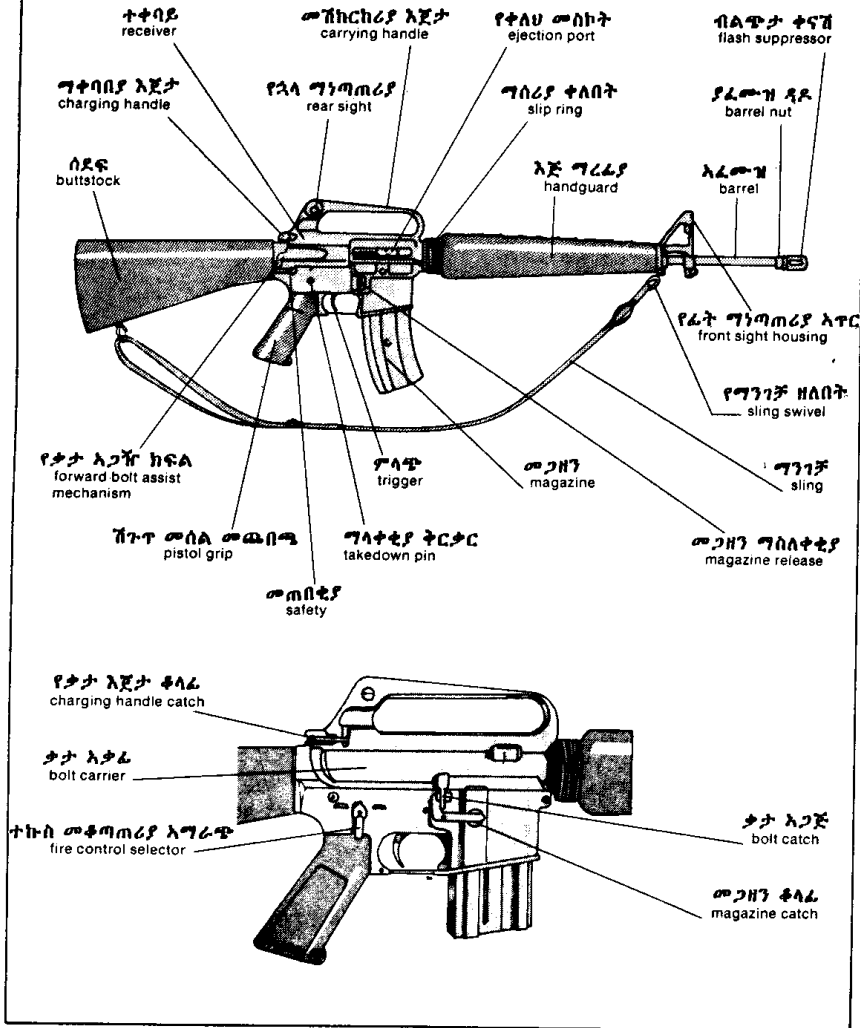

ባዙታ
bazooka

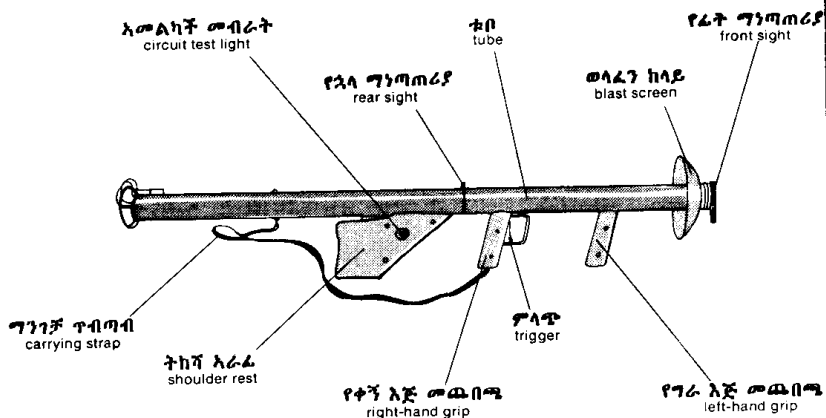

የግድሬገጥ ጠመንጃ
recoilless rifle

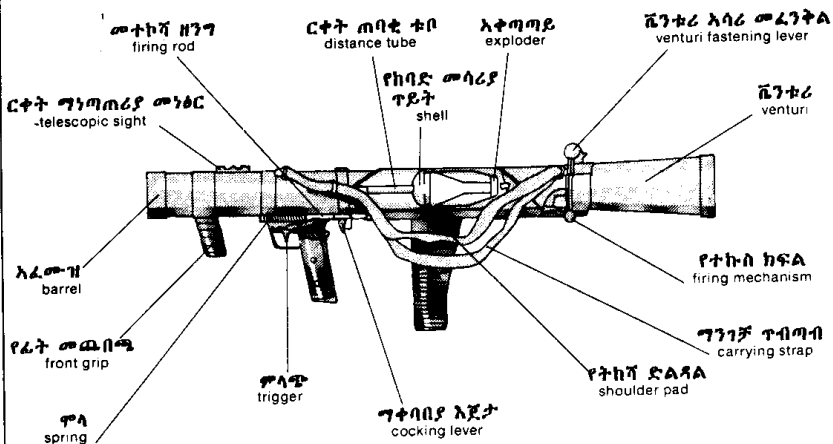

ከባድ መትረፍስ
heavy machine gun

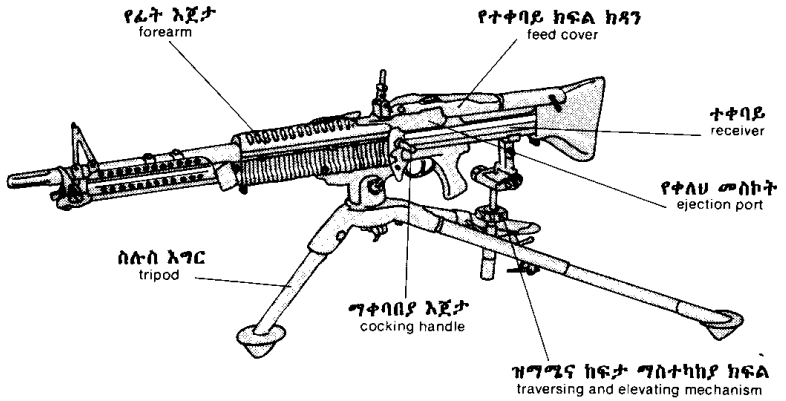

ቀላል መትረፍስ
light machine gun

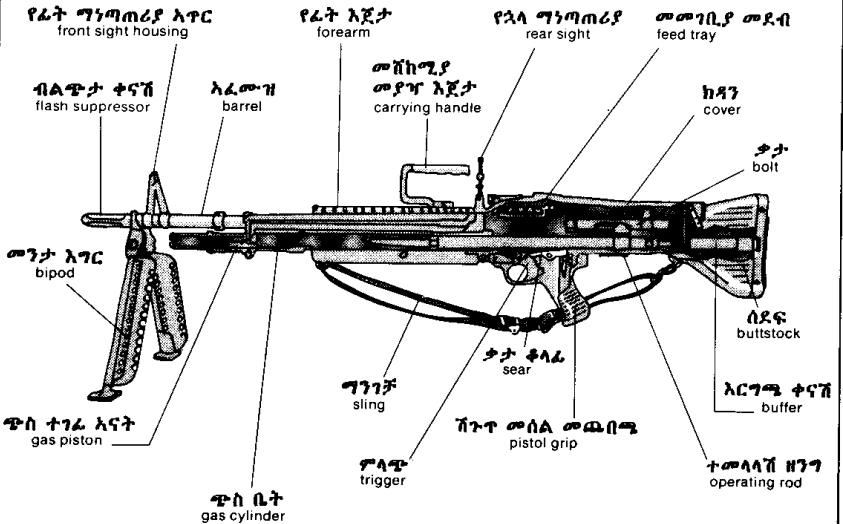

WEAPONS

የጦር መሳሪያዎች

**የአደን መሳሪያዎች
hunting weapons**

**ጠመንጃ (ባለመሽዙር)
rifle (rifled bore)**

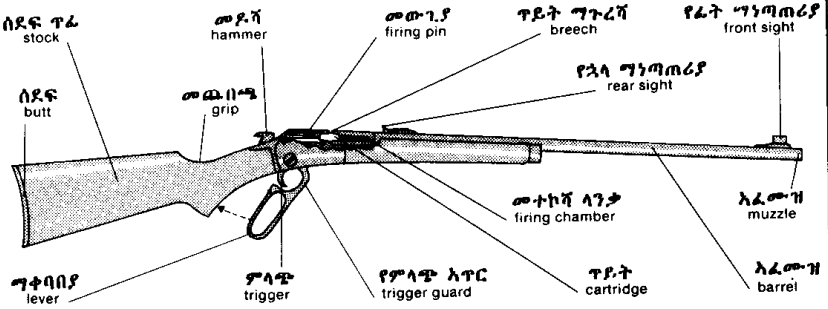

**ረሽ (መሽላዙር አልባ)
shotgun (smooth-bore)**

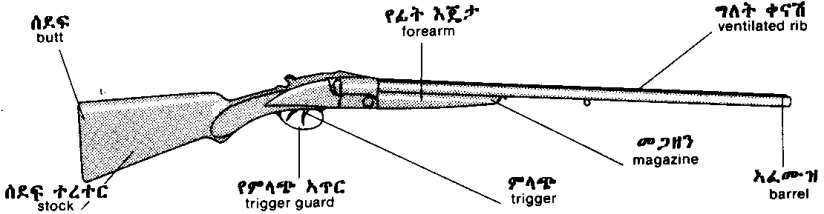

**ጥይት (የጠብ-መንጃ)
cartridge (rifle)**

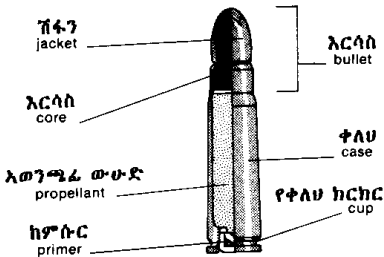

**ጥይት (የረሽ)
cartridge (shotgun)**

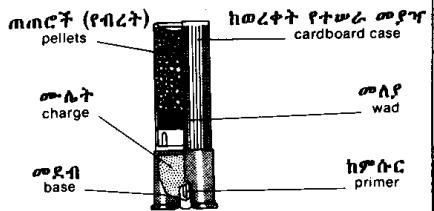

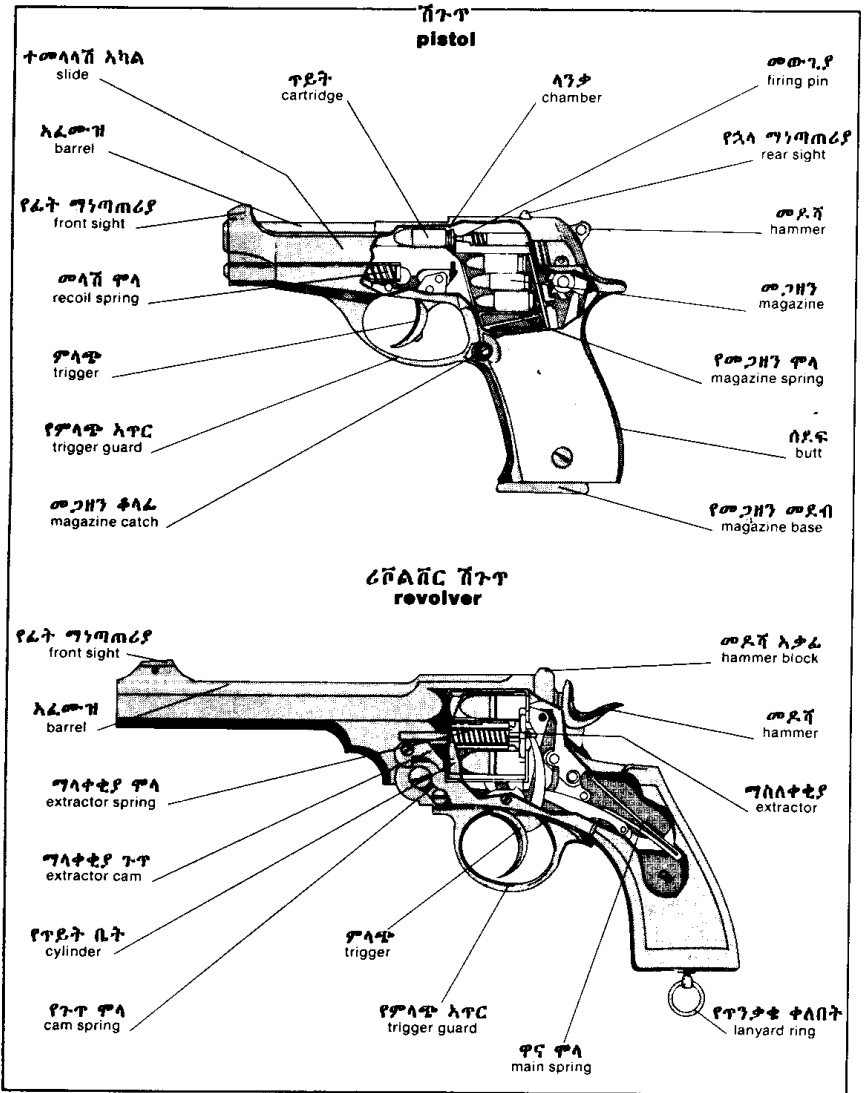

WEAPONS

የጦር መሳሪያዎች

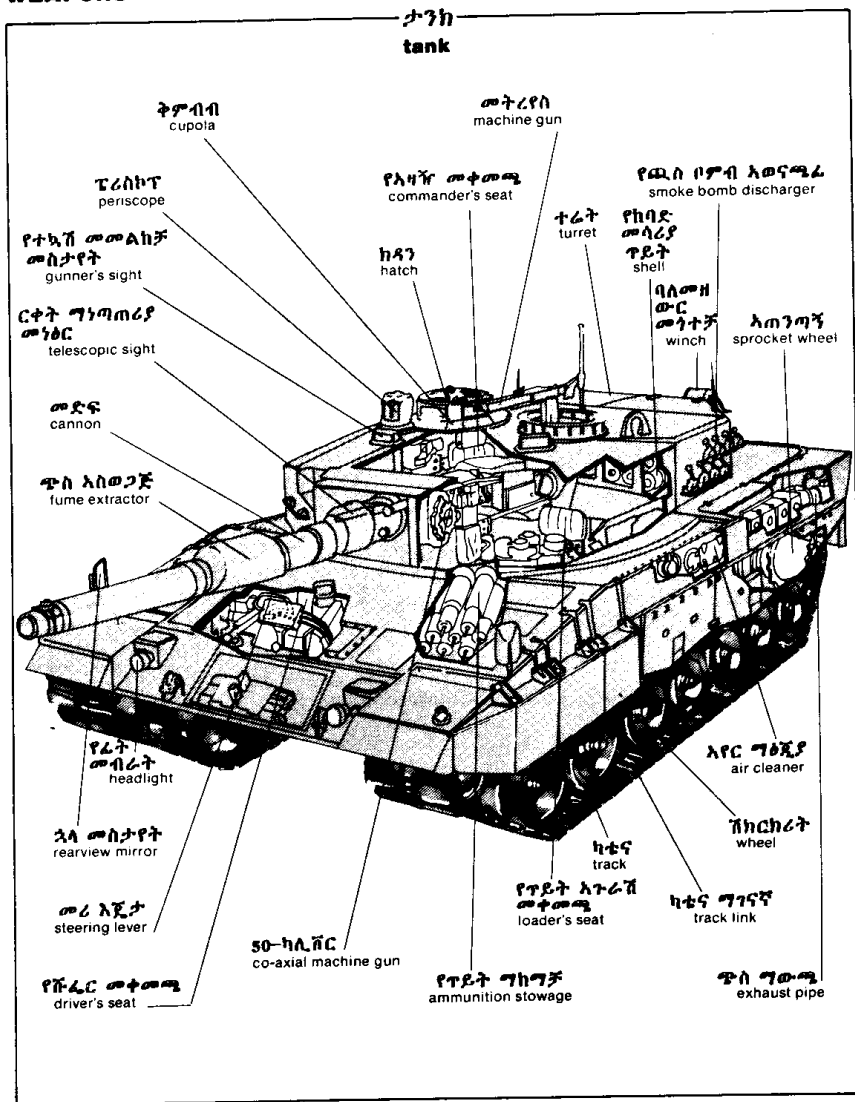

የውጊያ አውሮፕላን
combat aircraft

አቅጣጫ መቆጣጠሪያ
ዊራ ጫፍ
fin wing tip

አቅጣጫ አመልካች
መብራት
position light

አየር አጋጅ
air brake

አየር አጋጅ
ሃይድራሊክ ጃክ
air brake hydraulic
jack

ጭስ መውጫያ
ቱቦ
exhaust
nozzle

እርጋታ ሰጪ
stabilizer

ፈርጣጭ ማነቂያ መንጠቆ
runway arrester hook

ፍላፕ ሀይድራሊክ ጃክ
flap hydraulic jack

የክንፍ ውስጥ ሳፕን
wing box

ዋና ማኩብኩብያ ጉማ
main undercarriage wheel

ድራብ
flap

አጉቦር
canopy

አሌሮን
aileron

ቦጋ እልም መብራት
stroboscopic light

የጀት ሞተር
jet engine

ሚሳይል ግጥን ጨፊያ ሃዲድ
missile launch rail

አየር ለአየር ሚሳይል
missile air-to-air

አስፈንጣሪ ወንበር
ejection seat

ነፋስ ከል
windshield

ራዶም
radome

ላላላይ ከፍተኛ ሞገድ
UHF-IFF aerial

ፒቶቱ
Pitot tube

ተሰብሳቢ መሳሪያ መሰላል
retractable boarding ladder

ነዳጅ ተሸካሚ አውሮፕላን
tanker

የበረራ ነዳጅ መውያ ቱቦ
in-flight refuelling probe

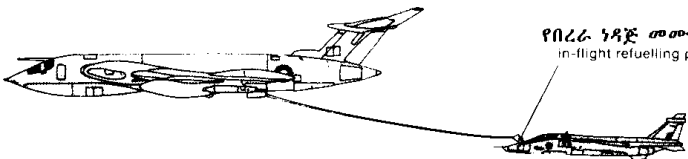

ሚሳይል

missiles

የሚሳይል አወቃቀር
structure of a missile

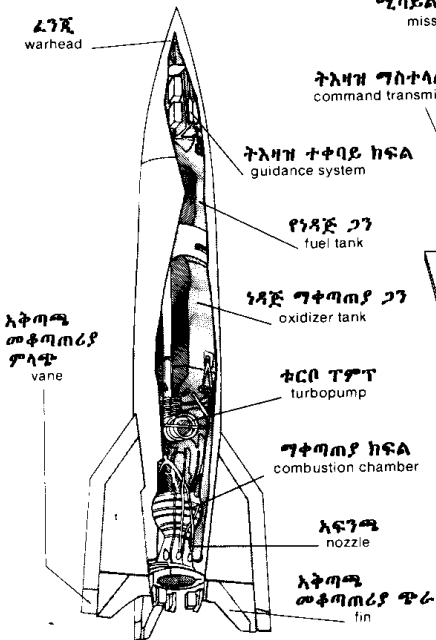

ትእዛዝ መስጫ ስርአት
command system

ሚሳይል መከታተያ ራዳር
missile tracking radar

የረጅም ርቀት ራዳር አለፊር
long-range radar system

ትእዛዝ ማስተላለፊያ
command transmission

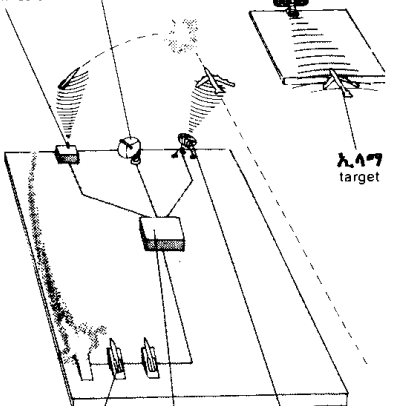

ዋና ዋና የሚሳይል አይነቶች
major types of missiles

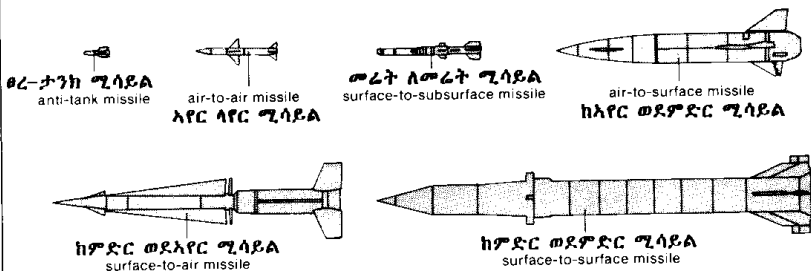

ተምሳሌት
SYMBOLS

የሰንደቅ አላማ ክፍሎች
parts of a flag

የሰንደቅ አላማ ክፍሎች
parts of a flag

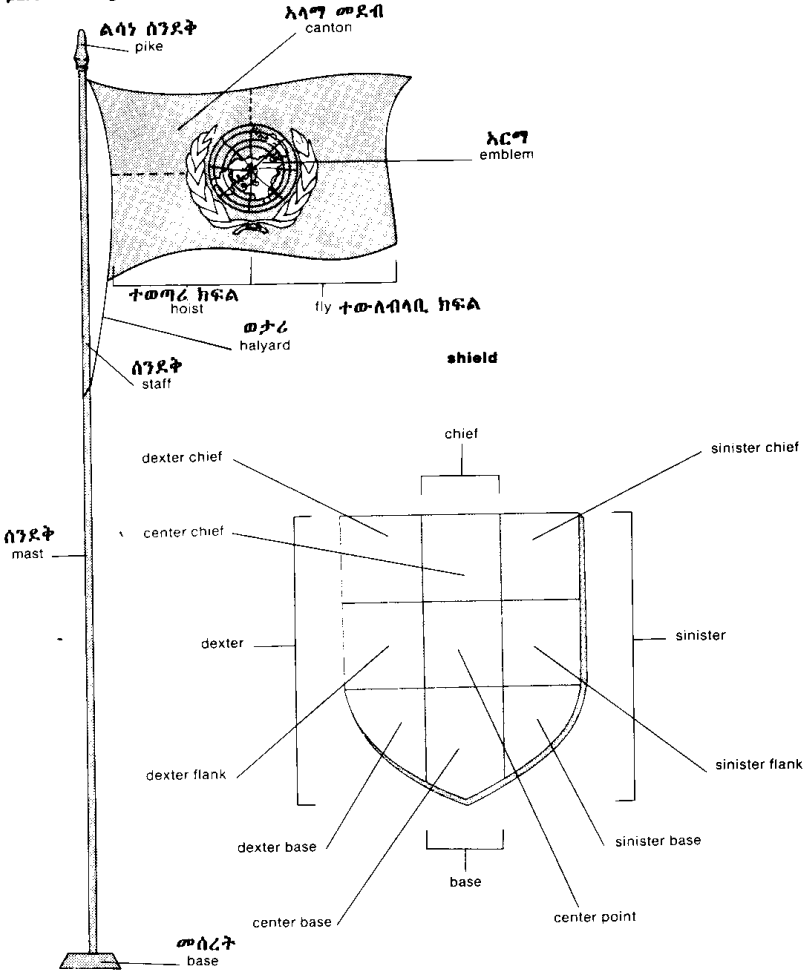

የተምሳሌት ግራፊካዊ ቅንጣቶች
graphic elements for symbols

ቀለማት
colors

ቀይ = አደጋ፣ አይቻልም ወይም አታድርግ
red = danger, no... or do not...

ምሳሌዎች
examples



አይታጠብ
do not wash

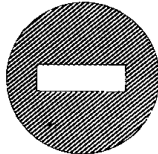

no entry
የተከለከለ አቅጣጫ

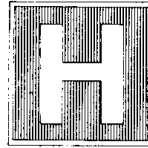

hospital
ሆስፒታል

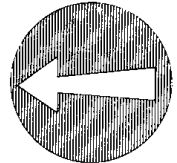

direction to be followed
የግለጫ አቅጣጫ

ቢጫ : ጥንቃቄ
yellow = be careful

ምሳሌዎች
examples



ለሰባለ ውሃ በእጅ ይታጠብ
hand wash in lukewarm water

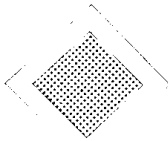

ቅድሚያ ሰጭ መንገድ
priority road

አረንጓዴ : ፈቃድ ምልክታ
green = permission, indication

ምሳሌ
example



machine wash in warm water
at a normal setting

በተመለከተው መጠን በሞቀ ውሃ በመኪና ግጠብ

ሀትመታዊ ቅንጣቶች
graphic elements



ወይም
or



የማይቻል፣
የተከለከለ
= do not... no..

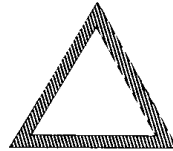

አደጋ፣ ይጠንቀቁ
= danger, be careful

ምሳሌዎች
examples

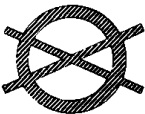

do not dry clean
በደረቁ አይታጠብ

ምሳሌዎች
examples



no entry for
power-driven vehicles
ለባለሞተር ተሽከርካሪዎች የተከለከለ



flammable
አሳት ላቢ



pedestrian crossing
የእግረኛ ግዳረጫ

**አለም አቀፍ የመንገድ ምልክቶች
international road signs**

**የአደጋ ግንዛቤ ምልክቶች
danger warning signs**

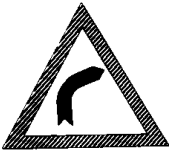

right bend
ቀኝ ታጣፊ



double bend
ዳግም ታጣፊ



dangerous bend
አደገኛ ታጣፊ



dangerous descent
አደገኛ ቱልቱለት



steep hill
ቀጥ ያለ ዳገት



roadway narrows
የጊጠብ መንገድ



bumps
ፍጥነት ገዥ ጉብታ



ridge
ጉብታ



slippery road
አንሸራታች መንገድ



loose gravel
ጠጠርግ መንገድ



falling rocks
ናዳ



school zone
የትምህርት ቤት አካባቢ



pedestrian crossing
የእግረኛ ግዳረጫ

አለም አቀፍ የመንገድ ምልክቶች
international road signs

የአደጋ ማስጠንቀቂያ ምልክቶች
danger warning signs (cont.)



cyclists entering or crossing

ለባለብስክሌቶች ግለፊያ ወይም ግድግዳ



cattle crossing

የክብቶች ግድግዳ



wild animals crossing

የጭር አራዊት ግድግዳ



road works

የመንገድ ስራ



light signals

የትራፊክ መብራት

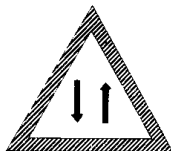

two-way traffic

ጊዜያዊ የሁለት አቅጣጫ መንገድ



other dangers

ሌሎች አደጋዎች



traffic circle

የትራፊክ ኡደት



priority intersection

ቅድሚያ መስጫ መጋጠሚያ



grade crossing

ባለመዝጊያ የሃዲድ ግድግዳ

በመጋጠሚያ መንገዶች የቅድሚያ አሰጣጥ ምልክቶች
signs regulating priority at intersections

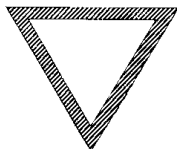

ቅድሚያ ለእግረኞች

- give way - sign



መስቀልኛ መንገድ

stop at intersection

በጥንቃቄ ይታለፍ

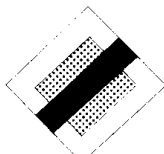

ቅድሚያ ሰጭ ምልክት

- priority road - sign

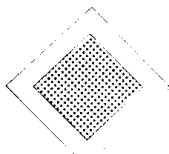

የቅድሚያ ሰጭ

- end of priority - sign

ምልክት መሠረሻ

ክልካይ ወይም አስገዳጅ ምልክቶች
prohibitory or regulatory signs

አለም አቀፍ የመንገድ ምልክቶች
international road signs

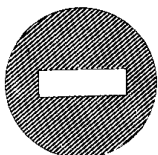

no entry
የተከለከለ አቅጣጫ



no entry for mopeds
ለሞፕዶች የተከለከለ



no entry for bicycles
ለብስክሌቶች የተከለከለ



no entry for motorcycles
ለሞተር ብስክሌቶች የተከለከለ



no entry for goods vehicles
ለጭነት መኪናዎች የተከለከለ



no entry for pedestrians
ለእግረኞች የተከለከለ



no entry for power-driven vehicles
ለባለሞተር ተሽከርካሪዎች የተከለከለ



width clearance
ከወርዶ መጠን ላለፈ የተከለከለ



overhead clearance
ከከፍታው መጠን ላለፈ የተከለከለ



weight limitation
ከክብደቱ ወሰን ላለፈ የተከለከለ



no left turn
ወደ ገራ መታጠፍ አይቻልም



no U-turn
በ "U" ቅርፅ ታጥፎ መመለስ አይቻልም



passing prohibited
መቅደም የታገደ

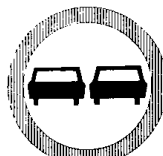

end of prohibition of passing
የመቅደም እገዳ ግብይቷ



maximum speed limit
የፍጥነት ወሰን



use of audible warning devices prohibited
ለድምጫ ግስጠንቀቂያ የተከለከለ

አለም አቀፍ የመንገድ ምልክቶች
international road signs

ፈቃድ ምልክቶች
mandatory signs

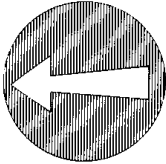

direction to be followed
የግለፊያ አቅጣጫ

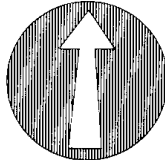

direction to be followed
የግለፊያ አቅጣጫ

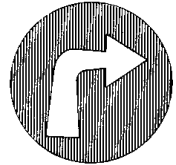

direction to be followed
የግለፊያ አቅጣጫ



direction to be followed
የግለፊያ አቅጣጫ

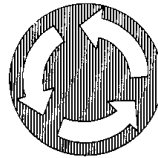

compulsory roundabout
ቅድሚያ የሚሰጥበት የትራፊክ ኮደት

አሰሪዎች ምልክቶች
informative signs



one-way traffic
አንድ አቅጣጫ መንገድ

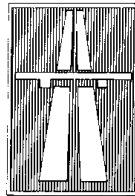

superhighway
አቢይ አውራ ጉዳና

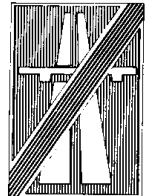

end of superhighway
የአቢይ አውራ ጉዳና ግብይት

ለአጭርና ለረጅም ጊዜ ተሽከርካሪ
ግቆሚያ ምልክቶች
standing and parking signs

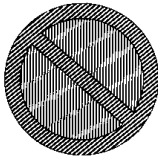

parking prohibited or restricted
ተሽከርካሪ አቅም መውረድ የተከለከለ

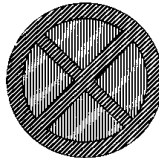

standing and parking
prohibited or restricted
ተሽከርካሪ ግቆም
ፍፁም የተከለከለበት

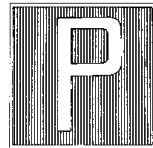

parking
የተሽከርካሪ ግቆሚያ

የተለመዱ ምልክቶች
common symbols

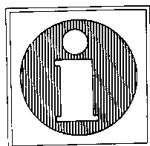

information
መረጃ



first aid
የመጀመሪያ እርዳታ

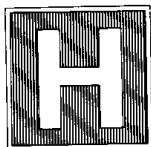

hospital
ሆስፒታል



police
ፖሊስ

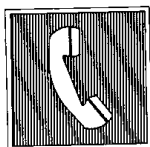

telephone
ስልክ



do not enter
መግባት አይቻልም



no dogs
ለውጾች የተከለከለ



fire hose
እሳት ግጥሥ ተዕ



fire extinguisher
የእሳት ግጥሥ



caution,
pedestrian crossing
ጥንቃቄ፣ የእግረኞች ግድረጫ



caution, slippery floor
ጥንቃቄ፣
አንሸራታች ወለል

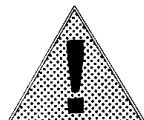

caution
ጥንቃቄ



danger, electrical hazard
አደጋ፣ የኮረንቲ



danger, poison
አደጋ፣ የመርዝ



danger, flammable
አደጋ፣ እሳት ሳቢ

የተለመዱ ምልክቶች
common symbols



access for physically
handicapped

ለአካል ጉዳተኞች የተፈቀደ



do not use for wheelchairs

ለተሸከርካሪ
ወንበር የተከለከለ

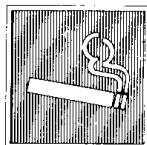

smoking permitted

የማጫኛ ክፍል



smoking prohibited

የማይጨስበት ክፍል

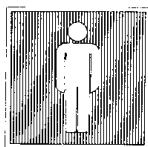

toilet for men

የወንዶች መፀዳጃ

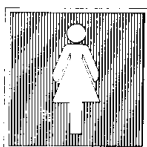

toilet for women

የሴቶች መፀዳጃ

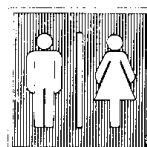

toilet for men and women

የወንዶችና የሴቶች መፀዳጃ

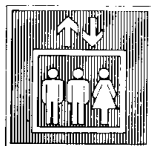

elevator for people

ሰው ጫኝ አሳንሰር

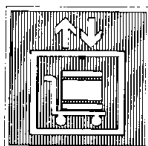

freight elevator

እቃ አውጭ አውራጅ

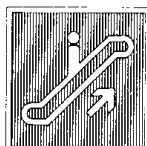

escalator, up

ደረጃ አውጭ

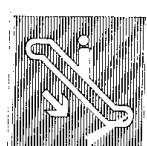

escalator, down

ደረጃ አውራጅ



stairs

ደረጃዎች

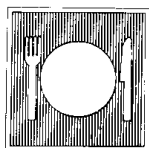

restaurant

ሬስቶራንት

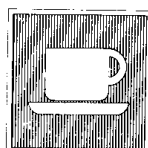

coffee shop

ቡና ቤት

**የተለመዱ ምልክቶች
common symbols**

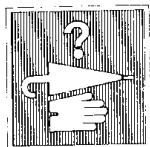

lost and found articles
ጠፍተው የተገኙ እቃዎች

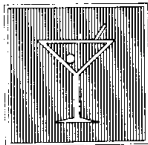

bar
መጠጥ ቤት

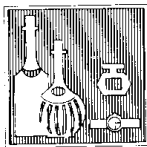

duty-free
ከቀረጥ ነፃ

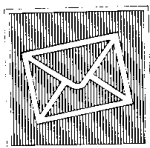

post office
ፖስታ ቤት

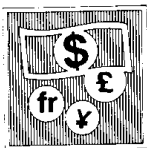

currency exchange
የገንዘብ መለዋወጫ

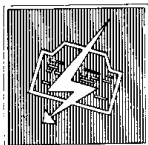

telegrams
ቲሌግራም

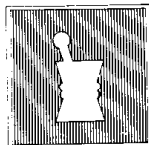

drug store
መድሃኒት መሸጫ

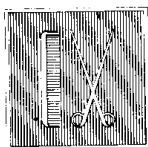

barber
ፀጉር እስተካካይ

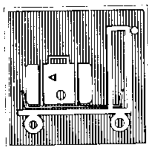

baggage carts
የጓዝ ጋሪዎች



do not use
for baggage carts
ለሻንጣ ጋሪዎች የተከለከለ

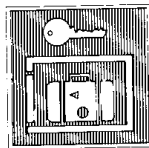

lockers
የእቃ ግዳያ ሳጥን

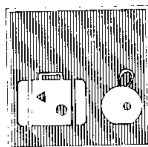

baggage claim
ጓዝ መረከቢያ

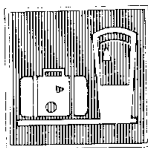

check-in
የሻንጣ ግብረከቢያ

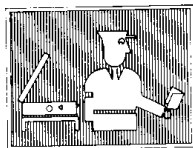

inspection services
የፍተሻ አገልግሎት

የተለመዱ ምልክቶች
common symbols



hotel information
የኮቴል አገልግሎት መረጃ

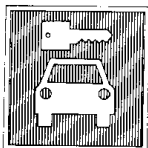

car rental
መኪና አክራይ

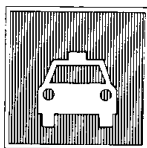

taxi transportation
የታክሲ ትራንስፖርት

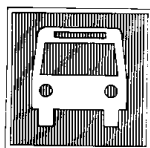
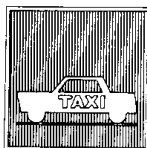

bus transportation
የአውቶቡስ ትራንስፖርት

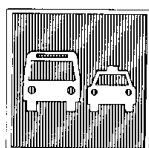

ground transportation
የየብስ ትራንስፖርት

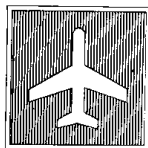

air transportation
የአየር ትራንስፖርት

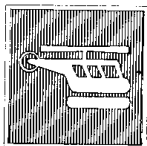

helicopter transportation
የሂሊኮፕተር ትራንስፖርት

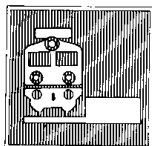

rail transportation
የባቡር ትራንስፖርት

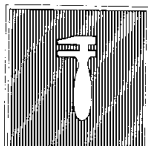

breakdown service
የጥገና አገልግሎት

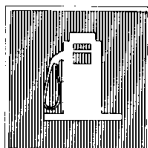

service station
ነጻጅ ግደያ

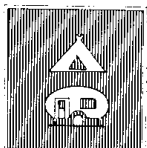

camping and caravan site
የተጓጉሾች ድንኳን
መትከያና መስፈሪያ

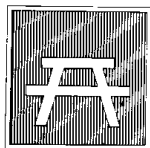

picnic area
የሽርሽር ክልል



picnics prohibited
ለሽርሽር የተከለከለ

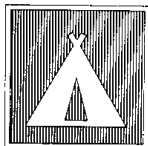

camping area
የድንኳን መትከያ ክልል



camping prohibited
ድንኳን መትከያ
የተከለከለ

**የጨርቃጨርቅ እጥበት ጥንቃቄ
fabric care**

**እጥበት
washing**

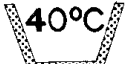

machine wash
in lukewarm water at a gentle
setting-reduced agitation
ለብ ባለ ውሃ በዝቅተኛ
እንቅስቃሴ በመኪና ይታጠብ



machine wash
in warm water at a gentle
setting-reduced agitation
በሞቀ ውሃ በዝቅተኛ
እንቅስቃሴ በመኪና
ይታጠብ



do not wash
አይታጠብ



hand wash
in lukewarm water
ለሰ ባለ ውሃ በእጅ ይታጠብ



machine wash
in warm water at a
normal setting



machine wash
in hot water at a
normal setting
በተመለከተው መጠን
በፈለ ውሃ ይታጠብ



do not use chlorine bleach
የግንጫ መርዝ አትጠቀም

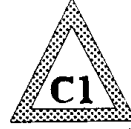

use chlorine bleach
as directed
በመመሪያው መሰረት
የግንጫ መርዝ ተጠቀም

**ግድረት
drying**



dry flat
ተዘርግቶ ይድረት



tumble dry
at low temperature
በዝቅተኛ ሙቀት
እያገለበጡ ግድረት



tumble dry
at medium to high
temperature



hang to dry
ተሰቅሎ ይድረት



drip dry
ባይጨመት ይድረት

**ልብስ መተኮስ
ironing**



do not iron
አይተኮስ

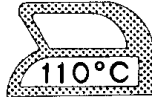

iron at low setting
በዝቅተኛ ግለት ይተኮስ

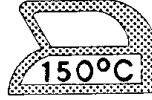

iron at medium setting
በመካከለኛ ግለት ይተኮስ



iron at high setting
በከፍተኛ ግለት
ይተኮስ

**በደረቁ እጥበት
dry cleaning**

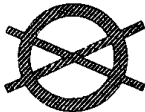

do not dry clean
በደረቁ አይታጠብ



dry clean
በደረቁ ይታጠብ

ስነ-ሀይወት
biology

♂ ተባእት
male

♀ እንስት
female

† ሞት
death

* ልደት
birth

ማቴማቲክስ
mathematics

+

መደመር
addition

-

መቀነስ
subtraction

×

ማባዛት
multiplication

÷

ማካፈል
division

+
-

ሲደመር ወይም ሲቀነስ
plus or minus

=

እኩል ነው
is equal to

≠

እኩል አይደለም
is not equal to

≡

እንደ ነው
is identical with

≠

እንደ አይደለም
is not identical with

≈

በግምት እኩል ነው
is approximately equal to

≡

ተመጣጣኝ ነው
is equivalent to

>

ይበልጣል
is greater than

≥

እኩል ነው ወይም ይበልጣል
is equal to or greater than

<

ያንሳል
is less than

≤

እኩል ነው ወይም ያንሳል
is equal to or less than

√

ዳግም ዘር
square root of

∞

እልቀ ቢስ
infinity

%

በመቶ
percent

∪

ውህደት
union

∩

የጋርዮሽ
intersection

⊂

ታህታይ ስብስብ
is contained in

∈

አባል ነው
is a member of

∅

ባዶ ስብስብ
empty set

Rx

የመድሃኒት ማዘገፍ
prescription

&

እና
ampersand

©

የማሳተም መብት
copyright

®

የተመዘገበ የንግድ ምልክት
registered trademark

\$

ዶላር
dollar

¢

ሳንቲም
cent

£

ፓውንድ
pound

→

የአገልግሎት አቅጣጫ
reaction direction

⇌

ተቀልባኝ አገልግሎት
reversible reaction

+

አወንታዊ ሙሉ
positive charge

-

አሉታዊ ሙሉ
negative charge

ማቲማቲክስ

 \parallel

ትይዩ

 \perp

ቀጠ ድረ

 \Rightarrow

ቢሆን...ነው

 \Leftrightarrow

የሚሆን ከሆነ ብቻ

 \wedge

አጣጣሪ

 \vee

አማራጭ

 \exists

ነዋሪ

 \forall

ለሁሉም

 \cong

ልክክ

 $n!$

ጠ ብዜት

የተለመዱ የሳይንስ ምልክቶች

ፈቋቋስ



ቀጥተኛ ኸረት



ተቀያያሪ ኸረት



መዳሪ መሬት



ክፍት ማብሪያ ማጥፊያ



ዝግ ማብሪያ ማጥፊያ



አንቴና



ደረቅ ህዋስ



አሜትር



ቮልትሜትር



ዋትሜትር