



IBM Software

Managing z/VM and Linux on System z (and Other Guests)

Tracy Dean, IBM
tld1@us.ibm.com

April 2012

Agenda

- **Security**
 - RACF and zSecure Manager for z/VM
- **Performance monitoring**
 - OMEGAMON XE on z/VM and Linux
- **Automation and operational monitoring**
 - Operations Manager for z/VM
 - Including integration with existing monitoring and alert systems
- **Backup and recovery**
 - Backup and Restore Manager for z/VM
 - Tape Manager for z/VM
 - Tivoli Storage Manager
- **Management of production workloads**
 - Requirements tooling/management software
 - Recommended practices

Agenda

- **Demos**
 - Automation scenarios
 - Backup and recovery scenarios, including automation
- **Reference information**



IBM Software

Automating Operations
Operations Manager for z/VM

Recommended Practices – Operational Management

Generate alerts and/or automatically recover from

- Service machine disks approaching full
- Termination messages
- Abend messages
- Critical user IDs being logged off or entering error state
- Spool and/or page space approaching full

Schedule automated system maintenance procedures

- Spool cleanup based on policies
- Minidisk cleanup (from logs) – may include archiving
- Orderly shutdown and relocation of critical guests to another member in SSI cluster

Recommended Practices – Operational Management

Generate alerts and/or automatically recover from

- Abend, termination, or error messages
- Critical user IDs or guests being logged off or entering error state
- Spool and/or page space approaching full
- Service machine disks approaching full

Schedule automated system maintenance procedures

- Spool cleanup based on policies
- Minidisk cleanup (from logs), including archiving
- Orderly startup or shutdown of guests
- Orderly shutdown and relocation of critical guests to another member in SSI cluster
- Backups of z/VM system

Operations Manager for z/VM

Increase productivity

- Authorized users to view and interact with monitored virtual machines without logging onto them
- Multiple users view/interact with a virtual machine simultaneously

Improve system availability

- Monitor virtual machines and processes
- Take automated actions based on console messages
- Reduce problems due to operator error

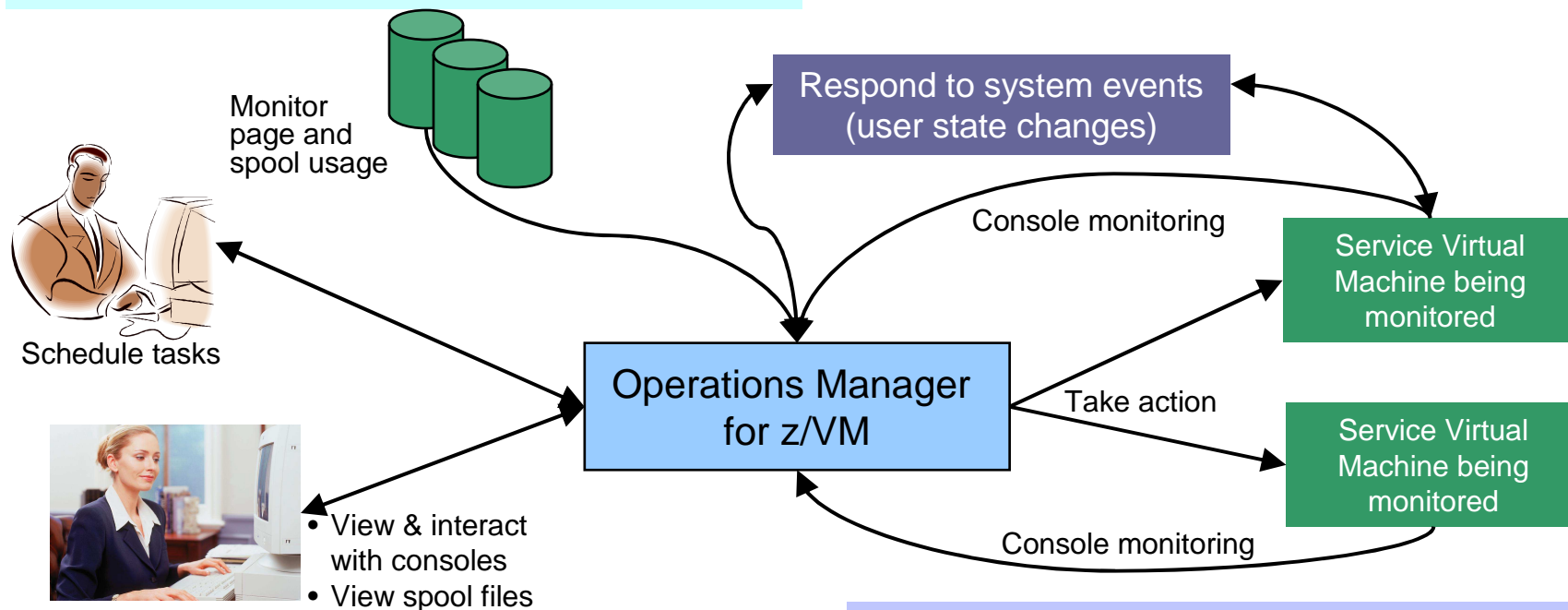

Automation

- Routine activities done more effectively with minimal operations staff
- Schedule tasks to occur on a regular basis

Integration

- Fulfill take action requests from performance monitoring products (e.g. OMEGAMON XE on z/VM and Linux)
- Send alerts to email, central event management systems (e.g. Netcool\OMNIbus), etc.

Features and Functions

- **Monitor service machine consoles**
- **Monitor page space and spool usage**
- **Monitor system events**
- **Schedule events/actions**
- **Take actions automatically based on monitoring results**
- **View and interact with monitored consoles from authorized user IDs**
- **Find and view spool files**
- **Dynamic configuration**
- **Separation of access control**

Monitor Service Machine Consoles

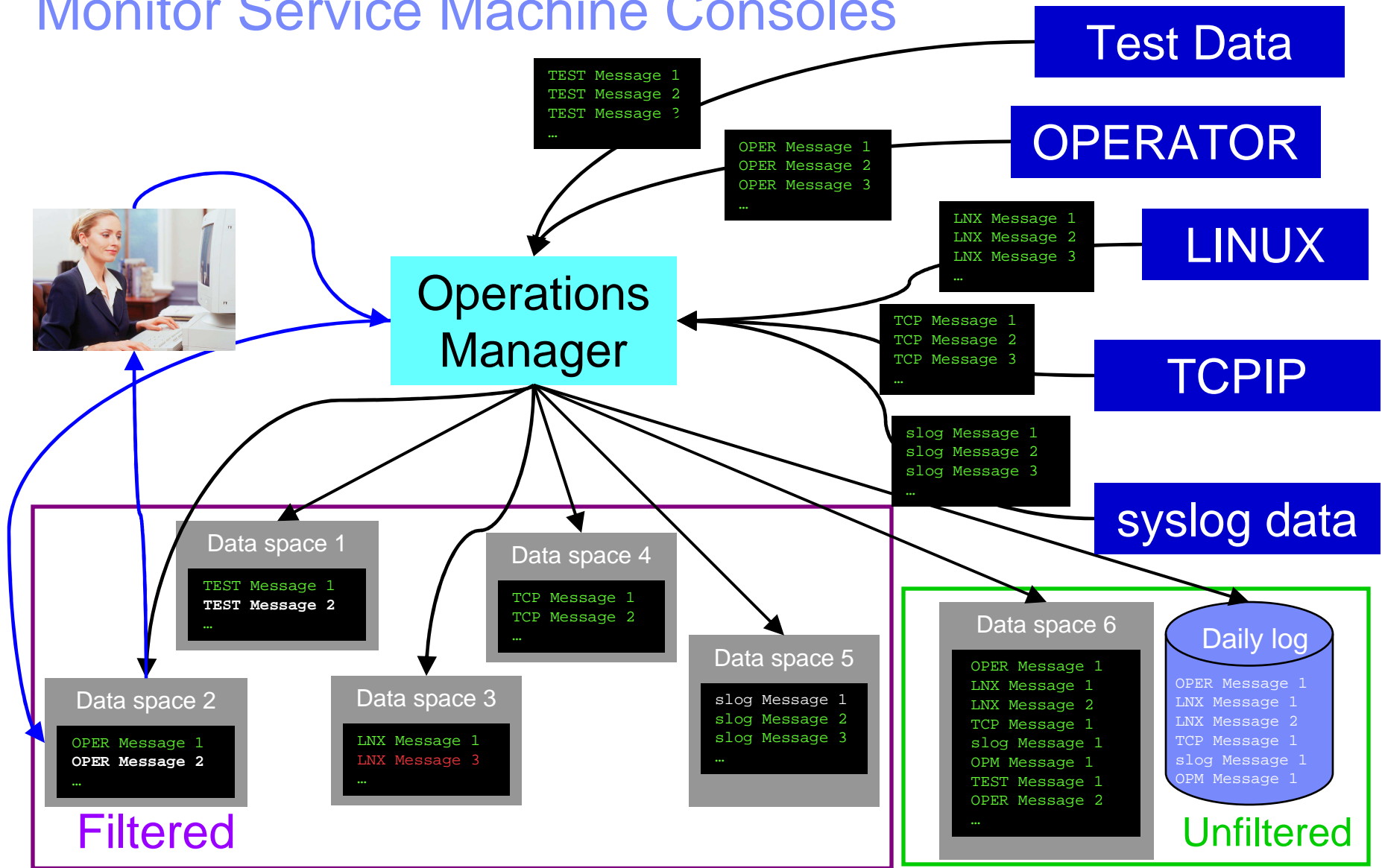

Monitor Service Machines

- **Define rules to**
 - Scan console messages for text matching
 - Includes column, wildcard, and exclusion support
 - Optionally restrict to specific user ID(s)
 - Take actions based on matches
 - Change color, highlight, hold, or suppress a console message
 - CP or CMS commands
 - REXX EXECs
- **Multiple rules can apply to one message**
 - Rules processed in order of definition in the configuration file
 - FINAL option available to indicate no additional rules should be evaluated
- **Take multiple actions based on one message**
 - Chain actions together
- **Rules apply to consoles received by local Operations Manager server**

View and Interact with Consoles

- **Authorized users can view live consoles of monitored service machines and guests**
 - Multiple users can view the same console simultaneously
 - No need to logon to the service machine to see its console
 - Test data and Linux syslog data treated as a “console”
 - Views can be defined to look at a group of consoles in one view
- **Full screen mode**
 - Scroll up and down to view and search historical data
 - Auto scroll (on or off) as new output is displayed on the console
 - From command line, issue commands back to the monitored console
- **Amount of data that is visible depends on specified or default data space size**
- **Rules/actions may modify the view**
 - Suppress messages from the console
 - Hold or highlight messages with color, blinking, etc.
- **Authorized users can view the log file**
 - Can also request a copy of the log file from today or a previous day

Operations Manager - non-SSI Environment

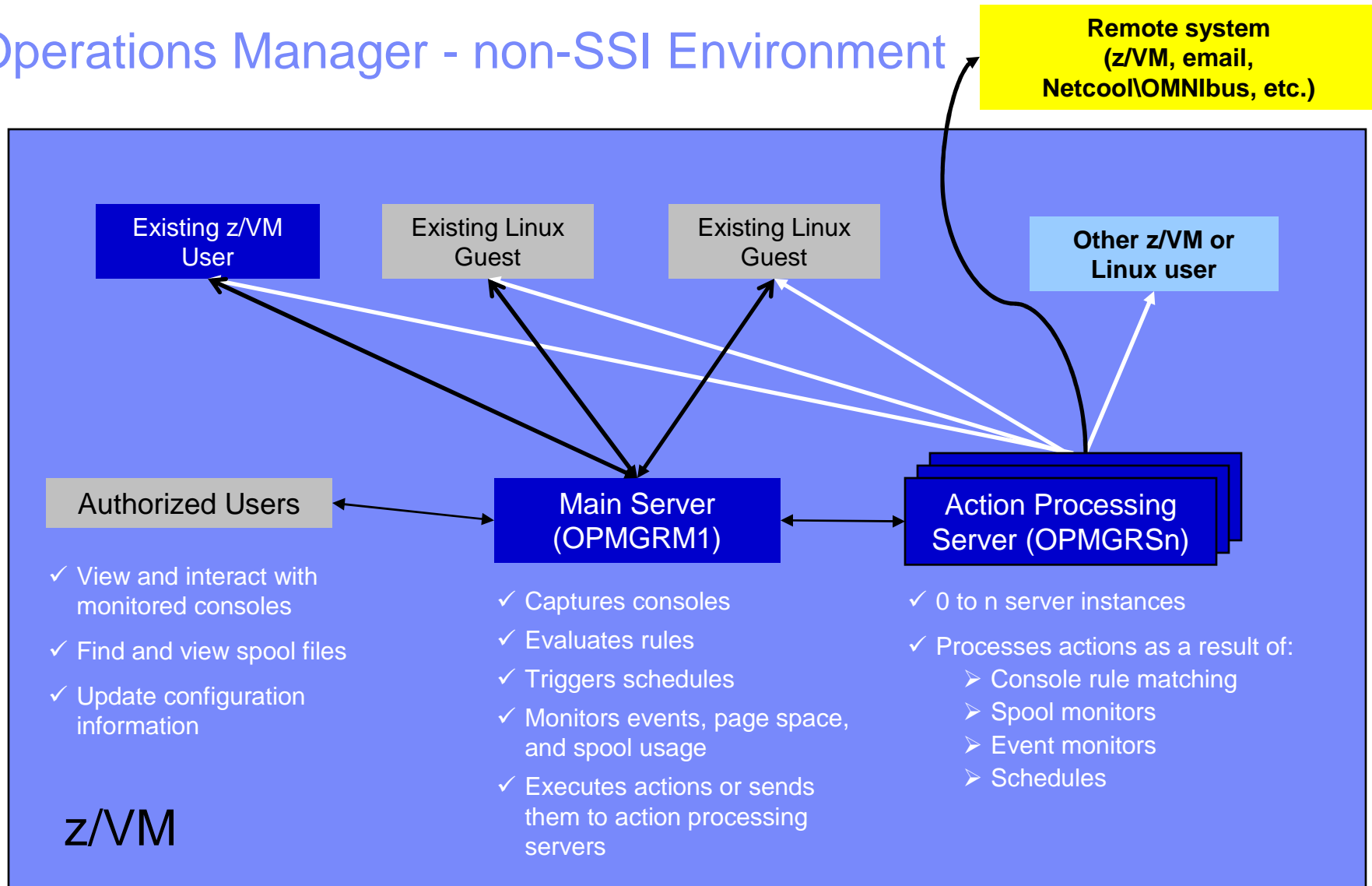

Single Config User

Multiconfig User

SSI Considerations for Console Monitoring

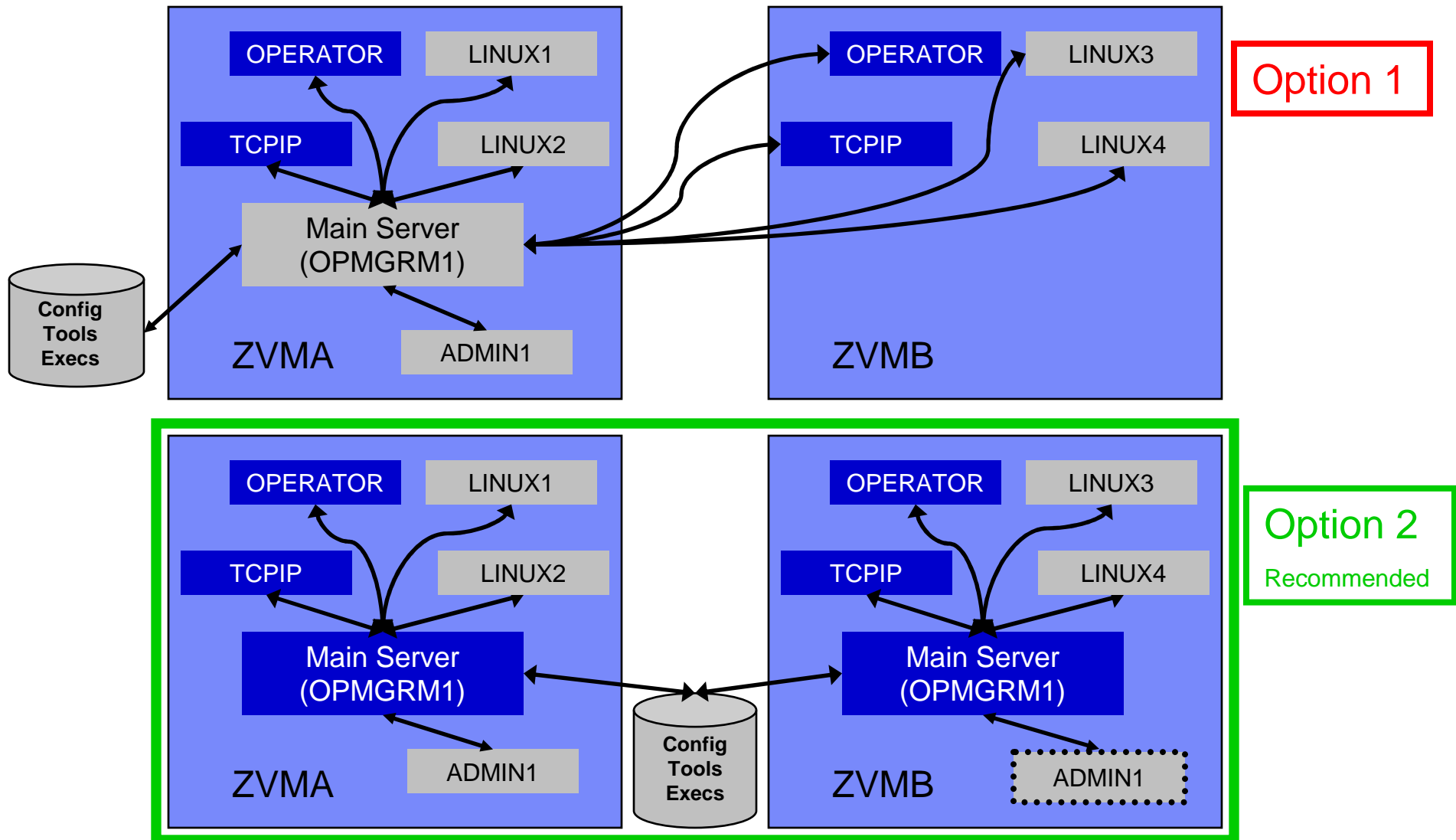

Monitor Service Machines - Considerations

- **Consoles received by Operations Manager via SECUSER or OBSERVER**
 - Prefer SECUSER
 - OBSERVER won't detect CP and VM READ messages
 - Output of actions on OBSERVED console may not be viewable in console
 - OBSERVER allows Operations Manager to receive console output even when user is logged on
- **Single System Image allows SECUSER and OBSERVER across members of cluster**
 - Content does not contain member name information
 - Rules, actions, and users wouldn't be able to distinguish between IDENTITY users on multiple members
 - Creates single point of failure on one member
- **Recommendation for zVM V6.2 Single System Image Environments**
 - Have all consoles monitored by an Operations Manager server on the same member as the monitored guest
 - Requires action processing servers (OPMGRSn) to be on same member as main server
 - Share configuration data on minidisk owned by single configuration user
 - For example: VMTOOLS 198
 - Master configuration file unique to each member
 - Imbed common file(s) used by all members

Monitor Page and Spool Usage, View Spool Files

- **Create page and spool space monitors to trigger actions when**
 - Percent of spool usage falls within a specified range
 - Percent of spool usage increases at a specified rate
 - Percent of page space usage falls within a specified range
 - Percent of page space usage increases at a specified rate
- **Actions triggered can be the same actions used by console monitoring**
- **For spool files, authorized users can**
 - Display a list of spool files based on one or more attributes
 - Owner
 - Size
 - Date created
 - From the list, the user can
 - View the contents of an individual spool file
 - Purge, transfer, or change a spool file

SSI Considerations for Spool and Page Space Monitoring

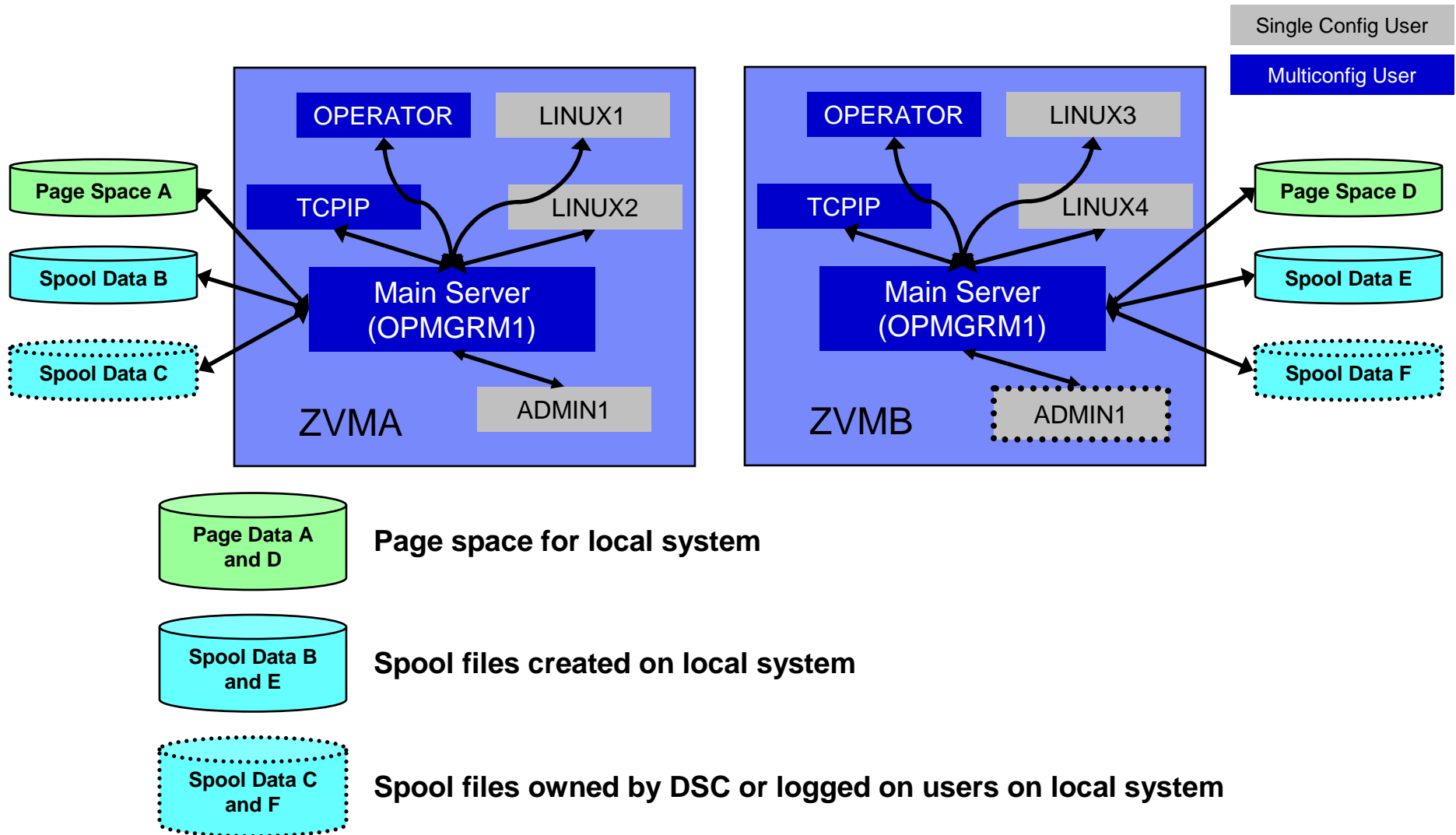

Spool and Page Space Monitoring - Considerations

- **Page space is local**
 - Separate space for each member and only visible to the local member
- **Spool data – visibility to authorized users**
 - Spool data for multiconfiguration users
 - Only files owned by the local instance of that user are visible on the local member
 - No visibility to spool files owned by other instances of that user on other members
 - Spool data for single users
 - Files created while logged onto that member are always visible on that member
 - Files owned by the user but created while logged onto another member are only visible to the local member when the user is logged on (or running disconnected) on the local member
- **Another way of putting it**
 - Spool data created on a member is always visible on that member
 - Whether the owning user is currently logged on or not
 - This includes
 - Files created by single configuration users while logged onto that member
 - Files created by multiconfiguration users with subconfig info for that member
 - Spool data owned by single configuration users is seen by the local member when the user is logged on (or running disconnected on) the local member
 - Even if data was originally created while logged onto another member of the cluster
- **Recommendation**
 - Have an Operations Manager server on each member to monitor spool and page space

Schedule Events and Actions

- **Define schedules**
 - Hourly, daily, weekly, monthly, or yearly, nth weekday of the month
 - Once on specified month, day, year, and time
 - At regular intervals
 - Every x hours and y minutes
 - Within a specified window of time
 - Specify start time
 - Specify conflicting schedules
 - Specify maximum time to defer this schedule
 - Within limits
 - Restrict to specific days of the week: Monday through Sunday plus holidays
 - Restrict to certain hours of the day

- **Specify the action associated with the schedule**
 - Actions specified are the same as those for console and spool monitoring

- **No impact from SSI**

Respond to System Events

- **Create monitors for z/VM system events (*VMEVENT) related to user IDs**
 - 0 - Logon
 - 1 - Logoff
 - 2 - Failure condition (typically CP READ)
 - 3 - Logoff timeout started
 - 4 - Forced sleep started
 - 5 - Runnable state entered (VM READ)
 - 6 - Free storage limit exceeded
 - 9 - Outbound relocation started
 - 10 - Inbound relocation started
 - 11 - Outbound relocation complete
 - 12 - Inbound relocation complete
 - 13 - Outbound relocation terminated
 - 14 - Inbound relocation terminated
 - 15 - Time bomb exploded
- **Optionally restrict to specific user ID(s)**
- **Specify the action associated with the event**
 - Actions specified are the same as those for schedules and console and spool monitors
- **Future PTF to support CLASS value**

Dynamic Configuration

- **Initial configuration file loaded at startup**
 - May imbed other configuration files
- **Most configuration options can be updated while Operations Manager is running**
 - Add, delete, or change:
 - Rules, actions, monitors, schedules, holidays, groups, user authorization
 - Suspend or resume rules, monitors, schedules
- **Multiple methods**
 - CMS command interface
 - Load a new or updated configuration file
 - Commands in action routines
 - Request reload from user IDs on other members of a cluster
 - Use SMSG OPMGR1 at <member> CONFIG ...

Operations Manager in SSI Cluster - Example

Remote system
(z/VM, email,
Netcool\OMNibus, etc.)

- Multiconfiguration users: OPMGRM1, OPMGRSn, OPERATOR, MAINT
- Single configuration users: RHEL5G, RHEL5G2, SLES11C, OPERSSI, DEMOADMN
 - Must “relocate” OPERSSI and DEMOADMN “manually”

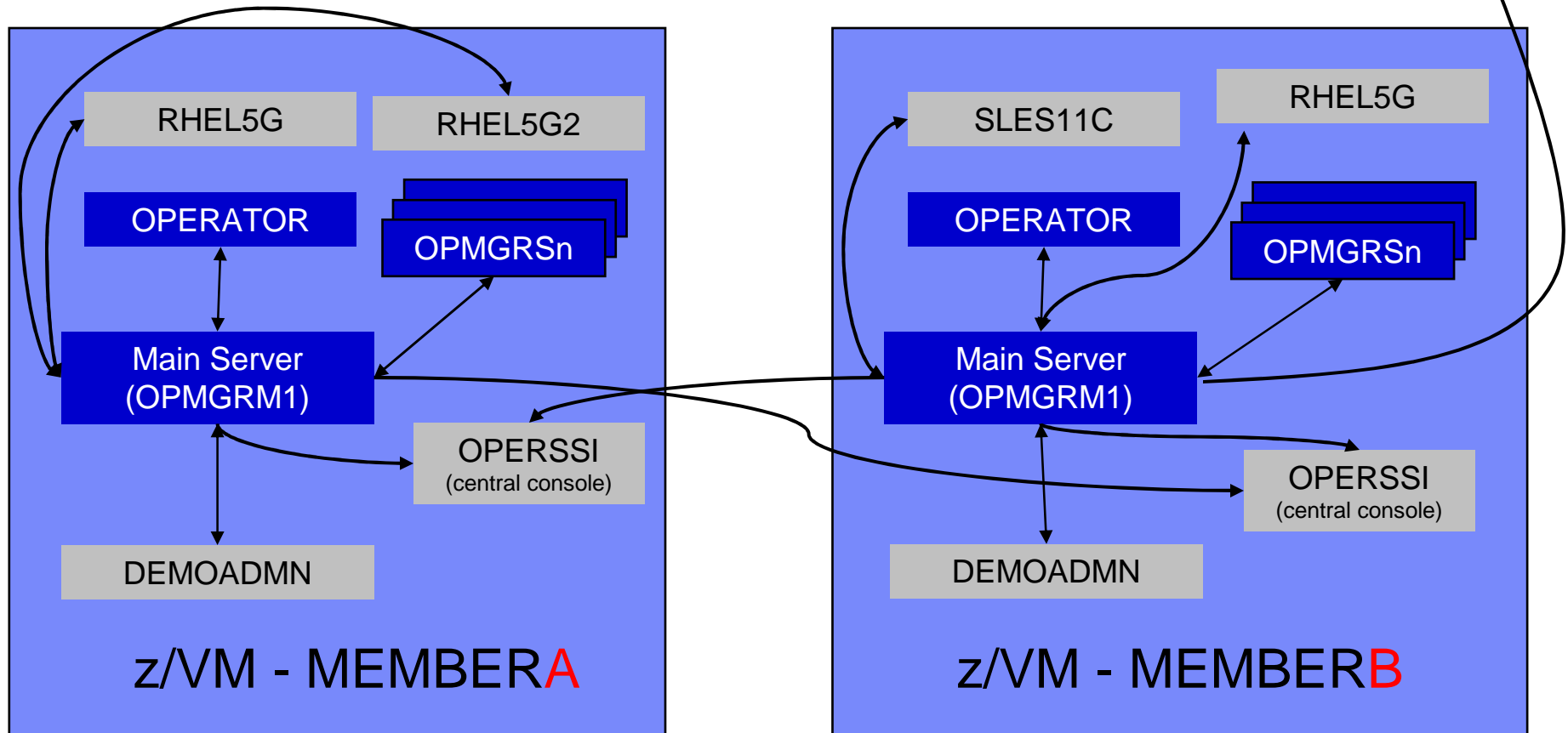

Recommended Practices – Operational Management

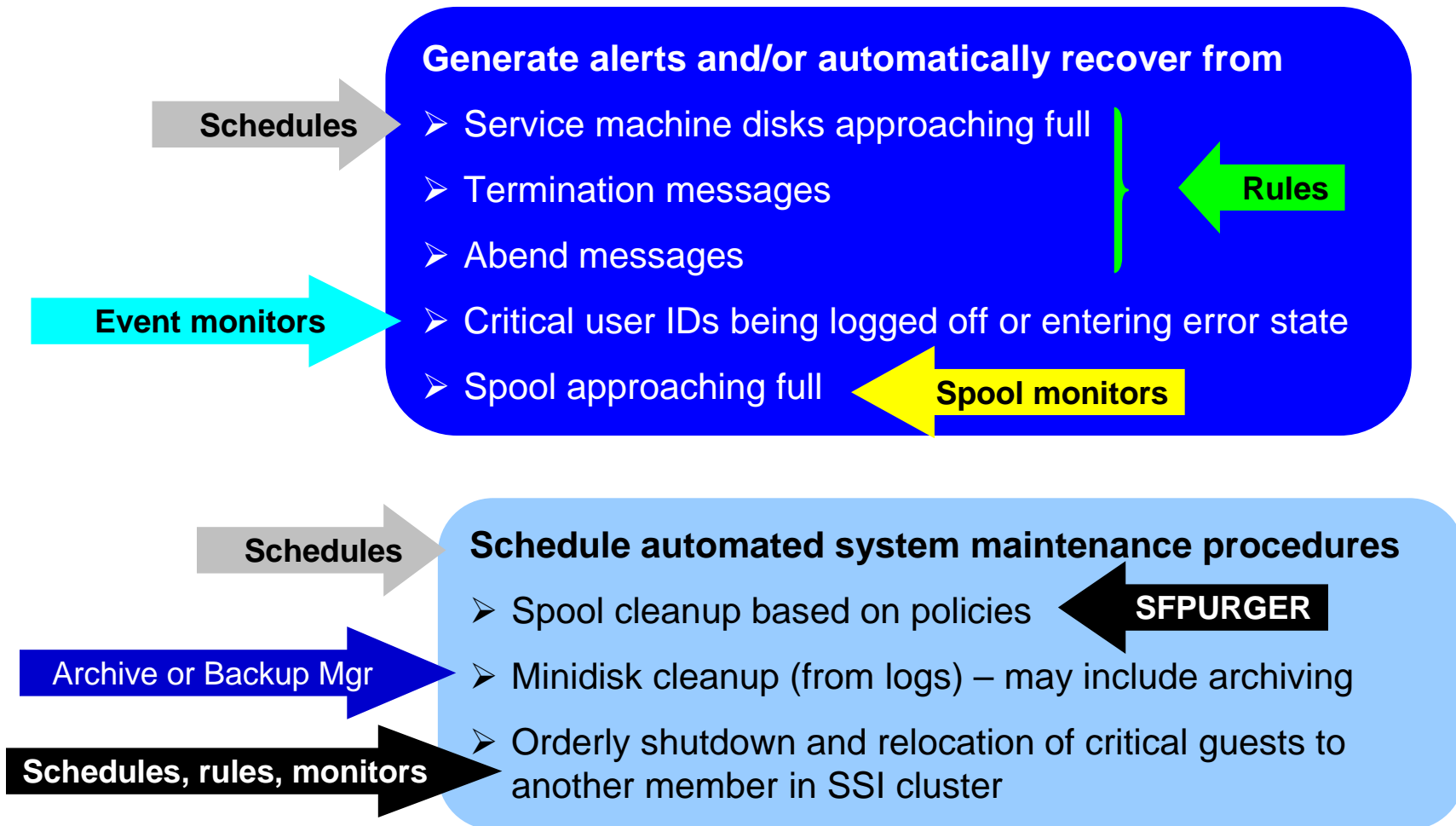

Recommended Practices – Operational Management

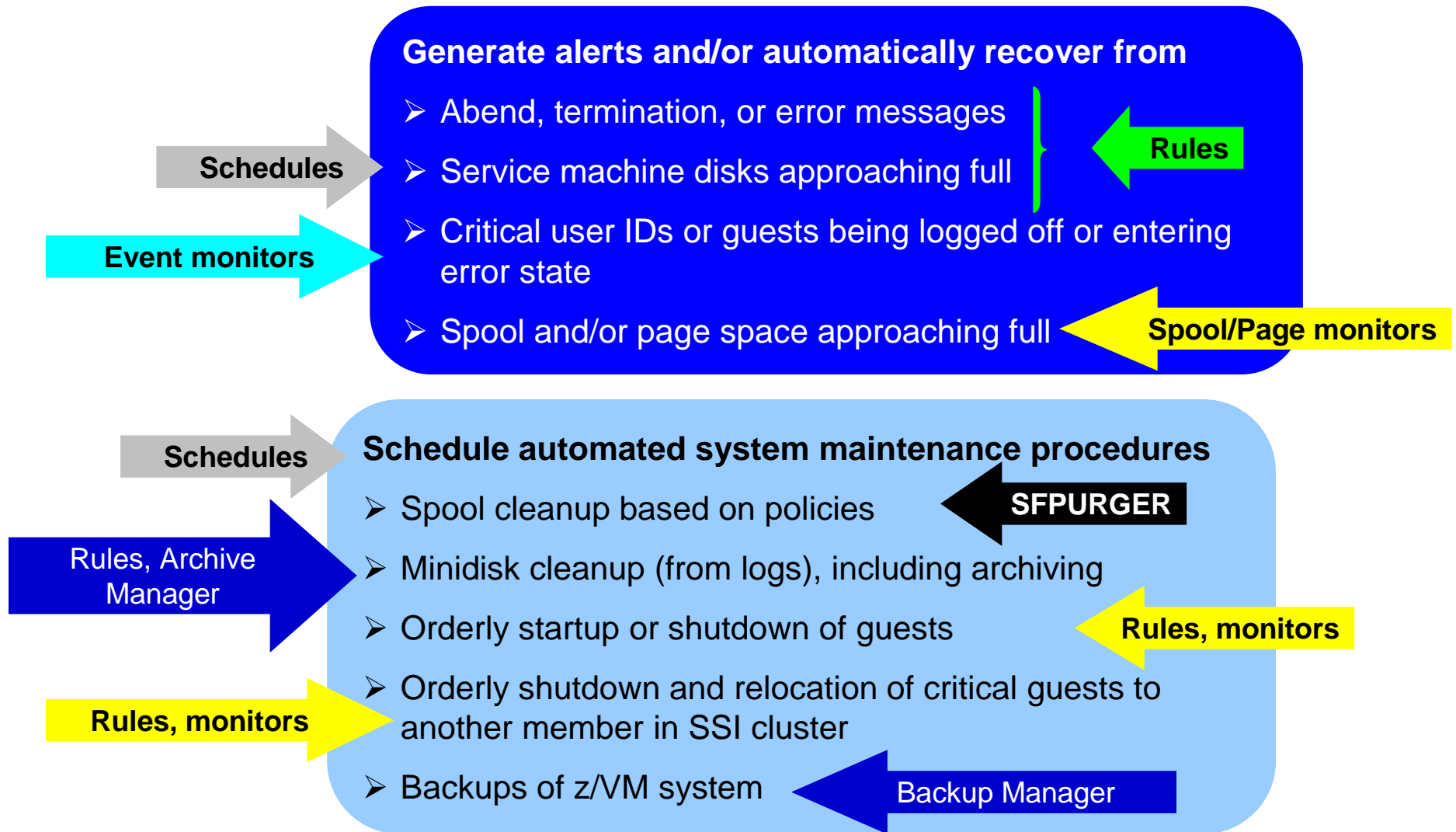

Summary

- **Use Operations Manager to**
 - Automate daily operations
 - Integrate your z/VM and Linux on System z environment with existing enterprise monitoring and alerting
 - Prevent problems rather than react to them
 - Automate reactions to problems when they can't be prevented
 - Improve problem determination procedures
 - Increase programmer and operator productivity
 - Continue to monitor locally with improved management of clusters



IBM Software

Managing Backup and Recovery

Backup and Restore Manager for z/VM

Recommended Practices – Backup and Recovery

Image level backup of z/VM

- Operating system

File level backup of z/VM data

- Directory information
 - Configuration files
 - Log files
 - Tools – REXX EXECs, automation scripts, etc.
- 

Image level backup of Linux guests

- Operating system
- Applications
- Application data (maybe)

File level backup of Linux guests

- Configuration files
- Log files
- Tools

Disaster recovery of z/VM system, including Linux guest

- Dependence on z/OS
- versus
- Independent recovery in parallel with z/OS
- 

Product Overview

▪ Backup

- Requested by administrators
- Full or incremental
- Flexible selection of disks and files to back up
- Review job before submitting for backup

▪ Restore

- Performed by users for their own data
- Extending to other users available via exit
- Performed by administrators for any data
- Selection of data to restore
 - Full screen interface or commands

Catalog in Shared File System (SFS) – presentation on web site for installation and setup

- **Integration with Tape Manager for z/VM**
- **Optional compression of data during backup via exits**
 - Call your own compression algorithm
 - Use IBM provided routine
- **Encryption available via exits**
 - Call your own routine
 - Use vendor-written routine, such as V/Soft Software's Encrypt/Backup for z/VM
 - Use encryption capable tape devices

Backup Data and Media

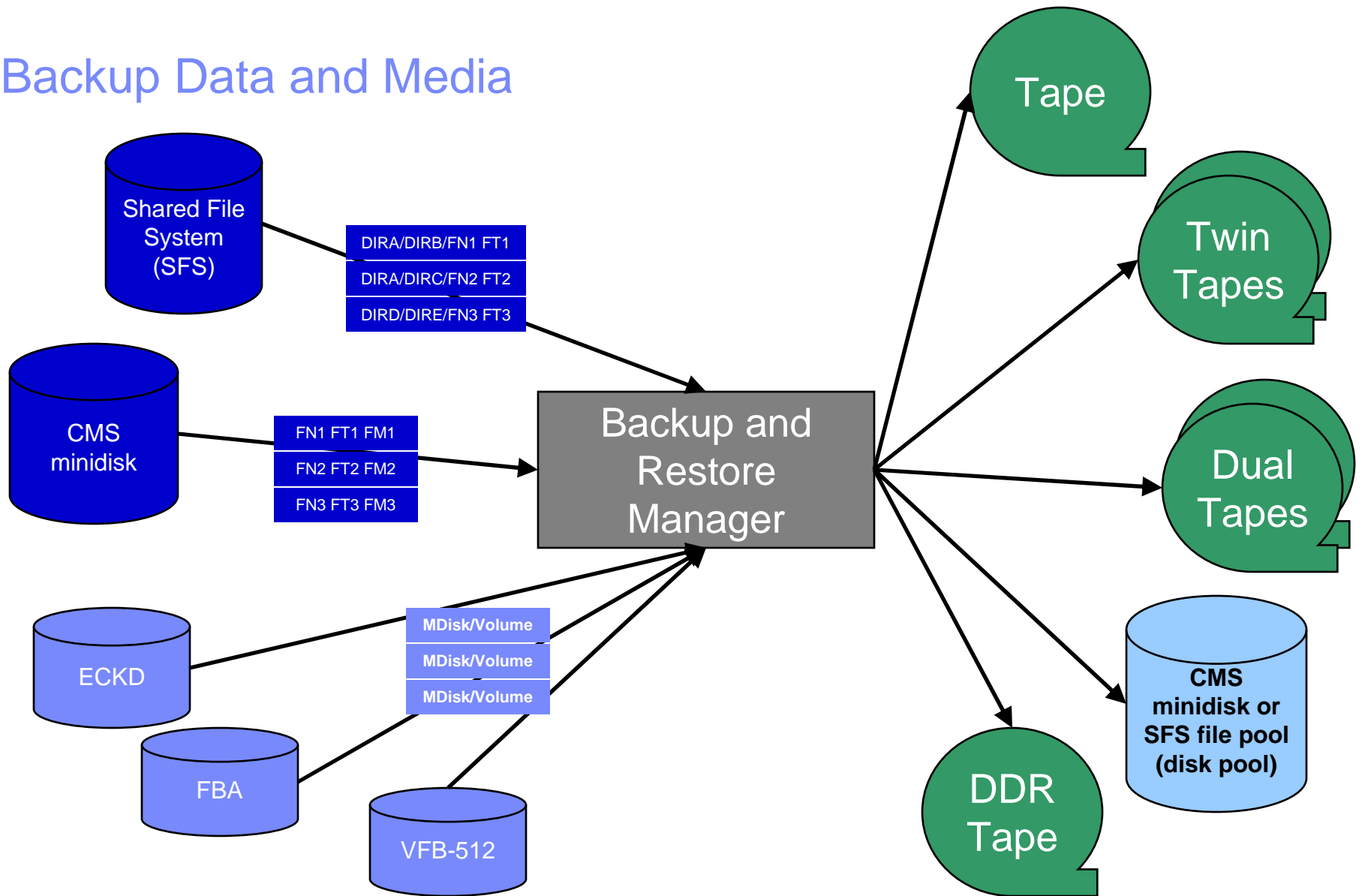

Restore Data and Media

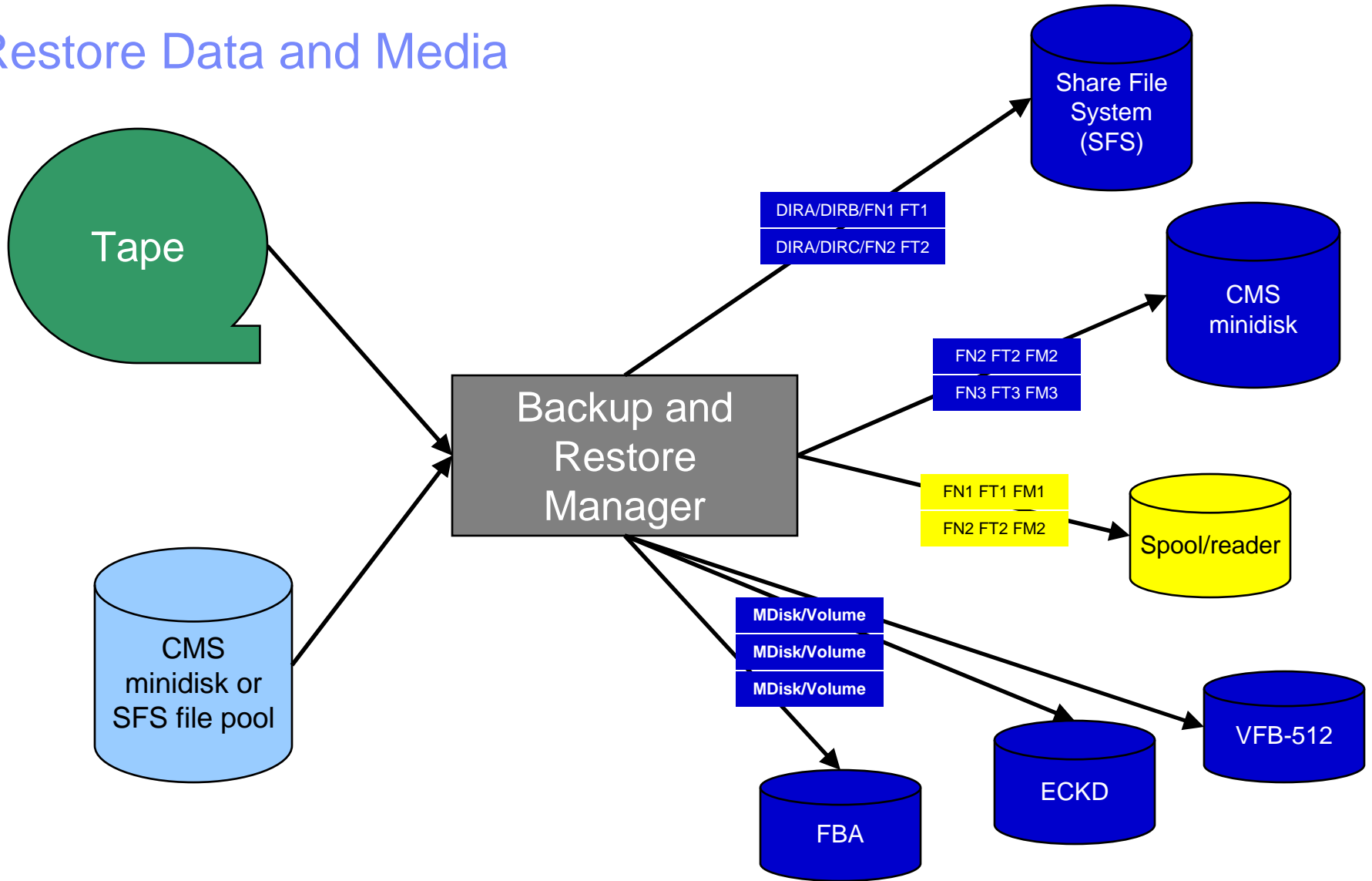

Backup and Restore Manager and Linux Guests

Using Backup and Restore Manager with Tivoli Storage Manager

Choose the solution that meets your needs – or combine for file recovery and DR

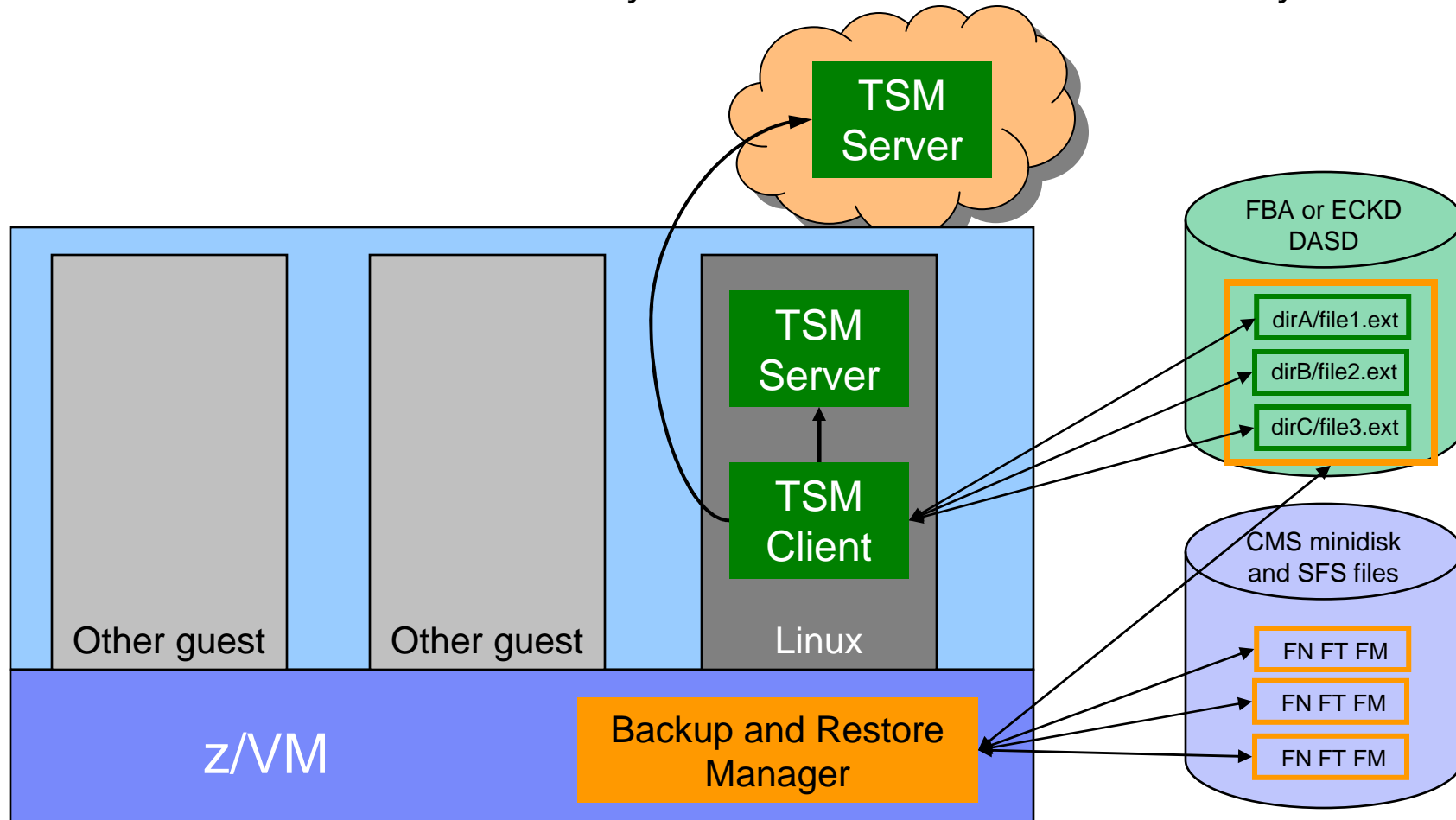

Key Benefits

- **System backups available for Disaster Recovery**
 - Option to restore using DDR or Backup and Restore Manager
 - Manage retention of DR backups
 - Retrieve a list of tapes associated with a specific backup
 - Pull list for movement to off-site storage
- **Guest backups available for restoring to a previous state or level**
- **Backups of user data available for**
 - Restoring to a previous state or level
 - Replacing files accidentally erased or corrupted
- **Users restore their own data**
 - No administrator interaction required

Key Benefits Cont...

- **Flexible selection of data to back up**
 - Include/exclude
 - Minidisks, directories
 - Real device addresses or volsers
 - Extents
 - Mask by filename, filetype, or SFS path
 - Review a defined backup job before submission
- **Management of backup data**
 - Retention set as part of the backup job
 - Automatic aging and pruning of the backup catalog
 - Including associated tapes and disk pools
 - View/query the list of expired backups
- **Reduced backup window with concurrent processing**
 - Multiple worker service machines sharing the job
 - Suggest one worker service machine for each available tape drive

Defining a Backup Job

```

/* Include/Exclude definitions */
/*****/

FUNCTION MEDIATYPE OWNER VDEV VOLUME DEVTYPE START END SIZE
-----|-----|-----|---|----|-----|-----|---|-----|---|-----|
INCLUDE MINIDISK * = * * * = * = * = *
EXCLUDE MINIDISK *LNX* = * * * = * = * = *
EXCLUDE MINIDISK MAINT = 0123 * * = * = * = *
EXCLUDE MINIDISK MAINT = 0124 * * = * = * = *
EXCLUDE MINIDISK * = * * * = * = END = *
EXCLUDE MINIDISK * = * * * = * = * > 3300
INCLUDE MINIDISK MAINT = 012* * * = * = * = *

FUNCTION MEDIATYPE ADDRESS
-----|-----|-----|
INCLUDE RDEVICE 900-90F
EXCLUDE RDEVICE *B

FUNCTION MEDIATYPE VOLSER
-----|-----|-----|
INCLUDE RDEVVOL 610*

FUNCTION MEDIATYPE POOLNAME OWNER FS
-----|-----|-----|-----|----|
INCLUDE SFS VMSYSU: * SFS
EXCLUDE SFS VMSYSU: VMSERVU SFS
    
```

Backup and Restore Manager Architecture – non-SSI

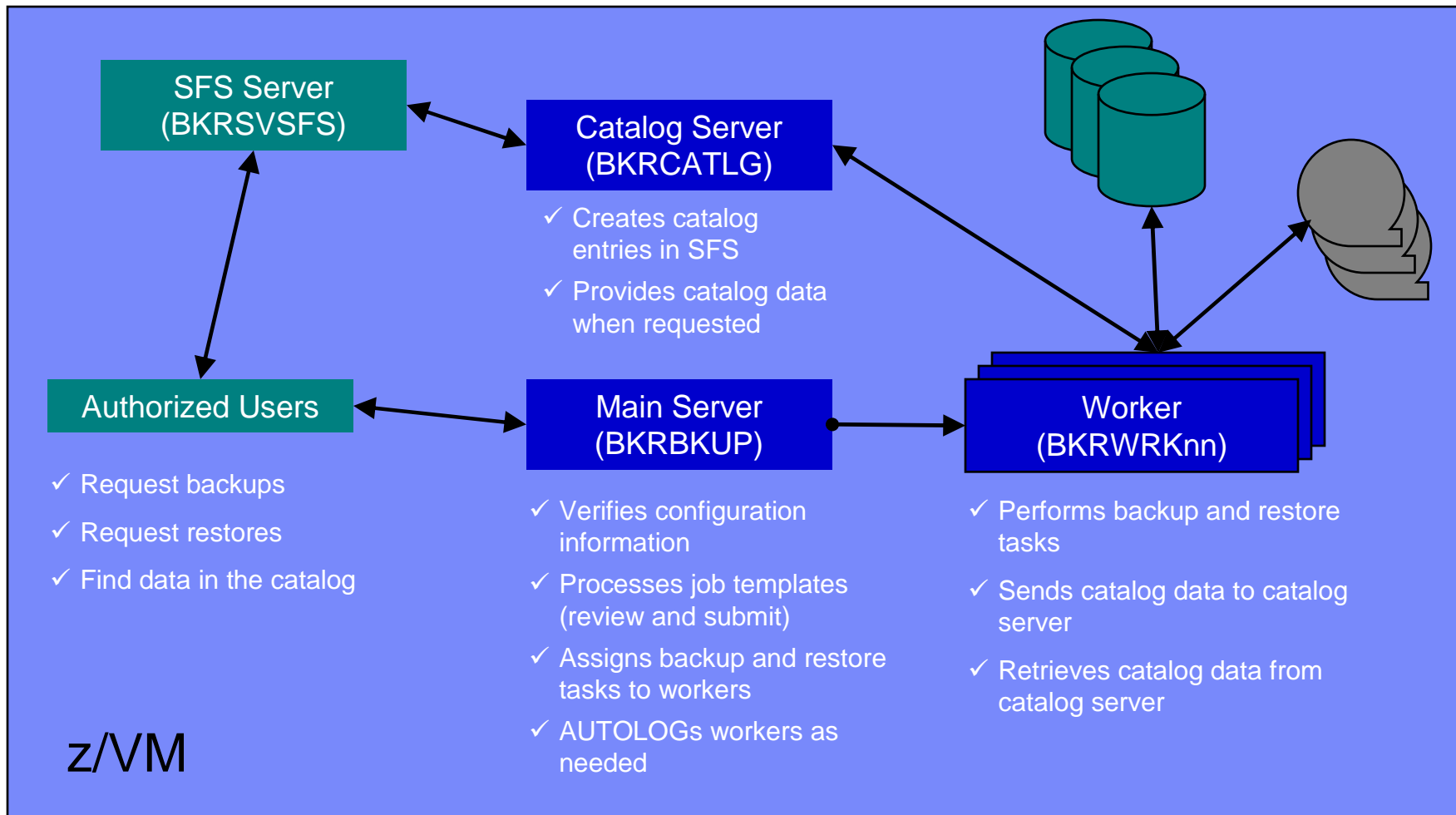

Single Config Users and MDisks

Multiconfig Users and MDisks

SSI Considerations for Backup and Restore

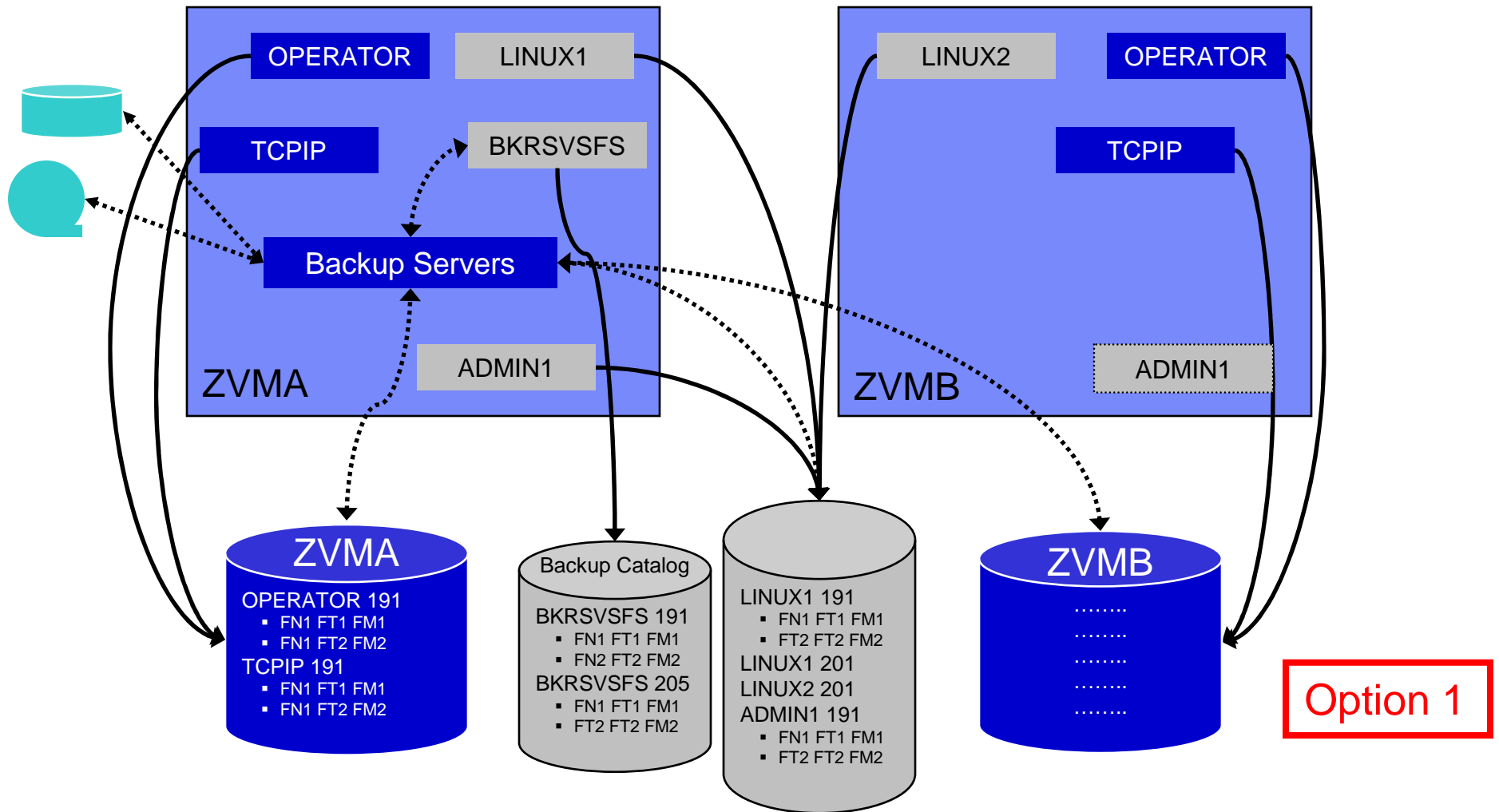

Single Config Users and MDisks

Multiconfig Users and MDisks

SSI Considerations for Backup and Restore

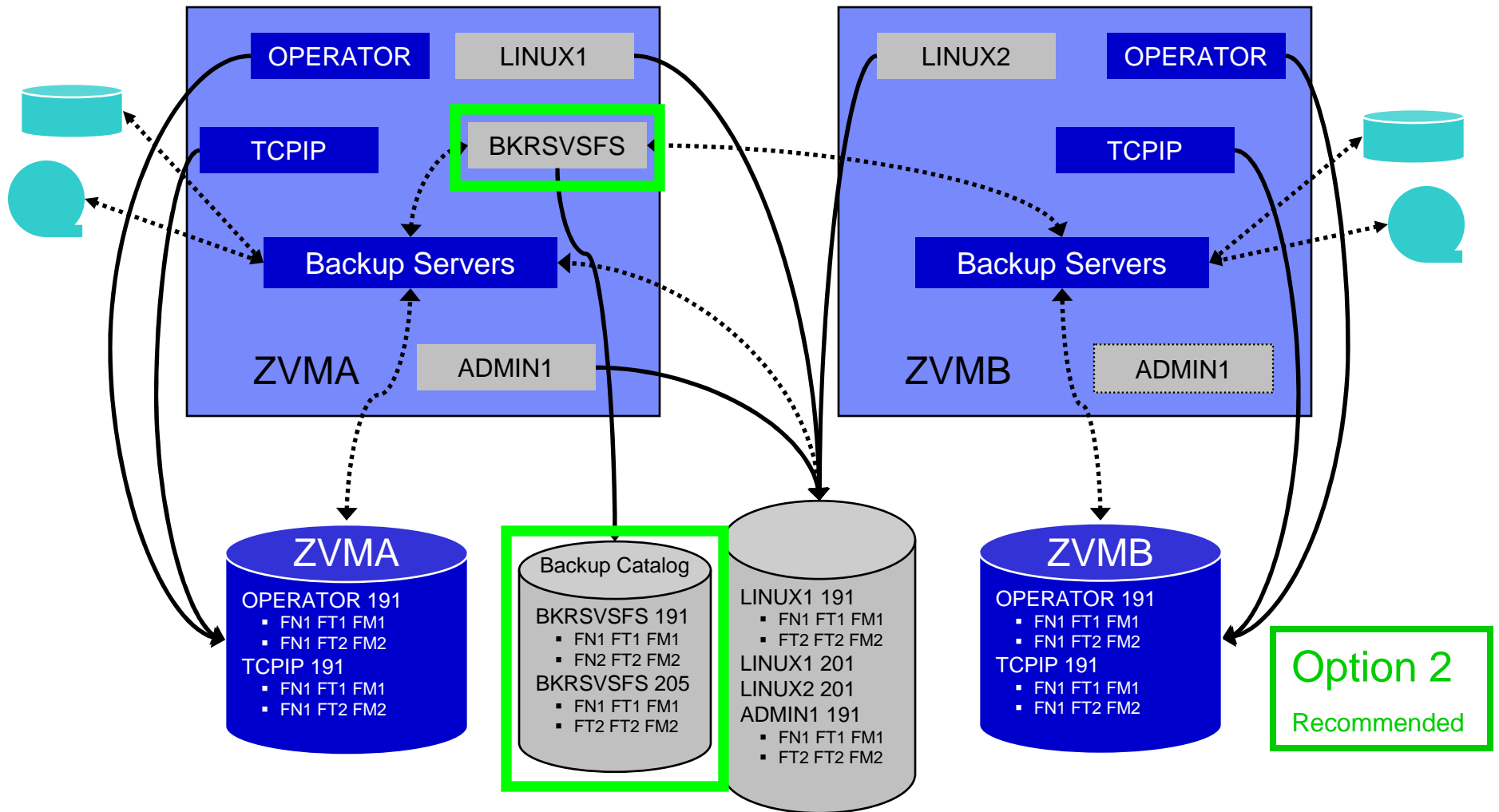

SSI Considerations for Backup and Restore

- **Backup Manager service machines on any member can see all minidisks of single configuration users**

- **Backup Manager service machines on any member can see all minidisks of local multiconfiguration (IDENTITY) users**
 - Can not see minidisks of IDENTITY users on other members
 - Can only see DASD volume (if shared/available) of IDENTITY users on other members

- **Recommendation**
 - Create Backup Manager service machines as IDENTITY users on each member
 - Create one single configuration user for SFS server/filepool for the backup catalog
 - Configure as SSI (or REMOTE) in DMSPARMS file
 - Allows single configuration users to restore their own data when logged onto any member
 - Create multiple backup jobs
 - One job for all single configuration users – only run it from one member
 - For multiconfiguration (IDENTITY) users
 - One job per member
 - Use a unique job name on each member
 - Run the member specific job on that member's backup server

Recommended Practices – Backup and Recovery

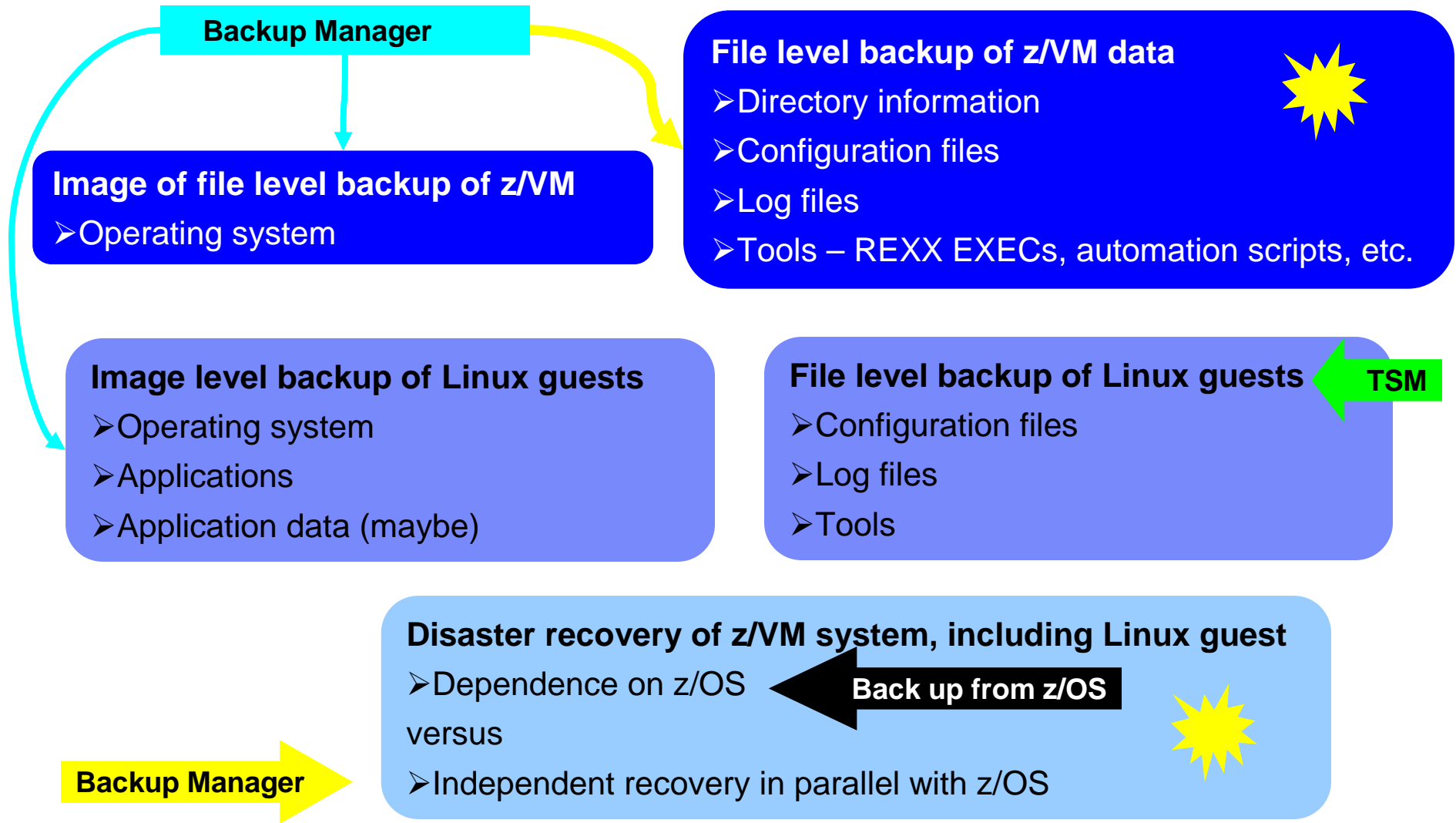

Summary

- **Use Backup and Restore Manager to**
 - Perform file-level backups of z/VM data
 - Perform image level backups of non-z/VM guest data
 - Use Tivoli Storage Manager for file level backups of Linux
 - Perform disaster recovery backups of entire system
 - Easily find and restore data as needed
 - Automatically manage retention of backup data
 - Carefully plan for SSI configurations



IBM Software

Managing Tapes and Tape Devices

Tape Manager for z/VM

Product Overview

■ Manage tapes

- Define tapes in a catalog, including:
 - Free or used
 - Retention/expiration information
 - ATL/VTS or manual mount
 - Data Security Erase
- Group tapes together into pools
 - Ownership and access control
 - Media type

■ Manage devices

- Define available devices
 - Dedicated or assignable
- Group devices together into device pools
 - ATL/VTS or manual mount
 - Any other grouping you choose
(read only vs. write, location, etc.)
- Share devices with other systems

■ Manage mount requests

- Volume specific and scratch requests
 - Standard Label
 - Non-Label
 - Bypass Label Processing

Key Benefits

- **Effective management of tapes in ATL or VTS**
 - Granular access control
 - Expiration processing
 - Notification for low threshold for tape resources
 - Interacts with IBM devices through DFSMSRMS on z/VM
 - Interacts with STK devices through STK Host Software Component for VM, or STK VM Client

- **Improved accuracy of manual tape processing**
 - Granular access control
 - Automated interface to Operator for manual mounts
 - Internal label verification at attach/give and detach (SL only)
 - Read/Write verification at attach/give

- **Integrated management of z/OS and z/VM tapes using DFSMSrmm on z/OS**
 - Optionally use RMM on z/OS as the tape catalog for z/VM and z/OS tapes
 - Tapes, access control, and retention managed by the existing RMM catalog
 - Accessible via Tape Manager on z/VM
 - Tapes managed by RMM
 - Devices managed by Tape Manager
 - Not available for STK libraries

Tape Volumes, Tape, Pools, and Device Pools

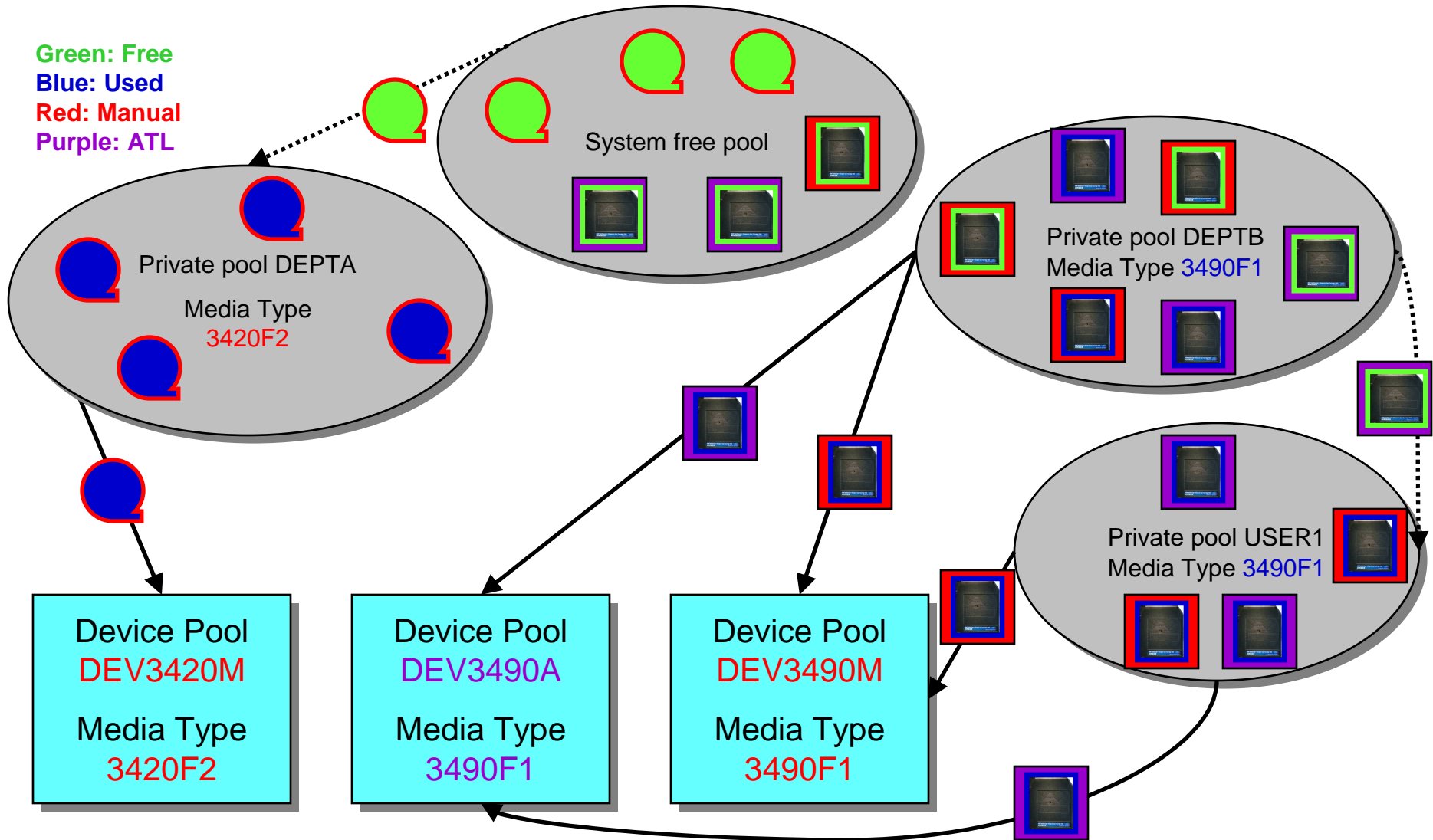

Access Control

Authority	Modify Pool Attributes and Delete Pool	Modify Tape Attributes	Add Tapes to the System Inventory (System Free Pool or Private Pools)	Delete Tapes from the System Inventory	Transfer Tapes into or out of this Pool; Delete External Tapes from this Private Pool	Modify Tapes	Read Tapes	Tape Attributes Modified Only as a Byproduct of Other Commands	Use Tape Pool as a Free Pool	Receive messages related to this pool
Sys Admin	✓	✓	✓	✓	✓	✓	✓	✓		
Pool Admin	✓	✓			✓	✓	✓	✓		
Tape					✓	✓	✓	✓		
Write						✓	✓	✓		
Read							✓	✓		
None										
Free									✓	
ExceptID										Threshold messages
MntID1 and MntID2										Mount messages, query and cancel mounts

Tape Mount Support: ATL, VTS, Manual

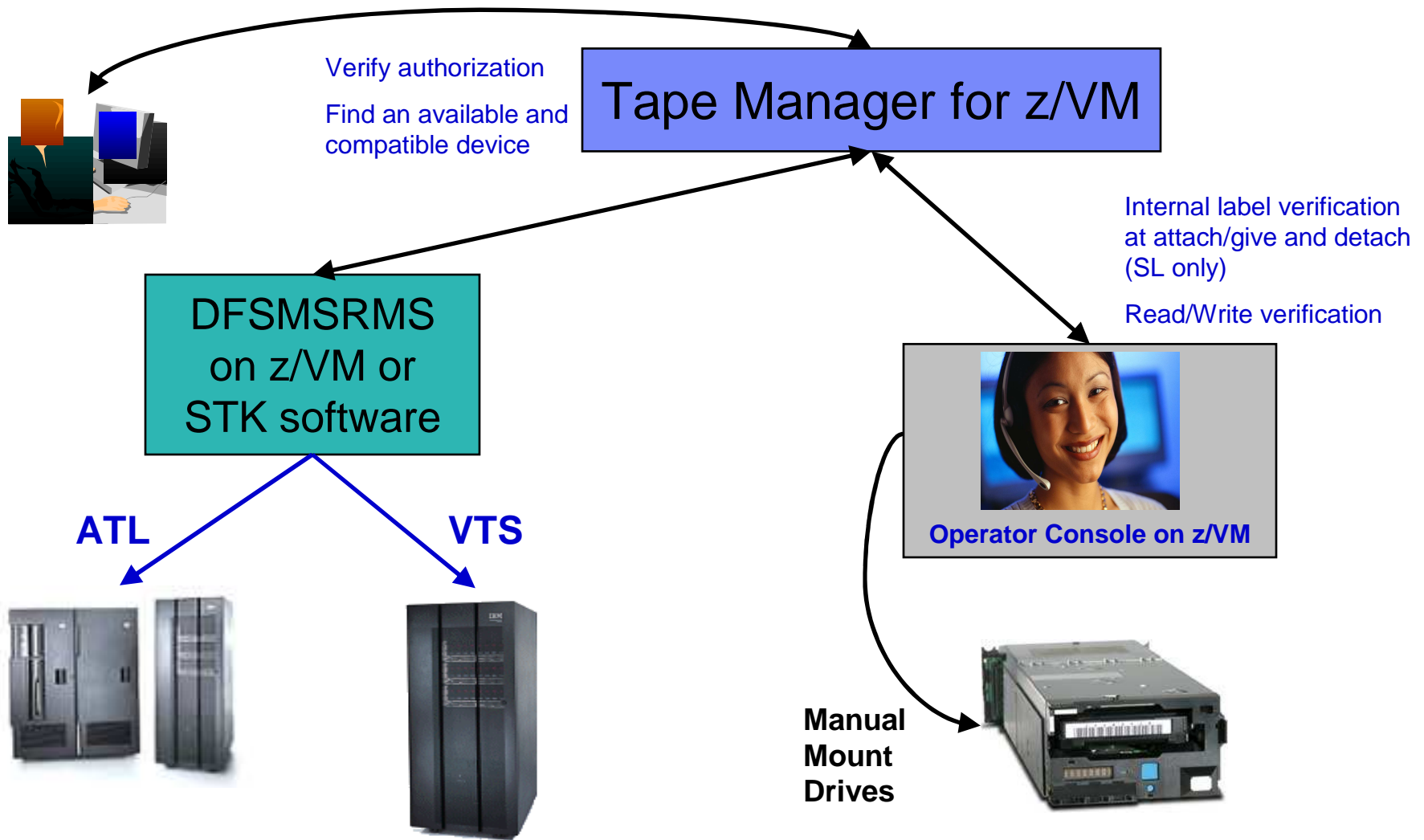

Scratch Mount Requests in Standard Mode

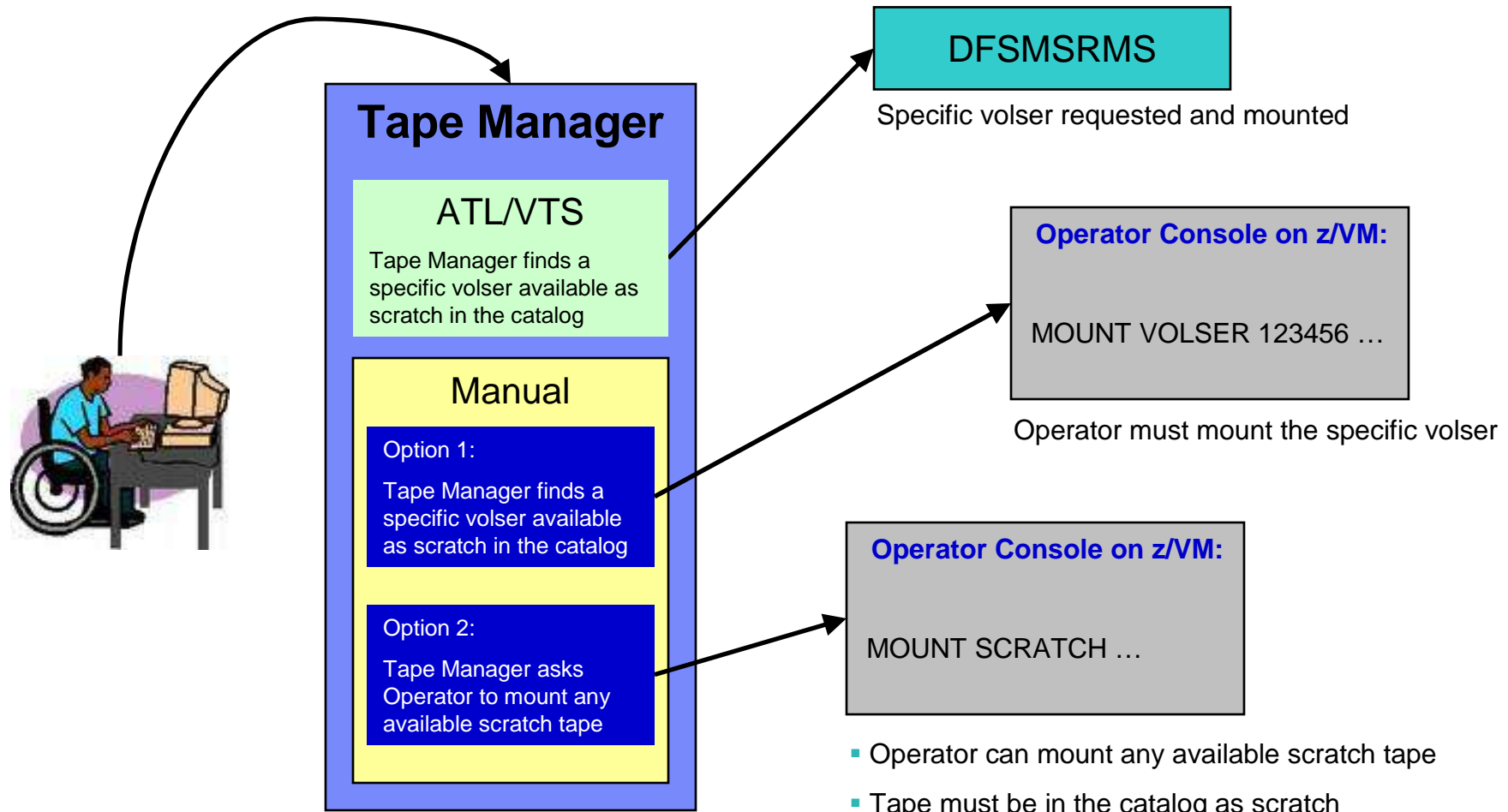

- Operator can mount any available scratch tape
- Tape must be in the catalog as scratch
- Tape must be in requesting mount pool or free pool

Option 1 vs. Option 2 controlled by GENSCRATCH statement in SYS CONFIG

Data Security Erase (DSE)

- **Erase (sensitive) data before tape is reused**
- **Option to enable DSE at tape pool or individual tape level**
 - DSE-enabled flag included in each catalog entry
- **DSE-enabled tapes marked as DSE-ready when freed**
- **Tape Manager DSE utility (TMDSE) executed on a separate user ID**
 - Started manually or automatically with Operations Manager
 - Queries the catalog to find all tapes with DSE-ready flag on
 - Mounts each tape
 - Verifies volume label if possible
 - Configuration option to perform DSE on NL tapes or not
 - Erases tape
 - Turns off DSE-ready flag in catalog
 - Tape is now available for scratch unless its HOLD flag is on

Tape Manager in Standard Mode

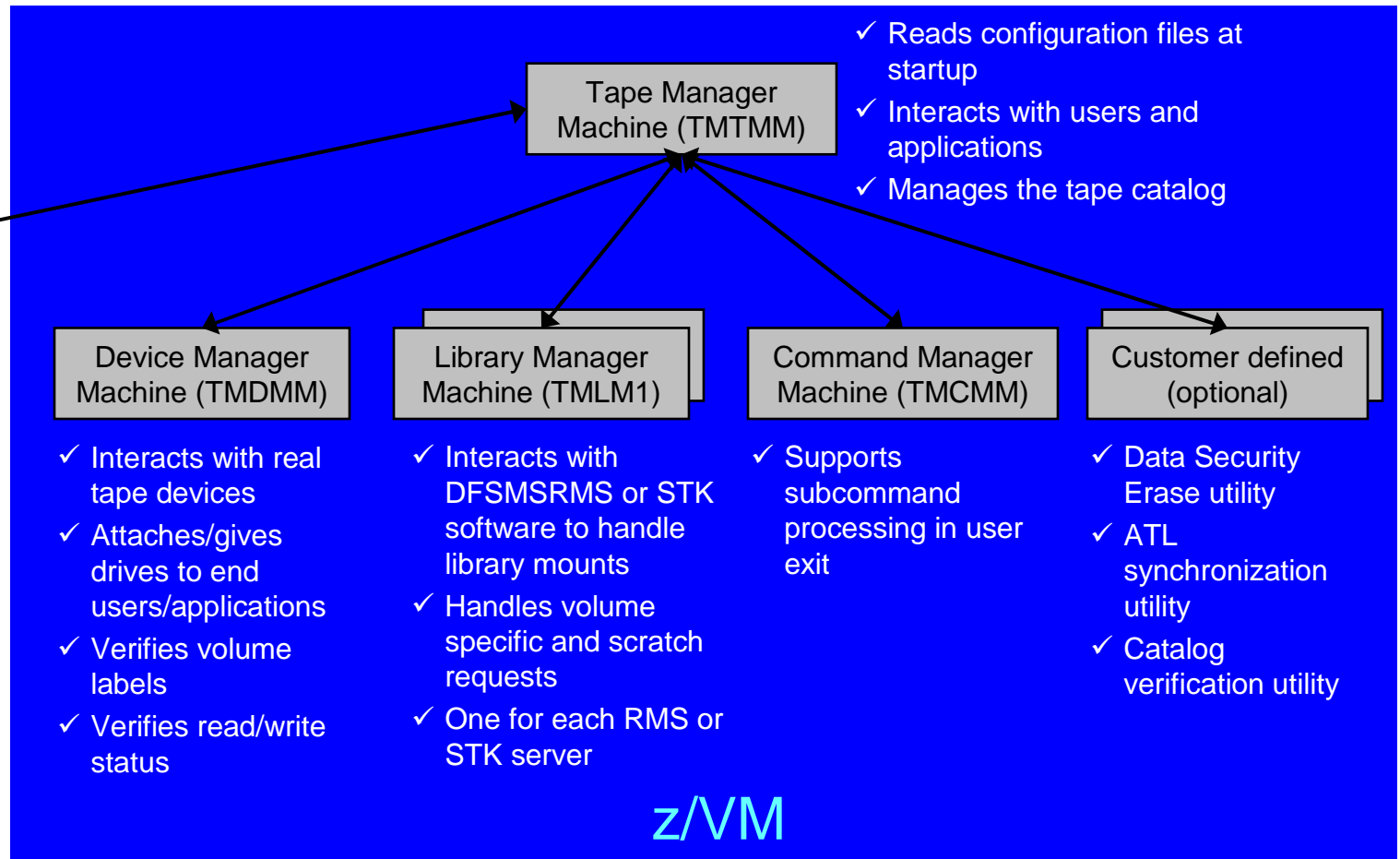

Tape Manager in RMM Mode

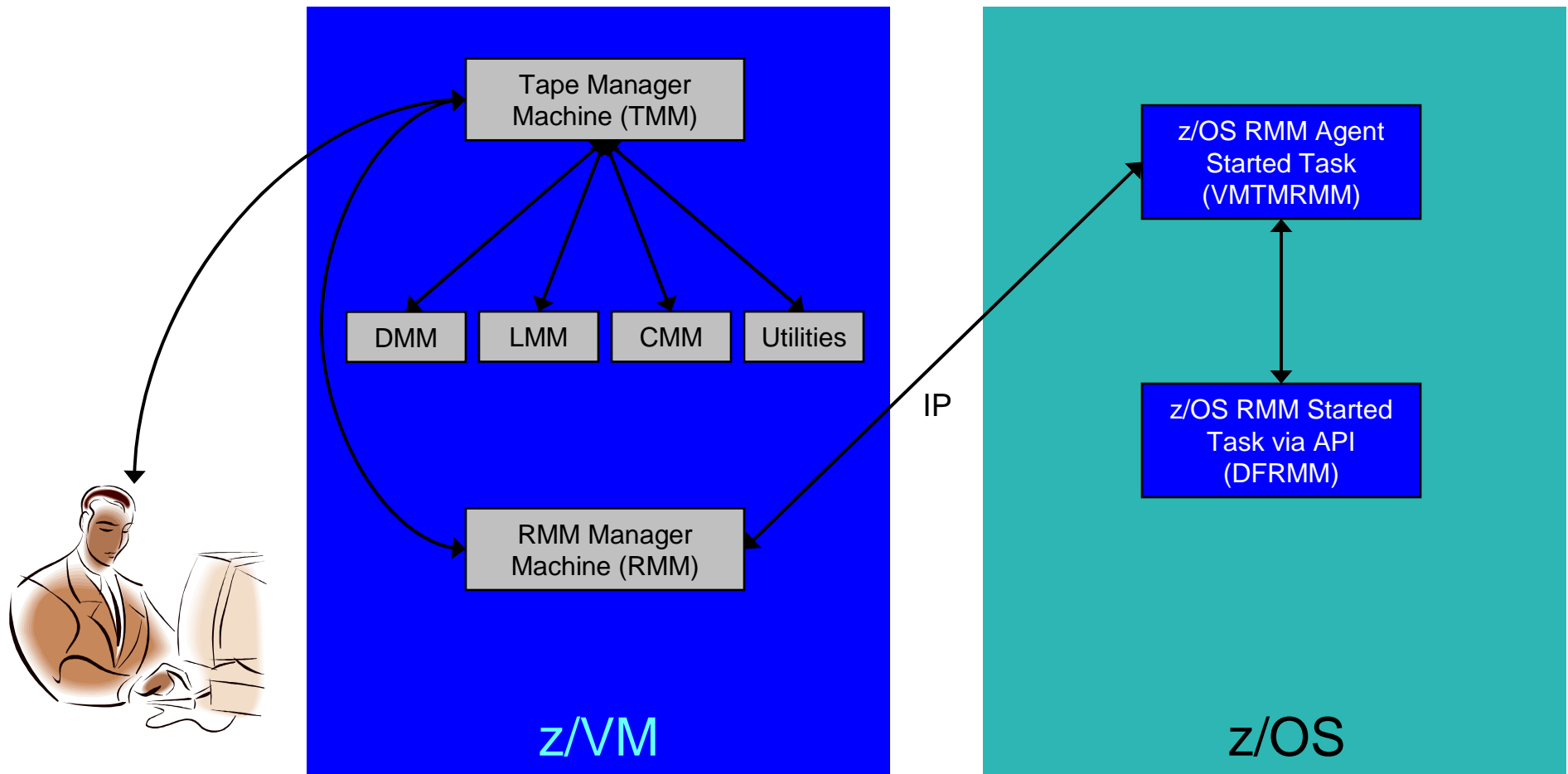

Support for One Tape Catalog Across Multiple z/VM Systems

- **One “catalog node”**
 - Responsible for the tape catalog contents
- **Multiple “request nodes”**
 - Manage requests on the local system
 - Communicate with catalog node to read or update catalog data
- **One catalog used by multiple z/VM systems**
 - No longer need to create a catalog on each z/VM system, each with its own range of volsers
 - All z/VM systems share one catalog
- **IP used for communication between systems**

Communication Between Service Machines and Systems

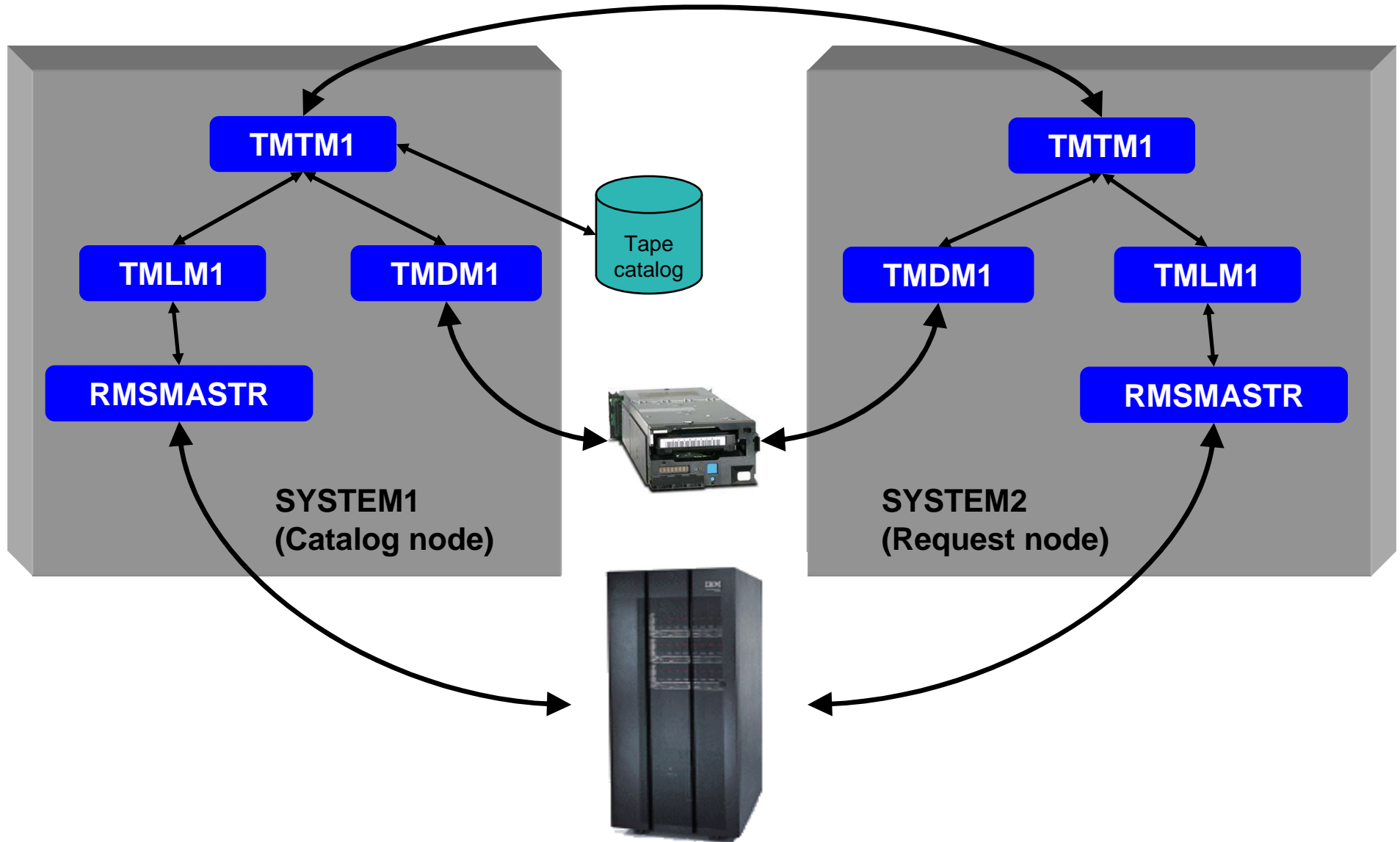

Dynamically Share Tape Devices

- z/VM systems with IBM Tape Manager
- z/OS systems with IBM Automated Tape Allocation Manager
- Linux systems with software supporting mainframe tape devices

* No multi-user attach support

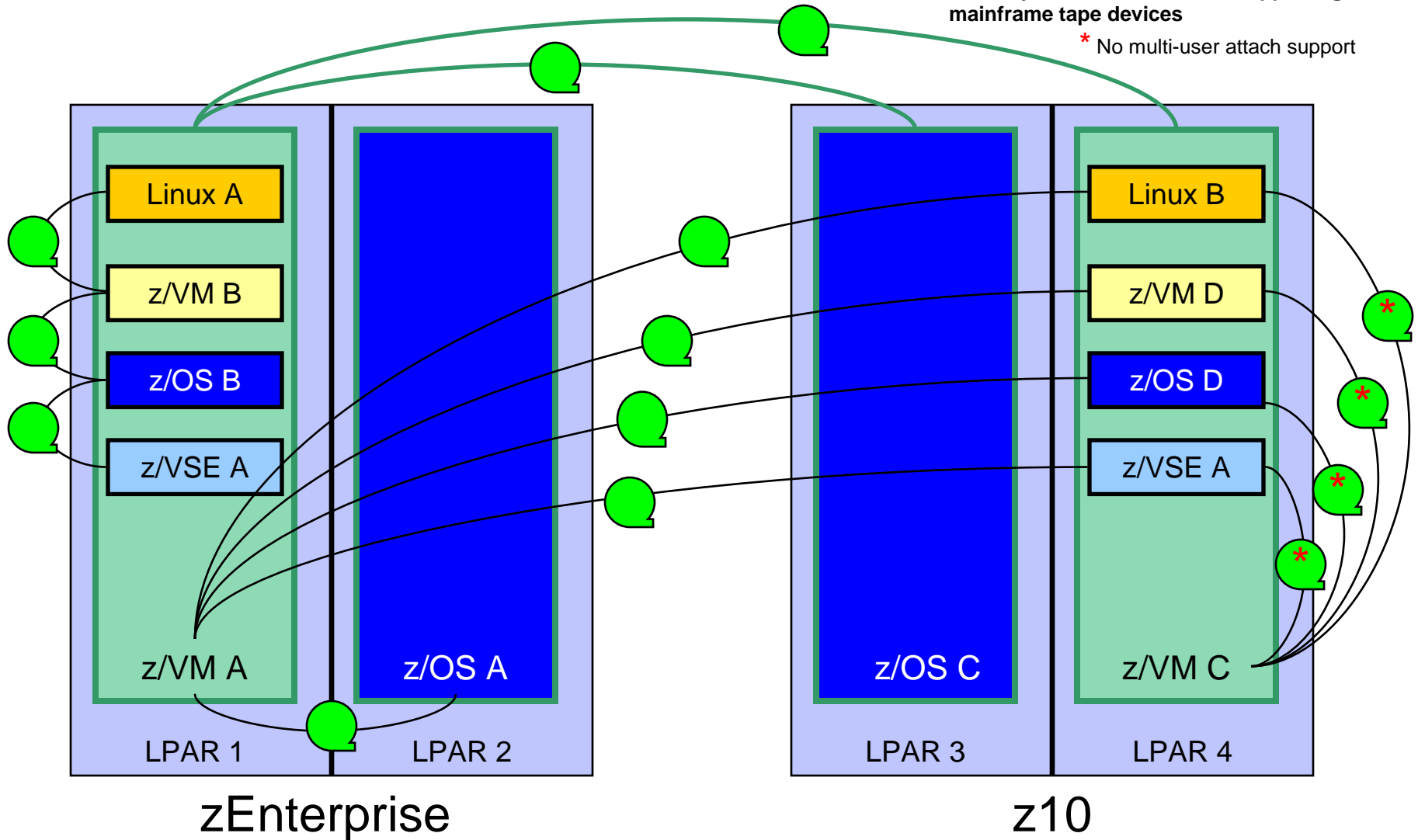

- z/VM systems with IBM Tape Manager
 - z/OS systems with IBM Automated Tape Allocation Manager
 - Linux systems with software supporting mainframe tape devices
- * No multi-user attach support

Dynamically Share Tape Devices

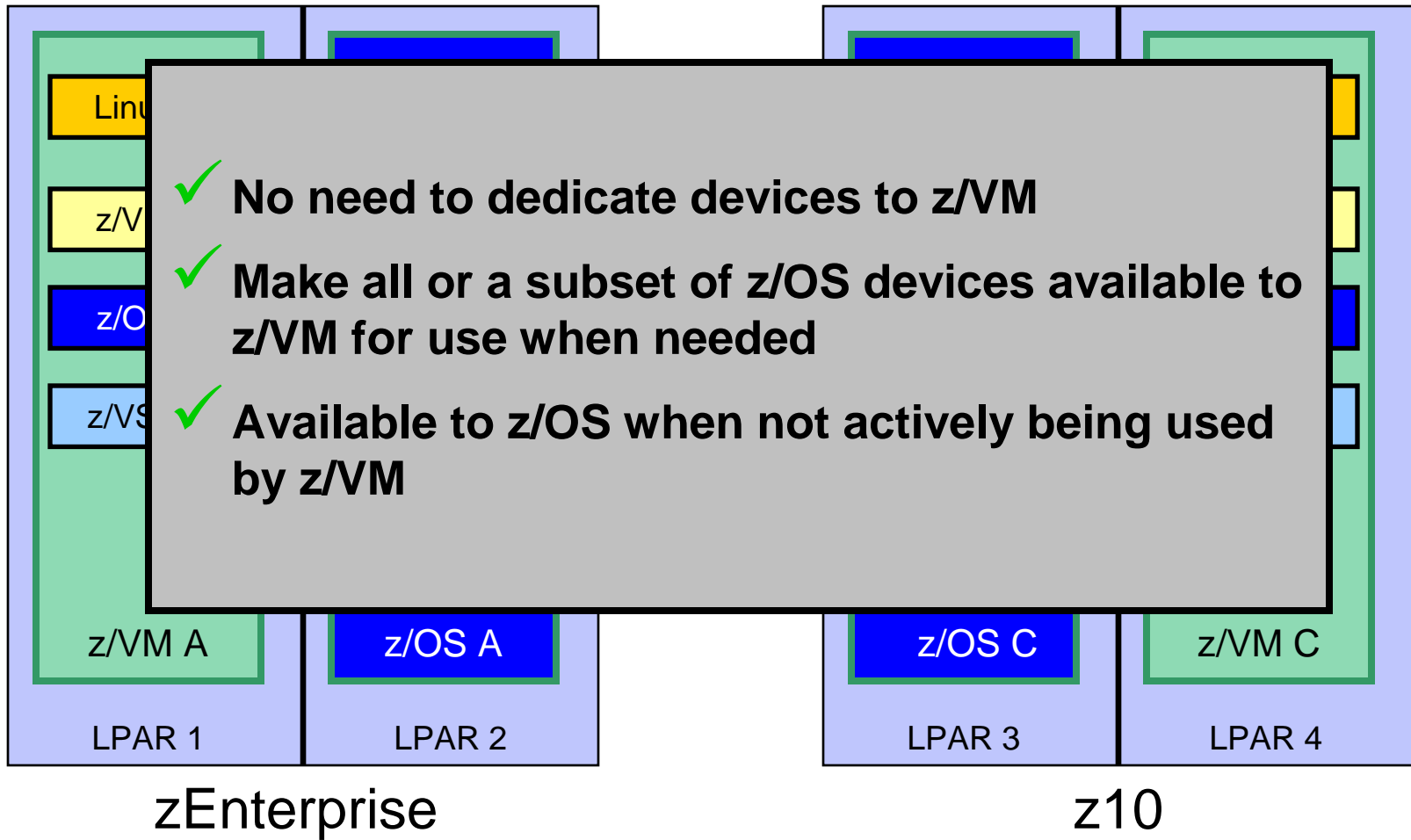

Summary

- **Use Tape Manager to**
 - Manage and share devices
 - Manage tape volumes
 - Access control
 - Retention
 - Data Security
 - Improve accuracy of mount requests



IBM Software

Managing Disk Space

Archive Manager for z/VM

Archive Manager for z/VM

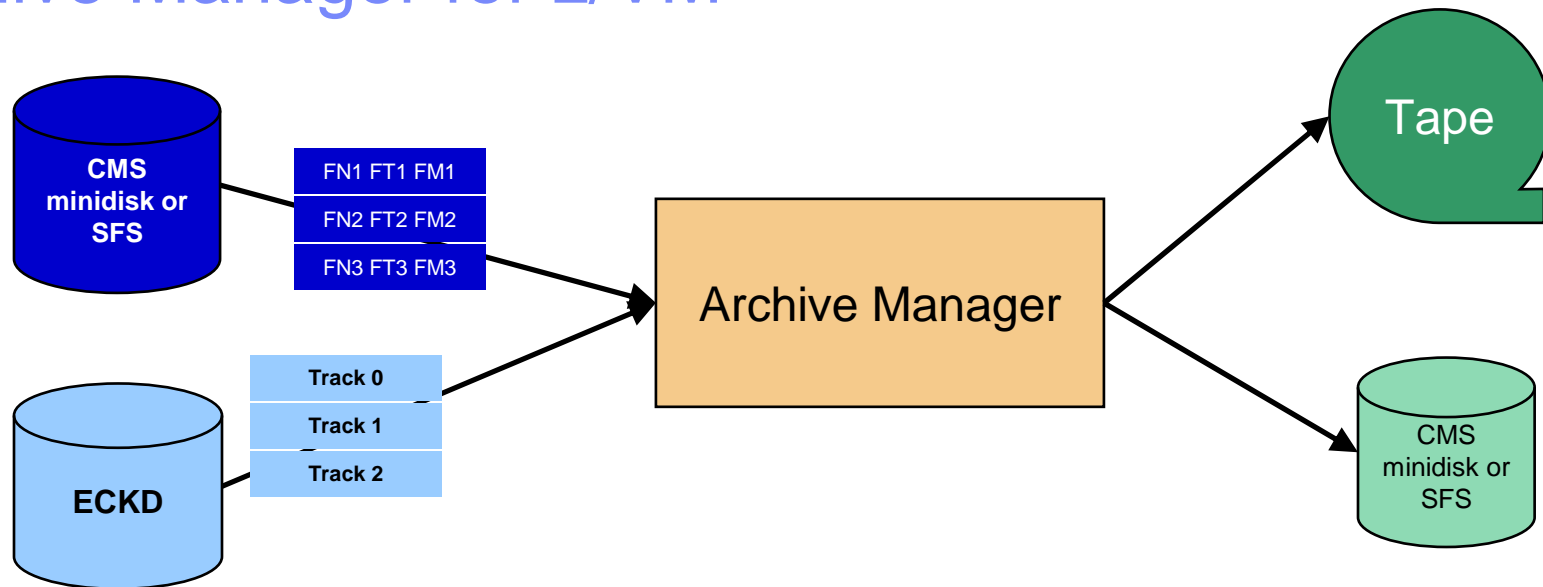

- **Improve end user satisfaction and productivity**

- Users manage their own disk space
- Move infrequently used files to tape or other disk
- Archive and recall functions are initiated and controlled by the user
- Archived data staged to DASD, then tape if applicable
 - Users don't wait for a tape mount for archive request to complete

- **Reduce DASD space requirements**

- Archive older files to less expensive storage media
- Continue to provide users access to the archived data/files

- **Control location, retention, and access to archived data**

- **Integration with Tape Manager for z/VM**

Summary

- **Use Archive Manager to**
 - Improve management of disk space
 - Easily and immediately archive data when a disk is approaching full
 - Manage retention of archived data

Summary

- **Management of z/VM systems with Linux guests requires monitoring and management tools**
- **IBM solutions exist**
 - OMEGAMON XE on z/VM and Linux
 - zSecure Manager for z/VM
 - Operations Manager for z/VM
 - Tape Manager for z/VM
 - Backup and Restore Manager for z/VM
 - Archive Manager for z/VM
- **Demos are available**

Reference Information

- **Product Web site**
 - Start at <http://www.ibm.com/software/stormgmt/zvm/>
 - Product pages include
 - Publications
 - Pre-requisites
 - Announcements
 - Presentations
 - White papers
 - Support
- **e-mail**
 - Mike Sine, sine@us.ibm.com, Technical Marketing
 - Tracy Dean, tld1@us.ibm.com, Product Manager
- **White papers on Operations Manager website (Library page)**
 - Routing Linux syslog data
 - Sending alerts from Operations Manager to Netcool/OMNIbus
 - Using Shared File System to store Operations Manager configuration files and automation EXECs
 - Automatically logging on a user at Linux system boot time for easier console management
- **White paper and presentation on Backup and Restore Manager website (Library page)**
 - Getting Started with Installation, including SFS server creation and installation of Backup Mgr
 - Backing up z/VM and Linux on System z – Tivoli Storage Manager vs Backup Manager



| IBM Software

Demonstration Scenarios

Automation Demos Available

1. **Send an e-mail based on a console message** (page 62)
2. **Send an alert to Netcool/OMNIBus based on a console message**
 - a. Using POSTZMSG interface to Netcool/OMNIBus (page 70)
 - b. Using SNMP interface to Netcool/OMNIBus (page 78)
3. **Send an email if spool approaches full**
 - a. Send a message if spool usage is too high on any member of an SSI Cluster (page 88)
 - b. Send an email if spool usage is too high on a single system (page 91)
4. **View and clean up spool files** (page 99)
5. **Automated spool cleanup** (page 106)
6. **Archiving DIRMAINT's log files when disk gets full** (page 117)
7. **Process a file of test messages as a console** (page 127)
8. **Process Linux syslog data as a console** (page 135)
9. **Create a central operations console on one z/VM system** (page 147)
10. **Create a central operations console across multiple z/VM systems**
 - a. When the systems are in an SSI cluster (page 157)
 - b. When the systems are not in an SSI cluster (page 160)
11. **Integration with OMEGAMON XE on z/VM and Linux - take action based on CPU usage of a Linux guest** (page 171)
12. **Monitor service machines for logoff – and autolog them** (page 182)
13. **Send an email if page space approaches full** (page 188)
14. **Monitor SSI connectivity between 2 cluster members** (page 192)
15. **Suppress passwords on Linux consoles** (page 196)

Backup Demos Available (Including Automation)

- 16. Perform an incremental backup** (page 200)
- 17. Find and restore a file from the backup catalog** (page 212)
- 18. Backup and restore single and multiconfiguration users in an SSI environment** (page 220)
- 19. Automatically shut down, back up, and restart a Linux guest** (page 224)
- 20. Reviewing a disaster recovery backup** (page 237)
- 21. Reviewing other ways to find data in the backup catalog** (page 245)

धन्यवाद

Hindi

多謝

Traditional Chinese

감사합니다

Korean

Спасибо

Russian

Gracias

Spanish

شكراً

Arabic

Thank You

English

Obrigado

Brazilian Portuguese

Grazie

Italian

Danke

German

多谢

Simplified Chinese

Merci

French

நன்றி

Tamil

ありがとうございました

Japanese

ขอบคุณ

Thai