

IBM System z Technology Summit



SOA connectivity and integration solutions on System z



Agenda

- **ESB and Connectivity Overview**
- **Processing Scenarios & Usage Patterns**
- **Pattern Technology Demonstration**
- **Product Overview and Roadmap**

ESB and Connectivity Overview

ESBs Simplify Connectivity

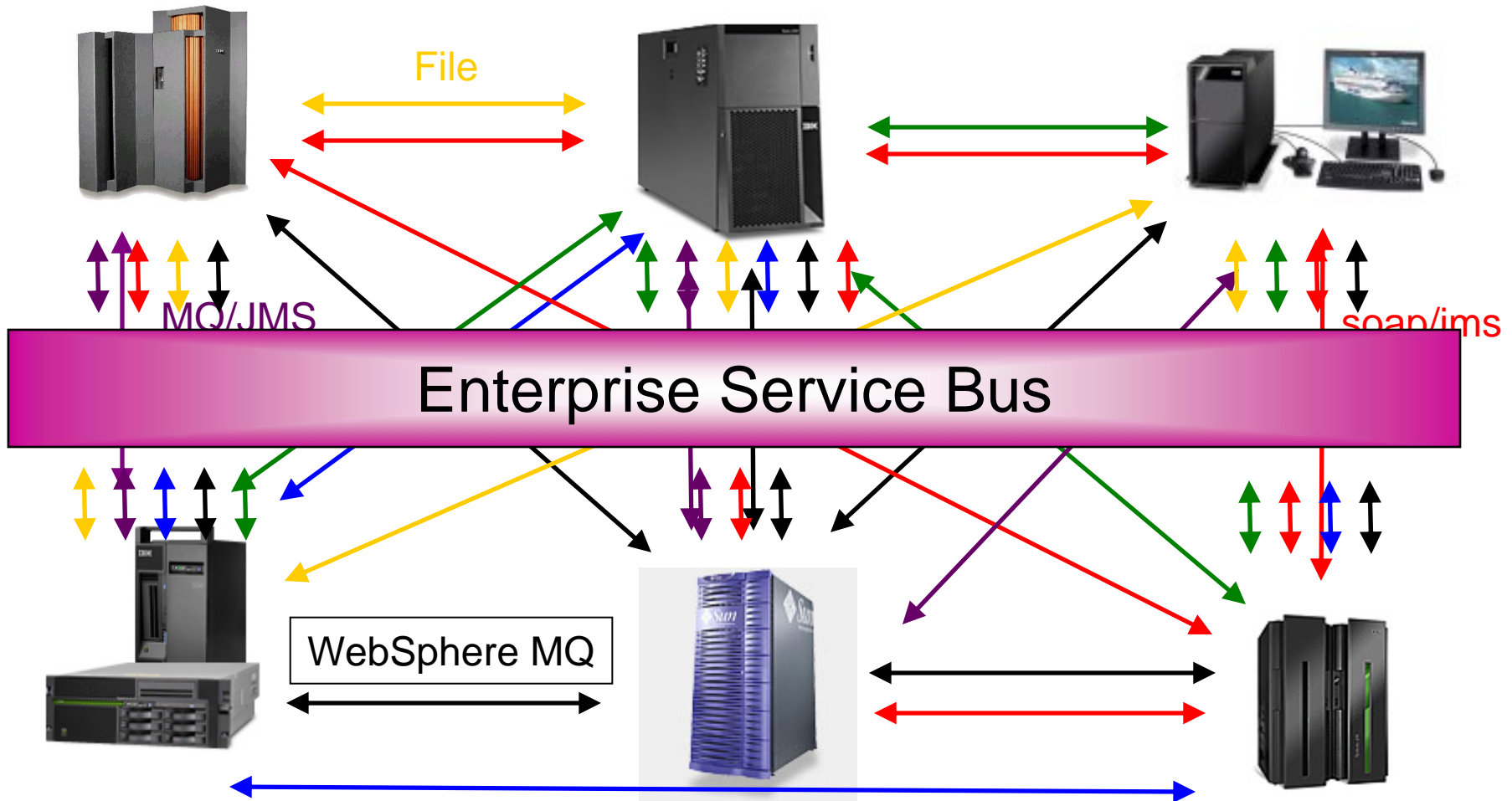

Enrich your SOA connectivity ...

Service Enrichment

- Match & Route communications between services
- Converts between transport protocols
- Transforms between data formats
- Identifies and distributes bus events

... simplifying the overall architecture

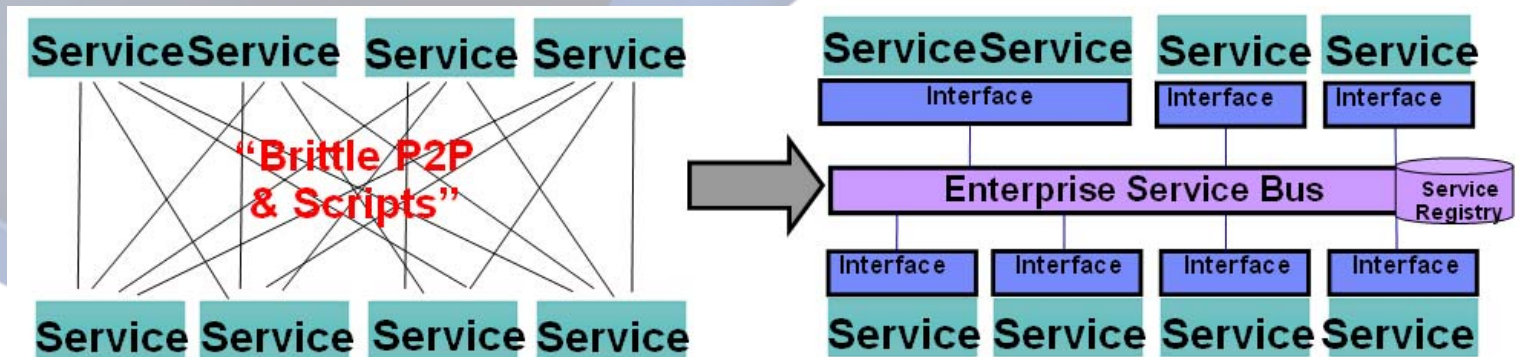

Agile Connectivity: The Enterprise Service Bus (ESB)



**Connects everything
to everything**



**Matches & routes communications
between services**



**Transforms
between different
data formats**



**Converts between
different transport
protocols**



**Distributes
Business events**

An ESB enables flexible SOA connectivity for integrating business applications, services and processes

Two core principles enable flexibility

The ESB facilitates the *decoupling of interactions* between requestor(s) and provider(s)

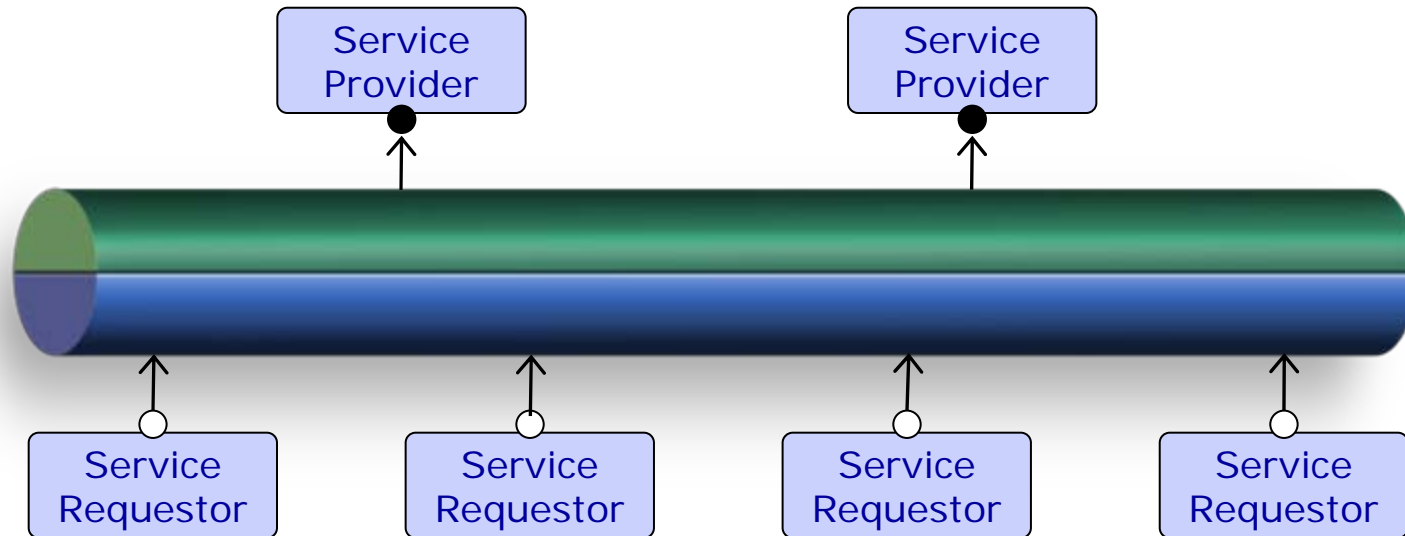

The ESB fulfils *two core principles* in support of *separation of concerns*:

Service Virtualization

- ★ Routing
- ★ Protocol and transports
- ★ Transformation of interfaces

Aspect Oriented Connectivity

- | | |
|--------------|------------------|
| ★ Security | ★ Log and Audit |
| ★ Management | ★ Event tracking |
| etc ... | |

Processing Scenarios & Usage Patterns

Many Defined Patterns for ESB-based Solutions

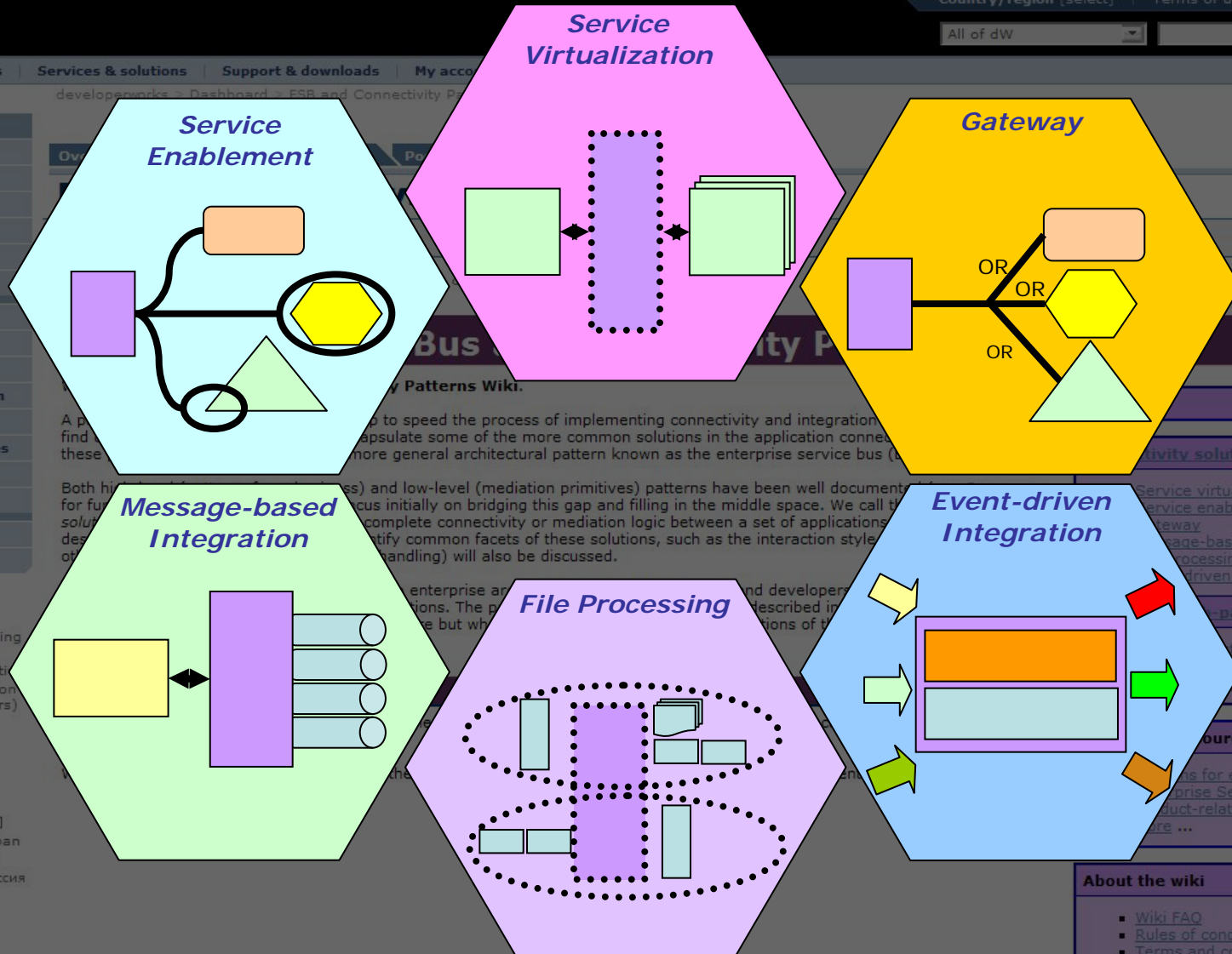

Pattern Technology Demonstration

Key Scenarios Deliver Significant Business Value

- **Extend the Reach of Existing Applications: Multi-channel Processing**
- **Easily transform batch-oriented file work into online requests**
- **Get the Most from Packaged Applications**
- **Connect Devices to the Enterprise**
- **Provide a Policy Enforcement Point for secure application connectivity**
- **Make an Application Inventory and Govern Processing with a Registry**
- **Apply Business Rules to achieve Smart Connectivity**
- **Monitor your Business Activity and Act Intelligently**
- **Initiate and Support Business Processes**
- **A Flexible Infrastructure to Support Change**

Extend the Reach of Existing Applications (1/2)

Provide and Consume Web Services

- Web services are now established as an interoperability standard
 - Vitrally important from a business to business connectivity perspective
 - Businesses to consume each others' services using these well defined standards
 - Internal standardization between parts of the same organization via Web Services
- Adoption of Web Services by many subsystems is not universal
 - ESB allows your existing applications to be exposed as web services
 - ESB 'universal translator' converts web service to existing formats and protocols
 - Existing applications can consume web services without change
 - Exploit web services with limited new development skills and platforms

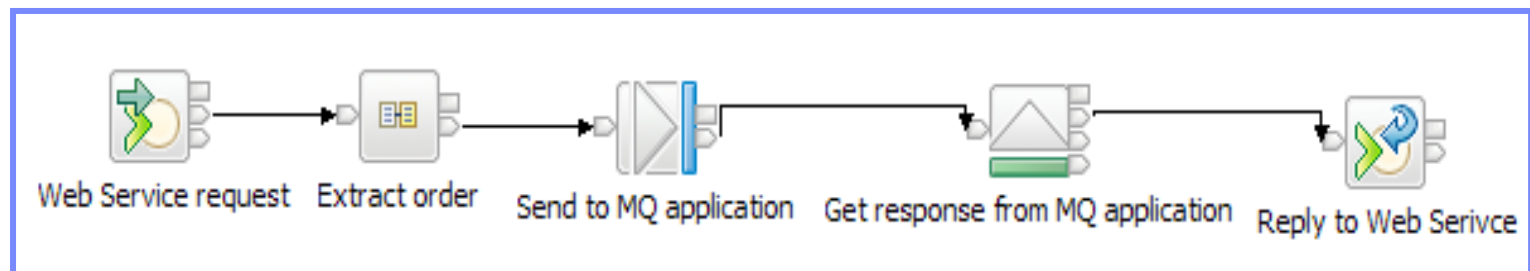

Extend the Reach of Existing Applications (2/2)

MQ enable all your applications

- ESBs allows you to use MQ technology to the fullest extent
 - Robust, transactional, reliable, high-performance messaging
 - ESB provides an incredibly broad range of connectivity mechanisms available to MQ
 - Any application can easily connect to the MQ infrastructure inbound or outbound
- Examples
 - Transform a TCP/IP based application by allowing it to consume regular MQ messages
 - MQ applications access an external Web Services provided by a Business partner
 - MQ applications access ERP systems such as SAP, SEBL, PeopleSoft...
- The Goal: Multi-Channel Connectivity
 - Consuming Services and Applications independent of client implementation
 - Increasingly relevant in world of device proliferation

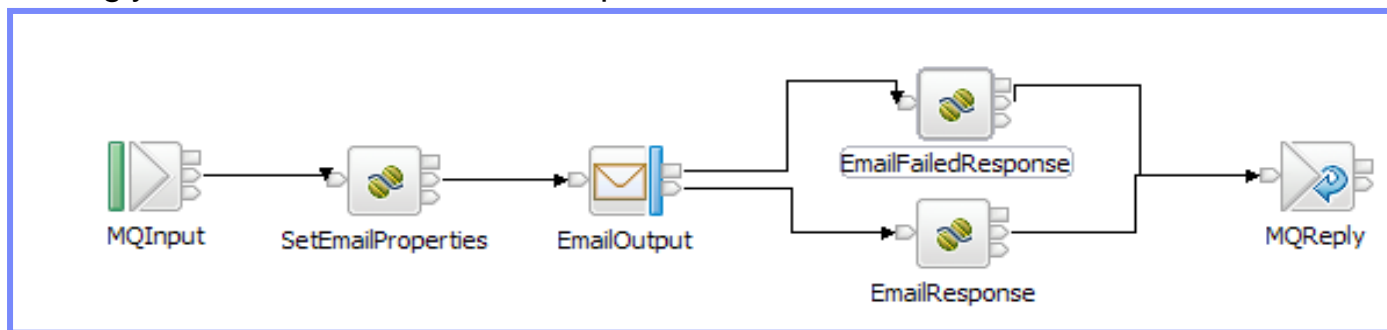

Combine File-based and On-line Processing

Unlock the valuable business data in your files

- Files exchange between applications still popular and effective
 - Flexible method of exchange: Neither enterprise has to mandate technology
- There are legitimate reasons for using files to exchange information
 - Usually relate to the way businesses run or physical processes occur
- Examples
 - A cargo ship has thousands of containers each with hundreds of palettes
 - Reduce unit transaction costs by aggregating numerous clients requests
- End to End File Movement and File Processing
 - Reliable and secure delivery File Transfer with MQ FTE
 - File processing allows clients to get file/batch work online, easily

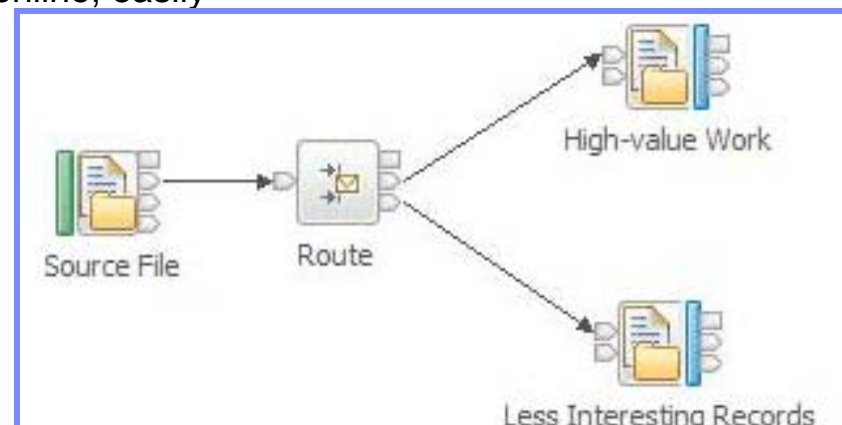
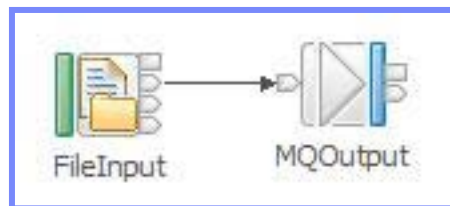

Get the Most From Packaged Applications

Move information to and from packaged applications

- **Packaged applications play a vital role**

- SAP for purchasing, sales, inventory...
- SEBL for Sales, PeopleSoft for HR
- Oracle, JDEdwards...



- **Interfaces are often non standard: e.g. SAP BAPIs, IDOCs**

- Processing and data are isolated from other applications
- Result: packaged apps have difficulty using/generating information for other apps
- Inhibits adoption of a best of breed philosophy

- **Support for SAP, SEBL, PeopleSoft, inbound and outbound**

- Adapter components built-in to ESB
- Drive new work into its packaged application from any other supported source
- Can send information from packaged application to any other supported target
- Packaged applications can focus on what they do best **and** be integrated

Connect Devices to the Enterprise

To and from a broad range of devices

▪ Industry Observation

- “How to I get information from everywhere, understand it, and act?”
- Medical, Energy and Utilities, Distribution, Transport, Gaming...
- Issues based e.g. traffic congestion, efficient energy, timely supply...

▪ A Smarter Planet is full of devices

- Data is generated *outside* the enterprise
 - Typically very large numbers of devices
 - Often concentrator technology; differentiate, integrate & forward
- MQTT for standards based device integration
 - Small footprint client, embeddable
 - Lightweight protocol for bandwidth cost (by-the-byte)
 - Fragile network support for hostile environments

▪ Connect Devices, Apply Intelligence

- ESB connects devices to enterprise systems
- Apply intelligence in near real-time
 - Passive and active systems



IBM is working with Brisbane, London, Singapore and Stockholm to deploy smarter traffic systems. Stockholm has seen approximately 20 percent less traffic, a 12 percent drop in emissions and a reported 40,000 additional daily users of public transportation.

Provide a PEP for Secure Application Connectivity

Secure application identity, authentication and authorization

- **Application connectivity => security domain changes**
 - Identity management, access control, authorization, and authentication mechanisms (AAA) are essential
 - ESB support many protocols and transports
 - Web Services, MQ, JMS, HTTP and HTTPS
 - ESB supports a broad variety of security tokens
 - Userid/pw, X509, SAML, Kerberos, LTPA...

- **ESB performs role of Policy Enforcement Point (PEP)**
 - PDP combination provides a secure infrastructure
 - Ensures conformance to centralized security policy
 - Many different PDP technologies supported
 - Lightweight Directory Access Protocol (LDAP)
 - Microsoft Active Directory, Open LDAP...
 - Tivoli Federated Identity Manager (TFIM)
 - zOS SAF including RACF
 - Security hardened DMZ device strengths

Configure LDAP Search Parameters

Main

LDAP Search Parameters

Apply Cancel

Name	<input type="text"/>	*
Admin State	<input checked="" type="radio"/> enabled <input type="radio"/> disabled	
Comments	<input type="text"/>	
LDAP Base DN	<input type="text"/>	*
LDAP Returned Attribute	dn	
LDAP Filter Prefix	<input type="text"/>	*

MQInput Node Properties - MQInput

Identity token type	Username
Identity token location	\$Root.MDMD.UserIdentifier
Identity password location	
Identity issuedBy location	<optional, specify a string or path exp
Treat security exceptions as normal exceptions	<input checked="" type="checkbox"/>

Derive Value from an Application Inventory

Understand your application assets and control their access dynamically

- Catalog application and service assets using a registry, e.g. WSRR
 - Web Service and MQ Service definitions
 - Classifications: by function, owning department
 - Relationships: applications dependencies for lifecycle management, versioning
 - User defined properties (metadata): Application=GOLD or Service=SILVER
- Use registry information in ESB routing
 - Built-in facilities allow ESB to access registry
 - Enables policy based processing

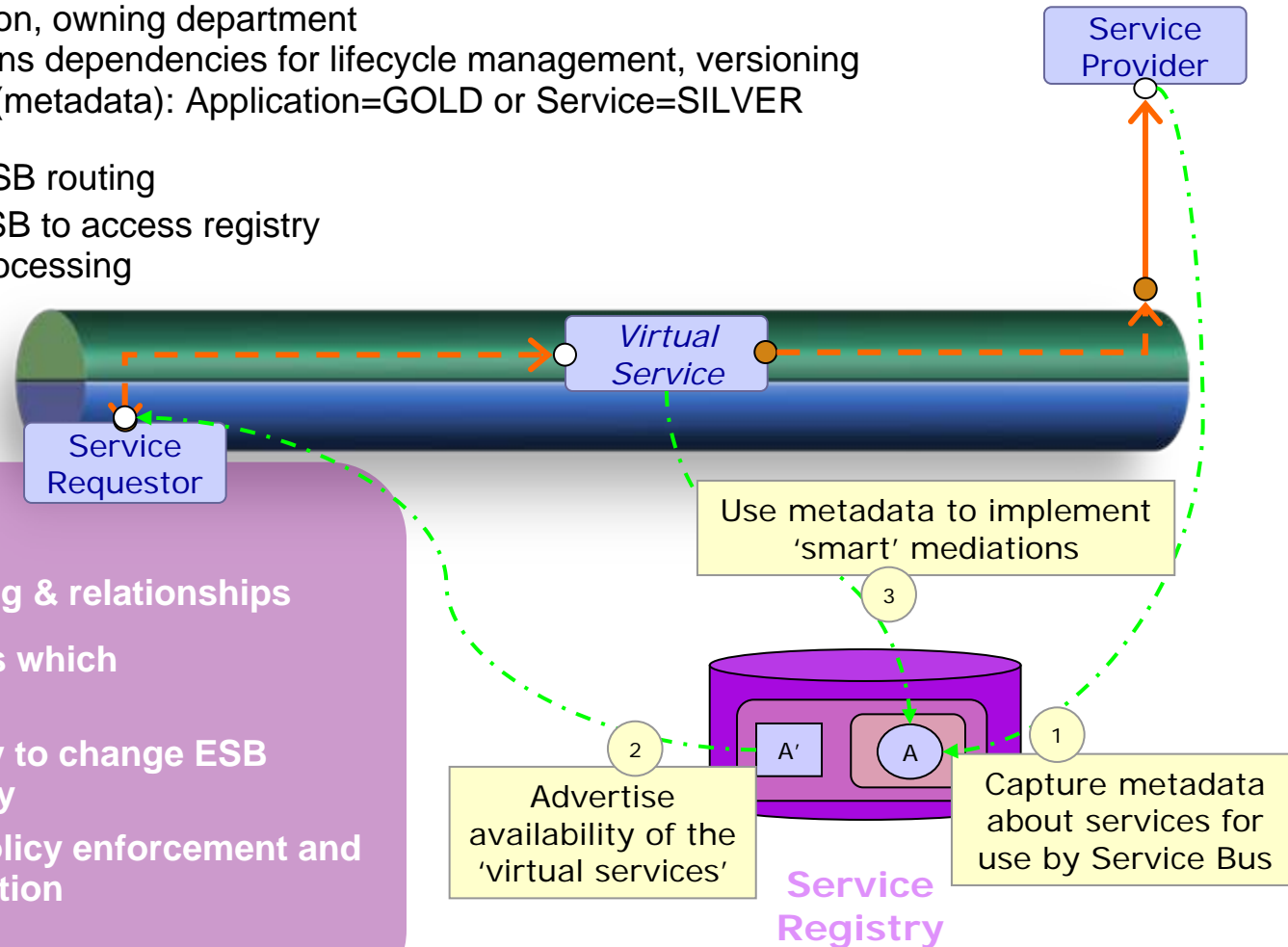

Primary use cases:

- Visibility: application catalog & relationships
- Governance: who accesses which applications/services
- Dynamicity: update registry to change ESB behaviour without redeploy
- Policy based Processing: policy enforcement and policy based service selection

Business Rules for Smart Connectivity

Apply rules to ESB data in-flight

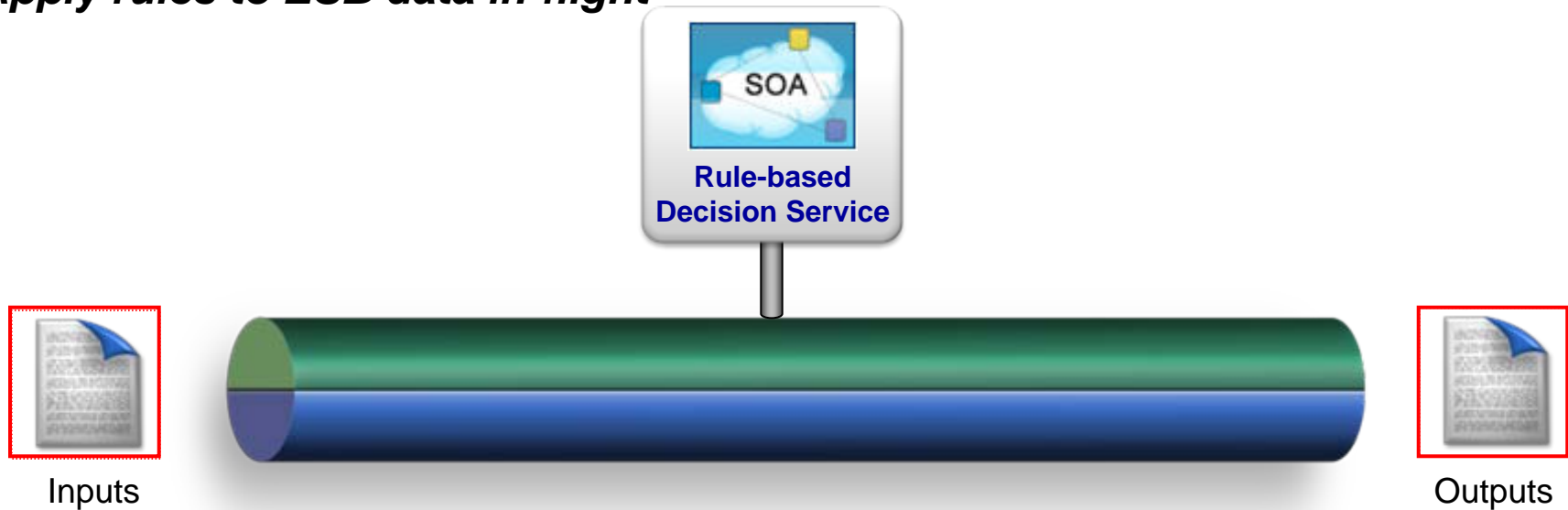

Rule-based Decision Services render decisions on input data

Most often this data comes from a variety of data sources
i.e. aggregation, transformation is needed

Rule-based Decision Services send outcome decisions to other systems

Output data needs to be transported and dispatched to one or many systems

- Automate decisions
- Implement, manage & share decisions services across IT infrastructure
- ILOG JRules for Embedded rules and ILOG Rules Server subsystem

Business Activity Monitoring & Event Intelligence

Understand the importance of ESB data and detect business situations

- ESB connectivity allows processing of events from many sources, targets
 - Capture business relevant information to feed to WebSphere Business Monitor
 - Examples: total dollar trade value per day, total number of orders per hour
 - Capture business events for correlation using WebSphere Business Events
 - Look for correlations in data, e.g. fraud, Up-sell and Cross-sell opportunities, CRM
 - Audit, Repair and Replay transported events

- Generate Business Monitoring Events from existing connectivity
 - Enables integration with WebSphere Monitor to display and analyze KPIs
 - Design time and operational time event activation
 - Notification via CEI & Publish subscribe

- WebSphere Business Events
 - Capture events from ESB and other sources
 - Analyse to generates interesting new event
 - Stimulus for business process

- Capture Events for Audit and Logging
 - Verify transport of traffic; dates and payloads
 - Replay recorded messages to consumers
 - Includes replay to ESB for reprocessing

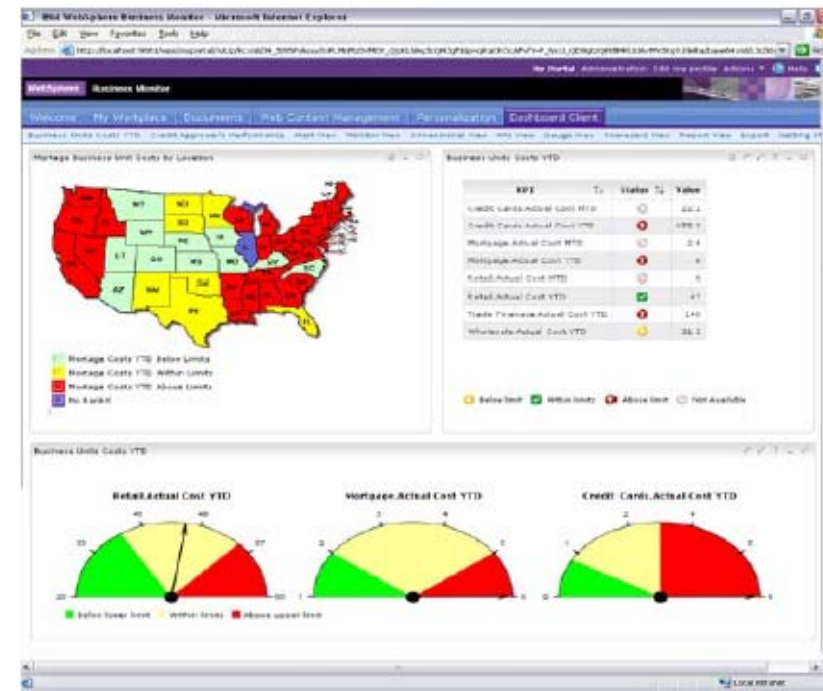

Initiate and Support Business Processes

Compose existing applications and services to create new value

▪ ESB Event Capture and Process Initiation

- Breadth of ESB connectivity enables multiple business process starting points
 - Identify event and initiate business process
 - e.g. message, file, web service, device endpoints can start business process
- Synchronous and asynchronous invocation for short & long running transactions
 - Multiple options with Process Server, Lombardi, FileNet...

▪ Business Process Connectivity

- Exploit range of ESB connectivity to abstract and simplify BPM
- Process focus on WHAT rather than ESB focus on WHERE, HOW concerns
- ESB receives service request and routes, re-formats, interacts with provider

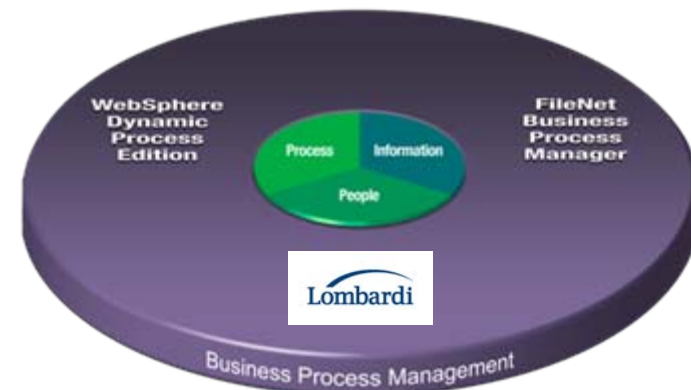
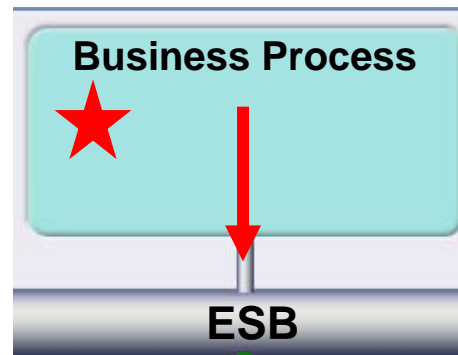

A Flexible Infrastructure to Support Change

Enable Application and Service Replacement with minimum risk

- **ESB creates a Virtual Service**
 - Implementation details of a service to be hidden
 - Flexibility in implementation; change implementations without affecting consumers
 - Introduce new interfaces to existing service in parallel with new interfaces

- **Examples include M&A, Decommissioning & External partner communication**
 - Connect newly acquired systems, particularly relevant in M&A
 - Formats and Protocols of acquired technology differ from current systems
 - ESB provides managed interface to acquired systems for in-house systems
 - Provides new interface for acquired systems
 - Staged decommission of legacy implementations
 - Maintain existing interface to new implementation
 - Allows Managed risk of client migration
 - Often combined with new interface definition, often to enable service orientation
 - External partner communication
 - ESB provides interface to external systems
 - Allows partners to be swapped in and out without affecting consumers

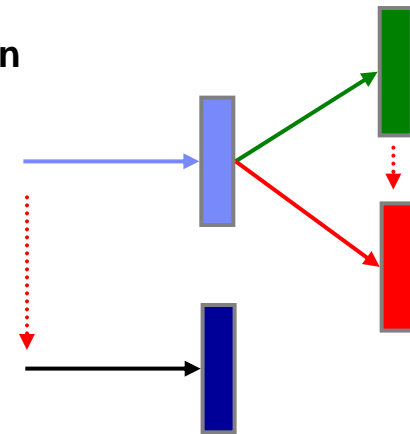

Patterns for Simplified Development

▪ **Patterns Based Development**

- Create top-down, parameterized connectivity solutions
 - e.g. Web Service façades, Message oriented processing, Queue to File
- IBM pre-supplied patterns
 - Simplifies creation of most common scenarios according to best practices
- Complements existing bottom-up constructional approach for bespoke connectivity

▪ **Patterns Explorer**

- Inventory of key patterns available for solution generation
- Each pattern contains clear help to explain context and applicability

▪ **Pattern Generation**

- Enables simple creation of solution artefacts from pre-supplied pattern
- Pattern Properties allow configuration of behaviour
- Solutions can be modified and/or regenerated

▪ **Evolution**

- Pattern Capture creates user patterns from solution artefacts
- Pattern Management: provides post deployment customization and operation of solutions

Pattern Technology Demo (1/3)

Broker Application Development - Pattern Specification - WebSphere Message Broker Toolkit - Message Broker - C:\Data\workspaces\runtime\WBIMB-7.0\Patterns

File Edit Navigate Search Project Run Window Help

Broker Development Patterns Explorer

Patterns

- Application Integration
 - SAP
 - MQ one-way (IDoc)
- File Processing
 - Record Distribution
 - MQ one-way
- Message-based Integration
 - Message Correlator
 - MQ request-response with persistence
 - MQ request-response without persistence
 - Message Splitter
 - MQ one-way (XML)
- Service Enablement
 - Service Facade
 - MQ one-way with acknowledgment
 - MQ request-response
- Service Virtualization
 - Service Proxy
 - Static endpoint

View Pattern Specification

View information about the selected pattern and click the "Create New Instance" button or click [here](#) to start using a pattern.

Message Correlator for WebSphere MQ: request-response with persistence pattern

Use the Message Correlator for WebSphere MQ: request-response with persistence pattern to accept requests from many client applications on a single queue, and to return responses to the correct client by using transactional flows and persistent WebSphere MQ messages.

Because this pattern uses reliable communications with persistent messages and transactional flows, it is appropriate to use when the message interchanges result in updates that require no loss of data.

Solution

Create New Instance

Properties Problems

Not connected <No Current Work>

Pattern Technology Demo (2/3)

Broker Application Development - My_MQ_Pattern - WebSphere Message Broker Toolkit - Message Broker - C:\Data\workspaces\runtime\WBIMB-7.0\Patterns

File Edit Navigate Search Project Run Window Help

Broker Developm Patterns Explore Pattern specification My_MQ_Pattern

Configure Pattern Parameters

Provide values for pattern parameters. Click the "Generate" button or click [here](#) to generate a pattern instance.

Pattern parameters are ready. Click the "Generate" button to generate a pattern instance.

Pattern Parameters

- Input information
- Response information**
 - Response queue and validation requirements
 - Response queue *
 - Validation of response messages
 - Response data type
 - Response message set *
 - Response message type *
 - Response message format *
- Provider information
- Logging
- Error handling
- General

Pattern Parameters Details

- Input information
- Response information

Pattern parameter	Description
Response queue	This pattern parameter identifies the broker queue on which client requests are received.
Validation of response messages	This pattern parameter identifies the level of validation required for response messages. Valid values are: <ul style="list-style-type: none"> None Content Content and value This property is configurable in the bar file. You can configure this property to switch off validation. You should not use this property to switch on validation unless the request message

Generate

Specification Configuration Properties Problems

Not connected <No Current Work>

Pattern Technology Demo (3/3)

The screenshot displays the IBM WebSphere Message Broker Toolkit interface. The main workspace shows a message flow diagram for 'Request.msgflow'. The flow starts with a 'Read Request' activity, which branches into two paths. One path goes through 'Set Request Mode' and 'Error' activities. The other path goes through 'Save First', 'Extract Original MQMD', 'Request Processor', 'Add Reply Address', and 'Propagate Request' activities. A second path from 'Save First' goes through 'Store Reply Address' and 'Save to Store' activities. The 'Request.msgflow' file name is circled in red in the top toolbar and in the left-hand project tree.

The left-hand pane shows the project structure for 'My_MQ_Pattern_Flows'. The 'Request.msgflow' file is highlighted with a red circle. Below the project tree is an 'Outline' view showing the components of the 'Request' message flow:

- Request
- Save First
- Read Request
- Request Processor
- Add Reply Address
- Propagate Request
- Extract Original MQMD
- Store Reply Address
- Save to Store
- Error
- Set Request Mode

The bottom-right pane shows the 'Default Values for Message Flow Properties - Request' configuration. The 'Basic' tab is selected, and the 'ErrorLoggingOn' property is checked.

Patterns for Simplified Development (rpt.)

▪ **Patterns Based Development**

- Create top-down, parameterized connectivity solutions
 - e.g. Web Service façades, Message oriented processing, Queue to File
- IBM pre-supplied patterns
 - Simplifies creation of most common scenarios according to best practices
- Complements existing bottom-up constructional approach for bespoke connectivity

▪ **Patterns Explorer**

- Inventory of key patterns available for solution generation
- Each pattern contains clear help to explain context and applicability

▪ **Pattern Generation**

- Enables simple creation of solution artefacts from pre-supplied pattern
- Pattern Properties allow configuration of behaviour
- Solutions can be modified and/or regenerated

▪ **Evolution**

- Pattern Capture creates user patterns from solution artefacts
- Pattern Management: provides post deployment customization and operation of solutions

Product Overview and Roadmaps

Multiple ESB offerings

Solutions to Meet Any and Every Demand



Platform Based

WebSphere Enterprise Service Bus

- Optimized with WebSphere Application server for an integrated SOA platform
- Shares common registry, security, administrative and development tools
- Services hosted on the application server

ESB offerings from IBM WebSphere



Appliance Based

WebSphere DataPower Integration Appliance XI50

- Hardware built for simplified deployment and hardened security
- Functions developed in one device



Integration Based

WebSphere Message Broker

- Built for universal connectivity and transformation in heterogeneous IT environments
- Message transformation developed to accommodate disparate service interfaces
- Adapters, protocol bridges packaged with applications and legacy platforms

IBM WebSphere Enterprise Service Bus

Built on WebSphere Application Server for an integrated SOA platform

- **Seamless integration** with the industry leading WebSphere platform
- **Delivers** business-critical qualities of service
- **Easily extended** to WebSphere Process Server
- **Continued Innovation:**
 - Delivers new policy-driven connectivity
 - Enhanced web services standards support
 - Enhanced service mediation capabilities

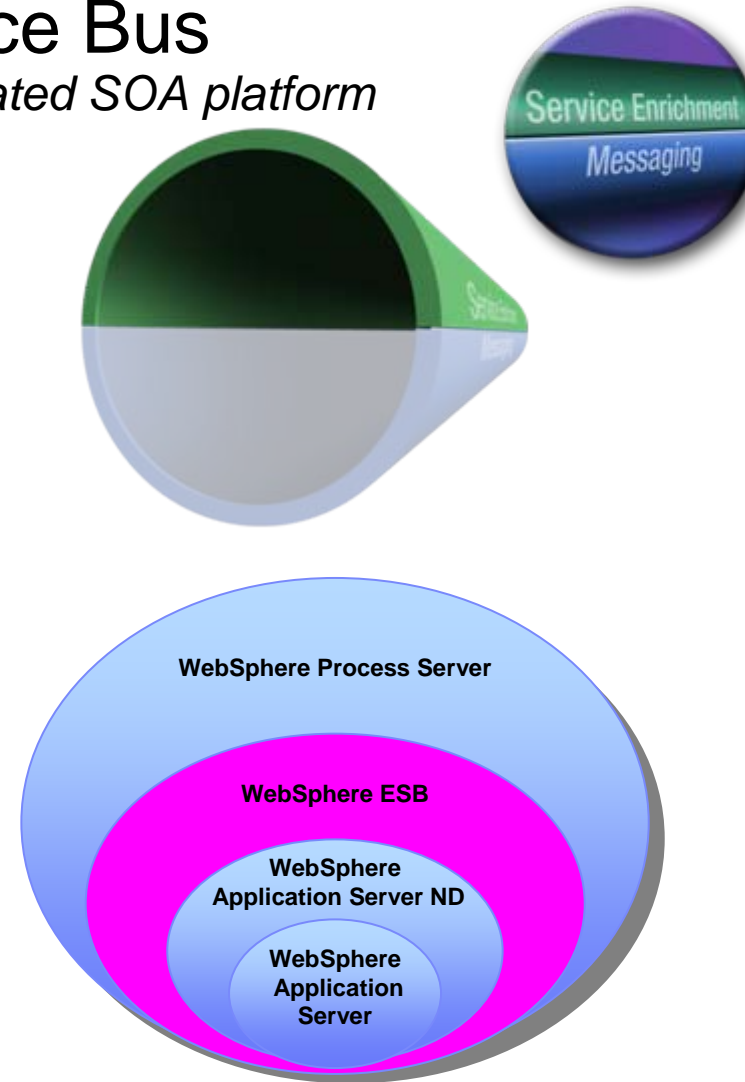



Optimized with WebSphere Application Server for an integrated SOA platform

**eGA 4Q/2009
z/OS GA 4Q/2009**

WebSphere ESB V7

- Accelerates productivity across user roles
 - Developers, Systems Administrators, Operations
- Exploits and extends WebSphere Application Server V7
 - Enhanced standards, administration, and integration
- Enables advanced ESB scenarios
 - Service Federation Management and value-add QoS
- Enhances support for open standards
 - Java, Web services, SCA

Service Monitor

WID Task Flow View

The screenshot shows the 'New Mediation Module' dialog box with fields for 'Module name', 'Location', and 'Target runtime environment'. A 'Context' pop-up window provides instructions on creating a mediation module. Below the dialog is the 'Create your First Service' task flow view, which includes steps like 'Setup', 'Develop', and 'Test' with sub-tasks such as 'Create the mediation module' and 'Test the Web service'.

This block contains two screenshots from the WebSphere ESB V7 administration console. The top screenshot, titled 'Service Monitor', displays a 'Service Monitor Graph Manager' with a line graph showing 'Rate (requests/sec)' over 'Elapsed Time (s)'. The bottom screenshot, titled 'Module Administration', shows the configuration for a 'CasePhoneAgent' module, including a 'TaskFlowReference' diagram and various properties like 'Version', 'Status', and 'Initial loaded context'.

Module Administration

What's Next in WebSphere ESB

- Service Gateway Scenario Support
- Mediation Policy
- Multiple MFCs in a module
- DataHandler Primitive for dynamic format handling
- Header manipulation primitives for: WMQ, JMS, HTTP
- Type Filter Mediation Primitive routing based on message type
- Web Services Standards: SOAP 1.2, ws-RM support
- Improved trace

V6.2
Dec 2008

- Mediation Policy Governance
- SOAP/Attachments

V6.2.0.1
April 2009

- Mediation Policy Admin Widget for IT Space
- Mediation promoted property control widget
- Samples for policy, gateway

WPS/WESB Featurepack
2Q09

v7

- WAS V7 Support
- XML performance and fidelity enhancements
- Endpoint-based mediation policy
- Gateway scenario usability and functional enhancements
- Custom Mediation Primitive Installer
- Initial Pattern support
- Event sequencing
- Store and forward
- Federated Connectivity Management
- EJB binding enhancements

v.NEXT+1

- Further WAS version support
- Message format support
- Simple "human readable" flow format
- Comprehensive pattern support

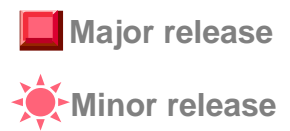

Continued Confirmation of WESB Success Stories



Government

- **manages 10,000 transactions per day at the top five U.S. state agencies.**



Banking

- **Is used worldwide in more than 50 banking institutions across 3 continents and in over 20 countries**



"We also have more flexibility and we can change configurations – that was something that we couldn't put a dollar value on. Now we can change the location of databases or servers, or add more servers in an effort to load balance, or have a backup site without making any changes to the business logic or actual code."

IT architect,
Retail

IBM WebSphere Message Broker Product Line

Built for universal connectivity and transformation in heterogeneous IT environments



- **Endless integration** to virtually any platform, operating system or device
- **Exploits** the industry-leading WebSphere MQ messaging infrastructure
- **Easily handles** complex messaging structures delivering extensive administration and systems management facilities
- **Continued Innovation:**
 - Over 100 nodes for connectivity, integration, and transformation
 - Starter to full enterprise versions
 - Works with the latest implementations of standards



- WebSphere Message Broker Starter Edition
- WebSphere Message Broker for Remote Deployment
- WebSphere Message Broker
- WebSphere Message Broker for Retail Store Edition

WebSphere Message Broker

- Universal Connectivity
 - Simplify application connectivity to provide a flexible and dynamic infrastructure
- Routes and transforms messages FROM anywhere, TO anywhere
 - Supports a wide range of protocols
 - MQ, JMS 1.1, HTTP(S), Web Services (SOAP, REST), File, ERP (SAP, SEBL...), TCP/IP, SCA
 - Supports a broad range of data formats
 - Binary (C/COBOL), XML, SOAP, CSV, Industry (SWIFT, EDI, HL7...), IDoc, User Defined
 - Interactions and Operations
 - Route, Filter, Transform, Enrich, Monitor, Distribute, Decompose, Sequence, Correlate, Detect
- Simple programming
 - Patterns based for top-down, parameterized connectivity of common use cases
 - e.g. Web Service façades, Message oriented processing, Queue to File...
 - Construction based for bottom-up assembly of bespoke connectivity logic
 - Message Flows to describe application connectivity comprising...
 - Message Nodes which encapsulate required integration logic which operate on...
 - Message Tree which describes the data in a format independent manner
 - Transformation options include Graphical mapping, PHP, Java, ESQL, XSL and WTX
- Operational Management and Performance
 - Extensive Administration and Systems Management facilities for developed solutions
 - Wide range of operating system and hardware platforms supported
 - Offers performance of traditional transaction processing environments
 - Available in Trial, Remote Deployment, Get Started and Enterprise deployment options

WebSphere Message Broker: Overview

Universal connectivity and transformation in heterogeneous IT environments

- ✓ Simple and flexible programming: message flows, message nodes and message model, patterns
- ✓ Multiple transformation options: including Graphical mapping, PHP, Java, ESQL, XSL and WTX
- ✓ Comprehensive data formats: Binary (C/COBOL), Text (XML/CSV/...), Industry (SWIFT/EDI/...), User Defined

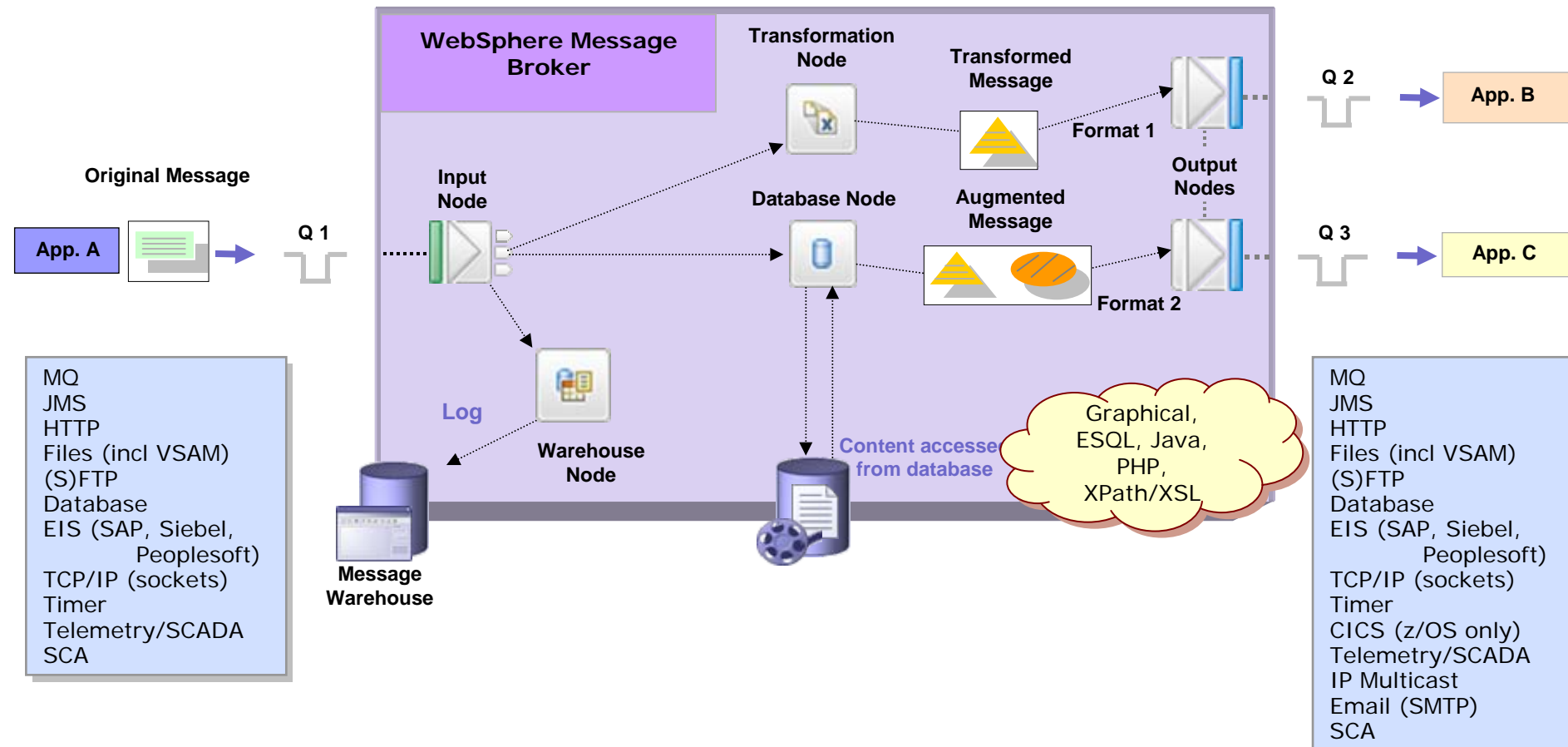

Message Broker 7 Overview



▪ Simplicity and Productivity

- Radically streamlined product prerequisites and components
- Simplified connectivity development using IBM pre-supplied patterns
- Impact Analysis to manage development artefact changes
- MB Explorer for dedicated administration tooling
- SCA nodes for WPS Interoperability

▪ Universal Connectivity for SOA

- Integrated content based MQ PubSub management & security
- PHP nodes for Web 2.0 support
- Enhanced SAP, Siebel, PeopleSoft packaged application support
- New Sequence and Resequencing nodes

▪ Dynamic Operational Management

- New operational facilities for audit and monitoring, including WBM
- Enhanced statistics to understand broker performance
- Improved user trace to easily understand message flow behaviour
- Enhancements for WSRR processing: Service Federation Management
- Software HA Multi-instance Queue Managers and Brokers

▪ Platforms, Environments and Performance

- Exclusively 64bit Broker support, including z/OS
- Performance monitoring tools and very reduced memory footprint

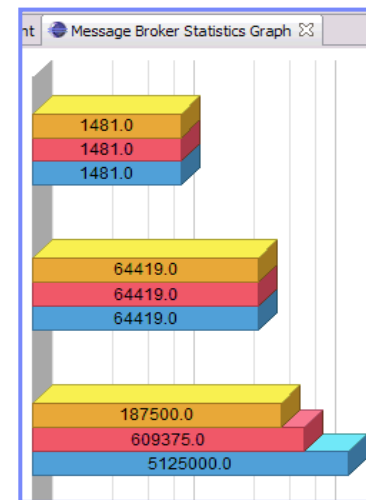
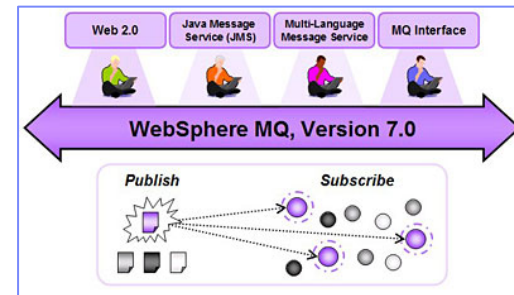

What's Next in WebSphere Message Broker?

IBM's plans, directions, and intent are subject to change or withdrawal

- User Defined Patterns for custom reuse
- User Defined Sub flows: encapsulate & distribute
- Expanded Patterns Explorer: more built-in patterns

- SOAP/JMS & more Web Service enhancements
- Database input node processing of relational data
- Multi-platform CICS node for direct connectivity
- FTE file nodes for end-to-end file processing
- CORBA request node to facade CORBA systems

- Extended security: SAML, Kerberos, LTPA, RACF tickets
- PEP node for mid-flow security processing
- Comprehensive operational resource statistics
- Web Services Policy Analytics for WSRR

- Windows 7, Server 2008 with 64 bit processes
- More databases: solidDB, SQL Server z/Linux

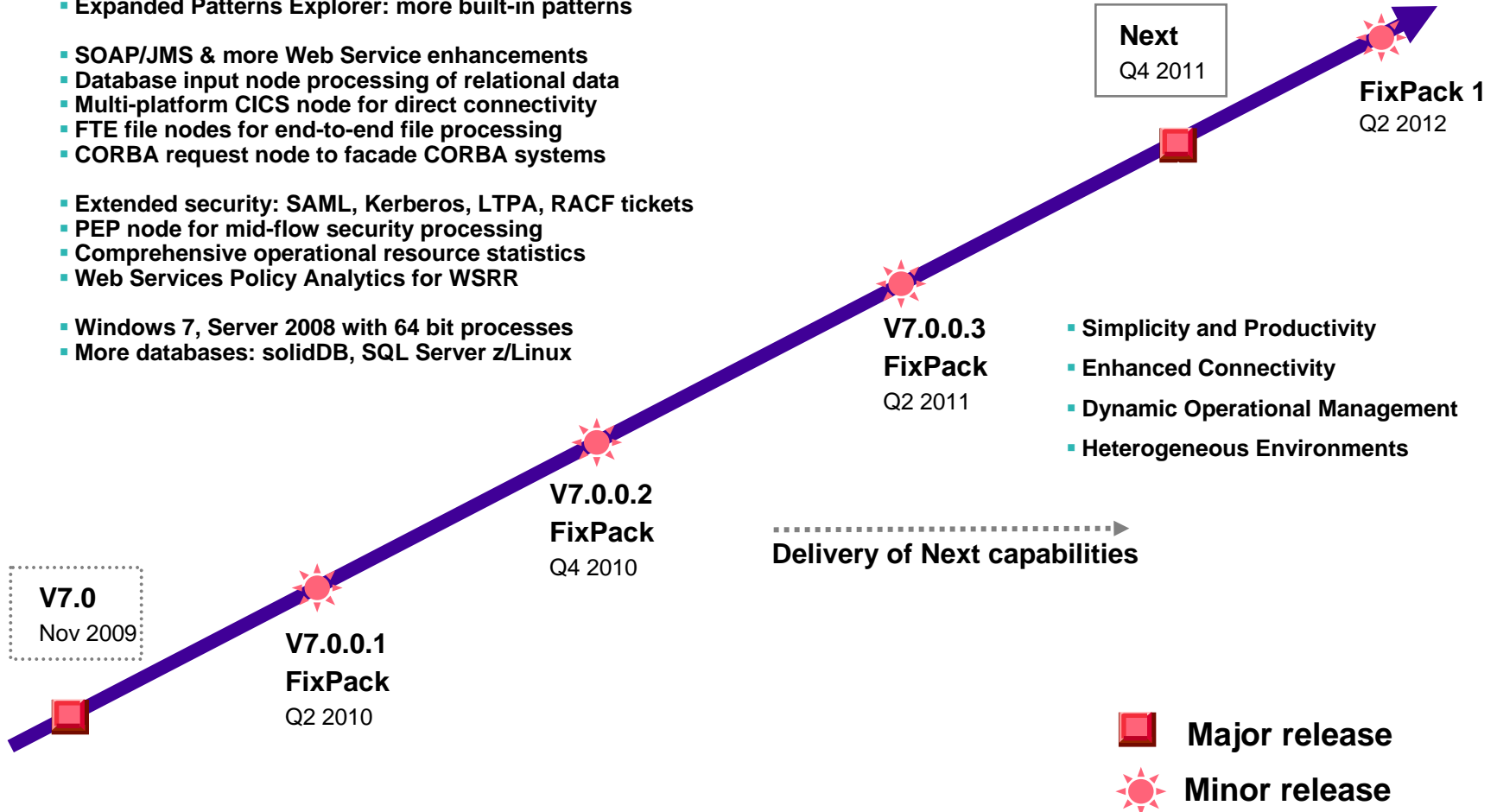

MB Hypervisor Edition



- A New Feature to simplify provisioning MB (and MQ)
 1. Simplify initial system deploy resulting in quicker time to solution value
 2. Simplify fix pack deploy to reduce recurring maintenance cost for existing systems

- 2 key components to Cloudburst
 - Hyper Visor Image (HVE) – a pre-built VM installed image
 - Provides OS+HW combination, e.g. RHEL 5.5 for VMWare ESX
 - HVE Scenario Configuration Information (“CB Pattern”)
 - Technical (e.g. Multi-instance HA) or business oriented (Healthcare)

- Hyper Visor Edition Packages
 - A new set of packages for MQ and MB forming part of SOE
 - RHEL for VMWare ESX x86-64 initial release
 - Updated when new fix pack levels released
 - Downloaded to customer site Cloudburst when required, iFixes also possible

- Configuration Patterns
 - Create most popular MQ and MB topology configurations
 - e.g. Standalone broker, HA Multi-instance MB+MQ cluster, Starter Edition...
 - Includes customization scripts required for operational system, e.g. listeners

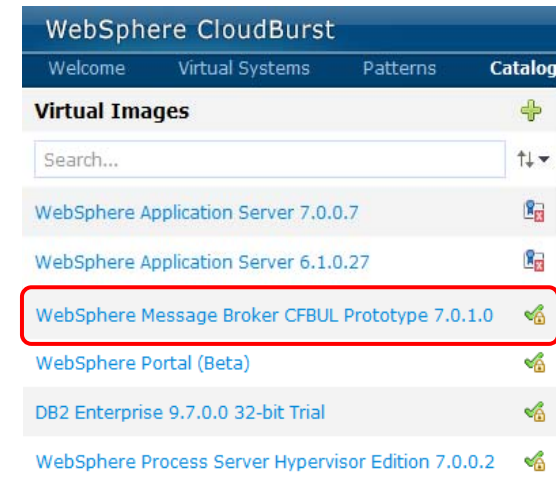

WebSphere Message Broker Continued Success



Financial Services

- **80% of the top 10 banks in America use Message Broker**
- **Millions of transactions per day**

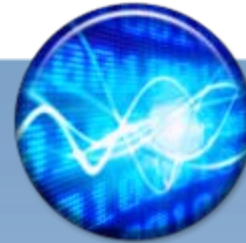

“It’s going to give us unprecedented agility. We’ll be able to re-merchandise our Web stores on the fly in response to competitive offers. That will make us much more relevant to the customer, which is critical..”

CIO,
Retailer



Insurance and Healthcare

- **90% of the top insurances companies use Message Broker**
- **One company handled 42% more transactions per day**

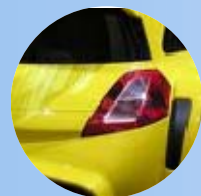

Automotive

- **Used in 9 of the top automotive companies**
- **Integrates supply chain management system with critical production data**

The ESB ...at the heart of a smart connectivity 'ecosystem'

Service Monitoring

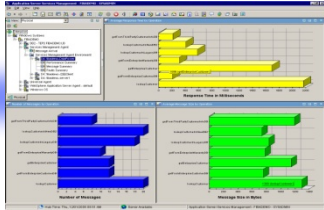

Tivoli CAM for SOA

Service Orchestration and BPM

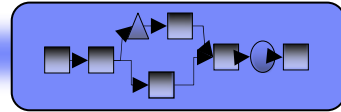

WebSphere Process Server

Business Rules

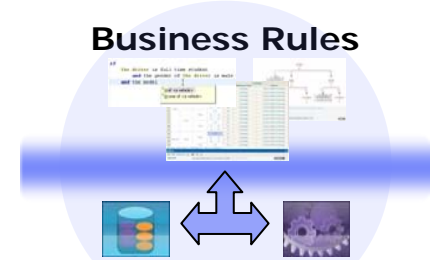

WebSphere iLog JRules
WebSphere Event Server

Service Security



Tivoli Security Products



ESB Offerings from IBM WebSphere



Universal Transformation

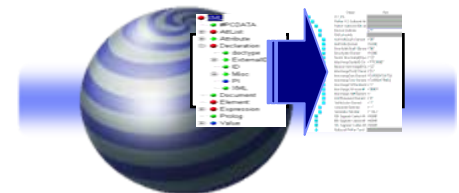

WebSphere Transformation Extender

Service Registry



WebSphere Services Registry and Repository

Messaging Backbone for SOA



WebSphere MQ

Whitepaper for you

- **Everyone will receive a copy of “Considerations for making System z your ESB deployment platform”**

- **System z might be the right platform for your ESB because:**
 - Enables cost-effective reuse of z assets
 - Offers significantly improved ESB execution characteristics with proximity to data

- **Read more!**

z doctor is in!

Visit the z Solution Suite for 1-1 consultations; see the zEnterprise in action

Save the Date

Impact2011

Changing the Way Business and
IT Leaders Work

Optimize for Growth.
Deliver Results.

April 10–15
Las Vegas, NV

ibm.com/impact

