

IBM iSeries Hardware

*2001 Announcements
ITSO Technical Overview
May 2001*

IBM @server. For the next generation of e-business.

SStar processors for higher performance

Base Processor features

Memory capacity x 2



- iSeries Model 270
 - 1 & 2 Way SStar (top 3 mdl)
 - Up to 16 GB Memory
 - Up to 421 GB Disk
 - Up to 2,350 CPW*
 - Up to 6,660 MCU*
 - New DSD Models



- iSeries Model 820
 - 1, 2 & 4 Way SStar (top 4 mdl)
 - Up to 32 GB Memory
 - Up to 4 TB Disk
 - Up to 3,700 CPW*
 - Up to 11,810 MCU*
 - New DSD Models



- iSeries Model 830
 - 2, 4 & 8 Way IStar
 - Up to 64 GB Memory
 - Up to 11 TB Disk
 - Up to 7,350 CPW*
 - Up to 22,900 MCU*



- iSeries Model 840
 - 12-24 Way SStar
 - Up to 128 GB Memory
 - Up to 18.9 TB Disk
 - Up to 20,200 CPW*
 - Up to 77,800 MCU*

HSL OptiConnect, DVD, and much more....

Dynamic LPAR

* 70% CPU utilization

IBM  server. For the next generation of e-business.

Extending the iSeries Servers

Important messages

- More power and price flexibility with new SStar processors
 - Improved price performance for models 270 and 8xx
 - New high end performance
 - New processor features for Capacity Upgrade on Demand
- Transition from AS/400e into iSeries is complete
 - iSeries provides a complete replacement line for AS/400e Server 170 and 7xx
 - Improved technology
 - Enhanced Application and Web serving capabilities
- Broader choice in performance and capabilities
 - New models fit in between existing stepstones
 - Base 820 models
 - More power and scalability for iSeries Dedicated Servers for Domino
- New features, new technologies, new possibilities
 - Optical attachments
 - Clustering with HSL
 - New DASD, DVD - RAM,.....

IBM  server. For the next generation of e-business.

This foil summarizes the topics to be covered in the remainder of this presentation - **new hardware announced April 2001**. The appendix of this presentation contains iSeries model hardware characteristics of iSeries processors made available during the year 2000.

See the System Builder books, SG24-2155-05B for Year 2000 hardware and SG24-2155-06 for Year 2001 hardware details.

IBM has now announced another milestone in semiconductor manufacturing: a new method for building microchips that can deliver up to a 30 percent boost in computing speed and performance. This new manufacturing technique uses a material technologists refer to as a "low-k dielectric" to meticulously shield millions of individual copper circuits on a chip. IBM is the first to use the low-k dielectric technique with copper wiring. For more information on IBM's chip technology including Copper, SOI, Low-k and Power4, see <http://www.chips.ibm.com/bluelogic/showcase/>

The V4R5 Technical Overview presentation and Hardware presentation contain details on the year 2000 processors, and PCI-based I/O processors and devices and the new technology High Speed Link (HSL) architecture for attaching I/O hardware.

iSeries Model 270

SStar Processor (540 MHz):

- 2431, 2432

SStar Processor (600 MHz):

- 2434 (2-way)

Dedicated Server for Domino, SStar Processor (540 MHz):

- 2452

Dedicated Server for Domino, SStar Processor (600 MHz):

- 2454 (2-way)

Maximum Disk Storage is 421 GB

Notes: iSeries Model 270

With V5R1, 5 new models of the iSeries model 270 and 2 of the iSeries DSD model 270's are introduced. These new 270s use the SStar SOI (Silicon On Insulator) technology. The enhanced iSeries model 270's replace the AS/400e model 170 and some of the 720 models, by delivering more capabilities and improved price performance. These enhanced iSeries model 270's complement and extend the earlier announced iSeries model 270's with new levels of performance.

IBM  server. For the next generation of e-business.

iSeries Model 270 Characteristics

	2431 Proc. Feat.	2432 Proc. Feat.	2434 Proc. Feat.
Processor CPW	465	1070	2350
Interactive CPW #1518 Int. Feat. #1516 #1519 #1520	30 (23E7)	0 (23F0) 50 (23F1)	0 (23F4) 70 (23F5)
# of processors	1	1	2
Storage (min/max) MB	256/8192	256/8192	256/16384
DASD (min/max) GB	8/421	8/421	8/421
Max DASD arms	24	24	24
Max DASD LUNs	23	23	23
Internal/External xSeries	3/2	3/2	3/2
CD-ROM/DVD/Int. Tape	2	2	2
Max External Tapes	3	3	3
Max Cryptographic Card	3	3	3
Max LAN ports	8	8	8
Max WAN lines	50	50	50
Max Twinax Ctlrs	6	6	6
Software Group	P10	P10	P10

IBM  server. For the next generation of e-business.

Notes: iSeries Model 270 Characteristics

This chart shows the characteristics of the new iSeries 270.

Logical Units or LUNs are used to designate the virtual disks in an Enterprise Storage Server.

0 interactive CPW means a single 5250 job can run normally according to its OS/400 run priority. If multiple 5250 jobs are actively consuming CPU utilization there performance will be become severely degraded.

The primary "entry level 270" is the #2248, which became available during 2000.

Remember, maximum values may be restricted by other I/O devices configured.

iSeries Model 270 Performance Range

IBM  server iSeries

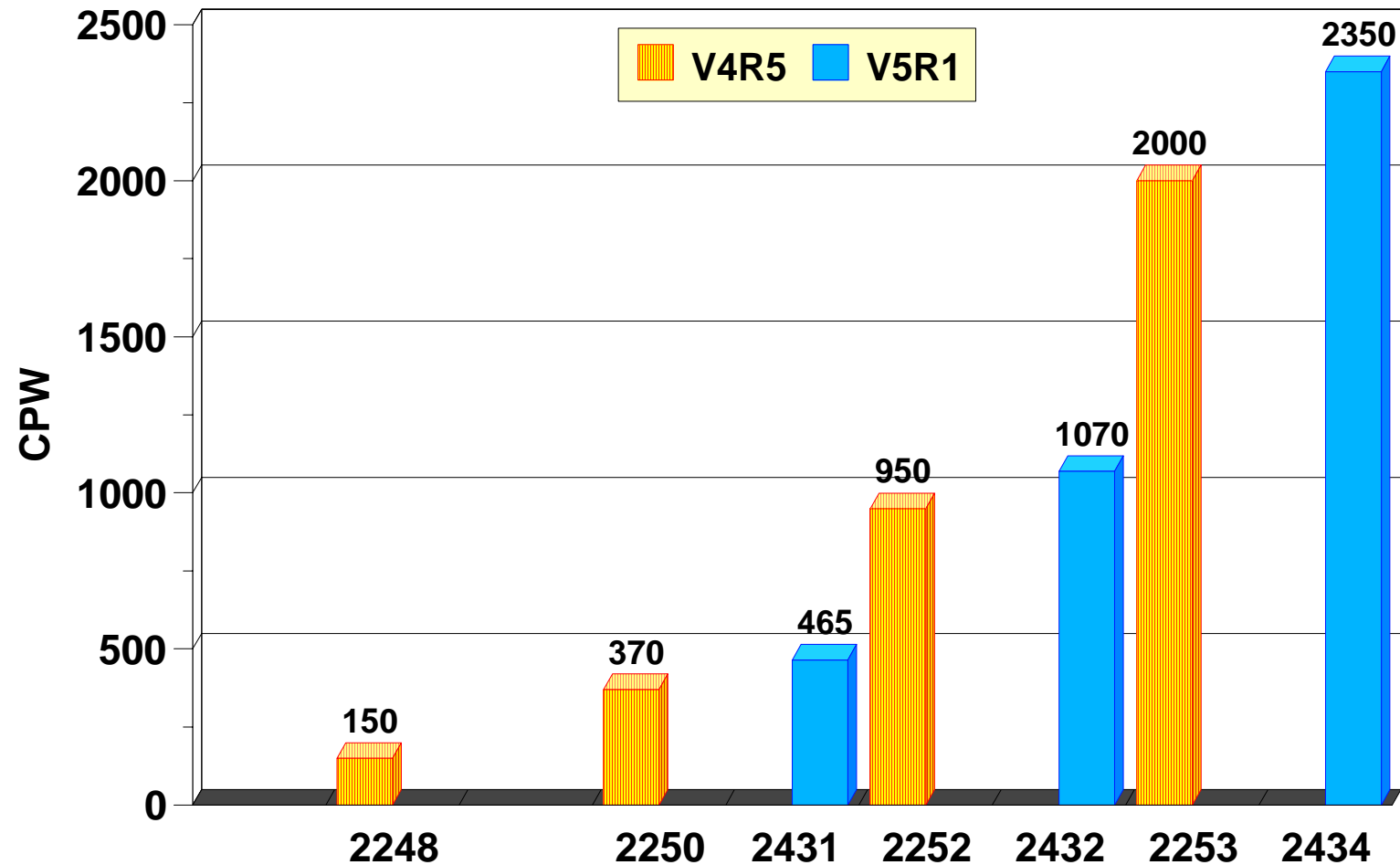

IBM  server. For the next generation of e-business.

SStar Processor (600 MHz):

- #2435, #2436, #2437 (2-way), #2438 (4-way)
- #0150, #0151 (2-way) and #0152 (4-way) base server processor features

Dedicated Server for Domino, SStar processor (600 MHz):

- #2456, #2457 (2-way) and #2458 (4-way)

Maximum disk capacity 4 TB

Maximum Main Storage doubled on all SStar processor features

- 32 GB on 2-way and 4-way processor features

This foil shows the overview of the enhancements and new processor points for the iSeries model 820. The performance values of the new SStar processor features do fit smoothly between the earlier announced iSeries model 820 processors performance values. The new "base" processor features are specially designed for customers who need powerful servers and do not need interactive capacity. These "base" processors provide equal CPW values as their "standard" processor feature counterparts, but they do not provide any interactive capacity, meaning that apart from the system management tasks no 5250 type sessions or tasks are supported. For larger Domino environments, the Dedicated Server Model 820 processor features #2456, #2457, #2458 offer improved enterprise-class scalability and capacity with uni, 2-way and 4-way processors. The iSeries Dedicated Server for Domino is particularly effective when combined with the partitioning capabilities of Domino Enterprise Server to support multiple Lotus Domino workloads (e.g., mail and Domino applications) on a single physical server.

The maximum main storage size for all iSeries model 820 doubled with V5R1, this can be accomplished by using the new memory features. The same is true for the maximum DASD capacity when you use the new disk drives.

The "base 820s" can do 5250 work similar to the way 270s with 0 interactive CPW can. That is, a single 5250 job runs according to normal OS/400 run priority. However, when multiple 5250 jobs are running, their total CPU utilization is becomes severely restricted if they consume more than a very small total CPU utilization.

iSeries Model 820 Characteristics

	#2435 Proc Feat.	#2436 Proc Feat.	0150	#2437 Proc Feat.	0151	#2438 Proc Feat.	#0152
Processor CPW	600	1100	1100	2350	2350	3700	3700
Interactive CPW Int. Feat.	#1521 #1522 #1523 #1524 #1525 #1526 #1527	35=249B 70=249C 120=249D 240=249E	35=24A8 70=24A9 120=24AA 240=24AB 560=24AC	35=24B0 70=24B1 120=24B2 240=24B3 560=24B4 1050=24B5	0	35=24B8 70=24B9 120=24BA 240=24BB 560=24BC 1050=24BD 2000=24BE	0
Number of processors	1	1	1	2	2	4	4
Storage (GB)	8	16	16	32	32	32	32
DASD (GB)	4159	4159	4159	4159	4159	4159	4159
Max DASD arms	237	237	237	237	237	237	237
Max DASD LUNs	236	236	236	236	236	236	236
Internal/External xSeries	12/4	12/4	12/4	12/4	12/4	12/4	12/5
CD-ROM/DVD/Int Tape	12	12	12	12	12	12	12
Max External Tapes	8	8	8	8	8	8	8
Max Cryptographic Cards	8	8	8	8	8	8	8
Max LAN Ports	30	30	30	30	30	30	30
Max WAN Lines	160	160	160	160	160	160	160
Max Twinax Ctlrs	62	62	62	62	62	62	62
Software Group	P10/P20	P20/P30	P20	P20/P30	P20	P30/P40	P30

IBM  server. For the next generation of e-business.

Notes: iSeries Model 820 Characteristics

Remember, maximum values may be restricted by other I/O devices configured.

iSeries Model 820 Performance Range

IBM  server iSeries

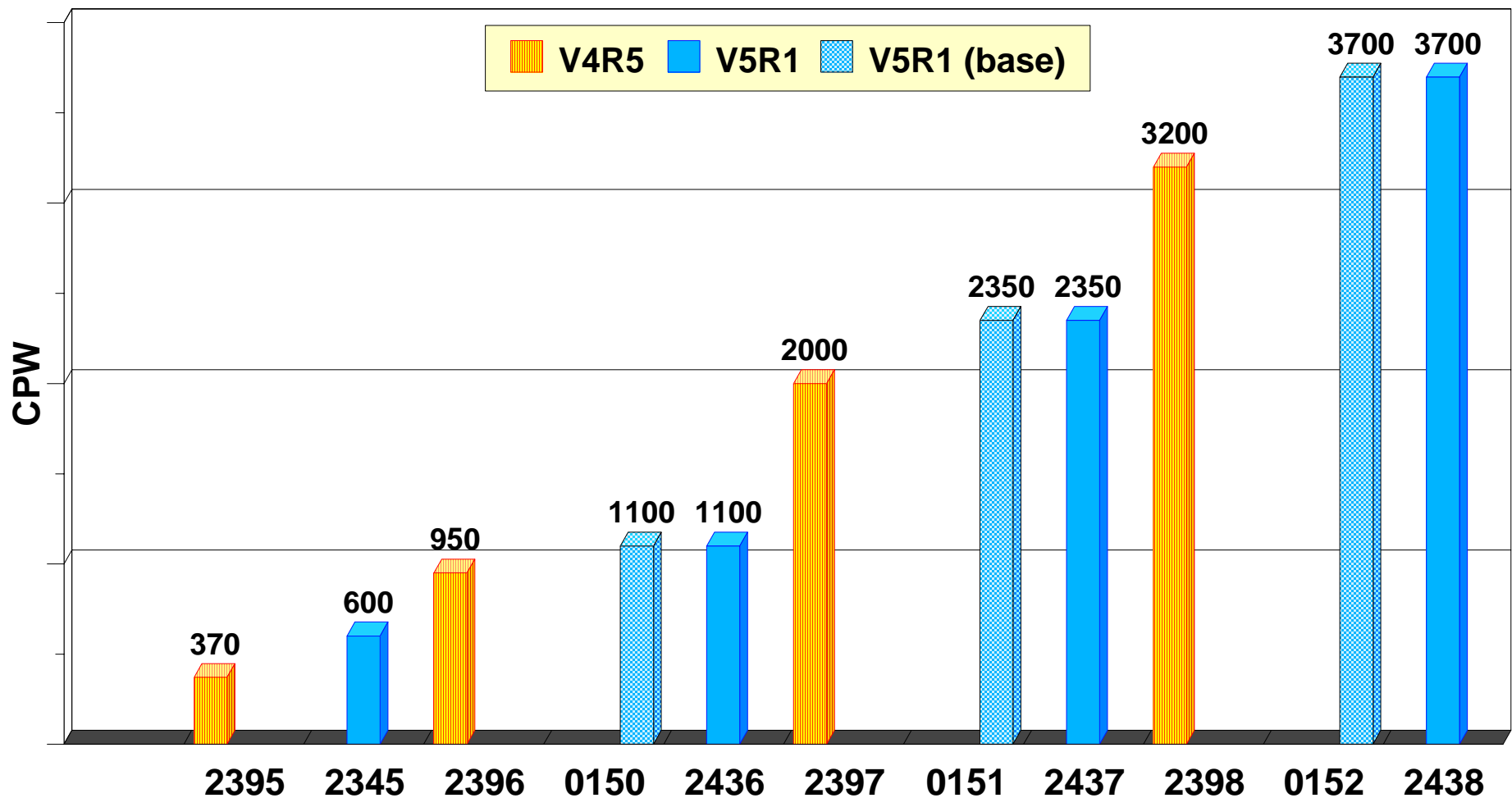

IBM  server. For the next generation of e-business.

Memory and disk capacity

- Up to 64 GB Main Storage (2x)
- Up to 11 TB disk capacity

#2351 CUoD processor feature and specify #1605

- Base has 1 processor active and 1200 CPW
- For each additional processor activation specify one #1605 (up to seven)
- Maximum 7350 CPW with all 8 processors activated
- Only available via I-Listed RPQ

Capacity Upgrade on Demand (general)

- Immediate activation, no IPL required (V5R1) on all CUoD processors
- Temporary activation for 14 days

Notes: iSeries Model 830 and RPQ CUoD

Although no new processor points are made available for the iSeries Model 830 in this time frame, there are several enhancements announced together with V5R1. Just like as for the model 820 the maximum DASD and main storage capacity is doubled. You may configure an iSeries Model 830 with up to 64 GB of main storage and up to a maximum DASD capacity of 22153.9 GB.

There is a new I-Listed RPQ that provides a new processor feature with the ability to increase the server processing capacity by adding an extra processor up to seven times from one active processor of the base processor feature up to eight processors activated as a maximum. This new Capacity Upgrade on Demand model 830 has processor feature 2351. Each additional processor activation requires an order for one specify #1605. With V5R1 an IPL is no longer required to activate an additional processor on a CUoD model. The same temporary activation period of 14 days still applies.

iSeries Model 830 Characteristics

	#2400 Proc Feat.	#2402 Proc Feat.	#2403 Proc Feat.	#2351 Proc Feat.
Processor CPW	1850	4200	7350	7370
Interactive CPW	70=23C1	70=23D1	70=23D8	70=23D8
Int. Feat.	120=23C2	120=23D2	120=23D9	120=23D9
#1531	240=23C3	240=23D3	240=23DA	240=23DA
#1532	560=23C4	560=23D4	560=23DB	560=23DB
#1533	1050=23C5	1050=23D5	1050=23DC	1050=23DC
#1534		2000=23D6	2000=23DD	2000=23DD
#1535			4550=23DE	4550=23DE
#1536				
#1537				
Number of processors	2	4	8	4/8
Storage (GB)	64	64	64	64
DASD (GB)	11056	11056	11056	11056
Max DASD arms	630	630	630	630
Max DASD LUNs	629	629	629	629
Internal/ External. xSeries	28/8	28/8	28/8	28/8
CD-ROM/DVD/	18	18	18	18
Internal/External Tapes	18/10	18/10	18/10	18/10
Max Crypto. Cards	8	8	8	8
Max LAN Ports	72	72	72	72
Max WAN Lines	300	300	300	300
Max Twinax Ctlrs	152	152	152	152
Software Group	P10/P20	P20/P30	P20/P30	P30/P40

Notes: iSeries Model 830 Characteristics

Remember, maximum values may be restricted by other I/O devices configured.

iSeries Model 840

SStar (600 MHz) based processor:

- 2461 (24 way)

Capacity Upgrade on Demand (CUoD):

- 2352 (8 to 12 way)
- 2353 (12 to 18 way)
- 2354 (18 to 24 way)

Maximum disk capacity 18.9 TB

Maximum Main Storage 128 GB

AA new high-end iSeries Model 840 processor feature (#2461) is available with V5R1. This new processor has an improved price performance over the iSeries Model 840 processors announced in 2000. Three new Capacity Upgrade on Demand options are also based on the new Sstar processors. These processors can provide "on-demand" capacity for customers with dynamic growth. Additional processor capacity (processors physically resident in the server can be activated when needed. Maximum CPW values are more than 23 percent higher compared to the CPW values of the V4R5 iSeries Model 840 processors. The maximum main storage capacity increased from 96 GB up to 128 GB or 33 percent. The new high end capacities of processing, main storage and disk provide the environment to implement business solutions serving an even larger number of clients than the previously announced iSeries Model 840 could.

iSeries Model 840 Characteristics

		#2461 Proc. Feat.	#2352 Proc. Feat	#2353 Proc. Feat	#2354 Proc. Feat
Processor CPW		20200	9000 - 12000	12000 - 16500	16500 - 20200
Interactive CPW Int. Feat.	#1540	120=26D0	120=26B0	120=26B8	120=26C0
	#1541	240=26D1	240=26B1	240=26B9	240=26C1
	#1542	560=26D2	560=26B2	560=26BA	560=26C2
	#1543	1050=26D3	1050=26B3	1050=26BB	1050=26C3
	#1544	2000=26D4	2000=26B4	2000=26BC	2000=26C4
	#1545	4550=26D5	4550=26B5	4550=26BD	4550=26C5
	#1546	10000=26D6	10000=26B6	10000=26BE	10000=26C6
	#1547	16500=26D7		16500=26BF	16500=26C7
	#1548	20200=26D8			20200=26C8
Number of processors		24	8/12	12/18	18/24
Max Storage (GB)		128	128	128	128
Max DASD (GB)		18953	18953	18953	18953
Max DASD arms		1080	1080	1080	1080
Max DASD LUNs		1079	1079	1079	1079
Max Internal/External xSeries		32/16	32/16	32/16	32/16
MaxCD-ROM/DVD		24	24	24	24
Max Internal/External Tapes		26/26	26/26	26/26	26/26
Max Cryptographic Cards		8	8	8	8
Max LAN Ports		96	96	96	96
Max WAN Lines		400	400	400	400
Max Twinax Ctlrs		175	175	175	175
Software Group		P40/P50	P40/P50	P40/P50	P40/P50

IBM  server. For the next generation of e-business.

Notes: iSeries Model 840 Characteristics

Remember, maximum values may be restricted by other I/O devices configured.

iSeries Model 840 Performance Range

IBM  server iSeries

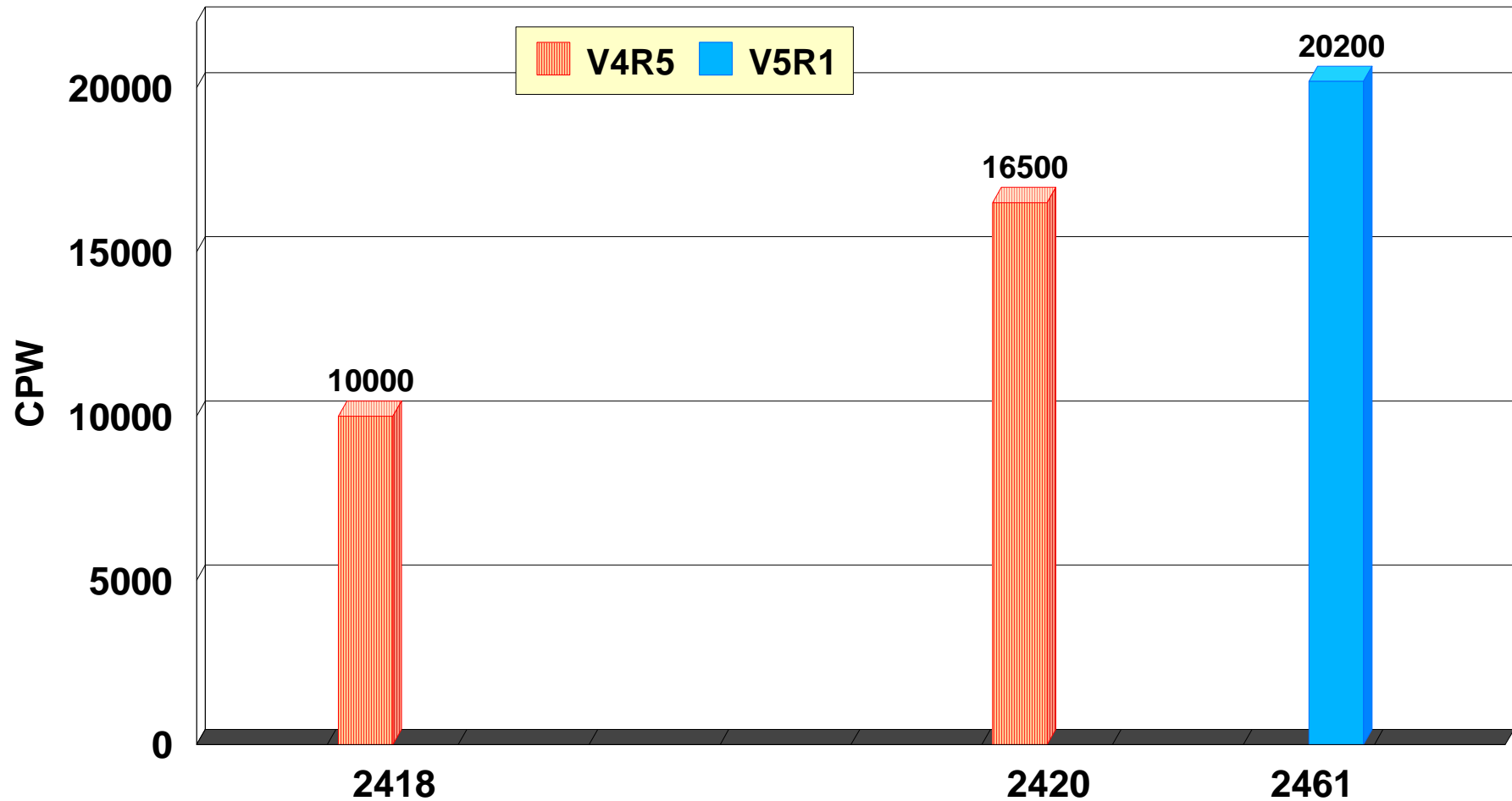

IBM  server. For the next generation of e-business.

iSeries Model 840 CUoD Performance Range

IBM  server iSeries

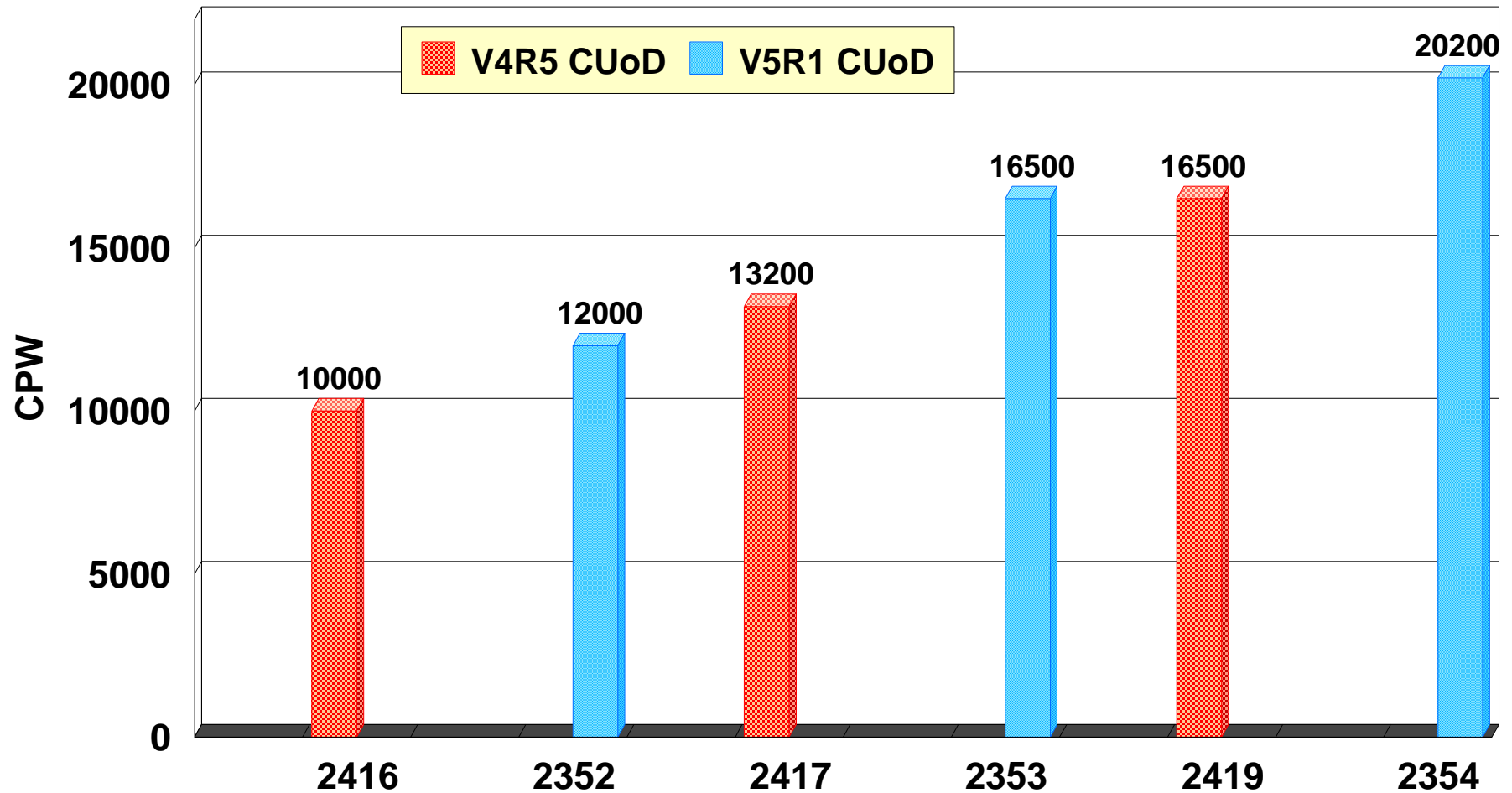

IBM  server. For the next generation of e-business.

iSeries Dedicated Server for Domino

IBM  server iSeries

New iSeries DSD Prereqs:
Domino R5.06a or later
OS/400 V5R1

iSeries DSD Model 820

#2458



#2457



#2454



#2452



#2456

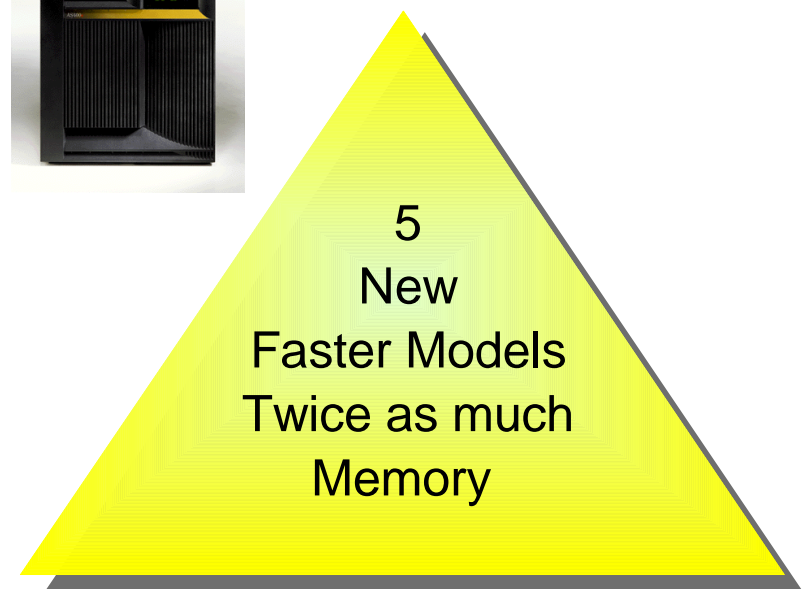

iSeries DSD Model 270

IBM  server. For the next generation of e-business.

iSeries Model 270 DSD Characteristics

	2452	2454
Non Domino CPW	100	240
Interactive CPW	0	0
# of processors	1	2
Storage (min/max) MB	256/4096	256/16384
DASD (min/max) GB	8/421	8/421
Max DASD arms	24	24
Max DASD LUNs	23	23
External xSeries	2	2
CD-ROM	2	2
Tapes	3	3
Max LAN Ports	8	8
Max WAN Lines	50	50
Max Twinax Ctlrs	6	6

iSeries Model 270 DSD Performance Range

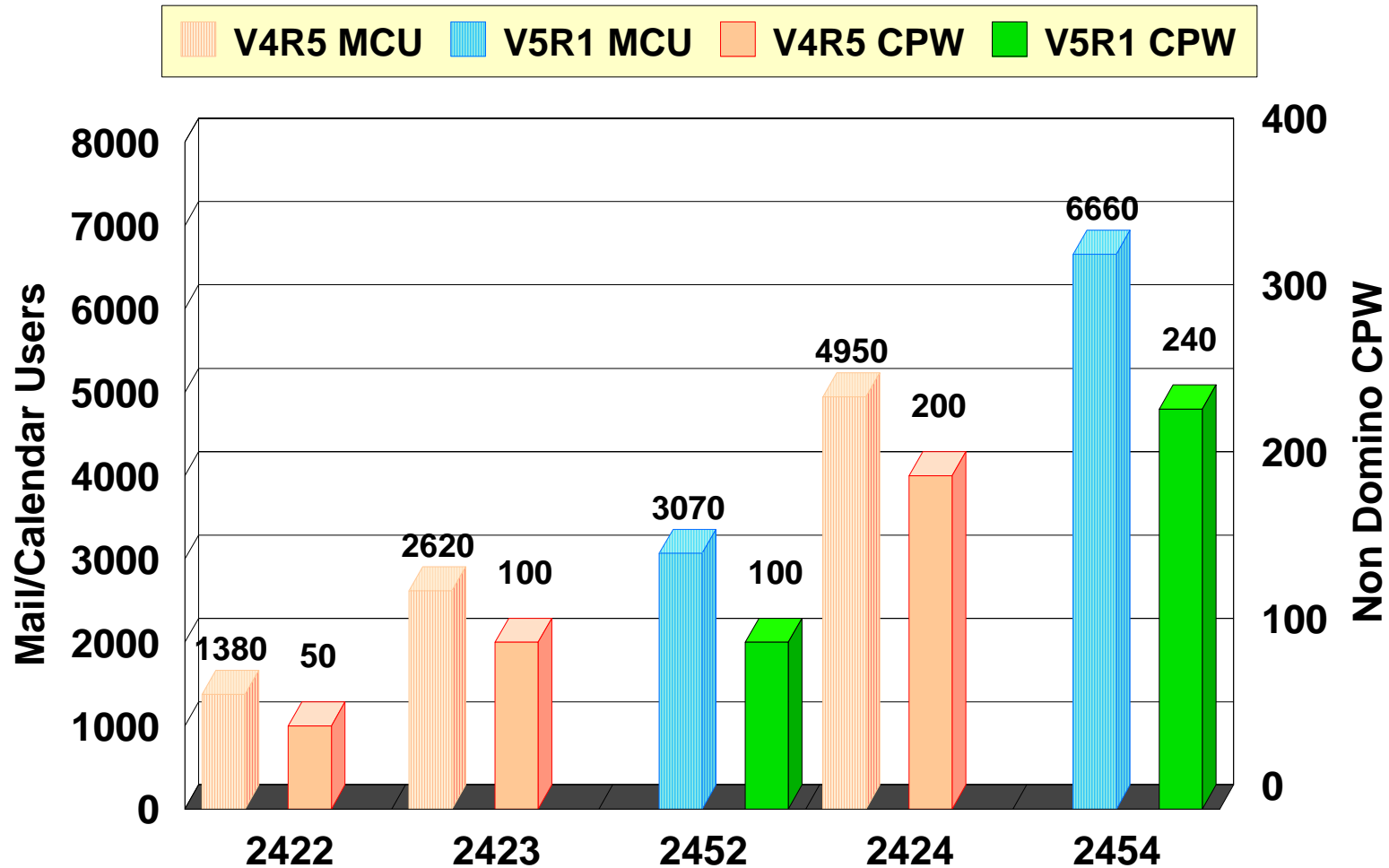

IBM  server. For the next generation of e-business.

iSeries Model 820 DSD Characteristics

	#2456	#2457	#2458
<i>Non-Domino CPW</i>	120	240	380
<i>Interactive CPW</i>	0	0	0
<i># of processors</i>	1	2	4
<i>Storage (GB)</i>	16	32	32
<i>DASD (GB)</i>	4159	4159	4159
<i>Max DASD arms</i>	237	237	237
<i>Max DASD LUNs</i>	236	236	236
<i>External xSeries</i>	4	4	4
<i>CD-ROM/DVD</i>	12	12	12
<i>Tapes</i>	8	8	8
<i>LAN</i>	30	30	30
<i>WAN</i>	160	160	160

iSeries Model 820 DSD Performance Range

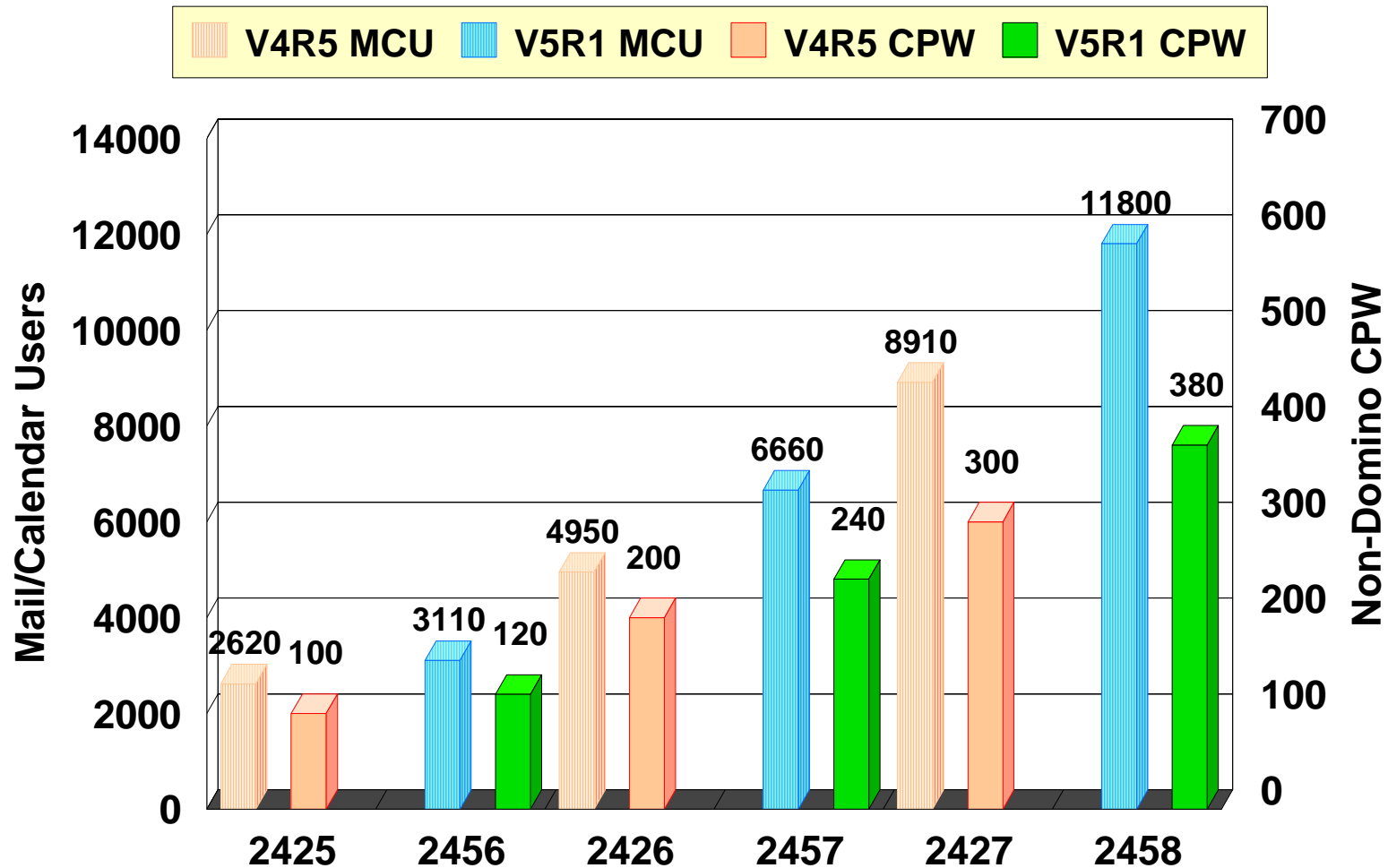

IBM  server. For the next generation of e-business.

Main Storage

IBM @server. For the next generation of e-business.

iSeries Model 270 Memory Features

270 - #2434 and #2454:

Feature	Capacity (MB)	Technology
#3022	256	64 Mb
#3024	256	128 Mb
#3025	512	128 Mb
#3026	512	256 Mb
#3027*	1024	256 Mb
#3029*	128	128 Mb

270 - #2431, #2432 and #2452:

Feature	Capacity (MB)	Technology
#3032*	256	DDR
#3033*	512	DDR
#3034*	1024	DDR

***New memory feature**

Notes: iSeries Model 270 Memory Features

The new iSeries 270 are equipped with the memory cards listed on this foil. The high end processors 2434 and 2454 can use the cards which were introduced with the 270 processor features 2248, 2250, 2252 and 2253 in 2000. However, the #3022 cards are orderable only up to the minimum number of DIMMs required to meet a pairing or quad system memory requirement.

On the processors 2431, 2432 and 2452, a single main storage DIMM feature is the minimum required. However, when the total number of main storage DIMMs is increased, the single existing DIMM must be paired up with a DIMM of the same capacity. Any additional DIMMs beyond the second one must be added in pairs of the same capacity. The DIMM features used on these processors are unique to this processor set and will not work on any other model 270 processor. These DIMMs are SDRAM DDR (Double Data Rate) technology cards. SDRAMs are based on standard dynamic RAM chips, but have sophisticated features that make them considerably faster. First, SDRAM chips are fast enough to be synchronized with the CPU's clock, which eliminates wait states. Second, the SDRAM chip is divided into two cell blocks, and data is interleaved between the two so that while a bit in one block is being accessed, the bit in the other is being prepared for access. This allows SDRAM to burst the second and subsequent, contiguous characters at a rate of 0ns, compared to 60ns for the first character. SDRAM provides up to 1.1 GBps data transfer, and DDR SDRAM (Double Data Rate SDRAM) doubles the rate to 2.2 GBps. DDR is also known as DSDRAM (Double-Speed DRAM), DDR DRAM (Double Data Rate DRAM) and SDRAM-II.

The processors 2434 and 2454 ship with a base #2884 main storage expansion card, and support up to 16 DIMMs. Features must be added in quads, but a single pair of DIMMs is allowed on the initial order if they are the only two on the system.

Each set of DIMMs must be of the same capacity and technology.

iSeries Model 820 / 830 Memory Features

820 Feature	Capacity (MB)	Technology
#3000	128	
#3002	128	64 Mb
#3009	128	128 Mb
#3004	256	128 Mb
#3005	512	128 Mb
#3006	512	256 Mb
#3007	1024	256 Mb

830 Feature	Capacity (MB)	Technology
#3000	128	
#3062	128	64 Mb
#3064	256	128 Mb
#3065	512	128 Mb
#3066	512	256 Mb
#3067	1024	256 Mb

Notes: iSeries 820 / 830 Memory Features

The new iSeries 820 and 830 main storage support are equipped with the memory cards listed on this foil.

For the "older" Pulsar 2395 processors, main storage DIMMs must be in pairs of the same capacity and technology. These DIMMs plug directly onto the processor and do not use the main storage expansion cards (#2884).

For the 2436 and 2456 processors, the DIMMs can be plugged directly onto the processor, but if more than 8 DIMMs total are required, a main storage expansion card (#2884) must be used and all DIMMs must then reside on the #2884. Without the #2884, the DIMMS must be paired. With the #2884, the DIMMs must be in sets of four (quads) of the same capacity and technology. There is an exception that allows a single set of two main storage DIMMs on a #2884, if these are the only two on the system. If any additional DIMMs are added above the initial two, the initial two must be paired up to make a quad and then only DIMM quads can subsequently be added. In addition, the #2884 can be ordered/installed, at any time, even with 8 or fewer DIMMs present. If a #2884 is installed, all DIMMs must be placed on it.

For the 2437, 2438, 2457, 2458 and 2350 processors, main storage DIMMs must be plugged onto a main storage expansion card (#2884) and must be added in sets of four (quads) of the same capacity and technology. There is an exception that allows a single set of two main storage DIMMs if these are the only two on the system. A single pair of DIMMS is not allowed on these systems with a feature #2884 present or ordered. If any additional DIMMS are added above the initial two, the initial two must be paired up to make a quad and then only DIMM quads can subsequently be added. A feature #2884 may be ordered/installed at any time, even if the base main storage expansion card is not full (For these processors, if a #2884 is ordered, a #5157 Feature Power Supply must be present or ordered).

All main storage DIMMS on the model 830 must be added in sets of eight (octals) of the same capacity and technology. There are a total of 64 DIMM slots available on the model 830, 32 are "base" and an additional 32 are available with feature #2881 installed. The maximum main storage with V5R1 is 64 GB when all DIMM positions are occupied with 1GB DIMMs.

As in V4R5, feature 3000 is only available on upgrades into the Models 820 or 830 with a maximum quantity of 2. This memory feature is supported in quads with feature 3002 on the Model 820 and in octals with feature 3062 on the Model 830.

iSeries Model 840 Memory Features

Feature	Capacity (MB)	Technology
#3195*	4096	64Mb
#3196	8192	256Mb
#3197*	1024	64 Mb
#3198*	2048	64 Mb
#3612	1024	128 Mb
#3613	2048	256 Mb
#3614	4096	256 Mb

***Not usable with SStar processors**

New Features and New Devices

IBM @server. For the next generation of e-business.

Internal DVD-RAM

- #4430 is mounted in the system unit of models 830, 840, SB2 and SB3 and in the #5074 and #5079 PCI Expansion Towers
- #4530 is mounted in the system unit of models 270 and 820
- Both install in a removable media slot
- Can be used for Alternate IPL, program distribution and data interchange.

External DVD-RAM

- Device type 7210 model 025
- Attaches to new #2768 PCI Adapter and existing #2718 PCI Adapter
- Can be daisy-chained
- Can be used for program distribution and data interchange.
- Not supported by Boot Manager in V5R1

DVD-RAM is a new optical technology that advances the capabilities that CD-ROM brought to the iSeries. It provides the software distribution capability of CD-ROM, but can also write DVD media. The capacity of the media is eight times larger than CD-ROM. The software that may have been distributed on multiple CDs may now only need one DVD-RAM cartridge or one DVD-ROM disk. The media capacity for a DVD-RAM cartridge is 4.7GB per side vs. 650 MB on CD. The drive can also read DVD-ROM media. Its highest capacity can be as much as 9.4GB per side. The drive will read CD-ROM, CD-R, CD-RW, DVD-ROM, and DVD-RAM media. It cannot write CD-ROM media. When the data is compressed in a 3:1 compression ratio, which is average for the AS/400, then a single DVD-RAM cartridge can save about 13GB of data for an unattended save. This may be ideal for backing up the smaller iSeries models such as a model 270. These attributes also allow iSeries to use this media as an interchange and distribution option. The large capacities will also enable cheaper distribution and make SW keys a viable option.

iSeries can have external as well as internal DVD-RAM drives. The possible options are on this foil. Internal DVD-RAM features attach to the internal DASD IOPs in the system units, the base expansion towers, the 5074 and 5079

Disk Controller and Disk Unit

RAID Disk Controller #2778/#4778 or #9778 (base):

-
- Write cache of 104 MB
- Supports up to 18 disk units
- Mode Jumper
- Supports CD-ROM, DVD and internal tape

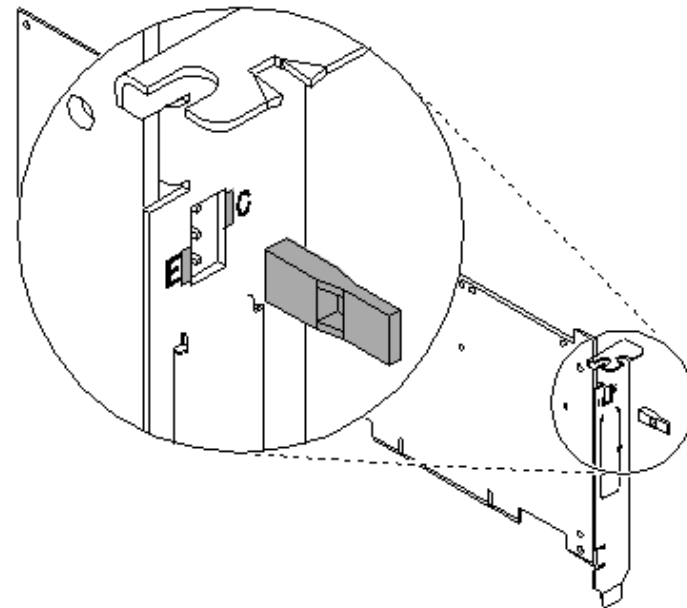

Notes: DASD IOA and DASD Unit

The #4778/#9778 is an Ultra2 SCSI adapter with a maximum compressed write cache size of 104MB that provides RAID-5 protection and compression for internal disk units and also supports internal tape units, CD-ROM and DVD-RAM units.

The #4778/#9778 supports both disk compression and enhanced modes. The mode of operation is determined by a hardware jumper. The Ultra2 SCSI adapter #4778/#9778 is shipped in enhanced mode, which enables compression of the write cache while Extended Adaptive Cache (a Read Cache Device is needed for Extended Adaptive Cache, see below) and/or RAID-protection are also supported. By moving the hardware jumper the adapter will function in **disk compression** mode and you can start compression for selected drives under control of the adapter.

In addition to providing RAID-5 protection for disks, #4778/#9778 is also designed to work as a high performance controller for disks protected by system mirroring or disks with no protection.

#4778/#9778 also supports the #4331 1.6GB Read Cache Device, which is used by Extended Adaptive Cache to provide increased performance. The Read Cache Device (#4331) is supported only when #4778/#9778 is in enhanced mode.

The #4778/#9778 controller supports a maximum of 18 disk units. (NOTE: Due to system CEC and external tower disk unit cage SCSI bus designs, only the model 270 will have a suitable system configuration to allow 18 disk units to attach to a single #4778. All other CEC/tower disk unit configurations will restrict the number of attaching disk units to 15 or less.

Note: The #2778 and #4778 are the identical card. #4778 is installed by the customer and the 2778 is installed by a service technician.

New 1/4 Inch Cartridge Tape Support

Internal Tape Device - 50 GB 1/4-Inch Cartridge Tape Drive

- #4487 can be mounted in 830, 840, SB2 and SB3 and in #5074 and #5079
- #4587 can be mounted in 270 and 820
- Up to 50 GB uncompressed, 100 GB compressed
- Uses Scalable Linear Recording technology (SLR100)

External Tape Device - IBM 7329 Model 308 SLR100 Tape Autoloader

- SCSI attachment to iSeries
- 1/4-inch cartridge tape autoloader
- 8 cartridge capacity
- Up to 400 GB uncompressed, 800 GB compressed
- UP to 2.5 times faster than previous internal 1/4-inch tape drive
- Use new SLR100 50 GB or 5 GB cartridge
- Tape format is compatible with iSeries #4487, #4587 QIC format
- Read/write backward on MLR3 (25 GB) media, read backward on media types MLR1 (16 GB, 13 GB, 2 GB) and SLR5 (4 GB)



IBM  server. For the next generation of e-business.

The 50 GB 1/4-inch cartridge tape features #4487/#4587 may be used for save/restore, alternate IPL, program distribution, migration and 1/4-Inch Cartridge tape exchange (see read and write capabilities below for restrictions). The 1/4-inch cartridge tape features #4487 and #4587, provide up to 100GB of storage capacity, per cartridge using Scalable Linear Recording (SLR), an extension of the Quarter Inch Cartridge (QIC) tape technology. At up to 100GB capacity per cartridge, the new #4487 and #4587 tape units provide unattended backup capability for a broad range of small and medium sized iSeries servers. You will need OS/400 V5R1 and a disk unit controller in CEC/tower where device is to be located.

Read and write capabilities for both the internal and external 50GB 1/4-Inch Cartridge Tape Drives :

- Read / write capability on media types SLR100 (50 or 5 GB) and MLR3 (25 GB)
- Read only capability on media types MLR1 (16, 13 and 2 GB) and SLR5 (4 GB)
- Read/write backward on MLR3 (25 GB) media, read backward on media types MLR1 (16 GB, 13 GB, 2 GB) and SLR5 (4 GB)

Higher function and higher capacity solutions for iSeries AS/400

The 7329 Model 308 Scalar Linear Recording (SLR) 100 Tape Autoloader is a stand-alone SCSI-based device that provides iSeries AS/400 customers with an automated way to back up mission-critical data on their system. The 7329 Model 308 uses the same state-of-the-art tape technology as the system internal tape drive, thus providing interchangeability of all media. Customers are seeking tape backup solutions that provide the best protection for their network's data. The use of tape storage automation has shown that eliminating individual tape handling can actually improve reliability by reducing the incidence of operator error. Also an unattended backup can lower overhead costs.

The 7329 Model 308 with its new high-performance SLR100 tape drive and high technology robotics offers an excellent tape storage solution for iSeries AS/400 customers who use existing QIC technology, or who require higher performance automated tape backup. This new autoloader, with a magazine capable of holding 8 - SLR100 data cartridges, provides up to 400 GB of uncompressed data (800 GB assuming 2:1 compression) and a transfer rate of 5 MB/sec (10Mb per second with 2:1 compression) that significantly increases with data compression.

Attachment to iSeries is via the SCSI interface of the #2768 or #2718 adapter.

Excellent investment protection

The SLR100 Autoloader is read and write compatible with current MLR3 QIC technology, and read-only compatible with three previous QIC tape generations used on AS/400, thus protecting customer tape technology investment and helping ensure data availability. The 7329 Model 308 provides an excellent migration and interchange path from current generations of QIC tape drives. The 7329 autoloader also offers selectable drive cleaning. A cleaning cartridge stored in the magazine is automatically moved to the tape drive when cleaning is required.

Operational modes

The 7329 autoloader is designed to operate in either random or sequential mode depending on user preference. In random mode a tape cartridge may be selected from any slot in the magazine and loaded into the tape drive. In sequential mode tapes are automatically fed into the tape drive beginning with slot one of the magazine.

High-quality media

Scalar Linear Recording data cartridges are designed to improve overall readability and reliability over other current tape technologies. SLR100 media cartridges are available in either 45 meter 5 GB or 455 meter 50 GB capacities.

All cartridges are precision manufactured to exact specifications to ensure consistently high quality and reliability. Each cartridge features an IBM lifetime warranty.

Media for the 7329 Model 308 can be ordered from IBM Media Supplies Distribution or from authorized dealers. To order media and supplies in the United States, call toll-free 1-888-IBM- MEDIA (1-888-426-6344).

iSeries and IBM 3580 LTO

- Linear Tape-Open: 1/2 " cartridge
- Low cost, High performance
 - Uncompressed: 100 GB/cartridge and 15 MBps
- Available 4Q 2000
- OS/400 V4R4 or later
- Overlaps IBM 3570 Tape Library
- V5R1 News: **#2765 new Fibre Channel attach of 3584**



3580

- ▶ Single drive
- ▶ SCSI

3581

- ▶ Auto Loader
- ▶ 7 cartridge
- ▶ SCSI

3583

- ▶ Small Library
- ▶ 18-72 cart.
- ▶ 1-2 drives
- ▶ SCSI

3584

- ▶ Large library
- ▶ 210-2480 cart.
- ▶ 1-32 drives
- ▶ SCSI **or Fibre Channel with drive feature #1456**

IBM  server. For the next generation of e-business.

The new 358x Ultrium tape family of devices support the new industry standard Linear Tape Open (LTO) technology. LTO is a new industry standard for a common server tape, a powerful open tape architecture, setting the stage for a new generation of tape storage products expected to surpass current tape capacity and performance benchmarks while maintaining the highest data integrity. Ultrium is the name given to IBM's implementation of LTO technology. The 358x family uses Small Computer Systems Interface (SCSI) for attachment to iSeries, AS/400®, RS/6000®, Netfinity®, RS/6000 SP™, UNIX® and PC servers, and supports OS/400®, AIX®, Sun Solaris, HP-UX, Windows 2000, and Windows NT™ open systems

Details of iSeries and AS/400 support include:

- 3580 Ultrium Tape Drive, 3581 Ultrium Tape Autoloader, 3583 Ultrium Scalable Library and 3584 Ultrascalable Tape Library
- Requires V4R4 or later and attaches via a #6501, #6534, #2729, #2749 adapter, or new for V5R1 Fibre Channel Tape Controller #2765.
- iSeries and AS/400 servers support the SCSI HVD (High Voltage Differential) electrical interface for these externally attached devices
- Supported in iSeries and AS/400 starting 11/17/2000. OS/400 performance test results should be available approximately May, 2001.

The next foils give an overview of the 3580 Ultrium tape family. OS/400 does not support all 358x functions. For more details refer to the following website addresses:

- <http://www.storage.ibm.com/hardsoft/tape/lto/>

358x Ultrium Family - LTO Technology

IBM  server iSeries



IBM  server. For the next generation of e-business.

The 3580 is built on LTO (Linear Tape Open) technology, a powerful open tape architecture, setting the stage for a new generation of tape storage products expected to surpass current tape capacity and performance benchmarks while maintaining the highest data integrity. LTO technology combines the advantages of linear multi-channel bi-directional formats with enhancements in servo technology, data compression, track layout and error correction code to maximize capacity, performance and reliability.

The LTO Ultrium format offers exceptional investment protection. As a truly open tape solution, the LTO Ultrium format has gained widespread industry acceptance from leading tape drive, media, and automation companies. More than 30 licensees have already demonstrated their endorsement of the technology. Simplified product planning means faster cycle time for new features. Compliance testing ensures that LTO Ultrium drives and media cartridges conform to the specification to deliver data interchange among multiple vendors' products.

One of the LTO implementations is Ultrium, a high-capacity, single-reel that offers up to 200 GB of capacity assuming a 2:1 compression ratio (100 GB native). This is the technology used in the 3580.

The 3580 tape device is IBM's System Storage Division version of the LTO (Linear Tape Open) Ultrium high capacity tape drive. The first generation will provide 15 MB/s with 100 GB/cart native. Data compaction is provided. LTO is new tape technology and is not compatible with any existing tape devices. LTO is a new industry standard for a common server tape. Compressed rate transfer may be up to 30 MB/s.

Aggregate sustained data rates of up to 108 GB/hour (with 2:1 data compression) on a single drive allow extremely high data transfer performance.

The IBM 3580 Ultrium Tape Drive, a stand-alone, Small Computer Systems Interface (SCSI)-attached, LTO Ultrium tape drive, attaches to AS/400®, RS/6000®, Netfinity®, RS/6000 SP™, UNIX® and PC servers, and supports OS/400®, AIX®, Sun Solaris, HP-UX, Windows 2000, and Windows NT™ open systems. It provides a media capacity of up to 100 GB (200 GB with 2:1 compression) data storage per cartridge and a sustained data rate of up to 15 MB per second (uncompressed).

IBM  server. For the next generation of e-business.

With support for Ultrium tape data cartridges, the 3580 Tape Drive provides an excellent migration path from digital linear tape (DLT), ¼-inch, 4-mm, or 8-mm tape drives. The first in a family of IBM Ultrium tape solutions, it is a cost-effective solution for save-and-restore and archiving functions.

The 3580 tape device is an Ultra SCSI device and is supported on the following AS/400 attachments #6534, #2729 and #2749 (V4R5).

The model L11 has an Ultra2 Wide SCSI (low voltage differential) interface. The model H11 attaches through an Ultra Wide SCSI (high voltage differential) interface.

The 3584 Ultrascalable Tape Library 3584 is a new tape library that can be tailored to your needs. Depending on the capacity you require, you can upgrade the library to hold from 14 TB up to 248.1 TB (28 TB to 496.2 TB with 2:1 compression). Model L32 with up to 4 drives gives a native maximum 14.1 TB (141 cartridges), with the maximum of 9 to 12 drives, you get a maximum of 8.7 TB native (87 cartridges) . Expansion frame D32 (up to 5 can be attached) can also hold up to 12 drives. The D32 has a capacity of 44 TB with 1 to 4 drives and 39.6 TB with 9 to 12 drives. In a full configured library, with the minimum of drives, (1 to 4) maximum capacity is 2481 cartridges and with a maximum of drives (68 to 72) 2383 cartridges. Bar code reader is included.

The 3583 Scalable Tape Library should be considered for smaller capacities. The model L18 can contain 18 cartridges, model L36 has 36 cartridge slots and the L72 can hold 72 cartridges. Every cartridge can contain 200 GB of data (assuming a 2:1 compression ratio) or 100 GB native. Maximum capacity of the 3583 would be 14.4 TB again assuming a 2:1 compression ratio. Maximum number of drives in the 3583 Library is six. For capacity requirements over 14 TB, you should consider the Tape Library 3584. Bar code reader is included.

Less capacity requiring configurations can use the 3581 Tape Autoloader with integrated Ultrium tape drive. The model L17 has an Ultra2 Wide SCSI (low voltage differential) interface. The model H17 attaches through an Ultra Wide SCSI (high voltage differential) interface. The 3581 Tape Autoloader accommodates 7 cartridges.

The following web location provides much more detail on LTO technology:

- http://www.storage.ibm.com/hardsoft/tape/lto/prod_data/ultrium.html

See OS/400 Information APAR II12621 for more information.

PCI Expansion Features 5078 and 0578

Up to 4 Expansion Features 0578 can be mounted in a 0551 Rack

5078 placed on top of 5074 or 9079

Provides additional 14 PCI slots for 11 PCI IOAs

Power Distribution Units in 0551

Cable requirements

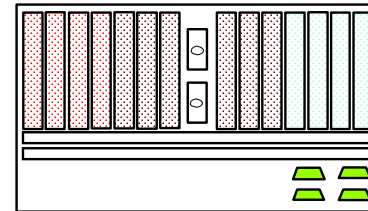

#5074
or
#9079

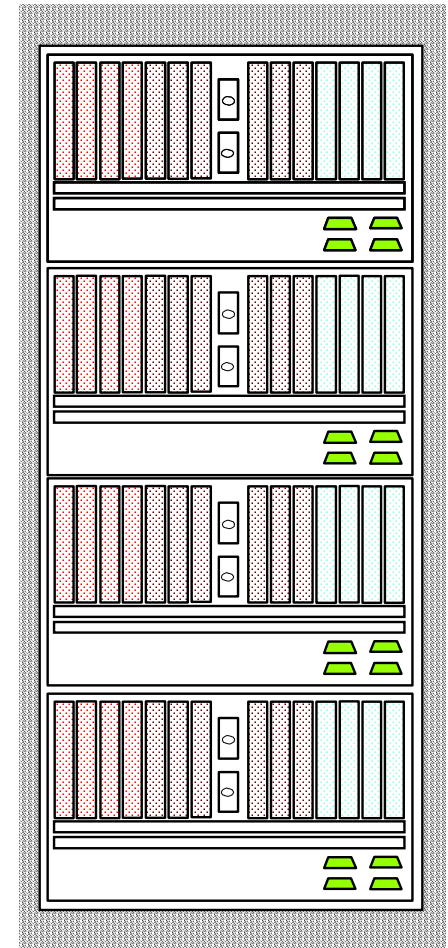

Notes: PCI Expansion #5078 / Specify #0578

The #5078 PCI Expansion Unit is a "top hat" that installs on top of the #9079 Base I/O Tower (model 840 only, not allowed with model SB3) or on top of the #5074 PCI Expansion Tower. The #5078 has 14 PCI slots, which allows up to 11 PCI IOAs to be added. Disk units and removable media devices are not supported and may not be installed in the #5078. The #5078 includes a #9691 bus adapter to provide the HSL interface to the system.

The #5078 includes an electrical cable to connect to the #5074 power source. The #5078 may be ordered with a #5074/#9079 on initial orders and the #5074/#9079 will ship with the #5078 installed. The #5078 may also be ordered as an MES install on an existing #5074/#9079. The #5078 may be on the same HSL loop as the #5074 / #9079, or it may be on a separate HSL loop from the #5074/#9079. If the #5078 and the #5074/#9079 are on the same HSL loop, then a #1460 3m HSL Cable must be ordered to connect the #5078 and the #5074/#9079. If the #5074/#9079 and the #5078 are on separate HSL loops, then 1 or 2 of the following HSL cables must be on the order.

- #1460 - 3m HSL Cable
- #1461 - 6m HSL Cable
- #1462 - 15m HSL Cable

The #0578 is the specify for a #5078 mounted in a #0551 iSeries rack (#0551 announced October 2000). Up to 4 units can be mounted in such a rack. One to four Power Distribution Units (#5160, #5161, 5162) must be ordered or present in the #0551 when a #0578 is ordered. Each #0578 has two power cords , while a Power Distribution Unit has six power cord receptacles, this is why a minimum of one Power Distribution Unit is required if one, two or three #0578s are ordered to be installed in the same #0551. A minimum of two Power Distribution Units are required if four #0578s are ordered for the same #0551 iSeries rack.

#2817 155 Mbps MMF ATM

- Replaces #4816 155 Mbps ATM, when OS/400 V5R1 is ordered

#2760 1 Gbps / 100Mbps / 10Mbps UTP Ethernet UTP IOA

- Unshielded twisted pair (UTP) lower cost than current #2743 1 Gbps Ethernet IOA (multi-mode fibre optic cable)
- Negotiates to 1 Gbps, 100 Mbps, or 10 Mbps
- TCP/IP only, full or half duplex

#2772 and #2773 two line WAN adapters (RJ11) for V.90 support

- Integrated modem on both lines (similar to first line of #9771 shipped with every iSeries system)

#2817 PCI 155 Mbps MMF ATM

#2817 is a 155Mbps Asynchronous Transfer Mode (ATM) PCI card that allows the server to be attached into an ATM network using the Multi-Mode Fiber (MMF) 62.5 micron interface. This interface is intended for connection to both local area switches and direct connection to service provider equipment. #2817 will typically be used where 155Mbps speeds are required over distances of less than 2Km. This card is a 64-bit card, but is allowed to plug into any 32-bit or 64-bit slot. This feature replaces #4816, on orders with V5R1 OS/400 in the configuration.

The #2817 ATM is a Non-Assist IOA. Functions that the card might handle are moved to the system level. Such things as fragmentation reassembly, address verification, IP filtering, and checksum generation verification are handled by the system. This allows the card to process data faster. Increased performance has also come from the more optimized transmit/receive path. This new adapter can potentially move 3 to 5 times more data than the previous PCI 155 Mbps MMF ATM #4816 could move.

#2760 PCI 1 Gbps / 100Mbps / 10Mbps UTP Ethernet Adapter

The #2760 PCI 1Gbps Ethernet IOA feature will allow to attach to IEEE standard 802.3Z high speed Ethernet LANs (1Gbps) to provide a significant performance improvement over other LAN solutions. The adapter supports a UTP CAT 5 media interface. The #2760 PCI Ethernet adapter only supports TCP/IP. This adapter can directly attach to 10Mbps or 100Mbps networks. A #2760 is supported under a #2790, #2791, #2890 or #2891 Integrated Netfinity Servers with V5R1. It is recommended that Enhanced Category 5 cable be used for the best results. The Enhanced Category 5 cable will be less likely to experience problems.

iSeries Ethernet support details

The Gigabit Ethernet Adapter Card (features 2743 (optical fibre) or 2760 (unshielded twisted pair) are one gigabit per second input/output adapters (IOAs) that supports **only TCP/IP**. The #2760 supports half and full-duplex mode while the #2743 supports only full-duplex. The sending and receiving channels can transfer data at approximately one Gbps.

#2760 is lower cost than #2743, but runs at a slightly lower maximum throughput.

Both 1Gbps IOAs support the IEEE 802.3 and the Ethernet Version 2 standards. It also supports frame sizes that include 1496 to 8996 bytes. This card attaches to the 2842 PCI IOP(270), or 2843 PCI IOP(8xx), and Integrated xSeries Servers 2890, 2891, 2790, 2791.

#2743 requirement: You must ensure that all "devices" (switches, routers, bridges) within the communications path can handle the 1 Gbps speed . This card does not negotiate to a lower speed. Speed negotiation is performed only on the #2760 1 Gbps Ethernet adapter, #4838 100 Mbps/10 Mbps Ethernet adapter, or the #2744 100/16/4 Mbps Token Ring adapter.

The industry standard states that gigabit Ethernet frames are to be the same size as 10/100 Ethernet frames, which ranges from 64 to 1518 bytes. All known Ethernet vendors know and meet this requirement. Since the card technology used with #2743 and #2760 supports larger frame sizes you can realize maximum throughput over the 1Gbps communication link by using switches that support frame sizes in the 1518 through 8996 bytes range. At the time of publication there is only one known vendor switch that supports the larger frames. See the Notes that follow. If you are in doubt about the switch frame size capacity you must not specify a frame size greater than 1496 on the AS/400 Ethernet Line description MAXFRAME parameter.

1 Gbps Ethernet support continued

If the maximum frame size specified is greater than 1496 bytes, LINESPEED(1G) or LINESPEED(*AUTO) and DUPLEX(*FULL) or DUPLEX(*AUTO) must be specified for the #2743. For the 2760 DUPLEX(*FULL or *HALF or *AUTO) may be specified..

For the #2743:

- The technology used in the 2743 card does not negotiate to a lower speed than 1 Gbps. The #2743 1 Gbps Ethernet Adapter) requires a 1 Gbps-capable switch with at least one port that supports a 1000BASE-SX interface with IEEE 802.3z and 802.3u compliance. The 2743 supports only a multi-mode fiber optic cable connection from the AS/400 adapter to the switch.
- Depending on the switch capabilities, other devices on the network could use different cable types (UTP) and speeds (100 Mbps or 10 Mbps).
- A customer-supplied cable with the following specifications is used to attach the adapter to the switch: SC (fiber optic) connector, multi-mode fiber cable (62.5/125 micron fiber or 50/125 micron fiber).

Vendors that provide the required 1 Gbps switch hardware interface include the following. There are others.:

- Alteon Web Systems - <http://alteonwebsystems.com>
This vendor provides 1 Gbps switches with the capability to process 8996 byte frames
- N Base Communications Giga Frame Switch - <http://www.3com.com/util/contact.html>
- 3COM Super Stack II Switch 9000 - <http://www.nbase-xyplex.com/contactus/index.cfm>

Notes: Communication Adapters...

#2772 and #2773 two line WAN adapters

#2772 and #2773 are basically the same interface, the #2772 is the non-CIM (Complex Impedance Matching) version of this card. Both are 2-line WAN adapters, with two ports (RJ11) supporting V.90 56K Async PPP and FAX applications at data rates up to 14.4K via internal modems. Connection to the V.90 ports is via telephone cable. Both these features do not support remote power on. The new cards can be used for the purpose of Multilink. These cards need country specific telephone cables (minimum one and maximum two per card). **Feature #2773, the Complex Impedance Matching version is intended for Australia and New Zealand only.**

Compared with the existing #4761 with eight analog modem ports, the #2772/#2773 and #4761 both have fax capabilities, but the #4761 is more robust in this area. This is because the #4761 handles the fax process in the card whereas the #2772/#2773 passes it off to the system. The #2772/#2773 is a good option for those wanting to add some additional ports, but not wanting to add eight and if you do not need V.34 synchronous support that is provided by the #4761.

The feature code #9771 integrated V.90 modem will continue to be shipped with new systems. The two ports of the #2772 or #2773 are the same as the V.90 port of the #9771.

Minimum of one modem cable, maximum of two must be selected/ordered for each #2772 / #2773. Cable features that can be ordered:

#1010 Modem Cable - Austria	#1014 Modem Cable - Italy	#1018 Modem Cable - Iceland/Sweden	#1022 Modem Cable - Netherlands
#1011 Modem Cable - Belgium	#1015 Modem Cable - France	#1019 Modem Cable - Australia (note)	#1023 Modem Cable - Swiss
#1012 Modem Cable - Africa	#1016 Modem Cable - Germany	#1020 Modem Cable - HK/NZ (note)	#1024 Modem Cable - Denmark
#1013 Modem Cable - Israel	#1017 Modem Cable - UK	#1021 Modem Cable - Fin/Nor	#1025 Modem Cable - US/Canada

Note : Only cable #1019 and cable #1020 can be ordered with #2773; all cables except #1019 can be ordered for #2772. All modem cables for #2772 / #2773 that are ordered/present on one iSeries server must have the same feature number.

IBM  server. For the next generation of e-business.

#2754 Bus Expansion with 8 HSL ports

- Enables Clustering over HSL on iSeries Models 830 and SB2 (all processor features except #2400)

#2777 Bus Expansion with 8 HSL ports

- Enables Clustering over HSL on iSeries Model 830 processor #2400

#2755 Bus Expansion with 16 HSL ports

- Enables Clustering over HSL on iSeries Models 840 and SB3

Enable clustering over HSL on the Model 270 or Model 820:

- Upgrade to an SStar (Year 2001) 270, 820

Notes: New HSL Adapters

The HSL adapters mentioned in the previous foil can be purchased to replace the existing HSL adapters in the iSeries models 830, 840, SB2 and SB3 announced in 2000. The installed adapters in these models do not support HSL OptiConnect. If you want to use these models in a cluster using HSL OptiConnect with physical HSL connections between the clustered servers, you must order and install the appropriate HSL adapter for your server. These new adapters also support switching of HSL towers with Independent Auxiliary Storage Pools between HSL connected iSeries servers.

To enable clustering over HSL on a model 270 or a model 820 you must upgrade your existing server to one of the V5R1 processor features. The upgrade contains the parts enabling the HSL ports for clustering. There is no support for clustering over HSL on the V4R5 iSeries hardware of the models 270 and 820.

Attach 5035 to new 820 (RPQ 847120)

Obtain Migration tower 5035 on new 820:

- Allows to install SPD cards into new 820 configuration
- Allows to attach expansion towers via optical cable and optical adapter (#2688)
- Requires HSL cables and SPCN cable

Notes: Attach 5035 to new 820 (RPQ 847120)

This chargeable RPQ allows a new Migration Tower 1 (FC 5035) to be ordered, shipped, and attached to a plant-shipped 820. A typical Migration Tower 1 is created from the Model 620/S20/720 system unit during an MES upgrade to a Model 820. Before this RPQ, there was no way to order a migration tower for a new, non-MES Model 820. As the migration tower was the only way to use the older SPD adapters and older SPD bus-attached I/O towers, this caused a restriction for the few functions which had not yet been implemented using newer AS/400 PCI packaging.

This RPQ migration tower is equivalent to the 620/S20/720/820's no-charge Feature Codes 5035 and 9331. Feature Codes 5035 and 9331 are in fact used in the configuration record. It provides six SPD slots and eleven PCI slots. These slots may be used at the customer's discretion for any supported configuration. Only a small subset of the possible SPD/PCI adapters which will work in this RPQ migration tower can be installed by manufacturing in the migration tower and shipped to the customer. Adapters not on the following list can be ordered/shipped separately and installed at the customer site.

Feature codes which can be ordered and installed by IBM manufacturing plant, if ordered with this RPQ on the same MES order:

- #6501 - Magnetic Storage Controller (SCSI adapter for external disk - maximum 3 in migration tower)
- #6534 - SPD Magnetic Media Controller SCSI card
- #2688 - Optical Link Processor (maximum 2).

As this migration tower does not come from an MES upgrade, it does not contain a CD-ROM, tape, or any disk drives in the migration tower itself. These I/O devices could be ordered after the migration tower has been installed via a separate MES order. However, most customers should choose to use newer I/O devices located in the 820 or in newer technology PCI I/O towers such as FC 5074 or 5075. The Migration Tower 1 includes one Optical Bus Adapter. No additional Optical Bus Adapters can be added. The Optical Bus Adapter supports up to two 1063 Mbps Optical Link (#2688) cards. Each Optical Link card can attach up to two 50xx SPD I/O towers. This migration tower is not CSU (customer setup). #14xx line cord and HSL cable(s) should be specified on the order.

The RPQ does not come with a redundant power supply. If a redundant power supply is desired, it must be ordered separately.

Allows a single PC to serve as an Operations Console for multiple iSeries servers and/or for multiple iSeries partitions

Service Tools Security

- Service Tools Device Profile
- Service Tools User Profile

Specify Codes for iSeries with V5R1

- Specify 5546 for Operations Console on Token Ring LAN
 - Requires #2744 : 4 / 16 / 100 Mbps Token Ring Adapter
- Specify 5548 for Operations Console on Ethernet LAN
 - Requires #4838 : 10 / 100 Mbps Ethernet Adapter

Placement rules and dedicated IP address

Operations Console has been enhanced in V5R1 to enable connections across a local area network (LAN), besides enabling directly cabled and dial-in (modem) connections. A single PC can have multiple connections to multiple iSeries servers and can be the console for multiple iSeries servers. An example would be a logically partitioned server using the same PC as the console for all partitions. Since each partition is considered a separate iSeries server, you need a separate interface for each partition for which you want to be the console. Operations Console on the LAN allows multiple connections to a single iSeries server, but only one PC can have control of an iSeries server at a time. It also allows multiple local controlling system (LCS) connections, but only one directly cabled LCS configuration. You can use the remote control panel functions on the same PC for any connected iSeries server. You can use the remote control panel for secondary partitions through a LAN connection to the primary partition. The details of the setup wizard and the different possibilities you have for configuring functions on your Operations Console PC connected on the LAN will be explained in the following foils.

You will have a high level of security for the connections of Operations Console on the LAN. Enhanced authentication and data encryption provide network security for console procedures. Operations Console with LAN connectivity uses a version of SSL which supports device and user authentication but without using certificates. Details are fully documented in the Operating System presentation. What you need to know for the purpose of understanding the flow in this presentation however is the concept of the:

- **Service Device Profile** : the service device profile is a device description with an associated password (can be 128 characters long). Service device authentication assures which physical device is the console. More explanation later in this presentation
- **Service User Profile** : the service user profiles are not a new concept, there have always been the shipped service user profiles of QSECOFR, QSRV, 11111111 and 22222222. The service user profiles are used to access the service tools functions were this profile has been granted authorization to. New for V5R1 is that you can create service user profiles yourself and grant it authority for specific selected service tools functions.
- **Service tools security log** : a service user profile with the proper authority can work with the service tools security log and view, display, print, save or restore service tools security log data. The service tools security log contains loggings for actions performed against service tools security such as granting or revoking authority, creating or deleting profiles or attempts to violate service tools security.

Operations Console on the LAN: The Concept

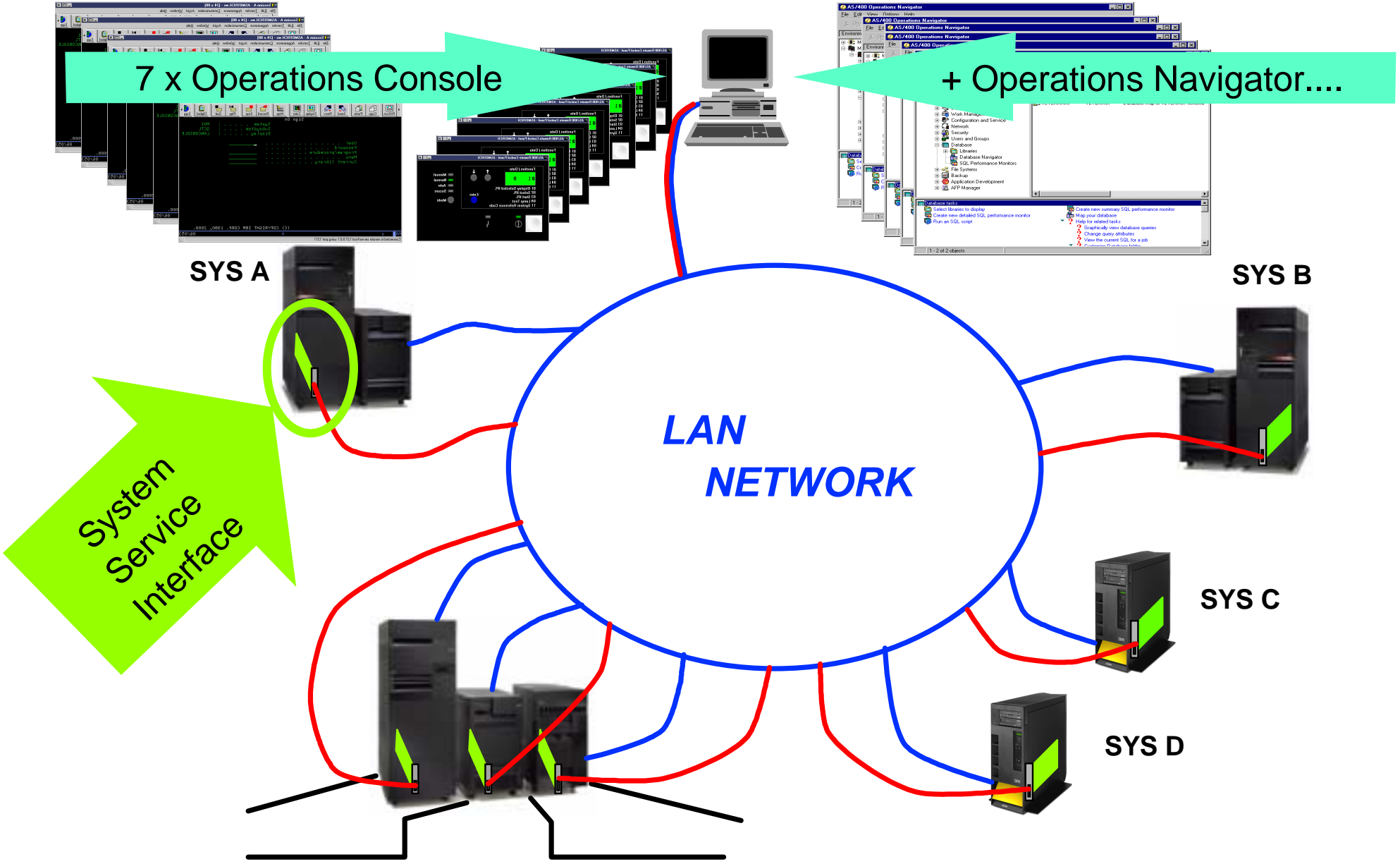

IBM e server. For the next generation of e-business.

Operations Console - Direct attach or via a switched connection has been available for several releases as a console device alternative to twinax attached 5250 workstations. Now in V5R1 a 3rd console device attachment - over an existing LAN network, becomes available. The objective of the Operations Console on the LAN support is to enable a single workstation device to be the console to multiple AS/400 or iSeries systems and/or multiple partitions in a single iSeries or AS/400 system.

The Operations Console on the LAN console attachment is specified as one of the following:

- Specify 5546 for Operations Console on Token Ring LAN
 - Requires #2744 : 4 / 16 / 100 Mbps Token Ring Adapter
- Specify 5548 for Operations Console on Ethernet LAN
 - Requires #4838 : 10 / 100 Mbps Ethernet Adapter

V5R1 Client Access Express either under EZ-Setup wizards or on the client workstation at a later time under Operations Console are used to configure the client workstation side of Operations Console.

On the host/server side, new V5R1 Service Tools Security is used to secure Dedicated Service Tools (DST) functions as well as System Service Tools (SST) functions for Disk Unit and Logical Partition functions from either a console device or Operations Navigator Configuration and Services-Hardware interface. For Operations Console on the LAN there is additional Service Tools Device Profile security that must be configured to perform console functions.

You can specify certain device profile security that permits only specific PC workstations to perform LAN Console (and Control Panel) functions. Multiple LAN console connections can be active per system/partition at a time, but only one can have an active emulator with console screen data, the others would be void screen data. This is accomplished on a first in first served basis.

As depicted in this foil, Operations Console for the LAN assumes complete control over a specific 270, 8xx LAN adapter per system or partition. If concurrent standard LAN activity, such as running Operations Navigator functions, is desired, a second LAN adapter must be configured and varied on. Separate IP addresses are required.

The system service interface requires a dedicated LAN adapter. See the red line from a workstation to the green rectangle in each system/partition. If concurrent standard LAN activity, such as running Operations Navigator functions, is desired, a second LAN adapter must be configured and varied on. Separate IP addresses are required. The dark blue line from the PC to each system/partition represents the "normal function" IP address on each system.

Operations Console on the LAN does not need a cable (#0382) to be able to work with the functions of the Remote Control Panel. Selecting the function during the setup and given the fact that the privileges have been granted for the Service Device Profile as well as for the Service User Profile using the function is enough to get the Remote Control Panel to work on the PC. When you select the Operations Console on the LAN for your iSeries Server, IBM will deliver one #0367 Operations Console cable with a new order, or deliver you one with an upgrade if that cable is not yet on your configuration.

For more details on setting up Operations Console, refer to:

- V5R1 *Operations Console Setup*, SC41-5508-02
- V5R1 Technical Overview presentation - OS/400

For more details on Service Tools security and Device Profile security, refer to :

- V5R1 *Tips and Tools for Securing your iSeries*, SC41-5300-05
- V5R1 Technical Overview presentation - OS/400

Setup Operations Console on the LAN

IBM  server iSeries

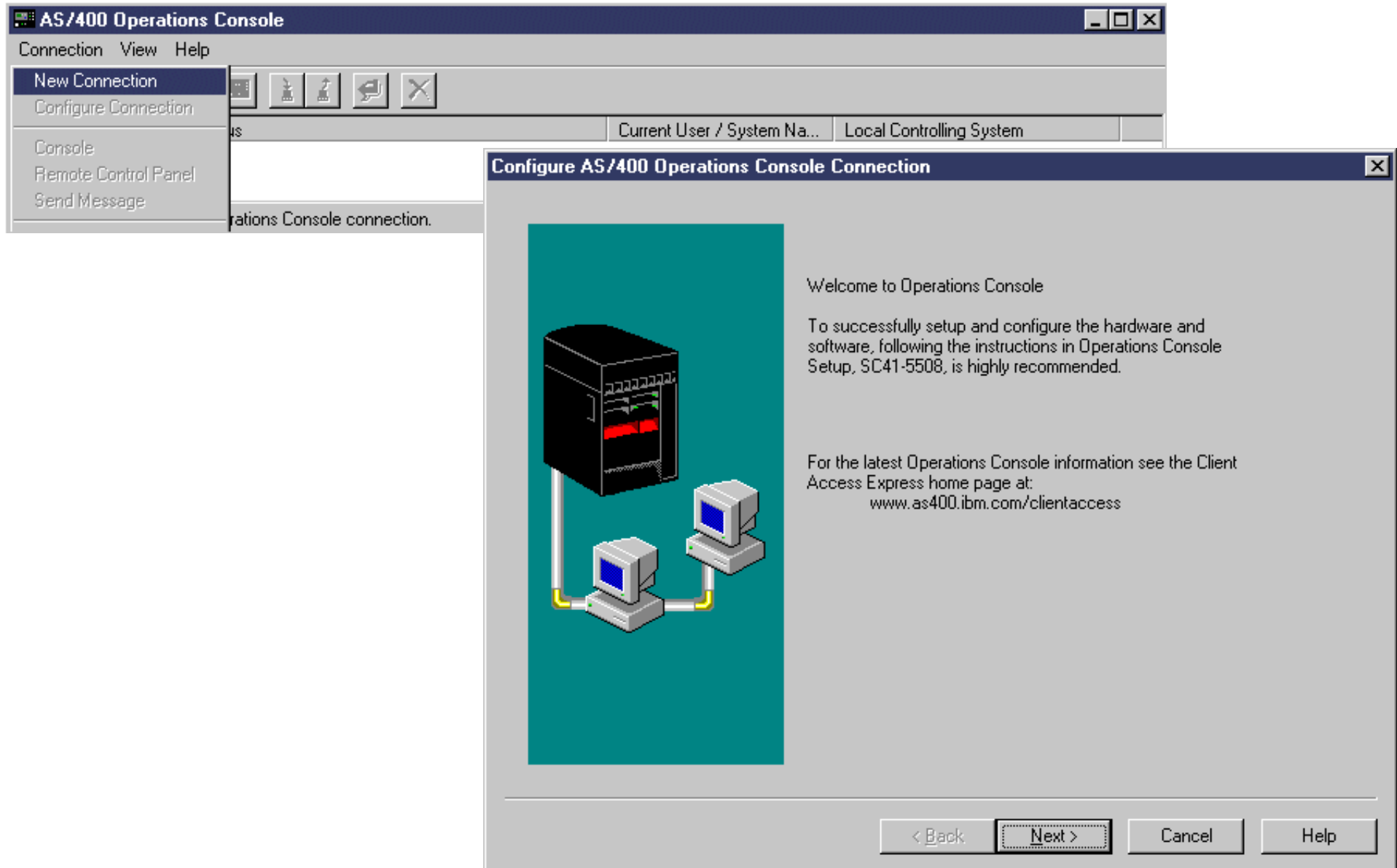

The screenshot displays the AS/400 Operations Console interface. The main window has a menu bar with 'Connection', 'View', and 'Help'. The 'Connection' menu is open, showing options: 'New Connection', 'Configure Connection', 'Console', 'Remote Control Panel', and 'Send Message'. Below the menu is a toolbar with icons for connection management. The main area shows 'Current User / System Na...' and 'Local Controlling System'. A dialog box titled 'Configure AS/400 Operations Console Connection' is overlaid on the main window. The dialog box contains the following text:

Welcome to Operations Console

To successfully setup and configure the hardware and software, following the instructions in Operations Console Setup, SC41-5508, is highly recommended.

For the latest Operations Console information see the Client Access Express home page at:
www.as400.ibm.com/clientaccess

The dialog box also features a diagram on the left showing an AS/400 server rack connected to two desktop computers via network cables. At the bottom of the dialog box are four buttons: '< Back', 'Next >', 'Cancel', and 'Help'.

IBM  server. For the next generation of e-business.

Notes: Setup Operations Console on the LAN

IBM  server iSeries

After you installed all required Client Access components and the additional programs for the Operations Console on the LAN on your PC from the **iSeries Operations Console Update CD-ROM**, open Client Access and Click AS/400 Operations Console. The first pane show in this foil will appear. You may now start configuring a new connection. Just click the Next button on the pane.

IBM  server. For the next generation of e-business.

Setup Operations Console on the LAN...

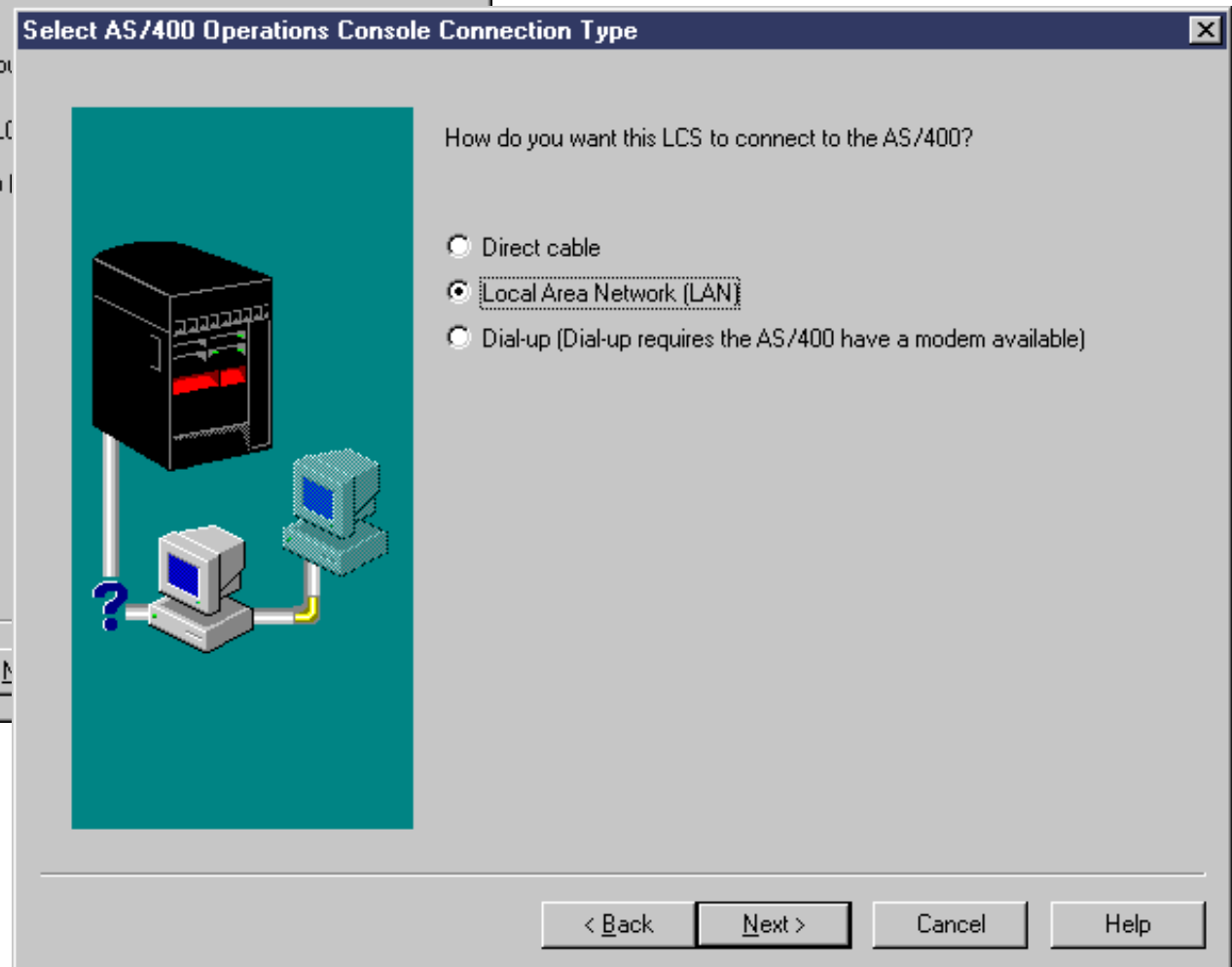
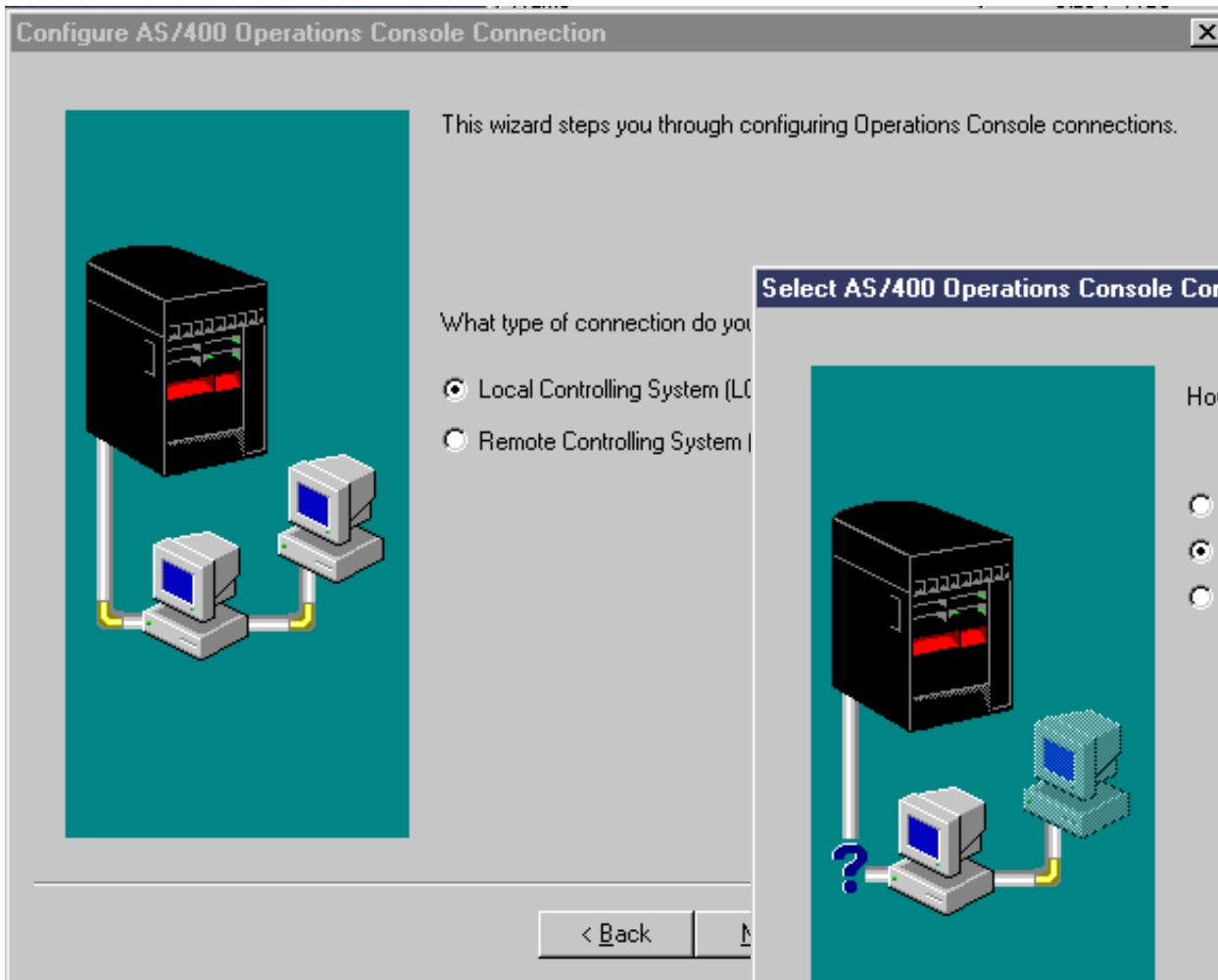

IBM  server. For the next generation of e-business.

Notes: Setup Operations Console on the LAN...

The next two panes that appear on your PC are shown on this foil. For configuring the Operations Console on the LAN, you must select the Local Controlling System and in the follow on pane the LAN option.

IBM @server. For the next generation of e-business.

Setup Operations Console on the LAN....

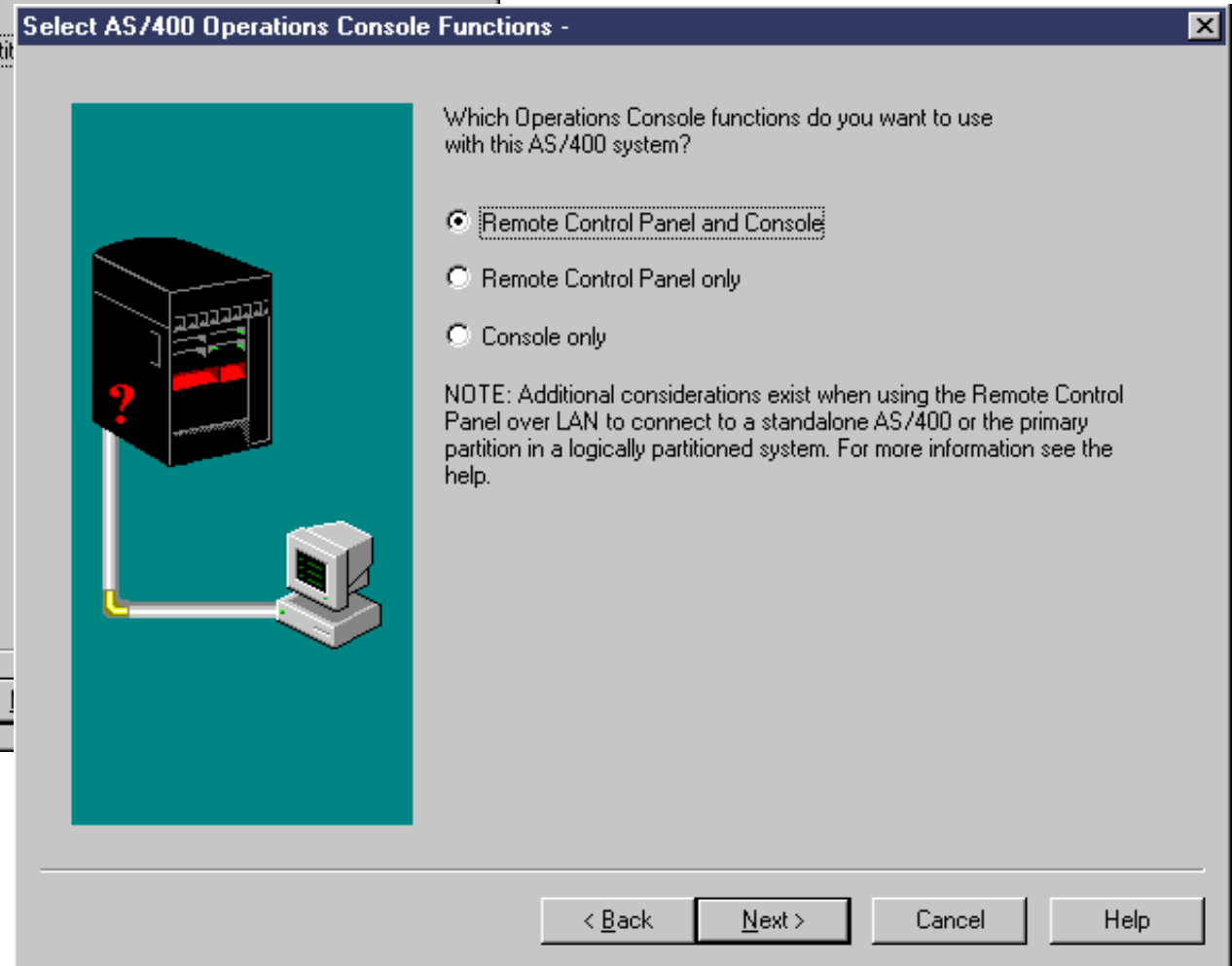
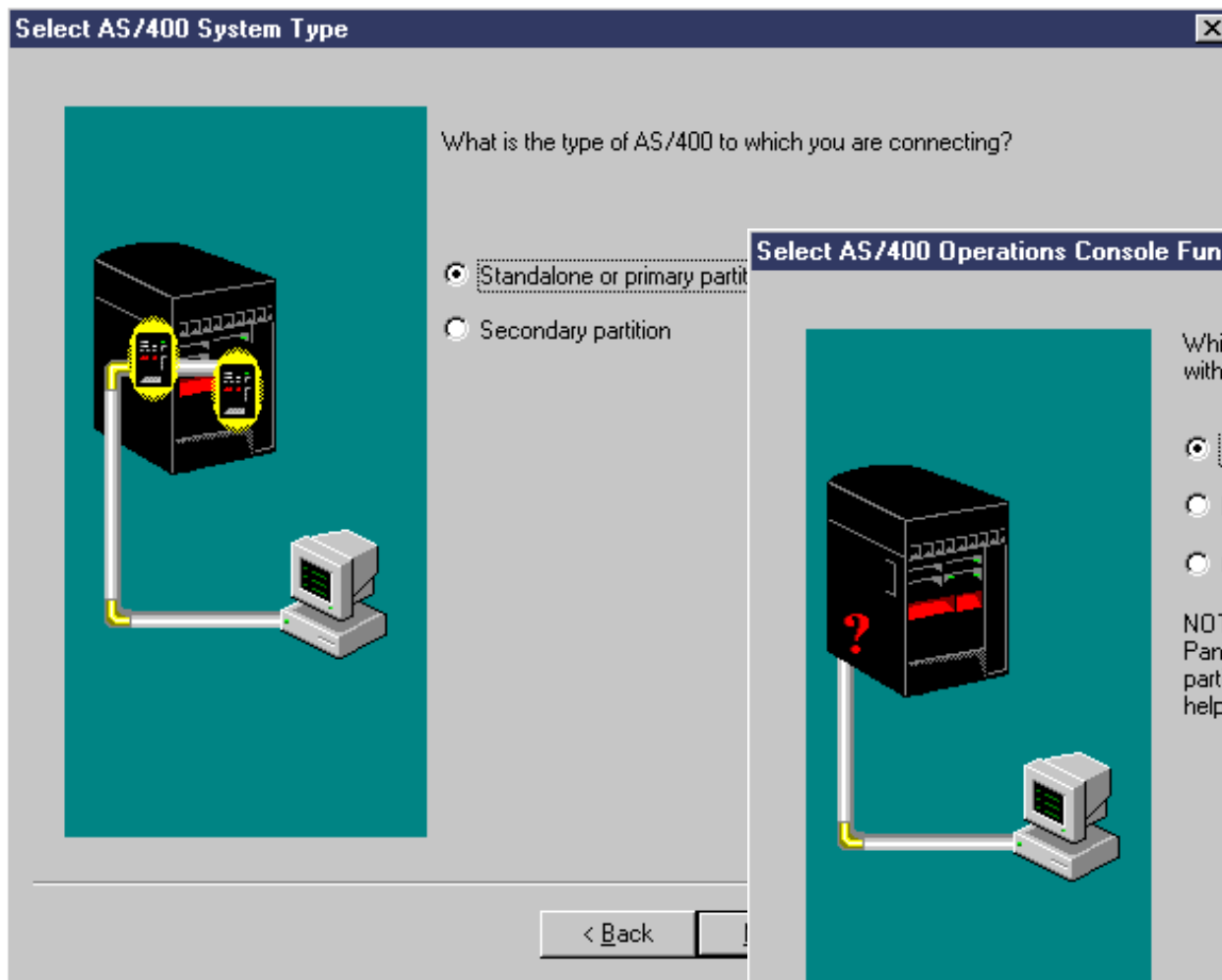

Notes: Setup Operations Console on the LAN....

IBM @server iSeries

The selectable options in the next two panes are fairly straightforward to select. Depending the partition where you are configuring the console for, you can select either the primary or the secondary partition. Next you must select the function or the combination of functions you want to use on the Service Device you are configuring. You may select the Remote Control panel only, the Operations Console only or the combination of both. With the shipped QCONSOLE service device, you have authority to use both. However, when you create a service device profile yourself, you must grant the service device profile authority to use the remote control panel function. **It makes sense to restrict the authority for the remote control panel to only one or two service device profiles, thus avoiding confusion by multiple or concurrent use of the remote control panel functions.**

IBM @server. For the next generation of e-business.

Setup Operations Console on the LAN....

IBM  server iSeries

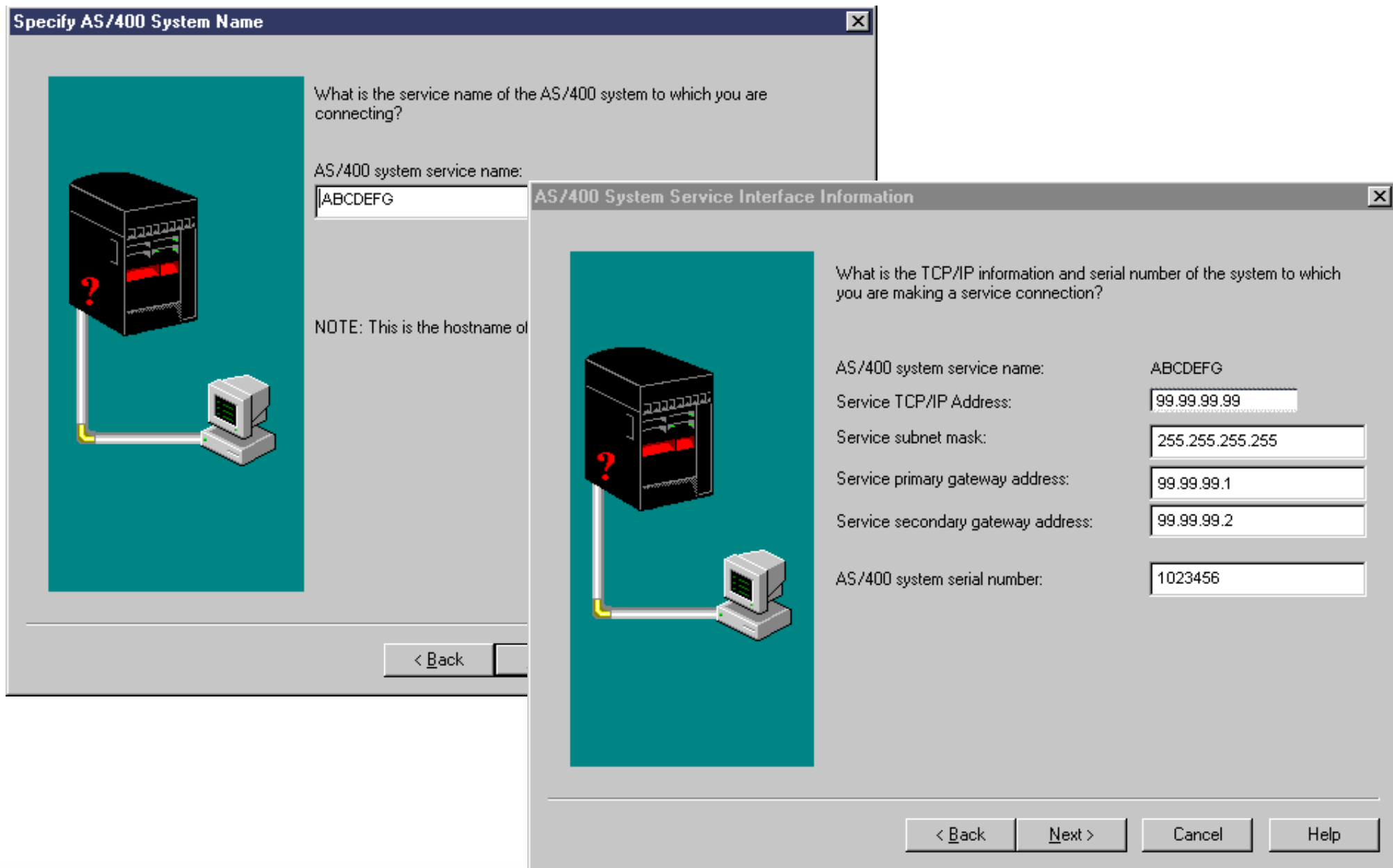

The screenshot displays two overlapping windows from the Setup Operations Console. The background window, titled "Specify AS/400 System Name", asks for the service name of the AS/400 system. The text "ABCDEFG" is entered in the input field. A note below states "NOTE: This is the hostname of". To the left is an illustration of an AS/400 system connected to a computer. The foreground window, titled "AS/400 System Service Interface Information", asks for TCP/IP information and the serial number. It contains several input fields with the following values: "ABCDEFG" for the service name, "99.99.99.99" for the TCP/IP address, "255.255.255.255" for the subnet mask, "99.99.99.1" for the primary gateway, "99.99.99.2" for the secondary gateway, and "1023456" for the serial number. Both windows feature a "Back" button, and the foreground window also has "Next >", "Cancel", and "Help" buttons.

Specify AS/400 System Name

What is the service name of the AS/400 system to which you are connecting?

AS/400 system service name:

NOTE: This is the hostname of

< Back

AS/400 System Service Interface Information

What is the TCP/IP information and serial number of the system to which you are making a service connection?

AS/400 system service name:

Service TCP/IP Address:

Service subnet mask:

Service primary gateway address:

Service secondary gateway address:

AS/400 system serial number:

< Back Next > Cancel Help

IBM  server. For the next generation of e-business.

In the next step you have to give the service interface a name. This name is independent of the system name that you may specify in the network attributes, it may be easier for you to select the same name and simplify the association of the server name used in the operating system with the one you use with the service interface. The name you specify will be configured in the iSeries during the first successful connection process. In the next pane you must specify the correct IP address for your iSeries service interface. **Remember that this IP address cannot be used for other communication activities other than those for the Operations Console and /or the remote control panel functions from the service interface.** You will also notice later when the Operations Console on the LAN is configured and working that the LAN adapter associated with the service interface can't be used for other LAN activities such as for example Operations Navigator communications. The resource of this adapter can be used to configure a line description, but the user will not be able to vary it on as DST has taken the ownership of the resource.

Setup Operations Console on the LAN.....

AS/400 Operations Console Service Tools Device Information - ABCDEFG

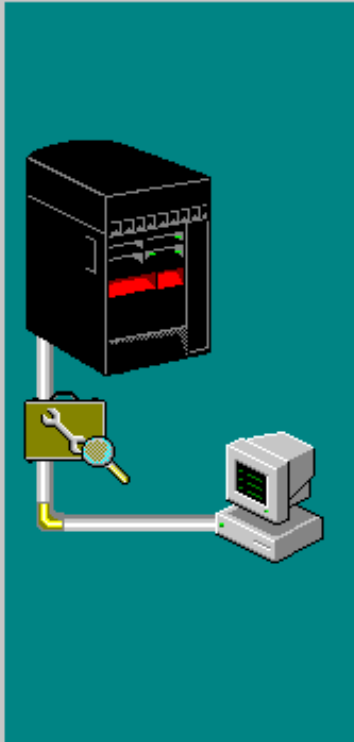

To safely use AS/400 service functions with a LAN connection you must specify the following information. This protects access to AS/400 service functions such as the console and remote control panel. For more information see the help.

AS/400 system service name: ABCDEFG

Service tools device profile information

Service tools device profile for this PC: QCONSOLE

Password:

Confirm password:

Note: This must exactly match what you specify on the AS/400.

Service tools device profile information password

Password to access the service tools device profile information:

Confirm password:

< Back Next > Cancel Help

Notes: Setup OpsConsole on the LAN.....

As shown in this foil, when using Operations Console with LAN connectivity, the setup wizard will add the necessary information to the PC by asking you for the service tools device profile, the service tools device profile password, and a password to protect the service tools device profile information.

The shipped name for the default Operations Console service device is QCONSOLE, the associated password is QCONSOLE in capitals (***service device names and associated passwords are case sensitive***). This password is used by the **PC and iSeries** and not by the user. You do not have to remember it for any other activity apart for the initial setup of your service device on your PC. The Operations Console function re-encrypts changes and re-encrypts the service tools device profile password during each successful connection.

For the password to access the Service tools device profile information, type the password you want to use to protect the service tools device profile information and type it again in to confirm it. The password is also case sensitive and can be a maximum of 128 characters of mixed case long. **It is very important that you remember this password.** You will use this password later, during the connection process, to sign on the Service Device Sign-on window. This password is for the **user of the service device.**

Setup Operations Console on the LAN.....

IBM  server iSeries

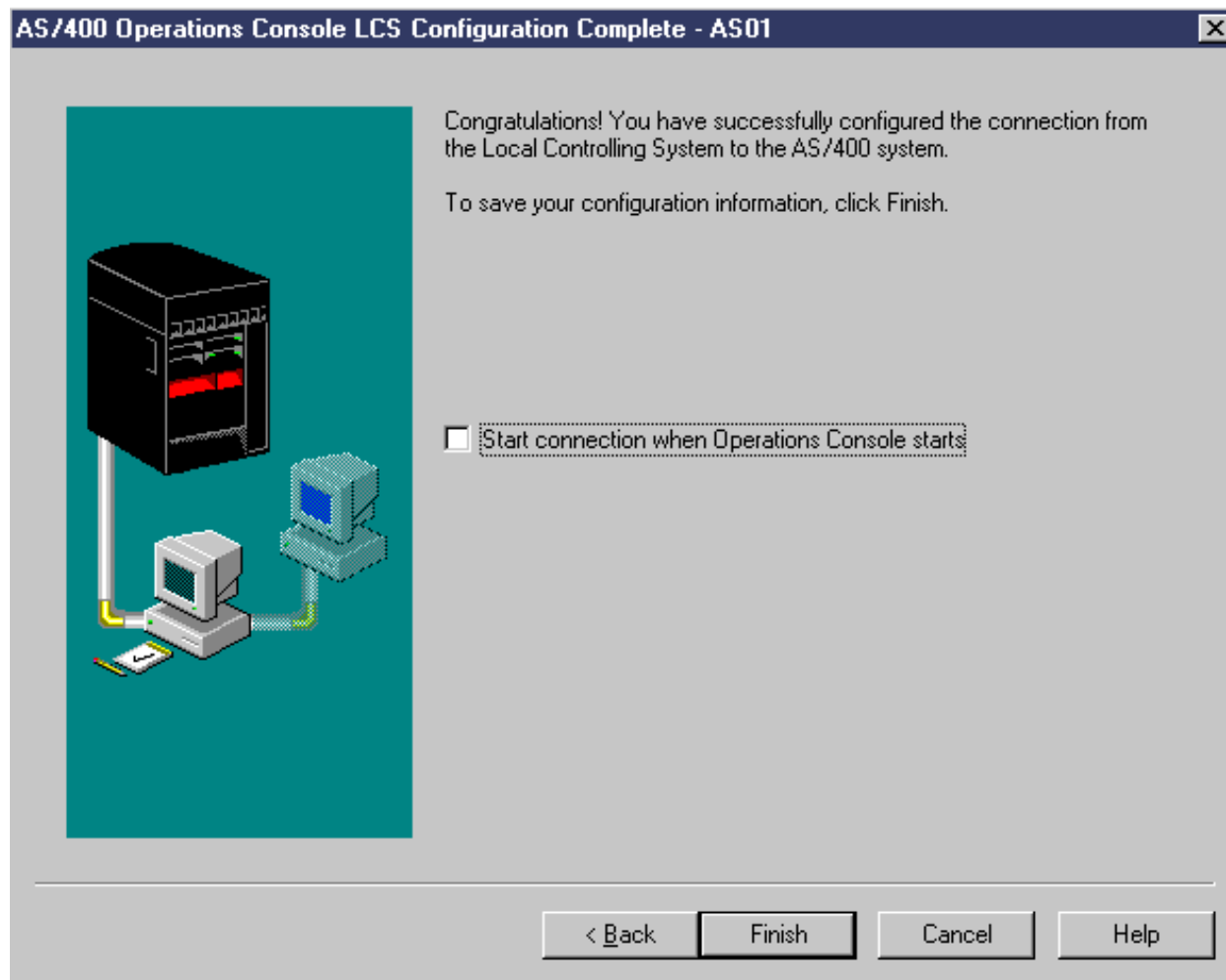

IBM  server. For the next generation of e-business.

Notes: Setup OpsConsole on the LAN.....

Before you finish the setup, you can choose to either start the previously configured connection automatically whenever you start the Operations Console function from Client Access or to manually start the connection. It is recommended that you leave the Start connection when Operations Console starts check box unchecked until you verify that the connection and functions work properly. It is difficult to work with setup problems once the connection is started.

Operations Console on the LAN

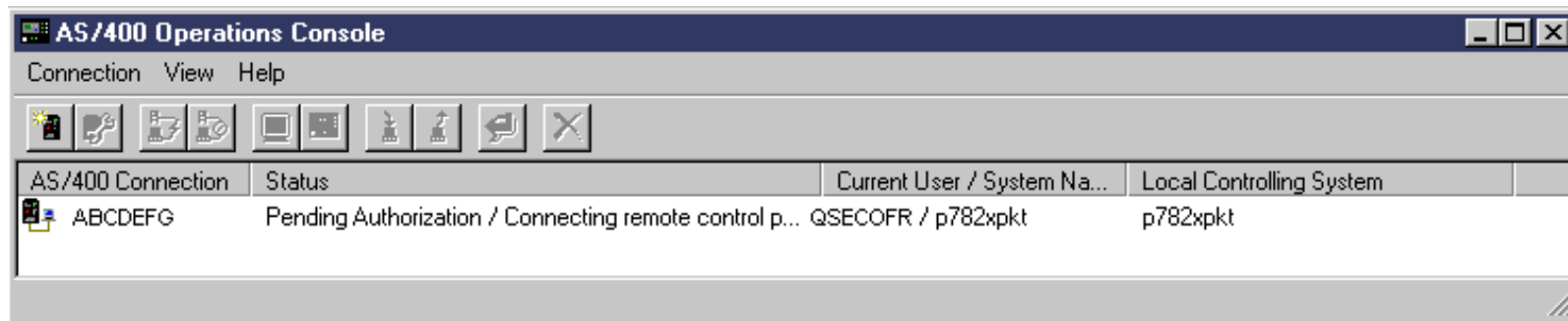
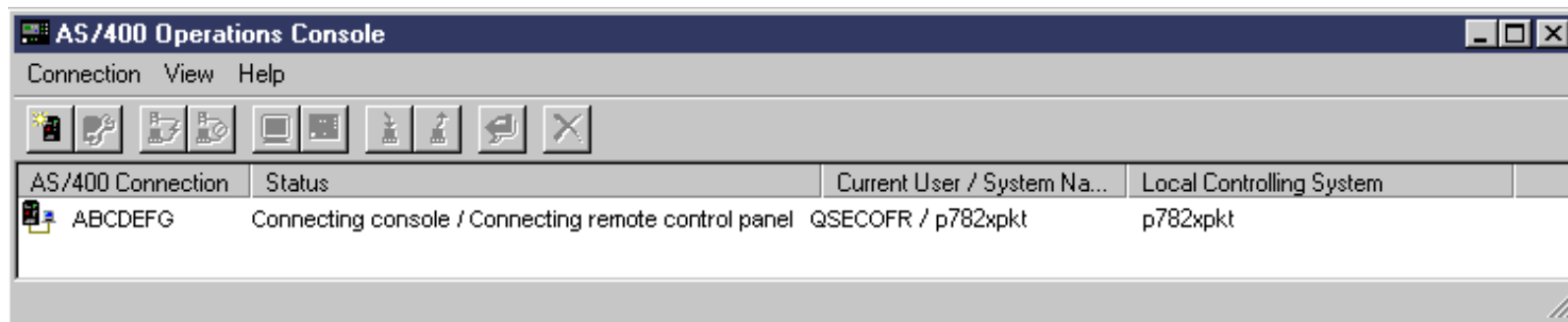
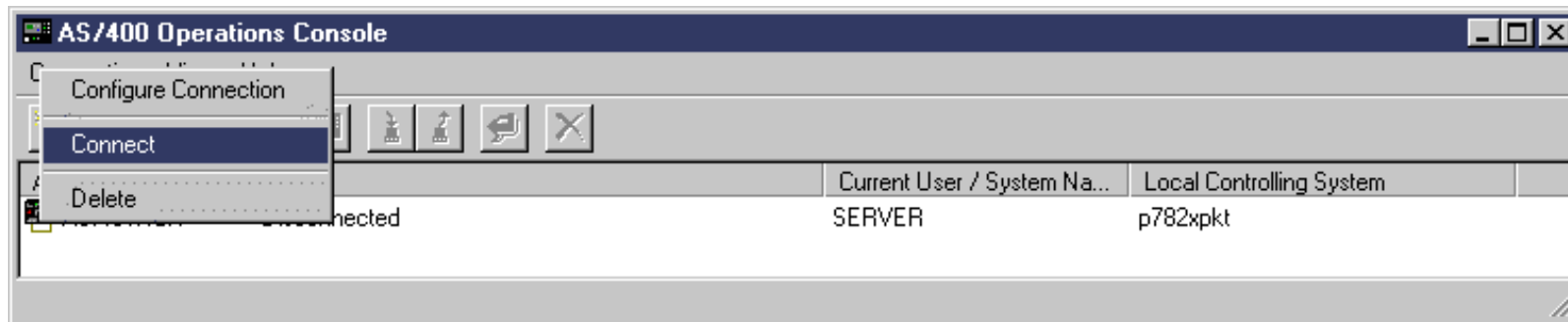

Notes: Operations Console on the LAN

IBM  server iSeries

This foil shows how the Operations Console pane changes when you start the connection of the service device with the service device interface on the iSeries server.

IBM  server. For the next generation of e-business.

Operations Console on the LAN

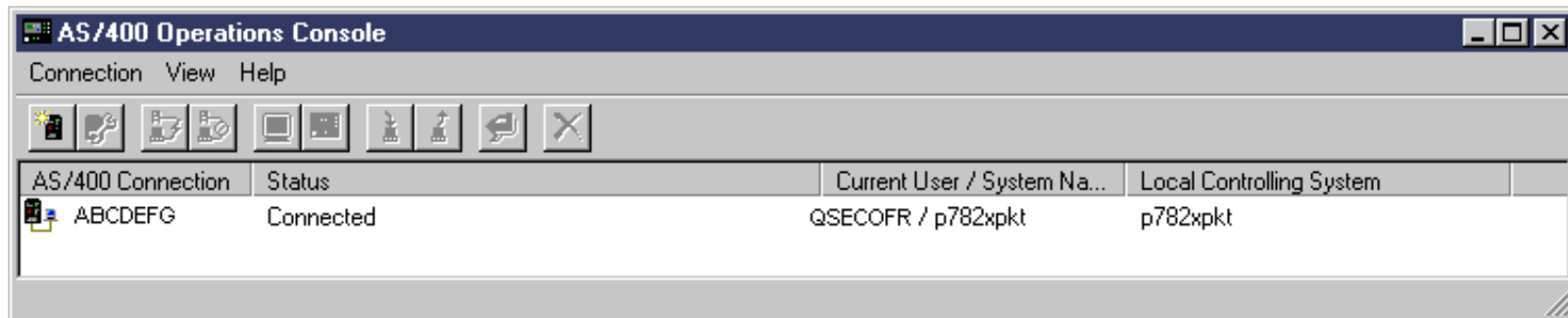
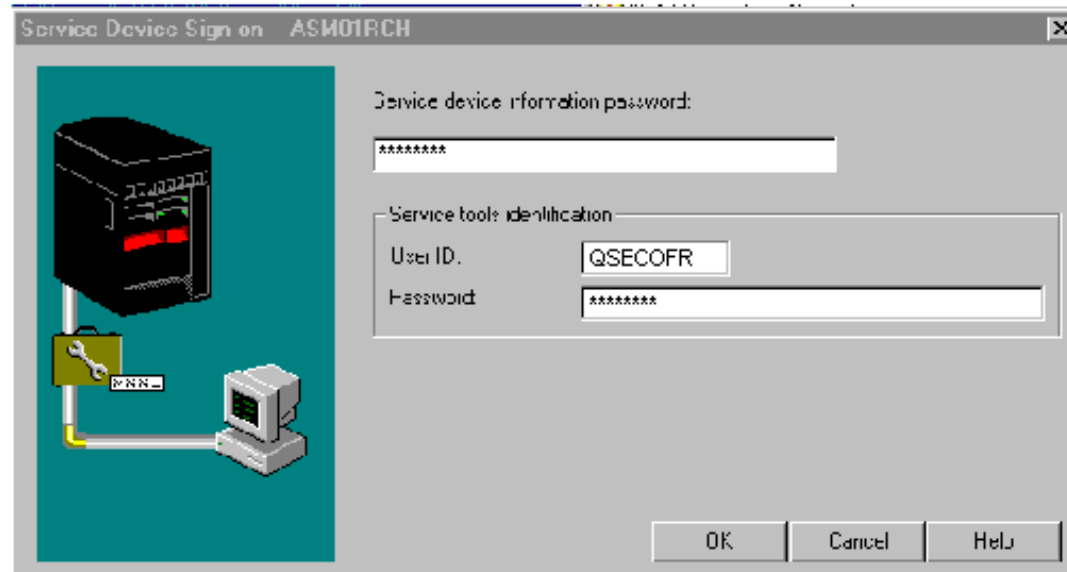

Notes: Operations Console on the LAN

IBM  server iSeries

The service tools device profile information password is used to protect the service tools device profile information (service tools device profile and password) on the PC. When establishing a network connection, the Operations Console setup wizard will prompt the user for the service device information password to access the encrypted service tools device profile and password. The user will also be prompted for a valid service tools user identification and password.

IBM  server. For the next generation of e-business.

Operations Console on the LAN

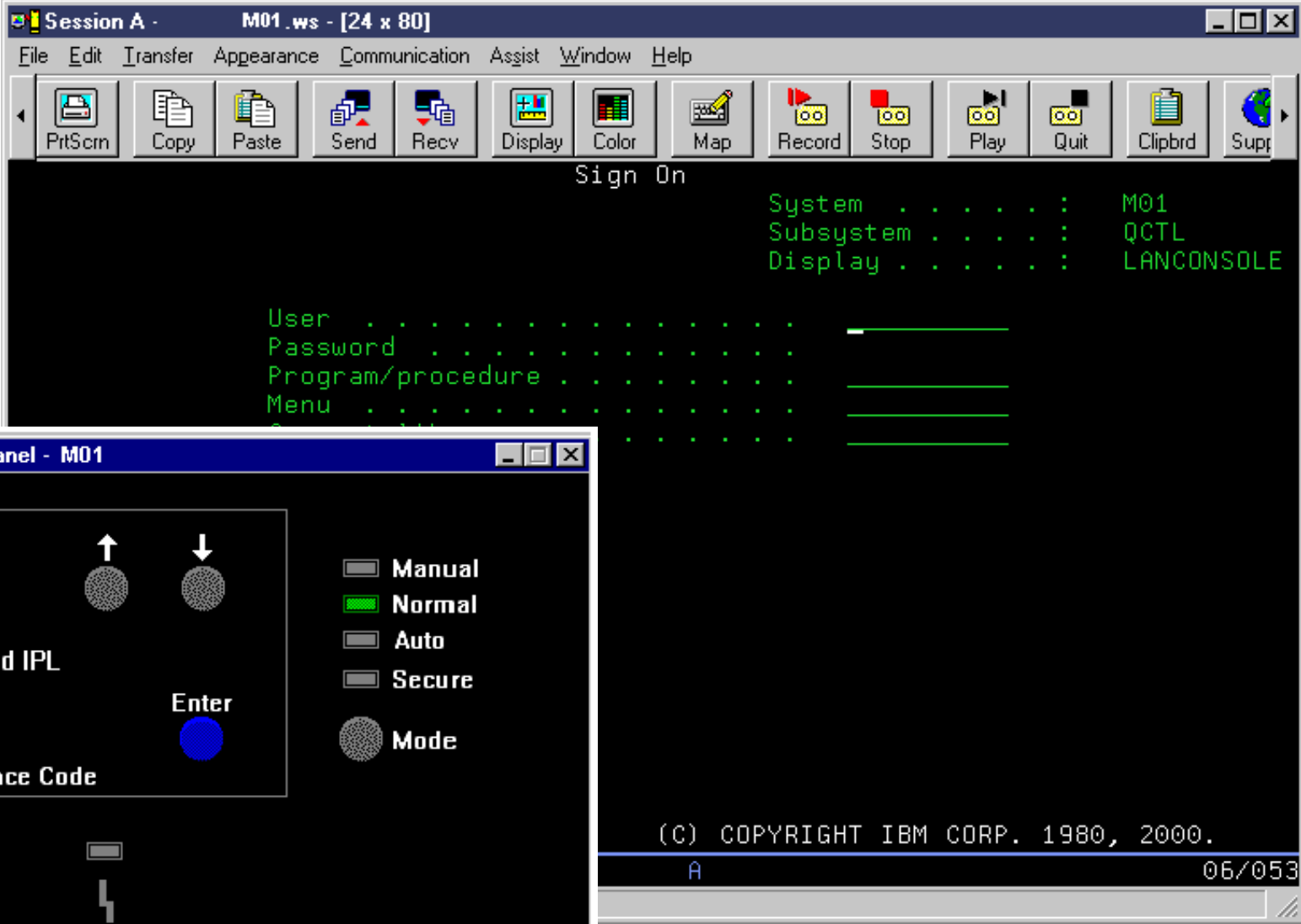

Notes: Operations Console on the LAN

This foil shows how the Operations Console 5250 emulation session and the remote control panel function pane will appear on the screen of your PC after the secure connection over the LAN is established. You can now sign on to the emulation session and perform all actions over the LAN as you are able to perform from a direct attached console. Bringing the server to restricted condition for example from this Operations Console session over the LAN will be exactly the same as from over a direct attached or remote console when you are logged on with a user profile that has the correct authority.

Operations Console on the LAN

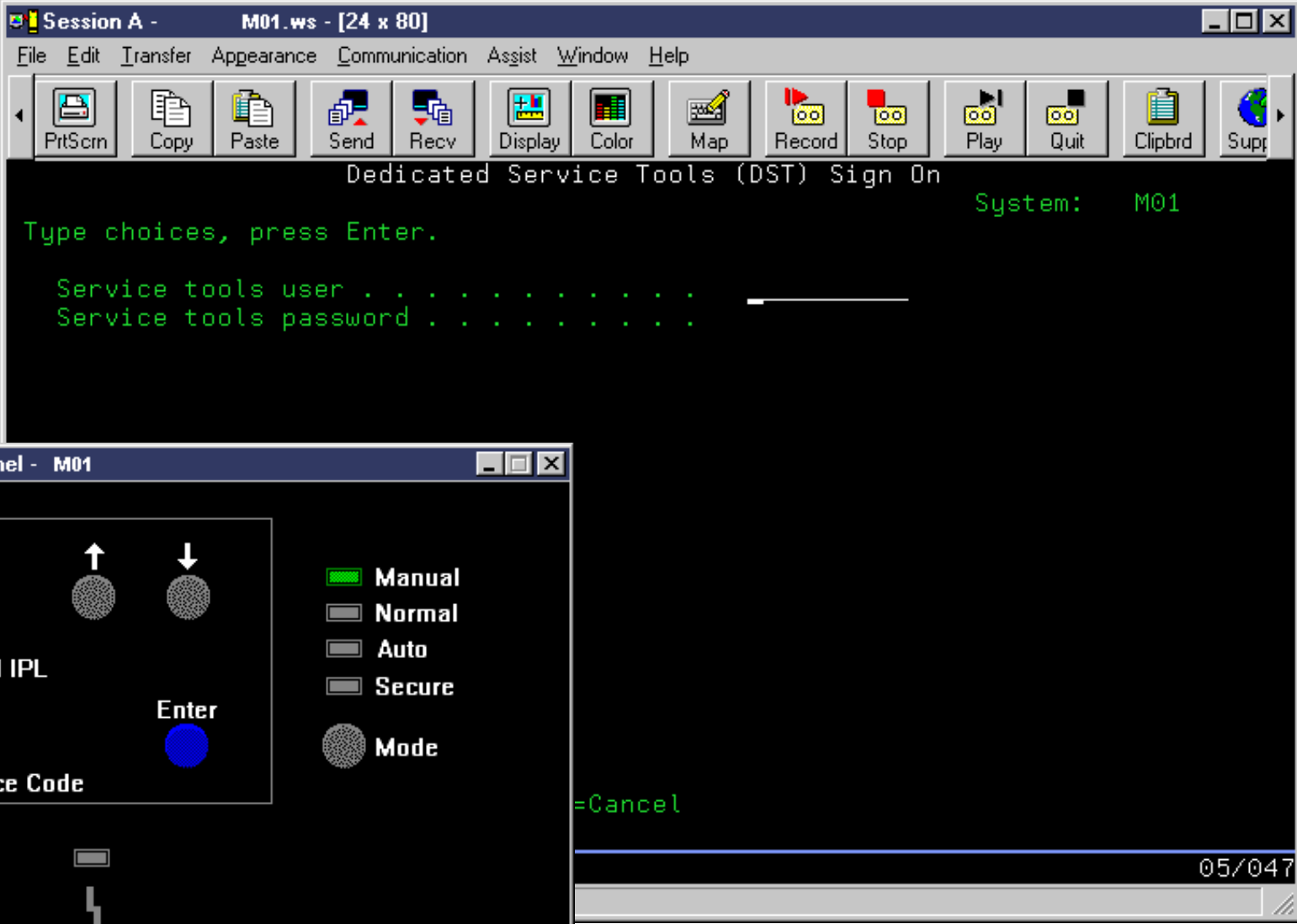

IBM @server. For the next generation of e-business.

Notes: Operations Console on the LAN

Control Panel functions can be initiated from your PC by clicking the correct buttons on the remote control panel pane. In this foil, you can see the example of function 21 being issued from the remote control panel pane and the effect on the Operations Console emulation session over the LAN.

When the Operations Console over the LAN connection is broken for a reason such as for example the crash of the disk of your PC that contains the encrypted version of the service device password and you cannot get to DST functions through an other service device profile or an other console device, you must use the physical control panel function for resynchronizing the PC and iSeries device profile password of the QCONSOLE service device profile. This procedure can be found in the V5R1 *Operations Console Setup*, SC41-5508-02.

Integration with SAN

IBM @server. For the next generation of e-business.

HSL and Fibre Channel Positioning

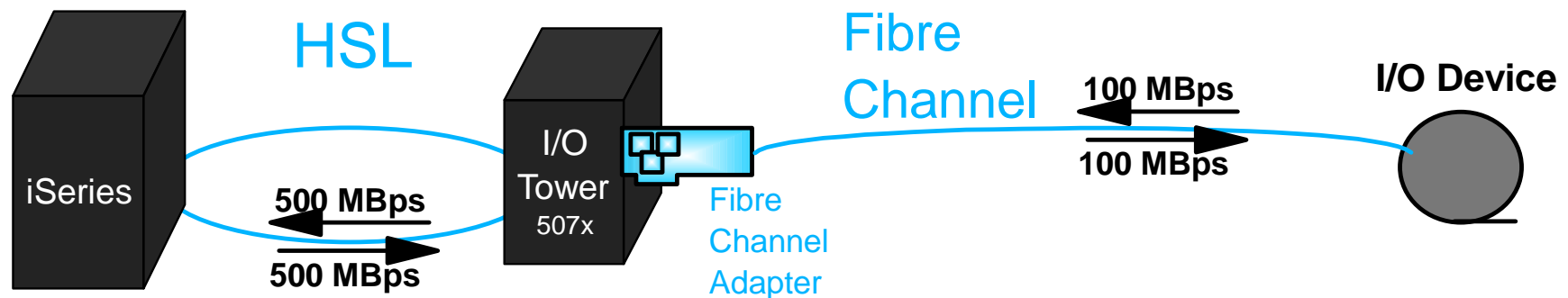

	HSL OptiConnect	Fibre Channel
What attaches	iSeries, xSeries, I/O towers	I/O devices (tape, disk)
Speed	1000 MB/sec	200 MB/sec
Distance	max 15 meters	max 10 kilometers
Device Switching / sharing	some	strength

Notes: HSL and Fibre Channel Positioning

Before going into more details it is good to overview that "HSL and Fibre Channel are totally different things." They were architected and designed for different functions. One does not replace the other. They can and do work together as a Fibre Channel Adapter is plugged into an HSL-attached I/O tower..

HSL is a proprietary way to connect iSeries and iSeries I/O towers and xSeries at very high speeds over relatively short distances. iSeries Fibre Channel is based on an industry standard for attaching/switching disk or tape. They are different.

Fibre Channel cables

- point-to-point without other components

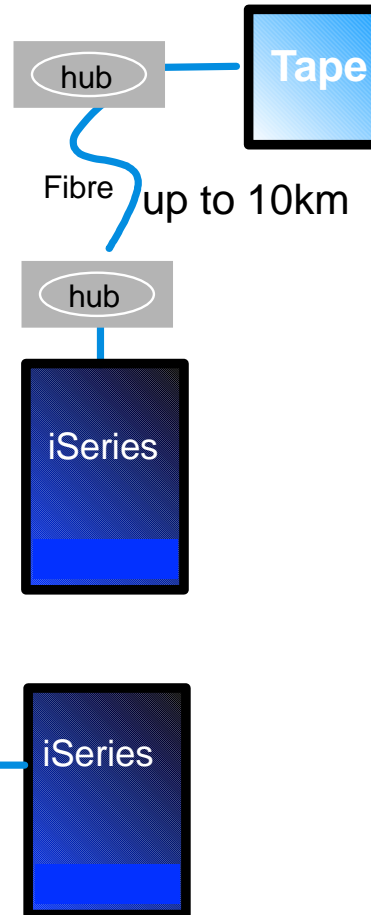
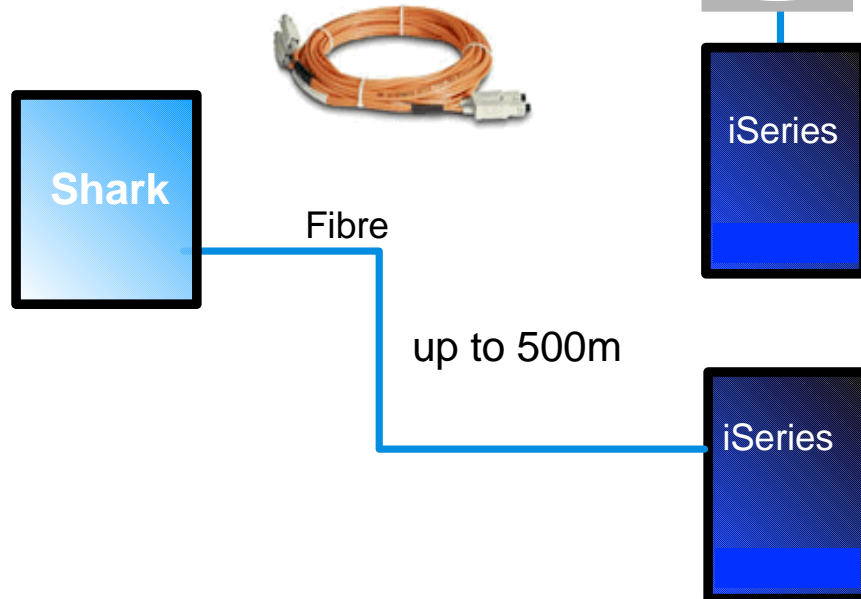

Managed Hub

- limited switch, smarter than a regular hub

Notes: iSeries SAN Connectivity Examples

There are a lot of definitions of Storage Area Networks (SANs). One of its commonly referenced aspects is the ability to attach and share a lot of I/O. Fibre Channel is technology which is often used in many of the more flexible topologies and is gaining popularity and usage.

Let's start with the basics, Fibre Channel cables. Without other components a Fibre Channel cable runs directly from an iSeries Fibre Channel adapter to a Fibre Channel adapter in a tape drive or Shark. The cable can be up to 500 meters long.

Now if more than 500 meters is needed, a pair of hubs or switches is added to the configuration. Then you can get up to 10,000 meters (10 km) distance. The iSeries supports a specific managed hub. A Managed hub is a hybrid, a limited switch, but smarter than a plain, regular hub. In V5R1 iSeries also supports a regular switch, the 2109 in Quick Loop mode only..

Fibre Channel cables

- point-to-point without other components

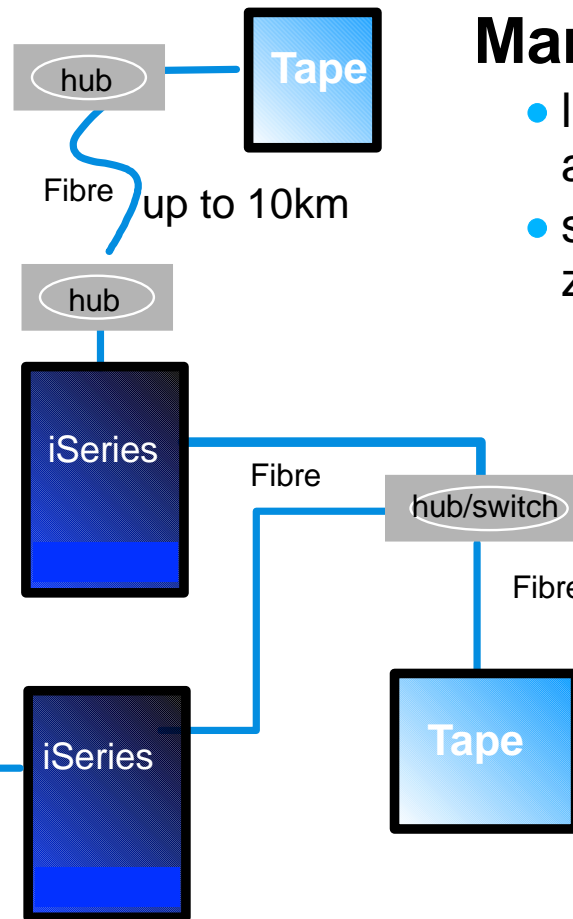
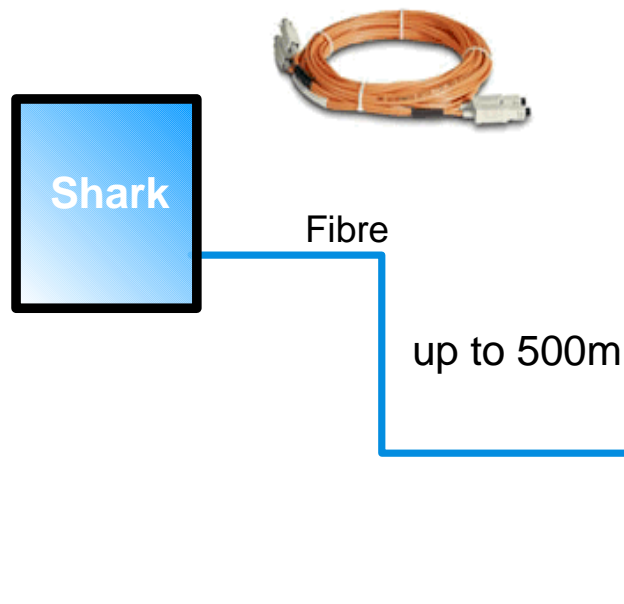

Managed Hub

- limited switch, smarter than a regular hub
- sharing of single device (per zone) with multiple hosts

Switch

- Smarter sharing of device(s) with multiple hosts
- smarter and more efficient than hub

Now building on these components, this shows how a device such as a tape can be shared between multiple servers. This shows two iSeries, but it could be non-iSeries sharing as well.

It's important to note the word "examples" in the slide's title. This is only a portion of the possible configurations possible. But it does show some examples which are very likely to be leveraged.

Notes:

- If unfamiliar with SAN and Fibre Channel terminology, you'll need some education. There are different diameter cables, different connector types, ports, zones, arbitrated loops, quick loops, management software, performance implications, gateways and much more.
- At V5R1 OS/400 only supports a portion of the possible SAN/Fibre Channel options. The portion it supports are expected to be the most commonly required options. For example, with V5R1, iSeries Fibre Channel support includes the 2109 switch in Quick Loop mode only.
- Additional enhancements are expected over time by both Fibre Channel standards, Fibre Channel connectivity products, and iSeries.

iSeries SAN Hardware Components

Fibre Channel Tape Controller iSeries #2765

- 3590 E11 an E1A
- 3584

Fibre Channel Disk Controller iSeries #2766

- 2105 Models F10 and F20

Fibre Channel Cables

- Multi-mode 62.5 and 50 micron
- Single-mode 9 micron

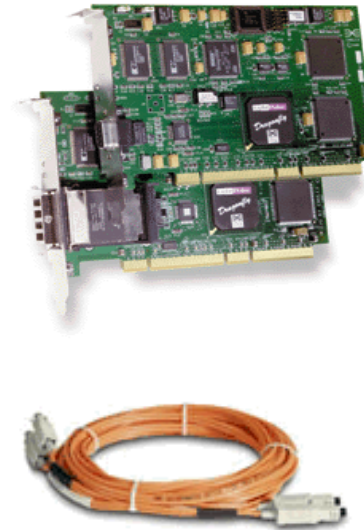

IBM Managed Hub (3534 Model 1RU)

- 8 ports; 1 Gigabit Interface Converter, 7 short wave optical ports
- Supports zoning (by port)
- Serial, Ethernet/Browser Interfaces

IBM 2109 Switch

- Models S08, S16
- 8/16 port switch, supports zoning
- Supported by V5R1 with Arbitrated Loop via QuickLoop

SAN Infrastructure Components



Notes: iSeries SAN Infrastructure Components

Here are the specific iSeries SAN Infrastructure hardware components supported by OS/400 V5R1:

- iSeries features - Fibre Channel Tape Controller (#2765) and Fibre Channel Disk Controller (#2766)
- Fibre Channel Cables for attachment: Fibre cables come in two distinct types: Multi-mode fibre (MMF) for short distances (up to 2 km), and Single-Mode Fibre (SMF) for longer distances up to 10 km). IBM supports the following distances for fibre cables:

Diameter (microns)	Mode	Laser type	Distance
9	Single-mode	Long-wave	<= 10 km
50	Multi-mode	Short-wave	<= 500m
62.5	Multi-mode	Short-wave	<=175m

- Non-iSeries SAN infrastructure components the IBM 3534 Managed Hub and IBM 2109 Fibre Channel Switch.

The IBM 3534 Managed Hub offers less function and a lower price than the IBM 2109 Switch. They each have their own type/model identifier and are not iSeries feature codes.

3534

The IBM Fibre Channel Storage Hub (IBM 3534 Managed Hub) provides unmanaged 7-ports connectivity for Fibre Channel Arbitrated Loop (FC-AL) topologies and supports up to 100 MB/s data transmission speeds between systems and storage systems. Hot pluggable ports enable the attachment of new devices without requiring to restart the host.

The 3534 Managed Hub is used to attach network devices to fiber-based transmission systems such as fibre channel and gigabit ethernet. It converts the serial electrical signals to serial optical signals and vice versa.

This IBM SAN Fibre Channel Managed Hub offers:

- Industry standard Fibre Channel attachment
- High-speed performance utilizing nonblocking switch-based technology.
- Simultaneous 100 MB/second full duplex data transfers across all ports.
- Eight ports, one that is configurable with either a short wave or long wave optical GBIC. (see detail below)
- StorWatch FC Managed Hub Specialist, a Web browser interface for configuration, management, and service.
- Support of industry standard MIBs enabling standard SNMP management.
- IBM SystemXtra support services and financing.

The managed hub is designed for implementing multinode server clusters and storage systems for high-availability and disaster recovery solutions. Seven ports incorporate fixed short-wave laser optical media for device interconnection at a maximum distance of 500 meters. A single Gigabit Interface Converter (GBIC) slot accommodates an optional GBIC, which supports either short-wave or long-wave laser fibre optic cabling with a maximum distance of 10 kilometers.

2109

The 2109 SAN FC Switch is offered in two models:

- Model S08, 8-port model for departmental SANs
- Model S16, 16-port model for enterprise SANs

Common features include four short-wave (SW) laser (500M) GBICs (Gigabit Interface Converter), 10/100BaseT Ethernet port for StorWatch specialist console with Web Interface and either rack mount or desktop packing options. Optional features include one or more SW or long wave (LW, 10 KM) -laser GBICs, redundant power supply and SW, multi-mode 5M/25M FC cables. The eight port model provides for 1 or 4 additional GBICs, a serial port for telnet terminal attachment with a simple command line interface for setting configuration variables such as IP-address, and a 1U (1.75") form factor. The sixteen port model provides for 1 to 12 additional GBICs.

For use on the iSeries, the QuickLoop RPQ provides the firmware that enables devices connected to ports of the switch to be handled as private loop devices. QuickLoop creates a unique fibre channel topology that allows host bus adapters (such as the #2765 and #2766) that use fibre channel arbitrated loop (FC-AL) without knowledge of SAN fabric, commonly to communicate with fibre channel arbitrated loop storage devices through IBM 2109 Fibre Channel Switches. QuickLoop allows individual switch ports to be designated as arbitrated loop ports, allowing a private host initiator to communicate with arbitrated loop storage devices as though they were all contained in one logical loop. These QuickLoop switch ports can be located on one switch, or on two switches either directly connected to each other or connected within a SAN fabric. A SAN fabric can contain many independent Quickloops but only one or two switches can be designated to build a single logical arbitrated loop in which private loop initiators can communicate.

The iSeries hardware features are discussed on the following foils.

PCI Fibre Channel Tape Controller

IBM  server iSeries

Feature Code # 2765

Distance

- Up to 500m / 10 km

Switching/sharing flexibility

- Multiple hosts per tape device with hub, switch or gateway

Highest performance capability

- 1 Gigabit per second (instantaneous)
- Up to 23% more capacity than the Ultra Magnetic controller, Feat code # 2749, announced in 2000
- Actual performance improvement dependent upon specific workload compression

Tape drives attachable via Fibre Channel

- 3584 and 3590 E11 and E1A

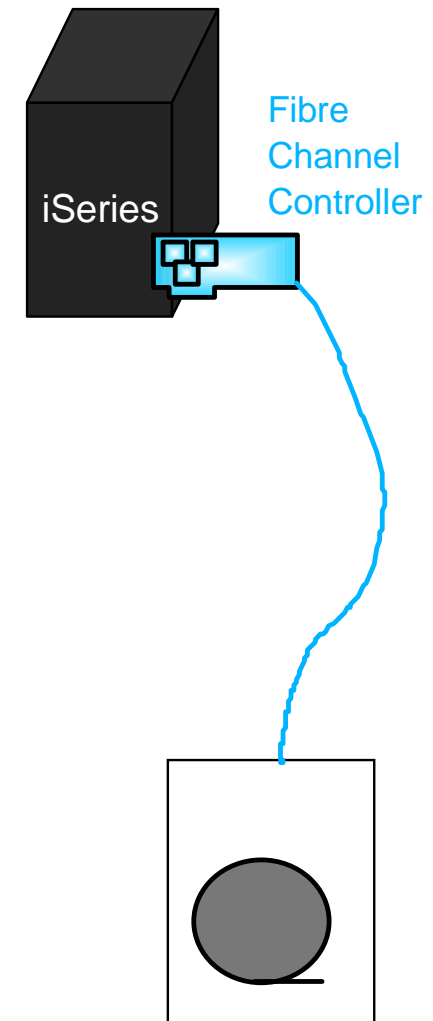

IBM  server. For the next generation of e-business.

2765

The iSeries PCI Fibre Channel Tape Controller allows a tape which supports the Fibre Channel capabilities reviewed earlier 500 meter distance, 10 km with hubs/switches, switching flexibility.

The #2765 PCI Fibre Channel Tape Controller provides fibre channel attachment capability for external tape devices. The #2765 supports point-to-point and arbitrated loop topologies. Each #2765 is shipped with a wrap connector (PN#05N6767). The following options are available to attach SC-type fibre cables :

- #0371 is a two meter LC-SC Adapter kit that can be used to connect the #2765 to a 50µm (50 micron) cable.
- #0372 is a two meter LC-SC Adapter kit that can be used to connect the #2765 to a 62.5µm (62.5 micron) cable.

Fibre channel attachment for tape drives offers tremendous performance capabilities and long distance options. It is also easier for you to share these valuable resources with multiple systems.

The following Tape subsystems with FC capability that are supported by the #2765 PCI Fibre Channel Tape Controller are the 3590 Models E11 or E1A with feature #9510 (on new orders) or feature #3510 (SCSI to FC conversion on installed models) and the 3584 with drive feature #1456.

This new controller offers the highest possible tape performance. The controller itself is rated at 1 Gigabit per second instantaneous capacity. Its capacity is up to 23% greater than the previously fastest tape controller for iSeries announced just last year, the Ultra Magnetic Controller. But before you replace one of these controllers be aware that the ability to use this increased capacity is actually dependent upon the amount of compression in the data being handled by the tape drive. Both the Ultra Magnetic controller and the Fibre Channel controller are extremely powerful. If the data stream is only moderately compressible, there will be no measurable performance difference between the two.

Notes: PCI Fibre Channel Tape Controller-2

IBM  server iSeries

Note: The high speed tape drives are usually limited by the actual number bits which can be written/read by the tape head. The higher the compression the tape drive can realize, the fewer bits which need to be handled by the tape head as the tape media goes by. Thus with the higher compression the tape drive can be accept/transmit more data from/to the server. The customer's data stream will probably have to be compressible to a factor larger than threefold in order for the Fibre Channel adapter to outperform the Ultra Magnetic controller.

IBM  server. For the next generation of e-business.

PCI Fibre Channel Disk Controller

Feature Code # 2766

- with no-charge, informative RPQ 847126

For Shark attachment

Current PCI technology

- Versus older SPD FC # 6501 SCSI card
- Fewer I/O attachment components

Distance flexibility, up to 10km

Maybe performance

- One 6501 controller to one 2766 controller: Fibre Channel much faster
- Scenario: -> multiple 6501 controllers
- Scenario: -> "internal" disk (integrated SAN capabilities)

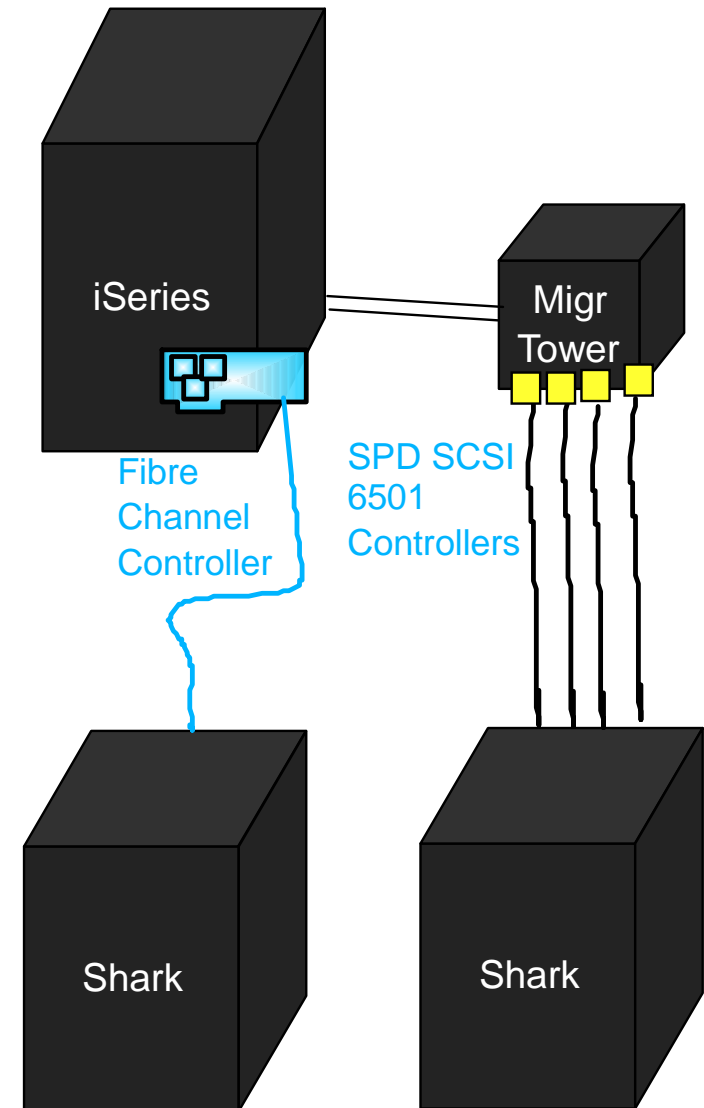

#2766

The #2766 PCI Fibre Channel DASD Controller provides fibre channel attachment capability for external disk devices. The #2766 supports point-to-point and arbitrated loop topologies. Each #2766 is shipped with a wrap connector (PN#05N6767). Just as for the #2765, the following options are available to attach SC-type fibre cables :

- #0371 is a two meter LC-SC Adapter kit that can be used to connect the #2765 to a 50µm (50 micron) cable.
- #0372 is a two meter LC-SC Adapter kit that can be used to connect the #2765 to a 62.5µm (62.5 micron) cable.

Some iSeries customers may find SAN-attached DASD devices to be appealing for their environment. If consolidating large amounts of DASD from different platforms is important, you should consider SAN. Note, however, a complex commercial business environment usually requires good, predictable response time to maintain user productivity and satisfaction. Carefully consider the performance implications of sharing resources in this environment, as the sharing may introduce more variable performance. For these critical workloads, dedicated direct attach DASD resource can ensure more predictable performance.

Feature #2766, PCI Fibre Channel Disk Controller, for attachment into Storage Area Networks for DASD is offered as an optional feature, when ordered with **RPQ 847126**.

Fibre Channel Adapters require OS/400 V5R1.

IMPORTANT NOTE: IBM will withdraw #6501 from marketing on July 31, 2001. Attachment to IBM ESS will be through #2766 Fibre Channel Adapter on iSeries and OS/400 V5R1.

There are several factors which impact the performance and benefits which an iSeries can realize from a Shark. For this reason, a no-charge, informational RPQ is required when a Fibre Channel disk controller is ordered.

Certainly if compared to the older SPD external disk controller, the new PCI technology is far more advanced and a better long term investment. It also allows a connection to external disk with fewer components, avoiding the use of the migration tower and/or SPD I/O towers. It can also support a Shark up to 10 km away. And if a customer is already committed to a Shark strategy for heterogeneous server reasons and wants to attach iSeries to it, the Fibre Channel is by far the best implementation choice.

Performance one key area which needs to be understood and proper expectations established. Certainly if you compare the performance possible with just one older SPD 6501 controller versus one new PCI Fibre Channel, the Fibre Channel is at least four times faster. But if you already have a Shark installed and attached via enough SPD 6501 controllers such that there are no performance bottlenecks, then replacing the 6501s with Fibre Channel controllers may not yield any performance benefits assuming the workload doesn't change or grow. Replacing SPD technology with newer PCI technology for current and future flexibility is fine, but don't assume you'll automatically see performance benefits without doing a little homework before hand.

The final scenario is the most complex to evaluate. Using Fibre Channel attached Shark compared to "internal" iSeries disk drives. You need to understand that OS/400 advanced architecture has already implemented many of the techniques a disk SAN uses to boost performance. For example, data is automatically and dynamically spread over multiple drives, skip-read-write reduces disk I/O, and caching is done both at the disk controller and also in main memory.

Private Loop Direct Attach

- Single target per FC adapter
- Homogeneous (iSeries only) loop
 - Hub zoning allowed
- Maximum 5 initiators per loop

Component limitations

- No more than 2 cascaded hubs
- 2109 Switch in Quick Loop mode only

Point to Point connections

- ESS only

With Version 5 Release 1, there are limitations to the implementation of SAN for the iSeries. With one FC adapter such as the #2765 or the #2766 you can only target one storage device, one tape device for the #2765 adapter and one ESS per #2766 adapter. Heterogeneous loops are not supported on the iSeries with V5R1. Multiple iSeries servers can access the same storage device in a so called homogeneous FC loop. You can only set up a hub to be shared between pSeries, xSeries and iSeries when you use zoning within the hub. You need to understand the initial support of fibre channel connectivity to the iSeries with V5R1. For examples, tape drives cannot be configured in a point-to-point mode, and are required to be set up in a fibre channel arbitrated loop (FC-AL) topology over short-wave transceivers. When you need to cross distances of over 500 meters, you will need to attach two hubs and convert the signals from short-wave to long-wave from the host end, and back to short-wave at the device end. You can use the 2109 switches (Models S08 or S16) in Quick Loop Mode for connectivity your iSeries server to devices like disk storage or tape subsystems.

The next foil give a an example "network" of iSeries systems connected to a SAN attached to ESS disk resources. Complete coverage of planning considerations are beyond the scope of this presentation.

There are excellent V5R1 Marketing presentation you may review, such as the iSeries and SAN presentation. You could also refer to the iSeries web site - <http://www.ibm.com/eserer/series/storage>

Examples of iSeries and IBM ESS

iSeries to IBM ESS
Point to Point Connectivity

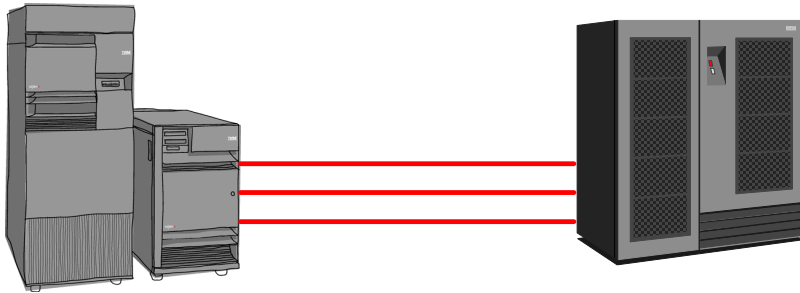

Multiple iSeries to IBM ESS
Fibre Channel Arbitrated Loop via zoned hub

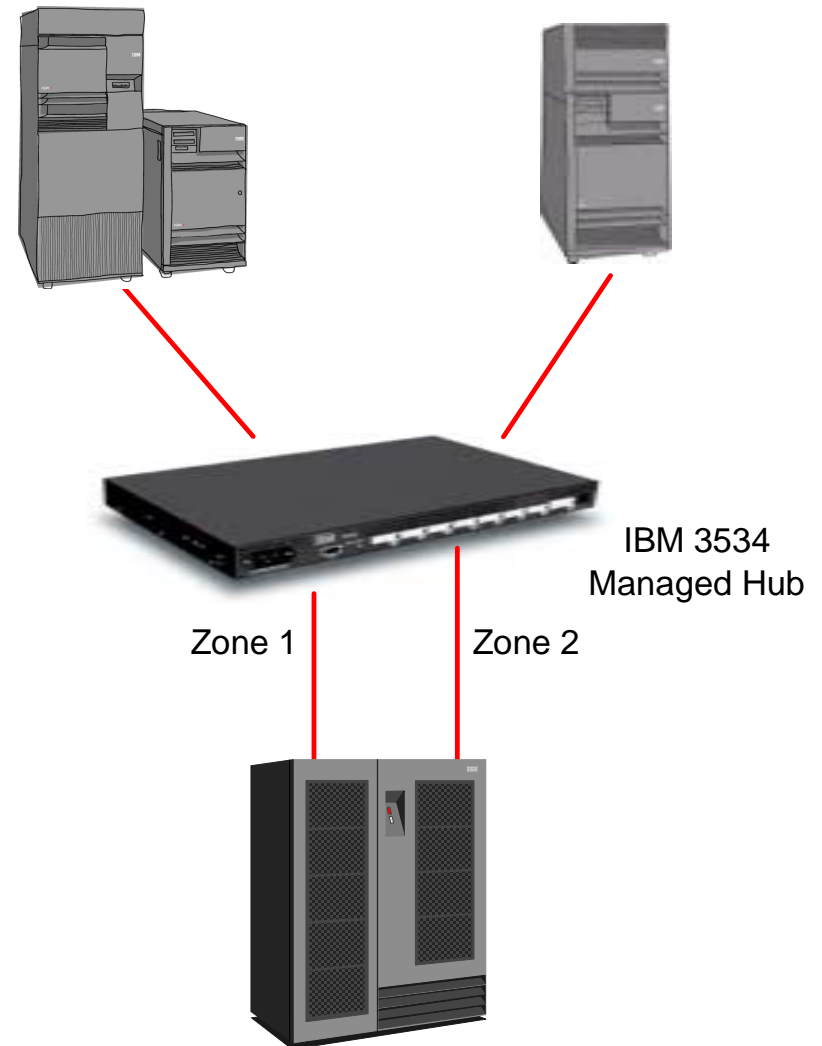

Fibre Channel Support (#2766) for IBM ESS

- Point-to-Point or FC-AL
- Up to 32 LUNs per adapter
- Support for 8.58, 17.54, 35.16, 36.00, 70.56 GB per LUN
- SCSI (9337) to Fibre channel (2105) migration - no data movement
 - 4.0 GB LUN migration not supported
- Load source on iSeries

Notes: Examples of iSeries and IBM ESS

There are several ways in which you can attach your iSeries systems to IBM Enterprise Storage Server and the configuration will depend on the number of hosts you have, the level of SAN fabric complexity, and how you go about using multiple hubs and zones.

The examples shown here are quite simple where you have one host that is attached directly (point-to-point) to the ESS, and the other showing how you can use an IBM managed hub and zoning to have one system attached to one half of ESS, and the other attached to the second half of ESS. These examples are really for demonstration purposes only. You should always conduct a pre-installation systems assurance and complete the planning requirements to set up your hosts and storage servers.

You will need to be at least at OS/400 V5R1 and on the iSeries platform with #2766 PCI Fibre Channel Adapter to participate in a SAN environment. Each fibre channel adapter can support up to 32 LUNs. If you are already using SCSI interfaces, you can migrate to fibre by making the hardware configuration changes, and by migrating your LUNs emulating 9337s to emulate 2105. Data migration is not required as long as your LUNs are of 8 GB capacity or above. If you have 4 GB capacity LUNs, these cannot be automatically migrated to emulate 2105.

During migration from SCSI to Fibre Channel Adapter, you can replace 2 x 6501s with one #2766.

The iSeries requires to have the load source disk unit to be internal and direct-attach. You cannot place the load source inside the ESS. However, you can mirror the load source inside the ESS.

IMPORTANT NOTE: As of JULY 2001, the #6501 I/O processor will be withdrawn from marketing.

iSeries Integrated xSeries Server

IBM @server. For the next generation of e-business.

Integrated xSeries Server Intel 850 MHz Pentium III (GA 02/2001)

- Feature 2791 on iSeries Models 8XX and feature 2891 on iSeries Model 270
- Hot plug PCI on selected iSeries servers
 - Some 270 models excluded
- Up to 4 GB memory
 - from 2790 and 2890 can be used
- Up to 2 TB of disk storage
- Up to 32 per iSeries
- Up to 3 LAN adapters (all hot plug PCI adapters), the following are supported:
 - 16/100Mb Token Ring, 10/100Mb Ethernet, 1Gb Ethernet Optical or UTP
- 2 x Universal Serial Bus (USB) ports
- Device drivers to share iSeries disk, tape, DVD, and CD-ROM
- Supported on iSeries models 270, 820, 830, 840
- Supported with OS/400 V4R5 or later
 - Some features and or maximums have V5R1 or later as prerequisite
- The Integrated xSeries Servers 2791 and 2891 both support the Windows NT 4.0 or Windows 2000 operating system only

The #2791/#2891 PCI Integrated xSeries Server contains a 850MHz processor and 4 memory slots. The #2791 is supported in the CEC of models 820, 830, 840, SB2 and SB3, in the #5074 PCI Expansion Tower, in the #5079 1.8M I/O Tower, in the #5078 PCI Expansion Unit and in the #5075 PCI Expansion Tower when it is attached to the model 820. The #2891 is supported in the CEC of model 270 and in the #5075 PCI Expansion Tower when it is attached to the model 270. Each server memory slot can contain either a 128MB server memory card, a 256MB server memory card or a 1024MB server memory card providing a total server memory capacity ranging from 128MB to 4096MB (4GB). When the maximum memory is installed, only 3712MB will be addressable.

The following memory features are available on the #2791/#2891 PCI Integrated xSeries Server:

- #2795/2895 - 128MB Server Memory
- #2796/2896 - 256MB Server Memory
- #2797/2897 - 1GB Server Memory

The following hot-plug (only valid on hot-plug capable iSeries) PCI network adapters can be installed under the Integrated xSeries for iSeries:

- PCI 100/10 Mbps Ethernet IOA (#4838)
- PCI 100 Mbps Token-Ring IOA (#2744)
- PCI 1 Gbps Ethernet IOA #2743 (optical)
- PCI 1 Gbps Ethernet IOA#2760 (UTP)

V5R1 supports the 1 Gbps adapters.

Integrated xSeries Adapter

IBM @server. For the next generation of e-business.

Integrated xSeries Adapter

Direct attach n-Way xSeries to iSeries Models 8xx and 270

- Retains iSeries storage consolidation and systems management
- Specific xSeries models supported:
 - Netfinity 7100 / 7600
 - xSeries 250 or 350
- HSL Adapter is Machine Type 1519 Model 100

HSL Adapter



iSeries



High-Speed Link Connection

Power control



xSeries

IBM  server. For the next generation of e-business.

Integrated xSeries Adapter Attachments

Number of supported external xSeries Servers per iSeries Model

Model	Max. xSeries
270	2
820	4
830	8
840	16



xSeries Model 350



Netfinity 7100



Netfinity 7600,
xSeries Model 250

Topology rules

- End of loop concept
- Special considerations

Ordering

- #0092 used in iSeries configurator
- Machine Type 1519 Model 100
- xSeries or Netfinity Server

Notes: Integrated xSeries Adapter Attachments

The IBM Integrated xSeries Adapter for iSeries provides a direct high-speed attachment of an xSeries server to an iSeries server. The Integrated xSeries Adapter, installed in select xSeries servers, extends iSeries integration with Microsoft Windows 2000 Server to xSeries high performance n-way Intel architecture servers. With the Integrated xSeries Adapter, more Windows users and more complex Windows applications can be integrated with iSeries servers. The Integrated xSeries Adapter provides a unique level of integration between standard iSeries and xSeries servers. Server, storage, and user management are consolidated by iSeries for up to 16 direct-attached xSeries servers, depending on iSeries model, with up to 2 TB of disk storage capacity per Windows server.

Initial servers supported are the xSeries 7100, 7600, 250, and 350.

- 7100: Current models: 86663RY, 866631Y 86664RY, 866641Y
- 7600: Current models: 86651RY, 86654RY, 86655RY, 866571Y, 86657RY, 86655RY
- 250: 866581Y, 86658RY
- 350: 86824RY

The Integrated xSeries Adapter attaches the xSeries servers to the iSeries HSL bus and the SPCN bus. A special card combination plugs into the standard PCI bus inside the xSeries server. While it will only plug into one slot, it will take up two slots worth of space. The Integrated xSeries Adapter requires standby power from the PCI bus (*jumper*). The adapter also contains the following connectors:

- Two HSL connectors that use the same data interface as an iSeries I/O tower.
- One RS485 Connector providing a cabled interface to xSeries Service Processor.
- One SPCN Connector that uses same system power and control interface as iSeries I/O tower with the exception that it uses a port splitter cable to accept the incoming and outgoing SPCN signals when the Direct Attached xSeries Server is not at the end of the SPCN line.

The external IXS appears to the iSeries as an I/O tower on the HSL bus. The integration features of the internal IXS are also available with the external IXS. Device drivers are provided to use iSeries tape, CD-ROM, and DASD. xSeries servers configured as an external IXS contain no hard drives. iSeries DASD is used (the same as internal Integrated xSeries servers). All DASD traffic goes over the HSL bus. The xSeries service processor is used by the IXA for power control (by iSeries SPCN) and error reporting (both SPCN and IxS).

IBM @server. For the next generation of e-business.

The maximum of Direct Attach xSeries Servers by model (these maximums are in addition to the maximum number of I/O towers that can attach to these models):

- Model 270 - system max is 2
- Model 820 - system max is 4
- Model 830 - system max is 8
- Model 840 - system max is 16

The maximum Direct Attach xSeries Servers per HSL loop by model (these maximums are in addition to the maximum number of I/O towers that can attach per HSL loop to these models):

- Model 270 - max per loop is 2
- Model 820 - max per loop is 4
- Model 830 - max per loop is 4 (limit on 1st loop is 1)
- Model 840 - max per loop is 4 (limit on 1st loop is 2)

For performance reasons, the Direct Attach xSeries Servers should be placed in the middle of an HSL loop (end of the HSL strings attached to each HSL port), that is, no I/O tower should communicate with the system by having it's data flow through an External xSeries Server. The 'end of loop' concept can be explained as follows: the iSeries server identifies the towers on a loop alternately from the loop ports. The user must make sure that the HSL attached xSeries servers are identified by the iSeries Server after that iSeries Server has identified the other (DASD or PCI) towers in the HSL loop. This topology will avoid problems that could arise when the iSeries CEC communicates with one of other towers through the HSL adapter in the attached xSeries Server.

Ordering Information:

The specify #0092 used in the iSeries configurator in order to assure the correct type and number of cables are on the order. The HSL adapter for the xSeries can be ordered as Machine Type 1519 Model 100 and is supported as a peripheral in the iSeries e-Config configurator tool.

The supported Netfinity or xSeries Servers must be ordered through the xSeries marketing channel.

Integrated xSeries Adapter Requirements

Easy to install

■ Hardware

- Unpack and install xSeries server
- Install Integrated xSeries Adapter in xSeries server
- Connect cables

■ Software

- 5722-WSV *BASE Integration for Windows Server and 5722-WSV Option 2 Integration for Windows 2000 must be installed on the iSeries server
- Set up the Netserver on the iSeries
- Windows 2000 Server CD in iSeries
- Run INSWNTSVR Command to start installation
- Configuration and user enrollment tasks

Setting up....

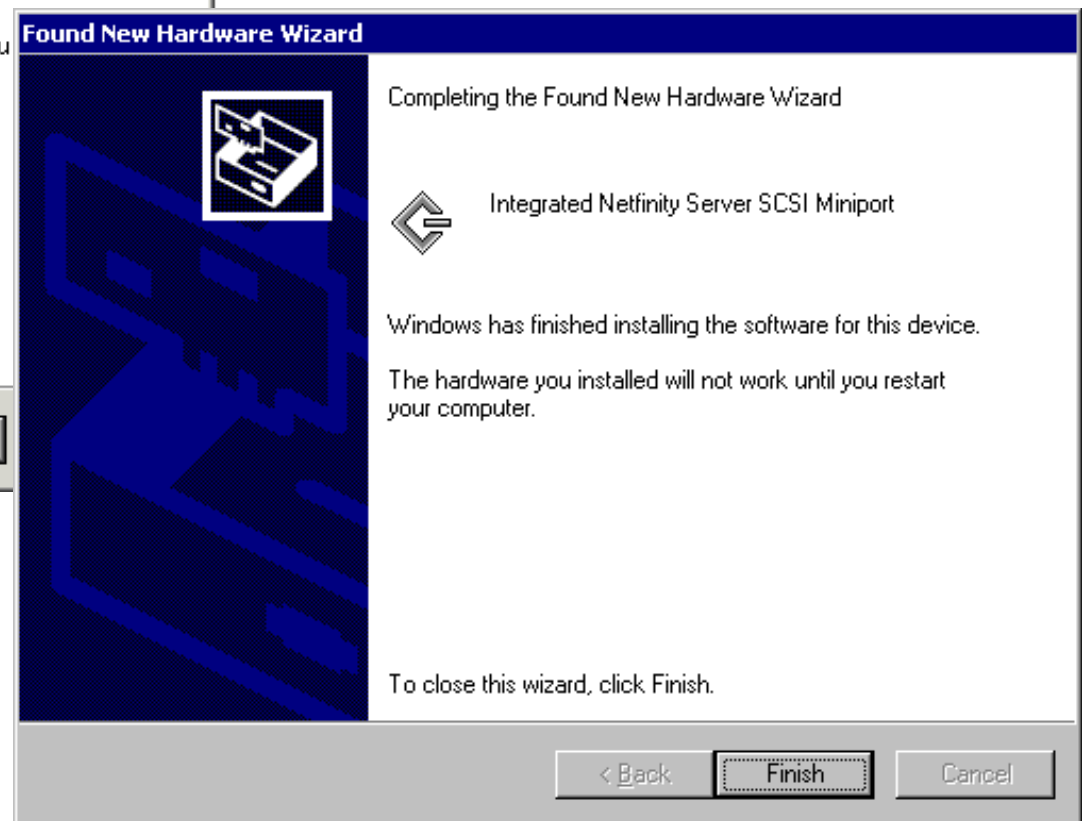
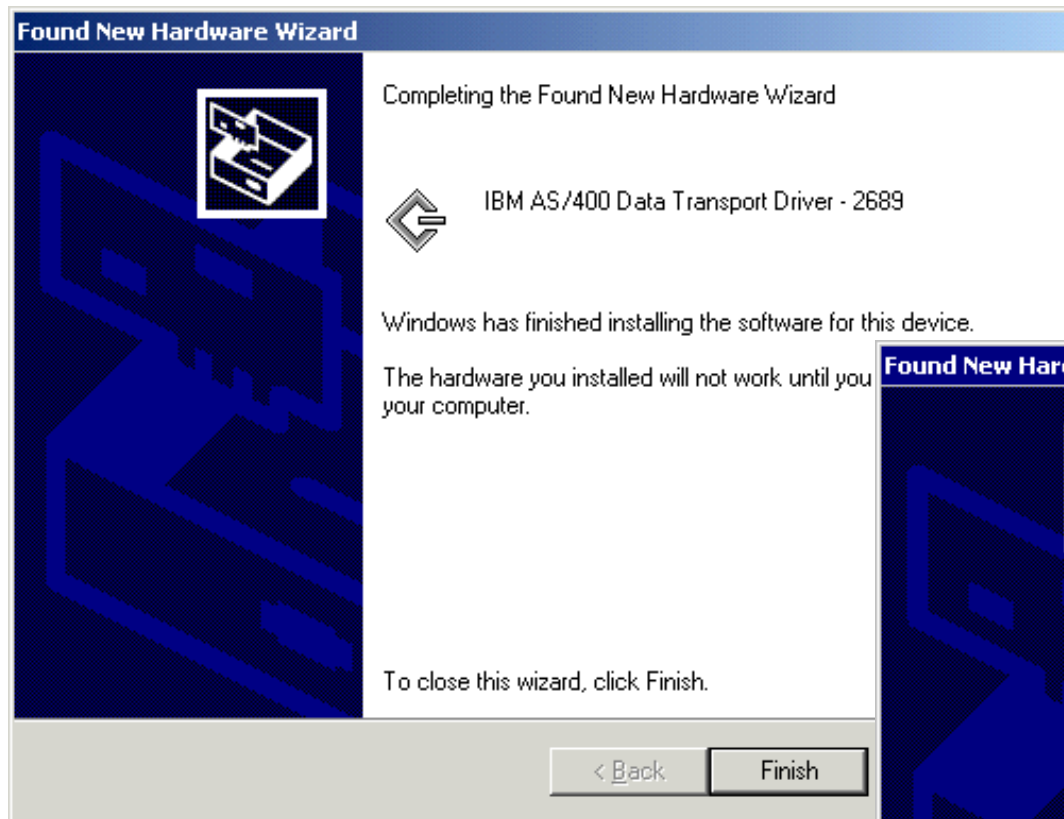

Ease of use through Operations Navigator and Management Central

iSeries operator can centrally:

- Monitor and reboot servers
- Add or distribute disk
- Distribute fix packages
- Submit commands
- Add and manage users
- Manage iSeries device drivers

Managing Your xSeries Server

IBM  server iSeries

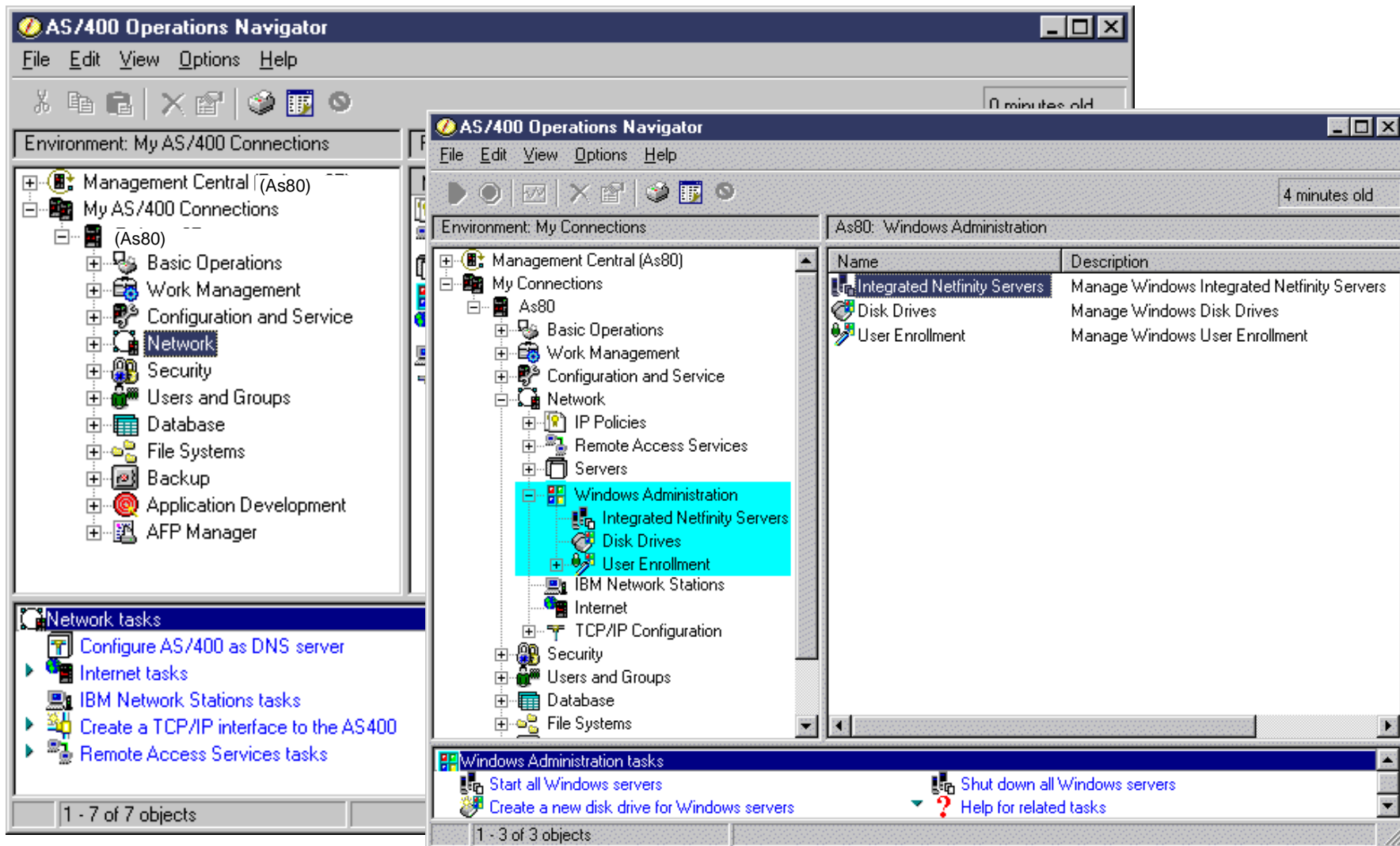

The image displays two overlapping screenshots of the AS/400 Operations Navigator interface. The left screenshot shows the 'My AS/400 Connections' tree with 'Network' selected. The right screenshot shows the 'As80: Windows Administration' view with a table of tasks.

Name	Description
Integrated Netfinity Servers	Manage Windows Integrated Netfinity Servers
Disk Drives	Manage Windows Disk Drives
User Enrollment	Manage Windows User Enrollment

IBM  server. For the next generation of e-business.

Managing Your xSeries Server - messages

IBM  server iSeries

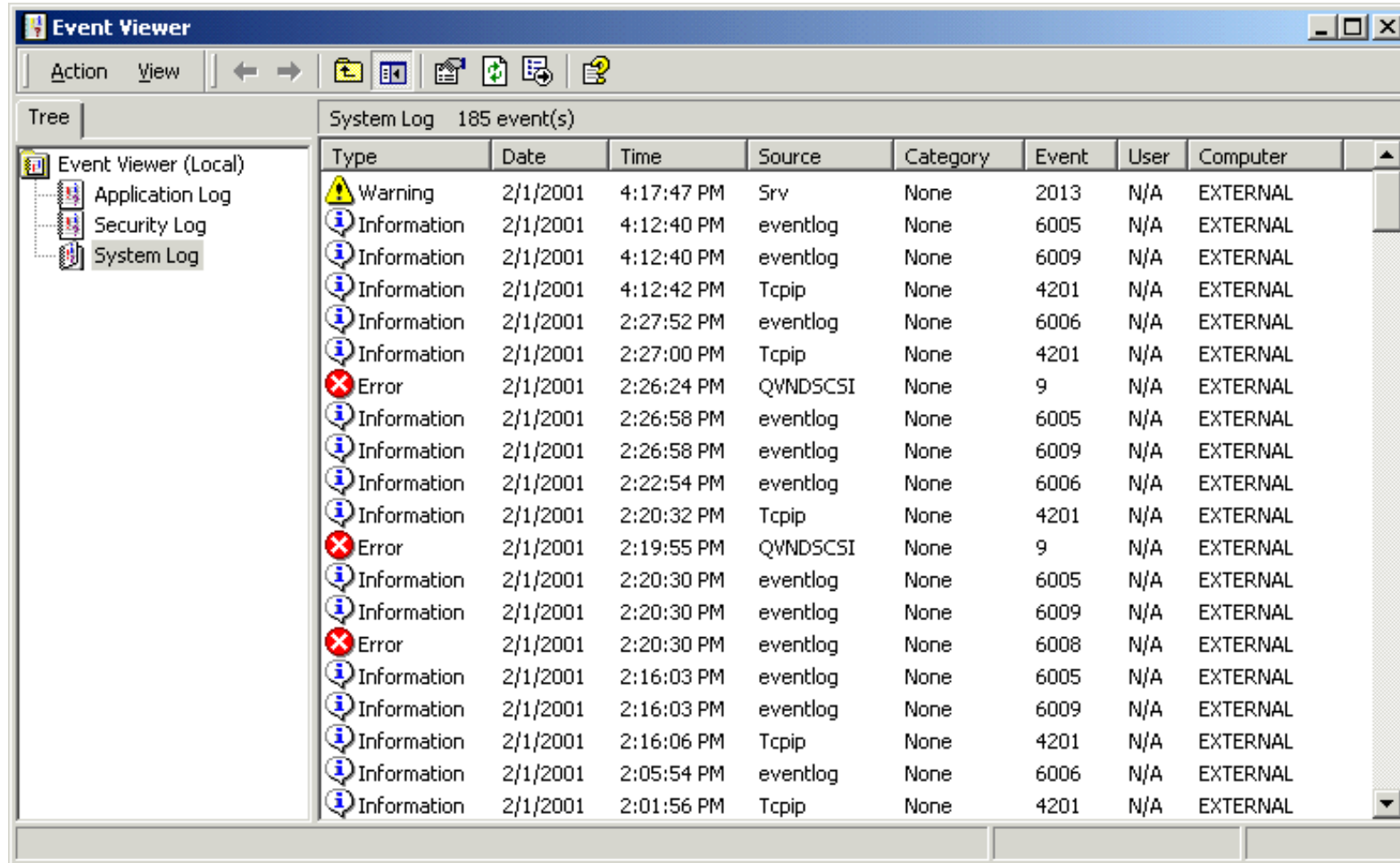

Event Viewer

System Log 185 event(s)

Type	Date	Time	Source	Category	Event	User	Computer
Warning	2/1/2001	4:17:47 PM	Srv	None	2013	N/A	EXTERNAL
Information	2/1/2001	4:12:40 PM	eventlog	None	6005	N/A	EXTERNAL
Information	2/1/2001	4:12:40 PM	eventlog	None	6009	N/A	EXTERNAL
Information	2/1/2001	4:12:42 PM	Tcpip	None	4201	N/A	EXTERNAL
Information	2/1/2001	2:27:52 PM	eventlog	None	6006	N/A	EXTERNAL
Information	2/1/2001	2:27:00 PM	Tcpip	None	4201	N/A	EXTERNAL
Error	2/1/2001	2:26:24 PM	QVNDSCSI	None	9	N/A	EXTERNAL
Information	2/1/2001	2:26:58 PM	eventlog	None	6005	N/A	EXTERNAL
Information	2/1/2001	2:26:58 PM	eventlog	None	6009	N/A	EXTERNAL
Information	2/1/2001	2:22:54 PM	eventlog	None	6006	N/A	EXTERNAL
Information	2/1/2001	2:20:32 PM	Tcpip	None	4201	N/A	EXTERNAL
Error	2/1/2001	2:19:55 PM	QVNDSCSI	None	9	N/A	EXTERNAL
Information	2/1/2001	2:20:30 PM	eventlog	None	6005	N/A	EXTERNAL
Information	2/1/2001	2:20:30 PM	eventlog	None	6009	N/A	EXTERNAL
Error	2/1/2001	2:20:30 PM	eventlog	None	6008	N/A	EXTERNAL
Information	2/1/2001	2:16:03 PM	eventlog	None	6005	N/A	EXTERNAL
Information	2/1/2001	2:16:03 PM	eventlog	None	6009	N/A	EXTERNAL
Information	2/1/2001	2:16:06 PM	Tcpip	None	4201	N/A	EXTERNAL
Information	2/1/2001	2:05:54 PM	eventlog	None	6006	N/A	EXTERNAL
Information	2/1/2001	2:01:56 PM	Tcpip	None	4201	N/A	EXTERNAL

IBM  server. For the next generation of e-business.

You can shut down the Windows NT 4.0 / Windows 2000 server by varying off the network server description for the server from an OS/400 interactive session. If you shut down the server this way, you need to restart the server by varying on the network server description. You cannot restart the server from the Windows 2000 console.

The iSeries Integration for Windows software provides drivers for iSeries devices. This approach has major advantages such as a single supplier, a single configuration and integrated testing and support. The fixes to the device drivers are deployed via OS/400 PTFs. This also simplifies the distribution across your entire network.

The OS/400 operator can monitor Windows 2000 Server operations through Management Central

The iSeries can filter and send Windows messages to OS/400 operator

- System, security and application messages

The OS/400 operator can submit commands to Windows 2000 Server.

Adding disk storage to Windows 2000 Server dynamically is also supported:

- New Dynamic Network Storage Space
- Does not require Windows 2000 Server to be shut down
- Attach up to 2 TBs of disk to each server. Up to 32 storage spaces, each from 1 MB to 64 GB. Up to 16 Static and up to 16 Dynamic storage spaces.

For additional details see the Operations Navigator presentation.

Additional references:

- Redbook: Consolidating Windows 2000 Servers in iSeries *SG24-6056-00*
- Redbook: Direct attached xSeries for iSeries *SG24-6222-00*

V4R5 HSL Technology Review

IBM @server. For the next generation of e-business.

High-Speed Link

- 1 GigaByte/sec bandwidth - up to 10x performance increase
 - 700 MB/sec achievable in duplex environment
 - 350 MB/sec achievable to Migration Tower
- Over 2 Terabyte/hour Save performance
- Loop provides redundancy for improved availability
- Attaches PCI Expansion Towers and Migration Towers
- OptiConnect over High-Speed Link (HSL)*

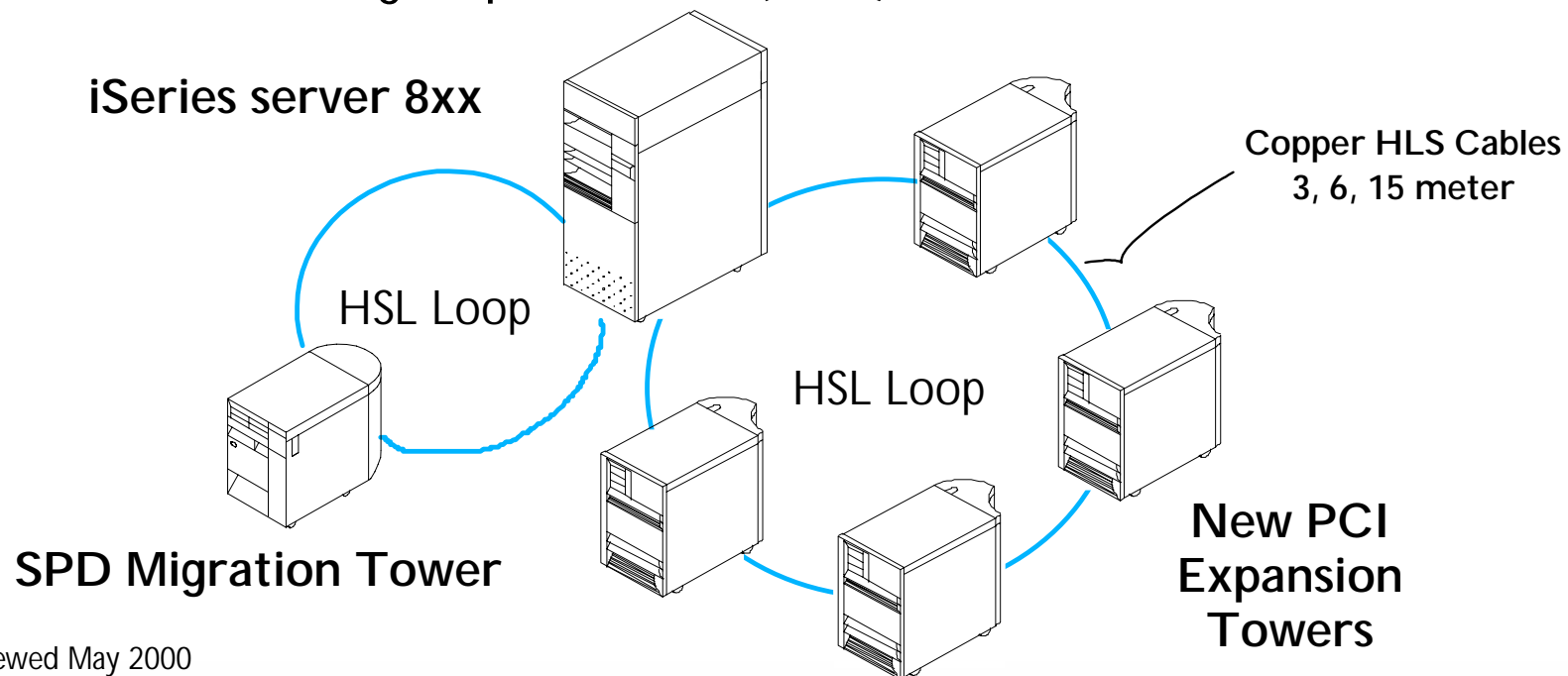

* Product Previewed May 2000

IBM  server. For the next generation of e-business.

iSeries servers 270 and 8XX make use of the new High Speed Link (HSL), using Copper cabling to connect new PCI Expansion Towers and SPD Migration Towers to the servers. HSL provides the following:

- Rated full duplex bandwidth of up to 1 Gigabyte/sec (700 MB/sec effective via duplex traffic) offering an I/O throughput up to ten times faster than the previous implementation. This 10x comparison is derived from the top speed rating of 40 MB/sec of the SPD bus, in comparison to the top rating of 400 MB/sec of the PCI bus.
- Allows running multiple 3590s and disk in the same tower at rated speed
- Enables over 2 Terabyte/hour Saves on 8XX servers (840-2420 with 24 3590s)
- Enables up to 100 Megabyte/hr Saves on 270 server
- Cable loops provide redundancy for the new PCI Expansion Towers

For V4R5 the maximum cable length between a system and a tower or between towers is 15 meters.

The following HSL OptiConnect Product Preview was made during May 2000:

- IBM intends to further leverage the significant bandwidth, flexibility, and speed of High-Speed Link (HSL) for system-to-system connectivity by offering HSL OptiConnect

High Speed Link - Loops and Towers

MODEL	HSL Loops	Towers / Loop	Total Towers
270	1	1	1
820	1	5	5
830	4	4	13
840	8	4	23

Each system has specific maximum supported numbers of loops, towers per loop, and maximum towers per system.

These tower maximums do NOT include existing SPD towers that could be migrated and attached via a migration tower.

Notes: High Speed Link - Loops and Towers

IBM  server iSeries

This chart shows a summary of the number of High Speed Links supported by each 270/8xx server and the number of PCI-based Towers per HSL. If a Migration Tower is involved, that is an additional tower supported.

We discuss more about the Towers following the next set of foils on I/O-based features.

IBM  server. For the next generation of e-business.

270 High Speed Link

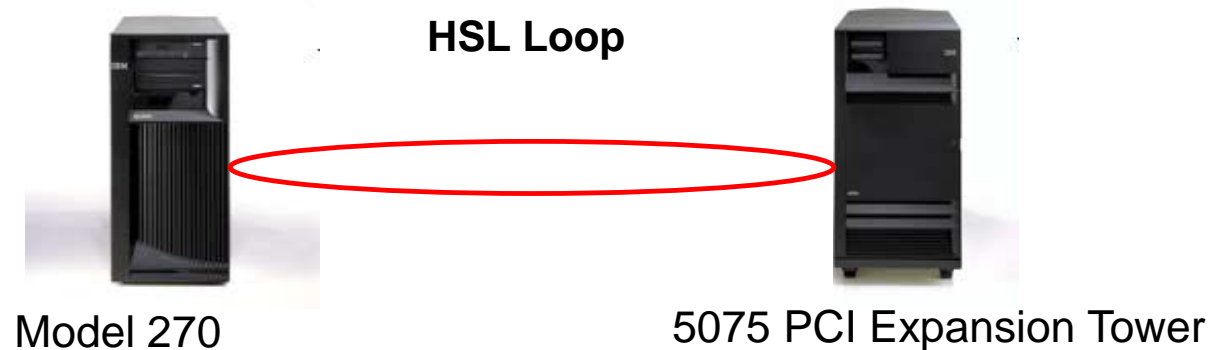

Model 270 - one HSL loop - one tower

Notes: 270 High Speed Link

The 15 meter HSL cable (#1462) is not supported on the 270. The HLS 3 meter (#1460) and 6 meter (#1461) cables are supported.

820 High Speed Link

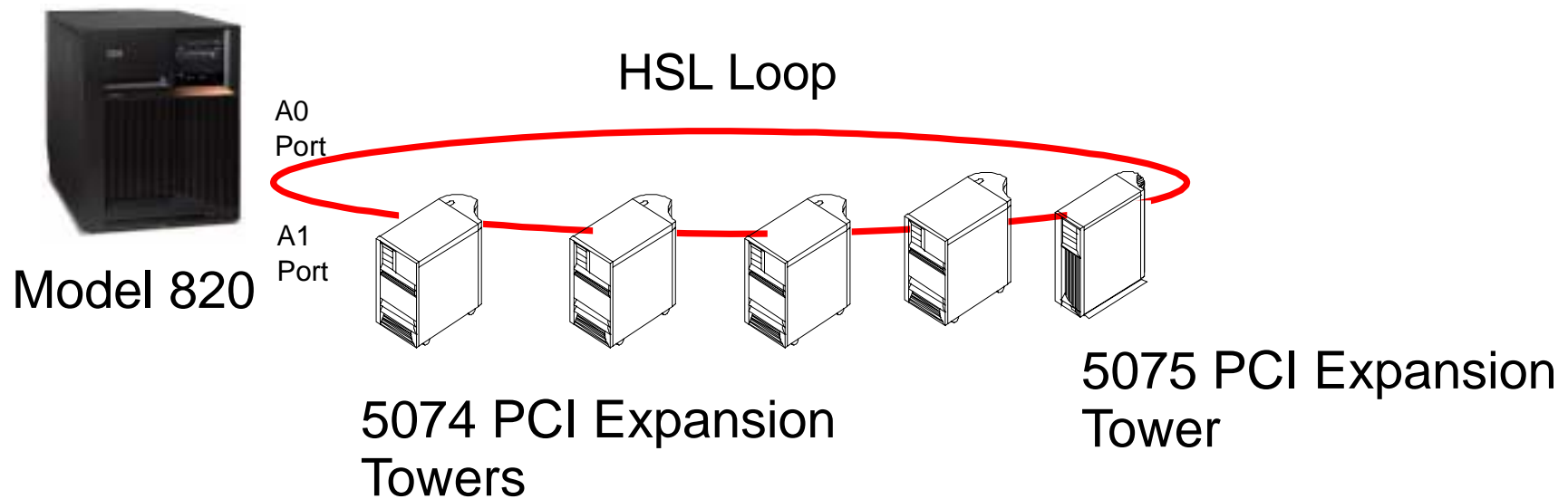

Model 820 - one loop - can support 5 towers or 4 towers plus a migration tower

IBM  server. For the next generation of e-business.

Notes: 820 High Speed Link

A 15 meter HSL cable (#1462) cannot be used to directly connect system unit port A1 on the model 820 to a 5075, 5074, 5079. It can be used on HSL port A1 of the model 820 to directly connect Migration Towers #5033, #5034 and #5035. It can be used for all other connections on the Model 820

- A #1462 cable can be used for all connections on an 830 or 840.

830 High Speed Link

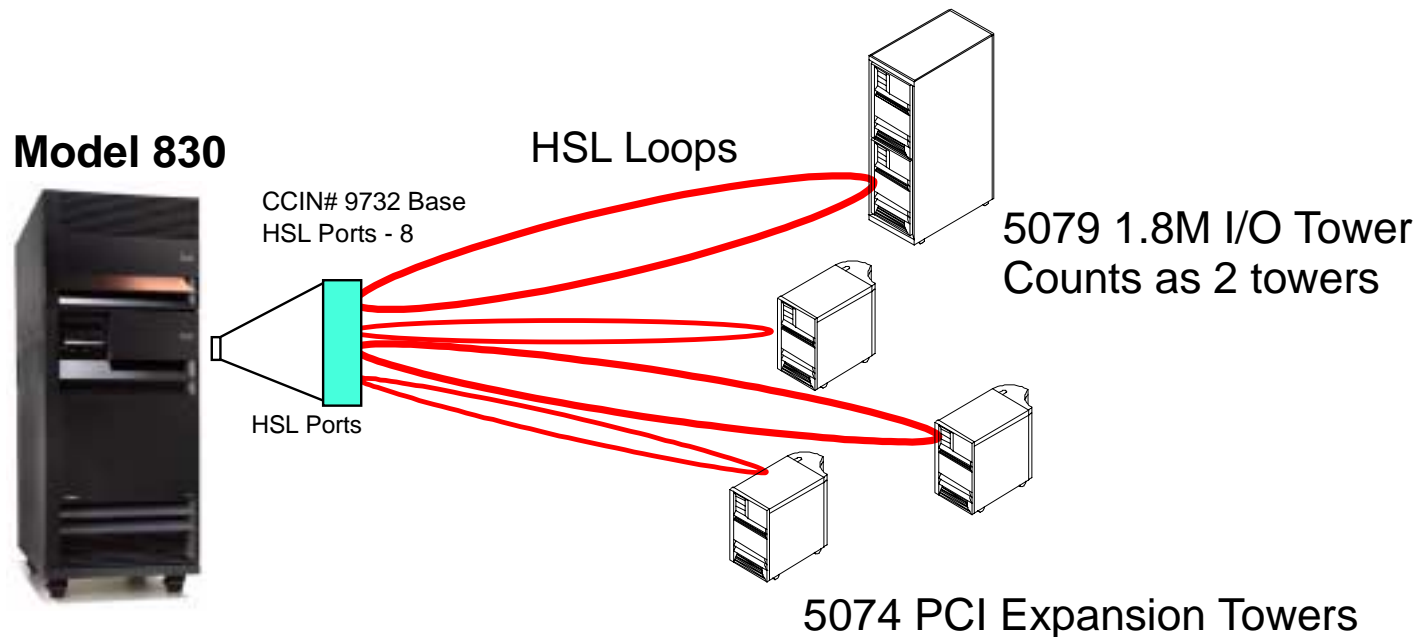

- Model 830 - 4 loops - maximum towers is 13
- Loop 1 can support exactly 1 tower.
 - Loops 2,3,4, can support 4 towers each.
- Note: SPD towers attached via a migration tower do not count towards the total

830 High Speed Link Plugging Order



ALL HSL ports for the 830 are located in the rear of the system unit.

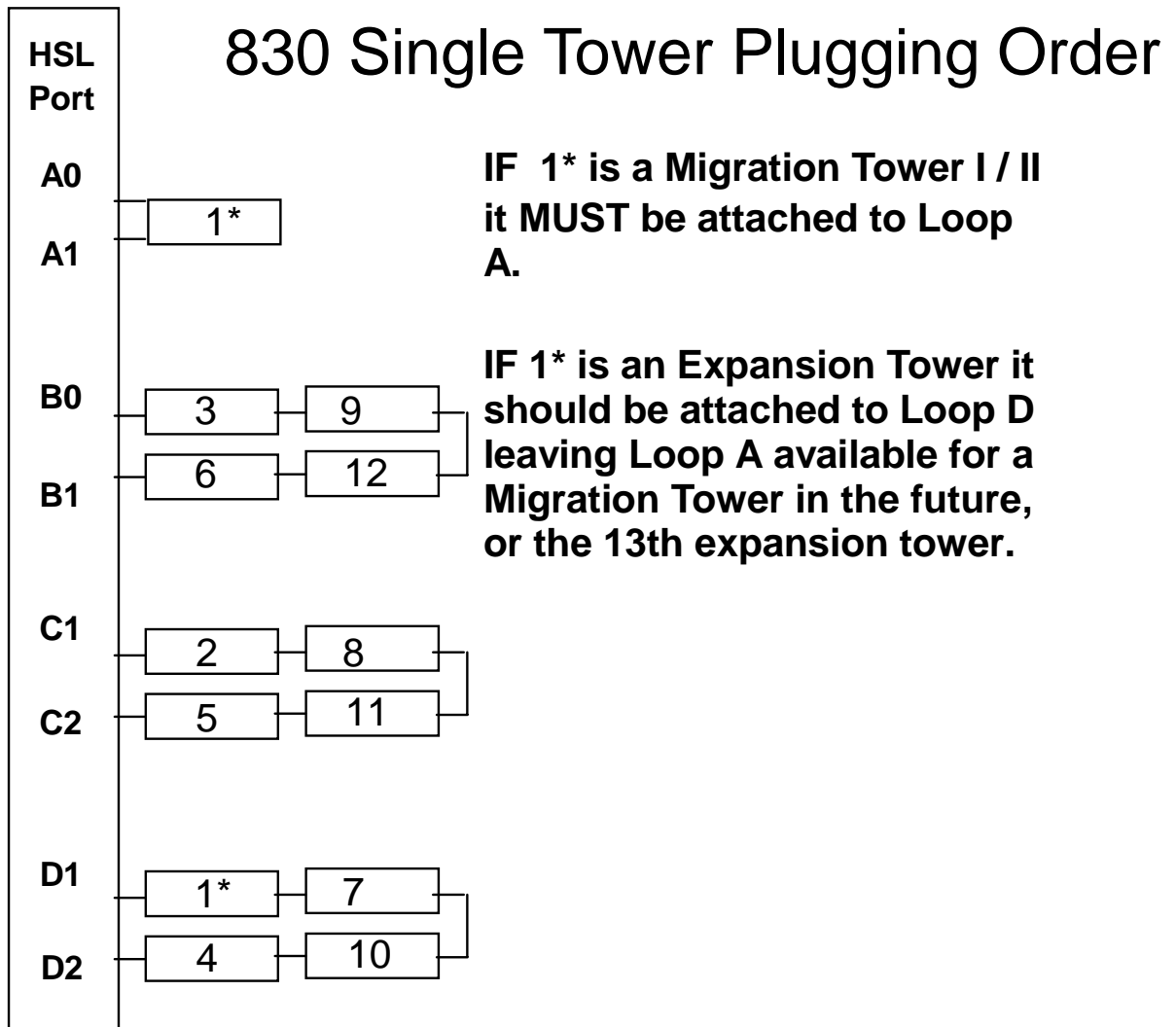

Note that the sequence numbers shown in this figure suggest the optimum I/O performance for tower connection. That is, connecting the second I/O tower to port C1 and the third I/O tower to port B1, would ensure there are no performance bottlenecks within the system configuration.

Only in an extreme performance situation, such as with a large save file or library function with a 3590 class tape device is the performance degraded if, for example, you place 2 I/O towers on cables connected to ports D0 and D1. The Migration presentation contains a discussion on this topic.

840 High Speed Link

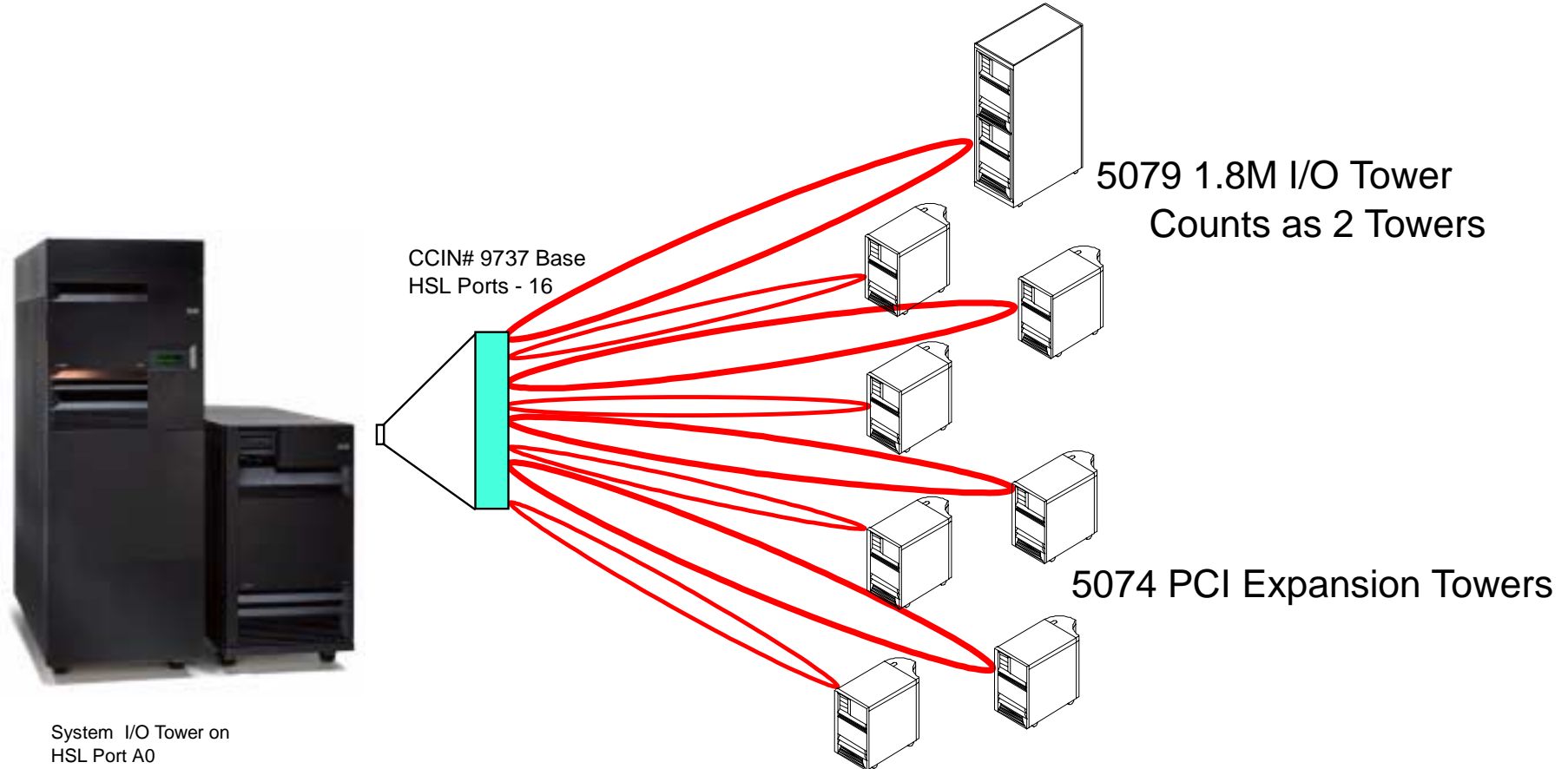

Model 840 - 8 loops - maximum towers is 23

- Loop 1 can support 2 towers !

- Loops 2 - 8 can support 4 towers each up to the system maximum of 23.

Note: If a migration tower is on loop 1 then the "downstream" SPD towers are allowed and do not count towards the system total of thirteen.

840 High Speed Link Plugging Order



840 Single Tower Plugging Order

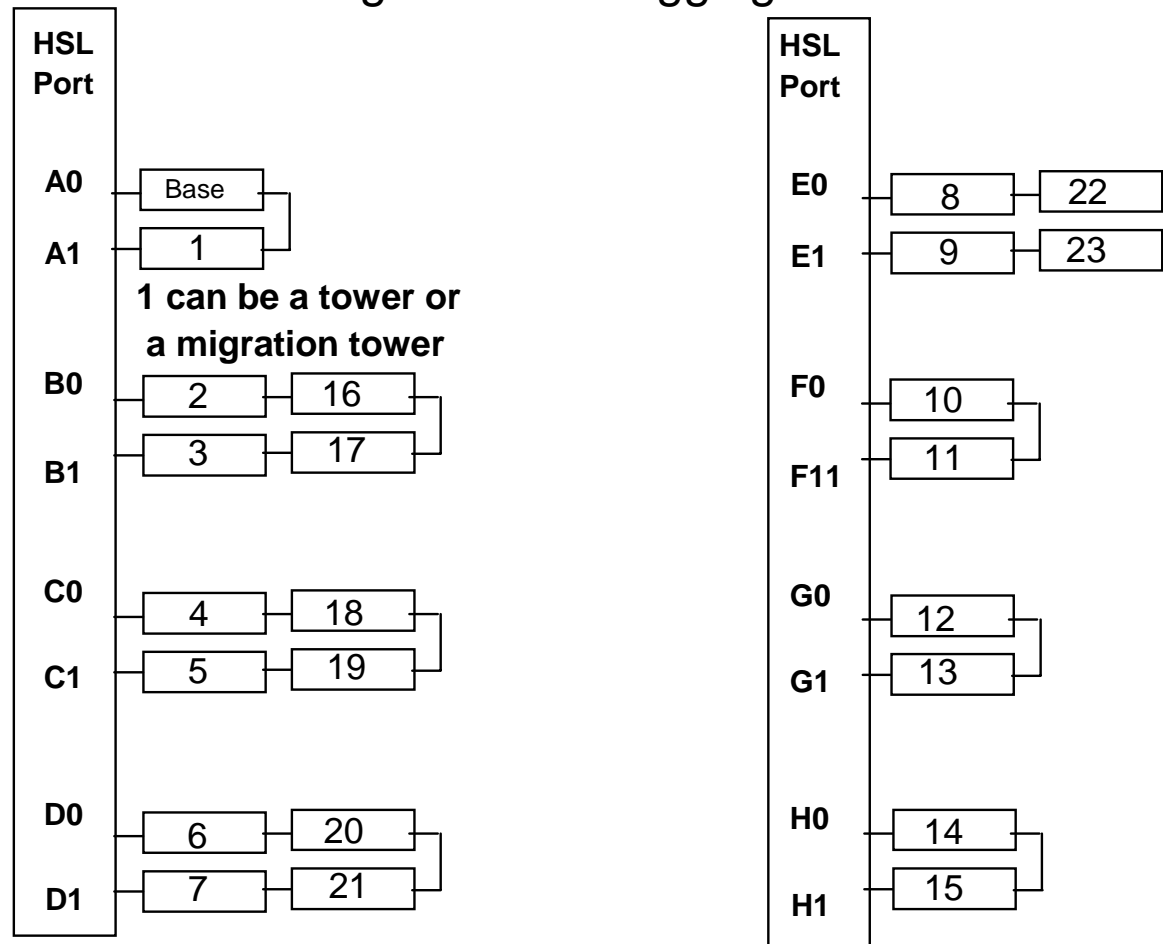

The 840 system includes the System I/O unit (like previous high end systems 650/740/S40). This I/O unit will always be present on Loop 0...the A0,A1 port pair.

Note that the sequence numbers shown in this figure suggest the optimum I/O performance for tower connection. That is, connecting the second I/O tower to port B0, the third I/O tower to port B1, the fourth I/O tower to C04, and so on, would ensure there are no performance bottlenecks within the system configuration.

Only in an extreme performance situation, such as with a large save file or library function with a 3590 class tape device is the performance degraded if, for example, you place I/O towers numbers 4 and five on cables connected to ports B0 and B1. The Migration presentation contains a discussion on this topic.

Notes: 840 High Speed Link-2

The new V4R5 generation of Servers have much faster processors and are able to handle massive amounts of instructions and data. The new DASD and their controllers are also much faster than the previous generation. New and again much faster adapters such as for example the 1 Gb Ethernet card can present amounts of data to be processed that exceed the capabilities of the previous transport mechanism. In order to keep a balanced system concept, all these fast components must be connected together using a new technology that is able to keep up with the highly demanding performance of these components. The High Speed Link cables interconnect the new towers and the Server CEC (and eventually the migration tower). Not only the speed, but also the bandwidth of the connections is important. High Speed Links can have an overall throughput of up to 700 MB/sec operating in full duplex mode, this is when the loop is considered to be closed. It is very important to plan for the cabling of the High Speed Link, especially in the high end range of Servers. The physical planning is important due to the restricted cable length. You also have to take the number of towers, ports and loops into consideration when you plan for the new hardware.

Official naming conventions in V4R5 are different than what is used under Hardware Service Manager :

HSM Screen	V4R5 Name
System Interconnect Network	System Area Network
System Interconnect Controller	HSL Network Interface Controller (local)
System Interconnect Ring	HSL Loop
System Interconnect I/O Adapter	HSL I/O Bridge
System Interconnect System Adapter	HSL Network Interface Controller (remote)

The First HSL Loop is Loop 256. When you look in an Hardware Service Manager screen it is called ring 256.

Hardware Service Manager functions provide a way to "walk the loop". Under the option Display System Interconnect Information the F7 and F8 Keys allow you to step completely around the loop, with the ability to see the status of every HSL port connection that makes up the loop.

V5R1 HSL OptiConnect

IBM @server. For the next generation of e-business.

V5R1 Connectivity: Connecting iSeries using the HSL fabric

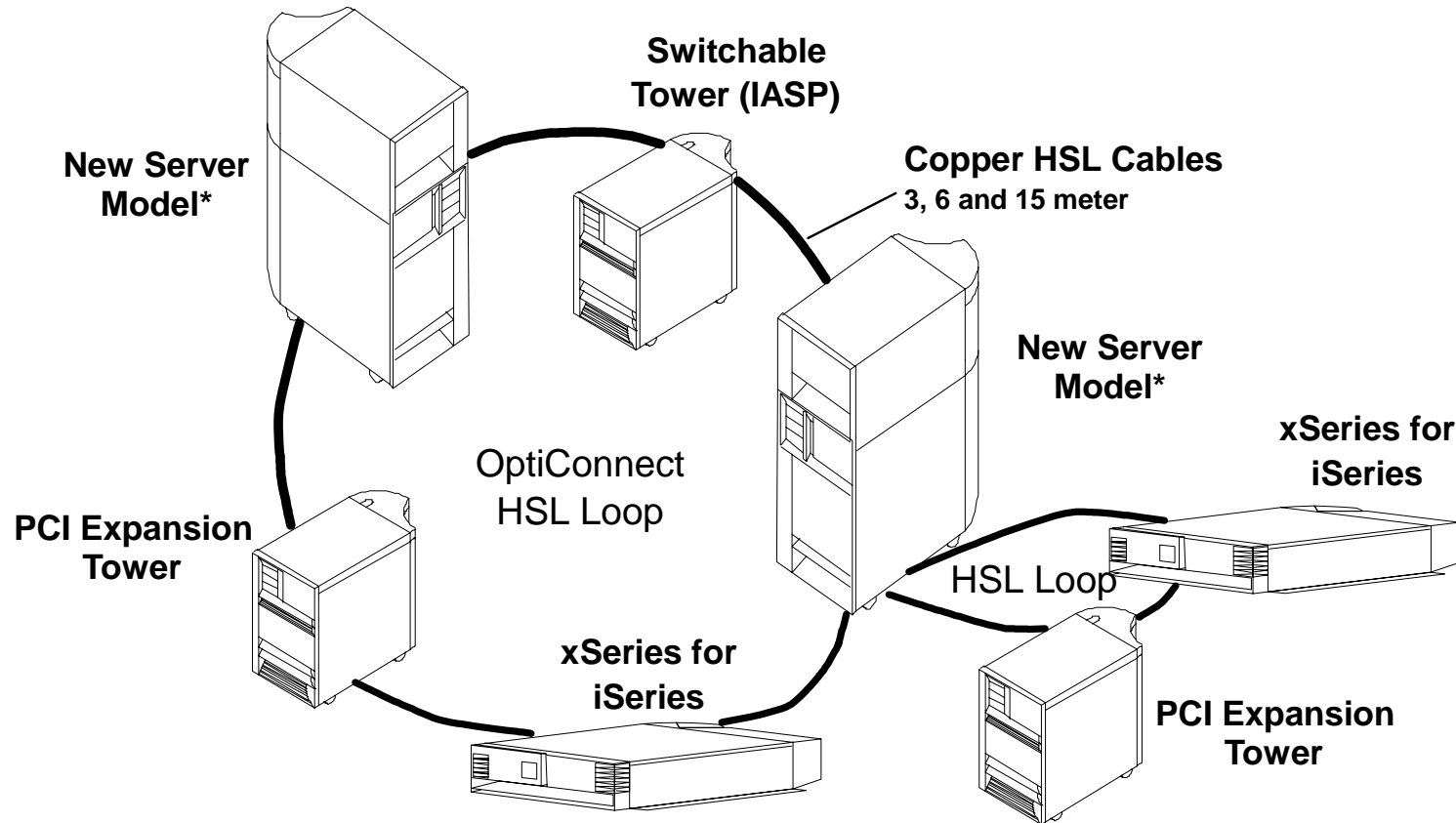

*All 270, 820, 840 SStar models announced April 2001 have new technology HSL adapters that support OptiConnect. Pre April 2001 830 and 840 iStar models may take advantage of new HSL Adapters (#2754, #2755, #2777) that support OptiConnect

The V4R5 HSL technology was introduced as the means for attaching I/O towers to the base system unit. With V5R1 you can use this HSL fabric for high-speed system to system interconnect running ten times faster than the existing SPD OptiConnect which HSL OptiConnect replaces. The result is greatly expanded capability for high-availability options and distributed application scenarios. In the world of eBusiness, continuous availability and distributed workload are minimum requirements. HSL OptiConnect is available throughout the iSeries product line from the smallest Model 270 to the largest Model 840 with V5R1 processors.

The new "April 2001" processors - SSTAR models have the new "OptiConnect-capable" HSL adapters. The pre-April 2001 270 and 8xx servers do not already have this new technology HSL adapters.

The following pages of these notes for this foil give more hardware and software requirement details.

HSL Fabric :A new bus structure using High Speed Links (HSL) was created to provide a faster data transportation mechanism for the iSeries 270 and 8xx models. These new systems have faster processors, more on-chip cache, a faster memory bus, a super fast crossbar switch complex (with speeds up to 43.2 GB per second), faster DASD, and much faster IOPs and IOAs including the new fibre channel adapters that are the first step of the iSeries in the world of SAN. This structure is shown in the hierarchy of processors diagram on page 21.

HSL at OS/400 V5R1 is implemented using copper interconnect cables. These cables allow for very high speed and high quality parallel data transfer. The previously used technology with the optical fibers and optical adapters to interconnect the CEC and the towers of the AS/400 could no longer provide the required performance capability necessary to satisfy the new iSeries demands regarding data movement between the external components (towers) and the Central Electronic Complex. Reasons for this are, that with that optical technology, data transfer is serial, the core is large enough to permit the light to bounce around as it travels down the cable, taking many paths or modes, cable and connector attenuation and the other factors that influence latency (time between when the signal is sent and when it arrives).

This new bus structure provides:

- Performance enhancement and future system growth
 - 1 GB/sec technology
 - 700 MB/sec maximum deliverable capacity running full duplex
- Simplified implementation
 - Loop technology for redundancy
 - Multiple towers per loop
 - 3m, 6m, 15m copper HSL cables
 - Migration tower attachment supports SPD I/O towers and PCI expansion Towers (#5065/#5066)
- Homogeneous HSL network with V5R1 HSL adapters
 - Simple HSL Clusters (2 iSeries)
 - xSeries for iSeries HSL connectivity
 - Switchable HSL connected tower with IASP

In system complexes that contain only V5R1 HSL hardware, the HSL implementation consists of loops that may contain any expansions (#5074/#5075/#5078/#5079s) and up to 4 iSeries servers. These HSL loops provide redundancy to all attached towers. In addition, the implementation of HSL and OS/400 provide data flow balancing across the loop by assigning communication paths during an IPL to optimize loop throughput based upon loop and tower configurations.

In system complexes that contain pre-V4R5 hardware, a migration tower is needed to interface to the existing SPD and PCI towers. The migration tower has the appropriate number of #2695 SPD Optical Bus Adapters and #2688 Optical Link Processors to support the number of towers to be attached. This connection interface uses the existing SPD fiber cables. For further details, see the product sections within the *V4R5 System Handbook* or *System Builder* or *AS/400e to iSeries Migration: A Guide to System Upgrades at V4R5*, SG24-6055

HSL Components: The list of HSL components has three categories, cables, adapters and code.

Cables

In V5R1 the same three cable types are available for the iSeries servers as in V5R4

A 3 meter HSL cable feature #1460

A 6 meter HSL cable feature #1461

A 15 meter HSL cable feature #1462 (remains maximum cable length supported)

HSL Adapters

The HSL adapters that shipped with the iSeries servers V4R5 Models are not cluster enabled. The iSeries servers V5R1 Models are shipped with the cluster enabled adapters. In order to make your servers and towers cluster enabled, you must ensure that they either already have the proper adapters or you may order one from the following list:

- #2754 Bus Expansion with 8 HSL ports
 - Enables Clustering over HSL on iSeries Models 830 and SB2 (all processor features except #2400)
- #2777 Bus Expansion with 8 HSL ports
 - Enables Clustering over HSL on iSeries Model 830 processor #2400
- #2755 Bus Expansion with 16 HSL ports
 - Enables Clustering over HSL on iSeries Models 840 and SB3
- HSL Adapter Machine Type 1519 Model 100 is used in the HSL connected xSeries for iSeries.
 - The HSL adapter for the xSeries can be ordered as Machine Type 1519 Model 100 and is supported as a peripheral in the iSeries e-Config configurator tool.

If you want HSL cluster enabled adapters in the V4R5 iSeries Models 270 and/or 820, you must upgrade them to a V5R1 Model because the HSL adapter is part of the CEC.

Code

V5R1 System Licensed Internal Code delivered with every iSeries server enables the high speed communication over the HSL connection between the iSeries CEC and the towers that are connected to it. The rules for the physical attachment are explained in the next paragraph.

HSL OptiConnect: HSL OptiConnect is the software that enables server to server communication in a simple cluster over a HSL connection. You can order this software as part of the operating system V5R1 (5722-SS1 Option 23 OptiConnect). There is also a hardware feature (#0141) to allow additional HSL cables to be ordered for connecting the HSL OptiConnected systems. Prerequisite is a HSL OptiConnect capable iSeries server with cluster enabled adapters.

HSL OptiConnect connections between LPAR partitions are not supported

HA Switchable resources: This V5R1 software allows you to switch resources between iSeries servers that are HSL OptiConnect capable. In V5R1 you can switch towers between HSL connected iSeries servers in a simple cluster environment when the towers contain Independent Auxiliary Storage Pool. You will also be able to switch an Independent Auxiliary Storage Pool between V5R1 logical partitions at IOP level using this software. Order this software also as part of the V5R1 OS/400 ((5722-SS1 Option 41 HA Switchable Resource).

This is a separately priced licensed software option of OS/400.

OptiConnect and Placement Rules

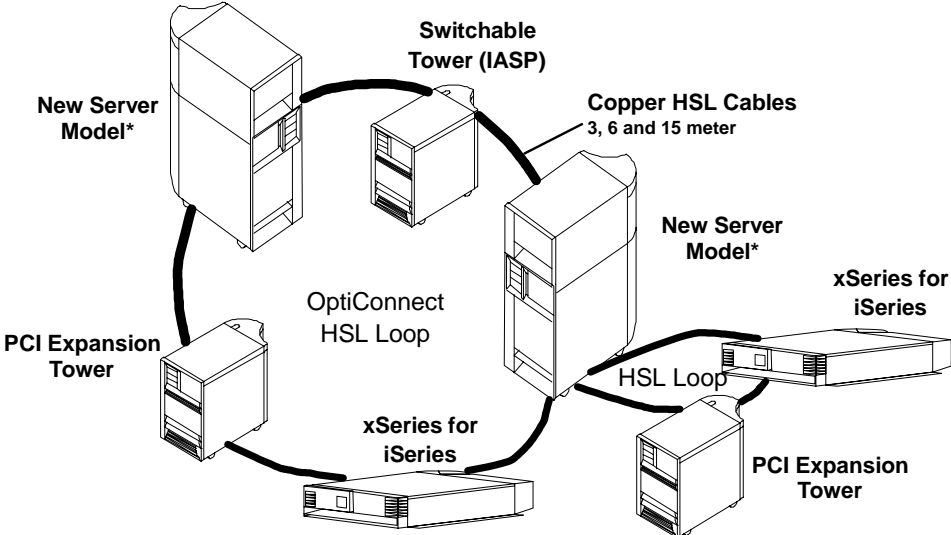

OR ...

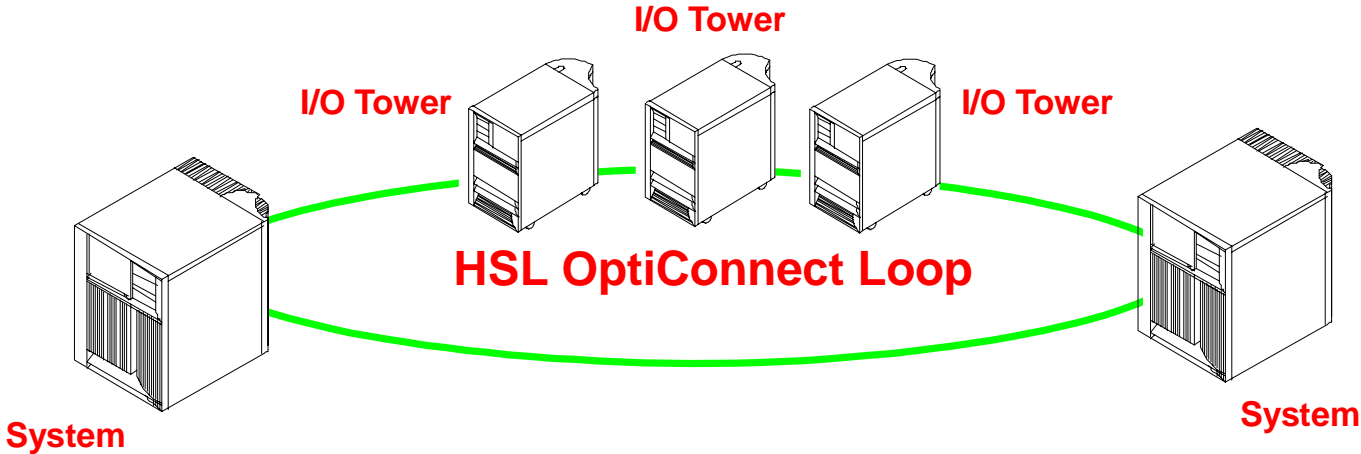

IBM  server. For the next generation of e-business.

General V5R1 HSL rules for the iSeries

If more than one rule applies, the most restrictive rule will define the limitation. The base rules for tower placement can be found in the iSeries V5R1 System Builder in Chapter 3 under 3.7 Models 820, 830 and 840 High Speed Link Tower Placement.

Maximum I/O Nodes rule

- For any HSL loop, the maximum number of I/O nodes per loop is 10. A node is not always equal to a tower, the Model 820 CEC for example represents two nodes. The maximum number of I/O nodes that can be owned by one system is defined by the maximum tower ownership.
- The internal nodes of the Model 270 and Model 820 CECs do not count in this limit

Maximum CEC Nodes rule

- For any HSL loop, the maximum number of CEC nodes (i.e. systems) per loop is 2
- HSL loops may contain a mixture of CEC nodes and I/O nodes.

Maximum towers on a shared loop rule

- For any HSL loop which contains two CEC nodes, the maximum number of external towers per loop segment is 2

The above limits apply to the sum of all types of external towers, including xSeries for iSeries towers.

Maximum OptiConnect connections rule (not HSL exclusive)

- Between any two systems a total of 4 HSL OptiConnect connections plus 2 SPD OptiConnect connections are supported.
- Between any two LPAR partitions a single Virtual OptiConnect connection plus 2 SPD OptiConnect connections are supported.
- HSL OptiConnect connections between LPAR partitions are mutually exclusive with Virtual OptiConnect.
- The total of 64 systems and 128 individual connections are supported by OptiConnect from a single system. (The current hardware does not support this many OptiConnect connections)

Notes:

- Many functionally supported configurations may not provide optimal or even acceptable performance for a given application. Some towers or CECs may contain more than one node like the Model 270 and the Model 820 base towers. The maximum numbers of towers per iSeries Model can easily be found in each of the different Model overview tables
- Adjacency rule: A switchable tower must be immediately adjacent in the HSL loop to the alternate iSeries Server, or to a tower that is not switchable and owned by the alternate iSeries Server. See the next foil for reference
- HSL Loop Segment Rule: Two systems define the ends of an HSL loop segment on which a switchable tower resides. One of those systems must be the home system and the other must be the alternate system for that tower. (This rule is essentially a direct result of the adjacency rule.) See the next foil for reference.
- Internal towers, that is towers being part of the iSeries base such as for example the #9079 can not be switchable towers.
- xSeries for iSeries towers can not be switchable towers.
- Multiple HSL loop segments may exist in a single HSL loop

Multiple System (HSL OptiConnect)

- The maximum CEC nodes rule (see above) defines the configuration limit in this case.
- Any mixture and order of iSeries Models is allowed.

Combinations - Multiple Systems, Multiple Towers, Multiple Loops

- Multiple systems and multiple towers may be configured in any combination within a single HSL loop which complies with the other rules above.
- Multiple loops may be used to interconnect multiple systems in more complex configurations. No additional configuration restrictions apply, but each HSL loop must comply with the other rules above.

In simple cluster environments you may think that some basic rules can be broken by for example switching towers to an other iSeries server in the HSL loop. You can for example switch a #5074 tower to Model 270. This situation can make you think that the Model 270 supports more DASD than allowed. However, this is not really true since the Model 270 can not own the #5074 tower and will only see it as a switched tower (never in a switchable tower).

V5R1 Switch Disk Placement Rules

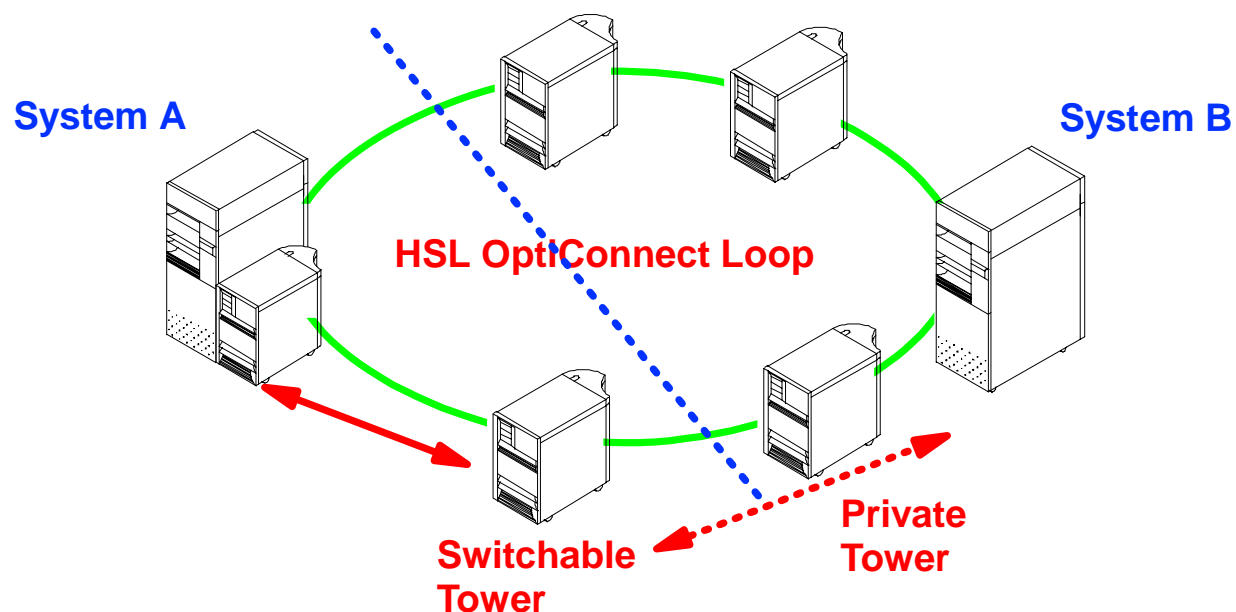

Adjacency rule

- ★ switched tower must be physically adjacent to the alternate system or tower owned by the alternate system

HSL Segment Rule

- ★ switch tower must reside on the HSL segment connecting home and adjacent systems for that tower

Hardware not supported by V5R1

Features

- Cryptographic processors
 - #2620
 - #2628
- Integrated PC Servers
 - #2850, #2851, #6516, #6517, #6518, #6526, #6527, #6528, #6529
 - #6616

Devices

- Tape
 - Device types 2440, 3422, 3430, 9347
- Diskette
 - Device type 9331
- Optical
 - Device type 3995 models A43, 043, 143, 042 and 142
 - No support for 3995 via #2621

Appendix

IBM @server. For the next generation of e-business.

iSeries Physical Specifications

DIMENSIONS	Height mm / in	Width mm / in	Depth mm / in	Weight (max.) Kgs / lbs
250 Server	610 / 24	340 / 13.4	662 / 26.1	38.6 / 85
250 with #7102	610 / 24	550 / 21.7	662 / 26.1	70.5 / 155
270 Server	610 / 24	246 / 9.7	728 / 28.7	52.7 / 116
270 with #7104	610 / 24	432 / 17	728 / 28.7	82.0 / 181
0551 Rack (2 270s)	1800 / 70.9			
820 Server	610 / 24	483 / 19	728 / 28.7	96.0 / 212
830/SB2 Server	1270 / 50	483 / 19	1080 / 42.5	400 / 882
0550 1.8m rack	1800 / 70.9			
840/SB3 Server	1577 / 62.1	565 / 22.2	1320 / 52.0	397 / 875
Base #9079 tower	910 / 35.8	485 / 19.1	1075 / 42.3	280 / 617
8079 1.8m rack	1800 / 70.9			
<u>Expansion Towers</u>				
Tower #5075	610 / 24	246 / 9.7	728 / 28.7	52.7 / 116
Tower #5074	910 / 35.8	485 / 19.1	1075 / 42.3	282 / 622
Tower #5079	1800 / 70.9	650 / 25.6	1020 / 40.2	726 / 1601

IBM  server. For the next generation of e-business.

250 Server Summary

Attributes	Processor Feature	
	#2295	#2296
Processor CPW	50	75
Interactive CPW	15	20
Software Tier	PPS/P05	PPS/P05
Main Storage (MB)		
Minimum	256	256
Maximum	1024	1024
DASD Capacity (GB)		
Minimum	8.58	8.58
Maximum	175.4	175.4
Communication Lines	1-30	1-30
LAN Ports	1-5	1-5
IPCS (With 1 or 2 LANs)	0-2	0-2
High-Speed PCI Slots (ATM, 10/100 Ethernet)	0-3	0-3
Twinaxial Controllers	0-6	0-6
Twinaxial Workstations	240	240
1/4-Inch Cartridge Tape	0-1	0-1
External Tape / Tape Libraries	0-2	0-2
Optical Libraries	0-2	0-2

IBM  server. For the next generation of e-business.

Year 2000 270 Server Summary

Processor Feature	#2248	#2250	#2252	#2253
Attributes				
Processors	Single	Single	Single	2-way
Processor CPW	150	370	950	2000
Orderable Interactive Feature, Interactive CPW (Processor Feature)	#1517 = 25 (22A2)	#1516 = base/0 (22A4) #1518 = 30 (22A5)	#1516 = base/0 (22A7) #1519 = 50 (22A8)	#1516 = base/0 (22AA) #1520 = 70 (22AB)
Software Tier	P05	P10/P10	P10/P10	P20/P20
Main Storage (MB) Minimum Maximum	256 MB 4096 MB	256 MB 4096 MB	256 MB 8192 MB	256 MB 8192 MB
DASD Capacity (GB) Minimum Maximum	8.58 421.1	8.58 421.1	8.58 421.1	8.58 421.1
Communication Lines	50	50	50	50
LAN Ports	8	8	8	8
Integrated Netfinity Servers (With 1 or 2 LANs)	3	3	3	3
1 GB Ethernet	3	3	3	3
Twinax Controllers	6	6	6	6
Twinax Workstations	240	240	240	240
1/4-Inch Cartridge Tape Internal	1	1	1	1
External tapes / Tape libraries	3	3	3	3
Optical Libraries	4	4	4	4

Note: Maximums shown require a #7104 and a #5075

IBM  server. For the next generation of e-business.

Year 270 DSD Summary

Processor Feature Attributes	#2422	#2423	#2424
Processor	Single	Single	2-way
Processor CPW	370	950	2000
Interactive CPW/Non-Domino CPW	0/50*	0/100*	0/200*
Software Tier	P05	P05	P05
Main Storage (MB) Minimum Maximum	256 MB 4096 MB	256 MB 8192 MB	256 MB 8192 MB
DASD Capacity (GB) Minimum Maximum	8.58 421.1	8.58 421.1	8.58 421.1
Communication Lines	50	50	50
LAN Ports	8	8	8
Integrated Netfinity Servers (With 1 or 2 LANs)	3	3	3
1 GB Ethernet	3	3	3
Twinax Controllers	6	6	6
Twinax Workstations	240	240	240
1/4-Inch Cartridge Tape Internal	1	1	1
External tapes / Tape libraries	3	3	3
Optical Libraries	4	4	4

*DSD non-Domino CPW indicates the capacity on the system available for use by non-Domino workloads

IBM  server. For the next generation of e-business.

Year 2000 820 Server Summary

IBM  server iSeries

Processor Feature	#2395	#2396	#2397	#2398
Attributes				
Processor	Single	Single	2-way	4-way
Processor CPW	370	950	2000	3200
Orderable Interactive Feature, Interactive CPW (Processor Feature)	#1521 = 35 (23A1) #1522 = 70 (23A2) #1523 = 120 (23A3) #1524 = 240 (23A4)	#1521 = 35 (23A9) #1522 = 70 (23AA) #1523 = 120 (23AB) #1524 = 240 (23AC) #1525 = 560 (23AD)	#1521 = 35 (23B1) #1522 = 70 (23B2) #1523 = 120 (23B3) #1524 = 240 (23B4) #1525 = 560 (23B5) #1526 = 1050 (23B6)	#1521 = 35 (23B8) #1522 = 70 (23B9) #1523 = 120 (23BA) #1524 = 240 (23BB) #1525 = 560 (23BC) #1526 = 1050 (23BD) #1526 = 2000 (23BE)
Software Tier	P10 (23A1)/P20	P20 (23A9)/P30	P20 (23B1)/P30	P30 (23B8)/P40
Main Storage (MB)				
Minimum	256 MB	256 MB	256 MB	256 MB
Maximum	4096 MB	8192 MB	16384 MB	16384 MB
DASD Capacity (GB)				
Minimum	8.58	8.58	8.58	8.58
Maximum	4159.1	4159.1	4159.1	4159.1
Communication Lines	160	160	160	160
LAN Ports	30	30	30	30
Integrated Netfinity Servers (With 1, 2, 3) LANs)	12	12	12	12
1 GB Ethernet LAN	17	17	17	17
Twinax Controllers	62	62	62	62
Twinax Workstations	2480	2480	2480	2480
Internal Tape / CD-ROM	12	12	12	12
External tapes / Tape libraries	8	8	8	8
Optical Libraries	14	14	14	14

IBM  server. FOR THE NEXT GENERATION OF e-BUSINESS.

Year 2000 820 DSD Summary

Processor Feature Attributes	#2425	#2426	#2427
Processor	Single	2-way	4-way
Processor CPW	950	2000	3200
Interactive CPW/Non-Domino CPW	0/100*	0/200*	0/300*
Software Tier	P05	P10	P10
Main Storage (MB) Minimum Maximum	256 MB 8192 MB	256 MB 16384 MB	256 MB 16384 MB
DASD Capacity (GB) Minimum Maximum	8.58 4159.1	8.58 4159.1	8.58 4159.1
Communication Lines	160	160	160
LAN Ports	30	30	30
Integrated Netfinity Servers (With 1, 2, 3 LANs)	12	12	12
1 GB Ethernet LAN	17	17	17
Twinax Controllers	62	62	62
Twinax Workstations	2480	2480	2480
Internal Tape / CD-ROM	12	12	12
External tapes / Tape libraries	8	8	8
Optical Libraries	14	14	14

*DSD processor CPW indicates the capacity on the system available for use by non-Domino workloads

IBM  server. For the next generation of e-business.

Year 2000 iSeries 830 Server Summary

Processor Feature		#2400	#2402	#2403
Attributes				
Processor		2-way	4-way	8-way
Processor CPW		1850	4200	7350
Orderable Interactive Feature, Interactive CPW (Processor Feature)		#1531 = 70 (23C1) #1532 = 120 ((23C2) #1533 = 240 (23C3) #1534 = 560 (23C4) #1535 = 1050 (23C5)	#1531 = 70 (23D1) #1532 = 120 ((23D2) #1533 = 240 (23D3) #1534 = 560 (23D4) #1535 = 1050 (23D5) #1536 = 2000 (23D6)	#1531 = 70 (23D8) #1532 = 120 ((23D9) #1533 = 240 (23DA) #1534 = 560 (23DB) #1535 = 1050 (23DC) #1536 = 2000 (23DD) #1537 = 4550 (23DE)
Software Tier		P20 (23C1)/P30	P30 (23CD)/P40	P40 (23D8)/P50
Main Storage (MB)	Minimum Maximum	1024 MB 32768 MB	1024 MB 32768 MB	1024 MB 32768 MB
DASD Capacity (GB)	Minimum Maximum	8.58 11055.8	8.58 11055.8	8.58 11055.8
Communication Lines		300 / 550 *	300 / 550 *	300 / 550 *
LAN Ports		72 / 120 *	72 / 120 *	72 / 120 *
Integrated Netfinity Servers (With 1, 2, 3 LANs)		16	16	16
1 Gbps Ethernet LAN		41	41	41
Twinax Controllers		152 / 316 *	152 / 316 *	152 / 316 *
Twinax Workstations		6080 / 12640 *	6080 / 12640 *	6080 / 12640 *
Internal Tape / CD-ROM		18 / 36 *	18 / 36 *	18 / 36 *
External tapes / Tape libraries		10 / 20 *	10 / 20 *	10 / 20 *
Optical Libraries		22 / 44 *	22 / 44 *	22 / 44 *

*Maximum may be restricted, based upon other I/O devices configured

IBM  server. For the next generation of e-business.

iSeries SB2 Server Summary

Processor Feature		#2315
Attributes		
Processor		8-way
Processor CPW		7350*
Interactive CPW		0
Software Tier		P30
Main Storage (MB)		12288 MB
DASD Capacity (GB)	Minimum Maximum	34.3 GB 70.1 GB (1)
Communication Lines		38
LAN Ports		5
Integrated Netfinity Servers (With 1, 2, 3 LANs)		2
1 Gbps Ethernet LAN		2
Twinax Controllers		1
Twinax Workstations		28
Internal Tape / CD-ROM		3
External tapes / Tape libraries		4
Optical Libraries		2

*Processor CPW values are not valid representations of performance characteristics for SB2/SB3 servers due to the limited amount of disk storage. Disk space is not a high priority for these servers intended to perform CPU-intensive work because they are always connected to another system acting as the "database" server in a multi-tier implementation.

IBM  server. For the next generation of e-business.

Year 2000 iSeries 840 Server Summary

Processor Feature		#2418	#2420
Attributes			
Processor		12-way	24-way
Processor CPW		10000	16500
Orderable Interactive Feature, Interactive CPW (Processor Feature)		#1540 = 120 (23E8) #1541 = 240 (23E9) #1542 = 560(23EA) #1543 = 1050 (23EB) #1544 = 2000 (23EC) #1545 = 4550 (23ED) #1546 = 10000 (23EE)	#1540 = 120 (23F8) #1541 = 240 (23F9) #1542 = 560(23FA) #1543 = 1050 (23FB) #1544 = 2000 (23FC) #1545 = 4550 (23FD) #1546 = 10000 (23FE) #1547 = 16500 (23FF)
Software Tier		P40 (23E8)/P50	P40 (23F8)/P50
Main Storage (MB)	Minimum	4096 MB	4096 MB
	Maximum	98304 MB	98304 MB
DASD Capacity (GB)	Minimum	8.58	8.58
	Maximum	18952.9	18952.9
Communication Lines		400	400
LAN Ports		96	96
Integrated Netfinity Servers (With 1, 2, 3 LANs)		16	16
1 Gbps Ethernet LAN		71	71
Twinax Controllers		175	175
Twinax Workstations		7000	7000
Internal Tape / CD-ROM		24 / 26	24 / 26
External tapes / Tape libraries		26	26
Optical Libraries		26	26

IBM  server. For the next generation of e-business.

Year 2000 iSeries SB3 Server Summary

Processor Feature		#2316	#2318
Attributes			
Processor		12-way	24-way
Processor CPW		10000*	16500*
Interactive CPW		0	0
Software Tier		P40	P40
Main Storage (MB)		16384 MB	24576 MB
DASD Capacity (GB)		34.3 GB	34.3
Minimum		105.2 (*)	140.3 (*)
Maximum			
Communication Lines		38	38
LAN Ports		5	5
Integrated Netfinity Servers (With 1 or 2 LANs)		2	2
1 Gbps Ethernet LAN		2	2
Twinax Controllers		1	1
Twinax Workstations		28	28
Internal Tape / CD-ROM		3	3
External tapes / Tape libraries		4	4
Optical Libraries		2	2

*Processor CPW values are not valid representations of performance characteristics for SB2/SB3 servers due to the limited amount of disk storage. Disk space is not a high priority for these servers intended to perform CPU-intensive work because they are always connected to another system acting as the "database" server in a multi-tier implementation.

IBM  server. For the next generation of e-business.

New Component Reference Chart

Number	Description	Earliest Release Supported	270 / 8xx announced 2001	270 / 8xx announced 2000	6xx / 7xx
# 2754/55/77 (for 830/840)	HSL OptiConnect	V5R1	Y-base	Y-830/840 N-270/820	N
1519-100	Direct attached IXS adapter	V5R1	Y	Y	N
#2791/2891	850 MHz Integrated xSeries Server	V4R5	Y	Y	N
#2765/2766	PCI Fibre Channel controllers	V5R1	Y	Y	N
3534-1RU	Managed Hub	V5R1	Y	Y	N
2109-S08/S16	Switch	V5R1	Y	Y	N
#4778/2778	new PCI RAID disk controller	V5R1	Y	Y	Y
#5078/0578	PCI Expansion Unit	V5R1	Y-8xx N-270	Y-8xx N-270	N
#4430/4530	DVD internal feat code #	V4R5	Y	Y	N
7210-025	DVD external box	V5R1	Y	Y	Y
#4487/4587	50 GB QIC (SLR100) FC#	V5R1	Y	Y	Y
7329-308	50 GB QIC (SLR100) Auto Loader	V4R5	Y	Y	Y
#5546/5548	Operations Console for LAN Connective.	V5R1	Y	Y	N
#2760	PCI UTP 1 Gb Ethernet IOA	V5R1	Y	Y	N
#2772/2773	PCI Dual integrated modem comm IOA	V5R1	Y	Y	N
#2817	PCI 155 Mbs ATM MMF IOA	V5R1	Y	Y	N
#0551	Rack feature	V4R5	Y	Y	N

New processor and memory feature codes not included

IBM  server. For the next generation of e-business.

Withdrawal from Marketing Announcements

IBM  server iSeries

For any AS/400 or iSeries running any release

na=not available

No orders after May 31, 2001		A Probable Alternative	
Features			
#2629 LAN/WAN Workstation IOP	SPD	#2824 IOP (+PCI IOA with iSeries)	PCI
#2740/2741 RAID Disk Controller (Mdl 720)	PCI	#2778/4778 RAID disk controller	PCI
#2790/2890 Integrated Netfinity Server (700 MHz)	PCI	Integrated xSeries Server (850 MHz): #2791/#2891	PCI
#2809 LAN/WAN Workstation IOP	PCI	#2824 IOP (+PCI IOA with iSeries)	PCI
#2810 LAN/WAN Workstation IOP	SPD	#2824 IOP (+PCI IOA with iSeries)	PCI
#2815/2818 155 Mbps UTP/SMF ATM IOA	SPD/ PCI	#2817 155 Mbps ATM MMF IOA	PCI
#3001/3182 32 MB Main Storage	na	larger memory cards	
#6050 Twinax workstation controller	SPD	#2746/4746 Twinax Workstation IOA	PCI
#6149 16/4 Mbps Token Ring Network IOA	SPD	#2744 100 Mbps Token Ring IOA	PCI
#6533 RAID Disk Controller	SPD	#2778/4778 RAID disk controller	PCI
#6534 Magnetic Media Controller	SPD	#2749 Ultra Magnetic Media Control	PCI
#7101 Expansion Unit for Mdl 170	na	#7102 Expansion Unit	
IBM Devices (also May 31, 2001)			
9309 Model 001 Rack	na	#0551 1.8m rack	
3488/3489 InfoWindow II Model V1Z	na	3488/3489 Model V13	

IBM  server. For the next generation of e-business.

Withdrawal from Marketing Announcements...IBM server iSeries

For any AS/400 or iSeries running any release

No orders after July 31, 2001		A Probable Alternative	
#2699 Two-line WAN	SPD	#2745/2771/2772/2773 Two-line IOA	PCI
#2722 Twinax Controller	PCI	#2746/4746 Twinax Workstation IOA	PCI
#2724 16/4 Token Ring IOA	PCI	#2744 100 Mbps Token Ring IOA	PCI
#6180 Twinax Workstation IOA	SPD	#2746/4746 Twinax Workstation IOA	PCI
#6181 Ethernet LAN IOA	SPD	#2838/4838 100/10 Ethernet IOA	PCI
#6501 Tape/Disk Controller	SPD	#2778/4778 or #2765/2766	PCI
#6513 Internal Tape Controller	SPD	#2749 Ultra Magnetic Media Cntrl	PCI
No orders after December 28, 2001			
#2624 Storage Device Controller	SPD	#2778/4778 or #2766	PCI
#2669 SPD Shared Bus Interface Card	SPD	not applicable	
#2680/2683/2685 OptiConnect Receiver	SPD	not applicable	
#2686/2688 Optical Link Processor	SPD	not applicable	
#2723 Ethernet LAN IOA	PCI	#2838/4838 100/10 Ethernet IOA	PCI
#2816/4815/4816/4818 155 Mbps ATM IOA	PCI	#2817 155 Mbps ATM MMF IOA	PCI
#4723 10 Mbps Ethernet IOA	PCI	#2838/4838 100/10 Ethernet IOA	PCI
#5073/5083 System Unit/Storage Expansion	SPD	#5065 PCI I/O tower (#5074 iSeries)	PCI
#6618 Integrated Netfinity Server (333 MHz)	SPD	Integrated xSeries Server (850 MHz)	PCI

IBM  server. For the next generation of e-business.

These are old, low-demand features which have already been superseded by newer technology. One thing you can quickly see is that most of these are SPD features. It is getting especially harder and harder for IBM to obtain the components for many of the SPD features as they were first used many years ago. PCI adapters (IOAs and controllers) are IBMs strategic I/O technology as evidenced by its exclusive use by iSeries. The migration towers provide a bridge for customers to conveniently transform their server from a mixed SPD/PCI into PCI technology.

Speaker note:

- It is important for customers to be current to take advantage of some of these features. Customers who have fallen too far behind can only use a subset of the alternative features shown.
- For example, the new PCI RAID Disk Unit Controller, FC# 2778/4778, must have V5R1. Or the new Fibre Channel Adapter needs both V5R1 and iSeries hardware.

Users of the 13 GB QIC (1/4-Inch Cartridge) Tape

- FC # 6385 / # 6485
- Will run OS/400 V5R1.
- Will NOT run any following releases or versions after V5R1.
- Suggestion: order a feature conversion from #6385/6485 to:
 - 16 GB (#4483/4583/6383/6483) QIC,
 - 25 GB (#4486/4586/6386/6486) QIC,
 - or 50 GB (#4487/4587)

For 8xx customers considering facility electrical work:

- In the future IBM intends to provide a dual power cord option for the 820, 830, 840 and I/O towers FC#5074 and #5079 as another high availability option
- I/O Expansion Unit FC#5078/0578 already has dual power cord option

Trademarks & Disclaimers

© Copyright International Business Machines Corporation 2001

References in this document to IBM products or services do not imply that IBM intends to make them available in every country.

The following terms are trademarks or registered trademarks of International Business Machines Corporation in the United States, other countries, or both

AIX	Application Development	AS/400
AS/400e	DB2	Domino
IBM	OfficeVision	OS/400
Integrated Language Environment	Net.Commerce	Net.Data
PowerPC	PowerPC AS	SanFrancisco
Host on Demand	Screen Publisher	Host Publisher
PCOM	WebSphere Commerce Suite	Payment Manager
WebSphere	WebSphere Standard Edition	WebSphere Advanced Edition
MQSeries	MQSeries Integrator	Host Integration Series
WebSphere Development Tools for AS/400	VisualAge for Java	VisualAge for RPG
CODE/400	DB2 UDB for AS/400	HTTP Server for AS/400
iSeries		

Lotus, Freelance, and Word Pro are trademarks of Lotus Development Corporation in the United States, other countries, or both.

Tivoli and NetView are trademarks of Tivoli Systems Inc. in the United States, other countries, or both.

C-bus is a trademark of Corollary, Inc. in the United States, other countries, or both.

Java and all Java-based trademarks and logos are trademarks or registered trademarks of Sun Microsystems, Inc. in the United States, other countries, or both.

Microsoft, Windows, Windows NT, and the Windows logo are trademarks of Microsoft Corporation in the United States, other countries, or both.

PC Direct is a trademark of Ziff Communications Company in the United States, other countries, or both and is used by IBM Corporation under license.

ActionMedia, LANDesk, MMX, Pentium and ProShare are trademarks of Intel Corporation in the United States, other countries, or both.

UNIX is a registered trademark of The Open Group in the United States and other countries.

SET and the SET Logo are trademarks owned by SET Secure Electronic Transaction LLC.

Other company, product and service names may be trademarks or service marks of others.

Information is provided "AS IS" without warranty of any kind.

All customer examples described are presented as illustrations of how those customers have used IBM products and the results they may have achieved. Actual environmental costs and performance characteristics may vary by customer.

Information in this presentation concerning non-IBM products was obtained from a supplier of these products, published announcement material, or other publicly available sources and does not constitute an endorsement of such products by IBM. Sources for non-IBM list prices and performance numbers are taken from publicly available information, including vendor announcements and vendor worldwide homepages. IBM has not tested these products and cannot confirm the accuracy of performance, capability, or any other claims related to non-IBM products. Questions on the capability of non-IBM products should be addressed to the supplier of those products.

All statements regarding IBM future direction and intent are subject to change or withdrawal without notice, and represent goals and objectives only. Contact your local IBM office or IBM authorized reseller for the full text of the specific Statement of Direction.

Some information in this presentation addresses anticipated future capabilities. Such information is not intended as a definitive statement of a commitment to specific levels of performance, function or delivery schedules with respect to any future products. Such commitments are only made in IBM product announcements. The information is presented here to communicate IBM's current investment and development activities as a good faith effort to help with our customers' future planning.

Performance is based on measurements and projections using standard IBM benchmarks in a controlled environment. The actual throughput or performance that any user will experience will vary depending upon considerations such as the amount of multiprogramming in the user's job stream, the I/O configuration, the storage configuration, and the workload processed. Therefore, no assurance can be given that an individual user will achieve throughput or performance improvements equivalent to the ratios stated here.

Photographs shown are of engineering prototypes. Changes may be incorporated in production models.

IBM  server. For the next generation of e-business.