

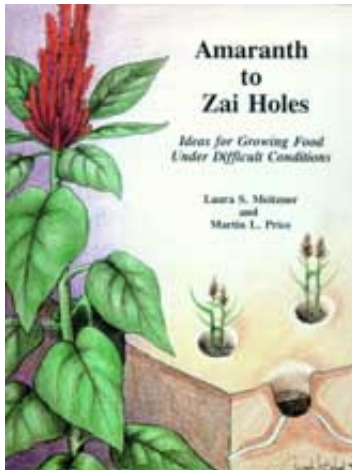

Home-immediately access 800+ free online publications.
Download CD3WD (680 Megabytes) and distribute it to the 3rd World. CD3WD is a 3rd World Development private-sector initiative, mastered by Software Developer Alex Weir and hosted by GNUveau Networks (From globally distributed organizations, to supercomputers, to a small home server, if it's Linux, we know it.)[ar](#).[cn](#).[de](#).[en](#).[es](#).[fr](#).[id](#).[it](#).[ph](#).[po](#).[ru](#).[sw](#)



 Amaranth to Zai Holes, Ideas for Growing Food under Difficult Conditions (ECHO, 1996, 397 p.)

➔  10: Food science

 *(introduction...)*

 Nutrition

 Storage and preservation

 Food preparation

Amaranth to Zai Holes, Ideas for Growing Food under Difficult Conditions (ECHO, 1996, 397 p.)

10: Food science

The goal of most agricultural development is to improve people's nutrition, with an increase in quality, quantity, and diversity of food produced. Each issue of ECHO Development Notes discusses plants and techniques which can enable farmers to produce more food of higher nutritional value. Beyond increased production of more nutritious crops, there is much to be done to improve nutrition. It is important to know about food preparations which enhance nutrition, and some recipes to make new plants palatable and appealing.

Another major area deserving attention is protecting food during storage. Significant percentages of harvested foods are lost to pests and spoilage. Improved techniques for protecting

and preserving products can have a tremendous impact on available food supplies and nutrition during seasonal food shortages. This chapter offers ideas on improving nutrition through new methods of food storage and preparation.

Nutrition

TECHNICAL NOTE "A BEGINNER'S GUIDE TO NUTRITION ON THE SMALL

FARM" by Dr. Frank Martin is a primer for those with little or no experience in this area. He offers some simple guidelines for a balanced diet. Discussed are nutrients in food, recommended daily allowances, individual differences and special needs, balancing the diet, and what to do when milk is missing from the diet. Available from ECHO.

NUTRITION RESEARCH PROGRAM at Judson College involves undergraduate biochemistry and cell biology students in

nutrition-related research for developing countries. They have studied the toxin levels in velvet beans (see Chapter 11 on Human Health), and determined which methods are most suitable on the home scale; they plan to pursue similar research with jack bean. Interested students and others should contact Dr. Rolf Myhrman, Nutrition Research Program, Judson College, 1151 N. State St., Elgin, IL 60123, USA; phone 708/695-2500.

A SIMPLE WAY TO IMPROVE STARCHY "WEANING FOODS."

The following is abstracted from information provided by Noel Vietmeyer (U.S. National Academy of Sciences) in the June 1993 issue of Spore.

"Throughout the developing world boiled starchy grains and roots are given as weaning food.... Boiled starch is so thick and pasty that it is difficult for the very young to swallow enough to gain adequate nourishment." Germinated grains

release enzymes that break down starch (as in the process of malting). "A very small quantity of malted millet or sorghum flour added to a pot of mush made from corn meal, cassava, arrowroot, potato or other boiled staples turns it to liquid in minutes. It is liquid enough for the baby to swallow but dense enough to be filling. It is also more tasty because most of the starch has been converted to sugar." [Ed: Sprouted sorghum should not be eaten because of its cyanide content, but 2-3 grains should be harmless.]

We found further information in the book *Food from Dryland Gardens*, p. 332. It states that you can make 100 g of a millet porridge of suitable consistency for a weaning food that contains 25 kcal of energy and 0.4 gram of protein. On the other hand, 100 g of porridge of the same consistency made with addition of malt contains 83 kcal and 1.3 g of protein. We spoke with Mark Dafforn, Noel's assistant, for more details.

Q. Is this process actually used in some location among the poor or is it a totally new idea? Where did the idea come from?

A. Baby food manufacturers in developed countries routinely liquify their products, but it has a very short track record in developing countries. Noel found the recommendation in a technical report on a Swedish Development Agency (SEDA) project. It has been used in Tanzania and India, and the idea has now been picked up and is being tried in several other places. No one-including ourselves-has done a comprehensive look at its usefulness.

In a way, the concept of liquefying staples is like oral rehydration therapy (ORT) twenty years ago...an idea that was so simple it was ignored by scientists but picked up by desperate development workers-and since then ORT has saved hundreds of thousands of lives at a few pennies apiece.

Q. Does malting change the nutritional value of the porridge?

A. The porridge will be more runny, but that is because the water that was tied up in the starch is released. The starch is essentially predigested. All the original nutrients are still there.

Here is how malnutrition can develop if the porridge is not malted. Children in third world countries often go through a nutritional crisis when they are weaned. Babies are often weaned directly onto traditional adult porridges. Because babies have trouble swallowing the thick porridge, mothers dilute it with water. It can be so diluted that the child's stomach is filled without eating as much food as he or she should. Also, if unboiled water is used, disease organisms are introduced.

Q. The directions said "a small quantity" per pot of mush. How much is a small quantity?

A. Let's say a teaspoon, half a teaspoon, or even less malt for a big bowl. As you know, enzymes are catalysts which speed up reactions without being used up in the process. If you use less enzyme it will take longer. Of course, if the mush is really thick-think of dry mashed potatoes-it doesn't contain enough water to liquify in the first place.

Q. Where does one get malt? We used to buy malted milk shakes. Is this the same thing?

A. I think there's usually an important difference. In those malts the enzyme (called amylase) has been deactivated by heat so you get the flavor but you don't get runny milk shakes! (By the way, so little malt is used in liquefying staples that traditional flavors aren't overwhelmed.) You can usually purchase malt flour at health food stores. It's often called brewer's malt, because it's used to convert the starches in grains to sugars as the first step in making beer. By the way, please point out that though malt is used in brewing, it has no

alcoholic content itself...that comes later, from fermenting sugars with yeast.

Q. Let's be very specific. When you used sprouted wheat, did you mash the fresh sprouts, or did you dry them first and then make them into a flour?

A. Well, actually I just crushed the fresh sprouts between my fingers, and stirred. The amylase content is reportedly highest just after the seed has softened and begun to burst.

Q. Are there other applications?

A. It can be used with people needing a liquid diet with a high nutrient density. A starch based dish like mashed potatoes can be liquified while still retaining its familiar taste. If your readers have other ideas or experiences, we'd be glad to know. Just ask them to drop a brief, informal note to us at the National Academy of Sciences, 2101 Constitution Avenue,

Washington, D.C. 20418, USA. [End of interview.]

Isabel Carter, editor of Footsteps, provided additional details about using "power flour" to convert thick porridge into a sweeter, more runny food for infants. The following is abstracted from the September 1992 Footsteps. "Grains can be germinated by leaving them in water for a day. [Ed: They will not have spouted but the biochemical transformations involved in germination will begin.] During the sprouting process they develop high concentrations of amylase [the enzyme that converts starch to sugar]. Soak cereal grains (maize, rice, millet) for up to one day in a covered pot or bucket. Legumes such as mung beans, haricot beans and cowpeas can also be germinated. They need longer soaking-up to two days. Dry the grains well in the sun. If sorghum is the main cereal, this can also be used to make power flour, but it must be allowed to act for a few minutes, then the porridge must be cooked for a few additional minutes. Mill as usual for

ordinary grains." They recommend using either cereal grain flour alone or a mix of 1 part legume to 2-3 parts cereal. Power Flour is available commercially in Tanzania as "kimea" and in India as "ARF" (amylase-rich flour).

This issue also had some interesting comments about fermented foods. Fermented cereals "are widely used in Africa. Fermented legumes are often used in Indonesia and other Asian countries. The advantage ... is that naturally occurring bacteria [make the food acidic]. This improves the taste and also has the advantage that diarrhoea-causing germs cannot grow so easily. ...Because of lack of time and fuel, mothers are usually not able to prepare fresh food throughout the day, especially for feeding young children who need several meals a day. In a recent study in Ghana, it was found that the number of diarrhoea-causing organisms in food prepared using fermentation was less than half that in food which had been prepared freshly, then left lying around. The fermentation

process also breaks down some of the fiber in the food and increases iron absorption. [The traditional process lasts 48 hours, not long enough to produce alcohol.] Why have people stopped using fermented food? A study in Kenya suggests that health workers feel that traditional fermented foods are not modern, and should be discouraged." Footsteps always includes this kind of practical information. It is free to individuals working to promote health and development. Specify English, French or Spanish. Write to Tear Fund, Footsteps, 100 Church Road, Teddington, Middx TW11 8QE, UK.

CAN THE TRYPSIN INHIBITOR IN SOYBEANS BE OVERCOME BY GERMINATING THE SEEDS? In Chapter 9, we discussed treatment of soybeans to inactivate the trypsin inhibitor prior to feeding to animals. Someone wrote suggesting that sprouting might have the same effect without the need to use a heat treatment. We found an interesting article that looks at

various methods of preparing soybeans for food, including sprouting, in the Journal of Plant Foods, 1983, 5, 31-37, (1983). Whole soybeans were soaked in water at 50 C for 3 hours, then allowed to germinate for 3 days, with a daily spray of water. Seed coats were discarded (I presume to make them more acceptable in human diets) and beans were dried in a hot air oven. The trypsin activity dropped from 107.5 in raw soybean to 59.7 in the germinated product. In a feeding trial with rats, rats fed a casein control (a milk product with exceptionally high quality protein) gained 64 grams in 4 weeks, rats fed raw soybeans gained 20.5 grams and rats fed germinated soybean gained 42.8 grams. Unfortunately the article did not test soybeans that had been treated for use in commercial animal feed. This information would have been very helpful. What is my conclusion? Without more information, I would suggest that heat treatment is preferable, but sprouting is a lot better than using raw soybeans.

RELATIVE NUTRIENT VALUES OF FRUITS. We made a "score" for each fruit by adding up its percent of the U.S. Recommended Daily Allowance (USRDA) for 9 nutrients plus fiber. (We printed only 3, because the others were usually low.) There is no USRDA for fiber or potassium (K), so we used 25 g for fiber and 3500 mg for K. For example, a quarter of a cantaloupe has 86% of the USRDA for vitamin A, 94% for vitamin C, 12% for potassium, 6% for folate, 4% each for fiber and niacin, 3% for thiamin, 2% each for iron and riboflavin, and 1% for calcium. After rounding, that adds up to a score of 213. Numbers for canned fruit are for two halves or slices, including the juice. If no number was available for a nutrient, we assigned it a value of 0, which makes the scores for some fruits lower than they should be.

Fruit	Score	Vit. A	Vit. C	K	Fiber
Papaya (1/2)	252	X	X	X	X
Cantaloupe (1/4)	213	X	X	X	
Strawberries (1 cup)	186		X	*	X
Oranges (1)	169	*	X	*	X

Orangerines (4)	168	X	X	*	X
Kiwis (1)	154		X	*	X
Mango (1/2)	153	X	X		*
Apricots (4)	143	X	X	X	X
Persimmons (1)	134	X	X	*	X
Watermelon (2 cups)	122	X	X	X	*
Raspberries (1 cup)	117		X	*	X
Grapefruit, red or pink (1/2)	103	*	X		
Blackberries (1 cup)	101		X	*	X
Apricots, dried (10)	97	X		X	X
Grapefruit, white (1/2)	84		X	*	
Honeydew melon (1/10)	81		X	X	
Peaches (2)	77	X	X	*	X
Pineapple (1 cup)	77		X	*	*
Star Fruit (1)	73	X	X	*	na
Blueberries (1 cup)	68		X		X
Cherries, sweet (1 cup)	64	*	X	*	X
Pomegranates (1)	61	na	X	X	X
Bananas	60		X	X	*
Plums (2)	60	*	X	*	*
Prunes, dried (5)	59	X		*	X
Apples, w/skin (1)	58		X	*	X
Boysenberries (1 cup)	57		*	*	na
Pears (1)	48		X	*	X
Grapes, green (60)	46		X	*	
Peaches, canned in juice	43	X	*	*	
Apples, no skin (1)	42		X	*	X
Pineapple, canned in juice	40		X		
Figs, dried (2)	39			*	X
Currants, dried (1/4 cup)	36			*	
Rhubarb, cooked (1/2 cup)	36		*		na
Raisins (1/4 cup, packed)	35			*	*

Dates (5)	30	*	*
X = contains at least 10 percent of the USRDA available		na = not	
* = contains between 5 and 9 percent of the USRDA			
Copyright 1995, CSPI. Adapted from "The Fruit Stand," <i>Nutrition Action Healthletter</i> (1875 Connecticut Ave., N.W., Suite 300, Washington, D.C. 20009-5728. \$24.00 for 10 issues).			

nutrient value of fruits

A NEW IDEA FOR AN EMERGENCY MILK SUBSTITUTE IN WEST AFRICA. Ken Flemmer with Adventist Relief and Development International sent us the following report from two of his staff, Jim and Yoko Rankin. It concerns a totally new use for the egusi melon.

During a training seminar in Ghana a local farmer stated "that his wife did not have sufficient milk to feed their 6- month-old baby. Our first thoughts went to soy milk, but as they do not have soybeans it was not a practical solution. Also, soy milk is not easy to prepare and becomes acidulated very quickly."

"Someone suggested agushi melon seed [Ed: this is surely a Ghanian spelling of egusi]. I set up the blender, took 100 grams dehulled agushi seed and blended it with two cups (400 ml) of water and tasted it, added another cup of water, 2 teaspoons of honey and 1/4 teaspoon of salt and behold, we had a milk tastier and creamier than soy milk with a closer texture resemblance to real milk."

"The dry dehulled seeds resemble a large pumpkin seed. In the village every home has stone mills or small grinding plates. The seeds are easily crushed into a peanut butter consistency. Mixed with water, honey and salt -instant raw milk. To make it equal to mother's milk we found that we must add 6/7 cup of water per 1 cup (100 g) dehulled seed. It does not form gas and the school children who have tasted it have not complained of any problems."

"The agushi melon grows throughout Togo, Ghana, Cote

d'Ivoire and Benin [Ed: also Nigeria, Zaire and probably elsewhere]. One type has large seed and a very thin papery hull which slips off when seeds are rubbed between the palms of the hand. The other two types have a very hard shell on seeds that are slightly larger than cantaloupe seed. We have tried making milk from all three types, but the smaller varieties with hulls intact make a slightly bitter tasting milk. I presume that if the hulls can be removed the bitter taste would disappear."

I mentioned all this to gardener Glen Munro in Indiana, lamenting that we had no idea how the "milk" tasted. Surprisingly, Glen had grown egusi in the summer and could do a few trials for us. Here are some highlights of his experience. Unlike in Ghana, he did not dehull the seeds.

"I blended 75 g seed, 1.5 cup water, 1/16 teaspoon salt and 1 teaspoon honey in our Osterizer blender at the 'liquify' setting.

After straining I had 1/3 cup of meal and 1.5 cup of what looked like milk. It had a subtle raw cucumber-like taste. The meal was similar to corn meal mush with a distinct feel of some additional fiber and a raw flavor. After boiling the flavor was unchanged, but good. The flavor was a bit strong, but I believe I could adjust to eating it as a breakfast cereal.

"I repeated, using a Vita-Mix juice blender that more completely pulverized the seed, leaving out the honey. I then did a taste test with various additives, using 2% milk as a standard (rating of 5). The raw cucumber taste came through in all samples, but was hardly noticeable with Hershey chocolate syrup added (rating of 5-). After drinking 2 ounces, though, I noticed an itchy feeling in my throat, I think due to the fine fiber. Adding honey or maple syrup gave drinks that I rated as 4+."



Agushi melon

The variety of egusi that ECHO distributes has seeds larger than watermelon seeds. Egusi, *Citrullus lanatus* ssp. *colocynthoides*, looks like a watermelon while growing, but the white flesh of the round, over 6-inch diameter fruits is bitter

and inedible.

Of course, just because something looks and tastes like milk does not mean it can be a milk replacement. We found no information comparing the nutritional value of egusi to milk, but did find a very helpful article Chemical, Functional and Nutritional Properties of Egusi Seed Protein Products (J. Food Sci, 47, 829-835, 1982). We can send a copy if you are interested in that much detail. Dehulled seeds contain approximately 50% oil and 30% protein. They are good sources for the essential amino acids arginine, tryptophan and methionine, and vitamins B1, B2 and niacin and the elements sulfur, calcium, magnesium, manganese, potassium, phosphorous, iron and zinc. Egusi has potential as a source of calcium and niacin in low-milk-consuming regions.

Biological indices of protein quality were "lower than soybean but comparable to or higher than most oilseeds." The most

limiting amino acids are lysine followed by threonine.

"Histidine has been known to be an essential amino acid for infants. ...Thus the low content of histidine in egusi seed should be considered in the use of this product in food formulations, especially if the foods are intended for infants."

Heating the "milk" is going to be a problem. Glen writes, "as soon as the liquid felt hot to my finger it began to curdle. By the time it boiled it was clumped into 1/4 to 1/2 inch (0.6-1.2 cm) diameter particles that easily broke up when stirred."

One visitor from Africa told me that whenever a group of men were standing around talking, their hands were usually busy dehulling egusi seeds. It is ground into a paste and mixed with a variety of condiments to make stews, is made into a substance like peanut butter, roasted, cooked in soups, etc. The Paulsons in Central African Republic tell us that dry dehulled seeds can be placed on a skillet and popped like

puffed rice. They add that egusi is one fruit that monkeys do not bother.

It is usually intercropped, e.g. with corn, coffee and cotton. After 4 weeks of growth the plants completely cover the soil surface. Flowering occurs 4-5 weeks after planting and fruits mature at 7-8 weeks. Fruits are softened by beating with a club and allowed to rot for about a week to make the seeds easier to remove. Seeds are washed and dried for storage.

Since it is such an important crop in West and Central Africa, it is surprising that we have heard no reports of acceptance elsewhere from people to whom we have sent seed. Perhaps its possible use as an emergency milk will make a difference. ECHO has seeds if you would like to try egusi. Please let us know if you try this technique.

Fr. Gerold Rupper in Tanzania wrote concerning mothers with

insufficient milk for nursing. "This was the problem which led to the introduction of soybeans into southern Tanzania. But the scheme is only succeeding because we were fortunate to get the solution for making pure soy flour without any nasty taste-remove the hulls (skin). The flour tastes like chocolate. It keeps fresh for at least one month under our conditions. It is true that the milk does not keep long, but this is the case with any milk."

MORINGA AND CAROTENE. Dr. C. E. Peterson wrote, "I have removed fresh moringa leaves and left them overnight in my greenhouse, where they very promptly dry and can be rubbed over a screen to make a powder. The fresh weight value of beta-carotene is about 88 ppm and the dried leaves will be about 300 ppm, equal to some of our best high-carotene carrots.

"Even if addition to rice were to be limited to a teaspoon or so

without any detectable flavor change, if it were done 2-3 times a day every day it could be a very substantial source of vitamin A where deficiency is causing blindness and other serious health problems."

I would add that if people eat soups, substantially more of this powder could be added. Joel Matthews in Niger says people there preserve dried moringa leaves (not crushed) for use during the dry season as a food. They use it in their sauces. One popular food is a mixture of leaves and peanut press cake.

Dr. Warwick Kerr in Brazil wrote, "Concerning moringa, Drs. Rodrigues, Godoi and I tested the leaves and found them to contain 22,000 units of vitamin A per 100 g, more than reported in the literature [Ed: my sources list 11,500]. This means that one glass of leaves gives the daily dosage of vitamin A to 10 people!"

LEAF CONCENTRATE (LC) is an extremely nutritious food used to alleviate malnutrition. The process of making LC separates the protein, vitamins, and minerals from the fibrous portion of fresh green leaves. LC can be made from by-product leaves of commercial vegetables (beets, broccoli, etc.) or even from productive forages or cover crops not normally used as human food. Incorporated into local recipes, it boosts the nutritional content of a variety of foods.

LC is very rich in vitamin A, iron, calcium, high-quality protein, and other key dietary elements. Green leaves are very efficient producers of these nutrients, and leaf products can be the lowest cost source of iron and vitamin A, critical nutrients often missing in poor diets. LC technology is most appropriate for nutrition programs with groups of children, pregnant or nursing women, or elderly people who suffer from dietary deficiencies. For a community project designed to supplement children's diets, mechanized equipment costs

about US\$1500.

The basic process for making LC is to harvest and wash fresh leaves, grind them to a pulp, press juice from the pulp, bring the juice to a boil, separate out the curds which form in the heated juice, and press the liquid out of the curd. The solid portion of the mild-flavored curd is the leaf concentrate, which can be added to traditional recipes fresh or preserved in various forms. David Kennedy of Leaf For Life (see below) visited ECHO and prepared some pasta using LC made from broccoli leaves (in a household blender) and flour; even the staff who ate only a small portion of this (green) pasta for lunch did not feel hungry for the rest of the afternoon due to the high protein content of the leaf concentrate.

One difficulty in introducing LC-enriched foods is that the concentrate imparts an intense green color to the foods. Considerable work on recipe development has been helpful.

One recipe which can substantially increase the leaf nutrient intake by children takes advantage of the bright color: green LC lemonade. To make the syrup, dissolve two kilograms of sugar and 40 g of salt in 1 liter of lemon juice. Mix this into 1 kg of moist LC. The mixture is ground or blended in a high speed mixer until smooth, then bottled. The concentrate is stable for months. Prepare the lemonade by mixing 30 ml of syrup in 200 ml of water. Combining the LC with a good source of vitamin C improves the body's absorption of the leaves' iron as well. A pitcher of LC lemonade made from moringa leaves was served at a staff dinner at ECHO. Most people seemed surprised at how tasty it was, though a few added extra sugar to reduce a "green grassy taste."

It is important to remember that not every leaf is suitable for LC production. David Kennedy states that "many edible leaf crops such as Basella alba [Malabar spinach], sweet potatoes, chaya, okra, lettuce, and many cucurbit family leaves do not

work well. Leaves that are too wet or dry (above 90% or below 80% water) don't usually work well in the LC process. Neither do leaves that are acidic like sorrel or dock [Rumex sp.]; mucilaginous leaves like Basella alba, purslane [Portulaca oleracea] or roselle [Hibiscus sabdariffa].

"A fairly large number of edible leaves, such as sweet potatoes and mulberry, form a curd that is very fine and hard to separate. In some leaves, like cassava, phenolic compounds combine with proteins when the leaves are pulped and render the protein much less available to the body. Amaranth consistently gives lower yields of LC than leaves from legumes like alfalfa, cowpeas, peas, berseem clover or common beans or from wheat. Amaranth typically makes a fine curd that is difficult to separate in filter cloth.

"[Disagreeable] taste often has to do with poorly made LC that is either burnt during coagulation, made from partially spoiled

leaves, has spoiled during storage, or very often was inadequately pressed. When the moist curd is not pressed to about 60% moisture there are often strong flavors from saponins or other antinutritional substances like oxalic acid and nitrates remaining in the curd. ...When the leaves are well pulped and pressed, the residual fiber is pale green in color and far too fibrous to make an acceptable human food."

Very small scale LC production without some mechanization is generally not feasible because of the very high labor demands on women. LC yields are substantially lower when leaves are pulped and strained by hand compared to mechanical grinders and presses. About 50 g of LC may be produced from 1000 g of fresh leaves, and "a fair amount of that will be lost sticking to the pan or clinging to the filter cloth. Making tiny amounts of LC involves a lot of clean-up relative to the benefit. Effective LC programs will necessarily have powered leaf grinding equipment...for sufficient cell rupture, and at least a

manual hydraulic press for adequate separation of the juice from the fiber and of the curd from the whey.

"I also think they need to operate on a larger scale; probably processing a minimum of 100 kg of fresh leaf crop per day and more likely 500 or 1000 kg per day. These projects are most likely to succeed where there is commercial production of leguminous forage crops such as alfalfa, berseem, or cowpeas that can be used for preparing LC. The issues of quality control, preservation of the LC, economic use of the fiber, and distribution become much more important as one moves from a domestic to a village or cooperative level of production.

"A project processing a ton of leaf crop per day should be able to provide about 3300 children with 6 g of dried LC or 15 g of fresh LC per day. This can make a genuine contribution to community health, but it requires some infrastructure, capital, and organization. In many villages where malnutrition is

prevalent, conditions don't indicate that LC is likely to be a cost-effective food for nutrition intervention. In many of these areas, simpler techniques to increase consumption and improve utilization of leaf crops will probably be more appropriate. These techniques include better leaf crop selection, and improved methods of blanching, drying, and grinding of leaves, as well as innovative uses of dried leaf powders."

The organization Leaf For Life (called Find Your Feet in the UK) has been investigating and promoting LC for improved nutrition in tropical villages for thirty years. They also work with simpler techniques to better utilize leaf crops for food enrichment, such as drying leaves in ways that maintain more of their nutrients. They have a comprehensive, experience-based "Field manual for small scale leaf concentrate programs" (192 pp.) which details processing of LC, basic nutrition, information for evaluating and growing various leaf crop

species, economic considerations in organizing a LC program, and recipes from around the world. The manual is available in English (Spanish translation in process) for US\$20 within the US/\$25 overseas surface mail from Leaf For Life, 260 Radford Hollow Road, Big Hill, KY 40405, USA; tel/fax: 606/986-5418. In the UK, contact Find Your Feet, 37/39 Great Guildford St., London, SE1 0ES; fax 44 1 71 261 9291.

VALOR NUTRITIVO Y USOS EN ALIMENTACION HUMANA DE ALGUNOS CULTIVOS AUTOCTONOS SUBEXPLORADOS DE MESOAMERICA, by FAO. 115 pages, Spanish only. The book was written to help professionals working in agriculture, food science, and nutrition promote Mesoamerican crops to contribute to the nutritional and economic development of the region. It provides a brief overview of native Central American fruits, vegetables, roots and tubers, and cereals. Each plant receives a two-page description with plant family, scientific and common names, nutritional value, uses, geographic

distribution, morphological description, and areas of needed research. Information on known toxicities of some of these plants was lacking; for example, no reference to toxicity was given in the description of *chaya*, which contains cyanide. Each plant has an accompanying color picture.

As a nutritional guide, this book does not offer much information on the indigenous uses or agricultural practices for the described plants. It is a good introduction to anyone interested in becoming familiar with native Central American plants and their nutritional contribution to the diet. Available free upon request from Dr. Cecilio Morn, Oficial Regional de Política Alimentaria y Nutrición, Oficina Regional de la FAO para América Latina y el Caribe, Casilla 10095, Santiago, Chile; fax (56-2) 2182547.

TOXICITY AND FOOD SECURITY: A review of health effects of cyanide exposure from cassava and of ways to prevent these

effects. For several years I have been on the lookout for something that could provide a perspective on this important question. Many thanks to Dr. Hans Rosling for sending the 31-page booklet with the above title that he wrote for UNICEF. It is just what I had hoped to find. The subject is so important that I have summarized much more of the material than in a normal review. I include the extra detail so you will be able to anticipate when conditions such as dietary limitations, economic changes or social turmoil might cause a problem to suddenly appear.

Dr. Rosling does not like the statement "cassava contains cyanide." A food that contained pure hydrogen cyanide could be easily detoxified (it would be driven off as a gas by cooking). If any free cyanide is present in cassava, it can easily be driven off into the air by temperatures over 28 C (82 F).

The "cyanide" in cassava is actually a complex and very stable molecule called linamarin, one part of which is a cyanide molecule. If that part of the molecule is broken off it will become cyanide. Compounds such as this that produce cyanide when broken down are called "cyanogenic" compounds. Some cyanogenic compounds are broken down by boiling. For example, although chaya leaves contain a cyanogenic compound, the cyanide is driven off by boiling for 5 minutes.

Unfortunately the cyanogenic compound in cassava is largely unaffected by boiling. Boiling whole pieces of cassava does little to reduce the danger of cyanide poisoning (although boiling fermented or grated cassava will remove most of the cyanide, as we will see later).

Linamarin is not itself toxic. If some of it is absorbed from the gut into the blood it is probably excreted unchanged in the urine. The "cyanide" in linamarin can be liberated in two ways.

First, enzymes secreted by microbes in the gut can decompose linamarin, liberating cyanide in the process. Second, certain enzymes in the cassava root itself can liberate cyanide from linamarin. In the intact plant, these enzymes never get a chance to degrade linamarin because they are stored in separate places. But when the root structure is disrupted by grating or fermentation, the two come into contact and cyanide is liberated (and will evaporate at temperatures of 28 C or higher).

I am preparing this review while visiting a major cassava-growing area in the Amazon Basin of Brazil. It is interesting to fit observations about farmers' practices into the understanding provided by the book. For example, I am told that the roots are fermented and/or grated (which puts the enzyme and linamarin together), then washed with water and squeezed. Free cyanide is washed out in the water. As the water is left to stand, tapioca settles to the bottom. If a hog or

other animal drinks this water, unless it is cooked or considerable time has elapsed, they reportedly can die quickly from the dissolved cyanide. There would be very little cyanide nor linamarin remaining in either the tapioca or the ground, dried cassava, which are consumed in large amounts along with fish.

"Considerable cassava consumption has developed in some areas using processing methods like sun drying, which are very ineffective in removing cyanide. This has probably been possible because initially only the less toxic sweet varieties were used. When these varieties were later replaced by more productive toxic varieties, the established processing practices may suddenly have become insufficient. ... this is probably the case in many cassava growing areas of East Africa. ... sun drying for long periods is not fully efficient, although levels will be lower than after only a few days of drying."

"From the toxicological aspect, strict adherence to the method is as important as the type of method. Soaking in water ... as well as grating and sack-fermenting processes ... are effective as long as the soaking or fermenting steps are not shortened and fermentation conditions are not changed. Sun drying, if performed according to traditional practices, should be extended over several weeks. Populations using prolonged sun drying probably rely on infestation of insects in the roots to achieve a sufficient removal of cyanide.

What if there is an emergency situation in which the water for soaking or some necessary equipment is lacking? A method emerging in coastal Tanzania and Mozambique and Rwanda which "is probably an appropriate and effective way of reducing the cyanide" is called dry fermentation. "A pile of peeled root pieces is covered with leaves or peels for 3-4 days, after which each root piece is completely covered by a black mould growth. The root pieces are dried in the sun and as

much of the mould is removed as possible. These pieces are finally consumed after pounding. Unfortunately this method seems to result in a very high exposure to aflatoxins from the mould growth...aflatoxin exposure must thus also be considered as a possible side-effect when cassava provides food security in drought-affected areas." Aflatoxins cause liver damage and are powerful carcinogens.

What happens to cyanide in the body? The body is protected from cyanide in two steps. The blood contains a substance which can, within minutes, bind up to 10 mg of cyanide. This is then taken to the liver and detoxified in a process that takes a few hours.

If more than 10 mg of cyanide is consumed, but not enough to be fatal, it is converted to a far less toxic substance called thiocyanate. The thiocyanate is eventually excreted in the urine. This detoxification process requires the element sulfur,

which is obtained from protein in the diet. In protein deficient diets the detoxification process ceases to operate. So lack of protein in the diet accentuates the toxicity of cassava. "It should be noted that considerable amounts of fish are consumed in areas of the Amazon, the Congo basin and southern India where cassava has been established as the dominating staple for centuries."

If other food is not available, "an adult will consume daily about ... 0.5 kg dry (1.5 kg wet) weight of cassava." "The newly developed high-producing varieties with less cyanide-yielding capacity still contain 50-100 mg of cyanide per kg of fresh weight. This amount will easily be removed by processing, but if roots are consumed unprocessed, even these varieties may cause intoxication." ["Intoxication" is medical terminology for "have a toxic effect."]

Diseases related to cassava toxicity: immediate symptoms.

Symptoms usually occur 4-6 hours after a meal and consist of vertigo (dizziness), vomiting, collapse and, in some cases, death within 1-2 hours. Antidotes are effective, safe and cheap. Intravenous injection of thiosulfate will increase the sulfur available to convert cyanide to thiocyanate. Nitrite acts more rapidly but must be handled with care as an overdose is itself toxic.

Cyanide intake from cassava is probably a factor in two types of paralysis. In tropical ataxic neuropathy, one of the sensory tracts in the spinal cord is damaged. This results in an uncoordinated gait called ataxia. It occurred in Nigeria, mostly in adult males, with successive occurrences over several years. High cyanide intake with low protein diets were suggested causes.

Epidemic spastic paraparesis occurs mainly among women and children. It permanently cripples the victim "from one day to

the next" [in a 24 hour period?] by damaging parts of the spinal cord that transmit signals for movement. Muscles are not flaccid, as in polio, so the legs usually support affected persons sufficiently to let them stand, especially if supported by a stick. Walking is often uncontrolled jerks. Outbreaks have been reported in two locations in Zaire during the dry season and during a drought in one location each in Tanzania and Mozambique.

In each of these four cases cassava was the only food available in quantity and roots were inefficiently processed. This disease has never been reported from a population that did not consume cassava, nor from populations eating balanced diets.

In Mozambique 1102 people were stricken. Cassava was the only food due to a drought [hence no protein for the body's own detoxification process]. Once other foods were gone, they did not have enough processed cassava to replace them. Also

the people wanted to leave the roots in the ground as long as possible so that they would grow bigger. When they finally harvested, the people had no time for the lengthy sun-drying process. Studies on this population indicated "that acute intoxication may appear when cyanide intake reaches 30 mg in 24 hours."

Health workers should be aware of the following possible causes of cyanide poisoning: 1) varieties that are normally sweet may produce high levels of linamarin under adverse conditions; 2) a new, but toxic, variety may be introduced to the market and surprise people; 3) hungry, unsupervised children have been known to eat toxic roots in spite of their bitterness; and 4) cassava is sometimes introduced without adequate training in processing methods.

Diseases related to cassava: delayed symptoms. Other diseases develop only after exposure to cyanide over a long

period of time. Continuous exposure to insufficiently processed cassava can lead to goiter and cretinism. This problem is especially prevalent in Africa. The thyroid gland, situated in front of the neck, is not normally visible. Its main function is to produce iodine-containing hormones that regulate body metabolism. If the diet contains too little iodine the thyroid gland becomes larger so as to be more efficient in extracting what little iodine is in the blood. Some children born to iodine-deficient mothers suffer from cretinism (mental retardation and stunted growth).

How is inadequately processed cassava responsible? The thiocyanate produced when cyanide is detoxified (see above) interferes with uptake of iodine by the thyroid gland. Fortunately this interference can happen only when iodine intake is already low, below 200 micrograms per day. Populations in northern Zaire with very low iodine in the diet and who regularly ate inadequately processed cassava suffered

from severe endemic goiter and a high prevalence of cretinism. When iodine supplements were used the goiter problem decreased considerably even though the cassava was still not adequately processed due to adverse conditions.

Do all varieties of cassava contain cyanide? The hundreds of cassava varieties are grouped according to taste into bitter and sweet. The bitter varieties generally have more linamarin than the sweet, but there is no clear-cut division into the two groups. "Cassava-growing peasants plant several varieties. The sweet ones in smaller amounts are eaten as snacks or cooked fresh as vegetables. The bitter varieties are grown in large quantities to serve as staple food after processing."

In most cassava-growing areas the bitter and more toxic varieties have been found to be more productive, probably because of the toxicity. For example, monkeys and wild pigs will not feed on toxic varieties. "Peasants often plant small

amounts of sweet varieties in the center of a field of toxic varieties" to keep animals from eating the former.

"Breeding programs should continue to take cyanide levels into consideration, but so far no high yielding variety has been found that makes processing unnecessary." "Even 'high-yielding low-cyanide' varieties developed by IITA in Nigeria have a cyanide-yielding capacity of about 5-10 mg of cyanide per 100 g of fresh weight. ...consumption of these new varieties without any processing may still result in considerable cyanide exposure. ... strict adherence to efficient processing methods is still needed if large amounts of roots from these new varieties are consumed."

Dr. Rosling has offered copies of his book Cassava Toxicity and Food Security free of charge as long as they are available. Write him at International Child Health Unit, Dept. of Pediatrics, S-751 85 Uppsala, Sweden.

An update from Dr. Rosling. Three recent articles give additional details on the occurrence of spastic paraparesis in the Bandundo region of Zaire (110 live and 24 dead cases). The start of these outbreaks in 1974 coincided with the completion of a new tarmac road to the capital, which facilitated the transport of cassava and made it the main cash crop. "The affected population consumed flour made from short-soaked (one day) cassava roots and thus had high dietary exposure to cyanide (urinary thiocyanate in 31 children was 757 vs. 50 units for a population where cassava had been soaked for the normal three days)."

"The reason for processing shortcuts ... [is that cassava is] exclusively produced and processed by women in very poor households. Roots are short-soaked when women are in a 'hurry' to gain cash."

SWEET AND BITTER CASSAVA AND CYANIDE CONTENT. Dr. M.

Bokanga writes in the March 1993 issue of IITA Research that "varieties of cassava classified as sweet may have a high cyanogenic potential and those classified as bitter may be low." He measures cyanide as "cyanogenic potential" because pure cyanide does not occur in cassava-it is produced upon processing or eating. A panel rated several cassava varieties as bitter or nonbitter. Taste was not a reliable indicator of cyanogenic potential. Nonbitter varieties ranged from 0.91 to 10.6 mg cyanide per 100 g fresh weight of cassava. The range for bitter varieties was 5.0 to 39.9 mg.

Boiling is not an adequate method for detoxifying cassava, but it does reduce the toxin, according to the authors. "Boiling cassava roots, which is considered minimal processing, reduces the cyanogenic potential by at least half." This conflicts with the book Toxicity and Food Security reviewed above. Other processing methods can reduce it by more than 90%.

ARE RAW VEGETABLES MORE NUTRITIOUS THAN COOKED ONES? People taking the educational tour at ECHO often ask, "Can this vegetable be eaten raw?" The unexpressed implication may be that raw vegetables are better for you. Delia Hammock, registered dietitian and nutrition editor for Good Housekeeping magazine says this is not necessarily the case. "While it's true that overcooking reduces the nutritive value of all foods and even moderate heat can destroy certain vitamins, raw foods are not always more nutritious. Some raw foods contain natural substances that actually block the digestion of nutrients or interfere with the absorption or use of vitamins. Cooking inactivates these nutrient blockers." There are also many examples of toxic substances in plants that are detoxified by cooking.

In addition, the digestibility of many foods is improved as heat alters their physical structure. "Cooking carrots breaks down the cell walls making more of the carotenes available for

absorption by the body. While on average only 5 percent of the beta-carotene is absorbed from a raw carrot, cooking makes 25-30 percent available. This is a 5-6 fold increase. Pureeing cooked carrots boosts absorption even more."

Storage and preservation

IS MORNING ALWAYS THE BEST TIME TO HARVEST VEGETABLES AND HERBS? Not in the case of basil. National Gardening magazine (July/August 1994) reports findings from a University of Michigan project that basil picked in the evening stored twice as long as basil picked in the morning. A possible explanation is that basil picked in the evening has just spent the day building up sugars. This may somehow help it to survive the shock of being cut longer than basil that has been actively growing all night (and using up sugars).

No extrapolation was made to other plants. In light of the

magnitude of the effect, however, it might be worth checking the influence of harvest time on leafy vegetables or herbs if you are having trouble with storage life.

INSECTS IN TROPICAL STORES (A POSTER). The Natural Resources Institute has a poster with color pictures of 14 insects which are found where food is stored in the tropics. Accompanying an enlarged photo of each insect are the scientific and common names, a guide to actual size, and notes on the commodities they damage and their biological development and behavior. From NRI, Publications Distribution Office, Central Ave, Chatham Maritime, Kent ME4 4TB, UK.

USE OF VEGETABLE OILS TO PROTECT STORED BEANS FROM BRUCHID BEETLE ATTACK. Steve Mason at Purdue University sent us this interesting article on research done at CIAT in Colombia, which was inspired by an ancient Indian method. African palm oil or crude (i.e. unpurified) cottonseed oil were

applied to dry beans, *Phaseolus vulgaris*, at a rate of 5 ml of oil per kg of beans, and tumbled at 35 rpm for 5 minutes. They were then infested with bruchid beetles, *Zabrotes subfasciatus*, at 1 day and again at 75 days. After 6 months the adults were counted. The untreated controls averaged 251 beetles, the African palm oil had none and the crude cotton seed oil averaged 0.2 beetles per 100 g sample of beans. Treatment with 1 ml of oil per kg of beans was less effective (6.4 and 5.2 beetles per 100 g). It is not clear how the oils work. Dormant oil sprays on fruit trees are thought to interfere with insect respiration. Their action must be more complex, however, because other work has shown that insects completely deprived of oxygen still live longer than those treated with oil.

Other oils (purified cottonseed, maize or corn, purified soybean, crude or purified coconut palm) averaged roughly 75% reduction in the number of beetles, but this may not be

enough for consumer needs. Cottonseed oil even reduced the number of beetles emerging when the oil was applied after the larvae had penetrated the seeds, but only from 650 to 387. The added oils did not decrease germination of the beans. Manual mixing of the oil and beans for 5 minutes in a glass jar was much less effective than tumbling, apparently because the surface of the beans was less completely covered. Crude oils are not only cheaper than refined oils, but also contain more antioxidants. These delay rancidity, which might affect taste. Of course the treatments are not toxic. Based on prices of oil and beans in 1978, the oil would cost 0.5% of the market price of beans.

The April 1986 issue of Agricultural Science Digest summarized a report in Agriculture, Ecosystems and Environment showing good control of rice weevils in stored corn (maize). Shelled corn was shaken with peanut, coconut or palm oils at a rate of 1, 5 and 10 ml of oil per kg of grain,

until the grain was evenly coated. Adult weevils were then introduced. Most were killed within a day and all were dead within a week at the 5 and 10 ml/kg concentrations. Few eggs were laid and fewer offspring hatched. After 60 days the 10 ml treatment was reinfected with adult weevils. Again nearly all were dead within one day, except for the palm oil treatment. (Palm oil gave the best results in the earlier study.) The oil treatment did not affect germination of treated seed corn, nor water uptake during cooking.

Burus Ali in Nigeria reports they have had success controlling weevils in their community projects by adding 1 tablespoonful (about 5 ml) of peanut (groundnut) oil to each kilogram of cowpeas. In this way, 1 liter of oil will treat about 200 kg (440 pounds) of peas. After thorough mixing, peas treated this way can keep 4-6 months without any problem. Beetles lay their eggs on the surface, then larvae bore into the seed and later emerge as mature beetles leaving a characteristic hole. Oil

interferes with egg laying and development of larvae. Once inside the seed, oil has no effect. If about 6 months after treatment farmers begin to see holes left by emerging beetles, they can extend protection easily up to a year by a second identical treatment. This is based on a procedure recommended by the International Institute of Tropical Agriculture in Nigeria. (Oil treatment reportedly works with cereals too. We would like to hear of your experiences with oil treatment.)

BANANA JUICE PROTECTS SEEDS FROM INSECTS. Duane Neuenburg wrote from Mozambique, "While working at a German hospital/orphanage in Uganda I observed an effective seed storage method to protect against insect damage. They immersed beans and maize kernels momentarily in a vat of banana juice. The juice is the material from which they ferment an alcoholic beverage (rombe), only they used it before fermentation in this application. They then spread the

seeds on a rack to dry. As soon as they were dried they were placed in sacks. The seeds showed no damage 4 months later." This is a new one to us at ECHO. Has anyone else seen this method? How is the banana juice prepared? Have you seen it tried with an untreated control to prove whether or not there is a difference? Do you have any idea why it works (if it does)?

THE SIMPLEST WAY TO CONTROL BEAN BEETLES. According to the Michigan State University News-Bulletin, a graduate student from Tanzania, Martha Quentin, and her research advisor, Dr. J.R. Miller, developed a simple solution to one of the world's major food storage problems. The following is taken from that article and the authors' technical publication, "Bean Tumbling as a Control Measure for the Common Bean Weevil."

Weevil larvae bore entry holes in the bean surface and eat the insides, leaving empty shells. Fumigation methods are

effective, but are not always possible [or desirable] in the third world. Quentin attacked the problem by studying how soft-bodied larvae are physically able to bore through the smooth hard surface of a dried bean.

They learned that the larvae scrape the holes with their mouths, but first must brace themselves against a hard surface—a neighboring bean or the wall of a container holding the beans. A bean that does not abut another bean or other hard surface cannot be invaded.

They also learned that it takes 19-24 hours for a weevil to bore an entry hole. They hit on the idea of occasionally tumbling stored beans in order to dislodge weevil larvae before they could finish scraping their holes.

They calculated that it would be highly unlikely after tumbling that a previously started hole would still be close enough to an

abutting surface to be useful to a larva. The larvae would have to start new holes.

Experiments proved them right. "Rather than the normal 20-fold increase per generation, beetle populations in tumbled beans fell to 1/3 of the starting population." Tumbling intact beans morning and evening in a variety of glass and plastic containers, as well as burlap bags, consistently gained excellent results. The tumbled containers had 97 to 98% fewer weevils than were found in stationary control containers. Even when many of the beans had been cracked during harvesting, results were excellent (95%). After only two or three days, the larvae, except for the few that manage to enter a bean, either starve or are crushed by the tumbling.

How was the tumbling done? "Sacks of beans were twice turned end-over-end 2-3 times a day. Tumbling was faithfully conducted until about one week after inspection revealed no

live adults."

Will tumbling be a useful control for other storage pests?

"Tumbling is unlikely to be as disruptive to the cowpea weevil, whose larvae bore directly into beans from eggs glued to the seed surface." Several criteria of pest biology are listed to help in evaluating the likely success of tumbling. But even if the pest biology is not known, "regular tumbling could be attempted, just to see if there were benefits worth the modest effort."

APPROPRIATE TECHNOLOGY JUICE PASTEURIZER. The "tubular juice pasteurizer," as it is formally called, strikes me as an "appropriate technology" with unusual promise.



Dr. Crandall pours fresh juice into funnel while graduate student directs pasteurized juice into recycled bottles.

benefit of an inexpensive juice pasteurizer

It is designed for situations where a large quantity of fruit is available for a limited period of time and for which there is no ready market or where marketing is not feasible because of difficulties in transporting the fruit to market. It also assumes

a segment of the population would benefit either financially or nutritionally if it could produce an inexpensive pasteurized fruit drink.

The technology was developed in the late 1980s by Dr. Phil Crandall and colleagues while he was with the University of Florida's Lake Alfred Experiment Station. Dr. Crandall's team developed the pasteurizer specifically for difficult third world situations. His criteria included: low cost, no moving parts, easy to build, easy to move, rugged, and providing agitation (for even heating). Heating lowers quality, so an emphasis was placed on what he called HTST (high temperature short time). The result is a pasteurizer which can be carried by one person to the most remote site.

ECHO waited on this innovation for several years in hopes that the pasteurizer would become available commercially. It now appears that this will not happen. We had a volunteer, Dale

Fritz, make four units for ECHO and are convinced that this simple device can be made in any country with no special tools or mechanical skills for a little over \$100 counting accessories. So here are the details.

Pasteurization of fresh citrus juice requires a temperature of 90 C (194 F) for a few seconds. Calculations showed that an acid fruit juice could be pasteurized by passing it through a stainless steel coil of precise dimensions that was immersed in a container of boiling water. Dr. Crandall bent a 6 m (20 ft) length of stainless steel tubing into nine coils 19 cm (7.5 in) in diameter by wrapping by hand around a cylinder of the appropriate size (he said the cylinder could be something as simple as a log). The tubing used was grade 316 seamless, 9.5 mm outside diameter and 7.7 mm inside diameter. Inlet and outlet tubes protruded 30 cm over the sides of the can and were connected to plastic tubes. The coil rested on a block of wood to prevent it from touching the bottom of the can.

The length of time the juice is in the coil is controlled by hydrostatic pressure. The inlet to the coil is attached via a tube (he used tygon) to a plastic funnel into which the juice is poured. The higher the funnel, the greater the pressure and so the faster the juice flows. In practice it is usually fastened about 1 meter above the coil. The temperature of the juice as it leaves the coil is periodically checked. If it is too low, the funnel is lowered to reduce the flow rate; if too high, it is raised.

Juice is collected in recycled bottles. Dr. Crandall used brown beer bottles, but soft drink bottles would also work well. After attaching a cap, bottles are laid on their side for 3 minutes to sterilize the cap, then are cooled in running water (if available).

Dr. Crandall says that juice can be stored without refrigeration for some months. Pasteurization did not significantly decrease

vitamin C content, but 3 months' storage at 21 C did, by about the amount that would be expected for pasteurized juice stored at that temperature. However, each bottle (375 ml) still contained over three times the US recommended daily allowance of 60 mg. Effects on color were similar. An instrument that measured the vacuum in the bottle showed that no fermentation had occurred after 3 months. Though there is no microbial degradation, chemical oxidation of canned or pasteurized foods still occurs. So the lower the storage temperature the better.

To keep the water boiling efficiently, construct a simple oven with loose bricks (see illustration). Dr. Crandall built it from used housing bricks to make a 40 cm diameter circle with an air draft in the front and out the top. An iron grate at 55 cm supported the fire and another at 75 cm supported the can.

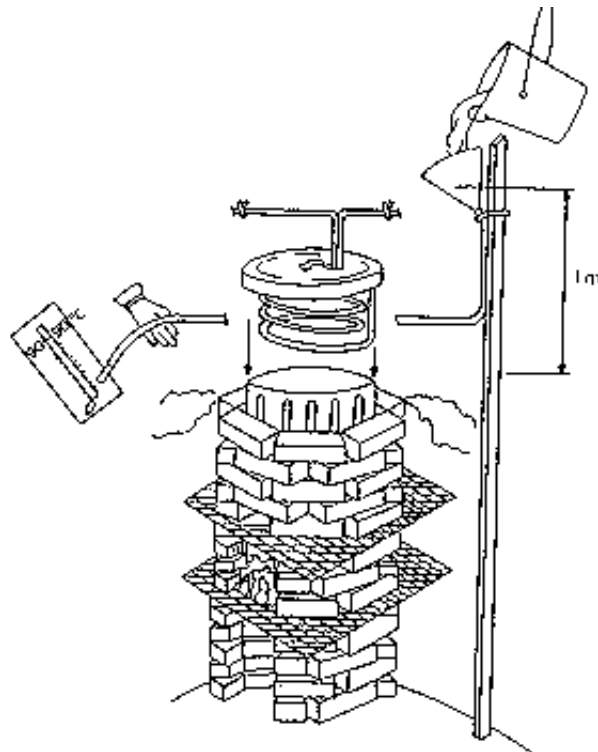

An overview of the portable pasteurizer showing the gravity juice feed, heating oven, coil (lifted out of place), and checking the outlet temperature.

construct a simple oven with loose bricks

A tasting panel of 21 experienced assessors graded juices from 1 (dislike extremely) to 9 (like extremely). The fresh orange juice was rated 7.2 (liked moderately); pasteurized 4.2 (disliked slightly). Dr. Crandall suggests this may be due to the panel's familiarity with commercial juice, which has flavoring oils added after heating.

I tasted the orange juice while visiting the Small Farm Resource Development Center in Belize (Christian Reformed World Relief Committee). Tom Post took me to a small store operated out of a home. If I recall correctly, the owner spent about 10 on juice and labor and sold the juice for 30, about half the price of a bottle of cola. I found the taste similar to other pasteurized orange juice, which is always a much different taste than fresh juice. The next season Tom took the pasteurizer to different communities which kept the bottles for

their own use during the Christmas season. This was in 1991.

In 1994 I called Tom for an update. He had been assigned outside the country for some time and then returned. The pasteurizer was not being used. He cited three reasons. Belize is relatively well off for a third world country; the cost of a drink is not prohibitive for most, so they are not that motivated to use the pasteurizer. "If I had been around promoting it, they would have been happy enough to use it. But their interest is not great enough to take the initiative in seeking it out." Also there are fewer oranges around than appears at first sight, especially when large quantities are picked for processing. Finally, the season of excess ripe fruit is extremely short there, only a couple weeks or so. The pasteurizer would have been much more successful if there was some juice available for processing at many other times of the year.

This brings up the subject of what other juice can be processed. About the only limit is that it must be an acidic juice ($\text{pH} < 4.5$; safer to say < 4.0). This includes apple, some tomatoes, lemon, lime, passion fruit, cashew etc. Dr. Crandall only experimented with orange and apple juice and a drink similar to one liked in Nepal called "orange squash" (25% orange concentrate, 42.5% sugar and 32.5% water).

The apple juice only required a temperature of 80 C, so the height of the funnel was raised accordingly. The taste panel rating was essentially unchanged (7.0 and 6.7 for fresh and pasteurized juice respectively). The "orange squash" was not evaluated.

If someone was willing to do some "recipe developing," it should be possible to come up with some very tasty juices. Different fruits, mixtures of fruits, and adding sugar or flavorings could all be tried. Concentrates to be mixed with

water or lemon juice and sugar by the consumer might be popular. If the juice is not quite acidic enough, it could be adjusted with a bit of lemon, lime or passion fruit. Also consider: Andean blackberry, guava/passion fruit, tamarind, grapefruit, soursop, red mombin, etc.

Dale Fritz said it cost him \$25 to make a coil (made from seamless stainless steel 3/8 inch od x 20 ft long, type 316 tubing). He checked out the current retail price of other accessories that would be needed. Input and outflow tubing \$1.60; thermometer \$11.90 - \$19.95; bottle capper \$29.95; bottle caps, 10 gross for \$19.00; a potato ricer/fruit press, \$8.99; funnels about \$1.50. You would also need a 5 gallon metal bucket with lid, bottles, container for the extracted juice, a pitcher for pouring, a stick to support the funnel and material for the fire box. He points out that the USA and Canada use different sized beer bottles, so one must be sure the size of caps and bottle capper is right for the country. [Dr.

Crandall has never found this to be a problem.] He said that both are readily available in stores that sell supplies to people who make their own beer.

I phoned Dr. Crandall to clarify some points. The interview follows.

Q. Your article states that orange juice was heated to 90 C and apple to 80 C. How do we know what temperature a juice will require?

A. I would just recommend that every juice be heated to 90 . The microbes in orange juice are probably killed at a lower temperature, but it must reach that temperature to inactivate an enzyme called pectin esterase. Have you noticed that a couple days after you extract fresh orange juice there is a clear layer on top and "crud" on the bottom? When this enzyme breaks down esters in the juice, some complex acids

are formed. These combine with calcium to make something that at the molecular level might be described as a 'fish net,' which settles to the bottom. Apple juice does not have this enzyme, so it does not need the extra temperature. Solids still settle out in apple juice for a different reason. This is going to happen even with the most sophisticated equipment.

Q. What is the margin for error in temperature?

A. This depends on how great a content of microbial life is in the juice and on the pH. A target temperature of 90 C allows some margin for error. The pH (a measure of acidity) is really important. Below 4.5 clostridia spores will not germinate even if they are present. Over pH 4.5 one bottle could kill a person! You should have some pH test paper which turns different colors based on pH. With simple equipment, it might be well to shoot for a pH of 4.0 for an extra margin of safety.

Q. How is the pH lowered?

A. Just add lemon or lime or any other very sour juice. Be sure not to have acidic juices in contact with lead, aluminum or copper containers as the acid can react to produce toxic heavy metals compounds.

Q. At what pH is food too sour to enjoy? Give us a perspective.

A. Apple and pineapple juices are less than 4.5. Tomato juice is borderline (caution!). Most citrus juice is about 3.5; lemons and limes are about 2.0.

Q. Are all citrus equally suited for pasteurizing?

A. The citrus that are easy to peel, like mandarins, make terrible juice. A chemical is formed (a lactone) that tastes like kerosene. That is why you almost never see pasteurized tangerine juice on the market. Use oranges that are difficult to peel.

Always run the raw juice through a strainer or colander to

remove larger particles, which might plug up the coil. We chose a small diameter coil because it makes the "ride" through the coil more turbulent for the juice. This assures that every bit of it is in contact with the hot sides of the tube and reaches 90 C.

Q. Do you have any thoughts on mixtures of juices and flavorings?

A. Almost any culture will prefer a colored, sweet and acidic juice. Add some passion fruit for color, acid and flavor and sugar for sweetness. For a first test, heat some juice in a pan on the stove, let it cool, then taste. If you like it, you will love it when pasteurized in the coil (which is a lot gentler treatment than heating in a pan).

Q. Where do you buy bottle caps in the third world?

A. I recommend recycling bottle caps. You can simply flare out the sides on an appropriately sized rock, then cap it down

tightly on the bottle with the bottle capper.

Q. Is there danger of using bottles in which chemical poisons have been stored?

A. Every bottle must be cleaned in hot, soapy water. After that if the human nose cannot detect a smell it is very unlikely that enough of something will be present to cause a serious health problem.

ECHO recommends that you purchase all the parts that you can in the country where you work. Dale is putting together 4 complete kits for ECHO. One we will set up at ECHO (and demonstrate during our agricultural missions conference!) and one we are sending to Haiti where we are helping with a Small Farm Resource Center (at Bohoc near Pignon).

LARGE CAPACITY SOLAR RICE DRYER. Harry Leightner in Costa Rica asked me to keep my eyes open for a solar dryer

with a capacity large enough to dry beans. They must be harvested during the wet season and dried before they can be shelled. We obtained plans for a one ton solar rice dryer from the Renewable Energy Resources Information Center (RERIC) in Thailand which appears to be well tested and is recommended for the drying of many products in addition to rice, including beans, fish, cocoa, coffee, cassava, maize, bananas, coconuts, et. al. For a handbook, contact the Director/RERIC, AIT., P.O. Box 2754, Bangkok, THAILAND. Part One is intended mainly for agricultural scientists and officials and gives general information on the background, design calculations and principles involved. Part Two is intended for those who will make and use the dryer. This part includes 86 photographs and 45 figures and is in considerable detail. They estimate the cost of materials in Thailand to be \$112, or \$57 if free locally grown bamboo is available (1982 prices). If you give this a try, please consider sharing your experiences with us and our other readers.

WOOD ASH TO PRESERVE TOMATOES FOR MONTHS. Ken Hargesheimer sent us a copy of the "From Garden to Kitchen" newsletter published by UNICEF. It provides a way for Pacific Island populations to share gardening and nutrition information suited to the local region. If you are in the Pacific Islands, you are eligible to receive this newsletter (no fee). Write South Pacific Commission Community Education Training Centre, c/o UNDP, Private Mail Bag, Suva, FIJI; phone 300439; fax (679) 301667. The following is from issue #10.

Farmers know all too well the problem of large quantities of tomatoes (and low prices) during season, followed by short supply and higher prices. The Bureau of Education in the Philippines says you can extend the season in which tomatoes are available. Fresh tomatoes can be preserved in wood ash for up to three months.

Preserve only newly picked tomatoes which are ripe but not

soft and overripe. They must be free of bruises and blemishes. Select a wooden or cardboard box or woven basket and line it with paper. Gather cool ash from the cooking fire and sift to remove sharp particles. Spread the ash evenly on the bottom, 1.5 inches (4 cm) thick. Arrange the tomatoes upside down (stem end facing down) in one layer and pour another thin layer of ash on top. Continue layering tomatoes and ash until the container is full. Cover and seal the container and keep in a cool dry place. [The article does not say how to cover and seal. My best guess is to cover with ash then a loose-fitting cover to keep the ash from being disturbed.] The skin will wrinkle but the pulp inside will remain juicy.

The article does not mention what effect the wrinkling of the skin has on marketability. If you try this method, I would be interested in your observations.

CASHEW FRUIT DRYING AND NUT PROCESSING. [Summarized

from an article in the September 1990 *Appropriate Technology*.] The cashew "apple" is a bell-shaped pseudocarp which holds the "nut" below it. The "apple" (or fruit) is often used for juice, preserves, candy, and jam in Asia. The first step in drying the fruit is to boil the apples in salty water for 15 minutes to remove the bitter taste that is unpleasant to some. Then the apples are perforated and compressed in specially cured wooden devices. The compressed apples are then boiled in sugar for two hours. Some 350 kg of sugar are used with every 1,000 apples with enough water to cover the apples. The sugar is re-used twice.

The boiled apples are then dried in a solar drier. The apples are put in 1.2m x 0.6 m wire trays to a depth of 2.5 cm, inside a 1.5 m x 1.2 m wooden cabinet which is covered with plastic film. Underneath the wire trays there is a black collector plate. The cabinet is inclined at 80°, set toward the east in the morning and moved during the day. The apples are dried in

one day and have a shelf-life of 6-8 months.

This has been extremely successful. By 1985, over 5,000 kg of cashew produce had been marketed and orders for 1987 were more than 35,000 kg. This provides employment for 2,000 families at £5.00 (rather than £1.50) a day.

Ian Wallace, Igreja Evangelica da Guine-Bissau, wrote on cashew: "On the whole I am not greatly enamored with cashew as a crop and would advise anyone thinking of large-scale cashew production to proceed with caution." His letter arrived just as I had visited some sites in the Amazon basin where cashews seemed to produce well and was wondering if I had been too negative (see page 123). Perhaps someone in our network knows of a very successful cashew project. If so, please drop me a line. I would like to correspond with you. Ian's helpful observations follow:

"I was interested in your article on cashew production. Here vast areas of virgin bush have been cleared and planted with cashew trees in the past 10 years. Certainly the crop has not fulfilled all that was expected of it. Perhaps expectations were too high, or orchards are inadequately tended. Because the initial stages of raising the trees is so straightforward, there is a tendency to sit and wait for the tree to do its stuff with many orchards remaining uncleaned. The crop is unreliable.

"The little that is processed locally is of poor quality, the toxic skin being burnt off in an open fire. The majority of the nuts are exchanged by the government for rice then shipped raw to foreign processing centers. The true value of the crop remains unrealized since much of the profit is only added after processing. We have seen a disastrous fall in rice production as well. It is easier to collect cashew nuts and exchange them for imported rice than it is to work the rice fields. Although this is obviously a fault of the exchange policy, it is hard to

see an alternative. There are no other markets for unprocessed nuts and the government has no other means of paying.

"You are right in saying that it is a labor intensive crop. Harvest time involves an army of workers, many of whom are children from age 6 upwards who are taken out of school for that purpose. It is rare to see men involved in the harvest. It appears that the system which is evolving is oppressive to the weaker members of the community, who rarely see any great benefit from the harvest.

"Cashew production has aggravated another social problem, drunkenness. The squeezed juice ferments quickly and without human intervention, to make a strong alcoholic drink in days. The cashew wine is available in far greater quantities than palm wine. Cashew season sees a very marked increase in drunkenness."

Food preparation

BREADFRUIT BREAD. Another interesting item in the UNICEF "From Garden to Kitchen" newsletter (see above) was this recipe for one loaf of bread using 25% (by volume) grated cooked breadfruit and 75% wheat flour (originally from the Methodist Handicraft and Farming School in Fiji). If breadfruit goes to waste where you live, this is a good use and will cut down on need for imported wheat flour.

Sift 1 3/4 cup flour, 3 teaspoons baking powder and a dash of salt. Pound very ripe breadfruit until mushy. Mix 1 1/4 cup breadfruit pulp, 1/3 cup oil, 2 tablespoons of milk, 2 eggs. Add 2/3 cup sugar. Stir into flour mixture, pour into greased pan and bake 1 hour at 350 F (175 C).

STORING COOKED EGGS. Just because eggs can be stored for some time without refrigeration does not mean the same is

true of cooked eggs, according to Science News (August 10, 1985). "In its raw state, the egg has several antimicrobial defenses. The cuticle, or outside portion of the shell, protects the eggs from bacterial invasion as long as this layer remains intact." The shell membrane may be an even more resistant barrier for bacteria. Furthermore an enzyme called lysozyme in the shell membrane and in the egg white destroys many bacteria. Cooking not only inactivates the egg's lysozyme, but also enlarges the shell's pores. The most important breakdown in defenses may occur when boiled eggs are cooled in water. The egg's contraction during cooling creates an air pocket which produces a vacuum that can draw in bacteria present in the cooling water.

Eggs that were cooled in water that had been inoculated with botulism spores resulted in the toxin being produced in the eggs. Because botulism bacteria thrive in the absence of oxygen, eggs stored in complete absence of oxygen spoiled

first (2-3 days), those in tightly sealed plastic storage containers in a week and those in open air about 8 days.

So keep these three facts in mind: (1) Hard-boiled eggs spoil more quickly than uncooked eggs and should be refrigerated. (2) Cooling in the air may be preferable to cooling in water, especially if the water is not pure. (3) It is better not to store them in air-tight containers.

WHAT IS THE HOT PEPPER AROMA that is released when they are heated in cooking oil? The substance that makes peppers hot, capsaicin, breaks down into vanillin and some other substances. Vanillin is the main flavor in vanilla. (Abstracted from Organic Gardening, p. 25, April 1993.)

PINEAPPLE JUICE SHORTENS COOKING TIME OF BEANS.
Amaglo Newton at the University of Science in Kumasi, Ghana is excited about a discovery of one of his masters students,

Viggo Dadoo-Ghana. "For some time I have been working to introduce soybeans to some missionaries. One major problem is the difficult cooking properties of the bean. ...[We now find that] a group of proteolytic enzymes (bromelin) found in pineapple juice is able to digest the outer seedcoat and ease the difficulty of cooking the bean.

"The beans are soaked for 6-10 hours in water to which pineapple juice has been added. It is then easy to peel off the seed coat. The cooking is then easy." [Ed: There is a good chance that the enzyme has been destroyed in canned juice, in which case you would need to make fresh juice.]

A few years ago Roland Bunch told me that women in Guanople, Honduras used papaya leaves when they cooked beans. Apparently papain in the leaves softened the seed coat also. I have no further details. A volunteer tried cooking some beans the way we imagined the process would be, but the

taste was so bitter they were inedible.

Both of these approaches might be worth pursuing. A shorter cooking time for beans would both be more convenient for the cook and use less firewood. If you experiment, let us know the results.

SQUASH CATSUP. When I give educational talks, I help the audience visualize the importance of new plant introductions by asking them to imagine what Italian cooking must have been like before the tomato was introduced from the Andes. Where would fast foods be without catsup? This recipe from "From Garden to Kitchen" (see above) stretches my imagination a bit. But many of you work where it is difficult to grow tomatoes. If it works, and you could get used to orange catsup, it might be worth a try. "Squash catsup can be made using squash [or tropical pumpkin] puree cooked with varying amounts of vinegar, salt, pepper, sugar and other spices. Corn

flour is used as a binder and thickener." Presumably winter squash or tropical pumpkin would be interchangeable.

Another interesting squash/pumpkin recipe is suggested. "Mix 7 parts of squash puree and 3 parts corn flour then form into chips and dry. Later they are deep fried in oil...."

PREPARE DIFFUSION-PROCESSED SWEET POTATO AT HOME. Dr. Frank Martin is a research specialist in sweet potato breeding. He writes, " A persistent nagging question is why people don't eat and don't want to eat more sweet potatoes. We believe this is due to sweetness itself, as well as flavors and textures that are not liked. We developed a new product that anyone can make at home that is less sweet, of more agreeable texture, and of better flavor than most sweet potatoes. People who don't like sweet potatoes do like our product. Please try this recipe in your kitchen and let us know what you think: (1) Peel the sweet potato and eliminate any

bad spots. (2) Cut very carefully into slices about 1/8" (3mm) thick. (3) Cover the slices with water. Leave for two hours, moving slices 3-4 times so that all sides are exposed to the water. (4) Discard the water and rinse. (5) Boil 20 minutes. (6) Discard the water. (7) Mash. At this time salt, milk or margarine can be added. (8) Serve mixed with mayonnaise or salad dressings, beans or bean sauce, meats or gravy, or mixed into soups. It can also be molded into patties and fried. The product is best used fresh, and should not be stored for long periods."

HOW ARE WINGED BEANS COOKED? Peace Corps volunteer Henry Kobie in Liberia wrote that he has had considerable success introducing winged beans, but folks know little about how to cook them. I thought our readers might be interested in what we turned up for him. I have often wondered why a plant that has received so much attention, because of its potential both for production in hot humid climates and also

for its high nutritional value, is not making a greater global impact. Uncertainty on how to use it is no doubt part of the problem.

The most difficult question is how to prepare the mature seeds. A few years ago I asked a researcher at CIAT in Colombia why they were not eaten on a large scale. He said that if I had ever tasted them I would know! The long cooking time required to soften whole, mature beans is also a problem in firewood-short countries. I think we can take a lesson from the soybean. In the countries where soybean is an important food, they have developed rather elaborate and unusual processing methods (making "milk", tempeh, etc.). The winged bean seed is nutritionally comparable to the soybean and, I suspect, requires similar processing methods.

A friend here in town makes a spread from ground up mature winged bean seeds that I quite enjoyed. He adapted this and

other recipes from soybean recipes in "Recipes for a Small Planet." Perhaps you could adapt it to local conditions, at least for the palates of our American readers. The ingredients are 2/3 c dry beans cooked until tender, a large onion sauteed in oil with a bit of garlic, juice of 2 lemons, a tablespoon soy sauce, 1/4 cup sesame butter (or any nut butter), 1/2 cup roasted and ground sesame seed, and 1/2 tsp salt.

The National Academy of Sciences' most recent booklet on the "Winged Bean: A High Protein Crop for the Tropics" (1981) is quite helpful. The following are excerpts adapted from that booklet, with my comments in []. Pods are the most popular part of the plant in most countries where the bean is grown and the easiest to introduce as food. They can be eaten raw or used in salads, soups, stews and curries and may be boiled in water or coconut milk or sauteed in oil. [If you grasp the pod in both hands it should be flexible. If not it will be too stringy to eat. Varieties differ in how long pods can grow before

becoming fibrous.] In Papua New Guinea, pods that are too fibrous to eat whole are often steamed in oil drums or the "mumu" pit, or baked in open fires; the seeds and mucilage are then scraped out and eaten. [This is probably of higher nutritional value because protein accumulates as the pods mature.] Alternatively, the half-ripe seeds can be removed from the pod and cooked. The immature pod provides primarily bulk with comparatively low energy content, but is valuable for the minerals and vitamins. No adverse effects have been reported from cooked immature pods. [A missionary recently told me that he required his workers to eat at least one raw bean at the beginning of each day. They were seriously under-nourished. They soon began feeling so much better that they ate it on their own and requested seed.]

The seeds are the most nutritious part. They can be steamed, boiled, fried, roasted, fermented, or made into milk, tofu (bean curd) or tempeh. Because of antinutritional substances, they

should be soaked overnight, then boiled in water until tender, with the soaking liquid discarded. [I understand that some varieties from regions that grow winged beans primarily for tubers may have more toxic substances present in the seeds, so be cautious if collecting your own varieties in such places.] If seeds are soaked in a hot, 1-percent sodium bicarbonate [as in Arm and Hammer soda] solution, the hard seed coats are more easily removed. Mature seeds are more difficult to dehull by this process because the cotyledons swell and press firmly against the hull. When fried or baked, they make a delicious nut-like snack. The high temperature breaks open the tough seed coat. It is not certain, however, whether this method of cooking removes the antinutritional substances. Sprouted winged bean seed can be used as an alternative to mung bean sprouts. Extracting oil from winged bean seeds leaves a high-protein meal. Infants fed winged bean meal suffer little or no flatulus discomfort [gas]. In storage the seeds show remarkable resistance to bruchid beetles which are such a bad

pest of stored legumes.

Tubers have several times the protein of potatoes. They can be boiled, steamed, fried or baked. The brown skin peels off readily after 40 minutes of cooking, leaving a white or cream-colored flesh that is firm and moist, with a distinctive nutty, earthy flavor. They are always eaten cooked.

Winged bean sprouts and shoots may be eaten raw or cooked as green vegetables. The top three sets of leaflets are the most tender; they taste slightly sweet. They have an average amount of protein, but are exceptionally high in the amino acid tryptophan. Thus even a small amount of the leaves can greatly improve tryptophan-deficient diets, e.g. those based on corn. Adding cooked leaves to diets of weaned infants and preschool children is recommended for the minerals and vitamin A precursor. The latter is among the highest ever recorded in green leaves of tropical plants. Excessive

consumption of raw leaves has produced dizziness, nausea and flatulence, so large amounts of raw leaves should not be encouraged. Properly cooked they are safe in quantity. Also flowers can be eaten raw. When steamed or fried they have the color and consistency of mushrooms.

Commercial efforts were just getting underway when the book was published. Efforts are underway to make flour. A gruel for weaning infants has been produced in Ghana. Mixed with corn, it provides the nutritive equivalent of milk. In Thailand a similar gruel made of winged bean meal, rice, and banana is being fed to refugees from Cambodia. Because of its similarity to the soybean, many soybean recipes are being tried. Tempeh and tofu are made commercially in Indonesia. Both white milk and a chocolate-flavored milk have been made from the seed in Thailand and sterilized for longer shelf life. Researchers have made tasty snacks from tubers sliced thin, fried and salted, or softened in sugar syrup. Immature pods are used in

pickles commercially in South India. One researcher in Indonesia has made a coffee substitute by roasting the seed (the grounds are edible) and a tobacco substitute from the dried leaf. Both of these should be free of alkaloids.

By the way, the dry pod left after threshing contains 10% protein and has been tested satisfactorily in animal feeds. In Thailand this pod residue is being used successfully as a medium for growing straw mushrooms.

Let me know if you are able to adapt any of these ideas and what the people's reactions are. We would be especially interested to know of any successful introductions you have made and how the local people prepare them. Winged beans are native to hot, humid tropical regions. If you have had success introducing them into other climates we would especially like to know the details (e.g. in dry or high altitude regions).

WINGED BEAN RECIPES. Dr. Andy Duncan sent us several recipes; write us for a photocopy. Dr. Frank Martin sent this information on winged bean seeds: "Probably no region of the tropics uses the seeds regularly as food. Seeds are parched in Java, but probably only immature seeds are used. They are used for making a vegetable curd similar to tofu from soybean, but our experience showed that such curds are definitely inferior to those of soybean. The 4-hour cooking time is an obstacle [to use of the seed]. ...The heavy seed has been suggested to cause abdominal pain. The evidence is persuasive that dry winged bean seeds are difficult to eat."

This was "confirmed in tests of 20 different lines.... Seeds left to soak absorbed water slowly, and some not at all. Three or four hours were required to cook soaked beans, and then some remained hard and unswollen. Cooked beans were harsh and nut-like, acceptable as an occasional food, but not attractive to the eye or the palate. When cooked beans were

ground into soups and flavored with other ingredients, an acceptable product was obtained. Although variety differences were seen, these were not sufficient to permit selection of lines of acceptable value."

Frank suggested a different method of cooking. "The beans treated in this fashion are very soft. Even the seed coats are pliable and edible. Such beans have a mild and agreeable flavor comparable to that of other beans. Tests so far suggest that people who eat beans regularly accept them readily. [They can be] used in many traditional dishes. Not all varieties are equally suited to this technique. In many, a few seeds remain hard, and many are intermediate. In these lines, however, the softened seeds can be separated from the hard seeds with a large mesh screen. Here is that better method:

"Measure the volume of beans to be cooked. Rinse and add 5 volumes of water. To the water add 1% sodium bicarbonate

sold as soda or baking powder [about 1/2 teaspoon per cup of water]. Boil the beans and simmer for 3 minutes. Remove from heat and soak the beans in the solution overnight. The following day, discard the soaking water, rinse twice with fresh water and boil in double their volume of fresh water for 20 to 25 minutes."

FOOD CYCLE TECHNOLOGY SOURCEBOOKS are eleven well-illustrated manuals (40-70 pages) which discuss different aspects of food processing, both traditional practices from around the world and modern equipment and techniques. With specific, basic information on technology choice for individuals and small businesses, they are most relevant for people who introduce innovations in food processing. Each book has a helpful checklist for planning your project or enterprise before you begin.

Most ideas involve a purchased technology upgrade, suitable

for medium-scale processing with commercial potential. However, interesting and simple local technologies are also included. For example, the book on Root Crop Processing mentions the "wedge press, an adaptation of a traditional Chinese press used to extract oil. Tree stumps or logs provide support for a wooden beam inserted between them [see drawing]. Sacks of grated pulp are placed on the beam and pressure is applied when wooden wedges are hammered into the space between the sacks and tree stump."

The eleven titles are: Oil, Fruit and Vegetable, Cereal, Fish, Root Crop, and *Dairy Processing; Drying; Packaging; Storage; *Rural Transport; and *Women's Roles in the Innovation of Food Cycle Technologies. The books are particularly helpful for those interested in adding value to harvests by processing crops for storage or market. Available for US\$13.50 (* for \$15.50) plus postage. Discounts are available for orders of 10 or more books. Request the catalog

from Women, Ink.; 777 United Nations Plaza, New York, NY 10017 USA; phone 212/687-8633; fax 212/661-2704.

CULTIVOS ANDINOS SUBEXPLORADOS Y SU APOORTE A LA ALIMENTACION, by Mario Tapia, FAO. 205 pages, Spanish only. This book was prepared by the FAO to provide practical knowledge of Andean ecology and agriculture, the domestication of Andean species and agricultural techniques used to grow these plants, agroindustrial potential, and their nutritional value and use. The task of the book is to provide a base to develop and improve underexploited Andean crops.

The book begins with a brief history of the domestication of Andean plants. There are listings of wild relatives of modern Andean crops and the plants cultivated at the time of the Spanish invasion. The book also contains ecological classifications of different areas of the Andes, and the elevations at which the principal Andean plants are grown.

However, most of the book provides detailed information of principal Andean cereal, tuber, and root crops (quinoa, kaiwa, amaranth, tarwi, oca, ulluco, isao, arracacha, yacn, maca, and chago). For each crop there is a botanical description, comparison of varieties, cultivation and rotational practices, pests and diseases, brief harvesting and storage techniques, uses, and nutritional value tables. The book contains excellent color pictures and diagrams of the different Andean species. The cereal crops quinoa, kaiwa, amaranth, and tarwi receive more attention than many others. The author briefly explains indigenous and mechanized practices to remove toxins present in some plants. He also devotes a chapter to the commercial development of underexploited Andean crops so that indigenous people might benefit from growing their native plants.

The book is written for people who conduct research oriented toward larger-scale development. However, the book could be

helpful to anyone working in the Andes in agriculture or nutrition. For anyone interested in introducing Andean crops into their own communities, it is a good starting point with many references.

MANUAL SOBRE UTILIZACION DE LOS CULTIVOS ANDINOS (121 pp., FAO) is a recipe source complementary to the above book. Traditional and non-traditional soups, drinks, desserts, breads, and other dishes are included. Most of these recipes include several Andean crops and would be most appropriate for the region. The books are only available in Spanish (with some Quechua throughout the text). Available free upon request from Dr. Cecilio Morn, Oficial Regional de Poltica Alimentaria y Nutricin, Oficina Regional de la FAO para Amrica Latina y el Caribe, Casilla 10095, Santiago, CHILE; fax (56-2) 2182547.



[Home](#)-immediately access 800+ free online publications.
[Download](#) CD3WD (680 Megabytes) and distribute it to the 3rd World. CD3WD is a 3rd World Development private-sector initiative, mastered by Software Developer [Alex Weir](#) and hosted by [GNUveau Networks](#) (From globally distributed organizations, to supercomputers, to a small home server, if it's Linux, we know it.)[ar](#).[cn](#).[de](#).[en](#).[es](#).[fr](#).[id](#).[it](#).[ph](#).[po](#).[ru](#).[sw](#)

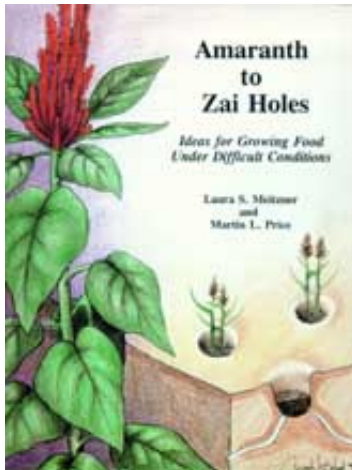

 Amaranth to Zai Holes, Ideas for Growing Food under Difficult Conditions (ECHO, 1996, 397 p.)

➔  11: Human health care

 *(introduction...)*

 Health care

 Health risks

 Antinutritive factors and plant



Amaranth to Zai Holes, Ideas for Growing Food under Difficult Conditions (ECHO, 1996, 397 p.)

11: Human health care

Health care encompasses many areas: improved quality of life, better nutrition, safety, building good relationships, and prevention and cure of illness and disease. This chapter presents resources and ideas you may use in promoting health in your community. There are many resources available for training and technical assistance. We also focus on how several plants mentioned elsewhere in this book may be used in medicine.

Health care

SOME REFLECTIONS. No doubt the word "hunger" in ECHO's name leads people to think of hunger as ECHO's only concern. ECHO is involved in much more than alleviating hunger. I often tell people that even if no one was dying of starvation in the world, ECHO would still be ministering to the poor in the name of Christ. So would most of our readers. There is much more to life than not dying of hunger! It is the quality of life that is our concern, spiritual and physical-the same things for which we all work and pray for ourselves and our families. The following letter is an eloquent example of this greater need. (It is from Cesar Maes, a Belgian Catholic priest in Guatemala, and was forwarded to us by Mel West.)

"Our new fish pond is a source of joy. How important is entertainment for development projects? How important is it in the lives of well-off people? A project that only takes the stomach into account is crippled from the start. There is more in a human being than a stomach and one can still feel hungry

in many ways even when well fed.

"Don Tomas had to wait 75 years for an opportunity to see fishes. He showed his plastic bag with some colored little carp. 'Look, Padrecito, how beautiful!' And he hurried home to his water pit. There are hundreds of pits and miniponds in a wide environment and uncountable are the children and adults having lots of fun with them. The fact that several carp are already the size of a frying pan increases the enthusiasm. People tenderly look at the fishes. They smile, and believe in God. Wonder is the most intimate relative of faith.

"Humble people dream around the fish pond. It took a lot of time to remove hundreds of tons of dirt, using wheelbarrows and primitive implements. It was worth-while. They had never seen swallows skimming the water, never felt the sensation of a quivering fishing rod when a fish wriggles at the hook, never seen a water lily, never miraculously stayed dry floating on

water [in a boat]. Their delight is our joy. The model farm becomes with this huge pond an entertainment area especially for families. It is the only one in our highland.

"Healthy entertainment is scarce. This partially explains the alcohol abuses, the sexual deviations and the vulnerable family ties. It also explains the successful religious meetings where they do a lot of singing, usually mishandling guitars."

RESOURCE CENTER WELCOMES INQUIRIES FROM COMMUNITY HEALTH WORKERS. MAP International is a non-profit Christian global health organization providing donated medicines, medical supplies, and development training services to over 300 missions, denominations, and national church groups around the world. MAP's Learning Resource Center has a collection of helpful reference materials related to community health and development in the third world. Christians involved in health work in the third world are

welcome to write to them for information difficult to obtain locally (much like ECHO addresses questions related to your agricultural work). A full-time librarian responds to requests for information with photocopies (\$0.10/page), suggested readings, and recommendations from MAP's stock of publications for sale. On-site use of the resource center is also welcomed. Direct inquiries to Flor Oamil, Learning Resource Center, MAP International, 2200 Glynco Parkway, P.O. Box 215000, Brunswick, GA 31521-5000, USA; phone 912/265-6010; fax 912/265-6170.

THE APPROPRIATE TECHNOLOGY INSTITUTE (ATI) offers training modules at Providence Farm in North Carolina. ATI prepares missionaries to use technology appropriately as they assist in church planting movements. The 12-week courses run in the spring and are repeated in the early fall. The training is devoted to spiritual, cross-cultural, and technical preparation for overseas living in the areas of appropriate

technologies, food production, and community health systems. Participants examine a holistic approach to development (sprinkled throughout the other courses) and experience community living in an isolated setting throughout the course. The extensive readings and the technical preparation in the curriculum cover most aspects of village living a missionary is likely to encounter overseas. Instructors for each module are highly qualified, and the learning is largely hands-on. Those not able to participate in the full curriculum can take one or more of the modules (each lasts about a month). Total cost for the full 12-week program is approximately \$1500/couple, \$850 single.

They also offer 2-week intensive courses in missionary medicine (in March, June, and November if classes fill). These are designed to prepare students to use the Village Medical Manual as a diagnostic tool for common health issues in developing countries. Total cost of the medical course is \$362

per person. Write for other times and places the course will be offered. Contact ATI, P.O. Box 1126, Marion, NC 28752, USA; phone 704/738-3891; fax 704/738-3946.

MEDICAL AMBASSADORS INTERNATIONAL offers a program in Community Health Evangelism "developed and tested over many years to train people who want to establish a community-based health care program which also integrates evangelism and discipleship. We can also assist those who have already established their own program and want to integrate evangelism and discipleship components." They quote a past participant: "My organization talks about integration of physical and spiritual but they do not tell me how to do it. This training has given me the How-To's to help us establish such a work."

The one-week training in Colorado Springs is in October and costs \$300 for room, board and tuition. Contact Missionary

Internship, P.O. Box 50110, Colorado Springs, CO 80949;
phone 209/524-0600; fax 209/571-3538.

Health risks

HOW CONCERNED SHOULD I BE THAT LEAD MAY CONTAMINATE URBAN GARDENS? This question was asked by Craig Shuck with World Concern. I spoke with Dr. Nina Bassuk, the program director of Cornell University's Urban Horticulture Institute and asked her to give us a perspective on this question. There are two situations where lead may be a problem: (1) if you are gardening near a busy highway and (2) if you are planting in the rubble of a building in which lead paint had been used. Of the two, the second is the more serious. Dr. Bassuk said that there is no reason to panic over the question. If your entire diet is not from such a garden and children are over 6 years old, there is no reason for real concern. There would be some concern for children under 6 for

whom a large portion of their diet came from a lead contaminated garden. However, if they play in the area, the hand to mouth ingestion of lead is far more serious. Plants naturally exclude most of the lead. She believes that contamination by cars would only be a serious problem for gardens planted quite close to cars on a busy highway.

She has developed a "cure" for such soils, based on experiments from urban gardens in New York City. The cure calls for adding large amounts of organic matter such as compost or manure and maintaining the pH near neutral. In soils containing large amounts of lead, organic matter representing at least 25% of the total volume may be needed. Lettuce grown in soils with 40-50% organic matter had zero lead uptake, even though the concentrations in the soil were as high as 3,000 ppm. The organic matter is more effective if it is well decomposed. When the pH drops below 6.0, the level of lead uptake increases. [However, that much organic matter

should itself help buffer the pH.] Adjusting the pH to levels >6.5 is also effective against cadmium, another toxic heavy metal.

Leafy and root crops such as lettuce, spinach, potatoes and beets are likely to absorb lead. Crops grown for seed or fruit such as corn, tomatoes, beans, squash, eggplant and peppers normally do not absorb lead from soil in any appreciable amount. In spite of organic matter in the soil, plants near a busy highway can still become contaminated as lead from exhaust is deposited directly on the leaves. Water removes only a small amount of the lead, but 1% vinegar added to the water or 0.5% dishwashing liquid removed it effectively.

FUTURE FERTILITY: Transforming Human Waste into Human Wealth by John Beeby addresses a question many development workers face. "The soil here is so depleted and so few inputs are available. Is it safe to recycle human waste into our fields or gardens?" This book takes a careful look at the

topic of processing human urine and manure so it may be safely added to the soil to sustain productivity. For those of you in areas where human waste is currently unmanaged and causes the spread of disease, this book may be very helpful in defining treatment options you could implement. Nine different methods for recycling manure (aquaculture, algae, solar heating, composting, trees, grains, etc.) are outlined and compared based on purification levels, resources required, and the value of the finished product as fertilizer. This book will answer many of your questions about how to manage a waste recycling system safely and effectively. The 164-page book is US\$18.50 plus postage (\$4.50 within the USA; others write for exact cost) from: Bountiful Gardens, 18001 Shafer Ranch Rd., Willits, CA 95490- 9626, USA.

MORINGA SEEDS USED IN WATER PURIFICATION. We learned of another use for the multipurpose tree *Moringa oleifera* from Dr. Samia Al Azharia Jahn with the Deutsche Gesellschaft für

Technische Zusammenarbeit (GTZ) in Germany. Suspensions of the ground seed of the moringa tree are used as primary coagulants to clarify Nile water. At high turbidities their action was almost as fast as that of alum, and at medium and low turbidities >30 FTU it was comparable with the optimum dose and proper stirring technique. The doses required did not exceed 250 mg/l.

Coagulating the solid matter in water so that it can be easily removed can remove a good portion of the suspended bacteria. "River water is always faecally polluted. At our sampling site the total coliforms amounted during the flood season to 1600-18,000 per 100 ml. Turbidity reductions to 10 FTU were achieved after one hour, reducing the coliforms to 1-200 per 100 ml. Good clarification is obtained if a small cloth bag filled with the powdered seeds of the moringa is swirled round in the turbid water." "With raw water turbidities below 30 FTU no satisfactory removal of suspended matter can be

achieved unless the seed suspension is used in combination with alum."

The material can clarify not only highly turbid muddy water but also waters of medium and low turbidity which may appear milky and opaque or sometimes yellowish or greyish (showing annual turbidity fluctuations between 50-300 FTU, such as the White Nile or several African lakes). During the cool season, complete clarification, which takes only one hour in warmer water, may take two hours unless the water is left in the sun for some time to raise its temperature."

The number of seeds required for treatment depends on the local average weight of their white kernels, found to range from 130-320 mg in different clones. "In the case of the Blue Nile, for example, water of low turbidity in the initial and final flood season needs doses equivalent to about one quarter of a 200 mg seed per liter, water of medium turbidities needs half

a seed per liter and at high turbidities the dose should be 1-1.5 seeds per liter." Water from a different river will require different quantities of clarifier because of variable characteristics of suspended material. Simple experiments in a jar will determine the best dose.

To prepare the seed for use as a coagulant, remove the seed coats and the "wings." The white kernel is then crushed to a powder, using a mortar or placing in a cloth on top of a stone and crushing. The powder should be mixed with a small amount of clear water (about a 2% suspension) in a small bottle. Close the bottle, then shake at least 5 minutes to obtain a good water extract. This milky extract is then poured through a tea strainer before being added to the turbid water. It is even better to put some thin clean wide-mesh cotton cloth on the strainer.

"The milky white suspension has to be added to the turbid

water and stirred fast for at least one minute. If a wooden soup whisk is used, the nails sometimes present in these gadgets should be replaced by small wooden sticks. After that the floc will not form unless it is stirred slowly and regularly (15-20 rotations per minute) for about five minutes." "After stirring the treated water should be covered and left to settle for at least an hour." If moved or shaken before then, clarification will take much longer or fail to reach completion. The GTZ is planning implementation projects in Indonesia and Kenya. Dr. Jahn has retired, but you may still write her at GTZ, Abt. 414; Postfach 5180; D-65726 Eschborn, GERMANY.

Dr. Samia Al Azharia Jahn has written a 539-page book, Proper Use of African Natural Coagulants for Rural Water Supplies. (Chapter titles: Annual fluctuations in raw water quality, Water treatment with traditional plant coagulants, Special microbiological and toxicological studies on water purification, Cultivation of moringa trees, Introducing domestic

water treatment to rural people, Practical guide to domestic water coagulation and hygienic water storage). Much of the book is devoted to moringa. French and Spanish translations are in preparation. The book may be available from the Deutsche Gesellschaft für Technische Zusammenarbeit (GTZ) at the address above; fax 06196-79-73-17. Dr. Jahn has sent us seed for two related, more drought-tolerant species which, if we get them to produce, we will offer to you. Dr. Jahn would like to hear from you if you are working with moringa in a major way.

She also sent us an article from the East African Medical Journal that investigated whether water treated with moringa seed powder might be toxic to people. Pounded seeds were fed to rats for 6 weeks with no toxic effects. "As the plant material acts as a flocculent [makes solids come together and settle], one might assume that most of it will get trapped in the sediment and only easily dissolvable substances will be

present in the water." Furthermore, moringa "seeds are used for food; they are roasted like peanuts, pounded for tea and curries are prepared from the green pods." [I have not heard of the mature dried seeds being eaten, and at least the variety we have is quite distasteful, so I wonder if these food uses are not all for green seeds.]

Dr. Mike Bengé with the forestry department of AID has put together a 196-page photocopied compilation on moringa which he titles "Moringa: a Multipurpose Vegetable and Tree That Purifies Water." He wrote, "If you have people who would like this kind of information, just send their addresses." You should contact him at Agroforestry, G/ENV, Rm. 413-E, SA-18, Agency for International Development, Washington, D.C. 20523- 1812, USA; phone 703/875-4063; fax 703/875-4639; e-mail mbenge@usaid.gov.

USING MORINGA ON A LARGER SCALE. Use of moringa seed

on a small scale (household level) to purify water has been mentioned. Dr. Geoff Folkard at the University of Leicester in England sent us articles concerning recent work in Malawi. "This is the first time that *Moringa oleifera* seed has been used as a primary coagulant [to clarify water in a treatment plant] at this scale (flow rate 16 m³ per hour)."

The water plant normally uses alum, an imported chemical, to clarify the water. They only had enough seed to run the plant six hours. Water quality was monitored before and after the switch from alum to moringa was made. There was no deterioration in performance. They used twice as much moringa as alum (50 mg/ml of moringa seed vs. 75 mg/ml).

Laboratory trials show that using alum and moringa together (they call it co-coagulation) can give superior results to either used alone. Moringa seed (either *M. oleifera* or *M. stenopetala*) was equivalent to alum and even superior in water of

unusually high turbidity. (If you are interested in the chemistry involved, the active ingredients in moringa seed have been identified as two small water-soluble proteins with a net positive charge.)

"For many countries, imported alum is the major cost element in the provision of potable water. Malawi currently spends in excess of £220,000 each year on imported alum. Switching to moringa would both save foreign exchange and generate farm and employment income.

"Further full scale trials in Malawi are planned for January 1994. It is hoped that demonstrations for interested parties from other developing countries will be arranged." Dr. Folkard's address is University of Leicester, University Road, Leicester LE1 7RH, England. Write him for his 1995 technical reports if you have serious interest in large-scale water treatment.

Dr. Folkard is now working on extracting the oil from moringa seed. Preliminary tests indicate that the cake remaining after the oil is extracted is still able to clarify water. He is conducting further tests. Because the oil is quite valuable, this could have a big impact on the economic viability of a moringa-based water treatment program. A LIVING FENCE THAT MIGHT BE DEADLY? The following is based on a note in the October-December 1991 issue of Agroforestry Today, which in turn is based on an article in The Economist (July 6, 1991 pp 86-87) and The Lancet (May 30, 1987 pp 1257-58).

"Farmers near Kabale in Kenya describe traditions, now considered superstitious, that certain euphorbias cause cancer when planted near the homestead." [Euphorbias in Africa fill many of the environmental niches that are filled by cacti in the Americas.] Now the carcinogenic effects of one common living fence species, *Euphorbia tirucalli*, have been described. The active carcinogen has been found not only in the plant

itself, but in extracts from nearby soil, vegetables and drinking water. "The report suggests that Burkitt's lymphoma, a common childhood cancer in East Africa, is caused in part by consumption of water and vegetables from sites near this euphorbia." The plant grows profusely in Kenya's Eastern, Western and Nyanza Provinces and in parts of Tanzania. In southwestern Uganda it is widely planted as a living fence to exclude livestock from protected springs, suggesting the frightening prospect that water that has been assumed safe is in fact very hazardous. It is also commonly used as a living fence to protect food crops.

Antinutritive factors and plant toxins

TAKE A LESSON FROM THE DEER. I worked one summer in the laboratory of forage scientist Dr. VanSoest at Cornell University. He said we should learn a lesson from the deer. Deer can eat plants with no ill effect that are poisonous to

cattle. The difference is that deer are browsers. They eat a small amount of one thing, then move on to many other things during the course of the day. In contrast, when a cow likes something it keeps eating. The body is capable of detoxifying small amounts of a great many things. This is sound advice to keep in mind when evaluating plant nutrition and toxicities.

I have thought of that many times since working with so many kinds of plants at ECHO. No doubt a steady diet of some would be harmful, as is the case with many common foods like cassava which contains cyanide or spinach with oxalates. There is a comforting degree of safety in "browsing" among a large selection of foods. Not only will your body more likely be able to detoxify the small amounts of any particular toxin, but it is more likely to find at least a minimal amount of the various nutrients it requires. All the more reason to work to bring diversity to the diets of people with whom we work.

A PERSPECTIVE ON NUTRITIONAL LIMITATIONS OF AMARANTH. (Excerpted from ECHO's Technical Note on amaranth.) Based on the content of nutrients, amaranth seed and leaves are exceptionally nutritious. Amounts of vitamin C, iron, carotene, calcium, folic acid and protein are especially high in the leaves. There are reports that the incidence of blindness in children due to poor nutrition has been reduced with the use of 50 to 100 g of amaranth leaves per day. On a dry weight basis, the protein content of the leaves is about 30%. Amaranth seeds have more protein than many grains (15%) and this protein is high in the amino acid lysine that is usually low in cereals, and sulfur-containing amino acids that are usually low in legumes. Based only on an analysis of those nutrients that are present, amaranth would seem to be almost a "miracle food."

The presence of rather high amounts of oxalic acid and nitrates place some limitation on the quantity of leaves that

should be consumed daily. The amount of oxalic acid is roughly the same as that found in spinach and chard. Excessive amounts (over 100 g per day?) may result in a level of oxalic acid that begins to reduce the availability of calcium in humans. This is especially a concern if calcium intake levels are low to begin with. Nitrate in vegetable portions of amaranth is a concern because it is hypothesized that nitrates may be chemically changed in our digestive tracts into poisonous nitrosamines. Evidence for this is lacking at the present time. Nevertheless, over 100 g per day may be an unsafe amount to eat according to some scientists. The levels of both oxalic acid and nitrates are reduced by boiling the leaves like a spinach, then discarding the water.

The seed should be as nutritious as cow's milk or soybeans, based only on the quality and amount of protein present. But there are apparently some "anti-nutritional" factors in raw amaranth that lead to quite unexpected results in feeding

trials. Performance is improved somewhat by cooking. For example, Dr. Peter Cheeke at the University of Oregon compared the rate of weight gain for rats on diet of corn and ground amaranth seed (*Amaranthus hypochondriacus*), either raw or cooked. The average daily gain for rats on the corn-soybean diet during the first 20 days was 3.9 grams. Rats fed the corn-amaranth diet gained on 0.3 grams per day. The average daily gain for rats fed corn and cooked amaranth was 1.6 grams. Raw amaranth seed is extremely unpalatable to rats (i.e. they will not eat it readily). This does not seem to be improved much by cooking. In another study, Dr. Cheeke found that after 11 days on corn-amaranth diet, rats "had an unthrifty, hunched-up appearance, and exhibited symptoms typical of semi-starvation."

I phoned Dr. Cheeke to get his perspective on the seriousness of these negative results. He told me that there are definitely toxins and/or anti-nutritional factors in the raw grain and that

it is less of a problem with cooked grain. He said that a scientist in Australia has been feeding raw amaranth seed to poultry as the major component of the diet. He found that chickens went into spasms, convulsions, and finally died. This unidentified factor causes liver damage. Other problems are caused by saponins, including the unpalatability. But to keep this in perspective, Dr. Cheeke pointed out that there are few raw foodstuffs which do not have problems. Raw soybeans contain 10 kinds of toxins. Raw kidney beans will kill rats, but the problem is eliminated by cooking. The key seems to be to use the seed in moderate amounts and to cook it. I asked whether I could say that unless people had little other than amaranth to eat, there should be no problem. He thought that this was probably a fair statement. It is our opinion that more research needs to be done before we can recommend amaranth grain as a major ingredient in animal feed. To our knowledge it has not been shown whether these factors decrease the value of amaranth in human nutrition. It is quite

possible that some varieties may lack these anti-nutritional factors. Until more work is done, however, the feeding trial results must moderate our otherwise enthusiastic promotion of amaranth grain. But remember, the Aztecs did quite well on at least selected varieties!

TOXIC PLANTS CONSUMED BY GOATS MAY AFFECT HUMANS WHO DRINK THEIR MILK. A reader sent us an interesting news note from the August 1983 issue of Popular Science. Dr. Donald Crosby at the University of California at Davis reported that a woman from a backwoods area had a deformed baby. Dr. Crosby noted a striking resemblance to the deformed limbs of calves born to cows that forage such toxic plants as lupines. Throughout her pregnancy, the woman had drunk milk from a goat that had foraged freely in an area where lupines are abundant. Dr. Crosby then fed lupine seeds to a goat and found dangerous levels of the toxins in the milk four hours later. The goat in question had also given birth to deformed

offspring. The evidence is circumstantial, but persuasive. It is something you should keep in mind.

CAN PEACH PITS BE USED AS FOOD? Dennis Zehr wrote from Lesotho that they are blessed with an abundance of peach trees. The children eat the pits in limited quantity and they have been fed in limited amounts to chickens. He asked about their safety.

We passed the question on to Dr. Julia Morton. "As with certain varieties of lima bean and cassava, kernels of the peach, bitter almond, chokecherry, apricot and apple contain cyanogenic glycosides which, under certain conditions, release hydrogen cyanide gas. Some have caused human and animal fatalities when consumed in quantity. Pre-soaking and thorough cooking may render them safe for animal feed. But marketing would be a hazard as one would have no control of the manner in which they would be used. Peach kernels have

been employed in homicide." It does not sound like it is worth the risk.

DO NOT EAT SPROUTED SORGHUM. You have heard of the added nutritional benefits that can come from sprouting seeds before eating them. Grain sorghum is an example of how it is not safe to assume that any edible seed can be eaten after sprouting. According to an article in Science News, this practice used to be recommended to improve the nutritional value of sorghum. The sprouts were eaten fresh or dried and ground into a meal. "The average fatal dose of HCN (cyanide) is 50 to 60 mg, and this amount was readily obtained from sprouts grown from 100 grams of sorghum seed. Consumption in a single meal of sorghum sprouts or the dried product derived from 100 g of seed is entirely possible." Dried sprouts retained the high levels of cyanide. The authors say this presents a special risk to people with chronic cyanide poisoning from diets high in cassava and sorghum grain.

Sprouting could increase the already serious levels of cyanide in their diets by as much as 500 to 1000 fold. We now have the original research article and will share it with you if this is a matter of special concern.

IS VELVET BEAN SAFE TO EAT? [NOTE: Read the following articles to see the development of research's answer and current perspective on this question.] Velvet bean is generating so much interest and the pressure to use it for human food is considerable. The multiple uses of velvet bean (*Mucuna* spp.) as a green manure plant, for weed and erosion control and for moisture conservation has been discussed (see chapter on Soil Health). Its use in Central America is increasing rapidly. It is among the most frequently requested seed in ECHO's seedbank and others are starting to get excited too. For example, Felix Quero in the Philippines says, "What impresses us most is its aggressiveness. It could even compete with the problem grass *Imperata cylindrica* and has potential

of at the same time controlling this grass and providing food."

Yet its safety as a human food is questionable. The book Food Legumes says the plants are mainly used for grazing although mature seeds are also fed to animals. "They are used mainly for feeding cattle or sheep [i.e. ruminants] and can only be fed to pigs if they constitute less than 25% of the diet. They are considered unsuitable for poultry." [This may not be as bad as it sounds if, as I presume, they are speaking of raw beans. You cannot feed very much raw soybean either and a raw kidney bean diet will kill rats.] "Velvet beans can be used as a human food but require considerable care in their preparation... In many parts of Africa and Asia they are regarded as a famine food. The toxic principle can be removed by boiling and soaking the seeds in several changes of water."

Their safety is a very important question. The vines produce beans abundantly. It would be a terrible waste to not use such

a nutritious bean [28-32% protein] for human food unless it is indeed dangerous. For example, when I visited the World Neighbors project in Honduras last December a drought had destroyed the regular bean crop. Yet there was a heavy yield of velvet beans. Because velvet beans were all they had, I understand that the people were eating and enjoying them regularly. They boiled them with corn, removed the seed coats by hand, then ground equal amounts of beans and corn to make tortillas. I also enjoyed refried velvet beans there.

Roland Bunch reports that velvet bean coffee is becoming popular in their project area, where it is sold as "nutricafe." Daniel Salcedo's organization Pueblo to People wanted to market nutricafe in the States to provide income to small farmers in Honduras. He mentions that older people who have had trouble with coffee because it is diuretic (increases urination) love nutricafe, which does not have this effect. (The "nutri" part of the name is probably misleading. Daniel told me

he had brewed nutricafe tested for protein and found little.)
But if the toxic material is removed by boiling the beans and discarding the water, might this be a dangerous drink? Or does roasting the beans or the boiling process itself render it harmless?

TOXICITY. The instruction to "boil in several changes of water" does not provide perspective. The same warning could mean that velvet beans that are not so prepared could prove fatal with a single meal or that they would cause some slight symptom if consumed regularly for a year-or any degree in between.

The most likely toxic principle is L-dopa. Velvet beans contain so much L-dopa (6-9% of the dry weight of seeds with seed coats removed) that they are the primary natural source of this compound. It is one of the most effective drugs against Parkinson's disease. Neurophysiologist Dr. Judy Toronchuk

tells us that L-dopa causes neurological symptoms. These can include hyperactivity, muscle spasms, cardiac irritability, hypotension and vasoconstriction. But it causes nausea at much lower doses. "So probably if people were to ingest the un-degraded L-dopa they would voluntarily stop eating it, due to nausea, before they had eaten enough to affect the brain."

Judy checked with a pharmacology professor. He felt that the L-dopa would break down sufficiently with cooking, particularly if cooked in water. It breaks down readily in the presence of moisture and forms the harmless pigment melanin. In fact the drug must be stored in dry, brown bottles which must not be allowed to exceed room temperature. (Might beans that have been stored for a year in the hot, humid tropics have less L-dopa than freshly harvested beans?)

There is also an unusual compound (a cyclic imino acid) that presumably is a natural derivative of L-dopa. The articles I

reviewed mentioned no biological effect of this compound.

RESEARCH. This brings us to an aspect of ECHO's ministry that is not normally visible to our network. Many undergraduate programs require research as part of the science major. ECHO encourages such students and their professors to undertake projects that would benefit small farmers in the third world. One of the projects we suggested in our "Research Opportunities" write-up was to look into this question of safety of velvet bean. Senior premedical major Sarah Kramer and her advisor Dr. Bob Kistler at Bethel College in Minnesota did just that, and came up with some very interesting information.

First, a computerized literature search turned up two journal article reports of people eating velvet beans. One study mentioned that they found a village in Ghana where some people ate velvet bean daily. Another study found that rural people in southern Nigeria use it as a soup thickener by first

boiling to remove the hard seed coat, then grinding it.

Tom Post in Belize forwarded us a report like none other I have encountered from the book *Poisonous Plants of the United States and Canada* by J. M. Kingsbury. Using the velvet bean grown in Florida years ago "even boiled for an extended time, the beans were unpalatable and produced, an hour or more after ingestion, symptoms of nausea and discomfort. While cooking, the beans gave off a volatile substance which produced a smarting sensation in the eyes and a pronounced headache among those experimenting with them." This is so unlike recent reports where the tropical velvet bean is being used that there must be considerable differences in toxicity between varieties. ECHO distributes two varieties of velvet beans. One is the kind that has no itch-producing fuzz on the pods and produces seed only during short days. We call it our "tropical velvet bean." That is the one we normally send overseas unless specified differently. Seeds may be white,

mottled or colored. The other is the less vigorous kind grown in the southeastern USA which we call the 90-day velvet bean and is possibly the kind mentioned in this report. However, Sarah's experiments with mice described below were with this 90-day type and she found no such problems.

Sarah's computer search turned up a rat feeding trial in Ghana using velvet beans. Results were reported in terms of grams of weight gain per gram of protein eaten (the protein efficiency ratio or PER). Rats fed raw beans lost weight (PER -3.03). The PER for rats fed autoclaved (i.e. pressure cooked) beans was 2.31, and for rats fed only the ideal diet it was 3.41. The lower value for beans does not necessarily mean there was still some toxicity. The protein of many legumes is not always digestible, or may be lower in one of the essential amino acids than the ideal control diet. The latter appears to be the case here because rats fed autoclaved beans to which the amino acid methionine (which is often in inadequate supply in

legume seeds) was added had a PER of 3.59.

A study in the States showed that the likely benefit to the plant of such a high concentration of L-dopa is protection of the seed. "Mature seeds of velvet bean are conspicuously free from attack by small mammals and insects." Small amounts of L-dopa that they added to an insect diet produced toxic effects. Concentrations as high as found in velvet bean seeds inhibited feeding completely.

THE FEEDING EXPERIMENT. Sarah did a 27-day feeding trial with mice. She used the 90-day variety of velvet bean because we did not have enough of the tropical kind to do a feeding trial. Four mice were assigned to each of 9 experiments. The control mice were fed commercial mouse chow. When an experimental diet was used, every third day 4.0 grams of the control diet (mouse chow) was added to provide nutrients missing in the experimental diet. This amount was chosen

because that was the average daily amount eaten by rats fed only the control diet. Mice fed the control diet gained 8 grams. Mice fed the control plus the amino acid methionine gained 7.5 grams, which statistically was not significantly different at the 1% confidence level.

[A note to those not familiar with statistics. In everyday English we use the word "significant" about the same as the phrase "a lot." "A Mercedes is significantly more expensive than a Volkswagon" means it costs "a lot" more. A scientist uses the word differently. If the weight of rats in two experiments is "significantly" different we mean that statistically speaking the probability is small that random chance could have accounted for the results.]

EFFECT OF "NUTRICAFFE." One set of mice was fed the control diet except that velvet bean coffee was the only thing available to drink. Beans were roasted at 300 F on a cookie

sheet for one hour. To make coffee, 40 g of roasted beans were boiled in 700 ml of water for one hour. Mice gained 10.2 grams, which was not significantly different from the control.

EFFECT OF RAW VELVET BEANS. Mice fed raw beans lost 5.6 grams. With added methionine they lost 6 grams. This could be caused by the L-dopa, but so many harmful things occur in raw bean seeds that some other cause cannot be ruled out. This was significantly different from the control.

EFFECT OF BOILING THE BEANS. Beans that had been soaked with one change of water were boiled 30 minutes (40 g in 700 ml water) then another 30 minutes in fresh water. They gained 4.8 grams. Mice fed boiled beans with added methionine gained 3.8 grams. These were not significantly different from the control.

For your consideration, Doug Welch in Malawi wrote, "Velvet

beans are consumed here. They were displayed at the trade fair as one of the beans produced for consumption. There is a story of how villagers fled when attacked and left some partially cooked velvet beans. The hungry raiders ate them and all died. They have to cook the beans twice."

EFFECT OF ROASTING THE BEANS. Mice fed beans roasted at 300 F on a cookie sheet for one hour gained 1.5 grams. Those fed roasted beans plus methionine gained 3.0 grams. Both were significantly less than the control but not than the cooked beans.

WHAT PERSPECTIVE CAN WE GIVE? There is not enough evidence to say with certainty that there are no problems from eating cooked velvet beans. We very much need more research, but human need does not wait for science. What should you recommend in the meantime? Considering everything that has been said above, if velvet beans were

available and I was hungry or my diet was low in protein, I would definitely eat them after thorough cooking. If I were neither hungry nor malnourished, but was living at a subsistence level, I would occasionally eat velvet beans. (I am none of the above and do not eat velvet beans except as a curiosity if they are offered.) I would definitely eat modest servings at first, and consider changing my cooking methods if nausea occurred. I would warn families of possible symptoms and ask them to report any problems to me. I would not eat the wild velvet beans unless forced to do so and would be doubly cautious. The same would go for any new variety that I might obtain unless I knew that it was eaten elsewhere. I would feed them freely to pigs and chickens only if I had the firewood to cook them first. If at all possible I would "take a lesson from the deer" and browse small quantities of many foods, not eating too much of one thing.

New evidence has led us to offer the following guidelines at

present. Has there been a failure of the bean crop in your area, but velvet beans are abundant? If so, it is almost certainly better to make use of velvet bean than to suffer hunger or protein malnutrition. Is the food situation a bit less desperate than that, but people still do not have enough to eat? If so, consider using velvet beans in moderation and not every day. Are there plenty of alternative sources of protein? If so, do not eat the velvet beans. Velvet bean coffee has a lot of dopa in it. It should not be consumed regularly.

NEW INFORMATION ON THE TOXIC SUBSTANCE IN VELVET BEANS. Velvet beans are being grown more widely, because corn yields can be increased considerably by intercropping with velvet beans. Velvet beans have potential to be a significant food. Bean yields are high, sometimes when common beans fail due to drought. The beans are nutritious, with a high protein content. Many recipes have been developed for their use and people enjoy the taste. Herein lies

a major dilemma for farmers and their advisors. About 5% of the weight of the bean is a psychoactive substance called "dopa." Dopa is still a commonly prescribed treatment for Parkinson's disease, though it has side effects such as uncontrolled muscle twitches and, in extreme cases, even psychotic disorders including schizophrenia.

Dr. Rolf Myhrman brought both good and bad news on the subject at ECHO's Conference for Agricultural Missions. In his lab at Judson College in Illinois, he has been studying dopa in velvet beans from different countries and after different methods of preparation for human consumption. One thought has been that one might get rid of the dopa by removing all the seed coats. This can be easily done by hand after cooking. However, Rolf was unable to detect any dopa in the seed coats.

One major use of velvet bean by humans is to make a coffee

substitute. (The coffee is called "nutri cafe" in Central America and the bean is sometimes called "Nescafe bean.") Ideally, the dopa would either be destroyed by the heat or remain in the grounds, leaving the coffee free of dopa. Rolf found, on the contrary, that making "coffee" is an ideal way to extract intact dopa! "An 8-ounce cup of velvet bean coffee can be expected to contain between 250 and 300 mg of dopa. For comparison, a physician might start a Parkinson's patient on 500-1,000 mg of dopa per day." [The other side of the question is whether someone with Parkinson's disease, but who cannot afford prescription dopa, could drink velvet bean coffee as a treatment. Do any physicians in our network have ideas on this?]

Rolf is working closely with Dr. Dan Buckles at CIMMYT, the International Center for Improvement of Corn and Wheat. According to Dr. Buckles, many people in Ghana eat velvet beans most days, using them primarily as a soup thickener.

People in Benin mix 10-30% velvet bean flour with corn meal. Various preparation techniques are being used and sent to Rolf for analysis.

The good news is that a large fraction of the dopa can be removed from beans by grinding and soaking in water. Simple detoxification techniques might soon be available to remove most of the dopa. "Soaking the powder in room-temperature water, even for only two minutes, removes over half of the dopa. A second two-minute soak removed another 29%. Eighty percent is removed in two short soaking periods." Soaking 5-10 minutes does not remove additional dopa.

Using 50 C water is no more effective than water at room temperature. However, soaking 5 minutes in boiling water removed 89% of the dopa and repeating the soak removed 99%.

Dr. Buckles sent Rolf velvet beans from a community in Ghana where people regularly eat velvet beans. Might these be extra low in dopa? Surprisingly, they had even more dopa than some others. Rolf suspected that they are detoxifying the beans and requested details of food preparation methods.

"We now understand how the Ghanians remove the dopa. They boil the beans 45-60 minutes, discard the water, add cool water and let the beans cool, then discard that water. Although our extraction techniques have all been with flour, it does not surprise me that they are removing a significant amount from whole beans by boiling."

You may contact Dr. Myhrman at fax 708/695-0407 or e-mail rmyhrman@nslsilus.org. This work began when Rolf requested an ECHO publication called Hunger-Related Research Opportunities, which lists research projects that could be performed with a modest budget that would benefit peasant

farmers.

SPANISH-ENGLISH VELVET BEAN RECIPES. Aware of all these cautions, some of you still may decide it is necessary to use velvet bean as a food source, if people are hungry or suffer from protein deficiencies and there are no other alternatives. When I visited the World Neighbors project in Honduras a few years ago they were in the midst of a drought. The crop of common beans had failed, but the velvet beans produced abundantly. This led to efforts to incorporate velvet bean into local recipes. Additionally, new recipes were developed based on their work with soybean, after changes to improve the taste and consistency.

Milton Flores of CIDICCO shares his own experience.

"Although many people are eating the velvet bean in more than one way, we are careful to caution them to use it with care. We have observed symptoms such as drowsiness and

headaches. This is especially true when people mix several [velvet bean] dishes at a time. In my own opinion, some people are more sensitive than others. I can stand only one cup of velvet bean coffee and one or two velvet bean tortillas at one time. When we have cooking demonstrations, with several dishes prepared and offered at the same time, it is usual that a couple people report symptoms like those I have mentioned. Most people, however, do not seem to be affected in any way."

A recipe book can make everything look very straightforward and safe. Eating velvet bean has not been proven to be safe, but it is safer than trying to live without protein. (I imagine other beans could be made to fit into these interesting recipes.) World Neighbors/ACORDE has made available the Spanish-English recipe book Nutri-Cocina/Nutri-Kitchen. It gives guidelines for using seeds of this productive green manure crop to prepare 23 foods. The toasted nutri-flour and

mashed cooked beans are used to prepare hot, high-protein drinks, tortillas, doughnuts, ravioli, pasta, and several sweet cakes and desserts. Ingredients are simple and common, and the directions are complete and easy to follow. You can order the book for US\$7 plus postage: \$3 in US/\$7 overseas, from World Neighbors, 4127 NW 122 St., Oklahoma City, OK 73120-8869, USA; phone 405/752-9700; fax 405/752-9393; e-mail 635893@mcimail.com. If you are in Central America, contact the regional office of Vecinos Mundiales, Aptdo. Postal 3385, Tegucigalpa, HONDURAS; tel/fax (504) 32-7471. They are an excellent source of information on the uses of velvet bean in Central America.

ARE JACK BEANS SAFE TO EAT? I have become uneasy recently. I can tell by letters that some of you are excited at the human food potential of the large seeds from the high-yielding jack beans (*Canavalia ensiformis*) that we sent. They are edible, but read the following cautions carefully. (You may

react like one reader who was frustrated at my discussion of whether velvet beans are safe to eat. He wanted to know either "yes" or "no." Unfortunately, the world is often ambiguous.)

The book Food Legumes says, "The mature dry seeds can be used as food, but are not popular because of their unattractive flavor and texture, and the fact that they require soaking and boiling in salt water for several hours to remove the toxic constituents and to soften them. [Ed: Flavor and texture might be less of a problem if beans were just one ingredient in a recipe.] In Indonesia they are often boiled twice, left in running water for 2 days after the removal of the seed-coat, then fermented 3-4 days and finally cooked once more." "Dried seeds can be used in livestock feed, but are not very palatable and can cause outbreaks of poisoning unless cooked or limited to less than 30% of the total feed."

Legumes in Human Nutrition says "the flowers, leaves and immature pods and seeds are used as vegetables." The Handbook of Tropical Food Crops says, "Foliage and seeds often contain poisonous substances and these have been implicated in occasional fatal poisonings. ...Apparently the amounts of poisonous substances vary with age of plant, maturity of seed, and possibly with environmental factors. Some varieties contain such small quantities of poisonous substances that they are commonly eaten and are considered harmless. There is no easy way to distinguish poisonous from nonpoisonous varieties. The commonly used varieties are not dangerously poisonous, judging from their popular usage."

Roland Bunch in Honduras says to "make sure people boil the bean and change the water twice. This means there will be an extra expense in firewood, but it is necessary to prevent ... problems." Tom Post in Belize says people there cut the immature pods into pieces and serve them in soups.

Young jack bean pods can be eaten as a vegetable without any special precautions. Allen Voelkel wrote from Mexico, "I received approximately nine jack bean seeds. These I planted around the school. Some of the plants got destroyed, others were neglected but, year after year, the plants continued to pop up around the place. I was tremendously impressed by their resistance to drought. At the time, they were the only green thing in sight for miles, and they were one of the few plants that could withstand the ever devouring leaf-cutter ants. One of our workers took some of the seeds out to a community and showed a family how to plant and, then later, to prepare [the young pods] to eat. The family loved them, and they continue to grow them as a garden vegetable. Apparently other families are now interested."

A CAUTION ABOUT USING MORINGA TREE ROOTS AS A HORSERADISH SUBSTITUTE. An extensive review of uses of the moringa tree, written by Dr. Julia Morton, appeared in

Economic Botany. I thought I should bring one paragraph to your attention.

"The root, best known in India and the Far East, is extremely pungent. When the plant is only 60 cm tall, it can be pulled up, its root scraped, ground up and vinegar and salt added to make a popular condiment much like true horseradish. ...The root bark must be completely removed since it contains two alkaloids allied to ephedrine- benzylamine (moringine), which is not physiologically active, and the toxic moringinine which acts on the sympathetic nerve endings as well as on the cardiac and smooth muscles all over the body. Also present is the potent antibiotic and fungicide, pterygospermin. The alkaloid, spirachin (a nerve paralyzant) has been found in the roots.... Even when free of bark, the condiment, in excess, may be harmful." The key words are "in excess": take a lesson from the deer (see above).

Disease and treatments

WHERE THERE IS NO DOCTOR AND OTHER RESOURCES. This book by David Werner is so widely used that most of you in the field probably already have a copy. An extremely useful health handbook for villages, it includes helpful signs in diagnosis and simple, basic treatments common in tropical situations. It is readable and easy to use, and would be a useful tool in health teaching. Copies are available at bookstores around the world and in several languages. If you cannot find it locally, write The Hesperian Foundation, P.O. Box 1692, Palo Alto, CA 94302, USA. You may also want to use other books in the same style and level of practicality: Where There is No Dentist, Disabled Village Children, and Helping Health Workers Learn. These are all handbooks which are both interesting and immediately applicable in your work.

VITAMIN A USED IN TREATMENT OF MEASLES. Don Mansfield

with William Carey International University brought the following item in the Footsteps newsletter to our attention. "Children with severe measles do benefit from having a capsule of vitamin A. Two studies from South Africa and Tanzania have shown that childhood mortality from measles can be reduced by about 30% if a capsule of 200,000 is given on each of two successive days. In fact, the World Health Organization recommends that this should be the routine management of measles where there is obvious vitamin A deficiency or where the proportion of children dying from episodes of measles exceeds 1%."

Don adds, "In Mali we had kids die every year from measles. We had hundreds of bottles of vitamin A that had been donated. JoAnn just never knew to use it for measles. Maybe EDN can help get the word out to remote mission clinics."

ELECTRIC SHOCK AS FIRST AID FOR POISONOUS BITES. I

received the following account of scorpion bites from Don and JoAnn Mansfield in Mali. Don works in agriculture; JoAnn runs the clinic.

"The missionary I replaced had told me how to treat scorpion stings with a pair of 'electric shockers.' Frankly I did not believe it. Three weeks after we arrived a woman we knew came to the clinic. She had been stung on the side of her foot by a BIG scorpion of the kind that are common here. She was bent over with pain. We had nothing but an antihistamine, which did not help. I told her about the shock treatment. She was in so much pain that she was willing to try anything.

"We could not find the equipment my predecessor had told me about, but we did have a Briggs and Stratton power plant. I put the metal portion of the spark plug wire right on the spot where she had been stung, and had someone pull the rope. She jerked, but kept on moaning, hardly noticing the shock.

The second pull had the same result. After the third pull she immediately straightened up, stopped moaning and began to leave. I stopped her and asked about the pain. She had none.

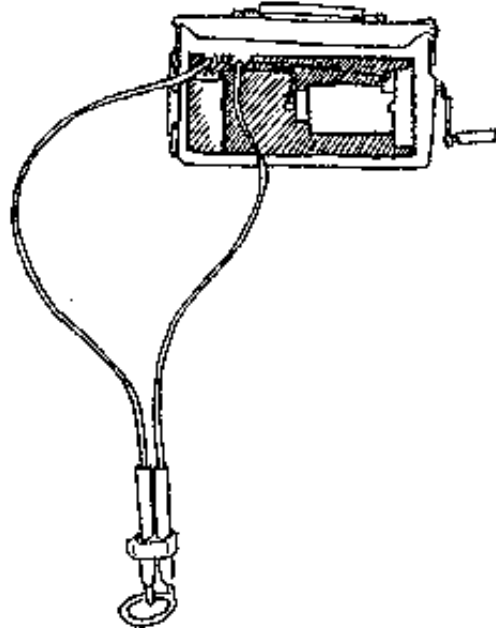

shock treatment for scorpion bites

"In the next couple years we treated 4 or 5 more people similarly. In one case, where the sting was in a difficult spot to shock, there was still pain although it was a lot better. The others had total relief from pain, sometimes with one pull. None took more than three pulls."

Research into treating poisonous bites with electric shock began with Dr. Ron Guderian, a missionary in Ecuador, wondering about a widespread notion in Ecuador that electricity was therapeutic for snakebite. We wrote to Dr. Guderian for an update. A summary of his comments follow:

"In the laboratory we are trying to determine how the electric shock actually deactivates the venom, or what protein components the shock affects and how. This would give us the scientific basis to say how the shock works, not just that it appears to on trial." [The electric field changes the three-dimensional structure of the toxin, converting the venom to

inert material. The shock eliminates the venom's biological activity.]

"We have been using the electric shock as a first aid measure for snake bites in Ecuador since 1980 and have found some very interesting results. If the shock treatment is given at the site of the bite and in an appropriate time frame, there is no reaction on the part of the person bitten." Shock has been used as first aid on the venomous bites of Portuguese men-of-war, Conga ants, scorpions, spiders, and even poison oak. It is used for snakes with hemotoxic venom which destroys blood cells and coagulation proteins, and does not have the same action on neurotoxic snakes (such as the cobra, mamba, and coral snakes).

"In the past two months we have treated several patients who have come to us 4-6 hours after being bitten. The site of the bite and surrounding tissues were edematous [Ed: in other

words, venom had definitely been injected]. Having no other resource, the electric shock was given on the chance that it might help in some manner [Ed: Even though shock treatment is normally done much sooner than 4-6 hours]. To our surprise, the swelling decreased and in three days the site of the bite and surrounding tissues were normal. Without treatment, swelling usually increases and can last for weeks. The reduction is important because swelling causes much of the secondary complications from snake bites." In addition, the shock kills the anaerobic bacteria present in the bite which can lead to tissue death on the site.

THIS IS ONLY FOR USE IN REMOTE LOCATIONS WHERE ANTI-VENOM IS NOT AVAILABLE. "To answer your question, yes, shock should be used only if anti-venom is not available. Shock is not used along with anti-venom, nor in place of it. I have recorded 353 reports [by 1995] of the use of electrical shock with positive results."

TECHNICAL DETAILS. NEVER USE CURRENT FROM THE POWER COMPANY OR ALTERNATING CURRENT FROM YOUR OWN GENERATORS! "You need a DC pulsating electric current, 20-25 Kv and only milliamps of current. [An AC current can affect the heart; DC does not.] The best source of shock that we have found is the spark plug of an auxiliary gas motor such as a chain saw, motorcycle or outboard motor. Shock can also be applied directly from the coil of a car. Again let me say that this is experimental. The most important concept is that the patient be treated as soon as possible, preferably within 10-20 minutes. Otherwise permanent tissue damage may have already occurred.

"Most snake bites occur on the limbs. Ground the limb on the side opposite the bite. Hold the electrodes in place with tape as contact is otherwise broken during the discharge. Apply the shock directly to the bite for 2 seconds, rest and repeat 2- 3 times depending on the size of the snake." [Don Stilwell with

SIM sent us a summary of a conversation with Dr. Guderian saying that the larger and more potent the snake and the more venom injected, the more shocks may be necessary, even up to eight discharges.]

To be effective, the skin should be washed (with alcohol, if available) and dried; sweat is a good conductor. Ground the plate on the opposite side of the bite and apply the shock on the bite marks for best penetration of the skin (skin is very resistant, and 15,000-20,000 volts are needed to penetrate it). After this first aid is applied, send the patient to a medical center for evaluation. They should take 2 cc's of blood and put it in a clear tube undisturbed for 20 minutes. Tilt after 20 minutes; if a clot has formed, the patient should be fine. Repeat this test every 6 hours for 48 hours, and if clots still form, the patient may go home. If clots do not form, give antivenom; this may be necessary if treatment is delayed.

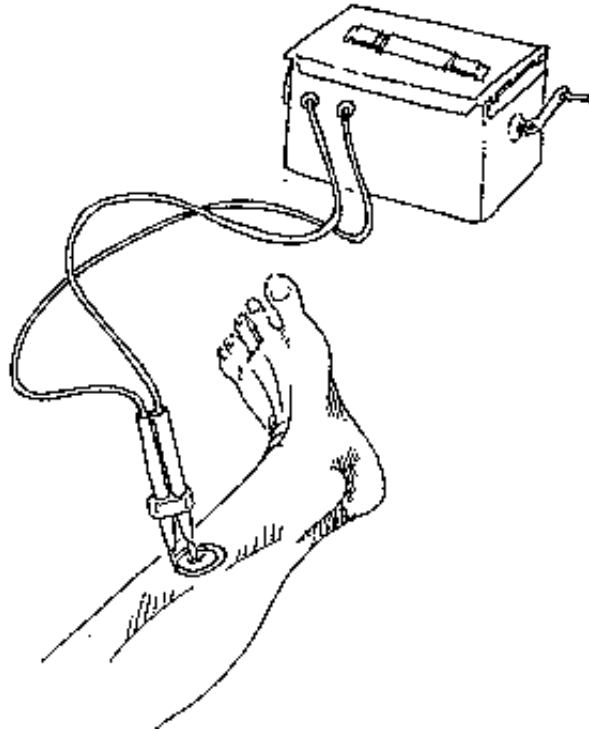

shock treatment

Dr. Guderian requests that, if you use this method, please keep a record of patients treated and note the type and

location of bite, type of snake, time elapse between bite and treatment, source for current and patient's response. "Since we are still collecting data to prove that this method works in other parts of the world, I would appreciate receiving any such data." His address is Hospital Vozandes, HCJB Casilla 17-17-691, Quito, ECUADOR, South America; fax 593-2-447-263; e-mail rguderian@mhs.hcjb.com.ec. ECHO would like to know your results too.

REACTION TO BEE STINGS. The July 1987 issue of Florida's cooperative extension service bulletin on beekeeping, Apis, dedicated all four pages to the subject of reaction to bee stings (ask for a copy if you are very interested). The facts are even subject to controversy in the medical profession. The normal "local" reaction is "pain, swelling, redness, and itching... [such people are] at little risk of death unless the mouth or throat is affected so that the respiratory tract is obstructed." "Many people continue to believe that because they swell up they are

at risk of losing their life when stung by bees. Ironically, it may in fact be the reverse. Those far more at risk may show no reactions to stings at all." It is systemic or allergic reactions that can be life-threatening. "There is no evidence that the very few who die as a result of a bee sting come from the pool of those who once before sustained a systemic reaction. On the contrary, no reaction at all may be a more ominous predictor of a lethal outcome on a subsequent sting." Stings inside the mouth and on the eyeball require special attention and are so very serious that when working with bees a veil should always be worn.

Death usually comes from multiple causes, not simple anaphylactic shock or allergy. In fact, most allergic reactions are in children, while 90% of those who die of bee stings are over age 25. "One may readily see how (1) a hot summer day, plus (2) strenuous exercise, plus (3) coronary atherosclerosis, plus (4) a bee may add up to death, whether or not one

invokes an allergic mechanism...." "Panic by the person stung or those around him/her can produce a systemic reaction in itself." "The frightening aspect of being stung cannot be ruled out as a cause of a systemic reaction. A patient who suddenly develops hives, shortness of breath (sometimes with bronchospasm) and giddiness ... is terrified, as are those about him. The patient may think he is going to die, as may his family or physician. What people need to know is that the vast majority of patients, particularly if aged under 25, will quickly recover. ... patients who have these terrifying experiences need to know that there is no evidence either that they came to the brink of death or that they are at greater risk of dying from a subsequent sting than anyone else."

The conclusion: "the risk of fatality ... is lower than previously thought. What must be emphasized, however, is that environmental factors and physical well being of the individual being stung cannot be ignored when judging who is at risk of

dying from a bee sting. Nor can perceptions by the individual being stung. Panic by the person stung or those around him/her can produce a systemic reaction in itself.

IS THE AFRICANIZED BEE STING MORE LETHAL THAN THAT OF ITALIAN BEES? David Unander sent us a report in Nature which concluded that the lethality of Africanized ("killer") bees is entirely due to their tendency to attack in mass. In South and Central America colony defenses result in attacks during which thousands of stings may be inflicted on one individual. "Although attacks of 300-500 stings have been survived without treatment, more than 500 stings are commonly fatal." Venom was collected from worker honeybees in Arizona and Africanized bees in Costa Rica. Analysis of venom pooled from 1,000 bees of each type showed that European bees contained more venom (145 micrograms dry weight) than the smaller Africanized bees (94 micrograms). In a trial with mice, the lethal dose for the purified venom was identical for both kinds

of bees with one strain of mice. For the other strain of mice, the dose of Africanized bee venom required to have the same effect as honeybee venom was considerably higher (7.1 vs 4.6 mg/kg).

DO MOSQUITOES CARRY THE AIDS VIRUS? In case you are worrying about this frequent rumor, the following is quoted from World Development Forum, November, 1986. "The Pasteur Institute's Jean-Claude Chermann, a co-discoverer of the AIDS virus in 1983, says they do. A study in Zaire of 50 insects, reports Asia Week, indicated that all-including mosquitoes, tsetse flies and cockroaches-were infected. But the reassuring news is that the 'insects don't carry nearly enough of the virus to infect a human.' There is no way, he said, that the virus could be transmitted to humans by mosquitoes or other insects."

NEWSLETTER ON AIDS in Latin America. Boletn SIDA is a

Spanish language bulletin published three times a year by MAP-Latin America. "We have produced this bulletin to inform the Evangelical churches in Latin America about the advance of the disease, its consequences, the methods of prevention, treatment and accompanying emotional issues for those affected. We hope to stimulate the church to take part in the struggle against AIDS." To subscribe (no charge, but donations welcome) send them your name and address. Also mention the kind of work you do and whether your work currently involves you in AIDS issues. Write MAP, Boletn SIDA, Casilla 17-08-8184, Quito, ECUADOR; phone (593-2) 452-373; fax (593-2) 435-500.

MALARIA VACCINE WITH ARTEMISIA. Because malaria is caused by a protozoan (a small animal) rather than bacteria or a virus, a vaccine has been difficult to develop. Experiments in Colombia suggest that it may be possible, however. They synthesized several polypeptides which are identical to

segments of proteins on the protozoan. (Proteins are very large polypeptides.) Monkeys inoculated with the right mixture of these polypeptides developed partial to complete immunity to malaria. It has not yet been tried in humans. If you want a copy of the article let us know. (It is pretty heavy biochemistry.)

The following is abstracted from *World Watch*, May/June 1994. "More than 20 years ago Chinese scientists confirmed the antimalarial qualities of artemisinin, ... extracted from a fern-like plant *Artemisia annua*." This plant has been used as an anti-malarial drug for more than 1,500 years. Now derivatives of artemisinin that can be taken orally or injected have been developed and are widely used in Southeast Asia, and in parts of Africa and Latin America. The injectable form acts more rapidly than any other antimalarial and is effective against multi- drug-resistant parasites. It is not yet approved in any developed country.

The article in World Watch says that clinical trials have now been done and that "40-66% of participants were protected from the most common and deadly strain, Plasmodium falciparum, which is responsible for 95% of malaria cases." "Although Patarroyo's initial field trials were criticized because they did not meet international protocols, he answered their skepticism by conducting trials that did meet those standards. One of those trials, completed in 1992 in Ecuador, showed that the vaccine was successful in protecting 66% of the volunteers from the common malaria strain." It has been tested on 41,000 people in South America. Finally the World Health Organization and the Walter Reed Army Institute of Research are beginning tests in Africa and Asia.

"Meanwhile, other researchers are ... studying the feasibility of altering the mosquito's genetic makeup so that it will be unable to carry and transmit the parasite to humans."
[Presumably this mosquito would compete with normal

mosquitos for food and breeding grounds, so the number capable of infecting people would drop.]

HOMEMADE MOSQUITO REPELLENT FROM NEEM. Dr. V.P. Sharma, Director of the Malaria Research Centre in New Delhi, says the repellent is particularly effective against the Anopheles mosquito which spreads malaria. When the preparation is applied to the body, mosquitoes are effectively repelled. Low-cost neem oil is mixed with coconut oil in concentrations of 1-2%. This information is taken from *Neem News*, vol 1, p. 4, published by the Neem Association, 1511 Oneco Ave., Winter Park, FL 32789, USA. The non-profit association is organized to promote communication between neem scientists, growers and producers; promote its various uses and seek other uses; promote research to develop superior varieties of neem and to develop new uses.

POTENTIAL CONTRACEPTIVE FROM NEEM TREE OIL. I do not

normally include items in EDN that are not yet ready for use. Because we have mentioned neem so often, though, I thought you would be interested in this item taken from Agroforestry Today. Indian scientists have isolated a neem oil extract which they believe can be refined into a birth control agent for women. They report it has spermicidal qualities and also can prevent a fertilized egg from being implanted in the uterus, possibly by interfering with estrogens. Unfortunately their "ultimate aim is to refine it into a powder that can be synthesized in the laboratory." I hope someone follows up to see whether a technique might be developed for making contraceptives directly from neem in a simple laboratory that could be set up anywhere.

ORAL VACCINE FOR TYPHOID. When I think of typhoid shots I think of finding time for three trips to a doctor, major soreness and some fever. A trip that comes up suddenly often does not allow time for completing the series. So when Glen Munro told

me that he was immunized with no noticeable side effects by taking four pills, one every other day, I asked for details. He said the immunity is supposed to last 5 years. The series cost him \$30. It is a live vaccine and must be refrigerated at all times. It is manufactured by the Swiss Serum and Vaccine Inst., Berne, Switzerland. I contacted Andy Murai at their U.S. subsidiary, Berna Products Corporation, 4216 Ponce de Leon Blvd., Coral Gables, FL 33146; phone 800/533-5899 or 305/443-2900; fax 305/567-1043. He said they are glad to ship overseas, even if orders are small.

EFFECTIVENESS OF A MORINGA SEED EXTRACT IN TREATING A SKIN INFECTION. There are powerful antibiotic and fungicidal effects of pterygospermin from the flowers and roots of the moringa tree. Now Axel Bosselmann has brought to our attention a study by Drs. Caceres and Lopez at the University of San Carlos in Guatemala. The article is summarized below.

Herbal applications are commonly used to treat skin infections in developing countries, although few investigations are conducted to validate scientifically their popular use. The small drought-resistant *Moringa oleifera* tree produces edible leaves, pods, flowers and roots. A previous study had showed that seeds are effective against skin infecting bacteria *Staphylococcus aureus* and *Pseudomonas aeruginosa* in vitro (i.e. in a test tube). This study showed that mice infected with *S. aureus* recovered as quickly with a specially prepared aqueous extract of moringa seed as with the antibiotic neomycin.

This study proves only the effectiveness of moringa as they prepared it. That preparation could be done in any country, but not with just household utensils. It was prepared by infusing 10 g powdered moringa seeds in 100 ml of 45 C water for 2 hours. The part that is a bit more complicated is reducing the 100 ml down to 10 ml by placing it in a rotavaporator. This

is a very common piece of laboratory equipment which continually rotates a flask containing the liquid. An aspirator attached to a faucet produces a modest vacuum when the water is turned on. A rubber tube from the aspirator is connected to the rotavaporator, reducing the pressure and causing the water to evaporate rather quickly without boiling it. The ointment was prepared by placing 10% of the extract in vaseline. (We can send a copy of the article to medical personnel.)

Are you in a situation where there is a shortage of antibiotics? This ointment could be prepared for use in the local community anyplace where there is electricity and running water. I would not be surprised if much simpler methods, better suited to preparation as needed in the home, might not also be effective. I hope someone will devise and test such preparations.

USING NEEM LEAVES TO TREAT SCABIES. Larry Radice, of Maryknoll Fathers and Brothers in Tanzania, wrote, "After reading in EDN about use of moringa to treat a skin infection, I thought I might share with you and your readers my experience using neem tree leaves to treat scabies. (Scabies, also called seven year itch, is especially common in children. It causes very itchy little bumps that can appear all over the body, but are most common between fingers, on wrists, the waist and genitals. It is caused by little animals similar to tiny ticks or chiggers, which tunnel under the skin.)

"I lived in Tanzania for almost 8 years. One day while visiting a friend's home I noticed his daughter had a very bad case of scabies. ... I was told that she had gone to the local clinic, bought some medicine, but it had run out and the scabies had not cleared up. ... Her scalp was horribly encrusted and she had no hair in the infected area.

"I knew that neem tree leaves had insecticidal properties and that scabies is caused by a small mite. So I thought it would be worth a try.... I had the mother take neem tree leaves, about a hand full, and pound them into a mush adding a bit of water. I believe she then heated this, boiling off the excess water and leaving a paste. I told her to apply the poultice to the infected area twice a day for five days, leaving it to dry on the scalp.

"When I visited the home again two weeks later I had hardly said hello before she was excitedly telling me that her daughter was well. In fact by the third day the scabies was drying and by the end of that first week she could see new hair growing. When I saw the child the scabies were gone. I suggested the cure two other times and in both cases I later heard that the scabies had cleared up, but I did not get to see those results for myself."

In response to this letter, Dr. S. X. Charles at the Medical and Cancer Research and Treatment Center in India sent us the results of a study of 814 people treated with neem and turmeric. Scabies is normally treated with a scrub bath, boiling the fomites (clothes and bed linens), and application of benzyl benzoate. "The drug caused skin reaction when rubbed on the face, and children accidentally rubbing it ... in the eyes was common." Where There is No Doctor recommends a homemade but dangerous alternative to those who cannot afford the benzyl benzoate. In this, the very toxic insecticide lindane is mixed with 15 parts of vaseline. The neem method is far less toxic and essentially free.

"Fresh neem leaves and turmeric are ground to a paste in the proportion of 4:1 by weight. The measurement that is taught to mothers is a handful of neem leaves and a piece of turmeric $\frac{1}{2}$ the length of the index finger. This paste is rubbed all over the body and left to dry. The procedure is repeated daily until

the patient is cured. (Boiling clothes and scrub bath is carried out daily before application of the paste.)

"Paste rubbed on the face has not caused any skin reaction or other toxic symptoms. Because of the bitter taste, chances of children swallowing it was remote, and even if swallowed [is not toxic]." "Of the 824 cases, 98% showed complete cure within 3-15 days of treatment. Those cases (95.8%) with localized lesions showed cure in 3-5 days. When lesions were all over the body and there was secondary infection, treatment needed for a cure was 6-15 days. Failure of treatment was only 2%. The reasons for failure were irregular application of paste and not doing the preliminary treatment of scrub bath and boiling of fomites to prevent reinfection."

HONEY AS A DRESSING FOR WOUNDS. (Based on an article in the October 1992 issue of Apis.) New Zealand bee scientist Dr. Peter Molan says that "honey is used in many countries in the

treatment of burns, blisters, bed sores and major wounds. Honey has long been used as a wound dressing and is probably the perfect substance for such a use. Not only is it antibiotic (killing almost all bacteria), it also keeps the wound from dehydrating. Almost all other wound dressings either keep the wound dry (avoiding infection, but leading to scarring), or moist (avoiding the severe effects of dehydration, but making a great medium for bacteria to grow).

"Honey is also better than man-made antibiotics, Dr. Molan contends, because such antibiotics actually slow down the rate of cell growth. The moisture-attracting nature of honey, on the other hand, pulls body fluids and nutrients to the wound surface where they help speed skin growth and healing."

"All honey gives off hydrogen peroxide, a known antibiotic. The hydrogen peroxide is produced when the glucose in honey reacts with oxygen. The problem with peroxide as an antibiotic

is that in large concentrations it breaks down in the presence of a common enzyme, producing the characteristic fizz we see when we put it on a cut. Because it is produced slowly in honey, at a low level, the peroxide doesn't lose its effectiveness. Provided honey is kept away from light, the enzyme which breaks down the hydrogen peroxide won't even activate."

Dr. Molan has now discovered a second antibacterial property, present in some but not all New Zealand honey. It has been shown to be effective against *Helicobacter pylori*, which is thought to be the major cause of stomach ulcers. Tests will begin soon in which patients will be given a tablespoon of this honey five times a day. This substance also works against highly resistant bacteria such as the MRSA bacterium which is gaining a reputation for closing down hospital wards.

DON'T LIMIT CALCIUM WHILE TRYING TO PREVENT KIDNEY

STONES. (Adapted from Science News, Vol 143, March 27, 1993.) Most kidney stones are made up of crystals of calcium and a naturally- occurring substance in some plants called oxalates. Many plants contain such high amounts of oxalates that we must temper our enthusiasm for those plants. Amaranth leaves and carambola fruit are good examples.

The conventional wisdom is that people with kidney stones should cut back on calcium in their diet. According to a study reported in the New England Journal of Medicine, men who ate a diet rich in calcium had a 34% lower risk of kidney stones than men who followed a restricted calcium diet.

"This goes against everything we have been taught," said one of the authors, kidney specialist Gary Curhan. He suggests that the reason may be that oxalates in the diet combine with calcium in the intestine in normal diets, creating insoluble crystals that are excreted. A low calcium diet would allow

more oxalate to enter the bloodstream and eventually form insoluble crystals with calcium in the kidneys.

Dr. Curhan is not recommending added calcium, but that calcium not be reduced. I cannot help but wonder, though, whether taking extra calcium when I am going to be eating high oxalate foods might result in more of the oxalates being excreted harmlessly.

On a side note, the same study also found that men who ate a potassium-rich diet had a 50% lower risk of stones than those who ate the least amount of potassium. Bananas, oranges and grapefruit are good sources of potassium.

HERBALGRAM is the journal of the American Botanical Council and the Herb Research Foundation. For those interested in botany and pharmacology, this will make a fascinating read. Articles often discuss toxicities and traditional medicinal uses

of various plants, with a chemical-scientific focus. We often find an interesting but otherwise obscure abstract about a new use for one of the tropical plants we have on ECHO's farm. The book list is unbelievable; we often wish we had the budget to buy everything on the page! Subscriptions are \$25/year, \$60/3 years; foreign subscriptions add \$10/year. Write the American Botanical Council, P.O. Box 201660, Austin, TX 78720, USA; phone 512/331-8868; fax 512/331-1924.

CAB INTERNATIONAL (CABI) HEALTH AND DISEASE PUBLICATIONS provide up-to-date medical information on a wide variety of topics. (CABI also works with agriculture, forestry, and natural resource management in developing countries.) The latest catalog mentions a new health and disease database which covers parasitology, tropical diseases, communicable diseases, human nutrition, public health, and medicinal and poisonous plants. The catalog lists newsletters, journals, books, and computer resources. Items listed are

expensive, but this is a good resource for those needing specific medical information on a variety of health problems in tropical countries. Request information from CAB International, Wallingford, Oxon OX10 8DE, UK; phone (01491)832111; fax (01491)883508; e-mail cabi@cabi.org; <http://www.cabi.org/>.



[Home](#)-immediately access 800+ free online publications. [Download](#) CD3WD (680 Megabytes) and distribute it to the 3rd World. CD3WD is a 3rd World Development private-sector initiative, mastered by Software Developer [Alex Weir](#) and hosted by [GNUveau Networks](#) (From globally distributed organizations, to supercomputers, to a small home server, if it's Linux, we know it.)[ar](#).[cn](#).[de](#).[en](#).[es](#).[fr](#).[id](#).[it](#).[ph](#).[po](#).[ru](#).[sw](#)



Amaranth to Zai Holes, Ideas for

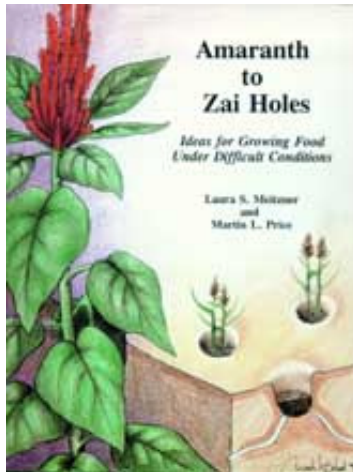

Growing Food under Difficult Conditions (ECHO, 1996, 397 p.)

- ➔ □ 12: Seeds and germplasm
 - 📄 *(introduction...)*
 - 📄 ECHO's seedbank
 - 📄 Storing seed
 - 📄 Germination and propagation
 - 📄 Seed production and sources

Amaranth to Zai Holes, Ideas for Growing Food under Difficult Conditions (ECHO, 1996, 397 p.)

12: Seeds and germplasm

Many people's first thought about ECHO is "seeds." Our seedbank specializes in little- known plants with great potential to provide food under difficult growing conditions. We

also have several improved varieties of common plants. Each year we distribute hundreds of trial seed packets to development workers who grow them in their own gardens. If the plants produce well and are accepted, they may harvest the seed and distribute it in the community. In this way, a community in one part of the world may benefit from the plants of another region to which they might otherwise not have access.

Plant introduction through seeds and germplasm (living tissue that can be grown into a plant) holds tremendous promise for improving nutrition and food production. This book contains information on many such plants which can thrive in poor soils, drought, and other stresses. There are also dangers and risks in plant introduction about which we need to be aware. This chapter discusses working with underexploited plants, seeds and other germplasm, and seed production and sources.

ECHO's seedbank

ORDERING SEEDS FROM ECHO. Only people who work overseas helping small farmers should write for free trial seed packets from ECHO; those who qualify include overseas missionaries, development workers, extension agents, and scientists. People who do not qualify for free trial seed packets include individual farmers anywhere in the world, home gardeners in North America and Europe, and others who do not work directly to benefit small farmers. Those not involved in development work must pay US\$2.50 per packet of seeds, postage included. People overseas should write ECHO for a current seed catalog, which is updated periodically. (Those in North America may purchase our descriptive catalog of selected seeds appropriate for outside the tropics; cost is \$1 plus \$1 postage.)

HISTORY AND PURPOSE OF ECHO'S SEEDBANK. The seedbank

was begun in response to the National Academy of Sciences book *Underexploited Tropical Plants with Promising Economic Value* (1975), which described 36 plants selected as among the most promising plants for tropical regions. Unfortunately, at the time (and even today) there were few accessible sources for seeds or cuttings of these plants. Few scientists and research institutions were able to supply seed for these plants. ECHO was convinced of the tremendous benefit from putting seeds for these plants into your hands, so our seedbank was established for this purpose.

ECHO's seedbank began in 1981 with the top recommendations of tropical plant specialist Dr. Frank Martin-quail grass, amaranths, tropical pumpkins, lablab beans, tropical lettuce, and more. In 1996 our seedbank holds over 1200 accessions, and we actively maintain and distribute about 125 of these. We grow out most accessions to produce seed on ECHO's farm in Florida; we purchase others which will

not grow on our site or for reasons of seed purity or disease we choose to obtain from another source. We do not carry seeds of many staple crops, as there are large organizations committed to research and improvement of these crops. We do not supply common vegetable or fruit seeds, which are commercially available through seed catalogs.

Our seedbank is a central part of ECHO's work. Though these plants are exciting, how much of your effort should go into working with them? Given the frequent difficulty in introducing a new food to a culture, it would most likely be unwise for you to make introduction of these promising but unusual plants a cornerstone of your work. You need to make an immediate impact on your community. Probably you have found some things that do this with little risk. Furthermore, people usually expect project results within a few years. A project to get winged beans, for example, widely accepted in your country would not be likely to succeed in that short time.

We believe that working with PVOs presents an ideal way to introduce such plants however. Why? Because you or your organization have made a long-term commitment to your region and can see the long-term possibilities. What is unlikely in 3 years becomes possible in 10 or 30 years. We are just as concerned with the people who will be living there in 30 years as we are for those today-and they may use winged beans as a staple! For example, the potato was introduced to Rwanda by European missionaries in the early 1900s. The people would not eat it. Today it has become a staple and 45,000 hectares are grown.

The cost of trying a few of these special plants is almost nothing. I cannot think of many things which can have such an impact in the long term at such a small cost today. Initial acceptance will probably come as a crop to be consumed by the farmer, with cash crop possibilities coming much later if at all. Do not feel embarrassed if you cannot report back to us

that the masses are now growing the crop. Such reports are rare. If something catches on in 10 years, do not forget about us! We would be greatly encouraged to hear about it.

When you consider which "new" plants you want to try from ECHO's seedbank, it is often good to start with something which can be easily incorporated into the local diet. For example, while West Africans who eat a variety of leaves may readily accept a new leafy vegetable, a community in Latin America which considers leaves as animal food may not accept the same plant, no matter how tasty your recipes. People who eat soups often readily add a new plant to the soup pot. Watch for local cooking techniques which can be used with other plants. Be prepared for surprises, too: people in the community may find the new plants appealing for their novelty value, as occurred with rhubarb in highland Ecuador. Quail grass from ECHO spread rapidly through a village in Panama in part because people appreciated its colorful and ornamental

appearance.

THE NATURE OF PLANT INTRODUCTION: SOME IMPORTANT CAUTIONS. ECHO supplies small seed packets for trial. It is important to understand that the plants must be treated at first as experimental before making recommendations to members of your community. Many, many development workers have introduced and promoted "miracle technologies" and "wonder plants" before giving them adequate trial and experimentation on site. Not even studies in the same country can guarantee acceptance or success. Hasty introductions of new ideas or plants are likely to encounter serious problems. Farmers may have planted their fields with the new varieties or invested their savings in the new tool when the problems surface; perhaps a pest or disease strikes, or the equipment is faulty or unsuitable. In the end, farming families will suffer, and the development worker will understandably have a very difficult time promoting any further ideas or innovations.

People may lose confidence or trust, with serious consequences for your work or ministry.

There are many advantages to conducting your own trials before disseminating seeds in the wider community. It is important to know whether the plant can grow in your area before farmers devote land and time to cultivating it. Through conducting trials you may find the best "window" in your seasons for the optimal performance. You receive only a small packet of seeds from ECHO; if the plants produce well, you will have plenty of seeds to share. If the plants do not grow and produce seed, perhaps they are not suited to your region. Should the species be enthusiastically accepted, ECHO can refer you to commercial sources for some seeds if you need larger quantities or want to broaden the genetic base. If the plant holds great promise in your area, it is best to obtain more seeds from another source before the planting areas become too large. Genetic diversity not only offers potential

for superior plants to be identified, but also affords protection in case of disease outbreak. (See the discussion of the Small Farm Resource Development Project in the first chapter for more about conducting trials.)

Beyond avoiding the risk of total planting failure, small trials allow you to evaluate the "weed potential" of certain species in your area. Watch the planting carefully the first few seasons to make sure it is not likely to become a problem plant. Unfortunately, one definition of a weed, "plants which thrive under stressed conditions, often with high seed production," fits some of the plants in ECHO's seedbank. We are very aware of this risk and have in fact eliminated certain species from our seedbank when the danger of introducing a weed seemed too great. However, hardy plants which can establish themselves may be a great blessing in many situations; for example, it is difficult to imagine a tree which could become a pest in certain areas of Africa or Haiti with severe fuelwood

shortages. Sending out only small trial packets of seed is another safeguard against introducing a weed, as too-aggressive plants may be identified and controlled easily in a small area. Finally, remember that the plants in ECHO's seedbank are commonly accepted food plants somewhere in the world, even if very localized. In this, too, there is a measure of safety as we can all learn and benefit from the years of plant selection by people in other parts of the world.

ECHO's seedbank is very small. We do not guarantee the seed count in each package, the viability may sometimes be low, and there may only be a small number of seeds in your packet if our supplies are limited and demand is great. We cannot supply quantities of seed for routine production. Rather, we expect you to increase your own seed if the performance of the plant warrants this. Sometimes we may send more than one variety of a requested seed, so that you may determine which of these gives superior performance in your region.

In all cases, we look upon those who request seed as collaborators with us in field trials. This does not mean that you must do elaborate experimentation, but we do expect you to take time to write to us after the food has been harvested, letting us know your general impressions on its suitability to the region and the culture. A seed trial report form (in English, French, or Spanish) is sent along with your seeds. We enter your results in our database and use this information to make more refined recommendations to others and to share with interested scientists. These reports are very important to us, to be aware of germination or weediness problems, as well as to learn of successful introductions and acceptance of the plant in the community. We are always glad to receive the seed trial reports, but we also have special interest in longer-term results of plant introductions and the effects of ECHO's work. If you receive seed from ECHO and the plants are adopted in the fields and gardens in your area, please let us know.

TRANSPORTING SEEDS AND CUTTINGS. We should all be aware of the danger of inadvertently introducing a new pest or disease to an area along with a new plant. This is a serious concern, and it is one of the reasons we do not distribute major cereal grains or commercially important crops. Many pest outbreaks (the cassava mealybug in Africa and hundreds more such cases) have occurred when someone carried an infected/infested plant to a new area which lacked the natural predators or controls of the pest's native habitat. We do not send seeds known or suspected to carry such problems. All of our seeds are treated with fungicide and insecticide to minimize this risk. You should also keep a close watch on new plants for pests and diseases, and let us know of any problems you experience.

ECHO will send you the seeds you order, treated as described above. You are responsible for the seeds upon arrival. The next time you are in the capital city of your country, you

might inquire about any special procedures for importing seed, then send us any required forms with your order. (If your plant import permit requires a phytosanitary certificate, the certificates are issued by a government plant inspector certifying that he/she has visited the farm, seen the plant material and that it is free of disease and insects. These are most likely going to be required for shipments of live plants or cuttings. We must pay the inspector \$20 for the certificate, so please enclose that amount with any order requiring it.)

Like many universities, ECHO has an "unofficial" phytosanitary certificate in which we certify that, to the best of our knowledge, seed came from disease-free and insect-free plants and that the seeds have been treated with insecticide and fungicide. If requested, we enclose this with seed orders large enough to require a package. If you believe this certificate would be helpful you can request that we enclose it. However, it will not be enough with higher-risk imports, such as cuttings

or roots of sweet potatoes, and certainly will not suffice if your import permit requires an official phytosanitary certificate.

WHEN YOU SEND SEED TO ECHO. Our seedbank has been greatly enriched by seeds sent by overseas members of ECHO's network. If you have seeds to share, write first telling why you think we might be interested and giving as much information as you can. If it is a seed that we could use, we will send a green and yellow mailing label (a plant import permit) issued in our name by the Department of Agriculture. All you need to do then is put the seeds in a package, identify each packet, and use the permit as your mailing label. The seeds will be forwarded to us after inspection.

When you send seed to ECHO, please treat it with a modest amount of insecticide. Please do not cover the seeds in quantities of powders; our customs inspectors do not appreciate that, and they may dispose of overtreated seed. We

do need to be careful about pests. Years ago, there were two containers of seed sitting on my desk, each with a different type of adult insect pest crawling all over them, both sent to us from overseas. Fortunately the containers were well sealed and I was able to destroy the pests promptly. In another instance I was not so fortunate. I had a bouquet of a dozen dried sorghum heads in a vase, each a different type from Purdue University's International Sorghum Variety Trial, which I had cherished for twelve years. Someone sent an envelope of corn from overseas, and it was left in my office for a few weeks. One day I noticed that small insects had emerged from the seeds inside the envelope. I immediately put the envelope in the freezer to kill the insects, and I disposed of the grain. A few weeks later, however, the same insect was discovered destroying my sorghum bouquet; by that time, it was too late to save the bouquet, and it had to be discarded as well.

A related issue: please do not send infested seed or a diseased

leaf or soil in an envelope for us to identify. ECHO does not have an entomologist on staff, and we cannot have your problem getting loose at ECHO! If it is important to know what the insect is and you cannot find someone in country to identify it, you might be able to send it in alcohol. Be sure it is in a very sturdy and tightly sealed container. However, a description might be sufficient. In most cases, precise identification is not important. Given the lack of resources available in most peasant farming situations, it is usually enough, for example, to know that it is some kind of caterpillar or some kind of grain weevil. The low-technology options for control that are available are probably generic caterpillar controls or generic weevil controls anyway.

GETTING YOUR OWN SEED IMPORT PERMIT. It is easy for U.S. citizens to obtain their own permit. Permits are designed for mailing seeds to the States, but usually help get you through customs with modest amounts of permitted seeds that you are

carrying with you. Some plants are not allowed entry, especially those listed as "noxious weeds." It might also be more difficult (and dangerous) to bring seeds of crops of major economic importance in the States. The inspector probably would not let you bring citrus or corn because of the economic damage that could be done by introduction of a new disease or pest. Permits can be easily obtained by any citizen by writing to Permit Unit, USDA, APHIS, PPQ, 4700 River Rd., Unit 136, Riverdale, MD 20737, USA; phone 301/734-8645; fax 301/734-5786. The USDA must first send you a formal application, so allow plenty of time for two exchanges by mail. Permits are good only for the particular port of entry that you specify (so ECHO's Miami permit cannot be used in New York). For living plants, you also need a post-entry quarantine permit and a place (it could be a residence) where the plant will be kept and federally inspected for two years.

Storing seed

ECHO'S SEEDBANK HAS FOIL-LINED SEED PACKAGES. The lengthy trip in the mail and, sometimes, time sitting on your shelf waiting for the rainy season, is hard on seeds. The two best ways to increase the life of seeds are to reduce moisture and temperature. The foil in our seed packages forms a moisture barrier. Each seed lot is dried and treated with insecticide and fungicide. Seeds are measured into labelled packets, which are sealed with a quick brush of an iron (like those used to iron clothes). If you can put the sealed packets in a refrigerator you should have a much improved chance of good germination. You can reseal them with an iron if you wish.

BASIC SEED HARVEST GUIDELINES FROM ECHO'S SEEDBANK. For plants with seeds that mature and dry on the plant, like corn, beans, amaranth, millet, sorghum, peas, lettuce, tarwi, kaniwa, etc.: Only harvest fully mature seed. The plant may start to die before the seed is ready. Harvest

seed when dry (not wet with morning dew or after a rain). A good guide is when the first seeds are exposed or shatter (fall to the ground), as with the grains, or when pods are brown and crisp, for beans. (Amaranth can be a difficult plant to harvest-keep a close eye on it so you don't miss the seeds and lose them as they fall; you may even need to "milk" the seed clusters a few times to get the seed as it matures.) To avoid bean borers and fungal problems, however, it is best to harvest continuously toward the end of the season, so mature seeds do not stay in the garden too long. Many of these seeds can simply be threshed or shelled and cleaned from debris by winnowing with the wind or a fan.

For plants with fleshy fruits, like gourds, squashes, pumpkins, and peppers: Be patient. Only harvest fully mature fruits. The plant may be completely dead by the time the seed is ready for harvest. Remove fruits from plants and allow them to get soft, past the point you would want to eat them (except

pumpkins, which do not soften, but do ripen during a few months after removal from the vine). Seeds are perfect for harvest if they separate easily from the flesh when rubbed out under water, for example. Scoop all the seeds and flesh into a large bowl or bucket of water, and work the seeds free with your fingers. Healthy, mature seeds will usually sink, although if all the floating seeds look better than those sinking, the case may be reversed for your plant. (Sometimes, good pumpkin seeds may float, while dead ones sink. Many cucurbit seeds, among others, have a 'dormant' period after harvest, so wait a few months to test the germination. In one case, freshly harvested, dried pumpkin seeds had zero germination, but another test several months later had over 80% germination.) This makes it very easy to clean the seed: simply rub the flesh away from the seeds, and tip the dirty water and flesh off the top; add more water, swirl the bowl, and pour off that water; continue for a few more washes until only the seed is left at the bottom; strain and dry immediately. Please note that

seeds should not be left in the water for a long time, as they may absorb water, swell, and start to germinate. Some seeds benefit from a period of "fermenting" in the water before cleaning the seeds from the fruits; in tomato, for example, this treatment is said to reduce some of the diseases which can affect the seedling during germination.

SURFACE CLEANING. Seeds are treated in an antibiotic solution (10% bleach is good) for 2 minutes. This eliminates much of the bacteria or fungi from the seed surface. (Vinegar has some antibiotic action. If that is all you have available you might wish to experiment on a small scale to determine how much you could use without reducing viability. I do not know how effective this would be.) Seeds are then washed in clean water.

DRYING. Be sure seeds are completely dry before storage. (Fruit seeds are exceptions to this rule, as many do not

survive drying; see below.) This is best accomplished slowly and gently; after threshing or cleaning, allow most seeds about a week in a very dry place for this process to be complete.

Some basic principles to keep in mind: Once a seed is dry, it is best to keep it dry, even if that means leaving some chaff in with the seed or leaving a bit of dried "skin" on the seed. Do not re-moisten seed once it has begun to dry. Internal moisture is more damaging to seeds in storage than heat. Your seed may dry adequately simply by spreading it out on a screen in the sun for a day or two; avoid oven-drying, as it is often too fast or hot and can kill the seeds. Temperatures over 96 F can damage seeds. Stir drying seeds once a day to ensure even drying. Dry seeds break rather than bend and shatter when hit with a hammer. Then store the seeds in airtight containers with proper labels identifying the seed and date of harvest. Store in a cool, dry place if that is available.

The humidity is the most critical factor; seeds can live in hot, dry deserts for much longer than in a cool but damp environment.

The bean seedbank at CIAT in Colombia places dry seeds in a chamber containing a desiccant to reduce moisture below 10%. This has probably been achieved if the color indicator on the desiccant has not changed over a period of about 5 days with the seeds present. In the past, we adapted this procedure, placing dried seeds in a small open container on top of some Drierite in the bottom of a large-mouth peanut butter jar with the lid tightly closed. We mixed a small amount of the more expensive colored indicator with the inexpensive white Drierite. If the blue turned to pink in only a couple days, we replace the Drierite. Once it remained blue for nearly a week we assumed that moisture content of the seeds was below 10%. If you cannot purchase Drierite or other desiccant, Organic Gardening magazine says that you can use an equal

volume of powdered milk (perhaps with a few crystals of indicator desiccant thrown in?). Desiccant (or milk, rice, etc.) can be rejuvenated by heating for a time in an oven at a low temperature. You may be able to locate some kind of desiccant at a nearby medical clinic.

RULES OF THUMB FOR SEED STORAGE CONDITIONS. We contacted two knowledgeable seed experts for details. Bob Heisey with Peto Seed Company, a supplier to the major retail seed catalogs, said that if saving seed for only a few years (not for decades, as in projects to preserve rare varieties), you can use this rule of thumb to store on open shelving in an air-conditioned room: the temperature in Fahrenheit plus the relative humidity should be less than 100. For example, if I can afford to keep a room at 70 F I would need to get the relative humidity to 30 or lower. [For those who have forgotten the formula, you can convert Centigrade to Fahrenheit as follows: $F = 9/5 C + 32$.] If the humidity of the

entire room cannot be lowered that far, you can store seed in airtight containers together with a desiccant to absorb excess moisture. Effective desiccants include charcoal, powdered milk, rice or other material which you have noticed absorbs water. The desiccant should first be dried at very low setting in an oven.

Ron Hurov, a botanist formerly in the seed business, believes that this rule of thumb is not adequate. He says that the main objective in storing seed is to reduce respiration. This is accomplished in three ways; adjusting temperature, humidity, and oxygen levels where seeds are located. Temperature: All seeds should be stored just above freezing level (34-35 C). An inexpensive walk-in unit or commercial refrigerator is sufficient. Humidity: Through Ron's experience, he has characterized seed into three areas: wet, semi-wet, and dry. The rule of thumb here is to copy a plant's natural environment. If the plant likes it wet, such as the botanical

family Araceae, then store the seeds in water. A semi-wet example would be the Citrus family. A plant family stored in dry conditions is Leguminosae. Oxygen: Seeds should be kept in airtight containers free of oxygen. Vacuum sealing is ideal. A cheap (\$150) vacuum sealer/dryer can be purchased through a health food company. The best suggestion for an airtight container is a mason jar. Ziploc bags and other plastic containers are not good enough.

THE COMMUNITY SEEDBANK KIT. Millions of people have been fed by the higher yields as farmers switched to new "green revolution" varieties. But what happens to all those varieties that farmers used to grow? Some of them are the result of plant selection through centuries. "The introduction of modern grain varieties in the Mid East has led to widespread losses of traditional varieties. African rice is nearly extinct in its native homelands. ...a variety called IR-36 now extends over 60% of the rice lands of Southeast Asia where, only a few years ago,

thousands of farmer varieties were common. ...the black beauty egg plant is ... destroying its own diversity in the Sudan."

These lost varieties may have traits that would be invaluable if, for example, a new disease strikes. One of those varieties might be much better adapted to difficult growing conditions in another part of the country that wishes to begin growing the crop. They will also be invaluable to producing future "green revolution" crops. This loss of genetic diversity is of equal concern to the small farmer, the international center and the big seed company.

The purpose of the Community Seedbank Kit is to help private volunteer agencies develop community seedbanks to collect, preserve and assure easy community availability of seeds of crops in their region before further "genetic erosion" takes place. The kit is not a book. Rather, it is a loose collection of

several 4-15 page sections. Topics include: Building the bank (the need); Building the bank (practical); The role of the voluntary agency; Sources and resources; Overview and issues.

The section on building the bank (practical) discusses how to select the crops to be collected, timing the collection, the collection strategy once you are in the field, documentation, seed cleaning and drying, seed storage, collection grow-outs and a table indicating whether a seed is self- or cross-pollinated and its relative storability index.

If you can envision your organization undertaking such a project, the kit will be a great help. They anticipate future revisions. If those include some case studies and greater detail on practical techniques such as testing seed viability and appropriate technology alternatives to seed drying and storage, the kit will be even more helpful. The price is \$4.50

in North America, or \$8.50 (including airmail) elsewhere. Indicate whether you prefer English, French or Spanish. Order from Rural Advancement Foundation International (RAFI-USA), P.O. Box 655, Pittsboro, NC 27312; phone 919/542-1396.

LOST CROPS OF THE INCAS. The National Research Council of the U.S. National Academy of Sciences produced this book, and it is one of their best in the underexploited plants series. This series opened for me the world of plants that God has given to humanity which are still used in only a few countries and are little known elsewhere. This series ultimately led ECHO to establish our seedbank of underexploited plants. If you write to ECHO for information on any of the Andean crops, we will probably turn here first to answer your questions.

This book, written under the leadership of Dr. Noel Vietmeyer and a panel of experts, takes a close look at the wealth of

plants native to the Andes mountains of South America. The region that gave us the pepper and potato has a lot more yet to offer. All together, 31 little-known fruits, nuts, grains, legumes, vegetables, and root crops are described in some detail. A chapter is devoted to each plant and includes a general introduction; prospects for the crop in the Andes, other developing countries, and industrialized regions; the plant's uses, nutrition, agronomy, harvesting, and limitations; and research needs. Chapters end with a short synopsis useful for people interested in growing the plant. Each chapter is well-illustrated with several photographs and drawings. The book provides an introduction to and stimulates interest in these crops, providing a valuable overview.

With the notable exceptions of the pepper and potato, Andean crops are seldom seen outside their native habitat. This is surprising in light of the wealth of crops that were developed over the centuries under the extremes of soil, rainfall, and

temperatures of the Incas' vast empire. Many of the crops are quite nutritious and have only recently attracted the attention of researchers, but have the potential for worldwide usefulness.

Root crops include: achira (*Canna edulis*), containing a starch with unusually large grains; ahipa (*Pachyrhizus ahipa*), a legume whose sweet roots remain crunchy even after cooking; arracacha (*Arracacia xanthorrhiza*, pictured), carrot-like roots that can be boiled as a table vegetable; maca (*Lepidium meyenii*), a sweet, tangy delicacy in the highlands; mashua (*Tropaeolum tuberosum*), a staple that requires little labor; mauka (*Mirabilis expansa*), a "cassava of the highlands" that turns sweet after lying in the sun; oca (*Oxalis tuberosa*), a very hardy staple; little known potatoes (*Solanum* sp.) that have potential as germplasm; ulluco (*Ullucus tuberosus*), a brightly colored source of carbohydrates; and yacn (*Polymnia sonchifolia*), a sweet, yet almost calorie-free tuber.

Legumes detailed in the book include: basul (*Erythrina edulis*), a tree with large edible seeds; nuas or popping beans (*Phaseolus vulgaris*), which are popped rather than boiled and make a tasty snack; and tarwi (*Lupinus mutabilis*), a lupine richer in protein than beans and peanuts with as much oil as soybeans. Vegetables include lesser-known peppers (*Capsicum* sp.) and squashes (*Cucurbita* sp.).

Several fruits have particular promise, especially in specialty markets: unusual or large berries (*Vaccinium* sp., *Myrtus* sp., and *Rubus* sp.); capuli cherries (*Prunus capuli*), a popular city tree; cherimoya (*Annona cherimola*, pictured), a delicious fruit grown commercially in the Mediterranean; goldenberries (*Physalis peruviana*), a very flavorful jam berry; highland papayas (*Carica* sp.), which have potential as germplasm; lucuma (*Pouteria lucuma*), a staple fruit which bears year round; naranjilla (*Solanum quitoense*), a good fruit for juices; pacay (*Inga* sp.), a sweet-fleshed pod; passion fruit (*Passiflora*

sp.) that are superior to most commonly known cultivars; pepino (*Solanum muricatum*), a prospect for premium fruit; and tamarillo (*Cyphomandra betacea*), a popular juice fruit.

Three grains were also researched: kaniwa (*Chenopodium pallidicaule*), a nutritious grain with 16-19% protein; kiwicha (*Amaranthus caudatus*), with good quality protein high in lysine; and quinoa (*Chenopodium quinoa*), a better-known protein source. Two nuts are listed as well: Quito palm (*Parajubaea cocoides*), a high producer of tiny coconuts; and walnuts (*Juglans neotropica*), a fast-growing tree with good quality nuts.

It is particularly difficult for ECHO to keep seed in our seedbank of Andean crops, as most of them do not produce seed in Florida. With some exceptions, high altitude crops are the most difficult in the world for us to propagate. Between Florida's normal seasons and our "semi-arid" and "rain forest"

greenhouses, we can duplicate many climates. Duplicating a very long but cool growing season is our greatest challenge. If you work in the Andes and would be willing to supply us with seed for crops, ask for our "Andean seeds wish list" and we will send you a plant import permit.

The book (415 pp.) is being reprinted with color photocopies by Craig Dremann at Redwood City Seed Co., Box 361, Redwood City, CA 94064, USA; phone 415/325-7333. Cost is \$40 including surface mail. For airmail add: Americas, \$12; Europe, \$16; Pacific Rim, \$20. His home page is <http://www.Batnet.Com/rwc-feed/>.

LOST CROPS OF AFRICA. VOLUME 1: GRAINS (383 pp.) is the newest in the National Academy of Sciences series on very promising but little-known or neglected species. Writing was funded by USAID. This inspiring volume (the first of three which are planned) discusses the potential of African grains for

producing food and other products in Africa and around the world.

The series is "intended as a tool for economic development" among those who may promote these crops for local cultivation, develop markets for the grains, and explore the multiple uses of these species. The species discussed in this series were selected from nominations by people around the world. The information given about the crops helps readers to understand and appreciate the unique value of each plant and evaluate its potential for a given area. There are also very insightful appendixes on "potential breakthroughs" in some of the most pressing problems for development workers, including grain handling and child nutrition.

The species covered include: African rice, finger millet, fonio (acha), pearl millets, sorghums (subsistence, commercial, specialty, and fuel and utility types), tef, other cultivated

grains (guinea millet, emmer, irregular barley, and Ethiopian oats), and wild grains. These plants offer much promise because they tolerate many extreme growing conditions and produce well with minimal inputs. They are generally nutritious and offer new flavors. They also offer other benefits; for example, the "fuel and utility sorghums" are used as firewood, liquid fuels, soil reclamation, wind erosion protection, weed control, crop support, fibers, brooms, and animal feeds. As with all the NAS books, further reading and many research contacts are given for each crop.

Readers in Western countries can purchase the book for \$24.95 plus \$4.00 surface postage and handling. Noel Vietmeyer and Mark Dafforn with the National Research Council told us they can think of no group more likely to make use of this book than those of you in ECHO's network who work in Africa. So they will donate enough books to send you a free copy while our supply lasts. IF you are already a

member of ECHO's overseas network working in any third world country you may request one free copy of the book by writing clearly the address where the book is to be sent and enclosing postage if your work is not in Africa. For addresses in Africa only ECHO will pay surface postage. For all others (and in Africa if you want airmail) please send appropriate postage: surface \$4; airmail Latin America, \$6.00; airmail Europe, \$11.00; airmail Africa and Asia, \$11.70. MasterCard and Visa or checks in US dollars written on a US bank are the only payments we can accept.

Germination and propagation

MEASURING THE VIABILITY OF YOUR SEEDS. It is a good idea to check the viability of your seeds before planting time. If the percent that germinate is low, you will know to plant a larger number of seeds. It is very important to test the germination of seeds that you have stored, and old garden seeds that have

been given to your project. Local farmers can be seriously hurt if they rely on those seeds when the critical planting time comes, only to find that they germinate poorly or not at all.

We used this method to check the seeds in our seedbank. Remove a representative sample (do not select the biggest seeds) of 20 seeds or more from the container and label it. (The sample size depends on how many seeds are available. The larger the sample, the more reliable the results.) Soak the sample in 10% bleach for two minutes, then drain and rinse with water. Distribute the seeds on a clean damp paper or cloth towel and roll it carefully into a long cylinder. Enclose it in a plastic bag and store it in a warm damp place. Label each roll. Record the number of seeds that have germinated each day or two. Remove those that germinate, and replace the roll until the next inspection. Remember that seeds vary widely in the time it takes to germinate. Some germinate in 3 days, while others take 3 weeks or even longer for many fruit seeds.

(Once we had a vegetable ivory palm come up from a seed that we had planted 16 months earlier!) Finally, calculate the percent that have germinated.

David Knight in Zaire asked, "Why is it necessary to count the germination on each of several days?" There are two criteria for good seed that the viability test measures: how many will germinate and how uniformly they will germinate. Sometimes a few seeds in a package will germinate quickly, followed by a few each day for several days. For example, winged beans often have non-uniform germination rates. Some kind of fruit tree seeds can do this to an extreme. It is helpful to know what to expect so you will know to keep watering. If you only want to know the percent that will germinate eventually, you can wait a few weeks to make the count. A disadvantage of uneven germination is that thinning and harvesting is extra work when plants germinate and grow at different times, but a strength is that more of the seeds are likely to survive in the

event of a drought or some interruption just after planting.

ECHO tries to test the germination of each active accession in our seedbank at least annually. The procedure we currently use measures emergence from the soil, in addition to seed viability as described above. (A seed may be alive, and it may even germinate, but emergence is the true test if it is to take root and grow.) It is a simpler test and allows us to transplant the plants after the test, as well. Count out, label, and plant a sample of seeds. Record the tally every week to obtain your germination rate.

GERMINATING SEEDS CONTAINING CHEMICAL INHIBITORS.
Seeds of some wild species contain chemicals that inhibit germination. "For such species, continuous leaching in running water for up to two weeks is needed-washing or soaking is not enough." A recently published book, *Germination of Local Native Plant Seed for Revegetation, Tree Planting and Direct*

Seeding Projects (Murray Ralph, A\$13.45 from Granny Smith), gives a novel solution. "The seed is placed in a permeable bag, such as a nylon stocking, and hung in your toilet cistern. The cycles of soaking and flushing produced in the cistern are ideal for easy breaking of the chemical-based dormancy." (Adapted from Quandong, Vol 21 #2, 1995; Nut and Tree Crops Centre, P.O. Box 27, Subiaco, WA 6008, AUSTRALIA.)

TROPICAL ONION SEED GERMINATION was poor, according to the seed trial reports many of you returned to us. Onion seeds are short-lived, so we were not surprised to see some reports of low germination in the field. However, the onion seeds in our seedbank were continuously tested for acceptable germination, and at ECHO we successfully grew many of the onion varieties for evaluation. Based on your results, we asked the researchers who supplied ECHO with the onion trials to send us fresh seed. This comment from their letter may explain why some people enjoyed great onion harvests while

others had no germination:

"Please note that the onion seed sent to you is packaged very dry, so the packets should be opened and the seed allowed to take in moisture from the atmosphere overnight before the seed is sown. You risk damaging the seed by imbibition [water uptake] injury if it is sown straight from the packet into damp ground. Another approach is to sow the seed into dry ground, then water it the following day. This also allows it to equilibrate naturally before it gets wet. Seed not wanted for use at once should be resealed in the foil packet immediately after removal of the amount you need, not allowed to remain open to the air for long."

It is generally good to let well-dried seeds sealed in airtight packets absorb some moisture from the air before planting them directly in wet soil. Other seeds harvested at ECHO for our seedbank are dried thoroughly, but not so much that such

imbibition injury is likely.

If you had poor results with the onion trials, write ECHO for more seed and let us know your results using this method. Your seed trial reports are very important to us in identifying problems such as this, as well as learning of successful introductions of the crops in our seedbank. Harvest report forms which accompany the seeds should be returned to ECHO. People interested in conducting an extensive onion study should contact Dr. Lesley Currah, Horticulture Research International, Wellesbourne, Warwick CV35 9EF, UK.

CHART ON PROCEDURES FOR GROWING TROPICAL FRUIT FROM SEED. The California Rare Fruit Growers publish the excellent magazine Fruit Gardener, which would be extremely interesting to folks working with fruits in the tropics. We copied a table from one issue that lists storage life of seeds, type of storage that is needed, dormancy breaking

requirements, days to germination and cold hardiness. It covers 92 genera. We will send a photocopy to you upon request. Subscriptions (6/year) are US\$16 in US, \$25 Canada/Mexico, \$30 foreign surface, \$40 airmail from California Rare Fruit Growers, The Fullerton Arboretum, CA State University, Fullerton, CA 92634; 714/638-1796. This is among the favorite magazines in ECHO's library.

WILL CARAMBOLA TREES COME TRUE FROM SEED?

Carambola fruit, *Averrhoa carambola*, also known as "star fruit" has gone from an obscure, inexpensive fruit in the U.S. to an exceptionally expensive "yuppie" fruit. When sliced, the star shape makes it popular on top of fruit salads, added to stir-fried vegetables, dried, or as a decorative addition to desserts. Most people in southern Florida who have tasted the old dooryard seedling trees find the fruit too sour to be of interest. They are usually amazed to taste the new, sweet grafted varieties. Since carambola bears at a young age and

produces one of the heaviest crops of any small tree over a long season, the good varieties are great dooryard trees.

We wondered what would happen if ECHO sent out seed taken from fruit of one of the superior trees. Would it give fruit just like the parent, or would the fruit be sour and unappealing? To find out, we planted seven seeds taken from the commercial yellow Florida variety 'Arkin.' The great variation in shape and flavor is such a good demonstration of why people prefer grafted fruit trees (where every tree is like its parent) that we have left the entire planting to use in our educational program.

Trees began to produce fruit in 2-3 years. Four give orange fruit, but on three the fruit turns from green to nearly white, to pale orange as it ripens. Two of the orange-fruited trees are very sour, one is moderately sour, and the other is sweet. Two of the light-colored fruits are slightly sour with fair flavor, but

we think that one tastes as good as or better than commercial varieties. (It will not become a commercial variety because the ideal commercial shape here is long with short "wings," which are less likely to be damaged in shipping. All these seedlings were shorter and had longer wings than the commercial varieties.) Several are good enough to leave for fruit production.

If you do not have sweet carambola in your country, you may request a packet of seed and we will send seed when available. Seeds reportedly cannot be stored, so we will probably send them in moist peat moss. They may be germinating by the time they arrive, so plant at once. You will probably find that you like fruit from some trees very much and some not at all. You may even find one that will be so good it will become a new variety for your country. (At ECHO we graft our best varieties to limbs of trees with sour fruit.)

ECHO's interns tell us carambola is one of their favorite juices. They remove any green tips on the "wings" (which can have an off-flavor) and mix with some kind of citrus juice and sugar. Dr. Julia Morton warns that the content of oxalates is so high that the fruit should not be consumed in large quantity. The less sour varieties have less oxalic acid. (An ECHO intern once read a research report which stated that most of the oxalates are found in the "wing tips" of the fruit, so presumably cutting off the tips could reduce the oxalate content. We have not been able to locate the report to confirm this, however.)

WHAT VARIETIES OF CITRUS WILL GROW TRUE FROM SEED?
Jerry Larson with Double Harvest in Haiti asked us what varieties of citrus might come true from seed. I checked with Dr. Carl Campbell at the University of Florida Extension research center, who gives us many in-depth, insightful answers to tropical fruit questions from our readers. He said

that a great number of citrus trees will come true from seed. You can tell by examining a few seeds from the tree. Peel off the outer and inner seed coat; if the seed is polyembryonic (i.e. has many embryos) it will come true. (In some of the polyembryonic citrus, some of the embryos are of gametic origin and therefore do not come true. The percentage varies by species and variety.) I asked what it would look like if it were polyembryonic. Carl said that the various embryos would be convoluted upon each other. If it is mono-embryonic there will be one embryo with two distinct cotyledons. Almost any sweet orange will come true from seed, as well as key limes, grapefruit, tangerine and tangelo. Two varieties that will not come true from seed are temple and pomelo.

What are the advantages and disadvantages of growing citrus from seed when that is possible? One obvious advantage is that it is much less labor intensive to simply sow citrus seeds and eliminate the grafting step. Another advantage is that the

seedling will most likely be free from viruses that sometimes get into the budwood that is used for grafting large numbers of trees. I asked Carl about reports that non-grafted citrus trees live longer, up to twice as long, as grafted trees. He said that this can be true, depending on the number and kinds of disease organisms that may be present in the budwood. If one uses certified disease-free budwood, and if there are no microorganisms present that we do not even know to look for yet, then there should be no difference in the longevity of the trees.

One advantage to grafting is that one can combine the best traits of the above ground part of the tree with the best adapted rootstock for the particular soils and conditions of the area. A seedling will tend to grow upright, tending toward a single trunk, and becoming quite thorny. A grafted tree will be more highly branched. The seedling tree will not fruit for 6-7 years, contrasted to 3-4 years for a grafted tree. The earlier

fruiting of the grafted tree is partly responsible for the more highly branched form of growth. Apparently the weight of the fruit after about 3 years bends the branches and causes new buds to begin growing, resulting in a more highly branched tree. But not all of the reasons for the differences between seedling and grafted trees are known.

If you live in an area where citrus is not a major crop but would like to introduce it, you might consider trying some of the polyembryonic seeds. If you are more adventuresome, in a few years also plant some accepted rootstock varieties for grafting using budwood from the new trees you have introduced. If you prefer to start with a Florida variety rather than a good local variety, and want only a few seeds, we can at times provide them. If you want larger amounts, request a price list from Chuck Reed at Reed Brothers Citrus (see below), who routinely ship overseas; he can provide phytosanitary certificates if you so request and include your

full address and phone number. I asked about the danger of introducing a new disease. This does not appear to be a problem with citrus seed. A citrus disease has never been proven to have been introduced by seed.

PURCHASE OF CITRUS SEEDS AND BUDWOOD. Carl Berg, a Peace Corps volunteer in Ecuador, inquired about citrus rootstock and how best to introduce assorted varieties of citrus into his part of the country. I phoned Reed Brothers Citrus for help.

Some rootstocks that they recommend for almost anyone, anywhere (though they sell many more) are: sour orange (no longer a commercial variety in Florida, as it is susceptible to the tristeza virus), 'Carrizo' citrange, 'Swingle' citrumelo, 'Cleopatra' mandarin and *Poncirus trifoliata* (trifoliate orange). If there is no danger of freeze or frost, he would add to the list 'Volkameriana' for lemons and limes. Order sour orange and

Poncirus before September of the year before so they can specially acquire seeds for you.

The prices per quart range from \$40 to \$70, so most of ECHO's collaborators would be unable to try more than perhaps one variety. I asked if he would be willing to prepare an assortment in smaller packets. He agreed to the following. You can send him \$50 for an assortment of some or all of those mentioned above, ask for an assortment of citrus that will come true from seed, or a combination of these options. He will arrange packet size to make the bill come out to \$50. We agreed to allow him some flexibility, as he would not have time for precise measurements, etc. You will receive approximately 1.5 pounds of seed. I would recommend that you add about \$20 for airmail postage, as citrus seeds begin to lose viability within a few weeks after removal from refrigerated storage. Alternatively, if someone in the States is about to visit you, the seeds could be sent to them via UPS.

Mr. Reed is doing this as a favor to help your work and does not assume responsibility for delivery by international mail systems. Send your order, mentioning the ECHO package arrangement, to Mr. Reed at Reed Brothers Citrus, P.O. Box 1863, Dundee, FL 33838, USA; phone 941/439-1916; fax 941/439-4268.

The citrus canker scare in Florida has been cleared up, so Reed Brothers Citrus can ship budwood again; write them for a price list. You should be aware that many countries have strict budwood regulations, so check on your regulations before purchasing.

ANSWERS TO SOME QUESTIONS ON CITRUS. Two of our readers asked some interesting questions about citrus. We called Reed Brothers Citrus (see above) for some help.

Q. (From William Boykin in Zambia.) "The navels, valencias

and hamlins do not have the sweet flavors we had hoped. Is there anything we can do, or might it be the rootstock? We budded onto cape lemon."

A. The cape lemon rootstock is your major problem. Lemon rootstocks produce big quantities of fruit, but the quality is always poor. Lemon rootstock is for commercial juice production where they want to emphasize quantity. They then mix with smaller amounts of other juices to get the right taste. An advantage of the lemon stock is rapid growth, it being more vigorous than other stock. However, this also results in poor taste. Climate can also cause inferior taste. It would help if the climate were cooler. I would suggest budding onto either Carizzo or sour orange. They may not allow sour orange into the country because it is so susceptible to tristeza. For example, Brazil's citrus industry was wiped out some years ago by tristeza. But it depends a lot on how virulent is the strain in your country. It is so good that I would take the risk

and not worry too much about tristeza. My third choice would be Cleopatra mandarin. The disadvantage with it is foot rot. This world-wide problem is caused when workers injure the root while cultivating. It is most susceptible during the first 5 years. The safest thing would be to use a combination of rootstocks. Then it will be unlikely that you will be wiped out.

If you wish to plant some true-to-type seeds I would recommend two varieties: ridge pineapple or what is called "old sweet seedling." By the way, any true-to-type seedling [plant grown from seed that will give fruit like the parent tree] is susceptible to foot rot.

Q. (From Peter van Lonkhuyzen in Haiti.) I have used budwood from some three year old trees that are not bearing fruit yet. Someone told me that by using such young trees my grafted trees will start bearing late and never will give good yields. Is this true?

A. A grafted tree will normally start bearing some fruit within a year. The fact that the parent trees you used were not bearing at three years suggests that they were seedlings. If so, you will have to wait about as long as if you had planted the seed.

There is one way you can get some quick budwood. Take budwood from a mature bearing tree and graft onto a rootstock in your area. As soon as this has grown to produce some branches, you can use this to bud other trees. They call this "first generation budwood." However, the second generation of trees should not be used for budding until they have started bearing.

Q. What rootstock should I use that is resistant to both drought and tristeza?

A. Sour orange is drought resistant, but if you want tristeza

resistance also I would recommend Carizzo. Of course, even that is only drought resistant to a point. True-to-type seedlings will never tolerate drought as well as the normal rootstocks. I might also mention that a rooted cutting from any variety of citrus will have about half the normal life expectancy of a grafted citrus, due to susceptibility to a range of root diseases.

Q. How is it possible that in some places they have Washington naval trees without thorns while somewhere else the same variety has thorns?

A. There can be some differences in thorniness within a variety. In the one location they must have budded from trees that did not have thorns. You will still have some thorns of course. Alternatively, the thorny ones could be seedlings, as they tend to have more thorns.

I also asked about susceptibility to Phytophthora root rot. He said that rough lemon is one of the worst root stocks in regions where Phytophthora is a problem. It once was the primary root stock in Florida, but has been totally replaced. All citrus trees are susceptible to Phytophthora root rot to some degree. If a workman injures a root and the organism is in the soil, it can enter and damage the tree. It can then kill after a few months or just reduce production. Some trees in a row may become infected and others not. Budwood is not infected.

ARE THERE DWARF CITRUS TREES? Robert Weaver in Thailand asked us. From Dr. Carl Campbell: Yes, there are dwarfing citrus rootstocks. The research station in Florida has a few. I asked why almost no one is planting them. Carl said it is not that there is a problem so much as that no one knows just what to expect. The risk that in 8 or 9 years the tree might die is too great for large-scale movement to the untested rootstock.

GROWING YOUR OWN GRAFTED SUBTROPICAL VARIETIES OF DECIDUOUS FRUIT TREES. Dennis Desmond in Ecuador asked some interesting questions concerning a project to produce 5,000 fruit trees (subtropical varieties of temperate fruit) annually for local farmers. He already has a few apple, peach, pear, plum and apricot trees going that he can use for grafting material. Now he wants to begin growing rootstock [seedlings to which superior varieties will be grafted]. I know a lot of you have similar questions. For example, what kind of apple seed should he buy, where would he get it, what pretreatment is needed, etc. This prompted a call to Dr. Wayne Sherman in the Fruit Crops Department of the University of Florida. A summary of this most interesting conversation follows.

In the States nurseries buy rootstock (very young trees) from specialized companies, usually in Washington and Oregon. Unless a particular name is specified, they most likely were grown from seed collected at cider mills. Dr. Sherman said

that the easiest solution in the tropics also gives the best results—simply save seed from the subtropical fruits that are already bearing on your present trees. For example, Anna and Dorsett Golden apples will give better rootstock for a mountainous site in the tropics than would purchased seed taken from a cider mill in the States.

How can one get dwarf trees? He said that this is going to be expensive and hard to get. There is no good history of how they will do in the tropics, although the seedling stock is well adapted.

What about "clonal" propagation where trees are grown from root cuttings? The problem is that every tree will be genetically identical, in contrast to seedling trees which have a lot of genetic variability. If a particular pest comes along that is able to attack one of the trees, it will also successfully attack all the other clonally propagated trees! If trees came

from seedlings there would be a much better chance that some would be resistant. For example, wooly aphids could wipe out an entire orchard if it were clonally propagated, but not if the rootstock came from seeds.

What kind of pretreatment is needed? After removing seeds from the apple, wash them. Put 100-500 moist seeds in a brown paper towel, roll the towel up, and place it in a refrigerator at normal refrigerator temperatures (40-50 F) for a month. Keep the towel moist. After a month start checking to see if seeds are germinating. They will probably start to germinate after about six weeks (longer if you were not starting with seed from the subtropical apples). At that point plant the entire bunch of seeds.

You should likewise save your own seeds from subtropical peaches. Crack the shell and put only the kernel in the moist paper towel. They should be ready to plant in about eight

weeks. In three months they will be over two feet tall and are ready to T-bud. Five months later they can be set into the field. (In contrast apple trees must grow a year before grafting and another year before being set into the field.)

At higher elevations you may find a "Spanish" type of cling peach growing. If root knot nematodes are a problem in your area, however, you will have big trouble because peaches are susceptible to this pest. There is a nematode-resistant variety called nemaguard that is used for peach rootstock, but this would have to be purchased from a temperate country (importing a large package of peach seeds will not be easy or cheap). I asked if you could plant a nemaguard seed then in a few years have your own nematode resistant seeds. He doubts that it would ever produce because it requires such a long period of chilling. Clonal propagation of peach trees from the roots is very difficult.

Pears are treated the same as apples, again using any locally available pear seed. Plums are treated the same as peach. However, many prefer to graft plums onto the peach rootstock. Dr. Sherman said that plum seedlings vary so tremendously in vigor that three-fourths of them may not be usable. Apricots can likewise be grafted onto peach rootstock. (Do not graft peaches onto plum or apricot, nor plum to apricot, nor apricot to plum.)

DIFFICULTY GERMINATING PAULOWNIA TREES? We received many reports that our seed for Paulownia trees (no longer in ECHO's seedbank) is not germinating. Recently, "Tree Project News" reported that paulownia is extremely sensitive to shade and requires intensive light for germination and seedling growth. To determine whether light and surface planting were necessary, we undertook a simple trial in our greenhouse to ascertain the viability of our seed and the proper germinating conditions.

Nearly all seeds germinated in all of the experiments. What is different when the seeds are planted at ECHO? We can only guess. One possibility is that people are expecting a much larger seedling. Paulownia seedlings are very small (approximately 2-5 mm across) and can easily be overlooked or mistaken for weeds. The seeds did not germinate for three weeks, a bit longer than most familiar garden seeds. People may be giving up too quickly. Seedlings are exceptionally subject to damping off (being killed by fungus disease). They can probably germinate and die before they are even noticed.

Here is what we did. First we used sterile potting soil, in 6-packs. In one trial the seeds were barely covered with soil, placed in regular lighting, and received watering once per day. The second trial was similar except that the seeds were placed directly on the soil surface and placed in a mist chamber (soil was kept moist by a mist every few minutes). In the third trial the seeds were placed directly on the soil surface, covered

with clear plastic and placed out of direct sunlight. They were watered once a day. In most cases, 5-6 out of 6 seeds germinated, even when in the shade. The shaded trial, however, evidenced distorted growth of the small seedlings.

Here are our recommendations. You will need to give these seeds daily or twice daily care. Use sterile potting soil or treat with fungicide. Just barely cover the seeds (this will mean that they can dry out easily). Good intentions are not good enough-you must make sure that they never dry out whatever it takes to ensure that. If this will be too difficult, cover with a clear plastic, which must be removed as soon as they germinate to prevent fungal disease. Water very carefully so as not to wash seeds away or cover them too deeply by disturbing the soil. Place in bright light but not in direct sunlight. If sterile potting soil is not available you can sterilize your own by heating the soil over a fire or in an oven long enough to kill all microorganisms. If it is heated inside, the soil

can give off a bad smell.

(By the way, ECHO no longer carries Paulownia seeds. The trees were discovered growing wild in West Virginia, USA in the late 1970s and since then they have received a lot of attention from researchers. A good source of information and seeds is Dr. Peter Beckjord at the National Paulownia Center, 10908 Dresden Dr., Beltsville, MD 20705, USA; phone 301/937-4635. You must send him US\$1 to cover postage for basic instructions, a brochure, and an introductory packet of 500-1000 seeds. He also has much more information available if your trials go well. A source of *P. tomentosa* and *P. fortunei* is the Early Bird Nursery, c/o David Sutton, 2975 Salem Rd., Parrottsville, TN 37843, USA.)

Seed production and sources

AGRICULTURAL AND HORTICULTURAL SEEDS. We turn to this

useful 531-page book by the Food and Agriculture Organization to answer such questions as whether one of you can produce your own onion or cabbage or tomato seed in your region and, if so, how. The book is in two parts. Part I covers general principles, such as development, evaluation and choice of varieties, agronomy, drying, cleaning and storage, quality control and evaluation and seed distribution. Part II covers seed production of specific crops (11 cereal crops, 6 drug crops, 6 fiber crops, some florist crops, 13 grain legume and pulse crops, 8 forage crops, 10 oil crops, 9 tropical tree crops, and 22 common vegetables). For each crop, typical subjects include climate and soil, planting and cultivation, nutrition and irrigation, pollination and isolation, diseases and pests, and harvesting and threshing seed. Order for US\$26 (minus the 35% discount for developing countries) plus postage from Distribution & Sales Section, Food & Agriculture Organization, Via delle Terme di Caracalla, 00100 Rome, ITALY, or ask them if there is an FAO agent in your country.

Price will not be the same in each country. In the USA, order from UNIPUB, 4611 F Assembly Drive, Lanham, MD 20706-4391.

CORNUCOPIA: A SOURCE BOOK OF EDIBLE PLANTS is one of those books I always wished someone would write. We are contacted weekly by folks looking for hard-to-find seeds. Our own seedbank contains many species, but as a service to our network we try to find a source if it is something we do not carry. Until Cornucopia, this was accomplished by looking one-at-a-time through the many catalogs we have accumulated over the years. If only someone would make a master index of all suppliers, world wide. Well, it's done.

In this 677-page paperback Steve Facciola has compiled descriptions and sources for 3,000 species of food plants (7,000 varieties). Names and addresses are supplied for more than 1,300 sources worldwide. Almost any edible plant you

can imagine can be found, from vegetables and herbs to rare fruits and edible flowers. There are 226 pages of botanical listings by family (including fungi, algae, and bacteria) followed by 308 pages of cultivar listings, and 53 pages of sources. Then there's nearly 100 pages of useful information in the indices and appendices (vernacular names, uses of edible parts, families and genera, etc.).

Let's say we are looking for quinoa. The index of vernacular names tells us the Latin name is *Chenopodium quinoa*. The index of families and genera tells us that *Chenopodium* is found on page 66. On page 67 quinoa is listed as follows: "*Chenopodium quinoa*-Quinoa, Petty rice {S} The nutritious seeds are used in soups, stews, breads, biscuits, cakes, cereals, and pasta, or made into tempeh and chicha. Young leaves can be used like spinach. Sprouted seeds are eaten in salads. An alkaline ash from the burned stems is chewed with coca leaf. Andean South America, cultivated." This entry is

followed by 2 references and 13 different sources, both for seed (planting) and grain (eating). We are then referred to page 460 for information on cultivars (23 listed with descriptions and sources) and page 485 for specific information on methods of sprouting quinoa seeds.

The book is a wealth of information. Prices including postage are \$37.75 US; overseas \$40.25 surface and about \$56 airmail. Order from Kampong Publications, 1870 Sunrise Drive, Vista, CA 92084, USA. (See the chapter on Multipurpose Trees for details on a similar sourcebook for multipurpose trees and inoculants.)

ARE FREE SEEDS A GOOD IDEA? We frequently get letters lamenting that gardeners cannot obtain vegetable seed. Dr. Henry Munger at Cornell University told me that a seed company tried to get started in the Philippines some years ago. About the same time both a U.S. agency and Mrs. Marcos

began a free seed distribution program. He believes this put the company out of business. The donors soon tired of giving away seeds, leaving the people with no place to buy them.

The owner of a small seed store in a tropical country told me there was an onion seed shortage in his region the year I visited him. He had used his hard-earned foreign exchange to import onion seed the previous year. Then one day a nearby mission began selling onion seed at much below wholesale price, as someone had given them the seed. The next year the seedsman was wise enough not to get caught with onion seed again, but the mission did not give away seed that year. Consequently there was a shortage of seed for one of the major crops of the region.

With very few exceptions, farmers can save their own seed from plants grown from the kind of seed that ECHO provides. In the long run, it is much more helpful to enable local people

to take care of themselves than to bail them out sporadically with gifts. This is the ministry that ECHO is continuing and expanding. Development is more lasting than relief.

SEEDS FOR THE AMERICAS sends garden seeds to participating agencies throughout Latin America and the Caribbean (please only write if you are in these areas). End users might include needy individual families, orphanages, schools, churches, 4H clubs, community groups, prisons, etc. One unit of 1,400 packets of seeds normally include 12 kinds of vegetable and two kinds of flower seeds for each garden, packed 100 packets of each seed per bag. The quality of the seed is checked by Mississippi State University before packing. They charge 3 per package to help defray costs.

I asked whether seeds were selected for various micro-climates. "The seed we distribute is very well received, but has not been tested in all the microclimates in which they may be

used. In many cases the varieties/hybrids are superior to what is available locally. Seeds distributed in the program are for vegetables that are normally grown and have proven successful in many places in Latin America and the Caribbean." If your organization is interested, contact John Batcha for further details: 4947 Foxbriar Trail, Charlotte, NC 28269, USA; phone/fax 704/597-7789; e-mail GGFG89A@prodigy.com. This is one resource for those situations in which supplying free seeds to gardeners may be appropriate. But please also consider the following issues.

Some words of caution. Though such seeds can be a blessing, you need to be aware of certain pitfalls. If your idea is to just request seeds and then give them out, please don't.

1. This is old seed, and it might not germinate. ECHO has planted seeds that were donated to us. Most of the time, the results are excellent. But every so often we have done the

work of preparing the soil, planting and watering only to find that the seed was dead. That is frustrating to anyone-and can quickly ruin your credibility. Damage can be even worse. If there is a short period during which gardens must be planted, there might be no time left for replanting. Your effort to save them the cost of seed may have lost them their entire harvest.

I would absolutely never distribute free seed to farmers unless I had tested its viability first. Just plant a few seeds from a packet or two of each variety near your home and see what percent comes up. There is no need to use normal spacing, as this is just a test. Perhaps 50 seeds half an inch apart would suffice. Not all packets of a particular vegetable may be good; some may have been in a store without air conditioning. One way to make sure that the occasional farmer does not get one of these bad packets is to open every packet of that species, mix thoroughly, and check viability in bulk. If it is acceptable, repackage in some manner.

2. The seed may be good, but the vegetable will not grow in your location. If farmers or gardeners in your area are used to and fond of the idea of experimenting, they may enjoy finding out. Others may lose interest very quickly. Except to such experimenters, I would never give out seed for a vegetable I had not grown myself or seen grown in the community. (If your climate is mild due to high elevation and rainfall is uniform, there is a good chance that most temperate vegetables will grow. If you are in the hot lowlands, many will not.)

3. Only some varieties of a vegetable may be adapted to your area. For example, varieties may differ in susceptibility to disease. Most varieties of cucumber will not produce here in our hot, humid summers, but the 'Poinsette' variety does give some fruit. Be especially wary of onion seeds. Only seeds marked "short day onions" have any chance of forming bulbs in the short days found in the tropics and subtropics. Others

will produce leaves and stems for green onions.

4. You can disrupt local businesses, as in the article above. Any retailers who may be selling seeds in your community provide an essential service. If you distribute free seeds on any substantial scale to people who normally buy from a local business, they may stop carrying seed or reduce inventory. What will farmers do in a year or two when you are on furlough for a year or distributing seeds is no longer a priority for you?

5. The seed may be a hybrid. For many vegetables, seed saved from hybrid plants gives unpredictable results and often inferior plants. If farmers do not save their own seed, hybrid seed might be preferred. But if some farmers save their own seed for the next season, they may be hurt next year and you may not even know you caused it.

SAVING SEEDS FROM HYBRIDS? [The following is based on an article in International Agricultural Development July/August 1994.] Research aimed at transferring the "apomixis" gene from a wild grass into rice could result in farmers being able to save seed year after year from hybrid plants. Normally the special traits that cause farmers to purchase hybrid seeds are lost if seed from that crop are saved and planted and yields may be low and unreliable. "Plants with the apomixis gene are able to reproduce asexually through their own seeds" (i.e. without cross-pollination). So these seeds would be identical to the original hybrid seed. "Although the apomixis gene occurs in around 300 wild plants, it is rare in crops of economic importance. Wild plants are so different that scientists have had little success in transferring their genes into domesticated crops."

Scientists at CIAT in Colombia have identified "markers" for apomixis in a grass called brachiaria and confirmed that in this

grass a single dominant gene controls apomixis ("This is a little like finding the road signs"). When the gene is found, the next step is to clone it into unrelated crops. "Cloning may take 3-5 years."

BAMBOO BREEDING. Have you ever thought how frustrating it would be to be a graduate student in plant breeding studying bamboo? You could only make the crosses between varieties when they flowered. In bamboo, flowering occurs most commonly after 30 years, but can be on other multiples of 15, even 120 years for different species. Then there is the problem that the two varieties you wanted to cross might not flower at the same time. That is why this terribly important plant has never been improved by plant breeding.

Dr. Larry Butler at Purdue University alerted us to a breakthrough (*Nature*, vol. 344, p 291, 1990). Researchers have found that "tissue cultured shoots from bamboo seedlings

on medium supplemented with cytokinin [a plant hormone] and coconut milk flowered ... after only three subcultures." The varieties they work with would normally flower after 30 years. Similar advances have been found with other species. For example, date palm shoots can be made to flower in five months after tissue culture rather than the usual 9 years.

There should now be "an explosion of new types [of bamboo]...". There is plenty of variation to chose from in making crosses. "Leaves, for example, vary between species from great sheets 4.15 meters long and 30 centimeters wide (on a plant only 3 meters high) to hair-like threads." "Bamboo hay has four times the protein content of hay from grasses and paper from bamboo is much better than newsprint."

WHERE CAN I FIND SEED FOR BREADFRUIT? We were recently asked that question. Actually breadfruit does not produce seed. It must be propagated asexually. On a recent

trip to Malaysia, however, I learned from Dr. Lee Ming Yong at the Tenom Agricultural Experiment Station that they are able to V-graft breadfruit onto breadnut trees. The breadnut has a lot of seeds.

HOW TO PRODUCE CARROT SEED WHERE WINTERS ARE NOT COLD. We often hear from people in our network who want to do gardening projects, but who are frustrated because seeds are not available in local stores or people cannot afford the seeds.

We have become so dependent on seed companies that we forget they have only been around a century or so. Except for situations where weather interferes with the harvest, there should be no need to purchase seed for any non-hybrid vegetable that produces seed in your garden. Just save your own seed. (Seeds saved from hybrid plants usually give unsatisfactory results, which is why we do not recommend

hybrid plants for most situations. Because it is difficult to tell if a seed-containing vegetable in the local market has been grown from hybrid seed, it is safer to start with known non-hybrid seed. On the other hand, local produce may have been grown from especially well adapted varieties passed on from generation to generation, so it may be worth a try.)

There is a tendency for people who grew up in temperate climates to think only of vegetables that were popular there. Do not forget that the bulk of vegetables in a tropical garden should probably be what I refer to as "plants that God created for that climate." However, the temperate vegetables are good and often bring premium prices if a way can be found to obtain seed and to grow them.

Not every temperate vegetable will produce seeds in the tropics. If the following grow in your community, you should have no problem saving your own seed: pumpkins, squash,

eggplant, cucumber, lettuce, peppers, corn, radish, or tomato. You will probably need to purchase onion, leek, carrot, kale, beet, and cabbage seed. However, if you are willing to do some extra work, there is a way to produce carrot seed in most climates where carrots will grow. [ECHO has seed of the Uberlandia carrot which produces seed in one season in the tropics. However, this carrot is presently not selected enough to be of immediate commercial value: there is much variation in the carrots and the quality is generally lower than commercial carrot varieties.] The Beta III carrot from ECHO is not a hybrid, so you can use it to produce your own seed. The following is abstracted from a bulletin provided by Dr. Simon, who works extensively with carrots.

Carrots do not produce seed in the tropics because they are biennials. Carrots need two growing seasons with a period of cold (vernalization) in between. To produce seed, first grow plants and harvest roots as you normally would. Discard or eat

any that are not "ideal" carrots. Pencil-sized roots will do, but larger roots are preferable.

Trim the tops back to 2-4 cm, trim off lateral and fibrous roots, gently wash off the soil, and remove any yellowing leaves. Let the carrots dry on a shelf out of the sun until no surface moisture remains, pack in paper bags with an equal volume of wood shavings, and place in closed polyethylene bags in the refrigerator (2-5 C). After several weeks when water droplets accumulate inside the plastic bags, puncture the bags.

Even with all these precautions, carrots are very susceptible to infection during storage. In commercial production the roots are dipped in fungicide before vernalization, but this is dangerous unless you are CERTAIN that no one will be tempted to eat the carrots.

The next season plant the vernalized roots, taking care to

keep them well-watered but not in standing water. Seed stalk development will be evident in 4 to 6 weeks. It is very difficult to produce carrot seed where warm humid climates favor microbial growth. Control of fungal diseases and insect pests is essential. If the wild carrot, queen anne's lace, grows nearby, it will cross and yield white-rooted plants.

Pollination is by bees or flies. Alternatively, pollen movement is possible by hand or brush, but seed set will often be low. Within 4-6 weeks after pollination the developing seed turns brown. Before the seed shatters, harvest and place into paper bags to dry completely. If rains occur just before harvest, the yield of seed can be reduced drastically. Perhaps you can adjust planting time to increase the likelihood of dry weather while seeds are ripening. Remove spines from dry seed by rubbing. Because carrot seed requires no dormant period, the seed is now ready to plant. Store dry seed in a moisture-proof container in a refrigerator if possible.

HOW FAR APART MUST CORN BE KEPT TO PREVENT CROSS-POLLINATION BY OTHER LOCAL VARIETIES? Ray Vander Zaag in Haiti asked this question because he wanted to increase seed for the high lysine corn. I referred to Agricultural and Horticultural Seeds for the following summary. Because corn is pollinated by the wind, a considerable distance is required to eliminate the possibility of cross-pollination. In U.S. seed production, different varieties are isolated at least 180 meters, though the distance depends on normal wind velocity in the area. In South Africa varieties are kept 360-740 meters apart.

Natural barriers such as tall trees are useful, and give extra safety in case of very strong winds. Often several rows of the same variety are planted around the field as "border rows." The seed from these border rows are used as food, but not saved for seed. A good general practice would be to harvest seed from the interior parts of the field if neighboring farmers are growing other varieties of corn.

If the ideal distance cannot be maintained, you can reduce the required distance by either (1) increasing the size of your field or (2) planting several border rows. For example, a 16 hectare field requires 165 meters separation from other varieties and a 4 hectare field 200 meters. The effect of having several border rows can be dramatic. The same 16 and 4 hectare fields with 13 border rows require only 15 and 50 meters separation, respectively.

GROWING GARLIC. Why is garlic grown using vegetative material rather than seeds? The Asian Vegetable Research and Development Center (AVRDC) publication Centerpoint says it is because of sterility in garlic. This limits scientists' ability to improve the plant as well. Recently AVRDC scientist Dr. C. S. Pathak found garlic clones that flower. So far, eight clones of this flowering type have been collected in Taiwan, but pollen fertility was noted in only one. Hand-pollination resulted in excellent fruit development with healthy embryos. "This points

to the possibility of seed production in tropical garlic."

Laura Raab wrote from Kenya: "Some time ago I asked you how to get garlic to sprout and you referred me to Dr. Pathak with AVRDC in Taiwan. His answer is so simple that I thought it might benefit others. He said that the problem in sprouting garlic cloves may not be dependent only on temperature. The age of the bulb is equally important. If bulbs are freshly harvested, it is very difficult to get them sprouted. Bulbs which have been stored for 3-4 months will easily sprout once you put them in soil."

SAVING YOUR OWN LETTUCE SEED. Beth Adams and Mike Fennema in Haiti had decent production with three varieties of lettuce, but some started to go to seed. They asked whether they needed to be concerned about cross-pollination between varieties and for suggestions on harvesting. A frequent problem with lettuce in the tropics, or during hot weather

anywhere, is that the plants quickly bolt (send up seed stalks). That is actually good news for seed production, as long as rainfall and humidity are not so high that the seeds are damaged. If the variety performed reasonably well for you, and was not a hybrid, it should not be difficult to save your own seed. The following is excerpted from Agricultural and Horticultural Seeds.

Lettuce is mainly self-pollinated, but there can be 1-6% cross-pollination by insects. For pure seed production different varieties should be isolated by at least 30-60 meters OR separated 2-4 meters by a thick fence or tall- growing crop. The seed stalk may not be able to emerge from varieties with compact heads. In such cases the heads can be removed or cut in quarters with a sharp knife when mature.

Seed ripens unevenly and fully mature seed shatters readily. For large scale seed production it is advisable to harvest when

30-50% of the seeds in heads show white fluff. Heads are left on the ground for a few days to dry. In the U.S.A. plants are cut and windrowed when most flower heads are still yellow, and left to dry. These are later harvested with a combine. For hand harvesting, people either pick individual flower heads as they ripen or bend plants into a large bag and shake gently to remove ripe seed.

ECHO intern Karen Ebey found an easy way to separate the tiny black seeds of lettuce from the fluffy material to which they are attached. She placed the freshly harvested material in a cup and stirred briskly with a fork. The seeds quickly settled to the bottom. Seeds can be stored up to six years in a cool, dry place. In the tropics it can be stored in airtight containers for six months if thoroughly dried first to a moisture content of 8-10%.

ONION VARIETY TRIAL. Dr. Lesley Currah has put together

seed for a large onion variety trial that she sends to researchers around the world. Most members of ECHO's network would not have the resources to qualify to participate in such a large trial. However, she has sent one trial for ECHO to subdivide and make mini- trials available to you. We divided them into sets of six varieties each. We will send two sets at no charge to development workers assisting peasant farmers or to university researchers. When you report the results you can request another set. She asks that you be sure to include the best local varieties in your trial for comparison.

Dr. Currah is interested in learning how the onions grown from these seeds perform in many different environments. If you are willing to take some careful data, indicate this in your letter. We will then send some special report forms that she has provided, rather than ECHO's general forms. Formal researchers who need both more varieties and more seeds of each, write to Dr. Currah directly to inquire about joining her

onion research network: Horticulture Research International, Wellesbourne, Warwick CV35 9EF, UK; fax 0789-470552.

THE SOLO PAPAYAS ARE GREAT, BUT... We received a request from Honduras wanting to know where they could purchase several pounds of solo papaya seeds. Solo papayas have two (at least) special characteristics: (1) Each tree produces fruit, so you do not have to worry about whether a tree is a male or female and (2) the fruit are grapefruit-sized, about the right size for one meal and by far the most popular size in the U.S. market.

I understand the urgency to grow something on a large scale and take advantage of an export market. However, as a scientist I am always cautious about doing anything on a large scale until the new species or variety has been tried under local conditions. The solo papaya is at special risk, including the definite possibility of a serious crop failure. Though a

failure might not occur right away, it would always be a threat. I called Dr. Carl Campbell at the University of Florida experiment station for more details.

Dr. Campbell said that papaya ring spot disease is a serious problem here in Florida and is definitely present in Honduras. Because the solo types are so popular on the export market, people are planting them in the Caribbean in spite of the threat of disease, but may have to cut them down and replant every year or two. They apparently think the superior market price is worth it.

There is a resistant variety, however, called the Cariflora. It was developed at the experiment station in Florida. Dr. List, the man in charge of this research, said there is heavy disease pressure in Central America, both with the ring spot and a couple other viruses. Solo papayas do not do well there at all. He has only seen virus-free solo papayas in one location in

Central America (in Costa Rica). He felt our friend would probably not even get a crop. One man in Costa Rica who tried many varieties had to cut down the solo varieties without a harvest.

Because these virus diseases seem to attack cucurbits (e.g. cucumber), it may be difficult to grow solo papayas if there are serious cucurbit virus diseases in the area. Ordinary solo papayas have been taken out of production now in Taiwan. They currently grow only the Cariflora. It is about grapefruit size, neither as small nor as sweet as the solo. However, it is close to the general size demanded in U.S. markets. ECHO has a small quantity of seed in our seedbank to share with people overseas. By the way, the regular solo papayas do great for us here in southwest Florida and just might for you as well. You can order seed inexpensively from the Seed Program, Dept. of Horticulture, University of Hawaii, 3190 Maile Way, Room 112, Honolulu, Hawaii, 96822, USA.

MALAYSIA EXOTICA PAPAYA (Overseas network only). I toured agricultural research stations in Malaysia with a group. I especially enjoyed the papaya we were served by Dr. Tony Lamb at the Tenom Agriculture Experiment Station.

The "solo" sunrise papaya from Hawaii that is so successful commercially does not do exceptionally well in Malaysia. (It also does not do well in many parts of Central America and the Caribbean, where it is badly affected by virus diseases.) However, the solo has many positive characteristics. Every tree will bear fruit, in contrast with most papayas for which half of the trees are males which bear nothing. The fruit is small enough (grapefruit size) that the entire fruit can be used without the need to store leftovers. The flavor is good and there is no objectionable smell.

So the sunrise solo was crossed with suban, a local Malaysian papaya, then backcrossed again to solo. The resulting fruits

have a deep orange color and great taste and smell. The trees are better adapted to the heat and other conditions in Malaysia.

We can share some small packets with our network. If they do well for you, you can keep the line pure by harvesting seed only from the hermaphroditic fruit (same flower has both male and female parts). Dr. Lamb said that if you plant seed from a hermaphroditic papaya, $\frac{1}{3}$ of the trees will be female (F) and $\frac{2}{3}$ will be hermaphroditic (H). (Half of the trees grown from seeds of female solo trees pollinated by solo trees will be $\frac{1}{2}$ F and $\frac{1}{2}$ H. Trees grown from seeds of a female solo pollinated by a male tree will be $\frac{1}{3}$ each H, F, and M.) At the research station trees are marked either F or H, then seed is saved only from the H trees. Hermaphroditic fruits bring a better price too. They are oblong with a small seed cavity compared to fruits of female trees which are round with a large seed cavity.

WHY IS THERE SUCH HIGH TURNOVER IN THE TREE SEED BUSINESS? Starting a tree seed company would be one of my last choices if my goal were to make money. The reasons for my opinion may also explain why there are so few companies that specialize in this for a long period of time.

The market for seed of a particular tree is impossible to predict. Much depends on what publicity that tree has recently received or what the latest research results have been. In a given year, one group may receive a grant to do a large project and decide to order a large quantity of seed for a particular tree-but perhaps no other group in the world is making a large planting of that tree that year. The storage life of tree seeds ranges from a few weeks to years, and in some cases no one even knows.

About the only way to keep the company's inventory under control and still assure the customer of quality seed is to

collect seed after receiving the order. This is the policy of many companies, so do not be surprised if you cannot just mail off a check and receive seed in a few weeks. Especially if you have a large project, be prepared to make your order months ahead of the time you will need the seed. If seed comes from stock on hand, be sure to ask when it was harvested, how it was stored, and the life expectancy of the seed.

ROY DANFORTH AND PAUL NOREN'S TROPICAL FRUIT TREE PROJECT IN ZAIRE. [Excerpted from their December 1990 "Zaire Rare Fruit Newsletter."] The agroforestry project has suddenly captured the interest of the Zairians like never before! Nurseries have been established in selected villages for a faster method of fruit tree distribution. This has proven very successful as many of these villages have trees planted every- where: people's yards, school or church yards, etc. They cannot keep up with the demand. The interest in fruit

trees is on the rise because food is more scarce, because some of the trees are starting to fruit, and the growers really enjoy the new tastes! Rollinias, jackfruits, star apples and canistels are coming into production and are immediately becoming favorites with the Zairian people.

Seed is available on an exchange basis [though it is hard to imagine that anyone would have something that Roy and Paul still need!] or payment of one U.S. dollar per small packet. [Ed: I'm sure they will lose money at \$1 per packet, so be generous if you can. ECHO seeks special funding to give things to our network, but Roy is one of you, which means that his funding is for work in his community.]

I am taking the liberty of listing just a few of the trees for which he is offering seed. The number(s) in parenthesis show the month(s) during which seed can typically be collected; e.g. (12-3) means December through March. Get orders in early so

they can plan to collect what you need. His list contains many, many more trees that are not yet fruiting, that are lesser known or that are reforestation species. To get a copy of his list, write Roy Danforth, B.P. 1377, Bangui, CENTRAL AFRICAN REPUBLIC.

Achras sapota, Sapodilla (4); *Adansonia digitata*, Baobab (8); *Anacardium occidentale*, Cashew (12-3); *Artocarpus altilis*, Breadnut (most); *Artocarpus heterophyllus*, Jackfruit (most); *Averrhoa carambola*, Carambola (most); *Cinnamomum zeylandicum*, Cinnamon (rare); *Coffea* spp. (*liberica*), coffee (1-2); *Coffea robusta*, Coffee (10 & 1-2); *Coffea arabica*, *C. arabica* x *C. robusta*, Coffee (most); *Cola acuminata*, kola nut (most); *Elaeis guineensis*, Oil palm (most); *Eriobotrya japonica*, Loquat (8); *Garcinia livingstoneii*, Imbe (all); *Garcinia mangostana*, Mangosteen (7,8); *Macadamia tetraphylla*, *Macadamia* (1- 2); *Morus indica*, Mulberry (most); *Muntingia calabura*, Strawberry tree (most); *Murraya koenigii*,

Curryleaf tree (most); *Nephelium lappaceum*, Rambutan (8-9); *Passiflora* spp., passion fruit (most); *Pouteria caimito*, Abiu (6); *Psidium* spp., Guava spp. (8); *Theobroma cacao*, Cocoa (8-12); *Treculia africana*, African breadnut (8); *Zizyphus mauritiana*, Indian jujube (8).

MORE SEED SOURCES. It is very difficult to keep current information about seed companies. Unless they regularly send us new catalogs, we cannot be sure they are still in business or in the same location. We appreciate it when our network lets us know of their experiences with buying seed or plants: reasonable prices, helpful service, prompt delivery, quality of the plants, etc. If you try to contact a company listed here without success, please let us know that as well. The following list includes the most current information we have on seed or plant suppliers. If you cannot find sources of the seed you need through these groups, we can try to locate another source for you. Continue to let us know of more sources.

Wide selection and vegetables. The Inland & Foreign Trading Co. (Block 79A, Indus Road #04-418/420, Singapore 0316; phone 2722711; fax 2716118) is an excellent source of leguminous cover crop and pasture species (specialty), fruit trees, ornamental and flowering trees, and more. J.L. Hudson, Seedsman (Star Route 2, Box 337, La Honda, CA 94020, USA) offers a tremendous variety of seeds in the "Ethnobotanical Catalog of Seeds," including agroforestry species, unusual vegetables, flowers and ornamentals, and plants used medicinally, in small packets and at very reasonable prices. Seed Savers Exchange (3076 North Winn Rd., Decorah, IA 52101, USA) members maintain a tremendous variety of rare heirloom vegetable, herb, fruit, and other seeds. Native Seeds/SEARCH (2509 N. Campbell Ave. #325, Tucson, AZ 85719, USA; phone 520/327-9123; fax 520/327-5821) offers a 50% discount to native peoples on their tremendous selection of amaranth, beans, chili peppers, corn, cucurbits, okra, tomatoes, flowers, and more, suitable for very hot and

dry conditions; some are adapted to higher altitudes as well. High Altitude Gardens (P.O. Box 1048, Hailey, ID 83333, USA; phone 208/788-4363; fax 208/788-3452; e-mail higarden@micron.net) specializes in frost-tolerant, quick-maturing varieties for cold climates; their catalog lists over 300 varieties of vegetables, plus herbs, wildflowers, and grasses. The University of Hawaii (Seed Program, Department of Horticulture, 3190 Maile Way, Room 112, Honolulu, HI 96822, USA; they only ship to US addresses; phone 808/956-7890) offers high-quality seed of select varieties of solo papaya, pole bean, lettuce, sweet corn, eggplant, tomato, and other vegetables. Shivalik Seeds Corporation (47, Panditwari, P.O. Premnagar, Dehra Dun-248 007 (U.P.), INDIA; phone 91-135-683 348; fax 91-135-29944) offers seeds of a wide range of (agro)forestry, medicinal, horticultural, ornamental plants. CIMMYT (Centro Internacional de Mejoramiento de Maz y Trigo, Lisboa 27, Apartado Postal 6-641, 06600, MEXICO D.F.) has improved varieties of corn and wheat, including Quality

Protein Maize. Plants of the Southwest (Agua Fria, Rt. 6 Box 11-A, Santa Fe, NM 87505, USA; phone 505/471-2212; fax 505/438-8800) has corn, cover crops and vegetables for arid gardens. Richters Herb Specialists (Goodwood, Ontario LOC 1AO, CANADA; phone 905/640-6677; fax -6641; e-mail orderdesk@richters.com) has a very complete herb listing. Tomato Growers Supply Co. (P.O. Box 2237, Fort Myers, FL 33902, USA; phone 941/768-1119; fax -3476) has a huge selection of tomato and pepper varieties. Twilley Seed Co. (P.O. Box 65, Trevoise, PA 19053, USA) has common temperate vegetable and flower seeds. Pax World Service compiled a list of 36 non-profit international seed distributors in 1996; write them at 1111 16th St., NW, Suite 120, Washington, D.C. 20036, USA; phone 202/293-7290; fax 202/293-7023; e-mail paxwldsvc@aol.com; web site <http://members.aol.com/paxwldsvc>.

Fruit trees. ECHO has an Edible Landscape Nursery, which

includes many varieties of tropical fruits. ECHO does not ship plants at all, but if you visit us en route overseas, you might be able to take a few plants or cuttings with you. The Pacific Tree Farms (4301 Lynwood Drive; Chula Vista, CA 91910, USA; phone 619/422-2400) has quite a listing of grafted or air-layered tropical fruit trees, NOT SEEDS, for sale. They are expensive (average US\$38). However, if you want one tree of a particular variety to provide you with budwood in a year or two, they may be the answer. They will ship overseas, but that will be expensive too. The Chestnut Hill Nursery (Rt. 1, Box 341, Alachua, FL 32615, USA; phone 800/669-2067 or 904/462-2820; fax 904/462-4330) specializes in chestnuts, persimmons, and temperate/subtropical fruits (apple, pear, peach, fig, grapes, blueberry, citrus, berries, etc.) and nuts at reasonable prices. Peter B. Dow & Co. (P.O. Box 696, Gisborne 3800, NEW ZEALAND) is listed in Cornucopia as a source of fruit tree seeds. Fruit Spirit Botanical Gardens (Dorrroughby, N.S.W., AUSTRALIA 2480; phone 066 895 192) has a very

extensive listing of tropical fruits and nuts, gingers, and other plants. Small packets are A\$5, and bulk seed is available. The Borneo Collection (Treefarm, El Arish, North Queensland 4855, AUSTRALIA) has South American, Southeast Asian, and Borneo species available seasonally. CATIE (Centro Agronomico Tropical de Investigacin y Enseanza, BLSF, Turrialba, COSTA RICA) supplies fruit and forest trees.

Pasture and/or tree seeds. Samuel Ratnam, the director of The Inland & Foreign Trading Co. (see above), sent us a 2-page listing (prices only upon specific inquiry) of pasture, cover crop and shrub/tree seeds, which they have marketed for 40 years, especially to plantations, ranches and reforestation programs. Many pasture grasses and legumes are available from Frank Sauer and Sons (P.O. Box 117, Rockhampton 4700, Queensland, AUSTRALIA). The Australian Revegetation Corporation (Kimseed; 42 Sarich Court, Osborn Park 6017, Western Australia; phone 09-446-4377; fax 09- 446-3444)

catalog lists over 200 different species of Acacia, 19 species of Casuarina, over 500 species of Eucalyptus, and much more. Tropical, subtropical and temperate grasses and legumes for pastures and ground covers are also listed; for example, they have 9 species (29 varieties) of Trifolium (clovers) and 9 varieties of Medicago (alfalfa). M.L. Farrar PTY. LTD. (P.O. Box 1046, Bomaderry NSW 2541, AUSTRALIA; phone 044-217966; fax 044-210051) has a huge selection of trees. Agroforester Tropical Seeds (P.O. Box 428, Holualoa, HI 96725, USA; fax 808/324-4129; e-mail agroforester@igc.org) sells seed and also produces Rhizobium inoculants. The Australasian Tree Crops Sourcebook (1994; A\$12 from Granny Smith's Bookshop, P.O. Box 27, Subiaco, WA 6008, AUSTRALIA; fax 61-9-385-1612) is full of information on fruit, oil, and nut crops, and organizations of tree crop growers.

The Henry Doubleday Research Association (Ryton-on-Dunsmore, Coventry CV8 3LG, UK; phone 01203-303517; fax

01203-639229; e-mail pharris@hdra.demon.co.uk; Attn. Dr. Phil Harris), a registered charity in the United Kingdom, makes available easily understood information and advice on tropical organic agriculture to farmers, NGOs, self-help groups, schools, and other organizations in developing countries, helping them function more effectively in their extension, demonstration, and education roles. The HDRA also assists groups in selecting tree species for their required purposes, providing technical and practical details for their cultivation and use. Where available, they may provide small quantities of tree and shrub seed for local evaluation. Lusume Services (P.O. Box 42, Magoye, ZAMBIA) has a variety of multipurpose and fruit tree seeds at reasonable prices. For the Latin American Bank of Forestry Seeds, write to CATIE Seedbank, Box 111, Turrialba 7170, COSTA RICA. The Endangered Species (P.O. Box 1830, Tustin, CA 92680, USA; phone 714/544-9505; fax 714/669- 0740) catalog lists 140 kinds of bamboo and 105 palms (plants only). SETROPA (P.O. Box 203,

1400 AE Bussom, HOLLAND; phone 31/2152-58754; fax 31/2152-65424) has many tree seeds, with some legumes and grasses. Green Gold International (14071, Street 5, Prabhat Nagar, Dholewal, Ludhiana-114 003, INDIA; phone 91-1662-32326; fax 91-161-401513 or 91-1662-32120) specializes in seed and wax-sealed cuttings of neem; about 300 tree species are in their catalog.

Dr. Jean Hanson, head of ILCA's Forage Genetic Resources Section wrote, "The ILCA genebank holds about 12,000 accessions of a wide range of forage legumes, grass and fodder tree species. Small experimental quantities of seeds are available free of charge for forage research and development workers. It usually takes up to a month to fill seed requests." For large projects, they publish a catalogue in 3 volumes. Volume 1: multipurpose trees and large shrubs; Volume 2: tropical lowland forages; Volume 3: temperate and tropical highland forages. "ILCA also has a Herbage Seed Unit that can

provide larger quantities of a limited range of species to begin local forage seed multiplication programmes. You may wish to mention our service in your newsletter so that readers can write to request seeds." We have always found the people at ILCA to be very responsive and open to helping development workers. If you are having trouble finding something, keep them in mind. (Note: in 1996, ILCA merged with ILRAD-Kenya to form ILRI, the International Livestock Research Institute. We hope these same services are still available. The address is P.O. Box 5689, Addis Ababa, ETHIOPIA.)

If you still cannot find what you want, the FACT Net (see Chapter 4 on Multipurpose Trees) has addresses of other commercial tree seed companies, including a two-page listing of tree seed companies in the Pacific. Remember to order well in advance of planting date, because tree seed companies often must fill orders from the next harvest.

19/10/2011

meister11.htm

