

Guidelines for slaughtering, meat cutting and further processing

[Contents](#)

The designations employed and the presentation of material in this publication do not imply the expression of any opinion whatsoever on the part of the Food and Agriculture Organization of the United Nations concerning the legal status of any country, territory, city or area or of its authorities, or concerning the delimitation of its frontiers or boundaries.

M-72
ISBN 92-5-102921-0

All rights reserved. No part of this publication may be reproduced, stored in a retrieval system, or transmitted in any form or by any means, electronic, mechanical, photocopying or otherwise, without the prior permission of the copyright owner.

Applications for such permission, with a statement of the purpose and extent of the reproduction, should be addressed to the Director, Publications Division, Food and Agriculture Organization of the United Nations, Via delle Terme di Caracalla, 00 100 Rome, Italy.



FOOD AND AGRICULTURE ORGANIZATION OF THE UNITED NATIONS
Rome, © FAO 1991

Hyperlinks to non-FAO Internet sites do not imply any official endorsement of or responsibility for the opinions, ideas, data or products presented at these locations, or guarantee the validity

of the information provided. The sole purpose of links to non-FAO sites is to indicate further information available on related topics.

Contents

INTRODUCTION

GENERAL HYGIENE RULES FOR FACILITIES, EQUIPMENT AND PERSONNEL IN THE MEAT INDUSTRIES

Facilities

Equipment

Personnel hygiene

Routine cleaning of rooms and equipment

GENERAL HYGIENE PRINCIPLES FOR MEAT HANDLING

Effect of bacterial growth on the shelf-life of meat and meat products

Effect of contamination on sensoric properties of meat and meat products

Food poisoning

TECHNIQUES AND HYGIENE PRACTICES IN SLAUGHTERING AND MEAT HANDLING

Equipment

Treatment of livestock before slaughter and its impact on meat quality

Stunning and bleeding of slaughter animals

Scalding and dehairing of pigs (using simple equipment)

Skinning of cattle and small ruminants

Evisceration

Splitting, washing and dressing of carcasses

Refrigeration, handling and transport of carcasses and meat

MEAT CUTTING AND UTILIZATION OF MEAT CUTS

Variations in the sensoric quality of meat

Equipment for the meat-cutting operation

Beef cutting

Pork cutting

Lamb cutting

Hygiene rules for marketing chilled meat cuts

Cooking methods for different meat cuts

MEAT AS RAW MATERIAL, NON-MEAT INGREDIENTS AND BASIC TECHNIQUES IN FURTHER PROCESSING OF MEAT

Types of animal tissue suitable for meat processing

Simple standards of different qualities of meat used as raw material for different product qualities

Salt, curing agents, common spices, additives and natural smoke

Principles of heat treatment for non-sterilized products

Raw or cooked meat products fabricated from entire meat pieces

Meat products fabricated from comminuted meat, fat and offal

Meat extenders

Casings

Hamburger-type products

Dry sausages

Cooked sausages

Simple canning

Tables

Table 1

Effect of initial contamination on the storage life of lean beef

Table 2

Relationship between storage temperature and slime development

Table 3

Comparative differences in various compositional aspects of market-weight beef, pork and lamb

Table 4

Approximate chemical composition of different qualities of raw materials

Table 5

Typical concentration of salt in some meat products

Table 6

Typical amounts of nitrite and nitrate in cured products

Table 7

List of common spices used in sausage seasoning

Table 8

Influence of temperature and time of heat treatment on cured-meat colour development in bologna

Table 9

Heat treatment of different meat products

Table 10

Ingredients necessary for preparing curing brine for manufacturing regular hams, soyand water-added hams and ham imitations

Table 11**Raw material composition of regular hams, soy- and water-added hams and ham imitations****Table 12****Typical chemical composition of different soy products****Table 13****Different diameters of small intestines****Table 14****Common composition of hamburger-type products****Table 15****Typical composition of some dry sausages and salami****Table 16****The most important parameters in manufacturing dry sausages****Table 17****Raw materials suitable for manufacturing cooked sausages made of uncooked material****Table 18****Casings used in manufacturing cooked sausages made of uncooked raw materials****Table 19****Typical composition of different types of cooked sausage made of uncooked raw materials****Table 20****The most important parameters in manufacturing emulsion-type cooked sausages made from uncooked raw**

materials

Table 21

Typical composition of cooked sausages made of precooked raw materials



Introduction

The activities of the meat sector may be divided into three stages - slaughtering, meat cutting and further processing. Each stage involves completely different technical operations which must not be viewed as separate and independent processes. There are significant interactions between the stages and shortcomings at one stage can have a serious negative impact on the product or process in a subsequent stage. They may influence technological, biochemical or microbiological aspects.

Improper slaughtering techniques such as faulty stunning, bleeding, skinning, evisceration and carcass splitting can damage parts of the carcass and certain byproducts and make them unsuitable for further use. Poor standards of hygiene during slaughtering or carcass handling result in high levels of microbial contamination in the meat, thus reducing the shelf-life and adversely affecting the sensoric properties of products fabricated from this raw material. Although controls imposed on the meat industries have become more stringent and effective, improper treatment of slaughter animals and poor meat-handling techniques persist in many meat plants. These problems are evident in many developing countries. Apart from deficiencies in veterinary meat inspection, which is not the subject of this publication, serious shortcomings with regard to general meat hygiene and meat technology can frequently be

observed. This is to some extent due to the lack of adequate facilities in the meat sector in developing countries, but carelessness and lack of skills on the part of the personnel involved in meat operations are also important factors.

The purpose of these guidelines is to disseminate practical information on meat hygiene and meat technology to meat industry personnel, such as supervisors and extensionists, and to provide the necessary encouragement for improving production in the meat sector and reducing post-harvest losses. The guidelines comprise basic techniques in slaughtering, meat cutting and further processing and the respective hygienic regulations applicable to both the small-scale and the medium-sized meat plants. Adherence to these basic guidelines would contribute to the production and consumption of safe, good-quality meat and meat products.

Since there is a wide variety of procedures and products in the meat sector all over the world, some technologies and names of meat cuts and meat products known locally may differ slightly from the terms and descriptions used in this publication. However, the technological, microbiological and biochemical properties of the raw material (meat) do not vary significantly and the guidelines given in this publication can easily be adapted to local conditions.

Where appropriate, reference is made to the traditional meat-handling methods without refrigeration, since these conditions are likely to prevail in the near future in many developing countries, particularly in rural areas. On the other hand, in view of the growing populations not only in urban but also in rural areas, refrigeration as a means of meat preservation will become more and more important and information on these aspects is included. Refrigeration of meat will also have a positive impact on the introduction of further processing of meat in developing regions, since refrigerated meat under suitable hygienic conditions is essential for most meat-processing operations.

Furthermore, the strict adherence to general hygienic rules in the meat industry can minimize food-borne diseases. These guidelines can therefore also play a useful role in the public health sector.

The publication is based on contributions from the following authors:

J.J. Sheridan and P. Allen, National Meat Research Institute, Dunsinea (Ireland): *Hygienic slaughtering and meat handling*;

J.H. Ziegler, Meat Laboratory, Pennsylvania State University, Philadelphia (USA) (retired): *Meat cutting*;

M. Marinkov and M.D. Suvakov, Institute for Meat Technology, Belgrade (Yugoslavia): *Meat processing*.

The technical editor is G. Heinz, Senior Officer (Meat Technology), FAO, Rome.



General hygiene rules for facilities, equipment and personnel in the meat industries

It is essential that all meat-processing operations, whether slaughtering, cutting or further processing, be carried out in a clean area and, as much as possible, that the products be

protected from contamination from all sources.

When meat-processing operations are carried out within a facility specifically built and maintained for meat processing, sources of contamination can be much more easily and adequately controlled. The following requirements are considered essential to good sanitary preparation of meat and meat products.

FACILITIES

***Floors.* Brick, tile, smooth concrete or other impervious, waterproof materials are suitable for floors. In some areas wooden floors will suffice if they are tight, smooth, in good repair and properly maintained. Wooden floors are not suitable in areas where slaughtering or curing takes place and meat juices and moisture collect.**

***Drains.* To carry away waste liquids, there should be sufficient drains of the proper size that are correctly located, trapped and vented. All floors should be sloped toward the drains. Generally for adequate waste disposal, one drain is needed for each 18 m² of floor space in slaughtering areas, and one drain for each 46m² in processing and other areas.**

***Walls.* Glazed tile, smooth cement plaster, rustproof metal panels and smooth plastic panels that are properly caulked are all acceptable for walls in processing and refrigerated areas because they can all be effectively cleaned and sanitized. Other materials are also acceptable if they can be satisfactorily cleaned. In no instance should walls be made of materials that absorb moisture or other liquids. Ceilings must be tight, smooth and free from any scaling that may fall into the meat products, and should also be of moisture-resistant materials. All light bulbs should be covered with unbreakable material to prevent broken pieces from falling into the product.**

Doors and doorways. All doorways through which the product must pass, whether suspended on rails or lying on hand trucks, should be wide enough to ensure that the meats never touch the doorways risking contamination. Wooden doors and doorways should be covered with metal with tightly soldered seams.

Water supply. Whether from individually owned and controlled sources such as wells or streams or from a municipal system, the water supply must be potable and abundant cold and hot water must be distributed to all parts of the operation.

Lighting. In all areas where products are critically examined during sanitary control or for cleanliness, 50-foot candles of light should be provided. For adequate visibility 20-foot candles of light should be provided wherever any processing occurs. In all other areas, such as dry storage, there should be sufficient light to keep the area orderly and sanitary.

Refrigeration. The main purpose of refrigeration is to cool the meat down after slaughter and to maintain it in a chilled state for shorter or longer storage periods and for cutting and further processing. If frozen storage is provided and utilized, it should be maintained at the lowest possible temperature for maximum shelf-life. Minus 18° to -12°C is satisfactory freezer storage; however, large quantities of product must either be quickfrozen prior to storage or thinly spread out to facilitate freezing. It is also recommended that all rooms where meat is processed, except in the slaughter and cooler storage areas, should be maintained at a temperature of about 12°C. In facilities where no refrigeration or cooling is furnished in processing areas, the handling of meat products is possible if all equipment contacting the products is thoroughly cleaned and sanitized from time to time (recommended every four hours). Frequent cleaning is necessary because in warmer temperatures bacteria multiply rapidly and the risk of product contamination increases.

EQUIPMENT

The equipment needed for converting livestock into meat products need not be elaborate and expensive. The amount of equipment will depend on the slaughtering and processing procedures employed. If possible, all equipment should be made of stainless steel or plastic, be rust resistant and easily cleaned and sanitized.

All equipment should be constructed of stainless steel, galvanized steel, aluminium or approved plastic. Wooden tables are not acceptable because wood absorbs meat juices and fats and cannot be thoroughly cleaned. Hardwood cutting-boards maintained smooth and free from checks and cracks may be used. Cutting tables covered with other than hard plastic are not acceptable for contact with meat.

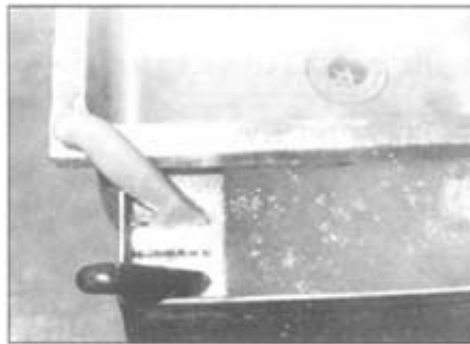

2. A knife sterilizer mounted on a stainless steel sink should contain water at 82°C

1. Sinks for workers' use should be stainless steel with soap dispensers and paper towels at hand. This is an example of a stainless-steel sink with kneeoperated taps. Foot-operated types are also acceptable, but not handoperated types



All other equipment should be of the type that can be taken apart and thoroughly cleaned. Any stationary equipment must be located far enough from walls to permit proper cleaning around and under it.

In all areas there should be conveniently located foot-pedal or kneeoperated wash-basins with hot and cold water, soap and disposable towels (Fig. 1). In slaughtering areas, lavatories should be convenient to the dressing operations. Hot-water containers, either electric or steam-heated to 82°C, should be available for sanitizing tools contaminated with diseased material or other filth during dressing (Fig. 2).

Rails must be located high enough to prevent meat from touching the floor. For beef carcasses, the minimum height for rails should be 3.4 metres, while 2.4 metres is sufficiently high for small livestock such as goats, hogs and sheep. Rails should also be far enough away from fixed objects and walls to avoid contact.

PERSONNEL HYGIENE

Probably as important as anything in the production of clean, wholesome, unspoiled products is the attitude of the workers toward cleanliness. Personnel with clean hands, clothing and good hygienic practices are absolutely essential to the production of high-quality foods.

All clothing should be clean, in good repair and made of washable material. Street clothing should be covered with coats or gowns while handling exposed product. White or light-coloured clothing is most desirable and garments that become soiled or contaminated should be changed when necessary.

All persons working with exposed meat products should have their hair under control, either completely covered with a clean cap or hat or confined by a hairnet to prevent hair from falling into products.

Safety devices such as aprons, wrist guards and mesh gloves must be made of impervious material, clean and in good repair. At no time should leather aprons, wrist guards or other devices be worn unless clean, washable coverings are used over them. Light-coloured rubber or plastic gloves may be worn by product handlers only if clean and in good repair (Fig. 3).

No person working with meats should wear any kind of jewellery, badges or buttons that may come loose and be accidentally included in the product.

Shoes and boots should be worn at all times and should be appropriate for the operations being conducted. They should also be made of impervious materials (Fig. 4). Any aprons, knives and footwear that become contaminated during operations should be routinely cleaned in areas or facilities provided for that purpose.

No cloth twine, belts or other similar materials should be used to cover implement handles or used in other places where they may harbour filth and serve as a ready source of product contamination.

3. Workers must wear clean and protective clothing. Note the hairnet to prevent contamination from loose hairs and the chain-mail apron and glove to protect from knife cuts



4. Footwear should be waterproof so that it can be washed frequently, and always when moving to another part of the factory



All unsanitary practices should be avoided by meat handlers. No one should smoke or use tobacco in areas where edible products and ingredients are handled, prepared or stored, or where equipment and utensils are cleaned. When handling edible products, scratching the head, placing fingers in or around the nose or mouth, sneezing or coughing on the product should never occur. Workers must also guard against contaminating products from localized infections or sores.

Workers can contaminate carcasses and meat through handling, coughing and sneezing. This may cause rapid spoilage of the meat or, more seriously, food poisoning. Coughs and sneezes are a particularly effective way of transmitting bacteria to meat. Transfer of faecal matter either of animal or human origin to the meat is particularly hazardous. Most contamination on the hands of workers in slaughter floors with faecal matter comes from the hides and fleeces.

5. Hands should be frequently washed

6. Particular attention should be paid to

under running hot water and always after cleaning under the fingernails with a brush
visiting the toilet, smoking, coughing or sneezing, handling money, garbage, soiled or infected material



Hands should be washed frequently to remove all visible soiling. Stainless-steel sinks without plugs should be conveniently accessible to all workers. Water should be supplied at approximately 43°C to a simple tap which is foot- or knee-operated. Liquid disinfectant soap and paper towels should be available (Fig. 5). Particular attention should be paid to cleaning under the fingernails (Fig. 6). Hands should also be thoroughly washed after using the toilet, smoking, coughing or sneezing, handling money, garbage or soiled or infected material.

7. The cleaning operation begins with clearing all

debris from the floor



8. All surfaces must be thoroughly washed down at the end of each day



All precautions should be taken to prevent product contamination by visitors or other persons who are simply passing through the work area.

ROUTINE CLEANING OF ROOMS AND EQUIPMENT

The floors should be kept clear of all debris (Fig. 7), such as hooves and horns, in

slaughterhalls or other inedible parts or fat and meat particles in cutting, processing and by-product handling areas, and must be frequently washed down. At the end of each day a thorough cleaning programme should be followed (Fig. 8). All matter should be removed from floors, platforms, gullies, etc., followed by a thorough hosing down of walls, floors and all surfaces to loosen dirt. Finally a strong cleaning solution should be applied and left for a while before being rinsed off. A thorough inspection should be made afterwards and any areas remaining soiled should be cleaned again.

In order to maintain the cleanest possible products a standard cleaning routine of the equipment should be established. Initially all large pieces of refuse material should be scraped or swept together and disposed of. Follow-up should include scrubbing of the equipment using brushes and a soap or detergent and a complete sanitizing with hot water at 82°C and an approved chlorine or iodine rinse. Finally, a coating of light mineral oil can be applied to metal equipment, particularly that not fabricated of stainless steel, to prevent rust.



General hygiene principles for meat handling

Current recommendations for handling all meat products are to keep them clean, cold and covered in order to maintain quality and protect against food poisoning and disease. Generally contamination occurs when the product comes into contact with dirty hands, clothing, equipment or facilities. If the product is kept clean there will be little or no contamination by

microorganisms whether bacteria, yeasts, moulds, viruses or protozoa or by helminths and poisonous chemicals.

EFFECT OF BACTERIAL GROWTH ON THE SHELF-LIFE OF MEAT AND MEAT PRODUCTS

The total viable count of bacteria (TVC) expressed as organisms/cm² or as organisms/g on fresh meat or a meat product sets a limit to its shelf-life. Meat will “spoil” with TVC at 10⁶/cm² because of off-odours. Slime and discoloration appear at 10⁸/cm². The main factors determining the time taken for the TVC to reach these levels are the initial count due to contamination during slaughtering and processing, further contamination during storage, temperature, pH and relative humidity. An example of how the level of contamination affects shelf-life is shown in Table 1.

After cleanliness, keeping meat products cold is the second most important requirement in order to achieve a desirable shelf-life. Microorganisms rapidly proliferate at elevated temperatures and slime development is a definite visual sign of microbial growth. The importance of temperature in the control of microbial growth is shown in Table 2.

Bacteria relevant to meat, meat products and other food are divided into three groups according to the temperature range within which they can grow: mesophiles 10–45°C, psychrophiles 0–28°C and psychrotrophs 10– 45°C, or slow growth at 0–10°C. Mesophiles will not grow below 10°C but psychrotrophs, of which Pseudomonas are the more important, will grow down to 0°C. The nearer to 0°C the storage temperature the slower the growth of the spoilage bacteria and the longer the shelf-life (Fig. 9).

TABLE 1

Effect of initial contamination on the storage life of lean beef

Initial bacterial count (<i>org./cm²</i>)	Days at 0°C before slime development
100 000	8
10 000	10
1 000	13
100	15
10	18

TABLE 2
Relationship between storage temperature and slime development

Storage temperature (°C)	Days before slime develops
0	10
1	7
3	4
5	3
10	2
16	1

Under ideal conditions bacteria double in number every 20 minutes. A single bacterium multiplies to over one million in less than seven hours:

Time
12.00

Number of bacteria
1

12.20	2
12.40	4
13.00	8
14.00	64
15.00	512
16.00	4 096
17.00	32 768
18.00	262 144
18.40	1 048 576

Some bacteria cause product spoilage, others cause food poisoning. The former limit product shelf-life but the latter cause illness. Almost all foodpoisoning bacteria are mesophiles so refrigeration below 10°C offers good protection. Many mesophiles cause spoilage, but since meat is refrigerated most spoilage is due to psychrophiles. Storing meat at temperatures close to 0°C will inhibit the growth of psychrotrophs. Shelf-life will be extended by avoiding contamination through good hygiene practices.

Aerobic bacteria have an absolute requirement for oxygen which limits their growth to the meat surface. Anaerobic bacteria grow within the meat as they need the absence of oxygen. Facultative anaerobes can grow slowly within oxygen but grow better in its presence. Food-poisoning bacteria are anaerobes and facultative anaerobes. The most important spoilage bacteria (*Pseudomonas* spp.) are aerobic.

9. Different types of bacteria

can grow within different temperature ranges

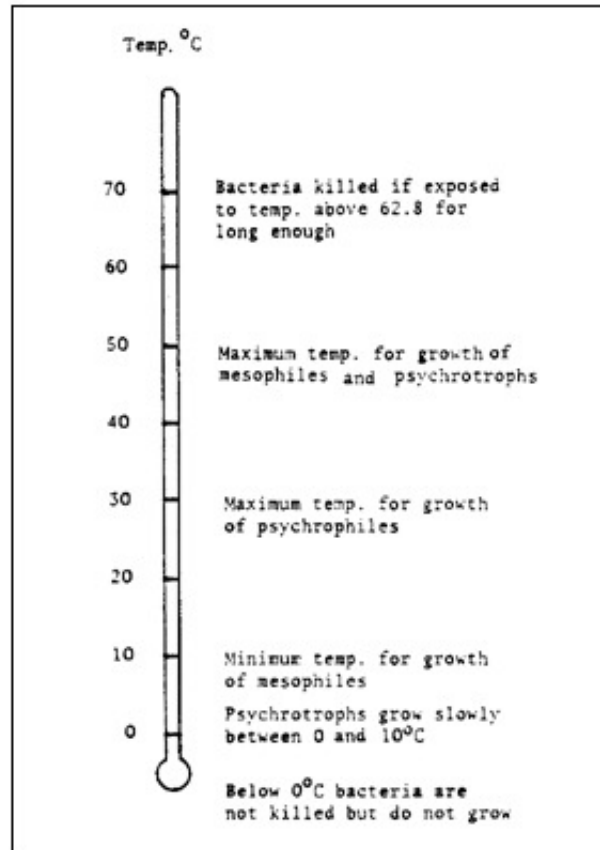

Water is required by micro-organisms so reducing the water available below the optimum level will prolong shelf-life. If meat is stored at a relative humidity (RH) below 95 percent, moisture will be lost from the surface. Since most spoilage bacteria, being aerobic, can grow only on the surface, this surface drying will extend the shelf-life. Moulds (fungi) are able to grow in drier conditions than bacteria so that desiccation has a selective effect on microbial growth.

Meat pH is the level of acidity in meat. Stored sugars are broken down to lactic acid. In living muscle it is near 7.0 (above this is alkaline, below is acid). It falls to 5.4–5.6 within 24 hours.

High final-pH values result when animals are exhausted at slaughter, for instance because of fighting in lairage or transport. Spoilage bacteria multiply rapidly on high-pH meat and shorten the shelf-life. Exhausted animals should be rested before slaughter.

A high TVC resulting from severe contamination during slaughter or processing will shorten the shelf-life even in ideal conditions. It also indicates poor hygiene so that contamination with food-poisoning bacteria is likely.

EFFECT OF CONTAMINATION ON SENSORIC PROPERTIES OF MEAT AND MEAT PRODUCTS

Aerobic spoilage by bacteria and yeasts usually results in slime formation, undesirable odours and flavours (taints). Colour changes, rancidity, tallowy or chalky flavours from the breakdown of lipids may also occur. Colour changes as a result of pigment oxidation may be grey, brown or green discoloration. Aerobic spoilage by moulds results in a sticky surface, musty odours, alcohol flavours and creamy, black or green discoloration.

Anaerobic spoilage which occurs either within the meat or on the surface in sealed containers where oxygen is absent or very limited is marked by a souring due to the production of organic acids and gases.

FOOD POISONING

Food poisoning may be due to infection or intoxication. Infection is caused by the consumption of live bacteria which multiply in the body producing characteristic symptoms. Intoxication is due to toxins in food produced by bacteria before the food was eaten. Toxins are chemical compounds which may linger in food with no microbes growing in it, and are therefore very dangerous.

Salmonellae are facultative anaerobes which cause infectious food poisoning. Ten or 20 cells of *Salmonella typhi* are sufficient to cause typhoid but 10 000 to 100 000 cells of other species may be necessary to cause an infection. Some are host-specific affecting the animal from which the meat was produced but failing to cause infection when consumed by man. Typical symptoms of salmonellosis include diarrhoea, fever and vomiting. The illness may last one to 14 days after a 12 to 24-hour incubation period. Victims may excrete the bacteria for weeks after the symptoms subside. Poor personal hygiene will cause contamination of meat.

***Staphylococcus aureus* is a facultative aerobe that causes intoxication. It lives in the nose, throat, hair and skin and on animal hides. Meat is contaminated by handling and by sneezing or coughing. Minute amounts of the toxin will cause illness, which starts within one to eight hours of eating poisoned food. Nausea, vomiting and shock may last for one to two days. On rare occasions it is fatal. This bacterium does not produce off-odours or spoilage so it cannot be easily checked. Refrigeration will control its growth. Cooking may destroy the bacteria but not the toxin as it is heat stable. It is particularly troublesome in cooked cured meats, normally as a result of recontamination after the curing process in subsequent handling, for instance during slicing.**

***Clostridium botulinum*, an anaerobe, produces the toxin botulin, one of the most poisonous substances known. This attacks the central nervous system causing death by respiratory paralysis. Dormant cells occur everywhere in the soil, fish, animals and plants. High-moisture, low-acid, low-salt conditions at above 3°C favour growth and toxin production. Control measures must destroy spores or prevent growth and toxin formation. Botulism is usually due to undercooking processed meats. Pressure-cooking will give commercial sterility. Pasteurization (heating to 70°C) and adding salt (NaCl) and sodium nitrite (NaNO₂) is used for canned ham. Refrigeration (0–10°C) is essential for vacuum-packed meats. Frozen storage prevents growth.**

***Clostridium perfringens*, an anaerobic bacterium, is a common cause of food poisoning but is rarely fatal. It grows well in warm meats so is usually found in left-over meats that have not been kept chilled and not been reheated to 70°C to kill the bacteria present. The main symptoms are diarrhoea and weakness which last for 12 to 24 hours after an incubation period of eight to 20 hours.**



Techniques and hygiene practices in slaughtering and meat handling

EQUIPMENT

Slaughtering equipment, particularly for smaller-scale operations, need not be elaborate and expensive. The amount of equipment will depend on the slaughtering procedures employed. If possible, all equipment should be made of stainless steel or plastic, be rust resistant and easily cleaned and sanitized. Equipment which does not get in contact with the meat (e.g. overhead rails, working platforms, knocking pen) is usually made of galvanized steel.

Basic equipment needed for the slaughtering operation:

- stunning gun, electrical head tongs or simple stunning equipment for direct blow
- knives:
 - sticking - 15 cm sharpened on both sides

skinning - 15 cm curved

- **a sharpening steel**
- **oil or water sharpening stone**
- **scabbard and belt for holding knives**
- **meat saw - hand or electric and cleaver**
- **block and tackle or chain hoist strong enough to hold the weight of the animal to be slaughtered**
- **pritch, chocks or skinning rack (dressing cradle)**
- **a strong beam, tripod or track 2.4 to 3.4 m from floor**
- **spreader - gambrel or metal pipe**
- **several buckets**
- **working platforms**
- **scalding barrel or tank**
- **pot, barrel or system for boiling water**
- **bell scrapers**
- **solid scraping table or platform**
- **thermometer registering up to 70°C**
- **hog or hay hook**
- **torch or flame for singeing**

The last seven items indicate additional equipment required when hogs are scalded and scraped rather than skinned.

Useful additional equipment:

- **knocking pen**
- **bleeding hooks (for vertical bleeding)**

- **blood-catching trough**
- **wash trough (tripe) Sanitation of hands and tools:**
- **hand wash-basin**
- **implement sterilizers**

Means should be available to clean thoroughly all equipment coming into contact with carcasses or meat. Implement sterilizers are stainless-steel boxes holding hot (82°C) water, shaped to suit particular equipment knives, cleavers, saws, etc. (Fig. 2). Knife sterilizers should be placed in positions where every operator who uses a knife has immediate access. Handles as well as blades must be sterilized. Each operator should have at least two knives etc., one to use while the other sterilizes (Figs 10 and 11).

Failure to sterilize all knives and equipment regularly will result in carcass contamination. Bacteria will be transferred from the hide to the carcass and from carcass to carcass (Fig. 12).

TREATMENT OF LIVESTOCK BEFORE SLAUGHTER AND ITS IMPACT ON MEAT QUALITY

Stress in its many forms, e.g. deprivation of water or food, rough handling, exhaustion due to transporting over long distances, mixing of animals reared separately resulting in fighting, is unacceptable from an animal welfare viewpoint and should also be avoided because of its deleterious effects on meat quality. The most serious consequence of stress is death which is not uncommon among pigs transported in poorly ventilated, overcrowded trucks in hot weather. From loading on the farm to the stunning pen animals must be treated kindly, and the lorries, lairages and equipment for livestock handling must be designed to facilitate humane treatment. Stress immediately prior to slaughter, such as fighting or rough handling in the lairage, causes stored glycogen (sugar) to be released into the bloodstream. After slaughter this is broken down in the muscles producing lactic acid. This high level of acidity causes a

partial breakdown of the muscle structure causing the meat to be pale, soft and exudative (PSE). This condition is mostly found in pigs.

10. Plastic (right) handles are more hygienic than wooden (left) for knives and other equipment. Note the excessively worn knife (third from left) which should be discarded



12. Poor hygiene during carcass dressing causes the spread of bacteria from the skin of the carcass to knives and to operators' hands

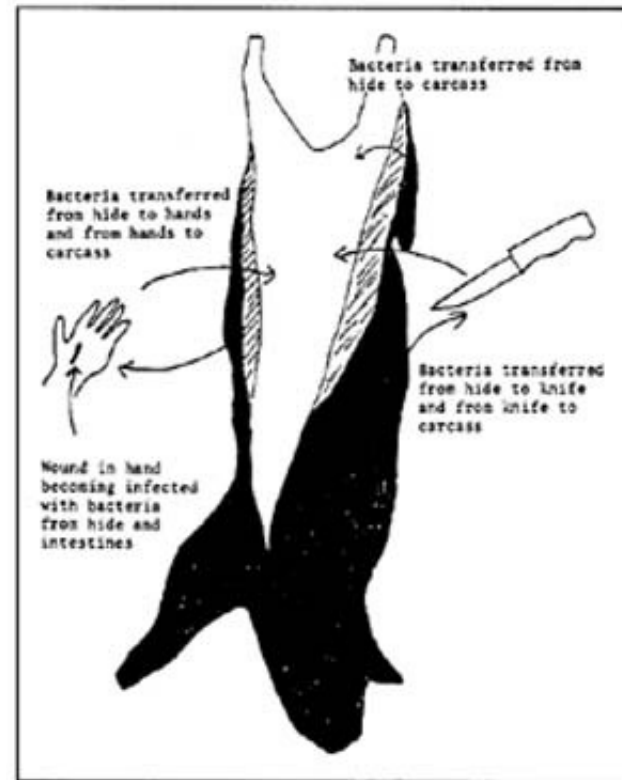



11. Knives and other equipment should be kept sharp and in good repair

Long-term stress before slaughter such as a prolonged period of fighting during transport and/or lairage leads to exhaustion. The sugars are used up so that less is available to be broken down and less lactic acid is produced.

The reduced acidity leads to an abnormal muscle condition known as dark, firm and dry (DFD) in pigs or dark cutting in beef. The condition is rarer in lamb. Such meat has a high pH (above 6.0) and spoils very quickly as the low acidity favours rapid bacterial growth.

Handling animals during transport and lairage

An electric goad (Fig. 13) should be used rather than a stick or tail-twisting not only to avoid stress but also to prevent carcass bruising. Grabbing sheep by the fleece also causes bruising (Fig. 14).

To avoid fighting, animals not reared together must not be mixed during transport and lairage. Load and unload using shallow stepped ramps to avoid stumbles. Trucks should be neither over- nor underloaded. Overloading causes stress and bruising due to crushing. Underloading results in animals being thrown around and falling more than necessary. Drivers should not corner at excessive speed and must accelerate and decelerate gently.

The lairage should have small pens. Corridors must curve and not bend sharply so that stock can see a way forward. Stock must not be slaughtered in sight of other stock. Plenty of clean water must be available. The lairage must be well lit and ventilated. Do not hold stock in lairage for more than a day. Only fit, healthy stock may be slaughtered for human consumption.

Fasting before slaughter reduces the volume of gut contents and hence bacteria and therefore reduces the risk of contamination of the carcass during dressing. It is usually sufficient for the animals to receive their last feed on the day before slaughter. Stock should have a rest period after arrival at the slaughterhouse. However, long periods in the lairage can lead to DFD if the animals are restless and fighting or mounting.

Animals should be as clean as possible at slaughter. Producers should wash their animals before leaving the farm. Trucks used for transport must be washed after each load and the lairage at the slaughterhouse should be kept clear of faecal matter and frequently washed (Figs 15 and 16).

STUNNING AND BLEEDING OF SLAUGHTER ANIMALS

Stunning prior to bleeding

Most countries have legislation requiring that animals are rendered unconscious (stunned) by a humane method prior to bleeding. Exceptions are made for religions which require that ritual

slaughter without prior stunning is practised, provided the slaughter method is humane. Stunning also makes sticking (throat-slitting) less hazardous for the operator. The animal must be unconscious long enough for sticking to be carried out, and for brain death to result from the lack of blood supply.

13. An electric goad delivers a small electric current via two electrodes to encourage animals to move. It avoids stress and carcass damage



14. Unsightly bruising caused by striking the



15. Trucks must be thoroughly washed after each load

animal with a stick. This not only causes loss of product but is also inhumane



16. Pens will need washing after emptying

Methods of stunning

***Direct blow* to skull using a club or poleaxe. The blow must be dealt with precision and force, so that the skull is immediately smashed, causing instantaneous unconsciousness. In cattle the aiming point is in the middle of the forehead in line with the ears, where the skull is thinnest. Horses have thinner skulls and are therefore easier to stun by this method. In sheep and goats the brain is more easily reached from the back of the neck. Pigs have a well-developed frontal cavity so the blow should be aimed slightly above the eyes.**

***Slaughtering mask.* A bolt held in the correct position by the mask is driven into the animal's brain by a hammer blow. The device is usually fitted with a spring which returns the bolt to its original position.**

***Free bullet* fired from a pistol into the skull is effective but unsafe. This method has been used on horses and cattle.**

***Captive-bolt pistols* fitted with a blank cartridge are effective on cattle and sheep but not pigs whose skulls are thicker (Figs 17 and 18). After firing, the bolt returns to its original position in the pistol. The bolt may or may not be designed to penetrate the skull. With penetrating types the brain becomes contaminated with hair, dirt and bone fragments. If brains are to be saved as edible tissue then the non-penetrating type with a mushroom-shaped head should be used.**

***Electrical stunning.* An electric current of high frequency but, in the case of manually operated equipment, of relatively low voltage (60–80 V) is passed through the brain of an animal for a few seconds to produce unconsciousness. If applied correctly a deep state of unconsciousness is invariably achieved. Strict safety rules must be observed. Head tongs (Fig. 19) are suitable for pigs and sheep but not for cattle. The electrodes carried on the ends of the tongs must be accurately placed (Figs 20 and 21). Places where the skull is thick must be avoided. Electrical contact is impeded by hair and caked mud. Water or brine will improve contact but the head must not be completely wet otherwise the current will have a short-circuit path avoiding the brain. The electrodes must be applied with strong pressure.**

19. Head tongs are used to stun pigs and sheep electrically but are not suitable for cattle. The electrode on the end of each tong is ridged for better contact



17. Captive-bolt stunner suitable for cattle

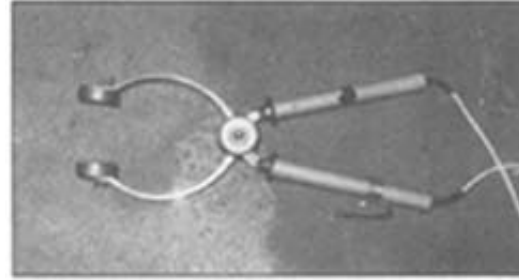

20. The electrodes must be applied firmly to either side of the head so that the electrical current passes through the brain causing unconsciousness in a few seconds

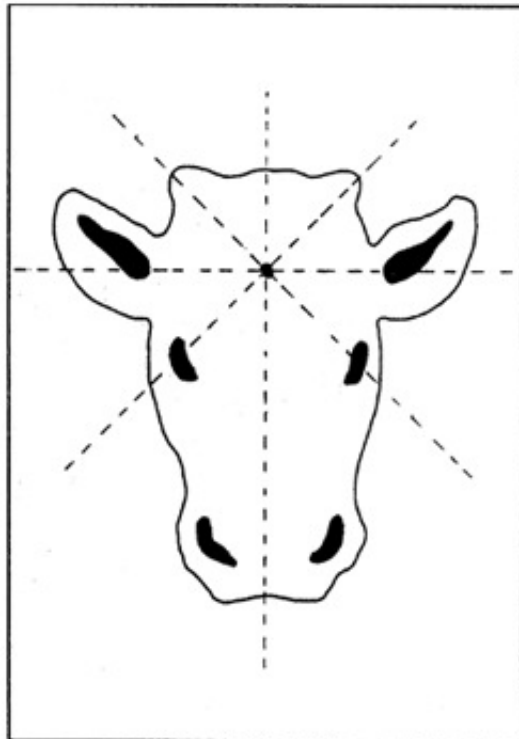

21. Head tongs are also suitable for stunning pigs



18. Aiming point for stunning cattle

Carbon dioxide stunning is used only in large pig abattoirs. Pigs are induced into a chamber and exposed to a concentration of 85 percent CO₂ for about 45 seconds. Although effective for anaesthetizing sheep, it is impractical because of large amounts of CO₂ collecting in the wool and affecting operators on the killing line.

Bleeding after stunning

The objectives of bleeding are to kill the animal with minimal damage to the carcass and to remove quickly as much blood as possible as blood is an ideal medium for the growth of bacteria.

Sticking, severing the major arteries of the neck, should immediately follow stunning. Care must be taken not to puncture the chest cavity or it will fill with blood.

22. Immediately following stunning the animal is hoisted by one leg and stuck. For sheep the sticking point is in the side of the neck, the gash cut severing all the major blood vessels in a single movement

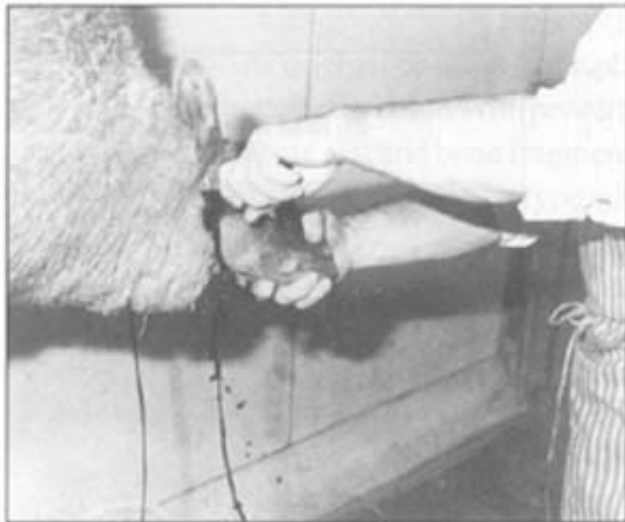

23. The sticking point for pigs is in the centre of the neck just in front of the breastbone



***Cattle.* Insert the sticking knife carefully just above the breastbone at 45° pointed toward the head. Ensure that the carotid arteries and jugular veins are severed in one movement.**

***Sheep.* Draw the knife across the jugular furrow close to the head severing both carotid arteries. Alternatively, the knife may be inserted through the side of the neck, though this**

requires more skill (Fig. 22).

Figs. As for cattle but do not go in too far or a pocket of blood will collect at the shoulder (Fig.23). To reduce contamination by the scalding tank water the cut should be as small as possible.

Bleeding on a rail

The most hygienic system of bleeding and dressing is to shackle the animal immediately after stunning, then hoist it on to a moving rail. The animal is stuck while being hoisted to minimize the delay after stunning. Bleeding continues until the blood flow is negligible when carcass dressing should begin without further delay (Fig. 24)

Blood for human use must be collected with special equipment to avoid contamination from the wound, the gullet of the knife. A hollow knife directs blood away from the wound into a covered stainless-steel container without touching the skin or hide. The knife may be connected to a hose to reduce the risk of contamination. The hose may even be connected to a pump to speed the blood flow. Between 40 and 60 percent of the total blood volume will be removed though this will be reduced if sticking is delayed. To prevent coagulation, citric acid solution made up with one part citric acid to two parts water is added at a rate up to 0.2 percent of the blood volume. The main sources of contamination during sticking and bleeding include the knife, the wound and the food-pipe. The knief should be changed after each operation and returned to a sterilizer. Cutting the hide of sheep and cattle and opening out to make a clean entry for the sticking knife reduces contamination from the wound. If the food-pipe is pierced semi-digested food may be regurgitated contaminating the blood and neck wound.

Horizontal bleeding

Horizontal bleeding is claimed to give faster bleeding rates and a greater recovery of blood. This may be due to certain organs and blood vessels being put under pressure when animals are hoisted, thus trapping blood and restricting the flow. Bleeding on the floor is very unhygienic. The operation should take place on a specially designed, easily cleaned stainless-steel table which should be cleaned frequently. If blood is to be saved it must not come in contact with the table before reaching the collecting vessel.



24. After sticking, the animal should be left to bleed until the blood flow becomes negligible

25. Scalding/dehairing tank which accommodates four pigs: one awaiting immersion, two immersed and one just completing immersion. When the bars are rotated the pigs change position





26. After immersion any remaining loose hairs are scraped from the skin

27. Simple tank for combined scalding/dehairing. The tank is filled with water at 60°C, a pig is lowered in, the lid is closed and the paddles rotate, the rubber tips loosening the hairs

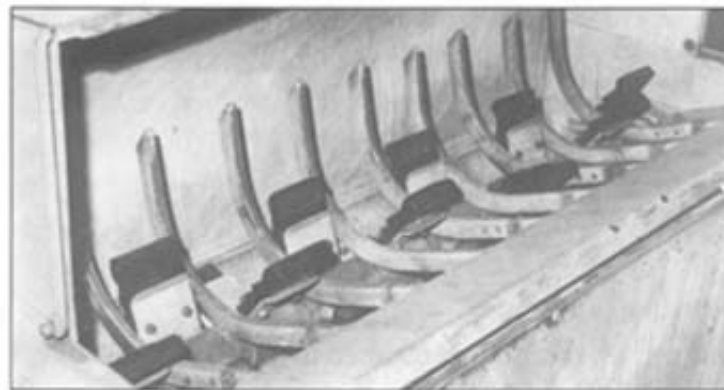

Bleeding without stunning

The Jewish and Muslim religions forbid the consumption of meat which was killed by any method other than bleeding. Since it is difficult to guarantee that all animals will recover consciousness after being stunned by any particular method, stunning is not generally allowed. There are exceptions, however. Some communities do accept low-voltage electrical stunning.

Because animals are fully conscious at the time of sticking, ritual slaughter may be less humane than sticking after stunning. To reduce the suffering operators must be highly skilled so that a successful gash cut severing all the veins and arteries is made quickly at the first

attempt. Different communities have different regulations as to the orientation of the animal at sticking, some favouring a position lying on its side, others insisting it lie on its back. The animal should not be hoisted until unconsciousness due to lack of blood supply to the brain is complete.

SCALDING AND DEHAIRING OF PIGS (USING SIMPLE EQUIPMENT)

Scalding in water at around 60°C for about six minutes loosens the hair in the follicle. Too low a temperature and the hair will not be loosened and too high a temperature and the skin will be cooked and the hair difficult to remove. The simplest equipment consists of a tank into which the pig is lowered by a hoist. The water is heated by oil, gas, electricity or an open steam-pipe.

To check the effectiveness of the scald, rub the skin with the thumb to see if hair comes away easily. Some machines have the thermostatic controls and timers. To reduce contamination, scalding water should be changed frequently, pigs should be as clean as possible at sticking, and bleeding should be fully completed before immersion.

In large factories pigs are transported through scalding tanks with rotating bars (Fig. 25) or through long scalding tanks stretching from the sticking point to the dehairing point in the time required for an effective scald.

Dehairing is done with a specially formed scraper (bell scraper or knife). If the scald is effective all the hair can be removed by this manual method (Fig. 26). Another simple method is to dip the pig in a bath containing a hot resin adhesive. The pig is removed from the bath and the resin allowed to set partially when it is peeled off pulling the hair with it from the root. This is less labour-intensive than scraping and produces a very clean skin. After use the adhesive is melted again, strained to remove the hair and returned to the tank.

Another method of removing dirt and hair in one operation is to skin the carcass though this is only done when the skin is required for leather goods.

With the simple scalding tank, dehairing and scalding may be combined in one operation. Inside the tank are rotating rubber-tipped paddles which are started after closing the lid. As the hair is loosened by the scalding water it is removed by the rubbing effect of the paddles against the skin (Fig. 27).

Singeing removes any remaining hairs, shrinks and sets the skin, decreases the number of adhering micro-organisms and leaves an attractive clean appearance. It may be done with a hand-held gas torch (Fig. 28). Automated systems transport the pig into a furnace and leave it long enough for an effective singe.

After singeing, black deposits and singed hairs are scraped off (Fig. 29) and the carcass is thoroughly cleaned before evisceration begins.

SKINNING OF CATTLE AND SMALL RUMINANTS

Cattle

The outer side of the hide must never touch the skinned surface of the carcass. Operators must not touch the skinned surface with the hand that was in contact with the skin.

Combined horizontal/vertical methods

***Head.* After bleeding, while the animal is still hanging from the shackling chain, the horns are removed and the head is skinned. The head is detached by cutting through the neck muscles and the occipital joint. Hang the head on a hook (Fig. 30). Lower the carcass on its back into**

the dressing cradle.

Legs. Skin and remove the legs at the carpal (foreleg) and tarsal (hind leg) joints. The forelegs should not be skinned or removed before the carcass is lowered on to the dressing cradle or the cut surfaces will be contaminated. The hooves may be left attached to the hide.

28. After scraping away loose hairs any remaining hairs can be singed and the skin set with a hand-held gas torch



30. The head is completely skinned and hung on a hook to await inspection



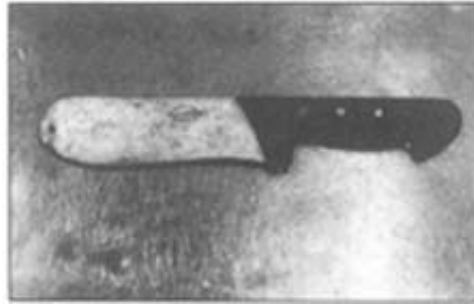

29. A special knife, the black scrape, is used to scrape off any singed hairs and black deposits

32. In the combined horizontal/vertical dressing method the carcass is lowered on to a cradle, the legs, brisket and flanks are skinned, then the carcass is raised to the half-hoist position.

Note that this is much less hygienic than verticaldressing on a rail

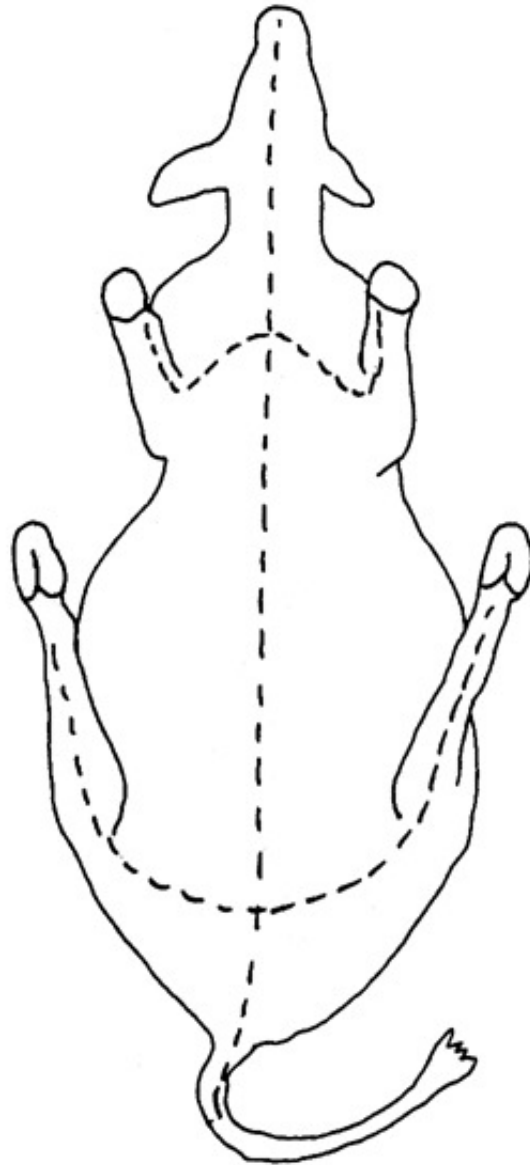

33. Note the possible contamination of the carcass by the intestines and the hide dragging on the floor in the combined horizontal/vertical dressing method



31. Correct cutting lines for hide removal

Flaying. Cut the skin along the middle line from the sticking wound to the tail. Using long firm strokes and keeping the knife up to prevent knife cuts on the carcass, skin the brisket and flanks, working backwards toward the round (Fig. 31). Skin udders without puncturing the glandular tissue and remove, leaving the supermammary glands intact and attached to the carcass. At this point raise the carcass to the half-hoist position, the shoulders resting on the cradle and the rump at a good working height (Figs 32 and 33).

Clear the skin carefully from around the vent (anus) avoiding puncturing it and cut the abdominal wall carefully around the rectum. Tie off with twine to seal it. Skin the tail avoiding contamination of the skinned surface with the hide. Raise the carcass free of the floor and finish flaying.

Vertical methods

High-throughput plants have overhead rails which convey the carcass from the sticking point to the chills. Hide removal is carried out on the hanging carcass (Figs 34, 35 and 36). The operations are as in the combined horizontal/vertical method, but as it is not possible to reach the hide from ground level more than one operator is needed. A single operator may work with a hydraulic platform which is raised and lowered as required.

Automatic hide pullers are used in high-throughput slaughterhouses. Some types pull the hide down from the hind, others from the shoulders upwards toward the rump.

Automation of hide removal reduces contamination since there is less handling of the carcass and less use of knives. Moving overhead rails also improve hygiene by reducing carcass

contact with operators, equipment such as dressing cradles and with each other since carcasses are evenly spaced.

Small ruminants

Sheep fleeces can carry large volumes of dirt and faeces into the slaughterhouse. It is impossible to avoid contamination of sheep and lamb carcasses when the fleece is heavily soiled. The fleece or hair must never touch the skinned surface, neither must the operator touch the skinned surface with the hand that was in contact with the fleece.



34. The leg is freed from the skin and the hock cut off

35. Pneumatically operated rotating knives (flayers) speed the removal of the hide from the flanks

36. Flaying knives are used for the more intricate parts of hide removal



Combined horizontal/vertical method

The animal is turned on its back and cuts are made from the knuckles down the forelegs. The neck, cheeks and shoulders are skinned. The throat is opened up and the gullet (food-pipe) is tied off (see Fig. 41). The skin on the hind legs is cut from the knuckles down to the tail root. The legs are skinned and the sheep is hoisted by a gambrel inserted into the Achilles tendons. A rip is made down the midline and skinning proceeds over the flanks using special knives or the fists (see Fig. 39). The pelt is then pulled down over the backbone to the head. If the head is for human consumption it must be skinned or it will be contaminated with blood, dirt and hairs.

Moving cratch and rail system. The hanging carcass is lowered on to a horizontal conveyor made up of a series of horizontal steel plates, bowed slightly and divided into sets large enough to cradle a single animal. Two operators usually work together on each lamb

performing the legging operations and opening the skin to the stage where it can be pulled off the back. When the gambrel is inserted into the hind legs it is hoisted on to a dressing rail.

Vertical method

At sticking the animal is shackled by one hind-leg and left to bleed. Dressing commences with the free leg which is skinned and the foot removed (Fig. 37). A gambrel is inserted into this leg and hung on a runner on a dressing rail. The second leg is freed from the shackle, skinned and dressed, then hooked on to the other end of the gambrel. The skin is opened down the midline and cleared from the rump.

A spreader frame (a bar U-shaped at each end) spreads the front legs to simplify work on the neck, breast and flanks. The front toes are held in each end of the frame which is then slung up on to a separate travelling hook. The animal is therefore suspended by all four legs belly uppermost (Figs 38 and 39). Skinning continues as in the combined horizontal/vertical method. To clear the shoulders and flanks, the forelegs are freed from the spreader and the feet removed, the animal returning to a vertical position. The skin can now be completely pulled off (Fig. 40), including the head if this is for consumption, though this takes some work with the knife. In both methods, after fleece removal the vent and food-pipe are cleaned and tied off (Fig.41).

37. Fleece removal starts with skinning the free hind leg. Care must be taken to avoid the hide touching the skinned surface or the carcass will be contaminated with faecal matter



38. With forelegs in a spreader frame and hind legs in a gambrel, the sheep is suspended in a horizontal position



39. The fists can be used to clear the fleece from the breast

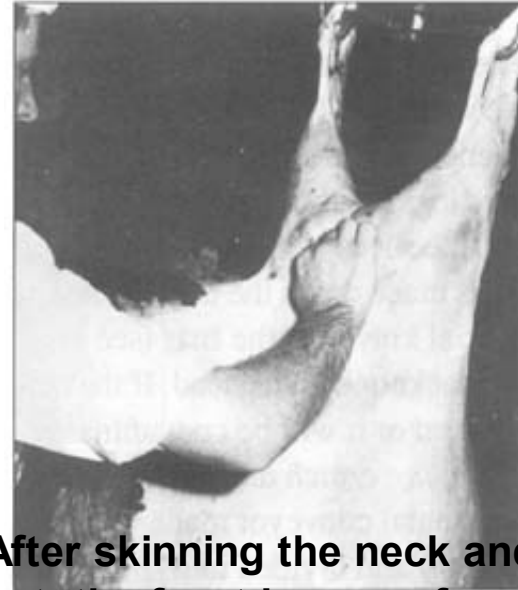

40. After skinning the neck and breast, the front legs are freed and skinning continues in the vertical position with the flanks and back





41. After skinning the neck, the food-pipe is freed and tied off to prevent regurgitation of stomach contents

EVISCERATION

With all species care must be taken in all operations not to puncture the viscera (Fig. 42). All viscera must be identified with the carcass until the veterinary inspection has been passed. After inspection the viscera should be chilled on racks etc. for better air circulation (Fig. 43).

Cattle

The brisket is sawn down the middle (Fig. 44). In the combined horizontal/ vertical system this is done with the animal resting on the cradle. The carcass is then raised to the half-hoist position and when hide removal is complete the abdominal cavity is cut carefully along the middle line. The carcass is then fully hoisted to hang clear of the floor so that the viscera fall out under their own weight (Fig. 45). They are separated into thoracic viscera, paunch and intestines for inspection and cleaning (Figs 46 and 47). If any of the stomachs or intestines are to be saved for human consumption, ties are made at the oesophagus/stomach, stomach/duodenum boundaries, the oesophagus and rectum having been tied off during hide removal. This prevents cross-contamination between the paunch and the intestines.

Small ruminants

A small cut is made in the abdominal cavity wall just above the brisket, and the fingers of the other hand are inserted to lift the body wall away from the viscera as the cut is continued to within about 5 cm of the cod fat or udder.

The omentum is withdrawn, the rectum (tied off) loosened, and the viscera freed and taken out. The food-pipe (tied off) is pulled up through the diaphragm. The breastbone is split down the middle taking care not to puncture the thoracic organs which are then removed.

Pigs

Loosen and tie off the rectum. Cut along the middle line through the skin and body wall from the crotch to the neck (Fig. 48). Cut through the pelvis and remove the bladder and sexual organs. In males the foreskin must not be punctured as the contents are a serious source of contamination. All these organs are considered inedible.

42. When cutting through the abdomen wall, if the viscera are punctured their contents will severely contaminate the carcass

43. A portable rack suitable for hanging offal for chilling

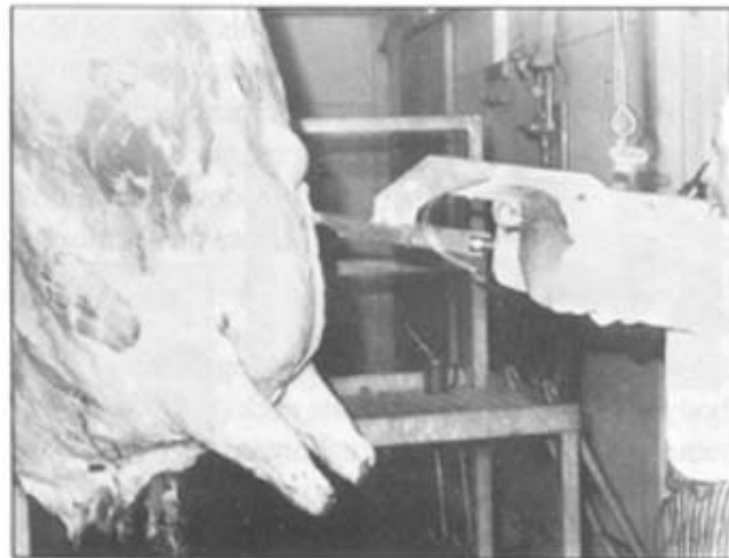

44. A mechanical saw speeds the splitting of the brisket but care must be taken not to puncture the viscera

45. After carefully cutting the abdominal wall along the midline

46. A suitable receptacle should catch the viscera so that they

the viscera fall out under their own weight **are not contaminated by contact with the floor**



47. A portable cart suitable for catching cattle stomachs and intestines with a separate tray for edible offal such as liver, heart and lungs



Remove the abdominal and thoracic viscera intact. Avoid contact with the floor or standing platform.

The kidneys are usually removed after the carcass has been split down the backbone. The head is usually left on until after chilling.

SPLITTING, WASHING AND DRESSING OF CARCASSES

Hygienic carcass splitting with simple equipment

Cattle

Work facing the back of the carcass. Split the carcass down the backbone (chine) with a saw or cleaver from the pelvis to the neck (Figs 49 and 50). Sawing gives a better result but bone dust must be removed (Fig. 51). If a cleaver is used, it may be necessary to saw through the rump and loin in older animals.

The saw and cleaver should be sterilized in hot (82°C) water between carcasses. Power saws increase productivity.

48. The body wall is split down the midline taking care not to puncture the viscera



49. Mechanical saw for splitting the backbone (chine) of beef carcasses

51. Carcasses should be spray-washed to remove visible staining, paying particular attention to bone dust and the internal surface, but without using excessive amounts of water

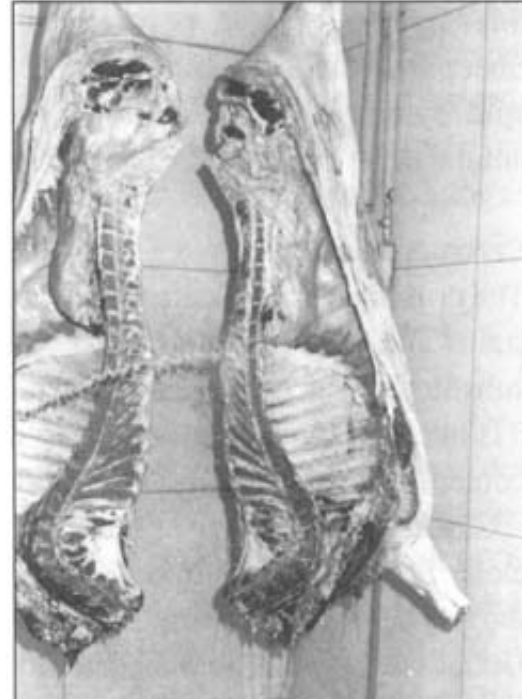
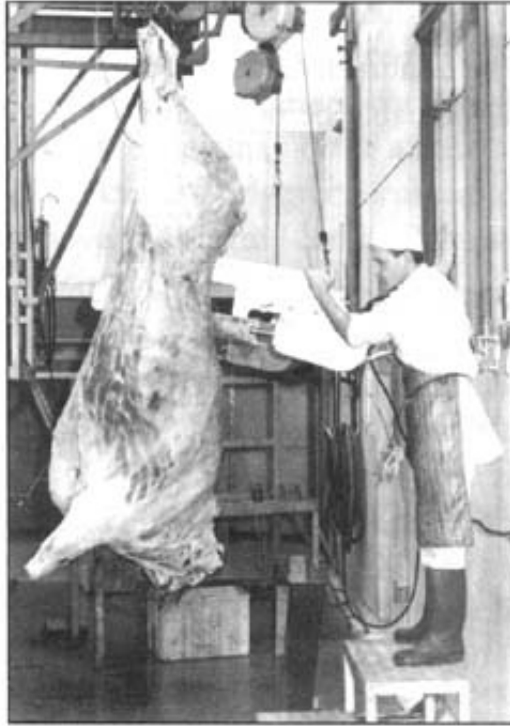

50. Hand-saws are much slower than mechanical saws though they are preferable to cleavers which splinter bones

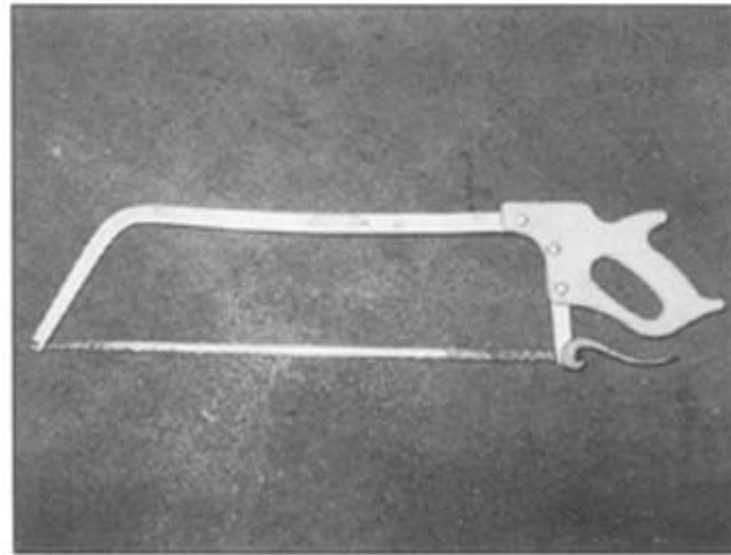

Pigs

These are suspended and are split down the backbone as for cattle, but the head is generally left intact (Fig. 94).

Sheep

Sheep and lamb carcasses are generally sold entire. If necessary they can be split by saw or cleaver, but a saw will probably be necessary for older animals.

Carcass washing

The primary object of carcass washing is to remove visible soiling and blood stains and to improve appearance after chilling (Fig. 51). Washing is no substitute for good hygienic practices during slaughter and dressing since it is likely to spread bacteria rather than reduce total numbers. Stains of gut contents must be cut off. Wiping cloths must not be used.

Carcass spraying will remove visible dirt and blood stains. Water must be clean. Soiled carcasses should be sprayed immediately after dressing before the soiling material dries, thus minimizing the time for bacterial growth. Under factory conditions bacteria will double in number every 20 or 30 minutes.

In addition to removing stains from the skinned surface, particular attention should be paid to the internal surface, the sticking wound and the pelvic region.

A wet surface favours bacterial growth so only the minimum amount of water should be used and chilling should start immediately. If the cooler is well designed and operating efficiently the carcass surface will quickly dry out, inhibiting bacterial growth.

Bubbling of the subcutaneous fat is caused by spraying with water at excessively high

pressure, which may be due to the pressure in the system or a result of holding the spray nozzle too close to the carcass.

Carcass dressing

The object of carcass dressing is to remove all damaged or contaminated parts and to standardize the presentation of carcasses prior to weighing. Specifications will differ in detail for different authorities. Veterinary inspection of carcasses and offal can only be carried out by qualified personnel. Where signs of disease or damage are found the entire carcass and offal may be condemned and must not enter the food chain, but more often the veterinarian will require that certain parts, for instance those where abscesses are present, be removed and destroyed. Factory personnel must not remove any diseased parts until they have been seen by the inspector otherwise they may mask a general condition which should result in the whole carcass being condemned. Any instructions from the inspector to remove and destroy certain parts must be obeyed.

REFRIGERATION, HANDLING AND TRANSPORT OF CARCASSES AND MEAT

Refrigeration of carcasses

Carcasses should go into the cooler as soon as possible and should be as dry as possible. The object of refrigeration is to retard bacterial growth and extend the shelf-life. Chilling meat post-mortem from 40°C down to 0°C and keeping it cold will give a shelf-life of up to three weeks, provided high standards of hygiene were observed during slaughter and dressing.

Carcasses must be placed in the cooler immediately after weighing. They must hang on rails and never touch the floor (Fig. 52). After several hours the outside of a carcass will feel cool to the touch, but the important temperature is that deep inside the carcass. This must be

measured with a probe thermometer (not glass), and used as a guide to the efficiency of the cooling.

52. Sheep carcasses in the chill-room, hung on rails clear of the floor and spaced to allow air circulation to speed drying



The rate of cooling at the deepest point will vary according to many factors including the efficiency of the cooler, the load, carcass size and fatness. As a general guide a deep muscle temperature of 6–7° C should be achieved in 28 to 36 hours for beef, 12 to 16 hours for pigs and 24 to 30 hours for sheep carcasses. Failure to bring down the internal temperature quickly will result in rapid multiplication of bacteria deep in the meat resulting in off-odours and bone-taint.

High air speeds are needed for rapid cooling but these will lead to increased weight losses due to evaporation unless the relative humidity (RH) is also high. However, if the air is near to saturation point (100 percent RH) then condensation will occur on the carcass surface, favouring mould and bacteria growth. A compromise between the two problems seems to be an RH of about 90 percent with an air speed of about 0.5 m/second. Condensation will also occur if warm carcasses are put in a cooler partially filled with cold carcasses.

The cooler should not be overloaded beyond the maximum load specified by the manufacturers and spaces should be left between carcasses for the cold air to circulate. Otherwise cooling will be inefficient and the carcass surface will remain wet, favouring rapid bacterial growth forming slime (see below).

Once filled, a cooler should be closed and the door opened as little as possible to avoid sudden rises in temperature. When emptied, it should be thoroughly washed before refilling. Personnel handling carcasses during loading and unloading operations should follow the strictest rules regarding their personal hygiene and clothing and should handle carcasses as little as possible.

Marketing of meat under refrigeration

Chilled meat must be kept cold until it is sold or cooked. If the cold chain is broken, condensation forms and microbes grow rapidly. The same rules about not overloading, leaving space for air circulation, opening doors as little as possible and observing the highest hygiene standards when handling the meat apply. An ideal storage temperature for fresh meat is just above its freezing point, which is about - 1°C (- 3°C for bacon because of the presence of salt). The expected storage life given by the International Institute of Refrigeration of various types of meat held at these temperatures is as follows:

<i>Type of meat</i>	<i>Expected storage life at - 1°C</i>
Beef	up to 3 weeks (4–5 with strict hygiene)
Veal	1–3 weeks
Lamb	10–15 days
Pork	1–2 weeks

Edible offal	7 days
Rabbit	5 days
Bacon	4 weeks (at - 3°C)

Under commercial conditions, meat temperatures are rarely kept at - 1°C to 0°C, so actual storage times are less than expected. The times would also be reduced if RH were greater than 90 percent.

Meat should be placed in the refrigerator immediately following receipt. Any parts which show signs of mould growth or bacterial slime should be trimmed off and destroyed. Hands must be thoroughly washed after handling such trimmings and knives must be sterilized in boiling water. The refrigerator should be thoroughly cleaned after finding such meat and should also be cleaned on a regular basis.

Carcasses, quarters and large primals should not be cut into smaller portions before it is necessary as this will expose a greater surface area for bacteria to grow. Freshly cut surfaces are moist and provide a better medium for bacterial growth than the desiccated outer surfaces of cuts that have been stored for some time.

An accurate thermometer should be placed in the refrigerator and checked regularly. The temperature should remain within a narrow range (0° to + 1°C).

Transport of meat

Vehicles for transporting meat and carcasses should be considered as an extension of the refrigerated storage. The object must be to maintain the meat temperature at or near 0°C. Meat should be chilled to 0°C before loading. Meat should hang on rails, not on the floor. If

stockinettes are put on carcasses they must be clean. Meat trucks should not carry anything other than meat.

The refrigeration is usually produced by injecting liquid nitrogen or carbon dioxide (CO₂) into the compartment or by blowing air over CO₂ chunks (dry ice). The temperature in these vans can be set and controlled to minimize the temperature rise and to avoid condensation on the meat surface (Fig. 53).

Insulated vans without refrigeration may be refrigerated by adding dry ice. While this is a reasonably good alternative to the refrigerated truck it does not allow the temperature to be controlled.

Uninsulated vans and open trucks should not be considered as suitable transport for meat, particularly in hot climates. In addition to the temperature abuse, condensation will occur when the meat goes back into refrigeration, and in open trucks the meat is exposed to attack from insects. Loading and unloading should be done quickly. If there are any unavoidable delays then dry-ice blocks should be placed in the partly filled van.

**53. Insulated vans with refrigeration units should be used
for transporting meat**



Carcass and meat handling and marketing without refrigeration

Where refrigeration is unavailable either owing to financial or technical reasons (e.g. no power supply), the shelf-life of meat is reduced to days or hours, not weeks. Slaughter and dressing must be near the point of sale and it must be quick and clean. If carcasses and meat are kept in well-insulated rooms, the temperature can be reduced with dry-ice blocks, if these are available. Since it is easier to chill boneless cuts rather than whole carcasses, hot-boning should be considered.

Stock must be handled carefully to avoid producing high-pH meat which will spoil more quickly. Rooms used for slaughter and handling meat must be clean and well ventilated, but out of direct sunlight, dust-free and verminfree (rodents and insects). Hot water (82°C) must be

available to clean all equipment and surfaces and personnel must work very hygienically. Receive all blood into sealed containers and have separate skips on wheels for hooves, skins, green offal and trimmings.

54. Processing and packing of offal must be done in a room separated from the slaughter hall or other meat-handling facilities



Dressing on a vertical hoist will minimize contamination by floor or cradle contact. Let nothing drop on the floor, only into skips. Personal hygiene must be scrupulous. Any spills of gut contents on to the meat should be cut off, but careful work will avoid this. The dressed carcass should be hung on rails. If beef is quartered to facilitate handling, the cut surface is at risk.

Red offal should be hung on hooks. Any offal processing must be in rooms away from meat-handling facilities (Fig. 54). Intestines for human consumption must be thoroughly cleaned and washed.

Storage and transport without refrigeration

Meat should be put on sale within a day of slaughter. If it has to be held it should be hung in a

clean, well-lit hall with good ventilation. Insects, rodents and birds must be kept out, dust must not blow in. Trays of offal should be on shelves, not on the floor. Barrows for wheeling carcasses and quarters are better than carrying on shoulders, as they can be cleaned frequently. All staff must wear clean clothing and observe strict personal hygiene. Transport of non-refrigerated meat is very hazardous. If meat is to be put in stockinettes and sacks these must be very clean. Meat should be on rails in the truck or wagon, and it is not advisable to carry it more than a day's journey before sale.



Meat cutting and utilization of meat cuts

VARIATIONS IN THE SENSORIC QUALITY OF MEAT

Large differences exist in the tenderness, juiciness and flavour of the various meat animal carcasses because of breeding, age, feeding and management. Within each animal carcasses and associated with the different muscles there are variations in tenderness that dictate how different cuts of meat should be prepared to yield the most palatable foods. Because of these differences in tenderness, juiciness and flavour, each meat cut should be merchandised according to its availability and palatability characteristics. Consequently, different prices should be charged for different cuts from the various meat animals so that consumers have choices. The tenderloin of beef is a relatively small cut and therefore of limited quantity but it is extremely tender and requires a minimum of cooking. Generally it is high-priced because of its

high quality and consumer demand for a cut that is easy to prepare and serve. Roasts from the chuck or shoulder of beef are less tender than the tenderloin; however, when properly prepared by pot-roasting, they too will be tender, juicy, flavourful and will provide good nutritional value. Because there are more kilograms of chuck roast on any one beef carcass and because they require more time and effort to cook correctly, chuck roasts do not and should not demand the same high price per kilogram as tenderloin.

Throughout the world, countries have varied natural resources and capabilities for producing livestock and different methods must be used to utilize all meat products correctly and completely whether they are cut from cattle, goats, sheep, swine, deer or other animals and whether they come from the tender or less tender parts of those animals. In order to get the maximum eating satisfaction and also the maximum nutritional value, each cut must be matched with the correct cooking procedure. Loin cuts which are generally tender should be prepared by broiling or other dry-heat methods while cuts with considerable bone and connective tissue from the shanks should be either braised or simmered for stews and soups.

TABLE 3

Comparative differences in various compositional aspects of marketweight beef, pork and lamb

	Beef	Pork	Lamb
Average live animal weight (<i>kg</i>)	454–544	95–104	45
Age (<i>months</i>)	36	6	8–12
Dressing percentage (<i>carcass/live weight</i>)	60	70	50
Carcass weight (<i>kg</i>)	272–318	68–73	23
Carcass composition (%)			
Lean	52	50	55

Fat	32	32	28
Bone	16	18	17

Generally, meat animals should be maintained in an environment that permits optimum growth and development. Animals gaining weight rapidly are usually in good condition and the meat derived from their carcasses will be fatter, juicier and richer in flavour. Additionally, the amount of meat in proportion to hide, bone and offal will be greater.

The age to slaughter animals varies depending on many things. The highest quality beef comes from animals that are under 36 months of age. Old cows produce highly acceptable beef if properly fattened and processed. Depending on the calf and the feeding regime, calves are best slaughtered between three and 16 weeks of age. Hogs may be killed any time after they reach six weeks of age, but for the most profitable pork production may need to be fed for five to ten months. Sheep and goats may be killed anytime after six weeks, but the more desirable age is from six to 12 months.

All meat animal carcasses are composed of muscle, fat, bone and connective tissue. The chief edible and nutritive portion is the muscle or lean meat. The muscle is seldom consumed without some of the attached fat and connective tissue. The carcass composition of animals slaughtered after usual fattening periods is shown in Table 3. It can be noted that the carcass composition varies little between species and is some what dependent on the fatness of the animal at slaughter.

The lean of each meat animal carcass consists of about 300 individual and different muscles of which only about 25 can be separated out and utilized as single muscle or muscle combinations. The separated muscles are not all the same. They vary widely in palatability (tenderness, juiciness, flavour) depending on the maturity or age of the animal and the body

location from which they were taken.

Generally, muscles of locomotion found in the extremities or legs are less tender and more flavourful than muscles that simply support the animal such as those found along the back. The latter are usually more tender and less flavourful. Other factors may influence palatability but maturity and body location are probably the most important.

Colours of the lean and fat are important characteristics of a normal, wholesome products. Most diseased or unnatural conditions will change the colour from what is considered normal for the species. Generally the colour of the fat will be from pure white to a creamy yellow for all animals. Pink or reddish fat probably means that the animal had a fever or was extremely excited prior to slaughter. The colour of the muscle tissues for normal product should be:

<i>Meat</i>	<i>Colour</i>
Beef	Bright cherry red
Goat meat	Light pink to red
Lamb	Light pink to red
Pork	Greyish pink
Veal	Light pink to red
Venison	Dark red

Almost always tissues from older animals are darker in colour. At times the fat on some carcasses from young animals will be dark yellow because of the breed which lacks the ability to convert yellow carotene to colourless vitamin A and/or because the animals have consumed large amounts of green forage. It is not uncommon for aged ruminant animals to have carcasses with yellow fat.

At times animals will suffer from stress prior to slaughter and signs of their reaction will be evident in the carcass. Stressed cattle often produce dark cutters in which the muscle is not the normal bright cherry red but rather is dark red and sticky. Hogs suffering from porcine stress syndrome (PSS) prior to slaughter may yield carcasses that are pale, soft and exudative (PSE) or dark, firm and dry (DFD). Exudative carcasses are watery and rapidly lose water. None of these conditions produced by ante-mortem stress renders the product inedible but both lower the palatability and eye appeal of the beef and pork and can be confused with other more serious disease conditions.

EQUIPMENT FOR THE MEAT-CUTTING OPERATION

- **solid cutting table, preferably made of non-corrosive material (stainless steel, aluminium or galvanized material) with hard plastic top. If wood has to be used instead of plastic only tight wooden tops/cutters should be used.**
- **oil or water sharpening stone**
- **sharpening steel**
- **knives**
 - **boning - 20 cm straight**
 - **steak - 30 cm curved**
- **meat saw - hand or electric**
- **totes, bins and meat trucks (plastic or other non-corrosive material)**
- **wrapping table**
- **paper or plastic foil/bags for meat wrapping**
- **tool holder**
- **metal mask/safety gloves**
- **boning aprons/safety aprons**
- **hand wash-basin**

- **knife sterilizer**

BEEF CUTTING

Four essential points when cutting beef (or any other meat animal carcass) are:

- **Cut across the grain of meat when possible.**
- **Use sharp knives and saws for speed and good workmanship.**
- **Keep the cutting table orderly and have a place for everything.**
- **Be clean and sanitary in all operations.**

There are different ways to cut the fore- and hindquarters of beef depending on its use, the wishes of the consumers, and the quality of the carcass (Figs 55 and 56). Poor-quality meat is normally used for further processing, while higher-quality and thicker-fleshed carcasses are used as fresh meat in the form of steaks and roasts.

55. The beef carcass and its bones

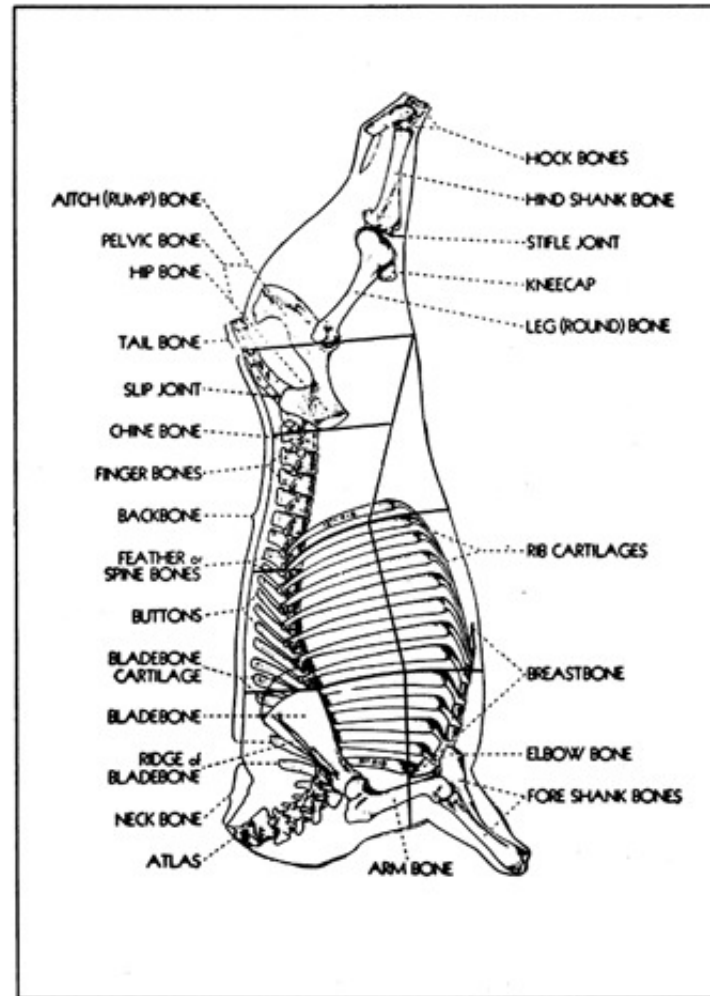

Halving

Halving is done immediately after the animal has been dressed and every effort should be made to saw the carcass into equal sides through the centre of the backbone.

Quartering

Quartering or ribbing down is the division of a side of beef between the twelfth and thirteenth ribs into fore-and hindquarters. One rib is usually left on the hindquarter to hold the shape of the loin and to make it easier to cut steaks.

56. The beef carcass and its cuts

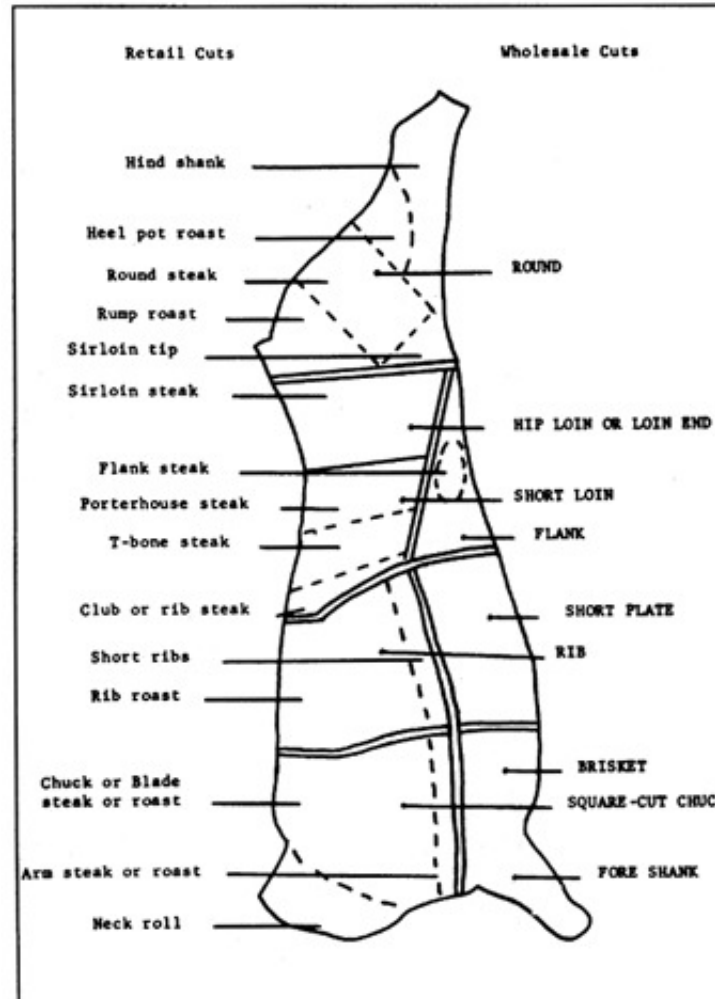

Dividing between the twelfth and thirteenth ribs splits the carcass almost in quarters, usually with slightly heavier forequarters. Make this cut straight and neat. Locate the exact place

between the ribs on the inside of the carcass and make the cut about 5 cm from the midline at the flank. The flank part should be left attached until the quarter is ready to be carried to the cutting table. Then saw the backbone, making the cut even with the incision that was made with the knife to produce a smooth and attractive appearances to the small end of the loin. Make this cut from the inside. The large muscle exposed when this cut is made is the “eye of beef” in which most of the quality characteristics of the meat can be seen including colour, marbling, firmness and texture. High-quality beef will have a bright cherry-red colour, some intramuscular fat or marbling, be firm to the touch and fine in texture.

When the person carrying the meat has a firm grip on the forequarter, the small strip of flesh holding the quarters together should be cut. With some practice and experience, one can learn to carry a forequarter easily by holding below the shank so that the full weight of the quarter is on the carrier's shoulder when it is cut down. By taking a step forward as the cut is being made, it is easier to have the quarter drop with the right proportion of weight on the shoulder. The right forequarter should be carried on the left shoulder and the left forequarter on the right shoulder. When placing the forequarter on the cutting table, always have the inside up.

Bone-in method

By far the easiest way to merchandise meat is to have some basic information relative to the bone and muscle structure of the carcass and to utilize an electric saw to cut up the whole carcass. This is now being done to a large extent by meat packers who cut out what is commonly referred to as a wholesale or primal cut such as a whole chuck (shoulder), rib, loin or round of beef. The cut may or may not be trimmed of some bone and fat and then vacuum-packaged and shipped to a retail store. The vacuum-packaging provides an anaerobic atmosphere and the refrigerated shelf-life of the product may be extended as much as two or three months. The store personnel need have only the slightest knowledge of meat cutting.

The primal is positioned correctly and run across the saw in a prescribed fashion, the saw dust is scraped off, and the consumer-sized cut packaged for retail sale.

Common wholesale or primal cuts of beef from the forequarter are the square-cut chuck, shank, brisket, plate and rib, and from the hindquarter the flank, loin and round. The kidney knob consisting of kidney and fat is removed from the loin. Since the hindquarter contains a higher proportion of tender cuts, it is usually in greater demand and returns higher prices.

***Forequarter.* The first cut to make is between the fifth and sixth ribs counting from the neck back (Fig. 57). This cut is made parallel with the ribs and produces a cross-cut chuck consisting of a square-cut chuck (also called chuck and blade), foreshank and brisket. Next the foreshank and brisket are removed by cutting through the first sternal cartilage (the first soft segment of the breastbone), and making the cut almost parallel with the backbone of the carcass (Figs 58 and 71).**

***Foreshank.* The foreshank is separated from the brisket by following the natural connective tissue seam between the muscles with a knife. The foreshank can then be sawn into small pieces to be used for soup stock or the lean may be removed and used for ground meat (Fig. 59).**

***Brisket.* The brisket, boned and made into a roll, can be used either as a pot roast or can be cured (corned) (Fig. 73).**

***Square-cut chuck.* This wholesale cut contains the first five ribs of the forequarter and may be sawn into steaks or roasts. Several cuts are usually made across the bottom or shank end of the chuck resulting in arm steaks or roasts (Fig. 60). The chuck is then turned and cuts are made parallel with the ribs, resulting in blade steaks and roasts (Fig. 61). If the carcass is of**

high quality and thickly fleshed, steaks cut from the rib end of the chuck or across the arm bone will be highly desirable. Blade cuts to be used as roasts should contain two or three ribs and should be trimmed as for standing rib roasts, although for convenience in carving all bones may be removed. The portions nearest the neck usually have more connective tissue and are recommended for simmering rather than for steaks and roasts.

**57. Dividing a forequarter
(lower part comprising
square-cut chuck, foreshank
and brisket and upper part
comprising rib and short
plate)**



**58. Removing foreshank and
brisket (left) from square-cut
chuck**

59. Foreshank cut into small pieces



60. Arm steaks

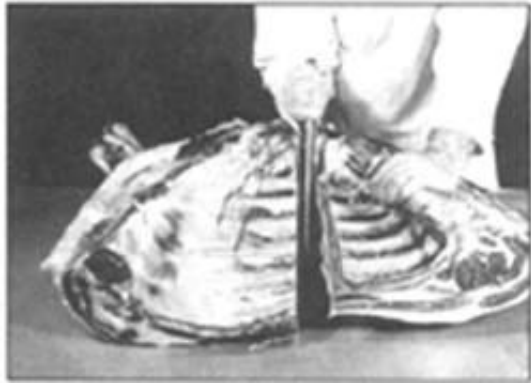

61. Blade steaks



Only the neck remains to be processed. It is usually severed at a point where it enlarges to meet the shoulder. The neck contains a large amount of bone and connective tissue and is generally used for simmering, corning or grinding. All bloody portions should be trimmed off before other cutting is done.

***Short plate.* The cut to divide the short plate from the rib is made 18–25 cm from the inside edge of and parallel with the chine or backbone (Fig. 62). This division varies according to the thickness of the carcass. With a thick carcass, the cut may be made further down the ribs, and with a thin carcass nearer the spinal column.**

The plate may be used for different purposes, but it is commonly used for stews or further processing. Short ribs, which are suited for broiling, are also cut from the upper portion of the plate, usually about 5–8 cm in length (Fig. 63). If the plate is to be used for corning, all of the ribs should be removed. If used for stews, the ribs can be left in and the plate sawn crosswise into small pieces. The plate can also be boned and the meat used for ground meat or sausage products. Before cutting the plate in any way, remove the tough membrane lining the inner portion below where the ribs join the breastbone.

***Rib.* The rib cut is made up of the rear seven ribs in the forequarter. This is the most valuable piece of meat from the forequarter because it is the most tender and has the least amount of bone. It has a large bundle of muscle fibre that runs parallel to the backbone.**

There are several different ways to prepare the rib cut for cooking as a roast. It may also be used for steaks (Fig. 64). It may be prepared as a bone-in, folded or rolled roast. If prepared as a bone-in roast, the superior spinous processes of the vertebrae or featherbones are loosened from the meat and then cut off with a saw. In making this cut, keep the knife as close to the bone as possible to avoid removing the thin lining that surrounds the bundle of muscle fibre next to the bone. With the saw, cut across the ribs at intervals of about 8 cm, just deep enough to cut through the ribs. Also remove the yellow connective tissue or ligament found between the outer covering and the layer of muscle.

The only difference between bone-in and a folded rib roast is that a small 5-cm piece of rib is removed so that the thin end of the cut may be folded and skewered to the heavy portion. This simply makes a neater, more compact package.

***Hindquarter.* Place the hindquarter on the cutting table with the inside of the carcass up because the first cut made is to remove the kidney knob from the inside of the loin. (However,**

loosening of meat cuts is also possible from the hanging beef side or beef quarter.)

62. Dividing the short plate (left) from the rib (right)

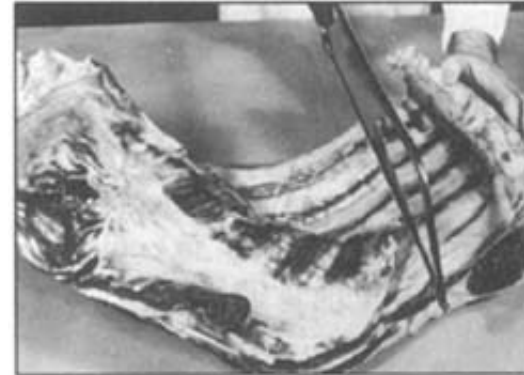

63. Cutting short ribs from the blade

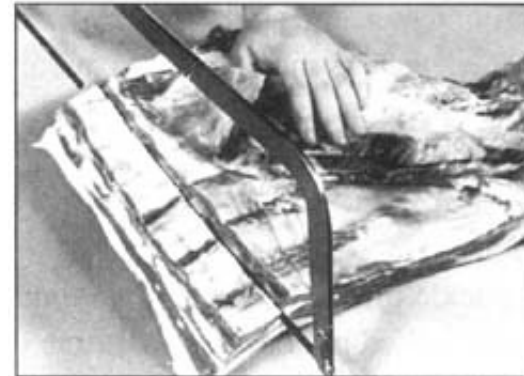

64. Cutting rib steaks



***Kidney knob.* Begin removing the kidney fat at the lower end and loosen it with a knife where it**

is attached to the loin, leaving a thin covering on the inside of the loin and being careful not to cut into the tenderloin muscle.

***Flank.* Remove the flank next by cutting into the scrotum or udder, following the round muscle and cutting close enough so little of the lean meat is taken from in front of the stifle joint. Continue cutting along and below the outer portion of the line of the kidney fat, or in a straight line to leave 10 cm of the thirteenth rib in the flank. This cut may vary with the thickness of the carcass and is lowest in thick or heavy carcasses (Figs 65 and 66).**

The tough membrane covering the inside of the flank must be removed by cutting off a thin strip on the lower side and then peeling off the membrane. A small piece of lean meat on the inside of the end portion of the flank, weighing 1.2–1.4 kg, is known as the flank steak (Fig. 67). This heavy bundle of muscle fibres is dry and if used for steak is often scored on both sides, marinated or sliced thin to make it more tender and desirable as a steak. The entire defatted flank may be used for stew or ground beef or rolled around stuffing and pot-roasted.

***Round.* The round and loin are divided at about the fourth sacral joint in the spinal column to almost parallel with the back end of the round, or to about 5 cm in front of the stifle joint (Fig. 68). The aim is to cut the tip of the ball-and-socket bone in the hip joint, cutting off a piece about 2.5 cm in diameter. The round includes the rump, round cushion (consisting of knuckle piece and inside round muscle or topside), outside round muscle (also called bottom round muscle or silverside) and hind shank.**

Remove the rump by cutting just below the exposed pelvic or aitchbone. The rump usually has a large amount of bone (Fig. 69). The most desirable piece of rump is cut from the upper portion and is composed of eye and bottom round muscles. The removal of bone and tying the rump means that it requires less oven space and is easier to carve.

Round steak is cut in comparatively thin slices from the full round after removal of the rump. The choicest round steaks are cut from the centre section.

The remaining portion is made up of the hind shank and the piece called the heel of the round. The heel of round is used as a pot roast and is removed by cutting close to the bone and tearing away as much meat as possible from the backside. The shank can be sawn into pieces to be used for soup stock.

65. Removing the flank on the cutting table (sawing through 13th rib after cutting through soft parts)



66. Removing the flank (hanging position)

67. Cutting off the flank steak



68. Separating the round and the loin



69. Cutting off the rump (left)

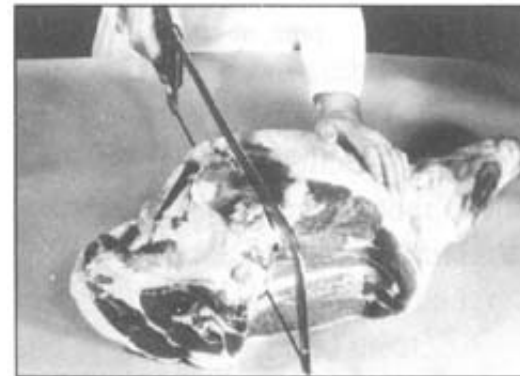

Loin. The loin is usually completely sawn into steaks beginning at the large end. Sirloin steaks are cut first and the first three or four are known as wedge or round bone sirloin steaks. These are the least desirable pieces of the sirloin. The last sirloin is cut where the hip-bone is separated from the spinal column and the steak cut there is known as the hip-or pin-bone sirloin steak.

The small portion of the loin known as the short loin is the source of Tbone steaks. This area contains the two most tender muscles in the whole carcass, namely, the loin eye muscle above the bone and the tenderloin muscle below the bone. T-bone steaks are cut to about 10 cm from

the end of the short loin. This tip portion can either be used as a roast or be cut into rib steaks. Rib steak from the short loin is identified by the piece of the thirteenth rib remaining on it (Fig. 70).

When beef is to be cured and dried, pieces should be taken from either the chuck or the round. If the round is used, remove the rump and follow the procedure for muscle boning. If taken from the chuck, use the heavy muscle lying over the outside of the shoulder-blade commonly known as shoulder clod.

Muscle-boning method

One excellent approach to the cutting up of meat animal carcasses which is becoming more popular and utilized by large meat processors is the procedure commonly referred to as “muscle-boning”. While this procedure is particularly adaptable to large carcasses such as beef, it can be successfully used on carcasses or cuts of any size. Muscle-boning is also popular among hunters who do not have meat saws but who want to cut up a whole carcass with a knife while removing the bone that would otherwise fill valuable freezer space. Any animal carcass with a complete and thick layer of subcutaneous or cover fat would have to have most of the fat removed in order to expose the muscles. Once the fat is removed, a boning knife can be used to separate each large individual muscle or group of muscles. This is done along the seams of connective tissue that encases each muscle. Once separated the muscle mass is then cut from the bone, thus the term “muscle-boning”. The advantages of this procedure are numerous; however, the principal reasons for using it are to obtain small-sized portions for sale or preparation; to permit each muscle or muscle combination to be treated or prepared according to its individual characteristics of size, tenderness, flavour or fibre orientation; and to remove much of the bone and fat that would otherwise take up packaging and storage space.

70. Loin cut into steaks: left, sirloin steaks; middle, T-bone steaks; right, rib steaks



Directions for muscle-boning a side of beef are given here. Initially for muscle-boning, the side of beef is divided into fore-and hindquarters as described for the bone-in method. Also, both the fore-and hindquarters are placed on the cutting table with the inside up. One muscle-boning method is as follows:

Forequarter. The forequarter is sawn into square-cut chuck, foreshank, brisket, rib and plate as in the bone-in method (Fig. 71, see also Figs 57, 58 and 62).

Foreshank. The foreshank has attached to it, behind the elbow joint, a relatively large, thick piece of muscle. This is usually cut out by following the connective tissue seams and produces a fairly large triangular-shaped cut correctly identified as boneless arm roast (Fig. 72). The remainder of the foreshank can be sawn into soup bones or can be separated into bone and soft tissue with a knife. The soft tissue is composed of muscle, fat and a large amount of connective tissue which is best utilized as ground meat.

Brisket. The ribs and sternum are lifted from the inside of the brisket (Fig. 73) and the excess

fat is removed. The brisket can either be rolled and tied to be used as a pot roast or it can be cured.

***Square-cut chuck.* The neck is sawn from the chuck and trimmed of bone, fat and the large prescapular lymph gland. The boneless neck can be utilized as a pot roast; however, it is more often cut into cubes (Fig. 74) for stew or ground meat.**

From the large remaining portion of the chuck, the ribs and feather bones (superior spinous processes) are removed with a knife (Fig. 75) and the heavy, yellow connective tissue or elastin is removed from the top of the cut. With a knife the thick portion is then separated into outside and inside portions by following the inside or smooth side of the blade-bone (Fig. 76) which is then lifted from the outside piece along with what remains of the arm bone. The inside portion which contains some of the rib eye muscle is often rolled and tied to be used as a pot roast (Fig. 77). There is a part of the outside chuck, a muscle that somewhat resembles the tenderloin muscle in size and shape but not in tenderness, which is often cut into steaks known as chuck fillets (Fig. 78).

71. Forequarter cut into five pieces prior to boning

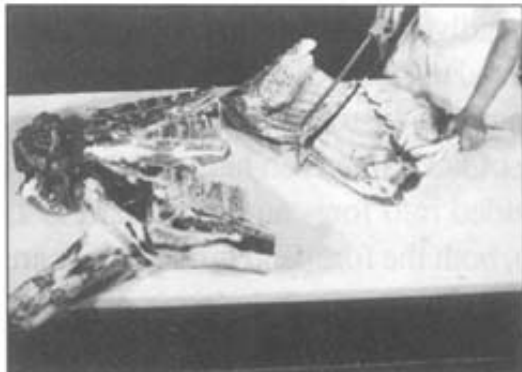

73. Removing ribs and sternum from brisket



72. Cutting boneless arm roast from foreshank**74. Cutting the boneless neck into cubes**

Rib. The rib is prepared by first sawing across the rib bones to facilitate the removal of both the backbone and the ribs with the knife (Figs 79 and 80). Another procedure often used to bone out a rib is carefully with a sharp knife to loosen the small strip of meat found between the ribs. The ribs are then loosened by cutting close to the bone and removed by striking with a blunt instrument. After removing all bones and the heavy yellow connective tissue, the meat may be rolled into a tight bundle with the thin portion on the outside and tied tightly. Preparing ribs in this way makes for convenient carving and requires less cooking and storage space. About 25 percent of the initial rib weight is lost when the bones are removed. The boneless rib may also be sliced into boneless rib steaks (Fig. 81).

75. Removing the ribs and feather bones from the square-cut chuck**77. Inside portion of the chuck rolled and tied**



76. Subdividing the thick portion of the chuck along the inside of the blade-bone into inside and outside portion



78. Cutting outside chuck into fillets



Plate. After the heavy connective tissue lining is peeled from the inside of the plate, the bones are removed and the lean meat cubed for stew or prepared for grinding in a way similar to the trimming of the brisket.

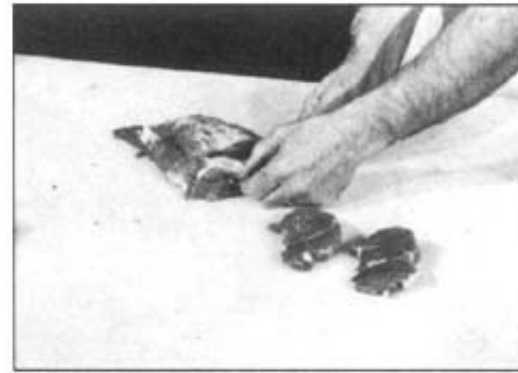

Hindquarter. As a first step, the kidney and accompanying fat are removed from the hindquarter carefully with a knife so as not to cut into the tenderloin muscle. The hindquarter is then separated into flank, round and loin as described in the bone-in method.

79. Sawing across the rib bones**80. Removing backbone and rib bone from rib****81. Cutting boneless rib steaks****82. Removing the pelvic bone**

Flank. Remove the flank by cutting into the scrotum or udder, following the round muscle and cutting close enough so that little lean meat is taken from the front of the stifle joint. Continue cutting along and below the outer portion of the line of the kidney fat in a straight line and saw through the thirteenth rib. Again the flank steak is removed as described in the bone-in method (Figs 65 and 66).

Round. The round and loin are separated with a saw as described in the bone-in method (Fig. 68). The pelvic bone is removed from the round and the muscle sections of the round are exposed (Fig. 82).

83. Tip or knuckle piece being separated from round



85. Silverside or bottom round muscle being separated from round



84. Topside or inside round muscle being separated from round



86. Hind shank



Muscle-boning the round means that the large muscle masses of the round are separated from

each other by following the natural connective tissue seams. In front of the stifle joint, the tip or knuckle piece is removed (Fig. 83), then the topside or inside round muscle (Fig. 84), and then the remaining silverside or bottom round muscles (Fig. 85). The latter is often divided and the eye of the round removed separately. All of the separated muscles may then be used as roasts or sliced into steaks. Muscle-boning is particularly useful when beef is prepared for roasting for large groups such as pit barbecuing.

Hind shank. The hind shank, somewhat like the foreshank, has a large muscle group attached to it that can be removed and utilized as a pot roast. This cut is sometimes referred to as the “duck” of beef (Fig. 86).

Loin. The tenderloin muscle is carefully cut from the inside of the loin (Fig. 87) and usually cut into individual steaks (Fig. 88). The remainder of the loin is then sawn just in front of the hip-bone into the short loin and sirloin sections. The bone is removed from the sirloin which is a somewhat complicated procedure because the pelvic bone is fused with the backbone (Fig. 89). The short loin is boned and the muscle that is known as boneless top loin (Fig. 90) is usually cut into boneless top loin steaks (Fig. 91).

On-the-rail boning

This is a modification of the muscle-boning method. Typical for on-the-rail boning is the hanging position of the hindquarter or the entire beef side (Fig. 92) during the boning procedure. The removal of the different meat cuts from the hanging carcass is considerably facilitated. Beef cuts can easily be pulled downwards under their own weight after cutting them free along their natural connective tissue seams. Special hooks with handles used by the operators are an additional aid for the correct fixation of the cuts during boning (Fig. 92).

On-the-rail boning is the most hygienic way of meat cutting. Contamination by hands of operators, tools, cutting-boards, etc. is less than with other methods.

The technique is also suitable for smaller operations. Final trimming of the meat cuts takes place on cutting tables as usual.

87. Cutting the tenderloin from the inside of the loin



88. Tenderloin cut into individual steaks



90. Boning the short loin



91. Cutting boneless top loin steaks



89. Removing the bone from the sirloin



When meat cuts are produced by muscle-boning it is often difficult to identify them, primarily because traditionally the size and shape of the accompanying bone has been used as the major means of identification. Also, the traditional shape of muscle in a cut of meat is often determined because of its attachment to bone. Many conventional cuts of meat combine muscles because of their association, size and proximity to bone or general location. The basic principle of merchandising meat is to separate the tender from the less tender and to sell each according to its palatability characteristics and its possible method of preparation. Muscle-boning facilitates this type of merchandising.

PORK CUTTING

Halving is done immediately after the animal has been dressed and every effort should be made to saw the carcass into equal sides through the centre of the backbone. The side to be cut should be laid on the cutting table with the inside up (Figs 93, 94 and 95).

**92. On-the-rail boning of entire beef side.
Removing strip loin together with rump**



The primal cuts of pork are: ham, fore-end or forequarter, loin and belly.

***Hind foot.* The hind foot is removed by sawing through the hock joint at a right angle to the long axis of the leg (Fig. 96).**

***Ham.* The ham may be removed in several ways to make either long-cut or short-cut hams. One procedure (short-cut) is to locate the division between the second and third (or the third and fourth) sacral vertebrae and saw perpendicularly to the long axis of the ham (Fig. 97). After the bone has been severed with the saw, the knife is used to complete the removal of the ham. The ham is further trimmed by removal of the tail bone on one side and the flank on the other side. Commonly a skinned ham is produced by removal of three-fourths of the skin and fat from the rump end (Fig. 98). For the production of special cured dried hams the skin is left on (Fig. 99).**

93. The pork carcass and its bones

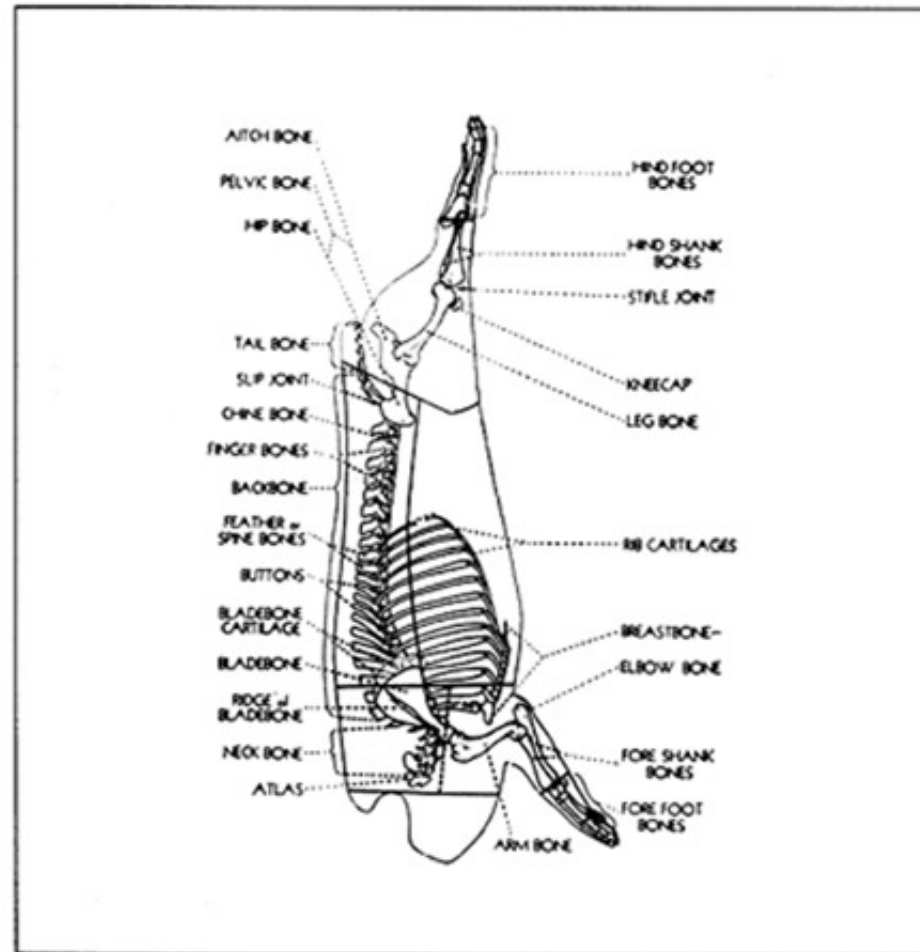

In order to obtain a long-cut ham the division is made between the last two (fifth and sixth) lumbar vertebrae. The long cut is composed of a rump or chump portion and a leg portion comprising centre section and shank portion. Nowadays more processors are removing the bones thus fabricating a boneless rump (chump) and a boneless ham. The ham is commonly merchandised in smaller portions (topside, silverside, thick flank, shank).

94. The pork carcass and its cuts

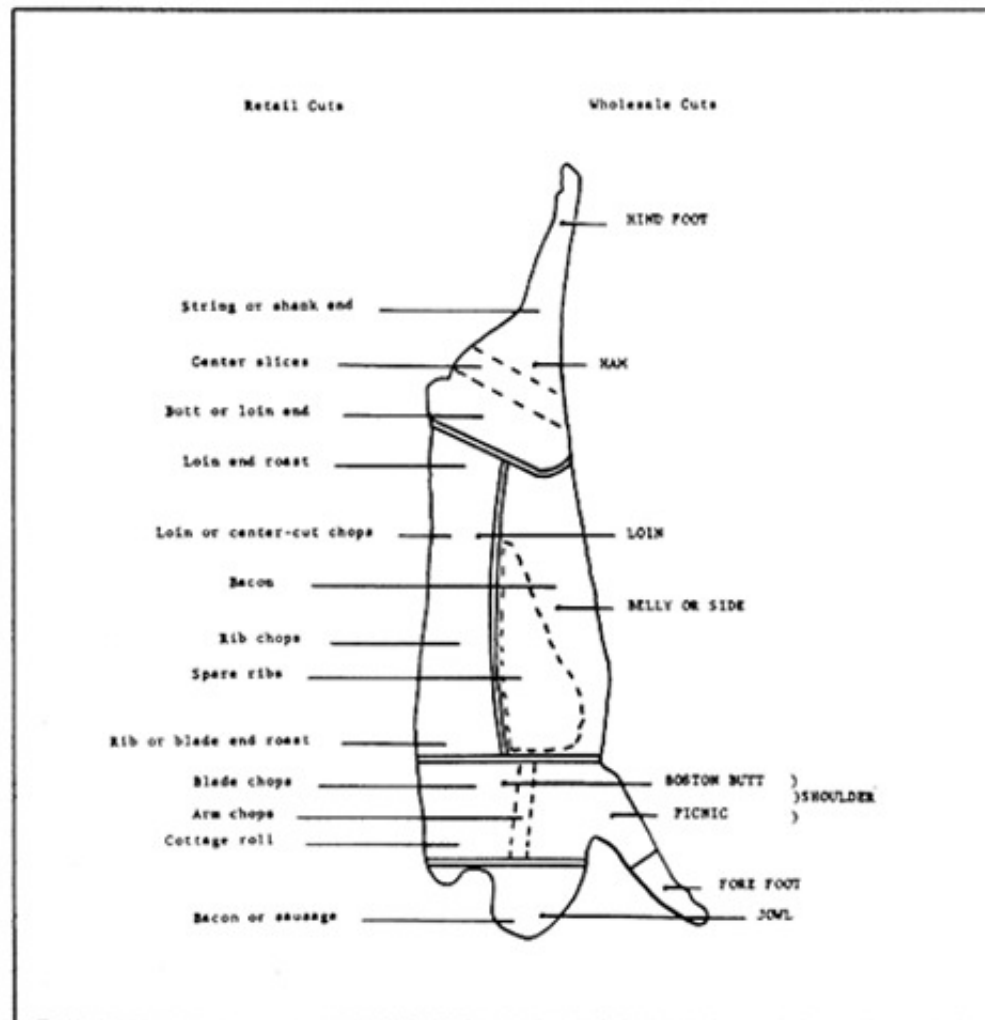

95. Pork carcass split into left and right side

97. Short cut of ham

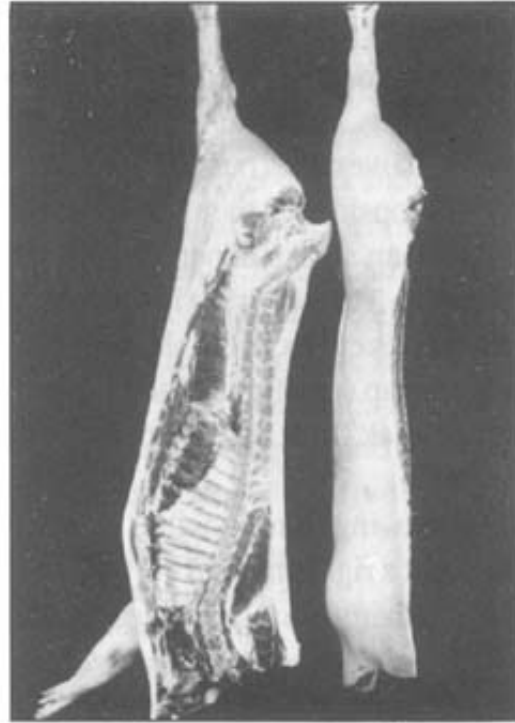

96. Severing the hind foot



98. Removing skin and fat from the rump end of the ham



99. Pork leg cut into ham, shank and

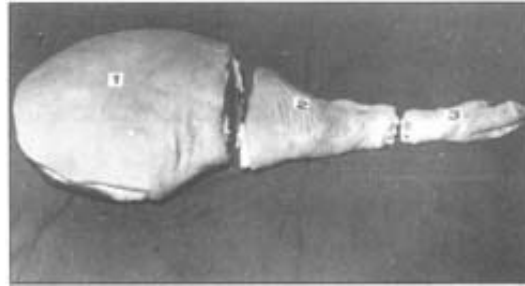

foot

The cutting procedure of the ham is as follows. Remove tail bone and aitch bone and cut the rump off. Peel back the rind and associated fat to expose the topside muscle on the interior side of the leg. Separate the topside by following the natural seam between it and the silverside (outside portion of leg) and thick flank (front position of leg). The topside can then be sliced into steaks. This produces between five and six lean steaks depending on the thickness and weight required by the customer. The next step is to remove the leg bone (femur). The thick flank (knuckle) is cut from the silverside by following the natural seam. Remove the kneecap (patella) and the internal fat deposits before further preparation of the thick flank, e.g. for diced pork or steaks.

Forefoot. The forefoot is removed by sawing through the junction between the foreshank and the forefoot bone at a right angle to the length of the foot. This foot contains some muscle and is therefore more desirable than the hind foot for food.

Fore-end. Considerable variation exists as to where the fore-end is removed. Generally one to three ribs are left on the pork fore-end. Locate the division between the third and fourth ribs

from the head end and saw perpendicularly to the length of the backbone. The fore-end is trimmed of the hock which is cut off about halfway up the leg and about two-thirds of the skin and fat is removed from the butt or top end. Additionally the neckbone (all cervical and three thoracic vertebrae) and the jowl or cheek meat are removed (Fig. 100). The jowl is removed by a straight cut parallel to the cut that separates the fore-end from the side just behind the site where the ear was removed (Fig. 101). The fore-end may be divided into two cuts (spare-rib, also called blade Boston, and hand, also called arm picnic) by sawing just below the exposed lower end of the blade-bone parallel to the top of the shoulder (Fig. 102). The spare-rib can be sliced into steaks or used as a roast. It can easily be made into a boneless cut by removing the corner of the blade-bone.

Besides this method some other ways of cutting and boning the pork foreend exist. In order to obtain boneless cuts (shoulder and neck-end) from the fore-end the following technique is recommended. Seam the shoulder carefully from the rest of the side, leaving the rind and associated fat behind. Release the under-blade steak and remove the blade-bone (scapula) and the shoulder-bone (humerus). Separate the main muscle block from the smaller group. The smaller group, after trimming the fat off, can be used for dicing. The main shoulder block should be trimmed of excessive connective tissue. It can be separated further into the blade and feather muscles and the main shoulder muscle. These can then be sliced into a number of boneless steaks. The group of muscles on either side of the spinous processes of the neckbone and the two or three following segments of the backbone is called the neck-end. The neck-end is loosened from the backbone and after trimming off excessive rind, fat and any adhering ragged edges it can be cut into attractive steaks.

**100. Pork shoulder (middle),
jowl or cheek meat (left), neck
bone (right below)**

**102. Dividing the shoulder into
two cuts (left, spare-rib; right,
hand or arm picnic)**

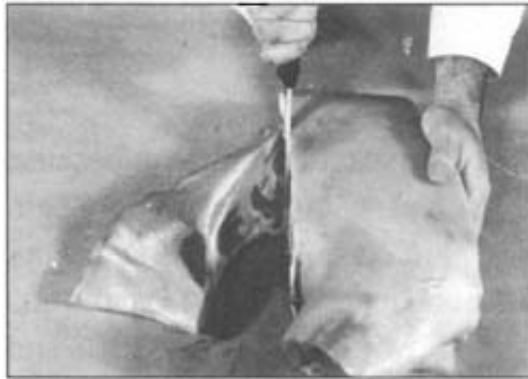
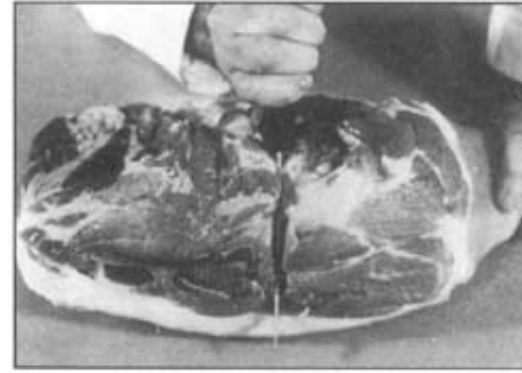

101. Removing the jowl or cheek meat

Loin. The middle or centre section of the pork side is divided into loin and belly by a straight cut from the edge of the tenderloin muscle on the ham end through a point on the front rib tight against the protruding edge of the split backbone (Fig. 103). The fat back (skin and excess fat) is removed from the loin so that a complete fat cover about 0.5 cm thick remains. Starting along the backbone side at the shoulder end, cut and lift the fat over the curve of the loin muscles without cutting into the lean (Fig. 104). The loin can be roasted whole, cut into smaller roasts or cut into chops. Shoulder, rib, loin and sirloin chops are made from the loin. Chops for broiling or frying should be cut 1.3–1.9 cm thick. Thicker chops may be made and a pocket cut into them for stuffing (Fig. 105).

Belly. Separate the spare-ribs from the belly by cutting closely underneath the ribs beginning

at the flank end (Fig. 106). Prepare the bacon side from the belly by removing any thin or ragged pieces of lean. Turn the belly over and remove the lower edge with a straight cut just inside of the teat line. Trim the flank edge of the belly to square the whole piece to prepare it for curing.

LAMB CUTTING

Method

This procedure as described may also be followed for the processing of deer, goats, sheep or other animal carcasses of similar size.

Cooling

All lamb carcasses should be promptly chilled and kept at a low temperature (-2° to 2°C) until cut and utilized. Do not permit lamb carcasses to freeze within a day after slaughter or the meat may toughen. Lamb carcasses can be cut into retail cuts after they have been chilled for 24 to 48 hours.

Carcass

Lamb carcasses are generally not split into halves after dressing because they are not thick enough in any location to create cooling problems. Begin cutting the lamb carcass by removing the thin cuts, i.e. flank, breast and foreleg. Lay the carcass on the cutting table and mark one side from the cod or udder fat in front of the hind leg to the elbow joint (Figs 107, 108 and 109). After removing the thin cuts from both sides, remove the kidneys, kidney fat and diaphragm (Fig. 110). Next the carcass is turned over and the neck removed either in thin slices to be braised or in one piece to be added to stew or to be boned and ground.



103. Dividing the centre section of the pork side into loin and belly



104. Removing the fat cover of the loin

106. Separating spare-ribs from the belly



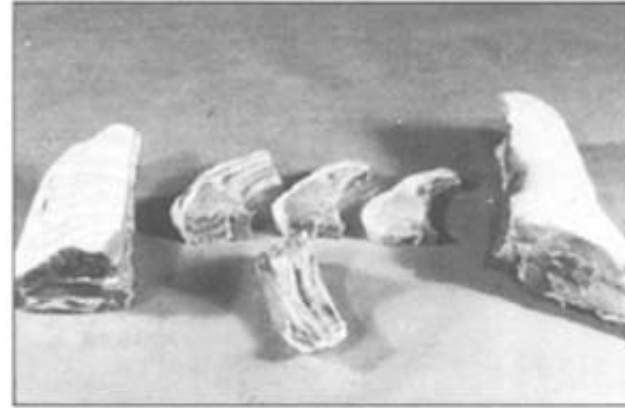

105. Smaller roasts and chops from the loin

The trimmed carcass can then be separated into four primal cuts, each with different characteristics. A cut between the fifth and sixth rib removes the shoulder. Another cut between the twelfth and thirteenth (last) rib separates the rib from the loin. The loin and legs are separated just in front of the hip bones by cutting through the back where the curve of the leg muscles blends into the loin (Fig. 111).

107. The lamb carcass and its bones

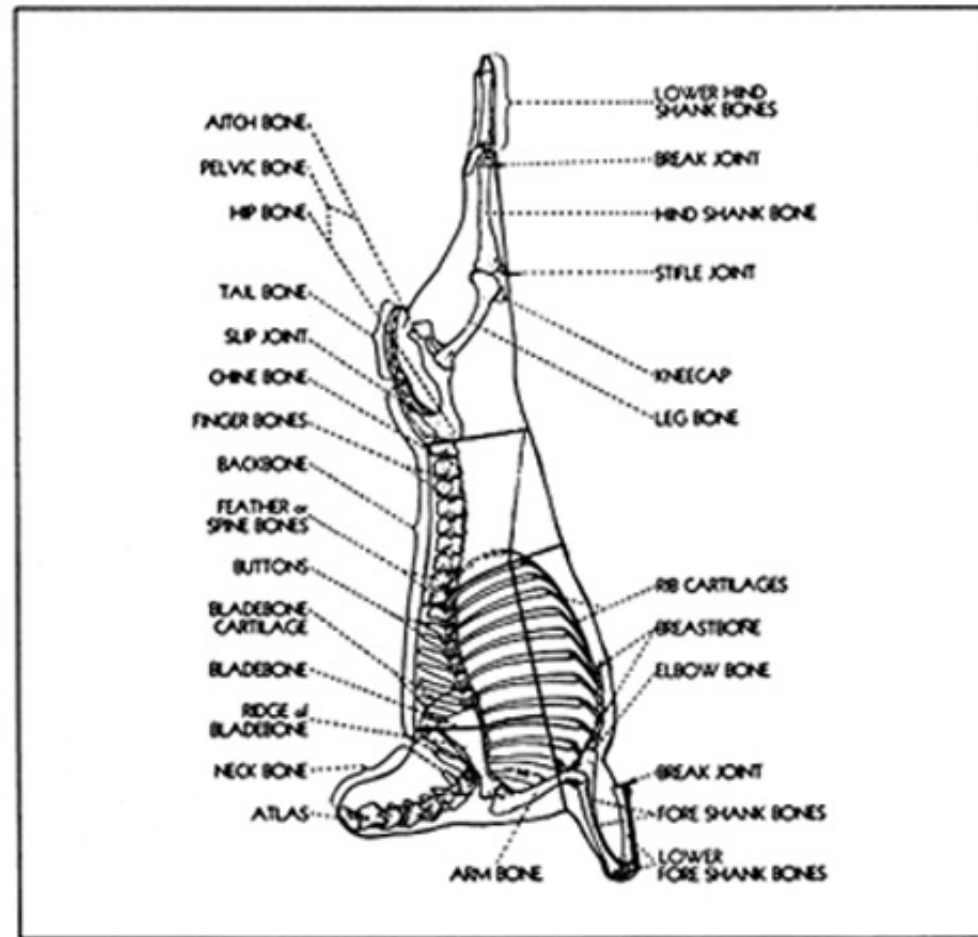

Legs. Split the legs through the centre of the backbone (Fig. 112). Trim off the flank and cod or udder fat. Utilize the saw and knife to remove the backbone from the leg. The leg may be further trimmed by cutting through the knee-joint which is located about halfway between where the muscles of the shank end and the muscles of the lower leg begin. Work the knife and cut through the joint (Fig. 113). Several sirloin chops may be cut from the loin end of the leg. Legs may either be prepared with the bone in or the bones completely removed and the leg rolled and tied.

108. The lamb carcass and its cuts

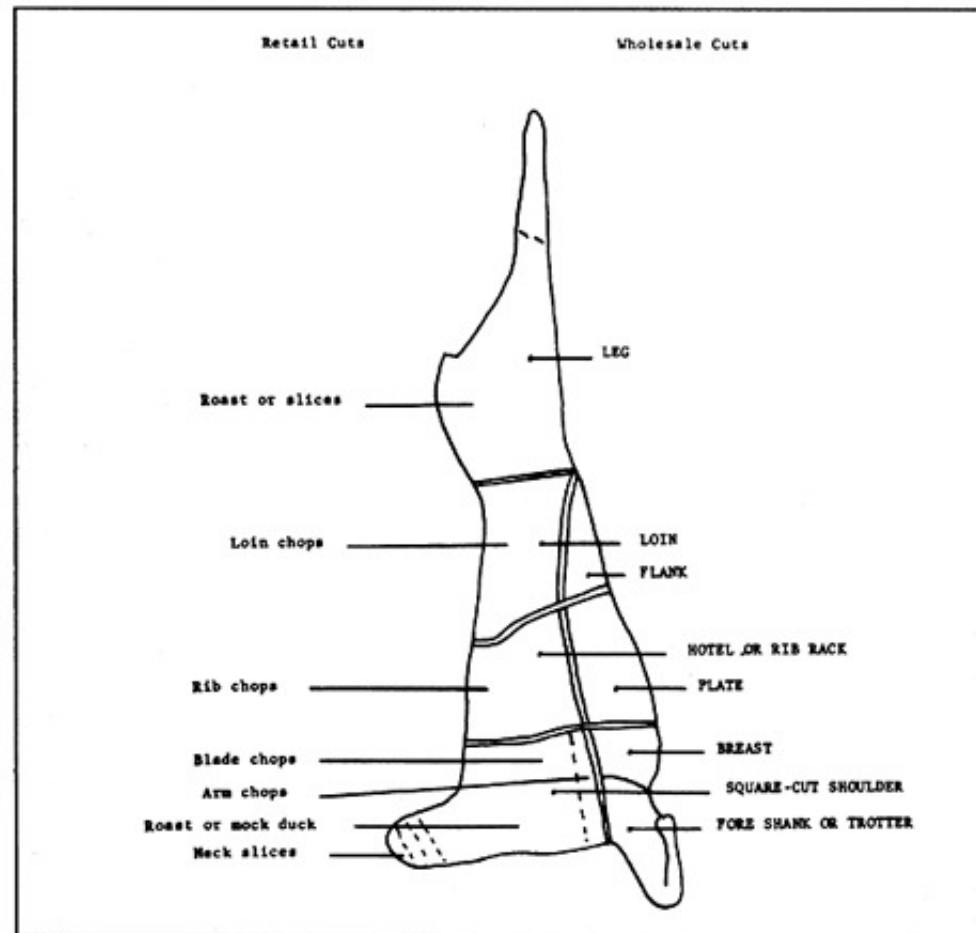

Loin. The loin is usually split through the middle of the backbone and chops are cut perpendicularly to the backbone (Fig. 114). Lamb chops are cut about 2.5 cm thick. Double or “English” chops are made from a loin that has not been split. Remove the fell or connective tissue covering before cooking chops (Fig. 115).

Rib. The rib of lamb is prepared by sawing through the ribs on both sides of the backbone (Fig.

116). The main portion of the backbone is then removed with a knife. Rib chops are easily made by cutting between the ribs. Remove the fell before cooking the chops. The breast portion may be barbecued in one piece or made into riblets by cutting between the ribs (Fig. 117).

***Shoulder.* After splitting through the backbone, the shoulder may be roasted as is, made into chops, or boned and rolled into a roast. Arm chops should be made first by cutting parallel to the surface where the foreleg and breast were removed. Blade chops are made by cutting between ribs and sawing through the blade- and backbones. To prepare a boneless shoulder, first remove the ribs and backbone by cutting closely underneath the ribs, backbone and neck vertebrae. Next from the rear surface cut along the inside of the blade-bone to expose it and the arm bone. Cut along the edges of the bones and remove them (Fig. 118). Roll the meat and tie it securely with clean twine. The boneless shoulder may also be made into a pocket roast and stuffed with ground lamb or other dressing. The edges of the pocket roast are stitched together.**

109. Removing the thin flank cuts

110. Kidneys, kidney fat and diaphragm removed from carcass





Shanks. Both the fore- and hind shanks when removed can be barbecued, cut into pieces for stew or boned and the meat ground.

111. Lamb carcass separated into four primal cuts (shoulder, rib, loin, legs) **113. Separating the shank from the leg**





112. Splitting the legs



Lean trimmings. Lean trimmings of lamb in chunks are suitable for stews or to be marinated and used for special roasts. Other lean trimmings can be ground and used as one would prepare ground veal or beef.

HYGIENE RULES FOR MARKETING CHILLED MEAT CUTS

Chilled meat is usually kept for the sale in refrigerated display cabinets, either unwrapped or portioned and packaged for self-service outlets. Refrigerated display cabinets may have fan-assisted convection and/or natural convection. Fan-assisted types are better able to maintain a lower temperature as they are less affected by draughts. Cabinets should be stacked to maintain a good air flow around all meat (Fig. 119).

114. Cutting chops from the loin

116. Splitting the rib along the backbone



115. Removing the connective tissue covering the loin

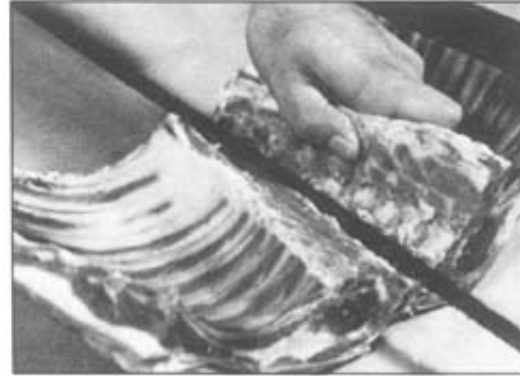

117. Rib chops and breast portion

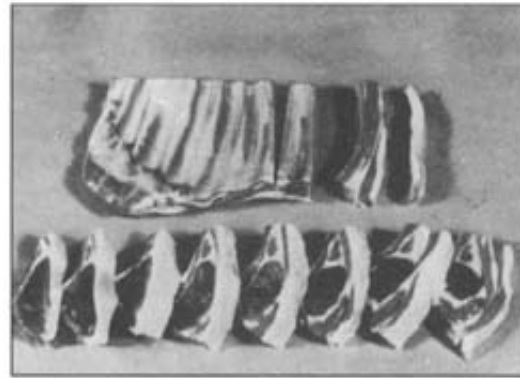

Do not store or display unwrapped cooked and raw meat together. Use separate refrigerators, display cabinets etc. to avoid cross-contamination. Raw-meat exudate on to cooked meat gives an explosive bacterial growth.

Simple packaging of fresh meat with plastic foil has become very popular with the availability of suitable and inexpensive film. The main objective of simple packaging is to provide hygienically protected portioned meat for self-service retail outlets. But the meat portions must also satisfy the customers' preference for bright red fresh meat. This colour is due to the pigment myoglobin loosely binding oxygen to form oxymyoglobin. For this colour to develop and be

maintained, the wrapping film must have a high-oxygen permeability. To avoid desiccation of the cut surface, the film should have a low-moisture permeability. After a time the cut surface becomes more brown as a result of myoglobin binding the oxygen more tightly to form metmyoglobin. This may take up to three days depending on the temperature, the number of bacteria and other conditions.

Simple packaging for retail sale in self-service outlets usually involves placing the meat portion in a plastic tray and overwrapping with a clear plastic film (Fig. 120). Plastic trays are more hygienic than cardboard. The portions cut should be based on local demand and only a day's sales should be cut at a time.

118. Boneless shoulder (left) and ribs, backbone, blade- and armbone (right)

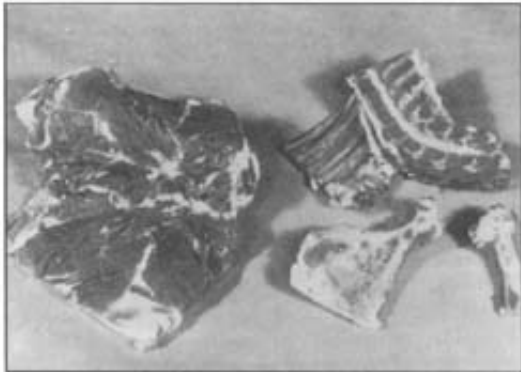

119. Chill display cabinets should have a clearly visible thermometer which is set to $0^{\circ} \pm 1^{\circ} \text{C}$. Meat trays should not be stacked on top of each other

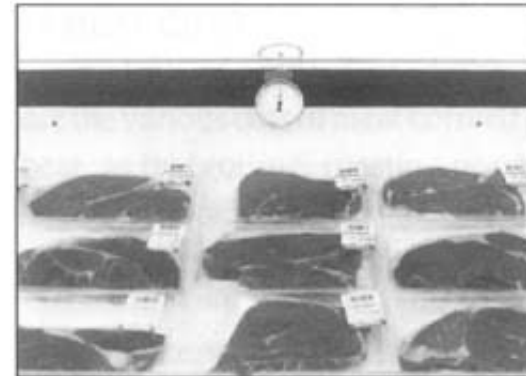

The principal object of this type of simple packaging from a hygiene point of view is to reduce contamination from airborne micro-organisms. High standards of hygiene are required in the cutting and packaging operations. On large pieces of meat the bacteria mainly colonize the

outer surfaces. When meat is cut even with a clean knife they will be spread on to the freshly cut moist surface and multiply rapidly. This is not an argument for relaxing hygiene standards, rather it underlines the need not to add to the bacterial load by further contamination.

All surfaces and tools in the cutting and packaging room must be kept thoroughly clean. Packaging materials should be stored in hygienic conditions protected from dust and attack from insects or vermin. It is most important that personnel involved in cutting and packaging pay particular attention to personal hygiene as they are the most likely source of food-poisoning pathogens which may survive better in the package environment than on unpackaged meat. This is in part due to the packaging preventing surface desiccation. The moist surface favours bacterial growth as does the high relative humidity that builds up within the pack.

120. Overwrapping meat in a tray with clear film is a simple form of packaging suitable for self-service retail outlets



121. Minced meat has a short shelf-life as the surface microorganisms are spread throughout the product and the surface area is increased

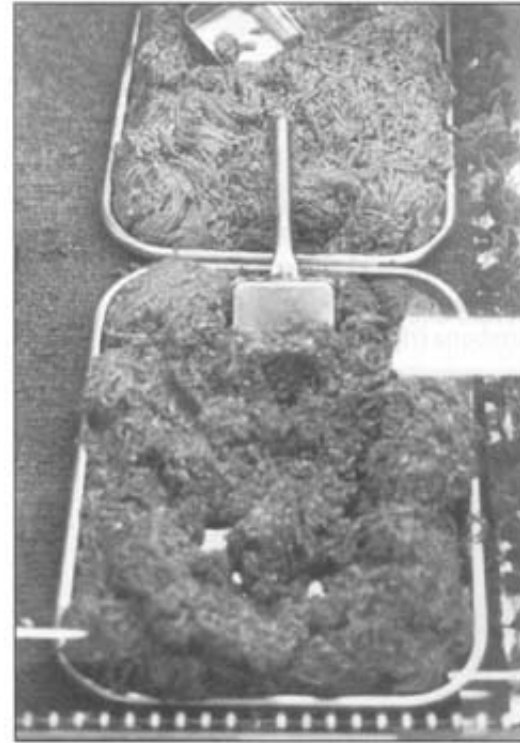

It is important to retard bacterial growth by maintaining a low temperature during the display life of the packs. Overwrapping actually increases the meat temperature as the layer of trapped air acts as an insulator. Heat generated by light warms the upper surface. Meat should be thoroughly cooled before packaging to help maintain a low temperature during its display life.

Mincing meat spreads bacteria on the surface all through the meat which therefore has a shorter shelf-life than cuts. Mince may be packaged and overwrapped but the mincer must be kept scrupulously clean and the packs kept well chilled (Fig. 121). Only small quantities of mince should be prepared at a time.

Cooked meats, which typically have much lower bacteria counts than fresh, are more open to attack from airborne micro-organisms as these will be faced with little competition. Packaging is therefore particularly beneficial in preventing this type of contamination for cooked meats.

Bacteria introduced during cutting and packaging face little competition and may be of the food-poisoning type if personal hygiene is poor. If very high standards of hygiene cannot be maintained then a pasteurizing treatment after packaging will be necessary. Even this, however, will not guarantee destroying *Bacillus* and *Clostridium* spp. if these have been introduced.

COOKING METHODS FOR DIFFERENT MEAT CUTS

Primarily because of natural tenderness or lack of tenderness, different cooking procedures are utilized to prepare the various cuts of meat correctly. Tender cuts are best cooked with dry heat, as by broiling, roasting or pan broiling. Less tender cuts are tenderized by cooking with moist heat. Connective tissue is softened and made tender by cooking slowly in moisture.

Temperature control is important in meat cookery. Meat loses moisture, fat and other substances such as soluble proteins during cooking. Cooking losses can be minimized by controlling the cooking temperature and the final internal temperature of the meat. Higher oven and higher internal temperatures increases shrinkage. Whenever possible a meat thermometer should be used to determine accurately the degree of doneness of meat. Time and temperature guides can be used to ascertain doneness, but cooking time is affected by fat, bone and moisture content and the shape and size of the cut. The basic types of meat cookery follow.

Broiling

Broiling is recommended for all tender cuts and for best results:

- **Set the oven for broiling**
- **Place thin cuts of meat on a rack at a distance from the heat equal to two times the thickness of the cut plus 2.5 cm**

- **Broil steaks, chops or patties for approximately one-half the desired cooking time before turning**
- **Season and serve at once.**

Pan-broiling

Pan-broiling is recommended for tender cuts suitable for broiling. For best results:

- **Place meat in a hot frying-pan or on a griddle**
- **Do not add fat or water**
- **Cook slowly over moderate heat, turning occasionally**
- **Pour off or remove fat as it accumulates**
- **Brown meat on both sides**
- **Avoid overcooking.**

Roasting

Roasting is recommended for large, tender cuts. Some beef cuts suitable for roasting are rib and top sirloin roasts. For best results:

- **Season with salt and pepper as desired**
- **Place the meat, fat side up, on a rack in an open shallow roasting-pan**
- **Insert a meat thermometer so that the bulb is in the centre of the largest muscle without touching bone.**
- **Add no water and do not cover**
- **Roast at oven temperature of 176°C to desired internal temperature.**

Meats are usually cooked to degrees of doneness as follows:

- | | |
|-------------|------|
| - Rare | 60°C |
| - Medium | 71°C |
| - Well done | 77°C |

Pan-frying

Pan-frying is usually recommended for tender cuts 2.5 cm thick or less. For best results:

- **Place meat in a hot frying-pan or on a griddle**
- **Fat may be added**
- **Cook slowly over moderate heat, turning occasionally**
- **Allow fat to accumulate**
- **Brown meat on both sides**
- **Avoid overcooking.**

Braising

This method is best used for less tender cuts such as beef round or chuck steak, pot roast, stew or short ribs. For best results:

- **Use a heavy pan**
- **If desired, brown meat slowly on all sides with sufficient fat to keep meat from sticking**
- **Season with salt, pepper, herbs or spices**
- **Add a small amount of liquid**
- **Cover tightly**
- **Cook slowly over low heat on a stove burner or in a moderate oven until meat is tender.**

Braising with large cuts is often called pot-roasting and with thin cuts may be known as

Swissing.

Simmering

This method consists of cooking a small amount of meat with a large amount of water. For best results the container should be tightly covered and the meat cooked slowly below the boiling point until tender. This method is used for the production of soups to which vegetables, grains or pasta products may be added.



Meat as raw material, non-meat ingredients and basic techniques in further processing of meat

TYPES OF ANIMAL TISSUE SUITABLE FOR MEAT PROCESSING

Meat is defined as those animal tissues which are suitable for use as food. These are the main soft tissues of the carcass: muscle, mainly skeletal (30– 65 percent), fatty (10–45 percent) and connective tissues. Other animal tissues used as food, and also to some extent in meat processing, are the internal organs including the blood.

Muscle tissue

The structural unit of muscle is a specialized cell, the muscle fibre, which constitutes 72–92

percent of the muscle volume. The membrane surrounding the muscle fibre is called the sarcolemma and the intracellular substance the sarcoplasm. The muscle fibre is composed of many myofibrils, which consist of thick and thin filaments (myofilaments). The special arrangement of these and the bands of myofibrils give the fibre a striated appearance under a microscope (cross-striated muscle). The filaments consist almost entirely of the myofibular proteins actin (thin 20– 25 percent) and myosin (thick 50–55 percent) (Fig. 122). Although they make up only 7 percent of muscle weight, they are mainly responsible for a very important property of meat, its ability to retain water and bind added water (water-holding capacity, WHC). The water-holding capacity is of particular importance in meat processing.

Connective tissue

Connective tissues are distributed throughout all body components -skeleton, skin, organs, fat, tendons and muscles. There are three kinds of connective tissue fibre: collagen, reticulin and elastin. Collagen constitutes 20–25 percent of total protein, and has a major (negative) influence on meat tenderness.

Skin (from pigs only) (Fig. 123) has excellent swelling and binding abilities owing to its high collagen content. It is therefore ideal for meat products such as emulsion-type cooked sausages provided it is properly scalded, completely dehaired, usually singed, scraped, washed and de fattened.

Fatty tissues

The main fatty tissue deposits are in septa between muscle bundles (intramuscular fat), in spaces between muscles (intermuscular) and between skin and muscles (subcutaneous or backfat) (Fig. 123 and 124). Fat depots are also found around internal organs. The main depot

is found around the kidneys (perirenal, leaf or kidney fat) (Fig. 124). Fatty tissues can be graded as “firm” (backfat, jowl and brisket) and “soft” fatty tissues (leaf perirenal fat) depending mainly on their connective tissue content.

Internal organs

Depending on local regulations and eating habits, the following are commonly used in sausage manufacture (Figs 125, 126 and 127):

122. Whole muscle and crosssection of a muscle cell: 1 whole muscle; 2 muscle cell (muscle fibre); 3 sarcolemma; 4 sarcoplasm; 5 band of myofibrils; 6 myofibrils; 7 thin myofilament (actin); 8 thick myofilament (myosin)

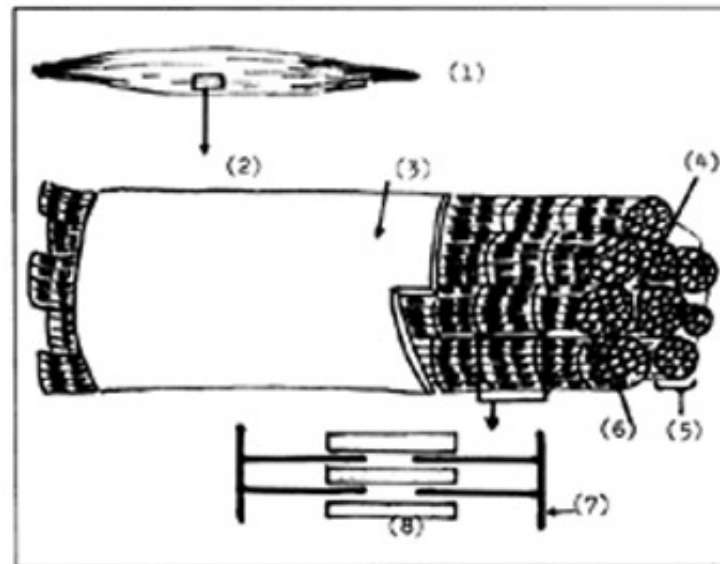

- Heart after removing the pericardium is used as any other kind of meat.
- Liver is used for making various types of liver sausage and paste, because its proteins have high emulsifying capacity.
- Tongue trimmed of all the hyoid bones, tonsils, and mucous membranes, can be cured and dried whole, used to make meat batter, or cured and canned (ox or pork tongues).
- Lungs. Beef lungs can be used to make cooked sausages. Pork lungs are frequently not fit

for human consumption as they can be contaminated by scalding water.

- **Kidneys are often contaminated to a certain extent with heavy metals or other residual substances and the consumption in higher quantities is not recommended in some countries.**
- **Tripe is the rumen and reticulum of ruminants, opened and rinsed. All the dark tissues (internal linings) must be removed by cooking (62– 65°C).**
- **Stomach of pigs, properly cleaned, is used as a natural casing for cooked sausages.**
- **Intestines are mainly used as casings for various sausages.**
- **Blood is highly perishable and must be handled carefully to avoid contamination during collection. To prevent coagulation blood is either defibrinated (Fig. 127) or a solution of sodium citrate 1.6 percent or phosphate 1 percent is added. Blood plasma obtained by centrifuging should be cooled as quickly as possible to 0°C. Whole blood is used to make blood sausage, liver sausage, and blood pudding. Blood plasma can be used for meat emulsions (batter).**

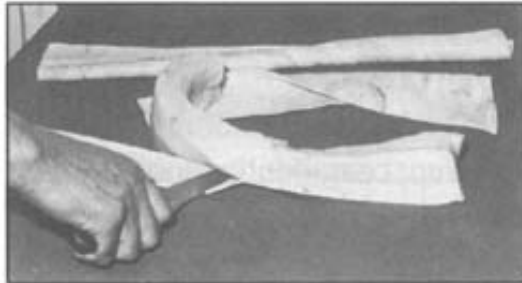

123. Pieces of defatted pork skin (above), and cutting off the skin from stick of pork backfat (below)

124. Cutting off the pork fat on pork side (A) and the brisket (below), and perirenal (above) fatty tissues on beef side (B)



125. Some internal organs of pig: 1 heart; 2 liver; 3 tongue; 4 kidneys; 5 lungs; 6 stomach

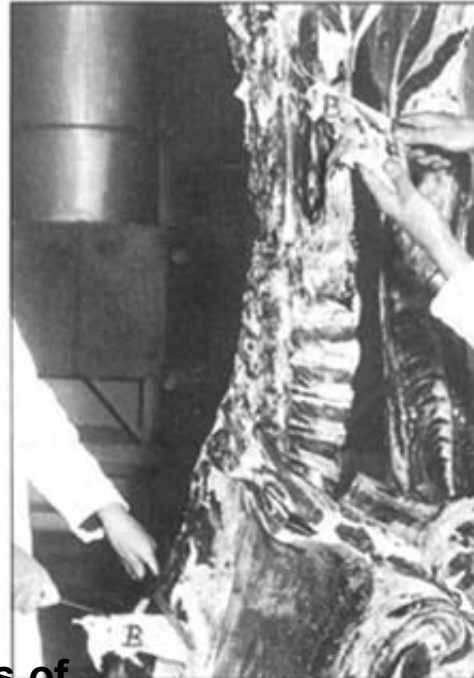

126. Some internal organs of beef: 1 heart; 2 liver; 3 tongue; 4 kidneys; 5 lungs; 6 stomach



127. Blood being manually defibrinated (left), blood



coagulated (right)

General remarks

All raw materials must be fit for human consumption. After inspection, final dressing, removal of condemned and dirty parts and washing, all meat and organs must be immediately hung on hooks and moved to a cooler to await processing.

Carcasses may be fully or partially boned before chilling provided high hygienic standards are rigidly observed. A high degree of skill and special organization of labour is required. If small-scale producers cannot chill the carcasses, they may use hot-boned meat for sausage production or meat batter. Hot-boned meat has a high WHC so the use of phosphate is avoided. However, beef must be processed within four hours and pork within one hour of slaughter.

***PSE and DFD meat.* Pre-slaughter stress may result in abnormal undesirable muscle conditions called “pale, soft and exudative” (PSE), and “dark, firm and dry” (DFD) (Fig. 128). PSE meat is frequently found in pork caused by a sudden stress before slaughter. Glycogen levels are raised in response to the stress so that post-slaughter glycolysis is elevated leading to a build-up of lactic acid and a rapid fall in muscle pH to below 5.8 within one hour. This results in partial protein denaturation reducing WHC and increasing drip loss. A prolonged period of stress prior to slaughter such as fighting during transport and lairage causes exhaustion and the depletion of glycogen reserves. Post-mortem glycolysis and lactic-acid production are**

therefore reduced, the pH falls slowly and protein degradation is reduced. The resulting DFD meat which is found in pork and beef has a high WHC but spoils very quickly because the high pH and dry surface favour bacterial growth.

SIMPLE STANDARDS OF DIFFERENT QUALITIES OF MEAT USED AS RAW MATERIAL FOR DIFFERENT PRODUCT QUALITIES

Manufacturers must aim for uniform quality of their meat products. To attain this, raw materials must be standardized for different qualities. Good quality carcasses are usually divided into primal cuts (ham, shoulder, loin, neck, etc.). The remainder of the carcass and trimmings from the primal cuts are standardized into different qualities of meat. Poorer-quality carcasses are used entirely for processing after being deboned and trimmed.

Basic parameters for simple quality standards are size and shape of meat pieces, amount of visible fatty and connective tissues, and chemical composition. Meat must not contain skin, lymphatic glands, particles of bones, bristles, large blood vessels or blood clots.

Different qualities of meat

First quality (Meat I). Meat pieces of relatively uniform size and shape, trimmed of connective tissue, with about 8 percent visible fatty tissue obtained from larger primal cuts, mostly hindquarter. It is used to make meat batter for sausages and high-quality canned products (Fig. 129).

Second quality (Meat II). Meat pieces of irregular size and shape, partially trimmed of connective tissue with about 15 percent visible fatty tissue, obtained mostly from forequarters. It is used to manufacture meat batter, or medium-quality meat products (Fig. 130).

Lean trimmings are small irregular pieces of meat, with pervading connective and fatty tissue (about 25 percent), obtained during deboning and trimming of primal cuts, Meats I and II, and meat parts of the head and flank. They are used to make meat batter for all kinds of medium- and lowquality cooked sausages (Fig. 131).

Fatty trimmings are meat pieces containing about 50 percent visible fatty tissue, derived from all trimming operations. They are used as the fatty ingredient of meat batter of medium and low quality (Fig. 132).

Standards of fatty tissues

Ruminants

Firm (external) fatty tissues are trimmed from any part of the carcass and hump of zebu and are used as the fatty component of the meat batter or sausage mixture (mutton, goat, etc.) or all-beef higher-quality sausages.



128. Cross-section of pork loins: DFD (1) and PSE (2) meat



129. First-quality meat (Meat I)



131. Lean trimmings



130. Second-quality meat (Meat II)



132. Fatty trimmings

Soft (internal) fatty tissues are perirenal and sacral in origin and are not generally used in sausages.

Pork

Jowl (firm) contains much muscular (even up to 30 percent) and connective tissues. It is suitable for manufacturing dry sausages, summer sausages, salamis and emulsion-type sausages of the highest quality (Fig. 133).

Back fat (firm) is used for semi-dry and dry sausages, and in frankfurter sausages of the highest quality (Fig. 134).

Side fat (firm) contains about 60 percent visible fatty tissue. It is used to manufacture medium-quality cooked sausages made of uncooked or precooked materials (Fig. 135).

133. Pieces of pork jowl



135. Uniformly sized and shaped pieces of pork side fat



134. Pieces of pork back fat



136. "Soft" pork fatty tissues



Belly fat and leaf (soft) are used to make cooked sausages of low quality (Fig. 136).

Chemical parameters

Typical quality standards based on average chemical composition are shown in Table 4.

SALT, CURING AGENTS, COMMON SPICES, ADDITIVES AND NATURAL SMOKE

Common salt

Common salt (sodium chloride, NaCl, salt) which may be extracted from sea water (sea salt) or mined (rock salt), has three major effects upon meat.

Flavour enhancement of meat and meat products. The salty taste of a meat product depends on the relative amounts of salt and water. Typical ranges of salt concentration for various products are shown in Table 5. Products with less water require higher levels of salt concentration to achieve the same degree of saltiness.

Functional properties of meat proteins. Depending upon its concentration salt can increase or decrease the WHC of a meat product. The dehydrating effect of salt is used for meat drying (lowering WHC). The opposite effect of increasing WHC is very important and results from the swelling and solubilizing of the muscle proteins (actin and myosin).

137. Samples of different nonmeat substances used in manufacturing sausages and other meat products: 1 salt; 2 nitrite; 3 nitrate; 4 nitrite salt; 5 phosphate; 6 ascorbate; 7 GDL; 8 glutamate

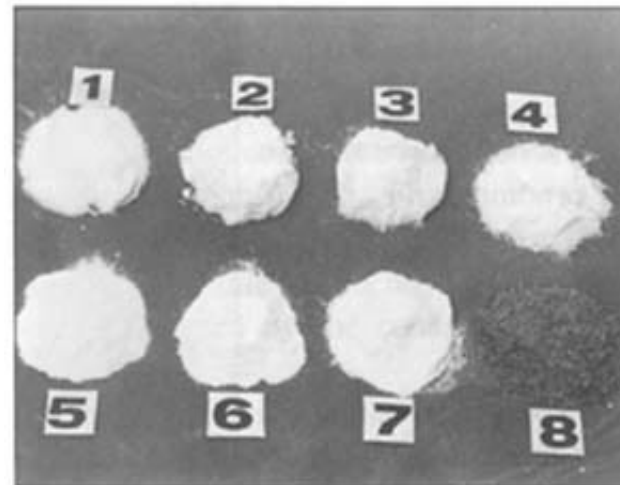

TABLE 4**Approximate chemical composition of different qualities of raw materials**

Raw materials	Water	Fat	Protein		
			Muscle	Connective tissue	Total
Meat I	71	10	16	3	19
Meat II	63	20	12	5	17
Lean trimmings	53	33	10	2	12
Fat trimmings	30	60	7	2	9
External beef fat	27	67	1	5	6
Internal beef fat	5	93	-	2	2
Jowl	17	78	3	3	6
Back fat	8	90	-	2	2
Side fat	32	60	7	1	8
Soft fat	5	93	-	3	3
Pork skin	55	15	0	30	30

138. Samples of different common spices in sausage seasoning: 1 black pepper; 2 white pepper; 3 onion in powder; 4 coriander; 5 anise; 6 paprika

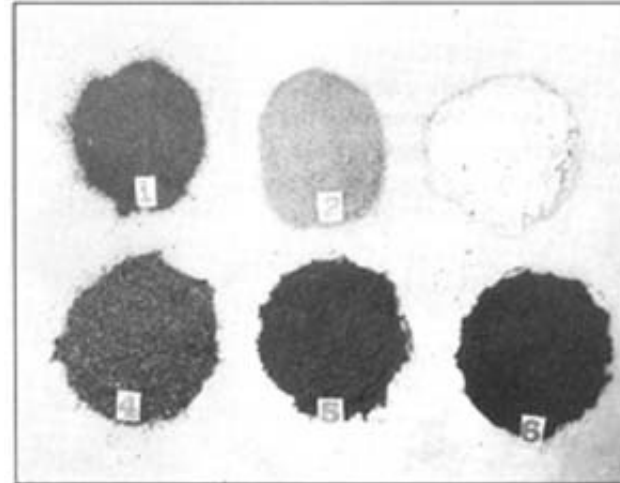

TABLE 5
Typical concentration of salt in some meat products

Finished meat products	Range of salt concentration (%)
Sausages	
fresh and cooked	1.6–2.2
dry, small-diameter	2.4–3.8
dry, large-diameter	3.0–5.0
Hams	
cooked	2.6–3.2
dry	2.5–6.0

Preservation. Salt is one of the most important food additives in food preservation. The salt concentration determines what types of microorganism, if any, can grow by dehydrating or by lowering the amount of water available for growth.

Curing agents

Nitrates. Sodium (NaNO_3) or potassium nitrate (saltpeter, KNO_3) allow cured meat colour to develop in products where drying is a long-term process (Fig. 137). Nowadays, they are used less frequently because to be effective they have to be reduced to nitrites under the influence of bacterial enzymes, and this is a time-consuming process.

Nitrites are indispensable for meat curing, and no substitute has yet been found. Sodium nitrite (NaNO_2), a toxic substance, can be fatal even in small doses (Fig. 139). For this reason they are often mixed with common salt at a concentration of about 0.6 percent (so-called “nitrite salt”) when used for curing. If excessive levels of nitrite are accidentally reached the accompanying salty taste will be rejected by the consumer, thereby preventing nitrite poisoning.

The maximum amount of nitrite permitted in finished meat products is usually 200 ppm (parts per million, or mg per kg), or may be less subject to the type of meat product or country legislation. Saltpeter can be added to the nitrite salt at a concentration of 1 percent and used for curing dry hams and dry sausages. Typical levels of nitrite and nitrate in meat products are shown in Table 6.

TABLE 6

Typical amounts of nitrite and nitrate in cured products

Curing agents	Amount of nitrite or nitrate in cured-meat products
Nitrite salt (99.4% NaCl + 0.6% NaNO_2)	all-meat products, 100 ppm as nitrite dry hams, 150 ppm as nitrite

Salt peter (KNO_3)

dry sausages, 100 ppm as nitrate low-sodium products,

Nitrite salt + salt peter

100 ppm as nitrate
dry hams, 600 ppm as nitrate

Three processes in meat curing are due to the effect of nitrites:

Cured-meat colour development is achieved when the muscle pigment (myoglobin) in an acid environment combines with nitric oxide (NO) (formed from nitrite) to form NO myoglobin. This reaction is affected by temperature, pH and oxygen-reducing agents. NO-myoglobin is relatively resistant to light and oxygen and, most importantly, it is heat stable. Thus, cured cooked meat and meat products maintain a bright red colour in contrast to uncured meat which turns grey after cooking.

Nowadays it is considered that 3–50 ppm is sufficient to achieve colour in cooked sausages.

Cured-meat flavour development is based on various reactions between nitrite and the meat component. Typical flavour of cured-meat products is achieved with 20–40 ppm nitrite.

Preservative effect. Even in small doses (80–150 ppm), nitrite prevents the growth of numerous micro-organisms, and food-poisoning bacteria (*Clostridium botulinum*, salmonella, staphylococci, etc.). However, the effect of nitrite on shelf-life or prevention of food-poisoning bacterial growth must not be overestimated and decreases with increasing storage temperature.

Common spices

Spices act on the salivary and gastric glands to promote secretion, stimulating appetite and improving digestibility of meat products (Fig. 138). Their use varies from country to country

depending on the climate, customs and eating habits. There are spices whose taste and smell remain unchanged even after exposure to high temperatures (chilies and sage). Less resistant are cardamom, clove, pepper, rosemary and thyme, and the least heatresistant are coriander, mace, marjoram, nutmeg, allspice and ginger.

Useful additives

***Phosphates* are used to restore WHC to chilled meat, approximately to the same level as hot-boned meat. Certain countries forbid phosphates, whereas some allow their use only where there is a proven technological effect. Where permitted they should be restricted to 0.3–0.5 percent of the sausage mixture weight. Phosphates break down actomyosin into actin and myosin, which can be solubilized by salt to increase the WHC. This effect is retained even in cooked products, increasing the yield.**

***Ascorbic acid* (vitamin C) and its salts (sodium ascorbate) contribute to the development of cured-meat colour.**

Sodium ascorbate is used in the manufacture of cooked sausages, made from uncooked or precooked raw materials. Ascorbic acid used is at a concentration of 0.03–0.05 percent, whereas sodium ascorbate is added at a concentration of 0.07 percent. Ascorbic acid is a strong reducing agent, enabling quicker formation of the NO-myoglobin so that less nitrite is needed, and it inhibits the formation of an undesirable colour in cured-meat products. It must not be added to, or mixed with nitrites, because they will be broken down instantly and will become useless for curing. Thus, the nitrite salt must be added to meat at the very beginning, whereas ascorbic acid is always added at the end of comminution.

Ascorbic acid decomposes rapidly especially in a humid warm environment. Its salt (sodium

ascorbate), being more stable, is often used in sausage production, as is erythorbic acid and its salt (sodium erythorbate).

***Glutamates.* Monosodium glutamate and other salts of glutamic acid are substances which improve the flavour of meat products, and are usually added in concentrations up to 0.2 percent.**

TABLE 7

List of common spices used in sausage seasoning (g/kg sausage mixture)

Spice	Dry sausages	Made of raw material	
		Precooked	Uncooked
Allspice	0.5–1.0	0.3–0.5	0.1–1.0
Anise	-	0.1–0.3	-
Bay leaves	0.01	0.05–0.1	-
Caraway seed	0.2–1.5	0.2–0.7	-
Cardamon	0.1–0.5	0.2–0.5	0.3–0.5
Cinnamon	-	0.05–0.2	-
Cloves	0.2–0.5	0.1–0.3	0.3–0.5
Coriander	0.3–0.5	0.3–1.0	0.2–1.0
Cumin seed	0.1–0.5	0.2–1.5	0.2–0.7
Ginger	0.1–0.3	0.3–1.0	0.3–0.5
Mace	0.1–1.1	0.3–1.0	0.3–2.0
Marjoram	0.2–0.3	0.5–2.0	0.2–1.0

Nutmeg	0.2–0.5	0.3–1.0	0.3–1.0
Paprika	0.1–1.0	0.4–1.0	0.5–2.0
Pepper	1.0–4.0	1.5–3.0	1.0–4.0
Sage	0.05–0.5	0.1–0.3	0.05–0.5
Tarragon	-	0.1–0.3	0.05–0.5
Thyme	-	0.1–0.3	0.1–0.3
Garlic	according to taste	according to taste	
Onion	-	according to taste	
Mustard seed	0.5–2.0	0.1–0.2	

Natural smoke

Natural smoke is a very complex mixture, consisting of a great number of compounds, and is obtained by controlled combustion of moist sawdust at low temperature. Sawdust from hardwoods is most commonly used to generate the smoke. Nowadays, it is considered that optimal smoke composition is obtained at temperatures of 300–500°C.

Smoke consists of gases (phenols, organic acids, carboniles and other compounds) and particles (pitch, tar, ash and soot). Gaseous components penetrate into a product through the casing to a certain level, and react with other components of meat products. Other components are deposited on to the surface. Smoke provides typical flavour and distinctive colour, and hardens the surface of the meat product.

General remarks

All substances which are added to meat products must have food grade purity. They should

not contain any food-poisoning bacteria, so must be treated according to the highest hygienic standards. It is important to keep them in properly closed containers or intact packages, away from any dampness and dust. They are usually kept in special, dry premises away from the workshop, in which they can be pre-weighed, blended and packed into plastic bags in the proportions required for sausage formulations. The nitrate must be kept under lock and key (Figs 139 and 140).

139. Nitrite and nitrate stored locked in metallic containers (access only for authorized personnel because of toxicity of substances in higher concentrations)



140. Storage of different nonmeat substances and spice mixtures (dosage by scales for sausage formulation in waterproof plastic bags)



Dosage by hand of any non-meat ingredient is not allowed (Fig. 141). The only correct way is with scales which must be checked occasionally for accuracy (Fig. 142).

One of the most serious consequences of failure to protect all non-meat substances is contamination with dirt, excreta from rodents, birds or other animals and infestation with insects (Fig. 143).

**141. Improper handling:
dosage by hand**



**143. Impurities of common
salt**





**142. Correct handling:
dosage with scales**

PRINCIPLES OF HEAT TREATMENT FOR NON-STERILIZED PRODUCTS

During processing many meat products are subject to specific heat treatment. The first task of heat treatment is to reach satisfactory shelf-life by reduction of micro-organisms. The second task is to obtain desirable organoleptic characteristics, to preserve nutritive value and improve digestibility of the product.

Reduction of micro-organisms

Bacteria are destroyed if exposed to sufficiently high temperatures for long enough. There is a direct relationship between bacteria survival and time of exposure to temperatures. As an example, if 10 000 000 bacteria (per ml) suspended in broth are exposed to heat (70°C), after the first five minutes 1 000 000 will survive (90 percent are destroyed), after the next five minutes the number of surviving will be 100 000 (again 90 percent are destroyed), and so forth.

This tenfold reduction in bacterial numbers between fixed time intervals is called decimal

reduction. The time interval for decimal reduction varies between different bacteria and depends on the temperature applied. The number of bacteria present in a meat product just before the heat treatment (initial number) should be as low as possible so that a shorter time or lower temperature is needed to achieve a satisfactory shelf-life for the product.

As sausage fillings as well as most other meat products represent a very good medium for bacterial growth, they should immediately be exposed to heat treatment in order to prevent bacterial growth. It is also important to perform all operations as quickly as possible, and to maintain the highest hygienic standards so that the initial bacterial count remains as low as possible. The manufacturer must always bear in mind that bacteria grow very fast. Their number may be doubled every 20 minutes.

Organoleptic changes

These are caused by heat treatment (doneness, flavour, firmness, consistency and cured-meat colour development) are time-temperature-dependent processes. The basic effect of the heat treatment is coagulation of meat proteins. Between 70° and 80°C the majority of meat proteins are completely coagulated, forming a structural matrix which entraps fat and water droplets released during heat treatment. With coagulation of meat proteins, WHC is decreased and the meat loses a certain amount of water (thermal weight loss). Those structural changes of proteins are responsible for characteristic firmness of heat-treated products. Frankfurters have an elastic firmness, and on reheating prior to consumption become even more firm. Products containing connective tissue become more tender owing to solubilization of the collagen (gelling). Products such as paste which are in a liquid state prior to heating change for more viscous and spreadable consistency. Sausages made from larger meat pieces also attain a characteristic consistency. The exudate released during massaging or tumbling coagulates and binds the pieces of meat.

144. Temperature measurement in a cooking vat



146. Simple cooking equipment with the movable vat



145. Temperature measurement with thermometer in large-diameter cooked sausage (centre), during chilling by cold water (showering)

TABLE 8

Influence of temperature and time of heat treatment on cured-meat colour development in bologna (diameter 90 mm)

Temperature of heating medium

Time necessary to develop
Pinkish Red colour
(not stable) (stable)

(°C)	(min)	
70	90	110
75	75	90
80	60	75
100	30	45
110	15	30

Such products (cooked hams, ham sausages) become sliceable. Heat treatment also makes products chewable.

In addition to these physical changes resulting from heat treatment, some biochemical reactions also take place which contribute to the typical flavour of heat-treated products. Many compounds present in the raw material are broken down by heat to produce the characteristic flavour. Fatty components give the meat product a distinctive flavour, specific to the animal species from which fat is obtained.

Cured-meat colour is not stable unless the raw product is heat-treated.

All these changes occurring during heat treatment give the product its typical overall sensation of doneness.

Duration of heat treatment

The duration of the heat treatment primarily depends upon the size and shape of the meat product. Treatment continues until the coldest point (innermost part) reaches the defined temperature. It is essential to check temperatures of the heating medium and of the innermost part of the products and to observe exact times (Figs 144 and 145).

TABLE 9
Heat treatment of different meat products

Product	Temperature	
	Heating medium	In product
	(°C)	
Fresh sausages, hamburgers	150–350	65–110
Sausages made of uncooked raw material	75–85	70–75
Sausages made of precooked raw material	80–98	85–90
Canned cured hams, shoulders and loins	75–85	70–75

Types of heat treatment

***Heat treatment by dry heat* is performed in special ovens (roasting) or on a gridiron (grilling). Meat loaves and similar products are roasted. Meat patties, hamburgers and fresh sausages are grilled.**

***Heat treatment by hotwater* is the most common and is usually performed in large cooking vats. When applied to canned hams or ham sausages, it is called pasteurization (Figs 144, 145 and 146).**

***Heat treatment by steam* is one in special steam cabinets and is in particular applied in cases when treatment in cooking vats is not desirable because of substantial losses of aroma and flavour of the products into the cooking water.**

Frequent faults committed during heat treatment

***Undercooking* may be due to the temperature being too low, the time of treatment being too short, or both. The consequences are in a reduced shelflife due to spoilage and the possibility of food-poisoning. Spoilage results in a bad smell, discoloration, softened consistency and souring.**

***Overcooking* results from either too high a temperature or too long a duration or both. The consequences are increased cooking losses, fat separation in some sausages, undesirable changes of flavour and a softer consistency.**

General remarks

In order to keep the initial bacterial numbers as low as possible it is important to keep the temperature of the raw materials as low as possible before heat treatment. After filling sausages and mixing other meat products heat treatment must be applied immediately.

RAW OR COOKED MEAT PRODUCTS FABRICATED FROM ENTIRE MEAT PIECES

Raw and dry meat pieces

These are prepared from primal cuts with or without bones. They are cured and dried without heat treatment and must be produced from wellrefrigerated carcasses.

This process is based on two principles: the stabilization of the product by decreasing water activity and adequate ripening. Decreasing water activity (= amount of water available for microbiological growth) is achieved by penetration of salt into the meat pieces and consequent dehydration. With 3–5 percent salt penetration, 5–9 percent of the water will migrate out of the meat. Dehydration continues during drying and ripening and prevents bacterial growth. Nitrite, which is either added directly or formed from nitrate, also contributes to this bacteriological effect. If these preservative conditions are completed, the finished dry product will be bacteriologically stable and need not be cooked before consumption. At the same time, these processes destroy possible live trichinae in pork. Repeated rearrangement during curing of stocked meat cuts is important to eliminate pressed-out water.

Smoking, drying and ripening contribute to the development of very pleasant flavour, which is due to biochemical changes taking place in muscle and fatty tissue. First lipolysis takes place in which complex molecules of fat are broken down under the influence of enzymes, not only those normally present in fatty tissue, but also those of bacterial origin (especially Micrococceae). Second, oxidation is initiated by higher temperatures. Intensive oxidation of fat can cause undesirable rancidity.

All these reactions taking place during processing develop very slowly, because the useful enzymes are enclosed in the cells. Drying and ripening must therefore be long-term processes for the enzymes to be effective.

Raw dry hams

Dry hams are uncooked, cured, dried and usually smoked pork legs.

***Raw material.* The legs are cut from the pork sides (Fig. 99) and quickly chilled to an internal**

temperature of 2°C within 18 hours. Legs having blood clots, PSE or DFD muscles are not suitable. The minimum weight of a deboned leg is 5 kg.

***Additives.* A mixture of salt (10 kg), nitrate (400 g), sugar (500 g) and spices, usually black and white pepper, sage and ginger, is used for dry curing. Instead of salt and nitrate, the so-called nitrite salt can also be used. In some traditional methods only common salt is used.**

147. Dry-curing of pork legs placed in a cask



148. Ripening of pork legs (skin on) in dry ham production



***Manufacturing.* In the cold season and at high altitudes hams may be dried under natural conditions, according to the traditional method. Because of air purity and better circulation,**

nitrate is not usually used, so a larger quantity of coarse salt must be added, giving the finished product a more salty taste.

After overnight chilling, legs are cut off between the aitch bone and femur. Feet are removed but the skin is usually left on, but may be removed from the upper third of the leg to improve salt penetration. The legs are rubbed with the curing mix, arranged in a wooden cask (Fig. 147) placed in a cool place (about 0°C) and hand sprinkled with the same mix. Salting lasts about three weeks. After a week they are salted separately and rearranged in another properly washed cask. After salting the legs are rinsed and the remaining salt is removed. They are tied and hung in a cool place for further drying and ripening for at least five to six months (Fig. 148). The windows and doors should occasionally be opened and closed and ventilation provided. Legs should be rearranged so that they are all uniformly dried.

Smoking can be applied in the processing of dry hams. Its purpose is to give the product a typical flavour, distinctive colour and to harden it.

Smoking quality depends on many factors, but the most important are the smoke temperature at the product surface and air humidity. It is most important that the surface is dry enough before smoking starts. If smoking is a long-term process, drying occurs simultaneously but with a shorter process it must be done first in a drying room. In raw dry ham production only cold-smoking is used (below 25°C). Smoke density and duration depends on local preferences.

The industrial method uses special air-conditioned coolers, in which standardized conditions (temperature, relative humidity (RH), air ventilation and circulation) can be maintained all year round.

***Frequent faults committed during production.* Faults may arise due to the use of poor-quality**

raw material, inadequate manufacturing, unclean containers, and/or non-hygienic conditions.

The most common are:

- **Crust on the upperface (3–5 mm thick), of hard consistency and darker colour which arises during smoking caused by low air humidity (below 65 percent) and/or very strong air circulation.**
- **Cracks around the head of the leg bone of varying size and depth, due to careless deboning and excessive drying.**
- **Insufficient drying of certain parts can appear in large hams, seen as lighter areas with a softer consistency. It is caused by improper processing (especially during drying and ripening), crust formation (which prevents uniform drying of the inner parts), and/or insufficient air ventilation (especially when dealing with legs weighing more than 9 kg).**
- **Mould (yellowish or greenish) is caused by drying at high RH, due to poor ventilation and air circulation and/or mould contamination of equipment and workshop.**
- **Oversalty taste is the consequence of improper desalting.**
- **Rancidity arises from the oxidation of unsaturated fatty acids and in severe cases results in a yellow discoloration. High temperatures applied during smoking, drying and ripening, or poor-quality feed may be the cause.**
- **Spoilage within the product usually occurs around large blood vessels and is usually due to the raw material being contaminated during deboning, trimming and/or curing in non-hygienic containers. The characteristic brownish colour and unpleasant smell are caused by anaerobes.**
- **Acarid findings show that products have not been properly protected against insects.**

149. Finished meat product fabricated from entire meat pieces: A whole dry ham; B

150. Different dry meat products (above, country pork shoulder, left middle, dry

pieces; C slices of raw dry ham; smoked pork belly, right below, D rolled dry pork side **smoked pork belly, right below, cured dried beef)**



Storage and shelf-life. If the process is carefully followed, the dry-cured ham is very tasty, nutritive and bacteriologically stable. Stored at room temperature, but not more than 30°C, and RH between 55–65 percent, the shelf-life should be four to six months.

Raw dry hams are ready for sale immediately after production and final control (Fig. 149). They are sold as they are, or may be packed (half or small pieces) into plastic bags. All deboned meat pieces may also be sliced and packed under vacuum, in different consumer sizes, as trade demands.

The most common use of dry hams and all other uncooked meat products is in the form of very thin slices (Fig. 149), for use in sandwiches or as starters. Bone-in products are used for preparing various cooked dishes.

Other uncooked processed meat pieces

In addition to dry hams, many other uncooked dry processed meat pieces may be manufactured from different primal cuts of pork carcasses and other species (Fig. 150). All

parts of a pork carcass may be used (ham, shoulder, loin, neck, back fat, jowl, head, tongue, ears, spare-rib, shank, feet, tail, bones etc.). A long shelf-life is achieved by a combination of long drycuring (more than two weeks) and long cold-smoking, with simultaneous drying and ripening.

Dry-curing is always followed by repeated salt rubbing during weekly rearranging of meat pieces. Duration of salting or curing depends on size and on the coverage of skin or fatty and connective tissues.

All uncooked processed meat pieces must have: a regular shape without unnecessary cuts and rough spots; dry, clean surfaces; moderate cured salty taste and agreeable bouquet; and a water content in finished product not exceeding 30 percent. If the product has skin, it should be clean, light to dark gold-brownish colour, without bristles.

“Country pork shoulder” is processed in a similar way to raw dry hams, though with a shorter production time. The combined period for curing and salt equalization should be at least 25 days, and the total production time at least 50 days.

Dry neck can be made with or without the bones. If bone-in it is cut along the neck bones and first three vertebrae and the upper parts of the first three ribs (3 cm in length). Both types are dry-cured for a minimum of three weeks. Well-cured deboned necks can be filled firmly into fibrous casing or elastic nets. The thicker part must be tied and hung on a stick, and left dripping for five to six hours. When the surfaces are dry enough, coldsmoking can start and should last three to four weeks.

Dry loin can also be made with or without the bones. In both cases it must be cut between the third back bone and last lumbar vertebrae, with the corresponding ribs to a width of 3 cm. The

external layer of fatty tissue must not exceed 0.5 mm. If all muscles except the long back muscle are trimmed off it is called “dry real loin”.

Dry spare-ribs are the cured, smoked and dried lower half of the ribs, with muscles between them.

Dry head is the cured, smoked and dried half head of all kinds of small animal, totally deboned, without salivary and lymphatic glands and tonsils.

Dry shanks and feet are well-cleaned, singed, cured, smoked and dried sheep, goat, deer and pig feet.

Dry tail, usually cut off together with the aitch bone, is a cured, smoked and dried product.

Sheep, goat or small venison pastrami are cured, smoked and dried carcasses or sides, without the head and neck, either bone-in or partially deboned. In the first case, for better salt penetration, the largest muscles must be incised, the joints opened in the interior part, and the long bones broken longitudinally. In partially deboned products, all bones except the vertabrae are removed. In both cases, dry-curing agents are rubbed in and the carcasses or sides are spread in wide vats, to prevent creasing. Curing lasts from three to four weeks, depending on the thickness. During that time the product is recured twice, with repeated rubbing. After curing it must be flushed, tied with many loops and hung on a stick for stretching by placing two rods longitudinally in the shoulder and ham. Smoking lasts for at least a month to give a desirable gold-brownish colour and an attractive flavour.

Beef pastrami is dry-cured and smoked beef navel part or well-trimmed brisket.

The raw material must be rubbed on both sides with a mix of nitrite salt and saltpeter and left

in curing vats for two weeks. After seven days, the product must be repacked and, if necessary, some parts rubbed again. After curing residual salt is eliminated by washing and the product is hung for dripping. Smoking starts when the surfaces are dry enough, at 54°C, with light smoke, for three hours. The amount of smoke and the temperature are gradually raised until the inside temperature of 74°C is reached. The product is then removed from the smokehouse and hung at room temperature for a minimum of two hours before being placed in the cooler prior to sale.

Cooked hams and cured and cooked meat pieces

The majority of this type of processed meat is fabricated from pork, but there are also certain cured and cooked beef products.

Cooked hams are made either from entire hams (pork leg muscles, with or without shank) or reconstituted from leg muscles or parts of them. As a rule, hams are produced as boneless, skinless, shankless and defatted products. Most often, they are packed in a can or plastic pouch sealed under vacuum. In both cases, pasteurization (cooking at temperature lower than 100°C) is done in the final container in which they remain until slicing (Fig. 156). Being perishable they must be kept under refrigeration. The exception is with small packages (lighter than 1.4 kg) of hams which can be produced as commercially sterile products.

Beef hams are made from meat from younger cattle and the same process is applied as for the manufacture of cooked hams.

***Additives.* Water, salt, sugar, phosphate, nitrite and sometimes salts of ascorbic acid and soy isolates are the basic ingredients of curing brine. The amount injected depends on product quality. Water used for preparing curing brine must meet the standards of potable water. All**

ingredients should be well chilled.

Data presented in Tables 10 and 11 show that injecting 12, 31 or 36 percent curing brine of appropriate composition will give the desirable amount of salt (2.6 percent) and nitrites (0.016 percent) in the finished product. The amount of other additives may vary with local regulations.

***Manufacturing.* The highest standards of hygiene must be maintained at all stages. The processing steps are:**

Brine injection. For small production one-needle brine injectors are sufficient (Fig. 151). The modern method uses pickle injectors with a large number of needles, providing a more even distribution of the curing brine (Fig. 152). Pressure during injection can be regulated, as well as the speed of the conveyor providing the material. These multi-needle injectors allow more brine to be injected into products than the traditional method. The pressure of injection varies from 1 to 2 atm, depending on the number of needles used and the amount of brine to be injected. For high brine injection rates (20 percent or more) it is better to inject twice under low pressure than once under high pressure, to avoid the formation of “lakes” of brine in the muscles. The weight of meat must be checked before and after injecting. If the percentage of injected brine is less than that required, it can be made up by adding it in the massaging vat.

TABLE 10

Ingredients necessary for preparing curing brine for manufacturing regular hams (I), soy- and water-added hams (II) and ham imitations (III)

Ingredients	Quality of hams		
	I	II	III
		(%)	

Tap water	70.43	82.11	84.59
Nitrite salt	21.73	8.49	7.26
Dextrose	4.16	1.61	1.39
Phosphate	3.60	1.39	1.19
Soy isolate	-	6.40	5.55

Mechanical treatment of meat after brine injection has become a recommended process for larger-scale production, not only for cured entire meat pieces but also in the production of reconstituted smaller pieces. During mechanical treatment, muscular cells are ruptured so that myofibrillar proteins quickly come in contact with the brine and swell. Exudate which consists of cell juices, brine, meat particles and salt-soluble proteins acts like a “glue” to bind meat pieces together. Processed ham can therefore be easily sliced without falling apart.

The advantages of mechanical treatment are shorter curing time, better yield, less cooking loss, improved tenderness and better sliceability. Duration of the mechanical treatment depends on the machine and usually lasts from nine to 24 hours at 2–4° C.

There are two kinds of machine used for mechanical treatment:

Tumblers are containers in the form of a cylinder rotating around the axis.

The speed of rotation is 10–20 revolutions per minute (rpm) and the total number of revolutions should be 4 000–8 000, depending on the size of meat pieces and machine size. As a rule, tumbling lasts for about 18 hours, with five-to ten-minute tumbling intervals followed by 20- to 25-minute pauses.

152. Injection of curing brine by

151. Injection of curing brine with the manual method **multi-needle pickle injector into skinless pork legs**



153. Massaging of cured-meat pieces (cooked ham production)



TABLE 11

Raw material composition of regular hams (I), soy-and water-added hams (II) and ham imitations (III)

Ingredients	Quality of hams		
	III	I	II

		(%)	
Whole muscles	85.00	66.00	0.00
Chopped muscles	3.00	3.00	64.00
Total meat	88.00	69.00	64.00
Water	8.45	25.45	30.45
Nitrite salt	2.62	2.62	2.62
Dextrose	0.50	0.50	0.50
Phosphate	0.43	0.43	0.43
Soy isolate	-	2.00	2.00
Total brine injected	12.00	31.00	36.00

Tumbling under vacuum is recommended to avoid foaming and to improve colour stability.

Massaging vats have handles placed horizontally on the vertical axis propelled by the electrical engine which squeeze the larger pieces of meat (Fig. 153). The duration of massaging, time intervals and total time are similar to tumbling. The use of a vacuum is not possible with these machines.

Heat treatment (pasteurization) of the product in plastic pouches, cans or ham boilers, is done either in an autoclave or a cooking vat in water at 80-85°C (Fig. 154). Cooking lasts until the temperature at the geometrical centre (the coldest point of the product) reaches 70–75°C. Containers are cooled under running water until the temperature in the centre of the product falls to 35°C, when they are moved into coolers at 2–4° C.

Frequent faults committed during production

- **Improper trimming of connective tissue which contracts during thermal treatment resulting in an uneven surface and holes in the cross-section.**
- **Bad sliceability of hams (pieces fall apart) is the result of insufficient mechanical treatment and/or insufficient exudate (Fig. 155).**
- **Holes in the cross-section result from insufficient vacuum used during can stuffing.**
- **Uneven colour of slices due to incomplete trimming of PSE muscles whose pale colour persists to the finished product.**
- **Excessive cooked-out juice results from incorrect brine composition (insufficient salt or phosphate) or improper mechanical or heat treatment.**
- **Overcooking beyond the temperature required for pasteurization increases the amount of cooked-out juices, and gives the product surface a softer consistency.**
- **Undercooking due to insufficient heat treatment is the greatest and most serious fault. The most important consequences are shorter shelf-life and/or rapid spoilage. Less important are harder consistency and uneven colour of slices.**

**154. Cooking of cured
canned hams in cooking
vat**

**156. View of whole skinless cooked
hams (left), crosssection (middle), and
slices (on the slicing machine); the
oval piece is a reconstituted cooked
ham**

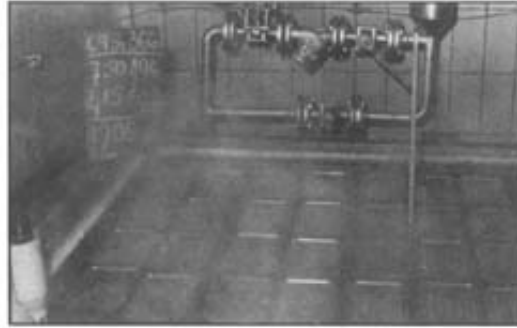

155. Cross-section of lowerquality cooked ham having poor sliceability and excessive fatty tissues

Storage and shelf-life. Canned cooked hams should be kept at 5°C to give a shelf-life of six months.

Thin slices of ham are used for sandwiches or as starters. Smaller slices are used for ham and eggs (Fig. 156).

Other products such as canned cured shoulders, loins, necks, etc. are manufactured in a similar way.

MEAT PRODUCTS FABRICATED FROM COMMINUTED MEAT, FAT AND OFFAL

Comminuted meat products

Comminution is the mechanical process of reducing raw materials to small particles. The degree of comminution differs among various processed products and is often a unique characteristic of a particular product ranging from very coarsely comminuted, to finely comminuted, to form an emulsion.

***Machines for comminuting.* The range and quality of finished products prepared from comminuted meat depend on the skill of personnel and the equipment available. A minimum layout should include grinder, cutter, emulsion mill and ice-maker. Machines must be designed for easy cleaning. All surfaces in contact with products must be smooth, free from pits, crevices and scales. Machines must be constructed either of stainless steel, or heat-resistant, non-toxic plastic material. All machines and tools must be carefully cleaned several times during the working day and disinfected at the end of the day. Manufacturer's instructions about the use and the maintenance of the machines must be strictly followed.**

The grinder is usually the first machine used in the comminution of sausages. For non-emulsion-type sausages, grinding is often the only form of comminution. It is used to cut the raw material and thoroughly mix the ingredients. Meat is pushed along a worm-screw and then through perforated plates. The holes of the grinder plates vary both in size (2–30 mm) and shape (Fig. 157). If the plates and knives are not kept in good condition, and particularly if they are not sharp, meat will be overheated, become greasy and lose its binding ability.

The cutter is the most important comminuting machine, for simultaneous comminution and mixing. Meat revolves in a bowl and passes through a set of knives mounted on a high-speed rotating arbor in a fixed position. The meat is guided toward the knives by a plough fixed inside the bowl. There are usually two speeds each for the bowl and the knives. The knives can differ in size and shape from rectangular to round. There can also be a special device for charging and discharging the bowl.

To eliminate heating of the batter caused by friction, ice water is added. This is better than ice flakes alone. To avoid excessive heating, properly sharpened knives must be used and the clearance between the knives and the bowl should not exceed 0.7 mm. A thermometer is mounted on the cover of the bowl to monitor the temperature of the meat batter. Modern cutters can operate under vacuum, which improves the colour and other properties of the finished meat products.

Depending on the meat-particle size desired, it is possible to produce a satisfactory comminuted meat product using only the cutter. For very fine products, such as frankfurter or bologna, it is often preferable to pass the emulsion obtained in the cutter through an emulsion mill.

The emulsion mill (Fig. 168) is operated by one or more rotating knives, revolving at extremely high revolutions, pulling the sausage mixture through one or more plates. Emulsion temperature rises by up to 3°C on each pass through the emulsion mill.

157. Grinder (mincer) with a set of different plates (with small, medium and large holes) and two three-armed knives

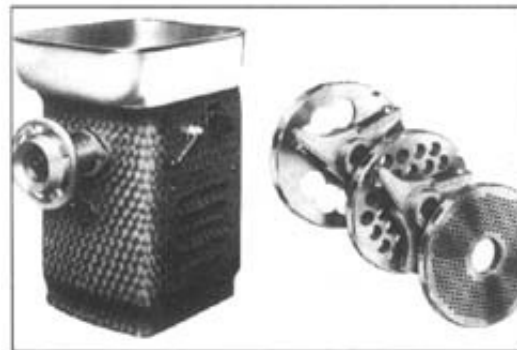

The ice-maker freezes water on the spot into ice flakes.

***Tools.* There are many tools used in meat comminution (Fig. 158).**

Trays, metallic or plastic, are used to keep, transport and weigh small quantities of the various raw materials and for washing dismantled parts of machines.

Vats, metallic or plastic, are used to hold larger quantities of raw materials (up to 200 l).

Container trolleys are movable containers used to keep and transport raw materials from the cooler to the workshop, or between machines.

Filling tables are metallic tables upon which the filled sausages run from the filler. They are made with raised rims, except under the filler.

Sticks are wooden or preferably metallic equipment for hanging up linked sausages (individually or in links), or meat pieces, for dripping, smoking, heat processing and storage.

Cages are metallic structures in which loaded sticks are transported for further processing (smoking and heat processing).

158. Different tools used in manufacturing of comminuted meat products. Above: trays (left), vat (right); below: container trolley (left), cage (right)



Balance and scales (Fig. 142) are used for weighing various raw materials, salt, curing agents and all additives. They are also used for checking product weight before and after each stage of processing to control weight loss.

Thermometers are used to check product temperature during comminution.

Basic technology of meat comminution

Comminution is a procedure which modifies the properties of fresh meat, so that the finished product consists of small meat and fatty pieces, or it can be finely subdivided to obtain a meat batter. This meat batter is a viscous mass, with many properties of an emulsion. A major problem in manufacturing emulsion-type sausages is the tendency of fat to be separated during heat treatment. The sausage batter, at least in part, is formed of a “fat/water emulsion”

(meat emulsion or, better to say, dispersion), employing salt-soluble proteins of meat as emulsifying agents.

Comminution, the basic method for sausage making can be: coarse, to produce non-emulsified sausages like salamis and summer sausages, or fine, to produce emulsified sausages like frankfurters, bologna, etc. (Fig. 159).

***Coarse comminution* is used to manufacture sausages with a coarse texture with small pieces of meat and fatty tissues visible. For Meat I and for Meat II a 15- to 25-mm grinder plate is used while trimmings and fatty tissues are passed through a 2- to 6-mm plate so that the connective tissues are less visible and more digestible. Meat I and Meat II are passed through the grinder first, followed by the trimmings and finally the fatty tissues. This avoids fat separated from the fatty tissues greasing the surface of meat pieces thereby decreasing their binding ability. The meat should be well refrigerated (2–3°C) and firm, so that it will be cut cleanly by the grinder knives and not squeezed.**

Correctly pre-ground meat is transferred into the mixer or mixed manually for formulation. Nitrite salt and phosphate are added and the mixing starts. All other non-meat components are added during mixing, finishing with ascorbic acid. When the mixture is uniform the sausage mixture is formed.



159. Processing in comminuting machines in medium-sized industries: grinder (right), cutter (middle) and filler (left)



160. Cutter with meat pieces put into the cutter bowl, lid opened to show set of knives



161. Comminution of meat in bowl cutter of industrial type. Addition of ice flakes to chopped meat



162. View of the finished sausage mixture for frankfurter sausages

Fine comminution used to manufacture emulsion-type sausages is performed in a high-speed cutter (Figs 160, 161, 162, 163 and 164). The knives must be kept thoroughly sharpened and properly adjusted to the bowl. During comminution bundles of fibres, myofibrils and filaments are separated and disrupted and the size of meat and fatty tissues is continuously reduced. The muscle tissue, having a stronger structure than fatty tissue, determines the total comminution time required. Heat produced during comminution helps the salt-soluble proteins

to concentrate at the fatglobule surface and come in contact with water from the protein matrix. Higher speeds produce a better distribution of fat due to the temperature rise but excessive temperatures (more than 15°C in pork and 18°C in beef) can partially destroy the protein membrane which surrounds fat particles, and cause a breakdown of the sausage mixture. Unprotected melted fat migrates to the surface, forming easily visible fat pockets between the sausage surface and the casings. The melting point of fat is the parameter for determining the maximum temperature for the meat batter. Overcomminution can also provoke breakdown. As the fat particle size continuously decreases, there is a proportional increase in the total surface of fat particles requiring proteins. Generally, as particle size decreases more meat and meat-extender proteins are required to form a heat-stable emulsion.

Frozen and chilled meat for different products. Frozen meat must be sliced in a frozen-meat slicer prior to grinding. The block of meat (Fig. 165) is placed upon the carriage and passed under a large knife which cuts the meat into large slices (Fig. 166) or smaller meat flakes.

Frozen meat is not suitable for coarse comminuted sausages but may be used in manufacturing fine comminuted meat products. So that the optimal temperature (3–5°C) for extraction of salt-soluble proteins is reached, only water without ice is added in the cutter.

Some meat extender must be added to bind juices from the frozen meat which will be separated during heat treatment.

Chilled meat is more suitable for both coarse and fine sausages as the meat batter can be more readily maintained at the optimal temperature. Another advantage is that neither a frozen-meat storage facility (minimum -18°C) nor a frozen-meat slicer is necessary.

Methods of addition of salt, additives and spices. The aim of using salt and/or nitrite salt in

manufacturing comminuted meat is to separate the maximum quantity of salt-soluble proteins from the muscle cells. Optimum salt concentration for total extraction is 5–6 percent, and the optimum temperature is 3–5°C. Salt must be sprinkled on the pre-ground meat in the bowl as soon as possible. By mixing meat and salt at the slowest speed, salt starts to extract proteins from broken muscle cells. Half the ice water (1:1) is added to speed this process and control the temperature rise.

Additives contribute to improving and intensifying some properties of meat proteins, especially water-holding, water-binding and emulsifying capacities. In order to achieve this they are sprinkled on the meat after the salt has completed its effects, but always before adding fatty tissues.

To achieve uniformly and well-flavoured comminuted meat products, spices must be properly sprinkled in the meat batter and are added after additives, but always before fatty tissue to avoid them sticking to it causing a non-uniform colour. All spices for sausage formulation should be weighed and mixed in a plastic bag before adding to the meat batter.

**163. Preparing sausage mixture
in small-scale production**

**164. Emptying cutter bowl
manually and transferring batter
in manual sausage stuffer (left)**



Hygienic aspects of comminuted meat. Comminuted meat is more highly perishable owing to the large surface area exposed to many sources of contamination, the availability of the meat juice, water and nutrients, and the distribution of surface flora during comminution. The flora count varies greatly, presumably reflecting the initial contamination. For example, the count in ground beef is usually less than in minced pork. High counts will arise during comminution if the temperature of the sausage mixture is not properly controlled. It may however be preserved in different ways: adding salt and nitrite, smoking, heat treatment, and adequate storage. The preservative effect of salt is due to its capacity to lower water activity to a level that inhibits bacterial growth. For a longer shelf-life other preservative methods must be used such as the addition of nitrite which has a marked bacteriostatic effect.

If the sausage mixture is kept at a relatively high temperature (above 20°C) before it is filled

into casings, vegetative bacteria will grow and cause deterioration. In order to kill most micro-organisms present, emulsion-type sausages must be heat-treated to an internal temperature of 72–75°C. The product shelf-life is thereby significantly extended.

The product must be quickly chilled after heat treatment, in order to prevent growth of any surviving flora. After the final inspection it is ready for sale. Finished products must not come into contact with the floor (Fig. 167) or any other contaminated materials, especially raw meat or natural casings.

Hygienic faults committed during meat comminution

The basic objective of meat comminution is to manufacture sausages of standard quality with a desirable hygienic level, and an acceptable shelf-life. For this reason, during comminution all improper handling which can promote growth of micro-organisms must be eliminated. The meat products are not only highly perishable, but may also become the source of foodborne diseases.

Sources of contamination during comminution

***Unclean machines.* Meat batter and sausage mixture represent very good nutritive media for rapid growth of micro-organisms, owing to the presence of the soluble nutrients. If any interruption in production is greater than half an hour the machine must be emptied, the sausage mixture placed in the cooler, and the machine immediately washed. Failure to do so will lead to heavy contamination of the next batch. The contamination will be even more serious if residual material stays in unclean machines overnight or even during the weekend. To eliminate these hazards the machine must be washed immediately after use with hot water. The best method of washing for machines, containers and walls and floors is with a special**

cleaning machine. When attached to the water supply the machine can increase the water pressure tenfold to make cleaning very effective. Liquid disinfectant may also be added. Hot water (minimum 83°C) gives the best results.

During dismantling of any machine, either for daily washing or routine control of cleanliness, dismantled pieces must not be placed on the floor (Fig. 168). They should be put in a plastic (not metallic) tray or vat and after washing hung on a rack, for draining overnight. The next day their cleanliness and sharpness must be checked before use. Water remaining after cleaning must be eliminated before leaving the workshop (Fig. 169).



165. Cross-section of frozen meat block



166. Slices of frozen meat cut by frozen-meat slicers

***Unhygienic handling.* There are many manual operations in a nonautomated production line for**

comminuted sausages. Unhygienic handling can provoke rapid bacterial growth, which will persist even after hightemperature heat treatment, resulting in a shorter shelf-life.

Meat trays, other tools, plastic aprons etc. must never be washed on the floor (Fig. 170). Any material falling on the floor must not be reused in further processing (Fig. 171). All dirty and contaminated material must be placed in a special watertight non-corrosive bucket, with a lid fastener, to prevent access to unauthorized persons and clearly marked in large red letters “condemned”.

MEAT EXTENDERS

Meat extenders are usually protein additives, defined as non-meat proteins. A wide variety of meat extenders are available for use in emulsion-type sausages to improve consistency and emulsifying and water-binding capacities. They can also serve to enhance protein content, improve processing yields and reduce formulation costs. The most important meat extenders are soy proteins, milk proteins, starch, flours and yeast. The permitted maximum amount of meat extenders in sausage production is usually 3.5 percent and is strictly regulated by law in certain countries.



167. Pre-packed sausages in contact with floor (hygienic fault)

Soy proteins

These are table proteins from soybeans in the form of flours, grits, concentrates and isolates, texturized, untexturized and extruded.

Soy flour is a screened, graded product, obtained after extracting most of the oil from dehulled soybeans.

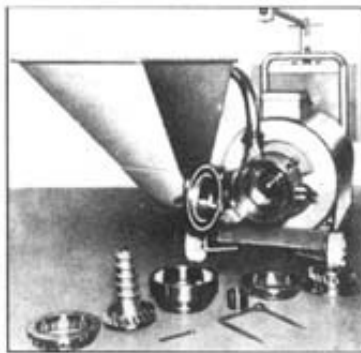

168. Emulsion mill,



dismantled parts lying on floor (hygienic fault)



169. Water remaining in grinder (hygienic fault)

170. Improper washing apron on the floor (hygienic fault)



171. Meat fallen on the floor and reused for processing in cutter (hygienic fault)

***Soy grits* are particles of larger size, described as coarse, medium and fine.**

Soy flours and grits may be defatted, low-fat, or high-fat. Owing to their functional properties (emulsion stabilization, and fat- and juice-binding), soybean flour and grits are used in the production of all emulsion-type sausages, meat patties and canned-meat products. However, both flour and grits give a slightly bitter taste to meat products, which limits their use (up to 2 percent).

***Soy protein concentrates* are high-protein products (not less than 70 percent). They possess good water-absorption abilities and are used in emulsion-type sausages, luncheon loaves and meat patties (2.5–3 percent).**

***Soy protein isolates* are the most refined form of soy proteins, without water-soluble sugars**

and other insoluble components. Owing to their highprotein content (minimum 97 percent) they have excellent dispersing, emulsifying, gelling and water-and fat-binding properties. They are used in production of bologna, miscellaneous sausages, canned and dietary meat products.

***Textured soy proteins* are available in a variety of shapes, sizes, flavours (beef, pork, ham, chicken etc.), textures and colours. They are used as extenders in comminuted sausages, meat patties and canned-meat products. Some physical properties and typical chemical composition of different soy protein products are given in Table 12.**

Application of soy proteins

Soy proteins and meat proteins interact differently with salt. While salt aids the extraction of salt-soluble proteins from meat, it has the opposite effect on soy proteins since it prevents their hydration. It is important therefore to add meat, soy proteins and salt in the correct order. Salt should be added only after hydration of soy proteins has been completed. For complete hydration sufficient water must be available and enough time allowed. The soy product/water ratio should be 1:4 or 1:5, with a minimum of three minutes' chopping with the knives and cutter at the highest speed. Soy proteins may be used in sausage production in dry gel and emulsion forms.

***Dry form.* Meat is placed in the bowl at slow speed and soy product is added. The correct amount of water is added at the highest speed to allow complete hydration of the soy proteins. When the mix is homogenous, phosphate is added and finally nitrite salt.**

TABLE 12

Typical chemical composition of different soy products

Soy flour	Grits	Soy	Isolated
-----------	-------	-----	----------

Chemical components			protein concentrate	soy protein
	(fine)	(coarse)	(coarse)	(fine)
			(%)	
Water	6.5	8.0	9.1	4.8
Protein	53.0	52.0	65.3	92.0
Sugar	31.0	31.0	16.9	-
Ash	6.0	6.0	4.8	4.0
Fibre	2.5	2.5	3.6	0.25

Gel. Using soy gel ensures that the soy proteins are completely hydrated. To 15 kg of dry soy product, 60 kg of water is added. Complete hydration can be seen by the appearance of the gel consistency. Such gel, if used in sausage production, must be added to meat batter before fatty tissues and other additives. The remaining gel is stored in a cooler and, if not required until the next day, 2 percent salt is added.

Emulsion. Soy products can be added to emulsion-type sausages in the form of a pre-processed soy emulsion. These can be produced by processing with cold or hot water, depending on whether fatty tissues are used. The ratio between soy product, fatty tissues and water is 1:5:5 for firm and 1:4:4 for soft fatty tissues. In both cases, soy product is placed in a bowl, water is added, and the mix is comminuted to complete hydration (minimum three minutes). Fatty tissue is added and chopping is continued at the highest speed. For better bacterial stability 2 percent salt must be added. Coldprocessed emulsion can be used the same day, but hot-processed emulsion must be chilled overnight in flat trays in layers not more than 10 cm thick.

Milk proteins

These are casein, lactalbumin, lactoglobulin and other serum proteins. Casein is one of the most important proteins, used as an emulsifying agent in sausage manufacturing as caseinate (dry milk-protein isolate). It is a fine white powder with neutral taste and a protein content of approximately 94 percent. Unlike the coagulable soy proteins, egg albumen and blood plasma, milk protein does not coagulate, shrink or form a gel while heating.

If caseinate is added to meat before salt addition, it will surround free fat particles during comminution. Thus, the binding capacity of meat saltsoluble proteins may be enhanced to form a more stable emulsion.

In sausage manufacture, caseinate may be used in three ways:

***Prefabricated caseinate emulsion.* When making this emulsion, the order of addition, the necessary emulsifying time and temperature, and the protein:fat:water ratio are of major importance.**

After the fatty tissue has been comminuted to a fine paste, dry caseinate must be added immediately, followed by all the hot water. After four to six minutes of comminution the emulsion is ready. During the last few rotations 1.5 percent salt is added. For high-emulsion stability it is necessary to reach a minimum emulsifying temperature of 45°C for pork and 50°C for beef fatty tissues. The emulsion must be chilled overnight in flat trays. Next day the emulsion may be added to the meat batter, together with fatty tissues.

The usual caseinate:fat:water ratio for the lower-viscosity caseinate (EM-6) is 1:5:5 and for high viscosity (HV) is 1:8:8. If cooked pork skin is used, the ratio of caseinate:fat:water and skin is 1:8:8:2 for sausages.

***Dry powder* caseinate may be used when prefabricated emulsion or gel are unavailable. As this is absorbed at the fat-water interface it is absolutely necessary to add caseinate before fatty tissues to ensure that the emulsion is heat stable.**

***Prefabricated gel* is a concentrated solution of caseinate in water. Optimum results can only be expected when the caseinate is completely dissolved in water (1:8). It is recommended to moisten caseinate in the cutter with an equal amount of ice (1:1). After a few minutes of comminution the remaining seven parts of water are added. The gel is used in sausage formulations containing relatively small quantities of fat and in coarse comminuted sausages.**

Starch

This is a complex sugar of plant origin. The basic technological function of starch is to absorb released water and juice during heat treatment. The most frequently used starches are wheat, maize, potato, rice and manioc. Starch is used in doses up to 4 percent. During heat treatment of sausages, added starch binds part of the free water and swells, thus decreasing weight losses.

Flour

Wheat flour is the most commonly used binder following hydration. Approximate chemical composition is starch 65–75 percent, gluten 8–14 percent, and water 12–16 percent. If flour is added in sausage formulation, care must be taken to prevent quick decomposition of the sausage mixture. Owing to the activity of flour enzymes, flour is commonly used in lowquality sausages (up to 4 percent).

Yeast

Brewer's inactivated yeast with the bitter taste removed is frequently used. It is a fine yellow-grey or grey-pink powder, with distinctive taste and smell. Approximate chemical composition of yeast is: 53 percent proteins, 36 percent sugars and 3 percent water.

In the meat industry the most important application of yeast is based on the ability of its proteins to emulsify fat. A heat-stable emulsion is obtained if the yeast, water and fat ratio is not more than 1:5:5. In comparison with soy isolate and caseinate, yeast proteins have a lower ability to emulsify tallow. A heat-stable emulsion with tallow is only obtained with a ratio of 1:1.3:1.3.

Yeast can be used as an emulsifier in cooked and in canned chopped meat products and can easily replace caseinate in paste production. Yeast used in these products may improve their flavour. The content of free amino-acids improves the flavour of the meat product. Yeast also intensifies the flavour of certain seasonings, especially those with hot components.

Yeast extract

This is obtained from special yeasts cultivated on cane-sugar nutrient media. It contains many proteins, amino-acids and B-complex vitamins. It is used for improving the flavour of canned meat.

CASINGS

Casings are special cylindrical containers used to protect sausages and various meat products. Since sausages are comminuted products they must be placed in some type of forming device to give them shape, to hold them together during further processing and for protection. Casings may be natural or artificial.

Natural casings

These are derived almost exclusively from the gastro-intestinal tracts of swine, cattle, sheep, goats and horses. Hog casings are prepared from stomach, small intestine (smalls), large intestine (middles) and terminal end (colon) of the large intestine (bung). Beef casings may be from the oesophagus (weasands), small intestine (rounds), large intestine (middles), bung and bladder (Fig. 172). The intestines of sheep and goats are used to produce casings primarily for fresh sausages, frankfurters, hot dogs etc. Natural casings can be classified as narrow, medium and wide.

172. Natural casings:
oesophagus (1), small (2) and large (3) intestine, bung (4), caecum (5), bladder (6) of pig; small (7), and large (8) beef intestine

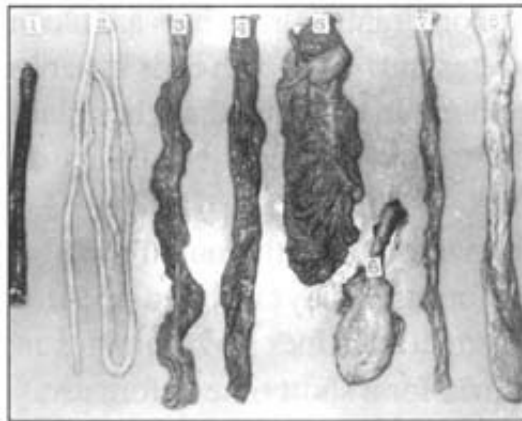

173. Treatment of pork small intestines (calibration)



TABLE 13

Different diameters of small intestines

Type of animal	Diameter		
	Narrow	Medium	Wide
		(mm)	
Sheep	16–28	20–22	22–24
Hog	30–34	35–38	38–40
Beef	34–37	40–43	43–46

Treatment and storage. Intestines intended for use as casings for sausages must be immediately processed after evisceration. First they are emptied and well flushed. Pig, sheep and goat small intestines are scraped thoroughly without inversion to remove the exterior (serous) and interior parts (mucous membrane), preserving the middle elastic muscle (Fig. 173). The same method is applied to the large intestines of all animals.

Well-scraped, flushed and drained intestines are well sprinkled with common salt (dry salting) or saturated salt solution (wet salting), spun and tied into intestine completes. They are arranged into plastic casks. The top of the intestines is pressed down and salted again in order to eliminate air contact. These casks must be firmly closed and stored in a dark cooler. If intestines are prepared for long storage (more than three months), they must be salted with a mixture of salt and 0.2 percent antioxidant.

Large intestines and bladders can be preserved by means of air-drying. In this case, after scraping, flushing and a short draining intestines are blown up in order to eliminate the remaining water and tied at both ends in hanks, for quicker air-drying. They should be hung in a sunny, draughty place. When well dried they are sorted according to diameter and packed.

Such dry casings do not require storage in a cooler.

***Application.* All salted natural casings should be thoroughly flushed inside with running water the morning before use. They are then dipped into warm water to regenerate their elasticity (small intestines 10–20 minutes and large intestines 30–60 minutes) and drained for a short time before use.**

Artificial casings

The advantages of these are uniform cylindrical shape, a range of specific diameters, suitable tensile strength, resistance to damage, ease of use, variety of sizes and low microbial level. They can be filled uniformly and linked either by hand or machine into regular lengths.

Four types of artificial casings are available (Fig. 174):

***Cellulose casings* are prepared from cotton linters in sizes ranging from 1.5 to 15 cm. They are easy to handle and fill, possess a high degree of resistance and are permeable to smoke when moist. The degree of permeability decreases as the casing dries during processing. Small cellulose casings are used for skinless frankfurters or wieners, skinless smoked link sausages and many other small sausage products (cocktail sausages). Small cellulose casings are also available in shirred form.**

Large cellulose casings are available in three types: regular, highstretched and large. They are used in making all types of sausages and smoked meat. Cellulose casings are inedible and must be removed before consumption.

***Inedible and edible collagen casings* are regenerated from collagen extracted from skins and hides. The inedible collagen casings combine some of the advantages of both natural and**

artificial casings, especially their strength, uniformity and shrink characteristics. They must be removed prior to consumption. Edible collagen casings are mostly used for fresh pork sausages and frankfurters.

174. Different artificial casings prepared in shirred (above) and flat form (below) for sausage manufacturing

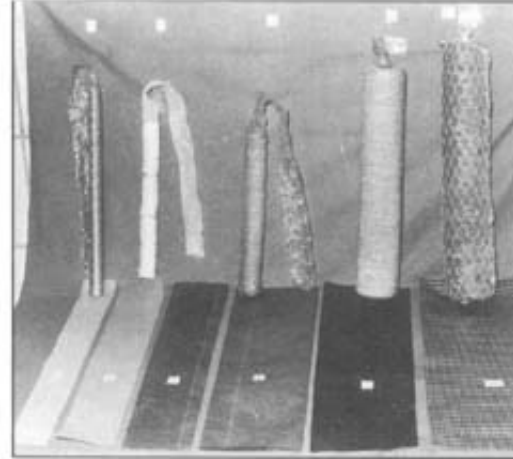

***Synthetic casings and bags* are impermeable to smoke and moisture. They are used with unsmoked products such as liver sausages or products which are heat-processed in water or a retort.**

Tying of casings

Artificial casings are delivered either tied at one end with loops prepared in the factory or in hanks. As casings in hanks can be easily stored and their length and the method of tying can be chosen at will, they are well suited to small-scale production. One end of the casing is submerged in cold water (one to two minutes), then tied either in a “doll” or “bow” knot (Figs 175 and 176). To make a “doll” knot, place a string on the casing and twist around, slip the thumb and forefinger on the string 1 cm toward the end of the casing, pass the string through the bight and set the knot, tighten the string, and prepare the loop and tighten with a double

knot.

When tying a “bow” knot, casings need not be submerged except the end of every dry casing. The method is to place string on casing and tighten by means of a simple knot, fan-shape casing end with knot in the middle, and tie knot underneath the wing (the tied casing has no loop). This method of tying prevents slipping off.

175. Manually tied casings in strings (left); first step of manual tying (right)

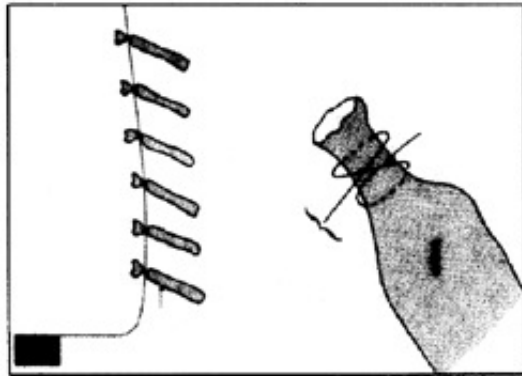

176. Manual tying of casings, with loop (left), and string of tied casings

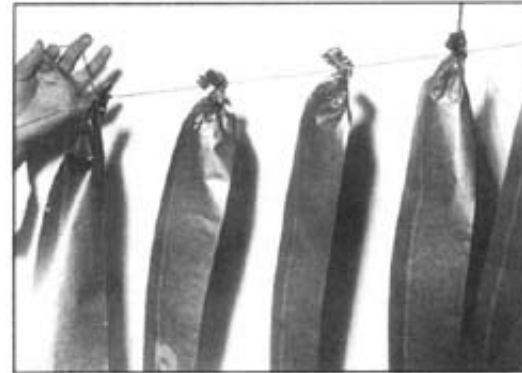

HAMBURGER-TYPE PRODUCTS

Hamburger-type products are made from minced meat and fatty tissue to which salt and seasonings are added. Soy is a common additive but curing agents need not be used.

Raw material

Well-chilled Meat I and Meat II and fatty trimmings are the basic raw materials. All beef, all mutton, all pork or combinations of different meat and fatty tissues in various proportions may

be used.

Additives

Extruded soy proteins (ESP) are often used in manufacturing hamburgertype products. They should be hydrated in water (70°C for 35–40 minutes) in the ratio of ESP to water of 1:1, 1:2 or 1:3. Salt, seasonings and dry or fresh onions are the other basic ingredients. If these products are intended for long-term storage some antioxidants may be added.

177. Frozen hamburgers



TABLE 14

Common composition of hamburger-type products

Products

Raw material	All-beef	Beef-pork (%)	All-pork
Beef I	53	25	-
Beef fatty trimmings	10	5	-
Pork I	-	40	65
Pork fatty trimmings	-	10	20
ESP: water (1:1)	30	15.5	10
Breadcrumbs	2.5	-	0.5
Salt	2	2	2
Onions	2	2	2
Seasonings (according to taste)	0.5	0.5	0.5

Manufacturing

Selected meat is minced through a 5-mm, fatty trimmings through a 3-mm, and hydrated ESP through a 3-mm plate. After mincing, the components are mixed with the additives and seasonings until all components are evenly blended. The mixed batter is then ready for forming and shaping. Weight and shape can vary but patties are usually round, weighing 80–120 g and 5–10 mm thick. After freezing, the hamburgers are packed into suitable plastic bags or cardboard boxes, and immediately transported to a storage room (Fig. 177).

Beef II or Pork II are used with lower-quality products and ESP is hydrated with more water (1:2, 1:3). Hamburger-type products should contain 10 to 25 percent fat but if hydrated ESP is used up to 30 percent may be added.

Storage and shelf-life

Hamburger-type products are stored at -20°C to give a shelf-life of 90 days. They may be cooked without thawing by grilling, frying in deep fat or toasting on a hot plate.

DRY SAUSAGES

Dry sausages are specific coarse-comminuted meat products whose successful manufacture depends upon bacterial fermentation. At some stages of processing, usually during smoking, these sausages are deliberately held at temperatures which encourage bacterial growth and fermentation. Dried sausages should never exceed 30°C at any stage as this would stop growth. The useful organisms responsible for desirable fermentation (lactic acid-producing bacteria) originate from the natural flora of the meat, processing equipment and the plant environment. Fermentation causes a characteristic tangy flavour to develop, resulting from the accumulation of lactic acid and many other fermentation compounds. The pH usually falls to 4.8–5.4. Another basic processing preservative step is dehydration achieved by keeping the product under controlled temperature and air humidity (drying and ripening).

One of the distinctive features of dry sausages is that they are processed uncooked. The low pH (high acidity), low-water content and high-salt content extend their shelf-life. Some but not all dry sausages are smoked. The best known are dry pork sausages, dry beef sausages, mixed dry sausages, summer sausages and salamis.

Raw material

In general, dry sausages are composed of two-thirds meat and one-third fatty tissues to which curing agents and spices are added. Meat I and Meat II (Figs 129 and 130) of all species of slaughter animals can be used, including camel, donkey and horse meat, but rarely mutton, goat or venison. Trimmings are not used owing to their softness, neither are shanks or head or

boar meat. Pork jowl and back fat (Figs 133 and 134), beef external fatty tissues and humps are used as fatty components.

Only well-chilled (-1° to 0°C) and/or frozen (-1° to -18°C) meat is used. Frozen meat is thawed for 48 hours on slanting racks to allow the drip to run off. The meat is chopped with sharp regular cuts, without crunching. The temperature of meat and fatty tissues should be adjusted to stay in the range of -2° to 5°C during chopping (Fig. 178) so that temperatures in the filler will be between -1° and -3°C. If the temperature in the filler is higher, drops of fat are deposited on the interior walls of the filler horn. During further filling they are pressed into the casing and will grease the interior of the casings lowering their porosity, making smoking, drying and ripening more difficult.

Main additives

***Salt* (28–37 g per kg) is used to prevent the growth of many undesirable aerobes, favouring the growth of non-spoilage halophile and halotolerant bacteria. Salt also extracts the salt-soluble proteins to form a protein gel which binds the pieces of meat and improves sliceability of the finished product.**

***Curing substances* are used in the form of nitrite salt or a dry mix of common salt with 0.6 percent nitrite salt and nitrate (0.3–0.5 g nitrate per kg).**

***Sugars* speed acidification and are transformed into lactic acid by certain bacteria. Dextrose is the most commonly used sugar (8–10 g per kg) but can be replaced by saccharose.**

***Spices.* White and black pepper (0.5–3 g per kg), ground or crushed, are the most frequently used spices. Fresh crushed garlic, paprika, cardamom, mustard etc. are also used. In some countries wine is added to improve the flavour. Some antioxidative substances may also be**

added.

Starter cultures. To overcome the problems associated with bacterial fermentation, starter cultures of selected lactic acid-producing flora have recently been used. The starter culture provides a predominant flora of the desired bacteria (*Micrococcus*, *Pediococcus cerevisiae* etc.) in the sausage mixture, and fermentation is initiated within a minimum time.

178. Manufacturing dry sausage mixture consisting of frozen particles of lean meat and fatty tissue, and salt, spices and additives



TABLE 15

Typical composition of some dry sausages and salami

Components	Variation of dry sausages			All-pork dry sausage	All-beef dry sausage	Beef soujouk	Salami
	1	2	3				
	(%)						
Pork I and II	-	29	30	69	-	-	67

Beef I and II	61	47	37	-	74	86	-
Mutton I and II	-	-	7	-	-	-	-
Pork back fat	14	19	10	10	-	-	28
Pork jowl	-	-	5	5	-	-	-
Side pork fat	20	-	-	10	-	-	-
Beef ext. fat	-	-	-	-	10.5	5	-
Hump (zebu)	-	-	4	-	10	5	-
Salt	3.5	3.5	3.5	3.5	3.5	3.5	3.5
Nitrate	0.05	0.05	0.05	0.05	0.05	0.05	0.05
Sugar	0.6	0.6	1.0	0.45	0.4	-	0.5
Garlic	0.25	0.25	0.45	0.5	0.45	0.2	0.3
White pepper	0.2	0.2	0.3	0.3	0.3	-	0.3
Black pepper	0.1	0.1	0.2	0.2	0.2	0.25	0.1
Paprika	-	-	0.2	-	0.3	-	0.25
Anise	-	-	0.1	-	0.1	-	-
Mustard	-	-	0.2	-	0.2	-	-
Wine	-	-	1.0	1.0	-	-	-
Cognac	0.3	-	-	-	-	-	-

Rum	-	0.3	-	-	-	-	-
-----	---	-----	---	---	---	---	---

Casings

These may be natural or synthetic. Natural casings are usually small intestine of hog (for small-diameter dry sausages), beef small intestine (for middle-diameter dry sausages), and large hog or beef intestine (for largediameter dry sausages). As for salami (diameter more than 40 mm) and summer sausages the most convenient casings are small horse intestine. The best synthetic casings are the so-called “dry sausage fibrous casings”, as they adhere very well to the product as it shrinks during drying.

TABLE 16

The most important parameters in manufacturing dry sausages

Technological operations		Parameters
Choice of raw materials	meat	-1° to -30°C
	pork	pH 5.8 and lower
	beef	pH 6.0 and lower
	fatty tissues	-10° to -30°C
Cutting	cutting room	not more than +15°C
Chopping	finished sausage	-2°C to -5°C
	mixture	pH 5.9 and lower a _w 0.97–0.96
Filling	filling	-1° to -3°C
Curing	curing room	21° to 24°C
	(2–5 days)	RH 75–80%

Smoking	dry sausages	maximum 30°C
Drying and ripening:	drying room (2–4 days)	18° to 25°C, RH 94–90; air velocity 0.5–0.8 m/sec
	product	pH 5.6–5.2 a_w 0.96–0.94
first stage	drying room (5–10 days)	18° to 22°C, RH 90–80%; air velocity 0.2–0.5 m/sec pH 5.2–4.8
	product	a_w 0.95–0.90
second stage	drying room (to 90 days)	12° to 15°C, RH 80–65%; air velocity 0.05–0.1 m/sec
	product	pH 5.3–5.8 a_w 0.92–0.85
third stage	store-room	10° to 15°C, RH 80–65%; air velocity 0.05–0.1 m/sec
Storage	packing room	10° to 15°C, RH 65–75%
Package		

Composition of some popular dry sausages

Like all other sausages there is much variation in the composition of dry sausages and salamis. A common factor is that they do not contain any added cereal, ice or water.

Manufacture

In the successful manufacture of many varieties of dry sausages and salami, a great deal of technical skill is indispensable. In manufacturing coarsely chopped sausages the grinder and mixer are used but for less coarsely chopped sausages only the cutter is used (Fig. 178).

179. Different forms of tying dry sausages (singles and in strings)

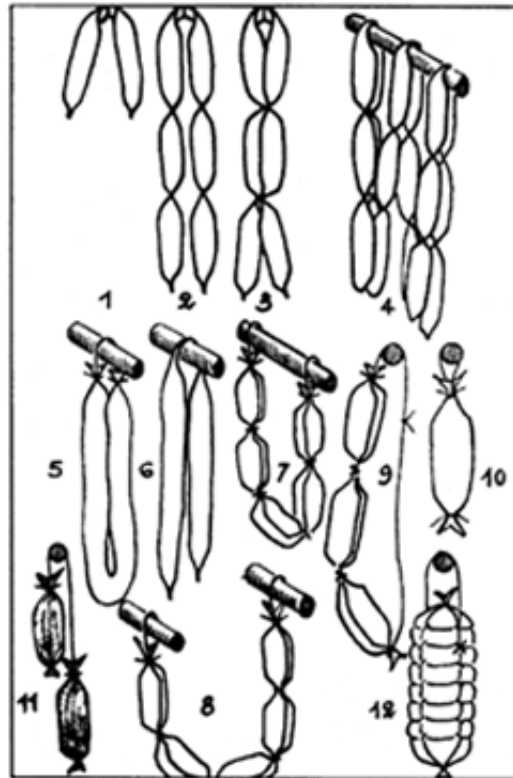

180. Ripening of dry sausages in a drying room



In the first case, meat and fatty tissues pass through the grinder (beef 15-mm, pork 2–6-mm and fatty tissues 8–10-mm plate) and the sausage mixture is made in the mixer. In the second case, chopping and mixing are done in the cutter at slow speed. After adding the curing agents

the meat is chopped to the required size then fatty tissues and all other components are added. The mixture is firmer and without residual air if a vacuum is applied. The sausage mixture must be firmly filled into casings. The casings are punctured with small needles over the entire surface to allow entrapped air to escape. Tied sausages are hung on sticks and transferred into a curing room (Fig. 179). Curing time depends on the sausage diameter, three days for diameters up to 3 cm, and five days for larger. During this period, the cured meat colour is developed and fermentation is initiated.

After curing, sausages are transferred to a drying room (Fig. 180). The rate of drying is controlled by keeping the products between narrow limits of both temperature and RH. Too rapid drying will result in the formation of an outer crust on the sausages, which will retard or stop internal drying. If the drying rate is too slow and RH is too high, then surface mould, yeast and bacterial growth are excessive. During drying and ripening, flavour develops, texture changes and the product hardens. Degree of drying can vary according to local preferences. Ripening can either follow or precede cold-smoking, depending on the particular product.

Dry sausages must be stored in an environment in which temperature and humidity do not provoke overdrying. They are ready for sale immediately after production. All dry sausages may be sliced and packed under vacuum in different consumer sizes. They are consumed sliced, as starters or in sandwiches.

Only complete fulfilment of all technological parameters at all stages of production can guarantee the desired quality of finished products. Dry sausages, like dry hams, are high-quality meat products. The main characteristics of dry sausages are agreeable bouquet, i.e. flavour and taste of a well-matured cured-meat product, attractive colour, good sliceability and long shelf-life. In order to achieve all these, sufficient time must be allowed of at least a month for small-diameter sausages and three to six months for large-diameter sausages and salami.

Organoleptic tests and weight-loss control may confirm the end of ripening. Water content of finished dry sausages (of any diameter) should be between 25 and 30 percent. Sausages should not be overdried or they are hard to chew and less acceptable to consumers.

Semi-dry sausages

They are produced by quick drying without ripening. Depending upon the diameter, this lasts from two to three weeks. In order to shorten the process, reducing agents (such as Glucono-delta-Lactone) and a starter culture must be added to the meat mixture. Weight loss is lower than in dry sausages, so the water content of the finished product is always greater than 40 percent, resulting in a shorter shelf-life, a sour taste and a poor flavour. Sliceability is also owing to reduced binding of meat and fatty tissues. Semi-dry sausages have a maximum shelf-life of one month at room temperature.

Frequent faults committed during production of dry sausages

***Creases or detachment* appear in sausages with synthetic casings if the filling dries at a faster rate than the casing. Small creases become larger as drying continues, and overdrying causes detachment of the casing. This can be prevented by using more elastic casings and by a slower drying rate (Fig. 181).**

***Crust formation* results from rapid drying, especially at the initial stage, and can be detected by careful palpation. If the crust is not firm a preventive measure is to increase the humidity in the drying room to soften and rehydrate the sausage (Fig. 181).**

***Greasy casing* results from using soft fatty tissues or from overheating the sausage mixture. Melted fat, under pressure during filling, greases the interior walls of the casing reducing its porosity and preventing normal water migration from inside the sausage. The consequence is a**

soft sour sausage. If the melted fat penetrates the casing walls, then the product also becomes greasy.

Sausage mould, usually greenish in appearance, is the sign of contaminated equipment and workshop. It is eliminated by using good antifungicidal agents in cleaning operations.

Sausage sliminess is the result of heavy micro-organism growth on the surface of the sausage casing, encouraged by too high a temperature and air humidity. Partial sliminess can be removed by washing in salty water, followed by dripping and more intensive and dense smoking. This fault may appear when the product is stored in cardboard boxes for a long time.

Sour sausage, being invisible, is unfortunately usually detected only at the end of drying during the final control. It has a sour taste, semi-rigid consistency and the periphery is darker than the centre. It is the result of the intensive growth of lacto-acid bacteria, feeding on the added sugar. Preventive measures are to decrease the added sugar and increase the added salt. Such products must be properly dried and ripened.

Sausage porosity usually appears in large-diameter sausages. Air in pores causes decomposition of fat, leading to changes in colour and taste (Fig. 182).

Poor sliceability is the result of insufficient curing and salting, uneven distribution of curing agents, and/or short curing. The lack of salt-soluble proteins reduces binding between meat and fat particles.

Blown-up sausages due to gas produced by sudden micro-organism growth result from contamination of raw materials, equipment, tools and unhygienic production.

Dry sausages are a very nutritive meat product which may be eaten immediately after

production, without any additional heat treatment. They are sold entire or packed in pieces in plastic bags. All dry sausages can be sliced and packed under vacuum, in various consumer sizes. Dry sausages are usually covered in very thin slices in sandwiches, or eaten as starters.

181. Unequal drying of sausages, overdrying (left) and detachment of the casing (right)

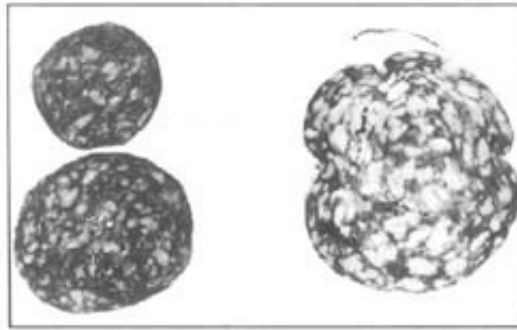

182. Decomposition of internal parts of dry sausage

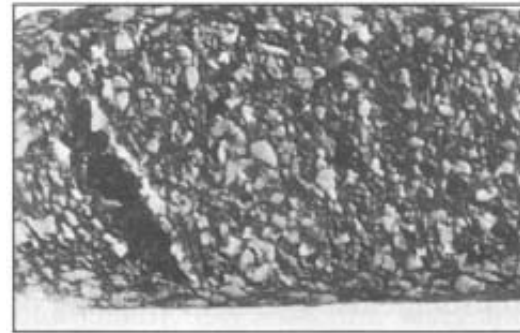

COOKED SAUSAGES

Cooked sausages are fine-comminuted sausages representing an important group of meat products. The basic technological aim is to increase the natural WHC of the meat batter to bind considerable quantities of added water. Cooked sausages may be made of uncooked or cooked raw materials.

Cooked sausages made of uncooked raw materials

These are emulsion-type sausages. The finished products are heat-treated to between 75° and 80°C to achieve desirable organoleptic properties and bacterial stability. They are juicy, tasty, easily chewable and digestible. To achieve such juiciness, about 25 percent water is added to the meat during manufacturing. Phosphate must be added to improve the WHC of the meat

proteins. Specific amounts of fatty tissues must also be added to achieve the characteristic consistency and flavour.

***Raw material.* Many different kinds and qualities of meat, organs and fatty tissues can be used. Beef, veal and pork are more frequently used, but camel, mutton, goat and venison can also be incorporated. Practical experience has shown that more desirable cooked sausages of the emulsion type are manufactured when hot-boned meat is used. In this case phosphate is not necessary, because hot-boned meat has a high WHC in the first three to four hours after slaughter and can emulsify 22 percent more fat than chilled or frozen. If hot-boned meat is not available only well-chilled and/ or frozen meat should be used. The chemical composition, water-binding and fat-emulsifying properties of the raw materials must be known in order to make products of uniform quality. Suitable raw materials are listed in Table 17.**

Offals such as heart, tongue, spleen, lungs, stomach, tripe or non-lactating udder are not commonly used in the manufacture of emulsion-type sausages. However, special products of this type may contain smaller quantities of certain offals.

Fatty tissues are also important raw materials. They contribute to the palatability, tenderness and juiciness of sausages. Variation in the ability to emulsify fat is due to the amount of soluble proteins potentially available, and their emulsifying capacity.

TABLE 17

Raw materials suitable for manufacturing cooked sausages made of uncooked material

Cattle	Pigs
Boneless primal cuts (Meat I)	Boneless primal cuts (Meat I)

Boneless bull and cow meat (Meat I & II)	Trimnings from primal cuts (Meat II)
Beef trimmings	Trimnings from blade and neck bones
Head and cheek meat	Head and cheek meat
Diaphragm meat	Diaphragm meat
Blood plasma	Skin
Suet and brisket fat	Blood plasma Jowl, backfat
<hr/>	
Calves	Sheep and goats
<hr/>	
Boneless primal cuts	Boneless primal cuts
Cheek meat and trimmings	Cheek meat and trimmings
<hr/>	

Ice water is used as a carrier for the curing agents, and improves the extraction of meat protein and the hydration of meat-extender proteins. The amount of added ice water depends on the raw material used. Water can be partly substituted by blood plasma which is an additional source of protein and improves the water-binding and emulsifying properties of the product. Regulations for emulsion-type sausages in many countries limit fat content to a maximum of 30 percent and water content to 40–60 percent in finished products.

***Additives.* A variety of additives can be used in addition to meat extenders. Phosphates and seasonings (spices, sweeteners, glutamates) may be used to create a range of products. If frozen and chilled meat is used, 0.3–0.5 percent phosphate must be added. Salt and pepper**

form the basis for a cookedsausage seasoning mixture. All other seasonings are only supplementary to them. Ascorbic acid, sodium ascorbate or sodium erythorbate (about 0.4 g per kg) are used in a 10-percent water solution at the end of the comminution.

***Casings.* Natural or synthetic casings can be used (Table 18) but in both instances they must be firmly filled.**

***Manufacture.* The basic aim in cooked-sausage manufacturing is to make a heat-stable meat batter, a meat “emulsion”, consisting mainly of water and protein. Heat treatment transforms it from a viscous form to a rigid and elastic solid structure which can be considered as a protein gel with entrapped fat particles. If the protein gel is strong enough, the fat will not be separated during heat treatment.**

***Principles of mincing.* Mincing completely destroys the meat structure. Meat proteins in the presence of salt, phosphates and cold water are dissolved forming a system consisting of a solution of salt-soluble proteins and muscle and connective tissue particles. When fatty tissue is added the fat particles will be emulsified with the salt-soluble proteins during comminution. The proteins will therefore be able to cover the total fat surface, surrounding each fat particle and so stabilize the emulsion.**

During comminution the structured breakdown of meat and fatty tissues occurs and new systems are formed: minced meat, suspension, after addition of salt, phosphate and ice water and emulsion, after addition of fatty tissues and stable sausage mixture after addition of all other additives (Figs 161, 162, 163 and 164).

***Principles of filling.* Cellulose and collagen casings are ready for transferring directly to the filling horn. Salted, natural casings should be flushed thoroughly prior to use, and filled firmly**

(Figs 183, 184 and 185).

Principles of heat treatment. Proteins show a great tendency to bind to and cross-link with each other upon heating. The binding properties of comminuted sausages originate from the heat-induced gelation of meat proteins. Gelation begins at about 43°C and produces a three-dimensional network structure which stabilizes the fat and water in comminuted meat products and binds meat and fat pieces together (Fig. 186).



183. Filling of frankfurter-type sausage mixture using manual sausage stuffer

184. Filling horn of automatic (hydraulic) sausage stuffer

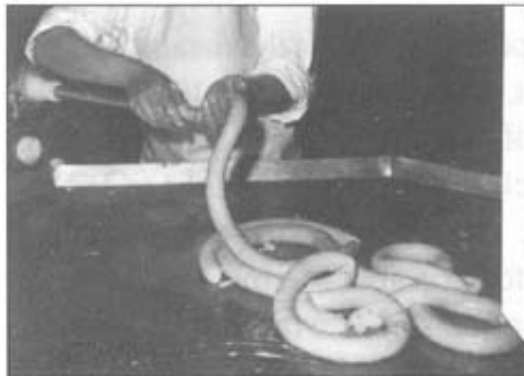

186. Cooking and smoking device for cooked sausages (industrial size)



185. Natural casings ready for filling (left), and filled sausage (hog casing)



187. High porosity of frankfurters (left), and emulsion breakdown manifested as fat pockets between surface and casing



TABLE 18

Casings used in manufacturing cooked sausages made of uncooked raw materials

Type of sausage	Length (cm)	Diameter	Casings
Frankfurter	12–14	small	sheep, goat and hog casings, or collagen or cellulose casings of similar diameter
Vienna sausage	12–14	small	as above
Hot dog	16–18	small	as above
Knackwurst	12–14	small	as above
Bologna			
• long	40–		beef middles or weasands, or cellulose

bologna	100	medium	casings of similar diameters
• large bologna	20–50	large	beef bungs or cellulose casings of similar diameter
• ring bologna	40–50	large	beef rounds or cellulose casings of similar diameter
Veal sausage	40–60	large	beef bungs or cellulose casings of similar size

Frequent faults committed during production

- **Separation of fat in the form of fat caps or fat pockets (Fig. 187) develops during heat treatment, due to emulsion breakdown, as a result of improper formulation (too much fatty tissue, especially soft or insufficient emulsifier), incorrect order of addition of raw materials and additives, and overcooking.**
- **Holes in sausage mixture caused by improper filling (Figs 187 and 188).**
- **Shrinkage of cooked sausages caused by improper smoking and/or heat treatment (temperature too high and RH too low).**
- **Difficult peeling of casings, can be the result of too much connective tissue in the formulation.**
- **Uneven colour of smoked sausage surface (unsmoked spots) occurs at places where links touch each other.**
- **High porosity of sausage mixture due to entrapped air.**

TABLE 19

Typical composition of different types of cooked sausage made of uncooked raw materials

	Beef	Mixed	Pork	Vienna Bologna
--	------	-------	------	----------------

Ingredients

frankfurter frankfurter frankfurter

1 2 1 2

 (%)

Meats

• Beef I and II	35.0	30.0	25.0	20.0	-	30.0	25.0
• Pork II	-	-	20.0	20.0	35.0	20.0	
• Beef fatty trimmings	33.0	20.0	-	4.0	-	-	-
• Pork fatty trimmings	-	-	5.0	5.0	5.0	42	4
• Beef fatty tissues	6.0	10.0	-	-	-	-	-
• Other by-products	-	-	7.0	8.0	-	-	-

Other ingredients

• Ice water	21.0	16.0	23.0	22.0	25.0	28	24
• Meat extenders	2.0	3.0	3.5	3.0	3.0	3.5	3
• Phosphates	0.3	0.4	0.4	0.3	0.3	0.5	0.5

Curing ingredients

• Nitrite salt	1.6	1.8	1.8	1.8	1.8	2.0	2.0
• Sugar	0.5	0.2	0.4	0.2	0.3	0.6	0.3
• Glutamate	0.15	0.2	0.2	0.2	0.2	0.2	0.2

Seasonings

• Pepper	0.12	0.13	0.3	.2	0.2	0.4	0.35
• Coriander	0.08	0.1	0.1	0.1		0.3	0.15
• Nutmeg	-	-	0.1	0.1	0.1	-	-
• Sage	0.05	0.05	-	0.05	-	-	-
• Cinnamon	0.05	0.05	-	0.05	-	-	-
• Fresh garlic	0.05	0.02	0.1	-	-	-	0.35
• Clove	-	-	0.05	-	0.05	-	-
• Mace	0.1	0.05	-	0.1	-	0.2	0.15
• Ginger	-	-	0.05	-	0.05	0.3	-

Different products. The best-known emulsion-type cooked sausages made of uncooked raw materials are frankfurter, Vienna sausage, hot dog, knackwurst, safalada, bologna and veal sausage.

Frankfurter-type sausages are sold under many names: frankfurters, wieners (braided in groups of links), Vienna-style sausage (twisted into a chain of links), hot dog, knacker, etc. All these types normally contain more beef than pork (1.5:1). The choice of raw material largely depends on the availability of the meat, the eating habits of the consumers and religious practices. In general, the lean-meat content varies between 25 and 40 percent, the average fat content is 25-30 percent, and 10-30 percent water is added. In low-quality frankfurters, 10 percent of the lean meat can be replaced by pork skin or organs. To maximize yield part of the fatty tissues and part of the water may be pre-emulsified (10–15 percent).

TABLE 20

The most important parameters in manufacturing emulsion-type cooked sausages made from uncooked raw materials

Technological operations		Parameters
Choice of raw material	meat	warm meat (hot-boned), chilled +2°C, or frozen minimum - 18°C
	fatty tissues	-1° to +2°C
Comminuting	finished sausage mixture	16° to 18°C (all pork) 18° to 20°C (all beef) pH 5.7–6.2, a _w 0.96–0.98
	Filling	filling mixture
Smoking + heat treatment	smokehouse	54°C (30 minutes), and 60 minutes; raise gradually to 80°C and hold 20–30 minutes
	product	70° to 75°C, pH 5.8–6.3, a _w 0.96–0.98
Cooling	cooling room (12–14 hours)	-1° to +2°C RH about 90%
	Storage	product
storage room		8° to 10°C RH 80-85%
packing		12° to 15°C

Package	room	RH 70–75%
Sale	sale rack	t = 5°C

If a high-speed cutter is not available, the first manufacturing step is grinding. The meat and trimmings must be ground through a 3-mm, and fatty tissue through a 5-mm plate.

The temperature of all raw material after grinding should not exceed 3°C. If a high-speed cutter is available, then a grinder is not necessary as the sausage mixture can be made in the cutter. Attention should be paid to the order in which raw materials are added (meat, curing agents, ice water, meat extenders, fatty tissues and seasonings). Water must be added early enough to ensure protein extraction. It is important to control the temperature during comminution, not only for the extraction of salt-soluble proteins but also for the hydration of meat-extender proteins. The final temperature of the sausage mixture should not exceed 18°C if pork fatty tissues are used, and 2°C if beef fatty tissues are used.

After filling in natural, synthetic, edible or inedible casings and linking, products should be smoked immediately. They are hung on sticks and placed on smokehouse racks (Fig. 186). Links should be separated on the stick so as not to touch each other, otherwise smoking and colour development will not be uniform. Surfaces in contact with the stick or with other links do not dry out sufficiently, favouring the growth of micro-organisms forming slimes, especially in warm conditions. This can be eliminated by shifting the links slightly at some time during smoking to expose the surfaces which have been in contact with the stick. This can be minimized by using “T” profile metal sticks with apertures.

188. Holes in medium-size cooked sausage due to improper filling of casings

190. Cross-section of bologna



189. Cross-section of coarse comminuted sausage and string of safaladas

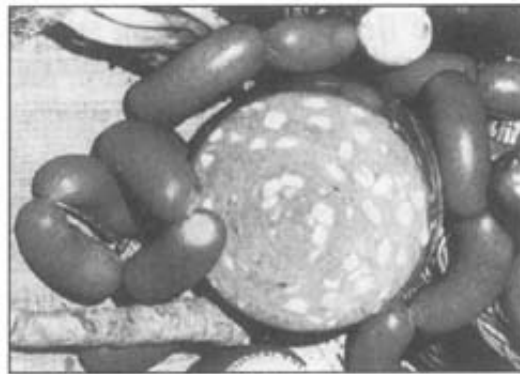
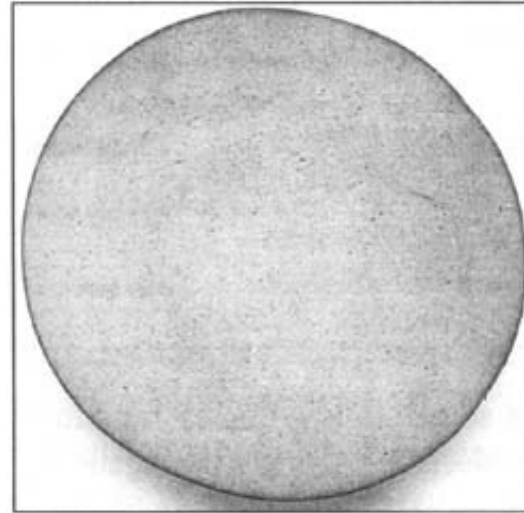

Smoking imparts an appetizing flavour and develops a desirable goldbrown smoked colour. It also contributes to the development of a smooth surface or skin beneath the cellulose casing, that facilitates peeling of the casing prior to packaging. Smoking lasts from one to three hours, depending on desirable colour, temperature and humidity, and type of smokehouse employed. A high smoke concentration and a rather high temperature are desirable during the final period of smoking. Smoking and heat processing start at 54–57°C and the temperature is gradually increased (5.5°C every 15 minutes), until it reaches 82°C. Smoking continues until an internal temperature of 70–75°C is reached. The next step is cold showering until an internal

temperature of 32°C maximum is reached. The product is then placed in a cooler.

Vienna sausages (Fig. 187) are manufactured using beef and pork trimmings with a maximum quantity of water (28–30 percent) and meat extenders, tied in similar lengths to frankfurters (12–14 cm).

Hot dogs have the same formulation as Vienna sausages but are tied longer than any other emulsion-type small-diameter cooked sausages (16–18 cm).

Safaladas/knackwursts (Fig. 189) have a frankfurter composition but the structure is finer than any other cooked sausage. It is obtained by passing the sausage mixture twice through an emulsion mill, after being manufactured in the cutter.

Bologna sausage (Fig. 190) is a typical emulsion-type cooked sausage filled into large casings. Curing is as in frankfurters but less water is added. Long bologna is filled into beef middles or weasand, large bologna into beef bungs, and ring bologna into beef rounds. Cellulose casings of corresponding size may also be used. Large bologna must be supported either by wrapping it two or more times with twine and hanging it on a loop in the twine or by supporting it in a stockinette bag. Bologna requires longer smoking (three hours for long and five for large) and cooking than frankfurters.

All parts of the bologna must reach 71°C during cooking or the inside of the sausage may become discoloured before it is sold to the consumer. After cooking the bologna is chilled in cold water, superface dried, then placed in a cooler.

***Shelf-life* of cooked sausages is about four to five days, or up to ten days in retail packages (vacuum) held at 10–15°C or as high as 12 to 14 months in cans or jars.**

Small and medium-diameter cooked sausages (Fig. 189) are reheated before eating in order to regain their firmness and juiciness. Reheating is done in boiling water for about ten minutes (or by toasting or grilling). Cooked sausages are eaten while hot with baked goods (rolls, buns), mustard, horseradish, ketchup etc. Large-diameter sausages are cut into slices (Figs 189 and 190) as a cold starter or used in sandwiches, Russian salads and similar light meals.

Cooked sausages made of precooked raw material

These are sausages made from edible offal and lower-quality meat and have a specific flavour. The raw materials are precooked, minced, mixed, filled into casings and finally heat-treated. Fine-comminuted sausages are processed in the cutter and coarse-comminuted in the grinder. There are also sausages with a mixture of both fine- and coarse-comminuted pieces of meat, tongue, liver, fatty tissue (all these components are most often cured). Uncooked cured blood (2 percent nitrite salt) is often added and precooked pigskin is also very often used, except with all-beef products in which tendons and other connective tissues are used instead.

***Raw materials* are all edible offals, head meat, lower-quality meat, fatty tissues and pigskin. All components except pigskin are fully cooked. Pigskin is partially cooked until soft enough to be ground in the grinder. Its function is to give the finished product its typical firmness.**

Precooking is done in boiling water with sufficient water in the cooking vats to cover all the material (Fig. 191). Cooking time depends on the size of pieces. Fully cooked raw materials are comminuted without delay. If comminution is done in the cutter then no blending is necessary (Fig. 192).

***Additives* used are nitrite salt, caseinate, blood-plasma powder, egg white, gelatine and seasonings. All except the seasonings can be added at a rate of up to 2 percent.**

Casings. Natural and synthetic casings can be used but in countries with a hot climate, if continuous refrigerated storage during retail sale is not possible, priority should be given to synthetic casings (Fig. 193). Such casings are also more convenient because they can be exposed to higher temperatures (up to 115°C retortable sausage) during heat treatment giving a longer shelf-life.

Composition. There are four types of precooked sausages which differ in composition and manufacturing method:

- liver paste;
- liver sausage;
- blood sausage; and
- cooked sausage with high collagen content.

The typical composition of these are given in Table 21.

191. Pre-treatment of raw materials for cooked sausages made of precooked material



193. Filling of cooked sausages in synthetic casings (largediameter)





192. Liver paste manufacturing in cutter (mixing and comminuting)

TABLE 21
Typical composition of cooked sausages made of precooked raw materials

Component	Type							
	Liver paste		Liver sausage		Cooked sausage with highcollagen content		Blood sausage	
	1	2	1	2	1	2	1	2
	(%)							
Liver	10	10	15	10	10	5	5	-
Fatty tissue	30	30	20	20	10	25	30	20
Head meat	20	30	20	30	40	33	15	5
Lean meat trimmings	5	-	5	-	5	-	-	5
Other organs	5	10	10	15	5	10	10	13
Pigskin/beef	-	10	5	13	15	20	30	-

tendons	14	15	15	15	15	10	-	15
Broth								
Caseinate	3	3	2	3	-	-	-	-
Seasonings	0.4	0.4	0.4	0.4	0.4	0.4	0.4	0.4
Nitrite salt	1.6	1.6	1.6	1.6	1.6	1.6	1.6	1.6
Fried onions	1	-	!	-	-	-	-	-
Cured blood	-	-	-	-	-	-	20	10

In all formulations meat can be substituted with other edible offal. Liver paste (Fig. 195) is fine-comminuted with high spreadability.

Liver sausage (Figs 194 and 195) contains 10–20 percent liver, usually coarse-ground, and other edible offals.

Blood sausage (Fig. 194) contains 10–20 percent whole blood with nitrite salt (not precooked). Other components are precooked meat, edible offals, fatty tissue and pigskin. Fatty tissue must be cooked sufficiently in order to separate fat with a low melting point. Components can be coarse- or fine-comminuted as in other precooked sausages. This type of sausage has a firm consistency due to swollen connective tissue components and gelatinized collagen.

Cooked sausage with high-collagen content resembles coarse-textured liver sausage but has more connective tissue (collagen and elastic of pigskin and beef tendons). Sometimes up to 10 percent dissolved gelatine solution is used to produce a sausage described as aspic in casing.

***Heat treatment.* The mixture is filled into the casings while still hot and the sausages are immediately heat-treated. Cooking time should be set according to the type (natural or synthetic) and diameter of casing. Natural casings exposed to temperatures higher than 85°C**

will burst, therefore their shelf-life is shorter (up to ten days at 5°C). Synthetic casings can be cooked in boiling water for about 90 minutes, or even in an autoclave at 110°C for 60 minutes. If they are kept at temperatures below 10°C they will have a shelf-life of one month.

Frequent faults committed during production

- **Undercooking resulting in a shorter shelf-life**
- **Overcooking may result in an oversoft consistency**
- **Insufficient connective tissue will also result in a soft consistency, and the filling will fall apart**
- **Fat separation may occur in the liver paste if insufficient emulsifier is added.**

The most serious fault is not to fill the casings immediately and not to heat-treat them immediately. In this case the product can spoil even before the heat treatment.

194. Sausages made of precooked raw material in natural casings (1 blood sausage, 2 liver sausage)

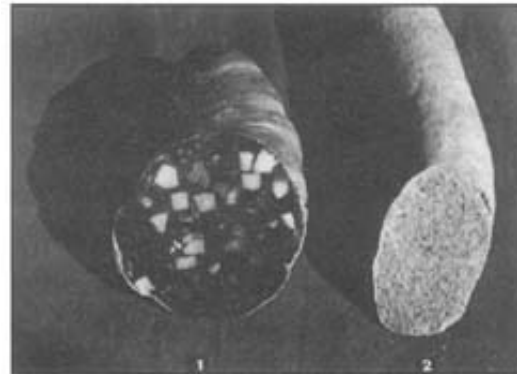

Different products. There are many products of this type which differ in the raw materials, grade of comminution and seasonings (Figs 194 and 195). Sometimes cooked rice is added to the sausage mixture.

***Eating method.* Liver paste is spread on bread or is used to make sandwiches. Other types of sausage are cut into slices and consumed cold.**

SIMPLE CANNING

The canning process involves two essential operations: the product must be heated at a sufficiently high temperature and for long enough to make it fully or commercially sterile, and it must be sealed in a hermetic container which will prevent recontamination of the product.

Commercial sterility differs from total sterility in that some organisms may survive the heat treatment but the conditions which prevail in the container during storage do not allow these to grow, produce toxins or spoil the product. However, in regions having a tropical climate, canners strive for total sterility of their canned products. The need to achieve at least commercial sterility determines the minimum heat process to be applied to a product. There is sometimes a temptation for canners to use less than the recommended minimum heat process. This may result in the product not being commercially sterile. It may then become toxic and poison consumers, or the product may be spoilt and the cans may swell and have to be destroyed. It is essential for people dealing with canning to know what heat processes are required for their products, how these are to be applied, and the nature of the risk they take if less than minimum processes are used. This is why in numerous countries only people having achieved the required level of expertise in canning technology and heat process calculations are authorized to approve heat processes.

195. Different sausages made of precooked raw material in synthetic casings (1 liver paste, 2, 3 liver sausage)

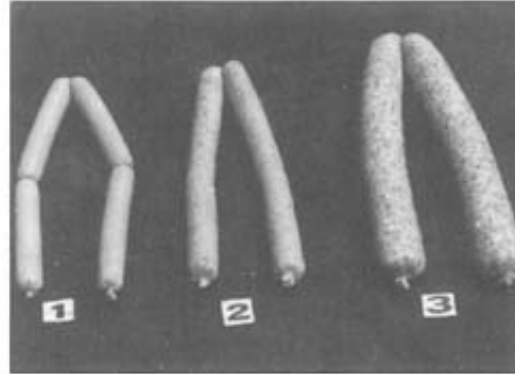

Commercial sterility is obtained in meat products which belong to lowacid foods (pH higher than 4.6) if the process applied is severe enough to inactivate the spores. Therefore, meat products are usually processed in steam (or water) under pressure at 116–121°C and sometimes in steam at 140°C. The organisms which are capable of spoiling meat products include those which form heat-resistant spores, thus high-temperature processes are needed to make them commercially sterile.

Usually heat processes for canned products are designed to inactivate large numbers of spores of the organism *Clostridium botulinum*. Although these spores are not as resistant as the spores of some other *Clostridium* and *Bacillus* types, *C. botulinum* is capable of producing lethal toxins, sometimes without swelling the container or obvious alteration of the appearance of the product. Since this organism presents a public health risk, recommended heat treatments must have a large safety margin.

196. Various small-size aluminium (1–5) and tin-plate cans (6–8)

198. Low quality of can (interior corrosion of can body and covers)

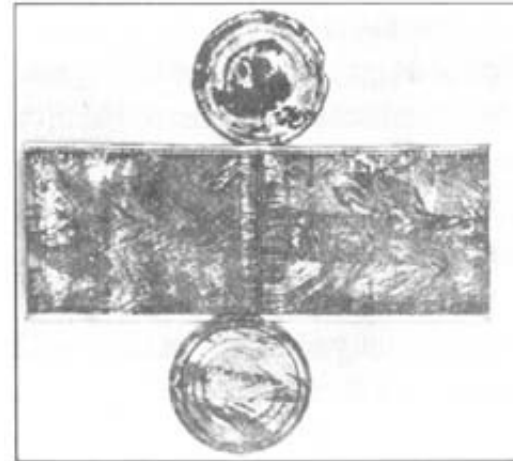

197. Various shaped and sized tinplate cans (1–2 pear-shaped; 3–4 oblong cans), and covers (5–6); can 2 is dirty (hygienic fault)

The severity of heat processes for canned meat products is measured in terms of F_0 -values which means that the product received a heat treatment with the same inactivating effect as exposure for one minute at 121°C. For example, one minute at 121°C gives the same amount of inactivation of spores as four minutes at 115°C or 13 minutes at 110°C or 40 minutes at 105°C, so all those processes will have the same F_0 -value. F_0 -value for the majority of canned meat products ranges between one and ten. Larger canned products require higher F_0 -values, even up to 20–25, owing to the longer period needed for heat penetration.

Meat products suited for canning

Meat products made from chopped cured meat that can be canned include corned beef (consisting of large and small pieces of beef, blanched to give a lower water content); corned mutton (similar product made from mutton); beef hash (similar product made from lower-quality meat to which some edible offal is added); minced beef; luncheon meat (similar to emulsion-type sausage) made from beef, pork, or a mixture of beef and pork, or from other kinds of meat; pressed beef (made from large cured high-quality meat pieces; picnic ham (usually weighing 0.5 kg); canned cured ox tongues. Similar products made from pork are: minced pork, chopped pork, lunch pork, pressed pork, pressed ham and many others. Stewed beef, stewed mutton, stewed veal and stewed venison are frequently canned, as well as dishes in jelly such as veal in jelly. Liver sausage, liver paste and some other pastes and frankfurters in brine are also suited for canning.

Containers suited for sterilization of meat products and hermetical closure

***Container.* The container protects the canned product from spoilage by recontamination with micro-organisms, therefore reliable containers and properly adjusted closing machines are essential to prevent access of spoilage organisms during the cooling operation and during the shelf-life of the product. Before filling, containers have to be rinsed or otherwise cleaned from dust or other impurities (Fig. 197).**

Tin-plate cans are most commonly used, such as the soldered side-seam three-piece can, consisting of can body, can end and lid. The cemented sideseam and welded side-seam cans constitute the majority of cans produced, and remain one of the most reliable and acceptable packages ever conceived. The benefits of using three-piece cans include no size limitations, a wide range of plate thicknesses and tempers for body and ends, abuse resistance, strong end

profiles and long shelf-life. Two-piece cans are becoming popular for some applications. Can end and body is drawn in a single piece from flat sheet stock. Only shallow cans (height less than half the diameter) can be fabricated this way. Enamelled cans are more suitable for canned meat products because interior corrosion of cans can be avoided (Figs. 196, 197 and 198).

Increasingly more attention is being given to aluminium for manufacturing cans and other containers for canned meat products, where special opening features are desired. Important advantages of aluminium cans are that they are lead-free and do not rust. Most often two-piece aluminium cans are used in meat canning (Fig. 196). Aluminium for can ends and bodies is, without exception, coated with enamel on both sides. It is widely used in flexible and semi-rigid containers as a protective packaging for a large number of meat products. As a result of extensive development, the use of flexible, laminated pouches and formed aluminium containers for shelf-stable sterilized products is a commercial reality.

The retortable pouch, a thin rectangular package used for heat-sterilized meat products, offers potential improvements in convenience and quality because of its shape and composition. During heat processing, its shape and size allows rapid heat transfer to destroy micro-organisms at the innermost part of the pouch without excessively overheating the product near the pouch wall. The contents are likewise more rapidly cooled at the end of sterilization. A suitable laminate used to make retortable pouches consists of three foils (polyester, aluminium and polypropylene film or resin). These containers are heat-sealed.

Glass containers. Glass is an inert container, although damage to the meat product may result from exposure to light. Glass jars are sealed with caps, twist-off lids and many other systems (crowns, side seal closures, rolled-on closure, screw caps or lug caps) and are used for frankfurters in brine and similar sausages and to some extent also for liver sausage mixtures

or sausage mixtures with high-collagen content.

Retortable synthetic casings. Recently a new kind of casing has been used for sausage filling, especially if it is necessary to obtain a longer shelf-life for sausages, sterilized in a retort. This kind of container is sealed with clips made of aluminium.

200. Principles of can-seaming operation (a, b) and cross-section of correct can closure by double seam (c). (a) initial stage of curling; (b) fully developed curling; (c) seam tightening. 1 seaming chuck, 2 seaming roll, 3 tin wall, 4 tin end, 5 seaming roll, 6 lining compound

199. Manual closing machine

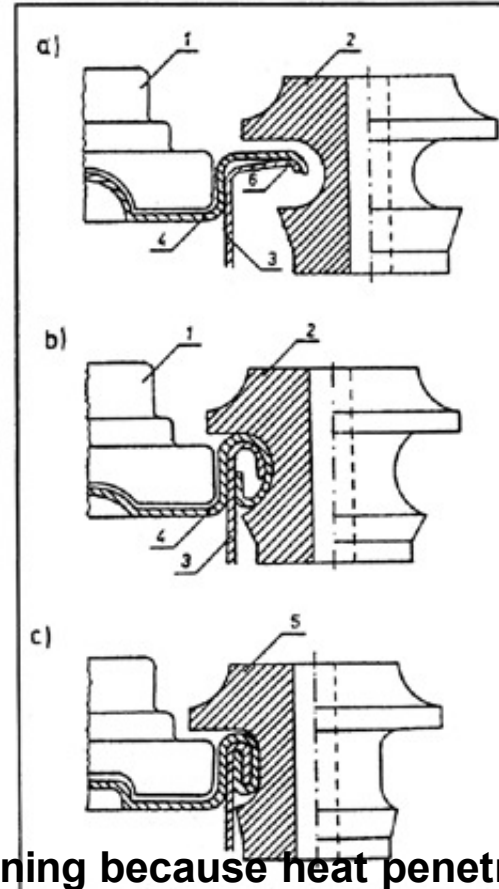
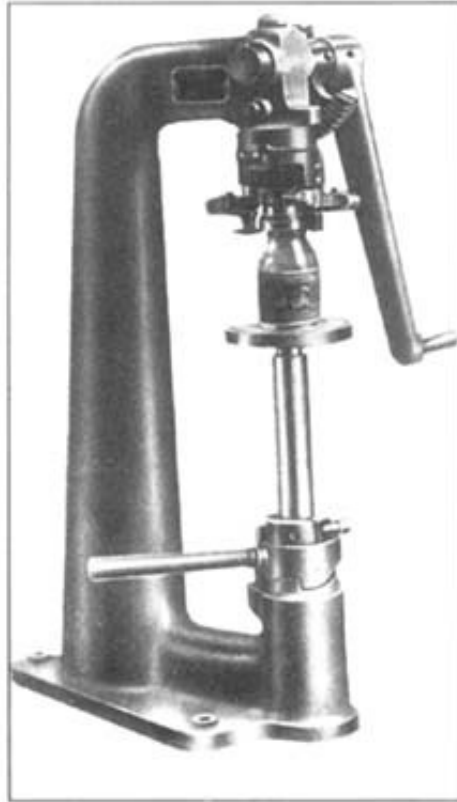

Smaller size containers are more suitable for meat canning because heat penetration of the meat is by conduction, so if larger containers are used extremely severe heat treatments will be necessary for sterilization. Such severe heat treatment will result in a much lower quality of canned product which will be extremely overcooked. That is why larger pieces, such as hams, shoulders, etc. are pasteurized at temperatures of about 80°C.

Hermetic closure. Tin-plate cans and aluminium cans are closed by machines which form a double seam in three stages: pressing the cover (lid) to the can body, forming the first operation roll seam, and forming the second-operation roll seam (Figs 199 and 200).

201. Autoclave (retort). 1

body, 2 lid, 3
counterbalance, 4 nuts, 5
heater, 6 vent, 7 relief
valve, 8 pressure gauge, 9
water supply valve, 10
steam supply valve

202. Autoclave (retort) for small-scale
production; retort lid opened (above
left), basket for loading cans (above
right)

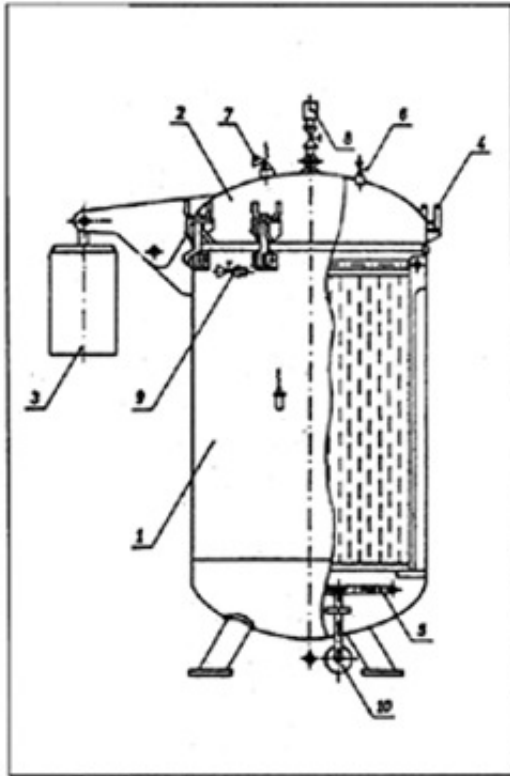

Good double seams are absolutely essential to prevent losses due to spoilage. The food processor is responsible for the quality of seams produced in the plant and must provide adequately trained personnel to perform seam evaluations and make closing machine adjustments. Making good seams requires careful closing machine maintenance, frequent, regularly scheduled seam evaluations and immediate correction of seam conditions which are

outside established tolerances. Hermetic closure of cans under vacuum is highly recommended, particularly for countries with a hot climate.

Autoclave (retort)

Batch retorts are heated with steam or water under pressure (Figs 201 and 202). Saturated air-free steam is an excellent heating medium for processing canned meat products. Hot water under pressure has many of the advantages of saturated steam as a heating medium but it must be circulated among containers and continually reheated.

The canning operation must be performed only by fully trained personnel. Operation of batch retorts heated with steam is performed in the following steps:

- **load the cans in trays or baskets and close and tighten the retort lid;**
- **open the drain, vent condensate valves and the high-and low-pressure steam supplies;**
- **remove the air by a flow of steam during venting;**
- **close drain and vent valves;**
- **bring retort to operating temperature and pressure;**
- **regulate steam supply by temperature control;**
- **time the process from when the retort reaches the specified temperature;**
- **turn off the steam at the end of the process;**
- **start cooling by flooding the retort with cold water for about ten minutes (smaller cans up to 500 grams capacity), or 20 minutes (larger cans up to 1 500 grams);**
- **continue cooling until the average temperature of the product is 40°C when the process is completed;**
- **open the lid of the retort, remove baskets with canned products and let them dry.**

Venting is one of the most important operations in processing canned meat products in steam, because air remaining among cans in an inadequately vented retort forms an insulating layer and will reduce the efficiency of the process.

In general, the same principles apply to processing in water. Some containers such as glass jars and flexible synthetic pouches are usually retorted in hot water in vertical retorts under superimposed air pressure.

Chlorination of cooling water is recommended (0.5 ppm free chlorine should be the lowest amount at the point of discharge).

Frequent faults committed during canning

***Insufficient sterilization* results in spoilage of canned product and is identified by can swell (hard, soft and springer swell) or by flat sour spoilage.**

203. Insufficient can closure (droop, lip and improper first roll seam caused by damaged can are shown)

205. Products in opened cans, liver paste (left) and luncheon meat (right)

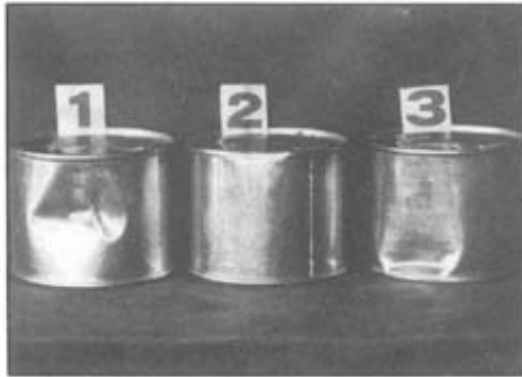
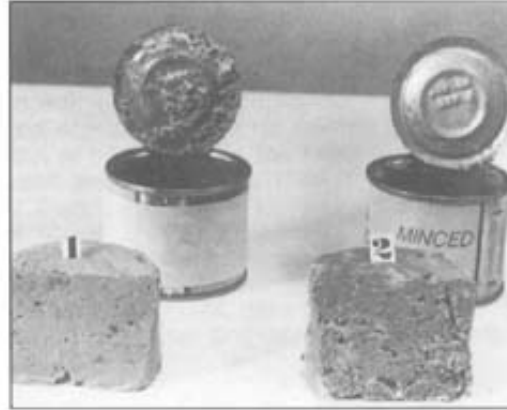
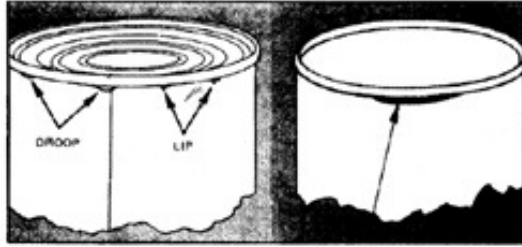

204. Can deformations (critical, because double seam (1 and 3) or side seam (2) is damaged)

Overprocessing results in too soft a consistency and a burnt taste.

Deformation of cans and semi-rigid containers, breakage of glass jars and bursting of casings are the results of a careless, cooling operation, especially improper superimposed pressure (Fig. 204).

Leaking cans are the result of improper closing machine adjustment and deformation of cans prior to closing or after being processed, especially near the double seam (Fig. 203).

Shelf-life

Fully preserved canned meat products keep up to four years, but in the tropics it is only about one year.

Canned pasteurized products should be clearly labelled as perishable product (keep under refrigeration or store at/below 5°C) and must not be confused with fully sterilized products which do not require refrigerated storage.

Most canned meat products are eaten after emptying the can (Fig. 205), without reheating, stews and frankfurters being the exceptions.

FAO TECHNICAL PAPERS

FAO ANIMAL PRODUCTION AND HEALTH PAPERS:

1. Animal breeding: selected articles from World Animal Review, 1977 (C* E* F* S*)
2. Eradication of hog cholera and African swine fever, 1976 (E* F* S*)
3. Insecticides and application equipment for tsetse control, 1977 (E* F*)
4. New feed resources, 1977 (E/F/S*)
5. Bibliography of the criollo cattle of the Americas, 1977 (E/S*)
6. Mediterranean cattle and sheep in crossbreeding, 1977 (E* F*)
7. Rev.Environmental impact of tsetse chemical control 1980 (E* F*)
- 7Rev. Environmental impact of tsetse chemical control, 1980 (E* F*)
8. Declining breeds of Mediterranean sheep, 1978 (E* F*)
9. Slaughterhouse and slaughterslab design and construction, 1978 (E* F* S*)
10. Treating straw for animal feeding, 1978 (C* E* F* S*)

11. Packaging, storage and distribution of processed milk, 1978 (E*)
12. Ruminant nutrition: selected articles from World Animal Review, 1978 (C* E* E* S*)
13. Buffalo reproduction and artificial insemination, 1979 (E**)
14. The African trypanosomiases, 1979 (E* F*)
15. Establishment of dairy training centres, 1979 (E*)
16. Open yard housing for young cattle, 1981 (E* F* S*)
17. Prolific tropical sheep, 1980 (E* F* S*)
18. Feed from animal wastes: state of knowledge, 1980 (E*)
19. East Coast fever and related tick-borne diseases, 1980 (E* S*)
- 20/1. Trypanotolerant livestock in West and Central Africa - Vol. 1 - General study, 1980 (E* F*)
- 20/2. Trypanotolerant livestock in West and Central Africa - Vol. 2 - Country studies, 1980 (E* F*)
- 20/3. Le bétail trypanotolérant en Afrique occidentale et centrale Vol. 3 - Bilan d'une décennie, 1988 (F*)
21. Guideline for dairy accounting, 1980 (E*)
22. Recursos genéticos animales en América Latina, 1981 (S*)
23. Disease control in semen and embryos, 1982 (E* F* S*)
24. Animal genetic resources - conservation and management, 1981 (E*)
25. Reproductive efficiency in cattle, 1982 (E* F* S*)
26. Camels and camel milk, 1982 (E*)
27. Deer farming, 1982 (E*)

28. Feed from animal wastes: feeding manual, 1982 (E*)
29. Echinococcosis/hydatidosis surveillance, prevention and control: FAO/UNEP/WHO guidelines, 1982 (E*)
30. Sheep and goat breeds of India, 1982 (E*)
31. Hormones in animal production, 1982 (E*)
32. Crop residues and agro-industrial by-products in animal feeding, 1982 (E/E*)
33. Haemorrhagic septicaemia, 1982 (E* F*)
34. Breeding plans for ruminant livestock in the tropics, 1982 (E* F* S*)
35. Off-tastes in raw and reconstituted milk, 1983 (E* F* S*)
36. Ticks and tick-borne diseases: selected articles from World Animal Review, 1983 (E* F* S*)
37. African animal trypanosomiasis: selected articles from World Animal Review, 1983 (E* F*)
38. Diagnosis and vaccination for the control of brucellosis in the Near East, 1983 (E* Ar*)
39. Solar energy in small-scale milk collection and processing, 1983 (E* F*)
40. Intensive sheep production in the Near East, 1983 (E* Ar*)
41. Integrating crops and livestock in West Africa, 1983 (E* F*)
42. Animal energy in agriculture in Africa and Asia, 1984 (E/E* S*)
43. Olive by-products for animal feed, 1985 (Ar* E* F* S*)
- 44/1. Animal genetic resources conservation by management, data banks and training, 1984 (E*)

Animal genetic resources: cryogenic storage of germplasm and molecular

- 44/2. engineering, 1984 (E*)
45. Maintenance systems for the dairy plant, 1984 (E*)
46. Livestock breeds of China, 1985 (E*)
47. Réfrigération du lait à la ferme et organisation des transports, 1985 (E *)
48. La fromagerie et les variétés de fromages du bassin méditerranéen, 1985 (E *)
49. Manual for the slaughter of small ruminants in developing countries, 1985 (E*)
50. Better utilization of crop residues and by-products in animal feeding: research guidelines - 1. State of knowledge, 1985 (E*)
- 50/2. Better utilization of crop residues and by-products in animal feeding: research guidelines - 2. A practical manual for research workers, 1986 (E*)
51. Dried salted meats: charque and carne-de-sol, 1985 (E*)
52. Small-scale sausage production, 1985 (E*)
53. Slaughterhouse, cleaning and sanitation, 1985 (E*)
54. Small ruminants in the Near East: Vol. 1 - Selected papers presented at Tunis Expert Consultation, 1986 (E*)
55. Small ruminants in the Near East: Vol. II - Selected papers from World Animal Review, 1986 (E* Ar *)
56. Sheep and goats in Pakistan, 1985 (E*)
57. Awassi sheep, 1985 (E*)
58. Small ruminant production in the developing countries, 1986 (E*)
- 59/1. Animal genetic resources data banks, 1986 (E*)
 - 1 - Computer systems study for regional data banks

- 59/2. Animal genetic resources data banks, 1986 (E*)
 2 - Descriptor lists for cattle, buffalo, pigs, sheep and goats
- 59/3. Animal genetic resources data banks, 1986 (E*)
 3 - Descriptor lists for poultry
60. Sheep and goats in Turkey, 1986 (E*)
61. The Przewalski horse and restoration to its natural habitat in Mongolia, 1986 (E*)
62. Milk and dairy products: production and processing costs, 1988 (E* F* S*)
63. Proceedings of the FAO expert consultation on the substitution of imported concentrate feeds in animal production systems in developing countries, 1987 (E*)
64. Poultry management and diseases in the Near East, 1987 (Ar*)
65. Animal genetic resources of the USSR, 1989 (E*)
66. Animal genetic resources - Strategies for improved use and conservation, 1987 (E*)
- 67/1. Trypanotolerant cattle and livestock development in West and Central Africa - Vol. I, 1987 (E*)
- 67/2. Trypanotolerant cattle and livestock development in West and Central Africa - Vol. II, 1987 (E*)
68. Crossbreeding *bos indicus* and *bos taurus* for milk production in the tropics, 1987 (E*)
69. Village milk processing, 1988 (E* F*)
70. Sheep and goat meat production in the humid tropics of West Africa, 1988 (E/F*)
71. The development of village based sheep production in West Africa, 1988 (E* F* S*)
72. Sugarcane as feed, 1988 (E/S*)
73. Standard design for small-scale modular slaughterhouses, 1988 (E*)

74. Small ruminants in the Near East, Volume III: North Africa, 1988 (E*).
75. The eradication of ticks, 1989 (E/E *)
76. *Ex situ* cryoconservation of genomes and genes of endangered cattle breeds by means of modern biotechnological methods, 1989 (E*)
77. Training manual for embryo transfer in cattle, 1991 (E*)
78. Milking, milk production hygiene and udder health, 1989 (E*)
79. Manual of simple methods of meat preservation, 1989 (E*)
80. Animal genetic resources - A global programme for sustainable development, 1990 (E*)
81. Veterinary diagnostic bacteriology - A manual of laboratory procedures of selected diseases of livestock, 1990 (E*)
82. Reproduction in camels - a review, 1990 (E*)
83. Training manual on artificial insemination in sheep and goats, 1991 (E*)
84. Training manual for embryo transfer in water-buffaloes, 1991 (E*)
85. The technology of traditional milk products in developing countries, 1990 (E*)
86. Feeding dairy cows in the tropics, 1990 (E*)
87. Manual for the production of anthrax and blackleg vaccines, 1991 (E*)
88. Small ruminant production and the small ruminant genetic resource in tropical Africa, 1991 (E*)
89. Manual for the production of Marek's disease, Gumboro disease and inactivated Newcastle disease vaccines, 1991 (E*)
90. Application of biotechnology to nutrition of animals in developing countries, 1991 (E*)
91. Guidelines for slaughtering, meat cutting and further processing, 1991 (E*)

Availability: May 1991

Ar - Arabic
C - Chinese
E - English
F - French
S - Spanish

*** Available**

**** Out of print**

***** In preparation**

The FAO Technical Papers are available through the authorized FAO Sales Agents or directly from Distribution and Sales Section, FAO, Via delle Terme di Caracalla, 00100 Rome, Italy.

