

































- ➔  **Better Farming Series 39 - Raising Ducks 1: How to Begin (FAO, 1990, 73 p.)**
-  **(introduction...)**
-  **Preface**
- Introduction**
-  **(introduction...)**
-  **What do you need to raise ducks?**
- Learning about ducks**
-  **Where can you raise ducks?**
-  **What kind of ducks can you raise?**
-  **What can ducks eat?**
-  **How many ducks should you raise?**
-  **How to keep ducks safe and well**
-  **Now you must decide**
- How to begin**
-  **Choosing a place to raise ducks**
-  **Building a shelter for your ducks**
-  **The floor of a duck shelter**
-  **Building nests**
- The ducks**
-  **(introduction...)**
-  **Choosing ducks for your flock**
-  **How to choose good ducks**

-  **How to tell the difference between female and male ducks**
-  **How to handle your ducks**
-  **After you get your ducks**
- Growing your own baby ducks**
 -  **(introduction...)**
 -  **Hatching your own eggs**
 -  **Setting the female duck**
 -  **The baby ducks**
 -  **Putting your new baby ducks with the flock**
 -  **When to use or sell the meat**
-  **Taking care of your ducks**
-  **Further improvement**

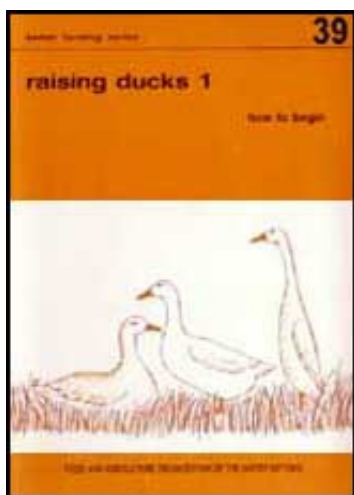

-  **Better Farming Series 39 - Raising Ducks 1: How to Begin (FAO, 1990, 73 p.)**
-   **(introduction...)**
-  **Preface**
- Introduction**
- Learning about ducks**
- How to begin**
- The ducks**
- Growing your own baby ducks**

-  **Taking care of your ducks**
-  **Further improvement**









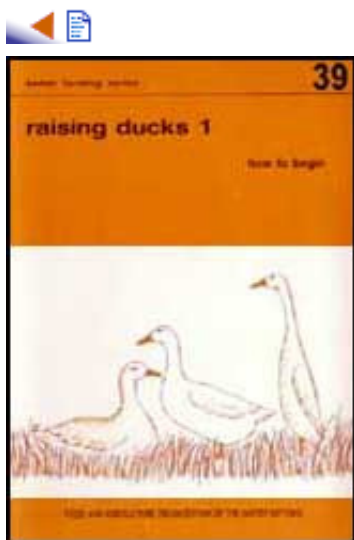

FOOD AND AGRICULTURE ORGANIZATION OF THE UNITED NATIONS **Rome, 1990**

P-69

ISBN 92-5-102939-3

© FAO 1991



-  **Better Farming Series 39 - Raising Ducks 1: How to Begin**
(FAO, 1990, 73 p.)
-  **(introduction...)**
-   **Preface**
-  **Introduction**
-  **Learning about ducks**
-  **How to begin**
-  **The ducks**
-  **Growing your own baby ducks**
-  **Taking care of your ducks**
-  **Further improvement**

Preface

The first 26 volumes in FAO's Better Farming Series were based on the Cours d'apprentissage agricole prepared in Cote d'Ivoire by the Institut africain de developpement economique et social for use by extension workers. Later volumes, beginning with No. 27, have been prepared by FAO for use in agricultural development at the farm and family level. The approach has deliberately been a general one, the intention being to create a basic model that can be modified or expanded according to local conditions of agriculture.

Many of the booklets deal with specific crops and techniques, while others are intended to give farmers more general information that can help them to understand why they do what they do, so that they will be able to do it better.

Adaptations of the series, or of individual volumes in it, have been published in Amharic, Arabic, Bengali, Creole, Hindi, Igala, Indonesian, Kiswahili, Malagasy, SiSwati, Thai and Turkish. This volume has been prepared by the Inland Water Resources and Aquaculture Service, Fishery Resources and Environment Division.

Requests for permission to issue this manual in other languages and to adapt it according to local climatic and ecological conditions are welcomed. They should be addressed to the Director, Publications Division, Food and Agriculture Organization of the United Nations, Via delle Terme di Caracalla, 00100 Rome, Italy.

Booklets 27 to 39 in the FAO Better Farming Series were written and illustrated by Tom Laughlin, working closely with the technical divisions responsible.



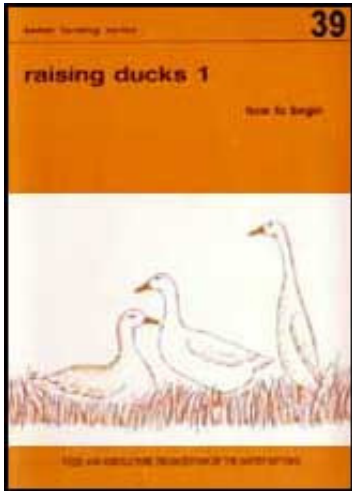

Better Farming Series 39 - Raising Ducks 1: How to Begin (FAO, 1990, 73 p.)

➔ **Introduction**

 ***(introduction...)***

 **What do you need to raise ducks?**

Better Farming Series 39 - Raising Ducks 1: How to Begin (FAO, 1990, 73 p.)

Introduction

- 1. Ducks lay eggs and give meat. They are good to eat and very good for you.**
- 2. By raising ducks you will have mom food. This will help to feed your family and keep it strong and healthy.**

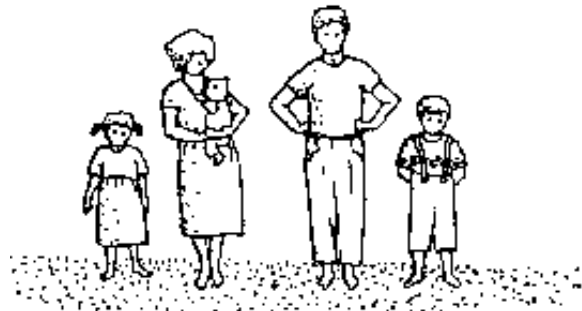

Family

3. Ducks are easy to raise. They need less care than chickens. Ducks are strong and hardy. They do not get sick easily.

4. With very little time and work you can raise a small flock of ducks.

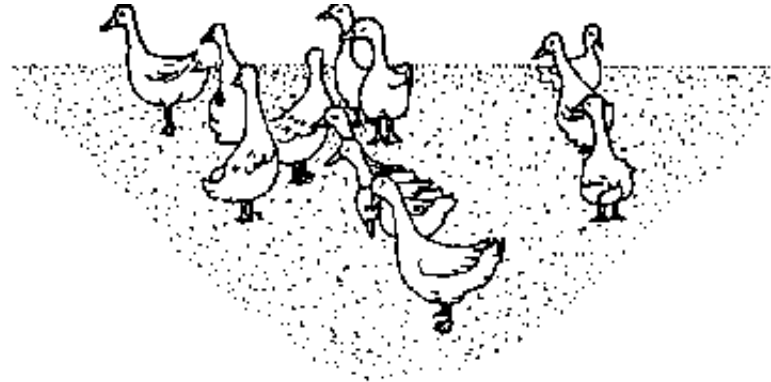

Small flock of ducks

5. If your family is not too big you may not need all of the eggs and all of the meat for food. Then, you can sell what you do not use to your neighbours or at the market.



at the market

At the market

6. With more food and with the money you get by selling eggs and meat you and your family can live better.

7. However, if your family is too big you will need to raise many more ducks if you are to have enough eggs and meat to eat and to sell at the market.

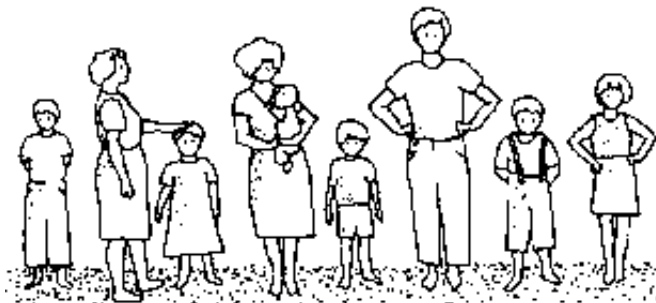

Too big family

What do you need to raise ducks?

You will need

- a good place near your house to keep a flock of ducks



A good place near your house

- a simple shelter for your ducks to protect them in cold, hot or wet weather and to keep them safe from their enemies or from people who may steal them

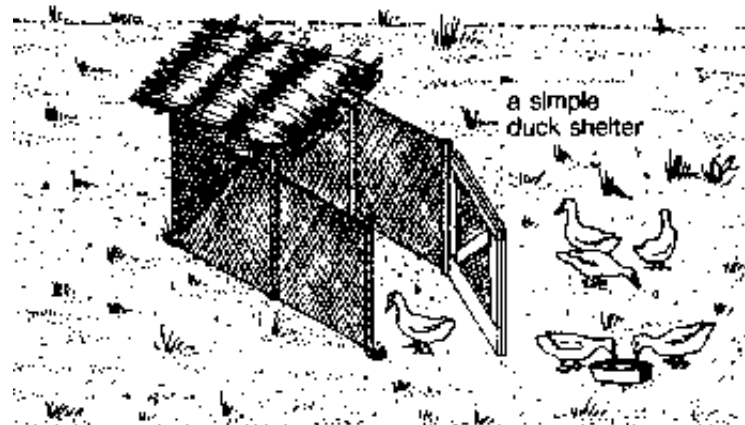

A simple duck shelter

- **enough food and water for your ducks to eat and drink**

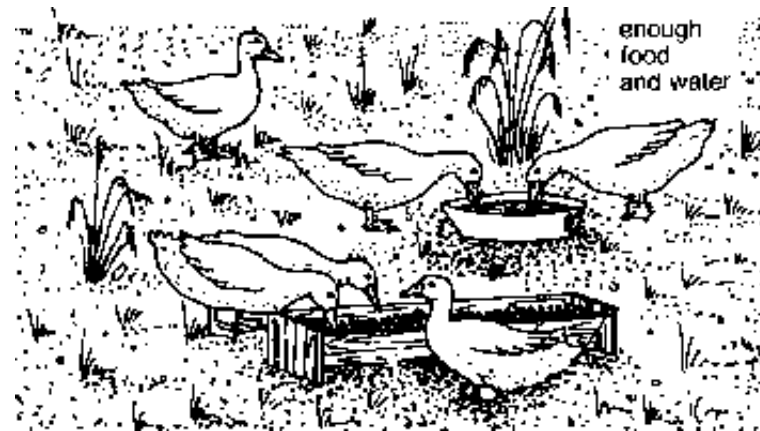

Enough food and water

- **enough strong and healthy fully grown or young ducks of the kind that you can get to start your flock (see also Items 19, 21 and 41).**

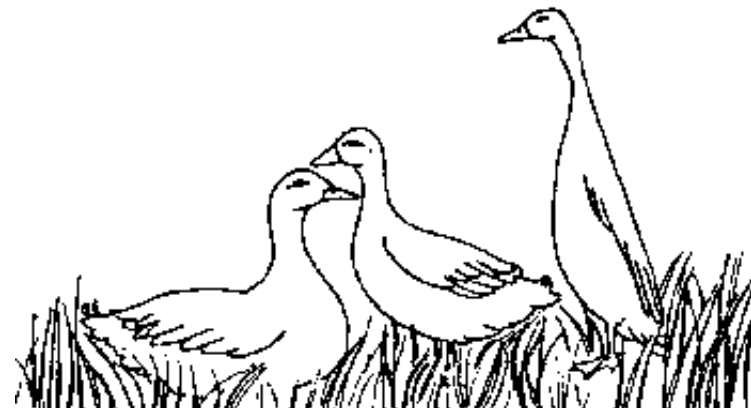





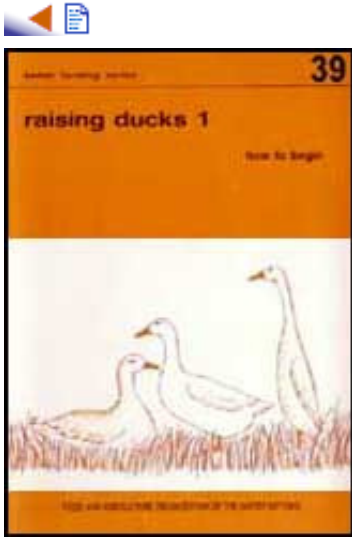

Strong and healthy ducks

8. If you have or can get all of these things you may want to raise your own flock of ducks.



Better Farming Series 39 - Raising Ducks 1: How to Begin (FAO, 1990, 73 p.)

- ➔  **Learning about ducks**
 -  **Where can you raise ducks?**
 -  **What kind of ducks can you raise?**
 -  **What can ducks eat?**
 -  **How many ducks should you raise?**
 -  **How to keep ducks safe and well**
 -  **Now you must decide**

Better Farming Series 39 - Raising Ducks 1: How to Begin (FAO, 1990, 73 p.)

Learning about ducks

Where can you raise ducks?

9. Ducks live very well outside by themselves.

10. They are water birds and live best on or near water, such as a lake, pond or stream where they can spend part of each day swimming.

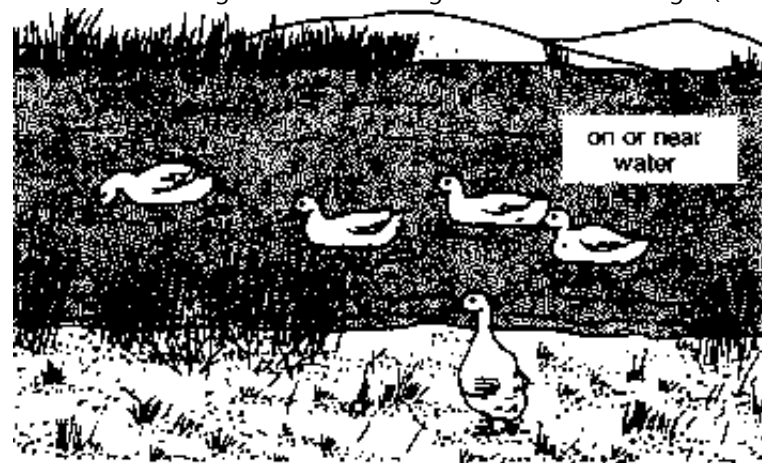

On or near water

11. However, if you live in a place where there is no water you can still raise ducks. You can raise them on land.

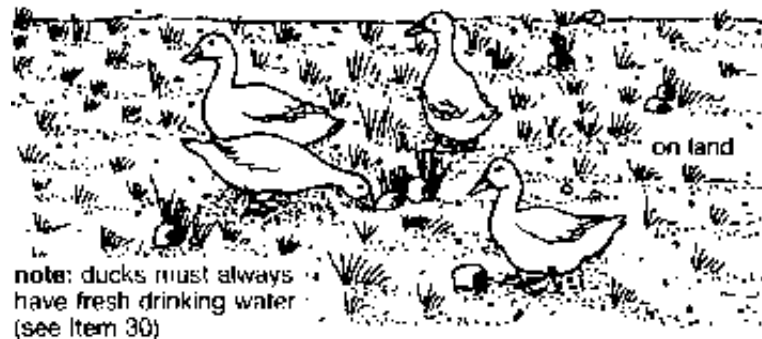

Ducks must always have fresh drinking water

12. Here are some places where you can raise ducks.

13. You can raise ducks in low wet land such as swamps or in low areas around ponds or streams.

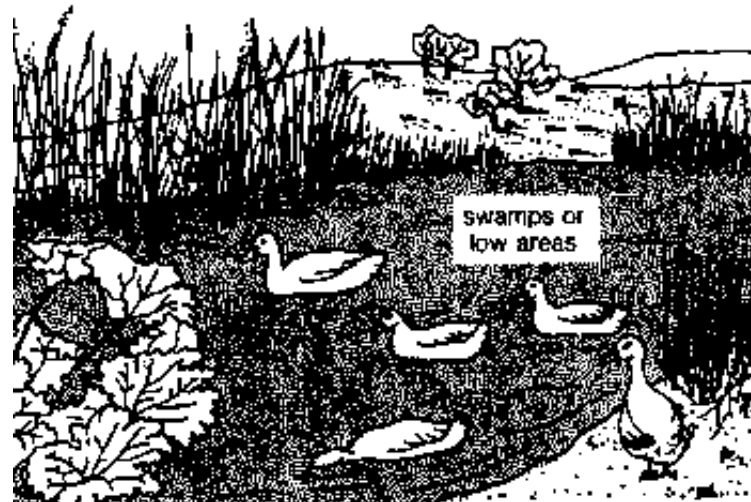

Swamp or low areas

14. You can raise ducks on sloping land or in places that have soil too poor to be used for planting.

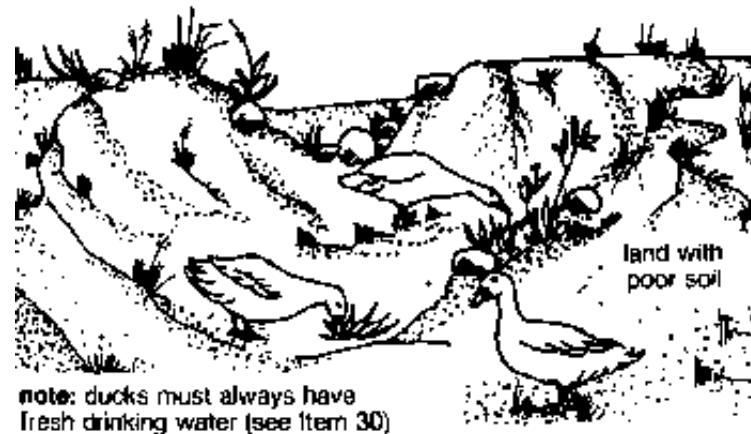

Land with poor soil

15. You can raise ducks near the sea where there is salt water. However, if you do this you will need to give them fresh water to drink.



Near the sea

16. If you do not have too many ducks you can raise them around your house.

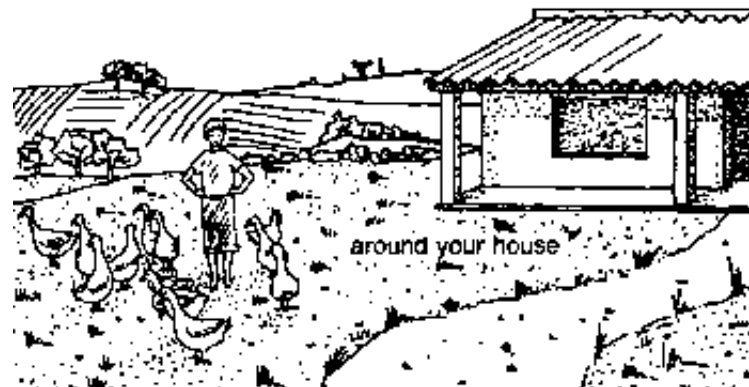

Around your house

17. You can also raise ducks your farm fields if you are growing crops that the ducks cannot hurt, (see items 31 to 39).

What kind of ducks can you raise?

18. There are several kinds of ducks that you can use. You must find out what

kinds of ducks you can get where you live.

19. Usually, you can get local ducks. Local ducks are strong and hardy and used to living in your area. So, they grow very well and do not get sick easily.

20. However, local ducks are often small, give little meat and few eggs.

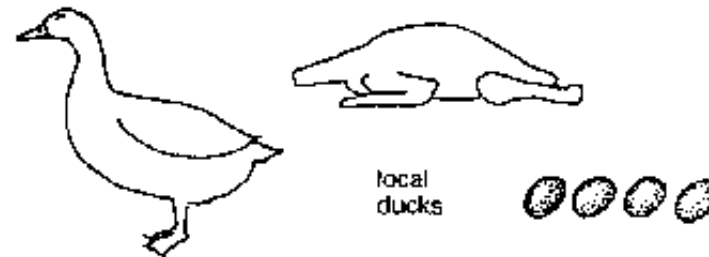

Local ducks

21. Sometimes, you can get improved ducks that have been brought from another place. Improved ducks have been carefully mated over many years and they are bigger and better than local ducks.

22. Improved ducks cost more money but they give more meat and more eggs.

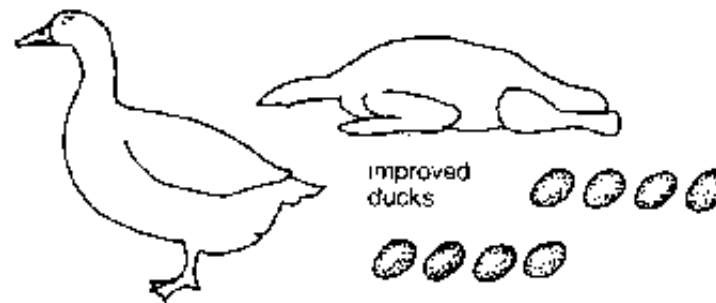

Improved ducks

23. Perhaps you can buy ducks at the local village market or there may be another farmer near where you live who will sell you some ducks from his own flock.

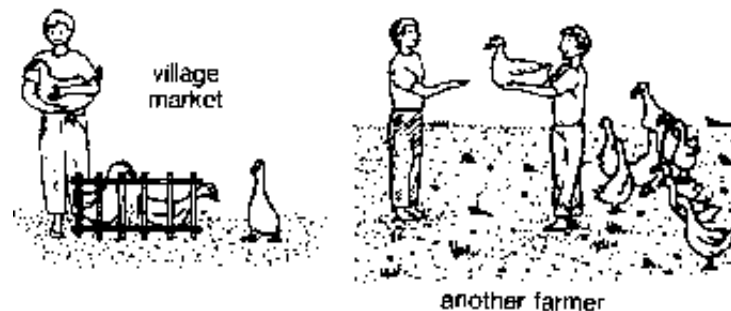

Village market; another farmer

24. Perhaps you can buy ducks from a nearby duck hatchery or from a government farm.

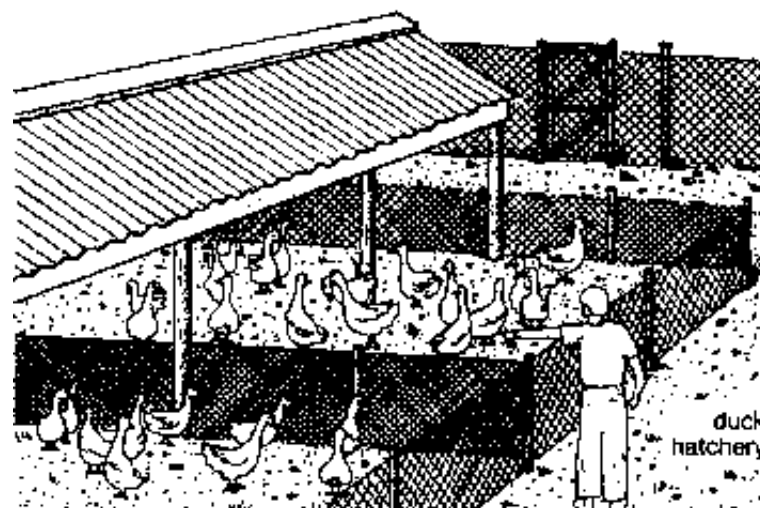

Duck hatchery

25. If you need help your extension agent will be able to give you good advice on the kinds of ducks you should get and where to get them.

What can ducks eat?

26. Ducks eat just about everything. So, it is not hard for them to find enough food for themselves, even if you feed them nothing.

Ducks eat

- insects, worms, slugs, snails, frogs
- grass, weeds, roots
- most water plants
- seeds, grain, plant materials
- materials left on the ground after harvest
- damaged or overripe fruits and vegetables

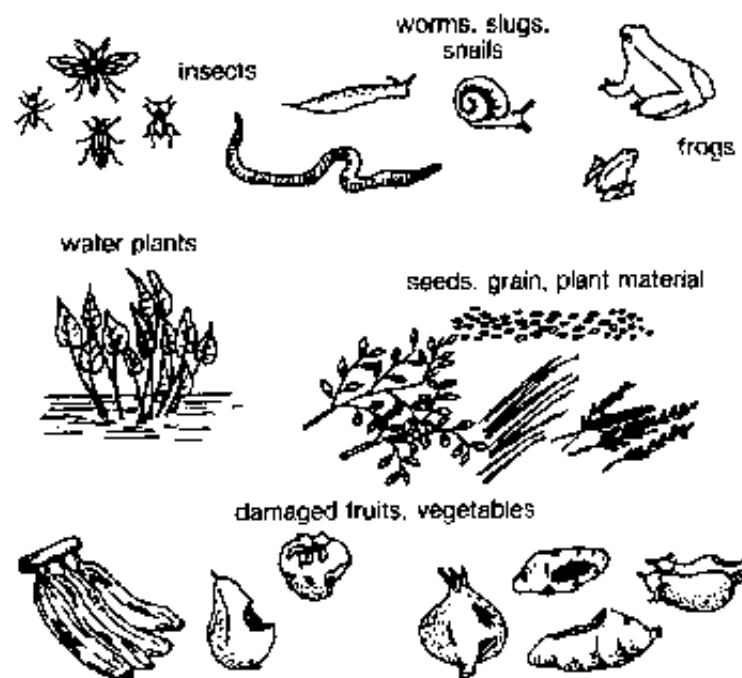

What ducks eat

27. You can also give ducks stale bread and food that is left after you have eaten.

28. However always remember that ducks must have fresh water with their food.

29. So, when you look for a place to raise your ducks, be sure to choose one with a lot of natural food and with enough water for them to eat and drink.



Natural food and enough water

30. If you are raising your ducks where there is no fresh water, see that they have plenty of fresh drinking water.

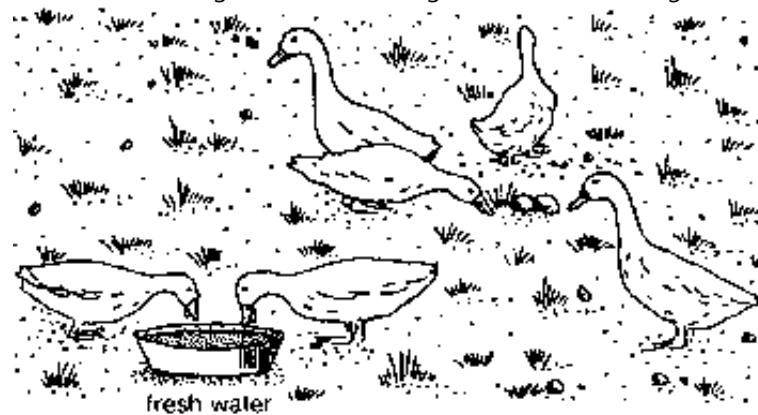

Fresh water is needed

31. Ducks can also find food to eat in home gardens and farm fields.

32. However, keep the ducks out of your gardens and fields when the plants are young and tender or the ducks may eat them.



Keep ducks far from young plants

33. After most plants are big, you can let your ducks feed between the rows.



Let ducks in big plants

34. When your crops are fully grown and you have harvested them, be sure to let your ducks look for food there.

35. After you have harvested your gardens or fields, your ducks will find a lot of food that is very good for them to eat which would otherwise be wasted.

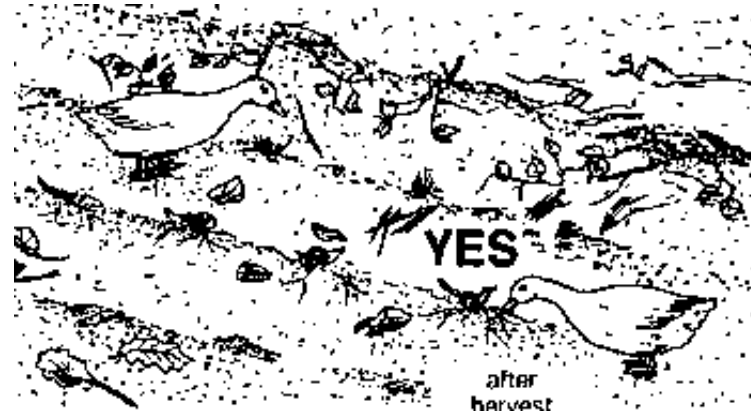

Let ducks in harvested gardens or fields

36. However, when ducks are in your home garden it is a good idea to watch them.

37. Ducks may eat snails, slugs, worms and other things on the ground such as seeds or fallen leaves. However, be sure that they do not eat the smaller plants as well.

38. You must also be very careful if you have low- growing berries or fruits for the ducks may eat them too.

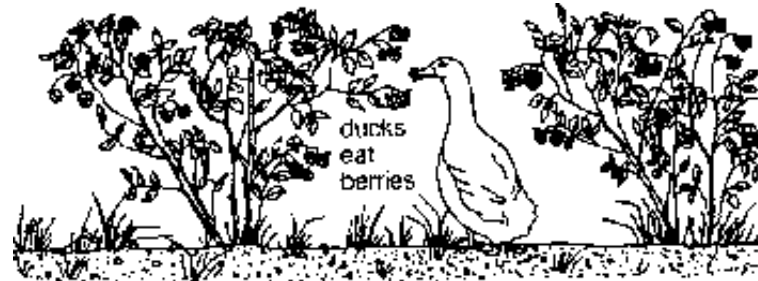

Ducks eat berries

How many ducks should you raise?

39. If you are going to raise ducks that live by themselves and find their own food, with very little help from you, you can raise up to 24 ducks.

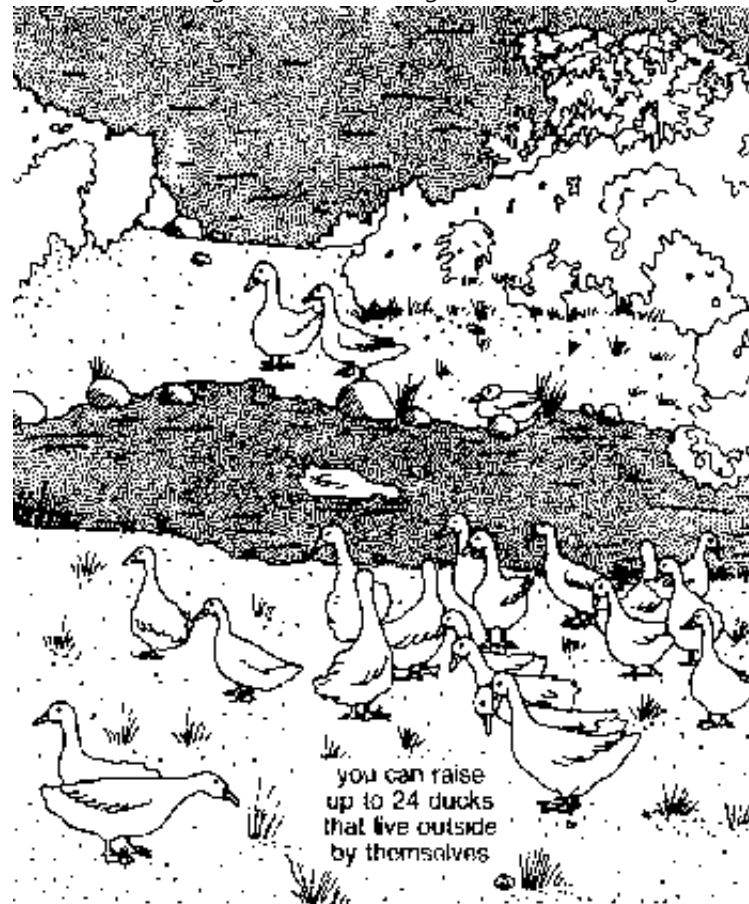

You can raise up to 24 ducks that live outside by themselves

40. However, until you know more about ducks and how to take care of them, it is best to start with a small flock.

41. Start with a flock of 6 ducks, 5 female ducks, and 1 male duck. With a flock of 6 ducks you will get 5 to 10 eggs each week.

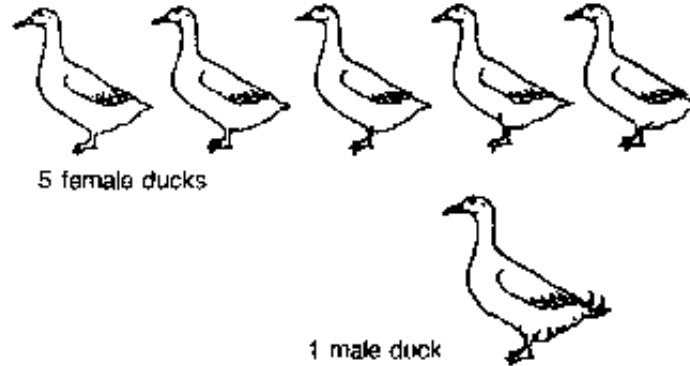

5 female ducks, 1 male duck

42. In addition, with a male in your flock the eggs you get will be fertile. This means that you can raise your own baby ducks.

43. After you have raised a small flock, you may find that you could use more eggs and more meat.

44. Later in this booklet you will learn how to use some of your eggs to raise baby ducks to make your flock bigger.



You can raise your own baby ducks

How to keep ducks safe and well

45. Although ducks can live outside by themselves, they will live much better if they have a shelter.



Ducks can live outside by themselves

46. The main reason for building a shelter for your ducks is to keep them safe from enemies at night when they are sleeping.

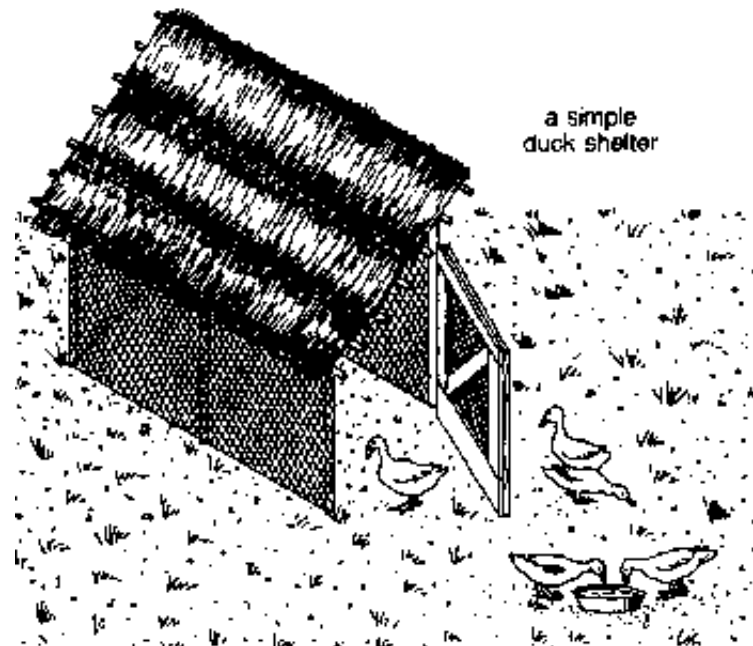

A simple duck shelter

47. Ducks, especially young ducks, have many enemies. You must be careful to protect them from

- dogs, cats, foxes
- rats, snakes
- meat-eating birds
- thieves

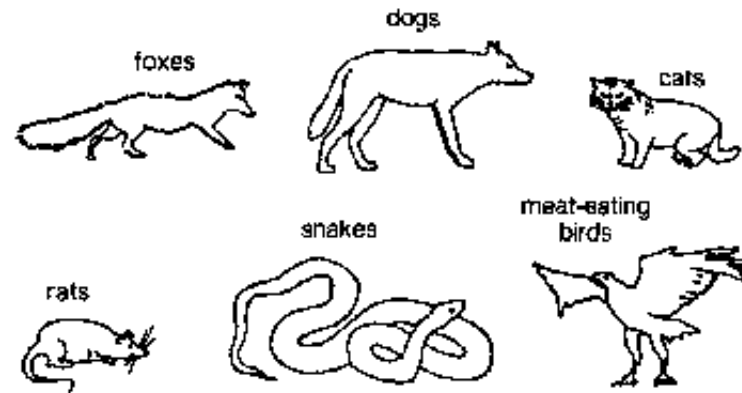

Duck enemies

8. There are also other reasons for building a shelter. Here are a few.

49. Ducks sleep on the ground. If the ground is cold or wet or dirty, they may get sick.



Ducks sleep on the ground

50. If you build them a shelter, you can keep it dry and clean so your ducks will not get sick.

51. Strong sunlight is bad for ducks. They need protection from the sun in very hot weather.

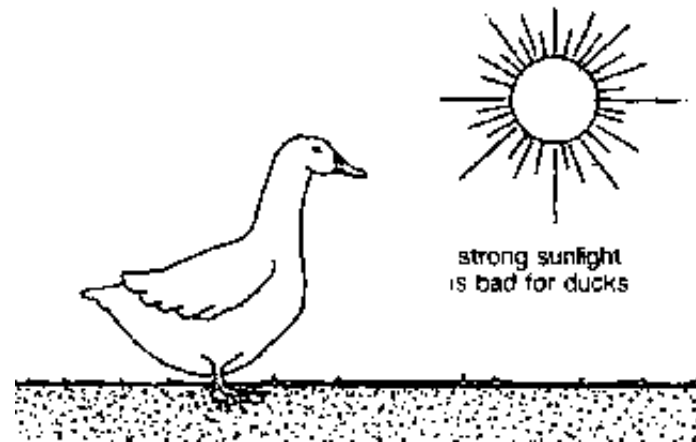

Strong sunlight is bad for ducks

52. If you build a shelter for your ducks, they can go inside when it is very hot.

53. Ducks lay eggs mostly at night or early in the morning.

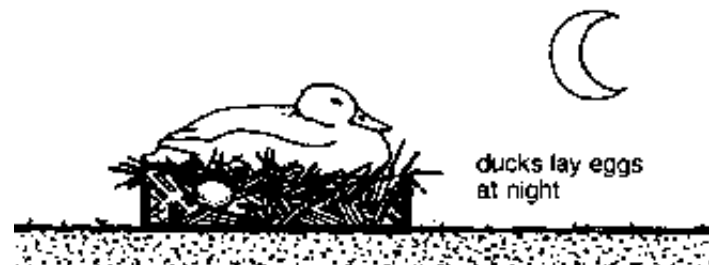

Ducks lay eggs at night

54. If you build a shelter with nests and keep your ducks inside at night, you will be able to collect the eggs more easily.

55. You will learn how to build several simple duck shelters in the next section of this booklet.

Now you must decide

56. You have already been told a number of things about ducks and about raising them.

57. You reamed that by raising ducks you can have fresh meat and eggs for you and your family.

58. You learned that you can keep as many as 24 ducks that live outside by themselves and find their own food.

59. You may have found that you can get healthy ducks to start your own flock where you live.

60. So, now you must decide if raising a flock of ducks would be a good thing for you and your family to do.

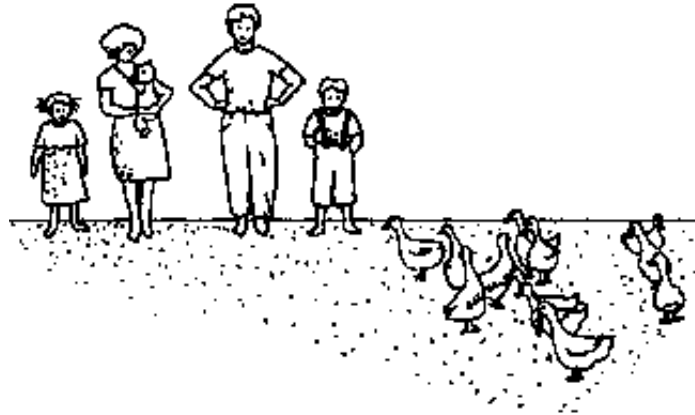

Decide if raising ducks is good

61. If you decide to begin, you will learn how in the rest of this booklet.

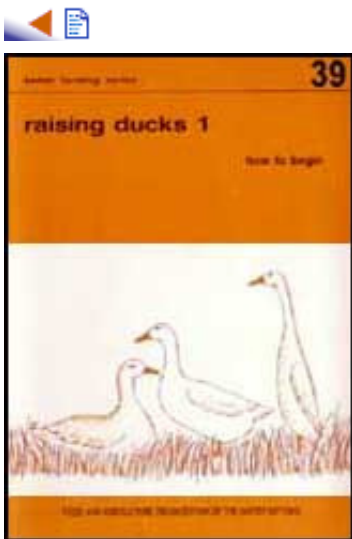

 **Better Farming Series 39 - Raising Ducks 1: How to Begin (FAO, 1990, 73 p.)**

➔  **How to begin**

-  **Choosing a place to raise ducks**
-  **Building a shelter for your ducks**
-  **The floor of a duck shelter**
-  **Building nests**

Better Farming Series 39 - Raising Ducks 1: How to Begin (FAO, 1990, 73 p.)

How to begin

Choosing a place to raise ducks

62. The first thing that you must do is to choose a place on your land that is good to raise ducks.

63. It is best to keep your ducks where you can watch them easily. So, the place that you choose should be as close as possible to where you live.

64. Look for a place on your land that has enough of the kinds of food that ducks like to eat (see Item 26).

65. Look for a place that has shade for your ducks on hot days. There should also be a place for them to go for protection from wind or on days when it is cold or wet.

66. A good place is one near a pond or a stream where your ducks can easily get to water and where they can swim.

67. Raising a flock of ducks is only one use for your land, so be careful not to choose a place for them that could be better used for something else, such as planting crops or growing a vegetable garden.

68. Remember, that ducks can live just about anywhere outside as long as they can find enough to eat and drink.



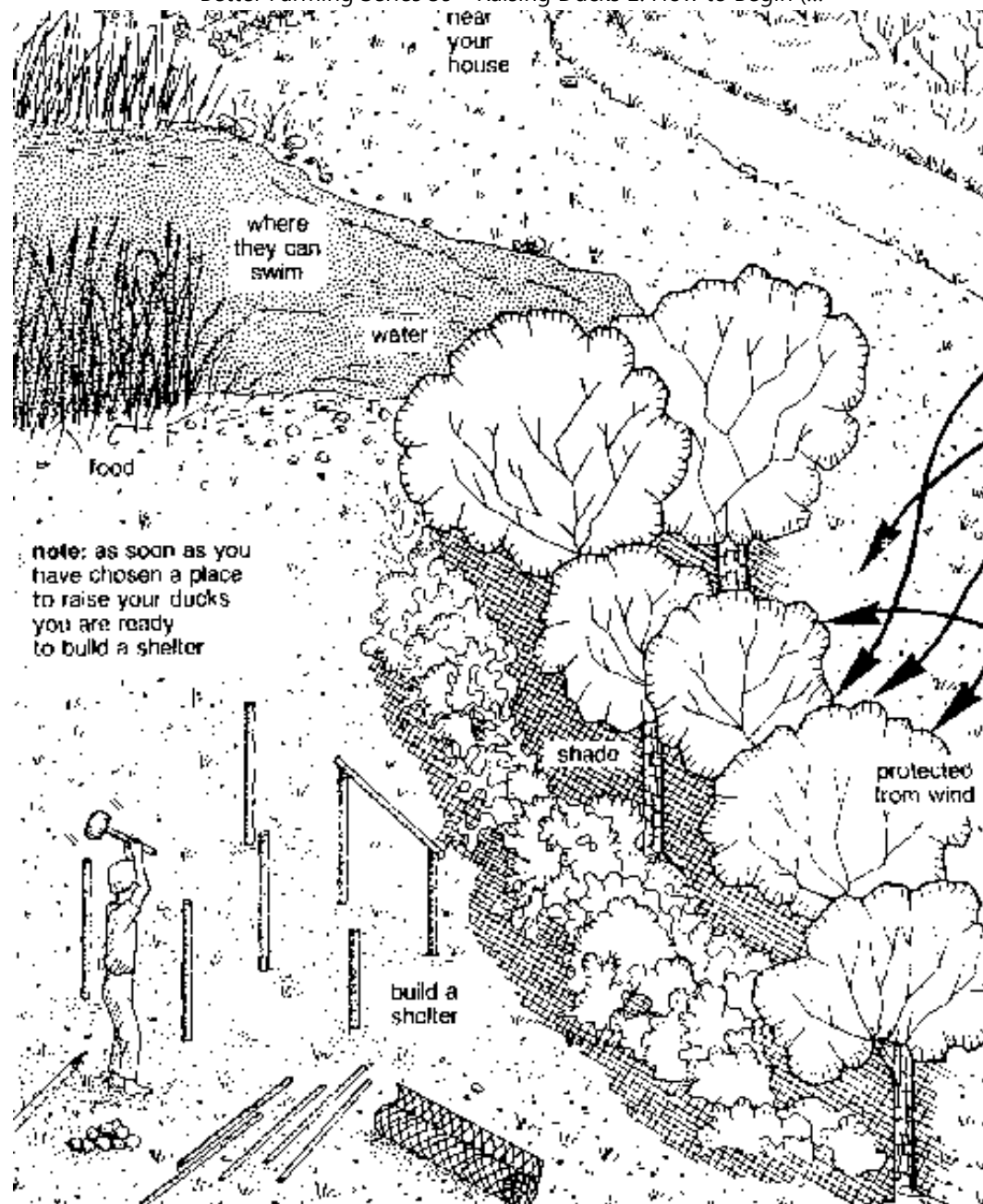

Ducks must have enough food and water

Building a shelter for your ducks

69. You can build either a pen or a house to shelter your ducks and keep them safe at night.

70. A pen should have about 1 square metre of space for 3 ducks. So, if you begin with a flock of 6 you will need a pen of 2 square metres.

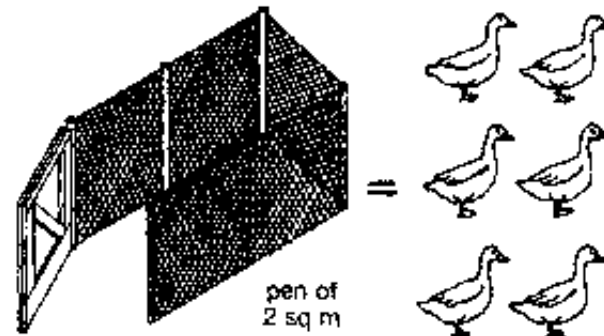

Pen of 2 m²

71. A house, where your ducks can sleep, should have about 1 square metre for a flock of 6.

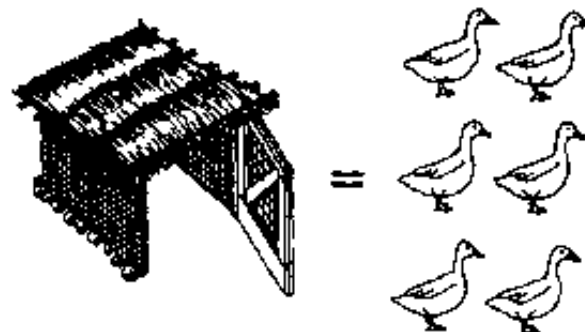

A house for ducks to sleep in

72. Never try to put too many ducks in either a pen or a house. If a shelter is too crowded, it will quickly become wet and dirty and your ducks may get sick.

73. You can build a pen or a house using local materials such as bamboo, used wood, palm leaves or grass.

74. A fence of woven bamboo, palm leaves or strong grass makes a good pen cover.

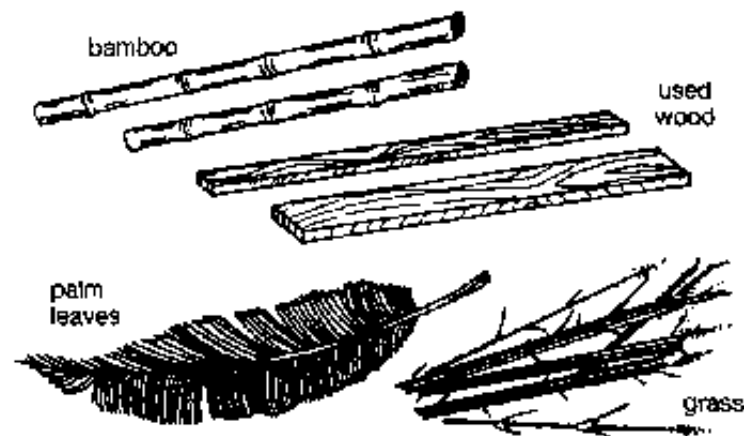

A fence

75. However, it must be strong enough to keep the enemies of your ducks out and fine enough to keep small ducks in.

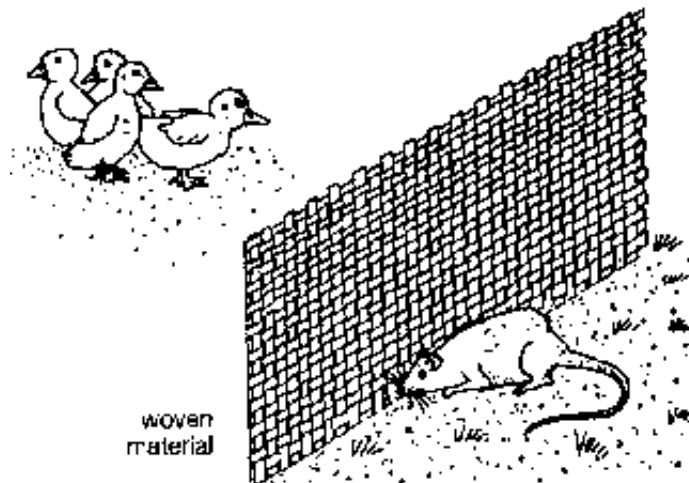

Woven material

76. If you can get wire mesh you can use that too. However wire mesh can cost a lot of money.

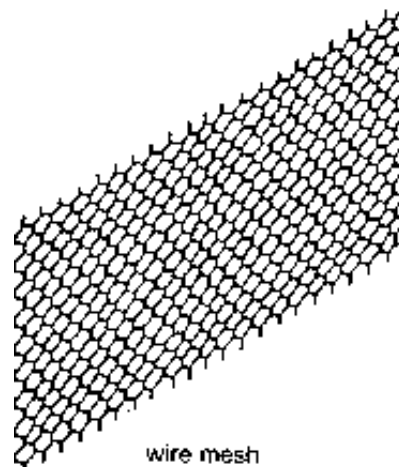

Wire mesh

77. Build the fence of your pen using posts at least 1.20 metres high to keep out harmful animals.

78. The posts should be about 1.00 metre apart and about 0.50 metre in the ground.

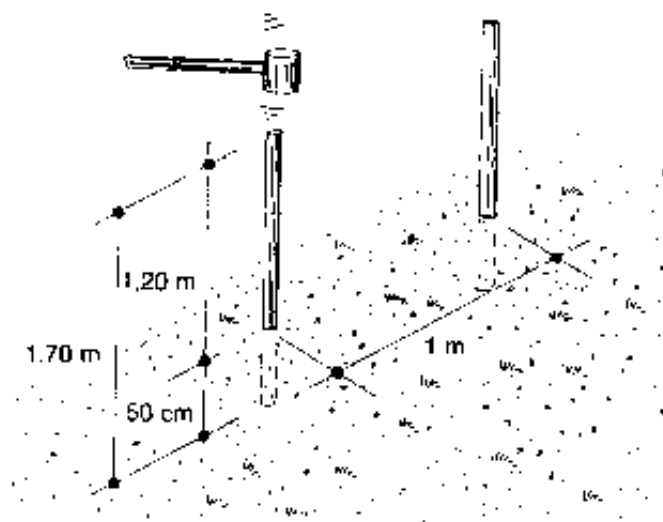

The posts

79. To keep animals from digging under the fence of a pen made of bamboo or woven material, put a row of stones along the bottom on the outside of the fence.

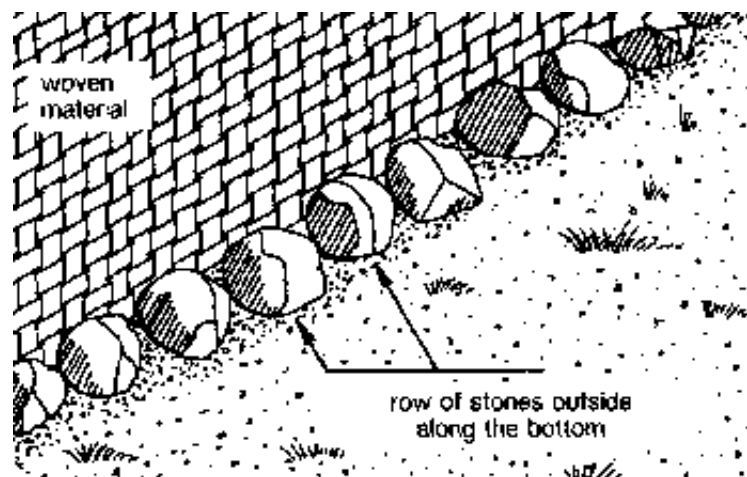

Put a row of stones along the fence

80. To keep animals from digging under the fence of a pen made of wire mesh, bury the wire mesh about 0.30 to 0.40 metre in the ground.

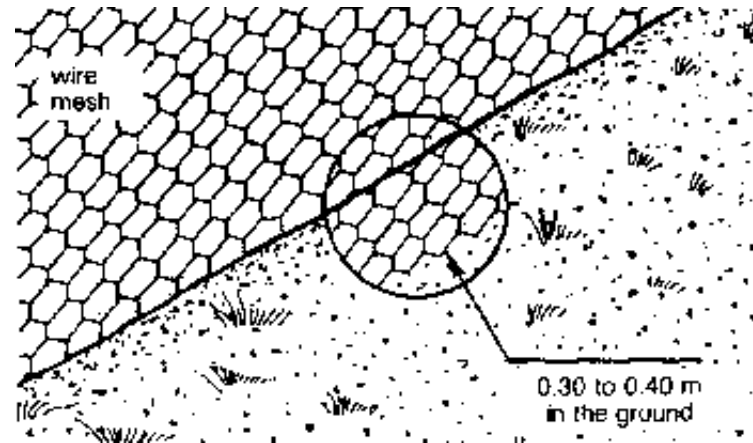

0.30 to 0.40 m in the ground

81. If there are meat-eating birds nearby, you should cover the pen as well. You can use the same material that you used for the fence.

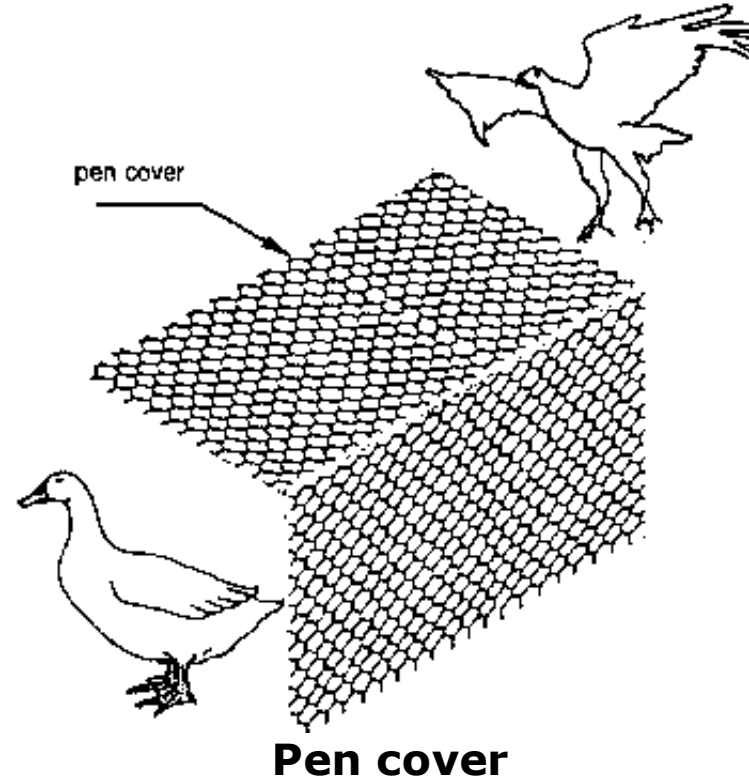

82. Try to find a place for your pen on ground which is higher so that the water will run away. That way your pen will stay dry.

83. Have the pen built and ready for your ducks before you get them. That way they can become used to their new home from the beginning.

84. The drawings on pages 27 to 41 will show you how to build several kinds of pens and houses.

How to build a duck pen

1 for a pen of 2 square metres, you will need 6 posts of 8 to 10 cm in diameter and

about 1.70 m long (each post should be buried in the ground about 0.50 m)



Wooden posts

2 drive the posts into the ground to form a rectangle

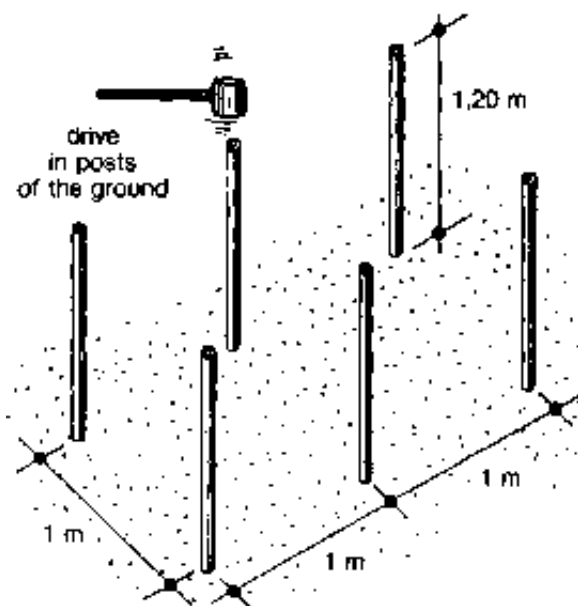

Drive in posts of the ground

3 if you are using woven material as a fence cover, be sure it is high enough to

reach from the post tops down to the level

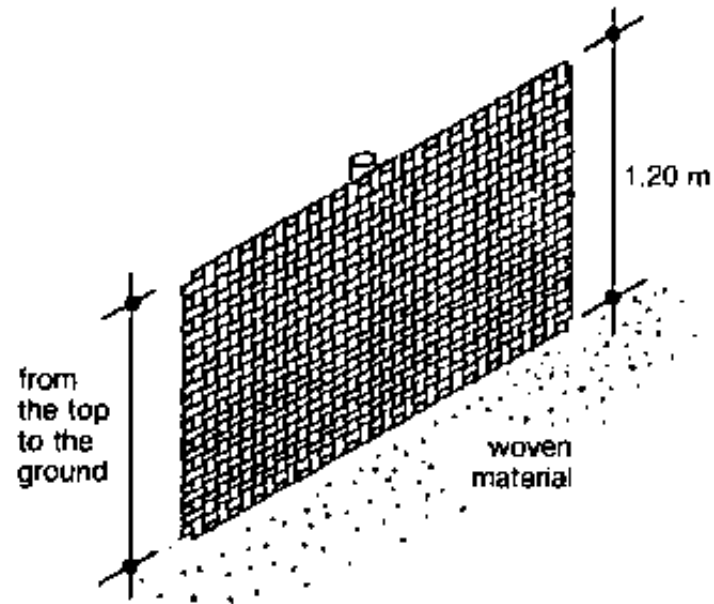

From the top to the ground

**4 cover 3 sides of the pen; tie the woven material to the posts using strong cord;
You can also use strong plant vines**

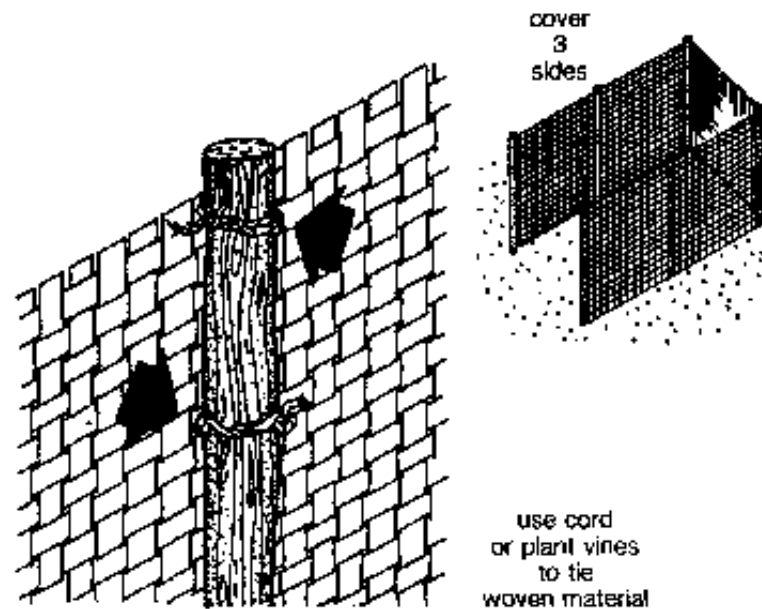

Use plant vines or cord to tie the woven material

5 put a row of stones around the 3 covered sides of the pen

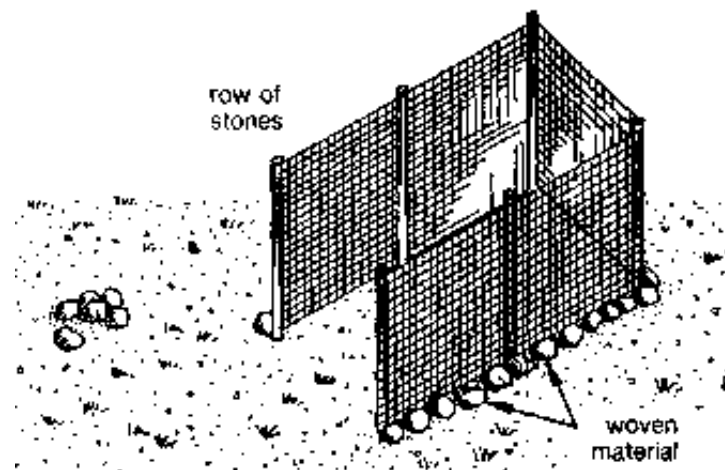

Row of stones

6 if you are using wire mesh as a fence cover dig a trench 0.30 to 0.40 m deep

around the 3 covered sides of the pen

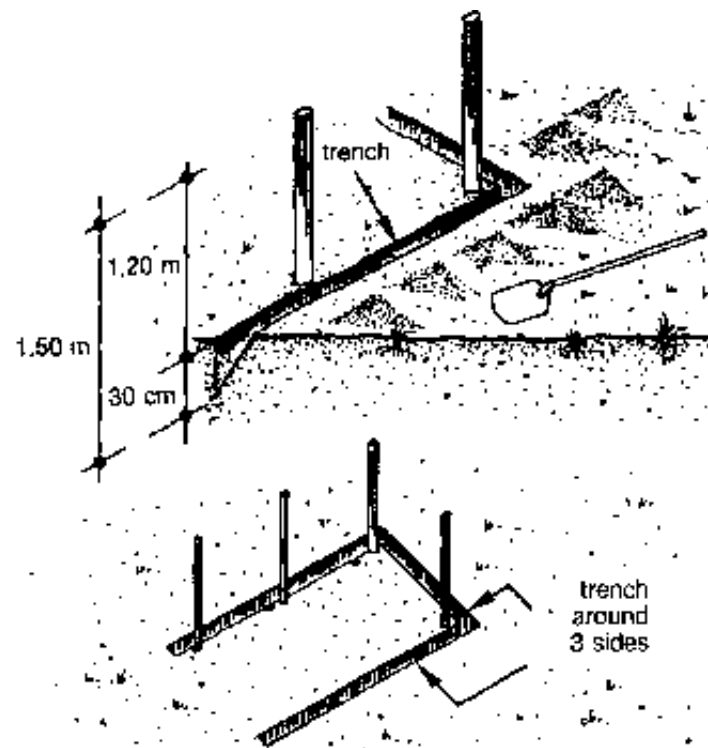

Trench around 3 sides

7 be sure that the wire mesh is high enough to reach from the post tops down to the bottom of the trench

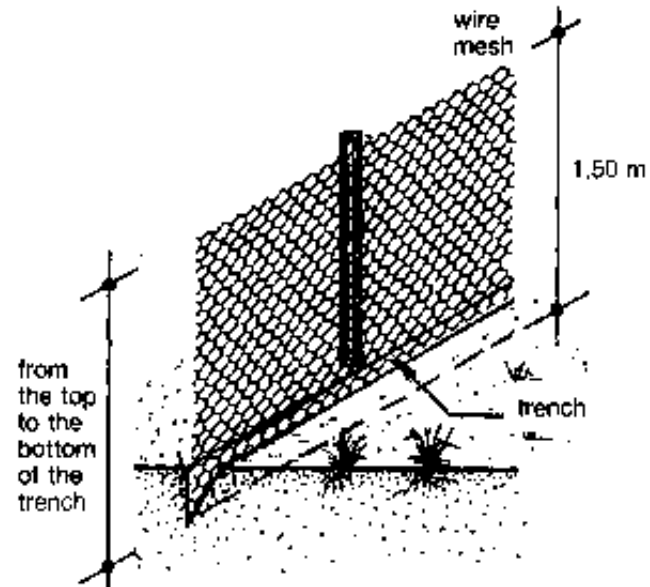

From the top to the bottom of the trench

8 cover 3 sides of the pen; fasten the wire mesh to the posts using light but strong wire

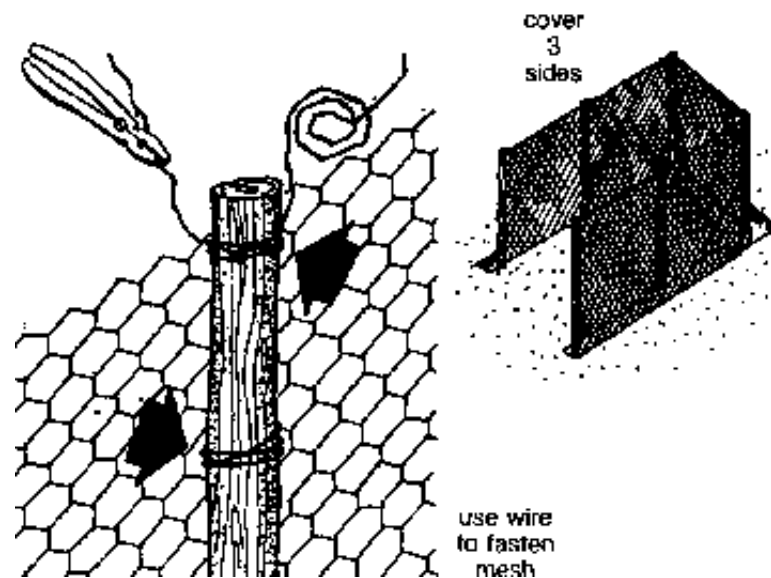

Use wire to fasten mesh

9 then, fill the trench

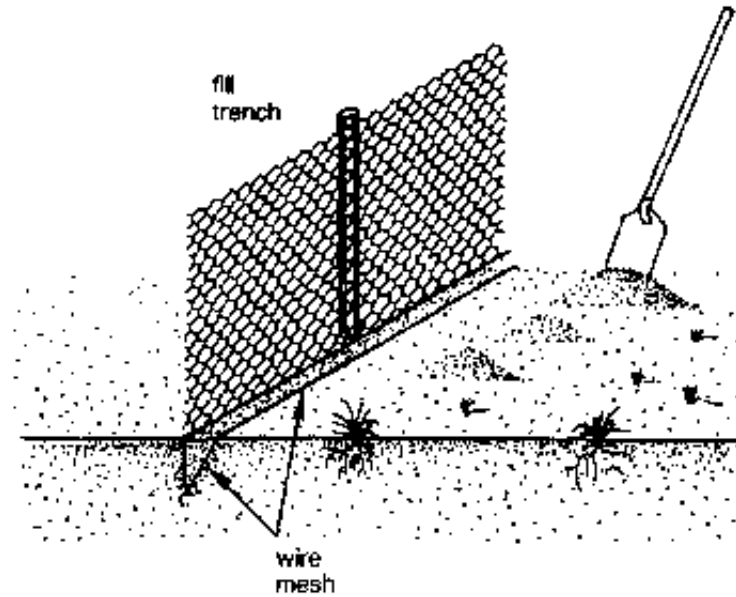

Fill trench

10 now, you are ready to build a swinging gate for the open end of the pen

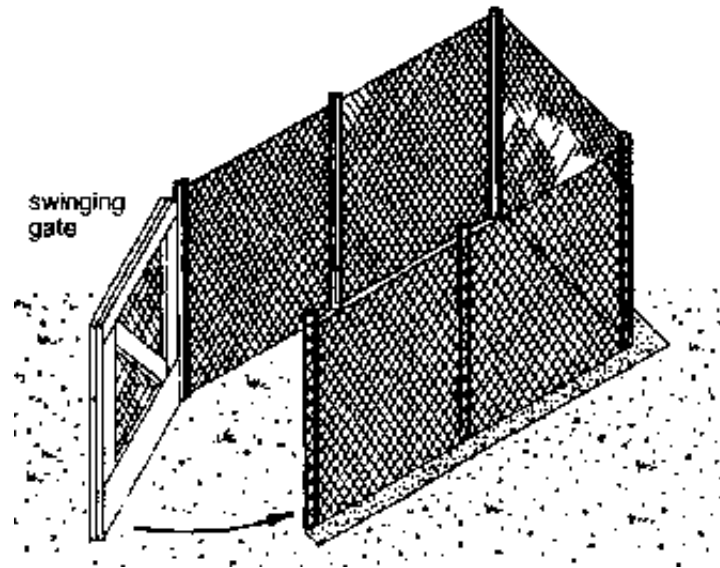

Swinging gate

11 you can build a gate frame from used or scrap lumber and corner angles of lightweight wood

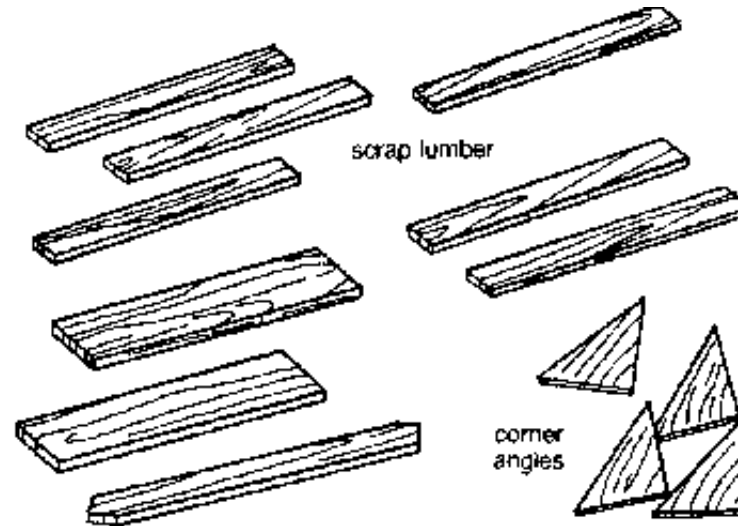

Scrap lumber, corner angles

12 first, build the inside part using 4 pieces of wood for the sides, top and bottom (make the bottom piece wider than the sides and top); a centre brace between two corners will make the gate stronger; lightly toenail the pieces as shown below

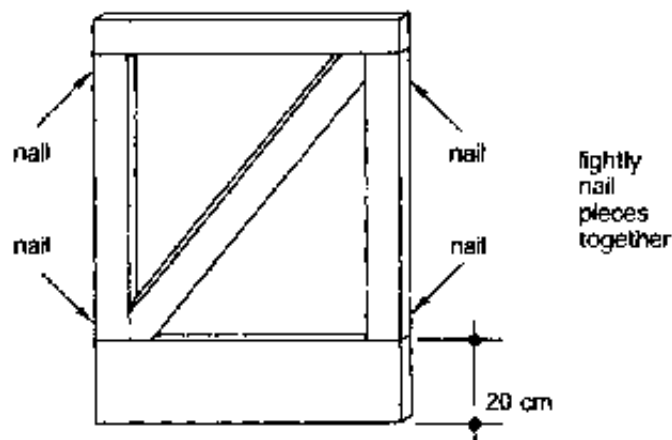

Tightly nail pieces together

13 then, turn the inside part over and nail on the 4 corner braces

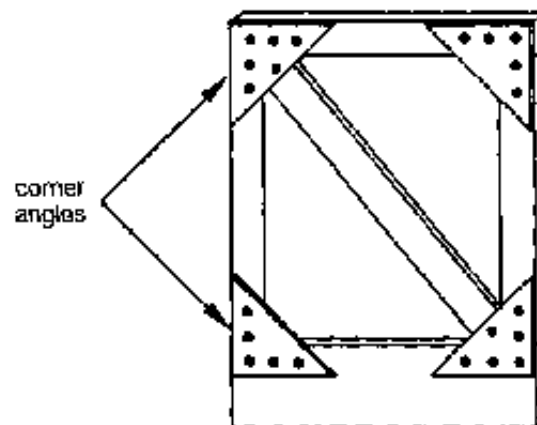

Corner angles

14 now, turn the inside part over again and cover it with the same material that you used for the fence; attach the material using flat-headed nails, tacks or staples

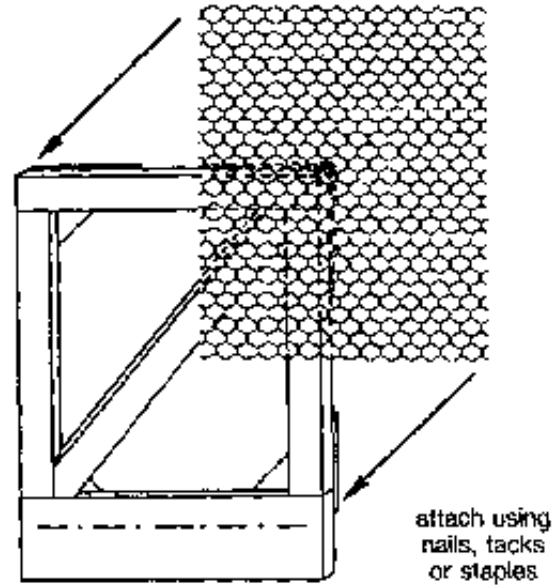

Attach using nails, tacks or staples

15 assemble the outside part of frame as shown

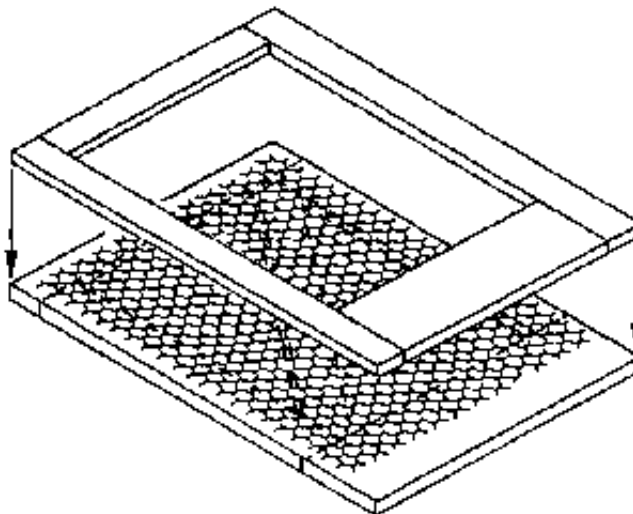

Assemble the outside part of frame

16 nail on the outside part; when you have done this the material will be held in place between the inside and outside parts of the frame

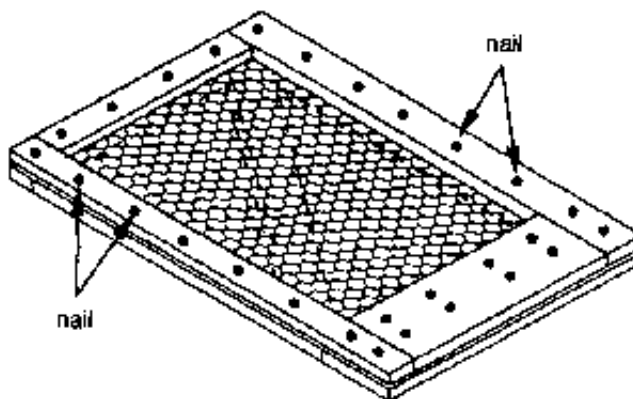

Nail on the outside part

17 fit the gate to the open end of the pen using rope or wire: you can also use hooks and eyes

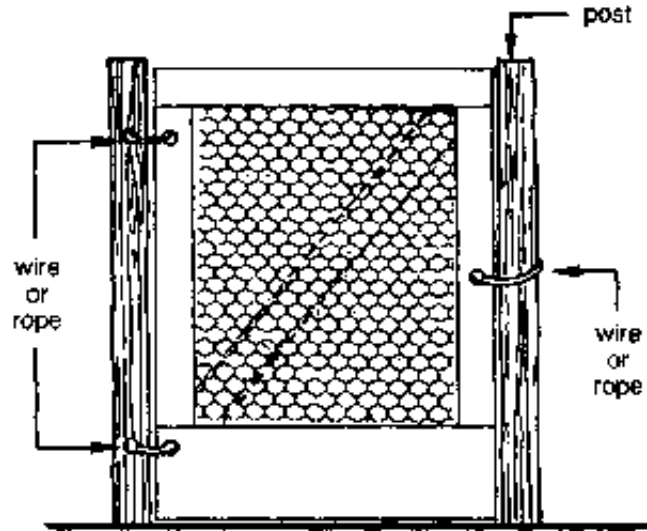

Fill the gate to the open

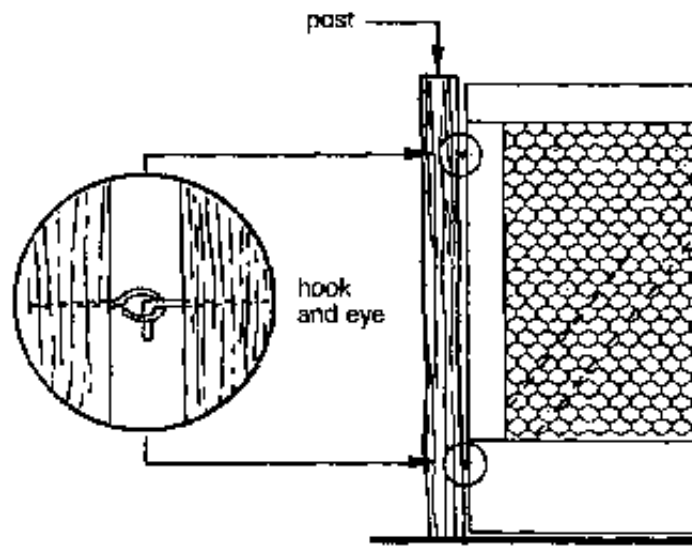

Fill the gate to the open

note: tie or wire the gate closed when the ducks are inside

How to build a duck house

1 you can build a duck house in much the same way and using the same materials that you use to build a duck pen

2 drive 4 posts into the ground to form a square and attach the 2 roof beams

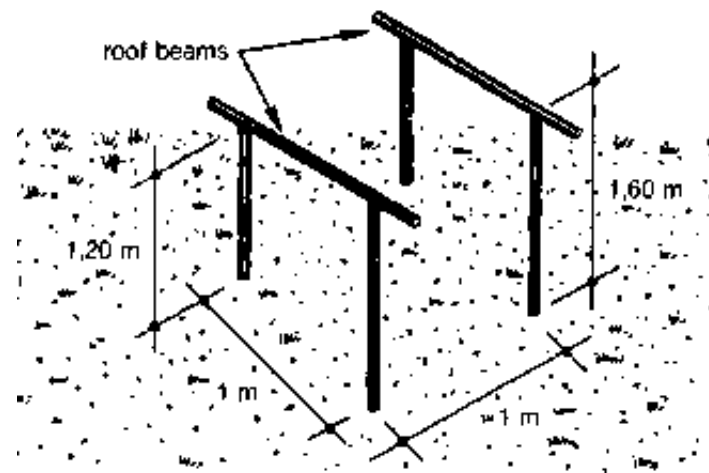

Roof beams

3 tie or wire lightweight poles for the rafters of the roof between the roof beams

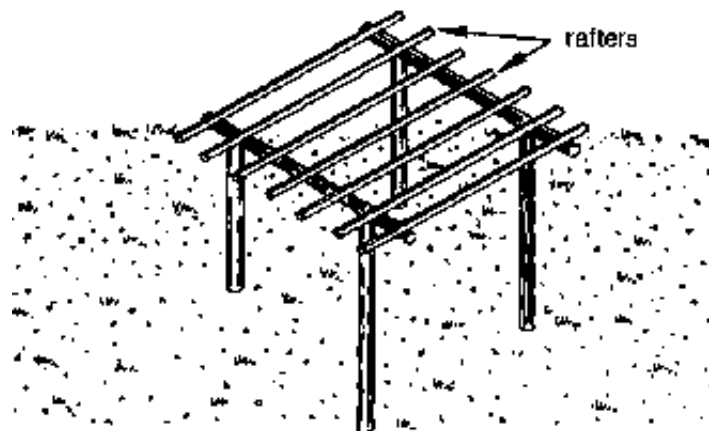

Rafters

4 cover the rafters with grass or thatch

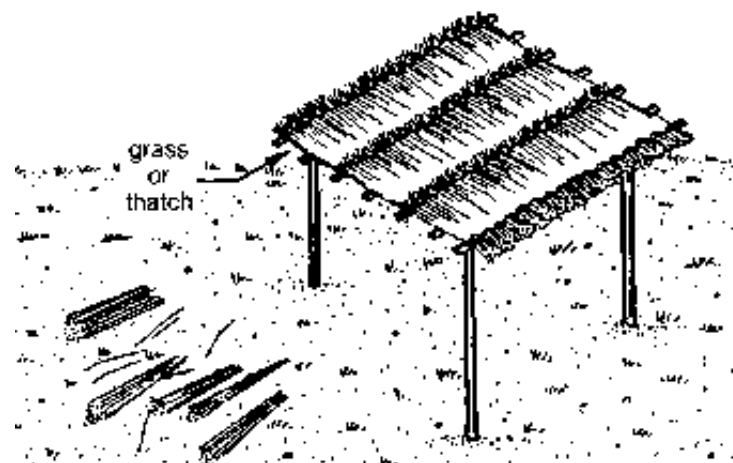

Grass or thatch

5 cover the side and back walls with woven material; put a row of stones outside around the 3 covered sides; for the front of the house, you can build a swinging gate like the one on pages 32 to 35

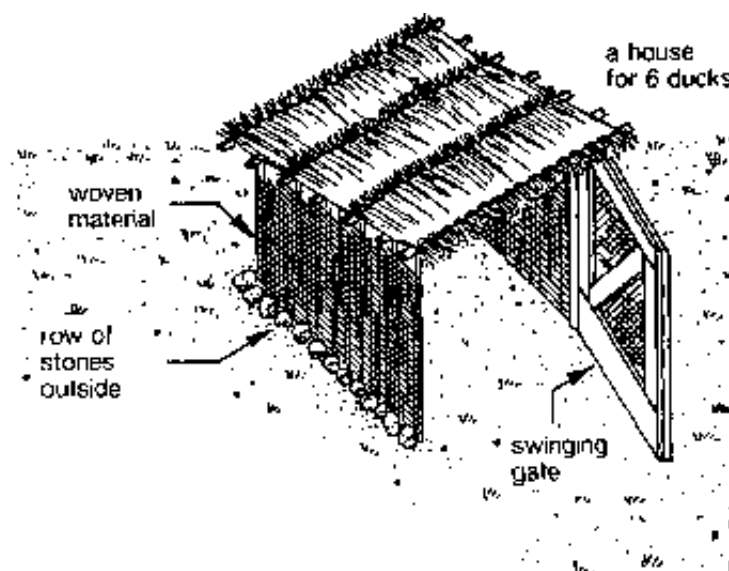

A house for 6 ducks

note: you can also cover the walls with wire mesh to keep out harmful animals before you put on the woven material

How to improve a duck pen

1 here are a number of simple things that you can do to a duck pen to make it better

2 a roof of grass or thatch will keep your ducks dry in wet weather

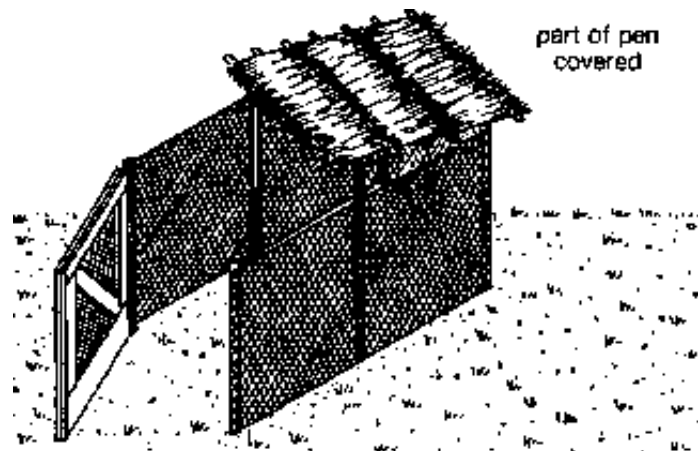

Part of pen covered

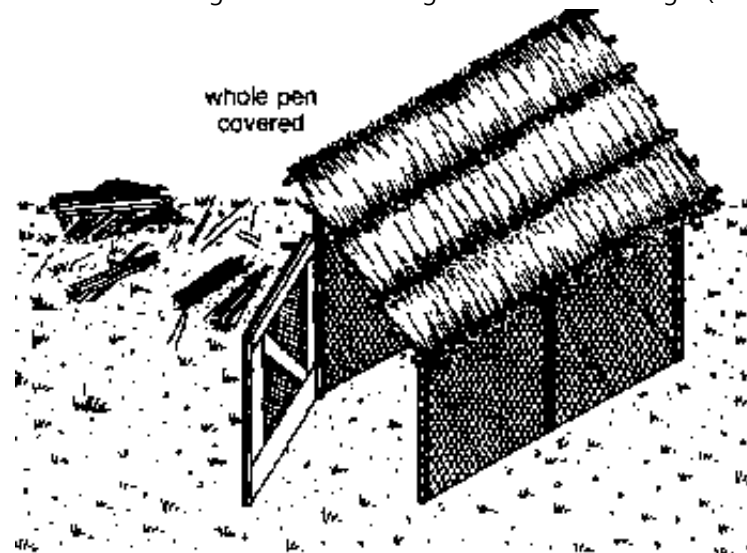

Whole pen covered

3 woven mats of grass or thatch tied to the fence will protect your ducks from wind

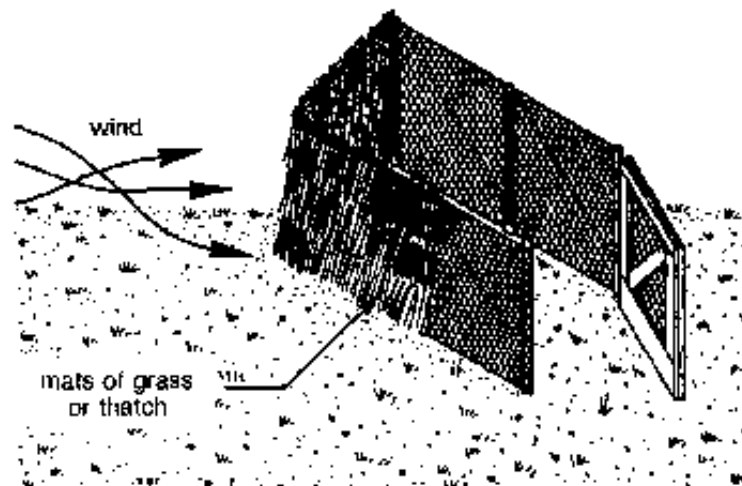

Mats of grass or thatch

4 a pen cover of the same material as the fence will protect your ducks from

harmful birds and animals

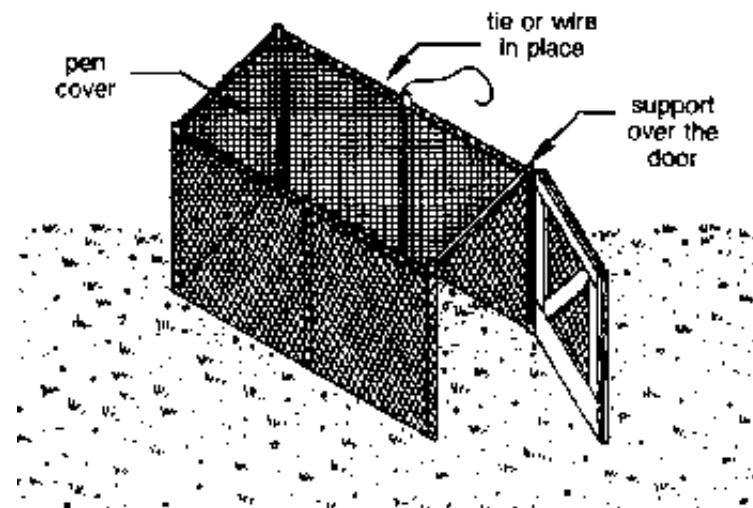

The fence will protect your ducks

5 you can build a duck house next to one corner of a pen so that the ducks can sleep inside at night

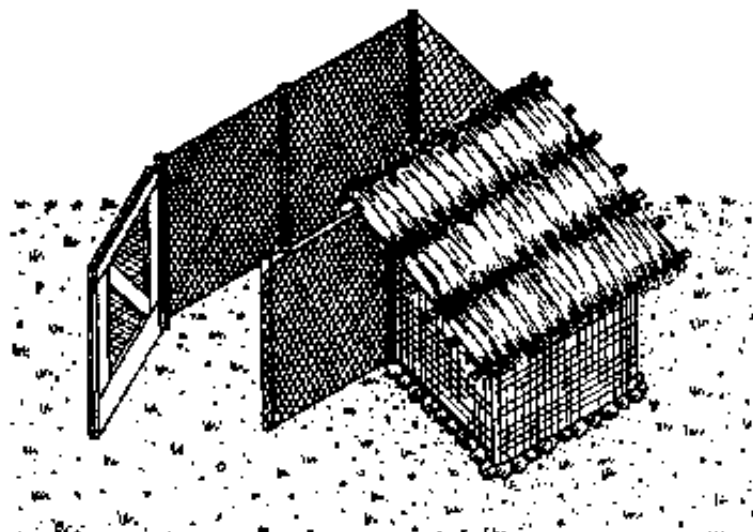

A house and pen for 6 ducks

6 you can also make your duck pen bigger

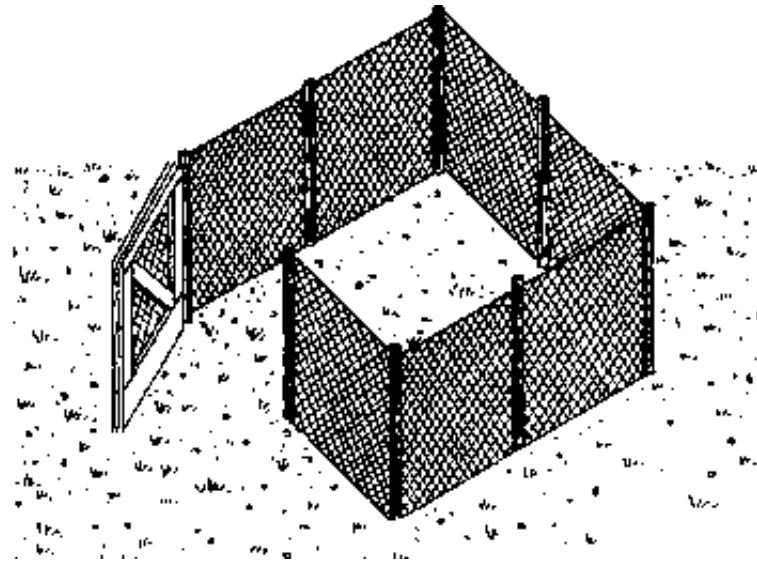

A pen for 12 ducks

7 however, if your bigger pen has a duck house attached and you have more than 6 ducks you will need a bigger house too

note: remember, for each 6 ducks you will need 2 square metres of pen and 1 square metre of house; so, with 12 ducks you will need 4 square metres of pen and 2 square metres of house

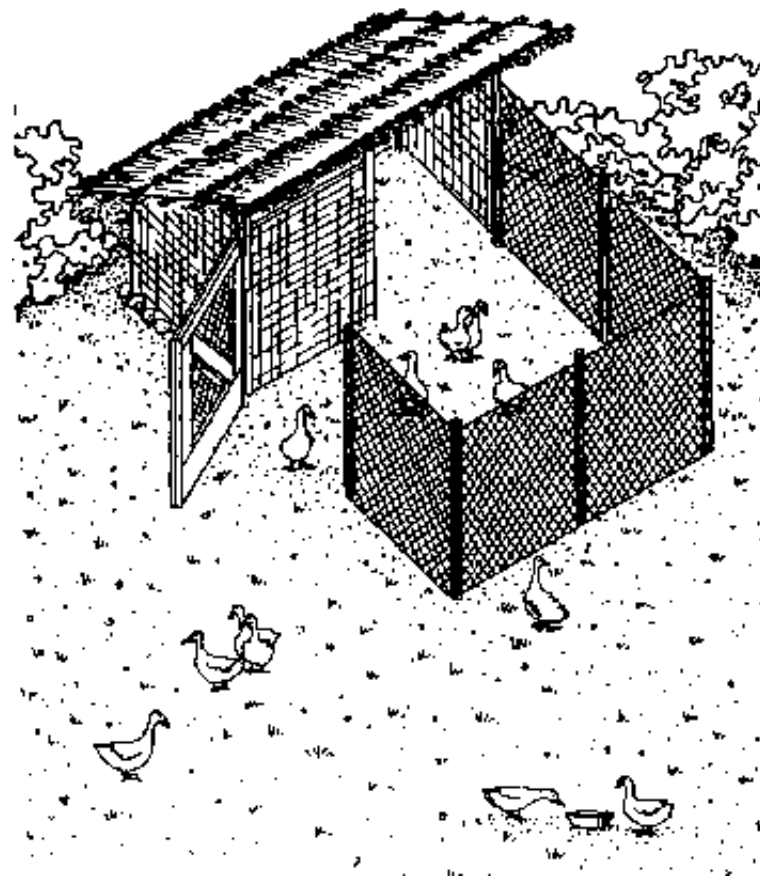

A house and pen for 12 ducks

The floor of a duck shelter

85. You have already learned that ducks sleep on the ground and if the ground where they sleep is cold or wet or dirty they may get sick.



Ducks sleep on the ground

86. So, you must be very careful to keep the floor of the shelter as dry and as clean as you can to keep the ducks healthy and well.

87. If you have a shelter which is on high enough ground for the water to run away, you can have a dirt floor.

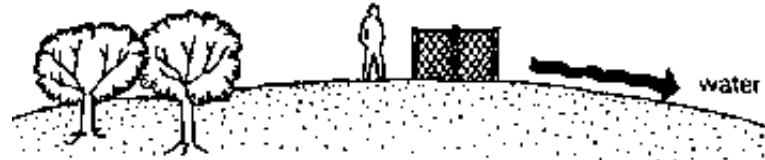

A shelter on high ground can have a dirt floor

88. However, if the shelter is built in a low, wet place you will need to keep it dry by covering the floor with some kind of dry material.

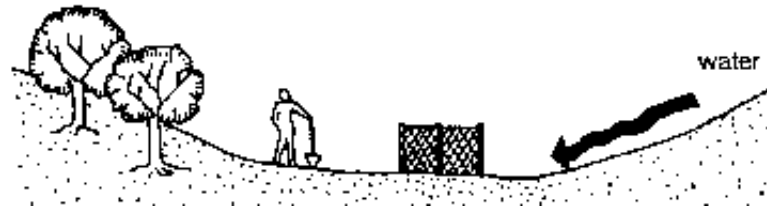

A shelter on low ground should have a floor of some kind of dry material

89. To cover the floor you can use sand or fine gravel, pine needles, wood chips or leaves and give your ducks a bed of straw or cut grass to sleep on as well.

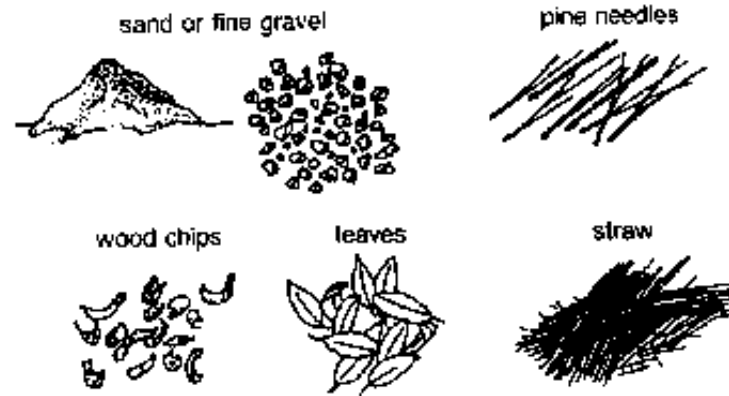

Figure

90. Change the floor material when it becomes wet or dirty and especially if it becomes mouldy. Mould will make your ducks sick.

91. With a flock of 6 ducks, change the floor covering at least once a month or sooner if it becomes wet, dirty or mouldy.

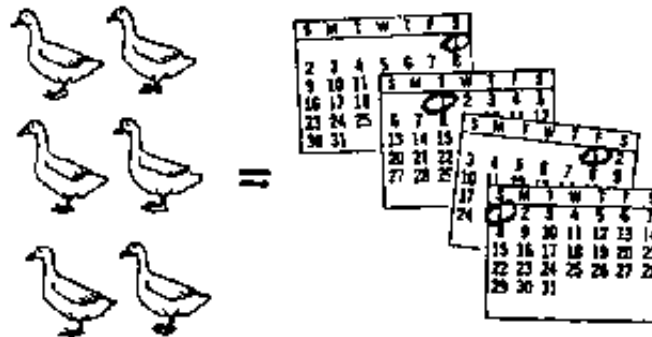

Pick a day each month, change floor covering once a month

Building nests

92. You have already learned that ducks mostly lay their eggs either at night or

very early in the morning.



Ducks lay eggs at night

93. If you keep your ducks inside at night and give them nests to use, there will be fewer broken eggs and you can collect them more easily.

94. As soon as you have finished building a pen or a house you are ready to build the nests.

95. You will need 1 nest for every 3 female ducks. So, when you first begin with a flock of 6 ducks (5 females and 1 male ducks you will need 2 nests.



with 5 female ducks
you need 2 nests



With 5 female ducks you need 2 nests

96. Ducks like small nests with just enough room to get in, turn around and sit

down. So, give your female ducks a cosy nest of just the right size.

97. A good duck nest is about 30 centimeters wide, 38 centimeters deep and, if it has a roof, from 30 to 35 centimeters high.

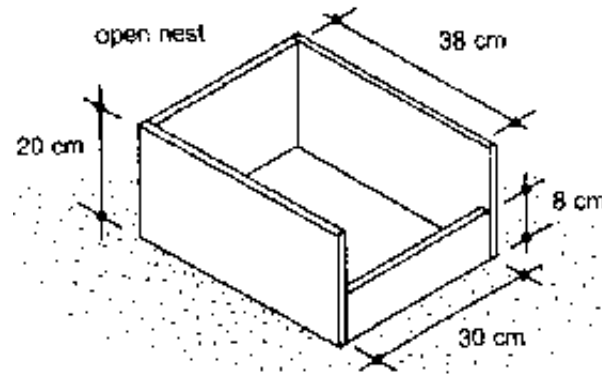

Open nest

note: nests rest on the ground and do not need a bottom

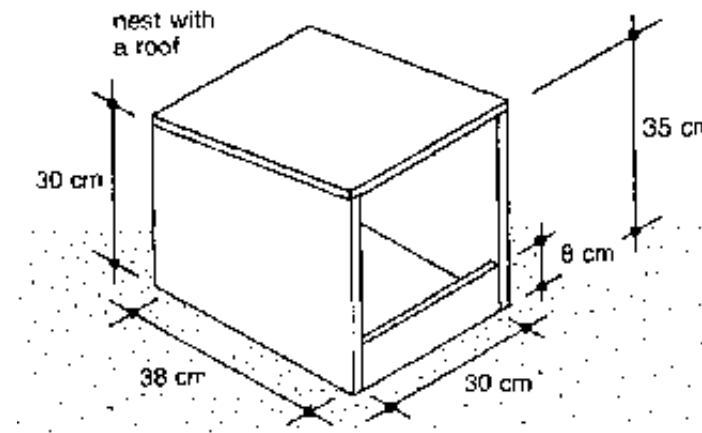

Nest with a roof

98. Ducks live and sleep on the ground and they prefer to lay their eggs on the

ground as well. So, put the nests on the ground.

99. A nest can be a hole in the ground or a box of bamboo or of wood which is lined with clean material such as cut grass or dry straw.

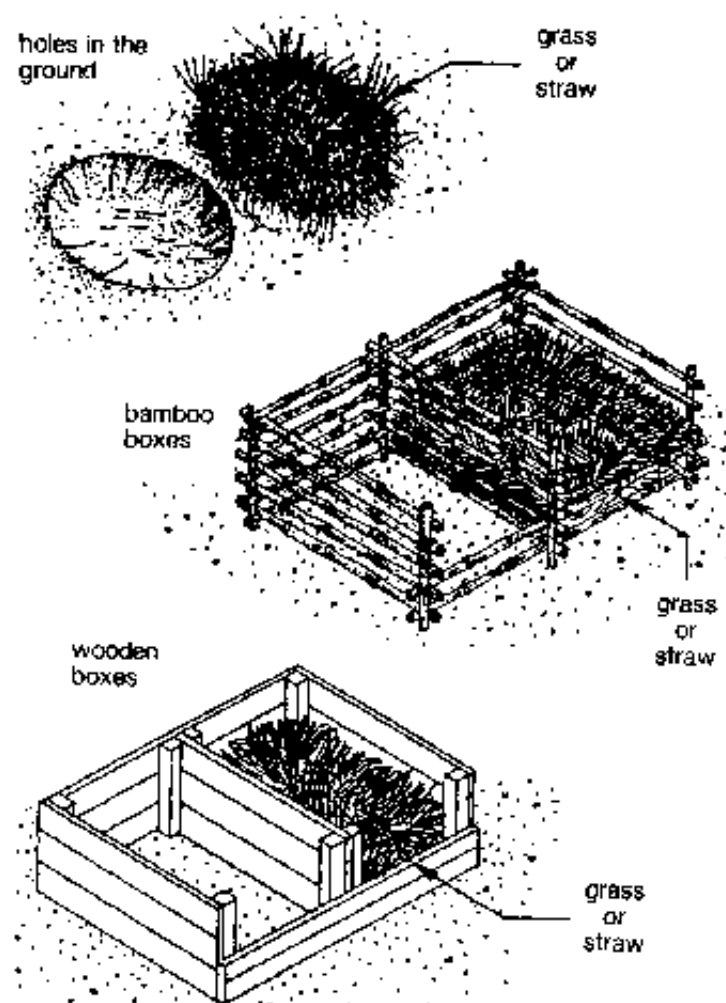

Holes in the ground and boxes

100. Ducks prefer dark, quiet places to lay their eggs. So, it is best to cover the

nest with a roof of thatch or wood to make it dark and quiet.

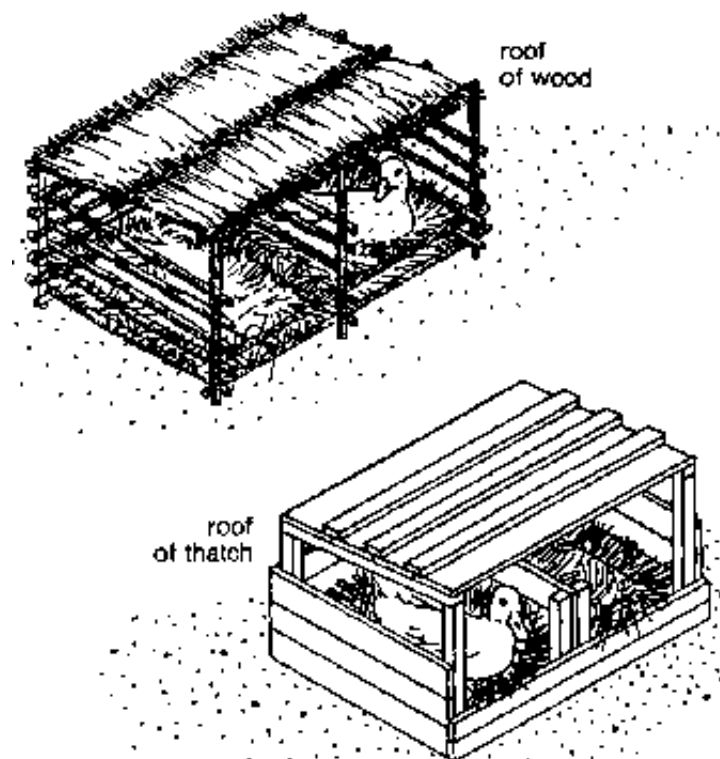

Roof of wood and roof of thatch

101. As soon as you have finished building the nests, put them in the shelter. That way your ducks can become used to their nests as soon as you bring them home.

102. Be sure to change the grass or the straw in each nest as soon as it gets dirty.



 **Better Farming Series 39 - Raising Ducks 1: How to Begin (FAO, 1990, 73 p.)**

 **The ducks**

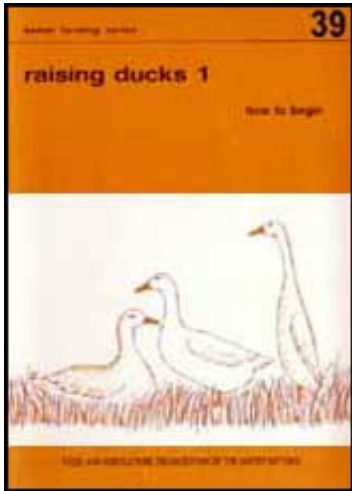

(introduction...)



Choosing ducks for your flock



How to choose good ducks



How to tell the difference between female and male ducks



How to handle your ducks



After you get your ducks

Better Farming Series 39 - Raising Ducks 1: How to Begin (FAO, 1990, 73 p.)

The ducks

103. Now it is time to get your fully grown or young ducks to start your flock.

104. Let us begin by learning the parts of a duck. This will help you when you choose yours.

105. Below is a drawing of a duck. Look at it carefully and learn the name of each part.

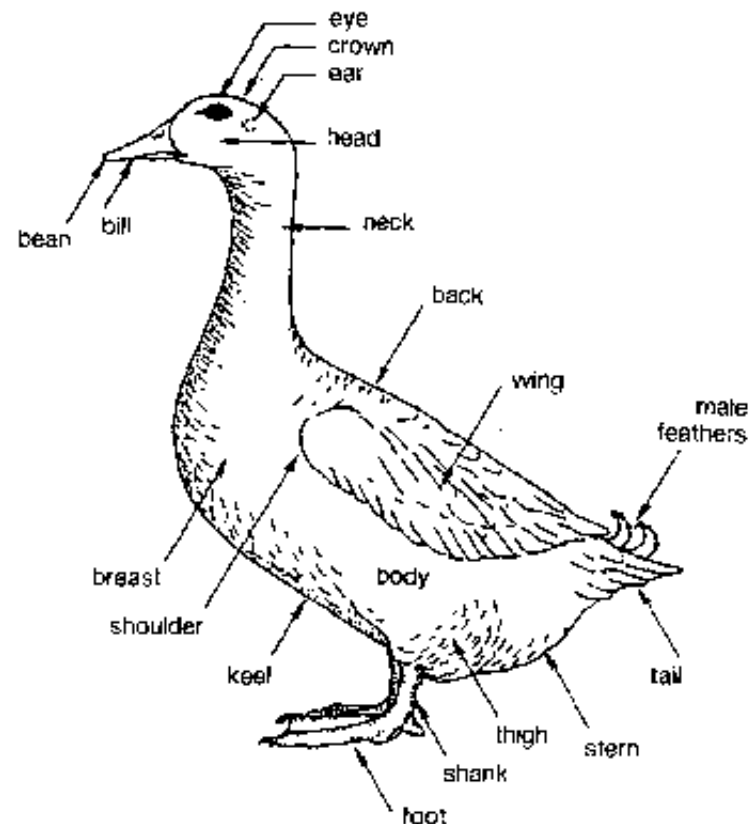

Parts of a duck

Choosing ducks for your flock

106. Some are best for eggs, some kinds are best for meat and some are good for both. The drawings below show you these 3 kinds of ducks.

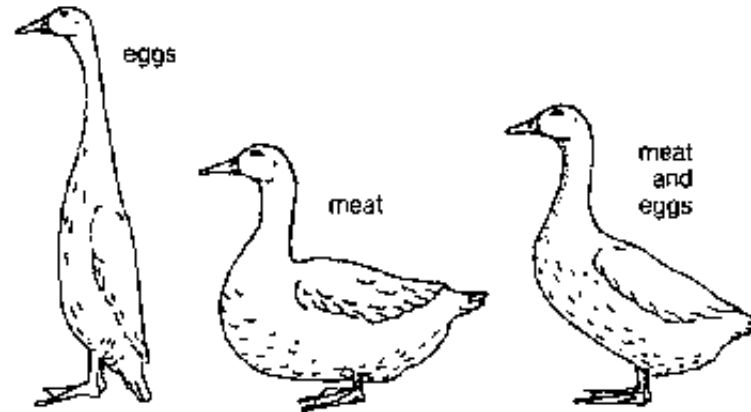

Kinds of ducks

107. When you are choosing ducks to start your first flock, try to get the kind of ducks that are good for both eggs and meat.

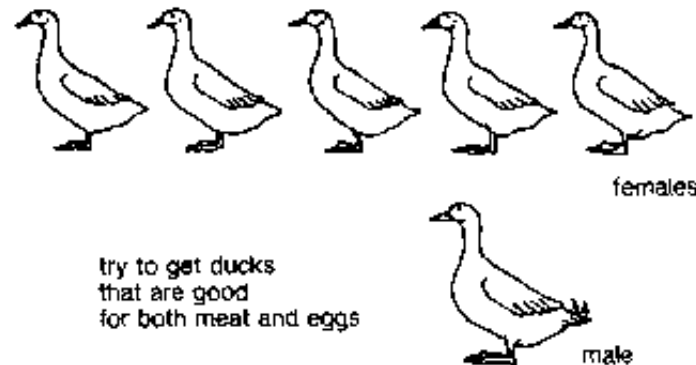

Try to get ducks that are good for both meat and eggs

How to choose good ducks

108. It is best to choose your ducks from a place where you can see them before you buy them. If you watch them carefully you will be able to see the difference between healthy, strong ducks and sick, weak ducks.

109. If a duck looks well, has well- shaped legs, feet, wings, back and head, and if it moves about well, it is probably a good duck to buy.

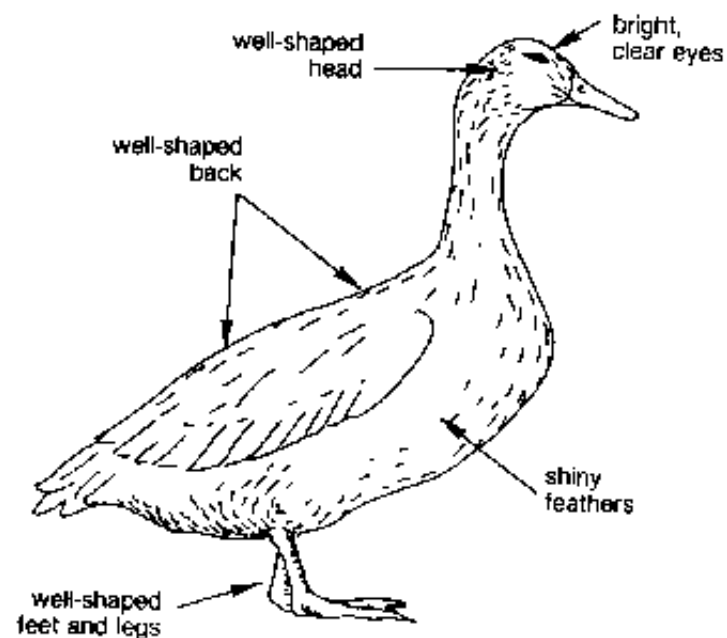

A duck that looks well and stands and moves well, is a good duck to buy

How to tell the difference between female and male ducks

110. When you first begin with a flock of 6 ducks you must have 1 male duck to be able to grow your own baby ducks.

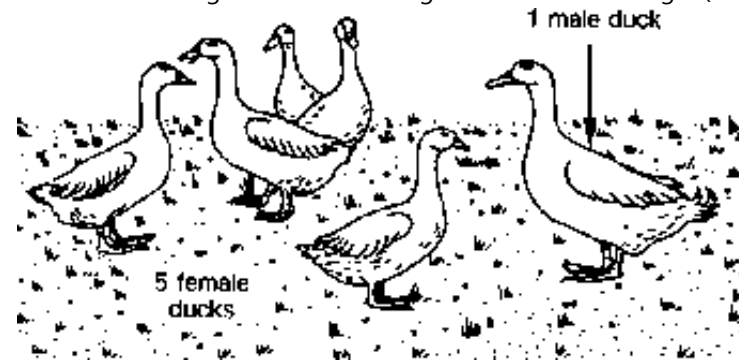

5 female ducks and 1 male duck

111. So, it is very important to be able to tell the difference between female and male ducks. You can tell the difference

- **by listening to the quack made by the duck**
- **by looking at the feathers near the tail of the duck.**

Listening to the quack

112. If you are going to begin with ducks of 8 weeks or older, you can tell female from male ducks by listening to them quack.

113. When ducks have reached this age, the quack made by a female is very different from the quack made by a male

114. Gently hold the duck by the tail until it begins to quack.

A female duck will make a hard, loud quack.

A male duck will make a soft, rough quack.

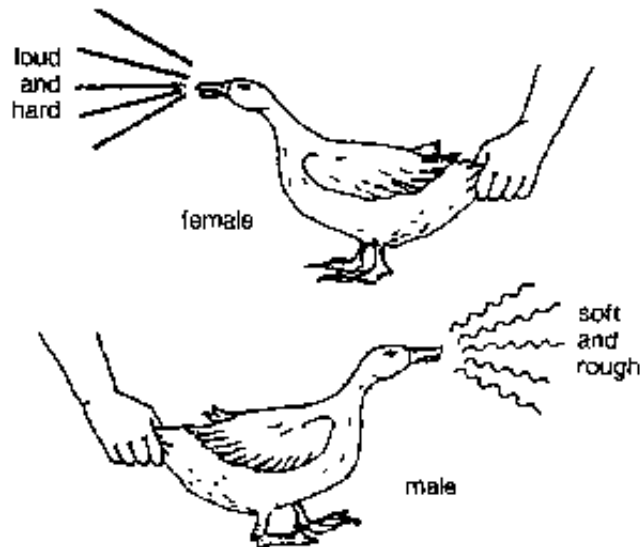

Quack at the female and male duck

Looking at the feathers

115. If you are going to begin with ducks of 4 months or over, you can tell female from male ducks by the feathers on their tails.

116. When ducks have reached this age, male ducks have curled feathers on their backs near the tail and female ducks have none.

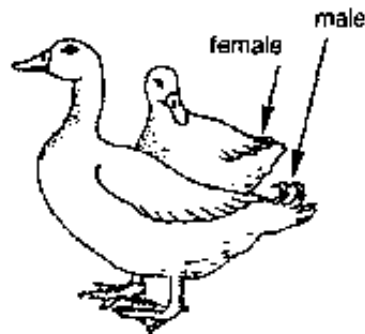

Flocks at the female and male duck

How to handle your ducks

117. The legs or wings of a duck can easily be hurt or even broken. So, never grab a duck by the legs or the wings.

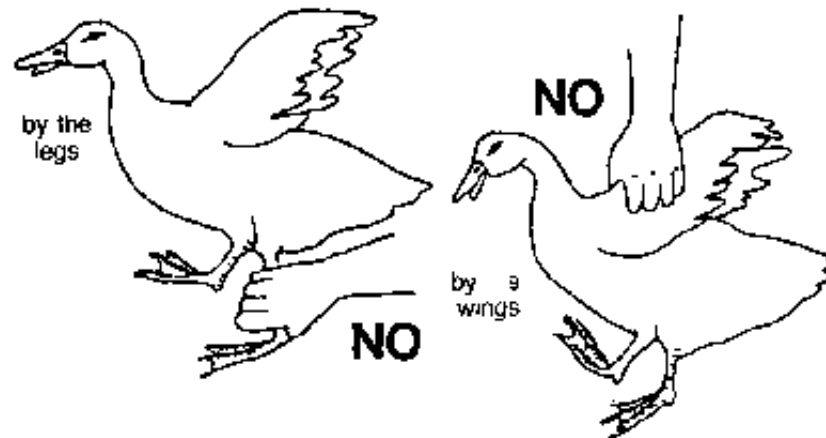

How to grab ducks

118. To catch a duck, grasp it firmly but gently at the base of the neck.

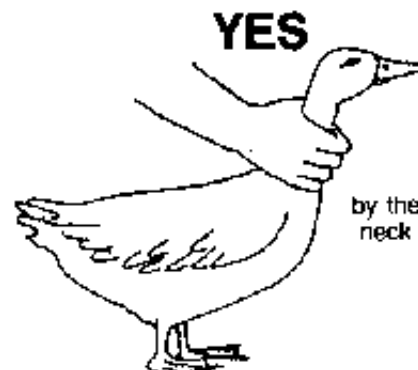

Grab the duck by the base of its neck

119. You can also catch a duck by holding its wings against its sides with one hand on each side of its body and a thumb over each wing.

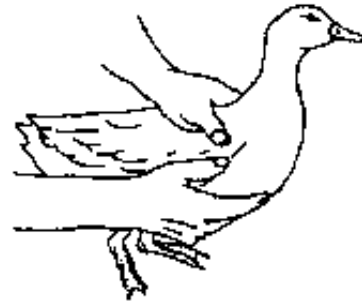

Hold the duck's wings against its sides

120. After you have caught a duck, slide one hand under its body and hold its legs firmly.

121. Then you can rest the body of the duck on the lower part of your arm and carry it easily.

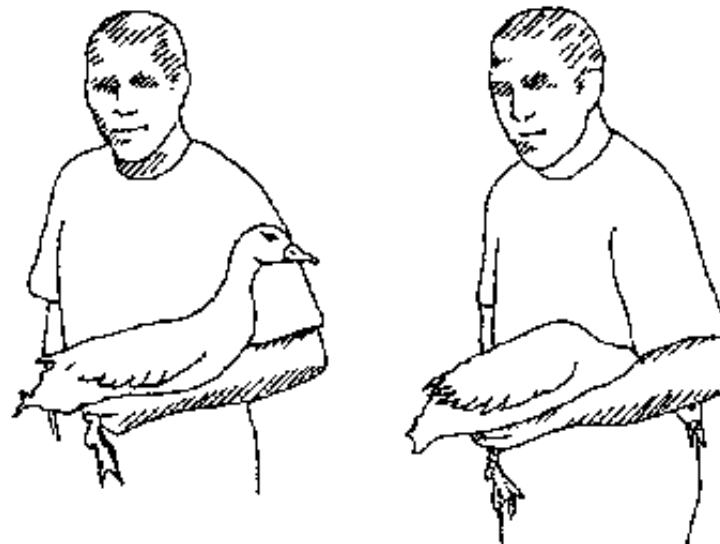

Rest the body of the duck on the lower part of your arm

122. If you have to move a duck from place to place, you can carry it in a basket or a crate with a cover.

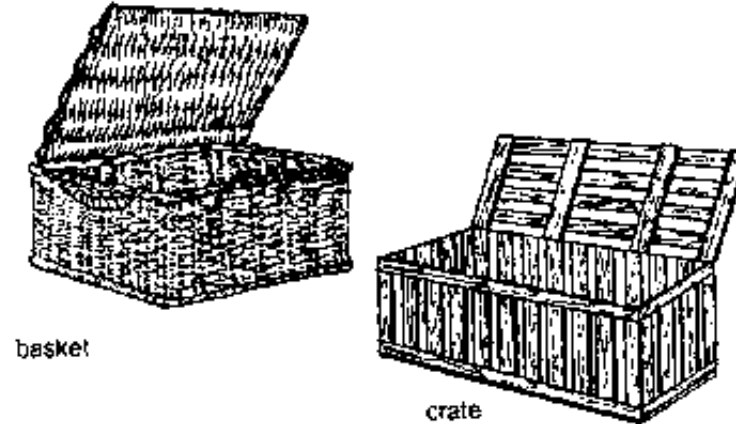

Basket; crate

123. First, tie the legs of the duck together. Then put it gently inside and put on the cover to keep the duck from getting out.

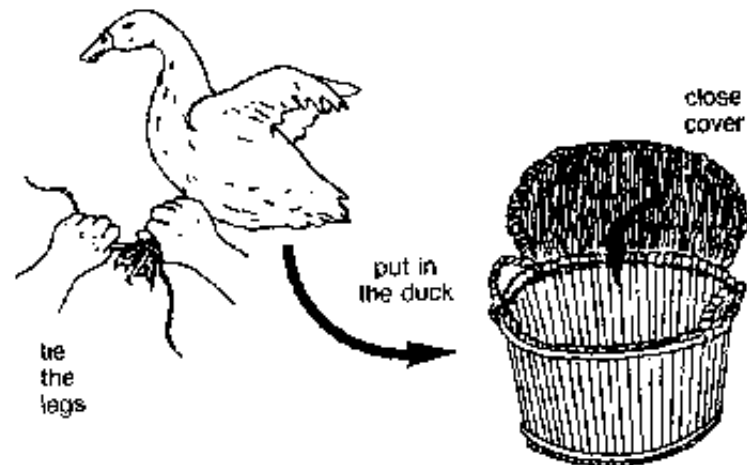

Put the duck in the basket

After you get your ducks

124. When you bring your ducks home, put them in their shelter, close the door and go away. That way they can settle down, become calm and get used to their new home.

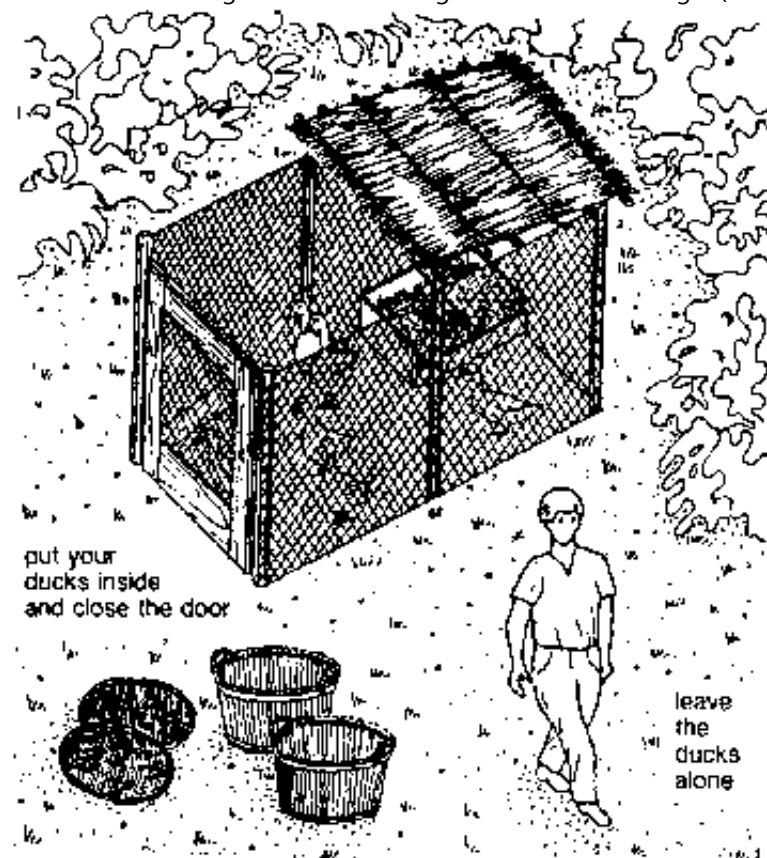

Put the ducks inside and close the door, leave the ducks alone

125. Later the same day, just before the sun goes down, give them some food to eat and some water to drink. However, give them the food and water inside the shelter.

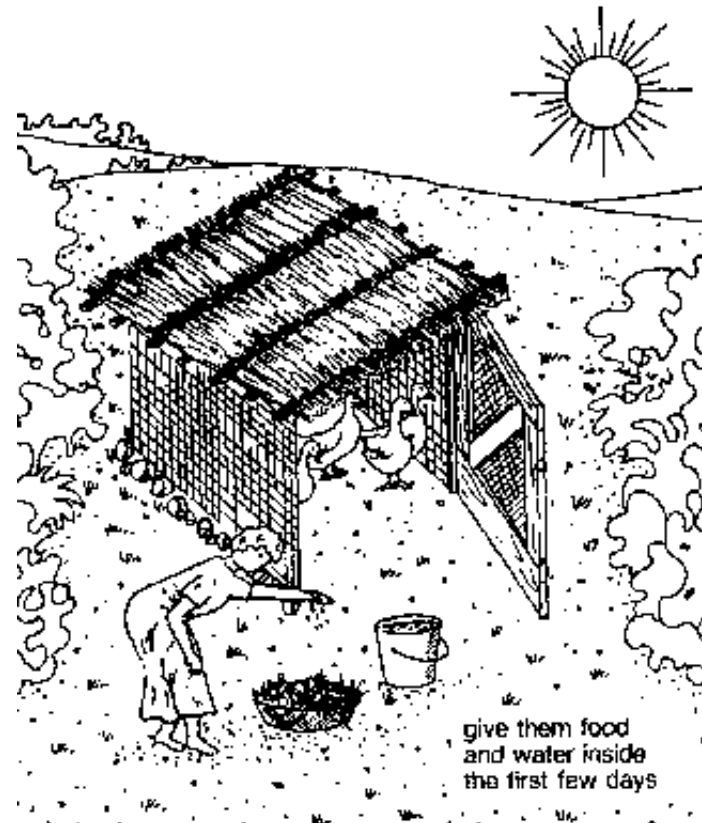

Give them food and water inside the first few days

126. You can give them food that is left from your last meal. You can also give them some chopped green plants.

127. If you see that your ducks eat all the food that you give them, give them a little more.

128. Keep your ducks in their shelter for the first 2 or 3 days. However, be sure to give them some left- over food and chopped greens each night just before dark and make sure that they have water.

129. When you see that your ducks are calm and used to their new home, you can let them out for the day.

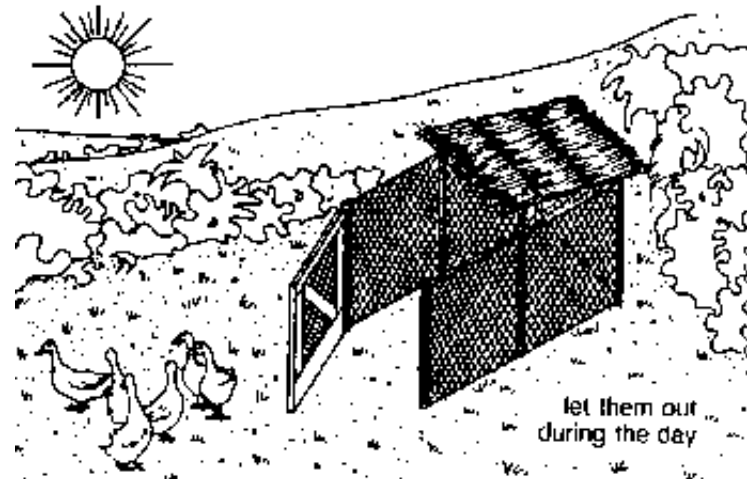

Let them out during the day

130. Let your ducks out a few hours after the sun is up. That way they will lay their eggs inside so that you can collect them easily.

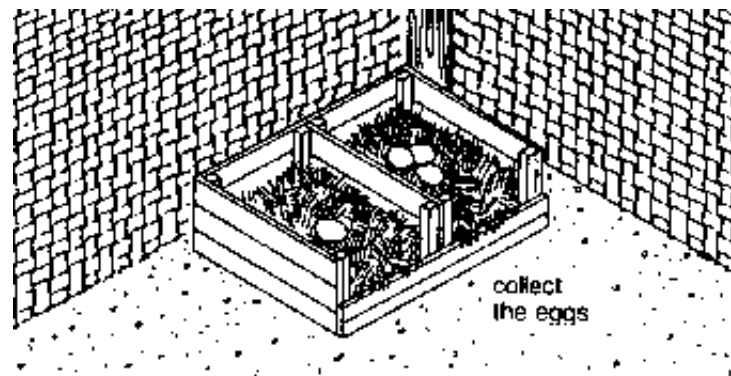

Collect the eggs

131. During the day your ducks will wander about looking for insects and worms

and grass and roots and other things that they like to eat.

132. Then, each night just before dark give them the left- over food from your table that day.

133. However, this time give them food in front of the shelter, not inside. That way it will stay clean inside.

134. By giving your ducks food in front of their shelter each night, they will become used to coming back to eat at that time.

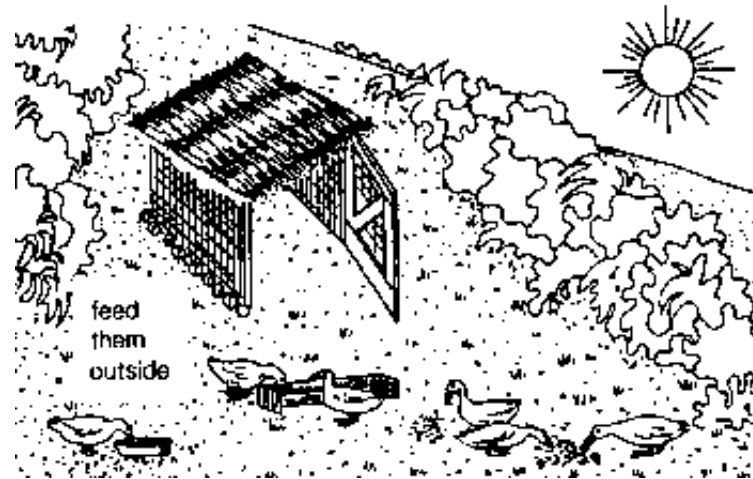

Feed them outside

135. When your ducks have eaten, you can close them safely inside until the next morning.

136. During the first few weeks, check on your ducks from time to time during the day to see where they are.

137. However, soon they will learn to go out in the morning and come back by themselves at night. You will have to do very little for your ducks.

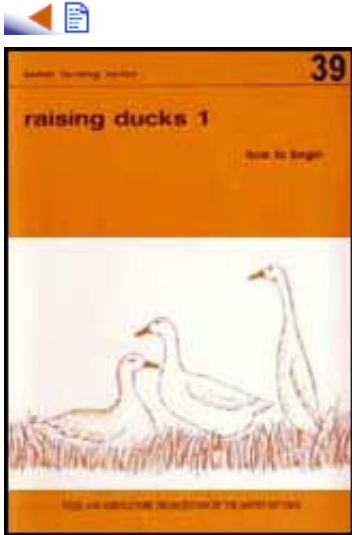

Better Farming Series 39 - Raising Ducks 1: How to Begin (FAO, 1990, 73 p.)

➔ **Growing your own baby ducks**

(introduction...)

Hatching your own eggs

Setting the female duck

The baby ducks

Putting your new baby ducks with the flock

When to use or sell the meat

Better Farming Series 39 - Raising Ducks 1: How to Begin (FAO, 1990, 73 p.)

Growing your own baby ducks

133. Earlier in this booklet, you were told that you can raise as many as 24 ducks that live by themselves and find their own food, with very little help from you.

139. So, if you would like to have more ducks, the easiest way to get them is to raise your own baby ducks.

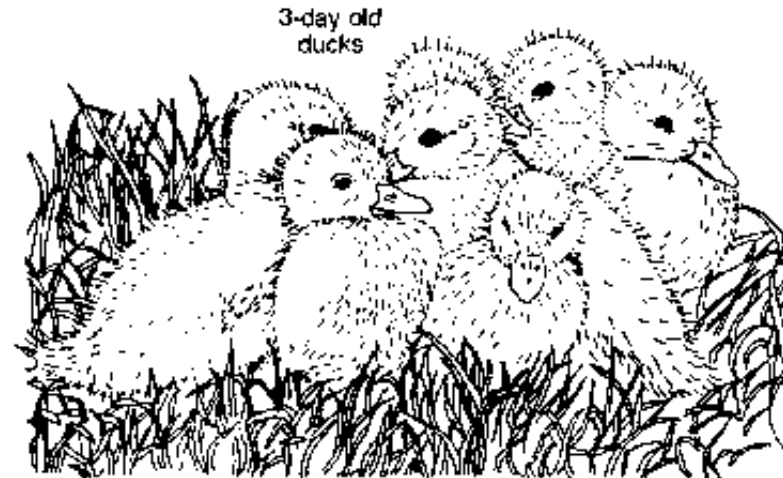

3- day old ducks

140. By raising your own baby ducks, you can add to your small flock little by little until it is the size you want.

141. However, you must have fertile eggs. If your small flock has a male duck, the eggs you get will be fertile and you can begin to raise baby ducks.

Hatching your own eggs

142. A baby duck grows inside the shell of a fertile egg when it is kept warm. Eggs are kept warm when a female duck sits on them. This is called setting.

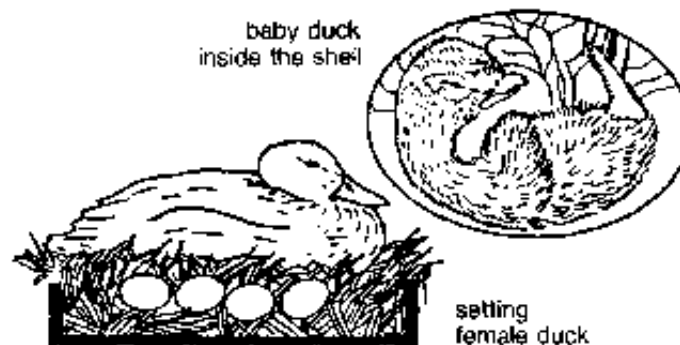

Setting female duck, baby duck inside the shell

143. After 28 days the baby duck is ready to come out of its shell. This is called hatching.



Hatching takes about 28 days

Note:

The eggs of most kinds of ducks that you are likely to find where you live take 28 days to hatch.

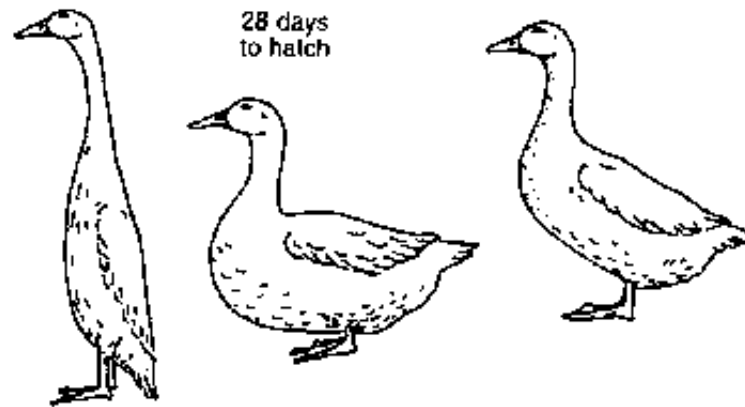

28 days to hatch

However, there is one exception. The eggs of a Muscovy duck take 35 days to hatch. You will learn more about the Muscovy in the next booklet in this series.

Muscovy duck 35 days to hatch

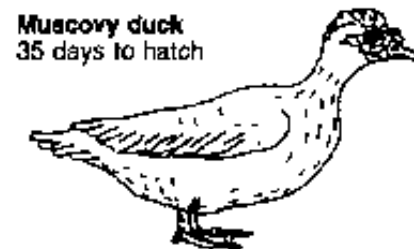

Muscovy duck - 35 days to hatch

Setting the female duck

144. When a female duck tries to hide or sits on a nest more and more, she is probably ready to set.

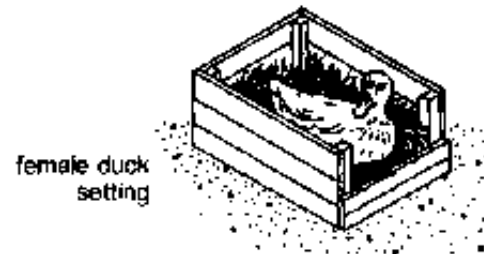
female duck
hidingfemale duck
setting

Female duck hiding; female duck sitting

145. Make her a setting nest in a quiet dark place well sheltered from rain, sun and wind.

146. You have already been told, that the nest can be a simple hole in the ground or a box lined with clean, dry grass or straw.

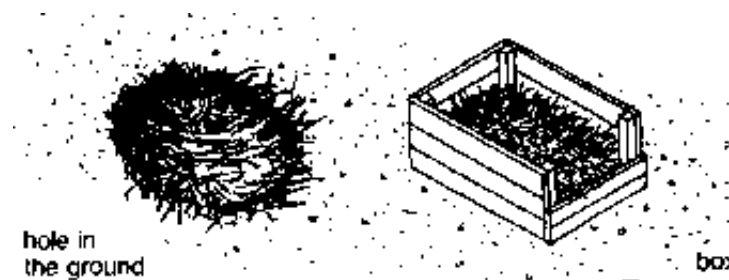
hole in
the ground

box

Hole in the ground; box

147. A female duck can cover 10 to 12 eggs. So, try to collect this many eggs from your flock.

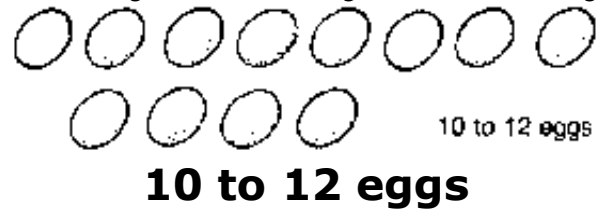

10 to 12 eggs

148. However when you collect the eggs handle them very carefully. If you shake eggs too much they may not hatch.

149. Eggs which are very small or very large may not hatch. So, choose medium sized eggs.

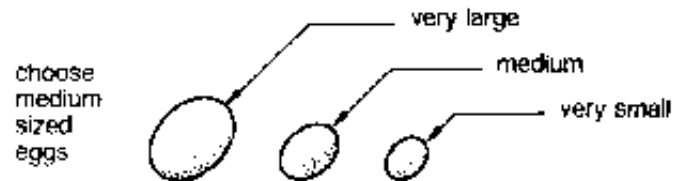

Choose medium- sized eggs

150. Eggs to be used for setting should be no more than 10 days old. Eggs which are older may not hatch.



no more than 10 days



No more than 10 days

151. The eggs should be clean. If they are dirty, clean them with a soft, damp cloth.



Clean dirty eggs

152. When you have the right number of eggs, put them in a nest in a quiet place and the female will begin to set.

153. When one of your female ducks is setting on a nest, make sure that she has enough food and water nearby.

154. If she has to go too far to find food and water the eggs may get cold and not hatch.

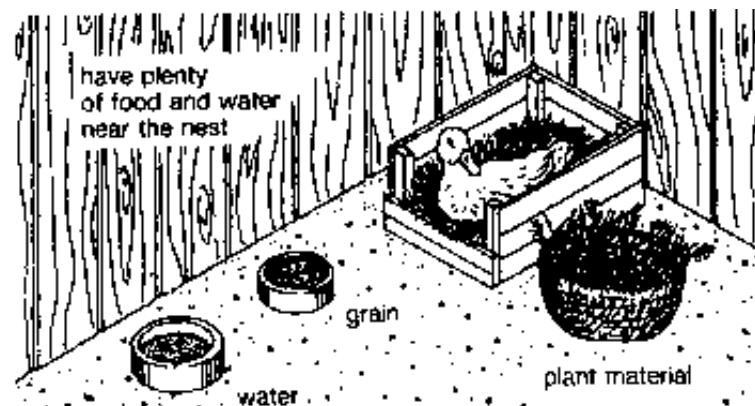

Have plenty of food and water near the nest

155. On or a little before the 28th day your baby ducks will begin to hatch.



28th day

156. They will begin breaking out of their shells little by little. It may take as long as 2 days until all the baby ducks are hatched.

157. As the baby ducks hatch, take away the pieces of broken shell from the nest.

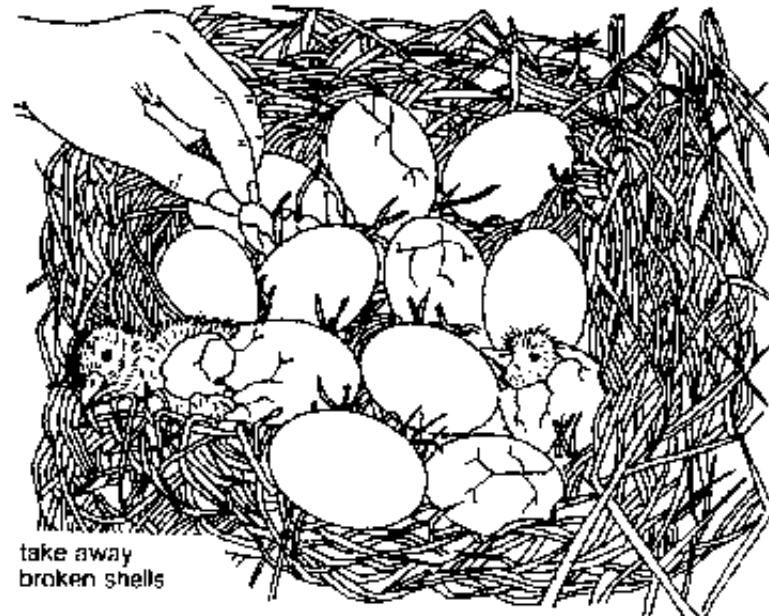

Take away broken shells

The baby ducks

158. After all the baby ducks have hatched, a good rule to follow is... bother them as little as possible. The female duck will take good care of her babies.

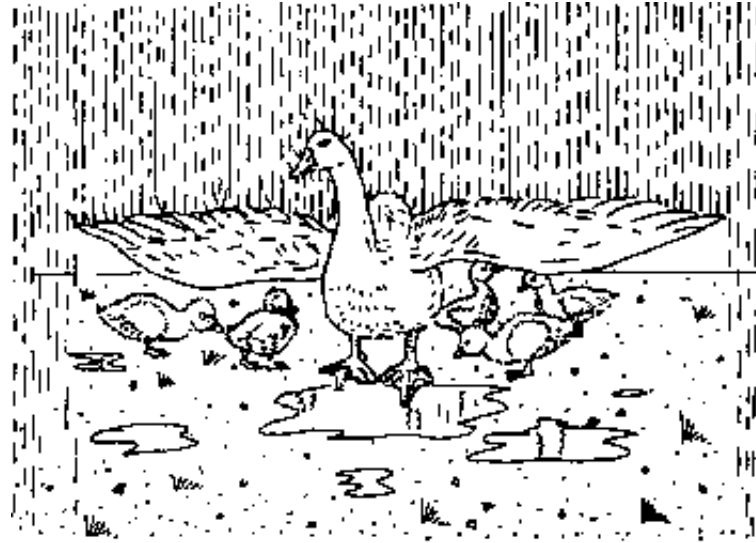

The female ducks taking care of their babies

159. However, your baby ducks will need some special care for the first 4 weeks. You should be sure to

- **see that they are warm**
- **give them shelter in bad weather**
- **keep them apart from the rest of the flock**
- **feed them well**

160. For the first 4 weeks give the baby ducks all of the left- over food that you usually give to the rest of the flock.

Putting your new baby ducks with the flock

161. When your baby ducks are 4 weeks old they can begin to live with the rest of the flock and eat the same food.

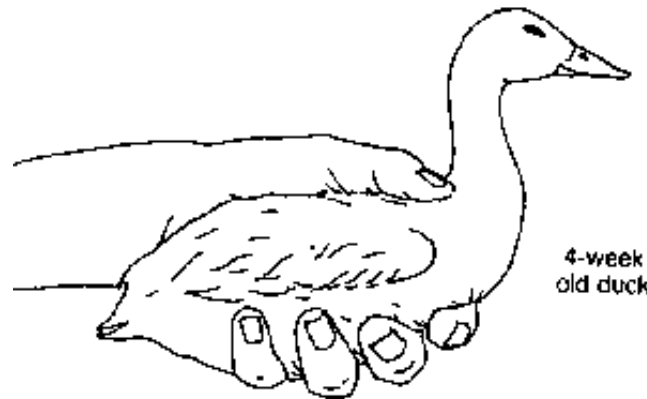

3- week old duck

162. If you see that the baby ducks are bitten by the older ducks and that they are not able to get enough food to eat, give them their food away from the rest of the flock.

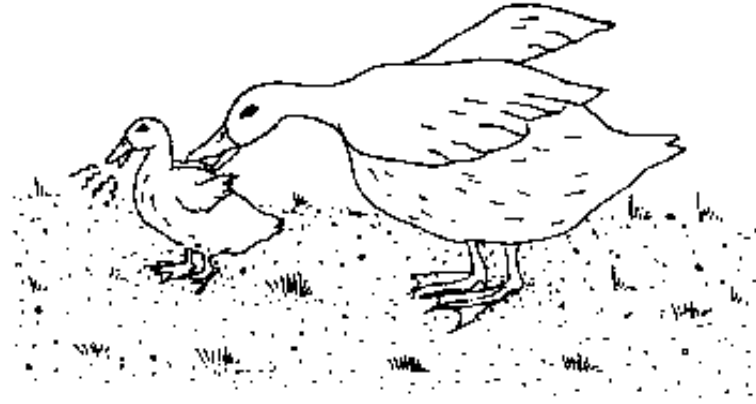

An older duck may bite a baby duck

163. At first you can leave all of your younger male ducks with the flock.

164. As the young males grow older, it is best to eat or to sell them. This is because the young male ducks may be from the same family as your female ducks.

165. However, as your flock grows larger you will need more male ducks. So, try to buy them at the market or from another duck farmer. You may even be able to trade one or two of your young males for new ones.



Buy ducks

166. Remember, with a larger flock you must be sure to have the right number of

male ducks.

FLOCK SIZE FEMALES MALES

6	5	1
8 to 12	6 to 10	2
14 to 18	11 to 15	3
20 to 24	16 to 20	4

When to use or sell the meat

167. As your ducks grow older you can take them to eat or to sell as soon as you have enough young ducks to keep your flock the size you want. However, take the male ducks first.

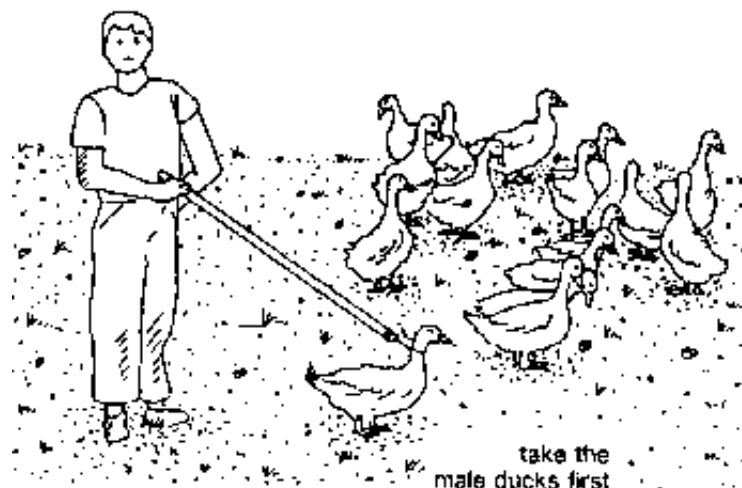







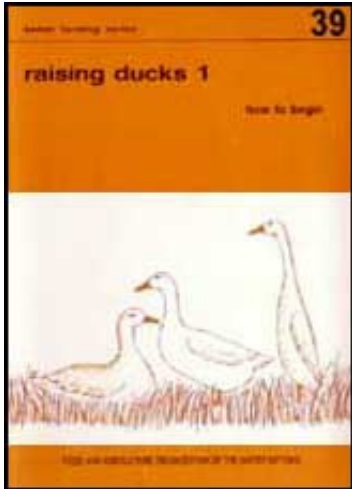



Take the male ducks first

168. Ducks are old enough to eat or to sell at 10 weeks. When your ducks reach 2

years of age, replace them with young ducks.



-  **Better Farming Series 39 - Raising Ducks 1: How to Begin (FAO, 1990, 73 p.)**
-  **(introduction...)**
-  **Preface**
-  **Introduction**
-  **Learning about ducks**
-  **How to begin**
-  **The ducks**
-  **Growing your own baby ducks**
-   **Taking care of your ducks**
-  **Further improvement**

Taking care of your ducks

169. Remember, your ducks must have plenty of fresh water to drink especially when they are eating. In addition, make sure that your ducks have fresh water to drink when they are eating in the fields.

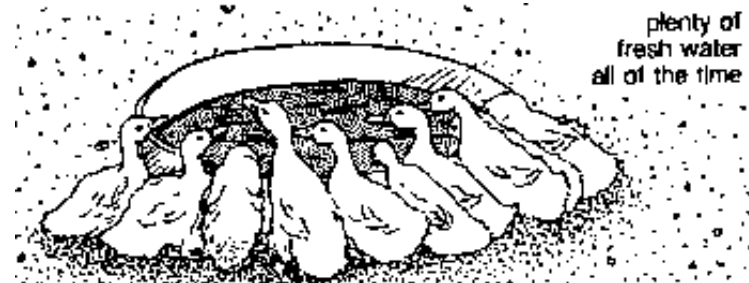

Plenty of fresh water all of the time

170. Every night when your ducks come back home to sleep give them the food that is left from your table that day and make sure they have fresh water.

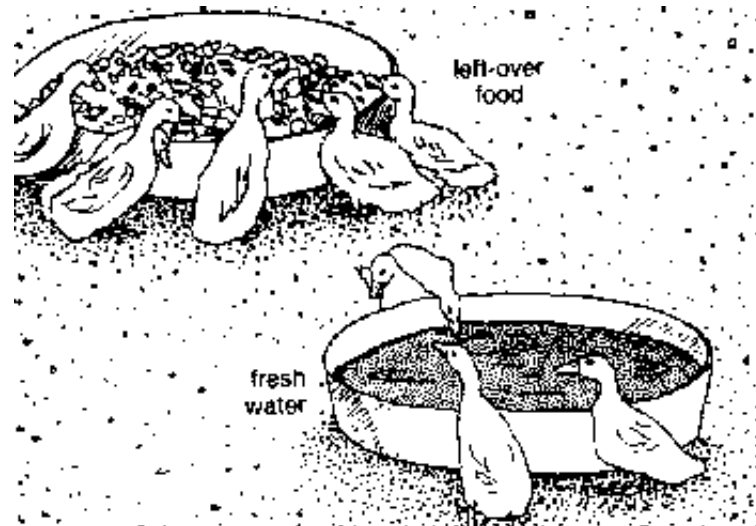

Left over food and fresh water

171. Never give your ducks food that is mouldy or rotten or they may become sick.

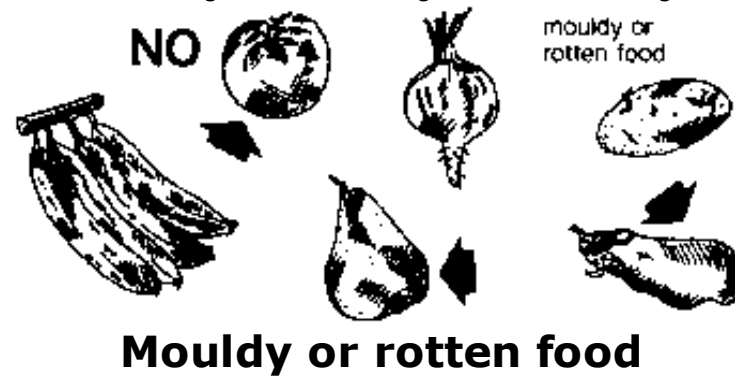

172. Keep the floor of their shelter as clean and as dry as you can. Change the floor material if it becomes wet, dirty or mouldy.

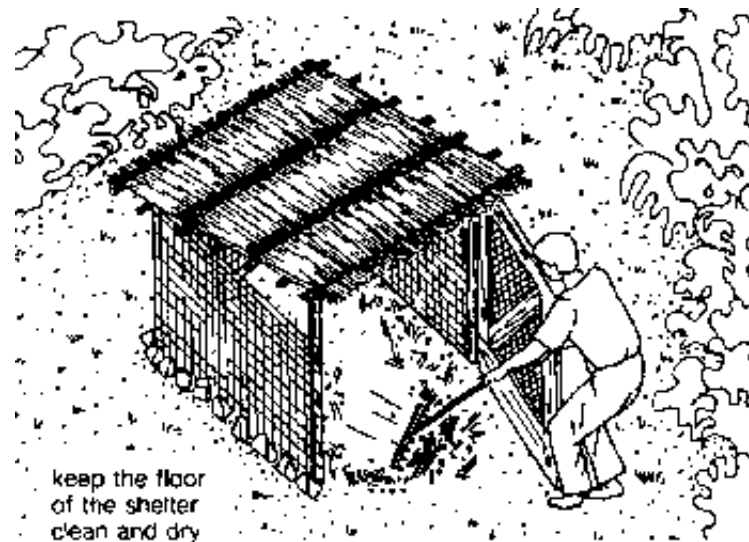

Keep the floor of the shelter clean and dry

173. If you do all of these things, your ducks will be healthy and well and you will see how very little you must do to raise a flock of ducks.



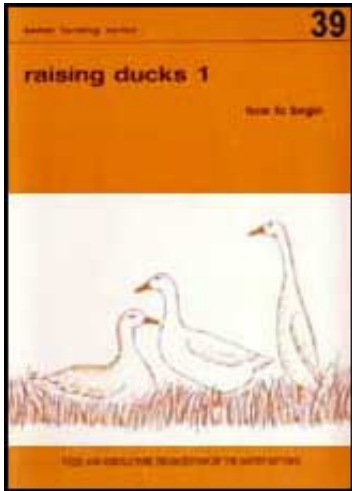

Better Farming Series 39 - Raising Ducks 1: How to Begin (FAO, 1990, 73 p.)

 **(introduction...)**

 **Preface**

 **Introduction**

 **Learning about ducks**

 **How to begin**

 **The ducks**

 **Growing your own baby ducks**

 **Taking care of your ducks**

  **Further improvement**

Further improvement

174. In this booklet you have learned how to raise and care for a flock of 6 to 24 ducks that live by themselves and find most of their own food with very little help from you.

175. You can also raise more ducks. You can raise as many as 60 ducks in much the same way as you raise a smaller flock.

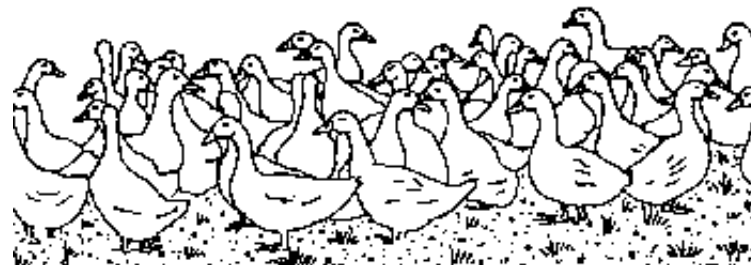

A flock

176. You will have to learn a little more about ducks and work a little harder. However, with 60 ducks you will get many more eggs and much more meat to eat and to sell at the market.

177. Perhaps you can raise more ducks with another farming family near you. Perhaps you can raise more ducks with other families in your village.

178. The next booklet in this series, Booklet No. 40, Raising ducks 2: further improvement, will tell you how.

