

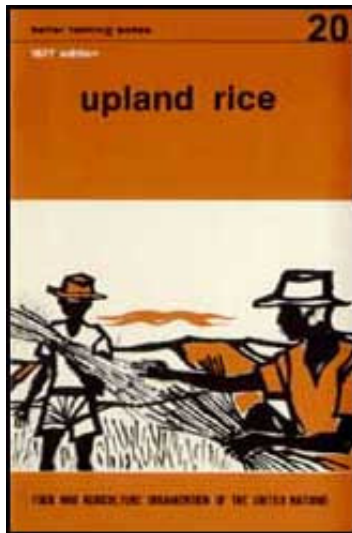

Home-immediately access 800+ free online publications.  
Download CD3WD (680 Megabytes) and distribute it to the 3rd World. CD3WD is a 3rd World Development private-sector initiative, mastered by Software Developer [Alex Weir](#) and hosted by [GNUveau Networks](#) (From globally distributed organizations, to supercomputers, to a small home server, if it's Linux, we know it.)[ar](#).[cn](#).[de](#).[en](#).[es](#).[fr](#).[id](#).[it](#).[ph](#).[po](#).[ru](#).[sw](#)

---



➔  Better Farming Series 20 - Upland Rice (FAO - INADES, 1977, 30 p.)

 *(introduction...)*

 Preface

People need more rice to eat

 *(introduction...)*

 Traditional cultivation of upland rice



## Disadvantages of traditional cultivation



How to improve upland rice cultivation



Using new implements



*(introduction...)*



Preparing the soil



Sowing



Cultivating



Using fertilizers



*(introduction...)*



Why apply manure or chemical fertilizers?



What fertilizers to use



Organic manure and chemical fertilizers



Harvesting

 Suggested question paper

Home-immediately access 800+ free online publications.  
Download CD3WD (680 Megabytes) and distribute it to the 3rd World. CD3WD is a 3rd World Development private-sector initiative, mastered by Software Developer [Alex Weir](#) and hosted by [GNUveau Networks](#) (From globally distributed organizations, to supercomputers, to a small home server, if it's Linux, we know it.)[ar.cn.de.en.es.fr.id.it.ph.po.ru.sw](#)

---

 Better Farming Series 20 - Upland Rice  
(FAO - INADES, 1977, 30 p.)

➔  (*introduction...*)

 Preface

 People need more rice to eat

 How to improve upland rice cultivation

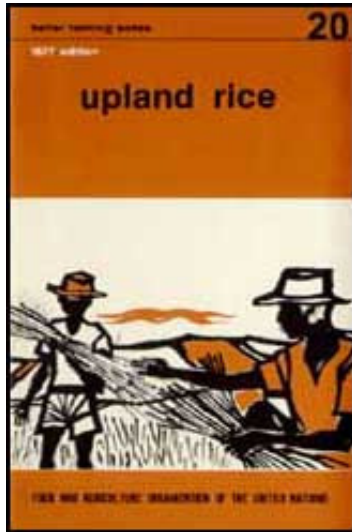

- Using new implements
- Using fertilizers
- Harvesting
- Suggested question paper

Published by arrangement with the  
Institut africain pour la dveloppement conomique et social  
B.P. 8008, Abidjan, Cte d'Ivoire

FOOD AND AGRICULTURE ORGANIZATION OF THE UNITED  
NATIONS  
Rome 1977

# FAO Economic and Social Development Series No. 3/20

First published 1970

Reprinted 1972, 1977, 1984

P-69

ISBN 92-5-100621-0

© French edition, Institut africain pour le développement  
conomique et social (INADES) 1967

© English edition, FAO 1970



[Home](#)-immediately access 800+ free online publications.  
[Download](#) CD3WD (680 Megabytes) and distribute it to the 3rd  
World. CD3WD is a 3rd World Development private-sector  
initiative, mastered by Software Developer [Alex Weir](#) and  
hosted by [GNUveau Networks](#) (From globally distributed

organizations, to supercomputers, to a small home server, if it's Linux, we know it.) [ar](#).[cn](#).[de](#).[en](#).[es](#).[fr](#).[id](#).[it](#).[ph](#).[po](#).[ru](#).[sw](#)

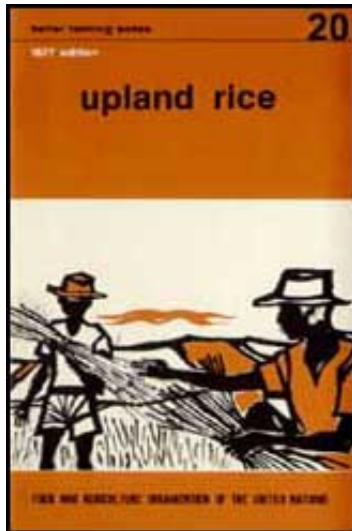

 Better Farming Series 20 - Upland Rice  
(FAO - INADES, 1977, 30 p.)

 (*introduction...*)

  Preface

People need more rice to eat

 How to improve upland rice cultivation

Using new implements

Using fertilizers

 Harvesting

 Suggested question paper

## Preface

The first twenty- six volumes in FAO's Better Farming Series were based on the Cours d'apprentissage agricole prepared in the Ivory Coast by the Institut africain de dveloppement conomique et social for use by extension workers. Later volumes, beginning with No. 27, have been prepared by FAO for use in agricultural development at the farm and family level. The approach has deliberately been a general one, the intention being to constitute basic prototype outlines to be modified or expanded in each area according to local conditions of agriculture.

Many of the booklets deal with specific crops and techniques, while others are intended to give the farmer more general information which can help him to understand why he does what he does, so that he will be able to do it better.

Adaptations of the series, or of individual volumes in it, have been published in Amharic, Arabic, Bengali, Creole, Hindi,

Igala, Indonesian, Kiswahili, Malagasy, SiSwati and Turkish, an indication of the success and usefulness of this series.

Requests for permission to issue this manual in other languages and to adapt it according to local climatic and ecological conditions are welcomed. They should be addressed to the Director, Publications Division, Food and Agriculture Organization of the United Nations, Via delle Terme di Caracalla, 00100 Rome, Italy.



[Home](#)-immediately access 800+ free online publications. [Download](#) CD3WD (680 Megabytes) and distribute it to the 3rd World. CD3WD is a 3rd World Development private-sector initiative, mastered by Software Developer [Alex Weir](#) and hosted by [GNUveau Networks](#) (From globally distributed organizations, to supercomputers, to a small home server, if



it's Linux, we know it.)[ar](#).[cn](#).[de](#).[en](#).[es](#).[fr](#).[id](#).[it](#).[ph](#).[po](#).[ru](#).[sw](#)

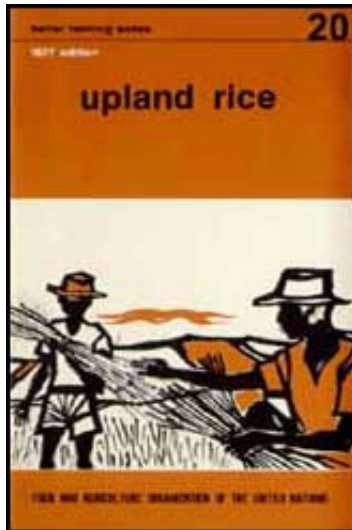

 Better Farming Series 20 - Upland Rice (FAO - INADES, 1977, 30 p.)

➔  People need more rice to eat

 *(introduction...)*

 Traditional cultivation of upland rice

 Disadvantages of traditional cultivation

**Better Farming Series 20 - Upland Rice (FAO - INADES, 1977, 30 p.)**

**People need more rice to eat**

1. In many parts of the world people eat a lot of rice.

But nowadays more people eat more rice than in the past.

Rice is a very good food.

In order to live, digest, work, resist the cold and the heat, people need foods that give them strength.

These are called energy foods.

Rice is an excellent energy food.

Rice keeps well.

Rice does not rot if it is protected from damp.

Rice can be kept a very long time if it is protected from rats and insects.

2. But some regions do not produce enough rice. Nearly all the countries of Africa have to buy rice abroad.

The countries of Africa spend on rice imports a lot of money that could be used in other ways.

If Africa produced more rice, it could sell rice to other countries with a large rice- eating population. In this way Africa could earn more money.

3. Farmers must therefore produce more rice.

There are many regions of Africa, for example, where rice can be grown: along the banks of streams and rivers, around dams, at the bottom of valleys.

But in order to increase rice production, it is necessary to adopt modern methods of rice cultivation.

In this booklet, we shall speak only about upland rice cultivation. In Booklet 21, we speak about wet paddy rice cultivation.

The two methods of cultivation are quite different.



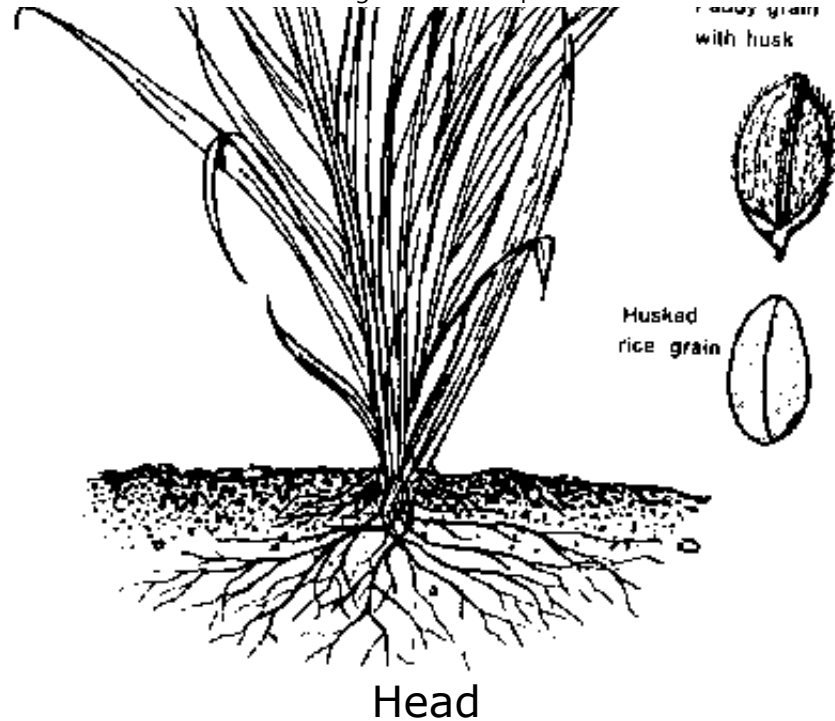

## Traditional cultivation of upland rice

4. Farmers work only with the hoe. They do not prepare the soil properly.

Farmers apply neither manure nor fertilizers: the rice takes all the mineral salts out of the soil and the soil soon loses its fertility.

After 2 or 3 years of rice crops, the soil must be left fallow, to rest.

This means that new fields have to be cleared.

With the traditional method of growing rice, farmers have little work to do, but they produce and sell little rice.

Yields are low.

## **Disadvantages of traditional cultivation**

5. Traditional methods use simple tools only.

When farmers have burned the brush and cleared the field,

they cannot prepare the soil properly, because they use only a hoe.

They can only scratch the earth and mix the ashes into the soil.

Like this, farmers cannot get a good harvest.

Brush fires ruin the soil.

Fire destroys the organic matter. It is true that the ashes enrich the soil, but the burned vegetation produces no humus and does not improve the soil structure.

Fire leaves the soil bare: erosion is more severe.

The soil is not loosened.

Water and air do not penetrate into the soil.

Roots cannot go deep enough into the soil to take up water and mineral salts.

The plants are not well nourished.

They do not produce many large grains of rice. The harvest is not plentiful.

6. No fertilizers are applied.

When a piece of land bears a crop for the first time, the plants take up all the mineral salts for their nourishment.

The soil soon becomes very poor.

After two or three years, the field must be left fallow. It takes a long time until the soil is again fertile.

Farmers have to leave the old fields fallow and to look for new



fields: this is called shifting cultivation.

7. It is time to stop shifting cultivation.

With shifting cultivation, a great deal of land is unused and yields no crop.

With shifting cultivation, farmers have to do a lot of work in clearing new fields every year. They often lose much time when crops should be sown.

The population is increasing. Bigger harvests are needed to feed it.

There is a very modern method of growing rice. But farmers cannot adopt this modern method at once: they have not enough tools and not enough money.



Home-immediately access 800+ free online publications.  
Download CD3WD (680 Megabytes) and distribute it to the 3rd World. CD3WD is a 3rd World Development private-sector initiative, mastered by Software Developer Alex Weir and hosted by GNUveau Networks (From globally distributed organizations, to supercomputers, to a small home server, if it's Linux, we know it.)[ar](#).[cn](#).[de](#).[en](#).[es](#).[fr](#).[id](#).[it](#).[ph](#).[po](#).[ru](#).[sw](#)

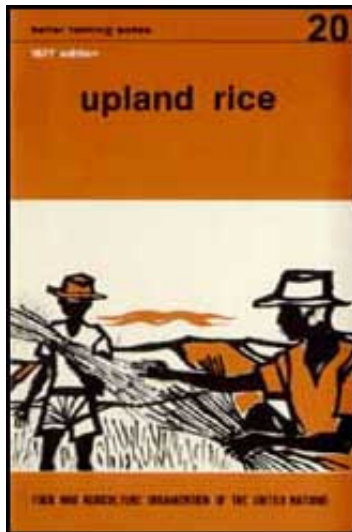



 Better Farming Series 20 - Upland Rice (FAO - INADES, 1977, 30 p.)

 *(introduction...)*

 Preface

People need more rice to eat

  How to improve upland rice cultivation

Using new implements



Using fertilizers



Suggested question paper

## **How to improve upland rice cultivation**

### 8. Farmers can use new implements

With animals and 8 plough the soil can be prepared better and more quickly. It is also possible to cultivate larger fields.

On a well- prepared soil the seed can be sown in rows. This makes it easier to remove weeds.

By preparing the soil, sowing in rows and weeding, yields can be greatly increased, even doubled.

### 9. They can apply manure and fertilizers.

Once farmers have used new tools they get a bigger harvest and more money. With the money they earn, the farmers can buy fertilizers.

If the plants are given manure or fertilizer, they will be well nourished. The harvest will be bigger, and the soil keeps its fertility. The same fields can grow crops for a longer time.

Once the farmers use new tools and also apply manure and fertilizers, they are growing upland rice by very modern methods.

10. They can protect the rice against pests.

It is difficult to keep off the rats and the birds. You can have a watchman near the field. Noise can frighten the birds away. Rice fields must be watched especially at the time when the grain begins to ripen.

There are also certain insects that damage rice, for example, rice borers, which lay their eggs on the leaves. When they grow, they eat through the stem. When the stems go white, apply BHC (benzene hexachloride) and Aldrin, a product which can kill these insects. Ask your extension service for this product.



[Home](#)-immediately access 800+ free online publications.  
[Download](#) CD3WD (680 Megabytes) and distribute it to the 3rd World. CD3WD is a 3rd World Development private-sector initiative, mastered by Software Developer [Alex Weir](#) and hosted by [GNUveau Networks](#) (From globally distributed organizations, to supercomputers, to a small home server, if it's Linux, we know it.)[ar](#).[cn](#).[de](#).[en](#).[es](#).[fr](#).[id](#).[it](#).[ph](#).[po](#).[ru](#).[sw](#)



Better Farming Series 20 - Upland Rice

(FAO - INADES, 1977, 30 p.)

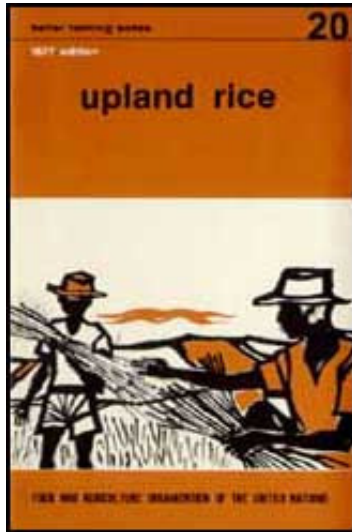

➔ □ Using new implements

📄 *(introduction...)*

📄 Preparing the soil

📄 Sowing

📄 Cultivating

## **Better Farming Series 20 - Upland Rice (FAO - INADES, 1977, 30 p.)**

### **Using new implements**

11. A plough, a harrow and a hoe drawn by animals help you work better and more quickly.

You can cultivate larger fields.

This will give you a more plentiful harvest.

Every year, you will earn a little more money. That way, you can pay for new implements and keep on making new progress.

As these implements are drawn by animals, you use the strength of the animals.

In studying animal husbandry, we have already seen how to use animals.

If you wish to use animal power, read Booklets 8, 9, 11 and 14 of this series.

Now we shall study how to plough, sow and cultivate. With good ploughing, good sowing, and several cultivations, you will

get much more plentiful harvests.

12. With a plough and a harrow the soil is better prepared.

The plough loosens the soil and tills it more deeply. The roots of the rice develop better, the rice gets more nourishment.

The soil is prepared more quickly.

You will be able to sow at the right time. It is very important to sow at the right time.

You will also be able to sow larger fields.

If you sow larger fields at the right time, your rice production will be much larger.

13. A hoe helps to remove weeds more quickly.



Whenever weeds have grown, you can remove them more quickly.

Then the weeds do not take water and mineral salts out of the soil.

The rice can use all the nourishment from the soil.

But in order to cultivate with a hoe, you must sow in rows.

The use of plough and hoe greatly increases the yield.

## **Preparing the soil**

Most often, rice is sown on a field that has already been cultivated perhaps after a crop of yams, or groundnuts, or cotton.

The work of clearing the field has already been done before

growing yams, or groundnuts or cotton.

#### 14. Tillage.

Before sowing, you must prepare the soil; that is, you must till it.

If you till 15 to 20 centimetres deep, this will stir the earth very well. Do this work with the plough or the hoe.

Tilling loosens the soil; it gets air and water well into the soil.

Tilling enables you to mix the herbage with the soil. When the herbage rots, it makes humus.

On flat land, if a soil has been well loosened by tilling, the water penetrates well and stays for a long time. Therefore, till at the beginning of the rainy season, so that the soil holds the water. This first tilling is very important; do it just as soon as

you can move the soil.

Slopes should not be tilled where there is a danger of rain carrying the soil away.

Tilling, or turning the soil over, can be done with the hoe, the spade or the digging fork. But this is slow and tiring work.

Nowadays, people use a plough drawn by donkeys or oxen. This way the work is done better and more quickly.

15. The plough.

Most often, people use a simple plough. The plough consists of a ploughshare, a mouldboard and two handles

Handles for holding the plough

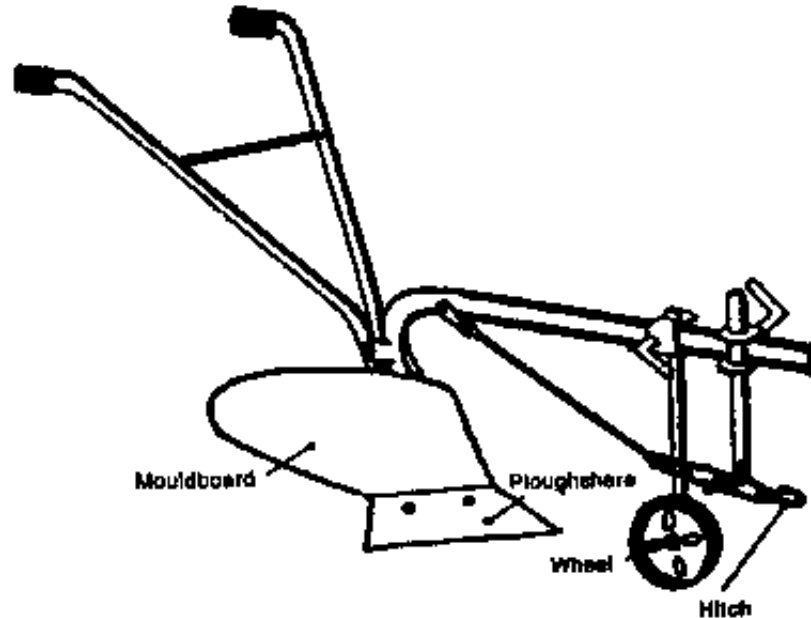

Handles for holding the plough

16. How to plough.

Make a first furrow with the plough across the whole length of

the field.

At the end of the field, turn. Make a second furrow alongside the first.

The second strip of ploughed field joins the first.

After that, keep turning around the double strip of ploughed field.

This is called conventional ploughing the field is divided into ploughed lance separated by a furrow.

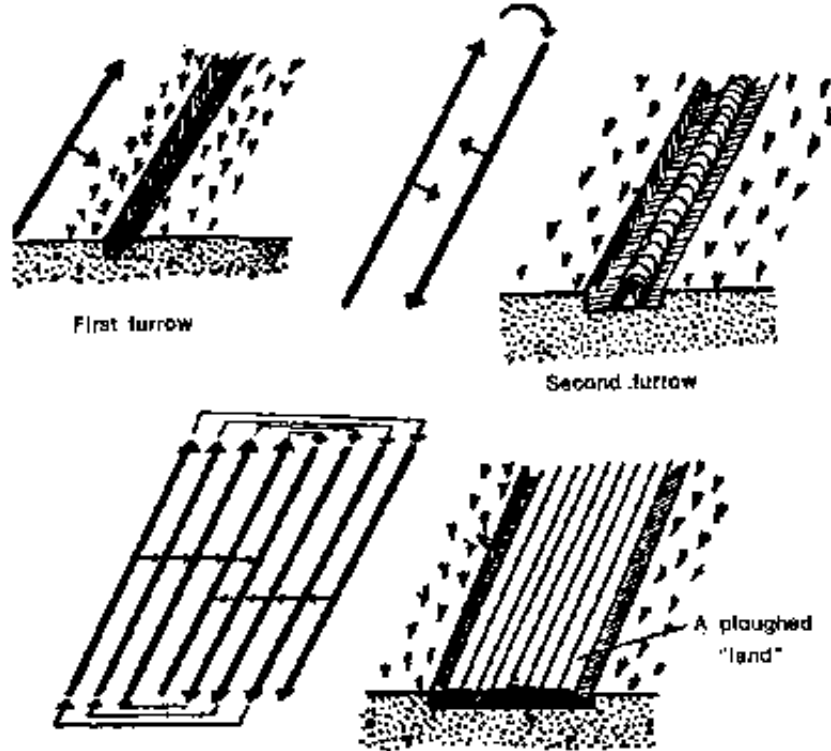

Conventional ploughing

17. Now the field is well ploughed. But ploughing often does not leave the soil flat. There are clods of earth

These clods of earth are broken up with a harrow. If you do not have a harrow, you can let an animal draw big branches of trees over the field. The branches crush the clods.

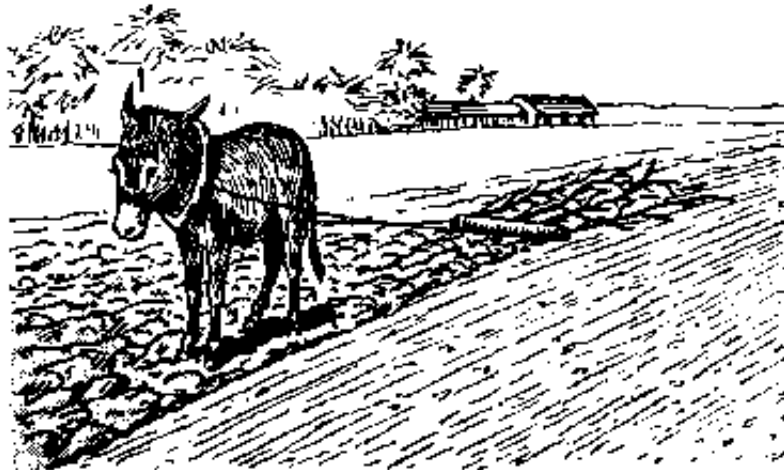
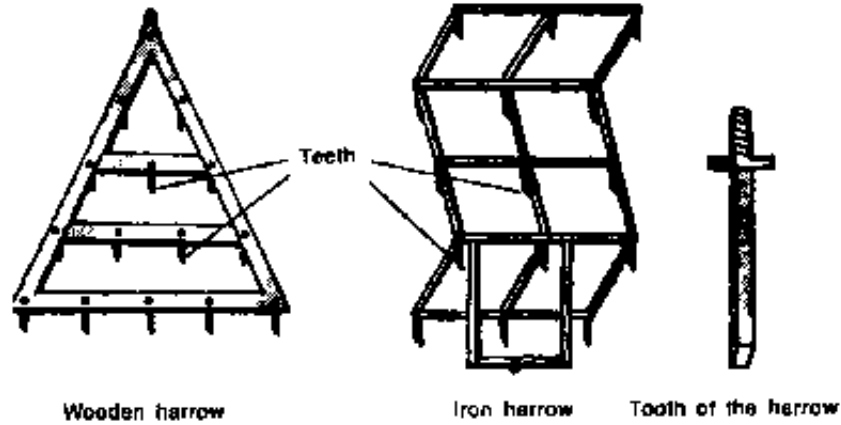



## The branches crush the clods

### **Sowing**

#### 18. Choosing the seeds.

If you have already grown a rice crop, choose the best seeds from your own harvest. Remove broken rice grains, misshapen grains, and grains attacked by insects.

It is best to use selected seeds.

If you have worked hard to prepare your field very well, you will get a better harvest if your seeds are well chosen.

The extension services and research centres have selected rice varieties best suited to the climate of each region, disease-resisting varieties which provide high yields.

Once you have chosen good seeds, use the finest seeds of your own harvest for sowing in the following years.

## 19. Disinfecting the seeds.

The disinfectant is available from the extension services. Mix the seeds and the disinfectant very well, so that the disinfectant covers all the seeds.

For example, you might mix 200 grammes of a disinfectant such as Crgan with 100 kilogrammes of rice seed.

## 20. Disinfectant is poisonous

Be very careful in using it:

- Wash your hands well after touching the disinfectant.
- Never give disinfected seeds to animals.

- Never leave the disinfectant where children can get at it.

Disinfected seeds are not eaten by insects. Disinfected seeds do not rot easily. All the seeds will grow, there will be very few plants missing.

Disinfection makes for good density, and so the yield is better.

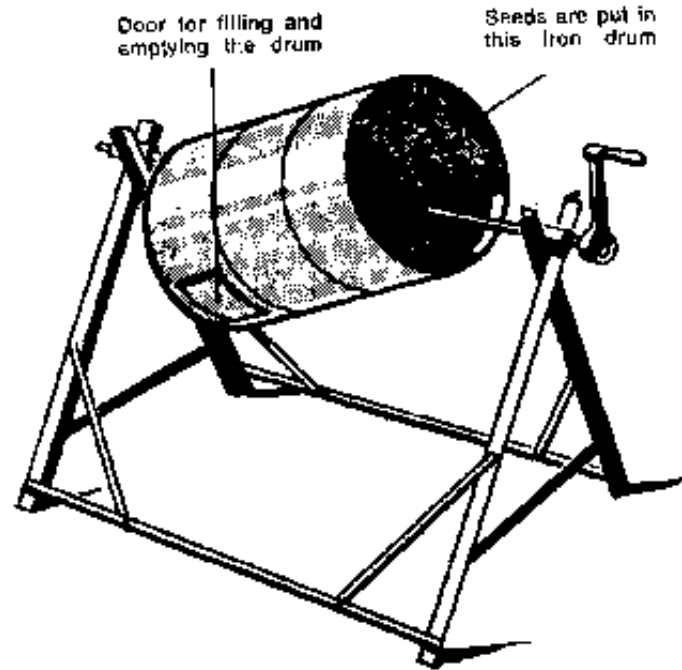

Device for disinfecting seeds

## 21. Sowing in rows.

Farmers have the habit of broadcasting their seed.

If the seed is broadcast, it is very difficult later to remove the weeds.

If the seed is sown in rows, it is easier to remove weeds.

The animal that draws the hoe can walk between the rows.

On flat soil, you can trace your rows with a marker. Leave 40 centimetres between rows. The spikes of the marker make a little furrow.

In this furrow, put your rice seeds.

Leave 1 to 2 centimetres between seeds. Cover the seeds with a little earth.

You will need between 30 and 50 kilogrammes of seed for 1 hectare.

22. On net soil you can use a seed- planting machine, called a seed drill.

In several countries people are beginning to use these seed drills, which are drawn by a donkey or by oxen. The seed drill makes a furrow and places the seeds in the soil at the same distance from each other and all at the same depth.

With some seed drills the fertilizer can be applied at the same time.

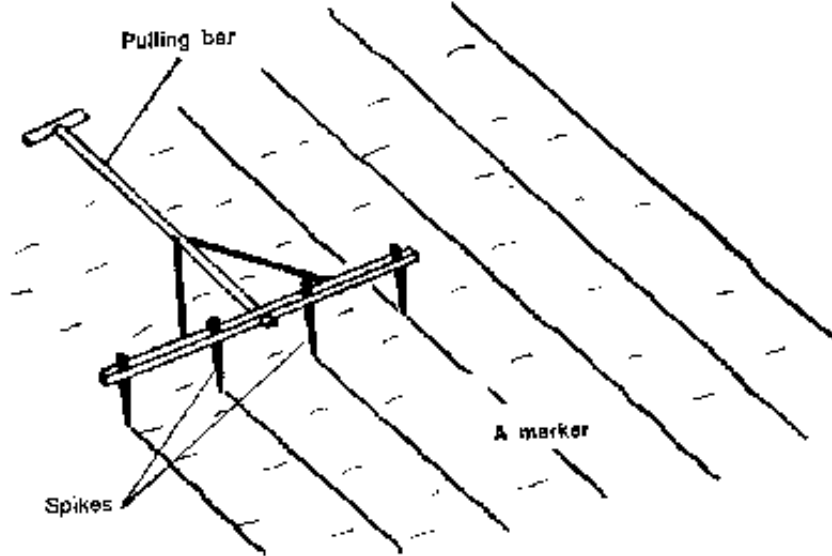

Use a seed- planting machine

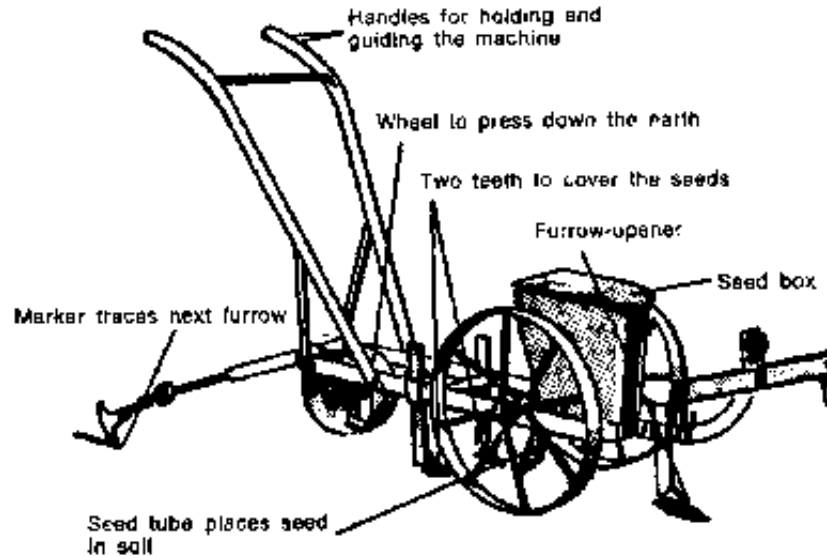

Seed drill

23. If the field is on a slope, make the seed rows along the contour lines and leave barrier strips between the different levels of soil.

This helps to reduce erosion.



Fast- flowing water carries away some soil.

It is dirty water mixed with soil.

When you slow up the water, the soil in the water drops to the ground.

The water becomes cleaner and the soil is not lost.

What is a contour line? Look at these two drawings.



Lines in the direction of the slope

These lines follow the direction of the slope. Water flows very fast and carries away the soil.

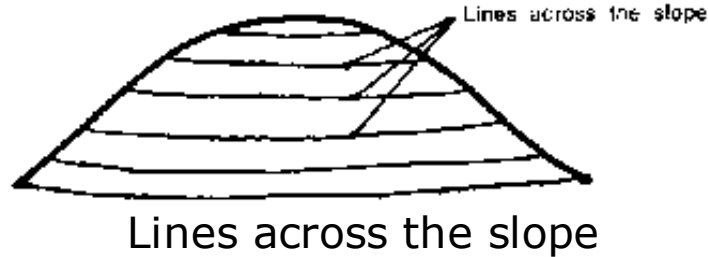

These lines cut across the slope along the contour lines. Water and soil are held back.

A contour line is a line across the slope running always at the same height.

24. What is a barrier strip?

A barrier strip is an uncultivated strip of land. Grass grows on this strip and holds back the water so that the soil drops to the ground. The barrier strips must also follow the contour lines. A barrier strip should be about 2 metres wide.

To hold back the water better, you can plant tall grasses.

If the slope is very gentle, you can leave 30 to 40 metres between barrier strips.

If the slope is steeper, leave only 10 to 20 metres between barrier strips.

Do not grow rice if the slope is very steep.

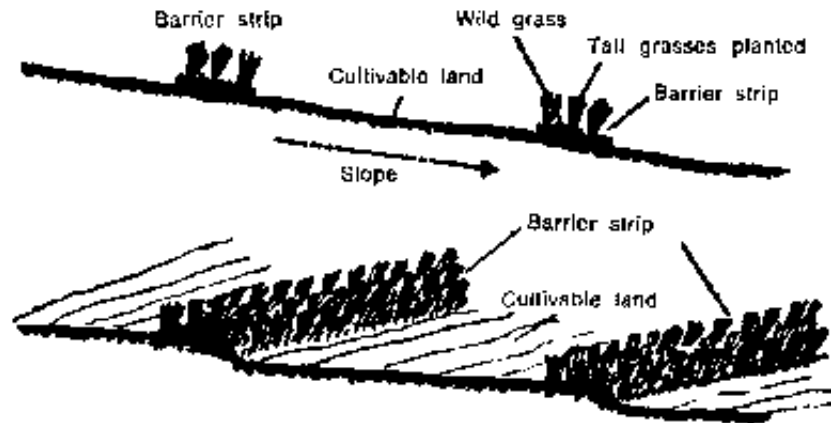

Do not grow rice if the slope is very steep

## Cultivating

Cultivate 15 to 20 days after sowing, and again whenever fresh weeds have grown.



Weeds prevent tillering: there are few panicles of rice



Good weeding encourages tillering: there are many panicles of rice

## Cultivating

25. Why cultivations are needed.

Cultivating means removing weeds by hoeing.

Weeds prevent the rice from growing well:

- they take water out of the soil
- they take mineral salts out of the soil.

When you cultivate well the buds at the bottom of the main stem can develop and make new stems. This is called tillering.

For every grain you sow, you will get several stems and every stem makes a head or panicle of rice.

26. How to cultivate.

You can cultivate either with a hand hoe or with an animal-drawn cultivator. With an animal-drawn cultivator, the work is done more quickly and you can cultivate more often.

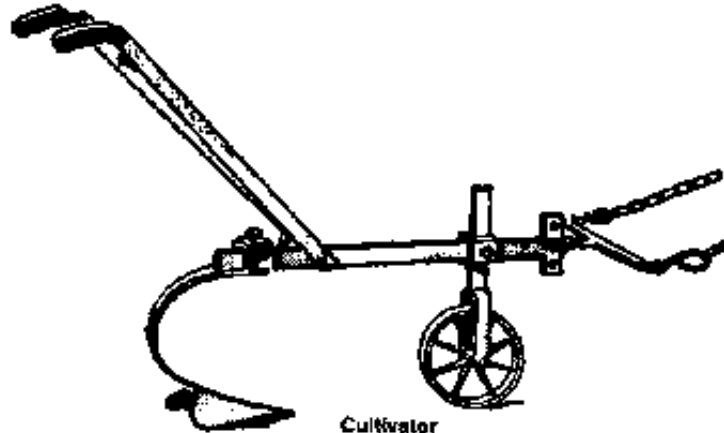

Side tines have been removed

## Cultivator

Whenever you see that weeds have grown, you must remove them.

Pull out the weeds that have grown between the rows. If any weeds grow in the rows, pull them out by hand. Remove the side teeth of the cultivator so that you can pass with it between the rows.

Rice sown on a well- prepared field, at the right time and In rows, and protected by frequent cultivations, will give a good harvest.



[Home](#)-immediately access 800+ free online publications.  
[Download](#) CD3WD (680 Megabytes) and distribute it to the 3rd World. CD3WD is a 3rd World Development private-sector initiative, mastered by Software Developer [Alex Weir](#) and hosted by [GNUveau Networks](#) (From globally distributed organizations, to supercomputers, to a small home server, if it's Linux, we know it.)[ar](#).[cn](#).[de](#).[en](#).[es](#).[fr](#).[id](#).[it](#).[ph](#).[po](#).[ru](#).[sw](#)

---

 Better Farming Series 20 - Upland Rice  
(FAO - INADES, 1977, 30 p.)

➔  Using fertilizers

 (*introduction...*)

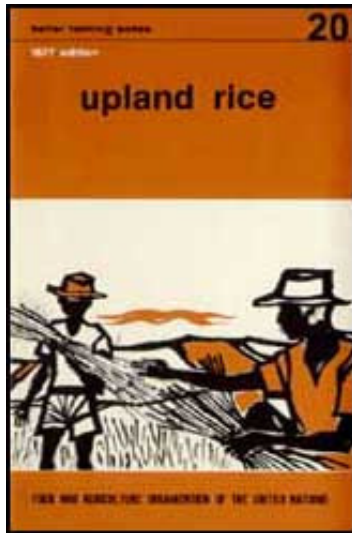

- Why apply manure or chemical fertilizers?
- What fertilizers to use
- Organic manure and chemical fertilizers

## **Better Farming Series 20 - Upland Rice (FAO - INADES, 1977, 30 p.)**

### **Using fertilizers**

27. You are now ready for further progress.



If you use new tools and also apply fertilizers, you will be growing upland rice by very modern methods. You have seen how you can make good use of animal- drawn tools.

You can get a good harvest if you:

- till your field well
- sow well
- weed well
- cultivate a larger field,

You will find that you earn more money.

With the money earned from your crop, you can buy fertilizers

We shall now study how to use fertilizers so that you can earn

a lot more money. If you use fertilizers, you keep the soil fertile or even make it more fertile.

Once you do that, you change from shifting cultivation to continuous cultivation.

## **Why apply manure or chemical fertilizers?**

28. To get a good harvest

If you apply manure or chemical fertilizers to your rice field, the rice will tiller vigorously (see paragraph 25) and bear many grains: The yield will be good.

29. To keep the soil rich

Chemical fertilizers give back to the soil the mineral salts which the plants take out. Manure gives the soil organic matter. It makes humus and improves the soil structure.

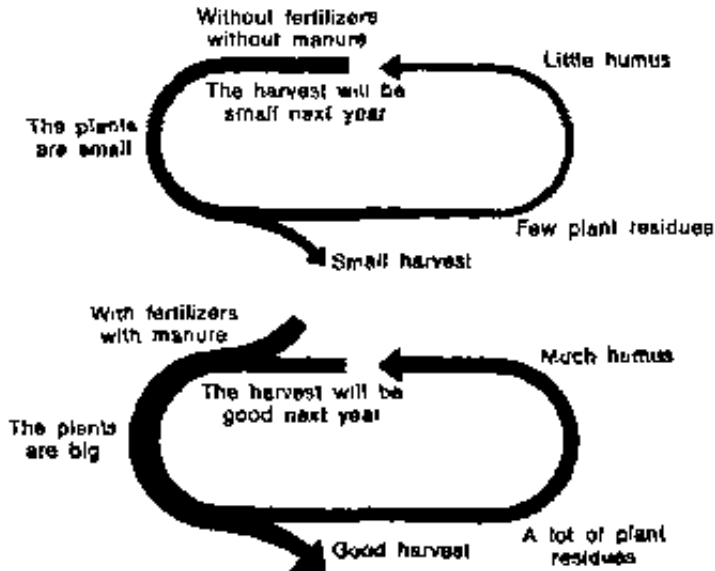

To keep the soil rich

30. Chemical fertilizers and manure cost a lot of money.

They will not pay

- if you grow your crop on too steep a slope the mineral salts

of the manure and fertilizers are washed away by water together with the soil.

- if you do not till the soil well because in badly prepared soil the roots cannot develop well.
- if you do not sow selected varieties because unimproved varieties use the manure and fertilizers less well.
- if you do not sow your seeds in rows and at the right time because plants sown too late will not yield so well.
- if you do not cultivate about 3 weeks after sowing and whenever new weeds grow because with fertilizers, the weeds grow better. If you do not remove them often, they may take a large part of the nourishment from the rice.
- if you do not rotate your crops correctly

After 8 rice crop, the soil will still have some of the mineral salts added by the manure and the chemical fertilizers. You must make the right choice of the crop you will grow on the same field after the rice. If possible, choose one that will use the mineral salts still in the soil.

The money earned from a good crop will easily pay for the fertilizers you need.

## **What fertilizers to use**

31. Fertilizers are different.

- according to the crop rotation:

Plants do not all take the same quantity of each mineral salt out of the soil. Before sowing rice, you must therefore give back to the soil the mineral salts taken out by the preceding crop.

These mineral salts are contained in chemical fertilizers.

- according to regions:

The soils of different regions are often different; they do not contain the same quantity of each mineral salt.

For example, a soil very poor in nitrogen must be given a lot of nitrogen.

You can see that a soil is poor in nitrogen if the young leaves turn yellow.

## **Organic manure and chemical fertilizers**

32. Organic manures are animal manure and green manure.

Organic manures improve the structure of the soil. Plants grow better in a soil of good structure, and the chemical fertilizers

are used better.

Organic manuring should therefore be done at the beginning of the rotation, that is, before growing the first crop on a field. For example

If in the first year after clearing the field you grow a crop of yams and the second year you grow rice, you must apply organic manure in the first year before you plant your yams.

### 33. Chemical fertilizers.

You know that the main chemical fertilizers are:

- Nitrogen (N)
- Phosphorus (P)
- Potassium (K)

Rice needs above all nitrogen.

The nitrogen fertilizer most often suitable for the soils of Africa is ammonium sulfate.

But rice also needs phosphorus and potassium. If the rice cannot take out of the soil enough phosphorus and potassium, the stems are not strong and so they bend down to the earth so that the grains cannot form and ripen well.

Ask advice from the extension services in your area. They will tell you how much fertilizer to apply to your rice field.

It is best to apply nitrogen, that is, ammonium sulfate, in three separate applications:

For example

It you have to give your field 100 kilogrammes of ammonium



sulfate, apply:

- 40 kg before sowing,
- 30 kg after the first cultivation,
- 30 kg when you see the panicles are forming.

Be careful not to let ammonium sulfate, get onto the leaves; the fertilizer may burn them.

Phosphoric acid and potassium are applied before sowing.



[Home](#)-immediately access 800+ free online publications.  
[Download](#) CD3WD (680 Megabytes) and distribute it to the 3rd World. CD3WD is a 3rd World Development private-sector initiative, mastered by Software Developer [Alex Weir](#) and

hosted by [GNUveau Networks](#) (From globally distributed organizations, to supercomputers, to a small home server, if it's Linux, we know it.)[ar.cn.de.en.es.fr.id.it.ph.po.ru.sw](#)

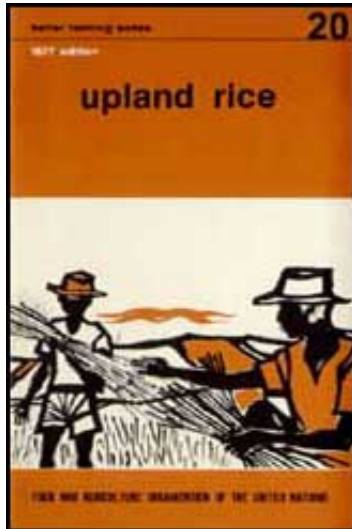

 Better Farming Series 20 - Upland Rice  
(FAO - INADES, 1977, 30 p.)

 *(introduction...)*

 Preface

 People need more rice to eat

 How to improve upland rice cultivation

 Using new implements

 Using fertilizers

  Harvesting

 Suggested question paper

## **Harvesting**

You will get a better price for your rice crop

- If you cut your rice only when it is ripe
- If the rice is well dried and threshed
- If it has been well stored.

### 34. Cutting.

Cut the rice when it is ripe.

Wait until the heads are almost entirely yellow.

You can cut the rice more quickly with a sickle.

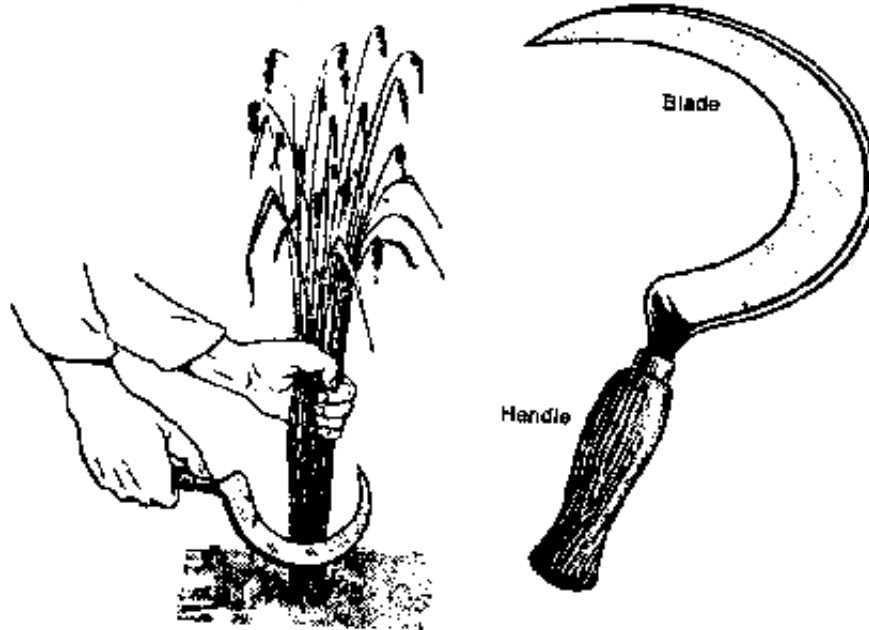

Cut the rice

### 35. Drying.

When you have cut the rice, make sheaves by binding a lot of stems together. There are two ways of drying sheaves well.

Wither: Stack the sheaves so that they lean against each other, standing upright with heads upward, and place one sheaf over the top of the heads, so as to protect the grains from the rain;

Or: Lean the sheaves against a stick supported by two poles.

Either way the rice can dry well.

Leave the rice to dry for three or four days before threshing.

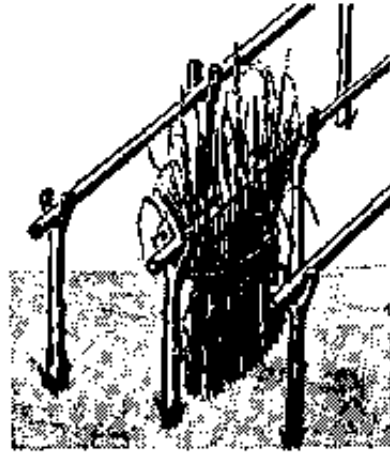

Sheaves leaning against a stick supported by 2 poles

Sheaves leaning against a stick supported by 2 poles

### 36. Threshing.

There are three ways of threshing well.

Wither: Put the rice on a hard piece of ground, very clean and without dust, or covered with mats, and beat the heads with a

stick;

Or: Beat the rice against a large stone or a tree trunk;

Or Use a small thresher. You can join with a few other farmers and buy a small thresher together. In this way the work can be done better and more quickly.

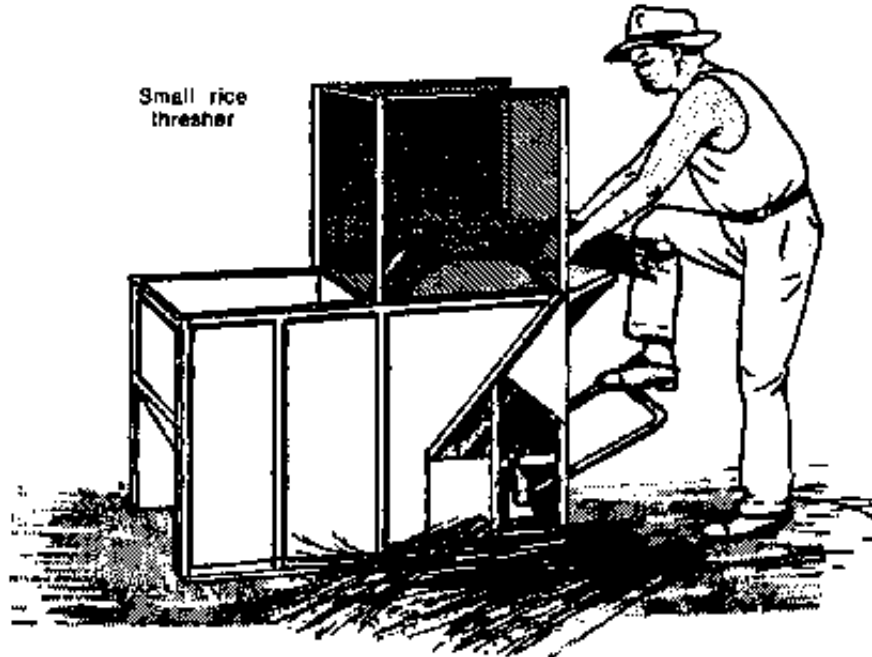

Small rice thresher

### 37. Winnowing.

It is important that the rice grains should be very clean, and not mixed up with earth and little stones. When you have



threshed your rice, winnow it to make it quite clean.

For winnowing, use a sieve or else pour the rice from one flat bowl into another.



The wind blows the dirt away

## 38. Storing.

Rice can be stored either in sacks or in a barn.

The sacks and the barn must be protected

- against damp, which makes the grains rot
- against rats and insects, which eat or spoil the grains.

The barn floor must not touch the ground. This will keep the rice dry.

The barns must be disinfected. Ask the local extension service what disinfectants to use and how to apply them: some disinfectants are poisonous.

Rice can be eaten by the family. Rice can also be sold, either on the market or to companies which resell it afterwards.

Rice is a crop which can pay well.



[Home](#)-immediately access 800+ free online publications.  
[Download](#) CD3WD (680 Megabytes) and distribute it to the 3rd World. CD3WD is a 3rd World Development private-sector initiative, mastered by Software Developer [Alex Weir](#) and hosted by [GNUveau Networks](#) (From globally distributed organizations, to supercomputers, to a small home server, if it's Linux, we know it.)[ar](#).[cn](#).[de](#).[en](#).[es](#).[fr](#).[id](#).[it](#).[ph](#).[po](#).[ru](#).[sw](#)

---

 Better Farming Series 20 - Upland Rice  
(FAO - INADES, 1977, 30 p.)

 (*introduction...*)

 Preface

 People need more rice to eat



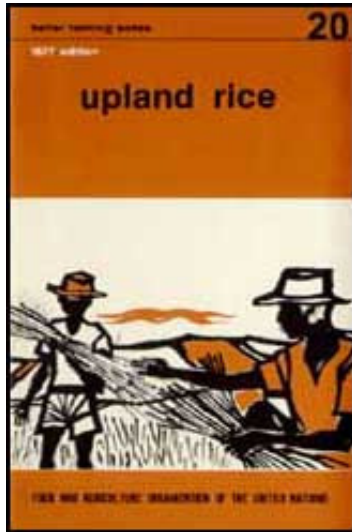

## How to improve upland rice

- cultivation
- Using new implements
- Using fertilizers
- Harvesting
- ➔  Suggested question paper

### **Suggested question paper**

#### FILL IN THE MISSING WORDS

You should no longer use the.....method of growing rice.

It is best to use..... seeds.

An uncultivated strip of land is called a.....

..... and ..... are organic manures.

Rice needs above all.....

The rice is cut when.....

To thresh rice you can use.....

## ANSWER THE FOLLOWING QUESTIONS

Why must rice production be increased?

Is much rice grown where you live?

Say why it is better to till the soil with a plough.

How can you break up the clods on the field after ploughing?

How can you control erosion when growing upland rice?

How should a farmer choose his seeds?

Why should shifting cultivation be stopped?

What is a quick and good way of removing weeds?

Why must you apply manure and fertilizers?

How is rice cut where you live?

What tool is used?

How is rice threshed where you live?

What is a good way of storing rice?

Is the use of fertilizers always profitable?

What must be done to make the use of fertilizers profitable?

