

Home-immediately access 800+ free online publications.  
Download CD3WD (680 Megabytes) and distribute it to the 3rd World. CD3WD is a 3rd World Development private-sector initiative, mastered by Software Developer Alex Weir and hosted by GNUveau Networks (From globally distributed organizations, to supercomputers, to a small home server, if it's Linux, we know it.)[ar](#).[cn](#).[de](#).[en](#).[es](#).[fr](#).[id](#).[it](#).[ph](#).[po](#).[ru](#).[sw](#)

---

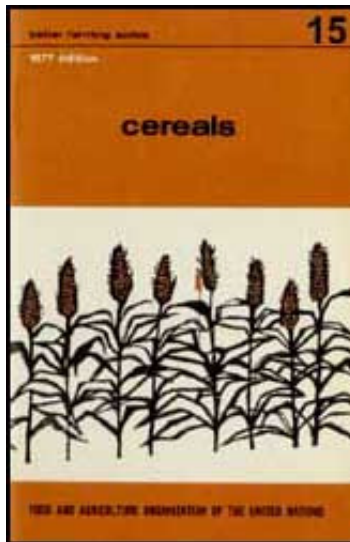

Better Farming Series 15 - Cereals  
(FAO - INADES, 1977, 51 p.)



*(introduction...)*



Preface



What are food crops?















*(introduction...)*

















What cereals are grown in Africa?



Why cereals are grown

-  Why we should produce and sell more cereals
-  Traditional cereal growing
-  Growing cereals in the modern way
  -  Clearing land and grubbing out trees
  -  Conserving and improving the soil
  -  Applying manure and fertilizers
  -  Preparing the soil
  -  Selecting and preparing seeds
  
  -  Sowing in rows
  -  How to look after cereals
  -  Harvesting
  -  Selling part of the harvest
-  Sorghum and millet

-  *(introduction...)*
-  Sorghum
-  Millet
  -  *(introduction...)*
  -  How to grow sorghum and millet
    -  *(introduction...)*
    -  Growing sorghum in the dry season
    -  Sorghum for animal feeding
-  Maize
  -  *(introduction...)*
  -  Traditional maize growing
  -  How to increase maize yields
-  Other cereals
  - 

 **Fonio** Finger millet **Wheat** Suggested question paper

[Home](#)-immediately access 800+ free online publications.  
[Download](#) CD3WD (680 Megabytes) and distribute it to the 3rd World. CD3WD is a 3rd World Development private-sector initiative, mastered by Software Developer [Alex Weir](#) and hosted by [GNUveau Networks](#) (From globally distributed organizations, to supercomputers, to a small home server, if it's Linux, we know it.)[ar](#).[cn](#).[de](#).[en](#).[es](#).[fr](#).[id](#).[it](#).[ph](#).[po](#).[ru](#).[sw](#)

---

 Better Farming Series 15 - Cereals  
(FAO - INADES, 1977, 51 p.)  (*introduction...*) Preface

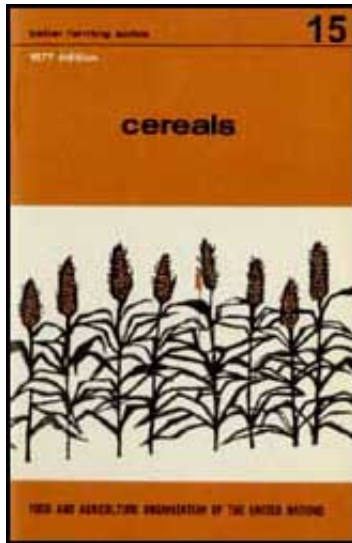

- What are food crops?
- Growing cereals in the modern way
- Sorghum and millet
- Maize
- Other cereals
- Suggested question paper

Published by arrangement with the  
Institut africain pour la dveloppement conomique et social  
B.P. 8008, Abidjan, Cte d'Ivoire

FOOD AND AGRICULTURE ORGANIZATION OF THE UNITED  
NATIONS  
Rome 1977

# FAO Economic and Social Development Series No. 3/15

First published 1977

Reprinted 1984

P-69

ISBN 92-5-100150-2

© French edition, Institut africain pour le dveloppement  
conomique et social (INADES) 1970

© English edition, FAO 1977



[Home](#)-immediately access 800+ free online publications.  
[Download](#) CD3WD (680 Megabytes) and distribute it to the 3rd  
World. CD3WD is a 3rd World Development private-sector  
initiative, mastered by Software Developer [Alex Weir](#) and  
hosted by [GNUveau Networks](#) (From globally distributed

organizations, to supercomputers, to a small home server, if it's Linux, we know it.)[ar](#).[cn](#).[de](#).[en](#).[es](#).[fr](#).[id](#).[it](#).[ph](#).[po](#).[ru](#).[sw](#)

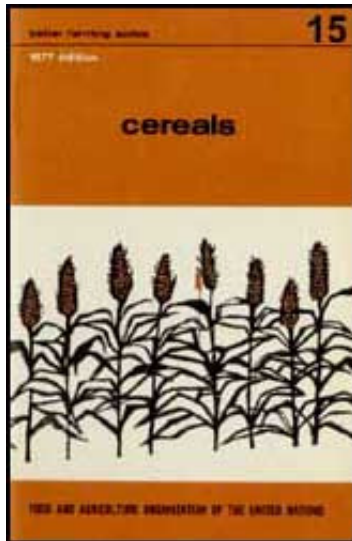

Better Farming Series 15 - Cereals  
(FAO - INADES, 1977, 51 p.)



*(introduction...)*



Preface



What are food crops?



Growing cereals in the modern way



Sorghum and millet



Maize



Other cereals



Suggested question paper

## Preface

The first twenty- six volumes in FAO's Better Farming Series were based on the Cours d'apprentissage agricole prepared in the Ivory Coast by the Institut africain de developpement economique et social for use by extension workers. Later volumes, beginning with No. 27, have been prepared by FAO for use in agricultural development at the farm and family level. The approach has deliberately been a general one, the intention being to constitute basic prototype outlines to be modified or expanded in each area according to local conditions of agriculture.

Many of the booklets deal with specific crops and techniques, while others are intended to give the farmer more general information which can help him to understand why he does what he does, so that he will be able to do it better.

Adaptations of the series, or of individual volumes in it, have been published in Amharic, Arabic, Bengali, Creole, Hindi,



Igala, Indonesian, Kiswahili, Malagasy, SiSwati and Turkish, an indication of the success and usefulness of this series.

Requests for permission to issue this manual in other languages and to adapt it according to local climatic and ecological conditions are welcomed. They should be addressed to the Director, Publications Division, Food and Agriculture Organization of the United Nations, Via delle Terme di Caracalla, 00100 Rome, Italy.





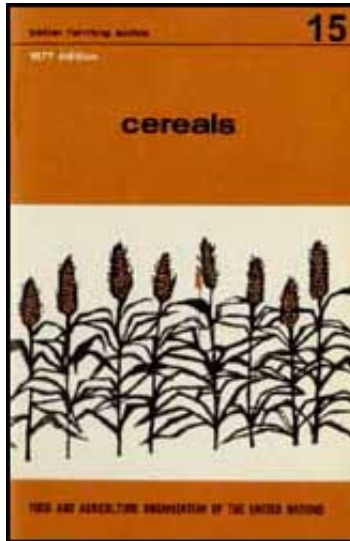

[Home](#)-immediately access 800+ free online publications. [Download](#) CD3WD (680 Megabytes) and distribute it to the 3rd World. CD3WD is a 3rd World Development private-sector initiative, mastered by Software Developer [Alex Weir](#) and hosted by [GNUveau Networks](#) (From globally distributed organizations, to supercomputers, to a small home server, if

it's Linux, we know it.)[ar.cn.de.en.es.fr.id.it.ph.po.ru.sw](#)



 Better Farming Series 15 - Cereals  
(FAO - INADES, 1977, 51 p.)

- ➔  What are food crops?
  -  *(introduction...)*
  -  What cereals are grown in Africa?
  -  Why cereals are grown
  -  Why we should produce and sell more cereals
  -  Traditional cereal growing

**Better Farming Series 15 - Cereals (FAO - INADES, 1977, 51 p.)**

**What are food crops?**

To live, man must eat.

- At one time men gathered and picked the fruits, leaves, and seeds of trees and plants. To get meat and fish they hunted and fished.
- But nowadays hunting, fishing and food gathering are no longer enough to feed all the people. Crops have to be grown to provide food. These crops are called food crops.
- Nowadays the inhabitants of African villages grow many food crops.

They grow mainly:

- cereals such as sorghum, millet, rice, maize;
- tubers such as yams, sweet potatoes, cocoyams, tania, potatoes;
- root crops such as cassava;

- legumes such as cow peas, Bambarra groundnuts, groundnuts and soybeans;
- bananas and plantains.

In this book/et we study only cereals.

We shall deal with other food crops in other booklets.

## **What cereals are grown in Africa?**

Cereals are plants that yield grains. Grains are used to feed both man and beast.

- Certain cereals are grown in almost all parts of Africa. These are mainly millet, sorghum, maize and rice. Millet and sorghum are grown in savanna country where it is dry. Maize is grown everywhere, in savanna country and in forest country. Rice used to be grown only in certain regions. But now more and more rice is eaten in Africa and it is grown

everywhere.

- Other cereals are less known. They are grown only in some regions. Fonio is grown in west Africa. Finger millet (Eleusine) is grown in Zaire, Rwanda and Burundi. Teff is grown in the mountains of Ethiopia. Wheat is a cereal of cold countries, but it grows well in regions near deserts such as Mauritania, Mali, Niger, Chad, as well as in hilly regions like eastern Zaire, Rwanda, Burundi.

In this book/et we shall deal chiefly with sorghum, millet and maize. We shall not speak about rice because there are two booklets on rice, one on upland rice and one on wet paddy or swamp rice. We shall deal briefly with fonio, finger millet and wheat.

## **Why cereals are grown**

## We grow cereals for their grain.

- Cereal grains are rich foods.

They are energy foods. To live, work, walk, men need plenty of energy, plenty of strength. Cereal grains give this strength.

They are body- building foods. Men need to eat such builder foods in order to grow, to make their bodies, their skin and muscles. These builder foods are the proteins. Cereal grains contain lots of protein.

- Cereal grains are good food
- for people. The inhabitants of savanna regions live mainly on millet. In all African countries rice has become a very important food.
- for animals. When animal power is used in farm work, the

animals have to be well fed. To make the animals strong, we give them millet or maize as a feed supplement. Maize can also be given to chickens and pigs.

Cereals can be grown in order to give their green stems to animals. With the green stems you can make hay and silage (See the course on animal husbandry).

## **Why we should produce and sell more cereals**

We must produce more food to feed more people.

There are more people in the world. Fewer children die. Men and women live longer.

- We must produce more food to sell to people who do not grow any.

Many people go to live in towns. These men and women do not

farm the land; they buy their food. Even in villages there are men and women who have new jobs, such as teachers, officials, traders. They do not farm the land. So the farmers have to produce more millet, more maize, more rice, to sell to people in towns and villages who do not farm the land.

- Farmers should produce more cereals.

But near the villages there are often no new fields to cultivate.

In savanna country there is no time during the short rainy season to cultivate bigger fields.

So farmers must produce more from the same area.

That means they must increase the yield of their cereal crops.

But you cannot increase the yield much if you farm in the traditional way.



## **Traditional cereal growing**

- In traditional farming the African farmer clears the land a little, cuts down the herbage and small trees, makes a brush fire and sows. He cultivates this field for two or three years, then leaves it and clears another field. This is called shifting cultivation.

This way of farming is bad. The brush fires spoil the soil and destroy the organic matter. Every year the farmer has to clear a new field. He loses much time and often sows too late.

With shifting cultivation a great deal of land is unused and produces no harvest. Sometimes there is not enough land to feed the people. In many places shifting cultivation cannot be done any more.

- The farmer works with only a few tools. He uses only a

machete and a hoe. He cuts the trees and the herbage with the machete. He scratches the soil a little with the hoe. The soil is not well turned over, and water and air do not get well into the soil. Plants are not well nourished.

- The farmer does not enrich the soil. Usually he has no animals, and so does not put any manure on the field. He does not use fertilizers. So the soil stays poor and yields a small harvest.







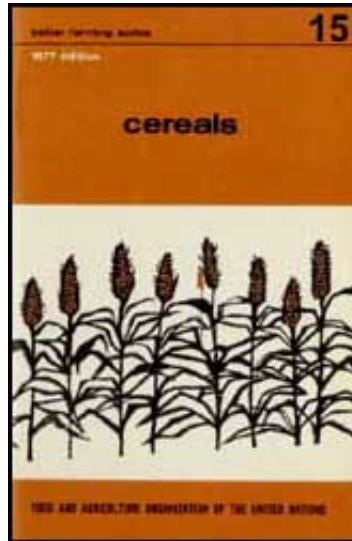



[Home](#)-immediately access 800+ free online publications. [Download](#) CD3WD (680 Megabytes) and distribute it to the 3rd World. CD3WD is a 3rd World Development private-sector initiative, mastered by Software Developer [Alex Weir](#) and hosted by [GNUveau Networks](#) (From globally distributed organizations, to supercomputers, to a small home server, if

it's Linux, we know it.)[ar.cn.de.en.es.fr.id.it.ph.po.ru.sw](#)



## Better Farming Series 15 - Cereals (FAO - INADES, 1977, 51 p.)

- ➔  Growing cereals in the modern way
  -  Clearing land and grubbing out trees
  -  Conserving and improving the soil
  -  Applying manure and fertilizers
  -  Preparing the soil
  -  Selecting and preparing seeds
  -  Sowing in rows
  
  -  How to look after cereals
  -  Harvesting



## Selling part of the harvest

# **Better Farming Series 15 - Cereals (FAO - INADES, 1977, 51 p.)**

## **Growing cereals in the modern way**

### **Clearing land and grubbing out trees**

A modern farmer who uses animal power must clear his fields and grub out the trees.

He must take out all the trees, even the biggest. And he must get out the tree stumps. If he does not remove the stumps, his tools (his hoe and plough) will get bent on the big roots. He will not be able to use animal power. He will not be able to sow in rows. He will not be able to use an animal- drawn cultivator.

The stumps and trees will go on taking food from the soil. Around the stumps and trees the crops will grow less well.

## HOW TO GRUB OUT TREES

You can pull out the trees and the stumps with a tractor. But that costs a lot, and most farmers have no tractor.

You can also pull out trees and their stumps with a winch. Fix the winch to a big strong tree and tie the cable of the winch to the tree you want to pull out.

Then turn the winch until the cable pulls out the tree, stump and all.

A winch does not cost much.

The farmers in a village can join together to buy a winch. Then they can quickly clear all the fields of the village.

You can also grub out trees with hand tools.

Take away the soil round the base of the tree, so as to uncover the roots. Then cut all the roots. Finally, with a rope pull down the tree. Its stump will be pulled out at the same time.

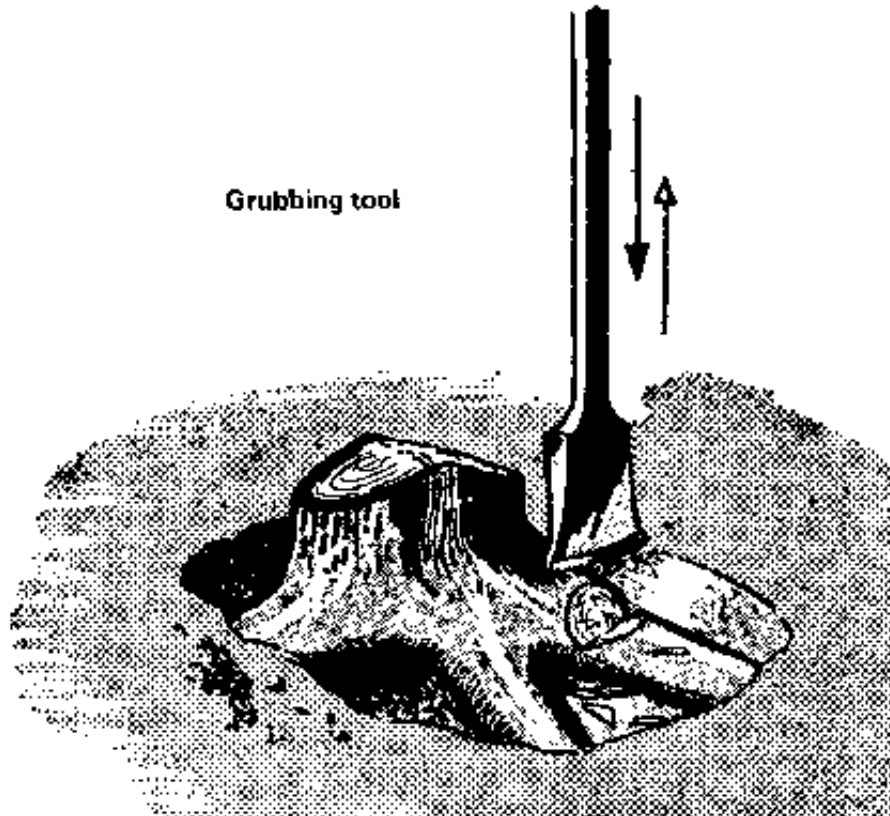

Grubbing tool

Grubbing must be done well before sowing, at the beginning of

the dry season. At that time the soil is still moist, and trees are easily pulled out, Thus the field will be cleared of stumps before sowing time. There will be time for tilling the soil and the sowing will not be late.

## **Conserving and improving the soil**

Soil must be protected against erosion

When a field is cultivated, the soil is often left bare. When it rains very hard, the water flows fast, and carries away the good soil. This is erosion. The soil becomes less fertile, and afterwards the harvests are less good.

When the ground is on a slope, you must till and make the rows across the slope, that is, on the contour lines. By this means the water will not flow so fast, and the good soil will not be carried away.



When the slope is very steep, terrace farming is used. You build little walls of earth or stones to hold back the good soil. In some mountainous regions there is a lot of terrace farming.

If the slope is not too steep, you can make ditches along the contour lines, or barrier strips, or ridges.

(See the first- year course on the soil).

- The soil must be protected against the sun.

When the sun is too strong it badly damages soil that is left bare. The sun quickly destroys the organic material in the soil. The soil loses its humus and becomes less fertile.

Bare soil must be covered. You can sow cover plants on land left fallow. For some crops you can use mulches which cover the soil and enrich it with humus.

- The fertility of the soil must be conserved.

To conserve soil fertility, crop rotation is used. Crop rotation means growing a different crop each year on the same field.

Why do we do this?

To feed, plants take different quantities of mineral salts from the soil. Different plants have different needs.

They take the mineral salts at different depths in the soil because they do not all have the same root system.

With crop rotation, the plants can use all the mineral salts in the soil and are better nourished. The soil does not get so poor.

For example: after groundnuts grow sorghum. Groundnuts and sorghum do not have the same root system, and they have

different needs.

An example of crop rotation is: yams; cotton; rice; groundnuts.

## **Applying manure and fertilizers**

Manure and fertilizer add to the soil mineral salts which feed the plants,

For the plants to make good use of the fertilizers, you must:

- Prepare the soil well.

In well-prepared soil, the plant roots develop well; they can take up all the mineral salts added by fertilizers and manure.

- Sow at the right time.

If you sow too late, the plants do not have enough water to grow and use all the mineral salts.

- Cultivate often.

Weeds take up mineral salts. Weeds must be removed whenever they grow.

- Rotate crops.

With good crop rotation, the different plants use all the mineral salts. The roots take up the mineral salts at different depths of soil.

Fertilizers are dear. Their cost is not repaid by the harvest, they are not profitable, if me farmer does not do all his work well.

## **Preparing the soil**

Farmers till their soil. Tilling means turning over the soil.

- Why tilling is needed

Tilling stirs up the soil. Then water and air can get right into it. Tilling loosens the soil. Seeds germinate easily in loose soil, and roots go well down.

Tilling mixes herbage with the soil. It cleans the soil. The herbage rots in the ground and makes humus. If manure has been spread, tilling mixes it with the soil.

- The time for tilling

Tilling is best done at the end of the rainy season, just after the harvest.

Then the ground will be prepared and sowing can be done as soon as the rains come.

If tilling is not possible after the harvest, it must be done as soon as the rains begin, so that the sowing is not too late.

- How to till

Tilling can be done with a hoe. But the work is long and tiring. The work is not done well; the soil is not fully turned over.

It is better to till with a plough. You must be a modern farmer, and till with an animal- drawn plough, using an ox or donkeys or a horse. Then the work is done more quickly and better. The soil is well turned over; water and air get well into the ground. You can sow in good time, you can cultivate bigger fields.

Handles for holding the plough

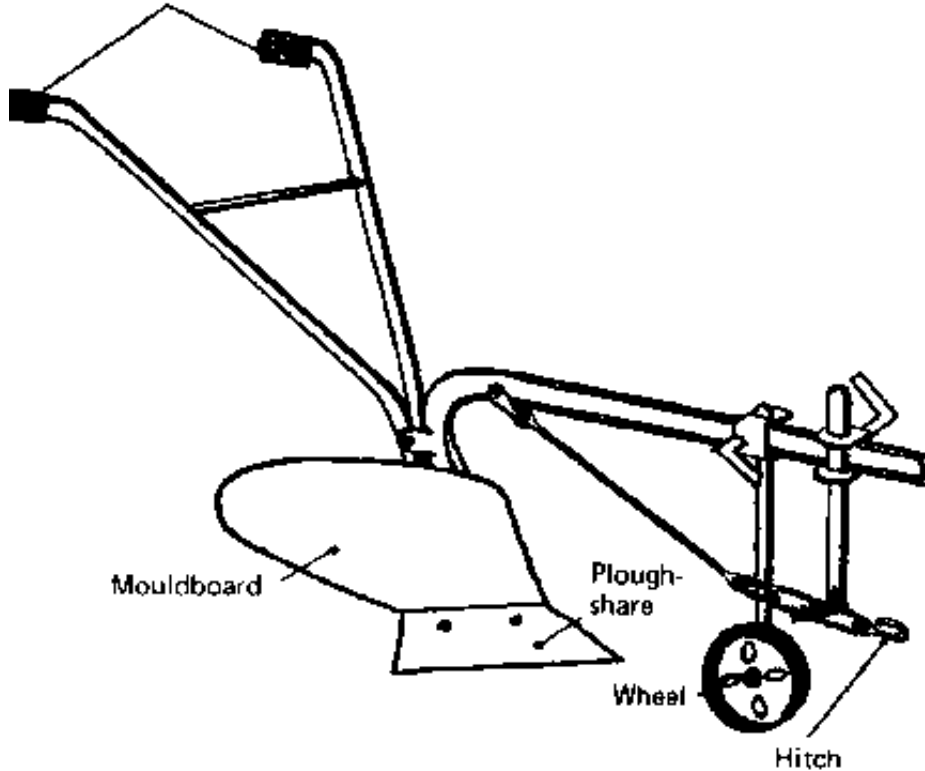

Handles for holding the plough

- Harrowing

After tilling, the soil is often not flat. There are big pieces of earth, big clods. To break up the clods, use a harrow. This is a tool with teeth that break the clods and make the soil flat. The harrow is drawn by an animal.

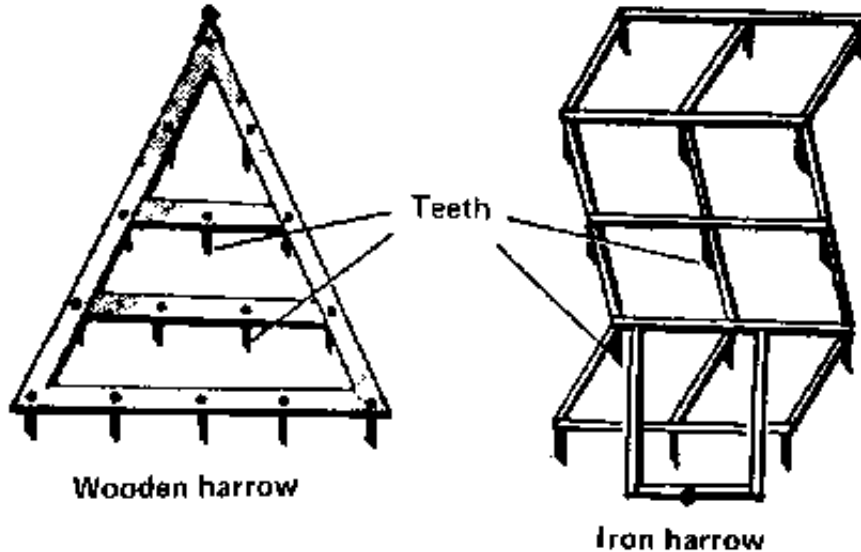

## Harrowing



If you do not have a harrow, make an animal drag large branches over the soil. The branches break up and crush the clods.

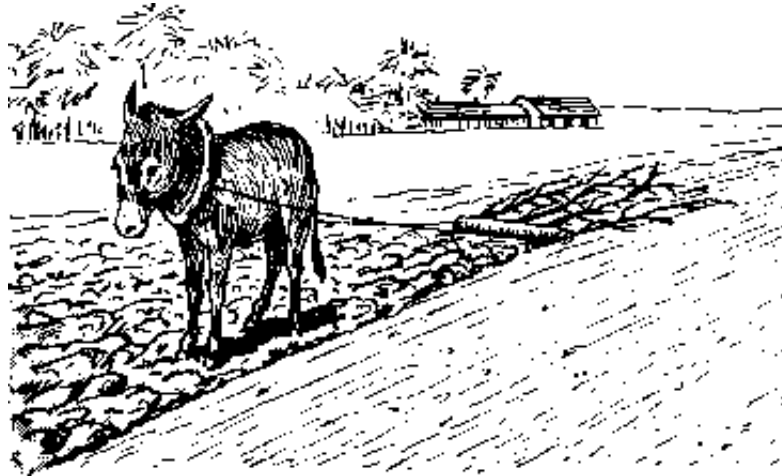

Animal drag large branches over the soil

## **Selecting and preparing seeds**

To get a good harvest, you must sow good seeds.

- Farmers can buy selected seeds.

Research stations select the best varieties, the ones which are best adapted to the climate which resist diseases well and give plentiful harvests.

These seeds are dear. To pay for them, you need a good harvest. The harvest will be good only if you do all your work well.

- Farmers can select seeds from their own crops.

Take the finest heads of grain, and from them only the well-formed seeds. The good qualities of these seeds will be passed on to the plants that grow from them.

- Farmers must store their seeds well.

Seeds should be dried before being put into the granary.

Seeds which are not quite dry may rot.

Cereal seeds must be protected against insects and rats. To protect seeds against insects, the seeds are mixed with an insecticide. To protect seeds against rats, the granary is raised well above the ground.

- Preparing seeds

Before sowing, take away all seeds that are broken, bitten, diseased or misshapen.

The seeds may also be disinfected. Mix the seeds with a pesticide, and see that the seeds are well covered by it.

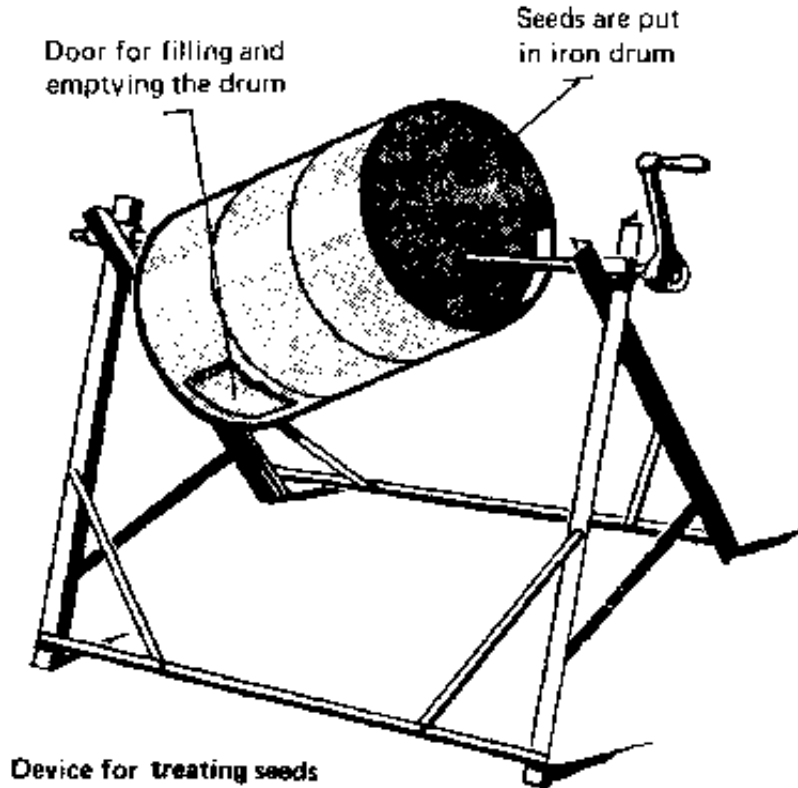

Disinfected seeds are not eaten by insects. They do not rot. All

the seeds will grow and very few plants will be missing in the rows.

By sowing disinfected seeds you get a good density; the yield is better.

## **Sowing in rows**

In Africa it is usual to sow cereals broadcast. This is a bad way of doing it.

- It is better to sow in rows.

Sowing in rows means that the seedlings will be at the same distance from each other. Animal power can be used and the cultivations are easier; the animal that pulls the hoe can pass between the rows. It is easier to give each plant the same amount of fertilizers.

On flat soil the rows can be traced with a marker. The marker

can be pulled by hand or by a donkey. The spikes of the marker trace the rows where the seed will be planted.

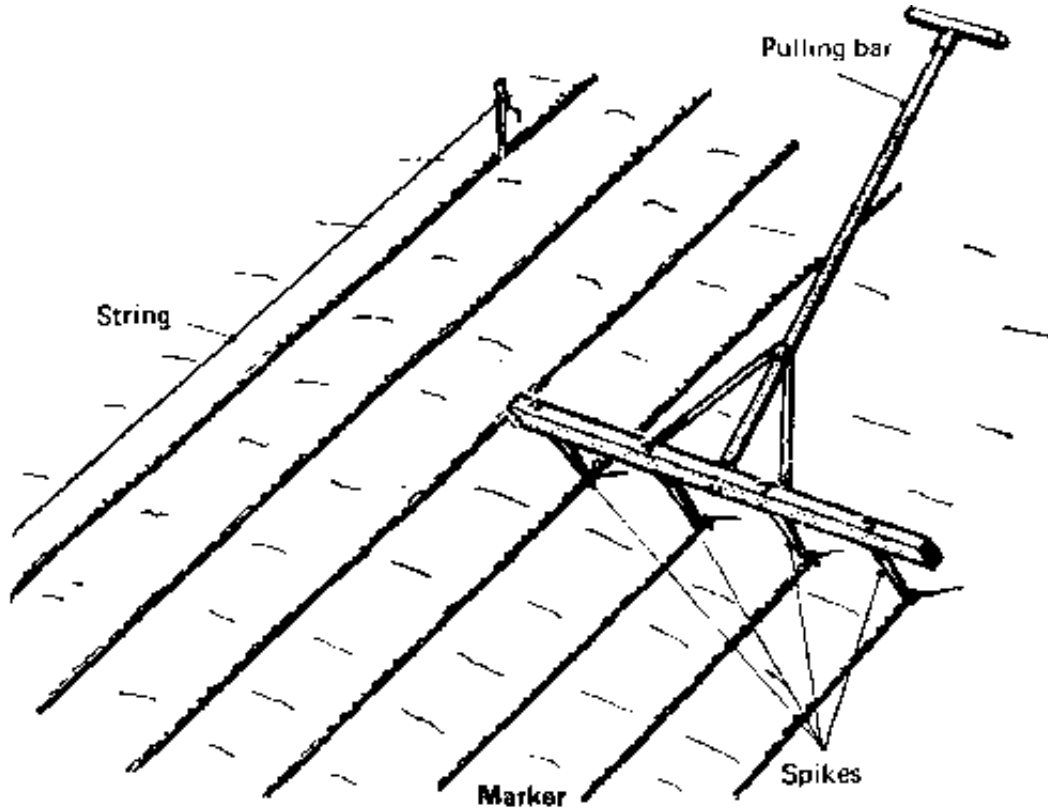

## Tracing rows with a marker

When the seed rows have been traced by the marker, the farmer puts the cereal seeds the same distance apart along each row.

- To do the work more quickly, a seed drill can be used. It is pulled by an animal. The seed drill makes a furrow in the soil and drops the seeds at the same distance from each other. A little wheel at the back of the drill covers the seeds with 2 or 3 centimetres of earth.

With this machine you can sow quickly and with an even density.

Some seed drills apply fertilizer at the same time.

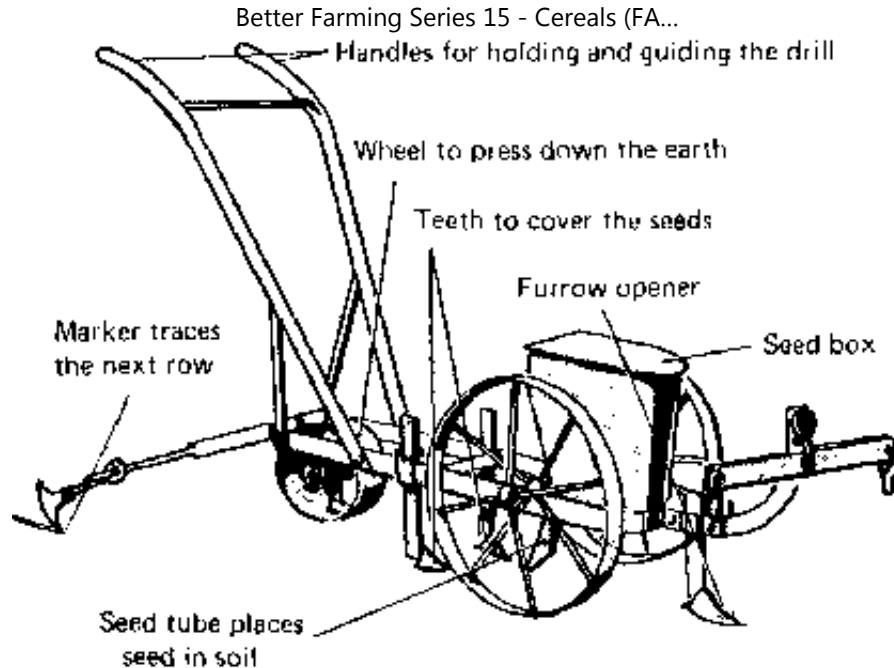

Seed drill

## How to look after cereals

- Seedlings which have not grown must be replaced.



A week after sowing you will see empty places where no plants have grown. Sow again in these empty places, so as to have a fully planted field of good density.

- Thinning must be done.

If you have sown in seed holes, there are often 4 or 5 young plants in each seed hole. To make the cereals grow better, it is best not to keep all the seedlings. Keep only two seedlings in each hole. Pull out the smallest, and keep the best plants.

When you pull out the unwanted seedlings, you disturb the soil. So you must press the soil back round the young plants that remain



You must press the soil

With one hand, hold the soil round the plants that are not removed.

## CULTIVATING

Cultivating means removing weeds.

- Why cultivating is needed

Weeds in the ground take food away from the crop. They take water and mineral salts out of the soil. They also take the mineral salts added in fertilizers.

Weeds take the place of good plants. They cast shade by cultivating, you stir up the soil. You mix air with the soil, break up the dry crust, and prevent water from rising and being lost. The soil remains moister.

- When to cultivate

The first cultivation must be done when the weeds are still small, two weeks after sowing.

This first cultivation is very important, because it enables the young plants to make a good start.

Afterwards you must cultivate twice more, each time when the weeds have grown.

When you cultivate you can also do the earthing up. At the base of the cereal stem there are adventitious roots. To make these roots grow well, earth must be placed around the foot of the stem. This is called earthing up. Do the earthing up at the same time as the first cultivation.

- How to cultivate

You can cultivate with a hand hoe or with an animal- drawn cultivator.

If the cereals are sown in rows, you can work more quickly by using an animal- drawn cultivator. The work is well done and

you can cultivate more often. The cultivator uproots the weeds between the rows. Afterwards you must go with the hand hoe to take out the weeds in the rows.

Leave uprooted weeds on the ground. They protect the soil against erosion and against the sun. They rot and form humus.

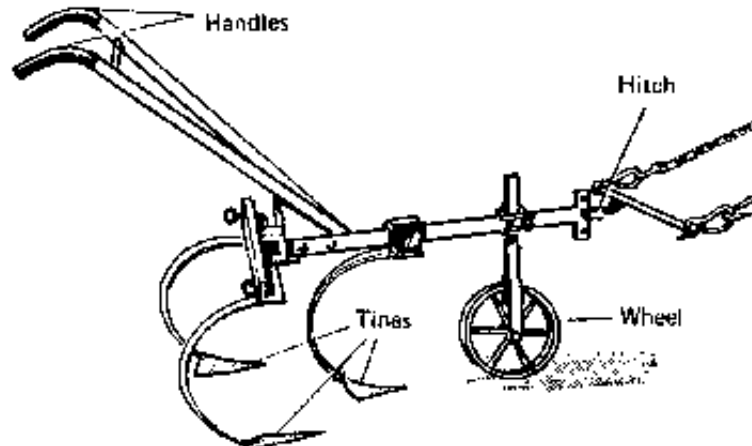

Animal- drawn cultivator

## CONTROLLING THE ENEMIES OF CEREAL CROPS

The chief enemies of cereals are animals, and above all, birds.

- Goats, sheep and cows go into fields of millet, maize and rice and eat the young plants. You can surround the fields with a fence so that the animals cannot get in. But the best way is to shut up all the animals. Put the oxen and cows in one paddock, and the sheep and goats in another. Then your fields will not be spoiled.
- But the most dangerous enemies are birds.

First of all, they may eat the seeds in the earth, just after sowing.

But above all, they come and eat the grains in the ear, when the crop is ripe.

Usually children guard the fields and chase the birds away.

But nowadays children go to school.

You can put scarecrows, dressed to look like a man, in the fields.

The birds are frightened and do not come and eat the grain.

- Different insects may also attack cereals, such as caterpillars, grasshoppers, aphids . You can control insects by using a pesticide such as BHC.

## **Harvesting**

Cutting the stems of cereals

When the grain is ripe, you must not wait too long before harvesting.

If you wait too long, the grain may fall to the ground, and birds may come and eat the grain on the plant.

Cut the stems with a machete, a sickle or a knife.



Cut the stems

- Afterwards cut off the heads of grain with a knife. Leave the stems on the ground. These stems cover the ground and protect the soil from the sun and from erosion. After rotting, the stems add organic matter to the soil.

If you keep animals, you can put the stems in their stalls or



paddock.

Mixed with the animal droppings, the stems make manure which will enrich the fields.

- Drying the grain

When you have cut the heads, you must not thresh them at once, nor put them in a granary. First of all, you must dry them very well. Spread the heads on a really clean surface. Stop sheep, goats and birds from eating the grain.

When the heads are well dried, you can thresh them, that is, separate the grain from the heads. But do not thresh all your crop at once. Keep the greater part of the harvest as heads of grain. Thresh only the amount you need for food.

- Threshing cereals

Threshing means getting the grain out of the heads. Threshing

can be done by beating the heads with a stick, or with a special tool called a flail. For rice there is a machine that separates the rice grains from the heads. It is called a thresher.

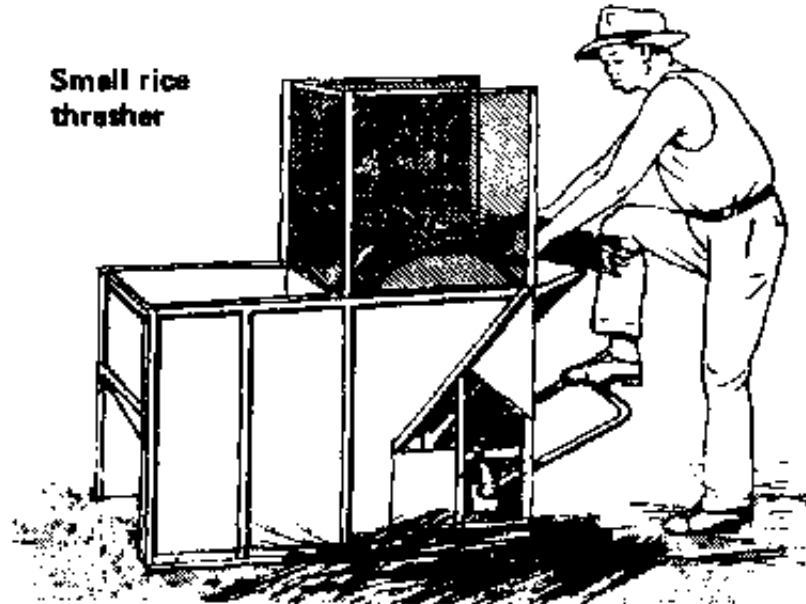

Small rice thresher

- **Winnowing the grain**

Cereal grain must be very clean. This is important. It must not be mixed with earth and little stones. When the grain has been threshed, it is winnowed to make it cleaner.

For winnowing, use a sieve, or else pour the grain from one flat bowl into another.



The wind blows the dirt away

- Storing cereal grain

Storing can be done in sacks or in granaries.

The sacks and the granaries must be protected against damp,

which makes the grain rot, and against rats and insects, which eat or spoil the grain.

The granaries must be above the ground to keep the grain dry.

The granaries must be disinfected. Ask the extension officer what pesticides to use and how to apply them. Some pesticides are poisonous.

Straw cover

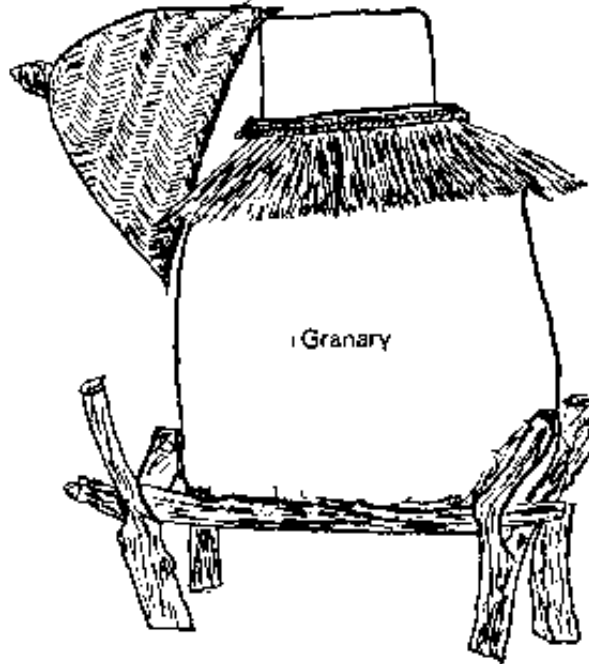

Clay granary in northern Cameroon

## **Selling part of the harvest**

- Often farmers sell millet or maize just after the harvest. At

that time, there is plenty of millet in all the villages. Nobody needs to buy any. The price of millet is very low. Farmers who sell their grain just after the harvest do not earn much money.

- Sometimes, at the beginning of the rainy season, these farmers have no millet left for food. At that time, there is hardly any millet in the granaries. Millet is very dear. Farmers buy a little millet, while waiting for the harvest. But they pay a high price.
- It is better not to sell your millet or maize at harvest time, for the selling price is low, and you will perhaps not have enough grain for food all through the year.
- Keep your harvest safe in your granaries. You can then sell your grain at the beginning of the rainy season, when food is beginning to get short. Then you will earn more money, for the price of millet or maize is much higher.

## Sell when the price is high.



Home-immediately access 800+ free online publications.  
Download CD3WD (680 Megabytes) and distribute it to the 3rd World. CD3WD is a 3rd World Development private-sector initiative, mastered by Software Developer Alex Weir and hosted by GNUveau Networks (From globally distributed organizations, to supercomputers, to a small home server, if it's Linux, we know it.)[ar](#).[cn](#).[de](#).[en](#).[es](#).[fr](#).[id](#).[it](#).[ph](#).[po](#).[ru](#).[sw](#)

---

 Better Farming Series 15 - Cereals  
(FAO - INADES, 1977, 51 p.)

➔  Sorghum and millet

 *(introduction...)*

 Sorghum





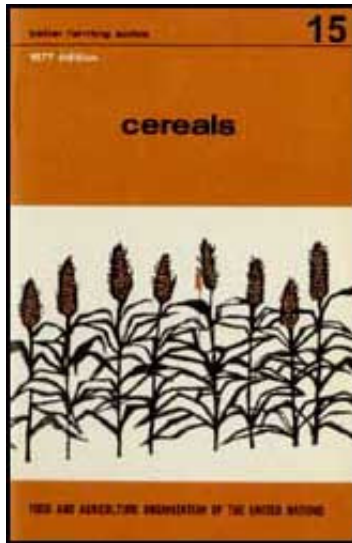

## Millet (introduction...)

### How to grow sorghum and millet

#### (introduction...)

#### Growing sorghum in the dry season

#### Sorghum for animal feeding

## **Better Farming Series 15 - Cereals (FAO - INADES, 1977, 51 p.)**

### **Sorghum and millet**

Sorghum and millet are very important cereals in savanna country.

They are grown in the same way.

We shall deal with the growing of sorghum and millet together.

## **Sorghum**

Sorghum is a tall cereal, more than 2 metres high.

Its stem has long leaves.

At the top of the stem is the spike.



Sorghum plant



Spike of sorghum

The spike contains the sorghum grains. Their colour is white, black, yellow or red.

Sorghum grows in savanna country that is not too dry. It needs about 1 metre of rain a year.

Sorghum likes light soil that lets rain run through, that is, permeable soil.

## VARIETIES Of SORGHUM

Sorghum is sometimes called "great millet" because it has

rather large grains.

- There are several very different varieties of sorghum:
- Grain sorghums These are the kind most grown in Africa. They yield grain for human food.
- Sweet sorghums The stem contains a sweet liquid. They are grown in equatorial Africa and Northern Cameroon.
- Broom sorghums These have very large spikes, like a broom.
- Fodder sorghums These are cut when still green for animal feeding.
- Each of these varieties includes several kinds that ripen at different times.
- Early sorghums ripen 80 to 110 days after sowing.

- Medium early sorghums ripen 115 to 130 days after sowing
- Medium late sorghums ripen 130 to 145 days after sowing.
- Late sorghums ripen about 190 days after sowing.

Some kinds of sorghum are preferred for human food, others for making beer.

## **Millet**

Millet is a tall cereal, more than 2 metres high.

Its stem has long leaves. At the top of the stem is the spike.

It is not like the spike of sorghum.

The spike contains the millet grains. They are smaller than sorghum grains. They are white or red in colour

- Millet grows in very dry regions north of the savanna. It even grows where the rainfall is only 300 millimetres a year.

Millet likes light, sandy and permeable soils.



## Millet plant

### VARIETIES OF MILLET

Different names for millet are bulrush millet, pearl millet, Japanese millet, broomcorn millet.

- There are a great many varieties of millet. They have different names in different countries, for instance: in Senegal: Souna, Sanio; in northern Cameroon: Youri, Yادiri; in Chad: Dokone.
- The different kinds of millet are distinguished by the length of the spike.
- Varieties with a long spike

In Niger there is Rongo, with spikes that may be more than 2 metres long, and Somno, with spikes 80 centimetres long.



These varieties are usually late ones that ripen 120 to 150 days after sowing.

- Varieties with medium or cylindrical spikes

The length of the spike is about 40 centimetres.

They are harvested about 100 days after sowing.

- Varieties with short spikes

For instance, in Niger,  
Batoutchani has spikes of 6 centimetres,

Boudouma, spikes of 10 to 20 centimetres.

These are usually early varieties.

They ripen 60 to 90 days after sowing.

## How to grow sorghum and millet

- Sorghum and millet have fibrous roots.

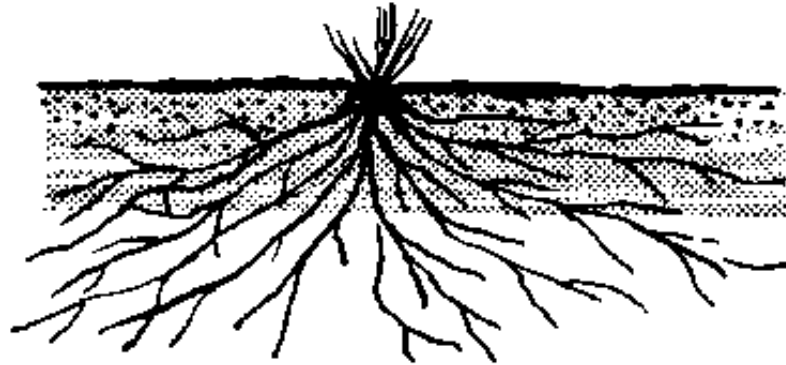

How to grow sorghum and millet

To be well nourished and resist dryness, sorghum and millet need well- developed roots.

The roots of sorghum and millet are thin. They are not strong enough to penetrate hard earth, soil that is much compacted,

and clods. They must have fine, well-loosened soil, without clods.

After tilling, break up the clods with a harrow or large branches drawn by an animal.

If the soil is not deep, make little mounds or ridges.

- The place of sorghum in crop rotation

It is best to sow sorghum after growing another crop such as groundnuts or cotton.

If sorghum is grown after groundnuts or cotton, it will use the remainder of the mineral salts added for these industrial crops.

## HOW TO SOW

## Selected your seed.

You can keep the seed from the best spikes of your own harvest. Dry them, sort them and store them well, protect them against insects and diseases.

You can also buy seed of improved varieties from research stations.

Some varieties are harvested about 100 days after sowing. These varieties are sown in regions where the rainy season is short.

Other varieties are harvested 150 to 190 days after sowing. These varieties are sown in regions where the rainy season is longer.

Sow at the beginning of the rainy season. Sow in rows, and leave 80 to 100 centimetres between rows. Put 4 to 10 seeds

in each seed hole, and leave 40 to 60 centimetres between seed holes. Push the seed 2 centimetres into the soil.

## CARE OF THE CROP

Weed the field two weeks after sowing.

In seed holes where the seeds have not grown, new seed can be sown, or seedlings can be transplanted. Take them from seed holes where all the seeds have grown.

In seed holes where all the seeds have grown, take out the smallest seedlings. It is better to have fewer but finer plants with bigger spikes. Then there will be more grain.

When the plants are 50 centimetres high, weed again.

At the same time, earth up the plants. After earthing up, new roots will grow.

## HARVESTING

When the grain is ripe, do not wait too long before harvesting sorghum and millet. If you wait too long, birds may eat a lot of the grain.

After harvesting, you can thresh the spikes and store the sorghum and millet grain. But you can also store the spikes with the grain in them.

### Supplementary Note

#### **Growing sorghum in the dry season**

In countries such as Niger, Cameroon and Chad, sorghum is sown along rivers and streams and by the side of lakes at the end of the rainy season.

When the rain stops, the water subsides along the river banks

and lake sides, but the soil, which is rather clayey, retains water and remains moist. Sorghum is then sown on this moist earth. The sorghum grows during the dry season by taking up the water that remains in the soil. The sorghum becomes ripe during or at the end of the dry season. Thus, there is a sorghum harvest just before the hungry season.

Sorghum can also be started in nurseries. The seed is sown on a little plot which is watered. At the end of the rainy season when the water subsides, the young sorghum plants are lifted and transplanted to river banks or lake sides. The sorghum ripens in the middle of the dry season.

Sorghum grown during the dry season is called Berbere in Chad and Mouskouari in northern Cameroon.

## Supplementary Note

## **Sorghum for animal feeding**

When young sorghum plants are still green, they may be fed to animals.

But you must be very careful, because sorghum may contain a poison. The quantity of poison in the plants is not always the same. It differs according to the age of the plants, the variety, the soil, the climate.

Sometimes when you have cut the green sorghum, some plants may produce new stems. These new growths contain a lot of poison.

So take good care before giving green sorghum to animals.

The animals can be fed sorghum by putting them in the field where it is growing, or by giving it to them as hay or as silage.



## Never give the new growths to animals.

- Feeding animals in the fields

Animals are let into the field when the spikes of sorghum begin to ripen.

- Making sorghum hay

To make hay, cut the sorghum plants when the spikes have come out of the stem. Leave the stems and leaves to dry.

Because of the poison, you must wait two months before giving this hay to animals.

- Making silage

To make silage, cut the sorghum plants when the spikes are well formed, but before the grains have become hard. Then

wait two months before giving the silage to animals.

Never make silage with new growths of sorghum.

There are some varieties of sorghum that are grown only as fodder. These varieties are very good for making silage.



[Home](#)-immediately access 800+ free online publications.  
[Download](#) CD3WD (680 Megabytes) and distribute it to the 3rd World. CD3WD is a 3rd World Development private-sector initiative, mastered by Software Developer [Alex Weir](#) and hosted by [GNUveau Networks](#) (From globally distributed organizations, to supercomputers, to a small home server, if it's Linux, we know it.)[ar.cn.de.en.es.fr.id.it.ph.po.ru.sw](#)

---



Better Farming Series 15 - Cereals

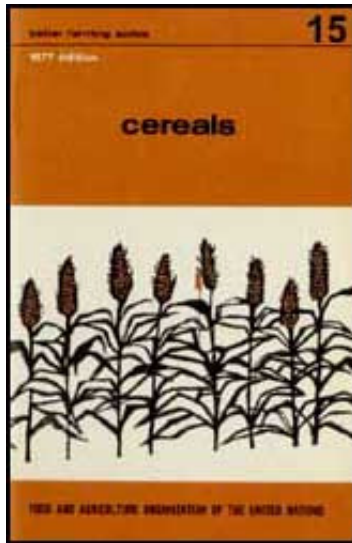

Better Farming Series 15 - Cereals (FAO -

INADES, 1977, 51 p.)

➔  Maize

(introduction...)

Traditional maize growing

How to increase maize yields

**Better Farming Series 15 - Cereals (FAO - INADES, 1977, 51 p.)**

**Maize**

VARIETIES OF MAIZE

- There are many varieties of maize:
- Soft maize The grain has no hard husk, and it is very floury;
- Hard maize

The grain has a hard husk.

It can be kept for a fairly long time.

- Sweet maize

It is eaten before ripening.

- There is also the difference in colour between white maize and yellow maize.

When the maize plants are still green, they can be used as fodder. Silage can also be made from them.

Some parts of Africa could produce more maize to feed the

growing population and to feed the animals better.

Maize could also be grown to sell to foreign countries.

In a maize plant, stamens and ovaries are in different flowers.

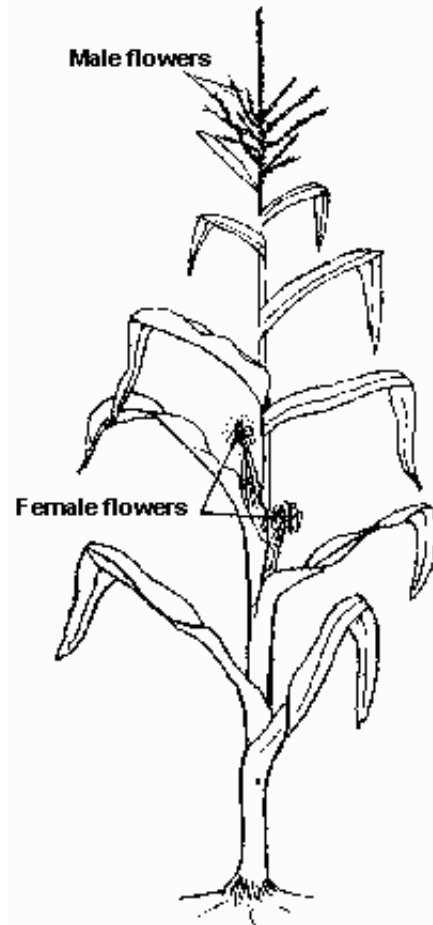

## Maize plant

### **Traditional maize growing**

- Traditionally, maize is grown in association with other crops.

It is grown in the same field with yams, cotton or groundnuts. When several crops are grown in the same field, harvests are poor, sowing is not done at the right time, weeding is not well done, and much time is lost in harvesting.

- Traditionally, maize is grown without the use of new tools.

The soil cannot be well worked with the hand hoe, and so the soil is not loosened; the roots cannot penetrate well into the soil to take up water and mineral salts; the plants are not well nourished. There is not much grain; the yield is low.

- Traditionally, maize is grown without fertilizers.

No mineral salts are added to the soil; the soil becomes poor. So old fields must be left fallow and new fields have to be cleared. This is shifting cultivation.

With shifting cultivation, much land is not cultivated and yields no harvest. Farmers lose a lot of time clearing new fields.

Shifting cultivation must stop in order to increase maize production.

## **How to increase maize yields**

### Choosing the seeds

If you want a good harvest, you must sow good seeds.

You can choose seeds from your own crop. When you harvest, choose the biggest cobs. Keep these cobs. For sowing, take only the best- shaped grains from the centre of the cobs. If



you choose your seeds in this way, you will have a better harvest. Seed dressing is also useful.

**The finest grains from  
the centre of the cob  
are chosen**

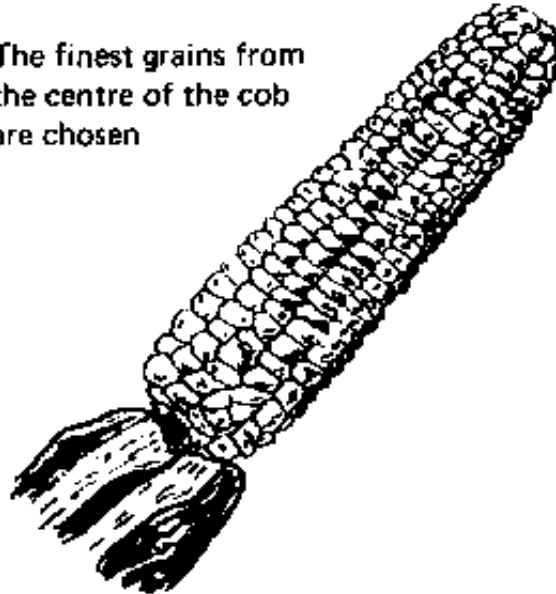

The finest grains from the centre of the cob are chosen

But yields become smaller if you sow every year seeds from last year's crop. After a few years, the maize loses its good

qualities. So you must buy new seeds.

- The research stations have improved varieties of maize which produce very good seeds.

Several varieties of maize are grown at the research stations. The female flowers of one variety are fertilized with the pollen from the male flowers of another variety to produce hybrids. Otherwise, selection breeding is carried out within the same variety.



Pollen from the male flowers of one variety fertilizes the female flowers of another variety



The little bag prevents pollen from fertilizing the female flowers of the same plant

When the female flowers of one maize variety are fertilized by pollen from the male flowers of another maize variety, this is called crossing. The flowers fertilized in this way produce a new variety of maize called a hybrid, which is better than the two original varieties. But after several years of growing maize from the previous crop's seeds, this new variety loses its good qualities. So new seeds have to be bought.

Crossing two varieties may also result in new varieties that are more resistant to disease.

- Preparing the soil

Maize needs fine earth, without clods, a loose soil, in order to develop its root system. Tilling with a plough loosens the soil. The clods are broken up with the harrow.

## HOW TO SOW

Sow your maize at the beginning of the rainy season. Sow in rows, leaving 80 centimetres between rows. Put 3 to 4 seeds in one hole, leaving 50 centimetres between holes.

Make each hole 7 centimetres deep and cover the seeds with a little earth. Like that, the seeds have more protection against rats and birds.

## HOW TO LOOK AFTER MAIZE

- Weeding is very important.

This work can be done better and more quickly with an animal- drawn cultivator.

Weed for the first time 15 days after sowing.

Pull out the smallest seedlings from holes where all the seeds have come up; leave only the largest seedling.

Weed for the second time when the plants are 50 centimetres high. When you weed, also earth up the plants. After earthing up, the plants will have more adventitious roots, and the maize will be more resistant to drought. The maize will be better nourished.

- Manure and chemical fertilizers

Organic manure and chemical fertilizers cannot be used well and it is not profitable to apply them:

- if the soil is not well prepared,
- if the seeds are not well chosen,
- if sowing is not done at the right time, in rows and at a good density,
- if the weeds are not removed whenever they grow,
- if the crop rotation is not good.
- Different manures and fertilizers have to be applied:
- according to your crop rotation.

Different plants do not all take the same amount of each mineral salt out of the soil. Before sowing maize, you must therefore give back to the soil the mineral salts taken out by the previous crop. These mineral salts are contained in the fertilizers.

- according to the region.

The soils of different regions do not all contain the same amount of each mineral salt. They must therefore be given different fertilizers.

For example:

If a soil is poor in nitrogen, the tips of the young leaves turn yellow. You must therefore add nitrogen to the soil.

You can use:

- organic manures

These are animal manure and green manure.

Organic manure improves the structure of the soil. Plants grow better in a soil of good structure, and the chemical fertilizers



are used better. Organic manuring should therefore be done at the beginning of the rotation, that is, before growing the first crop on a field.

- chemical fertilizers

Maize needs above all nitrogen.

The nitrogen fertilizer most often used in Africa is ammonium sulphate.

But maize also needs phosphate and potassium.

Ask the extension services for advice. They will tell you how much fertilizer to apply to your maize field.

For example: At Bouake (Ivory Coast), the following fertilizers are applied before sowing one hectare of maize: 100 kg ammonium sulphate, 100 kg dicalcium phosphate, 50 kg

## potassium chloride

After the first cultivation, another 100 kg ammonium sulphate may be added. Be careful not to put any fertilizer on the leaves; the fertilizer may burn the leaves.

## HARVESTING

Maize can be fed to animals when the plants are still green. In that case, cut the maize when the male flowers begin to go dry. You can also make silage.

If you want to roast the maize cobs, harvest the cobs when the grains are not too ripe.

If you want to make flour, harvest the cobs when the grains are quite ripe.

## STORING MAIZE

Maize cobs can be stored in their husks. That way, the cobs keep better.

They can also be stored without their husks, but then the cobs may be attacked by insects. There are insecticides which kill these insects.



Maize cob in husk





Maize cob without husk

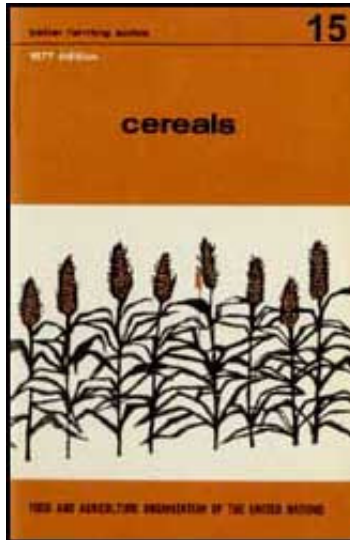

[Home](#)-immediately access 800+ free online publications.  
[Download](#) CD3WD (680 Megabytes) and distribute it to the 3rd World. CD3WD is a 3rd World Development private-sector initiative, mastered by Software Developer [Alex Weir](#) and

hosted by [GNUveau Networks](#) (From globally distributed organizations, to supercomputers, to a small home server, if it's Linux, we know it.)[ar.cn.de.en.es.fr.id.it.ph.po.ru.sw](#)



 Better Farming Series 15 - Cereals  
(FAO - INADES, 1977, 51 p.)

➔  Other cereals

 Fonio

 Finger millet

 Wheat

**Better Farming Series 15 - Cereals (FAO - INADES, 1977, 51 p.)**

## **Other cereals**

### **Fonio**

Fonio is a short cereal, about 45 centimetres high. It yields very small grains.

Fonio is chiefly grown in savanna regions of west Africa, such as Senegal, Mali, Guinea, Upper Volta, Niger.

Fonio grows and ripens quickly. It can be harvested long before millet or sorghum. Thus, the inhabitants of savanna regions who have no millet or sorghum during the hungry season can eat fonio.

Fonio grows well even on poor soil. It is much grown in certain mountainous regions such as Fouta Djallon in Guinea, and on soils with a little laterite in Upper Volta and Mali. It is a plant that needs very little water to grow well. It is grown on very

dry and poor soils.

Fonio should be sown at the end of a rotation, just before the fallow.

Fonio fields must be protected from birds that eat the grain.

Harvesting fonio is difficult, because the grain is very small. Much grain can be lost in harvesting. Do not wait until the grain is too ripe.

## **Finger millet**

Finger millet (Eleusine) grows to between 60 and 150 centimetres high. It is grown in Zaire, in the Central African Empire, in Rwanda, in Burundi, in Ethiopia, in Kenya, and in Tanzania.

At the top of the stem there are 5 to 10 ears; they are curved

and contain the grain.

Finger millet needs plenty of water. It is chiefly grown in hilly regions, on high tablelands.

Finger millet grows well even on poor soil. It is often grown together with other crops such as maize and groundnuts, or after other crops such as cotton.

The ears are harvested by hand and put in bundles to dry. Then they are stored in granaries. The ears store well, and are not attacked by insects.

Finger millet is used for food; flour made from it is cooked. It is also eaten in the form of paste. Some kinds of finger millet are used for making beer.

## **Wheat**



Wheat is a cereal that is chiefly grown in cold countries. Flour is made from wheat and is used for making bread. In Africa, especially in towns, people eat more and more bread. Until now, African countries bought wheat or wheat flour from foreign countries. But that is costly. It is better, when possible, to produce the wheat needed for food.

In Africa, wheat is grown in regions where there is a very cold season, that is:

- on the edge of the desert, near rivers and lakes:
- in Mauritania and Senegal, along the Senegal river; in Mali and Niger, along the Niger river;
- in Chad, near Lake Chad;
- in mountainous and hilly regions such as:
- eastern Zaire;
- Rwanda and Burundi.

Some countries, such as Chad, are making a great effort to develop wheat growing. This is being done chiefly in the Lake Chad region which will soon be able to meet all the country's needs of wheat. Chad will no longer have to import wheat.



[Home](#)-immediately access 800+ free online publications.  
[Download](#) CD3WD (680 Megabytes) and distribute it to the 3rd World. CD3WD is a 3rd World Development private-sector initiative, mastered by Software Developer [Alex Weir](#) and hosted by [GNUveau Networks](#) (From globally distributed organizations, to supercomputers, to a small home server, if it's Linux, we know it.)[ar.cn.de.en.es.fr.id.it.ph.po.ru.sw](#)







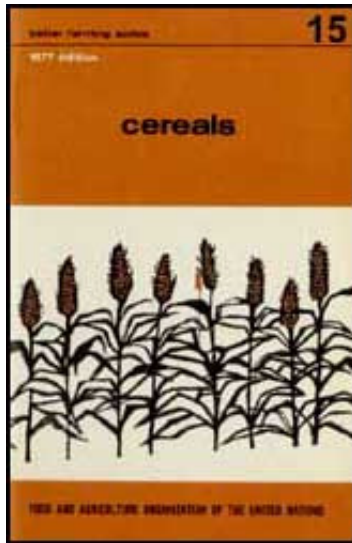

Better Farming Series 15 - Cereals  
(FAO - INADES, 1977, 51 p.)



(*introduction...*)



-  Preface
-  What are food crops?
-  Growing cereals in the modern way
-  Sorghum and millet
-  Maize
-  Other cereals
-  Suggested question paper

## Suggested question paper

### FILL IN THE MISSING WORDS

Cereals are plants which yield .....

When the slope is vary steep .....is used.

Crop rotation means growing a .....each year

on.....

Farmers who sell their grain just after the harvest  
.....money.

Cereal grains are good food for .....and for

Millet stems are cut with a .....

Grain should be sold when .....

Wheat flour is used for making .....

### ANSWER THE FOLLOWING QUESTIONS

What cereals are grown in your region?

Where you live are cereal grains given to animals?

Why must more cereals be produced?

What is shifting cultivation?

Why must trees be grubbed out?

Where you live is a winch used for grubbing?

How do you protect the soil against the sun?

What is thinning?

Which are the chief enemies of cereals?

How do they thresh cereals where you live?

When should the farmer sell his millet? Why?

What are the different names of millet in the language of your country?

What is each variety of millet used for (food, beer, ...)?

What is the way to get a new variety of maize? Why must you sow at the right time?

Are fonio, finger millet or wheat grown where you live?

