

➔  **Better Farming Series 14 - Farming with Animal Power (FAO - INADES, 1977, 57 p.)**

 **(introduction...)**

 **Preface**

 **Introduction**

**Choosing and preparing fields**

 **(introduction...)**

 **Size and shape of fields**

 **Marking the boundaries of a field**

 **Grub out all the trees in the field**

 **Get permission to farm for a long time**

**Working animals**

**Oxen**

 **Choosing oxen for farm work**

**Training oxen**

 **(introduction...)**























 **Harnessing oxen with a yoke**

 **How to train oxen**

 **How many hours a day can oxen work?**

 **How to feed working oxen**

 **Looking after working' oxen**





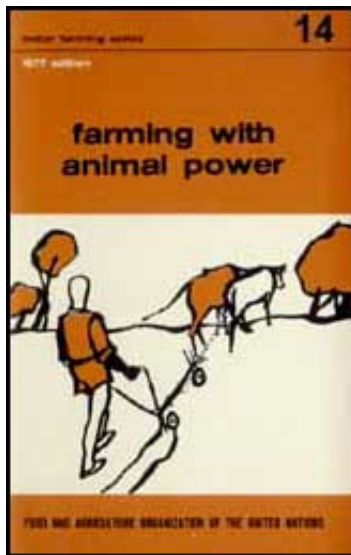

-  **Donkeys**
-  **Horses**
-  **Mules**
-  **Camels**
-  **Tools for use with animal power**
  -  **Choice of tools**
    -  *(introduction...)*
    -  **The plough**
    -  **The harrow**
    -  **The Manga cultivator**
    -  **The seed drill**
    -  **The cart**
    -  **Other tools**
-  **Income from animal power**
  -  *(introduction...)*
  -  **What animal power costs**
    -  *(introduction...)*
    -  **Buying animals and tools**
    -  **Amortization**
    -  **Interest**
    -  **The animals' food**
    -  **Upkeep and repair of tools**
  -  **What animal power farming costs him:**

-  **Mechanized farming**
-  **Some examples of animal power farming**
-  **Suggested question paper**



[Home](#) > [ar](#).[cn](#).[de](#).[en](#).[es](#).[fr](#).[id](#).[it](#).[ph](#).[po](#).[ru](#).[sw](#)



-  **Better Farming Series 14 - Farming with Animal Power (FAO - INADES, 1977, 57 p.)**
- ➔  ***(introduction...)***
-  **Preface**
-  **Introduction**
- Choosing and preparing fields**
- Working animals**
- Tools for use with animal power**
- Income from animal power**
-  **Mechanized farming**
-  **Some examples of animal power farming**
-  **Suggested question paper**

**Published by arrangement with the  
Institut africain pour la dveloppement conomique et social  
B.P. 8008, Abidjan, Cte d'Ivoire**

# **FOOD AND AGRICULTURE ORGANIZATION OF THE UNITED NATIONS**

## **Rome 1977**

**FAO Economic and Social Development Series - No. 3/14**

**First published 1977**

**Reprinted 1984**

**P-69**

**ISBN 92-5-100157-X**

**© French edition, Institut africain pour le dveloppement conomique et social (INADES) 1971**

**© English edition, FAO 1977**



**[Home](#)** > **[ar.cn.de.en.es.fr.id.it.ph.po.ru.sw](#)**

 **Better Farming Series 14 - Farming with Animal Power (FAO - INADES, 1977, 57 p.)**

 ***(introduction...)***

 **Preface**

 **Introduction**

 **Choosing and preparing fields**

 **Working animals**

 **Tools for use with animal power**

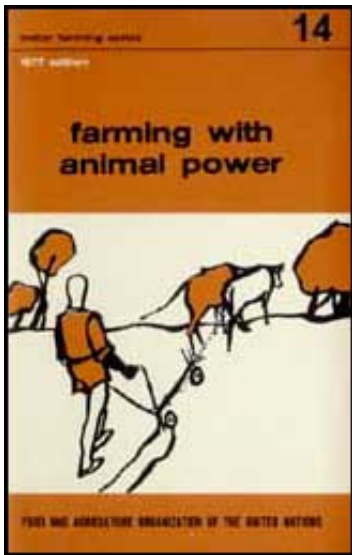

- ☐ **Income from animal power**
- 📄 **Mechanized farming**
- 📄 **Some examples of animal power farming**
- ➔ 📄 **Suggested question paper**

## **Suggested question paper**

### **FILL IN THE MISSING WORDS**

**With animal power you can make use of the.....of animals.**

**You can farm..... fields.**

**You must..... in the fields in order not to break your tools.**

**Animals that can be used are**

**.....or.....or.....**

**Oxen are strong enough to work at the age of .....**

**Oxen are harnessed with a .....**

**The left- hand ox must always remain on the .....**

**The right- hand ox must always remain on the .....**

**Oxen can work .....hours a day.**

**When oxen are working give them a.....supplement.**

**It is best to choose .....that are light, strong, simple and not too**

**dear. A good farmer care of his tools.**

**He .....them and them from the rain.**

**With a .....work is done more quickly, but it costs a lot of**

**.....**

## **ANSWER THE FOLLOWING QUESTIONS**

**At what age should oxen be harnessed? How should tools be chosen?**

**What is a feed supplement?**

**Do you know an animal training station near where you live? Where is it?**

**What sort of oxen should be chosen for work?**

**Two oxen bought in 1964 cost 30 000 francs. They are resold in 1970 for 18 000 francs. Calculate the annual amortization.**

**If you are going to use animal power, how should the fields be laid out?**









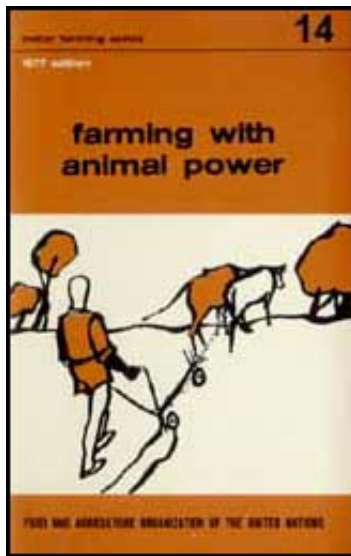

[Home](#) > [ar](#).[cn](#).[de](#).[en](#).[es](#).[fr](#).[id](#).[it](#).[ph](#).[po](#).[ru](#).[sw](#)

 **Better Farming Series 14 - Farming with Animal Power (FAO  
- INADES, 1977, 57 p.)**

 **(*introduction...*)**

  **Preface**



-  **Introduction**
-  **Choosing and preparing fields**
-  **Working animals**
-  **Tools for use with animal power**
-  **Income from animal power**
-  **Mechanized farming**
-  **Some examples of animal power farming**
-  **Suggested question paper**

## Preface

**The first twenty- six volumes in FAO's Better Farming Series were based on the Cours d'apprentissage agricole prepared in the Ivory Coast by the institut africain de developpement economique et social for use by extension workers. Later volumes, beginning with No. 27, have been prepared by FAO for use in agricultural development at the farm and family level. The approach has deliberately been a general one, the intention being to constitute basic prototype outlines to be modified or expanded in each area according to local conditions of agriculture.**

**Many of the booklets deal with specific crops and techniques, while others are intended to give the farmer more general information which can help him to understand why he does what he does, so that he will be able to do it better.**

**Adaptations of the series, or of individual volumes in it, have been published in Amharic, Arabic, Bengali, Creole, Hindi, Igala, Indonesian, Kiswahili, Malagasy,**

## SiSwati and Turkish, an indication of the success and usefulness of this series.

Requests for permission to issue this manual in other languages and to adapt it according to local climatic and ecological conditions are welcomed. They should be addressed to the Director, Publications Division, Food and Agriculture Organization of the United Nations, Via delle Terme di Caracalla, 00100 Rome, Italy.



[Home](#) > [ar](#).[cn](#).[de](#).[en](#).[es](#).[fr](#).[id](#).[it](#).[ph](#).[po](#).[ru](#).[sw](#)

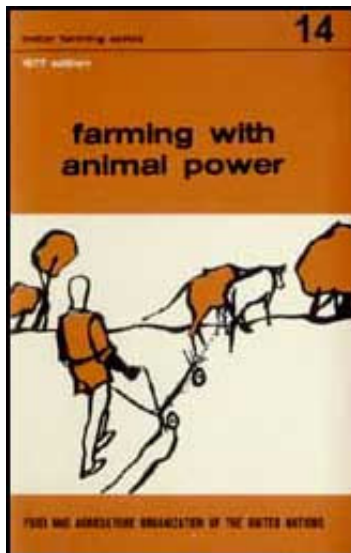

### Better Farming Series 14 - Farming with Animal Power (FAO - INADES, 1977, 57 p.)

 *(introduction...)*

 Preface

 **→ Introduction**

Choosing and preparing fields

Working animals

Tools for use with animal power

Income from animal power

 Mechanized farming

 Some examples of animal power farming

 Suggested question paper

## Introduction



**In traditional farming all the work in the fields is done by hand, with very few tools, by man- power alone.**

**Everything is carried on the head. Each trip you carry only a small amount of goods - a basket of cocoa beans, of groundnuts, of rice, a can of oil, a load of wood.**

**With animal power for tilling, sowing, hoeing and transport you can make use of the strength of animals.**

**With animal power the farmer gets less tired. He lives better. Farming is done better. Fields are bigger. Harvests are finer.**

**The farmer can pay for the animals and tools. He has more money than when he does everything by hand.**

**For example:**

**At Agoudou- Manga (Central African Empire), with traditional farming, the farmer makes 8000 CFA francs a year.**

**With animal power, He can make 30000 francs. Each year he repays part of the cost of the oxen, the plough, and the cultivator, that is, 12 000 francs. So he has left:  $30000 \text{ less } 12000 = 18000$  francs. Thus he makes 10000 francs more than with traditional farming.**

**In Upper Volta (Mossi country), with traditional farming, the farmer makes 17000**

**francs.**

**With animal power he can make 66000 francs. Each year he pays 29000 francs for the donkey, the cultivator, fertilizers and pesticides. So he has left 66000 less 29000 = 37000 francs. Thus he makes 19000 francs more than with traditional farming.**

**With animal power the farmer can:**

- **save time, because work is done much faster with animals;**
- **get farming jobs done in good time;**
- **do some of his jobs better;**
- **have bigger fields.**

**Saving time**

**Work is done much faster with animals.**

**For example:**

**At Niangoloki (Upper Volta), to grow a hectare of groundnuts, that is, an area equal to a football field, 190 eight- hour days are needed each year if work is done by hand.**

**But with animal power only 145 eight- hour days are needed each year.**

**To grow a hectare of food crops such as millet, maize or sorghum requires 85 working days a year if work is done by hand.**

**With animal power only 57 working days a year are needed.**

**The time the farmer saves by using animal power should be used to work other fields.**

**But although the work is done more quickly, the farmer has to spend some time in looking after his oxen, his donkey, in training them and feeding them.**

**Getting jobs done In good time**

**We saw in an earlier course (Booklet No. 7) that crop yields are much better if the sowing is done at the right time.**

**For example:**

**Cotton sown at the beginning of the rains yields 656 kilogrammes per hectare; but cotton sown one month after the first rains yields only 240 kilogrammes per hectare.**

**Sowing seed and applying fertilizer by hand on a one- hectare field requires 30 working days.**

**With animal power, sowing the seed and applying the fertilizer requires 4 working days.**

**Animal power is very useful chiefly because with it you can get certain jobs done well and quickly**

## **Doing jobs better**

**Animal power also helps to work the soil better.**

**Tilling is more regular and deeper  
(see Booklet No. 7, page 8).**

**Sowing in rows (see Booklet No. 7, page 15) is done at a good density (see Booklet No. 1, page 16).**

**Intercultivations are done more often (see Booklet No. 7, page 21).**

**Harvesting is quicker.**

## **Bigger fields**

**With animal power, as the work is done more quickly, the farmer makes better use of his time and can farm bigger fields.**

**For example:**

**At Niangoloko (Upper Volta), a farmer works by hand a field of 1 hectare.**

**With animal power he can work a field of 2 to 4 hectares.**

**But, to farm with animal power, you must:**

- make a good choice of fields and lay them out well, that is: choose fertile land; lay out big, rectangular fields; clear all the fields and grub out all the trees;**

- **make a good choice of crops;**
- **make a good choice of oxen and donkeys;**
- **train the animals well: teach them to work;**
- **feed the animals well: a well- fed animal is strong, so make a reserve of food for the dry season;**
- **take good care of the animals;**
- **make a good choice of tools, and take care of them;**
- **work out correctly what animal power costs and what it brings in.**



[Home](#) > [ar.cn.de.en.es.fr.id.it.ph.po.ru.sw](#)

 **Better Farming Series 14 - Farming with Animal Power (FAO - INADES, 1977, 57 p.)**

  **Choosing and preparing fields**

 **(introduction...)**

 **Size and shape of fields**

 **Marking the boundaries of a field**

 **Grub out all the trees in the field**

 **Get permission to farm for a long time**

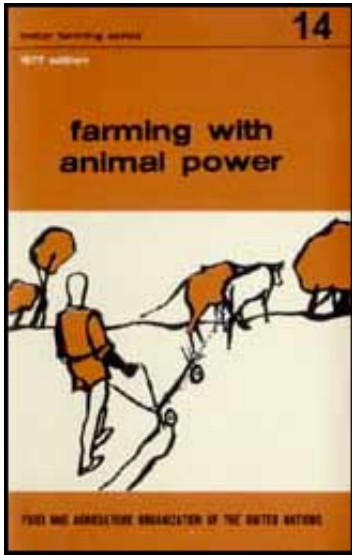

## **Better Farming Series 14 - Farming with Animal Power (FAO - INADES, 1977, 57 p.)**

### **Choosing and preparing fields**

**Choose land where plants grow well; if you see tall herbage, the land there is good.**

**If you can, choose fields near your house, so as not to lose time getting there and back. All the time spent getting to and for is time lost on the fields.**

### **Size and shape of fields**

**The fields should be big, and especially they should be very long.**

**If a field is very short, you lose a lot of time turning the oxen at the end of the**

**field. You get more tired turning the plough.**

**The fields should have a regular shape; they should be rectangles. That shape makes it easier to plough, to sow in rows, to hoe and cultivate.**

**If you must have several fields, make them as close to each other as possible, so as not to lose time getting from one to the other with the animals and tools.**

**Marking the boundaries of a field**

**A good field must have its proper boundaries. Before preparing your field, mark out its boundaries.**

**You will need to know how to measure your field.**

**Example: You want to make a field of 1 hectare.**

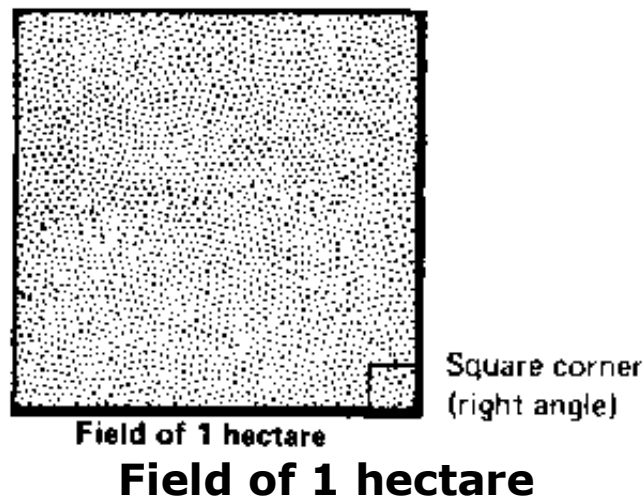

**This field should be either square or rectangular. This means that its corners must**

**be right angles.**

**How to make a right angle**

**The corner of a book let is a right angle.**

**Measure 4 metres along side OA and 3 metres along side OB.**

**Now the length of AB should be 5 metres.**

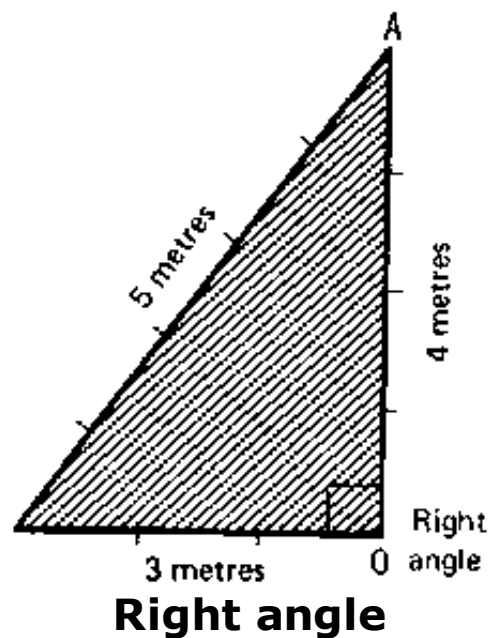

**Why make a field with right- angled corners?**

**It is easy to calculate the area of such a field.**

**You can reckon better the density of sowing (see Booklet No. 1, page 26).**



**You know how much fertilizer to apply.**

**You know whether the field yields a good or a poor harvest.**

- **It is easier to till with animals.**

## **HOW TO CALCULATE THE AREA OF A FIELD**

**To calculate the area of a field with right angles at the corners, multiply the length by the width of the field.**

**Example: a field is 100 metres long and 100 metres wide; its area is  $100 \times 100 = 10000$  square metres ( $m^2$ ).**

**A square metre is a square measuring 1 metre in length and 1 metre in width.**

**One hectare = 10 000  $m^2$**

**Example: a field is 200 metres long and 50 metres wide; its area is  $200 \times 50 = 10000$   $m^2$  . It is aIso 1 hectare.**

100 metres

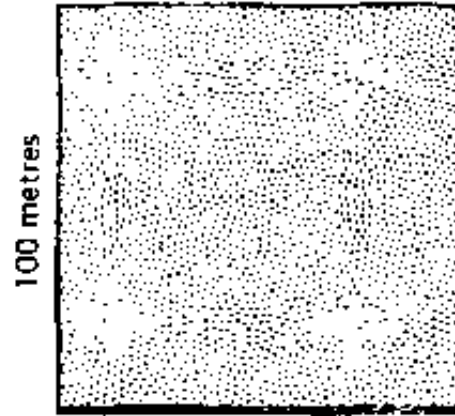

**A field**



50 metres

**Two fields of 1 hectare**

**A field which is 71 metres long and 71 metres wide has an area of  $71 \times 71 = 5\,041$  m<sup>2</sup>,**

**A field which is 100 metres long and 50 metres wide has an area of  $100 \times 50 = 5\,000$  m<sup>2</sup>**

**These are both fields of half a hectare.**

**In order to work with animal power:**

**Grub out all the trees in the field**

**You cannot use animal power on fields with tree stumps.**

**You must grub out the tree stumps so as not to break your tools (see Booklet No. 6, page 21).**

**This requires a lot of work, but once it is done, it is done for good.**

**It does not have to be done again every year.**

**Each year grub out the tree' on a part of the field.**

**At the end of two or three years the whole field is cleared.**

**In savanna country you need 120 working days to clear a hectare and grub out the tree stumps.**

**Do this during the dry season when there is not too much other work.**

## **Get permission to farm for a long time**

**Before grubbing out the trees, ask the land authorities for permission to farm the field for a very long time, so as to get the benefit of your work.**

- **Choose the right crops and rotation**

**When you use animal power, you must include fodder for the animals in your crop rotation (see Booklet No. 5, page 27).**

**For example:**

**Grow a fallow crop (see Booklet No. 5, page 23) and cereals such as rice or maize or sorghum as supplementary feeds (see Booklet No. 8, page 14).**

**Grow more cash crops such as cotton or groundnuts. With the extra money earned, pay off the cost of the oxen and the tools.**

**After the cash crops, raise food crops for your family.**

**The food crops will benefit from the remains of the fertilizers used on the cash crops. The harvest will be better. You will get enough food for your family from a smaller field.**

**Using animal power means you have to use a good crop rotation.**



**[Home](#) **"'" "''''''> [ar.cn.de.en.es.fr.id.it.ph.po.ru.sw](#)****

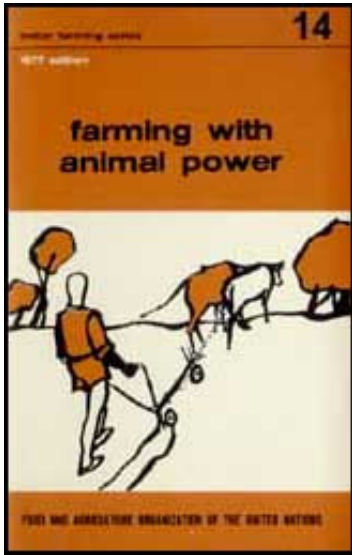

## **Better Farming Series 14 - Farming with Animal Power (FAO - INADES, 1977, 57 p.)**

### ➔ **Working animals**

#### **Oxen**

 **Choosing oxen for farm work**

#### **Training oxen**

 **(introduction...)**

 **Harnessing oxen with a yoke**

 **How to train oxen**

 **How many hours a day can oxen work?**

 **How to feed working oxen**

 **Looking after working' oxen**

 **Donkeys**

 **Horses**

 **Mules**

 **Camels**

**Better Farming Series 14 - Farming with Animal Power (FAO - INADES, 1977, 57 p.)**

**Working animals**

**Oxen**

**Choosing oxen for farm work**

## **You should choose:**

- **Big and rather heavy oxen**

**The bigger an ox is, the stronger it is. An ox that is too small cannot do much work.**

**Some oxen are too small for clearing the land and deep ploughing.**

- **Healthy oxen**

**The animals must breathe easily and not cough. The bones and muscles must be well developed. The legs, especially, must be strong. The hocks (joints) must be well formed, the hoofs must be solid and smooth.**

**An animal that walks with difficulty is not good for work.**

**Look at how an animal walks and you will see whether it will make a good working ox.**

**The horns must be hard; they must not be tender. You cannot put a head yoke (see page 19) on an ox with broken horns. The neck must be short and strong.**

- **Oxen not too difficult to train**

**If an ox is vicious, you cannot train it easily.**

**Bulls are castrated in order to make them easier to train. But they should not be castrated too young. Wait 18 to 24 months before castrating a bull, for then it will**

**be stronger for work. But in that case it must be separated from the herd so that it does not cover the cows.**

**If an ox is spiritless and lazy it is not good for training, for it will not do much work.**

- **Oxen of the same size**

**If one ox is bigger than the other, the yoke cannot fit well. Then the yoke bothers the oxen and they cannot work well.**

**If one ox is stronger than the other, the strength of the stronger ox is not fully used.**

- **Oxen of about the same age**

**They will be able to work together for several years.**

- **Oxen of the right age**

**Do not take animals that are too old. Oxen that are too old are difficult to train. After being trained they will work for fewer years than oxen trained when young.**

**Do not take animals that are too young. They are not strong enough; they have not finished growing. Their bones are not hard enough. An animal that works when it is too young does not grow,**

**At the age of 2 or 3 years, you can begin to train oxen. If you begin early, the oxen**

**get into good habits. But before the age of 4, let them do only light work.**

**At the age of 4 years, oxen are strong enough to work hard. You can then keep them for several years. Oxen can work up to the age of 10 years.**

## **Training oxen**

**Oxen can be very useful if they are well trained.**

**When oxen are very well trained, one man alone can drive them and hold the plough.**

**If the oxen are not well trained, three people are needed: one in front to lead; one at the side, to make the oxen go forward; one behind, to hold the plough.**

**It takes time to train oxen well, but this time is not wasted. Afterwards, only one man will be needed to drive the oxen and hold the plough.**

**Once oxen are trained, they should be harnessed fairly often.**

**Never leave them too long without harnessing them. If you do not harness your oxen for 6 months, they will lose their good habits. In the dry season when there is no ploughing or cultivating to do, harness your oxen for transport. Then they will not lose their good habits.**

## **Harnessing oxen with a yoke**

**A yoke is a piece of wood placed on the heads or necks of oxen which is used for**



## **pulling farm implements.**

**The yoke must be made of strong wood; it must not be too heavy; it should weigh 6 to 9 kilogrammes.**

- **The neck yoke**

**There are neck yokes for harnessing a single ox, and yokes for harnessing two oxen together.**

**The yoke is placed on the neck of the animals.**

**When the oxen pull, the yoke settles down in the right place.**

**Farmers can easily make such a yoke, or the village blacksmith or carpenter can do it.**

**It is used mainly for zebu oxen which have a longer and weaker neck than some other oxen.**

**With the neck yoke you cannot make the animals walk backward because the yoke is not fastened to them.**

**With the neck yoke the animals have more freedom but they more easily spoil the crops during cultivation.**

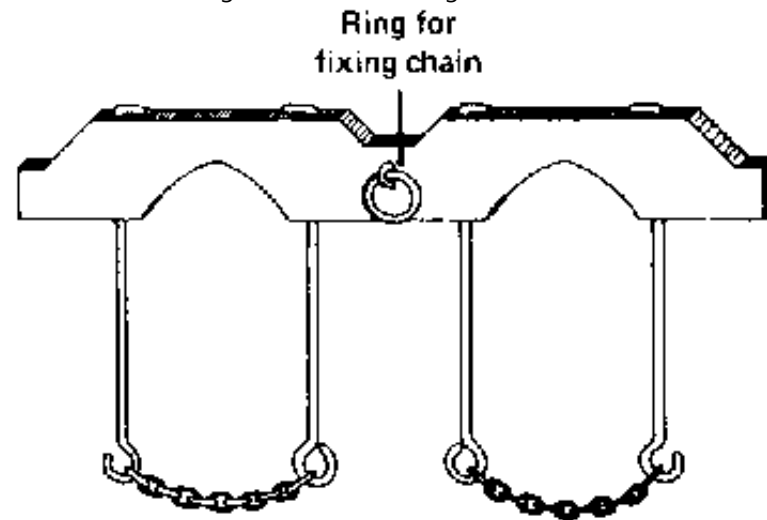

**Double neck yoke for two oxen**

- **The head yoke**

**The head yoke is placed behind the horns and is tied to them with rope or thongs of leather.**

**In order not to injure the animal put a pad of straw or kapok wrapped in cloth between the yoke and the head.**

### **Hook for a fixing chain**

**A yoke with its chains costs between 1 500 and 2 000 CFA francs.**

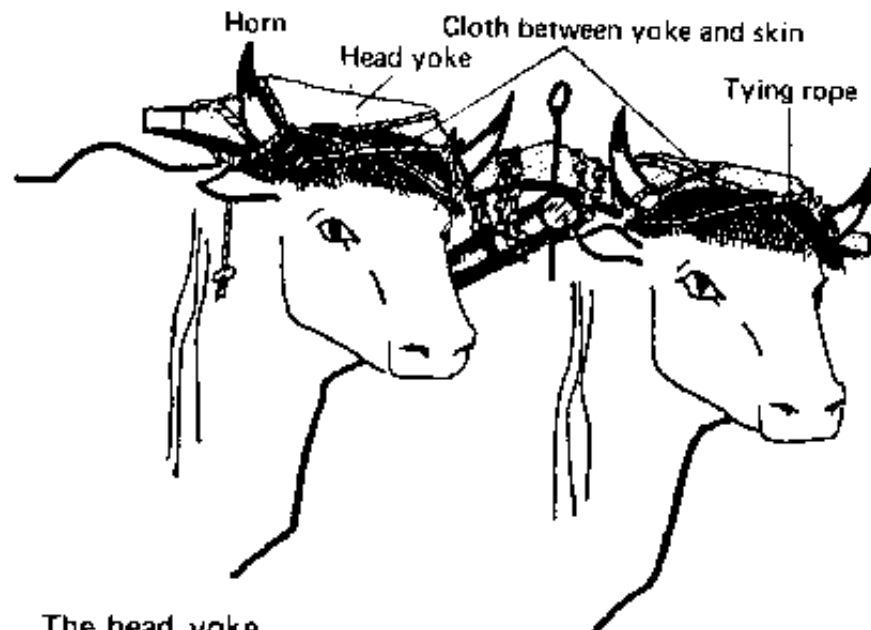

The head yoke  
is mostly used for oxen other than zebus.  
This yoke gradually develops the neck muscles.  
So do not start with work  
that is too tiring.

### **The head yoke**

- **The single yoke**

**The single yoke is used to harness one animal.**

**A chain is fixed to either side of the single yoke.**

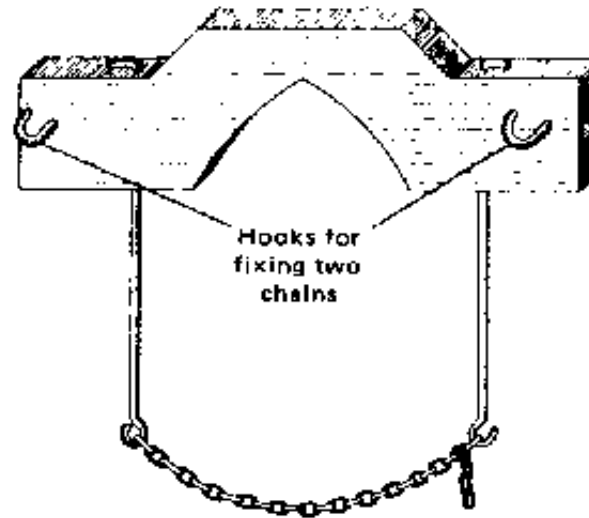

**Single neck yoke**

**It can also be used as a collar, in the same way as for donkeys (see page 37).**

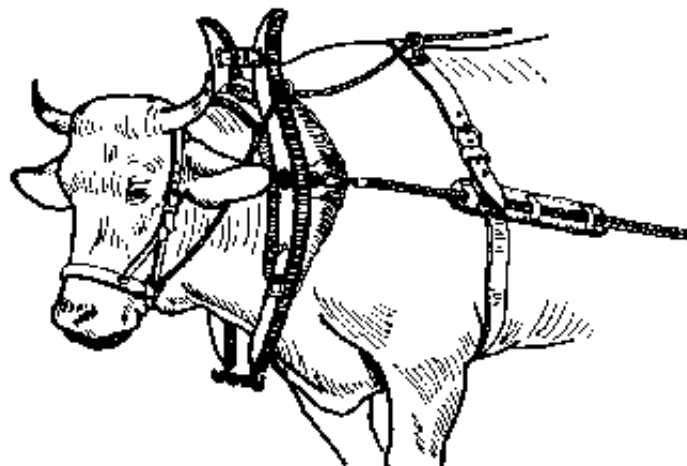

**A collar**

**Ox with collar**

**How long should the yoke be?**

**The yoke should be rather short. The oxen should be quite close to each other. But there should be 20 to 25 centimetres between the two oxen so that the chain that pulls the tool does not bother them.**

**So the yoke should be 1.10 to 1.30 metres long. If the animals have large horns, make the yoke a little longer.**

**For certain work, like ridging or cultivating between rows of crops, longer yokes are sometimes used, so that there are two rows of crops between the two animals.**

**So you must have two yokes, a short yoke and a long yoke.**

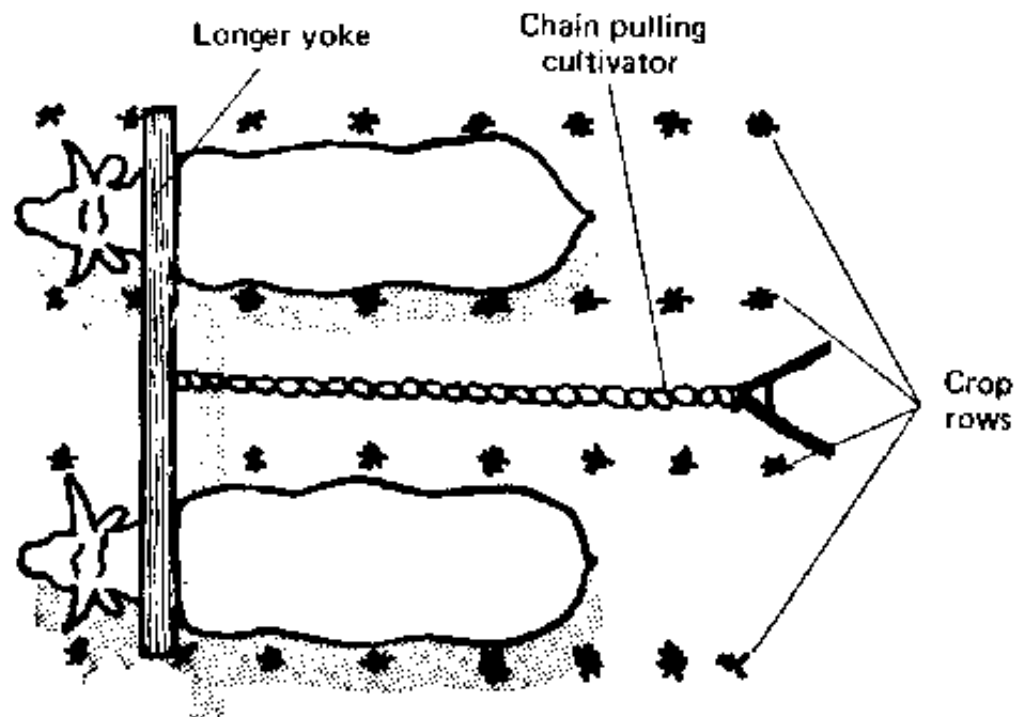

**Two oxen harnessed with a long yoke for cultivating**

## **How to train oxen**

**You have chosen two oxen of the same age, the same size and the same strength.**

- **Men and oxen must get used to each other**

**Before beginning to train your oxen, you must get them used to being with men.**

**Putting the animals in a modern pasture is itself enough to make the animals used to the presence of men.**

**If a man is unkind to his oxen, if he hits them, the oxen will be afraid of the man and become vicious.**

**If a man looks after his oxen well, they become quieter.**

**The man and the animals must become friends.**

- **Teaching oxen to wear the yoke**

**Two days before beginning the training, tie the oxen for a few hours to a tree. The animals will get used to being tied, and will be quieter.**

**Always put the same ox on the same side of the yoke.**

**The left- hand ox must always be on the left, and the right- hand ox must always be on the right.**

**To get young oxen used to the yoke, you can put the ox which is to be trained**

**along with an ox already trained. Be sure to put the left- hand ox always on the left, and the right- hand ox on the right.**

**When tie the oxen to be trained to the same yoke for 2 or 3 days. Let them go free for 2 or 3 hours, but keep an eye on them. To prevent them moving too much, tie a rope to a foreleg and loop it round the animal's back.**

**On the fifth day, get the oxen to walk in a straight line.  
Do not hit them.**

**You need a lot of patience.**

**It is better to drive the oxen from behind; then the trainer disturbs them less.**

**When the animals are used to wearing the yoke and to walking side by side, tie a chain or a rope to the middle of the yoke, and to the other end of the chain or rope fix a piece of wood weighing about 40 kilogrammes.**

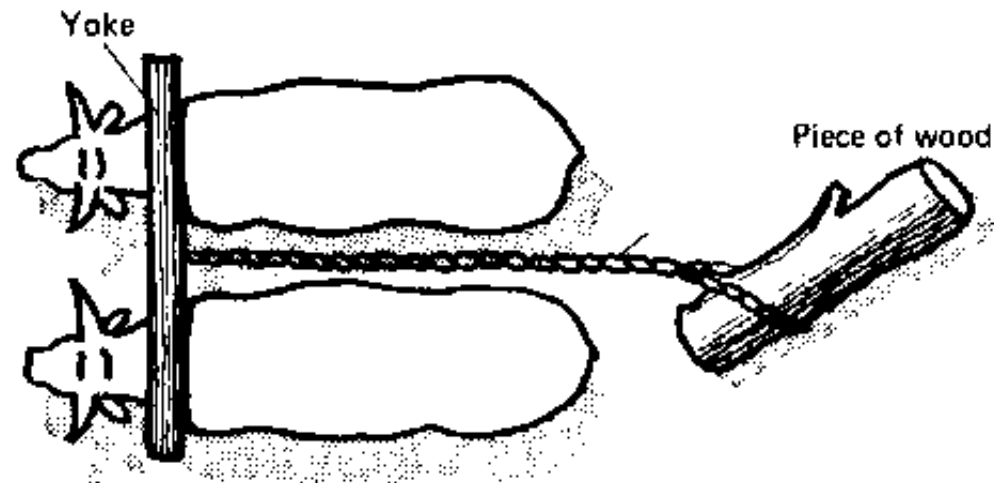

**Training oxen**

**When the oxen are used to wearing the yoke, and to walking while dragging something, you must teach them to walk straight ahead, to stop, to turn to the left, to turn to the right.**

**You can get oxen to obey at the words:**

Hu Forward

Hoo Stop

Dia Left

Ya Right

**The driver's voice should be the chief means of driving the oxen.**

**You have to do the same movements over and over again.**

**The oxen learn to obey by this means. To get them to obey better, you can give each one a name, and give them orders by calling their names.**

**You must teach the oxen to walk steadily in a straight line.**

**At the beginning of training, use the oxen only for light work, such as cultivation and light transport.**

**Gradually make them do more tiring work. After ten days, harness the oxen to a plough (see page 42).**

**The oxen must walk in a straight line, and pull steadily. To begin with, do a light**



**ploughing (see Booklet No. 7, page 8).**

**At the end of each furrow, let the animals rest for 1 or 2 minutes.**

**In this way the oxen gradually become used to all kinds of work, and the farmer also becomes used to handling the tools.**

**In some places there are animal training stations where the farmer can learn how to train his oxen.**

**Remember that oxen should not do very tiring work before they are 4 years old (see page 16).**

**The animals must do some work such as transport even outside the main farming season; they must not lose the habit of work.**

**How many hours a day can oxen work?**

**When a man works, he gets tired. When an ox works, it gets tired.**

**We know too that oxen need plenty of time to find their food and digest it.**

**For tiring work like ploughing, oxen should not be worked for more than 5 hours a day.**

**For less tiring work, like light transport, oxen can be worked a little longer.**

**It is best to make the oxen work when the sun is not too hot, early in the morning. When it is very hot, the oxen get tired more quickly, and work less.**

**You must not work the oxen too long. They will get too tired and will fall sick. The farmer must know his oxen well, so that he can judge what work they can do and remain well.**

**How to feed working oxen**

**A man who does not eat well cannot work well.**

**An ox that does not eat well cannot work well.**

**Working oxen must be well fed.**

**We know that cattle need a lot of time to feed.**

**An ox that works has less time to get its food than animals that do not work.**

**So rich pastures near the village must be kept for working oxen, and grass or hay must be taken to them in their shed.**

**You must store green fodder for the dry season, by making silage or hay (see Booklet No. 8, page 28).**

**You must also give working oxen feed supplements.**

**An ox that works 5 hours a day must have, besides green fodder, a feed supplement.**

**A well- fed ox works well and does not get thin.**

**The oxen stay well, can be used for a longer time, and then sold for a good price. You spend money to feed the oxen well, but you earn more by their work and by selling them.**

**You are advised to give working oxen every day 2 feed units for light work, and 3 feed units for heavy work (see Booklet No. 8, page 13).**

**This feed supplement is provided by: 2.5 kilogrammes of rice bran mixed with crushed maize, or 2.5 kilogrammes of rice bran mixed with crushed sorghum, or 6 kilogrammes of groundnut stems and leaves, or 5 kilogrammes of good brush hay.**

**You must also give the oxen a mineral supplement every day.**

**For example, calcium carbonate mixed with dicalcium phosphate.**

**And do not forget a salt lick.**

**Even when the animals are not working, you must give them enough to eat.**

**If you do not do this, when you need them for working, they will be too weak, they will take too long doing the work; sowing will be late, and the harvest will not be so good.**

**Without good feeding, animal power is useless.**

**Looking after working' oxen**

**The cattle shed**

## Working oxen must be able to rest.

To shelter them from the wind, sun and rain, build a shed for them. Use wood, millet straw, other local materials.

The shed should not cost much.

Next to the shed, make a paddock.

In the paddock put feeding racks or troughs for the feed supplement you give the oxen (see page 27).

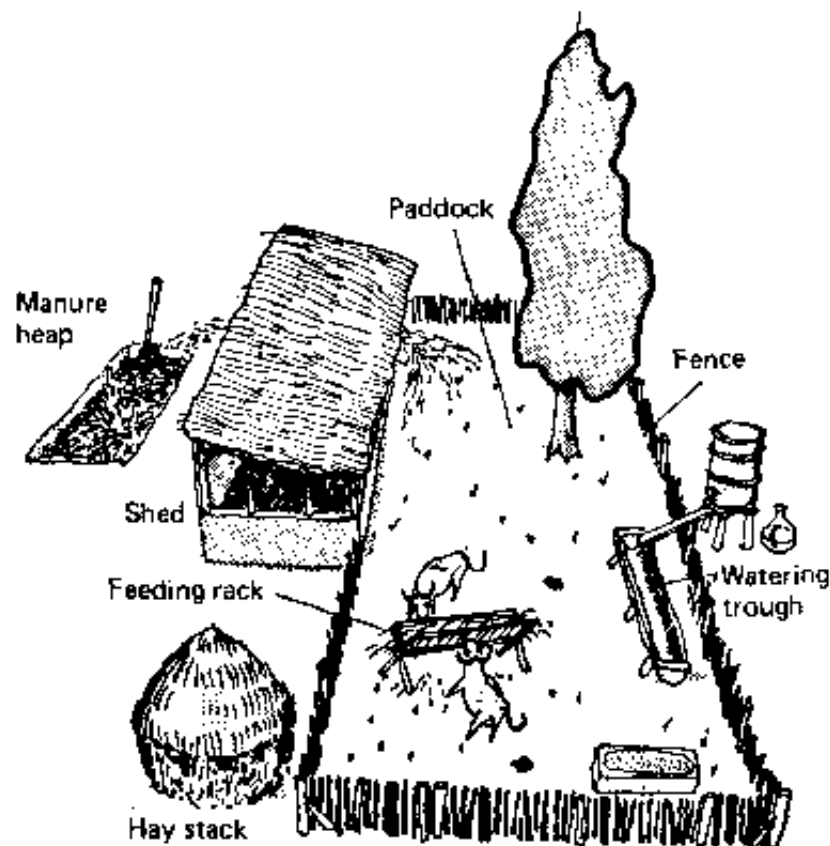

## **Put feeding racks or troughs in the paddock**

### **Watching over the health of working oxen**

- **Every week look to see if the oxen have ticks. Ticks prevent oxen from working well; the animals get restless, walk with difficulty, and lose their strength. You can kill ticks with paraffin or mineral oil. They can also be cut out.**
- **Look out for any injuries. If an ox is injured, find out why. Has it got a thorn in its foot? Has a piece of wood or iron torn its skin? To avoid hurting the oxen, the yoke must be well placed (see page 19); make sure that the cloth is in place.**

**When you have found what hurts the ox, take away the cause of the injury. Do not make the ox work. It is better to lose a few days' work than to lose an ox.**

**You must treat the wound.**

**Clean the wound with hot water. Add disinfectant to the water to prevent the wound getting infected, for example, soap, or potassium permanganate or cresol. Wash the wound often. A wound that is kept clean soon heals.**

### **Donkeys**

**A donkey is much like a horse. It is smaller and not so strong. It has a big head with big ears. Its feet are slender but firm. The leg ends in a single hoof.**

**The donkey is not as strong as the ox. It is useful for light work such as harrowing, hoeing and sowing. Two donkeys harnessed side by side can do**

## **ploughing in light soils.**

**The donkey is very useful for transport. It walks easily over rough tracks.**

**A donkey costs much less than an ox. It is seldom ill and it is easy to feed and look after.**

## **Choosing a donkey for farm work**

**Like oxen, a working donkey must:**

- **be in good health;**
- **have strong feet;**
- **have hard hoofs.**

**A donkey can be trained from the age of 18 months.**

## **Feeding donkeys**

**Donkeys eat grass and herbage.**

**A donkey's stomach has only one gut; it has no rumen.**

**Donkeys are not ruminants.**

**A donkey needs several hours at pasture and some hay during the night. When a donkey is working, give a feed supplement such as 1 kilogramme of crushed millet or sorghum mixed with rice bran.**

**A donkey likes very clean water to drink. But do not let it drink at once after working when it is hot and sweating.**

**If a donkey is used to carry water, let it drink while at the spring.**

**Do not leave a donkey at large, but keep it in a paddock {see Booklet No. 8, page 32), or tie it with a long rope to a post so that it cannot damage the crops.**

### **Housing donkeys**

**Make a shelter for the donkeys as you did for the oxen.**

**Build a wall on the side where the wind blows most often.  
The shelter will protect the donkeys from wind and rain.**

**Put straw on the floor. The donkeys will rest better, and there will be manure for the fields.**

**A donkey needs an area 3 metres long by 1.75 metres wide.**

**For the donkey's feed supplement, make a feed trough from a hollowed tree trunk, or from a barrel cut in half. Fix the trough to the wall so that the donkey cannot knock it over.**

**For the hay make a rack (a kind of ladder made of bamboo).**

**Then the hay will not get mixed with the manure and will always be clean.**

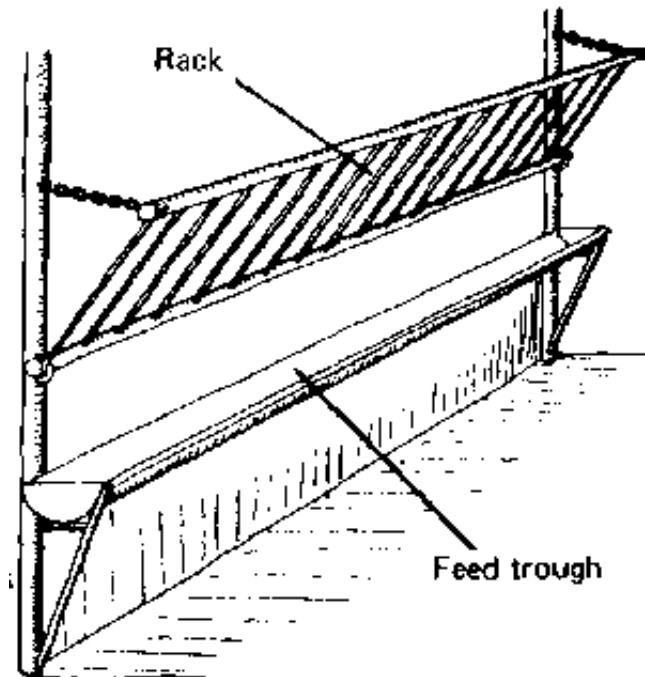

**The shelter for donkeys and horses is called a stable.**

## **Looking after donkeys**

**To prevent diseases, brush the donkey's coat every day with a sort of metal brush**



**A curry- comb**

**Like that, your donkey will always be clean.**

## **• Pests: ticks**



## **Like oxen, donkeys may have ticks.**

**Kill them with paraffin or mineral oil. They can also be cut out. Ticks may also be found on the ears. Do not forget to deal with them.**

### **• Diseases**

**Donkeys are resistant to diseases except sleeping sickness (trypanosomiasis).**

**The animal husbandry services have medicaments for treating this illness, and others to prevent the animals falling ill.**

**There are no donkeys in forest regions because of the sleeping sickness.**

### **Donkeys at work**

#### **• Carrying loads**

**Put a pack- saddle on the donkey's back.**

**A pack- saddle is made of**

- two pads placed on the donkey's back;**
- a piece of leather or plaited rope called a back- strap which is fixed to the pads;**
- thongs of leather or rope called girths which hold the pack saddle on the animal's back.**

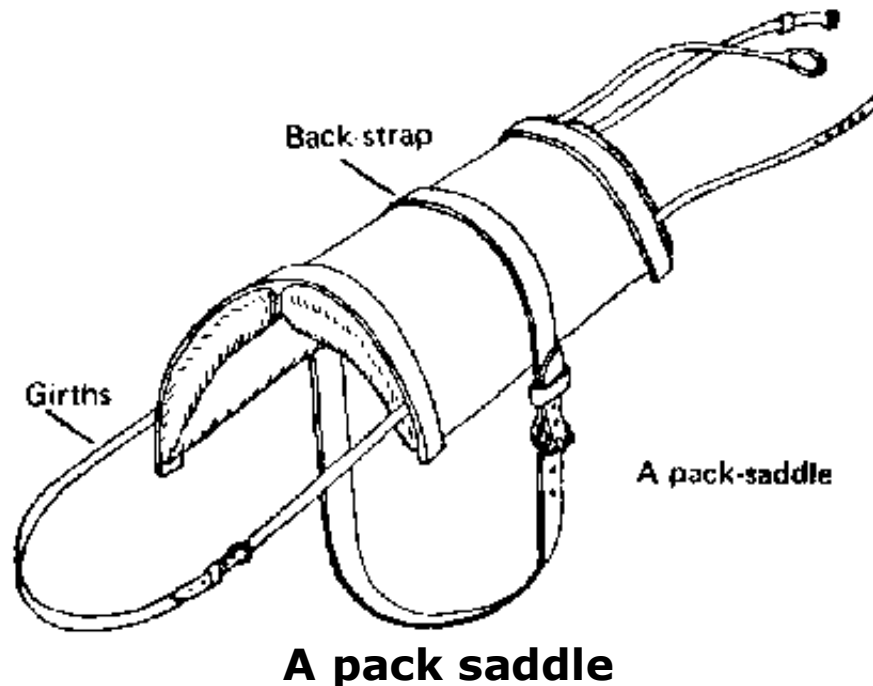

**Baskets are fixed on the pack- saddle.**

**You can easily make a pack- saddle yourself. The pads are made with old sacks stuffed with grass and sewn up. The back- strap and the girths can be made of leather or plaited rope.**

**The donkey must get used to carrying the pack- saddie. At first put it on without a load, then gradually increase the load.**

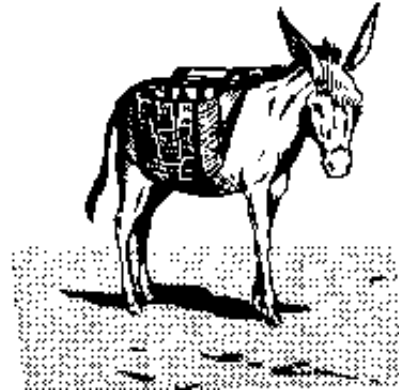

**Donkey with pack- saddle**

**A donkey can carry 100 kilogrammes of goods over long distances and bad tracks,**

**A donkey can also pull a light cart. Do not put a load of more than 300 kilogrammes in the cart.**

**The pack- saddle is used for carrying loads in places where a cart cannot go.**

- **Pulling carts or implements**

**When a donkey is to pull a cart or an implement, give it a collar (see page 37) or a breast- strap (see page 38) and fix a chain to each side of it.**

**A donkey is not as strong as an ox. But it can easily pull a harrow, a hoe or a seed drill. Two donkeys can plough in light soil.**

**You can harness a donkey with a collar**

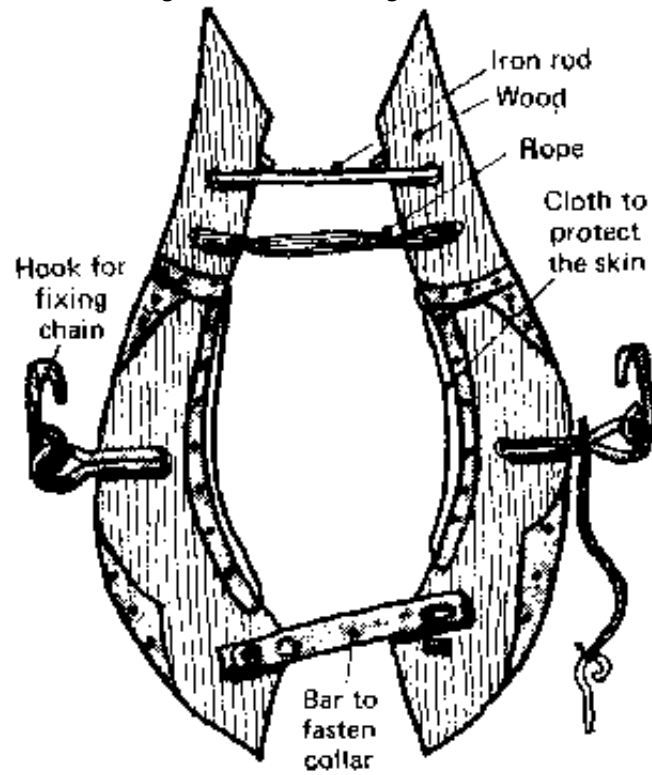

**Donkey collar**

**It is difficult to make a good collar.**

**It must not hurt**

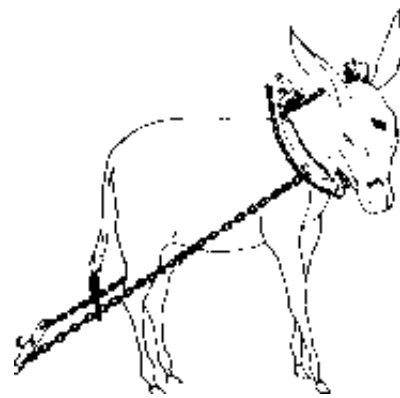

**Donkey with collar**

## **Horses**

**In Africa, horses, saddled, are chiefly used for carrying people.**

**But they can also be used for pulling farm implements. For that the horse has a collar (see page 37) or a breast- strap.**

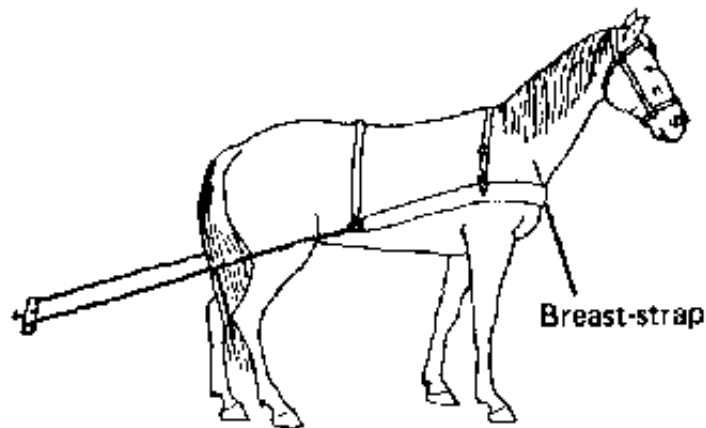

**Horse with breast- strap**

**The horse is stronger than the donkey but more difficult to train well.**

- **These words are useful to learn: a male horse is called a stallion; a female is called a mare; a young horse is called a colt or foal.**
- **A horse needs the same care as a donkey.**
- **Like the donkey, the horse eats grass.**

**When it is working, give it a feed supplement every day, such as 2 to 4 kilogrammes of crushed millet or sorghum mixed with rice bran, for light work, and 4 kilogrammes of millet for heavy work.**

## **Mules**

**Mules are the offspring of a mare and a donkey.**

**Mules are strong and resistant to diseases except sleeping sickness.**

**They are very useful in hilly places, on steep slopes, because they walk very well on difficult paths.**

**Mules often have a bad character, but if they are trained without harshness, with a lot of patience, they are more obedient.**

**Mules need the same care and the same food as donkeys.**

**In some places you find animals called hinnies. A hinny is the offspring of a stallion and a she- donkey.**

## **Camels**

**Camels are also called dromedaries. Camels withstand heat well. They are chiefly used for transport with a pack- saddle (see page 35), but they can also be given a breast- strap (see page 38) but they can also be given a breast- strap collar(see page 37).**

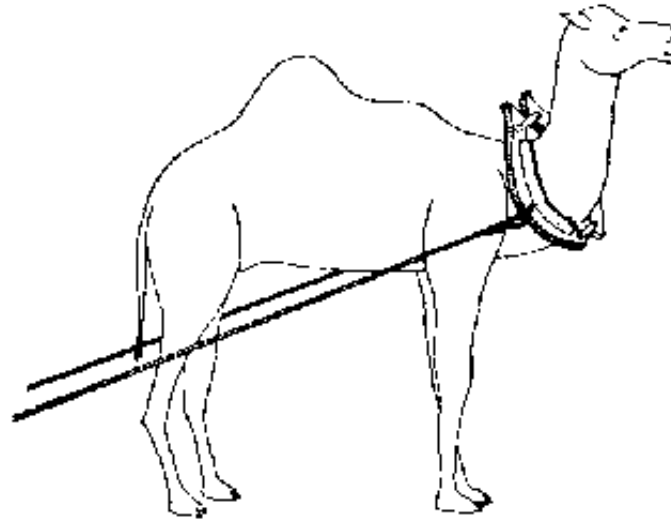

**Camel with collar**

## **Food**

**Camels eat rough and coarse herbage, even when it is dry.**

**They need 6 to 7 hours a day at pasture.**

**When they are working in the day they go to pasture at night. But they need 3 or 4 hours rest during the day.**

**They need 15 litres of water a day. But they can store up water, and drink every 3 or 4 days up to 80 litres of water.**



[Home](#) > [ar](#).[cn](#).[de](#).[en](#).[es](#).[fr](#).[id](#).[it](#).[ph](#).[po](#).[ru](#).[sw](#)

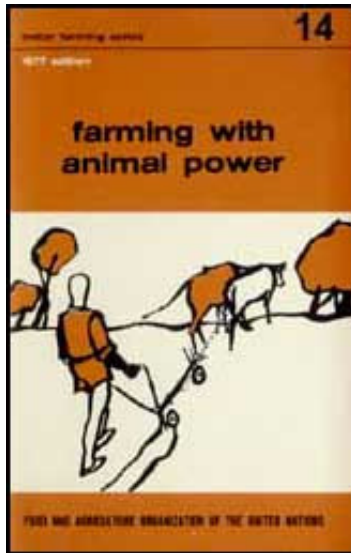

## Better Farming Series 14 - Farming with Animal Power (FAO - INADES, 1977, 57 p.)

### Tools for use with animal power

#### Choice of tools

 *(introduction...)*

 The plough

 The harrow

 The Manga cultivator

 The seed drill

 The cart

 Other tools

**Better Farming Series 14 - Farming with Animal Power (FAO - INADES, 1977, 57 p.)**

**Tools for use with animal power**

**Choice of tools**

**In choosing tools look for those that are:**

- **light,**



- **strong,**
- **simple,**
- **not too dear.**

**You do not have to buy all your tools at once.**

**It is best to buy first the tools that are most useful and that enable you to get your work done in good time.**

**For example:**

**If you have sandy soil (see Booklet No. 4, page 17), ploughing will not make big clods.**

**So it is useless to buy a harrow (see Booklet No. 7, page 12). A big branch will do the job.**

**There are many makers of tools, many different brands.**

**You must buy tools of a brand that is well known in your country, for it is easier to get them mended.**

**Choose strong tools, even if they cost a little more.**

**They will last longer.**

**The plough**

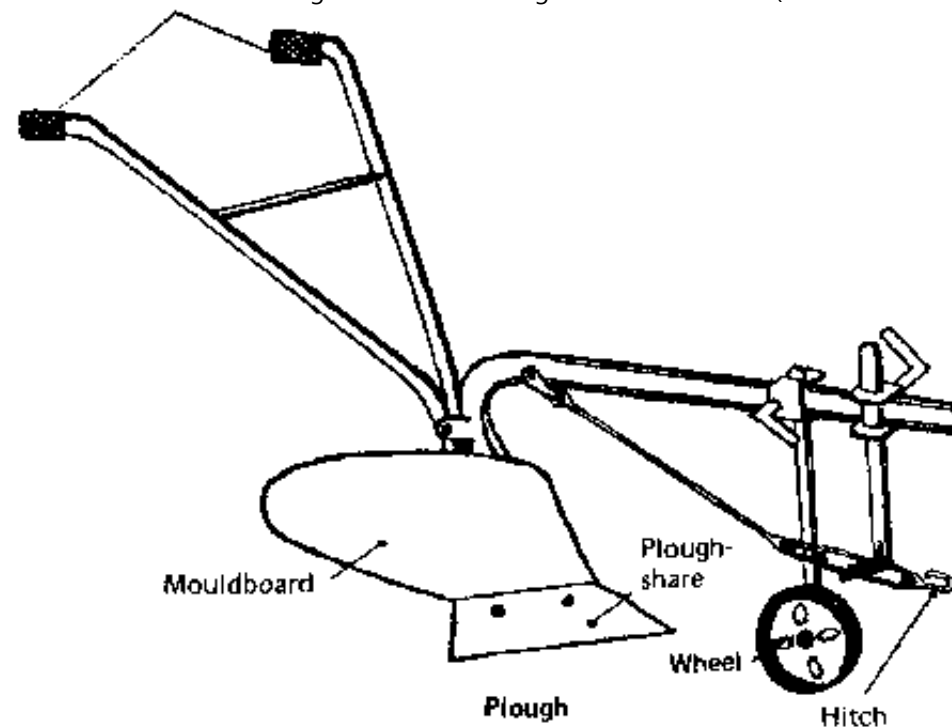

### **Handles for holding the plough**

**Usually simple ploughs are used.**

**A plough is made up of a ploughshare, a mouldboard and two handles.**

**A plough costs between 5 000 and 15 000 CFA francs**

**The harrow**

**The harrow is used for breaking clods. A harrow costs between 2 000 and 5 000 francs.**

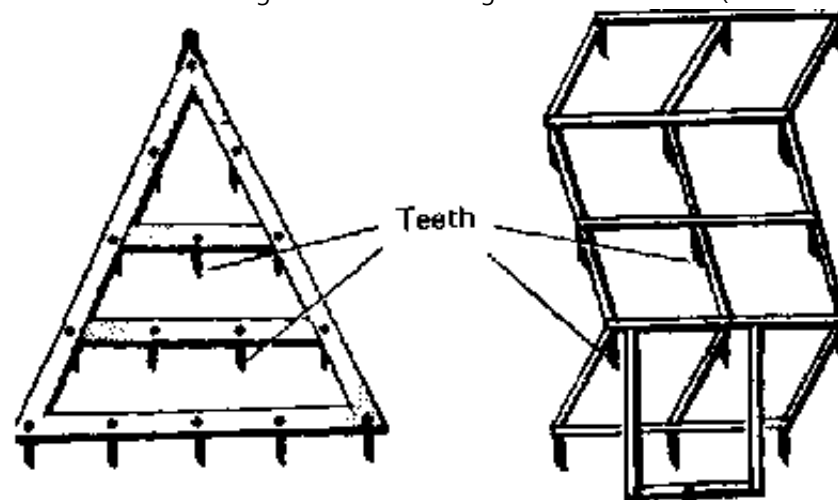

**Wooden harrow; Iron harrow; Tooth of harrow**

## **The Manga cultivator**

**This cultivator is used in Upper Volta. It is drawn by donkeys or oxen.**

**It has five tines or teeth. It is chiefly used for preparing the soil before sowing. In light, sandy soil the Manga cultivator does the same job as a plough. It is a very useful tool, because, if you change certain parts, it can do all sorts of work. It is in fact a multi- purpose implement.**

- **if you fix a marking bar on the machine it can draw the seed rows.**
- **if you fix hoeing tines it does intercultivations.**
- **if you fix two ploughshares it will earth up the crops.**
- **if you fix only one slanting ploughshare it can be used as a plough.**

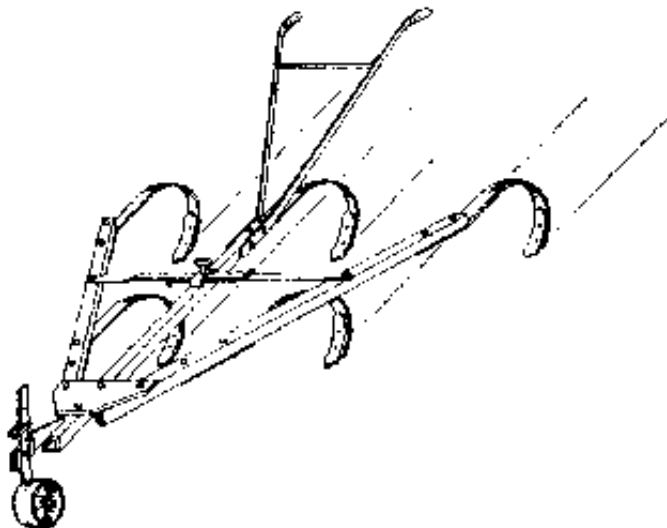

**The Manga cultivator costs about 15 000 francs**

## **The seed drill**

**The seed drill is used for putting seeds in the earth. To sow seeds of different sizes such as millet, sorghum, cotton or groundnuts, a part of the machine has to be changed. There are different parts for each size of seed.**

**The seed drill is difficult to regulate. You must follow the advice of the dealer who sells the drill, or of the extension service technician.**

**Oxen can pull a seed drill that sows several rows at once.**

**A seed drill costs a lot: between 9000 and 15000 CFA francs. Several farmers can get together to buy a drill between them.**

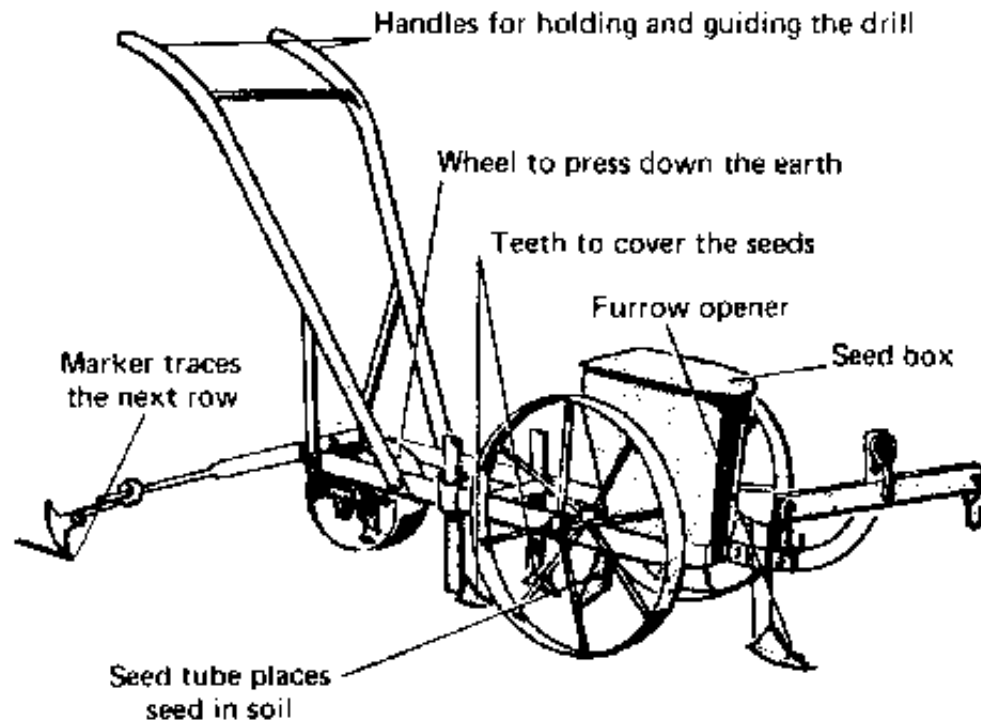

**Seed drill**

## The cart

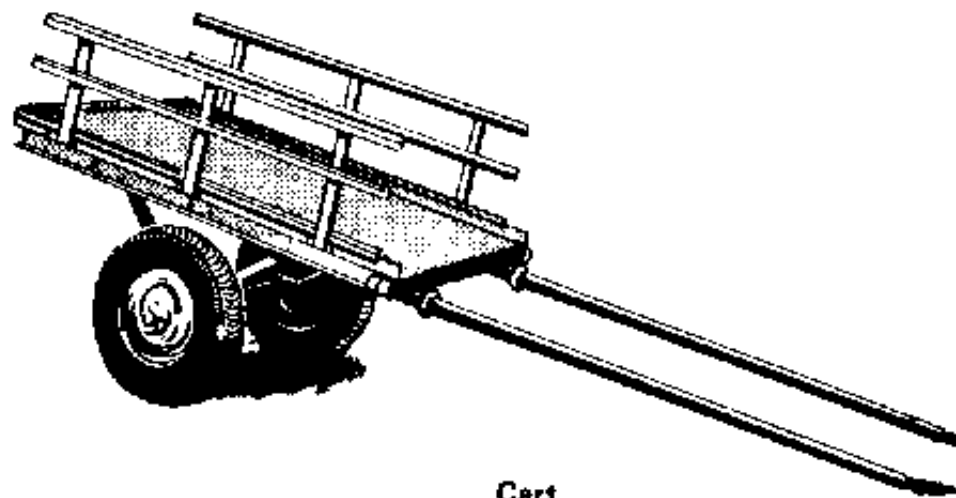

**Cart**

## Cart

**A cart costs between 25000 and 30000 CFA francs.**

**It is very useful for carrying manure, harvests, wood, water.**

**You can also transport things for other farmers.**

**Some kinds have iron wheels, others have tires.**

**Oxen can pull a cart loaded with 1000 kilogrammes of goods.**

## Other tools

● Groundnut lifting plough

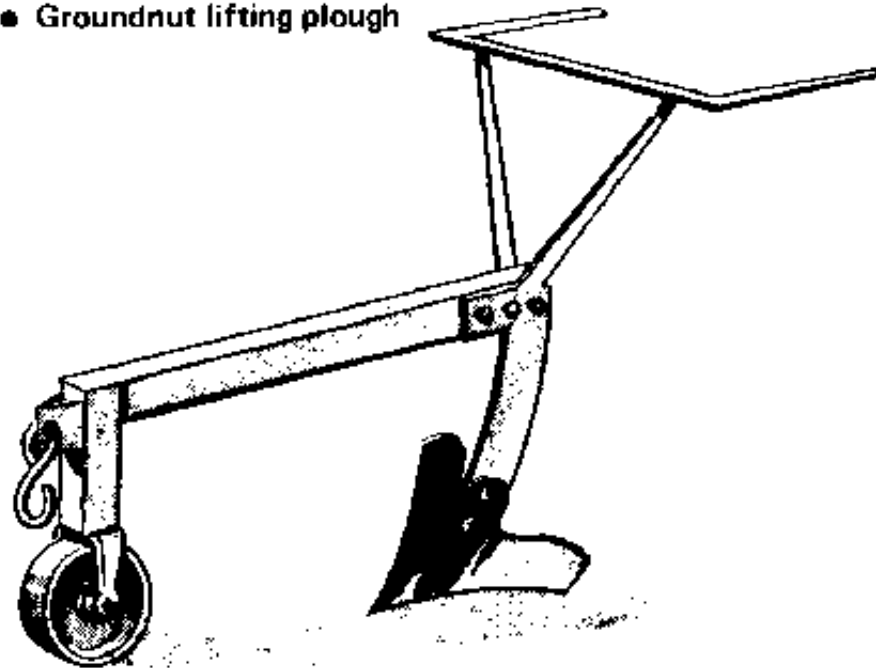

**Lifting plough**

- **Reaper**

**It is used for cutting cereals, for example, rice.**

- **Fertilizer spreader**

**A good farmer takes care of his tools; knows how to mend them; protects them from rain.**



[Home](#) > [ar](#).[cn](#).[de](#).[en](#).[es](#).[fr](#).[id](#).[it](#).[ph](#).[po](#).[ru](#).[sw](#)

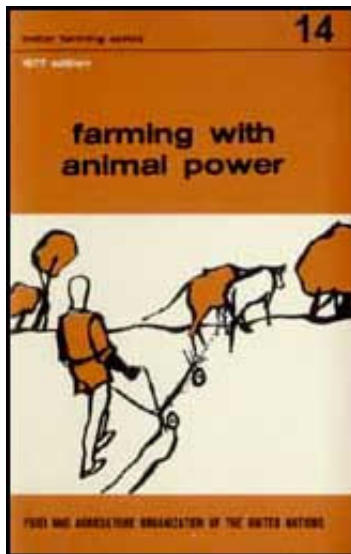

 **Better Farming Series 14 - Farming with Animal Power (FAO - INADES, 1977, 57 p.)**

➔  **Income from animal power**

 **(introduction...)**

 **What animal power costs**

 **(introduction...)**

 **Buying animals and tools**

 **Amortization**

 **Interest**

 **The animals' food**

 **Upkeep and repair of tools**

 **What animal power farming costs him:**

## **Better Farming Series 14 - Farming with Animal Power (FAO - INADES, 1977, 57 p.)**

### **Income from animal power**

**Farming with animal power is costly.**

**The farmer spends money on buying his animals and tools, on feeding and looking after the animals, on mending the tools.**

**The animals get old, the tools wear out.**

**After five or six years, you have to buy new oxen and new tools.**

**The farmer must know how much money he spends on farming with animal power.**

**He must know what it costs him.**

**The farmer also knows how much money he makes from working by hand.  
He knows how much money he gets from working with animals.**

**So he knows how much more money he gets from the use of animal power.**

**The extra money earned with the animal power, less the money spent on it, is the income from animal power.**

### **What animal power costs**

**To know what animal power costs,**



## **you must know what you have to spend on:**

- **buying animals and tools;**
- **feeding the animals;**
- **the upkeep and repair of the tools.**

**Prices vary from country to country and from region to region.  
The prices given here do not apply to all of Africa.  
They are only two examples.**

### **Buying animals and tools**

**Let us take two farmers, Toumba and Gambara.  
Toumba and Gambara each buy**

a plough                    8000 francs

a pair of oxen        32 000 francs

They each spend 40 000 francs (CFA)

**Toumba buys a plough for 8000 francs. In 5 years the plough is worn out. Toumba has to buy another one. He needs money. But he never thought of putting aside any money. So he cannot buy a new plough. Toumba cannot use his oxen any more. He cannot farm with animal power.**

**Gambara also buys a plough for 8 000 francs. At the end of 5 years the plough is worn out. But Gambara has put some money aside every year. So he can buy a new plough and go on farming with animal power.**

## **How much money be put aside?**

**Putting money aside to replace tools or oxen is called amortization.**

- **To replace a plough**

**The plough costs 8 000 francs.**

**It lasts 5 years.**

**To get 8 000 francs in 5 years, you must put aside each year**

**$8\ 000 / 5 = 1\ 600$  francs**

**These 1 600 francs are the amortization of the plough.**

- **To replace the oxen**

**The oxen cost 32 000 francs.**

**After 6 years they are too old and are sold for 20 000 francs.**

**In 6 years the oxen have lost in value**

**$32\ 000$  francs less  $20\ 000$  francs =  $12\ 000$  francs.**

**In order to have enough money in 6 years' time to buy new oxen a farmer must put money aside every year for the amortization of the oxen, that is:**

**francs /6= 2 000 francs.**

**For the amortization of the plough and the oxen the farmer must put aside every year**

**1 600 francs plus 2 000 francs = 3 600 francs.**

## **Amortization**

**Amortization means putting aside every year the money to replace your tools and oxen.**

## **Interest**

## **Gambara buys**

|                |               |
|----------------|---------------|
| a plough       | 8 000 francs  |
| two oxen       | 32 000 francs |
| Gambara spends | 40 000 francs |

**But Gambara hasn't got 40 000 francs.**

**So he asks a friend or a bank to lend him the money.**

**His friend, or a bank that has 40 000 francs, could use the money to buy a shop and do business.**

**The 40 000 francs would bring in money.**

**This is why the friend or the bank that lends you money asks you to pay back more.**

**If the bank lends you 100 francs for one year, and asks you to pay back 105 francs at the end of the year, and say that the bank asks for 5 percent (5%) interest. The extra 5 francs are the price you must pay for the loan of 100 francs for one year.**

**For a farmer who is lent 40 000 francs, interest at 5% a year works out as follows:  
40 000 francs x 5/100 = 2 000 francs interest each year.**

**Interest is the money a farmer must pay each year for the use of money lent to him**

**Each year Gambara must put aside in order to pay for his oxen and his plough:**

Amortization 3 600 francs

Interest 2 000 francs

**Total**

**\_5 600 francs**

**To replace his animals and his plough, Gambara puts aside each year 5 600 francs.**

**The animals' food**

**Gambara gives a feed supplement to his working oxen (see page 27). Each animal gets 2 kilogrammes of sorghum on days when it works.**

**Instead of giving the sorghum to the animals Gambara could have sold the sorghum at, say, 12 francs a kilogramme.**

**Gambara should know how much money he could have got for this food.**

**Each working day the food for the two oxen costs him: 4 kilogrammes x 12 francs = 48 francs.**

**The oxen work 100 days a year.**

**Their food costs him: 48 francs x 100 = 4 800 francs.**

**Upkeep and repair of tools**

**Work wears out tools.**

**They must be mended, the ploughshare must be replaced.**

**Gambara spends 500 francs a year for mending tools.**

**• Gambara reckons**

**What animal power farming costs him:**

amortization 3 600 francs

interest 2 000 francs

Animals' food 4 800 francs

upkeep of tools 500 francs

Total 10 900 francs

• **Gambara reckons what animal power farming brings in:**

**Before he used animal power Gambara earned:**

for cotton 26 francs X 300 kg 7 800 francs  
 for food crops 20 francs X 100 kg 2 000 francs  
 for groundnuts 15 francs X 200 kg 3 000 francs  
 Total 12 800 francs

**With animal power, Gambara earns more money because he gets bigger yields:**

for cotton 26 francs X 800 kg 20 800 francs  
 for food crops 20 francs X 400 kg 8 000 francs  
 for groundnuts 20 francs X 600 kg 12 000 francs  
 Total 40 800 francs

**by using animal power Gambara has earned more, namely, 40 800 francs less 12 800 francs = 28 000 francs.**

**But Gambara has spent 10 800 francs for the costs of animal power farming.**

**So the animal power has brought in, has raised his income by 28 000 francs less 10 900 francs = 17 100 francs.**

**Before using animal power, you must work out how much more income you can earn by it.**

**For animal power to bring in more money, you must be able to farm 3 or 4 hectares of land and have, in addition, 2 hectares of fallow land to feed the oxen.**

**If the oxen work less than 100 days, they cost too much.**

**The amortization and the interest to be paid per working day are too costly.**

**Look at the example once more:**

**For amortization and interest on his oxen and tools, Gambará must pay 5 600 francs.**

**If the oxen work 100 days, amortization and interest cost him:  $5\ 600 \text{ francs} / 100 = 56 \text{ francs a day}$**

**If the oxen work 50 days, amortization and interest cost him:  $5\ 600 \text{ francs} / 50 = 112 \text{ francs a day}$**

**If a farmer has not got enough land to keep his oxen working, he can combine with other farmers, so as to give the oxen more work.**



**[Home](#) > [ar](#).[cn](#).[de](#).[en](#).[es](#).[fr](#).[id](#).[it](#).[ph](#).[po](#).[ru](#).[sw](#)**

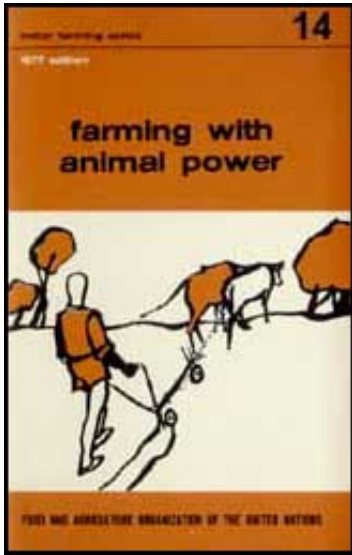

## **Better Farming Series 14 - Farming with Animal Power (FAO - INADES, 1977, 57 p.)**

 **(introduction...)**

 **Preface**

 **Introduction**

**Choosing and preparing fields**

**Working animals**

**Tools for use with animal power**

**Income from animal power**

  **Mechanized farming**

 **Some examples of animal power farming**

 **Suggested question paper**

### **Mechanized farming**

**With a tractor, the work is done more quickly.**

**A tractor can work all day. It does not get tired like oxen.**

**There is no delay in sowing. You can farm bigger fields. You can carry heavy loads. You can clear land more easily.**

**But**

**You need a lot of money to buy a tractor.**

**A tractor costs between 700 000 francs and 1 000 000 francs.**



**You also need plenty of money to buy the tools.**

**A plough to use with a tractor costs much more than a plough for oxen. It is bigger and more complicated.**

**You also need plenty of money to buy petrol (gasolene); to buy lubricating oil; to pay for repairs; to pay insurance.**

**You must know how to drive the tractor and make good use of the tools.**

**You must know how to mend the tractor if there is no garage in your village. Repairs are costly.**

**To pay for all this, you must farm a lot of land, say 50 hectares. You must grow crops that bring in a lot of money.**

**In many places the agricultural service has tractors.**

**Farmers can pay to have these tractors work in their fields.**

**You can hire them.**







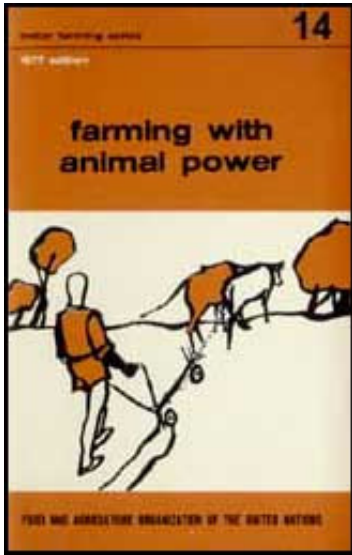

**[Home](#) > [ar](#).[cn](#).[de](#).[en](#).[es](#).[fr](#).[id](#).[it](#).[ph](#).[po](#).[ru](#).[sw](#)**

---

 **Better Farming Series 14 - Farming with Animal Power (FAO - INADES, 1977, 57 p.)**



-  **(introduction...)**
-  **Preface**
-  **Introduction**
- Choosing and preparing fields**
- Working animals**
- Tools for use with animal power**
- Income from animal power**
-  **Mechanized farming**
-  **Some examples of animal power farming**
-  **Suggested question paper**

## **Some examples of animal power farming**

### **At Korhogo (Ivory Coast)**

**animal power enables farmers to farm fields 3 times as big, and to harvest 3 times as much on the same area. The harvest is 9 times as big.**

### **At Darou (Senegal)**

**with animal power fields twice as big were farmed, and the farmers earned twice as much.**

### **At Banfora (Upper Volta)**

**with animal power one man can farm more than 2 hectares instead of 1 hectare.**

## **At Ouaka (Central African Empire)**

**the production of cotton per family is: 157 kilogrammes without animal power,  
473 kilogrammes with animal power.**

