READ THIS FIRST

INSTALLATION GUIDE

**WD1007V-SE1/SE2
Winchester/Floppy Disk Controller**

WESTERN DIGITAL

COPYRIGHT © 1989 WESTERN DIGITAL CORPORATION

ALL RIGHTS RESERVED

Information furnished by Western Digital Corporation is believed to be accurate and reliable. However, no responsibility is assumed by Western Digital Corporation for its use; nor for any infringements of patents or other rights of third parties which may result from its use. No license is granted by implication or otherwise under any patent or patent rights of Western Digital Corporation. Western Digital Corporation reserves the right to change specifications at any time without notice.

Trademarks used in this text: IBM, AT, and Personal Computer AT are registered trademarks of International Business Machines Corporation. Xenix and MS-DOS are registered trademarks of Microsoft Corporation. NetWare and CompSurf are registered trademarks of Novell Incorporated. SCO is a trademark of Santa Cruz Operation, Incorporated.

TABLE OF CONTENTS

INTRODUCTION	v
PRELIMINARY STEPS	1-1
GATHER SUPPLIES	1-1
BASIC INPUT/OUTPUT SYSTEM (BIOS)	1-3
IDENTIFY BOARD	1-4
IDENTIFY DRIVE	1-4
IDENTIFY CABLES	1-5
UNPACKING THE CONTROLLER BOARD	1-7
HOW TO CONFIGURE AND INSTALL YOUR HARDWARE	2-1
HARD DISK DRIVE CONFIGURATION.....	2-1
FLOPPY DRIVE CONFIGURATION.....	2-2
WD1007V JUMPER CONFIGURATION.....	2-2
W1 Jumper Connections	2-6
W3 thru W12 Jumper Connections	2-10

W3 Jumper Connection.....	2-11
W5 Jumper Connection.....	2-11
W6 and W12 Jumper Connections.....	2-11
W7 Jumper Connection.....	2-12
W8 Jumper Connection.....	2-12
INSTALLATION OF THE WD1007V	2-13
PERFORMING AN INITIAL SETUP	2-19
FORMATTING YOUR HARD DRIVE.....	3-1
LOW-LEVEL FORMATTING	3-2
WD1007V BIOS	3-2
HIGH-LEVEL FORMATTING	3-9
MSDOS (FDISK and FORMAT)	3-9
SCO Xenix	3-10
Novell Netware	3-11

HOW TO CHECK YOUR INSTALLATION	4-1
START SYSTEM FROM HARD DISK.....	4-1
HOW TO HANDLE PROBLEMS	4-2
APPENDIX A	A-1
TRANSLATION.....	A-1
FORMATTING	A-2
ALTERNATE SECTOR	A-4
APPENDIX B	B-1
BASIC INPUT/OUTPUT SYSTEM (BIOS)	B-1
Using your system's setup program	B-2
Using the DOS Utility to examine the AT BIOS	B-3
LOW LEVEL FORMATTING WITH WDFMT	B-5
APPENDIX C	C-1
DIAGNOSTIC UTILITY	C-1

TECHNICAL SUPPORT BULLETIN BOARD	C-1
--	-----

FIGURES

FIGURE 1-1. HARD DRIVE CABLES	1-6
FIGURE 2-1. HARD DISK DRIVE SELECT & CABLES	2-3
FIGURE 2-2. WD1007V-SE2.....	2-4
FIGURE 2-3. DEFAULT JUMPER SETTINGS	2-5
FIGURE 2-4. JUMPER W1 FIRMWARE OPTIONS.....	2-6
FIGURE 2-5. DEFAULT JUMPER SETTINGS (W3 THRU W12).....	2-7
FIGURE 2-6. INSTALLATION.....	2-18
FIGURE 3-1. WD1007V BIOS UTILITY.....	3-4
FIGURE A-1. SECTOR SKEW.....	A-3
FIGURE B-1. WDFMT UTILITY.....	B-8

INTRODUCTION

The WD1007V-SE2 Winchester/Floppy Disk Controller interfaces two ESDI-compatible hard disk drives and two floppy disk drives (5.25 or 3.5 inch) to a PC-AT system processor. The WD1007V-SE1 is a hard drive only version of the controller. The WD1007V BIOS ROM provides parameter tables, low-level formatting, surface analysis and defect management routines to fully integrate ESDI drive capabilities into your system.

This document describes installation of the WD1007V-SE1/SE2 Winchester/Floppy Disk Controller in the IBM Personal Computer AT or compatible.

The following is a summary of the steps you will take to configure and install your controller board for use with your hard disk drive(s) and floppy drive(s).

1. Gather together necessary equipment and software
2. Unpack and inspect controller board
3. Configure and install hardware
4. Run setup utilities
5. Format the hard drive
6. Check installation

1

PRELIMINARY STEPS

This section describes steps you must take before installing the WD1007V controller in your system.

GATHER SUPPLIES

Make sure you have all the necessary equipment and software for installation of the WD1007V controller and configuration of your drive(s).

- screwdriver
- WD1007V-SE1 (Hard drive only controller) *or* WD1007V-SE2 (Hard drive and floppy controller)
- One 34-pin control cable (daisy-chained, if connecting two hard drives)
- One 20-pin data cable (two cables, if you are connecting two hard drives)

- One 34-pin floppy cable (daisy-chained, if you are connecting two floppy drives)
- IBM PC-AT or compatible system with a maximum of two ESDI hard drives *or* a maximum of two ESDI hard drives and two ANSI standard floppy drives with a density sensor
- MS-DOS version 3.3 or higher, Xenix, NetWare or other operating systems that provide disk partitioning
- If you are disabling the WD1007V BIOS ROM, then you will also need Western Digital's WDFMT for the low-level formatting

BASIC INPUT/OUTPUT SYSTEM (BIOS)

Many system BIOS ROMs support only the older MFM/ST506 drives that have 17 sectors per track. The ESDI disk drive typically has 34 or more sectors per track. Therefore, your system's BIOS ROM may not be adequate to support your ESDI drive.

In terms of maximum flexibility and adaptability with different drives, Western Digital recommends that you use the WD1007V BIOS ROM. ESDI drives have the ability to present actual drive characteristics to the controller. The WD1007V BIOS ROM reads the ESDI information and generates the appropriate drive table.

If you are installing a hard drive in your system and you want to use your system's BIOS ROM to configure your drive, disable the WD1007V BIOS as described in section 2, and refer to Appendix B for low-level formatting information.

IDENTIFY BOARD

You have the following controller board choices:

- **Install the 1007V-SE1:**

If you are installing a hard drive and your floppy controller is on the motherboard or you currently have a separate floppy controller.

- **Install the 1007V-SE2:**

If you are installing a hard drive(s) and a floppy drive(s) for the first time (there is no floppy controller on the motherboard) or you wish to replace your current controller(s). *You must remove or disable any other controller in your system.*

IDENTIFY DRIVE

The 1007V-SE1/SE2 controller supports two ESDI drives, each having no more than 53 sectors per track, 16 heads and 2048 cylinders.

The 1007V-SE2 additionally supports two floppy disk drives (5.25 inch or 3.5 inch with single density, double density, and high density formats).

IDENTIFY CABLES

If you are installing a new hard drive along with the WD1007V controller board, here are a few words about cables. Figure 1-1 shows both a twisted and a non-twisted daisy chain cable for hard drives. Be careful not to confuse the twisted hard disk cable with a floppy daisy chain cable. **They are not interchangeable.** Floppy daisy chain cables also have 34-pin connectors and are usually twisted. The only distinguishing mark may be that the floppy cable has the twist located closer to pin 1 position. Also note that the twisted portion of the hard drive cable must have exactly five wires.

If you only have one hard drive in your system, then you will probably use a standard two-connector, 34-pin cable (not shown).

Note that the cable or cable connectors have been "keyed" in some fashion, such as a colored stripe on the cable identifying pin 1 position and/or a notch on the connector. This is to ensure proper connection of the cables to the drive(s) and controller card.

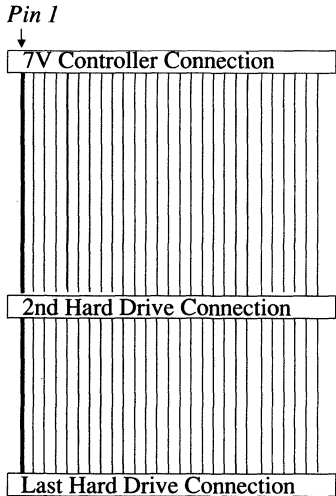

Cable without a twist

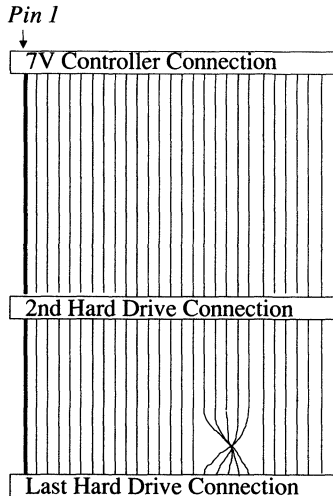

Cable with a twist

FIGURE 1-1. HARD DRIVE CABLES

UNPACKING THE CONTROLLER BOARD

CAUTION

Hold the controller board by the ends. Static electrical discharge can permanently damage components if the board is not carefully handled.

Remove the controller board from its antistatic pouch and inspect it for any visible signs of damage (scratches, loose components, broken connectors). Contact your dealer if there is damage.

Retain any packing materials for reuse if it becomes necessary to return your controller.

2

HOW TO CONFIGURE AND INSTALL YOUR HARDWARE

HARD DISK DRIVE CONFIGURATION

Your hard disk drive has jumpers, switches, and/or termination resistors that must be configured before you install the drive in your computer system. Before proceeding with the installation of your controller card, make certain your drive(s) is properly configured and physically installed according to the manufacturer's instructions.

- Verify proper termination of the last hard disk drive. The last drive (and only the last drive) in your system requires a termination resistor.
- Verify proper setting of drive select switches on your hard drive, if necessary. Your hard drive must be configured to support the hard sector mode. See Figure 2-1.

Figure 2-1 shows the proper drive selection settings and connections for your hard drive, depending upon whether you are using a twisted or non-twisted daisy chain cable. You may also have a standard two connector cable (not shown) for a single hard disk drive. If you have such a cable, set your drive select as "1" and do not remove the termination resistor.

FLOPPY DRIVE CONFIGURATION

Floppy drives are similarly selected and cabled. Be sure there is a termination resistor on the last floppy drive. Refer to your Owner's Manual for your floppy drive for proper selection and cabling information.

WD1007V JUMPER CONFIGURATION

Before you install the WD1007V, verify that the controller's jumpers (small shorting plugs) are properly set to reflect your configuration choices. Modification of the standard factory settings on the controller is rarely necessary. Modify the jumpers only under the direction of a qualified individual, i.e., your dealer. Figure 2-2 illustrates the jumper locations on the WD1007V-SE2 controller board. Figure 2-3 illustrates the default jumper set-

34-PIN TWISTED CABLE

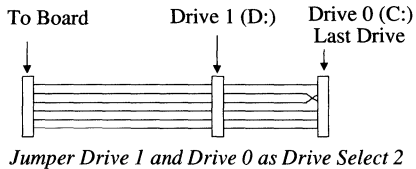

34-PIN NON TWISTED CABLE

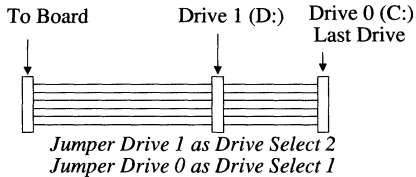
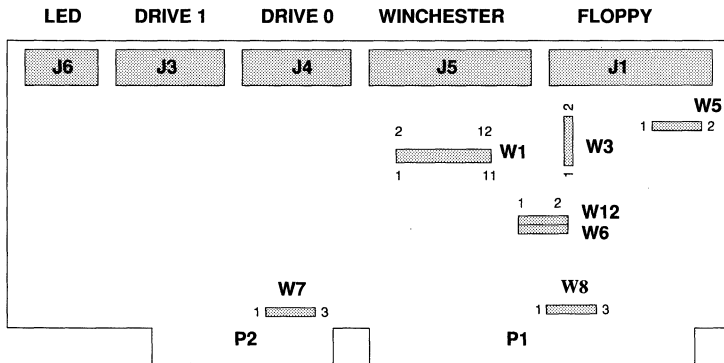

FIGURE 2-1. HARD DISK DRIVE SELECT & CABLES

tings for the WD1007V-SE2. The WD1007V-SE1 board does not have jumpers W5 and W6. **Please read the jumper descriptions which follow.**



Note: The WD1007V-SE1 version of this controller does not support floppy drives and jumpers W5 and W6 are not used.

FIGURE 2-2. WD1007V-SE2

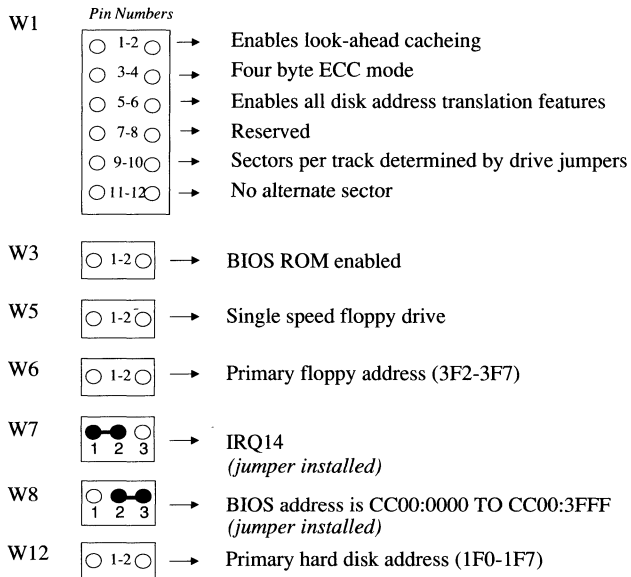

FIGURE 2-3. DEFAULT JUMPER SETTINGS

W1 DEFAULT SETTINGS - NO JUMPERS INSTALLED

Pin Numbers	
<input type="radio"/> 1-2 <input type="radio"/>	→ Enables look-ahead cacheing
<input type="radio"/> 3-4 <input type="radio"/>	→ Four byte ECC mode
<input type="radio"/> 5-6 <input type="radio"/>	→ Enables all disk address translation features
<input type="radio"/> 7-8 <input type="radio"/>	→ Reserved
<input type="radio"/> 9-10 <input type="radio"/>	→ Sectors per track determined by drive jumpers
<input type="radio"/> 11-12 <input type="radio"/>	→ No alternate sector

Note: To be compatible with the WD1007A mode, install jumpers on 9-10 and 11-12.

FIGURE 2-4. JUMPER W1 FIRMWARE OPTIONS

W1 Jumper Connections

Module jumper W1 selects the firmware options illustrated in Figure 2-2 when no jumpers are installed. *If you are merely replacing a WD1007A controller with a WD1007V controller and you do not wish to reformat your currently installed drive(s), you must install jumpers on W1 9-10 and W1 11-12.*

WI 1-2: When a jumper is installed, no cacheing occurs.

When no jumper is installed, cacheing is enabled. Cacheing increases overall system performance by reading ahead and buffering data sectors likely to be requested by the host on subsequent read commands.

WI 3-4: When a jumper is installed, the host receives seven bytes of error correction code (ECC) during Read Long and Write Long operations.

When no jumper is installed, four byte ECC mode is selected. This is the most common selection. When using four byte ECC mode, three ECC bytes are temporarily saved until the next command or data transfer occurs.

WI 5-6: When a jumper is installed, the controller assumes that the values indicated by the Set Parameters command are the true physical values of the drive. Install this jumper only if your system supports the true physical parameters of your drive (number of heads, cylinders, SPT).

If you have a system which cannot support drives which have more than 17 SPT or drives that have more than 1024 cylinders, you require the default selection (no jumper). This provides a translation scheme to more fully utilize the capacity of your drive. See "Translation" in Appendix A for further explanation.

WI 7-8: This is reserved. No jumper is installed.

WI 9-10: When a jumper is installed, it forces the drive to 35 SPT by issuing a Set Unformatted Bytes per Sector command to the drive. This overrides the drive's switches which select the SPT value. This jumper has no effect on drives having data transfer rates of 15 Mbits per second.

Without a jumper, the controller uses the physical SPT value presented by the drive (as determined by the drive's jumper settings).

WI 11-12: When a jumper is installed, an alternate sector per track is provided. The alternate sector is useful when deallocating media defects. Mapping out media defects is important if you have an operating system which can accom-

modate only a certain number of errors. If you choose to format an alternate SPT for deallocation of media defects, you will lose some of your drive's storage capacity. This feature is explained further in Appendix A.







	JUMPER	DEFAULT SETTINGS
W3		BIOS ROM enabled
W5		Single speed floppy drive
W6		Primary floppy address (3F2-3F7)
W7		IRQ14 <i>(jumper installed)</i>
W8		BIOS address is CC00:0000 TO CC00:3FFF <i>(jumper installed)</i>
W12		Primary hard disk address (1F0-1F7)

FIGURE 2-5. DEFAULT JUMPER SETTINGS (W3 THROUGH W12)

W3 thru W12 Jumper Connections

Figures 2-4 illustrates the W3 through W12 jumper default settings for the WD1007V-SE2. Note that if you have the WD1007V-SE1 version (hard disk only), jumpers W5 and W6 are not used.

W3 Jumper Connection

To disable the installed WD1007V BIOS ROM, place a jumper on W3 1-2. Use the system BIOS for low level formatting. See Appendix B.

W5 Jumper Connection

Without a jumper on W5 1-2, the WD1007V supports single-speed floppy drives. When jumpered, dual-speed floppy drives are supported.

W6 and W12 Jumper Connection

To select the module's secondary address ranges, install jumpers on W6 1-2 (floppy drives) and W12 1-2 (fixed drives). The primary address ranges of 1F0-1F7 and 3F2-3F7 are selected when jumpers are not installed. Secondary address ranges are selected only when using a second controller or as a means of disabling a device.

	Primary address ranges	Secondary address ranges
Hard drives:	1F0-1F7	170-177
Floppy drives:	3F2-3F7	372-377

W7 Jumper Connection

The 1007V-SE1/SE2 controller offers the default interrupt request, IRQ14. Jumper W7 1-2 is factory installed. Note that MS-DOS, OS/2, and most other operating systems work with IRQ14. Some operating systems may work with IRQ15 if custom drivers are installed. If your particular application requires IRQ15, install the jumper on W7 2-3.

W8 Jumper Connection

W8 2-3 is jumpered to select the BIOS address range CC000 through CFFFF or, if expressed as a "segment:offset" address, CC00:0000 to CC00:3FFF (CF00:0FFF).

By removing the jumper from W8 2-3 and placing it on jumper W8 1-2, the BIOS address range can be changed to C8000 through CBFFF or, if expressed as a segment:offset address, C800:0000 to C800:3FFF (CB00:0FFF). You only need to do this when there is a conflict between the BIOS address range and another device's address.

INSTALLATION OF THE WD1007V

CAUTION

To avoid electrical shock, make sure that all power to your computer is off and the power cord is disconnected from the electrical source.

1. Remove the power cord from the computer. If you remove any cables, note their location (for easy reassembly).
2. Remove the cover of the computer according to the instructions in your Owner's Manual.
3. Install your hard drive(s) and floppy drive(s) according to the manufacturer's instructions. Refer to your Owner's Manual for information about proper drive termination and select switches. *Be certain there is a termination resistor on the last hard drive and last floppy drive in*

your system. Be sure you use the right kind of cables for each device. (See Chapter 1, "Identifying Cables".

4. Remove or disable any other disk controller in your system if you are installing the WD1007V-SE2. If you have a controller on your motherboard, disable it according to the manufacturer's instructions.
5. Select any 16-bit expansion slot and remove the expansion slot cover. It is best to locate the controller in the closest available expansion slot relative to the drive. Put the expansion slot cover away and save it for possible future use. Retain the screw to hold the controller board in place.
6. Connect the hard drive(s) to the controller board by following these steps:

CAUTION

When routing the cables, be careful not to pinch them. Cables must not get caught between the cover and the boards nor should they obstruct any air flow path from fans or vents.

Do not confuse a daisy chain cable for a hard drive with a floppy daisy chain cable. They are not interchangeable.

- a. Connect the 34-pin control cable from the drive(s) to J5 connector on the controller. (See Figure 2-6.) Match the keyed connectors. Keyed connectors prevent accidental reversal of the cables which can cause severe damage to the drive and the controller.

The daisy chain control cable has three connectors. If you have a second drive, plug the middle connector into the back of the second drive. The shorter length of the cable connects the drives: the longer length connects the drives to the controller card.

- b. Attach the 20-pin data cable to J4 connector on the controller.

- c. If you have a second hard disk drive, attach the second 20-pin data cable to J3 connector on the controller.

J4's cable connects to Drive 0: J3's cable connects to Drive 1.

Note (DOS only)

Your system will identify Drive 0 as Drive C: Subsequent drives or partitions are identified as D:, E:, F:, etc.

7. Connect the floppy drive(s) to the controller board by following these steps:
 - a. Attach the 34-pin floppy cable to J1 connector.

A daisy chain cable has three connectors. If you have a second drive, plug the middle connector into the back of the second drive. The shorter length of the cable connects the drives: the longer length connects the drives to the controller card.

8. If your system provides an activity LED indicator for the drive, plug it into J6 on the controller.
9. Carefully slide the controller board into the expansion slot. Ensure that the board is seated properly by pressing down evenly on both ends of the board. Secure the board with the expansion cover screw. The completed cabling should resemble that shown in Figure 2-6.
10. Replace computer cover.
11. Reattach all cables and power cords to the back panel of the system. The hardware installation is now complete.
12. Follow the instructions for system setup.

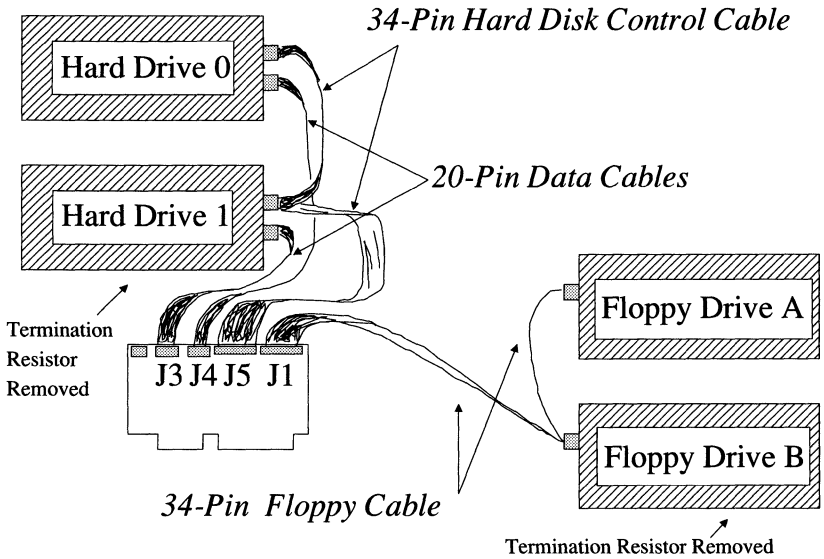

FIGURE 2-6. INSTALLATION

PERFORMING AN INITIAL SETUP

Your setup utility performs numerous tasks that are essential to the definition of your system. Whether this is an initial setup or a change to your existing system, you need to run the setup utility to tell the system what types of hardware are installed.

Follow the instructions in your operating system manual, system BIOS manual or use whatever means your particular system provides to perform an initial setup. If later you experience problems with any hardware device, be sure to check your system setup. You may have incorrectly defined a device or not identified it at all.



3

FORMATTING YOUR HARD DRIVE

Before you can use your ESDI drive, you need to perform these three steps:

1. Perform low-level formatting using the WD1007V BIOS utility or, if you are not using the WD1007V BIOS, use WDFMT. (See Appendix B for WDFMT instructions.)
2. Partition your drive using MS-DOS 3.3 or higher (FDISK utility) or use other operating systems that allow partitioning, such as Xenix and NetWare.
3. Perform high-level formatting using the operating system's normal formatting program. For MS-DOS use the "Format C: (or D:)/S" command which formats the drive to accept MS-DOS files and copies the operating system to the drive.

LOW-LEVEL FORMATTING

If you decided to disable the WD1007V BIOS ROM (W3 has pins 1 and 2 jumpered), skip the following instructions and instead go to Appendix B for low level formatting instructions.

WD1007V BIOS

If you are using the WD1007V BIOS to configure your drive, **there must be no jumper installed on jumper connector W3**. Proceed with the following steps.

1. Place your DOS system diskette in Drive A and turn on your system. At the A:\> prompt type:

debug and press the ENTER key

2. At the program prompt "-", type:

G=CC00:5 (Use C800:5 if W8 1-2 is jumpered)

This causes the system to execute program code stored at location CC005 (or C8005, if W8 1-2 is jumpered) in ROM. The BIOS then tries to read the parameter tables from the drive and store them in the shadow RAM. You will see the screen shown in Figure 3-1.

To execute a function, simply enter the number of the desired routine. The BIOS executes that routine and then prompts you to press a key to return to the main menu. **Note that after you have finished formatting and running the various routines, you must make a proper exit through function 7 to set the drive type.**

CAUTION

Selection of any of the menu choices will cause permanent loss of any data files that may exist on the drive. If you have not backed up your files and you wish to exit, press CONTROL-C or CONTROL-BREAK. Perform a power-up reboot to clear the shadow RAM.

*** Western Digital 1007A/1007V BIOS Utilities, Rev. x.x ***

DRIVE 0 CYLINDERS XXX HEADS XX PRECOMP CYLINDER XXX SPT XX
DRIVE 1 CYLINDERS XXX HEADS XX PRECOMP CYLINDER XXX SPT XX

Help ----->	1
Low Level Format All of Drive ----->	2
Mark Defect List Automatically ----->	3
Mark Defect List by Hand ----->	4
Verify Drive All of Drive ----->	5
Surface Analysis All of Drive ----->	6
Set Drive Type and Exit ----->	7

Enter Choice (1-7) ----->

FIGURE 3-1. WD1007V BIOS UTILITY

Following is a brief description of the formatting routines performed by the WD1007V BIOS utility. We recommend that you select and perform the routines in this order:

- Low Level Format
- Mark Defect List Automatically
- Verify Drive
- Surface Analysis
- Change Drive Type and Exit

The WD1007V BIOS offers these features:

1. *On-screen HELP menu*
2. *Low-level format* - Formatting routines are present to do the low-level initialization of the disk surface. The drive is formatted according to the number of physical sectors per track. You may also format an alternate track if you have placed a jumper on W1 11-12. (See "Alternate Sector", Appendix A.

Transparent to the user, this routine formats with a sector skew. The sector skew, which is fixed at two, allows the controller to maintain a 1:1 interleave across head boundaries on most drives. Sector skewing is a method of formatting in which the sector numbers are rotated in the interleave table for each track. (See "Format " in Appendix A for further information.) If a sector skew other than 2 is needed, use WDFMT to do a low level format, but use WD1007V BIOS for the rest of the options.

Note

When performing a low-level format of an ESDI drive, use the drive's physical parameters.

3. *Mark Defect List Automatically* - This routine automatically reads the manufacturer's defect list for each head and identifies and marks bad sectors. If an alternate sector is available, a bad sector can be deallocated without having to mark a sector as bad. This routine allows you to present an error-free drive to the system.

4. *Mark Defect List by Hand* - This routine is the same as the previous one, except that it allows the user to enter the list of media defects provided by the manufacturer. Use this routine if you are unable to enter the defects automatically.
5. *Verify Drive routine* - This routine performs a quick media verification. If a bad spot is discovered and an alternate sector is available, the bad sector is deallocated. If an alternate sector is not available, the sector is marked as bad.
6. *Surface Analysis routine* - This routine performs a long-term test on the entire drive. It identifies bad tracks on the drive and, in the event that there is only one bad sector on the track (and it is NOT sector zero), it uses the alternate sector when reformatting the track. This prevents the controller from identifying the sector as "bad".
7. *Change Drive Type and Exit routine* - There are five possible options available for defining drive type. The drive type can be changed by using the "+" and "-" keys.

- *No Drive Present.* The BIOS automatically selects a drive type 0 if there is no drive present. You will see the message "**** NONE SELECTED OR NO DRIVE PRESENT !****" next to the drive number.
- *Non-translation.* This option uses the drive's actual physical parameters (number of cylinders, heads, and SPT). The maximum number of cylinders is 1023.
- *Translation - 17 SPT.* Select this option when the drive is being used in a system that does not support drives with SPT values greater than 17 SPT. The low-level format uses the actual physical SPT, while the parameter tables created will show 17 SPT.
- *Translation - 63 SPT.* Select this option if the drive has more than 1024 cylinders, and it is being used in a system which can only recognize a maximum of 1024 cylinders. Translation must always be enabled when such a condition exists. Translation provides greater use of the drive capacity even though most types of AT BIOS recognize only a maximum of 1024 cylinders.

- *Special non-translation.* Select this option only if your drive has more than 1023 cylinders and you are using a custom device driver or operating system to obtain full usage of your ESDI drive. If you choose this option and don't have a custom driver or a special operating system, you will greatly reduce your storage capacity.

HIGH-LEVEL FORMATTING

After you have completed the low-level formatting of your drive using the WD1007V BIOS utility, you will need to partition your drive and perform a high-level format. The three main operating systems (MS-DOS, NetWare, and Xenix) all handle disk usage differently.

MS-DOS (FDISK and FORMAT)

After you have completed the low-level formatting of each hard drive in your system, use the FDISK and FORMAT utilities to prepare your drive for the MS-DOS operating system. Refer to your operating system manual for complete instructions.

1. Use FDISK to partition your drive. If your version of MS-DOS does not support the creation of multiple logical drives, disk enhancement software drivers can be used to obtain full usage of your high capacity drive or you may wish to upgrade your operating system.
2. Use the "Format C:(D:)/S" command to perform high-level formatting of the drive. This utility formats the drive to accept your operating system's files and allows you to copy the operating system to the drive. **You must format all logical drives (partitions).**

SCO Xenix

The SCO Xenix operating system does not limit the size of the disk partition. During the installation of the Xenix operating system, the user is prompted for information on how to partition the disk. The entire disk may be used for Xenix or separate partitions can be created for both Xenix or MS-DOS. (Note: Create the MS-DOS partition first using MS-DOS FDISK.) The Xenix installation performs all tasks comparable to the DOS FDISK and FORMAT utilities.

SCO Xenix 2.1 can create a parameter table for the drive outside of the system BIOS. The user is prompted at installation time to supply the drive parameters. Previous versions of the SCO Xenix operating system assumed 17 sectors per track, regardless of the information contained in the parameter table. If you have an older version, use the 17 sector translation option provided by the WD1007V BIOS utility.

Novell NetWare

Novell NetWare is a local area network (LAN) operating system. If you are using NetWare 2.0a, you must select the 17 SPT drive type offered by the WD1007V BIOS utility. If you are using NetWare 2.1 or later, any number of sectors per track is permissible. If you are running NetWare in a non-dedicated mode or if you are using the standard AT hard disk driver that comes with NetWare, we recommend that you select these parameters: 63 SPT and 16 heads. This will accommodate a drive size of 512 Mbytes.

NetWare requires you to run a program called CompSurf to prepare the disk drive. When running CompSurf, do not format your drive. **Answer "NO" when asked "Format the disk?" or you will lose all the BIOS information**

and defect information on your drive. When asked if you wish to maintain the defect map, respond "Yes" if you use the WD1007V BIOS utility.

7

4

HOW TO CHECK YOUR INSTALLATION

After you have completed the hardware installation and properly formatted your drive, you are ready to use your system.

START SYSTEM FROM HARD DISK

With your operating system installed on your hard drive, you can now boot your system from your active MS-DOS (or other operating system) partition. Remember to remove any diskettes from Drive A or your system will default to Drive A when you reboot.

Simultaneously press the **CTRL ALT DEL** keys to reboot the system.

The system should respond and your monitor should finally display the C prompt (C>). Your installation is complete.

HOW TO HANDLE PROBLEMS

If you have a problem with your system, first re-read the instructions to be sure you followed them correctly. It is important to type information exactly as instructed.

Repeat the procedures a second time. If you obtain the same results, then check the next section "If You Have a Problem".

If You Have a Problem

First check your physical installation. Check for reversed cables, an overloaded system power supply, incorrect drive selection, etc.

The following section lists some common problems and possible solutions to try.

- PROBLEM:** No response.
- SOLUTION:** Change cables. Do NOT interchange floppy disk drive cables with hard drive cables. Check your system setup configuration.
- PROBLEM:** Winchester activity LED always on.
- SOLUTION:** Check cable connections. Replace cables. Verify that drive is not malfunctioning.
- PROBLEM:** "Error Reading Fixed Disk" message after booting the system.
- SOLUTION:** DOS partition not active. See FDISK instructions in your DOS manual.

PROBLEM: "Hard Disk Drive Not Ready" or "01" Error Code.

SOLUTION: You may have an overloaded power supply. Update system power supply. read your system/drive manufacturers' manuals to see if the power supply can handle the drive.

PROBLEM: You can't get full capacity from your drive.

SOLUTION: This problem has several possible causes and several solutions. These are listed below:

1. You have a drive with more than 1024 cylinders and you selected a drive type with more than 1023 cylinders. Most operating systems cannot handle this. Repeat the low level format and this time select a drive type with less than 1024 cylinders.
2. You are using physical mode and you have a drive with more than 1024 cylinders. You selected a drive with 1023

cylinders and a specific number of physical heads and a specific number of SPT. Try using translation mode and select a drive type with 16 heads and 63 SPT. (Jumper W1 5-6 removed, and use the WD1007V BIOS).

3. You are using alternate sectors. This option will improve performance, but decreases capacity by one sector per track. For example, if you have a drive with 35 SPT then 1/35th of your drive capacity is lost.

4. Your current operating system may only recognize a maximum capacity of 512 Mbytes. To gain access to the full capacity of your hard drive, you will need to change your operating system or possibly obtain a special driver. Contact the dealer that sold you your drive. He should be able to recommend a solution so that you can fully utilize your drive's capacity.

PROBLEM: You have a dual density floppy drive, but you can format/read only one density of diskettes (either 720KB or 1.44MB).

SOLUTION: You do not have an ANSI standard floppy drive with a density sensor. Therefore your drive will only read one media density. Contact your drive manufacturer.

PROBLEM: You need to use WDFMT, but don't have a copy of it.

SOLUTION: Contact the Western Digital Bulletin Board. Appendix C has the instructions for obtaining software from the Bulletin Board.

If you are unable to resolve a problem, contact your dealer.

APPENDIX A

TRANSLATION

In order to utilize the maximum storage capacity of ESDI drives, the WD1007V-SE2 controller resolves two types of problems associated with the implementation of ESDI drives in an AT environment:

1. An older BIOS or some operating systems may only recognize 17 SPT, whereas ESDI drives have 34 or more SPT.

The WD1007V BIOS provides translation schemes to more fully utilize the capacity of the ESDI drive, even though the system can only recognize 17 SPT.

2. Most personal computers address disk space via the INT 13 BIOS software interface. This software interface provides only four bits to specify head number, six bits for a sector number and ten bits for a cylinder

number. Thus, the ideal drive for the INT 13 software interface could have 16 heads, 63 sectors per track, and 1023 cylinders.

The WD1007V BIOS provides translation schemes to maximize the disk space that can be addressed by INT 13. The standard 63 SPT translation creates a logical drive with 16 heads and 63 sectors per track. It maps the drive's physical characteristics into these logical parameters by converting the logical disk address parameters supplied by the host into a logical sequential sector number. These logical sector numbers are then translated into actual physical parameters so that all physical sectors on the drive are utilized.

When disk address translation is disabled (jumper on W1 5-6), mapping is one-to-one. Each physical sector maps directly to a logical sector.

FORMATTING

Formatting routines perform the low-level initialization of the disk surface. The drive is formatted with the physical characteristics read from the drive.

Formatting is done at a 1:1 interleave ratio which makes it possible to read or write an entire track in one rotation of a disk. The format routine formats with the selected sector skew (a skew of 2 is recommended for optimal performance) and also may format an optional spare sector on each track. This spare sector is used to deallocate a bad sector on a track.

The sector skew, when fixed at two, allows the controller to maintain a 1:1 interleave across all head boundaries. Sector skewing is a method of formatting by which the sector numbers are rotated in the interleave table each time a new head on a cylinder is formatted. Selecting a skew of 2 causes the first sector

HEAD	SECTOR NUMBERS									
0	1	2	3	4	5	6	7	8	9	10
1	9	10	1	2	3	4	5	6	7	8
2	7	8	9	10	1	2	3	4	5	6

Interleave: 1:1
Sector skew: 2

FIGURE A-1. SECTOR SKEW

after index on Head 0 to be identified as Sector 1. The sector identified as Sector 1 on Head 1 is the third physical sector from index as shown in Figure A-1.

This formatting procedure allows the controller to maintain 1:1 interleave when reading across the head boundary. This becomes critical when the number of sectors per track increases and the time allowed for completion of overhead functions decreases. By changing the sector numbers the controller has enough time to complete needed tasks and be ready to read the ID field of the first sector on the next head.

ALTERNATE SECTOR

The WDFMT 2.10 utility and the WD1007V BIOS utility both provide the ability to format an alternate sector on the track. This spare sector is identified as Sector 0, making it invisible to the system BIOS which expects sector numbers starting at 1. This sector is always formatted as the last physical sector on the track. WDFMT and the WD1007V BIOS use the spare sector if an error is encountered with any sector on a track. The program reformats the track, num-

bering the bad sector as zero and shifting the following sectors one to the right. If more than one sector is bad, the entire track is marked as bad when reformatted.

The alternate sector feature provides the ability to map out defects so that an error-free drive can be presented to the operating system. This may be important to you if your operating system can handle only a certain number of media defects. Note that formatting an alternate sector will somewhat reduce the available storage space on your drive.

APPENDIX B

BASIC INPUT/OUTPUT SYSTEM (BIOS)

Before you disable the WD1007V BIOS ROM and use the system BIOS, you need to determine if your system BIOS provides the appropriate drive tables for integration of your ESDI drive into your AT system. If it does not, you require the WD1007V BIOS. In order to properly install your ESDI drive, your system must have drive tables whose parameters match those of your drive. The drive tables specify the number of cylinders, heads, and sectors per track (SPT). It is often difficult to match the drive and the drive table exactly. When integrating an ESDI hard disk drive into your system, you must match sectors per track and number of heads exactly.

If you are installing a hard drive in your system and you plan to disable the WD1007V BIOS, you then need to examine your system BIOS. Use one of the following two methods to examine your system BIOS:

1. Use your system's set-up program
2. Use the debug utility to examine the AT BIOS

Note

If you are unable to determine whether your system BIOS is adequate, then use the WD1007V BIOS ROM.

Using your system's setup program

To determine if a system BIOS has the physical drive parameters required for your ESDI drive, refer to the appropriate manual for information about your setup utility, i.e., MS-DOS Users Guide, Advanced Diagnostics Guide, system BIOS guide, or user guide for other operating system. This utility can provide you with information about the drive types your system supports. If your drive tables do not support more than 17 sectors per track, we recommend that you use the WD1007V BIOS. The WD1007V BIOS provides translation schemes to fully utilize the capacity of your drive within the limits of the operating system.

Using the DOS Debug Utility to examine the AT BIOS

Use the DOS Debug Utility to examine the system parameter tables to see if the drive is listed in the AT BIOS.

1. Place your DOS system diskette in Drive A and boot your system.
2. At the prompt (A:\>) type:

debug and press the ENTER key

Although some systems locate drive parameters in other locations, the standard location in the AT BIOS is F000:E401. The proper command at the Debug prompt (-) is as follows:

D F000:E401 and press the ENTER key

This displays eight lines of data from the BIOS ROM corresponding to drive types 1 through 8. By entering another "D" at the debug prompt, another eight lines of data will be displayed, corresponding to drive types 9 through 16. Con-

tinue this procedure until all drive parameter information for all drive types is displayed. If your drive's parameters are encountered in this process, the system BIOS supports your particular drive.

Each parameter table has 16 bytes of data. Data from the BIOS ROM is displayed in hexadecimal, least significant byte first. This data breaks down as follows:

Bytes 1 and 2	Number of Cylinders
Byte 3	Number of Heads
Bytes 4 & 5	Not Used
Bytes 6 & 7	Write Precompensation Cylinder
Byte 8	Not Used
Byte 9	Control Byte (=08H for 8 heads)
Bytes 10-12	Not Used
Bytes 13 & 14	Landing Zone 3
Byte 15	Sectors per Track
Byte 16	Not Used

LOW-LEVEL FORMATTING WITH WDFMT

If you are using the drive tables provided by your system BIOS, then use WDFMT to low-level format your drive. If you do not already have it, you can obtain WDMFT from the Western Digital Bulletin Board. See Appendix C.

Note

When low-level formatting an ESDI drive, use the drive's physical parameters, i.e., 8 heads and 34 or more sectors per track. If a format for 17 sectors per track is attempted, only the data fields will be initialized.

The WDFMT utility performs low-level formatting, bad track entry, disk verify, and surface analysis and defect management. Use a 1:1 interleave, a skew of 2, and format the drive using the physical parameters of the drive. If Jumper W1 11-12 is installed, also format an alternate sector.

To use WDFMT follow these instructions:

CAUTION

Back up any valuable files that may exist on your drive. Use of WDFMT will cause permanent loss of any existing data files.

1. Insert the WDFMT utility diskette in Drive A and type:

WDFMT and press the ENTER key

2. When the utility screen appears on your monitor, you will be prompted to supply the following information. For each prompt for information, type in your response and press ENTER.
- Drive 0 or 1 (Select drive to be formatted.)
 - The number of cylinders...
 - The number of heads ...
 - The number of sectors per track...
 - The interleave value (Select an interleave value of 1.)
 - The precompensation value (Enter the number of cylinders plus one.)
 - The sector skew (Enter 2)
 - Alternate sector (Enter "yes" only if Jumper W1 11-12 is installed.)

3. When you have completed your entries, the utility program will advance to the following screen.

```
***Western Digital Corporation***
      AT Disk Format Utility
      Rev. 2.10
      Current drive parameters are:
      Drive (0/1)   :      0
      Cylinders    :    1023
      Heads        :      8
      Sectors      :     35
      Interleave   :      1
      Precomp     :    1024
      Skew         :      2
      Alt Sector   :     No

      ENTER MENU CHOICE

      Format disk   CAUTION this will destroy
                  all data on drive!
      Verify disk
      Bad sector entry
      Surface test CAUTION this will destroy
                  all data on drive!
      Quit
```

FIGURE B-1. WDFMT UTILITY

You have four menu choices: format disk, verify disk, bad sector entry, and surface test.

Following is a brief description of the formatting routines offered by WDFMT:

Format Disk - This routine performs a low-level format of the drive. It formats the drive according to the information which you previously entered.

Verify Disk - This routine is a short-term test of the surface that identifies bad tracks on the drive and lists them by head and cylinder number. If an alternate sector is available, a bad sector can be deallocated without having to mark an entire track as "bad".

Bad Sector Entry - This routine allows you to enter the list of bad tracks. The bad track information is marked on the label on top of the drive. Entering the manufacturer's list of bad tracks ensures the safety of your data by identifying all bad tracks or marginally defective tracks on your drive. Once these defective tracks have been marked, they will not be used to store data.

Surface Test - This routine is a long-term test of the surface that identifies bad tracks.

4. From the menu select the routine you wish to perform.,

We recommend you follow these steps:

- a. Select "Format disk" and press the ENTER key to begin low-level formatting.
- b. When you have finished formatting, return to the main menu and select Verify Disk or Surface Test.
- c. When the verify and/or surface test is finished, select "Bad sector entry" and press the ENTER key. Locate the bad track information marked on the label on top of the drive. Type in the bad track list as follows:

ccc and press ENTER

h and press ENTER

where ccc = bad track cylinder number (1-4 digits) and

h = bad track head number (1-2 digits)

Type in the cylinder number and press ENTER. Type in the head number and press ENTER. Continue until all bad track information has been entered.

- d. When you have finished, select Quit to exit the WDFMT utility.

Return to Chapter 3 for the high level formatting instructions.

APPENDIX C

DIAGNOSTIC UTILITY

Western Digital has a low-level formatting utility called WDFMT which is available on Western Digital's Technical Support Bulletin Board. If you decide to disable the WD1007V BIOS ROM, then you need to use the WDFMT utility. You can execute this program by entering "WDFMT" and following the directions provided by the On-line Help.

TECHNICAL SUPPORT BULLETIN BOARD

You may download Western Digital's diagnostic utility, WDFMT, and other product information from the Bulletin Board if you have a modem.

To access the bulletin board you require:

- A Hayes compatible modem
- 1200 or 2400 Baud rate

- Format: 8 data bits, 1 stop bit, no parity

The Bulletin Board number is (714) 756-8176. The Bulletin Board will ask you some preliminary questions about your modem setup and the type of system you are calling from before sending you to the main menu. Refer to your modem manual for instructions on proper modem setup.

Once you gain access to the main menu, follow these general steps:

- Select <S> for software
- Select "Storage"
- Select "Utilities"
- Specify WDFMT

To receive the software program, select <D> and then the transfer protocol. Respond to the prompts for transfer protocol, file name, etc.

On screen Help (H) is available if you have any problems. If you need additional assistance, contact Technical Support at (800) 832-4778.

Radio Frequency Interference Statement

This Western Digital product has been verified to comply with the limits for a Class B computing device pursuant to subpart J of Part 15 of FCC rules. This does not guarantee that interference will not occur in individual installations. Western Digital is not responsible for any television, radio, or other interference caused by unauthorized modifications of this product.

If interference problems do occur, please consult the system equipment owner's manual for suggestions. Some of these suggestions include relocation of the computer system away from the television or radio or placing the computer AC power connection on a different circuit or outlet.

This digital apparatus does not exceed the Class B limits for radio noise for digital apparatus set out in the Radio Interference Regulations of the Canadian Department of Communications.

Western Digital
2445 McCabe Way
Irvine, CA 92714
(800) 847-6181 (714) 863-0102
FAX (714) 863-1656 TLX 910-595-1139
Technical Support: (800) 832-4778
Bulletin Board Support (714) 756-8176

Part No. 79-000367-000

WD0027S 8/89

**If you require further information or other technical support,
please contact your authorized dealer:**