

WangNet Backbone

COMPANY PROPRIETARY STATEMENT

This document is the property of Wang Laboratories, Inc. All information contained herein is considered Company Proprietary, and its use is restricted solely to assisting you in servicing Wang products. Neither this document nor its contents may be disclosed, copied, revealed, or used in whole or in part for any other purpose without the prior written permission of Wang Laboratories, Inc. This document must be returned upon request of Wang Laboratories, Inc.

PREFACE

This document is the Standard Maintenance (STD) Manual for the WangNet Backbone. It is organized in accordance with the approved STD outline established at the Field/Home Office Publications meetings conducted on September 14th and 15th, 1982. The scope of this manual reflects the type of maintenance philosophy selected for this product (swap unit, printed circuit assembly, chip level or any combination thereof).

The purpose of this manual is to provide the Wang-trained Customer Engineer (CE) with instructions to operate, troubleshoot and repair the WangNet Backbone. It will be updated on a regular schedule.

Third Edition (January 1985)

This edition of the WangNet Backbone STD manual obsoletes document(s) no. 729-1102-A and 729-1102-A1. The material in this document may only be used for the purpose stated in the Preface. Updates and/or changes to this document will be published as Publications Update Bulletins (PUB's) or subsequent editions.

© Copyright WANG Labs., Inc. 1982, 1983, 1985

TABLE OF CONTENTS

SECTION 1
INTRODUCTION

1.1	SCOPE AND PURPOSE.....	1-1
1.2	GENERAL DESCRIPTION.....	1-1
1.3	SPECIAL TOOL AND TEST EQUIPMENT.....	1-3

SECTION 2
THEORY OF OPERATION

2.1	INTRODUCTION.....	2-1
2.2	HEADEND.....	2-1
2.3	MAIN TRUNK CABLES.....	2-4
2.4	BRANCH CABLES.....	2-5
2.5	SUB-LOOP CABLES.....	2-6
2.6	BACKBONE COMPONENTS.....	2-7
2.6.1	Amplifier.....	2-7
2.6.2	Equalizer.....	2-11
2.6.3	Adjustable Equalizer.....	2-12
2.6.4	Diplexer.....	2-14
2.6.5	Splitter.....	2-18
2.6.6	Directional Coupler.....	2-22
2.6.7	Directional Tap.....	2-24
2.6.8	Outlet.....	2-27
2.6.9	Power Converter.....	2-28
2.6.10	Power Combiner.....	2-30

SECTION 3
OPERATION

.....	3-1
-------	-----

SECTION 4
INSTALLATION

.....	4-1
-------	-----

SECTION 5
MAINTENANCE

5.1	INTRODUCTION.....	5-1
5.2	PREVENTIVE MAINTENANCE.....	5-1
5.3	CORRECTIVE MAINTENANCE.....	5-1
5.4	MAINTENANCE TESTS.....	5-2
5.4.1	Amplitude Response Test.....	5-2
5.4.2	Hum Modulation Test.....	5-2
5.4.3	Signal to Noise Ratio Test.....	5-3
5.4.4	Amplifier Gain and Slope Test.....	5-3
5.4.5	Cable System Response Tests.....	5-5

TABLE OF CONTENTS (Continued)

5.5	INSTRUMENT PROCEDURES FOR MAINTENANCE TESTS.....	5-5
5.5.1	Amplitude Response Test.....	5-6
5.5.2	Hum Modulation Test.....	5-8
5.5.3	Signal to Noise Ratio Test.....	5-10
5.5.4	Amplifier Gain and Slope Test.....	5-12
5.5.5	Equalizer Adjustment Procedure.....	5-14
5.6	REMOVAL AND INSTALLATION PROCEDURES.....	5-16
5.6.1	Amplifiers.....	5-16
5.6.2	Taps.....	5-20
5.6.3	Diplexer.....	5-23

SECTION 6
SCHEMATICS

.....	6-1
-------	-----

SECTION 7
ILLUSTRATED PARTS BREAKDOWN

.....	7-1
-------	-----

SECTION 8
TROUBLESHOOTING

8.1	INTRODUCTION.....	8-1
8.2	TROUBLESHOOTING TESTS.....	8-1
8.3	TEST EQUIPMENT.....	8-1
	Troubleshooting Chart.....	8-2

APPENDICES

APPENDIX A	SPECIAL TEST EQUIPMENT.....	A-1
APPENDIX B	BIBLIOGRAPHY.....	B-1
APPENDIX C	WANGNET SITE LOG BOOK.....	C-1
APPENDIX D	WANGNET COMPONENT IDENTIFICATION NUMBERS.....	D-1
APPENDIX E	SYMBOLS USED IN BACKBONE ENGINEERING DRAWINGS.....	E-1
APPENDIX F	WANGNET MULTI-NODE TRUNK AND DISTRIBUTION SYSTEM.....	F-1
APPENDIX G	POWER TRANSFER UNIT OPTION.....	G-1

LIST OF ILLUSTRATIONS

FIGURE	DESCRIPTION	PAGE
1-1	Elementary Backbone Configuration.....	1-1
1-2	General Backbone Configuration.....	1-2
2-1	Typical Headend, Front View.....	2-2
2-2	Typical Headend, Rear View.....	2-3
2-3	Distribution Panel.....	2-5
2-4	Diplexer Functional Diagram.....	2-6
2-5	Amplifier Block Diagram.....	2-7
2-6	Amplifier Exterior View.....	2-8
2-7	Amplifier Interior View.....	2-9
2-8	Plug-In Pad and Equalizer.....	2-10
2-9	Equalizer Housing.....	2-11
2-10	Adjustable Equalizer.....	2-12
2-11	Adjustable Equalizer Schematic.....	2-13
2-12	Diplexer Block Diagram.....	2-15
2-13	Diplexer Exterior View.....	2-16
2-14	Diplexer Interior View.....	2-17
2-15	Splitter (Combiner) Application.....	2-19
2-16	Splitter Functional Diagram.....	2-19
2-17	Typical Splitter Exterior View.....	2-20
2-18	Typical Splitter Interior View.....	2-20
2-19	Headend Combiner.....	2-21
2-20	Directional Coupler Functional Diagram.....	2-22
2-21	Directional Coupler Application.....	2-23
2-22	Typical Directional Coupler Exterior View.....	2-23
2-23	Typical Directional Coupler Interior View.....	2-24
2-24	Directional Tap Functional Diagram.....	2-25
2-25	Directional Tap Application.....	2-25
2-26	Typical Directional Tap Exterior View.....	2-26
2-27	Typical Directional Tap Interior View.....	2-26
2-28	User Outlet.....	2-27
2-29	Power Converter Functional Diagram.....	2-28
2-30	Power Converter Front View.....	2-29
2-31	Power Converter Rear View.....	2-29
2-32	Power Combiner Functional Diagram.....	2-30
2-33	Typical Power Combiner Exterior View.....	2-31
2-34	Typical Power Combiner Interior View.....	2-31

LIST OF ILLUSTRATIONS (Continued)

FIGURE	DESCRIPTION	PAGE
5-1	Instrument Control Settings, Amplitude Response Test.....	5-6
5-2	Instrument Control Settings, Amplitude Response Test.....	5-7
5-3	Instrument Control Settings, Hum Modulation Test.....	5-8
5-4	Instrument Control Settings, Hum Modulation Test.....	5-9
5-5	Instrument Control Settings, Signal to Noise Ratio Test.....	5-10
5-6	Instrument Control Settings, Signal to Noise Ratio Test.....	5-11
5-7	Instrument Control Settings, Amplifier Gain and Slope Test....	5-12
5-8	Instrument Control Settings, Amplifier Gain and Slope Test....	5-13
5-9	Adjustable Equalizer Controls.....	5-14
5-10	Wang Model 2904 Amplifier.....	5-12
5-11	Amplifier Detail Views.....	5-17
5-12	Amplifier Detail View.....	5-18
5-13	Cover Bolt Tightening Sequence.....	5-19
5-14	RMS CA-4504 4-way Tap Plate.....	5-20
5-15	RMS CA-4508 8-Way Tap Plate & CA-4500 Tap Case.....	5-21
5-16	Jerrold FFT-4 4 Port Tap Plate.....	5-22
5-17	Diplexer.....	5-23
5-18	Diplexer RF Module.....	5-24
5-19	Diplexer Power Supply Module.....	5-25
5-20	Cover Bolt Tightening Sequence.....	5-26
7-1	Adjustable Equalizer.....	7-1
7-2	Wang Power Converter.....	7-1
7-3	Wang Amplifier.....	7-2
7-4	Wang Diplexer.....	7-3
7-5	C-COR Plug-In Pad.....	7-4
7-6	Jerrold Directional Coupler.....	7-5
7-7	RMS Directional Tap (housing only).....	7-6
7-8	RMS 4-Port Directional Tap.....	7-7
7-9	Jerrold 4-Port Directional Tap.....	7-8
7-10	RMS Power Passing Coupler.....	7-9
7-11	C-COR Directional Coupler....	7-10
7-12	Jerrold 8-Port Directional Tap.....	7-11
7-13	RMS 8-Port Directional Tap.....	7-12
7-14	Jerrold Power Combiner.....	7-13
7-15	Jerrold Headend Combiner.....	7-14
7-16	C-COR Power Inserter.....	7-15
7-17	RMS Power Passing Splitter.....	7-16
7-18	C-COR Equalizer.....	7-18
7-19	C-COR Equalizer Housing.....	7-19
7-20	Jerrold SWS-4 4-Way Splitter.....	7-20
7-21	Wangnet Outlet.....	7-21
7-22	C-COR Equalizer.....	7-23

SECTION

1

**INTRO-
DUCTION**

Section 1 INTRODUCTION

1.1 SCOPE AND PURPOSE

This manual contains the information required to maintain the Backbone of the Wangnet local networking system. It includes detailed descriptions of the Backbone, special test equipment, and all of the procedures required to be performed in the field after the initial hardware installation and certification. Lists of other reference documents, data sheets, and spare parts are in the appendices.

1.2 GENERAL DESCRIPTION

The Backbone of the Wangnet local networking system is a two-section, broadband, coaxial cable communications network. All users of the network are connected to both sections. The OUTBOUND section distributes communications signals to all users of the network, while the INBOUND section collects communications signals from all users of the network. The two sections come together at the HEADEND, and the terms Inbound and Outbound refer to the direction of signal flow relative to the Headend. Within the Headend, an RF LOOP connects signals from the Inbound section of the network to the Outbound section. Thus, signals transmitted toward the headend through the Inbound cable will be received by all users through the Outbound cable. The Backbone components are standard CATV (cable television) hardware items.

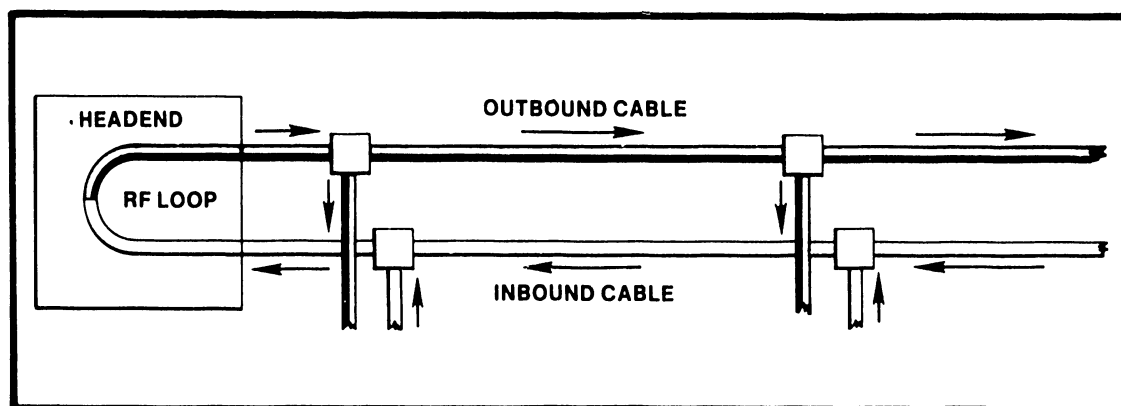

Figure 1-1

The two-section Backbone is further divided into MAIN TRUNK Distribution Cables, SUB-LOOP Distribution Cables, and BRANCH Distribution Cables. Normally, only the Sub-Loop and Branch cables service the network users. AMPLIFIERS with attenuators and equalizers are used at various locations along the cables for the purpose of maintaining signal quality throughout the network.

Other components of the Backbone include DIPLEXERS, DIRECTIONAL COUPLERS, SPLITTERS/COMBINERS, TAPS, CABLE DROPS, and OUTLET BOXES. These components provide the means of forming the Sub-Loops and Branches of the network, as well as the connections to and from the network users.

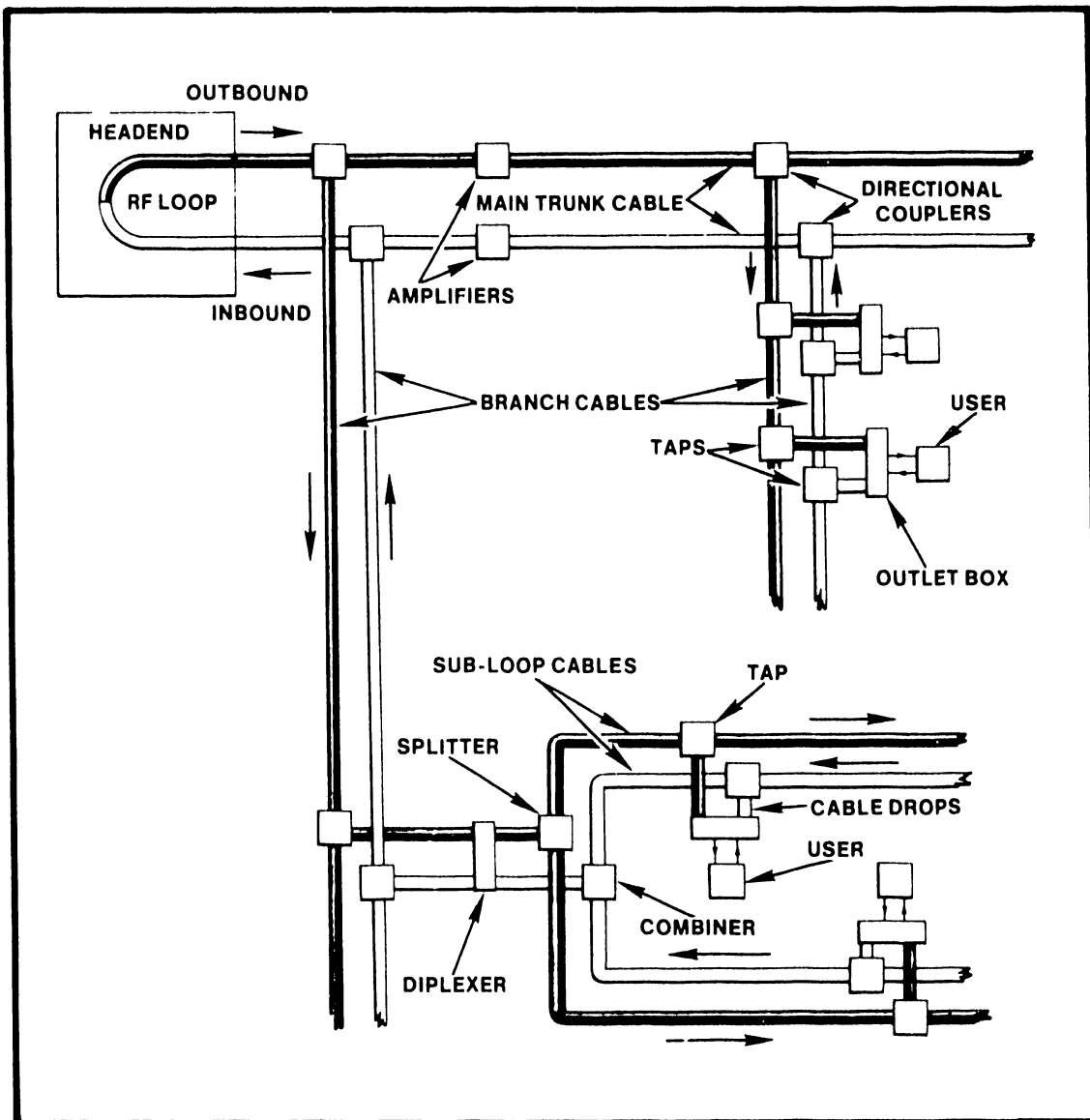

Figure 1-2

1.3 SPECIAL TOOLS AND TEST EQUIPMENT

The following items of specialized test equipment are required for alignment, certification, and maintenance of the Wangnet Backbone:

1. Avantek Sweep System *
 - a) CT-4010 Transmitter
 - b) CR-4010 Spectrum Analyzer
2. Wavetek SAM I Signal Analysis Meter
3. Wang Four Frequency Test Signal Generator

Test equipment part numbers are listed in APPENDIX A.

* Not required for Branch level maintenance.

SECTION

2

THEORY

OF

OPERA-

TION

SECTION 2

THEORY OF OPERATION

2.1 INTRODUCTION

This Theory of Operation Section of the Wangnet Backbone Manual will be limited to detailed descriptions of a typical Backbone and its components.

The Wangnet Backbone may be divided into four basic parts for the purposes of analysis. These parts are the Headend, Main Trunk Cable, Branch Cables, and Sub-Loop Cables. Each of these will use some combination of essential auxiliary components to carry out its function. The auxiliary components include Amplifiers, Diplexers, Equalizers, Splitters/Combiners, Directional Couplers, Directional Taps, Outlets, Power Converters, and Power Combiners. This section will describe the parts and auxiliary components in detail. Note, however, that every Wangnet Backbone has a unique design. Therefore, the following descriptions do not apply precisely to any particular system, but are representative of the general case.

2.2 HEADEND

The Headend of a Wangnet Backbone is a centrally located terminal point toward which all network signals are transmitted, and from which all network signals are received. It provides the RF Loop that joins the Transmit (Tx) and Receive (Rx) cables, terminal facilities for access to the system, and power to operate the active components (additional power sources may be provided at locations other than the Headend).

Typical Headend equipment includes Inbound (Tx) and Outbound (Rx) Trunk Amplifiers, a Power Converter, Power Combiners, an arrangement of signal Combiners/Splitters, auxiliary signal sources, and monitoring devices. The Amplifiers provide gain and equalization for the network signals, the Power Converter provides constant-voltage low-level AC power for the system, and the Power Combiners feed the AC power into the Tx and Rx Trunk Cables. Signal Combiners/Splitters form interface ports for auxiliary and external signals.

Pilot Carrier Generators and Test Signal Generators are typical auxiliary signal sources, while external signal sources include television and radio broadcasting facilities. Field Strength Meters, Spectrum Analyzers, and Video Monitors are examples of Headend monitoring devices that are often used; Tx and Rx cable current meters are included in the Power Converter.

Figures 2-1 and 2-2 illustrate a typical Headend. Again, every Wangnet Backbone is unique, and so is the arrangement of its components. The Headend shown is not, therefore, definitive. It is merely an example.

In the rear view, Figure 2-2, the main signal path is shown by small arrows along the cable. It runs from the Inbound Trunk Cable at the top right of the drawing to the Outbound Trunk Cable at the top left. The signal path passes through the Inbound Amplifier, Inbound Power Combiner, two 4-Way Splitter/Combiners, the Output Power Combiner, and the Outbound Amplifier.

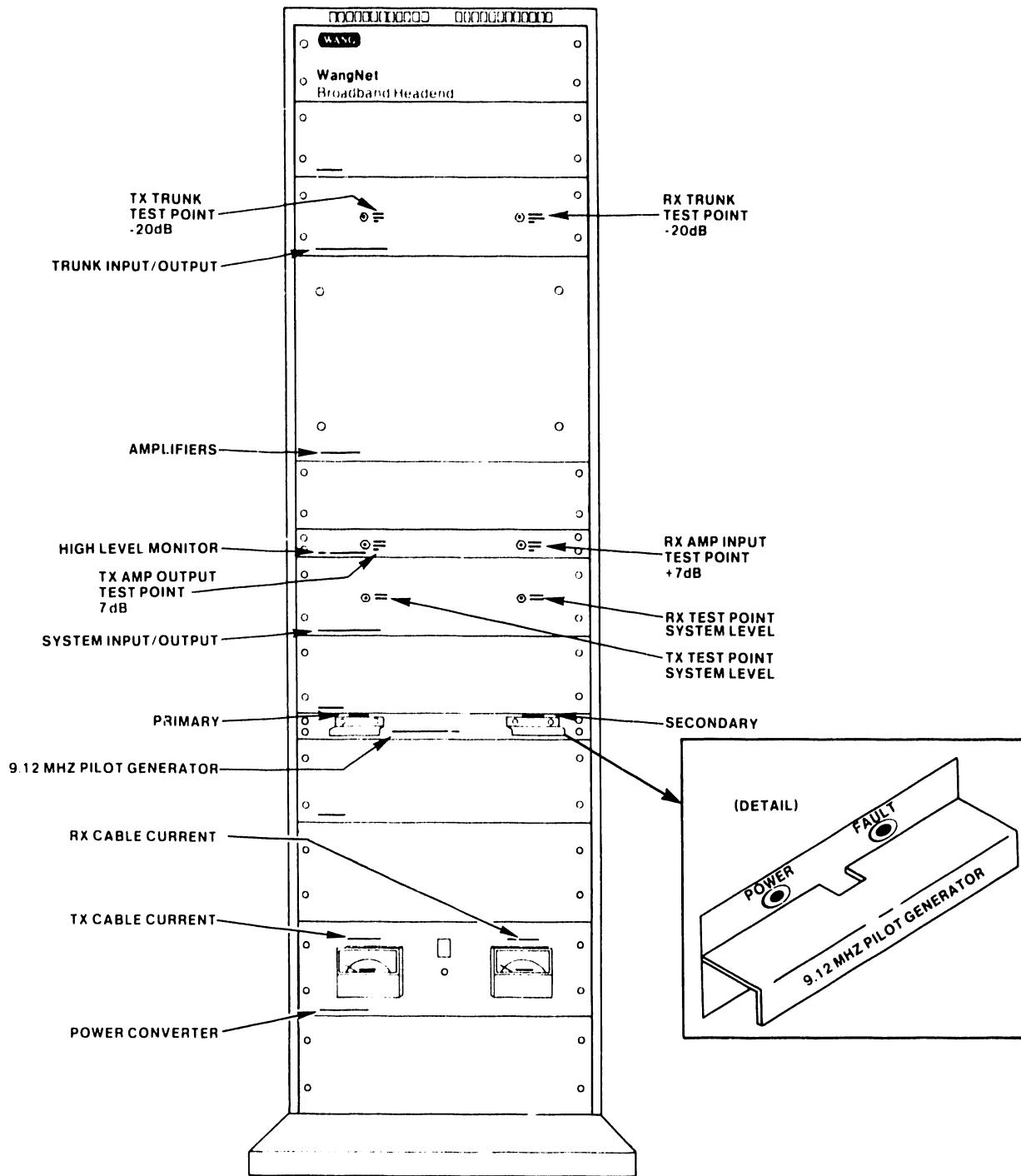

TYPICAL HEADEND, FRONT VIEW

Figure 2-1

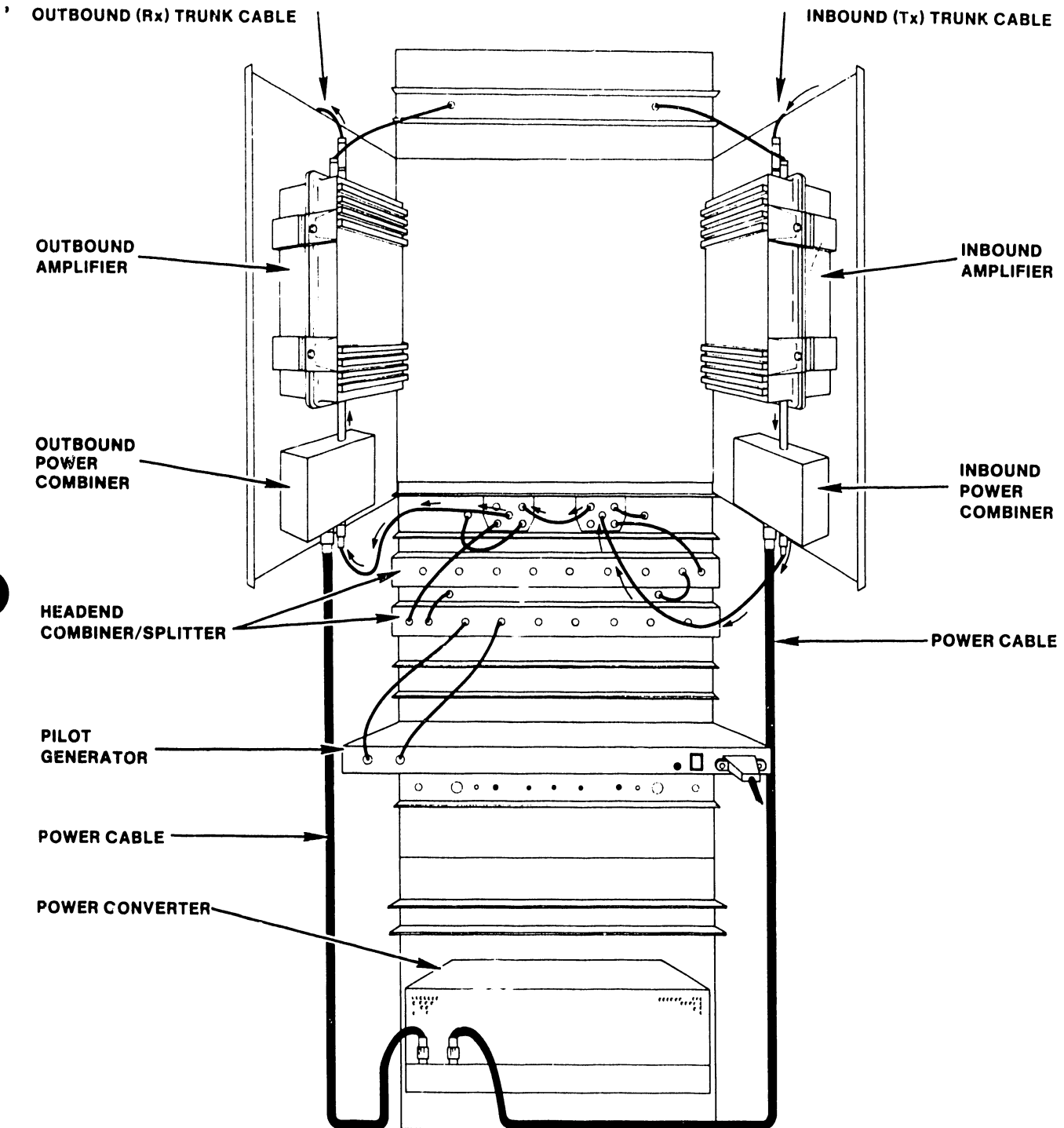

TYPICAL HEADEND, REARVIEW

Figure 2-2

The 4-Way Splitter/Combiners shown in the example are Jerrold SWS-4UV Splitters. These units can function either as splitters or as combiners. The unit on the inbound side functions as a signal splitter, and feeds the inbound signal to a test point, to a larger splitter, and to the 4-Way Splitter/Combiner on the outbound side. The flexible cable between the 4-Way Splitter/Combiners is the so-called RF Loop that joins the Inbound and Outbound Trunks.

The 4-Way Splitter/Combiner on the outbound side functions as a combiner. As such, it combines signals from the RF Loop, a larger combiner, and a test point to form the outbound signal.

The two large splitter/combiners shown in the example are Jerrold HC-8D Headend Combiners. These also can function either as combiners or as splitters. In this example, the upper unit is being used as a splitter. It receives a portion of the inbound signal from the 4-Way Splitter, and further splits it 8-ways. The illustration shows one port of this splitter connected to a test point, while the other ports are available to provide inbound signals required for other purposes. All unused ports are terminated.

The lower Headend Combiner is being used as a combiner. As shown, it combines a primary and a secondary signal from the Pilot Carrier Generator with a signal from a test point and feeds them to the 4-Way Combiner where they are combined with the outbound signal. The remaining input ports of the Headend Combiner are available for injecting any other desired signals into the Outbound Trunk.

The Power Converter is essentially a ferro-resonant constant-voltage step-down transformer. It provides 30 volt AC power for distribution throughout the Backbone for the operation of the system amplifiers (Very large Backbone systems may require additional Power Converters away from the Headend). In the example shown, the 30 volt AC power is fed through two lengths of RG-11 type coaxial cable to the two Power Combiners which apply the power to the Tx and the Rx Trunk Cables. Note that the Power Converter is equipped with two AC Ammeters that monitor the current flow to the Tx and Rx cables.

2.3 MAIN TRUNK CABLES

The Main Trunk Cables of a Wangnet Backbone are hardline coaxial cables that make up the central signal path to and from the Headend. The standard cable diameter is .500 inch, but larger sizes are employed in long runs. These Trunk Cables may be relatively short, as in a single building system; or they may be very long, as in a system that services several buildings throughout a large geographical area.

Typical Main Trunk Cables in a single multi-story building system extend vertically from the Headend, and pass through each floor of the building. At each floor, Branch Cables extend the Backbone to each user location on that floor.

The Main Trunk Cables of a multi-building system run from the headend past each building to be serviced. Branch Cables extend the Backbone to each building, and additional Branch Cables are used to extend it to each user location.

A set of Main Trunk Cables will be equipped with a number of auxiliary components, varying with the individual design. These might include additional Power Converters and Power Combiners, Amplifiers, Equalizers, and Directional Couplers.

Amplifiers are used to maintain the signal level along the trunk, and also maintain the slope of the system by means of built-in equalizers. Separate Equalizers are often used between amplifiers for additional slope control.

Additional Power Converters and Power Combiners may be used in very large trunk systems, and Directional Couplers will be used to establish each Branch from the Main Trunk.

2.4 BRANCH CABLES

The Branch Cables of a Wangnet Backbone are hardline coaxial cables that extend the signal path from the Main Trunk to the users of the system. The standard cable diameter is .500 inch, but larger sizes are employed in long runs.

A typical set of Branch Cables services one floor of a multi-story building. It begins at Directional Couplers located on the Main Trunk at the point where it passes through the floor. A long Branch in a large system will likely require additional components at the junction with the Main Trunk. In that case, the components are mounted together on a Distribution Panel. Figure 2-3 shows a typical Distribution Panel with Amplifiers, Power Combiners, and a Power Converter. Two Branches from the Main Trunk are shown in the drawing.

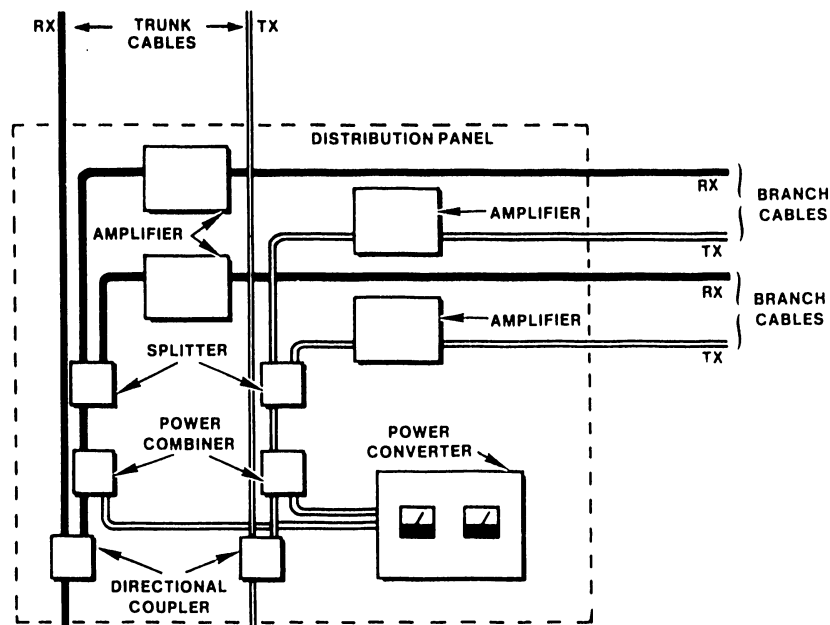

Figure 2-3

While the main function of a set of Branch Cables is to extend the Backbone to system users, it may also be used to feed one or more additional Branches. Any Branch, in fact, is subject to additional branching to suit the system requirements. A set of Branch Cables may feed a single new Branch through Directional Couplers, or it may divide into two or three new Branches by means of Splitters.

2.5 SUB-LOOP CABLES

Sub-Loop Cables in a Wangnet Backbone system are Branch Cables that are equipped to restrict certain signals to the Sub-Loop. The restricted signals do not propagate throughout the network, although network signals continue to propagate through the Sub-Loop. The purpose of the Sub-Loop is to provide communications between a user's computer system and its peripheral devices, without interfering with similar communications on other Sub-Loops.

The restriction of some signals to a Sub-Loop, while allowing normal circulation for others is accomplished through the use of a Diplexer. The Diplexer provides a Tx to Rx crossover point for the restricted signals, and at the same time prevents those signals from propagating to the Headend and the rest of the system. Other network signals are unaffected by the Diplexer, and propagate in the normal manner.

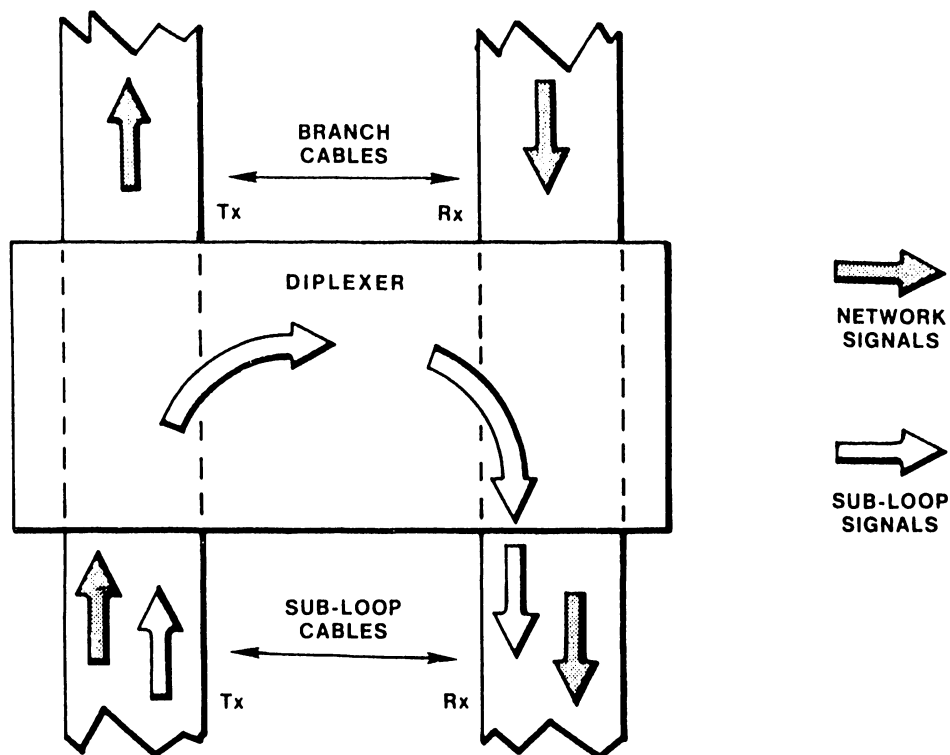

Figure 2-4 Diplexer Functional Diagram

2.6 BACKBONE COMPONENTS

The Headend, Main Trunk Cables, Branch Cables, and Sub-Loop Cables all use some combination of auxiliary components to carry out their functions in the Wangnet Backbone. These components include Amplifiers, Equalizers, Diplexers, Directional Couplers, Splitters/Combiners, Taps, and Outlets. Each of these components will be described in the following paragraphs.

2.6.1 Amplifier

The Wang (C-Cor) Model 2904 Amplifier is used throughout the Backbone, including the Headend. This unit is a broadband push-pull amplifier with a ± 2 dB frequency response from 10 to 400 MHz, and a gain of 23 dB. A 30 dB gain version (Trunk Amplifier, WLI #723-0002) is used in some long cable runs. Plug-in pads and equalizers may be used on the input and/or output ends of the amplifier for course adjustment of the output level and slope, while internal gain and slope controls are provided for fine adjustments. RF test points, are located adjacent to the input and output cable connectors. Signal levels at the test points are 20 dB below the respective input and output signals.

DC power for the amplifier is provided by an internal regulated power supply that operates from 30v AC power fed along the Backbone Cable with the network signals. The AC power may originate at a point either up-stream or down-stream from the amplifier, and may also be used to power additional amplifiers located further along the cable. The actual AC level fed to the power supply rectifiers can be adjusted, if required, by switch-selectable taps on the power transformer.

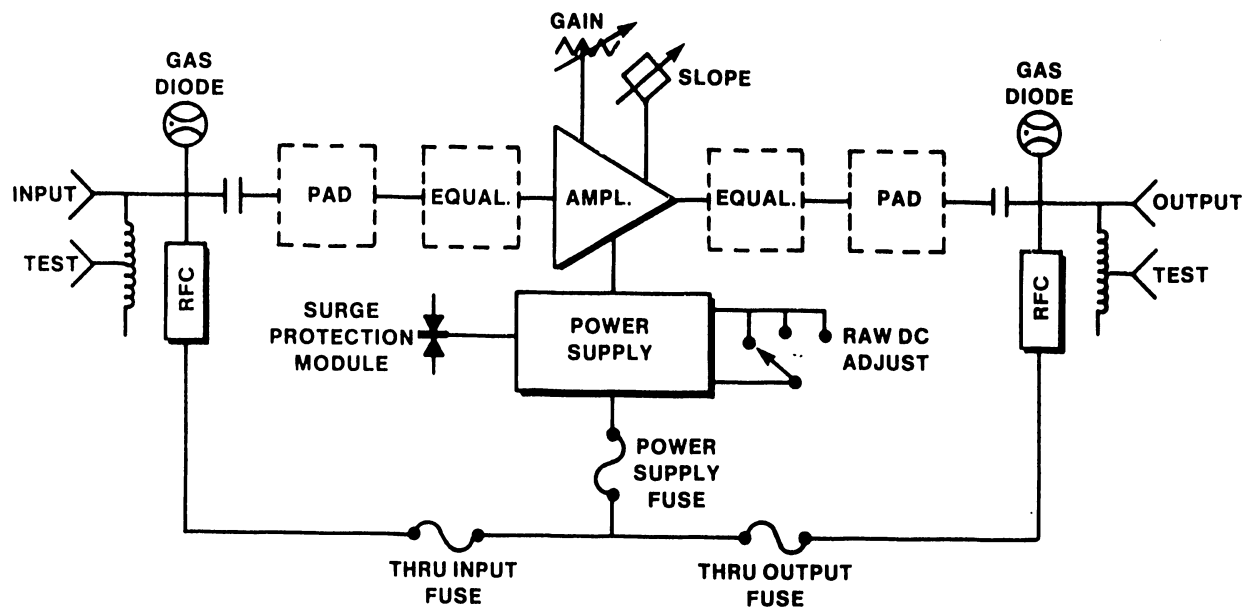

Figure 2-5 Amplifier Block Diagram

Selection of an up-stream or down-stream power source is made by inserting a power-passing fuse in either the Thru-In or Thru-Out fuse clips. AC power is passed through the amplifier module, and made available to power additional units by inserting power-passing fuses in both sets of fuse clips. An overload protection fuse is provided for the power supply, while a surge protection module and plug-in gas diodes afford protection from AC line transients.

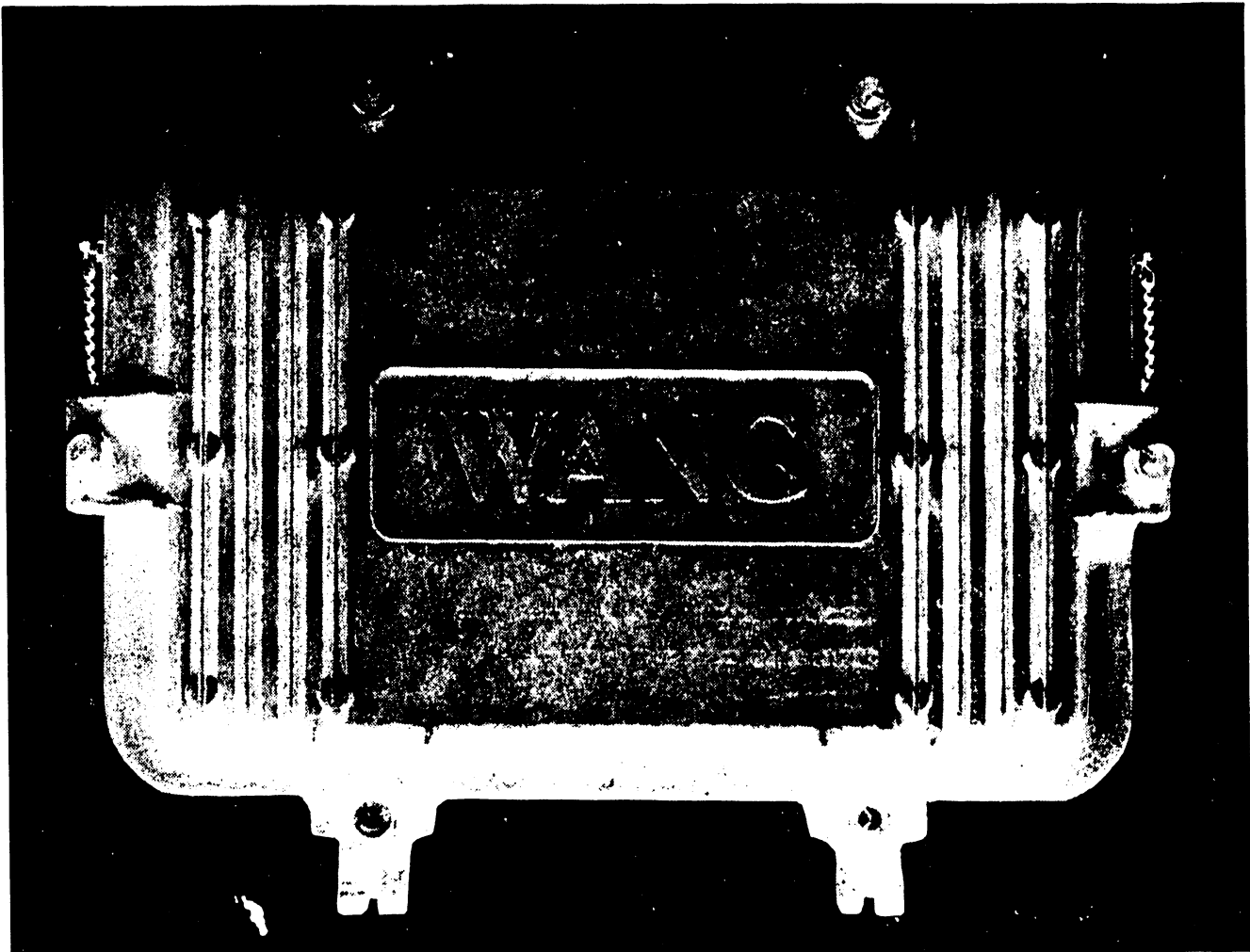

Figure 2-6 Amplifier Exterior View

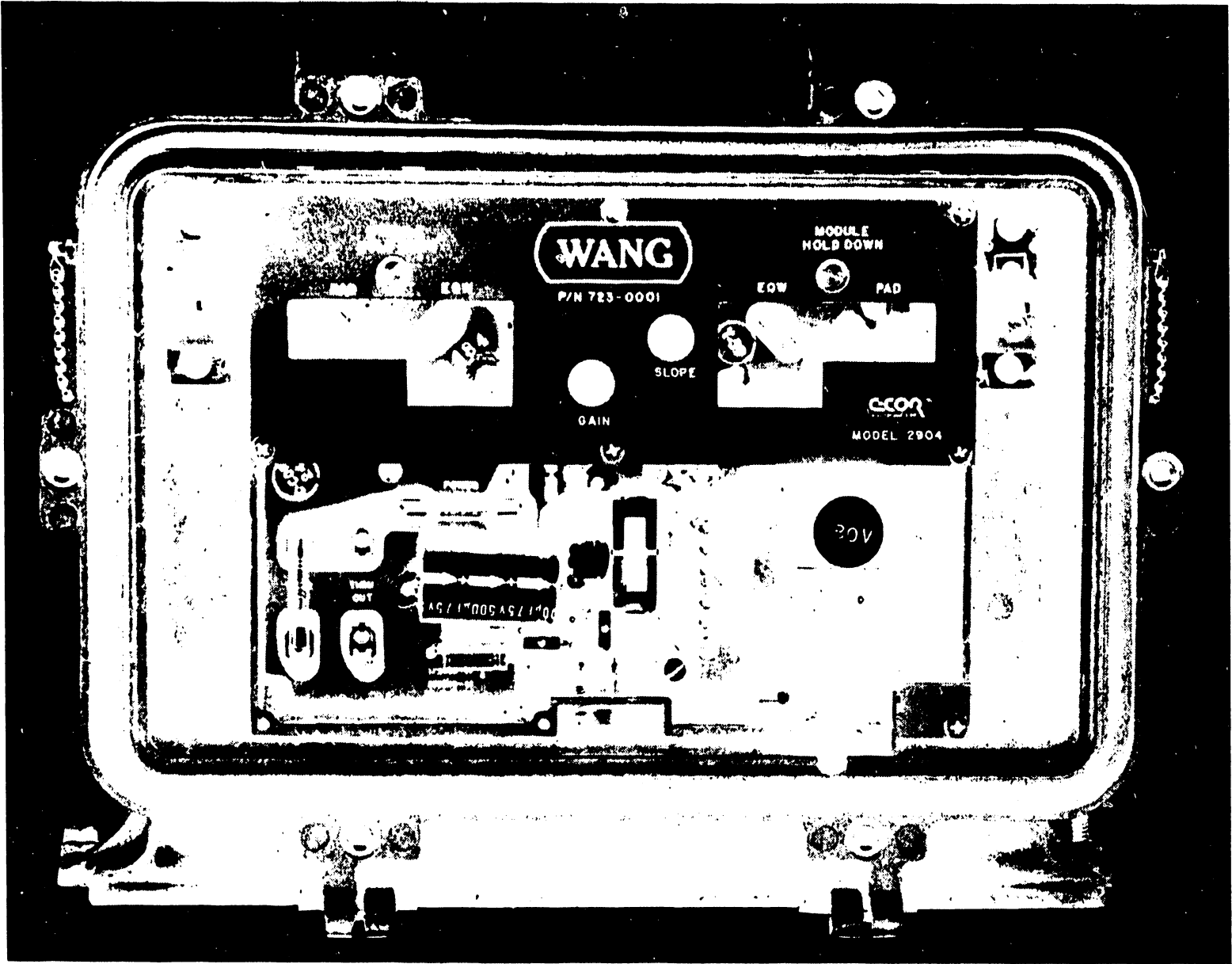
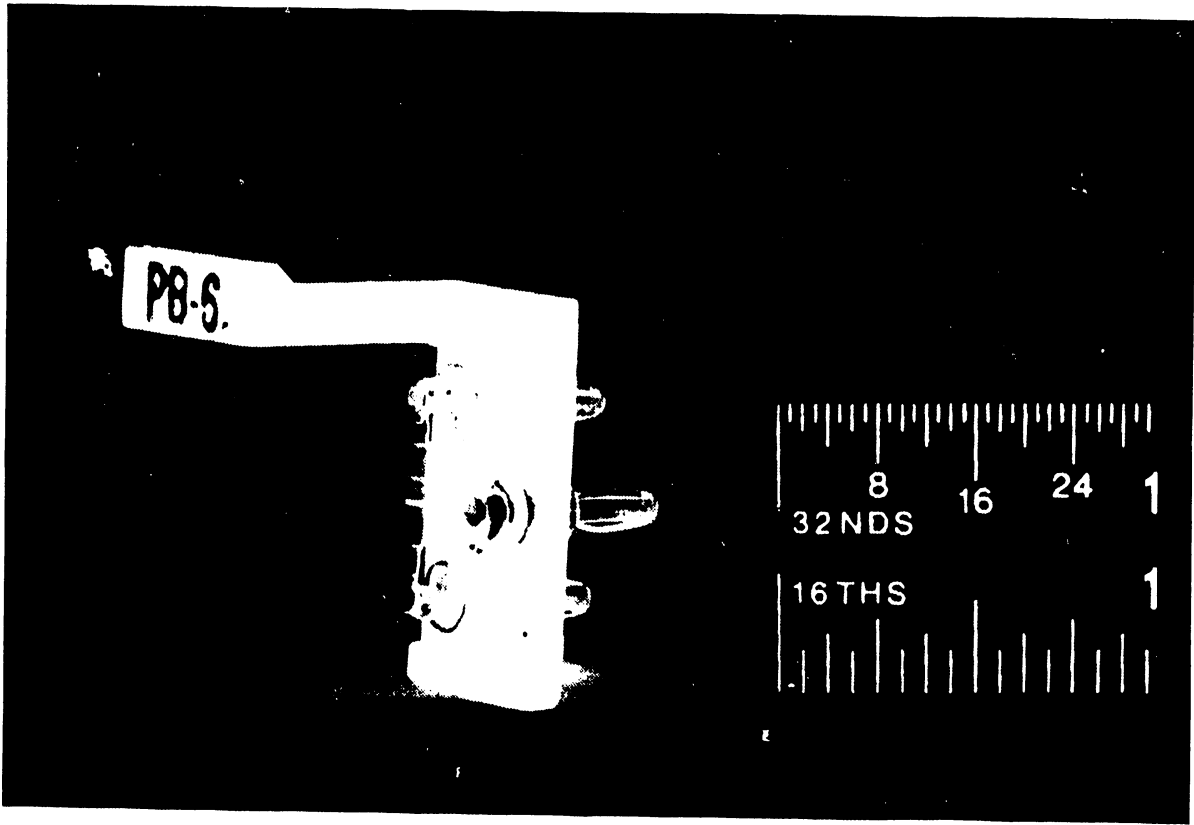
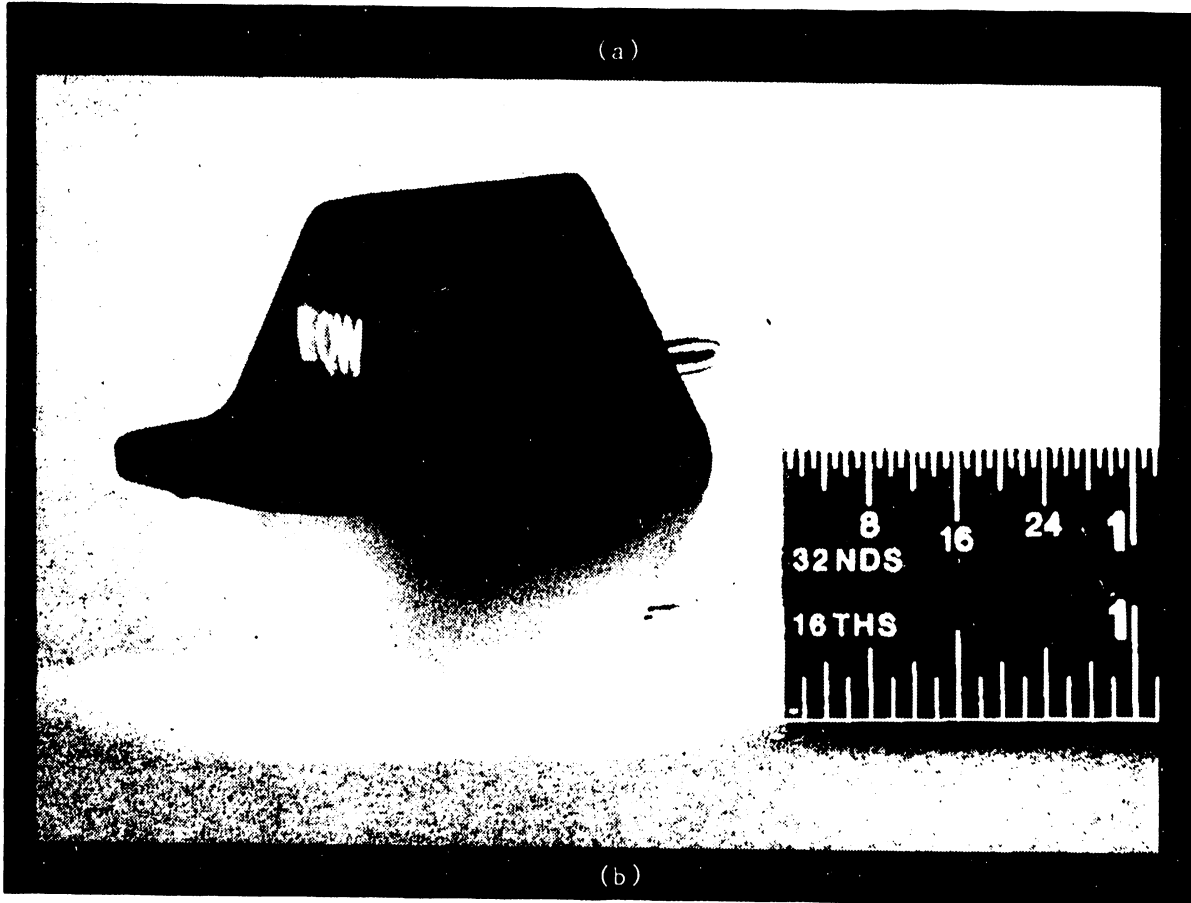

Figure 2-7 Amplifier Interior View



(a)



(b)

Figure 2-8 Plug-In Pad (a) and Equalizer (b)

2.6.2 Equalizer

An equalizer is a passive network that compensates for "cable tilt," caused by unequal losses across the frequency passband of the cables. The term, "cable tilt," actually refers to a tilt in the amplitude response curve of the cable. Tilt-compensating equalizers are used at the input and/or output of amplifiers, and also at intermediate points between amplifiers.

Equalizers used at amplifier locations plug into receptacles provided on the amplifier chassis, while those at intermediate locations mount in a special Equalizer Housing that also provides for power-passing. Six different plug-in equalizer networks are available, providing compensation of 0, 3, 6, 9, 12, or 15 dB across the passband. The 0dB equalizer provides no compensation, but is used to provide a signal path through an equalizer receptacle that lacks an internal jumper.

NOTE

An older series of equalizer networks with compensation characteristics of 5, 8, 11, and 13 dB may be encountered in the field. If replacement of any of these networks is required, they should be replaced with 6, 9, 12, and 15 dB networks, respectively.

Figure 2-9. Equalizer Housing.

- (a) Exterior View.
- (b) Interior View Without Equalizer.
- (c) Interior View With Equalizer Installed.

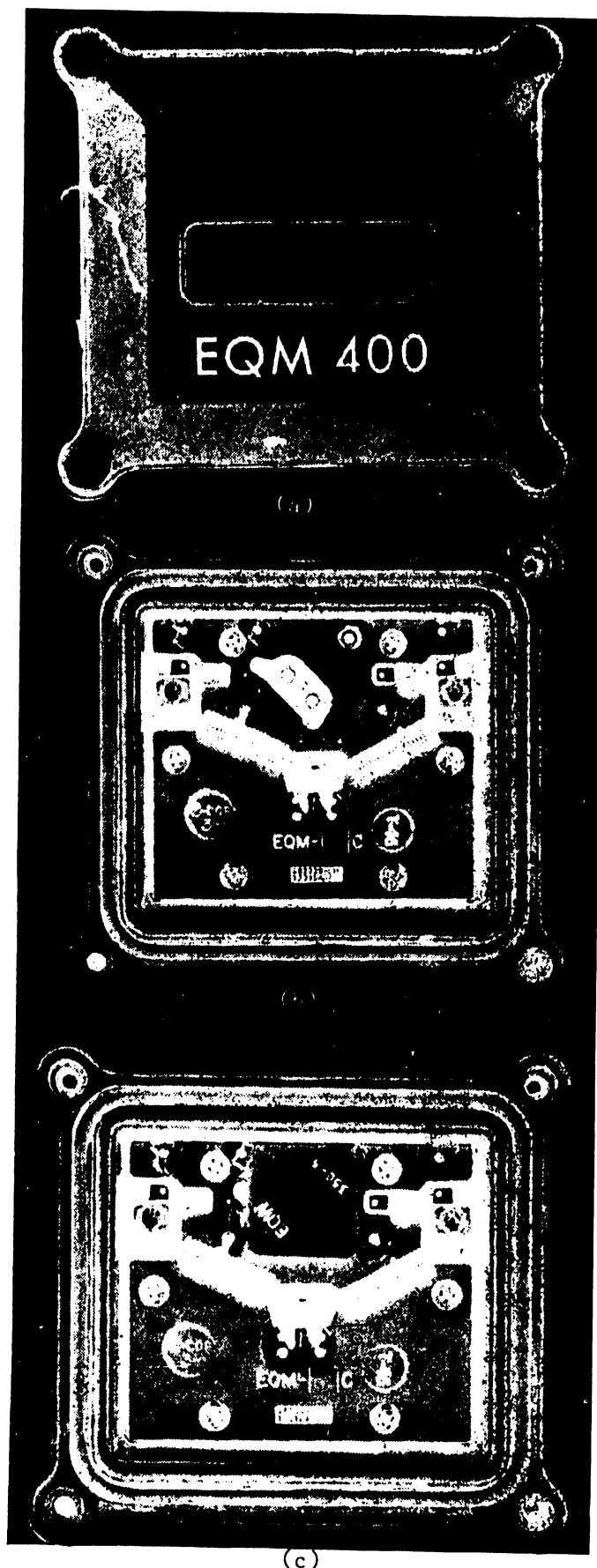

2.6.3 Adjustable Equalizer

The adjustable equalizer is used to flatten out peaks and valleys in the cable system response. This equalizer has a minimum insertion loss of approximately 2.5 ± 0.5 dB and it should be used only when the cable flatness specification is about to be exceeded (eg. $+2.5$ dB with a $+3$ dB specification). It is generally inserted in the unused equalizer position in the WangNet broadband or trunk amplifier but it may also be used in an equalizer housing (723-0199). The adjustable equalizer is shown in Figure 2-10.

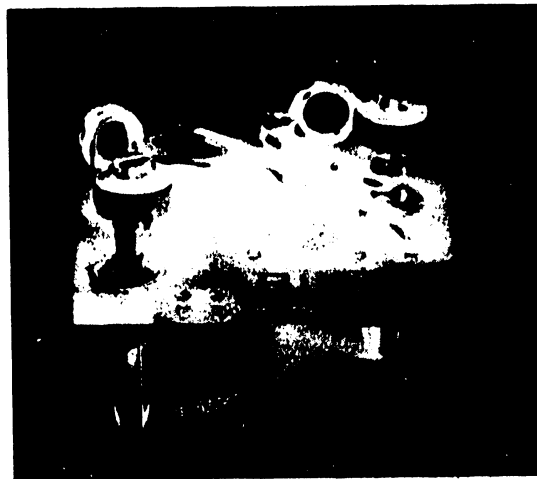

B-01630-FY85-1

Figure 2-10 Adjustable Equalizer

The Wang designed adjustable equalizer is typically capable of increasing the 400 mHz level approximately 1-1.5 dB. It can also decrease the level of a peak in the region of 250 to 300 mHz by up to 4 dB. However, it does this at the expense of a 2 ± 0.5 dB flat loss with the settings at minimum. Figure 2-11 is a schematic drawing of the equalizer.

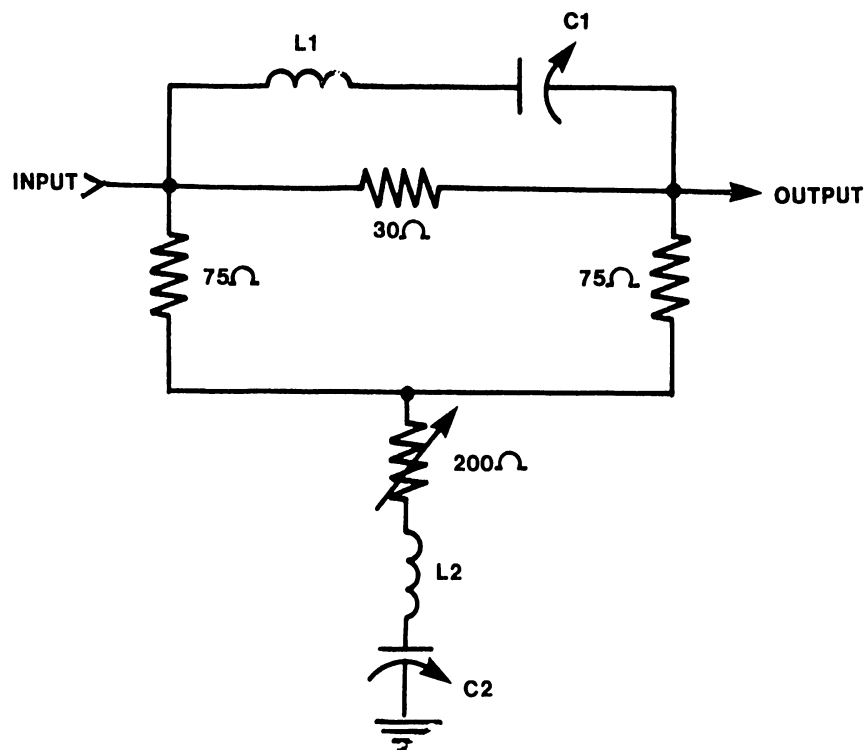

B-01630-FY85-10

Figure 2-11 Adjustable Equalizer Schematic

2.6.4 Diplexer

The Wang (C-Cor) 2905 Diplexer is a four-port network of filters and amplifiers that provides expanded capacity for the Peripheral Band in a Wangnet Backbone system. Capacity expansion is achieved by establishing a Sub-Loop within the Backbone system, and restricting to the Sub-Loop all Peripheral Band signals that originate in the Sub-Loop. All other Wangnet signals propagate normally through the Backbone system. Since the Peripheral Band signals in the Sub-Loop cannot propagate beyond the Diplexer, all of the Peripheral Band frequencies become available for simultaneous use elsewhere in the system.

The essential features of the Diplexer are that it separates Peripheral Band signals from all others, and provides a crossover path in the Sub-Loop for Peripheral Band signals only. At the same time, the Diplexer allows normal propagation for all other signals.

All signals originating in the Sub-Loop are fed to Port 2 of the Diplexer and into a Splitter. From the Splitter, the signals are fed along two paths. The first path passes through a filter and an amplifier to Port 1, which is connected to the transmit cable of the Backbone. The Band-Stop Filter prevents Peripheral Band signals from passing through to the transmit cable, but passes all other signals. The amplifier restores signal losses caused by the splitter and filter.

The second signal path includes two filters, an amplifier, and a combiner. This is the crossover path for Peripheral Band Signals. The Band-Pass Filters pass Peripheral Band Signals and reject all others. The amplifier provides sufficient gain to overcome the losses caused by the Splitter, Filters, and the Combiner leading to Port 4.

All signals received from the Headend are fed to Port 3, and pass through a filter, combiner, and an amplifier before emerging at Port 4 and the Sub-Loop Receive cable. The Band-Stop Filter prevents passage of Peripheral Band signals that originate elsewhere in the system, and thus prevents interference within the local Sub-Loop. The combiner brings together the Sub-Loop Peripheral Band signals and non-interfering signals from the Headend. These combined signals are fed to the amplifier, which restores losses caused by the combiner and filters.

The Diplexer housing contains two field replaceable modules ... an RF Module, and a Power Supply Module. RF test points are provided by "F" connectors located adjacent to each of the four ports. The signal levels at the test points are 20 dB below the levels at the ports.

The Power Supply Module is a switching mode power supply, and is mounted in the housing cover. The supply power transformer has switch-selectable taps for adjusting the raw DC voltage fed to the regulator. Power supply protection is provided by an AC line fuse and a Surge Protection Module, while a fused crowbar circuit protects the RF module from overvoltage on the B+ line. Gas diodes at the Diplexer ports protect the RF module against high voltage transients on the Backbone Cables.

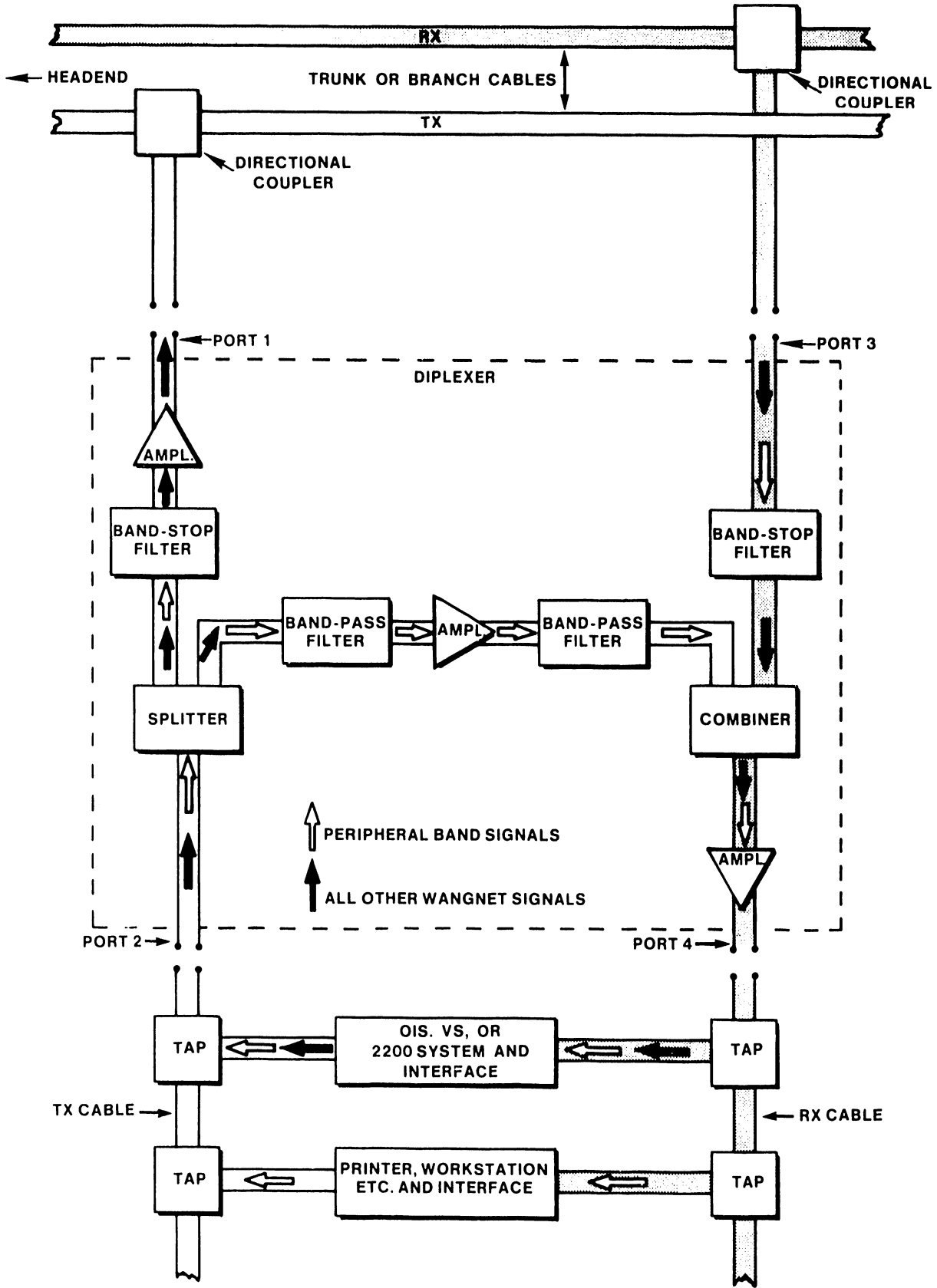

Figure 2-12 Diplexer Block Diagram

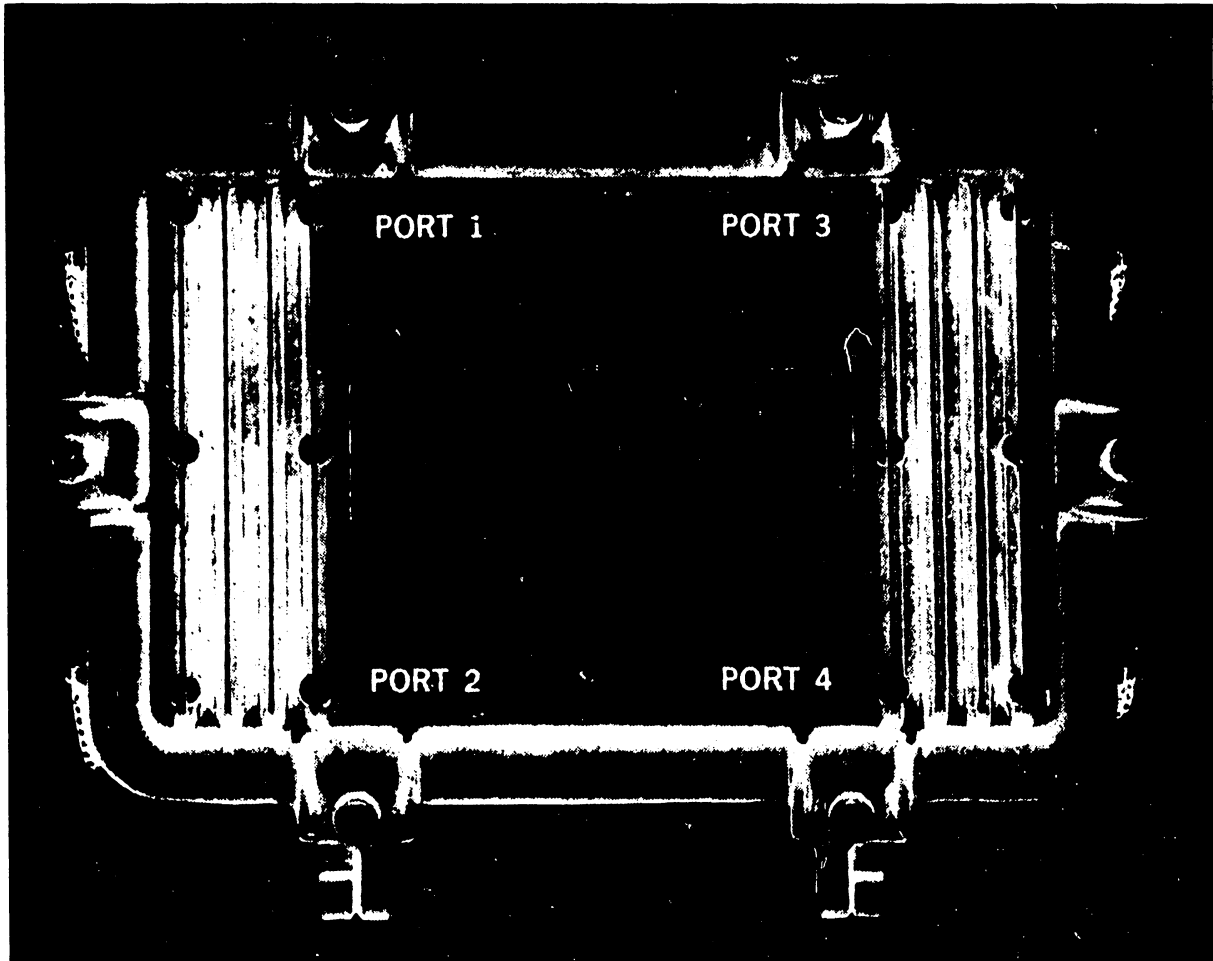

Figure 2-13 Diplexer Exterior View

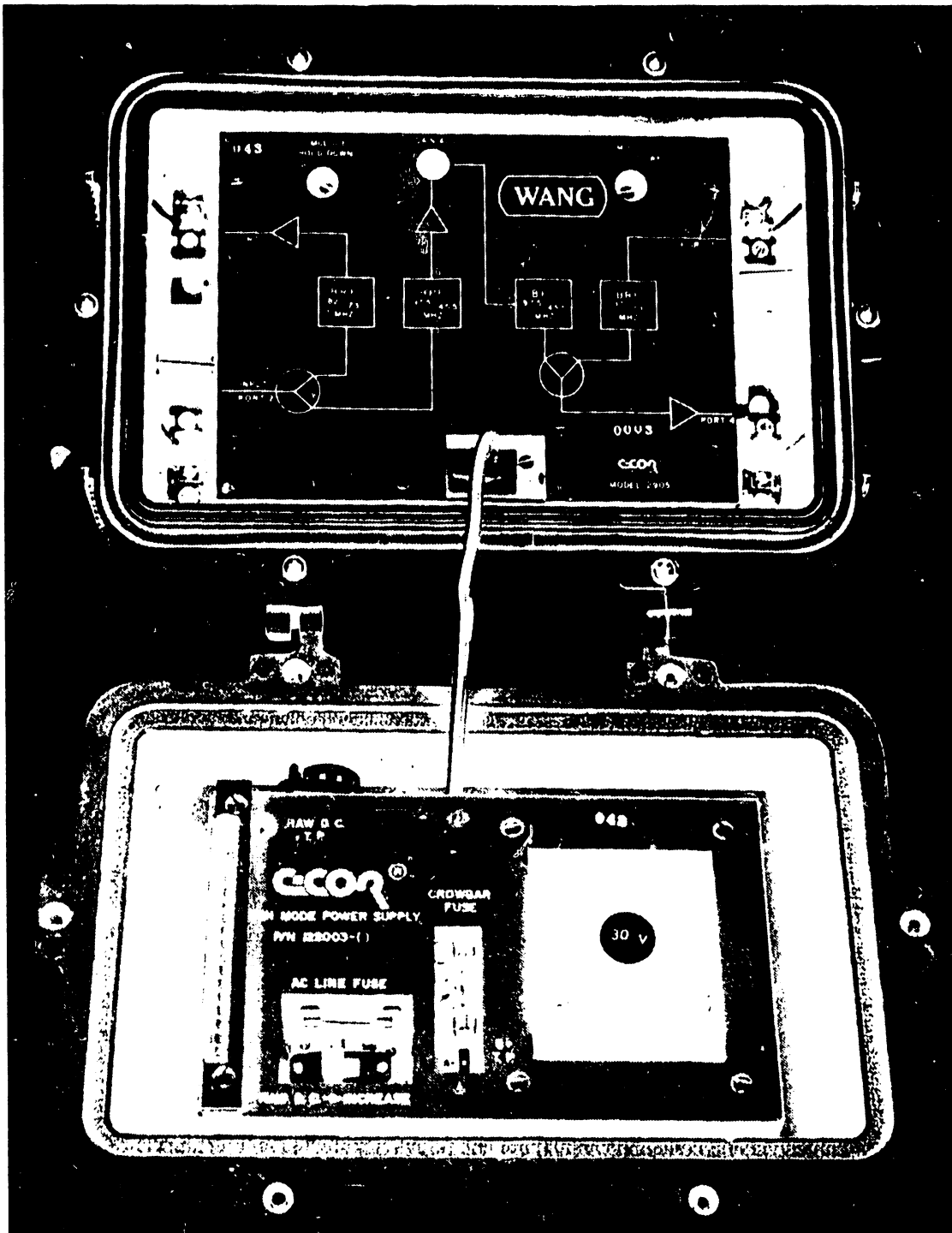

Figure 2-14 Diplexer Interior View

2.6.5 Splitter

A Splitter is passive network that is used to distribute signals from the end of a Main Trunk or Branch. Receive Cable to two or more additional Branch Cables. The signal levels fed to each Branch Cable may be equal, or unequal, depending on whether a Balanced or Unbalanced Splitter is used. The Balanced Splitter provides equal signal levels to each Branch Cable, while the Unbalanced Splitter provides different signal levels to each Branch Cable. Two-Way and Three-Way Splitters are used in Wangnet Backbone installations. They are used, respectively, to feed two or three additional branches. Power-passing fuses or jumper wires allow low frequency AC power to be selectively routed through the Splitter.

Each output port of a Splitter is RF isolated from the others. This characteristic reduces the possibility of trouble on one branch affecting the other branches. The isolation characteristic is specified in decibels, and is typically 25 to 30 dB.

Splitting Loss is another characteristic of a Splitter. It specifies the amount of signal reduction between the input port of a splitter and a single output port. An "ideal" Two-Way Balanced Splitter would have a Splitting Loss of 3 dB between the input and each of the two output ports. Such a loss level would indicate that half of the input power was distributed to each port. However, a typical "real" Two-Way Balanced Splitter would also exhibit a small Insertion Loss at each output port, due to internal power dissipation. Thus, a 3.6 dB Splitting Loss at each output port is typical for a Two-Way Splitter.

A typical Three-Way Balanced Splitter would exhibit a 5.8 dB Splitting Loss to each output port, indicating that approximately one-third of the available power is distributed to each port. A Three-Way Unbalanced Splitter would have a 3.6 dB loss to one output port, and a 7.2 dB loss to each of the other two ports. Those figures indicate that one-half of the available power is fed to one port, while the remainder is divided between the other ports.

The Splitter is also used to combine signals from two or more Branch Transmit Cables and feed them to a single Branch or Main Trunk Transmit Cable. In that application, the Splitter is referred to as a Combiner, but it is the identical device. The isolation characteristics are unchanged; and the splitting and insertion losses remain the same.

The Jerrold HC-8D Headend Combiner is a special application Splitter/Combiner. This unit is used only at the Headend of a Wangnet Backbone system. Installed in the Transmit Cable, the HC-8D provides the means for connecting test equipment and other monitors to the incoming signal cable. It also provides a connection point for feeding signals originating in the network to external destinations. When installed in the Receive Cable, the HC-8D provides the means for connecting Pilot Signal Generators, and other external signal sources to the system.

The Jerrold SWS-4UV 4-Way Splitter is another special application Splitter/Combiner that is used only at the Headend. The SWS-4UV is used in conjunction with the HC-8D, as shown in Figure 2-2 on page 2-3 of this section.

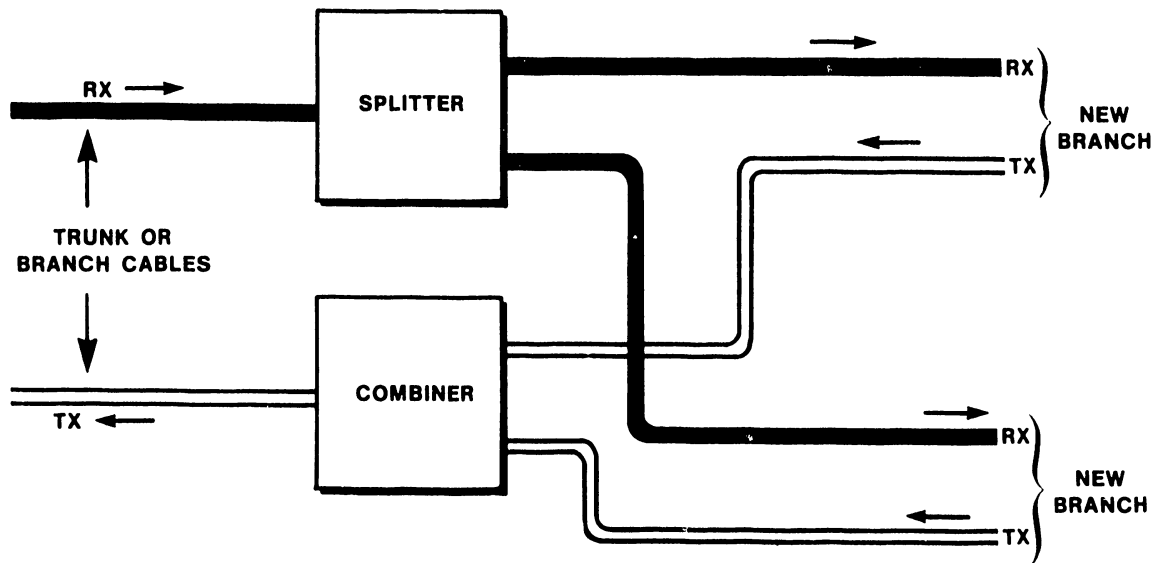

Figure 2-15 Splitter (Combiner) Application

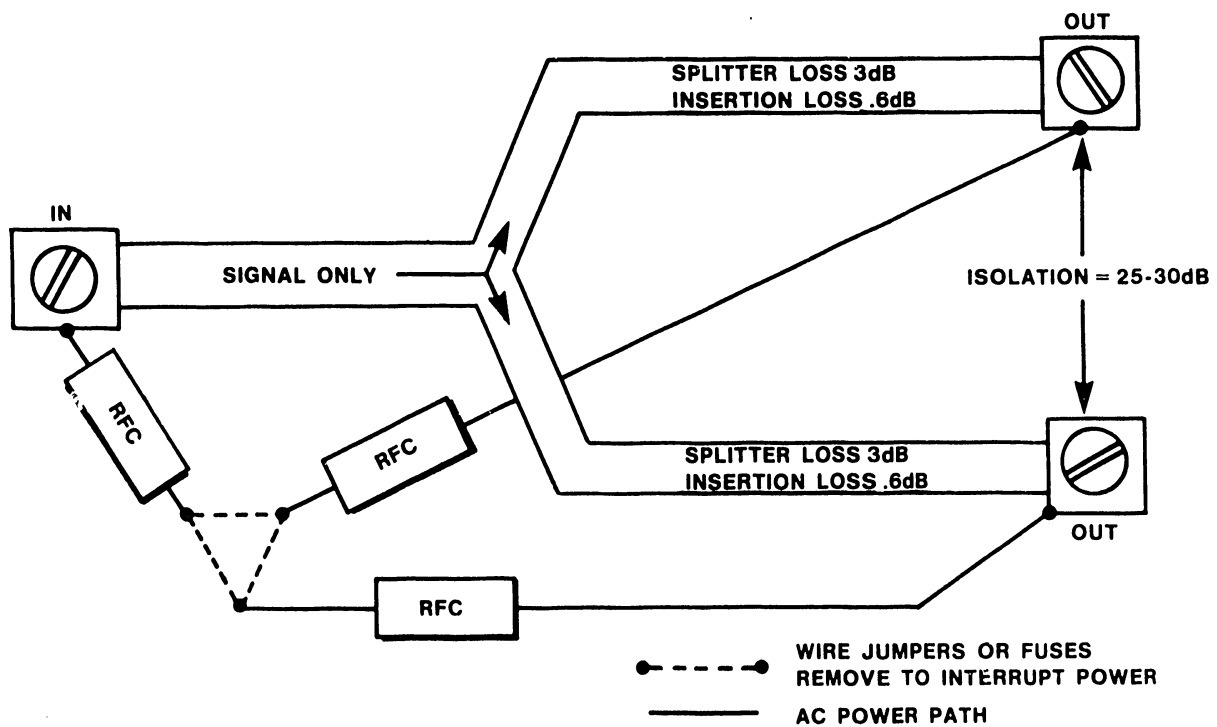

Figure 2-16 Splitter Functional Diagram

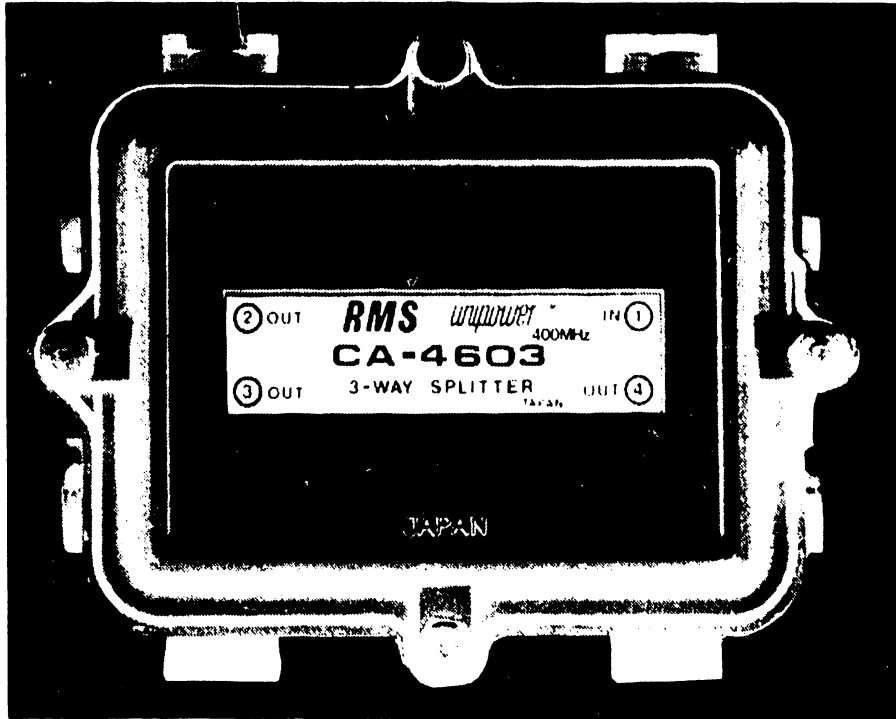

Figure 2-17 Typical Splitter Exterior View

POWER-PASSING FUSES

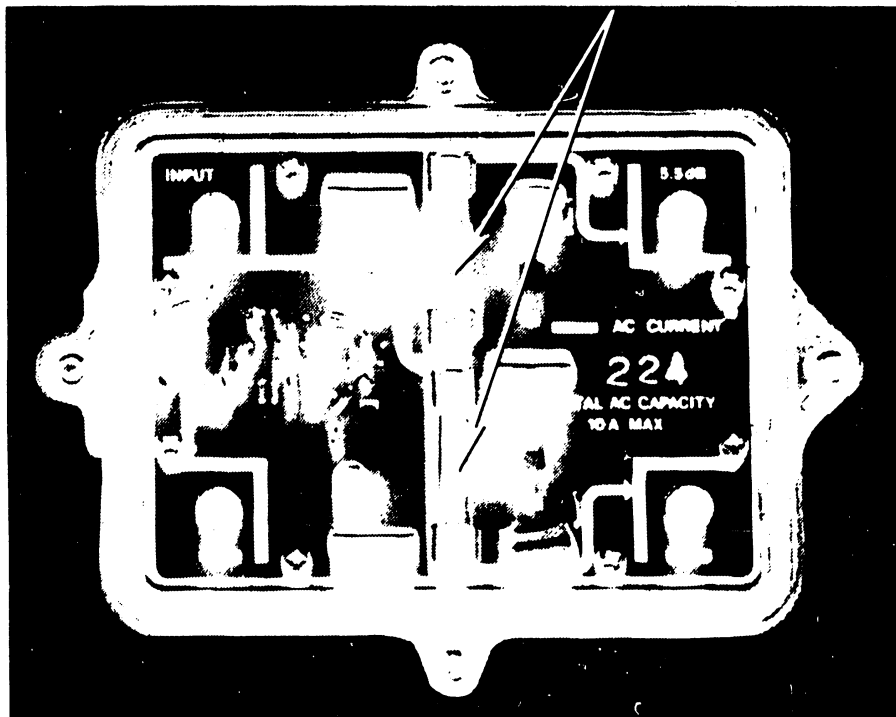

Figure 2-18 Typical Splitter Interior View

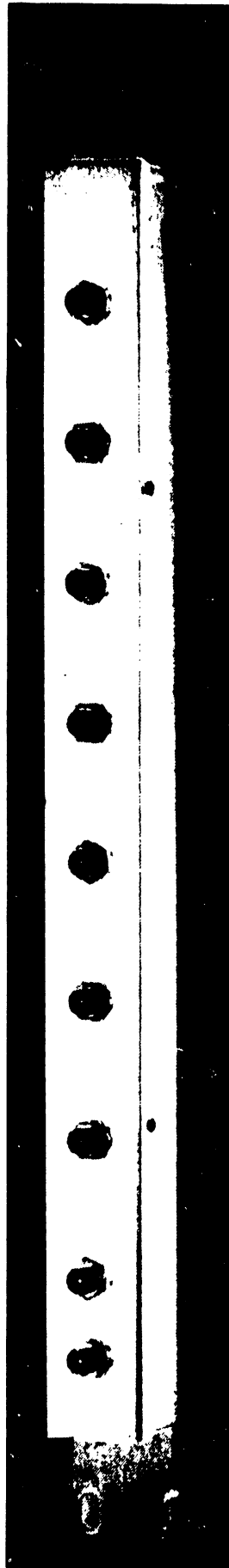

Figure 2-19 Headend Combiner

2.6.6 Directional Coupler

A Directional Coupler is a three-port passive network through which signals flow from the Input port to the Output port, with a specified fraction of the signal energy going to the Tap. The directional characteristic is that the Tap will not receive any energy from signals flowing in the reverse direction through the coupler. The coupler is used to attach a Branch Cable to a Main Trunk Cable, or to another Branch Cable. Two couplers are required for Wangnet Backbone applications; one for the Receive Cable, and the other for the Transmit Cable.

Signals flow from the Input port to the Output port of the Directional Coupler with only a small insertion loss due to internal power dissipation. There is a more substantial attenuation of signals that pass from the Input port to the Tap. This attenuation is referred to as Tap Loss, and is a design specification dictated by the requirements of the system. The Wangnet Backbone uses Directional Couplers with Tap Losses of 3, 8, 12, 16, 20, and 24 dB. Power-passing fuses or jumper wires allow low frequency AC power to be selectively routed through the Directional Coupler.

The Output port and Tap are RF isolated from each other. This characteristic reduces the possibility of mutual interference by problems originating downstream of either port.

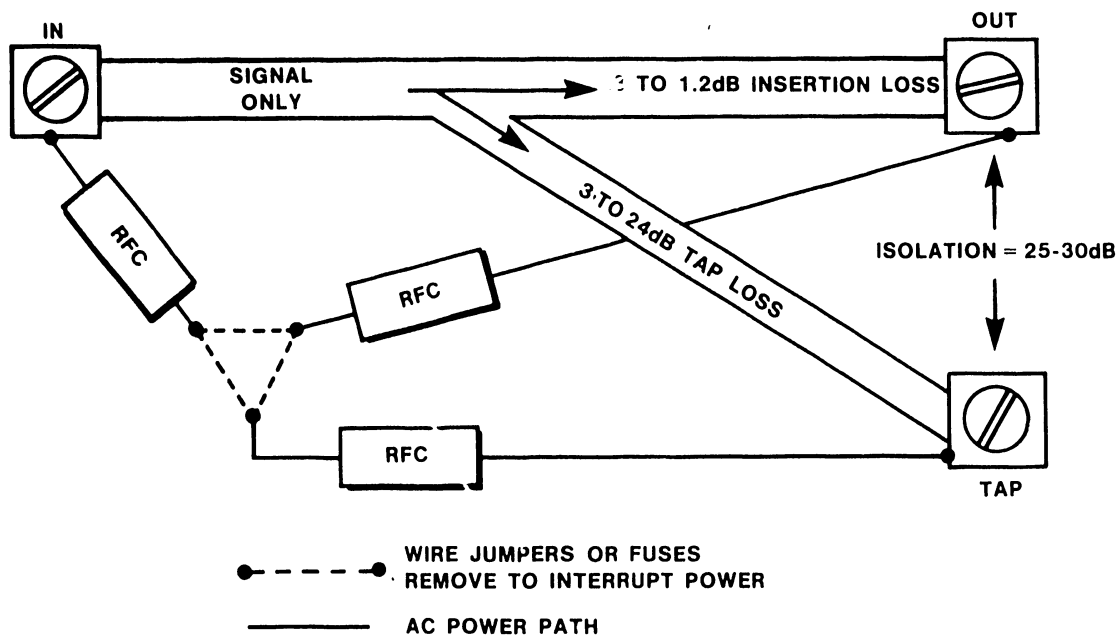

Figure 2-20 Directional Coupler Functional Diagram

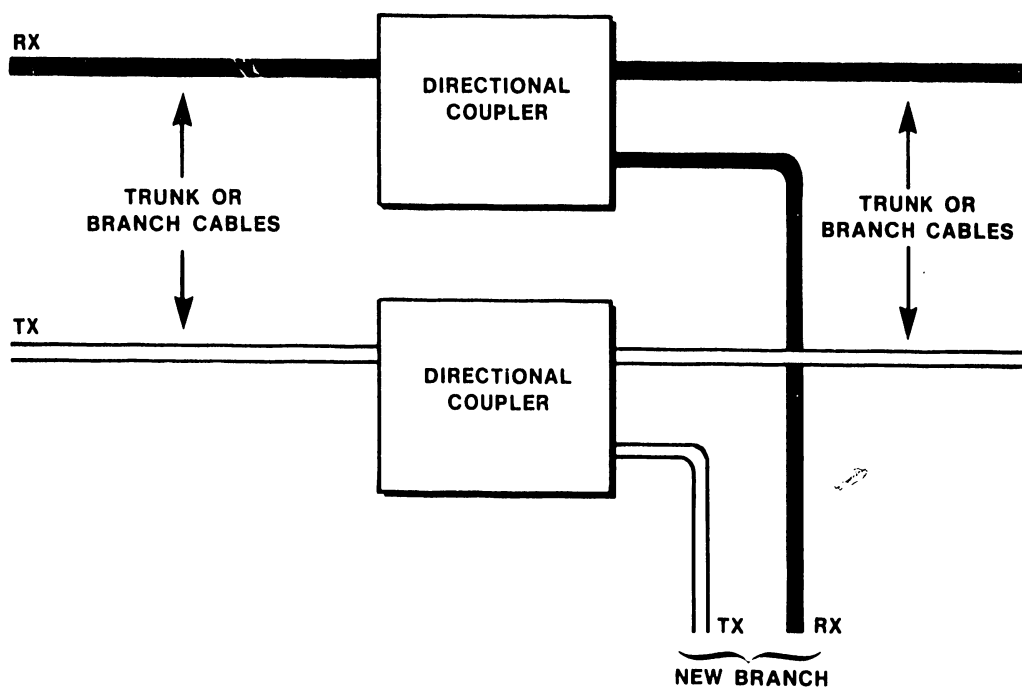

Figure 2-21 Directional Coupler Application

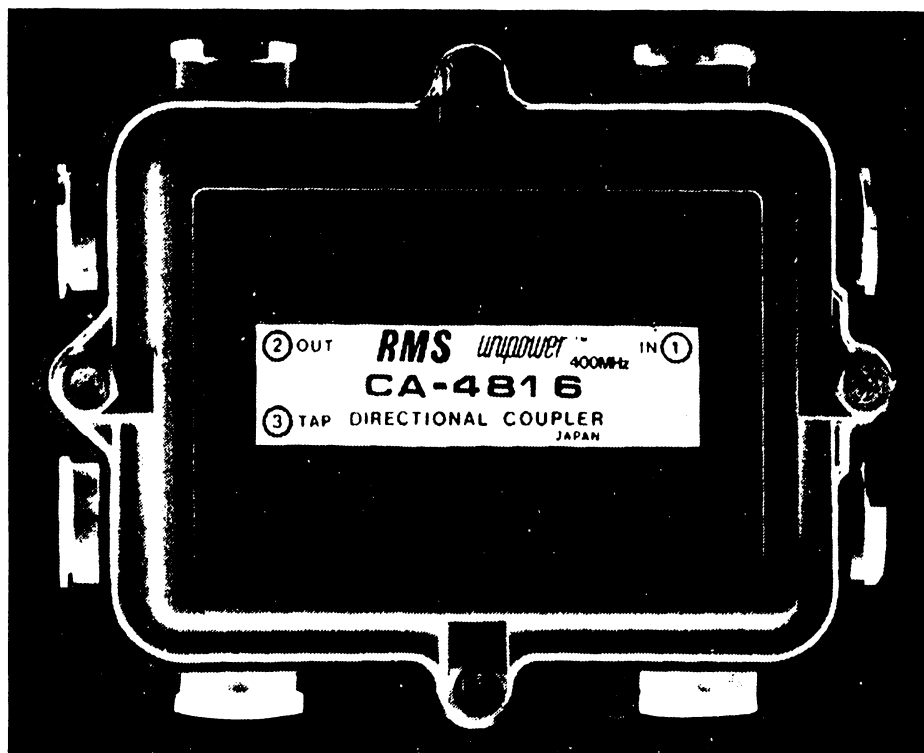

Figure 2-22 Typical Directional Coupler Exterior View

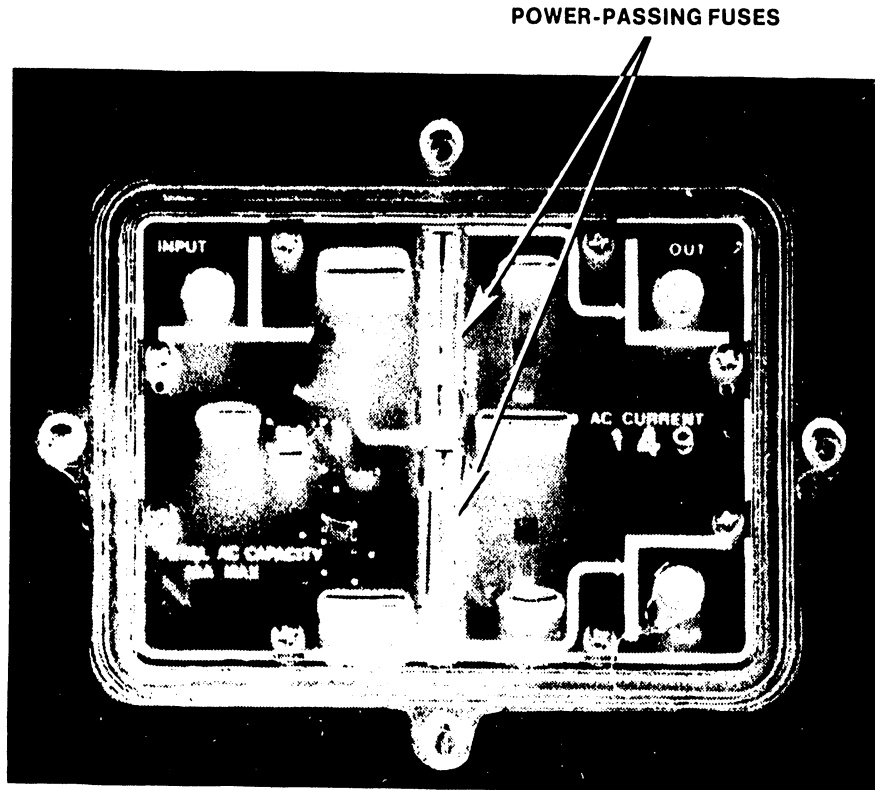

Figure 2-23 Typical Directional Coupler Interior View

2.6.7 Directional Tap

A Directional Tap is a specialized directional coupler. It is a multi-port passive network through which signals flow from the Input port to the Output port, with a specified fraction of the signal energy going to each of several Tap ports. The directional characteristic is that the Taps will not receive any energy from signals traveling in the reverse direction through the coupler.

The Directional Tap is used to establish two or more Drop Cables that provide a signal path between a Backbone Cable and a User Outlet. Two Directional Taps are required to establish a set of Drop Cables; one for the Receive Cables, and the other for the Transmit Cables.

Signals flow from the Input port to the Output port of the Directional Tap with only a small loss due to internal power dissipation. There is a more substantial attenuation of signals that flow from the Input port to each of the Taps. This attenuation is referred to as Tap Loss, and is a design specification dictated by the requirements of the system.

Directional Taps used with the Wangnet Backbone system may have two, four, or eight Tap ports. Each port will have a specified Tap Loss ranging from 4 to 29 dB.

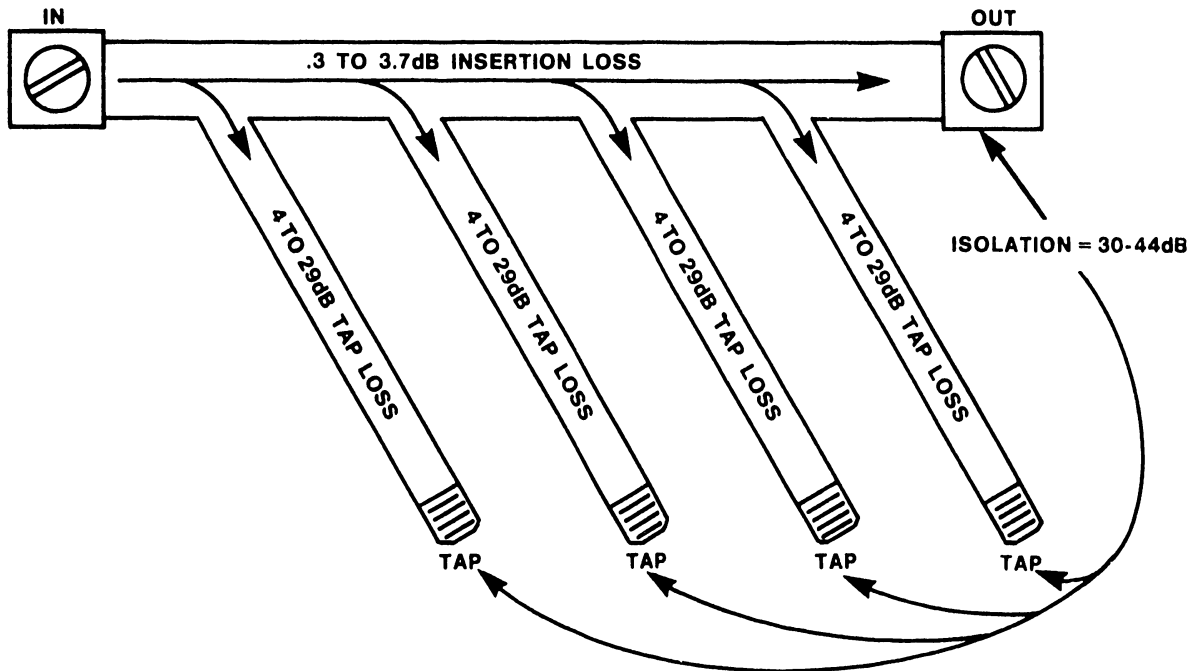

Figure 2-24 Directional Tap Functional Diagram

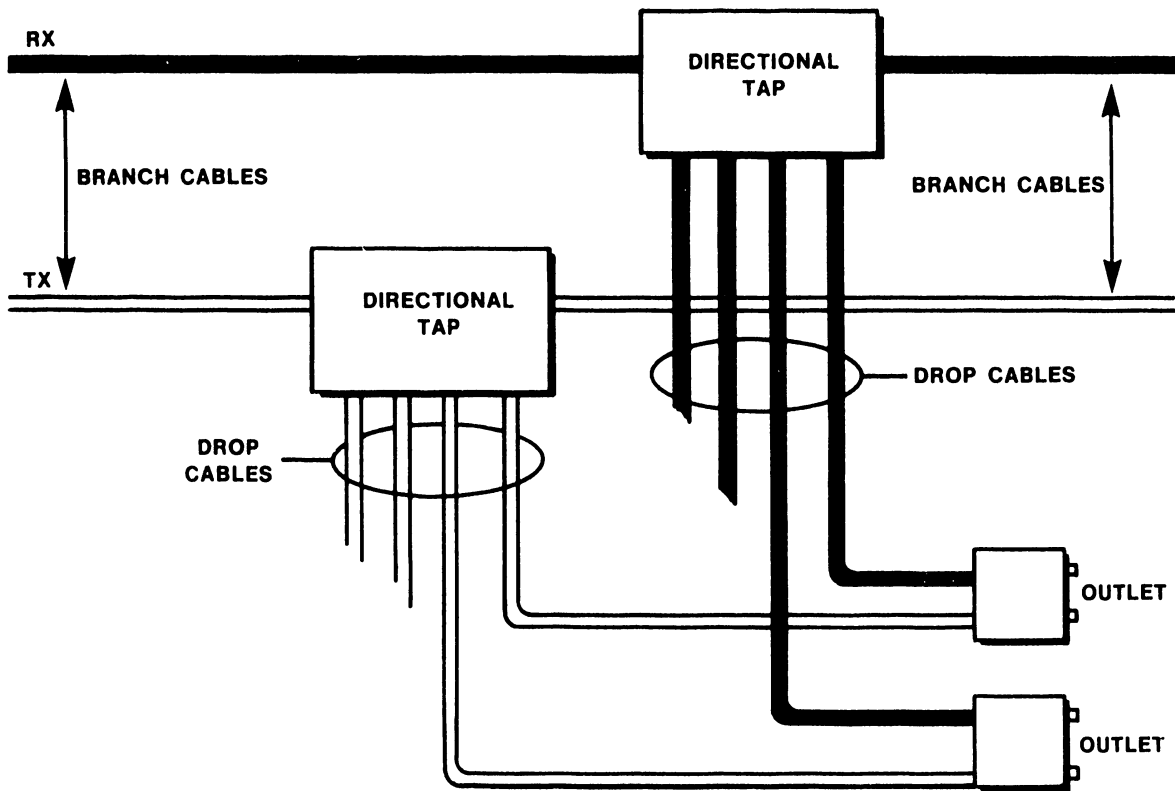

Figure 2-25 Directional Tap Application

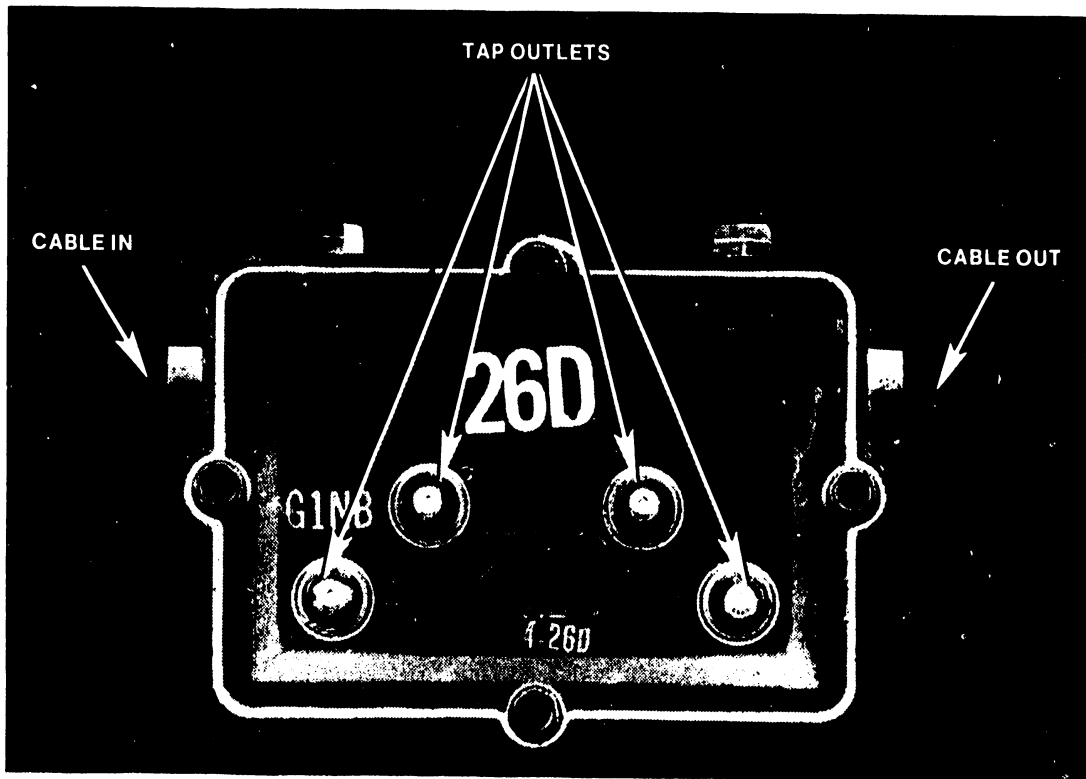

Figure 2-26 Typical Directional Tap Exterior View

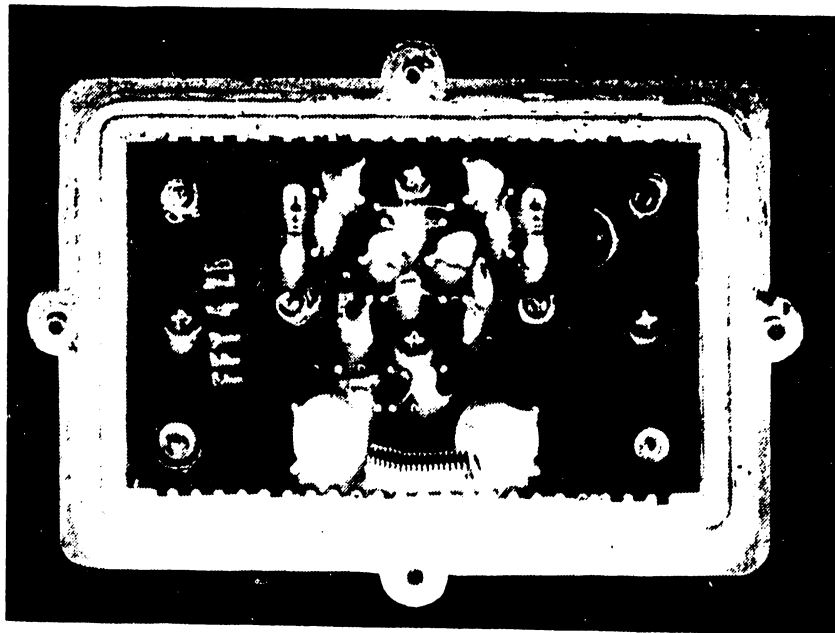

Figure 2-27 Typical Directional Tap Interior View

2.6.8 Outlet

An Outlet, also known as a User Outlet, is a convenient connection point between a set of Backbone Drop Cables and an individual user of the Wangnet system. The Outlet consists of a box, an escutcheon plate, and two bulkhead feedthrough coaxial cable connectors. The connectors are both Type F, but differ in thread and finish. One connector is right-hand threaded and has a natural aluminum finish, while the other connector is left-hand threaded and has an iridite finish. The left-hand threaded, iridite finished connector is the Transmit Cable connector.

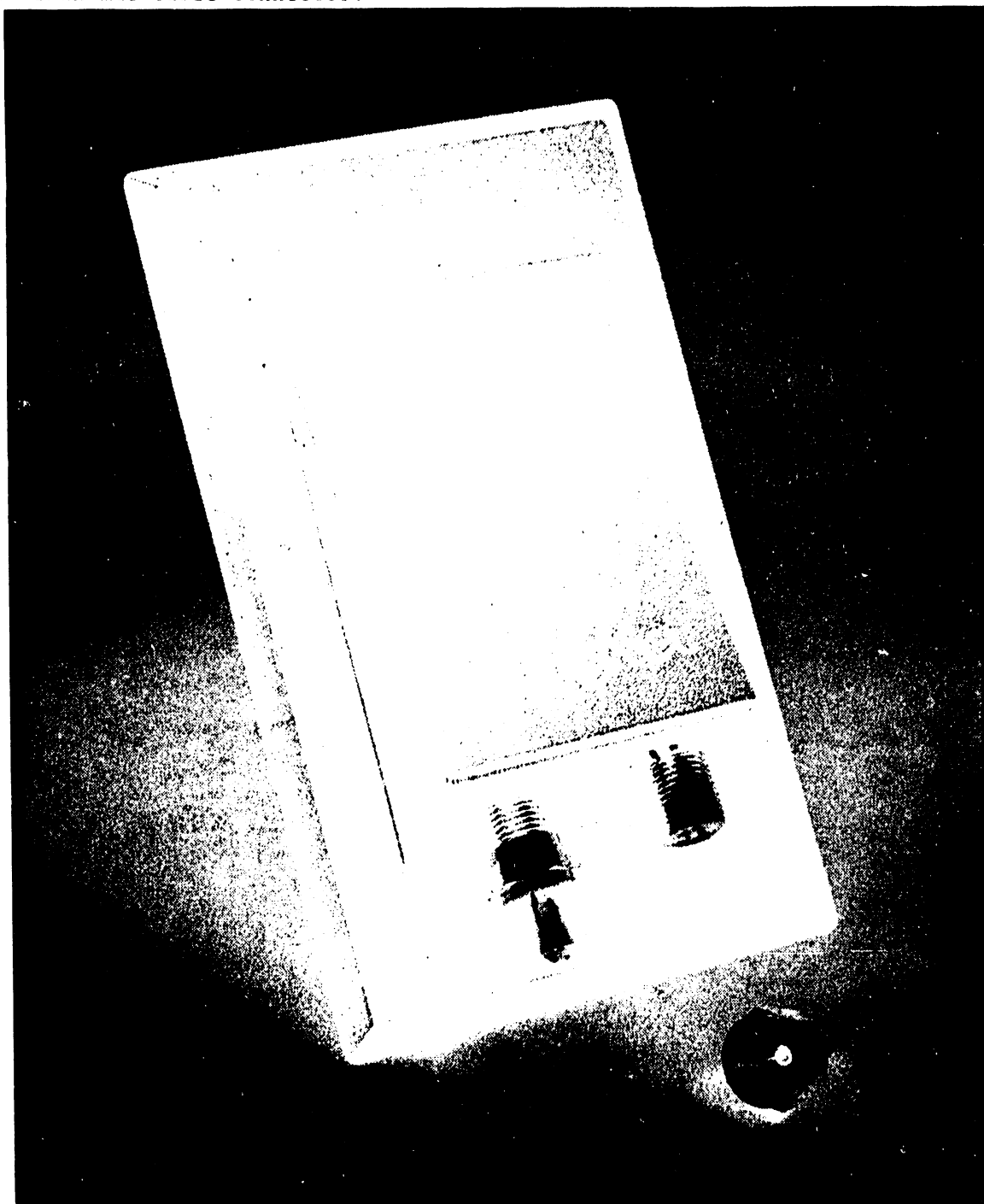

Figure 2-28 User Outlet

2.6.9 Power Converter

The Wang Power Converter is essentially a ferro-resonant constant-voltage step-down transformer, with accessories. It converts 120 VAC commercial power to 30 VAC power for the operation of the system amplifiers. The AC power is distributed to the amplifiers over the same coaxial cables that carry the system signals.

The Power Converter delivers AC power to the system through two UHF-Series coaxial connectors located at the rear of the chassis. One connector feeds power to the Transmit Cable, while the other connector feeds power to the Receive Cable. The current delivered through each connector is monitored by individual AC Ammeters on the front panel.

The constant-voltage feature of the Power Converter provides a substantial amount of line regulation. That is, as the commercial power line voltage varies over the usual wide range, the output of the Power Converter remains 30 VAC. The regulation process also results in a flattening of the output waveform of the converter. Since standard voltmeters will not accurately measure non-sinusoidal waveforms, an oscilloscope must be used to perform voltage level checks.

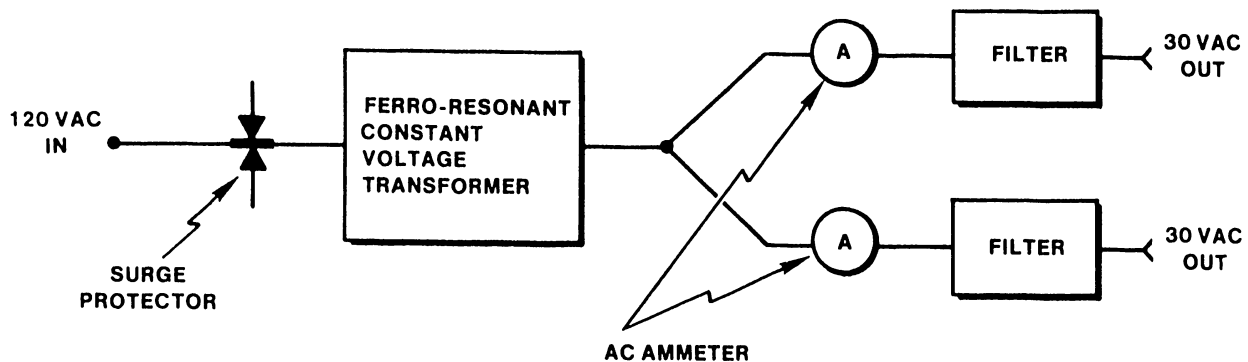

Figure 2-29 Power Converter Functional Diagram

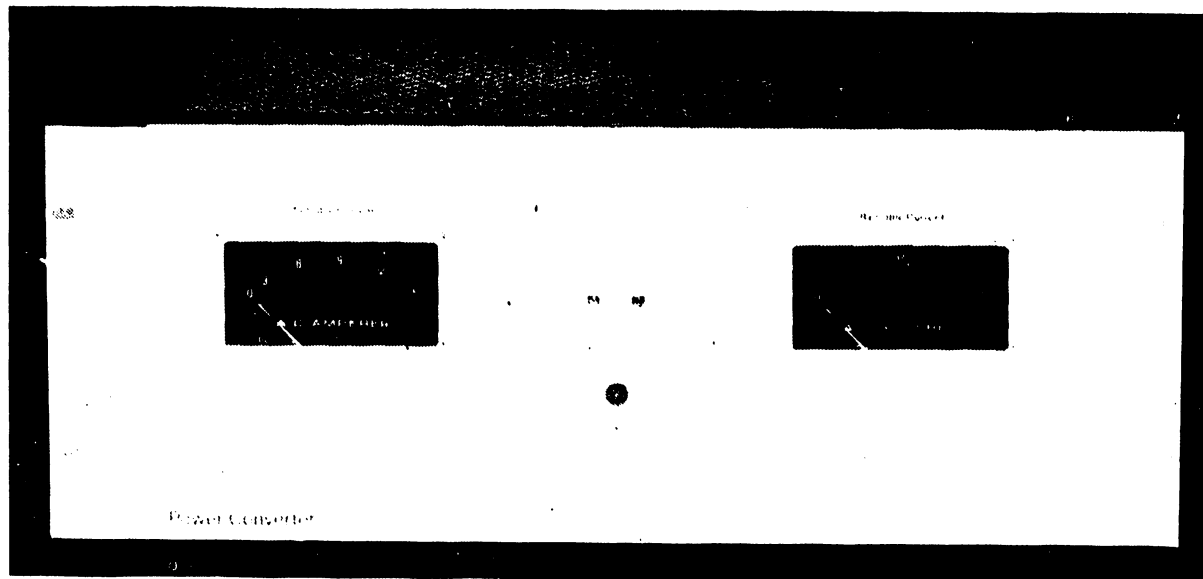

Figure 2-30 Power Converter Front View

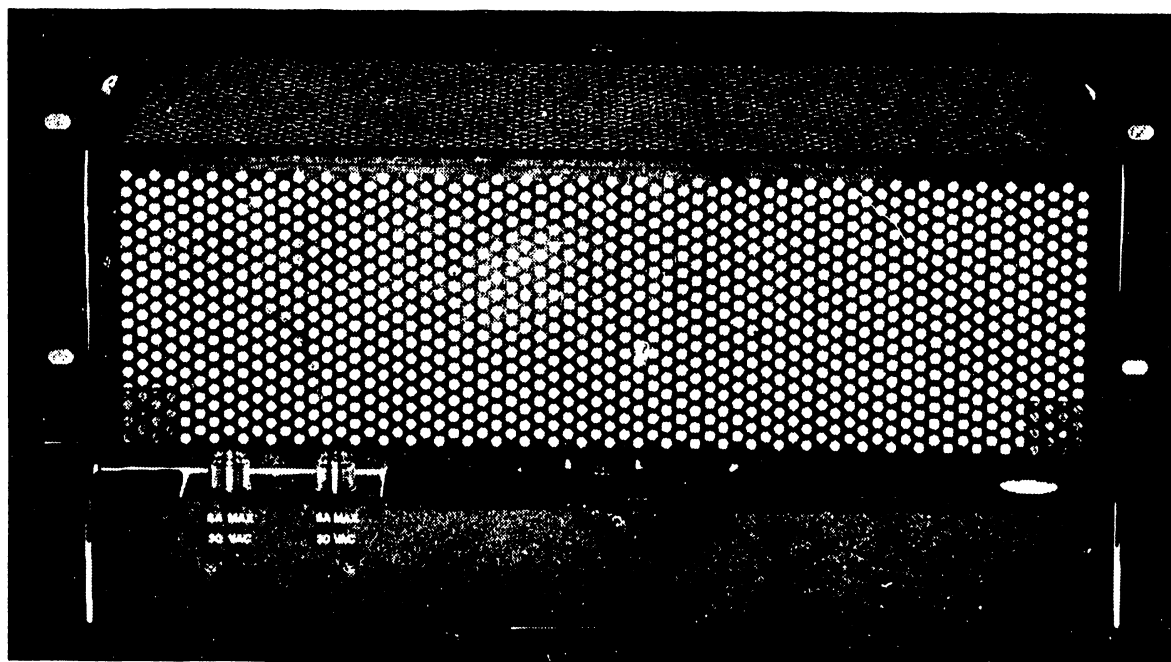

Figure 2-31 Power Converter Rear View

2.6.10 Power Combiner

A Power Combiner, also known as a Power Inserter, is a three-port passive network through which AC power is introduced to a Wangnet Backbone Cable. The Power Combiner passes RF signals from Port 1 to Port 2 with minimum signal loss. AC Power is introduced at Port 3. Filter elements within the combiner control the distribution of both RF energy and low frequency AC power.

The Power Combiner can feed AC power to the Backbone cable connected to Port 1 only, or to the cable connected to Port 2 only, or it can feed power to both cables simultaneously. At the same time, filter elements prevent the passage of RF energy either to or from Port 3, preventing the introduction of extraneous RF signals or the loss of system signals through the power cable.

The AC power paths within the Power Combiner are controlled either by jumper wires or power passing fuses, depending on which model is used. The Jerrold SPJ-3D uses two power passing fuses, either of which can be removed to interrupt power to the corresponding cable. The C-Cor PS-400-C uses jumper wires to perform the same function.

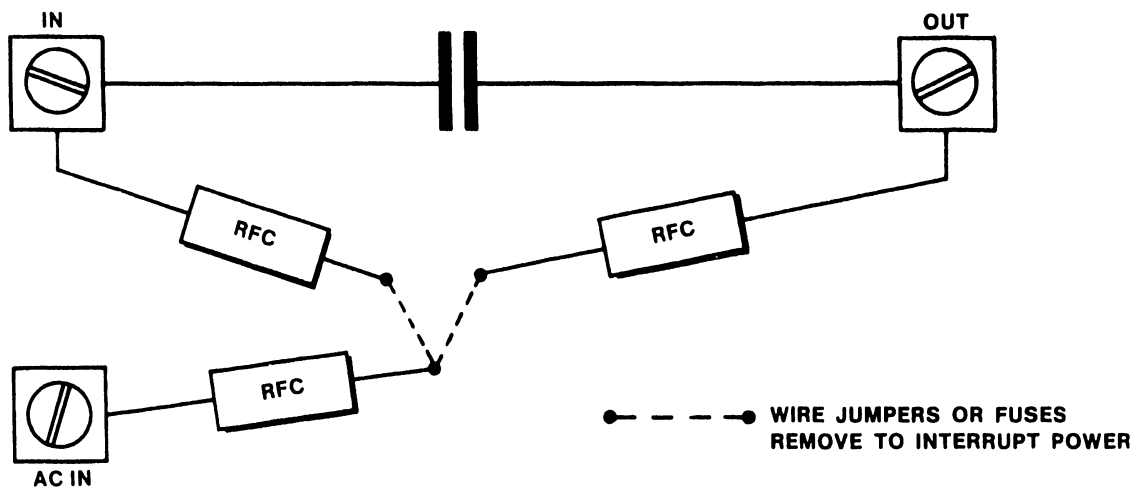

Figure 2-32 Power Combiner Functional Diagram

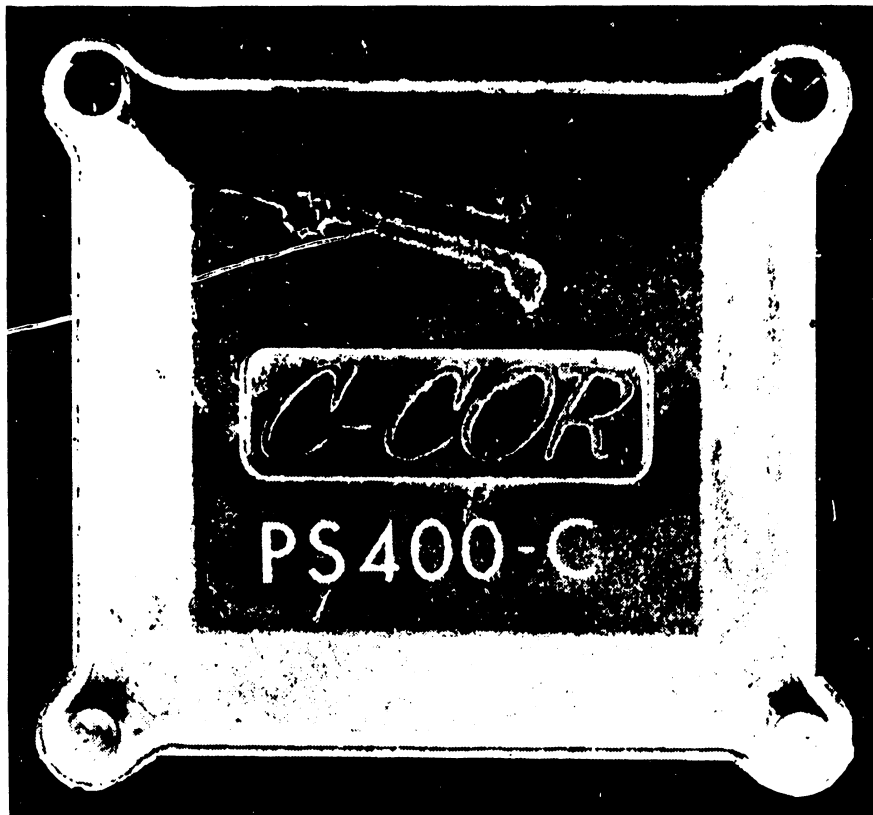

Figure 2-33 Typical Power Combiner Exterior View

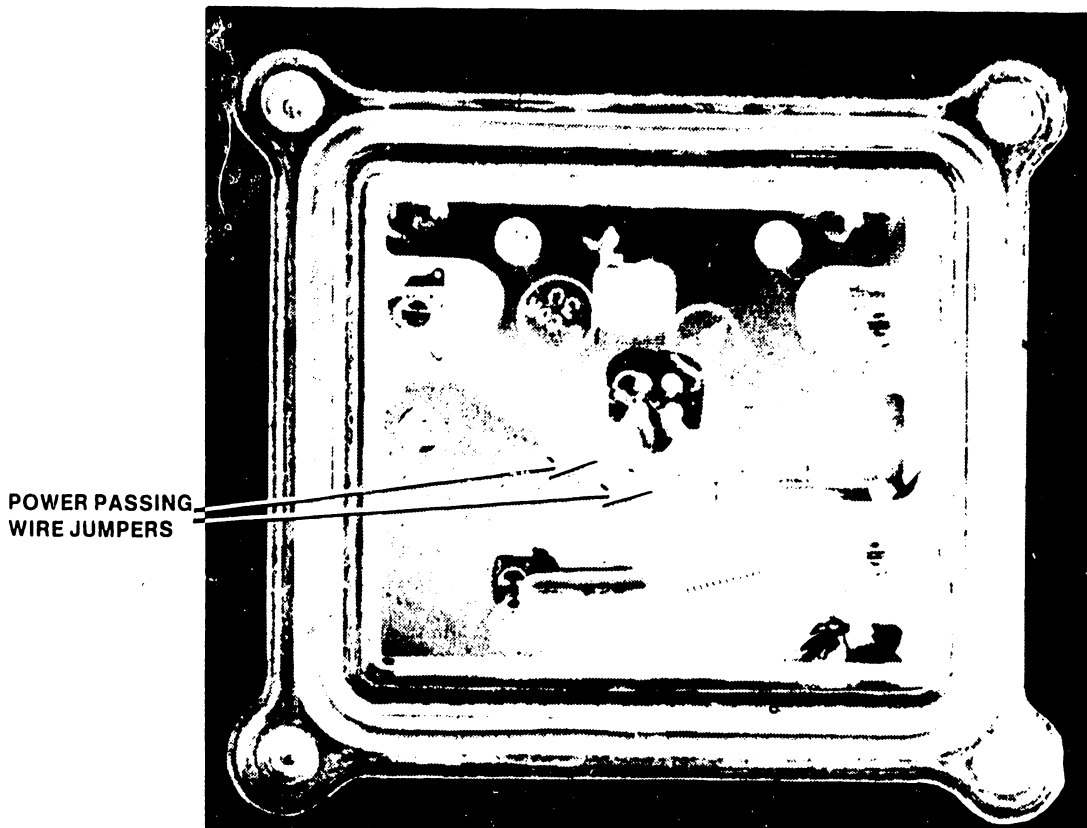

Figure 2-34 Typical Power Combiner Interior View

SECTION

3

OPERA-

TION

SECTION 3

OPERATION

The Wangnet Backbone and its component parts neither require nor allow operator intervention. Therefore, this section of the manual is not used.

SECTION

4

INSTAL-

LATION

SECTION 4

INSTALLATION

All Wangnet Backbone installations are made by CATV Installers, Electrical Contractors, or Customer Personnel. Each installation is unique, and is made in accordance with a custom plan prepared by the Wang Customer Engineering Cable Design Group.

At the time of Backbone certification, the local Customer Engineer assists with the preparation of the Site Log, and accepts the Backbone. The Customer Engineer is not otherwise involved with hardware installation.

SECTION

5

PREVENTIVE AND

CORRECTIVE

MAINTENANCE

SECTION 5

PREVENTIVE AND CORRECTIVE MAINTENANCE

5.1 INTRODUCTION

This section describes the field maintenance procedures to be used on all Wangnet Backbone Systems. Maintenance is categorized as being either preventive or corrective in nature. Accordingly, two sets of procedures are detailed here. One is designed to detect deterioration before it becomes a serious problem, while the other serves as an aid to eliminating problems as they are uncovered.

5.2 PREVENTIVE MAINTENANCE

The following preventive maintenance procedure is prescribed by the Wangnet Maintenance Plan. Since the purpose of preventive maintenance is to discover latent problems, this procedure must be performed even though there is no other indication that a problem exists.

The preventive maintenance procedure consists of an Amplitude Response Test of the Backbone Outlets. The test will be performed on a representative sample of the system outlets. The specific outlets to be tested in each branch are designated in the Site Log. Instruments required for the test are:

- 1) Wang Four Frequency Test Signal Generator
- 2) Wavetek SAM I Signal Analysis Meter

To perform the test, connect the Wang Four Frequency Test Signal Generator to the Tx connector of the outlet to be tested. Connect the SAM I Signal Analysis Meter to the Rx connector of the same outlet. Transmit the four test signals along the network, and measure the amplitude of each signal as received by the SAM I. Log the results, and compare them to the original test values recorded in the Site Log.

Test results that vary from the original values by more than 2 dB indicate that corrective action is required. Troubleshooting procedures are detailed in Section 8 of this manual.

5.3 CORRECTIVE MAINTENANCE

Prescribed corrective maintenance procedures are detailed in the Troubleshooting Chart of Section 8. The following instruments are required for troubleshooting Backbone problems:

- 1) Wang Four Frequency Test Signal Generator
- 2) Wavetek SAM I Signal Analysis Meter
- 3) Avantek CR-4010 Spectrum Analyzer *
- 4) Avantek CT-4010 Transmitter *
- 5) Oscilloscope

* Avantek CR/CT 4000 series instruments are not required for Branch level maintenance.

5.4 MAINTENANCE TESTS

The troubleshooting procedures described in Section 8 require the performance of six specific tests, other than common voltage and waveform checks.

- 1) Amplitude Response
- 2) Hum Modulation
- 3) Signal to Noise Ratio
- 4) Amplifier Gain and Slope
- 5) Stray and Spurious Signal Search (not required at Branch level)
- 6) Cable System Response Test

The following instruments are required for performing the tests:

- 1) Wang Four Frequency Test Signal Generator
- 2) Wavetek SAM I Signal Analysis Meter
- 3) AvanteK CR-4000 Spectrum Analyzer (not required at Branch level)

5.4.1 Amplitude Response Test

The Amplitude Response Test measures the loop loss from a specific Outlet at four discrete frequencies across the passband of the Backbone. The results of this test are compared with the original test data recorded in the site log, and provide an indication of the general condition of the loop being tested.

To perform the test, connect the Wang Four Frequency Test Signal Generator to the Tx connector of the outlet to be tested. Connect the SAM I Signal Analysis Meter to the Rx connector of the same outlet. Transmit the four test signals along the network; measure and record the amplitude of each signal as received by the SAM I.

5.4.2 Hum Modulation Test

The Hum Modulation Test measures the percentage of amplitude modulation at power frequencies on an otherwise unmodulated carrier. This test is initially performed at specific Outlets designated in the Site Log, or at Outlets where a hum problem is suspected. The maximum allowable hum modulation is 5%, but typical values are in the 1% or 2% range. If excessive hum modulation is present, expand the test in order to isolate the source of the hum.

Perform the initial test by injecting an unmodulated 172 MHz test signal at the Tx port of the Outlet. Measure the hum modulation level at the Rx port of the same outlet. Use the Wang Four Frequency Test Signal Generator as the test signal source, and the Wavetek SAM I Signal Analysis Meter to measure the hum modulation level. If excessive hum modulation is present, determine whether the source of trouble is on the Tx (Inbound) or Rx (Outbound) line.

NOTE: Both pieces of test equipment must be operated on internal batteries for this test!

Check the Tx line by injecting the test signal at the Outlet, and measuring the hum modulation at the Headend. Check the Rx line by injecting the signal at the Headend, and measuring the hum modulation at the Outlet. Excessive hum modulation on both lines indicates that a Power Converter is the source of trouble. If only one line is affected, isolate the defective component by measuring the hum modulation at each Amplifier along the affected line.

5.4.3 Signal to Noise Ratio Test

The Signal to Noise Ratio Test measures the degree to which RF signal levels exceed the RF noise levels on the Backbone. This test is initially performed at specific Outlets designated in the Site Log, or at Outlets where a noise problem is suspected. The minimum acceptable S/N Ratio is 40 dB, assuming a Tx signal level of +45 dBmV. If it is less than 40 dB, expand the scope of the test to isolate the trouble source.

Use the Wang Four Frequency Test Signal Generator as the signal source, and the Wavetek SAM I Signal Analysis Meter as the level measuring device for this test. Inject the test signals at the Tx port of the Outlet, and measure the signal and noise levels at the Rx port of the same Outlet. Since the test signal level is 15 dB below the specification level of +45 dBmV, a 15 dB correction must be added to the signal level measurement. Make the measurements at each of four test frequencies, and calculate the S/N Ratios by algebraically subtracting the noise level from the corrected signal level (e.g. Measured Signal Level = -10 dBmV; Corrected Signal Level = +5dBmV; Noise Level = -38 dBmV; S/N Ratio = 43dB).

5.4.4 Amplifier Gain & Slope Test

The Amplifier Gain and Slope test compares the gain and slope of an Amplifier with the original values recorded in the Site Log. The test is normally performed when an Amplifier is replaced in the system, and may also be used to check a suspected bad unit.

Perform the test by injecting test signals from the Four Frequency Test Signal Generator into the input test terminal of the Amplifier, and measuring the respective signal levels with the SAM I at the output test terminal of the Amplifier (The test points are the "F" connectors adjacent to the hardline input/output connectors). Check the output signal levels at all four test frequencies, and compare them to the original values recorded in the Site Log. Then, adjust the Amplifier gain and slope controls to bring the level of all four test signals to within 1 Db of the original values.

The slope control has its principal effect at the low end of the pass-band. Therefore, the initial adjustment should be to set the gain for the correct value at the high end (351 MHz). Then, adjust the slope control so that the output level at the low end (9.5 MHz) is the same as at the high end. Slight touch-up adjustments of both controls may be required to complete the procedure.

(This page intentionally left blank)

5.4.5 Cable System Response Tests

This test is a part of the WangNet Certification procedure. Its purpose is to determine the need for adjustable equalizers in the system. A sweep frequency test of the cable system is made to determine the frequency response flatness and to verify that there are no return loss problems. Adjustable equalizers should be used only as a last resort. If the peak-to-valley variations in the response are 1 to 2 dB better than the system specification, the use of adjustable equalizers is not recommended. Furthermore, the gain of the amplifier should be close to the 20 dB specified operating level. If an adjustable equalizer is used, the amplifier gain must be set at a nominal 17-18 dB before installing the equalizer. This gain adjustment is accomplished by setting the gain control at maximum (nominally 23-24 dB in the standard line amplifiers) and then beeking off approximately 6 dB. Note that the amplifier output power level ahead of the adjustable equalizer should never exceed +35 dB.

5.5 INSTRUMENT PROCEDURES FOR MAINTENANCE TESTS

Specific instrument procedures for performing the prescribed maintenance tests are described on the following eight pages:

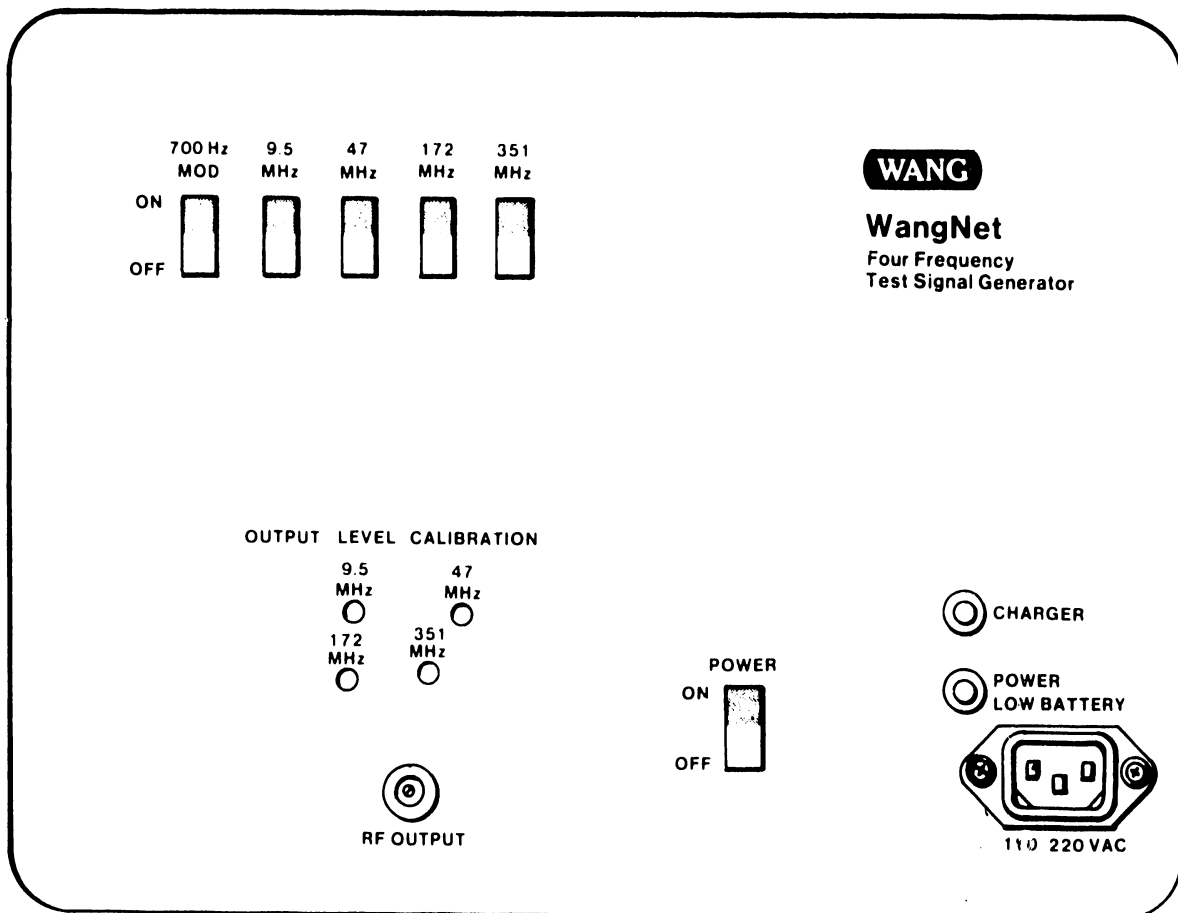
5.5.1 Amplitude Response Test

B-01630-FY85-3

Figure 5-1

1. Connect RF Output to the Wangnet Outlet Tx terminal. Use coaxial cable with left hand threaded F connectors on both ends.
2. POWER switch "on."
3. All four test signal switches "on." Modulation switch "on."

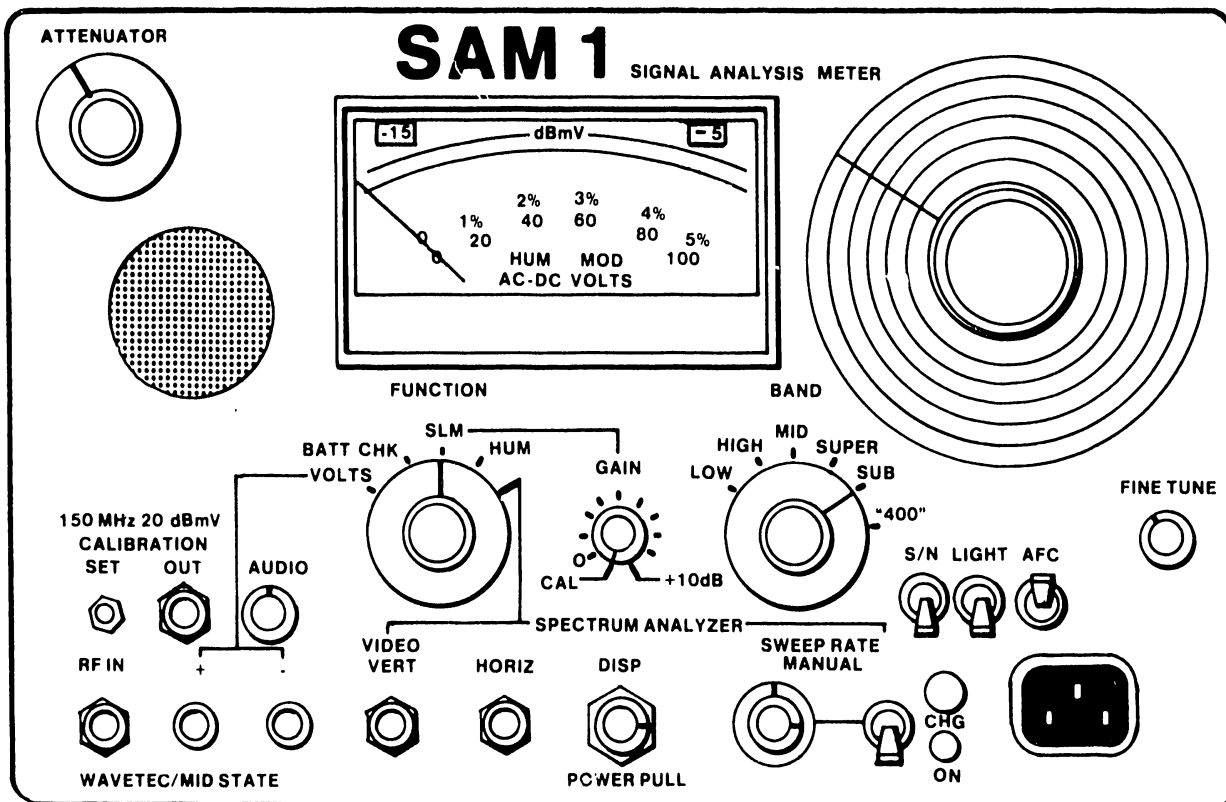

Figure 5-2

1. Connect RF IN to the Wangnet Outlet Rx terminal. Use a coaxial cable with right-hand threaded F connectors on both ends.
2. Set: ATTENUATOR to show -15 and -5 in Meter Range Windows.
 FUNCTION switch to "SLM."
 GAIN control to "CAL."
 AUDIO control for switch "on" and volume as required.
 POWER-PULL switch to "on."
3. Set the BAND switch to "SUB" range, and
 - a) Tune in 9.5 MHz signal with the main tuning control and adjust for a peak meter reading with the FINE TUNE control. Record the signal level.
 - b) Tune in and peak the 47 MHz signal. Record the level.
4. Set the BAND switch to "HIGH" range; tune in and peak the 172 MHz signal. Record the level.
5. Set the BAND switch to "400" range; tune in and peak the 351 MHz signal. Record the level.

5.5.2 Hum Modulation Test

Figure 5-3

1. Connect RF Output to the Wangnet Outlet Tx terminal. Use coaxial cable with left hand threaded F connectors on both ends.
2. POWER switch "on." Use internal battery power only, for this test.
3. 172 Mhz signal switch "on." MODULATION switch "on."
4. MODULATION switch "off" before making hum modulation measurement.

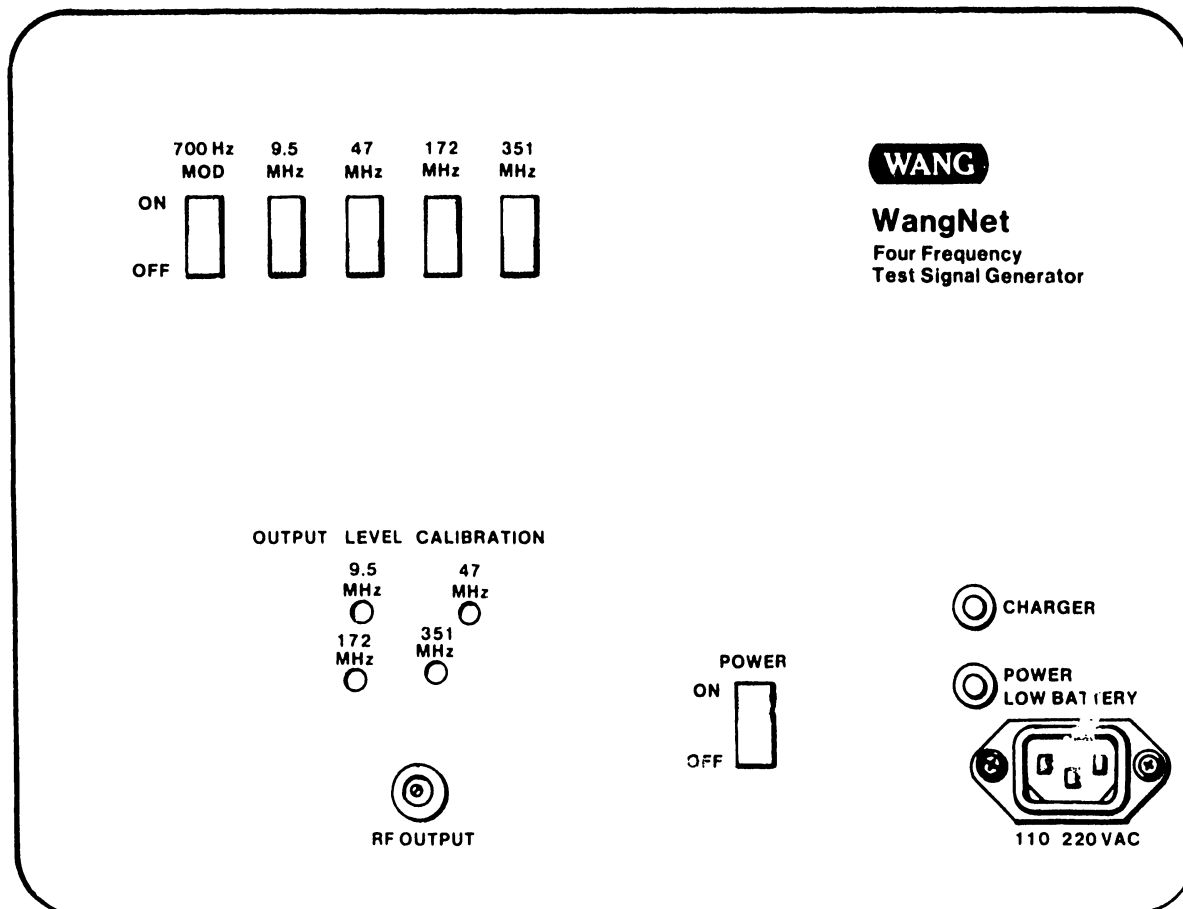
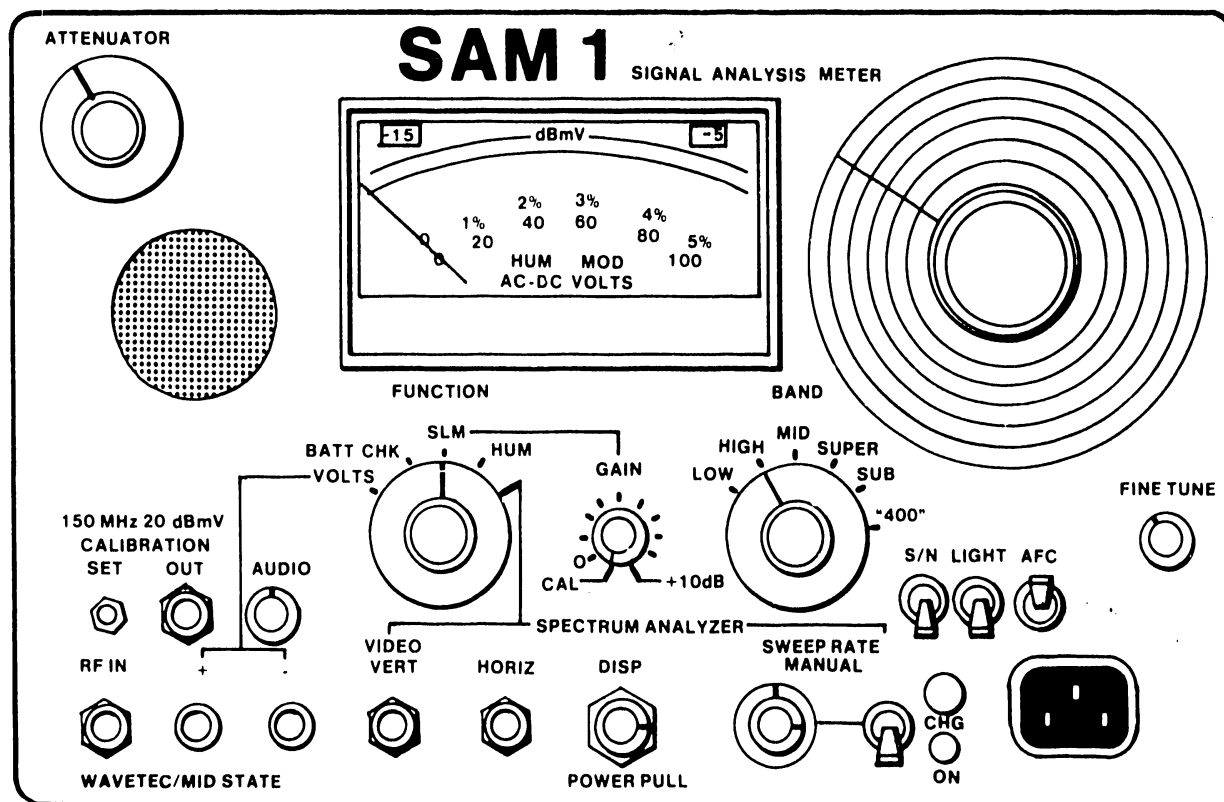

Figure 5-4

1. Connect RF IN to the Wangnet Outlet Rx terminal. Use a coaxial cable with right-hand threaded F connectors on both ends.
2. Set: ATTENUATOR to show -15 and -5 in Meter Range Windows.
FUNCTION switch to "SLM."
GAIN control to "CAL."
AUDIO control for switch "on" and volume as required.
POWER-PULL switch to "on." Use only internal battery power for this test.
3. Set the BAND switch to "HIGH" range, tune in 172 MHz signal with the main tuning control and adjust for a peak meter reading with the FINE TUNE control. (Switch test generator modulation "off" before continuing.)
4. Readjust ATTENUATOR, if necessary, to obtain a meter reading in the upper half of the scale.
5. Set the FUNCTION switch to "HUM" and record the hum modulation level (%) when the meter needle stabilizes.

5.5.3 Signal to Noise Ratio Test

Figure 5-5

1. Connect RF Output to the Wangnet Outlet Tx terminal. Use coaxial cable with left hand threaded F connectors on both ends.
2. POWER switch "on."
3. All four test signal switches "on." Modulation switch "on."

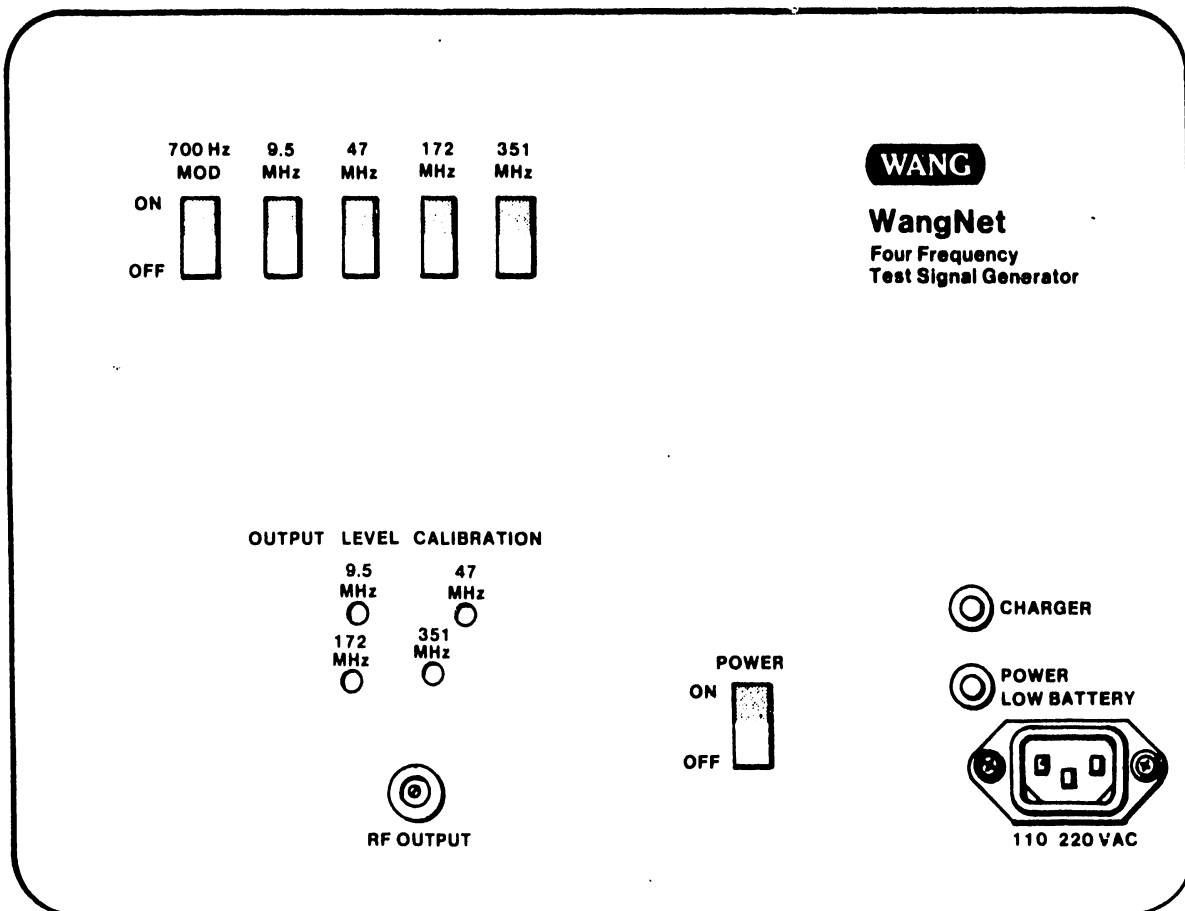
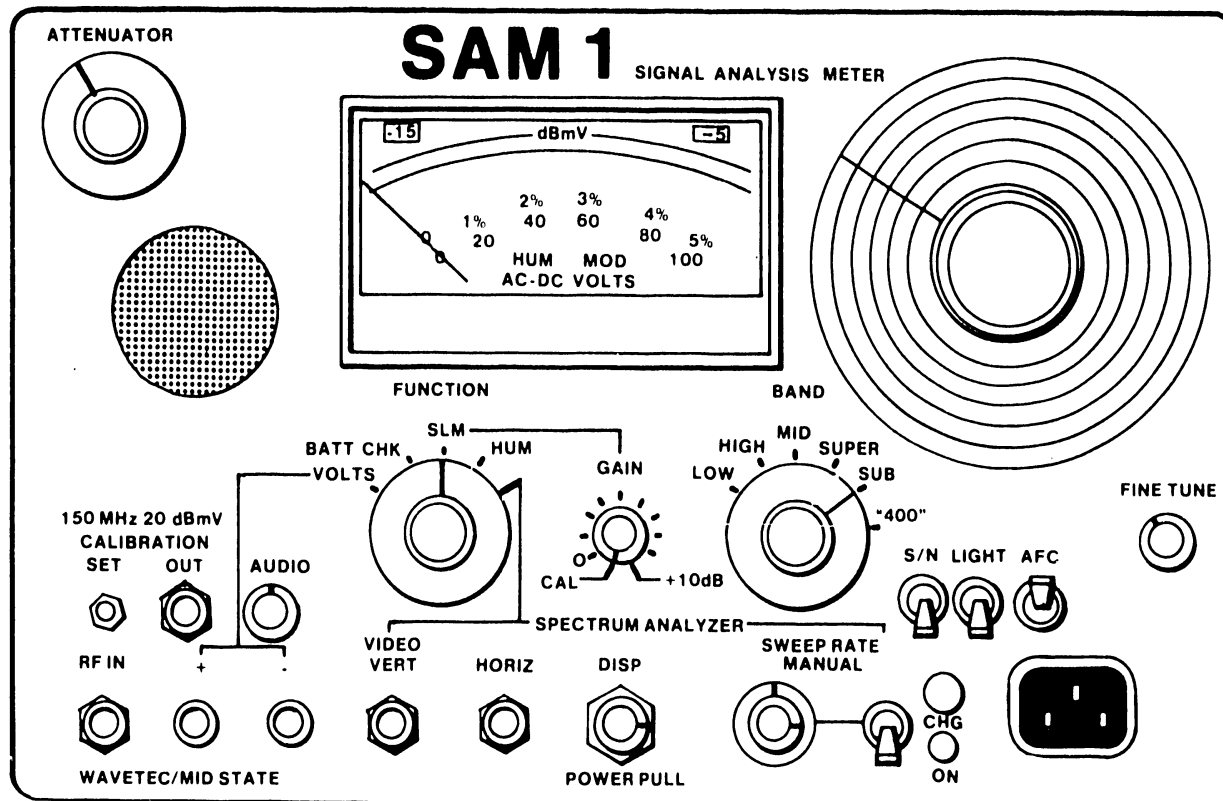

Figure 5-6

1. Connect RF IN to the Wangnet Outlet Rx terminal. Use a coaxial cable with right-hand threaded F connectors on both ends.
2. Set: ATTENUATOR to show -15 and -5 in Meter Range Windows.
FUNCTION switch to "SLM."
GAIN control to "CAL."
AUDIO control for switch "on" and volume as required.
POWER-PULL switch to "on."
3. Set the BAND switch to "SUB" range; tune in 9.5 MHz signal with the main tuning control and adjust for a peak meter reading with the FINE TUNE control. Add 15dB correction to the reading obtained, and record the corrected signal level.
4. All test signal switches "off" at the signal generator.
5. Reset ATTENUATOR to show -25 and -15 in Meter Range Windows, reset GAIN control to +10dB, and push S/N switch "up." The noise level is 10 dBmV less than the indicated value. Record the noise level and calculate the S/N Ratio by algebraically subtracting the noise level from the corrected signal level (e.g. Corrected Signal Level = +5 dBmV; Noise Level = -38 dBmV; S/N Ratio = 43dB).
6. Repeat the test at the 47, 172, and 351 MHz test frequencies.

5.5.4 Amplifier Gain & Slope Test

Figure 5-7.

1. Connect RF Output to the amplifier input test terminal. Use coaxial cable with a left hand threaded F connector on one end, and a right hand threaded F connector on the other end.
2. POWER switch "on."
3. All four test signal switches "on." Modulation switch "on."

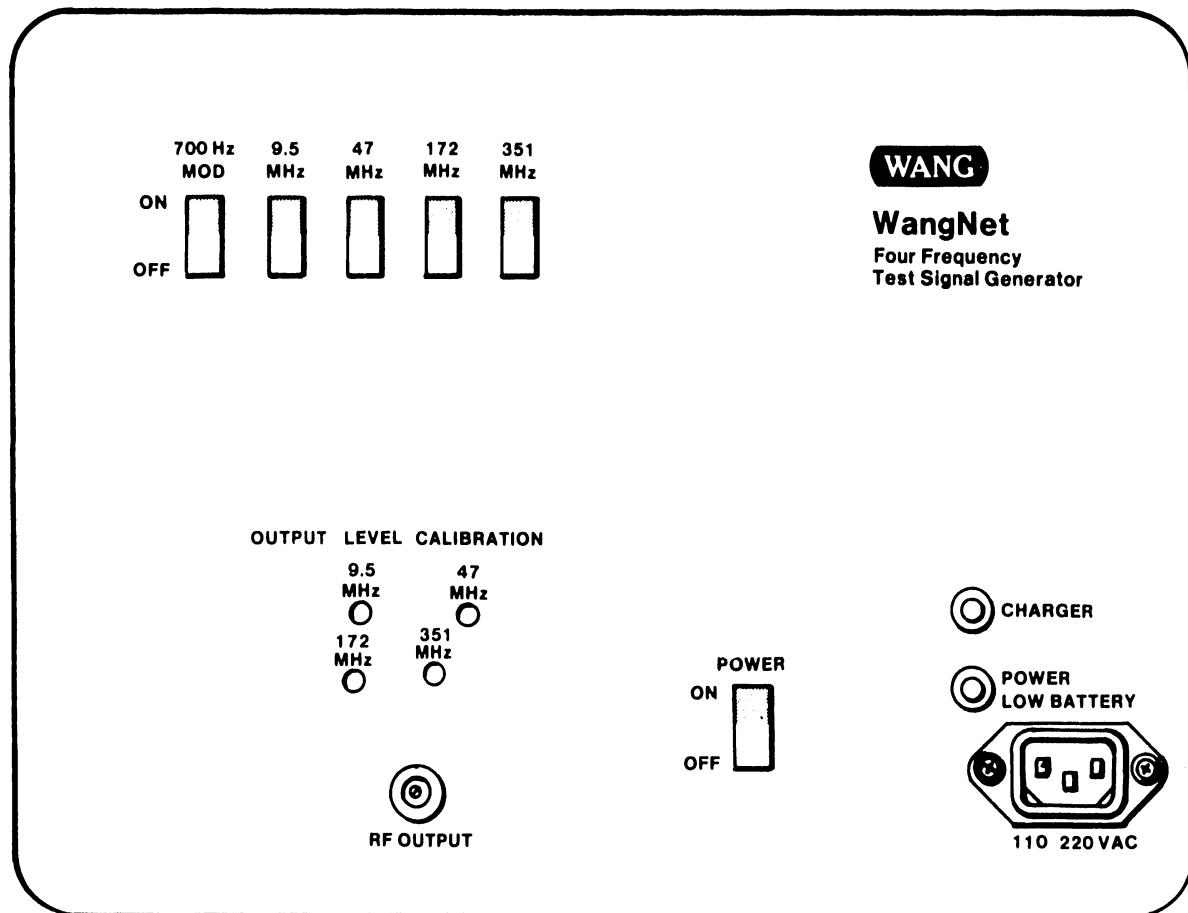
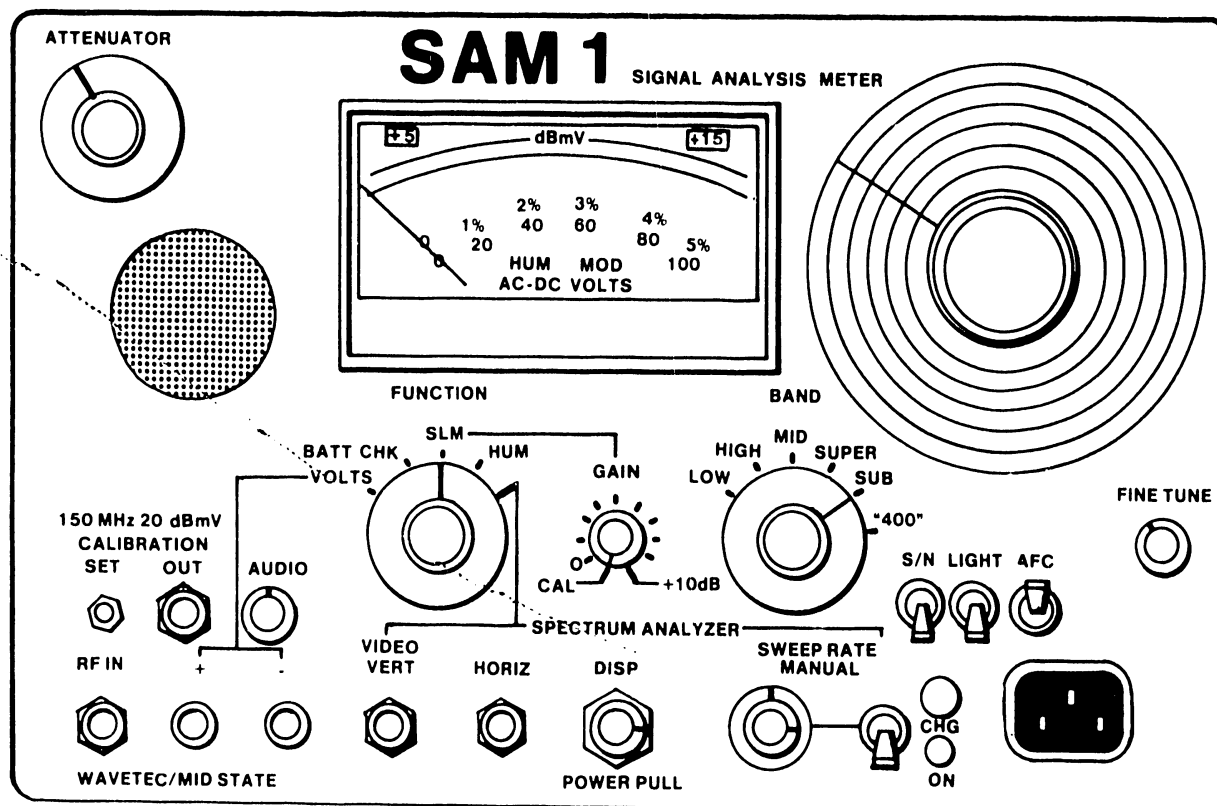

Figure 5-8

1. Connect RF IN to the amplifier output test terminal. Use a coaxial cable with right-hand threaded F connectors on both ends.
2. Set: ATTENUATOR to show +5 and +15 in Meter Range Windows.
FUNCTION switch to "SLM."
GAIN control to "CAL."
AUDIO control for switch "on" and volume as required.
POWER-PULL switch to "on."
3. Set the BAND switch to "SUB" range, and
 - a) Tune in 9.5 MHz signal with the main tuning control, resetting the ATTENUATOR as necessary. Adjust the FINE TUNE control for a peak meter reading. Record the signal level.
 - b) Tune in and peak the 47 MHz signal. Record the level.
4. Set the BAND switch to "HIGH" range; tune in and peak the 172 MHz signal. Record the level.
5. Set the BAND switch to "400" range; tune in and peak the 351 MHz signal. Record the level.
6. Compare the recorded test results with the original values recorded in the Site Log. Reset amplifier gain at 351 MHz, and adjust slope at 9.5 MHz.

5.5.5 Equalizer Adjustment Procedure

NOTE

The following procedure is to be performed only by Wang Customer Engineering personnel.

1. Make a sweep frequency test on the system and observe the amplifier output at some convenient monitoring point. Determine that the amplifier is operating near a nominal gain of 17-18 dB and that the passband ripple is close (within 0.5 to 1 dB) to the system specification limit.
2. If the adjustable equalizer is to be installed in an outbound amplifier, cut the wire that bridges across the output equalizer plug-in position and insert the equalizer, making sure it is firmly seated in position.
3. Set the 200 ohm adjustable resistor on the equalizer (see Figure 5-8A) at maximum resistance (fully clockwise). While observing the roll-off at 400 MHz, adjust the variable capacitor C1 for maximum boost.

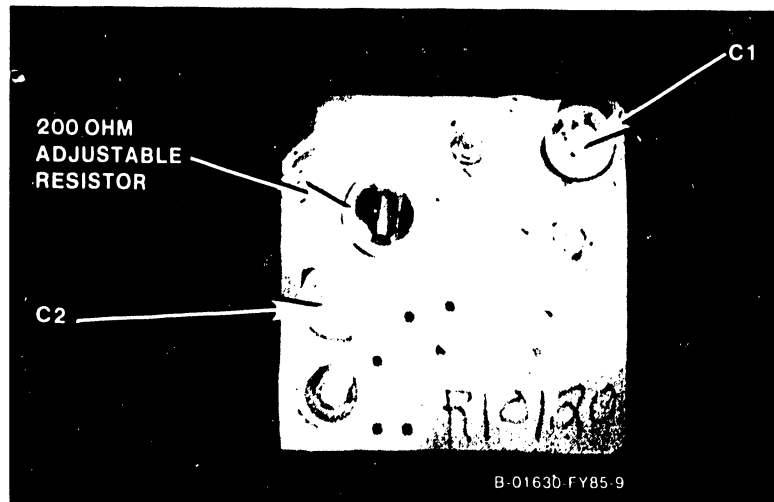

Figure 5-9 Adjustable Equalizer Controls

4. Next, adjust variable capacitor C2 to lower the peak near 250-300 MHz. If the peak does not decrease sufficiently, decrease (turn counterclockwise) the 200 ohm resistor by a tenth of a turn and repeat this step. Keep repeating this step until the peak is low enough but not so low that it starts to lower the 400 MHz response. After this adjustment is completed, increase the gain in the amplifier to the nominal 20 dB near the middle of the passband.
5. Readjust C1, C2 and the resistor on the equalizer for best response. Then adjust the internal amplifier equalizer, if required, to enhance the ripple reduction. Continue to fine tune the equalizer adjustments until the maximum passband flatness has been attained. Finally, readjust the amplifier gain for the desired system gain. This completes the adjustment procedure for the adjustable equalizer.

Final Test

After completing the above equalizer adjustment procedure, again verify that the signal level at the output of the amplifier ahead of any equalizer (if applicable) does not exceed +35 dBmV and that the amplifier is operating at a nominal gain of 20 +1 dB.

5.6 REMOVAL AND INSTALLATION PROCEDURES

Several individual components of the Wangnet Backbone are subject to removal and replacement as a normal maintenance procedure. The following paragraphs describe the methods to be employed in replacing those components that can be replaced without compromising the integrity of the Backbone cable. Disassembly of hardline cable connections is not a normal maintenance procedure, may seriously compromise the cable integrity, and is not intended to be done by Customer Engineers. Any such disassembly must be performed by qualified cable installers, and may require re-alignment of the Backbone.

5.6.1 Amplifiers

Wang (C-Cor) Model 2904 amplifiers are used throughout the Backbone, including the Headend. These amplifiers are power-passing, and may be equipped with plug-in input and/or output pads and equalizers. Therefore, special attention must be given to the location of power-passing fuses, pads, and equalizers whenever removal and replacement of an amplifier is required. The replacement unit must be equipped exactly as the original, and must have its gain and slope adjusted to match those of the original, as recorded in the Site Log.

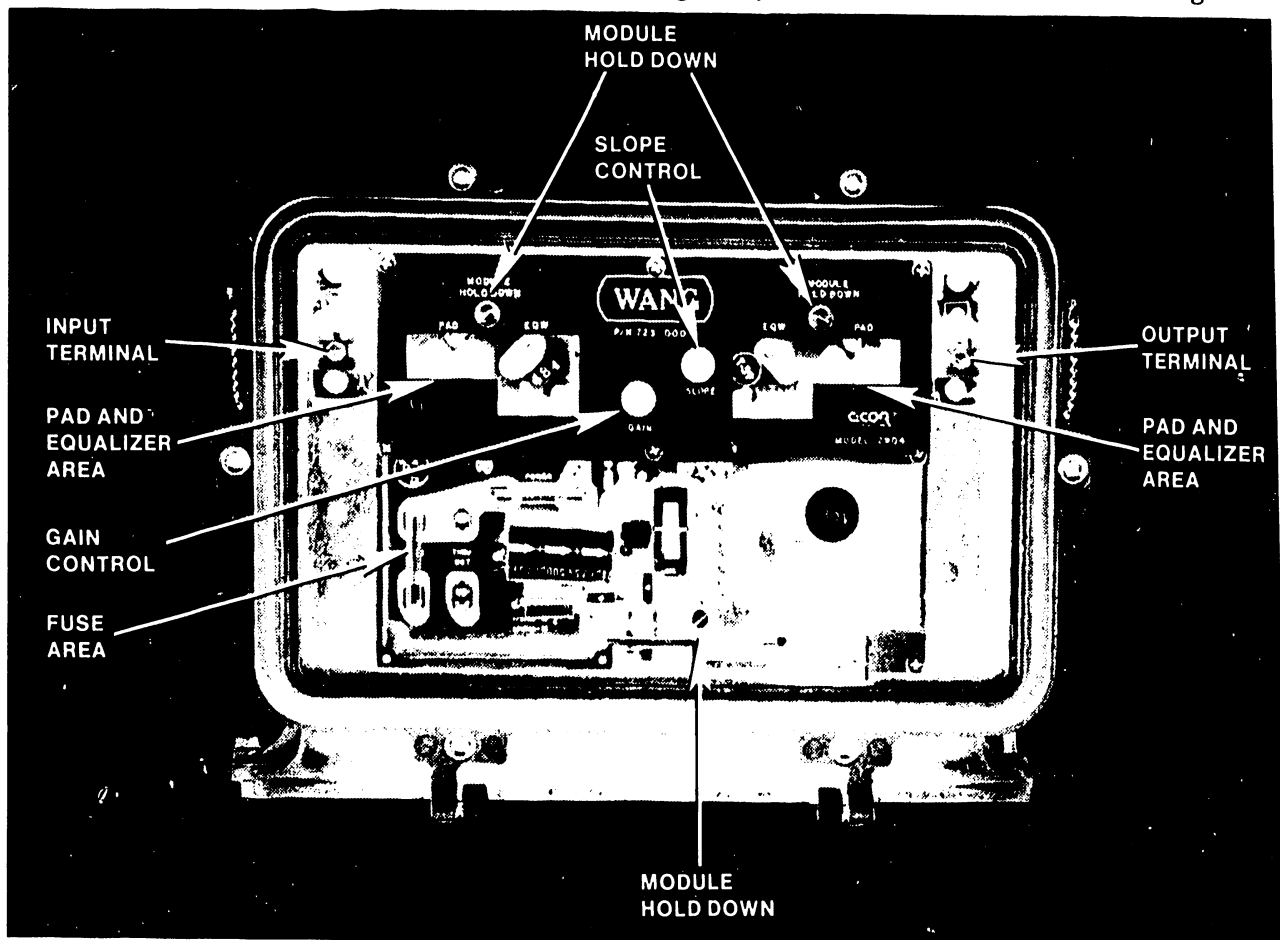

Figure 5-10 Wang Model 2904 Amplifier

The pad and equalizer receptacles are originally equipped with wire jumpers to provide signal path continuity without pads or equalizers in place. The jumpers must be removed whenever a pad or equalizer is installed in a replacement amplifier. To remove a jumper, cut it at its mid-point; and bend each half away from the other sufficiently to insure that there will be no further contact. Be certain, also, that the cut jumper does not contact the shield area of the PC board.

One or two power-passing fuses will have been installed in any given amplifier, in addition to the protective fuse for its power supply. Be sure to install an identical arrangement of power-passing fuses in a replacement amplifier.

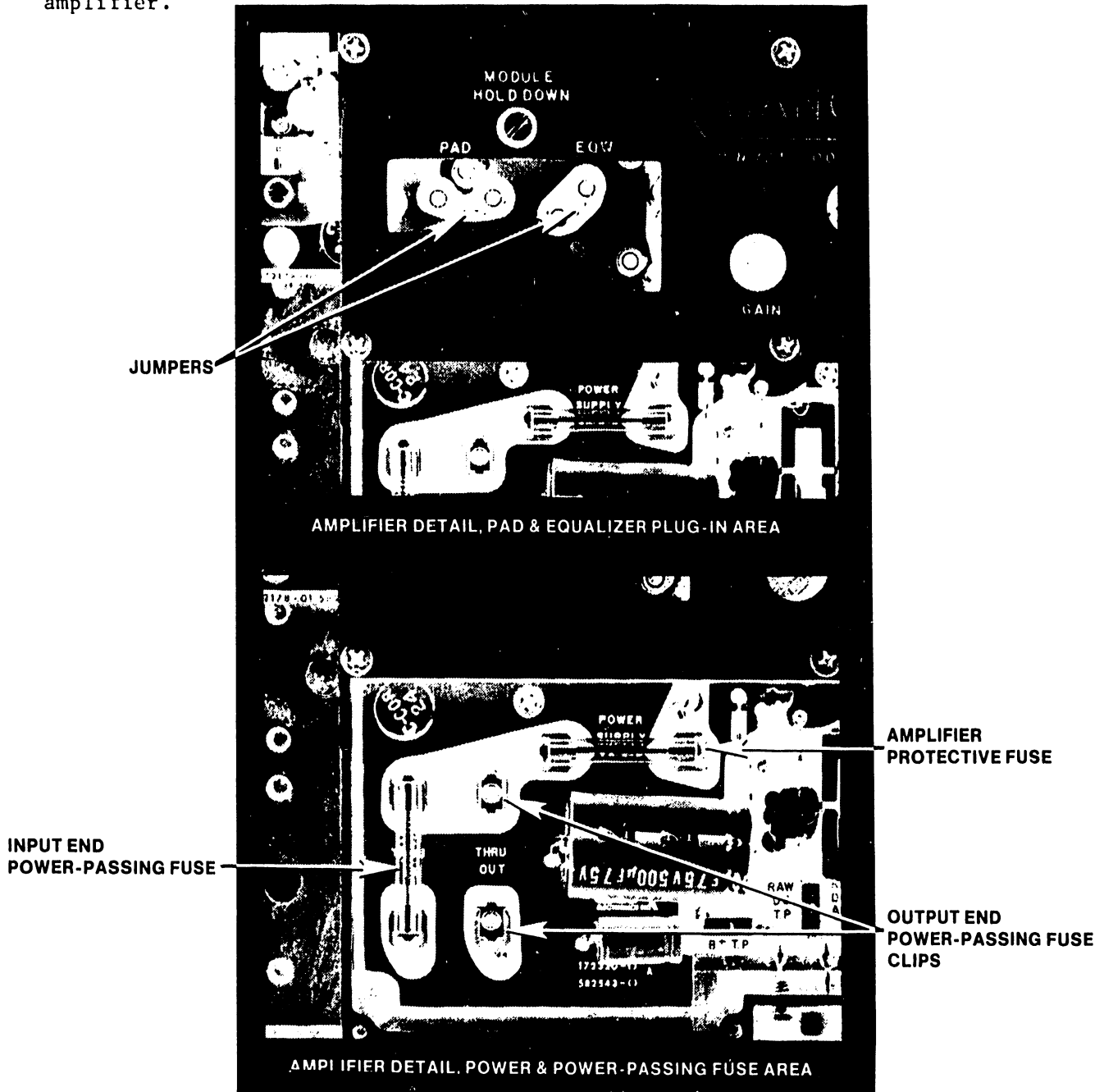

Figure 5-11

Caution! Remove or replace amplifiers with care, as 30 Vac power is present. Although the shock hazard is minimal, careless handling can generate harmful transients.

To remove the amplifier from the housing, loosen three module hold-down screws (captive), grasp the chassis near the input and output terminals, and gently pull the assembly straight away from the housing. Install the replacement amplifier in the housing by reversing the removal procedure. Note that the amplifier connects to the input and output terminals of the housing by means of dual banana plugs at each end of the amplifier. Carefully align the plug and socket elements before attempting to seat the amplifier in the housing.

When the replacement amplifier is firmly seated in the housing, use the SAM I to check the voltage levels at the Raw DC and B+ Test Points. The B+ voltage should be 24 Volts, ± 1.2 Volts, with respect to ground. However, the Voltage Regulator will be unable to maintain the B+ level at 24 Volts unless the Raw DC voltage level is at least 3 Volts higher. Therefore, the Raw DC voltage should be adjusted to a minimum of 28 Volts. The maximum allowable Raw DC Voltage is 35 Volts; but a substantially lower value is preferred, in order to avoid wasteful power dissipation in the voltage regulator.

Complete the amplifier replacement by adjusting its gain and slope controls to obtain the correct output level and response across the pass-band. Inject the Four Frequency test signals at the amplifier input test point, and use the SAM-I to measure the signal levels at the output test point (The test points are the "F" connectors adjacent to the hardline input/output connectors).

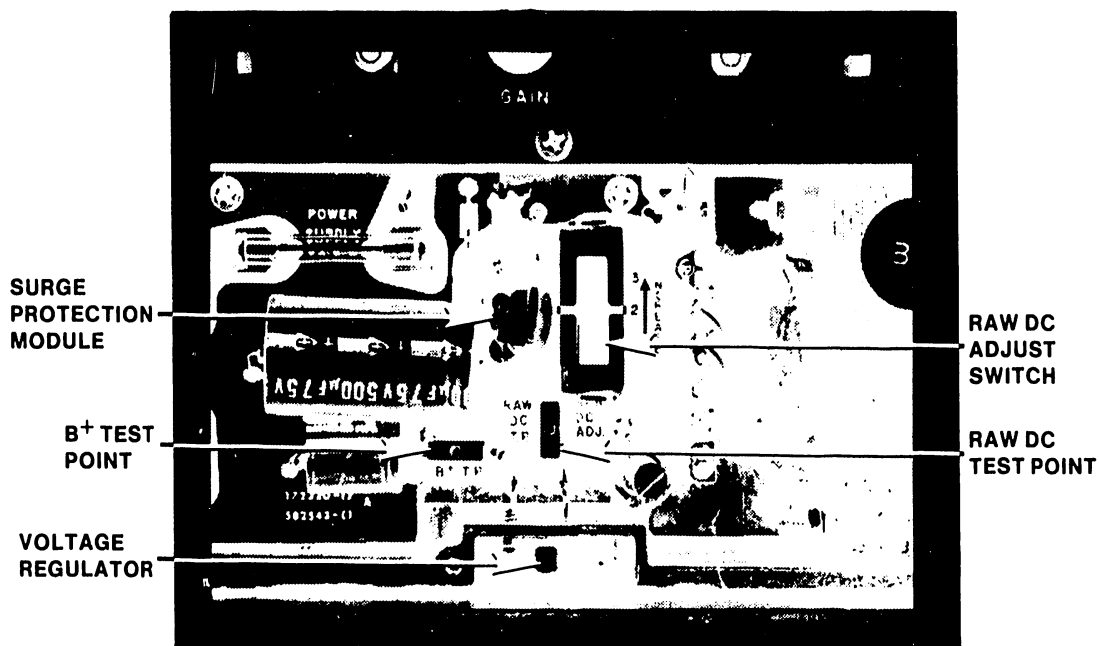

Figure 5-12 Amplifier Detail, Power Supply Area

The slope control has its principal effect at the low end of the pass-band. Therefore, the initial adjustment should be to set the gain for the correct value at the high end (351 MHz). Then, adjust the slope control so that the output level at the low end (9.5 MHz) is the same as at the high end. Check the output signal levels at all four test frequencies, and compare them to the original values recorded in the Site Log. Slight touch-up adjustments of both controls may be required to bring all four test signals to within ± 1 dB of the original levels.

Close the amplifier housing cover, and tighten the cover bolts in the sequence shown in Figure 5-13. Make the bolts finger tight on the first pass, and moderately tight using a 7/16 inch nut driver on a second pass.. Finally, tighten the bolts firmly, but do not use more leverage than is normally available with a common nut driver.

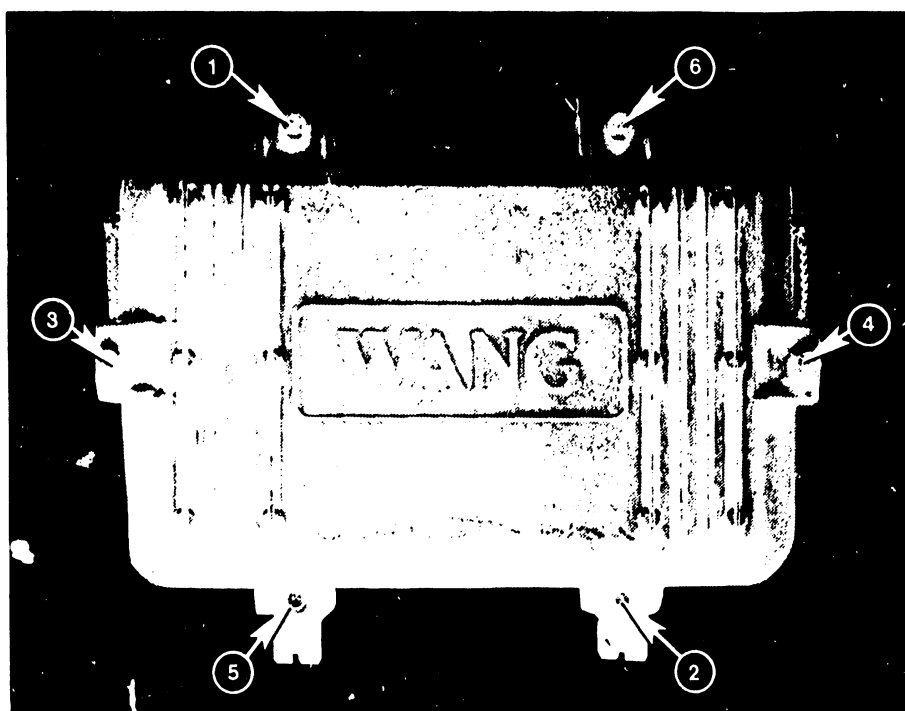

Figure 5-13 Cover Bolt Tightening Sequence

5.6.2 Taps

Both RMS CA-4500 Series and Jerrold FFT Series Taps are used on the Backbone. Each series is available in 4-port and 8-port versions, and with a wide range of tap losses. In every case, the Tap cover plate contains all of the Tap circuitry. Thus, replacement of a Tap consists of merely replacing the cover plate. In the case of the Jerrold FFT Series Taps, the 4-port and 8-port versions are interchangeable. However, no such interchange should be made by a Customer Engineer, because the balance of the system would be disturbed, and re-alignment would be required.

Each Tap is marked with the value of the Tap loss to each port. It is imperative that Taps be replaced with identical units. An RMS 4504-20 has a 20 dB tap loss, and is marked with a large "20". A Jerrold FFT-4-17D has a 17 dB tap loss and is marked with a large "17D".

Remove a Tap plate by completely loosening the captive cover bolts; and using them as handles, gently pull the plate straight away from the housing. Note that the electrical connections are made through male plugs on the Tap plate, and female receptacles in the housing.

Replace a Tap plate by reversing the removal procedure. Carefully align the plugs and receptacles before attempting to seat the Tap plate in the housing. The cover bolts should be tightened in the same manner as the amplifier cover bolts...finger tight on the first pass, moderately tight using a nut driver on a second pass, and then firmly tight with the nut driver. Do not exert more torque, nor use more leverage than is available with a common nut driver.

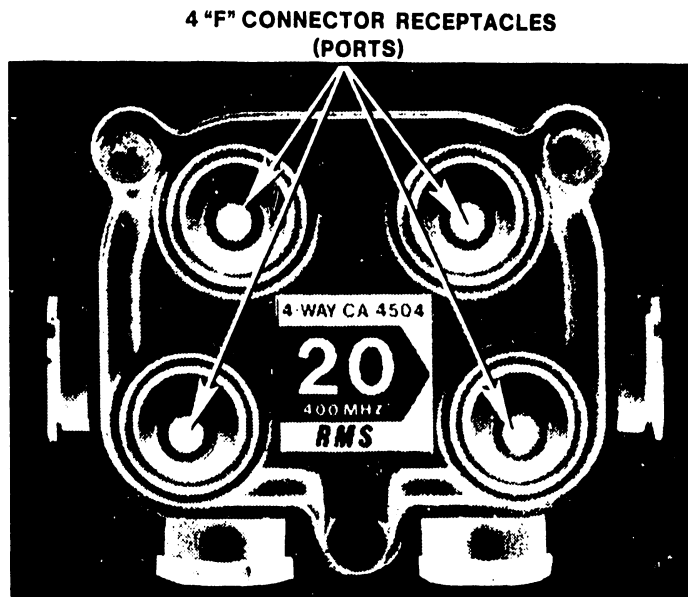

RMS CA-4504 4-WAY TAP EXTERIOR VIEW

Figure 5-14



RMS CA-4508 8-WAY TAP EXTERIOR VIEW

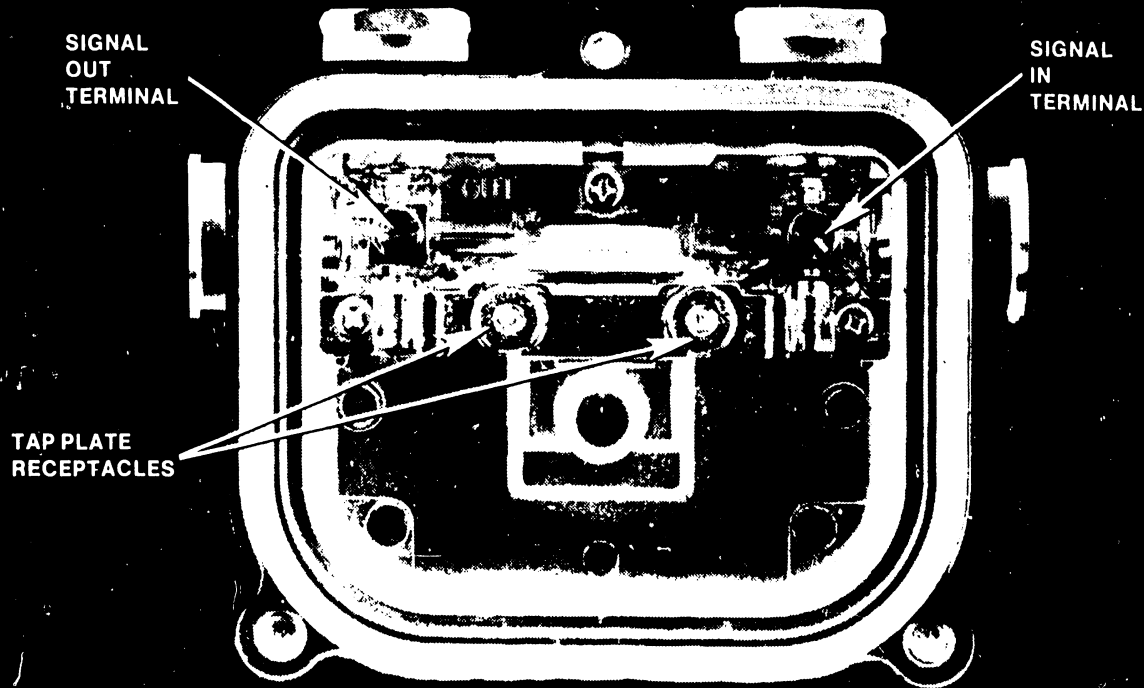

RMS CA-4500 TAP CASE INTERIOR VIEW

Figure 5-15

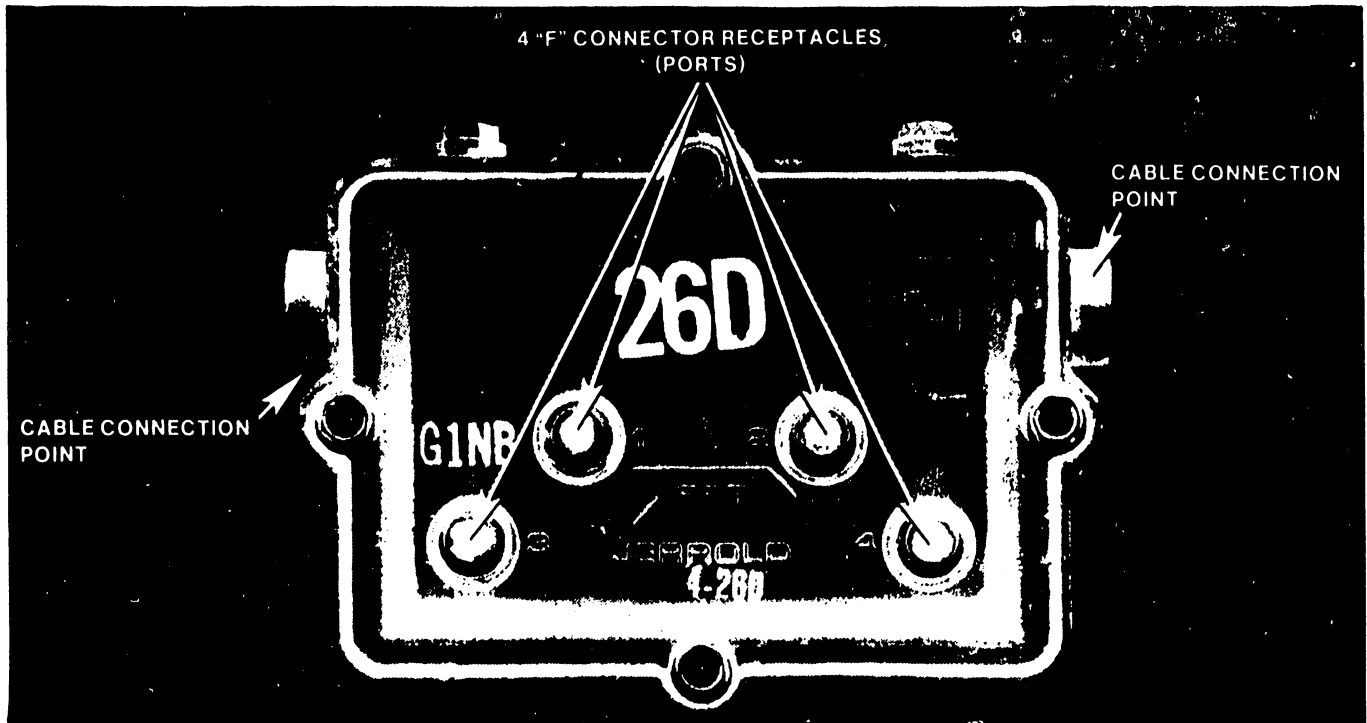
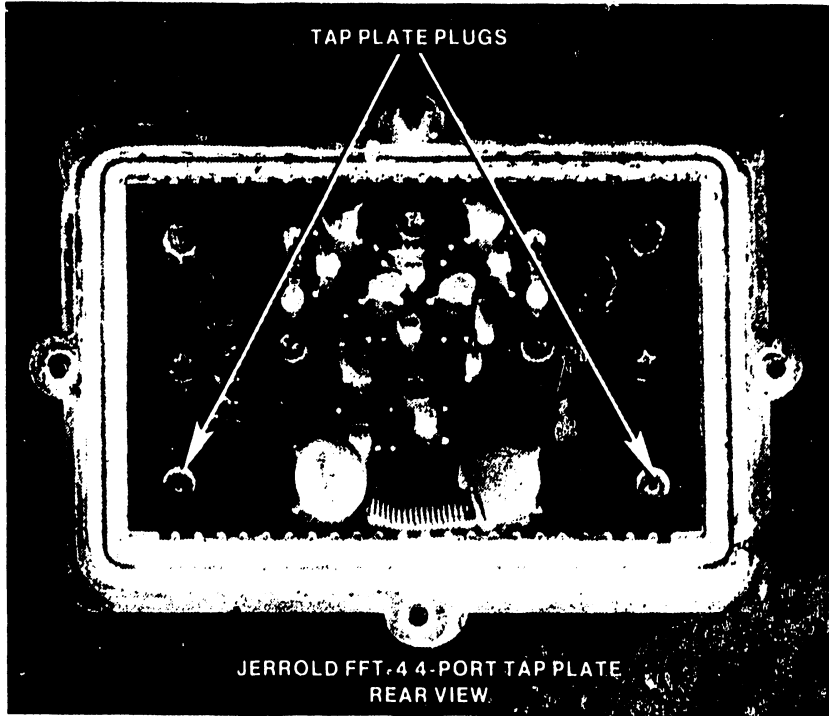

JERROLD FFT-4 4-PORT TAP

Figure 5-16

Removal and replacement procedures are simple and straightforward, with only two adjustments required ... RF Loop Gain for the RF module, and Raw DC Adjust for the Power Supply module. Power-passing through the Diplexer is fixed, so no special attention to power-passing fuses or jumpers is required.

The first step in removing either module is to remove the AC Line Fuse from the Power Supply module, and un-plug the power cable from the RF module.

To remove the RF module from the housing, loosen three module hold-down screws (captive). Grasp the chassis, and gently pull the assembly straight away from the housing. Note that the RF module connects to the four Port Terminals by means of dual banana plugs at each Port.

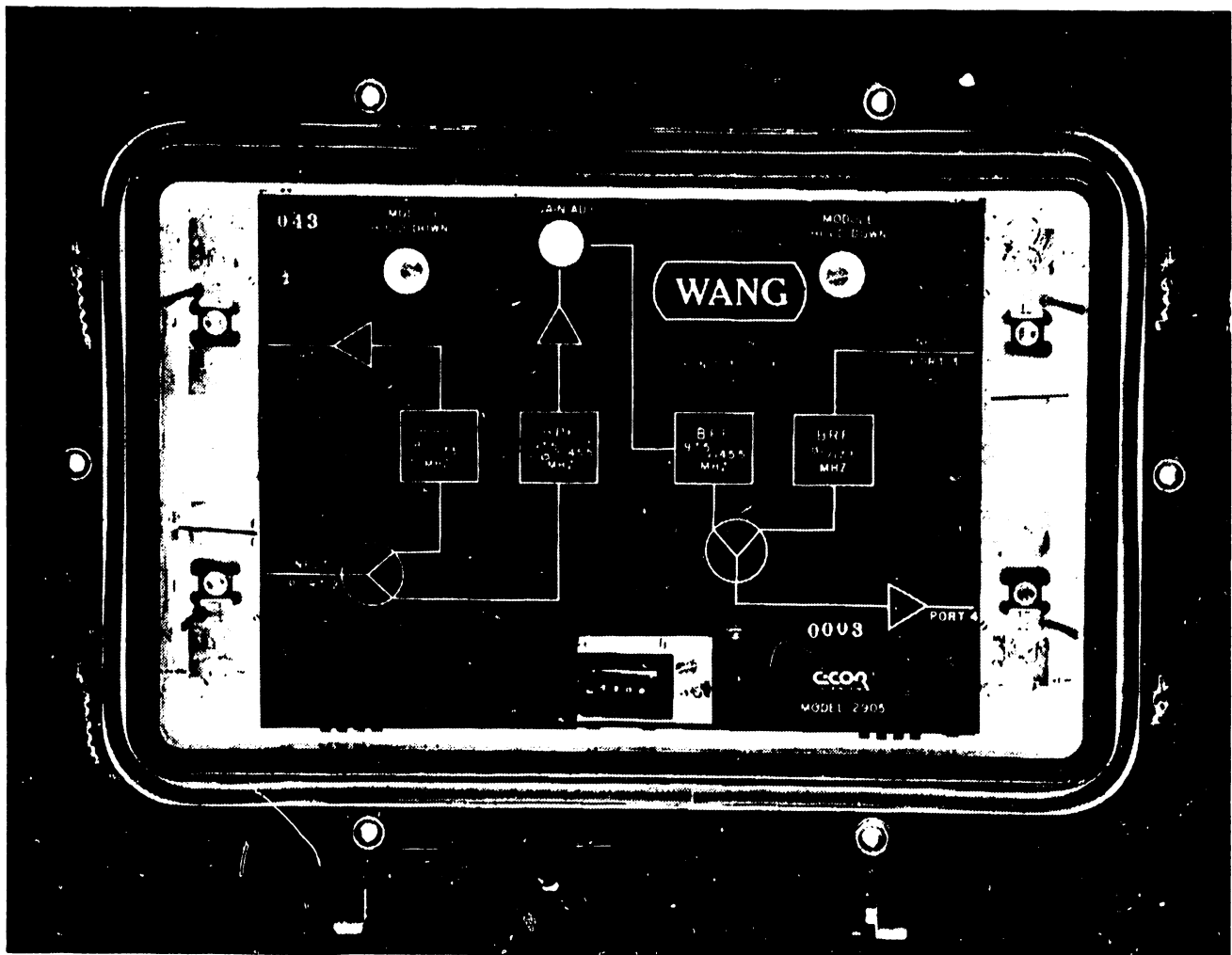

Figure 5-18 Diplexer RF Module

To remove the Power Supply Module from the housing cover, loosen four machine screws. Slide the chassis until it clears the machine screw heads, and lift it clear of the housing.

Replace the modules by reversing the removal procedures. In the case of the RF module, carefully align the banana plug and socket elements before attempting to seat the module in the housing. Re-connect the power cable, replace the AC Line Fuse, and adjust the Raw DC voltage level to 38 VDC.

Complete the Diplexer replacement by adjusting the gain of the RF Loop. Inject a 105 MHz test signal at the Port 2 test point and measure the signal level at the Port 4 test point (The test points are the "F" connectors adjacent to the hardline cable connectors). The RF Loop gain must be adjusted to provide the same signal level at the Port 4 test point as was originally recorded in the Site Log.

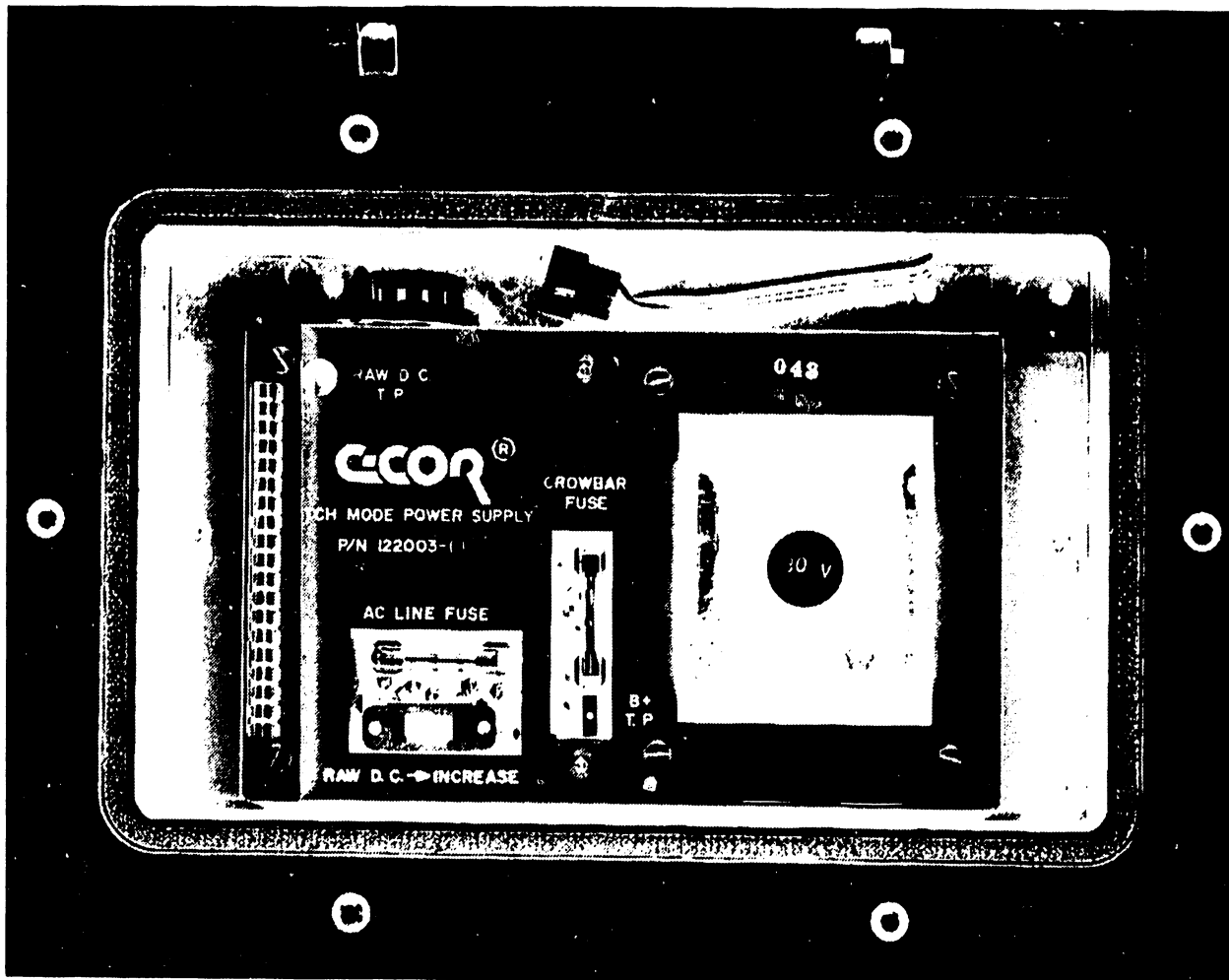

Figure 5-19 Diplexer Power Supply Module

Close the Diplexer housing cover, and tighten the cover bolts in the sequence shown in Figure 5-20. Make the bolts finger tight on the first pass, and moderately tight using a 7/16 inch nut driver on a second pass.. Finally, tighten the bolts firmly, but do not use more leverage than is normally available with a common nut driver.

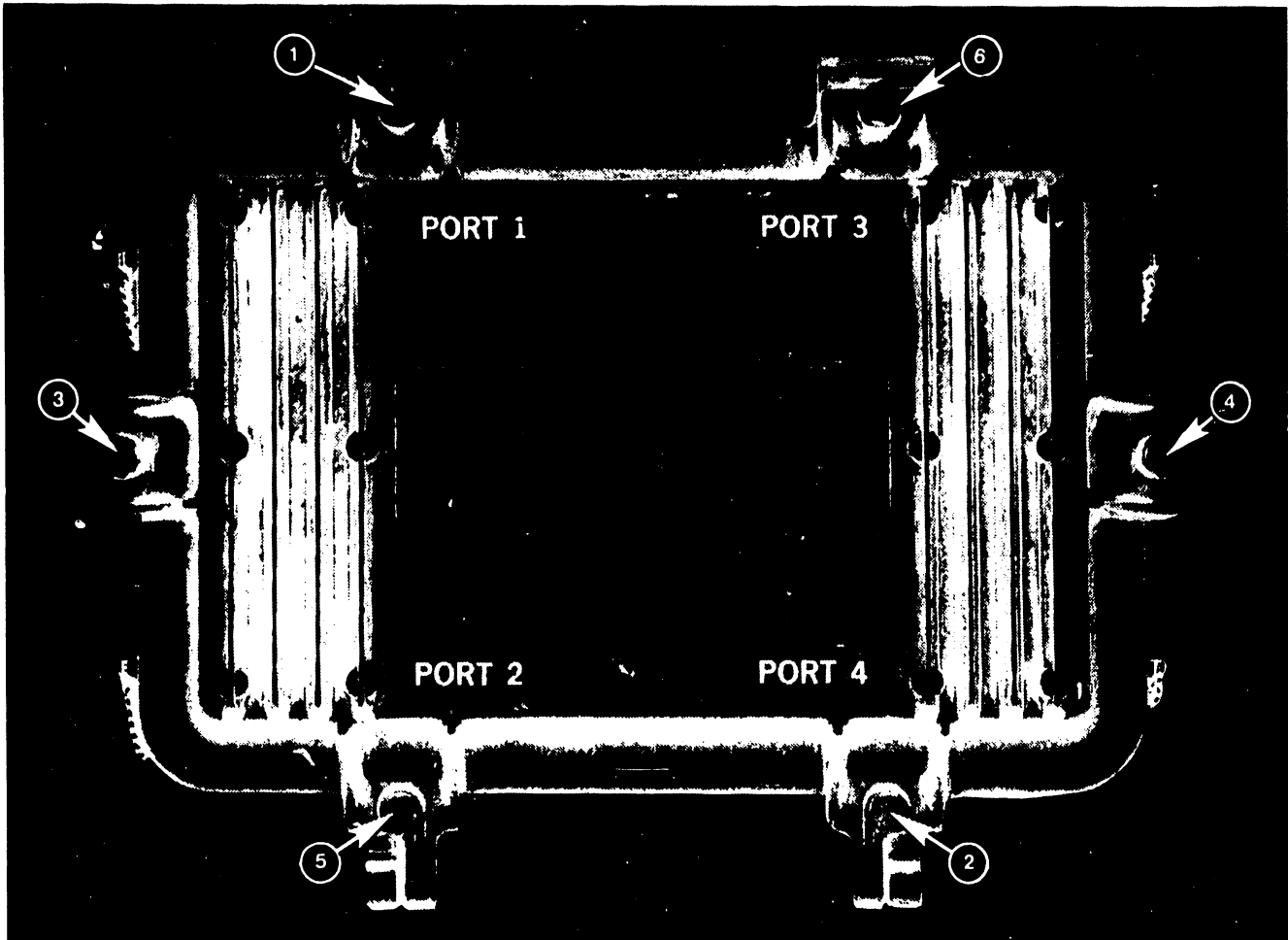

Figure 5-20 Cover Bolt Tightening Sequence

SECTION

6

SCHE-

MATICS

SECTION 6

SCHEMATICS

Individual components of the Wangnet Backbone are not field repairable. Therefore, schematic diagrams are not provided in this manual.

SECTION

7

ILLUSTRATED

PARTS

BREAKDOWN

SECTION 7

ILLUSTRATED PARTS BREAKDOWN

WANGNET BACKBONE PARTS LIST

WLI No.	DESCRIPTION	PRIMARY VENDOR	VENDOR NUMBER
120-2308	60 FT DROP CABLE ASSEMBLY	WANG	
190-0911	WANGNET UNIVERSAL HEADEND		
210-8460	ADJUSTABLE EQUALIZER	WANG	

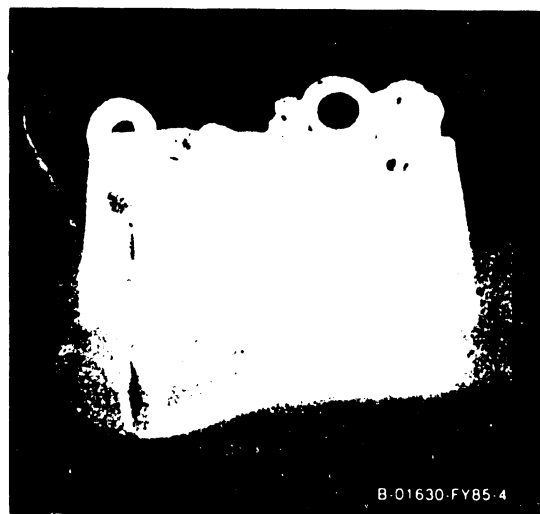

Figure 7-1 Adjustable Equalizer

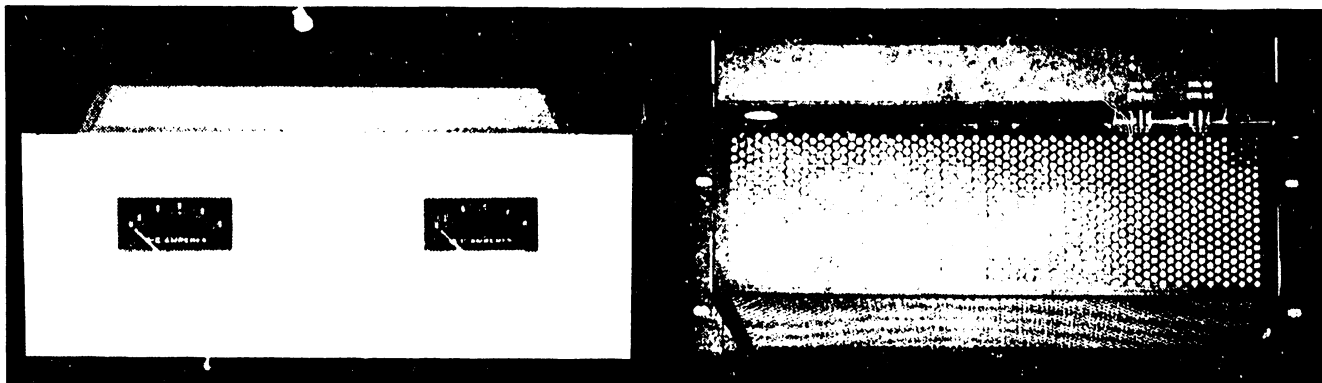

Figure 7-2 Wang Power Converter

270-0798	POWER CONVERTER, 60 HZ	WANG
270-0798-1	POWER CONVERTER, 50 HZ	WANG
279-0535	BLACK OUTLET BOX KIT	
279-0536	ALMOND OUTLET BOX KIT	

WANGNET BACKBONE PARTS LIST

W.I. No.	DESCRIPTION	PRIMARY VENDOR	VENDOR NUMBER
360-1161	FUSE 6.25A		
420-0138	CBL SNGL PVC RG59-TYPE	COMM/SCOPE	5088
420-0139	CBL DUAL PVC RG59-TYPE	COMM/SCOPE	ADF-2590BL
420-0145	CBL DUAL TEFLON RG59-TYPE	TELEDYNE	
451-4995	XA BRACKET, TAP		
451-4996	XA BRACKET, AMPLIFIER		
458-1207	XA AMP MOUNTING STANDOFF		
458-1208	XA MOUNTING STANDOFF		
458-1209	XA UNIV MNTING STANDOFF		
665-0012	PANEL METER 0-15A		

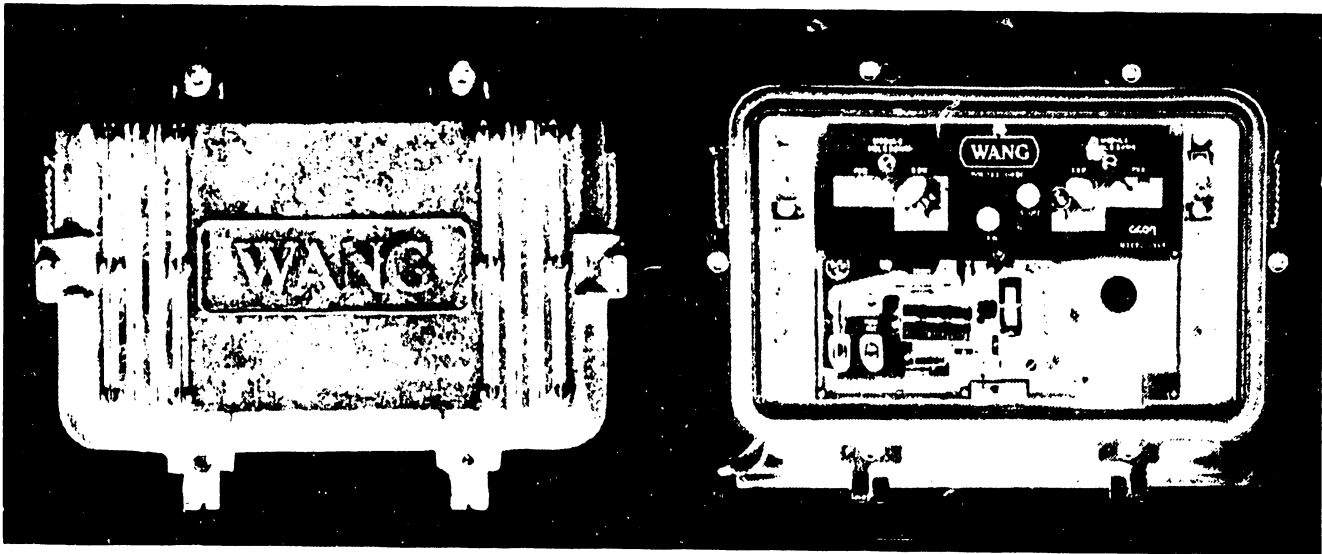

Figure 7-3 Wang Amplifier

723-0001	AMPLIFIER	C-COR	2904
723-0002	TRUNK AMPLIFIER 30DB		

WANGNET BACKBONE PARTS LIST

WLI No.	DESCRIPTION	PRIMARY VENDOR	VENDOR NUMBER
723-0003	DIPLEXER 928W	C-COR	2905
723-0015	6DB PAD W/W FEM CONN	JERROLD	PDA-6

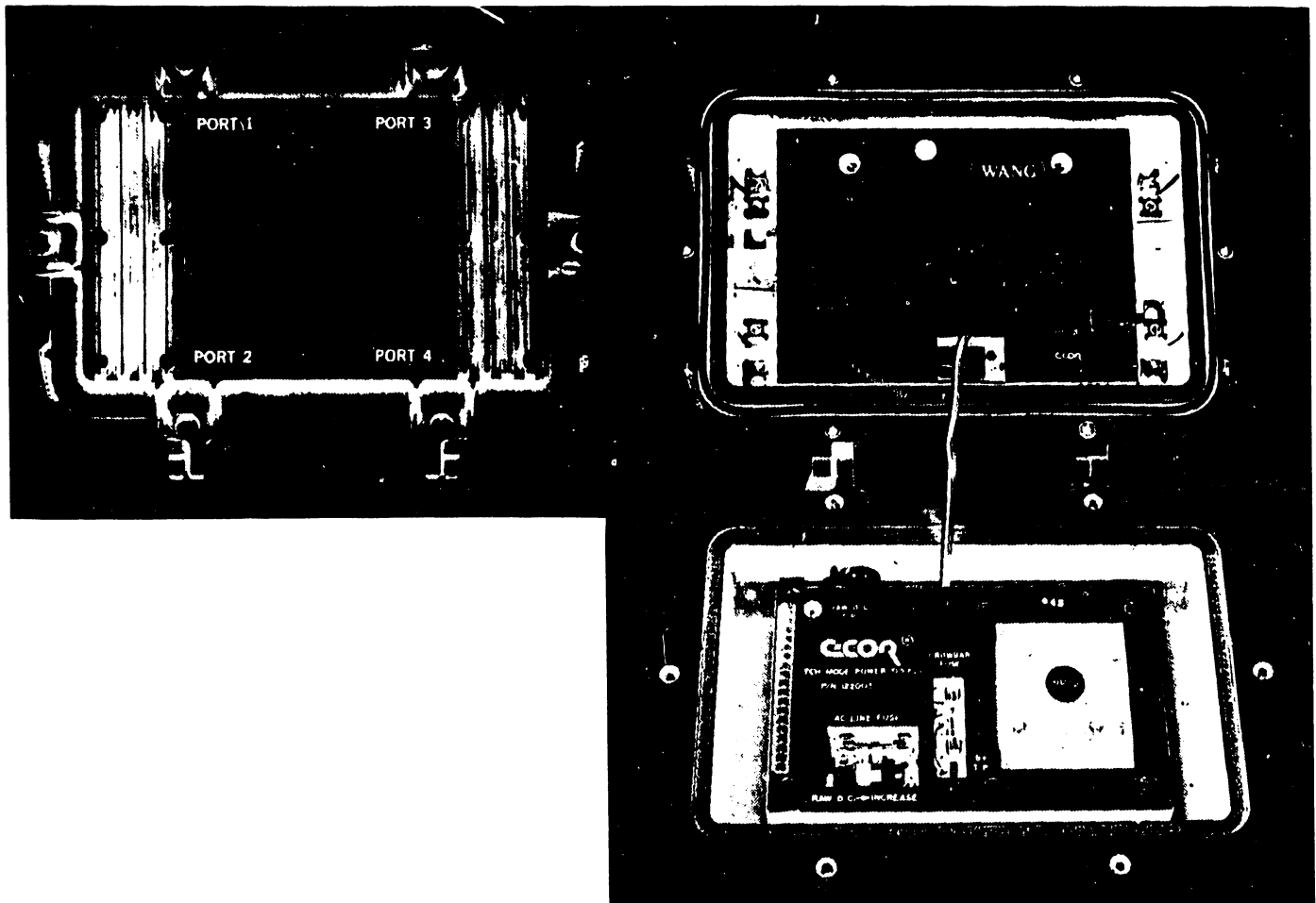

Figure 7-4 Wang Diplexer

WANGNET BACKBONE PARTS LIST

WLI No.	DESCRIPTION	PRIMARY VENDOR	VENDOR NUMBER
723-0016	0DB PAD	C-COR	PB-0
723-0017	3DB PAD	C-COR	PB-3
723-0018	6DB PAD	C-COR	PB-6
723-0019	9DB PAD	C-COR	PB-9
723-0020	12DB PAD	C-COR	PB-12
723-0021	15DB PAD	C-COR	PB-15
723-0022	18DB PAD	C-COR	PB-18
723-0023	21DB PAD	C-COR	PB-21

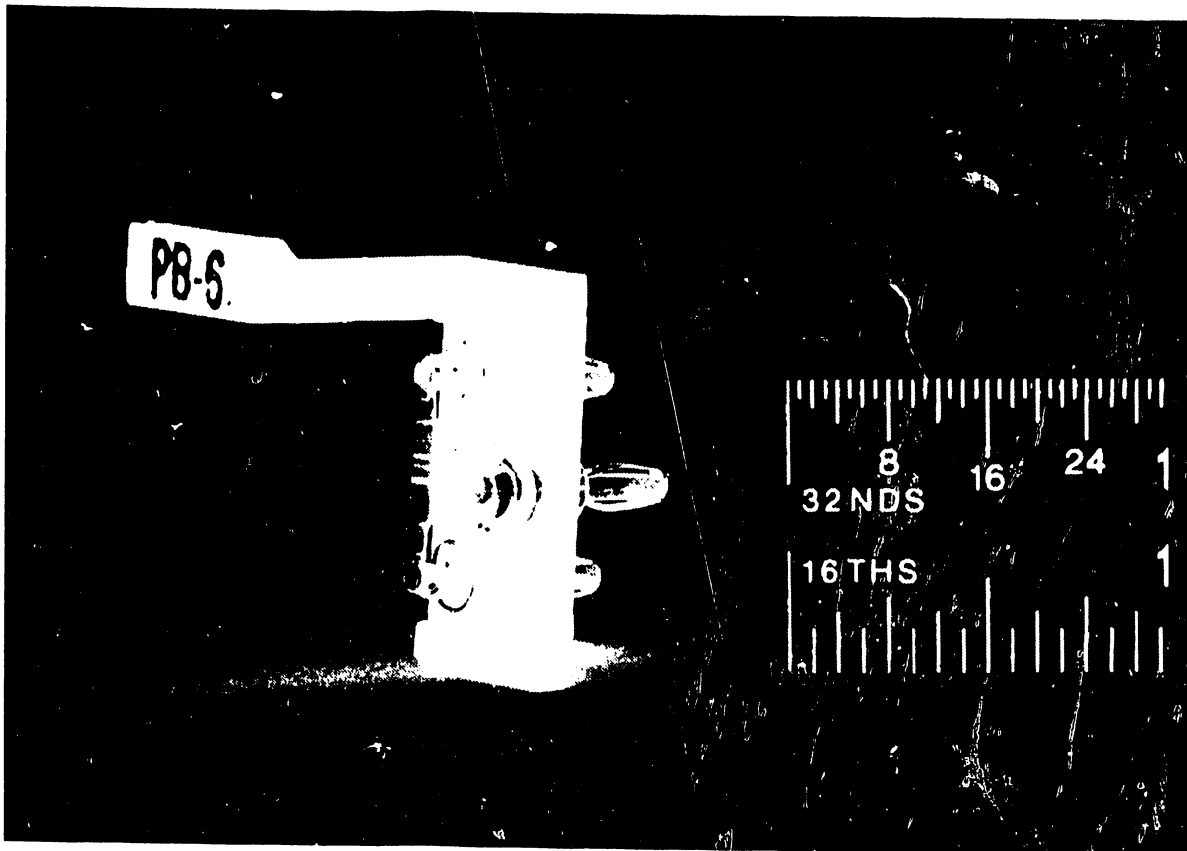

Figure 7-5 C-COR Plug-In Pad

WANGNET BACKBONE PARTS LIST

WLI No.	DESCRIPTION	PRIMARY VENDOR	VENDOR NUMBER
723-0030	3DB DIRECTIONAL COUPLER	JERROLD	STC-3D
723-0031	8DB DIRECTIONAL COUPLER	JERROLD	STC-8D
723-0032	12DB DIRECTIONAL COUPLER	JERROLD	STC-12D

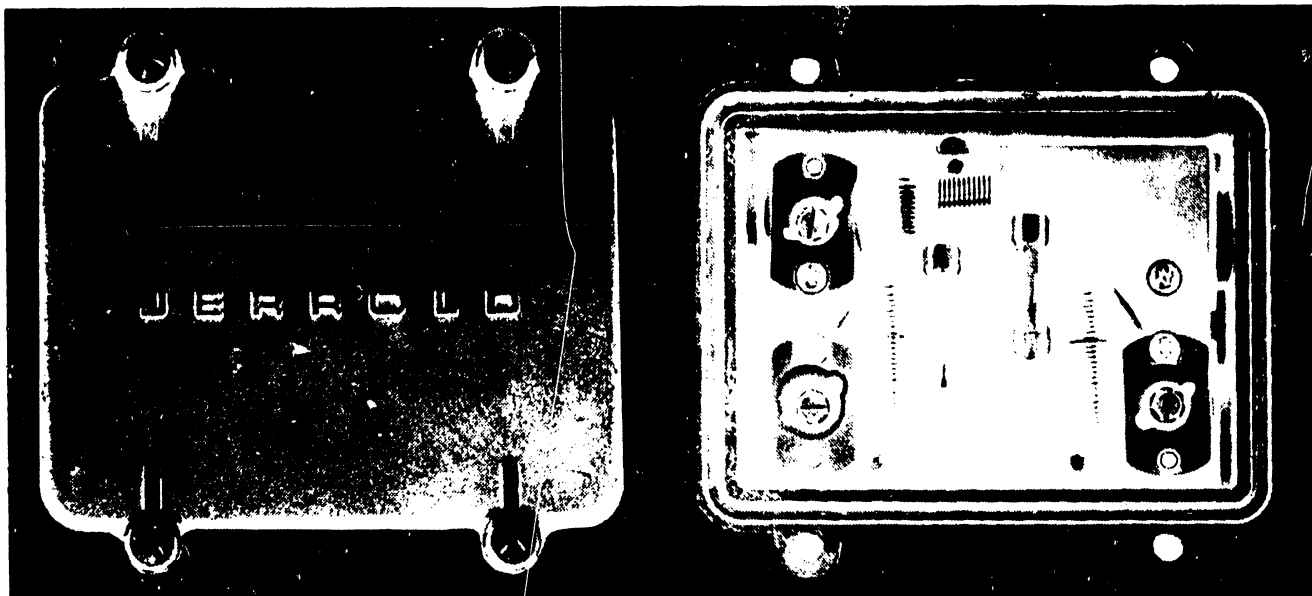

Figure 7-6 Jerrold Directional Coupler

WANGNET BACKBONE PARTS LIST

WLI No.	DESCRIPTION	PRIMARY VENDOR	VENDOR NUMBER
723-0033	DIRECTIONAL TAP 8 OUTPUTS	RMS	CA-4507
723-0034	DIRECTIONAL TAP 4 OUTPUTS	RMS	CA-4500

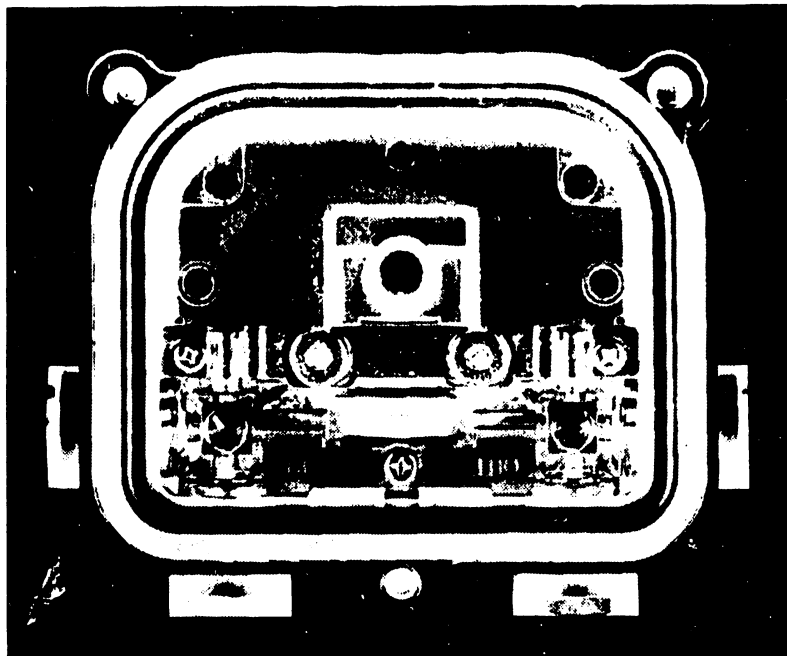

Figure 7-7 RMS Directional Tap (housing only)

WANGNET BACKBONE PARTS LIST

WLI No.	DESCRIPTION	PRIMARY VENDOR	VENDOR NUMBER
723-0040	8DB 4 PORT DIRECTIONAL TAP	RMS	CA4500/04-08
723-0041	11DB 4 PORT DIRECTIONAL TAP	RMS	CA4500/04-11
723-0042	14DB 4 PORT DIRECTIONAL TAP	RMS	CA4500/04-14
723-0043	17DB 4 PORT DIRECTIONAL TAP	RMS	CA4500/04-17
723-0044	20DB 4 PORT DIRECTIONAL TAP	RMS	CA4500/04-20
723-0045	23DB 4 PORT DIRECTIONAL TAP	RMS	CA4500/04-23
723-0046	26DB 4 PORT DIRECTIONAL TAP	RMS	CA4500/04-26
723-0047	29DB 4 PORT DIRECTIONAL TAP	RMS	CA4500/04-29

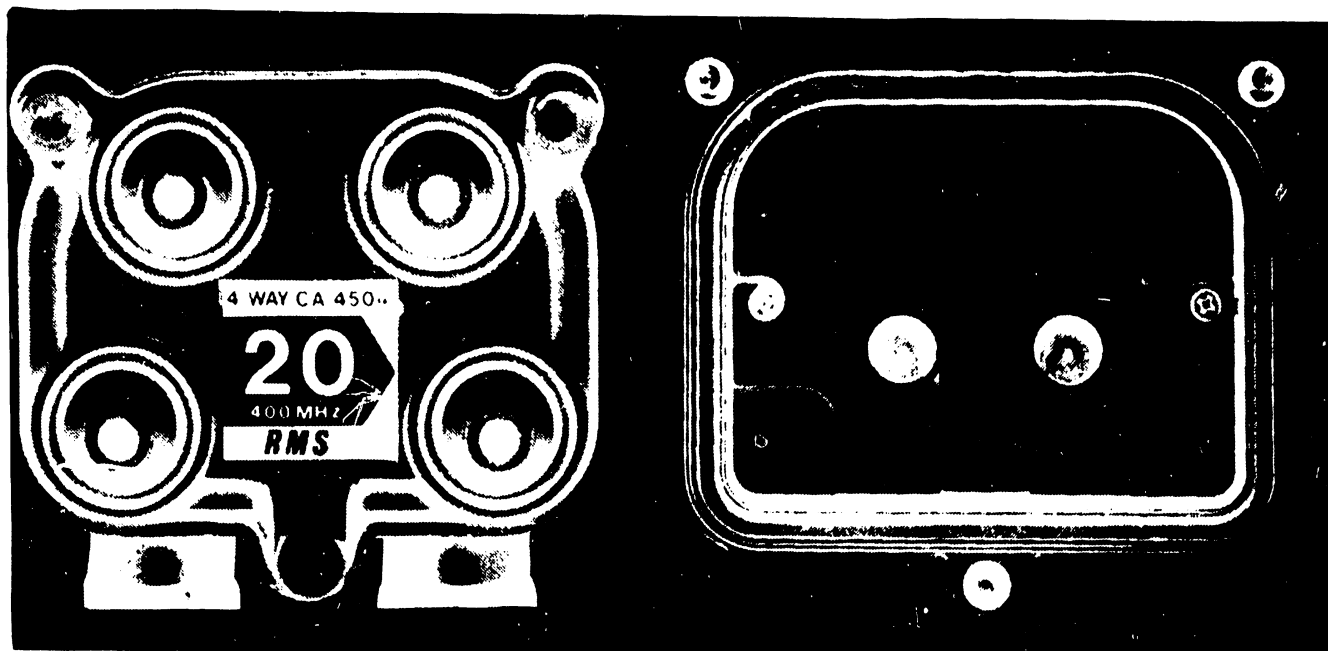

Figure 7-8 RMS 4 Port Directional Tap

WANGNET BACKBONE PARTS LIST

WLI No.	DESCRIPTION	PRIMARY VENDOR	VENDOR NUMBER
723-0050	7DB 4 PORT DIRECTIONAL TAP	JERROLD	FFT-4-7TD
723-0051	10DB 4 PORT DIRECTIONAL TAP	JERROLD	FFT-4-10TD
723-0052	12DB 4 PORT DIRECTIONAL TAP	JERROLD	FFT-4-12TD
723-0053	14DB 4 PORT DIRECTIONAL TAP	JERROLD	FFT-4-14TD
723-0054	15.5DB 4 PORT DIRECTIONAL TAP	JERROLD	FFT-4-15.5D
723-0055	17DB 4 PORT DIRECTIONAL TAP	JERROLD	FFT-4-17D
723-0056	20DB 4 PORT DIRECTIONAL TAP	JERROLD	FFT-4-20D
723-0057	23DB 4 PORT DIRECTIONAL TAP	JERROLD	FFT-4-23D
723-0058	26DB 4 PORT DIRECTIONAL TAP	JERROLD	FFT-4-26D
723-0059	29DB 4 PORT DIRECTIONAL TAP	JERROLD	FFT-4-29D

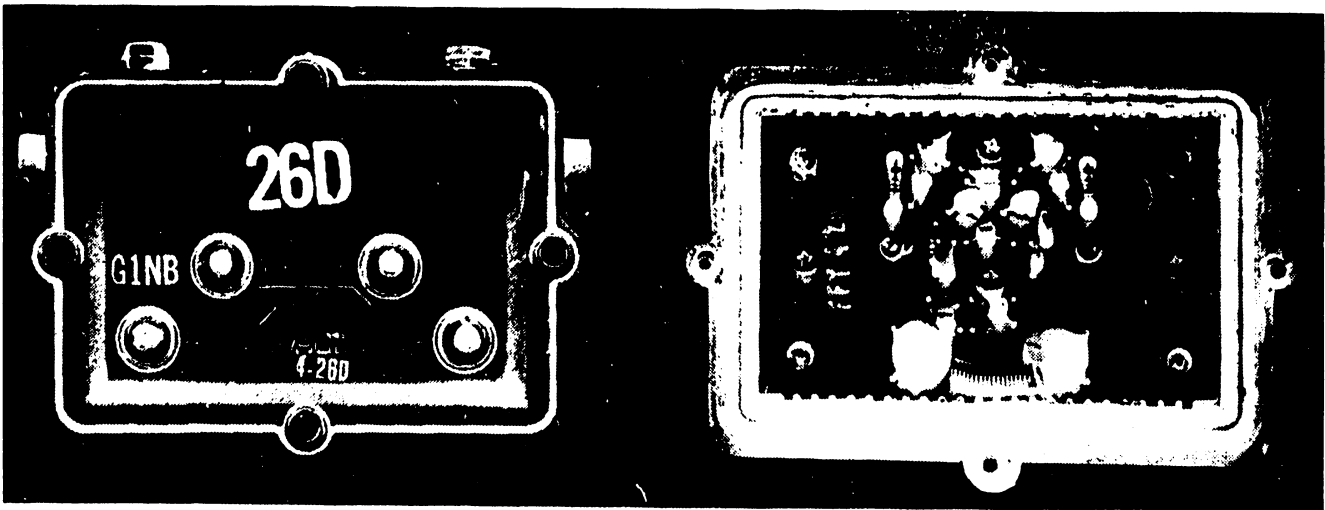

Figure 7-9 Jerrold 4 Port Directional Tap

WANGNET BACKBONE PARTS LIST

WLI No.	DESCRIPTION	PRIMARY VENDOR	VENDOR NUMBER
723-0062	8 DB POWER PASSING COUPLER	RMS	CA4808
723-0063	12DB POWER PASSING COUPLER	RMS	CA4812
723-0064	16DB POWER PASSING COUPLER	RMS	CA4816
723-0065	20 DB POWER PASSING COUPLER	RMS	CA4820
723-0066	24 DB POWER PASSING COUPLER	RMS	CA4824

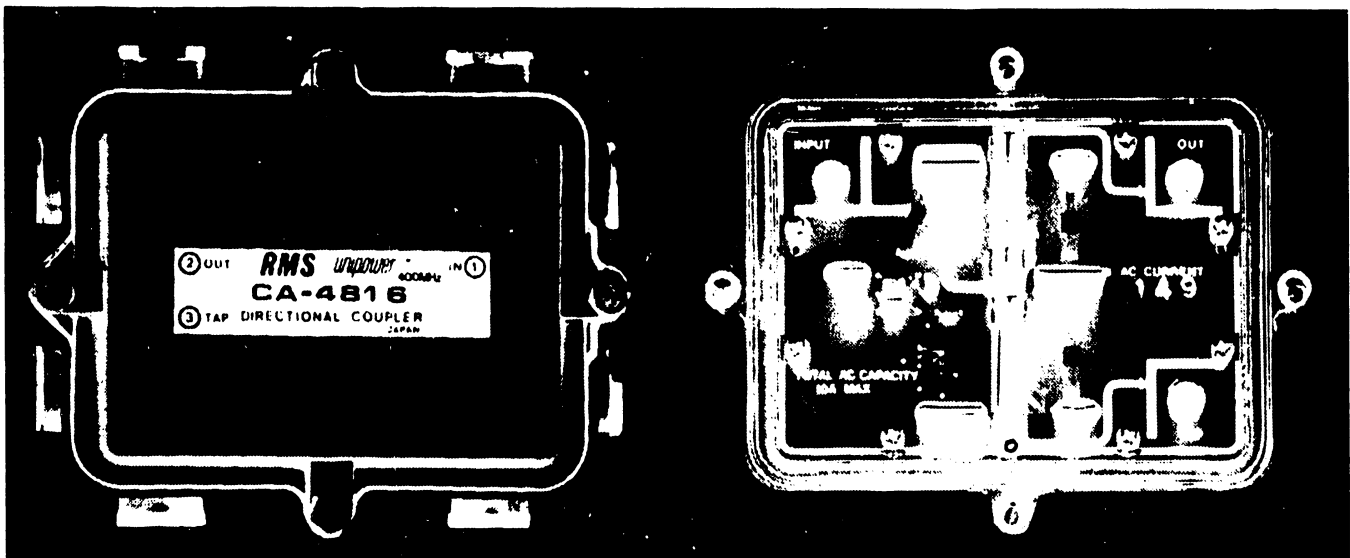

Figure 7-10 RMS Power Passing Coupler

WANGNET BACKBONE PARTS LIST

WLI No.	DESCRIPTION	PRIMARY VENDOR	VENDOR NUMBER
723-0067	DIRECTIONAL COUPLER 8DB	C-COR	S400-DC-8
723-0068	DIRECTIONAL COUPLER 12DB	C-COR	S400-DC-12
723-0069	DIRECTIONAL COUPLER 16DB	C-COR	S400-DC-16

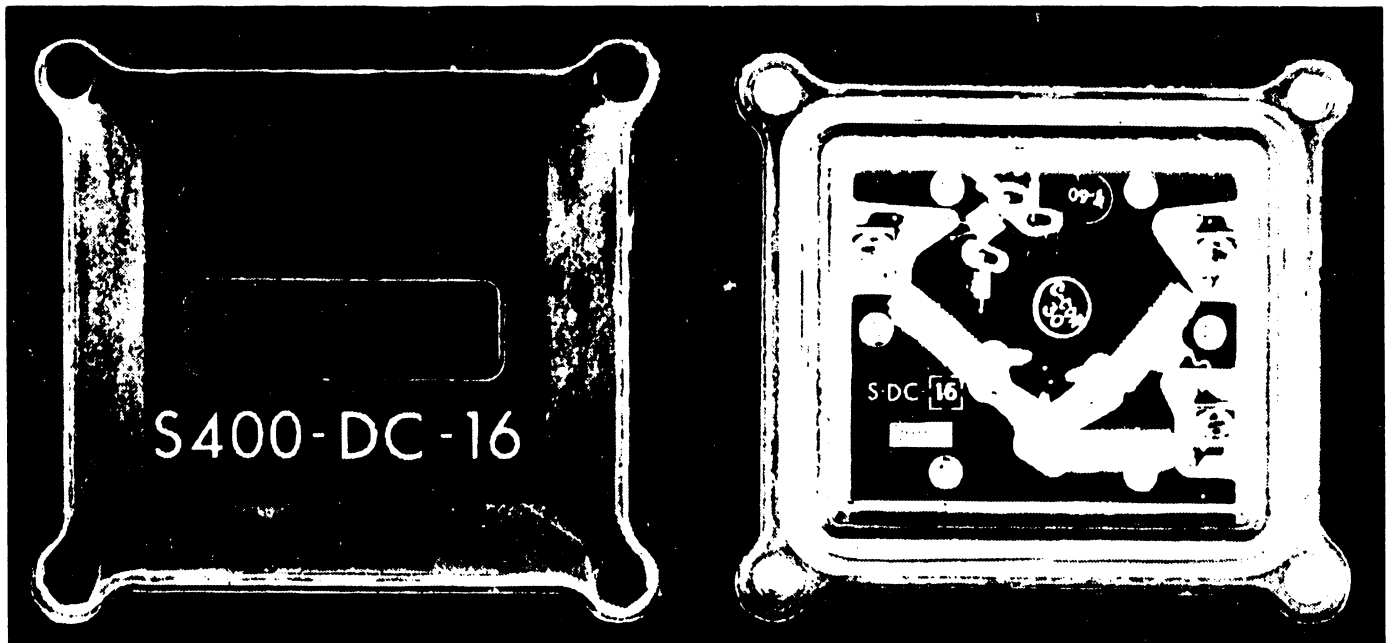

Figure 7-11 C-COR Directional Coupler

WANGNET BACKBONE PARTS LIST

WLI No.	DESCRIPTION	PRIMARY VENDOR	VENDOR NUMBER
723-0070	10DB 8 PORT DIRECTIONAL TAP	JERROLD	FFT-8-10T
723-0071	14DB 8 PORT DIRECTIONAL TAP	JERROLD	FFT-8-14D
723-0072	17DB 8 PORT DIRECTIONAL TAP	JERROLD	FFT-8-17D
723-0073	20DB 8 PORT DIRECTIONAL TAP	JERROLD	FFT-8-20D
723-0074	23DB 8 PORT DIRECTIONAL TAP	JERROLD	FFT-8-23D
723-0075	26DB 8 PORT DIRECTIONAL TAP	JERROLD	FFT-8-26D
723-0076	29DB 8 PORT DIRECTIONAL TAP	JERROLD	FFT-8-29D

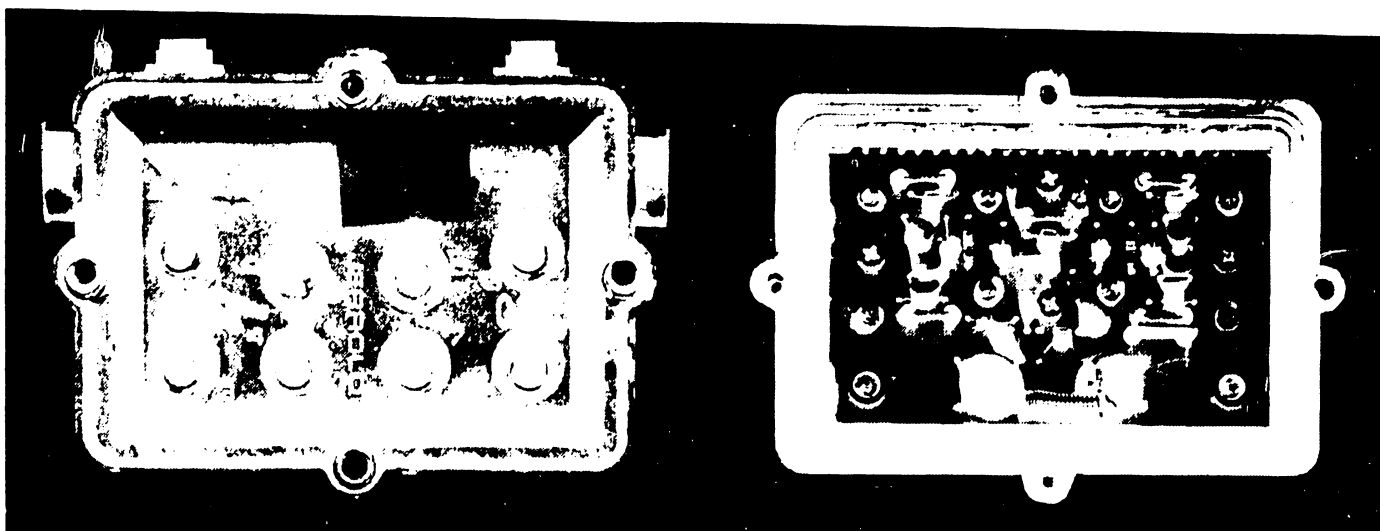

Figure 7-12 Jerrold 8 Port Directional Tap

WANGNET BACKBONE PARTS LIST

WLI No.	DESCRIPTION	PRIMARY VENDOR	VENDOR NUMBER
723-0079	11DB 8 PORT DIRECTIONAL TAP	RMS	CA4507/4508-11
723-0080	14DB 8 PORT DIRECTIONAL TAP	RMS	CA4507/4508-14
723-0081	17DB 8 PORT DIRECTIONAL TAP	RMS	CA4507/4508-17
723-0082	20DB 8 PORT DIRECTIONAL TAP	RMS	CA4507/4508-20
723-0083	23DB 8 PORT DIRECTIONAL TAP	RMS	CA4507/4508-23
723-0084	26DB 8 PORT DIRECTIONAL TAP	RMS	CA4507/4508-26
723-0085	29DB 8 PORT DIRECTIONAL TAP	RMS	CA4507/4508-29
723-0088	DIRECTIONAL TAP 2-WAY 4DB	RMS	CA4500/02-4DB

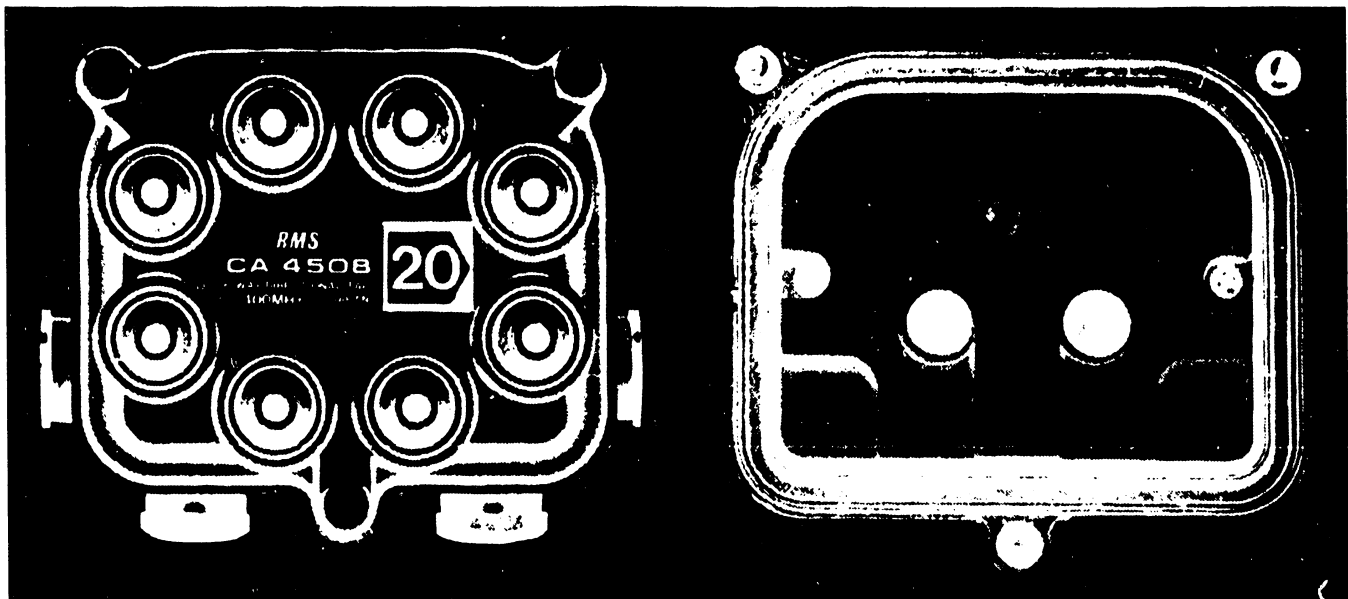

Figure 7-13 RMS 8 Port Directional Tap

WANGNET BACKBONE PARTS LIST

WLI No.	DESCRIPTION	PRIMARY VENDOR	VENDOR NUMBER
723-0100	POWER COMBINER	JERROLD	SPJ-3D

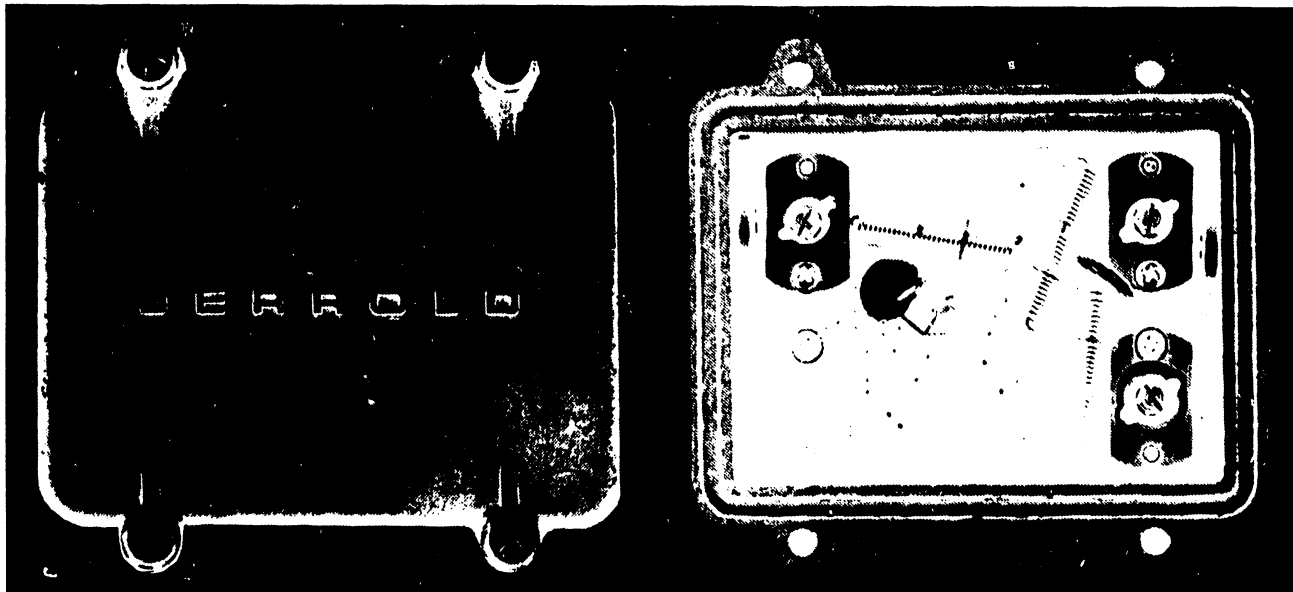

Figure 7-14 Jerrold Power Combiner

WANGNET BACKBONE PARTS LIST

WLI No.	DESCRIPTION	PRIMARY VENDOR	VENDOR NUMBER
723-0101	HEADEND COMBINER	JERROLD	HC-8D

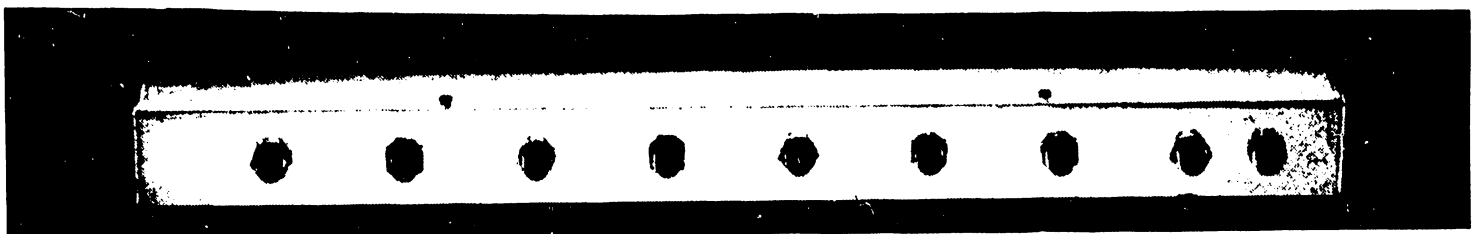

Figure 7-15 Jerrold Headend Combiner

WANGNET BACKBONE PARTS LIST

WLI No.	DESCRIPTION	PRIMARY VENDG.	VENDOR NUMBER
723-0102	POWER INSERTER 30V 60HZ	C-COR	PS-400-C

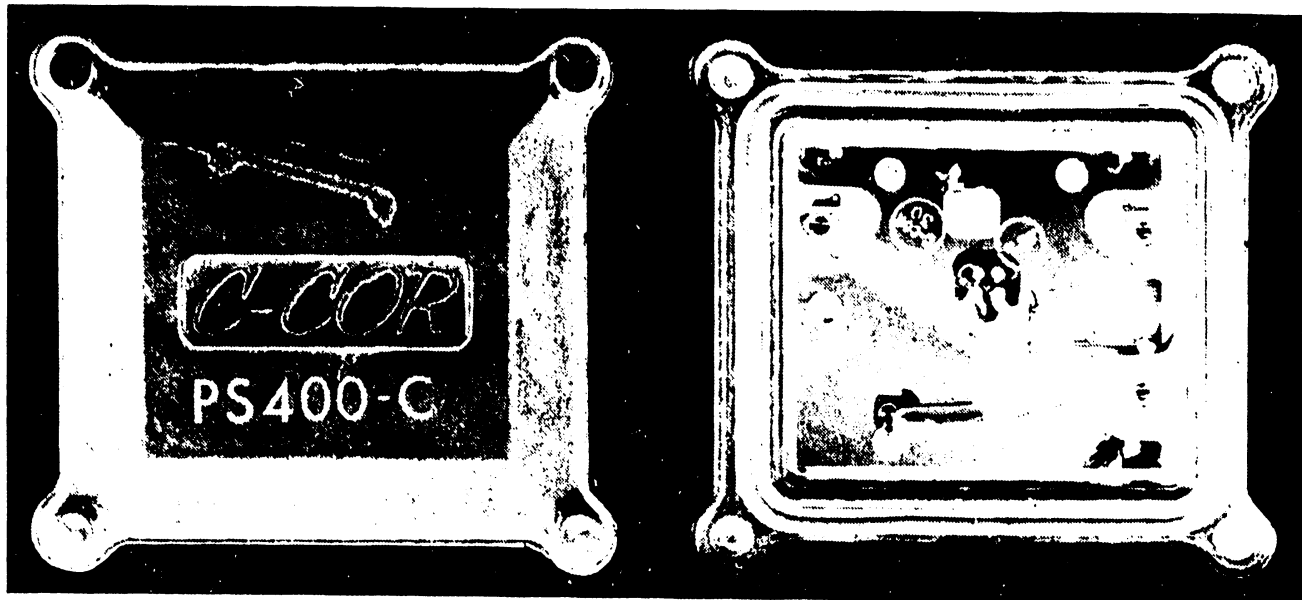

Figure 7-16 C-COR Power Inserter

WANGNET BACKBONE PARTS LIST

W.I. No.	DESCRIPTION	PRIMARY VENDOR	VENDOR NUMBER
723-0103	PWR PASSING SPLTR 2 WAY	RMS	CA4602
723-0104	PWR PASS SPLTR 3 WAY BAL	RMS	CA4603
723-0105	PWR PASS SPLTR 3 WAY UNBAL	RMS	CA4603UB

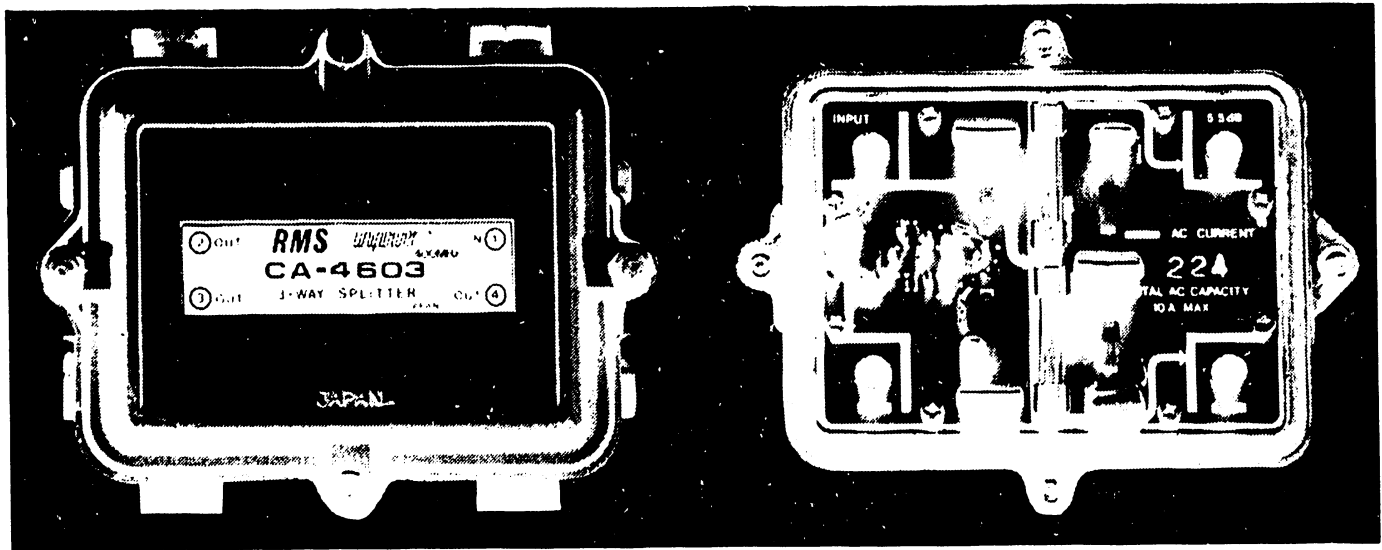

Figure 7-17 RMS Power Passing Splitter

723-0110	TERMINATOR FOR HARDLINE	JERROLD	STR-75D
723-0111	F TERMINATOR AC BLOCKING	JERROLD	TR-75-FCW
723-0112	F TERMINATOR RF ONLY	JERROLD	TR-75F
723-0113	OUTLET TERMINATOR RH	LRC	TRF
723-0114	OUTLET TERMINATOR LH	LRC	TRF-LH
723-0115	TERMINATOR STRAP	AUTO MOULD	
723-0120	CONNECTOR, FEEDTHRU	JERROLD	VS-412S
723-0121	CONNECTOR, FEEDTHRU	JERROLD	VSF-500S
723-0130	CONNECTOR, ADAPTER	JERROLD	F-412-SS
723-0131	CONNECTOR, ADAPTER	JERROLD	F-500-SS
723-0140	CONNECTOR, SPLICE	JERROLD	SC-412SS
723-0141	CONNECTOR, SPLICE	JERROLD	SC-500SS
723-0142	UNIV SPLICE CONNECTOR	JERROLD	PBA-2

WANGNET BACKBONE PARTS LIST

WLI No.	DESCRIPTION	PRIMARY VENDOR	VENDOR NUMBER
723-0143	CONN SPLICE FEM 18-24 AWG	LRC	
723-0144	CONN SPL FEM LH 18-24 AWG	LRC	
723-0145	CONN SPLICE FSD DISK 25MM	GILBERT	GRS-25.0-SP-DU-01
723-0146	CONN SPLICE 1.0 CABLE	GILBERT	GRS-1000-SP-DU-01
723-0147	CONN PIN FUSED DISK 25MM	GILBERT	GRS-25.0-CH-DU-01
723-0148	CONN PIN 1.00 CABLE	GILBERT	GRS-1000-CH-DU-01
723-0149	CONN SPL CBL FSD DISK 19MM	GILBERT	GRS-19.0-SP-DU-01
723-0150	CONNECTOR, COUPLING	JERROLD	VHH-1
723-0151	CONNECTOR, F TO VSF	JERROLD	VSF-59A
723-0152	VSF TO F ADAPTER	RMS	CA1211
723-0153	F RIGHT ANGLE ADAPTER	RMS	CA1208
723-0154	CONN PIN CBL FSD DISK 19MM	GILBERT	GRS-19.0-CH-DU-01
723-0155	CONN FML CBL FSD DISK 13MM	GILBERT	GRS-13.0-BAFF-DU-01
723-0156	CONN SPL CBL FSD DISK 13MM	GILBERT	GRS-13.0-SP-DU-01
723-0157	CON CBL F-DSK FD THRU 13MM	GILBERT	GRS-13.0-B-DU-01
723-0158	CONN CBL M RG-59 TEF TYP F	GILBERT	GF59-AHP284-SN
723-0162	CONN COAX CABLE MALE	LRC	F-59CH
723-0163	CONN COAX CABLE MALE LH	LRC	F-59CH-LH
723-0164	CONN COAX CABLE FEMALE	LRC	F-81/59L
723-0165	CONN COAX CABLE FEM LH	LRC	F-81/59L-LH
723-0166	ADAPTER, RIGHT ANGLE	RMS	CA90
723-0167	CONN, STINGER .750 CABLE		
723-0168	CONN SPLICE .750 CABLE	JERROLD	SC-2750SS
723-0169	UNIV SPLICE BOX/DUMMY TAP	RMS	CA4500/4501 FBP
723-0170	CONNECTOR, BNC-F	JERROLD	BNC-F
723-0171	CONNECTOR, COUPLING, FEM	JERROLD	F-81C
723-0172	CONNECTOR, COUPLING MALE	JERROLD	F-71B
723-0173	CONN ADPTR GF-79 CLIP "F"	GILBERT	NS-2467-7
723-0174	CONN ADPTR GF-59 CLP F LH	GILBERT	NS-2467-9
723-0175	CONN MALE TYPE F FOR RG-11	GILBERT	GF-11-AH-S/480

WANGNET BACKBONE PARTS LIST

WLI No.	DESCRIPTION	PRIMARY VENDOR	VENDOR NUMBER
723-0193	3DB EQUALIZER (OBSOLETE)*	C-COR	EQW-350-3
723-0194	5DB EQUALIZER (OBSOLETE)*	C-COR	EQW-350-5
723-0195	8DB EQUALIZER (OBSOLETE)*	C-COR	EQW-350-8
723-0196	11DB EQUALIZER (OBSOLETE)*	C-COR	EQW-350-11
723-0197	13DB EQUALIZER (OBSOLETE)*	C-COR	EQW-350-13
723-0198	0DB EQUALIZER	C-COR	EQW-500

* Use WLI Nos. 723-0272 through 723-0276 for replacement.

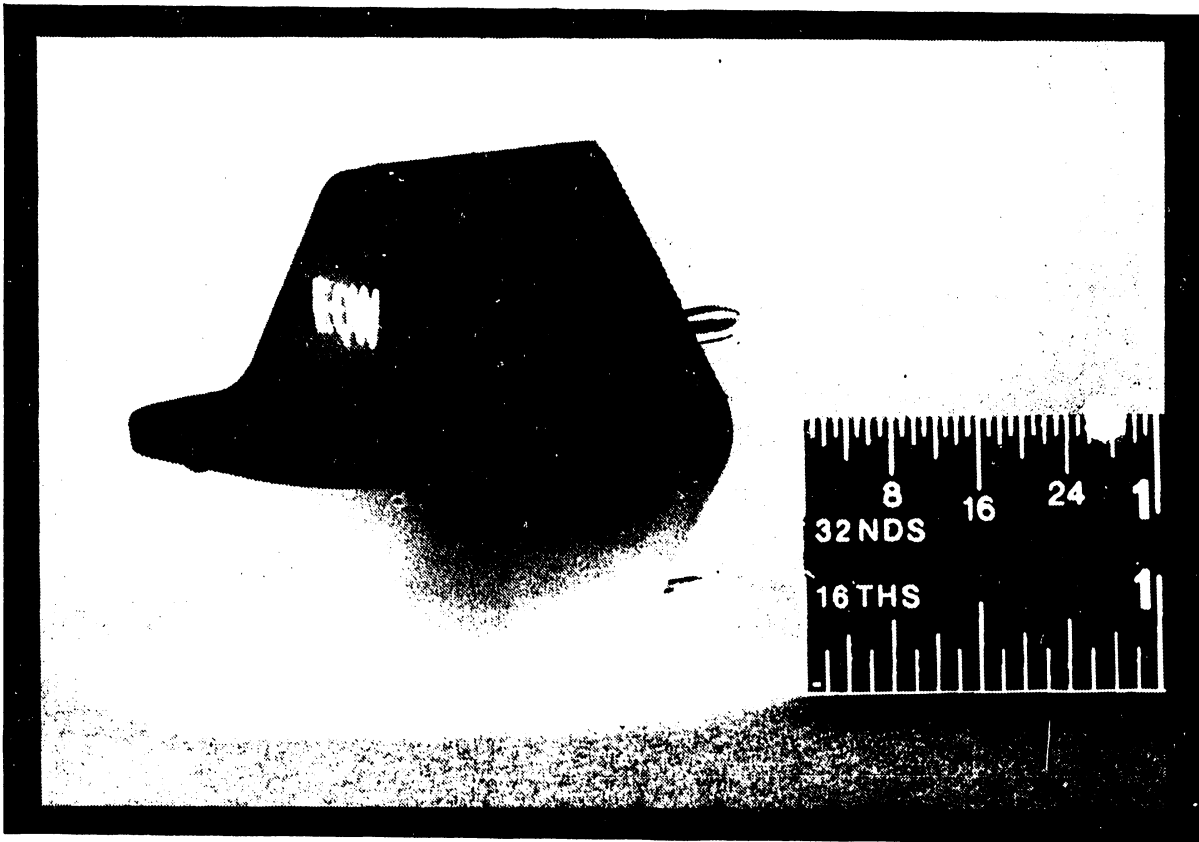

Figure 7-18 C-COR Equalizer

WANGNET BACKBONE PARTS LIST

WLI No.	DESCRIPTION	PRIMARY VENDOR	VENDOR NUMBER
723-0199	EQUALIZER HOUSING PWR PASS	C-COR	EQM-400

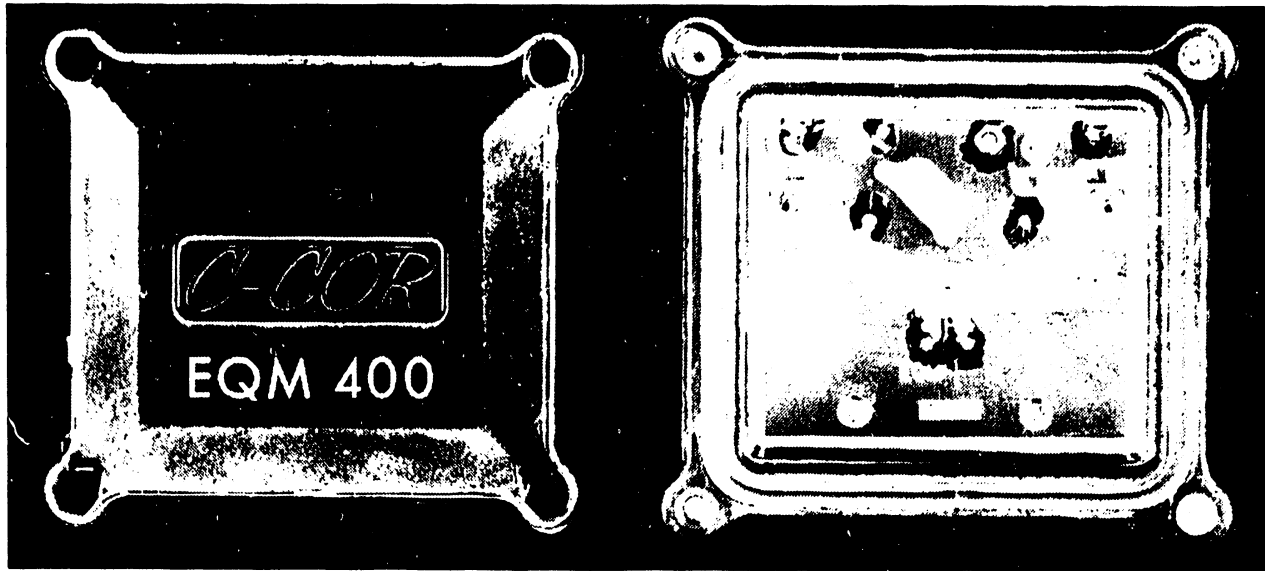

Figure 7-19 C-COR Equalizer Housing

WANGNET BACKBONE PARTS LIST

WLI No.	DESCRIPTION	PRIMARY VENDOR	VENDOR NUMBER
723-0200	DUAL SPLITTER	JERROLD	STC-3-636D
723-0201	2 WAY SPLITTER	JERROLD	SWS-2
723-0202	4 WAY SPLITTER	JERROLD	SWS-4

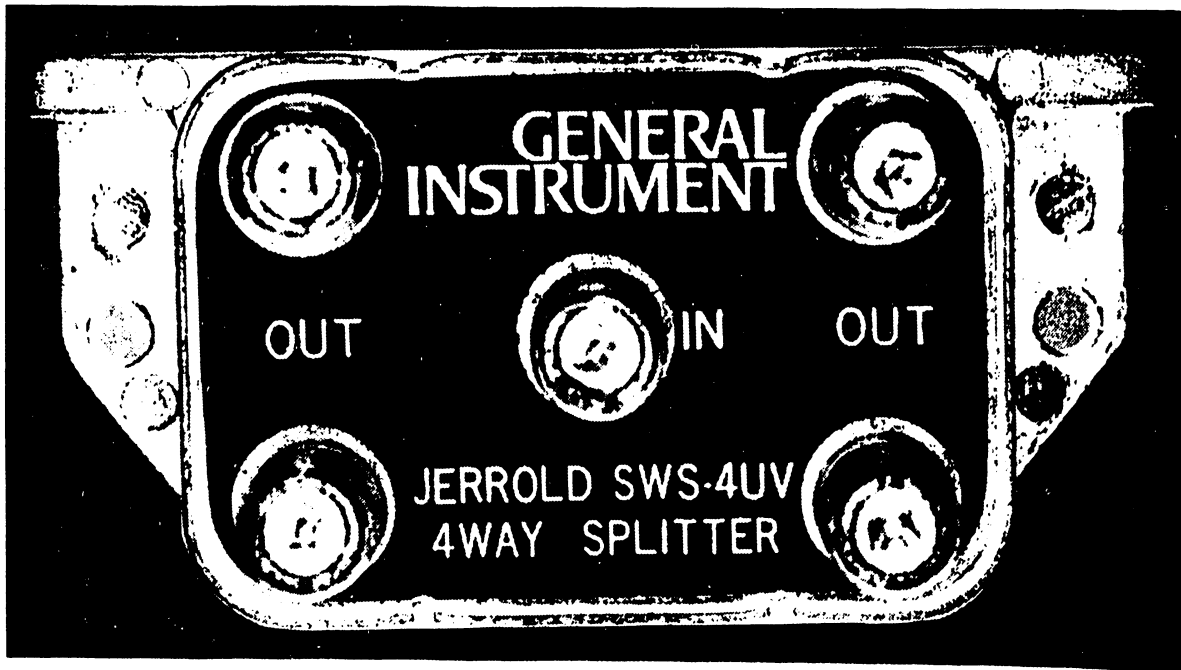

Figure 7-20 Jerrold SWS-4 4 Way Splitter

WANGNET BACKBONE PARTS LIST

WLI No.	DESCRIPTION	PRIMARY VENDOR	VENDOR NUMBER
723-0222	BLACK OUTLET PLATE	PLASTIC	EG C10088-5001
723-0223	ALMOND OUTLET PLATE	PLASTIC	EG C10088-5001
723-0224	BLACK OUTLET PLATE MTG SCR	NE ELEC	
723-0225	ALMD OUTLET PLATE MNTG SCR	NE ELEC	
723-0231	WANGNET OUTLET BOX KIT-BLACK		
723-0032	WANGNET OUTLET BOX KIT-ALMOND		

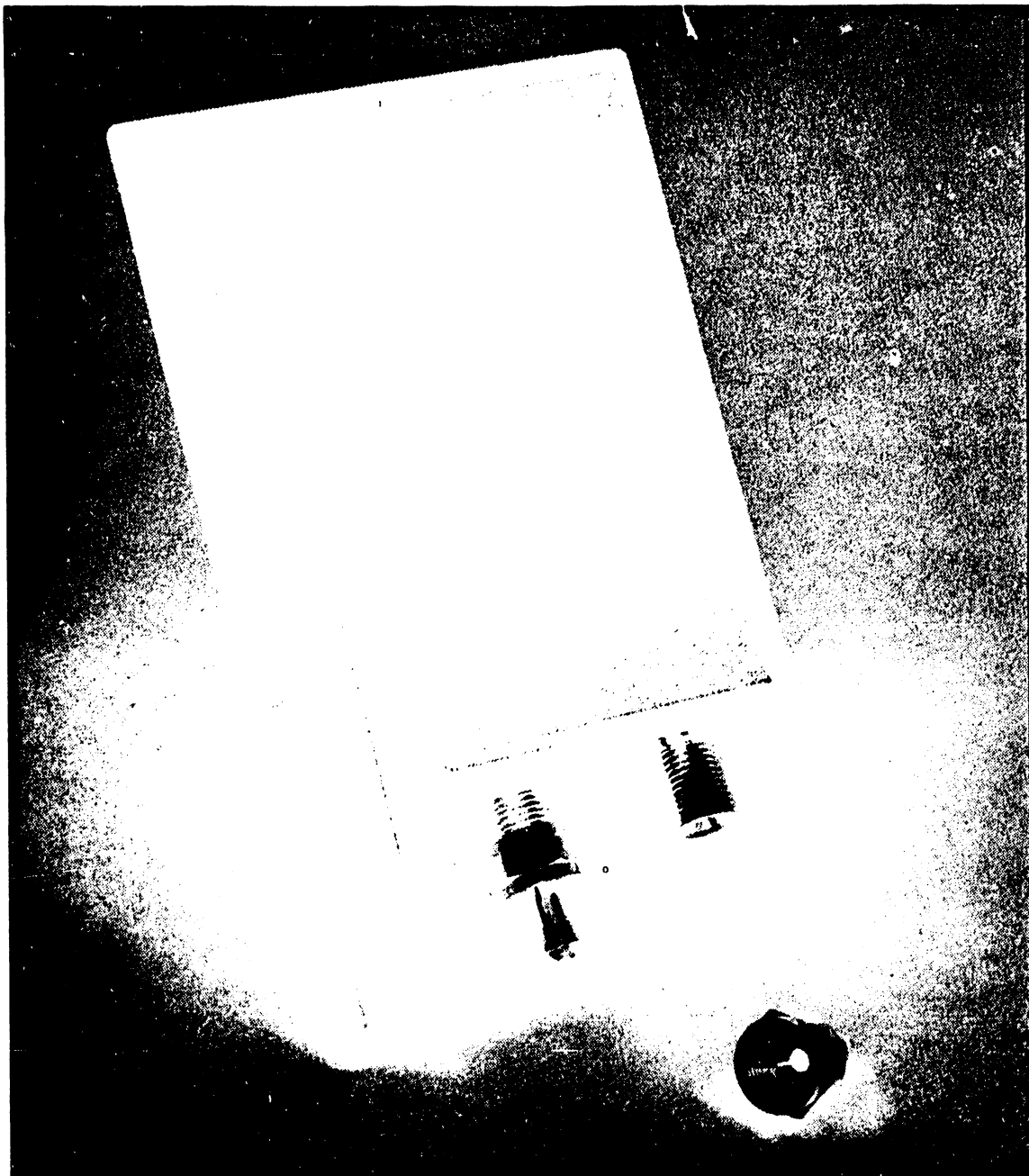

Figure 7-21 Wangnet Outlet

WANGNET BACKBONE PARTS LIST

WLI No.	DESCRIPTION	PRIMARY VENDOR	VENDOR NUMBER
723-0233	CBL COAX 75 OHM .500 DIA	COMM/SCOPE	P3-75-500 JCA
723-0234	CBL CAX UNJKTD 75 OHM .5D	COMM/SCOPE	P3-75-500 CA
723-0235	CBL COAX 75 OHM .5 D CMPD	COMM/SCOPE	P3-75-500 JFCASS
723-0236	CBL CX 75 OHM .5 ARM/CMPD	COMM/SCOPE	P3-75-500 JACA
723-0237	CBL CX UNJKTD 75 OHM .75D	COMM/SCOPE	P3-75-750 CA
723-0238	CBL COAX 75 OHM .75D	COMM/SCOPE	P3-75-750 JCA
723-0239	CBL CX 75 OHM .75D ARM/CMPD	COMM/SCOPE	P3-75-750 JACA
723-0240	CBL COAX 75 OHM .75D CMPD	COMM/SCOPE	P3-75-750 JFCASS
723-0241	CBL COAX 75 OHM 1. D CMPD	COMM/SCOPE	P3-75-1000 JFCASS
723-0242	CBL COAX 75 OHM ARM/CMPD	COMM/SCOPE	P3-75-1000 JACA
723-0243	CBL COAX UNJKTD 75 OHM 1.D	COMM/SCOPE	P3-75-1000 CA
723-0244	CBL COAX 75 OHM 1.0D	COMM/SCOPE	P3-75-1000 JCA
723-0246	CBL FSD DSK MIII GP ARM	GEN CABLE	25.0 MM C/C GP
723-0247	CBL TEFLON 75 OHM .500D	COMM/SCOPE	41-00-02
723-0248	CBL F-DSK M111 JKT 19MM	GEN CABLE	19MM (.750) C/C JAU
723-0249	CBL F-DSK M111 GP ARM 19MM	GEN CABLE	19MM (.750) C/C GP
723-0250	CBL F-DSK M111 BARE 13MM	GEN CABLE	13.0MM (.5) C/C B
723-0251	BRACKET, TAP TYPE "A"		
723-0252	BRACKET, AMP TYPE "B"		
723-0253	STAND-OFF AMP MTG TYPE "B"		
723-0254	MTG STANDOFF TYPE "C"		
723-0255	MTG STANDOFF TYPE "D"		
723-0256	BRKT "F" MTG UNIVERSAL AMP		
723-0257	CBL F-DSK M111 BARE 19.0MM	GEN CABLE	19.0MM (.750) C/C B
723-0258	CBL F-DSK M111 BARE 25.0MM	GEN CABLE	25.0MM (1.00) C/C B
723-0259	CBL F-DSK M111 JKT 25.0MM	GEN CABLE	25.0MM (1.) C/C JAU
723-0260	MTG STANDOFF		
723-0261	CBL COAX MESSENGERED .500	COMM/SCOPE	P3-75 500CA-M109
723-0262	CBL DUAL RG-11 BOND SHIELD	COMM/SCOPE	ADF 2110 BL PV
723-0263	CBL COAX 75 OHM .750 W/MESS	COMM/SCOPE	P3-75-750CA-M250
723-0264	CBL COAX 75 OHM 1.0 MESS	COMM/SCOPE	P3-75-1000CA-M250
723-0265	CBL FSD DISK 25MM FLOODED	GEN CABLE	25.0MM (1.) C/C F8F
723-0266	CBL FSD DISK 19MM FLOODED	GEN CABLE	19MM (.750) C/C F8F
723-0267	CBL FSD DISK 13MM FLOODED	GEN CABLE	13MM (.5) C/C F8F
723-0268	BLOCK CNTR SIEZURE PLASTIC	C-COR	MT 0048
723-0269	CLIP DIODE TERMINAL GND	C-COR	MT 00494
723-0270	TERMINAL GND DIODE CLIP	C-COR	MT 0017
723-0271	SCR 1/4-28NF-2A SS WIR LUG	C-COR	

WANGNET BACKBONE PARTS LIST

WLI No.	DESCRIPTION	PRIMARY VENDOR	VENDOR NUMBER
723-0272	EQUALIZER PLUG-IN 3DB	C-COR	EQW-400-3
723-0273	EQUALIZER PLUG-IN 6DB	C-COR	EQW-400-6
723-0274	EQUALIZER PLUG-IN 9DB	C-COR	EQW-400-9
723-0275	EQUALIZER PLUG-IN 12DB	C-COR	EQW-400-12
723-0276	EQUALIZER PLUG-IN 15DB	C-COR	EQW-400-15

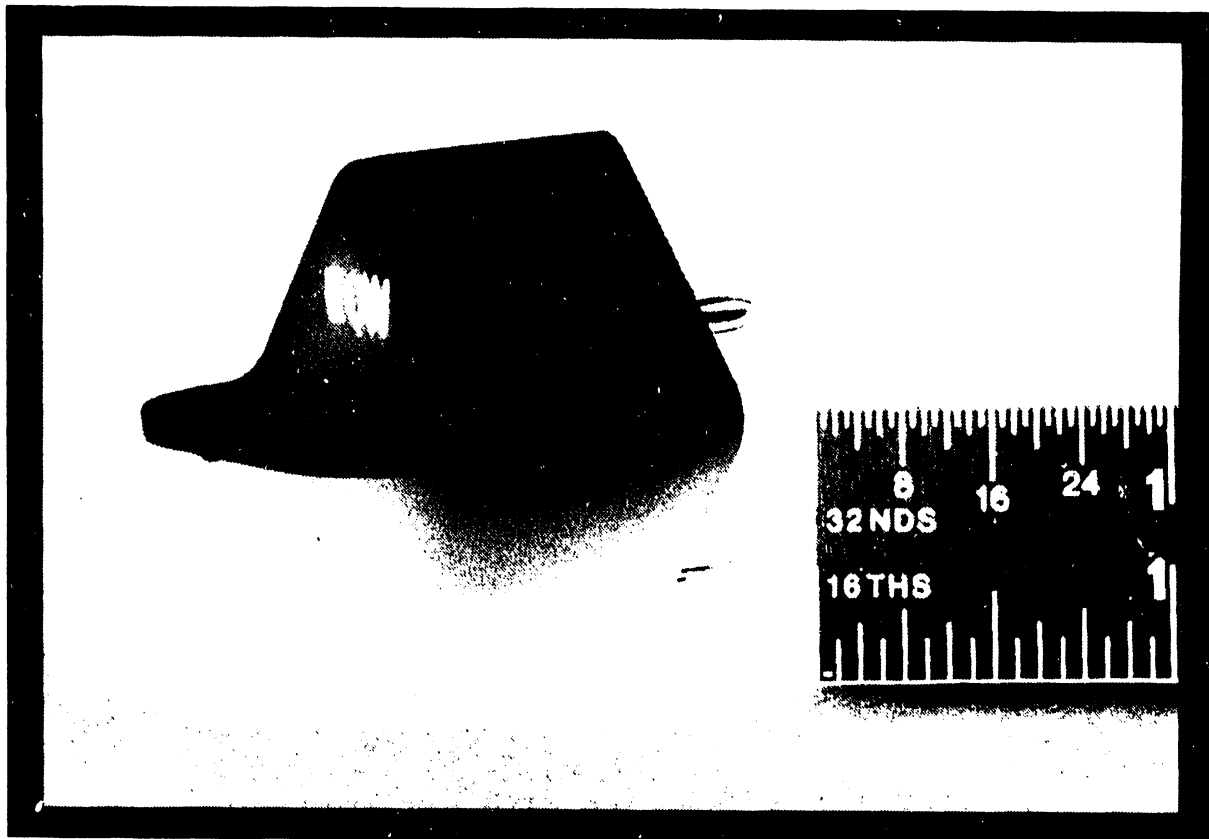

Figure 7-22 C-COR Equalizer

SECTION

8

**TROUBLE-
SHOOTING**

SECTION 8

TROUBLESHOOTING

8.1 INTRODUCTION

This section contains a troubleshooting chart for Wangnet Backbone Systems. It should be used in conjunction with the maintenance procedures specified in "Section 5, Preventive and Corrective Maintenance."

8.2 TROUBLESHOOTING TESTS

The troubleshooting procedures specified in the Troubleshooting Chart require the performance of five specific tests, other than common voltage and waveform checks:

- 1) Amplitude Response
- 2) Hum Modulation
- 3) Signal to Noise Ratio
- 4) Amplifier Gain and Slope
- 5) Stray and Spurious Signal Search *

Detailed procedures for performing these tests are contained in "Section 5, Preventive and Corrective Maintenance."

8.3 TEST EQUIPMENT

The following instruments are required for performing the tests prescribed in the Troubleshooting Chart:

- 1) Wang Four Frequency Test Signal Generator
- 2) Wavetek SAM I Signal Analysis Meter
- 3) AvanteK CR-4000 Spectrum Analyzer *

* Not required for Branch level maintenance.

BACKBONE TROUBLESHOOTING

SYMPTOMS	WANG SPEC.	PROBABLE CAUSE	CORRECTIVE ACTION
<p>Low signal level at single outlet.</p>	<p>Loop Loss: 40 dB + 6 dB - 6 dB</p>	<p>Defective Outlet box connector.</p> <p>Defective Drop Cable.</p> <p>Defective Tap port (Rx or TX).</p> <p>Defective "F" connectors.</p>	<p>1) Measure the loop loss at the Tx and Rx Tap ports for the affected outlet. If correct, then the drop cable or connection to the outlet plate may be defective. Replace.</p> <p>2) If the loop loss at the Tap ports is excessive, make the level measurement at a different port of the same Rx Tap. If correct, original Rx port is defective. Replace Tap plate.</p> <p>3) If the loop loss is still excessive, inject the test signal at a different port of the same Tx Tap, and measure the level at the original Rx port. If correct, original Tx port is defective. Replace Tap plate.</p>
<p>Low signal level at all outlets (4 or 8) fed from a tap that is not the only tap being fed by an amplifier.</p>	<p>Loop Loss: 40 dB + 6 dB - 6 dB</p>	<p>Defective Rx Tap plate.</p> <p>Defective Tx Tap plate.</p> <p>Defective hardline cable connection to either Tx or Rx plate.</p> <p>Defective connection at "F" connector.</p>	<p>1) Inject the test signal at an Outlet of the next closest Tap to the Headend, and measure the signal level at an Outlet of the suspect Tap. If the level is close to the value in the Site Log, the Tx Tap plate or its connection to the hardline may be defective. Replace.</p> <p>2) If the signal level remains low at the Rx Outlets of the suspect Tap, measure the level at a Rx Outlet of the Tap at which the test signal is being injected. If the level is correct, replace the suspect Rx Tap plate.</p>

BACKBONE TROUBLESHOOTING

SYMPTOMS	WANG SPEC.	PROBABLE CAUSE	CORRECTIVE ACTION
<p>Low signal level at some outlets, but not at others.</p>	<p>Loop Loss: 40 dB + 6 dB - 6 dB</p>	<p>Defective amplifier ahead of affected outlets.</p>	<p>Identify the problem Outlets on the System Drawings and determine which Amplifiers (Tx and Rx) service them. Measure the DC voltage levels at the Amplifiers, and compare the RF levels with the Site Log values. If incorrect, replace the Amplifier(s).</p>
<p>Low signal level at all outlets of the system.</p>	<p>Loop Loss: 40 dB + 6 dB - 6 dB</p>	<p>Defective 30v Power Converter.</p>	<p>1) Measure the level of the 30v square wave at the Power Converter outlet to the Cable. If incorrect, replace the Power Converter. 2) If the Power Converter output level is correct, suspect a break in the cable.</p>
<p>All 9.6K FFM's are inoperative.</p>	<p>9.12 MHz Pilot Carrier must be present at Outlets.</p>	<p>Inoperative 9.12 MHz Pilot Generator.</p>	<p>Check the indicator lamps of the 9.12 MHz Pilot Generator at the Headend. If both the primary and secondary circuits have failed, replace them. If failure is not indicated, measure the Pilot Carrier level at the outlets and compare with the Site Log. If the level is low, replace the Pilot Generator. If the 9.6K FFM's remain inoperative, suspect a cable problem.</p>

BACKBONE TROUBLESHOOTING

SYMPTOMS	WANG SPEC.	PROBABLE CAUSE	CORRECTIVE ACTION
<p>All 64K FFM's are inoperative.</p>	<p>48 MHz Pilot Carrier must be present at Outlets.</p>	<p>Inoperative 48 MHz Pilot Generator.</p>	<p>Check the indicator lamps of the 48 MHz Pilot Generator at the Headend. If both the primary and secondary circuits have failed, replace them. If failure is not indicated, measure the Pilot Carrier level at the outlets and compare with the Site Log. If the level is low, replace the Pilot Generator. If the 64K FFM's remain inoperative, suspect a cable problem.</p>
<p>Excessively high signal levels at outlet.</p>	<p>Loop Loss: 40 dB + 6 dB - 6 dB</p>	<p>Amplifier gain set too high.</p>	<p>Identify the problem Outlet on the System Drawings and determine which Rx Amplifier feeds it. Measure the Amplifier gain and adjust to 20 dB, if necessary.</p>
<p>AC hum bars in video pictures.</p>	<p>Hum Modulation: less than 5% on an unmodulated carrier</p>	<p>Defective Amplifier or Power Converter.</p>	<p>Determine whether hum modulation on the system is 5% or less. If not, test the outbound (Rx) line from Headend to last outlet; and test inbound (Tx) line from last outlet to Headend. If both lines fail the test, replace the Power Converter. If only one line fails the test, isolate the defective unit by measuring the hum modulation from amplifier to amplifier in that line.</p>
<p>Poor signal to noise ratio.</p>	<p>S/N Ratio: More than 40 dB at any outlet.</p>	<p>Defective Amplifier or poor connection in Cable, Tap, or "F" connectors.</p>	<p>If the S/N Ratio on the entire system is less than 40 dB, isolate the defective line by measuring S/N on the outbound (Rx) line from Headend to last Outlet, and on the inbound (Tx) line from last Outlet to Headend. Isolate the defective component by measuring S/N from amplifier to amplifier on the defective line.</p>

BACKBONE TROUBLESHOOTING

SYMPTOMS	WANG SPEC.	PROBABLE CAUSE	CORRECTIVE ACTION
Stray interference to data signal.	All ingress and egress of stray signals shall be less than the level described in FCC Rules, Section 76.610	Cracked or broken Cables, defective or loose connectors, or unterminated Tap ports/Outlets.	Set up the Avantek Spectrum Analyzer to display the stray and spurious signals on the system. Tighten "F" connectors and terminations and observe the results.
High-frequency attenuation.	System Frequency Response: ± 6 dB from 9 to 400 MHz.	System slope out of adjustment, kinked Cable, defective connections.	Use the Avantek Transmitter and Analyzer to sweep the system over the 9 to 400 MHz range. Check the Cable section by section to isolate the trouble area. Inspect all connectors and search for kinks.
Some modems work but other types do not (i.e. 9.6K F.F.M.'s and 64K F.F.M.'s and 4.27MB work, but 9.6K FAM's do not).	System Frequency Response: ± 6 dB from 9 to 400 MHz.	Kinked Cable or connector may produce an effective "notch filter" at some frequencies.	Use the Avantek Transmitter and Analyzer to sweep the system over the 9 to 400 MHz range. If excessive attenuation exists at any frequencies within the range, re-sweep the Cable section by section to isolate the trouble area. Inspect all connectors and search for kinks.
Peripheral Band inoperative.	Diplexer must be located within one mile of transmit and receive points.	Defective Diplexer.	Determine condition of Diplexer by checking DC voltage levels. Replace Diplexer.

APPENDIX

A

APPENDIX A
SPECIAL TEST EQUIPMENT

WLI No.	DESCRIPTION	POWER FREQ.
727-0166	Avantek CR4010 Receiver (Spectrum Analyzer)	60 Hz
727-0167	Avantek CT4010 Transmitter	60 Hz
727-0168	Avantek CR4020 Receiver (Spectrum Analyzer)	50 Hz
727-0169	Avantek CT4020 Transmitter	50 Hz
727-0170	Wavetek SAM I Signal Analysis Meter	60 Hz
727-0171	Wavetek SAM I Signal Analysis Meter	50 Hz
190-0737	Wang Four Frequency Test Generator	60/50 Hz

APPENDIX

B

APPENDIX B

BIBLIOGRAPHY

- Carmichael, David A., CATV Systems Maintenance and Proof-of-Performance Testing Handbook. Santa Clara, California, Avantek, Inc., 1982
- Cunningham, John E., Cable Television, 2nd ed. No. 21755. Indianapolis, Indiana, Howard W. Sams & Co., Inc., 1980.
- Four Frequency Test Signal Generator. 729-1180. Lowell, Massachusetts, Wang Laboratories, Inc.
- SAM I/SAM II Signal Analysis Meter Operating Handbook. Beech Grove, Indiana, Wavetek/Mid State, 1981
- Wangnet Technical Description Manual. 700-7173. Lowell, Massachusetts, Wang Laboratories, Inc.
- Wang Networking Primer. 777-4004. Lowell, Massachusetts, Wang Laboratories, Inc.

APPENDIX

C

APPENDIX C

WANGNET

SITE LOG BOOK

	Vendor
Total # of Amplifiers _____	_____
Total # of Taps _____	_____
Total # of Users _____	_____

Total # of Power Converters _____
(30V)
SUPPLYS

Customer _____
Installed by _____
Certified by _____

	Input Pad PB-()	Input Equalizer EQW-400-()	Power Fuse Placement - 6.25A -		Output Pad PB-()	Output Equalizer EQW-400-()
			Input	Output		
1. Headend Amplifiers		Serial Number	a. _____		b. _____	
a. outbound(RX) _____		_____	yes/no	yes/no	_____	_____
b. inbound (Tx) _____		_____	yes/no	yes/no	_____	_____
2. _____ Amplifier		Serial Number	a. _____		b. _____	
a. outbound _____		_____	yes/no	yes/no	_____	_____
b. inbound _____		_____	yes/no	yes/no	_____	_____
3. _____ Amplifier		Serial Number	a. _____		b. _____	
a. outboard _____		_____	yes/no	yes/no	_____	_____
b. inbound _____		_____	yes/no	yes/no	_____	_____
4. _____ Amplifier		Serial Number	a. _____		b. _____	
a. outbound _____		_____	yes/no	yes/no	_____	_____
b. inbound _____		_____	yes/no	yes/no	_____	_____
5. _____ Amplifier		Serial Number	a. _____		b. _____	
a. outbound _____		_____	yes/no	yes/no	_____	_____
b. inbound _____		_____	yes/no	yes/no	_____	_____

<u>Location</u>	<u>Frequency (MHZ)</u>	<u>Level</u> <u>45db Generator</u>	<u>dbmv</u>	<u>Using</u> <u>30 db Generator</u>	<u>Selected</u> <u>Outlets</u> <u>Hum (%)</u>	<u>Selected</u> <u>Outlets</u> <u>C/N</u>	<u>What is attached</u> <u>to Outlet</u>
	9.12 Pilot 48. Pilot 9.5 47. 172. 351.						
	9.12 Pilot 48. Pilot 9.5 47. 172. 351.						
	9.12 Pilot 48. Pilot 9.5 47. 172. 351.						

Figure 1 { *Four Frequency Test Generator Injected Into Tx Outlet
 **Sam I Hooked Into RX Outlet

Figure 2 { ***Four Frequency Test Generator Injected to Input Test Point of Amplifier
 ****Sam I Hooked to Output Test Point of Amplifier

DESIGNATED TEST POINTS

<u>Location</u>	<u>Frequency (MHZ)</u>	<u>Level dbmw</u>		<u>Hum (%)</u>	<u>C/N (db)</u>
		<u>45db Generator</u>	<u>Using 30db Generator</u>		
	9.12 Pilot 48. Pilot 9.5 47. 172. 351.				
	9.12 Pilot 48. Pilot 9.5 47. 172. 351.				
	9.12 Pilot 48. Pilot 9.5 47. 172. 351.				
	9.12 Pilot 48. Pilot 9.5 47. 172. 351.				
	9.12 Pilot 48. Pilot 9.5 47. 172. 351.				

Figure 1 { • Four Frequency Test Generator injected into Tx Outlet
 ** Sam 1 Hooked onto Rx outlet

Head End Test Points (Tx Injected)

<u>Test Point</u>	<u>Frequency (MHZ)</u>	<u>Level</u> <u>45db Generator</u>	<u>dbmv</u> <u>Using</u> <u>30db Generator</u>	<u>Figure</u>
Tx Amp Output Test Point	9.12 Pilot 48. Pilot 9.5 47. 172. 351.			3
Tx Test Point System Level	9.12 Pilot 48. Pilot 9.5 47. 172. 351.			3
Rx Trunk Test Point	9.12 Pilot 48. Pilot 9.5 47. 172. 351.			3

*All measurements on this sheet are made with the following setup.

- 1.) Four Frequency Test Generator injected into Tx Trunk Test PT.
- 2.) Sam I Hooked to Appropriate Test Point above

Head End Test Points (Rx injected)

<u>Test Point</u>	<u>Frequency (MHZ)</u>	<u>Level</u> <u>45db Generator</u>	<u>dbmv</u> <u>Using</u> <u>30db Generator</u>	<u>Figure</u>
Rx Trunk Test Point (Using Rx Test Point System Level as Input For Four Frequency Test Generator)	9.12 Pilot 48. Pilot 9.5 47. 172. 351.			4
Rx Trunk Test Point Rx Trunk Test Point (Using Rx Amp Input Test Point as Input For Four Frequency Test Generator)	9.12 Pilot 48. Pilot 9.5 47. 172. 351.			4

These measurements are made with the following setup

- 1.) Four Frequency Test Generator Injected Into Rx Test Point System Level First
Then Into Rx Amp Test Point.
- 2.) Sam I hooked to Rx Test Point

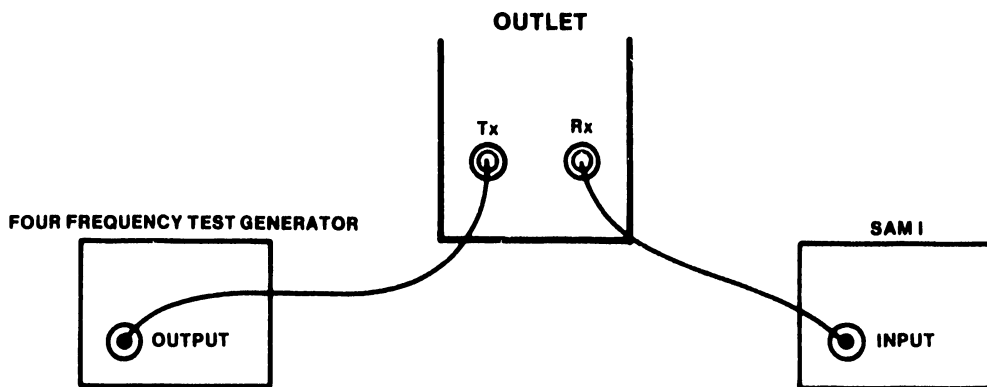

FIGURE 1

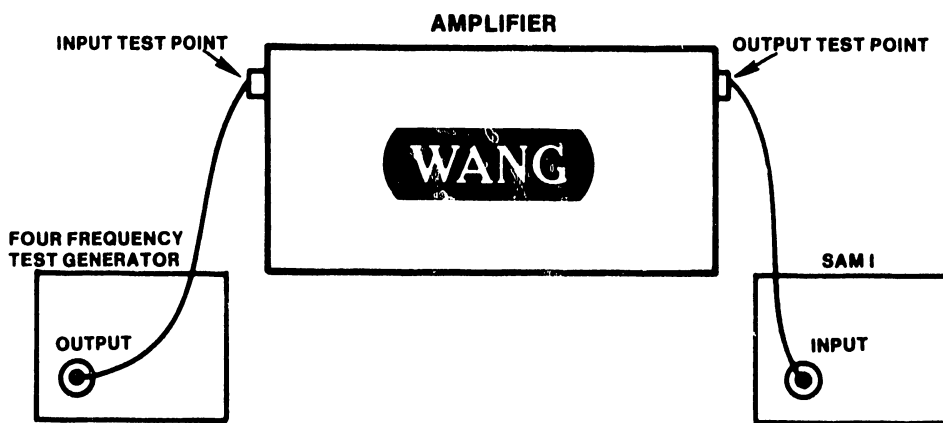

FIGURE 2

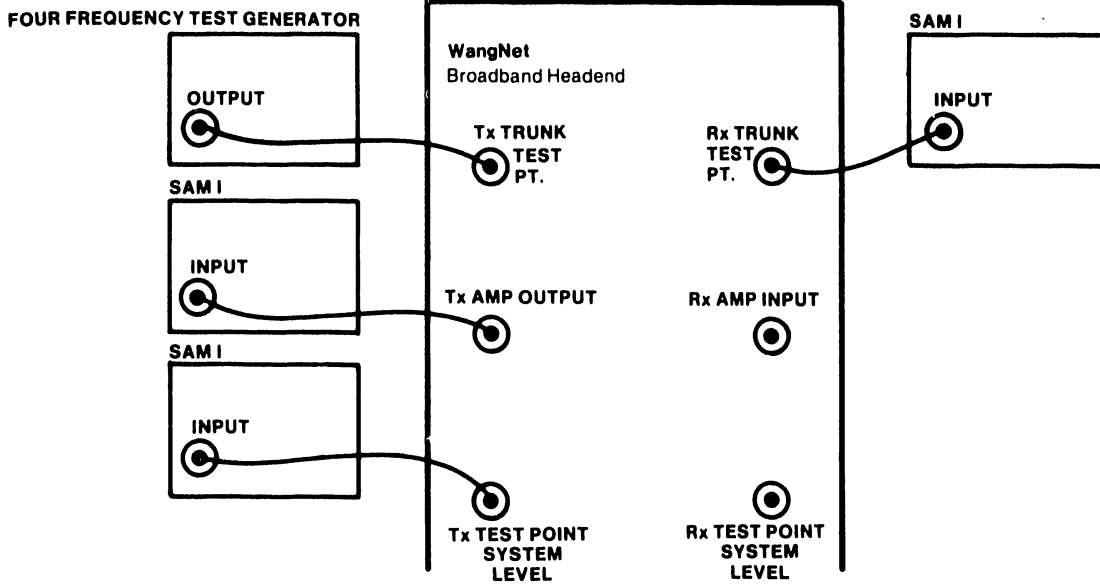

FIGURE 3

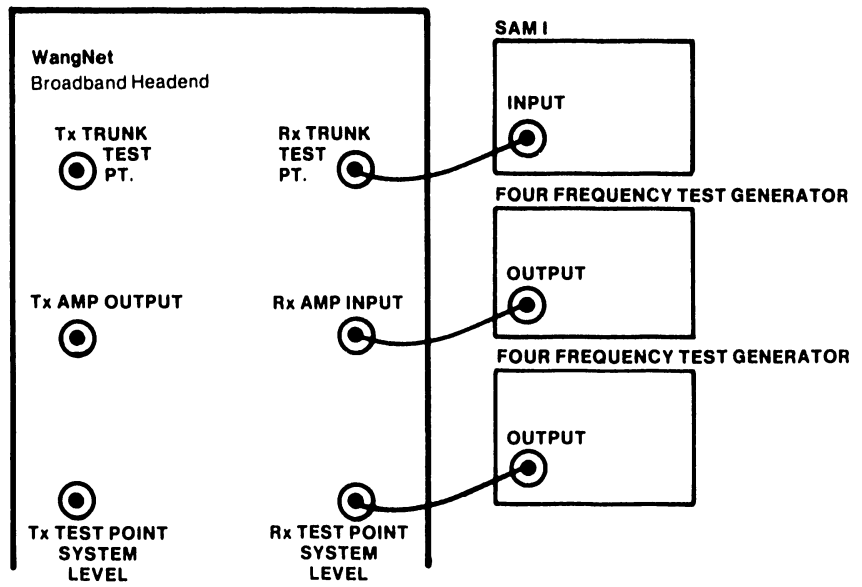

FIGURE 4

APPENDIX

D

APPENDIX D

WANGNET COMPONENT IDENTIFICATION NUMBERS

The components of each Backbone system are assigned unique identification numbers to simplify location and identification during installation and/or maintenance. Since each Wangnet Backbone has a unique design, the numbering scheme is subject to some variation. A typical scheme is described by the legend printed below. The specific scheme for a particular system will be described by a legend on the Engineering Drawings of that system.

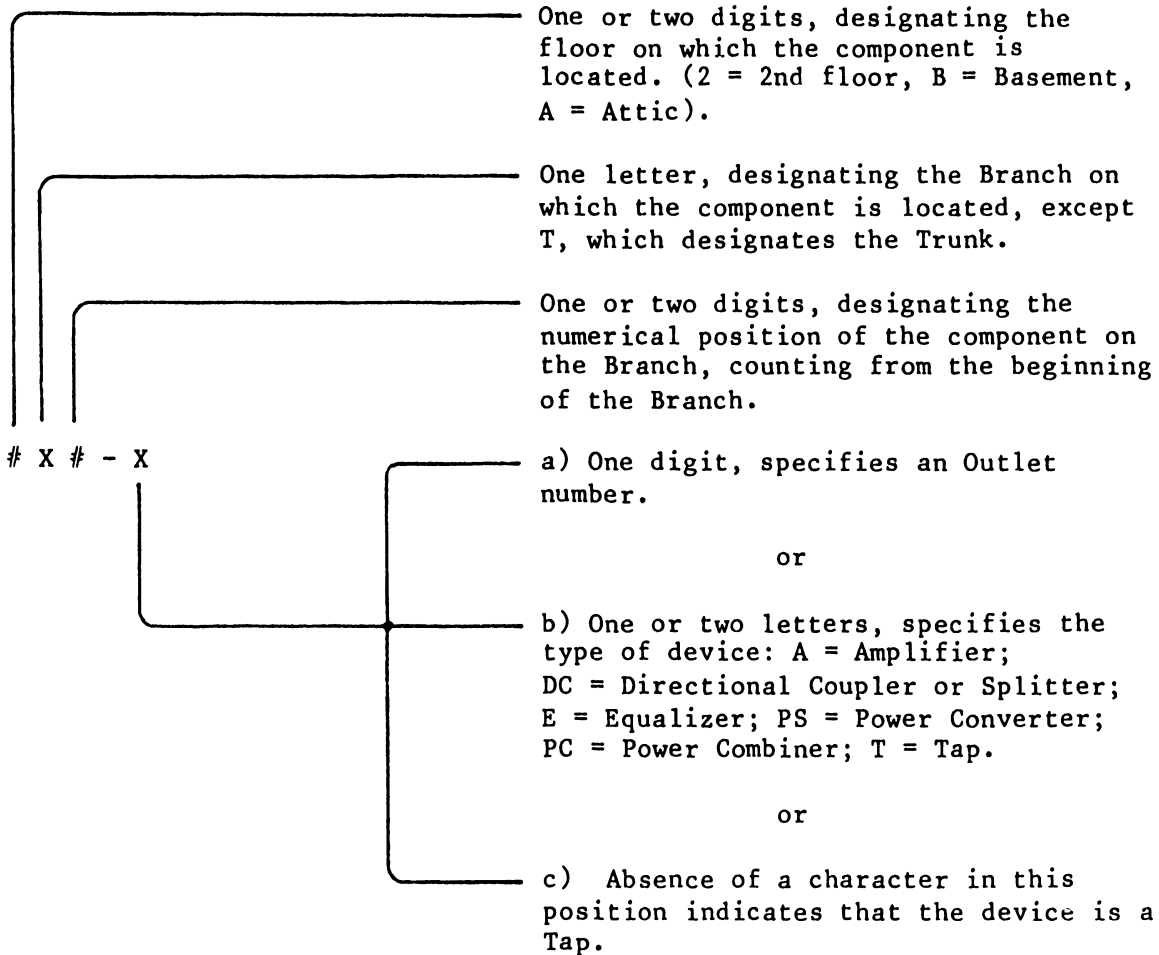

EXAMPLE:

1B4-T3 designates Outlet number three, fed from Port 3 of the Tap in the fourth component position of Branch B on the first floor.

12T1-A designates an Amplifier in the first component position of the Trunk at the 12th floor.

2C3-DC designates a Directional Coupler in the third component position of Branch C on the second floor.

4F2 designates a Tap in the second component position of Branch F on the fourth floor.



















APPENDIX

E

APPENDIX E

SYMBOLS USED IN BACKBONE ENGINEERING DRAWINGS

LEGEND

	HEADEND
	SPLITTER, DUAL HYBRID 2 WAY BALANCED
	SPLITTER, HYBRID 3 WAY BALANCED OR UNBALANCED (DOT INDICATES LOW VALUE TAP OFF)
	DIRECTIONAL COUPLER (NUMBER IS TAP OFF LOSS)
	TERMINATOR, 75 OHM, AC BLOCKING
	AMPLIFIER, LINE EXTENDER
	MULTITAP, 4-PORT (NUMBER IS TAP VALUE) (ARROW INDICATES TAP PLACEMENT DIRECTION)
	MULTITAP, 8-PORT (NUMBER IS TAP VALUE) (ARROW INDICATES TAP PLACEMENT DIRECTION)
	EQUALIZER (NUMBER IS EQUALIZER VALUE)
	DIPLEXER
	CABLE, COAXIAL, TRUNK/DISTRIBUTION
	POWER COMBINER/INSERTER
	POWER SUPPLY
	POWER STOP
	OUTLET, FLOOR MOUNTED
	OUTLET, WALL, FLUSH MOUNTED
	OUTLET, WALL, SURFACE MOUNTED
	OUTLET, MOUNTED UNDER RAISED FLOOR
	OUTLET, FLUSH MOUNTED ON FLOOR

APPENDIX

F

APPENDIX F

WANGNET MULTI-NODE TRUNK AND DISTRIBUTION SYSTEM

[Appendix F applies only to a special project, and is not a part of this manual. This page is included for reference only.]

APPENDIX

G

POWER TRANSFER UNIT OPTION

The Power Transfer Unit is an automatic device that switches a WangNet Backbone between alternate power sources in the event of failure of either source. The unit works in conjunction with two WangNet Power Converters, and is intended to be mounted with the converters in a standard equipment rack at a Headend, or in a special cabinet at a Distribution Panel.

OPERATION

The power Transfer Unit operates automatically, and derives its operating power from the associated WangNet Power Converters. The two Power Converters operate from separate AC sources. Typically, the primary Power Converter operates from a standard AC utility power circuit, while the secondary Power Converter operates from a different circuit, an Uninterruptible Power Source (UPS), or an auxilliary generator.

When network operating power is simultaneously available from both Power Converters, the Power Transfer Unit selects power from the primary converter alone. Should that source fail, the Power Transfer Unit immediately switches to the secondary Power Converter, and indicates that a "Fault" has occurred.

INDICATORS

The Power Transfer Unit has three indicator lamps on the front panel. Green Primary Power and Secondary Power lamps indicate, when lit, that network operating power is available from the respective primary and/or secondary Power Converters. The red Fault lamp, when lit, indicates that power is not available from one of the Power Converters, and thus confirms that an extinguished green lamp is not merely defective.

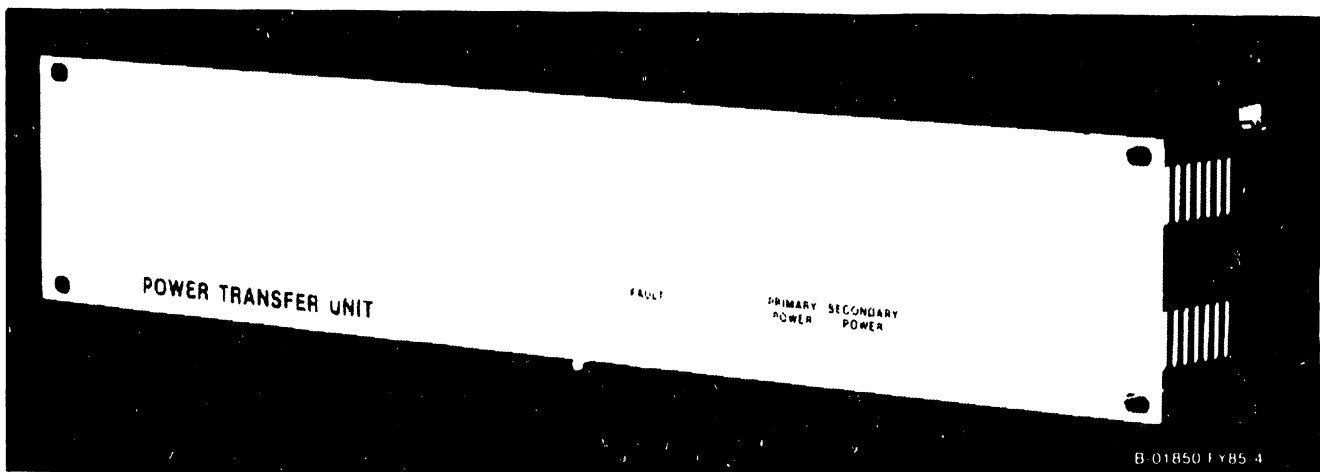

Figure G-1 Power Transfer Unit, Front View

INSTALLATION

The Power Transfer Unit is intended to be rack-mounted along with its associated Power Converters. A typical Headend arrangement is shown in Figure G-3. All three units are mounted in the bottom of the Headend equipment rack. The Power Transfer Unit is situated between the two Power Converters, with the primary converter at the very bottom.

Inter-unit cabling is straightforward. Refer to Figure G-3 for connection guidance. All cables are RG-11 coaxial cables with UHF series connectors.

WARNING

Remove AC power from both Power Converters before connecting or disconnecting any cables.

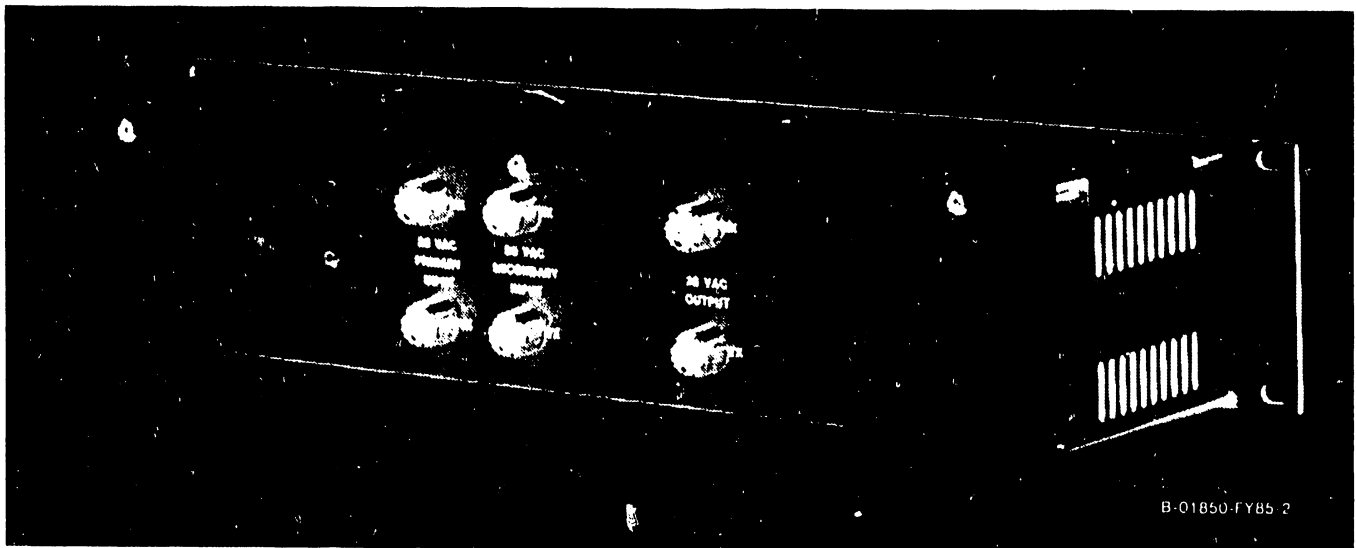
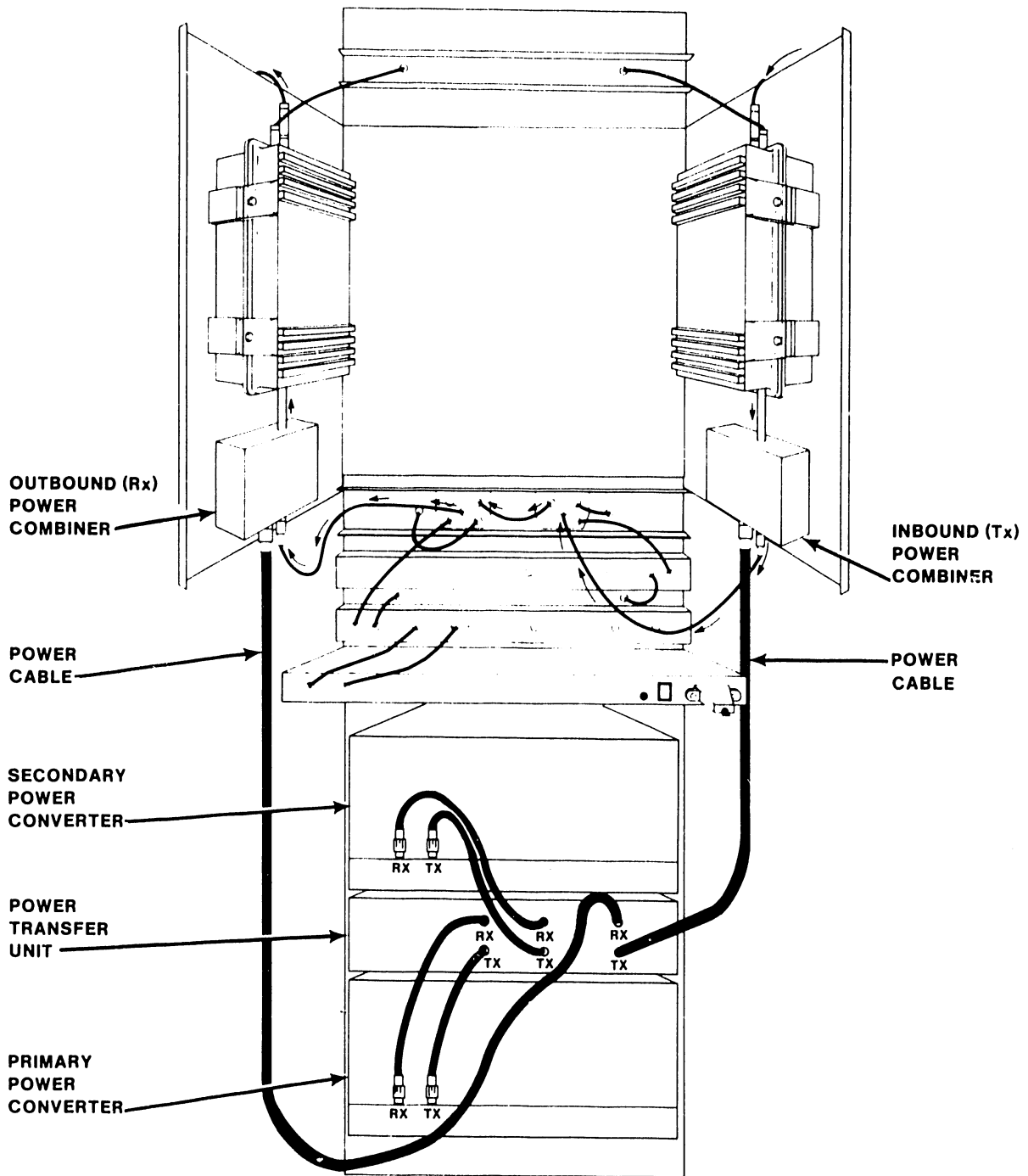

Figure G-2 Power Transfer Unit, Rear View

With the Power Transfer Unit and Power Converters connected as shown in Figure G-3, energize both Power Converters and observe the indicators on the Power Transfer Unit front panel. The red Fault indicator should be extinguished, and the green Primary Power and Secondary Power indicators should be lit, indicating that power is available from both Power Converters.



B-01850-FY85-5

Figure G-3 Typical Headend, Rear View

Check normal functioning of the Power Transfer Unit by removing AC power from the primary Power Converter. The Primary Power indicator lamp should extinguish, and the Fault lamp should light. Restore AC power to the primary converter, and remove it from the secondary converter. The Primary Power lamp should light and the Secondary Power lamp should extinguish. The Fault lamp should also be lit. Remove AC power from both converters, and all indicator lamps should extinguish.

WARNING

Do not check normal functioning by disconnecting power cables between the Power Transfer Unit and Power Converters. Remove AC power to the Power Converters only.

Distribution Panel installations are similar to Headend installations except for the mounting arrangement and connection procedure. The units are installed in a special wall-mounted cabinet at a Distribution Panel. Since the wall-mounted cabinet does not allow access to the rear panel connections, all interconnecting cables must be attached before mounting the units.

With the cabinet securely attached to the wall and/or Distribution Panel, proceed as follows:

1. Connect two coaxial cables to the Primary Power Converter output terminals, mount the converter in the bottom position of the cabinet, and plug the AC power cord into the outlet provided. Draw the free ends of the coaxial cables out of the cabinet center position for later connection to the Power Transfer Unit.
2. Connect two coaxial cables to the Secondary Power Converter output terminals, mount the converter in the top position of the cabinet, and plug the AC power cord into the outlet provided. Again, draw the free ends of the coaxial cables out of the cabinet center position for later connection to the Power Transfer Unit.
3. Connect the coaxial cables from both Power Converters to the associated Input terminals of the Power Transfer Unit, and connect the coaxial cables from the Distribution Panel Power Combiners to the Power Transfer Unit Output terminals.
4. Mount the Power Transfer Unit in the center position of the cabinet.

FUNCTIONAL DESCRIPTION

Figure G-4 is a simplified schematic diagram that indicates the basic functional characteristics of the Power Transfer Unit. The diagram does not necessarily reflect the actual circuitry contained in the unit, and must not be used for maintenance purposes.

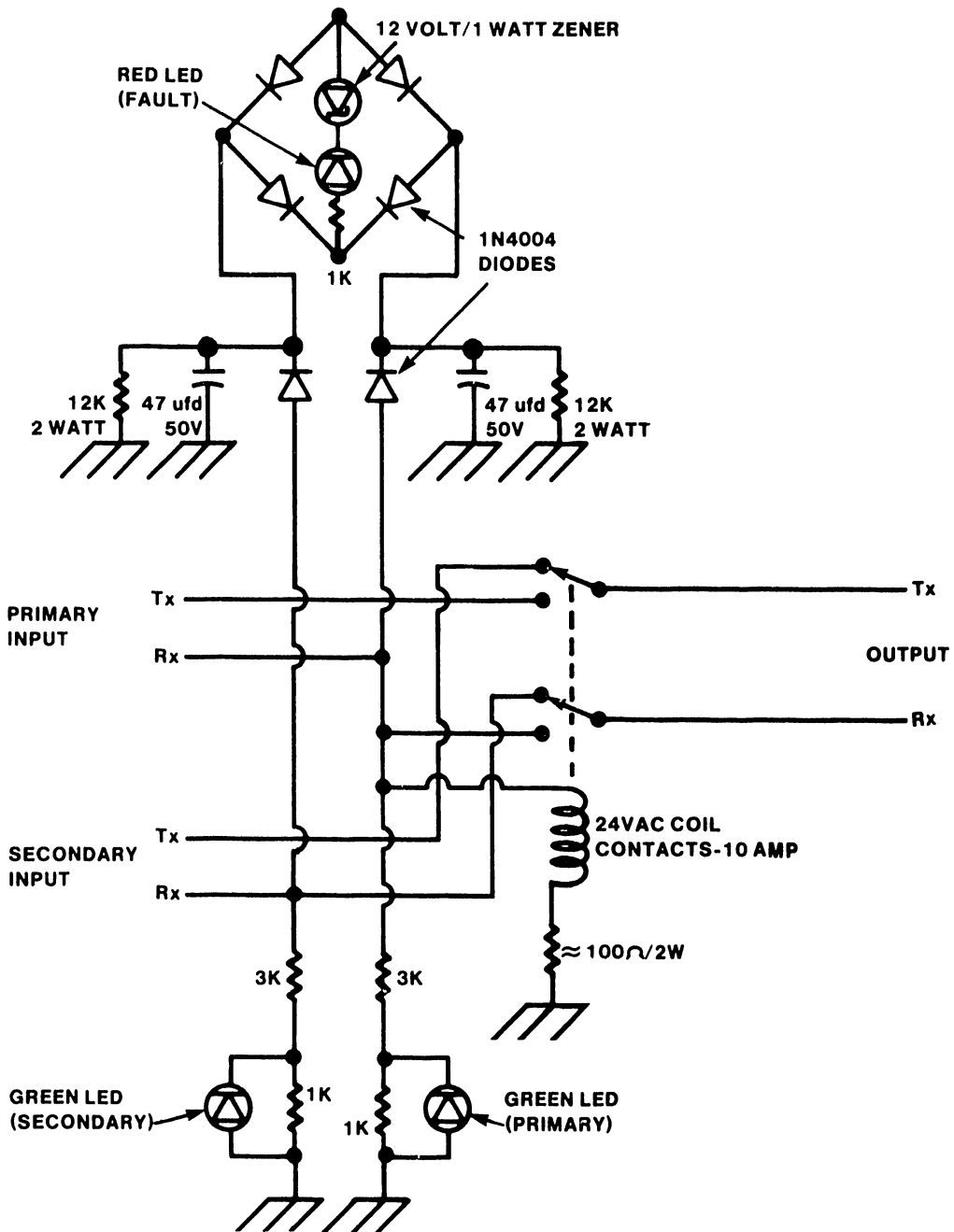

B-01850-FY85-1

Figure G-4 Simplified Schematic Diagram

MAINTENANCE

Field repairs to the Power Transfer Unit are restricted to the renewal of defective AC Power Harness connections, and the replacement of the components identified in Figure G-6 and Table G-1.

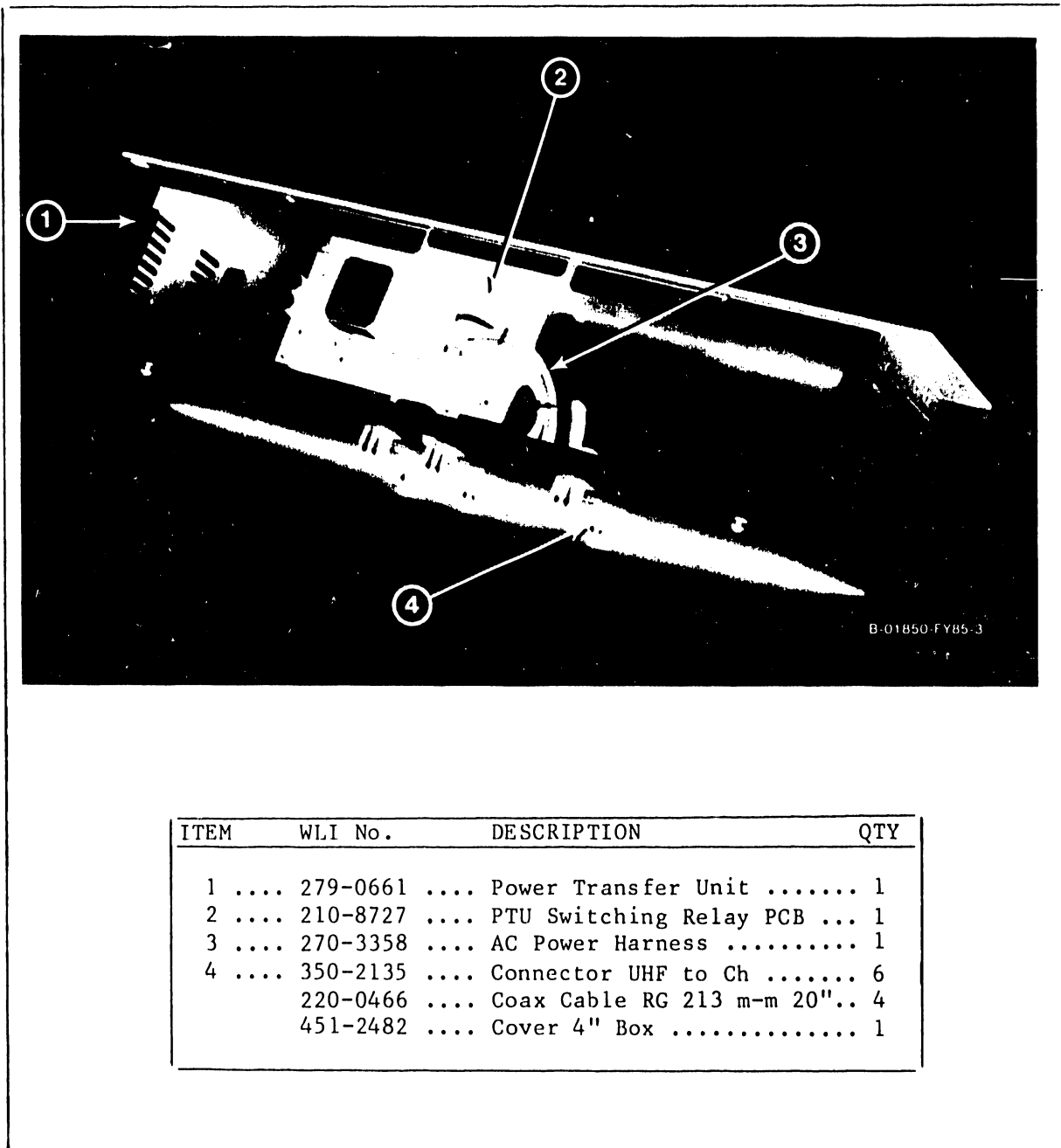

Figure G-5 Illustrated Parts Breakdown

Table G-1 AC Power Harness Connections

FROM UHF CONNECTOR	TO PCB CONNECTOR	COLOR CODE
Primary Tx	Pin 1	Blue
Output Rx	Pin 2	Red
Primary Rx	Pin 3	Orange
Secondary Tx	Pin 4	Brown
Output Tx	Pin 5	White
Secondary Rx	Pin 6	Violet



LABORATORIES, INC

ONE INDUSTRIAL AVENUE, LOWELL, MASSACHUSETTS 01851. TEL. (617) 459-5000. TWX 710 343-6769. TELEX 94-7421

PRINTED IN U.S.A.

END