

C-2

REVISIONS		DATE		BY	

SIRIUS SYSTEMS TECHNOLOGY, INC.  
 SCHEMATIC OF VIDEO BOARD  
 VIDEO BOARD  
 100691  
 2 OF 2

C-3

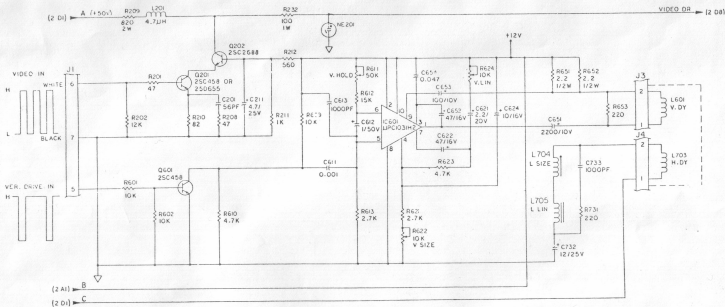

2 ALL RESISTORS ARE  $\pm 5\%$  1/4 W.

1 ELECTRICAL VALUES ARE IN OHMS, MICROFARADS AND MICROHENRIES  
NOTES : UNLESS OTHERWISE SPECIFIED :

CRID	T2	
L4	S62	
U1	DS1	
O9	F1	
C31	J4	
R51	P2	RZ
LAST USED	NOT USED	
REFERENCE DESIGNATIONS		

DATE	REV.	DESCRIPTION	BY
SIRIUS SYSTEMS TECHNOLOGY, INC.			
SCHEMATIC		C L D	
VIDEO BOARD		S Y L	
DATE	REV.	DESCRIPTION	BY
PART NUMBER: IC0091			
PAGE 1 OF 2			

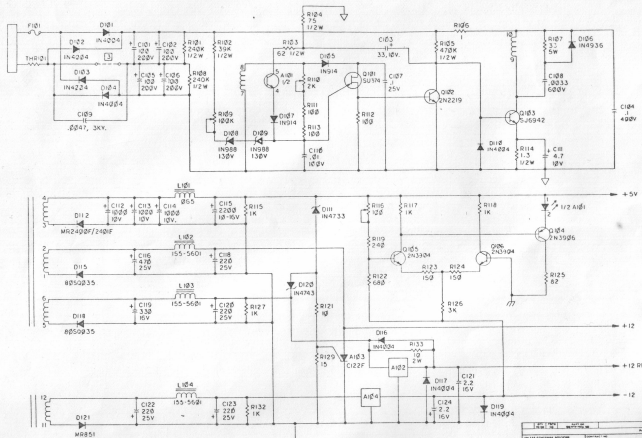

4 REF COMPOMER CORP. CP 5102 SCHEMATIC, DWG NO. 90017.  
 5 CUT FOR 220V OPERATION  
 2. ALL RESISTORS ARE 5%, 1/4W.  
 1. ELECTRICAL VALUES ARE IN OHMS, MICROFARADS AND MICROHENRIES.  
 NOTES: UNLESS OTHERWISE SPECIFIED.

THE INFORMATION ON THIS DOCUMENT IS THE PROPRIETARY PROPERTY OF COMPOMER CORP. THIS DOCUMENT ARE FOR THE EXCLUSIVE USE OF SIRIUS SYSTEMS TECHNOLOGY, INC. AND SHOULD NOT BE SUPPLIED TO OUTSIDE SOURCES.

Q133	Q128, 150, 151
D121	D113, D114
C124	C121
A104	A102
LAST USED	NOT USED
REFERENCE	DESIGNATIONS

DATE	REV	BY	CHK	APP'D
SIRIUS SYSTEMS TECHNOLOGY, INC.				
SCHEMATIC, POWER SUPPLY.				
100701				

C-4

C-5

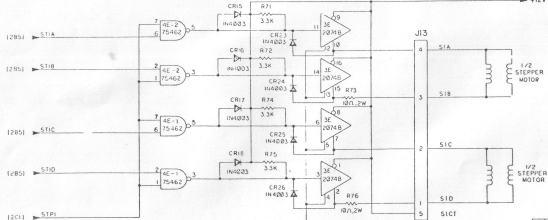
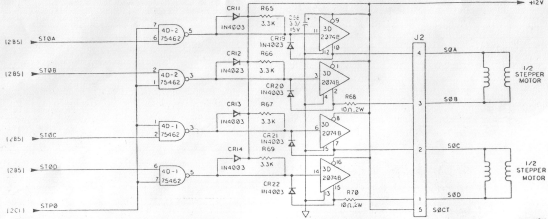

STEPPER CONTROL

REV. 1.0 DISK DRIVE SCHEMATIC PARTS LIST		Sirius Systems Technology, Inc. DISK DRIVE SCHEMATIC	
DATE: _____ DRAWN BY: _____ CHECKED BY: _____ APPROVED BY: _____ TITLE: _____	DATE: _____ DRAWN BY: TAYLOR, S-14-2 CHECKED BY: _____ APPROVED BY: _____ TITLE: _____	PART NO.: _____ QTY.: _____ UNIT PRICE: _____ TOTAL: _____	PART NO.: _____ QTY.: _____ UNIT PRICE: _____ TOTAL: _____
APPLICATION: _____		100671 Rev. 5.0	

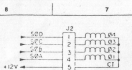

**STEPPER A**  
(SHT 9)

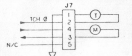

**MOTOR A** (8748, DAC, DISCRETE)  
(SHT 3)

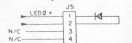

**ACTIVITY LED A**  
(SHT 6)

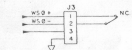

**WRITE PROTECT A**  
(SHT 6)

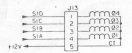

**STEPPER B**  
(SHT 9)

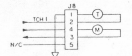

**MOTOR B**  
(SHT 3)

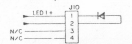

**ACTIVITY LED B**  
(SHT 6)

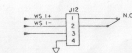

**WRITE PROTECT B**  
(SHT 6)

**CPU INTERFACE (6522)**  
(SHT 2)

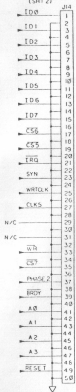

**POWER CONNECTOR**  
(SHT 1)



DRIVE A HEAD 0  
(SHT 5)



**MOTOR START SWITCH A**  
(SHT 6)

DRIVE A HEAD 1  
(SHT 5)



**DISK A**  
(SHT 2)

DRIVE B HEAD 0  
(SHT 5)



**MOTOR START SWITCH B**  
(SHT 6)

DRIVE B HEAD 1  
(SHT 5)



**DISK B**  
(SHT 2)

C-6

**DISK CONNECTORS (REF)**

SHT 1		SHT 2		SHT 3		SHT 4		SHT 5	
DATE	REV	DATE	REV	DATE	REV	DATE	REV	DATE	REV
<p>DESIGNED BY: J. R. TAYLOR (7-751)</p> <p>APPROVED BY: J. R. TAYLOR (7-751)</p> <p>DATE: 10/25/71</p> <p>PROJECT: SIRIUS SYSTEMS TECHNOLOGY, INC.</p> <p>DESCRIPTION: DISK DRIVE SCHEMATIC</p> <p>100571</p> <p>REV: 1</p>									
APPLICATION: <input type="checkbox"/> DO NOT SCALE DRAWING					<p>DISK DRIVE SCHEMATIC</p> <p>100571</p> <p>REV: 1</p>				

C-7

(2B5) CS7

(4B1) READ CLOCK

(4B1) READ DATA

(2A5) WRASNC

(2C5) WRDNC

(2D1) /RDW

WRT CLK

J14

WRT CLK

WRT CLK

WRT CLK

WRT CLK

WRT CLK

WRT CLK

WRT CLK

WRT CLK

WRT CLK

WRT CLK

WRT CLK

WRT CLK

WRT CLK

WRT CLK

WRT CLK

WRT CLK

WRT CLK

WRT CLK

WRT CLK

WRT CLK

WRT CLK

WRT CLK

WRT CLK

WRT CLK

WRT CLK

WRT CLK

WRT CLK

WRT CLK

WRT CLK

WRT CLK

WRT CLK

WRT CLK

WRT CLK

WRT CLK

WRT CLK

WRT CLK

WRT CLK

WRT CLK

WRT CLK

WRT CLK

WRT CLK

WRT CLK

WRT CLK

WRT CLK

WRT CLK

WRT CLK

WRT CLK

WRT CLK

WRT CLK

WRT CLK

WRT CLK

WRT CLK

WRT CLK

WRT CLK

WRT CLK

WRT CLK

WRT CLK

WRT CLK

WRT CLK

WRT CLK

WRT CLK

WRT CLK

WRT CLK

WRT CLK

WRT CLK

WRT CLK

WRT CLK

WRT CLK

WRT CLK

WRT CLK

WRT CLK

WRT CLK

WRT CLK

WRT CLK

WRT CLK

WRT CLK

WRT CLK

WRT CLK

WRT CLK

WRT CLK

WRT CLK

WRT CLK

WRT CLK

WRT CLK

WRT CLK

WRT CLK

WRT CLK

WRT CLK

WRT CLK

WRT CLK

WRT CLK

WRT CLK

WRT CLK

WRT CLK

WRT CLK

WRT CLK

WRT CLK

WRT CLK

WRT CLK

WRT CLK

WRT CLK

WRT CLK

WRT CLK

WRT CLK

WRT CLK

WRT CLK

WRT CLK

WRT CLK

WRT CLK

WRT CLK

WRT CLK

WRT CLK

WRT CLK

WRT CLK

WRT CLK

WRT CLK

WRT CLK

WRT CLK

WRT CLK

WRT CLK

WRT CLK

WRT CLK

WRT CLK

WRT CLK

WRT CLK

WRT CLK

WRT CLK

WRT CLK

WRT CLK

WRT CLK

WRT CLK

WRT CLK

WRT CLK

WRT CLK

WRT CLK

WRT CLK

WRT CLK

WRT CLK

WRT CLK

WRT CLK

WRT CLK

WRT CLK

WRT CLK

WRT CLK

WRT CLK

WRT CLK

WRT CLK

WRT CLK

WRT CLK

WRT CLK

WRT CLK

WRT CLK

WRT CLK

WRT CLK

WRT CLK

WRT CLK

WRT CLK

WRT CLK

WRT CLK

WRT CLK

WRT CLK

WRT CLK

WRT CLK

WRT CLK

WRT CLK

WRT CLK

WRT CLK

WRT CLK

WRT CLK

WRT CLK

WRT CLK

WRT CLK

WRT CLK

WRT CLK

WRT CLK

WRT CLK

WRT CLK

WRT CLK

WRT CLK

WRT CLK

WRT CLK

WRT CLK

WRT CLK

WRT CLK

WRT CLK

WRT CLK

WRT CLK

WRT CLK

WRT CLK

WRT CLK

WRT CLK

WRT CLK

WRT CLK

WRT CLK

WRT CLK

WRT CLK

WRT CLK

WRT CLK

WRT CLK

WRT CLK

WRT CLK

WRT CLK

WRT CLK

WRT CLK

WRT CLK

WRT CLK

WRT CLK

WRT CLK

WRT CLK

WRT CLK

WRT CLK

WRT CLK

WRT CLK

WRT CLK

WRT CLK

WRT CLK

WRT CLK

WRT CLK

WRT CLK

WRT CLK

WRT CLK

WRT CLK

WRT CLK

WRT CLK

WRT CLK

WRT CLK

WRT CLK

WRT CLK

WRT CLK

WRT CLK

WRT CLK

GCR EN/DE-CODER

[REV] PART NO.		D.R.G. 05M		REV. 01	
ALL INFORMATION CONTAINED HEREIN IS UNCLASSIFIED EXCEPT WHERE SHOWN OTHERWISE		DATE		BY	
CLASSIFICATION		DATE		BY	
AUTHORITY		DATE		BY	
CLASS		DATE		BY	
CONTROL		DATE		BY	
FORM		DATE		BY	
REV. 01		DATE		BY	
DATE		DATE		DATE	
BY		BY		BY	
APPROVAL		DATE		BY	
DO NOT SCALE DRAWING		DATE		BY	

Sinus Systems Technology, Inc.

DGK DRIVE SCHEMATIC

120671

12D11 SIDE SELECT

12D16 DRIVE SELECT

12D11 LED RA

+5V  
R52  
300



12D11 LED 1A

+5V  
R54  
300



12D11 Drive

17C11 GCR DATA

12C11 ERASE

12A51 DOOR OPEN 0

12A50 DOOR OPEN 1

+5V  
R56  
510



+5V  
R57  
510

+5V  
R59  
330

+5V  
R60  
330

+5V  
R61  
330

+5V  
R62  
330



+5V  
R57  
510

+5V  
R59  
330

+5V  
R60  
330

+5V  
R61  
330

+5V  
R62  
330

DRIVE SELECT, LED, DECODE

DATE	DESIGNED BY	DESIGNED IN	DESIGNED FOR
REVISED	CHECKED BY	REVISED IN	REVISED FOR
APPROVED	DATE	BY	
DESCRIPTION	DISK DRIVE SCHEMATIC		
PROJECT NO.	102671		
SCALE			
APPLICATOR	DO NOT SCALE DIMENSIONS		

Sirius Systems Technology, Inc.  
DISK DRIVE SCHEMATIC  
102671

C-18



C-9

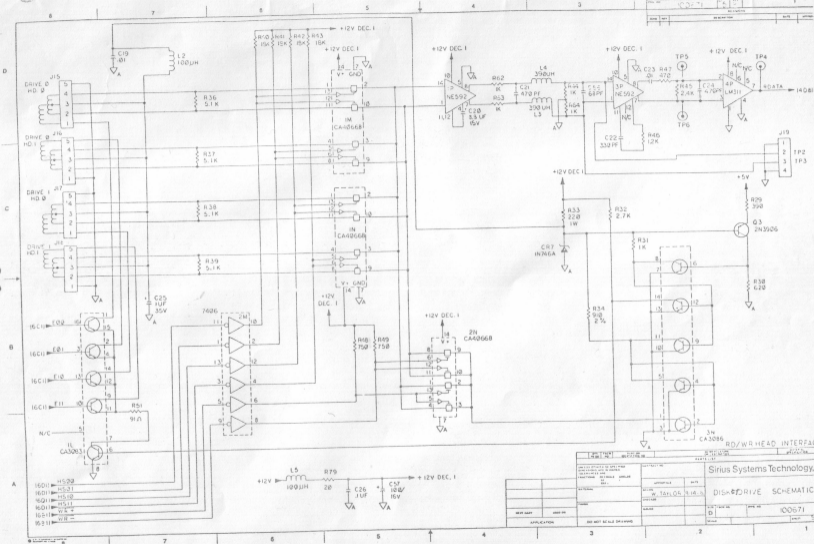

APPLICATION		DATE	
DESIGNER		DRAWN	
CHECKED		APPROVED	
REVISED		SCALE	
MATERIAL		PART NO.	
QUANTITY		PRICE	
REVISIONS		DATE	
DESCRIPTION		DRAWN BY	
DATE		CHECKED BY	
APPROVED BY		DATE	
MATERIAL		PART NO.	
QUANTITY		PRICE	
REVISIONS		DATE	
DESCRIPTION		DRAWN BY	
DATE		CHECKED BY	
APPROVED BY		DATE	

Sirius Systems Technology, Inc

DISK DRIVE SCHEMATIC

100671

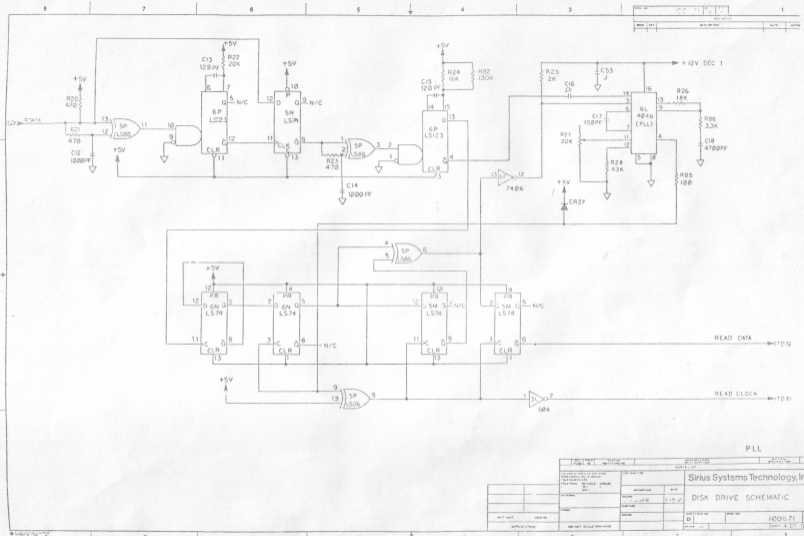

C-10

PLL

DESIGN INFORMATION		PARTS LIST	
DATE	DESIGNER	QTY	DESCRIPTION
10/05/71			
SIRIUS SYSTEMS TECHNOLOGY, INC.		DISK DRIVE SCHEMATIC	
REV. 1	10/05/71	1	DISK DRIVE SCHEMATIC

C-11

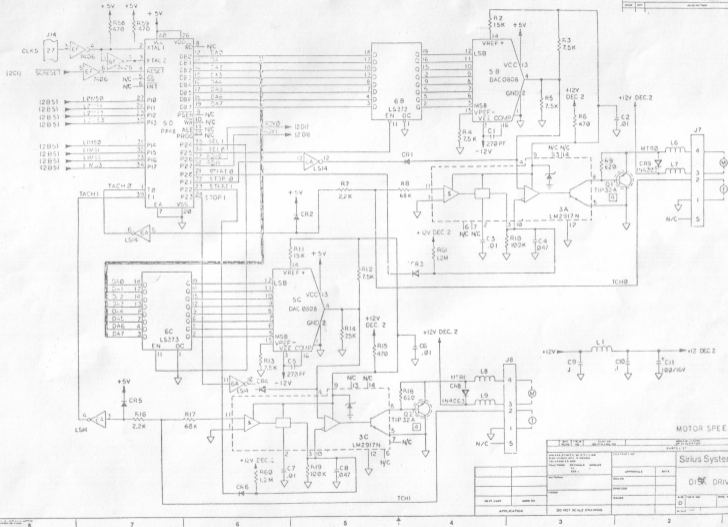

ID0 1  
ID1 3  
ID2 5  
ID3 7  
ID4 9  
ID5 11  
ID6 13  
ID7 15  
ID8 17  
ID9 19  
ID10 21  
ID11 23  
ID12 25  
ID13 27  
ID14 29  
ID15 31  
ID16 33  
ID17 35  
ID18 37

WR 39  
RD 41  
A0 43  
A1 45  
A2 47  
A3 49  
RESET 51  
PHASE 2 53

CS7 35  
TR0 21  
CS4 17  
CS5 19

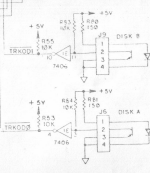
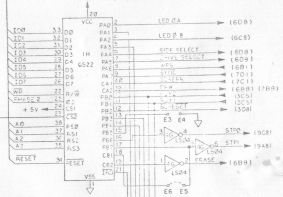
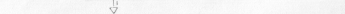
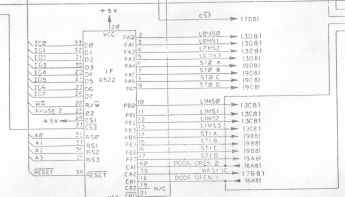
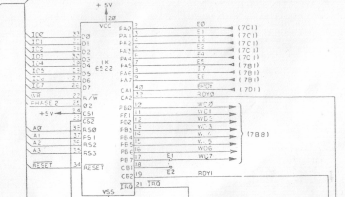

Sirius Systems Technology, Inc

**DISK DRIVE SCHEMATIC**

DATE: 12/81	REV: 1
PROJECT: 102671	
DRAWN BY: J. J. JONES	
CHECKED BY: J. J. JONES	
APP'D:	DATE:
REV:	DATE:
DISK DRIVE: 102671	
SHEET NO. 1 OF 1	

C-12

REV	NO	DESCRIPTION	DATE
1	1	INITIAL DESIGN	7/1/82
2	1	DESIGNED BOARD FOR 1041	7/1/82
3	1	REVISED PER EC 10420	8/4/82
4	1	REVISED PER EC 10411	7/14/82
5	1	REVISED PER EC 10440	8/21/82
6	1	DESIGNED PER EC 10444	8/11/82
7	1	DESIGNED PER EC 10448	8/11/82
8	1	REVISED PER EC 10451	9/1/82

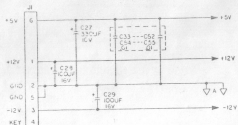

NOTES UNLESS OTHERWISE SPECIFIED.

1. ELECTRICAL VALUES ARE IN OHMS, MICROFARADS AND MICROMHENRIES.

2. ALL RESISTORS ARE 1% 1/4W.

3. FS IS FACTORY SELECT COMPONENTS.

4. DIODES ARE MOUNTED ON HEATSINK.

5. ALL INTEGRATED CIRCUITS ARE SN74 SERIES.

6. I.C. PINS ARE GND=7,10,14 EXCEPT FOR:

TYPE	GND	+5V
74LS173	8	16
74LS155	8	16
74LS159	8	16
74LS17	8	16
74LS145	8	16
74LS192	8	16
74LS171	8	16
74LS175	10	20
2510	11	24
75-102	4	9

7. ALL DIODES ARE 1N4148.



SPARE GATES

SHEET	DESCRIPTION
1	POWER & SPARES
2	CPU INTERFACE (6522)
3	MULTI SPEED (5716 & 104)
4	RAM
5	12.5V REG. INTERFACE
6	12.5V SELECT LED DECODE
7	12.5V EN-12.5V
8	12.5V 12.5V BISTEEP
9	STEPPER CONTROLS

POWER & SPARES

REF	VALUE	DESCRIPTION
R24	10K	
R25	10K	
R26	10K	
R27	10K	
R28	10K	
R29	10K	
C27	330µF	
C28	100µF	
C29	100µF	
D1	1N4148	
D2	1N4148	
D3	1N4148	
D4	1N4148	
D5	1N4148	
D6	1N4148	
D7	1N4148	
D8	1N4148	
D9	1N4148	
D10	1N4148	
D11	1N4148	
D12	1N4148	
D13	1N4148	
D14	1N4148	
D15	1N4148	
D16	1N4148	
D17	1N4148	
D18	1N4148	
D19	1N4148	
D20	1N4148	
D21	1N4148	
D22	1N4148	
D23	1N4148	
D24	1N4148	
D25	1N4148	
D26	1N4148	
D27	1N4148	
D28	1N4148	
D29	1N4148	
D30	1N4148	
D31	1N4148	
D32	1N4148	
D33	1N4148	
D34	1N4148	
D35	1N4148	
D36	1N4148	
D37	1N4148	
D38	1N4148	
D39	1N4148	
D40	1N4148	
D41	1N4148	
D42	1N4148	
D43	1N4148	
D44	1N4148	
D45	1N4148	
D46	1N4148	
D47	1N4148	
D48	1N4148	
D49	1N4148	
D50	1N4148	
D51	1N4148	
D52	1N4148	
D53	1N4148	
D54	1N4148	
D55	1N4148	
D56	1N4148	
D57	1N4148	
D58	1N4148	
D59	1N4148	
D60	1N4148	
D61	1N4148	
D62	1N4148	
D63	1N4148	
D64	1N4148	
D65	1N4148	
D66	1N4148	
D67	1N4148	
D68	1N4148	
D69	1N4148	
D70	1N4148	
D71	1N4148	
D72	1N4148	
D73	1N4148	
D74	1N4148	
D75	1N4148	
D76	1N4148	
D77	1N4148	
D78	1N4148	
D79	1N4148	
D80	1N4148	
D81	1N4148	
D82	1N4148	
D83	1N4148	
D84	1N4148	
D85	1N4148	
D86	1N4148	
D87	1N4148	
D88	1N4148	
D89	1N4148	
D90	1N4148	
D91	1N4148	
D92	1N4148	
D93	1N4148	
D94	1N4148	
D95	1N4148	
D96	1N4148	
D97	1N4148	
D98	1N4148	
D99	1N4148	
D100	1N4148	

POWER & SPARES

DATE: 7/1/82

DESIGNED BY: [Signature]

CHECKED BY: [Signature]

APPROVED BY: [Signature]

REVISIONS:

NO.	DESCRIPTION	DATE
1	INITIAL DESIGN	7/1/82
2	DESIGNED BOARD FOR 1041	7/1/82
3	REVISED PER EC 10420	8/4/82
4	REVISED PER EC 10411	7/14/82
5	REVISED PER EC 10440	8/21/82
6	DESIGNED PER EC 10444	8/11/82
7	DESIGNED PER EC 10448	8/11/82
8	REVISED PER EC 10451	9/1/82

Sirius Systems Technology, Inc.

12.5V SELECT LED DECODE

12.5V EN-12.5V

12.5V 12.5V BISTEEP

100671

Sheet 1 of 1

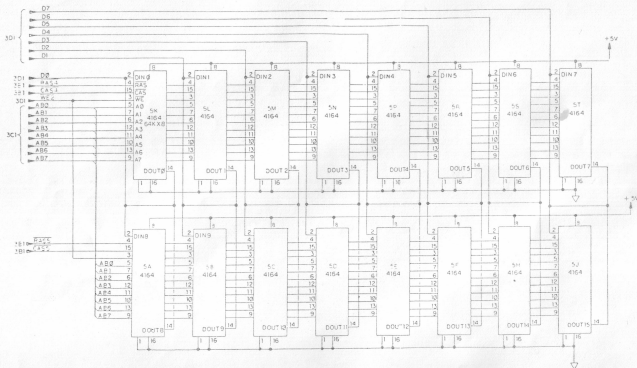

C-14

DATE: 10/10/71		DRAWN BY: [Signature]		SIRUS SYSTEMS TECHNOLOGY, INC.	
CHECKED BY: [Signature]		APPROVED BY: [Signature]		SCHEMATIC	
PART NAME: 31-K MEMORY		PART NO: 101071		REV: A	
APPLICATION: [Blank]		SEE ALSO: [Blank]		DATE: 10/10/71	

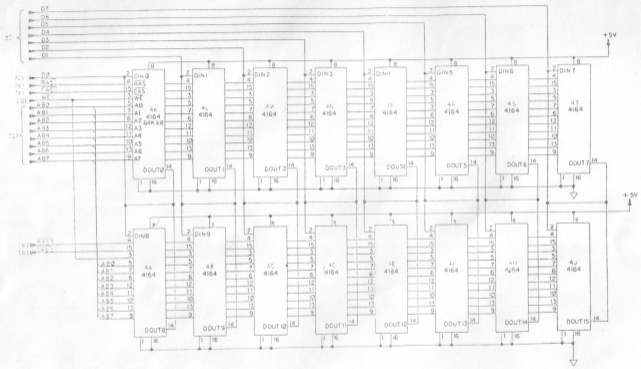

C-15

PART NUMBER: 101C71 REV: 1		DATE: 10/1/71	
DRAWN BY: [Signature] CHECKED BY: [Signature]		DESIGNED BY: [Signature]	
TITLE: 3144 MEMORY		SIRIUS SYSTEMS TECHNOLOGY, INC.	
APPLICATION: DO NOT SCALE DRAWING		SCALE: 1:1	

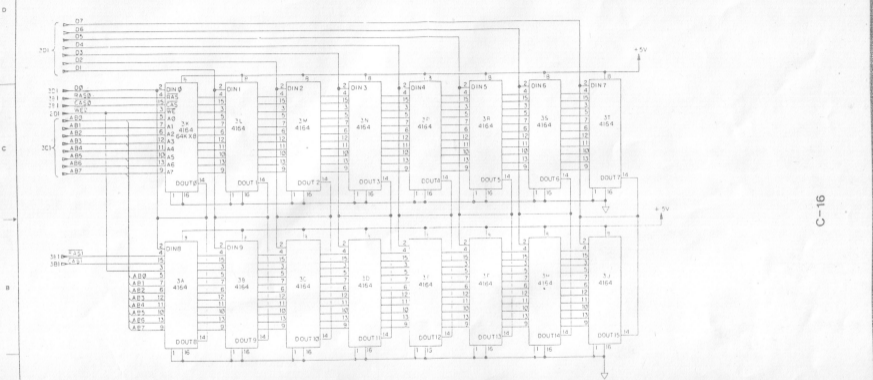

32I  
D0  
D1  
D2  
D3  
D4  
D5  
D6  
D7  
AB0  
AB1  
AB2  
AB3  
AB4  
AB5  
AB6  
AB7  
ZC0  
ZC1  
ZC2  
WEK

3BI  
ABQ0  
ABQ1  
ABQ2  
ABQ3  
ABQ4  
ABQ5  
ABQ6  
ABQ7

8	7	6	5	4	3	2	1
---	---	---	---	---	---	---	---

C-16

<p>10107X REV. 10/73</p>		<p>Sirius Systems Technology, Inc.</p> <p>SCHEMATIC 24K MEMORY</p> <p>10107X</p>
------------------------------	--	--



C-17

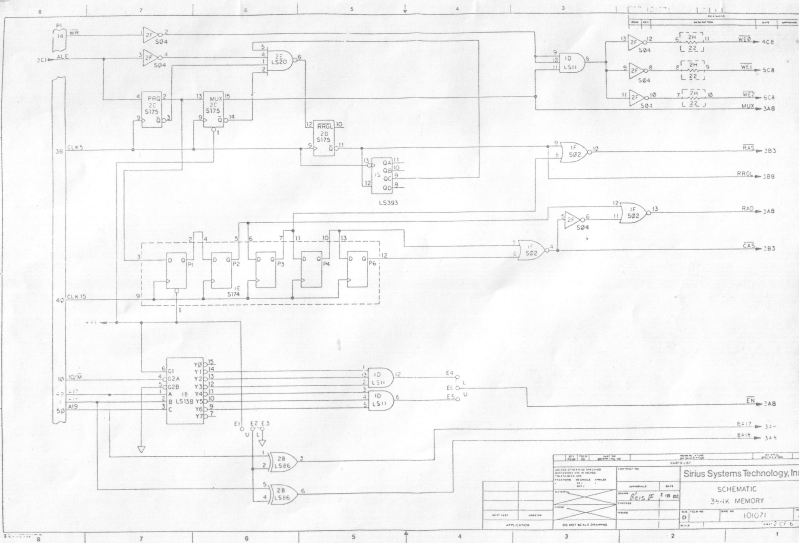

[REVISION]		[DATE]		[DRAWN]	
SIRIUS SYSTEMS TECHNOLOGY, INC.					
SCHEMATIC					
36-BIT MEMORY					
101071					
[REVISION]					
[DATE]					
[DRAWN]					
[CHECKED]					
[APPROVED]					
[REVISION]					
[DATE]					
[DRAWN]					
[CHECKED]					
[APPROVED]					

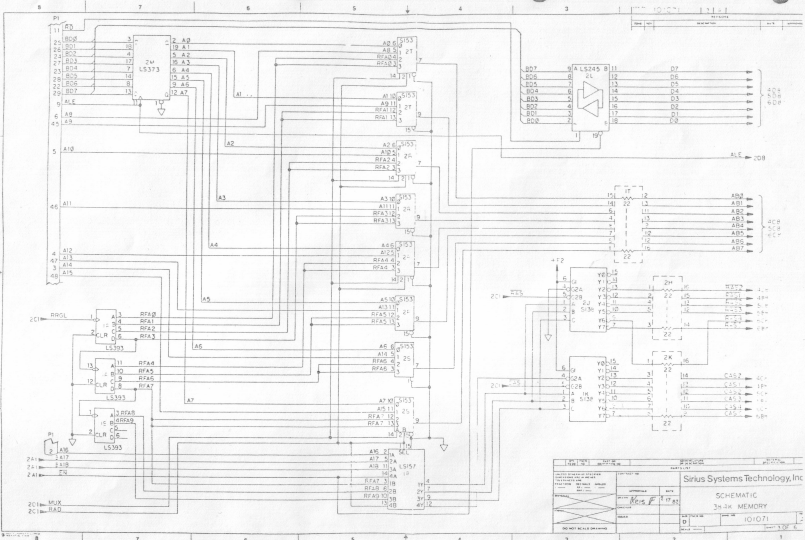

REV	DATE	DESCRIPTION	APPROVED	DATE
1	10/07	SCHEMATIC		
Sirius Systems Technology, Inc.				
34-BIT MEMORY				
IO1071				
REV 1				
D				

C-18

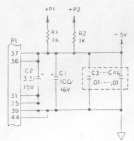

- NOTES UNLESS OTHERWISE SPECIFIED
1. ELECTRICAL VALUES ARE IN OHMS, MICROFARADS, AND MICROHENRIES.
  2. ALL RESISTORS ARE ±5%, 1/4W
  3. ALL INTEGRATED CIRCUITS ARE SN74 SERIES.
  4. IC PINS ARE, GND=7, +5V=14

IC TYPE	GND	+5V
74LS138	8	16
74LS153	8	16
74LS157	8	16
74LS174	8	16
74LS175	8	16
74LS245	10	20
74LS373	10	20
4164	16	8 (REF)

C-19



SPARE GATES

ES					
R2					
C10					
LAST USED	NOT USED	REF DESIG	APP DESIG	APP DESIG	APP DESIG
REFERENCE DESIGNATION					

Sirius Systems Technology, Inc

SCHEMATIC

2 - 1K MEMORY

10-C 71

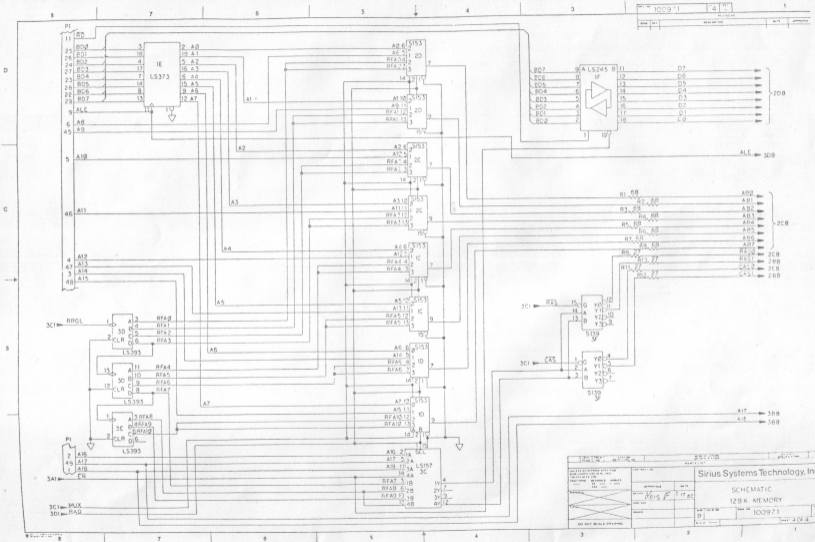

C-20

PART NUMBER: 100971 REV: 4		DATE: 11/11/81	
<b>Sirius Systems Technology, Inc.</b>			
SCHEMATIC 128K MEMORY			
PART NUMBER: 100971	REV: 4	DATE: 11/11/81	DRAWN BY: J. J. J.

C-21

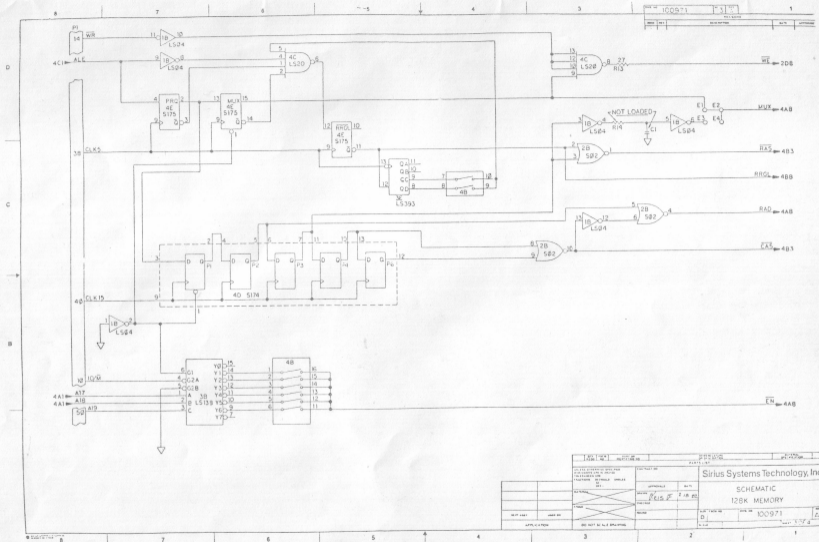

REV	DESCRIPTION	DATE	BY
Sirius Systems Technology, Inc.			
SCHEMATIC			
128K MEMORY			
DATE			
DRAWN			
CHECKED			
APPROVED			

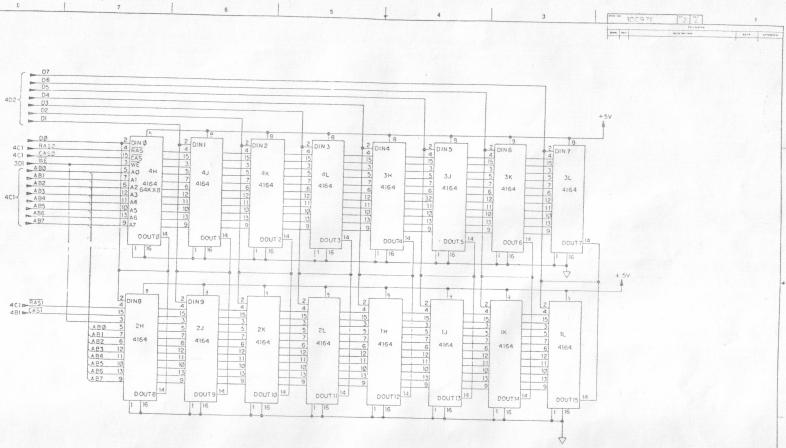

REV	100073	2/78
DATE	10/11/78	REV
DESIGNER	W. J. ...	APP'D
CHECKED		DATE

4164 SRAM 16K MEMORY		SIRIUS SYSTEMS TECHNOLOGY, INC. SCHEMATIC 16K MEMORY	
PART NO. 100073	REV 2/78	DATE 10/11/78	DRAWN BY W. J. ...
CHECKED BY ...	APPROVED BY ...	TITLE SCHEMATIC	PART NO. 100073

C-22

FORM NO.	100971	REV	1	DATE	1
PREPARED BY: S. S. J. / P. B. J.					
DESIGNED BY: S. S. J. / P. B. J.					
CHECKED BY: S. S. J. / P. B. J.					
DATE: 11/11/69					

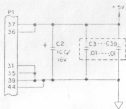

- NOTES-UNLESS OTHERWISE SPECIFIED
- ELECTRICAL VALUES ARE IN OHMS, MICROFARADS, AND MICROHENRIES.
  - ALL RESISTORS ARE  $\pm 5\%$ ,  $1/4W$
  - ALL INTEGRATED CIRCUITS ARE SN74 SERIES.
  - IC PINS ARE GND=7, +5V=14

IC TYPE	GND	+5V
74LS138	8	16
74 139	8	16
74 153	8	16
74LS157	8	16
74 174	8	16
74 175	8	16
74LS245	10	20
74LS373	10	20
4864	16	8

C-23



SPARE GATES

REV	C39	LAST USED	NOT USED	REF. DESIGNATION	APPLIC. PR. DATE
DO NOT SCALE DRAWING					
PART NO.		PART NAME			
REV.		REV.			
DATE		DATE			
BY		BY			
CHECKED		CHECKED			
DATE		DATE			
BY		BY			
DATE		DATE			
BY		BY			
DATE		DATE			
BY		BY			
DATE		DATE			

Sirius Systems Technology, Inc.

SCHEMATIC  
128 K MEMORY

100971

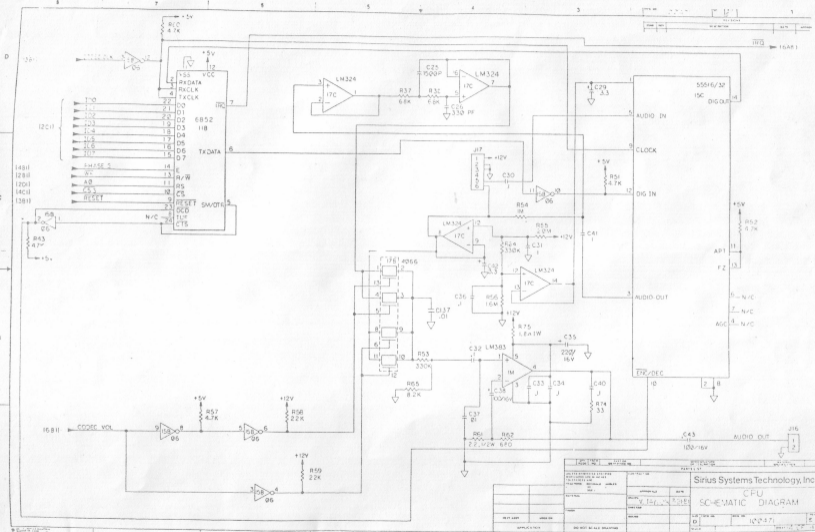

C-24

REVISIONS		DATE		BY	

Sirius Systems Technology, Inc.	
CPU	
SCHEMATIC DIAGRAM	
DATE	10/2/87
BY	



C-25

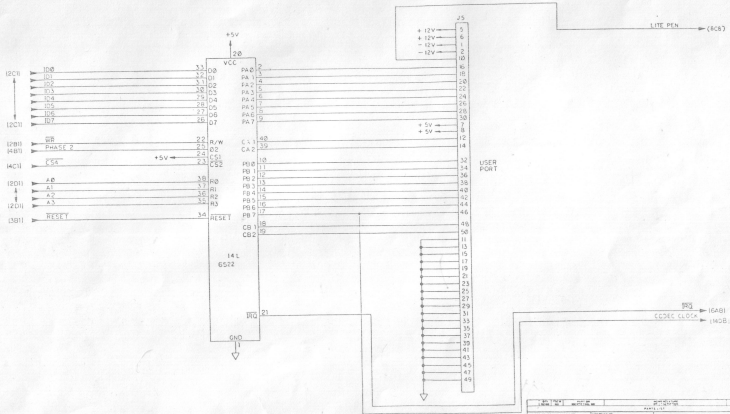

14L6572 (14L6572)		PART NO: 100471 DATE: 1/12/91	
SIRIUS SYSTEMS TECHNOLOGY, INC. 100471		SIRIUS SYSTEMS TECHNOLOGY, INC. 100471	
APPLICATION:		DATE:	
DO NOT SCALE DRAWING		CPU SCHEMATIC DIAGRAM	
100471		100471	

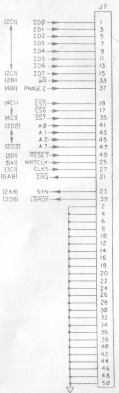
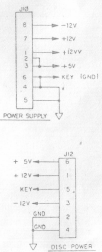
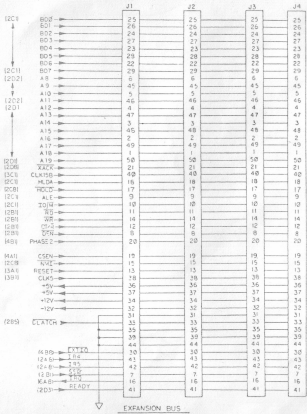

DISK DRIVE

Sirius Systems Technology, Inc.

CPU SCHEMATIC DIAGRAM

122471

REV. 2/77

DATE: 12/27/77

BY: [Signature]

APPROVED: [Signature]

DESIGN: [Signature]

TEST: [Signature]

WORK IN PROGRESS

DO NOT REPLY TO THIS PAGE