

UNIVAC 9000 SERIES

Applications Software Directory

APPLICATION SERVICES

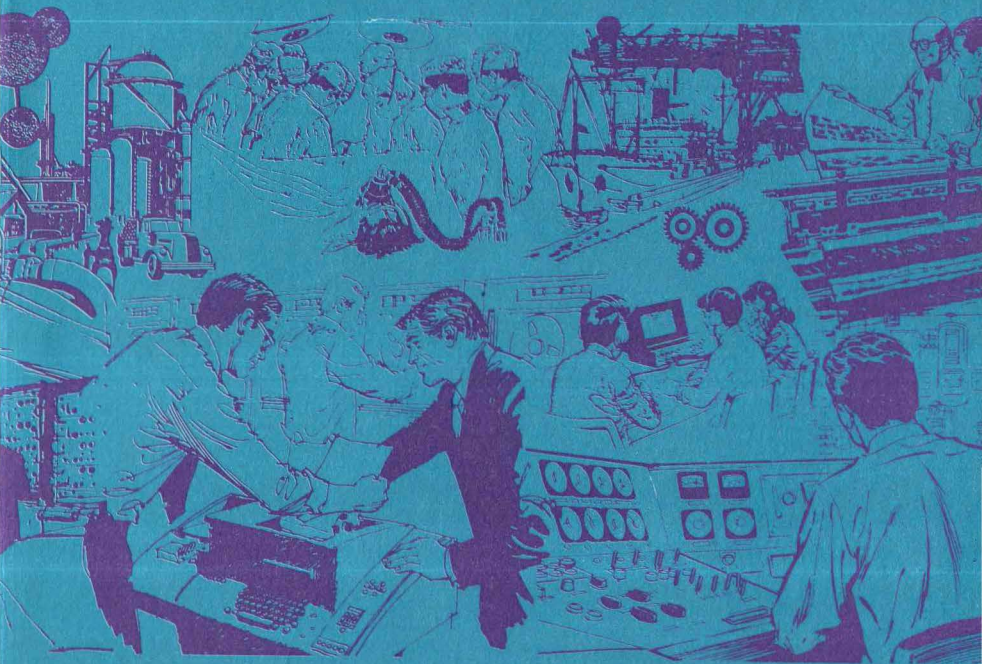

SPERRY  **UNIVAC**
COMPUTER SYSTEMS

DATE	3/74	TABLE OF CONTENTS UA-0076
REVISION		

APPLICATIONS SOFTWARE

TABLE OF CONTENTS

General Information	1
UNIVAC 9200/9300	11
UNIVAC 9400	143
Applications Index	A-1

APPLICATIONS SOFTWARE

General Information

DATE 3/74	GENERAL INFORMATION
REVISION	

APPLICATIONS SOFTWARE

INTRODUCTION

The Applications Software Directory (ASD) is designed to acquaint Univac personnel with applications programs which are available, as well as programs which are currently in development, in various application fields.

The ASD is produced by the Worldwide Applications Development Center, Sperry Univac, P. O. Box 500, Blue Bell, PA 19422 U.S.A. It is for internal use only. No program should be committed contractually to any customer without prior divisional approval.

This directory is published in four major, individual sections with each section related to specific Univac computer systems. The four sections, with document numbers, are:

UNIVAC 400 Series; Series 70	UA-0075
UNIVAC 9000 Series	UA-0076
UNIVAC 1100 Systems	UA-0077
UNIVAC Series 90	UA-0078

The UNIVAC 400 Series; Series 70 document provides information about applications programs for the UNIVAC 418, the UNIVAC 490, the UNIVAC 494, and the UNIVAC Series 70.

The UNIVAC 9000 Series directory covers applications programs for the UNIVAC 9200, the UNIVAC 9300, and the UNIVAC 9400.

The UNIVAC 1100 Systems volume describes applications programs which are available for systems in that series.

Applications programs for the UNIVAC 9700, and UNIVAC Series 90 equipment are included in the UNIVAC Series 90 publication.

The directory will be reprinted periodically as new programs are added, as revisions are made to current programs, etc. All Univac offices will be notified when reprints become available.

Certain programs described in the directory are restricted in nature and are so denoted individually. Restrictions may apply to international and/or domestic users. Please observe these restrictions when ordering a particular program.

DATE 3/74	GENERAL INFORMATION
REVISION	

APPLICATIONS SOFTWARE

Programs described in the ASD are divided into categories according to source and degree of Univac support provided. These categories are:

- 1 - RELEASED and SUPPORTED. These are programs implemented by Univac and supported to the degree necessary to achieve successful installation of all user systems. Documentation follows Univac standards, and maintenance is provided on a continuing basis.
- 2 - FIELD TEST. Univac may offer software to volunteering users during the development phase if it furthers the development of such programs.
- 3 - UNIVAC SUPPLIED, NOT SUPPORTED. These programs have been implemented successfully on the initial user's system. No further support is offered.
- 4 - USER SUPPLIED, NOT SUPPORTED. Customer implemented. Univac distributes as is, but does not support, e.g., USE Program Library Interchange, 1100 Series.
- 5 - IN DEVELOPMENT. Programs are not available but notification is provided of a development effort with target dates for completion.

The Worldwide Applications Development Center is appreciative of the efforts of those who have contributed programs and documentation to be listed in the Applications Software Directory. Additions to the directory are always welcome. Continuing support from the field will help make the directory even more valuable as a marketing tool.

All requests for additional information, data to be used in updating, problems with programs (even if not supported), and suggestions of any type concerning the directory should be sent to:

Manager, Applications Services
Sperry Univac
P. O. Box 500
Blue Bell, PA 19422 U.S.A.

APPLICATIONS SOFTWARE

DATE 3/74	GENERAL INFORMATION
REVISION	

CONTENTS OF DIRECTORY

Each of the directories related to specific Univac systems is composed of three sections:

- General Information
- Program Abstracts
- Applications Index, Appendix A

The General Information section provides details about ordering procedures for programs and documentation, sample requests for programs, and other information to assist in efficient use of the ASD.

In the Program Abstract section of the ASD, a Table of Contents prefaces each section and shows the programs in alphabetical order by Index Name. All abstracts are arranged alphabetically by Index Name in the directory. Each abstract includes the minimum hardware configuration required, the operating system required, the title and number of available documentation, the support category, the developing organization, the source of the program, and the order number.

Abstracts are also supplied for applications programs which are still in development. These are supplied for informational purposes only. When these programs become available, all Univac branches will be notified. Under no circumstances should commitments be made concerning programs shown as being in development. Orders for programs in development will be returned unfilled.

The Applications Index, in Appendix A, lists all programs contained in the directory according to an application field or industry. This index lists each Program Name, the Univac system on which it operates, and the Index Name. A program may be useful in areas not noted in the directory. In such cases, information concerning different application areas should be sent to the Manager, Applications Services.

The Univac Worldwide Applications Development Center acts solely as a distribution center for the programs described in the directory. The programs and related materials are believed to be accurate and reliable. However, no warranty, expressed or implied, is made by the contributors, or the Applications Development Center as to the accuracy and functioning of any programs and/or related program materials described herein. No responsibility is assumed by the contributors or the Univac Worldwide Applications Development Center in connection therewith.

DATE	3/74	GENERAL INFORMATION
REVISION		

APPLICATIONS SOFTWARE

ORDERING PROCEDURES

Items listed in the Applications Software Directory are available from a variety of sources, and obtained by means of several procedures.

1. UPLI and UUAPLI (User Program Library Interchanges). Programs of this nature are identified under the Availability heading on the abstract pages. Procedures, distribution points, and worldwide availability vary considerably. It is recommended that the divisional or regional technical director be consulted for clarification as required. For example, domestic marketing offices should submit requests through the branch Systems Analyst manager, using published Library Interchange procedures and the correct order form. Figure 1 shows a sample of the UPLI and the UUAPLI order forms.

NOTE: Do not use the Applications Software Requisition (UD1-1986) to order Library Interchange items.

2. SUPPORT SERVICES or SOFTWARE ORDER SERVICES. These items originate at St. Paul for major systems or at Blue Bell for basic systems. As such, they are often part of the standard systems library which is released periodically. They may be available also on separate requests using the established procedures for ordering standard systems tapes. These procedures may vary depending on the branch, subsidiary, or division involved. Please consult your librarian or S/A manager for clarification as required.
3. INTERNATIONAL SUBSIDIARIES. Programs available from overseas branches and subsidiaries may be ordered directly by contacting the S/A manager at the source. Arrangements to share reproduction and shipping costs may be necessary. If preferred, these items may be ordered through Applications Services in Blue Bell. In this case, considerable lead time must be allowed.
4. APPLICATIONS SERVICES. Domestic branches should use the Applications Software Requisition, UD1-1986, current revision, and complete it as follows:
 - A. Fill in your name, address, Zip code, and if applicable, your Sales Office Location No. or Home Office Div. & Dept. No., etc. You may wish to maintain a sequential record of your requisition numbers in the appropriate space on the order form.
 - B. Specify the quantity, order number, and index name for each item desired. The majority of the programs are delivered on magnetic tape. Therefore, a 2400' tape should be included with the requisition with the tape ID noted on the form.

DATE 3/74	GENERAL INFORMATION
REVISION	

APPLICATIONS SOFTWARE

- C. When ordering documentation, show the quantity desired, the document number, and the title. Check the appropriate box on the requisition, indicating Card Program, Tape Program, or Documentation. One copy of documentation is automatically provided with each program requested.

NOTE: Do not order programs and documentation on the same requisition.

- D. Requisitions from domestic locations should be sent, with any necessary tapes, to:

Manager, Applications Services
Sperry Univac
P. O. Box 500
Blue Bell, PA 19422

- E. Requisitions from overseas locations should not include tapes, and should be sent to:

Manager, Publications Dissemination
Sperry Univac
P. O. Box 500
Blue Bell, PA 19422 U.S.A.

Figure 2 and Figure 3 illustrate Applications Software Requisitions completed correctly for tape programs and documentation, respectively.

5. SERIES 70 SYSTEMS CENTER. Requests from domestic locations require the use of different forms when ordering documentation, and when ordering programs.

- A. Documentation is ordered on a Sales Help Requisition (UD1-578) which is sent to:

Customer Information Distribution Center (CIDC)
Sperry Univac
381 Brooks Road
King of Prussia, PA 19406

- B. Programs are ordered on a Library Systems Support Request (UD1-292), shown in Figure 4, and sent to:

Systems Programming, Series 70 Operations
Sperry Univac
1905 Rowland Street
Cinnaminson, NJ 08077
Attn: Customer Services

DATE 3/74	GENERAL INFORMATION
REVISION	

APPLICATIONS SOFTWARE

<p>SPERRY UNIVAC</p> <p>P. O. BOX 500 BLUE BELL, PA. 19422 U. S. A.</p>			<p>APPLICATIONS SOFTWARE REQ'N. ORDER PROGRAMS AND PROGRAM DOCUMENTATION ON SEPARATE REQUISITIONS. DO NOT COMBINE.</p> <p><input type="checkbox"/> CARD PROGRAM <input checked="" type="checkbox"/> TAPE PROGRAM <input type="checkbox"/> DOCUMENTATION</p>		
SALES OFFICE LOCATION NO. 1360	HOME OFFICE DIV. & DEPT. NO.	YOUR REQUISITION NO. 68	QUANTITY	MANUAL NO. OR ORDER NO.	DOCUMENTATION TITLE OR INDEX NAME OR TAPE ID NOS.
<p>SHIP TO J. R. Adams Sperry Univac 1510 Willow Lawn Dr. Richmond, VA 23230</p>			1	940007	IMS94 003476
<p>U01-1784 REV. 9-72</p>			<p>SEND REQUISITION TO: MANAGER, APPLICATIONS SERVICES SPERRY UNIVAC P. O. BOX 500, BLUE BELL, PA. 19422 U.S.A.</p>		

Figure 2. Applications Software Requisition For Program

<p>SPERRY UNIVAC</p> <p>P. O. BOX 500 BLUE BELL, PA. 19422 U. S. A.</p>			<p>APPLICATIONS SOFTWARE REQ'N. ORDER PROGRAMS AND PROGRAM DOCUMENTATION ON SEPARATE REQUISITIONS. DO NOT COMBINE.</p> <p><input type="checkbox"/> CARD PROGRAM <input type="checkbox"/> TAPE PROGRAM <input checked="" type="checkbox"/> DOCUMENTATION</p>		
SALES OFFICE LOCATION NO. 1360	HOME OFFICE DIV. & DEPT. NO.	YOUR REQUISITION NO. 67	QUANTITY	MANUAL NO. OR ORDER NO.	DOCUMENTATION TITLE OR INDEX NAME OR TAPE ID NOS.
<p>SHIP TO J. R. Adams Sperry Univac 1510 Willow Lawn Dr. Richmond, VA 23230</p>			6	UAD055R	PROFITS Gen. Des.
<p>U01-1784 REV. 9-72</p>			<p>SEND REQUISITION TO: MANAGER, APPLICATIONS SERVICES SPERRY UNIVAC P. O. BOX 500, BLUE BELL, PA. 19422 U.S.A.</p>		

Figure 3. Applications Software Requisition For Documentation

APPLICATIONS SOFTWARE

UNIVAC 9200/9300

APPLICATIONS SOFTWARE

UNIVAC 9200/9300 APPLICATIONS SOFTWARE

<u>INDEX NAME</u>	<u>PROGRAM NAME</u>	<u>PAGE</u>
ACCPAY	Accounts Payable	19
ACCREC	Accounts Receivable	21
ACTS1	IBM 1400 to UNIVAC 92/9300 Translator	23
ALT	Card Reproducing Program	24
A92	Enhanced Card Assembler	25
BIC	Basic Inventory Control	26
BSC	Building Supplies Calculation	27
CALC	Payroll Package	28
CALP3	CALCOMP Postprocessor	29
CAMEL	Computer-Aided Management Educational Language	30
CAMPUS	Student Scheduling Package	31
CBCS	COBOL Cross Reference	33
CCAMEL	Conversational CAMEL	34
COMASR	ASR33 to UNIVAC 9300 Communications Handler	35
COMCDC	UNIVAC 9200 to CDC 6400/6500 Communications Handler	37
COMIO	Communications I/O, UNIVAC 9300/IBM 360	39
COMKSR	KSR35 to UNIVAC 9200/9300 Communications Handler	40
COM360	UNIVAC 9200 to IBM 360/40 Communications Handler	42
COM418	UNIVAC 9300 to 418 II Communications Handler	43
COM92	UNIVAC 9200/2780 to 9300 Communications Handler	45
CPM	Critical Path Method Scheduling	46
CRDEDT	Card Edit	48
CRJCL	Create JCL Cards	49

APPLICATIONS SOFTWARE

UNIVAC 9200/9300 APPLICATIONS SOFTWARE

<u>INDEX NAME</u>	<u>PROGRAM NAME</u>	<u>PAGE</u>
CRSRPG	RPG Cross Reference	50
CSEXT	Extension to Supervisor	51
CSRDR	Control Stream Reader, 90-Column	52
DAIRY	Dairy Route Accounting	53
DCS1	Data Communications Subsystem Test Program	55
DPRU	Disc Print and Update Program	56
DSFOR	UNIVAC 9200/9300/8411/8414 Disc FORTRAN System	57
EPA93	Economic Planning Agency	58
FASACC	Fixed Assets Accounting	59
FLOMAT	Assembler Program Flowcharter	61
GAMA10	GAMMA10 to UNIVAC 9300 Translator	62
GARCUT	Garment Cutting Optimization	63
GDAT	Generator of Data Files	65
GENACC	General Accounting Program	66
GENLED	General Ledger Processing	67
GEP93	General Payroll Application Package	68
GIR	Information Retrieval System	69
HAFD	Half Duplex 9000 to 9000 Communications Handler	70
HAL	RPG Halt/Display/Accept Routine	71
HEXCVT	Packed Decimal to Hexadecimal Conversion Program	72
ICL	Introductory Computer Language	73
JCLG	Job Control Extension	74

DATE	TABLE OF CONTENTS 9200/9300
3/74	
REVISION	
7	

UNIVAC 9200/9300 APPLICATIONS SOFTWARE

<u>INDEX NAME</u>	<u>PROGRAM NAME</u>	<u>PAGE</u>
IP92	Linear Programming System	75
IP93	Linear Programming System	76
MARGO	Report Generator	78
MEDPAK	Medical Accounting Package	79
MINAPT	Automatically Programmed Tools	80
MINILP	Linear Programming for Minimum System	81
MNCB	Mini-COBOL	82
MNFT	Mini-FORTRAN	83
MORACC	Mortgage Accounts Processing	84
MRA93	Multiple Regression Analysis	85
MSC068	Tape, Card, Print Utility	86
NET93	UNIVAC 9300 Network Emulator	87
OS600	OS600 Operating System	90
PACSII	Communications Control Program	92
PAYROL	Payroll Program	93
PERTCD	PERT/CPM for Card System	95
PLOT92	General Plot with Histogram	96
PR79	UNIVAC 1050 to 9000 Tape Conversion	97
PR97	UNIVAC 9000 to 1050 Tape Conversion	98
PTCUP	Card Utility Program	99
PTSYM	Paper Tape Symbiont	100
PUR	IBM 360/20 to UNIVAC 9200/9300 Translator	101

APPLICATIONS SOFTWARE

UNIVAC 9200/9300 APPLICATIONS SOFTWARE

<u>INDEX NAME</u>	<u>PROGRAM NAME</u>	<u>PAGE</u>
REMFIX	Throughput Improvement	102
RE1004	UNIVAC 1004 Handler	103
SAVACC	Savings Accounts Processing	104
SCORE	School Curriculum Oriented Ratings and Evaluation	105
SIMS	Scientific Inventory Management System	106
SIM05	UNIVAC 1005 Simulator	107
SISIO	Special Indexed-Sequential IOCS	108
SNAP9	Snap Dump Routine	109
SORT2	Generative Sort Routine	110
S01001	Sort Utility Routine, 9200/9300/1001	111
SPUC	Simulator for UNIVAC 1004 PUC Programs	112
STAT92	Statistical Package	113
STSP	Special Tape Sort Package	114
SWITCH	Utility Program, IBM 360/20 to UNIVAC 9200/9300	115
TALC	UNIVAC 1005 to 9200/9300 Translator	117
TAPE	I/O for Nonstandard Tape Files	118
TAPE45	Enhancements to Tape I/O Routine	119
TAPE79	Magnetic Tape Conversion	120
TRAN93	UNIVAC 9300 to UNIVAC 9400 Translator	121
TVSCH	Television Scheduling	123
UCA	Client Accounting	124
UHASPA	UNIVAC 9200/9300 to IBM 360 HASP II Communications Handler	126

APPLICATIONS SOFTWARE

UNIVAC 9200/9300 APPLICATIONS SOFTWARE

<u>INDEX NAME</u>	<u>PROGRAM NAME</u>	<u>PAGE</u>
UHASP2	UNIHASP 9200 to IBM 360 HASP Handler using DCS-1C	127
UNIBAU	Building Industry Program	128
UNICOG	Univac Coordinate Geometry System	129
UNIS93	Univac Industrial System	130
UNITST	Testing Aid	133
UTRG	RPG Utility Program	134
U100H	UNISCOPE 100 Handler	135
WICA	Wholesale Ice Cream Accounting	136
WICS	Wholesale Inventory Control System	138
WMATH	Double Precision Mathpac	140
92LIST	Listing Program	141

DATE	SYSTEM TYPE	INDEX NAME
10/72	9200	ACCPAY
REVISION		
5		

APPLICATIONS SOFTWAREACCOUNTS PAYABLE

The ACCOUNTS PAYABLE application is a generalized package that can be easily modified to fit any specific payable situation. This application package satisfies the following three objectives:

- . To record the liability at the initiation of a purchase order
- . To record disbursements and provide an accurate accounting of the distribution of cash
- . To provide a control over the flow of money from a company and at the same time take advantage of all discounts due

The package contains the necessary programs to produce the following reports or registers:

- . Purchase order commitments
- . Due date register
- . Accounts Payable checks
- . Accounts Payable register
- . Check reconciliation report

Configuration: 9200; 8K; Serial Reader and Punch

Operating System: RPG

Documentation: ACCOUNTS PAYABLE, Users Manual, UX-5313; Applications Brief, UX-5312

Support: Category 3

Developed By: Americas Division

Availability: Applications Services

Order No.: 920047

DATE	SYSTEM TYPE	INDEX NAME
10/72	9200	ACCPAY
REVISION	9300	
5		

APPLICATIONS SOFTWARE

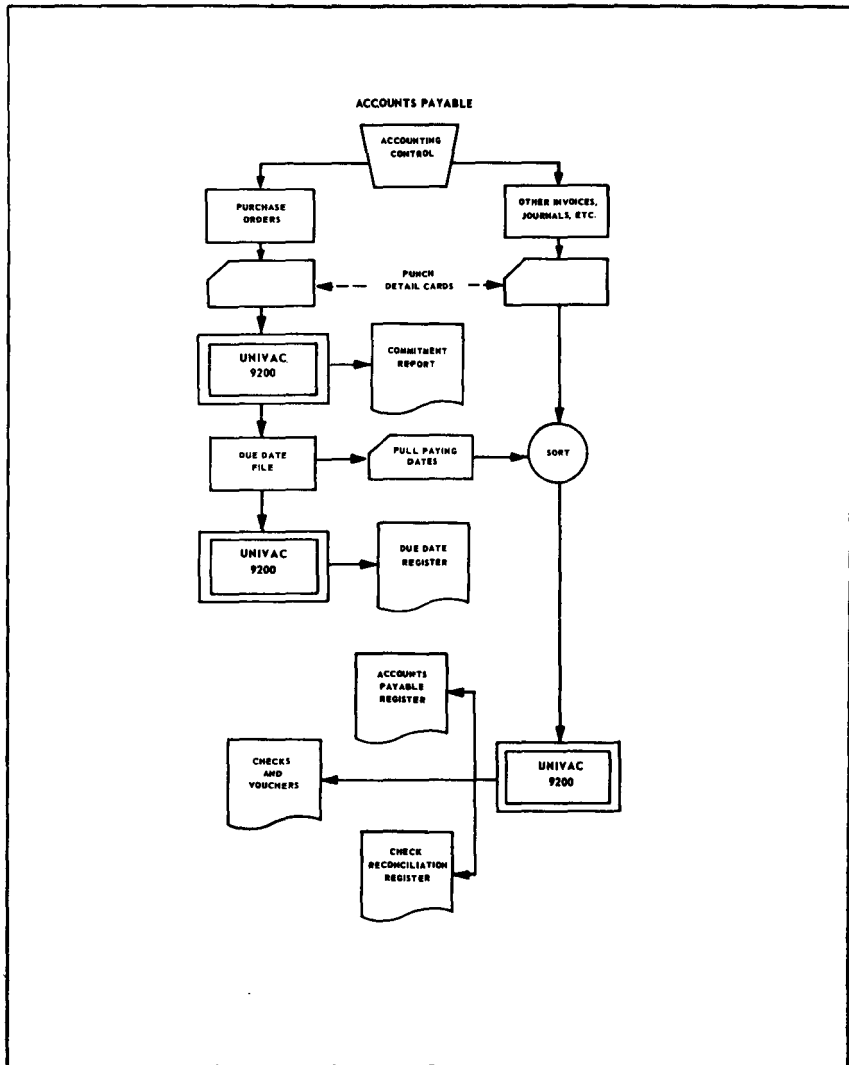

DATE 2/72	SYSTEM TYPE 9200	INDEX NAME ACCREC
REVISION 3		

APPLICATIONS SOFTWARE

ACCOUNTS RECEIVABLE

A comprehensive application designed to provide the user with maximum control in the efficient processing of one of the most important assets.

The UNIVAC 9200 Accounts Receivable package provides the capabilities to maintain customer's accounts, credit payments, to produce accurate statements of unpaid balances, provide internally aged trial balances and produce summarizations used in evaluating the history and status of each account.

The package provides programs to handle the standard functions:

- Invoice registers
- Invoice corrections
- Invoice correction notices
- Accounts receivable registers
- Cash receipts
- Aged trial balance
- Customer statements
- Credit limits
- Demand notices

Configuration: 9200; 8K

Operating System: RPG

Documentation: Accounts Receivable Processing, User's Manual, UA-0010

Support: Category 3

Developed By: Americas Division

Availability: Applications Services

Order No.: 920001

DATE	SYSTEM TYPE	INDEX NAME
2/72	9200	ACCREC
REVISION	9300	
3		

APPLICATIONS SOFTWARE

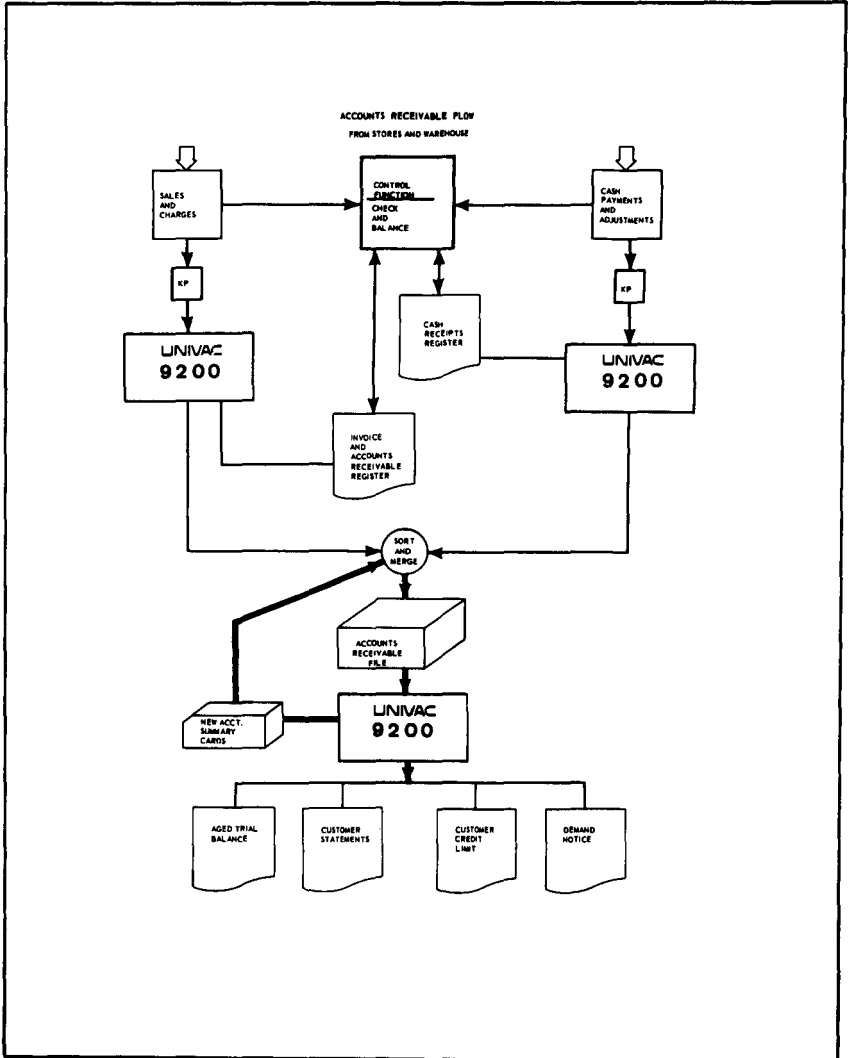

DATE	SYSTEM TYPE	INDEX NAME
2/72	9200	ACTS1
REVISION 3	9300	

APPLICATIONS SOFTWARE

ACTS I

IBM 1400 TO 92/9300 TRANSLATOR

The ACTS I Translator provides the 92/9300 user with a 1400 conversion capability. Accepting as input 1401/1440/1460 Autocoder or SPS source programs, the ACTS Translator produces UNIVAC 92/9300 assembly language source programs. The translated programs are ready for assembly under the UNIVAC 92/9300 Tape, Tape/Disc, or Card Assembler and can be run on 92/9300 computer systems using the NCOS or Exec I Operating System.

During translation a listing of the original source statements and the translated 92/9300 target statements will be produced. In addition, questionable 92/9300 translations will be flagged by a warning diagnostic message and untranslatable statements will be flagged by a critical diagnostic message. Translation supported for 8410 Disc only.

Configuration: 9200; 16K (24K recommended); column card punch

Operating System: Nonstandard

Documentation: User's Manual, UX-5270

Support: Category 3

Developed By: Americas Division

Availability: Applications Services

Order No.: 920041

DATE 8/71	SYSTEM TYPE 9200 9300	INDEX NAME ALT
REVISION		

APPLICATIONS SOFTWARE

CARD REPRODUCING PROGRAM (ALT)

ALT permits the reproducing of any column to any column with features for gang-punching up to ten columns of fixed information. BAL, COBOL, FORTRAN or RPG decks may be renumbered using this program. Input may be 90-column cards if the 90 read feature is on the system.

Configuration: 9200/9300; minimum

Operating System: MOS

Documentation: Operator's Instructions

Support: Category 3

Developed By: Americas Division

Availability: Applications Services

Order No.: 920073

DATE	SYSTEM TYPE	INDEX NAME
2/72	9200	A92
REVISION	9300	

APPLICATIONS SOFTWARE

ENHANCED CARD ASSEMBLER

The A92 Card Assembler is an expanded version of the standard card assembler. It has the following major enhancements:

- . Produces loadable object program, unless otherwise specified, with minimum of effort by user.
- . Includes capability of generating IOCS for the following macro calls: DTFCR, DTFCFS, DTFRP, DTFRW, DTFRP, DTFCG, DTFTPT.
- . Produces alphabetized symbol table.
- . Produces more helpful macro-pass diagnostics than the "Pre-Assembly Macro Pass" does.
- . Is easier to use than standard macro generator/assembler/linker system.
- . Generates MFD, EDIT, and all normally required translate tables.
- . Produces output that is completely compatible with that of the Tape/Disc Assembler.
- . A92 has the option of permitting run-time patches to object programs.

Configuration: 9200; 8K; Reader or 1001; Punch; Printer

Operating System:

Documentation: User's Guide, Loose-Leaf Pages

Support: Category 3

Developed By: Americas Division

Availability: Applications Services

Order No.: 920090

DATE 10/72	SYSTEM TYPE 9200	INDEX NAME BIC
REVISION 3		

APPLICATIONS SOFTWAREBASIC INVENTORY CONTROL

This package may be used by organizations stocking any type of produce in any quantity and at any number of locations.

The output of the program consists of two reports which provide all necessary details to audit and control inventory of parts. The transaction register lists all transactions to be processed for a particular period, and it includes controlled totals to insure that all intended transactions are included in the run. The stock status report will update the inventory status of each part, by location, as desired. Designating and calculating fields upon updating are printed and simultaneously punched into cards for subsequent runs. The report will also show part availability and suggested replenishment quantity as applicable.

The program contains two basic types of fields: Designating field and calculating fields. Designating fields are those that relate to purely descriptive information, i.e., part number, description, etc. These fields do not involve transaction quantities but do control totaling operations when so indicated, i.e., a part number change can give a resulting number of transactions for that given part number. Calculating fields are those that are manipulated by a transaction quantity, i.e., on order, quantity received, replenishment quantity, etc.

Configuration: 9200; 8K; Card System

Operating System: Assembler

Documentation: Basic Inventory Control, Loose-Leaf Pages

Support: Category 3

Developed By: Americas Division/ Univac Canada

Availability: Application Services

Order No.: 920003

DATE 8/71	SYSTEM TYPE 9300	INDEX NAME BSC
REVISION 1		

APPLICATIONS SOFTWAREBUILDING SUPPLIES CALCULATION

This package has been designed specifically for the construction industry to calculate the areas and volumes of materials used both in the excavation and the erection of structures of all types.

The program uses formulas found in civil engineering handbooks to calculate areas such as rectangles, trapezoids, triangles, pentagons, circle segments, spirals, etc., and volumes such as cylinders, cones, etc.

Configuration: 9300; 24K; 4 tapes

Operating System: Assembler

Documentation: Building Supplies Calculation, Marketing Brochure, IN-7737

Support: Category 3

Developed By: Northern European Division/Univac Austria

Availability: Applications Services

Order No.: 930005

DATE	SYSTEM TYPE	INDEX NAME
8/71	9200	CALC
REVISION 2	9300	

APPLICATIONS SOFTWARECALC AND NON-CALC PAYROLL PACKAGE

This package includes two complete procedures to satisfy the requirements of two basic user types.

The first, labeled CALC Payroll Procedure, offers complete processing of a user's payroll. It includes such phases of Payroll Processing as:

- . Gross-to-Net Register
- . Deductions Register
- . Check Writing
- . Quarterly and Year-To-Date Earnings Recap
- . Quarterly and Year-To-Date Deductions Recap
- . 941 Reports
- . W-2 Forms

The second system, labeled NON-CALC Payroll Procedure, is intended for the maintenance of a client's payroll by a service bureau. In this case the client has already done the calculations of gross-to-net and also has written the checks.

Configuration: 9200/9300; serial punch; 120 print positions

Operating System: RPG

Documentation: General Description Manual, Loose-Leaf Pages

Support: Category 3

Developed By: Americas Division

Availability: Applications Services

Order No.: 920040

DATE 8/73	SYSTEM TYPE 9200	INDEX NAME CALP3
REVISION	9300	

APPLICATIONS SOFTWARE

CALCOMP POSTPROCESSOR

The CALCOMP postprocessor is designed to process MINIAPT output, (CLDATA), into a form suitable for driving a CALCOMP 780/763 plotter. This software plots CLDATA exactly or with transformation, (translation, rotation or scaling). By using this, the cutter path can be checked easily.

Configuration: 9200; 9300; 32K; 3tapes

Operating System: NCOS; Tape FORTRAN

Documentation: 9000 MINIAPT CALCOMP 780/763 Postprocessor Programming Manual

Support: Category 3

Developed By: Africa-Asia Division/Univac Japan

Availability: Univac Japan

Order No.:

DATE 2/72	SYSTEM TYPE 9200	INDEX NAME CAMEL
REVISION 3		

APPLICATIONS SOFTWARE

CAMEL

CAMEL (Computer Aided Management Educational Language) is a programming language designed to instruct beginners in the techniques of programming.

The CAMEL language is similar to a subset of FORTRAN, having similar assignment statements, transfer statements, input/output statements, etc.

The CAMEL compiler has an extensive set of error diagnostics to facilitate the debugging phase and assist the user in the understanding of programming.

Configuration: 9200; 8K

Operating System: Assembler

Documentation: CAMEL, User's Manual, Loose-Leaf Pages

Support: Category 3

Developed By: Africa-Asia Division/Univac Japan

Availability: Applications Services

Order No.: 920062

DATE 8/78	SYSTEM TYPE 9200 9300	INDEX NAME CAMPUS
REVISION		

APPLICATIONS SOFTWARE

STUDENT SCHEDULING PACKAGE

CAMPUS supplies a means of scheduling students with options needed by most secondary schools. The system provides the following features:

- . Students may request up to twelve courses with identification of each as absolutely necessary, a replaceable elective, or an alternate for an elective.
- . School day may be from one to ten periods and each student is considered to be enrolled for the school's regular day.
- . Master schedule seats and sections available are tallied and reported to show weak spots and overloads in the proposed schedule. Selection is possible by course number so that available seats and sections for a group of courses can be reported.
- . Student requests are tallied by course number and are reported on the Initial Tally and the Conflict Matrix. The latter report is selective so that a matrix of certain courses can be prepared.
- . Automatic class level loading.
- . A specific teacher or a specific section may be designated on a student's request for a course. The student will only be scheduled into the specific section, or into a class taught by the specified teacher.

(continued)

Configuration: 9300; disc

Operating System: NCOS/COS

Documentation: Loose-Leaf Pages

Support: Category 3

Developed By: Americas Division

Availability: Applications Services

Order No.: 930021

DATE	SYSTEM TYPE	INDEX NAME
8/73	9200	CAMPUS
REVISION	9300	

APPLICATIONS SOFTWARE

- . Course sections may be restricted to boys or girls only, and may be restricted to include students from only one grade, or to exclude all students in one grade.
- . Classes may be one or more periods in length. Multiple period sections need not meet in one continuous time frame; noncontiguous periods are permitted.
- . Six-day school weeks are acceptable. Reports are printed with space for a week beginning Monday and ending Saturday.
- . The requests for a student who was not scheduled are reported with an indication of full courses and the schedule of courses offered. Conflicts are easy to see and correct.
- . Scheduling priority is established by a record sort (#SCA 090) prior to the sectioning process. Priority may be given to higher or lower grades by a simple change to the control cards for that sort.
- . Master files may include records for several schools but the sectioning process (Phase III) accepts only one school at a time for faster processing.

DATE 10/72	SYSTEM TYPE 9200	INDEX NAME CBCS
REVISION		

APPLICATIONS SOFTWARE

COBOL CROSS REFERENCE

The program takes COBOL source cards and produces an 80/80 list with sequence numbers on the left.

Following that is printed a sequential list of nonreserved words and literals (not 'XXX' type) that appear in record descriptions and procedure division with the card number where they appear. Within the procedure division the continuation of a name or literal is not handled.

It is set up for a 24K system linked at X'2000' which gives a capacity of 480 labels of 15 characters used 5 times each. The table is variable length so the more characters in a data-name the more core taken.

COBOL param cards will be ignored if DATA T,? is used. If X'2000' is not X'00' source listing is eliminated. Location X'214A' has address of highest memory available to program. If a 32K system is used, change this parameter to fully utilize the system.

Using DSKO extend a program file with the supplied card deck, which is a loadable module.

Configuration: 9200/9300I; 24K

Operating System: DNCOS

Documentation: NONE

Support: Category 3

Developed By: Americas Division

Availability: Applications Services

Order No.: 920094

DATE 8/73	SYSTEM TYPE	INDEX NAME
REVISION	9200	CCAMEL

APPLICATIONS SOFTWARE

CONVERSATIONAL CAMEL

This system offers conversational capabilities with the CAMEL language.

Configuration: 9200; 8K; UNISCOPE 300

Operating System: Any

Documentation: User's Manual, Loose-Leaf Pages

Support: Category 3

Developed By: Africa-Asia Division/Univac Japan

Availability: Univac Japan

Order No.:

DATE 2/72	SYSTEM TYPE 9300	INDEX NAME COMASR
REVISION 3		

APPLICATIONS SOFTWARE

ASR 33 TO 9300 (WITH CONCURRENCY) COMMUNICATION HANDLER

This package provides multiple remote Teletype communications to a UNIVAC 9300 at the same time central site batch work is being processed. The standard concurrent operating system is modified to bypass the normal console display routine and allows the displays to be shown on a central site Teletype unit used as a console. This allows continuous processing of either the communications or batch data while the other is being serviced by the operator.

The communications routine is written as a symbiont and operates as a background program. The changes required for CGS are supplied along with the source program for the communications routine.

Configuration: 9300; 32K; DCS-4; 4 Tapes

Operating System: COS; Tape Assembler

Documentation: Communications Handler, ASR 33 to 9300, User's Manual, UX-5203

Support: Category 3

Developed By: Americas Division

Availability: Applications Services

Order No.: 930007

DATE	SYSTEM TYPE	INDEX NAME
2/72	9200	COMASR
REVISION	9300	
3		

APPLICATIONS SOFTWARE

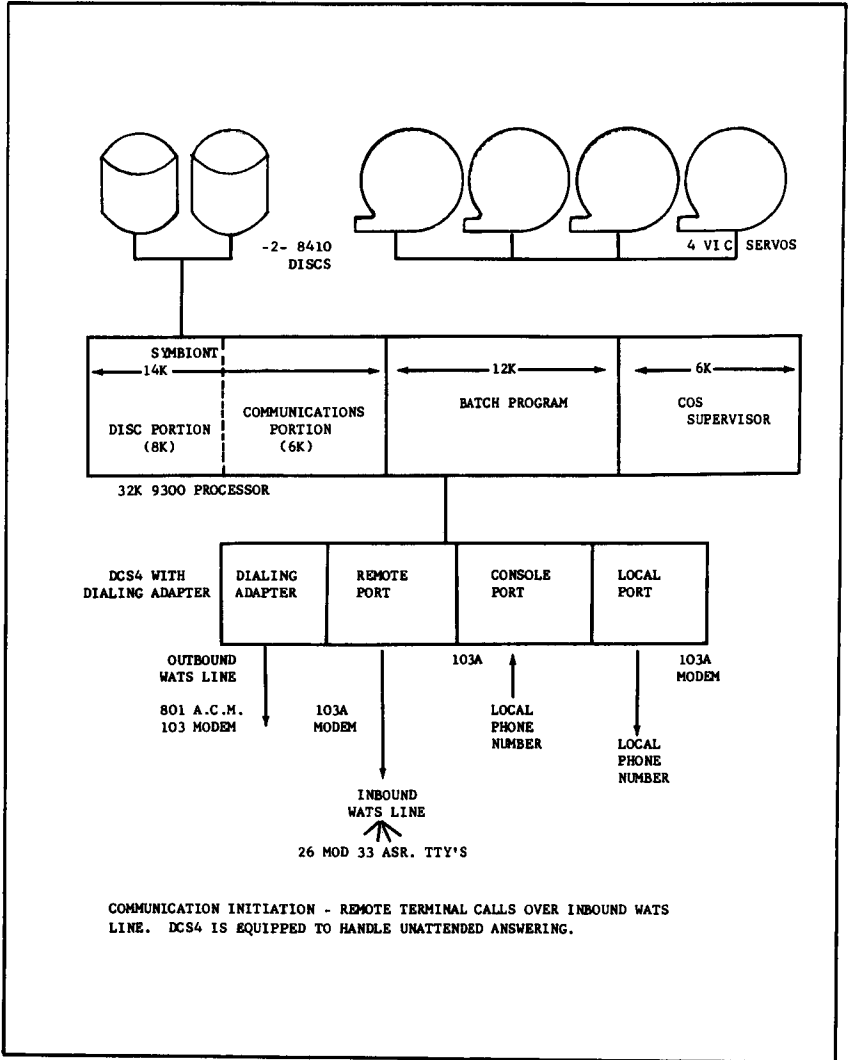

DATE	SYSTEM TYPE	INDEX NAME
10/72	9200	COMCDC
REVISION 4		

APPLICATIONS SOFTWARE

9200 TO CDC 6400/6500 COMMUNICATION HANDLER

This Communications Handler is designed to provide remote input/output capability between UNIVAC 9200s and/or DCT-2000s and a CDC 6400 or 6500.

The handler is available in two versions:

One allows the 9200 to simulate a DCT-2000 where mixed remotes are used (UMAR). The other is written strictly for the 9200 (REMM). Both versions include a program for offline listing and reproducing cards. A modified card deck for MOS is also provided.

The 9200 communicates through a DCS-1 and Bell 201B data sets. There are no special hardware requirements for the CDC Computer.

Note: Use of this package requires a modification to the standard CDC operating system.

Configuration: 9200; 8K; DCS-1

Operating System: MOS; Card Assembler; (MACE on CDC 6400)

Documentation: Communications Handler 9200 to CDC 6400/6500,
User's Manual, UP-7765

Support: Category 3

Developed By: Americas Division

Availability: Applications Services

Order No.: 920005

DATE	SYSTEM TYPE	INDEX NAME
10/72	9200	COMCDC
REVISION 4	9300	

APPLICATIONS SOFTWARE

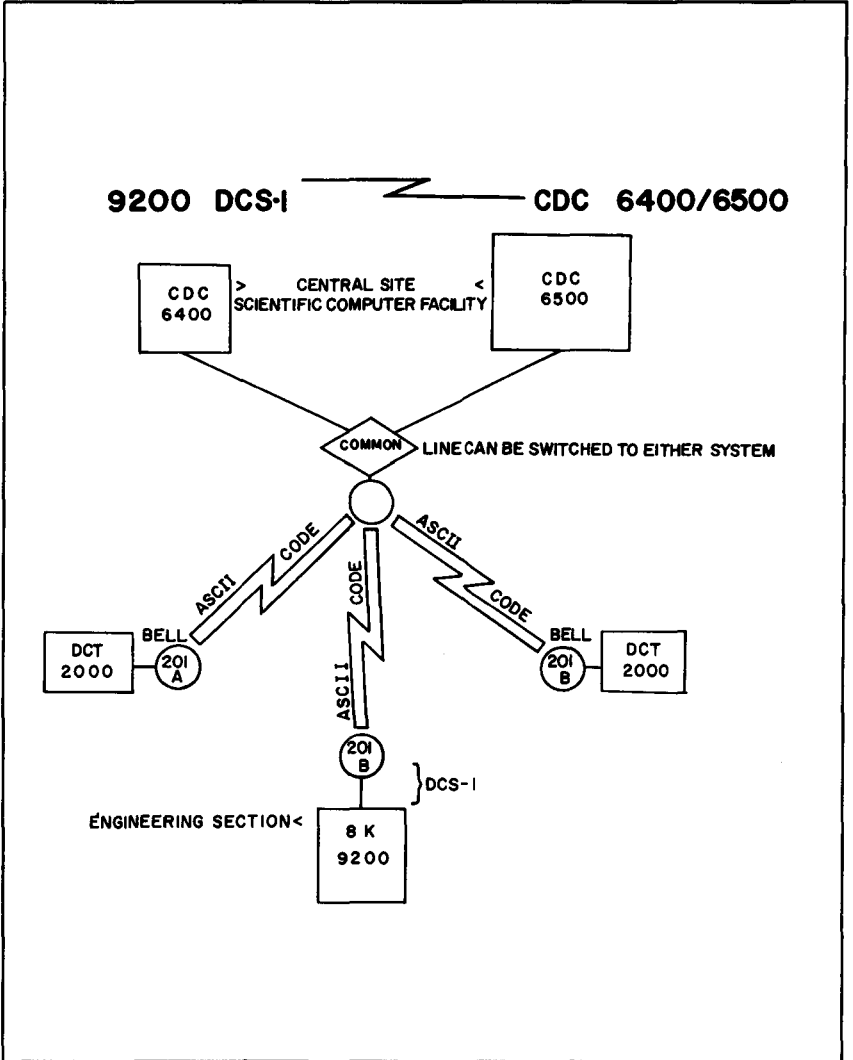

DATE 10/72	SYSTEM TYPE 9300	INDEX NAME COMIO
REVISION 1		

APPLICATIONS SOFTWARE

REMOTE COMMUNICATION 9300/IBM 360

This system permits the use of a UNIVAC 9300 for the transmission of information from remote branches to a central site containing another computer manufacturers equipment.

For example, a leading bank in Germany used it for remote processing of its "current account" business for eight central accounting departments. In this case the 9300 was linked to IBM systems 360/30 (65K) and Model 40 (131K) equipped with 2311/14 magnetic disc storage units, tape units and a telecommunications control unit plus other peripherals.

Configuration: 9300; 8K; Card Reader; Paper Tape Reader; DCS-1

Operating System: 9300; Assembler

Documentation: Remote Communication, Sales Brochure, Loose-Leaf Pages (German)

Support: Category 3

Developed By: Central European Division/Univac Germany

Availability: Application Services

Order No.: 930022

DATE	SYSTEM TYPE	INDEX NAME
8/71	9200	COMKSR
REVISION		
2		

APPLICATIONS SOFTWARE

KSR 35 TO 9200/9300 COMMUNICATIONS HANDLER

COMKSR is an asynchronous communications software package that will service a minimum of one input and one output line and a maximum of eight input and eight output lines concurrently through two DCS-4s. Input is by direct input through KSR 35 TELETYPE units. Individual lines can be stopped and restarted without interfering with the operation of other lines.

The routine is written in the form of an assembler macro. It may be assembled on a tape system and then punched and linked with MOS for a card system if desired.

Configuration: 9200; DCS-1

Operating System: NIOS/MOS; Tape/Disc Assembler

Documentation: Communications Handler KSR 35 to 9200/9300, User's Manual, UP-7764

Support: Category 3

Developed By: Americas Division

Availability: Applications Services

Order No.: 920007

DATE	8/71	SYSTEM TYPE	9200	INDEX NAME	COMKSR
REVISION	2				

APPLICATIONS SOFTWARE

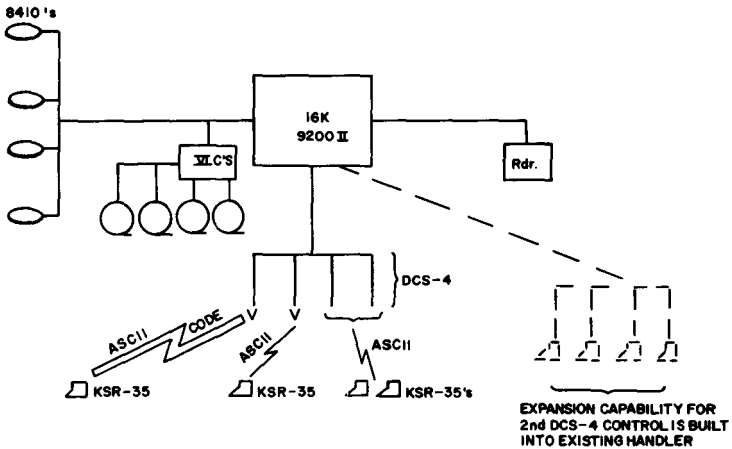

COMMUNICATION LINES-PRIVATE 110 BAUD TTY LINES

MODEMS- BELL - PRIVATE 108C-1

KSR-35 SPEED-10 ch./SECOND

RESPONSE TIME - 2/10 SECOND

DATE 2/72	SYSTEM TYPE 9200	INDEX NAME COM360
REVISION 3		

APPLICATIONS SOFTWARE

9200 TO IBM 360/40 COMMUNICATIONS HANDLER

This Communications System was originally designed to transmit basic payroll data from a UNIVAC 9200 in a remote location to a central site 360/40 computer. This data was then processed on the 360/40 and the results transmitted back to the 9200 for printing and punching. Only the 9200 communications routine is supplied. It may be incorporated with the user's processing routines.

Sending speed from the 9200 is approximately 130 CPM at 80 columns of data per card. Receiving and printing speed is 116 LPM at 100 characters per line. Receiving and punching speed is 75-130 CPM depending on the number of columns to be punched.

Configuration: 9200; 8K; DCS-1

Operating System: Card Assembler, MCS; (BTAM on 360/40)

Documentation: Communications Handler 9200 to 360/40, User's Manual, UP-7767

Support: Category 3

Developed By: Americas Division

Availability: Applications Services

Order No.: 920006

DATE 2/72	SYSTEM TYPE 9300	INDEX NAME COM418
REVISION 3		

APPLICATIONS SOFTWARE

9300 TO 418 II COMMUNICATIONS HANDLER

The UNIVAC 9300 remote system is designed to provide the central site with a high speed terminal capable of printing at extremely high rates. The 9300 can also transmit cards over a TELPAK line at over 550 CPM and receive/punch at approximately 175 cards per minute. Tape input may also be used on a limited scale. Only one input stream is provided for; therefore, card read and tape input share common routines and cannot occur simultaneously. Four output streams are run concurrently and are dedicated to the row punch, on-line printer and two 0768 high speed printers. The two 0768 printers are driven simultaneously at 1200-1400 LPM. Remote punching is at slightly less than rated speeds.

Configuration: 9300; 32K; DCS-4; (1 or 2) 0768 Printers; On-Line Printer; Row Punch; Reader

Operating System: Card Assembler; MOS

Documentation: Communications Handler 9300 to 418 II, User's Manual, UP-7763

Support: Category 3

Developed By: Americas Division

Availability: Applications Services

Order No.: 930006

DATE 2/72	SYSTEM TYPE 9200	INDEX NAME COM418
REVISION 3	9300	

APPLICATIONS SOFTWARE

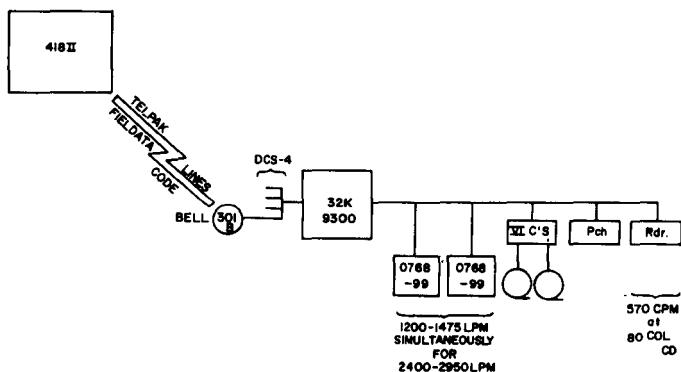

DATA IS BLOCKED INTO 18 CD. BLOCKS
BELL 301 B PRIVATE WIDEBAND MODEM
CODE USED - FIELDATA

DATE 2/72	SYSTEM TYPE 9300	INDEX NAME COM92
REVISION 3		

APPLICATIONS SOFTWARE

9200 & 2780 TO 9300 COMMUNICATIONS HANDLER

This communications utility handles remote batch input from punched cards read at remote sites and transmitted to a central information processing facility where the information is received by a UNIVAC 9300 and written on magnetic tape. The information can then be processed offline and the results returned to the 9200 later.

The 9200 and 9300 communications routines are available. The 9200 acts as a remote device to the 9300. The 9300 routine is written to control up to six remote 9200s on one DCS-4 and up to four IBM 2780 remote devices on another DCS-4. The 9300 handler requires approximately 20K bytes of memory to support all remote devices.

Configuration: Remote: 9200; 8K; DCS-1
Central: 9300, 24K; DCS-4

Operating System: MOS; Card Assembler

Documentation: Communications Handler, 9200/2780 to 9300, User's Manual, UP-7766

Support: Category 3

Developed By: Americas Division

Availability: Applications Services

Order No.: 930011

DATE 2/72	SYSTEM TYPE 9200	INDEX NAME CPM
REVISION 4		

APPLICATIONS SOFTWARE

CPM - CRITICAL PATH METHOD SCHEDULING

CPM provides project scheduling information for each activity including earliest start, latest start, earliest finish and latest finish dates. It also provides the number of days for which the activity may be delayed without changing the project completion date, plus the number of days for which an activity can be delayed without changing the earliest start date of another activity.

The required input consists of: the starting event number, the ending event number, the activity duration in days and the activity description.

Version 1 is for 8K providing for 450 activities.

Version 2 is for 16K providing for 950 activities.

Version 3 is for 1001 input with 1 and 2 above.

Version 4 is for 12 K, 450 activities, row punch.

Configuration: (See above description)

Operating System: Assembler

Documentation: Critical Path Method Scheduling, User's Manual, UA-0003;
Critical Path Method Scheduling, Advertising Brochure, U-4763

Support: Category 3

Developed By: Americas Division

Availability: Applications Services

Order No.: 920009

DATE 2/72	SYSTEM TYPE 9200	INDEX NAME CPM
REVISION 4	9300	

APPLICATIONS SOFTWARE

CPM SCHEDULING

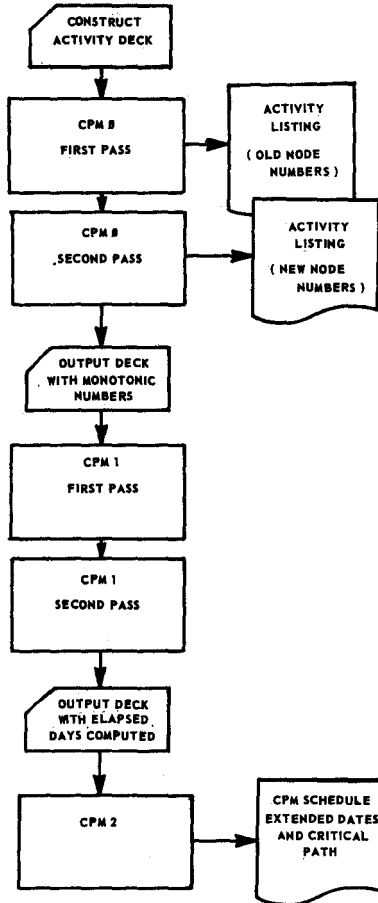

DATE	SYSTEM TYPE	INDEX NAME
10/72	9200	CRDEDT
REVISION		

APPLICATIONS SOFTWARECARD EDIT

This program will search an entire card for multiple sets of characters and upon match, replace with desired data. Output may be directed to printer and/or punch with all images, or only when search values are found.

Configuration: 9200; 8K; Printer, Hardware Edit, 120 Print Positions;
Serial Punch

Operating System: Card or DNCOS

Documentation: One page of instructions

Support: Category 3

Developed By: Americas Division

Availability: Applications Services

Order No.: 920092

DATE 10/72	SYSTEM TYPE 9200	INDEX NAME CRSRPG
REVISION		

APPLICATIONS SOFTWARE

RPG CROSS REFERENCE

RPG Cross Reference takes RPG source cards and produces an 80/80 list with sequence numbers.

Configuration: 9200; 8K; Printer (hardware edit, 96 print positions)

Operating System: Card or DNCOS

Documentation: None

Support: Category 3

Developed By: Americas Division

Availability: Applications Services

Order No.: 920091

DATE 3/74	SYSTEM TYPE	INDEX NAME
REVISION	9300	CRJCL

APPLICATIONS SOFTWARE

CREATE JCL CARDS FOR ASSEMBLING PROGRAMS

The program maintains source and object libraries, using LIBS. It punches out JCL cards to update, assemble, and link up to 20 source modules and update an object library.

Each module to be processed requires a control card which indicates various options available, followed by the LIBS source correction commands and source code. The program punches a deck of cards which contains all control cards required to update the source module, (including checking the LIBS correction commands), compile and link the program, and update the object library. It makes use of a separate LINK library which contains precompiled modules which are frequently used, i.e., card, tape, disc IOCS. The program ensures that the JCL cards are correct before actual processing starts.

Configuration: 9300; 3 discs, 8414; Reader; Printer; Punch

Operating System: DNCOS

Documentation: User's Guide, Loose-Leaf Pages

Support: Category 4

Developed By:

Availability: UUA Program Library Interchange

Order No.: 693003

DATE	SYSTEM TYPE	INDEX NAME
8/71	9200	CSEXT
REVISION	9300	
1		

APPLICATIONS SOFTWARE

EXTENSION TO SUPERVISOR

Resident memory dump and logging of control cards are added to the capability of NCOS. These features facilitate the operation of the UNIVAC 9200 II/9300/9300 II in a closed shop.

Control cards are provided to control the printer log as follows:

```

/LOG      Job control cards are logged
/LOG ALL  All cards are logged
/NOLOG    No logging
/OPR      Verbal message to Operator
/OPR      Skip to next page
  
```

These cards may appear anywhere in the control stream (even among data cards). No logging is permitted after a user program starts printing until the program executes EOJ.

The MSG command in Assembly language programs will be logged on the printer with the operator's reply, if any. Cancellation of a job is logged on the printer.

The resident memory dump may be initiated by the operator using the restart procedure (CLEAR, START).

Configuration: 9200/9300

Operating System: NCOS; Assembler

Documentation: Listing with comments (Source Deck and Test Deck)

Support: Category 3

Developed By: Northern European Division/Univac Sweden

Availability: Applications Services

Order No.: 920008

DATE	SYSTEM TYPE	INDEX NAME
8/71	9200	CSRDR
REVISION	9300	

APPLICATIONS SOFTWARE

90-COLUMN CONTROL STREAM READER

This program permits 90-column cards to be used as the control stream for NCOS and COS. Under this system all of the standard NCOS and COS software can be used.

This system consists of SUPR (Proc), JBCN (Proc) and DRFGS (Source).

Configuration: 9200 II/9300; 16K; 90-column card reader

Operating System: NCOS/COS; Assembler

Documentation: User's Manual (Japanese)

Support: Category 3

Developed By: Africa-Asia Division/Univac Japan

Availability: Univac Japan

Order No.:

DATE	SYSTEM TYPE	INDEX NAME
8/71	9200	DAIRY
REVISION		
2		

APPLICATIONS SOFTWARE

DAIRY ROUTE ACCOUNTING

The Dairy Route Accounting System is designed for route settlement accounting and related activities. It handles both wholesale and retail routes in both local and remote areas. It provides daily route settlement; daily, weekly and monthly summaries and sales reports; route statistics; driver and supervisor gross earnings; a daily inventory and a butterfat report.

Prices, descriptions, product codes and costs are provided from tables in memory, loaded from master decks by the program. Only basic sales quantities and item numbers are keypunched. Extensions are made and punched by the computer via the read/punch unit.

Configuration: 9200; 16K; 96 Print Position; Serial Read/Punch; Reader

Operating System: 9200 RPG

Documentation: Dairy Route Accounting, User's Manual, UX-5202

Support: Category 3

Developed By: Americas Division

Availability: Applications Services

Order No.: 920013

APPLICATIONS SOFTWARE

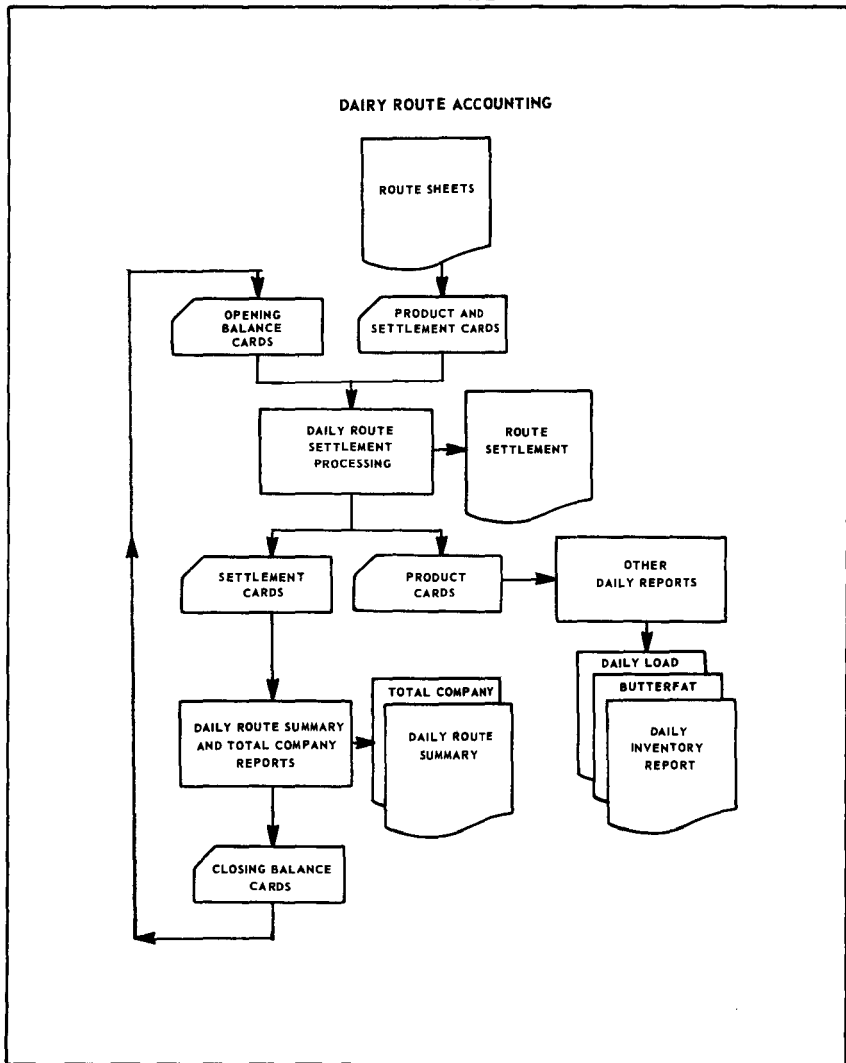

DATE	SYSTEM TYPE	INDEX NAME
2/72	9200	DCS1
REVISION	9300	

APPLICATIONS SOFTWARE

DATA COMMUNICATION SUBSYSTEM TESTING PROGRAM (DCS-1)

DCS-1 provides a procedure for testing the quality of the various components of data communications lines, i.e., DCS, modems, line. With 4-wire lines, it operates from a single 9200/9300; with 2-wire lines, a support computer (UNIVAC 9200/9300/1108 or IBM 360/370) is required.

There are three areas of application:

- . Regular daily line testing and control.
- . Fault localization at installation time and during daily operation of data terminals.
- . Acquisition of statistical data, i.e., bit, character and block error rates, as an aid to systems planning.

DCS-1 works by sending, receiving and comparing data through progressively greater loops. Each new loop extends to the next component of the data communications connection. DCS-1 operates in halfduplex or fullduplex mode.

Configuration: 9200/9300; 8K; DCS-1

Operating System: MCS (modified)

Documentation: User's Manual, Loose-Leaf Pages (German)

Support: Category 3

Developed By: Central European Division/Univac Germany

Availability: Univac Germany

Order No.:

DATE	SYSTEM TYPE	INDEX NAME
3/74	9200	DPRU
REVISION	9300	

APPLICATIONS SOFTWARE

DISC PRINT AND UPDATE

DPRU is a special-purpose routine that can be used effectively to change a limited number of disc records. It uses a display/response method allowing changes to be keyed into memory for a record which has been mapped on the printer.

This routine is available as a source code module to be assembled and linked.

Configuration: 9200/9300

Operating System: MOS/NCOS/COS

Documentation: User's Guide, Loose-Leaf Pages

Support: Category 3

Developed By: Americas Division

Availability: Applications Services

Order No.: 930034

DATE	SYSTEM TYPE	INDEX NAME
2/72	9200	DSFOR
REVISION	9300	

APPLICATIONS SOFTWARE

9200/9300-8411/8414 DISC FORTRAN SYSTEM

The UNIVAC 9200/9300-8411/8414 disc FORTRAN system parallels the tape FORTRAN system. Extensions to the compiler include user-specified optional input translation tables, control of paper homing during compilation, and the inherent ability to save source programs on disc.

The FORTRAN library distributed with the disc FORTRAN system contains all of the same elements as the standard Rev. 05 tape FORTRAN library plus an additional subroutine called PHASER. This subroutine is for use by a FORTRAN program divided into phased segments. All of the elements in the library have been placed in a revised sequence to facilitate linking. The sequence is such that all elements required for a link will be obtained during one pass through the FORTRAN library. The library also contains some embedded groups to further reduce linking time.

The UNIVAC 9200/9300-8411/8414 disc FORTRAN system is distributed in card form as a completely self-contained control stream. It is necessary only to execute this complete control stream to obtain a usable FORTRAN system.

Configuration: 9200/9300; 16K; 8411/8414; Card Reader, Card Controller or 1004 Reader; Bar Printer

Operating System: DNCOS

Documentation: User's Manual, Loose-Leaf Pages

Support: Category 3

Developed By: Americas Division

Availability: Software Order Services, Blue Bell

Order No.:

DATE 8/73	SYSTEM TYPE 9300	INDEX NAME EPA93
REVISION		

APPLICATIONS SOFTWARE

ECONOMIC PLANNING AGENCY

EPA, (Economic Planning Agency), is a technique for seasonal adjustment of economic time series. This variation of CENSUS method is available to users of relatively small-scale computers. A multiplicative model, (TCxI²S), and an additive model, (TC+I+S), are available.

(*T:trend C:cycle I:irregular S:seasonal)

Configuration: 9300; 32K

Operating System: NCOS

Documentation: User's Manual (Japanese)

Support: Category 3

Developed By: Africa-Asia Division/Univac Japan

Availability: Univac Japan

Order No.:

DATE 2/72	SYSTEM TYPE 9200	INDEX NAME FASACC
REVISION 3		

APPLICATIONS SOFTWAREFIXED ASSETS ACCOUNTING

The Fixed Assets Accounting System provides improved methods for periodic recognition of the progressive decline in value of fixed assets, and for recovery of value loss through adequate depreciation charges to expense.

In addition to the basic information developed for inventory control and periodic accrual of depreciation for tax purposes, it generates additional data for an extensive reporting system.

Various byproduct analyses are issued such as vendor relationships and cost accounting figures, which lead to vendor consolidation.

Configuration: 9200; 8K; 132 print positions

Operating System: RPG

Documentation: User's Manual, UA-0001

Support: Category 3

Developed By: Americas Division

Availability: Applications Services

Order No.: 920021

DATE	SYSTEM TYPE	INDEX NAME
2/72	9200	FASACC
REVISION	9300	
3		

APPLICATIONS SOFTWARE

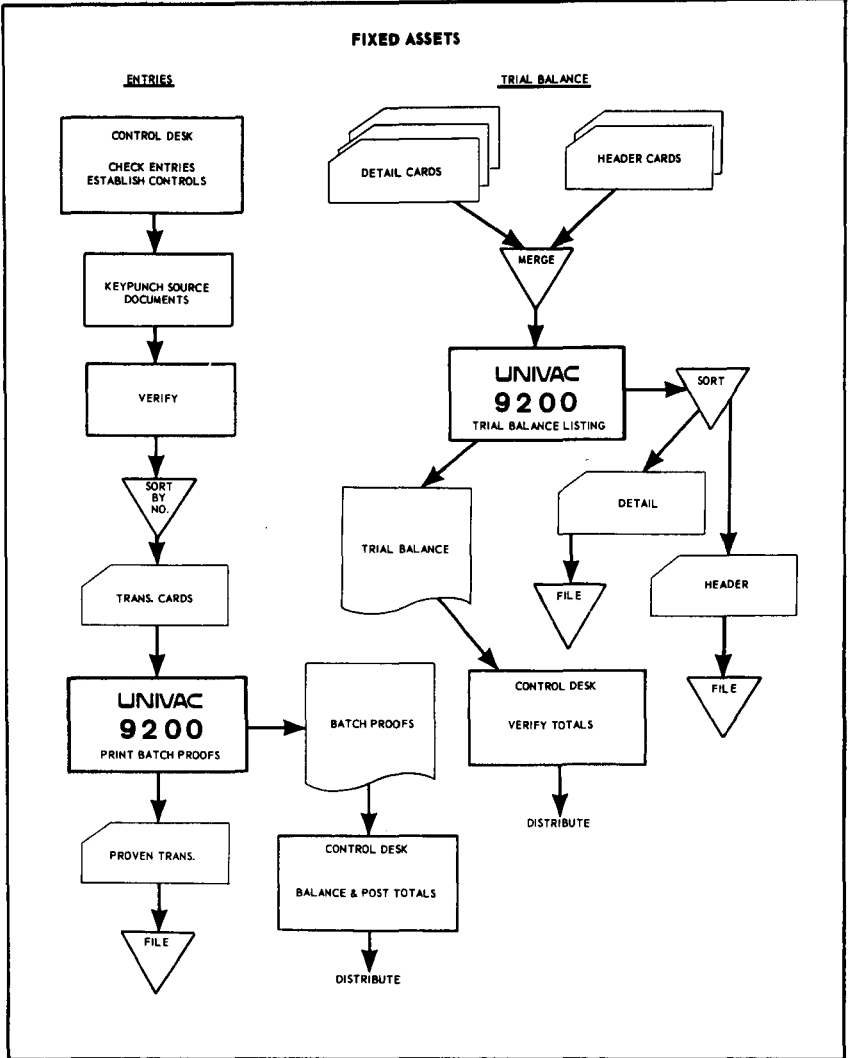

DATE	SYSTEM TYPE	INDEX NAME
4/71	9200	FLOMAT
REVISION	9300	

APPLICATIONS SOFTWAREFLOMAT

This Program produces a flowchart of a UNIVAC 9200 Card or Tape/Disc Assembler program on the bar printer. The flowchart is generated from codes supplied by the programmer in the comment field of the source cards. Either the instruction image or the comment field may be printed in the flowchart block.

Configuration: 9200; 8K; Card System

Operating System: Basic Card Software

Documentation: Memo Operating Instructions, Loose Leaf Pages

Support: Category 3

Developed By: Central European Division /Univac Germany

Availability: Applications Services

Order No.: 920060

DATE 2/72	SYSTEM TYPE 9200II 9300	INDEX NAME GAMA 10
REVISION 2		

APPLICATIONS SOFTWARE

GAMMA-10 TO 9300 TRANSLATOR

This program translates GAMMA-10 source assembly language programs to 9300 source coding. It is executed on the 9300.

Output consists of final 9300 source statements and a printer listing. Untranslatable statements are indicated allowing manual translation in areas not directly definable to the program.

The translator examines the GAMMA-10 source statements, converting them to equivalent 9300 instructions or instruction series. IOCS macros, translate tables, peripheral assignments, etc., are taken into consideration. Parameter cards defining configurations, IOCS requirements, etc., are entered via cards. Completeness and accuracy of translation is estimated to be as high as 98 percent.

The translated source program is ready to be assembled using the 9000 tape assembler, then linked to create a loadable program ready for execution.

Configuration: 9200 II/9300; 16K; (4) Tapes; Multiply/Divide; Reader; Printer

Operating System: NCOS or COS

Documentation: GADIX Translator User's Manual, Loose-Leaf Pages (French and German)

Support: Category 3

Developed By: Central European Division/Univac France

Availability: Univac France

Order No.:

DATE 2/72	SYSTEM TYPE 9300	INDEX NAME GARCUT
REVISION 3		

APPLICATIONS SOFTWARE

GARMENT CUTTING OPTIMIZATION

The planning of efficient cutting is a complex matter for the garment industry. This package was designed to enable garment cutting to be carried out with the least amount of cutting operations. Several factors must be considered:

- . Different designs must be cut separately, and many different sizes per model must be taken into consideration.
- . Checks and stripes must be cut separately with special patterns.
- . Because of cloth slippage from some fabrics they can not be cut together.
- . Fabrics vary in width.
- . Customer requirements are for various colors and sizes per design which must be delivered at the same time.

The program optimizes maximum layer thickness and minimum amount of strokes in order to limit the labor factor and to make optimum use of the cutting table length.

Configuration: 9300; 32K; Printer/132 Position; 4 tapes

Operating System: FORTRAN

Documentation: Garment Cutting Optimization, Sales Brochure, IN-7730; Technical Documents (Dutch/English), Loose-Leaf Pages

Support: Category 3

Developed By: Central European Division/Univac Holland

Availability: Applications Services

Order No.: 920067

DATE	SYSTEM TYPE	INDEX NAME
2/72	9200	GARCUT
REVISION 3	9300	

APPLICATIONS SOFTWARE

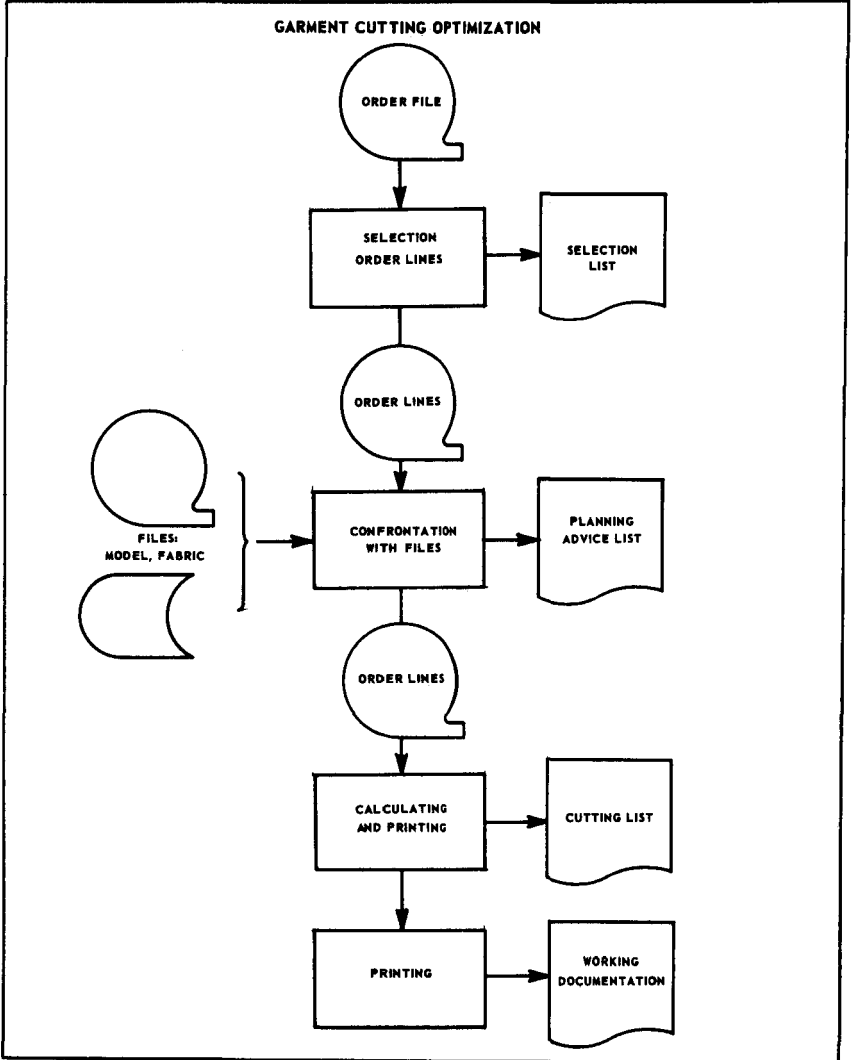

DATE	2/72	SYSTEM TYPE	9200	INDEX NAME	GDAT
REVISION	2		9300		

APPLICATIONS SOFTWAREGENERATOR OF DATA FILES (GDAT)

GDAT is a program for generating test data files.

The user has to define the format of the record. The contents of the fields may be specified by the user; otherwise, it will be generated by GDAT.

Configuration: 9200; 8K

Operating System: Exec I / MOS/NCOS

Documentation: GDAT-Program Library

Support: Category 3

Developed By: Central European Division/Univac Germany

Availability: Applications Services

Order No.: 920071

DATE 8/71	SYSTEM TYPE 9300	INDEX NAME GENACC
REVISION 2		

APPLICATIONS SOFTWARE

GENERAL ACCOUNTING

This program allows either separate or joint bookkeeping for the financial accounting of a company and its subsidiaries. The data from the subsidiary offices (up to eight) is passed directly to the financial accounting office, i.e., the joint entries from the subsidiary accounting offices pass to the finance accounting office in the same phase of processing. The credit and debit accounting is completely integrated into the computer operation.

In the creditor accounting sector, a record of liabilities and terms of payment is kept. In debtor accounting the credit situation is checked and payment reminders are issued.

Daily reports such as trial and final balances, statements of account, liabilities in order of terms, and statements of unpaid items can be obtained. Monthly reports of financial accounts are also prepared.

Configuration: 9300; 32K; 5 tapes

Operating System: NCOG; Assembler

Documentation: General Accounting, User's Manual, Loose-Leaf Pages
UNIREF Manual (German)

Support: Category 3

Developed By: Central European Division/Univac Germany

Availability: Applications Services

Order No.: 930008

DATE 2/72	SYSTEM TYPE 9200	INDEX NAME GENLED
REVISION 3		

APPLICATIONS SOFTWARE

GENERAL LEDGER PROCESSING

General Ledger Processing is a dual purpose application that can be used by an individual business, a service bureau operation, or any certified public accounting firm that keeps the books of many small businesses.

The UNIVAC 9200 General Ledger application operates from one common data base so that entries, either debits or credits, will have the same input format. Summarizations through manual, mechanical or electronic methods should produce this input generally in the form of punched cards.

Configuration: 9200; minimum

Operating System: RPG

Documentation: General Ledger Processing, User's Manual, UX-5204

Support: Category 3

Developed By: Americas Division

Availability: Applications Services

Order No.: 920022

DATE	SYSTEM TYPE	INDEX NAME
10/72	9200	GEP A93
REVISION	9300	
3		

APPLICATIONS SOFTWARE

GENERAL PAYROLL APPLICATION PACKAGE

General Payroll is designed to provide the user with all calculations, processing and reports that are common to payrolls.

The user must provide some of his own routines. A sort and calculation of state and local taxes must be written for a basic payroll. Provisions are provided to print time sheets, quarterly summary report and zero earnings records. Special quarterly and year-end runs allow inclusion of routines to produce 941-A and W-2 forms.

The system provides a comprehensive magnetic tape file which can be used and expanded by the user in building a total system specialized for his needs. The RPG coding and the UNIVAC 9000 series compatibility guarantee the user the ability to expand his system without large expenditures for reprogramming.

Configuration: 9200/9300; 16K; 3 tapes; 132 print positions

Operating System: RPG

Documentation: General Description Manual, Loose-Leaf Pages

Support: Category 3

Developed By: Americas Division

Availability: Applications Services

Order No.: 920064

DATE 2/72	SYSTEM TYPE	INDEX NAME
REVISION 2	9300	GIR

APPLICATIONS SOFTWARE

INFORMATION RETRIEVAL SYSTEM (IR 9000)

IR 9000 is a magnetic tape file oriented information retrieval system. It consists of five absolute program modules written in assembly language:

- . Creation module - creates an input file from a card deck.
- . Format module - creates a master tape file.
- . Input module - creates internal tables from control cards.
- . Retrieval module - searches the input file based on the queries and creates the output file of the records which meet the conditions set by the queries.
- . List module - lists the output file.

When the user sends a set of queries to the system, a search of the input file is made to find records which satisfy the conditions set by the query, and then writes those records on the output file. The user may create an input file by his own program (in COBOL or RPG) or by using SORT or a standard utility routine. He may process the output file in the same manner if necessary.

Configuration: For NCOS: 9300; 32K; printer (132 positions); 4 tapes
For MOS: 9300; 24K; printer (132 positions); 3 tapes

Operating System: MOS/NCOS; Assembler

Documentation: User's Manual (Japanese)

Support: Category 3

Developed By: Africa-Asia Division/Univac Japan

Availability: Applications Services

Order No.: 920068

DATE	SYSTEM TYPE	INDEX NAME
8/71	9200	HAFD
REVISION	9300	

APPLICATIONS SOFTWARE

HALF DUPLEX 9000 TO 9000 COMMUNICATION HANDLER

HAFD is a communications handler for 9000 to 9000 communications using ASCII code. It features:

- . Simultaneous I/O
- . Message validation
- . Automatic error recovery
- . Online utilities
- . Bit toggle check on messages
- . Transmit and receive statistics
- . Facility for user-written I/O routines

Configuration: 9200/9300; 8K; serial punch; DGS-1; multiplexer

Operating System: MOS

Documentation: System Description and Operating Instructions,
Loose-Leaf Pages

Support: Category 3

Developed By: Americas Division

Availability: Applications Services

Order No.: 920002

DATE	SYSTEM TYPE	INDEX NAME
3/74	9200	HAL
REVISION	9300	

APPLICATIONS SOFTWARERPG HALT/DISPLAY/ACCEPT ROUTINE

HAL offers an alternative to the RPG standard halt/display routine. The routine is included at program generation time. It allows an immediate halt and variable display with operator response.

The program execution may be varied based on the operator response to the halt display.

The subroutine requires about 70 bytes.

Configuration: 9200/9300

Operating System: RPG

Documentation: Loose-Leaf Pages

Support: Category 3

Developed By: Americas Division

Availability: Applications Services

Order No.: 920086

DATE	SYSTEM TYPE	INDEX NAME
3/74	9200	HEXCVT
REVISION	9300	

APPLICATIONS SOFTWARE

PACKED DECIMAL TO HEXADECIMAL CONVERSION

HEXCVT is a BAL subroutine that will convert packed decimal numbers zero through 32,767 to hexadecimal values 0000 through 7FFF.

The decimal value must be stored in a 3-byte, packed decimal, field. The subroutine will convert the decimal value to the equivalent hexadecimal value which is then stored in a half-word.

The subroutine uses 108 bytes of memory.

Configuration: 9200/9300

Operating System: Assembler

Documentation: User's Guide, Loose-Leaf Pages

Support: Category 4

Developed By:

Availability: UUA Program Library Interchange

Order No.: 693001

DATE	SYSTEM TYPE	INDEX NAME
2/72	9200	ICL
REVISION	9300	

APPLICATIONS SOFTWARE

INTRODUCTORY COMPUTER LANGUAGE - ICL

ICL is a programming language specifically designed to teach commercial students the fundamentals of data processing. It is an ideal aid for introducing basic computer concepts and programming. ICL may also be used effectively in courses where elementary problem-solving material lends itself to computer application.

ICLEX is an extended version of the language. ICL EXTENDED includes the UNIVAC 9000 series MATHPAC routines, thereby enhancing the versatility of the basic language.

Configuration: 9200; 8K; reader; printer; multiply, divide, edit options.
20K for ICLEX

Operating System: Exec I; NCS/COS; assembler

Documentation: Introductory Computer Language ICL, loose leaf pages;
Introductory Computer Language ICL Handbook by A. E. Lott,
Published by Sir Isaac Pitman (Canada), Limited;
MATHPAC Routines, UP-7558, Rev. 1

Support: Category 3

Developed By: Americas Division/Univac Canada

Availability: Applications Services

Order No.: 920083 for ICL version
920084 for ICLEX version

DATE	SYSTEM TYPE	INDEX NAME
10/72	9200	JCLG
REVISION	9300II	

APPLICATIONS SOFTWAREJOB CONTROL EXTENSION

Job control is extended to allow recording of program names, elapsed times, and messages to a sequential access file on 8411/8414 discs.

RPG halts 'ODO2' and 'O333' have been eliminated.

Configuration: 9200/9300II; 24K or 32K; 8411/8414

Operating System: DNCOS

Documentation: Complete logic description, output description, and operating instructions.

Support: Category 3

Developed By: Americas Division

Availability: Applications Services

Order No.: 920093

DATE	SYSTEM TYPE	INDEX NAME
8/71	9200 9300	LP92
REVISION		
3		

APPLICATIONS SOFTWARELINEAR PROGRAMMING SYSTEM 9000 SERIES

This is a general purpose linear programming system for the Univac 9200/9300. It has the normal optimization features. Furthermore, it has post-optional features for determining the ranges of validity for optimal solutions. It incorporates row and vector bounds, allowing the user to omit explicit constraints for placing lower and upper limits on values for particular activities.

The user may specify many objective functions, selecting the one to be optimized when the program is run. He may also specify many right hand sides, selecting the one to be used in the optimization for a given run.

The system is programmed in assembler language and is constructed in a modular manner to facilitate future expansion. LP model sizes are:

- . 16K memory: 125 rows x 1000 vectors
- . 32K memory: 700 rows x 2000 vectors

Configuration: 9200; 8410 Dual Disc

Operating System: NCOS

Documentation: Applications Brief, UX-5318; User's Manual, UX-5319

Support: Category 3

Developed By: Americas Division

Availability: Applications Services

Order No.: 920049 (cards only)

DATE	8/71	SYSTEM TYPE	9300	INDEX NAME	LP93
REVISION	2				

APPLICATIONS SOFTWARE

LINEAR PROGRAMMING (LP-9300)

Linear Programming is a minimization or maximization of a linear form subject to the set of linear constraints. It is a technique for determining the optimal allocation of resources (such as capital, raw materials, manpower, plant facilities, etc.), to achieve an objective such as the minimization of cost or the maximization of profit, when there are alternatives and limits on the disposition of these resources.

LP-9300 uses the Self-Dual Simplex method to solve the LP and a product matrix method to calculate it. The problem restrictions are:

The number of constraints: $m \leq 100$

The number of variables: $n \leq 200$

The problem is given as the assembly of limited equations with one dimension.

Configuration: 9300; 32K; 4 tapes

Operating System: NCOS; FORTRAN

Documentation: Linear Programming, User's Manual, IN-7755;
Systems Manual, loose leaf pages

Support: Category 3

Developed By: Africa-Asia Division/Univac Japan

Availability: Applications Services

Order No.: 920024

APPLICATIONS SOFTWARE

LINEAR PROGRAMMING

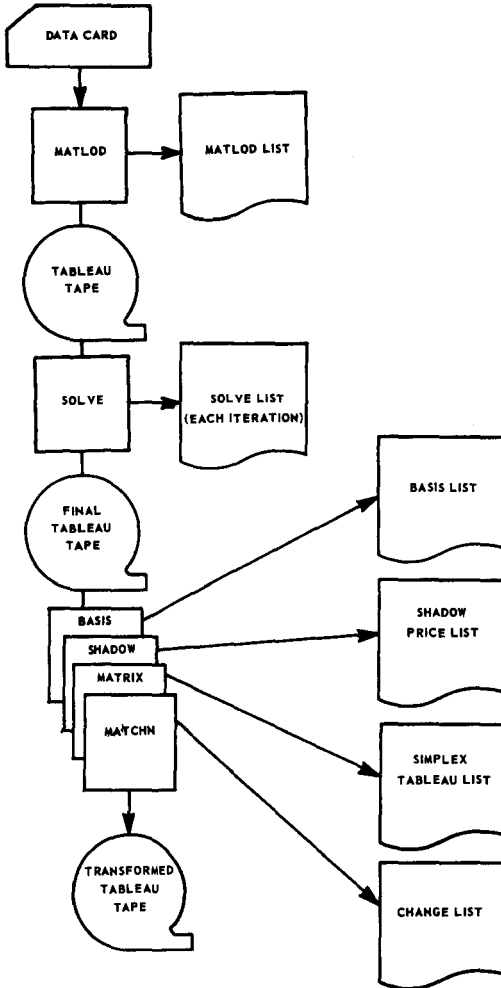

DATE	SYSTEM TYPE	INDEX NAME
8/73	9200	MARGO
REVISION 1	9300	

APPLICATIONS SOFTWARE

REPORT GENERATOR (MARGO)

MARGO is a report generator program for the 80-column 9200/9300 that will allow a person with little or no programming knowledge to quickly and efficiently produce a variety of reports. Each desired report is specified by key-punching parameters into a deck of 15 cards called a MARGO control deck. By the use of various MARGO decks, many different reports may be produced with a minimum of preparation time and without making changes to the program.

Configuration: 9200/9300; minimum

Operating System: NCOS

Documentation: User's Manual, loose leaf pages

Support: Category 3

Developed By: Americas Division

Availability: Applications Services

Order No.: 920069

DATE	SYSTEM TYPE	INDEX NAME
3/74	9200	MEDPAK
REVISION	9300	
2		

APPLICATIONS SOFTWARE

MEDICAL ACCOUNTING PACKAGE

The medical accounting package consists of a series of application procedures and programs designed for hospital or clinic accounting. It includes the following:

- Accounts Payable - register and checks bimonthly; automatic general ledger entries.
- Accounts Receivable - daily and monthly status of accounts; delinquent messages; discharge bills; general ledger entries; both inpatient and outpatient.
- Fixed Assets - straight line depreciation of major movable equipment.
- General Ledger - based on American Hospital Association chart of accounts.
- Payroll - biweekly paid on an hourly rate; registers, changes and checks are provided.

NOTE: MEDPAK combines programs formerly listed under index names of MEDAP, MEDAR, MEDFA, MEDGL, and MEDPA.

Configuration: 9200/9300; 16K; 4 VI-C tapes; Reader, Printer; Punch
Multiply; Divide

Operating System: MOS/RPG

Documentation: Program Description and Implementation, Loose-Leaf Pages

Support: Category 3

Developed By: Americas Division

Availability: Applications Services

Order No.: 920054

DATE	3/74	SYSTEM TYPE	9300	INDEX NAME	MINAPT
REVISION	6				

APPLICATIONS SOFTWARE

AUTOMATICALLY PROGRAMMED TOOLS

This system reduces the effort of manual part programming for Numerical Control equipment. Basically, the Numerical Control (N/C) process involves the operation of machine shop equipment through the use of information contained on a punched tape which is read into an electronic control unit attached to a machine tool. The tape is prepared by a part programmer who specifies the machining operations to be performed. These part programs can be prepared more quickly and more accurately with Univac MINIAPT than with manual techniques.

Univac MINIAPT is a subset of the APT (Automatically Programmed Tools) processor which has become the most widely accepted N/C programming language. Univac MINIAPT provides two axes geometric definition capability and three axes point-to-point positioning.

Configuration: 9300; 32K; 2 tapes

Operating System: TOS; FORTRAN

Documentation: User's Reference Manual, UA-0084; User's Vocabulary Dictionary, UA-0073; APT Programming Marketing Brochure, IN-7785; Postprocessor Linkage, Loose-Leaf Pages

Support: Category 3

Developed By: Central European Division/Univac Germany

Availability: Applications Services

Order No.: 920082

DATE	SYSTEM TYPE	INDEX NAME
8/71	9200	MINILP
REVISION	9300	
1		

APPLICATIONS SOFTWARELINEAR PROGRAM FOR MINIMUM SYSTEM

The minimum LP system is designed to run on any 9200 or 9300 utilizing memory configurations from 8K to 32K. The limit of the matrix depends on the size of memory. Matrices may range from 15 rows and 522 elements to 45 rows and 4,692 elements.

The package consists of three loadable programs which share common data areas. Each program calls in the loader for the next program without operator intervention.

Configuration: 9200/9300; 8K

Operating System: MOS

Documentation: MINI-IP User's Manual, Loose-Leaf Pages

Support: Category 3

Developed By: Americas Division

Availability: Applications Services

Order No.: 920045

DATE	SYSTEM TYPE	INDEX NAME
8/73	9200	MNCB
REVISION	9300	

APPLICATIONS SOFTWARE

MINI-COBOL

This is a subset of 9300 COBOL designed to run on a 9200/9300 card system with 16K of main storage. A card reader and a printer are the only peripherals needed. The processor is loaded from cards. The source program and data are entered via the card reader. An executable program is produced in main memory.

Documentation supplied describes the restrictions imposed by MINI-COBOL.

Configuration: 9200/9300; 16K; Reader; Printer

Operating System:

Documentation: Loose-Leaf Pages

Support: Category 3

Developed By: Africa-Asia Division/Univac Japan

Availability:

Order No.:

DATE	SYSTEM TYPE	INDEX NAME
8/73	9200	MNFT
REVISION	9300	

APPLICATIONS SOFTWARE

MINI-FORTRAN

This is a limited version of 9300 FORTRAN designed to run on the small system. The processor is the compile and go type where the final phase allocates main storage, links, and executes.

Configuration: 9200/9300; 16K

Operating System: Any

Documentation: User's Memo, Loose-Leaf Pages

Support: Category 3

Developed By: Africa-Asia Division/Univac Japan

Availability: Applications Services

Order No.: 930030

DATE 8/71	SYSTEM TYPE 9200	INDEX NAME MORACC
REVISION 2		

APPLICATIONS SOFTWARE

MORTGAGE ACCOUNTS PROCESSING

The mortgage accounting package includes programs to handle batch proof listing, daily mortgage update, mortgage amortization, monthly interest calculation, mortgage trial balance, late charge computation, escrow analysis, and mortgage statements.

The program can be easily modified where certain aspects of a program may differ from the customer's present policy. This saves valuable man hours, expense, and reprogramming costs while still achieving a program best suited for the customer's installation.

Configuration: 9200; 8K; Read/Punch; Printer

Operating System: RPG; Assembler

Documentation: Mortgage Accounts Processing, User's Manual, UP-7684
Announcement Brochure, U-4935

Support: Category 3

Developed By: Americas Division

Availability: Applications Services

Order No.: 920025

DATE	SYSTEM TYPE	INDEX NAME
8/71	9300	MRA 93
REVISION		
1		

APPLICATIONS SOFTWAREMULTIPLE REGRESSION ANALYSIS

Regression analysis provides a systematic technique for estimating with confidence limits the unspecified constants in an equation. From theoretical or experimental work one may be able to hypothesize that the relation among several variables is of a given form (such as second-degree polynomial) without necessarily specifying the numerical values of all the constants in the equation. By regression analysis, it is possible to estimate these constants or to test whether they are consistent with the hypothesis.

An important special case of a function of x 's for predicting y is the linear function. By regression analysis, one may determine the function effect of continuous variables, x_1, x_2, x_n .

The output of MRA93 includes observation data and category, observation values, regression factors, and multicorrelation coefficient.

Configuration: 9300; 32K

Operating System: FORTRAN

Documentation: Multiple Regression Analysis, User's Manual,
Loose-Leaf Pages

Support: Category 3

Developed By: Africa-Asia Division/Univac Japan

Availability: Applications Services

Order No.: 930012

DATE	SYSTEM TYPE	INDEX NAME
3/74	9300	MSC068
REVISION		

APPLICATIONS SOFTWARE

TAPE, CARD, PRINT UTILITY

This parameter-driven program reads an input file and selectively produces output for printer, punch, tape, or any combination of these devices. The input file can be read from tape or cards. Input tapes may have standard, nonstandard, or no labels. Output tapes may have standard or no labels.

Field select, compare, unpack, and gangpunch options are controlled by the parameter cards.

Modified DMTIO and ASSGN macros facilitate control over mode and label processing.

Configuration: 9300; 32K; VI-C tape

Operating System: NCOS

Documentation: User's Guide, Loose-Leaf Pages

Support: Category 4

Developed By:

Availability: UUA Program Library Interchange

Order No.: 693002

DATE 8/73	SYSTEM TYPE 9300	INDEX NAME NET93
REVISION		

APPLICATIONS SOFTWARE

9300 NETWORK EMULATOR FOR THE 1100 SERIES

This emulator provides a means to test 1100 Series, EXEC 8, communications software via a remote 9300. The system actually set up is a 9300 but the simulator can be software-configured to simulate any combination of Uniscope 100's and DCT-1000's connected to a multidrop line, a terminal multiplexer, or multiple cascaded terminal multiplexers. Responses from the simulator to pools from the central computer are identical to the corresponding network. The central computer must have its communications control software configured in a manner consistent with the terminal network to be simulated.

When the 8K 9300 is used, simulation is limited to a maximum of 19 terminals. If more terminals are needed in the simulation it is necessary to expand 9300 main storage or add a disc unit. Note that the 1100 configuration will be dependent upon the system under test.

The Simulator programs perform the following functions:

1. Reads cards from the card reader attached to the UNIVAC 9300.
2. Constructs, from the card input, messages in the same format as those from the simulated devices.

Configuration: 9300; 8K; Multiplexer channel; DCS-1

Operating System: MTE

Documentation: User's Manual, loose leaf pages

Support: Category 3

Developed By: Americas Division

Availability: Application Services

Order No.: 930025

DATE 8/73	SYSTEM TYPE 9300	INDEX NAME NET93
REVISION		

APPLICATIONS SOFTWARE

3. Transmits the messages to the central computer.
4. Receives responses to the messages from the central computer.
5. Logs all input and output messages and error responses for diagnostics and evaluation.

FIGURE 1. 9300 SIMULATION OF REMOTE NETWORK

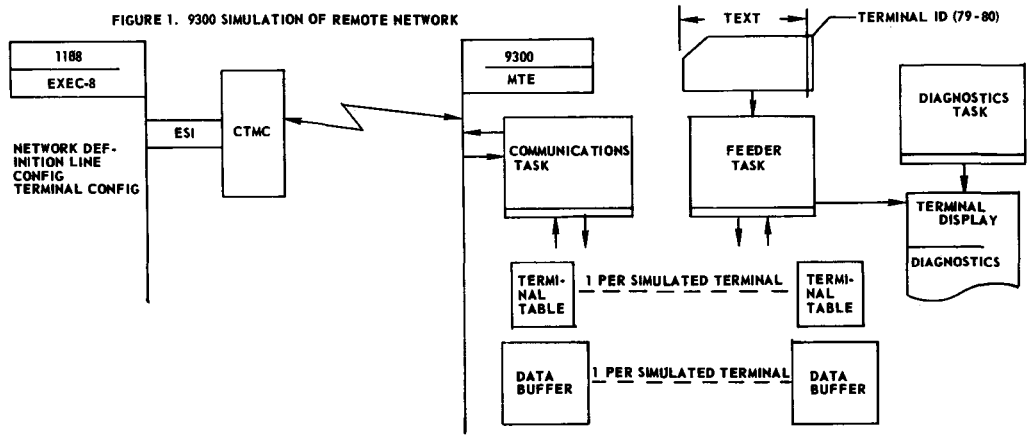

ACTUAL SIMULATING

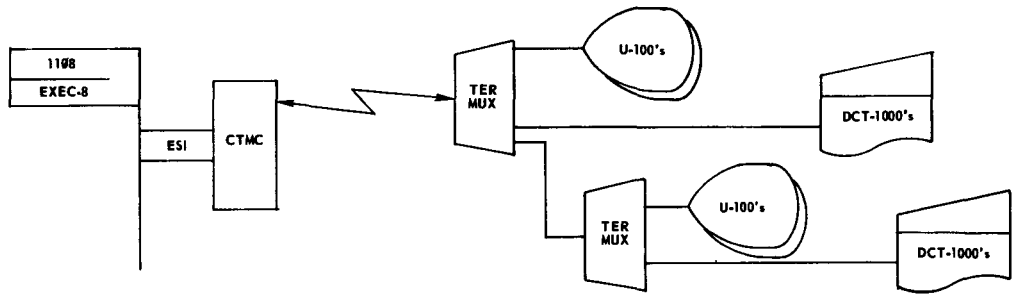

08/73	SYSTEM TYPE	UNIT NAME
REVISION	9300	NET93

DATE 2/72	SYSTEM TYPE 9300	INDEX NAME OS600
REVISION		

APPLICATIONS SOFTWARE

OS 600

This operating system was developed for the 9300 using UNISCOPE 100's. The 9300 operates as a normal batch job processor with the real-time system being run from the U-100 terminal. Use of the buffered terminal allows the user to format messages and program parameters offline, thus saving CPU time. An update function is provided which runs as two programs, "Display" and "Change". The user calls for information to be changed which is updated offline thereby taking advantage of the buffered device.

The system specifications include the ability to stop the main program, dump it to disc, call up and execute an inquiry program, and then restore the original program to memory and begin re-execution. Up to 12 U-100's may be used with COBOL or ASM Inquiry Programs.

The system's operation may be described as follows:

1. A main program (batch) is currently being executed on the 9300.
2. Each second the supervisor polling routine polls each U-100 on a pool list for status.

(continued)

Configuration: 9300; 32K; up to 12 UNISCOPE 100's

Operating System: DOS/NCOS

Documentation: OS 600 User's Manual, Loose-Leaf Pages

Support: Category 1

Developed By: Americas Division/Denver Board of Water Commissioners

Availability: Applications Services

Order No.: 930014

DATE	SYSTEM TYPE	INDEX NAME
2/72	9300	OS600
REVISION		

APPLICATIONS SOFTWARE

3. If no units are requesting an inquiry, then the system returns to the main program.
 - . If a particular unit does not respond, it is marked down and will be polled at 64 second intervals.
 - . If a particular unit's status shows that it is requesting an inquiry, the main program is brought to an orderly stop and put to disc.
4. An inquiry handler routine called "INQHAND" is brought in and executed.
5. INQHAND will check to see if the main program is suspendable.
6. If not, INQHAND will send a message to the requesting U-100 informing the user of the situation and then continues with the main program.
 - . If the main program is suspendable, INQHAND will tell the locator routine which programs to get.
7. Control is transferred to the supervisor.
8. The inquiry program desired is brought in and executed from a file of inquiry programs.
9. The inquiry program terminates with a call to the supervisor to roll back in the main program.
10. The original program then continues where it left off.
11. If a halt should occur during normal running and the operator cannot press start to continue, he may put the 9300 into an "IDLE" mode with an operator request key-in. This allows normal polling and inquiry activity to continue while the machine would ordinarily be halted.

DATE 2/72	SYSTEM TYPE 9300	INDEX NAME PACSII
REVISION 2		

APPLICATIONS SOFTWARE

PACS II

PACS II is a communications control program for the control of remote terminal and communications lines and the transfer of data for processing after checking it. The system also transfers processed data from the processing system to the communications line.

PACS II provides a supervisory function of priority level control and time allocation plus the control function for the communications line. This frees the user from additional areas of programming inherent to online systems.

PACS II is comprised of macro library routines; each routine may use macro call procedures.

PACS II exists in two versions:

- . The 8410 version can control UNISCOPE 300 and OKIDATA 50/200 terminals.
- . The 8411 version can control UNISCOPE 100 and Olivetti TC 349 BI terminals.

Configuration: 9300; 8410 or 8411 disc

Operating System: TOS

Documentation: UNISCOPE IOCS Manual, Loose-Leaf Pages (English);
PACS II Reference Manual, Loose-Leaf Pages (Japanese);
8410 version documentation (English)

Support: Category 3

Developed By: Africa-Asia Division/Univac Japan

Availability: Univac Japan

Order No.:

DATE	SYSTEM TYPE	INDEX NAME
2/72	9200	PAYROLL
REVISION 4	9300	

APPLICATIONS SOFTWARE**PAYROLL**

This package is designed for companies employing a significant number of people and with payroll characteristics which include fixed salary, hourly rated or both, weekly, biweekly or monthly pay periods, pension plans and income tax deductions. Some of the major features are:

1. Easily obtainable detailed payroll distribution summary by account number, division, department, on which to base a system of cost control.
2. An excellent base for additional reports and summaries to improve operations analysis and cost control.
3. An excellent base for simple preparation of year-end reports for federal, state and local income tax, unemployment compensation, workmen's compensation, etc.
4. Tightening of clerical effort at the time-keeping level.

Configuration: 9200; 8K; Card

Operating System: RPG

Documentation: Payroll, User's Manual, IN-7720

Support: Category 3

Developed By: Americas Division/Univac Canada

Availability: Applications Services

Order No.: 920026

DATE 2/72	SYSTEM TYPE 9200	INDEX NAME PAYROL
REVISION 4	9300	

APPLICATIONS SOFTWARE

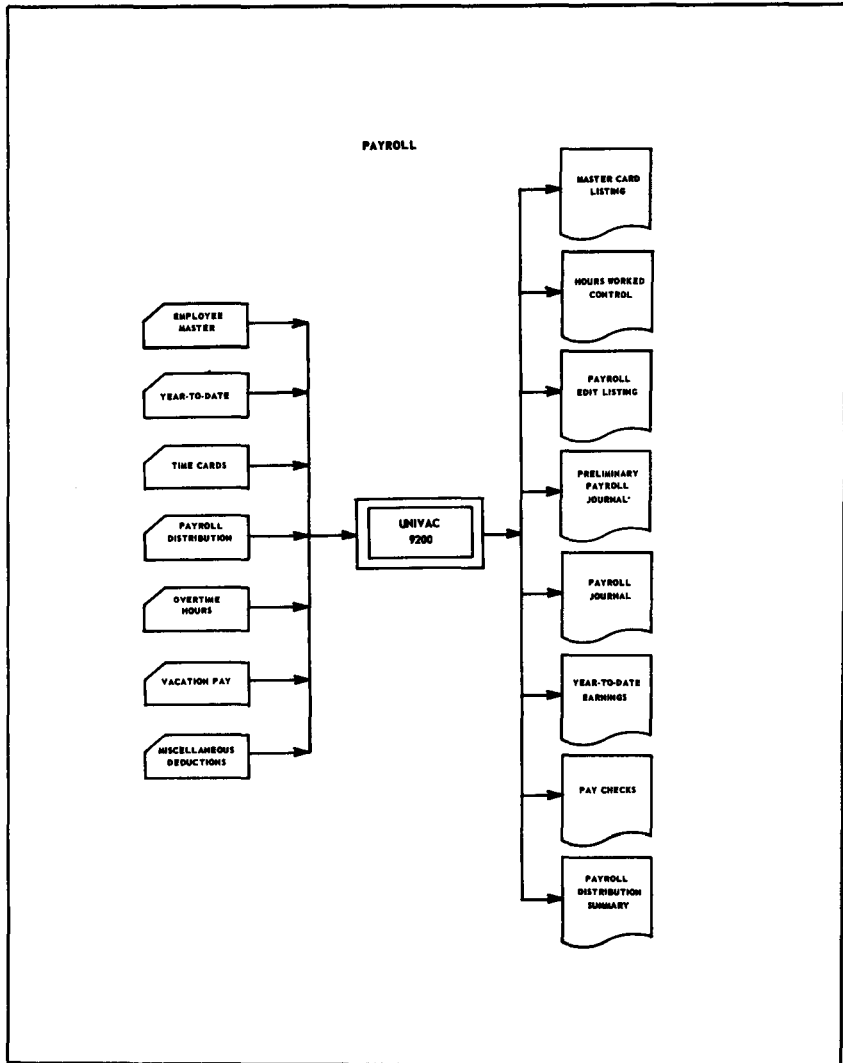

DATE	SYSTEM TYPE	INDEX NAME
8/71	9200	PERTCD
REVISION	9300	
1		

APPLICATIONS SOFTWARE

CPM-PERT FOR CARD SYSTEM

This network planning system is designed to be used on a 9000 series card system. All activities of the network are characterized by numeric starting and ending events, by the execution times and by a semantic description as well as the naming of the executing department.

The printed results contain an aggregate of all activities and dates separated according to executing department, plus a list of the critical activities and a bar diagram.

The network size is related to storage availability as follows:

8K - 100 activities
 12K - 200 activities
 16K - 250 activities
 24K - 500 activities
 32K - 600 activities

Configuration: 9200/9300; 96 print positions; punch

Operating System: NCOS

Documentation: CPM/PERT User's Manual, Loose-Leaf Pages (German and English)

Support: Category 3

Developed By: Central European Division/Univac Germany

Availability: Applications Services

Order No.: 920014

DATE	SYSTEM TYPE	INDEX NAME
8/71	9200	PLOT 92
REVISION	9300	
1		

APPLICATIONS SOFTWARE

GENERAL PLOT WITH HISTOGRAM

This is a general plot and histogram subroutine which can be linked with a user program written in assembly language or FORTRAN.

The output is a one-page plot or histogram as selected by the user. The dimensions are 50 units on the vertical axis and 100 units on the horizontal axis. The histogram can display up to 34 intervals along the horizontal axis.

Characters 1-F may be used to show the number of data points plotted in the same position (F implies 15 or more).

Configuration: 9200; 8K with 120 print positions for assembly language; 9200II: 9300; 16K; 4 tapes for FORTRAN

Operating System: Card Assembler; Exec I

Documentation: General Plot With Histogram, User's Manual, Loose-Leaf Pages

Support: Category 3

Developed By: U.S. Junior Achievement Program in Cooperation with Univac

Availability: Applications Services

Order No.: 920053

DATE 8/73	SYSTEM TYPE 9200 9300	INDEX NAME PR79
REVISION 2		

APPLICATIONS SOFTWARE1050 TO 9000 TAPE CONVERSION (PR 79)

PR 79 is a general-purpose program for converting standard-formatted 1050 tapes (7-track) to 9-track tapes in 9000 series standard format.

The variable parameters (LU, EKSZ, RCSZ) for I/O are defined on control cards. The code is translated from XS-3 to EBCDIC.

Configuration: 9200-II/9300

Operating System: NCOS/MOS

Documentation: User Instructions, loose leaf pages (German)

Support: Category 3

Developed By: Northern European Division/Univac Austria

Availability: Applications Services

Order No.: 930027

DATE	SYSTEM TYPE	INDEX NAME
8/73	9200	PR97
REVISION 2	9300	

APPLICATIONS SOFTWARE9000 TO 1050 TAPE CONVERSION (PR 97)

PR 97 is a general-purpose program which converts standard 9000 series tapes (9-track) to standard 1050 tapes (7-track). Only fixed-length records are allowed! The code is translated from EBCDIC to XS-3.

The user may specify the parameters for I/O on control cards.

Configuration: 9200-II/9300

Operating System: NCOS/MOS

Documentation: User Instructions, loose leaf pages (German)

Support: Category 3

Developed By: Northern European Division/Univac Austria

Availability: Applications Services

Order No.: 930028

DATE 2/72	SYSTEM TYPE 9200	INDEX NAME PTCUP
REVISION		

APPLICATIONS SOFTWARE

FSU-TAB CARD UTILITY PROGRAM

FSU-TAB is a general-purpose card utility program which, in many cases, can be used in lieu of writing a special program. FSU-TAB provides gangpunch/reproduce functions on the serial punch by means of a header card, and the printing of output records on the bar printer. It can also be used as a list-only or a list-and-punch program by means of the operator-selected keyins. In addition, it has provision for up to three tab fields, also operator-selected by a series of keyins. Record numbering is an automatic function of the print option, and the final record count total is an automatic function of the TAB option.

Configuration: 9200; 8K; 96 print positions, serial punch

Operating System: MOS; Assembler; BAL

Documentation: User's Manual, loose leaf pages

Support: Category 3

Developed By: Americas Division

Availability: Applications Services

Order No.: 920085

DATE	SYSTEM TYPE	INDEX NAME
8/71	9300	PTSYM
REVISION		

APPLICATIONS SOFTWARE

PAPER TAPE SYMBIONT

There are two paper tape symbionts; one is an input symbiont (paper tape to magnetic tape); the other is an output symbiont (magnetic tape to paper tape).

These symbionts can run concurrently with a main program using 9300 COS.

Configuration: 9300; 24K; 5 VI-C tapes; PTU (PTR/PTP)

Operating System: COS

Documentation: User's Manual, Japanese

Support: Category 3

Developed By: Africa-Asia Division/Univac Japan

Availability: Univac Japan

Order No.:

DATE	SYSTEM TYPE	INDEX NAME
8/71	9200	PUR
REVISION 1	9300	

APPLICATIONS SOFTWARE

IBM 360/20 TO 9200/9300 TRANSLATOR (PUR)

PUR is a source program converter which converts 360/20 assembler to 9200/9300.

Two versions are available. PUR 1 converts 360/20 card system programs (MFCM not included). PUR 2 converts 360/20 tape system programs.

The converters run on 8K/16K 9200/9300's respectively. The programs operate under extended card Exec or NCCS with the extensions being a part of the conversion process.

Configuration: 9200; 8K; or 9300; 16K; 2 tapes

Operating System: Exec or NCCS (Extended)

Documentation: User's Manual, Loose-Leaf Pages

Support: Category 3

Developed By: Central European Division/Univac Germany

Availability: Applications Services

Order No.: 920042

DATE	SYSTEM TYPE	INDEX NAME
10/72	9200 9300	REMFIX
REVISION		
1		

APPLICATIONS SOFTWARE

REM-1 THROUGHPUT IMPROVEMENT

REMFIX provides for communications between 9200/9300 and 1100 series computers. It allows for greater throughput capacity than is possible with the standard REM-1 software. REMFIX will permit the 9000 series computer to operate as fast as the communications line will allow.

Configuration: 9200/9300; 8K; Reader, Serial or Row Punch; Bar Printer

Operating System: MOS/NCOS: Assembler

Documentation: 92/9300 Release Memo #129

Support: Category 3

Developed By: Americas Division

Availability: Software Order Services, Blue Bell

Order No.:

DATE 2/72	SYSTEM TYPE 9300	INDEX NAME RE1004
REVISION 2		

APPLICATIONS SOFTWARE

1004 HANDLER

Job Control statements and data are submitted by the user to the UNIVAC 9400 operating system by way of a card reader and stored on the resident direct access storage device for subsequent processing.

This reader handler provides for loading these cards into the system using the reader on a UNIVAC 1004 system. The difference between this and the standard handler is the capability of reading 90 column cards.

Configuration: 9300; 1004

Operating System: DOS/TOS

Documentation: Loose Leaf Pages (Japanese)

Support: Category 3

Developed By: Africa-Asia Division/Univac Japan

Availability: Univac Japan

Order No.:

DATE 8/71	SYSTEM TYPE 9200	INDEX NAME SAVACC
REVISION 2		

APPLICATIONS SOFTWARE

SAVINGS ACCOUNT PROCESSING

The UNIVAC 9200 Savings Account System, in addition to processing a depositor's records at high speed and with extreme accuracy, can be used to generate a wide variety of management reports. The programs in the savings accounts package include the daily teller proof journal, daily update journal, management activity report, savings trial balance journal, dividend trial balance journal, and the 1099 U.S. information return. The programs may be modified to suit specialized needs.

The UNIVAC 9200 and the savings account processing program promote savings accounts growth through better service and help handle rapidly increasing volume at stabilized costs.

Configuration: 9200; 8K; 132 Print Position

Operating System: RPG

Documentation: Savings Account Processing, User's Manual, U-4724;
Announcement Brochure, U-4723

Support: Category 3

Developed By: Americas Division

Availability: Applications Services

Order No.: 920027

DATE 8/73	SYSTEM TYPE 9200 9300	INDEX NAME SCORE
REVISION 2		

APPLICATIONS SOFTWARE

SCHOOL CURRICULUM ORIENTED RATINGS AND EVALUATION (SCORE)

SCORE is used to test and evaluate students' understanding in a particular learning situation. Also, the test problems themselves are evaluated to determine how well the instructor prepared the course materials and how well these course materials were presented to the students.

Output from SCORE comprises:

- . Evaluation statistics on individual students
- . Comparative statistics of all students in a class
- . Analysis chart of the examination
- . Distribution list of correct/incorrect answers to the problems

Analysis portion remains as a user option and must be written by user. An analysis portion, based on Guttman scale, is in design.

Configuration: 9200/9300; 4 tapes

Operating System: NCOS; Assembler

Documentation: User Instructions, loose leaf pages (English);
Operational Instructions (Japanese)

Support: Category 3

Developed By: Africa-Asia Division/Univac Japan

Availability: Applications Services

Order No.: 930024

DATE	SYSTEM TYPE	INDEX NAME
8/71	9200	SIMS
REVISION	9300	
2		

APPLICATIONS SOFTWARESCIENTIFIC INVENTORY MANAGEMENT SYSTEM

SIMS was developed basically for the 9200 card system but may easily be incorporated into a tape system. The programs were designed to be integrated with an overall data processing system. They supply the more complex calculations required for forecasting and ordering.

SIMS is made up of four basic subsystems:

- . Demand history analysis
- . Computing a new forecast and updating the mean average deviation
- . Calculating EOQ, Reorder Point and inventory valuation
- . Printing the inventory valuation

Configuration: 9200; 8K

Operating System: MOS; Assembler

Documentation: Scientific Inventory Management System, IN-7716

Support: Category 3

Developed By: Northern European Division/Univac United Kingdom

Availability: Applications Services

Order No.: 920036

DATE	SYSTEM TYPE	INDEX NAME
2/72	9200	SIM05
REVISION	9300	
2		

APPLICATIONS SOFTWARE

1005 SIMULATOR

This program simulates UNIVAC 1005 object programs on the UNIVAC 9200/9300.

Supported peripherals are: Reader, Printer, Punch; a second reader may be simulated by tape input.

Configuration: 9200; 16K; Reader; Printer (132 Positions); Punch

Operating System: Exec I/MOS/NCOS

Documentation: SIM1005 - Programmbibliothek (German)

Support: Category 3

Developed By: Central European Division/Univac Germany

Availability: Applications Services

Order No.: 920079

DATE	SYSTEM TYPE	INDEX NAME
8/71	9200	SISIO
REVISION	9300	
2		

APPLICATIONS SOFTWARE

SPECIAL INDEXED SEQUENTIAL IOCS

Special Indexed Sequential IOCS is similar to the standard processor in the UNIVAC 8410 Disc IOCS (UP-7639) but is designed to meet the requirements of the Bill of Materials Processor (BMP). Each record is stored in a separate sector. The data for each record is stored in the same sector as its key. Records added to the file are stored in an overflow area and linked to records in the prime area.

Configuration: 9200/9300; 12K; (2) 8410 Discs (16K if used with Bill of Materials Processor)

Operating System: MOS

Documentation: Special Indexed Sequential IOCS, *User's Manual*, UX-5296

Support: Category 3

Developed By: Americas Division

Availability: Applications Services

Order No.: 920048

DATE	SYSTEM TYPE	INDEX NAME
3/74	9200	SNAP9
REVISION	9300	

APPLICATIONS SOFTWARE

SNAP DUMP ROUTINE

This is a snap dump routine for I/O mode only. It allows the selection of start and end dump addresses.

This is an assembler language subroutine.

Configuration: 9200/9300

Operating System: MOS/NCOS

Documentation: Source code listing

Support: Category 3

Developed By: Americas Division

Availability: Applications Services

Order No.: 920088

DATE	8/73	SYSTEM TYPE	9200 9300	INDEX NAME	SORT2
REVISION	2				

APPLICATIONS SOFTWARE

SORT-II

This sort routine is a generative type and uses the Backward-Cascade Method. The routine is designed for small data files and sort applications which are scheduled very frequently.

Configuration: 9200 II/9300; 16K; (4) VI C tapes

Operating System: NCOS/COS

Documentation: User's Manual (Japanese)

Support: Category 3

Developed By: Africa-Asia Division/Univac Japan

Availability: Applications Services

Order No.: 930019

DATE	SYSTEM TYPE	INDEX NAME
8/71	9200	S01001
REVISION	9300	
2		

APPLICATIONS SOFTWARE

SORT UTILITY ROUTINE 9200/9300/1001

9200/9300 String SORT routine using the 1001 as input. Sorting is processed on up to 15 different fields specified in order of importance. The limit on field size is the full 80 columns of the card.

Sorting can be either numeric or alphabetic or a combination of both. The high speed printer is used to monitor and print instructions to the operator.

Configuration: 9200/9300; minimum; 1001 on line

Operating System: 9200; Assembler

Documentation: 9200/9300/1001 SORT Routine, User's Manual, UP-7699

Support: Category 3

Developed By: Americas Division

Availability: Applications Services

Order No.: 920028

DATE	SYSTEM TYPE	INDEX NAME
1/71	9200	SPUC
REVISION	9300	

APPLICATIONS SOFTWARE

SIMULATOR FOR UNIVAC 1004-PUC PROGRAMS

SPUC is a simulator, running on a 9200/9300, which allows a PUC program for an 80 column, two memory bank, 1004 to be accepted unchanged by the 9200/9300 (with the exception of programs using the read-punch).

The program can be considered as a special operating system for the 9200/9300. It is loaded with the first PUC program. Further PUC programs can be loaded using the restart procedure (CLEAR, START).

PUC is an assembler type program for the 1004.

Configuration: 9200; 8K; Serial or Row Punch; Reader

Operating System: Exec I

Documentation: SPUC, User's Manual, Loose-Leaf Pages (German and English)

Support: Category 3

Developed By: Central European Division/Univac Germany

Availability: Univac Germany

Order No.:

DATE	SYSTEM TYPE	INDEX NAME
8/71	9200	STAT92
REVISION	9300	
1		

APPLICATIONS SOFTWARESTATISTICAL PACKAGE

This package consists of four subroutines which can be linked with Assembly Language programs:

- . Simple Data Description (SDD)
- . Correlation (COR)
- . Analysis of Variance (VAR)
- . Simple Linear Regression (RGR).

Demonstration user programs which process statistical data on cards are also included. The capabilities of these programs are comparable to the following programs from the Bio-Medical System (BMD):

- . Simple Data Description
- . Correlation with Transgeneration
- . Simple Linear Regression
- . Analysis of Variance for One-Way Design.

(See BMD entry under 1100).

Configuration: 9200 (minimum)

Operating System: Card Assembler; Exec I

Documentation: Statistical Package, User's Manual, Loose-Leaf Pages

Support: Category 3

Developed By: U. S. Junior Achievement Program in cooperation with Univac

Availability: Applications Services

Order No.: 920052

DATE	SYSTEM TYPE	INDEX NAME
2/72	9200	STSP
REVISION	9300	

APPLICATIONS SOFTWARE

SPECIAL TAPE SORT PACKAGE

The Special Tape Sort Package consists of four routines which supplement the standard 9200 II/9300 tape sort. They are as follows:

- .S0C0 - Sort any number of card input files
- .ST80 - Sort any number of tape input files (81 byte maximum record size)
- .ST00 - Sort any number of tape input files (256 byte maximum record size)
- .SCAT - Sort any number of card and/or tape input files

With these special tape sort routines one may input data to be sorted from the card reader, input several reels of either nonstandard or unlabeled tapes without the use of the VOL option, and a combination of input from a mixture of cards and tape.

Configuration: 9200/9300; 8K; 3 VI C (7 or 9 track)

Operating System: MOS/NCOS

Documentation: User's Manual, Loose-Leaf Pages

Support: Category 3

Developed By: Americas Division

Availability: Applications Services

Order No.: 920087

DATE	SYSTEM TYPE	INDEX NAME
2/72	9200	SWITCH
REVISION	9300	
3		

APPLICATIONS SOFTWARESWITCH UTILITY PROGRAM, IBM 360/20 TO 9200/9300

SWITCH provides conversion from 360/20 RPG Source Code to 9200/9300 RPG Source Code for use on card or tape oriented UNIVAC computers.

The package consists of a series of three programs:

The first converts the file file extension, and input section; the second converts the calculate section; and, the third converts the output section. Differences between the two languages are analyzed and conversions performed to make the new reproduced deck ready for compilation on the series 9000 computer.

Source Code programs are distributed to allow modification to other configurations.

Configuration: 9200/9300; 8K; 96 Print Position Printer; Reader; Serial Punch

Operating System: RPG

Documentation: SWITCH RPG Translator, 360/20 to 9200/9300, User's Manual, UP-7705

Support: Category 3

Developed By: Americas Division

Availability: Applications Services

Order No.: 920029

DATE 2/72	SYSTEM TYPE 9200 9300	INDEX NAME SWITCH
REVISION 3		

APPLICATIONS SOFTWARE

SWITCH

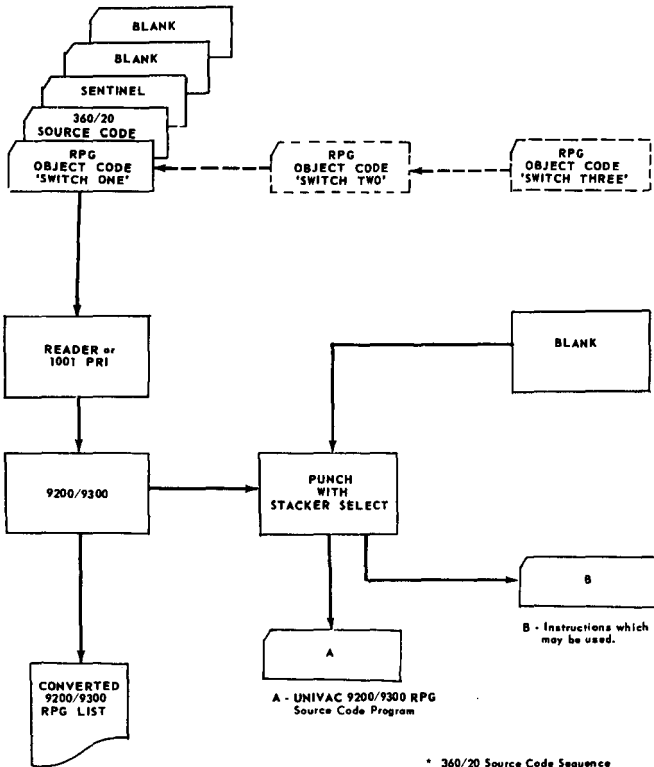

* 360/20 Source Code Sequence
File, File Extensions, Input,
Calculate and Output.
Table Cards omitted

DATE 2/72	SYSTEM TYPE 9200	INDEX NAME TALC
REVISION 4	9300	

APPLICATIONS SOFTWARE

1005 TO 9200/9300 TRANSLATOR (TALC)

TALC enables the user of a 1005 I, 1005 II, or 1005 III computer system to translate their assembly language source programs for the 9200/9300 computer systems. All standard 1005 peripherals are supported.

Input to TALC is the noncondensed 1005 object deck for an operational 1005 program (80 or 90 column). Output is a card assembler source program for the 9200.

A listing is produced during the translation showing the original 1005 source code and comments, and the associated source code or macro code generated to execute an equivalent function on the 9200/9300. Caution notes are printed for certain 1005 instructions.

Configuration: 9200/9300; 16K; card punch; printer (132 print positions)

Operating System: MOS

Documentation: User's Documentation, loose leaf pages

Support: Category 3

Developed By: Worldwide Marketing Support

Availability: Applications Services

Order No.: 920065

DATE	SYSTEM TYPE	INDEX NAME
10/72	9200	TAPE
REVISION	9300	
2		

APPLICATIONS SOFTWARE

TAPE

TAPE is designed to allow I/O for nonstandard tape files. TAPE writes or reads a block. Each block size, logical unit or direction may be defined.

All hardware tape instructions can be executed by a control macro (CNTRL).

Configuration: 9200-II; 9300

Operating System: NCOS; MOS

Documentation: German, Loose-Leaf Pages

Support: Category 3

Developed By: Northern European Division/Univac Austria

Availability: Applications Services

Order No.: 930020

DATE	SYSTEM TYPE	INDEX NAME
11/70	9200	TAPE45
REVISION	9300	

APPLICATIONS SOFTWARE

TAPE 4/5

TAPE 4/5 is a set of changes and enhancements to the standard 9000 series software tape input/output routine to handle tapes from other UNIVAC systems on the 9200/9300.

Implementation is based on DMTIO (System Tape Rev. 3). It allows the user to work with U 1050, U 1004 and U 1005 tape as standard tapes. All differences are defined in DTFMT by keyword parameters.

Configuration: 9200-II; 9300

Operating System: NCOS; MOS

Documentation: Loose Leaf Pages (German)

Support: Category 3

Developed By: Northern European Division/Univac Austria

Availability: Univac Austria

Order No.:

DATE	SYSTEM TYPE	INDEX NAME
8/71	9300	TAPE79
REVISION		
2		

APPLICATIONS SOFTWARE

MAGNETIC TAPE CONVERSION

The tape conversion program utilizes various parameter cards to define the fields of an input tape and to define the fields of the output tape. These parameters permit the reformatting or exclusion of fields, addition of constant information, 'packing' of the output fields, while at the same time designating one of three options as to mode of translation. The user may convert 7 channel to 7 channel, 7 to 9, or 9 to 9.

Configuration: 9300; 16K

Operating System: NCOS

Documentation: User's Manual, UP-7768

Support: Category 3

Developed By: Americas Division

Availability: Applications Services

Order No.: 930010

DATE 2/72	SYSTEM TYPE 9300	INDEX NAME TRAN93
REVISION 3		

APPLICATIONS SOFTWARE9300 TO 9400 TRANSLATOR

This routine translates 9300 source assembly language programs to 9400 source coding. It is a three phase translator, executed on the 9300.

The translator uses magnetic tape as intermediate storage during translation with final 9400 source statements punched in cards. Instructions and directives that cannot be translated directly are flagged. Instruction cards are entered on the next phase to allow proper translation or correction. This is mainly in the area of IOCS macros and assembler directives.

It is also possible to insert and delete coding to modify the original program.

Configuration: 9300; 16K; 3 Tapes; Reader; Printer; Punch

Operating System: TOS; Assembler

Documentation: 9300 to 9400 Translator, loose leaf pages (Japanese and English)

Support: Category 3

Developed By: Africa-Asia Division/Univac Japan

Availability: Applications Services

Order No.: 940001

APPLICATIONS SOFTWARE

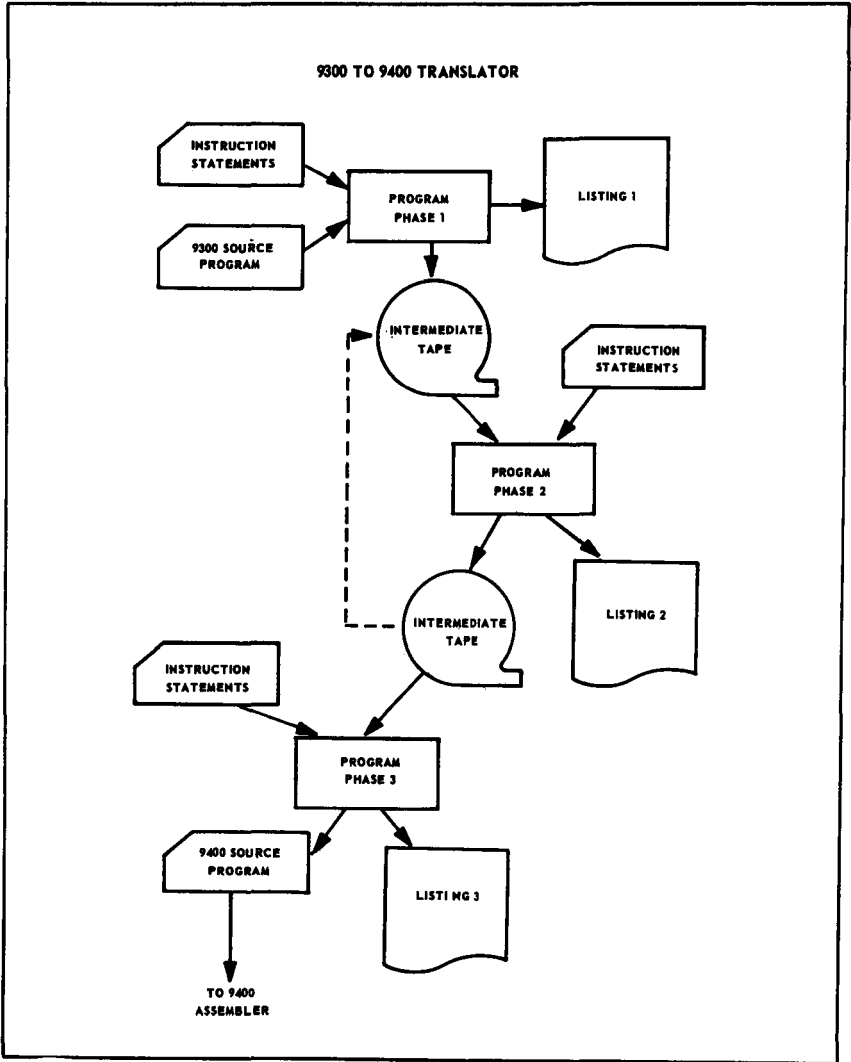

DATE	SYSTEM TYPE	INDEX NAME
8/71	9200	TVSCH
REVISION	9300	
1		

APPLICATIONS SOFTWARE

TELEVISION SCHEDULING

This package is used for the efficient selling, scheduling and billing of commercial time for television stations.

The broadcasting industry has its own unique inventory problem. It sells a perishable commodity with an arbitrary value which fluctuates in accordance with the popularity of the station and its programs, yet the product is time.

The TVSCH package takes contracts for time sales (commercials) and merges these with a program master file which provides:

- . Sales and Traffic with a forecast (the availabilities)
- . A daily program log
- . Sales accounting with a card produced as a byproduct from the log. This can be used in billing procedures (monthly invoicing, commercial contents, etc.).

Configuration: 9200; 8K; Card Reader; Row Punch; 96 Position Printer

Operating System: MOS

Documentation: Television Scheduling, User's Manual, IN-7748

Support: Category 3

Developed By: Americas Division/Univac Canada

Availability: Applications Services

Order No.: 920030

DATE 2/72	SYSTEM TYPE 9200	INDEX NAME UCA
REVISION 3		

APPLICATIONS SOFTWARE

CLIENT ACCOUNTING

This system is designed for the professional accountant to provide a complete accounting and advisory service for his smaller clients. The package provides the following features:

- . Detailed Transaction Journal
- . General Ledger
- . Financial Statement Reports
- . Subsidiary Ledger

Each transaction journal records all related transactions during the period and in the order received.

The General Ledger shows the opening balance, current period's posting, net transactions and the new balance for each General Ledger Account.

The subsidiary ledger can be obtained as desired.

The statement of income shows current trading results, together with a year-to-date figure with percentages for comparison purposes.

Configuration: 9200; 8K; Cards

Operating System: Assembler

Documentation: Client Accounting, User's Manual, Loose-Leaf Pages

Support: Category 3

Developed By: Americas Division/Univac Canada

Availability: Applications Services

Order No.: 920031

DATE	SYSTEM TYPE	INDEX NAME
2/72	9200	UCA
REVISION	9300	
3		

APPLICATIONS SOFTWARE

CLIENT ACCOUNTING

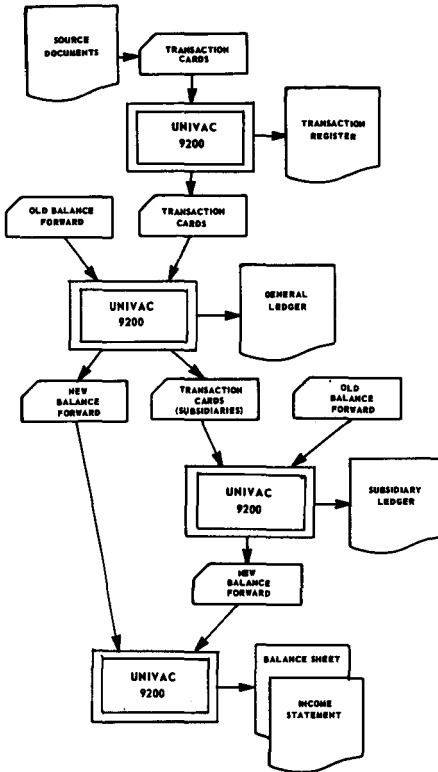

DATE	SYSTEM TYPE	INDEX NAME
2/72	9200	UHASPA
REVISION 2	9300	

APPLICATIONS SOFTWARE

UNIHASP-9200/9300 TO 360 HASP II SYSTEMS - COMMUNICATIONS HANDLER

HASP is an automatic spooling, priority system which will operate any number of remote peripheral devices simultaneously with normal job execution. UNIHASP can be considered a logical extension of the HASP system.

UNIHASP communicates through a DCS-1 to an IBM 2701 or 2703 with a Synchronous Data Adapter Type II, ASCII mode nontransparent. Modifications are made to HASP to handle the binary synchronous transmission with the 9200/9300.

Configuration: 9200; 8K; DCS-1

Operating System: MOC

Documentation: User's Manual, UX-5271

Support: Category 3

Developed By: Americas Division and John Deere Corporation

Availability: Applications Services

Order No.: 920046 for Version 2.3
920080 for Version 3.0

DATE 8/73	SYSTEM TYPE 9200 9300	INDEX NAME UHASP2
REVISION 3		

APPLICATIONS SOFTWARE

UNIHASP 9200 TO 360 HASP HANDLER USING DCS-1C

HASP (Houston Automatic Spooling Program) is a 360 program which complements OS 360 in the execution of the OS Job Management and Input/Output Functions. It compares functionally with Exec 8's symbionts and elements of the coarse scheduler.

UNIHASP is an extension of the HASP system. It is used to communicate with OS 360 using a 9200/9300 as a terminal. This version of UNIHASP will communicate through a DCS-1C using Binary Synchronous Communications Procedures. Capabilities provided by this version beyond the original UNIHASP are:

- . Transparent transmission
- . Multi-leaving is available
- . A supported console/inquiry unit

The necessary instructions to generate the handler for the 9000 terminal under HASP and OS 360 are provided along with the UNIHASP program. HASP version 3.0 is currently being used.

Configuration: 9200; 8K; DCS-1C; reader; punch; printer

Operating System: MCS

Documentation: User's Guide, loose leaf pages

Support: Category 1

Developed By: Americas Division

Availability: Applications Services

Order No.: 920089

DATE 8/73	SYSTEM TYPE 9300	INDEX NAME UNIBAU
REVISION 2		

APPLICATIONS SOFTWARE

BUILDING INDUSTRY PROGRAM (UNIBAU 91)

This program is used for calculations in the General Building Industry. It may also be used for superstructure, deep workings, road construction and dike construction. Besides computations of lengths, areas and volumes of bodies, the following special features are noteworthy :

- . Overall flexibility (free format) for any mathematical formula
- . No fixed and assigned formulas. Every formula must be defined previously with a "FUNK" instruction
- . A symbol may be assigned to each result for later use in other computing operations
- . For each operation, the scale factor may be changed by centesimal graduation (400^o) or normal graduation (360^o)
- . Arc - measurement for angular functions is permitted
- . Variable headings
- . Variable number of lines per page

Configuration: 9300; 32K; (2) Tapes; card punch

Operating System: NCOS; FORTRAN

Documentation: Loose Leaf Pages (German)

Support: Category 3

Developed By: Central European Division/Univac Germany

Availability: Application Services

Order No.: 930026

DATE 8/71	SYSTEM TYPE 9200	INDEX NAME UNICOG
REVISION 1		

APPLICATIONS SOFTWARE

UNIVAC COORDINATE GEOMETRY SYSTEM

UNICOG is used in civil engineering for computations associated with surveying and subdivision design. Solutions are provided for traverse, inverse, circular curves, areas, and intersection problems.

UNICOG goes beyond the mere solution of individual problems; for example, all input data, as well as intermediate results, may be assigned identifying numbers by which they may be recalled for subsequent computation. This feature makes it possible to plan a detailed subdivision and compute all lines, curve parts, and areas from a minimum amount of input data.

A FORTRAN area calculation program is also included.

Configuration: 9200; 12K (for UNICOG); 16K, 4 tapes (for FORTRAN)

Operating System: MOS; FORTRAN

Documentation: UNICOG and FORTRAN Area Calculation, Loose-Leaf Pages

Support: Category 3

Developed By: Americas Division

Availability: Applications Services

Order No.: 920044

DATE	SYSTEM TYPE	INDEX NAME
3/74	9200	UNIS93
REVISION	9300	
3		

APPLICATIONS SOFTWARE

UNIVAC INDUSTRIAL SYSTEM

UNIS is an integrated, modular system used for solving management information problems in the manufacturing industry. It is designed to handle problems associated with bill of materials processing, inventory management, and production planning and scheduling. The modularity and flexibility of UNIS permit a tailored solution for a specific application. The basic problem of applying a single system to all types of manufacturing organizations is overcome by UNIS by providing the user with a choice of processing methods.

UNIS is composed of three major modules, each described separately in this abstract. The modules are:

- . Bill of Materials Processor (UNIBORS/UNIBOSS)
- . Inventory Management System (ALDIN)
- . Planning and Scheduling System (UNITEK-1)

An interface is established between UNIS and the standard IOCS to handle files.

UNIS is also available for the UNIVAC 9400 and the UNIVAC 1100 under index names of UNIS94 and UNIS11, respectively.

Configuration: 9200/9300; UNIBOSS, 4 tapes or 2 discs (8411/8414)
UNIBORS, ALDIN, UNITEK-1, 1 disc minimum

Operating System: NCOS

Documentation: UNIVAC 9000 Bill of Material Processing System, UNIBORS General Description, UA-0039; User's Reference, UA-0038
UNIVAC 9000 Production Planning and Scheduling System, UNITEK-1, General Description, UA-0036; User's Reference, UA-0066
UNIVAC 9000 Inventory Management System, ALDIN General Description, UA-0072; User's Reference, UA-0071
UNIBOSS Bill of Material User's Manual, Loose-Leaf Pages

Support: Category 1

Developed By: Central European Division/Univac Germany

Availability: Applications Services

Order No.: UNIBORS, 930016; UNIBOSS, 930017; ALDIN, 930032;
UNITEK-1, 930033

DATE	SYSTEM TYPE	INDEX NAME
3/74	9200	UNIS93
REVISION	9300	
3		

APPLICATIONS SOFTWARE

UNIBORS/UNIBOSS

The Bill of Material Processor provides parts lists and input data for the Inventory Management System, and the Planning and Scheduling System. It is composed of a number of subprograms which may be categorized into three groups:

- . Loading programs
- . Processing programs
- . Updating programs

All data defining the component and product structure is collected and used to create two master files; the parts file, and the structure file. These files are used to produce the various bill of material lists, and parts usage lists. They also calculate the total demand requirements.

Various types of output result from the bill of material processing. For example, a bill of materials explosion gives the time relationship for components which make up the finished product. Other types of output include an indented explosion, which shows the hierarchical structure from the finished product to the lowest production level; a review list; a function list; an assembly list; a standard list; and a customer list. The processor may also be used to compile part usage lists which show all higher level components or assemblies which use a specified part.

Two bill of material processors are available. The primary difference between them is that one uses a sequential processing method, and the other a random method.

The sequential processor, UNIBOSS, requires shorter processing time than the direct access system. It is particularly useful in the following environment:

- . A large volume of data exists (scientific storage)
- . Update is frequent
- . Many batched calculations are necessary
- . Other data processing problems warrant the use of a tape-/disc-oriented system

The random processor, UNIBORS, is recommended where:

- . An average volume of data exists
- . Frequent updating is not necessary
- . The number of necessary calculations is not great

DATE	SYSTEM TYPE	INDEX NAME
3/74	9200	UNIS93
REVISION 3	9300	

APPLICATIONS SOFTWARE

ALDIN

The Inventory Management System is a multilevel system based on five major elements:

- . Total requirements calculations
- . Stock level control
- . Net requirements calculations
- . Reorder calculations
- . Material requirements planning

The concept of a multilevel inventory management system is used to control raw materials, parts, or assemblies at different production levels. Thus, it is a system which will improve stock availability, reduce capital investment, and improve the speed and accuracy of stock information. The program provides information regarding stock levels. It anticipates safety stock penetration, and calculates economic reorder quantities and the value of stock on hand, whereby all of these functions are carried out and optimized at different production levels.

UNITEK-1

The objectives of the Production Planning and Scheduling System are to improve adherence to planned completion dates, to reduce lead times, and to reduce the capital tied up in work in process. The work order file is maintained, each job is scheduled, and the resulting load is placed in the work center file. Infinite capacity scheduling is used.

The input is composed of production data, operation planning data, and control parameters. The system creates and maintains the work order and work center files, thereby providing the necessary data for a user to produce work order schedules, work center schedules, work center load reports, and other manufacturing reports.

DATE	SYSTEM TYPE	INDEX NAME
8/71	9200	UNITST
REVISION	9300	
1		

APPLICATIONS SOFTWAREUNITST

UNITST is a testing aid which allows alteration, addition and insertion of coding, snap-shooting, tracing, and postmortem dumps.

The error documentation which is available with the program abort includes error diagnostics, the last eight branch instructions, the contents of the program registers, and a memory dump.

Configuration: 9200/9300; 16K; reader or 1001; printer

Operating System: Exec I/MOS/NCOS

Documentation: User's Manual, Loose-Leaf Pages (English and German)

Support: Category 3

Developed By: Central European Division/Univac Germany

Availability: Applications Services

Order No.: 920074

DATE	SYSTEM TYPE	INDEX NAME
3/74	9200	UTRG
REVISION	9300	

APPLICATIONS SOFTWARE

RPG UTILITY TO RE-ID AND RENAME

This is an RPG programmer's aid to simplify the task of modifying existing RPG source decks. This utility program will perform up to six functions while producing a corrected source deck during a single pass.

The functions provided in this program are:

- Punch program ID in columns 75-80
- Punch new sequence numbers in columns 1-4
- Automatically produce a new header card
- Change indicators using an external replacement table
- Rename variables using an external replacement table
- Shift output print positions any number of positions to the right or left. This function also may be used to shift other forms of output.

Configuration: 9200/9300

Operating System: RPG

Documentation: User's Guide, Loose-Leaf Pages

Support: Category 4

Developed By:

Availability: UUA Program Library Interchange

Order No.: 692001

DATE	SYSTEM TYPE	INDEX NAME
8/71	9200	U100H
REVISION	9300	

APPLICATIONS SOFTWAREUNISCOPE 100 HANDLER

The UNISCOPE 100 Handler is a set of subroutines which enable an assembly language user program to receive and transmit messages to one synchronous UNISCOPE 100. The handler uses GCCR (Generalized Communication Control Routine).

Configuration: 9200/9300; 12K; DCS-1 with synchronous checking LT; multiplexer

Operating System: MOS; Card Assembler

Documentation: User's Manual, loose leaf pages

Support: Category 3

Developed By: Americas Division

Availability: Applications Services

Order No.: 920070

DATE 2/72	SYSTEM TYPE 9200	INDEX NAME WICA
REVISION 3		

APPLICATIONS SOFTWARE

WHOLESALE ICE CREAM ACCOUNTING

This is a companion package to the Dairy Route Accounting System, index name DAIRY. The system provides for the use of a preheaded, itemized customer sales ticket. Pricing is computer-verified according to pre-determined price lists established by type of customer. Volume discounts are calculated and accrued for later payment.

Sales may be made on either a cash or charge basis. An accounts receivable system is provided for charge customers. Various sales analysis programs are also included.

Configuration: 9200; 16K; Reader; 96-Print Position Printer; Read/Punch; 1001 Card Controller optional

Operating System: RPG

Documentation: Wholesale Ice Cream Accounting, User's Manual, UX-5273

Support: Category 3

Developed By: Americas Division

Availability: Applications Services

Order No.: 920033

DATE 2/72	SYSTEM TYPE 9200	INDEX NAME WICA
REVISION 3	9300	

APPLICATIONS SOFTWARE

WHOLESALE ICE CREAM ACCOUNTING

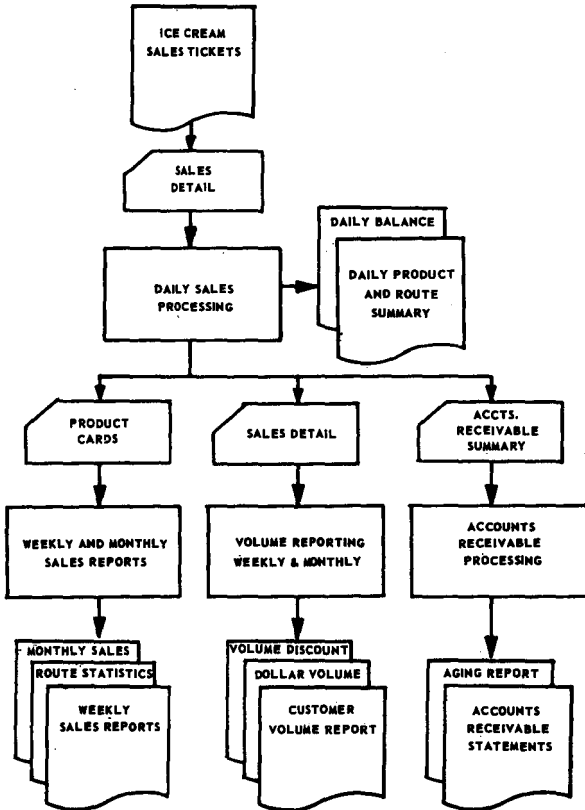

DATE	SYSTEM TYPE	INDEX NAME
2/72	9200	WICS
REVISION	9300	
4		

APPLICATIONS SOFTWARE

WHOLESALE INVENTORY CONTROL SYSTEM

This system provides procedures for customer billing, credit memos, stock status updating and control, purchase orders and various sales analysis and lost sales programs.

Stock status processing includes a forecast based on a moving average of prior demand, minimum order, desired level, critical point, and a suggested order calculation.

This program was designed originally for a drug wholesaler but the basic procedure, particularly the stock status and reorder processing, may be applied to most wholesale concerns.

Configuration: 9200/9300; 8K

Operating System: RPG

Documentation: WICS User's Manual, UX-5299; Application Brief, UX-5298

Support: Category 3

Developed By: Americas Division

Availability: Applications Services

Order No.: 920034

DATE	SYSTEM TYPE	INDEX NAME
8/71	9200	WMATH
REVISION	9300	
1		

APPLICATIONS SOFTWARE

DOUBLE PRECISION MATHPAC

This program provides a library of closed subroutines which perform arithmetic and elementary and analytic function evaluation. The routines may be incorporated into a problem program at assembly time or at linker time.

There are four classes of routines in WMATHPAC:

- . Conversion instructions which perform the conversion of single precision data to or from double precision
- . Floating point routines which perform the basic floating point arithmetic operations of addition, subtraction, multiplication and division
- . Basic mathematical routines which include functions such as sine, cosine, square root and logarithms
- . Error test routines which test error indicators set as a result of the execution of floating point or mathematical routines

Configuration: 9200/9300; 8K; 4 tapes

Operating System: NCOS; Assembler

Documentation: WMATHPAC, User's Manual, Loose-Leaf Pages

Support: Category 3

Developed By: Africa-Asia Division/Univac Japan

Availability: Applications Services

Order No.: 920035

DATE 8/71	SYSTEM TYPE 9200	INDEX NAME 92LIST
REVISION 1		

APPLICATIONS SOFTWARELISTING PROGRAM

The 92 LIST program is used to list and/or reproduce 80-column cards. The output is obtained either through a row punch or a serial punch.

RPG, COBOL, or FORTRAN sequencing of reproduced decks may be selected by an option card. The user may specify translation of selected card codes to permit listing or punching 100%-coded cards on the UNIVAC 9200.

The options are controlled by a leading '80-80' control card or by a console keyin. '0' option causes the printing of all operating instructions.

Configuration: 9200; 8K; Serial Reader and Row or Serial Punch

Operating System:

Documentation: Operating Instructions, Loose-Leaf Pages

Support: Category 3

Developed By: U.S. Junior Achievement Program in Cooperation with Univac

Availability: Applications Services

Order No.: 920059

APPLICATIONS SOFTWARE

UNIVAC 9400

APPLICATIONS SOFTWARE

UNIVAC 9400 APPLICATIONS SOFTWARE

<u>INDEX NAME</u>	<u>PROGRAM NAME</u>	<u>PAGE</u>
ACTS2	IBM 1400 to UNIVAC 9400 Translator	149
BALCON	Basic Assembly Language Converter	150
BTA94	Branch Trace Accounting and Analyzer	151
CALP4	CALCOMP Postprocessor	152
COB	COBOL Converter	153
COBAUT	AUTOCODER to COBOL Converter	154
COCON	COBOL Conversion System	155
COMET9	Computer-Oriented Model by Econometrics	156
C2094	IBM 360/20 to UNIVAC 9400 Conversion Program	157
DBS9	Data Base Management System	159
DCOPY	Disc-to-Disc Copy	160
DISCSP	Disc Space Utilization Report	161
DITTUM	Generalized DOS Utility Program	162
EDIT	UNIVAC 9400 Edit Program	163
FIMAT	UNIVAC 9400 Assembler Flowchart Program	164
FRSA	Sales Forecasting	165
GNSRT	Generalized Sort Program	166
HAN93	UNIVAC 9300 Handler	167
HCOB	Honeywell 200 COBOL to UNIVAC 9400 Conversion Aid	168
HR4000	Hardware Log and Downtime Analysis	169
HTAFC	Honeywell BCD to EBCDIC Conversion Aid	170
IMS94	UNIVAC 9400 Information Management System	171
JSAR	Job Step Accounting Routine	172
JSARN	Job Step Accounting Routine	173
KWIC94	Key-Word-in-Context Indexing Program	174

APPLICATIONS SOFTWARE

UNIVAC 9400 APPLICATIONS SOFTWARE

<u>INDEX NAME</u>	<u>PROGRAM NAME</u>	<u>PAGE</u>
LNCO4	LINCO III Typesetting Program	175
LP9400	Linear Programming	176
MAPT4	Automatically Programmed Tools	177
MATH94	MATH-PACK Mathematical Subprograms	178
MCS	Management Control System	179
MMC94	Mini-Message Control Program	180
MUPS	Multiutility Program System	181
NCR420	NCR 420 Handler	182
NCR671	NCR 671 to UNIVAC 9400 Interface	183
NEWS4	Newspaper Composition Program	184
PACS4	Packaged Communications System	185
PATAPE	Paper Tape Handler	186
PLBOL	PL/1 to COBOL Translator	187
PROF1	PROFITS Time Deposits and Loans Applications	188
PROF2	PROFITS CIS and Multiple Associations Capability	190
PTRG	Paper Tape Reader	192
RCOB	RPG to COBOL Translator	193
REA90C	90-Column Online Reader Handler	194
RTCNM	Real-Time Communications Network Model	195
RTCSM	Real-Time Control Site Model	196
SI1050	UNIVAC 9400 System 1050 Simulator	197
STATPA	STAT-PACK Statistical Program	198
TERMS	Terminal Management System	199

APPLICATIONS SOFTWARE

UNIVAC 9400 APPLICATIONS SOFTWARE

<u>INDEX NAME</u>	<u>PROGRAM NAME</u>	<u>PAGE</u>
THAN94	UNIVAC 1004/1005 Tape Handler	200
TMS94	Transaction Management System	201
TP3T04	FORTRAN Data Tape Conversion, 9300 to 9400	203
UNICG	Coordinate Geometry Language	204
UNIS94	Univac Industrial System	205
UPACS	Hospital Financial System	208
USEX	System Exerciser	210
UTL94	Utility Package for UNIVAC 9400	211
UTOBJ	Load Module Output Program	212
UTSRT	Utility Sort for UNIVAC 9400	213
UTST94	Program Module Testing Package	214
WIMS	Wholesale Inventory Management System	215
93SORT	UNIVAC 9300 Sort	216
93TRAN	UNIVAC 9300 to UNIVAC 9400 Translator	217

DATE 2/72	SYSTEM TYPE 9400	INDEX NAME ACTS2
REVISION 3		

APPLICATIONS SOFTWARE

ACTS II

IBM 1400 TO 9400 TRANSLATOR

The ACTS II Translator provides the 9400 user with a 1400 conversion capability. Accepting as input 1401/1460 AUTOCODER or SPS source programs, the ACTS Translator produces 9400 assembly language source programs. The translated programs are ready for assembly under the 9400 Tape, Tape/Disc, or Disc Assembler and can be run on 9400 computer systems using the Tape or Disc Operating System.

During translation a listing of the original source statements and the translated 9400 target statements will be produced. In addition, questionable translation will be flagged by a warning diagnostic message and untranslatable statements will be flagged by a critical diagnostic message.

Configuration: 9400; 32K

Operating System: TOS/TDOS/DOS

Documentation: User's Manual, Loose-Leaf pages

Support: Category 3

Developed By: Americas Division

Availability: Applications Services

Order No.: 940004

DATE	SYSTEM TYPE	INDEX NAME
8/71	9400	BALCON
REVISION		
1		

APPLICATIONS SOFTWARE

BALCON - BASIC ASSEMBLY LANGUAGE CONVERTER

This program converts 9200/9300 source assembly language programs to 9400 programs.

BALCON converts instructions and directives automatically if possible. Otherwise, the program will set a flag for a manual check.

BALCON also generates and inserts statements for register coverage, save-area, etc. The IOCS will also be exchanged by the program.

Configuration: 9200/9300; Printer (132 Positions); 3 Tapes

Operating System: NCOS

Documentation: User's Manual, loose leaf pages

Support: Category 3

Developed By: Central European Division/Univac Germany

Availability: Applications Services

Order No.: 940008

DATE 2/72	SYSTEM TYPE 9400	INDEX NAME BTA94
REVISION		

APPLICATIONS SOFTWARE

BRANCH TRACE ACCOUNTING AND ANALYZER

BTA94 is a debugging aid consisting of two modules (Branch Trace Accounting Module and Branch Trace Analyzing Module).

The Branch Trace Accounting Module is a relocatable module included in the user's load program at linker time. Its function is to log on tape the following instructions:

SUPERVISOR CALL (SUC), BRANCH AND LINK (BAL), AND BRANCH ON CONDITION (BC).

The Branch Trace Analyzing Module is a loadable program to be run by the user. It is used to selectively print the output tape.

Configuration: 9400; 32K; tape

Operating System: DOS/TOS

Documentation: Loose Leaf Pages

Support: Category 3

Developed By: Northern European Division/Univac United Kingdom

Availability: Applications Services

Order No.: 940017

DATE 8/73	SYSTEM TYPE 9400	INDEX NAME CALP4
REVISION		

APPLICATIONS SOFTWARE

CALCOMP POSTPROCESSOR

The CALCOMP postprocessor is designed to process MINIAPT output, (CLDATA), into a form suitable for driving a CALCOMP 780/763 plotter. This software plots CLDATA exactly or with transformation, (translation, rotation, or scaling). This reduces the effort of providing a correct Numerical Control tape.

Configuration: 9400; 98K; 2 discs

Operating System: DOS; FORTRAN

Documentation: 9000 MINIAPT CALCOMP 780/763 Postprocessor Programming Manual

Support: Category 3

Developed By: Africa-Asia Division/Univac Japan

Availability: Univac Japan

Order No.:

DATE 3/74	SYSTEM TYPE 9400	INDEX NAME COB
REVISION		

APPLICATIONS SOFTWARECOBOL CONVERTER

This COBOL Converter translates UNIVAC Series 70 or IBM 360 COBOL on cards to 9480 extended COBOL on cards.

Configuration: UNIVAC 9400, 9480, 90/60 or 90/70; 48 K, (2) 8411, 8414, 8424 or 8425 discs; (1) UNISERVO, 9-track, 1600 bpi; reader; printer; punch.

Operating System: OS/4

Documentation: Loose-Leaf Pages

Support: Category 1

Developed By: Worldwide Applications Development Center, Blue Bell

Availability: Applications Services

Order No.: 940047

DATE 3/74	SYSTEM TYPE	INDEX NAME
REVISION	9400	COBAUT

APPLICATIONS SOFTWARE

AUTOCODER TO COBOL CONVERTER

The AUTOCODER-to-COBOL converter generates standard ANS COBOL. As a result, the user may use the COBOL program on different computer equipment with a minimum of conversion effort.

A cross-reference listing of the generated COBOL statements, the original AUTOCODER statements, and diagnostic aid messages are produced as the COBOL statements are being punched out. Area defining statements, such as 'DCW', are produced prior to the cross-referencing of AUTOCODER statements because they must be grouped into the file and working storage sections of the COBOL program.

Standard COBOL statements are generated for 1401 SPS programs to simulate 1401 printer and punch commands. Standard 1401 card reader, card punch, and printer areas are defined in the file control paragraph and in the file section. These files are opened in the initialization paragraph at the beginning of the procedure division. Sense switches are defined in the working storage section and set in the initialization paragraph.

Configuration: 9400; 9480; 90/60; 90/70; 98K; (2) 8414; Reader; Printer, Punch

Operating System: OS/4

Documentation: Loose-Leaf Pages

Support: Category 1

Developed By: Worldwide Applications Development Center, Blue Bell

Availability: Applications Services

Order No.: 940050

DATE 8/73	SYSTEM TYPE 9400	INDEX NAME COCON
REVISION 1		

APPLICATIONS SOFTWARE

COBOL CONVERSION SYSTEM

COCON provides UNIVAC 9400 users with an aid for automatic conversion of IBM 360 COBOL programs to UNIVAC 9400 extended COBOL programs.

The system employs a two-phase processing cycle.

During the conversion cycle translation of non-identical statements is performed, the detection and flagging of statements presenting restrictions is accomplished, and a listing of the converted program and a diagnostic review is produced.

During the updating cycle post conversion corrections are processed and the output tape is updated to include a control stream.

Advantages offered by this system include minimizing the need for manual corrections and eliminating the need to modify the original source deck.

Configuration: 9400; 65K; 2 disc units; 2 tapes, card reader, line printer

Operating System: DOS; Extended COBOL Compiler

Documentation: Programmer's Reference Manual

Support: Category 3

Developed By: Central European Division/Univac Holland

Availability: Applications Services

Order No.: 940035

DATE	SYSTEM TYPE	INDEX NAME
8/73	9400	COMET9
REVISION		

APPLICATIONS SOFTWARE

COMPUTER ORIENTED MODEL BY ECONOMETRIC TECHNIQUE

COMET 9 is a generalized package for analysis of econometric models. It may be used for economic planning, analysis of financial markets, analysis of balance of payments, analysis of business investments, short or long range production planning and demand forecasting for sales planning. The model size which can be handled is large enough to handle most econometric problems.

The COMET 9 system consists of 15 programs grouped into six subsystems. These are:

- . System Control
- . File Maintenance
- . Processing of Time Series Data
- . Processing of Cross Section Data
- . Structural Analysis
- . Simulation

Configuration: 9400; 131K

Operating System:

Documentation: 9400 COMET Reference Manual (Japanese)

Support: Category 3

Developed By: Africa-Asia Division/Univac Japan

Availability: Univac Japan

Order No.:

DATE	SYSTEM TYPE	INDEX NAME
2/72	9400	C2094
REVISION		

APPLICATIONS SOFTWARE

360/20 TO 9400 CONVERSION PROGRAM

C2094 is a tape-oriented conversion aid. Conversion source code is always output to tape, and input may be from cards or tape, or both (merging in any manual changes from cards). Tape output contains job control records which are suitable for U 9400 files. Job includes link edit and library programs with appropriate link and library data records.

The conversion program performs the following:

- . All half word constant and storage areas to full word
- . Changes BAS and BASR to BAL and BALR
- . Ability to reblock data files
- . Converts all DTF's used by this 360/20 user
- . Resolves print overflow problem
- . Changes print skip controls
- . Resolves ISAM contingency incompatibility
- . Clears program memory to binary 0's before loading program
- . Loads cover registers
- . REG 13 pointed to save area
- . Single buffered files are double-buffered
- . Indexed sequential files have an index in memory
- . Converts HPR and MSG
- . Converts COMRG to users desire

Configuration: 9400

Operating System: TOS; Assembler

Documentation: User's Manual

Support: Category 3

Developed By: Americas Division

Availability: Applications Services

Order No.: 940014

DATE	SYSTEM TYPE	INDEX NAME
2/72	9400	C2094
REVISION		

APPLICATIONS SOFTWARE

- . Changes all use of REG 13-15 to REG 07-05
- . Drops all ORG, PHASE, REPRO, WAITC, FETCH, ACTION, DIFEN, XFR as the user was using these in a way that the conversion program could resolve

DATE	SYSTEM TYPE	INDEX NAME
8/73	9400	DBS9
REVISION		

APPLICATIONS SOFTWARE

BATA BASE MANAGEMENT SYSTEM

DBS9 is an application package for the disc-oriented 9400 system, including the main features of the CODASYL-DTBG Report, April 1971.

It is composed of three program levels:

DBS9 Handler (relocatable element)
 interface for using DBS9 in COBOL programs (relocatable element)
 procedure for declarative and imperative macros (source element)

The arrangement of the data base is indexed-sequential (index file) and in a random (data file) manner. The data base can have up to 60 logical files. The record length within one logical file is fixed.

Each logical data file may be a master file and/or a chain file.

A master file may be addressed by one or more user keys and by one unique data base key. A chain file may only be addressed by one unique data base key.

The user program provides macros and parameters to DBS9 with the function to be performed such as LOAD, ADD, READ, WRITE, CHAIN, DELETE, etc.

Configuration: 9400; 48K; 8414 (2) or 8411 (2)

Operating System: DOS; Assembler; COBOL

Documentation: DBS9 Manual, AS0010, (German)

Support: Category 3

Developed By: Northern European Division/ Univac Austria

Availability: Univac Austria

Order No.:

DATE 8/73	SYSTEM TYPE 9400	INDEX NAME DCOPY
REVISION		

APPLICATIONS SOFTWARE

DISC TO DISC COPY FOR 9400

This system allows the user to dump a disc considerably faster than with the standard software.

Configuration: 9400

Operating System:

Documentation: Loose Leaf pages

Support: Category 3

Developed By: Americas Division/Univac Canada

Availability: Applications Services

Order No.: 940040

DATE 3/74	SYSTEM TYPE	INDEX NAME
REVISION	9400	DISCSP

APPLICATIONS SOFTWARE

DISC SPACE UTILIZATION REPORT

This utility program will report pertinent data about all disc files contained in the Volume Table of Contents and will recap with the available space remaining on the pack.

The program is written in BAL. The disc I/O is written in physical level IOCS.

Configuration: UNIVAC 9400; 5K; 1 disc; 1 printer

Operating System: DOS

Documentation: Loose-Leaf Pages

Support: Category 4

Developed By:

Availability: UUA Program Library Interchange

Order No.: 694002

DATE 3/74	SYSTEM TYPE	INDEX NAME
REVISION	9400	DITTUM

APPLICATIONS SOFTWARE

GENERALIZED DOS UTILITY PROGRAM

This program is a generalized utility for use in a Disc Operating System. There are thirty-six functions available; ten disc functions, sixteen tape functions, eight card functions, and two common functions.

DITTUM should help in the conversion from an IBM 360/370 system to a UNIVAC 9400, 90/60, 90/70 system. It enhances some of the DITTO program functions to allow the user to take full advantage of the Univac system.

The program is written in assembler language and uses PIOCS to minimize the job control stream and take advantage of the power of the UNIVAC 9400, 90/60, 90/70 systems.

Configuration: UNIVAC 9400, 49K, Reader, Printer

Operating System: OS/4

Documentation: Loose-Leaf Pages

Support: Category 3

Developed By: Americas Division

Availability: Applications Services

Order No.: 940046

DATE 3/74	SYSTEM TYPE 9400	INDEX NAME EDIT
REVISION		

APPLICATIONS SOFTWARE

UNIVAC 9400 EDIT PROGRAM

This program allows a user to edit UNIVAC 9400 system library files. Source and copy library files may be processed online from a UNISCOPE 100 or a DCT 1000 through MCP. Through the use of several commands, the user may create, change, selectively print, and delete lines of an element. Either an existing element may be processed, or a new one may be created. Commands are available to read and write elements in library files. The number of terminals which can be supported is variable and can be set at run time by the computer operator. Approximately 30 error messages are provided to aid the user.

Configuration: 9400; 65K; 8414 discs. EDIT requires X'21D0' + n*X'2E0' where n is the number of active terminals. Edit uses MCP and supports UNISCOPE 100 and DCT 1000 terminals on a single line (LINE1). Directions are provided to modify the program to support multiple lines.

Operating System: OS/4

Documentation: Installation Memorandum; User's Manual, Loose-Leaf Pages

Support: Category 3

Developed By: Applications Development Center, Blue Bell

Availability: Applications Services

Order No.: 940054

DATE 2/72	SYSTEM TYPE 9400	INDEX NAME FLMAT
REVISION 1		

APPLICATIONS SOFTWARE

FLOWMAT

This program produces a flowchart of a 9400 assembler program. The flowchart is generated from codes supplied by the programmer in the comment field of the source cards. Either the instruction image or the comment field may be printed in the flowchart block.

Configuration: 9400

Operating System: TOS/DOS

Documentation: Operating Instructions, loose leaf pages (German)

Support: Category 3

Developed By: Central European Division/Univac Germany

Availability: Application Services

Order No.: 940023

DATE	SYSTEM TYPE	INDEX NAME
8/73	9400	FRSA
REVISION		

APPLICATIONS SOFTWARE

SALES FORECASTING

This program accepts monthly sales data and will estimate coming months' sales figures. The user can forecast from three to ten years.

Configuration: 9400 Minimum

Operating System: TOS/DOS

Documentation: Loose-Leaf Pages

Support: Category 3

Developed By: Americas Division

Availability: Applications Services

Order No.: 940037

DATE	SYSTEM TYPE	INDEX NAME
2/72	9400	GNSRT
REVISION		
1		

APPLICATIONS SOFTWARE

GENERALIZED SORT PROGRAM

This utility program utilizes the Sort/Merge facilities of the 9400. The program is operated by way of control card input whereby certain parameters (description of I/O file, sort key, type of work area for the sort (tape/disc), etc.) are all that are necessary. No assembly or processing through the Linkage Editor is needed.

Configuration: 9400; same I/O facilities as for Sort/Merge

Operating System: TOS/DOS

Documentation: User's Manual

Support: Category 3

Developed By: Africa-Asia Division/Univac Japan

Availability: Applications Services

Order No.: 940020

DATE	SYSTEM TYPE	INDEX NAME
8/71	9400	HAN93
REVISION		
1		

APPLICATIONS SOFTWARE

9300 HANDLER

Job Control statements and data are submitted by the user to the 9400 Operating System by way of a card reader and stored on the resident direct access storage device for subsequent processing.

This reader handler provides for loading these cards into the system using the standard reader on a 9300 computer.

Configuration: 9400 / 9300

Operating System: DOS/TOS; Assembler

Documentation: Loose Leaf Pages (Japanese)

Support: Category 3

Developed By: Africa-Asia Division/Univac Japan

Availability: Univac Japan

Order No.:

DATE	SYSTEM TYPE	INDEX NAME
2/72	9400	HCOB
REVISION		

APPLICATIONS SOFTWARE

HONEYWELL-200 COBOL TO 9400 CONVERSION AID

HCOB converts COBOL source cards for the Honeywell-200 (with reader, printer, punch and tapes) to COBOL source code for an equivalently configured 9400. The conversion includes translation of characters and some instructions.

Configuration: 9400; minimum

Operating System: TOS/DOS

Documentation: Operating Instructions, loose leaf pages

Support: Category 3

Developed By: Americas Division

Availability: Application Services

Order No.: 940026

DATE 3/74	SYSTEM TYPE 9400	INDEX NAME HR4000
REVISION		

APPLICATIONS SOFTWARE

HARDWARE LOG AND DOWNTIME ANALYSIS

The purpose of this UNIVAC 9400 Hardware Log and Downtime Analysis Report program is to record monthly computer usage (i.e., hours worked, PM hours, down hours, etc.)

A monthly Hardware Log Report shows the daily hours worked, PM hours, downtime by device, and operator comments. The Hardware Analysis Report produced by the program shows downtime by device with totals and percentages for the current month, current year-to-date and previous year on a contract year basis.

Configuration: UNIVAC 9400; 21K; reader; disc; printer

Operating System: DOS

Documentation: Loose-Leaf Pages

Support: Category 4

Developed By:

Availability: UUA Program Library Interchange

Order No.: 694001

DATE	SYSTEM TYPE	INDEX NAME
2/72	9400	HTAPC
REVISION		

APPLICATIONS SOFTWAREHONEYWELL BCD TO EBCDIC CONVERSION AID

HTAPC converts 7-track Honeywell BCD tapes to 9-track EBCDIC tapes. It includes translation of characters and stripping of octal 77 padding.

Configuration: 9400; minimum

Operating System: TCS/DOS

Documentation: Operating Instructions, loose leaf pages

Support: Category 3

Developed By: Americas Division

Availability: Application Services

Order No.: 940025

DATE 8/73	SYSTEM TYPE 9400	INDEX NAME IMS94
REVISION 4		

APPLICATIONS SOFTWARE9400/IMS - 9400/INFORMATION MANAGEMENT SYSTEM

The UNIVAC 9400 Information Management System (9400/IMS) is an application program for the disc oriented 9400 System. It provides the user of interactive data terminals with a simplified command language for retrieving information from his indexed sequential (ISAM) data files.

The 9400/IMS operates as an independent user program working in conjunction with the 9400 Supervisor, Data Management System, and Message Control Program (MCP). It does not duplicate or replace any function of these or any other 9400 software packages.

The interactive commands used to operate from data terminals are:

- . Open/Secure
- . Display
- . Update
- . Process

A system utility program, "enter", is used to describe the user data files to the IMS, to define and change passwords in the system, and to specify user reports and user-written "process" programs.

Configuration: 9400; 65K; (2) 8411/8414 discs; data terminals

Operating System: DOS with Communications

Documentation: 9400/IMS Programmer Reference Manual, UP-7877

Support: Category 1

Developed By: Marketing Support/Technical Support, Special Projects

Availability: Applications Services

Order No.: 940007

DATE	SYSTEM TYPE	INDEX NAME
3/74	9400	JSAR
REVISION		
2		

APPLICATIONS SOFTWARE

JOB STEP ACCOUNTING ROUTINE

This system is comprised of seven transients, one relocatable module, and one load module. It provides the UNIVAC 9400 DCS user with the facility to automatically save job and step accounting information on the systems disc (8411 or 8414).

The following output will be on the printer:

- . Job Name
- . Job Number
- . Date
- . Time: On
- . Time: Off
- . CPU TIME
- . Memory Time
- . CPU Usage (%)
- . Memory Size

The time required for implementation is approximately 45 minutes.

Configuration: 9400; 32K

Operating System: DCS/TOS

Documentation: Loose-Leaf Pages

Support: Category 3

Developed By: Northern European Division/Univac United Kingdom

Availability: Applications Services

Order No.: 940027

DATE 3/74	SYSTEM TYPE 9400	INDEX NAME JSARN
REVISION 2		

APPLICATIONS SOFTWARE

JOB STEP ACCOUNTING ROUTINE (NORWAY)

The Job Step Accounting Routine produces a sequential disc file containing unblocked records within a single extent upon the system resident pack. For every job step that produces accounting information, a record is written containing data as follows:

- . Job name
- . Module name
- . CPU time used
- . Run time
- . Number of skips to head of form
- . End of program (normal/abnormal)
- . Date
- . End of job step time
- . File Name (DTF name)
- . Number of records read and written for respective file name

A selective accounting procedure is used based on the first character of the DTF. Also specific peripheral device types may be accounted. The selective accounting is controlled by the reserve library which has had specific modules prefixed with coding associated with the accounting routine.

Configuration: 9400; minimum

Operating System: DCS

Documentation: Program Description, Loose-Leaf pages

Support: Category 3

Developed By: Northern European Division/Univac Norway

Availability: Applications Services

Order No.: 940042

DATE 2/72	SYSTEM TYPE 9400	INDEX NAME KWIC94
REVISION 2		

APPLICATIONS SOFTWARE

KEY-WORD-IN-CONTEXT

KWIC lists items, i.e., Titles, by highlighting each significant (or key) word in the title in the context of the words on either side of it. It aligns the key words of all titles alphabetically in a vertical column. Several outputs are available including listings of title index, group code index, document identification number index, and special field name index.

The system consists of four programs:

- . KWICI - Creates a data tape from cards and/or maintains an existing tape.
- . KWICM - Reads data tape and creates title index tape and special field index tape.
- . KWIRT - Prints the desired index lists.

Configuration: 9400; 32K; 4 tapes

Operating System: TOS

Documentation: General Description, loose leaf pages (English)

Support: Category 3

Developed By: Africa-Asian Division/Univac Japan

Availability: Applications Services

Order No.: 940016

DATE 3/74	SYSTEM TYPE 9400	INDEX NAME LNCO4
REVISION 3		

APPLICATIONS SOFTWARE

LINCO III TYPESETTING

The LINCO III package is a line-justification program which offers the printing industry complete control of its own process. Its flexibility gives the user complete latitude in selecting input text preparation devices, device keyboards, and program configurations. The program does not dictate operational procedures, input codes, output codes or input/output formats. LINCO III contains subroutines that are preassembled programs. These programs can then be used to prepare either paper or magnetic tapes to drive any one of a number of photographic or hot metal typesetting machines.

Full computer utilization may be realized by using the computer for any number of data processing applications along with LINCO III.

A videotape training program, demonstration text manual and tape, operating, and linking instructions are available.

Configuration: UNIVAC 9400; 49K; paper tape subsystem; 4 tapes or equivalent are required for assembly and linking.

Operating System: TOS/DOS; Assembler

Documentation: LINCO III Automatic Typesetting System, User's Manual, UP-7683; Advertising Brochure, U-4934; Student Workbook, UE-90021

Support: Category 5

Developed By: Americas Division/Univac Canada

Availability: Second Quarter, 1974

Order No.: **IN DEVELOPMENT**

DATE	SYSTEM TYPE	INDEX NAME
8/73	9400	LP9400
REVISION 1		

APPLICATIONS SOFTWARE

LINEAR PROGRAMMING LP 9400

LP 9400 is a modern, general-purpose linear programming system for the UNIVAC 9400. It has the standard optimization features as well as postoptimal capabilities such as ranging, and objective row and right-hand-side parameterization. It has bounded variable capability which allows the user to omit explicit constraints for bounding rows and columns.

LP 9400 accepts model input in both 8-character and SHARE formats. The input accepts multiple objective rows and multiple right-hand sides. The user specifies which objective row and which right-hand side is to be used for the optimization at execution time.

The 9400 LP performs extensive checking for format errors in the input data and the instruction agenda.

The user can interrupt the optimization process and continue it at a later time.

This system operates with 17 decimal digit precision and makes efficient use of an 8414 disc pack.

The model size accepted by this system is 500 rows for 65 K of main storage and 1500 rows for 131 K of main storage.

Configuration: 9400; 65K; (2) 8411/8414 discs

Operating System: DCS

Documentation: LP 9400 User's Manual, UP-7875

Support: Category 1

Developed By: Development and Manufacturing Division/Philadelphia

Availability: Software Order Services, Blue Bell

Order No.:

DATE	SYSTEM TYPE	INDEX NAME
3/74	9400	MAPT4
REVISION		

APPLICATIONS SOFTWARE

AUTOMATICALLY PROGRAMMED TOOLS

This system reduces the effort of manual part programming for Numerical Control equipment. The Numerical Control (N/C) process involves the operation of machine shop equipment through the use of information contained in a punched tape which is read into an electronic control unit attached to a machine tool. The tape is prepared by a part programmer who specifies the machining operations to be performed. These part programs can be prepared more quickly and more accurately with Univac MINIAPT than manually.

When using Univac MINIAPT, the programmer segments the part into geometric forms and then instructs the computer how to make the part by describing the path to be followed by the tool. The computer translates the instructions and carries out the mathematical calculations to produce the instructions required by the machine tool and control system.

Univac MINIAPT is a subset of the APT (Automatically Programmed Tools) processor, which has become the most widely accepted N/C programming language. Univac MINIAPT provides two axes geometric definition capability and three axes point-to-point positioning.

Configuration: 9400; 98K; 2 discs (65K longest program phase)

Operating System: OS/4; FORTRAN

Documentation: User's Reference Manual, UA-0084; User's Vocabulary Dictionary, UA-0073; APT Marketing Brochure, IN-7785; Postprocessor Interface Description, Loose-Leaf Pages

Support: Category 3

Developed By: Africa-Asia Division/Univac Japan

Availability: Applications Services

Order No.: 940052

DATE 10/72	SYSTEM TYPE 9400	INDEX NAME MATH94
REVISION 3		

APPLICATIONS SOFTWARE

MATH-PACK

This package is a conversion of the 1108 MATH-PACK, which includes subprograms in the following functional areas:

- . Interpolation
- . Numerical Integration
- . Solution of Equations
- . Differentiation
- . Polynomial Manipulation
- . Matrix Manipulation
- . Ordinary Differential Equations
- . Systems of Equations
- . Curve Fitting
- . Pseudo Random Number Generators
- . Specific Functions

Configuration: 9400; minimum

Operating System: DOS/TOS; FORTRAN

Documentation: None (Use 1108 MATH-PACK Documentation, UP-7542)

Support: Category 3

Developed By: Africa-Asia Division/Univac Japan

Availability: Applications Services

Order No.: 940024

DATE	SYSTEM TYPE	INDEX NAME
8/73	9400	MCS
REVISION 2		

APPLICATIONS SOFTWARE

MANAGEMENT CONTROL SYSTEM (MCS)

MCS is an advanced PERT-type system which includes all former PERT-TIME capabilities. MCS is one of the few management control systems that can assist systems management in the planning and control of schedules in a multi-project, multi-network organization. A data base file maintenance capability allows the updating and retrieval of activity, network, and project information.

At the user's option, reports are available at the level of key activities, network, multi-network, project or multi-project. Reports can be produced based on a previously generated data base and schedules.

MCS meets or exceeds industrial and ANSI standards, and Government Directive DOD 7000.2.

Configuration: 9400; 65K; (2) 8411 discs, (1) 8414 disc, or (1) 8424 disc; 2 tapes

Operating System: DOS

Documentation: 9400 MCS User's Manual, UP-7873

Support: Category 1

Developed By: Development and Manufacturing Division/Philadelphia

Availability: Software Order Services, Blue Bell

Order No.:

DATE	SYSTEM TYPE	INDEX NAME
10/72	9400	MMC94
REVISION		
1		

APPLICATIONS SOFTWARE

MINI MESSAGE CONTROL PROGRAM

MINI-MCP is a physical and a logical IOCS for data communication configurations. It was especially designed for applications with only one telecommunication line. The number of terminals on this line is unlimited. Two handlers are presently available:

- . UNISCOPE 100
- . Burroughs TC 500/700

The major advantage of MINI-MCP is its very small memory requirement:

- . MINI + U 100 Handler + Term. MUX = 3.5 K
- . MINI + U 100 (no Term. MUX) + TC 500 = 5K

It is not necessary that the supervisor contain the physical IOCS for data communications (CPIOCS) but 500 bytes must be reserved to hold the subchannel control words.

Configuration: 9400; 49K

Operating System: DOS

Documentation: Loose-Leaf Pages, German

Support: Category 3

Developed By: Northern European Division/Univac Austria

Availability: Applications Services

Order No.: 940030

DATE	SYSTEM TYPE	INDEX NAME
8/73	9400	MUPS
REVISION		
1		

APPLICATIONS SOFTWARE

MULTI UTILITY PROGRAM SYSTEM

This system consists of three programs:

- . File Generator (MFFILE)
- . File Merge (MPMERG)
- . Lister (MPLIST)

MUPS is used for program debugging. MFFILE generates output data on either tape or disc. The input may be on cards, tape, or disc. MPMERG merges the input file to generate test data. Then MPLIST prints each data field or prints all the data of several fields in the record contained on tape or disc. Input and output options are handled by control cards.

Configuration: 9400

Operating System: TOS/DOS

Documentation: User's Manual (Japanese)

Support: Category 3

Developed By: Africa-Asia Division/Univac Japan

Availability: Applications Services

Order No.: 940036

DATE	SYSTEM TYPE	INDEX NAME
8/71	9400	NCR420
REVISION		
1		

APPLICATIONS SOFTWARE

NCR 420 HANDLER

This handler is for the NCR 420 journal reader. A new Physical Unit Block was implemented in the EXEC for the NCR 420. The handler is incorporated in the "READIN" program. It provides EXEC level instructions and error recovery coding.

The user has only to access this subroutine to get an OCR image from the NCR 420 unit. Therefore, this handler does not assume LIOCS like a standard I/O device.

Configuration: 9400; minimum

Operating System: DOS/TOS; Assembler

Documentation: Loose Leaf Pages (Japanese)

Support: Category 3

Developed By: Africa-Asia Division/Univac Japan

Availability: Univac Japan

Order No.:

DATE	8/73	SYSTEM TYPE		INDEX NAME	
REVISION		9400		NCR671	

APPLICATIONS SOFTWARENCR671 TO 9400 INTERFACE

NCR's Reader-Sorter can be run on a Univac 9400 system via a multiplexer channel. The user operates his sorter by a series of macro calls, OPEN, READ, SORT, CLOSE, which are included in the user program.

Due to the operation of this device it is necessary that a run which references the peripheral be placed in the highest priority at run time. When NCR671 is used, it is necessary to place a new entry in the PUB/LUT tables of the EXEC.

The system is limited in that two Read-Sorters are supported and an RPQ item is required.

Configuration: 9400; Multiplexer channel; Interface, RPQ W-1560.3

Operating System: DOS/TOS; Assembler

Documentation: NCR 671 User Specification, Loose-Leaf pages

Support: Category 3

Developed By: Central European Division/Univac Spain

Availability: Univac Spain

Order No.:

DATE 3/74	SYSTEM TYPE 9400	INDEX NAME NEWS4
REVISION 1		

APPLICATIONS SOFTWARE

NEWSPAPER COMPOSITION PROGRAM

NEWSCOMP is an online, real-time newspaper composition system, using UNISCOPE 100 terminals for input, correction, and editing. Three major newspaper composition applications are provided; news copy, display advertising copy, and classified advertising copy.

LINCO (see LNCO4) is used for production of composed material (justification, hyphenation, organization, and sizes.) For classified advertising, pre-processing of the file is provided to add, sort, and/or delete individual ads based on expiration, and usage data. Following input, editing, and correction, the text is processed and output is justified, formatted on paper or magnetic tape for a full range of hot metal linecasting and photocomposition equipment. Suitable phototypesetters may be operated online.

Hyphenation is accomplished by the use of hyphenation rules and an exception dictionary. An extensive library of equates provides unlimited formatting capability. A computer room operator is not required; one online UNISCOPE may be designated as the control scope to control all system operations.

Input may also be via online Compuscan Optical Page Readers.

Configuration: UNIVAC 9400; 65K; Discs

Operating System: Standard

Documentation: NEWSCOMP Application Brief, UA-0059
NEWSCOMP User Reference Manual, UA-0070
Installation Memorandum

Support: Category 5

Developed By: Worldwide Applications Development Center, Blue Bell

Availability: Second Quarter, 1974

Order No.: **IN DEVELOPMENT**

DATE	SYSTEM TYPE	INDEX NAME
10/72	9400	PACS4
REVISION		
1		

APPLICATIONS SOFTWARE

PACKAGED COMMUNICATION SYSTEM (PACS IV)

PACS IV is a real-time software package which performs the functions of a Message Control Program (MCP). In addition, this package provides the user with the capability of preparing an automatic restart/file recovery system for all kinds of applications.

The MCP, the main program of PACS IV, writes three kinds of logs on a magnetic tape for each communication message, and the user programs write records ("before looks") in a log on the same tape when they update the disc file. Using this logging tape, the restart program and the file recovery program perform their purpose.

PACS IV consists of the following programs:

- . MCP (with logging function)
- . Restart program
- . Disc file recovery program
- . Debugging aid for user real-time program
- . Log tape preparation program

Configuration: 9400; 65K; (2) 8411/8414 discs; (1) 6C/12/16 tape

Operating System: DOS/TOS

Documentation: PACS IV Programmer Reference (Japanese)

Support: Category 3

Developed By: Africa-Asia Division/Univac Japan

Availability: Applications Services

Order No.: 940019

DATE 8/77	SYSTEM TYPE 9400	INDEX NAME PATAPE
REVISION 1		

APPLICATIONS SOFTWARE

PAPER TAPE HANDLER

This handler is for a Japanese paper tape unit. The physical characteristics of the unit are almost the same as the UNIVAC 920-C2 paper tape unit.

Open and Close Transient routines have been made by slight modification of card reader and punch routines. The Physical Unit Block in EXEC, DTF-Table and LIOCS code are new in order to handle paper tape. The user can access LIOCS using OPEN, GET, PUT or CLOSE to get or put the paper tape image directly from or to the paper tape unit.

Configuration: 9400; minimum

Operating System: DOS/TOS; Assembler

Documentation: Loose-Leaf pages (Japanese)

Support: Category 3

Developed By: Africa-Asia Division/Univac Japan

Availability: Univac Japan

Order No.:

DATE 3/74	SYSTEM TYPE 9400	INDEX NAME PLBOL
REVISION		

APPLICATIONS SOFTWARE

PL/1-TO-COBOL TRANSLATOR

The PL/1-to-COBOL translator generates standard ANS COBOL. An original listing of the PL/1 program is provided at the beginning of the system. A cross-reference listing of the generated COBOL statements, the original PL/1 statements, and diagnostic messages are generated as the COBOL source is being produced.

Comments from the PL/1 program are inserted into the COBOL program. In some instances, they may be entered in both the data division and in the procedure division of the COBOL program.

Configuration: UNIVAC 9400, 9480, 90/60 or 90/70; 98 K; (2) 8414; reader, printer, punch.

Operating System: OS/4

Documentation: Loose-Leaf Pages

Support: Category 1

Developed By: Worldwide Applications Development Center, Blue Bell

Availability: Applications Services

Order No.: 940048

DATE 8/73	SYSTEM TYPE 9400	INDEX NAME PROF1
REVISION 2		

APPLICATIONS SOFTWARE

TIME DEPOSITS AND LOANS APPLICATIONS

PROFITS, an acronym for Personalized Real-Time Oriented Financial Institutions Time Saving System, is a 9400 online application program designed to service financial institutions of the thrift and credit industry.

The PROFITS Control Element contains the control and communications modules which permit interfacing to essentially any type window terminal device or other communication devices (similar to the UNISCOPE 100 terminals) without modification to the applications modules. Modules that are common to and/or required by the PROFITS Applications are also located in the Control Element.

The PROFITS Applications are completely modularized to provide for customizing according to individual user requirements. The Time Deposits Application handles regular savings accounts, savings certificates, club accounts, and some smaller applications pertaining to the daily activities of tellers. The Loan Application was developed to handle mortgage loans, construction loans, discount loans and commercial type loans. PROFITS support programs provide for the construction and maintenance of various PROFITS files.

Device Handlers Released: Bunker Ramo 1000, U-100, FDSI.

Configuration: See Below

Operating System: TDOS/DOS

Documentation: PROFITS General Description UA-0055 Rev. 1;
PROFITS Technical Description UA-0060;
PROFITS Logic Charts UA-0061;
PROFITS Main Storage Configurator UA-0067;

Support: PROFITS Program: Category 1;
Device Handlers: Category 3;
Message Interface Modules: Category 3

Developed By: Applications Development Center and selected users in the UNIVAC Financial Users Group

Availability: Applications Services (Restricted Distribution; Non-disclosure Agreement must be signed before ordering)

Order No.: 940002 (See also PROF2)

DATE 8/73	SYSTEM TYPE 9400	INDEX NAME PROF1
REVISION 2		

APPLICATIONS SOFTWARE

Configurations:

Time Deposits Application

The following minimum hardware configuration is required for the online operation of the Control Element and Time Deposits application:

UNIVAC 9400/9480 Central Processor
65,536 Bytes of Main Storage
Disc File Control
8414 or 8424 Disc Drives (2)
Card Reader
Printer
Communications Subsystem - Tailored to the requirements of the user
and the communications units selected.

Time Deposits and Loans Applications

The following minimum hardware configuration is required for the online operation of the Control Element, Time Deposits and Loan applications:

UNIVAC 9400/9480 Central Processor
98,304 Bytes of Main Storage
Disc File Control
8414 or 8424 Disc Drives (3)
Card Reader
Printer
Communications Subsystem - Tailored to the requirements of the user
and the communications units selected.

DATE 8/73	SYSTEM TYPE	INDEX NAME
REVISION 3	9400	PROF2

APPLICATIONS SOFTWARE

CIS APPLICATION AND MULTIPLE ASSOCIATIONS CAPABILITY

A. CIS Application:

The Central Information System (CIS) application provides the user with a Central Information File (CIF) into which he can inquire either directly or through as many as ten associated index files. In addition, this PROFITS application provides the capability to produce management reports in a real-time mode or retrieve reports generated previously in a batch operation.

The 9400 IMS system interfaced with PROFITS provides the basic inquiry, security, updating, and reporting capabilities. Both PROFITS and IMS will operate concurrently under the control of the 9400 DOS supervisor. The contents and size of the records within the CIF are user selectable with the exception of three required fields; the CIF master record key, principal name and principal address fields.

As many as 10 CIF index files may be specified to cross-reference the contents of selected fields with the CIF record to the CIF master record key. Sample index file would be account number, address or social security number index files.

Configuration:

Operating System: TDOS/DCS

Documentation: PROFITS General Description UA-0055 Rev. 1;
 PROFITS Technical Description UA-0060;
 PROFITS Logic Charts UA-0061;
 PROFITS Main Storage Configurator UA-0067

Support: PROFITS Program: Category 1;
 Device Handlers: Category 3;
 Message Interface Modules: Category 3

Developed By: Worldwide Applications Development Center and selected users in the UNIVAC Financial Users' Group

Availability: Applications Services (Restricted Distribution; Non-disclosure Agreement must be signed before ordering)

Order No.:

IN DEVELOPMENT

DATE	SYSTEM TYPE	INDEX NAME
8/73	9400	PROF2
REVISION		
3		

APPLICATIONS SOFTWARE

An off-line file maintenance program will be provided to allow additions, changes and deletions to the user defined CIF and index files.

Configuration:

The following minimum hardware configuration is required for the online operation of the Control Element, Time Deposits, Loans and CIS applications:

UNIVAC 9400/9480 Central Processor
 131,072 Bytes of Main Storage
 Disc File Control
 8414 or 8424 Disc Drives (3)
 Card Reader
 Printer
 Communications Subsystem - Tailored to the requirements of the user and the communications units selected.

B. Multiple Associations Capability

The multiple associations capability will enable the PROFITS program to process transactions for two or more financial institutions preventing access to any other association's data files by an online terminal of a different association. Associations serviced under the PROFITS multiple associations feature may have a total of 28 branch offices. Access to the associations data files are available to any terminal of the association.

The multiple associations feature will provide for the following capabilities:

Multiple application files for the time deposits, loans and CIS applications,
 Multiple teller journal and daily transaction files,
 Single system audit file for recovery purposes,
 File and record security through association identifier in all records of all files,
 Same record layout and field size for each file,
 Same classification codes for all files,
 Any type terminal and visual display devices require like output/input formats,
 All time deposits, loans and CIS applications processing the same.

Configuration:

The minimum hardware configurations defined for time deposits, loans and CIS applications apply with the exception of main storage. The increased main storage requirement for each additional association is estimated to be approximately 18.5K.

IN DEVELOPMENT

DATE 2/72	SYSTEM TYPE 9400	INDEX NAME PTRG
REVISION		

APPLICATIONS SOFTWARE

PAPER TAPE READER

PTRG provides input/output control for the 0921 Paper Tape Reader.

A paper tape file can be of any length or of as many tapes as you wish. Data frames are normally punched as a continuous stream, without interblock gaps.

Two processing methods are available:

- . Fixed-length record format unblocked. Using this format, blocks or records of equal, constant length are input for processing.
- . Variable-length record format unblocked. Using this format, records of variable length are input for processing. The end of a record is defined as a specific character which must be included in each record.

The fixed-length record format must be used with care, since one character too few or too many in a record can cause displacements in all subsequent records.

The routine for the Paper-Tape Reader on the UNIVAC 9400 reads paper tape data and transfers it to the working program within fixed or variable length records. These are the individual record formats which can be processed by the routine. Code translation in either format may be specified.

Configuration: 9400; 0921 Paper Tape Reader

Operating System: DOS/TOS

Documentation: User's Manual, loose leaf pages

Support: Category 3

Developed By: Central European Division/Univac Germany

Availability: Applications Services

Order No.: 940015

DATE 3/74	SYSTEM TYPE	INDEX NAME
REVISION	9400	RCOB

APPLICATIONS SOFTWARE

RPG-TO-COBOL TRANSLATOR

The RPG/RPGII-to-COBOL translator is designed to convert RPG source code to COBOL source code for execution on the UNIVAC 1100 Series, UNIVAC 9000 Series and IBM 360 equipment. The translator is oriented toward commercial application programs.

The RPG/RPGII-to-COBOL language conversion package accepts all of the various RPG language source programs as input and generates standard ANS COBOL source programs as output. All standard RPG language elements are converted.

The system provides a cross-reference listing in which the RPG statements and the corresponding generated COBOL statements are listed side-by-side for easy reference. An original listing of the RPG program is provided at the beginning of the system to provide continuity for the conversion task. The generated COBOL program uses the programmer's original tags when available.

The basic RPG processing loop is maintained where possible, which provides a great assistance and manageability to existing documentation.

Configuration: UNIVAC 9400, 9480, 90/60 or 90/70; 98K; (2) 8414;
Reader, Printer, Punch.

Operating System: OS/4

Documentation: Loose-Leaf Pages

Support: Category 1

Developed By: Worldwide Applications Development Center, Blue Bell

Availability: Applications Services

Order No.: 940049

DATE	SYSTEM TYPE	INDEX NAME
8/71	9400	REA900
REVISION		
1		

APPLICATIONS SOFTWARE

90 COLUMN ON-LINE READER HANDLER

Job Control statements and data are submitted by the user to the UNIVAC 9400 Operating System by way of a card reader and stored on the resident direct access storage device for subsequent processing.

This reader handler provides for loading these cards into the system using 90 column cards via an 0711 reader.

Configuration: 9400; 0711 Reader

Operating System: DOS/TOS; Assembler

Documentation: Loose Leaf Pages (Japanese)

Support: Category 3

Developed By: Africa-Asia Division/Univac Japan

Availability: Univac Japan

Order No.:

DATE	SYSTEM TYPE	INDEX NAME
8/71	9400	RTCNM
REVISION 1		

APPLICATIONS SOFTWAREREAL TIME COMMUNICATIONS NETWORK MODEL (RTCNM)

The Real-Time Communications Network Model (RTCNM) is a simulation model which computes the time required for real-time transactions to flow through the communications network.

The model assumes half duplex lines and a polling algorithm of the type utilized in the 9400 MCP. Network queue statistics and line utilizations are computed along with the network's response time.

The model has been designed with the user in mind and can be used to balance a communications network and measure the network's performance with a balanced workload.

Configuration: 9400; disc subsystem

Operating System: DOS; FORTRAN

Documentation: General Description, loose leaf pages

Support: Category 3

Developed By: Americas Division

Availability: Applications Services

Order No.: 940009

DATE	SYSTEM TYPE	INDEX NAME
8/71	9400	RTCSM
REVISION		
2		

APPLICATIONS SOFTWARE

REAL TIME CENTRAL SITE MODEL (RTCSM)

The Real-Time Central Site Model (RTCSM) is a static model which traces the progression of a real-time transaction through the Message Control Program (MCP) and the user defined application programs.

Throughput capabilities are determined, and statistics are gathered on the various wait and service times which develop in the transaction processing. The central site response time of the various transactions defined is also calculated.

The model is easy to use and quickly estimates the ability of a 9400 System to perform within given specifications in the application under consideration.

Configuration: 9400; disc subsystem

Operating System: DOS; FORTRAN

Documentation: RTCSM Reference Manual, loose leaf pages

Support: Category 3

Developed By: Americas Division

Availability: Applications Services

Order No.: 940003 (cards only)

DATE	SYSTEM TYPE	INDEX NAME
10/72	9400	SI1050
REVISION		
2		

APPLICATIONS SOFTWAREUNIVAC 9400 SYSTEM 1050 SIMULATOR

The UNIVAC 9400/1050 Simulator is a generalized program which allows the 9400 System to execute programs written for the 1050 System. The simulator accepts programs written for any UNIVAC 1050 processor, card or tape oriented, with no coding modification.

The 9400/1050 program simulates 1050 hardware; it provides all logical 1050 machine functions. Any program or combination of programs used at the original 1050 installation can be used with the simulator. Thus, assemblies and compilations can be performed; all standard system and service programming (such as loaders, input/output routines, sort and dump programs) can be utilized. Operator procedures also remain essentially the same; the 1050 operator's control panel is simulated on the 9400 console typewriter by a simple type-in procedure. The 1050 typewriter is also simulated on the 9400 typewriter.

The major 1050 input/output devices are simulated: card reader, punch, printer and magnetic tape. The only major restriction imposed by the simulator is that timing-dependent programs may not execute properly.

Configuration: 9400 CPU: I/O Dependent on 1050 Configuration

Operating System: DOS

Documentation: UNIVAC 9400 System 1050 Simulator, UP 7858

Support: Category 1

Developed By: Manufacturing and Development Division, Philadelphia

Availability: Software Order Services, Blue Bell

Order No.:

DATE	SYSTEM TYPE	INDEX NAME
2/72	9400	STATPA
REVISION		
3		

APPLICATIONS SOFTWARE

STAT-PACK

This package is a conversion of the 1108 STAT-PACK, which includes subprograms in the following functional areas:

- . Descriptive Statistics
- . Elementary Population Statistics
- . Distribution Fitting and Plotting
- . Chi-Square Tests
- . Significance Tests
- . Confidence Intervals
- . Analysis of Variance
- . Regression Analysis
- . Time Series Analysis
- . Distribution Function
- . Inverse Distribution Function
- . Miscellaneous

Configuration: 9400; minimum

Operating System: DCS/TCS; FORTRAN

Documentation: None (Use 1108 STAT-PACK Documentation, UP-7502.)

Support: Category 3

Developed By: Africa-Asia Division/Univac Japan

Availability: Applications Services

Order No.: 940012

DATE	SYSTEM TYPE	INDEX NAME
3/74	9400	TERMS
REVISION		

APPLICATIONS SOFTWAREUNIVAC 9400 TERMINAL MANAGEMENT SYSTEM

The UNIVAC 9400 Terminal Management System (9400/TMS) is a communications monitor for the disc-oriented UNIVAC 9400 system. It provides the users of interactive data terminals with a simple command language for initiating the processing of conversational type transactions used in applications such as Order Entry, Interactive Data Management, Inventory Control, Order Shipping, and Insurance.

While TMS is not expected to meet the needs of every user, it is designed to satisfy the requirements of 9400 customers who are primarily COBOL/BAL oriented and do not possess inhouse communications expertise.

The 9400/TMS operates as an independent user program working in conjunction with the 9400 Supervisor, Data Management System, and Message Control Program (MCP or MMCP). The routines to process the different transactions are user-written and linked with TMS. The 9400/TMS is the supervisor for user-written, real-time programs.

The 9400/TMS accepts instructions keyed into remote or on-site terminal devices such as the UNISCOPE 100 Display Terminal, UNIVAC DCT-1000 Data Communications Terminal, and UNIVAC DCT-500 Data Communications Terminal.

Configuration: UNIVAC 9480; 65K; 8414 or 8425 disc.
UNIVAC 90/60, 90/70; 131K; 8414 or 8425 disc.

Operating System: OS/4

Documentation: Loose-Leaf Pages

Support: Category 3

Developed By: Americas Division/Univac Canada

Availability: Applications Services

Order No.: 940051

DATE 3/74	SYSTEM TYPE 9400	INDEX NAME THAN94
REVISION		

APPLICATIONS SOFTWARE

1004/1005 TAPE HANDLER

The 1004/1005 tape handler (THAN94) provides a UNIVAC 9400 user program with the capability of accessing and controlling the UNIVAC VI-C tape units of an online 1004/1005. Usage of these tapes is restricted to user-generated files only. System-resident files or librarian files can not be used on the tapes. Also, the design of the user interface being unique for accessing the 1004/1005 tapes only, no software elements such as language processors, compilers, job control programs, utilities, sort, librarian, data management, etc., are capable of accessing these tapes.

The handler was designed to minimize the procedures to add or include the handler in the operating system without source code changes to the card handler or the supervisor. Modifications to the standard 1004/1005 online plugboard are specified to handle the VI-C tape units.

Configuration: 9400 Minimum

Operating System: DOS

Documentation: User Reference Manual, Loose-Leaf Pages

Support: Category 3

Developed By: Applications Development Center

Availability: Applications Services

Order No.: 940044

DATE 10/72	SYSTEM TYPE 9400	INDEX NAME TMS94
REVISION 1		

APPLICATIONS SOFTWARE

TRANSACTION MANAGEMENT SYSTEM

TMS is an enhancement of the logical IOCS for data communication devices. Its advantages lay in the internal organization of message processing. Any number of RT programs for any number of terminals may be serviced.

Functions include the following:

- . Load and start message processing elements controlled by input (data) from terminals
- . Initialize the output functions of IOCS controlled by request from the message processing module
- . Direct communication between operators on the terminals and the machine console
- . Program start and stop from terminals or console
- . Repetition of messages called by operator
- . Terminal-Swap called by operator
- . Intercommunication between terminals
- . Checkpoint/Restart from disc (each second)
- . Logfile on tape for reconstruction of disc-files
- . Record lock-out (not yet implemented)

TMS is presently working with a special IOCS-routine called MINI-MCP(Message Control Program). See MMC94. An interface with standard MCP is possible and scheduled for implementation.

Configuration: 9400; 49K; 1 disc; 1 tape

Operating System: DCS

Documentation: Loose Leaf Pages (German)

Support: Category 3

Developed By: Northern European Division/Univac Austria

Availability: Univac Austria

Order No.:

DATE 2/72	SYSTEM TYPE 9400	INDEX NAME TMS94
REVISION		

APPLICATIONS SOFTWARE

Each Real-Time program needs a group of control routines which are part of the user programs. The logic of these routines depends on the special application, but with minor changes the routines can be used in nearly all applications. All message processing elements running with TMS are only one job.

Advantages of TMS include:

- . Simpler programming of data communication problems
- . Communication between terminals, computer and console-operation
- . Full error recovery
- . Data security

Disadvantages of TMS include:

- . Slow-down of processing speed by use of standard IOCS routines for disc accesses
- . In connection with MINI-MCP no simultaneity in working with more than one line.

DATE	SYSTEM TYPE	INDEX NAME
8/71	9400	TP3T04
REVISION		
1		

APPLICATIONS SOFTWAREFORTRAN DATA TAPE CONVERSION, 9300 TO 9400

Data tapes written by 9300 FORTRAN programs are incompatible with 9400 data tapes conventions. This program eliminates the existing incompatibility by writing new data tapes in accordance with 9400 FORTRAN format.

Configuration: 9400; 32K; 2 tapes

Operating System: TOS/DOS

Documentation: TP3T04 - 9400 - Programmbibliothek (German)

Support: Category 3

Developed By: Central European Division/Univac Germany

Availability: Univac Germany

Order No.:

DATE	SYSTEM TYPE	INDEX NAME
2/72	9400	UNICG
REVISION		

APPLICATIONS SOFTWARE

COORDINATE GEOMETRY LANGUAGE (UNICG)

UNICG (UNIVAC Coordinate Geometry) is a problem oriented language suitable for the solution of coordinate geometry problems such as those occurring in land surveys.

Programs written in UNICG execute a series of commands that describe in short notation the operations and calculations to be done. Because of its simplicity a program can be written in minutes by the engineer, and does not require any previous computer experience.

Problem solving capabilities of UNICG can be expanded simply by adding new commands to the system.

Configuration: 9400; 65K

Operating System: TOS/DOS; FORTRAN

Documentation: UNICG Manual (Spanish)

Support: Category 3

Developed By: Americas Division/Univac Argentina

Availability: Univac Argentina

Order No.:

DATE 3/74	SYSTEM TYPE	INDEX NAME
REVISION 3	9400	UNIS94

APPLICATIONS SOFTWARE

UNIVAC INDUSTRIAL SYSTEM

UNIS is an integrated, modular system used for solving management information problems in the manufacturing industry. It is designed to handle problems associated with bill of materials processing, inventory management, and production planning and scheduling. The modularity and flexibility of UNIS permit a tailored solution for a specific application. The basic problem of applying a single system to all types of manufacturing organizations is overcome by UNIS by providing the user with a choice of processing methods.

UNIS is composed of three major modules, each described separately in this abstract. The modules are:

- . Bill of Materials Processor (UNIBORS/UNIBOSS)
- . Inventory Management System (ALDIN)
- . Planning and Scheduling System (UNITEK-1)

An interface is established between UNIS and the standard IOCS to handle files. A set of model installation programs (UNIS-MIP) is available.

UNIS is also available for the UNIVAC 9300 and the UNIVAC 1100 under index names of UNIS93 and UNIS11, respectively.

Configuration: 9400/9480; UNIBOSS, 4 tapes or 2 discs (8411/8414)
UNIBORS, ALDIN, UNITEK-1, 1 disc minimum

Operating System: OS/4

Documentation: UNIVAC 9000 Bill of Material Processing System, UNIBORS
General Description, UA-0039; User's Reference, UA-0038
UNIVAC 9000 Production Planning and Scheduling System,
UNITEK-1, General Description, UA-0036; User's
Reference, UA-0066
UNIVAC 9000 Inventory Management System, ALDIN
General Description, UA-0072; User's Reference, UA-0071
UNIBOSS Bill of Material User's Manual, Loose-leaf pages

Support: Category 1

Developed By: Central European Division/Univac Germany

Availability: Applications Services

Order No.: UNIBORS, 940028; UNIBOSS, 940029; UNITEK-1, 940043;
ALDIN, 940045

DATE	SYSTEM TYPE	INDEX NAME
3/74	9400	UNIS94
REVISION 3		

APPLICATIONS SOFTWARE

UNIBORS/UNIBOSS

The Bill of Materials Processor provides part lists and input data for the Inventory Management System and the Planning and Scheduling System. It is composed of a number of subprograms which may be categorized into three groups:

- . Loading programs
- . Processing programs
- . Updating programs

All data defining the component and product structure is collected and used to create two master files; the parts file, and the structure file. These files are used to produce the various bill of material lists and parts usage lists. They also calculate the total demand requirements.

Various types of output result from the bill of materials processing. For example, a bill of materials explosion gives the time relationship for components which make up the finished product. Other types of output include an indented explosion, which shows the hierarchical structure from the finished product to the lowest production level; a review list; a function list; an assembly list; a standard list; and a customer list. The processor may also be used to compile part usage lists which show all higher level components or assemblies which use a specified part.

Two bill of material processors are available. The primary difference between them is that one uses a sequential processing method, and the other a random method.

The sequential processor, UNIBOSS, requires shorter processing time than the direct access system. It is particularly useful in the following environment:

- . A large volume of data exists (scientific storage)
- . Update is frequent
- . Many batched calculations are necessary
- . Other data processing problems warrant the use of a tape-/disc-oriented system

The random processor, UNIBORS, is recommended where:

- . An average volume of data exists
- . Frequent updating is not necessary
- . The number of necessary calculations is not great

DATE	SYSTEM TYPE	INDEX NAME
3/74	9400	UNIS94
REVISION		
3		

APPLICATIONS SOFTWARE

ALDIN

The Inventory Management System is a multilevel system based on five major elements:

- . Total requirements calculations
- . Stock level control
- . Net requirements calculations
- . Reorder calculations
- . Material requirements planning

The concept of a multilevel inventory management system is used to control raw materials, parts, or assemblies at different production levels. Thus it is a system which will improve stock availability, reduce capital investment, and improve the speed and accuracy of stock information. The program provides information regarding stock levels. It anticipates safety stock penetration, and calculates economic reorder quantities and the value of stock on hand, whereby all of these functions are carried out and optimized at different production levels.

UNITEK-1

The objectives of the Production Planning and Scheduling System are to improve adherence to planned completion dates, to reduce lead times, and to reduce the capital tied up in work in process. The work order file is maintained, each job is scheduled, and the resulting load is placed in the work center file. Infinite capacity scheduling is used.

The input is composed of production data, operation planning data, and control parameters. The system creates and maintains the work order and work center files, thereby providing the necessary data for a user to produce work order schedules, work center schedules, work center load reports and other manufacturing reports.

DATE 3/74	SYSTEM TYPE 9400	INDEX NAME UPACS
REVISION 3		

APPLICATIONS SOFTWARE

HOSPITAL FINANCIAL SYSTEM

UPACS provides a comprehensive hospital accounting capability for one or more hospitals. Five applications are provided:

- . Patient Accounting
- . Accounts Payable
- . Inventory
- . Property Accounting
- . General Ledger

Each of the UPACS applications can be used independently of the others. All programs are written exclusively in COBOL. Communications terminals such as the DCT-1000 and UNISCOPE 100 may be used.

Patient Accounting provides a complete patient accounting system for inpatients and outpatients including inpatient census, insurance proration, Accounts Receivable, revenue and hospital utilization statistics.

(continued)

Configuration: 9400; 98K; 196K with communications; 3 tapes; (3) disc, Reader, Printer

Operating System: DCS

Documentation: UPACS Application Brief UA-~~0034~~; Billing User's Manual; Accounts Payable User's Manual; General Ledger User Reference, UA-0074; Inventory User's Manual; Property Accounting User's Manual.

Support: Category 5

Developed By: Worldwide Applications Development Center

Availability:

Order No.: **IN DEVELOPMENT**

DATE 3/74	SYSTEM TYPE	INDEX NAME
REVISION 3	9400	UPACS

APPLICATIONS SOFTWARE

Accounts Payable provides control over authorized purchase orders and reconciles invoices against purchase orders, provides for check requests, estimates cash requirements to pay vendors, writes checks, and provides for check reconciliation.

Inventory provides an inventory file for central stores which is updated daily to show issues and receipts. Items requiring re-order are flagged. Provision is made to adjust inventory records to a physical count. Buyers are provided with demand history on inventory items.

Property Accounting provides for control of fixed and movable capital assets. Depreciation is calculated by the appropriate method for each item at intervals selected by the user.

General Ledger is based on the AHA Chart of Accounts. Monthly operating statements and balance sheets are provided showing cumulative performance during the current accounting year against the previous year and against budget. Comprehensive reports are provided showing departmental revenue and expenses.

IN DEVELOPMENT

DATE 2/72	SYSTEM TYPE 9400	INDEX NAME USEX
REVISION		

APPLICATIONS SOFTWARE

SYSTEM EXERCISER (USEX)

USEX is a program module which will allow the user to debug and execute real time programs without using MCP or Communications hardware. This is effected by replacing MCP by the UNISEX module (thereby defining dummy LDP's and TERMTB's), then submitting control stream and input data on cards or tape and executing as normal.

Configuration: 9400; 32K

Operating System: TOS/DOS

Documentation:

Support: Category 3

Developed By: Northern European Division/Univac United Kingdom

Availability: Applications Services

Order No.: 940013

DATE	SYSTEM TYPE	INDEX NAME
8/73		
REVISION	9400	UTL94

APPLICATIONS SOFTWARE

UTILITY PACKAGE FOR 9400

When the program is loaded the user can have the following operations performed:

1. Card to card reproduce (JCL or data cards)
2. Card to printer (JCL or data)
3. Card to tape (unlabelled, unblocked, BKSZ=80)
4. Tape to card (blocked multiple of 80, or unblocked 80)
5. Tape to printer BCD)
6. Tape to printer hex.
7. Write a tape mark.
8. Rewind a tape.
9. Forward space tape a specified number of blocks.
10. Backward space tape a specified number of blocks.
11. Tape to tape copy STD, NSTD, No-labels.
12. Change disc volume serial number (8411 or 8414)
13. List VTOC (F4,F5,F1,F2,F3 labels) (8411 or 8414)

Configuration: 9400

Operating System:

Documentation: Loose-Leaf Pages

Support: Category 3

Developed By: Americas Division/Univac Canada

Availability: Applications Services

Order No.: 940041

DATE 8/71	SYSTEM TYPE 9400	INDEX NAME UTOBJ
REVISION		

APPLICATIONS SOFTWARE

LOAD MODULE OUTPUT PROGRAM (UTOBJ)

This program places loadable modules, which are the output of the disc linker, on tape without using the Disc Librarian. Either a single module or any number of modules can be stored in a single run of UTOBJ. The output modules on tape can be loaded and be handled by LIBS, DAPS and DISCLIBRARIAN.

Configuration: 9400

Operating System: TOS/DOS

Documentation: User's Manual (Japanese)

Support: Category 3

Developed By: Africa-Asia Division/Univac Japan

Availability: Univac Japan

Order No.:

DATE 8/73	SYSTEM TYPE 9400	INDEX NAME UTSRT
REVISION 1		

APPLICATIONS SOFTWARE

UTILITY SORT FOR 9400

Utility Sort is an enhanced and simplified version of the standard 9400 Sort routine.

UTSRT is available as a loadable module that may be used by either tape or disc systems; the program may accept data from any one of four sources - control stream, magnetic tapes, sequential disc files or index sequential files; output may be to magnetic tape, sequential disc file or to create or extend an index sequential file.

The operation of the program is controlled by Parameter cards in the control stream; parameters take the form of keyword parameters similar to those used by 9400 Data Management and 9400 Sort Merge.

Configuration: 9400; minimum

Operating System: DOS/TOS

Documentation: UTSORT

Support: Category 3

Developed By: Northern European Division/Univac Norway

Availability: Application Services

Order No.: 940034

DATE 2/72	SYSTEM TYPE 9400	INDEX NAME UTST94
REVISION 1		

APPLICATIONS SOFTWARE

PROGRAM MODULE TESTING PACKAGE (UNITEST)

This routine can be linked with one or more user program modules and is used to control the testing of that program module (or modules). The user can recycle through the module many times to test each logic path; and, if the module aborts, the testing can be continued.

The following facilities are provided:

- . To set up input data or parameters in main storage
- . To initialize the test module's problem program register set
- . To simulate the processing of a "called" module that is not included in the load module
- . To monitor the results achieved by an execution of the test module
- . To provide diagnostics and rerun facilities in the event of the test module aborting
- . To provide an exit to user own code for complicated or user-standardized initialization routines

Configuration: 9400; minimum

Operating System: DOS/TOS

Documentation: Description Manual and Guide to Modular Programming

Support: Category 3

Developed By: Northern European Division/Univac United Kingdom

Availability: Applications Services

Order No.: 940018

DATE	SYSTEM TYPE	INDEX NAME
3/74	9400	WIMS
REVISION		
1		

APPLICATIONS SOFTWARE

WHOLESALE INVENTORY MANAGEMENT SYSTEM

The Univac Wholesale Inventory Management System provides a distributor with the information necessary to determine when and how much to order for items in inventory to minimize the overall cost of inventory maintenance, purchasing and receiving, freight costs, and loss of discounts. Factors considered are lead time and variability thereof, forecast demand and error, service required for each item, inventory carrying costs, purchasing and receiving costs, discount structures, carload and pallet requirements, and item minimums, shelf lives, and pack size. Information is also generated which allows advance understanding of the results of inventory management decisions, e.g., results of varying costs of carrying a unit of inventory or varying the degree of service available to a customer.

The complex and demanding nature of this program requires a dedicated effort on the part of the customer and the branch with a relatively high level of training, guidance, and support during preinstallation phases. Some postinstallation support is also required which will vary according to the caliber of personnel receiving the initial guidance and the customer/branch involvement.

- Configuration:* UNIVAC 9400, 9480; 65K; 2 tapes or 2 discs
UNIVAC 90/60; 131K; 2 tapes or 2 discs
- Operating System:* UNIVAC 9400, 9480 - OS/4
UNIVAC 90/60 - OS/4 & OS/7
- Documentation:* WIMS Application Brief, UA-0032; WIMS General Description Manual, UA-0033; WIMS Macros Operations Manual; WIMS Macros Program Description Manual; WIMS Main Programs Operations Manual; WIMS Main Programs Description Manual; WIMS Demonstration Program and Operator's Manual
- Support:* Category 3
- Developed By:* Americas Division
- Availability:* Applications Services
- Order No.:* 940021 (COBOL Version Only)

DATE	SYSTEM TYPE	INDEX NAME
8/73	9400	93SORT
REVISION		

APPLICATIONS SOFTWARE

9300 SORT FOR THE 9400

9300 SORT input parameters are placed in the job control stream along with standard SORT II PARAM cards, to define the necessary work files. The major restriction of this technique is fixed length records.

Configuration: 9400; minimum

Operating System: TOS/DOS

Documentation: Sample control stream and description paragraph

Support: Category 3

Developed By: Americas Division/Univac Canada

Availability: Applications Services

Order No.: 940039

DATE	SYSTEM TYPE	INDEX NAME
8/73	9400	93TRAN
REVISION		

APPLICATIONS SOFTWARE

9300 TO 9400 TRANSLATOR FOR THE 9400

93 TRAN runs on the 9400 reading UP00 format source modules from tape or cards and produces a 9400 source tape in library format. Input is 9300 assembler source code interspersed with translator control cards.

Configuration: 9400; minimum

Operating System: TOS/DCS

Documentation: User's Guide, Loose-Leaf pages

Support: Category 3

Developed By: Americas Division/Univac Canada

Availability: Applications Services

Order No.: 940038

APPLICATIONS SOFTWARE

Applications Index

APPLICATIONS SOFTWARE

APPLICATIONS INDEX

The following Industry and Applications categories make up the Applications Index. All applications packages are listed by name within one or more of these categories:

Accounting and Payroll	Linguistics
Advertising	Management
Banking and Finance	Manufacturing
Chemical Engineering	Mathematics
Communications	Mechanical Engineering
Construction and Civil Engineering	Medical and Hospitals
Conversion Aids	Misc. Programs and Programming Aids
Data Management	Oil Industry
Demonstration Packages	Operating Systems and Extensions
Diagnostic Programs	Operations Research
Documentation and Printing	Physics
Economics	Production Control
Education	Public Utilities
Electrical Engineering	Publishing
Flowcharting	Radio and Television
Government	Retail and Wholesale
Graphics	Seismology
Handlers	Simulation and Modeling
Hydraulics	Statistics
Information Management	Steel Industry
Insurance	Textile Industry
Inventory Control	Translators
Law and Law Enforcement	Transportation/Reservations
Linear Programming	Utility Programs

APPLICATIONS SOFTWARE

<u>ACCOUNTING AND PAYROLL</u>	<u>COMPUTER</u>	<u>INDEX NAME</u>
(See also "Banking and Finance")		
Accounts Payable	9200	ACCPAY
Accounts Receivable	9200	ACCREC
Client Accounting	9200	UCA
Dairy Route Accounting	9200	DAIRY
Distribution Accounting and Control System	Series 70	DACS
Fixed Assets Accounting	9200	FASACC
General Accounting	9300	GENACC
General Ledger Accounting	9200	GENLED
General Payroll Application Package	9300	GEPA93
Medical Accounts Payable	92/9300	MEDAP
Medical Accounts Receivable	92/9300	MEDAR
Medical Fixed Assets	92/9300	MEDFA
Medical General Ledger	92/9300	MEDGL
Medical Payroll	92/9300	MEDPR
Mortgage Accounts Processing	9200	MORACC
Multidivision Payroll System	Series 70	MDP
Patient Accounting System	9400	UPACS
Payroll	92/9300	PAYROL
Payroll Package	9200	CALC
Savings Account Processing	9200	SAVACC
Television Scheduling	92/9300	TVSCH
Wholesale Ice Cream Accounting	9200	WICA

APPLICATIONS SOFTWARE

<u>ADVERTISING</u>	<u>COMPUTER</u>	<u>INDEX NAME</u>
(See also "Radio and Television")		
Television Scheduling	92/9300	TVSCH
<u>BANKING AND FINANCE</u>		
(See also "Accounting and Payroll")		
Computer Oriented Model by Econometric Technique	1100	COMET
General Accounting	9300	GENACC
Investment Profitability Analysis	1100	INPRAN
Mortgage Accounts Processing	9200	MORACC
OKI-Banking Terminal Handler	1100	OKIBK
PROFITS, Time Deposits Application	9400	PROF1
PROFITS, Loans Application	9400	PROF2
Proof and Transit Accounting System	Series 70	PTS
Saving Account Processing	9200	SAVACC
<u>CHEMICAL ENGINEERING</u>		
Central Composite Designs	1100	CENCOM
Chemical Engineering Programs	1100	CHMENG
Process Simulator of Steady State System	1100	PROCSM
Seal-Shell-2, Stress Analysis	1100	SHELL
X-RAY Crystallographic System	1100	XRAY

APPLICATIONS SOFTWARE

<u>COMMUNICATIONS</u>	<u>COMPUTER</u>	<u>INDEX NAME</u>
(See also "Graphics" and "Handlers")		
Adage Graphics Terminal Communications Subroutines	1100	AGTCS
ASR 33 to 9300 Communications Handler	9300	COMASR
Back-to-Back Diagnostic Routine	418-III	BTB41
Communications Control Program	9300	PACSII
Communications Remote Handler, FACOM 230/50	1100	FACOMH
Communications Input/Output 9300/IBM 360	92/9300	COMIO
Communications Remote Handler, OKI-CCC	1100	OKICCC
Communications Remote Handler, OKIDATA Series	1100	OKIRD
Data Communications Subsystem Test Program	92/9300	DCS1
Half-Duplex 9000 to 9000 Communications Handler	92/9300	HAFD
IBM 1050 Remote Handler	1100	105ORH
KSR 35 to 92/9300 Communications Handler	92/9300	COMKSR
Mini-Message Control Program	9400	MMD94
NUK CM Handler	1100	CMHAN
OKI Banking Terminal Handler	1100	OKIBK
OKISCOPE-1000 Demand Symbiont	1100	OKIDS
Package Communications Subsystem	9400	PACS4
REM-1 Throughput Improvement	92/9300	REMFIX
Remote Communications 9300/IBM 360	9300	REMCOM
Remote Transmission Symbiont	92/9300	CZREM
Remote 1004 Handler	1100	RMD4H
Remote 1004 Symbiont, with Paper Tape Unit	1100	RO4PT
Remote 9300	9300	REM9
SHINKO-100 Remote Device Handler	1100	SHNK1

DATE 3/74	APPLICATIONS INDEX
REVISION 7	

APPLICATIONS SOFTWARE

<u>COMMUNICATIONS (Cont'd)</u>	<u>COMPUTER</u>	<u>INDEX NAME</u>
Systems Exerciser	9400	USEX
Telex Demand Symbiont	1100	TLXDEM
Transaction Management System	9400	TMS94
Transaction-Oriented Program System	1100	TOPS
UNIHASP 9200 to 360 HASP Handler, Using DCS1C	92/9300	UHASP2
UNIHASP 9200 to 360 HASP II Handler, Using DCS1	92/9300	UHASPA
UNISCOPE 100 Handler	494	U1H49
UNISCOPE 100 Maintenance Routines	1100	OLCMR
UNISCOPE 300 Handler	494	U3H49
494 to 494 Communications Handler	494	CH49
9200 to CDC 6400/6500 Communications Handler	92/9300	COMCDC
9200 to IBM 360/40 Communications Handler	9200	COM360
9200/2780 to 9300 Communications Handler	92/9300	COM92
9300 to 418-II Communications Handler	9300	COM418
9400-1108 Link	9400	LNK98
<u>CONSTRUCTION AND CIVIL ENGINEERING</u>		
(See also "Mechanical Engineering" and "Mathematics")		
Building Industry Program	9300	UNIBAU
Building Supplies Calculation	9300	BSC
Cement Routines	1100	CEMENT
Civil Engineering Language	Series 70	COGO
Civil Engineering Language	1100	COG090
Continuous Beam Analysis	1100	COBEM
Coordinate Geometry Language	9400	UNICG
Digital Terrain Model	Series 70	DTM1

DATE 3/74	APPLICATIONS INDEX
REVISION 7	

APPLICATIONS SOFTWARE

<u>CONSTRUCTION AND CIVIL ENGINEERING (Cont'd)</u>	<u>COMPUTER</u>	<u>INDEX NAME</u>
Digital Terrain Model	1100	DTM
General Thermal Pipe Stress and Deflection Program	1100	PIPEB
Hardy-Cross Gas Distribution Analysis	Series 70	HCGAS
Hardy-Cross Method	1100	HCROSS
Hardy-Cross Water Network Series Program	Series 70	HCWTR
Highway Profile Program	Series 70	PROFE
Integrated Civil Engineering System	Series 70	ICES7
Integrated Civil Engineering System	1100	ICES
Piping Flexibility Analysis Program	1100	PIPEA
Seal-Shell-2, Stress Analysis	1100	SHELL
Slope Stability Analysis	1100	SLOPE
Storm Sewer Design	1100	SSDP
Structural Analysis System	1100	STRESS
Structural Analysis System	1100	NAST
Structural Engineering Programs	Series 70	STEP
Univac Coordinate Geometry System	9200	UNICOG
<u>CONVERSION AIDS</u>		
(See also "Translators")		
BAL to COBOL Translator	1100	BALCO
Basic Assembly Language Converter	9400	BALCON
CDC 3300 COBOL to UNIVAC 1100 COBOL	1100	CDCB
Character Conversion Program	92/9300	CHACON
COBOL 360 to 1108 COBOL Conversion	1100	COB360
COBOL Conversion System	9400	COCON
Conversion from Spectra 70/45 to 1108 COBOL	1100	COB70

APPLICATIONS SOFTWARE

<u>CONVERSION AIDS (Cont'd)</u>	<u>COMPUTER</u>	<u>INDEX NAME</u>
Convert B5500 COBOL to 1108 COBOL	1100	SIEVE
Convert EBCDIC to Fielddata Tape in 1108 COBOL Format	1100	TRANFD
DLT Conversion Program	1100	DLTCNV
EASYCODER to 1100 COBOL	1100	ECCB
EASYTRAN to 1100 COBOL	1100	ETCB
EXEC II to EXEC 8 Processor	1100	EXEC28
FASTRAND Alphanumeric File Dump	1100	FDUMP
FORTRAN Data Tape Conversion, 9300 to 9400	9400	TP3T04
GAMMA 10 to 9300 Translator	9300	GAMA10
Generator of Data Files	92/9300	GDAT
Honeywell BCD to EBCDIC Conversion Aid	9400	HTAPC
Honeywell 200 COBOL to UNIVAC 9400 Conversion Aid	9400	HCOB
Honeywell 200 COBOL to UNIVAC 1100 COBOL	1100	HGB
IBM EBCDIC to Fielddata Tape Dump	1100	TDUMP
IBM FAP to Univac EXEC II Assembly Language Translator	1100	FAPTRA
IBM 1400 to UNIVAC 92/9300	9300	ACTS1
IBM 1400 to UNIVAC 9400	9400	ACTS2
IBM 1401 Simulator	1100	S14018
IBM 1401 Simulation Program	Series 70	SMP1S
IBM 360 COBOL Level F Conversion Aid	1100	COBCON
IBM 360/20 to UNIVAC 92/9300 Translator	92/9300	PUR
IBM 7044 to UNIVAC 1108 Converter, COBOL, FORTRAN	1100	C7044
Japan Assembler	494	JASM
Microfilm Conversion Program	1100	MCROFM
PL/1 to 1100 COBOL	1100	PLCB

DATE	3/74	APPLICATIONS INDEX
REVISION	7	

APPLICATIONS SOFTWARE

<u>CONVERSION AIDS (Cont'd)</u>	<u>COMPUTER</u>	<u>INDEX NAME</u>
PL/1 to 1100 FORTRAN	1100	PLFT
RPG to 1100 COBOL	1100	RPGCB
Signed LIONA/LIONB Conversion Technique	1100	LIOCON
Tape Conversion Routines	1100	ATPTR
TAPETLAN Processor	1100	TPTRN
UNIVAC III Conversion Aid	1100	CONU3
Utility Program, 360/20 to 92/9300	92/9300	SWITCH
VERTRAN-DOD to USASI COBOL Translator	1100	VERTRN
1100 Card File Maintenance Routines	1100	CFMR
1005 to 92/9300 Translator	92/9300	TALC
1050 to 9000 Tape Conversion	92/9300	PR79
1400 AUTOCODER to 1100 COBOL	1100	AUCB
360/20 to 9400 Conversion Program	9400	C2094
360 Assembler to 1100 COBOL	1100	ASMCB
418 to 1100 Conversion Aid	418	ESC41
7- to 9-Track Conversion Aid	9300	TAPE79
7074 AUTOCODER to 1100 COBOL	1100	AUCB70
9000 to 1050 Tape Conversion	92/9300	PR97
9300 to 9400 Translator	9400	TRAN93
<u>DATA MANAGEMENT</u>		
(See also "Information Management")		
Data Base Management System	9400	DBS9
Data Management System	Series 70	OCRCA
Data Management System	1100	DMS11
File Management System	1100	FMS8
Information Management System	1100	FORIMS

DATE 3/74	APPLICATIONS INDEX
REVISION 7	

APPLICATIONS SOFTWARE

<u>DATA MANAGEMENT (Cont'd)</u>	<u>COMPUTER</u>	<u>INDEX NAME</u>
Information Management System	1100	FORM1
Information Management System	1100	FORM0
Information Management System	1100	IMS8
Information Retrieval System	9300	GIR
Key-Word-in-Context	9400	KWIC
Report Writer	1100	IMO
Statistical and Numerical Analysis Program	1100	OMTAB
Univac Information Management System	1100	UNIMS
Information Management System, 9400	9400	IMS94
<u>DEMONSTRATION PACKAGES</u>		
Bill of Materials Processor (8410 Disc)	92/9300	MAG1C0
Bill of Materials Processor (8411 Disc)	92/9300	MAG1C1
COBOL Demonstration	9300	DP7
Concurrency Demonstration	9300	DP1
Cumulative Savings Through Ownership Demonstration	9200	DP6
Inventory Control Demonstration	9200	DP5
LINCO III Demonstration	92/9300	LINCOD
Local Tax Billing Demonstration	92/9300	DP3
Payroll Register Demonstration	92/9300	DP2
Payroll Register Demonstration	9200	DP4
Student Scheduling Demonstration Program	9300	SSDEMO

DATE 3/74	APPLICATIONS INDEX
REVISION 7	

APPLICATIONS SOFTWARE

<u>DIAGNOSTIC PROGRAMS</u>	<u>COMPUTER</u>	<u>INDEX NAME</u>
(See also "Miscellaneous Programs and Programming Aids")		
Arithmetic Error Handling	1100	ARERR
Back-to-Back Diagnostic Routine	418-III	BTB41
Branch Trace Accounting and Analyzer	9400	BTA94
Data Communications Subsystem Testing Program	92/9300	DCS1
Diagnostic FORTRAN IV Compiler	1100	DFOR
Error Processing Routines	418-III	ERR41
General Plot with Histogram	92/9300	PLOT92
Interactive Terminal Debugging Under EXEC 8	1100	AIDS2
Memory Dump Tape Editor	418-III	DUMPR
Multiutility Program System	9400	MUPS
Panic Dump Analysis	1100	PANAL
Program Module Testing Package	9400	UTST94
Programming Test Aid	92/9300	UNITST
UNISCOPE 100 Maintenance Routines	1100	OICMR
U.S. Navy COBOL Test Routines	1100	USNCT
Utility Debugging Aid, 418-III	418-III	UD418
<u>DOCUMENTATION AND PRINTING</u>		
(See also "Publishing")		
Braille Print Processor	1100	BPP
Braille Processor	1100	BRAILL
Document Processor	1100	DOCUMT
Key-Word Indexing	1100	KWICN8
KWOC Index Format	1100	KWOCEX
LINCO III Demonstration	92/9300	LINCO8

APPLICATIONS SOFTWARE

<u>DOCUMENTATION AND PRINTING (Cont'd)</u>	<u>COMPUTER</u>	<u>INDEX NAME</u>
LINCO III Typesetting	92/9300	LINCO3
LINCO III Typesetting	9400	LINCO4
Special Print Forms	1100	SPF
Text Processing System	1100	TPS
Univac Automated Documentation System	1100	UNADS
<u>ECONOMICS</u>		
Autoregressive Data Analysis	1100	AUTOREG
Capital Investment Analysis Program	1100	CIAP
Computer-Oriented Model by Econometric Technique	418	COMET4
Computer-Oriented Model by Econometric Technique	1100	COMET
Computer-Oriented Model by Econometric Technique	9400	COMET9
Exponential Smoothing Technique	1100	EXPONS
Factor Analysis	1100	FACTAN
Investment Profitability Analysis	1100	INPRAN
Multiple Regression Analysis	9300	MRA93
Multiple Regression Analysis	418	MRA418
Sales Forecast and Control	Series 70	SFC
Seasonal Adjustment Program	1100	CENSUS
Statistical Package	92/9300	STAT92
Stepwise Regressive Program	1100	STEREG
<u>EDUCATION</u>		
All-Purpose Grading Program	1100	GRADER
Automatic Conversion and Test Score Analysis	Series 70	ACORN
Computer-Aided Management Educational Language	9200	CAMEL
Computer-Aided Management Educational Language	494	CML49

APPLICATIONS SOFTWARE

<u>EDUCATION (Cont'd)</u>	<u>COMPUTER</u>	<u>INDEX NAME</u>
Computer-Oriented Programmed Instruction	1100	COPI2
Computer-Oriented Programmed Instruction	9300	COPI90
Educational Accounts Payable	Series 70	EAP
Educational Accounts Receivable	Series 70	EAR
Educational Payroll System	Series 70	EPS
File-Oriented Interpretive Language	1100	FOIL
Flexible Modular Student Scheduling System	1100	FMSS
Grade Processing and Evaluation	1100	GRADE
Grade Processing and Evaluation	1100	GRAPE
IITRAN Compiler	1100	IITRAN
Interactive Language	1100	UIL
Introductory Computer Language	92/9300	ICL
Language for Differential Equations	1100	MIMIC
Program Language for Time Sharing	1100	BASIC
School Curriculum Rating and Evaluation	92/9300	SCORE
School II Student Scheduling System	1100	SCHL2
Statistical Analysis of Test Answers	Series 70	SATAN
Student Scheduling Application System	Series 70	SSCH
Student Scheduling Demonstration	9300	SSDEMO
Student Scheduling Package	92/9300	CAMPUS
Traditional Integrated Scheduling System	1100	TISS
Tuition and Dormitory System	1100	TDS
University Package	1100	UNIV

APPLICATIONS SOFTWARE

<u>ELECTRICAL ENGINEERING</u>	<u>COMPUTER</u>	<u>INDEX NAME</u>
Bus Fault Analysis	Series 70	BUS1
Bus Transient Stability	Series 70	BUS5
Circuit Analysis and Transient Response	1100	SCEP
Electronic Circuit Analysis	Series 70	ECAP
Electronic Circuit Analysis	1100	ECAP
Electronic Circuit Simulation Program	1100	CIRCUS
General Purpose Circuit Analysis	1100	SNAP2
Graphical Output Circuit Analysis Program	1100	GOCAP
Language for Differential Equations	1100	MIMIC
Transient Radiation Analysis by Computer	1100	TRAC
<u>FLOWCHARTING</u>		
Assembler Program Flowchart	9400	FLMAT
Assembler Program Flowchart	92/9300	FLOMAT
Automatic FORTRAN Flowchart Generator	1100	FORFLO
COBOL Flowcharting System	1100	FLOBOL
Flowcharted Output for COBOL Users	1100	FOCUS
Flowcharting Language for User's Simplified Handling	1100	FLUSH
FORTRAN Flowcharter	1100	FLOWCH
<u>GOVERNMENT</u>		
(See also "Statistics" and "Law Enforcement")		
Law Enforcement Application Program	418	LEAP
Local Tax Billing Demonstration	92/9300	DP3
Seasonal Adjustment Program	1100	CENSUS
Seasonal Adjustment Program, Method II	1100	CENS2
Statistical Programs	1100	STAT11

APPLICATIONS SOFTWARE

<u>GOVERNMENT (Cont'd)</u>	<u>COMPUTER</u>	<u>INDEX NAME</u>
Statistical Programs	92/9300	STAT92
Statistical Programs	9400	STATPA
String Manipulating Language	1100	SNOBOL
U.S. Navy COBOL Test Routines	1100	USNCT
<u>GRAPHICS</u>		
(See also "Communications", "Handlers", "Mathematics", and "Statistics")		
Adage Graphics Terminal Communications Subroutines	1100	AGTCS
Advanced Graphic Display System (1557/1558) Subroutines	1100	ASPAC
ALGOL Extended	1100	AEDO
Basic Graphic Software for Storage Display	1100	TKBGS
CALCOMP Postprocessor	9400	CAIP4
CALCOMP Postprocessor	92/9300	CAIP3
Curve Plot Routine	1100	GRAPH
Demand Symbiont, M-340 Color Display Device	1100	M340
General Interface for Graphic Display Terminals	1100	IOG
General Plot With Histogram	92/9300	PLOT92
Graphical Output Circuit Analysis Program	1100	GOCAP
Graphics Programming Language, Version 5.1	1100	GPL5
Graphics Programming Language, Version 6.0	1100	GPL6
Intelligent Graphics System	1100	IGSS
Picture Processing Programs	1100	PAX2
Plotting Subroutines, Zeta Plotter 230	1100	ZETAP
Plotting Subroutines Package	1100	PSP
Printed Circuit Pattern Layout	1100	PPLS

APPLICATIONS SOFTWARE

<u>GRAPHICS (cont'd)</u>	<u>COMPUTER</u>	<u>INDEX NAME</u>
Support Symbiont	1100	UNGSPS
Univac Interactive Graphics	1100	UNGSP
<u>HANDLERS</u>		
(See also "Communications" and "Graphics")		
Adage Graphics Terminal Communications Subroutines	1100	AGTCS
ASR 33 to 9300 Communications Handler	9300	COMASR
DCT 2000 Symbiont, with Paper Tape Unit	1100	DCTPT
Demand Symbiont, M-340 Color Display Device	1100	M340
Demand Symbiont, OKIDATA-200	1100	OKI200
Demand Symbiont, OKI-TTY	1100	OKITTY
Drum File Handler	490	GOGET
Half-Duplex 9000 to 9000 Communications Handler	92/9300	HAFD
IBM 1050 Remote Handler	1100	105ORH
KSR 35 to 9200/9300 Communications Handler	92/9300	COMKSR
Melcom-340 Handler	494	MEL340
Modified Onsite 9000 Symbiont	1100	OS9SM
Modified Remote 9000 Symbiont	1100	MR9
NCR 420 Handler	9400	NCR420
NCR 671 to 9400 Interface	9400	NCR671
Onsite 1004 Symbiont, with Paper Tape Unit	1100	OS4PT
Onsite 9000 Handler for EXEC 8	1100	SITE2
Paper Tape Handler	9400	PATAPE
Paper Tape Reader I/O Control	9400	PTRG
Paper Tape Symbiont, Input/Output	9300	PTSYM
Remote Transmission Symbiont	92/9300	CZREM

APPLICATIONS SOFTWARE

<u>HANDLERS (Cont'd)</u>	<u>COMPUTER</u>	<u>INDEX NAME</u>
Remote 1004 Symbiont, with Paper Tape Unit	1100	RO4PT
Remote 9300 Handler	494	R93H
Tape Handler, IV-C	1100	IVCHAN
Tape Utility Program	1100	TUTIL
Telex Demand Symbiont	1100	TLXDEM
UNISCOPE 100 Handler	494	U1H49
UNISCOPE 100 Handler	92/9300	U100H
UNISCOPE 100 Symbiont, with Pagewriter	1100	U1PWR
UNISCOPE 300 Handler	494	U3H49
UNISCOPE 300 Handler	1100	USS300
UNISCOPE 300 Symbiont, without Pagewriter	1100	U3WOPR
Univac Array Processor Software	1100	UAPS
1004 Handler	9400	RE1004
418-II Handler for Demand Symbiont	1100	DEM418
90-Column Online Reader Handler	9400	REA90C
9200 to CDC 6400/6500 Communications Handler	9200	COMCDC
9200 to IBM 360/40 Communications Handler	9200	COM360
9200/2780 to 9300 Communications Handler	92/9300	COM92
9200/9300 to 360 HASP-II System Communications Handler	92/9300	UHASPA
9300 Handler	9400	HAN93
9300 Input/Output	494	SITSP
9300 Subsystem Handler	494	93H49
9300 to 418-II Communications Handler	9300	COM418

APPLICATIONS SOFTWARE

<u>HYDRAULICS</u>	<u>COMPUTER</u>	<u>INDEX NAME</u>
(See also "Mechanical Engineering")		
Hardy-Cross Method	1100	HCROSS
Piping Flexibility Analysis Program	1100	PIPEA
Piping Flexibility Analysis Program	1100	PIPEB
<u>INFORMATION MANAGEMENT</u>		
(See also "Data Management")		
AIGOL Extended for Design	1100	AEDO
Data Management System	1100	DMS11
File Management System	1100	FMS8
File Save/Restore Utility Program	1100	FILSAV
Information Management System	1100	FORIMS
Information Management System	1100	FORM1
Information Management System	1100	FORMO
Information Management System	1100	IMS8
Information Management System, 9400	9400	IMS94
Information Retrieval System	9300	GIR
Key-Word-in-Context Indexing System	9400	KWIC
Key-Word-in-Context Indexing System	1100	KWIC11
Key-Word-out-of-Context Indexing System	1100	KWOC11
Report Generator	1100	COGENT
Report Generator, EXEC II	1100	RPG11
Report Writer	1100	IMO
Special Indexed-Sequential IOCS	92/9300	SISIO
Statistical and Numerical Analysis Program	1100	OMTAB
Univac Information Management System	1100	UNIMS

APPLICATIONS SOFTWARE

<u>INVENTORY CONTROL</u>	<u>COMPUTER</u>	<u>INDEX NAME</u>
(See also "Information Management" and "Retail and Wholesale")		
Automatic Warehouse Disposition for Industry	9400	ALDIN4
Basic Inventory Control	9200	BIC
Fixed Assets Accounting	9200	FASACC
Purchased Material Receiving System	1100	INMAT
Scientific Inventory Management System	92/9300	SIMS
Univac Industrial System	1100	UNIS11
Univac Industrial System	9300	UNIS93
Univac Industrial System	9400	UNIS94
Warehouse Location Program	1100	MINWAR
Wholesale Inventory Control System	9200	WICS
Wholesale Inventory Management System	9400	WIMS
<u>LAW AND LAW ENFORCEMENT</u>		
(See also "Government")		
Law Enforcement Application Program	418	LEAP
<u>LINEAR PROGRAMMING</u>		
(See also "Mathematics" and "Operations Research")		
Functional Mathematical Programming System	1100	FMPS
Garment Cutting Optimization	9300	GARCUT
Interactive Linear Programming	Series 70	TSIP
Linear Programming	1100	ILONA
Linear Programming	1100	LP1100
Linear Programming	490	LP49X
Linear Programming	92/9300	LP93
Linear Programming	9400	LP9400

APPLICATIONS SOFTWARE

<u>LINEAR PROGRAMMING (Cont'd)</u>	<u>COMPUTER</u>	<u>INDEX NAME</u>
Linear Programming	1100	SIMPDX
Linear Programming	1100	SIMPLX
Linear Programming	418	LP418
Linear Programming	9200	LP92
Linear Programming Data Conversion	1100	LPDATA
Linear Programming for Minimum System	92/9300	MINIIP
Marie-Claire Linear Programming System	1100	MARCL
Mathematical Programming System	494	MPS49
Primal Flow Transportation Code	1100	PFTC
Route Organization and Optimization	1100	ROUTE
Series 70 Linear Programming	Series 70	SCECIP
Transportation Linear Programming	Series 70	TRANSP
University of Houston Easy Linear Language	1100	UHELP
<u>LINGUISTICS</u>		
ALGOL Extended for Design	1100	AEDO
APL Processor	1100	APL
BEEF Data Processing Routines	1100	BEEFDP
Business and Engineering Enriched FORTRAN	418-II	BF418
Business and Engineering Enriched FORTRAN	494	BEEF49
Compiler of Ludicrous User-Defined General Expressions	1100	CLUDGE
Computer-Aided Management Educational Language	494	CML49
Coordinate Geometry Language	9400	UNICG
Dual Language Compiler	1100	RALPH
Enhanced Card Assembler	92/9300	A92
FORTRAN V Editing Program	1100	TIDYF5

APPLICATIONS SOFTWARE

<u>LINGUISTICS (Cont'd)</u>	<u>COMPUTER</u>	<u>INDEX NAME</u>
IITRAN Compiler	1100	IITRAN
Introductory Computer Language	92/9300	ICL
LISP 1.5 Programming Language	1100	LISP
Low-Level Linked List Language	1100	XL6
MiniCOBOL	92/9300	MNCB
MiniFORTRAN	92/9300	MNFT
Navy Electronics Lab. International Algorithmic Compiler	1100	NELIAC
Princeton Interactive FORTRAN	Series 70	PIFOR
Programming Language Preprocessor	1100	TAB17
Report Generator	92/9300	MARGO
RPG Processor	1100	RPG40
RPG Under EXEC 8	1100	CHIRP
String Manipulating Language	1100	SNOBOL
String Manipulating Language	1100	SNOB04
Syntax Checking Processor, Remote Source Language	1100	UBASIC
U. S. Navy COBOL Test Routines	1100	USNCT
User Language 1	Series 70	UL1
9200/9300/8411/8414 Disc FORTRAN System	92/9300	DSFOR
<u>MANAGEMENT</u>		
Analysis of Market Research	1100	AMAS
Capital Investment Analysis Program	1100	CIAP
Computer-Aided Management Educational Language	9200	CAMEL
Control of Work Activities by Individuals	1100	CNTROL
Conversational CAMEL	9200	CCAMEL
Corporate Planning Model	1100	PLNMD

DATE	3/74	APPLICATIONS INDEX
REVISION	7	

APPLICATIONS SOFTWARE

	<u>COMPUTER</u>	<u>INDEX NAME</u>
MANAGEMENT (Cont'd)		
CPM/PERT for Card System	92/9300	PERTCD
Critical Path and Man Scheduling	1100	MANPWR
Critical Path Method Scheduling	9200	CPM
Critical Path Method Scheduling	490	CPM49
Critical Path Method-I Scheduling	1100	CPM1
Critical Path Method-II Scheduling	1100	CPM2
Dynamic Models	1100	DYNAMO
Economic Planning Agency	9300	EPA93
Fixed Assets Accounting	9200	FASACC
Investment Profitability Analysis	1100	INPRAN
Key-Word Indexing System	1100	KWIC88
Management Control System	9400	MCS
Management Game, Business Environment Simulator	1100	BES
NASA PERT/TIME II	Series 70	PERTTO
Program Evaluation and Review Technique	1100	PERT11
Program Evaluation and Review Technique	418	PERT41
Planning and Control System	1100	OPTIMA
Resource Allocation and Network Scheduler	1100	RANSER
RPG Processor	1100	RPG40
RPG Under EXEC 8	1100	CHIRP
Sales Forecast and Control	Series 70	SFC
Sales Forecasting	9400	FRSA

APPLICATIONS SOFTWARE

<u>MANUFACTURING</u>	<u>COMPUTER</u>	<u>INDEX NAME</u>
(See also "Production Control")		
APT CALCOMP Postprocessor	1100	APTCAL
APTRAN System	1100	APTRAN
Automatically Programmed Tools	1100	APTIII
Automatically Programmed Tools	1100	APTIV
Automatically Programmed Tools	9300	MINAPT
Automatically Programmed Tools	9400	MAPT4
Bill of Materials Processor, Cards	9200	BOMC
Bill of Materials Processor, 8410 Disc	92/9300	BOMD10
Bill of Materials Processor, 8411 Disc	92/9300	BOMD11
Bill of Materials Processor, Tape	9300	BOMT
Call/APT System	1100	CALAPT
Control of Production Machine Tools	Series 70	AUT
Critical Path Method Scheduling	9200	CPM
Critical Path Method Scheduling	490	CPM49
EXAPT CALCOMP Postprocessor	1100	EXCAL
Instrument Calibration Control System	1100	CALCON
Integrated Planning and Scheduling	1100	IPS2
Manufacturing Data Base Management	Series 70	MDB70
Numerical Control Language	1100	EXAPT
PERT Programming via Teletype	1100	CGAPT
Program Evaluation and Review Technique	1100	PERT11
Program Evaluation and Review Technique	418	PERT41
Princeton Interactive Programmed Tools	Series 70	PIAPT
Purchased Material Receiving System	1100	INMAT

APPLICATIONS SOFTWARE

<u>MANUFACTURING (Cont'd)</u>	<u>COMPUTER</u>	<u>INDEX NAME</u>
Univac Industrial System	1100	UNIS11
Univac Industrial System	92/9300	UNIS93
Univac Industrial System	9400	UNIS94

MATHEMATICS

(See also "Graphics", "Linear Programming", and "Statistics")

Analysis of Market Research	1100	AMAS
Autoregressive Data Analysis	1100	AUTREG
Building Industry Program	9300	UNIBAU
Central Composite Designs	1100	CENCOM
Coordinate Geometry Language	9400	UNICG
Curve Plot Routine	1100	GRAPH
Double Precision Mathematical Subprograms	92/9300	WMATH
Dynamic Models	1100	DYNAMO
Exponential Smoothing Routines	1100	EXPONS
Factor Analysis	1100	FACTAN
Functional Mathematical Programming Technique	1100	FMPS
Hardy-Cross Method	1100	HCROSS
JOSS Adaptation	1100	MATH
Language for Solving Differential Equations	1100	MIMIC
Large Scale Matrices	1100	LSM
Linear Programming System	1100	ILONA
Linear Programming System	1100	LP1100
Linear Programming System	490	LP49X
Linear Programming System	92/9300	LP93
Linear Programming System	9400	LP9400

APPLICATIONS SOFTWARE

<u>MATHEMATICS (Cont'd)</u>	<u>COMPUTER</u>	<u>INDEX NAME</u>
Linear Programming System	92/9300	LP92
Linear Programming for Minimum System	92/9300	MINIIP
LISP 1.5 Programming Language	1100	LISP
Marie-Claire Linear Programming System	1100	MARCL
MATH-PACK Mathematical Subprograms	9400	MATH94
MATH-PACK Mathematical Subprograms	418-III	MP418
MATH-PACK Mathematical Subprograms	1100	MATHPA
MATH-PACK Mathematical Subprograms	418-II	MA418
MATH-STAT Mathematical/Statistical Subprograms	494	MASTAT
MATH-STAT Mathematical/Statistical Subprograms (Lockheed)	494	MSLCK
Mathematical Programming System	494	MPS49
Matrix Operating Routines	1100	BUMP2
Modified Integration Digital Analog Simulator	1100	MIDAS
Nonlinear Regression	1100	EXNLON
Numerical Integration Routines	1100	NIR
Quintuple Precision Arithmetic Subroutines	418-III	QUINT
Scientific Subroutine Series	Series 70	SSS70
Seal-Shell-2 Stress Analysis	1100	SHELL
STAT-PACK Statistical Subprograms	1100	STAT11
STAT-PACK Statistical Subprograms	9400	STATPA
Statistical Package	92/9300	STAT92
Stepwise Regression Program	1100	STEREG
Two-Level Factorial Design	1100	FACTOR

APPLICATIONS SOFTWARE

<u>MECHANICAL ENGINEERING</u>	<u>COMPUTER</u>	<u>INDEX NAME</u>
(See also "Construction and Civil Engineering" and "Mathematics")		
Civil Engineering Language	1100	COG090
General Thermal Pipe Stress and Deflection Program	1100	PIPEB
Hardy-Cross Method	1100	HCROSS
Language for Solving Differential Equations	1100	MIMIC
Piping Flexibility Analysis Program	1100	PIPEA
Structural Analysis System	1100	STRESS
X-RAY Crystallographic System	1100	XRAY
<u>MEDICAL AND HOSPITALS</u>		
(See also "Statistics")		
Biomedical System	1100	BMD
Biomedical System	418-III	BMD41
Computerized Hospital Administration Management Package	1100	CHAMP
Hospital Accounting	Series 70	HAP
Laboratory Information System	Series 70	LIS
Medical Accounts Payable	92/9300	MEDAP
Medical Accounts Receivable	92/9300	MEDAR
Medical Fixed Assets	92/9300	MEDFA
Medical General Ledger	92/9300	MEDGL
Medical Payroll	92/9300	MEDPR
Patient Accounting System	9400	UPACS
Seasonal Adjustment Program	1100	CENSUS

APPLICATIONS SOFTWARE

<u>MISCELLANEOUS PROGRAMS AND PROGRAMMING AIDS</u>	<u>COMPUTER</u>	<u>INDEX NAME</u>
(See also "Utility Programs", "Conversion Aids" and "Diagnostic Programs")		
BEEF Data Processing Routines	1100	BEEFDP
Braille Print Processor	1100	BPP
Braille Processor	1100	BRAILL
Branch Trace Accounting and Analyzer	9400	BTA94
Card Edit	9200	CRDEDI
Card Utility Program	9200	PTCUP
COBOL Cross-Reference	9200	CBCS
Compiler of Ludicrous User-Defined General Expressions	1100	CLUDGE
Control Card Sort	1100	CCSORT
Cross-Reference Dictionary	1100	CRDICT
Current Time-of-Day Routine	1100	MYTIME
Definition Analyzer	1100	ANLYZR
Demand Monitor	1100	DM
Dump/Load High-Speed Drum to/from Tape	1100	CHKDMP
EBCDIC to Fielddata Conversion	1100	CONVT
Enhanced Card Assembler	92/9300	A92
Enhancement to Standard UNIVAC 494 Sort Routine	490	NSORT
File Allocation and Layout Program	1100	FLAP
File Save/Restore Utility Program	1100	FILSAV
FORTRAN Editing Program	1100	TIDY
FORTRAN Sort	494	FORST
FORTRAN Sorting Programs	Series 70	FRTSRT
FORTRAN Sort Linkages	1100	FORLNK
General Purpose Listing Routine	1100	LISTER

APPLICATIONS SOFTWARE

<u>MISCELLANEOUS PROGRAMS AND PROGRAMMING AIDS (Cont'd)</u>	<u>COMPUTER</u>	<u>INDEX NAME</u>
Generalized Tape Dump	1100	RWDUMP
Interval Arithmetic Package	1100	INTARI
Job Control Extension	92/9300	JCLG
Key-Word-in-Context Indexing Program	9400	KWIC
Key-Word-in-Context Indexing Program	1100	KWIC11
Key-Word-out-of-Context Indexing Program	1100	KWOC11
Microfilm Conversion Program	1100	MCFROM
Multiutility Program System	9400	MUPS
Multiple Precision Arithmetic Package	1100	MULPRE
Navy Electronics Lab. International Algorithmic Compiler	1100	NELIAC
Parameter Card Subroutine	1100	PARCAR
Printing Routines	490	SPRINT
Program Module Testing Package	9400	UTST94
Programming Language Preprocessor	1100	TAB17
Reformatter	1100	REFORM
Report Generator	92/9300	MARGO
Report Program Generator, Disc Resident	9200	RPGRD
RPG Cross-Reference	9200	CRSRPG
Special Indexed-Sequential IOCS	92/9300	SISIO
System Availability Model	1100	SAM
System Exerciser	9400	USEX
UNISCOPE 100 Maintenance Routines	1100	OLCMR
U.S. Navy COBOL Test Routines	1100	USNCT
User Program Evaluation	1100	UPE
9200/9300/1001 Sort Routine	92/9300	S01001

APPLICATIONS SOFTWARE

<u>OIL INDUSTRY</u>	<u>COMPUTER</u>	<u>INDEX NAME</u>
(See also "Mathematics")		
Central Composite Designs	1100	CENCOM
Functional Mathematical Programming System	1100	FMPS
Linear Programming System	1100	ILONA
Linear Programming System	1100	LP1100
Linear Programming System	490	LP49X
Linear Programming System	9300	LP93
Linear Programming System	9400	LP9400
Linear Programming System	418	LP418
Linear Programming System	92/9300	LP92
Marie-Claire Linear Programming System	1100	MARCL
Mathematical Programming System	494	MPS
Seismic Processing System	1100	USPS
Univac Array Processor Software	1100	UAPS
<u>OPERATING SYSTEMS AND EXTENSIONS</u>		
Basic Remote Job Entry Operating System	9400	UNIROS
Conversational Time Sharing	1100	CTS
EBCDIC Card Input to Fieldata	1100	ESECI
EXEC II to EXEC 8 Processor	1100	EXEC28
EXEC II Report Generator	1100	RFG11
EXEC 3 FORTRAN Loader	418-III	LINKR
EXEC 8 Sort Time Estimating Routine	1100	ESTER
Extension to Supervisor	92/9300	CSEXT
Inverse Configuration Matrix	1100	IMATRX
Mini Message Control Program	9400	MMC94

DATE	APPLICATIONS INDEX
3/74	
REVISION	
7	

APPLICATIONS SOFTWARE

<u>OPERATING SYSTEMS AND EXTENSIONS (Cont'd)</u>	<u>COMPUTER</u>	<u>INDEX NAME</u>
Operating System, UNIVAC 9300/UNISCOPE 100	9300	OS600
Paper Tape Symbiont	9300	PTSYM
Print EXEC 8 Print Tapes Under EXEC II	1100	ESPRNT
Remote Transmission Symbiont	92/9300	CZREM
Skeleton Systems Generation	1100	SSG
Tape Boot Loader/Drum Library Write Program	418-III	GBOOT
Transaction Management System	9400	TMS94
Transaction-Oriented Program System	1100	TOPS
UNIHASP 9200 to 360 HASP Handler Using DCS-1C	92/9300	UHASP2
90-Column Control Stream	92/9300	CSRDR
<u>OPERATIONS RESEARCH</u>		
(See also "Information Management", and "Statistics")		
Communications Simulation Model	1100	COSMO
Corporate Planning Model	1100	PLNMD
Flow Simulator	Series 70	FLSIM
General Purpose Systems Simulator	494	49GPSS
Information Retrieval System	9300	GIR
Linear Programming System	1100	ILONA
Linear Programming System	1100	LP1100
Linear Programming System	490	LP49X
Linear Programming System	92/9300	LP93
Linear Programming System	418	LP418
Linear Programming System	9200	LP92
SIMULA Simulation Language	1100	SIMULA
STAT-PACK Statistical Subprograms	1100	STAT11

APPLICATIONS SOFTWARE

<u>OPERATIONS RESEARCH (Cont'd)</u>	<u>COMPUTER</u>	<u>INDEX NAME</u>
STAT-PACK Statistical Subprograms	9400	STATPA
System Availability Model	1100	SAM
Train Performance Calculator II	1100	TPC2
<u>PHYSICS</u>		
Transient and Steady State Temperature Distribution	1100	TRUMP
<u>PRODUCTION CONTROL</u>		
(See also "Manufacturing")		
Bill of Materials Processor	9400	ASSIES
Bill of Materials Processor, Cards	9200	BOMC
Bill of Materials Processor, 8410 Disc	92/9300	BOMD10
Bill of Materials Processor, 8411 Disc	92/9300	BOMD11
Bill of Materials Processor, Tape	9300	BOMT
Control Work Activities by Individuals	1100	CNTROL
CPM/PERT for Card System	92/9300	PERTCD
Critical Path Method and Man Scheduling	1100	MANPWR
Critical Path Method Scheduling	9200	CPM
Critical Path Method Scheduling	490	CPM49
Critical Path Method-I Scheduling	1100	CPM1
Critical Path Method-II Scheduling	1100	CPM2
Instrument Calibration Control System	1100	CALCON
Integrated Planning and Scheduling	1100	IPS2
Management Control System	9400	MCS
Program Evaluation and Review Technique	1100	PERT11
Purchased Material Receiving System	1100	INMAT
Time and Capacity-Dependent Planning in Manufacturing	1100	UNITEK

DATE	3/74	APPLICATIONS INDEX
REVISION	7	

APPLICATIONS SOFTWARE

<u>RETAIL AND WHOLESALE</u>	<u>COMPUTER</u>	<u>INDEX NAME</u>
Automatic Warehouse Dispositioning for Industry	9400	ALDIN4
Basic Inventory Control	9200	BIC
Dairy Route Accounting	9200	DAIRY
Scientific Inventory Management System	92/9300	SIMS
Seismic Processing System	1100	USPS
Warehouse Location Program	1100	MINWAR
Wholesale Ice Cream Accounting	9200	WICA
Wholesale Inventory Control System	9200	WICS
<u>SEISMOLOGY</u>		
Seismic Processing System	1100	USPS
Univac Array Processor Software	1100	UAPS
<u>SIMULATION AND MODELING</u>		
APL Processor	1100	APL
Central Site Queueing Model	1100	CSQ
Central Site Simulation Model	1100	CSSM
Communications Analysis Package	1100	CAP
Communications Simulation Model	1100	COSMO
Continuous Systems Simulation	Series 70	CSS
Dynamic Models	1100	DYNAMO
File Allocation and Layout Program	1100	FLAP
Flow Simulator	Series 70	FISIM
GASP II Simulation Language, FORTRAN	418	GASPII
GASP II Simulation Language, FORTRAN	1100	GASP2
General Purpose Systems Simulator	1100	GPSSX8
General Purpose Systems Simulator	494	49GPSS

DATE 3/74	<u>APPLICATIONS INDEX</u>
REVISION 7	

APPLICATIONS SOFTWARE

<u>SIMULATION AND MODELING (Cont'd)</u>	<u>COMPUTER</u>	<u>INDEX NAME</u>
General Purpose Systems Simulator	1100	GPSSII
IBM 1401 Simulator	1100	S1401
IBM 1410 Simulator	1100	S1410
IBM 360 to UNIVAC 9400 Translator/Simulator	9400	ACTS3
Management Game, Business Environment Simulator	1100	BES
Modified Integration Digital Analog Simulator	1100	MIDAS
Network Simulator	490	UNS494
Process Simulator of Steady State System	1100	PROSM
Real-Time Central Site Model	9400	RTCSM
Real-Time Communications Network Model	9400	RTCNM
SIMSCRIPT 1.5 Simulation Language	1100	SIMSCR
Simulator for UNIVAC 1004/PUC Programs	92/9300	SPUC
System Availability Model	1100	SAM
UNIVAC I/II Simulator	1100	U1U2U8
UNIVAC 418 Simulator	1100	SIM418
UNIVAC 1005 Simulator	92/9300	SIM05
UNIVAC 9400/1050 Simulator	9400	SI1050
<u>STATISTICS</u>		
(See also "Mathematics" and "Graphics")		
Autoregressive Data Analysis	1100	AUTOREG
Biomedical System	1100	BMD
Biomedical System	418-III	BMD41
Biomedical System	Series 70	BMD
Central Composite Designs	1100	CENCOM
Curve Plot Routine	1100	GRAPH

APPLICATIONS SOFTWARE

<u>STATISTICS (Cont'd)</u>	<u>COMPUTER</u>	<u>INDEX NAME</u>
Exponential Smoothing Technique	1100	EXPONS
Factor Analysis	1100	FACTAN
Mathematical Subprograms	92/9300	WMATH
MATH-PACK Mathematical Subprograms	1100	MATHPA
MATH-PACK Mathematical Subprograms	418	MP418
MATH-PACK Mathematical Subprograms	9400	MATH94
MATH-STAT Mathematical/Statistical Subprograms	494	MASTAT
MATH-STAT Mathematical/Statistical Subprograms (Lockheed)	1100	MSLCK
Multiple Regression Analysis	418	MRA418
Nonlinear Regression	1100	EXNLON
Seasonal Adjustment Program	1100	CENSUS
Seasonal Adjustment Program, Method II	1100	CENS2
Statistical Interpretive Language	1100	STIL
Statistical Package	92/9300	STAT92
Statistical Programs	1100	STJOB
Statistical Series	Series 70	STARCA
Statistical Series	Series 70	VSTAT
STAT-PACK Statistical Subprograms	418-III	STA41
STAT-PACK Statistical Subprograms	9400	STATPA
STAT-PACK Statistical Subprograms	1100	STAT11
Stepwise Regression Program	1100	STEREG
Test of Hypothesis	Series 70	TOH
Variance Analysis	418	VARAN
<u>STEEL INDUSTRY</u>		
Structural Analysis System	1100	STRESS

DATE	3/74	APPLICATIONS INDEX
REVISION	7	

APPLICATIONS SOFTWARE

<u>TEXTILE INDUSTRY</u>	<u>COMPUTER</u>	<u>INDEX NAME</u>
Garment Cutting Optimization	9300	GARCUT
<u>TRANSLATORS</u>		
(See also "Conversion Aids")		
BAL to COBOL Translator	1100	BALCO
Basic Assembly Language Converter, 9200/9300 to 9400	9400	BALCON
B5500 to UNIVAC 1108 COBOL	1100	SIEVE
COBOL/360 to 1108 COBOL	1100	COB360
COBOL Conversion System	9400	COCON
Customer-Oriented Assembly Translator	1100	COAT11
FORTRAN Data Tape Conversion, 9300 to 9400	9400	TP3TO4
GAMMA 10 to 9300 Translator	9300	GAMA10
IBM FAP to Univac EXEC II Assembly Language	1100	FAPTRA
IBM 1400 to UNIVAC 9200/9300 Translator	9300	ACTS1
IBM 1400 to UNIVAC 9400 Translator	9400	ACTS2
IBM 1401 to UNIVAC 9300 Translator	9300	UNITRN
IBM 360 to UNIVAC 9400 Translator/Simulator	9400	ACTS3
IBM 360/20 to UNIVAC 9200/9300 Translator	92/9300	PUR
Spectra 70/45 to UNIVAC 1108 COBOL	1100	COB70
TAPETRAN Processor	1100	TPTRN
Utility Program, IBM 360/20 to UNIVAC 9200/9300	92/9300	SWITCH
VERTRAN DOD to USASI COBOL Translator	1100	VERTRN
UNIVAC 1005 to UNIVAC 9200/9300 Translator	92/9300	TALC
UNIVAC 9300 to UNIVAC 9400 Translator	9400	TRAN93

DATE	3/74	APPLICATIONS INDEX
REVISION	7	

APPLICATIONS SOFTWARE

<u>TRANSPORTATION/RESERVATIONS</u>	<u>COMPUTER</u>	<u>INDEX NAME</u>
(See also "Accounting" and "Information Management")		
Information Retrieval System	9300	GIR
Primal Flow Transportation Code	1100	PFTC
Traffic Progression Analysis	Series 70	TRAFIC
Train Performance Calculator II	1100	TPC2
Transportation Linear Programming	Series 70	TRANSP
<u>UTILITY PROGRAMS</u>		
BELLCOMM EXEC 8 FORTRAN I/O Library	1100	BCMIO
BRKDN Processor	1100	BRKDN
Card Reproducing Program	92/9300	ALT
Card Utility Program	9200	PTCUP
COBOL File Handler Format Data File Handler	1100	CFHHAN
CPU Utilization	418-III	GREEN
Disc-to-Disc Copy	9400	DCCPY
Drum Array	494	DRARR
FASTRAND Alphanumeric File Dump	1100	FDUMP
FASTRAND Sort	418-III	FSORT
File Analysis	1100	FIAN
File Listing Aid	1100	PROFI
File Save/Restore Utility Program	1100	FILSAV
FORTTRAN Sort	494	FOSRT
FORTTRAN Source Code Tidy UP	1100	FRTDY
General Drum Maintenance	418-III	GDM41
General-Purpose Alpha Print Routine	1100	TPALPH
Generalized Sort Routine	9400	GNSRT

APPLICATIONS SOFTWARE

<u>UTILITY PROGRAMS (Cont'd)</u>	<u>COMPUTER</u>	<u>INDEX NAME</u>
Generative Sort Routine	92/9300	SORT2
Generator Merge	418-III	GMERG
IBM EBCDIC to Fieldata Tape Dump	1100	TDUMP
Job Step Accounting Routine	9400	JSAR
Job Step Accounting Routine	9400	JSARN
List Processor	1100	SLIP
Listing Program	9200	92LIST
Load Module Output Program	9400	UTOBJ
Mapper	1100	MAPER
Multiutility Program System	9400	MUPS
Paper Tape Reader	9400	PTRG
Print File Control	418-III	PFC41
Print File Dump	418-III	PF41
Program Cross-Reference	418-III	CULL
Special Print Forms	1100	SPF
Special Tape Sort Package	92/9300	STSP
Supersort	1100	SRSORT
Table of Contents Processor	1100	TOC
Tape I/O Routine	92/9300	TAPE
Tape to/from Drum Copy Routine	1100	CFHCO
Tape Utility Program	1100	TUTIL
Test File Generator for COBOL	1100	TFG11
Utility Package for UNIVAC 9400	9400	UTI94
Utility Sort for UNIVAC 9400	9400	UTSRT
1100 Card File Maintenance Routines	1100	CFMR

DATE 3/74	APPLICATIONS INDEX
REVISION 7	

APPLICATIONS SOFTWARE

<u>UTILITY PROGRAMS (Cont'd)</u>	<u>COMPUTER</u>	<u>INDEX NAME</u>
90-Column Control Stream Reader	92/9300	CSRDR
9300 Network Emulator	9300	NET93
9300 Sort for the 9400	9400	93SORT
9300 to 9400 Translator for 9400	9400	93TRAN



STRENGTH UNIVAC

COMPUTER SYSTEMS

UNIVAC 90000 SERIES
Applications Software Directory