

# Tekniques

# SOLUTIONS



# Tekniques

## In This Issue

Architectural Firm Expands Without Adding Staff	2
Solution Vendor Program	4
Product Design, Engineering and Manufacturing	4
Data Representation	4
Architecture/Facilities	5
Bringing Computers into the Chemistry Lab at SUNY at Cobleskill Inspires Students and Faculty	6
4110 Local Programmability Brings Distributed Processing to Graphics Applications	10
4052 Helps Reveal Secrets of Antarctica Data	12
PLOT 50 2-D Drafting New Release Offers Increased Performance for Automated Drafting	14
PLOT 50 Software Supports 4909 Hard Disk	14
New 4907 ROM Pack Enhances and Adds Commands	15
Input/Output	15
Crisp Images, Vibrant Colors Distinguish New Color Copier	16
Tektronix GPIB Extender Stretches the Data Link	18
Editor's Note	19
4050 Series Graphic Systems Workshops Scheduled	19
Programming Tips	20
Basic Bits	24
New Abstracts	25
Program Updates	29
IDD Graphic Displays and Computing System Publications	30
Library Addresses	32

*TEKniques*, the IDD Applications Newsletter, is published in the Information Display Division of Tektronix, Inc., Group 451, P.O. Box 500, Beaverton, Oregon 97077. It is distributed to TEKTRONIX computer and terminal users.

Publishing Manager	Ken Cramer
Managing Editor	Patricia Kelley
Technical Editor	Dan Taylor
Graphic Design	John Ellis
Circulation	Rory Gugliotta
Typesetting	Jean Bunker

Copyright © 1982, Tektronix, Inc.  
All rights reserved.

To submit articles to *TEKniques* or for information on reprinting articles, write to the above address. Changes of address should be sent to the IDD Library serving your area (see Library addresses).

## Architectural Firm Expands Without Adding Staff

Familiar, friendly, powerful, a natural fit ... Rollin Gardner expressed his pleasure for his recently acquired computer aided design and drafting system.

A commercial architectural firm, Gardner Associates-Architects, Inc. works with a range of projects from small office buildings of 3000 to 4000 square feet up to six story medical buildings. Shopping centers and banks also form a large part of their portfolio.

As with many firms in the greater Houston area, work for Gardner Associates is growing. But it's tough for a four-member firm to compete against larger firms for big projects. With the volatility of construction as it is, adding more people for a project could mean laying them off at its completion. "I knew an increased workload was coming up, so I chose to automate rather than expand my personnel," explained Rollin.

"Last December (1981) we researched several CADD systems. We were looking for a system within a certain price range, and one on which we could be productive very quickly. We found it in the Arrigoni Computer Graphics TOUCH 'N DRAW™ system."

Rollin reflected that the system was easy to use, the most friendly, and one of the most powerful of those analyzed. He cited the Touch Control Station™ as an example of the Arrigoni attention to detail. "The system is very graphic and utilizes language common to my profession. The Touch Control Station eliminates the need for menus or prompts on the screen. This saves valuable screen space for drawing. The prompts given on the Touch Control Station are so complete that knowledge of computer language is not necessary."

Arrigoni's TOUCH 'N DRAW is designed specifically for the architectural market. Rollin feels this was a critical factor influencing his

decision to buy. "The people at Arrigoni are architects. The package is primarily architecture — terms, symbols, language and that sort of thing. Other systems that we looked at aimed at several disciplines; they addressed too wide of a field."

Other desirable features specified by Rollin include the large screen of the Tektronix 4054 Graphic System. "It allows plenty of space for designing at a scale large enough to be easily seen. The resolution is superb, and the thumb wheels are an efficient way for controlling the cursor."

The installation went smoothly with a couple of minor problems being handled promptly by the local Tektronix office. The Arrigoni package included one week of training in Gardner Associates' office by an Arrigoni field specialist. (He is also an Architect.)

Usable output, on a limited scale, came within a short time and has increased steadily. "The limitations of the system are found primarily in the user, not the hardware or software," commented Rollin.

"TOUCH 'N DRAW has met all of my expectations." Although he has no exact figures, eliminating the repetitive drafting work and the ability to make changes easily has saved Rollin and his staff many hours in just the short time they've had the system. "Every project has some of the same details and once these are drawn with the Arrigoni system, they will never have to be drawn again. As time goes on, I expect to pick up large amounts of time by carrying these repetitive details from project to project."

Right now Rollin and his staff are remodeling and adding to a bank. Any time additions are made as well as remodeling done, the job quickly becomes messy with lots of erasures. With TOUCH 'N DRAW, they were able to

put the existing bank drawings into the data base and proceed from there. The changes have been easily made.

As they have become more familiar with the system, the Gardner Associates staff feel that a hard disk instead of floppies would be profitable for speed and increased storage. They are anxious to acquire a Tektronix 4909 hard disk.

Wrapping up the conversation, Rollin wanted to stress another point he considered very important for someone considering a CADD system: attitude and responsiveness — both of which have been excellent from both Arrigoni and Tektronix. “When we have encountered problems, the solution has nearly always been just a phone call away.”

Questioned about his plans, Rollin responded, “While I don’t believe that you can eliminate manual drafting entirely, I intend to replace 90% of it by expanding our utilization of the TOUCH ’N DRAW system and acquiring a hard disk. I feel that computers will be playing an important role in the future of commercial architecture. The Arrigoni/Tektronix CADD system has allowed me to get a head start on that future — at a price I can live with.” 

Editor’s Note: *TEKniques* thanks Gardner Associates of Webster, TX, for taking time to share their reasons for purchasing the Arrigoni CADD system.

# Solution Vendor Program Includes Design-Manufacturing, Data Representation and Architectural Applications

By making users of Tektronix equipment aware of compatible software available from third party vendors, Tektronix is helping customers find timely solutions to their application problems.

The products of three firms which have recently been included in the program are profiled. For more information, contact your local Tektronix Sales Engineer.

---

## Product Design, Engineering and Manufacturing

**Manufacturing and Consulting Services, Inc.**  
17942 Cowan  
Irvine, CA 92714  
(714) 540-3921

Stimulating innovation by allowing designers to explore more alternatives, to perform a more thorough analysis of the result, and to produce a better product is the reason for the ANVIL™ series of CAD/CAM software. Manufacturing and Consulting Services, Inc. (MCS) has recently introduced its new ANVIL-4000L® as a significantly enhanced replacement for its AD-2000®, the most widely accepted, computer-independent CAD/CAM software ever developed.

ANVIL-4000L provides the capabilities for engineers to fully automate the design and manufacturing of a product. Some of its components are geometry generation, geometry manipulation and grouping, families of parts, file management, management of information, view and scale manipulation, mechanical drafting, geometric analysis, numerical control and user applications.

Its flexibility allows each user to customize his own environment. Examples are electronic design/drafting, finite element modeling, 2-D nesting, 3-D packaging, sheet metal bending, piping design/drafting or utility management.

The modular styling of ANVIL-4000L allows the user to choose only the configuration that suits his application, then add on as needed.

ANVIL-4000L can run on most of the world's wide-word (24-bit to 64-bit) computers.

ANVIL-4000L is designed so that information generated on one computer architecture with ANVIL-4000L can be retrieved and transmitted to any other computer running ANVIL-4000L.

An interactive graphics CAD/CAM system, ANVIL-4000L supports all the Tektronix 4010 and 4100 Series of graphics terminals, including storage tubes, and color or monochrome raster scan. All input configurations and various types of output configuration, such as plot files and numerical control output files can be run simultaneously on one computer.

MCS is committed to supplying the needs of their users by continually increasing the productivity of ANVIL-4000L as a design, management information, drafting and manufacturing system. And MCS guarantees that upward compatibility will be available as long as ANVIL-4000L is being produced by MCS. Thus, a drawing created in 1982 on ANVIL-4000L can be retrieved in 1986 on ANVIL-4000L.

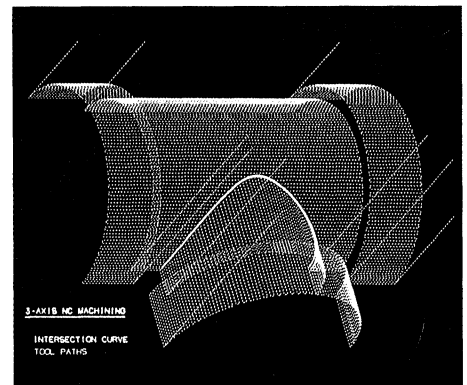

---

## Data Representation

**ISSCO**  
10505 Sorrento Valley Road  
San Diego, CA 92121  
(714) 452-0170

Regardless of the company's size or type of activity, ISSCO® offers decision makers of all kinds the software tools they need to make information immediately understandable and enlightening. TELL-A-GRAF® and DISSPLA® data representation graphics can reveal in a single chart or graph what is buried in pages of computer printouts. And,

whether on paper, 35 mm slides or transparencies, the graphics are professional.

By adding graphics to systems that monitor and analyze marketing, financial, scientific and engineering data, TELL-A-GRAF and DISSPLA can help communicate the message to any level of management or staff. Performance, productivity, and key trends can be quickly spotted; information buried in complex mathematical models becomes immediately clear; geophysical data and contours on maps are rapidly comprehended.

And the care that goes into acquiring and processing the data is reflected in its presentation. DISSPLA and TELL-A-GRAF are the only software systems that meet the presentation quality standards set by graphic artists. A page layout option even enables software typesetting for internal reports and publications. Superior features provide professional graphics.

### TELL-A-GRAF

The simple everyday English commands of TELL-A-GRAF put graphics in the hands of

non-programmers. Artists, managers, secretaries, and even programmers use TELL-A-GRAF daily to translate raw data into useful information.

Line, pie, horizontal and vertical bar charts, as well as text pages, are all generated by TELL-A-GRAF. A library of 68 standard plots may be invoked by simple sentences. Flexibility is not sacrificed to ease of use, however. A system of overrides and options can transform the standard graphics into intricately tailored plots. Full control over layout and embellishments is still possible, putting truly professional graphics within reach, without compromising the immediate availability of simple graphs.

## DISSPLA

Where TELL-A-GRAF's pre-programmed plots and conversational language give control to the user without programming skills, DISSPLA provides a library of over 400 sub-

outines for both business and scientific programmers.

Virtually any data can be turned into presentation-quality charts, graphs, 3-D diagrams, maps and contour plots. DISSPLA has equally broad applications in business, science and engineering.

Without being a graphics expert, the DISSPLA programmer can produce graphics of highest quality, quickly, accurately and easily.

TELL-A-GRAF and DISSPLA are the most widely used data representation software systems in the industry. Computer independent, the packages run on a variety of host computers, and both support the 4010 and 4100 Series of Tektronix Graphics Terminals.

ISSCO backs its software systems by comprehensive support. On-site installation and education, software enhancement releases, and technical information and programming

solutions all keep the user up to date. An independently run ISSCO Users' Group shares experiences and inputs to ISSCO's product planning. A phone-in consulting service provides prompt answers to questions concerning ISSCO graphics software.

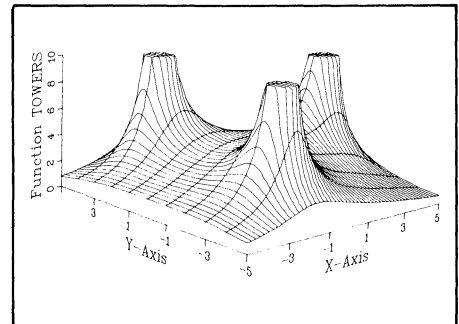

## Architecture/Facilities

**Arrigoni Computer Graphics**  
170 Knowles Avenue  
Los Gatos, CA 95030  
(408) 370-1400

Created by design professionals, TOUCH 'N DRAW™, a CADD system, is specifically tailored for architectural, interior design and facilities planning applications. The system opens up the opportunity for small to medium sized firms to implement computer aided design and drafting; however, TOUCH 'N DRAW is also being used by large architectural firms and in facilities planning departments for Fortune 1000 companies.

By using TOUCH 'N DRAW, complete, precise architectural floor plans may be produced, edited, and stored. Existing floor plans are easily modified allowing plans to keep pace with architectural changes. Single line work as well as very sophisticated work may be accomplished.

Symbol placement and texturing programs quickly and accurately enhance drawings. Stylized architectural lettering fonts are included for annotation. As the plan is created, areas or perimeters of selected rooms, boundaries, shapes, etc., may be automatically calculated. Accumulating material and labor for an entire project and figuring cost is accurate and rapid.

By performing the details of drafting, TOUCH 'N DRAW leaves the architect or

engineer free to create. Automatic scaling, snap-to alignment, global editing, multiple component (door/window/outlet, etc.) insertion, noodling, curve fitting, dimensioning, are just a few of the special functions and features found in TOUCH 'N DRAW.

Final drawings may be previewed on the screen and drawing output produced on accurate plotters at any scale, to produce complete working drawings for reproduction on a blueprint machine. Original quality drawings are readily available and recreated.

Utility programs take the drudgery out of using computer equipment by copying drawings from disk to disk, transferring data bases, and so on.

The Tektronix 4054 Desktop Computer forms the core of the hardware. Coupled to the 4054 is the unique Arrigoni Touch Control Station™, the Tektronix 4907 File Manager and 4663 Plotter, and a digitizing tablet with a Menu Board™. Combined with the hardware, the TOUCH 'N DRAW software and the complete architectural/interiors symbol library create a complete design and drawing production system.

A unique feature of the Arrigoni Computer Graphics TOUCH 'N DRAW system is the excellent user interface. The designer auto-loads a tape and the program prompts for input. Drawing command selection is done through the Touch Control Station or Menu Board in familiar architects' terms and sym-

bols using pre-prepared graphic menus. Drawing input mode is flexible — either graphically or numerically or both.

All prompts and questions are in language familiar to designers and draftsmen and 90% of the questions require "yes-no" responses. Visual feedback through messages and lights on the Touch Control Station keep the user informed of where he is. No computer programming knowledge is required to operate TOUCH 'N DRAW.

The total system (including the hardware, software and training) may be purchased; or it may be leased at a monthly cost approximating that of a typical draftsman/designer. Productivity improvements of 3-5 times are typical. More information on the system is available from your local Tektronix Sales Engineer. 



# Bringing Computers into the Chemistry Lab at SUNY at Cobleskill Inspires Students and Faculty

by Joe Nunes

Chemistry Laboratory Program  
Agricultural and Technical College  
Cobleskill, NY

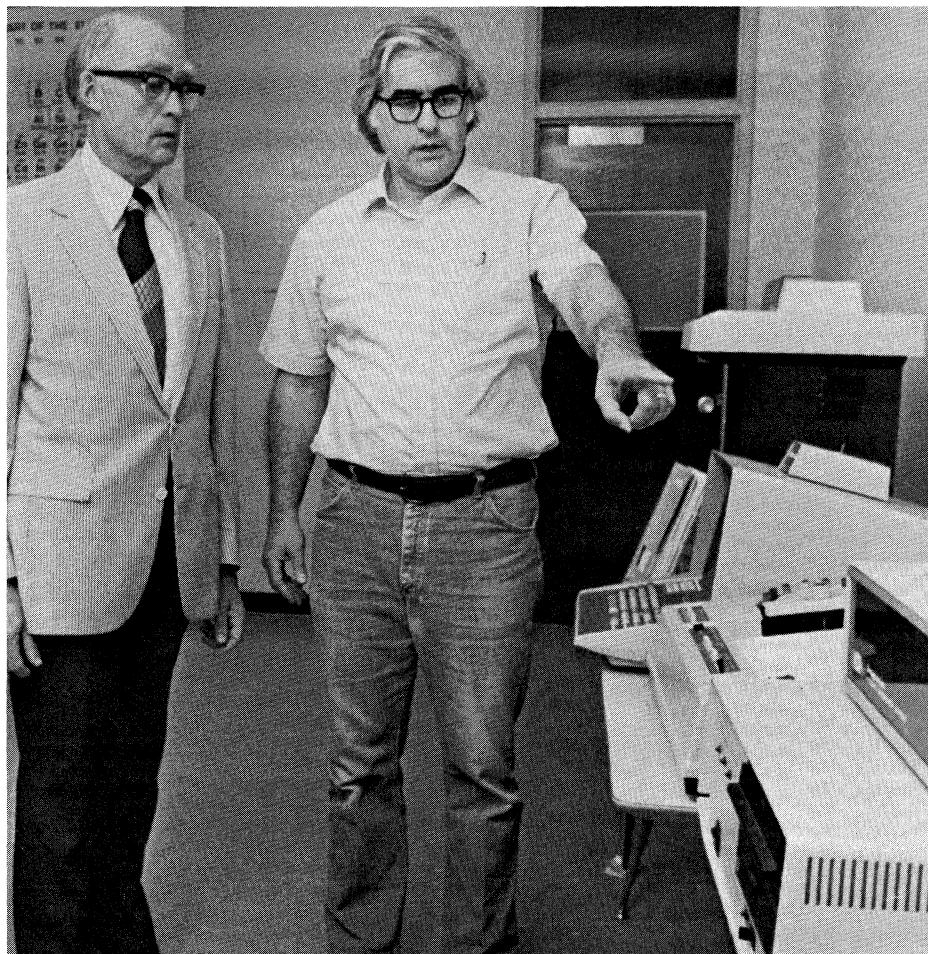

Professor Joe Nunes, right, points out one of the equipment configurations for the Laboratory-Computer Training Program in Chemistry to Walton A. Brown, president of Cobleskill College.

The chemistry program needed improvement. Pre-lab assignments to familiarize students with upcoming experiments were occupying valuable instructor time. Motivating students to accurately collect data, analyze it and graph it was wearying. Who wants to fit experimental points to theoretical equations which consistently require multiple tedious calculations? And, the graduates were expected to have some computer skills for data acquisition and analysis.

Computers, of course, were the solution. But which system and how? In a small college which has a very limited budget, the money

has hardly been adequate to purchase traditional equipment and supplies let alone expensive new equipment. An informal study begun in 1977 resolved these questions with the first delivery of Tektronix 4050 Graphics Systems in 1980.

At the Agricultural and Technical College at Cobleskill, the Chemistry Laboratory program equips future science technicians for the working world, or prepares them for further degree work. The students come from a variety of technical curriculums available at this accredited two-year college of the State University of New York. Training stu-

*Walton A. Brown, President  
SUNY at Cobleskill —*

*“The social impact of the computer became increasingly apparent during the decade of the seventies. To respond constructively to the resultant changes in our society, colleges are improving quality and efficiency by adopting computer resources and techniques to instruction.*

*“One such application is that of adopting the Tektronix graphics computing systems to instruction in chemistry. Specific techniques and software were developed at this college over the past five years. Students now experience computerized instrumentation as a complete data acquisition and processing system. The application of what they learn to “real life laboratories” is readily apparent to them and to their employers.*

*“The program of instruction developed by Professor Nunes has resulted in:*

- *More efficient use of faculty time,*
- *Improved student motivation,*
- *Establishment of more meaningful relationships between “background courses” such as Calculus and Statistics, and laboratory applications in chemistry,*
- *The ability in every student to program laboratory work in BASIC.*

*“This article describes a significant development in science education, and particularly in the preparation of industrial and research laboratory technicians.”*



dents in relevant occupational skills for job placement, competitive salaries, job advancement, or for advanced studies is critical, and the current Laboratory-Computer Training Program in Chemistry is doing the job.

Twelve 4051 systems and a variety of peripherals give students "hands-on" computer experience in a laboratory setting. Computerized pre-lab assignments have freed the instructors for more individual student assistance, and, surprisingly, have effected more actual lab time for students who desire it. A significant reaction has been the number of students who indicated that they now understand how "pure" math learned in other courses applied to their science courses. Wet-bench work for computer-related experiments is done more carefully and the students strive for precision and accuracy in their data. From written and computerized evaluations, it is evident that students have a better understanding of the laboratory activities which are computer related.

#### Equipment Acquisition

But to get to this point from 1977 took some groundwork. After extended research including contact with former Cobleskill graduates, employers of our graduates, and Science Advisory Board members, we found the most beneficial use of computers by the students in the chemistry laboratory program would be direct input of laboratory data into a computer located in the same lab or at least very close. From a functional, practical and cost (immediate as well as continuing) point of view, microcomputers appeared to be the best choice.

Three popular personal microcomputers were closely examined but these systems didn't provide the graphics capabilities which were important to the improvement of the chemistry program. Also, these systems were not being used by employers of our graduates. In fact, the computer systems most commonly encountered in the work places investigated were Tektronix graphics terminals or Tektronix 4050 Series stand-alone graphics computing systems.

The grant proposals submitted under the Vocational Educational Act (VEA) administered by the New York State Department of Education funded seven 32K 4051 Graphics Systems, four with the data communications interface, two 4631 hard copy units, two 4662 digital plotters, a 4956 graphics tablet, two 4641 line printers, two ROM expanders with a variety of ROM packs, the complete Tektronix PLOT 50 software library, a TransEra A/D Converter with a real time clock, and some startup supplies, all delivered in late 1980.

It readily became apparent that the training conditions needed improvement. The general chemistry laboratory sections had enrollments of 20-24 students and only seven 4051 systems were available. Thus, an average of three students worked with one system during the formally scheduled lab session. Observation clearly demonstrated that three students per 4051 system was not desirable, which was borne out in a subsequent written survey of the students. Students who worked alone or part of the time in pairs on a graphics system showed the highest degree of enthusiasm, interest and success.

To improve and update the training conditions, a second grant proposal was submitted to the same granting agency. This second grant (1981-82) funded five 32K 4051s, four with data communications interfaces, a 4611 hard copy unit, seven 4952 joysticks, two 4662 eight-pen plotters, two 4907 File Managers, and a Datagram Concentrator for interfacing with the host computer, a Burroughs 6810, in the college computer center.

The increased number of 4051 systems greatly improved the training conditions in the program for the 1982 Spring semester. This was clearly evident from observation, from informal student comments, and from a second student survey.

#### Equipment Configuration

Equipment is stationed in three rooms with different configurations; however, this arrangement is flexible since all equipment items are portable. Two configurations provide for the highest volume usage by students while the third configuration is used for direct interfacing with instruments in the analytical laboratories.

Eight 4051 graphics systems and two hard copy units are in a room adjoining the general chemistry laboratory. This configuration accommodates up to 16 students working in pairs. The immediate proximity to the lab makes it highly favored by the students throughout the formally scheduled lab session. At peak times, the overflow is handled by the systems located close by.

A second configuration of three 4051 systems, line printers, hard copy unit, file managers, and the tablet accommodates student use when peripheral equipment other than hard copy units are required for completing the laboratory activities. This area is also used by the faculty for software design and development. Located in this area is the Datagram Concentrator which allows up to 16 systems to be interfaced into one port of the college computer center's Burroughs 6810. Cable connections are available from the first configuration enabling those systems to be interfaced with the Datagram Concentrator.

The instrumentation configuration located in either of the two analytical laboratories includes a 4051 system, a plotter, and a TransEra A/D converter with a real time clock. This configuration can be interfaced with a variety of instruments used by students in the analytical courses.

#### Hardware and Software Applications

The Tektronix PLOT 50 System Software Tutorial has proven to be an excellent hands-on learning experience for students. No prior computer experience is required. With good training conditions, students become quite adept in working with the 4051 and in learning fundamental BASIC statements and graphics commands unique to the system. As the semester progresses, students are gradual-

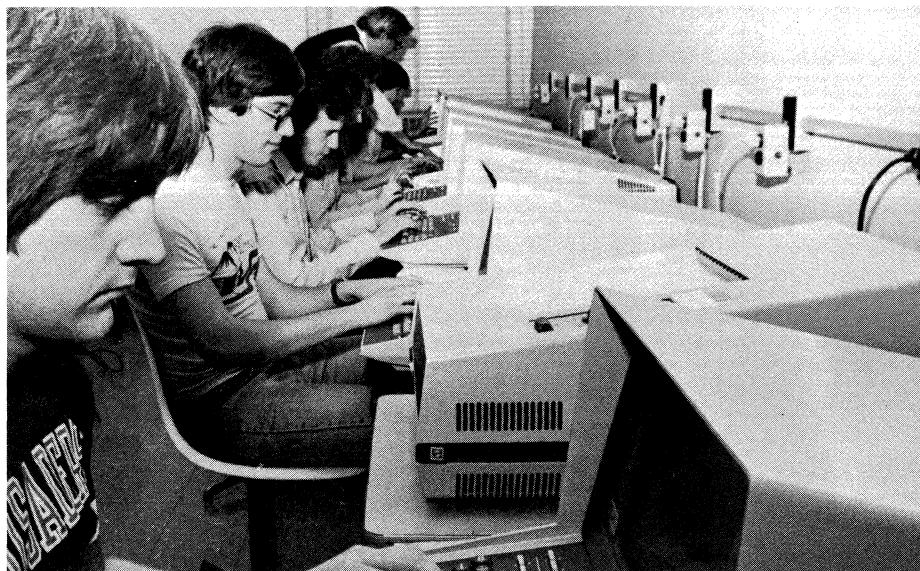

*Eight 4051 Graphics Systems in close proximity to the general chemistry laboratory provide science technician students with relevant training.*

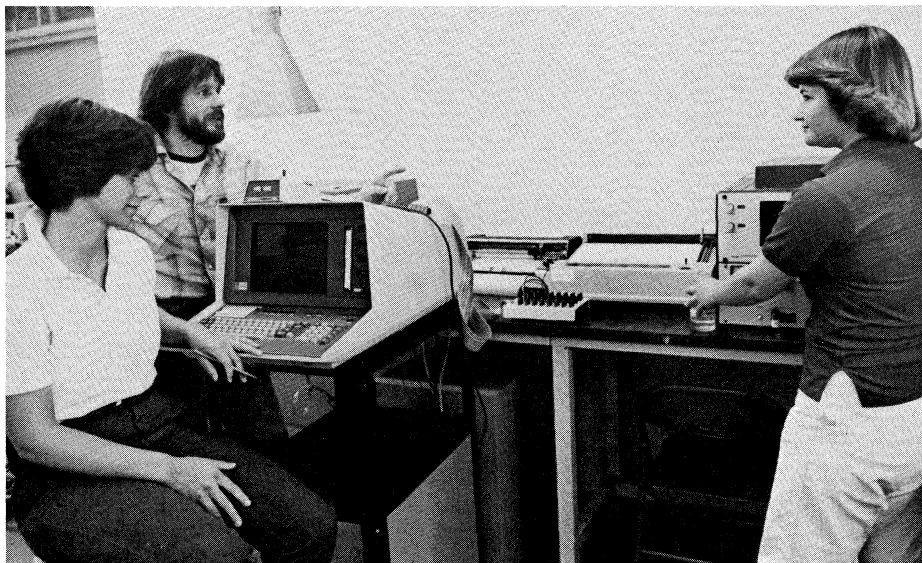

*In the analytical laboratory, the 4051 system can be interfaced with a variety of instruments using the TransEra A/D converter.*

ly introduced into the use of the peripheral devices.

Software has been developed by the faculty for some of the laboratory experiments used in the general chemistry courses. A typical program will verify the pre-lab assignment, request student input of experimental data, and require student experimental data analyses. A package of modules for a semester in a course can usually be contained on one or two tapes.

Because the students may use the tapes other than at scheduled lab sessions, often they will verify their pre-lab assignment prior to their scheduled lab, thus, providing themselves with more time for wet-bench work, for data analysis, for repeating part or all of the experiment, and for lab report completion.

All of the laboratory software modules have been student-tested and work well. Programs developed for the experiments include the atomic spectrum of hydrogen, geometrical structure of molecules, vapor pressure and heat of vaporization of liquids, determination of the equilibrium constant for a chemical reaction, and many others. The Simple Regressions program from the Tektronix Statistics Library is accessed by several of the programs for analyzing data. The program will fit eight functions to data of the form  $(X, Y)$ .

Tektronix equipment in the analytical laboratories is used exclusively by students in Instrumental Analysis, a second year course for science majors. The Tektronix 4051 is interfaced with an analytical instrument in two phases to provide students with a better understanding of how the final results are obtained.

As the first phase the students perform the experiment, manually measuring and recording all the data and then write their own program in BASIC to perform the analysis. This, we find, requires a more thorough understanding of the algorithm for the results than does a hand calculation. It also establishes the role of the 4051 in an integrated computerized system.

In the second phase the 4051 is interfaced directly with the instrument. A program running on the 4051 enables students to collect and manipulate data. This procedure provides the students with valuable experience for future jobs; they now recognize the computerized instrumentation as a complete data acquisition and processing system while using equipment representative of what they will encounter in future laboratory work.

#### Results

While still too early to determine the long range benefits, discussion with recent graduates who are now employed indicate they are often expected to write their own programs for data analysis. These visiting alumni also frequently encounter Tektronix equipment whenever graphics is essential in the work. In a recent survey by the College Placement Office, two 1982 science technician graduates reported starting salaries of approximately \$18,000.

The Tektronix equipment has met all expectations. Despite the relatively high volume use by inexperienced students as well as experienced ones, the equipment has proven to be reliable and durable. For the few occasions needed, Tektronix service has been prompt and efficient. The manuals are clear, concise and easy to follow. Using the two manuals, "Introduction to Programming in BASIC"

and "Introduction to Graphic Programming in BASIC," students with no computer experience learned to write programs on their own with little difficulty. The high resolution graphics of the systems are consistent with the intent of the training program, and similar to the kind of data analysis which is expected of our science technician graduates by prospective employers.

#### Future

Construction of new science facilities includes a scientific graphics computing laboratory. The graphics lab will contain the equipment described in the second configuration and some future acquisitions. Centrally located to all science labs, this lab will serve as a distribution center for a localized network of computing systems for scientific applications, and will serve as the intermediate link to the college mainframe computer. Interest and support indicate expanded use of computerized systems for other science labs.

The enthusiastic student response to the Chemistry Laboratory Computer Training Program coupled with the very positive results has provided the initiative for a separate course on computer programming emphasizing graphics in science applications.

We anticipate an increase in student enrollment as curriculums become more visible to prospective students. This, of course, would have an overall effect on the enrollment trends in the Chemistry Laboratory Training program.

The bottom line at Cobleskill has always been on how well the college has prepared its students for their future life goals after graduation. Without question, bringing Tektronix equipment into the Chemistry Laboratory Computer Training program has definitely stimulated the entire chemistry instructional program and is making a valuable contribution to the attainment of that college goal. 🖨️

*Editor's Note: Joe Nunes' original manuscript fully documents his grant procurements, and describes all aspects of the equipment's use. Unfortunately, space restrictions prevented TEKniques from printing the entire report including details which would be helpful to others interested in updating their educational program. Joe would be happy to send a copy of his complete documentation to those interested. He may be contacted by writing or calling:*

*Joe Nunes  
Suny Cobleskill Agricultural and Technical College  
Cobleskill, NY 12043*

*TEKniques is grateful to Professor Nunes for taking the time to describe his program and to Bill Longobardi, Tektronix Sales Engineer at Albany, NY, for bringing Joe and his work to our attention.*



## Excerpts from a pre-lab assignment

A laboratory simulation program used during acid-base experiments allows students to choose experimental variables and observe the effects of changing these variables. An added feature simulates a buret and Erlenmeyer flask with volume changes in both as the reagent is dispensed by variable volume amounts or by drops. The students prefer plotter output since it highlights the titration curve with different colors.

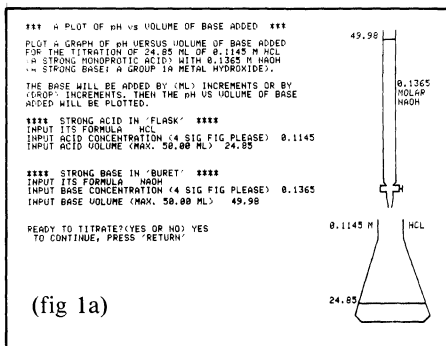

(fig 1a)

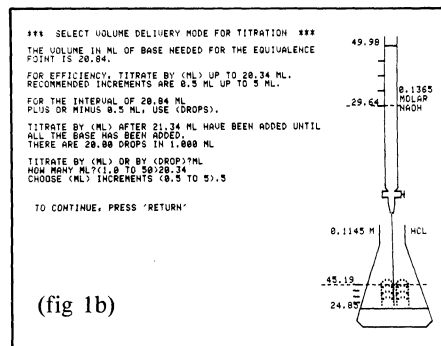

(fig 1b)

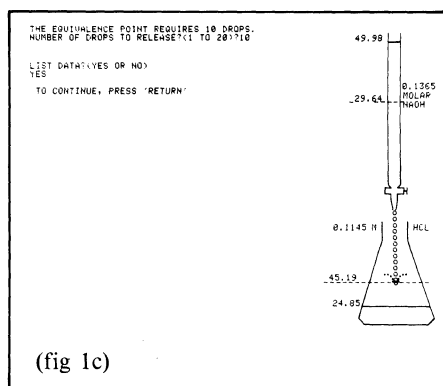

(fig 1c)

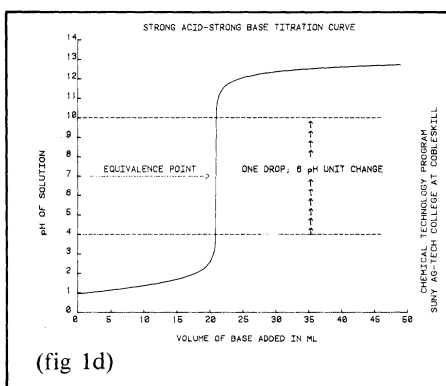

(fig 1d)

## Methods for teaching computerized analysis

Interfacing the Tektronix 4051 with an analytical instrument in two phases provides students with a better understanding of how the final results are obtained. A gas chromatograph was selected as the first instrument for this purpose.

A typical student experiment with this instrument is determining the percent composition of a mixture of volatile liquids. A mixture of known composition is injected into the chromatograph. The instrument separates the components and generates an analog signal which is recorded with a strip chart recorder.

Each peak in the chromatogram corresponds to a component in the mixture; the area under a peak is proportional to the amount of that component. Each component has a unique proportionality constant called a response factor which can be calculated from the chromatogram of the known mixture. The unknown mixture is then injected, peak areas are measured, proportionality constants are applied to the peak areas, and the percent composition is calculated. This procedure requires a lot of measurements and manual data transfers. It is, of course, very time consuming and error prone, especially when the calculations are done by hand.

First, the students perform the above experiment, manually measuring and recording all data from the chromatogram. They then write their own program in BASIC to perform the response factor and percent composition calculations. Results from a student program are shown below.

In the second phase, the students interface the Tektronix 4051 directly with the gas chromatograph using a TransEra 652 A/D Converter. A program written in BASIC allows

students to collect and manipulate data with the User-Definable Keys using a 4952 Joystick to interact with the data, defining peaks of interest and expanding portions of the chromatogram for closer examination. Output is directed to the 4662 Plotter, shown below.

Additional software will interface other departmental instruments such as infrared and ultraviolet spectrophotometers with the Tektronix equipment.

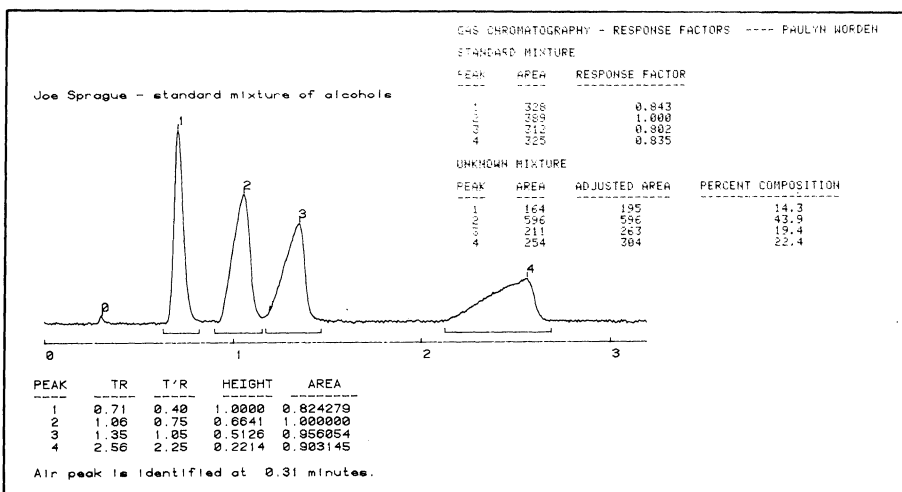

# 4110 Local Programmability Brings Distributed Processing to Graphics Applications

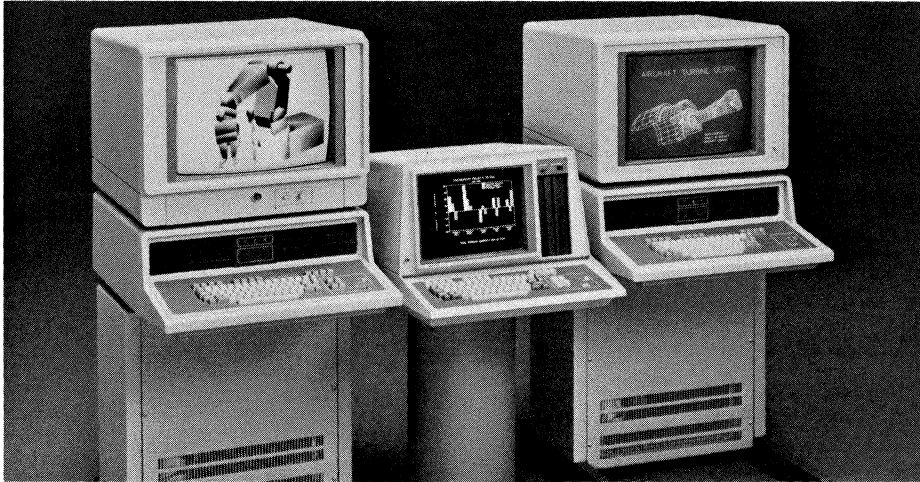

*The 4110 Series of Tektronix terminals enhanced your applications with low-cost, high-quality graphics. LOCAL PROGRAMMABILITY adds computing power allowing you to locally develop, debug and run programs on the 4110A terminals. All of the sophisticated graphics features of these raster scan and DVST terminals are directly accessible.*

Mapping, structural design, circuit board layout — the very nature of interactive graphic applications dictates that much of the activity takes place at the user's workstation, not within the host computer. But, ironically, the workstation terminal must depend on the remote host to drive this activity. Picture data must be transferred back and forth before being displayed, consuming precious host processing time while introducing inevitable delays at the terminal for turn-around. And, should the communications link fail, the terminal loses all graphics capabilities. It makes sense, therefore, to allow an intelligent terminal to process the graphics locally, leaving the host free to use its power for number crunching, data base management, or supporting more terminals.

The 4100 Series Local Programmability, recently introduced by Tektronix, distributes the processing by allowing the 4110A Series of Tektronix terminals to run applications programs locally. Although these intelligent terminals by themselves were able to relieve the host of retransmitting entire sequences of graphic data or commands,\* complete local control or stand-alone use wasn't possible. Local Programmability closes this gap.

## **A Typical Application**

Although some applications will continue to require a host for its computational power or large data base storage, using Local Programmability the preprocessing or post-processing of the graphics data can be assigned to the 4110A terminal. For example,

consider a finite element analysis application using a 4110A terminal with Local Programmability.

By running the program locally, without connection to the host, you can do all the preprocessing for the application at the 4110A terminal. First, you generate the model of a structure using the keyboard thumbwheels or graphics tablet. Local Programmability provides control of the terminal's intelligence allowing you to reposition, rotate and scale the displayed model, make changes, or even draw the structure on a plotter. Once satisfied with the model displayed on the screen, you log on and transmit the model description to the host computer for analysis. The analysis data from the host is then transmitted to the 4110A. After logging off the host, you continue the postprocessing at the 4110A terminal. In this case, the host system was needed to analyze the finite element model, but the locally programmed 4110A terminal did everything else.

Many application programs — mapping, CAD, CAM, curve and spline fitting, graphing and linear regressions — can run on the 4110A graphics terminal without any host support. Digitizing a map on a graphics tablet, for example, can be done locally on the 4110A terminal without the costs and line delays of communicating with a host system.

## **The Tools**

A powerful package of software, 4100 Local Programmability supplies all the elements necessary to develop and run programs local-

ly, to access the terminal's graphic and alphanumeric features, and to control all peripherals (plotters, printers, graphics tablets, mass storage devices) connected to the terminal.

Local Programmability relies on a new 8087 numeric coprocessor and ROM/RAM board as well as the 4110 terminal's standard 8086 processor. These hardware additions speed floating-point computations and enhance the processing of such applications as technical data analysis. Existing 4110 Series terminals are easily upgraded through Field Kits to 4110A terminals.

The 4110P01 Local Programmability package includes a FORTRAN-86 compiler, utility programs, and a library of Low-Level Terminal Interface (LTI) subroutines, all implemented with an industry-standard operating system, the CP/M-86. A local version of the PLOT 10 Interactive Graphics Library (IGL) may be included. For those programmers who need assembler support, Digital Research's ASM-86 assembler or Intel's ASM86 assembler are also available.

Designed specifically for the 8086 microprocessor and 8087 coprocessor, FORTRAN-86 is a superset of the ANSI FORTRAN-77 subset. FORTRAN-86 allows easier and quicker program development, easier manipulation of large amounts of data, and easier understood and maintained programs. But compatibility has been maintained and most earlier FORTRAN programs will run as is with possible minor input/output modification, thus protecting your current software.

FORTRAN-86 programs can directly output character data to the terminal or can call the LTI routines to access all the sophisticated 4110A Series graphics features. This library of routines provides a quick path to the terminal's firmware through FORTRAN-callable subroutines with easy-to-remember names.

Or, to save time and money, you can take advantage of the local PLOT 10 IGL. A core standard set of routines for graphics and text interaction, IGL acts as an interface between your application program and the LTI subroutines.

The powerful set of routines of local PLOT 10 IGL are compatible with the host version of PLOT 10 IGL. Thus, you may run locally on the 4110 terminal your existing host programs that use IGL. You simply download

your program source file. It is then compiled and linked to Local IGL.

The CP/M-86 operating system allocates system resources and provides program development aids and separate user libraries. In addition Tektronix has provided additional utilities which enhance the operating system's usability.

For those users who need the unique capabilities of an assembler and do not require direct interfacing with 4110A Firmware, Local Programmability provides support for the Digital Research ASM-86 and the Intel ASM86. The Digital Research assembler is small and fast and provides easy access to low level CP/M-86 operating system services. However, the ASM-86 output code cannot be easily linked with FORTRAN programs. The Intel ASM86 assembler output code is completely compatible with FORTRAN through the linker-editor.

### The Process

Using the tools provided by Local Programmability, you can create and edit your source program in FORTRAN-86 or ASM86 macro-assembly language. This source file is then compiled or assembled into 8086 executable object code.

A linker program — LINK86 — merges all of the 8086 object modules comprising your program into one module that can be executed by the 4110A terminal. For instance, all LTI and IGL subroutines are stored on disks in the form of object code. If your source program calls any of these subroutines, the LINK86 program extracts the called modules from the libraries. LINK86 resolves external references (e.g., any address field that refers to a location in a different object module) and generates a link map and error list.

The individual linked program modules are stored in a disk file and can be run locally on a 4110A terminal. The size of the program is limited only by the amount of available local memory.

You can also create and maintain your own library of object modules. A utility program provided by Local Programmability will join a series of object modules into a library, will add and delete library modules, and will generate a listing of the modules and public symbols in a library file.

The power, flexibility and diverse strengths of the 4110A Series terminals provide the hardware tools for a wide range of graphic applications; now Local Programmability offers the solution to slow data communication lines. No longer are you relegated to impatient waiting for even the simplest tasks and functions. Local Programmability gets the job done quickly by putting the graphic computing power where it belongs — at the fingertips of the user.

Contact your local Tektronix Sales Engineer for more information on how Local Programmability can help you with your application. 

\* *TEKniques* Vol. 6 No. 3 discussed segments, fonts, programmable keys and other unique strengths of the 4110 Series of color and monochrome raster scan and DVST terminals.

# 4052 Helps Reveal Secrets of Antarctica Data



Making annual treks to the Antarctic continent during its summer, Dr. Giesela Dreschhoff (left) and Dr. Edward Zeller collect ice core samples and mineral resource data which are later analyzed at the University of Kansas on the Tektronix 4052 Graphics System.

by Patricia Kelley  
TEKniques Staff

"Before I got this equipment I knew I would be dealing with a large number of data points. While raster scan has its place, without the storage tube I couldn't get the needed resolution to display all the data points and would have to look at my graph piecemeal. That would make it much more difficult. The Tektronix 4052 has an enormous advantage; I don't think I could find anything better."

The speaker is Dr. Edward Zeller, professor of geology at the University of Kansas. He is part of a team of scientists engaged in long-term studies aimed at improving our understanding of the sun.

## The Changing Sun Captured in Ice

Over the past centuries, solar activity (flares, sunspots, storms) has been pretty well documented, and periods of maximum and minimum activity identified. Captured within the frozen terrain of Antarctica, a series of physical clues not available anywhere else seems to echo the visual records informing of the sun's behavior. Nitrate concentrations within the ice correlate positively with some of the known features of the solar activity record.

Pursuing these clues, since 1975 and each year thereafter Dr. Zeller has been visiting Antarctica during the astral summer collecting ice core samples from various sites. In this "laboratory" a layer of snow is developed each season. Since these layers can be counted like tree rings, the amount of snow that falls each year is predictable over time.

Dr. Zeller and his colleagues collect the samples, from areas known as South Pole Station and Vostok Station, by digging pits and chiseling out plates of snow or by drilling ice cores. The samples are packed in sections in plastic tubes and sent back to the United States in refrigerated ships, and ultimately flown to Virginia Polytechnic Institute in Blacksburg.

There, the sections are carefully calculated for density and the average annual accumulation rate of snow and water. Professor Bruce Parker of the Department of Biology then chemically analyzes the cores for nitrate using ultraviolet spectrophotometric measurement.

The resulting data are sent to Dr. Zeller at the University of Kansas for processing. In the examples discussed here, samples covering approximately 1200 years were taken —

1655 individual analyses for a 108-meter South Pole ice core and 598 analyses from a 47-meter Vostok core.

## Samples Interpreted

With the help of the 4052 Desktop Computer, Dr. Zeller is extracting a picture from the ice sample data. He reflected, "We are able to connect with our central computer, but as far as we're concerned, the 4052 is a main-frame and it's been very satisfactory. Right now we use it primarily for data analysis. We routinely apply polynomial regressions, linear regressions and various smoothing functions from your Statistics and Mathematics packages. We've also modified some of the programs and have cooked up some ourselves."

Figure 1 shows the raw data from the two ice core samples plotted on the 4662 Plotter, and Figure 2 shows the same data smoothed.

Comparing the data from the two Antarctica locations, the raw data in Figure 1 and the smoothed curves in Figure 2, reveals the general similarity between the two. And reading the graphs from left to right, the correlation between the nitrate deposits and the observed solar activity periods is clearly shown:

present to 1850	— Modern Maximum
1820-1790	— unnamed short minimum
1715-1645	— Maunder Minimum
1510-1400	— Sporer Minimum
1280-1120	— Medieval Maximum

Where the nitrate levels are low, there has been less sunspot activity; where the nitrates are high, the solar activity has been high.

"We also do Fourier transform to determine the main frequencies present in the total signal," observed Dr. Zeller. "We have found the power spectra in the samples from the ice cores to be very similar for both locations."

By establishing the correlation between nitrate levels in the ice with known solar activity and cycles, Dr. Zeller and his colleagues can extend the correlation to get a longer backward look at solar activity from ice samples deposited before recorded solar history.

## Mineral Resources

A second program in which Dr. Zeller is involved also employs the 4052 Graphics System. He and Dr. Giesela Dreschhoff have been working since 1976 to determine if there is a resource potential for uranium and thorium on the Antarctic continent.

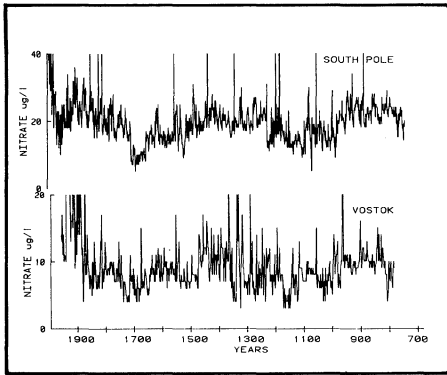

Figure 1. Plot of ice core samples from South Pole Station and Vostok Station with 1655 data points in the former and 598 in the latter.

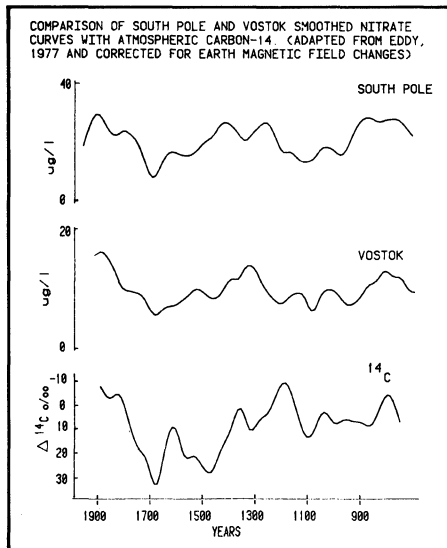

Figure 2. Applying one of the smoothing functions — the cubic spline program from the PLOT 50 Mathematics package — to incremental averages from the raw data obtained the 10-year interval smoothed curves.

Flying in a helicopter low and slow over peaks poking through the ice, they capture their data with a gamma ray detector. The signal is sent to the recorder and logged in analog form on a strip chart (digital recorders don't like to work in temperatures well below zero).

Back at the University, the strip charts are digitized into the 4052 and analyzed. The analysis will show the total count, the count from potassium 40, from uranium and from thorium, and the ratios of potassium to thorium and potassium to uranium.

The nitrate sampling and resource investigation are on-going. Sorting, analyzing, plotting, the Tektronix 4052 Graphics System is helping Dr. Zeller wade through volumes of data in his quest to open a window on the sun and to reveal Antarctica's resource potential.

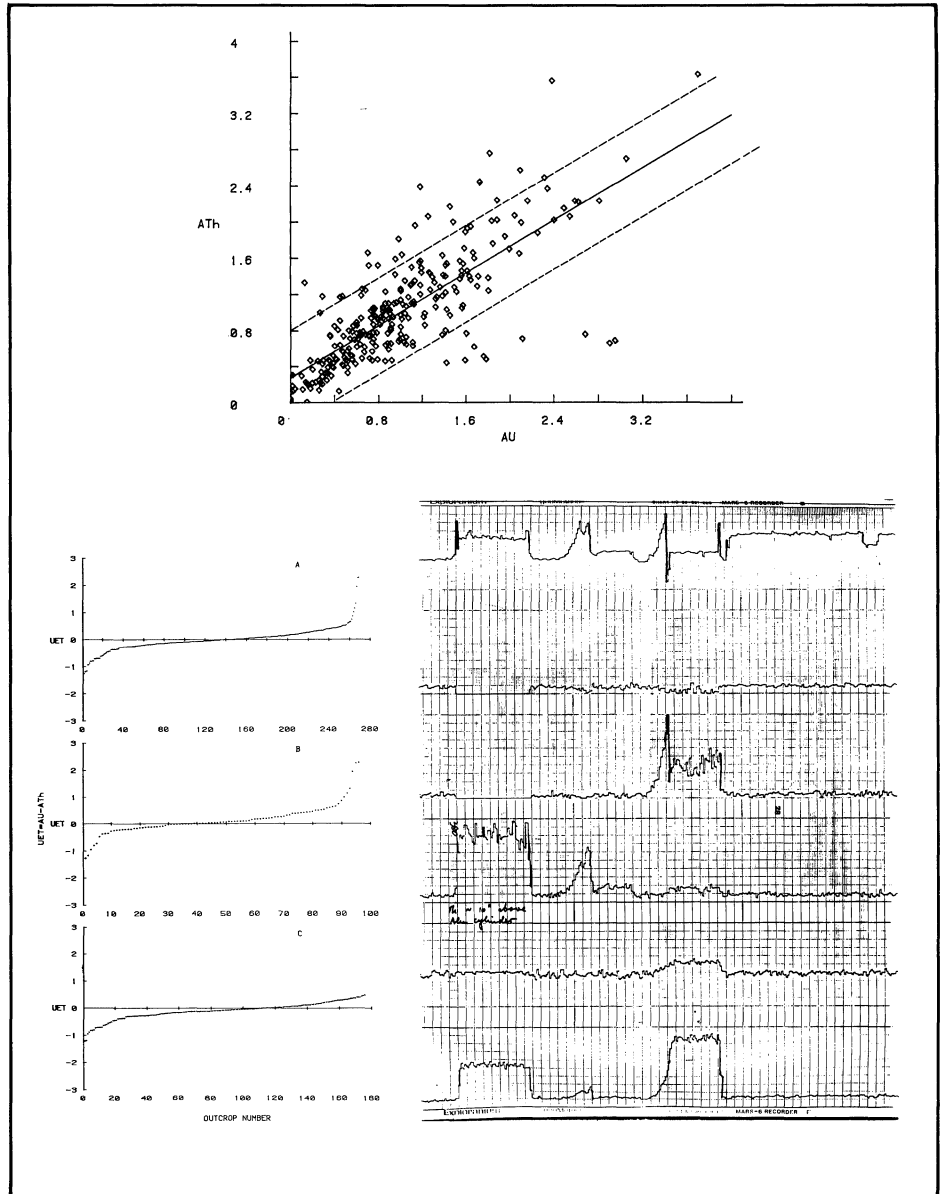

Figure 3. Back at the lab at the University of Kansas, strip chart recordings taken in Antarctica are digitized into the 4052 and analyzed.



The gamma ray detector and analog recorder shown will be loaded into a helicopter and flown over Antarctic mountain peaks to gather data on potential uranium and thorium resources.

# PLOT 50 2-D Drafting New Release Offers Increased Performance for Automated Drafting

Support for the Extended Memory File Manager,<sup>1</sup> the 4909 Multi-User File Manager and additional D and E size plotters has been included in the recent release of PLOT 50 2-D Drafting;<sup>2</sup> new functions and increased communication add to its performance. All at no additional cost.

PLOT 50 2-D Drafting enhancements offer users whose 4050 Graphics System is equipped with the Extended Memory unit several options for optimizing their drafting tasks. 2-D Drafting function overlays — some or all — may be stored in Extended Memory. Thus, a medium sized drawing could fit within Extended Memory along with the most used functions to provide rapid interaction. Or, a user with a huge drawing could use the disk for drawing space and all of Extended Memory for function overlays. Conversely, a designer may wish to use all of Extended Memory for drawing space and call the overlays from disk. Which option is best depends on the application and, therefore the user's choice.

Full 4909 Multi-User File Manager support<sup>3</sup> supplies the capacity for the PLOT 50 2-D drafting user to take advantage of the hard disk unit. File management is automatically provided; the PLOT 50 2-D Drafting user simply responds to prompts.

PLOT 50 2-D Drafting has always included plot drivers for CalComp and Tektronix plotters. Now Hewlett-Packard and Benson D and E (A1 and A0) size plotters are accommodated, directly through the software, or indirectly through TransEra ROM packs.

Users with the Tektronix 4054A Series Graphics Systems will find item selection and cross-hatching speeded since the new release of PLOT 50 2-D Drafting takes advantage of the "A" series capabilities. Enhancements for drawing creation and communication expand the system's versatility and ease of use.

The new release of PLOT 50 2-D Drafting is offered at the original price. Existing PLOT 50 2-D Drafting users under warranty

or Software Subscription Service will automatically be provided with the enhancements in this release.

Your local Tektronix Sales Engineer can provide you with more information on automating with PLOT 50 2-D Drafting. 

1. *TEKniques* Vol. 6 No. 3 outlined the capabilities of the Tektronix Extended Memory File Manager.
2. *TEKniques* Vol. 6 No. 3 described this stand-alone, two-dimensional drafting system for electrical, mechanical and other engineering disciplines.
3. See the accompanying article "PLOT 50 Software Supports 4909 Hard Disk" in this issue.

---

## PLOT 50 Software Supports 4909 Hard Disk

The success of Tektronix PLOT 50 2-D Drafting, Interactive Digitizing and Picture Composition application packages\* in streamlining and speeding drafting, mapping and drawing tasks causes a natural increase in users or data or both. To accommodate this growth, Tektronix has expanded these PLOT 50 software packages to offer users the advantages of the Tektronix 4909 Multi-User File Manager.

Full support of the 4909 hard disk unit by these packages permits up to 10 simultaneous users, and the 4909's capacity up to 768 megabytes provides the large local storage required for the data intensive applications. By sharing a 4909 unit, users achieve more value per byte of storage and solve the transportation problem for those who rely on the same data. The large capacity gives the user — one or many — a single source for storage. Program files and data can be stored and loaded quickly and easily. Passwords and access codes give users security features to control their files' accessibility.

For those applications which have outgrown the single user 4907 File Manager converting

to the 4909 version is painless. Functionally, the 4909-based software looks and acts similar to the 4907 versions. Users aren't required to re-learn a new system, just some minor terminology. Operationally, the performance of almost all operations is improved by the 4909.

PLOT 50 2-D Drafting, Interactive Digitizing and Picture Composition automate sizeable tasks. The 4909 Multi-User File Manager strengthens the process as the number of users or amount of data increase.

Your local Tektronix Sales Engineer can provide more information on PLOT 50 software support of the 4909's convenient, economical, multi-user mass storage. 

\* *TEKniques* Vol. 6 No. 3, Vol. 5 No. 3 and Vol. 5 No. 1 profiled the characteristics of these three packages.



# New 4907 ROM Pack Enhances and Adds Commands

by Pat Franz  
Tektronix, Inc.  
Wilsonville, OR

The BASIC language extensions of the 4052A and 4054A Desktop Computers necessitated a redesigned 4907 File Manager ROM pack to take care of such features as multicharacter variable names, comment tails and so forth. At the same time, the File Manager disk formatting function was streamlined and error handling routines were included.

Two choices of default parameters for the CALL "FORMAT" or CALL "FFRMT" functions simplify these commands:

```
CALL "FORMAT" , unit-number, volume-name, owner-name
CALL "FFRMT" , unit-number, volume-name, owner-name, password

      (password, volume#, #volumes, chains DEFAULTED)

or

CALL "FORMAT" , unit-number, volume-name, owner-name, password
CALL "FFRMT" , unit-number, volume-name, owner-name, password

      (volume#, #volumes, chains DEFAULTED)
```

The new ROM pack provides a default master password of "" (null) if it isn't specified. Since the *volume-number* and *number-of-volumes* must always be 1,1 on a 4907, these are automatically supplied in the default command versions. Directory block allocation parameters (chains) will default to 10,10,1,1,1. This allocates ample directory space for first and second level libraries and sufficient space for less common lower level libraries.

Three error handling commands facilitate program operation. CALL "ONERR" transfers control to a user-written routine when a File Manager error occurs. This circumvents the normal procedure of halting the program and displaying the error message when a File

Manager error occurs. This command would prove useful in checking to see if a peripheral was connected, if a disk was inserted in a drive, or if other similar operator responsibilities were carried out.

As part of the user's error-handling subroutine, a new command CALL "DSKERR" can be included to retrieve the error code and message, storing it in a target string variable for further processing.

CALL "OFFERR" turns off the special File Manager error handling set with "ONERR" and returns error handling back to the normal File Manager routine, i.e., halting the program and displaying the error message.

Although designed to handle the added features of the 4052A and 4054A Series computers, the new 4907 File Manager ROM pack can also benefit 4052/54-4907 users. An existing ROM pack may be upgraded through a kit, part number 040-1091-00. The new ROM pack is orderable by part number 020-0279-01. Both of these may be obtained by calling Central Parts Ordering. See page 25 in this issue of *TEKniques* for the telephone number serving your area. 

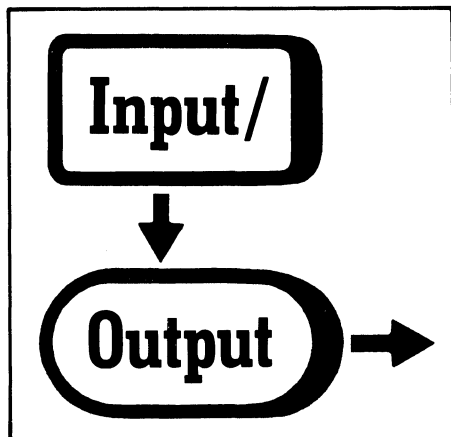

David Walcutt, Propagation & Frequency Management Specialist with Radio Free Europe in New York has three questions:

- 1) Is there an equivalent of SET NOKEY that would disable the BREAK key during critical periods of program execution?
- 2) How do you establish multiple data files within a program using DATA statements so that only the specific data file can be called?

- 3) Why is the length of the STRing of a number one plus the length of the original number? For instance, the LENGTH of STR(400) is four, while the LENGTH of STR (-400) is five.

Steve Duncan, Technical Support Specialist provided the answers:

- 1) The BREAK key is a very high priority interrupt in the 4050 Series and cannot be masked by any system operation.
- 2) Data statements may be implicitly selected by using a line number with the RESTORE command. For example:

```
100 INIT
110 DIM X(5)
120 DATA 1,2,3,4,5
130 DATA 6,7,8,9,10
140 DATA 11,12,13,14,15
150 DATA 16,17,18,19,20
160 RESTORE 140
170 READ X
180 REM: X CONTAINS 11,12,13,14,15
190 RESTORE 120
200 READ X
210 REM: X CONTAINS 1,2,3,4,5
```

Thus, data statements do not have to be read in sequence, and the array can be treated as a "data file." Or, perhaps you wish X-array to contain the numbers of tape data files on which you are working. In this case, you could

loop through the array by FIND X(I) and perform the operation on the desired data file.

- 3) The 4050 System automatically inserts a space before a number to separate values for readability. For example, if you were to print the above array, i.e., PRINT X, the result is " 1 2 3 4 5", not "12345". It is the STR function that supplies the separating space. 

# Crisp Images, Vibrant Colors Distinguish New Color Copier

The transition from monochrome to color in computer graphics is as natural as the transition from alphanumerics to graphics. Color on the screen of a computer graphics display communicates more information, more quickly, and more effectively. It is only logical, therefore, that color graphics terminals are rapidly entering a variety of areas from business management and technical data analysis to cartography and computer-aided design.

But high-resolution color graphics are of limited use if they can't be taken off the screen and put into the hands of colleagues or published in reports. Information sharing is a key factor in any application and to share information on the screen of the terminal, it needs to be seen by others. Thus, to achieve the full benefit of color, there is as much need for color graphics on paper as on the display.

Answering the need for accurate, economical, timesaving copies is the new Tektronix 4691 Color Graphics Copier. High image quality and vivid color at a low cost per copy are its trademarks. The 4691 yields copies in B (A3) as well as A (A4) size. And, it's easy to operate.

## Color Copies

Any application where color is essential will find the 4691 Color Graphics Copier a valuable tool. Designers of integrated circuits or printed circuit boards can copy their displays without losing the detail depicted by color. Layers of different material, overlapping areas, errors and mechanically conflicting areas, all distinctly portrayed in color on the graphics terminal, can be readily duplicated on the 4691.

Color copies from three-dimensional solid object or stress pattern modeling on the graphics terminal can go into the mechanical engineer's report. Architects can hand their clients a realistic color image of their designs. Piping and wiring circuits within a building, designated by different colors, can be hard copied for further analysis away from the graphics terminal.

Drawing attention to key points, or simply providing an aesthetic picture, color is inherent in effective presentations. The 4691 can reproduce charts and graphs for management reports, preserving the colors used on the original display.

## Quality Copies

Crisp, clear graphics and smooth uniform

colors distinguish the copies of the 4691 Color Graphics Copier. The excellent image produced by the 4691 is the result of its resolution and its color quality. When people speak of resolution, they are commonly referring to the total dot capability (or addressability) of the device, the accuracy of the dots and lines it produces, and the resultant ability to accurately reproduce fine patterns.

The 4691 Color Copier has the highest addressability — that is, more total dot capability — of any color copier available today. The 4691 places 150 dots per inch in both horizontal and vertical directions. This gives the potential for a B-size image to have over 2400 by 1500 dots!

High addressability and accuracy in dot placements allow the 4691 to faithfully reproduce fine screen patterns, thus simulating color shading as an extension of the basic eight colors.

These excellent image characteristics are produced by the 4691's exclusive implementation of on-demand ink jet technology. The true bright colors and superb color saturation of the 4691 are the result of a special match of ink and paper. Inside the 4691, droplets from the three primaries yellow, magenta, and cyan mix to form red, green, and blue. True black is supplied from a black ink cartridge, rather than from a mixture of primaries that can form an "off" color of black.

## Flexible Format

Image size and format often need to be tailored to the task being performed on the graphics display. The 4691 makes images in B or A size, with the choice of landscape or portrait format. B size is often used for the most complex drawings, with landscape orientation for the largest image size, showing as much detail as can be portrayed on a large screen. For example, geometric modeling displays are often copied and analyzed in the large size. A 4691 B size copy of a wire-frame model, say, of an automobile in landscape format would provide the design team a hard copy for scrutiny showing all the model's details.

A size is often used for reports. Here portrait orientation would provide easy reading in a notebook. The color reproduction of the final design or graph copied in A size in a portrait format could be inserted into the engineering or management report.

## Easy Operation

Relinquishing copy control to the program frees the operator for other tasks. Up to 50 copies of an image may be selected with a single command. Landscape and portrait image formats are also selectable under program control. And a status command in a program can detect ink or paper supplies, and the state of the copier: whether it's busy, for example.

Paper handling by the 4691 is automatic, with 50 cut sheets in the chosen size, vacuum-picked from the paper tray, and automatically stacked in the output tray. Copies come out dry, with the image side down to "colate" the copies.

Individual snap-in, self-sealing ink cartridges for each color avoid messy fingers and economize on total ink use. Depending on the density of the images, the large capacity 200 ml cartridges may last for over 4000 copies. The ink quantity is electrically monitored and only the cartridge that is empty need be replaced.

Front panel lights signal when ink and paper are low, or when service is required.

## Compatible Configuration

A firmware option permits the 4691 Color Copier to be plug-compatible with the 4113A pedestal and desk configurations. It allows 4113A copy either push button from the keyboard or under program control.

As a special feature, Plot 10 Easy Graphing II and Local Programmability packages can execute display patterning which adds as many as 125 shades to the 4691's basic eight colors. Hard copy colors are automatically matched to those on the screen.

Commands support image spooling to the optional 4113A internal disk which means an image file is created on disk that can be recycled to the 4691. This permits work at the terminal to continue virtually uninterrupted during the copy process.

The 4691 Color Graphics Copier is meant to be shared. The multiplexing option connects as many as four terminals at once to the 4691.

The high performance of the 4691 — in particular its ability to place 2400 by 1500 dots in a B size image — makes it appropriate for sharing as a host system resource. Host copy means connecting the copier directly to the mainframe processor instead of the terminal which allows the 4691 to copy the host data at its full resolution. Because it's connected to the central data source, a host-connected 4691 can serve all the workstations in a system. In future issues of *TEKniques*, we'll be talking more about host interfacing. 

HCAD 3.88 CURRENT ELEMENT- INC- KIL9 H2448 TK ID&REP 21/09/84.14.00.00. LEV 1

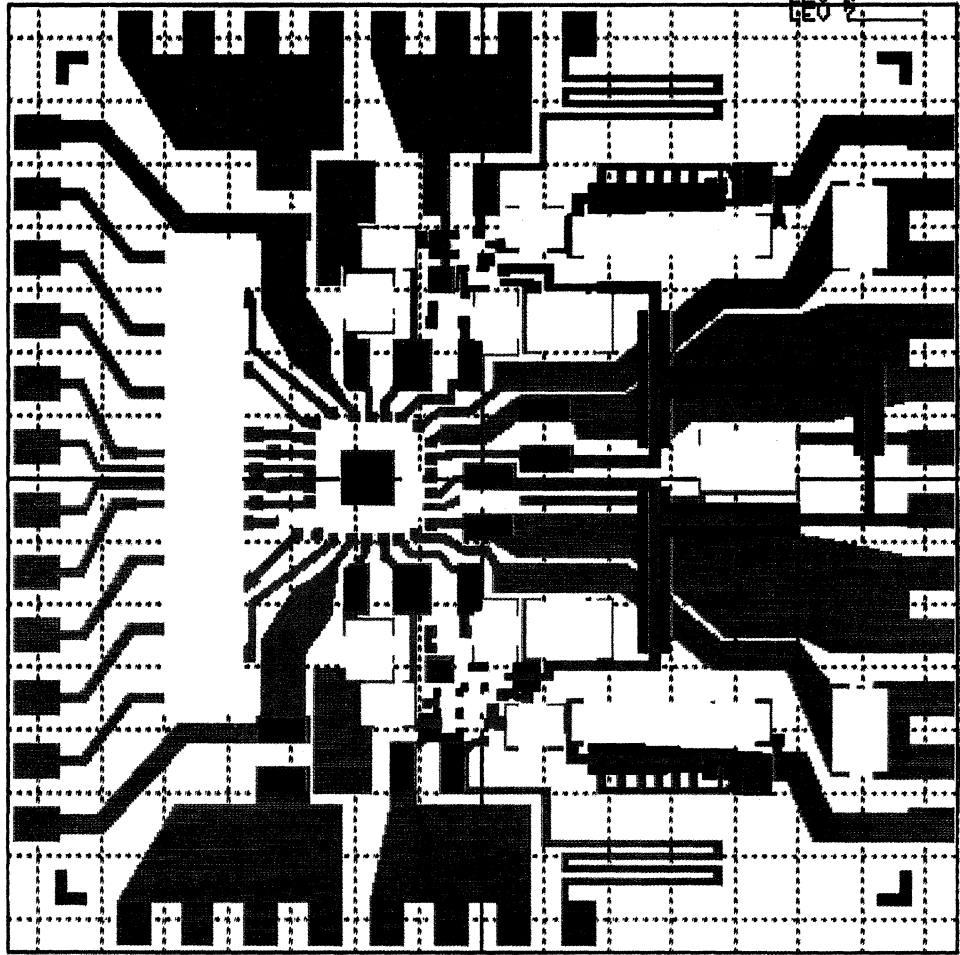

NO.	NAME	LEVE
1	CC1	02
2	CC2	02
3	CC3	02
4	CC4	02
5	CC5	02
6	CC6	02
7	CC7	02
8	CC8	02
9	CC9	02
10	CC10	02
11	CC11	02
12	CC12	02
13	CC13	02
14	CC14	02
15	CC15	02
16	CC16	02
17	CC17	02
18	CC18	02
19	CC19	02
20	CC20	02
21	CC21	02
22	CC22	02
23	CC23	02
24	CC24	02
25	CC25	02
26	CC26	02
27	CC27	02
28	CC28	02
29	CC29	02
30	CC30	02
31	CC31	02
32	CC32	02
33	CC33	02
34	CC34	02
35	CC35	02
36	CC36	02
37	CC37	02
38	CC38	02
39	CC39	02
40	CC40	02
41	CC41	02
42	CC42	02
43	CC43	02
44	CC44	02
45	CC45	02
46	CC46	02
47	CC47	02
48	CC48	02
49	CC49	02
50	CC50	02
51	CC51	02
52	CC52	02
53	CC53	02
54	CC54	02
55	CC55	02
56	CC56	02
57	CC57	02
58	CC58	02
59	CC59	02
60	CC60	02
61	CC61	02
62	CC62	02
63	CC63	02
64	CC64	02
65	CC65	02
66	CC66	02
67	CC67	02
68	CC68	02
69	CC69	02
70	CC70	02
71	CC71	02
72	CC72	02
73	CC73	02
74	CC74	02
75	CC75	02
76	CC76	02
77	CC77	02
78	CC78	02
79	CC79	02
80	CC80	02
81	CC81	02
82	CC82	02
83	CC83	02
84	CC84	02
85	CC85	02
86	CC86	02
87	CC87	02
88	CC88	02
89	CC89	02
90	CC90	02
91	CC91	02
92	CC92	02
93	CC93	02
94	CC94	02
95	CC95	02
96	CC96	02
97	CC97	02
98	CC98	02
99	CC99	02
100	CC100	02

A one-to-one reproduction of the copy produced by the Tektronix 4691 Color Graphics Copier demonstrates its clear graphics and vivid colors. The image was copied from a 4113A graphics display.

GRID- 100(MILS)

# Tektronix GPIB Extender Stretches the Data Link

by Gordon Gunderson  
Tektronix, Inc.  
Wilsonville, OR

Permitting GPIB communication over distances of 1650 feet (500 meters), the new Tektronix GPIB Extender puts the power of the 4909 Multi-User File Management System in the hands of remote users. Tektronix 2-D Drafting System users, for example, can employ the GPIB Extender to share a data base on the 4909 hard disk even though their design stations reside in different rooms or even different buildings. Tektronix GPIB test instruments linked as customized automated test packages at detached locations through a 4050 acting as a Controller could also share a 4909's storage capacity through the Extender.

But the GPIB Extender is not limited to the 4909 hard disk unit. It is compatible with any standard GPIB interface. Any workable local-only GPIB configuration may substitute the extenders in a portion of the configuration that may need to be remote. For example, a Tektronix 4663 Plotter could be accessed through GPIB Extenders by users of a 4050 Desktop Computer at a distant location. Or a central controller such as the 4050 system could control GPIB-compatible instruments at a separate site.

Using a GPIB Extender is easy. The Extender handles all interfacing details rendering its operation completely transparent to the user. To achieve this versatility, the GPIB Extender comes in two forms: the 4909F02 Extender unit especially designed for the Tektronix 4909 Multi-User Management System, and the 4932 Extender, a self-powered unit compatible with any standard GPIB interface.

The units are always used in pairs: a 4909F02 and a 4932, or two 4932 Extenders. The 4909F02 plugs directly into the 4909 system bus, whereas the 4932 directly connects with an instrument's GPIB interface. Both require a coaxial "link" cable connection to a remote 4932. The cable can be any length up to 500 meters, and several units may be linked together for increased distances. However, the benefit gained from chaining is at the expense of reduced data transfer rates.

For more information on how the GPIB Extender can increase the versatility and cost-effectiveness of your application, contact your local Tektronix Sales Engineer. 

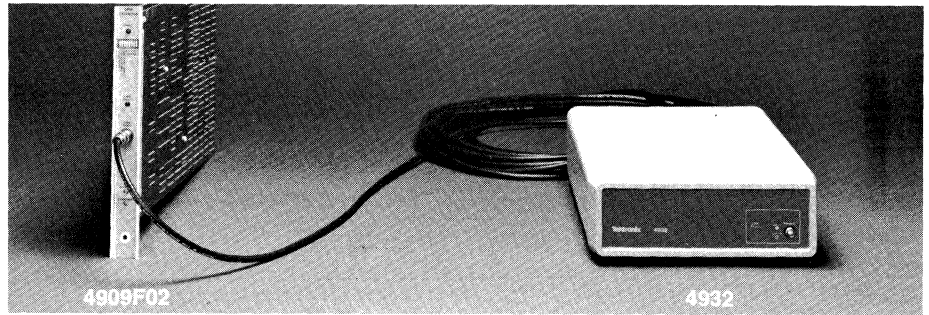

The 4909F02 GPIB Extender plugs directly into the Tektronix 4909 hard disk system bus and connects with a 4932 Extender through the coaxial "link" cable, extending GPIB data transmission over distances of 1650 feet to a 4050 System at the remote end.

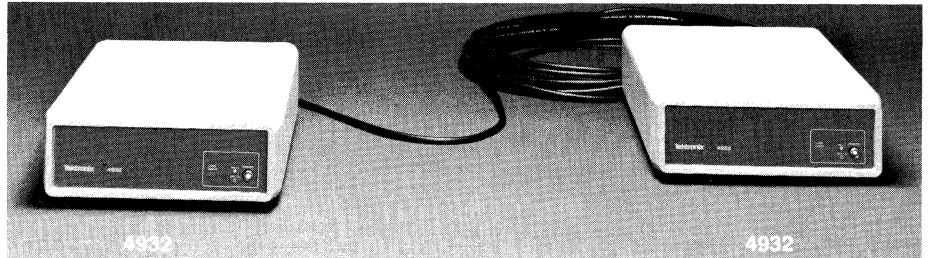

Two GPIB-compatible instruments at widely separated sites may communicate through two 4932 GPIB Extenders.

Various combinations provide optimum configuration flexibility.

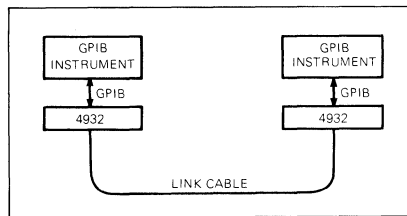

A 4050 system can communicate with a measuring unit or other GPIB devices over distances of up to 500 meters.

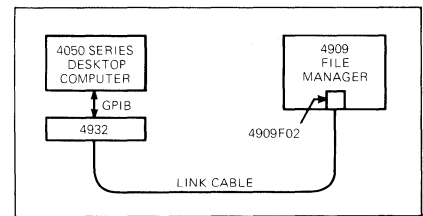

The 4909F02 installed in a 4909 hard disk connects it to the GPIB-compatible 4050 system through the link cable and 4932 unit. Multiple 4909F02s may be installed in a 4909 providing access for up to 10 remote users.

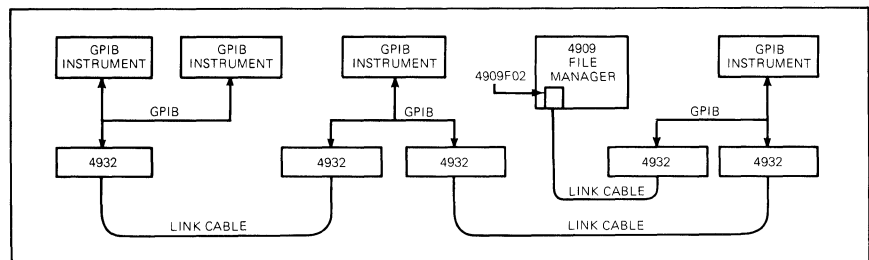

A tree configuration allows a 4050 system to control remote measuring and monitoring instruments and capture their results on the 4909 hard disk.

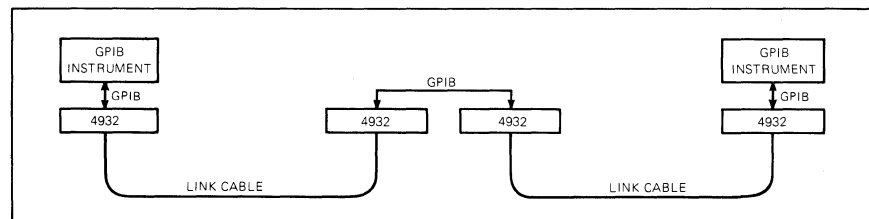

GPIB Extender pairs may be connected in a serial configuration to cover longer distances.

## \* Editor's Note:

### Back Issues and Reprints from *TEKniques*

*TEKniques* is in its sixth year of publication. Issues from the first three years (Volumes 1-3) have all been distributed. However, most of the articles from those issues have been assembled by application area and are available in the following reprints:

Engineering and Design . . . . . AX-4449  
Mapping . . . . . AX-4460  
Data Acquisition and Analysis . . AX-4450  
Business Graphing and  
Reporting . . . . . AX-4451  
Peripherals and ROM Packs . . . AX-4452

If you need an article from one of these previous volumes, and don't have your copy, one of the reprint sets will likely fill your needs. To obtain a copy of one of the reprint volumes, just contact your local Tektronix office or the IDD Applications Library office serving you.

### Programming Tips Handbook

The programming tips from the first three years have been collected into a handy booklet which is included in the Programming Aids T2 tape documentation (part #062-5972-00).

### 4050 Applications Library Changes Name to *IDD Program Exchange Library*

Effective January 1, 1983, the 4050 Applications Library will change its name to *IDD Program Exchange Library*. The new name more accurately reflects the scope of the library which includes application programs, utility programs and so on. As mentioned in the last issue of *TEKniques*, the library will encompass programs for all of the Tektronix Graphics Displays including the new 4100 Series and 4100 Local Programmability.

### Keep 4050 Series Catalog

The 4050 Series Applications Library catalog published in 1981 should be retained. New pages will be added periodically, but the original portion will not be reproduced. Present holders of the catalog should clip the New Abstracts pages from *TEKniques* and insert them in the back of the catalog. Those who do not have a copy of the catalog may order it through Tektronix Central Parts Ordering (see New Abstracts section for information) by part number 062-6343-00, or may call the local Tektronix Field Office.

### Textbook Based on 4050 Series

A textbook designed for draftspersons who have studied various specialty areas of drafting and have studied BASIC computer language has recently been published by Prentice-Hall. Written by Norman Neundorf, professor of computer aided drafting at San Antonio College, the one-semester course textbook is based on the Tektronix 4050 System including the Tektronix 4662 Plotter and 4642 Line Printer. The lessons and programs have been designed for the learning/teaching situation with many types of drawings presented rather than emphasizing only one type of drawing such as descriptive geometry. According to Professor Neundorf, the idea is to present many types of drawings because the drafting technology graduate may accept a position in many types of industries. The programs are designed for the student's understanding rather than sophistication or production types of programs. The book was produced using the Tektronix 4050 Graphics System.

*Computer Aided Drawing Using the Tektronix Graphic System* is an 8½" × 11" soft-cover book and may be ordered through:

Order Dept.  
Prentice-Hall, Inc.  
Englewood Cliffs, N.J. 07632

Pricing information is available by writing to the above, or calling area code (201) 592-extensions 5049 through 5053, e.g., 201-592-5051. 

## 4050 Series Graphic Systems Workshops Scheduled

The 4050 Series Graphic Computing Systems workshops are designed to help you get the most out of your graphic system. The week-long workshops combine classroom lecture with extensive laboratory sessions.

### The 1983 Schedule is:

Rockville, MD	Santa Clara, CA
December 6-10	January 10-14
January 3-7	March 7-11
January 31-February 4	May 2-6
February 28-March 4	
March 21-25	
April 4-8	
May 2-6	
May 23-27	

Tekniques  
Vol. 6 No. 4

### For additional information contact:

4050 Series Graphics Systems Workshop  
Registrar  
Mail Stop 63-574  
Tektronix, Inc.  
P.O. Box 1000  
Wilsonville, OR 97070  
(503) 685-3749 

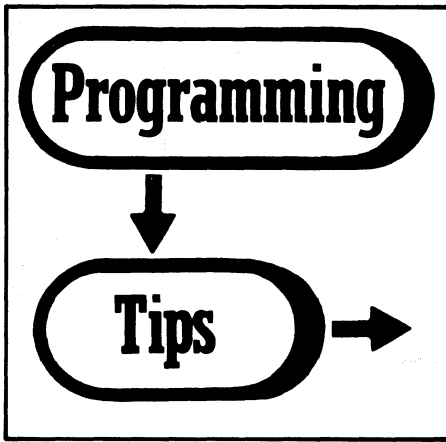

## 4052A/4054A Hints

by Lee Rainey  
Tektronix, Inc.  
Dayton, OH

Perhaps the most dramatic changes in the 4050A result from the upward-compatible superset of traditional BASIC. For most effective use, some cautions are in order as well as some examples.

### Mnemonic Names

The most obvious new capability is the multi-character variable names. This allows mnemonic names for readable code and overcomes the limit of only 26 possible string names — the new BASIC permits construction of  $8 \times 10^{46}$  different string names.

To use mnemonic names effectively, two requirements must be kept in mind. First, the variable name must not begin with three letters that match a keyword abbreviation. This may seem to be a limitation, as many good variable names are already keywords (LIST\$, DISTANCE, etc.). In such an instance, use the technique favored by Prime and begin the name with an underscore: LIST\$, DISTANCE.

A second caution applies to the use of the three arithmetic operators MIN, MAX, and MOD. In 4050 BASIC, one could enter a line such as

```
100 A = BMIN3
```

without spaces and it would be parsed to mean that A receives the lesser of the two values B or 3. In the A-series BASIC, this line assigns A the value of the variable BMIN3! In short, these three operators should always be delimited by spaces to avoid ambiguity. This also applies to AND and OR.

### Concluding Subprograms

The subprogram structure allows the use of

named subprograms that actually pass arguments. A subprogram begins with a SUB statement and concludes with END SUB. Don't try to use RETURN. If you do, you will leave the subprogram, but your destination will not be the line after the CALL statement. Instead, control is transferred either to immediate mode or to the line after a GOSUB, if one is on the stack.

### Subprogram Argument Passing

Before using subprograms, review the rules on passing by reference and by value, as these require some thought when combined with the LOCAL statement. Example 1 illustrates the considerations.

```
100 INIT
110 DATA 1,2,3,4
120 READ A,B,C,D
130 PRINT A,B,C,D
140 CALL _display(1,B,C,D)
150 END
160 SUB _display(W,X,Y,Z)
170 LOCAL A,B,C,D
180 B=3
190 B=B*5
200 PRINT W,X,Y,Z
210 END SUB

RUN
1          2          3          4
UNDEFINED VARIABLE IN LINE 200 - MESSAGE NUMBER 36
PRINT B
3125

END SUB
PRINT B
2
```

Variables A, B, C, and D are defined in the main program and then the subprogram is called with four formal parameters. The variable names A, B, C, and D are then declared as local, some processing occurs, and the values of the formal parameters are printed. Here is where LOCAL comes into play.

If a variable in a LOCAL list was previously defined, this previously defined value is put onto the stack and the variable is set to undefined. This explains the results of line 200.

Formal parameter W matches a literal 1 in the CALL, so it is passed by value and remains defined despite the LOCAL statement.

Formal parameter X is flagged as equivalent to the current value of the variable B. Thus, when LOCAL is executed, the current value becomes the value of the local variable B, not the variable B in the main program.

Y and Z obtain values passed by reference. As mentioned above, the LOCAL statement causes the referenced values to be placed on the stack, and the formal parameters become undefined. Note that the original, non-local variables are not accessible from the time that the LOCAL statement is executed through the point where an END SUB is reached.

(A convention to use “\_” as the last character in LOCAL variables, e.g., A\_, and never do that for non-local variables, would avoid confusing the two types.)

## New Graphics Commands

The following example illustrates many of the new graphics commands in a typical application. The DO-loop obtains a series of vertices via graphic input, checking the string variables as an exit criteria. The outline of the object is displayed and the new HATCH routines crosshatch the object.

One additional point is entered and several characteristics of the polygon are calculated using the new commands. To assess the value of the new commands, check the corresponding software algorithms that have been published in *TEKniques*. For instance, the three-line HATCH routine replaces the 44 lines of code published in *TEKniques* Vol. 3 No. 1. The one-line AREA function replaces 17 lines of code in *TEKniques* Vol. 5 No. 3.

```
100 INIT
110 SET DEGREES
120 PAGE
130 DIM Xarray(100),Yarray(100)
140 MOVE 0,95
150 PRINT "USE THE JOYSTICK TO LOCATE THE VERTICES OF A ";
160 PRINT "POLYGON. PRESS 'F' TO ";
170 PRINT "INDICATE THAT YOU ARE FINISHED. THE POLYGON ";
180 PRINT "MUST BE NON-INTERSECTING";
190 PRINT "OR ELSE MUST FOLLOW THE RULES IN THE ";
200 PRINT "DOCUMENTATION."
210 GIN Xpt,Ypt
220 VIEWPORT 0,130,20,80
230 WINDOW 0,13,0,6
240 FOR I=0 TO 13
250   X1S 0,0,1,1
260 NEXT I
270 H=0
280 REM - OBTAIN VERTICES OF POLYGON
290 DO
300   H=H+1
310   POINTER Xarray(H),Yarray(H),Z$
320   EXIT IF Z$="F" OR Z$="*"
330 LOOP
340 REM - DISPLAY AND CROSSHATCH POLYGON
350 DIM Xarray(N),Yarray(N)
360 MOVE Xarray(N),Yarray(N)
370 DRAW Xarray,Yarray
380 FOR I=0 TO 90 STEP 90
390   HATCH ROTATE 45+I
400   HATCH SPACE 4
410   HATCH Xarray,Yarray
420 NEXT I
430 VIEWPORT 0,130,0,100
440 WINDOW 0,130,0,100
450 MOVE 0,Ypt
460 PRINT "ENTER ONE MORE POINT."
470 VIEWPORT 0,130,20,80
480 WINDOW 0,13,0,6
490 REM - OBTAIN POINT TO COMPARE TO POLYGON
500 POINTER Xpt,Ypt,Z$
510 MOVE Xpt,Ypt
520 PRINT "X"
530 VIEWPORT 0,130,0,100
540 WINDOW 0,130,0,100
550 MOVE 0,15
560 REM - PRINT DATA ABOUT POLYGON
570 PRINT "THE PERIMETER IS "IDISTANCE(Xarray,Yarray)
580 PRINT "THE AREA IS "AREA(Xarray,Yarray)
590 CENTROID Xarray,Yarray,Xcenter,Ycenter
600 PRINT "THE CENTROID IS "Xcenter," "Ycenter
610 Place=INSIDE(Xarray,Yarray,Xpt,Ypt)
620 A$="OUTSIDE/INSIDE"
630 P=1*(Place=0)+8*(Place=1)+10*(Place=2)
640 A$=SEG(A$,P,5*(Place=0)+4*(Place=2)+2)
650 PRINT "THE POINT IS "A$;" THE POLYGON"
660 END
```

USE THE JOYSTICK TO LOCATE THE VERTICES OF A POLYGON. PRESS 'F' TO INDICATE THAT YOU ARE FINISHED. THE POLYGON MUST BE NON-INTERSECTING OR ELSE MUST FOLLOW THE RULES IN THE DOCUMENTATION.

ENTER ONE MORE POINT.

```
THE PERIMETER IS 13.8673737146
THE AREA IS -10.88484352
THE CENTROID IS 4.36333443157, 3.40360305211
THE POINT IS OUTSIDE THE POLYGON
```



## SEARCH

Similar parsimony can be obtained with the new SEARCH function for string operations. SEARCH accepts as an argument a series of character pairs, and returns the position of the first character in a string that falls within the range of one of the pairs. The following example shows this in the context of a routine to validate 4909 file specifiers.

Such specifiers must begin with a letter, and may contain only letters, digits, the dollar sign and the underscore. On the traditional 4050, it was necessary to segment out each character one at a time and subject it to a

long series of logical comparisons. With SEARCH, you check if the first character is in the range AZ or az, and then check the remainder of the string for any character in the prohibited ranges. It requires fewer statements and eliminates the FOR/NEXT loop. Also, SEARCH seems more readable than a long list of ADEs (ASCII decimal equivalents).

Upcoming issues of *TEKniques* will carry more hints on using the new BASIC language capabilities of the 4052A and 4054A.

```
4050
7380 REM -----
7390 REM - CHECK SYNTAX OF ANY PASSWORD OR SPECIFIER
7400 REM (CODE FOR CHECKING LENGTH, ETC. OMITTED)
7410 FOR I=1 TO LEN(Z$)
7420 X$=SEG$(Z$,I,1)
7430 C=ASC(X$)
7440 REM - FIRST CHARACTER MUST BE ALPHABETIC
7450 E1=E1+(C=1 AND C<65 OR C>90 AND C<96) OR C>122)
7460 IF E1 THEN 7580
7470 REM - NOW CHECK FOR UNDERSCORES, ETC
7480 E1=E1+(C<36)
7490 E1=E1+(C>36 AND C<48)
7500 E1=E1+(C>57 AND C<65)
7510 E1=E1+(C>90 AND C<96)
7520 E1=E1+(C=96)
7530 E1=E1+(C>122)
7540 E1=E1>0
7550 IF E1 THEN 7580
7560 NEXT I
7570 REM (ADDITIONAL ERROR CHECKING OMITTED)
7580 REM - PRINT AN ERROR MESSAGE

4050A
7380 REM -----
7390 REM - CHECK SYNTAX OF ANY PASSWORD OR SPECIFIER
7400 REM (CODE FOR CHECKING LENGTH, ETC. OMITTED)
7410 REM - FIRST CHARACTER MUST BE ALPHABETIC
7420 X$=SEG$(Z$,1,1)
7430 E1=SEARCH(X$,"azaz",1)
7440 IF E1=0 THEN 7490
7450 REM - NOW CHECK FOR PROHIBITED CHARACTERS
7460 E1=SEARCH(Z$,"%?:@!`<>~",2)
7470 IF E1=0 THEN 7490
7480 REM (ADDITIONAL ERROR CHECKING OMITTED)
7490 REM - PRINT AN ERROR MESSAGE
```

## Rounding Functions

Several readers have recently sent in functions for rounding. The variety of techniques used in the functions suggests a need for clarification of the binary nature of computers and the INT function.

In general, base 10 (decimal) integers can be represented precisely with another number base, but most decimal fractions can only be represented approximately. For example, 1/10 cannot be exactly represented in binary notation regardless of how many significant digits\* are used, just as 1/3 can't be represented exactly in decimal notation.

Because of the "almost, but not quite" binary internal representation of decimal fractions, arithmetic operations may result in close approximations but not exact. For instance, translating 0.1 and 10 into binary representation in the 4050 and multiplying them results in .FFFFFFFFF<sub>16</sub> which is close to the integer 1 but not close enough for the INT function; e.g., key INT(10\*0.1) into the 4050 to see what you get back.

Therefore, when testing a fraction for rounding, you must take into consideration its internal representation. A previous programming tip in *TEKniques* Vol. 2 No. 6 told how to set the internal value to agree with the value displayed on the screen, since the screen always rounds at the 12th place.

First, set E0 (or some variable) to 1E-12. Then use INT(A + ABS(A)\*E0) which results in a "fuzzy" integer.

\*See *TEKniques* Vol. 5 No. 4, page 14, for the discussion of internal representation in the 4050 of numeric data.

Incorporating this routine into a function for rounding results in the following:

```
DEF FNA(A)=INT(10^P*(A+10^-P*0.49)+ABS(A)*E0)/10^P
or
DEF FNA(A)=INT(10^P*(A+10^-P*0.5)+ABS(A)*E0)/10^P
```

(P is the number of digits to the right of the decimal, not digit of precision.)

For further clarification, we'll take a look at these two functions plus some others.

Four functions have been defined, each with two different values for determining the round off, namely, 0.49 and 0.50.

```
130 DEF FNA(A)=INT(10^P*(A-1.0E-8)+0.49)/10^P
140 DEF FNB(A)=INT(10^P*A+0.49)/10^P
150 DEF FNC(A)=INT(10^P*(A+10^-P*0.49))/10^P
160 DEF FND(A)=INT(10^P*(A+10^-P*0.49)+ABS(A)*E0)/10^P
170 DEF FNE(A)=INT(10^P*(A-1.0E-8)+0.5)/10^P
180 DEF FNF(A)=INT(10^P*A+0.5)/10^P
190 DEF FNG(A)=INT(10^P*(A+10^-P*0.5))/10^P
200 DEF FNH(A)=INT(10^P*(A+10^-P*0.5)+ABS(A)*E0)/10^P
```

A small program allows us to put in the number to be rounded and how many places to the right or left of the decimal.

```
100 INIT
110 D1=41
120 E0=1.0E-12
130 DEF FNA(A)=INT(10^P*(A-1.0E-8)+0.49)/10^P
140 DEF FNB(A)=INT(10^P*A+0.49)/10^P
150 DEF FNC(A)=INT(10^P*(A+10^-P*0.49))/10^P
160 DEF FND(A)=INT(10^P*(A+10^-P*0.49)+ABS(A)*E0)/10^P
170 DEF FNE(A)=INT(10^P*(A-1.0E-8)+0.5)/10^P
180 DEF FNF(A)=INT(10^P*A+0.5)/10^P
190 DEF FNG(A)=INT(10^P*(A+10^-P*0.5))/10^P
200 DEF FNH(A)=INT(10^P*(A+10^-P*0.5)+ABS(A)*E0)/10^P
210 PRINT "INPUT X: ";
220 INPUT X
230 IF X=0 THEN 300
240 PRINT "INPUT P: ";
250 INPUT P
260 PRINT @D1:"NUMBER :";X,"POSITION :";P
270 PRINT @D1:FNA(X),FNB(X),FNC(X),FND(X)
280 PRINT @D1:FNE(X),FNF(X),FNG(X),FNH(X)
290 GO TO 210
300 END
```

Let's take a look at the rounding results of these functions.

FNA/E	FNB/F	FNC/G	FND/H
NUMBER :0.55	POSITION :1		
0.5	0.5	0.5	0.5
0.5	0.5	0.5	0.6
NUMBER :-0.55	POSITION :1		
-0.6	-0.6	-0.6	-0.6
-0.6	-0.5	-0.5	-0.5
NUMBER :0.5	POSITION :0		
0	0	0	0
0	1	1	1
NUMBER :-0.5	POSITION :0		
-1	-1	-1	-1
-1	0	0	0
NUMBER :5	POSITION :-1		
0	0	0	0
0	0	0	10
NUMBER :-5	POSITION :-1		
-10	-10	-10	-10
-10	0	0	0
NUMBER :50	POSITION :-2		
0	0	0	0
0	0	0	100
NUMBER :-50	POSITION :-2		
-100	-100	-100	-100
-100	0	0	0
NUMBER :1.551	POSITION :1		
1.5	1.5	1.5	1.6
1.6	1.6	1.6	1.6
NUMBER :-1.551	POSITION :1		
-1.6	-1.6	-1.6	-1.6
-1.6	-1.6	-1.6	-1.6
NUMBER :1.552	POSITION :1		
1.6	1.6	1.6	1.6
1.6	1.6	1.6	1.6
NUMBER :-1.552	POSITION :1		
-1.6	-1.6	-1.6	-1.6
-1.6	-1.6	-1.6	-1.6
NUMBER :0.5	POSITION :8		
0.49999999	0.5	0.5	0.5
0.49999999	0.5	0.5	0.5

Functions FNA/FNE don't round on positive 0.55, but do round on negative 0.55. FNA doesn't give a true round on +1.551 (here's that internal representation factor). And, for each function, if the number should have eight positions, the result is completely in error.

FNB/FNF don't round on positive 0.55. However, FNF rounds on positive 0.5. FNB rounds on negatives, FNF doesn't. FNB doesn't give a true round on +1.551.

FNC and FNG don't round on positive 0.55, but do on 0.5. FNC rounds on negative 0.55; FNG doesn't. FNC doesn't give a true round on +1.551.

FND doesn't round on positive 0.55, but FND does. FND rounds on negatives, FND doesn't. Both give a true round on +1.551.

To sum it up, for consistent accuracy, use the functions shown in the defined functions FND and FNH.

In this issue are tips from readers for using defined functions. In each of the algorithms, we have inserted the suggested functions above.

## Numerical Roundoff Within a Program

by Seymour Hatch  
CR Industries  
Elk Grove Village, IL

A numerical roundoff procedure may be programmed with a defined function statement for use within a program. The following small routine demonstrates the method.

```

100 REN *** PROGRAM TO DEMONSTRATE
110 REN *** NUMERICAL ROUNDOFF WITH
120 REN *** A DEFINED FUNCTION
130 INIT
140 ED=1.0E-12
150 DEF FNA(A)=INT(10*PI*(A+101-PI*.49)+ABS(A)*E0)/10*PI
160 N=1000*PI
170 PRINT N
180 P=0
190 PRINT P,FNA(N)
200 P=2
210 PRINT P,FNA(N)
220 P=-2
230 PRINT P,FNA(N)
240 P=7
250 PRINT P,FNA(N)
260 END
1800 PRINT "LJJJ"
1810 LIST

RUN
3141.59265359
      0
      3
      -2
      7
      3141.593
      3100
      3141.5926536
  
```

## Numerical Roundoff of Arrays for Display

by James Love  
and Theodore C. Loder, III  
University of New Hampshire  
Durham, NH

Despite the powerful numerical formatting capabilities inherent in the PRINT USING statement, we have often found it simpler to round our final data values to a form suitable for printing. This routine should be used with caution, however, as considerable precision is lost in further calculations involving rounded numbers.

Recall that the PRINT USING statement formats numbers for display purposes only

and the original number is retained with full precision within the memory of the operating system. This is in contrast to the rounding routine that follows. It replaces a full precision array element with a column-specific rounded version whose precision is dependent on its remaining significant figures.

This routine is an alternative display formatting technique which can save programming effort, particularly if a complicated sequence of PRINT USING statements is required to achieve an equivalent result.

```

100 INIT
110 DIM F(R,C),D(C)
120 ED=1.0E-12
130 FOR I=1 TO R
140 RESTORE I70
150 FOR J=1 TO C
160 READ D(J)
170 DATA 2,1,3
180 F(I,J)=INT(10*(D(J)*A(C,I)+
190 101-D(J)*E0.49)+ABS(A(C,I,J))*E0)/10*(D(J)
200 NEXT J
210 END

INPUT AND OUTPUT FILES FOR D(J) OF 2,1,3
A: INPUT FILE

5.2368      3.8417      8.6879
18.8799      9.9999      -5.8781
6.5589      -11.55      2.0E-4

F: OUTPUT FILE

5.24      3.8      8.688
18.88      10      -5.87
6.56      -11.6      0
  
```

## Initializing Random Data Files on the 4907

by Les Rohssler  
American Forest Products  
Martell, CA

After a random data file is CREATED on the 4907, each record must be initialized by writing or printing data such as a blank character string or a numeric zero into each record. This can require a significant amount of time if a program creates and initializes many files, especially if files are lengthy (example 1).

```
100 LIST @51:
110 CALL 'TIME',X$
120 PRINT @51:'JJSTART FILE INIT: ';X$
130 CREATE '@INITFILE.SYS';175,10
140 OPEN '@INITFILE.SYS';1,'F',A$
150 FOR I=1 TO 175
160 WRITE #1,I:0
170 NEXT I
180 CLOSE
190 CALL 'TIME',X$
200 PRINT @51:'JJ END FILE INIT: ';X$
210 END
```

If many of the files created are the same length with the same record length, a faster method can be used. Write one file onto disk for permanent storage as a master initialization file. Whenever the program needs a new random data file, it need only COPY this master initialization file to a new file with the desired file identifier (example 2).

```
100 LIST @51:
110 CALL 'TIME',X$
120 PRINT @51:'JJSTART FILE COPY: ';X$
130 COPY '@INITFILE.SYS',0 TO
    '@DATAFILE.DAT',0
140 CALL 'TIME',X$
150 PRINT @51:'JJ END FILE COPY: ';X$
160 END
```

The routine in example 1 executed on a 4051 takes 32 seconds to initialize a random binary numeric data file 1750 bytes long with 10 byte records on the 4907. The routine in example 2 accomplishes the same results in three seconds!

## NOT Operator Requires Parentheses on 4051

The 4051 requires parentheses around the NOT operator in complex numeric expressions. The examples illustrate the effects.

The expression keyed in without parentheses:

```
190 I1=1*B+N1*NOT(B)
200 I2=N1*B+I*NOT(B)
```

4051 changes it:

```
190 I1=1*B*N1=NOT(B)
200 I2=N1*B*I=NOT(B)
```

The expression keyed in with parentheses:

```
190 I1=1*B+N1*(NOT(B))
200 I2=N1*B+I*(NOT(B))
```

4051 leaves it alone:

```
lis
190 I1=1*B+N1*(NOT(B))
200 I2=N1*B+I*(NOT(B))
```

## WINDOW/VIEWport Coordinate Conversions

by Duke Ganote  
Institut fuer Klinische Pharmakologie  
Bodenheim-am-Berg, FR Germany

Frequently when preparing plots, I have found it necessary to convert from WINDOW (UDU) to VIEWPORT (GDU) coordinates and vice versa, especially when working with labels on plots, or when adjusting the size of letters on the plotter.

Storing the WINDOW coordinates in an array W, and the VIEWPORT coordinates in an array V lets one use the following user defined functions to transform a point from one set of coordinates to the other.

When debugging, it becomes easy to find out the WINDOW and VIEWPORT values. The

V and W array data could be also stored in one DATA statement to conserve memory.

```
100 WINDOW W(1),W(2),W(3),W(4)
110 VIEWPORT V(1),V(2),V(3),V(4)
120 REM
130 REM ** FNA(X) converts X co-ordinate GDUs to UDUs
140 REM ** FNB(Y) converts Y co-ordinate GDUs to UDUs
150 REM
160 DEF FNA(X)=(X-V(1))*(W(2)-W(1))/(V(2)-V(1))+W(1)
170 DEF FNB(Y)=(Y-V(3))*(W(4)-W(3))/(V(4)-V(3))+W(3)
180 REM
190 REM ** FNC(X) converts X co-ordinate UDUs to GDUs
200 REM ** FND(Y) converts Y co-ordinate UDUs to GDUs
210 REM
220 DEF FNC(X)=(X-W(1))*(V(2)-V(1))/(W(2)-W(1))+V(1)
230 DEF FND(Y)=(Y-W(3))*(V(4)-V(3))/(W(4)-W(3))+V(3)
240 REM
250 REM ***** DEFAULT CHARACTER SIZE INTO UDUs
260 REM ***** see Tektronix 'Plot 50' Manual,
270 REM ***** ps 1-52 for default character sizes.
280 REM
290 PRINT 'CHARACTERS ARE ';FNA(1.55);' BY ';FNB(1.88)
```

## GDUs, UDUs, Relative UDUs and You

by Duke Ganote

Institut fuer Klinische Pharmakologie  
Bobenheim-am-Berg, FR Germany

To summarize and extend Herman D'Hondt's suggestion for "Drawing from Data Arrays" and David Yager's "Multiple MOVES/DRAWS In One Line of Code" (both in *TEKniques*, Spring '82, Vol. 6, No. 1), note that secondary addresses 20 and 21 will work for all of the following statements:

```
PRINT @32,Z:1X,Y      GDUs
DRAW/MOVE @32,Z:1X,Y  UDUs
RDRAW/RMOVE @32,Z:1X,Y relative UDUs
```

In all cases, X and Y can be one-dimensional arrays (with Z=20 or Z=21). The follow-

ing program illustrates this by drawing a square three times in the same position using different statements each time.

```
100 INIT
110 DEL S,X,Y
120 DIM S(5),X(5),Y(5)
130 DATA 21,20,20,20,20
140 DATA 60,70,70,60,60
150 DATA 45,45,55,55,45
160 RESTORE 130
170 READ S,X,Y
175 REM ***** GDUs
180 FOR I=1 TO 5
190 PRINT @32,S(I):X(I),Y(I)
200 NEXT I
205 REM ***** UDUs
210 WINDOW 0,260,0,200
220 X=X*2
230 Y=Y*2
240 FOR I=1 TO 5
250 DRAW @32,S(I):X(I),Y(I)
260 NEXT I
265 REM ***** relative UDUs
270 DATA 0,20,0,-20,0
280 DATA 0,0,20,0,-20
290 READ X,Y
300 MOVE @32,21:120,90
310 FOR I=1 TO 5
320 RDRAW @32,20:X(I),Y(I)
330 NEXT I
```

The principle advantage of using the PRINT statement is that the data pairs could be expressly put in for a sequence of DRAWS, for example:

```
335 REM ***** EXPLICIT GDU DATA PAIRS
340 INIT
350 PRINT @32,21:60,45
360 PRINT @32,20:70,45,70,55,60,55,60,45
```

I hope this clarifies the connection between the two aforementioned Programming Tips.

## 4662 Plotter Joystick Replaces Optional Joystick

by Jerry Steiner  
and John Tria

The Ohio State University  
Columbus, OH

During data analysis we indicate points of interest on our 4051 graphic display by moving a cursor across the display to the desired point. A GIN command then acquires the UDU coordinates for that point.

We have seen two other methods that move a cursor across a graphic display. One method uses the User-Definable Keys and exact placement of the cursor can be difficult. The second method uses the 4952 joystick and is quite easy to use. In our technique, a small subroutine and the joystick on the 4662 plotter replace the 4952 Joystick and the POINTER command.

This sample program sets up a box and asks two questions that require movement of the cursor. When control transfers to the pointer subroutine, the pen coordinates on the 4662 are GINNed and the 4051 cursor is moved to those coordinates where a flashing arrowhead is displayed. This loop is repeated allowing the 4051 to mimic the movement of the 4662 pen until an SRQ is issued from the 4662 <CALL> key. The SRQ command on line 280 transfers control to line 360, which POLLS the 4662. Line 370 resets the SRQ on the bus. Line 380 prints an arrowhead at the point chosen. Line 400 returns control back to the point at which the interrupt occurred. The loop is now broken because the condition  $Q < > -1$  is valid.

The two main keys to this program are the mimicking of the 4662 by the 4051 and the

forced SRQ that terminates the mimicking routine. 

```
100 INIT
110 PAGE
120 VIEWPORT 30,100,30,70
130 AXIS 0,0
140 AXIS 0,0,130,100
150 INIT
160 PRI "USE JOY STICK ON 4662 PLOTTER TO
MOVE ARROW AND THEN HIT 4662"
170 PRINT "2 <CALL> I KEY TO ENTER THE POINT."
180 PRINT "find upper right corner coordinates (actual:100,70)"
190 GOSUB 250
200 PRINT "I_I_I_J_J_"X;Y
210 PRINT "find lower left corner coordinates (actual:30,30)"
220 GOSUB 250
230 PRINT "I_I_I_J_J_"X;Y
240 END
250 REM..... POINTER SUBROUTINE.....
255 REM SET GRAPHIC FONT. D=PLOTTER PRIMARY ADDRESS
260 D=2
270 PRINT @32,18:5
280 ON SRQ THEN 360
300 Z=-1
310 GIN @D:X,Y
320 IF Z<>-1 THEN 400
330 MOVE X,Y
340 PRINT @32,24:""
350 GO TO 310
360 POLL A,B,D
370 INPUT @D,27:X,Y,Z
380 PRINT @32:"IG_"
390 RETURN
400 REM SET US FONT
410 PRINT @32,18:0
420 RETURN
```

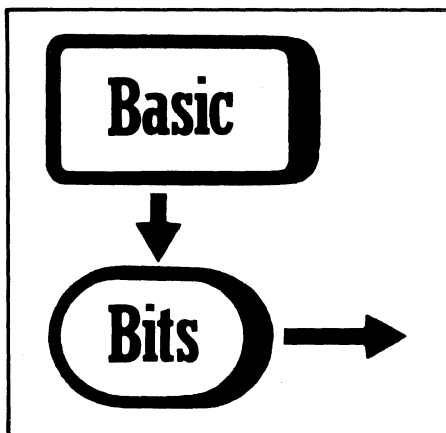

## Convert UDUs to GDUs

by Robert A. Thomson  
University of Dayton  
Dayton, OH

In *TEKniques*, Vol. 6, No. 1, Spring 1982, page 20, there is a Basic Bit titled "Multiple MOVES/DRAWS In One Line of Code." There is an Editor's Note appended which points out that this only works with graphic display units. I ran into the problem when using our Tektronix 4052 to drive a Nicolet Zeta pen plotter. My solution was to write two subroutines which convert X and Y coordinates in user data units to GDUs. These subroutines are:

```
S9=(V2-V1)/(W2-W1)
X=(X-W1)*S9+V1
S9=(V4-V3)/(W4-W3)
Y=(Y-W3)*S9+V3
```

where V1-V4 are the viewport parameters, and where W1-W4 are the window parameters in user data units.

A loop can be used to convert an array of data to GDUs using these subroutines, and then Professor Yager's PRINT statements will work properly. 

Editor's Note: Keep in mind that no clipping occurs if the GDUs are outside the window.

# IDD Applications Library Programs

## Ordering

### 4050 Series

The 4050 Series programs included in the Applications Library prior to September 1981 are packaged and nomenclated by function. Those programs accepted into the Library after September 1981 are packaged and nomenclated with the Volume and Number of the corresponding issue of **TEKniques** in which the package was announced.

Each package includes the source code on tape or disk (T=tape; D=disk) together with the supporting documentation; listings are not

included in the documentation. Documentation may be purchased separately.

The 4050 Series Applications Library Programs catalog contains the abstracts describing the programs in each package along with representative output in most cases. The catalog part number is **062-6343-00**.

Package Title	Documentation Part #	Package Part #
Business Aids T1	062-5987-00	062-5987-01
Business Aids T2	062-5988-00	062-5988-01
CAD T1	062-5976-00	069-5976-01
CAD D1	062-5977-00	062-5977-01
Character Generator T1	062-5951-00	062-5951-01
Education/Research T1	062-5982-00	062-5982-01
Education/Research T2	062-5983-00	062-5983-01
Electrical Engineering T1	062-5978-00	062-5978-01
Graphing T1	062-5964-00	062-5964-01
Graphing T2	062-5965-00	062-5965-01
Graphing T3	062-5966-00	062-5966-01
Graphing D1	062-5967-00	062-5967-01
Graphing D2	062-5968-00	062-5968-01
Interfacing T1	062-5984-00	062-5984-01
Mapping T1	062-5980-00	062-5980-01
Mechanical Engineering T1	062-5979-00	062-5979-01
Programming Aids T1	062-5971-00	062-5971-01

Package Title	Documentation Part #	Package Part #
Programming Aids T2	062-5972-00	062-5972-01
Project Aids T1	062-5985-00	062-5985-01
Project Aids D1	062-5986-00	062-5986-01
Recreational Plots T1	062-5989-00	062-5989-01
Slidemaker T1	062-5962-00	062-5962-01
Slidemaker D1	062-5963-00	062-5963-01
Text Processing T1	062-5969-00	062-5969-01
Text Processing D1	062-5970-00	062-5970-01
Utilities T1	062-5974-00	062-5974-01
Utilities D1	062-5975-00	062-5975-01
Tekniques Vol. 5 No. 4 T1	062-5981-00	062-5981-01
Tekniques Vol. 6 No. 1 T1	062-6443-00	062-6443-01
Tekniques Vol. 6 No. 1 D1	062-6442-00	062-6442-01
Tekniques Vol. 6 No. 2 D1	062-6515-00	062-6515-01
Tekniques Vol. 6 No. 3 D1	062-6516-00	062-6516-01
Tekniques Vol. 6 No. 3 T1	062-6514-00	062-6514-01
Tekniques Vol. 6 No. 4 T1	062-6704-00	062-6704-01

### 4110 Series

As 4110 Series program packages become available, they will be announced in **Tekniques**. A catalog will be published when a sufficient number of packages are collected.

### U.S. Orders

The field office has the current prices.

Order IDD Applications Library programs through the toll-free number of Tektronix Central Parts Ordering. The following map delineates the geographical regions and the toll-free number serving each region.

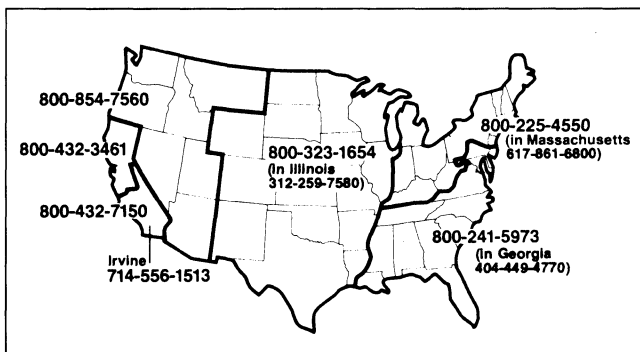

Call the number serving your area and give the customer service representative the nine-digit part number and name of the Applications Library program you wish. If you have any questions, call your local Tektronix Field Office.

### Orders Outside U.S.

To order a copy of the catalog, or to order a package, contact the local Tektronix sales office or one of the Libraries serving your area. See Library Addresses section of **TEKniques**.

### Program Contributions

Contribute one program to the Applications Library and receive the package of your choice in exchange. Send in the membership card from your 4050 Series Graphic System Reference Manual to get the details. In the U.S., you may call us at (503) 685-3618. Outside the U.S., call your local Tektronix sales office or your Applications Library. See Library Addresses section of **TEKniques**.

### Software Support Category C

The program material contained herein is supplied without warranty of any kind, and without any representation regarding quality, performance or suitability. **TEKTRONIX** specifically disclaims any implied warranties of merchantability of fitness for a particular purpose. Software support is **TEKTRONIX** Category C: Software is provided on an "as is" basis.

# TEKniques Vol. 6 No. 4 T1

## Part #062-6704-01

TEKniques Vol. 6 No. 4 T1 tape consists of 17 programs: two CAD, four Education/Research, three Graphing, two Interfacing, one Mechanical Engineering, two Programming Aids, one Recordkeeping, one Text Processing, and one Utility.

Four of the programs must be transferred to their own dedicated tapes. Complete instructions for accomplishing the transfers are included in the documentation.

The individual abstracts describe the programs.

### Program 1

**Title:** 4052A/54A Assembler  
**Author:** Ed Post  
Tektronix, Inc.  
Wilsonville, OR  
**Memory Requirement:** 64K  
**Files:** 1 ASCII Program  
**Statements:** 600

A CALL "EXEC" routine has been added to the 4052A and 4054A Series Graphics Systems to allow users to execute programs written in 6800 machine code. Extensions allow access to the enhanced A-series instruction set.

This program is an assembler written in 4052A/54A extended BASIC which will read an assembly language program from a tape/file, assemble it (generating relocation information as well), then store the object code in another file for later execution.

Any of the editors available in the Applications Library, or the 4052R06 Editor ROM pack, can be used to create an assembly program in a file.

This assembler program will prompt for the input file of the assembly program and the output file on which to store the object code. A listing will also be displayed on the screen with any syntax errors listed below the erring line of code. A symbol table is produced after the completed listing, showing all absolute and relative labels generated.

This is not meant to be a production assembler. It's missing several features commonly available in assemblers such as expressions, ASCII constants, decimal and octal modes.

It assembles about two lines of code a second. It does, however, document the command format for "EXEC", give some idea of the format of the extended opcodes designed into the 4052A/54A bit-slice processor, and really work.

Users who experiment with "EXEC", however, will undoubtedly crash the firmware regularly until they figure out what they are doing.

NO SUPPORT BY TEKTRONIX IS IMPLIED OR WILL BE PROVIDED.

Included in the 4052A/54A Assembler documentation is the complete description of all new instructions in the "A" instruction set, and a listing of "entry points" to system firmware routines. The user will also need the *M6800 Programming Reference Manual* published by Motorola, Inc.

*The program material contained herein is supplied without warranty of any kind, and without any representation regarding quality, performance or suitability. TEKTRONIX specifically disclaims any implied warranties of merchantability or fitness for a particular purpose. Software support is TEKTRONIX Category C: Software is provided on an "as is" basis.*

### Program 2

**Title:** 4050A TECO  
**Author:** Ed Post  
Tektronix, Inc.  
Wilsonville, OR  
**Memory Requirement:** 32K "A" Series  
**Files:** 1 ASCII Program  
**Statements:** 750

For those of you Real Programmers that think TECO is the only REAL text editor, there now exists one that runs on the 4052A and 4054A. This TECO implements most of the commands available in common versions running on DEC time sharing systems, and is capable of editing files on

tape, disk, or extended memory. Numeric and string 'Q' registers are available, and Q registers can be run as Macros. The combination of TECO, the 4050A assembler, and the extended memory option makes creation and testing of assembly language programs convenient.

### Program 3

**Title:** Printed Circuit Board Layout  
**Author:** Franz Reiter  
Rohde & Schwarz - Tektronix  
Austria  
**Memory Requirement:** 4054 Opt. 30, 64K  
**Peripherals:** 4663 Plotter  
**Files:** 1 Binary Program  
1 Data File (example)  
**Statements:** 844

Design the printed circuit board on the 4054 screen. Define symbols of up to 50 solder-tags for quick duplication. All lines and solder-tags are in the standard grid (DIP size, 2, 54 mm) or in half grid. Design two layers at once, one drawn in dashed lines on the screen or with the second pen on the plotter. Redraw just Layer 1 or Layer 2 or just all solder-tags or the whole drawing. Full zooming of any board section, no restriction of board size. Delete any line, solder-tag or symbol for correction. The standard line is 0.3 mm broad, any other value selectable. The standard solder-tap has a diameter of 1.5 mm, any other value selectable.

Plot the drawing on foil in any desired scaling. Generate your copper board now with an ultraviolet-sensitive lacquer or make a printing-foil of it. Store the drawing on tape. Retrieve the drawing, delete and add as you need, make a new plot and store again.

A program for listing coordinates of all the holes on a printer or on a paper tape punch on request. Data output for a light-plotter (direct to plotter, to paper tape or to tape) on request.

### Program 4

**Title:** Pipe Construction  
**Memory Requirement:** 16K  
**Peripherals:** Optional-4662/3 Plotter  
**Files:** 1 ASCII Program  
**Statements:** 290

This program illustrates the use of graphics in a mechanical engineering or construction area.

The program calculates and makes a scale drawing of two pipes connected together at any angle between 0° to 45°, giving inside and outside dimensions, wall thickness and bell diameter. Required inputs are pipe diameter, pipe lengths and bend angle. Measurements returned are in standard form, i.e., wall thickness is the standard size for the pipe diameter.

This program will draw on the 4050 screen or the plotter.

This particular program is used in a pipe prefabrication plant and gives the designer a graphic representation of the final product as well as supplying him with all measurements in standard pipe sizes.

### Program 5

**Title:** Moment of Inertia Optimization  
**Authors:** Khiem Ho  
George I. Tzitzikalakis  
Columbia University  
New York, NY  
**Memory Requirement:** 32K  
**Peripherals:** Optional-4662/3 Plotter  
**Files:** 1 ASCII Program  
**Statements:** 648

This program plots Moment-of-Inertia curves for six types of cross-sections: square, rectangle, solid circle, hollow circle, I-beam and hollow circular sector.

For plots with two independent variables, the user may select which variables will be on the X-axis and which on the Z-axis.

For a plot with more than two independent variables, the user may select which variable(s) will be constant(s) for the plot, so that there are only two independent variables at a time.

Discrete values of the plot are given if the user elects to have them.



#### Program 6

**Title:** FFT of 2048 Real Numbers  
**Author:** Piere Thore  
L.A.G.A.S.  
Roubault, France  
**Memory Requirement:** 4052/4 56K  
**Peripherals:** 4052R08 FFT ROM  
**Files:** 1 ASCII Program  
**Statements:** 38

This routine should be considered a subprogram of a master program that must compute the G array then lead to the computation of FFT through a GOSUB.

The routine performs FFT of an array of 2048 real numbers. It provides the result in the same G array, under the same format as after a ROM pack computing. The computation lasts 30 seconds.

#### Program 7

**Title:** IFT of 1024 Complex Numbers  
**Author:** Piere Thore  
L.A.G.A.S.  
Roubault, France  
**Memory Requirement:** 4052/4 56K  
**Peripherals:** 4052R08 FFT ROM  
**Files:** 1 ASCII Program  
**Statements:** 77

This routine should be considered a subprogram of a master program.

It performs the reverse operation with the same I/O formats as Program 6 of this tape.

The processing time is one minute.

#### Program 8

**Title:** Newton Integration and Plot  
**Author:** J.E. Jobaris  
U.S. Postal Service  
San Bruno, CA  
**Memory Requirement:** 16K  
**Files:** 1 ASCII Program  
**Statements:** 256

This program uses the Newton (sometimes called the Newton-Rhapson) method to solve an equation of two variables for which no direct or easy solution is available. The Newton method iterates the following equation:

$$X_{n+1} = X_n - F(X_n)/F'(X_{n+1}) \quad n=0, 1, \dots$$

until the term  $F(X_n)/F'(X_{n+1})$  has no effect on the last decimal place of accuracy as specified by the user.

An optional plot can be produced within the range of the independent variable as input by the user. The plot of the function can be produced with or without the root of the equation. The plot with the solution uses dashed lines whose intersection represents a root. Because the Newton method calculates only one root, the intersection of the horizontal dashed line and the function plot indicates other solution points.

The equation, its first derivative, and the value of the equation at which a solution is required are entered at specified lines in the program.

#### Program 9

**Title:** Bauer-Reinsch Inversion  
**Author:** Roger P. Denlinger  
USGS  
Lakewood, CO  
**Memory Requirement:** 16K  
**Files:** 1 ASCII Program  
**Statements:** 56

A modification of the Gauss Jordan algorithm solves the linear problem  $Ax = b$  where A is a positive definite symmetric matrix. The working storage needed is only the matrix itself, since the inverse is overwritten on the original matrix.

Matrix A must be computationally positive definite.

#### Program 10

**Title:** 4050-4010 Utilities  
**Author:** Ed Sawicki  
Tektronix, Inc.  
Wilsonville, OR  
**Memory Requirement:** 16K  
**Peripherals:** 4010 Graphics Terminals  
**Files:** 2 ASCII Programs  
**Statements:** 300

This is a package of routines for driving 4010 family terminals from a 4050 Graphics System. The routines are written in 4050 BASIC and are organized as callable subroutines.

Most of the routines perform conversion from 4010 style data to decimal data (or vice-versa) which can be manipulated easily by a user-written mainline program. Each routine is well documented with a banner preceding the actual code. The banner lists subroutine entry and exit requirements as well as temporary (scratch) variables used.

A sample program is included.

#### Program 11

**Title:** TELEX  
**Author:** Ruud Borstel  
Tektronix, Inc.  
Amstelveen, The Netherlands  
**Memory Requirement:** 16K  
**Peripherals:** Opt. 1 Data Comm. I/F  
RS-232 Paper Tape Punch  
Optional-4641/3 Printer  
**Files:** 1 ASCII Program  
**Statements:** 301

This program creates telex code paper tapes. As a source of data, it will use files from the internal cartridge tape. These files (containing ASCII data) can be produced by other programs (e.g., MATRIX package). This makes it possible to put (computer generated) data on a telex without human interference.

#### Program 12

**Title:** Data Chart  
**Author:** Hayward Hulick  
U.S. Army  
New Cumberland, PA  
**Memory Requirement:** 32K  
**Peripherals:** 4662/3 Plotter  
Optional-4907 File Manager  
**Files:** 1 ASCII Program  
**Statements:** 869

Displaying a graph with its tabular data gives this program a unique touch. Menu driven, the program plots a graph with corresponding data shown in formatted tabular form below.

Up to four curves, eight curve styles — 4 lines, 4 bar, or not plotted — and negative or positive data may be plotted. The scale, scale interval, X-axis label, and four title headings are user specified. Up to 15 periods on the X-axis with auto or user specified labels.

Chart files may be stored on a mounted disk, marked tape or both. The chart is plotted on the plotter and allows the user to change pen colors for each curve.

#### Program 13

**Title:** SDBAR  
**Author:** Leland C. Sudlow  
Purdue University  
West Lafayette, IN  
**Memory Requirement:** 8K  
**Peripherals:** 4662/3 Plotter  
**Files:** 2 ASCII Programs  
**Statements:** 194

SDBAR is a short program which will draw Standard Deviation bars on multiple line graphs that have been previously generated from any source.

Through the joystick on the plotter, the user defines the graph area. The

program prompts for the values to define the window then previews the width of the crossbar on the 4050 screen. The user may choose to increase or decrease this width.

Using the joystick the user indicates the point locations then keys in the standard deviation around the point. The program will draw the standard deviation lines up, down, or both.

#### Program 14

**Title:** 4050/468 Utility III  
**Author:** Craig Bulmer  
Tektronix, Inc.  
Chicago, IL  
**Memory Requirement:** 64K  
**Peripherals:** Tektronix 468 Oscilloscope  
4052R07/4052R08 ROMS  
**Files:** 1 ASCII Program  
Requires dedicated tape  
**Statements:** 1257

This program is similar to 4050/468 Utility II (in *TEKniques* Vol. 6 No. 1 T1 tape) with additional features. The addition of these functions was at the cost of plotter support.

The program will take waveforms from the 468 Oscilloscope and display the waveforms on the 4050 screen; with printed header information of Channel 1, 2 and/or Add; Volts/Div; Time/Div; Trigger Point; Max Volts; Min Volts; Min/Max Pulse Parameters; Histogram Pulse Parameters; Integrate Waveform; Differentiate Waveform; FFT; and Waveform Analysis.

Added functions will multiply waveforms (channel 1  $\times$  channel 2 waveform stored in Add channel); Lissajous pattern (channel 1 vs. channel 2), and waveform cursors on 4052 display with analysis of data between cursors. (Cursors are moveable with constant readout of both cursors' voltage and time from start of sweep and delta time and voltage between cursors.)

#### Program 15

**Title:** Inventory Control  
**Author:** Larry E. Davis  
Tektronix, Inc.  
St. Louis, MO  
**Memory Requirement:** 32K  
**Peripherals:** 4052R06 Editor ROM  
Optional-4641/3 Printer  
**Files:** 4 ASCII Programs  
**Statements:** 319

This is a simple, but quick, program to track approximately 465 11-digit (including hyphens, i.e., 670-4289-01) part numbers to control the inventory.

Each item is stored and listed by PART #, MODEL-DESCRIPTION and LOCATION. The entire inventory can be sorted or listed by any of these.

Five functions included are:

- Add
- Alter
- Locate
- List
- Sort

#### Program 16

**Title:** Flowcharter II  
**Author:** Richard G. Meitzler  
USN  
San Francisco, CA  
**Memory Requirement:** 32K  
**Files:** 5 ASCII Programs  
**Statements:** 1168

This program will flowchart any 4050 BASIC program stored in ASCII. The first pass of the program builds a branch table, a FOR...TO table and a NEXT table.

The second pass matches the FOR...NEXT statements in the two tables.

The third pass draws the actual flowchart using standard ANSI symbols.

The page number, starting and finishing line numbers are printed at the bottom of each page.

The user may store the program being analyzed and the results of the first two passes on tape.

Program limitations: 500 branches  
200 FOR statements  
200 NEXT statements

Program limitations: Output to screen

#### Program 17

**Title:** Friendly Graphing  
**Author:** Paul Howard  
Tektronix, Inc.  
Wilsonville, OR  
**Memory Requirement:** 4052/54 56K  
**Peripherals:** Optional-4662/63 Plotter  
-4641/43 Printer  
**Files:** 1 ASCII Program  
1 Binary Program  
1 ASCII Text  
Requires Dedicated Tape  
**Statements:** 1767

Friendly graphing allows a 4052/54 user to easily create, modify, save, copy or draw graphs. Defaults, automatic tape marking and graph directory maintenance mean a user needs minimal 4052/54 experience.

Similar to Data Graphing (Graphing T3 062-5966-01), Friendly Graphing adds some features.

Four Graphs may be plotted on one page, with up to six curves and 52 events per graph.

In addition to the normal curve display types, a triline (triangle with dot) has been added for point plotting.

Data sources include those specified in Data Graphing plus running average, moving average, difference of two previous curves, and % of two previous curves.

Enhancing the graph design choices of Data Graphing are a zoom on events and/or curves, and a grid on both axes. Three labels with one designated as free (placed anywhere on the graph) annotate the graph. A right Y-axis aids in comprehension.

Editing has been expanded to insert data at any point, delete an event from all curves and add a new curve in any sequence.

Utility functions maintain the tape files. Curves or graphs may be saved and recalled from tape (up to 30 per tape). A new Friendly Graphing tape may be automatically produced. And graphs stored on a Friendly Graphing tape may be transferred to another Friendly Graphing tape facilitating data base exchange. The Graph/Curve Directory is automatically maintained.

For those users with the 4662 Option 31 (8-pen) Plotter, Friendly Graphing provides for different pen colors. 

# 4050 Series Program Updates

## Package/Program/File

062-6443-01/*TEKniques* Vol. 6 No. 1 T1  
Program 1/4907 to 4909 File Transfer and  
Conversion Utility Documentation

The source code for this program was updated prior to its release in the *TEKniques* tape. Unfortunately, the old instructions were included in the documentation package.

Those of you who have received this tape and require the updated 4907 to 4909 File Transfer instructions, please call (503) 685-3618 (or write to the address noted on page 2) to receive a new set. The current set will carry the date of November, 1982, to identify it from the outdated set which carries a date of February, 1982. 

---

# IDD Graphic Displays and Computing System Publications

The following is a summary of all current manuals related to IDD products.

The manuals may be ordered through the Tektronix Central Parts Ordering office serving your area. See page 25 for the map and numbers.

## Key to Titles

Operator's = operation instructions for hardware product

Service = maintenance information

Instruction = operation and maintenance combined

User's = operation instructions for software product

Reference = programmable features

## 4010 Series Computer Display Terminals

### Standard

4006-1 User's	070-1891-00
4010/4010-1	070-1225-00
4012 User's	070-1460-00
4014 User's	070-1647-00
4015 User's	070-1649-00
4016-1 Operator's	070-2660-00
Data Communications	070-1458-00

### Service

4006-1	070-1892-01
4010/4010-1	070-1183-02
4012	070-1461-01
4014/4015 <B05XXXX	070-1648-00
4014/4015 >B05XXXX	070-2303-00
4016	070-2661-00

### Interface

RS-232	070-2188-00
DEC PDP-11/KL-11	070-1354-00
Data General	070-1356-00
GPIB	070-2668-01
GPIB Reference Card (Level 3)	070-3463-00
HP2100 Series	070-1355-00
DEC PDP-11/DL-11/11-05	070-1592-00
DEC PDP-8/E	070-1451-00
2741 Correspondence Code	070-2280-00
Display Multiplexer	070-1992-00

### Miscellaneous

Programmable Keyboard	070-2487-00
Programmable Keyboard Card (Level 3)	070-3463-00
Symbol & Character Generator	070-2487-00
Symbol & Character Generator Card (Level 3)	070-3463-00

## 4020 Series Computer Display Terminals

### Standard

4025A Operator's	070-4170-00
4025A Programmer's Reference	070-4172-00
4025A Reference Card	070-4174-00
4027A Operator's	070-4171-00
4027A Programmer's Reference	070-4173-00
4027A Reference Card	070-4175-00

### Service

4025A Vol. 1	070-4167-00
4025A Vol. 2	070-4168-00
4027A Vol. 1	070-4169-00
4027A Vol. 2	070-4176-00

### Interface

Current Loop	070-2519-01
RS-232	070-2520-01

GPIB	070-2521-01
Half-Duplex	070-4224-00

### Miscellaneous

4025A Character Set Expansion	070-2523-01
4025A French Keyboard	070-4226-00
4025A Swedish Keyboard	070-4227-00
4025A Keyboard Graphics Input	070-4501-00
4027A Character Set Expansion	070-3430-01
4027A French Keyboard	070-4228-00
4027A Swedish Keyboard	070-4225-00
Math Character ROM Instruction	070-2525-01
Rulings Character ROM Instruction	070-2524-01
United Kingdom Keyboard	070-2943-01

## 4110 Series Computer Graphics Terminals

### Standard

4112 Operator's	070-3683-00
4112 Host Programmer's	061-2565-00
4112 Intro Brochure	070-3682-00
4113 Operator's	070-4222-00
4113 Host Programmer's	061-2616-00
4113 Intro Brochure	070-4221-00
4114 Operator's	070-3673-00
4114 Host Programmer's	061-2564-00
4114 Intro Brochure	070-3672-00
4110 Command Reference	061-2566-02

### Service

4112 Vol. 1	070-3817-00
4112 Vol. 2	070-3819-00
4113 Vol. 1	061-2617-00
4113 Vol. 2	061-2618-00
4113 Display	070-4275-00
Low Voltage Power Supply	070-3732-00
4114 Vol. 1	070-3820-00
4114 Vol. 2	070-3818-00
4114 Color Enhanced Refresh	061-2511-00
Opt. 30 Desk Configuration	070-4264-00
3 PPI	070-3815-00
Flexible Disk	070-3812-00

### Options

3 PPI Installation Instruction	070-4203-00
Graphics Tablet Instruction	070-3814-00
Flexible Disk Instruction	070-2504-01
4113F12 External Video Instruc	070-4403-00

## PLOT 10 Software

### 4010A01 Terminal Control System

Installation Guide	070-4192-00
Verification User's	070-2266-00
Systems	070-2242-00
User's	070-2241-00
Reference Card	070-4166-00

### 4010A02 Advanced Graphing II

Installation Guide	070-4191-00
User's	070-2244-00
Reference	070-2245-00
Reference Guide	070-3650-00

### 4010A03 Interactive Graphing Package

Installation Guide	070-4197-00
User's	070-2247-00
Reference Card	070-2101-01

### 4010A04 Preview Routines for CalComp Plotters

Installation Guide	070-4196-00
User's	070-2378-00

### 4010A05 Character Generation System

Installation Guide	070-4195-00
User's	070-2251-00
Reference Card	070-1869-02

### 4010A06 Graphics Tablet Utility Routines

Installation Guide	070-2252-00
User's Manual	070-2253-00

### 4010A10 Terminal Control System (for IBM TSO)

Installation Guide	070-4194-00
Verification User's	070-2266-00
User's	070-2241-00
System	070-2242-00
Reference Card	070-4166-00

### 4010A14 Intelligent Graphics Enhancement Routines

User's	070-4193-00
--------	-------------

### 4010A15 TCS/IGL Bridge

Reference	070-4358-01
Installation Guide	070-4357-00

### 4662A01 Utility Routines

User's	070-2102-02
Verification Routines User's	070-2161-01
Reference Guide	070-4166-00
Installation Guide	070-4200-01

### 4663A01 Utility Routines

User's	070-2843-01
Verification Routines User's	070-4201-00
Reference Guide	070-4166-00
Installation Guide	070-4199-01

### B Series Easy Graphing

Installation Guide	070-3979-00
Non-Color System	070-2483-00
Non-Color User's	070-2484-00
Non-Color Reference Card	070-2485-01
Color System	070-2780-00
Color User's	070-2779-00
Color Reference Card	070-2755-00

### 4010B01 Installation Guides (paper tape)

Opt. 2 DEC PDP-11/RXS-11/RT-11	070-3977-00
Opt. 8 HP 3000/MPE	070-2602-00

### 4010B02 Installation Guides (punched cards)

Opt. 5 Univac/Exec-8	070-3975-00
Opt. 6 Honeywell 6000/GCOS	070-3980-00
Opt. 7 CDC/NOS/KRONOS	070-3981-00

### 4010B03 Installation Guides (mag tape)

Opt. 1 IBM 360/370/TSO	070-3978-00
Opt. 3 DEC 10/20/TOPS	070-3976-00
Opt. 9 VAX/VMS	070-4365-00

### 4010B04 Installation Guide (hard disk)

DEC/RSK-11/RT-11	070-3977-00
------------------	-------------

### 4010B05 Installation Guide (punched cards)

Opt. 1 IBM 360/370 TSO	070-3978-00
------------------------	-------------

### 4010C01 Interactive Graphics Library (Level 4)

User's	070-4482-00
Installation	070-4509-00
System	070-2676-00
Reference Guide	070-2686-02
I/O Routines Installation Guides	
Opts. 0A/0B IBM 360/370/TSO	070-4425-00
Opt. 0C IBM/VM/CMS	070-4400-00
Opt. 0D Prime 350-850/Primos	070-4399-00
Opt. 0E CDC/NOS	070-4426-00
Opt. 0F Perkin-Elmer 3200/OS/32	070-4398-00
Opt. 0G Univac/1100 EXEC	070-4427-00
Opt. 0J DEC 10/20/TOPS	070-4585-00
Opt. 0K DEC PDP-11/RXS-11M/VAX/VMS	070-4429-00
Opt. 0N HP 3000	070-4430-00
Standard Configurations	
4662/3 Plotter User's	070-4483-00
Segments User's	070-4485-00
Special Feature Escapes User's	070-4484-00
3-D Graphics Support User's	070-2967-01

### 4010C02 Preview Routines

Installation Guide	070-4338-00
User's	070-4339-00

## 4050 Series Graphic Computing Systems

### Standard

Operator's Reference 070-1940-02  
Reference Guide 070-2056-01  
Intro to Programming in BASIC 070-2142-02  
Intro to Graphic Programming 070-2058-01  
4052A/54A Programmer's Reference 070-2059-01  
Firmware Instruction Sheet (5.1 & 1.1) 070-4383-00  
070-4459-00

### Service

4051  
Vol. 1 Service 070-2065-00  
Vol. 2 Service 070-2286-01  
067-0962-00 ROM Pack Instruction 070-2988-00  
067-0746-00 Test Fixture Instruction 070-2304-00  
4052/54 (incl "A" enhancements)  
4052 Parts and Schematics 070-2829-01  
4054 Parts and Schematics 070-2839-03  
4052/54 Technical Data 070-2840-03  
4054 Dynamic Graphics Service 070-2601-01  
4052/54 Extended Memory Service 070-4384-00  
4052/54 067-0900-01 Diagnostic ROM Pack Instruction 070-2750-00  
4052/54 067-0902-00 System Test Fixture Instruction 061-2224-00  
4052/54 067-0942-00 Personality Board Instruction 070-4154-00  
4054 Dynamic Graphics 067-0943-00 Personality Board Instruction 061-2222-00  
067-0969-00 Tape Head Alignment Module Instruction 070-3385-00

### Options

4054 Dynamic Graphics Operator's Reference Guide 070-2289-00  
070-2586-00  
4052F02 4-slot ROM Instruction 070-2987-00  
4052/54 Extended Memory (Incl in 4907 Operator's) 070-2380-02

### ROM Pack

4050E01 ROM Expander Instruction 070-3833-00  
4051R01 Matrix Function Instruction 070-2127-00  
4051R05 Binary Program Loader Operator's 070-2171-00  
4050R06 Editor Operator's 070-2170-01  
4050R07 Signal Processing Instruction 070-2557-00  
4050R08 Signal Processing (FFT) Instruc 070-2841-00  
4050R09 Real Time Clock Instruction 070-3415-00  
4050R10 (4909) Instruction 070-3996-00  
4050R10 (4909) Reference Guide 070-3995-00  
4052R11 Character and Symbol Instruct 070-3794-00  
4052R11 Character and Symbol Guide 070-4248-00  
4050R14 GPIB Enhancement Instruction 070-4316-00  
4050R14 GPIB Enhancement Guide 070-4315-00

### Interface

4050 Option 1 Data Communications 070-2066-02  
4050 Option 10 RS-232 Printer Interface 070-2908-00  
GPIB Hardware Support 070-2270-00  
GPIB Application Support 070-2307-00  
GPIB Programming Guide 070-3985-00

### PLOT 50 Software

4050A01 Statistics Vol. 1 User's 070-2809-00  
4050A02 Statistics Vol. 2 User's 070-2810-00  
4050A03 Statistics Vol. 3 User's 062-1856-00  
4050A04 Mathematics Vol. 1 User's 070-2776-00  
4050A05 Mathematics Vol. 2 User's 070-2777-00  
4050A06 Electrical Engineering Vol. 1 User's 062-2280-00  
4050A07 Graph Plot User's 070-2288-01  
4050A08 General Utilities Vol. 1 User's 070-2287-01  
4050A09 Business Planning and Analysis Vol. 1 User's 070-2226-01  
4050A10 Statistics Vol. 4 User's 070-2214-00  
4050A11 Business Planning and Analysis Vol. 2 (tape) User's 070-2290-00  
4050A12 Business Planning and Analysis Vol. 2 (disk) User's 070-2888-00  
4050A16 Presentation Aids Vol. 1 (tape) User's 070-3766-00  
4050A17 MicroPERT (tape) User's 061-2478-00  
4050B01 Modeling and Reporting System (disk) User's 070-2673-01  
4050B01 Modeling and Reporting System (tape) User's 070-2544-00

4050D01 Easy Graphing Vol. 1 User's 070-2936-00  
4050D01 Easy Graphing Vol. 1 Card 070-2935-01  
4050D02 Statistics-Tests and Distributions-User's 070-3431-00  
4050D03 Statistics-Analysis of Variance-User's 070-3703-00  
4050D04 Statistics-Multiple Linear Regression-User's 070-3702-00  
4050D05 Statistics-Nonlinear Regressions-User's 070-3987-00  
4054D06 Picture Composition User's 070-3701-00  
4054D06 Picture Composition w/4909 User's 070-4394-00  
4052D07 Interactive Digitizing User's 070-3763-00  
4052D07 Interactive Digitizing w/4909 User's 070-4395-00  
4054D08 2-D Drafting User's 070-3796-00  
4054D08 2-D Drafting w/4909 User's 070-4401-00  
4052D10 Document Preparation User's 070-3764-00  
4052D10 Document Preparation Guide 070-3849-00  
4050D11 MicroPERT (disk) User's 061-2459-00  
PLOT 50 Applications w/4909 User's 070-4401-00

### 4600 Series Hard Copy Units

#### Standard

4611 Operator's 070-3450-00  
4612 Operator's 070-3452-00  
4631 User's 070-1830-01  
4632 User's 070-1660-02  
4634 User's 070-3636-00  
**Service**  
4611 070-3449-00  
4612 070-3451-00  
4631 070-1831-02  
4632 070-1686-04

#### Options

4611 Video Multiplexer Instruction 070-4128-00  
4612 Video Multiplexer Instruction 070-4127-00  
4632 Enhanced Grey Scale User's 070-2063-01

### 4600 Series Printers

#### Standard

4642/4642-1 Operator's 070-2486-01  
4643 Operator's 070-3871-00

#### Service

4642/4642-1 070-2489-01  
4643 070-3870-00

### 4600 Series Interactive Digital Plotters

#### Standard

4662 w/Opt. 31 Operator's 070-4165-00  
4662 w/Opt. 31 Programmer's Reference 070-4164-00  
4662 w/Opt. 31 Programmer's Guide 070-2556-01  
4663 Operator's 070-3807-00  
4663 Programmer's Reference 070-3806-00  
4663 Programmer's Guide 070-2828-01

#### Service

4662 w/Opt. 31 070-1933-01  
4662 067-0831-00 Diagnostic Test Fixture Instruction 070-2564-00  
4663 Vol. 1 070-2669-00  
4663 Vol. 2 070-3453-00  
4663 067-0859-00 Diagnostic Test Fixture Instruction 070-2842-00

#### Options

4662 Opt. 31 Installation 070-3767-00  
4663 TTY I/F Installation 070-3411-00

### 4900 Series File Manager Systems

#### Standard

4907 Installation Guide 070-2493-00  
4907 Operator's 070-2380-02  
4907 Reference Card 070-2381-01  
4909 Installation Instruction 070-4284-01  
4909 Operator's 070-3994-00  
4909 Site Preparation Sheet 070-3997-00

#### Service

4907 070-2405-00  
4907 Flexible Disk Drive 070-2504-01  
4909 061-2573-00  
4909 Power Supply 070-3732-00  
4909 Hard Disk Drive 070-3999-00

### Options

4050R10 ROM Pack Instruction 070-3996-00  
4050R10 ROM Pack Guide 070-3995-00  
4909 GPIB Reference 070-3993-00

## 4900 Series Tape Drive Systems

### Standard

4923 Operator's 070-1908-01  
4924 Operator's 070-2128-00  
4924 Reference Card 070-2302-00

### Service

4923 070-1909-01  
4924 070-2131-00

## 4932 GPIB Extender

Instruction 070-4324-00

## 4952 Joystick

Instruction for 4010 Series 070-1826-01  
Instruction for 4050 Series 070-2098-00

## 4900 Series Graphics Tablets

### Standard

4953/54 Instruction 070-1791-01  
4953/54 Reference Card 070-1787-00  
4956 Operator's 070-2210-00

### Service

4956 070-2211-00

## 4970 Cluster Controller/4970P01 Software

User's Reference Guide 070-4392-00  
Service 070-4393-00  
Instruction Sheet 070-4448-00

# IDD Applications Libraries

## Africa, Europe, Middle East

Contact local sales office

## Australia

IDD Applications Library  
Tektronix Australia Pty. Limited  
Sydney  
80 Waterloo Road  
North Ryde, N.S.W. 2113

## Canada

IDD Applications Library  
Tektronix Canada Ltd.  
P.O. Box 6500  
Barrie, Ontario  
Canada L4M 4V3

## Caribbean, Latin America and Far East (excl. Japan)

IDD Group  
Export Marketing  
Tektronix, Inc.  
P.O. Box 500  
Beaverton, Oregon 97077  
U.S.A.

## Japan

IDD Applications Library  
Sony/Tektronix Corporation  
9-31 Kitashinagawa-5  
Tokyo 141 Japan

## United States

IDD Applications Library  
Tektronix, Inc.  
Group 451  
P.O. Box 500  
Beaverton, Oregon 97077

Address Correction Requested — Forwarding and Return Postage Guaranteed.

CHARLES KOH  
PATHFINDER MINES CORP  
550 CALIFORNIA ST  
SAN FRANCISCO, CA 94133

TEKTRONIX, INC.  
Information Display Division  
IDD Applications Library  
Group 451  
P.O. Box 500  
Beaverton, Oregon 97077

COMMITTED TO EXCELLENCE  
**Tektronix**

TEKTRONIX, INC.

BULK RATE  
U.S. POSTAGE  
PAID