



*Please Check for
CHANGE INFORMATION
at the Rear of this Manual*

4907
FILE MANAGER
INSTALLATION GUIDE

Tektronix, Inc.
P.O. Box 500
Beaverton, Oregon 97077

MANUAL PART NO. 070-2493-00
PRODUCT GROUP 14

First Printing JAN 1978
Revised JUL 1982

Copyright © 1978 by Tektronix, Inc., Beaverton, Oregon.
Printed in the United States of America. All rights reserved.
Contents of this publication may not be reproduced in any
form without permission of Tektronix, Inc.

This instrument, in whole or in part, may be protected by one
or more U.S. or foreign patents or patent applications.
Information provided on request by Tektronix, Inc., P.O. Box
500, Beaverton, Oregon, 97077.

TEKTRONIX is a registered trademark of Tektronix, Inc.

MANUAL REVISION STATUS

PRODUCT: 4907, 4907 Option 30, and 4907 Option 31

This manual supports the following versions of this product: Serial Numbers B010100 and up.

REV DATE	DESCRIPTION
JAN 1978	Original Issue
AUG 1978	Revised: pages 1-3, 2-3, 3-5, 3-9 through 3-11, 5-1 through 5-5.
JAN 1979	Revised: pages 1-2, 7-1, and 7-2.
APR 1979	Revised: pages 2-2, 2-5, 3-12 through 3-14, 4-1, 6-1, 7-8, and 7-14.
NOV 1980	Revised: pages 1-1 and 2-5.
JAN 1981	Added: pages A-1 through A-4.
MAR 1981	Revised: pages iii, 3-1, 3-3, 3-12, and 3-13.
JUL 1982	Revised: pages 3-11 and 5-4.

TABLE OF CONTENTS

	Page
INTRODUCTION	
SECTION 1	STANDARD AND OPTIONAL ACCESSORIES
4907 Accessories	
Standard Accessories	1-1
Optional Accessories	1-1
4907 Option 30 Accessories	
Standard Accessories	1-1
4907 Option 31 Accessories	
Standard Accessories	1-2
4907F32 Kit Accessories	
Standard Accessories	1-2
Components	1-2
4907F48 Components	1-3
Test Calibration Fixtures	1-3

SECTION 2	SPECIFICATIONS
4907 Performance Specifications	2-1
4907 Physical Specifications	2-1
4907 Environmental Specifications	2-2
4907 Electrical Specifications	2-3
Flexible Disc Drive Specifications	2-3
Media Requirements	2-4
ROM Pack	2-5

WARNING

The remaining portion of this Table of Contents lists servicing instructions that expose personnel to hazardous voltages. These instructions are for qualified service personnel only.

SECTION 3	INSTALLATION INSTRUCTIONS FOR THE 4907 OPTION 30, AND 4907 OPTION 31
Changing Device Addresses	3-1
Changing Line Voltage	3-5
Line Cord and Ribbon Cable Installation	3-10
Line Cord	3-10
Ribbon Cable	3-10
GPIB and ROM Pack Installation	3-12
Power Up	3-14
4907 (Single Drive)	3-14
4907 Option 30 and 4907 Option 31	3-14
Loading the Drive	3-14

SECTION 4	PERFORMANCE CHECKS	Page
	Read/Write Test Program	4-1
	Program Description	4-2
	Sample Program Output	4-3
	Write-Protect Tests.....	4-3
SECTION 5	4907F30 FIELD UPGRADE KIT INSTRUCTIONS	
SECTION 6	4907F31 FIELD UPGRADE KIT INSTRUCTIONS	
SECTION 7	4907F32 FIELD UPGRADE KIT INSTRUCTIONS	
APPENDIX A	4907 FILE MANAGER STRAPPING INFORMATION	

ILLUSTRATIONS

Figure	Description	Page
1-1	4907 single drive	vii
1-2	4907 Option 30 (two drives).....	vii
1-3	4907 Option 31 (three drives)	vii
3-1	Removing base of drive cabinet.....	3-2
3-2	Location of drive address straps.....	3-3
3-3	Setting for device address 0 (DS1).....	3-3
3-4	Setting for device address 1 (DS2).....	3-4
3-5	Setting for device address 2 (DS3).....	3-4
3-6	Setting for device address 3* (DS4).....	3-5
3-7	Moving viewport to the left	3-6
3-8	Removing fuse	3-6
3-9	Removing line voltage selector card	3-7
3-10	Card position for 100 V	3-7
3-11	Card position for 120 V	3-8

Figure	Description	Page
3-12	Card position for 220 V	3-8
3-13	Card position for 240 V	3-8
3-14	Attaching line cord to rear of cabinet.....	3-10
3-15	Plugging ribbon cable to connector J-1 on auxiliary cabinet.....	3-11
3-16	Connecting GPIB cable to rear of main 4907 cabinet	3-12
3-17	Plugging in the ROM pack.....	3-13
3-18	Placing disc in drive	3-14
3-19	Closing drive door	3-15
4-1	Covering the write-protect hole with tape.....	4-4
5-1	Removing main 4907 cabinet cover.....	5-2
5-2	Connecting ribbon cable to J-8	5-3
5-3	Installing Strain Relief Bracket and clamp assembly	5-3
5-4	Securing ribbon cable at rear of main 4907 cabinet.....	5-4
5-5	Attaching ribbon cable to J-1.....	5-5
7-1	4907F32 Field Upgrade Kit components	7-2
7-2	Loosening drive clamp.....	7-3
7-3	Removing power switch connectors.....	7-4
7-4	Removing power switch.....	7-4
7-5	Removing front panel	7-5
7-6	Removing screws from drive chassis.....	7-5
7-7	Sliding drive into chassis.....	7-6
7-8	Reinstalling drive screws.....	7-6
7-9	Rear view of power switch wiring layout.....	7-7
7-10	Threading ribbon cable D through grommets in cabinet chassis	7-8
7-11	Connecting front panel leads of cable D.....	7-9
7-12	Placing new leads on line filter	7-10
7-13	Connecting ribbon cable D to J-11.....	7-11
7-14	Wire set E in place including a single connector to each drive, two ground connections, and two leads to the fan.....	7-12
7-15	Installing ribbon cable F.....	7-13
7-16	Installing ribbon cable G	7-13

TABLES

Table	Description	Page
2-1	Line Voltages.....	2-3
3-1	Fuse Specifications.....	3-9

INTRODUCTION

This manual describes the steps necessary to connect the 4907 to the 4051 Graphic System as well as the steps preparatory to operation. Combined, these two instruments with the ROM pack constitute the 4907 File Manager. The 4907 File Manager may be purchased in one of three configurations.

1. The basic 4907 with a single flexible disc drive.
2. The 4907 Option 30 with two flexible disc drives.
3. The 4907 Option 31 with three flexible disc drives.

Section 1 lists the standard and optional accessories for each of the three 4907 configurations.

Section 2 lists the performance, physical, and electrical specifications for the 4907, the disc drive, and the ROM pack.

Section 3 shows the installation sequences for all three configurations.

Section 4 describes performance checks. These are required to insure that the unit is functional when installed. If hardware problems arise, as indicated by error messages, see the 4907 Service Manual.

Section 5 demonstrates procedures for installing the 4907F30 Field Upgrade Kit. This kit consists of a cabinet with a single flexible disc drive that must be connected to the main 4907 cabinet.

Section 6 demonstrates procedures for installing the 4907F31 Field Upgrade Kit. This kit consists of a cabinet with two flexible disc drives that must be connected to the main 4907 cabinet.

Section 7 demonstrates procedures for installing the 4907F32 Field Upgrade Kit. This kit consists of a single flexible disc drive with all the components necessary for installation into the auxiliary cabinet which is part of the 4907 Option 30. This auxiliary cabinet already contains one flexible disc drive. Installation of this kit fills in the empty side of this cabinet. After installation of the kit, the system configuration is identical to that of the 4907 Option 31.

These procedures should be carried out by a Tektronix technician. If there are questions about system operations, refer to the 4907 File Manager Operator's Manual or the 4907 File Manager Pocket Reference Card. If service questions arise, refer to the 4907 Service Manual.

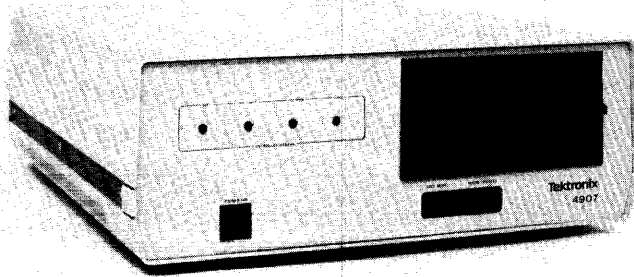

2493-1

Figure 1-1. 4907 (single drive).

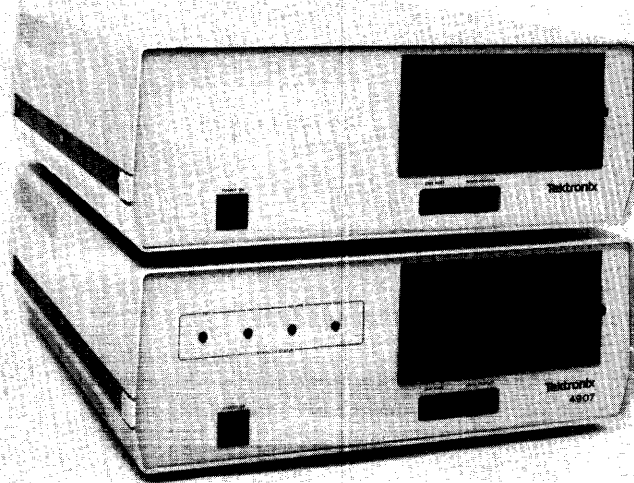

2493-2

Figure 1-2. 4907 Option 30 (two drives).

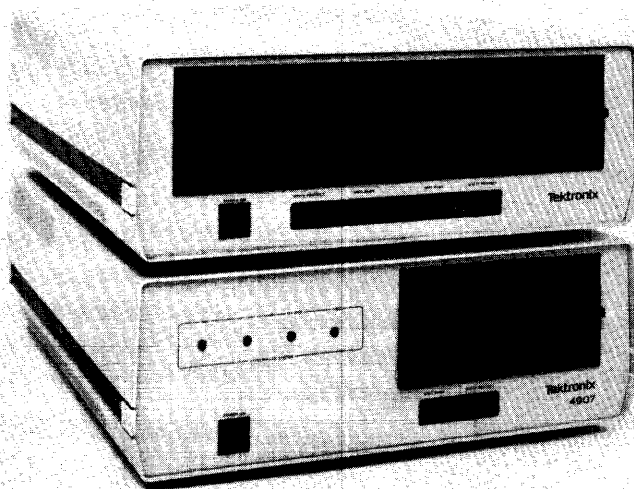

2493-3

Figure 1-3. 4907 Option 31 (three drives).

Section 1

STANDARD AND OPTIONAL ACCESSORIES

All 4907 File Manager systems come with the standard accessories listed directly below. The systems with Option 30 or Option 31 contain additional standard accessories which are listed under those headings.

4907 ACCESSORIES

Standard Accessories

4907 File Manager Operator's Manual
Power Cord
1 Flexible Disc Media
Box of Cleaning Pads (10)
GPIB Cable 2M
4907 Installation Guide
4907 File Manager Pocket Reference Card
4907 File Manager Label Set
File Manager ROM Pack¹

Optional Accessories

Box of Flexible Disc Media (10)
4907 Service Manual
GPIB Cable 4M
Flexible Disc Drive Service Manual
Alignment Disc

¹File Manager ROM Pack for 4051, ROM Packs for other Graphic Computing Systems are standard accessories with pertinent options.

4907 OPTION 30 ACCESSORIES (Also included in 4907F30 Kits)

Standard Accessories

Power Cord
Interconnect Cable
Strain Relief Bracket
Clamp
1 Flexible Disc Media
Box of Cleaning Pads (10)
4907 Installation Guide
4907 File Manager Label Set

4907 OPTION 31 ACCESSORIES (Also included in 4907F31 Kit)

Standard Accessories

Power Cord
Interconnect Cable
Strain Relief Bracket
Clamp
2 Flexible Disc Media
Box of Cleaning Pads (10)
4907 Installation Guide
2 4907 File Manager Label Sets

4907F32 KIT ACCESSORIES

Standard Accessories

1 Flexible Disc Media
Box of Cleaning Pads (10)
4907 Installation Guide
4907 File Manager Label Set

Components

6 Attaching Screws
Drive Kit
Front Panel
Wire Kit
Ribbon Cable, 50 Conductor
Ribbon Cable, 40 Conductor (2)
Write-Protect Switch with Bezel
LED for Write-Protect Switch
LED (Busy) with recessed washer
Cable Ties (3)

4907F48 COMPONENTS (For conversion to 50 Hz)

Belt
Pulley (50 Hz)
Set Screw
Fuse 1 A Slow Blow

TEST CALIBRATION FIXTURES

Alignment Disc
System Test Fixture
Test Prom

Section 2

SPECIFICATIONS

4907 PERFORMANCE SPECIFICATIONS

1. Data File Storage Capacity (formatted and accessible by operator)

Per Drive (includes 256-byte directory)	630,528 bytes
Per Track	8192 bytes
Per Sector	256 bytes

2. GPIB Data Transfer Rate

Burst	3900 bytes/sec
Sustained	1300 bytes/sec

3. Error Rate

Refer to FLEXIBLE DISC DRIVE SPECIFICATIONS.

4907 PHYSICAL SPECIFICATIONS

1. Dimensions

Height	7.94 in (20.17 cm)
Width	20.31 in (51.59 cm)
Depth (minus drive door handle projection)	25.25 in (64.14 cm)

2. Weight

Main Unit	51 lbs (23.1 kg)
Auxiliary Unit of Option 30	50 lbs (22.6 kg)
Auxiliary Unit of Option 31	62 lbs (28.1 kg)

SPECIFICATIONS

4907 ENVIRONMENTAL SPECIFICATIONS

1. Operating Environment

Ambient Temperature	50 degrees F to 100 degrees F (10 degrees C to 38 degrees C)
Relative Humidity	20% to 80%
Maximum Wet Bulb	78 degrees F (25 degrees C)
Maximum Altitude Above Sea Level	10,000 ft (3048 m)

2. Storage Environment

Ambient Temperature	50 degrees F to 125 degrees F (10 degrees C to 52 degrees C)
Relative Humidity	8% to 80%
Maximum Altitude Above Sea Level	50,000 ft (15,240 m)
Shipping Temperature	40 degrees F to 125 degrees F (-40 degrees C to 52 degrees C)

3. Shock (nonoperating)

Unit will not suffer damage or fail to operate when subjected to three impact shocks of 20 g's + in each direction along each main axis. Shock time is $11 \pm$ ms.

4. Vibration

Unit will not suffer damage or fail to operate when subjected to the following vibration for a period of 5 minutes along each main axis.

Nonoperating	5 to 25 Hz at 0.008 in displacement 25 to 55 Hz at 0.005 in displacement
Operating	5 to 25 Hz at 0.005 in displacement 25 to 55 Hz at 0.005 in displacement

4907 ELECTRICAL SPECIFICATIONS

1. AC Power Supply Requirements

A rear panel line voltage selector matches the transformer inputs to four different line voltages. 50 Hz systems can be used by changing the pulley and belt in the disc drives. Table 2-1 shows the allowable line voltages:

Table 2-1

LINE VOLTAGES

Line Voltage	Tolerance	Frequency	Fuse
100 Vac	90-110	50 or 60 Hz ±5 Hz	2 A Slow Blow
120 Vac	108-132		2 A Slow Blow
220 Vac	198-242		1 A Slow Blow
240 Vac	216-264		1 A Slow Blow

2. Power Dissipation

120 Vac 170W maximum

FLEXIBLE DISC DRIVE SPECIFICATIONS

1. Type

Rackmount Flexible Disc Drive, with hard sector (32), write-protect hole detect, and double-density recording.

2. Performance Specifications

Capacity (unformatted)

Per Disk	6.4 megabits
Per Track	83.4 kilobits
Transfer Rate	500 kilobits/sec
Latency (average)	83 ms
Access Time	
Track to Track	8 ms
Average	260 ms
Settling Time	8 ms
Head Load Time	35 ms

SPECIFICATIONS

3. Physical Specifications

Error Rates

Soft Read Errors	1 per 10E9 bits read
Hard Read Errors	1 per 10E12 bits read
Seek Errors	1 per 10E6 seek operations

4. Environmental Specifications

Same as 4907 ENVIRONMENTAL SPECIFICATIONS.

5. Safety

The flexible disc drive is listed with Underwriter's Laboratory, Inc. and certified by the Canadian Standards Association.

MEDIA REQUIREMENTS

1. Type	Double-density compatible
2. Storage Environment	
Temperature	40 degrees F to 140 degrees F (5 degrees C to 60 degrees C)
Humidity	8% to 80%
3. Media Lifetime	
Passes per track	3.5 x 10E5
Insertions	> 30,000

ROM PACK

(For 4051 Graphic Computing Systems. ROM Packs for other systems will vary.)

1. Dimensions

Length	466 in
Width	2.62 in
Depth	0.88 in

2. Weight 8 oz

3. Environmental Requirements

Same as 4907 ENVIRONMENTAL SPECIFICATIONS.

4. Power Requirements (from 4050 Series Graphic System)

+5 Vdc 300 mA

Section 3

INSTALLATION INSTRUCTIONS FOR THE 4907, 4907 OPTION 30, AND 4907 OPTION 31

Confirm that all components and accessories (described in Section 1) that you ordered have arrived. The following procedures demonstrate how to install your 4907.

Strapping information is summarized in Appendix A.

CHANGING DEVICE ADDRESSES

The address of any device (disc drive) in your 4907 may be specified as an integer from 0 to 3. The address depends on the location of the address straps in the base of the drive. The factory-set address strapping for each 4907 configuration is shown below.

4907 (single drive)	Device address 0
4907 Option 30 (two drives)	
Main cabinet drive	Device address 0
Auxiliary cabinet drive	Device address 1
4907 Option 31 (three drives)	
Main cabinet drive	Device address 0
Auxiliary cabinet left hand drive	Device address 1
Auxiliary cabinet right hand drive	Device address 2

If an address in one of your devices must be changed, the address strapping must be altered. The following procedure shows how this is done.

INSTALLATION INSTRUCTIONS

WARNING

The line cord to the cabinet must be removed to avoid exposure to dangerous voltages.

1. Be sure line cord has been removed.
2. Turn cabinet over and carefully place on a soft cloth.
3. Remove ten bottom screws then lift off base (Figure 3-1). Do not remove feet.

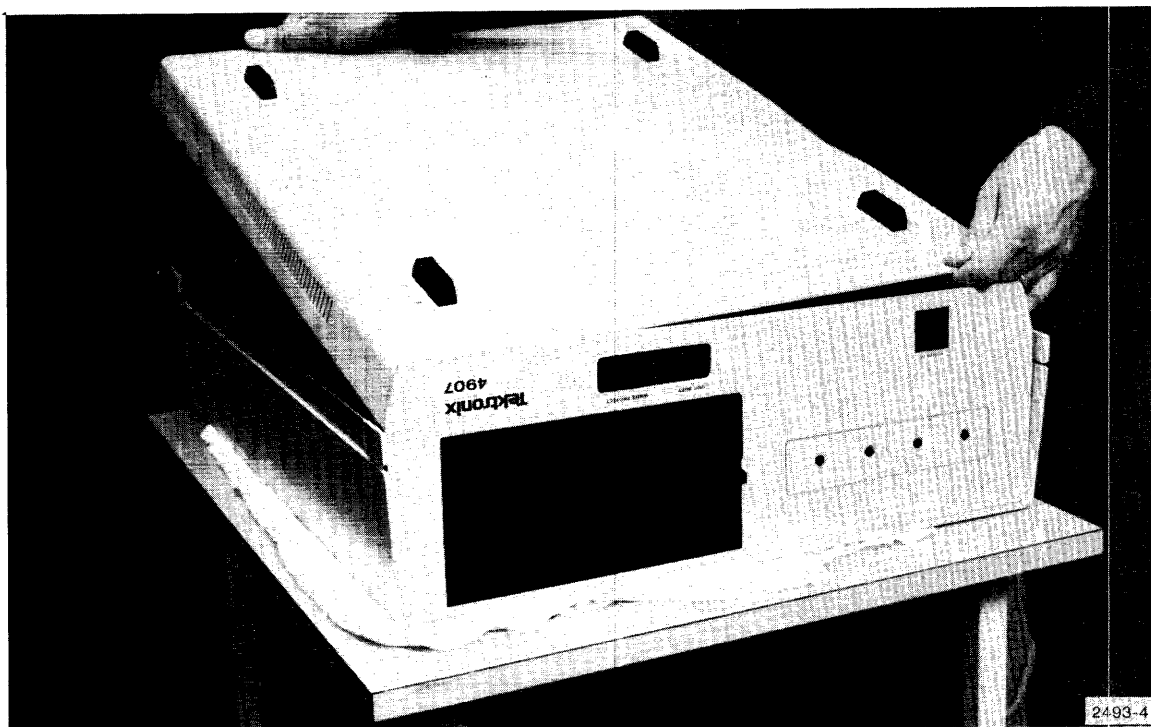

Figure 3-1. Removing base of drive cabinet.

4. Locate factory-set address strapping (Figure 3-2) and change strap to the desired address. See Figures 3-3, 3-4, and 3-5.

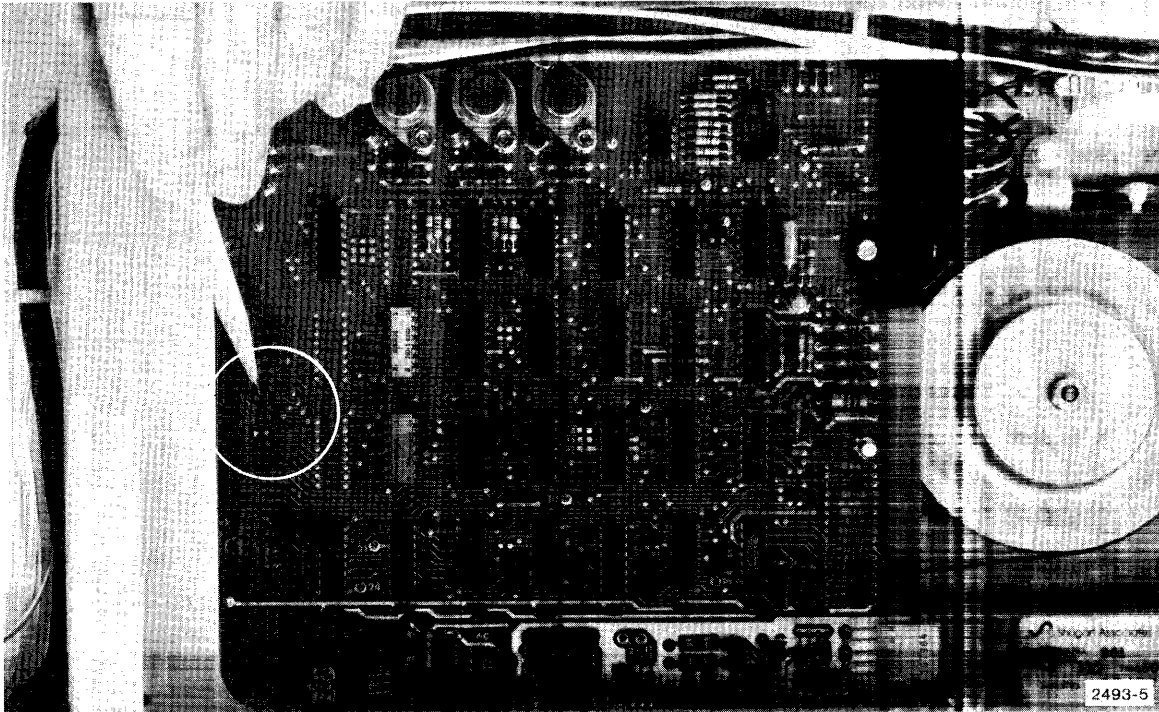

Figure 3-2. Location of drive address straps.

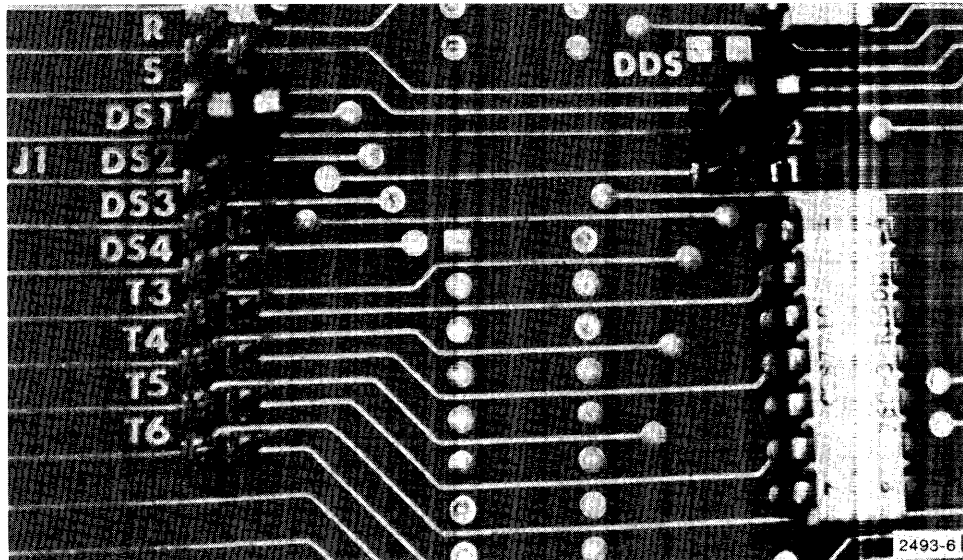

Figure 3-3. Setting for device address 0 (DS1).

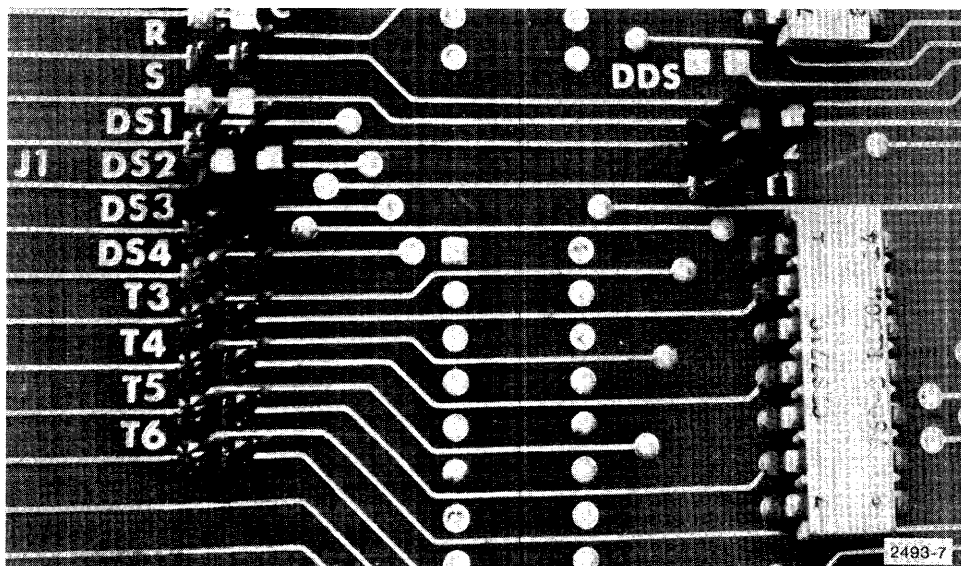

Figure 3-4. Setting for device address 1 (DS2).

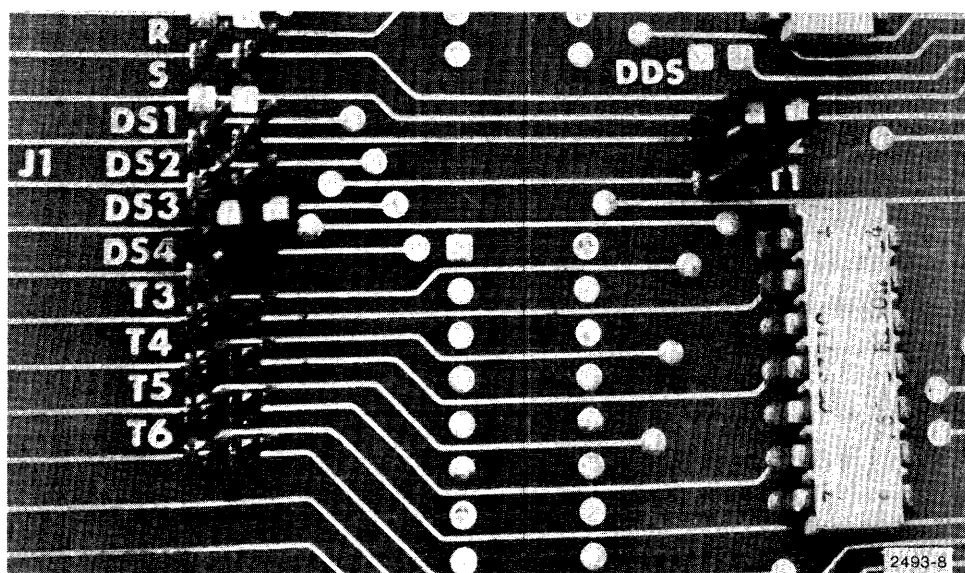

Figure 3-5. Setting for device address 2 (DS3).

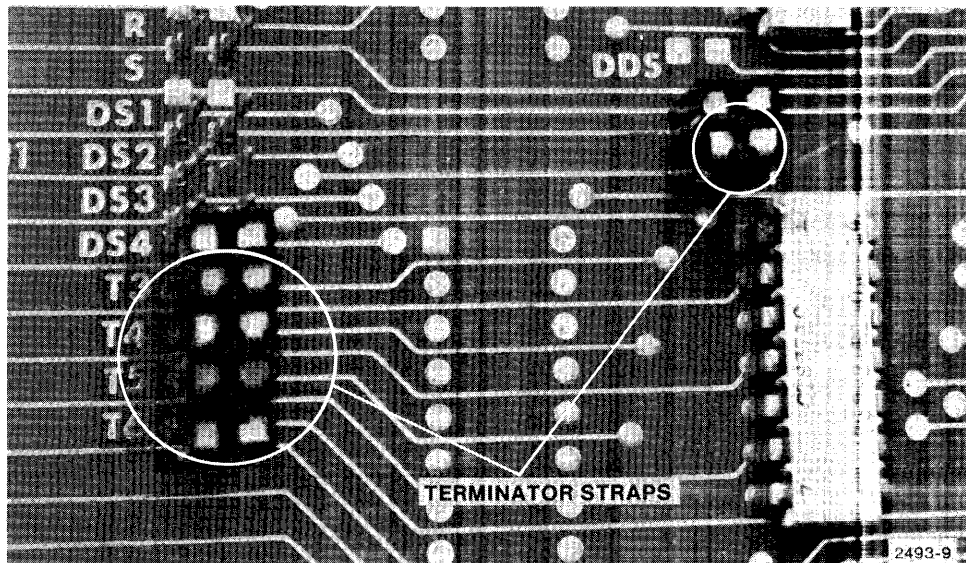

Figure 3-6. Setting for device address 3* (DS4).

5. Repeat procedures for additional drives if necessary.
6. Replace base and turn cabinet upright again.
7. Apply the labels with the correct device address to the front of the drives.

CHANGING LINE VOLTAGE

Line voltage in all 4907 cabinets have been factory-set to 100, 120, 220 or 240 volts. The voltage setting for your particular 4907 may be seen through the plastic viewport in the rear of the cabinet. See Figures 3-10 through 3-13. The voltage may be changed by following the procedures shown below.

WARNING

The line cord to the cabinet must be removed to avoid exposure to dangerous voltages.

* Note that terminator straps are present only on one drive. If your system has only one drive, the terminator straps must be present on that drive. If it contains two drives, the straps must be present on the second drive. If you have a three drive system, they must be present on the left drive of F31 or Option 31.

INSTALLATION INSTRUCTIONS

1. Each 4907 cabinet has a sliding plastic viewport over the line voltage selector located in the rear. Move the viewport to the left (Figure 3-7).

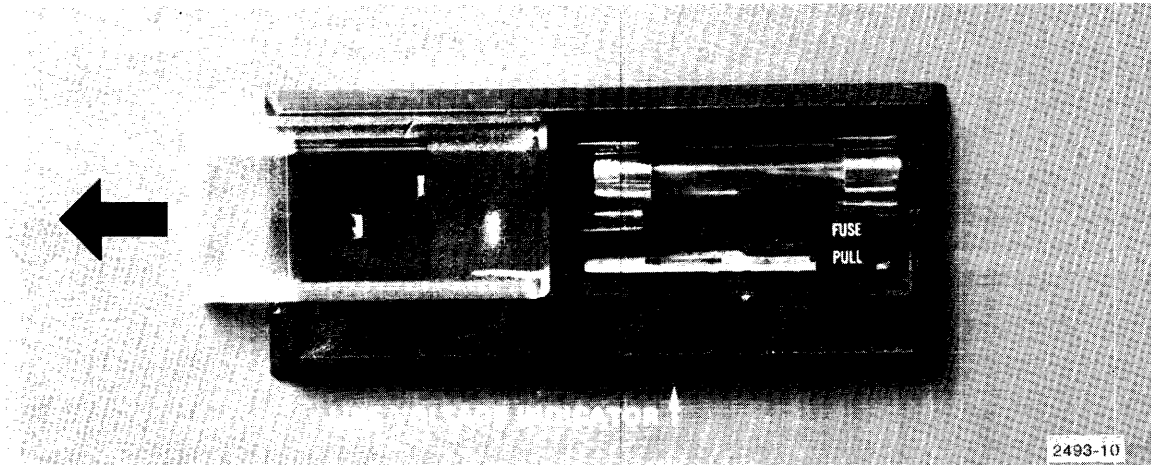

Figure 3-7. Moving viewport to the left.

2. Remove fuse by pulling out lever marked FUSE PULL (Figure 3-8).

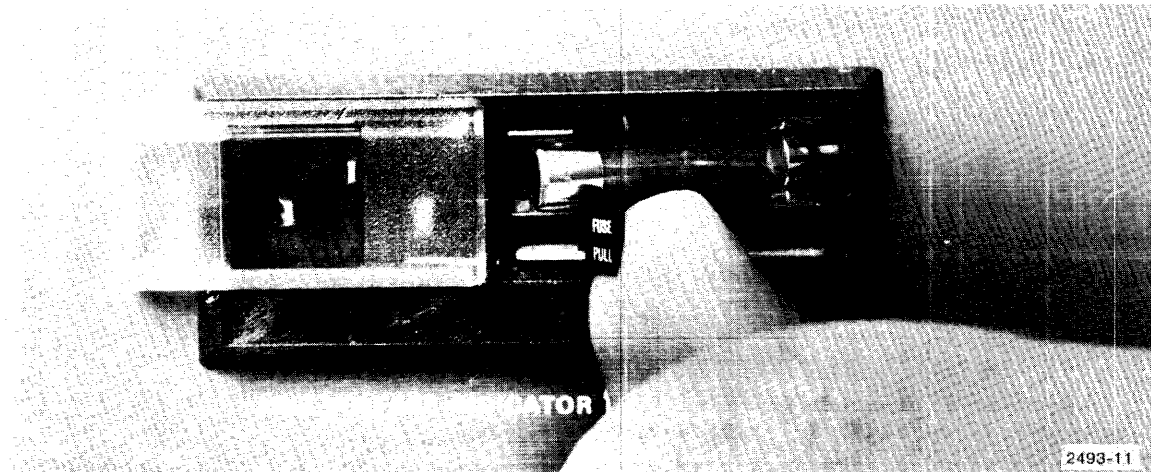

Figure 3-8. Removing fuse.

3. Remove line voltage selector card using pliers or pointed object (Figure 3-9).

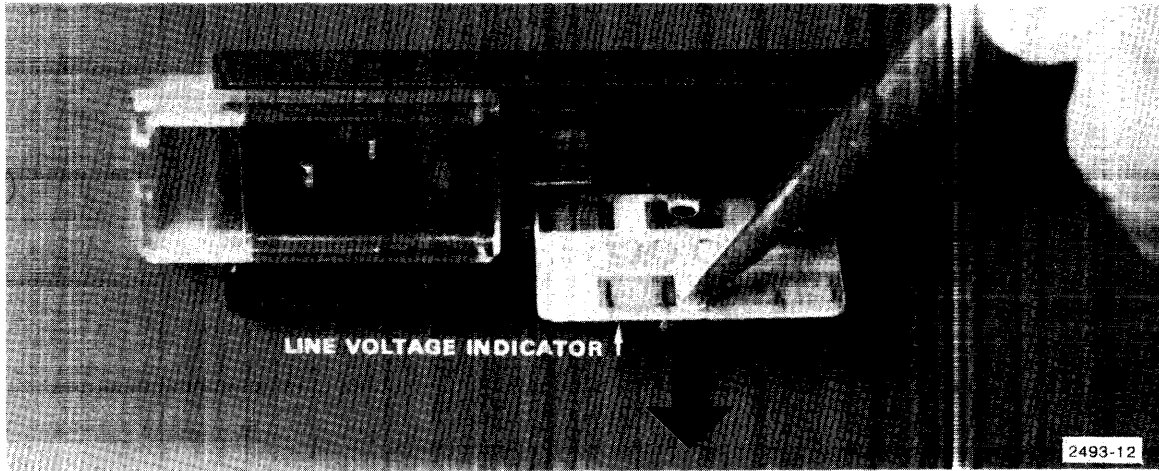

Figure 3-9. Removing line voltage selector card.

4. Reinsert circuit card so that only the line voltage desired may be read after card is reinserted and viewport closed (Figures 3-10, 3-11, 3-12 and 3-13).

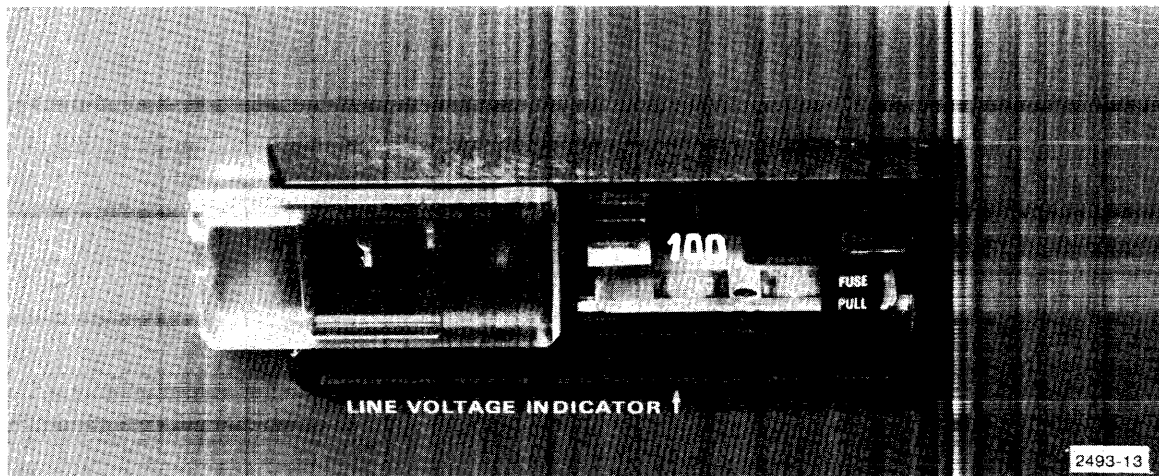

Figure 3-10. Card position for 100 V.

INSTALLATION INSTRUCTIONS

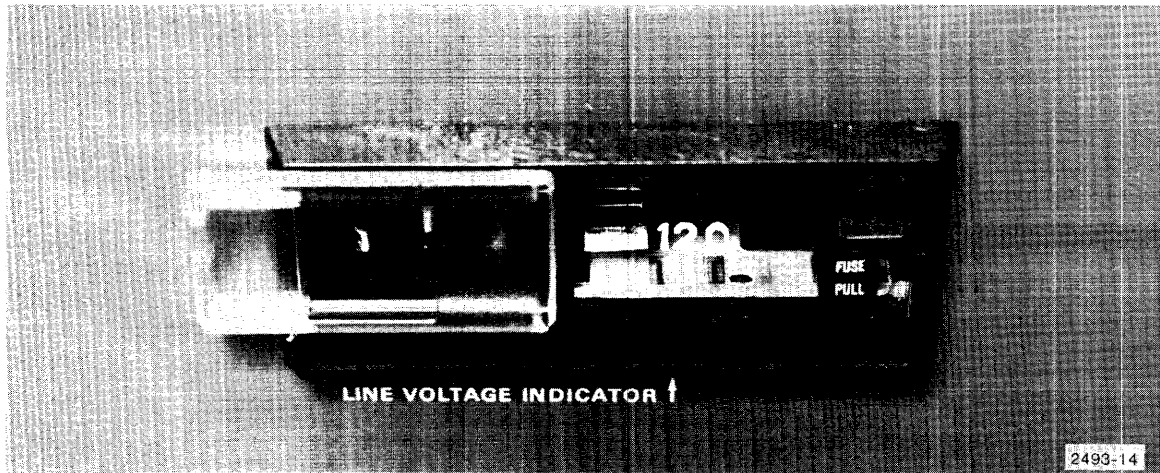

Figure 3-11. Card position for 120 V.

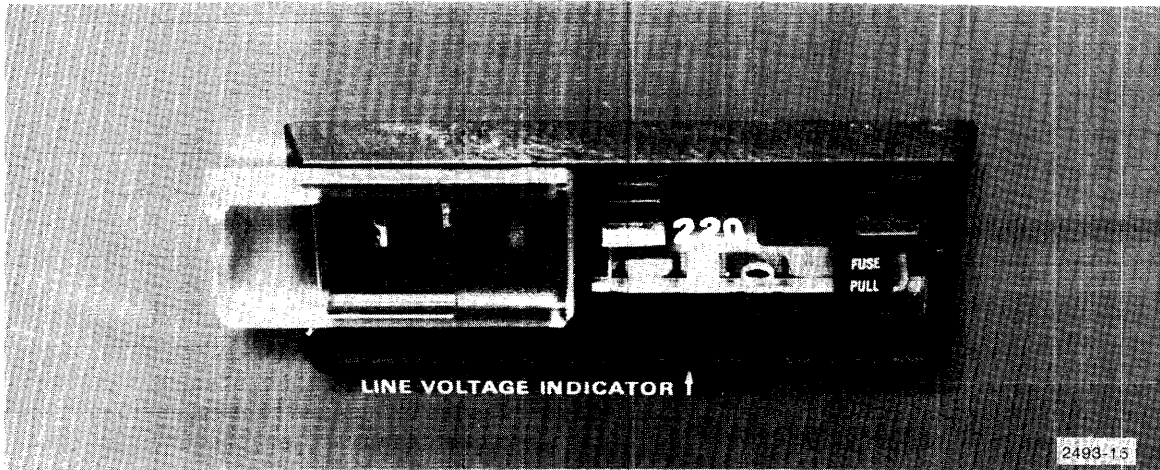

Figure 3-12. Card position for 220 V.

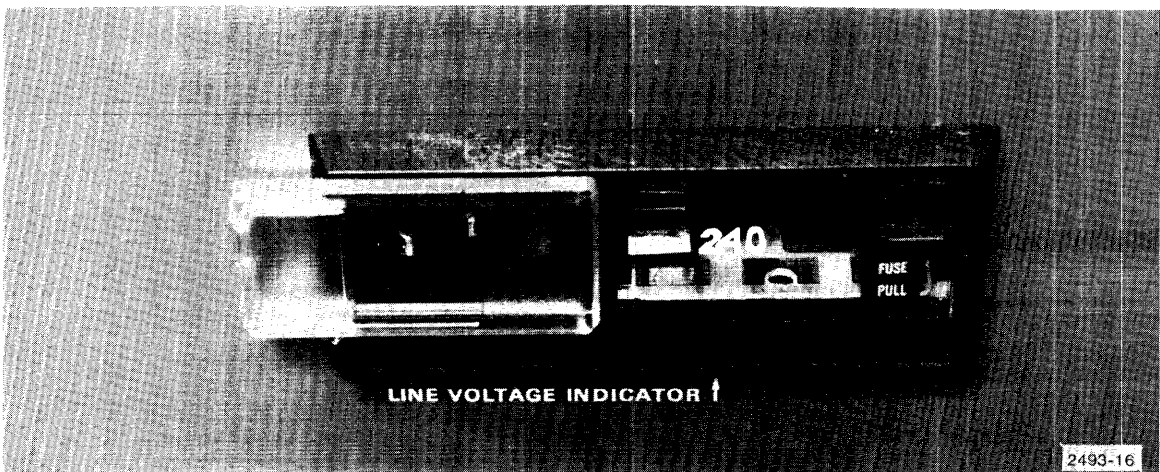

Figure 3-13. Card position for 240 V.

5. Replace fuse. If it is a new fuse, be sure it meets voltage range requirements shown in Table 3-1.

Table 3-1

FUSE SPECIFICATIONS

Voltage	Voltage Tolerance	Frequency	Fuse Capacity
100 or 120	10%	50 or 60 Hz	2A Slow Blow
220 or 240	10%	50 or 60 Hz	1A Slow Blow

6. Slide viewport back in place and plug in power cord.

7. Repeat procedure on any additional cabinet, if necessary.

NOTE

Changing from 60 to 50 Hz requires the use of a different pulley and belt. Contact your Tektronix Service Center.

LINE CORD AND RIBBON CABLE INSTALLATION

Line Cord

1. Attach end of line cord to rear of cabinet (Figure 3-14).

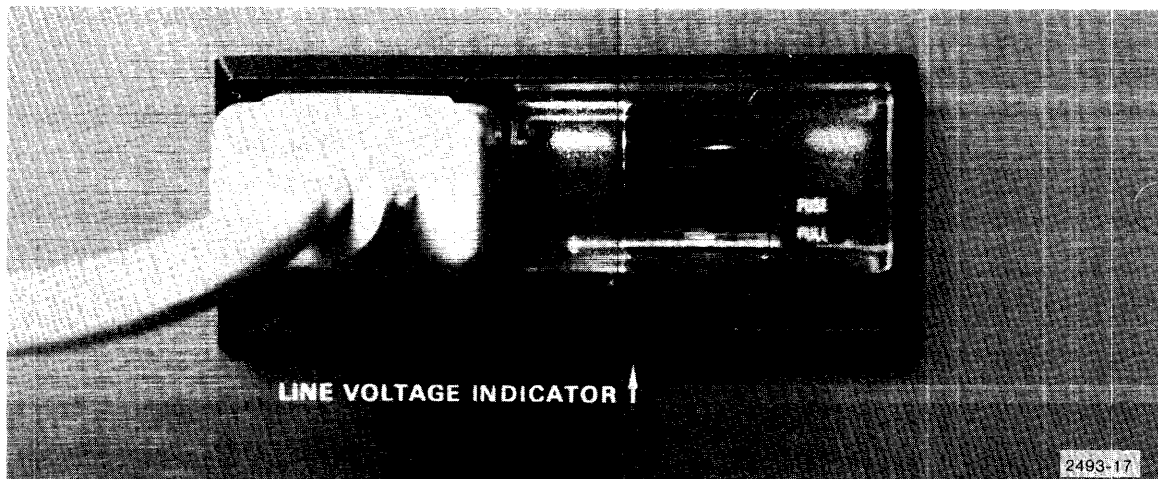

Figure 3-14. Attaching line cord to rear of cabinet.

2. Attach opposite end of line cord to convenient wall socket.
3. Repeat with any additional cabinet.

Ribbon Cable

Ribbon cable installation connecting the two 4907 cabinets is necessary ONLY on the 4907 Option 30 and 4907 Option 31. It is not required on the 4907 with the single drive.

1. Place main 4907 cabinet and auxiliary 4907 cabinet in the position in which they will be operated.
2. Plug one end of the ribbon cable with the ground braid and exterior ground strips in J1 of the auxiliary cabinet and the other end of the ribbon cable in J1 of the main cabinet.

Pin 1 of the cable is positioned to the left on both cabinets. This will position the ground braid out and the cable will be looped over at the top cabinet. Refer to Figure 3-15.

3. Install the ground clamps on each of the cabinets so that they trap the ribbon cable between the back of the cabinet and the clamp at the exterior ground strip on the ribbon cable. Tighten the screws securely, but do not overtighten. Refer to Figure 3-15.

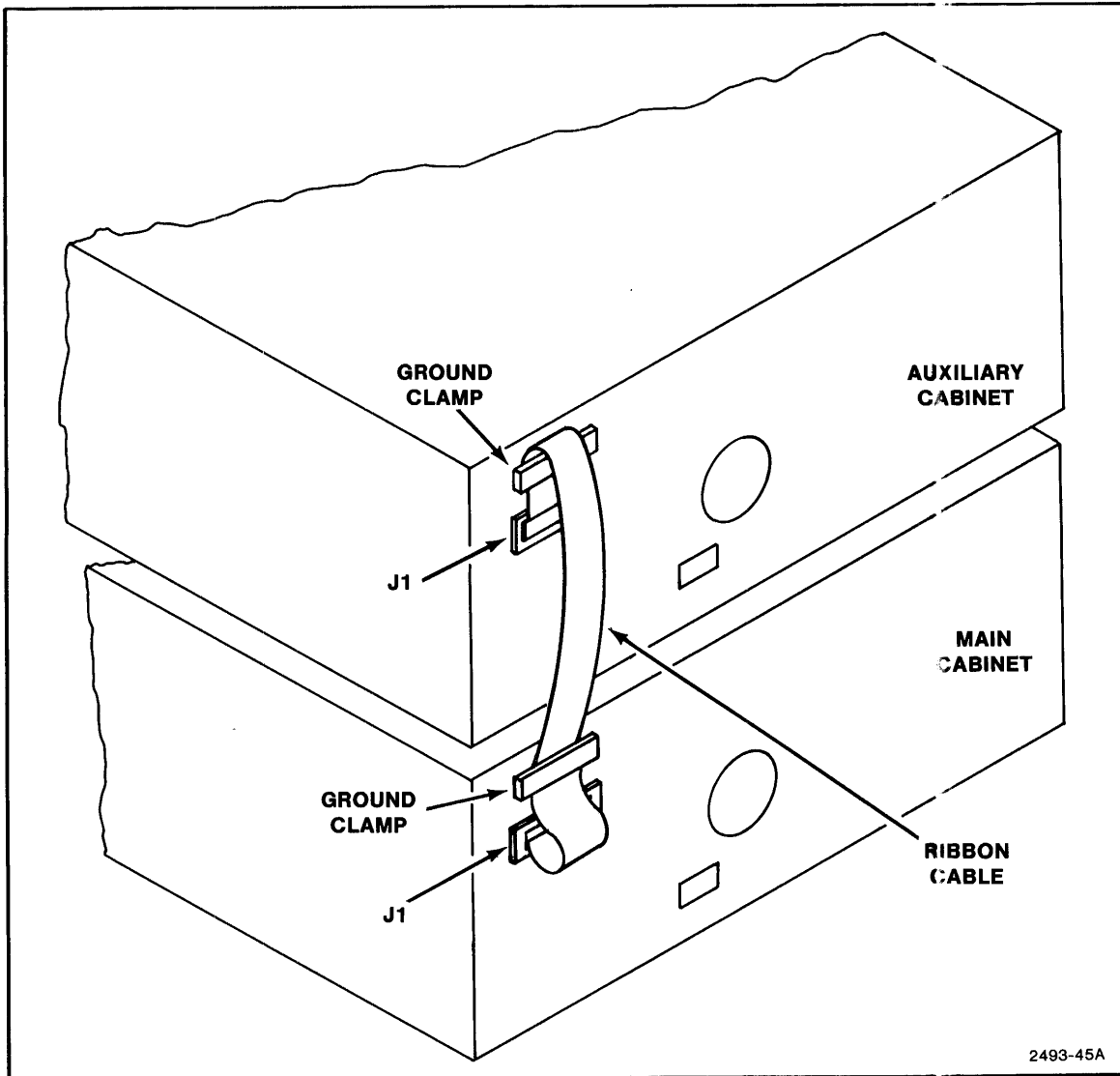

Figure 3-15. Plugging ribbon cable to connector J-1 on main and auxiliary cabinets.

GPIB CABLE AND ROM PACK INSTALLATION

1. Turn Graphic System power off.
2. Connect the GPIB cable from the rear of the Graphic system to the rear of the main 4907 cabinet (Figure 3-16). Use attached screws to secure the connector. If another GPIB cable is already attached, attach the new cable connector over the top of the current cable connector.

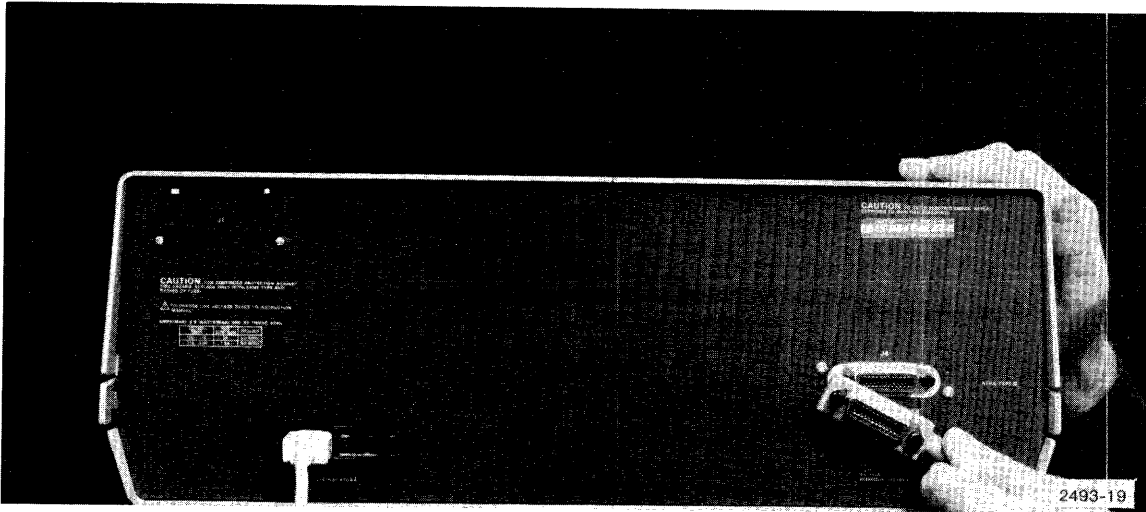

Figure 3-16. Connecting GPIB cable to rear of main 4907 cabinet.

3. Plug the File manager ROM Pack into the Graphic System backpack slot shown in Figure 3-17. Do not plug the ROM Pack into a ROM Expander unless ROM Expanders are connected to all backpack slots. **BE SURE THE GRAPHIC SYSTEM IS TURNED OFF.** If the Graphic System has the standard two-slot backpack, you should use Slot 41 (figure 3-17A). If the Graphic System has the optional four-slot backpack, you should use Slot 61 (Figure 3-17B).

CAUTION

Inserting any device into or removing any device from a 4050 Series Graphic System backpack slot or a ROM Expander slot when power is ON may cause memory to be erased.

NOTE

If the File Manager ROM pack is used with the 4051 E01 ROM Expander Unit, see that the serial number of the E01 is B020199 or higher. If lower, the File manager ROM pack will not work in the E01, unless the E01 has been modified. Check with your Tektronix Service center if your E01 is numbered lower than B020199. If your E01 Expander is not modified to support the File Manager ROM pack, install the ROM pack in the extra ROM pack slot on the rear of the 4051.

NOTE

Only one File Manager ROM pack may be plugged into a single System. Installing more than one of these ROM packs sets up a conflict since each 4907 would be considered GPIB device 0.

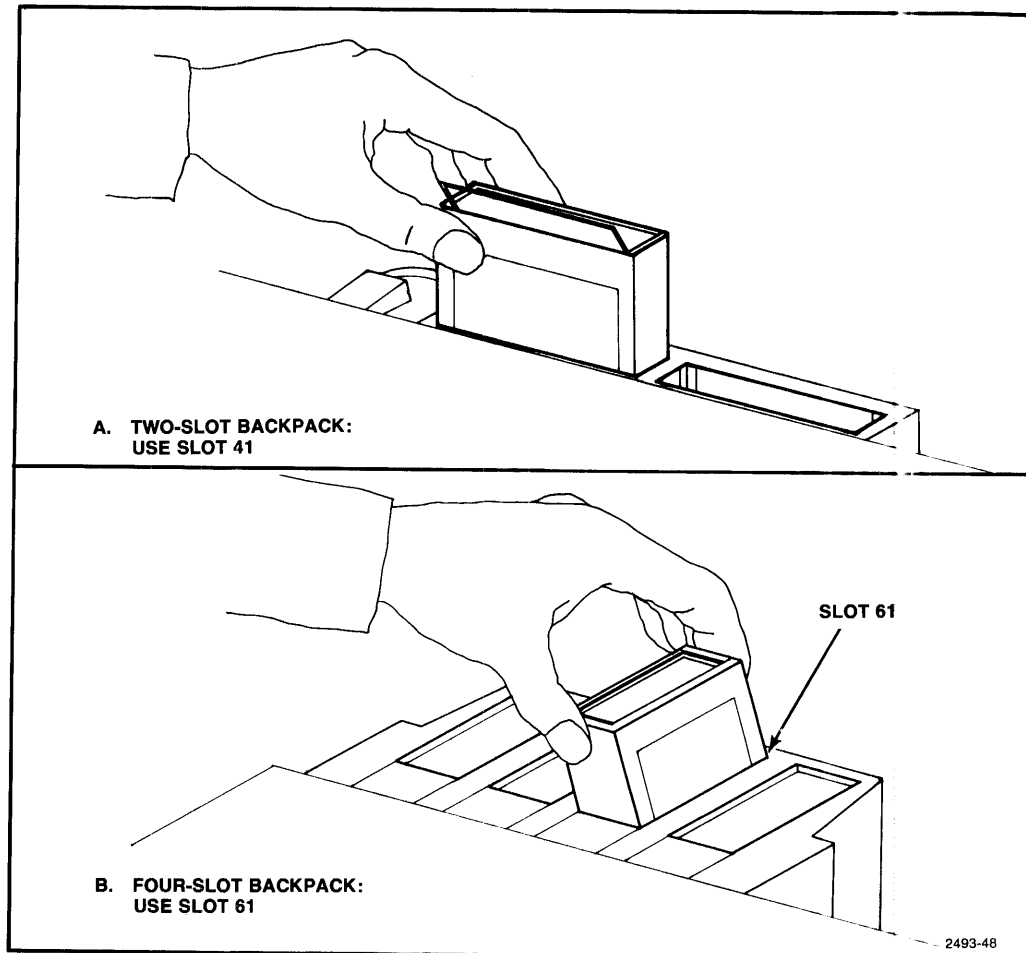

Figure 3-17. Plugging in the ROM pack.

CAUTION

Only one File Manager ROM pack may be plugged into a single 4050 Series Graphic System at the same time. Installing more than one of these ROM packs sets up a conflict since each 4907 must have a GPIB address setting of 0. For this same reason a 4050 Series Graphic System can support only one 4907.

4. The 4907 can now be powered up. See POWER UP.

INSTALLATION INSTRUCTIONS

POWER UP

4907 (Single Drive)

1. Turn on front panel power switch on main 4907 cabinet.
2. Turn on the Graphic System

4907 Option 30 and 4907 Option 31

1. Turn on front panel power switch on auxiliary cabinet.
2. Turn on front panel power switch on main 4907 cabinet.
3. Turn on the Graphic System

LOADING THE DRIVE

1. Raise the door on front of drive and place flexible disc in cavity as shown (Figure 3-18). Slide disc, with label up, as far in as it will go. Be sure tape is covering the write-protect hole whenever formatting or writing to a disc.

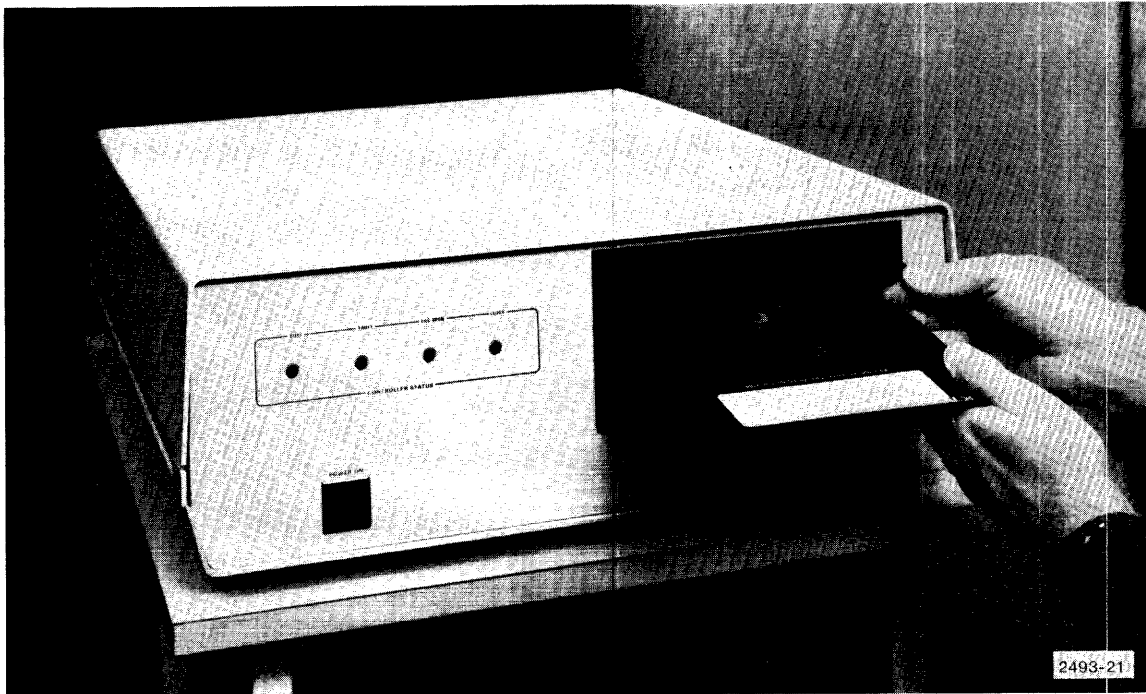

Figure 3-18. Placing disc in drive.

2. Close door (Figure 3-19).



Figure 3-19. Closing drive door.

3. Repeat sequence with additional drives, if necessary.
4. Start operation. (See 4907 File Manager Operator's Manual.)

Section 4

PERFORMANCE CHECKS

Once the 4907 has been interfaced to the 4050 Series Graphic System and all the necessary installation procedures have been performed, the performance checks must be carried out. This section contains instructions for testing I/O and write-protect performance.

READ/WRITE TEST PROGRAM

The program listed below automatically executes the I/O performance checks on each device (drive) on your 4907 when executed on the 4050 Series Graphic System. If error messages occur, check ERROR MESSAGES in the 4907 File Manager Operator's Manual. Be sure that all entries are correct and that all preparatory steps described earlier in this manual have been performed.

A sample of the program output and a description of the program operations follow the program listing below.

```
100 INIT
110 DIM R$(2000),F$(200)
120 CALL "TIME",R$
130 IF LEN(R$)>0 THEN 170
140 PRINT "ENTER DATE AND TIME (DD-MOM-YY HH:MM:SS):";
150 INPUT A$
160 CALL "SETTIM",A$
170 PRINT "HOW MANY DEVICES ON YOUR SYSTEM?:";
180 INPUT N
190 DIM D(N)
200 PRINT "ENTER DEVICE ADDRESSES:";
210 INPUT D
220 FOR I=1 TO N
230 PRINT "JJTHIS IS A SAMPLE PROGRAM FOR DEVICE ";D(I);"J"
240 CALL "UNIT",D(I)
250 CALL "DRES",D(I)
260 CALL "FORMAT",D(I),"SAMPLE",1,1,"OWNER","PASS",3,3,3,3,3
270 CALL "DREL",D(I)
280 CREATE "ASCFILE","A";1,0
290 CREATE "BINFILE";1,128
300 OPEN "ASCFILE";1,"F",F$
310 PRINT #1:"THIS IS AN ASCII SAMPLE (SEQUENTIAL FILE)"
320 OPEN "BINFILE";2,"F",F$
330 WRITE #2,1:"THIS IS A BINARY SAMPLE (RANDOM FILE)"
340 CALL "REWIND",1
350 INPUT #1:S$
360 PRINT S$
370 READ #2,1:S$
380 PRINT S$
390 CLOSE
400 NEXT I
410 END
```

PERFORMANCE CHECKS

Program Description

100 Initialize.
110
120
130
140
150 Set system clock, if necessary.
160
170
180 Enter the total devices on your system (1, 2, or 3).
190
200
210 Enter the device addresses (0 or 0, 1, etc.).
220
230 Print heading.
240 Set unit number.

250 }
260 } Format disc.
270 }

280 Create an ASCII, sequential file.
290 Create a binary, random file

300 }
310 } Open each file and store message.
320 }
330 }

340 Rewind sequential file.

350 }
360 } Access files and display messages.
370 }
380 }

390 Close both files.
400
410 End program.

Sample Program Output

```
RUN
ENTER DATE AND TIME (DD-MOM-YY HH:MM:SS):12-DEC-77 08:30:30
HOW MANY DEVICES ON YOUR SYSTEM?:1
ENTER DEVICE ADDRESSES:0
```

THIS IS A SAMPLE PROGRAM FOR DEVICE 0

```
FORMAT REQUESTED, OK TO DESTROY DATA ON DEVICE 0?Y
THIS IS AN ASCII SAMPLE (SEQUENTIAL FILE)
THIS IS A BINARY SAMPLE (RANDOM FILE)
```

WRITE-PROTECT TESTS

To insure that both the write-protect switch and the write-protect feature on the disc will work, the following procedure should be carried out.

1. Power up the system.
2. Choose the drive to be tested.
3. Turn the write-protect switch OFF. The write-protect indicator light should go off.
4. Load the drive with a formatted disc. Be sure the tape supplied with the disc is covering the write-protect hole (Figure 4-1).

PERFORMANCE CHECKS

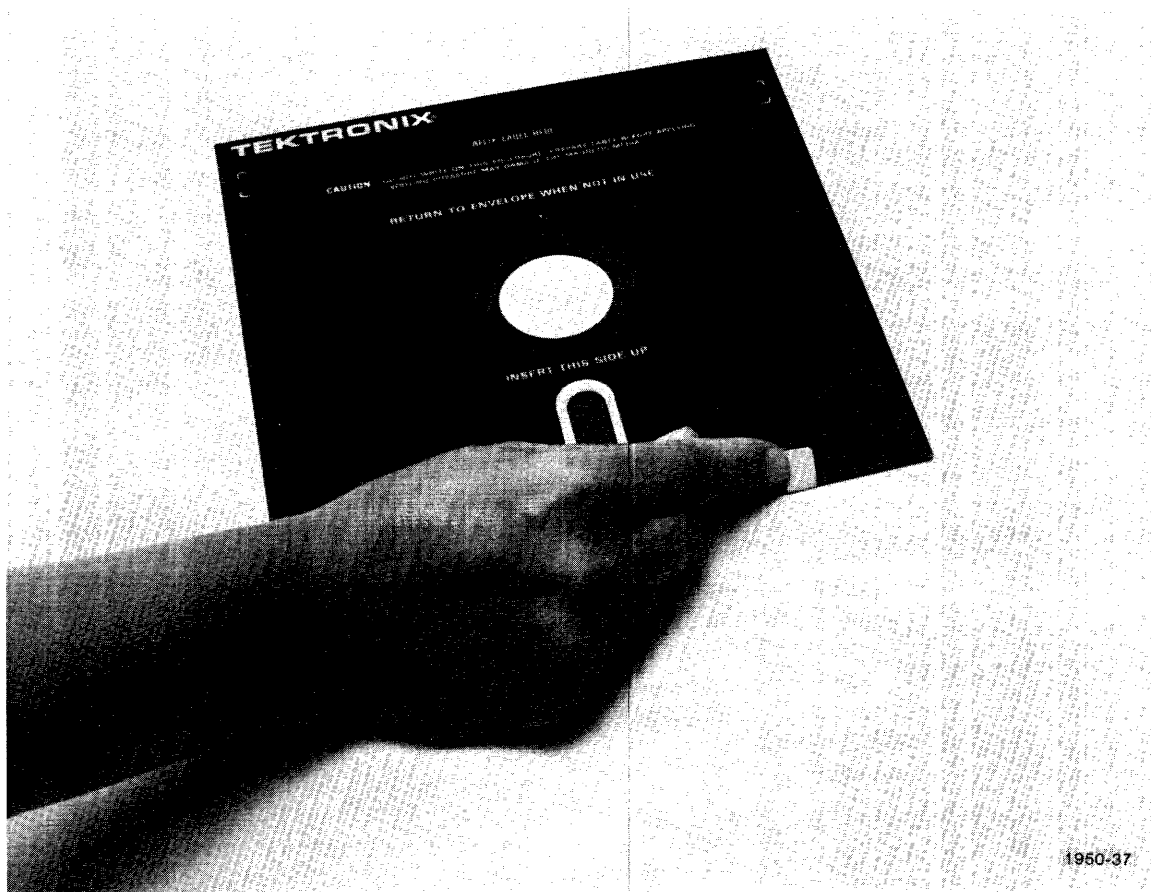

Figure 4-1. Covering the write-protect hole with tape.

5. Execute a CALL "CUSTAT". Be sure to dimension the string variable large enough to contain the device status messages.
6. Call the string variable.
7. The device status message should indicate that no write protection is in effect.
8. Turn ON the write-protect switch for that drive. The write-protect indicator should be lit.
9. Execute another CALL "CUSTAT" and recall the string variable.
10. The message should indicate that write-protection is now in effect for that drive.

11. Turn OFF the write-protect switch for that drive. The indicator should go out.
12. Take out the disc and remove the tape over the write-protect hole.
13. Replace the disc in the drive and close the door. The write-protect indicator should go on.
14. Execute another CALL "CUSTAT" and recall the string variable.
15. The message should indicate write-protection is in effect for that drive. You have now tested both the write-protect switch and the write-protect feature on the disc.
16. Repeat steps 2 through 15 for the remaining drives.

Section 5

4907F30 FIELD UPGRADE KIT INSTRUCTIONS

The 4907F30 Field Upgrade Kit includes:

1. Single flexible disc drive in a cabinet similar to the main 4907 cabinet.
2. Ribbon cable (shielded interconnect cable).
3. Ribbon cable with rear panel mount.
4. Line cord.
5. One flexible disc.
6. 4907 Installation Guide.
7. Box of cleaning pads (10).
8. 4907 File Manager label kit.
9. 2 Clamps.
10. 4 Screws, 2 each 6-32 x .375 & 2 each 4-40 x .500.
11. 2 Hex Nut 4-40.

The procedure below describes how to install this kit.

- a. Be sure all components listed above have been received.
- b. Place the 4907F30 cabinet on a flat surface next to the 4907.

WARNING

Be sure power has been turned off and line cord has been removed from cabinet.

- c. The new drive may require a different device address. The factory-set address is 1. If a change is necessary, see CHANGING DEVICE ADDRESSES in Section 3.
- d. Line voltage may require changing. If a change is necessary see CHANGING LINE VOLTAGE in Section 3.
- e. Remove three screws from each side and lift cover from main 4907 cabinet (Figure 5-1).

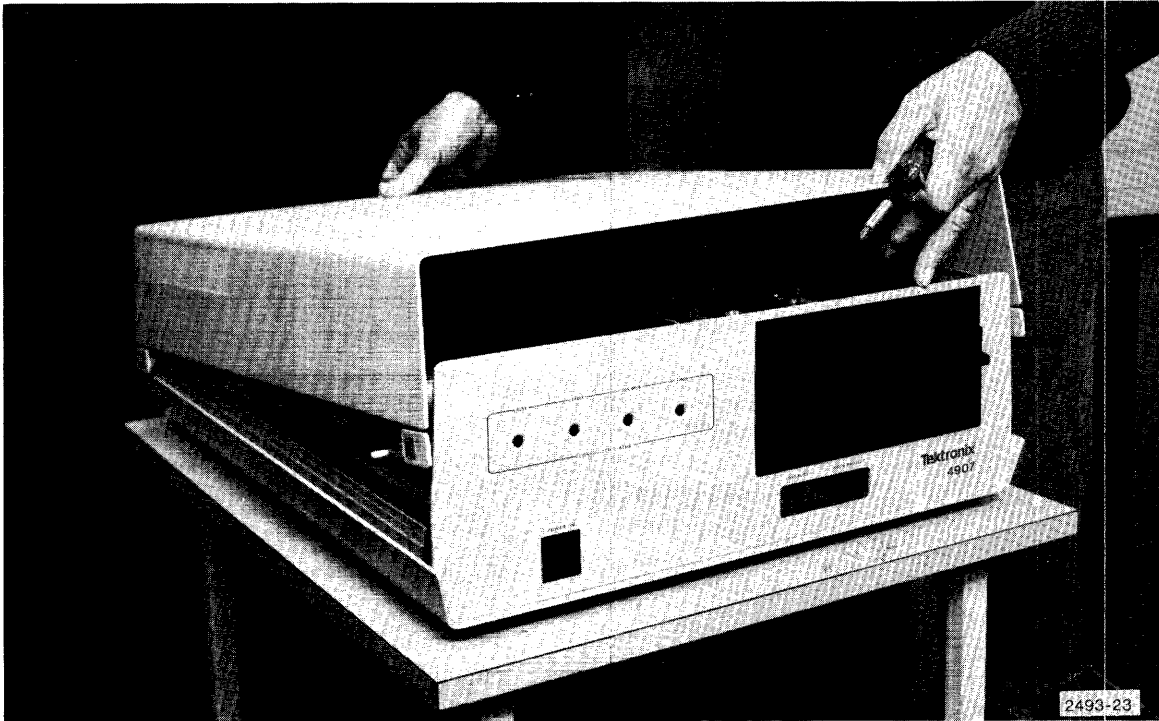

Figure 5-1. Removing main 4907 cabinet cover.

- f. Install ribbon cable to connector J-8 on the power supply board (Figure 5-2). Align red stripe with pin 1.
- g. Mount the plug on the back of the 4907 cabinet with pin 1 to the left as seen from the rear (Fig. 5-3).

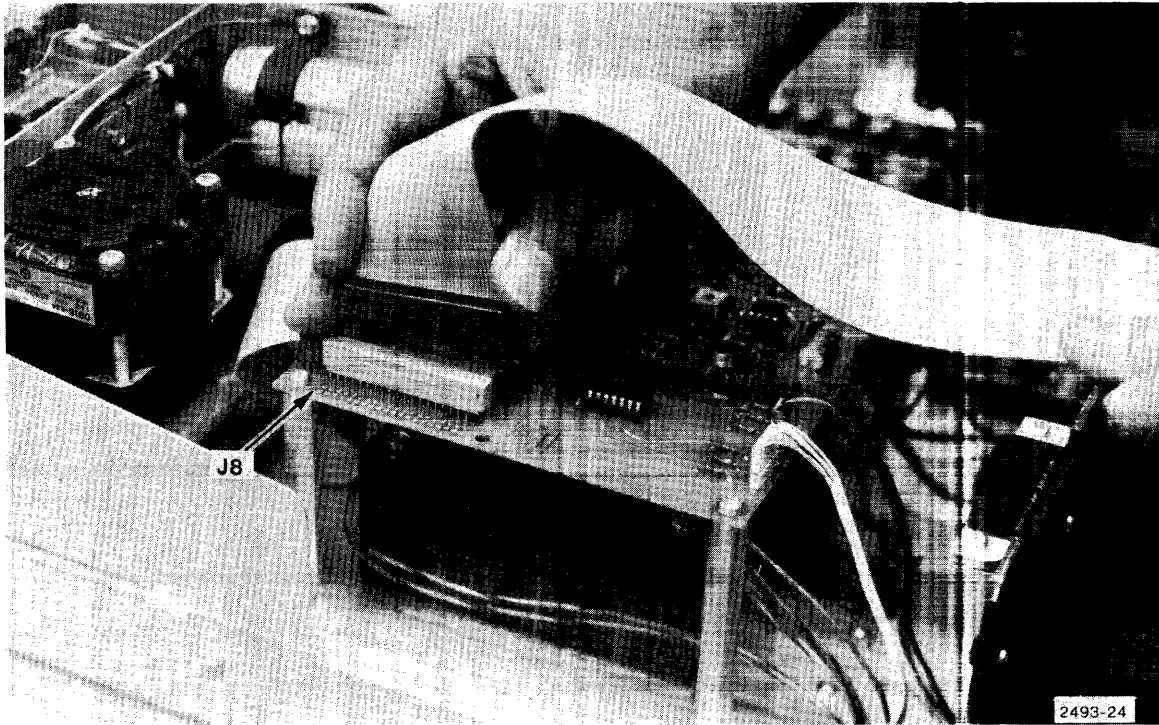

Figure 5-2. Connecting ribbon cable to J-8.

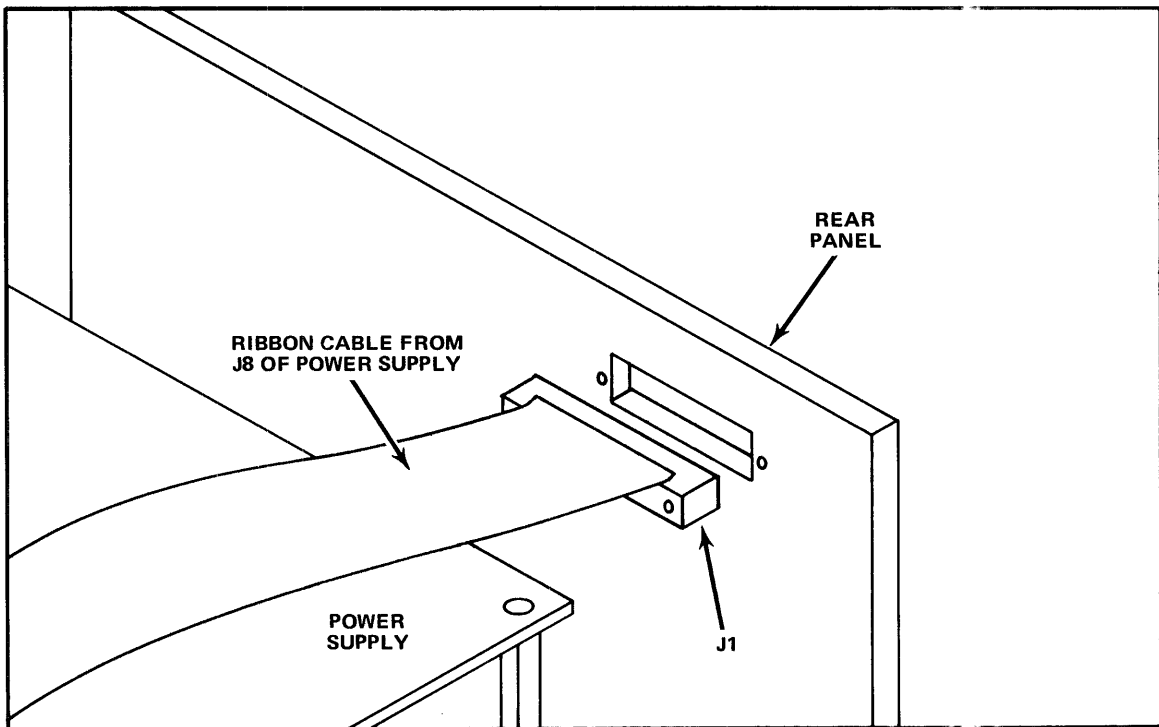

Figure 5-3. Mount J-1 connector on rear panel of main 4907 cabinet.

4907F30 FIELD UPGRADE KIT INSTRUCTIONS

- h. Plug one end of the shielded ribbon cable into the connector J-1 on the rear panel of the main 4907 cabinet and plug the other end of the cable into connector J-1 on the rear panel of the auxiliary 4907F30 cabinet. Pin 1 on the jack is on the left of both cabinets.

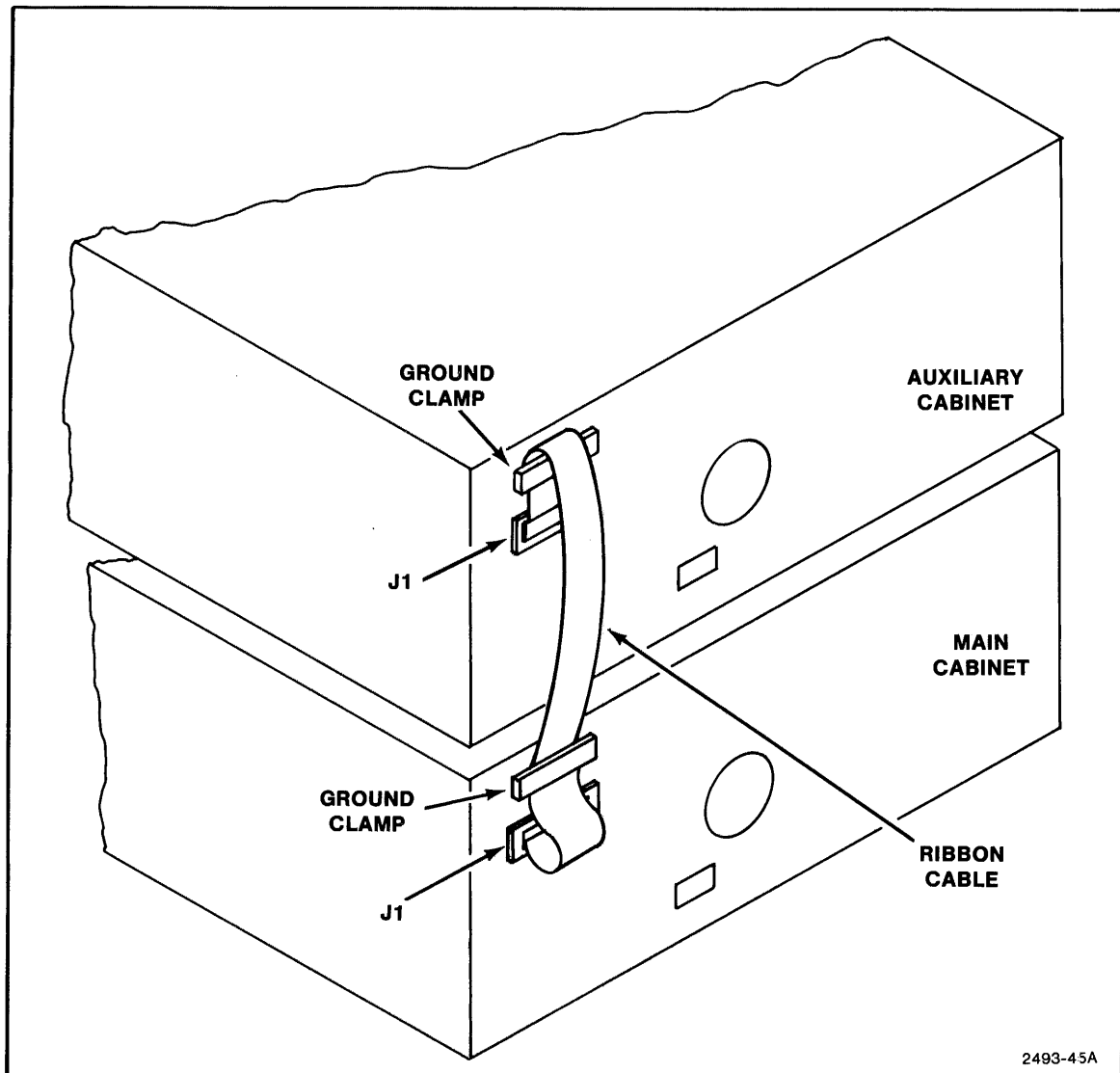

Figure 5-4. Securing ribbon cable to rear of main and auxiliary cabinets.

- i. Install the ground clamps on each cabinet. Be sure the ground clamps on both cabinets trap the ribbon cable between the back of the cabinet and the clamp at the exterior ground strip of the ribbon cable.

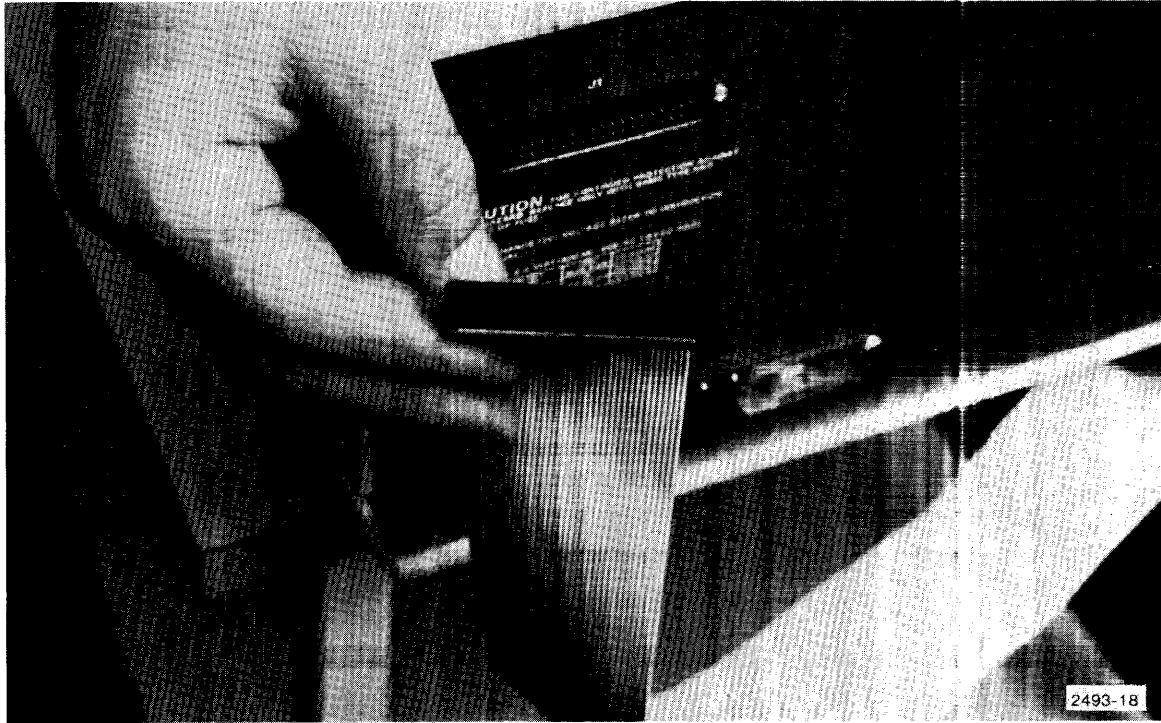

Figure 5-5. Attaching ribbon cable to J-1.

- j. Replace cover. Attach appropriate device address label to front of drive.
- k. Plug one end of line cord into rear of 4907F30 cabinet and the opposite end into a convenient wall socket.
- l. The system may now be powered up:
 - 1. Turn on 4051.
 - 2. Turn on front panel switch on main 4907 cabinet.
 - 3. Turn on front panel switch on 4907F30 cabinet.
- m. Flexible discs may now be loaded into the drives. See **LOADING THE DRIVE** in Section 3.
- n. Performance checks must be carried out on the new drive. See Section 4.
- o. The 4907 with the 4907F30 kit is now ready for operation. See 4907 File Manager. Operator's Manual.

Section 6

4907F31 FIELD UPGRADE KIT INSTRUCTIONS

The 4907F31 Field Upgrade Kit consists of:

1. Two flexible disc drives in a cabinet similar to the main 4907 cabinet.
2. Ribbon cable (interconnect cable).
3. Strain Relief clamps.
4. Line cord.
5. Two flexible discs.
6. 4907 Installation Guide.
7. Box of cleaning pads (10).
8. Two 4907 File Manager label sets.

The procedure below describes how to install this kit.

- a. Be sure all components listed above have been received.
- b. Place the 4907F31 cabinet on a flat surface next to the 4907.

WARNING

Be sure power has been turned off and line cord has been removed from cabinet.

- c. The new drives may require different device addresses. The factory-set address is 1 for the left-hand drive and 2 for the right-hand drive. See CHANGING DEVICE ADDRESSES in Section 3.
- d. Line voltage may require changing. If a change is necessary, see CHANGING LINE VOLTAGE in Section 3.
- e. See steps e through o in Section 5, 4907F30 FIELD UPGRADE KIT INSTRUCTIONS.

Section 7

4907F32 FIELD UPGRADE KIT INSTRUCTIONS

The 4907F32 Field Upgrade Kit consists of the parts shown in Figure 7-1 and includes:

1. One single flexible disc drive (A).
2. One dual drive front panel (B).
3. Two nylon tie wraps (C).
4. One ribbon cable (D).
5. One double daisy chain wire set (E) to fan, ground, etc.
6. One ribbon cable (F).
7. One ribbon cable (G).
8. Write-protect switch with LED and bezel (H).
9. Unit busy LED with recessed washer (J).
10. 4907 File Manager label set (not shown).
11. Box of cleaning pads (10)(not shown).
12. Six attaching screws (not shown).
13. Recessed washer (not shown).
14. One ribbon cable (K).

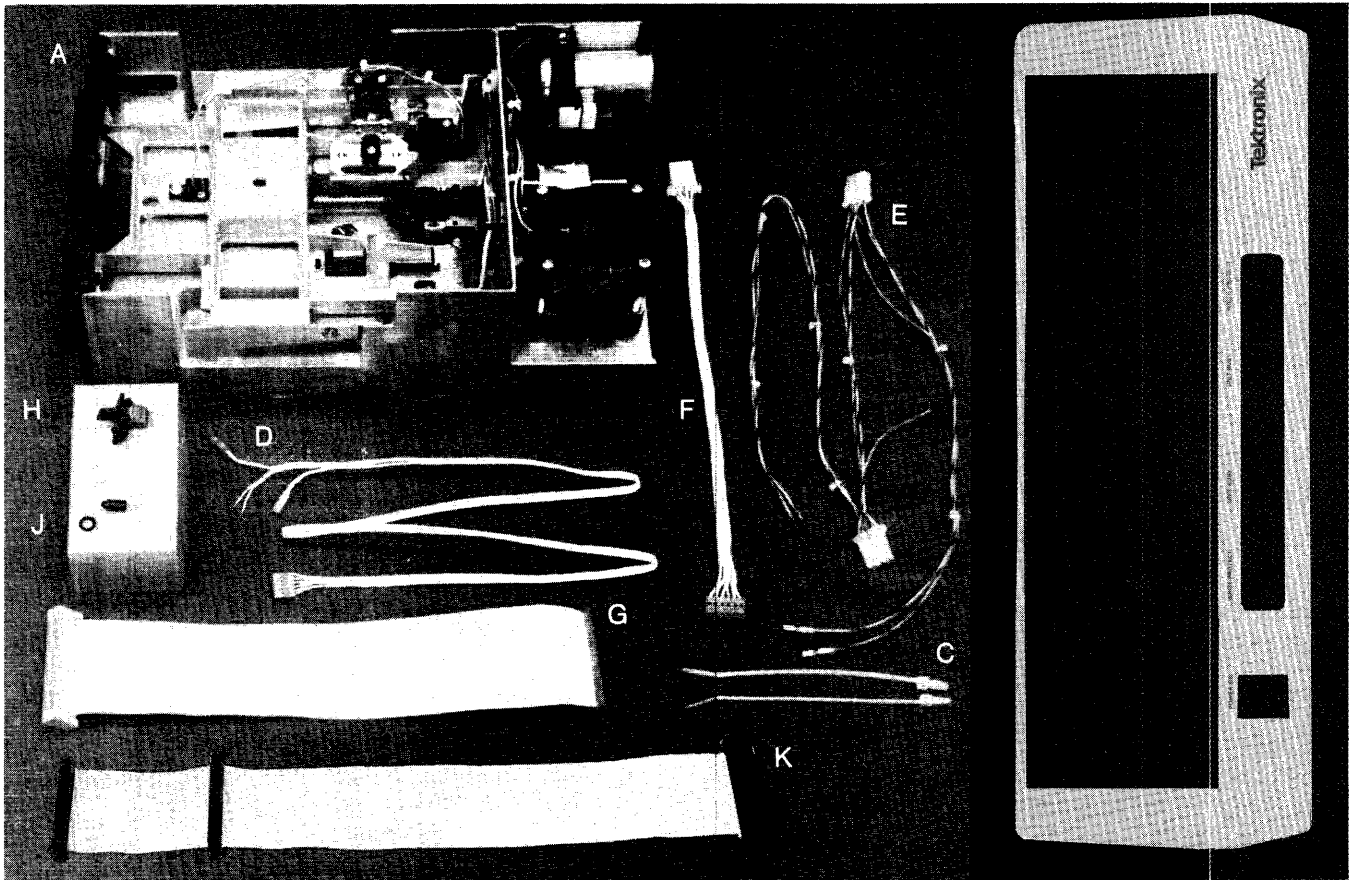

Figure 7-1. Field upgrade kit components.

The procedure below describes how to install this kit.

- a. Be sure all components listed above have been received.
- b. Disconnect ribbon cable from the rear of the 4907F32 cabinet.

WARNING

Be sure power has been turned off and line card has been removed from cabinet.

- c. Place the cabinet in a convenient working location.
- d. Remove three screws on each side and lift off cover.

- e. Loosen clamp holding drive to chassis (Figure 7-2).
- f. Turn unit over and place on soft cloth to prevent scratches. Next, remove ten bottom screws and lift off base.
- g. Remove power switch connectors (Figure 7-3).

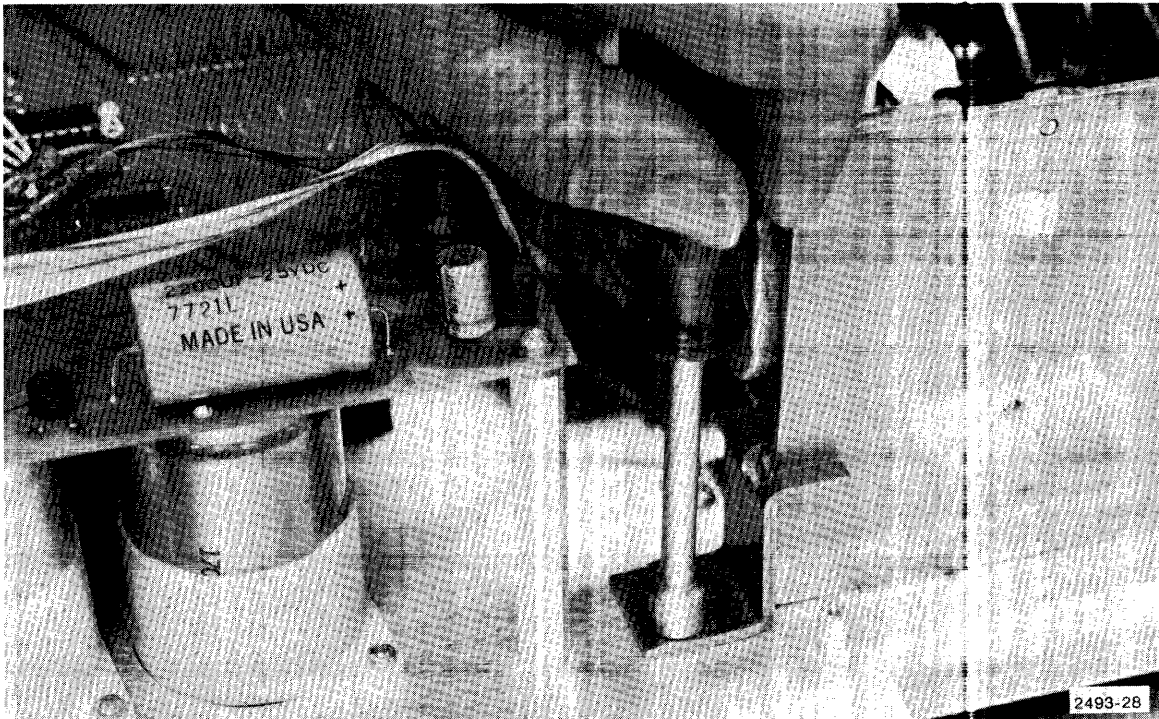

Figure 7-2. Loosening drive clamp.

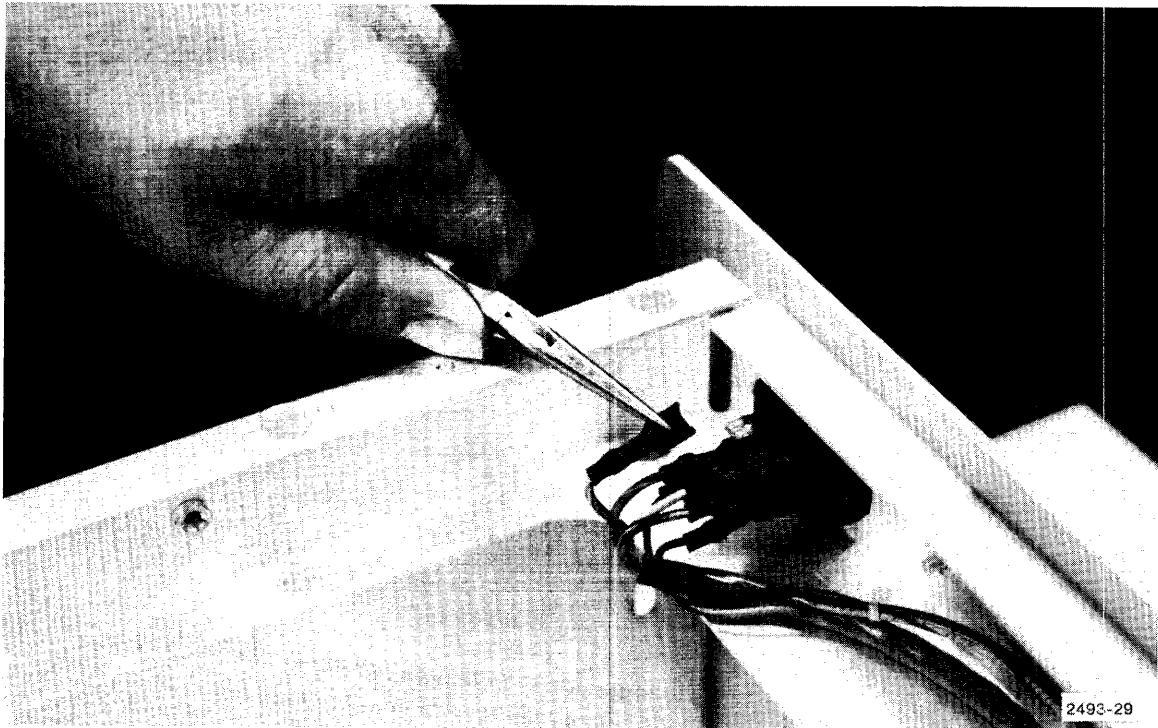

Figure 7-3. Removing power switch connectors.

- h. Remove power switch by pressing towards front of panel (Figure 7-4).

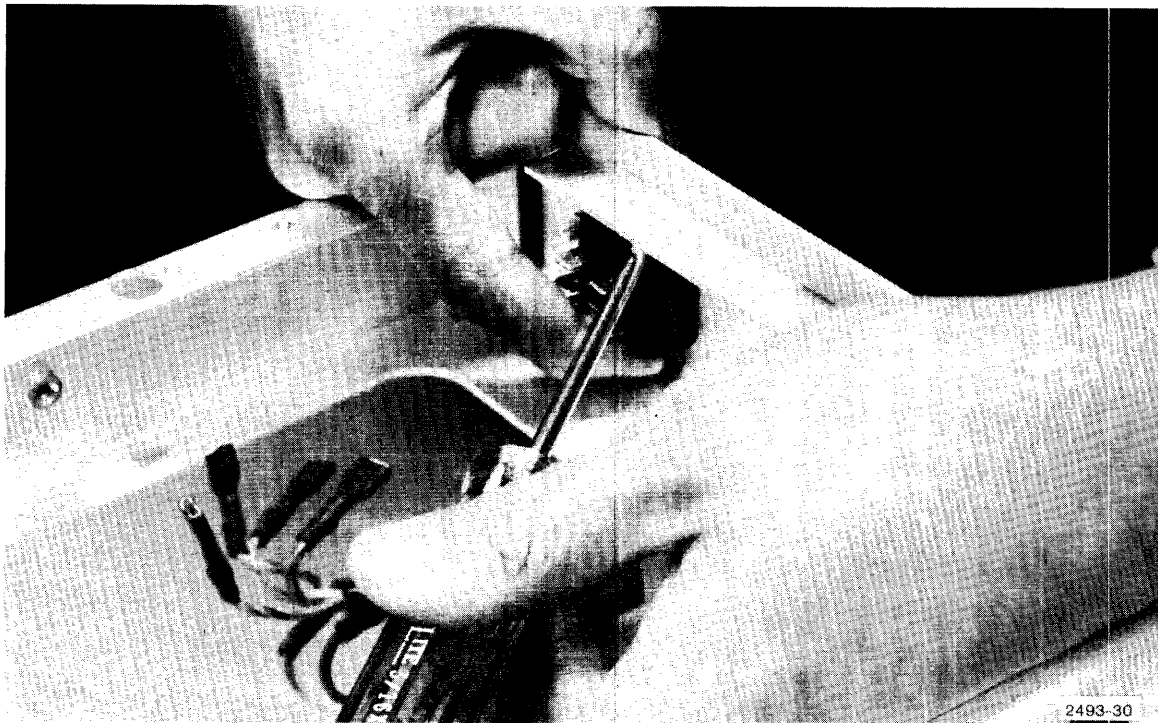

Figure 7-4. Removing power switch.

- i. Remove front panel from unit by removing eight nuts (Figure 7-5).
- j. Remove four screws from kit drive chassis (Figure 7-6).

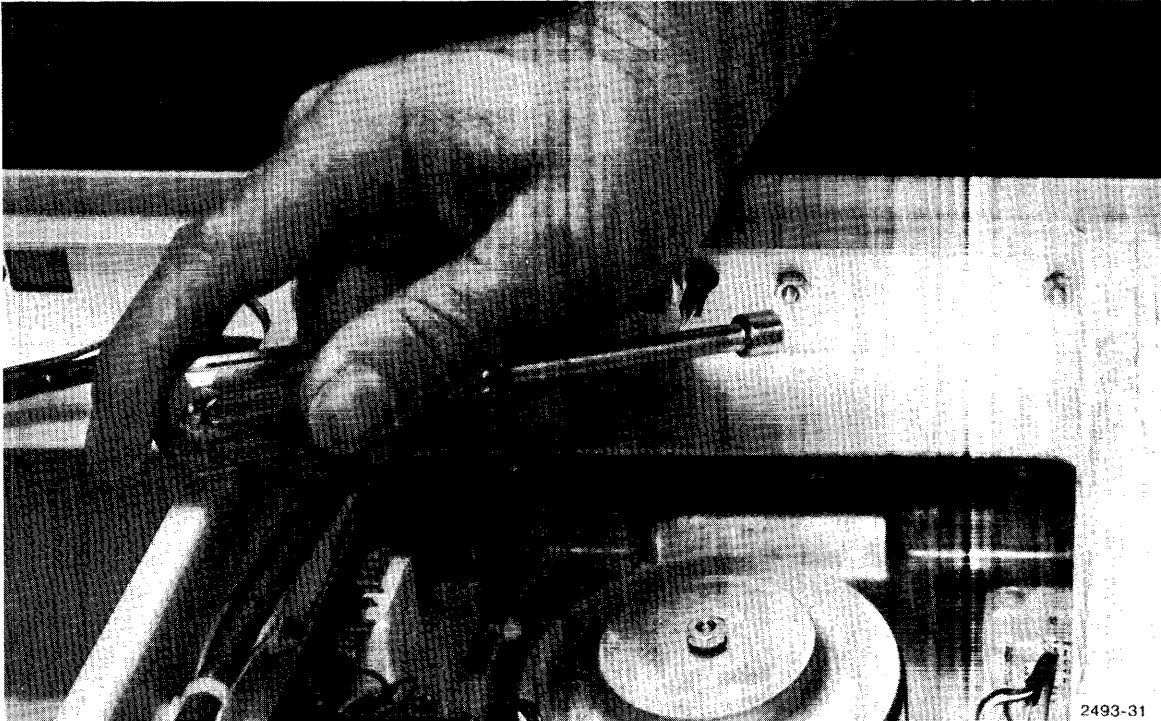

Figure 7-5. Removing front panel.



Figure 7-6. Removing screws from kit drive chassis.

4907F32 FIELD UPGRADE KIT INSTRUCTIONS

- k. Slide drive into chassis (Figure 7-7).
- l. Reinstall four screws through cabinet chassis (Figure 7-8) plus two side screws.

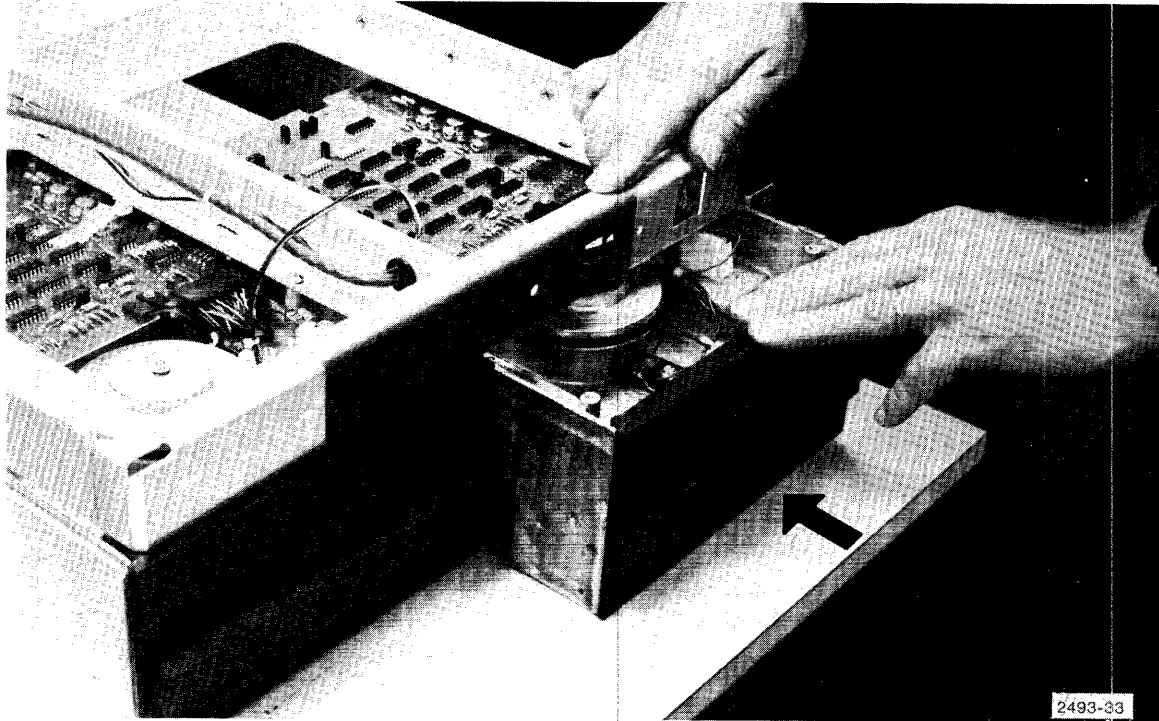

Figure 7-7. Sliding drive into chassis.

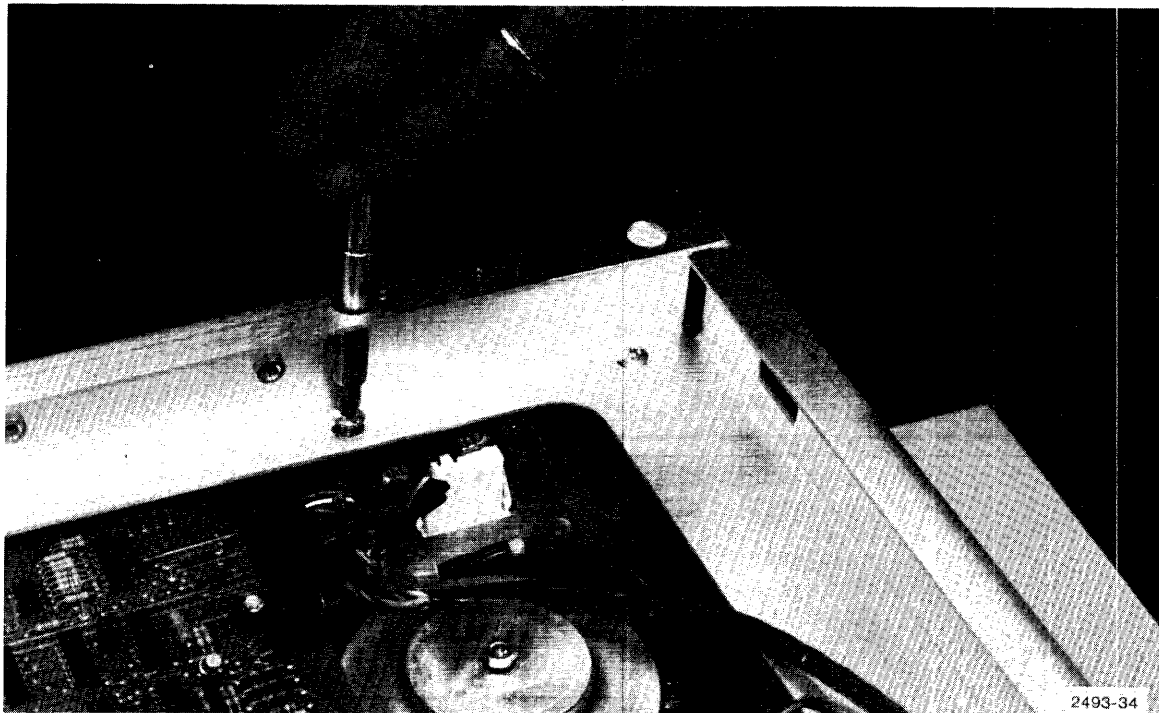
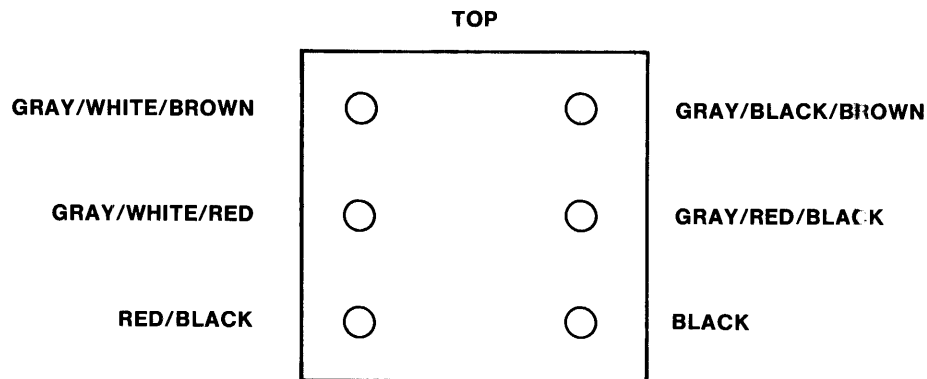

Figure 7-8. Reinstalling drive screws.

- m. Check CHANGING DEVICE ADDRESSES in Section 3 to see what the address setting is on the kit drive. If your current drives are set to 0 and 1, the address on the new drive should be set to 2. If current drive addresses are 1 and 2, the new drive address should be set to 3.
- n. Install new front panel.
- o. Install power switch and connectors (Figure 7-9).



2493-35

Figure 7-9. Rear view of power switch wiring layout.

- p. Install new unit busy LED and write-protect switch with LED in front panel. Note that the anode pin on the unit busy LED is indicated by a “+” at its base. The cathode side of the write-protect LED is indicated by a flat spot on the side of the LED itself. This flat spot can only be seen if the LED is removed from the write-protect housing.
- q. Thread front panel ribbon cable (D) through grommets 1, 2 and 3 in cabinet chassis (Figure 7-10).

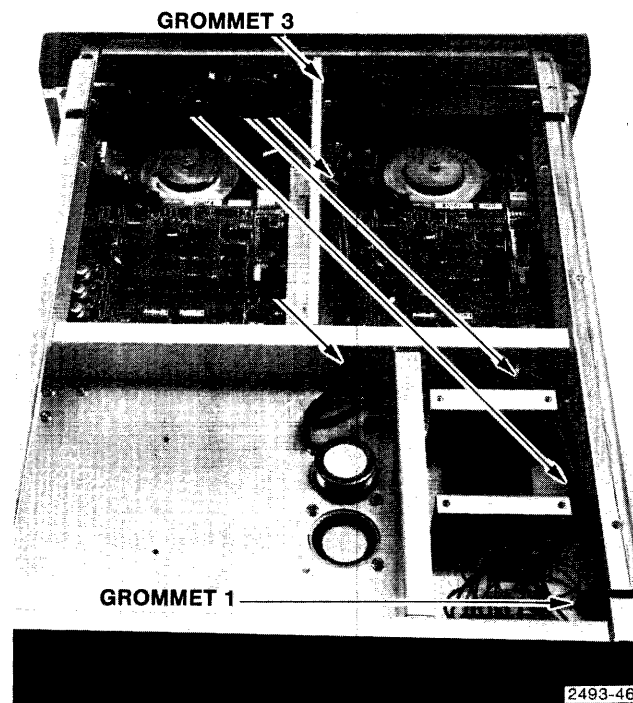

Figure 7-10. Threading ribbon cable D through grommets in cabinet chassis.

- r. Cut old tie wraps and secure new ribbon cable (D) to chassis walls and to adjacent wiring with new tie wraps (Figure 7-10).
- s. Attach cable D to new front panel LEDs and write-protect switch:
 - (1) Plug yellow connector into rear of the unit busy LED. Position the plug so the green and white wire is connected to the anode pin (Figure 7-11).
 - (2) Plug orange connector into rear of write-protect LED (Figure 7-11). Position the plug so the red and white wire is connected to the pin next to the flat side of the LED.
 - (3) Solder bare leads to write-protect switch lugs (Figure 7-11). Since polarity is unimportant, leads are interchangeable.

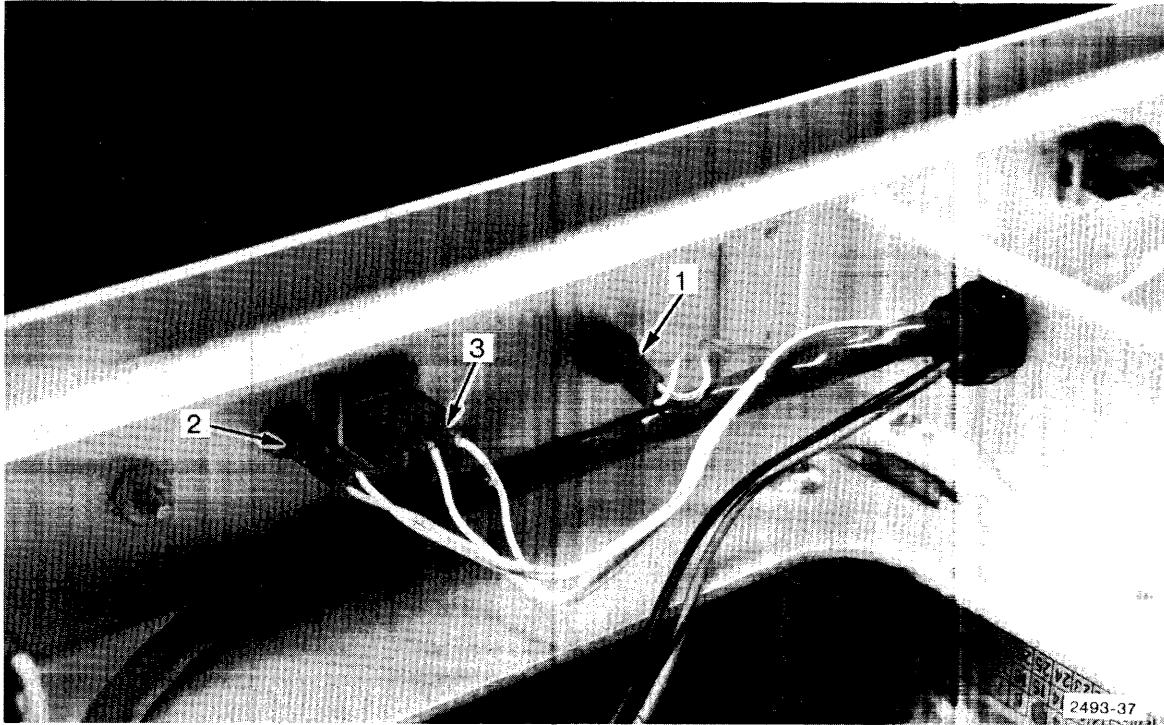

Figure 7-11. Connecting front panel leads of cable D.

4907F32 FIELD UPGRADE KIT INSTRUCTIONS

- t. Wire set E must now be attached to the line filter (Figure 7-12).
- (1) Thread the end of wire set E with MALCO connectors up into the cabinet chassis from below.
 - (2) Remove and discard existing MALCO connectors (brown and gray/brown and red) from line filter.
 - (3) Plug in MALCO connectors on wire set E to line filter: brown and gray to lug C, brown and red to lug E.

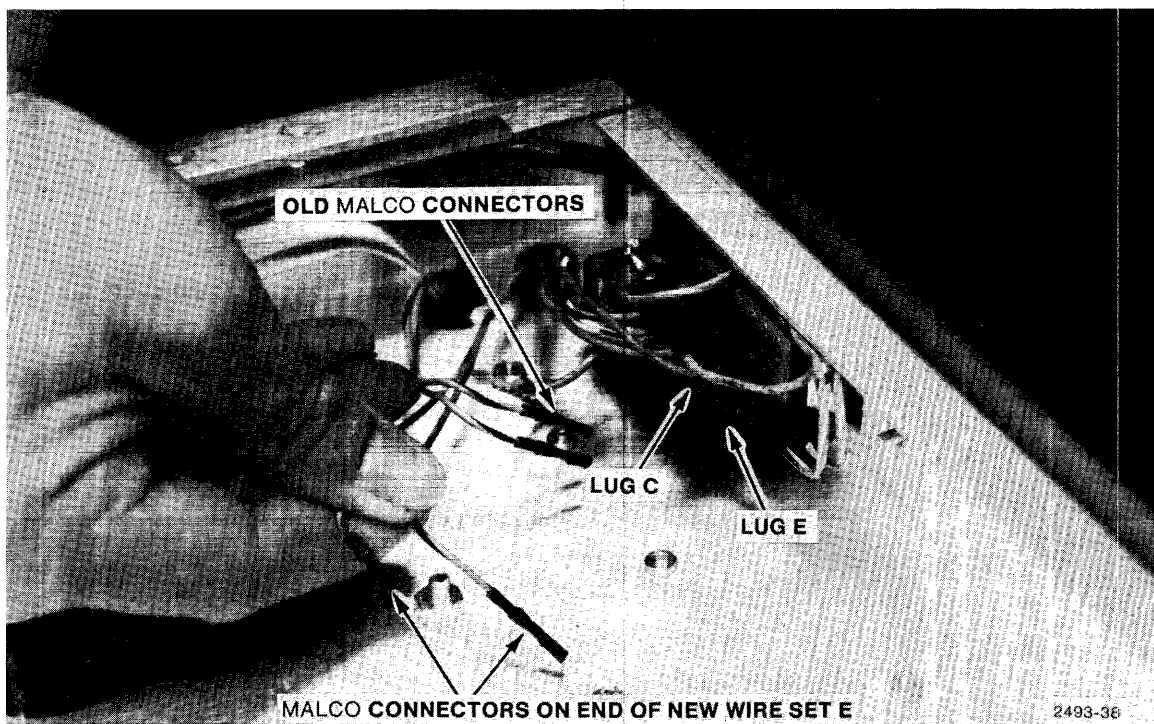

Figure 7-12. Placing new leads on line filter.

- u. Replace base and turn cabinet right side up.
- v. Tighten clamp loosened in step d. This secures both drives to chassis.
- w. Plug opposite end of ribbon cable D into J-11 on circuit board (Figure 7-13).

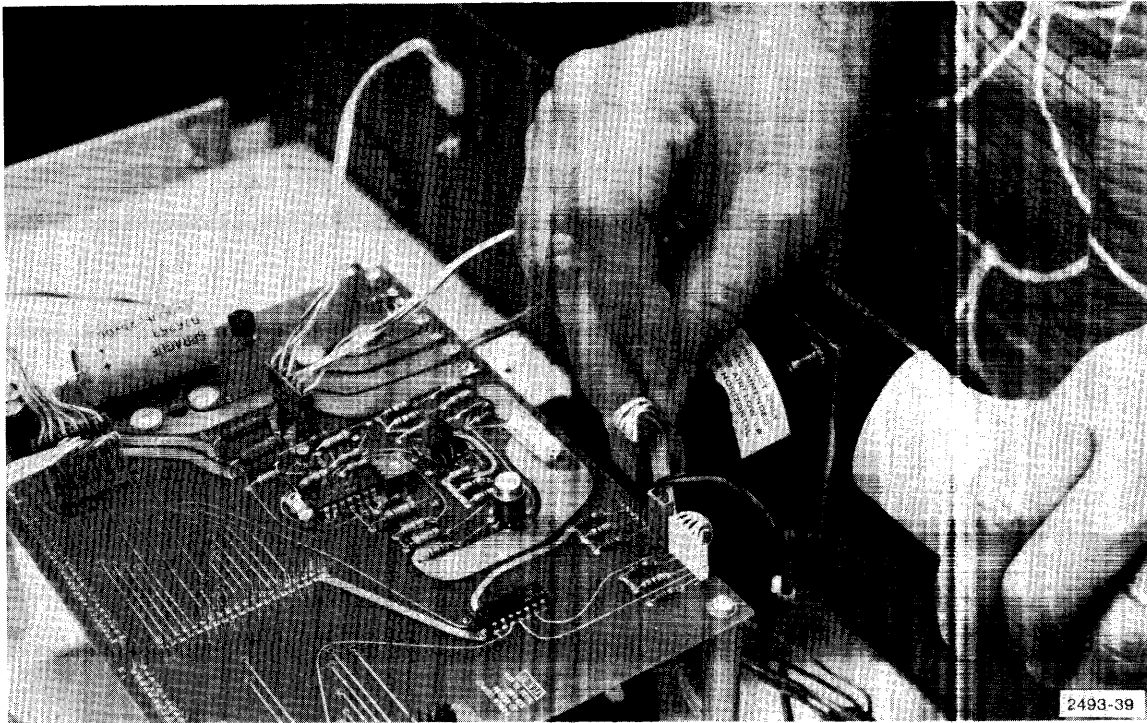

Figure 7-13. Connecting ribbon cable D to J-11.

4907F32 FIELD UPGRADE KIT INSTRUCTIONS

- x. After feeding ends of wire set E under power supply circuit board, connect as shown in Figure 7-14. Original single drive wire set must first be removed and discarded.

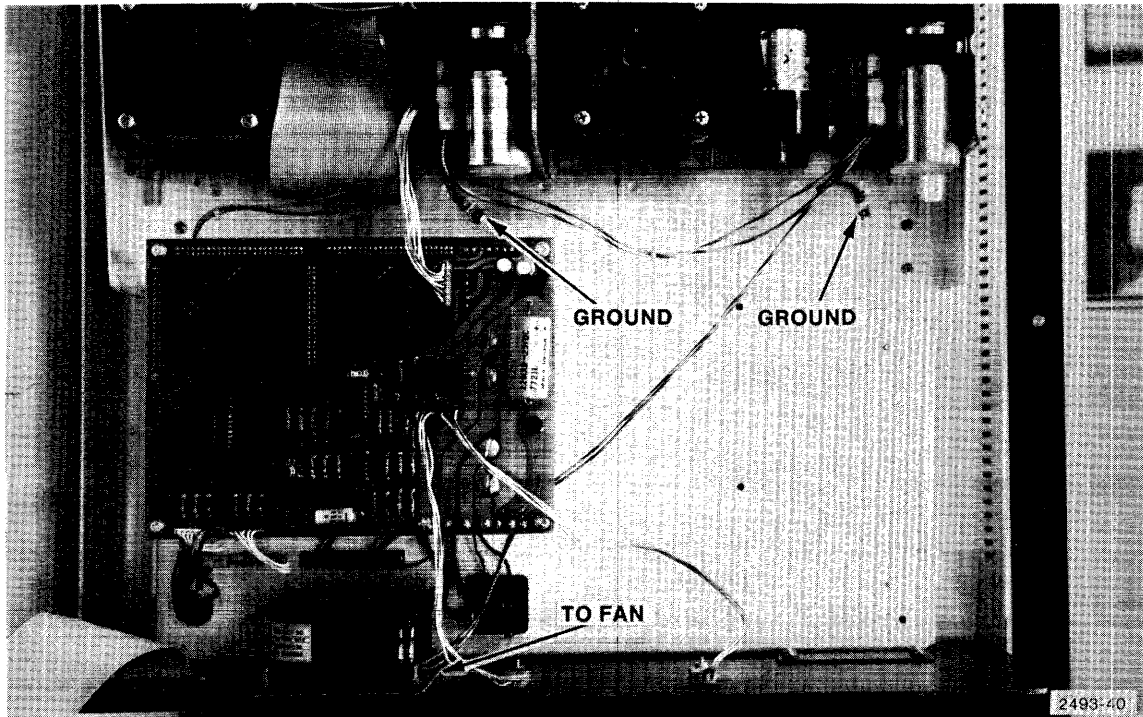

Figure 7-14. Wire set E in place including a single connector to each drive, two ground connections and two leads to the fan.

- y. Install ribbon cable F (Figure 7-15).
- z. Install ribbon cable G (Figure 7-16).

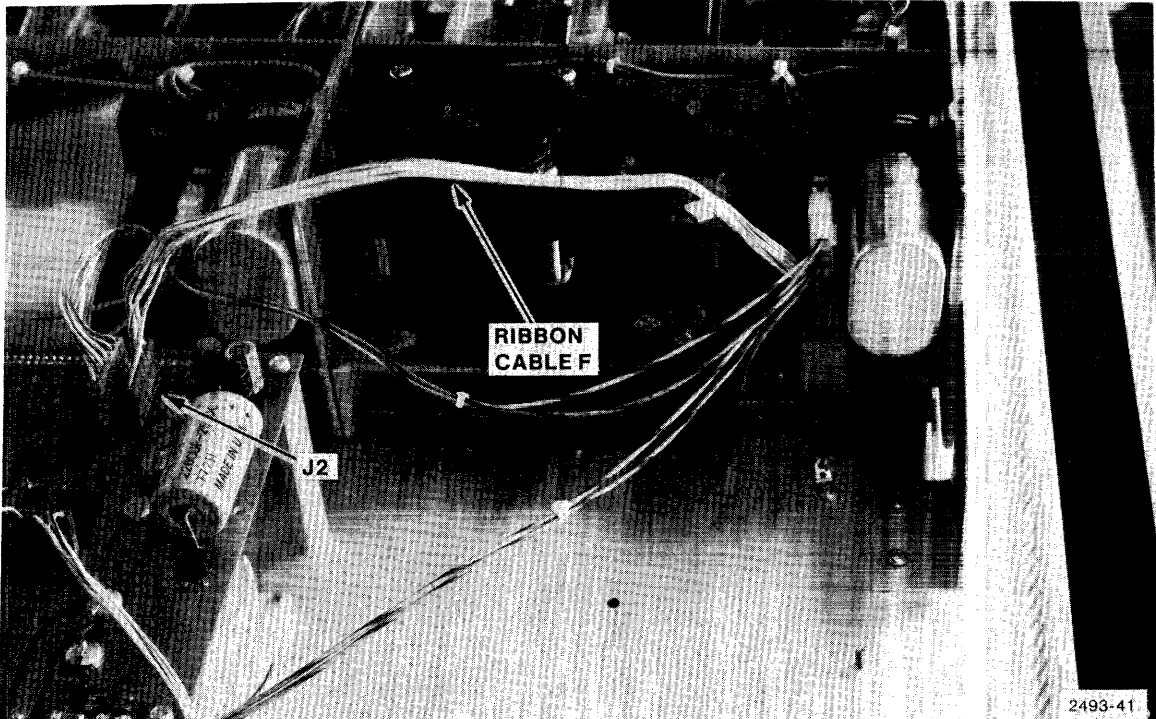

Figure 7-15. Installing ribbon cable F.

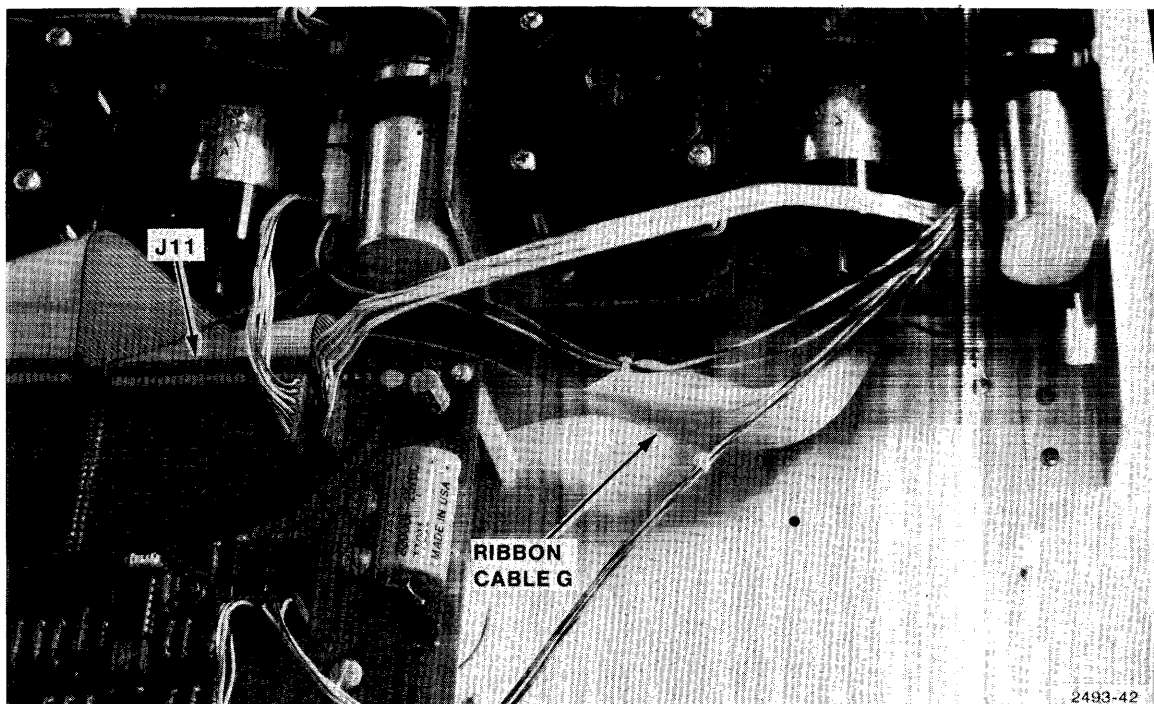

Figure 7-16. Installing ribbon cable G.

4907F32 FIELD UPGRADE KIT INSTRUCTIONS

- aa. Be sure all connections are accurately and securely in place, then reinstall cover.
- bb. Return cabinet to operating location. Attach appropriate device address labels to front of drives.
- cc. Replace ribbon cable and line cord leading to main 4907 cabinet.
- dd. Remove old cable. Add cable (K) from rear panel to two connectors on power supply circuit board.

The 4907F32 Field Upgrade Kit installation is now complete. The system is now identical to the 4907 Option 31. Tests described in Section 4, PERFORMANCE CHECKS should be carried out on the new drive. Regular operation may then be resumed.

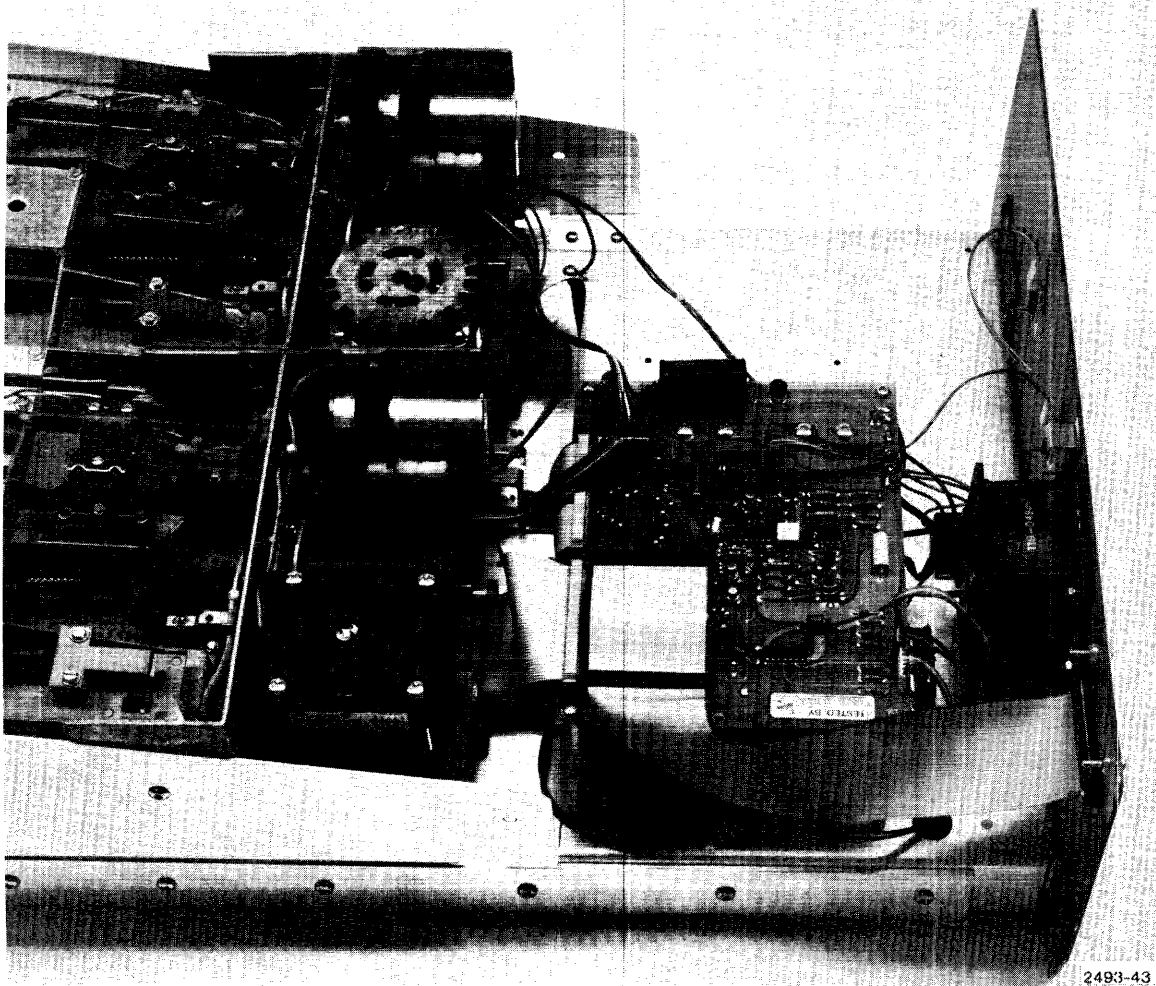

Figure 7-17. Installing ribbon cable K.

Appendix A

4907 FILE MANAGER STRAPPING INFORMATION

The File Manager Control, Power Supply, and Disc Drive boards are strapped differently for varying configurations and interface options. Factory strapping is for use with the 4050-series graphic systems. If the File manager is to be used with a 4010-series terminal with Option 5, strap the Control Board as shown below. Whenever the File Manager configuration is changed (disc drives added or deleted), all strap options should be checked.

Disc drives themselves are used in several configurations for the 4907 and other products. Whenever a new disc drive board is installed, refer to Table A-1 and Figures A-1 and A-2 for correct strapping information.

CONTROL BOARD

For use with 4050 series instruments, all address switches should be OFF (for address 0). For use with 4010 series instruments, strap to the desired GPIB address with the Option 5 GPIB Interface. RAM address select should be strapped to J13, pins 2 and 3 (normal operation), or J13, pins 1 and 2 (when using system test fixture 067-0746-00).

POWER SUPPLY

The CONT strap should be IN on the main cabinet and OUT on the auxiliary cabinet for 4907 Options 30 or 31.

DISC DRIVE BOARDS

All Disc Drive Boards have straps present in the following locations:

- T2, DS, C, DC, A, B, 801.
- Drive 0 should have a strap present on DS1.
- Drive 1 should have a strap present on DS2.

APPENDIX A

- Drive 2 should have a strap present on DS3.
- Terminator straps (see Figures A-1 & A-2): T1, T3, T4, T5, T6 should be present in the drive furthest electrically from the controller.
- In a single-drive configuration, the terminator straps will be present in Drive 0.
- In a dual-drive configuration, the terminator straps will be present in Drive 1 (Aux cabinet, right Drive).
- In a triple-drive configuration, the terminator straps will be present in Drive 1 (Aux cabinet, left Drive).
- A 3-wire cable is added to 118-0358-01 boards only which connects from:
 1. Pin 2 (edge connector J1) to Z strap pin 1.
 2. Pin 4 (edge connector J1) to IC4E pin 11.
 3. Pin 6 (edge connector J1) to eyelet hole between pins 5 & 6 of IC3D, which runs to IC3C pin 9.

For strap locations in the following table, see Figures A-1 and A-2.

Table A-1

STRAPPING INFORMATION FOR 4907 DISC DRIVES

Strap Name	Drive 0	Drive 1	Drive 2
T2	IN	IN	IN
T1,T3,T4, T5,T6	a	a	a
DS1	IN	OUT	OUT
DS2	OUT	IN	OUT
DS3	OUT	OUT	IN
DS4	OUT	OUT	OUT
HL	OUT	OUT	OUT
DS	IN	IN	IN
D	OUT	OUT	OUT
A	IN	IN	IN
B	IN	IN	IN
C	IN	IN	IN
Z	OUT	OUT	OUT
X,Y	OUT	OUT	OUT
L ^b	OUT	OUT	OUT
DC	IN	IN	IN
800	OUT	OUT	OUT
801	IN	IN	IN

^a“IN” only on the device the farthest cable distance away from the main cabinet connector J1. In a single-drive configuration, the terminator straps will be present in Drive 0. In a dual-drive configuration, the terminator straps will be present in Drive 1 (aux. cabinet, right side). In a triple-drive configuration, the terminator straps will be present in Drive 1 (aux. cabinet, left side).

^bFor circuit board 118-1004-XX, strap option L has been deleted.

APPENDIX A

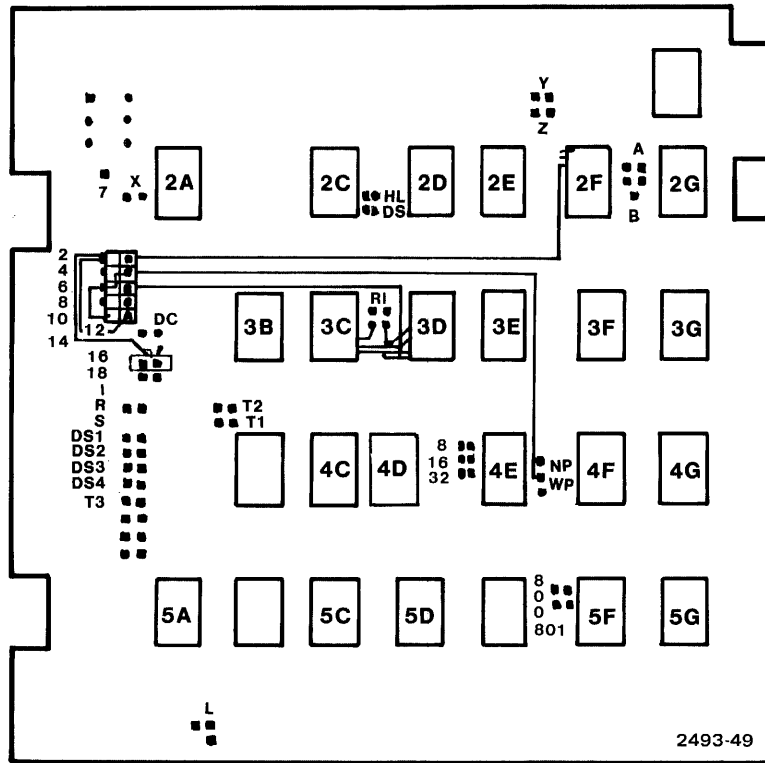

Figure A-1. Wire Harness and Plug Location for Disc Drive with 118-0358-02 Board.

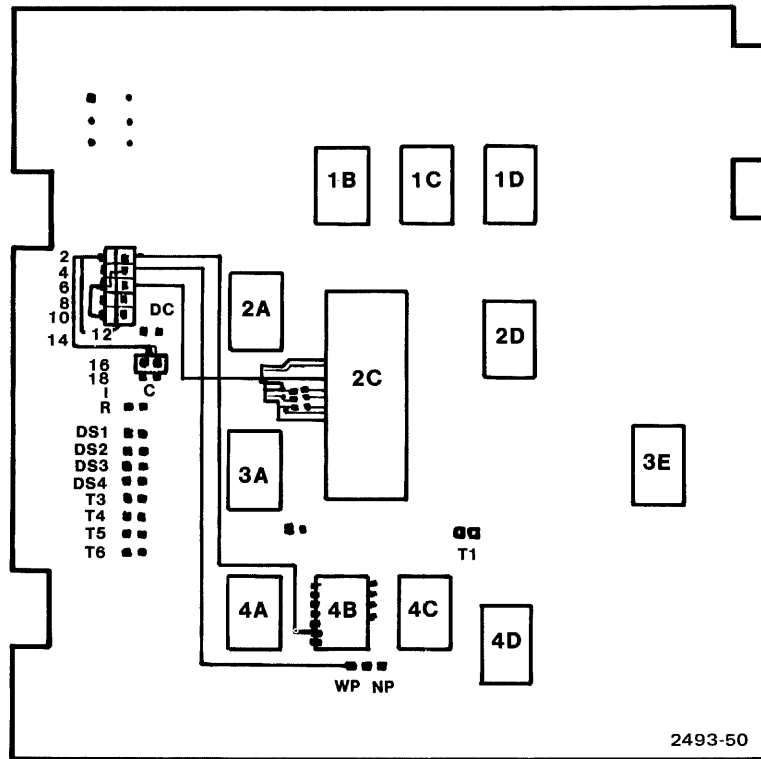

Figure A-2. Wire Harness and Plug Location for Disc Drive with 118-1004-XX Board.