



**4014 and 4014-1  
COMPUTER DISPLAY  
TERMINAL**

**USER'S MANUAL**

**Tektronix, Inc.  
P.O. Box 500  
Beaverton, Oregon 97077**

MANUAL PART NO.  
070-1647-00

First Printing JUL 1974  
This Printing NOV 1979

## WARRANTY

This Tektronix product is warranted against defective materials and workmanship, under normal use, for a period of one year from date of initial shipment. Tektronix will repair or replace, at its option, those products determined to be defective within the warranty period and returned, freight prepaid, to a Tektronix service center.

In addition, in those areas where Tektronix has service centers available for this product, on-site warranty repair is provided at no charge during the first ninety (90) days from the date of initial shipment.

There is no implied warranty for fitness of purpose.

Specification and price change privileges reserved.

U.S.A. and foreign TEKTRONIX products covered by U.S. and foreign patents and/or patents pending.

TEKTRONIX is a registered trademark of Tektronix, Inc.

Copyright © 1974 by Tektronix, Inc., Beaverton, Oregon.  
Printed in the United States of America. All rights reserved.  
Contents of this publication may not be reproduced in any form without permission of Tektronix, Inc.

---

# SECTION LOCATION GUIDE

**SECTION 1**

**SECTION 2**

**SECTION 3**

**APPENDICES**

**TABLE OF CONTENTS**

**INTRODUCTION**

**CONTROLS**

Front panel, strap options,  
and program controls

**OPERATION**

Checkout procedure,  
details of Mode Operation

**APPENDIX A**

Installation

**APPENDIX B**

ASCII Code Chart

**APPENDIX C**

Coordinate Conversion Chart

**APPENDIX D**

Interface Design

**APPENDIX E**

Accessories

**APPENDIX F**

Enhanced Graphic Module  
(Option 34)

**APPENDIX G**

Control Code Summary

**APPENDIX H**

Glossary

**INDEX**

# TABLE OF CONTENTS

<b>SECTION 1</b>	<b>INTRODUCTION</b>	page
	DATA FLOW	1-1
	Computer	1-1
	Communication Link	1-1
	Terminal	1-2
	Terminal Operating Modes	1-3
	Transmitting	1-4
	Receiving	1-5
	Alpha Mode	1-5
	Graph Mode	1-6
	Graphic Input	1-7
	Write Thru	1-9
	Local Operation	1-10
	Hard Copies	1-10
	Hold/View	1-11
<b>SECTION 2</b>	<b>CONTROLS</b>	2-1
	Keyboard	2-2
	Strap Options	2-4
	Control Characters	2-5
<b>SECTION 3</b>	<b>OPERATION</b>	3-1
	Introduction	3-1
	Installation	3-2
	Initialization	3-2
	View/Hold	3-3
	Character Transmission	3-3
	Alpha Mode	3-7
	Graph Mode	3-10
	Gin Mode	3-17
	Hard Copies	3-19
	Summary	3-21
	General Summary	3-22
	Alpha Mode Summary	3-23
	Graph Mode Summary	3-25
	GIN Mode Summary	3-29

## TABLE OF CONTENTS (cont)

<b>APPENDIX A</b>	<b>INSTALLATION</b>	
	General	A-1
	Pedestal-Mounting the Display	A-1
	Desk-Mounting the Display	A-1
	Operating Voltage and Fuse Size	A-1
	Regulated Power Supplies Current Drain	A-2
	Strappable Option Connections	A-3
	Connecting the Terminal to a Computer	A-4
<b>APPENDIX B</b>	<b>ASCII CODE CHART</b>	
<b>APPENDIX C</b>	<b>COORDINATE CONVERSION CHART</b>	
<b>APPENDIX D</b>	<b>INTERFACE DESIGN</b>	
	General	D-1
	Timing Requirements	D-1
	Minibus Details	D-2
	Minibus Signal Line Definitions	D-4
<b>APPENDIX E</b>	<b>ACCESSORIES</b>	
<b>APPENDIX F</b>	<b>ENHANCED GRAPHIC MODULE (Option 34)</b>	
	Introduction	F-1
	Installation	F-2
	Programming	F-4
	4096 Resolution	F-4
	Point Plot Mode	F-5
	Incremental Plot Mode	F-5
	Special Point Plot Mode	F-7
	Terminal Plotting Speed	F-9
	Mode Change Considerations	F-9
<b>APPENDIX G</b>	<b>CONTROL CODE SUMMARY</b>	
<b>APPENDIX H</b>	<b>GLOSSARY</b>	
<b>APPENDIX I</b>	<b>INDEX</b>	
<b>CHANGE INFORMATION</b>		



**Fig. 1-1. 4014 Computer Display Terminal.**

# INTRODUCTION

## General

The 4014 or 4014-1 Computer Display Terminal permits a person to deal directly with a computer. By using the keyboard (which is similar to a typewriter keyboard), a person can question or instruct the computer; the computer's response is returned to that person by way of the display screen, either alphanumerically or graphically (charts, graphs, pictures, etc.). The Terminal can also communicate with various peripheral units, and can act as a link between them and the computer.

The 4014 and 4014-1 are identical, except that the 4014-1 can be used with a hard copy unit to make permanent copies of displays. All information in this manual pertains to both instruments, except that hard copy information is applicable to only the 4014-1.

## DATA FLOW

A Terminal/Computer data flow diagram is shown in Fig. 1-2. The different sections are the Computer, the Communication Link, and the Terminal. Peripheral Devices can also be included in the configuration. A Hard Copy Unit may be included if a 4014-1 is being used.

Data entered at the Keyboard or from a Peripheral Device is routed through the Terminal Control, through the Interface, and thence to the computer via the Communication Link. If an echo condition exists (local echo or echoing accomplished by the Interface, the Communication Link, or the Computer), the data is also processed by the Terminal Control circuits just as though it originated at the computer.

## Computer

The Computer can speak and act only through the use of electrically coded information known as data. The job of the Computer is to accept data from the Terminal via the Communication Link, act upon it by performing the indicated instructions, and return its response to the Terminal, also via the Communication Link.

## Communication Link

**Direct Connection.** When the Computer is located near the Terminal (as in the same building), a direct connection is the most practical; a cable from the Terminal's Interface connects directly to the Computer.

**Telephone (Modem) Connection.** In many cases the Computer will be located a considerable distance from the Terminal, making a direct connection impractical. In such cases, the transfer of information between the Computer and Terminal must be by other means. The most convenient and readily available means of transmission is the standard telephone line. However, the Terminal and computer cannot be hooked directly to the telephone because of the low frequency response of the telephone lines (computers can talk faster electrically than the highest frequency of the human voice); therefore, the telephone hook-up consists of a modulator-demodulator (MODEM) which places the data on a voice frequency tone (modulation) for transmission over the lines and retrieves the data (demodulation) at the receiving end. Both the Computer end and the Terminal end of the telephone line have MODEMS; both ends operate the same.

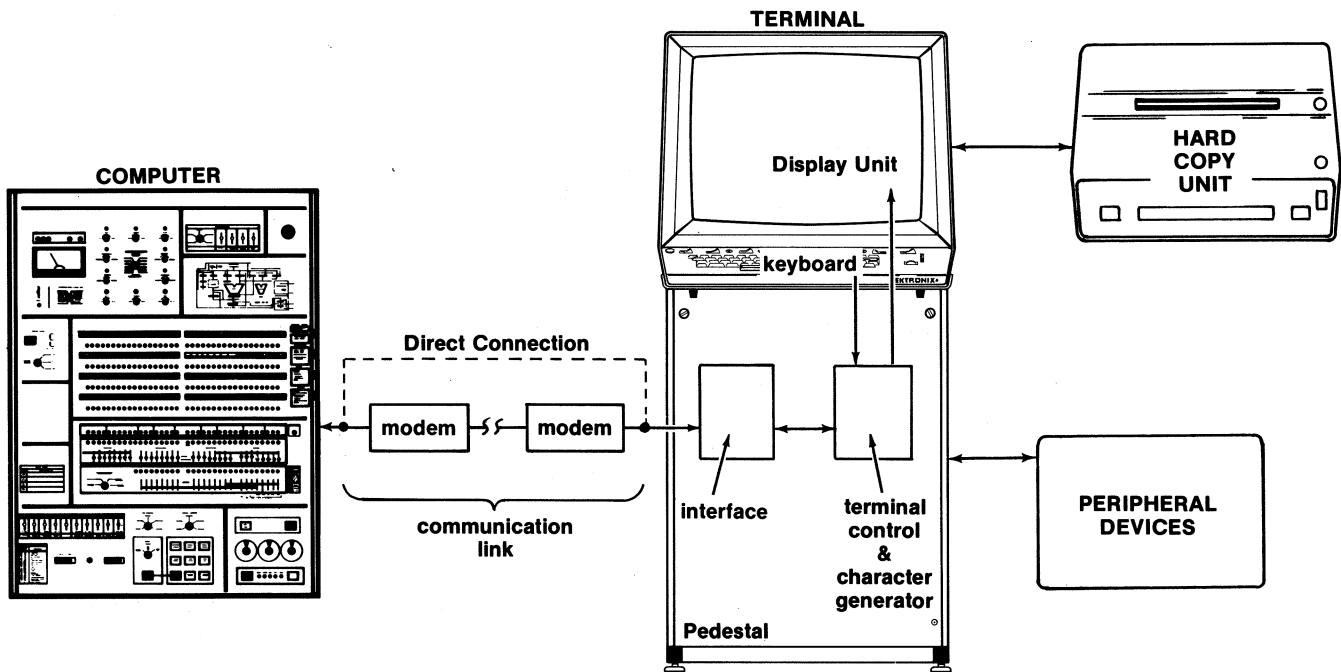

Fig. 1-2. Data flow diagram.

## Terminal

**Keyboard.** The Keyboard provides the operator with a readily understandable means of inputting data to the Computer. It is an electromechanical device which, as a result of the operator's depressing any one of its keys, produces electronic data that is distinctive for that key. The electronic representation of the depressed key provides the Terminal Control and the Computer circuits with a form of data they can understand. This representation conforms to the American Standard Code for Information Interchange (ASCII).

**Display Unit.** The Display Unit presents data visually for both alphanumeric and graphic operation by accepting writing beam position and writing beam on or off signals from the Terminal Control circuitry. These signals combine in the Display Unit to give a visual representation on the display screen of the data interchange between the operator and the computer.

The Display Unit contains a storage-type crt (cathode-ray tube). The data being displayed has only to be written once. The characteristics of the storage tube allow the image of the data to be displayed for 15 minutes without

damage to the display screen without having to continually redraw it, as would be necessary if a television-type crt were used. This 15 minutes can be increased to one hour in Alpha Mode because of an automatic reduced-intensity feature.

**Terminal Control and Character Generator.** This circuitry accepts data from either the Interface, the Keyboard or from Peripheral Devices. This circuitry also provides synchronization so that the data is handled in the proper sequence. When data is accepted by the Terminal Control circuits, they route this data to the Computer and/or the Terminal Display Unit, depending upon the data source and the function requested by the data. The Terminal Control circuits interpret this data as a writing character, as coordinate points on an X-Y axis (for beam positioning), as a special function to be performed (backspace, ring bell, etc.), or as mode control information. Another function of the Terminal Control is to allow the Terminal status and the X and Y coordinates of any point on the display area of the screen to be sent from the Terminal to the Computer upon command. The Character Generator provides character writing information to the Display Unit.



**Interface.** The Terminal's Interface applies data from the Computer to the Terminal's Control circuits. It also routes data from the Terminal Control Circuits to the Computer. Any one of several Interfaces may be used with the Terminal. The choice in direct-connection applications is dependent upon the specific Computer; in Modem-connection applications, the choice is dependent upon the degree of flexibility or communication sophistication desired.

## TERMINAL OPERATING MODES

The three primary operating modes are transmitting, receiving, and interactive. Transmission can occur as a result of Keyboard inputs, inputs from Peripheral Devices, or can occur automatically as a result of a Computer request.

Receipt of information from a Computer, Peripheral Device, or from the Terminal's own Keyboard (echo condition) can result in character writing (Alpha Mode), vector drawing (Graph Mode), control character execution (independent of mode), or Peripheral Device control.

Alpha Mode character writing can occur in any one of four sizes, dependent upon program commands.

Either a finely-focused writing beam (Write Normal) or a wider writing beam (Write Thick) can be selected; write Thick normally is used only for vector drawing.

Although information normally stores when written and remains visible until erased, a Write-Thru Mode (which permits information to be displayed without storing) can be program-selected. Previously stored information remains visible. Obviously, Write-Thru data must be repeatedly refreshed to be useful.

Interactive operation is referred to as Graphic Input or GIN Mode. A request from the Computer can initiate transmission of the Terminal's status and/or beam position to the Computer. The beam position may be indicative of the Alpha Mode next-character writing position, the Graph Mode beam position, or the position of an operator-controlled crosshair cursor.

An additional introduction to these operating modes is provided on the following pages, along with information about Hard Copy, Local/Line, and View/Hold operation.

## Installation and Care of the Terminal

Details regarding installation are provided in the Appendix. Essentially, installation consists of selecting the proper line voltage connections and fuse size, selecting strap options, and connecting the Terminal to the Computer (or Modem) and Auxiliary devices (if applicable). An optional Desk-Mounting Kit can be ordered to allow the Display Unit to be detached from the pedestal unit and used for desk-top operation up to ten feet away.

Care of the Terminal involves keeping it clean, providing proper ventilation, and operating it in a manner which insures a maximum life for the display screen. External surfaces, including the face of the display, can be cleaned with a mild soap and water solution. Proper ventilation can be assured by keeping the air vents free of obstructions and excessively warm air supplies. Maximum life for the screen can be obtained by the following: (1) Keep the Terminal turned off when not in use; (2) Keep the Terminal in Alpha Mode except when actually drawing graphs or utilizing GIN Mode; (3) Do not maintain a stored display for more than 15 minutes in View status, or one hour in Hold status; maintaining a stored display for longer periods may damage the screen. Details regarding modes and View/Hold status are contained on the following pages.

# TRANSMITTING

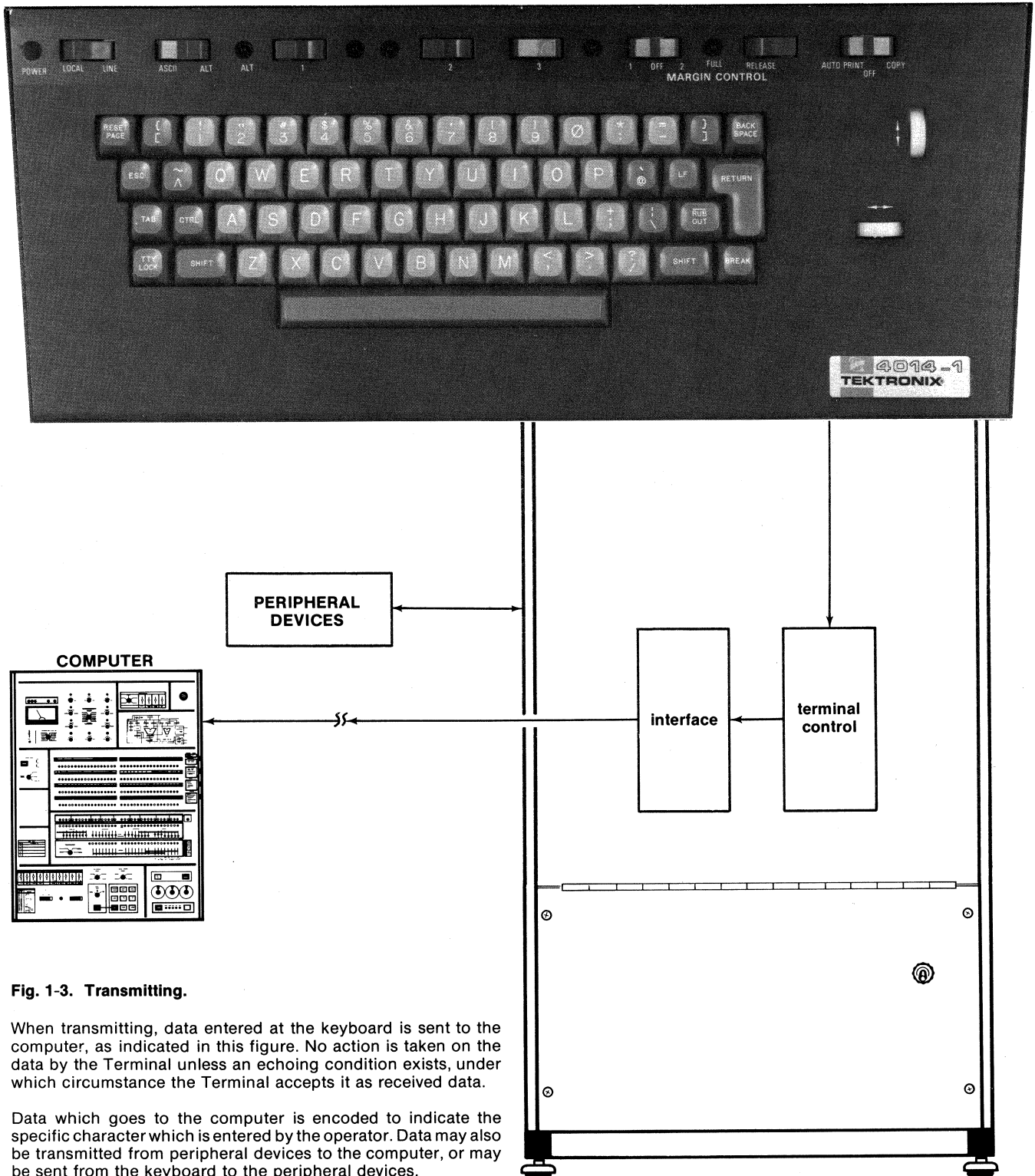

Fig. 1-3. Transmitting.

When transmitting, data entered at the keyboard is sent to the computer, as indicated in this figure. No action is taken on the data by the Terminal unless an echoing condition exists, under which circumstance the Terminal accepts it as received data.

Data which goes to the computer is encoded to indicate the specific character which is entered by the operator. Data may also be transmitted from peripheral devices to the computer, or may be sent from the keyboard to the peripheral devices.

# INTRODUCTION RECEIVING

The Terminal's receiving operation consists basically of writing characters, drawing lines (vectors), or executing control characters. Characters are written in Alphanumeric (Alpha) Mode; vectors are drawn in Graphic (Graph) Mode; control characters are executed in either mode.

## ALPHA MODE

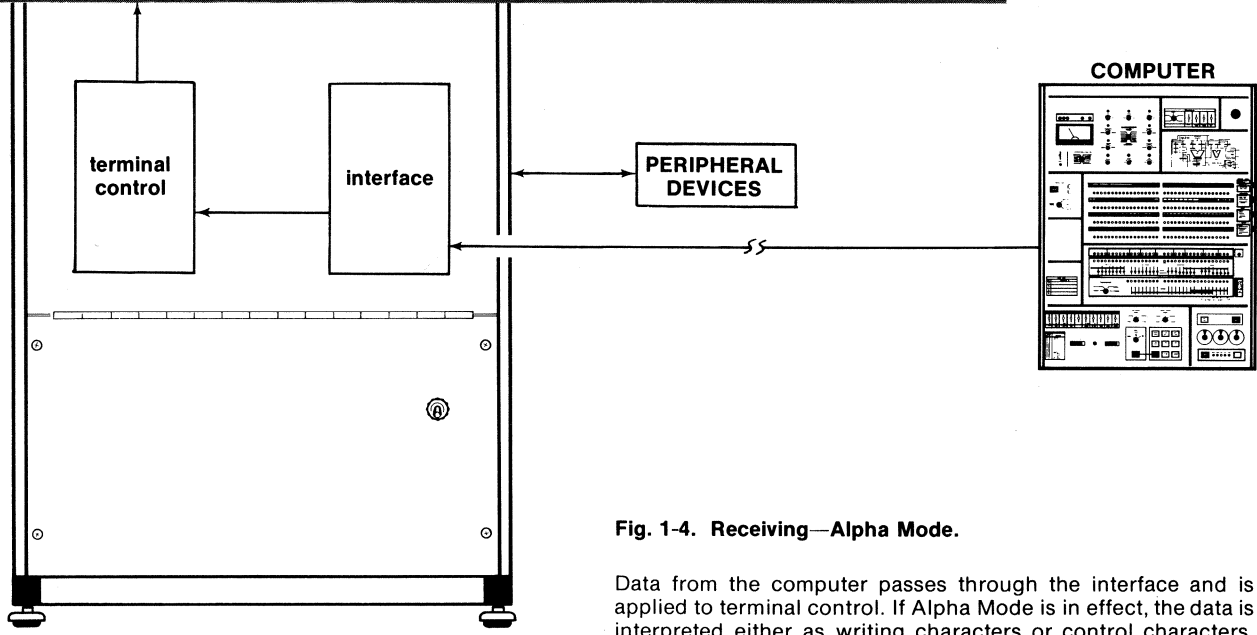
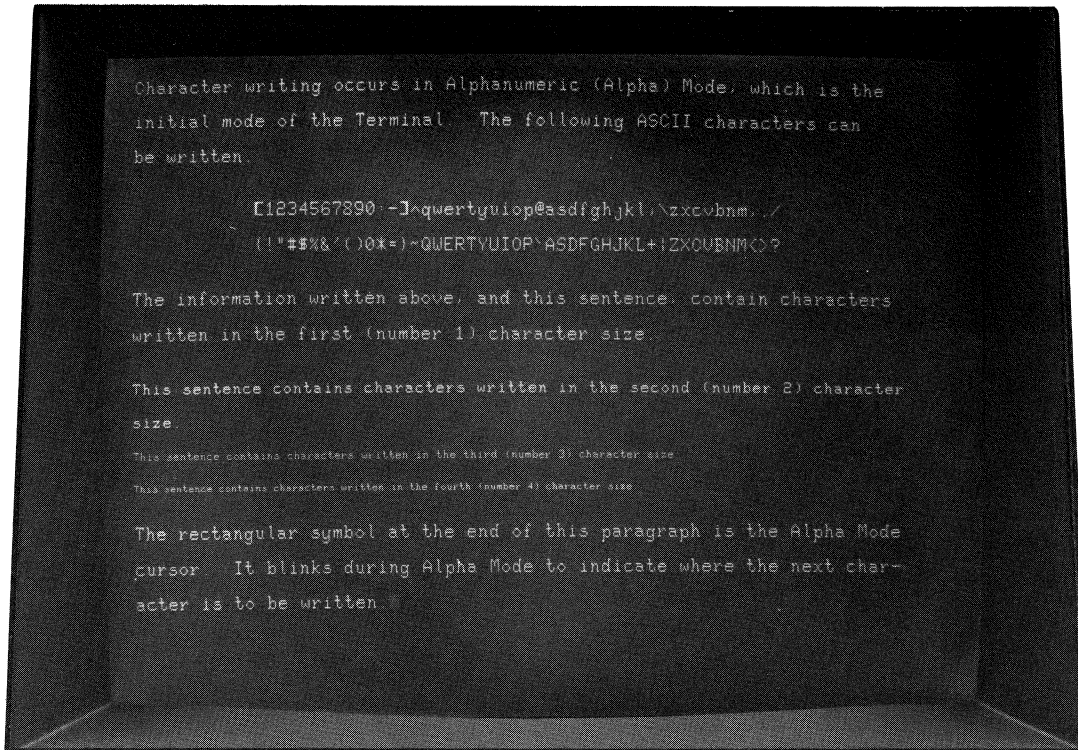

Fig. 1-4. Receiving—Alpha Mode.

Data from the computer passes through the interface and is applied to terminal control. If Alpha Mode is in effect, the data is interpreted either as writing characters or control characters. Writing characters are then displayed on the screen. Control characters are executed by the Terminal. Data can also be accepted from or by peripheral devices while in Alpha Mode.

## GRAPH MODE

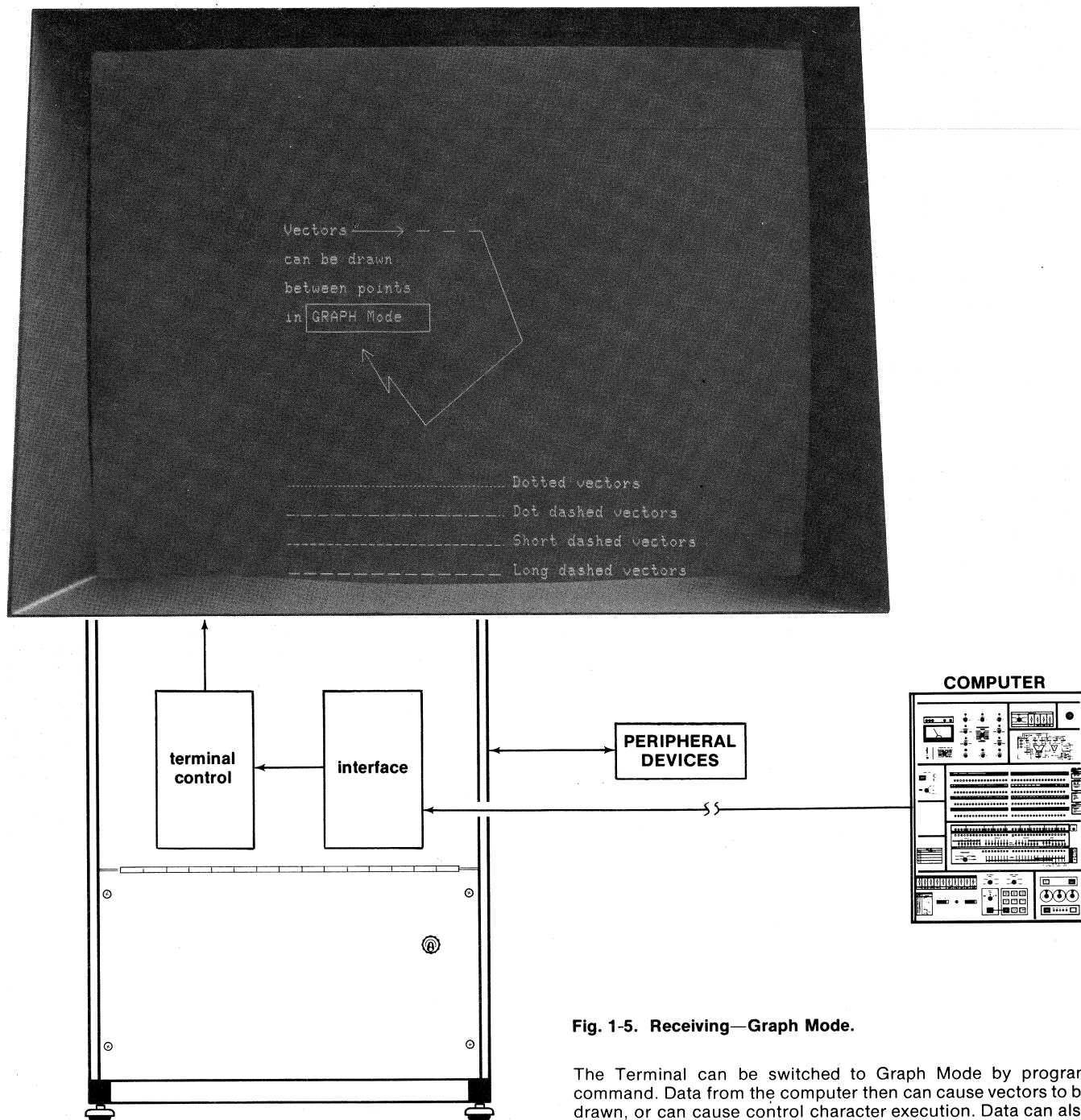

Fig. 1-5. Receiving—Graph Mode.

The Terminal can be switched to Graph Mode by program command. Data from the computer then can cause vectors to be drawn, or can cause control character execution. Data can also be accepted from, or by, peripheral devices while the Terminal is in Graph Mode. The optional Enhanced Graphics Module enables four additional vector types (dotted, dot dashed, short dashed and long dashed vectors) to be drawn as selected by the program.

# GRAPHIC INPUT (GIN)

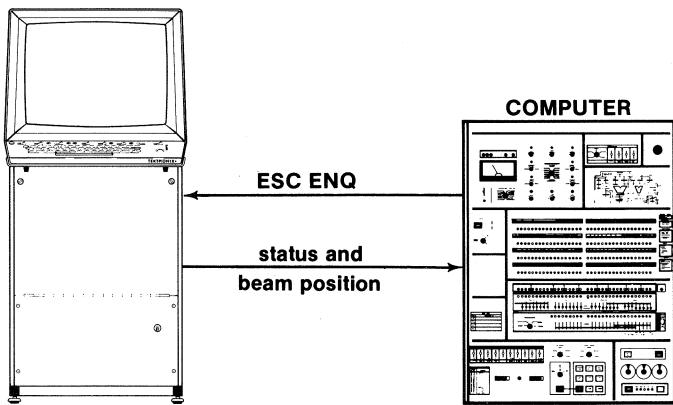

Fig. 1-6

The Graphic Input (GIN) operations are interactive, in that they involve computer requests for information, and the Terminal's response to the requests. The GIN operations are explained in the following paragraphs.

Fig. 1-7

Input of Terminal status and Alpha Mode cursor position. An ESC ENQ request from the computer while the Terminal is in Alpha Mode results in transmission of the Terminal status and the address of the bottom-left corner of the Alpha cursor. The Terminal responds automatically, and the operation is not noticeable to the Terminal user.

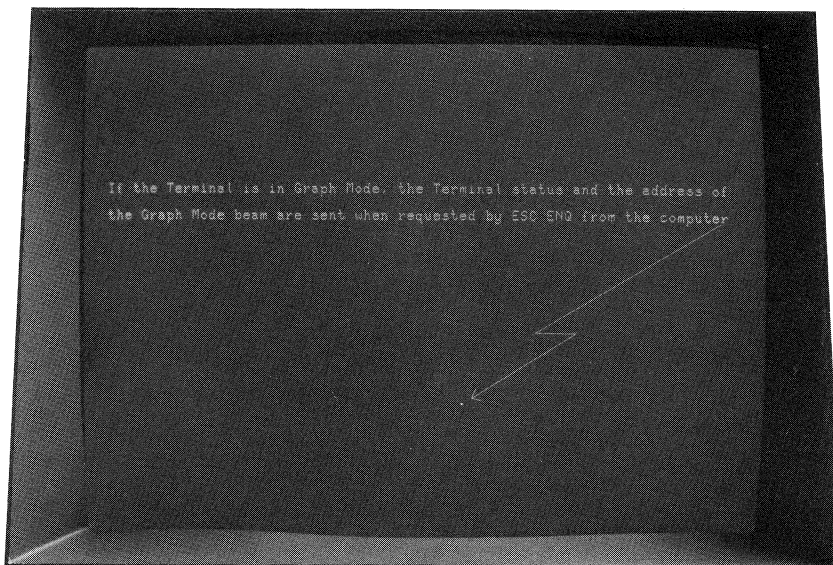
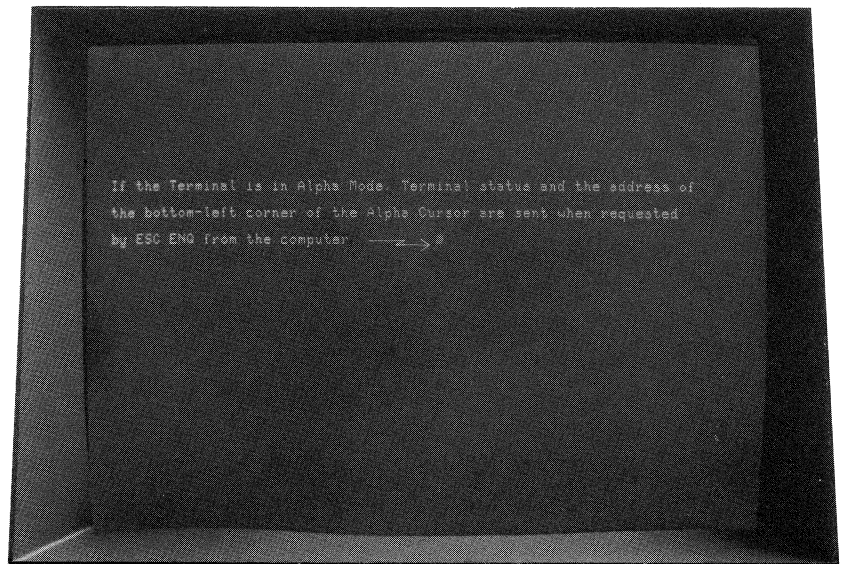

Fig. 1-8

Input of Terminal status and Graph Mode writing beam position. An ESC ENQ request from the computer while the Terminal is in Graph Mode results in automatic transmission of the Terminal status and the address of the writing beam, whether or not a display is present. The operation is not noticeable to the Terminal user.

# GRAPHIC INPUT (GIN)



Fig. 1-9. Crosshair Cursor controls.

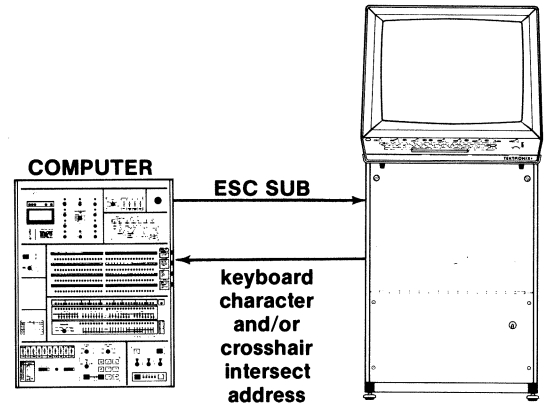

Fig. 1-10. GIN sequence.

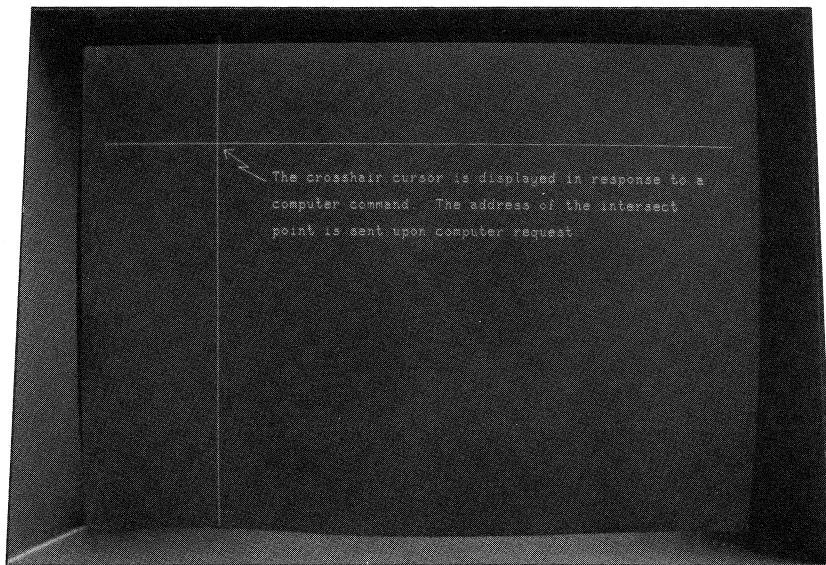
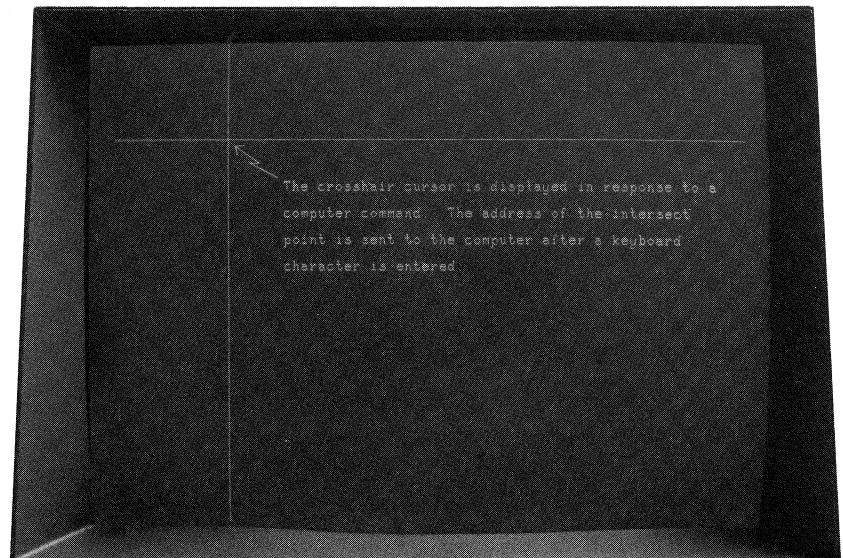

Fig. 1-11

Sending the crosshair cursor intersect address in response to computer request. An ESC SUB from the computer causes the Terminal to display a crosshair cursor. A subsequent ESC ENQ from the computer requests the crosshair cursor intersect address. The Terminal responds automatically, and the crosshair cursor disappears.

Fig. 1-12

Sending the crosshair cursor intersect address in response to a keyboard input. An ESC SUB from the computer causes the Terminal to display the crosshair cursor. The operator positions the cursor with the keyboard thumbwheels (or optional Joystick) and enters a selected character. The Terminal sends the character, and automatically follows it with the crosshair intersect address. The crosshair cursor disappears.



# INTRODUCTION

## WRITE-THRU

Arrows are displayed in Write-Thru to indicate the changes in wind direction and velocity. Other displayed information is stored.

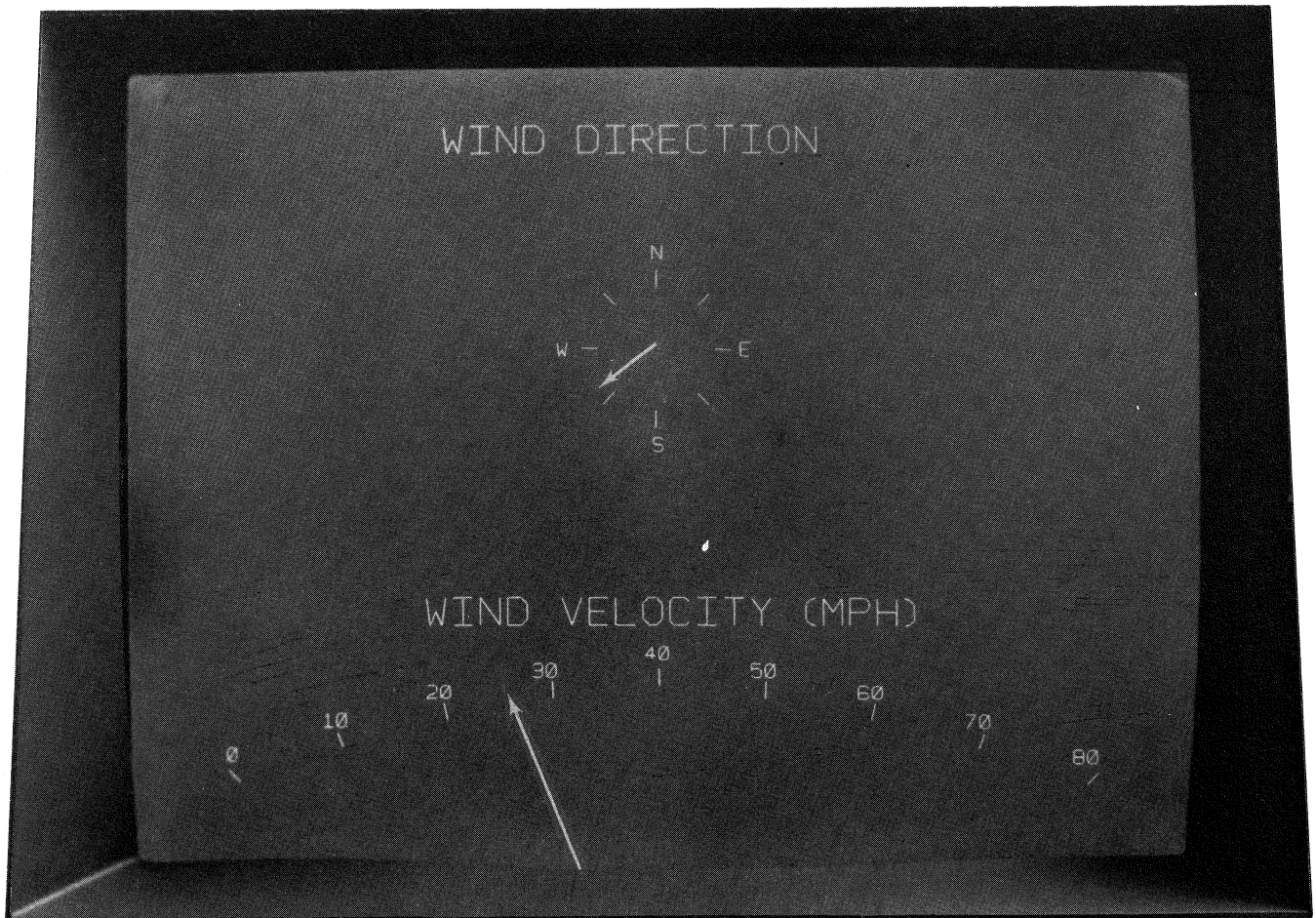

**Fig. 1-13.**

Write-Thru (simulated write-thru arrows). A display writing operation that prevents information from storing as it is being written, yet does not change the viewing status of previously stored information. Once Write-Thru is enabled, information being written must be "refreshed" by the computer (or peripheral) to be useful. Intensity of written data depends on the refresh rate and the Write-Thru adjustment on the right side of the keyboard. Write-Thru can be used in either Alpha or Graph modes. When in Write-Thru Alpha Mode, the Terminal automatically increases its maximum writing speed from the normal 1000 characters per second to 4000 characters per second.

# LOCAL OPERATION

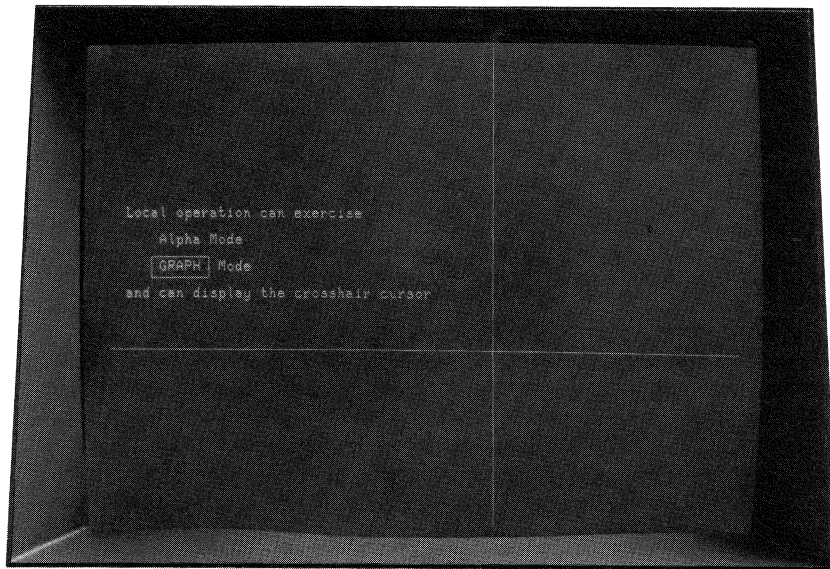

Fig. 1-14.

Local Operation. The Terminal is isolated from the computer when the keyboard switch is at LOCAL. Keyboard inputs are displayed or otherwise executed by the Terminal. All modes can be exercised except GIN, where only the display and positioning of the crosshair cursor can occur. The Terminal can interact with peripheral devices while in Local.

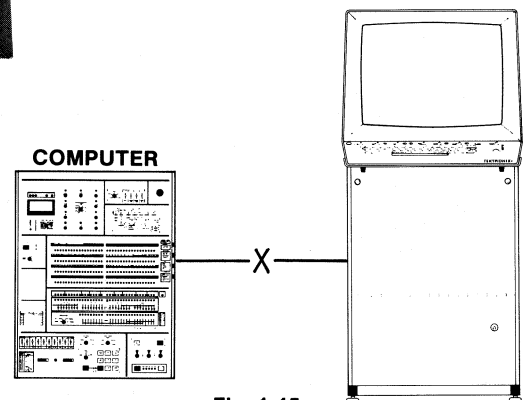
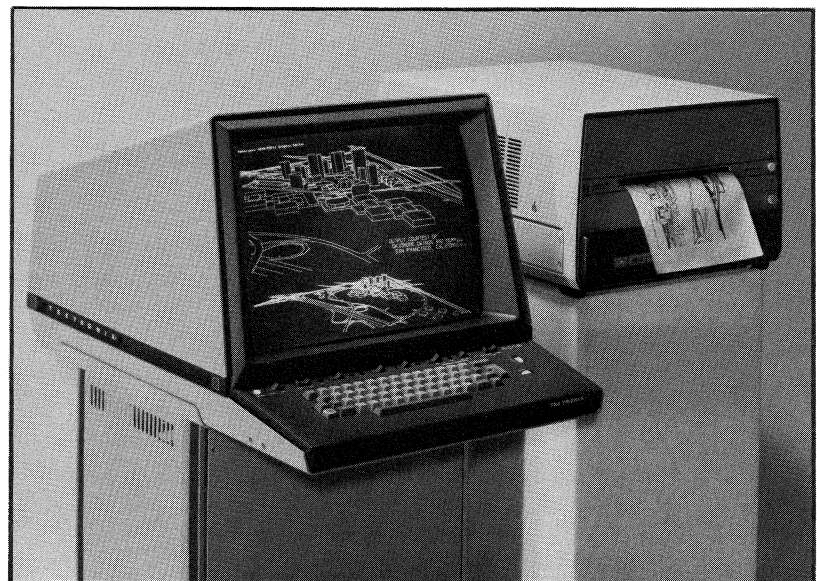

Fig. 1-15.

# HARD COPIES

Fig. 1-16.

Hard Copy Operation. A Hard Copy Unit can produce a permanent copy of a Terminal display in response to a "Make Copy" signal from the computer, Keyboard, Hard Copy Unit, or from peripheral devices. Control of the Terminal from any other source is precluded while the display is being copied.





# INTRODUCTION

## HOLD/VIEW

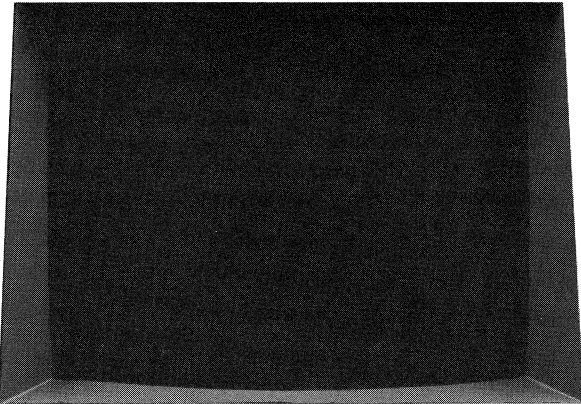

### HOLD STATUS

plus SHIFT or other Terminal activity

equals

### VIEW STATUS

**Fig. 1-17. View Status.**

Hold is an Alpha Mode reduced-intensity status which occurs after 60 to 120 seconds of Terminal inactivity. Data can be stored in Hold Status for up to one hour without damage to the display screen. The Terminal resets to View Status in response to any Terminal activity except control characters. In addition, the SHIFT key resets the Terminal to View Status without otherwise affecting the display. Hold is inoperative in Graph and GIN Modes; therefore, always return to Alpha Mode when operations are completed in either Graph or GIN.

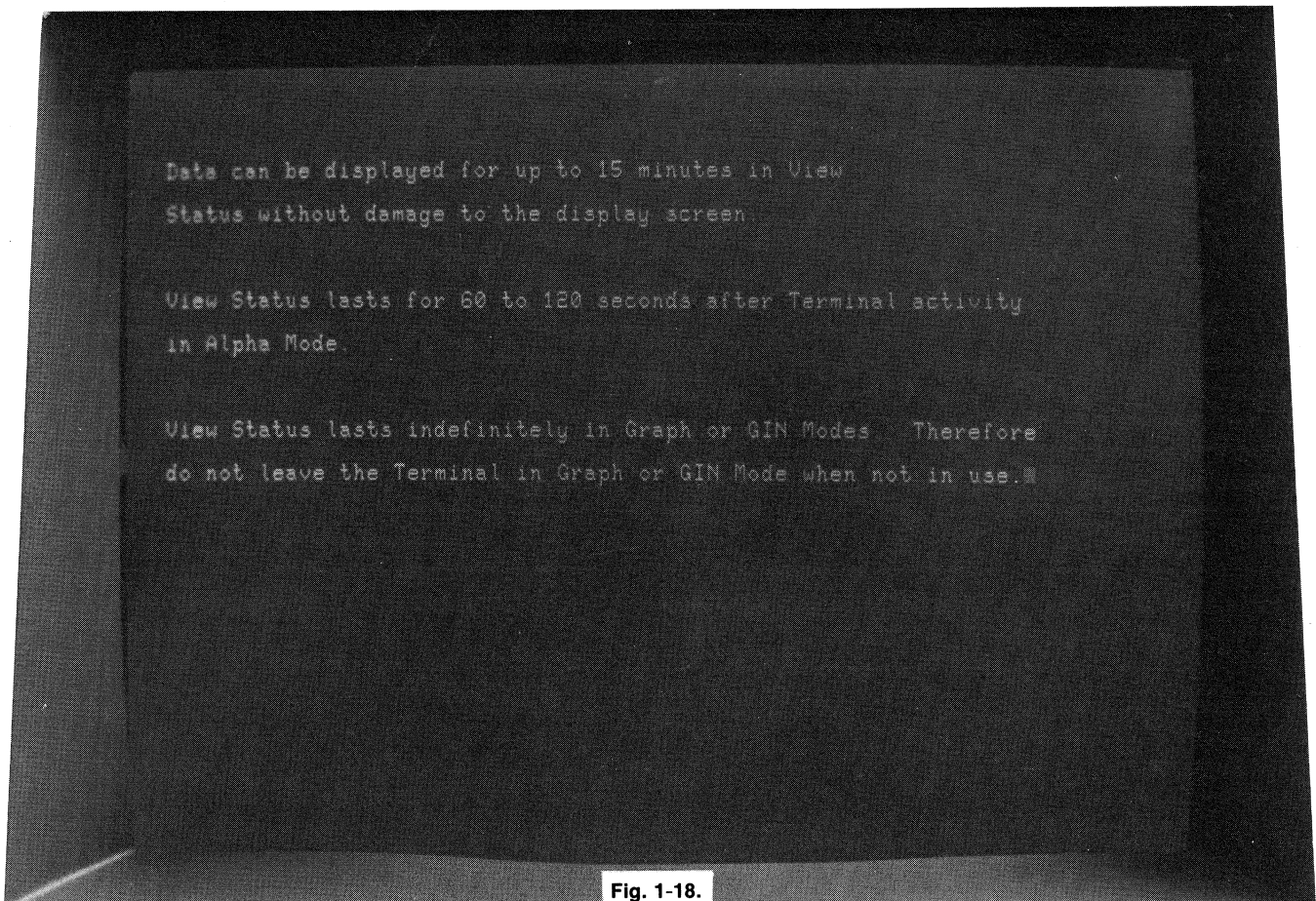

**Fig. 1-18.**



# CONTROLS

If the Terminal has been installed as explained in the appendix, operation of the Terminal consists of:

- Turning it on
- Selecting keyboard switch positions
- Entering Data
- Controlling the crosshair cursor
- Entering copy-making commands
- Adjusting hard copy intensity
- Selecting strap options

These functions are accomplished by using the following switches, keys, wire strap options, and adjustments.

## CONTROL PANEL

See Fig. 2-2 and accompanying control panel descriptions.

## KEYBOARD PANEL

Inputs data and controls the Terminal; see following pages.

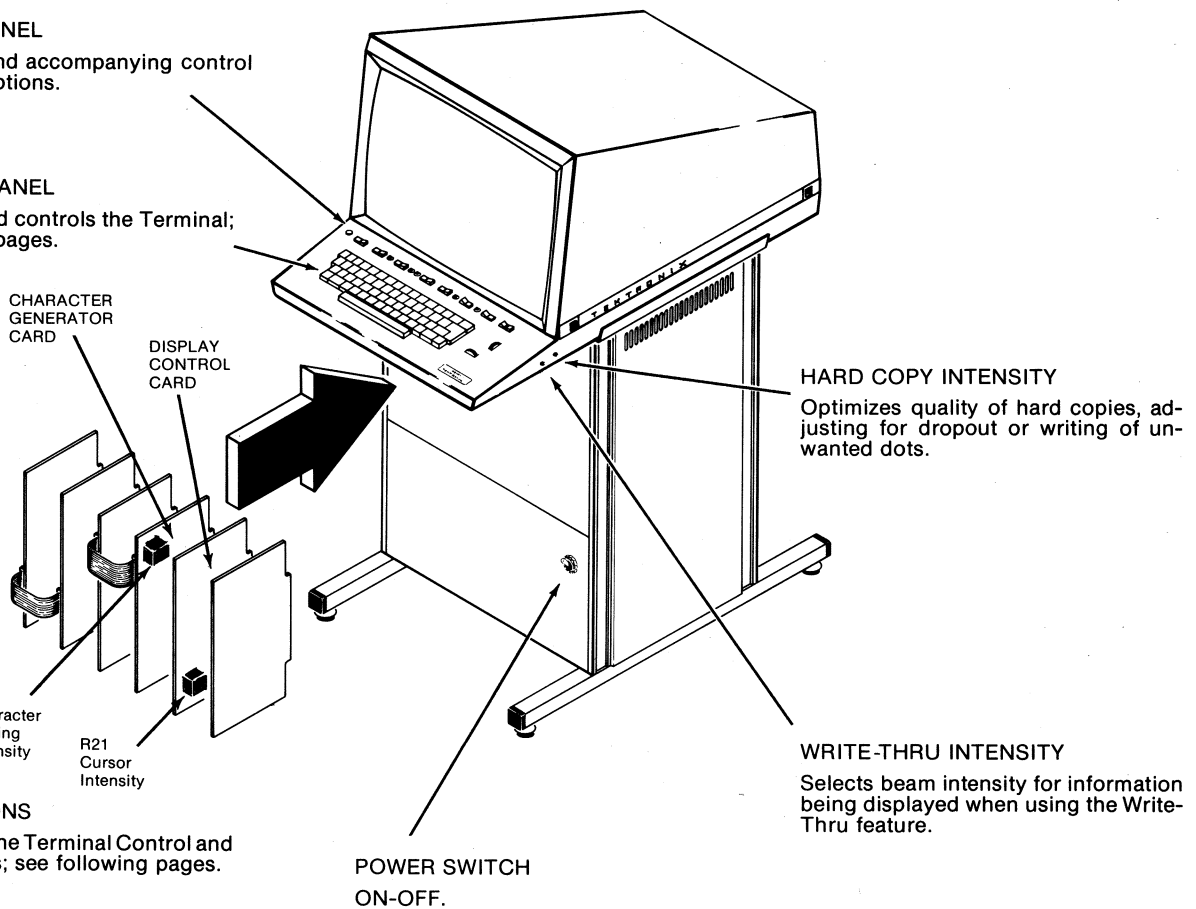

## STRAP OPTIONS

Contained on the Terminal Control and Interface cards; see following pages.

Fig. 2-1. Control locations.

# KEYBOARD

**LOCAL —**

Isolates the Terminal from the computer and causes the Terminal to execute keyboard inputs.

**LINE —**

Permits exchange of data between the Terminal and computer.

**ASCII —**

Permits only ASCII characters to be written

**ALT —**

Permits only the characters in the alternate character set to be within. ALT position only operative as a custom modification.

**Center Position —**

Permits either ASCII or Alternate character sets to be selected by program commands.

**ALT —**

Lights when the alternate character set is selected. (Only if Alternate Character set installed and wired to operate.)

**SPARE INDICATORS and SWITCHES**  
For use with Accessory Devices.

**POWER —**

Lights when the Terminal is on

**RESET —**

Entered with SHIFT held down; creates a "home" function, resetting the Terminal to initial status; does not erase.

**PAGE —**

Erases the display, resets to Alpha Mode and home position; resets to Margin 1 and cancels Bypass condition.

**TTY LOCK —**

With the lock in effect, transmission is limited to TTY code.

**CTRL —**

Converts key inputs to control characters; also used with SHIFT and character keys to enter control characters.



Fig. 2-2.

# CONTROLS KEYBOARD

**MARGIN CONTROL 1 —**

Causes a page full signal to occur when Margin 1 is set and the Terminal line feeds past the last alphanumeric line.

**MARGIN CONTROL 2 —**

Causes the page full signal to occur only after Margin 2 is set and the Terminal line feeds past the last alphanumeric line in the second column.

**MARGIN CONTROL OFF —**

Prevents generation of Page Full.

**FULL —**

Lights when Page Full is generated.

**RELEASE —**

A momentary switch that releases the Terminal from a Page Full condition.

**AUTO PRINT (4014-1 only)**

Stable position that results in a hard copy being generated (by attached Hard Copy Unit) when a Page Full is generated as selected by the MARGIN CONTROL switch. Completion of an auto copy cycle clears page full and erases the screen.

**MAKE COPY (4014-1 only) —**

Momentary position that initiates a Hard Copy command. Switch returns to OFF position when released from the MAKE COPY position.



**SHIFT —**

Used alone, it switches Terminal from Hold to View status; used with character keys, it shifts them to upper case; used with CTRL and letter keys, it enters control characters.

**BREAK —**

Generates a break signal. The Terminal Interface may use the break signal to interrupt the computer.

**CROSSHAIR POSITION THUMB-WHEELS —**

Control the position of the GIN Mode crosshair cursor.

Fig. 2-2 cont.

# STRAP OPTIONS

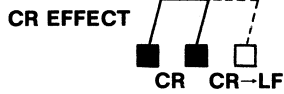

CR position provides carriage return in response to CR commands; CR-LF causes carriage return and line feed in response to CR commands.

The CR-LF position allows the Terminal to simulate the IBM Correspondence Code "New Line" character.

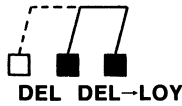

### DEL IMPLIES LOY

DEL-LOY enables logic to interpret the RUBOUT (127<sub>10</sub>) character or the ESC? sequence as a Low Order Y code. OUT prevents RUBOUT from being used as LOY; instead, ESC ? performs the same as RUBOUT.

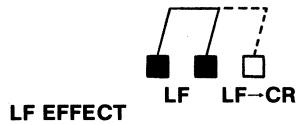

LF position provides line feed in response to LF commands; LF-CR position provides line feed and carriage return in response to LF commands. If generated, CR will reset the Graph mode to Alpha Mode.

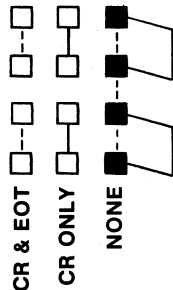

### GIN TERMINATORS

Determines which characters follow address transmission in GIN Mode.

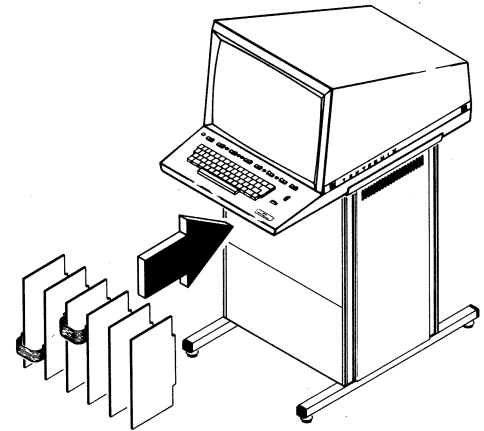
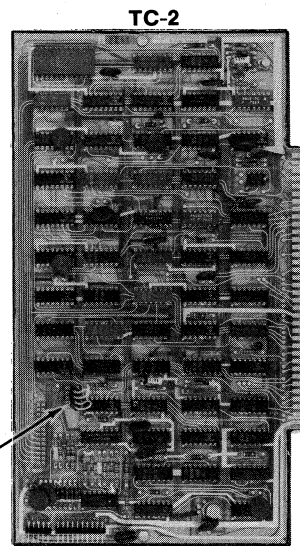
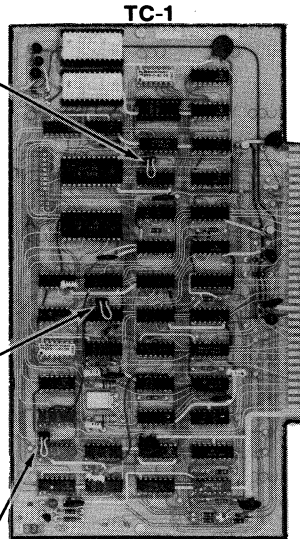

### INTERFACE CARD

Refer to appropriate manual for strap option information for interfaces and peripheral devices. Also, see the Installation appendix.

**CAUTION**

Do not install or remove circuit cards while the terminal is turned on.

Fig. 2-3. Strap Options.

# CONTROL CHARACTERS

Control characters are coded signals which are sent back and forth between the computer, Terminal, and accessory devices to control operation. Their use is relatively standard. The control characters, their keyboard equivalent, and their effect upon the basic Terminal are listed here. The transmission and effect is independent of ASCII or TTY selection.

## NOTE

Keying control characters from the keyboard requires two (and in some cases three) key closures. In the following table, a superscript C followed by a letter character indicates that the control character is formed by first pressing the CTRL key and then the indicated letter key. A superscript C and S, e.g., <sup>CS</sup>O, indicates the control character (in this case, US) is formed by first pressing the CTRL and SHIFT keys and then pressing the O key.

TABLE 2-1

Control Character Effect

Control	Keyboard Equivalent	Effect Upon Basic Terminal
ACK	<sup>CF</sup>	
BEL	<sup>CG</sup>	Rings bell; clears Bypass Condition.
BS	BACKSPACE or <sup>CH</sup>	Backspaces.
CAN	<sup>CX</sup>	As second character in ESC CAN sequence, it selects Bypass Condition to inhibit Terminal response to echoed data.
CR	RETURN or <sup>CM</sup>	Carriage return; resets Terminal from Graph to Alpha Mode; cancels crosshair cursor, setting Alpha Mode but leaving the Terminal in an undefined margin (page full) status; clears Bypass Condition. A strap on the TC-1 card can be set so CR also causes line feed.  <p style="text-align: center;">NOTE</p> <p><i>As the second character in an ESC sequence, CR will not be responded to. This can be used to advantage when it is required that the Terminal not respond to CR's. Any further CR's will be ignored. To get out of the ESC condition, send BEL, or some other non-operative control character that will change the mode selected.</i></p>
DC1	<sup>CQ</sup>	
DC2	<sup>CR</sup>	
DC3	<sup>CS</sup>	
DC4	<sup>CT</sup>	
DLE	<sup>CP</sup>	
EM	<sup>CY</sup>	

# CONTROL CHARACTERS

TABLE 2-1 (cont)

Control	Keyboard Equivalent	Effect Upon Basic Terminal
ENQ	<sup>c</sup> E	As second character in ESC ENQ sequence, it causes Bypass Condition and creates one of the following GIN Mode situations:  1) Causes Terminal status and address of lower left corner of the Alpha Cursor to be sent to the computer if received while the Terminal is in Alpha Mode.  2) Causes Terminal Status and address of the display beam to be sent to the computer if received while the Terminal is in Graph Mode. Polling the Terminal with an ESC ENQ immediately following a hard copy request results in a Terminal response after copying is completed.
EOT	<sup>c</sup> D	
ESC	ESC or <sup>cs</sup> K	Terminal "arming" character which makes the Terminal sensitive to certain control characters received immediately after ESC; see ENQ, ETB, FF, SI, SO, SUB. Other characters may be used in sequence with ESC for Terminal and peripheral device control. See other ESC sequences at the end of this section.
ETB	<sup>c</sup> W	As second character in ESC ETB sequence, it creates a Make Copy signal, which causes a hard copy of the display to be made if an energized Hard Copy Unit is attached. ESC ETB also clears Bypass Condition.
ETX	<sup>c</sup> C	
FF	<sup>c</sup> L	As second character in ESC FF sequence, it erases the screen, selects Alpha Mode, sets the cursor to home position, sets Margin 1, and clears Bypass Condition.
FS	<sup>cs</sup> L	Used with Enhanced Graphic Module; see Appendix F.
GS	<sup>cs</sup> M	Sets Terminal to Graph Mode; sets circuitry for dark vector.
HT	TAB or <sup>c</sup> I	Spaces one space to right. Spacing past end of a line causes an automatic line feed/carriage return.
LF	LF or <sup>c</sup> J	Cursor moves down one line; if cursor moves past the bottom of the display, it "wraps around" and appears at the top of the display, selecting the alternate margin. Also clears Bypass Condition. A strap on TC-1 can be set so LF also causes carriage return. See Margin Control switch description for further effects of line feeds past bottom line of display. LF has same effect as CR when preceded by ESC.



# CONTROL CHARACTERS

TABLE 2-1 (cont)

Control	Keyboard Equivalent	Effect Upon Basic Terminal
NAK	<sup>c</sup> U	
NUL	<sup>cs</sup> P	
RS	<sup>cs</sup> N	For use, see Appendix F on the Enhanced Graphic Module, Option 34.
SI	<sup>c</sup> O	As second character in ESC SI sequence, it selects the ASCII character set if the CHARACTER SET SELECT switch is at the center (PROGRAM SELECT) position.
SO	<sup>c</sup> N	As second character in ESC SO sequence, it selects the alternate character set if the CHARACTER SET SELECT switch is at the center (PROGRAM SELECT) position. (Requires factory installation of optional, alternate character set ROM.)
SOH	<sup>c</sup> A	
STX	<sup>c</sup> B	
SUB	<sup>c</sup> Z	As second character in ESC SUB sequence, it sets GIN Mode and starts the crosshair cursor. Clears Graph Mode and activates Bypass Condition.
SYN	<sup>c</sup> V	
US	<sup>cs</sup> O	Resets Terminal from Graph to Alpha Mode; clears Bypass Condition.
VT	<sup>c</sup> K	Causes reverse line feed.

## Other ESC sequences

The following ESC sequences are followed by some character other than a control character. These ESC sequences are used for controlling the character size and display writing characteristics. (For descriptions of ESC control character sequences, see preceding descriptions of control characters, ENQ, ETB, FF, SI, SO, and SUB.)

# CONTROL CHARACTERS

**TABLE 2-2**  
**OTHER ESC SEQUENCES**

ESC Sequence	Keyboard Equivalent	Effect on Basic Terminal
ESC 8	ESC 8	Selects 74 characters, 35 lines.
ESC 9	ESC 9	Selects 81 characters, 38 lines.
ESC :	ESC :	Selects 121 characters, 58 lines.
ESC ;	ESC ;	Selects 133 characters, 64 lines.
ESC 96 <sub>10</sub> through ESC 126 <sub>10</sub>	See Table 2-3	Provide program selectable display operating modes such as Normal, Write-Thru, and Defocused. Refer to Tables F-2 and F-3 in Appendix F for more information if the Optional Enhanced Graphics Module is installed in the Terminal.

**TABLE 2-3**

**ESC SEQUENCES FOR NORMAL, DEFOCUSED AND WRITE-THRU CONDITIONS**

(The Beam and Vector Selection table in Appendix F should be used in place of this table if an Enhanced Graphic Module is installed in the Terminal.)

ESC Sequences	Decimal Equiv.	Function Performed
ESC `	96	Normal Z axis
a	97	Normal Z axis
b	98	Normal Z axis
c	99	Normal Z axis
d	100	Normal Z axis
e	101	Normal Z axis
f	102	Normal Z axis
g	103	Normal Z axis

# CONTROL CHARACTERS

TABLE 2-3 (cont)

ESC Sequences	Decimal Equiv.	Function Performed
ESC h	104	Defocused Z axis
i	105	Defocused Z axis
j	106	Defocused Z axis
k	107	Defocused Z axis
l	108	Defocused Z axis
m	109	Defocused Z axis
n	110	Defocused Z axis
o	111	Defocused Z axis
p	112	Write-Thru mode
q	113	Write-Thru mode
r	114	Write-Thru mode
s	115	Write-Thru mode
t	116	Write-Thru mode
u	117	Write-Thru mode
v	118	Write-Thru mode
w	119	Write-Thru mode

In Alphanumeric Mode, the Normal (focused) condition is automatically set for the two smaller character sizes, and the Defocused condition is automatically set for the two larger character sizes. Normal, Defocused, and Write-Thru conditions can be selected for both Alpha and Graph modes.

### Carriage Return/Line Feed (CR/LF)

The Terminal performs an automatic carriage return/line feed anytime the Terminal spaces past the end

of a line in Alpha Mode. This is effective on either Margin 1 or 2. No CR or LF codes are transmitted.

TIME REQUIRED FOR THE OPERATION OF THE AUTOMATIC CR/LF CIRCUIT IS IN ADDITION TO THAT REQUIRED FOR THE CHARACTER WHICH CAUSED THE OVERFLOW. THE EXTRA TIME IS ABOUT 100 TO 200  $\mu$ s. CR OR LF ARE NOT GENERATED WHEN BACKSPACING PAST (WRAPPING AROUND) THE LEFT MARGIN (MARGIN 1).



# OPERATION

## Introduction

This operating procedure can be used in two ways. The entire procedure can be done, taking note of all information; this is beneficial for developing an understanding of the Terminal operation. The second use is to carry out only the left column; this method provides a Terminal check-out procedure for someone familiar with the Terminal operation.

If the Terminal has been installed in accordance with instructions contained in the Appendix, operator use of the Terminal consists of:

- Turning it on;
- Selecting the keyboard switch set-up;
- Entering Terminal control commands;
- Entering data;
- Controlling the crosshair cursor;
- Entering copy making commands;
- Adjusting hard copy intensity;
- Selecting strap options.

In addition, program command operation of the Terminal includes the following:

- Selecting modes;
- Formatting the display;
- Writing characters;
- Drawing vectors;
- Determining Terminal status and/or beam position;
- Controlling other Terminal features (such as the bell) and Terminal accessory devices.

The following procedure demonstrates most of these features.

### NOTE

*Additional operational check-outs have been incorporated in this procedure for the Enhanced Graphic Module option as well as hard copy check-outs for the 4014-1. If your Terminal has neither of these capabilities, ignore those check-outs.*

# INSTALLATION

1. **Select the proper line voltage**

Details are given in the Appendix.

2. **Select the proper strap options**

Instructions for TC-1 and TC-2 are given in the preceding section. Instructions for the interface and accessory devices are given in their respective manuals.



**Do not remove or install circuit cards while the terminal is turned on.**

3. **Connect the Interface to the data communication set (modem) or to the computer**

General instructions are given in the Appendix; specific instructions appear in the Interface manual.

4. **Connect the Terminal line cord to the power source**

The line cord is attached to the Pedestal, at the back, near the bottom.

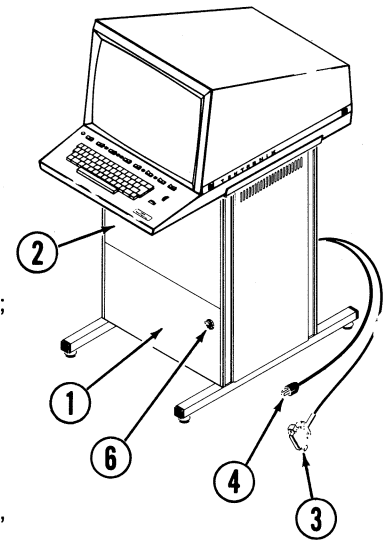

# INITIALIZATION

5. **Place the LOCAL/LINE switch to LOCAL**

LOCAL isolates the Terminal from the computer and causes keyboard inputs to be executed by the Terminal.

6. **Turn the Terminal ON**

The Power switch is on the front-lower-right of the pedestal. Pull up to turn it on. A green light at the left on the keyboard panel will light, and the display screen will be come bright (flood) after a few seconds.

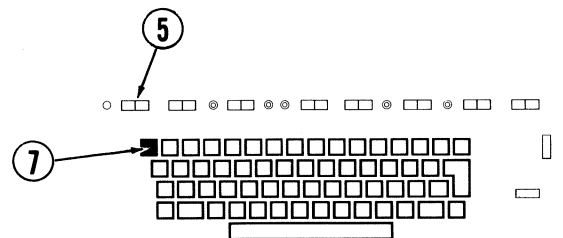

**7. Erase the display**

Push the PAGE key.

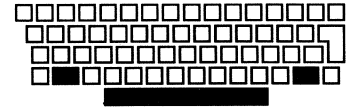

**8. Check the Hold Circuit**

Wait one to two minutes and note that the display becomes noticeably dimmer and the Alpha cursor disappears. Press the SHIFT key and note that the display brightens and the cursor returns. Again, wait one to two minutes until Hold status occurs; then enter any character key (try the Space bar) and note that View status is regained. Any keyboard character causes View status to return, but SHIFT does it without transmitting or affecting the display.

# CHARACTER TRANSMISSION

On the standard Terminal, the ASCII-ALT switch has no effect upon the code being transmitted by keyboard keys. However, on the Terminals equipped with an Alternate character set, the switch controls the Terminal receiving circuits, determining whether ALT or ASCII characters are written in response to the code.

**9. Observe the repeat function**

Hold down a writing character key. (Try the X.) Note that it causes transmission of the character, a pause of about 1/2 second, and then repeats transmission at approximately 10 characters per second.

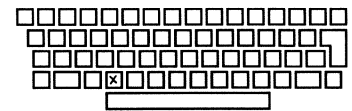

**10. Transmit code for unshifted writing characters**

Check that the TTY LOCK key is released. Then sequentially press each writing character key, and check transmission of unshifted characters, by comparing the resulting written characters with the characters etched on the lower half of the top surface of the key caps.

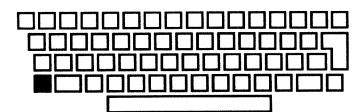

# CHARACTER TRANSMISSION

**11. Transmit code for shifted writing characters**

Hold down the SHIFT key, and sequentially press each writing key. Check transmission of shifted characters by comparing the resulting written characters with the characters etched on the upper half of the top surface of the key caps.

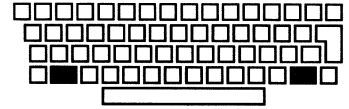

**12. Transmit code for control characters**

**12a Single key**

Enter TAB, BACKSPACE, LF and RETURN; check their transmission by observing spacing, backspacing, line feed, and return of the cursor to the left margin, respectively. LF may cause return of the cursor to the left margin, as well as causing line feed, if LF→CR has been selected by strap option on TC-1.

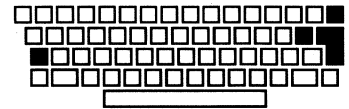

**12b Dual key**

Press letter keys while holding the CTRL key down, to enter the following control characters; note the effect on the receiving circuits:

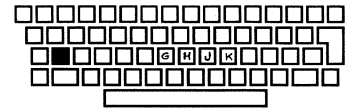

**NOTE**

*Keying control characters from the keyboard requires two (and in some cases three) key closures. In the following table, a superscript C followed by a letter character indicates that the control character is formed by first pressing the CTRL and then pressing the indicated letter key. A superscript C and S, e.g., <sup>CS</sup>O, indicates the control character (in this case, US) is formed by first pressing the CTRL and SHIFT keys and then pressing the O key.*

Keys	Control Character Effect
<sup>°</sup> G	BEL Rings bell
<sup>°</sup> H	BS Cursor backspaces
<sup>°</sup> I	HT Cursor spaces to right
<sup>°</sup> J	LF Cursor moves down one line
<sup>°</sup> K	VT Cursor moves up one line
<sup>°</sup> M	CR Cursor moves to effective margin



# OPERATION

# CHARACTER TRANSMISSION

The remaining letter keys transmit control characters (as listed in the preceding section), when pressed while the CTRL key is held down. However, they produce no noticeable effect on the basic Terminal.

### 12c Triple key

Hold down the CTRL and SHIFT keys and press the M. <sup>o</sup>M sets the receiving circuits to Graph Mode, as indicated by absence of the Alpha Cursor. Hold down the CTRL and SHIFT keys and press the letter O key. <sup>o</sup>O resets the receiving circuits to Alpha Mode, as indicated by the return of the Alpha cursor.

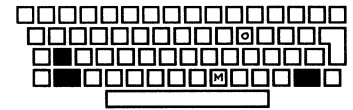

When pressed while the CTRL and SHIFT keys are held down, the letter keys K, L, M, N, O, and P transmit control characters as listed in the preceding section.

### 12d Command Sequences

The ESC key transmits the control character ESC, which has no observable effect unless used as part of a command sequence. Enter ESC; then hold down the CTRL key and enter an L (to send control character FF). The display will perform a PAGE function, erasing, selecting home position and Alpha Mode.

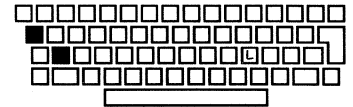

### 13. Transmit TTY code

ASCII character writing is normally selected during TTY transmission. Perform the following to shift the receiving circuits to ASCII: hold down the SHIFT key and press RESET. Press the H key and note that a lower case h is written. Then, depress the TTY LOCK key, and note that an upper case H is written in response to pressing the H key. TTY LOCK causes all letter keys to transmit the code for upper case ASCII letters, regardless of the position of the SHIFT key. The TTY LOCK key also causes @[\ and ^ to be transmitted in place of \ { ; and ~ respectively. Release the TTY LOCK key.

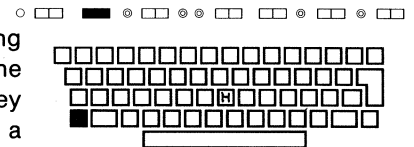

# CHARACTER TRANSMISSION

## 14. Check Bypass Condition

Set the LOCAL/LINE switch to line. Check the Interface Card to ensure that an echo of keyboard inputs can be obtained. Refer to your Interface Users Manual to find how to do this for your particular interface.

**CAUTION**

*Do not attempt to remove any circuit card from the pedestal with power applied.*

Enter ESC °X. Then enter some characters from the keyboard. Note that no characters are written; the cursor remains stationary.

## 15. Terminate Bypass Condition

Press CR and then enter some more characters from the keyboard. Note that character writing occurs.

Bypass Condition is used to suppress the Terminal's response to the majority of ASCII codes, particularly, the printable characters. Bypass can be set by the program, as illustrated above, and is automatically set during any of the graphic input (GIN Mode) sequences. See GIN Mode summary (Bypass Topic, in particular) at the end of this section for more information.

Restore the interface to its original configuration.

# OPERATION

## ALPHA MODE

### 16. Select Alpha Mode

This mode is automatically selected upon initialization. It is also selected by PAGE or SHIFT RESET from the keyboard, or upon receipt of control characters CR or ESC FF. US resets the Terminal from Graph to Alpha Mode.

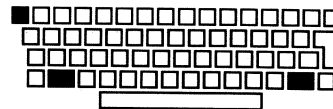

The ASCII/ALT switch on the standard Terminal (those without an alternate character set) is wired to be inoperative; therefore the ASCII character set is permanently enabled in Alpha Mode. However, for those Terminals that may contain an Alternate Character set, perform Steps 17 and 18; otherwise go on to Step 19.

### 17. Select Alpha-ALT Mode

On the Terminals equipped with an Alternate Character set, (installed at the factory as a custom modification), this writing mode is automatically selected upon initialization, if the ASCII/ALT switch is at ALT. With ASCII selected, ALT can be manually selected by putting the keyboard switch at ALT, or can be program selected by ESC SO (ESC °N from the keyboard), if the ASCII/ALT switch is in the center position.

Set the ASCII/ALT switch to the center position, then enter ESC °N and enter an h character. Note that a character other than an h character may appear as an indication of ALT being selected.

### 18. Select Alpha-ASCII Mode

This occurs upon initialization, if the ASCII/ALT switch is at ASCII or the center switch position. If the switch is at the center position and ALT is in effect, ASCII can be manually selected by SHIFT RESET from the keyboard, or can be program selected by ESC SI (ESC °? from the keyboard).

Enter ESC °O and enter an h character. ASCII selection is indicated by the writing of the h character.

# ALPHA MODE

### 19. Check character size selection

Enter a few characters from the keyboard. These are displayed in the largest characters size and are selected upon initialization, RESET, or program command.

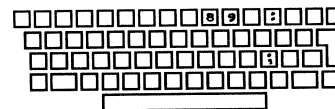

Enter ESC 9 and then enter a few more characters. Note the slight decrease in character size. This is the second largest character size.

Enter ESC : and then enter a few characters. Note the substantial decrease in character size to the third largest character size.

Enter ESC ; and once again enter a few more characters. Note a slight decrease in character size in comparison to the third largest character size. This is the smallest character size.

Enter ESC 8 and then a few more characters. Note that the largest character size is selected.

### 19a Check that PAGE does not clear selected character size

Enter ESC ; once again. Then enter PAGE from the keyboard followed by a few characters. Note that PAGE does not clear the selected character size. This is evident by the small size of the written characters.

### 19b Check that RESET function selects largest character size

Enter RESET function from the keyboard by simultaneously pressing the SHIFT and PAGE-RESET keys. Enter a few characters and note that the largest character size has been selected as evident by the large size of the written characters.

### 20. Observe automatic line feed and carriage return

Hold down a writing character key and note that the cursor line feeds and returns to the left margin (Margin 1). The line feed and carriage return automatically occur after the last character in a line is written.

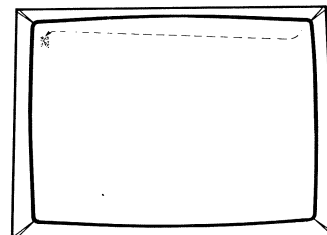

# OPERATION

## ALPHA MODE

### 21. Observe selection of Margin 2

Enter PAGE. Place MARGIN CONTROL switch to 1. Then hold down the LF key until the cursor moves down to the last line. Enter one more line feed and observe that it reappears at the top-center of the screen, in Margin 2 position. Note also that the FULL indicator is on. When Margin 2 exists, an accompanying signal (MARG) can cause a Terminal busy signal to occur.

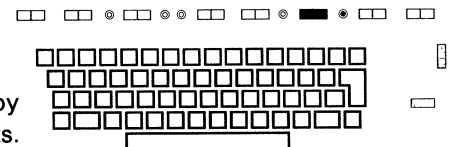

The Margin 2 selection is normally made only by line-feeding past the last line while Margin 1 exists.

Place the MARGIN CONTROL switch to 2. Enter PAGE. Enter 34 LF's, then one more. Note that the cursor positions to Margin 2 but the FULL indicator does not illuminate. Enter 34 more LF's, then one more. Note that the FULL indicator illuminates and the cursor positions to Home.

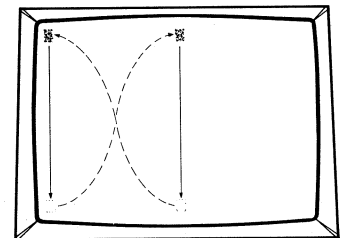

### 22. Observe carriage return with Margin 2 selected

Re-establish Margin 2 as previously explained. Enter several SP (Space bar) commands. Then enter CR (RETURN key); note that the cursor returns to the Margin 2 position. It may also move down to the next line if the CR EFFECT option strap is at CR-LF. Hold down a writing character key until a line is completed. Note that the cursor returns to Margin 2 position on the next line.

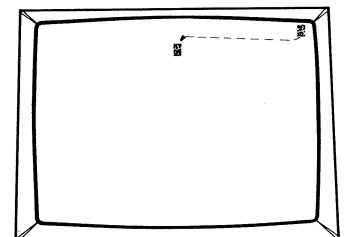
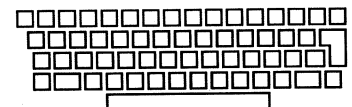

Again, enter LF commands until the cursor line feeds past the 35th line. Note that the cursor returns to Margin 1 position.

Line-feeding past the last line causes a change in margin selection, whether line-feeding is the result of an LF control character, or is the automatic line feed which occurs after the last character is written, in the last line of the display. The cursor maintains the same position with respect to the new margin as it held with respect to the previous margin, unless Carriage Return accompanies the change in margin selection. For example, assume that the Line Feed option on TC-1 is set so that LF does not cause CR,

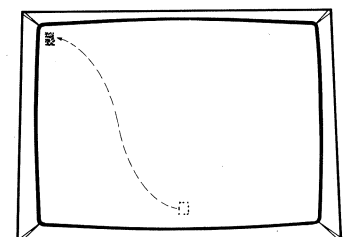

# ALPHA MODE

Margin 1 exists, and the cursor is on the bottom line, in the 10th character position. If a line feed causes Margin 2 to occur, the cursor will move to line 1, in the tenth character position to the right of Margin 2. An exception to this occurs if Margin 1 exists and the cursor is on the right half of the screen; line feeding past the last line will change the margin selection, but will not affect the horizontal position of the cursor unless a carriage return is also executed.

Margin 1 can also be selected by the following: program command ESC FF; executing a Graph Mode vector (written or unwritten); sending the GIN Mode crosshair cursor position to the computer; entering PAGE or SHIFT RESET at the keyboard.

# GRAPH MODE

## 23. Select Graph Mode

Program command GS (<sup>c</sup>M from the keyboard) places the Terminal receiving circuits in Graph Mode and permits vector drawing. Written or unwritten vectors of any length (including zero length) can then be executed.

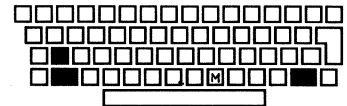

Enter <sup>c</sup>M to achieve Graph Mode. Note that the Alpha cursor disappears.

## 24. Execute an unwritten (dark) vector, establishing a starting point

An address made up of four characters directs the display writing beam to any point within the 0 - 1023X, 0 - 1023Y grid used by the Terminal. (However, 780Y - 1023Y are outside of the display quality area.)

Set the beam to approximate center of the screen with an address of 390Y, 512X. This can be done by entering the following characters at the keyboard:

,f0@

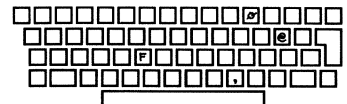

# OPERATION GRAPH MODE

Details regarding addressing the Terminal in Graph Mode are contained in the Graph Mode Summary at the end of this section.

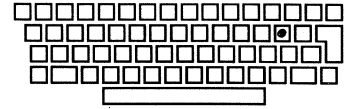

**25. Write a point (zero-length) vector to disclose the beam position**

Enter @ at the keyboard. Since it is an execution character and is not preceded immediately by a GS command, it will cause writing to occur. Since it is the same as the last character of the preceding address, no beam movement occurs during writing.

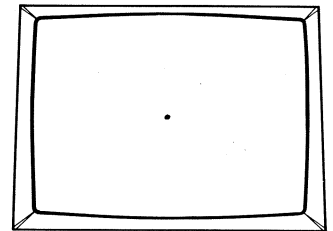

**25a Execute written vector following GS**

Press RETURN. Enter GS (<sup>c</sup>M) then enter f Space @ f 0 @ and note that a vector is drawn to the center of the screen.

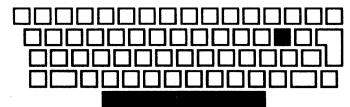
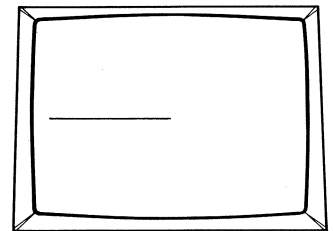

**26. Draw a vector**

Any address different from the preceding one causes beam movement, if an execution character is included. The beam will be turned on during movement to cause vector-drawing, unless the command is immediately preceded by a GS. Enter Space ` Space @ and a vector will be drawn to the lower left corner. (Address 0, 0.)

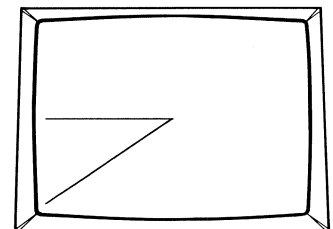

# GRAPH MODE

**27. Execute an unwritten (dark) vector**

Enter a GS (<sup>GS</sup>M at the keyboard) to command a dark vector. Then enter , f ? \_ to move the beam to right-center of the screen.

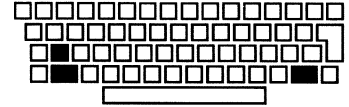

**28. Write a point to disclose the beam position**

Repeat the \_ entry and a written point will show that the beam has moved unseen to the right-center of the screen.

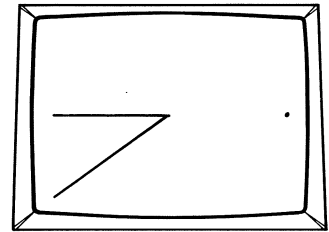

**29. Check shortened address transmission and the Graph mode memory circuit**

Enter ESC FF (ESC °L) at the keyboard to place the cursor at home in Alpha Mode. Enter GS (<sup>GS</sup>M) to return to Graph Mode.

Enter an \_ to execute a dark vector. Since the \_ is the same final character as in the previous Graph address, the beam will move to its previous address at right-center of the screen. Movement will be dark, since it immediately follows a GS command.

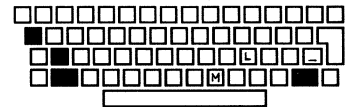

Enter another \_ to write a point and confirm this. The Graph Mode memory circuits retain the first 3 bytes of the last-executed address. Shortened address transmission is then possible, as explained in the Graph Mode summary at the end of this section.

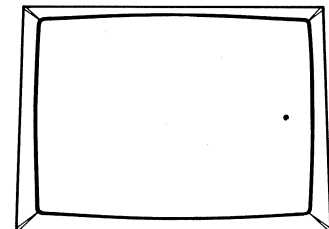



# OPERATION

# GRAPH MODE

### 30. Terminate the Graph Mode

Graph Mode can be ended manually by entering PAGE or SHIFT RESET at the keyboard, which returns the Terminal to Alpha Mode. Graph Mode can also be ended by program command US, CR, ESC FF or ESC SUB. US (<sup>°</sup>O) resets the Terminal to Alpha Mode, with the bottom-left corner of the cursor at the position previously occupied by the Graph Mode beam position. CR (<sup>°</sup>M) sets the Terminal to Alpha Mode and moves the Alpha cursor to the left margin. ESC FF (ESC <sup>°</sup>L) causes the screen to erase, and homes the Alpha cursor; ESC SUB (ESC <sup>°</sup>Z) selects GIN Mode and displays the crosshair cursor.

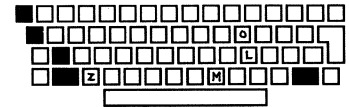

Check the effect of each by alternately selecting Graph Mode (<sup>°</sup>M) and entering one of the reset commands.

### 31. Check Write-Thru Feature

Enter PAGE to erase the display, then enter a few characters onto the screen. Now Enter ESC p. Enter more keyboard characters and note that previously stored information remains stored, and data entered after ESC p does not store.

Enter PAGE

#### NOTE

*If the Terminal contains the Enhanced Graphic Module option, continue with Step 32. If not, skip Steps 32-40b and continue with Step 41.*

### 32. Check 12-bit Addressing

Enter <sup>°</sup>M followed by

, \ \ 0 @

Repeat the @ entry and note a written point near display center. Enter

, o \ 0 @

Note a minute beam movement about the width of two written points up and to the right of the original point. Enter

, \ \ 0 @

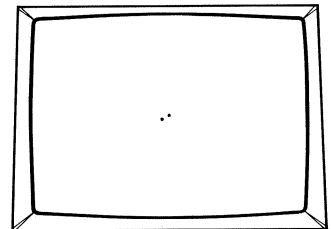

# GRAPH MODE

Note that the beam has positioned back over the first written point.

### 33. Check Dotted Vectors

Enter ESC a then enter  
SPACE RUBOUT SPACE @

Note that a dotted vector is drawn from the center of the display to the lower left corner.

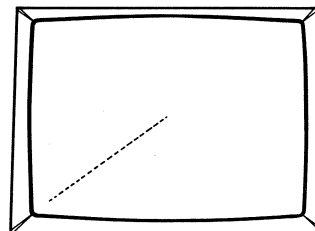

### 34. Check Dot-Dashed Vectors

Enter ESC b then enter  
SPACE RUBOUT ? ^

Note that a dot-dashed vector is drawn across the lower edge of the screen.

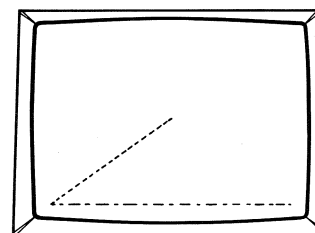

### 35. Check Short-Dashed Vectors

Enter ESC c then enter  
8 \ ? ^

Note that a short-dashed vector is drawn along the right side of the screen.

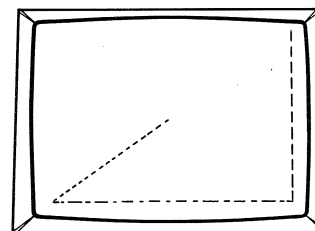

### 36. Check Long-Dashed Vectors

Enter ESC d then enter  
8 \ SPACE @

Note long-dashed vector across top of screen.

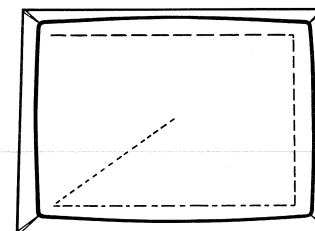

# OPERATION GRAPH MODE

**37. Return to Normal Vectors**

Enter ESC \ then enter  
SPACE RUBOUT SPACE @

Note solid vector along left side of display.

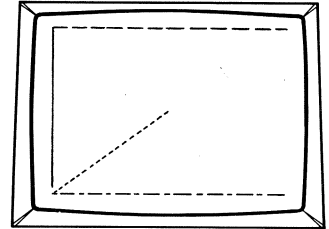

Enter PAGE to erase the Display

**38. Check Point Plot Mode**

Enter FS (<sup>CS</sup>L) then enter  
SPACE RUBOUT SPACE @

Repeat the @ entry and note a written point near the bottom left corner of the display.

Now enter , \ Ø @ and note a written point near display center. (It may be necessary to repeat the @ entry to affirm point location). Only the addressed point is written in Point Plot Mode.

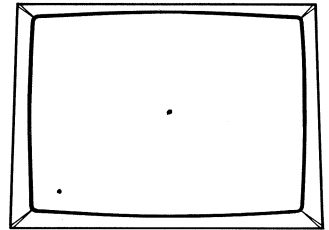

**39. Check Special Point Plot Mode**

Enter ESC then <sup>CS</sup>L. Now enter SPACE followed by  
, p Ø @

Hold down @ and note a blinking point about 1/4 inch above the written point at display center. Release @ key and note that no dot was stored.

**NOTE**

*Point intensity is directly related to the Z axis beam on time. It may be adjusted to cause the point to store. However, the intensity of the plotted point will still be low enough to show that point Intensity can be controlled in Special Point Plot Mode. Table F-6 shows Percentage of beam on time.*

# OPERATION

## GRAPH MODE

Enter SHIFT RESET

### 40. Check Incremental Plot Mode

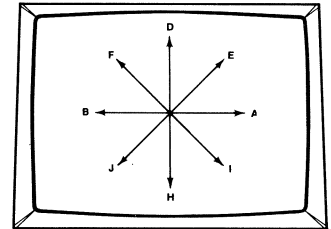

#### 40a Check Written Increments

Enter  $\text{^}N$  followed by P. Then referring to the accompanying illustration enter characters that exercise each of the eight directions of beam movement. Note that the beam increments and writes one point with each character pressed.

#### 40b Check Unwritten Increments

Enter PAGE. Position the cursor to approximately display center, then enter  $\text{^}N$ . Hold down the D key for a few increments, then enter a SPACE. Again hold down the D key and note that the beam does not turn on. After a few seconds release the D key and enter the P character once again. Hold down the D key again and note that the beam turns on. Note the blank space in the direction of movement.

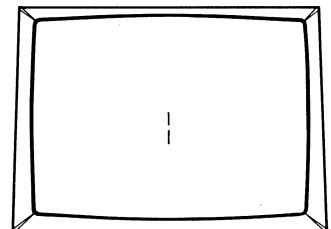

# OPERATION GIN MODE

**41. Computer requests Terminal status and Alpha cursor position**

This is automatically sent to the computer in response to ESC ENQ from the computer while in Alpha Mode. (ESC ENQ should not be entered at the keyboard.) The Terminal returns to Alpha Mode upon completion of transmission. (However, the receiving circuits must be reset upon completion of transmission before writing can occur.) This operation cannot be demonstrated in Local. See the GIN Mode Summary at the end of this section for transmission details.

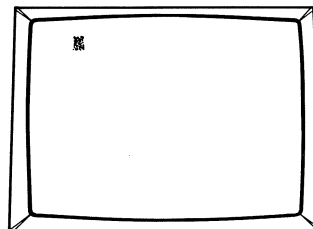

**42. Computer requests Terminal status and Graph Mode beam position**

This also is sent automatically in response to ESC ENQ from the computer, received while the Terminal is in Graph Mode. The Terminal returns to Graph Mode upon completion of transmission. This operation cannot be demonstrated in Local. See the GIN Mode Summary at the end of this section for transmission details.

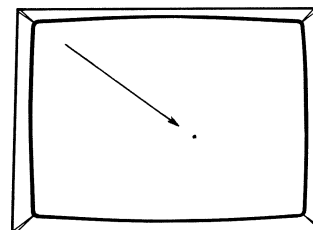

**43. Display and position the crosshair cursor**

The crosshair cursor is displayed upon receipt of control character sequence ESC SUB (ESC °Z). Enter ESC °Z and note that the crosshair cursor appears. Move the thumbwheels at the right of the keyboard and note the effect. If the horizontal thumbwheel is at either limit, only the horizontal line will appear. If the vertical thumbwheel is at the lower limit, only the vertical line will appear.

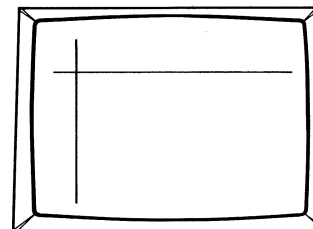
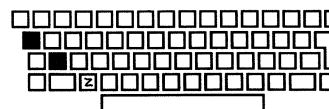

**44. Transmitting the address of the crosshair cursor in response to computer request**

If the Terminal is On Line and ESC ENQ is received from the computer while the crosshair cursor is being displayed, the address of the intersect point will automatically be sent to the computer. This will be followed by CR or CR and EOT, if selected by strap option in the Terminal. This feature cannot be demonstrated in Local. See the GIN Mode Summary at the end of this section for details.

# OPERATION

## GIN MODE

### 45. Transmitting the address of the crosshair cursor in response to keyboard entry by the operator

If On Line operation is selected and any keyboard character is entered while the crosshair cursor is being displayed, the entered character will be sent to the computer, and will automatically be followed by the address of the intersect point. This will also be followed by CR or CR and EOT if selected by strap option in the Terminal. See the GIN Mode Summary at the end of this section for details. This feature cannot be demonstrated in Local. The Terminal returns to Alpha Mode upon completion of transmission, but must be reset before character writing can again occur.

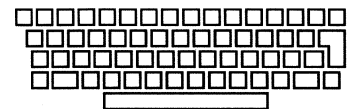
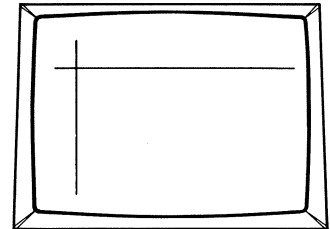

### 46. Terminate GIN Mode

GIN Mode is automatically terminated whenever the Terminal finishes sending the GIN Mode data. However, the Terminal's character generator must be reset before writing can again occur. If CR is part of the GIN Mode transmission, echoing it will provide the necessary resetting, but will also put the Terminal in Alpha Mode and place the cursor at the left margin. If CR is not echoed back, the terminal will be unable to write in Alpha mode (even though the Alpha cursor appears) until one of the following is received by the terminal: BEL, CR, ESC ETB, ESC FF, LF, SI, from the computer. Note that all except BEL, and ESC ETB affect the display or position of the cursor. The character generator can also be reset by PAGE or SHIFT RESET from the keyboard, by pressing the MAKE COPY button, or by placing the LOCAL/LINE switch at LOCAL.

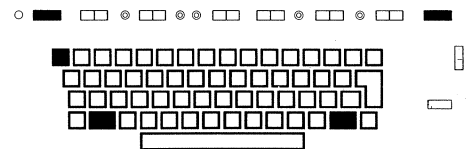

# OPERATION

## GIN MODE

GIN Mode can also be terminated while the crosshair cursor is being displayed, without transmitting to the computer. Program command CR or ESC FF will do it, switching the Terminal to Alpha Mode. However, CR may leave the Terminal in either Margin 1 or Margin 2 status, and ESC FF will erase the display. It may be better to terminate by sending ESC ENQ and ignore the transmission at the computer. The crosshair cursor can also be terminated, and Alpha Mode selected, by entering PAGE or SHIFT RESET at the keyboard.

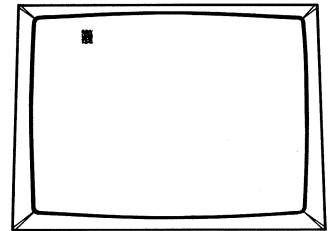

Press PAGE or SHIFT RESET and note that the crosshair cursor disappears and the Alpha cursor returns to home position.

## HARD COPIES

### 47. Check copy making

Connect a Hard Copy Unit to the connector on the back of the Terminal Display Unit (4014-1 only). Turn the Hard Copy Unit on. Enter an assortment of characters at the keyboard to provide a display. Press MAKE COPY at the Display Unit. A light bar should scan the display, but should not store. If it does store, adjust the Hard Copy Intensity on the side of the Display Unit and repeat the procedure. When scanning without storing is obtained, a satisfactory hard copy of the display should be provided by the Hard Copy Unit. If excessive "noise" appears on the copy, the Display Unit Hard Copy Intensity adjustment may be set too high. If information loss occurs on the hard copy, the Display Unit Hard Copy Intensity adjustment may be set too low. When the intensity is properly adjusted, the Hard Copy Unit should be able to provide at least five successive hard copies without excessive degradation of the display.

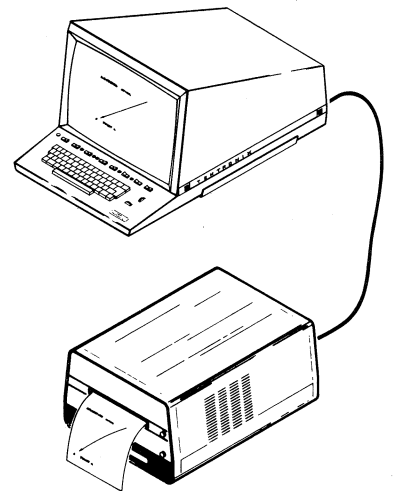

This concludes the operation procedure.





# OPERATION SUMMARY

The operating information contained in the foregoing procedure is summarized on the following pages. In addition, specifics are included to support operation and programming of the Terminal. This summary is separated into four sections, as listed here.

The **GENERAL SUMMARY** contains operating information which is not limited to any one specific mode.

The **ALPHA MODE SUMMARY** includes details concerning selection, operation, and programming of the Terminal's Alpha Mode. Specifics about character size, spacing, and writing rate also appear here.

The **GRAPH MODE SUMMARY**, in addition to condensing the Graph Mode operating information, contains the addressing instructions and other details which are needed for drawing vectors and points.

The **GIN MODE SUMMARY** explains in detail how the computer must solicit information from the Terminal. In addition, it defines the status bit and address bytes which the Terminal sends the computer in response to the query.

# GENERAL SUMMARY

**Interacting With A Computer.** The Terminal can interact with a computer when the Terminal power is on, the keyboard switch is at LINE, and an appropriate data communication link is in effect.

**Initial Status.** At turn-on, the Terminal is in Alpha Mode with the cursor at home position. A stored condition may exist on the screen, which can be cleared by pressing the PAGE key. Normal (large) character size is selected.

**Keyboard Transmission.** This is the result of (1) pressing only a character key; (2) pressing a character key while the SHIFT key is held down; or (3) entering a control character by pressing a letter key while CTRL or CTRL and SHIFT keys are held down.

**PAGE, SHIFT, RESET, and BREAK.** PAGE erases the display, selects Alpha Mode and homes the cursor. If used alone, SHIFT resets View Status without otherwise affecting the display. SHIFT RESET initializes the Terminal, selecting initial conditions for the Terminal circuits; it does not affect the stored display. BREAK generates a Break signal, which can be used by the interface to interrupt the computer.

**TTY LOCK.** When activated, this key permits the keyboard to transmit only TTY code.

**Control Character Execution.** With minor exceptions, the Terminal can execute control characters or control character sequences while the Terminal is in any mode except Hard Copy. One exception is that GS cannot be executed while the crosshair cursor is being displayed in GIN Mode. Another exception is that control characters cannot be executed during GIN Mode transmissions.

**Execution of Characters Other Than Control Characters.** Received data other than control characters causes character writing in Alpha Mode and vector drawing in Graph Mode. One exception is that when ESC precedes a non-control character, that character does not print but performs a pre-determined operation; i.e. the two character sequence of ESC ; selects smallest character size. Alpha and Graph Modes are summarized on the following pages.

**GIN Mode.** This is an interactive mode in which the Terminal can automatically supply the computer with data in response to a computer request. It is summarized on the following pages.

**Hold Status.** This is a reduced intensity status of Alpha Mode that occurs after 1 to 2 minutes of Terminal inactivity. The Terminal remains in View Status while in Graph or GIN Modes.

**Write-Thru.** A natural phenomenon of the bistable storage tube that will satisfy most needs for refreshed graphics displays while maintaining the operating flexibility of normal storage modes. Write-Thru enables the normal display of static (stored) information while enabling overlays of changing or dynamic elements. In other words, high density background data may be stored, with foreground data under control of the host computer. Write-Thru is accomplished by limiting the "on-time" of the writing beam to the point where the image "glows" but does not store. Whether operating Write-Thru in Alpha or Graphics Modes, the "refresh" capability is limited by the interface baud selection and the hardware limitations of the display unit. See Alpha and Graph Mode summaries for Write-Thru specifications and examples.

## NOTE

*The Alpha cursor, the crosshair cursor, and the Hard Copy scan (4014-1 only) are always displayed in the Write-Thru Mode and cannot be program controlled. This is a design characteristic of the Terminal.*

**Local Operation.** When the keyboard switch is at LOCAL, the Terminal is isolated from the computer and will respond to data from the keyboard. Alpha and Graph Modes can be exercised, but GIN Mode operation is limited to the display and positioning of the crosshair cursor. The Terminal can interact with peripheral devices; hard copies can be made.

# OPERATION

## GENERAL SUMMARY

**Hard Copy Operation.** Hard copies can be made while the 4014-1 Terminal is in any Mode. Inputs to the Terminal are disabled while copying is occurring. Copy quality is affected by the Terminal's Hard Copy Intensity control. Neither the Alpha nor crosshair cursor can be copied, since they are removed from the display during copying. Placing the Copy switch to AUTOPRINT causes a hard copy to be printed at page full, as controlled by the MARGIN CONTROL switch.

**Option Straps.** Straps on cards in the pedestal permit LF to control carriage return, allow CR to cause line feed, and can determine if CR or CR and EOT or neither will be sent as the final bytes of GIN transmission. One other strap allows an ESC ? sequence to be substituted for the RUBOUT code, in the event RUBOUT cannot be used as a Low Order Y Code.

## ALPHA MODE SUMMARY

**Mode Selection.** Alpha Mode is selected by initialization, program command CR, program command sequence ESC FF, program command US (except when in GIN Mode), keyboard command PAGE, or keyboard command SHIFT RESET.

**TTY LOCK.** If the TTY LOCK is active, the keyboard can transmit only TTY code.

**Display Formatting.** Display formatting is controlled by the following:

### Program Commands

ESC FF selects home and erases.

CR returns the cursor to the left margin; it may also cause line feed if selected by strap option on TC-1.

LF causes line feed; it may also cause carriage return if selected by strap option on TC-1.

HT causes the cursor to move right one space.

BS causes the cursor to move left one space. Backspacing past the left margin causes the cursor to move to the right side of the screen.

VT causes the cursor to move up one line.

### Automatic Commands

Home is selected upon initialization, as are large size characters.

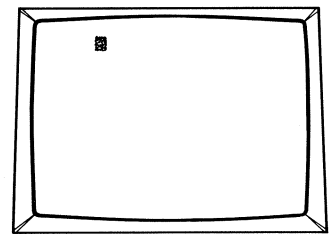

Line feed and carriage return occur after entering a writing character or a space in the last character position on any line.

A line feed (automatic or program command) past the bottom line causes a change between Margin 1 and Margin 2 as controlled by the MARGIN CONTROL switch.

### Operating Specifications

**Display Area.** Nominally 15 inches horizontal by 11 inches vertical. Fig. 3-1 illustrates display specifications.

**Character Size and Format.** This information is provided in Table 3-1.

**Character Spacing.** This information is provided in Table 3-2.

# ALPHA MODE SUMMARY

**TABLE 3-1  
CHARACTER SIZE AND FORMAT**

Characters Per Line	Character Size (mils)	Lines Per Page	Characters Per Display	Selected By
74	160 x 195	35	2590	Initializing or Reset or ESC 8
81	145 x 175	38	3078	ESC 9
121	95 x 115	58	7018	ESC :
133	90 x 110	64	8512	ESC ;

**TABLE 3-2  
CHARACTER SPACING**

Characters Per Line	Space Size		Line Feed Size	
	Tekpoints	Mils	Tekpoints	Mils
74	14.0	196	22.0	315
81	12.75	178.5	20.50	287
121	8.5	119	13.25	185.5
133	7.75	108.5	12	168

# OPERATION ALPHA MODE SUMMARY

**Character Writing Rate.** The effective writing rate is interface-dependent. Maximum limitation is imposed by the write parameters of the Terminal. The Terminal is capable of writing up to 1000 characters per second or, with Write-Thru Status enabled, up to 4000 characters per second.

**Character Capability.** The entire ASCII code can be transmitted and recognized while the TTY LOCK key is released. Activating the TTY LOCK key permits transmission of only TTY characters, without affecting receiving. RUBOUT does not space or print.

**Origin Shifting.** Each erasure repositions the cursor within a few Tekpoints of its preceding home position. This permits greater usage of display surface, prolonging life of crt.

**Viewing Time.** The display reverts to Hold Status after one to two minutes of inactivity, and returns to View Status when the SHIFT key is pressed, or when any Terminal activity occurs. A stored display can be retained in View Status for 15 minutes, or in Hold Status for one hour, without damage to the display screen. Residual images remaining after erasing may sometimes be removed by performing several erase cycles.

**General.** Linear Interpolate is the only Graphic display mode in the standard 4014 or 4014-1 Terminal, and is detailed below. Other Graphic Display Modes, such as enhanced vectors, incremental plot, etc. are dependent on optional accessories. For detailed information on other graphic display modes, refer to the Enhanced Graphic Module Appendix at the rear of this manual.

**Mode Selection.** Graph Mode is selected by program command GS.

**Character Write-Thru "Refresh" Display.** With Write-Thru enabled, 4000 hardware characters per second can be written. This is four times the normal character writing speed. Thus, any TTY Port with a baud capability greater than 40,000 will match the Terminal's character writing capability. To provide a flicker free display, the data must be refreshed at least 30 times a second. See the following for examples of character write-thru capabilities.

EXAMPLE 1: With the above in mind, the calculations for the maximum number of refreshed characters would be

$$\frac{4000 \text{ chars.}}{\text{sec.}} \times \frac{1 \text{ sec.}}{30 \text{ times}} = 133 \text{ characters re-freshed per second}$$

EXAMPLE 2. At 9600 baud (RS232C)

$$\frac{9600 \text{ baud}}{10 \text{ bits per char.}} \times \frac{1 \text{ sec.}}{30 \text{ times}} = 32 \text{ characters re-freshed per second}$$

The above calculations do not include control characters necessary for mode selection and format effectors such as LF, CR, BS, HT, and VT.

# GRAPH MODE SUMMARY

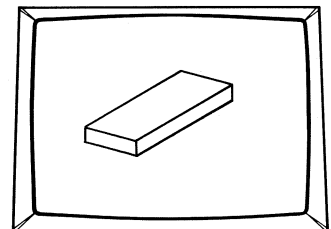

# GRAPH MODE SUMMARY

**Vector Writing Rate.** More than 10,000 centimeters per second.

**Address.** An address is any point within the 1024Y by 1024X capability of the Terminal's beam-positioning registers. In the standard Terminal, Y addresses higher than 779Y fall outside the screen's specified display area. See Fig. 3-1 for display format.

**Complete Address.** A complete graphic address consists of four data bytes — Hi Y, Lo Y, Hi X and Lo X, received in that order.

**Shortened Address.** Addresses may sometimes be reduced to one, two or three bytes, but must always contain a Lo X byte. See the Graph Mode Memory explanation.

**Vector Set-up Time.** The time required to receive and establish the vector address, exclusive of vector writing time. It is equal to or less than 6 microseconds.

**Vector Execution.** This is accomplished only upon receipt of the Lo X byte.

**Dark Vector.** A dark vector is an unwritten vector, which always occurs upon execution of the first vector to be received after a GS command (see Written Vector).

**Written Vector.** Normally, the second and any subsequent address received after a GS command results in a written vector. However, if the first vector following GS is preceded by BEL, the first vector will also be written.

**Vector Write-Thru "Refresh" Display.** With Write-Thru enabled, the maximum number of vectors possible is limited by (1) the baud at which the minicomputer and interface operate, and (2) a Terminal hardware limitation of 10,000 centimeters of vectors drawn per second. To provide a flicker-free display, the data must be refreshed at least 30 times a second. See the following for examples of Write-Thru graphics capability.

**EXAMPLE 1:** Assume that a Data General TTY Port Interface is connected to a Terminal with 4096 addressing capability. (The Enhanced Graphics Option provides 4096 addressing.) The Data General Interface has an effective baud of 100,000. Also, 4096 (12-bit) addressing requires up to five characters for each dark or light vector, versus four characters for 1024 (10-bit) addressing.

$$\frac{100,000 \text{ baud}}{10 \text{ bits per char.}} \times \frac{1 \text{ vector}}{5 \text{ chars.}} \times \frac{1 \text{ second}}{30 \text{ times}} = 66 \text{ vectors refreshed}$$

The actual number of vectors drawn is  $66 \times 30 = 1980$ . Because of the hardware limitation previously mentioned, the user must add up the vector lengths to ensure that the 5000 inches per second limit is not exceeded.

**EXAMPLE 2:** At 9600 baud (RS232C)

$$\frac{9600 \text{ baud}}{10 \text{ bits per char.}} \times \frac{1 \text{ vector}}{5 \text{ chars.}} \times \frac{1 \text{ second}}{30 \text{ times}} = 6 \text{ vectors refreshed}$$

The above calculations do not include control characters necessary for mode selection and format effectors such as LF, CR, BS, HT, and VT. These characters must also be refreshed.

**Point Writing.** A point can be written by executing a GS and then executing the same address twice. The second address command requires only the Lo X byte.

**Point Spacing.** There is approximately .014 inch of horizontal or vertical distance between adjacent point centers. If the optional Enhanced Graphic Module is installed, point spacing decreases to .0035 inch.

**Graph Mode Termination.** Graph Mode can be ended by any one of the following commands:

# OPERATION

# GRAPH MODE

# SUMMARY

## Program Commands

ESC FF selects Alpha Mode, homes the Alpha cursor, and erases the display.

CR selects Alpha Mode and sets the Alpha cursor to Margin 1 if a vector has been executed while in Graph Mode.

US selects Alpha Mode, leaving the Alpha cursor at the last Graph Mode address.

ESC SUB selects GIN Mode and displays the crosshair cursor.

RS selects Incremental Plot if the Enhanced Graphic Module is installed in the Terminal.

FS (or ESC FS) selects Point Plot (or Special Point Plot) if the Enhanced Graphic Module is installed in the Terminal.

## Keyboard Commands

PAGE selects Alpha Mode, homes the Alpha cursor, and erases the display.

SHIFT RESET selects Alpha Mode, homes the Alpha cursor, and initializes the Terminal circuitry.

**Vector Writing Time.** The time required to write a vector is dependent on vector length. The shortest vector (one Tekpoint) requires about 12  $\mu$ s. The longest vector (about 19 inches full screen diagonal) requires about 3.25 ms. As another example, a 14 inch vector can be drawn in about 2.5 ms. This is equivalent to a vector writing rate of 10,000 vector centimeters per second.

**Viewing Time.** The Terminal remains in View Status indefinitely while in Graph Mode, since the Hold circuitry is over-ridden. The Terminal should be returned to Alpha Mode when vectors are not being drawn.

**Stored Display.** A stored display can be retained in View Status for 15 minutes without damage to the display screen. The Terminal should be returned to Alpha Mode when vectors are not being drawn, to permit Hold Status to occur. (A stored display can be retained in Hold Status for one hour without damage to the display screen.)

**Viewable Address.** Any point within the 780Y by 1024X grid quality display area can be seen (see Fig. 3-1.)

**Addressing the Display Beam.** The beam is addressed to a point by sending to the Terminal the binary equivalent of the Y address and the X address of the point. For example, 205Y and 148X translates to 0011001101 $\gamma$ Y and 0010010100 $\gamma$ X.

Each binary equivalent must be separated into two bytes — the 5 most significant bits (MSB) and the 5 least significant (LSB). Continuing the example from the preceding paragraph, 0011001101 becomes 00110 Hi Y, 01101 Lo Y, and 0010010100 becomes 00100 Hi X, 10100 Lo X.

If these bytes are sent to the Terminal (in the sequence given) while it is in Graph Mode, the beam will move to 205Y, 148X position. These can be sent to the Terminal receiving circuits via the Terminal keyboard if LOCAL is selected, or if echoing is in effect. However, the keyboard equivalent must first be determined. This can be obtained from the Coordinate Conversion Chart (in the Appendix), which translates directly from the decimal address to the ASCII equivalents. The address in the example (205Y, 148X) can be represented by the keyboard characters & m \$ T.

**Graph Mode Memory.** Three bytes, Hi Y, Lo Y, and Hi X are stored in a register. Once these bytes have been sent to the Terminal, they need not be sent again unless different from the preceding transmitted values. In particular, they need not be reloaded each time the Terminal is reset to Alpha or GIN Modes. One initialization per program is sufficient unless power to the Terminal is cycled. (This fact may be used to advantage when displaying mixed graphics and alphanumeric.) The following table shows which bytes must be sent in response to specific byte changes. For example, if Lo Y changes, Lo Y and Lo X must be sent. As a second example, if the Hi Y and Lo Y bytes change, the Hi Y, Lo Y and Lo X bytes must be sent.

# GRAPH MODE SUMMARY

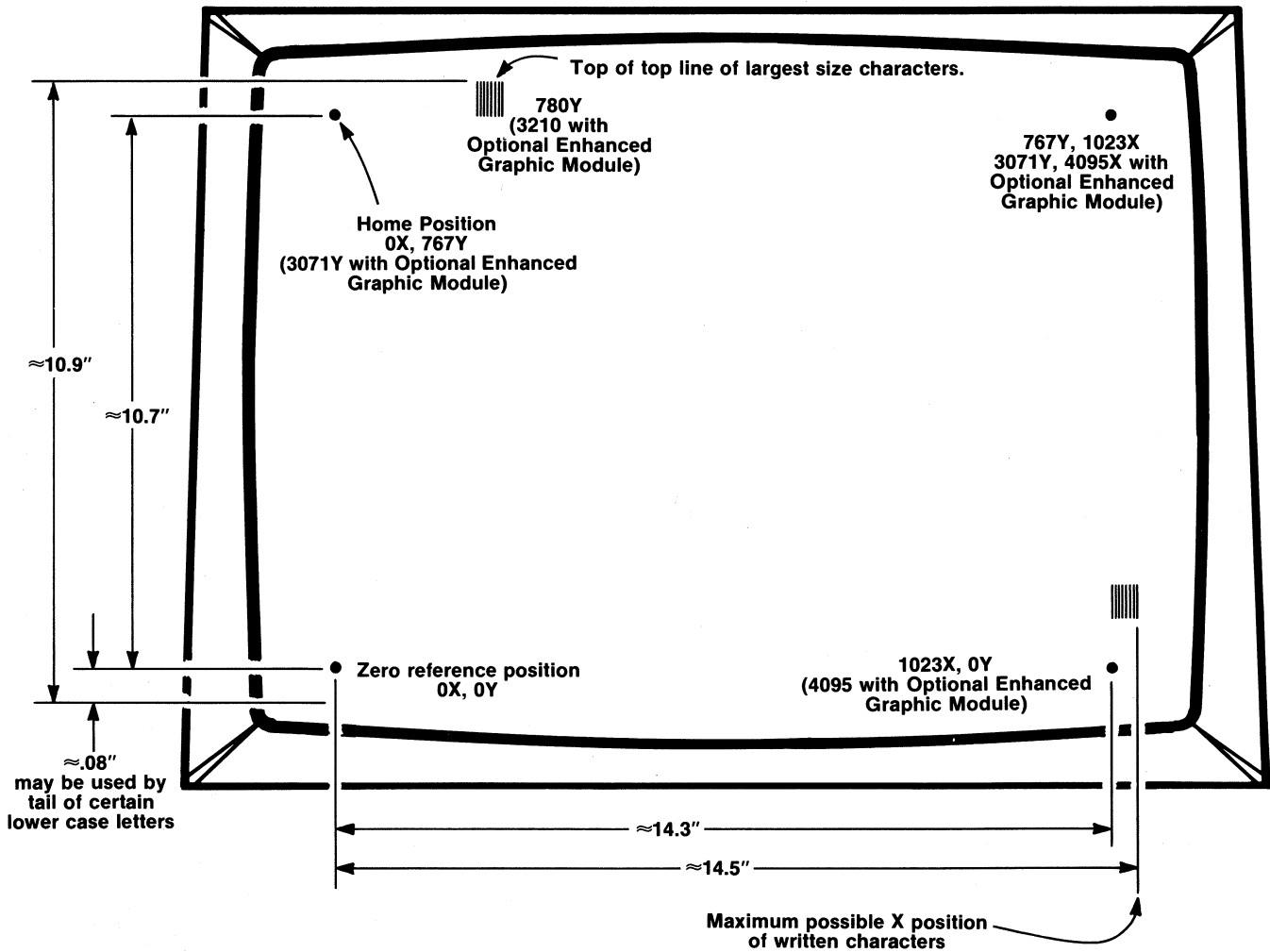

Fig. 3-1. Display format.

Bytes Which Change	Bytes which must be sent			
	Hi Y	Lo Y	Hi X	Lo X
Hi Y	#			#
Lo Y		#		#
Hi X		#	#	#
Lo X				#

Again, the Graph Mode memory remains in effect even though the Terminal is switched out of Graph Mode, and can be used again after Graph Mode is re-established.

**Vector Deviation From a Straight Line.** This does not exceed 0.5% of the line length, and is due to the geometry error of the crt.

**RUBOUT Equivalent.** Some systems may be unable to use the RUBOUT code as a LOY code. Therefore, a strap option on the TC-1 Control Card enables the ESC ? sequence to be substituted for RUBOUT. See Strap Options in the Installation Appendix.



# OPERATION

## GIN MODE

## SUMMARY

**Transmitting the Graph Mode Beam Address.** ESC ENQ received from the computer while in Graph Mode causes automatic transmission of the following: the Terminal status byte; the 4-byte address of the Graph Mode beam position; CR (if selected by strap option); and EOT (if selected by strap option; EOT cannot be sent without CR). The Terminal returns to Graph Mode upon completion of transmission.

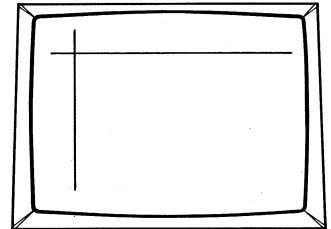

**Transmitting the Alpha Cursor Address.** ESC ENQ received from the computer while in Alpha Mode causes automatic transmission of the following: the Terminal status byte; the 4-byte address of the lower-left corner of the Alpha cursor; CR (if selected by strap option); and EOT (if selected by strap option; EOT cannot be sent without CR). The Terminal returns to Alpha Mode upon completion of transmission.

**Displaying the Crosshair Cursor.** ESC SUB causes the crosshair cursor to be displayed. The cursor can be positioned by the keyboard thumbwheels (or optional Joystick). (ESC SUB should not be entered at the keyboard while On Line.)

**Computer Request for Crosshair Address.** ESC ENQ received from the computer while the crosshair cursor is being displayed causes automatic transmission of the following: the 4-byte address of the crosshair cursor intersect point; CR (if selected by strap option); and EOT (if selected by strap option; EOT cannot be sent without CR). The Terminal returns to Alpha Mode upon completion of transmission. A 15 ms delay must exist between ESC SUB (which turns on the crosshair cursor) and ESC ENQ. This delay can be ignored under the following circumstances:

- (1) Whenever operating slower than 1000 baud.
- (2) Whenever only the Y address is required; X will also be sent, but cannot be relied upon to be correct.

- (3) If the Terminal is addressed  $\emptyset Y$  before sending the Terminal an ESC SUB. The Graph Mode memory circuit can be used to advantage in the last situation, if repetitive requests for crosshair position are to be made.

**Keyboard Initiation of Crosshair Address.** A character entered at the keyboard while the crosshair cursor is displayed will cause transmission of that character, automatically followed by transmission of the four-byte address of the crosshair intersect point, CR (if selected by strap option), and EOT (if selected by strap option; EOT cannot be sent without CR). The Terminal returns to Alpha Mode upon completion of transmission.

Neither ESC SUB nor ESC ENQ should be entered at the keyboard while On Line.

**Bypass Condition.** Bypass Condition is in effect during any of the above GIN Mode situations. Bypass prevents GIN Mode data and echoed GIN Mode data from being printed by the Terminal. If CR is selected to be transmitted as the last character of the GIN data string and is echoed, Bypass will be cleared. If CR is not transmitted and then echoed back to the Terminal, Bypass must be cleared as explained in the following topic.

# GIN MODE SUMMARY

**Clearing GIN Mode and Bypass Condition.** GIN Mode is automatically terminated whenever the Terminal finishes sending the GIN Mode data. GIN Mode can also be terminated while the crosshair cursor is being displayed, without transmitting to the computer. Program command CR or ESC FF will do it, switching the Terminal to Alpha Mode. However, CR may leave the Terminal in either Margin 1 or Margin 2 status, and ESC FF will erase the display. It may be better to terminate by sending ESC ENQ and ignore the transmission to the computer. The crosshair cursor can also be terminated, and Alpha Mode selected, by entering PAGE or SHIFT RESET at the keyboard.

As previously explained, Bypass prevents the Terminal's character generator from responding to the GIN Mode data. The character generator must therefore be reset before writing can again occur. If CR is part of the GIN Mode transmission and is echoed, it will provide the necessary resetting, but will also put the Terminal in Alpha Mode and place the cursor at either Margin 1 or 2. Any of the following program commands reset the character generator:

BEL, CR, ESC ETB, ESC FF, LF, US, SI or EX-  
ECUTING A DARK OR LIGHT VECTOR

Note that all except BEL, ESC ETB and US affect the display or position of the alpha cursor. The Character Generator can also be reset by PAGE or SHIFT RESET from the keyboard by, pressing the COPY button with a hard copy unit connected (4014-1 only), or by placing the LOCAL/LINE switch at LOCAL.

**Echoing GIN Mode Data.** GIN Mode data echoed back to the Terminal may affect the Graph Mode memory circuits, the Operating Mode, or the writing beam position. Therefore, it normally is best not to echo data. If none of these items are of concern, echoing GIN Mode data will clear Bypass, if CR is part of the transmission. (CR will also set Alpha Mode and return the beam to Margin 1 or 2.)

**Status Byte Definition.** The bits of the Terminal Status Byte are as follows:

Bit 8	Arbitrary; dependent on strap option on the Interface Unit and/or keyboard.
Bit 7	Always 0
Bit 6	Always 1
Bit 5	Hard Copy Unit Bit; 0 indicates a Hard Copy Unit is available and able to accept a copy request.
Bit 4	Vector Bit; 1 indicates that Graph Mode exists.
Bit 3	Graph Mode Bit; 0 indicates that Graph Mode exists.
Bit 2	Margin Bit; 1 indicates Margin 2 exists. With Margin 2 in effect, the most significant X bit (512) of the Alpha cursor address must be considered to be true (1), regardless of how it was transmitted. The cursor is therefore on the right half of the screen. If the transmitted address is less than 512, and Margin 2 exists, the X value must be increased by 512 to indicate beam position with respect to the left edge of the screen. (X=0 position).
Bit 1	Auxiliary Unit Sensing Bit; 0 indicates that some optional auxiliary unit other than a Hard Copy Unit is connected to the Terminal and interacting with the Terminal.

# OPERATION

## GIN MODE

## SUMMARY

**GIN Mode Address Bytes.** The four-byte address consists of the 5 most significant X bits, the 5 least significant X bits, the 5 most significant Y bits, and the 5 least significant Y bits, in that sequence. In each case, the address bytes are preceded by 01 as Bits 7 and 6, respectively.

### Transmission Limits

Alpha Cursor Position—0 through 1023 X, 0 through 767Y

Graph Beam Position—0 through 1023X, 0 through 1023Y

Crosshair Cursor Position—4 through 1023X, 0 through 779Y

#### NOTE

*If sending a Y address greater than 767, Bypass Operation becomes undefined.*

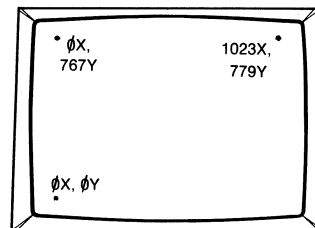

**Transmission Accuracy.** The actual address of the lower left corner of the character matrix, or of the Graph Mode beam position is sent. The address of the crosshair cursor intersect point is accurate to within  $\pm 1$  point with reference to the standard 1024 by 1024 grid. If the Enhanced Graphics Module (Option 34) is installed, the crosshair intersect point accuracy becomes referenced to a grid of 4096 by 4096. The accuracy then becomes +4 or -7.



# APPENDIX A

# INSTALLATION

### General

Installation consists of pedestal-mounting or optional desk-mounting the Terminal display unit, selecting proper operating voltage and fuse size, setting the desired strap options, and connecting the Terminal to the computer. These steps are discussed in the following paragraphs.

### Pedestal-Mounting the Display

Mounting of the display unit on the pedestal is accomplished by two people. It includes the following steps:

1. Remove the pedestal and display unit from the shipping cartons.
  
2. Lift the display unit over the pedestal.
  
3. Install four machine screws up through the pedestal top to fasten the display unit in place. (Install eight machine screws for SN B050000 and above.)
  
4. Remove the display cover by removing the three machine screws on each side of the display cover. Set the cover aside.
  
5. Unbolt the pedestal-to-display connector from the display back panel. Connect the display connector to the pedestal connector in the top of the pedestal. Do not bolt the two connectors together.



*Make sure the Display unit is bolted to the Pedestal as described in Step 3. This will prevent the Connector from pulling apart if the Display Unit is lifted. Otherwise, possible component failure may result to the Terminal Control and Power Supply circuits if the Display Unit is lifted and then allowed to settle back onto the Pedestal when power is on.*

6. Bolt the cover plate over the hole in the display back-panel and put the cover back on the display unit.
  
7. Adjust the four feet to a convenient position, and secure the lock nuts to hold them in position.

### Desk-Mounting the Display

To desk-mount the display unit, the optional Desk-Mounting package must be ordered. Desk-mounting consists of setting the display unit on a desk or other surface and then installing the interconnect cable. The pedestal can be placed as far as 10 feet away from the display unit. The air vents on the bottom and back should be kept free of obstructions.

If the Terminal has just been received from the factory, desk mounting consists of connecting one end of the cable to the plug on the back panel of the display, and the other end to the connector on top of the pedestal.

If the display unit has been mounted on the pedestal, desk-mounting consists of reversing the pedestal-mounting procedure and observing the instructions which have been previously outlined.

A dimensional drawing is provided in Fig. A-1 as an installation aid.

### Selecting Operating Voltage and Fuse Size

The Terminal is intended to be operated from a single-phase power source which has one of its current-carrying conductors (the neutral conductor) at ground (earth) potential. Operation from other power sources where both current-carrying conductors are live with respect to ground (such as phase-to-phase on a multi-phase system, or across the legs of a 117-234 V single-phase three-wire system) is not recommended, as only the line conductor has over-current (fuse) protection within the instrument.

The Terminal is provided with a three-wire power cord with a three-terminal polarized plug for connection to the power source. The grounding terminal of the plug is directly connected to the instrument frame as recommended by national and international safety codes.

**Power Cord Conductor Identification**

Conductor	Color	Alternate Color
Ungrounded (Line)	Brown	Black
Grounded (Neutral)	Blue	White
Grounding (Earthing)	Green-Yellow	Green-Yellow

# INSTALLATION

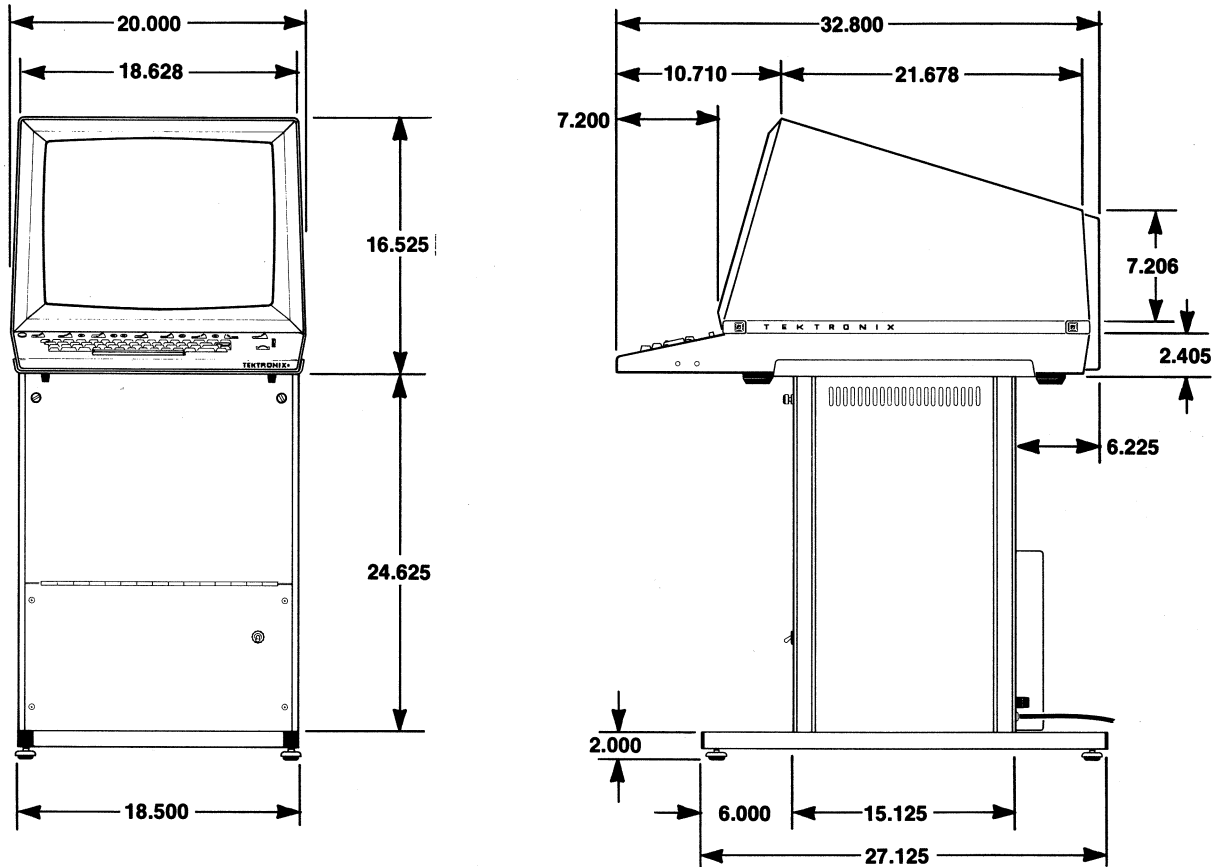

Fig. A-1. Dimensions.

The Terminal can be operated from either a 110 or 220-volt nominal line voltage source which has a frequency of between 48 and 440 Hz. A changeable fuse and a jumper arrangement on the transformer permits the Terminal to be modified to suit the supply. Both the 110 and 220-volt cords are color coded and connected the same at the Terminal; the difference between them being in the plug that connects to the voltage source.

The fuse holder is mounted on the back panel of the pedestal, near the lower left corner of the heat sink. Fuse size is indicated near the fuse holder. Access to the transformer jumper arrangement is obtained by removing the pedestal front cover. The jumper arrangement is located in the bottom right, of the pedestal. See Fig. A-2. Access to the jumper arrangement is obtained by removing the protective cover. Wiring instructions are contained on the inside of the front cover of the pedestal. Wiring instructions are repeated in Fig. A-3 for convenience.

**WARNING**

*Dangerous potentials exist at several places in the lower section of the pedestal. Disconnect the Terminal from the power source before changing transformer connections.*

### Regulated Power Supplies Current Drain

Current drain for the +5 vdc, +15 vdc, and -15 vdc regulated supplies is provided in Table A-1. Shown is the average value for the standard Terminal, for the Terminal with the Enhanced Graphics Module (Option 34), and the maximum current rating for each supply. Specific values apply from 104 vac to 126 vac.

**TABLE A-1**  
**CURRENT RATING (REGULATED SUPPLIES)**

Supply	Standard Terminal	Terminal with Enhanced Graphics Module	Maximum Current Rating
+5 vdc	5.5 A	6.0 A	9.0 A
+15 vdc	300 mA	300 mA	1.5 A
-15 vdc	450 mA	450 mA	1.5 A

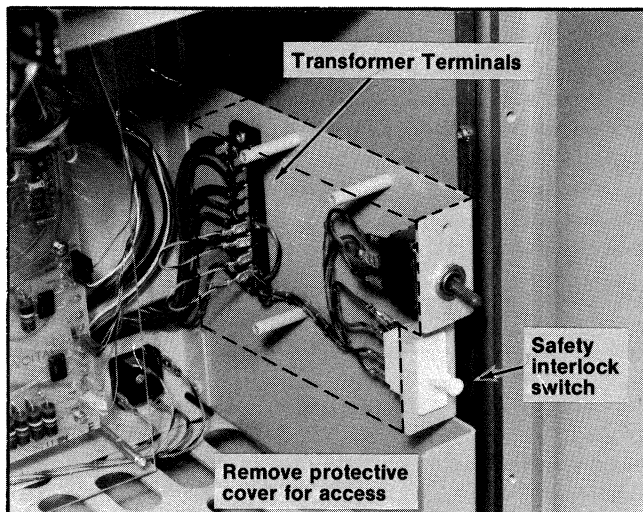

**Fig. A-2. Transformer terminals location.**

Specific current drain (on the listed supplies) caused by optional plug-in circuit cards can be found in the manual applicable to the optional accessory.

### Selecting Strappable Option Connections

Strappable options are found on circuit cards in the top section of the pedestal. Access to the cards is obtained by loosening the top screws in the front cover and swinging the top of the cover down. The cover should not be entirely removed except during servicing by an authorized technician, since dangerous voltages are contained in the lower section.

The circuit cards are installed in a minibus, and are interchangeable, since identical signal lines are provided at corresponding points of each of the minibus board connectors. TC-1 and the Character Generator, as well as TC-2 and TC-3 are also connected by short, multiwire straps. For this reason, each of the card pairs need to be located in adjoining minibus board connectors.



*Do not remove or install circuit cards while the Terminal is turned on.*

To remove the flat multiwire cables, grasp the plug as close to the circuit card as possible, then pull straight out from the card.

### NOTE

*Do not remove the cables by pulling on the flat cabling that joins the plugs; internal damage to the plugs may result.*

The positions of the straps are dependent upon computer and program requirements, and in some cases upon user preference. Strap locations for the terminal control cards (TC-1 and TC-2) and for the 021-0065-00 Data Communication Interface card are shown in Fig. A-4. Details regarding the strappable options are shown in Table A-2.

Details regarding the 021-0065-00 Data Communication Interface card strappable options are defined in its manual.

Any one of several optional interfaces may be installed in the Terminal in place of the 021-0065-00 Data Communication Interface, and in some cases more than one interface may be installed. Strappable option information for these interfaces is provided in their respective manuals.

# INSTALLATION

**TABLE A-2**  
**Strap Option Details**

FEATURE	LOCATION	EFFECT
LF EFFECT	TC-1	LF causes Line Feed only, LF-CR causes Line Feed and Carriage Return. LF-CR also resets the Graph Mode to Alpha Mode.
CR EFFECT	TC-1	CR causes Carriage Return only, CR-LF causes Carriage Return and Line Feed.
DEL IMPLIES LOY	TC-1	DEL-LOY position enables the Terminal to interpret the RUBOUT (DEL) character (127 <sub>10</sub> ) as a low order Y code. DEL position prevents RUBOUT from being used as LOY. Software can compensate for system's inability to use RUBOUT as LOY by sending ESC ? which is decoded as LOY, performing the same as if RUBOUT were being sent.
Graphic Input Terminators	TC-2	CR & EOT transmits CR & EOT in GIN Mode; CR transmits CR in GIN MODE: NONE transmits neither CR nor EOT in GIN MODE.

## Connecting the Terminal to a Computer

The two basic methods of connecting the Terminal to a computer are direct connection and telephone line connection. A direct connection is used when the Terminal and the computer are located close to each other, permitting hook-up without additional equipment. A telephone line connection can be made regardless of the distance which separates the Terminal and the computer.

**Direct Connection.** When the Terminal has its standard interface (021-0065-00 Data Communication Interface) installed, a direct connection can be made by connecting its plug to the interface card so that the plug index mark is matched with the "DIRECT TO CPU" index mark on the card. This is shown in Fig. A-4. The plug on the other end of the interface cable can then be inserted into the modem jack at the computer. The signal lines available to the computer are shown in Table A-3.

Other direct connections, such as connecting to the computer's teletypewriter port, require a different type of

interface, and may require a more extensive connection procedure. Details regarding connection of various interfaces are provided in the manuals which accompany those interfaces.

**Telephone Line Connection.** A modulator-demodulator (modem) is required to establish telephone line connection. Telephone companies rent these modems (also called data sets or data phones). There are a number of specialized modems available; the type required depends upon the specific needs of the installation.

When a standard interface (021-0065-00 Data Communication Interface) is installed in the Terminal, the plug on the interface card must be connected so that the plug index mark aligns with the "TO MODEM" index mark on the card. Then the other end of the interface cable must be plugged into the modem set. Signal names remain as listed in Table A-3.



# APPENDIX A INSTALLATION

**TABLE A-3**

**021-0065-00 Data Communication  
Interface Output Connector Signals**

Pin No.	RS-232C Circuit	CCITT Equiv.	Description
1	AA	101	Protective Ground
2	BA	103	Transmitted Data
3	BB	104	Received Data
4	CA	105	Request to Send (on while Terminal is on)
5	CB	106	Clear to Send
7	AB	102	Signal Ground (Common Return)
8	CF	109	Received Line Signal Detector
20	CD	108.2	Data Terminal Ready (on while Terminal is on)

Once connected to the modem, computer connection is achieved as follows: 1) Energize the equipment; 2) Dial the number of the computer installation; 3) When the computer responds with an audible tone, place the telephone headset on the cradle provided on the modem; or push the button marked DATA, and hang up the headset; or perform such other function as required by the specific modem in use; 4) Perform the sign-on procedure, which varies with the computer installation.

Other interfaces require different considerations which are discussed in detail in the applicable interface manuals. Refer to the Appendix entitled "Interface Design Information" if additional details are required.

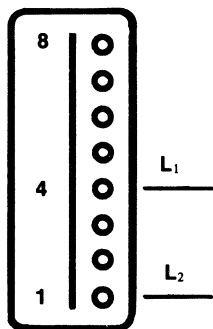

**JUMPER ARRANGEMENT**

VOLTAGE $\pm 10\%$	100	115	120	200	220	230	240
TERMINAL NO.	1-8 4-5	1-2 3-4	1-7 4-6	5-8	5-7	2-3	6-7
TWO JUMPERS REQUIRED				ONE JUMPER REQUIRED			

**Fig. A-3. Transformer terminals and jumper arrangement.**

# INSTALLATION

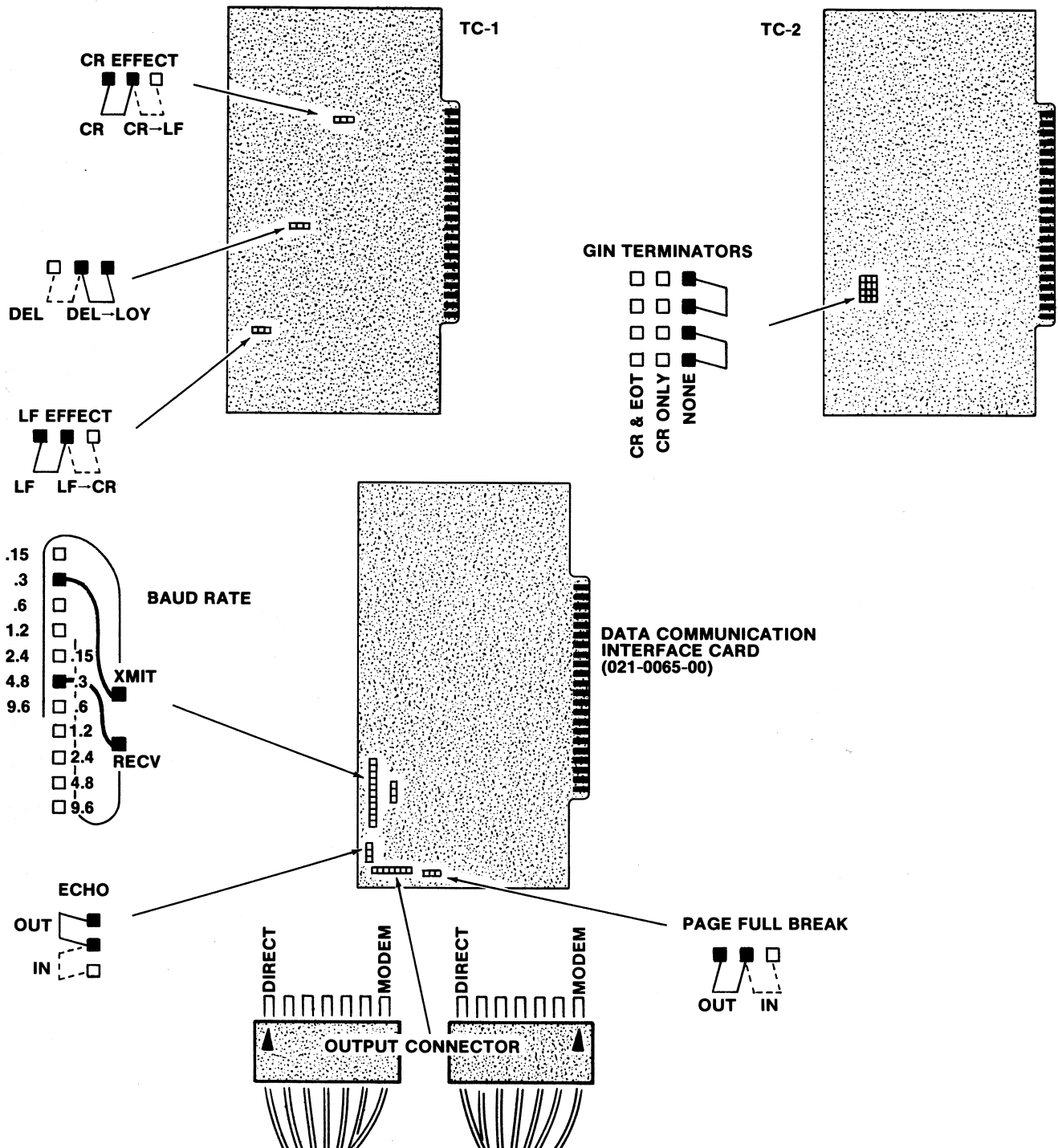

Fig. A-4. Strap option location for TC-1, TC-2, and the Data Communication Interface (021-0065-00) for a standard Terminal. Refer to the appropriate manual for strap information on optional cards.

# ASCII CODE CHART

BITS				CONTROL		HIGH X & Y GRAPHIC INPUT		LOW X		LOW Y	
B7	B6	B5	B4	B3	B2	B1					
0	0	0	0	NUL	DLE	SP	0	@	P	\	p
0	0	0	1	SOH	DC1	!	1	A	Q	a	q
0	0	1	0	STX	DC2	"	2	B	R	b	r
0	0	1	1	ETX	DC3	#	3	C	S	c	s
0	1	0	0	EOT	DC4	\$	4	D	T	d	t
0	1	0	1	ENQ	NAK	%	5	E	U	e	u
0	1	1	0	ACK	SYN	&	6	F	V	f	v
0	1	1	1	BEL BELL	ETB	'	7	G	W	g	w
1	0	0	0	BS BACK SPACE	CAN	(	8	H	X	h	x
1	0	0	1	HT	EM	)	9	I	Y	i	y
1	0	1	0	LF	SUB	*	:	J	Z	j	z
1	0	1	1	VT	ESC	+	;	K	[	k	{
1	1	0	0	FF	FS	,	<	L	\	l	:
1	1	0	1	CR RETURN	GS	-	=	M	]	m	}
1	1	1	0	SO	RS	.	>	N	^	n	~
1	1	1	1	SI	US	/	?	O	_	o	RUBOUT (DEL)



# APPENDIX C

# COORDINATE CONVERSION CHART

Low Order X										Low Order Y	
ASCII	DEC.	X or Y Coordinate								DEC.	ASCII
@	64	0	32	64	96	128	160	192	224	96	`
A	65	1	33	65	97	129	161	193	225	97	a
B	66	2	34	66	98	130	162	194	226	98	b
C	67	3	35	67	99	131	163	195	227	99	c
D	68	4	36	68	100	132	164	196	228	100	d
E	69	5	37	69	101	133	165	197	229	101	e
F	70	6	38	70	102	134	166	198	230	102	f
G	71	7	39	71	103	135	167	199	231	103	g
H	72	8	40	72	104	136	168	200	232	104	h
I	73	9	41	73	105	137	169	201	233	105	i
J	74	10	42	74	106	138	170	202	234	106	j
K	75	11	43	75	107	139	171	203	235	107	k
L	76	12	44	76	108	140	172	204	236	108	l
M	77	13	45	77	109	141	173	205	237	109	m
N	78	14	46	78	110	142	174	206	238	110	n
O	79	15	47	79	111	143	175	207	239	111	o
P	80	16	48	80	112	144	176	208	240	112	p
Q	81	17	49	81	113	145	177	209	241	113	q
R	82	18	50	82	114	146	178	210	242	114	r
S	83	19	51	83	115	147	179	211	243	115	s
T	84	20	52	84	116	148	180	212	244	116	t
U	85	21	53	85	117	149	181	213	245	117	u
V	86	22	54	86	118	150	182	214	246	118	v
W	87	23	55	87	119	151	183	215	247	119	w
X	88	24	56	88	120	152	184	216	248	120	x
Y	89	25	57	89	121	153	185	217	249	121	y
Z	90	26	58	90	122	154	186	218	250	122	z
[	91	27	59	91	123	155	187	219	251	123	{
\	92	28	60	92	124	156	188	220	252	124	:
]	93	29	61	93	125	157	189	221	253	125	}
^	94	30	62	94	126	158	190	220	254	126	~
_	95	31	63	95	127	159	191	223	255	127	RUBOUT (DEL)
DEC. →		32	33	34	35	36	37	38	39		
ASCII →		SP	!	"	#	\$	%	&	'		
High Order X & Y											

Coordinate conversion chart, part 1 of 4. INSTRUCTIONS: Find coordinate value in body of chart; follow that column to bottom of chart to find decimal value or ASCII character which represents the High Y or High X byte; go to the right in the row containing the coordinate value to find the Low Y byte, or go to the left to find the Low X byte. EXAMPLE: 200Y, 48X equals 38 104 33 80 in decimal code, and equals & h ! P in ASCII code.

# COORDINATE CONVERSION CHART

Low Order X		X or Y Coordinate								Low Order Y			
ASCII	DEC.											DEC.	ASCII
@	64	256	288	320	352	384	416	448	480		96	`	
A	65	257	289	321	353	385	417	449	481		97	a	
B	66	258	290	322	354	386	418	450	482		98	b	
C	67	259	291	323	355	387	419	451	483		99	c	
D	68	260	292	324	356	388	420	452	484		100	d	
E	69	261	293	325	357	389	421	453	485		101	e	
F	70	262	294	326	358	390	422	454	486		102	f	
G	71	263	295	327	359	391	423	455	487		103	g	
H	72	264	296	328	360	392	424	456	488		104	h	
I	73	265	297	329	361	393	425	457	489		105	i	
J	74	266	298	330	362	394	426	458	490		106	j	
K	75	267	299	331	363	395	427	459	491		107	k	
L	76	268	300	332	364	396	428	460	492		108	l	
M	77	269	301	333	365	397	429	461	493		109	m	
N	78	270	302	334	366	398	430	462	494		110	n	
O	79	271	303	335	367	399	431	463	495		111	o	
P	80	272	304	336	368	400	432	464	496		112	p	
Q	81	273	305	337	369	401	433	465	497		113	q	
R	82	274	306	338	370	402	434	466	498		114	r	
S	83	275	307	339	371	403	435	467	499		115	s	
T	84	276	308	340	372	404	436	468	500		116	t	
U	85	277	309	341	373	405	437	469	501		117	u	
V	86	278	310	342	374	406	438	470	502		118	v	
W	87	279	311	343	375	407	439	471	503		119	w	
X	88	280	312	344	376	408	440	472	504		120	x	
Y	89	281	313	345	377	409	441	473	505		121	y	
Z	90	282	314	346	378	410	442	474	506		122	z	
[	91	283	315	347	379	411	443	475	507		123	{	
\	92	284	316	348	380	412	444	476	508		124		
]	93	285	317	349	381	413	445	477	509		125	}	
^	94	286	318	350	382	414	446	478	510		126	~	
_	95	287	319	351	383	415	447	479	511		127	RUBOUT (DEL)	
DEC. →		40	41	42	43	44	45	46	47				
ASCII →		(	)	*	+	,	-	.	/				
High Order X & Y													

Coordinate conversion chart, part 2 of 4. (Refer to part 1 for interpretation instructions.)

# APPENDIX C

# COORDINATE CONVERSION CHART

Low Order X		X or Y Coordinate								Low Order Y	
ASCII	DEC.									ASCII	DEC.
@	64	512	544	576	608	640	672	704	736	`	96
A	65	513	545	577	609	641	673	705	737	a	97
B	66	514	546	578	610	642	674	706	738	b	98
C	67	515	547	579	611	643	675	707	739	c	99
D	68	516	548	580	612	644	676	708	740	d	100
E	69	517	549	581	613	645	677	709	741	e	101
F	70	518	550	582	614	646	678	710	742	f	102
G	71	519	551	583	615	647	679	711	743	g	103
H	72	520	552	584	616	648	680	712	744	h	104
I	73	521	553	585	617	649	681	713	745	i	105
J	74	522	554	586	618	650	682	714	746	j	106
K	75	523	555	587	619	651	683	715	747	k	107
L	76	524	556	588	620	652	684	716	748	l	108
M	77	525	557	589	621	653	685	717	749	m	109
N	78	526	558	590	622	654	686	718	750	n	110
O	79	527	559	591	623	655	687	719	751	o	111
P	80	528	560	592	624	656	688	720	752	p	112
Q	81	529	561	593	625	657	689	721	753	q	113
R	82	530	562	594	626	658	690	722	754	r	114
S	83	531	563	595	627	659	691	723	755	s	115
T	84	532	564	596	628	660	692	724	756	t	116
U	85	533	565	597	629	661	693	725	757	u	117
V	86	534	566	598	630	662	694	726	758	v	118
W	87	535	567	599	631	663	695	727	759	w	119
X	88	536	568	600	632	664	696	728	760	x	120
Y	89	537	569	601	633	665	697	729	761	y	121
Z	90	538	570	602	634	666	698	730	762	z	122
[	91	539	571	603	635	667	699	731	763	{	123
\	92	540	572	604	636	668	700	732	764	:	124
]	93	541	573	605	637	669	701	733	765	}	125
^	94	542	574	606	638	670	702	734	766	~	126
_	95	543	575	607	639	671	703	735	767	RUBOUT (DEL)	127
DEC →		48	49	50	51	52	53	54	55		
ASCII →		0	1	2	3	4	5	6	7		
		High Order X & Y									

Coordinate conversion chart, part 3 of 4. (Refer to part 1 for interpretation instructions.)

# COORDINATE CONVERSION CHART

Low Order X		X or Y Coordinate								Low Order Y			
ASCII	DEC.											DEC.	ASCII
@	64	768	800	832	864	896	928	960	992	96	`		
A	65	769	801	833	865	897	929	961	993	97	a		
B	66	770	802	834	866	898	930	962	994	98	b		
C	67	771	803	835	867	899	931	963	995	99	c		
D	68	772	804	836	868	900	932	964	996	100	d		
E	69	773	805	837	869	901	933	965	997	101	e		
F	70	774	806	838	870	902	934	966	998	102	f		
G	71	775	807	839	871	903	935	967	999	103	g		
H	72	776	808	840	872	904	936	968	1000	104	h		
I	73	777	809	841	873	905	937	969	1001	105	i		
J	74	778	810	842	874	906	938	970	1002	106	j		
K	75	779	811	843	875	907	939	971	1003	107	k		
L	76	780	812	844	876	908	940	972	1004	108	l		
M	77	781	813	845	877	909	941	973	1005	109	m		
N	78	782	814	846	878	910	942	974	1006	110	n		
O	79	783	815	847	879	911	943	975	1007	111	o		
P	80	784	816	848	880	912	944	976	1008	112	p		
Q	81	785	817	849	881	913	945	977	1009	113	q		
R	82	786	818	850	882	914	946	978	1010	114	r		
S	83	787	819	851	883	915	947	979	1011	115	s		
T	84	788	820	852	884	916	948	980	1012	116	t		
U	85	789	821	853	885	917	949	981	1013	117	u		
V	86	790	822	854	886	918	950	982	1014	118	v		
W	87	791	823	855	887	919	951	983	1015	119	w		
X	88	792	824	856	888	920	952	984	1016	120	x		
Y	89	793	825	857	889	921	953	985	1017	121	y		
Z	90	794	826	858	890	922	954	986	1018	122	z		
[	91	795	827	859	891	923	955	987	1019	123	{		
\	92	796	828	860	892	924	956	988	1020	124	:		
]	93	797	829	861	893	925	957	989	1021	125	}		
^	94	798	830	862	894	926	958	990	1022	126	~		
_	95	799	831	863	895	927	959	991	1023	127	RUBOUT (DEL)		
DEC →		56	57	58	59	60	61	62	63				
ASCII →		8	9	:	;	<	=	>	?				
High Order X & Y													

Coordinate conversion chart, part 4 of 4. (Refer to part 1 for interpretation instructions.)



# APPENDIX D

## INTERFACE DESIGN

### General

Communication between the Terminal and a computer falls into two general categories—direct interfacing and data communication interfacing. Direct interfacing simply means that a Terminal and computer are connected together by a wire or wires, without benefit of intervening devices. The data may be transferred back and forth in serial (one bit at a time) or parallel (several bits at a time) fashion. The only requirement is that the Terminal and computer be compatible.

Data Communication Interfacing implies that the Terminal and computer are connected via a data communication link, usually a telephone line with a modulator-demodulator (modem) unit on each end. The modem on the Terminal end of the telephone line accepts serialized digital data from the Terminal and uses it to encode a carrier signal, which is sent to the modem on the computer end. This encoding is referred to as modulation. The modem on the computer end of the telephone line extracts the digital data from the carrier signal in a process called demodulation. The serialized data is then applied to the computer. When the computer sends data to the Terminal, the functions of the two modems are reversed. This use of a telephone line and modems permits communication between Terminals and computers with little concern for the distance between them.

Regardless of whether direct or modem communication is in use, the Terminal must be equipped with an appropriate interface unit. The interface unit provides compatibility between the Terminal and the computer or modem. The jobs performed by the interface usually include parallel-to-serial conversion of outgoing data character bits, serial-to-parallel conversion of incoming data character bits, voltage level conversion, timing, and traffic control.

The parallel-to-serial conversion and serial-to-parallel conversion are required because the Terminal delivers characters to the interface in parallel bit form, while serial form is usually required for transmission to the computer. Fig. D-1 graphically presents these conversions.

Voltage level conversion is necessary because the integrated circuit logic levels in use in the Terminal differ from the levels at which modems operate.

Timing must be considered, since it is necessary that data be sent or received at a rate compatible with all of the devices in use. This is usually accomplished in the Data Communication Interface by appropriate division of the Terminal's master clock. Timing can also be provided by the modem or the computer. Typically, data can be transferred at 110, 300, 600, 1200, 2400, 4800 or 9600 bits per second. (Bits per second is commonly referred to as baud.) However, above 1200 baud, the cost increases significantly for modems and telephone lines.

Traffic control between the computer and Terminal is necessary to insure that data is not lost for any reason. The control signals may be simple or complex, as the occasion requires. Details regarding them can be found in the standards listed in the following paragraph.

Standards concerning data communication aspects are contained in several documents: EIA RS-232-C is generally observed in the United States; CCITT, V24 is used in most of Europe; other specifications exist, but have limited usage and generally follow the same standards as the two documents just mentioned.

Specifics regarding the numerous interfaces which can be used with the Terminal are found in the manuals provided with the interfaces. The manuals can also be ordered separately through Tektronix Field Offices.

### Timing Requirements

Certain signal lines are always necessary for interfacing to a modem or computer. These are listed at the end of this paragraph. Timing requirements associated with them appear in Fig. D-2. A variety of additional signals can be used for interfacing, at the discretion of the designer. A complete list of available signal lines is provided in the next topic.

$\overline{\text{TSTROBE}}$  must be asserted to transfer data to the Terminal.

$\overline{\text{CSTROBE}}$  is made available by the Terminal to transfer data to the modem or computer.

$\overline{\text{TBUSY}}$  indicates that the Terminal is busy processing data.

# INTERFACE DESIGN

## TRANSMITTING—PARALLEL TO SERIAL CONVERSION

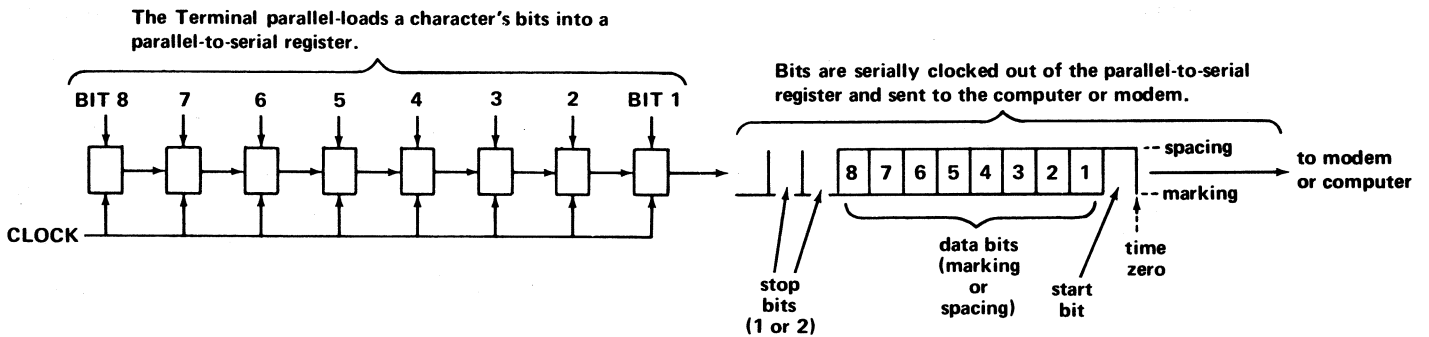

## RECEIVING—SERIAL TO PARALLEL CONVERSION

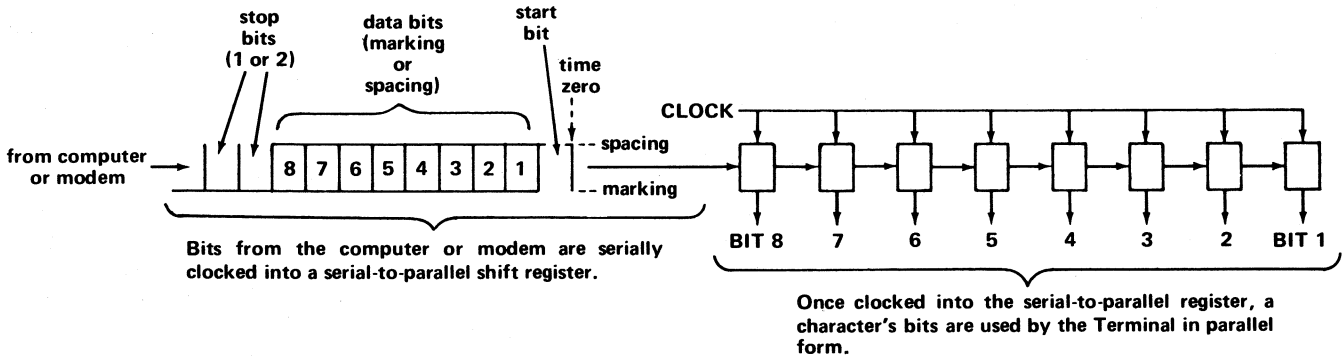

Fig. D-1. Serialization and de-serialization.

$\overline{\text{CBUSY}}$  can be generated by the interface to indicate that the computer is busy accepting data.

$\overline{\text{CPUNT}}$  is a command from the interface which indicates that data is about to be sent by the computer.  $\overline{\text{CPUNT}}$  is used by the Terminal to prevent minibus use until the data is received from the computer.

$\overline{\text{BIT 1}}$  through  $\overline{\text{BIT 8}}$  contain the data being transferred. During keyboard inputs,  $\overline{\text{BIT 8}}$  will always be either true or false as determined by a keyboard wire connection.

614 kHz and 4.9 MHz are available for clock signals.

### Minibus Details

The standard Terminal has a "minibus" board which has five card connectors or "jacks" on it. Corresponding points on each of the jacks are connected together, and are connected to the Terminal's signal lines. These lines or "busses" are thus available for use by any or all installed cards. The minibus board also has a facility for connecting a minibus extender board to it, to permit more than the standard six cards to have access to the signal lines. This board is available under Tektronix Part No. 018-0069-01. Empty circuit cards are also available for use by those who want to design their own interfaces or other circuits.

# APPENDIX D INTERFACE DESIGN

## A. TIMING OF DATA FROM THE TERMINAL TO THE INTERFACE

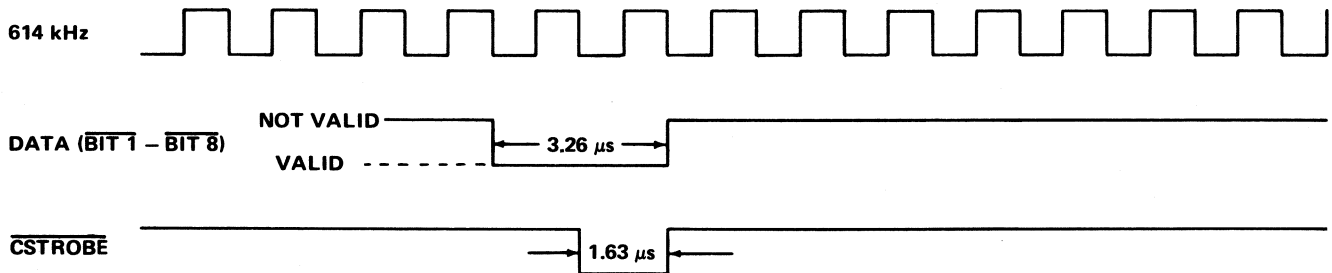

## B. TIMING REQUIREMENT FOR TRANSFERRING DATA ON THE MINIBUS

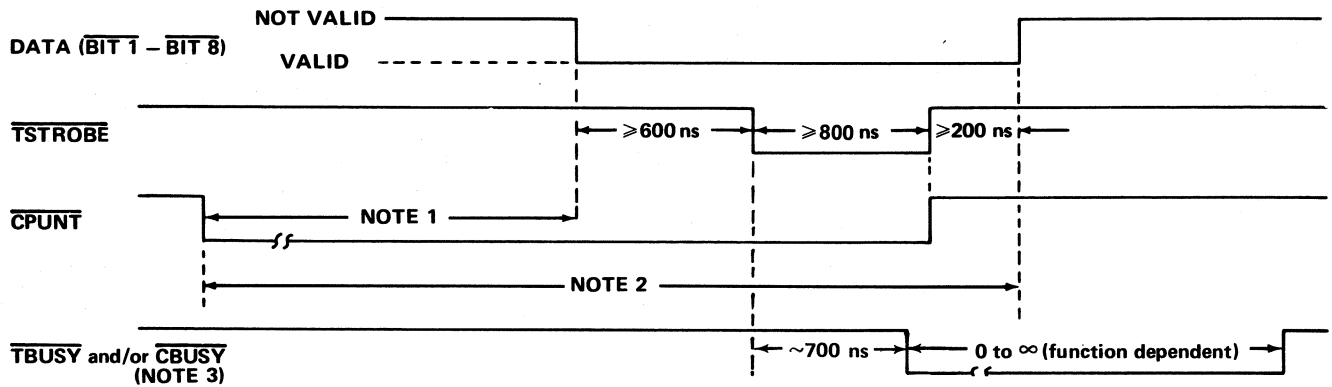

NOTE 1: Between 3.2 and 5  $\mu$ s (preferably 5  $\mu$ s) for parallel and TTY port interfaces; 10  $\mu$ s for data communication interfaces.

NOTE 2:  $\geq 3.2$   $\mu$ s for auxiliary devices;  $\geq 7$   $\mu$ s for parallel and TTY port interfaces.

NOTE 3:  $\overline{\text{TBUSY}}$  is asserted by the Terminal if data is being executed by the Terminal.  $\overline{\text{CBUSY}}$  should be asserted by the interface if data is being sent to the computer. Both should be asserted if data is being executed by the Terminal and is also being sent to the computer.

Fig. D-2. Timing information applicable to transferring data between the Terminal, interfaces, and auxiliary devices.

# INTERFACE DESIGN

Fig. D-3 depicts the connector orientation for each jack on the minibus. Note that letters identify signal lines on the component side of an installed circuit card, while numbers identify the signal lines on the "under" side of a card.

The signal lines are defined in the accompanying list. Unless otherwise indicated, sources are totem-pole configured, and loads are 16 mA at 0.4 V. Further details regarding use of these lines are available in the Terminal Maintenance Manual.

## MINIBUS SIGNAL LINE DEFINITIONS

**CODE:** \$ = Open collector bussed logic signals (otherwise totem-pole)

% = Sources must sink 48 mA to 0.4 V (otherwise 16 mA).

**AUXSENSE.** \$ Status bit line reserved for auxiliary device(s). DISABLES GRAPHIC LOOKAHEAD. (The HCU bus line may also be used by auxiliary device(s) if no Hard Copy Unit is connected and powered up.

**BIT 1—BIT 8.** \$% Data to and from the Terminal/CPU. See Fig. D-2 for timing.

**BREAK.** \$ Signal from the keyboard to the interface for computer signalling.

**BTSUP.** \$ Suppresses Terminal response to  $\overline{\text{TSTROBE}}$ . Should be asserted in response to  $\overline{\text{CPUNT}}$  by devices (such as buffers used in error correction schemes) intended to intercept data on behalf of the Terminal. In such cases the assertion of  $\overline{\text{BTSUP}}$  should be delayed 2 clock periods if it is desired to avoid interference with copy of locally generated data.

**CBUSY.** \$% CPU (interface) is busy accepting a character. Controls the timing of coordinate data transmitted to the CPU. A low on  $\overline{\text{CBUSY}}$  will not inhibit the keyboard,

allowing keyboard interrupts when  $\overline{\text{CPUNT}}$  is not asserted. Interfaces which must lock out the keyboard should do so with  $\overline{\text{KLOCK}}$ .

**CGZSUP.** \$ Suppresses Z signal from TC-1. Caused by  $\overline{\text{END COUNT}}$  into TC-1.

**CPUNT.** \$ Means data is about to be asserted by CPU (interface). Must be asserted  $\geq 3.2$  microseconds before data is placed on BIT 1-8 and must remain low until after the trailing edge of the strobe(s) associated with the transfer.

**CR.** CARRIAGE RETURN; high active signal.

**CSTROBE.** \$% Strokes data to the CPU. Pulse width  $\geq 0.5$  microseconds sync'd to the clock. Must not occur more than 2 microseconds after  $\overline{\text{CPUNT}}$  goes low.  $\overline{\text{TSTROBE}}$  may be asserted simultaneously (from the same source) to provide local copy to the Terminal. Should not occur  $< 0.5 \mu\text{s}$  after  $\overline{\text{CBUSY}}$  goes false (+3 V). See Fig. D-2 for timing requirements.

**CSUP.** \$ Inhibits the interface from accepting  $\overline{\text{CSTROBE}}$ . This signal is used by devices such as line buffers, which need to intercept data destined for the CPU.

**CURSE.** \$ Goes active when Terminal receives the ESC SUB control character sequence.

**DOWN.** \$ Counting pulse for Y register.

**DR BUSY.** \$% Occurs during erase cycle for about 1 second, inhibiting writing. Also asserted by the Hard Copy Unit to set up the display for hard copy readout.  $\overline{\text{DR BUSY}}$  should be asserted before the trailing edge of  $\overline{\text{MAKE COPY}}$  in order to hold the Terminal in BUSY during the scan. ( $\overline{\text{DR BUSY}}$  is also asserted by some scan converters.)

# APPENDIX D

## INTERFACE DESIGN

**ECHO.** \$ Directs input sources to assert  $\overline{\text{TSTROBE}}$  as well as  $\overline{\text{CSTROBE}}$  when sending data to the CPU to provide a LOCAL copy on the screen of data entered into the CPU.

**END COUNT.** \$ Disables register stepping circuits and suppresses  $\overline{\text{Z}}$  signal from TC-1,

**EOL.** \$ Indicates that the X register is counting past the right margin. Used by the AUTO CR/LF logic. Asserting  $\overline{\text{EOL}}$  will cause a CR/LF to be generated when in Alpha Mode. A Display Multiplexer could use this to shorten the right margin for small displays. In such use,  $\overline{\text{EOL}}$  should not be asserted after CR is activated to prevent wild and random counting of registers.

**FPAUSE.** \$ Indicates deflection amp is slewing (BUSY). Also briefly asserted by TC-2 to allow for D/A response time.

**FUZZ.** \$ Shifts crt resolution by defocusing and increasing writing current. For large characters or fat vectors.

**GIN.** \$ When originated in TC-2, indicates that the Crosshair Cursor is on or that coordinate information is being transmitted to the CPU. Disables the Alpha Cursor, top of page, and right margin CR/LF circuits. Sets Bypass Condition. Asserted by TC-1 and/or options when entering graphics in order to ensure that the Character Generator is off (reset).

**GND.** Circuit ground.

**GRAF.** \$% Originates in TC-1. Asserting a low on  $\overline{\text{GRAF}}$  will set Graf Mode.

**HCU.** Indicates that the Hard Copy Unit is capable of accepting a  $\overline{\text{MAKE COPY}}$  request.

**HIX.** \$ Used to load the HIGH X graphic byte into the X register.

**HIY.** \$ Used to load the HIGH Y graphic byte into the Y register.

**HOME.** \$% Master reset for all logic. Origin in keyboard (RESET key) and TC-1.

**INQUIRE.** \$ ESC ENQ control character sequence.

**KLOCK.** \$ Inhibits keyboard. Asserted by function keyboard to delay coordinate transmission.

**LCE.** High active arming signal caused by ESC control character.

**LED1, LED2.** \$% Turns on the light emitting diode (LED) indicators in the keyboard area.

**LEFT.** \$ Counting pulse for X register.

**LOCAL.** \$ Directs input sources to assert  $\overline{\text{TSTROBE}}$  providing screen display in the absence of computer echo. The interface(s) may also use this line. Originates in keyboard switch.

**LOXE.** \$% Used to load the LOW X graphic byte into the X register and to trigger the vector drawing.

**LOY.** \$ Used to load the LOW Y graphic byte into the Y register.

**MAKE COPY.** \$ Copy request: 866 microseconds wide minimum. Caused by MAKE COPY switch or by ESC ETB sequence.

# INTERFACE DESIGN

**MARG.** Indicates that the FULL LED is on. With a directly connected interface, this corresponds to page full. High active.

**NOLI.** \$ Suppresses Linear Interpolation vector drawing and timing circuitry on TC-1 and TC-3. Asserted by TC-1 unless in GRAF.

**PAGE.** \$ ESC FF control character sequence; also PAGE key. Causes the display to erase the screen.

**RIGHT.** \$ Counting pulse for X register.

**SELW.** \$ Selective write. Sets character generator to faster speed; places character Z width under control of Display Control card.

**SEND 8.** \$ Directs the interface to accept full 8-bit binary data instead of providing its own data for the 8th bit. (The keyboard provides a fixed 8th bit whose polarity is determined by wire strap.)

**SPD 1.** Spare.

**SPEAK.** \$ Audio connection to the loudspeaker. Other terminal of speaker is at +5 volts. Bypassed by a 0.01 microfarad capacitor.

**SRH.** \$ Contact closure for KEYBOARD SHIFT key. Resets "HOLD Mode".

**SW 1.** \$ Asserted by keyboard Switch 1.

**SW 2.** \$ Asserted by keyboard Switch 2.

**TAPEFETCH.** \$ A pulse provided by (typically) some small computer interfaces to cause a paper tape reader or analogous device to read one byte of data.

**TBUSY.** \$ % Terminal is busy writing a character or vector, etc.  $\overline{\text{TBUSY}}$  controls the timing of data transmitted to the Terminal. Upon receipt of a byte of data, the Terminal will assert  $\overline{\text{TBUSY}}$  by the trailing edge of  $\overline{\text{TSTROBE}}$  if that byte is to make the Terminal busy. No condition, with the exception of MARG, shall assert  $\overline{\text{TBUSY}}$  except momentarily. (MARG can be patched out of  $\overline{\text{TBUSY}}$ .) The Terminal will, however, accept data if  $\overline{\text{TBUSY}}$  is high or low although the results in the low case are not defined.  $\overline{\text{TBUSY}}$  does not inhibit transmission of data from the keyboard to the CPU.

**TSTROBE.** \$ % Stobes data into the Terminal, to be displayed on the screen, etc.  $\geq 0.8$  microsecond pulse synchronized to the 614 kHz clock. Should not occur  $< 0.5 \mu\text{s}$  after  $\overline{\text{TBUSY}}$  goes false (+3 V). See Fig. D-2 for timing requirements.  $\overline{\text{TSTROBE}}$  is not inhibited by GIN. Serrated  $\overline{\text{TSTROBE}}$ s should be avoided since they may cause improper operation.

**TSUP.** \$ Suppress Terminal response to  $\overline{\text{TSTROBE}}$ .  $\overline{\text{TSUP}}$  should be used by devices which need to blank the Terminal to incoming data, such as a paper tape punch when punching binary data.

**TTY MASTER.** Used only when a dual communication interface installation exists.

# APPENDIX D

# INTERFACE

# DESIGN

**UP**. \$ Counting pulse for Y register.

**VIEW**. \$ Controls the flood guns in the crt display unit. A high turns the guns on. As long as the Terminal is in GIN or HCU, and for about 90 seconds after the last information sent to the Terminal, TC-1 will allow a steady high on VIEW. Otherwise, TC-1 places the display in "HOLD Mode" by placing a 1200 hertz signal with 12.5% duty factor on VIEW.

**WRITE**. \$ Asserted any time a character, point, or unblanked vector is being drawn in any display mode. WRITE will activate selective write in the driver option in some scan converters.

**XANALOG**. Analog signal from TC-3 to display. -5 to +5 volts covers the screen. Positive signal corresponds to left deflection. 0 volts represents the physical center of the screen.

**XMAT**. Analog signal representing the X location within the character matrix. Originates on TC-2.

**YANALOG**. Analog signals from TC-3 to display. -5 to +5 volts covers the screen. Positive signal corresponds to down deflection. 0 volts represents the physical center of the screen.

**YMAT**. Analog signal representing the Y location within the character matrix. Originate on TC-2.

**Z**. \$% Z axis information.

**4.9 MHz**. % Clock signal.

**614 kHz**. % Clock signal. Sub-harmonic of 4.9 MHz.

# INTERFACE DESIGN

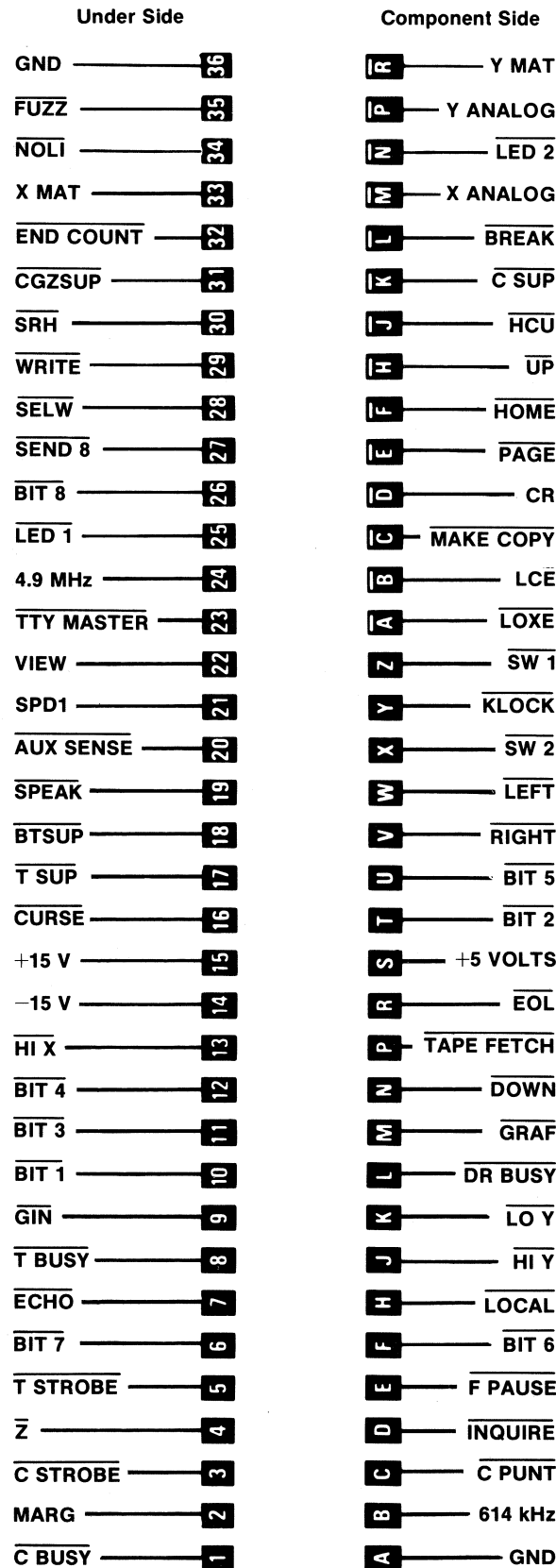

Fig. D-3. Minibus connector pin assignments.



# APPENDIX E

# ACCESSORIES

Refer to Tektroniix, Inc. advertising information or contact a TEKTRONIX Field Office for up-to-date listing of additional accessory devices.

**Standard Accessories**

**Data Communication Interface**                      **021-0065-00**

**Data Communication Interface**

**Instruction Manual**                                      **070-1458-00**

**4014/4014-1 Users Manual**                      **070-1647-00**

**Optional Accessories**

**4014/4014-1 and 4015/4015-1**

**Service Manual**                                      **070-1648-00**

**Optional Data**

**Communication Interface**                      **021-0074-01**

Provides switch-selectable baud rates, switch control of modes (echo, loopback, full duplex, half duplex, half-duplex-blanking, half-duplex-supervisory), switch selection of LF control over Terminal carriage return.

**TTY Port Interface (Part Number varies with computer)**

Permits the Terminal to operate directly into a computer's Teletype port.

**Desk-Top Mounting Kit**

**012-0511-00**

Permits the Display unit to be removed from the Pedestal and then connected to the Pedestal by a ten foot cable. This allows the Display to be operated in a desk-top configuration.

**Enhanced Graphics Module (Option 34)**

Increases the graphic capability of the Terminal, to include various vector types as well as point plot, and incremental plot. Increases Addressable points to 4096 in each axis. See Appendix F for more information about the Enhanced Graphic Module. Must be factory installed at time of purchase.

**Motherboard Extender**

**018-0069-02**

Needed when accessory devices require more than six circuit cards to be connected into the Terminal's minibus.

*NOTE*

*The standard minibus has connectors for six circuit cards. The standard Terminal uses five of these connectors, the sixth one is used by the interface card. Thus, a Motherboard Extender card must be used in any optional configurations which increase the number of circuit cards above the stated six.*

# ACCESSORIES

**Audio Recorder Interface****Not available**

Permits tape recording and playback from/to computer, Terminal, and peripheral devices.

**Display Multiplexer****CM 018-0067-01**

Allows the Terminal to control display devices other than its own display screen.

**Logic Extender Card****067-0653-00**

A design and maintenance device which can be independently inserted into the minibus to monitor signal lines or to inject signals into them. It can be used as a circuit card extender to perform those same functions, plus a signal interrupt function.

**72-pin Extender Card****067-0664-00**

Provides access to circuit cards by extending them out of the pedestal. Also equipped with test points for the minibus signal lines.

**Copy Holder****016-0291-01**

Similar to a typewriter copy holder; attaches to the left or right side of the Terminal display unit.

**Auxiliary Card****018-0065-01**

Empty thru-hole plated card for circuit development. Fits into the Terminal minibus.

**Terminal Auxillary Card****018-0068-00**

Similar to 018-0065-00, but contains ground and VCC bus lines. Ideal for use where large quantities of integrated circuits are involved.

**Wheel Kit****040-0714-00**

Set of four wheel-casters that can be installed in place of pedestal feet.

**View Hood****016-0599-00**

An attachment to the Terminal display unit that reduces the amount of "glare" on the face of the crt.

**Compatible Peripherals**

Refer to the Catalog or appropriate user manuals for more information on the peripherals listed.

**Hard Copy Unit****4911 Paper Tape Reader/Perforator****4921 Flexible Disc Memory (Single Disc Unit)****4922 Flexible Disc Memory (Dual Disc Unit)****4952 Joystick****4953 Graphics Tablet (11 in. X 11 in.)****4954 Graphics Tablet (40 in. X 30 in.)**

# APPENDIX F

# ENHANCED GRAPHICS MODULE

## OPTION 34

### INTRODUCTION

#### Description

**General.** The Enhanced Graphics Module (EGM) is offered as a factory installed option that includes a major modification to the Terminal Control circuitry plus an additional plug-in circuit card. The additional card (Discrete Plot) requires that a Motherboard Extender be installed.

**Features.** The list of features contained in the EGM are:

1. 12-bit graphic resolution (4096 by 4096 addressable points)
2. Vector Line Formats that include:
  - a) dotted vectors
  - b) short-dashed vectors
  - c) long-dashed vectors
  - d) dot-dashed vectors
3. Incremental Plot Mode
4. Point Plot Mode
5. Special Point Plot Mode (grey scale type capabilities)
6. Outputs available to drive a mechanical plotter.

**4096 Addressability.** This feature allows Graph Mode addressing of the Terminal on a matrix of 4096X by 4096Y points (4096X by 3120Y viewable). This increases the address resolution by a factor of four over the standard 1024X by 1024Y. This address resolution requires that two additional bits (12 bits total) be added to each axis address; therefore, an "Extra" byte must be inserted in the vector address string. 4096 addressability is upwards and

downwards compatible with 1024 (10 bit) software (4010, 4012, and 4013), and vice versa. (More detailed information is contained under Programming Considerations in this section.)

**Vector Line Formats.** Sending the ASCII control character ESC (27<sub>10</sub>) ("K from keyboard) followed by a specific lower case character will cause the Terminal to plot vectors as either dotted, dot-dash, short-dash, or long-dash lines. These vector types require no more time to plot than that required by the standard solid line vectors.

**Point Plot Mode.** When the Terminal receives the Point Plot command (FS), the Terminal plots (writes) the end point of the vector; hence, the term "Point Plot". The received data is identical to standard vector plotting.

**Incremental Plot Mode.** This mode is set when the Terminal receives the RS (30<sub>10</sub>) control character. The character following RS determines if the writing beam is turned on or off. This is synonymous with pen down and pen up, respectively, as far as a mechanical plotter is concerned. The next character determines the direction in which the writing beam moves (up, down, left, right, or any diagonal). Incremental Plot uses relative addressing (one 7-bit byte addresses a point). The majority of incremental mechanical plotters on the market today can be operated using this mode.

**Special Point Plot Mode.** This mode is set by sending the Terminal an ESC FS sequence. A subsequent "intensity" selection character allows the programmer to select different intensity levels to control the size of the plotted point. "Grey scale" is a function of plotted point size and the distance between points. The quality of a grey scale presentation on the screen approximates that seen in newspaper pictures.

**Mechanical Plotter Output.** Output pins are provided to allow cable connection to an outboard incremental mechanical plotter. Outputs are compatible with the majority of incremental mechanical plotters on the market today.

# ENHANCED GRAPHICS MODULE

## INSTALLATION

### Without Plotter

**Straps.** Two strap options on the Discrete Plot Card should be checked to ensure they are in the 4014 (4014 is synonymous with 4014/4014-1 and 4015/4015-1 Computer Display Terminals). These are the WRITE and TIMING (settling) straps. Fig. F-1 shows strap locations.

**Adjustments.** The grey scale adjust is used to adjust the intensity of the display when operating in Special Point Plot mode. Fig. F-1 also shows the location of this adjustment.

### With Plotter

**General.** Installation procedures are similar for most plotters that the Enhanced Module (EGM) is designed to interface with. Similar procedures include performing, as required, the steps provided in the above "Without Plotter" information. In addition, the EGM needs to be connected to the plotter and specific adjustments and straps need to be checked.

**Cabling.** Fig. F-2 lists the optional interconnecting cable pin assignments. The plotter cable connects to J5 on the Discrete Plot circuit card that in turn connects to the Terminal minibus. The cable is then routed through the opening in the back of the pedestal and fastened to the sill with a cable clamp. The other end of the cable is connected to the plotter. Apply power to equipment and make any necessary adjustments. See the following for information on strap options and adjustments.

**Strap Options.** (See Fig. F-1 for location of straps.) The position of the PLOTTER SELECT STRAP determines which of the spare Terminal console switches enables the plotter, Switch 1, 2 or 3. The OUT position is normally

strapped when no plotter is connected. The REMOTE SELECT strap is used when the plotter has a switch that can control plotter enabling.

**Adjustments.** With the plotter connected and applicable strap options selected, perform the following steps:

1. Turn the Terminal and plotter power on.
2. Select the Plotter by either remote or Switch 1, 2 or 3 (depending on strap position).
3. Switch the Terminal to LOCAL and then enter an RS (<sup>CS</sup>N).

### NOTE

*Each of the following steps are provided with a SLOW/FAST strap that extends adjustment range. Place the strap as required to meet adjustment specifications.*

4. Connect an oscilloscope to TP 73. Then, while entering a "P" character at the keyboard, adjust PEN DOWN (R73) for the required PEN DOWN delay as listed in Table F-1.
5. Connect the oscilloscope to TP 90, then while entering an "SP" (space) character at the keyboard, adjust R90 (PEN UP) for the required PEN UP delay as listed in Table F-1.
6. Connect the oscilloscope to TP 80, then while entering A's at the keyboard adjust STEP (R85) for the required STEP delay as listed in Table F-1.

**TABLE F-1**  
Typical Plotter Delays

Delay	Houston DP-10	Houston DP-3	0.005" Calcomp 565	0.01" Calcomp 565
STEP	3.3 ms	3.3 ms	3.3 ms	4 ms
Pen Down	60 ms	100 ms	100 ms	100 ms
Pen Up	10 ms	30 ms	100 ms	100 ms

# APPENDIX F

## ENHANCED GRAPHICS MODULE

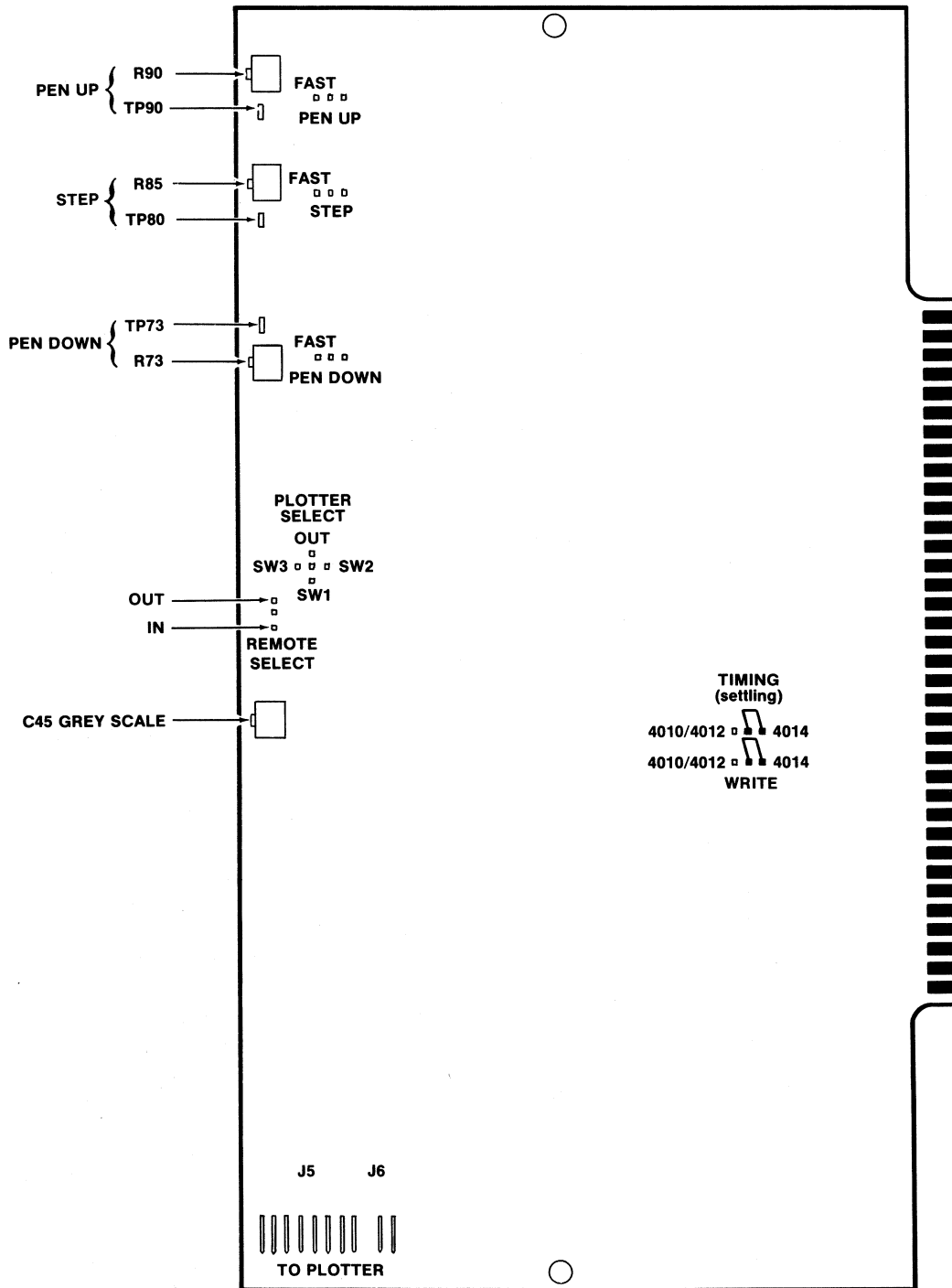

Fig. F-1. Location of strap options, adjustments and plotter connector.

# ENHANCED GRAPHICS MODULE

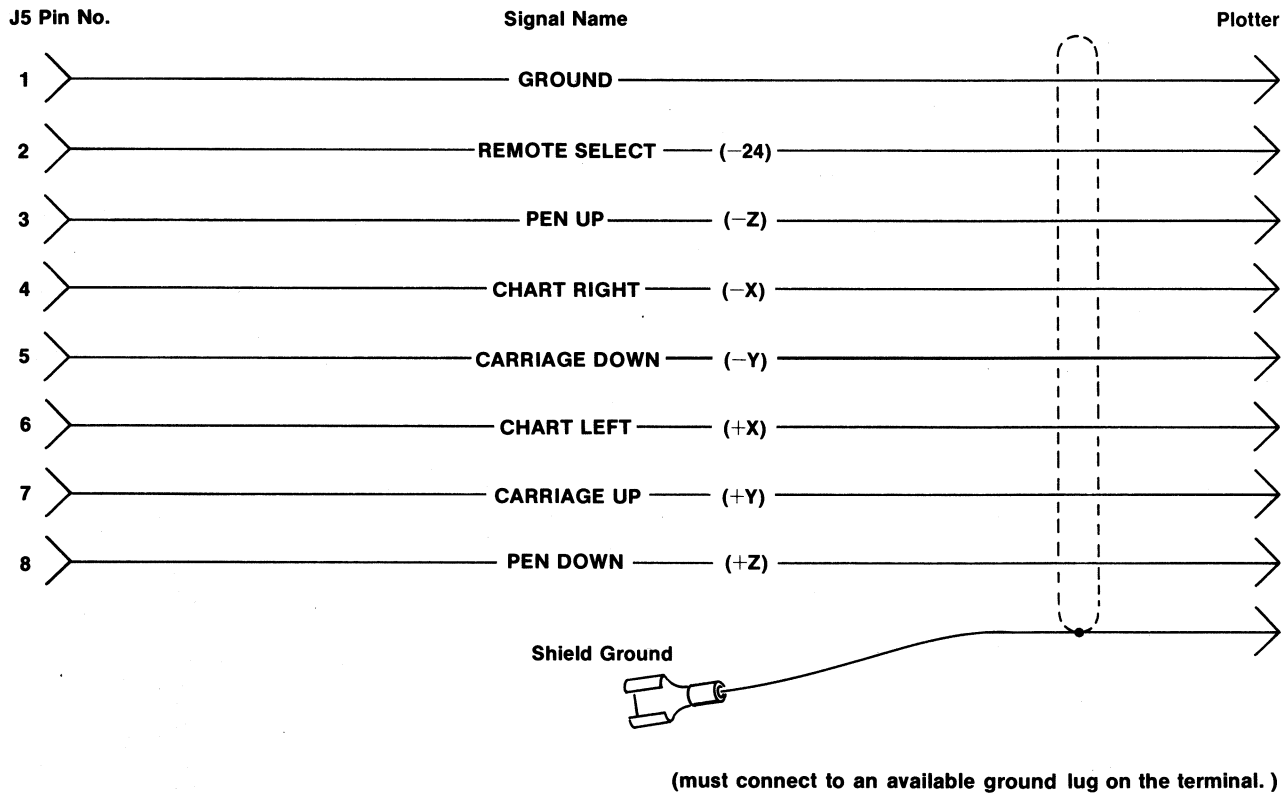

Fig. F-2. Plotter connector description.

## PROGRAMMING

### 4096 Resolution (12-Bit Addressing)

**Addressing.** To establish an address in the addressable point grid of 4096X by 4096Y, 12 bits of X and 12 bits of Y data (24 bits total) must be transmitted to the Terminal. This necessitates the use of an "Extra" 7-bit byte in the vector address. The transmission order is shown in Table F-2, which also shows the byte content.

This system of address transmission is both upward and downward compatible with 4010-series Computer Display Terminal, 10 bit addressability software. That is, if the 4014/4015 is driven from a program written for a 4010/4012/4013, the 4014/4015 will default to a 1024X by 1024Y addressable condition and the plot will appear full

screen, (therefore magnified by the ratio of screen sizes). Furthermore, if a 4010/4012/4013 is driven from a program written for the 4014/4015 with Enhanced Graphic Module installed, the plot will simply appear full screen on the 4010, (therefore reduced by the ratio of screen sizes).

The Extra Byte need not be sent, but the Low Order Y byte must always be sent if the Extra Byte is sent. The rules for Shortened Address Transmission only change (over that of the Standard Terminal as previously mentioned in preceding sections) when the Extra Byte changes; then send the Extra, Low Y, and Low X bytes.

The holding register for the Extra Byte always clears to 0 when Terminal power is turned on. It is also cleared by CR, PAGE, ESC FF, RESET KEY, and LF-CR, (if strapped). Margin selection has no effect except as GIN

# APPENDIX F

# ENHANCED GRAPHICS MODULE

status byte, but represents margin 1 in Alpha. CR (LF→CR) resets the holding register, but does not clear the margin selection or the 2 least significant Y bits.

**Written Vectors.** Vector types (continuous, dotted, short-dash, long-dash, dot-dash) and focus are dependent on the last control sequence received. GS sets the Graph Mode, but the next control sequence of ESC plus some lower case character code, determines the vector type. This information is provided in Tables F-3 and F-4. All vector writing starts at the beginning of the longest written element of the vector pattern; i.e., the dot-dash pattern always starts at the beginning of the dash.

Vector writing rate is the same as for the standard 4014 and 4015 Terminals.

**4096 Addressability Effects on GIN Mode.** The Enhanced Graphic Module does not affect the input of Graphic data to the computer. In other words, whether the Enhanced Graphic Module is installed or not, the Terminal inputs only 1024 address resolution. The GIN Mode input accuracy is the same as listed in the GIN Mode Summary in Section 3; however, when referenced to a 4096 by 4096 grid, the accuracy is +4 or -7.

### Point Plot Mode

To enter Point Plot Mode, send the Terminal the ASCII control character FS (28<sub>10</sub>). The keyboard equivalent is <sup>o</sup>L. Data format is identical to normal graphic input. The only

difference is that just the end point (addressed point) is drawn. The intensity of the plotted point can be varied. For details see Special Point Plot Mode.

### NOTE

*Point Plot Mode can only be entered from the Alpha or Graph Mode. Thus, if a graphic mode other than the standard graph mode has previously been selected, the Terminal will have to be returned to Alpha before Point Plot can be selected. For plotting speed specifications refer to the Terminal plotting speed topic in this Appendix.*

### Incremental Plot Mode

The Terminal plots in one point increments in this mode (usually 4096X and Y). The ASCII Control character RS (30<sub>10</sub>) sets this mode. (The keyboard equivalent is <sup>o</sup>N.) The character that follows RS must be a Write Command-Beam off or Beam on. (Pen Up and Pen Down are analogous to Beam off and on, respectively.) The Write command is followed by an increment command. The write status does not change until a different write command is received. If desired, the display beam can be addressed to the desired starting point in Graph Vector Mode; then placed in Incremental Plot Mode by RS, if no plotter is used. The ASCII characters shown in Table F-5 would result in the indicated action when received in Incremental Plot Mode.

**TABLE F-2**  
**Vector Address Data String**

BYTE NAME	7-BIT ASCII CHARACTER						
	TAG BITS		ADDRESS BITS				
	7	6	5	4	3	2	1
High Order Y (HIY)	0	1	5 MSB of Y Address				
Extra Byte	1	1	*	Y <sub>2</sub>	Y <sub>1</sub>	X <sub>2</sub>	X <sub>1</sub>
Low Order Y (LOY)	1	1	5 Intermediate bits of Y Address				
High Order X (HIX)	0	1	5 MSB of X Address				
Low Order X (LOX)	1	0	5 Intermediate bits of X Address				

\*Note that Bits 7 and 6 of the Extra Byte must be one's. Bit 5 can be used to set Margin 1. Bits 4 and 3 contain the two least significant bits of the 12-bit Y address, and Bits 2 and 1 contain the two least significant bits of the 12-bit X address.

# ENHANCED GRAPHICS MODULE

**TABLE F-3**  
**Beam and Vector Selectors**

Character versus Function for Focusing, Write-thru, Store, Vector Type.  
Character must be preceded by ESC to enable designated function.

ASCII CHARACTER	APL CHARACTER	DECIMAL EQUIV	FUNCTION PERFORMED
ESC /	ESC ◇	96	Normal Z axis and normal vectors or alpha
a	A	97	Normal Z axis and dotted line vectors
b	B	98	Normal Z axis and dot-dashed vectors
c	C	99	Normal Z axis and short-dashed vectors
d	D	100	Normal Z axis and long-dashed vectors
h	H	104	Defocused Z axis and normal vectors or alpha
i	I	105	Defocused Z axis and dotted vectors
j	J	106	Defocused Z axis and dot-dashed vectors
k	K	107	Defocused Z axis and short-dashed vectors
l	L	108	Defocused Z axis and long-dashed vectors
p	P	112	Write-Thru mode and normal vectors or alpha
q	Q	113	Write-Thru mode and dotted vectors
r	R	114	Write-Thru mode and dot-dashed vectors
s	S	115	Write-Thru mode and short-dashed vectors
t	T	116	Write-Thru mode and long-dashed vectors

**TABLE F-4**  
**Function versus Bit Configuration for Focusing, Write-Thru, Vector Type**

DESIRED STATUS	REQUIRED BIT CONFIGURATION						
	B7	B6	B5	B4	B3	B2	B1
*Normal Z Axis <sup>1</sup>	1	1	0	0			
*Defocused Z Axis <sup>1</sup>	1	1	0	1			
*Write-thru mode enable <sup>1</sup>	1	1	1	0			
*Normal vectors <sup>2</sup>	1	1			0	0	0
Dotted Line vectors <sup>2</sup>	1	1			0	0	1
Dot-dash vectors <sup>2</sup>	1	1			0	1	0
Short-dash vectors <sup>2</sup>	1	1			0	1	1
Long-dash vectors <sup>2</sup>	1	1			1	0	0

<sup>1</sup>Alphanumeric Mode and Graph Vector Mode

<sup>2</sup>Graph Vector Mode only.

\*Same as standard 4014, 4014-1, 4015, 4015-1.



# APPENDIX F

# ENHANCED GRAPHICS MODULE

**TABLE F-5**  
**Incremental Plot Mode Characters**

CHARACTER			BITS							INDICATED ACTION
ASCII	DECIMAL	APL	7	6	5	4	3	2	1	
SP	32	SP	0	1	0	0	0	0	0	**BEAM OFF (PEN UP)
P	80	*	1	0	1	0	0	0	0	**BEAM ON (PEN DOWN)
D	68	L	1	0	0	0	1	0	0	N ↑
E	69	ε	1	0	0	0	1	0	1	NE ↗
A	65	∞	1	0	0	0	0	0	1	E →
I	73	l	1	0	0	1	0	0	1	SE ↘
H	72	Δ	1	0	0	1	0	0	0	S ↓
J	74	o	1	0	0	1	0	1	0	SW ↙
B	66	⊥	1	0	0	0	0	1	0	W ←
F	70	—	1	0	0	0	1	1	0	NW ↖

**\*\*Not required when operating in Incremental Plot without a mechanical plotter.**

Once the Write condition is set (Beam off or Beam on), subsequent directional movement bytes have Bits 6 and 5 at zero. Also, the intensity during incremental Plot can be varied. For details see Special Point Plot Mode. For plotting speed specifications, refer to the Terminal plotting speed topic in this Appendix.

### Special Point Plot Mode

ESC followed by FS sets this mode of graphic operation. This feature permits grey scaling by varying the size of the stored point. The size of the stored point is controlled by an intensity character that precedes each point address. The effect of a given intensity character can also be varied by adjusting the Gray Scale Adjustment. (See Fig. F-1 for adjustment location.) Specific intensity characters permit different intensity levels (spot sizes) to

be selected. Table 5-6 shows percentage of beam on time. Coordinate data (addresses) that follows the intensity character is the same as Graph Vector data. However, during Special Point Plot, an intensity character must precede each point addressed. If normal Point Plot or Incremental Plot is selected after previously sending an intensity character, the setting established by the intensity character is retained.

For normal Point Plot and Incremental Plot modes, the intensity character does not change unless a keyboard RESET function occurs, or a new intensity character is received. (Of course, cycling the power OFF resets the intensity setting.) Thus, as long as the power is not cycled off and on, the Terminal can be switched in and out of modes and still retain a desired intensity for Point, Special Point, and Incremental Plot Modes.

# ENHANCED GRAPHICS MODULE

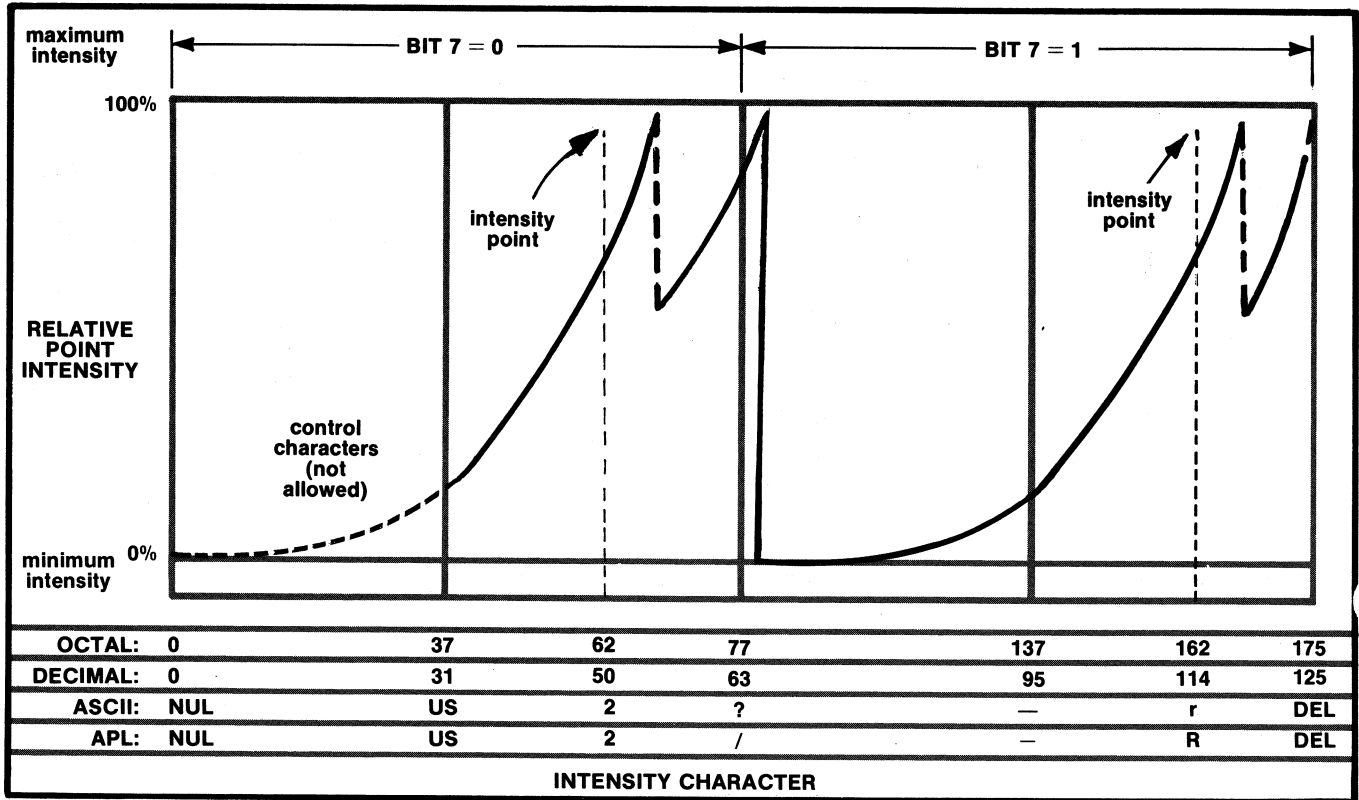

Fig. F-3. Intensity Control chart.

The Intensity Character Axis (see Fig. F-3) represents all possible values of the seven-bit Terminal Character, increasing from 0-175 octal (0-125 decimal). Intensity increases non-linearly over this range. The result is the two curves shown in Fig. F-3, the first with BIT 7=0 and the second with BIT 7=1.

Circuitry on the Discrete Plot Card prohibits the use of Control Characters (0-37 octal), or DELETE (176 or 177 octal) as Intensity Characters, see Table F-6.

The seven bits of the intensity character contain the following assignments. It should be noted that control characters (0<sub>10</sub> to 31<sub>10</sub>), Tilde and Rubout (126<sub>10</sub>, 127<sub>10</sub>) do

INTENSITY CHARACTER						
B7	B6	B5	B4	B3	B2	B1
FOCUS	INTENSITY LEVEL BITS					

not control intensity levels. It should also be noted that if illegal intensity characters are typed the next character will be used as the intensity character instead of beam positioning.

Example: Suppose the Intensity Character entered during Special Point Plot mode is an ASCII r (162 octal). The corresponding intensity point is near the maximum value. The Intensity Character ASCII 2 (62 octal) differs from ASCII r only by BIT 7, and thus also results in a near maximum intensity.

BIT 7 high causes the spot to be focused; low, the spot will be defocused. BIT 1-6 set the time the writing beam is on while writing the point.

Fig. F-3 shows the effect (if any) the ASCII Code has on the write intensity. For plotting speed specifications, refer to the Terminal Plotting Speed topic, this Appendix.

**TABLE F-6**  
**WRITE INTENSITY CODE CHART**  
 Intensity Settings provided by Special Point Plot Mode

BITS				CONTROL		DEFOCUSED INTENSITY SETTINGS		FOCUSED INTENSITY SETTINGS				
B7	B6	B5	B4	B3	B2	B1						
0	0	0	0	NUL	DLE	SP	ø	@	P	\	p	
						14%	56%	0%	4%	14%	56%	
0	0	0	1	SOH	DC1	!	1	A	Q	a	q	
						16%	62%	1%	4%	16%	62%	
0	0	1	0	STX	DC2	"	2	B	R	b	r	
						17%	69%	1%	4%	17%	69%	
0	0	1	1	ETX	DC3	#	3	C	S	c	s	
						19%	75%	1%	5%	19%	75%	
0	1	0	0	EOT	DC4	\$	4	D	T	d	t	
						20%	81%	1%	5%	20%	81%	
0	1	0	1	ENQ	NAK	%	5	E	U	e	u	
						22%	88%	1%	5%	22%	88%	
0	1	1	0	ACK	SYN	&	6	F	V	f	v	
						23%	94%	1%	6%	23%	94%	
0	1	1	1	BEL	ETB	'	7	G	W	g	w	
				BELL		25%	100%	2%	6%	25%	100%	
1	0	0	0	BS	CAN	(	8	H	X	h	x	
				BACK SPACE		28%	56%	2%	7%	28%	56%	
1	0	0	1	HT	EM	)	9	I	Y	i	y	
						31%	62%	2%	8%	31%	62%	
1	0	1	0	LF	SUB	*	:	J	Z	j	z	
						34%	69%	2%	9%	34%	69%	
1	0	1	1	VT	ESC	+	;	K	[	k	{	
						38%	75%	2%	10%	38%	75%	
1	1	0	0	FF	FS	,	<	L	\	l	;	
						41%	81%	3%	11%	41%	81%	
1	1	0	1	CR	GS	-	=	M	]	m	}	
				RETURN		44%	88%	3%	12%	44%	88%	
1	1	1	0	SO	RS	.	>	N	^	n	~	
						47%	94%	3%	12%	47%		
1	1	1	1	SI	US	/	?	O	_	o	RSUBOUT (DEL)	
						50%	100%	3%	13%	50%		

Note: Circuitry on the Discrete Plot card prohibits use of the shaded areas as Intensity Characters.

# ENHANCED GRAPHICS MODULE

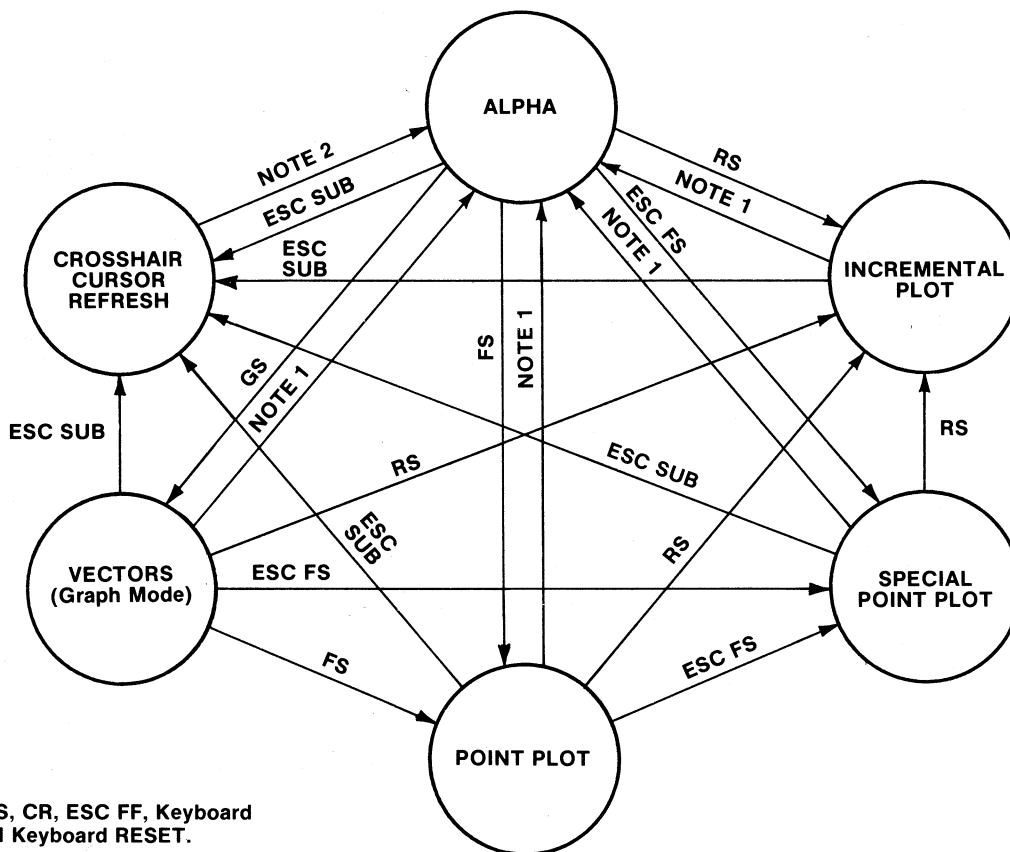

Note 1: US, CR, ESC FF, Keyboard PAGE and Keyboard RESET.

Note 2: CR, ESC FF, Keyboard PAGE and Keyboard RESET.

Fig. F-4. Illustration of permissible operating mode changes.

## Terminal Plotting Speed

Terminal plotting speed is a combination of writing beam settling time plus Z-axis on-time. In Point Plot or Special Point Plot mode, the Z-axis is held off to ensure that the deflection circuitry has had ample time to deflect the writing beam to the new address and then settle. Beam settling time is typically between 12 and 85 microseconds; worst case is 120 microseconds. Z-axis on-time is dependent on the Grey Scale Adjustment and the intensity character. Typical Z-axis on-times range between 0.5 microseconds and 96 microseconds. With these figures in mind, Terminal plotting times in Point Plot and Special Point Plot can be as short as 10.5 microseconds and as long as 217 microseconds.

If the software has not preset the Z-axis on-time with an intensity character, the on-time defaults to  $6.0 \pm 1.5$  micro-

seconds. Keep in mind that in Special Point Plot the intensity must be set by the software prior to each point's address.

In Incremental Plot, the plotting speed is three microseconds (beam settling time) plus Z-axis on-time. The Z-axis on-time is the same as in Point Plot Mode.

## Mode Changing Considerations

Fig. F-4 shows the six operating modes available with a Terminal that contains an Enhanced Graphic Module. Transition from one mode to another is represented by an arrow beginning at the mode exited and ending at the mode to be entered. Along side each arrow is the ASCII control character, or control character sequence that causes the mode change.

# CONTROL CODE SUMMARY

This Appendix provides a tabular listing of all characters of the ASCII Code Chart and the effect, if any, they have when received by the Terminal. Also incorporated are the effects when the Enhanced Graphic Module (EGM) option is installed.

Things to note: In Graph the receipt of an LF moves the beam downward slightly. If Bypass is in effect, the receipt of an LF moves the beam down one complete line. Thus, those systems that do not send carriage returns can put the LF→CR strap (on TC-1) to the LF→CR position that generates an automatic carriage return upon the Terminal receipt of the LF character. This enables the Terminal to exit from either Graph or Bypass just before receiving error codes. Point Plot, Incremental Plot, and Special Point Plot are included under FS and RS. ESC followed by ? produces a Low Y character substitution for RUBOUT for those systems that require the Rubout strap on TC-1 be strapped to NO-OP.

## CONTROL CODE SUMMARY

CHAR. ASCII	CHARACTER EFFECT				REMARKS
	ALPHA	GRAPH	BYPASS	LCE*	
NUL	—	—	—	SET LCE	FILLER NULLS WON'T INTERFERE
SOH	—	—	—		
STX	—	—	—		
ETX	—	—	—		
EOT	—	—	—		
ENQ	—	—	—	RETURN TERM STAT	
ACK	—	—	—		
BEL	RING BELL	RING BELL	RING BELL	RING BELL	
BS	MOVE ONE SP LEFT			MOVE ONE SP LEFT	
HT	MOVE ONE SP RIGHT			MOVE ONE SP RIGHT	
LF	MOVE ONE LN DOWN	MOVE DOWN	MOVE ONE LN DOWN	SETS LCE	
VT	MOVE ONE LINE UP			MOVE ONE LINE UP	
FF	—	—	—	ERASE AND HOME	PAGE FUNCTION
CR	MOVE TO LEFT MARG	GO NORM AND LEFT	GO NORM AND LEFT	SET LCE	FILLER CRS WON'T INTERFERE
SO	—			GO TO ALT CHARS	APL IN 4015
SI				GO TO ASCII CHARS	
DLE					
DC1					
DC2					
DC3					
DC4					
NAK					
SYN					
ETB	—	—	—	MAKE COPY	
CAN	—	—	—	SET BYPASS	
EM					
SUB	—	—	—	GIN, XHAIR & BYPASS	
ESC	SET LCE	SET LCE	SET LCE	SET LCE	
FS	POINT PLOT	POINT PLOT	POINT PLOT	SPECIAL PT PLOT	ONLY IF EGM INSTALLED
GS	GRAF& DARK VECTOR	DO A DARK VECTOR	GRAF& DARK VECTOR	GRAF& DARK VECTOR	
RS	INCREMENTAL PLOT	INCREMENTAL PLOT	INCREMENTAL PLOT	INCREMENTAL PLOT	ONLY IF EGM INSTALLED
US	—	SET NORMAL MODE	SET NORMAL MODE	SET NORMAL MODE	
SPACE	MOVE ONE SP RIGHT	High X or high Y			
!	PRINT CHARACTER	High X or high Y			
"	PRINT CHARACTER	High X or high Y			
#	PRINT CHARACTER	High X or high Y			
\$	PRINT CHARACTER	High X or high Y			
%	PRINT CHARACTER	High X or high Y			

# CONTROL CODE SUMMARY

## CONTROL CODE SUMMARY (cont)

CHAR.		CHARACTER EFFECT			REMARKS
ASCII	ALPHA	GRAPH	BYPASS	LCE*	
&	PRINT CHARACTER	High X or high Y			
'	PRINT CHARACTER	High X or high Y			
(	PRINT CHARACTER	High X or high Y			
)	PRINT CHARACTER	High X or high Y			
*	PRINT CHARACTER	High X or high Y			
+	PRINT CHARACTER	High X or high Y			
,	PRINT CHARACTER	High X or high Y			
-	PRINT CHARACTER	High X or high Y			
.	PRINT CHARACTER	High X or high Y			
/	PRINT CHARACTER	High X or high Y			
0	PRINT CHARACTER	High X or high Y			
1	PRINT CHARACTER	High X or high Y			
2	PRINT CHARACTER	High X or high Y			
3	PRINT CHARACTER	High X or high Y			
4	PRINT CHARACTER	High X or high Y			
5	PRINT CHARACTER	High X or high Y			
6	PRINT CHARACTER	High X or high Y			
7	PRINT CHARACTER	High X or high Y			
8	PRINT CHARACTER	High X or high Y		LARGE CHARACTERS	
9	PRINT CHARACTER	High X or high Y		#2 CHARACTERS	
:	PRINT CHARACTER	High X or high Y		#3 CHARACTERS	
;	PRINT CHARACTER	High X or high Y		SMALL CHARACTERS	
<	PRINT CHARACTER	High X or high Y			
=	PRINT CHARACTER	High X or high Y			
>	PRINT CHARACTER	High X or high Y			
?	PRINT CHARACTER	High X or high Y		Low Y for Graph %	In case rubout (DEL) can't be used
@	PRINT CHARACTER	Low X			
A	PRINT CHARACTER	Low X			
B	PRINT CHARACTER	Low X			
C	PRINT CHARACTER	Low X			
D	PRINT CHARACTER	Low X			
E	PRINT CHARACTER	Low X			
F	PRINT CHARACTER	Low X			
G	PRINT CHARACTER	Low X			
H	PRINT CHARACTER	Low X			
I	PRINT CHARACTER	Low X			
J	PRINT CHARACTER	Low X			
K	PRINT CHARACTER	Low X			
L	PRINT CHARACTER	Low X			
M	PRINT CHARACTER	Low X			
N	PRINT CHARACTER	Low X			
O	PRINT CHARACTER	Low X			
P	PRINT CHARACTER	Low X			
Q	PRINT CHARACTER	Low X			
R	PRINT CHARACTER	Low X			
S	PRINT CHARACTER	Low X			
T	PRINT CHARACTER	Low X			
U	PRINT CHARACTER	Low X			
V	PRINT CHARACTER	Low X			

# CONTROL CODE SUMMARY

## CONTROL CODE SUMMARY (cont)

CHAR.		CHARACTER EFFECT			REMARKS
ASCII	ALPHA	GRAPH	BYPASS	LCE*	
W	PRINT CHARACTER	Low X			The Z-axis control works in all 4014/4015, 4014-1 and 4015-1 Terminals. The vector control only if EGM# is installed.
X	PRINT CHARACTER	Low X			
Y	PRINT CHARACTER	Low X			
Z	PRINT CHARACTER	Low X			
[	PRINT CHARACTER	Low X			
,	PRINT CHARACTER	Low X			
]	PRINT CHARACTER	Low X			
^	PRINT CHARACTER	Low X			
_	PRINT CHARACTER	Low X			
\	PRINT CHARACTER	Low Y		Normal, normal	
a	PRINT CHARACTER	Low Y		Normal, dotted	
b	PRINT CHARACTER	Low Y		Normal, dot-dashed	
c	PRINT CHARACTER	Low Y		Normal, short-dash	
d	PRINT CHARACTER	Low Y		Normal, long-dash	
e	PRINT CHARACTER	Low Y		Normal, normal	
f	PRINT CHARACTER	Low Y		Normal, normal	
g	PRINT CHARACTER	Low Y		Normal, normal	
h	PRINT CHARACTER	Low Y		Defocused, normal	
i	PRINT CHARACTER	Low Y		Dfced, dotted	
j	PRINT CHARACTER	Low Y		Dfced, dot dashed	
k	PRINT CHARACTER	Low Y		Dfced, short-dashed	
l	PRINT CHARACTER	Low Y		Dfced, long-dash	
m	PRINT CHARACTER	Low Y		Defocused, normal	
n	PRINT CHARACTER	Low Y		Defocused, normal	
o	PRINT CHARACTER	Low Y		Defocused, normal	
p	PRINT CHARACTER	Low Y		Write-thru, normal	
q	PRINT CHARACTER	Low Y		Write-thru, dotted	
r	PRINT CHARACTER	Low Y		W-t, dot-dashed	
s	PRINT CHARACTER	Low Y		W-t, short-dash	
t	PRINT CHARACTER	Low Y		W-t, long-dashes	
u	PRINT CHARACTER	Low Y		Write-thru, normal	
v	PRINT CHARACTER	Low Y		Write-thru, normal	
w	PRINT CHARACTER	Low Y		Write-thru, normal	
x	PRINT CHARACTER	Low Y			
y	PRINT CHARACTER	Low Y			
z	PRINT CHARACTER	Low Y			
(	PRINT CHARACTER	Low Y			
!	PRINT CHARACTER	Low Y			
)	PRINT CHARACTER	Low Y			
≈	PRINT CHARACTER	Low Y			
Delete	—	Low Y or NOOP%		SET LCE	*Strap option on TC-1

\*Once LCE is received by the Terminal, the applicable ASCII character can perform the function as listed below.

#Enhanced Graphic Module (Option 34)

%In Graph Mode, the effect of RUBOUT as a LOY character can be disabled by the DEL IMPLIES LOY strap on TC-1. If RUBOUT cannot be used, the program can substitute ESC ? which performs the same as if RUBOUT were sent.

This glossary pertains to this manual and is not intended to be a universal reference. It excludes definitions of most control characters and signal lines, which are defined on pages listed in the index.

**Accessory**—See standard accessory or optional accessory.

**Active state**—Used with reference to signal lines; refers to the state indicated by the line name. For example the MARG line is active when it is high, whereas TSTROBE is active when low, as indicated by the "not line" drawn across the top of the name.

**Address**—A point within the 1024Y by 1024X coordinate capability of the Terminal's registers. 780Y and 1024X coordinates relate to the viewing area of the Terminal's screen, with 0Y, 0X being in the bottom left corner and 779Y, 1023X being in the top right corner.

**Address, Alpha cursor**—The position occupied by the lower-left corner of the Alpha cursor. Also the contents of the position registers in Alpha Mode.

**Address conversion**—Changing an address into a combination of characters which describes that address in ASCII, or decimal form; also the reverse operation.

**Address, Graphic**—The position of the beam in Graph Mode. Also the contents of the position registers in Graph Mode.

**Address, shortened**—A Graph Mode address of less than four bytes. Can be used when part of a new address is the same as part of the one which immediately precedes it.

**Addressable point**—Any point within the 0Y to 1023Y, 0X to 1023X capability of the Terminal's registers.

**Alpha cursor**—A blinking, non-storing rectangular symbol which indicates the next-character writing position. Exists only during view status in Alpha Mode.

**Alpha Mode**—A Terminal receiving mode which permits writing of a standard set of ASCII symbols or alternate character set symbols (if alternate character set is installed).

**Alphanumeric**—Refers to letters and numbers.

**Arming**—Preparing the Terminal so that the next-received character performs a function other than what it would cause if the Terminal were not "armed". The ESC control character normally is used to "arm" the Terminal.

**ASCII character**—Any one of 128 characters contained in the character set used by "American Standard Code for Information Interchange". See the ASCII Code Chart in the appendix.

**ASCII Code**—Seven-digit binary numbers which express any of the 128 ASCII characters. See the ASCII Code Chart in the appendix.

**Auxiliary/Auxiliary Unit**—A device which is designed for use with the Terminal, but which is not required for Terminal operation.

**Baud**—Signalling units per second; an expression of serial data transmission bit rate.



# GLOSSARY

**Beam**—The element (within the cathode-ray tube) which causes displays to appear on the screen.

**Binary**—Referring to a number system which uses two as its base. Only the digits 0 and 1 appear in binary expressions.

**Binary equivalent**—A number expressed in binary form to represent a number which has a different base or to represent a character from the ASCII code.

**Bit**—A binary digit.

**Blanked**—The non-writing status of the display beam.

**Board, circuit**—See circuit board.

**Break**—A signal sent from the Terminal to the computer to interrupt computer transmission in some installations. Also the command which initiates the signal.

**Bright vector**—A line stored on the screen as a result of smoothly changing the beam address while the beam is unblanked.

**Bus**—A wire which conveys electrical information between two or more points.

**Bypass Condition**—A condition similar to Echoplex Suppress that automatically occurs when GIN Mode is selected; can also be program selected. It inhibits the Terminal's response to data being input to the computer, during GIN Mode or whenever commanded by the computer.

**Byte**—A group of bits operated on as a unit.

**Card, circuit**—See circuit card.

**Carriage return**—Movement of the writing beam to the left or center margin. Also the command which causes this movement.

**Cathode-ray tube (crt)**—An evacuated glass envelope similar to a television display tube. The crt face is the Terminal's display screen.

**Character generator**—An electronic circuit within the Terminal, which provides the positioning and writing information required for displaying characters on the screen.

**Character keys**—The keys located on the Terminal's keyboard.

**Character**—A symbol within a set of symbols; also the encoded form of that symbol. Also see control character.

**Character set**—Characters which make up a defined group, such as ASCII.

**Character space**—The horizontal area allotted to writing of one character on the screen.

**Character writing**—Moving the beam through a 7 by 9 dot matrix and unblanking the beam in the positions required for constructing the character.

**Circuit board**—A bolt-in circuit assembly, as opposed to a plug-in circuit card assembly.

**Circuit card**—A plug-in circuit assembly, as opposed to a bolt-in circuit board assembly.

**Clock**—An oscillator or other signal-producing device which provides signals for circuit timing.

**Command sequence**—A sequence of characters, the first of which arms the Terminal so that the subsequent character(s) produce a result other than what they would produce alone.

**Communication link**—The connection between the Terminal and computer. It may be a wire cable, or may be a telephone line and modems.

**Control character**—A character which normally causes a function other than writing to occur, controlling the operation of equipment.

Keying control characters from the keyboard requires two (and in some cases three) key closures. A superscript C followed by a letter character indicates that the control character is formed by simultaneously pressing the CTRL and indicated letter key. A superscript C and S, e.g. <sup>CS</sup>O, indicates the control character (in this case, US) is formed by simultaneously pressing the CTRL and SHIFT and O keys.

**Control character command sequence**—See command sequence.

**Coordinate**—A horizontal or vertical line displayed on the screen; also the horizontal or vertical address of a point on the screen.

**Coordinate conversion**—See address conversion.

**Coordinate conversion chart**—A chart which provides address conversion to ASCII and decimal bytes. See the appropriate appendix.

**Copy making**—Generating a paper reproduction of a display.

**CPU**—Central processing unit; a term used interchangeably with computer in this manual.

**Crosshair cursor**—A non-storing image on the screen, created in GIN Mode by alternately cycling the X and the Y position registers and writing each point with a non-storing intensity.

**CRT**—See cathode-ray tube.

**CTRL key**—A keyboard key which, when held down, causes letter key entries to result in transmission of control characters.

**Cursor, Alpha**—See Alpha cursor.

**Cursor, crosshair**—See crosshair cursor.

**Dark vector**—Movement of the display beam from one address to another in Graph Mode, without unblinking the beam to cause writing.

**Data**—Basic elements of information which can be produced or processed by devices such as computer, Terminals, teletypewriters and associated devices.

**Data communication interface**—A device which provides compatibility between the Terminal and a computer, usually via a modem.

**Data communication standards**—A statement of particulars regarding interfacing between data terminal equipment and data communication equipment employing serial binary data interchange. Typified by documents such as EIA RS-232-C.

**Data lines**—Wires which carry data between or within devices.

# GLOSSARY

**Direct connection**—In computer interfacing, a direct connection infers connecting the Terminal to the computer without benefit of modems.

**Display**—Information written on the Terminal screen; sometimes also used to denote the screen itself.

**Display beam**—See beam.

**Display screen**—See screen.

**Display Unit**—That section of the Terminal which includes the screen, keyboard, and associated circuits.

**Dual key entry**—Pressing a character key while holding the CTRL or SHIFT key down.

**Echoplexing**—The return of transmitted data to the transmitting device.

**EGM**—See Enhanced Graphics Module.

**Enhanced Graphic Module (Option)**—An option that increases the graphic capability of the Terminal. See Enhanced Graphic Module Appendix for more information.

**Erasing**—Removing stored data from the screen.

**False**—A status associated with signal lines which occurs when the line is at the level opposite to that inherent in the line name. For example, in positive logic (such as is used in the Terminal, BIT 8 is false when the line is high (most positive), since a "not line" is part of the signal name. MARG is false when the line is low (least positive).

**Flooding**—A fully-written screen condition which occurs shortly after turn-on.

**Formatting**—Arranging the display in the desired manner by using positioning commands between writing commands.

**GIN Mode**—An interactive mode in which a computer request causes the Terminal to respond with graphic information. Status information and/or control characters may be part of the transmission.

**Graphic Look-Ahead**—Ability of the Terminal to receive up to three bytes of a vector address in Graph Mode, while the preceding vector is being drawn.

**Graph Mode**—A terminal mode which permits data to be interpreted as display beam positioning information. Points can be written or lines (vectors) can be drawn (written) between points.

**Graph Mode memory**—A feature which permits the Terminal to remember three of the four bytes of a graphic address, even if it is switched out of Graph mode.

**Graphic address**—See address.

**Graphic input**—See GIN Mode.

**Graphic vector**—See vector.

**\*Hard copy**—A reproduction (on paper) of a Terminal display.

**\*Hard Copy Intensity**—An adjustment on the side of the Terminal. It permits optimization of hard copy writing.

**\*Hard Copy Mode**—The operating status achieved by the Terminal during copy making.

**\*Hard Copy capability is contained in the 4014-1 only.**

# APPENDIX H

## GLOSSARY

**\*Hard Copy Unit**—An instrument which generates paper copies of Terminal displays. May also be used in certain other copying situations.

**Hardware**—The mechanical, magnetic, electrical, and electronic devices and components of data processing equipment.

**Hold status**—A reduced-intensity status (of the screen) which occurs in Alpha Mode.

**Home**—The Alpha Mode starting position. Exists at top-left of the screen (767Y, 0X).

**Incremental Plot**—A graphic Plot Mode provided by the Enhanced Graphic Module Option that permits plotting in one point increments, written or unwritten, in a choice of eight different directions.

**Initializing**—Turning the Terminal power on, or returning the Terminal to its initial condition.

**Input**—Data sent from the Terminal to the computer.

**Interactive graphics**—See GIN Mode.

**Interface**—The unit which permits two devices to interact with each other. Specifically, the unit which makes the Terminal compatible with a computer, modem, or peripheral equipment.

**Intersect point**—The point where the horizontal and vertical lines of the crosshair cursor meet.

**Jack**—The least portable of two mating connectors.

**\*Hard copy capability is contained in the 4014-1 only.**

**Joystick**—An optional device for the Terminal that controls the position of the crosshair cursor.

**Left margin**—See Margin 1.

**Letter keys**—Commonly used to denote the keys which generate the code for Roman (conventional English) letters.

**Light vector**—See written vector.

**Line**—A display consisting of horizontally adjacent characters; also the space allocated to such a display.

**Line feed**—Movement of the writing beam from a line to the next lower line; also the command which causes such movements.

**Line voltage**—The force of the supply at an electrical outlet. In the United States, it is usually 115 V or 230 V or some slight variation of those values.

**Lines, data**—See data lines.

**Lines, signal**—See signal lines.

**Local Echo**—Simulating echoing within the Terminal, so that the Terminal executes the data it transmits, without having it echoed by the receiving device.

**Local operation**—An operating status which isolates the Terminal from the computer, and sets up an echoplexing condition.

**LSB (least significant bit)**—The bit in the position of least magnitude in a binary expression; usually written as the last bit on the right.

# GLOSSARY

**Margin 1**—A left-margin position at the left side of the screen.

**Margin 2**—A left-margin position at the center of the screen.

**Minibus**—A wiring arrangement which makes all signal lines in the Terminal's pedestal available to all installed circuit cards.

**Minibus extender**—An optional circuit board which extends the minibus capability to permit inclusion of as many as five additional circuit cards.

**Modem (Modulator/demodulator)**—A device which can convert digital data to a signal (in a process called modulation) which can be conveyed over telephone lines, and can perform the reverse function in a process called demodulation. A modem is required on each end of the telephone line.

**Monitor**—As associated with the Terminal, monitor refers to a device which provides a copy of the Terminal display, or otherwise displays data which is processed by the Terminal.

**MSB (most significant bit)**—The bit in the position of greatest magnitude in a binary expression; usually written as the bit on the left.

**New line**—The operation that moves the alpha cursor to the selected margin (Margin 1 or Margin 2) and down one line.

**On line operation**—Communicating with the computer.

**Optional accessory**—A device which can be purchased from Tektronix for use with the Terminal, but is not supplied as part of the standard Terminal package.

**Options**—See soldered options or strappable options.

**PAGE**—A command which erases a display, sets Alpha Mode, and homes the Alpha cursor. Also a completed display.

**Page full busy**—A signal generated when a page full of information has caused the display to line feed past the last line. Also an option contained on the Data Communication Interface circuit card.

**Parallel transmission**—Simultaneous transmission of more than one data bit.

**Parallelization**—The process of converting sequential (serial) data bits to simultaneous (parallel) data bits.

**Pedestal**—That unit of the Terminal which houses the low voltage power supply, the terminal control circuit cards, and the interface unit(s). The display unit may be mounted on the pedestal.

**Peripheral devices**—Generally refers to the equipment used in support of, or under control of, the computer. Used in this manual to mean equipment other than the computer or Terminal.

**Plug**—The most portable of two mating connectors.

**Point Plot Mode**—A mode of graphic operation, provided by the Enhanced Graphic Option that plots (writes) only the addressed point.

**Point spacing**—The distance between addressable points on the display screen.

**Point writing**—The result of turning on the display writing beam without changing the beam location.

**Poll**—To question. Usually the act of electronically asking a device if it is waiting to use the asking device, or the equipment which it represents.

**Program**—A pre-defined course of action which controls computer or other equipment operation. May be written on paper, punched on tape, stored on magnetic tape, or stored in computer or other equipment memory.

**Program command**—A command sent from the computer to the Terminal or to peripheral equipment as a result of a program decision.

**Quality area**—That area of the screen which reliably displays information. It is specified as an area which is within one-fourth inch of being centered on the screen.

**Register**—A device for temporary storage of binary information. May be differentiated between data register and address register.

**Reset**—Return to initial status; also the command which causes return to initial status.

**Residual image**—A display which remains after erasing has been completed. Usually caused by storing information for an excessive time. May be permanent or temporary. If temporary, it will disappear after several erase cycles.

**Return**—See carriage return. Also the keyboard name for control character CR.

**Right margin**—The screen coordinate (X axis) that represents the right-most limit of alphanumeric characters. Any attempt to write alphanumeric data beyond the right margin causes a new line to be generated.

**Screen**—That area of the Terminal's display unit on which data is displayed. The face of the cathode-ray storage tube.

**Selective write**—See Write-thru.

**Serialization**—The process of converting simultaneously-occurring —parallel) data bits into sequentially-occurring (serial) data bits.

**Serial transmission**—Sequential transmission of single data bits.

**Shift key**—A key on the Terminal keyboard whose function is comparable to that of a typewriter shift key.

**Shifted character**—A character resulting from pressing a symbol key while the Shift key is held down.

**Signal lines**—Wires which are used to send command signals between or within devices.

**Software**—Programs, procedures and techniques for directing the hardware (computer, Terminal, etc.) to perform desired functions.

**Soldered options**—Operating features which are designed to be changed by soldering or unsoldering connections.

**Space**—The horizontal area allocated to writing a character in Alpha Mode. Also, the movement from a character writing area to the next writing area. Also the command which causes such movement without causing character writing.

# GLOSSARY

**Special Point Plot Mode**—A mode of Graphic operation provided by the Enhanced Graphic option. It is same as Point Plot operation, except that the intensity of the addressed point can be program controlled.

**Standard accessory**—A device which is supplied with the basic Terminal.

**Standards, data communication**—See data communication standards.

**Status byte**—Data bits which indicate the status of the Terminal and certain peripheral devices.

**Store**—To retain an image on the screen as a result of writing with sufficient beam intensity.

**Strappable options**—Operating features which can be changed by moving a friction-held wire from one point to another.

**Telephone line connection**—A communication link between the Terminal and computer. Sometimes generalized to include the associated modems.

**Teletypewriter**—A device similar in appearance to a typewriter, which produces a response to binary information. The trade name for such a device produced by AT&T.

**Teletype port**—The computer connection point for a Teletypewriter cable plug.

**Thumbwheels**—Adjustment knobs with partially exposed surfaces, a pair of which are used to control the position of the Terminal's crosshair cursor.

**Timing**—The control of operations between and within devices with respect to time.

**Traffic control**—Controlling the input and output of data to avoid loss of data.

**Transmitting**—Sending data to another device.

**Triple key entry**—Pressing a character key while holding down both the CTRL and SHIFT keys to generate the code for a control character.

**True**—A status associated with signal lines. This status exists when the line is at the level inherent in the line name. For example, in positive logic (such as is used in the Terminal), BIT 8 is true when the line is low (least positive), since a "not line" is part of the signal name. MARG is true when the line is high (most positive).

**TTY Code**—A code set consisting of all ASCII characters except lower case letters, grave accent, closing brace, vertical line and tilde.

**Unblanked**—The beam writing condition which produces the display on the screen.

**Unshifted character**—A character resulting from pressing a symbol key while the SHIFT and CTRL keys are both released.

**Unwritten vector**—See dark vector.

**Vector**—Movement in Graph Mode from one address to another. May be accompanied by a blanked or unblanked writing beam. Also, see dark vector or written vector.

**View Status**—The bright-screen condition (of the Terminal) associated with normal operation.

**Viewable address**—Those address points which are in the quality display area of the screen. In a standard Terminal, it consists of the 0 to 779 Y area and the 0 to 1023 X area.

**Viewable point**—Any point in the viewable address area.

**Voltage, data transfer**—The voltage levels required to denote the status of data being transmitted.

**Voltage, operating**—See line voltage.

**Wrap-around**—The condition associated with the position registers incrementing from 1023 to 0 or decrementing from 0 to 1023. The beam position moves from one edge of the screen to the opposite edge without writing.

**Write-Thru**—Also referred to as selective write. A type of display operation that prevents information from storing as it is being written on the screen. Previously stored information remains in view.

**Writing**—Storing information on the screen as a result of unblanking the display beam.

**Writing character**—Any of the numerous characters in the ASCII code which can be written by the Terminal's character generator.

**Written vector**—Movement of the display beam from one address to another in Graph Mode while the beam is unblanked. Also the stored effect of such movement.

**X**—The horizontal axis of the screen.

**X coordinate**—Any specific value of X. Also a line drawn through every Y value with X held constant.

**X register**—The register which holds the bits which determine the horizontal position of the display beam.

**Y**—The vertical axis of the screen.

**Y coordinate**—Any specific value of Y. Also a line drawn through every X value held constant.

**Y register**—The register which holds the bits which determine the vertical position of the display beam.



This index contains a listing of the principal subjects contained in this manual. Minibus line titles are not included individually, but can be found on the page by the general title.

## A

Accessory Devices—2-2, E-1, E-2, see Peripheral  
 Address—1-8, 1-9, 3-26, 3-27  
 Address crosshair—3-28  
 Alpha Cursor—2-6  
 Alpha Mode—1-3, 1-5, 1-9, 2-9, 3-7, 3-10  
   Character Writing Rate—3-25  
   Display Formatting—3-23  
   Operating Specifications—3-23  
   Selection—3-23  
   Write-Thru—3-25  
 Alternate Character Set—3-3, 3-7  
 ASCII—1-2, 2-2  
 ASCII/ALT Switch—2-2, 3-7  
 Auto Print Switch—2-3

## B

BEL Control Character—2-5, 3-4, 3-11  
 Break key—2-3  
 BS Control Character—2-5, 3-4  
 Bypass Condition—2-5, 2-7, 3-6, 3-29

## C

CAÑ Control Character—2-5, 3-6  
 Carriage Return—2-4  
 Character Generator—1-2  
 Character Repeat—See Repeat Function  
 Characters, Shifted—See Shifted Characters  
 Character Size Selection—2-8, 3-7  
 Command Sequences—3-5  
 Communication Link—1-1  
 Computer—1-1  
 Control Character—1-3, 1-5, 1-6, 2-3, 2-5, 2-7, 3-4, 3-22  
 Control Circuits—1-2  
 Control Code Summary—Appendix G  
 CR Control Character—2-5, 3-4, 3-6  
 CR EFFECT Strap—2-4, 3-9  
 CR/LF (Automatic)—2-9, 3-8  
 Crosshair Cursor—1-3, 1-8, 1-10, 3-17, 3-28  
 CRT—1-2  
 CTRL key—2-2, 3-4  
 Cursor—1-5

## D

Dark Vector—3-12, 3-26  
 Data—1-1, 1-4  
 Defocused Condition—2-9  
 DEL IMPLIES LOY Strap—2-4  
 Desk Mounting—1-3, A-1  
 Direct Correction—1-1, 1-3, A-4  
 Display—1-2  
 Display Area—3-23  
 Display Unit—1-3

## E

Echo—1-3  
 Echoing—1-4, 3-29  
 Enhanced Graphics Module—1-6, 2-6, 3-1, 3-13, Appendix F  
 ENQ Control Character—2-6  
 EOT Control Character—3-28  
 ESC Control Character—2-6, 3-5  
 ESC Sequences—2-8, 2-9  
 ETB Control Character—2-6  
 Extra Byte—F-4

## F

FF Control Character—2-6  
 Focused Conditioned—2-9  
 FS Control Character—2-6, F-4, F-7  
 Full Indicator—2-3, 3-9  
 Fuse Size—A-2

## G

GIN Mode—1-7, 2-3, 2-6, 3-6, 3-17, 3-28 thru 3-30  
   Address Bytes—3-30  
   Terminate—3-18, 3-19  
   Transmission Limits—3-30  
 GIN TERMINATOR'S Strap—2-4  
 Graph Mode—1-6, 1-7, 1-9, 2-7, 2-9, 3-10 thru 3-16  
   Memory—3-27  
   Selection—3-25  
   Terminate—3-13, 3-26, 3-27  
 Grey Scale Adjustment—F-2, F-7  
 Grey Scaling—F-7  
 GS Control Character—2-6

## H

Hard Copy Check—3-19  
 Hard Copy Unit—1-1, 1-10, 2-3, 2-6  
 Hold Status—1-3, 1-11, 3-3  
 HT Control character—2-6, 3-4

## I

Incremental Plot Mode (Option 34 only)—3-15, F-1, F-6, F-7  
 Initial Status—3-22  
 Installation—1-3, Appendix A  
 Installation, Enhanced Graphics Module—A-2  
 Intensity Character—F-7, F-8  
 Interactive Operation—1-3  
 Interface—1-1, 1-2, 1-3, 1-5, 2-3  
 Interface Card—2-4  
 Interface Design—Appendix D

## K

Keyboard—1-2

**L**

LF Control Character—2-6, 3-4  
 LF EFFECT Strap—2-4  
 Line—2-2  
 Linear Interpolate—3-25  
 Line feed—2-4  
 Line Voltage—3-2  
 LOCAL/LINE Switch—2-2, 3-2  
 Local Operation—1-10, 3-22

**M**

Margin Control Switch—2-3, 3-9  
 Margin 1—2-3, 2-6, 2-9, 3-9, 3-10  
 Margin 2—2-3, 2-9, 3-9  
 Minibus—D-2  
 Modem—1-1, 1-3, A-4, A-5

**O**

Operating Modes—1-3, see Alpha, Graph, and GIN Modes  
 Operating Voltage—A-1 thru A-2

**P**

Page Full—2-3  
 Page/Reset key—2-2  
 Pedestal—1-3  
 Pedestal Mounting—A-1  
 Peripheral—1-1, 1-3, 1-4  
 Plotter—F-1  
 Point Plot Mode (Option 34 only)—3-15, F-1, F-4, F-6  
 Power On Switch—2-1, 3-2  
 Programming, Option 34—F-4 thru F-8

**Q**

Quality Area, Display—3-23

**R**

Refreshing—1-9, also see Write-Thru  
 Release Switch—2-3  
 Repeat Function—3-3  
 RS Control Character—2-7, F-6  
 RUBOUT—2-4, 3-28

**S**

Screen—1-5  
 Shifted Characters—3-4  
 SHIFT key—2-3, 3-3  
 Shortened Address Transmission—3-12  
 SI Control Character—2-7, 3-7  
 SO Control Character—2-7, 3-7  
 Special Point Plot Mode (Option 34 only)—3-15, F-1, F-7, F-8  
 Status Byte Definition—3-29  
 Strap Options—2-4, A-3, A-4  
 SUB Control Character—2-7

**T**

Telephone Connection—1-1, A-4  
 Terminal—1-1  
 Terminal Control circuitry—1-2, 1-5  
 Terminal Status—1-2, 1-3, 1-7, 2-6, 3-17  
 Thumbwheels—1-8, 2-3  
 Transmission—1-3  
 Transmission, keyboard—3-22  
 Transmitting—1-4  
     Alpha Cursor Address—3-28  
     Crosshair Address—3-28  
     Graph Mode Beam Address—3-28  
 Triple Key Entry—3-5  
 TTY Code—3-5  
 TTY LOCK Key—2-2, 3-3, 3-5

**U**

Unwritten Vector—3-10  
 US Control Character—2-7

**V**

Vector Formats—F-1  
 Vectors—1-6, F-1  
 Vector Type Commands—3-14  
 Vector Writing Rate—3-26  
 Vector Writing Time—3-27  
 Ventilation—1-3  
 View Status—1-3, 1-11, 2-3, 3-3  
 VT Control Character—2-7, 3-4

**W**

Wrap-around—2-6, 2-9  
 Write-Thru—1-3, 1-9, 2-9, 3-13, 3-22, 3-25, 3-26  
 Writing Speed—1-9  
 Written Vector—3-11, 3-26, F-4

**X**

X Addressable Points—3-10  
 X Viewable Points—3-27  
 XY Plotter—See Plotter

**Y**

Y Addressable Points—3-10, F-1  
 Y Viewable Points—3-10, 3-27

**Z**

Zero-length Vector—3-11