

**MAVERICK
FAE
TRAINING GUIDE**

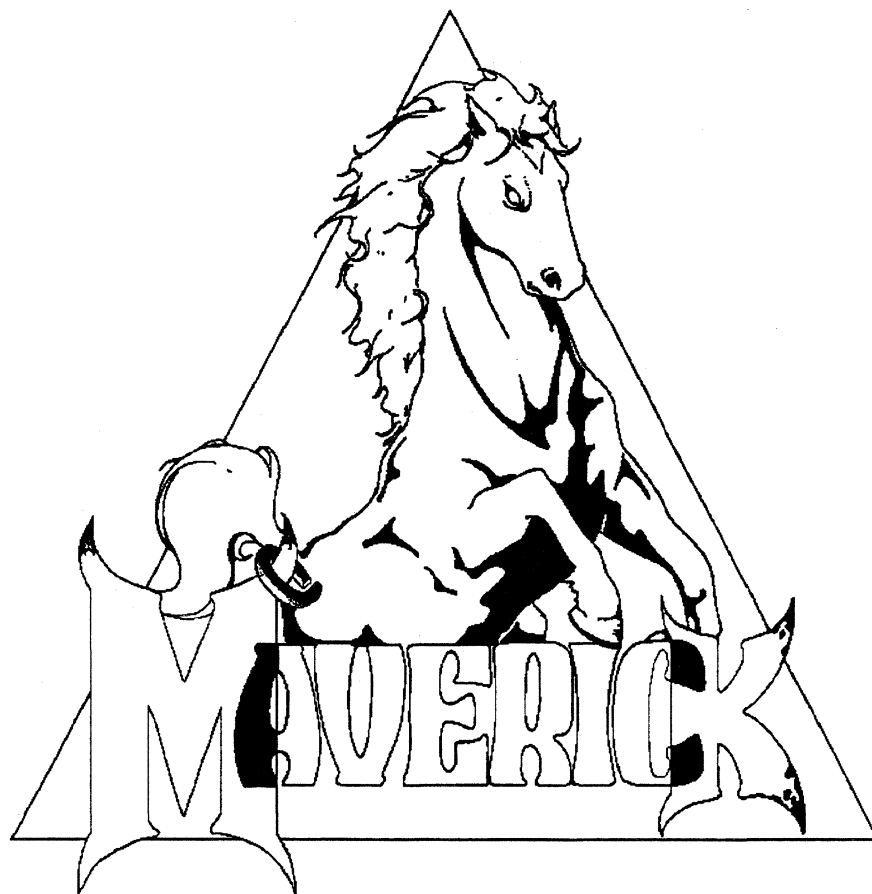

TABLE OF CONTENTS

SECTION 1: INTRODUCTION

SECTION 2: MARKETING OVERVIEW

SECTION 3: READ/WRITE

SECTION 4: FIRMWARE

SECTION 5: MECHANICAL

SECTION 6: SERVO

SECTION 7: TEST PROCESS

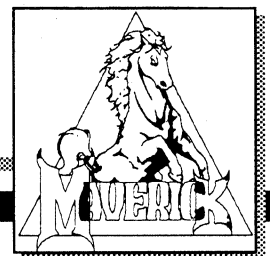

Maverick Product Leverage

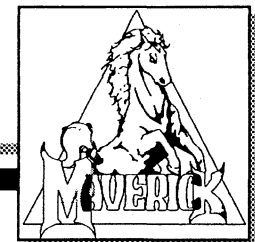
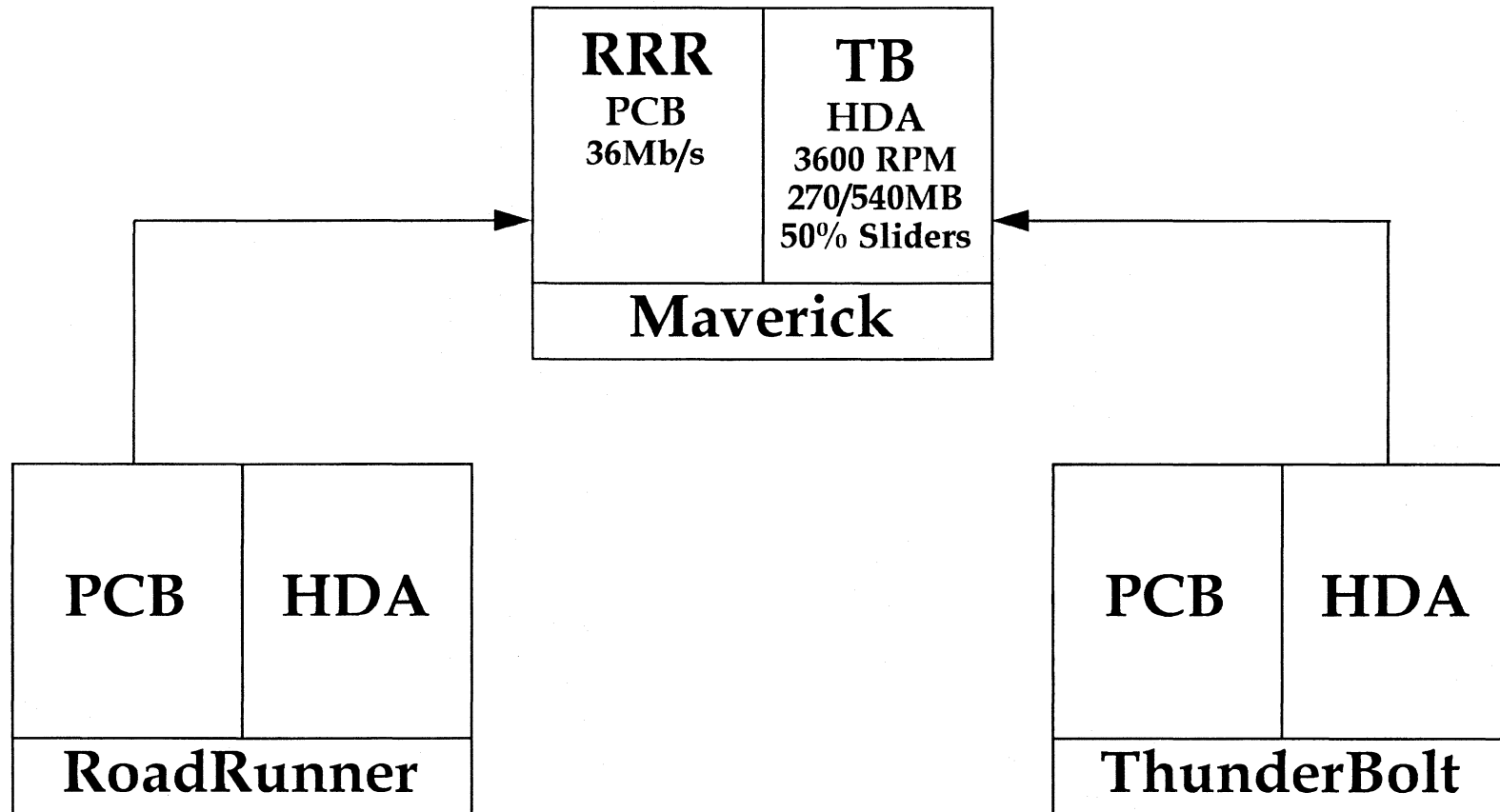

Specification Overview

	<u>Maverick 135</u>	<u>Maverick 270</u>	<u>Maverick 540</u>
User Capacity (MB) AT	131.072	270.663	541.327
SCSI	135.393	270.786	541.572
AT Logical Cylinder	1024	944	1120
AT Logical Heads	10	14	16
AT Logical Sectors	25	40	59
Interface Xfer Rate AT	6MB/Sec	6MB/Sec	6MB/Sec
SCSI Asynch	5MB/Sec	5MB/Sec	6MB/Sec
Sync	10MB/Sec	10MB/Sec	10MB/Sec
Data Cylinders	2853	2853	2853
Spare Sectors/Cylinder	1	1	2
Number of Disks	1	1	2
Number of Heads	1	2	4
Number of Zones	16	16	16
Seek Time (mSec)	14	14	14
Spindle Speed (RPM)	3600	3600	3600
Cache Size (KB)	96	96	96
Buffer Type	64k x 16	64k x 16	64k x 16
Idle Power (Watts)	3.6	3.6	3.6

Quantum
Confidential

Bob Beckenhauer
Project Mgr

26/3/1

(On Board/TBH/Consultant)

— Janice Bueno, Dept. Assistant

5/1/0

Ross Pace
Mech Mgr

- TBH 4835
- Frank Houghton
- Ting Kuo
- Corazon Caidoy

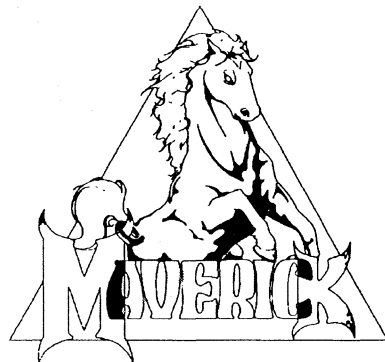

MAVERICK TEAM

Dept 7720

13/2/1

Jim Godwin
Elect Mgr

Drive Eng

- Jim Dickson
- Jamie Rivera
- Jeff Lundy
- Jim Saldaña (FTC)

Servo

- Eric Wong
- Babak Mazda
- TBH-5054
- TBH-5055
- Anthony Phan

Read/Write

- Joungki Min
- David Chau
- Roy Zeid
- Stuart Black

7/0/0

Bob Condie
F/W Mgr

- Rick Shimizu
- Mark Sompel
- Mike Thiels
- Gayle Noble
- Jing Booth*
- Woody Ho

- Rosa Shieh: Servowrite
- Change Lee: UPT
- Wing Kwan: Analog Parametrics
- Ed Romano: Materials
- David Shen: Head/Media
- Earl Allen: Quality
- Jerry Foster: Compatibility
- Stu Lerner: Marketing
- Carl Cashen: Applications Eng.

*Maternity Leave As of 7/15/94

MAVERICK CONTINUATION ENGINEERING

MANAGER -- JOE MUELLER (X4185)

SERVO -- TOM HUGUNIN (X5788)

READ/WRITE -- TERRY BURRIS (X6171)

FIRMWARE -- BOB MOORE (X4998)

DON ORBIN (X5635)

MECHANICAL -- SCOTT RUSSELL (X5855)

JOE CARDONA (X4223)

GENERALIST/FA -- ANDREW LEUNG (X4680)

BIJAN RAFIZADEH (X5224)

MIKE HENNINGS (X5587)

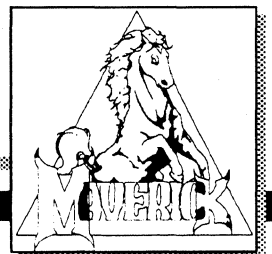

MARKETING OVERVIEW

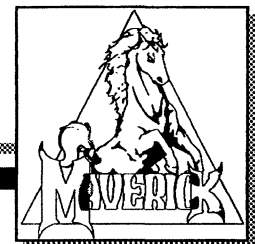

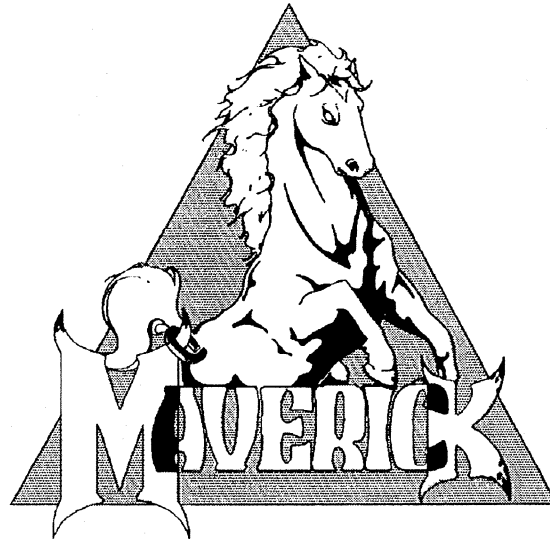

Training Presentation

**Stu Lerner
Program Marketing Manager**

August 1994

Price Wars

- Market share wars among major PC manufacturers
- New pricing structure for PC and HDD products
- Need for system differentiation to preserve margins and gain share

New Channels

- Mass Merchants, Office Supply superstores, Catalogs
- Focus on cost and capacity
- Sell as consumer product

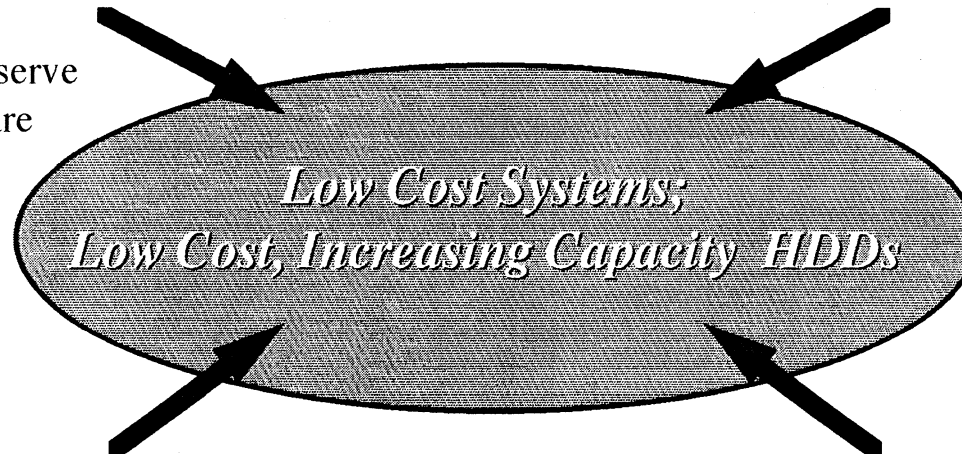

Emerging Markets

- Small Office
- Home Office
- Homework from school and work

New Applications

- Home budgeting/finance
- Multimedia apps for reference, education, “edutainment”, and games

Maverick

Desktop PC Product Roadmap

PC System Segmentation

Corporate /
Workgroup
Productivity

Small Business /
Individual
Productivity

Consumer / Home
Office &
Education

Thunderbolt

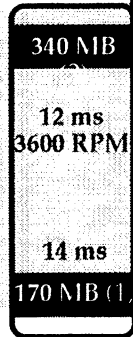
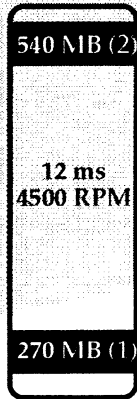

RoadRunner

June '94 - MP Lightning

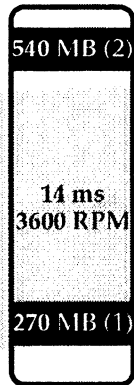
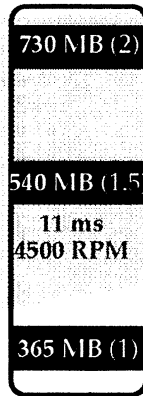

Maverick
June '94 - MP

CQ2 '95 - MP Fireball

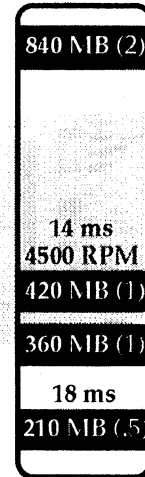
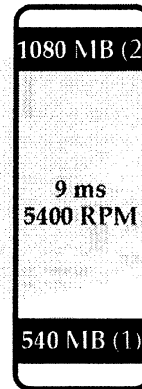

Trailblazer
CQ2 '95 - MP

CQ2'96 - MP PPC 3

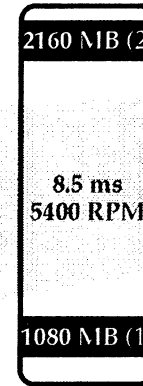

Performance
PC HDDs

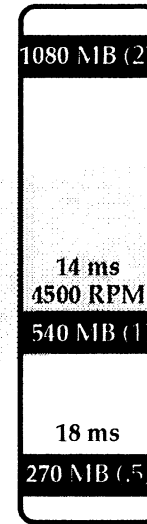

VPC 2
CQ1 '96 - MP

Value
PC HDDs

SDL 8/3/94

1993/94

1994/95

1995/96

1996/97

QUALITY STORAGE FOR BETTER SYSTEMS

Quantum

- **Provides best storage value for price sensitive PCs**
 - 540 MB will provide the best MB/\$ option for mid-level applications
 - 270 MB will provide the best MB/\$ option for entry-level applications
- **Capacity points enable price sensitive PCs to stay ahead of increases in software needs (multimedia). Also allows 270/540 customers to lower cost while maintaining capacity points in product line.**
- **"Firmware compatible" with RoadRunner for quick qualifications and advanced interface and power management features**
- **Manufactured by MKE with proven process technology for uncompromising product quality and reliability**

Maverick

Design Leverage

Time To Volume

- *Minimum Design Changes*

Low Cost

- *Common Parts & Vendors*

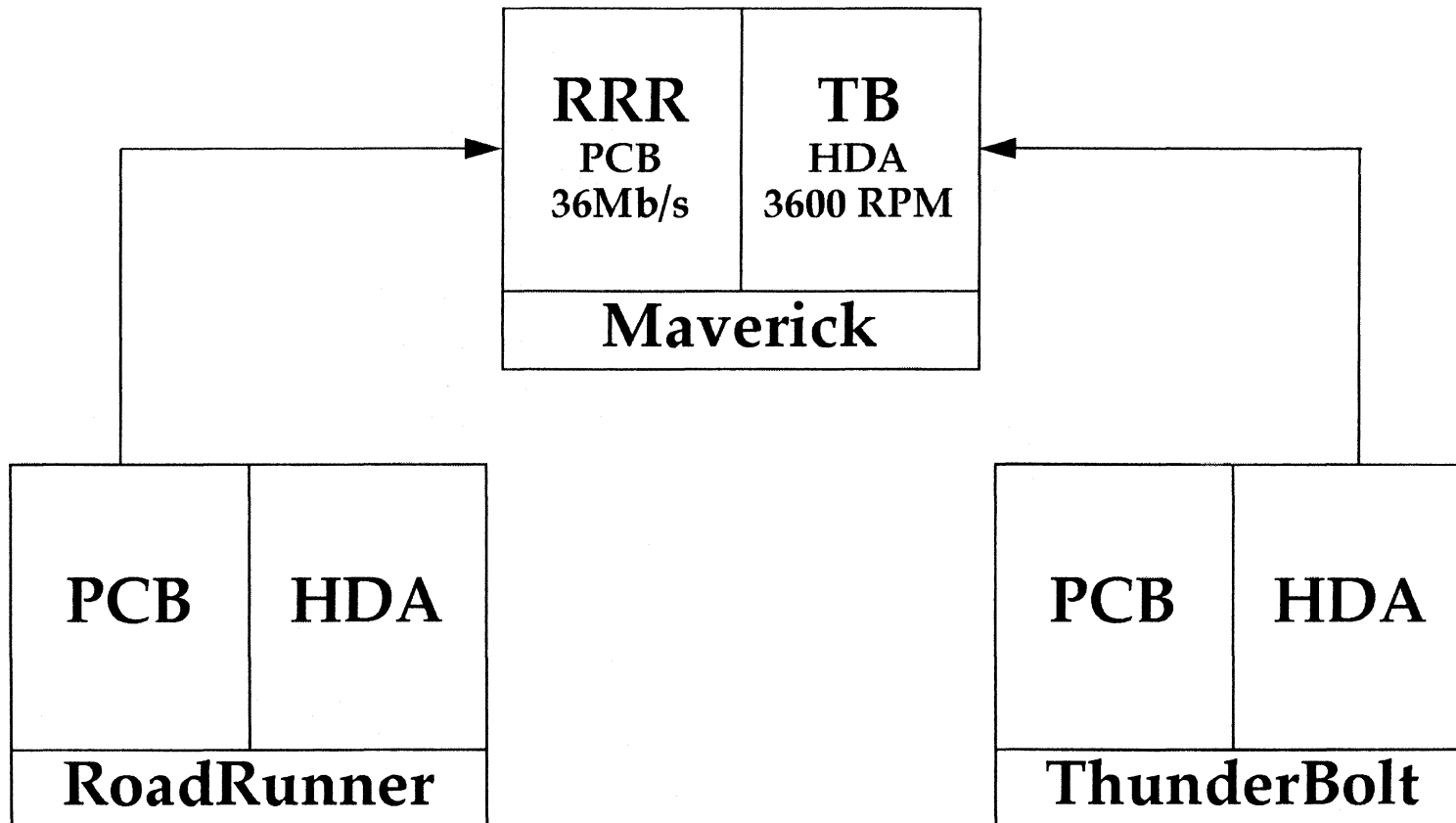

Key Product Specifications*

Form Factor:	3.5" x 1"
Interface:	IDE-AT/SCSI-2
Formatted Capacity:	270 MB/540 MB
Avg. Seek Time:	14 ms
Rotational Speed:	3600 RPM
Max. Data Transfer Rate:	
AT	13 MB/s (Local Bus)
SCSI	10 MB/s (Synch)
Typical Throughput:	
Random	20 KB/s
Sequential	1.5 MB/s
Power:	
Standby	1.0 W
Idle	3.7 W
Read/Write	4.6 W
Audible Noise:	34 dBA (Idle)
Projected MTBF:	300 K POH

Functionality/Features

DisCache/WriteCache	Self Diagnostics
Read-on-Arrival	SCSI Diagnostics
AutoRead/AutoWrite	Fast Multi-word DMA

Includes all RoadRunner performance features plus LBA support

■ Performance

- Read on Arrival
- Write Cache
- Discache
- ECC on the Fly
- Fast Multi-word DMA transfers
- Auto Task File Update
- Auto Read and Auto Write
- Synchronous SCSI

■ Reliability

- Error Logging Firmware
- Self Diagnostics

■ Versatility

- Power Saving Modes
- Cable Select
- Downloadable Firmware

NEW! Logical Block Addressing support

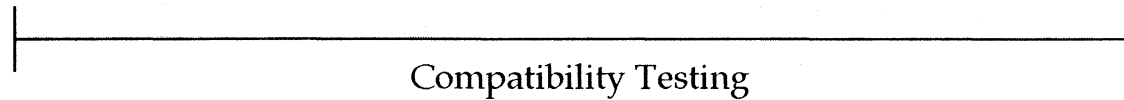
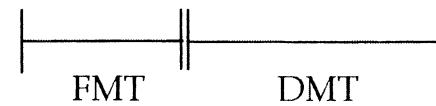
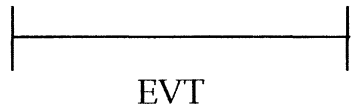
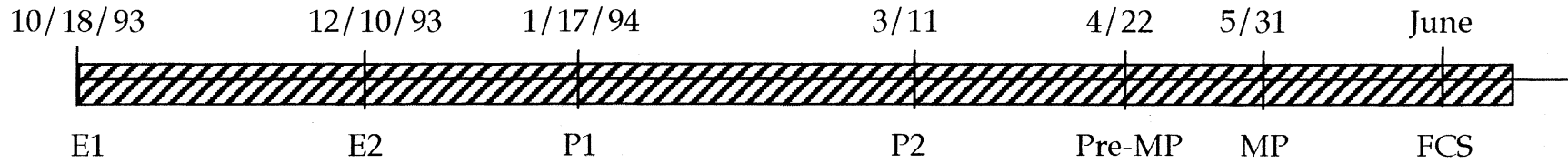

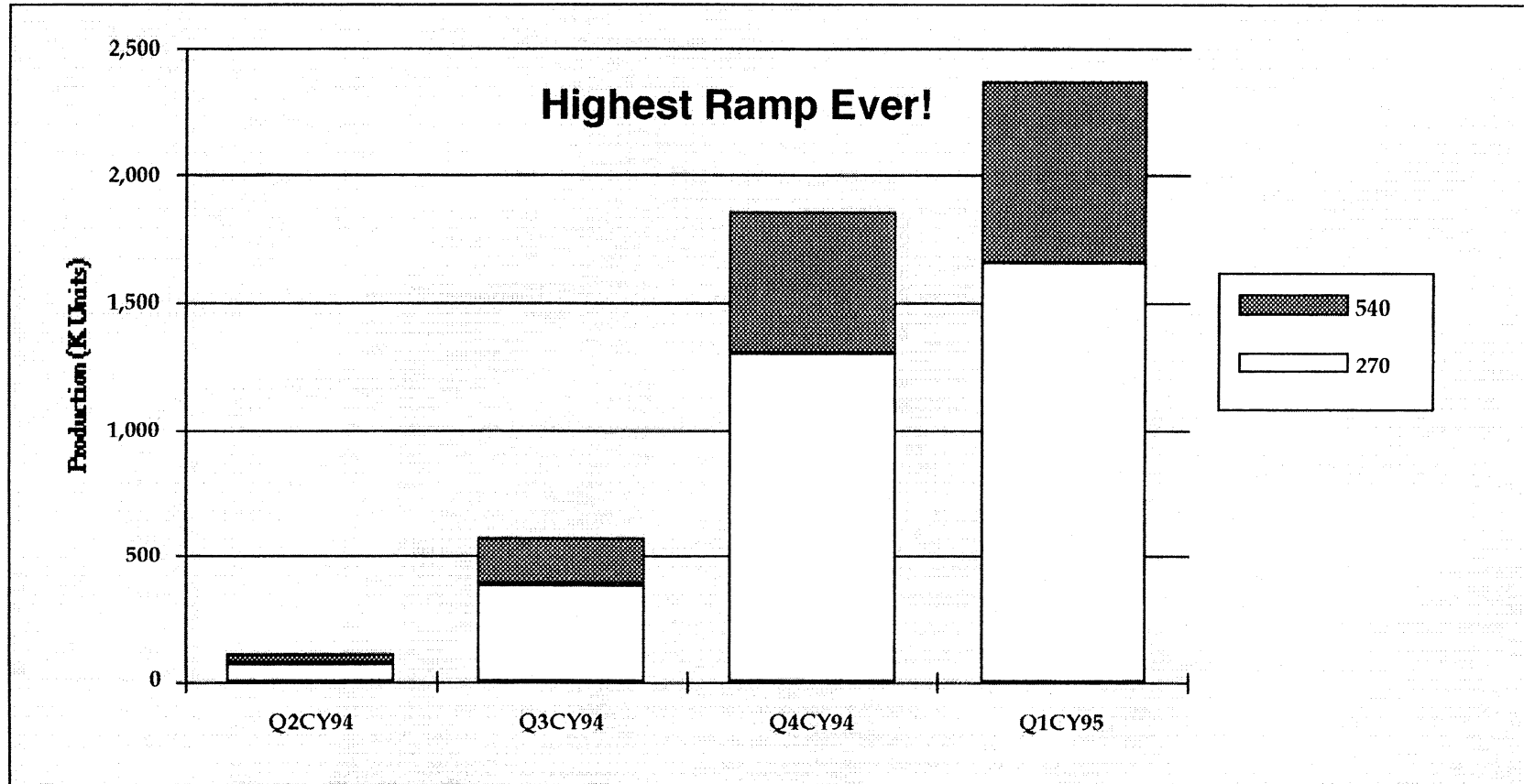

- No known technical barriers to ramp at this time
- Ramp has increased in response to customer demand

Yields

270MB 95.7%

540MB 94.4%

To date, over 150,000 drives have been built at MKE and KEIS (Singapore).

Maturity

- DMT successfully completed
- Compatibility testing complete
- Compaq and AST have completed quals
- Expect to be shipping to Compaq, IBM, Apple, AST by mid-August due based on qualification progress to date.

NEC μ P die shrink

*December customer
shipments*

- Need to qualify die shrink to continue ramp
- Propose "paper qual" to customers
- Plan to qual on separate schedule from 2nd release to ensure production capacity

Local Bus & 2nd release

*December/January
customer shipments*

- Need to ensure local bus functionality
 - 60% of 486 systems will support local bus
 - 95% of pentium systems will support local bus
 - Investigating firmware interim solution for disti
 - Developing "paddleboard" as back-up
 - PCB changes rolled into 2nd release
- 2nd release contains following changes:
 - Local bus (see above)
 - Firmware (specific changes TBD)
 - ID and OD crash stop color change
 - Ryan II spec change

MAVERICK

READ/WRITE

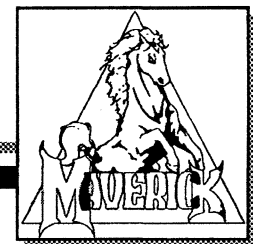

Heads

Thin film HEAD

Specifications

50% Slider

42 Turns

DC Resistance $\leq 45 \Omega$

Inductance $\leq 1.5 \mu$ henry, measured at 1 MHz

Write Current 13 mA 0-pk

Flying Height $76.2 \pm 19.1 \mu$ meters ($3.00 \pm 0.75 \mu$ inches)

Primary Pole Width 6.5μ meters

Gap (ref. only) $0.29 \pm 0.05 \mu$ meters

Approved Vendors

Read Rite

TDK

Possible Vendors

AMC

DEC

Media

Thin film DISK

Specifications

Coercivity 1600 ± 100 Oe

Thickness 0.8 mm (0.0315 inches)

PW $50 \leq 71$ n seconds at ID

Approved Vendors

AKCL

Fuji M

Possible Vendors

Fuji Y

Showa

MKC

Zone Bit Recording

Number of Zones: 16

RLL 1,7 code

Maximum Flux Changes per Inch: 45566 FCI, Zone 12

Data Rates

Maximum 36.08 M bits/sec

Minimum 18.67 M bits/sec

Tracks per Inch: 2950 TPI

Pre-amplifier

Vendors

VTC (VM7164-30)

Hitachi (HA166159RFP4)

Features

Channels: 4

Single 5V power supply

Low Noise: 0.65 nV/ $\sqrt{\text{Hz}}$

Low Input Capacitance: 16 pF max.

Diode coupled 400 Ω damping resistor across head input

The R/W Channel

Synthesizer

Vendor

TI (SN104225NS) SAKANA-II

Programable Digital Filter

Vendor

SSI (SSI32F8012)

Possible Vendor

Analog Devices (AD896JR-8012)

Read Channel

AGC Amplifier, Peak Detector and Data Separator

Vendor

AT&T (ATT91C014) RYAN-II

Maverick Track Format

ID-After-Wedge

Wedge:

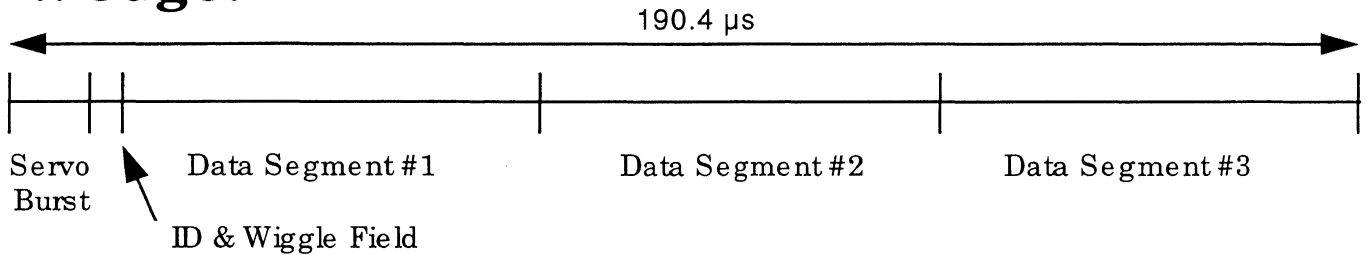

Servo Burst:

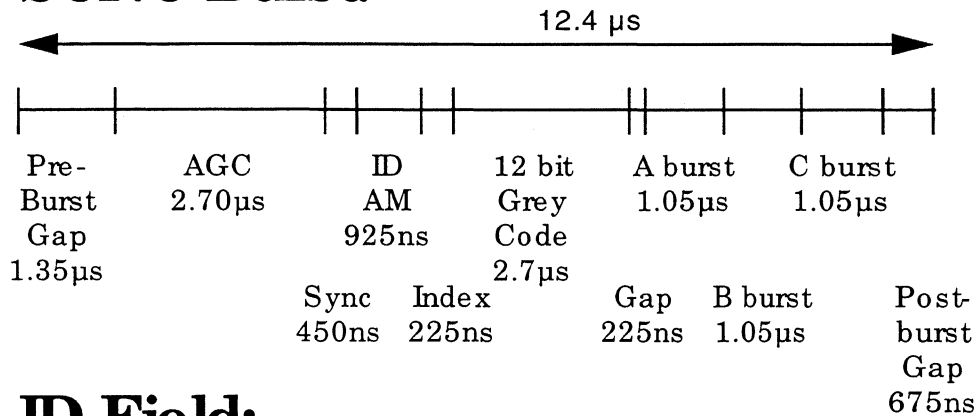

ID Field:

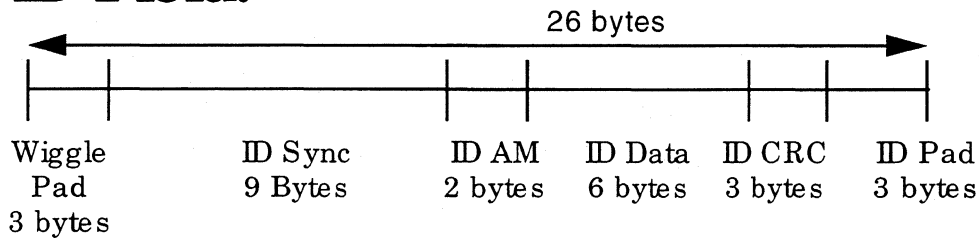

Data Segment:

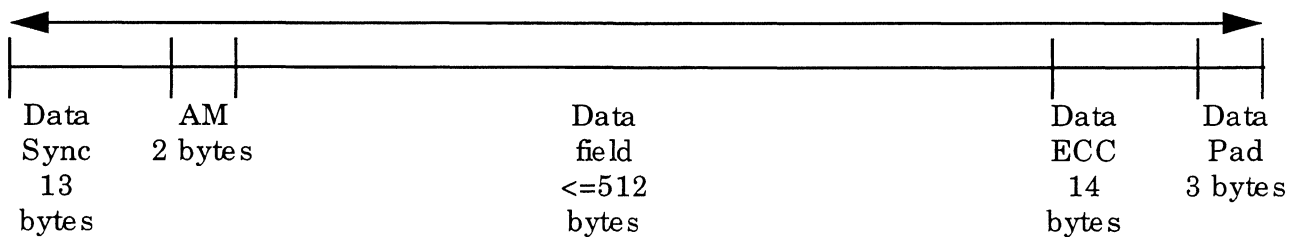

FCI

47000
45000
43000
41000
39000
37000
35000
33000
31000
29000
27000

System

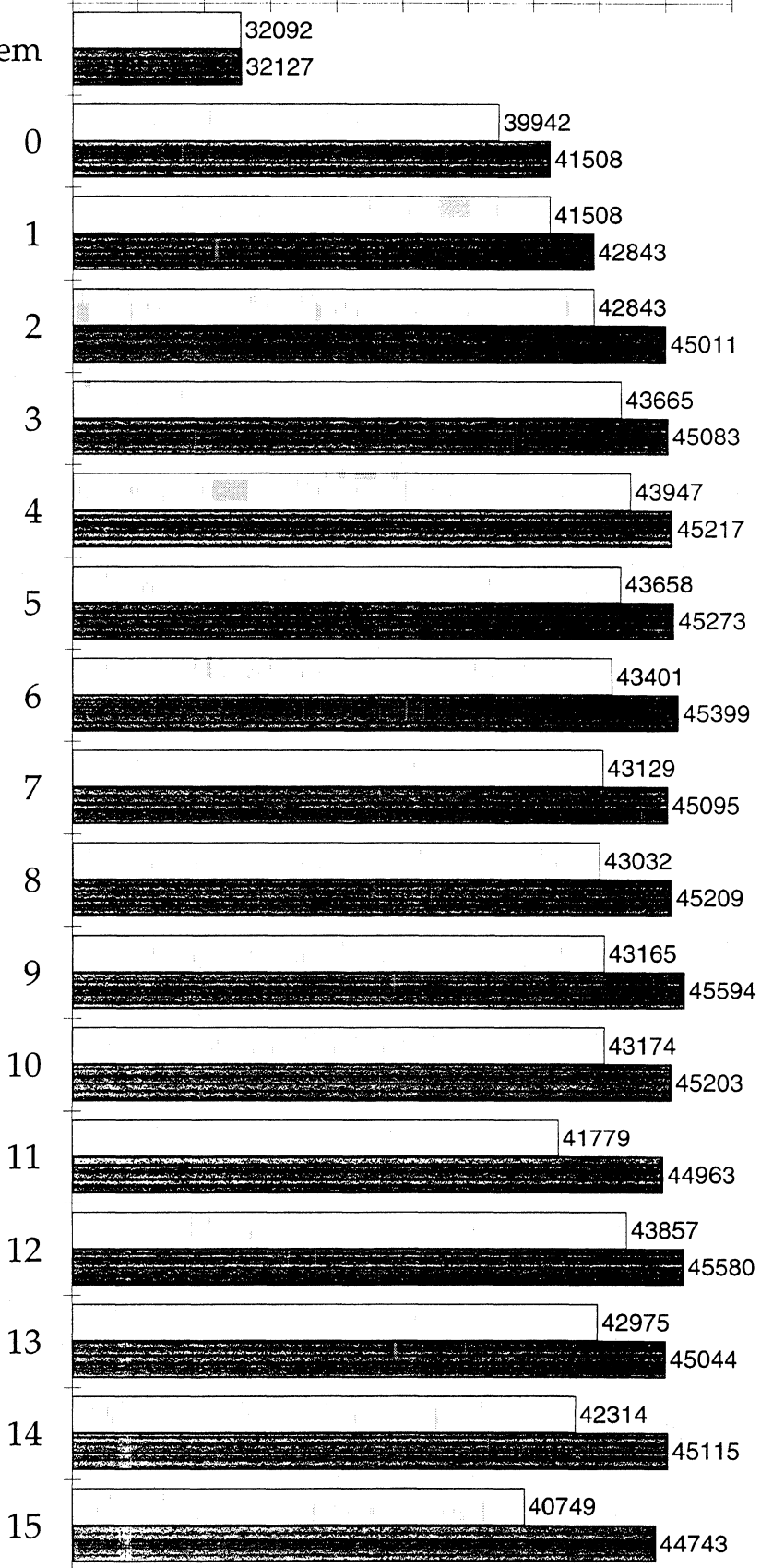

Zone min. FCI
 Zone max. FCI

Zone

**Maverick 270/540
FCI vs. Zone**

MAVERICK 270 TRACK LAYOUT

16 zones - ID after Wedge

Last Rev: 2/16/94 3:26 PM

Req Cap	270.749696 Million Bytes	lc270d.xlw
Spare	1 per cyl	
Surfaces	2	
Rod	1.7992 "	
Rid	0.8301 "	
Stroke	0.9691 "	
RPM	3599.54 rpm	
Trot	16668.7998 uSec	
Frot	59.9923 Hz	
TPI	2950	
Tot. tracks	2858	5711
Trks/zone		
max. FCI	45594	
% of req.	100.01%	
Total Cap	270.7860 Million bytes	
User sectors	481879	

	Bytes	uSec
ID Sync	9	
ID AM	2	
ID Data	6	
ID CRC	3	
ID Pad	3	
Total	23	
Data bytes	512	
Data Sync	13	
Data AM	2	
Data ECC	14	
Data Pad	3	
Tot. bytes	544	
Split ovhd	18	
AGC/Wiggle Gap	3	1.29
		max.

Srv Fq	26.654 MHz		
Srv Clk	37.518 nSec		
Srv T	1.801 uSec	(Pre & Post gaps)	
Srv N	417 Clocks	(Total of fields other than gaps)	
Nservos	78 samples		
Tservo	17.446 uSec	(includes pre & post gaps)	
Tdata	196.250 uSec		
Servo sample freq =	4679.4011 Hz	Srv OH	8.16%
Wedge-to-Wedge time =	213.7026 μ s	Fmt OH	9.70%

	Pre & Post Gaps	AGC Time	Servo Sync	SAM	Index	Gray code (12 bits)	DC Erase	A,B&C Bursts (each)
μ s	1.801	3.302	1.501	1.388	0.338	4.052	0.338	1.576
Clks	48	88	40	37	9	108	9	42
Total Sevo Burst length = 17.446 μ s = 465 T								

Zone	Zone Rod	Zone Rid	START CYLINDER	Cyls	Max. FC/in.	Data Rate [Mb/s]	Fclk [MHz]	Fmax [MHz]	1/2Twindow [nS]	ID time [μ s]	Sect. time [μ s]	Secl/burst w/o split	Time left [μ s]	Preamble & AM [μ s]	Split Sect	Total Sect (incl. spares)	Zone Cap per surface
OD		1.7992															
System	1.7992	1.7972	-5	5	32127	29.02	43.529	10.882	11.49	6.34	149.97	1	39.115	4.96	16	93	236800
0	1.7972	1.7294	0	200	41508	36.08	54.118	13.529	9.24	5.10	120.63	1	69.859	3.99	42	118	12032000
1	1.7294	1.6755	200	159	42843	36.08	54.118	13.529	9.24	5.10	120.63	1	69.859	3.99	42	118	9565440
2	1.6755	1.5948	359	238	45011	36.08	54.118	13.529	9.24	5.10	120.63	1	69.859	3.99	42	118	14318080
3	1.5948	1.5447	597	148	45083	35.00	52.500	13.125	9.52	5.26	124.34	1	65.964	4.11	38	114	8600576
4	1.5447	1.5013	745	128	45217	34.12	51.176	12.794	9.77	5.39	127.56	1	62.595	4.22	34	112	7307264
5	1.5013	1.4477	873	158	45273	32.94	49.412	12.353	10.12	5.59	132.11	1	57.821	4.37	30	108	8696320
6	1.4477	1.3840	1,031	188	45399	31.58	47.368	11.842	10.56	5.83	137.81	1	51.850	4.56	27	104	9962496
7	1.3840	1.3237	1,219	178	45095	30.00	45.000	11.250	11.11	6.13	145.07	1	44.250	4.80	20	97	8794624
8	1.3237	1.2599	1,397	188	45209	28.63	42.941	10.735	11.64	6.43	152.02	1	36.962	5.03	16	93	8903680
9	1.2599	1.1928	1,585	198	45594	27.33	41.000	10.250	12.20	6.73	159.22	1	29.421	5.27	11	88	8870400
10	1.1928	1.1393	1,783	158	45203	25.88	38.824	9.706	12.88	7.11	168.15	1	20.068	5.56	5	83	6673920
11	1.1393	1.0586	1,941	238	44963	23.92	35.882	8.971	13.93	7.69	181.93	1	5.627	6.02	-1	78	9443840
12	1.0586	1.0186	2,179	118	45580	23.33	35.000	8.750	14.29	7.89	186.51	1	0.821	6.17	-1	74	4440576
13	1.0186	0.9718	2,297	138	45044	22.00	33.000	8.250	15.15	8.36	197.82	0	186.795	6.55	71	69	4839936
14	0.9718	0.9115	2,435	178	45115	20.67	31.000	7.750	16.13	8.90	210.58	0	186.185	6.97	65	65	5878272
15	0.9115	0.8301	2,613	240	44743	18.67	28.000	7.000	17.86	9.86	233.14	0	185.107	7.71	59	58	7065600
ID	0.8301		TOTAL	2853													

Total cap = 270.78605
% of goal = 100.01%

Bytes/surface = 135393024
Bytes/disk = 270786048

MAVERICK 540 TRACK LAYOUT

16 zones - ID after Wedge

Last Rev: 2/16/94 3:29 PM

Req Cap	541.4994 Million Bytes
Spare	2 per cyl
Surfaces	4
Rod	1.7992 "
Rid	0.8301 "
Stroke	0.9691 "
RPM	3599.54 rpm
Trot	16668.800 uSec
Frot	59.9923 Hz
TPI	2950.0
Tot. tracks	2858
Trks/zone	166
max. FCI	45594
% of req.	100.01%
Total Cap	541.5721 Million bytes
User sectors	1057758

	Bytes	uSec
ID Sync	9	
ID AM	2	
ID Data	6	
ID CRC	3	
ID Pad	3	
Total	23	
Data bytes	512	
Data Sync	13	
Data AM	2	
Data ECC	14	
Data Pad	3	
Tot. bytes	544	
Split ovhd	18	
AGC/Wiggle Gap	3	1.29 max.

Srv Fq	26.653869 MHz	
Srv Clk	37.518005 nSec	
Srv T	1.801 uSec	(Pre & Post gaps)
Srv N	417 Clocks	(Total of fields other than gaps)
Nservos	78 samples	
Tservo	17.446008 uSec	(includes pre & post gaps)
Tdata	196.250 uSec	
Servo sample freq =	4679.4011 Hz	Srv OH 8.16%
Wedge-to-Wedge time =	213.7026 µs	Fmt OH 9.70%

	Pre & Post Gaps	AGC Time	Servo Sync	SAM	Index	Gray code (12 bits)	DC Erase	A,B&C Bursts (each)
µs	1.801	3.301584472	1.5007202	1.388166	0.337662	4.051945	0.337662048	1.575756225
Ckls	48.00361807	88	40	37	9	108	9	42
Total Sevo Burst length =		17.446	µs =	465.00362	T			

Zone	Zone Rod	Zone Rid	Cyls	Max. FC/in.	Data Rate [Mb/s]	Fclk [MHz]	Fmax [MHz]	½Twindow [nS]	ID time [µs]	Sect. time [µs]	Sect/burst w/o split	Time left [µs]	Preamble & AM [µs]	Split Sect	Total Sect (incl. spares)	Zone Cap per surface
OD		1.7992														
System	1.7992	1.7972	5	32127	29.02	43.529	10.882	11.49	6.34	149.97	1	39.115	4.96	16	93	236800
0	1.7972	1.7294	200	41508	36.08	54.118	13.529	9.24	5.10	120.63	1	69.859	3.99	42	118	12032000
1	1.7294	1.6755	159	42843	36.08	54.118	13.529	9.24	5.10	120.63	1	69.859	3.99	42	118	9565440
2	1.6755	1.5948	238	45011	36.08	54.118	13.529	9.24	5.10	120.63	1	69.859	3.99	42	118	14318080
3	1.5948	1.5447	148	45083	35.00	52.500	13.125	9.52	5.26	124.34	1	65.964	4.11	38	114	8600576
4	1.5447	1.5013	128	45217	34.12	51.176	12.794	9.77	5.39	127.56	1	62.595	4.22	34	112	7307264
5	1.5013	1.4477	158	45273	32.94	49.412	12.353	10.12	5.59	132.11	1	57.821	4.37	30	108	8696320
6	1.4477	1.3840	188	45399	31.58	47.368	11.842	10.56	5.83	137.81	1	51.850	4.56	27	104	9962496
7	1.3840	1.3237	178	45095	30.00	45.000	11.250	11.11	6.13	145.07	1	44.250	4.80	20	97	8794624
8	1.3237	1.2599	188	45209	28.63	42.941	10.735	11.64	6.43	152.02	1	36.962	5.03	16	93	8903680
9	1.2599	1.1928	198	45594	27.33	41.000	10.250	12.20	6.73	159.22	1	29.421	5.27	11	88	8870400
10	1.1928	1.1393	158	45203	25.88	38.824	9.706	12.88	7.11	168.15	1	20.068	5.56	5	83	6673920
11	1.1393	1.0586	238	44963	23.92	35.882	8.971	13.93	7.69	181.93	1	5.627	6.02	0	78	9443840
12	1.0586	1.0186	118	45580	23.33	35.000	8.750	14.29	7.89	186.51	1	0.821	6.17	0	74	4440576
13	1.0186	0.9718	138	45044	22.00	33.000	8.250	15.15	8.36	197.82	0	186.795	6.55	71	69	4839936
14	0.9718	0.9115	178	45115	20.67	31.000	7.750	16.13	8.90	210.58	0	186.185	6.97	65	65	5878272
15	0.9115	0.8301	240	44743	18.67	28.000	7.000	17.86	9.86	233.14	0	185.107	7.71	59	58	7065600
ID	0.8301		2853													

Total cap = 541.5721
% of goal = 100.01%

Bytes/surface = 135393024
Bytes/disk = 270786048

Maverick 270/540 Frequency Table

Zone	DataRate Mb/s	VCO MHz	OD Cyl	ID Cyl	# of cyl	Max. FCI	HF MHz	LF MHz	½ Twin nS	Synthesizer	
										Feedback	Prescaler
System	29.0196	43.5294	-5	-1	5	32127	10.8824	2.7206	11.4865	74	17
0	36.0784	54.1176	0	199	200	41508	13.5294	3.3824	9.2391	92	17
1	36.0784	54.1176	200	358	159	42843	13.5294	3.3824	9.2391	92	17
2	36.0784	54.1176	359	596	238	45011	13.5294	3.3824	9.2391	92	17
3	35.0000	52.5000	597	744	148	45083	13.1250	3.2813	9.5238	84	16
4	34.1176	51.1765	745	872	128	45217	12.7941	3.1985	9.7701	87	17
5	32.9412	49.4118	873	1030	158	45273	12.3529	3.0882	10.1190	84	17
6	31.5789	47.3684	1031	1218	188	45399	11.8421	2.9605	10.5556	90	19
7	30.0000	45.0000	1219	1396	178	45095	11.2500	2.8125	11.1111	81	18
8	28.6275	42.9412	1397	1584	188	45209	10.7353	2.6838	11.6438	73	17
9	27.3333	41.0000	1585	1782	198	45594	10.2500	2.5625	12.1951	82	20
10	25.8824	38.8235	1783	1940	158	45203	9.7059	2.4265	12.8788	66	17
11	23.9216	35.8824	1941	2178	238	44963	8.9706	2.2426	13.9344	61	17
12	23.3333	35.0000	2179	2296	118	45580	8.7500	2.1875	14.2857	63	18
13	22.0000	33.0000	2297	2434	138	45044	8.2500	2.0625	15.1515	66	20
14	20.6667	31.0000	2435	2612	178	45115	7.7500	1.9375	16.1290	62	20
15	18.6667	28.0000	2613	2852	240	44743	7.0000	1.7500	17.8571	56	20

Zone	Interval lengths													
	2T		3T		4T		5T		6T		7T		8T	
	MHz	nS	MHz	nS	MHz	nS	MHz	nS	MHz	nS	MHz	nS	MHz	nS
System	10.882	45.946	7.255	68.919	5.441	91.892	4.353	114.865	3.627	137.838	3.109	160.811	2.721	183.784
0	13.529	36.957	9.020	55.435	6.765	73.913	5.412	92.391	4.510	110.870	3.866	129.348	3.382	147.826
1	13.529	36.957	9.020	55.435	6.765	73.913	5.412	92.391	4.510	110.870	3.866	129.348	3.382	147.826
2	13.529	36.957	9.020	55.435	6.765	73.913	5.412	92.391	4.510	110.870	3.866	129.348	3.382	147.826
3	13.125	38.095	8.750	57.143	6.563	76.190	5.250	95.238	4.375	114.286	3.750	133.333	3.281	152.381
4	12.794	39.080	8.529	58.621	6.397	78.161	5.118	97.701	4.265	117.241	3.655	136.782	3.199	156.322
5	12.353	40.476	8.235	60.714	6.176	80.952	4.941	101.190	4.118	121.429	3.529	141.667	3.088	161.905
6	11.842	42.222	7.895	63.333	5.921	84.444	4.737	105.556	3.947	126.667	3.383	147.778	2.961	168.889
7	11.250	44.444	7.500	66.667	5.625	88.889	4.500	111.111	3.750	133.333	3.214	155.556	2.813	177.778
8	10.735	46.575	7.157	69.863	5.368	93.151	4.294	116.438	3.578	139.726	3.067	163.014	2.684	186.301
9	10.250	48.780	6.833	73.171	5.125	97.561	4.100	121.951	3.417	146.341	2.929	170.732	2.563	195.122
10	9.706	51.515	6.471	77.273	4.853	103.030	3.882	128.788	3.235	154.545	2.773	180.303	2.426	206.061
11	8.971	55.738	5.980	83.607	4.485	111.475	3.588	139.344	2.990	167.213	2.563	195.082	2.243	222.951
12	8.750	57.143	5.833	85.714	4.375	114.286	3.500	142.857	2.917	171.429	2.500	200.000	2.188	228.571
13	8.250	60.606	5.500	90.909	4.125	121.212	3.300	151.515	2.750	181.818	2.357	212.121	2.063	242.424
14	7.750	64.516	5.167	96.774	3.875	129.032	3.100	161.290	2.583	193.548	2.214	225.806	1.938	258.065
15	7.000	71.429	4.667	107.143	3.500	142.857	2.800	178.571	2.333	214.286	2.000	250.000	1.750	285.714

16.4 Maverick Read/Write channel block diagram

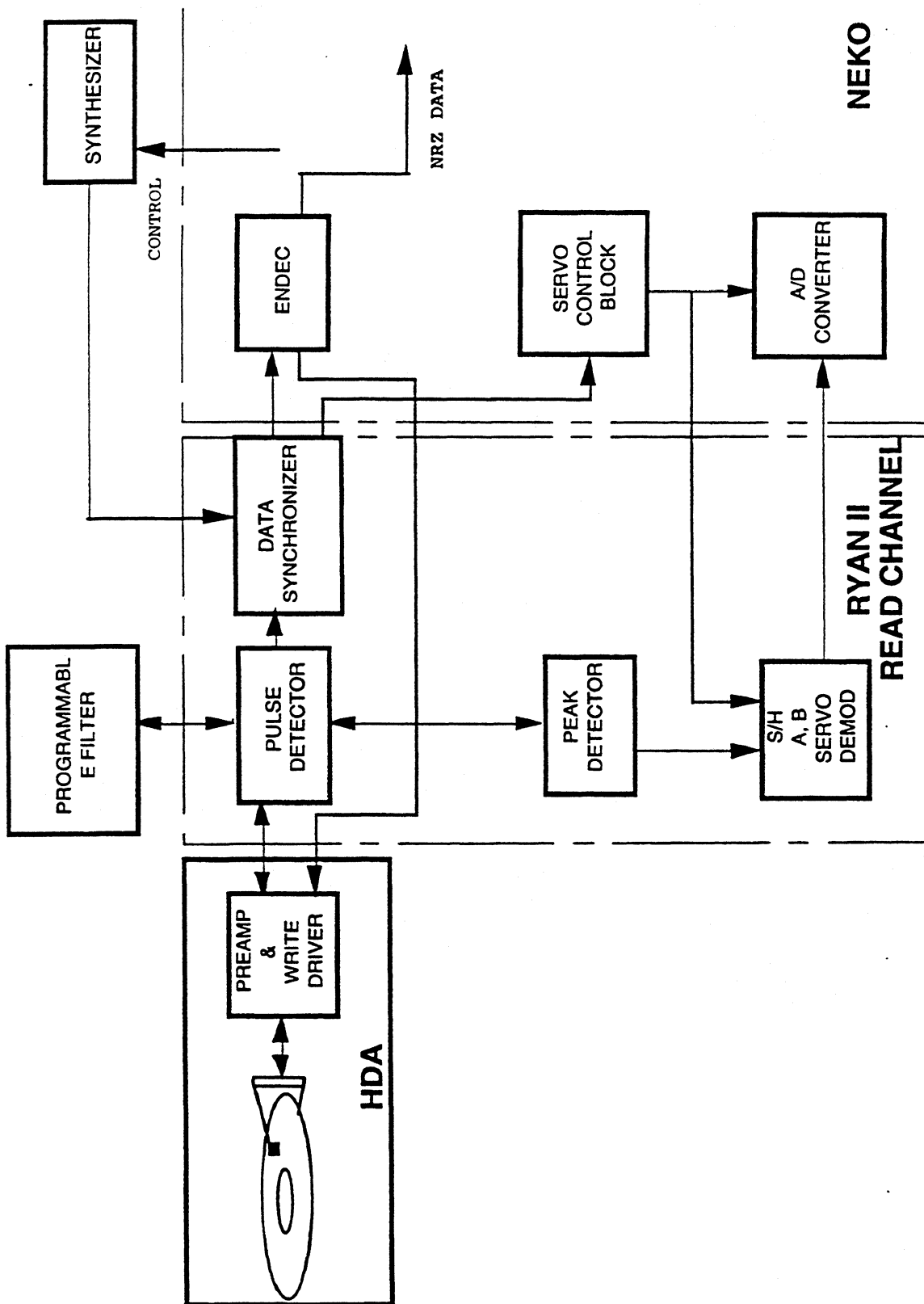

Figure 16-1 Maverick Read/Write Block Diagram

DRIVE SPECIFICATION

	Maverick 270	Maverick 540
1 Model		
2 Capacity Available to User (MB)	270	540
3 Interface (IDE, SCSI2 Fast, etc)	AT/SCSI2 Fast	AT/SCSI2 Fast
Interface Part (Mfg & Model)	Quantum Neko	Quantum Neko
Will Hot Plugging cause damage?	No	No
Will Hot Plugging corrupt bus?	TBD	TBD
4 Sustained I/F Transfer Rate (MB/s)	TBD	TBD
Transfer Rate @ Head (Mb/s)	36	36
Spindle RPM	3,600	3,600
Avg. Seek Time (typ/max ms)	14/28	14/28
Seek Time for 1 Cyl (typ/max ms)	5	5
Buffer Size (KB)	96	96
# Buffer Segments	4	4
Command Overhead (µs)	<1	<1
Track Skew (ms)	6	6
Cylinder Skew (ms)	6.8	6.8
Spinup Time (max sec)	8	8
5 # Data Cylinders (physical)	2,853	2,853
# Reserved Cylinders	5	5
# Data Heads (physical)	2	4
# Sectors/Track or . . .		
Table if Zoned Recording	See Product Manual	See Product Manual
Sector Interleave Factor	1	1
# Data Bytes/Sector	512	512
# Defect Mgmt Sectors/Cylinder	2	2
# Defect Mgmt Cylinders/Drive	0	0
Format Efficiency (%)	82%	82%
6 Power Supply Regulation Required	12V +10%/-8%	12V +10%/-8%
	5V +/-5%	5V +/-5%
Power Supply Ripple Limit	100mV @ 12V	100mV @ 12V
	50mV @ 5v	50mV @ 5v
Peak Amps @ Spinup	12V 1.0	12V 1.0
	5V 0.7	5V 0.7
Power @ Idle Spin (RMS W)	3.7	3.7
Power @ Random Rd/Wrt (RMS W)	5.2	5.2
Power @ Low Power Mode (RMS W)	<1	<1
7 Operating Temperature Range (°C)	4 to 50	4 to 50
Air Flow Requirement	TBD	TBD
Humidity Range (operating)	8 to 85%	8 to 85%
Incident E-Field Limit	10/m 0.2-20MHz	10/m 0.2-20MHz
Incident B-Field Limit	0.5 Gauss	0.5 Gauss
Operating Vibration/Shock Limits	1.0/10.0 G	1.0/10.0 G
NonOp Vibration/Shock Limits	2.0/70.0 G	2.0/70.0 G
Power Cycle/Start-Stop Limit	20,000	20,000
Sound Power @ Idle Spin (mean/max)	0/1.5	0/1.5
Sound Power @ Random Read (mean/max)	3/5.0	3/5.0
Weight	<1 lb.	<1 lb.
8 Mean Time Between Failure (Hrs)	300,000	300,000

HARDWARE SPECIFICS

	Maverick 270	Maverick 540
1 Model		
2 Areal Density (Mb/Inch ²)	178.8	178.8
Tracks/Inch	2,950	2,950
Bits/Inch (max)	60,603	60,603
Flux Changes/Inch (max)	45,566	45,566
Servo Type (Dedicated, etc)	Embedded	Embedded
Write Threshold (% of Track)	10	10
Read Detect Threshold (% of Track)	20	20
Read/Write Encoding Method	1,7	1,7
Encode/Decode Table (separate)		
3 Spin Motor Torque Constant	170 g-cm/A	170 g-cm/A
Spin Motor Type/Configuration	8 Pole, 9 Slot, Fixed Shaft	8 Pole, 9 Slot, Fixed Shaft
Starting Torque Available ... from Spin Motor (min)	146.5 g-cm	146.5 g-cm
Starting Torque Required by ... Head/Disk Interface (max)	TBD	112 g-cm
4 Latch Type (Magnetic, Solenoid)	AIRLOCK™	AIRLOCK™
Force Required to ... Pull Out of Latch (max)	3,100 RPM .20 g-cm	3,100 RPM .20 g-cm
Actuator Type	Voice Coil	Voice Coil
Actuator Force Constant	730 g-cm/A	829 g-cm/A
Actuator Coil Amps (max)	5	5
Actuator Moment of Inertia	48.25 g-cm ²	48.25 g-cm ²
Force Available to ... Pull Out of Latch (min)	3,600 RPM	3,600 RPM
5 Head Design Type	Thin Film	Thin Film
Nominal Head Fly Height (µin)	3	3
Min/Max Head Fly Height (µin)	2.25/3.75	2.25/3.75
Head Launch Velocity	3 m/sec	3 m/sec
Head Gap Width	3.5 µm	3.5 µm
Magnetic Track Width	6.5µm	6.5µm
Head Gap Length	11.5 µm	11.5 µm
Head Gram Load	7 gm	7 gm
Head Amplitude (min)	200µV	200µV
Head Resolution (min)	65%	65%
Head Overwrite (max)	26 db	26 db
Head Signal/Noise Ratio (min)	28 db	28 db
6 Media Coercivity	1,550 Oe	1,550 Oe
Media Glide Height	2.0µ"	2.0µ"
Media Roughness	400 nm	400 nm
Media Lube Thickness @ ID	200 Å	200 Å
Media Lube Thickness @ OD	200 Å	200 Å
Media Amplitude (min)	200µV	200µV
Media Resolution (min)	65%	65%
Media Overwrite (max)	26 dB	26 dB

7 Outer Crash Stop Radius	<u>1.8043"</u>	<u>1.8043"</u>
Outer Data Track Radius	<u>1.7975"</u>	<u>1.7975"</u>
Inner Data Track Radius	<u>.8310"</u>	<u>.8310"</u>
Inner Crash Stop Radius	<u>.761"</u>	<u>.761"</u>

8 Agency Certification

Yes or No (with expected date)

UL	<u>Yes</u>	<u>Yes</u>
CSA	<u>Yes</u>	<u>Yes</u>
TUV	<u>Yes</u>	<u>Yes</u>
FCC	<u>Yes</u>	<u>Yes</u>

MAVERICK FIRMWARE

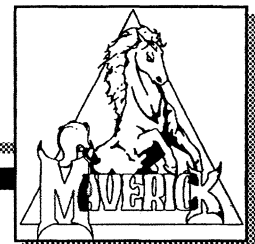

Firmware

for

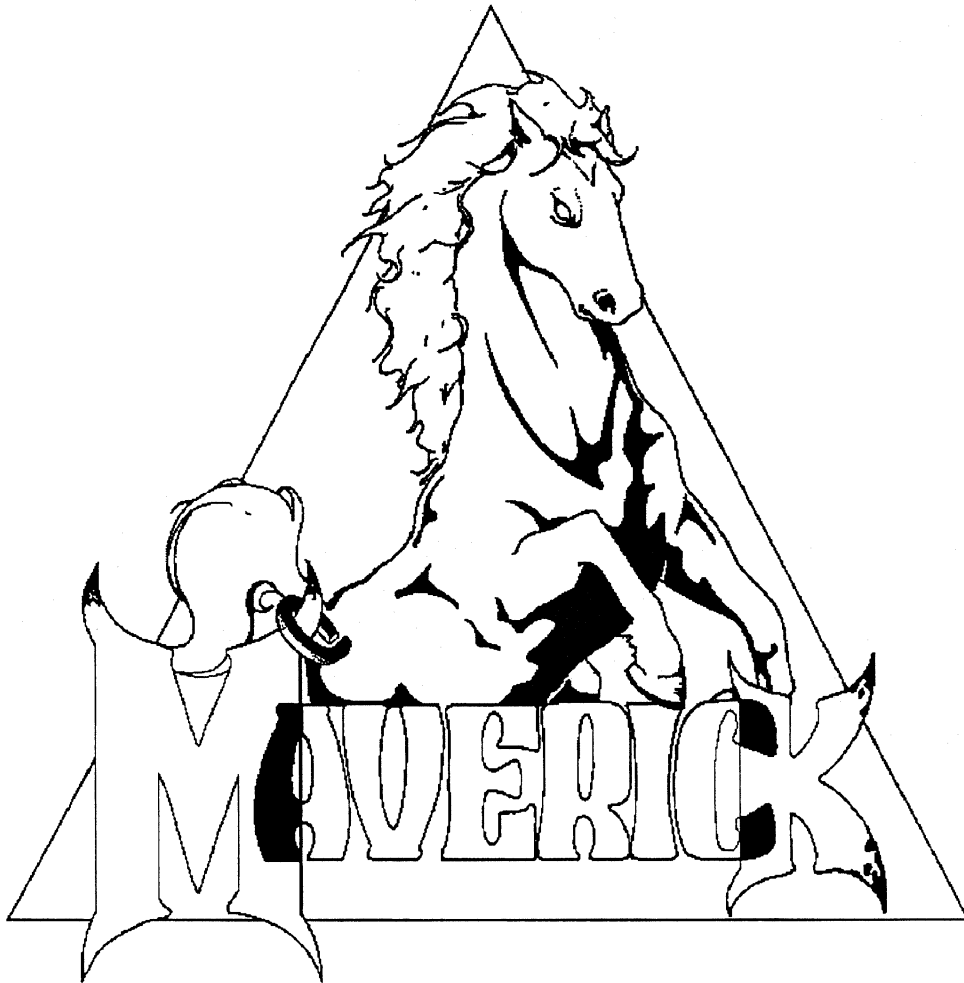

*By Donald Orbin
Quantum Corporation
August 3, 1994*

Quantum Firmware Migration Path

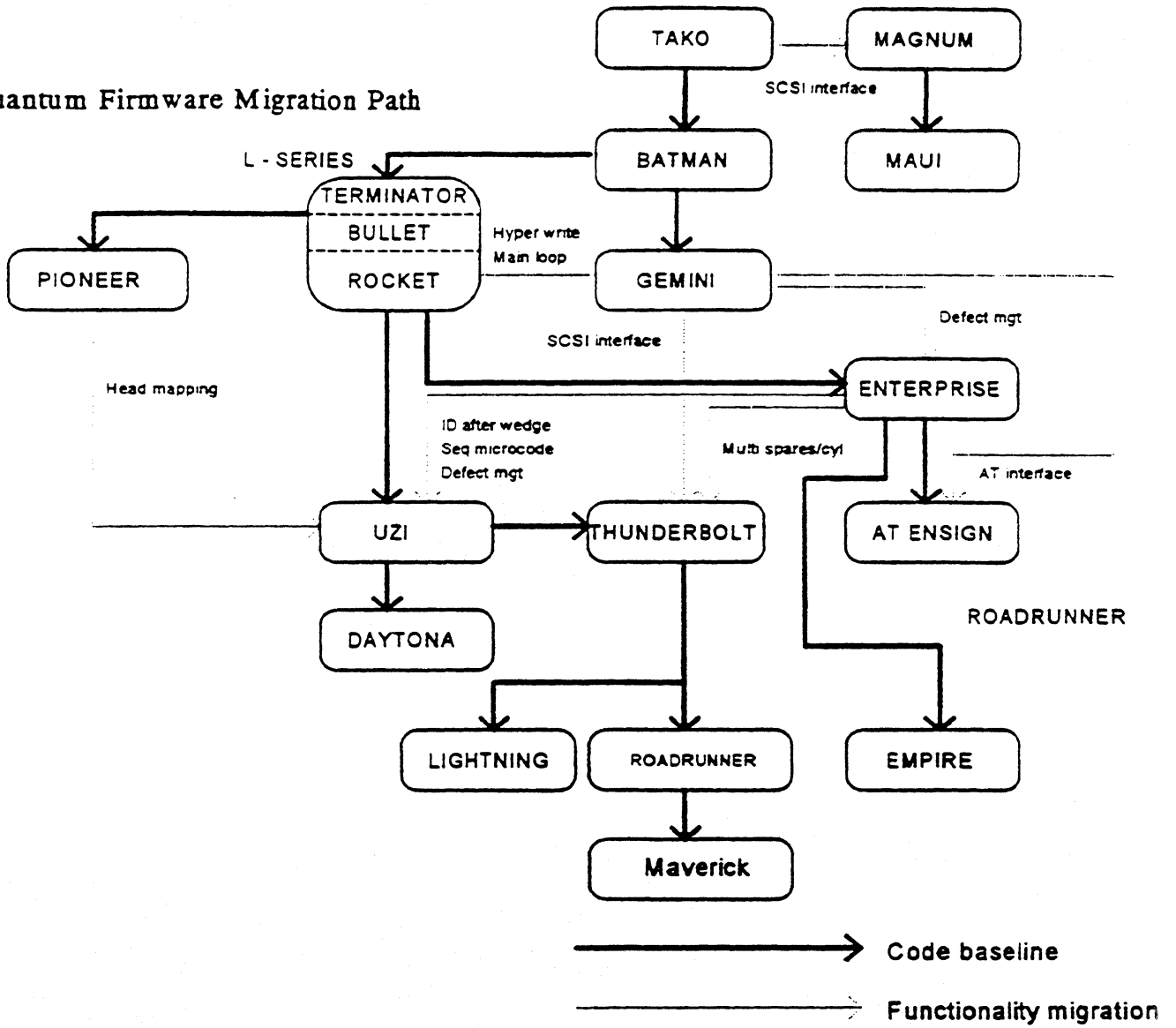

Firmware Overview / Features

- Leveraged from RoadRunner firmware
- Supports NEC 78352 processor and Neko ASIC (Koni follow on)
- Maintained RoadRunner firmware design overall
- Supports Drive Parameter Analysis (AT only)
- Committed to support new field firmware release and diskware download
- Initialization same as RoadRunner
- Maintained same Configuration / Mode Select as RoadRunner

Maverick PP2 Firmware

Differences from RoadRunner

Change	Reason	Implication
Wiggle recovery procedure. (In PP2 F/W)	RoadRunner used MIG head design on their HDA. Maverick HDA has thin film heads as used on the Thunderbolt HDA. Thin film heads known for "Barkhausen" noise phenomenon. Recovery procedure required for certain media related errors.	Possibly longer SelfScan time if test is added to determine head susceptibility to Barkhausen noise.
Geometry parameter changes (In PP1 F/W)	Different capacity. New TPI, maximum number of tracks, sectors per track, etc.	Needed for capacity.
LBA mode support. (In PP2 F/W)	2 platter capacity exceeds BIOS limited 528mb capacity. LBA mode added to support addressing above this limit. Note: Customers have devised alternate C:H:S methods to get around this limitation. LBA will become more standard in 1995!	Thunderbolt implementation added.
Adaptive Equalization. (In Process Test at PP2)	Wider variety of heads and media combinations warrant maximizing each head for each surface.	Longer test process time as the heads are optimized for each surface.
Cache algorithm. (In PP2 F/W)	Increase probability of a cache hit.	Better benchmark performance.
External Diskware patches moved to internal ROM. (In PP2 F/W)	Free up Diskware space to allow for new Diskware patches.	None.
Interface fixes for IBM AT Loop test. (In PP2 F/W)	RoadRunner AT never went through an IBM Qualification so some IBM specific issues still remain.	Will use Thunderbolt code as a starting point. Maverick still needs testing IBM compatibility testing to identify problem areas.

FIRMWARE ORGANIZATION

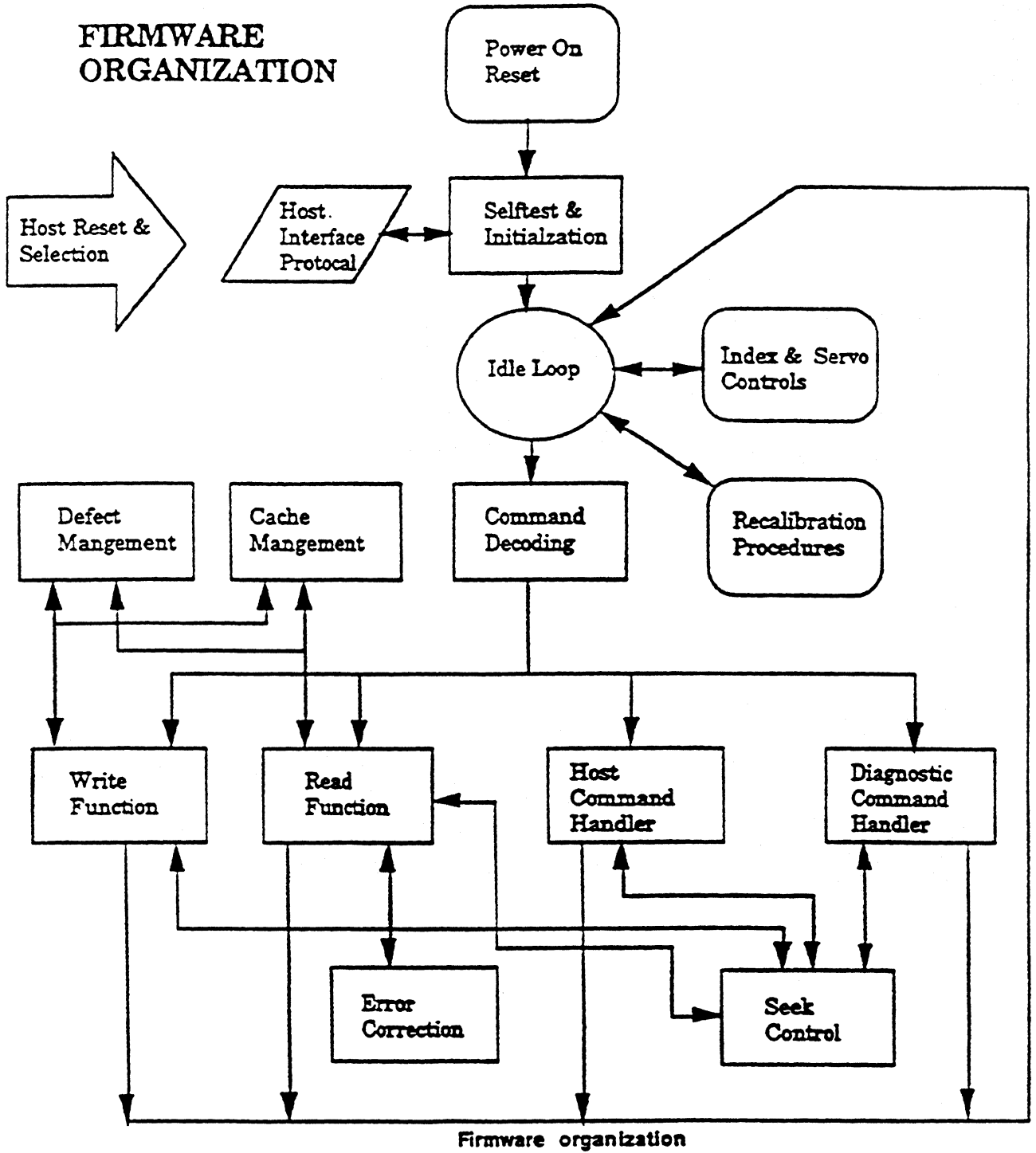

Diskware

Introduction

The Maverick architecture has been designed to support diskware. Part of the Buffer memory is used to load firmware from disk and the processor is able to execute the firmware directly from the buffer.

Memory Map

The memory map for MAVERICK is organized as follows:

<u>Address Range</u>	<u>Length</u>	<u>Description</u>
0000h - 7FFFh	32K	CPU ROM.
8000h - DFFFh	24K	Diskware code.
E000h - EFFFh	4K	Buffer access - floating block 1.
F000h - FAFFh	2.8K	Buffer access - floating block 2.
FB00h - FC7Fh	384	ASIC.
FC80h - FEFFh	640	Internal ram.
FF00h - FFFFh	256	Internal special function registers.

The firmware is partitioned between the CPU ROM and the Diskware. The CPU ROM code contains all of the routines necessary to power up the drive and read the diskware into the Buffer. It also contains routines that allow the Diskware to be written to the disk via the host interface. All time critical code is located in the CPU ROM because the processor is able to execute CPU ROM code much faster than Diskware code. The Diskware code contains non time critical code that is not required for powering up the drive. The Diskware code also contains provisions to allow firmware bugs in the CPU ROM code to be corrected by mapping erroneous subroutines from CPU ROM into the Diskware.

The MAVERICK firmware uses only the address range 8000-DFFF for diskware; it is divided into 2 segments. The first segment name is RESIDENT and the second segment is MAIN. The code in segment RESIDENT cannot be swapped during drive operations. But the code in MAIN segment can be swapped in and out of the memory. This is mainly used by Selfscan and Drive Parameter Analysis codes.

Diskware Code Organization

The diskware code space is partitioned into two parts, a resident part and an overlay part. The Resident diskware is loaded during the drive power up initialization and remains in memory while the drive is powered on. The Overlay diskware is loaded on an as needed basis, at present there are three tasks defined: Selfscan, Drive Parameter Analysis (former Apple Burn-in), and normal operation.

<u>Address Range</u>	<u>Description</u>
8000 - BFFF	Resident Diskware Vector Table Code
C000 - DFFF	Overlay Diskware 1 - Normal Operating Code Code 2 - Selfscan Code Code 3 - Drive Parameter Analysis Code

The Resident Diskware contains a vector table which is used by the CPU ROM code for accessing Diskware subroutines and data, and for mapping erroneous CPU ROM subroutines into Diskware subroutines. During power up initialization a default vector table is copied from CPU ROM, this is replaced by the actual vector table when the Diskware is loaded from disk.

The Maverick firmware has only rudimentary overlay management, in general because of speed considerations it is the responsibility of the calling routine to ensure that the required Overlay is loaded.

Diskware Storage Requirements

The diskware is stored on reserved system cylinders in memory image format. Configuration page 15 specifies where the overlays are stored on the system cylinders and where the overlays are loaded into the processor memory. Generally system cylinder information is stored in multiple places for redundancy, the overlay configuration page only specifies where the first copy of the diskware is stored. Redundant copies of the diskware are stored according to the firmware redundancy algorithm for system cylinder information. The Maverick firmware stores redundant system cylinder information on all physical heads in system cylinder areas.

Configuration Page 15 - Overlay Page

<u>Field Offset</u>	<u>Description</u>
0	00h - Overlay 0 - Vector Table.
1	Load address.
3	Number of sectors.
4	Cylinder.
6	Head.
7	Starting sector.
8	01h - Overlay 1 - Resident diskware.
9-15	Same fields as above.
16	02h - Overlay 2 - Normal operating diskware.
17-23	Same fields as above.
...	03h-06h - Overlays - Selfscan diskware
	07h - Overlay 7 - Drive Parameter Analysis
64	FFh - End marker.

Overlay Integrity Verification

The integrity of the Resident and Overlay Diskware is checked by means of a checksum and a revision number. The checksum is written in the last address of the overlay and is calculated such that the one byte sum of all the bytes in the overlay is zero. The revision number is used check compatibility between the Resident diskware, Overlay diskware and the CPU ROM code, the revision number is stored at the end of the overlay and has the following format.

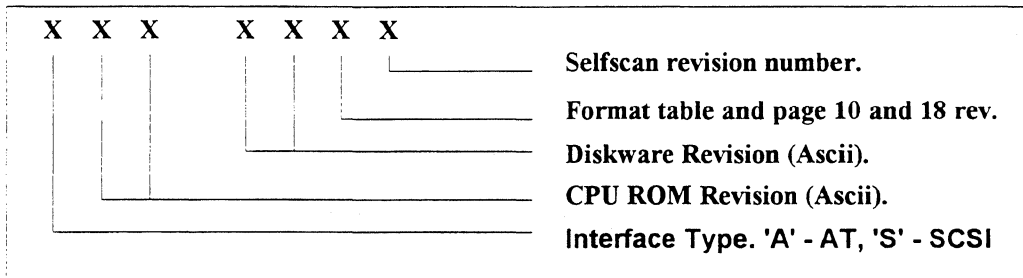

Compatibility between the CPU ROM code and the Resident Diskware code is determined by comparing the revision number of the Resident Diskware with the revision number of the CPU ROM. The codes are compatible if the Interface Type and CPU ROM Revision are equal. Compatibility between the Resident Diskware code and the Overlay Diskware code is also determined by comparing their revision numbers. The codes are compatible if the Interface Type, CPU ROM Revision and Overlay Revision are equal. The Overlay SubRevision code is not used for checking compatibility, it is used to allow the Overlay Diskware (Selfscan code) to be revised independently of the Resident Diskware.

System Cylinders

General Information

Seven cylinders on all drives are reserved for system and test usage. These cylinders contain drive configuration information, drive test information, and diskware. Customers cannot access these reserved cylinders. The reserved cylinders are only accessible with physical address commands which are protected diagnostic commands.

Data is read from and written to these areas according to the firmware redundancy algorithm.

The reserved cylinders are assigned as follows:

<u>Cylinder</u>	<u>Description Outer System Area</u>
-1	Test data
-2	System and firmware data and Diskware
-3	Copy of cylinder -2
-4	Firmware diskware
-5	Copy of cylinder -4
-6	Reserved for future overlays
-7	Reserved for future overlays

Test Equipment Cylinder

The test equipment cylinder is reserved for test process usage. This cylinder contains test parameters and data collected during production test.

The sector usage's are as follows:

Sector	Description	Size
0	Servo Writer	1
1	Test interlock	1
2	Reclassification	1
3-12	History queue	10
13-20	DS defect list	8
21-28	AS defect list	8
29-36	SS defect list	8
37-40	Selfscan test script	4
41-48	Selfscan test results	8
49-52	Selfscan runout results	4
53-54	Selfscan wedge defects	2
55	Selfscan command history	1
56-59	Selfscan reserved	4
60-62	Drive Parameter Analysis	3
63-92	Reserved	30

System / Firmware Cylinder

This cylinder is reserved for system and firmware usage. It contains mode page information, configuration information, defect lists, and format information for the drive.

Description of Sectors (Cylinder -2, -3)

<u>Sector</u>	<u>Description</u>	<u>Size</u>
0	Saved mode pages 1, 2, 20h, 37h, 38h, and 39h	1
1	Saved mode pages 3 and 4	1
2-7	Configuration pages	6
8-12	Working defect list	5
13-17	Primary defect list	5
18-22	Temporary defect list	5
23-39	Format header bytes for 17 zones	17
40	Apple system sector for read/write of OS information	1
41-44	Selfscan overlay 1	4
45-56	Selfscan overlay 2	12
57-68	Selfscan overlay 3	12
69-80	Selfscan overlay 4	12
81-84	Reserved	4
85-88	Reserved for inline sparing --- NA	4
89-92	Reserved	4

Sector usage's of cylinder -4 and -5.

<u>Sector</u>	<u>Description</u>	<u>Size</u>
0-47	Diskware overlays	48
48-63	Reserved	16
64-79	Drive Parameter Analysis overlay	16
80-84	Reserved	5
85-88	Reserved for inline sparing ----NA	4
89-92	Reserved	4

Saved Mode Select Sectors

The data stored on these sectors is only the changeable part of the mode select pages.

Configuration Pages

This area contains the drives configuration information such as the revision level, number of heads, etc.

Defect List Sectors

These sectors contain the defect lists used during the drives normal operation.

Format Header Sectors

In order for the firmware to format the drive, it needs to know the count byte information for the split sector data fields. Since there is no simple algorithm to generate this information, the count bytes must be stored in a table. We allocated 16 sectors on the system cylinder to hold this information. Each sector contains the count byte information for a particular zone.

Cache

- 96K Cache buffer
- Adaptive cache segment control with 1 to 4 segments. Segment size is from 3 x the number of blocks, to 64K.
- Supports partial hit.
- Supports continuous Prefetch to improve performance. Prefetch will overwrite or back fill the requested read data.
- Supports hyper-write (write cache). Deferred error reported as Drive Not Ready maintained until a power cycle.
- Dynamic allocation on write cache segment. Usually 64K to allow for appending on subsequent sequential writes
- Supports Auto Read and Auto Write of 1 block and Auto Transfer
- Compatibility
 - Prefetch only when cache is enabled
 - Auto Read only when cache, Prefetch and Auto Transfer are enabled
 - Auto Transfer (& Auto Read) only in CHS mode (because of task file updating)
 - Auto Transfer (& Auto Read) only with read and write sector commands -- Not Rd/Wr Multiple
 - LBA mode will disregard Auto Transfer and Auto Read settings

MAVERICK Cache Change

Read Cache Optimization (Algorithm same as RRR)

RoadRunneR

During Cache/Prefetch if the block of data requested is larger than the cache segment, the algorithm would extend the ending pointer into the next segment overlapping existing data thus setting the "Dirty" bit in segment being "overlapped". If the next request for data was in the "dirty" segment then data would be retrieved from disk.

Maverick

The handling of data in Cache was changed in that when a block of data requested is larger than the cache segment, the algorithm allows the segment to "overlap" the next, but without setting the "Dirty" bit of the segment being overlapped. What happens is the starting pointer for the segment being "overlapped" is moved and the data is left intact in the buffer for future retrieval from a cache hit.

This allows higher throughput performance on random cache hits as the data is stored longer in cache.

EXAMPLE:

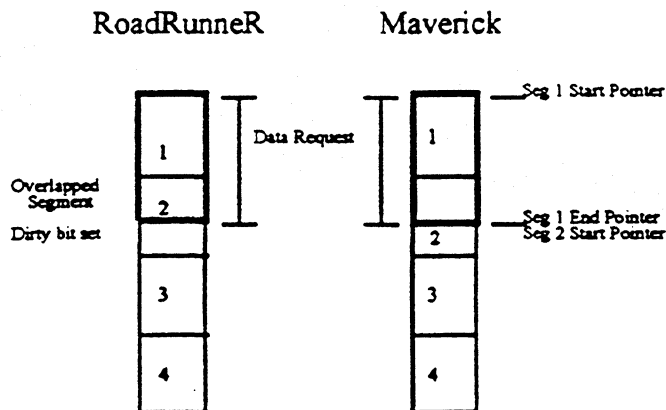

Caching Flow

10/25/9

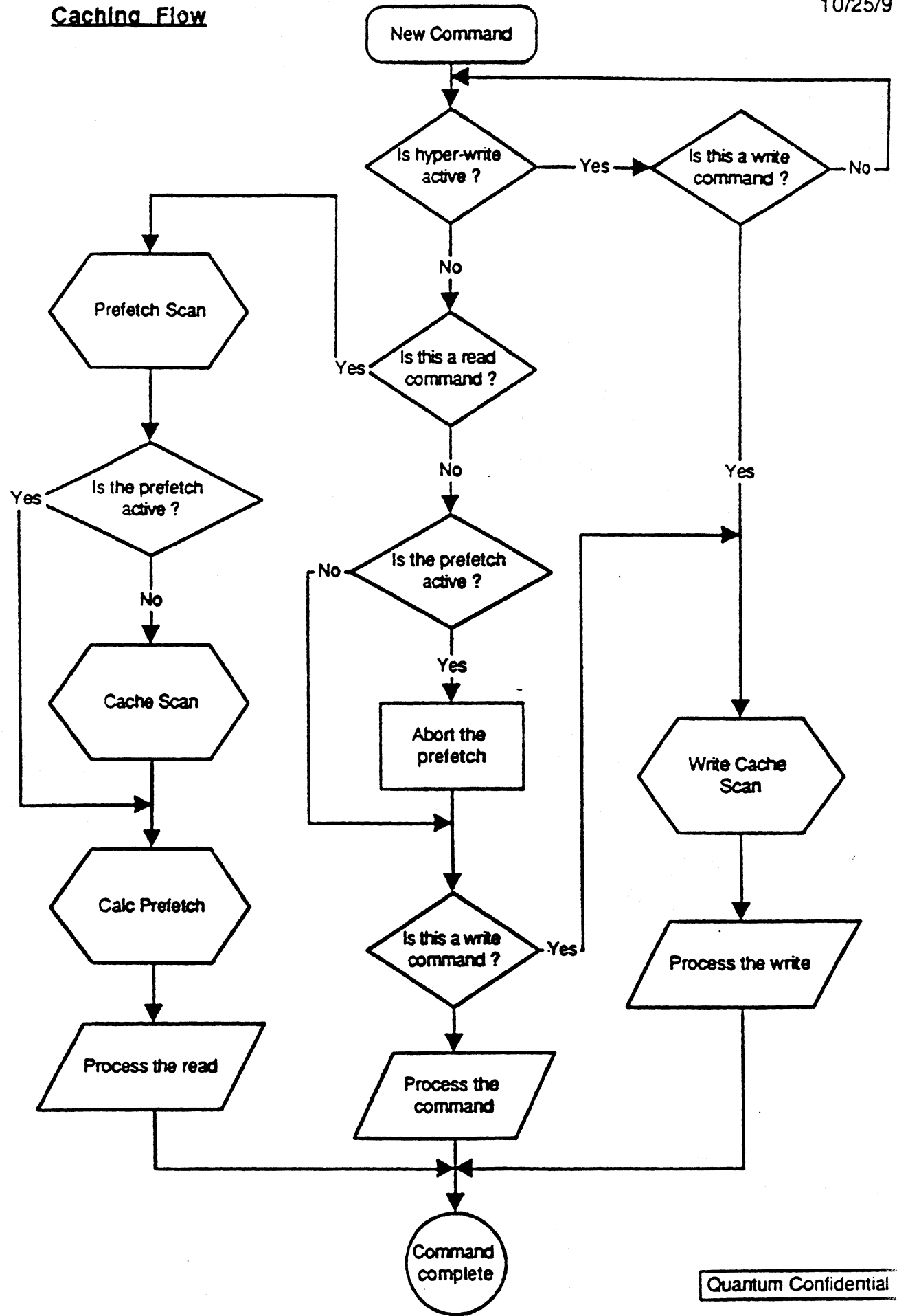

Defect Management

The Defect Lists

Three different lists are stored on system cylinder -2 and -3:

1. Primary defect list (P list) - this list contains the defects found in defect scans at the factory. The P list contains the locations of the defects only. No information regarding their replacement is included.
2. Working list (W list) - typically, the W list is a union of the P and G lists, plus it contains all information necessary to locate the replacement to all defects. Grown defect list (G list) - this list contains the defects found in the field during operation of the drive. All user's reassigned defects (i.e. with Reassign Blocks) and auto-reallocated defects are recorded in this list.
3. Temporary list - During an update of the W list (a block reallocation for example), the old W list is stored to this area before any modifications are made to it. This allows for the recovery of the old list if an abort happens during the generation of the new list.

The host may access the P and G lists with the Read Defect Data SCSI command. The G list is decoded from information stored in the W list.

The W list is used by defect management whenever a logical-to-physical address conversion is called for. This list is not accessible with standard SCSI commands.

Replacement Strategy

Maverick reserves one spare sector per cylinder for 135mb, 270 Mb, 405 Mb and 540 Mb drives; it utilizes two methods for sector replacement - inline and offline sparing.

Inline Sparing

Inline sparing is where a defective sector is replaced by the next immediate sector; all sectors thereafter within the same cylinder is shifted, logically, by one. (see figure 4.1) The access penalty is very small for inline replacement which is one sector time. Whenever possible, defects are spared with inline replacement at the factory. In the unlikely event where there are multiple defects on the same cylinder, additional spare sectors must be allocated from adjacent cylinders. This is defined as offline replacement. Accessing the defective sector requires a short seek and latency. All grown defects are offline spared during drive operation. However, the drive will attempt to inline spare all known defects when a Format Unit command is issued.

Offline Sparing

Off line sparing is where a defective sector is replaced by a spare sector located at the end of a cylinder. Defect management will try to replace the defective sector with a spare on the same cylinder. If this is not possible, as in the case of the spare is already in use, defect management will find a spare sector located on an adjacent cylinder. The disadvantage to this is the performance hit caused by the seek. Figure below contains an example of an offline spare.

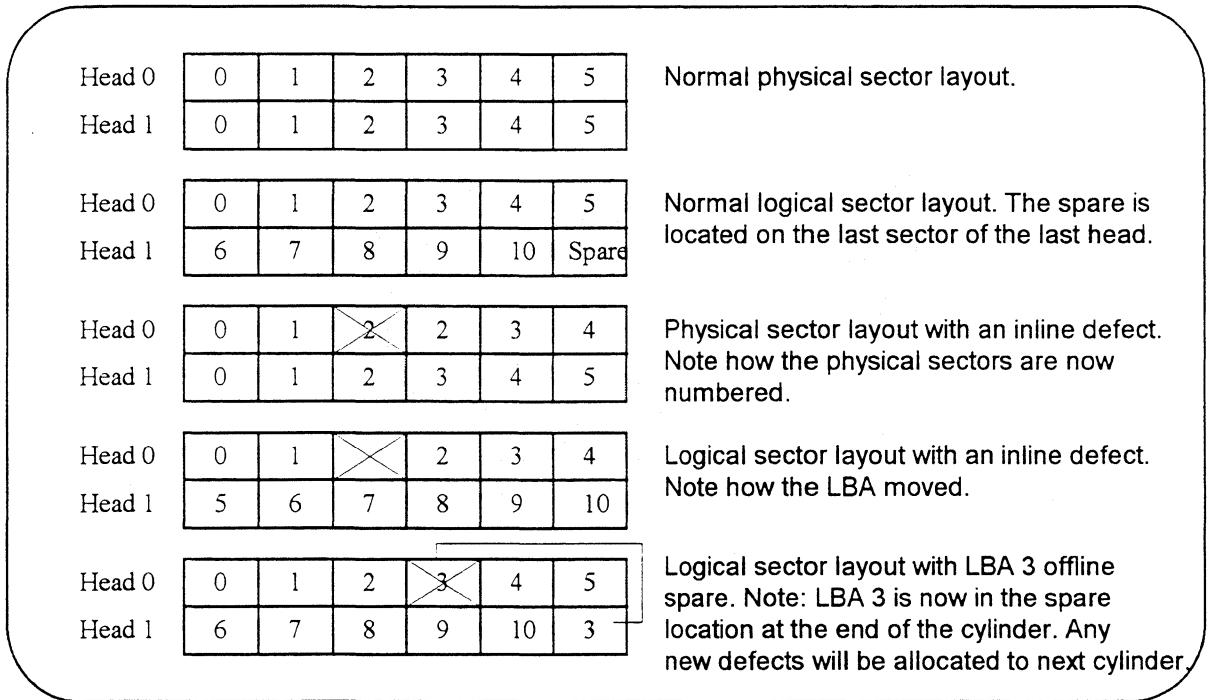

Example of Inline and Offline Sparing

Orphans

An orphan occurs when a replacement sector goes bad. The replacement is assigned a new sector and the original replacement sector is tagged as an orphan in the defect list. It is no longer used. Defect management skips over defect entries that are tagged orphans.

Defect List Data Structure

The defect lists maintained and accessed by the defect management system consist of 7 byte defect entries. The P list contains only defect entries while the W list contains both defect and replacement cylinder information. The defect list structure is illustrated below.

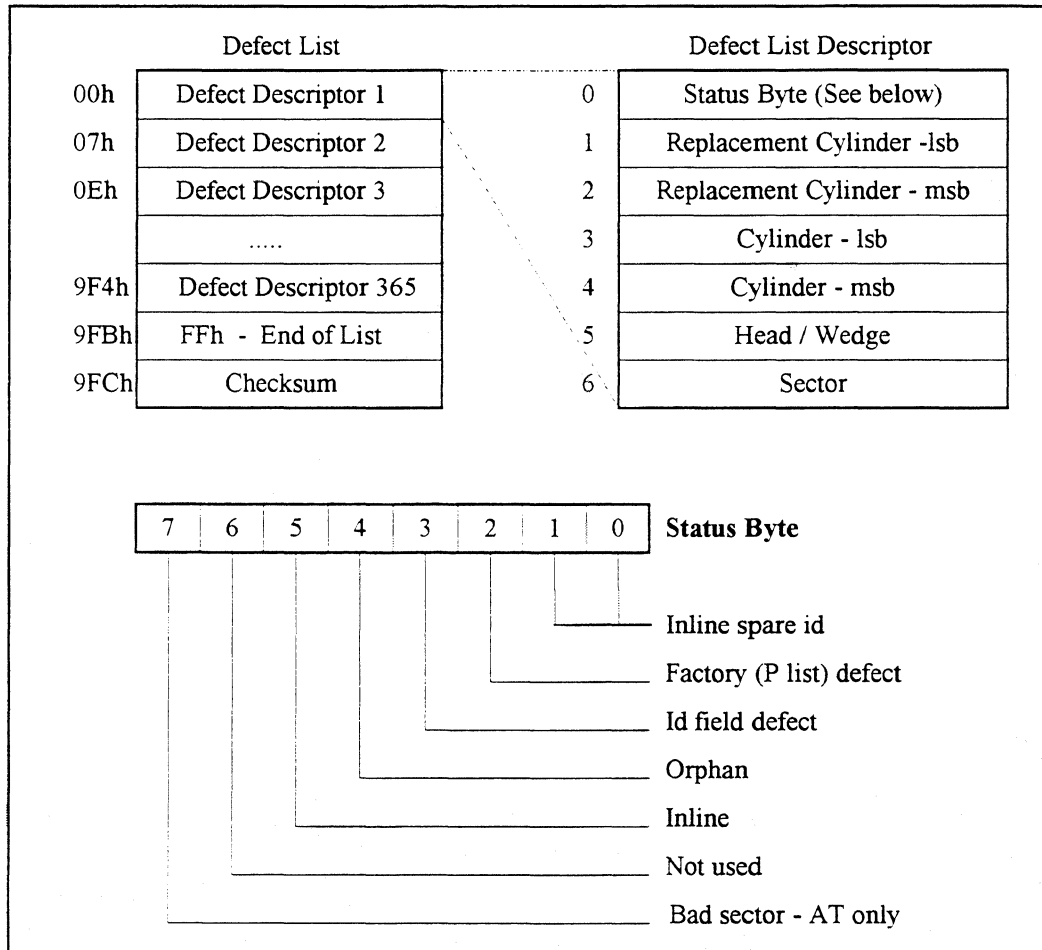

Defect List Data Structure

The end of list marker is placed after the last entry in the list.

The checksum is placed at the end of the list, and the empty area in the list is filled with zeros. When this byte is added to the rest of the bytes in the list, the **lsb** of the checksum will equal ascii 'L'.

Defect type is used to distinguish between P list entries (factory defect) and G list entries (auto reallocated and user reassigned).

Replacement type is used by defect management to find the correct physical sector for a given LBA.

Defect List Storage

Up-to-date versions of the P and W lists are saved on the disk, only the W list needs to be resident in RAM during drive operation. Each defect list may require up to 2560 bytes of storage, therefore, a total of 5 sectors per list are reserved to hold the defect lists on a system track. Since the W list is limited to 2560 bytes in size, a maximum of 365 defects may be recorded in a Maverick drive.

Error Handling

- Has ECC on the fly
- Does have Wiggle/Write Glitch retry
- Read retries
 1. ECC only
 2. ECC on data from ontrack read
 3. ECC on data from ontrack read
 4. ECC on data from positive offtrack read
 5. ECC on data from ontrack read
 6. ECC on data from negative offtrack read
 7. Wiggle retry
 8. ECC on data from ontrack read
- Write retries
 1. Ontrack write operation
 2. Ontrack write
 3. Ontrack write
 4. Ontrack write
 5. Ontrack write
 6. Ontrack write
 7. Wiggle retry
 8. Ontrack write
- Has auto-reallocation on both read error and write error
 1. Unrecovered error
 2. Do write / verifies of block
 3. If media defect
 4. Reallocate to a spare sector with "Apple Bit" sync byte
- Error/Event logging not available

RD_WR_ERROR_RETRY

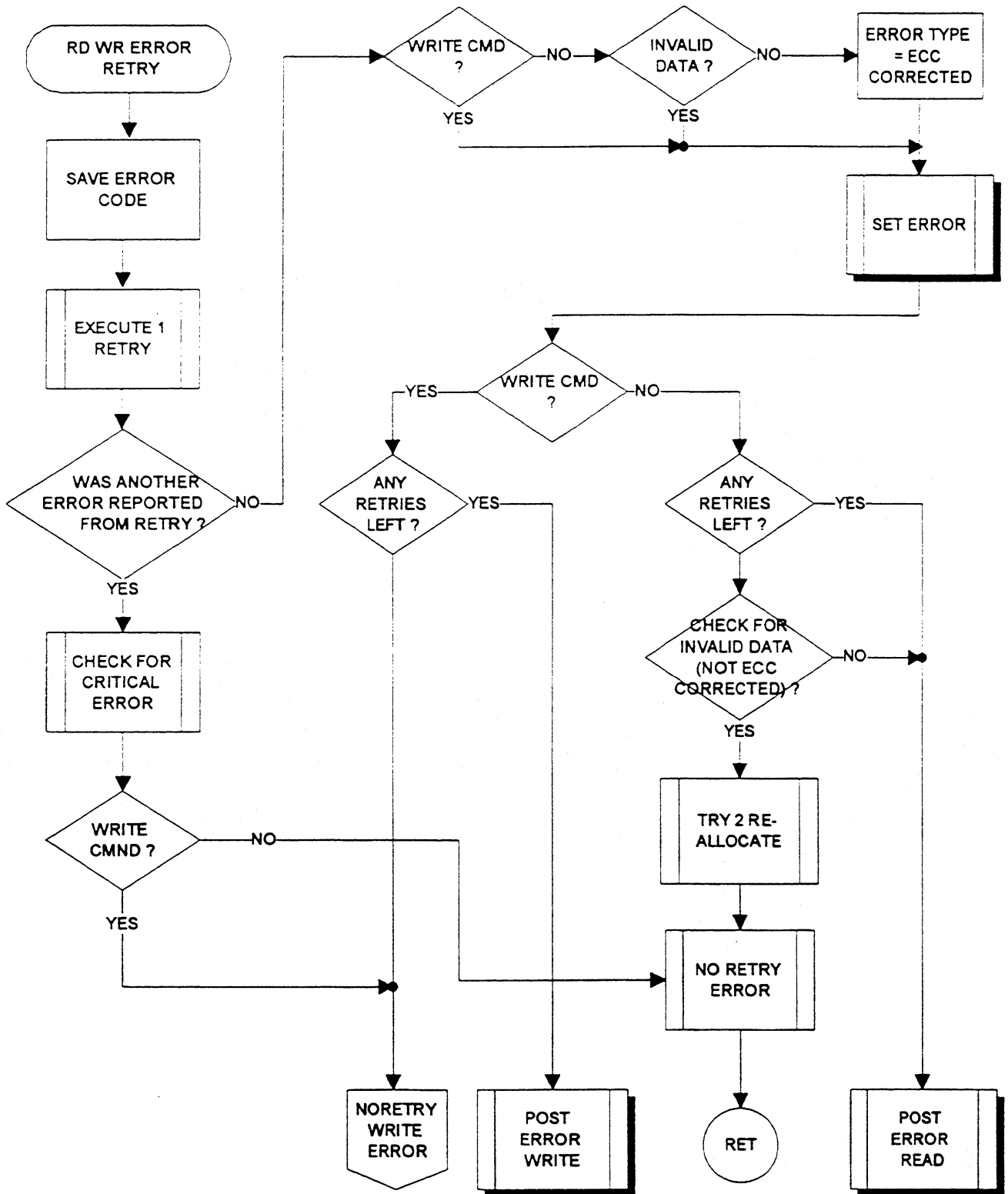

Power Management

- Idle mode
 - This is the normal mode when no disk access task is running (active command, Prefetch or hyper write)
 - The read channel is turned off between servo wedges
- Standby mode
 - Turns off VCM, spindle motor and read channel
 - Any command requiring a disk access will wake up the drive
- Sleep mode
 - Same power management as Standby mode
 - Only a RESET can wake up the drive

Drive Parameter Analysis

- Activate by setting bit 7 of byte 1 on config page 19.
After activating, a power cycle must be performed before continuing.
Until activated, the command Opcode of 0B0h is disabled
- A new command Opcode has been defined as 0B0h
A password is required
04Fh - in Cylinder Low
0C2h - in Cylinder High
- The command function is set in the Features register
 - 0D0h - Return drive attributes
returns 512 bytes of data and writes the attributes to the disk
 - 0D1h - Read warranty failure thresholds
returns 512 bytes of pre-written warranty threshold data
 - 0D2h - Reserved
 - 0D3h - Write current attribute values to disk
writes the attributes to the disk
 - 0D4h - Perform Off-Line data collection
 - 0D5h - Read drive logging sectors
 - 0D6h - Write drive logging sectors
 - 0D7h - Write warranty failure thresholds
writes pre-defined warranty threshold data to the disk
 - 0D8h - Enable failure prediction
enables all of the function decodes
 - 0D9h - Disable failure prediction
disables all of the function decodes except the enable function (0D8h)
 - 0DAh - 0DFh - Reserved
- Only functions 0D0h - 0D3h & 0D7h - 0D9h are implemented on Maverick
- Only 4 attributes are monitored which are all "count" attributes
 - Attribute ID #4 is the Start/Stop count
 - Attribute ID #5 is the Re-allocated sector count
 - Attribute ID #9 is the Power-On hours count
 - Attribute ID #12 is the Power cycle count
- Each attribute consists of a 12 byte data structure
 - byte #1 is the Attribute ID number
 - byte #2 & 3 is the status flag
 - byte #4 is the normalized value
A range from 1 to 100 with 100 as the "new drive" value
 - byte #5 is the worst ever normalized value
the same as byte #4 for count attributes
 - bytes #6-11 are the raw attribute value
 - byte #12 is reserved



Preliminary **New Product Configuration Map**

Page	Name	Empire	Thunderbolt	RoadRunner	Maverick
0	Customer Number	1 Byte Unused	1 Byte 0 Generic 1 Apple 2 Sun 3 Nixdorf 4 Nippon (MEI, Fujitsu)	RoadRunner is currently exactly the same as Thunderbolt because they share the same code.	Maverick is currently exactly the same as Thunderbolt because they share the same code.
1	Jumper Setting	2 Bytes	Same as left	Same as Thunderbolt	Same as Thunderbolt
2	Vendor ID	16 Bytes "QUANTUM"	Same as left	Same as Thunderbolt	Same as Thunderbolt
3	Product ID	16 Bytes	Same as left	Same as Thunderbolt	Same as Thunderbolt
4	Drive Revision	8 Bytes	Same as left	Same as Thunderbolt	Same as Thunderbolt
5	Drive Serial Number	12 Bytes	Same as left	Same as Thunderbolt	Same as Thunderbolt
6	Customer Name	32 Bytes	Same as left	Same as Thunderbolt	Same as Thunderbolt

Page	Name	Empire	Thunderbolt	RoadRunner	Maverick
7	AT Configuration Flags	<p>6 Bytes</p> <p>Byte 0 0 Pg 7 CHS in ID cmd 1 2 3 Save command history 4 5 6 7</p> <p>Byte 1 0-3 Unused 4-5 Unused 6-7 DMA mode 00 Single word 01 Demand -1 10 Demand Mode 11 Unused</p> <p>Bytes 2-3 AT logical cyls/drive Byte 4 AT logical heads/cyl Byte 5 AT logical sect/trk</p> <p>(Ensign AT doesn't use auto transfer on writes. Read auto transfer is controlled by a jump on the PCB)</p>	<p>8 Bytes</p> <p>Byte 0 0 1 2 Diabile wiggle retry 3 Cache debug enable 4 Save command history 5 Auto transfer enable 6 Auto read enable 7 Idle Cmd spins drive down (default = don't spin down)</p> <p>Byte 1 0 Use 528 MB CHS (default = use page 7 CHS) 1-3 Unused 4-5 IO read delay 00 0 ns (default) 01 10 ns 10 20 ns 11 30 ns 6-7 DMA mode 00 Single word 01 Demand -1 10 Demand Mode 11 Unused</p> <p>Bytes 2-3 AT logical cyls/drive Byte 4 AT logical heads/cyl Byte 5 AT logical sect/trk Bytes 6-7 ??</p>	<p>8 Bytes</p> <p>Byte 0 0 1 2 Diabile wiggle retry 3 Cache debug enable 4 Save command history 5 Auto transfer enable 6 Auto read enable 7 Idle Cmd spins drive down (default = don't spin down)</p> <p>Byte 1 0-3 Unused 4-5 IO read delay 00 0 ns (default) 01 10 ns 10 20 ns 11 30 ns 6-7 DMA mode 00 Single word 01 Demand -1 10 Demand Mode 11 Unused</p> <p>Bytes 2-3 AT logical cyls/drive Byte 4 AT logical heads/cyl Byte 5 AT logical sect/trk Bytes 6-7 ??</p>	<p>8 Bytes</p> <p>Byte 0 0 1 return page 7 logical CHS always. 0 return current logical CHS 1 silent servo 2 Disable wiggle retry 3 Cache debug enable 4 Save command history 5 Auto transfer enable 6 Auto read enable 7 Motor status -- Standby Imm 0 = Don't wait for spindle stop when returning status. 1 = Wait for spindle stop</p> <p>Byte 1 0 1 = Slow seek 1 1 = Firmware variable Servo POS_OFFS through all seeks 0 = Clears POS_OFFS with every seek 2-3 Unused 4-5 IO read delay 00 0 ns (default) 01 10 ns 10 20 ns 11 30 ns 6-7 DMA mode 00 Single word 01 Demand -1 10 Demand Mode 11 Unused</p> <p>Bytes 2-3 AT logical cyls/drive Byte 4 AT logical heads/cyl Byte 5 AT logical sect/trk Bytes 6 # minutes to Auto Power Down</p>
8	Number of Heads	1 Byte	Same	Same as Thunderbolt	Same as Thunderbolt
9	Configuration Validation Bytes	0,1,0FF,2,0FE,3,0FD,4,0FC,5,0FB,6,0FA,7,0F9,8	Same	Same as Thunderbolt	Same as Thunderbolt

Page	Name	Empire	Thunderbolt	RoadRunner	Maverick																																																						
10	Software Zone Table	<p>165 bytes</p> <p>0-1 Zone 0 starting cylinder 2-4 Zone 0 starting logical adrs 5 Zone 0 sectors per track 6-7 Zone 0 sectors per zone 8 Zone 0 logical track skew 9 Zone 0 logical cyl skew</p> <p>10-159 Repeated for zones 1-15</p> <p>Byte 165 Track wedge skew Byte 166 Cyl. wedge skew</p>	<p>613 bytes</p> <p>0-1 Zone 0 starting cylinder 2-4 Zone 0 starting logical adrs 5 Zone 0 sectors per track 6-7 Zone 0 sectors per zone 8 Zone 0 logical track skew 9 Zone 0 logical cyl skew 10-37 R/w channel info for this zone</p> <p>28-613 Repeated for zones 1-15</p> <p>Note: Zone 0 is for negative cylinder only. User data is contained in 15 zones. Zone 13 has the wedge skew data for the whole drive.</p>	<p>613 bytes</p> <p>0-1 Zone 0 starting cylinder 2-4 Zone 0 starting logical adrs 5 Zone 0 sectors per track 6-7 Zone 0 sectors per zone 8 Zone 0 logical track skew 9 Zone 0 logical cyl skew 10-37 R/w channel info for this zone</p> <p>28-613 Repeated for zones 1-15</p> <p>Note: Zone 0 is for negative cylinder only. User data is contained in 15 zones. Zone 13 has the wedge skew data for the whole drive.</p>	<p>613 bytes</p> <p>0-1 Zone 0 starting cylinder 2-4 Zone 0 starting logical adrs 5 Zone 0 sectors per track 6-7 Zone 0 sectors per zone 8 Zone 0 logical track skew 9 Zone 0 logical cyl skew 10-37 R/w channel info for this zone</p> <p>28-613 Repeated for zones 1-15</p> <p>Note: Zone 0 is for negative cylinder only. User data is contained in 15 zones. Zone 13 has the wedge skew data for the whole drive.</p>																																																						
11	Number of User Accessable Sectors	3 Bytes	Same as left	Same as Thunderbolt	Same as Thunderbolt (1sb first)																																																						
12	Trigger Mask	<p>1 Byte</p> <p>0 1 Motor interrupt 2 3 4 ECC error 5 Sequencer rd/wr error 6 Courtesy retry 7 Sequencer timeout</p>		Same as Thunderbolt	<p>1 Byte</p> <p>0 1 Seek Timeout 2 Seek Fault 3 4 ECC error 5 Sequencer rd/wr error 6 Sequencer over/underrun 7 Sequencer timeout</p>																																																						
13	Drive Family and Model	<p>2 Bytes</p> <table border="1"> <thead> <tr> <th>Byte 0</th> <th>Byte 1</th> <th>Model</th> </tr> </thead> <tbody> <tr> <td>10</td> <td>0</td> <td>?? 540</td> </tr> <tr> <td>10</td> <td>1</td> <td>?? 1080</td> </tr> </tbody> </table>	Byte 0	Byte 1	Model	10	0	?? 540	10	1	?? 1080	<p>2 Bytes</p> <table border="1"> <thead> <tr> <th>Byte 0</th> <th>Byte 1</th> <th>Model</th> </tr> </thead> <tbody> <tr> <td>2</td> <td>0</td> <td>LP 131</td> </tr> <tr> <td>2</td> <td>1</td> <td>LP 262</td> </tr> <tr> <td>2</td> <td>2</td> <td>LP 540</td> </tr> </tbody> </table>	Byte 0	Byte 1	Model	2	0	LP 131	2	1	LP 262	2	2	LP 540	<p>2 Bytes</p> <table border="1"> <thead> <tr> <th>Byte 0</th> <th>Byte 1</th> <th>Model</th> </tr> </thead> <tbody> <tr> <td>9</td> <td>0</td> <td>??90</td> </tr> <tr> <td>9</td> <td>1</td> <td>??180</td> </tr> <tr> <td>9</td> <td>2</td> <td>??270</td> </tr> <tr> <td>9</td> <td>3</td> <td>??360</td> </tr> <tr> <td>9</td> <td>17</td> <td>??137</td> </tr> </tbody> </table>	Byte 0	Byte 1	Model	9	0	??90	9	1	??180	9	2	??270	9	3	??360	9	17	??137	<p>2 Bytes</p> <table border="1"> <thead> <tr> <th>Byte 0</th> <th>Byte 1</th> <th>Model</th> </tr> </thead> <tbody> <tr> <td>17</td> <td>0</td> <td>135</td> </tr> <tr> <td>17</td> <td>1</td> <td>270</td> </tr> <tr> <td>17</td> <td>2</td> <td>405</td> </tr> <tr> <td>17</td> <td>3</td> <td>540</td> </tr> </tbody> </table>	Byte 0	Byte 1	Model	17	0	135	17	1	270	17	2	405	17	3	540
Byte 0	Byte 1	Model																																																									
10	0	?? 540																																																									
10	1	?? 1080																																																									
Byte 0	Byte 1	Model																																																									
2	0	LP 131																																																									
2	1	LP 262																																																									
2	2	LP 540																																																									
Byte 0	Byte 1	Model																																																									
9	0	??90																																																									
9	1	??180																																																									
9	2	??270																																																									
9	3	??360																																																									
9	17	??137																																																									
Byte 0	Byte 1	Model																																																									
17	0	135																																																									
17	1	270																																																									
17	2	405																																																									
17	3	540																																																									
14	Head Map	<p>1 Byte Unused</p>	<p>6 Bytes</p> <p>0 Hardware head map - bit n is set if head n was found on power up. 1-2 Unsed 3 User head map - bit n is set if head n is mapped into use 4-5 Unsed</p>	Same as Thunderbolt	Same as Thunderbolt																																																						

Page	Name	Empire	Thunderbolt	RoadRunner	Maverick
15	Diskware Overlay	1 Byte Unused	64 Bytes (8 Entries @ 8 bytes per entry) Byte 0 Overlay number 0 Resident overlay 1 Main overlay 2 Self scan overlay Byte 1-2 RAM load address Byte 3 Size in sectors Byte 4-5 Cylinder Byte 6 Head Byte 7 Sector	Same as Thunderbolt	Same as Thunderbolt
16	HDA Control Flags	1 Byte Unused	1 Byte Byte 0 0 1 Allow recal on fatal power-up error 2 Enable output to DAC board for servo 3 Disable idle servo mode 4 5 Latch test done 6 Latch was open at power up	Same as Thunderbolt	1 Byte Byte 0 0 Don't spin down when recal failed on power up 1 Allow recal attempt on fatal power-up error 2 Reserved 3 Disable idle servo mode (power saving) 4 Reserved 5 Trace DAC on 6 Enable read on arrival
17	Hardware Zone Table	160 Bytes 0,1 Bank (0,0) 84910 2,3 Bank (0,1) 4,5 Bank (1,0) 6,7 Bank (1,1) 8 AGC bytes 9 CPGAIN 10-159 Repeat for zones 1-15	16 Bytes 0-15 Window center for each zone	1 Byte Unused	1 Byte Unused
18	Servo Variables	1 byte Unused	322 Bytes Various servo variables	Same as Thunderbolt	Same as Thunderbolt

Page	Name	Empire	Thunderbolt	RoadRunner	Maverick
19	Error Log	1 byte Unused	2 Bytes 0-1 Time between logging to disk (in seconds)	Same as Thunderbolt	Same as Thunderbolt
20	Password Access	Not Used	Not Used	Same as Thunderbolt	Same as Thunderbolt
21	Available for use (originally intended for use with Uz as Power Management page, but currently not used)	Not Used	Not Used	Same as Thunderbolt	Same as Thunderbolt
22	E2Prom Bytes	Not Used	AT Not Used SC 3 Bytes 0 QCP flags 0 QCP configuration 1-7 Unused 1 0 Req filter 1-7 Unused 2 SCSI active pull-up control [Koni reg. 2Eh] 0-1 Req slew rate 2-3 Data slew rate 4-5 Data/req pull-up 6-7 Unused	Same as Thunderbolt	Same as Thunderbolt

Configuration Through AT DIAG



Preliminary **New Product AT Configuration Map**

Name	Empire	Thunderbolt	RoadRunner	Maverick
TFLAGS (Byte 0)	0 Read cache enable 1 Prefetch enable 2 3 4 5 6 7	0 Read cache enable 1 Prefetch enable 2 3 4 5 6 7	Same as Thunderbolt	Same as Thunderbolt
NUMSEGS (Byte 1)	Not used	Not used	Same as Thunderbolt	Same as Thunderbolt
MAXPREF (Byte 2)	Not used	Not used	Same as Thunderbolt	Same as Thunderbolt
MINPREF (Byte 3)	Not used	Not used	Same as Thunderbolt	Same as Thunderbolt
ERRBITS (Byte 4)	0 DCR (disable correction) 1 DTE (disable transfer on error) 2 PER (post error) 3 EEC (enable early correction) 4 RC (read continuous) 5 TB (transfer block on error) 6 ARRE (auto read reallocate) 7 AWRE (auto write reallocate)	Same as left	Same as Thunderbolt	Same as Thunderbolt
RETRIES (Byte 5)	Valid range 0-255	Same as left	Same as Thunderbolt	Same as Thunderbolt

Name	Empire	Thunderbolt	RoadRunner	Maverick
ECCSPAN (Byte 6)	????????? "0-7" Disable ECC on the fly "8-15" Disable double burst correction; enable ECC on the fly single burst correction "16" Enable ECC on the fly and double burst correction	Same as left	Same as Thunderbolt	Same as Thunderbolt
CONFLAGS (Byte 7)	0 1 RUEE (Reallocate uncorrectable ECC error) 2 WCE (Write cache enable) 3 Read on arrival enable 4 5 6 7	0 1 RUEE (Reallocate uncorrectable ECC error) 2 WCE (Write cache enable) 3 Cache debug 4 5 Auto transfer enable 6 Auto read enable 7	Same as Thunderbolt	Same as Thunderbolt

Mode Pages

The **Mask** column of the lists if set to 1 denotes that bit can be configured by the customer.

Page 1h Error recovery parameters.

<u>Byte</u>	<u>Mask</u>	<u>Default</u>	<u>Description</u>
0		81h	Page code.
1		06h	Page length.
2	FFh	C0h	AWRE, ARRE.
3	FFh	08h	Retry count.
4	FFh	10h	Maximum ECC error burst on which to perform corrections.
5		00h	2's complement value of microsteps offset from track center.
6		00h	Data strobe offset count.
7		00h	Recovery time limit in units of 10 ms.

Page 2h Disconnect/reconnect control parameters.

<u>Byte</u>	<u>Mask</u>	<u>Default</u>	<u>Description</u>
0		82h	Page code.
1		0Ah	Page length.
2	FFh	00h	On reads, how full buffer should be before reconnecting.
3	FFh	FFh	On writes, how empty buffer should be before reconnecting.
4		00h	Bus inactivity limit - msb.
5		00h	Bus inactivity limit - lsb.
6		00h	Disconnect time limit - msb.
7		00h	Disconnect time limit - lsb.
8		00h	Connect time limit - msb.
9		00h	Connect time limit - lsb.
10		00h	Reserved.
11		00h	Reserved.

Page 3h Direct access device format parameters.

<u>Byte</u>	<u>Mask</u>	<u>Default</u>	<u>Description</u>
0		03h	Page code.
1		16h	Page length.
2		00h	Tracks per zone as defined in CCS - msb.
3	00h	02h	Tracks per zone as defined in CCS - lsb.
4		00h	Alternate sectors per zone - msb.
5		01h	Alternate sectors per zone - lsb.
6		00h	Alternate tracks per zone - msb.
7		00h	Alternate tracks per zone - lsb.
8		00h	Alternate tracks per volume - msb.
9		00h	Alternate tracks per volume - lsb.
10	00h	00h	Sectors per track - msb.
11		3Ah	Sectors per track - lsb.
		44h	“
12	00h	02h	Bytes per sector - msb.
13		00h	Bytes per sector - lsb.
14		00h	Interleave - msb.
15		01h	Interleave - lsb.
16		00h	Track skew factor - msb.
17	00h	12h	Track skew factor - lsb.
		0Fh	”
18		00h	Cylinder skew factor - msb.
19	00h	13h	Cylinder skew factor - lsb.
		18h	“
20		40h	Drive type definition bits. (40H = hard sector format).
21		00h	Reserved.
22		00h	Reserved.
23		00h	Reserved.

Page 4h Rigid disk drive geometry parameters.

<u>Byte</u>	<u>Mask</u>	<u>Default</u>	<u>Description</u>
0		04h	Page code - 04h.
1		12h	Page length - 18.
2	00h	00h	Number of cylinders - msb.
3		03h	Number of cylinders - middle.
		04h	“
4		66h	Number of cylinders - lsb.
		49h	”
5	00h	02h	Number of heads.
6		00h	Starting cylinder for write precompensation.
7		00h	Starting cylinder for write precompensation.
8		00h	Starting cylinder for write precompensation.
9		00h	Starting cylinder for reduced write current.
10		00h	Starting cylinder for reduced write current.
11		00h	Starting cylinder for reduced write current.
12		00h	Drive step rate.
13		00h	Drive step rate.
14		00h	Landing zone cylinder.
15		00h	Landing zone cylinder.
16		00h	Landing zone cylinder.
17		00h	Reserved.
18		00h	Reserved.
19		00h	Reserved.

Page 8h Cache page.

<u>Byte</u>	<u>Mask</u>	<u>Default</u>	<u>Description</u>
0		88h	Page code.
1		0Ah	Page length.
2	05H	04h	Write cache enable (bit 4 = 1); Read Cache Disable (bit 0) = 0.
3		00h	None of the features in the Priority byte is supported.
4		00h	Disable Prefetch Transfer Length - msb is not supported.
5		00h	Disable Prefetch Transfer Length - lsb is not supported.
6		00h	Minimum number of blocks to Prefetch - msb is not supported.
7		00h	Minimum number of blocks to Prefetch - lsb is not supported.
8		00h	Maximum number of blocks to Prefetch - msb is not supported.
9		00h	Maximum number of blocks to Prefetch - lsb is not supported.
10		00h	Maximum Prefetch Ceiling - msb, not applicable.
11		00h	Maximum Prefetch Ceiling - lsb, not applicable.

Page Ch Notch page.

<u>Byte</u>	<u>Mask</u>	<u>Default</u>	<u>Description</u>
0		0Ch	Page code.
1		16h	Page length.
2		80h	Device is notched. with physical boundaries.
3		00h	Reserved.
4		00h	Maximum number of notches - middle.
5		08h	Maximum number of notches - lsb.
6	FFh	00h	Active notch high not used.
7	FFh	00h	Active notch low by default is 0 (entire device).
8		00h	Starting cylinder - msb.
9	00h	00h	Starting cylinder - middle.
10		00h	Starting cylinder - lsb.
11		00h	Starting head 0.
12		00h	Ending at cylinder max. minus 1.
13	00h	03h	Ending cylinder middle.
		04h	“
14		65h	Ending cylinder lsb.
		48h	”
15	00h	01h	Ending head.
16		00h	Indicate pages 3, 4 and C are notched.
17		00h	Indicate pages 3, 4 and C are notched.
18		00h	Indicate pages 3, 4 and C are notched.
19		00h	Indicate pages 3, 4 and C are notched.
20		00h	Indicate pages 3, 4 and C are notched.
21		00h	Indicate pages 3, 4 and C are notched.
22		10h	Indicate pages 3, 4 and C are notched.
23		18h	Indicate pages 3, 4 and C are notched.

Page 32h Auto power down page.

<u>Byte</u>	<u>Mask</u>	<u>Default</u>	<u>Description</u>
0		B2h	Page code.
1		02h	Page length.
2	FFh	00h	Standby mode disabled with 0.
3	FFh	00h	Shutdown mode disabled with 0.

Page 37h Tako (Cache) page.

<u>Byte</u>	<u>Mask</u>	<u>Default</u>	<u>Description</u>
0		B7h	Page code.
1		0Eh	Page length.
2	3Fh	03h	Tako configuration bits.
3	FFh	02h	Number of segments in cache.
4		00h	Minimum number of blocks to Prefetch is not supported.
5		00h	Maximum number of blocks to Prefetch is not supported.
6-15		00h	Unused

Firmware Error Codes

Internal Error Code	Sense Key	Sense Code	Sense code qualifier	Description
0	0	00	00	No Error detected at Drive level
1	3	03	00	Write fault
2	1	03	00	Recovered Write Fault
4	3	11	00	Uncorrectable data field ECC error
5	1	17	01	Recovered data field ECC error
6	6	9A	00	A target attempted to re-select
7	3	13	00	Data field sync timeout
8	1	13	00	Recovered data field sync timeout
9	3	14	01	No record found
A	1	14	00	Recovered no record found
B	4	15	00	Seek error
C	1	15	00	Recovered seek error
D	1	18	00	Recovered data error via ECC w/2 = syndromes
E	1	18	01	Recovered data error via ECC on last retry
F	5	1A	00	Parameter overrun
10	5	20	00	Invalid command
11	5	21	00	Invalid LBA
12	5	24	00	Invalid bits set in CDB
13	5	26	00	Invalid field in parameters
14	6	29	00	Reset occurred
15	6	2A	00	Mode select parameters were changed
16	4	40	00	RAM error (most likely found in a diagnostic)
17	4	87	00	Logical assertion/firmware consistency check err
18	4	42	00	Internal ROM checksum error
19	B	47	00	SCSI Bus parity error
1A	4	42	01	Marker for resident code checksum
1B	3	80	00	Error in writing to system sector
1C	3	81	00	Error in reading from system sector
1D	4	9E	00	Motor unable to get up to speed
1E	1	9E	00	Recovered motor unable to get up to speed
1F	4	84	00	Failure in writing to sequencer format table
20	4	86	00	Unexpected sequencer error
21	1	86	00	Recovered unexpected sequencer error
22	4	8A	00	Head read from ID not equal to selected head
23	5	8A	00	Invalid head specified
24	5	8B	00	Invalid cylinder specified
25	5	8D	00	Bytes per block/bytes per sector gives a remaindr
26	2	04	00	Drive is up to speed and recalibrating
27	2	04	01	Drive is spinning up
28	2	04	02	Drive has not been told to spin up
29	3	32	01	No more alternate sectors available
2A	5	8F	00	Invalid sector specified
2B	4	95	00	Sequencer timeout
2C	1	95	00	Recovered sequencer timeout
2D	4	09	00	Bump timeout
2E	1	09	00	Recovered bump timeout
2F	E	1D	00	Read buffer miscompare
30	4	A1	00	Sequencer rollover register failure
31	3	A3	00	Failure reading sector in Reassign Blocks command
32	5	AE	00	Bad parameter(s) found in mode pages during init
33	3	31	01	FDPE write failed during format unit command
34	3	10	00	ID ECC error
35	1	10	00	Recovered ID ECC error
36	3	12	00	AM mark not found for ID field
37	1	12	00	Recovered AM mark not found for ID field
38	3	AA	00	Read Data written on realloc of uncorrectbl data
39	1	AA	00	Recovrd Rd data Wr on realloc of uncorrectbl data
3A	3	19	00	Bad defect list
3B	3	32	00	Defect list is full
3C	1	AB	00	Requested format in Read Defect Data not avail
3D	4	97	00	Underrun error
3E	1	97	00	Recovered underrun error
3F	4	06	01	RCL FLT- Coarse Slope PES Gain calibration

Internal Error Code	Sense Key	Sense Code	Sense code qualifier	Description
40	1	06	01	Recovered RCL FLT- Coarse Slope PES calibration
41	4	06	02	RCL FLT- Fine Slope PES Gain calibration at AEQBH
42	1	06	02	Recovered RCL FLT- Fine Slope PES calib at AEQBH
43	4	06	03	RCL FLT- Fine Slope PES Gain calib at AEQBL
44	1	06	03	Recovered RCL FLT- Fine Slope PES calib at AEQBL
45	4	06	04	RCL FLT- Cannot Lock to track
46	1	06	04	Recovered RCL FLT- Cannot Lock to track
47	4	06	05	RCL FLT- Cannot detect SAM during unparking
48	1	06	05	Recovered RCL FLT- Can't detect SAM during unpark
49	4	42	06	Marker for diskware vector table checksum
4A	4	FF	00	Autowr cmd received while host channel disabled
4B	4	FF	01	ID in format track descriptor list not found
4C	4	FF	02	Bad descriptor in format track descriptor list
4D	3	14	01	Bad block mark set for ID (AT)
4E	4	AC	00	Airlock stuck open
4F	4	03	00	WUS Write fault (bump)
50	1	03	00	Recovered WUS Write fault (bump)
51	3	82	00	Error during reading of diskware
52	4	09	04	Unrecoverable Bad servo sync
53	1	09	04	Recovered bad servo sync
54	4	09	05	Unrecoverable Bad servo address mark (SAM)
55	1	09	05	Recovered bad servo address mark (SAM)
56	4	09	06	Unrecoverable Bad track number data
57	1	09	06	Recovered bad track number data
58	4	09	07	Unrecoverable Servo Defect
59	1	09	07	Recovered Servo Defect
5A	4	09	08	Unrecoverable Bump
5B	1	09	08	Recovered Bump
5C	4	15	01	Unrecovrd Gray code != desired track while ontrk
5D	1	15	01	Recovered Gray code != desired track while ontrk
5E	4	15	03	Unrecovrd multi bad Sync/SAM while Settle/Ontrk
5F	1	15	03	Recovered multi bad Sync/SAM while Settle/Ontrk
60	4	9E	01	Unrecoverable Speed out of range
61	1	9E	01	Recovered speed out of range
62	4	15	04	Seek timeout with no servo fault
63	1	15	04	Recovered seek timeout with no servo fault
64	3	11	01	Marker for CRC/Continue
65	1	17	08	Recovered marker for CRC/Continue
66	4	42	02	Marker for resident and overlay are incompatible
67	4	42	03	Marker for ROM and resident are incompatible
68	4	42	04	Marker for ROM and overlay are incompatible
69	4	42	05	Marker for overlay checksum
6A	4	06	06	RCL FLT - DAC offset calibration failure
6B	1	06	06	Recovered RCL FLT - DAC offset calib failure
6C	4	86	01	Unexpected SEQ Err during recovery from SEQ TMO
6D	1	86	01	Recovrd unexpect SEQ err during SEQ TMO recovery
6E	4	86	02	Read/write ID miscompared
6F	1	86	02	Recovered read/write ID miscompared
70	3	12	01	AM not found for ID field with internal continue
71	1	12	01	Recovrd AM not found for ID w/ internal continue
72	3	03	00	Write gate still asserted when wedge detected
73	4	15	05	Unrecovrd multi bad Sync/SAM during Seek ISR
74	1	15	05	Recovered multi bad Sync/SAM during Seek ISR
75	4	06	06	RCL FLT - Cannot detect reliable SAM on any head
76	1	06	06	Recovrd RCL FLT-Can't detect SAM on any head
77	4	06	07	RCL FLT - Can't seek to OD to get near Sys yl
78	1	06	07	Recovrd RCL FLT - Can't seek to OD near Sys Cyl
79	4	06	08	RCL FLT - Can't seek to Fine Slope PES calib trk
7A	1	06	08	Recovrd RCL FLT-Can't seek to Fine SLP calib trk
7B	4	06	09	RCL FLT - Seek failure during Nulli calibration
7C	1	06	09	Recovrd RCL FLT - Seek fail during Nulli calib
7D	4	06	0A	RCL FLT - Seek failure during V_SCALE adaptation
7E	1	06	0A	Recovered RCL FLT-Seek fail during V_SCALE adapt
7F	4	06	0B	RCL FLT - Seek failure during KLOOP calibration
80	1	06	0B	Recovrd RCL FLT - Seek fail during KLOOP calib

Internal Error Code	Sense Key	Sense Code	Sense code qualifier	Description
81	4	06	0C	RCL FLT - Seek failure during RRO calibration
82	1	06	0C	Recoverd RCL FLT - Seek fail during RRO calib
83	4	06	0D	RCL FLT - Seek failure to track 0 during rezero
84	1	06	0D	Recoverd RCL FLT-Seek fail to trk 0 during rezero
85	4	06	0E	RCL FLT - Unable to complete KLOOP calibration
86	1	06	0E	Recoverd RCL FLT - Unable to complete KLOOP calib
87	4	06	0F	RCL FLT - Unable to complete RRO calibration
88	1	06	0F	Recoverd RCL FLT - Unable to complete RRO calib
89	3	01	00	No disk index found on current track
8A	1	17	09	Data corrected by ECC on the fly
8B	4	42	07	Invalid diskware version.
8C	4	42	08	Invalid ROM version
8D	4	1B	00	Synchronous transfer error
8E	5	9B	00	Invalid period or offset in synchronous message
8F	5	9C	00	Active initiator attempted a select while disconnected
90	5	25	00	Invalid LUN specified
91	4	43	00	Invalid message
92	B	45	00	Reselection timeout
93	B	48	00	Initiator detected error
94	4	85	00	Reject of message that should not been sent
95	B	00	00	Response of an Abort message
96	5	8C	00	Attempt by intruding initiator to select drive a second time
97	6	8E	00	Unexpected SIC interrupt occurred
98	4	90	00	Synchronous acknowledge error
99	4	91	00	Synchronous request error
9A	4	94	00	SIC error
9B	4	4A	00	FIFO load error
9C	4	49	00	FIFO unload error
9D	4	4B	00	FIFO predicted full error
9E	B	29	00	RAM parity error
A0	3	31	00	Medium format corrupted
A1	5	C2	00	Command not implemented
A2	2	C0	00	Burn-In test in progress



Preliminary **New Product Super Command Map**

Command Op Code	Empire	Thunderbolt	RoadRunner	Maverick
00	Read Micro Memory	Same as left	Same as left	Same as left
01	Write Micro Memory	Same as left	Same as left	Same as left
02	Read Configuration	Same as left	Same as left	Same as left
03	Write Configuration	Same as left	Same as left	Same as left
04	Call Subroutine	Same as left	Same as left	Same as left
05	Convert LBA to CHS	Same as left	Same as left	Same as left
06	Compute Starting Sector	Same as left	Same as left	Same as left
07	Read Command History	Same as left	Same as left	Same as left
08	Read Cache Table	Same as left	Same as left	Same as left
09	Read ECC Results	Same as left	Same as left	Same as left
0A	Seek Physical	Same as left	Same as left	Same as left
0B	Seek Verify	Same as left	Same as left	Same as left
0C	Read Physical	Same as left	Same as left	Same as left
0D	Read Long Physical	Same as left	Same as left	Same as left
0E	Write Physical	Same as left	Same as left	Same as left
0F	Write Long Physical	Same as left	Same as left	Same as left
10	Reassign Physical	Same as left	Same as left	Same as left
11	Read Index Time	Same as left	Same as left	Same as left
12	Read ID	Same as left	Same as left	Same as left
13	Read Peak Amplitude	Same as left	Same as left	NOT IMPLEMENTED
14	Microstep	Same as left	Same as left	Same as left
15	Recalibrate	Same as left	Same as left	Same as left
16	Erase Track	Same as left	Same as left	NOT IMPLEMENTED
17	Erase Track Data	Same as left	Same as left	NOT IMPLEMENTED
18	Format Track	Same as left	Same as left	Same as left
19	Seek And Write (Immediate)	Same as left	Same as left	NOT IMPLEMENTED
1A	Read Sequencer WCS	Same as left	Same as left	Same as left
1B	Write Sequencer WCS	Same as left	Same as left	Same as left
1C	Peek Buffer	Same as left	Same as left	Same as left
1D	Poke Buffer	Same as left	Same as left	Same as left
1E	Read Variables	Same as left	Same as left	Same as left

Command Op Code	Empire	Thunderbolt	RoadRunner	Maverick
1F	Factory Format	Same as left	Same as left	Same as left
20	Start/Stop	Same as left	Same as left	Same as left
21	CHS To LBA	Same as left	Same as left	Same as left
22		AT Mode Select	Same as left	Same as left
23		AT Mode Sense	Same as left	Same as left
24		Init Error Log	Same as left	NOT IMPLEMENTED
25		Force Update Error Log	Same as left	NOT IMPLEMENTED
26		Write Physical Same	Same as left	NOT IMPLEMENTED
27		Set Buffer End	Same as left	NOT IMPLEMENTED
28-40				
41				
42-48				
49				
4A				
4B				
4C				
4D				
4E-5F				
60		Write SSI 4743	Same as left	NOT IMPLEMENTED
61		Set Write Current	Same as left	NOT IMPLEMENTED
62		Sequencer Trigger	Same as left	Same as left
63		Wedge Format	Same as left	Same as left
64		Window Margin Test	Same as left	NOT IMPLEMENTED
65		Extended Low Z	Same as left	NOT IMPLEMENTED
66-7F				
80	Write R/W Chip			
81	Servo Verify	Same as left	Same as left	Same as left
82	Read Current Cylinder	Same as left	Same as left	Same as left
83	Thermo Update			
84				
85		Self Scan Test	Same as left	Same as left
86	Read PERR Variable	Same as left	Same as left	Same as left
87		Set Mux	Same as left	Same as left
88-8F				
90	Read DSP Memory			
91	Write DSP Memory			
92-93				

Command Op Code	Empire	Thunderbolt	RoadRunner	Maverick
94	Thermo Update			
95	Start Servo Acquire			
96	Control Threshold			
97-C5				
C6				
C7				
C8		Read OS Information	Same as left	NOT IMPLEMENTED
C9				
CA		Write OS Information	Same as left	NOT IMPLEMENTED
CB-CF				
D0				
D1		Move Data Strobe	Same as left	NOT IMPLEMENTED
D2		Window Margin Data	Same as left	NOT IMPLEMENTED
D3				
D4		Read Offset Units	Same as left	NOT IMPLEMENTED
D5-DF				
E0				
E1				
E2-E5				
E6				
E7				
E8-FF				

MAVERICK

MECHANICAL

PRODUCT TRAINING REVIEW

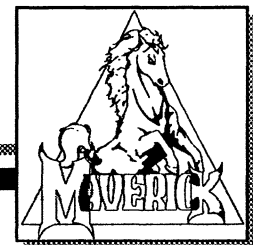

DRIVE CONFIGURATION - HDA

❖ Changes from ThunderBolt HDA

- * 3600 RPM Spindle Motor
 - * 7 Gram Load w/Modified Rails
 - * 50% Sliders
 - * New OD Crash Stop
 - * One Side VCM Magnets
 - * Redesigned Flex Circuit w/New Preamp
 - * Add RRR PCB Mounting Holes
 - * Slots in Base for Push Pin Servowriter
 - * Machined Surface on E-Block
- ▶ Lower Data Rate/Lower Power
 - ▶ Proper Fly Height at New RPM
 - ▶ Increased Data Stroke
 - ▶ More Tracks / Lowers FCI
 - ▶ Reduced Seek Spec, cost savings.
 - ▶ Interface RRR PCB to TB HDA
 - ▶ Interface RRR PCB to TB HDA
 - ▶ Servowrite w/Cover On
 - ▶ Reliable Push Pin Contact

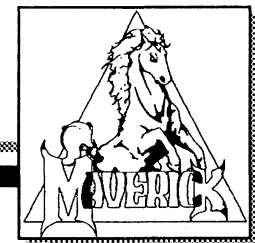

MECHANICAL SPECIFICATIONS

<u>PARAMETER</u>	<u>THUNDERBOLT</u>	<u>LIGHTNING</u>	<u>MAVERICK</u>
Access Time (ms)	12.0	11.0	14
RPM	4500	4500	3600
Vibration:			
Non Operating	2.0 G P-P (5-500 Hz.)	2.0 G P-P (5-500 Hz.)	
Operating	1.0 G P-P (5-300 Hz.) .5 G P-P (300-500 Hz.)	1.0 G P-P (5-300 Hz.) .5 G P-P (300-500 Hz.)	
Shock:			
Non Operating	60 G, 11 ms	70 G, 11 ms	
Operating	6.0 G,11 ms(no soft err) 10 G,11 ms(no hard err) 18 G, 3 ms (no hard err)	6.0 G,11 ms(no soft err) 10 G,11 ms(no harderr) 18 G, 3 ms (no hard err)	

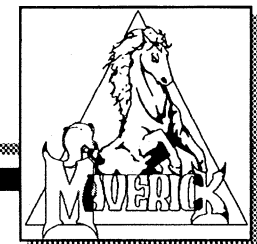

MECHANICAL SPECIFICATIONS

ACOUSTICS

THUNDERBOLT

LIGHTNING

MAVERICK

Sound Pressure:

(Distance = 1 Meter)

Idle (Avg./Max.)

33 dBA / 36 dBA

33 dBA / 36 dBA

34dBA / 38dBA

Seeking (Avg./Max.)

40 dBA / 45 dBA

40 dBA / 45 dBA

39dBA / 42dBA

Sound Power:

Idle (Avg./Max.)

40 dBA / 42 dBA

40 dBA / 42 dBA

40dBA / 45dBA

Seeking (Avg./Max.)

48 dBA / 50 dBA

48 dBA / 50 dBA

48dBA / 50dBA

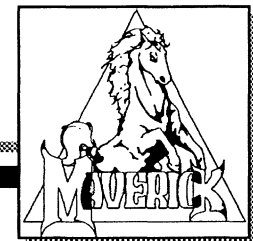

MECHANICAL DESIGN ASSEMBLY

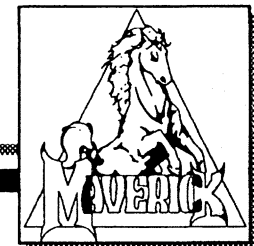
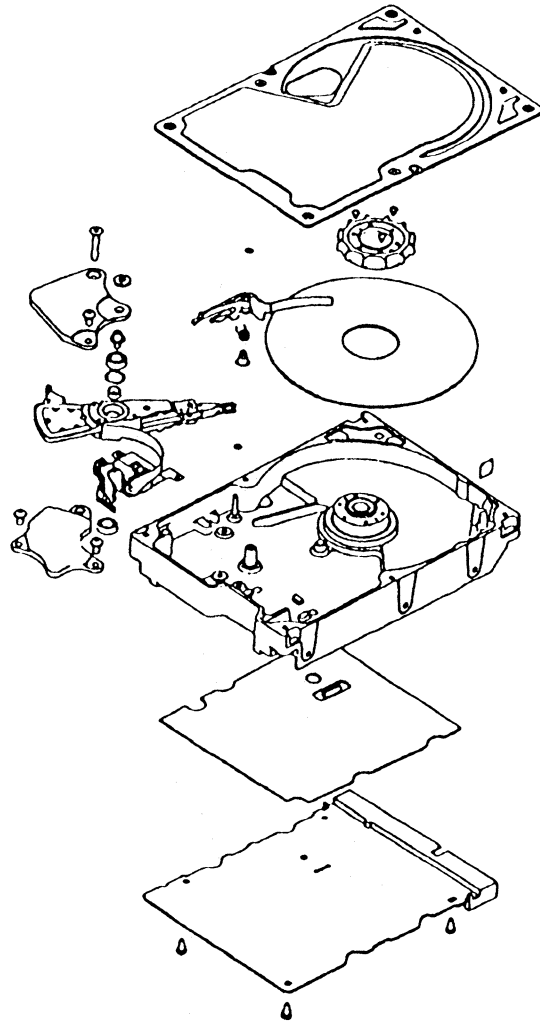

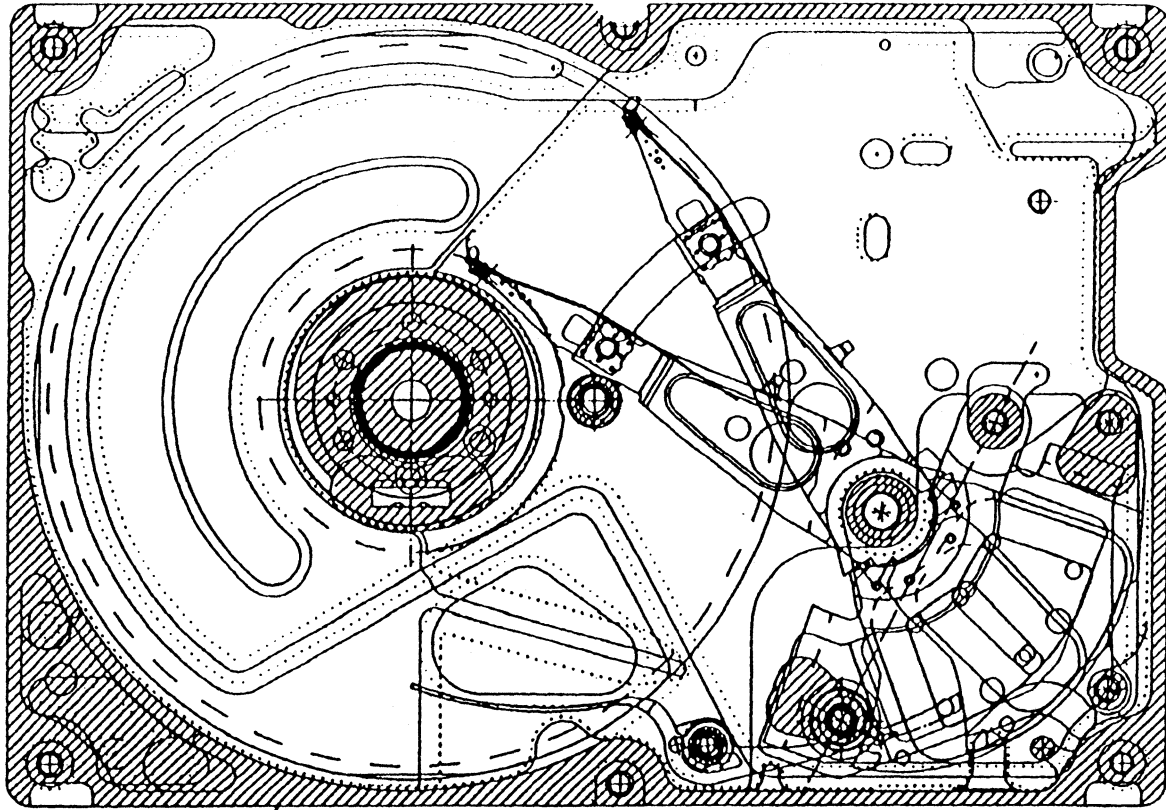

MAVERICK 540 MB

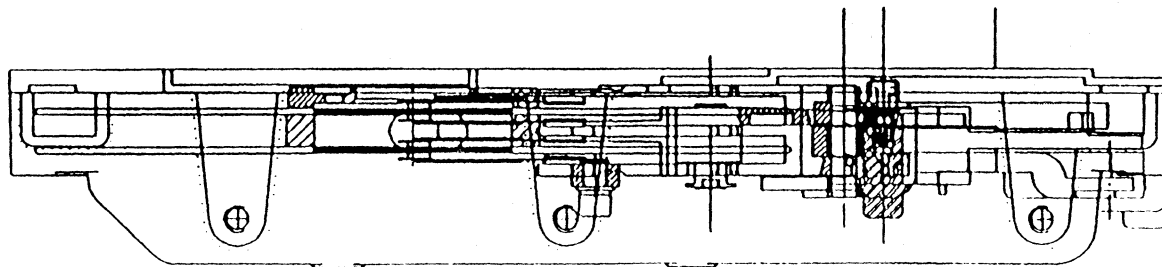

CHANGES FROM THUNDERBOLT BASE CASTING

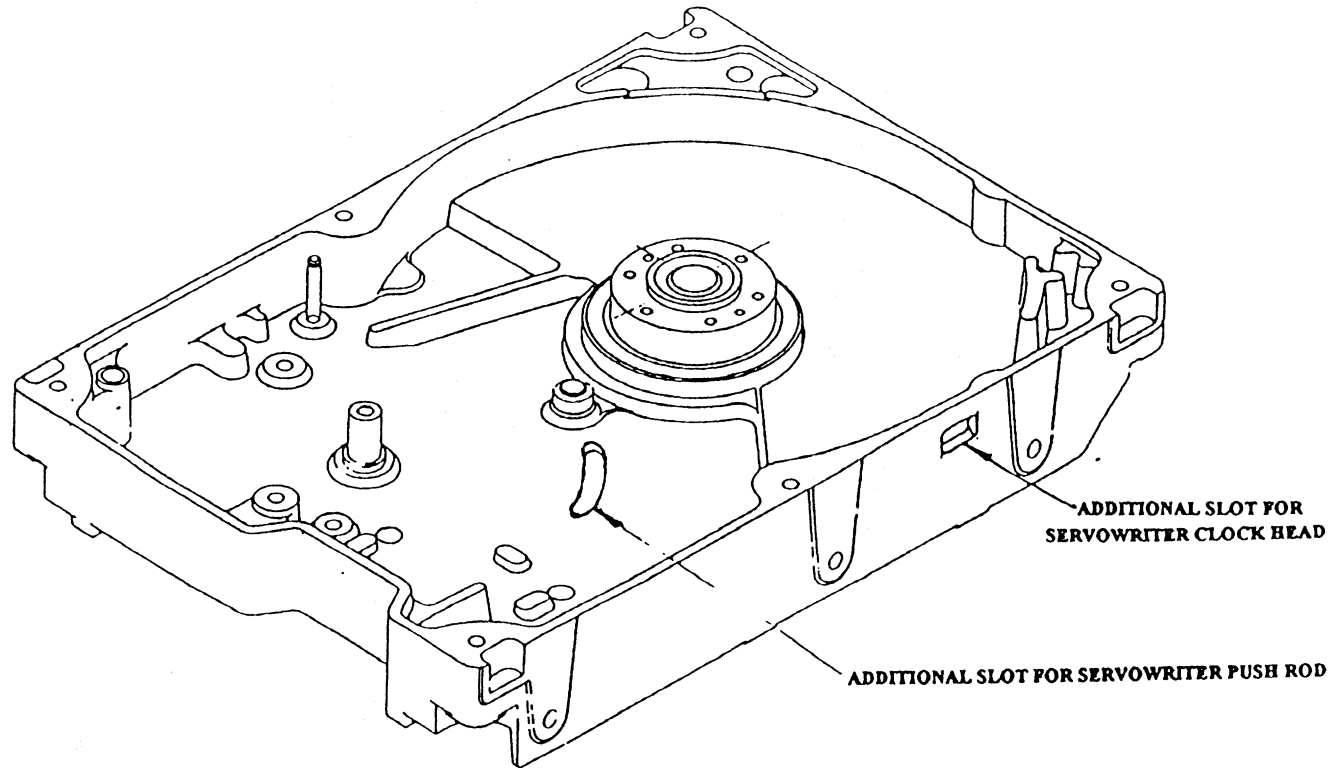

BASE MODIFICATIONS FOR PUSH ROD SERVOWRITER

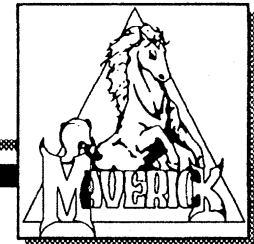

CHANGES FROM THUNDERBOLT HEAD STACK

❖ Heads

- * 50% sliders on type 8 suspensions.
- * Thunder bolt uses 70% sliders.
- * Lower gram load: 7gm. vs. 9.5gm. on Thunderbolt
- * Track width 6.5 microns, same as Thunderbolt

❖ Rotor Machining for Push Pin Servowriter

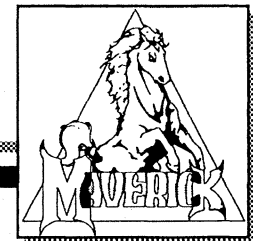

CHANGES FROM THUNDERBOLT HEAD STACK

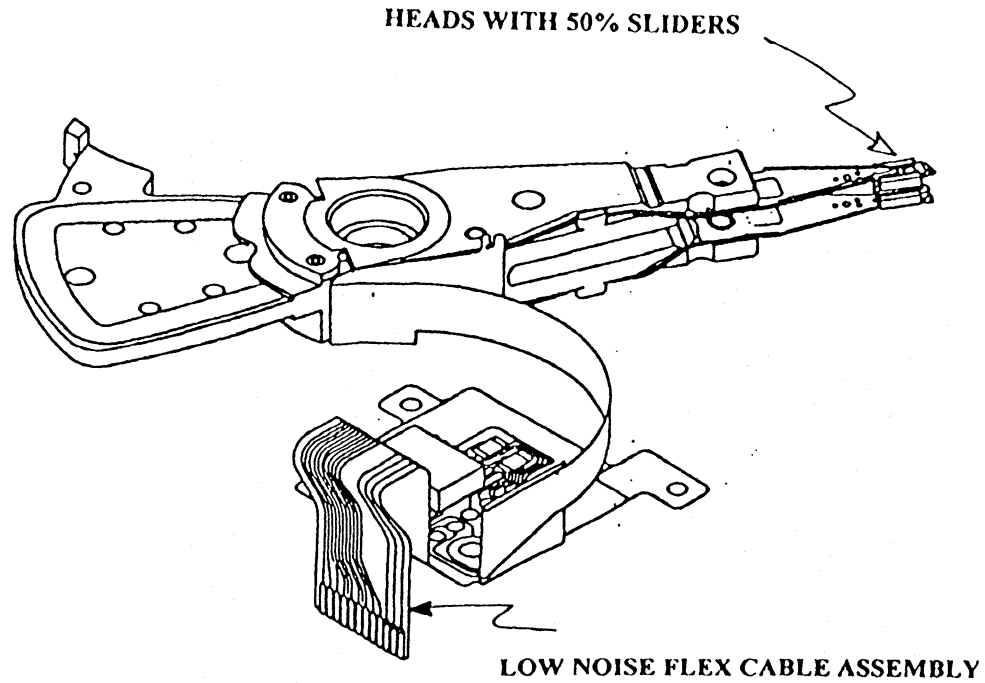

MODIFICATIONS TO THE ACTUATOR ASSEMBLY

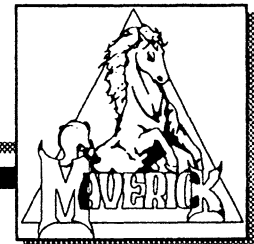

OTHER MECHANICAL CHANGES

❖ Crash Stop

- * Smaller crash stop at OD for increased track capacity.
- * Harder material required for reduced dynamic compression
- * Compression .036 in. vs. .055 on Thunderbolt
- * Material changed to EPDM for reduced contamination and cost savings.

❖ Air Lock

- * Reduced margin at 3600 RPM
- * Base casting changed to restore operating margin
- * Balance requirement 0.010gm-cm vs. 0.020gm-cm on Thunderbolt

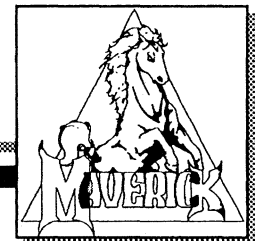

MAVERICK SERVO

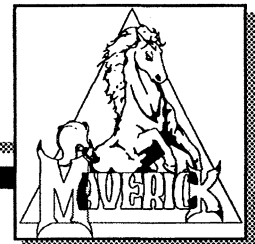

SERVO-MECHANICAL

TPI	2950
TRACK PITCH	339 μin
USER CYLINDERS	2853
ROTATIONAL SPEED	3600 rpm
SERVO SAMPLES/REV	78
SERVO SAMPLE RATE	4.68 KHz
SERVO SAMPLE TIME	214 μs
SERVO BANDWIDTH	350 Hz
AVERAGE SEEK TIME	14 ms

SERVO MECHANICAL

COIL RESISTANCE	16.2 Ω
HEAD RADIUS	5.98 cm
INERTIA 1 DISK	50 g-cm²
INERTIA 2 DISK	60 g-cm²
K_{torque} 1 DISK	712 g-cm/amp
K_{torque} 2 DISK	787 g-cm/amp

SERVO ARCHITECTURE

EMBEDDED SERVO

DIGITAL COMPENSATION SYSTEM

ESTIMATOR BASED SEEK SYSTEM

DIGITAL PID BASED TRACK FOLLOW

DOUBLE RATE DIGITAL NOTCH FILTER

SERVO RECAL

Initialize servo parameters to defaults.

Start Spindle.

Wait for spindle to reach 3600 rpm.

Unpark actuator.

Map all heads.

Calibrate course head gains.

Lock onto track.

Calibrate fine head gains.

Calibrate torque bias.

SERVO RECAL

Calibrate seek velocity.

Seek to track zero.

Maverick Servo Recal

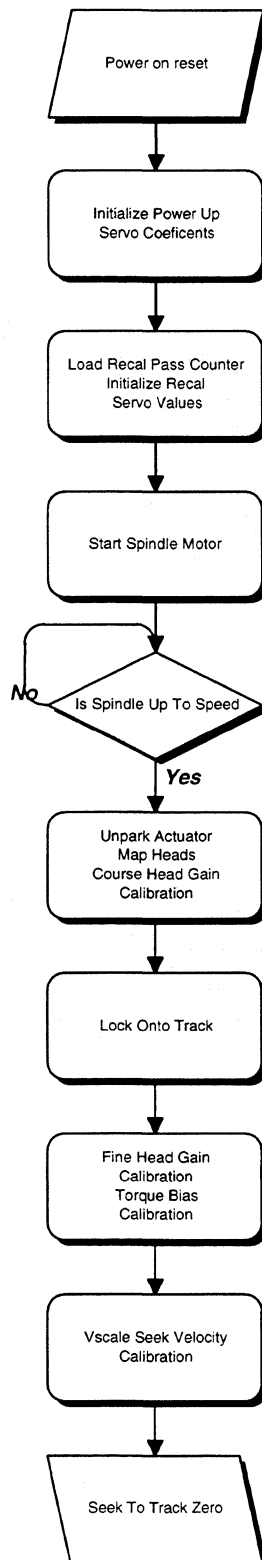

Maverick Head Map

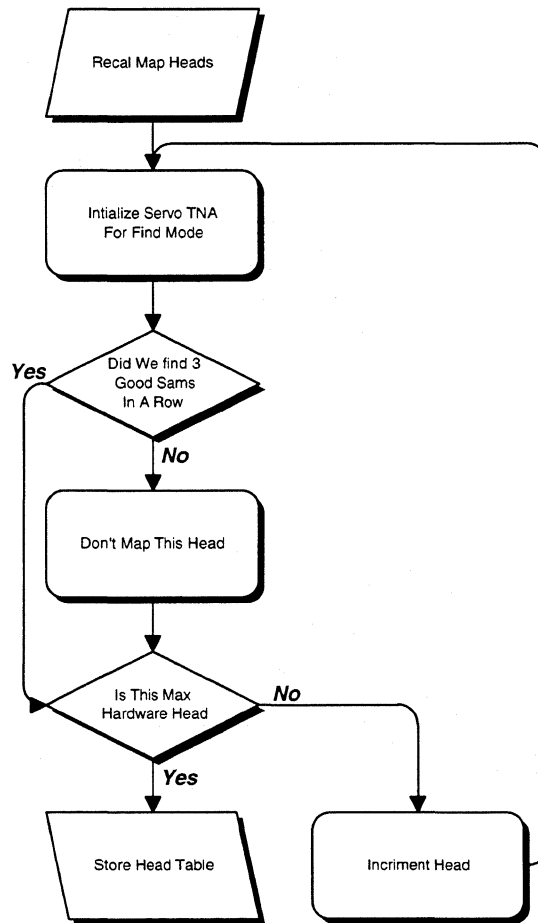

Maverick Coarse Head Gain Calibration

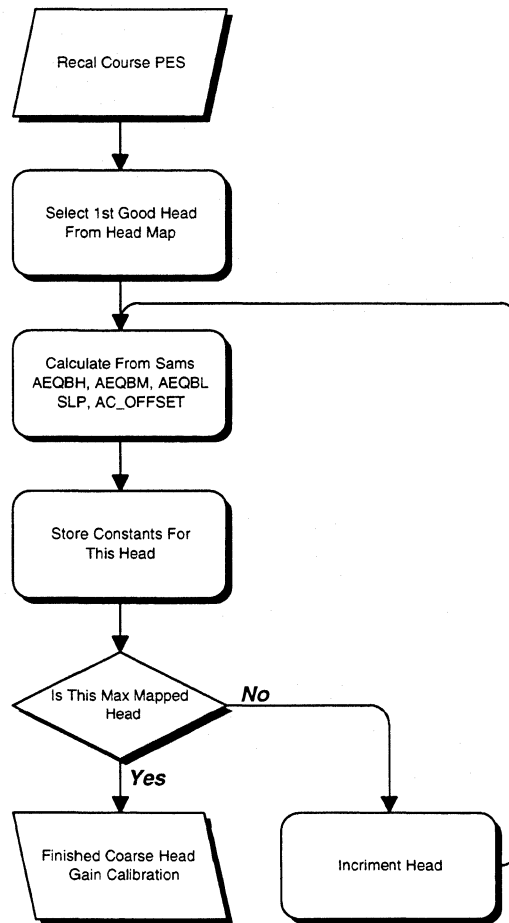

Maverick Lock Onto Track

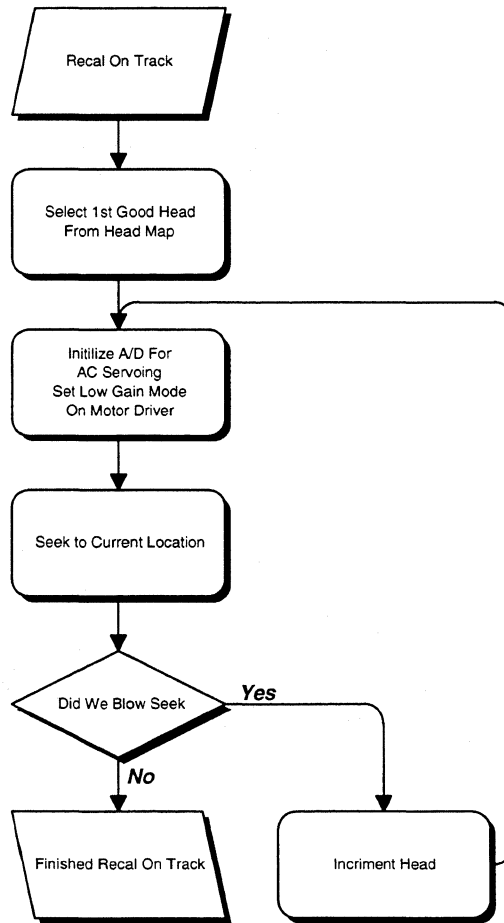

Maverick Fine Head Gain Calibration

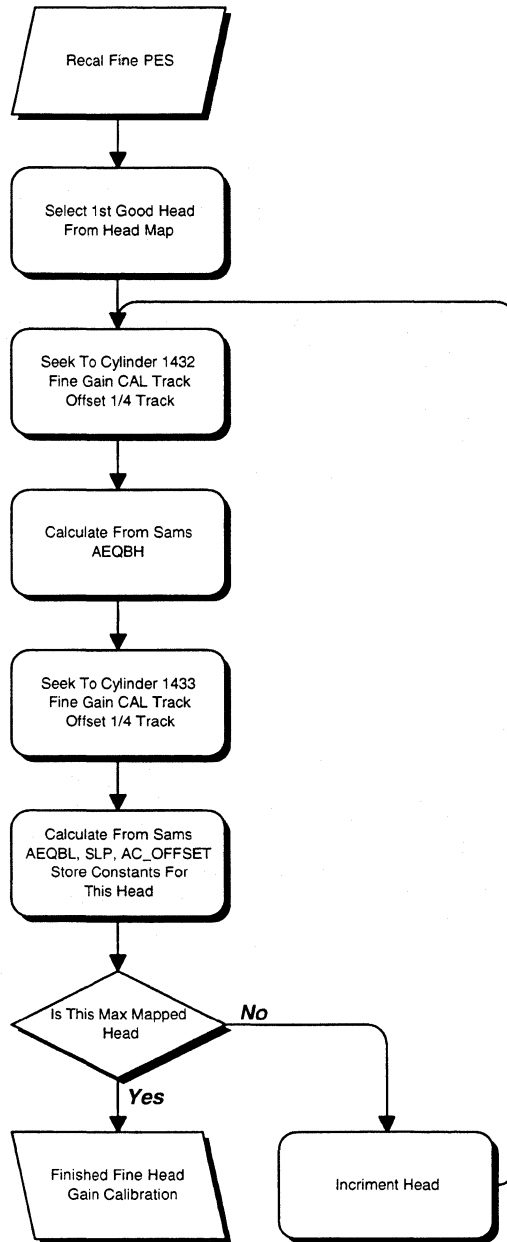

Maverick Torque Bias Calibration

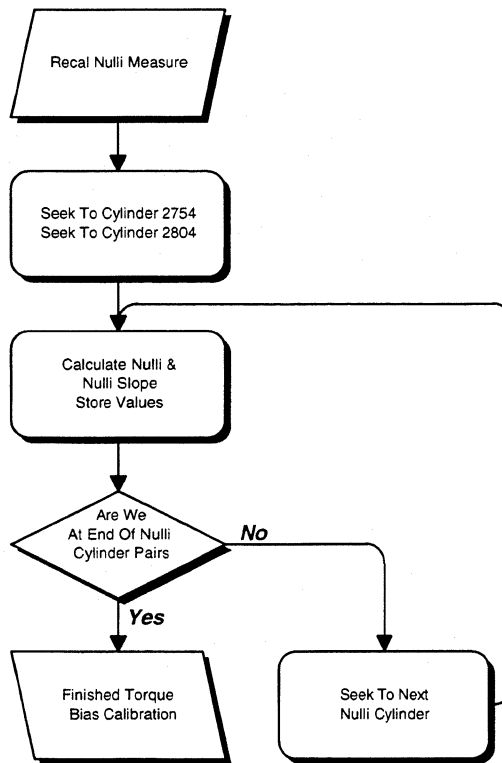

Maverick Seek Velocity Calibration

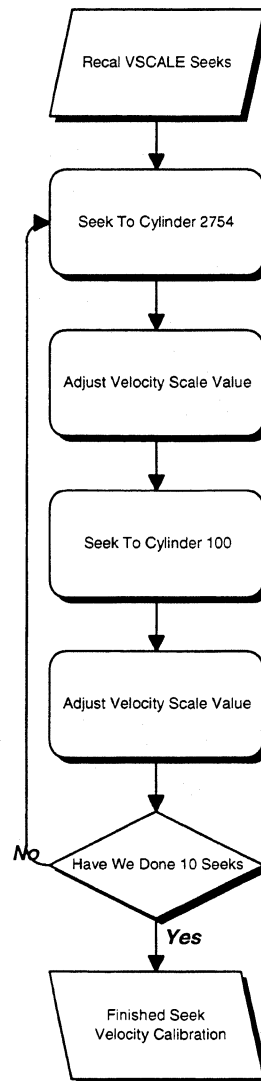

SERVO WRITE UNSAFE CRITERIA

2 Bad syncs or SAM's in a row.

2 Track ID errors in a row.

Bumped Wedge $\geq 10\%$

Defect Wedge $\geq 40\%$

Out of speed error $\geq 0.3\%$

SERVO WEDGE

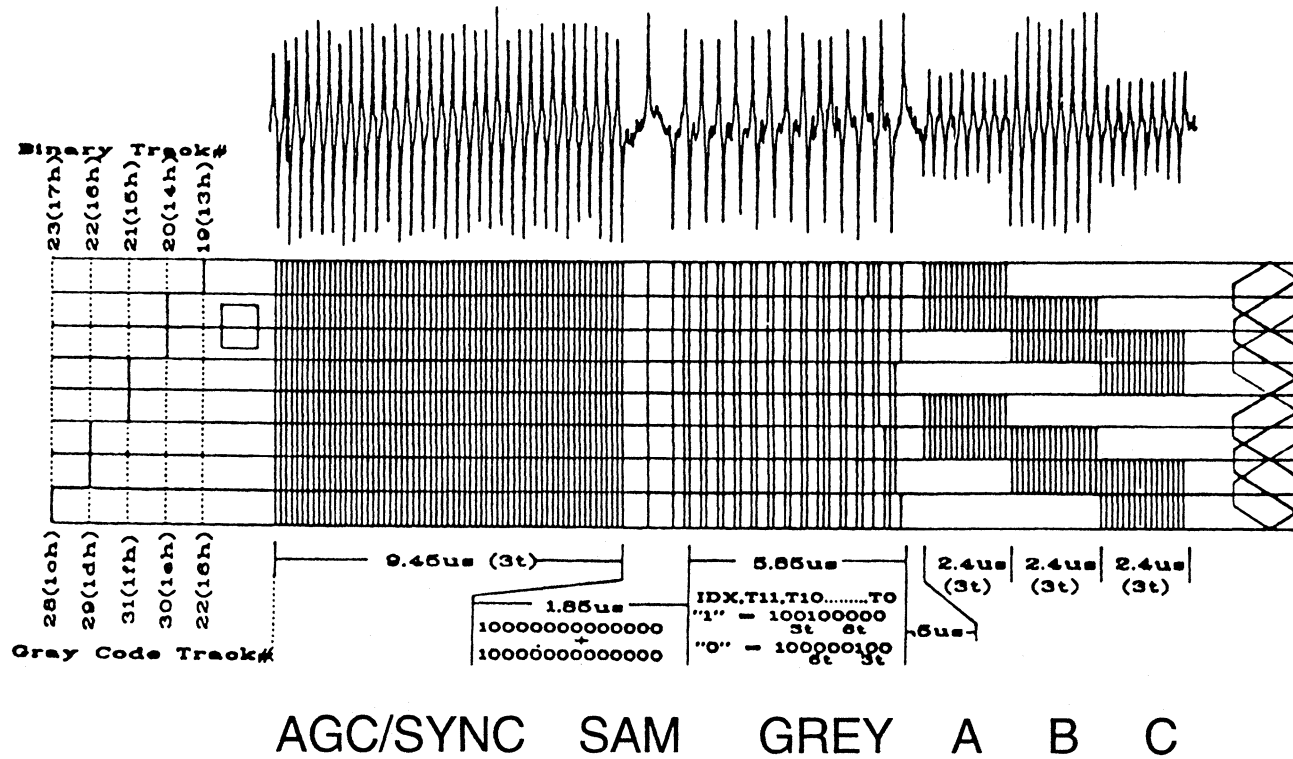

TEST POINTS

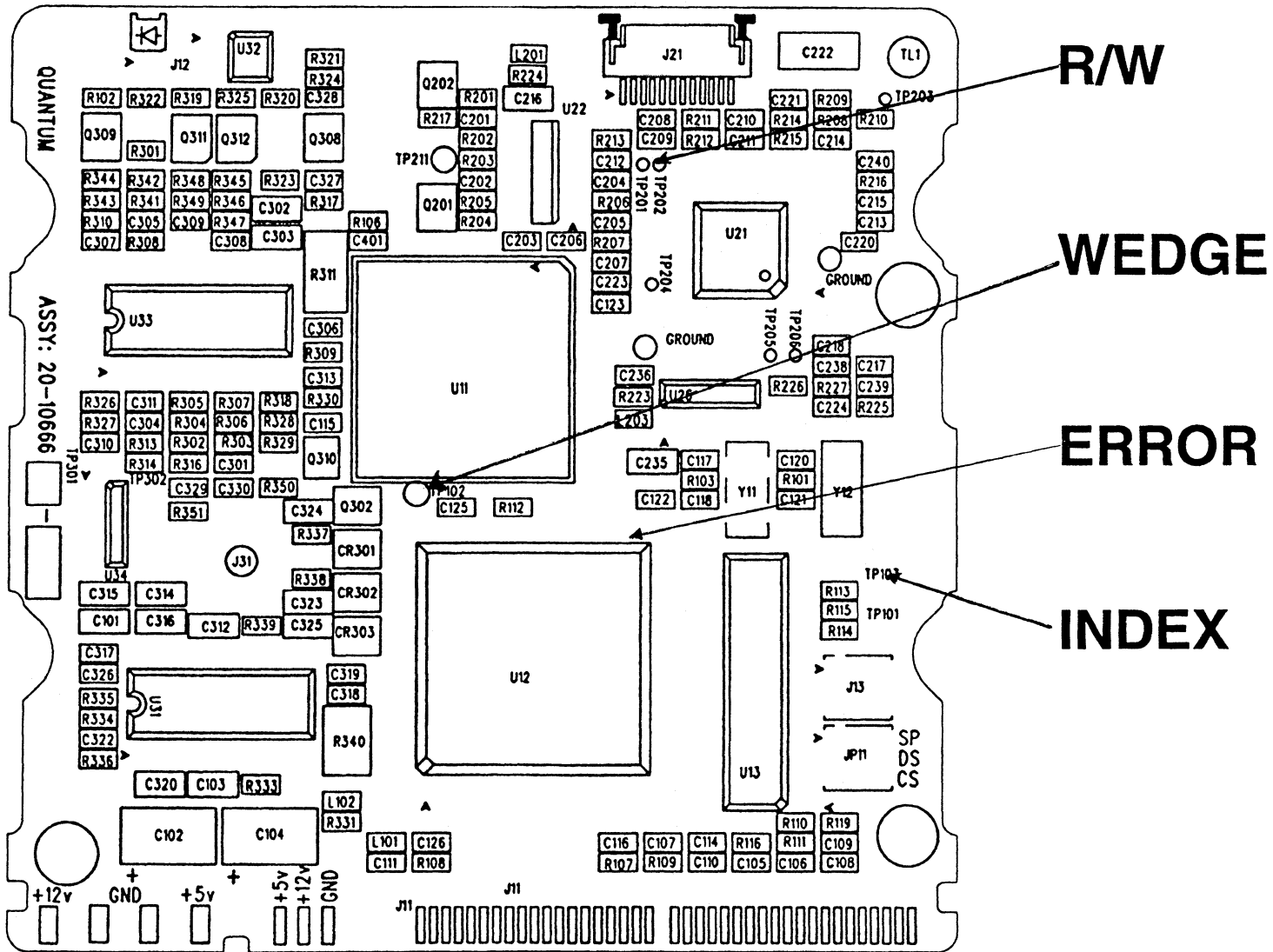

DIAG HINTS

DISABLING POWER SAVE MODE:

SUPER,SP 0,DEPB 0 48h,WRCONF 16

TURNING OFF READ AHEAD:

CACHE OFF

TRANSLATING LOGICAL TO PHYSICAL:

SUPER,CLBA

DISABLING RETRIES:

SP 0,ATRDCONF,RETRIES 0,ATWRCONF

ERROR TRIGGER

Config page 12 byte 0

7	6	5	4	3	2	1	0
Seq. Time-out	Seq. Data Error	Uncorr. Error	ECC Corr. Error	Wedge Error	Seek Fault	Seek Time-out	Servo Bump

Trigger Output is pin 34 of microprocessor.

Diag command:

SUPER,SP 0,DEPB 0 020h,WRCONF 12

MAVERICK

TEST PROCESS

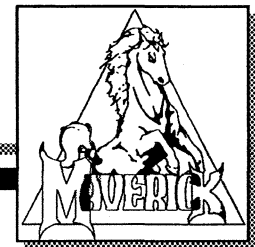

Maverick

Test Process

Topics:

- 1) Introduction
- 2) MKE process flow overview
- 3) DOALL Test Detail
- 4) Misc...

We are Test Process Software group, the provider of MKE Process Test Software.

We provide QPT-series software for RoadRunner (RRPT), Thunderbolt (QPT), Lightning (LIGHT) and Maverick (MPT) products. Currently, we are working on a unified set of test code (UPT2) for TrailBlazer, Fireball, Europa and the follow-on products.

Manager: Chang Lee @6284

DOALL.BAT does these:

- 1) Initialize drive
- 2) Load discware
- 3) Load SelfScan
- 4) Start SelfScan
- 5) Wait till SelfScan time up.

We call THE ABOVE steps Discware/SelfScan Station.

We call THE FOLLOWING steps Final Station. They are performed when the time runs out.

- 6) Read servo writer information.
- 7) Read SelfScan result and decide if the drive meets defect limit. If failed, is reclass possible?
- 8) Run ECC test.
- 9) Run Logical Sequential to test interface and unmapped defect.
- 10) If SCSI drive, run sequential and random throughput test.
- 11) Configure the drive.

The components of MPT package.

MPT	PRM	MPT	EXE		
MPTFULL	PRM	MPTFULL	EXE		
MAVERICK	ERR	MAVSCSI	CPG	MAVAT	CPG

100HOUR	BAT	100HOUR	SCR		
12HOUR	BAT	12HOUR	SCR		
16HAUDIT	BAT	16HAUDIT	SCR		
20HOUR	BAT	20HOUR	SCR		
BEGINDS	BAT	BEGINFS	BAT		
CACHE	BAT	CACHETST	SCR		
CSSTEST	BAT	CSSTEST	SCR		
DATAFER	BAT	DOALL	BAT		
DOALLSLO	BAT	DOSELF	BAT		
DS-SS	BAT	DWLOAD	BAT		
FAST	BAT	HISTORY	BAT		
INIT	BAT	INITBC	BAT		
INITSS	BAT	LOADSS	BAT		
MPTAUDIT	BAT	MPTAUDIT	SCR		
MPTDS	SCR	MPTDS-SS	SCR		
MPT_FS	SCR	MPT_FT	SCR		
PCB	BAT	QUICK	BAT		
RECLASS	BAT	RUNSS	BAT		
SEEK	BAT	SERVO	BAT		
SLOW	BAT	SSRPT	BAT	UPGRADE	BAT
README		TEST	OUT		
SLED	COM	PWROFF	COM	PWRON	COM
LIST	COM	HX	PRO		

Maverick Process Flow

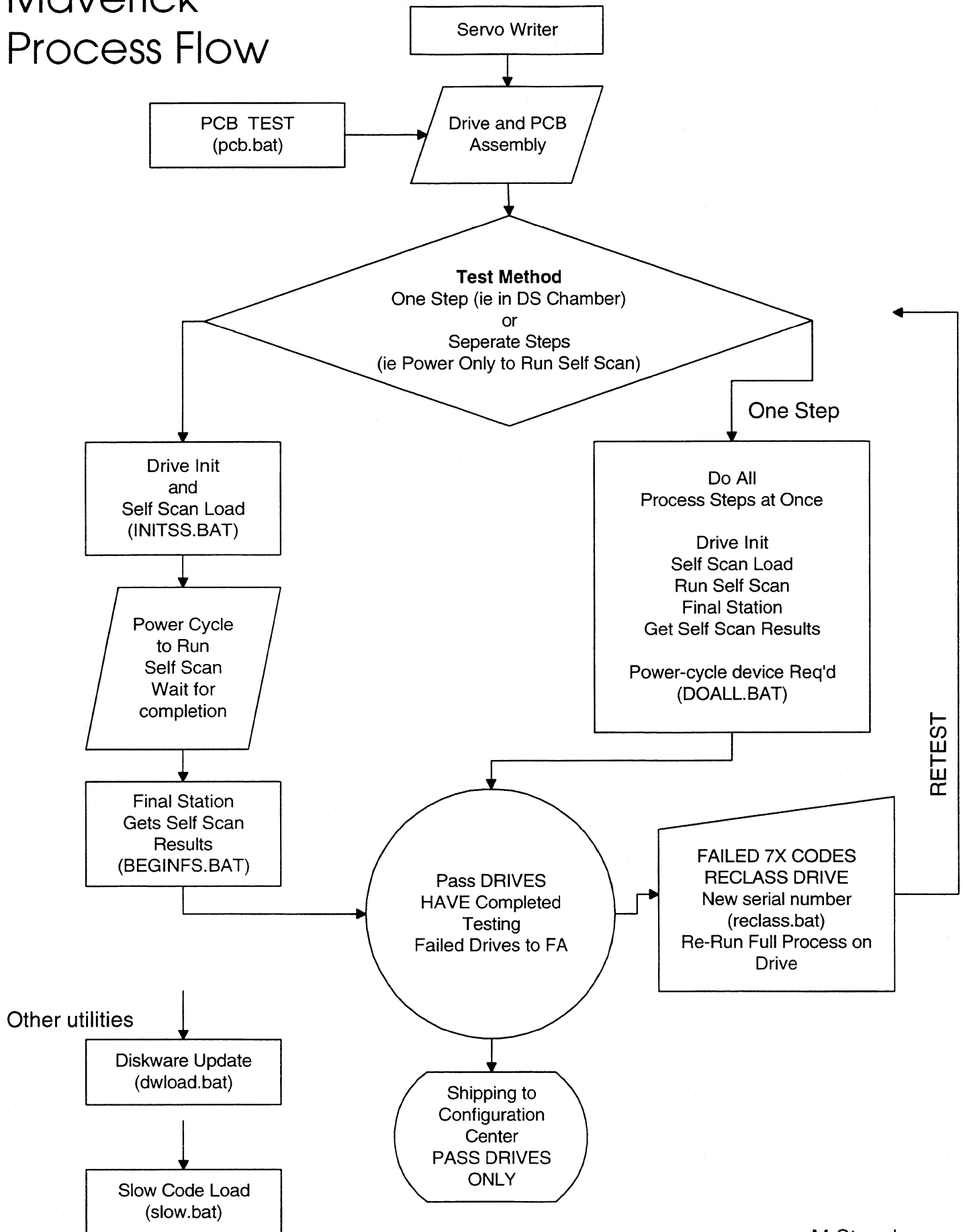

The steps MPT takes to initialize a drive:

1) Read serial number from servo writer sector to match with model names provided in the PRM file.

2) Initialize the interface (AT or SCSI?)

3) Load ramware

Read UPD from CPG file.

Verify ROM version

Poke code into buffer.

Load CP10

Spin up drive

Write serial number to CP5

Load config pages as specified in PRM.

4) Load diskware

Format system cylinders

Write diskware to firmware cylinders.

Power cycle the drive.

5) Initialize drive

Check for reclassification. Set new model if reclassified.

Initialize the defect list.

Write configuration (WriteConfig)

Write head map

Write model number to CP3

Write serial number to CP5

Write CP7

Write CP13

Write zone table.

Write format table (WriteFmtTable)

Write mode parameters

Mark off SelfScan script

Power cycle the drive.

6) Turn on super mode.

7) Turn on SCSI ASYN mode

Some useful functions provided by MPT:

barcode	FLAG	Get S/N from bar code
dumphistory	Non-TEST	dump all history sectors
unreclass	FLAG	un reclass operation on the drive
reclass	FLAG	do reclass operation on the drive
dwload	FLAG	Load Diskware Only
ramware	FLAG	Load Ram Ware
init	FLAG	Initialize firmware cyls
noclear	FLAG	Do NOT clear defect lists
loadcfgPages	TEST	load config pages
config	TEST	generic config
slowenable	TEST	Enable Slow mode
drvhist	TEST	dump the drive interface history
sv	FLAG	Set short verbose output mode
logallerrors	FLAG	error dump on all errors
stoponerror	FLAG	stop on error condition
aacc	TEST	average access time by selected seek lengths
skr	TEST	random seek of entire drive
nulli	TEST	measure friction accross drive stroke
sts	TEST	single track seek time test
sq	TEST	sequential seek of entire drive
shw	TEST	sequential head switch time test
rand	TEST	average random seek time test
svfy	TEST	average random seek verify test
perr	TEST	measure rro and nro
headgain	TEST	get head gain on specific cylinders

servodmp	TEST	dump servo status data
newwdgv	TEST	test each tracks wedges
sqsr	TEST	sequential seek of entire drive .. every head
vh	TEST	set voltage high
vn	TEST	set voltage normal
vl	TEST	set voltage low
pwoff	FLAG	power off the drive ... last step
pwr	IMMED.	power on
defectdump	TEST	dump the current defect list to display
mem	TEST	Memory Pattern Test
fmt	TEST	call drives format unit command for defect list
fnd	TEST	format w/NO defects
fd	TEST	format
eccoff	NON TEST	
eccon	NON TEST	
arrivalmode	NON TEST	
ss	TEST	start stop
readdefects	TEST	read PT Defects
writedefects	FLAG	enable PT Defect Save to Drive
pseq	TEST	physical sequential
hscchk	FLAG	verify pattern writes to HSC RAM
lseq	TEST	logical sequential
lrnd	TEST	logical random
verify	FLAG	do verify mode during logical mode tests
dmp	FLAG	dump defect list after each defect scan routine

dmphardonly	FLAG	dump hard defects only on the defect list dump
dssummary	TEST	output Defect Summary
fin	TEST	format defects inline
rddef	TEST	read defect list from factory list
sssload	TEST	Load SelfScan Script
runsspwr	TEST	Run SelfScan power cycle
ssrpt	TEST	Report SelfScan Results:
thrurand	TEST	Random through put test
thruseq	TEST	Sequential through put test
pcbrdwr	TEST	pcb rd wr : format/read/write test
otr	TEST	off track capability test
ecc2	TEST	verify Ecc Corrections

Other hints:

1) Set TFPORT and IRQ address:

```
SET TF_ADDRESS=170,11
```

2) Read-Only protection of your CPG files.

a) We do not provide CPG files.

b) CPG files should be renamed to

MAVSCSI.CPG or MAVAT.CPG

(you can change the names by...)

c) Read protect your CPG files.

3) TOREN utility.

4) Power control circuitry:

```
SET NEW_BLUE=1
```

```
SET PCS1250=1
```

5) MPT can be obtained from

BLUE_LIGHT\VOL1:

release\maverick\process

6) *Satisfaction guaranteed.*