

PRELIMINARY

MORROW DESIGNS
DECISION 1 COMPUTER
TRAINING PROGRAM

SBXMDT020

Published by:

Xerox corp., Rochester, New York 14644

Prepared by:

Multinational Documentation and Training Service
Xerox Corporation, Rochester New York 14644

Copyright 1983 by Xerox Corp. All rights reserved.
Xerox is a trademark of Xerox Corporation.

Morrow Designs is a trademark of Morrow Designs Inc.

PRELIMINARY

CONTENTS

SECTION	PAGE
Program Overview.....	1
System Overview.....	3
System/Software Operation.....	7
Major Assemblies.....	11
Service Manual.....	17

PRELIMINARY

PROGRAM OVERVIEW

PROGRAM OVERVIEW

This training program will prepare you to service the Morrow Decision 1 Computer system. You will learn the basic operation of the computer as well as what you need to know to use the service manual to make assembly level repairs.

MODULE 1 SYSTEM OVERVIEW

This module describes and defines the configuration of the various Decision 1 systems that are available.

MODULE 2 SYSTEM/SOFTWARE OPERATION

This module locates and explains the operator controls and gives a brief description of the operating systems available for use on the Decision 1.

MODULE 3 MAJOR ASSEMBLIES

This module provides you with the names, location and functions of the major replaceable assemblies.

MODULE 4 SERVICE MANUAL

This module will familiarize you with the contents of the service manual.

PREREQUISITES

There are no prerequisites for this training program.

TRAINING PROGRAM OBJECTIVES

The training program objectives are stated within each module.

ESTIMATED TIME TO COMPLETE THIS PROGRAM

?

REQUIRED RESOURCES

- Morrow Decision 1 Service Manual ~~600xxxx~~

SBXMDS020

TRAINING PROGRAM DIRECTIONS

This training program is self paced and does not require the interaction of a Course Monitor. Program and module times are approximate and should be used to pace yourself. This manual is reuseable. Do not write in it. Answer all question on a piece of scratch paper. Answers to the questions will be found at the end of each module. Proceed through each module sequentially and follow all directions. This training program does not require that you have a Decision 1 system available.

PRELIMINARY

MODULE 1 SYSTEM OVERVIEW

MODULE OVERVIEW

This module defines and describes the configuration of the various Decision 1 systems that are available.

PREREQUISITE

Completion of the Program Overview.

MODULE OBJECTIVE

At the end of this module you will be able to answer two questions about the features available with the Decision 1 System.

ESTIMATED TIME TO COMPLETE THIS MODULE

?

SYSTEM OVERVIEW

The Morrow Decision 1 System is a Z80 based computer that uses an S100 bus motherboard to provide multiboard capabilities. The system is available in both single user and multi-user configurations. Multi-user systems utilize one terminal for system management and that terminal is designated as the console. In addition to the console a system may have a combination of other terminals, built-in floppy and hard disk drives, external disk drives and printers.

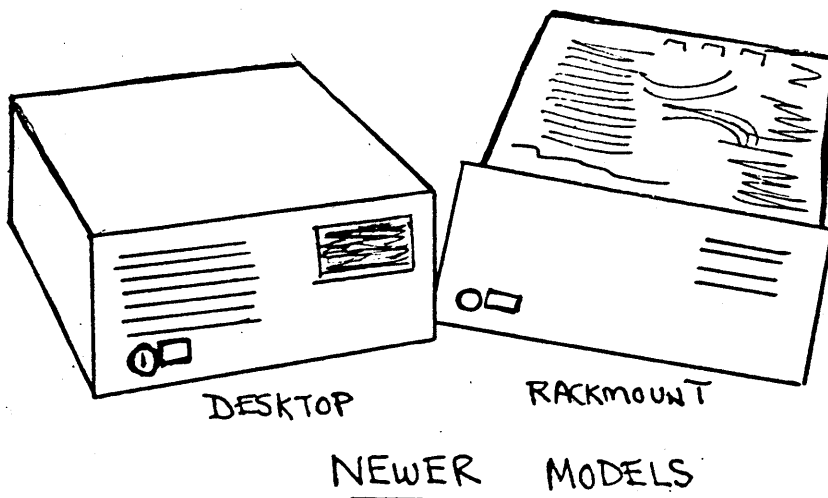

PRELIMINARY

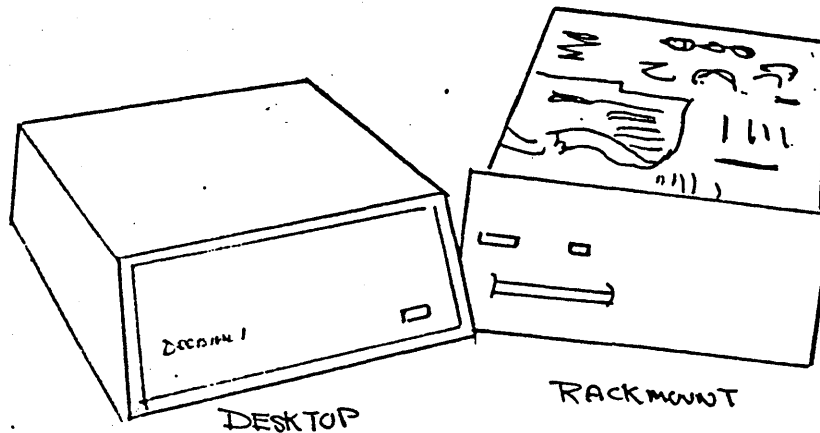

OLDER MODELS

CONFIGURATION OVERVIEW

The 100 Series Decision 1 computers are single user systems and include the D100 and D120. The 200 Series are multi-user systems and include the D200, D210 and D220. The differences among models include the available operating systems, the RAM capacity, the disk drive configurations and the number of input/output ports. All systems include the following:

- CPM 2.2 Operating System
- 14 Slot Motherboard (IEEE 696/S-100 Bus structure)
- MP Z80 CPU Board
- 2K Byte Bootstrap Prom
- Realtime CMOS Clock/Calendar and Programmable Interrupt Controller
- 2 RS232C Serial Ports
- 1 Parallel Daisy Printer Port

The differences among systems are as follows:

D100

- 64K Bytes of High Speed RAM

D120

- 64K Bytes* of high speed RAM
- 5-1/4" Double Sided 48 TPI floppy drive (400K Bytes Formatted) with DMA Controller

- 10M Byte 5-1/4" Hard Disk with DMA Controller

D200

PRELIMINARY

- Micronix Operating System
- 256K Bytes of High Speed RAM
- Memory Protect Hardware
- 5-1/4" Floppy Disk (400K Formatted) with DMA Controller
- 5-1/4" Hard Disk (10M Bytes) with DMA Controller

D210

- Includes all D210 features except that it has a 16M Byte Hard Disk.

**NOTE: The Micronix Operating System and 256K Bytes may be included in the model 120 if Kit D510 has been installed.*

D220

Includes all features of D210, plus:

- Additional 256K RAM Board for a total of 512K RAM
- Multi I/O Board with three additional RS232C Serial Ports and one additional Parallel Printer Port

NOTE : Earlier Decision 1 computers were not designated by model number and may contain any combination of the aforementioned features.

As you can see, the Decision 1 Computers are basically the same but vary in features depending on the PCB's used and the disk drives available. Besides configuration differences you can expect to see a variety of physical differences depending on the vintage of the system being serviced.

Some systems will have the on/off switches mounted on the front; some on the rear. Some will be key operated, others will not. Some will have disk drives on the left side, others will have the drives on the right side. Some cabinets will be plastic, others will be metal. Some systems will be desktop, others will be rack mounted.

This module has described the configuration of the various Decision 1 Computer systems that are available. If you feel confident that you understand the information presented in this module, take the following self test.

PRELIMINARY

SELF TEST

1. All Decision 1 Computers contain which three of the following?

- A Multi I/O Board
- A Motherboard
- A 2K Byte Bootstrap Prom
- An MPZ80 CPU Board
- A hard disk drive

2. What two operating systems does Morrow offer with the Decision 1 Computer?

- CPM 2.2
- MS DOS
- Micronix

ANSWERS

1. A Motherboard, A 2K Byte bootstrap Prom and an MPZ80 CPU Board. The Multi I/O Board and hard disk drive are optional.
2. CPM 2.2 and Micronix. MS DOS is not compatible.

PRELIMINARY

SYSTEM/SOFTWARE OPERATION

MODULE 2 SYSTEM/SOFTWARE OPERATION

MODULE OVERVIEW

This module locates and explains the operator controls and gives a brief description of the operating systems available for use on the Decision 1.

PREREQUISITE

Completion of module 1.

MODULE OBJECTIVE

At the end of this module you will be able to answer three questions about the Decision 1 controls and operating systems.

ESTIMATED TIME TO COMPLETE THIS MODULE

SYSTEM OPERATION

Operation of the Decision 1 is similar to the operation of most microcomputers. The only operator controls on the Decision 1 mainframe are the on/off and reset switches. On some models the on/off and reset are key operated and are on the front panel. When the unit is turned on, a panel next to the switch will light. On other models the on/off switch may be either front or rear mounted and a front mounted reset switch will light to indicate when the unit is on.

The reset switch is used to "boot" the system, that is, to load or reload the operating system into the CPU. When using the diagnostic procedures in the service manual you will be asked to reset the system several times.

CAUTION: You will be using the CPM operating system when troubleshooting the Decision 1 computer and therefore will have

OLDER MODELS

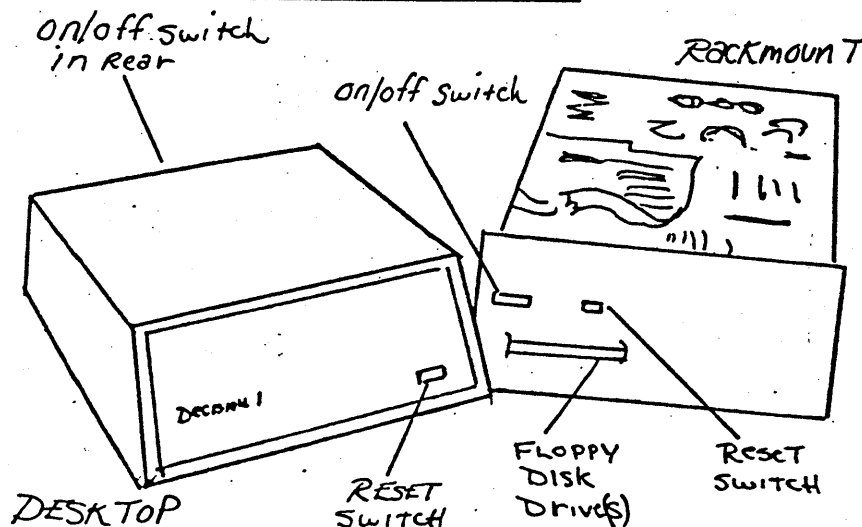

PRELIMINARY

no need to use the Micronix operating system. However, in case you ever do use Micronix, never abort a program by using reset or turning off the power. Damage could occur to the file system.

One or two floppy disk drives may be included in the mainframe cabinet and each will have an LED indicator that lights when the disks are driving. You may find any of several types of disk drive doors but the operation of each will be obvious. When inserting a diskette make sure the write protect notch is to the left. Never close a door without a disk in place.

A Decision 1 cabinet may contain a 5, 10 or 16 megabyte hard disk drive. If so, the LED indicator for the drive will be near the bottom of the front panel.

NEWER MODELS.

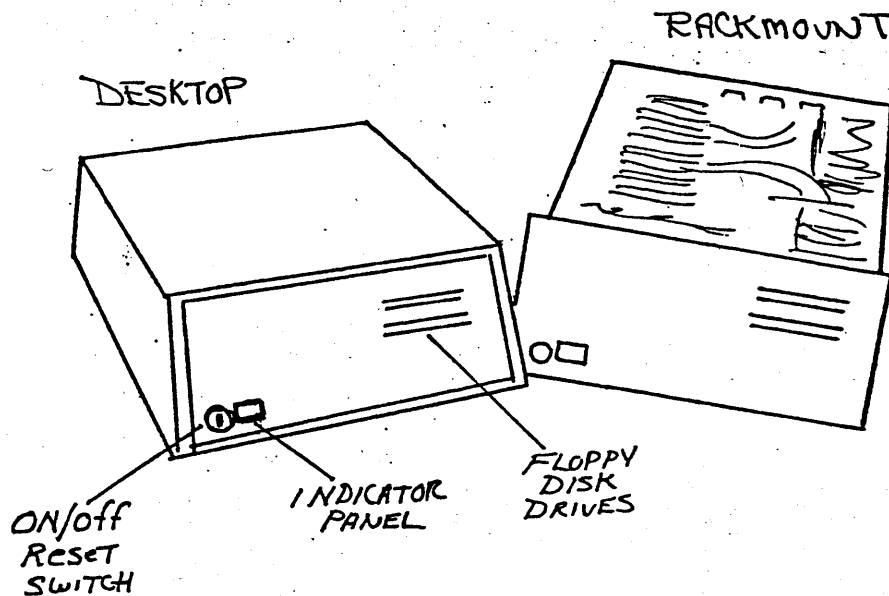

SOFTWARE

CPM

All Decision 1 systems can operate on CPM 2.2 which is the system you will use to verify that the computer will boot and to run the diagnostic program when troubleshooting. It is important to note that a hard sectored disk must be used to boot the system. Specific instruction on how to boot the system and how to run the diagnostic disk will be found in the troubleshooting section of the service manual.

If a system is set to boot from a 5 1/4" floppy disk drive, and the system also has an 8" floppy disk drive, it will try to boot from the 8" drives first, even if the diskette is in the 5 1/4" drive. Open the doors to the 8" drives and the system will select the 5 1/4" drive.

MICRONIX

As an additional operating system some Decision 1 computers will use Micronix which is an operating system designed by Morrow and is similar to the Bell Laboratories Unix. Micronix is a complex operating system and takes considerable file space. If a system has Micronix, the Micronix will be loaded on a hard disk and the system may boot from the hard disk. Micronix has the following features:

- Multi user capability Up to 15 individual users
- Multi Tasking Each user can run several programs at once
- Heirarchical file management Files are organized logically as in an outline
- File protection Data can be protected or shared. For example, some reports can be open to some users and closed to others
- CPM compatibility Micronix includes a CPM emulator that runs CPM applications programs unchanged. Micronix can read and write CPM floppy diskettes and read IBM PC/DOS diskettes.
- Unix compatibility Micronix is compatible with Bell Lab's version 6 Unix at the system call and library level. Source code written to run under Unix will compile and run under Micronix.

HARD DISK BOOTING

If a system has a hard disk drive it is likely that the customer will have the system configured to boot from the hard disk so that they will not have to load a floppy disk to use the system. You must, however, reconfigure the system to boot from a floppy

disk because the diagnostic program you will be using is on a floppy disk. That procedure is included in the troubleshooting FIP in the service manual.

Caution: Whenever you are working on a system that has a hard disk drive, remember that the hard disk contains files and they will be lost if the hard disk is formatted. The files can also be lost when performing certain tests that are on the diagnostic program. There are appropriate warnings in the service manual whenever there is a danger of losing information from a hard disk.

This completes the System/Software Operation module. If you feel confident that you understand the information presented in this module, take the following self test.

SELF TEST

1. What operating system will be used if the Decision 1 is being used as a multi-user system?
 - CPM
 - Micronix
 - MS-DOS

2. What may happen if you abort a program by resetting the system while using Micronix?
 - Damage could occur to the file system.
 - The screen will go blank.
 - The Decision 1 will change to the CPM operating system.

3. What will a Decision 1 system generally have if the Micronix operating system is being used?
 - At least 6 multi-user terminals.
 - Two floppy disk drives.
 - A hard disk drive.

ANSWERS

1. Micronix. One of the advantages of Micronix is its multi-user capabilities.
2. Damage could occur to the file system. The reset switch should never be used while a Micronix program is running.
3. A hard disk drive. Because Micronix requires considerable file space.

MODULE 3 MAJOR ASSEMBLIES

MODULE OVERVIEW

This module provides you with the names, locations and functions of the major replacable assemblies of the Decision 1.

PREREQUISITE

Completion of module 2.

MODULE OBJECTIVE

At the end of this module you will be able to identify the major assemblies of the Decision 1 on an exploded view drawing. *How?*

ESTIMATED TIME TO COMPLETE THIS MODULE

?

COMPONENT IDENTIFICATION

The assembly level repairs that you will be performing on the Decision 1 Systems require that you are able to locate the assemblies that are spared and also know a little about the function of each. Following is a list of the major spared assemblies along with a brief description of their function.

(Refer to the diagram on p.13)
Replaceable Component

Features/Functions

1. Wunderbuss I/O PCB
 - 14 slot S-100 motherboard
 - Programmable interrupt controller
 - Real-time clock
 - Parallel daisy wheel printer port
 - Three serial ports

2. Other Circuit Boards
 - CPU PCB
 - Z80 Microprocessor chip
 - Trap system that allows operating system control over user access and operation
 - 2K Byte bootstrap prom
 - 1K Byte of RAM
 - 24 Bits of address space allowing access to over 16M Bytes of physical memory

MAJOR ASSEMBLIES

PRELIMINARY

- 65K Memory PCB
 - 256K Memory PCB
 - DJ/DMA PCB
 - HDC/DMA PCB
 - Multi I/O PCB
 - 3. Floppy Disk Drive(s)
 - 4. Hard Disk Drive
 - 5. Card Cage
 - 6. Card Cage Brackets
 - 7. Fan Filter
 - 8. Fan
 - 9. Power Supply
 - 10. Rear Panel
 - 11. Front Panel
- 65K RAM
 - Two independent banks of 23K memory
 - Optional bank select or extended addressing
 - Four 64K RAM chips
 - Extended addressing
 - Handles 8 or 16 bit data transfers
 - Floppy disk direct memory access controller
 - controls up to four 5 1/4" or four 8" hard disk drives
 - Hard disk direct memory access controller
 - Controls up to four 5 1/4" or four 8" hard disk drives
 - Up to four Multi I/O PCB's may be used per system
 - Three RS232 serial ports
 - Three parallel ports
 - CMOS real time clock calander
 - 1K Byte 2708 EPROM
 - 1K Byte high speed static 2114 RAM
 - Space for one or two 5 1/4" floppy disk drives
 - One 5M byte, 10M byte or 16M byte hard disk drive
 - A cage that positions PCB'S in the wunderbuss
 - Brackets that secure the PCB'S
 - A replaceable cooling fan filter
 - A 12 volt air circulating fan
 - 165 watt switching power supply that provides 8, 12, 16, -16 volts
 - Contains power connectors
 - Plastic bezel that attaches to the chasis base

12. Switch Key Mechanism

- Key operated combination switch that provides on/off and reset functions. Note: Older models are not key operated. An on/off switch is located on the back of desktop models or on the front of rackmount models. A reset button is located on the front of older rackmount and desktop models.

13. Power/Reset Indicator

- Backlit display indicating that power is on

14. Chassis Base

- The cabinet

15. Foot

- Four replaceable rubber feet

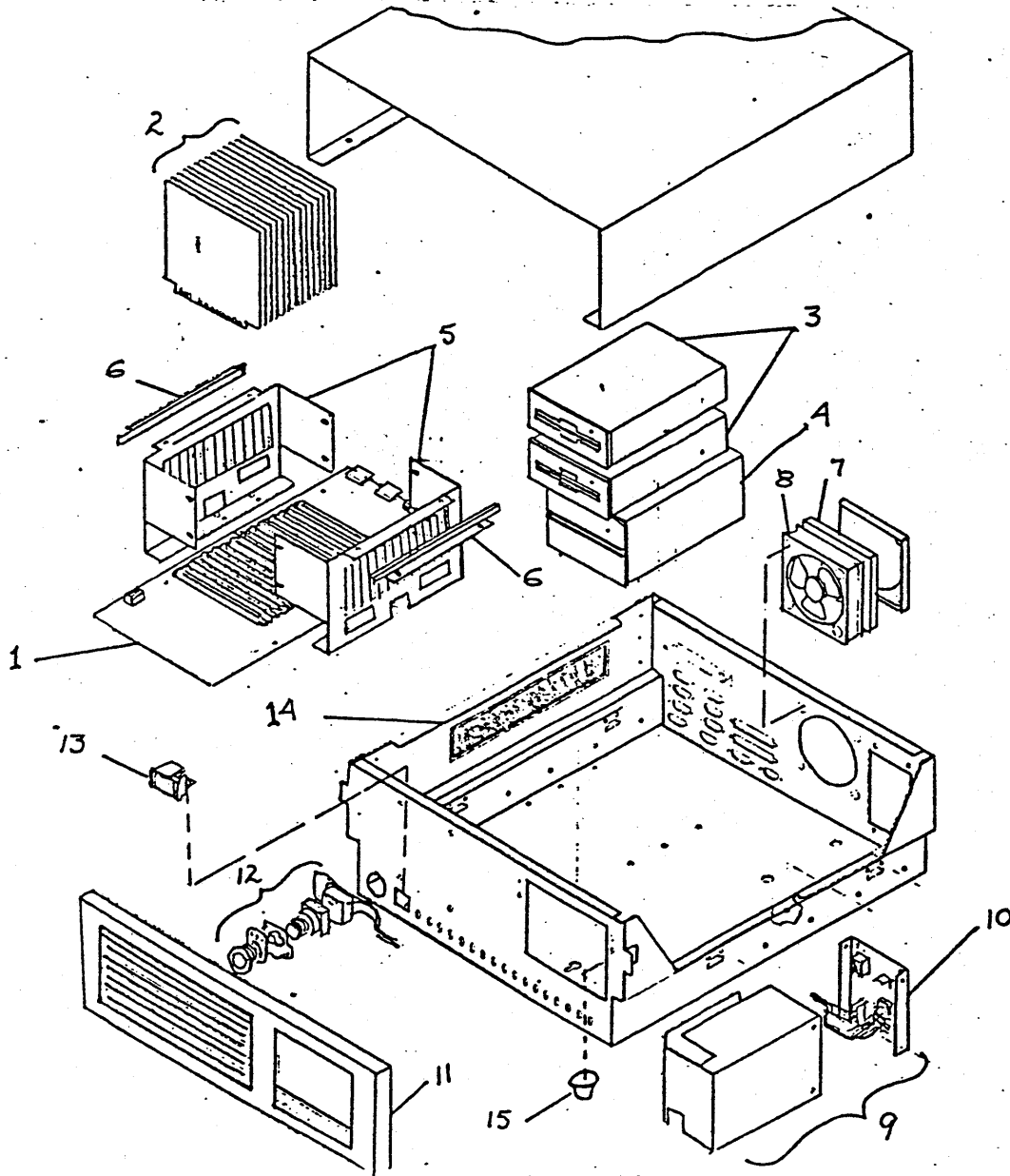

PRELIMINARY

This completes the major assemblies module. If you feel confident that you understand the information in this module, take the following self test.

SELF TEST

1. The Wunderbuss I/O PCB is which of the following?

- An optional board
- A Motherboard
- The CPU board

2. Which microprocessor chip is used in the CPU PCB?

- Z80
- 8085
- 8080

3. What PCB must a system have that has a hard disk drive?

- DJ/DMA PCB
- Multi I/O PCB
- HDC/DMA PCB

4. Fill in the blanks on the following list of assemblies with the appropriate numbers from the illustration.

PRELIMINARY

MAJOR ASSEMBLIES

- Wunderbuss I/O PCB
- Printed Circuit Boards
- Floppy Disk Drives
- Hard Disk Drive
- Card Cage
- Card Cage Brackets
- Fan Filter
- Fan

- Power Supply
- Rear Panel
- Front Panel
- Switch Key Mechanism
- Power Reset Indicator
- Chassis Base
- Foot

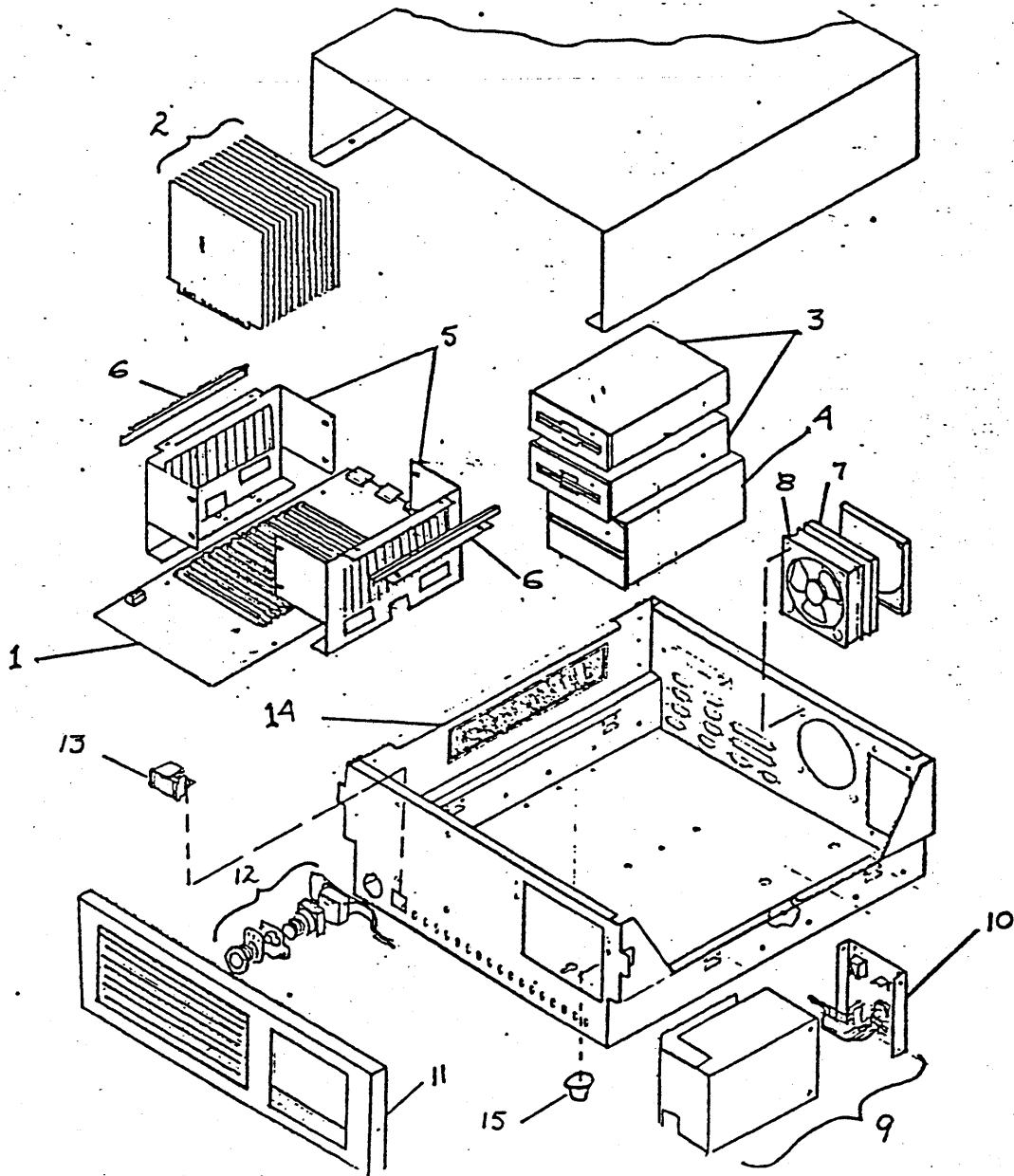

MAJOR ASSEMBLIES

ANSWERS

1. Motherboard
2. Z80
3. HDC/DMA PCB
4. Check the illustration in the module for the correct numbers.

MODULE 4 USING THE SERVICE MANUAL

MODULE OVERVIEW

This module will familiarize you with the contents of the service manual.

PREREQUISITE

Completion of module 3

MODULE OBJECTIVE

?

ESTIMATED TIME OF COMPLETION

?

COMPONENT LOCATION

The component location section of the service manual identifies the various boards that may be found in the Decision 1 system and identifies any components on the boards that you must be aware of to maintain the system.

REPAIRS

The Repairs section of the service manual provides any special instructions that are necessary to know when replacing components.

PARTS LISTS

This section of the service manual provides instructions that you will need to know when replacing components.

TROUBLESHOOTING

The major portion of the troubleshooting section of the service manual consists of a lengthy Fault Isolation Procedure (FIP). The FIP will identify any of the following components that are defective:

- ON/OFF Reset Switch
- Power Indicator
- Cooling Fan
- Power Supply
- All PCB's
- All Floppy or Hard disk drives
- Cables & Harnesses

PRELIMINARY

The FIP consists of the following checks and Tests:

- A. Check for Primary Power
- B. Check for System Boot
- C. Memory PCB check
- D. DJ/DMA PCB Test
- E. QRUN Test
- F. Check Test (Hard Disk Drive Test)
- G. FORMATMW TEST
- H. Floppy Disk Drive Test
- J. Floppy Drive Alignment Check
- K. CRT Terminal Test
- L. Printer Test

A. CHECK FOR PRIMARY POWER

This check assures that power is getting to the power supply.

B. CHECK FOR SYSTEM BOOT

This check assures that the system is able to load and execute programs. This is necessary because the remainder of the FIP uses a floppy disk loaded series of programs called Diagnostics II to test the major assemblies of the system.

In some cases the customer's system will be configured to "boot" from a disk drive other than drive "A" This requires that some switch settings on the CPU board be reset. The Check for System Boot procedure will tell you what to do. The procedure also leads you to various checks that will indicate whether any of the major assemblies are causing a booting problem.

REMAINDER OF CHECKS AND TESTS

The remainder of the Checks and Tests use the Diagnostic II test disk to test the major assemblies of the system. The disk is a series of programs developed by Supersoft Inc. to interface with the hardware through CPM, thereby testing the major components of a system. The FIP was designed to use specific portions of the Diagnostic II programs to their best advantage for servicing the Decision I system.

The Checks and Tests consist of inputting certain information on the terminal and verifying that the appropriate response is displayed on the screen. Basically the procedures consist of having you check cable connections, reseating the boards, checking switch positions and replacing assemblies as necessary.

PRELIMINARY

MORROW DESIGNS
DECISION 1 COMPUTER
SERVICE MANUAL

SBXMD5020

Published by:
Xerox Corporation, Rochester, New York 14644

Prepared by:
Multinational Documentation and Training Service
Xerox Corporation, Rochester New York 14644

Copyright 1983 by Xerox Corporation. All rights reserved.
Xerox is a trademark of Xerox Corporation

Morrow Designs is a trademark of Morrow Designs Inc.

PRELIMINARY

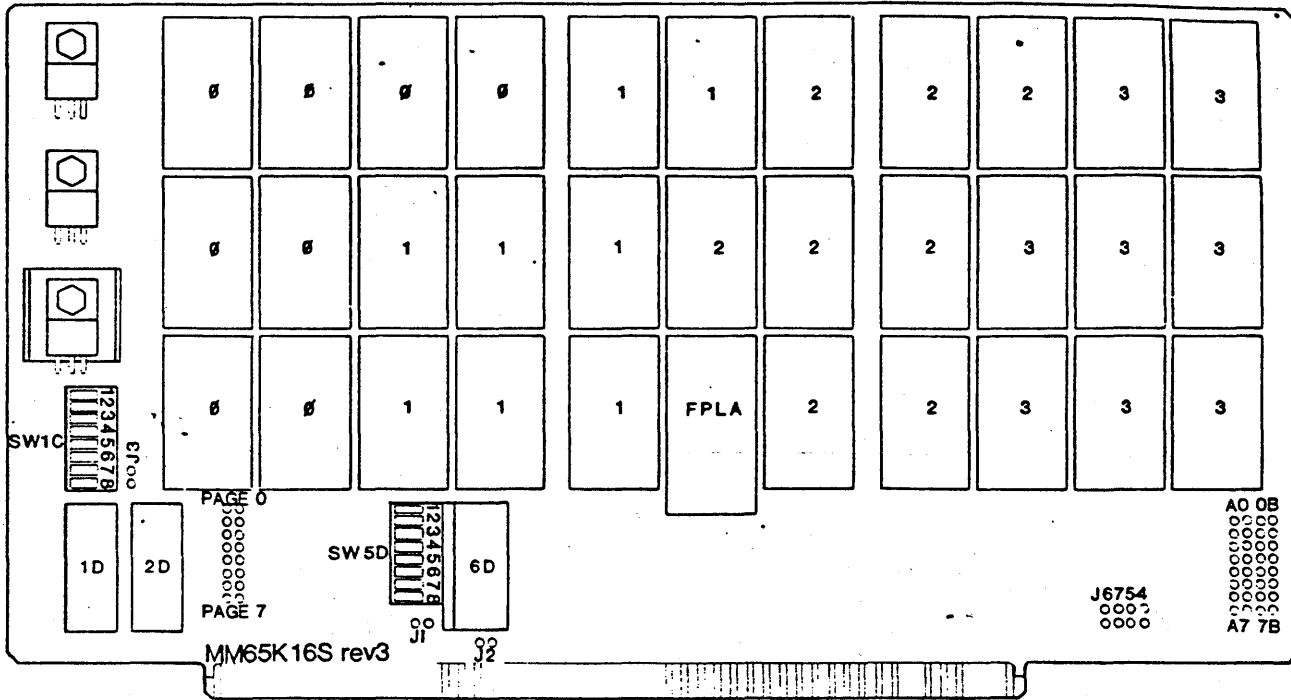

MEMORY PCB (MM65KS)

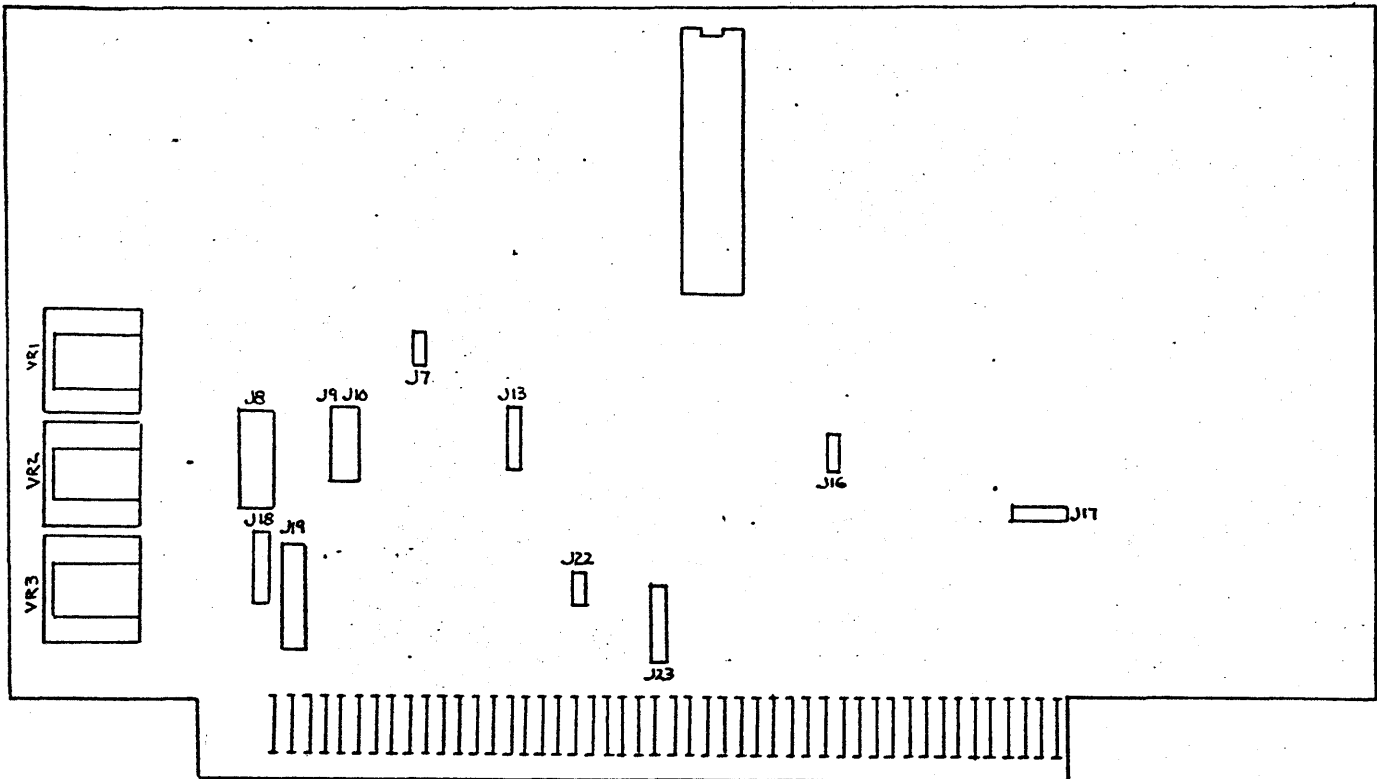

MEMORY PCB (MM256KD)

COMPONENT LOCATION

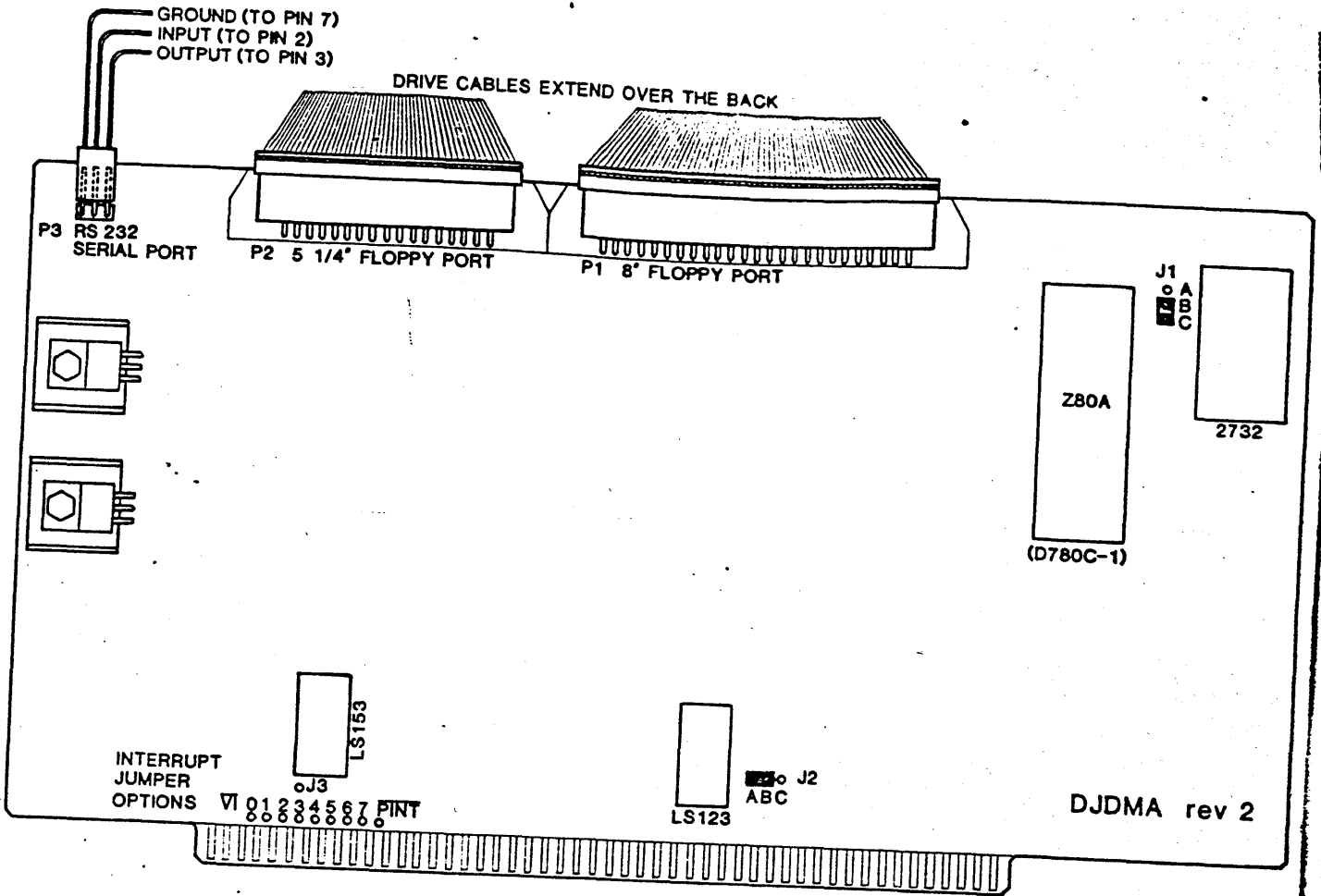

DJ/DMA FLOPPY DISK CONTROL PCB

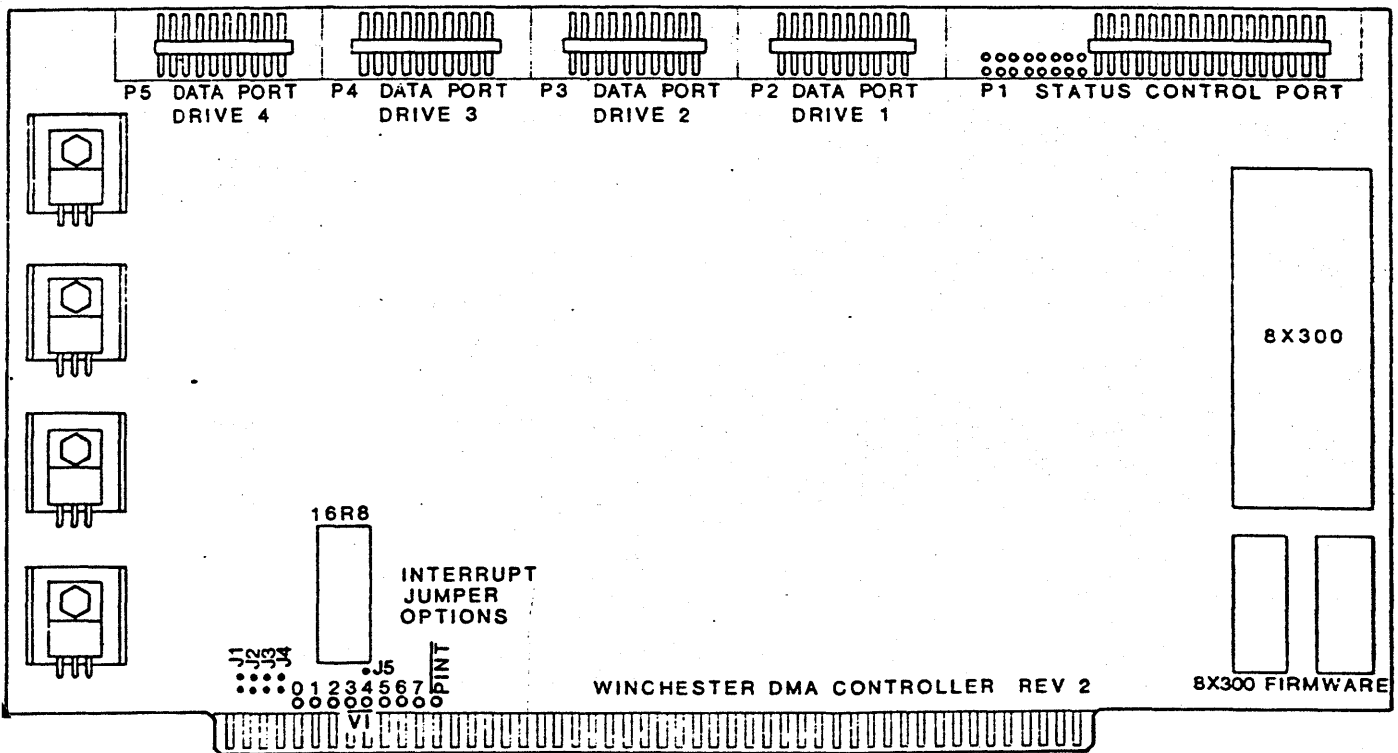

HD/DMA HARD DISK CONTROL PCB

PRELIMINARY

PRELIMINARY

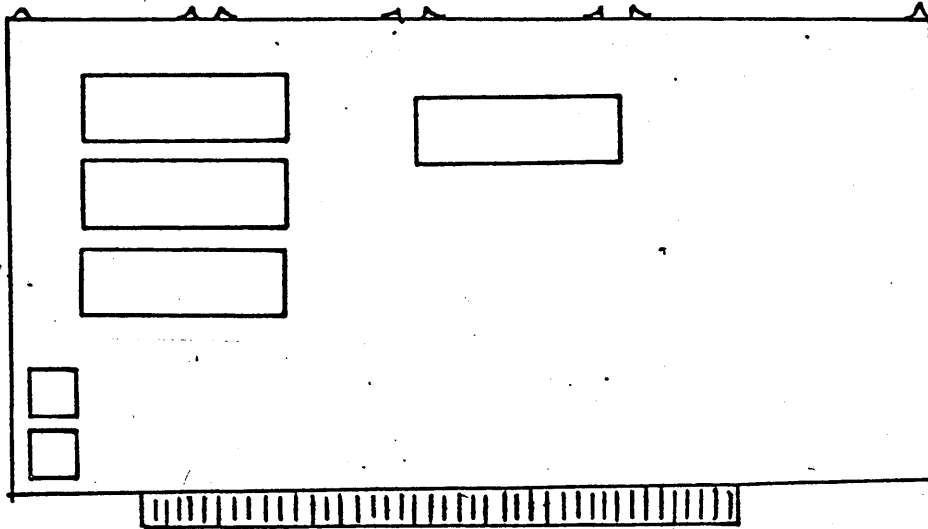

MULTI I/O PCB

PRELIMINARY

REPAIRS

PRINTED CIRCUIT BOARDS

Removal

To remove any PCB except the wunderbuss, remove the two card cage brackets, remove ribbon cable as necessary and pull the board straight up.

Replacement

When installing a new board be sure to position any switches and jumpers to the same positions as on the replaced board.

Any board may be installed into any socket on the wunderbuss. When possible do not place boards next to each other in order to leave room for air circulation.

WUNDERBUSS

Removal

1. Remove card cage brackets.
2. Remove PCB's.
3. Remove six screws that hold the card cage to the chassis.
4. Remove 8 screws that hold the wunderbuss to the card cage.
5. Disconnect the reset cable from the rear of the wunderbuss.
6. Disconnect the ribbon cable from the rear of the wunderbuss.
7. Disconnect one end of the DC power cable from the front of the wunderbuss and the other end from the power supply.
8. Carefully lift the wunderbuss and card cage from the chassis.

Replacement

There are two different wunderbuss configurations. They are electrically the same but mechanically different. A matrix is being developed to enable you to order the proper wunderbuss.

REPAIRS

PRELIMINARY

POWER SUPPLY

Removal

1. Disconnect power cord and all cables.
2. Remove screw that holds power supply to bottom of chassis.
3. Remove four screws that hold power supply to rear of chassis.
4. Lift power supply out of chassis.

Replacement

There are five power supply configurations. They are all electrically interchangeable but are mechanically different. A matrix is being developed to enable you to order the proper supply.

DISK DRIVE ASSEMBLY

Removal

1. Disconnect harnesses.
2. Loosen four screws on the underside of the chassis.
3. Slide the disk drive assembly back and lift it out of the chassis.

NOTE: If the system has two floppy disk drives mark the position of each.

PRELIMINARY

TROUBLESHOOTING

This Section of the service manual will assist you in repairing problems within the Morrow Decision 1. The procedures are "directive". Directive means you will be given a series of statement, checks and or observations to be made. Then depending upon your response you will be given directions to help you in each phase of troubleshooting.

PLEASE NOTE:

The troubleshooting procedures contain recommended replacement parts for the correction of problems. If the recommended part replacement does not correct the problem, reinstall the old part and continue troubleshooting.

Tools Required

You will need a Diagnostic II diskette, a blank formatted hard sectored diskette, digital volt meter and a Phillips screwdriver.

The following is a list of cautions and troubleshooting hints to be observed when testing the Decision 1 system.

THINGS TO REMEMBER:

Before doing any testing or troubleshooting of the Decision 1 system be sure that all information stored on the Hard disk has been saved on backup diskettes.

Always remove the floppy diskette and when possible run the "DOWN" program before turning power off.

Only press reset when the red activity LED on the floppy disk drive is off.

When opening the floppy disk drive door and or removing the diskette insure the activity LED is off.

CAUTIONS:

The Hard Disk Drive is a delicate instrument. Before moving or turning the Decision 1 on its side be sure to run the "DOWN" program to park the heads of the hard disk in a safe zone. This will prevent the heads from damaging the disk surfaces.

When replacing a PCB in the WB I/O, be sure the component side of the PCB is facing the front of the unit.

The ribbon cables in the Decision 1 are not keyed. When replacing or reconnecting the cables insure that they are oriented exactly as they were removed.

On some of the CPU PCBs the Monitor switch in location 16D may have been installed in the wrong direction such that the label for switch 1 is closest to the bottom of the PCB. Switch 1 is actually the top position on the bank of switches.

DECISION 1 COMPUTER FAULT ISOLATION PROCEDURE

This procedure consists of the following checks and tests:

- A. Check For Primary Power
- B. Check For System Boot
- C. Memory PCB Check
- D. DJ/DMA PCB Test
- E. QRUN Test
- F. Check Test ard Disk Drive Test)
- G. FORMATMW Test
- H. Floppy Disk Drive Test
- J. Floppy Drive Alignment Check
- K. CRT Terminal Test
- L. Printer Test

PRELIMINARY

TROUBLESHOOTING

Before starting to troubleshoot the Decision 1, insure that the unit is plugged into an adequate power source with no other major electrical appliances such as air conditioners, space heaters, etc.. Such appliances can cause voltage variations which may cause erratic performance or intermittent problems with the computer.

A. CHECK FOR PRIMARY POWER

1. With power off visually inspect the Decision 1 system for obvious problems (disconnected or loose cables, broken components, etc.).
2. Now apply power by either reversing the position of the rocker switch or by turning the keyswitch to the on position.
3. Check that the power indicator and the Decision 1 cooling fan are on. If so proceed to step B, "Check For System Boot".
4. If neither the power indicator nor the fan came on, turn power off and check the following:
 - The circuit breaker on the back of the Decision 1 (key-switch models only).
 - The wall outlet and power cord for the correct voltage.
 - The connection of the power cord to the Decision 1. The socket is deep and must be fully inserted for a good connection.
 - The power switch itself for proper operation. (NOTE: On keyswitch modles the power on side of the switch is the side with the black and red wire pair.)
5. If the cooling fan is operating but the power indicator is out, the system may be operational with the exception of the lamp. Check the lamp and the connections to it.

B. Check For System Boot

1. Check the level of software installed in the Decision 1. Insure that you have the proper level CP/M and Diagnostic floppy diskette for the system.
2. Check to see if the system is configured to boot from the floppy disk drive. If not proceed as follows:
 - a. Press power off and remove the CPU PCB.
 - b. Record the settings of Monitor switch (lower right hand corner of the CPU PCB).

PRELIMINARY

CONTENTS

SECTION	PAGE
Component Location.....	1
Repairs.....	5
Troubleshooting.....	7
Parts Lists.....	34

COMPONENT LOCATION

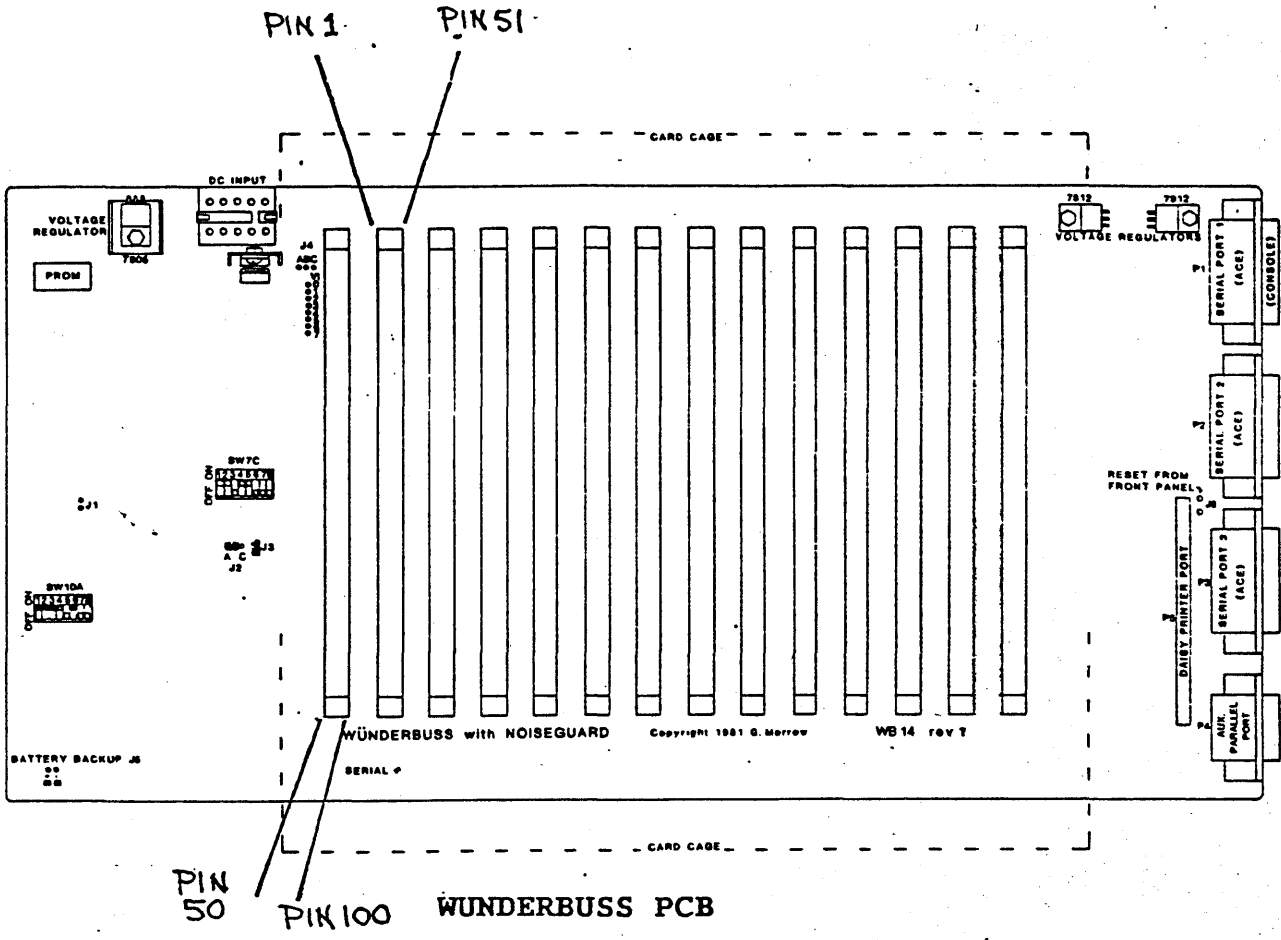

PIN 50
PIN 100
WUNDERBUSS PCB

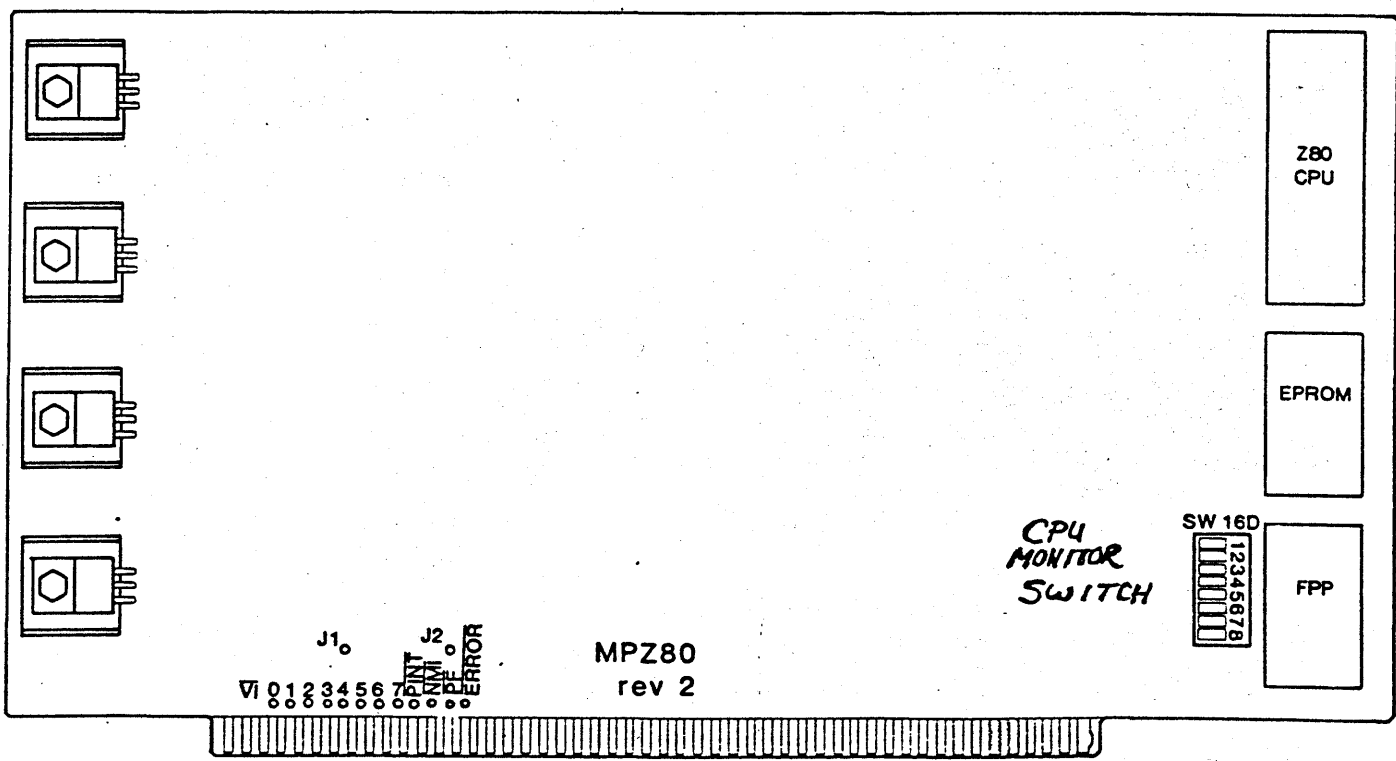

CPU PCB

PRELIMINARY

PRELIMINARY

- c. Set positions 4 and 6 OFF and all other positions ON.
- d. Install the CPU PCB, check all connections, and press power on.

3. Insert the Decision 1, Diagnostic Diskette into the floppy disk drive and press "RESET".
4. After a pause the screen should display a sign-on message followed by an "A>" prompt.

example: s 64K CP/M 2.2 E--
 AB: DJDMA 5 1/4", CD: DJDMA 8", E: HDDMA
 A>

5. If "A>" is present proceed to STEP E, the QRUN TEST.
6. If not, check that a properly operating CRT is connected to port 1.
7. If so, remove the diskette, turn power off and proceed as follows:
 - a. Check the two wires from the system reset switch to J6 on the WB I/O PCB. (NOTE: On keyswitch modules the reset wires are the black and blue wire pair on the same side of the switch.)
 - b. Turn power on. Insert the appropriate diagnostic diskette and press reset. If system now "boots" proceed to STEP E, the QRUN TEST.
 - c. If the system still does not "boot" proceed to step 8.
8. Remove and reinstall the CPU PCB in a different connector on the WB I/O PCB.
9. Check to see that all boards and cables are seated properly.
10. Turn power on. Insert the appropriate diagnostic diskette and press reset. If system now "boots" proceed to STEP E, the QRUN TEST.
11. If the system still does not "boot", check output voltages of the Decision 1 power supply by measuring voltage at both the disk drive and the Wunderbuss I/O power connector J6 (see tables 1-1 and 1-2).

Table 1-1: P6 - WB I/O Power Connector

<u>PIN</u>	<u>INPUT</u>
1	-16VDC
2	+16VDC
3	+8VDC
4	blank
5	+8VDC
6	+8VDC
7	ground
8	ground
9	ground

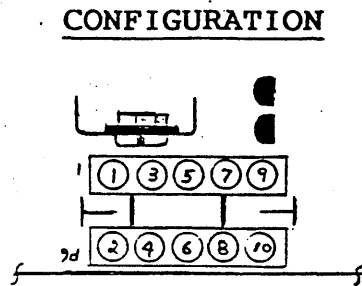

WB I/O location 1C
(J6 viewed from harness side
of connector)

Table 1-2: DISK DRIVE POWER CONNETOR

(on both Hard and Floppy disk drive units)

<u>PIN</u>	<u>VOLTAGE</u>
1	+12 VDC
2	ground
3	ground
4	+5 VDC

12. If any voltages are missing, turn power off and check the continuity of the harness. If good, replace the Decision 1 Power Supply.
13. If the red activity LED on the disk drive comes on and stays on or continuously flashes on and off, check the following:
 - o That the diskette you are using is the correct one⁷ and is inserted in the disk drive correctly. *which one?*
 - o That the ribbon cable between the floppy disk drive and the DJ/DMA PWB is installed with the red stripe toward the left side of the Decision 1, in both connectors. *from the front or back?*
14. If problem still exists remove the diskette and turn power off.
15. Remove all printed circuit boards from the mother board.

PRELIMINARY

TROUBLESHOOTING

PRELIMINARY

16. On the CPU PCB, locate and record the Monitor switch settings (8 position dip-switch, lower right corner of the PCB). Place S6 and 8, in the on position and all other switches off. This forces the CPU to power up in the Monitor program.

17. Install the CPU PCB and press power on.

18. Press Reset:

19. If console displays the following, go to step "C. MEMORY PCB CHECK".

MOBAD

:

20. If not, press power off.

21. Install a new CPU PCB, insure the Monitor switch has S6 in the On position.

22. Press power on and reset.

23. Check that the console displays the following:

MOBAD

:

24. If it does, press power off and perform the following:

a. Place the Monitor switch on the CPU PCB back to a floppy boot condition (S4 and S6 Off all other positions on) and install the CPU PCB.

b. Install the remaining PCB's and connect all cables.

c. Press power on and insert the diagnostic diskette.

d. Press reset and proceed to STEP E, the QRUN TEST.

25. If not press power off perform the following:

a. Replace Wunderbuss I/O PCB.

b. Place the Monitor switch on the CPU PCB back to a floppy boot condition (S4 and S6 Off all other positions on) and install the CPU PCB.

c. Install the remaining PCB's and connect all cables.

d. Press power on and insert the diagnostic diskette.

e. Press reset and proceed to STEP 5: QRUN TEST.

PRELIMINARY**C. MEMORY PCB CHECK**

1. Press power off.
2. Insert the Memory PCB.
3. Press power on and reset. After a brief pause the console should display:

```
:FFFF
:
```

4. If it does not, go to step 8. If it does, type in the following:

```
:T1000,FFFF <return>
```

5. After a pause the console should display a ":". If it does go to step "D. DJ/DMA PCB TEST".
6. If the screen displays a series of rolling "lllllllll" down the screen, press power off and proceed as follows:
 - a. Install a new Memory PCB (make sure that all board jumpers are in the same position as on the original Memory PCB).
 - b. Remove the CPU PCB and place the Monitor switch back to a floppy boot condition (S4 and S6 Off all other positions on) and reinstall the CPU PCB.
 - c. Install the remaining PCB's and connect all cables.
 - d. Press power on and insert the diagnostic diskette.
 - e. Press reset and proceed to STEP E, the QRUN TEST.
7. For any other condition proceed to STEP D, the DJ/DMA PCB TEST.
8. If ":FFFF" followed by a ":" on the next line was not displayed, press power off and proceed as follows:
 - a. Remove the Memory PCB and install it back in a different connector on the WB I/O PCB.
 - b. Press power on and reset. If the display is correct this time proceed to step "E. QRUN TEST". If not proceed to step 9.

TROUBLESHOOTING

9. Install a new Memory PCB (make sure that all board jumpers are in the same position as the original Memory PCB).
 - a. Remove the CPU PCB and place the Monitor switch back to a floppy boot condition (S4 and S6 Off all other positions on) and install the CPU PCB.
 - b. Install the remaining PCB's and connect all cables.
 - c. Press power on and insert the diagnostic diskette.
 - d. Press reset and proceed to step "E. QRUN TEST".

D. DJ/DMA PCB TEST

1. Press power off.
2. Insure that jumpers J1 and P3 on the DJ/DMA PCB are in the following positions.

<u>JUMPER</u>	<u>POSITION</u>
J1	B to C
P3	2 to 3

3. Insert the DJ/DMA PCB and connect the appropriate cables.
4. Place the Monitor switch on the CPU PCB back to a floppy boot condition (S4 and S6 Off all other positions on) and install the CPU PCB.
5. With floppy drive door open press power on and reset. The red activity LED on the front of the drive should blink on and off. If not check the ribbon cable between the floppy drive and the DJ/DMA PCB. It may be reversed.
6. Insert the Diagnostic diskette and press reset.
7. If the system "boots" and displays an "A>" prompt proceed as follows:
 - a. Remove the Diagnostic diskette and press power OFF.
 - b. Install any remaining PCB's and connect all cables.
 - c. Press power ON and go to STEP E, the QRUN TEST.
8. If the system does not boot, check the jumper on the floppy disk drive PCB (location F1). Position DS1 should be jumpered.

PRELIMINARY

TROUBLESHOOTING

9. If the display reads " DRIVE NOT FOUND " perform the following:
- Check the voltage at the Floppy Disk Drive PCB power connector.

<u>PIN</u>	<u>VOLTAGE</u>
1	+12 VDC
2	ground
3	ground
4	+5 VDC

- If voltage readings are ^{correct} good replace the Floppy Disk Drive and perform the following:
 - Install any remaining PCB's and connect all cables.
 - Press power ON and return to step "B. Check For System Boot".
10. If the display reads " DRIVE SELECT ERROR " replace the DJ/DMA PCB and perform the following:
- Install any remaining PCB's and connect all cables.
 - Press power ON, insert the Diagnostic diskette and press reset. Proceed to step "E. QRUN TEST".
11. If ^{the} system still does not boot replace the WB I/O PCB and perform the following:
- Install any remaining PCB's and connect all cables.
 - Press power ON, insert the Diagnostic diskette and press reset. Proceed to step "E. QRUN TEST".

E. QRUN TEST

The "QRUN" test consists of the following tests:

- * MEMORY
- * QDISK
- * CPU

- With an A> prompt displayed enter:

A>QRUN <return>

The console should indicate the following:

PRELIMINARY

TROUBLESHOOTING

PRELIMINARY

SuperSoft Associates Diagnostics II
Quick test Copyright (c) 19XX

Memory test
Memory test complete

Disk test
Read/write test
Random Seek test
0 read/write errors detected
0 seek errors detected

<<<<<

DIAGNOSTICS II V1.2 - CPU TEST
COPYRIGHT (C) 19XX - SUPERSOFT ASSOCIATES

ABCDEFGHIJKLMNOPQRSTUVWXYZ

CPU IS Z80
BEGIN TIMING TEST
EN
CPU TEST OK

A>

2. If all tests were good or only the Disk test had errors proceed to step "F. CHECK TEST (Hard Disk Drive Test)".
3. If the Memory test has errors (Perform the following:
 - a. Remove the Diagnostic diskette and press power off.
 - b. Remove the Memory PCB and reinstall it in a different connector on the WB I/O PCB.
 - c. Press power on and insert the diagnostic diskette.
 - d. Press reset and run the "QRUN" test again.
 - If ^{the} Memory test passes proceed to step "F. CHECK TEST (Hard Disk Drive Test)".
 - If ^{the} Memory test still fails install a new Memory PCB and repeat step "d.".
 - If ^{the} problem still exists install a new WB I/O PCB and repeat step "d.".
4. If the CPU test has errors perform the following:
 - a. Remove the Diagnostic diskette and press power off.
 - b. Remove the CPU PCB and reinstall it in a different connector on the WB I/O PCB.
 - c. Press power on and insert the diagnostic diskette.

d. Press reset and run step E the "QRUN" test again.

- If CPU test passes proceed to step "F. CHECK TEST (Hard Disk Drive Test)".
- If CPU test still fails install a new CPU PCB and repeat step "d.".
- If problem still exists install a new WB I/O PCB and repeat step "d.".

F. CHECK TEST (Hard Disk Drive Test)

This test is designed for systems equipped with a 5 1/4" hard disk drive. If system does not have a hard disk proceed to step "H. FLOPPY DISK DRIVE TEST".

NOTE: Before performing this test insure that both ribbon cables between the hard disk drive and the HDC/DMA PCB are correctly installed: The connectors on both ribbon cables should be installed so that the center stripe on the ribbon is facing in the same direction on both ends of the same cable. Either face-up or face-down. (The stripes do not have to be facing in the same direction on both cables.)

1. With an "A" prompt displayed enter:

A>CHECK <return>

2. Enter the correct response to the questions on the screen for the Decision 1 configuration under test.

NOTE: To select m5, m10 or m16 (the Hard Disk size) check the model number on the back of the drive under test:

MODEL CM 5619 = M16

MODEL CM 5412 = M10

MODEL SEAGATE 506 = M5

3. If no errors are detected proceed to step "H. Floppy Disk Drive Test".

4. If errors are detected proceed to step "G. Formatmw Test".

G. FORMATMW TEST

CAUTION: THIS TEST WILL DESTROY ALL DATA ON THE HARD DISK. INSURE CUSTOMER HAS BACKUP DISKS FOR THESE FILES.

1. With the Diagnostic disk installed and a "A>" prompt present, enter the following: (Enter hard disk size in place of "m#".)

formatmw m# size 512 <return>

- This test will take approximately 5 minutes.
- The information on the screen during the process should look like the following example:

example: A>formatmw m16 size 512
Formatting.
Checking format.

Testing.
Bad sector report.
No bad sectors detected.

A>

2. If the test completes with "No bad sectors detected" return to step "F" and run the ~~run the~~ "CHECK" test again.

- If OK go to STEP H, the Floppy Disk Drive Test.

3. If the word "Formatting." does not appear on the display or system does not appear to be formatting, measure the voltages on the power connector to the hard disk drive:

Pin 1 - +12 VDC
 Pin 2 - ground
 Pin 3 - ground
 Pin 4 - +5 VDC

- If any reading is incorrect perform the following:
 - a. Enter:
A>DOWN <return>
 - b. Remove diskette and press power off.
 - c. Check the harness and repair if necessary.
 - d. If problem still exists replace the Power Supply and return to step "A. CHECK FOR PRIMARY POWER".

PRELIMINARY

TROUBLESHOOTING

4. If a hard sector error is displayed on the screen for Track "0" or if there are 3 or more hard errors on any head ~~on~~ the drive perform the following:
 - a. With an "A>" prompt displayed enter:
A>DOWN <return>
 - b. Remove the diskette and press power off.
 - c. Install a new Hard Disk Drive and return to the beginning of STEP F the CHECK TEST.
5. If 3 or more Soft Sector errors with 5 or more retries appear on the screen perform the following:
 - a. With an "A>" prompt displayed enter:
A>DOWN <return>
 - b. Remove the diskette and press power off.
 - c. Install a new HD/DMA PCB.
 - d. Press power on, install the Diagnostic Diskette and press reset.
 - e. Return to step "F" and run the "CHECK" test again.
 - If no errors are detected proceed to step "H. Floppy Disk Drive Test".
 - If errors are still present proceed as follows:
 - a. Enter:
A>DOWN <return>
 - b. Remove the diskette and press power off.
 - c. Install a new Hard Disk Drive.
 - d. Press power on, install the Diagnostic Diskette and press reset.
 - e. Run the "CHECK" test again. If problem still exists call for assistance.

TECHNICAL SUPPORT IN DALLAS

6. If less than 3 Soft and or Hard sector errors per head appear on the screen proceed as follows:

NOTE: The following test must be set up for the particular system configuration under test. In the example below the responses to the questions asked are for a standard Decision 1 configuration with a M16 (CM 5619) hard disk installed in the unit (keyboard entries are in bold). The length of time required to run this test will vary depending on the size of the hard disk under test (M16 takes approximately 30 minutes).

a. Enter:

Example:

A>HT9 <return>

HDC/DMA Controller Production Test (14-Feb.-83)

Is drive 0 to be tested? (y=yes) y <return>

1-m5S

2-m10S

3-m16C

4-m32

5-m34

6-Not listed

Please select one of the above

3 <return>

1-128

2-256

3-512

4-1024

5-2048

Please select one of the above

3 <return>

Is drive 1 to be tested (y=yes)

<return>

Is drive 2 to be tested (y=yes)

<return>

Is drive 3 to be tested (y=yes)

<return>

Enter the number of triles?

1 <return>

Type Y to start test

Y <return>

Drive 0 has the following characteristics

306 tracks

6 heads

512 bytes / sector

17 Sectors per track

Drive 0

Beginning Seek Test

Beginning Data Test

Drive 0 PASSED

Error Report on trial: 1

Drive 0 PASSED

STOP

A>

PRELIMINARY

TROUBLESHOOTING

- b. If the test passed proceed to step "H. Floppy Disk Drive Test".
- c. If the test failed proceed as follows:
 - With an "A>" prompt displayed enter:
A>DOWN <return>
 - Remove the diskette and press power off.
 - Install a new Hard Disk Drive and return to the beginning of step "F. CHECK TEST".

H. FLOPPY DISK DRIVE TEST

1. With an "A>" prompt present, enter the following:

A>DISK <return>

CAUTION: The following test will erase portions of the Diagnostic Diskette. A blank formatted diskette should be used to complete this test.

2. Remove the Diagnostic diskette from drive "A" and insert a blank, formatted diskette.
3. Respond to statements on the screen as follows:

Enter drive name for disk Log (CR=log off): <return>

Select drive to be tested: A <return>

Respond to all remaining statements with a default by pressing the "RETURN" key.

The screen should display the following:

Labeling all sectors

.....

Totals: 0 hard errors, 0 seek errors, 0 data transfer errors

4. If no errors were detected perform the following:
 - a. Remove the blank diskette and insert the Diagnostic Diskette.

b. Press reset and proceed to step "K. CRT (Terminal) TEST".

5. If errors are present proceed as follows:

- a. Remove the blank diskette and press power off.
- b. Install a new DJ/DMA PCB. (Insure that the ribbon cables are orientated properly.)
- c. Press power on, insert the Diagnostic Diskette and press reset.

d. Enter:

A>DISK <return>

CAUTION: This test will erase portions of the Diagnostic Diskette. A blank formatted diskette should be used to complete this test.

- e. Remove the Diagnostic Diskette and insert a blank formatted diskette.
- f. Respond to all statments as before to complete the test.
 - If no errors detected proceed to step K. CRT (Terminal) TEST.
 - If problem still exists remove diskette, press power off and proceed as follows:
 - a. Install a new Floppy Disk Drive (check ribbon cable orientation).
 - b. Press power on, install Diagnostic Diskette and press reset.
 - c. Proceed to step "J".

J. FLOPPY DRIVE ALIGNMENT CHECK

1. With an "A>" prompt present enter:

A>DISK <return>

CAUTION: The following test will erase portions of the Diagnostic Diskette. A blank formatted diskette should be used to complete this test.

2. Remove the Diagnostic diskette from drive "A" and insert a blank, formatted diskette.

3. Answer the following questions on the screen as follows:

Enter drive name for disk Log (CR=log off): <return>

Select drive to be tested: A <return>

Answer all remaining questions with a default by pressing the "RETURN" key.

The screen should display the following:

Labeling all sectors

.....

Totals: 0 hard errors, 0 seek errors, 0 data transfer errors

4. If no errors were detected proceed as follows:

a. Remove the blank diskette, insert the Diagnostic Diskette and press reset.

b. Proceed to step "K. CRT (Terminal) TEST".

5. If errors still present proceed as follows:

a. Remove the blank diskette, insert the Diagnostic Diskette and press reset.

b. Enter:

A>ALIGN <return>

NOTE: This test does not align the drive, it checks for read errors only.

c. Respond to statements on the screen as follows:

Enter drive name for disk Log (CR=log off): <return>

Select drive to be aligned: A <return>

d. Respond to all remaining statements with a default by pressing the "RETURN" key.

PRELIMINARY

e. Check that the screen displays the following.

Totals: 0 hard read errors

ALL done!

A>

- o If no errors are present proceed to step "H. CRT (Terminal) TEST.
- o If problem still exists remove the diskette, press power off and proceed as follows:
 - a. Install a new WB I/O PCB.
 - b. Install all PCB's, connect all cables and return to step "A. CHECK FOR PRIMARY POWER".

K. CRT (Terminal) TEST

NOTE: The CRT Terminal Test ("TERM") requires close operator attention. Various functions will be tested. While the tests are taking place you must watch the screen closely to note any errors that occur.

SCREEN DISPLAYS:

A sequence of screens will appear, each testing some function of the terminal. Each screen will hold for about 5 seconds or until a key is struck.

- o First, all ASCII printing characters will be displayed in each character position in a "barber pole" pattern.
- o Next, a cursor addressing test is run. In this test a row of "X"s is printed on the terminal screen from the bottom up. On some terminals, the bottom row may have the last few "X"s missing or cause an unwanted line feed. Do Not worry about this. After the "X"s have been printed in reverse scroll fashion, the following message will be printed with alternating character positions being printed each time. This should create the effect of four cursors acting simultaneously.

SuperSoft Associates Terminal Test program 0123456789abc----wxyz*

The last line of the terminal will be used to test the backspace five times. The cursor will move out and then back repeatedly.

PRELIMINARY

TROUBLESHOOTING

- At this point the foreground/background test begins. First, the screen is cleared using repeated CLEARLINE commands instead of clear screen and the cursor is addressed in the home position. If your screen does not clear properly, then CLEARLINE is not functioning properly.
- Next, the screen will be filled with alternating foreground and background messages. As in the example below the background message will be of much lower intensity than the foreground message:

```
----- This is in foreground -----  
<<<<< This is a test of the background feature >>>>>
```

The cursor will then jump back to the top and the screen will be cleared. the test is then terminated and a "A>" prompt will be displayed. (Some terminals may not have all the above mentioned functions.)

Beginning the CRT (Terminal) Test

1. Enter:

```
A>TERM <return>
```

2. Press return to enter the default mode for each question asked.

NOTE: To study the screen the display may be halted at any time by simultaneously pressing the "CTRL" and "S" keys at the same time. Press any other key to continue.

3. If no errors were observed on the screen proceed to step "I. PRINTER TEST".
4. If errors were present check all switch settings and connections. Proceed as follows:
 - a. Replace the Terminal and or key board.
 - b. Run "TERM" test again.
 - If no errors present proceed to step "L. PRINTER TEST".
 - If problems still exist replace the WB I/O PCB.

L. PRINTER TEST

NOTE: The Printer Test exercises all the features of the printer that can be exercised under CP/M. It requires close observation of the printer while it is being put through its paces to note any inadequacies in its performance.

All information necessary to run the printer test may be entered on the command line. The following convention holds:

A>PRINTER P=x L=n T=n,n . . . C=n P=n O=n

Where:

P: Specifies printer type.

Enter:

- "S" for Spinwriter
- "D" for Diablo
- "Q" for Qume
- "O" for everything else

L: Sets the line length of the printer.

T: Sets the tests performed, used only if P is not set to "O"

The tests are entered by their number:

- 1: normal forward and backward
- 2: interleaved overprinting
- 3: same line forward & backward
- 4: horizontal tabbing
- 5: bold face
- 6: superscript & subscript
- 7: scale horizontal
- 8: scale vertical
- 9: barber pole

The numbers are entered in sequence separated by commas.
(see example below)

C: Selects the character set.

Enter:

- "1" for 96 character ASCII
- "2" for 64 character

R: Sets the number of repetitions.

N: sets the number of nulls after carriage motion.

PRELIMINARY

TROUBLESHOOTING

O: Determines whether output is directed to printer or the punch.

Enter:

"1" for Punch

"2" for Printer

Example:

A>PRINTER P=S L=80 T=1,2,3 C=1 R=2 N=1 O=0

BEGINNING PRINTER TEST:

1. Run a Printer self test and replace the printer if errors are detected.
2. Next, connect the printer cable (RS-232) to port 3 of the Decision 1 and check the baud rate.
3. With an "A>" prompt present on the screen enter:

A>PRINTER and desired test conditions followed by a <return> or just press return for the default mode.
4. Check the printer output.
 - a. If the output is not satisfactory go to step 5.
 - b. If the output is satisfactory enter the "DOWN" program and when complete remove the diskette and press power off.
 - c. Return the Decision 1 to its original configuration and have the customer reload the hard disk if necessary.
5. If the printer output appears to have problems check all connections and switch settings. Run the "PRINTER" test again. If a problem still exists proceed as follows.
 - a. Remove the diskette and press power off.
 - b. Install a new WB I/O PCB.
 - c. Connect all PCBs and cables and run the "PRINTER" test again.
 - d. If problem still exists call for assistance.

Technical Support in Dallas

CPU PCB MONITOR SWITCH

The following monitor switch table applies to MPZ80 EPROMs at revision level 3.7 and above. This description is slightly different for Micronix (versions marked MON 4.4*).

The following table depicts common switch settings for Morrow Design products. The switch is located on the CPU PCB in board location 16D.

Table 1-1: MPZ80 Switch Boot Addresses

<u>S1</u>	<u>S2</u>	<u>S3</u>	<u>S4</u>	<u>S5</u>	<u>ADDRESS</u>
OFF	OFF	OFF	OFF	OFF	F800h
OFF	OFF	OFF	OFF	ON	F000h
OFF	OFF	OFF	ON	OFF	E800h
OFF	OFF	OFF	ON	ON	E000h
OFF	OFF	ON	OFF	OFF	D800h
OFF	OFF	ON	OFF	ON	D000h
OFF	OFF	ON	ON	OFF	C800h
OFF	OFF	ON	ON	ON	C000h
ON	ON	ON	OFF	ON	BOOT DJDMA
ON	ON	ON	ON	OFF	BOOTMW
ON	ON	ON	ON	ON	BOOTHD

Switches S6 and S8 should be set as follows. Switch S7 is not used.

- S6 - ON Forces the CPU to power up in the Monitor program.
- S6 - OFF Forces the CPU to perform a power on jump to location or boot to appropriate disk device as specified by Switches, S1 - S5.
- S8 - ON Enables the decoded S-100 signal, "MWRITE" to go out on the S-100 bus. The DJ2B requires this signal for correct operation.
- S8 - OFF Disables "MWRITE" from coming out on the S-100 bus.

PRELIMINARY

TROUBLESHOOTING

WB I/O CONNECTORS, SWITCHES AND JUMPER OPTIONS

The following is a list of connectors, switch settings and jumper options and their functions:

The WB I/O board has the following I/O connectors available at the rear of the circuit board. As viewed from the rear of the Decision 1 cabinet they are left to right:

<u>Connector</u>	<u>PC Location</u>	<u>Function</u>
P4	12E - 13E	Auxiliary 8-bit multi-purpose bi-directional parallel port.
P5	8E - 12E	This 50-pin header is the connection for a daisy-wheel printer. (not visible from the rear panel)
P3	9E - 10E	ACE Serial Device #3 - This port is usually reserved for printers in systems which require a serial printer.
P2	6E - 7E	ACE Serial Device #2 - normally the second CRT terminal port.
P1	2E - 3E	ACE Serial Device #1 - This port is the standard console I/O port for all Morrow Designs software.
P6	1C	This connector is the power input to the WB I/O PCB. See table below for pin configuration. (connector not visible from rear panel)

Table 1-2: P6 - WB I/O Power Connector

<u>PIN</u>	<u>INPUT</u>	<u>CONFIGURATION</u>
1	-16VDC	
2	+16VDC	
3	+8VDC	
4	blank	
5	+8VDC	
6	+8VDC	
7	ground	
8	ground	
9	ground	
10	ground	

WB I/O location 1C
J6 view from wire side

BAUD RATE SELECTION

The system baud rate is switch selected by using the dip-Switch in location 10A on the Wunderbuss I/O. The following table indicates the switch settings for the baud rates available in the standard version of the Decision 1.

Table 1-3: Switch 10A - STANDARD BAUD RATE SETTINGS

<u>S1</u>	<u>S2</u>	<u>S3</u>	<u>BAUD RATE</u>
ON	ON	ON	9600 (normal setting)
ON	ON	OFF	19200
ON	OFF	ON	9600
ON	OFF	OFF	4800
OFF	ON	ON	2400
OFF	ON	OFF	1200
OFF	OFF	ON	300
OFF	OFF	OFF	110

NOTE: Switch positions S4, S5 and S6 are not yet dedicated.

Switch positions S7 and S8 are not connected.

PRELIMINARY

TROUBLESHOOTING

BASE PORT ADDRESS SWITCH 7C

This switch on WB I/O board location 7C is used by Morrow Design's software to set the BASE port address, wait states and polarity of auxiliary parallel port handshaking inputs. The normal base address for all Morrow Designs software is 48 hex. The following summarizes this switch:

Table 1-4: Switch 7C - BASE PORT ADDRESS SWITCH SETTINGS

<u>PADDLE</u>	<u>NORMAL CONDITION</u>	<u>FUNCTION</u>
1	ON	When on causes the WB I/O to generate a wait state on I/O and Interrupt Acknowledged cycles during which the WB I/O has been selected. The "ACE" (Asynchronous Communications Element) and PIC (Programmable Interrupt Controller) chips have a minimum access time of 250 ns.
2	ON	Maps to CPU address line A7 for address of Base Port.
3	OFF	Maps to CPU address line A6 for address of Base Port.
4	ON	Maps to CPU address line A5 for address of Base Port.
5	ON	Maps to CPU address line A4 for address of Base Port.
6	OFF	Maps to CPU address line A3 for address of Base Port.
7	OFF	When OFF allows parallel handshake latch to respond to a strobe of negative polarity.
8	OFF	When OFF allows parallel handshake latch to respond to a strobe of negative polarity.

WUNDERBUS I/O - JUMPERS

There are six jumper locations on the WB I/O PCB. When replacing the Wunderbus be sure that all jumpers are in the same configuration as the one being removed. Refer to the table below for the PCB location and normal factory configuration of these jumpers.

Table 1-5: JUMPERS ON THE - WB I/O PCB

<u>JUMPER</u>	<u>PCB LOCATION</u>	<u>FACTORY CONFIGURATION</u>
J1	8A	Not installed
J2	8C	Jumpered A to B
J3	8C	Installed
J4	2C	No jumpers
J5	13A	Battery - user supplied
J6	8E	Connected to front panel reset

PRELIMINARY

PRELIMINARY

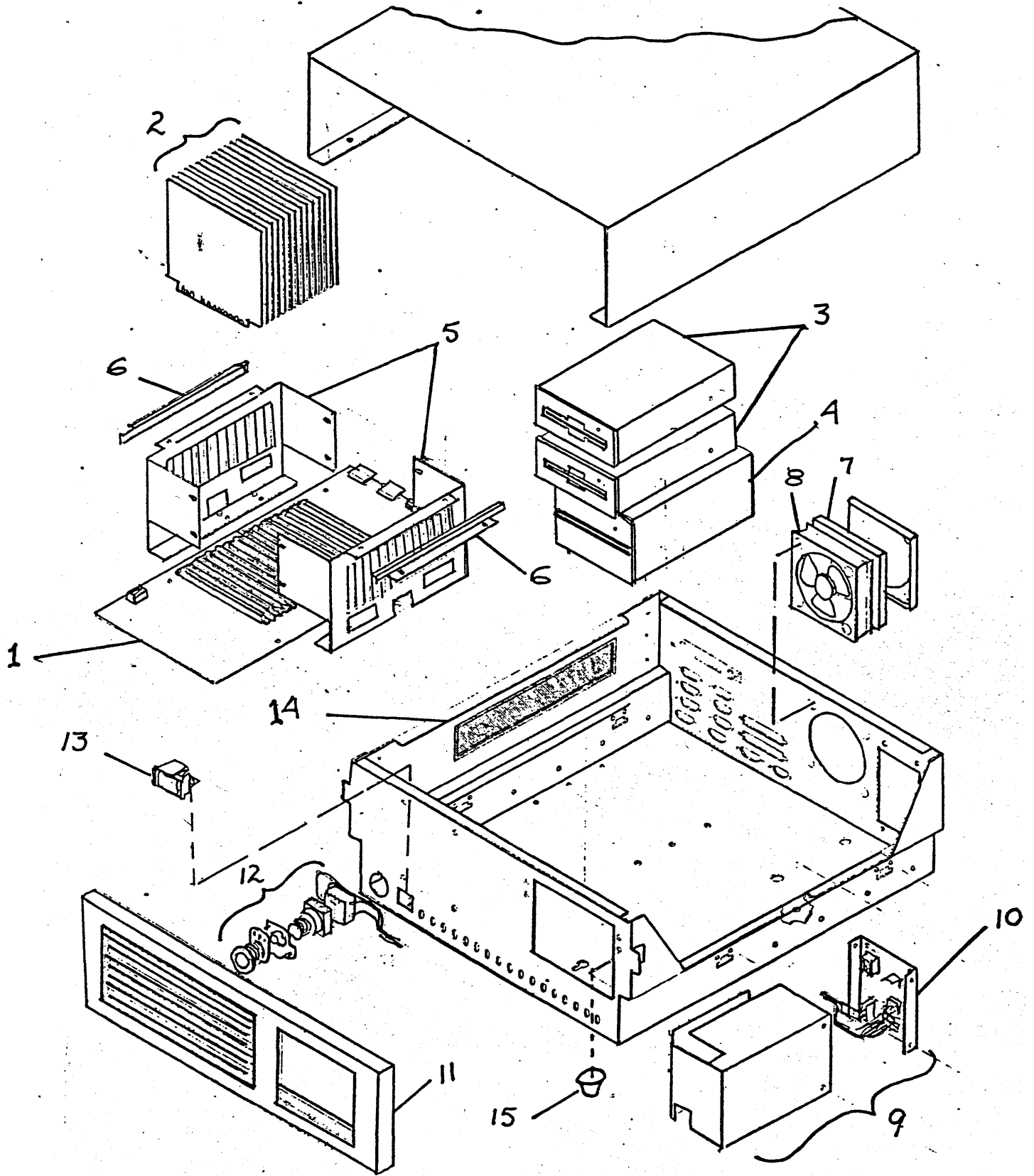

PRELIMINARY

PARTS LISTS

ITEM	MORROW PART NUMBER	XEROX PART NUMBER	DESCRIPTION
1.	500-31	140N375*	Wunderbuss PCB
2.	-----	-----	Printed Circuit Boards
a.	500-20	140N376	CPU PCB
b.	500-19	140N377	Memory Board MM65KS
c.	500-7	140N378	Memory Board MM256KD
d.	500-21	140N381	Multi I/O Board
e.	500-6	140N379	DJ/DMA Floppy Disk Control Board
f.	500-11	140N380	HD/DMA Hard Disk Control Board
3.	800-14	23N34	Hard Disk Drive - 16M byte
	20F-5200	6N12	Disk Drive
	20F-5QT142	6N13	Disk Drive
4.	800-4	23N33	5 1/4" Floppy Disk Drive
5.	600-33	547N216	Card Cage
6.	184-29	30N35	Card Cage Bracket
7.	230-9	127N82	Fan Filter
8.	225-32	127N81	Fan
9.	500-14	105N99*	Power Supply
10.	183-18	123N10	Rear Panel
11.	80-MFP	101N45	Front Panel
12.	226-6	110N79	On/Off-Reset switch (Newer Models) Order reset switch separately for older models
--	41-RSWM	110N27	Reset Switch (older models)
13.	28-LRD3105	101N44	Power/Reset Indicator
14.	180-23	101N155	Chassis Base
15.	108-RF5514	17N13	Foot

* The wunderbuss is available in two configurations and the power supply in five configurations. All are electrically interchangeable but may not be mechanically interchangeable. A matrix is being developed to aid you in ordering the correct part.

The following parts are not illustrated.

400-18	152N111	Flat Cable ASM 50
400-44	152N125	Flat Cable ASM 50S 3
200LMTD50	116N26	Terminal
28LED3105-1	117N72	LED Wire
50-C02M	120N17	LED Connector
50-C04MF	120N18	Connector FL
60-341220	117N29	Cable 34S
146-4	116N35	Faston 250F18-226A
184-27	19N21	Rear Panel Cable Clamp

PRELIMINARY

PARTS LISTS

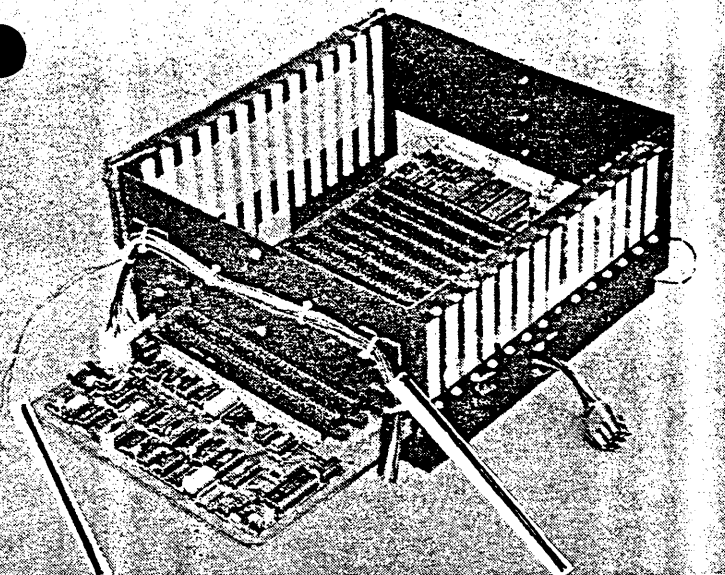

Reset Harness
152N126
400-42

DC Harness
152N129
400-41

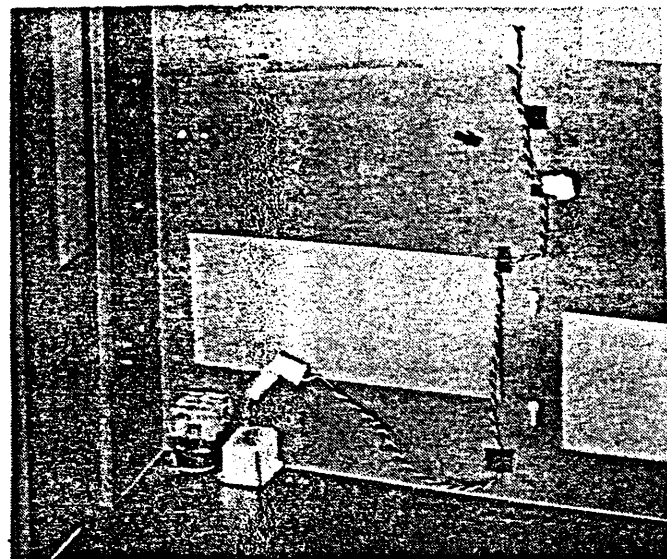

Lamp Housing Harness
152N127
400-45

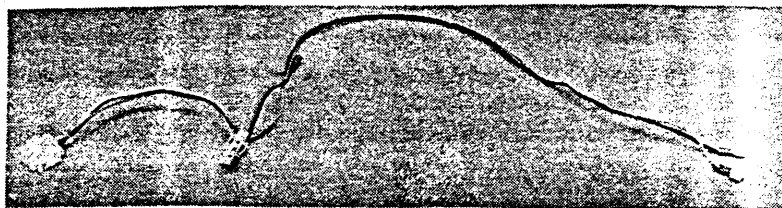
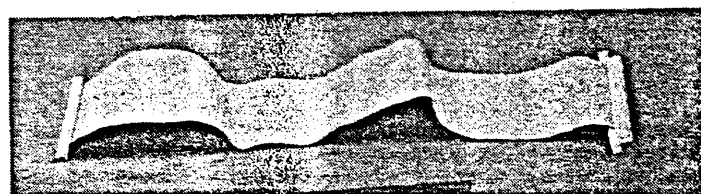
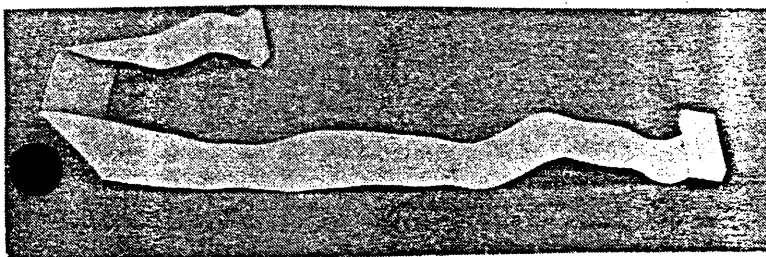

AC Harness
152N128
400-43

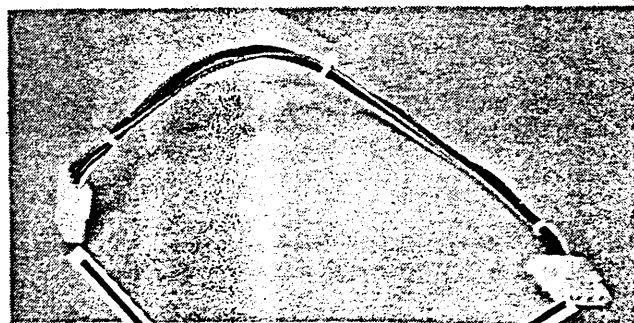
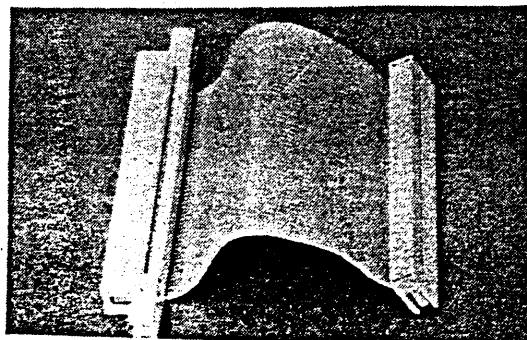
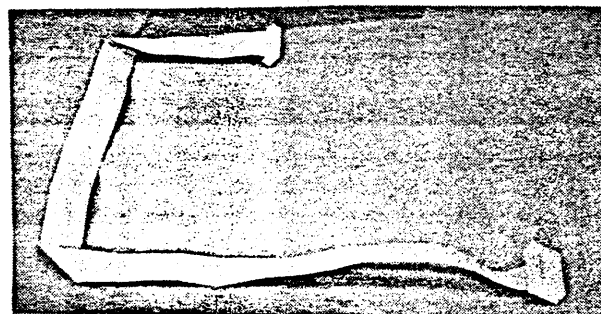

Connector 4 Pin
50-350342-4
120N16