

MASSACHUSETTS INSTITUTE OF TECHNOLOGY
ARTIFICIAL INTELLIGENCE LABORATORY

A.I. Memo 567

March, 1980

SHAPE FROM REGULAR PATTERNS
(AN EXAMPLE OF CONSTRAINT PROPAGATION IN VISION)

by

Katsushi Ikeuchi

ABSTRACT

An algorithm is proposed for obtaining local surface orientation from the apparent distortion of surface patterns in an image.

A spherical projection is used for imaging. A mapping is defined from points on this image sphere to a locus of points on the gaussian sphere which corresponds to possible surface orientations. This mapping is based on the measurement of the local distortions of a repeated known texture pattern due to the imaging projection. This locus of possible surface orientations can be reduced to a unique orientation at each point on the image sphere using 3 vantage points and taking the intersection of the loci of possible orientations derived from each vantage. It is also possible to derive a unique surface orientation at each image point through the use of an iterative constraint propagation technique along with the orientation information available at occluding boundaries. Both methods are demonstrated for real images.

KEYWORDS

Shape from regular patterns

Texture gradient, Spherical projection, Gaussian sphere, Propagation of constraints,

Texture stereo, Gauss-Seidel method

This report describes research done at the Artificial Intelligence Laboratory of the Massachusetts Institute of Technology. Support for the Laboratory's artificial intelligence research is provided in part by the Office of Naval Research under contract N00014-77-c-0389.

0 OVERVIEW OF THIS PAPER

0.1 Main Result

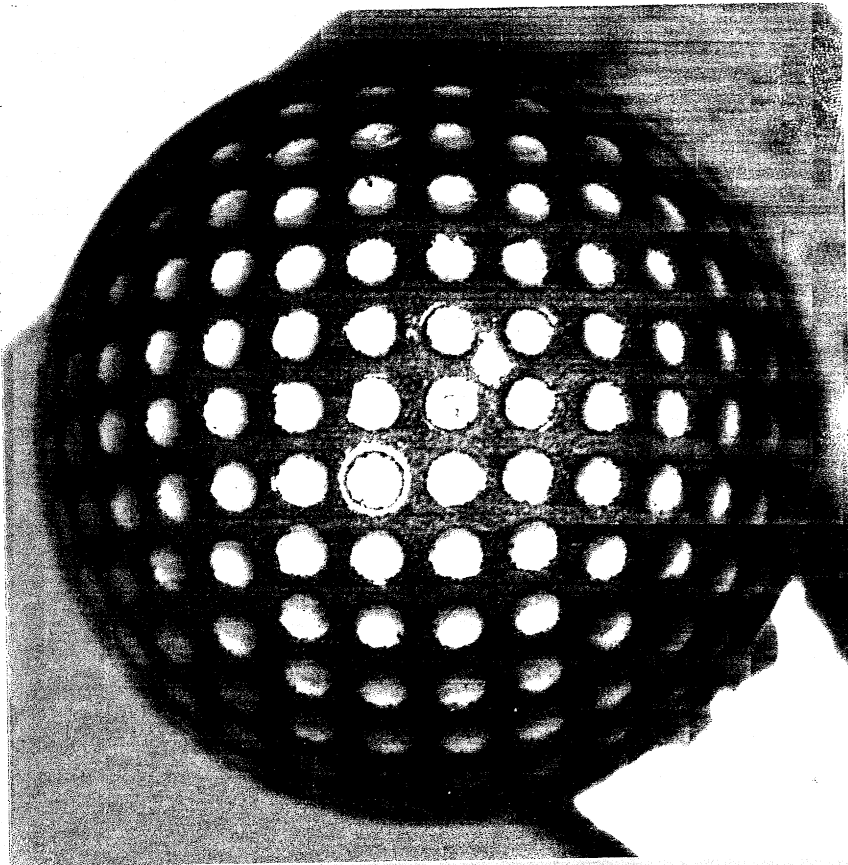

Fig. 1 A picture of a golf ball.

The distortion of these circles on the golf ball can be used to recover local surface orientations.

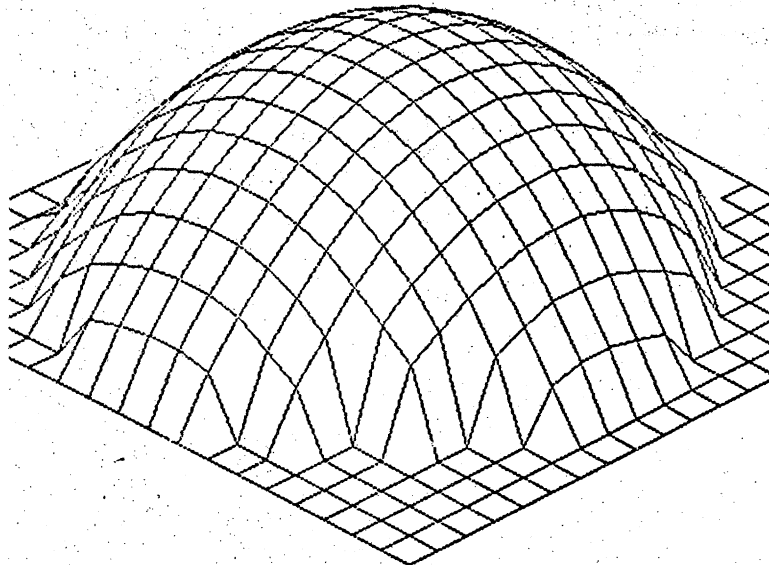

Fig. 2 A obtained surface.

0.2 Summary of the Approach¹

- (1) We use a spherical projection to treat the perspective view.

(A NEW TOOL TO DEVELOP A CONSTRAINT)

We will propose to use a spherical surface as an image surface. This gives us an image surface perpendicular to all lines of sight from the viewer.

- (2) We propose a mapping which expresses regular-pattern gradients.

(A STATIC CONSTRAINT TO BE USED IN THE PROPAGATION TECHNIQUE)

Although Kender proposed two kinds of maps for texture gradients, neither of them can be applied to our shape-from-regular-pattern problem. The first one does not have the ability to express surface orientations from regular patterns on a surface. The second one requires aggregation of many lines to determine any one direction. Thus, we consider here the way in which the distortion of a regular pattern depends on surface orientations.

- (3) Our iterative propagation method for the shape-from-shading problem can also be used to solve the shape-from-regular-pattern problem.

(HOW TO PROPAGATE CONSTRAINTS)

We have proposed an iterative propagation method for the shape-from-shading problem. If we can describe regular-pattern gradients in the same way that the reflectance map expresses shading information, we can apply the algorithm to the shape-from-regular-pattern problem. Moreover, the shape-from-regular-pattern-problem always involves observable occluding boundaries required by the algorithm.

- (4) We also consider a technique for determining the surface orientation of a planar surface without iteration.

(ENOUGH STATIC CONSTRAINTS CAN ALSO SOLVE A PROBLEM)

If a surface contains more than three regular patterns and if we can assume that the surface is planar, we can determine its orientation without iteration using a method similar to the photo metric stereo method.

¹Note that we will use two spheres. One sphere is the image surface. The other sphere (a Gaussian sphere) is used to express surface orientations. Both of the spheres are projected onto a plane using the stereographic projection for illustration in this paper.

TABLE OF CONTENTS

1	A SPHERICAL PROJECTION	5
2	MEASURING TEXTURE DISTORTION DUE TO SURFACE ORIENTATION	8
2.1	Definition of the Problem	8
2.2	A Measure for Distortion in Regular Patterns	8
2.3	The Gaussian Sphere (How to Express Surface Orientations)	12
2.4	A Regular-Pattern Gradient Map	12
2.5	Viewer-Centered Coordinate System and Spatial Coordinate System	12
2.6	Obtaining Surface Orientation from Multiple View (How to Use Regular-Pattern Gradient Map)	15
3	CONSTRAINTS AND THE PROPAGATION OF CONSTRAINTS (TO GET SURFACE ORIENTATION FROM A SINGLE VIEW)	19
3.1	The Smoothness Constraints (Propagation Constraints)	19
3.2	Regular-Pattern-Gradient Map (Static Constraints) and A Propagation Algorithm	20
3.3	Occluding Boundary Constraints (External Constraints)	22
4	EXPERIMENTS	23
4.1	Experiment 1 (A Infinite Planar Surface)	23
4.2	Experiment 2 (A Golf Ball)	28
5	CONCLUDING REMARKS	31
	ACKNOWLEDGMENT	33
	REFERENCES	34
	APPENDIX	35
A.1	Derivation of the Distorted Value, I	35
A.2	Conversion from the Perspective Projection to the Sphere Projection	38

1 A SPHERICAL PROJECTION

We propose a spherical projection to treat the perspective view. An observer is located at the center of the sphere. All image contours are projected on this sphere with respect to its center. We will use the term *image sphere* as opposed to *image plane* in this paper to refer to the spherical projection. Every point in the real world is projected onto the image sphere with respect to its center. All lines of sight of the viewer are extended radii of the sphere and thus are perpendicular to the image plane.

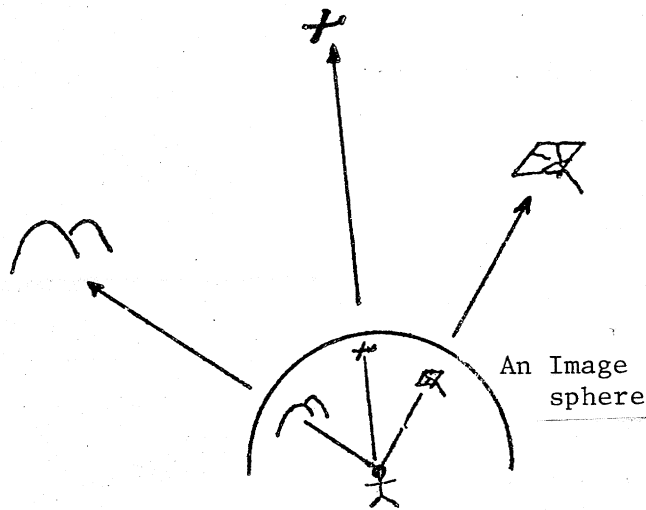

Fig. 3 An Image Sphere.
All contours are projected on the image sphere with respect to the center.

All contours on the image sphere are foreshortened by the relationship between the direction of the surface normal and the line of sight. At each point of the image sphere the line of sight is perpendicular to the image sphere, so there is no foreshortening of the image due to the position of a pattern on an image.² Thus, all contours on the image sphere are due to the relationship between a line of sight and the surface normal of the

²The perspective projection is different from the spherical projection. In the perspective projection a pattern on an image is distorted twice. The first distortion is due to the relationship between the viewed surface normal and the direction of viewer's line of sight. The second one is due to the relationship between the line of sight and the image plane. Thus, the second distortion depends on the position of a pattern on the image plane.

surface patch viewed from the viewer.

The essential point of a perspective view obtained with the spherical projection there exists only one viewing position. the viewer observes and interprets the outer world with respect to his position alone. He does not have to compensate for the orientation of an image plane. For example, consider the perspective projection of an extended planer surface parallel to the image plane which is covered with small squares (Fig. 4). The squares on the plane always project as squares, no matter where the squares lie on the surface. With the spherical projection the squares would appear as various rectangles depending on their positions on the surface.

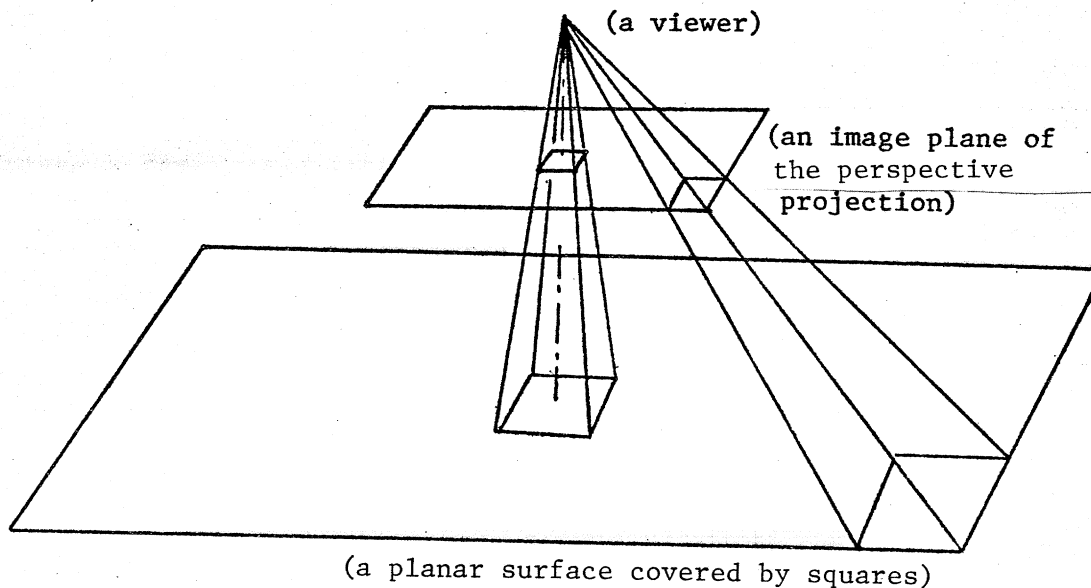

Fig. 4 A Defect of the Perspective Projection.
The so-called perspective projection cannot express foreshortened effect when an object exists on the plane parallel to the image plane.

The spherical projection has several advantages over the conventional perspective projection.

- (1) The local geometry in an image does not change when the orientation of the viewer changes. This is not the case with the conventional perspective projection where a change in the orientation of the image

plane can cause a dramatic change in the resulting image geometry. Thus, for the spherical projection distortion of a pattern depends only on the direction of line of sight and the direction of the surface normal.

(2) The spherical projection can treat 360 degree scenes.

(3) We can use the same regular-pattern gradient map at each image point in the spherical projection, because each contour depends only on the relationship between the direction of line of sight and the direction of the viewed surface normal.

The spherical projection also has psychological validity. The most sensitive area of the retina (the fovea) has an extent of only 3-4 degrees over the visual field. Eye movements (and head movements) are required to examine patterns in different directions. Thus, the line of sight is always perpendicular to the image plane. It is interesting that some kinds of dragonfly have compound eyes which give rise to projection like that in the image sphere. Most photographs taken by cameras cover no more than a 20 degree field of view. Within this range, one can regard the image plane as a part of a sphere.³

³Appendix 2 shows how to convert an image on the perspective projection into an image on the spherical projection. However, this adjustment is usually unnecessary, because the extra distortion of the perspective projection is proportional to the cosine of the angle between the direction of the optical axis and the direction of the line of sight, namely $\cos 20 \text{ deg}$ or 0.94. Thus, the distortion due to the perspective projection is small compare with the distortion due to the orientation of the viewed surface.

2 MEASURING TEXTURE DISTORTION DUE TO SURFACE ORIENTATION

2.1 Definition of the Problem

We will determine surface orientation based on the apparent distortion of regular patterns on an image sphere, provided that:

(1) *The surface is covered with a uniform texture of repeated texture element.*

We call the uniform texture as a regular pattern.

(2) *Each texture element is small, compared with the distance between the viewer and the viewed surface.*

If the texture element is small, the texture element can be regarded as projected onto a tangential plane of the image sphere. All apparent distortion of the texture element is caused between the direction of the line of sight from the viewer and the direction of the surface normal.

(3) *Each texture element is small, compared with a change of surface orientation there.*

Each texture element is assumed to lie in the plane of the viewed surface.

(4) *The original shape of the texture element (a generator) is known.*

Since we will decode surface orientations from the apparent distortion of a pattern, it is necessary for us to have a standard pattern with which to compare the distorted pattern. This requirement is similar to that of the albedo ratio in using the reflectance map. If one does not know the albedo ratio, one cannot make a correspondence between actual intensities and brightness values on the reflectance map.

2.2 A Measure for Distortion in Regular Patterns

In this section we examine the relationship between surface orientation and the distortion of regular patterns. Fig. 5 shows the projections of squares on a plane inclined 45 degrees in the vertical direction. Even though the generators (squares) lie on the same tilted plane, their images are different from each other. Their distortion depend on two factors. One factor is the orientation of the surface. This is what we are interested in.

The other is the orientation of the squares in the plane of the surface. This in surface rotation causes the variations shown in Fig. 5. Our goal is to find some intrinsic measurement that depends only on surface orientation. Kender's first method[1] treats only a few particular cases: when edges of the pattern are parallel to the coordinate axis and the edges are perpendicular to each other (only case A or case D in Fig. 5). Because the first method only takes a ratio of apparent lengths of two edges. The map cannot be applied to case B nor case C in Fig. 5. Kender's second method[2] requires a large number of edge vectors in order to determine a single surface orientation. This method fails, when a surface has different orientations everywhere. For example, Kender's second method will not decode surface orientation from the distortion of the small circles on the golf ball in Fig. 1. What we want is a way of measuring surface orientation independent of the in surface orientation of the texture elements.

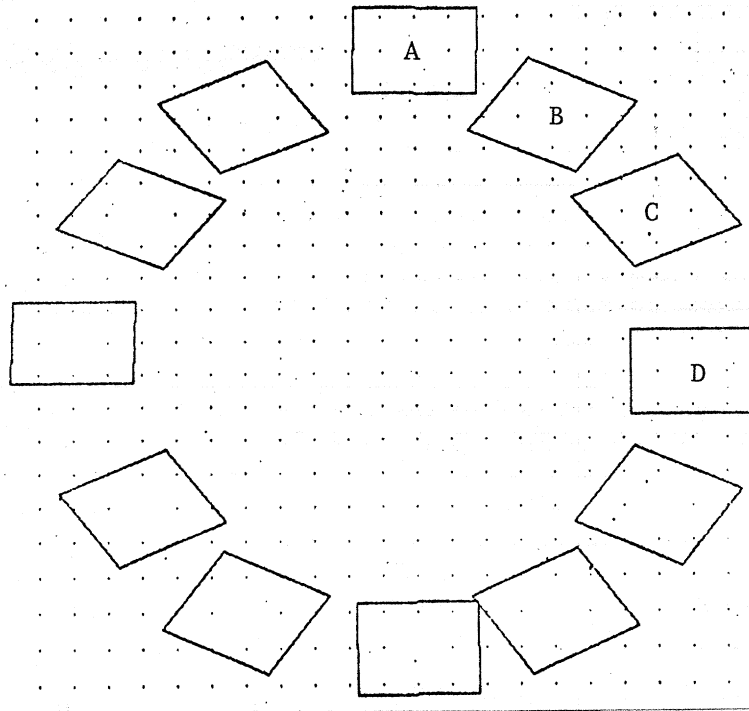

Fig. 5 Projections of Squares

All squares lie on a plane inclined in north-south 45 degrees and east-west 0 degrees. Their distortion depend on both the orientation of the surface and the orientation of the squares in the plane of the surface.

If two perpendicular axis vectors can be associated with a texture element in a unique manner, we can use this pair of vectors as a kind of generalized texture element (See Fig. 6). When a pattern is distorted because of the angle between the direction of the surface normal and the direction of the viewer, the two vectors will also be distorted. This distortion of two axis vectors is the same as the distortion of the regular pattern, because the axis vectors are fixed on the regular pattern. We will, therefore, concentrate on the distortion of these two axis vectors.

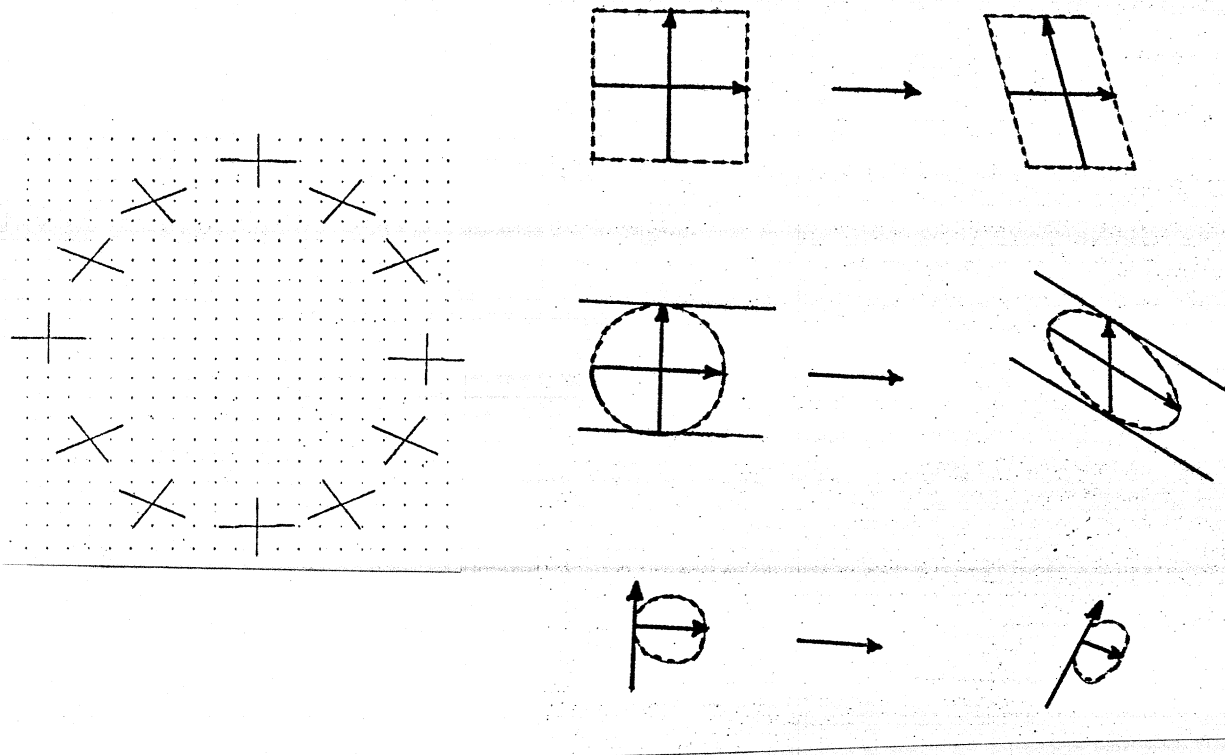

Fig. 6
Pairs of axis vectors

The calculation in Appendix 1 shows us that the magnitude of the cross product of two axis vector projections

is proportional to $\cos \omega$ and the sum of squares of their lengths is proportional to $1 + \cos^2 \omega$ where ω is the angle between the direction of the viewer and the direction of the surface orientation. These two values depend only on the surface orientation; and they are independent on the rotation angle of the regular pattern. For example, the patterns in Fig. 5 will yield the same value since they are all on the same tilted surface.

The ratio of the cross product of the two axis vectors to the sum of the lengths of the two axis vectors is the desired measure for the regular-pattern gradient map. The length of a small object on the image sphere depends on the distance between the viewer and the object. A distant object is small while near objects are large. Both the cross product and the sum of lengths depend on the distance, but these effects cancel when their ratio is taken as shown in Appendix 1. Thus, the ratio is independent of the distance between the viewer and the pattern. This ratio is also independent of the viewer's orientation, because of the spherical projection. The ratio only depends on the angle between the direction of the viewer and the direction of the surface orientation. This means that we can use the same regular-pattern gradient map everywhere on the image sphere.

We will call I in Eq. 1 the distortion value.

$$I = \frac{fg \sin \tau}{f^2 + g^2}, \quad (1)$$

where f and g are the observed lengths of axis vectors on the image sphere and τ is the angle between the two projected axis vectors. f , g , and τ can be measured directly from an image.⁴ Thus, I can be obtained from a image, no matter how the pattern is rotated or reduced due to distance. I has the following relation with surface orientation:

$$I = \frac{\cos \omega}{1 + \cos^2 \omega}, \quad (2)$$

where ω is the angle between the direction of the viewer's line of sight and the direction of the surface normal.

This I will be the basis of the regular-pattern gradient map in the discussion to follow.

⁴If the two axis vectors have different three-dimensional lengths, this difference can be corrected for at the time of measurement since the projected length of each vector is proportional to its actual length. Namely $g' = \tau g$ where g is the measured length of the second axis vector and τ is the ratio of the three-dimensional length of the first axis vector over the length of the second.

2.3 The Gaussian Sphere (A Method for Representing Surface Orientations)

Surface orientations can be associated with points on the gaussian sphere.⁵ The gaussian sphere is a sphere of unit radius whose Z-axis is taken as an extended line through the north and south poles of the sphere. Assume that we put a surface patch of an object at the center of the sphere and that the direction of the viewer is the direction from the center to the north pole. The surface patch faces some point on the sphere. For example, if a surface normal has the same direction as the south pole, the surface patch is perpendicular to the viewer's line of sight. All possible orientations of a surface patch are represented on the gaussian sphere. Thus, we can describe local surface orientation on an object in terms of points on the gaussian sphere.

2.4 A Regular-Pattern-Gradient Map

We can associate the distortion value I with points on the gaussian sphere. Since the distortion value I depends only on the angle ω between the direction of the surface normal and the direction of viewer's line of sight, I is a function of the zenith angle of the gaussian sphere. Thus, we have circles of constant distortion values on the gaussian sphere.

Fig. 7 shows our regular-pattern gradient map.⁶ The curves shown are contours of constant distortion value. This map always applies to the shape-from-regular pattern problem. This is analogous to a situation in the shape-from-shading problem where the surface is known to be a Lambertian reflector and the light source is known to be near the viewer.

2.5 Viewer-Centered Coordinate System and Spatial Coordinate System

There are two kinds of spheres: the image sphere and the gaussian sphere. The image sphere is a spatial coordinate system with which the image is specified. The gaussian sphere can be thought of as a kind of ruler for measuring surface orientation relative to the north-south axis of the sphere. When a pattern is at the origin

⁵This gaussian sphere is different from the image sphere.

⁶We project the gaussian sphere onto a plane using the stereographic projection. The stereographic projection puts the sphere on a plane and projects points on the sphere to the plane with respect to the north pole. Precise explanations are given in [4,5,10].

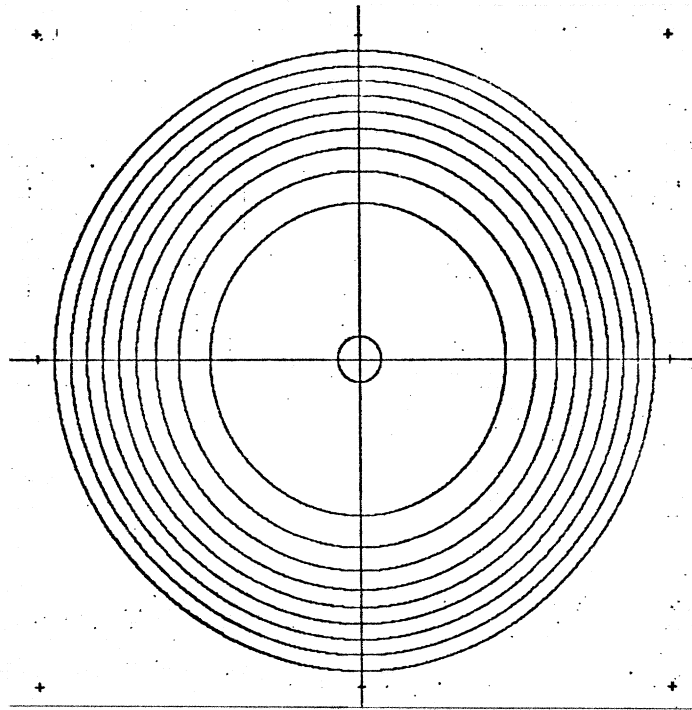

Fig. 7 The Regular-Pattern Gradient Map

Each circle corresponds to a constant distortion value I . The gaussian sphere is projected onto a plane by the stereographic projection.

of the image sphere, the two spheres are aligned. In other words, the viewer coordinate system on the gaussian sphere is same as the spatial coordinate system of the image sphere. When a pattern exists at some other point on the image sphere, then one must rotate the gaussian sphere so that its north pole points in that direction (V in Fig. 8).

Fig. 8 shows the relationship between the viewer coordinate system and the spatial coordinate system. (X, Y, Z) is the spatial coordinate system. (x, y, V) is the viewer coordinate system. The direction V denotes the direction of line of sight of the viewer, or the position of a regular pattern.

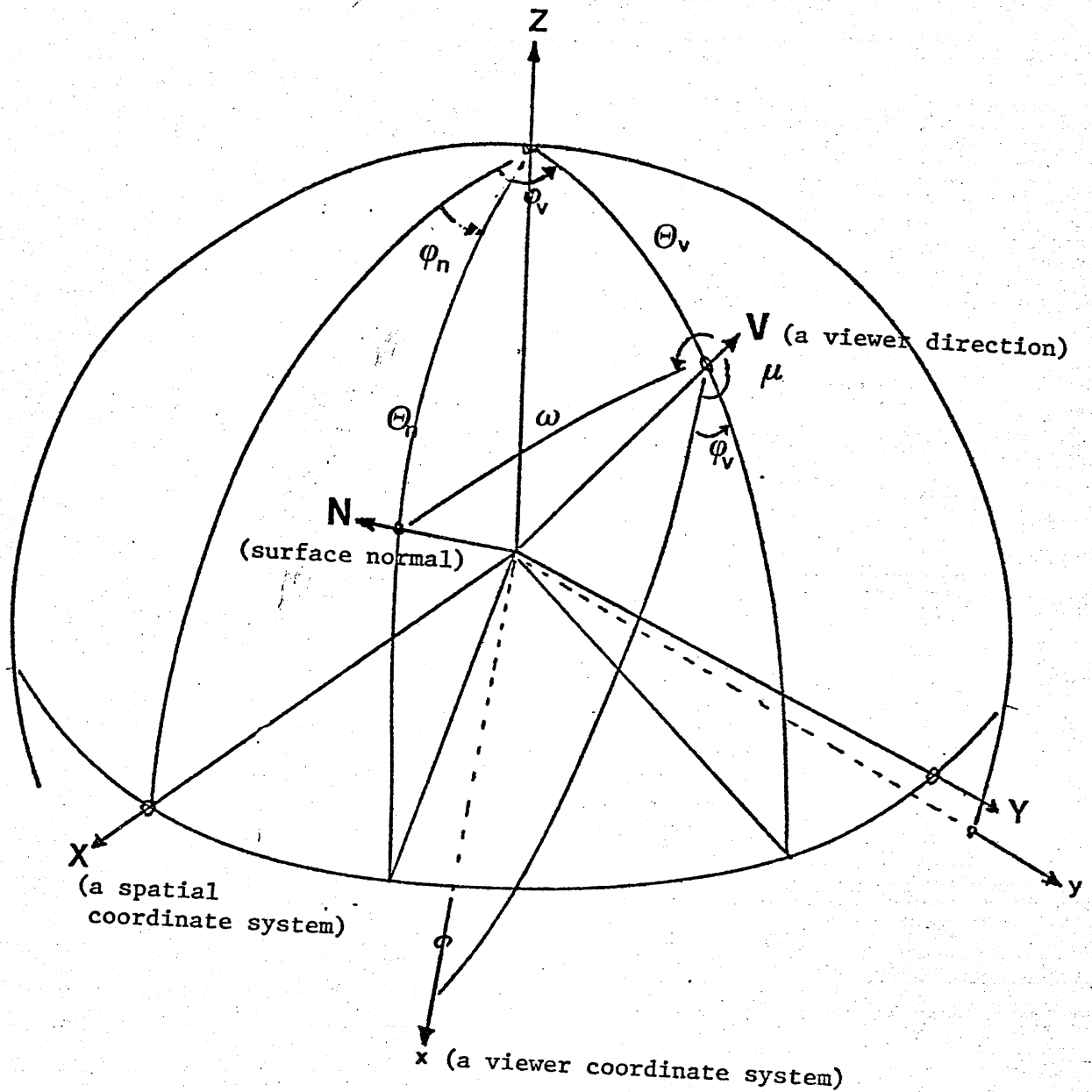

Fig. 8 Viewer-Centered Coordinate system (A gaussian sphere) and Spatial Coordinate System (An image sphere)

Formulas from spherical trigonometry give the following relationships;

$$\cos \theta_n = \cos \theta_v \cos \omega + \sin \theta_v \sin \omega \cos(\mu - \pi - \phi_v),$$

$$\sin(\phi_v - \phi_n) = \frac{\sin \omega \sin(\mu - \pi - \phi_v)}{\sin \theta_n}, \quad (3)$$

$$\cos(\phi_v - \phi_n) = \frac{\cos \omega - \cos \theta_n \cos \theta_v}{\sin \theta_n \sin \theta_v},$$

where ω and μ are the zenith and azimuth angles of the surface normal in the viewer coordinate system, θ_n and ϕ_n are the zenith and azimuth angles of the surface normal in the spatial coordinate system, and θ_v and ϕ_v are the zenith and azimuth angle of the view vector in the spatial coordinate system. Thus, using Eq. 3 we can convert ω and μ into θ_n and ϕ_n .

2.6 Obtaining Surface Orientation from Multiple View (How to Use Regular-Pattern Gradient Map)

Surface orientation can be determined uniquely, given enough constraints. Surface orientation has two degrees of freedom. All points on the gaussian sphere are candidates before observation of a distortion value. The measurement of a distortion value, I , eliminates one degree of freedom, leaving a one dimensional set of possible surface orientations on the gaussian sphere.⁷ More than two distortion values at the same point will uniquely determine the surface orientation there. This idea comes from the technique of the Photo-Metric Stereo[3,4]. In practice, however, this texture stereo requires three different vantage points.

There are two ways in which we can get more than three distorted values at a surface point. If there is one regular pattern on a surface, we can observe that regular pattern from several different vantage points. For

⁷It is possible in principle to determine surface orientation uniquely from the projections of the two axis vectors, however, we do not follow that approach in this paper favoring instead to explore the use of the technique of shading analysis for analyzing texture gradients.

example, this case occurs when you pass a building. The pattern of the building changes according to your position. We can also solve the problem from a single vantage point, if the surface is planer and contains more than three regular patterns, we can solve the problem from a single vantage point. Because the effect of several different vantage can be obtained by looking at different part of the planer surface. This case often occurs when we looks at a wall of a building that contains many windows. In either case surface orientation can be determined uniquely.

The locus of possible surface orientation corresponding to a distortion value obtained at a point is a circle on a gaussian sphere. The center of the circle is the direction of the line of the sight in the spatial coordinate system. The radius of the circle is obtained from the distortion value, I . Similarly, we will get another circle by using a different vantage point. The intersection of these circles is the solution.

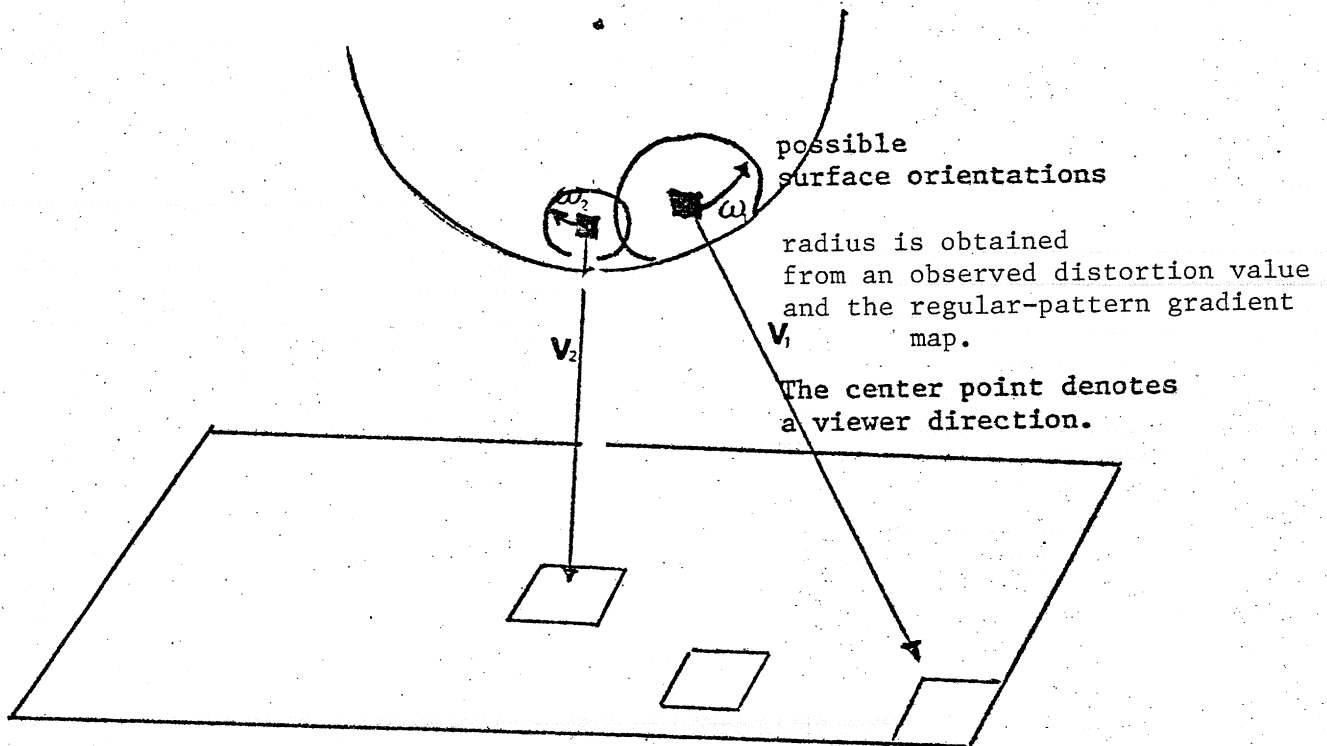

Fig. 9 Texture Stereo

The center of the circle is the direction of line of sight in the image sphere (a spatial coordinates). The radius is obtained from the distortion value.

Since the stereographic projection preserves circles, a circle on the image sphere projects to a circle on the stereographic plane. Thus, we can work with circles on the stereographic plane. Their centers are the projected viewing directions, and their radii can be calculated from distortion values, I .

Fig. 10 shows photographs of a square piece of paper taken from three different vantage points. Distortion values I_1, I_2 and I_3 were calculated for these using Eq. 1. Namely, $I = \frac{fg \sin \tau}{f^2 + g^2}$, where f and g are lengths of the projected axis vectors on the pictures and τ is the angle between two edges. For example, $f = 25mm, g = 37mm$, and $\tau = 131$ degrees in the first photo, giving $I = 0.35$. Since we know the viewing direction, we can draw the circle 1. In the same way, we can draw circles 2 and 3. They intersect to each other at the point $(0.0, 0.0)$ which gives us the surface orientation of the square in the spatial coordinate system.

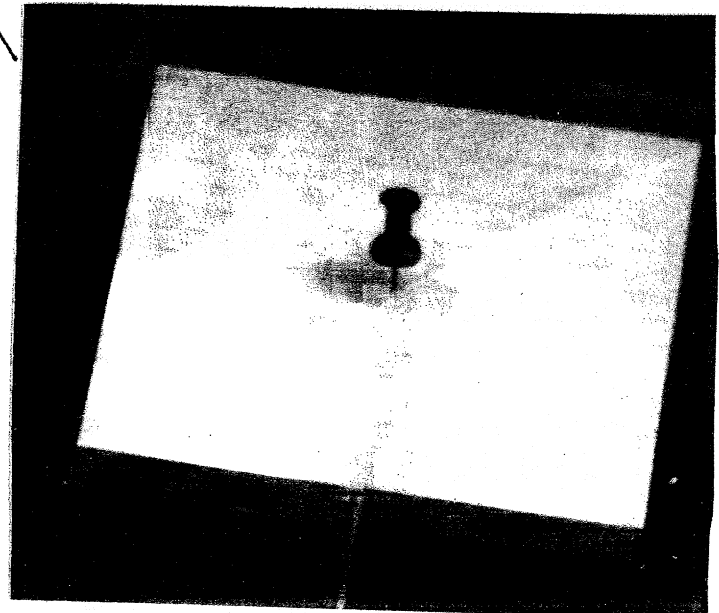
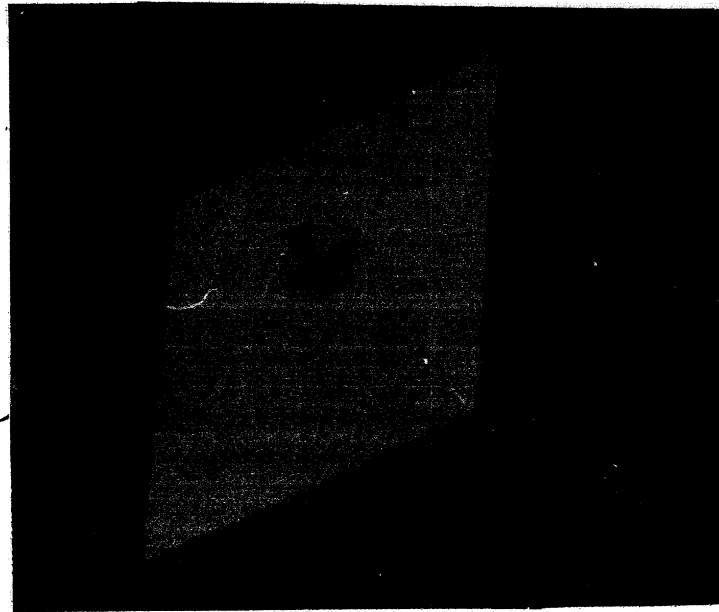
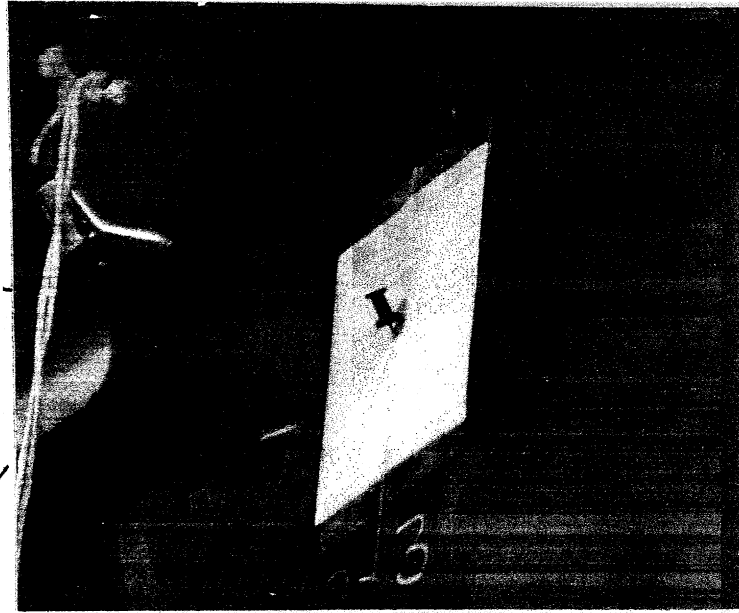
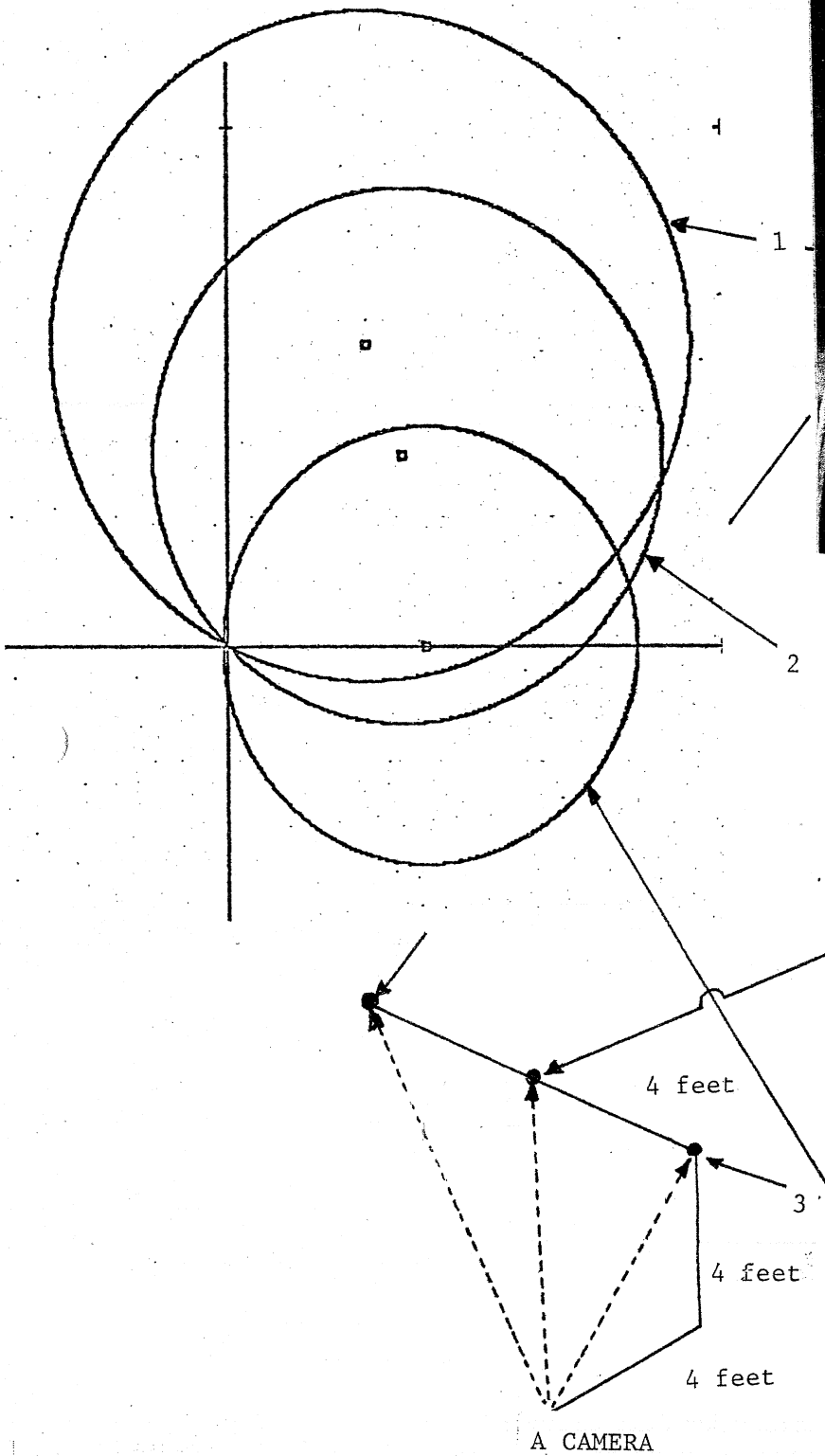

Fig. 10 A Real Example of Texture Stereo
 In case 1 $f:25$ $g:37$ $\tau:131$ $\text{azimuth}:63$ $\text{zenith}:66$ $I:0.35$,
 In case 2 $f:47$ $g:49$ $\tau:120$ $\text{azimuth}:45$ $\text{zenith}:55$ $I:0.43$,
 In case 3 $f:75$ $g:52$ $\tau:86$ $\text{azimuth}:0$ $\text{zenith}:45$ $I:0.47$.
 The third circle does not go through the intersection of the first two,
 but one can see that the accuracy is rather high given that real data
 is being used.

3 CONSTRAINTS AND THE PROPAGATION OF CONSTRAINTS (TO GET SURFACE ORIENTATION FROM A SINGLE VIEW)

Constraint propagation is an important technique for problems involving analog values. Originally, this propagation idea was proposed for problems in designing electrical circuits by Sussman[6]. If a node in a diagram has a value, that value can effect surrounding nodes, reducing the range of possible values neighboring points can assume. In other words, the value propagates through a network, and becomes a new constraint on the surrounding nodes. This propagation technique is more effective than the search technique, when the solution space has an large number of states.

Smoothness gives us a tool for propagating constraints. If the surface is smooth, neighboring points must have nearly the same orientation. The smoothness constraint can be made explicit as a relationship between one node and its surrounding nodes.

3.1 The Smoothness Constraints (Propagation Constraints)

Surface smoothness requires that the surface orientation be continuous over the image sphere. Our smoothness requirement is equivalent to the requirement that the surface height function be class $c-1$ on the image sphere [5]:

- 1) surface is continuous on an image sphere. ($c-0$ w.r.t height)
- 2) surface orientation is continuous on an image sphere. ($c-1$ w.r.t height)

Eq. (5) is an "average" constraint which makes the smoothness requirement explicit. The definition of continuity can be expressed in a more convenient form;

A function F_i is continuous at (x_0, y_0)

if given an $\epsilon > 0$,

there exists a $\delta > 0$ such that when $(x - x_0)^2 + (y - y_0)^2 < \delta$,

$$|F_i(x, y) - F_i(x_0, y_0)| < \epsilon. \quad (4)$$

If we take our mesh size δ_0 smaller than the δ , Eq. (4) guarantees that
for $\forall \epsilon, \exists \delta$

$$|F_i(x_0 + \delta_0, y_0) + F_i(x_0 - \delta_0, y_0) + F_i(x_0, y_0 + \delta_0) + F_i(x_0, y_0 - \delta_0) - 4F_i(x_0, y_0)| < 4\epsilon. \quad (5)$$

Thus, the difference of the surrounding values and four times the central value approaches zero as the mesh is made smaller. We call these constraints "average" constraints. A more precise discussion will be found in [5].

3.2 Regular-Pattern Gradient Map(Static Constraints) and A Propagation Algorithm

The smoothness constraint can be used to reduce the locus of possible orientations on the gaussian sphere when only a single distortion value is obtained at each point. Each distortion value corresponds to a circle on the regular-pattern gradient map. Points on the circle are possible surface orientations at the point. We can make a propagation algorithm from the smoothness constraints to further reduce this locus of possible surface orientations.

Let

$$\begin{aligned} F_{i,j}^{n+1} &= F_{i,j}^{*n} + \left(\frac{\lambda}{16}\right)(I_{i,j} - R(F_{i,j}^{*n}, G_{i,j}^{*n}))\left(\frac{\partial R}{\partial F_{i,j}^n}\bigg|_{F_{i,j}^{*n}, G_{i,j}^{*n}}\right), \\ G_{i,j}^{n+1} &= G_{i,j}^{*n} + \left(\frac{\lambda}{16}\right)(I_{i,j} - R(F_{i,j}^{*n}, G_{i,j}^{*n}))\left(\frac{\partial R}{\partial G_{i,j}^n}\bigg|_{F_{i,j}^{*n}, G_{i,j}^{*n}}\right), \end{aligned} \quad (6)$$

where

$$F_{i,j}^{*n} = \frac{F_{i+1,j}^n + F_{i-1,j}^n + F_{i,j+1}^n + F_{i,j-1}^n}{4}$$

$$G_{i,j}^{*n} = \frac{G_{i+1,j}^n + G_{i-1,j}^n + G_{i,j+1}^n + G_{i,j-1}^n}{4}$$

F and G denote surface orientations. $I_{i,j}$ is a distortion value at the point (i,j) obtained from observation. R is the regular-pattern gradient map. Eq. (6) has three kinds of input; $I_{i,j}$ (distortion value) comes from local observation, and the other two (F^* and G^*) are propagated from surrounding nodes. In other words, this propagation algorithm makes a new estimate of the center node based on prior estimates of surrounding nodes and the observed distortion value (See Fig. 11) A more precise discussion on Eq. (6) is found in [5].

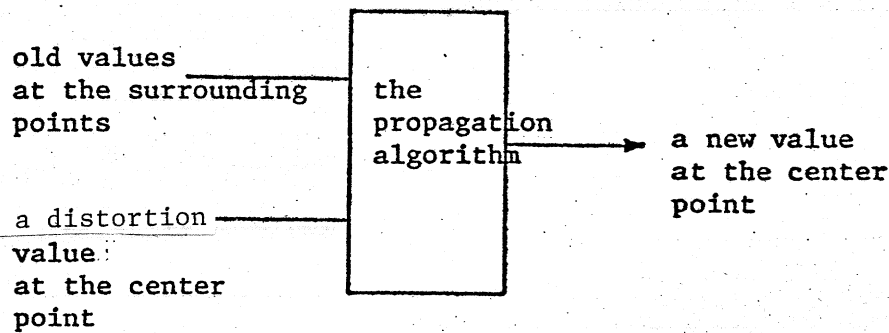

Fig. 11 A Propagation Algorithm

This algorithm is used iteratively. After the state of the estimation reaches equilibrium, the algorithm terminates.

3.3 Occluding Boundary Constraints (External Constraints)

At an occluding boundary we can determine the surface normal uniquely[5]. The line of sight is tangent to the object at the occluding boundary. So the surface normal is perpendicular to the line of sight. Since the line of sight of the viewer also lies at the tangent plane, the tangent plane is projected as a tangent line of the contour on the image plane. From the orientation of the occluding boundary we can determine surface normal uniquely at the occluding boundary⁸

This occluding information gives us the strong boundary conditions We need to start the propagation algorithm. The propagation constraints only convey information. In other words, the propagation constraints determine a relative relationship between nodes; but they cannot create new information. The occluding boundaries fix the surface orientation at those points. From these boundaries we can propagate the information inward over the image points adjusting the propagated value with the local constraints provided by the distortion value at each point.

This propagation method is more suitable than Horn's method[8] in the shape-from-regular-pattern problem. While it is possible to use Horn's method which starts at a singular point, and proceeds along characteristic lines, his method is not able to use the occluding information, which is available in this problem. Thus, errors accumulate to much greater extent and the quality of the solution depends rapidly over long stretches. On the other hand, the method presented here utilizes constraints at both end point.⁹ The use of the occluding boundary constraint makes our method is less sensitive to noise than Horn's. In addition the shape-from-regular-pattern problem provides fewer local constraints than the shape-from-shading problem. This shortage increases the need to utilize all available constraints.

⁸Note that [5] used the orthographic projection. while we use the spherical projection here. These projections are different from each other. However, the sphere projection has a image plane which is perpendicular to the lines of sight of the viewer everywhere. Thus, the same discussion is applicable to the occluding boundary.

⁹Actually, there are no start points and end points in our method. All information from occluding boundaries and a singular point is provided to the algorithm. Theoretically, however, a piece of information at an occluding boundary propagates inwards and interacts with information from the other occluding boundaries.

4 EXPERIMENTS

4.1 Experiment 1 (A Infinite Planar Surface)

Consider a plane covered by many squares. The squares are projected onto an image sphere using the spherical projection. Fig. 12 shows the synthesized image. For graphical clarity, the image sphere is mapped onto a planar surface using the stereographic projection¹⁰. This maps an infinite plane to the interior of the unit circle¹¹. Note that the infinite horizon line maps to a circle. This circle is equivalent to an occluding boundary. Thus, the surface orientation is fixed on that circle.

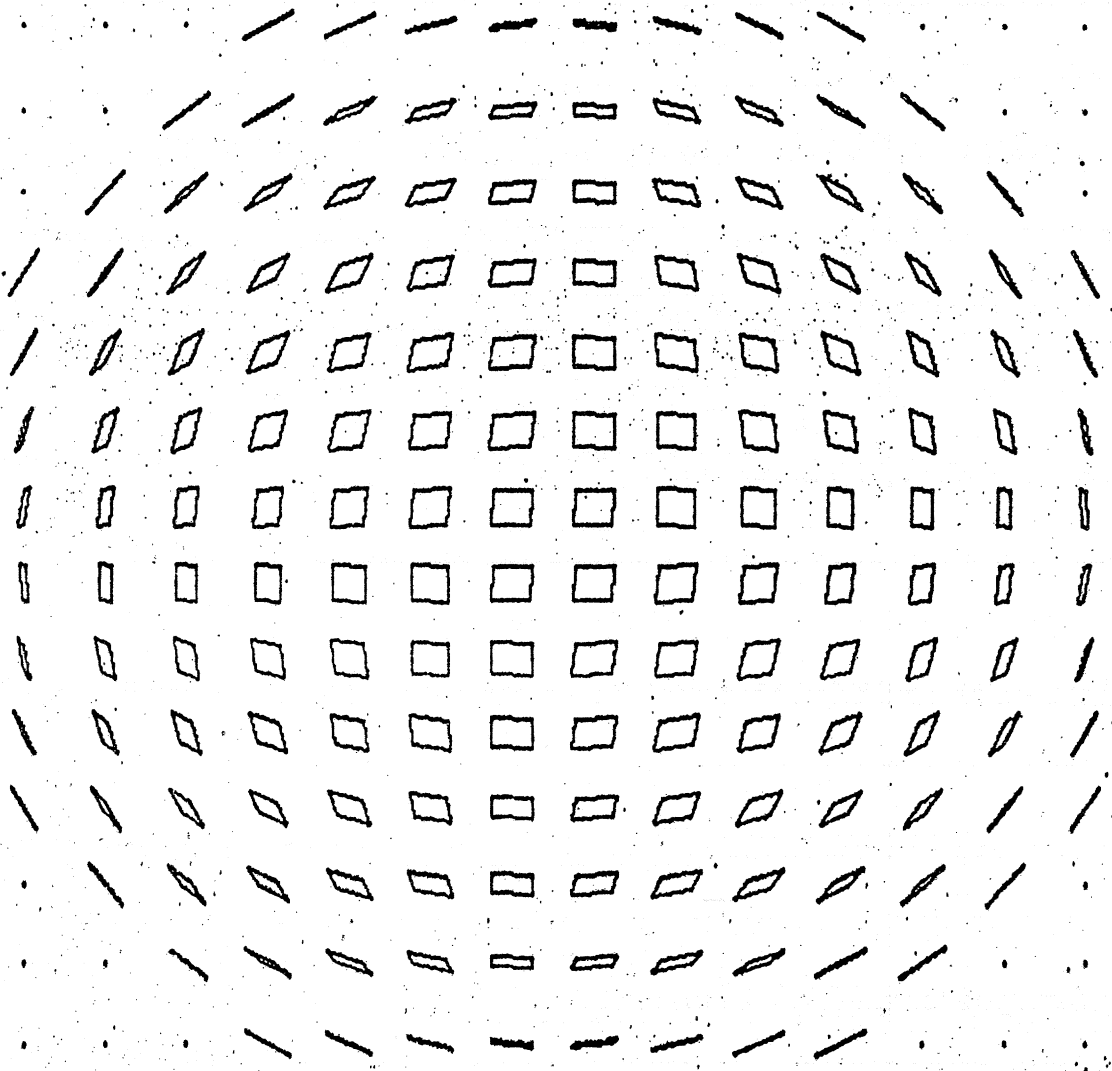

Fig. 12 The synthesized image
A plane is covered by many squares.
The squares are projected onto
an image sphere.

¹⁰Note that there are two spheres: the image sphere and the gaussian sphere. Both of them are projected onto a plane using the stereographic projection.

¹¹This figure resembles a picture taken using a fish-eye lens.

The process contains three main stages (Fig. 13). The first stage obtains distortion values from a picture and surface orientations on the occluding boundaries. The second stage is the main one. In this stage we compute surface orientation for all points using the propagation method. Since the surface orientations obtained from the second stage are expressed in a viewer-centered coordinate system, a third stage is required to convert the result to the spatial coordinate system.

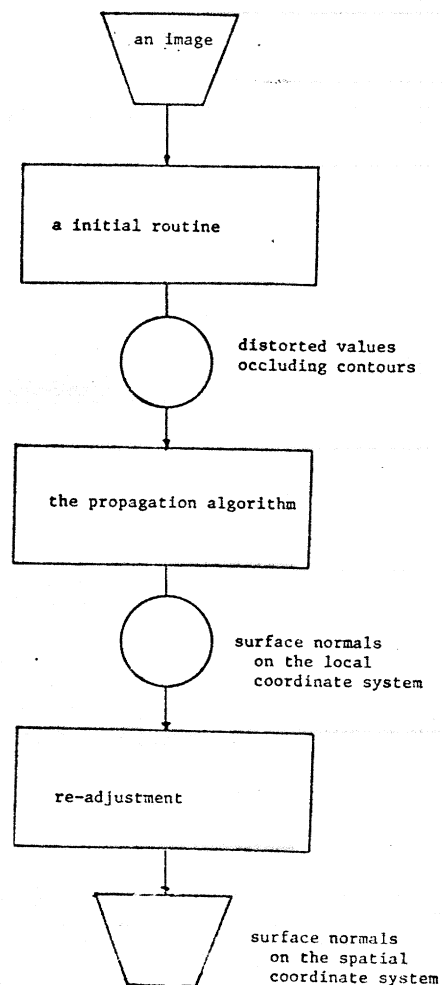

Fig. 13 Three stages

- (1) To obtain distortion values and surface orientations on the occluding boundary.
- (2) To compute surface orientation for all points.
- (3) To convert a viewer coordinate system to the spatial coordinate system.

We get the distortion using

$$I = \frac{fg \sin \tau}{f^2 + g^2},$$

where f and g are lengths of the projected squares edges and τ is the angle between the two edges. Sec 3.4 discusses the way in which surface orientations at the occluding boundaries is obtained. These distortion values and surface orientations are input to the propagation algorithm. Fig. 14 shows the distortion values and Fig. 15 shows surface orientations from occluding boundaries.

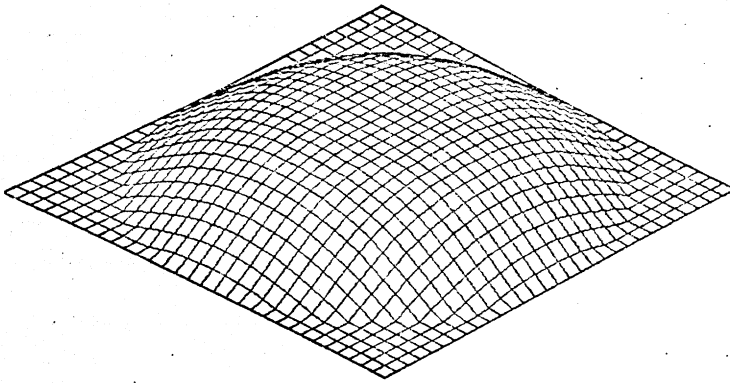

Fig. 14 The obtained distortion values

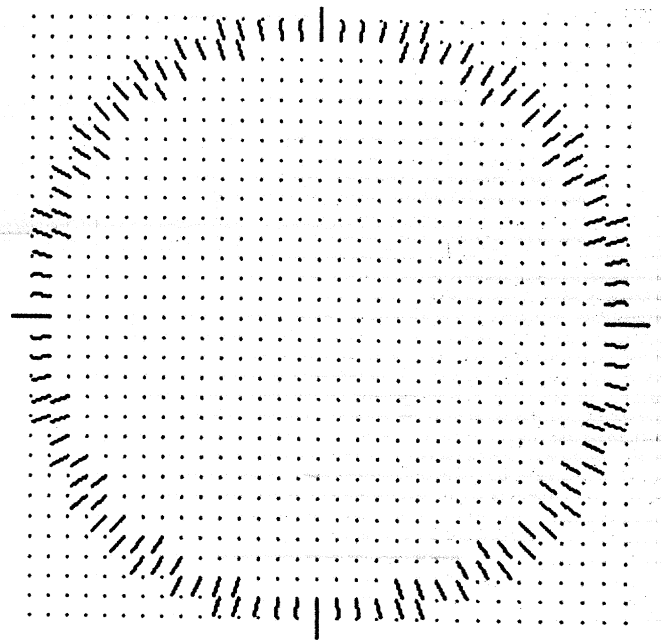

Fig. 15 Surface orientations from occluding boundaries.

The propagation algorithm estimates surface orientation at each point and is applied iteratively, at each node referring to the values of surrounding node and the corresponding distortion value. These estimates are the input information to the next iteration. When the entire system of nodes reaches a stable state, the algorithm

stops.

There are two parts to the algorithm, a propagation part, and a regular-pattern gradient part. The propagation part conveys information from surrounding nodes to the center node. The regular-pattern gradient part uses the gradient map and a distortion value to determine the locus of allowed orientation. The mathematical details (convergence, effect of open boundary etc.) will be found in [5].

Fig. 16 shows the needle diagrams obtained for a planar surface. They are expressed using the viewer coordinate system. The direction of the viewer's line of sight is taken as the z-axis, although the physical direction is different at each image point, because we are using the sphere projection. Fig. 17 is the planar surface depicted in the viewer coordinate system.

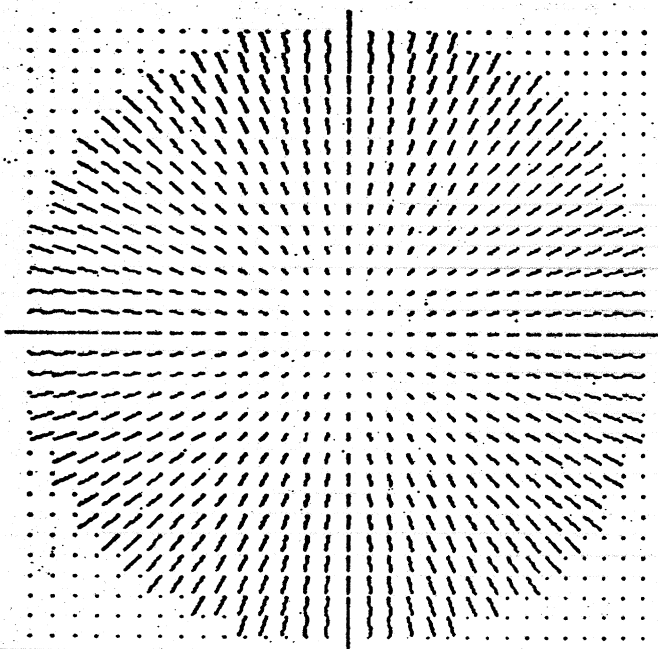

Fig. 16 The result needle diagram

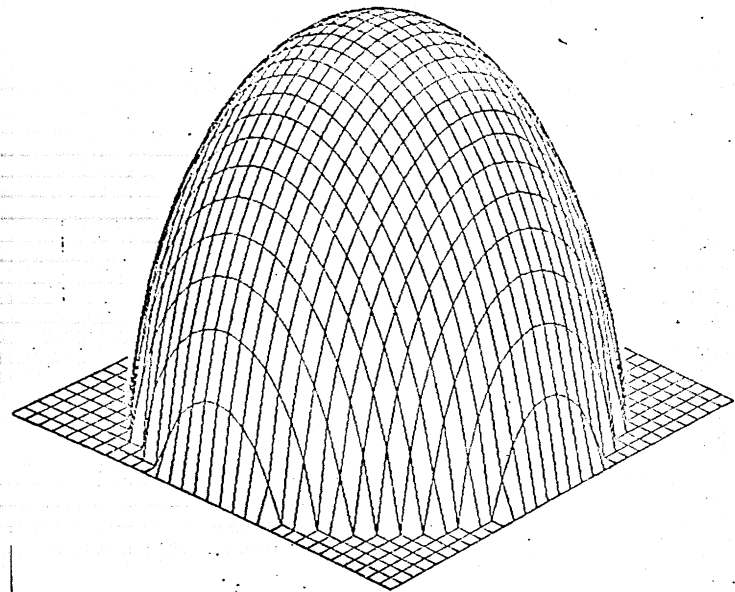

Fig. 17 The planar surface depicted in the viewer coordinate system.

Fig. 18 shows the same surface in the spatial coordinate system. The main source of error comes from the digitization of the third process.

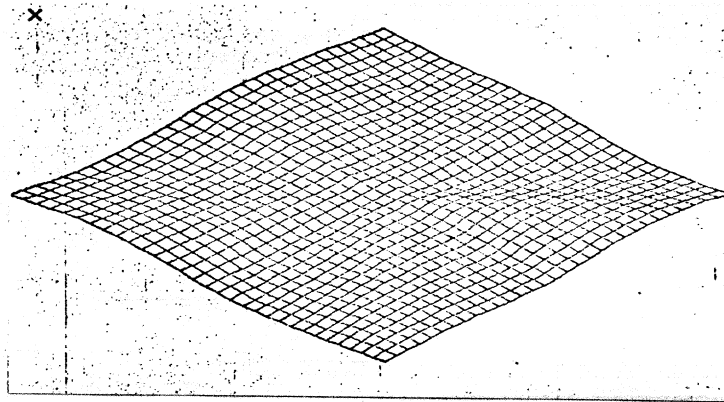

Fig. 18.A View angle = $\tan^{-1} 1.0$

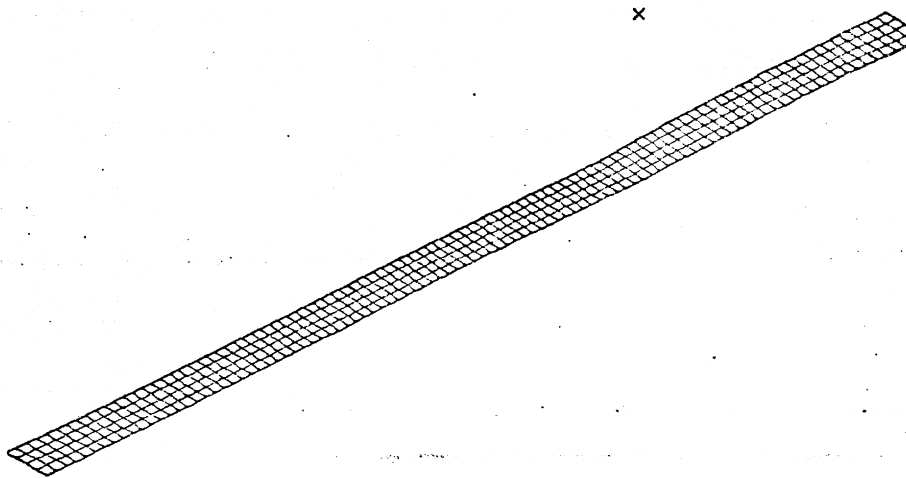

Fig. 18.B View angle = $\tan^{-1} 10.0$

Fig. 18 The planar surface in the spatial coordinate system

4.2 Experiment 2 (A Golf Ball)

We will compute the surface orientation for a golf ball using its surface texture. A golf ball has many small circles on its surface. The distortion of these circles can be used to recover local surface orientations. Fig. 19 shows input the picture.

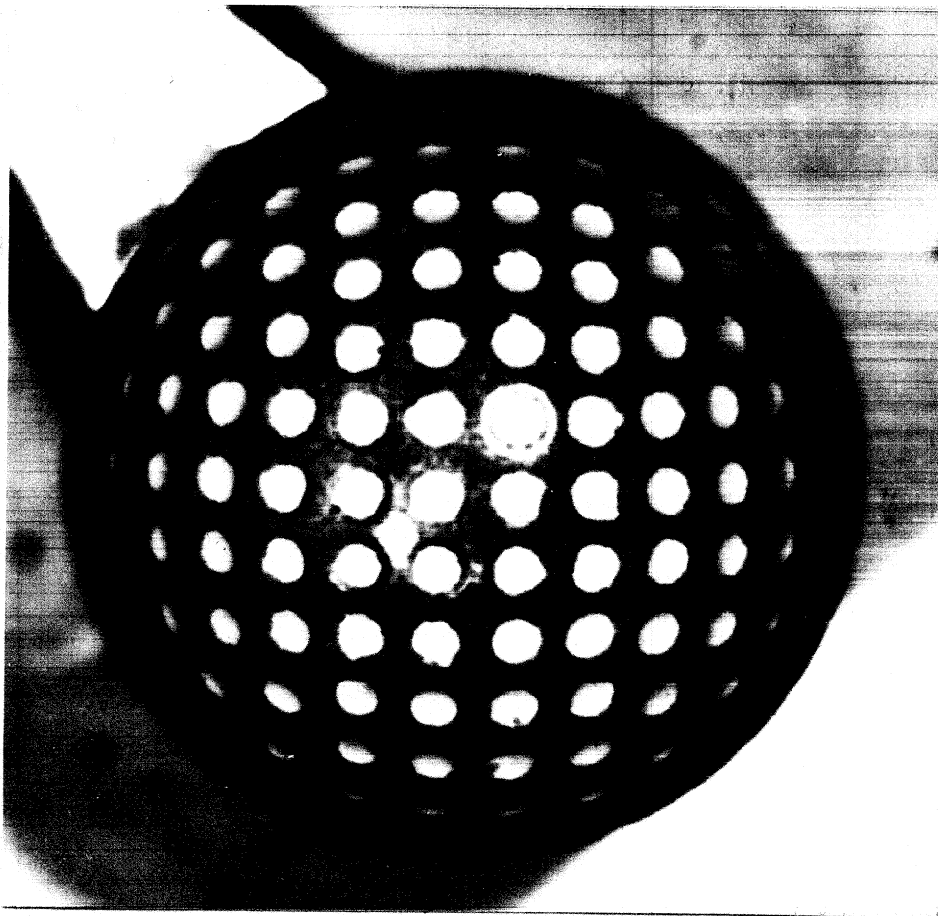

Fig. 19 A golf ball
The distortion of these circles on the golf ball can be used to recover local surface orientations.

We can get distortion values from this picture by drawing two parallel lines in an arbitrary orientation tangent to each circle. We connect the resulting tangent points on each circle and use this connecting line as one of the axis vectors. We then draw a line parallel to the tangential lines through the center of the first axis vector. The part of this line within the projected circle is the second axis vectors. We can compute the distortion values using Eq. 1. Fig. 21 shows the distortion values obtained.

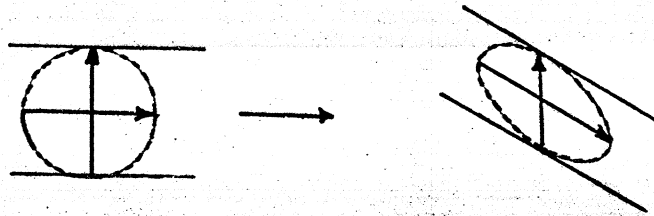

Fig. 20 How to get a pair of axis vectors from a circle.

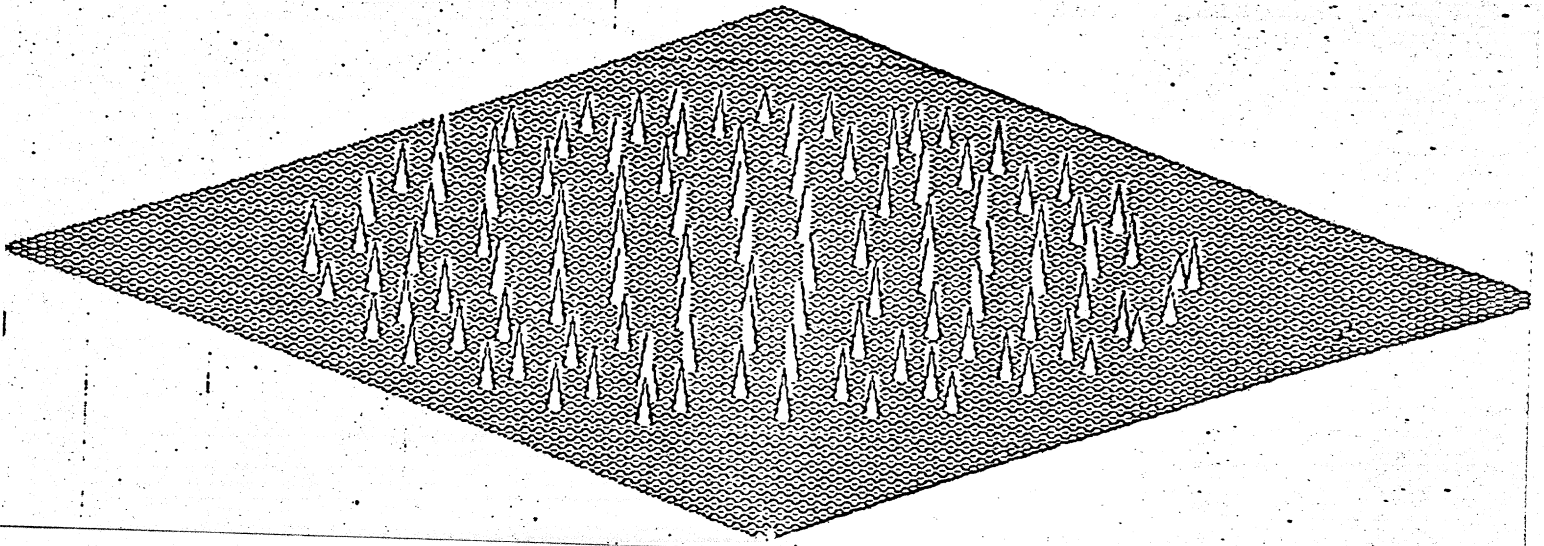

Fig. 21 Obtained distortion values.
Each needle corresponds to a little circle on the ball and expresses how much the little circle is distorted there.

We can calculate surface orientation by using the algorithm. In this case the object is very small compared with the distance between the viewer and the object. Thus, there is of no need to convert the result in the viewer coordinate system to the spatial coordinate system. Fig. 22 shows the resulting surface.

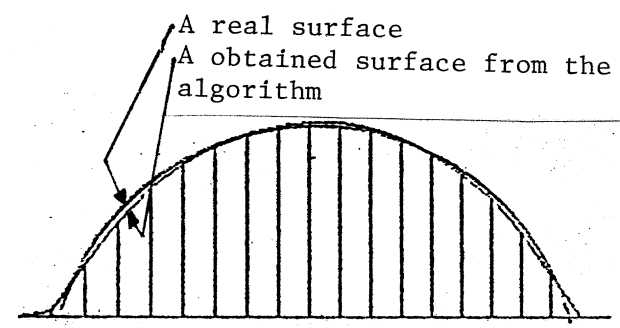
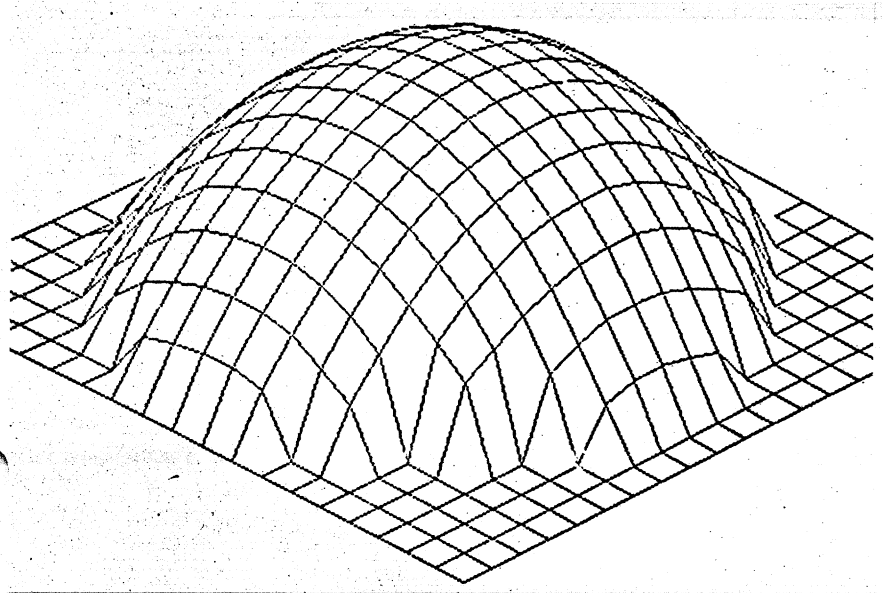
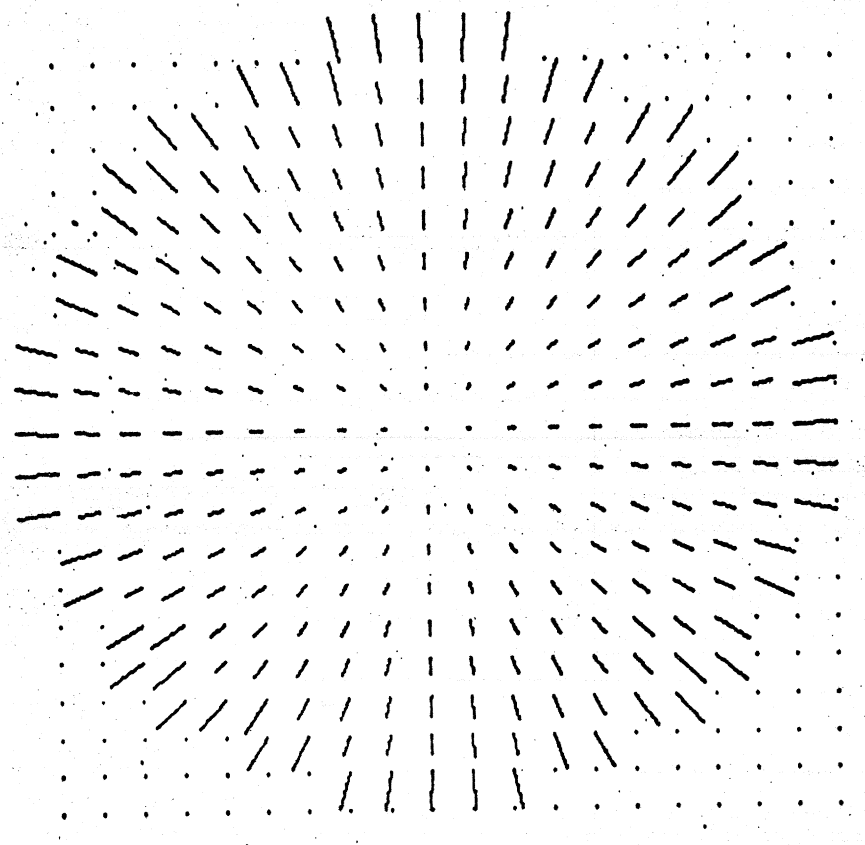

Fig. 22 A computed results

5 CONCLUDING REMARKS

- (1) We proposed a sphere projection to treat the perspective view.
- (2) We defined a distortion value for a regular pattern and proposed a regular-pattern gradient map using this measure.
- (3) We showed that the propagation algorithm can successfully determine surface orientations from regular-pattern gradients using the sphere projection, the regular-pattern gradient map, and occluding boundary constraints.

The propagation of constraints is a powerful idea in vision. Each node always has some relationship with the neighbors. Clarification of this relationship often gives us a key to the solution of vision problems. The propagation of constraints from neighboring nodes cuts down the area of possible solutions at the node. In vision the number of nodes is very large and each node takes analog values. This means that the solution space has a large number of states. Thus, the propagation technique is more effective than the search technique. Even if the propagation technique cannot determine a unique solution, it can reduce the number of possible solutions so that a subsequent search technique can be used more effectively.

There are several examples in vision where this technique has been used successfully. Marr and Poggio's first stereo algorithm used this idea [9]. Their continuity rule is an example of a positive propagation requiring that neighboring points have similar values (disparity values). Their uniqueness rule is an example of a negative propagation; A value at a node inhibits for another nodes from taking the same value. These two rules describe the relationship between nodes. Ikeuchi's shape from shading algorithm[5] has the same form as the shape from regular-patterns algorithm presented here. Third, Horn's lightness reconstruction algorithm [11] also used a propagation technique. The G operator calculated a lightness value at the center node based on both old lightness values at neighboring points and output from a laplacian operator at the center node.

The propagation of constraints technique is suited for array processing. The relationship between nodes

is homogeneous over an array. We can connect each node with the surrounding nodes in the same way everywhere, without regarding the position of nodes. An essential operation of the above mentioned algorithm is to compute an average of neighboring points. Thus, parallel hardware for array addition can implement the above mentioned algorithms very easily. The result can be obtained very rapidly.

ACKNOWLEDGMENT

The author would like to extend his sincere appreciation to Prof. B.K.P. Horn for his helpful discussions, brilliant suggestions, and warm regard, Prof. P.H. Winston for his encouragement and heartfelt regard, and Dr. H.K. Nishihara for his careful comment (footnote 7) and proofreading. Discussions with R. Sjoberg, W. Silver and K. Forbus were helpful. Thanks go to W.E.G. Grimson for helping to proofread this manuscript. This research could not have been completed so rapidly without the Lisp Machine and the support of the Lisp Machine group at the MIT AI Lab..

REFERENCES

- [1] Kender, J.R., "Shape from Texture: A Computational Paradigm," *Proc. of Image Understanding Workshop Nov. 1978, DARPA*,79-84.
- [2] Kender, J.R., "Shape from Texture: An Aggregation Transform that Maps a Class of Textures into Surface Orientation," *proc. of IJCAI 1980*,475-480.
- [3] Woodham, R.J., "Photometric Stereo: A Reflectance Technique for Determining Surface Orientation from Image Intensity," *Proc. S.P.I.E., Vol. 155, 1978*,
also available as *AI-Memo 479*,1978, AI Lab, MIT.
- [4] Ikeuchi, K. and Horn, B.K.P., "An Application of the Photometric Stereo Method," *AI-Memo 539*, 1979, AI Lab, MIT.
- [5] Ikeuchi, K., "Numerical Shape from Shading and Occluding Contours in a Single View," *AI-Memo 566*, 1980, AI Lab, MIT.
- [6] Sussman, G.J., "Electrical design A problem for Artificial Intelligence Research," *AI-Memo 425*, 1977, AI-Lab, MIT.
- [7] Marr, D., "Analysis of Occluding Contour," *Proc. R. Soc. London, Vol. B.197*, 1976, 441-475.
- [8] Horn, B.k.P., "Obtaining Shape from Shading Information," in *the Psychology of Computer Vision*, Winston, P.H. (Ed.), McGraw-Hill, New York, 1975.
- [9] Marr, D. and Poggio, T, "Cooperative Computation of Stereo Disparity," *AI-Memo 364* , 1976, AI Lab, MIT.
- [10] Horn, B.K.P., "SEQUINS and QUILLS Representation for Surface Topography," *AI-Memo 536*, 1979, AI Lab, MIT.
- [11] Horn, B.K.P., "On Lightness," *Computer Graphics and Information Processing*, Dec., 1974.

APPENDIX

A.1 Derivation of the Distortion Value, I 

Fig. A.1 The relationship between the viewer and a regular pattern

Fig. A.1 shows the relationship between the viewer and a regular pattern; the viewer is at $V = (0, 0, \cos \theta_v)$ and the texture element is at $R = (-\cos \phi_v \sin \theta_v, -\sin \phi_v \sin \theta_v, 0)^{11}$. Thus, the viewer vector \vec{V} is

$$\vec{V} = (\cos \phi_v \sin \theta_v, \sin \phi_v \sin \theta_v, \cos \theta_v).$$

The surface normal of a plane on which the regular pattern lies can be denoted as

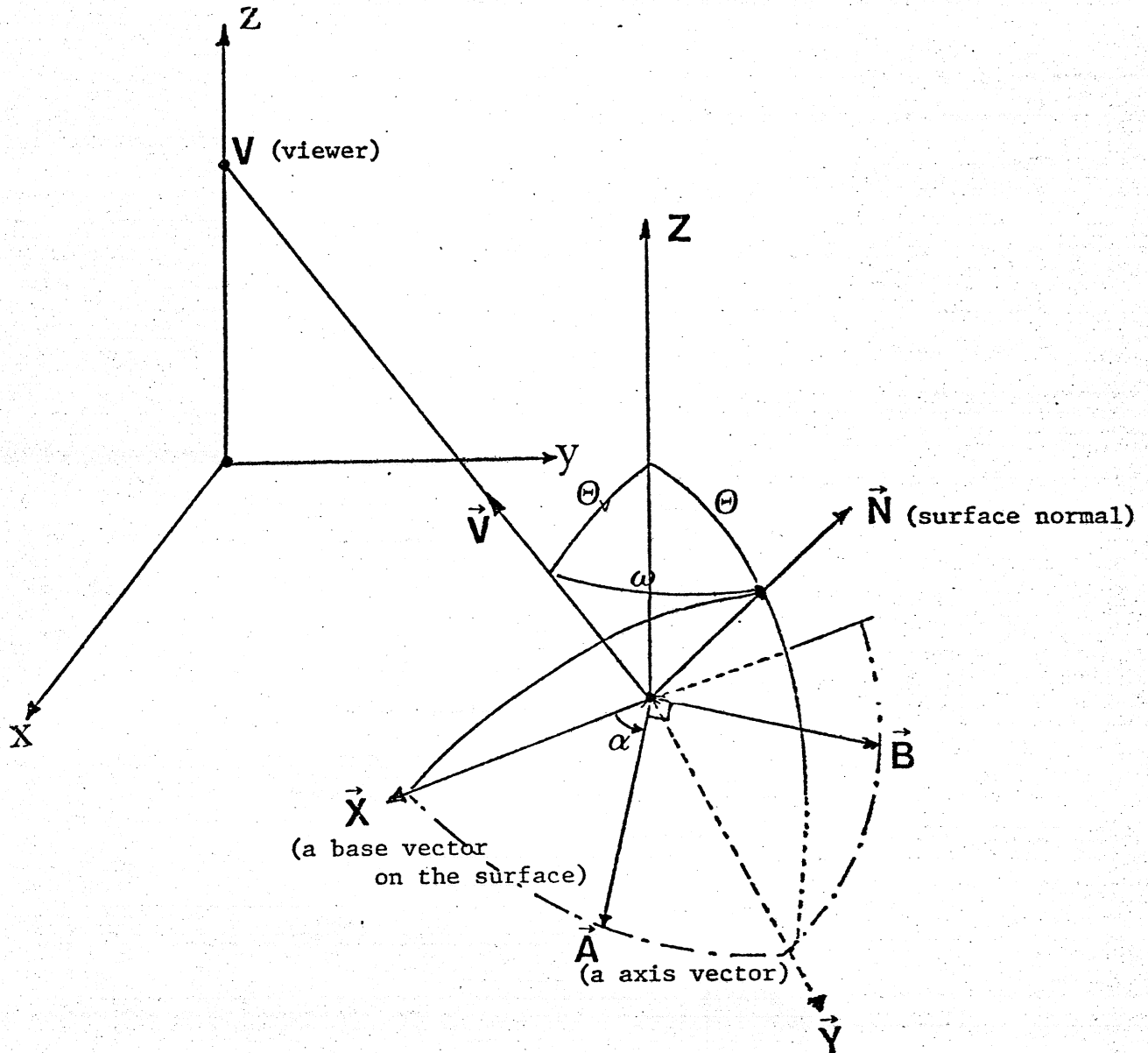
$$N = (\cos \phi \sin \theta, \sin \phi \sin \theta, \cos \theta)$$

in the spatial coordinate system. We can take two base vectors of this surface as

$$\begin{aligned} \vec{X} &= (\sin \phi, -\cos \phi, 0), \\ \vec{Y} &= (\cos \phi \cos \theta, \sin \phi \cos \theta, -\sin \theta). \end{aligned} \quad (A.1)$$

\vec{X} is a unit vector which lies on the intersection between the image plane and the surface on which the regular pattern lies. Thus, a general form for two axis vectors of the regular pattern is \vec{A}, \vec{B} where;

$$\begin{aligned} \vec{A} &= (\vec{X} \cos \alpha + \vec{Y} \sin \alpha), \\ \vec{B} &= (-\vec{X} \sin \alpha + \vec{Y} \cos \alpha), \end{aligned} \quad (A.2)$$

where α denotes the orientation of the texture element in the surface. Variation of this α causes changes like those shown in Fig. 6.

Projections \vec{a} and \vec{b} of axis vectors, \vec{A} and \vec{B} onto the image plane are

$$\begin{aligned} \vec{a} &= k(\vec{A} - (\vec{A} \cdot \vec{V})\vec{V}), \\ \vec{b} &= k(\vec{B} - (\vec{B} \cdot \vec{V})\vec{V}), \end{aligned} \quad (A.3)$$

where k is a scale factor, which depends on the distance between the regular pattern and the viewer.

We want to find an intrinsic value dependent on the surface normal but independent of the rotation angle α and the scaling factor k . With this intrinsic value we will be able to construct a regular-pattern gradient map.

¹¹The following calculation will be easier if the z-axis is the same as the direction of the viewer.

Consider the ratio of the cross product of the two projected axis vectors over the sum of the square of the lengths of the two projections.

The cross product of the axis vector's projections onto the image plane is:

$$\begin{aligned} |\vec{a} \times \vec{b}| &= k^2 |(\vec{V} \times \vec{X})(\vec{Y} \cdot \vec{V}) - (\vec{V} \times \vec{Y})(\vec{X} \cdot \vec{V})|, \\ &= k^2 |\vec{V} \cdot (\vec{X} \times \vec{Y})|, \\ &= k^2 \cos \omega, \end{aligned} \tag{A.4}$$

where ω denotes the angle between the direction of the line of sight of the viewer and the direction of the surface normal. Thus, the cross product of the projected axis vectors does not depend on the rotation angle α , and is proportional to the cosine of the angle between the direction of line of sight of the viewer and the direction of the surface normal.

The sum of the square of the lengths of the projected vectors is:

$$\begin{aligned} |a|^2 + |b|^2 &= k^2 (2 - [|\vec{X} \cdot \vec{V}|^2 + |\vec{Y} \cdot \vec{V}|^2]), \\ &= k^2 (1 + (\cos \theta_v \cos \theta + \sin \theta_v \sin \theta \cos(\phi - \phi_v))^2), \\ &= k^2 (1 + \cos^2 \omega), \end{aligned} \tag{A.5}$$

where we used a cosine formula from spherical trigonometry.

We can cancel the scaling factor by dividing Eq.(A.4) by Eq.(A.5) obtaining the distortion measure I :

$$I = \frac{|\vec{a} \times \vec{b}|}{|a|^2 + |b|^2} = \frac{\cos \omega}{1 + \cos^2 \omega}. \tag{A.6}$$

A.2 Conversion from the Perspective Projection to the Sphere Projection

We can take two base vectors on the surface of an object. Every vector on the surface can be expressed using these two vectors. Let one vector be \vec{e}_1 as on the extended plane of the meridian circle and let the other vector \vec{e}_2 as perpendicular to the first vector \vec{e}_1 .

The second vector \vec{e}_2 is projected in the same way in both the perspective projection and the sphere projection.

The first vector \vec{e}_1 is projected as in Fig. A.2.

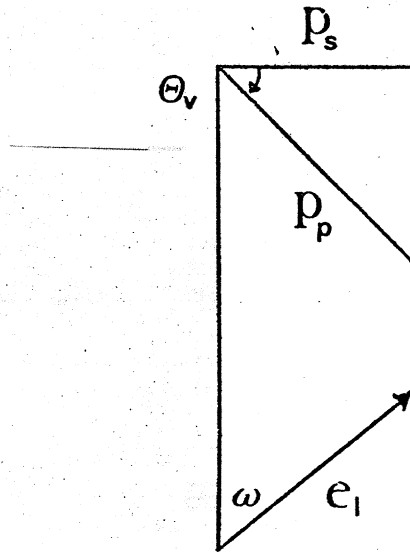

Fig. A.2

$$\begin{aligned} P_{sphere} &= |\vec{e}_1| \sin \omega, \\ P_{perspective} &= \frac{|\vec{e}_1| \sin \omega}{\cos \theta_v}, \end{aligned} \quad (A.7)$$

where P_{sphere} and $P_{perspective}$ are the projected lengths of \vec{e}_1 onto the image plane under the sphere projection and the perspective projection, respectively. ω denotes the angle between the direction of Viewer's line of sight and the direction of the surface normal. θ_v is the zenith angle of the image point based on the direction of the optical axis of the image plane.

Thus,

$$P_{sphere} = P_{perspective} \cos \theta_v. \quad (A.8)$$

Eq. (A.8) expresses the relationship between the sphere projection and the perspective projection.

Eq. (A.7) also explains why the perspective projection causes the problem discussed in Chapter 2. Imagine an infinite plane perpendicular to the optical axis of the perspective projection. The infinite plane contains many squares. Under the perspective projection these squares always projected as squares. Which is contrary to our experience. We actually see squares as rectangles whose shape depends on their positions. In this case ω is always as same as $(\frac{\pi}{2} + \theta_v)$. Thus, from Eq. (A.7) we get

$$P_{perspective} = |\tilde{e}_1|.$$

Thus, the perspective projection does not exhibit foreshortening effects.