

**MIPS-FORTRAN Programmer's Guide  
and Language Reference**

*Order Number 3103DOC*

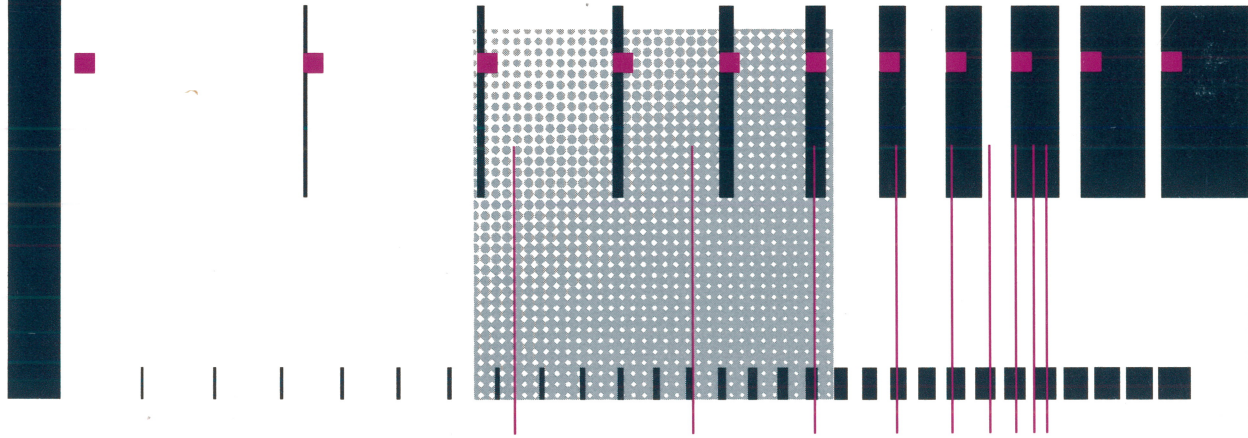

The power of RISC is in the system.

**MIPS-FORTRAN Programmer's Guide  
and Language Reference**

*Order Number 3103DOC*

**May 1989**

---

*Your comments on our products and publications are welcome. A postage-paid form is provided for this purpose on the last page of this manual.*

© 1989 MIPS Computer Systems, Inc. All Rights Reserved.

RISCompiler and RISC/os are Trademarks of MIPS Computer Systems, Inc.  
UNIX is a Trademark of AT&T.  
Ethernet is a Trademark of XEROX.

MIPS Computer Systems, Inc.  
930 Arques Ave.8  
Sunnyvale, CA 94086

---

Customer Service Telephone Numbers:

California:	(800)	992-MIPS
All other states:	(800)	443-MIPS
International:	(415)	330-7966

# Summary of Changes

---

## May 1989 Edition

The following summarizes the changes made to the former (July 1988) edition of this manual that appear in this edition:

### *Part I: Programmer's Guide*

**About This Book.** Removed first sentence in second paragraph of the first page that makes reference to full ANSI compatibility.

**Chapter 3.** Technical correction in Fortran/Pascal interface examples..

**Chapter 4.** Added MALLOC and FREE function extensions to Chapter 4.

### *Part II: Language Reference*

**Chapter 4.** Added a description of the POINTER specification statement.

*General.* Change highlighting of text that describes FORTRAN extensions from underline to shade. Made minor technical and editorial corrections throughout.

C

C

C

## About Part I of This Book

---

Part I of this book provides information on implementing MIPS–FORTRAN programs using RISC/os™ and the RISCompiler™ system. Refer to Part II (the *MIPS–FORTRAN Language Reference* manual) for the syntax and description of the language.

MIPS extensions provide full VMS FORTRAN™ compatibility to the extent possible when not actually using the VMS operating system or VAX data representation. MIPS–FORTRAN also contains extensions that provide partial compatibility with programs written in SVS FORTRAN™ and FORTRAN 66.

MIPS–FORTRAN is a superset of VMS FORTRAN; the MIPS RISCompiler system can convert source programs written in VMS FORTRAN into machine programs executable under RISC/os™.

### Scope

Although the RISC/os programming environment includes all standard UNIX driver commands and system tools, this book does not describe those tools in detail. For details, you may need to refer to the *RISC/os User's Reference Manual* and other associated publications listed at the end of this preface.

### Topics Covered

This book has these chapters:

- **Chapter 1: Compiling, Linking and Running Programs.** Gives an overview of components of the compiler system, describes how to compile, link edit, and execute a MIPS–FORTRAN program. Also describes special considerations for programs running on a RISC/os systems, such as file format, error handling, and programming invocation.
- **Chapter 2: Storage Mapping.** Describes how the size and value ranges for variables, and how they are mapped to the storage of a RISComputer system.
- **Chapter 3: Language Interfaces.** Provides reference and guide information on writing programs in FORTRAN, C, and Pascal that can communicate with each other.
- **Chapter 4: System Functions and Subroutines** Describes functions and subroutines that can be used with a program to communicate with the RISC/os operating system.
- **Appendix A: Runtime Error Messages.** Lists and explains the error messages that can be generated during program execution.
- **Index.** Contains index entries for this publication.

## For More Information

You may need to refer to the *MIPS-FORTRAN Language Reference* (Part II of this book) or one of the following as you use this manual:

- *MIPS Assembly Language Programmer's Guide* (3201DOC)
- *RISC/os User's Reference Manual* (3204DOC)

## ***About Part I of This Book***

Scope .....	iii
Topics Covered .....	iii
For More Information .....	iv

## ***Chapter 1: Compiling, Linking, and Running Programs***

Compiling and Linking .....	1-1
Drivers .....	1-1
Compilation .....	1-2
Compiling Multi-Language Programs .....	1-3
Linking Objects .....	1-4
Specifying Link Libraries .....	1-5
Driver Options .....	1-6
Debugging .....	1-12
Profiling .....	1-13
Optimizing .....	1-13
Performance .....	1-14
Byte Ordering Options .....	1-14
Object File Tools .....	1-15
Archiver .....	1-15
Run-Time Considerations .....	1-16
Invoking a Program .....	1-16
File Formats .....	1-16
Preconnected Files .....	1-16
File Positions .....	1-17
Unknown File Status .....	1-17
Run-Time Error Handling .....	1-17

## ***Chapter 2: Storage Mapping***

## ***Chapter 3: FORTRAN Program Interfaces***

FORTRAN/C Interface .....	3-1
Procedure and Function Declarations .....	3-1
Arguments .....	3-3
Array Handling .....	3-4
Accessing Common Blocks of Data .....	3-5
FORTRAN/Pascal Interfaces .....	3-6
Procedure and Function Declarations .....	3-6
Arguments .....	3-7
Execution-Time Considerations .....	3-9
Array Handling .....	3-9



Accessing Common Blocks of Data .....	3-10
<b>Chapter 4: System Functions and Subroutines</b>	
Library Functions .....	4-1
Intrinsic Subroutine Extensions .....	4-3
DATE .....	4-3
IDATE .....	4-4
ERRSNS .....	4-4
EXIT .....	4-4
FREE .....	4-4
TIME .....	4-5
MVBITS .....	4-5
Intrinsic Function Extensions .....	4-5
SECNDS .....	4-6
RAN .....	4-6
MALLOC .....	4-6
<b>Appendix A: Run-Time Error Messages</b>	

# Compiling, Linking, and Running Programs

---

This chapter contains the following major sections:

- **Compiling and Link Editing**, which describes the compilation environment, how to compile and link FORTRAN programs. Examples are included to show how to create separate linkable objects written in FORTRAN, C, Pascal, or other languages supported by the compiler system, and to link them into an executable object program.
- **Driver Options**, which gives an overview of the debugging, profiling, optimizing and other options provided with the FORTRAN `f77` driver.
- **Object File Tools**, which briefly summarizes the capabilities of the `odump`, `nm`, `file`, and `size` programs that provide listing and other information on object files.
- **Archiver**, which summarizes the functions of the `ar` program that maintains archive libraries.
- **Run-Time Considerations**, which describes how to invoke a FORTRAN program, how the operating system treats files, and run-time error handling.

You should refer to the **Release Notes** that accompanied your FORTRAN installation package. This document sometimes lists compiler enhancements, possible compiler errors, and how to circumvent them.

## Compiling and Linking

### Drivers

Intelligent programs called *drivers* actually invoke the major components of the compiler system: the FORTRAN compiler, the `uopt` optimizer, the code generator, the assembler, and the link editor. The `f77` command runs the driver that causes your programs to be compiled, optimized, assembled, and link edited.

The format of the `f77` driver command is as follows:

```
f77 [option] ... filename.f
```

where:

`f77` invokes the various processing phases that compile, optimize, assemble, and link edit the program.

*option* represents the driver options, through which you provide instructions to the processing phases. These options are discussed later in the chapter.

*filename.f* is the name of the file that contains the FORTRAN source statements. The file name must always contain the suffix *f*, for example *myprog.f*.

## Compilation

The driver command `f77` can both compile and link edit a source module. The next figure shows the primary drivers phases, and their principal inputs and outputs for the source modules *more.f*.

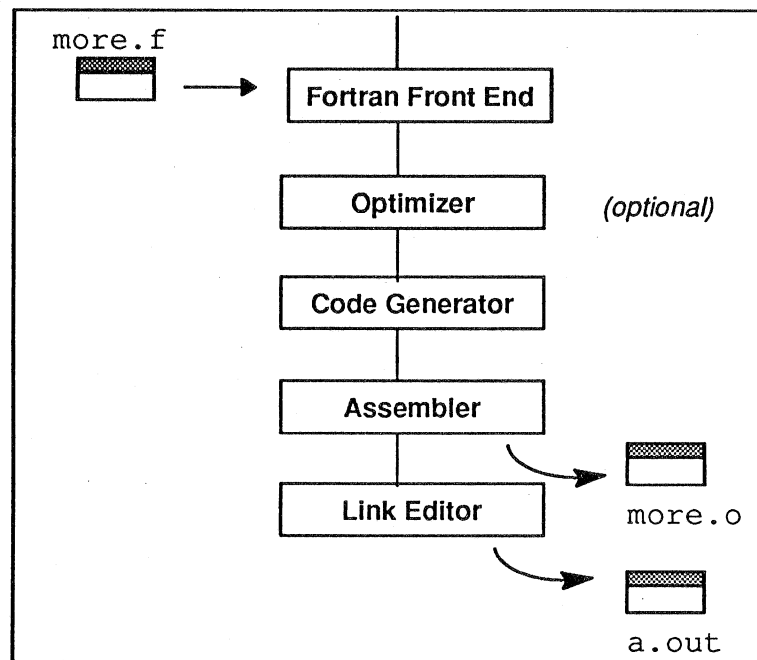

Note the following:

- The name of the source file ends with the required suffix *f*.
- The driver produces a linkable object file when you specify the `-c` driver option. This file has the same name as the source file, except with the suffix *.o*. For example, the following command line:

```
f77 more.f -c
```

produces the *more.o* file in the above example

- The default name of the executable object file is *a.out*. For example, the command line

```
f77 myprog.f
```

produces the executable object *a.out*.

- You can specify a different name for the executable object using the driver option `-o name`, where *name* is the name of the executable object. For example, the following command line

```
f77 more.o -o exec.myprog
```

link edits the object module *more.o* and produces an executable object named *exec.myprog*.

The following command line

```
f77 myprog.f -o exec.myprog
```

compiles and link edits the source module *myprog.f* and produces an executable object named *exec.myprog*.

**NOTE:** If you specify more than one object file on the command line, the file containing the main program must be specified first. The link editor requires this information.

## Compiling Multi-Language Programs

The compiler system provides drivers for other languages, including C, Pascal, COBOL, and PL/1. If one of these drivers is installed in your system, you can compile and link your FORTRAN programs to the language supported by the driver. (See the *Language Programmer's Guide* for a list of available drivers and the commands that invoke them; refer to Chapter 4 of this manual for conventions you must follow in writing FORTRAN program interfaces to C and Pascal programs.)

When your application has two or more source programs written in different languages, you should compile each program module separately with the appropriate driver and then link them in a separate step. You can create objects suitable for link editing by specifying the `-c` option, which stops the driver immediately after the assembler phase. For example:

```
cc -c main.c
f77 -c rest.f
```

The two command lines shown above produce linkable objects named *main.o* and *rest.o*, as illustrated in the next figure.

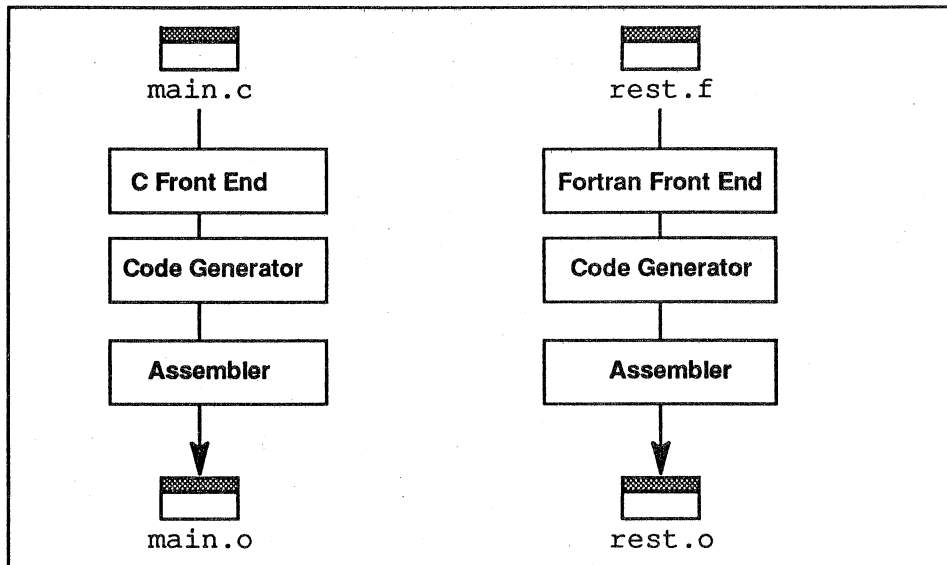

### Linking Objects

You can also use the `f77` driver command to link edit separate objects into one executable program when the main program is written in FORTRAN. The driver recognizes the `.o` suffix as the name of a file containing object code suitable for link editing and immediately invokes the link editor. The following command line link edits the object created in the last example:

```
f77 -o all main.o rest.o
```

This statement produces the executable program object `all`. Note that `main.o` contains the main routine and is specified, as required, first. If the main program is not written in FORTRAN, you should use the applicable driver. For example, if the main program were written in C, you would use the `cc` driver command, as shown below:

```
cc -o all main.o rest.o -lF77 -lU77 -lI77 -lisam -lm
```

The figure below shows the flow of control for this link edit.

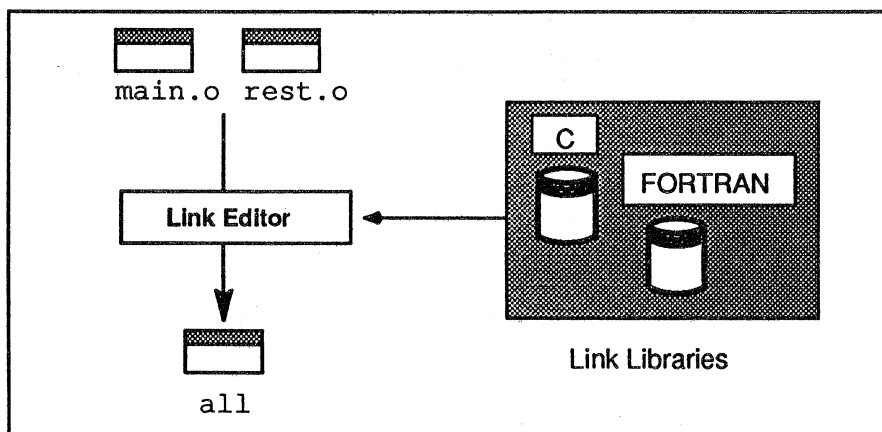

Both `f77` and `cc` use the C link library by default. However, the `cc` driver command does not know the names of the link libraries required by the FORTRAN objects; therefore, you must specify them explicitly to the link editor using the `-l` option as shown in the example. The characters following `-l` are short-hand for link library files as shown in this table:

<code>-l</code>	Link Library	Contents
F77	/usr/lib/libF77.a	Fortran intrinsic function library
I77	/usr/lib/libI77.a	Fortran I/O library
U77	/usr/lib/libU77.a	Fortran UNIX interface library
isam	/usr/lib/libisam.a	Indexed sequential access method library
m	/usr/lib/libm.a	Math library

See the FILES section in `f77(1)` of the *User's Reference Manual* for a complete list of the files used by the FORTRAN driver. See `ld(1)` in the same manual for information on specifying the `-l` option.

### Specifying Link Libraries

As noted, if you compile multi-language programs, you must explicitly load any required runtime libraries. For example, if you write your main program in FORTRAN, and some procedures in Pascal, you must explicitly load the Pascal library `libp.a` and the main library `libm.a` with the options `-lp` and `-lm` (abbreviations for the libraries `libp.a` and `libm.a`), as shown below, when you link these programs.

```
% cobol main.o more.o rest.o -lp -lm
```

To find the Pascal library, the link editor replaces the `-l` with `lib` and adds an `.a` after `p`. Then, it searches the `/lib`, `/usr/lib` and `/usr/local/lib` directories for this library. For a list of the libraries that a language uses, see the associated driver manual page `cc(1)`, `f77(1)`, `pc(1)`, `cobol(1)`, or `pl1(1)` in the *User's Reference Manual*.

You may need to specify libraries when you use UNIX system packages that are not part of a particular language. Most of the manual pages for these packages list the required libraries. For example, the plotting subroutines require the libraries listed in the `plot(3X)` manual page; these libraries are specified as follows:

```
% f77 main.o more.o rest.o -lp -lplot
```

To specify a library created with the archiver, type in the pathname of the library as shown below.

```
% f77 main.o more.o rest.o -libft.a -lp
```

**NOTE:** The link editor searches libraries in the order you specify. Therefore, if you have a library (for example *libft.a*) that uses data or procedures from *-lp*, you **MUST** specify *libft.a* first.

## Driver Options

The section contains a summary of the FORTRAN-specific driver options. See **f77(1)** in the *User's Reference Manual* for a complete description of the compiler options; see **ld(1)** in the same manual for a description of the link editor options.

Option Name	Purpose
-66	<p>Permits compilation of FORTRAN 66 source programs.</p> <p>The following three options when used at compile time generate various degrees of misaligned data in common blocks, and the code to deal with the misalignment.</p>
	<p><b>NOTE:</b> When specified, these options can degrade program performance; <b>-align8</b> causes the greatest degree of degradation and <b>-align32</b> causes the least.</p>
-align8	<p>Permits objects larger than 8 bits to be aligned on 8-bit boundaries. Using this option will have the largest impact on performance.</p>
-align16	<p>Permits objects larger than 16 bits to be aligned on 16-bit boundaries; 16-bit objects must still be aligned on 16-bit boundaries (MC68000-like alignment rules).</p>
-align32	<p>Permits objects larger than 32 bits to be aligned on 32-bit boundaries; 16-bit objects must still be aligned on 16-bit boundaries, and 32-bit objects must still be aligned on 32-bit boundaries.</p> <p>You must specify this option in the compilation of all modules that reference or define common blocks with misaligned data. Failure to do so could cause core dumps (if the trap handler is not used), or mismatched common blocks.</p> <p>To load the system libraries capable of handling misaligned data, use the <b>-L/usr/lib/align</b> switch at load time. The trap handler may be needed to handle misaligned data passed to system libraries not included in the <b>/usr/lib/align</b> directory (see <b>fixade(3f)</b>).</p>



Option Name	Purpose										
-automatic	Causes the current values of local variables to be saved each time procedures is called. This ensures that the correct values are preserved for the calling programs regardless of calls to the same procedure by other programs.										
-C	Generate code for runtime subscript range checking. The default suppresses range checking.										
-check_bounds	Causes an error message to be issued a run-time when the value of an array subscript expression exceeds the bounds declared for the array.										
-col72	<p>Sets the source statement format to the following:</p> <table border="1" data-bbox="768 747 1243 940"> <thead> <tr> <th>Column</th> <th>Contents</th> </tr> </thead> <tbody> <tr> <td>1-5</td> <td>Statement label</td> </tr> <tr> <td>6</td> <td>Continuation indicator</td> </tr> <tr> <td>7-72</td> <td>Statement body</td> </tr> <tr> <td>73-end</td> <td>Ignored</td> </tr> </tbody> </table> <p>If the source statement contains fewer than 72 characters, no blank padding occurs; the TAB-format facility (described in Chapter 1) is disabled.</p> <p>This option provides the SVS FORTRAN 72-column option mode.</p>	Column	Contents	1-5	Statement label	6	Continuation indicator	7-72	Statement body	73-end	Ignored
Column	Contents										
1-5	Statement label										
6	Continuation indicator										
7-72	Statement body										
73-end	Ignored										
-col120	<p>Sets the source statement format to the following:</p> <table border="1" data-bbox="768 1220 1256 1398"> <thead> <tr> <th>Column</th> <th>Contents</th> </tr> </thead> <tbody> <tr> <td>1-5</td> <td>Statement label</td> </tr> <tr> <td>6</td> <td>Continuation indicator</td> </tr> <tr> <td>7-120</td> <td>Statement body</td> </tr> <tr> <td>121-end</td> <td>Ignored</td> </tr> </tbody> </table> <p>If the source statement contains fewer than 120 characters, no blank padding occurs; the TAB-format facility (described in Chapter 1) is disabled.</p> <p>This option provides the SVS FORTRAN default mode.</p>	Column	Contents	1-5	Statement label	6	Continuation indicator	7-120	Statement body	121-end	Ignored
Column	Contents										
1-5	Statement label										
6	Continuation indicator										
7-120	Statement body										
121-end	Ignored										

Option Name	Purpose										
<p><b>-cpp</b></p> <p><b>-d_lines</b></p> <p><b>extend_source</b></p> <p><b>-F</b></p>	<p>Runs the C macro preprocessor on all source files (including those created by RATFOR or EFL) before compilation.</p> <p>Causes any lines with a D in Column 1 to be compiled. By default, the compiler treats all lines with a character in Column 1 as comment lines.</p> <p><i>flags</i> is a valid option for the EFL preprocessor. The valid flags are listed in the <b>efl(1)</b> description .</p> <p>The EFL input filename is <i>filename.e</i>; the resulting output is placed in <i>filename</i>. You must specify the <b>-K</b> option to retain the output file.</p> <p>Sets the source statement format to the following:</p> <table border="1" data-bbox="771 829 1291 1050"> <thead> <tr> <th>Column</th> <th>Contents</th> </tr> </thead> <tbody> <tr> <td>1-5</td> <td>Statement label</td> </tr> <tr> <td>6</td> <td>Continuation indicator</td> </tr> <tr> <td>7-132</td> <td>Statement body</td> </tr> <tr> <td>133-end</td> <td>Warning message issued</td> </tr> </tbody> </table> <p>If the source statement contains fewer than 132 characters, blanks are assumed at the end; the ability of TAB-formatted lines to extend past Column 132 is disabled.</p> <p>This option provides VMS FORTRAN 132-column mode, except that a warning, instead of fatal, error message is generated when text extends beyond Column 132.</p> <p>Calls the EFL and RATFOR preprocessors only, and puts output in an .f file. Doesn't produce .o files.</p>	Column	Contents	1-5	Statement label	6	Continuation indicator	7-132	Statement body	133-end	Warning message issued
Column	Contents										
1-5	Statement label										
6	Continuation indicator										
7-132	Statement body										
133-end	Warning message issued										

Option Name	Purpose										
-i2	<p>All small integer contents become <b>integer*2</b>. All variables and functions implicitly or explicitly declared type <b>integer</b> or <b>logical</b> (without a size designator, i.e. *2, *4, etc.) will be <b>integer*2</b> or <b>logical*2</b> respectively.</p> <p>If the generic function results don't determine the precision of an integer-valued intrinsic function, the compiler chooses the precisions that returns <b>integer*2</b>. The default is <b>integer*4</b>. Note that <b>integer*2</b> and <b>logical*2</b> quantities don't obey the FORTRAN standard rules for storage location.</p>										
-m	<p>Applies the M4 macro preprocessor to source files to be transformed with EFL or RATFOR. The driver puts the result in a .p file. Unless you specify the <b>-K</b> option, the compiler removes the .p file upon completion. See the <b>m4(1)</b> description in the User's Reference Manual for details.</p>										
-N[qxscl] nnn	<p>nnn is a decimal number changing the default size of the static tables in the compiler. See the <b>f77(1)</b> description in the <i>User's Reference Manual</i> for details.</p>										
-noextend_source	<p>Sets the source statement format to the following:</p> <table border="1" data-bbox="773 1157 1263 1339"> <thead> <tr> <th data-bbox="773 1157 948 1199">Column</th> <th data-bbox="953 1157 1263 1199">Contents</th> </tr> </thead> <tbody> <tr> <td data-bbox="773 1205 948 1247">1-5</td> <td data-bbox="953 1205 1263 1247">Statement label</td> </tr> <tr> <td data-bbox="773 1253 948 1295">6</td> <td data-bbox="953 1253 1263 1295">Continuation indicator</td> </tr> <tr> <td data-bbox="773 1302 948 1344">7-72</td> <td data-bbox="953 1302 1263 1344">Statement body</td> </tr> <tr> <td data-bbox="773 1350 948 1392">73-end</td> <td data-bbox="953 1350 1263 1392">Ignored</td> </tr> </tbody> </table> <p>If the source statement contains fewer than 72 characters, then blanks are assumed at the end; the ability of TAB-formatted lines to extend past Column 72 is disabled.</p> <p>This option provides the VMS-FORTRAN default mode, except that a warning, instead of a fatal, error message is generated when text extends beyond Column 132.</p>	Column	Contents	1-5	Statement label	6	Continuation indicator	7-72	Statement body	73-end	Ignored
Column	Contents										
1-5	Statement label										
6	Continuation indicator										
7-72	Statement body										
73-end	Ignored										
-noi4	<p>Same as <b>-i2</b> option.</p>										

Option Name	Purpose
<b>-nof77</b>	<p>Same as <b>-onetrip</b> switch except for the following:</p> <ol style="list-style-type: none"> <li>1. EXTERNAL statements have an altered syntax and functionality.</li> <li>2. The default value for the BLANK= clause in an OPEN statement is 'ZERO'.</li> <li>3. The default value for the STATUS= clause in an OPEN statement is 'NEW'.</li> </ol>
<b>-onetrip</b> <b>-1</b>	<p>Compiles DO loops so that they execute at least once if reached. By default, DO loops aren't executed if the upper limit is smaller than the lower limit. Similar to the <b>-nof77</b> option.</p>
<b>-Rflags</b>	<p><i>flags</i> is a valid option for the RATFOR preprocessor; the flags are given in the <b>ratfor(1)</b> page in the <i>User's Reference Manual</i>.</p> <p>The RATFOR input file name is <i>filename.r</i> the resulting output is placed in <i>filename.f</i>. You must specify the <b>-K</b> option to retain the output file.</p>
<b>-static</b>	<p>Local variables are saved in one static location, subsequent calls to the procedure containing the variables can change their values. This overrides the default <b>-automatic</b> option.</p>
<b>-systype name</b>	<p>Use the named compilation environment name. See <b>compilation(7)</b> for the compilation environments that are supported and their names.</p>
<b>-U</b>	<p>Causes the compiler to recognize upper- and lowercase alphabetic characters. For example, the compiler considers a and A as distinct characters.</p>
<b>-u</b>	<p>Turns off FORTRAN default data typing and any data typing explicitly specified in an IMPLICIT statement. Forces the explicit declaration of all data types.</p>
<b>-w66</b>	<p>Suppresses FORTRAN 66 compatibility warning messages.</p>
<b>-vms</b>	<p>Causes all defaults to be in accordance with VMS-FORTRAN specifications.</p>

## Debugging

The compiler system provides a source level, interactive debugger called **dbx** that you can use to debug programs as they execute. With **dbx** you can control program execution by setting breakpoints; then, when the program halts at a breakpoint, you can monitor what is happening, modify values, and evaluate results. **Dbx** keeps track of variables, subprograms, subroutines, and data types in terms of the symbols used in the source language. You can use this debugger to access the source text of the program, to identify and reference program entities, and to detect errors in the program's logic.

The next example shows a compilation with the `—g` option and the start of a **dbx** session.

```

mips[2]  f77 myprog.f -g ← Compile with full source-debugging
mips[3]  dbx ← Invoke the debugger
enter object file name (default is 'a.out'): <RETURN> ← Specify a.out as object
dbx version 1.30
Copyright 1986 MIPS Computer Systems Inc.
Type 'help' for help.
reading symbolic information ...
main:      Source not available
(dbx) help ← Enter help to display dbx commands available.

MOST USED COMMANDS

quit[!]          - quit dbx
run arg1 arg2 ... < f1 > & f2 - begin execution of the program
stop at <line>    - suspend execution at the line
[n] cont <signal> - continue with signal
return           - continue until the current procedure returns
print <exp> ...  - print the value of the expressions
printf "string", exp, ... - print expressions using format string(C)
where [n]        - print currently active procedures (stack trace)
status           - print trace/stop/record's in effect
func <proc>      - move to activation level of <proc>
<exp>[/ | ?]<count><format> - display count number of formatted memory item
file <file>      - change current file to file
list <exp>:<int> - list source lines at <exp> for <int> lines
sh <shell command> - perform shell command

HISTORY, ALIAS, and INPUT/OUTPUT REDIRECTION

quit[!]          - quit dbx
alias            - print aliases
alias name "string" - set name to alias "string"
                •
                •
                •

```

*Compiling a FORTRAN Program and Invoking the Debugger (dbx)*

## Reference Information

For a complete list of `—g` driver options, see **f77(1)** manual page in the *User's Reference Manual*.; see **dbx(1)** in the same manual for information on the debugger.

## Profiling

The compiler system permits the generation of profiled programs that, when executed, provide operational statistics. This is done through driver option `-p` (which provides pc sampling information) and the `pixie` and `prof` programs.

Below is an example of one use of the profiling facility, where default options produce a pc-sampling listing. However, a variety of other options and methods of profiling are available; if you wish to learn more about them (and the information displayed in the pc-sampling listing), read **Chapter 4** of the *Language Programmer's Guide*, which describes the advantages and methods of profiling, and gives examples of the various options and commands to achieve the desired results. See also `prof(1)` for detailed reference information.

```

mips[4]  f77 myprog.f -p -o myprog          ← Compile with profiling
mips[5]  myprog                            ← Execute resulting object
mips[6]  prof myprog                       ← Run profiler to display pc-sampling feature
Profile listing generated Wed Mar 30 10:27:03 1988 with:
  prof myprog

V$ADDDE8 is an alternate entry within V$SUBDE8 (../v_addde8.s)
blkclr and bzero (bzero.s) synonymous: using latter
-----
* -p[rocedures] using pc-sampling;          *
* sorted in descending order by total time spent in each procedure;      *
* unexecuted procedures excluded          *
-----
Each sample covers 8.00 byte(s) for 20% of 0.0500 seconds
%time      seconds  cum %   cum sec  procedure (file)
20.0       0.0100   20.0    0.01    P$DISPLAY.PUT_PART (../displa.pl1)
20.0       0.0100   40.0    0.02    tskip (termcap.c)
20.0       0.0100   60.0    0.03    read (read.s)
          .
          .
          .

```

### Generating Profile Information on a FORTRAN Program

## Optimizing

The table belows summarizes the optimizing function available:

### Option Result

- O2 The global optimizer (uopt) phase executes. It performs optimization only within the bounds of individual compilation units.
- O1 Default option. This option causes the code generator and assembler phases of compilation to improve the performance of your executable object.
- O0 No optimization.

The default option (`—O1`) causes the code generator and the assembler to perform basic optimizations such as constant folding, common subexpression elimination within individual statements, and common subexpression elimination between statements.

The global optimizer—invoked by the `—O2` option—is a single program that improves the performance of an object programs by transforming existing code into more efficient coding sequences. Although the same optimizer processes all compiler optimizations, it does distinguish between the various languages supported by the compiler system programs to take advantage of the different language semantics involved.

See the *Languages Programmer's Guide* for details on the optimization techniques used by the compiler and tips on writing optimal code for optimizer processing.

## Performance

In addition to the optimizing options, the compiler system provides other options that can improve the performance of your programs:

- The `—feedback` and `—cord` options (see `f77(1)` in the *User's Reference Manual*) together with the `pixie(1)` and `prof(1)` utilities can be used to reduce possible machine cache conflicts. See **Reducing Cache Conflicts** in Chapter 4 of the *Language Programmer's Guide* for an example using these facilities.
- The link editor `—G num` and `—bestGnum` options offer a means to control the size of the global data area, which can offer significant performance improvements. See **Limiting the Size of the Global Pointer Data** in Chapter 4 of the *Language Programmer's Guide* and `ld(1)` in the *User's Reference Manual* for more information.
- The `—jmopt` option permits the link editor to fill certain instruction delay slots not filled by the compiler front end. This option may improve the performance of smaller programs not requiring extremely large blocks of virtual memory. See the `ld(1)` for more information.

## Byte Ordering Options

The compiler can produce program objects executable on target machines with either a big-endian (with the `—EB` option) or little-endian (`—EL`) byte ordering scheme. By default, the compiler produces program objects executable on target machines with the same byte ordering scheme as the compilation machine. See **Appendix D** in the *Language Programmer's Guide* for a description of big and little endian byte ordering.

## Object File Tools

The following tools provide information on object files as indicated:

- **odump:** The **odump** tool lists headers, tables, and other selected parts of an object or archive file. An explanation of the information provided by **odump** can be found in **Chapters 10 and 11** of the *Assembly Language Programmer's Guide*.
- **nm:** The **nm** tool prints symbol table information for object files and archive files.
- **file:** The **file** tool lists the properties of program source, text, object, and other files. This tool often erroneously recognizes command files as C programs. It does not recognize Pascal or LISP programs.
- **size:** The **size** tool prints information about the *text*, *rdata*, *data*, *sdata*, *bss*, and *sbss* sections of the specified object or archive file(s). The contents and format of section data are described in **Chapter 10** of the *Assembly Language Programmer's Guide*.

For more information on these tools, see **odump(1)**, **nm(1)**, **file(1)**, or **size(1)** in the *User's Reference Manual*.

## Archiver

An archive library is a file that contains one or more routines in object (.o) file format; the term *object* as used in this chapter refers to an .o file that is part of an archive library file. When a program calls an object not explicitly included in the program, the link editor (**ld**) looks for that object in an archive library. The editor then loads only that object (not the whole library) and links it with the calling program.

The archiver (**ar**) creates and maintains archive libraries and has the following main functions:

- Copying new objects into the library
- Replacing existing objects in the library
- Moving objects about the library
- Copying individual objects from the library into individual object file.

See the **ar(1)** in the *User's Reference Manual* for additional information on the archiver.



## Run-Time Considerations

### Invoking a Program

To run a FORTRAN program, invoke the executable object module produced by the `f77` command, enter the name of the module as a command. By default, the name of the executable module is `a.out`. If you included the `-o filename` option on the `ld` (or `f77`) command line, the executable object module has the name that you specified.

### File Formats

FORTRAN requires four kinds of external files:

- sequential formatted
- sequential unformatted
- direct formatted
- direct unformatted.

The operating system implements such files as ordinary files and assumes that they have the proper internal structure.

FORTRAN I/O is based on records. When a program opens a direct file, the record length of the records must be given. The FORTRAN I/O system uses the length to make the file appear to be made up of records of the given length. When the record length is 1, the system treats the files as ordinary system files (as byte strings, in which each byte is addressable). A `READ` or `WRITE` request on such files consumes bytes until satisfied, rather than restricting itself to a single record.

Because of special requirements, sequential unformatted files will probably be read or written only by FORTRAN I/O statements. Each record is preceded and followed by an integer containing the length of the record in bytes.

During a `READ`, FORTRAN I/O breaks sequential formatted files into records by using each new-line indicator as a record separator. The FORTRAN 77 American National Standard does not define the required result after reading past the end of a record; the I/O system treats the record as being extended by blanks. On output, the I/O system writes a new-line indicator at the end of each record. If a user program also writes a new-line indicator, the I/O system treats it as a separate record.

### Preconnected Files

The following table shows preconnected files at program start.

Unit#	Unit
5	Standard Input
6	Standard Output
0	Standard Error

All other units are also preconnected when execution begins. Unit  $n$  is connected to a file name `fort.n`. These files need not exist, nor will they be created unless their units are used without first executing an open. The default connection is for sequentially formatted I/O.

## File Positions

The FORTRAN 77 standard does not specify where OPEN should initially position a file explicitly opened for sequential I/O. The I/O system positions the file to start-of-file, both for input and output. The execution of an OPEN statement followed by a WRITE on an existing file causes the file to be overwritten, erasing any data in the file. In a program called from a parent process, Units 0, 5, and 6 are positioned as they come from the parent process.

## Unknown File Status

When the parameter STATUS=UNKNOWN is specified in an OPEN statement, the following occurs:

- If the file doesn't already exist, it is created and positioned at start-of-file.
- If the file already exists, it is opened and any data in the file is truncated.

## Run-Time Error Handling

When the FORTRAN run-time system detects an error, the following action takes place:

- a message describing the error is written to the standard error unit (Unit 0) See **Appendix A** for a list of the error messages and the appropriate action to take when one is received.
- If the `f77-dump-flag` environment variable is set to `yes`, the program is terminated with a signal
- a core file, which can be used with `dbx` (the debugger) to inspect the state of the program at termination, is produced. For more information on `dbx`, see the *Languages Programmer's Guide*.

To invoke `dbx` using the core file, enter the following:

```
% dbx binary-file core
```

where *binary\_file* is the name of the object file output (the default is `a.out`). For more information on `dbx`, see **Chapter 1**.



This chapter describes how the FORTRAN compiler implements size, alignment, and value ranges for the various data types. This information is summarized in Table 1.1.

Type	Synonym	Size	Alignment	Value Range
byte	integer*1	8 bits	byte	-128 .. 127
integer*1		8 bits	byte	-128 .. 127
integer*2		16 bits	halfword <sup>1</sup>	-32,768 to 32,767
integer	integer*4	32 bits	word <sup>2</sup>	$-2^{31} .. 2^{31} - 1$
logical*1		8 bits	byte	0..1
logical*2		16 bits	halfword <sup>1</sup>	0..1
logical	logical*4	32 bits	word <sup>2</sup>	0..1
real	real*4	32 bits	word <sup>2</sup>	See Note 1.
double precision	real*8	64 bits	doubleword <sup>3</sup>	See Note 1.
complex	complex*8	64 bits	word <sup>2</sup>	
double complex	complex*16	128 bits	doubleword <sup>3</sup>	
character		8 bits	byte	-128 .. 127

<sup>1</sup>Byte boundary divisible by two.  
<sup>2</sup>Byte boundary divisible by four.  
<sup>3</sup>Byte boundary divisible by eight.

Table 1.1. Size, Alignment, and Value Range of FORTRAN Data Types

See the notes starting on the following pages for details on some of the items in the table.

1. Approximate valid ranges for real and double are:

	Maximum Value
real	$3.40282356 \times 10^{38}$
double	$1.7976931348623158 \times 10^{308}$

	Minimum Values	
	Denormalized	Normalized
real	$1.40129846 \times 10^{-46}$	$1.17549429 \times 10^{-38}$
double	$4.9406564584124654 \times 10^{-324}$	$2.2250738585072012 \times 10^{-308}$

**NOTE:** When a REAL\*16 declaration is encountered, the compiler issues a warning message. REAL\*16 items are allocated 16 bytes of storage per element, but only the first eight bytes of each element are used; those eight bytes are interpreted according to the format for REAL\*8 floating numbers.

When a REAL\*16 constant is encountered in a source program, the compiler issues a warning message. The constant is treated as a double precision (REAL\*8) constant. REAL\*16 constants have the same form as a double precision constant, except the exponent indicator is Q instead of D.

- Table 1.1 states that **double precision** variables always align on a doubleword boundary. However, FORTRAN permits these variables to align on a word boundary if a **common** statement or equivalencing requires this.
- Forcing **integer**, **logical**, **real**, and **complex** variables to align on a halfword boundary is not allowed., except as permitted by the **-align8**, **-align16**, and **-align32** command line options. See **Chapter 1**.

With the exception of equivalencing a double precision data item to a 32-bit data item, no other equivalencing can be done that will misalign the items.

- Within a program, **integer\*1**, **integer\*2**, and **integer\*4** are interchangeable if **integer\*2** doesn't force the **integer\*4** to align on a halfword boundary and if **integer\*4** isn't assigned a value outside the allowed range.
- A complex data item is an ordered pair of real numbers; a double-complex data item is an ordered pair of double-precision numbers. In each case, the first number represents the real part and the second represents the imaginary part.
- Logical** data items denote only the logical values TRUE and FALSE (written as: *.true.* or *.false.*).
- You must explicitly declare an array in a **dimension** declaration or in a data type declaration. The compiler follows these rules for dimension support:
  - Allows up to seven dimensions.
  - Assigns a default of one to the lower bound, if a lower bound isn't explicitly declared in the **dimension** statement.
  - Creates an array the size of its element type times the number of elements.

- Stores arrays in column-major order.
8. The following rules apply to shared blocks of data set up by the common statements:
- The compiler assigns data items in the same sequence as they appear in the common statement(s) defining the block.
  - You can allocate both character and noncharacter data in the same common block.
  - When a common block appears in multiple program units, the compiler allocates the same size for that block in each unit, even though the size required may differ (due to varying element names, types, and ordering sequences) from unit to unit. The size allocated corresponds to the maximum size required by the block among all the program units.



This appendix describes the coding interfaces between FORTRAN programs and programs written in C or Pascal; it gives rules and examples for calling and passing arguments among these languages.

You may need to refer to other sources of information as you read this appendix:

- For information on storage mapping—how the variables of the various languages appear in storage—refer to **Chapter 2** (for FORTRAN) of this manual and to **Chapter 2** in the *Languages Programmer's Guide* (for other languages).
- For information on the standard linkage conventions the RIS-Compiler system uses in generating code, see **Chapter 7** of the *MIPS Assembly Language Programmer's Guide*.

For information on built-in functions that help you communicate with non-FORTRAN programs, see **Chapter 4** of this manual.

## **FORTRAN/C Interface**

### **Procedure and Function Declarations**

This section discusses items you should consider before writing a call between FORTRAN and C.

#### **Names**

In calling a FORTRAN subprogram from C, the C program must append an underscore (`_`) to the name of the FORTRAN subprogram. For example, if the name of the subprogram is *matrix*, then call it by the name *matrix\_*. When FORTRAN is calling a C function, the name of the C function must end with an underscore.

Note that only one main routine is allowed per program. The main routine can be written in either C or FORTRAN. Below is an example of a C and a FORTRAN main routine.

<b>C</b>	<b>FORTRAN</b>
<pre>main() {   printf("hi!\n"); }</pre>	<pre>write(6,10) 10 format('hi!') end</pre>



## Invocations

Invoke a FORTRAN subprogram as if it were an integer-valued function whose value specifies which alternate return to use. Alternate return arguments (statement labels) are not passed to the subprogram but cause an indexed branch in the calling subprogram. If the subprogram is *not* a function and has no entry points with alternate return arguments, the returned value is undefined. The FORTRAN statement

```
call nret (*1, *2, *3)
```

is treated exactly as if it were the computed goto

```
goto (1, 2, 3), nret()
```

A C function that calls a FORTRAN subprogram can usually ignore the return value of a FORTRAN subroutine; however, the C function should not ignore the return value of a FORTRAN function. The table below shows equivalent function and subprogram declarations in C and FORTRAN programs:

C Function Declaration	FORTRAN Declaration
double dfort_()	double precision function dfort()
double rfort_()	real function rfort()
int ifort_()	integer function ifort()
int ifort_()	logical function lfort()

Note the following:

- Avoid calling FORTRAN functions of type **float**, **complex**, and **character** from C.
- You cannot return complex types between C and FORTRAN.
- A character-valued FORTRAN subprogram is equivalent to a C language routine with two extra initial arguments: a data address and a length.

Thus:

```
character*15 function g(...)
```

is equivalent to:

```
char result[];
long int length;
g_(result, length, ...)
```

and could be invoked in C by:

```
char chars[15];
g_(chars, 15);
```

## Arguments

The following rules apply to arguments passed between FORTRAN and C:

1. All arguments must be passed by reference. That is, the argument must specify an *address* rather than a value. Thus, to pass constants or expressions, their values must be first stored into variables and then the address of the variable passed.
2. When passing the address of a variable, the data representations of the variable in the calling and called routines must correspond, as shown in Table C.1.

FORTRAN	C
integer*2 x	short int x;
integer x	long int x; or just int x;
logical x	long int x;
real x	float x;
double precision x	double x;
complex x	struct { float real, imag; } x;
double complex x	struct { double dreal, dimag; } x;
character*6 x	char x[6];

Table C.1. Equivalent FORTRAN and C Data Types

Note that FORTRAN requires that each integer, logical, and real variable occupy 32 bits of memory.

3. The FORTRAN compiler may add items not explicitly specified in the source code to the argument list. The compiler adds the following items under the conditions specified:
  - Destination address for character functions, when called.
  - Length of a character string, when an argument is the address of a character string.

When a C program calls a FORTRAN subprogram, the C program must explicitly specify these items in its argument list *in the following order*:

1. Destination address of character functions.
2. Normal arguments (addresses of arguments or functions).
3. Length of character strings. The length must be specified as an absolute value or integer variable. The next two examples illustrate these rules.

*Example 1:* The following example shows how a C routine must specify the length of a character string (which is only implied in a FORTRAN call).

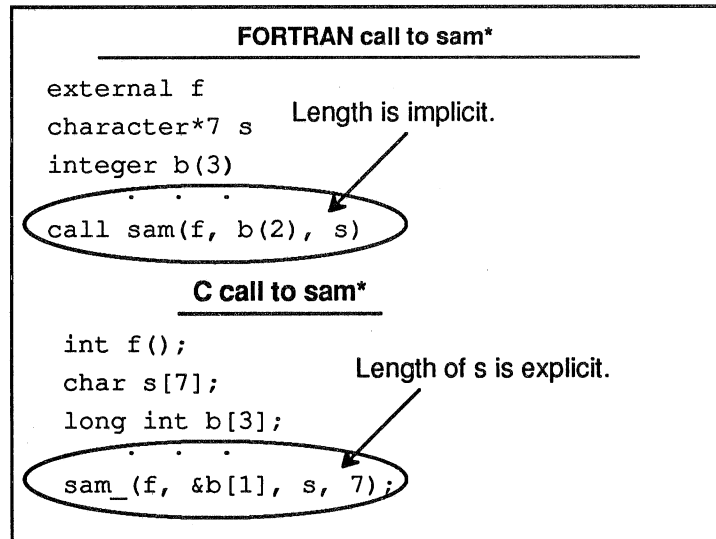

\*sam is a routine written in FORTRAN.

*Example 2:* The following example shows how a C routine can specify the destination address of a FORTRAN function (which is only implied in a FORTRAN program).

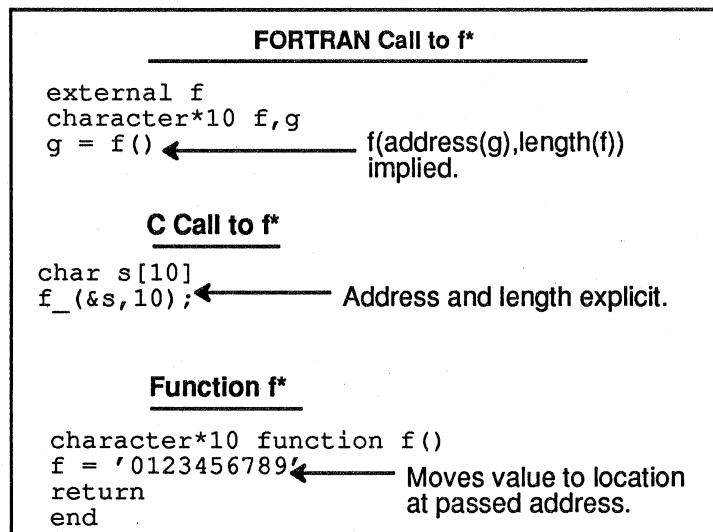

\*f is a function written in FORTRAN.

## Array Handling

FORTRAN stores arrays in column-major order with the leftmost subscript varying the fastest. C, however, stores arrays in the opposite arrangement, with the rightmost subscripts varying the fastest, which is called row-major order. Here's how the layout of FORTRAN arrays and C arrays looks:

FORTRAN
<pre>integer t(2,3)   t(1,1), t(2,1), t(1,2), t(2,2), t(1,3), t(2,3)</pre>
C
<pre>int t[2][3];   t[0][0], t[0][1], t[0][2], t[1][0], t[1][1], t[1][2]</pre>

Note that the default for the lower bound of an array in FORTRAN is 1, whereas it is 0 in C.

When a C routine uses an array passed by a FORTRAN subprogram, the dimensions of the array and the use of the subscripts must be interchanged, as shown in the following example.

FORTRAN caller:	C called routine:
<pre>integer a(2,3) call p(a, 1, 3) write(6,10) a(1,3) 10 format(1x,19) stop end</pre>	<pre>void P_( a, i, j ) int *i, *j, a[3][2];   a[*j-1][*i-1] = 99; }</pre>
<p><b>A</b> Dimensions and subscripts are reversed.</p> <p><b>B</b> 1 is subtracted from the indices. <i>j</i> and <i>i</i> are pointers to integers.</p>	

The FORTRAN caller prints out the value 99. Note the following:

- A** Because arrays are stored in column-major order in FORTRAN and row-major order in C, the dimension and subscript specifications are reversed.
- B** In FORTRAN, the lower-bound default is 1, whereas it is 0 in C; therefore, 1 must be subtracted from the indices in the C routine. Also, because FORTRAN passes parameters by reference, the *\*j* and *\*i* are pointers used in the C routine.

## Accessing Common Blocks of Data

The following rules apply to accessing common blocks of data:

- FORTRAN common blocks must be declared by **common** statements; C can use any global variable. Note that the common block name in C (*sam\_*) must end with an underscore.
- Data types in the FORTRAN and C programs must match unless you desire equivalencing. If so, you must adhere to the alignment restrictions for the data types described in **Chapter 2**.

- If the same common block is of unequal length, the largest of the sizes is used to allocate space.
- Unnamed common blocks are given the name `_BLNK_`.

The following gives examples of C and FORTRAN routines that access common blocks of data.

C	FORTRAN
<pre>struct S {int i; float j;}r_; main() {   sam_();   printf("%d %f\n", r_.i, r_.j); }</pre>	<pre>subroutine sam() common /r/i,r i = 786 r = 3.2 return</pre>

The C routine prints out 786 and 3.2.

## FORTRAN/Pascal Interfaces

This section discusses items you should consider before writing a call between FORTRAN and Pascal.

### Procedure and Function Declarations

#### Names

In calling a FORTRAN program from Pascal, you must place an underscore (`_`) as a suffix to routine names and data names.

To call FORTRAN from Pascal or vice versa, specify an underscore (`_`) as the suffix of the name of the FORTRAN or Pascal routine being called. For example, if the routine is called `matrix`, then call it by the name `matrix_`. When FORTRAN is calling Pascal, the name of the called Pascal routine must end with an underscore.

In Pascal, always declare the external FORTRAN subprogram or function with VAR parameters.

Note that only one main routine is allowed per program. The main routine can be written either in Pascal or FORTRAN. Below is an example of a Pascal and a FORTRAN main routine.

Pascal	FORTRAN
<pre>program p; begin   writeln("hi!"); end.</pre>	<pre>write(6,10) format('hi!') stop end</pre>

## Invocation

If you have alternate return labels, you can invoke a FORTRAN subprogram as if it were an integer-valued function whose value specifies which alternate return to use. Alternate return arguments (statement labels) are not passed to the function but cause an indexed branch in the calling subprogram. If the subprogram is *not* a function and has no entry points with alternate return arguments, the returned value is undefined. The FORTRAN statement

```
call nret (*1, *2, *3)
```

is treated exactly as if it were the computed goto

```
goto (1, 2, 3), nret()
```

A Pascal function that calls a FORTRAN subroutine can usually ignore the return value. The table below shows equivalent function declarations in Pascal and FORTRAN.

Pascal	FORTRAN
function dfort_(): double;	double precision function dfort()
function rfort_(): real;	real function dfort()
function ifort_(): integer;	integer function ifort()

FORTRAN's built-in data type **complex** doesn't exist in Pascal and therefore there isn't a compatible way of returning these values from Pascal.

A character-valued FORTRAN function is equivalent to a Pascal language routine with two extra initial arguments – a data address and a length.

The following FORTRAN declaration:

```
character*15 function g(...)
```

is equivalent to the Pascal code:

```
type string = array[1..15];
var
  length: integer;
  a      : array[1..15] of char;
procedure g_(var a: string; length: integer; ...); external;
```

and could be invoked by the Pascal line:

```
g_(a, 15);
```

## Arguments

The following rules apply to arguments specifications in both FORTRAN and Pascal programs:

1. All arguments must be passed by reference. That is, the argument must specify an *address* rather than a value. Thus, to pass constants or expressions, their values must be first stored into variables and then the address of the variable passed.

2. When passing the address of a variable, the data representations of the variable in the calling and called routines must correspond, as shown in Table C.2.

Pascal	FORTRAN
integer	integer*4, integer, logical
cardinal	
char	character
boolean	logical*1
enumeration	
real	real, real*4
double	double precision, real*8
procedure ..	subroutine
record r : real; i : real; end;	complex
record r : double; i : double; end;	double complex

Table C.2. Equivalent FORTRAN and Pascal Data Types

Note that FORTRAN requires that each integer, logical, and real variable occupy 32 bits of memory.

Functions of type integer, real, or double precision are interchangeable between C and Pascal, and require no special considerations.

3. The FORTRAN compiler may add items not explicitly specified in the source code to the argument list. The compiler adds the following items under the conditions specified:
- Destination address for character functions, when called.
  - Length of character strings, when an argument is the address of a character string.

When a Pascal program calls a FORTRAN subprogram, the Pascal program must explicitly specify these items in its argument list *in the following order*:

1. Destination address of character functions.
2. Normal arguments (addresses of arguments or functions).
3. Length of character strings. The length must be specified as an absolute value or integer variable. The next two examples illustrate these rules.

*Example:* The following example shows how a Pascal routine must specify the length of a character string (which is only implied in a FORTRAN call).

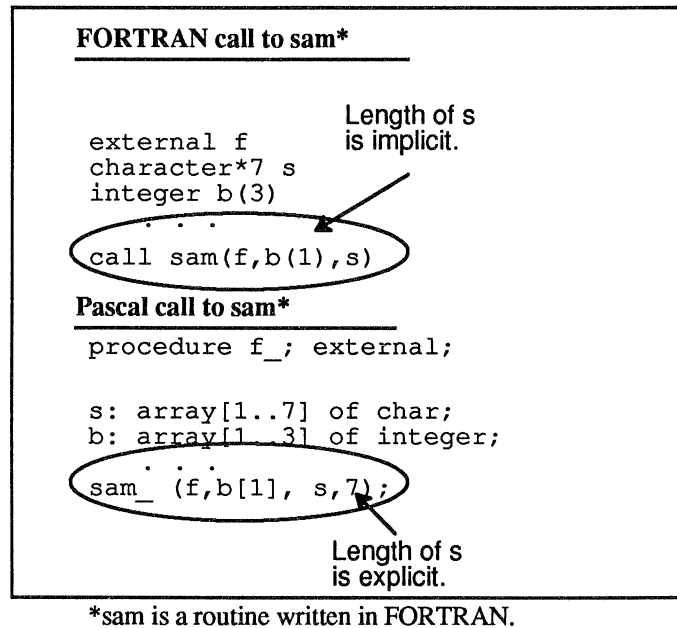

## Execution-Time Considerations

Pascal checks certain variables for errors at execution time, whereas FORTRAN doesn't. For example, in a Pascal program, when a reference to an array exceeds its bounds, the error is flagged (if runtime checks aren't suppressed). You cannot expect a FORTRAN program to detect similar errors when you pass data to it from a Pascal program.

## Array Handling

FORTRAN stores arrays in column-major order where the leftmost subscripts vary the fastest. Pascal, however, stores arrays in the opposite arrangement, with the rightmost subscript varying the fastest, which is called row-major order. Also, FORTRAN's default lower bound for arrays is 1. Pascal has no default; the lower bound must be explicitly specified. Here's how the different layouts look:

<b>Pascal</b>
var t: array[1..2,1..3] of integer; t[1,1], t[1,2], t[1,3], t[2,1], t[2,2], t[2,3]
<b>FORTRAN</b>
integer t(2,3) t(1,1), t(2,1), t(1,2), t(2,2), t(1,3), t(2,3)

When a Pascal routine uses an array passed by a FORTRAN program, the dimensions of the array and the use of the subscripts must be interchanged. The example below shows the Pascal code that interchanges the subscripts.



In the following example, the FORTRAN routine calls the Pascal procedure `p`, receives the value 99, and prints it out.

FORTRAN	Pascal
<pre>integer a(2,3) call p(a, 1, 3 ) write(6,10)a(1,3) 10 format(1x,I9) stop end</pre>	<pre>type array = array[1..3, 1..2]; procedure p_( var a: array; var i,j:integer); begin   a[j,i] := 99; end</pre>

In the next example, the Pascal routine passes the character string "0123456789" to the FORTRAN subroutine `s_`, which prints it out and returns.

<pre><b>Pascal</b> type string = array[1..10] of char; procedure s_( var a: string; i: integer);external; /* Note the underbar */ program s; var   r: string; begin   r:= "0123456789";   s_(r,10); end.</pre>
<pre><b>FORTRAN</b>       subroutine s(c)       character*10 c       write(6,10)c 10      format(6,10)c       return end</pre>

## Accessing Common Blocks of Data

The following rules apply to accessing common blocks of data:

- FORTRAN common blocks must be declared by **common** statements; Pascal can use any global variable. Note that the common block name in Pascal (`sam_`) must end with an underscore.
- Data types in the FORTRAN and Pascal programs must match unless you desire implicit equivalencing. If so, you must adhere to the alignment restrictions for the data types described in **Chapter 2**.
- If the same common block is of unequal length, the largest of the sizes is used to allocate space.
- Unnamed common blocks are given the name `__BLNK__`, (where `_` is the underscore character).

**Example**

The following gives examples of FORTRAN and Pascal routines that access common blocks of data.

Pascal	FORTRAN
<pre>var   a_: record     i : integer;     r : real;   end; procedure sam_;   external; program s; begin   a_.i := 4;   a_.r := 5.3;   sam_; end.</pre>	<pre>subroutine sam() common/a/i,r write(6,10)i,r format(1x,I5, F5.2) return end</pre> <p>10</p>

The FORTRAN routine prints out 4 and 5.30.



## System Functions and Subroutines

This chapter describes extensions to FORTRAN 77 that are related to the UMIPS operating and compiler systems.

### Library Functions

The following tables summarize the functions that are available in the FORTRAN run-time library. These functions provide an interface from FORTRAN programs to the system in the same manner as the C library does for C programs. The compiler automatically loads an interface routine when it processes the associated call.

Function	Purpose
abort	abnormal termination
access	determine accessibility of a file
alarm	execute a subroutine after a specified time
chdir	change default directory
chmod	change mode of a file
ctime	return system time
dtime	return elapsed execution time
etime	return elapsed execution time
exit	terminate process with status
fdate	return date and time in an ASCII string
fgetc	get a character from a logical unit
flush	flush output to a logical unit
fork	create a copy of this process
fputc	write a character to a FORTRAN logical unit
fseek	reposition a file on a logical unit
fstat	get file status
ftell	reposition a file on a logical unit
gerror	get system error messages
getarg	return command line arguments
getc	get a character from a logical unit
getcwd	get pathname of current working directory
getenv	get value of environment variables
getgid	get user or group ID of the caller
getlog	get user's login name

*Summary of System Interface Routine Library (Part 1 of 2).*

Function	Purpose
getpid	get process ID
getuid	get user or group ID of the caller
gmtime	return system time
iargc	return command line arguments
idate	return date or time in numerical form
ierrno	get system error messages
irand	return random values
isatty	find name of a terminal port
itime	return date or time in numerical form
kill	send a signal to a process
len	tell about character objects
link	make a link to an existing file
loc	return the address of an object
ltime	return system time
perror	get system error messages
putc	write a character to a FORTRAN logical unit
qsort	quick sort
rand*	return random values
signal	change the action for a signal
sleep	suspend execution for an interval
stat	get file status
time	return system time
ttynam	find name of a terminal port
unlink	remove a directory entry
wait	wait for a process to terminate

*Summary of System Interface Routine Library (Part 2 of 2).*

You can display reference information on the functions shown in the figure using the **man** command in the following format:

```
man 3f function
```

## Intrinsic Subroutine Extensions

This section describes the intrinsic subroutines that are extensions to FORTRAN 77. The following summarizes applicable rules for the subroutines.

1. The subroutine names are specially recognized by the compiler. A user-written subroutine with the same name as a system subroutines routine must be declared in an EXTERNAL statement in the calling subprogram.
2. Using a user-written subroutine with the same name as a system subroutine in one subprogram does not preclude using the actual system subroutine in a different subprogram.
3. To pass the name of a system subroutine as an argument to another subprogram, the name of the system subroutine must be declared in an INTRINSIC statement in the calling subprogram.
4. When a system subroutine name is passed as an argument to another subprogram, the call to the system subroutine via the formal parameter name in the receiving subprogram must use the primary calling sequence for the subprogram (when there is more than one possible calling sequence).

The following table gives an overview of the system subroutines and their functions; they are described in detail in the sections following the table.

Subroutine	Information Returned
DATE	Current date as nine-byte string in ASCII representation.
IDATE	Current month, day, and year, each represented by a separate integer.
ERRSNS	Description of the most recent error.
EXIT	Terminates program execution.
FREE	Deallocates an area of memory.
TIME	Current time in hours, minutes, and seconds as an eight-byte string in ASCII representation.
MVBITS	Moves a bit field to a different storage location.

The subroutines are described in detail starting on the next page.

### DATE

Returns the current date as set by the system; the format is as follows:

```
CALL DATE(buf)
```

where *buf* is a variable, array, array element, or character substring nine bytes long. After the call, *buf* contains an ASCII variable in the format *dd-mmm-yy*, where *dd* is the date in digits, *mmm* is the month in alphabetic characters, and *yy* is the year in digits.

**IDATE**

Returns the current date as three integer values representing the month, date, and year; the format is as follows:

```
CALL IDATE (m, d, y)
```

where *m*, *d*, and *y* are either INTEGER\*4 or INTEGER\*2 values representing the current month, day, and year. For example, the values of *m*, *d*, and *y* on August 10th, 1989, are as follows:

```
m = 8
d = 10,
y = 89
```

**ERRSNS**

Returns information about the most recent program error; the format is as follows:

```
CALL ERRSNS (arg1, arg2, arg3, arg4, arg5)
```

The arguments (*arg1*, *arg2*, etc.) can be either INTEGER\*4 or INTEGER\*2 variables; upon return from ERRSNS, they contain the information shown in the following table:

Argument	Contents
<i>arg1</i>	UNIX global variable <i>errno</i> , which is then reset to zero after the call.
<i>arg2</i>	Zero
<i>arg3</i>	Zero
<i>arg4</i>	Logical unit number of the file which was being processed when the error occurred.
<i>arg5</i>	Zero

Although only *arg1* and *arg4* return relevant information, *arg2*, *arg3*, and *arg5* are always required.

**EXIT**

Causes normal program termination, and optionally returns an exit-status code

```
CALL EXIT (status)
```

where *status* is an INTEGER\*4 or INTEGER\*2 argument containing a status code.

**FREE**

Deallocates an area of memory previously allocated by MALLOC; the format is as follows:

```
FREE (p)
```

where *p* is the pointer previously returned by MALLOC, but not already given to FREE. The memory is returned to the memory manager, making it unavailable to the programmer.

**TIME**

Returns the current time in hours, minutes, and seconds; the format is as follows:

```
CALL TIME(clock)
```

*clock* can be a variable, array, array element, or character substring; it must be eight bytes in length. After execution, *clock* contains the time in the format *hh:mm:ss*, where *hh*, *mm*, and *ss* are numerical values representing the hour, the minute, and the second.

**MVBITS**

Transfers a bit field from one storage location to another; the format is as follows:

```
CALL MVBITS(source, sbit, length, destination, dbit)
```

The arguments are defined in the following table:

Argument <sup>1</sup>	Type	Contents
<i>source</i>	integer variable or array element	Source location of bit field to be transferred.
<i>sbit</i>	integer expression	First bit position in the field to be transferred from <i>source</i> .
<i>length</i>	integer expression	Length of the field transferred from <i>source</i> .
<i>destination</i>	integer variable or array element	Destination location of the bit field.
<i>dbit</i>	integer expression	First bit in <i>destination</i> to which the field is transferred.

<sup>1</sup> The arguments can be declared as INTEGER\*2 or INTEGER\*4.

**Intrinsic Function Extensions**

The following table gives an overview of the intrinsic functions added as extensions of FORTRAN 77.

Function	Information Returned
SECNDS	Elapsed time as a floating point value in seconds.
RAN	The next number from a sequence of pseudo random numbers.
MALLOC	Allocates an area of memory.

These functions are described in detail in the following sections.



**SECNDS**

Returns the number of seconds since midnight, minus the value of the passed argument; the format is as follows:

$$s = \text{SECNDS} (n)$$

After execution,  $s$  contains the number of seconds past midnight less the value specified by  $n$ . Both  $s$  and  $n$  are single-precision, floating point values.

**RAN**

Generates a random number; the format is as follows:

$$v = \text{RAN} (s)$$

The argument  $s$  is an INTEGER\*4 variable or array element;  $s$  serves as a seed in determining the next random number and should initially be set to a large, odd integer value. This permits the computation of multiple random numbers series by supplying different variable names as the seed argument to RAN.

**MALLOC**

Allocates an area of memory and returns the address of the start of that area; the format is as follows:

$$p = \text{MALLOC} (n)$$

where  $n$  is an integer specifying the amount of memory to be allocated, in bytes. If successful, it returns a pointer to the first element of the region, otherwise it returns an integer 0. The region of memory is not initialized in any way.

# Appendix A

## Run-Time Error Messages

---

When the FORTRAN run-time system detects an error, the following action takes place:

- a message describing the error is written to the standard error unit (Unit 0)
- If the *f77-dump-flag* environment variable is set to *yes*, the program is terminated with a signal
- a core file, which can be used with *dbx* (the debugger) to inspect the state of the program at termination, is produced.

If the environment variable *f77-dump-flag* is set to any value other than *yes*, the program terminates with one of the error codes shown in the following table.

Diagnostic Message	Explanation
100 error in format	The format contained a syntactic error. The format is printed as part of the diagnostic message.
101 illegal unit number	No more units are available. All unit numbers have been used.
102 formatted io not allowed	Cannot do formatted I/O on a file opened as FORM='UNFORMATTED'. See the description of the FORM clause of the OPEN statement in Chapter 8 of the <i>FORTRAN Language Reference</i> manual.
103 unformatted io not allowed	Cannot do formatted I/O on a file <i>not</i> opened as FORM='UNFORMATTED'. See the description of the FORM clause of the OPEN statement in Chapter 8 of the <i>FORTRAN Language Reference</i> manual.

Diagnostic Message	Explanation
104 direct io not allowed	Cannot do direct access I/O on a file <i>not</i> opened as SEQUENTIAL='DIRECT'. See the description of the SEQUENTIAL clause of the OPEN statement in <b>Chapter 8</b> of the <i>FORTRAN Language Reference</i> manual.
105 sequential io not allowed	Cannot do sequential access I/O on a file opened as SEQUENTIAL='DIRECT'. See the description of the SEQUENTIAL clause of the OPEN statement in <b>Chapter 8</b> of the <i>FORTRAN Language Reference</i> manual.
106 can't backspace file	Cannot backspace on files not associated with a random access device, for example on a file associated with a tape device.
107	Not used
108 can't stat file	Access to a unit connected to a file was denied by the operating system, as indicated by the accompanying system error code. See the <b>intro(2)</b> manual page in the <i>System Programmer's Manual</i> for an explanation of the system error code.
109 unit not connected	The specified unit number is not connected to a file. This message can occur after a CLOSE is executed.
110 off end of record	An attempt was made to read or write past end-of-record.
111 truncation failed in endfile	An attempt to truncate a file using an ENDFILE statement failed.
112 incomprehensible list input	Input selected list-directed operations does not match the type of the variables in the input list. The expected type or invalid character encountered is specified in the diagnostic message.
113 out of free space	The operating system denied the request for space required by the Fortran run-time system.
114 unit not connected	An attempt was made to access a unit that was not connected; the open failed.
115 read unexpected character	Unexpected character encountered on a read operation. The character did not match the format specified for the READ.

Diagnostic Message	Explanation
116 blank logical input field	Invalid characters encountered in a read of logical value. Logical inputs must be specified as one of <i>t</i> , <i>f</i> , <i>true.</i> , <i>false.</i> (upper- or lowercase).
117-125	Not used.
126 'new' file exists	The file specified in an OPEN statement with STATUS=NEW already exists. The file cannot be overwritten when STATUS=NEW is specified.
127 can't find 'old' file	The file specified in an OPEN statement with STATUS=NEW does not exist. The file cannot be created when STATUS=OLD is specified.
128 unknown system error	A system error specified by the system error number in the diagnostic message occurred. See the <b>intro(2)</b> manual page in the <i>Programmer's Reference Manual</i> for an explanation of the error code.
129 requires seek ability	The unit is not connected to a random access device, as is required by the I/O statement causing the error condition.
130 illegal argument	Invalid 'form' specified.
131	Not used.



## Numbers

66 command line option, 1-6

### A

- align16 driver option, 1-7, 2-2
- align32 driver option, 1-7
- align32 driver option, 2-2
- align8 driver option, 1-7
- align8 driver option, 2-2
- ar (archiver), 1-15
- archiver, 1-15
- argument
  - exchanging with C programs, 3-3-3-4
  - exchanging with Pascal programs, 3-7-3-9
- array
  - handling with C programs, 3-4
  - handling with Pascal programs, 3-9-3-10
- automatic driver option, 1-8

### B

- bestGnum option, 1-14
- byte, alignment, size, and value ranges, 2-1-2-4
- byte ordering options, 1-14

### C

- C driver option, 1-8
- C language programs, interfacing with, 3-1
- C program interface
  - examples
    - argument passing, 3-4
    - comon block access, 3-6
    - passing arrays, 3-5
  - invoking a FORTRAN program, 3-2
- C programs, compiling with FORTRAN programs, 1-3
- cache conflicts, reducing, 1-14
- character, alignment, size, and value ranges, 2-1-2-4
- check\_bounds driver option, 1-8
- co120 driver option, 1-8
- col72 driver option, 1-8

- command line options, 1-6-1-9
- common blocks
  - accessing from C programs, 3-5-3-6
  - accessing from Pascal programs, 3-10-3-12
- complex, alignment, size, and value ranges, 2-1-2-4
- cord option, 1-14
- core dump, after error, 1-17
- cpp driver option, 1-9

### D

- DATE intrinsic subroutine, 4-3
- d\_lines driver option, 1-9
- dbx, 1-12-1-13
  - See also* debugging
- debugging, options, 1-12-1-13
- debugging (dbx), example, 1-12
- double precision, alignment, size, and value ranges, 2-1-2-4
- driver options, 1-6-1-9
- drivers, purpose, 1-1

### E

- EB option, 1-14
- EL option, 1-14
- ERRSNS intrinsic subroutine, 4-4
- EXIT intrinsic subroutine, 4-4
- error handling, run-time, 1-17
- examples
  - compiling object programs, 1-3
  - debugging (dbx), 1-12
  - linking object programs, 1-4
  - profiling, 1-13
- extend\_source driver option, 1-9

### F

- F driver option, 1-9
- F option, 1-9
- .f suffix, 1-1
- f77 driver command, syntax, 1-1
- feedback option, 1-14

file formats, 1-16  
file properties, listing with file utility, 1-15  
files  
  positions, 1-16, 1-17  
  unknown status on OPEN, 1-17  
functions, run-time library, 4-1-4-2

## G

G option, 1-14

## I

IDATE intrinsic subroutine, 4-4  
-i2 driver option, 1-10  
integer, alignment, size, and value ranges, 2-1-2-4  
intrinsic subroutines, 4-3-4-5  
invoking a program, 1-16

## J

jnopt option, 1-14

## L

library functions, 4-1-4-2  
library, archive, copying and replacing programs, 1-15  
link editing, using driver command, 1-2  
link libraries, required, 1-4-1-5  
linking objects, 1-4-1-5  
logical, alignment, size, and value ranges, 2-1-2-4

## M

MALLOC, intrinsic function, 4-6  
MVBITS intrinsic subroutine, 4-5  
-m driver option, 1-10

X-2

## N

-N driver option, 1-10  
new-line indicator, in output records, 1-16  
nm, printing symbol table information, 1-15  
-noextend\_source driver option, 1-10  
-noi4 driver option, 1-10

## O

.o suffix, 1-2  
odump, using to obtain object layout, 1-15  
optimizer, 1-13-1-14  
options, driver, FORTRAN-specific, 1-6-1-9  
options, driver, 1-6-1-9

## P

Pascal program interface  
  examples  
    argument passing, 3-8  
    array handling, 3-9-3-10  
    common block access, 3-11  
    invoking a FORTRAN program, 3-6  
    rules and conventions, 3-6-3-12  
Pascal programs, compiling with FORTRAN programs, 1-3  
PL/1 programs, compiling with FORTRAN programs, 1-3  
performance, improving, 1-14  
pixie program, 1-13, 1-14  
prof program, 1-13, 1-14  
profiling, 1-13

## R

RAN, intrinsic function, 4-6  
range checking, 1-8  
real, alignment, size, and value ranges, 2-1-2-4  
record formats, 1-16  
record separator, 1-16  
run-time  
  error handling, 1-17

library functions, 4-1—4-2

## **S**

size utility, 1-15

source file, naming convention, 1-2

subroutines, intrinsic, 4-3—4-5

subscript range checking, 1-8

symbol table, printing, 1-15

## **T**

TIME intrinsic subroutine, 4-5

## **U**

underscore, use when calling C program, 3-1

unformatted record formats, 1-16

## **V**

VMS-FORTRAN, default mode, 1-10





## About Part II of This Book

Part II of this book describes MIPS-FORTRAN, which contains full American National Standard (ANSI) Programming Language FORTRAN (X3.9-1978) plus MIPS extensions that provide full VMS FORTRAN compatibility to the extent possible without the VMS operating system or VAX data representation. MIPS-FORTRAN also contains extensions that provide partial compatibility with programs written in SVS FORTRAN and FORTRAN 66.

MIPS-FORTRAN is a superset of VMS FORTRAN; the MIPS RISCompiler™ system can convert source programs written in VMS FORTRAN into machine programs executable under RISC/os™ (UMIPS).

Standard FORTRAN 77 rules and syntax appear as normal text throughout the manual, whereas text that describes extensions is underlined, as is this paragraph. Also, extensions are shown within figures in shaded areas, for example:

Type Keywords	
INTEGER	COMPLEX
<u>INTEGER*1</u>	<etc.>
<u>BYTE</u>	

shows that INTEGER\*1 and BYTE are extensions while INTEGER and COMPLEX are standard Fortran 77 keywords.

### Intended Audience

This manual is intended as a reference manual rather than a tutorial, and assumes familiarity with some algebraic language or prior exposure to FORTRAN.

MIPS-FORTRAN is referred to as FORTRAN in this manual, except in such instances where distinctions between MIPS-FORTRAN and ANSI FORTRAN (FORTRAN 77 or FORTRAN 66) are being specifically discussed.

### Corequisite Publications

This manual describes the FORTRAN language specifications. Refer to the *MIPS-FORTRAN Programmer's Guide* (Part I of this book) for information on the following topics:

- How to compile and link edit a FORTRAN program.
- Alignments, sizes, and variable ranges for the various data types.
- The coding interface between FORTRAN programs and programs written in C and Pascal.

- 
- File formats, run-time error handling, and other information related to the operating system (RISC/os).
  - Operating systems functions and subroutines that are callable by FORTRAN programs.

Refer to the *Languages Programmer's Guide (3200DOC)* for information on the following topics:

- An overview of the compiler system.
- Information on improving the program performance, showing how to use the profiling and optimization facilities of the MIPS RISCompiler system.
- A detailed description of the debugger (DBX).
- The dump utilities, archiver, and other tools for maintaining FORTRAN programs.

For information on the interface to programs written in assembly language, refer to the *Assembly Language Programmer's Guide*.

## Organization of Information

The following topics are covered in this manual:

- FORTRAN language elements
- Data types, constants, variables and arrays
- Expressions
- FORTRAN statements, grouped according to the general class of functions they perform:
  - Specification statements
  - Assignment statements
  - Control statements
  - Input/output statements
  - Format specifications

**Appendix A** contains tables showing the intrinsic functions supported.

## Syntax Conventions

The following conventions and symbols are used in the text to describe the form of FORTRAN statements:

UPPER CASE	Upper case letters and words are to be written as shown, except where noted otherwise.
lower case	Lower case abbreviations and words represent characters or numerical values that you define. You replace the abbreviation with the defined value.
[ ]	Brackets are used to indicate optional items.
{ }	Braces surrounding two or more items indicate that at least one of the items must be specified.
	The OR symbol separates two or more optional items.
...	An ellipsis indicates that the preceding optional items may appear more than once in succession.
( )	A pair of parentheses is used to enclose entities and must be written as shown.
(blank)	Blanks have no significance unless otherwise noted.

Below are two examples illustrating the syntax conventions.

```
DIMENSION a(d) [, a(d)] ...
```

indicates that the FORTRAN keyword DIMENSION must be written as shown, that the entity  $a(d)$  is required, and that one or more of  $a(d)$  may be optionally specified. Note that the pair of parentheses ( ) enclosing  $d$  are required.

```
{STATIC | AUTOMATIC} v [, v] ...
```

indicates that either the STATIC or AUTOMATIC keyword must be written as shown, that the entity  $v$  is required, and that one or more of  $v$  items may be optionally specified.



## ***About Part II of This Book***

Intended Audience .....	iii
Corequisite Publications .....	iii
Organization of Information .....	iv
Syntax Conventions .....	v

## ***Chapter 1: FORTRAN Elements and Concepts***

Overview .....	1-1
FORTRAN Character Set .....	1-1
Escape Sequences .....	1-2
Collating Sequence .....	1-2
Symbolic Names .....	1-3
Scope of Symbolic Names .....	1-4
Source Program Lines .....	1-4
Comments .....	1-4
Debugging Lines .....	1-5
Initial Lines .....	1-5
Fixed Format .....	1-5
Continuation Lines .....	1-6
Blank Lines .....	1-7
Program Organization .....	1-7
FORTRAN Statements .....	1-7
Program Units .....	1-7
Main Program .....	1-7
Subprograms .....	1-8
Intrinsic Functions .....	1-8
Executable Programs .....	1-8
Executable and Nonexecutable Statements .....	1-9
Executable Statements .....	1-9
Nonexecutable Statements .....	1-9
Order of Statements .....	1-10
Execution Sequence .....	1-11

## Chapter 2: Data Types, Variables, and Arrays

Overview .....	2-1
Data Types of Symbolic Names .....	2-1
Implicit Typing of Data .....	2-2
Constants .....	2-2
Integer Constants .....	2-3
Hexadecimal Integer Constants .....	2-3
Octal Integer Constants .....	2-4
Real Constants .....	2-4
Double Precision Constants .....	2-5
Complex Constants .....	2-6
Logical Constants .....	2-7
Character Constants .....	2-7
Hollerith Constants .....	2-8
Rules .....	2-9
Bit Constants .....	2-9
Variables .....	2-11
Character Substrings .....	2-11
Substring Names .....	2-11
Substring Values e1, e2 .....	2-12
Records .....	2-13
Overview of Records and Structures .....	2-13
Record and Field References .....	2-14
Aggregate Assignment Statement .....	2-14
Arrays .....	2-14
Array Names and Types .....	2-15
Array Declarators .....	2-15
Value of Dimension Bounds .....	2-16
Array Size .....	2-17
Storage and Element Ordering .....	2-17
Subscripts .....	2-18

### **Chapter 3: Expressions**

Overview .....	3-1
Arithmetic Expressions .....	3-1
Arithmetic Operators .....	3-2
Interpretation of Arithmetic Expressions .....	3-2
Arithmetic Operands .....	3-3
Arithmetic Constant Expressions .....	3-4
Integer Constant Expressions .....	3-5
Rules for Evaluating Arithmetic Expressions .....	3-5
Single-Mode Expressions .....	3-5
Mixed-Mode Expressions .....	3-5
Exponentiation .....	3-6
Integer Division .....	3-6
Character Expressions .....	3-6
Concatenate Operator .....	3-7
Character Operands .....	3-7
Character Constant Expressions .....	3-8
Relational Expressions .....	3-8
Relational Operators .....	3-8
Relational Operands .....	3-8
Evaluating Relational Expressions .....	3-8
Arithmetic Relational Expressions .....	3-9
Character Relational Expressions .....	3-9
Logical Expressions .....	3-10
Logical Operators .....	3-10
Logical Operands .....	3-11
Interpretation of Logical Expressions .....	3-12
General Rules for Evaluating Expressions .....	3-13
Precedence of Operators .....	3-13
Integrity of Parentheses and Interpretation Rules .....	3-14



## Chapter 4: Specification Statements

Overview .....	4-1
AUTOMATIC STATIC .....	4-3
Use .....	4-3
Syntax .....	4-3
Method of Operation .....	4-3
Rules for Use .....	4-4
Example .....	4-4
BLOCK DATA .....	4-5
Use .....	4-5
Syntax .....	4-5
Method of Operation .....	4-5
Rules of Use .....	4-5
COMMON .....	4-6
Use .....	4-6
Syntax .....	4-6
Method of Operation .....	4-6
Rules of Use .....	4-7
Restrictions .....	4-7
Examples .....	4-8
DATA .....	4-10
Use .....	4-10
Syntax .....	4-10
Method of Operation .....	4-10
Rules .....	4-11
Restrictions .....	4-12
Data Type Statements (numeric) .....	4-13
Use .....	4-13
Syntax .....	4-13
Method of Operation .....	4-14
Rules for Use .....	4-14
Examples .....	4-15
Data Type Statements (character) .....	4-16
Use .....	4-16
Syntax .....	4-16
Rules for Use .....	4-16
Example .....	4-17
DIMENSION .....	4-18
Use .....	4-18
Syntax .....	4-18
Method of Operation .....	4-18
Rules for Use .....	4-18
Examples .....	4-18

EQUIVALENCE .....	4-19
Use .....	4-19
Syntax .....	4-19
Method of Operation .....	4-19
Rules of Use .....	4-19
Restrictions .....	4-20
Example 1 .....	4-20
Example 2 .....	4-21
EXTERNAL .....	4-22
Purpose .....	4-22
Use .....	4-22
Syntax .....	4-22
Rules for Use .....	4-22
Restrictions .....	4-23
Example .....	4-23
IMPLICIT .....	4-24
Use .....	4-24
Syntax 1 .....	4-24
Method of Operation — Syntax 1 .....	4-24
Syntax 2 .....	4-25
Method of Operation — Syntax 2 .....	4-26
Syntax 3 .....	4-26
Method of Operation — Syntax 3 .....	4-26
Rules for Use — All Syntaxes .....	4-27
Examples .....	4-27
INTRINSIC .....	4-28
Purpose .....	4-28
Use .....	4-28
Syntax .....	4-28
Rules for Use .....	4-28
Restrictions .....	4-28
Examples .....	4-28
NAMelist .....	4-29
Use .....	4-29
Syntax .....	4-29
Rules of Use .....	4-29
Examples .....	4-29
PARAMETER .....	4-30
Use .....	4-30
Syntax .....	4-30
Method of Operation .....	4-30
Rules for Use .....	4-30
Restrictions .....	4-32
Examples .....	4-32

POINTER .....	4-33
Use .....	4-33
Syntax .....	4-33
Rules for Use .....	4-33
Restrictions .....	4-33
Example .....	4-34
PROGRAM .....	4-35
Use .....	4-35
Syntax .....	4-35
Rules of Use .....	4-35
RECORD .....	4-36
Use .....	4-36
Syntax .....	4-36
Method of Operation .....	4-36
Examples .....	4-36
SAVE .....	4-37
Use .....	4-37
Syntax .....	4-37
Method of Operation .....	4-37
Rules of Use .....	4-38
Restrictions .....	4-38
Examples .....	4-38
STRUCTURE .....	4-39
Use .....	4-39
Syntax (General) .....	4-39
UNION Declaration Syntax .....	4-40
Method of Operation .....	4-40
Examples (General) .....	4-41
Examples (UNION) .....	4-42
VOLATILE .....	4-43
Use .....	4-43
Syntax .....	4-43

### ***Chapter 5: Assignment and Data Statements***

Overview .....	5-1
Arithmetic Assignment Statements .....	5-1
Logical Assignment Statements .....	5-5
Character Assignment .....	5-5
Aggregate Assignment .....	5-6
Statement Label Assignment .....	5-6
Data Initialization .....	5-7
Implied-DO .....	5-8
Use .....	5-8
Syntax .....	5-8
Method of Operation .....	5-8
Rules .....	5-8

## Chapter 6: Control Statements

CALL .....	6-3
Use .....	6-3
Syntax .....	6-3
Method of Operation .....	6-3
Rules of Use .....	6-3
Example .....	6-4
CONTINUE .....	6-5
Use .....	6-5
Syntax .....	6-5
Method of Operation .....	6-5
DO .....	6-6
Use .....	6-6
Syntax .....	6-6
Method of Operation .....	6-6
Rules of Use .....	6-8
Restrictions .....	6-8
Example .....	6-9
DO WHILE .....	6-10
Use .....	6-10
Syntax .....	6-10
Method of Operation .....	6-10
ELSE .....	6-11
Use .....	6-11
Syntax .....	6-11
Method of Operation .....	6-11
Rules of Use .....	6-11
Restrictions .....	6-12
Example .....	6-12
ELSE IF .....	6-13
Use .....	6-13
Syntax .....	6-13
Method of Operation .....	6-13
Rules of Use .....	6-14
Restrictions .....	6-14
Example .....	6-14
END .....	6-15
Use .....	6-15
Syntax .....	6-15
Method of Operation .....	6-15
Rules of Use .....	6-15
END DO .....	6-16
Use .....	6-16
Syntax .....	6-16

END IF .....	6-17
Use .....	6-17
Syntax .....	6-17
Rules of Use .....	6-17
Example .....	6-17
GO TO (Unconditional) .....	6-18
Use .....	6-18
Syntax .....	6-18
Example .....	6-18
GO TO (Computed) .....	6-19
Use .....	6-19
Syntax .....	6-19
Method of Operation .....	6-19
Rules of Use .....	6-19
Example .....	6-19
GO TO (Symbolic Name) .....	6-20
Use .....	6-20
Syntax .....	6-20
Method of Operation .....	6-20
Rules of Use .....	6-20
Example .....	6-20
IF (Arithmetic) .....	6-21
Use .....	6-21
Syntax .....	6-21
Method of Operation .....	6-21
Rules of Use .....	6-21
Example .....	6-21
IF (Branch Logical) .....	6-22
Use .....	6-22
Syntax .....	6-22
Method of Operation .....	6-22
Example .....	6-22
IF (Test Conditional) .....	6-23
Use .....	6-23
Syntax .....	6-23
Method of Operation .....	6-23
Restrictions .....	6-24
Example .....	6-24
PAUSE .....	6-25
Use .....	6-25
Syntax .....	6-25
Method of Operation .....	6-25
RETURN .....	6-26
Use .....	6-26
Syntax .....	6-26
Method of Operation .....	6-26

STOP .....	6-27
Use .....	6-27
Syntax .....	6-27
Method of Operation .....	6-27

### ***Chapter 7: Input/Output Processing***

Records .....	7-1
Formatted Records .....	7-1
Unformatted Records .....	7-1
Endfile Records .....	7-2
I/O Statements .....	7-2
Unformatted Statements .....	7-2
Formatted Statements .....	7-2
List-Directed Statements .....	7-3
Files .....	7-3
External Files .....	7-4
Internal Files .....	7-4
Methods of File Access .....	7-5
Sequential Access .....	7-5
Direct Access .....	7-6
Keyed Access .....	7-6
Units .....	7-7
Connection of a Unit .....	7-7
Disconnection of a Unit .....	7-7

### ***Chapter 8: Input/Output Statements***

Statement Summary .....	8-1
ACCEPT .....	8-3
Purpose .....	8-3
Syntax .....	8-3
Rules of Use .....	8-3
Example .....	8-3
BACKSPACE .....	8-4
Purpose .....	8-4
Syntax .....	8-4
Method of Operation .....	8-4
Examples .....	8-4
CLOSE .....	8-5
Purpose .....	8-5
Syntax .....	8-5
Method of Operation .....	8-6
DECODE .....	8-7
Purpose .....	8-7
Syntax .....	8-7
Parameter Explanations .....	8-7
Method of Operation .....	8-7

DEFINE FILE .....	8-8
Purpose .....	8-8
Syntax .....	8-8
Parameter Explanations .....	8-8
Method of Operation .....	8-8
DELETE .....	8-9
Purpose .....	8-9
Syntax .....	8-9
Parameter Explanations .....	8-9
Method of Operation .....	8-9
Examples .....	8-9
ENCODE .....	8-10
Purpose .....	8-10
Syntax .....	8-10
Parameter Explanations .....	8-10
Method of Operation .....	8-10
ENDFILE .....	8-11
Purpose .....	8-11
Syntax .....	8-11
Method of Operation .....	8-11
Examples .....	8-11
FIND .....	8-12
Purpose .....	8-12
Syntax .....	8-12
INQUIRE .....	8-13
Purpose .....	8-13
Syntax .....	8-13
Method of Operation .....	8-17
Examples .....	8-17
OPEN .....	8-18
Purpose .....	8-18
Syntax .....	8-18
Rules of Use .....	8-23
Examples .....	8-23
PRINT or TYPE .....	8-24
Purpose .....	8-24
Syntax .....	8-24
Rules of Use .....	8-24
Examples .....	8-24
READ (Direct Access) .....	8-25
Purpose .....	8-25
Syntax .....	8-25
Parameter Explanations .....	8-25
READ (Indexed) .....	8-26
Purpose .....	8-26
Syntax .....	8-26
Parameter Explanations .....	8-26
READ (Internal) .....	8-27

Purpose .....	8-27
Syntax .....	8-27
Parameter Explanations .....	8-27
READ (Sequential) .....	8-28
Purpose .....	8-28
Syntax .....	8-28
Namelist-Directed .....	8-28
Parameter Explanations .....	8-28
Method of Operation .....	8-29
Rules .....	8-29
Examples .....	8-32
REWIND .....	8-33
Use .....	8-33
Syntax .....	8-33
Method of Operation .....	8-33
Examples .....	8-33
REWRITE .....	8-34
Syntax .....	8-34
Parameter Explanations .....	8-34
Rules of Use .....	8-34
Example .....	8-34
UNLOCK .....	8-35
Purpose .....	8-35
Syntax .....	8-35
Parameter Explanations .....	8-35
Method of Operation .....	8-35
Examples .....	8-35
WRITE (Direct Access) .....	8-36
Purpose .....	8-36
Syntax .....	8-36
Parameter Explanations .....	8-36
Rules of Use .....	8-36
WRITE (Indexed) .....	8-37
Purpose .....	8-37
Syntax .....	8-37
Parameter Explanations .....	8-37
Rules of Use .....	8-37
WRITE (Internal) .....	8-38
Purpose .....	8-38
Syntax .....	8-38
Parameter Explanations .....	8-38
Rules of Use .....	8-38



WRITE (Sequential) .....	8-39
Purpose .....	8-39
Syntax .....	8-39
Parameter Explanations .....	8-39
Method of Operation .....	8-40
Rules .....	8-40
Examples .....	8-42
Control Information List — cilist .....	8-43
Unit Specifier — unum .....	8-44
Format Specifier — FMT .....	8-44
Namelist Specifier — NML .....	8-45
Record Specifier — REC .....	8-45
Key-Field-Value Specifier — KEY .....	8-45
Key-of-Reference Specifier — KEYID .....	8-46
Input/Output Status Specifier — ios .....	8-46
Error Specifier — ERR .....	8-46
End-of-File Specifier — END .....	8-47
Input/Output List — iolist .....	8-47
Input List .....	8-47
Output List .....	8-48
Implied-DO Lists .....	8-48
Example .....	8-48
Data Transfer Rules .....	8-49
Unformatted Input/Output .....	8-49
Formatted Input/Output .....	8-49

### **Chapter 9: Format Specification**

Overview .....	9-1
Format Stored as a Character Entity .....	9-1
FORMAT Statement .....	9-2
Format Specification .....	9-2
Repeatable Descriptors .....	9-3
Format Specifier Usage .....	9-3
Variable Format Expressions .....	9-5
General Rules for using FORMAT .....	9-7
Input Rules Summary .....	9-8
Output Rules Summary .....	9-8
Field and Edit Descriptors .....	9-9
Field Descriptor Reference .....	9-9
Numeric Field Descriptors .....	9-9
Default Field Descriptor Parameters .....	9-10
I Field Descriptor .....	9-10
O Field Descriptor .....	9-12
Z Field Descriptor .....	9-13
F Field Descriptor .....	9-14
E Field Descriptor .....	9-16
D Field Descriptor .....	9-18
G Field Descriptor .....	9-19

P Edit Descriptor .....	9-21
Scale Factor .....	9-22
L Edit Descriptor .....	9-23
A Edit Descriptor .....	9-24
Repeat Counts .....	9-25
H Field Descriptor .....	9-26
Character Edit Descriptor .....	9-26
Q Edit Descriptor .....	9-27
Edit Descriptor Reference .....	9-28
X Edit Descriptor .....	9-28
T Edit Descriptor .....	9-28
TL Edit Descriptor .....	9-28
TR Edit Descriptor .....	9-28
BN Edit Descriptor .....	9-29
BZ Edit Descriptor .....	9-29
SP Edit Descriptor .....	9-29
SS Edit Descriptor .....	9-29
S Edit Descriptor .....	9-29
Colon Descriptor .....	9-29
\$ Edit Descriptor .....	9-30
Complex Data Editing .....	9-30
Carriage Control .....	9-31
Slash Editing .....	9-31
Interaction Between I/O List and Format .....	9-32
List-Directed Formatting .....	9-33
List-Directed Input .....	9-33
List-Directed Output .....	9-35

## ***Chapter 10: Functions and Subprograms***

Overview .....	10-1
Statement Functions .....	10-2
Defining a Statement Function .....	10-2
Referencing a Statement Function .....	10-3
Operational Conventions and Restrictions .....	10-3
Parameter Passing .....	10-4
Dummy Arguments .....	10-4
Built-In Functions .....	10-5
Function and Subroutine Subprograms .....	10-6
Referencing Functions and Subroutines .....	10-6
Executing Functions and Subroutines .....	10-7
FUNCTION .....	10-9
Use .....	10-9
Syntax .....	10-9
Rules of Use .....	10-9
Restrictions .....	10-10

SUBROUTINE .....	10-11
Use .....	10-11
Syntax .....	10-11
Rules of Use .....	10-11
Restrictions .....	10-11
ENTRY .....	10-11
Use .....	10-12
Syntax .....	10-12
Method of Operation .....	10-12
Rules of Use .....	10-13
Restrictions .....	10-14

### ***Chapter 11: Compiler Options***

OPTIONS Statement .....	11-1
In-Line Options .....	11-2
\$COL72 Option .....	11-2
\$COL120 Option .....	11-2
\$F66DO Option .....	11-2
\$INCLUDE Option .....	11-3
\$INT2 Option .....	11-3
\$LOG2 Option .....	11-3

### ***Appendix A: Intrinsic Functions***

Generic and Specific Names .....	A-1
Referencing an Intrinsic Function .....	A-1
Operational Conventions and Restrictions .....	A-2
List of Functions .....	A-2

# FORTRAN Elements and Concepts

---

## Overview

This chapter provides definitions for the various elements that comprise a FORTRAN program. The FORTRAN language is written using a specific set of characters that form the words, numbers, names, and expressions that make up FORTRAN statements. These statements form a FORTRAN program. The FORTRAN character set, rules for writing FORTRAN statements, the main structural elements of a program, and the proper order of statements in a program are discussed in this chapter.

## FORTRAN Character Set

The FORTRAN character set consists of 26 upper-case and 26 lower-case letters (*alphabetic* characters), characters 0 through 9 (*digits*), and *special* characters. This manual refers to letters (uppercase and lowercase) together with the underscore ( `_` ) as *extended alphabetic* characters. The *extended alphabetic* characters together with the digits are also referred to as *alphanumeric* characters.

The complete character set is as follows:

**Letters:**    A B C D E F G H I J K L M N O P Q R S T U V W X Y Z  
                  a b c d e f g h i j k l m n o p q r s t u v w x y z

**Digits:**     0 1 2 3 4 5 6 7 8 9

**Special Characters:**

	Blank
=	Equals
+	Plus
-	Minus
*	Asterisk
/	Slash
(	Left Parenthesis
)	Right Parenthesis
,	Comma
.	Decimal Point
\$	Currency Symbol
'	Apostrophe
:	Colon
!	Exclamation Point
_	Underscore
"	Quotation Mark

Lower-case alphabetic characters, and the exclamation mark (!), underscore (\_), and the double quote (") are extensions to FORTRAN 77.

Digits are interpreted in base 10 when a numeric value is represented.

A special character may serve as an operator, a part of a character constant, a part of a numeric constant, or some other function.

Blank characters may be used freely to improve the appearance and readability of FORTRAN statements. They have no significance in FORTRAN statements, except in the following cases:

- When used in character constants
- When used in H- and character-editing in format specifications
- When used in Hollerith constants
- To signify an initial line when used in column 6 of source line
- When counting the total number of characters allowed in any one statement

These special considerations are discussed in more detail in the appropriate sections.

## Escape Sequences

The compiler accepts the following escape sequences for compatibility with C:

Seq.	Meaning
\n	New line
\t	Tab
\b	Backspace
\f	Form feed
\0	Null
\'	Apostrophe (doesn't terminate a string)
\"	Quotation mark (doesn't terminate a string)
\\	\
\x	x represents any other character

The compiler aligns character string constants and unequivalenced scalar local character variables on an INTEGER word boundary. It places a null character after each character string constant appearing outside a DATA statement for compatibility with routines written in C.

## Collating Sequence

The collating sequence for letters and digits defines the relationship between them and is used to compare character strings.

The collating sequence is determined as follows:

- A is less than Z, and a is less than z. The order of listing the alphabetic characters above specifies the collating sequence for *alphabetic* characters. The relationship between the same letter in lowercase and uppercase is unspecified.
- 0 is less than 9. The order in which digits are listed above defines the collating sequence for digits.
- Alphabetic characters and digits are not intermixed in the collating sequence.
- The blank character is less than the letter A (upper and lowercase), and less than the digit 0.
- The special characters given as part of the character set are *not* listed in any given order. There is no specification as to where special characters occur in the collating sequence.

## Symbolic Names

A symbolic name is a sequence of characters used to identify the following user-defined local and global entities:

<b>Local</b>	variable constant array statement function intrinsic function dummy procedure
<b>Global</b>	common block external function subroutine main program block data subprogram

A symbolic name can contain any alphanumeric characters; digits and \_ (underscore) are allowed in addition to upper- and lower-case alphabetic characters. However, the first character *must* be a letter.

1. FORTRAN symbolic names may contain any number of characters, but only the first 32 of these are significant in distinguishing one symbolic name from another. Symbolic names that are used externally (program names, subroutine names, function names, common block names) are limited to 32 significant characters.
2. The inclusion of the special period (.), underscore (\_), and dollar (\$) characters in symbolic names is an enhancement to FORTRAN 77. In FORTRAN 77, no special characters are allowed.

Examples of valid symbolic names are:

```
CASH  C3P0 R2D2  LONG_NAME  _THIS_
```

Examples of invalid symbolic names in are:

```
X*4      (Contains a special character)  
3CASH    (First character is a digit)
```

## Scope of Symbolic Names

The rules for determining the scope of symbolic names are as follows:

1. A symbolic name that identifies a global entity, such as a common block, external function, subroutine, main program, or block data subprogram has the scope of an executable program. It must not be used to identify another global entity in the same executable program.
2. A symbolic name that identifies a local entity, such as an array, variable, constant, statement function, intrinsic function, or dummy procedure, has the scope of a single program unit. It must not be used to identify any other local entity in the same program unit.
3. A symbolic name assigned to a global entity in a program unit must not be used for a local entity in the same unit. However, it may be used for a common block name, or an external function name, that appears in a FUNCTION or ENTRY statement.

## Source Program Lines

A source program line can be thought of as a sequence of character positions, called *columns*, numbered consecutively starting from Column 1 on the left. Lines can be classified as comment lines, initial lines, continuation lines, and debugging lines (an extension to FORTRAN 77).

## Comments

A comment line is used solely for documentation purposes and does not affect the execution of a program. A comment line may appear anywhere and has one of the following characteristics:

- An upper-case C (C) or an asterisk (\*) in Column 1, and any sequence of characters from Column 2 through to the end of the line
- A blank line

Text preceded by an exclamation mark ! at any position of the line is also treated as a comment.

## Debugging Lines

A upper-case **D** in Column 1 can be specified for debugging purposes; it permits the conditional compilation of source lines in conjunction with the `d_lines` option described in **Chapter 1** of the *FORTRAN Programmer's Guide*. When the option is specified at compilation, all lines with a **D** in Column 1 are treated as lines of source code and compiled; when the option is omitted, all lines with a **D** in Column 1 are treated as comments.

## Initial Lines

Initial lines contain the FORTRAN language statements that make up the source program; these statements are described in detail under Program Organization later in this chapter. Each FORTRAN line is divided into the following fields:

- Statement label field
- Continuation indicator field
- Statement field
- Comment field

The fields in a FORTRAN line can be entered either on a character-per-column basis, or by using the TAB character to delineate the fields, as described in the following sections.

## Fixed Format

Consider a FORTRAN line to be divided into columns, with 1 character per column as indicated below:

Field	Column
Statement Label	1 through 5
Continuation Indicator	6
Statement	7 to the end of the line or to the start of the comment field
Comment (optional)	73 <u>or</u> ! through end of line

The `--col72`, `--col120`, `--extend_source`, and `--noextend_source` command line options are provided to change this format. See **Chapter 1** of the *FORTRAN Programmer's Guide* for details. Several of these options can be specified in-line as described in **Chapter 11**.



**Tab Character Formatting.** Rather than aligning characters in specific columns, the TAB character can be used as an alternative field delimiter, as follows:

1. Type the Statement Label, and follow it with a TAB. If there is no Statement Label, *start* the line with a TAB.
2. After the TAB, type either a statement initial line or a continuation line. A continuation line must contain a digit (1 through 9) immediately following the TAB. If any character *other* than a non-zero digit follows the TAB, the line will be interpreted as an initial line.
3. In a continuation line beginning with a TAB followed by a digit, any characters following the digit to the end of the line are a continuation of the current statement.
4. TAB-formatted lines don't have preassigned comment fields. All characters to the end of the line are considered part of the statement. However, an exclamation mark (!) can be used to explicitly define a comment field, from the ! to the end of the line.

The rules for TAB formatting can be summarized:

```
<statement label>TAB<statement> (initial line)
TAB<continuation field><statement> (continuation line)
TAB<statement> (initial line)
```

Note that while many terminal and text editors advance the cursor to a predetermined position when a TAB is entered, this action is not related to how the TAB will be ultimately interpreted by the compiler. The compiler interprets TABs in the statement field as blanks.

## Continuation Lines

A continuation line is a continuation of a FORTRAN statement and is identified as follows:

- Columns 1 through 5 must be blank.
- Column 6 contains any FORTRAN character, other than a blank or the digit 0. Column 6 is frequently used to number the continuation lines.

As with initial lines, Columns 7 through the end of the line contain the FORTRAN statement or a continuation of the statement.

Alternatively, an ampersand (&) in Column 1 also can be used to identify a continuation line. When an & is used in Column 1, Columns 2 through the end of the line are considered part of the statement. In FORTRAN 77, any remaining columns (73- ...) of a continuation line are not interpreted.

Up to 19 continuation lines are allowed.

## Blank Lines

A line that is entirely blank is a comment line. It can be used to improve the readability of a program.

## Program Organization

Program units are made up of FORTRAN statements. A FORTRAN program consists of one or more program units.

## FORTRAN Statements

FORTRAN statements are used to form program units. Each statement is written from Column 7 onwards of an initial line and Column 7 onwards of as many as 19 continuation lines. A statement must not contain more than 1320 characters, including blank characters.

A statement must not begin on a line that contains any portion of a previous statement, except as part of a logical IF statement.

The END statement signals the physical end of a FORTRAN program unit, and begins in Column 7 or any later column of an initial line. No other statement may have an initial line that contains END as its first three nonblank characters.

All FORTRAN statements, except for assignment and statement function statements, begin with a keyword. A *keyword* is a sequence of characters that identifies the type of FORTRAN statement.

A statement label provides a means of referring to individual FORTRAN statements. A statement label consists of one to five digits—one of which must be nonzero—placed anywhere in Columns 1 through 5 of an initial line. Blanks and leading zeros are not significant in distinguishing between statement labels.

The following statement labels are equivalent:

```
" 123 "    "123 "    "1 2 3"    "00123"
```

Two or more statements in a program unit must not have the same statement label.

It is not necessary to label a FORTRAN statement. However, only labeled statements may be referenced by other FORTRAN statements. PROGRAM, SUBROUTINE, FUNCTION, BLOCK DATA, and INCLUDE statements must not be labeled.

## Program Units

A program unit consists of a sequence of statements and optional comment lines. It may be a main program or a subprogram. The program unit defines the scope for symbolic names and statement labels.

A program unit always has an END statement as its last statement.

## Main Program

The main program is the program unit that initially receives control upon execution.

A main program may have a PROGRAM statement as its first statement. It may contain any FORTRAN statement, except a FUNCTION, SUBROUTINE, BLOCK DATA, ENTRY or RETURN statement. A SAVE statement in a main program does not affect the status of variables or arrays. A STOP or END statement in a main program terminates execution of the program.

The main program may be a non-FORTRAN main program. See Chapter 3 of the *FORTRAN Programmer's Guide* for information on writing FORTRAN programs that interact with programs written in other languages.

A main program may not be referenced from a subprogram or from itself.

## Subprograms

A subprogram is a program unit that receives control when referenced or called by a statement in a main program or another subprogram.

A subprogram may be:

- A function subprogram identified by a FUNCTION statement
- A subroutine subprogram identified by a SUBROUTINE statement
- A block data subprogram identified by a BLOCK DATA statement
- A non-FORTRAN subprogram

Subroutines, external functions, statement functions, and intrinsic functions are collectively called procedures. A *procedure* is a program segment that performs an operational function.

An external procedure is a function or subroutine subprogram that is processed independently of the calling or referencing program unit. It may be written as a non-FORTRAN subprogram as described in Chapter 3 of the *FORTRAN Programmer's Guide*.

## Intrinsic Functions

Intrinsic functions are supplied by the processor and are generated as in-line functions or library functions. See Appendix A for a description of the functions, the results given by each, and their operational conventions and restrictions.

Program units are made up of FORTRAN statements. A FORTRAN program consists of one or more program units.

## Executable Programs

An executable program consists of exactly one main program and zero or more of each of the following entities:

- Function subprogram
- Subroutine subprogram

- Block data subprogram
- Non-FORTRAN external procedure

The main program must not contain an ENTRY or a RETURN statement. Upon encountering a RETURN statement, the compiler issues a warning message; at execution time, a RETURN statement stops the program. Execution of a program normally ends when a STOP statement is executed in any program unit or when an END statement is executed in the main program.

## Executable and Nonexecutable Statements

FORTRAN statements are classified as executable or nonexecutable statements.

### Executable Statements

An executable statement specifies an identifiable action and is part of the execution sequence in an executable program. Executable statements are organized into three classes.

Assignment statements:

- Arithmetic, logical, statement label (ASSIGN), and character assignment

Control statements:

- Unconditional, assigned, and computed GO TO
- Arithmetic IF and logical IF
- Block IF, ELSE IF, ELSE, and END IF
- CONTINUE
- STOP and PAUSE
- DO
- CALL and RETURN
- END

Input/Output statements:

- READ, WRITE, and PRINT
- REWIND, BACKSPACE, ENDFILE, OPEN, CLOSE, and INQUIRE, ACCEPT, ENCODE, DECODE, DEFINED FILE, FIND, REWRITE, DELETE, and UNLOCK.

### Nonexecutable Statements

A nonexecutable statement is not part of the execution sequence. A statement label is permitted on most types of nonexecutable statements but that label must not be used for an executable statement in the same program unit.

A nonexecutable statement may perform one of the following functions:

- Specify the characteristics, storage arrangement, and initial values of data
- Define statement functions
- Specify entry points within subprograms
- Contain editing or formatting information
- Classify program units
- Specify inclusion of additional statements from another source

The following data type statements are classified as nonexecutable:

CHARACTER type  
COMPLEX  
DIMENSION  
DOUBLE PRECISION  
INTEGER  
LOGICAL  
REAL  
BYTE

Other program statements that are also classified as nonexecutable include the following:

BLOCK DATA	INCLUDE
COMMON	INTRINSIC
DATA	PARAMETER
ENTRY	PROGRAM
EQUIVALENCE	SAVE
EXTERNAL	SUBROUTINE
FORMAT	Statement function
FUNCTION	VIRTUAL
IMPLICIT	

## Order of Statements

The following rules determine the order of statements in a main program or subprogram:

1. In the main program, a PROGRAM statement is optional; if used, it must be the first statement. In other program units, a FUNCTION, SUBROUTINE, or BLOCK DATA statement must be the first statement.
2. Comment lines can be interspersed with any statement and can precede a PROGRAM, FUNCTION, SUBROUTINE, or BLOCK DATA statement.
3. FORMAT and ENTRY statements may be placed anywhere within a program unit after a PROGRAM, FUNCTION, SUBROUTINE, or BLOCK DATA statement.

4. ENTRY statements may appear anywhere in a program unit except:
  - between a block IF statement and its corresponding END IF statement
  - within the range of a DO loop; that is, between a DO statement and the terminal statement of the DO loop
5. The FORTRAN 77 standard requires that specification statements, including the IMPLICIT statement, be placed before all DATA statements, statement function statements, and executable statements.

However, this implementation of FORTRAN permits the interspersing of DATA statements among specification statements.

Specification statements specifying the type of the symbolic name of a constant must appear before the PARAMETER statement that identifies the symbolic name with that constant.

6. The FORTRAN 77 standard allows PARAMETER statements to intersperse with IMPLICIT statements or any other specification statements, but a PARAMETER statement must precede a DATA statement.

The FORTRAN 77 standard is extended to permit the interspersing of DATA statements among PARAMETER statements.

PARAMETER statements that associate a symbolic name with a constant must precede all other statements containing that symbolic name.

7. All statement function statements must precede the first executable statement.
8. IMPLICIT statements must precede all other specification statements except PARAMETER statements.
9. The last statement of a program unit must be an END statement.

**NOTE:** These rules apply to the program statements after merging of lines included by all INCLUDE statements. INCLUDE statements may appear anywhere in a program unit.

## Execution Sequence

The execution sequence in a FORTRAN program is the order in which statements are executed. The normal sequence of execution is the order in which statements appear in a program unit. This is carried out as follows:

- Execution begins with the first executable statement in a main program and continues from there.
- When an external procedure is referenced in a main program or in an external procedure, execution of the calling or referencing statement is suspended. Execution continues with the first executable statement in the called procedure immediately following the corresponding FUNCTION, SUBROUTINE, or ENTRY statement.

- Execution is returned to the calling statement via an explicit or implicit return statement.
- Normal execution proceeds from where it was suspended or from an alternate point in the calling program.
- The executable program is terminated normally when the processor executes a STOP statement in any program unit or an END statement in the main program. Execution is also terminated automatically when an operational condition prevents further processing of the program.

Normal execution sequence may be altered by a FORTRAN statement that causes the normal sequence to be discontinued or causes execution to resume at a different position in the program unit. Statements that may cause a transfer of control are:

- GO TO
- Arithmetic IF
- RETURN
- STOP
- An input/output statement containing an error specifier or end-of-file specifier
- CALL with an alternate return specifier
- A logical IF containing any of the above forms
- Block IF and ELSE IF
- The last statement, if any, of an IF block or ELSE IF block
- DO
- The terminal statement of a DO loop
- END

## Data Types, Variables, and Arrays

---

### Overview

In general, there are three kinds of entities that have a data type: constants, data names, and function names. The types of data allowed in FORTRAN are:

- INTEGER – positive and negative integral numbers, and zero.
- REAL – positive and negative numbers with a fractional part, and zero.
- DOUBLE PRECISION – same as REAL but using twice the storage space and possibly greater precision.
- COMPLEX – ordered pair of REAL data: real and imaginary parts, as in  $m + ni$ .
- DOUBLE COMPLEX – ordered pair of double precision data.
- LOGICAL – boolean data representing *true* or *false*.
- CHARACTER – character strings.
- HOLLERITH – an historical data type for character definition.

Together, INTEGER, REAL, DOUBLE PRECISION, COMPLEX, and DOUBLE COMPLEX constitute the class of *arithmetic* data types.

The type of data is established in one of two ways: implicitly, depending on the first letter of its symbolic name (described in this chapter), or explicitly through a type statement (described in **Chapter 4**).

A data value may be a variable or a constant, that is, its value either can or cannot change during the execution of a program. An array is a sequence of data items occupying a set of consecutive bytes.

### Data Types of Symbolic Names

A symbolic name has a definite data type in a program unit, and the type may be any of the following:

```

BYTE
INTEGER [*1 | *2 | *4]
REAL [*4 | *8] or DOUBLE PRECISION
COMPLEX [*8 | *16]
LOGICAL [*1 | *2 | *4]
CHARACTER [*n]

```



The optional length specifier that follows the type name determines the number of bytes of storage for the data type. If the length specifier is omitted, the compiler uses the defaults listed in Chapter 2 of the *FORTRAN Programmer's Guide*.

In general, wherever the usage of a given data type is allowed, it can have any internal length. One exception to this is the use of integer variables for assigned GOTO statements. In this case the integer variable must be 4 bytes in length.

Data of a given type and different internal lengths may be intermixed in expressions and the resultant value will be represented in the larger of the internal representations present in the expression.

**NOTE:** The lengths of arguments in actual and formal parameter lists and COMMON blocks must agree in order to get predictable results.

## Implicit Typing of Data

If not explicitly specified by a type statement or a FUNCTION statement, the data type of a data item or a data name or function name is determined implicitly by the first character of its symbolic name. By default, a symbolic name beginning with I, J, K, L, M, or N (upper case or lower case) implies an INTEGER data type; names beginning with all other letters imply a REAL data type. The default implicit data type corresponding to each letter of the alphabet may be changed or confirmed through an IMPLICIT statement.

The data type of external functions and statement functions are implicitly determined in the same manner as above. The type of an external function may also be explicitly declared in a FUNCTION statement.

## Constants

A *constant* is a data value that cannot change during the execution of a program and can be of the following types:

- arithmetic constants
- logical constants
- character constants

As an extension, bit constants are also acceptable.

The form in which a constant is written specifies both its value and its data type. A symbolic name can be assigned for a constant using the PARAMETER statement. Blank characters occurring within a constant are ignored by the processor unless the blanks are part of a character constant.

The compiler supports the following types of *arithmetic* constants: integer, real, double precision, complex, and double complex. An arithmetic constant may be signed or unsigned. A *signed constant* has a leading plus or minus sign to denote a positive or negative number, respectively. A constant that may be either signed or unsigned is an *optionally signed constant*. Only arithmetic constants may be optionally signed.

Bit constants do not have an implicit data type associated with them; their type is determined by the context in which they appear.

The sections that follow describe the various types of constants in detail.

**NOTE:** The value zero is considered neither positive or negative: a signed zero has the same value as an unsigned zero.

## Integer Constants

An integer constant is a whole number with no decimal points; it can have a positive, negative, or zero value.

An integer constant has the following form:

$$sww$$

where:

$s$  is the sign of the number: – for negative, + (optional) for positive.

$ww$  is a whole number.

It is written with a sign (optional for +) followed by a string of decimal digits interpreted as a decimal integer. When used in FORTRAN, an integer constant must comply with the following rules:

- It must be a whole number, that is, without a fractional part.
- If negative, the special character minus (–) must be the leading character. The plus sign (+) in front of positive integers is optional.
- It must not contain embedded commas.

Examples of valid integer constants are:

0   +0   +176   –1352   06310   35

Examples of invalid integer constants are:

2.03   Decimal point not allowed. This is a *real constant* (described in a following section of this chapter).

7,909   Embedded commas not allowed.

## Hexadecimal Integer Constants

Hexadecimal integer constants permit the use of a base 16 radix. You must specify a dollar sign (\$) as the first character, followed by any of the digits 0 through 9 or the letters A through F (either uppercase or lowercase). The following are valid examples of hexadecimal integer constants.

\$0123456789  
\$ABCDEF  
\$A2B2C3D4

You can use hexadecimal integer constants wherever integer constants are allowed. Note that in mixed mode expressions, the compiler converts these constants from type integer to the dominant type of the expression in which they appear.

### Octal Integer Constants

Octal integer constants permit the use of a base 8 radix. The type of an octal integer constant is INTEGER, in contrast to the octal constant described in the **Bit Constants** section of this chapter. This constant is supported to provide compatibility with PDP-11 FORTRAN.

The format of an octal constant is as follows:

`o"string"`

where *string* is one or more digits in the range of 0 through 7.

### Real Constants

A real constant is a number containing a decimal point or exponent, or both; it can have a positive, negative, or zero value.

A *real constant* may have the following forms:

`sww.ff`      Basic real constant

`sww.ffEsee`    Basic real constant followed by a real exponent

`swwEsee`      Integer constant followed by a real exponent

where:

`s`            is the sign of the number: – for negative, + (optional) for positive.

`ww`          is a string of digits denoting the whole number part, if any.

`.`            is a decimal point.

`ff`           is a string of digits denoting the fractional part, if any.

`Esee`        denotes a real exponent, where *see* is an optionally signed integer.

A basic real constant is written as an optional sign followed by a string of decimal digits containing an optional decimal point. There must be at least one digit.

A real exponent denotes a power of ten.

The value of a real constant is either the basic real constant or, for the forms `sww.ffEsee` and `swwEsee`, the product of the basic real constant or integer constant and the power of ten indicated by the exponent following the letter E.

All three forms may contain more digits than the precision used by the processor to approximate the value of the real constant. See **Chapter 2** of the *FORTRAN Programmer's Guide* for information on the magnitude and precision of a real number.

The following examples illustrate real constants written in common and scientific notation with their corresponding E format:

Common Notation	Scientific Notation	Real Exponent Form
5.0	$0.5 \times 10$	.5E1 or 0.5E1
364.5	$3.465 \times 10^2$	.3645E3
49,300	$4.93 \times 10^4$	.493E5
-27,100	$-2.71 \times 10^4$	-.271E5
-.0018	$-1.8 \times 10^{-3}$	-.18E-2

The following real constants are equivalent:

5E4    5.E4    .5E5    5.0E+4    +5E04    50000.

Invalid Real Constant	Reason Invalid
-18.3E	No exponent following the E
E-5	Exponent part alone
6.01E2.5	Exponent part must be an integer
3.5E4E2	Only one exponent part allowed per constant
19,850	Embedded commas not allowed

## Double Precision Constants

A double precision constant is similar to a real constant, except it can retain more digits of the precision than a real constant. (The size and value ranges of double precision constants are given in **Chapter 2** of the *FORTRAN Programmer's Guide*.)

A double precision entity may assume a positive, negative, or zero value and may be written in one of the following forms:

*swwDsee*    An integer constant followed by a double precision exponent

*sww.ffDsee*    A basic real constant followed by a double precision exponent

where:

*s*            is an optional sign.

*ww*         is a string of digits denoting the whole number part, if any.

*ff*         is a string of digits denoting the fractional part, if any.

*Dsee*       denotes a double precision exponent, where *see* is an optionally signed exponent.

The value of a double precision constant is the product of the basic real constant part or integer constant part and the power of ten indicated by the integer following the letter D in the exponent part. Both forms can contain more digits than used by the processor to approximate the value of the real constant. See **Chapter**

2 of the *FORTRAN Programmer's Guide* for information on the magnitude and precision of a double precision constant.

Valid forms of double-precision constants are:

```
1.23456D3
8.9743D0
-4.D-10
16.8D-6
```

The following forms of the numeric value 500 are equivalent:

```
5D2 +5D02 5.D2 5.D+02 5D0002
```

The following table shows some invalid double-precision constants and the reasons they are invalid.

Invalid Constant	Reason Invalid
2.395D	No integer portion after the letter D.
-9.8736	Missing D exponent designator.
1,010,203D0	Embedded commas not allowed.

## Complex Constants

A complex constant is a processor approximation to the value of a complex number. It is represented as an ordered pair of real data values. The first value represents the real part of the complex number and the second represents the imaginary part. Each part has the same precision and range of allowed values as for real data.

A complex constant has the form:

$$(m,n)$$

where  $m$  and  $n$  each have the form of a *real constant*, representing the complex value  $m + ni$ , where  $i$  is the square root of  $-1$ .  $m$  denotes the real part;  $n$  denotes the imaginary part. Both  $m$  and  $n$  may be positive, negative, or zero.

Examples of valid forms of complex data are:

Valid Complex Constant	Equivalent Mathematical Expression
(3.5, -5)	3.5-5 $i$
(0, -1)	- $i$
(0.0, 12)	0+12 $i$ or 12 $i$
(2E3, 0)	2000+0 $i$ or 2000

The following table shows some invalid constants and the reasons they are invalid.

Invalid Constant	Reason Invalid
(1, )	No imaginary part
(1, 2.2, 3)	More than two parts
(10, 52.D5)	Double precision constants are not allowed for either part
(1.15, 4E)	Imaginary part has invalid form

## Logical Constants

A logical constant represents only the values true or false.

A logical constant is specified by one of the following forms and has the indicated value:

Form	Value
.TRUE.	true
.FALSE.	false

## Character Constants

A character constant is a string of one or more characters capable of being represented by the processor. Each character in the string is numbered consecutively from left to right beginning with 1.

**NOTE:** The quotation character (") is an extension to FORTRAN 77.

If the delimiter is ", then a quotation mark within the character string is represented by two consecutive quotation marks with no intervening blanks.

If the delimiter is ', then an apostrophe within the character string is represented by two consecutive apostrophes with no intervening blanks.

Blanks within the string of characters are significant.

The length of a character constant is the number of characters, including blanks, between the delimiters. The delimiters are not counted, and each pair of apostrophes or quotation marks between the delimiters counts as a single character.

A character constant is normally associated with the CHARACTER data type. The FORTRAN 77 standard is extended (except as noted below) to allow character constants to appear in the same context as a numeric constant. A character constant in the context of a numeric constant is treated identically as a Hollerith constant.

**NOTE:** Character constants cannot be used as actual arguments to numeric typed dummy arguments.

The following table gives examples of valid character constants and shows how they are stored.

Constant	How Stored
'DON''T'	DON'T
"I'M HERE!"	I'M HERE!
'STRING'	STRING
'LMN""OP'	LMN""OP

The following table shows some invalid character constants and the reasons they are invalid.

Invalid Constant	Reason Invalid
'ISN.T	Terminating delimiter missing
.Yes'	Mismatched delimiters
CENTS	Not enclosed in delimiters
' '	Zero length not allowed
""	Zero length not allowed

### Hollerith Constants

Hollerith constants are used to manipulate packed character strings in the context of integer data types. A hollerith constant consists of a character count, followed by the letter H (either upper or lower case) and a string of characters as specified in the character count, and has the following format:

$$nHx_1x_2\dots x_n$$

where  $n$  is a nonzero, unsigned integer constant and the  $x$ 's represent a string of exactly  $n$  contiguous characters. The blank character is significant in a Hollerith constant.

Examples of valid Hollerith constants are:

```
3H A
10H'VALUE = '
8H MANUAL
```

The following gives some examples of invalid Hollerith constants and the reasons they are invalid.

Invalid Constant	Reason Invalid
2H YZ	Blanks are significant; should be 3H YZ
-4HBEST	Negative length not allowed
0H	Zero length not allowed

## Rules

1. Hollerith constants are stored as byte strings; each byte is the ASCII representation of one character.
2. The Hollerith constant has no type and can be used in any context where a constant may appear. A hollerith constant assumes the data type and size within the constant in which the constant is used.
3. Hollerith constants have no type; they assume a numeric data type and size within the context in which they are used.
4. When used with a binary operator, octal and hexadecimal constants assume the data type of the other operand. For example:

```
INTEGER*2 HILO
HILO = 'FF'X
```

The constant is assumed to be of the INTEGER\*2 type and two bytes long.

5. In other cases, when used in statements that require a specific data type, the constant is assumed to be the required type and length.
6. A length of four bytes is assumed for hexadecimal and octal constants used as arguments; no data type is assumed.
7. In other cases, the constant is assumed to be of the INTEGER\*4 data type.
8. When a Hollerith constant is used in an actual parameter list of a subprogram reference, the formal parameter declaration within that subprogram must specify a numeric type, not a character type.
9. A variable may be defined with a Hollerith value through a DATA statement, an assignment statement, or a READ statement.
10. The number of characters  $n$  in the Hollerith constant must be less than or equal to  $g$ , the maximum number of characters that can be stored in a variable of the given type, where  $g$  is the size of the variable expressed in bytes. If  $n < g$ , the Hollerith constant is stored and extended on the right with  $(g-n)$  blank characters. (See Chapter 2 of the *FORTRAN Programmer's Guide* for the sizes of arithmetic and logical data types.)

## Bit Constants

Bit constants can be used anywhere a constant is allowed. The allowable bit constants and their format are shown in the following table:



Format*	Meaning	Valid <i>string</i> characters	Maximum
b' <i>string</i> ' or ' <i>string</i> ' b	Binary	0,1	64
o' <i>string</i> ' or ' <i>string</i> ' o	Octal	0-7	22
x' <i>string</i> ' or ' <i>string</i> ' x	Hexadecimal	0-9; a-f	16
z' <i>string</i> ' or ' <i>string</i> ' z	Hexadecimal	0-9; a-f	16
* b, o, x, and z may be lower- or uppercase (B, O, X, Z)			

Here is an example of bit constants used in a DATA statement.

```
integer a(4)
data a/b'1010',o'12',z'a',x'b'/'
```

The above statement initializes the first elements of a four-element array to binary, the second element to an octal value, and the last two elements to hexadecimal values.

The following rules apply to bit constants:

1. Bit constants have no type; they assume a numeric data type and size within the context in which they are used.
2. When used with a binary operator, octal and hexadecimal constants assume the data type of the other operand. For example:

```
INTEGER*2 HILO
HILO = 'FF'X
```

The constant is assumed to be of the INTEGER\*2 type and two bytes long.

3. In other cases, when used in statements that require a specific data type, the constant is assumed to be the required type and length.
4. A length of four bytes is assumed for hexadecimal and octal constants used as arguments; no data type is assumed.
5. In other cases, the constant is assumed to be of the INTEGER\*4 data type.
6. A hexadecimal or octal constant can specify up to 16 bytes of data.
7. Zero padding to the left occurs when the assumed length of the constant is more than the digits specified by the constant. Truncation to left occurs when the assumed length of the constants is less than that of the digits specified.

## Variables

A variable is an entity with a name, data type, and value. Its value is either defined or undefined at any given time during the execution of a program.

The variable name is a symbolic name of the data item and must conform to the rules given for symbolic names. The type of a variable is explicitly defined in a type-statement or implicitly by the first character of the name.

A variable may not be used or referred to unless it has been defined through an assignment statement, input statement, DATA statement, or through association with a variable or array element that has been defined.

## Character Substrings

A character substring is a contiguous sequence of *characters* that is part of a character data item. A character substring must not be empty; i.e., it must contain at least one byte of storage. Each *character* is individually defined or undefined at any given time during the execution of a program.

## Substring Names

A substring name allows the corresponding substring to be defined and referenced in a character expression. A substring name has one of the following forms:

$$v([e1]:[e2])$$

$$a(s[,s]...) ([e1]:[e2])$$

where:

$v$  is a character variable name.

$a$  is a character array name.

$e1$  and  $e2$  are integer expressions, called substring expressions.

A non-integer character can be specified  $e1$  and  $e2$ . If specified, each non-integer character is converted to integer before use; fractional portions remaining after conversion are truncated.

$s$  is a subscript expression.

The value  $e1$  specifies the leftmost character position of the substring relative to the beginning of the variable or array element from which it was abstracted, while  $e2$  is the rightmost position. Positions are numbered left to right beginning with 1. For example, EX(3:5) denotes characters in positions three through five of the character variable EX. C(2,4)(1:5) specifies characters in positions one through five of the character array element C(2,4).

A character substring has the length  $e2 - e1 + 1$ .

## Substring Values $e1$ , $e2$

The value of the numeric expressions  $e1$  and  $e2$  in a substring name must fall within the range:

$$1 \leq e1 \leq e2 \leq \text{len}$$

where  $\text{len}$  is the length of the character variable or array element. A value of one is implied if  $e1$  is omitted. A value of  $\text{len}$  is taken if  $e2$  is omitted. When both  $e1$  and  $e2$  are not specified, the form  $v(:)$  is equivalent to  $v$  and the form  $a(s [,s]...)(:)$  is equivalent to  $a(s [,s]...)$ .

The specification for  $e1$  and  $e2$  can be any numeric integer expression, including array element references and function references. Consider the character variable

```
XCHAR = 'QRSTUVWXYZ'.
```

Examples of valid substrings taken from this variable are:

Expression	Substring Value	Substring Length
EX1 = XCHAR(3:8)	STUVWX	6
EX2 = XCHAR(:8)	QRSTUVWXYZ	8
EX3 = XCHAR(5:)	UVWXYZ	6

Other examples are:

**BQ(10)(2:IX)** Specifies characters in positions 2 through integer IX of character array BQ(10). The value of IX must be 2 and the length of an element of BQ.

**BLT(:)** Equivalent to the variable BLT.

## Records

The record-handling capability enables you to declare and operate on multifield records in FORTRAN programs. The term record as it is used here is not to be confused with the term record used to describe input and output data records.

### Overview of Records and Structures

A record is a composite or aggregate entity containing one or more record elements or fields. Each element of a record can be, and usually is, named. References to a record element consist of the name of the record and the name of the desired element. Records allow you to organize heterogeneous data elements within one structure and to operate on them either individually or collectively. Because they can be composed of heterogeneous data elements, records are not typed as arrays are.

You define the form of a record with a group of statements called a structure definition block. You establish a structure declaration in memory by specifying the name of the structure in a RECORD statement. A structure declaration block can include one or more of the following items:

- Typed data declarations (variables or arrays)
- Substructure declarations
- Mapped field declarations
- Unnamed fields

The following sections describe these items. Refer to the RECORD and STRUCTURE declarations block sections in Chapter 4 for details on specifying a structure in a source program.

**Typed Data Declarations (Variables or Arrays).** Typed data declarations in structure declarations have the form of normal FORTRAN typed data declarations. Data items with different types can be freely intermixed within a structure declaration.

**Substructure Declarations.** Substructures can be established within a structure by means of either a nested structure declaration or a RECORD statement.

**Mapped Field Declarations.** Mapped field declarations are made up of one or more typed data declarations, substructure declarations (structure declarations and RECORD statements), or other mapped field declarations. Mapped field declarations are defined by a block of statements called a union declaration. Unlike typed data declarations, all mapped field declarations that are made within a single union declaration share a common location within the containing structure.

**Unnamed Fields.** Unnamed fields can be declared in a structure by specifying the pseudo-name %FILL in place of an actual field name. You can use this mechanism to generate empty space in a record for purposes such as alignment.

## Record and Field References

This manual uses the generic term *scalar reference* to refer to all references that resolve to single typed data items. A scalar field reference of an aggregate falls into this category. The generic term *aggregate reference* is used to refer to all references that resolve to references to structured data items defined by a RECORD statement.

Scalar field references may appear wherever normal variable or array elements may appear, with the exception of COMMON, SAVE, NAMELIST, and EQUIVALENCE statements. Aggregate references may only appear in aggregate assignment statements, unformatted I/O statements, and as parameter to subprograms.

## Aggregate Assignment Statement

Aggregates can be assigned as whole entities. This special form of the assignment statement is indicated by an aggregate reference on the left hand side of an assignment statement, and requires an identical aggregate to appear on the right hand side of the assignment.

## Arrays

An array is a nonempty sequence of data of the same type occupying consecutive bytes in storage. A member of this sequence of data is referred to as an array element.

Each array has the following characteristics:

- An array name
- A data type
- Array elements
- An array declarator specifying:
  - o The number of dimensions
  - o the size and bounds of each dimension

An array can be defined using a DIMENSION, COMMON, or type statement (described in **Chapter 4**); it can have a maximum of seven (7) dimensions.

**NOTE:** For information on array handling when interacting with programs written in another language, see **Chapter 3** of the *FORTRAN Programmer's Guide*.

## Array Names and Types

An array name is the symbolic name given to the array and must conform to the rules given in **Chapter 1** given for symbolic names. An array can be specified by the array name alone when reference is made to the array as a whole. An array name is local to a program unit.

An array element is specified by the array name and a subscript. The form of an array element name is:

$$a (s [, s] \dots)$$

where:

$a$  is a array name.

$(s [,s] \dots)$  is a subscript.

$s$  is a subscript expression.

The number of subscript expressions must be equal to the number of dimensions in the array declarator for the array name.

An array element can be any of the types of data allowed in FORTRAN. All array elements are the same data type. The data type is specified explicitly using a type statement, or implicitly by the first character of the array name.

A different array element may be referenced by changing the subscript value of the array element name.

## Array Declarators

An array declarator specifies a symbolic name for the array, the number of dimensions in the array, and the size and bounds of each dimension. Only one array declarator for an array name is allowed in a program unit. The array declarator may appear in a DIMENSION statement, a type statement, or a COMMON statement, but not more than one of these.

An array declarator has the form:

$$a (d [,d] \dots)$$

where:

$a$  is a symbolic name of the array.

$d$  is a dimension declarator of the following form:

$$[d1:] d2$$

where:

$d1$  is a lower dimension bound.

$d2$  is a upper dimension bound.

$d1$  must be a numeric expression.  $d2$  must be a numeric expression or an asterisk (\*). An asterisk is allowed only if  $d2$  is part of the last dimension declarator (see below).

If  $d1$  or  $d2$  is not of type integer, it is converted to integer values; any fractional part is truncated.

An array declarator is either an actual array declarator or a dummy array declarator. In an actual array declarator the array name is not a dummy argument. Conversely, a dummy array declarator is an array declarator that has a dummy argument as an array name. An array declarator may be one of three types: a constant array declarator, an adjustable array declarator, or an assumed-size array declarator.

Each of the dimension bounds in a *constant array declarator* is a numeric constant expression. An *adjustable array declarator* is a dummy array declarator that contains one or more dimension bounds that are integer expressions but not constant integer expressions. An *assumed-size array declarator* is a dummy array declarator that has integer expressions for all dimension bounds, except that the upper dimension bound  $d2$  of the last dimension is an asterisk (\*).

A dimension bound expression must not contain a function or array element name reference.

### Value of Dimension Bounds

The lower dimension bound  $d1$  and the upper dimension bound  $d2$  can have positive, negative, or zero values. The value of the upper dimension bound  $d2$  must be greater than or equal to that of the lower dimension bound  $d1$ .

If a lower dimension bound is not specified, its value is assumed to be one (1). An upper dimension bound of an asterisk (\*) is always greater than or equal to the lower dimension bound.

The *size of a dimension* that does not have an asterisk (\*) as its upper bound has the value:

$$(d2 - d1) + 1$$

The *size of a dimension* that has an asterisk (\*) as its upper bound is not specified.

## Array Size

The *size of an array* is exactly equal to the number of elements contained by the array. Therefore, the size of an array equals the product of the dimensions of the array. For constant and adjustable arrays, the size is straightforward. For assumed-size dummy arrays, however, the size depends on the actual argument corresponding to the dummy array.

There are three cases:

1. If the actual argument is a noncharacter array name, the size of the assumed-size array equals the size of the actual argument array.
2. If the actual argument is a noncharacter array element name with a subscript value of  $j$  in an array of size  $x$ , the size of the assumed-size array equals  $x - j + 1$ .
3. If the actual argument is either a character array name, a character array element name, or a character array element substring name, the array begins at character storage unit  $t$  of an array containing a total of  $c$  character storage units; the size of the assumed-size array equals:

$$\text{INT}((c - t + 1)/ln)$$

where  $ln$  is the length of an element of the dummy array.

**Restriction.** Given an assumed-size dummy array with  $n$  dimensions, the product of the sizes of the first  $n - 1$  dimensions must not be greater than the size of the array (the size of the array determined as described above).

## Storage and Element Ordering

Storage for an array is allocated in the program unit in which it is declared, except in subprograms where the array name is specified as a dummy argument. The former declaration is called an actual array declaration. The declaration of an array in a subprogram where the array name is a dummy argument is called a dummy array declaration.

The elements of an array are ordered in sequence and stored in column order. This means that the leftmost subscript varies first, as compared to row order, in which the rightmost subscript varies first. The first element of the array has a *subscript value* of one; the second element has a *subscript value* of two; and so on. The last element has a *subscript value* equal to the size of the array. Consider the following statement that declares an array with an *INTEGER* type statement:

```
INTEGER t (2, 3)
```

The elements of this array are ordered as follows:

t(1,1)	t(2,1)	t(1,2)	t(2,2)	t(3,3)	t(2,3)
--------	--------	--------	--------	--------	--------



## Subscripts

The subscript describes the position of the element in an array and allows that array element to be defined or referenced. The form of a *subscript* is:

$$(s [,s]...)$$

where:

*s* is a *subscript expression*. The term subscript includes the parentheses that delimit the list of subscript expressions.

A *subscript expression* must be a numeric expression and may contain array element references and function references. However, it must not contain any function references that affect other subscript expressions in the same subscript.

A non-integer character can be specified for *subscript*. If specified, the non-integer character is converted to integer before use; fractional portions remaining after conversion are truncated.

If a subscript expression is not of type integer, it is converted to integer values; any fractional part is truncated.

Because an array is stored as a sequence in memory, the values of the subscript expressions must be combined into a single value that is used as the offset into the sequence in memory. That single value is called the subscript value. The subscript value determines which element of the array is accessed. The subscript value is calculated from the values of all the subscript expressions and the declared dimensions of the array (see Table 2.1).

n	Dimension Declarator	Subscript	Subscript Value
1	(j1:k1)	(s1)	1 + (s1-j1)
2	(j1:k1, j2 : k2)	(s1, s2)	1 + (s1-j1) + (s2-j2)*d1
3	(j1:k1, j2 : k2, j3 : k3)	(s1, ~s2, ~s3)	1 + (s1-j1) + (s2-j2)*d1 + (s3-j3)*d2*d1
n	(j1 : k1, ...jn : kn)	(s1, ...Sn)	1 + (s1-j1) + (s2-j2) *d1 + (s3-j3)*d2*d1 + ... + (Sn-jn) *dn-1* ~dn-2* ...*d1

Table 2.1. Determining Subscript Values

The subscript value and the subscript expression value are not necessarily the same, even for a one-dimensional array. For example:

```
DIMENSION X(10, 10), Y(-1:8)
Y(2) = X(1, 2)
```

Y(2) identifies the fourth element of array Y, the subscript is (2) with a subscript value of four, and the subscript expression is 2 with a value of two. X(1,2) identifies the eleventh element of X, the subscript is (1,2) with a subscript value of eleven, and the subscript expressions are 1 and 2 with the values of one and two, respectively.

---

## Overview

An expression performs a specified type of computation. It is composed of a sequence of operands, operators, and parentheses. The types of expressions permitted in FORTRAN are:

- Arithmetic
- Character
- Relational
- Logical

This section describes the formation, interpretation, and evaluation rules for each of the expressions. Mixed-mode expressions are FORTRAN 77 enhancements of FORTRAN 66 and are also discussed in this chapter.

## Arithmetic Expressions

An arithmetic expression specifies a numeric computation which yields a numeric value upon evaluation. The simplest form of an arithmetic expression may be:

- An unsigned arithmetic constant
- The symbolic name of an arithmetic constant
- An arithmetic variable reference
- An arithmetic array element reference
- An arithmetic function reference

More complicated arithmetic expressions are constructed from one or more operands together with arithmetic operators and parentheses.

An arithmetic element may include logical entities because logical data is treated as integer data when used in an arithmetic context. When arithmetic and logical operands exist for a given operator, the logical operand is promoted to type INTEGER of the same byte length as the logical.

## Arithmetic Operators

The arithmetic operators are shown in the following table:

Operator	Function
**	Exponentiation
*	Multiplication
/	Division
+	Addition or Identity
-	Subtraction or Negation

An exponentiation, division, or multiplication operator can be used only with two operands and written between the two operands. An addition or subtraction operator can be used with two operands or one operand; in the latter case, it is written preceding that operand.

Two operators may not be written in succession. (Note that the exponentiation operator consists of the two characters \*\* but is a *single* operator.) Implied operators, as in implied multiplication, are not allowed.

## Interpretation of Arithmetic Expressions

Interpretation of arithmetic expressions using these operators are shown below.

Operator	Use	Interpretation
**	$x1 ** x2$	Exponentiate $x1$ to the power of $x2$ .
*	$x1 * x2$	Multiply $x1$ and $x2$
/	$x1 / x2$	Divide $x1$ by $x2$
+	$x1 + x2$	Add $x1$ and $x2$
	+x	x (identity)
-	$x1 - x2$	Subtract $x2$ from $x1$
	-x	Negate x

An arithmetic expression containing two or more operators is written and interpreted based on a precedence relation among the arithmetic operators, unless the order is overridden by the use of parentheses. This precedence is shown in the following table:

Operator	Precedence
**	Highest
*, /	Intermediate
+, -	Lowest

As an example:

$$A/B-C**D$$

The operators are executed in the following sequence:

1.  $C^{**}D$  denotes the result  $X$  to give  $A/B-X$ .
2.  $A/B$  denotes the result  $Y$  to give  $Y-X$ .
3.  $Y-X$  gives the final result.

A unary operator can follow another operator. This produces a variation on the standard order of operations when the preceding operator is exponentiation. The unary operator must be evaluated first in that case, resulting in exponentiation taking a lower precedence in the expression.

For example:

$$A^{**} - B * C$$

Is interpreted as:

$$A^{**} ( - B * C )$$

## Arithmetic Operands

Arithmetic operands must specify values with integer, real, double precision, complex, or double complex data types. Specific operands may be combined in an arithmetic expression. The arithmetic operands, in increasing complexity, are:

- Primary
- Factor
- Term
- Arithmetic expression

A *primary* is the basic component in an arithmetic expression. The forms of a primary are:

- Unsigned arithmetic constant
- Symbolic name of an arithmetic constant
- Arithmetic variable reference
- Arithmetic array element reference
- Arithmetic function reference
- Arithmetic expression enclosed in parentheses

A *factor* consists of one or more primaries separated by the exponentiation operator. The forms of a factor are:

- Primary
- Primary \*\* factor

Factors with more than one exponentiation operator are interpreted from right to left. For example,  $I^{**}J^{**}K$  is interpreted as  $I^{**}(J^{**}K)$ , and  $I^{**}J^{**}K^{**}L$  is interpreted as  $I^{**}(J^{**}(K^{**}L))$ .

The *term* incorporates the multiplicative operators into arithmetic expressions. Its forms are:

- Factor
- Term/factor
- Term \* factor

The above definition indicates that factors are combined from left to right in a term containing two or more multiplication or division operators.

Finally, at the highest level of the hierarchy, are the *arithmetic expressions*. The forms of an arithmetic expression are:

- Term
- + term
- - term
- Arithmetic expression + term
- Arithmetic expression - term

An arithmetic expression consists of one or more terms separated by an addition operator or a subtraction operator. The terms are combined from left to right. For example,  $A+B-C$  has the same interpretation as the expression  $(A+B)-C$ . Expressions such as  $A*-B$  and  $A+-B$  are not allowed. The correct forms are  $A*(-B)$  and  $A+(-B)$ .

An arithmetic expression may begin with a leading plus or minus sign.

### Arithmetic Constant Expressions

An *arithmetic constant expression* is an arithmetic expression containing no variables. Therefore, each primary in an arithmetic constant expression must be one of the following:

- An arithmetic constant
- The symbolic name of an arithmetic constant
- An arithmetic constant expression enclosed in parentheses

In an arithmetic constant expression, the exponentiation operator is not allowed unless the exponent is of type integer. Variable, array element, and function references are not allowed. Examples of integer constant expressions are:

```
7
-7
-7+5
3**2
x+3 (where x is the symbolic name of a constant)
```

## Integer Constant Expressions

An *integer constant expression* is an arithmetic constant expression containing only integers. It can contain constants or symbolic names of constants, provided they are of integer type. As with all constant expressions, no variables, array elements, or function references are allowed.

## Rules for Evaluating Arithmetic Expressions

The data type of an expression is determined by the data types of the operands and functions that are referenced. Thus, integer expressions, real expressions, double precision expressions, complex expressions, and double expressions have values of type integer, real, double precision, complex, and double complex, respectively.

## Single-Mode Expressions

Single-mode expressions are arithmetic expressions in which all operands have the same data type. The data type of the value of a single-mode expression is thus the same as the data type of the operands. When the addition operator or the subtraction operator is used with a single operand, the data type of the resulting expression is the same as the data type of the operand.

## Mixed-Mode Expressions

Mixed-mode expressions contain operands with two or more data types. The data type of the value resulting from evaluation of a mixed-mode expression depends on the rank associated with each data type, as follows:

Data Type	Rank
INTEGER*1	1 (lowest)
INTEGER*2	2
INTEGER*4	3
REAL*4	4
REAL*8 (double precision)	5
COMPLEX*8	6
COMPLEX*16	7 (highest)

Except for exponentiation (discussed below), the data type of the value produced by a mixed-mode expression is the data type of the highest-ranked element in the operation. The value of the lower-ranked operand is converted to the type of the higher ranked operand and the operation is performed on values with equivalent data types. For example, the data type of the value resulting from an operation on an integer operand and a real operand is real.

Operations which combine REAL\*8 (DOUBLE PRECISION) and COMPLEX\*8 (COMPLEX) are not allowed. The REAL\*8 operand must be explicitly converted (e.g., by using the SNGL intrinsic function).

## Exponentiation

Exponentiation is an exception to the above rules for mixed-mode expressions. When raising a value to an integer power, the integer is not converted. The result is a type of the left operand.

When a complex value is raised to a complex power, the value of the expression is defined as follows:

$$x_1^{x_2} = \text{EXP}(x_2 * \text{LOG}(X))$$

## Integer Division

One operand of type integer may be divided by another operand of type integer. The result of an integer division operation is a value of type integer referred to as an integer quotient. The integer quotient is obtained as follows:

- If the magnitude of the mathematical quotient is less than one, then the integer quotient is zero. For example, the value of the expression (18/30) is zero.
- If the magnitude of the mathematical quotient is greater than or equal to one, then the integer quotient is the largest integer that does not exceed the magnitude of the mathematical quotient and whose sign is the same as that of the mathematical quotient. For example, the value of the expression (-9/2) is (-4).

## Character Expressions

A *character expression* yields a character-string value upon evaluation. The simplest form of a character expression may be:

- A character constant
- A character variable reference
- A character array element reference
- A character substring reference
- A character function reference

More complicated character expressions are constructed from one or more operands together with the concatenate operator and parentheses.

## Concatenate Operator

Only one character operator is defined in FORTRAN: the concatenation (`//`) operator. A character expression formed from the concatenation of two character operands `x1` and `x2` is specified as:

$$x1 // x2$$

The result of this operation is a character-string with a value of `x1` extended on the right with the value of `x2`. The length is the sum of the lengths of the character operands. For example, the value of

$$'HEL' // 'LO2'$$

is a string `'HELLO2'`.

## Character Operands

A *character operand* must identify a value of type character and must be a character expression. The basic component in a character expression is the character *primary*. The forms of a character primary are as follows:

- Character constant
- Symbolic name of a character constant
- Character variable reference
- Character array element reference
- Character substring reference
- Character function reference
- Character expression enclosed in parentheses

A *character expression* consists of one or more character primaries separated by the concatenation operator. Its forms are:

- Character primary
- Character expression `//` character primary

In a character expression containing two or more concatenation operators, the primaries are combined from left to right. Thus, the interpretation of the character expression

$$'A' // 'BCD' // 'EF'$$

is a same as:

$$('A' // 'BCD') // 'EF'$$



The value of the above character expression is the same as the constant 'ABCDEF'.

Except in a character assignment statement, concatenation of an operand with an asterisk (\*) as its length specification is not allowed unless the operand is the symbolic name of a constant.

## Character Constant Expressions

A *character constant expression* is a character expression containing nothing that can vary. Each primary in a character constant expression must be either a character constant, the symbolic name of a character constant, or a character constant expression enclosed in parentheses. Variable, array element, substring, and function references are not allowed.

## Relational Expressions

A relational expression yields a logical value of either `.TRUE.` or `.FALSE.` upon evaluation and comparison of two arithmetic expressions or two character expressions. A relational expression may appear only within a logical expression.

## Relational Operators

The relational operators are:

<code>.EQ.</code>	Equal to
<code>.NE.</code>	Not Equal to
<code>.GT.</code>	Greater than
<code>.GE.</code>	Greater that or equal to
<code>.LT.</code>	Less than
<code>.LE.</code>	Less than or equal to

The precedence among FORTRAN operators is such that arithmetic and character operators are evaluated *before* relational operators.

## Relational Operands

The operands of a relational operator may be arithmetic or character expressions. Two operands are required to form a relational of the following form:

*e1 relop e2*

where:

*e1* and *e2* are arithmetic or character expressions.

*relop* is the relational operator.

Note that *e1* and *e2* must be both arithmetic or both character.

## Evaluating Relational Expressions

Evaluation of a relational expression produces a result of type logical, with a value of `.TRUE.` or `.FALSE.`. The manner in which the expression is evaluated depends upon the data type of the operands.

## Arithmetic Relational Expressions

An arithmetic relational expression has the form:

$$e1 \text{ relop } e2$$

where:

*e1* and *e2* are each an integer, real, double precision, complex, or double complex expression.

*relop* is a relational operator.

Complex type operands are allowed only when the relational operator `.EQ.` or `.NE.` is used.

An arithmetic relational expression has the logical value `.TRUE.` only if the values of the operands satisfy the relation specified by the operator. Otherwise, the value is `.FALSE.` If the two arithmetic expressions *e1* and *e2* differ in type, the expression is evaluated as follows:

$$((e1) - (e2)) \text{ relop } 0$$

where the value 0 (zero) is of the same type as the expression  $((e1) - (e2))$  and the type conversion rules apply to the expression. A double precision value must not be compared with a complex value.

## Character Relational Expressions

A character relational expression has the logical value `.TRUE.` only if the values of the operands satisfy the relation specified by the operator. Otherwise, the value is `.FALSE.` It has the following form:

$$e1 \text{ relop } e2$$

where *e1* and *e2* are character expressions and *relop* is a relational operator.

The result of a character relational expression depends on the collating sequence as follows.

- If *e1* and *e2* are single characters, their relationship in the collating sequence determines the value of the operator. *e1* is less than or greater than *e2* if *e1* is before or after *e2* respectively in the collating sequence.
- If either *e1* or *e2* are character strings with length greater than 1, corresponding individual characters are compared from left to right until a relationship other than `.EQ.` can be determined.
- If the operands are of unequal length, the shorter operand is extended on the right with blanks to the length of the longer operand for purpose of the comparison.
- If no other relationship can be determined after the strings are exhausted, the strings are equal.

The collating sequence depends partially on the processor; however, equality tests `.EQ.` and `.NE.` don't depend on the processor collating sequence and can be used on any processor.

## Logical Expressions

A logical expression specifies a logical computation which yields a logical value upon evaluation. The simplest form of a logical expression is a:

- Logical constant
- Logical variable reference
- Logical array element reference
- Logical function reference
- Relational expression

More complicated logical expressions are constructed from one or more logical operands together with logical operators and parentheses. Five logical operators are permitted in FORTRAN and are discussed in the next section.

## Logical Operators

The logical operators defined in FORTRAN are shown in the table below.

Operator	Function
<code>.NOT.</code>	Logical Negation
<code>.AND.</code>	Logical Conjunct
<code>.OR.</code>	Logical Disjunct
<code>.EQV.</code>	Logical Equivalence
<code>.NEQV.</code>	Logical exclusive OR
<code>.XOR.</code>	Same as <code>.NEQV.</code>

Only the logical negation operator `.NOT.` is used with one operand; all other logical operators require two operands.

When a logical expression contains two or more logical operators, the order in which the operands are combined is shown below, unless the order is changed by the use of parentheses.

Operator	Precedence
<code>.NOT.</code>	Highest
<code>.AND.</code>	•
<code>.OR.</code>	•
<code>.EQV., .NEQV., .XOR.</code>	Lowest

For example, in the expression

```
W .NEQV. X .OR. Y .AND. Z
```

The operators are executed in the following sequence:

- Y .AND. Z denote the result as A to yield W .NEQV. X .OR. A
- X .OR. A denote the result as B to yield W .NEQV.B
- W .NEQV.B gives the final result.

## Logical Operands

*Logical operands* specify values with a logical data type. The forms of a logical operand are:

- Logical primary
- Logical factor
- Logical term
- Logical disjunct
- Logical expression

The logical primary is the basic component of a logical expression. The forms of a logical primary are:

- Logical constant
- Symbolic name of a logical constant
- ~~Integer~~ or logical variable reference
- Logical array element reference
- ~~Integer~~ or logical function reference
- Relational expression
- ~~Integer~~ or logical expression in parentheses

When an integer appears as an operand to a logical operator, the other operand is promoted to type integer if necessary, and the operation is performed on a bit by bit basis producing an integer result. Whenever an arithmetic datum appears in a logical expression, the result of that expression will be of type integer due to the type promotion rules. After the result is computed, it may be converted back to LOGICAL if its usage requires.

Note that two logical operators may not appear in succession and that implied logical operators are not allowed.

The *logical factor* provides for the inclusion of the logical negation operator .NOT. and has the following forms:

- Logical primary
- .NOT. logical primary

The *logical term* uses the logical conjunct operator .AND. to combine logical factors. It takes the forms:

- Logical factor
- Logical term .AND. logical factor

In evaluating a logical term with two or more .AND. operators, the logical factors are combined from left to right. For example, X .AND. Y .AND. Z has the same interpretation as (X .AND. Y) .AND. Z.

The *logical disjunct* is a sequence of logical terms separated by the .OR. operator and has the following two forms:

- Logical term
- Logical disjunct .OR. logical term

In an expression containing two or more .OR. operators, the logical terms are combined from left to right in succession. For example, the expression X .OR. Y .OR. Z has the same interpretation as (X .OR. Y) .OR. Z.

At the highest level of complexity is the *logical expression*. A logical expression is a sequence of logical disjuncts separated by either the .EQV. , .XOR. , or .NEQV. operators. Its forms are:

- Logical disjunct
- Logical expression .EQV. logical disjunct
- Logical expression .NEQV. logical disjunct
- Logical expression .XOR. logical disjunct

The logical disjuncts are combined from left to right when a logical expression contains two or more .EQV. , .XOR. , or .NEQV. operators.

A logical constant expression is a logical expression in which each primary is either a logical constant, the symbolic name of a logical constant, a relational expression in which each primary is a constant, or a logical constant expression enclosed in parentheses. A logical constant expression may contain arithmetic and character constant expressions but not variables, array elements, or function references.

## Interpretation of Logical Expressions

In general, logical expressions containing two or more logical operators are executed according to the hierarchy of operators described previously, unless the order has been overridden by the use of parentheses. The form and interpretation of the logical operators is defined as shown in the following table:

IF		THEN				
$X_1 =$	$X \neq$	$\text{NOT } X_2$	$X_1 \text{ AND } X_2$	$X_1 \text{ OR } X_2$	$X_1 \text{ EQV } X_2$	$X_1 \text{ XOR } X_2$ $X \text{ NEQV } X_2$
.FALSE.	.FALSE.	.TRUE.	.FALSE.	.FALSE.	.TRUE.	.FALSE.
.FALSE.	.TRUE.	.FALSE.	.FALSE.	.TRUE.	.FALSE.	.TRUE.
.TRUE.	.FALSE.	-	.FALSE.	.TRUE.	.FALSE.	.TRUE.
.TRUE.	.TRUE.	-	.TRUE.	.TRUE.	.TRUE.	.FALSE.

## General Rules for Evaluating Expressions

Several rules are applied to the general evaluation of expressions. This section covers the priority of the different FORTRAN operators, the use of parentheses in specifying the order of evaluation, and the rules for combining operators with operands.

Note that any variable, array element, function, or character substring in an expression must be defined with a value of the correct type at the time it is referenced.

### Precedence of Operators

The precedence among arithmetic operators was given previously as:

Operator	Precedence
**	Highest
n * , /	Intermediate
n + , -	Lowest

The precedence among logical operators was given previously as:

Operator	Precedence
.NOT.	Highest
.AND.	•
.OR.	•
.EQV. } .NEQV. } .XOR. }	Lowest

No precedence exists among the relational operators, and there is only one character operator, // (concatenation).

The precedence among expression operators in each type is:

Type	Precedence
Arithmetic	Highest
Character	•
Relational	•
Logical	Lowest

### **Integrity of Parentheses and Interpretation Rules**

Parentheses are used to explicitly specify the order of evaluation of operators within an expression. Expressions within parentheses are treated as an entity.

In an expression containing more than one operation, the processor first evaluates expressions within parentheses. Subexpressions within parentheses are evaluated beginning with the innermost subexpression and proceeding sequentially to the outermost. The processor then scans the expression from left or right and performs the operations according to the operator precedence described previously.

**Overview**

Specification statements are nonexecutable FORTRAN statements that provide the processor information about the nature of specific data and the allocation of storage space for this data.

The specification statements are summarized below.

Statement	Purpose
AUTOMATIC, STATIC	Controls the allocation of storage to variables and the initial value of variables within called subprograms.
BLOCK DATA	First statement in a block data subprogram used to assign initial values to variables and array elements in named common blocks.
COMMON	Declares variables and arrays so that they are put in a storage area that is accessible to multiple program units, thus allowing program units to share data without using arguments.
DATA	Supplies initial values of variables, array elements, arrays, or substrings.
Data type	Explicitly defines the type of a constant, variable, array, external function, statement function, or dummy procedure name. Also, may specify dimensions of arrays and the length of the character data.



<b>Statement</b>	<b>Purpose</b>
DIMENSION	Specifies the symbolic names and dimension specifications of arrays.
EQUIVALENCE	Specifies the sharing of storage units by two or more entities in a program unit, thus associating those entities.
EXTERNAL	Identifies external or dummy procedure.
IMPLICIT	Changes or defines default implicit type of names.
INTRINSIC	Identifies intrinsic function or system subroutine.
NAMelist	Permits a group of variables or array names to be associated with a unique group name.
PARAMETER	Gives a constant a symbolic name.
POINTER	Establishes pairs of variables and pointers.
PROGRAM	Defines a symbolic name for the main program.
RECORD	Creates a record in the format specified by a previously declared STRUCTURE statement.
SAVE	Retains the values of variables and arrays after execution of a RETURN or END statement in a subprogram.
STRUCTURE	Defines a record structure that can be referenced by one or more RECORD statement.
VOLATILE	Prevents the compiler from optimizing specified variables, arrays, and common blocks of data.

Detailed descriptions of the above statements follow in alphabetical order.

## AUTOMATIC STATIC

### Use

The **STATIC** and **AUTOMATIC** keywords control, within a called subprogram, the allocation of storage to variables and the initial value of variables.

### Syntax

```
{STATIC | AUTOMATIC} v [,v] . . .
```

where *v* is the name of a previously declared variable, array, array declarator, symbolic constant, function, or dummy procedure.

### Method of Operation

The following table summarizes the difference between static and automatic variables upon entry and exit from a subprogram:

	<b>AUTOMATIC</b>	<b>STATIC</b>
<b>Entry</b>	Variables are unassigned. They do not reflect any changes caused in the previous execution of the subprogram.	Values of the variables in the subprogram are unchanged since the last execution of the subprogram.
<b>Exit</b>	The storage area associated with the variable is deleted.	The current values of the variable are retained in the static storage area.

**AUTOMATIC** variables have the following advantages:

- They permit the program to execute more efficiently by taking less space and reducing execution time.
- They permit recursion; a subprogram can call itself either directly or indirectly, and the expected values are available either upon a subsequent call or return to the subprogram.

## AUTOMATIC STATIC

### Rules for Use

1. By default, unless you specify the `-static` command line option (described in `f77(1)` in the *User's Reference Manual* and **Chapter 1** of the *FORTRAN Programmer's Guide*) all variables are **AUTOMATIC** *except* the following: initialized variables, common blocks and other equivalences to static data.
2. You can override the command line option in effect for specific variables by specifying as applicable the **AUTOMATIC** or **STATIC** keywords in the variable type statements, as well as in the **IMPLICIT** statement.
3. You cannot specify the **AUTOMATIC** or **STATIC** keywords in **EQUIVALENCE**, **DATA**, or **SAVE** statements. Any variable in these statements is **STATIC**, regardless of any previous **AUTOMATIC** specification.

### Example

```
REAL length, anet, total(50)
STATIC length, anet, total
COMPLEX i, B(20), J(2,3,5)
STATIC i
IMPLICIT INTEGER(f,m-p)
IMPLICIT STATIC (f,m-p)
```

---

## BLOCK DATA

### Use

First statement in a block data subprogram used to assign initial values to variables and array elements in named common blocks.

### Syntax

```
BLOCK DATA [sub]
```

where *sub* is a symbolic name of the block data subprogram in which the BLOCK DATA statement appears.

### Method of Operation

A block data subprogram is a nonexecutable program unit with a BLOCK DATA statement as its first statement, followed by a body of specification statements and terminated by an END statement. The specification statements allowed include: COMMON, DATA, DIMENSION, EQUIVALENCE, IMPLICIT, PARAMETER, RECORD, SAVE, structure declarations, and type statements. Comment lines are permitted.

Only entities in named common blocks or entities associated with an entity in a common block may be initially defined in a block data subprogram.

### Rules of Use

1. The optional name *sub* is a global name and must be unique. Thus, BLOCK DATA subprograms may have the same external name.
2. An executable program may contain more than one block data subprogram but may not contain more than one unnamed block data subprogram.
3. A single block data subprogram may initialize the entities of more than one named common block.

## COMMON

### Use

Declares variables and arrays so that they are put in a storage area that is accessible to multiple program units, thus allowing program units to share data without using arguments.

### Syntax

```
COMMON [/[cb]/] nlist [[,]/[cb]/ nlist] . . .
```

where *cb* is a common block name and *nlist* is a list of variable names, array names, array declarators, or records.

### Method of Operation

A storage sequence, composed of a series of storage units, that is shared between program units is referred to as common storage. For each common block, a common block storage sequence is formed consisting of the storage sequences of all entities in the list of variables and arrays for that common block. The order of the storage sequence is the same as their order of appearance in the list. In each COMMON statement, the entities specified in the common block list *nlist* following a block name *cb* are declared to be in common block *cb*.

In an executable program, all common blocks with the same name have the same first storage unit. This establishes the association of data values between program units.

The storage sequence formed above is extended to include all storage units of any storage sequence associated with it by equivalence association.

FORTTRAN has the following types of common storage:

- *Blank* common storage, which can be accessed by all program units in which it is declared. It has no identifying name and one blank common area exists for the complete executable program.
- *Named* common storage, which has an identifying name and is accessible by all program units in which common storage with the same name is declared.

Entities in a named common may be initially defined with the DATA initialization statement in a BLOCK DATA subprogram, but entities in blank common may *not* be initialized by the DATA statement.

## COMMON

The number of storage units needed to store a common block is referred to as its size. This includes any extensions of the sequence resulting from equivalence association. The size of a named common block must be the same in *all* program units in which it is declared. The size of blank common need *not* be the same size in all program units.

### Rules of Use

1. A variable name, array name, array declarator, or record may appear only once in all common block lists within a program unit.
2. A blank common block is specified by omitting the common block name *cb* for each list. Thus, if the first common block name is omitted, all entities appearing in the first *nlist* are specified to be in a blank common.
3. If the first *cb* is omitted, the first two slashes become optional. Two slashes with no block name between them declare the entities in the following list to be in blank common.
4. Any common block name *cb* or an omitted *cb* for blank common may occur more than once in one or more COMMON statements in a program unit. The list following each appearance of the same common block name is treated as a continuation of the list for that common block name.
5. All entities in a common block containing a character variable or character array must be of type character.

### Restrictions

1. Names of dummy arguments of an external procedure in a subprogram must not appear in a common block list.
2. A variable name that is also a function name must not appear in the list.

## COMMON

### Examples

```
COMMON //F,X,B(5)
COMMON F,X,B(5)
COMMON /LABEL/NAME,AGE,DRUG,DOSE//Y(33),
      Z,/RECORD/,DOC, 4 TIME(5), TYPE(8)
```

The first two examples are equivalent and define a blank common block (note that these two **COMMON** statements must not appear in the same program unit). The third example makes the following **COMMON** storage assignments:

1. **NAME**, **AGE**, **DRUG**, and **DOSE** are placed in common block **LABEL**.
2. **Y** and **Z** are placed in blank common.
3. **DOC**, **TIME**, and **TYPE** are placed in common block **RECORD**.

**COMMON**

The use of a COMMON statement by a subprogram and its calling program is:

```
c THIS PROGRAM READS VALUES AND PRINTS THEIR
c SUM AND AVERAGE
COMMON TOT, A(20), K, XMEAN
READ (5,10) K, (A(I), I = 1,K)
CALL ADD
WRITE (6,20) TOT, XMEAN
10 FORMAT (I5/F(10.0))
20 FORMAT (5X, 5HSUM =,2X,F10.4/5X,12HMEAN VALUE =,2X,F10.4)
STOP
END

c
c THIS SUBROUTINE CALCULATES THE SUM AND AVERAGE
c
SUBROUTINE ADD
COMMON PLUS, SUM(20), M, AVG
PLUS = SUM(1)
DO 5 I = 2,M
5 PLUS = SUM (I) + PLUS
AVG = PLUS/FLOAT(M)
END
```

Note that there are two COMMON statements: one in the calling program and one in the subroutine. Both define the same four entities in the COMMON even though each common statement uses a unique set of names. The calling program has access to COMMON storage through entities TOT, A, K and XMEAN. Subroutine ADD has access to the same common storage through the use of the entities PLUS, SUM, M, and AVG.



## DATA

### Use

Supplies initial values of variables, array elements, arrays, or substrings.

### Syntax

```
DATA nlist/clist/ [[ , ] nlist/clist/] . . .
```

where:

*nlist* is a list of variable names, array names, array element names, substring names or implied-DO lists (described later in this chapter).

*clist* is a list of the form:

$a$  [ $a$ ] . . .

where  $a$  has either of the forms:

$c$   
 $r*c$

$c$  is a constant or the symbolic name of a constant.

$r$  is a nonzero, unsigned integer constant or the symbolic name of a positive integer constant. The second form implies  $r$  successive appearances of the constant  $c$ .

### Method of Operation

In data initialization, the first value in *clist* is assigned to the first entity in *nlist*, the second value in *clist* to the second entity in *nlist*, and so on. There is a one-to-one correspondence between the items specified by *nlist* and the constants supplied in *clist*. Hence, each *nlist* and its corresponding *clist* must contain the same number of items and must agree in data type. If necessary, the *clist* constant is converted to the type or length of the *nlist* entity exactly as for assignment statements.

If the length of the character entity in *nlist* is greater than the length of its corresponding character constant in *clist*, then blank characters are added to the right of the character constant. But if the length of the character entity in *nlist* is less than that of its corresponding constant in *clist*, the extra rightmost characters in the constant are ignored; only the leftmost characters are stored. Each character constant initializes only one variable, array element, or substring.

## DATA

**NOTE:** As an enhancement to FORTRAN 77, an arithmetic or logical entity may be initially defined using a Hollerith constant for  $c$  in a *clist*, using the form:

$$nR \times 1 \ x_2 \ x_3 \ . \ . \ . \ x_n$$

where  $n$  is the number of characters  $x_n$  and  $x_1, x_2, x_3, \dots$  is the actual characters of the entity.

The value of  $n$  must be  $g$ , where  $g$  is the number of character storage units for the corresponding entity. If  $n < g$ , the entity is initially defined with the  $n$  Hollerith characters extended on the right with  $g - n$  blank characters. The compiler generates a warning message for data initializations of this type.

## Rules

1. Each *nlist* and its corresponding *clist* must have the same number of items and must correspond in type when either is LOGICAL or CHARACTER. If either is of arithmetic type, then the other must be of arithmetic type.
2. If an unsubscripted array name is specified in *nlist*, the corresponding *clist* must contain one constant for each element of the array.
3. If two entities are associated in common storage, only one can be initialized in a DATA statement.
4. Names of entities in named common blocks may appear in *nlist* only within a BLOCK DATA subprogram.
5. Each subscript expression in *nlist* must be an integer constant expression, except for implied-DO variables.
6. Each substring expression in *nlist* must be an integer constant expression.
7. A numeric value can be used to initialize a character variable or element. The length of that character variable or array element must be one, and the value of the numeric initializer must be in the range 0 through 255.
8. An untyped hexadecimal, octal, or binary constant can be used to initialize a variable or array element. If the number of bits defined by the constant is less than the storage allocation for that variable or array element, then leading zeros are assumed. If the number of bits exceed the number of bits of storage available for the variable or array element, then the leading bits of the constant are truncated accordingly.
9. A Hollerith constant can be used to initialize a numeric variable or array element. The rules for Hollerith assignment apply.

## DATA

### Restrictions

1. The list *nlist* must not contain names of dummy arguments, functions, and entities in blank common, or those associated with entities in blank common.
2. A variable, array element, or substring must not be initialized more than once in an executable program.
3. If a data statement accesses variables in a common block, only one data statement in the executable can access that common block.

### Example

```

REAL          A(4), B
LOGICAL       T
COMPLEX       C
INTEGER       P, K(3), R
CHARACTER*5   TEST(4)
PARAMETER     (P=3)
DATA A, B/0., 12, 5.12E5, 0., 6/, T/.TRUE./,
5 C/(7.2, 1.234)/, K/P*0/, TEST/3*'MAYBE', 'DONE?'/

```

The DATA statement above defines the variables declared immediately preceding it as follows:

```

A(1) = .0E+00  A(2) = .12E+02
A(3) = .SIZE6  A(4) = .0E+00
B = 6
T = .TRUE.
C = (.72E+01, .1234+01)
K(1) = 0  K(2) = 0  K(3) = 0
TEST(1) = 'MAYBE'  TEST(2) = 'MAYBE'
TEST(3) = 'MAYBE'  TEST(4) = 'DONE?'

```

The following gives examples of implied-DO statements used with a DATA statements:

```

DATA LIMIT /1000/, (A(I), I= 1,25)/25*0/
DATA ((A(I,J), J = 1,5), I = 1,10)/50*1.1/
DATA (X(I,I), I = 1,100) /100 * 1.1/
DATA ((A(I,J), J = 1,I), I =
1,3)/11,21,22,31,32,33/

```

## Data Type Statements (numeric)

### Numeric Data Types

#### Use

Overrides implicit typing or explicitly defines the type of a constant, variable, array, external function, statement function, or dummy procedure name. Also, may specify dimensions of arrays.

#### Syntax

```
type v [*len] [/clist/] [, v [*len] [/clist/]]
```

*type* is one of the keywords shown in the following table:

Type Keywords	
INTEGER	COMPLEX
INTEGER*1	DOUBLE COMPLEX
BYTE	COMPLEX*8
INTEGER*2	COMPLEX*16
INTEGER*4	
LOGICAL	REAL
LOGICAL*1	REAL*4
LOGICAL*2	REAL*8
LOGICAL*4	REAL*16
	DOUBLE PRECISION

*v* is a variable name, array name, array declarator, symbolic name of a constant, function name, or dummy procedure name.

*len* is one of the acceptable lengths for the data type being declared; *len* is one of the following: an unsigned, nonzero, integer constant; a positive valued integer constant expression enclosed in parentheses; or an asterisk enclosed in parentheses (\*). If the type being declared is an array, *len* follows immediately after the array name.

*clist* *clist* is a list of values bounded by slashes; the value becomes the initial value of the type being declared.

**NOTE:** When a REAL\*16 declaration is encountered, the compiler issues a warning message. REAL\*16 items are allocated 16 bytes of storage per element, but only the first eight bytes of each element are used; those eight bytes are interpreted according to the format for REAL\*8 floating numbers.

## Data Type Statements (numeric)

**NOTE:** The following pairs of keywords are synonymous:

BYTE and INTEGER\*1  
 REAL and REAL\*4,  
 DOUBLE PRECISION and REAL\*8,  
 COMPLEX and COMPLEX\*8  
 DOUBLE COMPLEX and COMPLEX\*16  
 LOGICAL and LOGICAL\*4

See **Chapter 2** of the *FORTRAN Programmer's Guide* for information on the alignment, size, and value ranges of these data types.

### Method of Operation

The symbolic name of an entity in a type statement establishes the data type for that name for all its subsequent appearances in the program unit in which it is declared.

The *type* specifies the data type of the corresponding entities. That is, the INTEGER statement explicitly declares entities of type integer and overrides implicit typing of the listed names. The REAL statement specifies real entities, the COMPLEX statement specifies complex entities, and so on.

### Rules for Use

1. Type statements are optional, and must be placed in the beginning of a program unit, but can be preceded by an IMPLICIT statement.
2. Symbolic names, including those declared in type statements, have the scope of the program unit in which they are included.
3. More than one type statement beginning with the same keyword may be included in the program unit.
4. A symbolic name must not have its type explicitly specified more than once within a program unit.
5. The name of a main program, subroutine, or block data subprogram must not appear in a type statement.
6. The compiler provides a DOUBLE COMPLEX version of the following functions:

Name	Purpose
dcmplx	Explicit type conversion
dconjg	Complex conjugate
dimag	Imaginary part of complex argument
zabs	Complex absolute value

## Data Type Statements (numeric)

7. The `-i2` compiler option (see `f77(1)` in the *Programmer's Reference Manual* or **Chapter 2** of the *FORTRAN Programmer's Guide*) causes the following to take place:

### Examples

```
REAL length, anet, TOTAL(50)
INTEGER hour, sum(5:15), first, uvr(4,8,3)
LOGICAL bx(1:15,10), flag, stat
COMPLEX I, B(20), J(2,3,5)
```

The example above declares that:

1. `length` and `anet` are names of type real. The specification of `anet` confirms implicit typing using the first letter of the name and could have been omitted in the REAL statement.
2. `total` is a real array.
3. `hour` and `first` are integer names. `uvr` and `sum` are integer arrays, and illustrate the use of the type statement to specify the dimensions of an array. Note that when an array is dimensioned in a type statement, a separate DIMENSION statement to declare the array is not permitted.
4. `flag` and `stat` are logical variables; `bx` is a logical array.
5. `I` is a complex variable; `B` and `J` are complex arrays.

## Data Type Statements (character)

### Use

Declares the symbolic name of a constant, variable, array, external function, statement function, or dummy procedure name and specifies the length of the character data.

### Syntax

```
CHARACTER [*len [,]] nam [,nam] . . .
```

where:

*len* is a length specification that gives the length, in number of characters, of a character variable, character array element, character constant, or character function. *len* is one of the following:

- An unsigned, nonzero, integer constant
- A positive valued integer constant expression enclosed in parentheses
- An asterisk enclosed in parentheses (\*)

*nam* is one of the following:

*v* [\**len*]

*v* is a variable name, symbolic name of a constant, function name, or dummy procedure name.

*a* [(*d*)] [\**len*]

*a*(*d*) is an array declarator.

### Rules for Use

1. The length specification *len* that follows the keyword CHARACTER denotes the length of each entity in the statement that does not have its own length specification.
2. A length specification immediately following an entity applies only to that entity. When an array is declared, the length specified applies to each array element.
3. If no length specification is given, a length of one is assumed.
4. The length specifier of (\*) can be used only for names of external functions, dummy arguments of an external procedure, and character constants.

## Data Type Statements (character)

- For a character constant, the (\*) denotes that the length of the constant is determined from the length of the character expression given in the PARAMETER statement.
  - For a dummy argument of an external procedure, the (\*) denotes that the length of the dummy argument is the length of the actual argument when the procedure is invoked. If the associated actual argument is an array name, the length of the dummy argument is the length of an element of the actual array.
  - For an external function name, the (\*) denotes that the length of the function result value and the local variable with the same name as the function entry name is the length that is specified in the program unit in which it is referenced. Note that the function name must be the name of an entry to the function subprogram containing *this* TYPE statement.
5. If an actual *len* is declared for an external function in the referencing program unit and in the function definition, *len* must agree with the length specified in the subprogram that specifies the function. If not, then the function definition must use the asterisk (\*) as covered previously, but the actual *len* in the referencing unit must not be (\*).
  6. The length specified for a character statement function or statement function dummy argument of type character must be an integer constant expression.

### Example

```
CHARACTER name*40, gender*1, pay(12)*10
```

In the above example:

1. *name* is a character variable of length forty.
2. *gender* has a length of one.
3. *pay* is a character array with 12 elements, each of which is 10 characters in length.



**DIMENSION****Use**

Specifies the symbolic names and dimension specifications of arrays.

**Syntax**

```
DIMENSION a(d) [, a(d)] ...
```

where  $a(d)$  is an array declarator.

To be compatible with PDP-11 FORTRAN, the VIRTUAL statement is a synonym for the DIMENSION statement, and carries the identical meaning.

**Method of Operation**

A symbolic name  $x$  appears in a DIMENSION statement causing an array  $x$  to be declared in that program unit.

**Rules for Use**

1. The dimension specification of an array can appear only once in a program unit.
2. The name of an array declared in DIMENSION statement may appear in a type statement or a COMMON statement without dimensioning information.

**Examples**

```
DIMENSION z(25), a(6,6), ams(2,5,5)
```

The DIMENSION statement declares  $z$  as an array of 25 elements,  $a$  as an array of 36 elements (6x6), and  $ams$  as an array of 50 elements (2x5x5).

---

## EQUIVALENCE

### Use

Specifies the sharing of storage units by two or more entities in a program unit thus associating those entities. This allows the same information to be referenced by different names in the same program unit.

### Syntax

```
EQUIVALENCE (nlist) [, (nlist)] ...
```

where *nlist* is a list of variable names, array element names, array names, and character substring names.

### Method of Operation

An EQUIVALENCE statement specifies that the storage sequences of the entities in the list have the same first storage unit. This causes association of the entities in the list or of other elements as well. The EQUIVALENCE statement only provides association of storage units and does not cause type conversion or imply mathematical equivalence. Thus, if a variable and an array are equivalenced, the variable does not assume array properties and vice versa.

Character entities may be associated by equivalence only with other character entities. The character entities may be specified as character variables, character array names, character array element names, and character substring names. Association is made between the first storage units occupied by the entities appearing in the equivalence list of an EQUIVALENCE statement. This statement may cause association of other character elements as well. The lengths of the equivalenced character entities are not required to be equal.

Variables and arrays may be associated with entities in common storage. The result may be to lengthen the common block. However, association through the use of the EQUIVALENCE statement must not cause common storage to be lengthened by adding storage units before the first storage unit in the common block.

### Rules of Use

1. Each subscript expression or substring expression in an equivalence list must be an integer constant expression.
2. If an array element name is specified in an EQUIVALENCE statement, the number of subscript expressions must be the same as the number of dimensions declared for that array.
3. An array name without a subscript is treated as an array element name that identifies the first element of the array.

## EQUIVALENCE

4. Multidimensional array elements may be referred to in an EQUIVALENCE statement with only one subscript. The compiler considers the array to be one-dimensional according to the array element ordering of FORTRAN. Consider the following example:

```
DIMENSION a(2,3), b(4:5,2:4)
```

The following shows a valid EQUIVALENCE statement using the arrays *a* and *b*:

```
EQUIVALENCE (a(1,1), b(4,2))
```

The following example achieves the same effect:

```
EQUIVALENCE (a(1), b(4))
```

The lower bound values in the array declaration are always assumed for missing subscripts (in the above example, 1 through 3 for array *a* and 2 through 4 for array *b*).

## Restrictions

1. Names of dummy arguments of an external procedure in a subprogram must not appear in an equivalence list.
2. A variable name that is also a function name must not appear in the list.
3. A storage unit can appear in no more than one EQUIVALENCE storage sequence.
4. An EQUIVALENCE statement must not specify that consecutive storage units are to occupy nonconsecutive storage positions.
5. An EQUIVALENCE statement must not specify that a storage unit in one common block be associated with any storage unit in a *different* common block.

## Example 1

```
DIMENSION M(3,2), P(6)
EQUIVALENCE (M(2,1), P(1))
```

The following figure shows the logical representation in storage caused by the above two statements:

## EQUIVALENCE

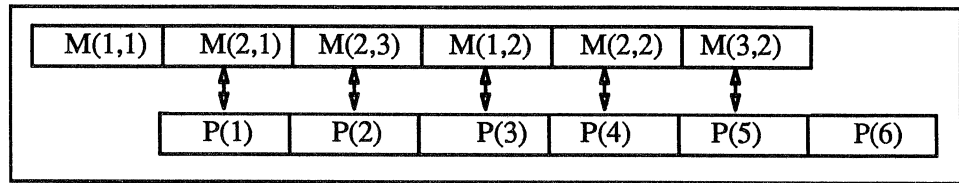

## Example 2

```
CHARACTER ABT*6, BYT(2)*4, CDT*3
EQUIVALENCE (ABT, BYT(1)), (CDT, BYT(2))
```

The following figure shows the logical representation in storage caused by the above two statements:

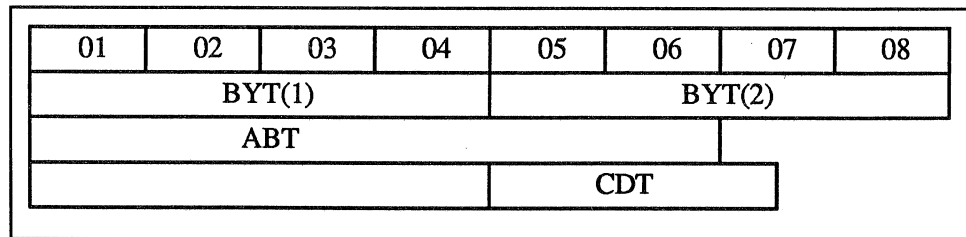

The following examples using EQUIVALENCE statements are invalid:

```
REAL A(2)
DOUBLE PRECISION S(2)
EQUIVALENCE (A(1), S(1)), (A(2), S(2))
```

This specifies that consecutive storage units are to occupy nonconsecutive storage positions. Note that a double precision variable occupies two consecutive numeric storage units in a storage sequence.

**Purpose**

Identify external or dummy procedure.

**Use**

Specifies that a symbolic name represent an external procedure or a dummy procedure. This allows that name to be used as an actual argument in a program unit.

**Syntax**

```
EXTERNAL proc [,proc] ...
```

where *proc* is a name of an external procedure or dummy procedure.

**Rules for Use**

1. An external procedure name or a dummy procedure name must appear in an EXTERNAL statement in the program unit, if the name is to be used as an actual argument in that program unit.
2. If an intrinsic function name appears in an EXTERNAL statement, indicating the existence of an external procedure having that name, the intrinsic function is not available for use in the same program unit in which the EXTERNAL statement appears.
3. A symbolic name must appear only once in all of the EXTERNAL statements of a program unit.
4. A `NOF77` qualifier in an `OPTIONS` statement or the `—nof77` command line option permits the following:
  - Intrinsic function names can appear in the list of subprograms in an EXTERNAL statement.
  - An asterisk (\*) can precede program names listed in an EXTERNAL statement. This indicates that a user-supplied function has the same name as a FORTRAN intrinsic function and that the user-supplied function is to be invoked.

## EXTERNAL

### Restrictions

A statement function name must not appear in an EXTERNAL statement.

### Example

Consider the following statements:

```
EXTERNAL G  
CALL SUB1 (X, Y, G)
```

and the corresponding subprogram:

```
SUBROUTINE SUB1 (RES, ARG, F)  
RES = F (ARG)  
END
```

The dummy argument F in subroutine SUB1 is the name of another subprogram; in this case, the external function G.

**Use**

Changes or defines default implicit type of names.

**Syntax 1**

```
IMPLICIT typ (a[,a]...) [,typ(a[,a]...)]...
```

where:

*type* is one of the keywords shown in the following table:

Type Keywords		
INTEGER	COMPLEX	CHARACTER
INTEGER*1	DOUBLE COMPLEX	
BYTE	COMPLEX*8	
INTEGER*2	COMPLEX*16	
INTEGER*4		
LOGICAL	REAL	
LOGICAL*1	REAL*4	
LOGICAL*2	REAL*8	
LOGICAL*4	DOUBLE PRECISION	

*a* is either a single *alphabetic* character or a range of letters in alphabetical order. A range of letters is specified as *l1 – l2*, where *l1* and *l2* are the first and last letters of the range, respectively.

*len* is a length specification that gives the length, in number of characters, of a character variable, character array element, character constant, or character function. *len* is one of the following:

- An unsigned, nonzero, integer constant
- A positive valued integer constant expression enclosed in parentheses

If *len* is not specified, the value of *len* is 1.

**Method of Operation — Syntax 1**

An IMPLICIT statement specifies a type for all variables, arrays, external functions, and statement functions for which no type is explicitly specified by a type statement. If a name has not appeared in a type statement, then its type is *implicitly* determined by the first character of its name. The IMPLICIT statement establishes which data type (and length) will be used for the indicated characters.

## IMPLICIT

By default, names beginning with the alphabetic characters A through H or O through Z are implicitly typed REAL; names beginning with I, J, K, L, M, or N are implicitly typed INTEGER. The IMPLICIT statement can be used to change the type associated with any individual letter or range of letters.

An IMPLICIT statement applies only to the program unit that contains it and is overridden by a type statement or a FUNCTION statement in the same subprogram.

### Syntax 2

```
IMPLICIT {AUTOMATIC|STATIC} (a[,a]...)  
[typ(a[,a]...)]...
```



### Method of Operation — Syntax 2

An **AUTOMATIC** or **STATIC** keyword in an **IMPLICIT** statement causes all associated variables to be assigned automatic or static storage characteristics. See the description of the **AUTOMATIC** and **STATIC** statements earlier in this chapter for information on their function. An example using these keywords is also given.

### Syntax 3

```
IMPLICIT {UNDEFINED | NONE}
```

**NOTE:** **UNDEFINED** and **NONE** are synonyms; each performs the same function, which is described in the next section.

### Method of Operation — Syntax 3

When a type isn't declared explicitly for a variable, the implicit data typing rules cause a default type of **INTEGER** to apply if the first letter of the variable is *i*, *j*, *k*, *l*, *m*, or *n*; or **REAL**, if the first letter is any other alphabetic character.

The compiler permits you, using either the *implicit undefined* or *implicit none* statement or the **—u** command line option, to turn off the implicit data typing.

Using Syntax 3 of the **IMPLICIT** statement within a program allows you to override the default assignments given to individual characters; the **—u** command line option (see **Chapter 1** of the *FORTRAN Programmer's Guide*) overrides the default assignments for all alphabetic characters.

The following example

```
IMPLICIT UNDEFINED
```

turns off the implicit data typing rules for all variables. The example has the same effect as specifying the **—u** command line option.

**IMPLICIT****Rules for Use — All Syntaxes**

1. IMPLICIT statements must precede all other specification statements except PARAMETER statements.
2. Multiple IMPLICIT statements are allowed in a program unit.
3. IMPLICIT statements cannot be used to change the type of a letter more than once inside a program unit. Since letters can be part of a range of letters as well as single, ranges of letters must not overlap.
4. Lower- and upper-case alphabetic characters are *not* distinguished. Implicit type is established for *both* the lower- and upper-case alphabetic characters or range of alphabetic characters regardless of the case of *l1* and *l2*.
5. The `-u` command line option turns off all default data typing and any data typing explicitly specified by an IMPLICIT statement.

**Examples**

```

IMPLICIT NONE
IMPLICIT INTEGER (F,M-P)
IMPLICIT STATIC (F,M-P)
IMPLICIT REAL (B,D)
INTEGER bin, dale

```

The example above declares that:

1. All variables with names beginning with the letters F(f), M(m), N(n), O(o), or P(p) are of type INTEGER and are assigned the **STATIC** attribute.
2. All variables with names beginning with the letter b or d are of type REAL, except for variables bin and dale only, which are explicitly defined as type INTEGER.

The following four IMPLICIT statements are equivalent:

```

IMPLICIT CHARACTER (g - k)
IMPLICIT CHARACTER (g - K)
IMPLICIT CHARACTER (G - k)
IMPLICIT CHARACTER (G - K)

```

## INTRINSIC

### Purpose

Identify intrinsic function or system subroutine.

### Use

Identifies a symbolic name as being the name of an intrinsic function or a system subroutine. The name of an intrinsic function can be used as an actual argument.

### Syntax

```
INTRINSIC func [, func] ...
```

where *func* is a name of intrinsic functions.

### Rules for Use

1. The name of every intrinsic function or system subroutine used as an actual argument must appear in an INTRINSIC statement in that program unit.
2. A symbolic name may appear only once in all of the INTRINSIC statements of a program unit.

### Restrictions

1. A name may not appear in both INTRINSIC and EXTERNAL statements in the same program unit.
2. A name must appear only once in all of the INTRINSIC statements of a program unit.
3. The names of intrinsic functions which perform type conversion, test lexical relationship, or choose smallest/largest value cannot be passed as actual arguments. These functions include the conversion, maximum value, and minimum value functions listed in **Appendix A**.

### Examples

Consider the following statements:

```
INTRINSIC ABS  
CALL ORD (ABS, ASQ, BSQ)
```

and its corresponding subprogram:

```
SUBROUTINE ORD (FN, A, B)  
A = FN (B)  
RETURN  
END
```

In the above example, the INTRINSIC statement allows the name of the intrinsic function ABS (for obtaining the absolute value) to be passed to subprogram ORD.

**NAMelist****Use**

Permits a group of variables or array names to be associated with a unique group name in a namelist-directed I/O statement.

**Syntax**

```
NAMelist /group-name/namelist[, ] /group-
name/namelist...
```

where *group-name* is the name to be associated with the variables or array names defined in *namelist*. Each item in *namelist* must be separated by a comma.

**Rules of Use**

1. The items in *namelist* are read or written in the order they are specified in the list.
2. The items can be of any data type, which can be specified either explicitly or implicitly.
3. The following items are not permitted in *namelist*:
  - Dummy arguments
  - Array elements, character substrings, records, and record fields

See also the description of the READ and WRITE statements in Chapter 8 for more information on *namelist* directed I/O.

**Examples**

```
NAMelist /input/ item, quantity /output/ item, to-
tal
```

In the above example, *input*, when specified to namelist-directed I/O statement, refers to *item* and *quantity*; likewise, *output* refers to *item* and *total*.

## PARAMETER

### Use

Gives a constant a symbolic name.

### Syntax

#### Format 1

```
PARAMETER (p=e [,p=e] ...)
```

#### Format 2

```
PARAMETER p=e [,p=e] ...
```

where  $p$  is a symbolic name and  $e$  is a constant, constant expression, or the symbolic name of a constant.

### Method of Operation

The value of the constant expression  $e$  is given to the symbolic name  $p$ . The statement defines  $p$  as the symbolic name of the constant. The value of the constant is the value of the expression  $e$  after conversion to the type of the name  $p$ . The conversion, if any, follows the rules for assignment statements.

Format 1, which has bounding parentheses, causes the symbolic name to be typed either of the following ways:

- according to a previous explicit type statement or
- if no explicit type statement exists, the name is typed according to its initial letter and the implicit rules in effect. See the description of the IMPLICIT statement in this chapter for details.

Format 2, which has no bounding parentheses, causes the symbolic name to be typed by the form of the actual constant which it represents. The initial letter of the name and the implicit rules do not affect the data type.

A symbolic name in a PARAMETER statement has the scope of the program unit in which it was declared.

### Rules for Use

1. If  $p$  is of type integer, real, double precision, or complex, then  $e$  must be an arithmetic constant expression.

## PARAMETER

2. If  $p$  is of type character or logical, then  $e$  must be a character constant expression or a logical constant expression, respectively.
3. If a named constant is used in the constant expression  $e$ , it must be previously defined in the same PARAMETER or a preceding PARAMETER statement in the same program unit.
4. A symbolic name of a constant must be defined only once in a PARAMETER statement within a program unit.
5. The data type of a named constant must be specified by a type statement or IMPLICIT statement prior to its first appearance in a PARAMETER statement, if a default implied type is not to be assumed for that symbolic name.
6. Character symbolic named constants must be specified as character type in a CHARACTER statement, or the first letter of the name must appear in an IMPLICIT statement with the type CHARACTER. Specification must be made prior to the definition of the name in the PARAMETER statement.
7. Once a symbolic name is defined, it can be used as a primary in any subsequent expressions or DATA statements in that program unit.
8. The functions IAND, IOR, NOT, Ieor, ISHFT, LGE, LGT, LLE, and LLT with constant operands can be specified in a logical expression.
9. The function CHAR with a constant operand can be specified in a character expression.
10. The functions MIN, MAX, ABS, MOD, ICHAR, NINT, DIM, DPROD, CMPLX, CONJG, and IMAG with constant operands can be specified in arithmetic expressions.
11. Symbolic names cannot be used to specify the character count for Hollerith constants.
12. Symbolic constants can appear in a FORMAT statement only within the context of a general expression bounded by angled brackets:  $\langle \rangle$ .
13. Symbolic constants cannot appear as part of another constant except when forming the real or imaginary part of a complex constant.

## PARAMETER

### Restrictions

A constant and a symbolic name for a constant are generally not interchangeable. For instance, a symbolic name of an integer constant cannot be used as a length specification in a CHARACTER type statement without enclosing parentheses. For instance, CHARACTER\*(I) is valid, but CHARACTER\*I is not.

However, a symbolic name of a constant can be used to form part of another constant, such as a complex constant, by using an intrinsic function as shown below:

```
complex c
real r
parameter (r=2.0)
parameter (c=cmplx(1.0,r))
```

### Examples

```
REAL X
PARAMETER (X = 1)
```

The example above declares that:

1 is converted to 1E0, making X the name of a REAL constant.

```
INTEGER I
PARAMETER (I = 3.14)
```

3.14 is converted to 3, making I the name of an INTEGER constant.

In the following example, *interest\_rate* is assigned the constant value of .087769.

```
REAL*4 interest_rate
PARAMETER (interest_rate = .087769)
```

The same result could be achieved using Format 2 as follows:

```
PARAMETER interest_rate = .087769
```

**POINTER****Use**

Establishes pairs of variables and pointers, where each pointer contains the address of its paired variable.

**Syntax**

```
POINTER (p1, v1) [, (p2, v2) ...]
```

where *v1, v2* are pointer-based variables, and *p1, p2* are the corresponding pointers. The pointer *integers* are automatically typed that way by the compiler. The pointer-based variables can be of any type, including structures. Even if there is a size specification in the type statement, no storage is allocated when such a pointer-based variable is defined.

**Rules for Use**

1. Once you have defined a variable as based on a pointer, you must assign an address to that pointer. You then reference the pointer-based variable with standard FORTRAN, and the compiler does the referencing by the pointer. (Whenever your program references a pointer-based variable, that variable's address is taken from the associated pointer.) It is your responsibility to provide an address of a variable of the appropriate type and size.
2. You must provide a memory area of the right size, and assign the address to a pointer, usually with the normal assignment statement or data statement since no storage is allocated when a pointer-based variable is defined.

**Restrictions**

1. A pointer-based variable cannot be used as a dummy argument or in COMMON, EQUIVALENCE, DATA, or NAMELIST statements.
2. A pointer-based variable cannot itself be a pointer.
2. The dimension expressions for pointer-based variables must be constant expressions in main programs. In subroutines and functions, the same rules apply for pointer-based variables as for dummy arguments. The expression can contain dummy arguments and variables in COMMON. Any variables in the expressions must be defined with an integer value at the time the subroutine or function is called.



## POINTER

### Example

```
pointer (ptr,v) (ptr2,v2)
character a*12, v*12, z*1, v2*12
data a/'abcdefghijkl' /
ptr = loc(a)
ptr = ptr +4
ptr2 = malloc(12)
v2 = a
z = v(1:1)
print *, z
z = v2(5:5)
print *, z
call free(ptr2)
end
```

## PROGRAM

### Use

Defines a symbolic name for the main program.

### Syntax

```
PROGRAM pgm
```

where *pgm* is a symbolic name of the main program, which must not be the name of an external procedure, block data subprogram, or common block, or a local name in the same program unit.

### Rules of Use

1. The PROGRAM statement is optional. However, it must be the first statement in the main program when used.
2. The symbolic name must be unique for that executable program. It must not be the name of any entity within the main program or any subprogram, entry, or common block.

## RECORD

### Use

Creates a record in the format specified by a previously declared `STRUCTURE` statement. The effect of a `RECORD` statement is comparable to that of an ordinary type declaration.

### Syntax

```
RECORD /structure-name/record-name[, record-name] [, record-name] ...
      [ /structure-name/record-name[, record-name] [, record-name] ... ] ...
```

where *structure-name* is the name of a previously declared structure (see the description of the `STRUCTURE` statement in this chapter) and *record-name* is a variable, an array, or an array declarator.

### Method of Operation

*record-name* can be used in `COMMON` and `DIMENSION` statements, but not in `DATA`, `EQUIVALENCE`, `NAMelist`, or `SAVE` statements. Record created by the `RECORD` statement are initially undefined unless the values are defined in the related structure declaration.

### Examples

```
STRUCTURE /weather/
  integer month, day, year
  character*40 clouds
  real rainfall
END STRUCTURE
RECORD /weather/ latest, past(1000)
```

The record *latest* has the format specified by the structure *weather*; *past* is an array of 1000 records, each record having the format of the structure *weather*.

Individual items in the structure can be referenced using *record-name* and the name of the structure item. For example,

```
past(n).rainfall = latest.rainfall
```

where *n* represents a number from 1 to 1000 specifying the target array element. See the description of the `STRUCTURE` statement for an example of declaring a structure format.

# SAVE

## Use

Retains the values of variables and arrays after execution of a RETURN or END statement in a subprogram. This allows those entities to remain defined for subsequent invocations of the subprogram.

## Syntax

```
SAVE [a[,a]. . .]
```

where *a* is one of the following:

- A variable or array name
- A common block name, preceded and followed by slashes

## Method of Operation

The SAVE statement prevents named variables, arrays, and common blocks from becoming undefined after the execution of a RETURN or END statement in a subprogram. Normally, all variables and arrays become undefined upon exit from a subprogram, except in the following cases:

- Entities specified by a SAVE statement
- Entities in blank common
- Entities in a named common that is declared in the subprogram and in a calling program unit in SAVE statements

All variables and arrays declared in the main program maintain their definition status throughout the execution of the program. If a local variable or array is not in a common block and is specified in a SAVE statement, it has the same value when the next reference is made to the subprogram.

All common blocks are treated as if they had been named in a SAVE statement. All data in any common block is retained on exit from a subprogram.

**NOTE:** Default SAVE status for common blocks is an enhancement to FORTRAN 77. In FORTRAN 77, a common block named without a corresponding SAVE statement causes the variables and arrays in the named common block to lose their definition status upon exit from the subprogram.

## SAVE

### Rules of Use

1. A SAVE statement without a list is treated as though all allowable entities from that program unit were specified on the list.
2. A SAVE statement may be placed in the main program but it has no effect.
3. A given symbolic name may appear in only one SAVE statement in a program unit.

### Restrictions

Procedure names and dummy arguments cannot appear in a SAVE statement. The names of individual entries in a common block are not permitted in a SAVE statement.

### Examples

```
SAVE L, V  
SAVE /DBASE/
```

**STRUCTURE****Use**

Defines a record structure that can be referenced by one or more RECORD statement.

**Syntax (General)**

```
STRUCTURE [/structure-name/] [field-names]
    [field-definition]
    [field-definition] . . .
END STRUCTURE
```

where:

*structure-name* is a name used to identify the structure in a subsequent RECORD statement. Substructures can be established within a structure by means of either a nested STRUCTURE declaration or a RECORD statement.

*field-names* For substructure declarations only. One or more names having the structure of the substructure being defined.

*field-definition* can be one or more of the following:

- typed data declarations, which may optionally include one or more data initialization values.
- substructure declarations (defined by either RECORD statements or subsequent STRUCTURE statements)
- UNION declarations, which are mapped fields defined by a block of statements. The syntax of a UNION declaration is described on the next page.
- PARAMETER statements, which do not affect the form of the structure.

## STRUCTURE

### UNION Declaration Syntax

```
UNION
  MAP
    [field-definition] [field-definition] ...
  END MAP
  MAP
    [field-definition] [field-definition] ...
  END MAP
  [MAP
    [field-definition] [field-definition] ...
  END MAP] . . .
END UNION
```

A UNION declaration is enclosed between UNION and END UNION statements, which contain two or more map declarations. Each map declaration is enclosed between MAP and END MAP statements.

### Method of Operation

1. Typed data declarations (variables or arrays) in structure declarations have the form of normal FORTRAN typed data declarations. Data items with different types can be freely intermixed within a structure declaration.
2. Unnamed fields can be declared in a structure by specifying the pseudo-name %FILL in place of an actual field name. You can use this mechanism to generate empty space in a record for purposes such as alignment.
3. All mapped field declarations that are made within a UNION declaration share a common location within the containing structure. When initializing the fields within a UNION, the final initialization value assigned overlays any value previously assigned to a field definition that shares that field.

## STRUCTURE

## Examples (General)

```

STRUCTURE /weather/
  integer month, day, year
  character*20 clouds
  real rainfall
END STRUCTURE
RECORD /weather/ latest

```

In the above example, the STRUCTURE statement produces the following storage mapping for the *latest* specification in the RECORD statement:

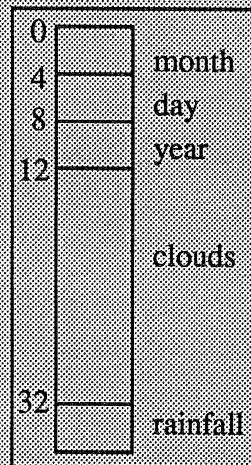

The following gives an example of initializing the fields of a within a structure definition block:

```

program weather
structure /weather/
  integer*1 month / 08 /, day / 10 /, year / 89 /
  character*20 clouds /' overcast' /
  real rainfall / 3.12 /
end structure
record /weather/ latest
print *,latest.month,latest.day, latest.year,latest.clouds,latest.rainfall
end

```

The above example prints on the following:

```

      8    10    89 overcast           3.120000

```



## STRUCTURE

### Examples (UNION)

```
program WriteDate
  structure /start/
    union
      map
        character*2 month
        character*2 day
        character*2 year
      end map
      map
        character*6 date
      end map
    end union
  end structure
  record /start/ sdate
  sdate.month = '08'
  sdate.day = '10'
  sdate.year = '89'
  write (*,10) sdate.date
10 format (A)
  stop
end
```

This example causes the following text to be written to the standard input/output device:

```
081089
```

**VOLATILE****Use**

Prevents the compiler from optimizing specified variables, arrays, and common blocks of data.

**Syntax**

```
VOLATILE volatile-items
```

where *volatile-items* is one or more names of variables, common blocks, or arrays. When two or more names are specified, each of the *volatile-items* must be separated by a comma.

For more information on optimization, refer to the *Languages Programmer's Guide* and the F77(1) manual page in the *User's Reference Manual*.



## Overview

Assignment statements assign values to variables and array elements. Five types of assignment statements are included in FORTRAN:

- Arithmetic assignment
- Logical assignment
- Character assignment
- Statement label assignment

DATA statements, implied DO lists in DATA statements, and BLOCK DATA subprograms are closely related and can be used to initialize variables and array elements. BLOCK DATA subprograms are described in detail in Chapter 4.

## Arithmetic Assignment Statements

An arithmetic assignment statement assigns the value of an arithmetic expression to a variable or array element of type INTEGER, REAL, DOUBLE PRECISION, COMPLEX, or DOUBLE COMPLEX. The form of an arithmetic statement is:

$$v = e$$

where:

$v$  is a name of an integer, real, double precision, complex, or double complex type variable or array element.

$e$  is an arithmetic expression.

When an arithmetic assignment statement is executed, the expression  $e$  is evaluated and the value obtained replaces the value of the entity to the left of the equal sign.

Both  $v$  and  $e$  need not be of the same type; the value of the expression is converted to the type of the variable or array element specified. The type conversion rules are:

V Declaration	Function Equivalent
INTEGER	INT( $e$ )
REAL	REAL( $e$ )
DOUBLE PRECISION	DBLE( $e$ )
COMPLEX	CMPLX( $e$ )
DOUBLE COMPLEX	DCMPLX( $e$ )

Table 5.1 gives the detailed conversion rules for arithmetic assignment statements.

The functions in the second column of the table are intrinsic functions described in **Chapter 10** and **Appendix A**.

The following are examples of arithmetic assignment statements:

I = 4	Assign the value 4 to I
J = 7	Assign the value 7 to J
A = I*J+1	Assign the value 29 to A

Variable or Array Element (v)	Expression(e)		
	INTEGER or LOGICAL	REAL	REAL*8
INTEGER or LOGICAL	Assign e to v	Truncate e to integer and assign to v	Truncate e to integer and assign to v
REAL	Assign fraction (.0) to e and assign to v	Assign e to v	Assign high order portion of e to v; low order order portion of e is rounded
REAL*8	Append fraction (.0) to e and assign to v	Assign e to high order portion of v; low order portion of v is 0	Assign e to v
REAL*16	As above	As above	As above
COMPLEX	Append fraction (.0) to e and assign to real part of v; imaginary part of v is 0.0	Assign e to real part of v; imaginary part of v is 0.0	Assign high order portion of e to real part of v; low order portion of e is rounded; imaginary part of v is 0.0.
COMPLEX*16	Append fraction (.0) to e and assign to v; imaginary part of v is 0.0	Assign e to high order portion of real part of v; imaginary part of v is 0.0	Assign e to real part of v; imagi- nary part is 0.0

Table 5.1 (Part 1 of 2). Conversion Rules for Assignment Statements

Variable or Array Element (v)	Expression(e)		
	REAL*16	COMPLEX	COMPLEX*16
INTEGER or LOGICAL	Truncate e to integer and assign to v.	Truncate real part of e to integer and assign to v; imaginary part of e is not used.	Truncate real part of e to integer and assign to v; imaginary part of e is not used.
REAL	Assign high order portion of e to v; low order portion of e is rounded.	Assign real part of e to v; imaginary part of e is not used.	Assign high order portion of the real part of e to v; low order portion of the real part of e is rounded; imaginary part of e is not used.
REAL*8	As above.	Assign real part of e to high order portion of v; low order portion of v is 0; imaginary part of e is not used.	Assign real part of e to v; imaginary part of e is not used.
REAL*16	As above.	As above.	As above.
COMPLEX	Assign high order portion of e to real part of v; low order portion of e is rounded; imaginary part of v is 0.0.	Assign e to v.	Assign high order portion of real part of e to real part of v; low order portion of real part of e is rounded. Assign high order portion of imaginary part of e to imaginary part of v; low order portion of imaginary part of e is rounded.
COMPLEX*16	As above.	Assign real part of e to high order portion of v; low order portion of real part is 0. Assign imaginary part of e to high order portion of imaginary part of v; low order portion of imaginary part is 0.	Assign e to v.

Table 5.1 (Part 2 of 2). Conversion Rules for Assignment Statements

## Logical Assignment Statements

The logical assignment statement is used to assign the value of a logical expression to a logical variable or array element. It takes the form:

$$v = e$$

where  $v$  is a name of a logical variable or logical array element and  $e$  is a logical expression.

When a logical assignment statement is executed, the value of the logical expression  $e$  is evaluated and replaces the value of the logical entity to the left of the equal sign. The value of the logical expression is either true or false.

## Character Assignment

The character assignment statement is used to assign the value of a character expression to a character variable, array element, or substring. The form of a character assignment statement is:

$$v = e$$

where  $v$  is a name of a character variable, array element, or substring and  $e$  is a character expression.

During the execution of a character string assignment statement, the character expression is evaluated and the resultant value replaces the value of the character entity to the left of the equal sign. None of the character positions being defined in  $v$  may be referenced in the evaluation of the expression  $e$ .

The entity  $v$  and character expression  $e$  may have different lengths. If the length of  $v$  is greater than the length of  $e$ , then the value of  $e$  is extended on the right with blank characters to the length of  $v$ . If the length of  $e$  is greater than the length of  $v$ , then the value of  $e$  is truncated on the right to the length of  $v$ .

The following examples show character assignment:

```
CHARACTER U*5, V*5, W*7
U = 'HELLO'
V = 'THERE'
W(6:7) = V(4:5)
```

If assignment is made to a character substring, only the specified character positions are defined. The definition status of character positions not specified by the substring remain unchanged.



## Aggregate Assignment

An aggregate assignment statement assigns the value of each field of one aggregate to the corresponding field of another aggregate. The aggregates must be declared with the same structure. The form of an aggregate assignment statement is:

$$v = e$$

where  $v$  and  $e$  are aggregate references declared with the same structure. See the Records section and Record and Field References subsections in Chapter 2 for more information.

## Statement Label Assignment

The ASSIGN statement causes a statement label to be assigned to an integer variable and is used in conjunction with an assigned GOTO statement or an input/output statement. The form of a statement label assignment statement is:

```
ASSIGN  $s$  TO  $e$ 
```

where:

$s$  is a statement label of an executable statement or a FORMAT statement that appears in the same program unit as the ASSIGN statement.

$e$  is an integer variable name.

Statement label assignment by the ASSIGN statement is the only way of defining a variable with a statement label value. A variable defined with a statement label value may be used only in an assigned GOTO statement or as a format identifier in an input/output statement. The variable thus defined must not be referenced in any other way until it has been reassigned with an arithmetic value.

An integer variable that has been assigned a statement label value may be redefined with the same statement label, a different statement label, or as an arithmetic integer variable.

Examples using the ASSIGN statement are shown below.

**Example 1:**

```
ASSIGN 100 TO KBRNCH
      .
      .
      .
      GO TO KBRNCH
```

**Example 2:**

```
ASSIGN 999 TO IFMT
999   FORMAT (F10.5)
      .
      .
      .
      READ (*, IFMT) X
      .
      .
      .
      WRITE (*, FMT = IFMT) Z
```

## Data Initialization

Variables, arrays, array elements, and substrings can be initially defined using the DATA statement or an implied-DO list in a DATA statement. The BLOCK DATA subprogram is a means of initializing variables and arrays in named common blocks and is discussed in **Chapter 4**.

Entities not initially defined or associated with an initialized entity are undefined at the beginning of execution of a program. Uninitialized entities must be defined before they can be referenced in the program.

## Implied-DO

### Use

Initializes or assigns initial values to elements of an array.

### Syntax

```
(dlist, i = e1, e2 [, e3] )
```

where:

*dlist* is a list of array element names and implied-DO lists.

*i* is a name of an integer variable, referred to as the *implied-DO variable*. It is used as a control variable for the iteration count.

*e1* is an integer constant expression specifying an initial value.

*e2* is an integer constant expression specifying a limit value.

*e3* is an integer constant expression specifying an increment value.

*e1*, *e2*, and *e3* are as defined in DO statements.

### Method of Operation

An iteration count and the values of the implied-DO variable are established from *e1*, *e2*, and *e3* exactly as for a DO-loop, except that the iteration count must be positive.

When an implied-DO list appears in a DATA statement, the *dlist* items are specified once for each iteration of the implied-DO list with the appropriate substitution of values for any occurrence of the implied-DO variable. The appearance of an implied-DO variable in an implied-DO has no effect on the definition status of that variable name elsewhere in the program unit. For an example of a implied-DO list, see the DATA section in Chapter 4.

The *range* of an implied-DO list is *dlist*.

### Rules

The integer constant expressions used for *e1*, *e2*, and *e3* may contain implied-DO variables of other implied-DO lists.

Any subscript expression in the list *dlist* must be an integer constant expression. The integer constant expression may contain implied-DO variables of implied-DO lists that have the subscript expression within their range.

## Control Statements

Control statements affect the normal sequence of execution in a program unit. They are described in alphabetical order in this chapter and summarized below.

Command	Purpose
CALL	References a subroutine subprogram in a calling program unit.
CONTINUE	Has no operational function; usually serves as the terminal statement of a DO-loop.
DO	Specifies a controlled loop, called a DO-loop, and establishes the control variable, indexing parameters, and range of the loop.
DO WHILE	Specifies a DO-loop based on a test for true of a logical expression.
ELSE	Used in conjunction with the block IF or ELSE IF statements.
ELSE IF	Used optionally with the block IF statement.
END	Indicates the end of a program unit.
END DO	Defines the end of an indexed DO loop or a DO WHILE loop.
END IF	Has no operational function; serves as a point of reference like a CONTINUE statement in a DO-loop.
GO TO (Unconditional)	Transfers program control to the statement identified by the statement label.

Command	Purpose
GO TO (Computed)	Transfers control to one of several statements specified, depending on the value of an integer expression.
GO TO (Symbolic Name)	Used in conjunction with an ASSIGN statement to transfer control to the statement whose label was last assigned to a variable by an ASSIGN statement.
IF (Arithmetic)	Allows conditional branching.
IF (Branch Logical)	Allows conditional statement execution.
IF (Test Conditional)	Allows conditional execution of blocks of code. The block IF can contain ELSE and ELSE IF statements for further conditional execution control. The block IF ends with the END IF.
PAUSE	Suspends an executing program.
RETURN	Returns control to the referencing program unit. It may appear only in a function or subroutine subprogram.
STOP	Allows termination of an executing program.

# CALL

## Use

References a subroutine subprogram in a calling program unit.

## Syntax

```
CALL sub([ [a[,a]... ] ])
```

where:

*sub* the symbolic name of the subroutine.

- a* an actual argument: an expression, array name, array elements, records, record elements, record arrays, record array elements, Hollerith constants, or an alternate return specifier of the form \*s where s is a statement label, or &s where s is a statement label.

## Method of Operation

Execution of a CALL statement causes an evaluation of the actual arguments, association of the actual arguments with the corresponding dummy arguments, and execution of the statements in the subroutine. Return of control from the referenced subroutine completes the execution of the CALL statement.

## Rules of Use

1. The actual arguments *a* form an argument list and must agree in order, number, and type with the corresponding dummy arguments in the referenced subroutine.
2. A subroutine that has been defined without an argument may be referenced by a CALL statement of the following forms:

```
CALL sub  
CALL sub()
```

3. If a dummy procedure name is specified as a dummy argument in the referenced subroutine, then the actual argument must be an external procedure name, a dummy procedure name, or one of the allowed specific intrinsic names. An intrinsic name or an external procedure name used as an actual argument must appear in an INTRINSIC or EXTERNAL statement, respectively.

## CALL

4. If an asterisk is specified as a dummy argument, an alternate return specifier must be supplied in the corresponding position in the argument list of the CALL statement.
5. If a Hollerith constant is used as an actual argument in a CALL statement, the corresponding dummy argument must not be a dummy array and must be of arithmetic or logical data type. This is another exception to rule (1) above.
6. A subroutine can call itself directly or indirectly (recursion).

**NOTE:** Recursion is an extension to FORTRAN 77. FORTRAN 77 does not permit a subroutine to reference itself.

### Example

In the following example, the main routine calls *pageread* passing the parameters *lwordcount*, *page*, and *nswitch*. After execution of *pageread*, control returns to the main program, which stops.

```

      program MakeIndex
      character*50 page
      dimension page (100)
      nswitch = 0
111  lwordcount = inwords1*2
      *
      call pageread (lwordcount,page,nswitch)
      stop
      *
      subroutine pageread(lwordcount,page,nswitch)
      character*50 page
      dimension page (100)
      icount = 100
      •
      •
      •
      end
      *
```

# CONTINUE

## Use

Has no operational function; usually serves as the terminal statement of a DO-loop.

## Syntax

```
CONTINUE
```

## Method of Operation

When a CONTINUE statement that closes a DO-loop is reached, control transfer depends on the control variable in the DO-loop. In this case, control will either go back to the start of the DO-loop, or flow through to the statement following the CONTINUE statement. (See the subhead Loop control processing under the DO statement for full information about control of DO-loops.)

## Example

In the following example, the DO loop is executed 100 times, and then the program branches to statement 50 (not shown).

```
        iwordcount = 100
        do 25, i= 1, iwordcount
          read (2, 20, end=45) word
20      format (A50)
25      Continue
        *
        goto 50
```



# DO

## Use

Specifies a controlled loop, called a DO-loop, and establishes the control variable, indexing parameters, and range of the loop.

## Syntax

```
DO [s] [,]i = e1, e2 [, e3]
```

where:

*s* is a statement label of the last executable statement in the range of the DO-loop. This statement is called the terminal statement of the DO-loop.

*s* can optionally be omitted. If *s* is omitted, the loop must be terminated with an END DO statement. Upon completion of the loop, execution resumes with the first statement following the END DO statement.

*i* is a name of an integer, real, or double precision variable, called the DO variable.

*e1* is an integer, real, or double precision expression that represents the initial value given to the DO variable.

*e2* is an integer, real, or double precision expression that represents the limit value for the DO variable.

*e3* is an integer, real, or double precision expression that represents the increment value for the DO variable.

## Method of Operation

The *range* of a DO-loop consists of all executable statements following the DO statement, up to and including the terminal statement of the DO-loop. In a DO-loop, the executable statements that appear in the DO-loop range are executed a number of times as determined by the control parameters specified in the DO statement. The execution of a DO-loop involves the following steps:

1. **Activating the DO-loop.** The DO-loop is activated when the DO statement is executed. The initial parameter *m1*, the terminal parameter *m2*, and the incremental parameter *m3* are established by evaluating the expressions *e1*, *e2*, and *e3*, respectively. The expressions are converted to the type of the DO variable when the data types are not the same. The DO variable becomes defined with the value of the initial parameter *m1*. The increment *m3* cannot have a value of zero and defaults to the value 1 if *e3* is omitted.

**DO**

2. **Computing the iteration count.** The iteration count is established from the following expression:

$$\text{MAX}(\text{INT}((m2 - m1 + m3)/m3), 0)$$

The iteration count is zero in the following cases:

$$m1 > m2 \text{ and } m3 > 0$$

$$m1 < m2 \text{ and } m3$$

If the initial value ( $m1$ ) of the DO exceeds the limit value ( $m2$ ), as in:

```
DO 10 I = 2, 1
```

The DO loop will not be executed unless the `—onetrip` compiler option is in effect. This option causes the body of a loop thus initialized to be executed once.

Ordinarily, upon encountering a DO loop whose upper or lower limit has already been reached, the compiler-generated code skips the loop. This conforms with FORTRAN standards.

To make FORTRAN 77 compatible with FORTRAN 66, the compiler allows you to generate code that performs a loop at least once, regardless of whether the upper or lower limit has already been reached. This is done by specifying the `—onetrip` compile option as described in Chapter I of the *FORTRAN Programmer's Guide*. This option is included for older programs written under the assumption that all loops would be performed at least once.

3. **Loop control processing.** This step determines if further execution of the range of the DO-loop is required. Loop processing begins by testing the iteration count. If the iteration count is positive, the first statement in the range of the DO-loop is executed. Normal execution proceeds until the terminal statement is processed. This constitutes one iteration of the loop. Incrementing is then required, unless execution of the terminal statement results in a transfer of control.

If the iteration count is zero, the DO-loop becomes inactive. Execution continues with the first executable statement following the terminal statement of the DO-loop. If several DO loops share the same terminal statement, incremental processing is continued for the immediately containing DO-loop.

4. **Incremental processing.** The value of the DO variable is incremented by the value of the incremental parameter  $m3$ . The iteration count is then decreased by one and execution continues with loop control processing as described above.

## DO

A DO-loop is either active or inactive. A DO-loop is initially activated when its DO statement is executed. Once active, a DO-loop becomes inactive when one of the following occurs:

- The iteration count is zero.
- A RETURN statement within the DO-loop range is executed.
- Control is transferred to a statement outside the range of the DO-loop but in the same program unit as the DO-loop.
- A STOP statement is executed or the program is abnormally terminated.

Reference to a subprogram from within the range of the DO-loop does not make the DO-loop inactive except when control is returned to a statement outside the range of the DO-loop.

When a DO-loop becomes inactive, the DO-variable of the DO-loop retains its last defined value.

### Rules of Use

1. DO-loops can be nested but must not overlap.
2. If a DO statement appears within an IF-block, ELSE IF-block, or ELSE-block, the range of the DO-loop must be contained within that block.
3. If a block IF statement appears within the range of a DO-loop, the corresponding END IF statement must appear within the range of the DO-loop.
4. The same statement may serve as the terminal statement in two or more nested DO-loops.

### Restrictions

1. The following statements must not be used for the statement labeled *s* in the DO-loop:

Unconditional GO TO	END IF
Assigned GO TO	RETURN
Arithmetic IF	STOP
Block IF	END
ELSE IF	Another DO statement
ELSE	

**DO**

2. If the statement labeled *s* is a logical IF statement, then it can contain any executable statement in its statement body, except for:

DO statement	END IF
Block IF	END
ELSE IF	Another logical IF statement
ELSE	

3. Except by the incremental process covered above, the DO variable must not be redefined during execution of the range of the DO-loop.
4. A program must not transfer control into the range of a DO-loop from outside the DO-loop.

**Example**

```
DO 10, i = 1, 10
    D
    D
    D
10 CONTINUE
    d
```

In the above example, the statements (noted with a D) following the DO statement are executed sequentially 10 times, then execution resumes at the statement (d) following CONTINUE.

## DO WHILE

### Use

Specifies a controlled loop, called a DO-loop, based on a test for true of a logical expression.

### Syntax

```
DO [s [,]] WHILE (e)
```

where

*s* is a statement label of the last executable statement in the range of the DO-loop. This statement is called the terminal statement of the DO-loop.

*e* is a logical expression.

If *s* is omitted, the loop must be terminated with an END DO statement.

### Method of Operation

The DO WHILE statement tests the specified expression prior to each iteration (including the first iteration) of the statements within the loop. When the logical expression *e* is found to be true, execution resumes at the statement specified by the label *s*. If *e* is omitted, execution resumes at the first statement following the END DO statement.

# ELSE

## Use

Used in conjunction with the block IF or ELSE IF statements.

## Syntax

```
ELSE
```

## Method of Operation

Two terms need to be defined to explain the ELSE statement:

ELSE-block (defined below) and IF-level (defined on the block IF statement page).

An *ELSE-block* is the code that is executed when an an ELSE statement is reached. An ELSE-block begins after the ELSE statement and ends before the END IF statement at the same IF-level as the ELSE statement. As well as containing simple, executable statements, an ELSE-block may be empty (contain no statements) or may contain embedded block IF statements. Don't confuse the ELSE-block and the ELSE statement.

An ELSE statement is executed when the logical expressions in the corresponding block IF and ELSE IF statements evaluate to false. An ELSE statement has no logical expression to evaluate; the ELSE-block is always executed if the ELSE statement is reached. After the last statement in the ELSE-block is executed (and provided it does not transfer control) control flows to the END IF statement that closes that whole IF-level.

## Rules of Use

1. There cannot be any ELSE IF or ELSE statements inside an ELSE-block at the same IF-level.
2. The IF-level of the ELSE statement must be greater than zero (there must be a preceding corresponding block-IF statement).

# ELSE

## Restrictions

1. The ELSE-block can be entered only by executing the ELSE statement. No transfer of control that jumps from outside the ELSE-block into the ELSE-block is allowed.
2. If an ELSE statement has a statement label, the label cannot be referenced by any statement.

## Example

```
IF (R) THEN
  A = 0
ELSE IF (Q) THEN
  A = 1
ELSE
  A = -1
END IF
```

## ELSE IF

### Use

Used optionally with the block IF statement.

### Syntax

```
ELSE IF (e) THEN
```

where  $e$  is a logical expression.

### Method of Operation

Two terms need to be defined to explain the ELSE IF statement: ELSE IF-block (defined below) and IF-level (defined on the block IF statement page).

An ELSE IF-block is the code that is executed when the logical expression of an ELSE IF statement evaluates to true. An ELSE IF-block begins after the ELSE IF statement and ends before the next ELSE IF, ELSE or END IF statement at the same IF-level as the ELSE IF statement. As well as containing simple, executable statements, an ELSE IF-block may be empty (contain no statements) or may contain embedded block IF statements. Don't confuse the ELSE IF-block and the ELSE IF statement.

When an ELSE IF statement is reached, the logical expression  $e$  is evaluated. If  $e$  evaluates to true, execution continues with the first statement in the ELSE IF-block. If the ELSE IF-block is empty, control is passed to the next END IF statement that has the same IF-level as the ELSE IF statement. If  $e$  evaluates to false, program control is transferred to the next ELSE IF, ELSE, or END IF statement that has the same IF-level as the ELSE IF statement.

After the last statement of the ELSE IF-block is executed (and provided it does not transfer control), control is automatically transferred to the next END IF statement at the same IF-level as the ELSE IF statement.



## ELSE IF

### Rules of Use

The IF-level of the ELSE IF statement must be greater than zero (there must be a preceding corresponding block-IF statement).

### Restrictions

1. Control cannot be transferred into an ELSE IF-block from outside the ELSE IF-block.
2. No statement is allowed to reference the statement label (if any) of an ELSE IF statement. The only way to reach an ELSE IF statement is through its block IF statement.

### Example

```
IF (R) THEN
  A = 0
ELSE IF (Q) THEN
  A = 1
END IF
```

**END****Use**

Indicates the end of a program unit.

**Syntax**

END

**Method of Operation**

An END statement in a main program has the same effect as a STOP statement; it terminates an executing program.

An END statement in a function or subroutine subprogram has the effect of a RETURN statement; it returns control to the referencing program unit.

**Rules of Use**

1. An END statement must be the last statement in every program unit.
2. An END statement must not be continued. No other statements should have END as the first three non-blank characters.

## END DO

### Use

Defines the end of an indexed DO loop or a DO WHILE loop.

### Syntax

```
END DO
```

---

# END IF

## Use

Has no operational function; serves as a point of reference like a CONTINUE statement in a DO-loop.

## Syntax

```
END IF
```

## Rules of Use

1. Every block IF statement requires an END IF statement to close that IF-level. (IF-level is described under the block IF statement.)
2. The IF-level of an END IF statement must be greater than zero (there must be a preceding corresponding block-IF statement).

## Example

See the example given with the description of the ELSE statement.

## GO TO (Unconditional)

### Use

Transfers program control to the statement identified by the statement label.

### Syntax

```
GO TO s
```

where *s* is a statement label of an executable statement appearing in the same program unit as the unconditional GO TO.

### Example

```
GO TO 358
```

Program control is transferred to statement 358 and normal sequential execution continues from there.

## GO TO (Computed)

### Use

Transfers control to one of several statements specified, depending on the value of an integer expression.

### Syntax

```
GO TO (s[,s]...)[,]i
```

where *s* is a statement number of an executable statement appearing in the same program unit as the computed GO TO, and *i* is an integer or non-integer expression. Non-integer expressions are converted to integer (fractional portions are discarded) before being used to index into the next set of labels.

### Method of Operation

A computed GO TO statement causes evaluation of the integer expression, followed by transfer of control.

In the computed GO TO statement with the following form:

```
GO TO (s1, s2, ... ,sn),i
```

If  $i < 1$  or  $i > n$ , the program control continues with the next statement following the computed GO TO statement; otherwise, program control is passed to the statement labeled *si*. Thus, if the value of the integer expression is 1, control of the program is transferred to the statement numbered *s1* in the list; if the value of the expression is 2, control is passed to the statement numbered *s2* in the list, and so on.

### Rules of Use

The same statement label may appear more than once in the same computed GO TO statement.

### Example

```
KVAL = 4
GO TO (100, 200, 300, 300, 350, 9000) KVAL + 1
```

Program control is transferred to statement 350 (KVAL + 1).

## GO TO (Symbolic Name)

### Use

Used in conjunction with an ASSIGN statement to transfer control to the statement whose label was last assigned to a variable by an ASSIGN statement.

### Syntax

```
GO TO i [[,] (s [, s]...)]
```

where *i* is an integer variable name and *s* is a statement label of an executable statement appearing in the same program unit as the assigned GO TO statement.

### Method of Operation

The variable *i* is defined with a statement label using the ASSIGN statement in the same program unit as the assigned GO TO statement. When an assigned GO TO is executed, control is passed to the statement identified by that statement label. Normal execution then proceeds from that point.

### Rules of Use

1. The same statement label may appear more than once in the same assigned GO TO statement.
2. If the list in parentheses is present, the statement label assigned to *i* must be one of those in the list.

### Example

```
GO TO KJUMP, (100, 500, 72530)
```

The value of KJUMP must be one of the statement label values; 100, 500, or 72530.

## IF (Arithmetic)

### Use

Allows conditional branching.

### Syntax

```
IF (e) s1, s2, s3
```

where:

*e* is an arithmetic expression of type integer, real, or double precision, but not complex.

*s1, s2, s3*

are statement numbers of executable statements in the same program unit as the arithmetic IF statement.

### Method of Operation

In the execution of an arithmetic IF statement, the value of the arithmetic expression *e* is evaluated. Control is then transferred to the statement numbered *s1*, *s2*, or *s3* if the value of the expression is less than zero, equal to zero, or greater than zero, respectively. Normal program execution proceeds from that point.

### Rules of Use

The same statement number may be used more than once in the same arithmetic IF statement.

### Example

```
IF (A + B*(.5)) 500, 1000, 1500
```

- If the expression evaluates to be negative, control jumps to statement 500.
- If the expression evaluates to be zero, control jumps to statement 1000.
- If the expression evaluates to positive, control jumps to statement 1500.



## IF (Branch Logical)

### Use

Allows conditional statement execution.

### Syntax

```
IF (e) st
```

where *e* is a logical expression and *st* is any executable statement except DO, block IF, ELSE IF, ELSE, END IF, END, or another logical IF statement.

### Method of Operation

Execution of a logical IF statement causes boolean evaluation of the logical expression. If the value of the logical expression is true, statement *st* is executed. If the value of the expression is false, execution continues with the next sequential statement following the logical IF statement.

Note that a function reference in the expression is allowed, but may affect entities in the statement *st*.

### Example

```
IF (A .LE. B) A = 0.0  
IF (M .LT. TOC) GOTO 1000  
IF (J) CALL OUTSIDE(B, Z, F)
```

## IF (Test Conditional)

### Use

Allows conditional execution of blocks of code. The block IF can contain ELSE and ELSE IF statements for further conditional execution control. The block IF ends with the END IF statement.

### Syntax

```
IF (e) THEN
```

where  $e$  is a logical expression.

### Method of Operation

Two terms need to be defined to explain the block IF statement:

IF-block and IF-level.

An IF-block is the code that is executed when the logical expression of a block IF statement evaluates to true. An IF-block begins after the block IF statement and ends before the ELSE IF, ELSE, or END IF statement that corresponds to the block IF statement. As well as containing simple, executable statements, an IF-block may be empty (contain no statements) or may contain embedded block IF statements. Don't confuse IF-block with block IF.

Block IF statements and ELSE IF statements may be embedded, which can make figuring which statements are in which conditional blocks very confusing. The IF-level of a statement determines which statements belong to which IF-THEN-ELSE block. Fortunately, the IF-level of a statement can be found systematically. The IF-level of a statement  $s$  is:

$$(n1 - n2)$$

where (starting count at the beginning of the program unit):  $n1$  is the number of block IF statements up to and including  $s$ , and  $n2$  is the number of END IF statements up to but *not* including  $s$ .

The IF-level of every block IF, ELSE IF, ELSE, and END IF statement must be positive because those statements must be part of a block IF statement. The IF-level of the END statement of the program unit must be zero because all block IF statements must be properly closed. The IF-level of all other statements must either be zero (if they are outside all IF-blocks) or positive (if they are inside an IF-block).

## IF (Test Conditional)

When a block IF statement is reached, the logical expression  $e$  is evaluated. If  $e$  evaluates to true, execution continues with the first statement in the IF-block. If the IF-block is empty, control is passed to the next END IF statement that has the same IF-level as the block IF statement. If  $e$  evaluates to false, program control is transferred to the next ELSE IF, ELSE, or END IF statement that has the same IF-level as the block IF statement.

After the last statement of the IF-block is executed (and provided it does not transfer control), control is automatically transferred to the next END IF statement at the same IF-level as the block IF statement.

### Restrictions

Control cannot be transferred into an IF-block from outside the IF-block.

### Example

```
IF(Q .LE. R) THEN
  PRINT ('Q IS LESS THAN OR EQUAL TO R')
ELSE
  PRINT ('Q IS GREATER THAN R')
END IF
```

# PAUSE

## Use

Suspends an executing program.

## Syntax

```
PAUSE [n]
```

where *n* is a string of not more than five digits or a character constant.

## Method of Operation

A PAUSE statement without an *n* specification suspends execution of a program and issues the following message:

```
PAUSE statement executed  
To resume execution, type go. Any other input  
will terminate job.
```

A PAUSE statement with an *n* specification displays the specified character constant or digits and issues the pause message. For example, the statement

```
Pause "Console Check"
```

the following message is displayed:

```
PAUSE Console Check statement executed  
To resume execution, type go. Any other input  
will terminate job.
```

If execution is resumed, the execution proceeds as though a CONTINUE statement were in effect.

At the time of program suspension, the optional digit string or character constant becomes accessible to the system as program suspension status information.

# RETURN

## Use

Returns control to the referencing program unit. It may appear only in a function or subroutine subprogram.

## Syntax

In a function subprogram:

```
RETURN
```

In a subroutine subprogram:

```
RETURN [e]
```

where *e* is an integer or non-integer expression specifying an alternate return. Non-integer expressions are converted to integer and the fractional portions, if present, are discarded, before control is returned to the alternate return argument.

## Method of Operation

A RETURN statement terminates the reference of a function or subroutine and transfers control back to the currently referenced program unit. In a function subprogram, the value of the function then becomes available to the referencing unit. In a subroutine, return of control to the referencing program unit completes execution of the CALL statement.

A RETURN statement terminates the association between the dummy arguments of the external procedure and the current actual arguments.

In a subroutine subprogram, if *e* is not specified in a RETURN statement or if the value of *e* is less than or greater than the number of asterisks in the SUBROUTINE or ENTRY statement specifying the currently referenced name, then control returns to the CALL statement that initiated the subprogram. Otherwise, the value of *e* identifies the *e*th asterisk in the dummy argument list of the currently referenced name. Control returns to the statement identified by the alternate return specifier in the CALL statement that is associated with the *e*th asterisk in the dummy argument list.

The execution of a RETURN statement causes all entities in an external procedure to become undefined except for the following:

- Entities that are specified in a SAVE statement
- Entities that are in blank or named common
- Entities that are initialized in a DATA statement that have neither been redefined nor become undefined

# STOP

## Use

Allows termination of an executing program.

## Syntax

```
STOP [n]
```

where *n* is a string of not more than five digits or a character constant.

## Method of Operation

The STOP statement terminates an executing program. If *n* is supplied, the digit string or character constant becomes accessible to the system as program termination status information.



Input statements copy data from external media or from an internal file to internal storage. This is called *reading*. Output statements copy data from internal storage to external media or to an internal file. This is called *writing*.

Input/output facilities in FORTRAN give you control over the input/output system. This section deals primarily with the programmer-related aspects of input/output processing rather than with the implementation of the processor-dependent input/output specifications.

See **Chapter 1** of the *FORTRAN Programmer's Guide* for information on extensions to FORTRAN 77 that affect input/output processing.

## Records

A *record* is simply a sequence of values or characters. FORTRAN has three kinds of records: formatted, unformatted, and endfile records. A record is a logical concept; it does not have to correspond to a particular physical storage form. However, external media limitations may also limit the allowable length of records.

### Formatted Records

A *formatted record* contains only ASCII characters and is terminated by a carriage-return or line-feed character. Formatted records are required only when the data must be read from the screen or a printer copy.

A formatted record can be read from or written to only by formatted input/output statements. Formatted records are measured in characters. The length is primarily a function of the number of characters that were written into the record when it was created, but it may be limited by the storage media or the CPU. A formatted record may have a length of zero.

### Unformatted Records

*Unformatted records* contain sequences of values, both character and non-character, are not terminated by any special character, and cannot be accurately comprehended in their printed or displayed format. Generally, unformatted records use less space than formatted records and thus conserve storage.

An unformatted record can be read from or written to only by unformatted input/output statements. Unformatted records are measured in bytes. That length is primarily a function of the output list used to write the record, but may be limited by the external storage media or the CPU. An unformatted record may be empty.



## Endfile Records

An *endfile record* marks the logical end of a data file. Thus, it may occur only as the last record of a file. An endfile record does not contain data and has no length. An endfile record is written by an ENDFILE statement.

## I/O Statements

The input/output statements that FORTRAN uses to transfer data can be categorized by how the data translated during the transfer, namely as formatted, list-directed, and unformatted input/output.

### Unformatted Statements

An unformatted input/output statement transfers data in the non-character format during an input/output operation. Unformatted input/output operations are usually faster than formatted operations, which translate data to character format.

In processing formatted statements, the system interprets some characters—for example, the line-feed character—as special controls and eliminates them from read records. Therefore, unformatted statements must be used when *all* characters in a record are required.

The absence of a format specifier (as well as an asterisk in the specifier) denotes an unformatted data transfer statement, as shown by the *write* statement in the following example:

**Unformatted Output**

```

program MakeIndex
character*12 word
open(2, file='v', form='formatted')
open (unit=10, status='new', file='NewV.out', form='unformatted')
116 read (2,666, end=45) word
      write (10) word
      goto 116
45   close (10)
      end

```

In the above example, formatted records are read into the variable *word* from the input file attached to Unit 2, and then written unformatted to the output file attached to Unit 10.

### Formatted Statements

A *formatted* input/output statement translates all data to character format during a record transfer. The statement contains a *format specifier* that references a FORMAT statement; the FORMAT statement contains descriptors that determine data translation and perform other editing functions. Here is an example of two formatted WRITE statements:

**Formatted Output**

```

program MakeIndex
character*18 message
message = 'Hello World'
write (6,100) message
Write (6,100) 'Hello World'
100 format (a)
end

```

Note that both statements contain the format specifier *100*, which reference a format statement with an *a* character descriptor (the descriptors are described in detail in Chapter 9); both statements perform the same function, namely writing the message *Hello World* to the device associated with Unit 6.

**List-Directed Statements**

A *list-directed* input/output statement performs the same function as a formatted statement. However, in translating data, a list-directed statement uses the declared data type rather than format descriptors in determining the format.

The following two list-directed *write* statements perform the same function as the formatted *write* statements in the example for formatted output.

**List-Directed Output**

```

program MakeIndex
character*18 message
message = 'Hello World'
write (6,*) message
write (6,*) 'Hello World'
end

```

In this example, the variable *message* in the first *write* statement determines that output is in character format; the character constant *Hello World* in the second statement make this determination. Note that list-directed statements contain an asterisk as the format specifier rather than a reference label.

**Files**

A file is a sequence of records. The processor determines the set of files that *exist* for each executable program. The set of existing files can vary while the program executes. Files that are known to the processor do **not** necessarily exist for an executable program at a given time. A file may exist and contain no records (all files are empty when they are created). Input/output statements can only be applied to files that exist.

Files may have names; if they do, they are called *named files*. Names are simply character strings.

Every data file has a position. The position is used by input/output statements to tell which record to access, and is changed when I/O statements are executed. The terms used to describe the position of a file are:

- **initial point.** The point immediately before the first record.
- **terminal point.** The point immediately after the last record.
- **current record.** The record containing the point where the file is positioned. There is no current record if the file is positioned at the initial point (before all records) or at the terminal point (after all records) or between two records.
- **preceding record.** The record immediately before the current record. If the file is positioned between two records (so there is no current record), the preceding record is the record before the file position. The preceding record is undefined if the file is positioned in the first record or at the initial point.
- **next record.** The record immediately after the current record. If the file is positioned between two records (so there is no current record), the next record is the record after the file position. The next record is undefined if the file position is positioned in the last record or at the terminal point.

There are two kinds of files: internal files and external files.

### External Files

An *external file* is a set of records on an external storage medium (for example, a disk or a tape drive). A file can be empty; that is, it can contain no records.

### Internal Files

An *internal file* is a means of transferring data within internal storage between character variables, character arrays, character array elements, or substrings.

An internal file is always positioned at the beginning of the first record prior to data transfer. Reading and writing records is only by sequential access formatted input/output statements that do not specify list-directed formatting.

The following is a simple example showing the use of internal file transfer to convert character and integer data.

```

        program Conversion
        character*4 CharRep
        integer NumericalRep
        NumericalRep = 10
1 write (CharRep,900) NumericalRep
        900 format (i2)
        CharRep = '222'
2 write (NumericalRep,999) CharRep
        999 format (a3)
        end

```

<sup>1</sup> Converts numerical 10 to character 10

<sup>2</sup> Converts character 222 to numerical 222.

In the first example, the contents of *NumericalRep* is converted to character format and placed in *CharRep*; in the second example, the contents of *CharRep* is converted to integer and placed in *NumericalRep*.

## Methods of File Access

The following methods of file access are supported:

- Sequential
- Direct
- Keyed

External files can be accessed using any of the above methods. The access method is determined when the file is opened or defined.

FORTRAN 77 requires that internal file must be accessed sequentially.

As an extension, the use of internal files in both formatted and unformatted input/output operations is permitted.

## Sequential Access

A file connected for *sequential access* has the following properties:

- For files that allow only sequential access, the order of the records is simply the order they were written.
- For files that also allow direct access, the order of files depends on the record number. If a file is written sequentially, the first record written is record number 1 for direct access, the second written is record number 2, etc.
- Formatted and unformatted records cannot be mixed in a file.
- The last record of the file may be an endfile record.

- The records of a pure sequential file must not be read or written by direct access input/output statements.

## Direct Access

A file connected for *direct access* has the following properties:

- A unique *record number* is associated with each record in a direct access file. Record numbers are positive integers that are attached when the record is written. Records are ordered by their record numbers.
- Formatted and unformatted records cannot be mixed in a file.
- The file must not contain an endfile record if it is direct access only. If the file also allows sequential access, an endfile record is permitted but will be ignored while the file is connected for direct access.
- All records of the file have the same length.
- Only direct access input/output statements may be used for reading and writing records. List-directed formatting is not permitted.
- The record number cannot be changed once it is specified. A record can be rewritten but it cannot be deleted.
- Records can be read or written in any order.

## Keyed Access

The *keyed access* has the following properties:

- Only files having an indexed organization can be processed using the keyed access method.
- A unique character or integer value called a *key* is associated with one or more fields in each record of the indexed access file. The field(s) are defined when the file is created with an OPEN statement. Each READ statement contains a key to locate the desired record in the indexed file.
- Use of the keyed access method and the sequential access method on the same opened file can be intermixed.

## Units

Files are accessed through *units*. A unit is simply the logical means for accessing a file. The file–unit relationship is strictly one–to–one: files may not be connected to more than one unit or vice–versa. Each program has a processor dependent set of existing units. A unit has two states: connected and disconnected.

### Connection of a Unit

A *connected unit* refers to a data file. A unit can be implicitly connected by the processor or explicitly by an OPEN statement. If a unit is connected to a file, the file is connected to the unit. However, a file may be connected and not exist. Consider, for example, a unit preconnected to a new file. A *preconnected unit* is a unit that is already connected at the time the program execution begins. See **Preconnected Files in Chapter 1** of the *FORTRAN Programmer's Guide* for these default connections.

As stated above, a file may only be connected to one unit and a unit may only be connected to one file.

### Disconnection of a Unit

A unit may be *disconnected* from a file by a CLOSE statement specifying that particular unit.



This chapter describes the statements that control the transfer of data within internal storage, and between internal storage and external storage devices. This chapter has the following major sections:

- **Input/Output Statement Summary**, an overview of the input/output statements described in this chapter.
- Statement descriptions, which give the syntax, rules, and examples for each input/output statement.
- **Control Information List** and **Input/Output List**, which describe in detail parameters specified as part of an input/output statement. The lists specify data source and *target* locations, data format, and other information associated with data transfer.
- **Data Transfer Rules**, which give general rules that apply to data transfer statements.

## Statement Summary

The input/output statements described in this chapter are grouped into the following classes:

1. Data transfer statements, which transfer information between two areas of internal storage or between internal storage and an external file. They are:
  - READ
  - DELETE
  - UNLOCK
  - ACCEPT
  - WRITE
  - REWRITE
  - PRINT or
2. Auxiliary statements, which explicitly open or close a file, provide current status information about a file or unit, or write an endfile record. They are:
  - OPEN
  - CLOSE
  - INQUIRE
  - ENDFILE



3. File positioning statements, which position data files to the previous record or to the file's initial point. These statements apply only to external files and they are:

- BACKSPACE
- REWIND

4. Statements that provide compatibility with earlier versions of FORTRAN. They are included to permit the older FORTRAN programs to be compiled and exist on the same system as standard FORTRAN 77 programs. The statements include the following:

- ENCODE
- DECODE
- DEFINE FILE
- FIND

# ACCEPT

## Purpose

Transfers data from the standard input unit to the items specified by the input list.

## Syntax

```
ACCEPT f [,iolist]
```

where *f* is the format specifier and *iolist* is an optional output list specifying where the data is to be stored. See the **Control Information List** and **Input/Output List** sections of this chapter for a description of the *f* and *iolist* parameters.

## Rules of Use

The ACCEPT statement specifies formatted input from the file associated with the system input unit; it cannot be connected to a user-specified input unit.

See the **Data Transfer Rules** section of this chapter for additional rules.

## Example

```
ACCEPT 3, X  
3    FORMAT (A)
```

transfers character data from the standard input unit into X.

# BACKSPACE

## Purpose

Positions a data file before the preceding record. It may be used with both formatted and unformatted data files.

## Syntax

```
BACKSPACE u
BACKSPACE (alist)
```

where *u* is an external unit identifier and *alist* is a list of the following specifiers:

- [UNIT =] *u* is a required *unit specifier*. *u* must be an integer expression that identifies the number of an external unit. If the keyword UNIT= is omitted, then *u* must be the first specifier in *alist*.
- IOSTAT=*ios* is an *input/output status specifier* that specifies the variable to be defined with a status value by the BACKSPACE statement. A zero value for *ios* denotes a no error condition while a positive integer value denotes an error condition.
- ERR=*s* is an error specifier that identifies a statement number to which control is to be transferred when an error condition occurs during the execution of the BACKSPACE statement.

**NOTE:** An error message is issued if this statement references a file with the an ACCESS="KEYED" or ACCESS="APPEND" specification.

## Method of Operation

The unit specifier is required and must appear exactly once. The other specifiers are optional, and can appear at most once each in the *alist*. Specifiers can appear in any order (exception: see *unit specifier*).

The BACKSPACE statement positions the file on the preceding record. If there is no preceding record, the position of the file is unchanged. If the preceding record is an endfile record, the file is positioned before the endfile record.

## Examples

```
BACKSPACE M
BACKSPACE (6, IOSTAT=LP, ERR=998)
```

# CLOSE

## Purpose

Disconnects a particular file from a unit.

## Syntax

```
CLOSE (cilist)
```

where *cilist* is a list of the following specifiers:

[UNIT =] *u* is a required *unit specifier*. *u* must be an integer expression that identifies the number of an external unit. If the keyword UNIT= is omitted, then *u* must be the first specifier in *cilist*.

IOSTAT=*ios* is an *input/output status specifier* that specifies the variable to be defined with a status value by the CLOSE statement. A zero value for *ios* denotes a no error condition while a positive integer value denotes an error condition.

DISPOSE=*disposition*

DISP=*disposition*

Provides the same function as the like parameters in the OPEN statement. The *disposition* parameters in the file's CLOSE statement override the disposition parameters in its OPEN statement.

ERR=*s* is an *error specifier* that identifies a statement number to which control is to be transferred when an error condition occurs during execution of the CLOSE statement.

STATUS=*sta* is a *file status specifier*. *sta* is a character expression which, when any trailing blanks are removed, has a value of KEEP or DELETE. The status specifier determines the disposition of the file that is connected to the specified unit.

KEEP specifies that the file is to be retained after the unit is closed. DELETE specifies that the file is to be deleted after the unit is closed. If a file has been opened for SCRATCH in an OPEN statement, then KEEP must not be specified in the CLOSE statement. If *iolist* contains no file status specifier, the default value is KEEP, except when the file has been opened for SCRATCH, in which case the default is DELETE.

# CLOSE

## Method of Operation

At the normal termination of an executable program, all units that are connected are closed. Each unit is closed with status KEEP unless the file has been opened for SCRATCH in an OPEN statement. In the latter case, the unit is closed as if with file status DELETE.

A CLOSE statement need not occur in the same program unit in which the file was opened. A CLOSE statement that specifies a unit that does not exist or has no file connected to it does not affect any file and is permitted.

A unit that is disconnected by a CLOSE statement may be reconnected within the same executable program, either to the same file or to a different file. A file that is disconnected may be reconnected to the same unit or a different unit, provided that the file still exists.

### Examples

```
CLOSE (UNIT=1, STATUS='KEEP')  
CLOSE (UNIT=K, ERR=19, STATUS='DELETE')
```

**DECODE****Purpose**

Transfers data between internal files, decoding the transferred data from character format to internal format.

**NOTE:** This statement provides primarily the same function as the READ statement using internal files, except that the input is read from a numeric scalar or array rather than a character string, the concept of multiple records isn't supported, and the record length is specified by the user. Where possible, use a READ statement instead of DECODE in new programs to make them compatible among different FORTRAN 77 operating environments.

**Syntax**

```
DECODE (n, f, target [, ERR=s] [, IOSTAT=rn]) [iolist]
```

**Parameter Explanations**

<i>n</i>	An integer expression specifying the number of characters to be translated to internal format.
<i>f</i>	Format specifier (as described in the <b>Format Specifier</b> section of this chapter).
<i>ERR=s</i> <i>IOSTAT=rn</i>	See the <b>Control Information List</b> section in this chapter for an explanation of these parameters.
<i>target</i>	Scalar reference or array indicating the destination of the characters after translation to external form.
<i>iolist</i>	Optional list specifying the source data, as described in the <b>Input/Output List</b> section of this chapter.

**Method of Operation**

1. The relationship between the I/O list and the format specifier is the same as for formatted I/O.
2. The maximum number of characters transmitted is the maximum number possible for the *target* data type. If *target* is an array, the elements are processed in subscript order.

## DEFINE FILE

### Purpose

Defines the size and structure of a relative file and connects it to a unit. Provides primarily the same function as the FORTRAN OPEN statement specifying ACCESS='DIRECT'.

### Syntax

```
DEFINE FILE u (reccount, reclen, U, asvar)
           [, u (reccount, reclen, U, asvar)] . . .
```

### Parameter Explanations

<i>u</i>	Integer expression that identifies the number of an external unit that contains the file.
<i>reccount</i>	Integer expression defining the number of records in the file.
<i>reclen</i>	Integer expression specifying in word (two-byte) units the length of each record.
<i>U</i>	Specifies an unformatted (binary) file. The U entry is always required and always in the same position shown in the above syntax.
<i>asvar</i>	Associated variable; <i>asvar</i> is an integer variable indicating the next higher numbered record to be read or written. It is updated after each direct access I/O operation.

### Method of Operation

1. Only formatted files can be opened with a DEFINE FILE.
2. The file defined by *u* is assumed to contain fixed-length records of two bytes each.
3. The records in the file are numbered 1 through *reccount*.
4. The DEFINE FILE statement or equivalent OPEN statement must be executed before executing a READ, WRITE, or other direct access statement.
5. The first direct access READ for the specified file opens an existing file; if the file doesn't exist, an error condition occurs.
6. The first direct access WRITE for the specified file opens the file, and creates a new relative file.

# DELETE

## Purpose

Deletes a record from an indexed file. An error condition occurs if the file is not indexed.

## Syntax

```
DELETE [UNIT=unum]  
DELETE ([UNIT=unum][, IOSTAT=rn] [, ERR=s])
```

## Parameter Explanations

UNIT=*unum*    Unit or internal file to be acted upon.

IOSTAT=*rn*    Name of variable in which I/O completion status is to be posted.

ERR=*s*        Statement label to which control is transferred after an error.

See **Control Information List** and **Input/Output List** sections in this chapter for details on these parameters.

## Method of Operation

Deletes the current record, which is the last record accessed on unit *u*.

## Examples

```
DELETE (10)
```

deletes the last record read in from the file connected to logical unit 10.



# ENCODE

## Purpose

Transfers data between internal files, encoding the transferred data from internal format to character format.

**NOTE:** This statement provides primarily the same function as the WRITE statement using internal files, except that the input is read from a numeric scalar or array rather than a character string, the concept of multiple records isn't supported, and the record length is specified by the user. Where possible, use a WRITE statement instead of ENCODE in new programs to make them compatible among different FORTRAN 77 operating environments.

## Syntax

```
ENCODE (n, f, target [, ERR=s] [, IOSTAT=rn]) [iolist]
```

## Parameter Explanations

<i>n</i>	An integer expression specifying the number of characters to be translated to character format.
<i>f</i>	Format specifier (as described in the Format Specifier section of this chapter).
ERR= <i>s</i> IOSTAT= <i>rn</i>	See the <b>Control Information List</b> section in this chapter for an explanation of these parameters.
<i>target</i>	Scalar reference or array indicating the destination of the characters after translation to external form.
<i>iolist</i>	Optional list specifying the source data, as described in the <b>Input/Output List</b> section of this chapter.

## Method of Operation

1. The relationship between the I/O list and the format specifier is the same as for formatted I/O.
2. The *target* is padded with blanks if fewer than *n* characters are transferred.
3. The maximum number of characters transmitted is the maximum number possible for the *target* data type. If *target* is an array, the elements are processed in subscript order.

# ENDFILE

## Purpose

Writes an endfile record as the next record of the file. It may be used with both unformatted and formatted data files.

## Syntax

```
ENDFILE u
ENDFILE (alist)
```

where *u* is an external unit identifier and *alist* is a list of the following specifiers:

[UNIT =] *u* is a required *unit specifier*. *u* must be an integer expression that identifies the number of an external unit. If the keyword UNIT= is omitted, then *u* must be the first specifier in *alist*.

IOSTAT=*ios* is an *input/output status specifier* that specifies the variable to be defined with a status value by the ENDFILE statement. A zero value for *ios* denotes a no error condition while a positive integer value denotes an error condition.

ERR=*s* is an *error specifier* that identifies a statement number to which control is to be transferred when an error condition occurs during the execution of the ENDFILE statement.

**NOTE:** An error message is issued if this statement references a keyed access file.

## Method of Operation

The unit specifier is required and must appear exactly once. The other specifiers are optional, and can appear at most once each in the *alist*. Specifiers can appear in any order (exception: see *unit specifier*).

An ENDFILE statement writes an endfile record and the specified file is then positioned after the endfile record. If a file is connected for direct access, only those records before the endfile record are considered to have been written and thus can be read in subsequent direct access connections to the file.

An ENDFILE statement for a file that is connected but does not exist creates the file.

After an ENDFILE statement, a BACKSPACE or REWIND statement must be used to reposition the file prior to the execution of any data transfer input/output statement.

## Examples

```
ENDFILE 2
ENDFILE (2, IOSTAT=IE, ERR=1000)
```

# FIND

## Purpose

Positions a file to a specified record number and sets the associate variable number (defined in an OPEN or DEFINE FILE statement) to reflect the new position. Functionally equivalent to a direct access READ statement except no *iolist* is specified and no data transfer takes place. The statement opens the file if it is not already open.

## Syntax

```
FIND ([UNIT=u], REC=rn [, ERR=s] [, IOSTAT=rn])
```

The parameter list is as follows:

- u* Integer expression that identifies the number of an external unit that contains the file. The number must refer to a relative file.
- ERR=*s*
- IOSTAT=*rn* See the **Control Information List** section in this chapter for an explanation of these parameters.
- REC=*rn*

# INQUIRE

## Purpose

Inquires about the properties of a particular named file or of the file connected to a particular unit. There are two forms: inquire by file and inquire by unit.

## Syntax

```
INQUIRE (FILE=fname [DEFAULTFILE=dname] ) inqlist
INQUIRE (UNIT=u, inqlist
```

The parameter list is as follows:

**FILE=*fname*** is a *file specifier*. *fname* is one of the following: a character expression, **numeric array** that specifies the name of the file being queried. The named file need not exist or be connected to a unit.

**[UNIT=*u*]** is a *unit specifier*. *u* must be an integer expression that identifies the number of an external unit. The specified unit need not exist or be connected to a file. If the keyword UNIT= is omitted, then *u* must be the first specifier in *inqlist*.

### DEFAULTFILE=*dname*

This parameter corresponds to the DEFAULTFILE parameter in an OPEN statement and is used to inquire about a file assigned a default name when it was opened. See the description of the OPEN statement for details.

*inqlist* is composed of one or more of the following parameters:

**ACCESS=*acc*** *acc* is a character variable or character array element to be assigned a value by the INQUIRE statement. The value assigned describes the type of file access as follows:

Value Assigned	File Access
SEQUENTIAL	Sequential
DIRECT	Direct
KEYED	Keyed
UNKNOWN	No connection

# INQUIRE

**BLANK=***blk* *blk* is a character variable or character array element to be assigned a value by the INQUIRE statement. The value assigned describes the blank specifier for the file as follows:

<b>blk=</b>	<b>Blank Control Specifier.</b>
NULL	Null blank control, connected for formatted input/output.
ZERO	Zero blank control.
UNKNOWN	Not connected or not connected for formatted input/output.

**CARRIAGECONTROL=***ccspec*

*ccspec* is assigned one of the following carriage control specifications made in the OPEN statement for the file: FORTRAN, LIST, NONE, or UNKNOWN.

**DIRECT=***dir* *dir* is a character variable or character array element to be assigned a value by the INQUIRE statement. *dir* is assigned the value YES if DIRECT is an allowed access method for the file.

*dir* is assigned the value NO if DIRECT is not an allowed access method. If the processor is unable to determine the access type, *dir* is assigned the value UNKNOWN.

**ERR=***s* is an *error specifier* that identifies a statement number to which control is to be transferred when an error condition occurs during the execution of the INQUIRE statement.

**EXIST=***ex* *ex* is a logical variable or logical array element to be assigned a value by the INQUIRE statement. *ex* is assigned the value .TRUE. if the specified unit or file exists; otherwise, *ex* is assigned the value .FALSE.. A unit *exists* if it is a number in the range allowed by the processor.

# INQUIRE

**FORM=*fm*** *fm* is a character variable or character array element to be assigned a value by the INQUIRE statement. The value assigned is the form specifier for the file as follows:

<b>fin=</b>	<b>Meaning</b>
FORMATTED	Formatted input/output.
UNFORMATTED	Unformatted input/output
UNKNOWN	Unit is not connected

**FORMATTED=*fmt***

*fmt* is a character variable or character array element to be assigned a value by the INQUIRE statement. *fmt* is assigned the value YES if FORMATTED is an allowed form for the file. *fmt* is assigned the value NO if FORMATTED is not an allowed form. If the processor is unable to determine the allowed forms of data transfer, *fmt* is assigned the value UNKNOWN.

**IOSTAT=*ios*** is an *input/output status specifier* that specifies the variable to be defined with a status value by the INQUIRE statement. A zero value for *ios* denotes a no error condition while a positive integer value denotes an error condition.

**KEYED=*keystat***

*keystat* is a character scalar memory reference assigned a value as follows:

<b>keystat =</b>	<b>Meaning</b>
YES	Indexed file, keyed access allowed
NO	Keyed access not allowed
UNKNOWN	Access type undetermined

**NAMED=*nmd*** *nmd* is a logical variable or logical array element to be assigned a value by the INQUIRE statement. *nmd* is assigned the value .TRUE. if the file has a name. Otherwise, *nmd* is assigned the value .FALSE..

**NAME=*fn*** *fn* is a character variable or character array element to be assigned a value by the INQUIRE statement. *fn* is assigned the name of the file if the file has a name. Otherwise, *fn* is undefined. If the NAME specifier appears in an INQUIRE by file statement, its value is not necessarily the same as the name given in the file specifier.

# INQUIRE

**NEXTREC=*nr*** *nr* is an integer variable or integer array element to be assigned a value by the INQUIRE statement. *nr* is assigned the value  $n + 1$ , where  $n$  is the record number of the last record read or written for direct access on the specified unit or file. If the file is connected but no records have been read or written, *nr* is assigned the value 1. If the file is not connected for direct access, *nr* is assigned the value 0.

**NUMBER=*num***

*num* is an integer variable or integer array element that is assigned a value by the INQUIRE statement. *num* is assigned the external unit identifier of the unit currently connected to the file. *num* is undefined if there is no unit connected to the file. This specifier must not be used with an INQUIRE by unit statement (INQUIRE (*iulist*)).

**OPENED=*od*** *od* is a logical variable or logical array element to be assigned a value by the INQUIRE statement. *od* is assigned the value .TRUE. if the file specified is connected to a unit or if the specified unit is connected to a file. Otherwise, *od* is assigned the value .FALSE..

**ORGANIZATION=*org***

*org* is a character scalar memory reference assigned the value of the file organization established when the file was opened; it has one of the following values: SEQUENTIAL, RELATIVE, INDEXED, or UNKNOWN (always assigned to unopened files).

**RECL=*rcl***

*rcl* is an integer variable or integer array element to be assigned a value by the INQUIRE statement. *rcl* is assigned the value of the record length in number of characters or in processor-dependent units for formatted or unformatted input/output, respectively. If there is no connection or if the connection is not for direct access, *rcl* becomes undefined.

**RECORDTYPE=*rectype***

*rectype* is a character scalar memory reference assigned the value of the record type file established when the file was opened; it has one of the following values: FIXED, VARIABLE, STREAM, LF or UNKNOWN.

# INQUIRE

## SEQUENTIAL=*seq*

*seq* is a character variable or character array element to be assigned a value by the INQUIRE statement. *seq* is assigned the value YES if SEQUENTIAL is an allowed access method for the file. *seq* is assigned the value NO if SEQUENTIAL is not an allowed access method. If the processor is unable to determine the allowed access methods, *seq* is assigned the value UNKNOWN.

## UNFORMATTED=*unf*

*unf* is a character variable or character array element to be assigned a value by the INQUIRE statement. *unf* is assigned the value of YES if UNFORMATTED is an allowed format for the file.

*unf* is assigned the value NO if UNFORMATTED is not an allowed format for the file. If the processor is unable to determine the allowed form, *unf* is assigned the value UNKNOWN.

## Method of Operation

Specifiers can be given in *iflist* or *iulist* in any order (exception: see *unit specifier*).

An INQUIRE statement assigns values to the specifier variables or array elements *nmd*, *fn*, *seq*, *dir*, *fmt* and *unf* only if the value of the file specifier *fname* is accepted by the processor and if a file exists by that name. Otherwise, these specifier variables become undefined. Each specifier can appear at most *once* in the *iflist* or *iulist*, and the *list* must contain at least one specifier.

An INQUIRE statement assigns values to the specifier variables or array elements *num*, *nmd*, *fn*, *acc*, *seq*, *dir*, *fm*, *fmt*, *unf*, *rcl*, *nr* and *blnk* only if the specified unit exists and if a file is connected to it. Otherwise, these specifier variables become undefined. However, the specifier variables *ex* and *od* are always defined unless an error condition occurs. All inquiry specifier variables, except *ios*, become undefined if an error condition occurs during execution of an INQUIRE statement.

## Examples

```
INQUIRE (FILE='MYFILE.DATA', NUMBER=IU, RECL=IR)
INQUIRE (UNIT=6, NAME=FNAME)
```



# OPEN

## Purpose

OPEN creates files and connects them to units. It can create a preconnected file, create and connect a file, connect an existing file, or reconnect an already connected file. See **File Positions** in **Chapter 1** of the *FORTRAN Programmer's Guide* for information on the relative record position in a file after an OPEN is executed.

## Syntax

```
OPEN (olist)
```

where *olist* is a list of the following specifiers, separated by commas:

[UNIT=] *u* is a required *unit specifier*. *u* must be an integer expression that identifies the number of an external unit. If the keyword UNIT= is omitted, then the *u* must be the first specifier in *olist*.

IOSTAT=*ios* is an *input/output status specifier* that identifies the variable to be defined with a status value by the OPEN statement. A zero value for *ios* denotes a no error condition, while a positive integer value denotes an error condition.

ERR=*s* is an *error specifier* that identifies a statement number to which program control is to be transferred when an error condition occurs during execution of the OPEN statement.

FILE=*fname* is a *file specifier*. *fname* is a character expression specifying the name of the external file to be connected. The file name must be a name allowed by the processor.

*fname* can also be a numeric variable to which hollerith data is assigned. A null character terminates the file name.

ACCESS=*acc* is an *access specifier*. *acc* is a character expression which, when trailing blanks are removed, has either of the values SEQUENTIAL, DIRECT, KEYED or APPEND.

SEQUENTIAL specifies that the file is to be accessed sequentially.

DIRECT specifies that the file is to be accessed by record number. If DIRECT is specified, then *olist* must also contain a record length specifier. If *olist* contains no access specifier, the value SEQUENTIAL is assumed.

# OPEN

KEYED specifies that the file is to be accessed by a key-field value.

APPEND specifies sequential access that, after execution of an OPEN statement, the file is to be positioned after the last record.

ASSOCIATEVARIABLE=*asvar*

Direct access only. After each input/output operation, *asvar* contains an integer variable giving the record number of the next sequential record number in the file. This parameter is ignored for all access modes other than direct access.

BLANK=*blnk* is a *blank specifier*. *blnk* is a character expression which, when all trailing blanks are removed, has the value NULL (the default) or ZERO.

NULL specifies that blank characters in numeric formatted input fields are to be ignored.

ZERO specifies that all blanks other than leading blanks are to be treated as zeros. If *iolist* contains no blank specifier, the value NULL is assumed.

CARRIAGECONTROL=*type*

*type* is a character expression that determines carriage control processing as follows:

type =	Meaning
FORTTRAN	Standard FORTRAN interpretation of the first character.
LIST	Single spacing between lines
NONE	No implied carriage control

LIST is the default for formatted files and NONE is the default for unformatted files. When the `--vms` option (Chapter 1 of the *FORTTRAN Programmer's Guide*) is specified, FORTRAN becomes the default for the standard output unit (unit 6).

# OPEN

## DEFAULTFILE=*fname*

*fname* is either a character expression specifying a pathname or an alternate prefix filename for the opened unit. When specified, the full file name of the opened unit is obtained by concatenating the string specified by *fname* with either the string in the FILE parameter (if specified) or with the unit number (when FILE is absent).

*fname* can also be a numeric variable to which hollerith data is assigned. A null character terminates the file name.

## DISPOSE=*disposition*

### DISP=*disposition*

*disposition* is a character expression that designates how the opened file is to be handled after it is closed, the table below gives the values that can be specified for *disposition* and the effect on the closed file.

DISPOSE=	File status after CLOSE
KEEP	Retained (default).
SAVE	Same as KEEP.
PRINT	Printed and retained.
PRINT/DELETE	Printed and deleted.
SUBMIT	Executed and retained.
SUBMIT/DELETE	Executed and deleted.

## FORM=*fm*

is a *form specifier*. *fm* is a character expression which, when all trailing blanks are removed has either of the values FORMATTED or UNFORMATTED. The file is connected for formatted or unformatted input/output, respectively. If *iolist* contains no form specifier, the default value FORMATTED is assumed for sequential and direct access file.

## OPEN

KEY=(*key1start:key1end:[type]* [ *key2start:key2end:[type]* ]...)

Defines the location and data type of one or more keys in an indexed record. The following rules apply to KEY parameters:

- At least one key (the primary key) must be specified when creating an indexed file.
- *type* is either INTEGER or CHARACTER (the default), defining the data type of the key.
- INTEGER keys must be specified with a length of 4.
- The maximum length of a key is 120 bytes.
- *key1start* and *key1end* are integers defining the start and ending byte position of the primary field, which is always required. *key2start* and *key2end*, and subsequent specifications, define the starting and ending position of alternate fields, which are optional. There is no limit to the number of keys that can be specified.
- The sequence of the key fields determines the value in a key-of-reference specifier, KEYID, described in the **Control Information List** section of this chapter. KEYID=0 specifies the field starting the *key1start* (primary) key; KEYID=1 specifies the field starting at *key2start*, and so forth.
- The KEY field must be specified *only* when an indexed file is created. The key specifications in the first OPEN remain in effect permanently for subsequent file openings. If KEY is specified when opening an existing file, the specifications must match those specified when the file was created.

MAXREC=*n* where *n* is a numeric expression defining the maximum number of records allowed in a direct access file. If this parameter is omitted, no maximum limit exists.

RECL=*rl* is a *record length specifier*. *rl* is a positive integer expression specifying the length in characters or processor-dependent units for formatted and unformatted files, respectively. This specifier is required for direct access files and **keyed access files**; otherwise, it must be omitted.

# OPEN

**READONLY** specifies that the unit is to be opened for reading only. Other programs may open the file and have read-only access to it concurrently. If this keyword isn't specified, both reading and writing to the specified file is permitted.

**RECORDSIZE=*rl***  
Same as RECL.

**RECORDTYPE=*rt***  
where *rt*, when creating a file, defines the type of records that the file is to contain; *rt* can be one of the following character expressions: FIXED, VARIABLE, or STREAM\_LF. If RECORDTYPE is omitted, the default record type depends on the file type, as determined by the ACCESS and/or FORM parameters. The default types are as follows:

File Type	Record type (default)
Relative or indexed	FIXED
Direct access sequential	FIXED
Formatted sequential access	STREAM_LF
Unformatted sequential access	VARIABLE

The following rules apply:

If RECORDTYPE is specified, *rt* must be the appropriate default value shown in the table shown above.

When writing records to a fixed-length file, the record is padded with spaces (for formatted files) or with zeros (for unformatted files) when the output statement doesn't specify a full record.

**SHARED** Specifies that other programs have concurrent access to the file.

**STATUS=*sta*** is a *file status specifier*. *sta* is a character expression which, ignoring trailing blanks, has one of the following values:

**OLD.** The FILE=*fname* specifier must also be given and the file must exist.

**NEW.** The FILE=*fname* specifier must be given; the file is created by open and the file status automatically turned to OLD. A file with the same name must not already exist.

# OPEN

**SCRATCH.** An unnamed file will be created which is connected to the unit from [UNIT=] and will be deleted when that unit is closed by CLOSE. Named files should not be used with SCRATCH.

**UNKNOWN.** Meaning is processor dependent. See the **Unknown Status** section in **Chapter 1** of the *FORTRAN Programmer's Guide* for more information.

If the STATUS parameter is omitted, UNKNOWN is the default.

**TYPE=sta\_** Same as STATUS.

## Rules of Use

1. Specifiers may be given in *iolist* in any order (exception: see *unit specifier*).
2. The unit specifier is required; all other specifiers are optional. The record length specifier is required for connecting to a direct access file.
3. The unit specified must exist.
4. An OPEN statement for a unit that is connected to an existing file is allowed. If the file specifier is not included, the file to be connected to the unit is the same as the file to which the unit is connected.
5. A file to be connected to a unit that is not the same as the file currently connected to the unit, has the same effect as a CLOSE statement without a file status specifier. The old file is closed and the new one is opened.
6. If the file to be connected is the same as the file to which the unit is currently connected, then all specifiers must have the same value as the current connection, except for the value of the BLANK specifier.
7. See the **Data Transfer Rules** section of this chapter for additional rules.

## Examples

```
OPEN (1, STATUS='NEW')
OPEN (UNIT=1, STATUS='SCRATCH', ACCESS='DIRECT', RECL=64)
OPEN (1, FILE='MYSTUFF', STATUS='NEW', ERR=14,
      ACCESS='DIRECT', RECL=1024)
OPEN (K, FILE='MAILLIST', ACCESS='INDEXED',
      FORM='FORMATTED', RECL=256,
      KEY=(1:20, 21:30, 31:35, 200:256))
```

## PRINT or TYPE

### Purpose

Transfers data from the output list items to the file associated with the system output unit.

### Syntax

```
PRINT f [, iolist]
```

where *f* is the format specifier and *iolist* is an optional output list specifying the data to be transferred as described in the **Control Information List and Input/Output List** sections of this chapter.

TYPE is a synonym for and can be used instead of PRINT.

### Rules of Use

The PRINT statement may be used for formatted output to the system output unit. See the **Data Transfer Rules** section of this chapter for additional rules.

### Examples

```
PRINT 10, (FORM(L), L=1, K+1)
PRINT *, X, Y, Z
TYPE *, ' VOLUME IS ', V, ' RADIUS IS ', R
```

## READ (Direct Access)

### Purpose

Transfers data from an external file to the items specified by the input list. Transfer occurs using the direct access method (see Chapter 7).

### Syntax

#### Formatted

```
READ ([UNIT=] unum, REC=rn, f [, IOSTAT=ios] [, ERR=s]) [iolist]
```

#### Unformatted

```
READ ([UNIT=] unum, REC=rn, [, IOSTAT=rn] [, ERR=s]) [iolist]
```

### Parameter Explanations

UNIT= <i>unum</i>	Unit or internal file to be acted upon.
<i>f</i>	A format specifier
REC= <i>rn</i>	Direct access mode. The number of the record to be accessed.
IOSTAT= <i>rn</i>	Name of variable in which I/O completion status is to be posted.
ERR= <i>s</i>	Statement label to which control is transferred after an error.
<i>iolist</i>	Specifies memory location where data is to be read.

See **Control Information List** and **Input/Output List** sections in this chapter for details on these parameters.

See the **Data Transfer Rules** section of this chapter and **Chapter 7** for more information on formatted and unformatted input/output.



## READ (Indexed)

### Purpose

Transfers data from an external indexed file to the items specified by the input list. Transfer occurs using the keyed access method (see **Chapter 7**).

### Syntax

#### Formatted

```
READ ([UNIT=unum, f, KEY=val [, KEYID=kn]
      [, IOSTAT=rn] [, ERR=s] ()) [iolist]
```

#### Unformatted

```
READ ([UNIT=unum, key [, keyid] [, IOSTAT=rn] [, ERR=s]) [iolist]
```

### Parameter Explanations

**UNIT=*unum*** Unit or internal file to be acted upon.

***f*** A format specifier.

**KEY=*val*** Value of key field in record to be accessed.

**KEYID=*kn*** Key-reference specifier.

**IOSTAT=*rn*** Name of variable in which I/O completion status is to be posted.

**ERR=*s*** Statement label to which control is transferred after an error.

***iolist*** Specifies memory location where data is to be read.

See **Control Information List** and **Input/Output List** sections in this chapter for details on these parameters.

See the **Data Transfer Rules** section of this chapter and **Chapter 7** for more information on indexed input/output and the differences between formatted and unformatted input/output.

## READ (Internal)

### Purpose

Transfers data from an internal file to internal storage.

### Syntax

#### Formatted

```
READ ([UNIT=] unum, f [, IOSTAT=rn] [, ERR=s] [, END=eof]) [iolist]
```

#### List-Directed

```
READ ([UNIT=] unum, * [, IOSTAT=rn] [, ERR=s] [, END=eof]) [iolist]
```

### Parameter Explanations

UNIT=*unum*    Unit or internal file to be acted upon.

*f*             A format specifier

\*             List-directed input specifier.

IOSTAT=*rn*    Name of variable in which I/O completion status is to be posted.

ERR=*s*         Statement label to which control is transferred after an error.

END=*eof*       Statement label to which control is transferred upon end-of-file.

*iolist*         Specifies memory location where data is to be read.

See **Control Information List** and **Input/Output List** sections in this chapter for details on these parameters.

See the **Data Transfer Rules** section of this chapter and **Chapter 7** for more information on formatted and list-directed input/output. **Chapter 7** also contains an example input/output using internal files.

**NOTE:** The **DECODE** statement can also be used to control internal input. See the **DECODE** statement description in this chapter for more information.

## READ (Sequential)

### Purpose

Transfers data from an external record to the items specified by the input list. Transfers occurs using the sequential access method or keyed access method (See Chapter 7.)

### Syntax

#### Formatted

```
READ ([UNIT=] unum, f[, IOSTAT=rn] [, ERR=s] [, END=eof]) [iolist]
READ f[, iolist]
```

#### List-Directed

```
READ ([UNIT=] unum, *[, IOSTAT=rn] [, ERR=s] [, END=eof]) [iolist]
READ f* [iolist]
```

#### Unformatted

```
READ ([UNIT=] unum[, IOSTAT=rn] [, ERR=s] [, END=eof]) [iolist]
```

#### Namelist-Directed

```
READ (unum, NML=group-name[, IOSTAT=rn] [, ERR=s] [, END=eof]) [iolist]
READ name
```

### Parameter Explanations

UNIT= <i>unum</i>	Unit or internal file to be acted upon.
<i>f</i>	A format specifier.
*	List-directed input specifier.
NML= <i>group-name</i>	A namelist specifier.
<i>name</i>	Same as above, except the keyword NML is omitted.
IOSTAT= <i>rn</i>	Name of variable in which I/O completion status is to be posted.
ERR= <i>s</i>	Statement label to which control is transferred after an error.
END= <i>eof</i>	Statement label to which control is transferred upon end-of-file.
<i>iolist</i>	Specifies memory location where data is to be read.

See **Control Information List** and **Input/Output List** sections in this chapter for details on these parameters.

## READ (Sequential)

### Method of Operation

#### Formatted

A formatted READ statement transfers data from an external record to internal storage. It translates the data from character to binary format using the *f* specifier to edit the data.

#### List-Directed

A list-directed READ statement transfers data from an external record to internal storage. It translates the data from character to binary format using the data types of the items in *iolist* to edit the data.

#### Namelist-Directed

A namelist-directed READ statement locates data in a file using the group name in a NAMELIST statement (see Chapter 4). It uses the data types of the items in the corresponding NAMELIST statement and the forms of the data to edit the data. See Namelist-Directed Rules in this section for more information on this format.

#### Unformatted

A unformatted READ statement transfers data from an external record to internal storage. The READ operation performs no translation on read-in data. The data is read directly to the items in *iolist*. The type of each data item in the input record must match that declared for the corresponding item in *iolist*.

### Rules

#### Unformatted

1. There must be at least as many items in the unformatted record as there are in *iolist*. Additional items in the record are ignored, and a subsequent READ accesses the next record in the file.
2. The type of each data item in the input record must match the corresponding data item in *iolist*.

See the **Data Transfer Rules** section of this chapter and **Chapter 7** for more information on formatted, list-directed unformatted, and namelist-directed input/output.

## READ (Sequential)

### Rules (continued)

#### List-Directed

1. The external record can have one of the following values:
  - A constant with a data type of integer, real, logical, complex, or character. The rules given in **Chapter 2** define the acceptable formats for constants in the external record.
  - A null value, represented by a leading comma, two consecutive constants without intervening blanks, or a trailing comma.
  - A repetitive format  $n*\text{constant}$ , where  $n$  is a nonzero, unsigned integer constant indicating the number of occurrences of *constant*.  $n^*$  represents repetition of a null value.
2. Hollerith, octal, and hexadecimal constants are not allowed.
3. A value separator must delimit each item in the external record; a value separator can be one of the following:
  - One or more spaces or tabs.
  - A comma, optionally surrounded by spaces or tabs.
4. A space, tab, comma, or slash appearing within a character constant are processed as part of the constant, and not as delimiters.
5. A slash terminates delimits the end of the record and causes processing of an input statement to halt; the slash can be optionally surrounded by spaces and/or tabs. Any remaining items in *iolist* are unchanged after the READ.
6. When the external record specified contains character constants, a slash must be specified to terminate processing of the record. If the external record ends with a blank, the first character of the next record processed follows immediately after the last character of the previous record.
7. Each READ reads as many records as is required by the specifications in *iolist*. Any items in a record appearing after a slash are ignored.

## READ (Sequential)

### Rules (continued)

#### Namelist-Directed

- The figure below gives some rules for namelist input data and shows its format:

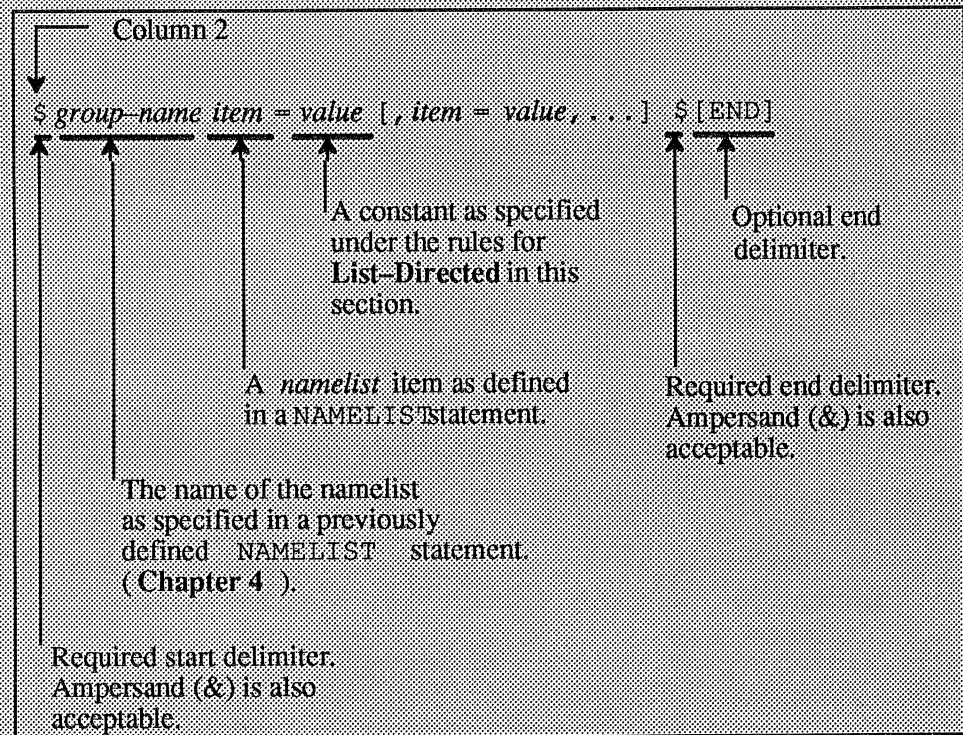

- Both *group-name* and *item* must be contained within a single record.
- Spaces and/or tabs aren't allowed within *group-name* or *item*. However, *item* can contain spaces or tabs within the parentheses of a subscript or substring specifier.
- The *value* item can any of the values given under Rule 1 in the previous section, List-Directed.
- A *value* separator must delimit each item in a list of constants. See Rules 3 and 4 under List-Directed.
- A separator must delimit each list of value assignments. See Rule 3 under List-Directed. Any number of spaces or tabs can precede the equal sign.
- When *value* contains character constants, a dollar sign (\$) or ampersand (&) must be specified to terminate processing of the namelist input. If the namelist input ends with a blank, the first character of the next record processed follows immediately after the last character of the previous record.

## READ (Sequential)

### Rules (continued)

#### Namelist-Directed

8. Entering a question mark (?) after execution of a namelist-directed READ statement is executed causes the group-name and current values of the namelist items for that group to be displayed.
9. You can assign input values in any order in the format *item=value*. Multiple-line assignment statements are allowed. Each new line must begin on or after Column 2; Column 1 is assumed to contain a carriage-control character. Any other character in Column 1 is ignored.
10. You can assign input values for the following data types: integer, real, logical, complex, and character. Table 5.1 in Chapter 5 gives the rules for conversion when the data type of the namelist item and the assigned constant value don't match.
11. Numeric-to-character and character-to-numeric conversions are not allowed.
12. Constant values must be given for assigned values, array subscripts, and substring specifiers. Symbolic constants defined by a PARAMETER statement are not allowed.

### Examples

In the following example, the name of a file is read from the standard input into *filename*, the file is opened, and the first record is read. A branch is taken to statement 45 (not shown) when end-of-file is encountered.

```
      read (*,10) filename
10 format (a)
      open (2,file=filename)
      read (2, 20, end=45) word
20 format (A50)
```

# REWIND

## Use

Positions a file at its initial point. It may be used with both unformatted and formatted data files.

## Syntax

```
REWIND u  
REWIND (alist)
```

where *u* is an external unit identifier and *alist* is a list of the following specifiers:

[UNIT =] *u* is a required *unit specifier*. *u* must be an integer expression that identifies the number of an external unit. If the keyword UNIT= is omitted, then *u* must be the first specifier in *alist*.

IOSTAT = *ios* is an *input/output status specifier* that specifies the variable to be defined with a status value by the REWIND statement. A zero value for *ios* denotes a no error condition while a positive integer value denotes an error condition.

ERR = *s* is an *error specifier* that identifies a statement number to which control is to be transferred when an error condition occurs during the execution of the REWIND statement.

## Method of Operation

The unit specifier is required and must appear exactly once. The other specifiers are optional, and can appear at most once each in the *alist*. Specifiers can appear in any order (exception: see *unit specifier*). The REWIND statement positions the specified file at its initial point. If the file is already at its initial point, the REWIND statement has no effect. A REWIND statement for a file that is connected but does not exist is allowed but has no effect.

## Examples

```
REWIND 8  
REWIND (UNIT=NFILE, ERR=555)
```



## REWRITE

Transfers data to an external indexed file from the items specified by the output list. The record transferred is the last record accessed from the same file using an indexed READ statement.

### Syntax

#### Formatted

```
REWRITE ([UNIT=] unum, f [, IOSTAT=rn] [, ERR=s]) [iolist]
```

#### Unformatted

```
REWRITE ([UNIT=] unum [, IOSTAT=rn] [, ERR=s]) [iolist]
```

### Parameter Explanations

[UNIT=]*unum* Unit or internal file to be acted upon.

*f* A format specifier.

IOSTAT=*rn* Name of variable in which I/O completion status is to be posted.

ERR=*s* Statement label to which control is transferred after an error.

See **Control Information List** and **Input/Output List** sections in this chapter for details on these parameters.

### Rules of Use

The REWRITE statement is supported for both formatted and unformatted indexed files. The statement provides a means for changing existing records in the file.

See the **Data Transfer Rules** section of this chapter for additional rules.

### Example

```
REWRITE (10), A, B, C
```

Rewrites the last record accessed to the indexed file connected to logical unit 10.

# UNLOCK

## Purpose

Makes the last record read from an indexed file available for access by other users.

## Syntax

```
UNLOCK [UNIT=] unum  
UNLOCK ([UNIT=] unum [, IOSTAT=rn] [, ERR=s])
```

## Parameter Explanations

UNIT=*unum*    Unit or internal file to be acted upon.

IOSTAT=*rn*    Name of variable in which I/O completion status is to be posted.

ERR=*s*        Statement label to which control is transferred after an error.

See the **Control Information List** section in this chapter for details on each of these parameters.

## Method of Operation

After a record is read from an indexed file, it cannot be accessed by other users until an UNLOCK statement is executed, the record is rewritten, or a new record is read.

## Examples

```
UNLOCK (10)
```

unlocks the last record read in from the file connected to logical unit 10.

## WRITE (Direct Access)

### Purpose

Transfers data from internal storage to an external indexed using the direct access method.

### Syntax

#### Formatted

```
WRITE ([UNIT=] unum, REC=rn, f [, IOSTAT=rn] [, ERR=s]) [iolist]
```

#### Unformatted

```
WRITE ([UNIT=] unum, REC=rn, [, IOSTAT=ios] [, ERR=s]) [iolist]
```

### Parameter Explanations

UNIT= <i>unum</i>	Unit or internal file to be acted upon.
REC= <i>rn</i>	Direct access mode. The number of the record to be accessed.
<i>f</i>	A format specifier
IOSTAT= <i>rn</i>	Name of variable in which I/O completion status is to be posted.
ERR= <i>s</i>	Statement label to which control is transferred after an error.
<i>iolist</i>	Specifies memory location from which data is to be written.

See **Control Information List** and **Input/Output List** sections in this chapter for details on these parameters.

See the **Data Transfer Rules** section of this chapter and **Chapter 7** for more information on formatted and unformatted input/output.

### Rules of Use

1. Execution of a WRITE statement for a file that does not exist creates the file.

**WRITE (Indexed)****Purpose**

Transfers data from internal storage to external records using the keyed access method.

**Syntax***Formatted*

```
WRITE ([UNIT=unum], f [, IOSTAT=rn] [, ERR=s]) [iolist]
```

*Unformatted*

```
WRITE ([UNIT=unum] [, IOSTAT=rn] [, ERR=s]) [iolist]
```

**Parameter Explanations**

UNIT=*unum* Unit or internal file to be acted upon.

*f* A format specifier.

\* List-directed out specifier.

IOSTAT=*rn* Name of variable in which I/O completion status is to be posted.

ERR=*s* Statement label to which control is transferred after an error.

*iolist* Specifies memory location from which data is to be written.

See **Control Information List** and **Input/Output List** sections in this chapter for details on these parameters.

See the **Data Transfer Rules** section of this chapter and **Chapter 7** for more information on formatted and unformatted input/output.

**Rules of Use**

1. Execution of a WRITE statement for a file that does not exist creates the file.

## WRITE (Internal)

### Purpose

Transfers data to an external file or an internal file from the items specified by the output list.

### Syntax

#### Formatted

```
WRITE ([UNIT=] unum, f [, IOSTAT=ios] [, ERR=s]) [iolist]
```

#### List-Directed

```
WRITE ([UNIT=] unum, * [, IOSTAT=rn] [, ERR=s]) [iolist]
```

### Parameter Explanations

<code>UNIT=<i>unum</i></code>	Unit or internal file to be acted upon.
<code><i>f</i></code>	A format specifier.
<code>*</code>	list-directed out specifier.
<code>IOSTAT=<i>rn</i></code>	Name of variable in which I/O completion status is to be posted.
<code>ERR=<i>s</i></code>	Statement label to which control is transferred after an error.
<code><i>iolist</i></code>	Specifies memory location from which data is to be written.

See **Control Information List** and **Input/Output List** sections in this chapter for details on these parameters.

See the **Data Transfer Rules** section of this chapter and **Chapter 7** for more information on formatted and list-directed input/output. **Chapter 7** also contains an example input/output using internal files.

### Rules of Use

1. Execution of a WRITE statement for a file that does not exist creates the file.

**NOTE:** The ENCODE statement can also be used to control internal output. See the ENCODE statement description in this chapter for more information.

## WRITE (Sequential)

### Purpose

Transfers data to an external file or an internal file from the items specified by the output list.

### Syntax

#### Formatted

```
WRITE ([UNIT=] unum, f [, IOSTAT=rn] [, ERR=s]) [iolist]
```

#### List-Directed

```
WRITE ([UNIT=] unum, * [, IOSTAT=rn] [, ERR=s]) [iolist]
```

#### Unformatted

```
WRITE ([UNIT=] unum [, IOSTAT=rn] [, ERR=s]) [iolist]
```

#### Namelist-Directed

```
WRITE ([UNIT=] unum, NML=group-name [, IOS-  
TAT=rn] [, ERR=s] [, END=eof])
```

### Parameter Explanations

UNIT= <i>unum</i>	Unit or internal file to be acted upon.
NML= <i>group-name</i>	A namelist specifier.
<i>f</i>	A format specifier.
*	List-directed out specifier.
REC= <i>rn</i>	Direct access mode. The number of the record to be accessed.
IOSTAT= <i>rn</i>	Name of variable in which I/O completion status is to be posted.
ERR= <i>s</i>	Statement label to which control is transferred after an error.
<i>iolist</i>	Specifies memory location from which data is to be written

See **Control Information List** and **Input/Output List** sections in this chapter for details on these parameters.

See the **Data Transfer Rules** section of this chapter and **Chapter 7** for more information on formatted, list-directed, and unformatted input/output.

## WRITE (Sequential)

### Method of Operation

#### *Formatted*

A formatted WRITE statement transfers data from internal storage to an external record using sequential access mode. The WRITE operation translates the data from binary to character format using the *f* specifier to edit the data.

#### *List-Directed*

A list-directed WRITE statement transfers data from internal storage to an external record using sequential access mode. The WRITE operation translates the data from binary to character format using the data types of the items in *iolist* to edit the data.

#### *Namelist-Directed*

A namelist-directed WRITE statement transfers data from internal storage to external records. It translates the data from internal to external format using the data type of the items in the corresponding NAMELIST statement (see Chapter 4). A namelist-directed READ or ACCEPT statement can read the output of a namelist-directed WRITE statement.

#### *Unformatted*

An unformatted WRITE statement performs no translation on read-in data. The data is read in directly to the items in *iolist*. The type of each data item in the input record must match that declared for the corresponding item in *iolist*.

### Rules

Execution of a WRITE statement for a file that does not exist creates the file.

#### *List-Directed*

1. The item to be transferred to an external record can be a constant with a data type of integer, real, logical, complex, or character.
2. The rules given in Chapter 2 define the acceptable formats for constants in the external record, except for character constant. A character constant does not require delimiting apostrophes; an apostrophe within a character string is represented by one, instead of two, apostrophes.

## WRITE (Sequential)

### Rules (continued)

#### List-Directed

3. The table below shows the data types and the defaults of their output format.

Data Type	Equivalent Format Specification of Default Output
LOGICAL*1	I5
BYTE	L2
LOGICAL*2	L2
LOGICAL*4	L2
LOGICAL	L2
INTEGER*2	I7
INTEGER*4	I12
INTEGER	I12
REAL*4	1PG15.7E2
REAL	1PG15.7E2
REAL*8	1PG24.16E2
REAL*16	1PG43.33E4
COMPLEX	' (' , 1PG15.7E2 , ' , ' , 1PG15.7E2 , ' ) '
COMPLEX*16	' (' , 1PG24.16E2 , ' , ' , 1PG24.16E2 , ' ) '
CHARACTER*n	A <i>n</i> , where <i>n</i> is the length of the character expression.

4. List-directed character output data cannot be read as list-directed input because of the different use of apostrophes described in Rule 2.
5. A list-directed output statement can write one or more records. Position 1 of each record must contain a space (blank), which FORTRAN uses for a carriage-control character.

Each value must be contained within a single record with the following exceptions:

- a character constant longer than a record can be extended to a second record
  - a complex constant can be split onto a second record after the comma
6. The output of a complex value contains no embedded spaces.
7. Octal values, null values, slash separators, or the output of a constant or null value in the repetitive format *n\*constant* or *n\*z* cannot be generated by a list-directed output statement.



## WRITE (sequential)

### Rules (continued)

#### *Namelist-Directed*

Namelist items are written in the order that the referenced NAMELIST defines them.

### Examples

The following statement writes the prompt *enter a filename* to standard output:

```
        write (*,105)
105    format (1x,'enter a filename')
```

The following statement opens the file *%%temp* and writes the record *pair* to the file.

```
        open (unit=10,status='unknown',file="%%temp")
        write (10,1910) pair
1910    format (A)
```

## Control Information List — cilst

This section describes the components of the control information list (*cilst*) and the input/output list (*iolist*), which can be specified as elements of the I/O statements described in this chapter.

The table below summarizes the items that can be specified in a *cilst*. Each *cilst* specifier shown in the table can appear at most once in a *cilst*. Note that the keywords UNIT= and FMT= are optional. Normally, the *cilst* items may be written in any order, but if UNIT= or FMT= is omitted, the following restrictions apply:

1. The keyword UNIT= may be omitted if and only if the unit specifier is the first item on the list.
2. The keyword FMT= may be omitted if and only if the format specifier is the second item in the *cilst* and the first item is a unit specifier in which the keyword UNIT= has been omitted.

A format specifier denotes a formatted input/output operation; default is an unformatted input/output operation. If a record specifier is present, then direct access input/output is denoted; default is sequential access.

Specifier	Purpose
[UNIT=] <i>u</i>	Unit or internal file to be acted upon.
[NML= <i>group-name</i> ]	Identifies the <i>group-name</i> of a list of items when namelist-directed I/O is used.
[FMT=] <i>f</i>	Formatted or unformatted input/output operations. If formatted, contains format specifiers for data to be read or written.
REC= <i>rn</i>	Number of a record to be accessed in direct access mode.
KEY[ <i>c</i> ]= <i>val</i>	Value of the key field in a record to be accessed in indexed access mode, where <i>c</i> can be the optional match condition EQ, GT, or GE.
KEYID= <i>kn</i>	Key-reference specifier, specifying either the primary key or one of the alternate keys in a record to be referenced in indexed access mode.
IOSTAT= <i>ios</i>	Name of a variable in which I/O completion status is to be returned.
ERR= <i>s</i>	Label of a statement to which control is transferred if an error occurs.
END= <i>s</i>	Label of a statement to which control is transferred if an end-of-file condition (READ only) occurs.

**Unit Specifier — *unum***

The form of a *unit specifier* is:

[UNIT=]*u*

where *u* is a unit identifier specified as follows:

1. A non-negative integer or non-integer expression specifying the unit. A non-integer expression is converted to integer, and the fractional portion, if present, is discarded prior to use.
2. An asterisk specifying a unit that is connected for formatted sequential access (external file identifier only). This denotes the system input unit in a READ statement, or the system output unit in a WRITE statement.
3. An identifier that is the name of a character variable, character array, character array element, or substring (internal file identifier only).

An *external unit identifier* can have the form described in Rule 1 or 2 above, but it cannot be an asterisk in an auxiliary output statement as described in Rule 2.

An *internal file identifier* must be specified as described in Rule 3.

The syntax shows that the keyword UNIT= may be omitted. If UNIT= is omitted, the unit identifier must be first in a control information list. For example, two equivalent READ statements are:

```
READ (UNIT= 5)
READ (5)
```

**Format Specifier — FMT**

The syntax of a *format specifier* is:

[FMT=] *f*

where *f* is a *format identifier*. As shown in the syntax, the keyword FMT= can be omitted from the format identifier. If so, the format identifier must be in second in a control information list, and the UNIT= keyword must also have been omitted.

The legal kinds of format identifiers are:

1. The statement label of a FORMAT statement (the FORMAT statement and the format identifier must be in the same program unit).
2. An integer variable name assigned to the statement label of a FORMAT statement (the FORMAT statement and the format identifier must be in the same program unit).
3. A character expression (provided it does not contain the concatenation of a dummy argument that has its length specified by an asterisk).
4. The name of a character array.

5. An asterisk that is used to indicate list-directed formatting.

### Namelist Specifier — NML

The namelist specifier indicates namelist-directed I/O within the READ or WRITE statement where NML is specified. It has the format:

[NML=] *group-name*

where *group-name* identifies the list in a previously defined NAMELIST statement (Chapter 4). NML can be omitted when preceded by unit specifier (*unum*) without the optional UNIT keyword.

### Record Specifier — REC

The form of a *record specifier* is:

REC=*rn*

where *rn* is an expression that evaluates the *record number* of the record to be accessed in a direct access input/output operation. Record numbers must be integers greater than zero.

### Key-Field-Value Specifier — KEY

The indexed access method use the key-field-value specified in a READ, REWRITE, or other input/output statement, and a key field in the record as criteria in selecting a record from an indexed file. The key fields for the records in an indexed file are established by the KEY parameter used in the OPEN statement that created the file).

The key-field-value specifier has the forms shown in the following table:

Specifier	Basis for Record Selection
KEY= <i>kval</i> KEYEQ= <i>kval</i>	The key-field value <i>kval</i> and the key field are equal.
KEYGT= <i>kval</i>	The key-field value is greater than the key field.
KEYGE= <i>kval</i>	The key-field value is greater than or equal to the key field.

The following rules apply to *kval*:

1. *kval* can be a character or integer expression; if an integer expression, it cannot contain any real or complex values. If the indexed file is formatted, *kval* should always be a character expression.
2. The character expression can be an ordinary character string or an array name of type LOGICAL\*1 or BYTE containing Hollerith data.
3. The character or integer type specified for *kval* must match the type specified for the key field in the record.

**Key-of-Reference Specifier — KEYID**

The key-of-reference specifier designates in a READ, REWRITE, or other input/output statement, the key field in a record to which the key-field-value specifier applies.

The specifier has the following format:

KEYID=*n*

where *n* is a number from 0 to the maximum number of keys defined for the records in the indexed file; 0 specifies the primary key, 1 specifies the first alternate key, 2 specifies the second alternate key, etc. The KEY parameter of the OPEN statement that created the files creates and establishes the ordering of the primary and alternate keys.

If KEYID isn't specified, the previous KEYID specification in an input/output statement to the same input/output unit is used. The default for KEYID is zero (0) if it isn't specified for the first input/output statement.

**Input/Output Status Specifier — ios**

An *input/output status specifier* has the form:

IOSTAT=*rn*

where *ios* is a *status variable* indicating an integer variable or an integer array element. Execution of an input/output statement containing this specifier causes *ios* to become defined with the value:

1. Zero if neither an error condition nor an end-of-file condition is encountered by the processor, indicating a successful operation.
2. Positive integer if an error condition occurred.
3. Negative integer if an end-of-file condition is encountered without an error condition.

**Error Specifier — ERR**

An *error specifier* has the following form:

ERR=*s*

where *s* is an *error return* label of an executable statement that appears in the same program unit as the error specifier.

If an error condition occurs during execution of an input/output statement with an error specifier, execution of the statement is terminated and the file position becomes indeterminate. If the statement contains an input/output input/output status specifier, the status variable *ios* becomes defined with a processor dependent positive integer. Execution then continues at the statement labeled *s*.

## End-of-File Specifier — END

The form of an *end-of-file specifier* is:

END=*s*

where *s* is an end-of-file return label of an executable statement that appears in the same program unit as the end-of-file specifier. An end-of-file specifier may only be used on the *cilist* of a READ statement.

If an end-of-file condition is encountered during the execution of a READ statement containing an end-of-file specifier and no error occurs, execution of the READ statement terminates. If the READ statement contains an input/output status specifier, the input/output status variable *ios* becomes defined with a processor-dependent negative integer. Execution then continues at the statement labeled *s*.

## Input/Output List — *iolist*

This section describes the components of input/output list (*iolist*), which can be specified as elements of the I/O statements described in this chapter.

An *input/output list* specifies the memory locations of the data to be transferred by the input/output statements READ, WRITE, and PRINT.

If an array name is given as an input/output list item, the elements in the array are treated as though each element were explicitly specified in the input/output list in storage order. Note that the name of an assumed-size dummy array (i.e. an array declared with \* for an upper bound) must not appear as an input/output list item.

## Input List

An input list item can be one of the following:

- A variable name
- An array element name
- A substring name
- An array name
- An implied-DO list containing any of the above and other implied-DO lists
- An aggregate reference (a structured data item as defined by a RECORD and STRUCTURE statement). An aggregate reference can be used only in unformatted input statements. When an aggregate name appears in an *iolist*, only one record is read regardless of how many aggregates or other list items are present.

Examples of input lists are:

```
READ (5, 3000, END=2000) X, Y(J, K+3), C(2:4)
READ (JFILE, REC=KNUM, ERR=1200) M, SLIST(M, 3), cilist
```

## Output List

An output list item can be one of the following:

- A variable name
- An array element name
- A substring name
- An array name
- Any expression, except a character expression involving concatenation of an operand with a length specification of asterisk (\*), unless the operand is the symbolic name of a constant
- An implied-DO list containing any of the above and other implied-DO lists
- An aggregate reference (a structured data item as defined by a RECORD and STRUCTURE statement). An aggregate reference can be used only in unformatted output statements. When an aggregate name appears in an iolist, only one record is written regardless of how many aggregates or other list items are present.

Note that a constant, an expression involving operators or function references, or an expression enclosed in parentheses may appear in an output list but not in an input list.

An example of an output list is:

```
WRITE (5, 200, ERR=10) ' ANSWER IS' , N, SQRT (X) + 1.23
```

## Implied-DO Lists

An implied-DO list in a specification that follows the input/output list (*iolist*) in an input/output statement. The list permits the iteration of the statement as though it were contained within a DO loop. An *implied-DO* list has the form:

$$(iolist, i=e1, e2[, e3])$$

where *iolist* is one or more valid names of the data to be acted upon; *i* is an iteration count; and *e1*, *e2*, and *e3* are control parameters. See the description of the DO statement in Chapter 6 for a description of *i*, *e1*, *e2*, and *e3*.

The control variable *i* must not appear as an input list item in *iolist*. The list items in *iolist* are specified once for each iteration of the implied-DO list with the appropriate substitution of values for each occurrence of the control variable *i*.

## Example

The following statements write *Hello World* to the standard output 100 times:

```
      write (*, 111) ('Hello World', i=1, 100)
111   format (1x, A)
      end
```

## Data Transfer Rules

Data are transferred between records and items specified by the input/output list. The list items are processed in the order in which they appear in the list.

The following restrictions apply to data transfer operations:

1. An input list item must not contain any portion of the established format specification.
2. If an internal file has been specified, an input/output list item must not be in the file or associated with the file.
3. Each output list item must be defined prior to the transfer of that item.
4. All values needed to determine which entities are specified by an input/output list item are determined at the beginning of the processing of that item.

The following section discuss the rules specific to unformatted and formatted input/output.

### Unformatted Input/Output

The execution of an *unformatted* input/output statement transfers data without editing between the current record and the items specified in the input/output list. Exactly one record is either read or written.

For an unformatted input statement, the record must contain at least as many values as the number of values required by the input list. The data types of the values in the record must agree with the types of the corresponding items in the input list. Character data from an input record must have the same length attribute as the corresponding item in the input list.

The following conventions apply to the execution of an unformatted output statement:

1. For direct access, the output list must not specify more values than can fit into a record. If the values specified by the output list do not fill the record, the remainder of the record is undefined.
2. For sequential access, the output list defines the size of the output record.

FORTRAN 77 allows unformatted data transfer only for external files and prohibits it for files connected for formatted input/output.

### Formatted Input/Output

The execution of a *formatted* input/output statement transfers data with editing between the items specified by the input/output list and the file. The current record and possibly additional records are read or written.

Each execution of a READ statement causes at least one record to be read, and the input list determines the amount of data to be transferred from the record. The position and form of that data is established by the corresponding format specification.



In a formatted output operation, each execution of the `WRITE` or `PRINT` statement causes at least one record to be written. The amount of data written to the specified unit is determined both by the output list and the format specification.

When a repeatable edit descriptor in a format specification is encountered, a check is made for the existence of a corresponding item in the input/output list. If there is such an item, it transmits appropriately edited information between the item and the record, and then format control proceeds. If there is no corresponding item, format control terminates. Formatted input/output is explained in more detail in **Chapter 9**.

## Overview

A format specification provides explicit editing information to the processor on the structure of a formatted data record. It is used with formatted input/output statements to allow conversion and data editing under program control. An asterisk (\*) used as a format identifier in an input/output statement specifies list-directed formatting.

A format specification may be defined in a FORMAT statement or through the use of arrays, variables, or expressions of type character. During input, field descriptors specify the external data fields and establish correspondence between a data field and an input list item. During output, field descriptors are used to describe how internal data is to be recorded on an external medium and to define a correspondence between an output list item and an external data field.

This section describes the FORMAT statement, field descriptors, edit descriptors, and list-directed formatting. It also contains a discussion of carriage control characters for vertical control in printing formatted records.

As extensions to FORTRAN 77, the compiler supports additional processor-dependent capabilities, which are described in Chapter 4 of the *FORTRAN Programmer's Guide*.

Format specifications can be given in two ways: in FORMAT statements and as values of character arrays, character variables, and other character expressions.

## Format Stored as a Character Entity

In a formatted input or output statement, the format identifier can be a character entity, provided its value has the syntax of a format specification, as detailed below, upon execution. This capability allows a character format specification to be read in during program execution.

When the format identifier is a character array name, the format specification is a concatenation of all the elements in the array. When the format identifier is a character array element name, the format specification is only that element of the array. Therefore, format specifications read via a character array name may fill the whole array, while those read via a character array element name must fit in a single element of that array.

## FORMAT Statement

The **FORMAT** statement is a nonexecutable statement that defines a format specification. It has the following syntax:

```
xx  FORMAT fs
```

where:

*xx* is a statement number that is used as an identifier in a **READ**, **WRITE**, **PRINT**, or **ASSIGN**(label) statement.

*fs* is a *format specification* (described in the next section).

### Format Specification

The syntax of a *format specification fs* is:

```
( [flist] )
```

where *flist* is a list of format specifiers of one of the following forms, separated by commas.

```
[r]fd  
ed  
[r]fs
```

where:

*r* is a positive integer specifying the *repeat count* for the field descriptor or group of field descriptors. If *r* is omitted, the repeat count is assumed to be 1.

*ffd* is a *repeatable edit descriptor*, or a *field descriptor*.

*efd* is a *non-repeatable edit descriptor*.

*fs* is a *format group* and has the same form as a complete *format specification* (described above) except the *flist* must be non-empty (it must contain at least one *format specifier*).

The comma used to separate the format specifiers in *flist* may be omitted as follows:

- Between a P edit descriptor and immediately following an F, E, D, or G edit descriptor (see **P Edit Descriptor** later in this chapter).
- Before or after a slash edit descriptor (see **Slash Editing** later in this chapter).
- Before or after a colon edit descriptor (see **Colon Descriptor** later in this chapter).

## Repeatable Descriptors

Some *descriptors* may be repeated, others may not.

The repeatable descriptors are:

Iw [.m]

Ow [.m]

Zw [.m]

Fw.d

Ew.d[Ee]

Dw.d

Gw.d[Ee]

L[w]

Q

where  $w$  and  $e$  are nonzero, unsigned integer constants; and  $d$  and  $m$  are unsigned integer constants. Their meanings are given in the section that describes the individual descriptors.

The non-repeatable descriptors are:

/	kP	TRc	SS	nHh...	\$
:	Tc	S	BN	'h...'	
nX	TLc	SP	BZ	"h..."	

where  $n$  and  $c$  are nonzero, unsigned integer constants;  $k$  is an optionally signed integer constant; and  $h$  is one of the characters capable of representation by the processor.

## Format Specifier Usage

Each *field descriptor* corresponds to a particular data type input/output list item:

- Integer *field descriptors* – Iw, Iw.m, Ow, Zw
- Real, Double Precision, and Complex *field descriptors* – Fw.d, Ew.d, Ew.dEe, Dw.d, Gw.d, Gw.dEe
- Logical *field descriptor* – Lw
- Character and Hollerith *field descriptors* – A, Aw

Ow and Zw are extensions to FORTRAN 77.

The terms  $r$ ,  $c$ ,  $n$ ,  $d$ ,  $m$ ,  $e$ , and  $w$  must all be unsigned integer constants and, additionally,  $r$ ,  $c$ ,  $n$ ,  $e$ , and  $w$  must be non-zero.  $k$  is an optionally signed integer constant. Their meanings are given in the section that describes the individual field descriptors.

$r$ , the repeat specifier, can be used only with the I, O, Z, F, E, D, G, L, and A *field descriptors* and with *format groups*.

The  $d$  is required in the F, E, D, and G field descriptors. Ee is optional in the E and G field descriptors and invalid in the others.

Use of named constants anywhere in a format specification is not allowed.

Table 9.1 is an alphabetical summary and brief explanation of the field and edit descriptors:

Form	Effect
A[w]	Transfers character or Hollerith values
BN	Specifies that embedded and trailing blanks in a numeric input field are to be ignored
BZ	Specifies that embedded and trailing blanks in a numeric input field are to be treated as zeros
D w.d	Transfers real values (D exponent field indicator)
E w.d [E e]	Transfers real values (E exponent field indicator)
F w.d	Transfers real values
G w.d	Transfers real values: on input, acts like F descriptor On output, acts like E descriptor or F descriptor, depending on the magnitude of the value
nHc...c	Transfers values between H edit descriptor and an external record 'h...' (output only)
I w[m]	Transfers decimal integer values
L w	Transfers logical values
O w[m]	Transfers octal integer values
kP	Scale factor for F, E, D, and G descriptors
S	Restores the default specification for SP and SS (MIPS FORTRAN default is SS)
SP	Writes plus characters (+) for positive values in numeric output fields
SS	Suppresses plus characters (+) for positive values in numeric output fields

Table 9.1 (1 of 2). Summary of Field and Edit Descriptors

Table 9.1 (2 of 2). Summary of Field and Edit Descriptors

Form	Effect
T <i>c</i>	Specifies positional tabulation
TL <i>c</i>	Specifies relative tabulation (left)
TR <i>c</i>	Specifies relative tabulation (right)
<i>n</i> X	Specifies that <i>n</i> column positions are to be skipped
Z <i>w</i> [. <i>m</i> ]	Transfers hexadecimal integer values
:	Terminates format control if the I/O list is exhausted
/	Record terminator
\$	Specifies suppression of line terminator on output (ignored on input)

Use of each of these field descriptors is described in the following sections.

### Variable Format Expressions

Variable format expressions provide a means for substituting run-time expressions for the field width and other parameters of the field and edit descriptors of the FORMAT statement. Any expression may be encoded in angle brackets (<>), and used in the same way that an integer constant would be in the same situation. This facility is not available for anything other than a compile time FORMAT statement.

Here is an example that uses a variable format expression:

```

program VariableExample
character*12 greeting
greeting = 'Good Morning!'
do 110 I = 1, 12
write (*,115) (greeting)
115          format (A<I>)
110          continue
end

```

In the above example, the field descriptor for *greeting* has the format *Aw*, where *w* is a variable width specifier *l* (initially set to 1) for the iolist item *greeting*. In 12 successive WRITE operations, *l* is incremented by 1 to produce the following output:

```
G
Go
Goo
Good
Good
Good M
Good Mo
Good Mor
Good Morn
Good Morni
Good Mornin
Good Morning
```

The following rules apply to variable format expressions:

- Functions calls, references to dummy, and any valid FORTRAN expression can be specified.
- Non-integer data types are converted to integer before processing.
- The same restrictions on size that apply to any other format specifier also apply to the value of a variable format expression.
- Run-time formats cannot use variable format descriptions.
- If the value of a variable changes during a READ or WRITE operation, the new value is used the next time it is referenced in an input/output operation.

## General Rules for using FORMAT

Because FORMAT allows *exact* specification of input and output format, it is necessarily complex. Some guidelines to its correct usage are outlined below.

1. A FORMAT statement must always be labeled.
2. In a field descriptor such as  $rIw[m]$  or  $nX$ , the terms  $r$ ,  $w$ , and  $n$  must be unsigned integer constants greater than zero. The term  $m$  must be an unsigned integer constant whose value is greater than or equal to zero; they cannot be symbolic names of constants. The repeat count  $r$  can be omitted.
3. In a field descriptor such as  $Fw.d$ , the term  $d$  must be an unsigned integer constant.  $d$  must be specified with F, E, D, and G field descriptors, even if  $d$  is zero. The decimal point is also required. Both  $w$  and  $d$  must be specified. In a field descriptor such as  $Ew.dEe$ , the term  $e$  must also be an unsigned non-zero integer constant.
4. In an H edit descriptor such as  $nHc1 c2.\backslash.\backslash.c$  sub  $n$ , exactly  $n$  characters must follow the H. Any character in the processor character set can be used in this edit descriptor.
5. In a scale factor of the form  $kP$ ,  $k$  must be an optionally signed integer constant. The scale factor affects the F, E, D, and G field descriptors only. Once a scale factor is specified, it applies to all subsequent real field descriptors in that format specification until another scale factor appears;  $k$  must be zero (OP) to reinstate a scale factor of zero. A scale factor of OP is initially in effect at the start of execution of each I/O statement.
6. No repeat count  $r$  is permitted in BN, BZ, S, SS, SP, H, X, T, TR, TL, :, /, \$, ', descriptors unless these descriptors are enclosed in parentheses and treated as a *format group*.
7. If the associated I/O statement contains an I/O list, the format specification must contain at least one I, O, Z, F, E, D, G, L, or A field descriptor.
8. A format specification in a character variable, character substring reference, character array element, character array, or character expression must be constructed in the same way as a format specification in a FORMAT statement, including the opening and closing parentheses. Leading blanks are permitted, and any characters following the closing parenthesis are ignored.
9. The first character in an output record generally contains carriage control information. See **Output Rules Summary** and **Carriage Control** later in this chapter.
10. A slash (/) is both a format specifier list separator and a record terminator. See **Slash Editing** later in this chapter.
11. During data transfers, the format specification is scanned from left to right. A repeat count,  $r$ , in front of a field descriptor or group of field descriptors enclosed in parentheses causes that descriptor or group of descriptors to be repeated  $r^*$  before left to right scanning is continued.



## Input Rules Summary

There are certain guidelines that are applicable specifically on input:

1. A minus sign (–) must precede a negative value in an external field; a plus sign (+) is optional before a positive value.
2. An external field under I field descriptor control must be in the form of an optionally signed integer constant, except that leading blanks are ignored and the interpretation of embedded or trailing blanks is determined by a combination of any BLANK= specifier and any BN or BZ blank control that is currently in effect (see **BN Edit Descriptor** and **BZ Edit Descriptor** later in this chapter).
3. An external field under F, E, D, or G field descriptor control must be in the form of an optionally signed integer constant or a real constant, except that leading blanks are ignored and the interpretation of embedded or trailing blanks is determined by a combination of any BLANK= specifier and any BN or BZ blank control that is currently in effect (see **BN Edit Descriptor** and **BZ Edit Descriptor** later in this chapter).
4. If an external field contains a decimal point, the actual size of the fractional part of the field, as indicated by that decimal point, overrides the *d* specification of the corresponding real field descriptor.
5. If an external field contains an exponent, the current scale factor *kP* descriptor has no effect for the conversion of that field.
6. The format specification together with the input list must not attempt to read beyond the end of a record.

## Output Rules Summary

There are certain guidelines that are applicable specifically on output:

1. A format specification cannot specify more output characters than the value in the record length specifier (see **OPEN**). For example, a line printer record might be limited to no more than 133 characters, including the carriage control character.
2. The field width specification, *w*, and exponent digits, *e*, must be large enough to accommodate all characters that the data transfer can generate, including an algebraic sign, decimal point, and exponent. For example, the field width specification in an E field descriptor should be large enough to contain  $d + 6$  characters or  $d + e + 4$  characters.
3. The first character of a record of a file intended to be printed is typically used for carriage control; it is not printed. The first character of such a record should be a space, 0, 1, or +. (See **Carriage Control** later in this chapter).

## Field and Edit Descriptors

The *format specifiers* in a format specification consist of *field*, or *repeatable descriptors*, and other, *non-repeatable edit descriptors*.

On input, the *field descriptors* specify what type of data items are to be expected in the external field so that data item values can be properly transferred to their internal (processor) representations.

On output, the *field descriptors* specify what type of data items should be written to the external field.

On input and output, the other, *non-repeatable edit descriptors* position the processor pointer in the external field so that data items will be transferred properly. For instance, edit descriptors can specify that lines or positions in the external field be skipped or that data items can be repeatedly read (on input) or written (on output).

The following sections describe each of the edit descriptors in detail.

## Field Descriptor Reference

### Numeric Field Descriptors

The I, O, Z,  F, E, D, and G field descriptors described here are used for numeric editing. The P scale factor, also described, can alter the effect of F, E, D, and G *field descriptors*.

Unless otherwise indicated, the following rules apply:

1. On input, these numeric field descriptors ignore leading blanks in the external field. If a BZ edit descriptor is in effect, embedded and trailing blanks are treated as zeros; otherwise, a BN edit descriptor is in effect and all embedded and trailing blanks are ignored. Either BZ or BN is initially in effect at the beginning of the input statement depending on the BLANK= specified (see OPEN). The default is BN.
2. A plus sign (+) is produced on output only if SP is in effect; however, a minus sign (−) is produced where applicable. When computing the field width for numeric descriptors, one character should be allowed for the sign, whether it is produced or not.
3. For input with F, E, D, and G descriptors, a decimal point in the input field overrides the *d* specification, and an explicit exponent in the input field overrides the current scale factor.
4. For output, fields are right justified. If the field width is too small to represent all required characters, asterisks are produced. This includes significant digits, sign, decimal point, and exponent.

## Default Field Descriptor Parameters

You can optionally specify a field width value (*w*, *d*, and *e*) for the I, O, Z, L, F, E, D, G, and A field descriptors. If you don't specify a value, the default values shown in the following table apply. The length of the I/O variable determines the length *n* for the A field descriptor.

Field Descriptor	Field Type	w	d	e
I, O, Z	BYTE	7		
I, O, Z	INTEGER*2, LOGICAL*2	7		
I, O, Z	INTEGER*4, LOGICAL*4	12		
O, Z	REAL*4	12		
O, Z	REAL*8	23		
O, Z	REAL*16	44		
L	LOGICAL	2		
F, E, G, D	REAL, COMPLEX*8	15	7	2
F, E, G, D	REAL*8, COMPLEX*16	25	16	2
F, E, G, D	REAL*16	42	33	3
A	LOGICAL*1	1		
A	LOGICAL*2, INTEGER*2	2		
A	LOGICAL*4, INTEGER*4	4		
A	REAL*4, COMPLEX*8	4		
A	REAL*8, COMPLEX*16	8		
A	REAL*2,6,	16		
A	CHARACTER*n	n		

### I Field Descriptor

The I field descriptor is used for conversion between an internal integer data item and an external decimal integer. It has the form:

$$Iw[.m]$$

where:

*w* is a nonzero, unsigned integer constant denoting the size of the external field, including blanks and a sign, if necessary. A minus sign (-) is always printed on output if the number is negative. If the number is positive, a plus sign (+) is printed only if SP is in effect.

*m* is an unsigned integer constant denoting the minimum number of digits required on output. *m* is ignored on input. The value of *m* must not exceed *w*; if *m* is omitted, a value of 1 is assumed.

In an input statement, the I field descriptor reads a field of  $w$  characters from the record, interprets it as an integer constant, and assigns the integer value to the corresponding I/O list item. The corresponding I/O list element must be of INTEGER or LOGICAL data type. The external data must have the form of an integer constant; it must not contain a decimal point or exponent.

A LOGICAL data type is displayed as either the value 0 (false) or 2 (true).

If the first nonblank character of the external field is a minus sign, the field is treated as a negative value. If the first nonblank character is a plus sign, or if no sign appears in the field, the field is treated as a positive value. An all blank field is treated as a value of zero.

#### Input Example:

Format	External Field	Internal Value
I4	3244	3244
I3	-15	-15
I9	213	213

In an output statement, the I field descriptor constructs an integer constant representing the value of the corresponding I/O list item, and writes it to the record right-justified in an external field  $w$  characters long. If the value does not fill the field, leading blanks are inserted; if the value exceeds the field width, the entire field is filled with asterisks. If the value of the list item is negative, the field will have a minus sign as its leftmost, nonblank character. The term  $w$  must therefore be large enough to provide for a minus sign, when necessary. If  $m$  is present, the external field consists of at least  $m$  digits, with leading zeros, if necessary.

If  $m$  is zero, and the internal representation is zero, the external field is filled with blanks.

#### Output Example:

Format	Internal Value	External Field
I3	311	311
I4	-311	-311
I5	417	417
I2	7782	**
I3	-213	***
I4.2	1	01
I4.4	1	0001
I4.0	1	

## O Field Descriptor

The O field descriptor transfers data values and converts them to octal form. It has the form:

$Ow[m]$

where:

- $w$  is a nonzero, unsigned integer constant denoting the size of the external field, including blanks and a sign, if necessary. A minus sign (-) is always printed on output if the number is negative. If the number is positive, a plus sign (+) is printed only if SP is in effect.
- $m$  is an unsigned integer constant denoting the minimum number of digits required on output.  $m$  is ignored on input. The value of  $m$  must not exceed  $w$ ; if  $m$  is omitted, a value of 1 is assumed.

This repeatable descriptor interprets and assigns data in the same way as the I field descriptor, except that the external field represents an *octal* number constructed with the digits 0 through 7. On input, if BZ is in effect, embedded and trailing blanks in the field are treated as zeros; otherwise, blanks are ignored. On output, S, SP, and SS do not apply.

In an input statement, the field is terminated when a non-octal digit is encountered. FORTRAN 77 treats embedded and trailing blanks as zeros.

In an input statement, the O field descriptor reads  $w$  characters from the record; the input field must have the following format:

- Optional leading blanks
- An optional plus or minus sign
- A sequence of octal digits (0 through 7)

A field that is entirely blank is treated as the value zero.

**Input Example:**

BN is assumed in effect, and internal values are expressed in decimal (base 10).

Format	External Field	Internal Value (INTEGER*4)
O20	-77	-63
O20	1234	668
O20	177777	65535
O20	100000	32768

In an output statement, the O field descriptor constructs an octal number representing the *unsigned* value of the corresponding I/O list element as follows:

- The number is right justified with leading zeros inserted (if necessary). FORTRAN 77 inserts leading blanks.
- If  $w$  is insufficient to contain all the digits necessary to represent the unsigned value of the output list item, then the entire field is filled with asterisks.

**Output Example:**

Format	Internal Value (INTEGER*4)	External Field
O20.2	3	03
O20.2	-1	3777777777
O3	-1	***
O20.2	63	77
O20.2	-2	3777777776

**Z Field Descriptor**

The Z field descriptor transfers data values and converts them to hexadecimal form. It has the form:

$$Zw[m]$$

where:

$w$  is a nonzero, unsigned integer constant denoting the size of the external field.

$m$  is an unsigned integer constant denoting the minimum number of digits required on output.  $m$  is ignored on input. The value of  $m$  must not exceed  $w$ ; if  $m$  is omitted, a value of 1 is assumed.

This repeatable descriptor interprets and assigns data in the same way as the I field descriptor, except that the external field represents a hexadecimal number constructed with the digits 0 through 9 and the letters A through F. On output, the output list item is interpreted as an unsigned integer value.

In an input statement, the O field descriptor reads *w* characters from the record. After embedded and trailing blanks are converted to zeros or ignored, as applicable, the input field must have the following form:

- Optional leading blanks
- An optional plus or minus sign
- A sequence of hexadecimal digits (0 through 9, A through F)

A field that is entirely blank is treated as the value zero.

#### Input Example:

BN is assumed in effect, and internal values are expressed in decimal (base 10).

Format	External Field	Internal Value (INTEGER*4)
Z10	-FF	-255
Z10	1234	4660
Z10	FFFF	65535
Z10	8000	32768

#### Output Example:

Format	Internal Value (INTEGER*4)	External Field
Z10.2	3	" 03"
Z10.2	-1	" FFFFFFFF"
Z10.2	63	" 3F"
Z10.2	-2	" FFFFFFFE"

## F Field Descriptor

The F field descriptor transfers real values. It has the form:

*Fw.d*

where:

- *w* is a nonzero, unsigned integer constant denoting field width.
- *d* is an unsigned integer constant denoting the number of digits in the fractional part.

The corresponding I/O list element must be of REAL, DOUBLE PRECISION, or COMPLEX data type.

In an input statement, the F field descriptor reads a field of  $w$  characters from the record and, after appropriate editing of leading, trailing, and embedded blanks, interprets it as an integer or a real constant, and assigns the real value to the corresponding I/O list element. Refer to Real Types in Chapter 2 for more information. If the external field contains an exponent, the letter E may be omitted as long as the value of the exponent is a signed integer. If the first nonblank character of the external field is a minus sign, the field is treated as a negative value. If the first nonblank character is a plus sign, or if no sign appears in the field, the field is treated as a positive value. An all-blank field is treated as a value of zero.

If the field contains neither a decimal point nor an exponent, it is treated as a real number in which the rightmost  $d$  digits are to the right of the decimal point, with leading zeros assumed if necessary. If the field contains an explicit decimal point, the location of that decimal point overrides the location specified by the value of  $d$  in the field descriptor. If the field contains a real exponent, the effect of any associated scale factor  $kP$  (see Scale Factor later in this chapter) is suppressed and the real exponent is used to establish the magnitude of the value in the input field before it is assigned to the list element.

**Input Example:**

Format	External Field	Internal Value
F8.5	123456789	0.12345678E+03
F8.5	-1234.567	-0.123456E+04
F8.5	12.34E+2	0.1234E+02
F5.2	1234567.89	0.12345E+03

In an output statement, the F field descriptor constructs a basic real constant representing the value of the corresponding I/O list element, rounded to  $d$  decimal positions, and writes it to the record right-justified in an external field  $w$  characters long.

The term  $w$  must be large enough to include:

- a minus sign for a negative value or a plus sign (when SP is in effect) for a positive value.
- the decimal point
- $d$  digits to the right of the decimal

If  $w$  is insufficiently large, the entire field width is filled with asterisks. Therefore,  $w$  must be  $d + 2$ .



**Output Example:**

Format	Internal Value	External Field
F8.5	.12345678E+01	1.23457
F9.3	.87654321E+04	8765.432
F2.1	.2531E+02	**
F10.4	.1234567E+02	12.3457
F5.2	.123456E+03	*****
F5.2	-.4E+00	-0.40

**E Field Descriptor**

The E field descriptor transfers real values in exponential form. It has the form:

$$Ew.d[Ee]$$

where:

- $w$  is a nonzero, unsigned integer constant denoting field width.
- $d$  is an unsigned integer constant denoting the number of digits in the fractional part.
- $e$  is a nonzero, unsigned integer constant denoting the number of digits in the exponent part. The  $e$  has no effect on input.

The corresponding I/O list element must be of REAL, DOUBLE PRECISION, or COMPLEX data type.

In an input statement, the E field descriptor interprets and assigns data in exactly the same way as the F field descriptor.

**Input Example:**

Format	External Field	Internal Value
E9.3	" 654321E3"	.654321E+06
E12.4	" 1234.56E-6"	.123456E-02
E15.3	"12.3456789 "	.123456789E+02
E12.5	"123.4567D+10"	.1234567E+13

Note that in the last example, the E field descriptor treats the D exponent field indicator the same as an E exponent indicator.

In an output statement, the E field descriptor constructs a real constant representing the value of the corresponding I/O list element, rounded to  $d$  decimal digits, and writes it to the record right-justified in an external field  $w$  characters long. If the value does not fill the field, leading spaces are inserted; if the value exceeds the field width, the entire field is filled with asterisks.

When an E field descriptor is used, data output is transferred in a standard form. This form consists of:

- a minus sign for a negative value or a plus sign (when SP is in effect) for a positive value
- digits to the left of the decimal point, if any, or an optional zero
- a decimal point
- $d$  digits to the right of the decimal point
- an  $e + 2$  character exponent or a 4 character exponent

The exponent has one of the following forms:

$Ew.d$       E +  $nn$  or E -  $nn$  if the value of the exponent in the range of -99 to +99

$Ew.d$       + $nnn$  or - $nnn$  if the value of the exponent is  $\leq -99$  or  $\leq +99$

$Ew.dEe$     E +  $n_1 n_2 \dots n_{sub e}$  or E -  $n_1 n_2 \dots n_{sub e}$ , where  $n_1 n_2 \dots n_x$  is the magnitude of the exponent with leading zeros, if necessary

The exponent field width specification is optional; if it is omitted, the exponent part is as shown above. If the exponent value is too large to be output with the given value  $e$  as shown in the third form above, the entire field is filled with asterisks.

The term  $w$  must be large enough to include:

- a minus sign when necessary (plus signs when SP is in effect)
- all significant digits to the left of the decimal point
- a decimal point
- $d$  digits to the right of the decimal point
- the exponent

Given these limitations and assuming a P edit descriptor is in effect (see later in this chapter),  $w$  is  $\geq d + 7$ , or  $\geq d + e + 5$  if  $e$  is present.

#### Output Example:

Format	Internal Value	External Field
E9.2	.987654321E+06	" .99E+06"
E12.5	.987644321E+06	" .98764E+06"
E12.3	.69E-5	" .690E-05"
E10.3	-.5555E+00	" -.556E+00"
E5.3	.7214E+02	"*****"
E14.5E4	-.1001E+01	" -.10010E+0001"
E14.3E6	.123E-06	" .123E-000003"

## D Field Descriptor

The D field descriptor transfers real values in exponential form. It has the form:

$Dw.d$

where:

$w$  is a nonzero, unsigned integer constant denoting field width.

$d$  is an unsigned integer constant denoting the number of digits in the fractional part.

The corresponding I/O list element must be of REAL, DOUBLE PRECISION, or COMPLEX data type.

In an input statement, the D field descriptor interprets and assigns data in exactly the same way as the F field descriptor.

### Input Example:

Format	External Field	Internal Value
D10.2	"12345 "	.12345E+03
D10.2	" 123.45	" .12345E+03
D15.3	"123.4567891D+04"	.1234567891E+07

In an output statement, the D field descriptor has the same effect as the E field descriptor, except that the D exponent field indicator is used in place of the E indicator.

**Output Example:**

Format	Internal Value	External Field
D14.3	123D-04	" .123D-04"
D23.12	123456789123D+04	" .123456789123D+04"
D9.6	14D+01	"*****"

**G Field Descriptor**

A G field descriptor is used for the conversion and editing of real data when the magnitude of the data is unknown beforehand. On output, the G field descriptor produces a field as with the F or E field descriptors, depending on the value. On input, the G field descriptor interprets and assigns data in exactly the same way as the F field descriptor. It has the form:

$$Gw.d[Ee]$$

where:

- $w$  is a nonzero, unsigned integer constant denoting field width.
- $d$  is an unsigned integer constant denoting the number of digits in the basic value part.
- $e$  is a nonzero, unsigned integer constant denoting the number of digits in the exponent part.

The corresponding I/O list element must be of REAL, DOUBLE PRECISION, or COMPLEX data type.

In an input statement, the G field descriptor interprets and assigns data in exactly the same way as the F field descriptor.

In an output statement, the G field descriptor constructs a real constant representing the value of the corresponding I/O list element rounded to  $d$  decimal digits, and writes it to the record right-justified in an external field  $w$  characters long. The form in which the value is written is a function of the magnitude of the value  $m$ , as described in Table 9.1. In the table,  $n$  is 4 if Ee was omitted from the G field descriptor, otherwise  $n$  is  $e + 2$ .

Data Magnitude	Effective Format
$m < 0.1$	E $w.d$ [E $e$ ]
0.1 $m < 1.0$	F( $w-n$ ). $d$ , $n$ ( ' ' )
1.0 $m < 10.0$	F( $w-n$ ).( $d-1$ ), $n$ ( ' ' )
•	•
•	•
•	•
$10^{d-2} \leq m < 10^{d-1}$	F( $w-n$ ).1, $n$ ( ' ' )
$10^{d-1} \leq m < 10^d$	F( $w-n$ ).0 $n$ ( ' ' )
$m \geq 10^d$	E $w.d$ [E $e$ ]

Table 9.1. Effect of Data Magnitude on G Format Conventions.

The term  $w$  must be large enough to include:

- a minus sign for a negative value or a plus sign (when SP is in effect) for a positive value
- a decimal point
- $d$  digits in the basic value part
- either a 4-character or  $e + 2$ -character exponent part

Given these limitations,  $w$  must therefore be  $\geq d + 7$ , or  $\geq d + e + 5$ .

Output Example:

Format	Internal Value	External Field
G13.6	.1234567E-01	" .123457E-01"
G13.6	-.12345678E00	" -.123457 "
G13.6	.123456789E+01	" 1.23457 "
G13.6	.1234567890E+02	" 12.3457 "
G13.6	.12345678901E+03	" 123.457 "
G13.6	-.123456789012E+04	" -1234.57 "
G13.6	.1234567890123E+05	" 12345.7 "
G13.6	.12345678901234E+06	" 123457. "
G13.6	-.123456789012345E+07	" -.123457E+07"

The following examples use the same values with an equivalent F field descriptor, for comparison purposes:

Format	Internal Value	External Field
F13.6	.1234567E-01	" .012346"
F13.6	-.12345678E00	" -.123457"
F13.6	.123456789E+01	" 1.234568"
F13.6	.1234567890E+02	" 12.345679"
F13.6	.12345678901E+03	" 123.456789"
F13.6	-.123456789012E+04	" -1234.567890"
F13.6	.1234567890123E+05	" 12345.678901"
F13.6	.12345678901234E+06	"123456.789012"
F13.6	-.123456789012345E+07	"*****"

## P Edit Descriptor

The P edit descriptor specifies a *scale factor* and has the form:

$$kP$$

where  $k$  is an optionally-signed integer constant, called the *scale factor*.

A P edit descriptor can appear anywhere in a format specification, but must precede the first field descriptor that is to be associated with it. For example:

$$kPFw.d \quad kPEw.d \quad kPDw.d \quad kPGw.d$$

The value of  $k$  must not be greater than  $d+1$ , where  $d$  is a number of digits in the  $Ew.d$ ,  $Dw.d$ , or  $Gw.d$  output fields.

## Scale Factor

The scale factor,  $k$ , determines the appropriate editing as follows:

- For input with F, E, D, and G editing (provided there is no exponent in the field) and F output editing, the magnitude represented by the external field equals the magnitude of the internal value multiplied by  $10^k$ .
- For input with F, E, D, and G editing containing a real exponent, the scale factor has no effect.
- For output with E and D editing, the basic value part is multiplied by  $10^k$ .  $10^k$  and the real exponent is reduced by  $k$ .
- For output with G editing, the scale factor has no effect unless the data to be edited is outside the range that permits F editing. If the use of E editing is required, the effect of the scale factor is the same as E output editing. (See Real Type in Chapter 2.)

On input, if no exponent is given, the scale factor in any of the above field descriptors multiplies the data by  $10^k$  and assigns it to the corresponding I/O list element. For example, a 2P scale factor multiplies an input value by .01. A -2P scale factor multiplies an input value by 100. However, if the external field contains an explicit exponent, the scale factor has no effect.

Format	External Field	Internal Value
3PE10.5	" 37.614"	.37614E-01
3PE10.5	" 37.614E2"	.37614E+04
-3PE10.5	" 37.614"	.37614E+05

On output, the effect of the scale factor depends on the type of field descriptor associated with it.

For the F field descriptor, the value of the I/O list element is multiplied by  $10^k$  before transfer to the external record: a positive scale factor moves the decimal point to the right, a negative scale factor moves the decimal point to the left. The value represented is  $10^k$  multiplied by the internal value.

For output with the E or D field descriptor, the basic real constant part of the external field is multiplied by  $10^k$ , and the exponent is reduced by  $k$ . The value represented is *unchanged*. A positive scale factor moves the decimal point to the right and decreases the exponent; a negative scale factor moves the decimal point to the left and increases the exponent. In summation,

- $k >> 0$       moves the decimal point  $n$  digits to the right  
 $k < 0$       moves the decimal point  $n$  digits to the left  
 $k = 0$       leaves the decimal point unchanged

#### Output Example:

Format	Internal Value	External Field
1PE12.3	-.270139E+03	" 2.701E+02"
1PE12.2	-.270139E+03	" 2.70E+02"
-1PE12.2	-.270139E+03	" 0.03E+04"

On output, the effect of the scale factor for the G field descriptor is suspended if the magnitude of the data to be output is within the range permitting F editing, because the G field descriptor supplies its own scaling function. The G field descriptor functions as an E field descriptor if the magnitude of the data value is outside its range. In this case, the scale factor has the same effect as for the E field descriptor.

On output under F field descriptor control, a scale factor actually alters the magnitude of the value represented, multiplying or dividing it by 10. On output, a scale factor under E, D, or G field descriptor control merely alters the form in which the value is represented.

If you do not specify a scale factor with a field descriptor, a scale factor of zero is initially assumed at the beginning of the execution of the statement. Once a scale factor is specified, it applies to all subsequent F, E, D, and G field descriptors in the same format specification, unless another scale factor appears. A scale factor of zero can be reinstated only with an explicit OP specification.

## L Edit Descriptor

The L edit descriptor is used for logical data. The specified input/output list item must be of type LOGICAL. It has the form:

Lw

where  $w$  is a nonzero, unsigned integer constant denoting field width.

For input, the field must consist of optional blanks, followed by an optional decimal point, followed by a T (for true) or F (for false). The T or F may be followed by additional characters that have no effect. The logical constants .TRUE. and .FALSE. are acceptable input forms.



For output, the field consists of  $w - 1$  blanks followed by a T or an F, for true and false, respectively, according to the value of the internal data.

Format	Internal Value	External Field
L5	.TRUE.	" T"
L1	.FALSE.	"F"

The L edit descriptor can also be used to process integer data items. All non-zero values are displayed as .TRUE. and all zero values as .FALSE..

## A Edit Descriptor

The A edit descriptor is used for editing of character or Hollerith data.

A[w]

where  $w$  is a nonzero, unsigned integer constant denoting the width, in number of characters, of the external data field. If  $w$  is omitted, the size of the I/O list item determines the length  $w$ .

The corresponding I/O list item can be of any data type. If it is of character data type, character data is transmitted. If it is of any other data type, Hollerith data is transmitted.

In an input statement, the A edit descriptor reads a field of  $w$  characters from the record without interpretation and assigns it to the corresponding I/O list item. The maximum number of characters that can be stored depends on the size of the I/O list item. For character I/O list elements, the size is the length of the character variable, character substring reference, or character array element. For numeric and logical I/O list elements, the size depends on the data type as follows:

I/O List Element	Maximum Number of Characters
LOGICAL*1	1
LOGICAL*2	2
LOGICAL*4	4
INTEGER*2	2
INTEGER*4	4
REAL*4 (REAL)	4
REAL*8 (DOUBLE PRECISION)	8
COMPLEX*8 (COMPLEX)	8
COMPLEX*16 (DOUBLE COMPLEX)	16

If  $w$  is greater than the maximum number of characters that can be stored in the corresponding I/O list item, only the rightmost characters of the field are assigned to that element. The leftmost excess characters are ignored. If  $w$  is less than the number of characters that can be stored,  $w$  characters are assigned to the list item, left-justified, and trailing blanks are added to fill it to its maximum size.

#### Input Example:

Format	External Field	Internal Value	Representation
A6	"FACE #"	"#"	(CHARACTER*1)
A6	"FACE #"	"E #"	(CHARACTER*3)
A6	"FACE #"	"FACE #"	(CHARACTER*6)
A6	"FACE #"	"FACE # "	(CHARACTER*8)
A6	"FACE #"	"#"	(LOGICAL*1)
A6	"FACE #"	"#"	(INTEGER*2)
A6	"FACE #"	"CE #"	(REAL*4)
A6	"FACE #"	"FACE # "	(REAL*8)

In an output statement, the A field descriptor writes the contents of the corresponding I/O list item to the record as an external field  $w$  characters long. If  $w$  is greater than the list item size, the data appears in the field, right-justified, with leading blanks. If  $w$  is less than the list element, only the leftmost  $w$  characters from the I/O list item are transferred.

#### Output Example:

Format	Internal Value	External Field
A6	"GREEK"	" GREEK"
A6	"FRENCH"	"FRENCH"
A6	"PORTUGUESE"	"PORTUG"

If you omit  $w$  in an A field descriptor, a default value is supplied based on the data type of the I/O list item. If it is of character type, the default value is the length of the I/O list element. If it is of numeric or logical data type, the default value is the maximum number of characters that can be stored in a variable of that data type as described for input.

## Repeat Counts

The I, O, Z, F, E, D, G, L, and A field descriptors can be applied to a number of successive I/O list items by preceding the field descriptor with an unsigned integer constant, called the *repeat count*. For example, a specification of the form 4F5.2 is equivalent to F5.2, F5.2, F5.2, F5.2.

Enclosing a group of field descriptors in parentheses, and preceding the enclosed group with a repeat count, repeats the entire group. Thus, 2(I6,F8.4) is equivalent to I6,F8.4,I6,F8.4.

## H Field Descriptor

The H field descriptor is used for output of character literal data. It has the form:

$$nHxxx...x$$

where:

- $n$  is an unsigned integer constant denoting the number of characters that comprise the character literal.
- $x$  comprises the character literal and consists of  $n$  characters, including blanks.

In an output statement, the H field descriptor writes the  $n$  characters following the letter H from the field descriptor to the record as an external field  $n$  characters long. The H field descriptor does not correspond to an output list item.

### Output Example:

Specification	External Field
6HAb CdE	Ab CdE
1H9	9
4H'a2'	'a2'

An H field descriptor must not be encountered by a READ statement.

## Character Edit Descriptor

A *character* edit descriptor has one of the following forms:

'X1 X2...X<sub>n</sub>'  
X1 X2...X<sub>n</sub>

where

X1 X2...X<sub>n</sub>

- are members of the FORTRAN character set forming a valid character literal.
- The width of the output field is the number of characters contained in the character literal, excluding the enclosing apostrophes or quotation marks.
- The character edit descriptor does not correspond to an output list item.
- Within a character edit descriptor delimited by apostrophes, an apostrophe is represented by two successive apostrophe characters.

Within a character edit descriptor delimited by quotation marks, a quotation mark is represented by two successive quotation mark characters.

**Example:**

Output Specification	External Field
' SUM ='	SUM =
.SUM =	SUM =
.DON' T	DON' T
' HERE' 'S THE ANSWER'	HERE' S THE ANSWER
' HE SAID, "YES"'	HE SAID, "YES"
.HE SAID, ""YES""	HE SAID, "YES"

A character edit descriptor must not be encountered by a READ statement.

Use of quotation marks as a character edit descriptor is an enhancement to FORTRAN 77.

**Q Edit Descriptor**

The Q edit descriptor is used to determine the number of characters remaining to be read from the current input record. It has the form:

Q

When a Q descriptor is encountered during the execution of an input statement, the corresponding input list item must be type integer. Interpretation of the Q edit descriptor causes the input list item to be defined with a value that represents the number of character positions in the formatted record remaining to be read. Therefore, if  $c$  is the character position within the current record of the next character to be read and the record consists of  $len$  characters, then the item is defined with the value:

$$n = \max(len - c + 1, 0)$$

If no characters have yet been read, then  $n=len$ , the length of the record. If all of the characters of the record have been read ( $c>len$ ), then  $n$  is zero.

The Q edit descriptor must not be encountered during the execution of an output statement.

**Input Example:**

```

      INTEGER N
      CHARACTER LINE * 80
      READ (5, 100) N, LINE (1:N)
100   FORMAT (Q, A)

```

## Edit Descriptor Reference

After each I, O, Z, F, E, D, G, L, A, H, or character edit descriptor is processed, the file is positioned after the last character read or written in the current record.

The X, T, TL, and TR descriptors specify the position at which the next character will be transmitted to or from the record. They do not change any characters in the record already written, or by themselves affect the length of the record.

If characters are transmitted to positions at or after the position specified by a T, TL, TR, or X edit descriptor, positions skipped and not previously filled are filled with blanks.

### X Edit Descriptor

The X edit descriptor specifies a position forward (to the right) of the current position. It is used to skip characters on the external medium for input and output. It has the form:

$$nX$$

where  $n$  is an unsigned, nonzero integer constant denoting the number of characters to be skipped.

### T Edit Descriptor

The T edit descriptor specifies an absolute position in an input or output record. It has the form:

$$Tn$$

where  $n$  indicates the next character transferred to or from the record is the  $n$ th character of the record.

### TL Edit Descriptor

The TL edit descriptor specifies a position to the left of the current position. It has the form:

$$TLn$$

where  $n$  indicates that the next character to be transferred from or to the record is the  $n$ th character to the left of the current character. The value of  $n$  must be greater than or equal to one.

If  $n$  is the current character position, then the first character in the record is specified.

### TR Edit Descriptor

The TR edit descriptor specifies a position to the right of the current position. It has the form:

$$TRn$$

where  $n$  indicates that the next character to be transferred from or to a record is a  $n$ th character to the right of the current character. The value of  $n$  must be greater than or equal to one.

## BN Edit Descriptor

The BN edit descriptor causes the processor to ignore blank characters in a numeric input field and to right-justify remaining characters, as though the blanks that were ignored were leading blanks. It has the form:

BN

The BN descriptor affects only I, O, Z, F, E, D, and G editing, and then only on input fields.

## BZ Edit Descriptor

The BZ edit descriptor causes the processor to treat all the embedded and trailing blank characters it encounters within a numeric input field as zeros. It has the form:

BZ

The BZ descriptor affects only I, O, Z, F, E, D, and G editing, and then only on input fields.

## SP Edit Descriptor

The SP edit descriptor specifies that a plus sign should be inserted in any character position that normally contains an optional plus sign and whose actual value is  $\geq 0$ . It has the form:

SP

The SP descriptor affects only I, F, E, D, and G editing, and then only on output fields.

## SS Edit Descriptor

The SS edit descriptor specifies that a plus sign should *not* be inserted in any character position that normally contains an optional plus sign. It has the form:

SS

The SS descriptor affects only I, F, E, D, and G editing, and then only on output fields.

## S Edit Descriptor

The S edit descriptor resets the option of inserting plus characters (+) in numeric output fields to the processor default. It has the form:

S

The S descriptor counters the action of either the SP or SS descriptor by restoring to the processor the discretion of producing plus characters on an optional basis. The default is to SS processing: the optional plus sign is not inserted when S is in effect.

The S descriptor affects only I, F, E, D, and G editing, and then only on output fields.

## Colon Descriptor

The colon character (:) in a format specification terminates format control if no more items are in the I/O list. The : descriptor has no effect if I/O list items remain.

**\$ Edit Descriptor**

The \$ edit descriptor suppresses the terminal linemark character at the end of the current output record. It has the form:

\$

The \$ descriptor is non-repeatable and is ignored when encountered during input operations.

**Output Example:**

```
PRINT 100, 'Enter a number:'
100 FORMAT (1X, A, $)
READ *, X
```

**Complex Data Editing**

A complex value consists of an ordered pair of real values. If an F, E, D, or G field descriptor is encountered and the next I/O list item is complex, then the descriptor is used to edit the real part of the complex item. The next field descriptor is used to edit the imaginary part.

If an A field descriptor is encountered on input or output, and the next input/output list item is complex, then the A field descriptor is used to translate Hollerith data to or from the external field and the entire complex list item. The real and imaginary parts together are treated as a single input/output list item.

In an input statement with F, E, D, or G field descriptors in effect, the two successive fields are read and assigned to a complex I/O list element as its real and imaginary parts, respectively.

**Input Example:**

Format	External Field	Internal Value
F8.5, F8.5	"1234567812345.67"	(.12345678E+03, .1234567E+05)
E9.1, F9.3	"734.432E8123456789"	(.734432E+11, .123456789E+06)

In an output statement with F, E, D, or G field descriptors in effect, the two parts of a complex value are transferred under the control of successive field descriptors. The two parts are transferred consecutively, without punctuation or spacing, unless the format specification states otherwise.

**Output Example:**

Format	Internal Value	External Field
2F8.5	(.23547188E+01, .3456732E+01)	" 2.35472 3.45673"
E9.2,' , ',E5.3	(.47587222E+05, .56123E+02)	" 0.48E+06 , ***** "

**Carriage Control**

A formatted record can contain a prescribed carriage control character as the first character of the record. The carriage control character is the first character of the record and determines vertical spacing in printing when the CARRIAGECONTROL keyword of the OPEN statement is set to FORTRAN (the default). The carriage control characters are:

Character	Effect on Spacing
Blank	Single space
0	Double space
1	To first line of next page (page eject)
+	No vertical spacing (overprint next line)
\$	Output starts at the beginning of the next line; carriage return at the end of the line is suppressed.
ASCII NUL	Overprints with no advance. Doesn't return to the left margin after printing.

The carriage control character is not printed and the remaining characters, if any, are printed in one line beginning at the left margin. If there are no characters in the record, the vertical spacing is one line and no characters will be printed in that line.

**Slash Editing**

A slash (/) placed in a format specification terminates input or output for the current record and initiates a new record. For example:

```
WRITE (6,40) K,L,M,N,O,P
40 FORMAT (3I6.6/I6,2F8.4)
```

is equivalent to

```
WRITE (6,40) K,L,M
40 FORMAT (3I6.6)
WRITE (6,50) N,O,P
50 FORMAT (I6,2F8.4)
```

On input from a sequential access file, the current portion of the remaining record is skipped, a new record is read, and the current position is set to the first character of the record.  $n$  slashes in succession cause  $n-1$  records to be skipped.



On output to a file connected for sequential access, a new record is created and becomes the last and current record of the file. Also,  $n$  slashes in succession causes  $n-1$  blank lines to be generated.

Through the use of two or more successive slashes in a format specification, entire records can be skipped for input and records containing no characters can be generated for output. If the file is an internal file, or a file connected for direct access, skipped records are filled with blank characters on output.

$n$  slashes at the beginning or end of a format specification result in  $n$  skipped or blank records. On input and output from a direct access file, the record number is increased by one and the file is positioned at the beginning of the record that has that record number. This record becomes the current record.

## Interaction Between I/O List and Format

The beginning of formatted data transfer using a format specification initiates *format control*. Each action of format control depends on information jointly provided by:

- the next descriptor contained in the format specification, and
- the next item in the input/output list, if one exists.

If an input/output list specifies at least one list item, at least one *repeatable descriptor* must exist in the format specification. Note that an empty format specification of the form ( ) may be used only if no list items are specified; in this case, one input record is skipped or one output record containing no characters is written.

Except for a field descriptor preceded by a repeat specification, *red*, and a format specification preceded by a repeat specification, *r (flist)*, a format specification is interpreted from left to right (see **Repeat Counts**). Note that an omitted repeat specification is treated the same as a repeat specification whose value is one.

To each repeatable field descriptor interpreted in a format specification, there corresponds one item specified by the input/output list, except that a list item of type complex is treated as two real items when an F, E, D, or G field descriptor is encountered. To each P, X, T, TL, TR, S, SP, SS, H, BN, BZ, slash (/), colon (:), dollar sign (\$), or character edit descriptor, there is no corresponding item specified by the input/output list, and format control communicates information directly with the record.

Whenever format control encounters a *repeatable edit descriptor* in a format specification, it determines whether there is a next item in the input/output list. If there is such an item, it transmits appropriately edited information between the item and the record, and then format control proceeds. If there is no next item, format control terminates.

If format control encounters the rightmost parenthesis of a complete format specification and no items remain in the list, format control terminates. However, if there are more items in the list, the file is positioned at the beginning of the next record, and format control then reverts to the beginning of the format

specification terminated by the last preceding right parenthesis ()). If there is no such preceding right parenthesis ()), format control reverts to the first left parenthesis (()) of the format specification. If such reversion occurs, the reused portion of the format specification must contain at least one *repeatable edit descriptor*. If format control reverts to a parenthesis that is preceded by a repeat specification, the repeat specification is reused. Reversion of format control, of itself, has no effect on the scale factor (see the Scale Factor description in the P Edit section of this chapter), the S, SP, or SS edit descriptor sign control, or the BN or BZ edit descriptor blank control.

## List-Directed Formatting

List-directed formatting allows formatted input and output without specifying a format specification. An asterisk (\*) is used as a format identifier to invoke a list-directed format.

List-directed formatting can be applied to both internal and external files. The rules for list-directed external input/output and internal input/output both apply to internal list-directed input/output.

### List-Directed Input

The characters in one or more list-directed records form a sequence of values and value separators. Each value is either a constant, a null value (see Note 5 below), or has one of the following forms:

$$r^*c r^*$$

where  $r$  is a nonzero, unsigned integer constant denoting the number of successive appearances of  $c$  or null values and  $c$  is a constant.

The  $r^*$  form is equivalent to  $r$  successive null values. Neither form may contain embedded blanks, except where permitted within the constant  $c$ .

Data values may be separated by one of the following value separators:

- A comma optionally preceded and followed by one or more contiguous blanks.
- A slash (/) optionally preceded and followed by one or more contiguous blanks. A slash encountered by a list-directed input statement ends the execution of the input statement after assignment of the previous value, if any; any remaining list items are treated as if null values were supplied. A slash is not used as a separator on output.
- One or more contiguous blanks between two constants or following the last constant. Blanks used in the following manner are not treated as part of any value separator in a list-directed input record:
  - o Blanks within a character constant

- o Embedded blanks surrounding the real or imaginary part of a complex constant
- o Leading blanks in the first record read by each execution of a list-directed input statement, unless immediately followed by a slash or comma

The end of a record has the effect of a blank, except when it appears within a character constant. Two or more consecutive blanks are treated as a single blank, unless they occur within a character constant.

There are three differences between the input forms acceptable to format specifiers for a data type and those used for list-directed formatting. A data value must have the same type as the list item to which it corresponds. Blanks are not interpreted as zeros. Embedded blanks are only allowed in constants of character or complex type.

Rules governing input forms of list items for list-directed formatting are:

1. For data of type real or double precision, the input form is the same as a numeric input field for F-editing that has no fractional part, unless a decimal point appears within the field.
2. For data of type complex, the input form consists of an ordered pair of numeric constants separated by a comma and enclosed in a pair of parentheses. The first numeric constant is the real part of the complex value, while the second constant is the imaginary part. Each of the constants representing the real and imaginary parts may be preceded or followed by blanks. The end of a record may occur between the real part and the comma or between the comma and the imaginary part.
3. For data of type logical, the input form must not include either slashes or commas among the optional characters allowed for L-editing.
4. For data of type character, the input form is a character constant: a nonempty string of characters enclosed in apostrophes or quotation marks. When apostrophes are used as the character constant delimiter, each apostrophe within the apostrophes is represented by a pair of apostrophes without an intervening blank or end of record.

When quotation marks are used as the character constant delimiter, each quotation mark within the quotation marks is represented by a pair of quotation marks without an intervening blank or end of record. Character constants may be continued on as many records as needed. Constants are assigned to list items as in character assignment statements.

5. A null value is specified by two successive value separators, by the *r\** form, or by not having any characters before the first value separator in the first record read by the execution of the list-directed statement. A null value has no effect on the corresponding list item. A single null value may represent an entire complex constant but may not be used as either the real or imaginary part alone.

6. You can specify commas as value separators in the input record when executing a formatted read of non-character variables. The commas override the field lengths given in the input statement. For example,

```
(i10, f20.10, i4)
```

reads the following record correctly:

```
-345, .05e-3, 12
```

## List-Directed Output

The form of the values produced is the same as that required for input, except as noted below:

1. Logical output constants are T for the value true and F for the value false.
2. Integer output constants are produced as for an *Iw* edit descriptor, where *w* depends on whether the list item is `INTEGER*2` or `INTEGER*4` type.
3. For complex constants, the end of a record will occur between the comma and the imaginary part only if the entire constant is as long as, or longer than, an entire record.
4. Character constants produced are not delimited by apostrophes or quotation marks, are not preceded or followed by a value separator, and have each internal apostrophe represented externally by one apostrophe and each internal quotation mark represented by one quotation mark. A blank character for carriage control is inserted at the beginning of a record containing the continuation of a character constant.
5. Slashes and null values are not produced but each record begins with a blank character to provide carriage control if the record is printed.
6. Two non-character values in succession in the same record will be separated by a value separator consisting of one or more blanks. No value separator is produced before or after a character value.



This chapter is divided into the following major sections:

- Statement Functions, which gives the syntax and rules for defining statement functions.
- Parameter Passing, which gives general rules in passing parameters to functions and subprograms.
- Function and Subroutine Programs, which gives rules for writing and using function and subroutine subprograms.
- The syntax and rules for the FUNCTION, SUBROUTINE, and ENTRY statements, used to specify function and subroutine subprograms.

## Overview

Functions and subprograms are program units that receive control when referenced or called by a statement in a main program or another subprogram. A subprogram is either written by the user or supplied with FORTRAN compiler. This chapter discusses user-written subprograms; compiler-supplied functions and subroutines are discussed in **Appendix A**.

There are three types of program units:

- *statement functions*, which consist of a single arithmetic statement defined within the main program unit or a subprogram.
- *function subprograms*, which consist of one or more statements defined external to the main program unit. It is invoked when referenced as a primary in an expression contained in another program unit.
- *subroutine subprograms*, which consist of one or more program statements defined external to the main program unit. It is invoked when referenced in a CALL (**Chapter 6**) statement in another program unit.

## Statement Functions

A statement function definition is similar in form to an arithmetic, logical, or character assignment statement. The name of a statement function is local to the program unit in which it is defined. A statement function definition must appear only after the specification statements and before the first executable statement of the program unit in which it appears.

### Defining a Statement Function

A statement function statement has the form:

$$\text{fun} ([d [,d]...]) = e$$

where:

*fun* is a symbolic name of the function.

*d* is a dummy argument.

*e* is an expression.

Each dummy argument *d* is a variable name called a statement function dummy argument. The statement function dummy argument list indicates the order, number, and type of arguments for the statement function. All arguments need not have the same data type. A specific dummy argument may appear only once in the list. A variable name that serves as a dummy argument can also be the name of a local variable or common block in the same program unit.

Each primary of the expression *e* may include:

- Constants
- Symbolic names of constants
- Variable references
- Array element references
- Library function references
- Reference to other statement functions
- Function subprogram references
- Dummy subprogram references
- An expression composed of the above forms and enclosed in parentheses

If a statement function dummy argument name is the same as the name of another entity, the appearance of that name in the expression of a statement function statement is a reference to the statement function dummy argument. A dummy argument that appears in a FUNCTION or SUBROUTINE statement may be referenced in the expression of a statement function statement with the subprogram.

A dummy argument that appears in an ENTRY statement may be referenced in the expression of the statement function only if the dummy argument name appears in a FUNCTION, SUBROUTINE, or ENTRY statement preceding the statement function definition.

## Referencing a Statement Function

A statement function is referenced by using its name with actual arguments, if any, enclosed in parentheses. The form of a statement function reference is:

$$fun([exp[,exp]...])$$

where:

*fun* is a statement function name.

*exp* is an expression.

## Operational Conventions and Restrictions

The expressions must agree in order, number, and type with the corresponding dummy arguments. The expressions may be any expression except a character expression involving concatenation in which the length attribute of one of the operands is specified with an asterisk.

Execution of a statement function reference results in:

- Evaluation of actual arguments *exp* that are expressions.
- Association of actual arguments with their corresponding dummy arguments.
- Evaluation of the expression *e* in the statement function definition.
- Type-conversion of the resulting value to the data type of the function, if necessary. This value is returned as the value of the statement function reference.
- A statement function may be referenced only in the program unit that contains its definition. A statement function can reference another statement function that has been defined prior to the referencing function, but not one which is defined after the referencing function.
- A statement function name is local to the program unit, and must not be used as the name of any other entity in the program unit except the name of a common block.
- The symbolic name used to identify a statement function must not appear as a symbolic name in any specification statement except in a type-statement (to specify the type of the function) or as the name of a common block in the same program unit.



- A dummy argument of a statement function must not be redefined or become undefined through a function subprogram reference in the expression of a statement function statement.
- The symbolic name of a statement function can not be an actual argument, and must not appear in an EXTERNAL statement.
- A statement function statement in a function subprogram must not contain a function reference to the name of an entry to the function subprogram.
- The length specification of a statement function dummy argument of type character must be an integer constant.

## Parameter Passing

### Dummy Arguments

Dummy arguments are used in function subprograms, subroutine programs, and statement functions to indicate the types of actual arguments and whether each argument is a single value, an array of values, a subprogram, or a statement label. Dummy argument names must not appear in EQUIVALENCE, DATA, PARAMETER, SAVE, INTRINSIC, or COMMON statements, except as common block names. Dummy argument names must not be the same as the subprogram name in FUNCTION, SUBROUTINE, ENTRY, or statement function statements in the same program unit.

Actual arguments are the items which are given in the call to the function. Actual arguments are bound to the corresponding dummy arguments when the subprogram call is reached. Actual arguments can change with each call to the subprogram. Of course, the types of the paired actual argument and dummy argument must match. The types do not have to match if the actual argument is a subroutine name or an alternate return specifier.

When a function or a subroutine reference is executed, an association is established between the corresponding dummy and actual arguments. The first dummy argument becomes associated with the first actual argument, the second dummy argument becomes associated with the second actual argument, and so on.

An array can be passed to a function or subroutine as an actual argument if the corresponding dummy argument is also an array declared in a DIMENSION or type statement, but not in a COMMON statement. The size of the array in the calling program unit must be smaller than or equal to the size of the corresponding dummy array in the subprogram. The array in the function or subroutine may also have adjustable dimensions.

## Built-In Functions

Built-in functions permit you to communicate with non-FORTRAN programs that require arguments passed in a specific format. (See **Chapter 3** of the *FORTRAN Programmer's Guide* for information specific to communicating with programs written in the C and Pascal languages.)

The built-in functions %VAL, %REF, and %DESCR are intended for use with arguments within an argument list. The built-in function %LOC is intended for global use.

### %VAL

The %VAL built-in function passes the argument as a 32-bit value; the function extends argument smaller than 32 bits to 32-bit signed values. The function has the following syntax:

%VAL (*a*)

where *a* is an argument within an argument list.

### %REF

The %REF built-in function passes an argument by reference; it has the syntax:

%REF (*a*)

where *a* is an argument within an argument list.

### %DESCR

The %DESCR built-in function has no functionality, but is included for compatibility with VAX FORTRAN; it has the syntax:

%DESCR (*a*)

where *a* is an argument within an argument list.

### %LOC

The %LOC built-in function returns a 32-bit run-time address of its argument; it has the syntax:

%LOC (*a*)

where *a* is an argument whose address is to be returned.

## Function and Subroutine Subprograms

A function subprogram consists of a `FUNCTION` statement followed by a program body that terminates with an `END` statement and has the following characteristics:

- it is defined external to the main program unit
- it is referenced as a primary in an expression contained in another program unit
- it is considered part of the calling program.

A FORTRAN program can call a subroutine subprogram written in any language supported by the RISCompiler System. (See **Chapter 3** of the *FORTRAN Programmer's Guide* for information on writing FORTRAN programs that interact with programs written in other languages.)

A subroutine subprogram consists of a `SUBROUTINE` statement (described in this chapter), followed by a program body that terminates with an `END` statement (**Chapter 6**), and is defined external to the main program.

### Referencing Functions and Subroutines

A function subprogram is referenced as a primary in an expression while a subroutine subprogram is referenced with a `CALL` statement (**Chapter 6**) contained in another program. Reference to a function subprogram has the form:

$$fun([a[,a]...])$$

where *fun* is a symbolic name of the function subprogram and *a* is an actual argument.

If *fun* is of type character, then its length must not have been specified with an asterisk (\*) in the calling subprogram.

You can write subroutines that call themselves either directly or via a chain of other subprograms if the automatic storage of variables is in effect. The `-automatic` command line option (**Chapter 11**) by default causes the automatic storage of variables.

The actual arguments comprise an argument list and must agree in order, number, and type with the corresponding dummy arguments in the referenced function or subroutine. An actual argument in a function reference must be one of the following:

- An expression, except a character expression, involving concatenation of an operand whose length is specified by an asterisk
- An array name
- An intrinsic function name
- An external function or subroutine name

- A dummy function or subroutine name
- A Hollerith constant

An actual argument may be a dummy argument that appears in a dummy argument list within the subprogram containing the reference.

The use of a dummy name allows actual names to be passed through several levels of program units.

If a Hollerith constant is used as an actual argument in a CALL statement, the corresponding dummy argument must not be a dummy array and must be of arithmetic or logical data type.

The same rules apply to the actual arguments in a subroutine reference, except that in addition to the forms described above, the actual dummy argument of a subroutine may be an alternate return specifier. An alternate return specifier has the form *\*s*, where *s* is the statement label of an executable statement appearing in the same program unit as the CALL statement.

For example:

```
SUBROUTINE MAXX (A, B, *, *, C)
```

The actual argument list passed in the CALL must include alternate return arguments in the corresponding positions of the form *\*s*. The value specified for *s* must be the label of an executable statement in the program unit that issued the call.

Note that the use of a subroutine name or an alternate return specifier as an actual argument is an exception to the rule requiring agreement of type. If an external function or subroutine name or a dummy name is used as an actual argument, the name must appear in an EXTERNAL statement. If an intrinsic name is used as an actual argument, the name must appear in an INTRINSIC statement and the name must be one of those listed in Appendix A as a specific name. It must not be one of the intrinsics for type conversion, for choosing the largest or smallest value, or for lexical relationship.

## Executing Functions and Subroutines

Execution of an reference to a function subprogram and subroutine subprogram results in:

- Evaluation of expressions that constitute actual arguments
- Association of actual arguments from the calling program unit with the corresponding dummy arguments in the subprogram
- Execution of the statements comprising the subprogram based on the execution control sequence of the program unit
- Return of program control to the calling program unit when either a RETURN statement is encountered or the execution control flows into the END statement

The name of a function subprogram must appear as a variable at least once in the subprogram and must be defined at least once during each subprogram execution. Once the variable is defined, it may be referenced elsewhere in the subprogram and become redefined. When program control is returned to the calling program, it is this value that is returned as the value of the function reference. If this variable is a character variable with a length specified by an asterisk, it may not appear as an operand in a concatenation operation, but may be defined in an assignment statement.

A subroutine does not return an explicit value to the point of invocation in the calling program unit. However, the subroutine and the function, as well, can return values to the calling program unit by defining their dummy arguments during execution.

# FUNCTION

## Use

First statement of a function subprogram; specifies the symbolic name of the function and its type.

## Syntax

```
[typ] FUNCTION fun [*len]
```

where:

*typ* optionally specifies the data type of the function name, which determines the value returned to the calling program. The following forms for *typ* are allowed:

INTEGER	DOUBLE PRECISION	LOGICAL
INTEGER*2	COMPLEX	LOGICAL*1
INTEGER*4	COMPLEX*8	LOGICAL*2
REAL	COMPLEX*16	LOGICAL*4
REAL*4	DOUBLE COMPLEX	CHARACTER[*len]
REAL*8		

*fun* is a symbolic name of the function subprogram in which the FUNCTION statement appears.

*len* specifies the length of the data type; *fun* must be an unsigned, nonzero constant. This specification isn't permitted when the function is type CHARACTER with an explicit length following the keyword CHARACTER.

*w* is a dummy argument and may be a variable name, array name, or dummy subprogram name.

## Rules of Use

1. A FUNCTION statement must appear only as the first statement of a function subprogram.
2. The type specification may be omitted from the FUNCTION statement and the function name may be specified in a type statement in the same program unit. If neither of these options is used, the function is implicitly typed.
3. The symbolic name of a function is a global name and must not be the same as any other global or local name, except a variable name, in the function subprogram.

## FUNCTION

4. If the function type is specified in the FUNCTION statement, the function name must not appear in a type statement.
5. In the type specification CHARACTER, *len* may have any of the forms allowed in a CHARACTER statement, except that an integer constant expression must not include the symbolic name of a constant. If the name of the function is type character, then each entry name in the function subprogram must be of type character. If the length is declared as an asterisk, all such entries must have a length declared with an asterisk.
6. A function specified as a subprogram may be referenced within any other subprogram or the main program of the executable program.

### Restrictions

1. A function subprogram must not contain a BLOCK DATA, SUBROUTINE, or PROGRAM statement.
2. A function name must not have its type explicitly specified more than once in a program unit.
3. In a function subprogram, a dummy argument name must not appear in an EQUIVALENCE, PARAMETER, SAVE, INTRINSIC, DATA, or COMMON statement, except as a common block name.
4. A character dummy argument with a length specified as an asterisk must not appear as an operand for concatenation, except in a character assignment statement.
5. The compiler system permits recursion if the automatic storage of variables is in effect. The `-automatic` command line option (Chapter 11) by default causes the automatic storage of variables.

# SUBROUTINE

## Use

First statement of a subroutine subprogram.

## Syntax

```
SUBROUTINE sub[( [d [,d]... ] )]
```

where *sub* is a symbolic name of the subroutine program unit and *d* is a dummy argument and may be a variable name, array name, dummy subprogram name, or an asterisk. The asterisk denotes an alternate return.

## Rules of Use

1. A SUBROUTINE statement must be the first statement of a subroutine subprogram.
2. If there are no dummy arguments, either of the following forms may be used:

```
SUBROUTINE sub  
SUBROUTINE sub()
```

3. One or more dummy arguments may become defined or redefined to return results.
4. The symbolic name of a subroutine is global and must not be the same as any other global or local name in the program unit.
5. A CALL statement within the body of a subroutine may reference the subroutine itself (recursion) if the automatic storage attribute is specified. See the description of the AUTOMATIC and STATIC keywords in Chapter 4 for more information.

## Restrictions

1. A subroutine subprogram must not contain a BLOCK DATA, FUNCTION, or PROGRAM statement.
2. In a subroutine, a dummy argument name is local to the program unit and must not appear in an EQUIVALENCE, SAVE, INTRINSIC, DATA, or COMMON statement, except as a common block name.
3. A character dummy argument whose length is specified as an asterisk must not appear as an operand for concatenation, except in a character assignment statement.



# ENTRY

## Use

Specifies a secondary entry point in a function or subroutine subprogram. It allows a subprogram reference to begin with a particular executable statement within the function or subroutine subprogram in which the ENTRY statement appears.

## Syntax

```
ENTRY en( ( [d [, d] ...] ) )
```

where *en* is a symbolic name of the entry point and *d* is a dummy argument. If there are no dummy arguments, the following forms may be used:

```
ENTRY en  
ENTRY en()
```

## Method of Operation

Each ENTRY statement in a function or subroutine provides an additional name which you may use to invoke that subprogram. When you invoke it with one of these names, it begins execution at the first executable statement following the entry statement which provided that name.

Within a function, each of its names (the one provided by the FUNCTION statement, plus the additional ones provided by the ENTRY statements) acts like a variable. By the time the function returns, you must have defined the function return value by assigning it to one of these variables.

If any of these variables is of type CHARACTER, all must be of type CHARACTER; but otherwise, the variables need not all have the same data type. Such variables are in effect equivalenced, which has the following implications:

- First, you need not assign the return value to the same name which you used to invoke the function; instead, you may assign to any of the names which has the same data type as that one.
- Second, if you assign to any of the names which does not have the same data type as the one you used to invoke the function, then the return value becomes undefined.

# ENTRY

## Rules of Use

1. The ENTRY statement may appear anywhere within a function subprogram after the FUNCTION statement or within a subroutine after a SUBROUTINE statement.
2. A subprogram may have one or more ENTRY statements.
3. The entry name *en* in a function subprogram may appear in a type statement.

4. In a function, a local variable with the same name as one of the entries may be referenced.

A subprogram can call itself directly if the automatic storage of variables is in effect. The `--automatic` command line option (Chapter 11) by default causes the automatic storage of variables.

5. The order, number, type, and names of the dummy arguments in an ENTRY statement may be different from the dummy arguments in the FUNCTION, SUBROUTINE, or other ENTRY statements in the same subprogram. However, each reference to a function or subroutine must use an actual argument list that agrees in order, number, and type with the dummy argument list in the corresponding FUNCTION, SUBROUTINE, or ENTRY statement.

**Restrictions**

1. An ENTRY statement must not appear between a block IF statement and its corresponding END IF statement or between a DO statement and the terminal statement of the DO-loop.
2. Within a subprogram, an entry name may not also serve as a dummy argument in a FUNCTION, SUBROUTINE, or ENTRY statement or be in an EXTERNAL statement.
3. In a function subprogram, an entry name may also be a variable name provided the variable name is not in any statement (except a type statement) preceding the ENTRY statement of that name. After the ENTRY statement, the name can be used as a variable name.
4. In a function subprogram, if an entry name is of type character, each entry name and the name of the function subprogram must also be of type character and must have the same length declared. If any are of length (\*), then *all* must be of length (\*).
5. In a subprogram, a name that appears as a dummy argument in an ENTRY statement is subject to the following restrictions:
  - It must not appear in an executable statement preceding that ENTRY statement unless it also appears in a FUNCTION, SUBROUTINE, or ENTRY statement preceding the executable statement.
  - It must not appear in the expression of a statement function unless the name is also a dummy argument of the statement function, appears in a FUNCTION or SUBROUTINE statement, or appears in an ENTRY statement preceding the statement function.

This chapter describes options that affect source programs both during compilation and at run-time. Three mechanisms are provided by which to execute these options:

- the `OPTIONS` statement, which is specified in the source code as the first statement of a program unit.
- *in-line options*, which are individual statements embedded in the source code.
- the `INCLUDE` statement, which allows the inclusion of FORTRAN source statements from an external library to be included into a program.

## OPTIONS Statement

```
OPTIONS option[ option. . .]  
  
/I4 /NOI4 /F77 /NOF77 /CHECK=BOUNDS  
/CHECK=NOBOUNDS  
/EXTEND_SOURCE /NOEXTEND_SOURCE
```

These options perform the same function as like-named command line options. See **Chapter 1** of the *FORTRAN Programmer's Guide* for a description of these options. An *option* specification overrides a command line option when they are the same; *option* must always be preceded by a slash (/).

The following rules apply to **OPTIONS** statement specifications:

- the statement must be the first statement in a program unit and must precede the **PROGRAM**, **SUBROUTINE**, **FUNCTION**, and **BLOCK DATA** statements.
- *option* remains in effect only for the duration of the program unit in which it is defined.

## In-Line Options

The syntax for in-line compiler options consists of a dollar sign (\$) in column one of a source record, followed by the name of the compiler option in either upper or lower case, with no intervening blanks or other separators.

When an in-line compiler option is encountered in a source file, that option is put into effect beginning with the source statement following the in-line compiler option. The sections that follow describe the in-line compiler options supported by the compiler.

**NOTE:** The compiler doesn't support the following options, but, for compatibility with other compilers, it does recognize them:

ARGCHECK	NOTBINARY
BINARY	SEGMENT
CHAREQU	SYSTEM
NOARGCHECK	XREF

Upon encountering one of these options, the compiler issues a warning message and treats it as a comment line.

### \$COL72 Option

The **COL72** option instructs the compiler to process all subsequent FORTRAN source statements according to the fixed format 72 column mode described under **Initial Lines** in Chapter 1. The compiler command line option **-col72** has an identical effect on a global basis.

### \$COL120 Option

The **COL120** option instructs the compiler to process all subsequent FORTRAN source statements according to the fixed format 120 column mode. The compiler command line option **-col120** has an identical effect on a global basis.

### \$F66DO Option

The **F66DO** option instructs the compiler to process all subsequent DO loops according to the rules of FORTRAN 66. This principally means that all DO loop bodies will be performed at least once regardless of the loop index parameters. The compiler command line option **-onetrip** has an identical effect on a global basis.

### **\$INCLUDE Option**

The **\$INCLUDE** option permits the inclusion of source lines from a secondary file (or files) into the current, primary, source program. This feature is especially useful when two or more separately compiled source programs require an identical sequence of source statements (for example, data declaration statements).

The form of the **\$INCLUDE** option is:

```
$INCLUDE filename
```

where filename is either an absolute or relative UNIX file name. If the filename is relative and no file exists by that name relative to the current working directory, an error is given and no attempt is made to search an alternative path. The material introduced into the source program by the **\$INCLUDE** option will follow the **\$INCLUDE** option, beginning on the next line. Nesting of **\$INCLUDE** options is permitted within the constraints of the operating system.

### **\$INT2 Option**

The **\$INT2** option instructs the compiler to make **Integer\*2** the default integer type, and **LOGICAL\*1** the default logical type. This convention stays in effect for the remainder of the program and involves any symbolic names which are assigned a data type either by implicit typing rules, or by use of the **Integer** or **LOGICAL** declaration statements without a type length being specified. This option is similar to the **-i2** command line option except for the effect on the default logical type.

### **\$LOG2 Option**

The **LOG2** option instructs the compiler to make **LOGICAL\*2** instead of **LOGICAL\*4** the default type for **LOGICAL**. This convention stays in effect for the remainder of the program and involves any symbolic names which are assigned a data type either by implicit typing rules, or by use of the **LOGICAL** declaration statement without a type length being specified.



# Appendix A

## Intrinsic Functions

---

This appendix describe the intrinsic functions provided with FORTRAN. FORTRAN intrinsic functions are identified by two categories of names: specific and generic. An IMPLICIT statement does not change the data type of an intrinsic function.

### Generic and Specific Names

A *generic name* is the single name given to a class of objects. Intrinsic functions that perform the same mathematical function, such as square root, are given a single name. For example, the generic name of the square root function is SQRT; this function has four specific names for different data types: SQRT, DSQRT, CSQRT, and ZSRT (see Part 5 of Table A.1). However, the generic name SQRT may be used regardless of the data type of the argument(s).

When a generic name is referenced, the processor substitutes a function call to a *specific name*, depending upon the data type of the arguments. In this way, the same name can be used for different types of arguments.

When an intrinsic function is to be used as the actual argument to another function, you must always use the specific name, never the generic name.

If a generic name is referenced, the type of the result is the same as the type of the argument, except for functions performing type conversion, nearest integer, and absolute value with a complex argument. Some intrinsic functions allow more than one argument, in which case all the arguments must be of the same type so that the function can decide which specific name function it should use.

If the specific name or generic name appears as a dummy argument of a function or subroutine, that symbolic name cannot identify an intrinsic function in that program unit.

A name in an INTRINSIC statement must be the specific name or generic name of an intrinsic function as given in Table A.1.

### Referencing an Intrinsic Function

Reference to an intrinsic function takes the following form:

$$fun(a[,a]...)$$

where:

*fun* is the generic or specific name of the intrinsic function.

*a* is an actual argument.



The actual arguments  $a$  constitute the argument list and must agree in order, number, and type with the specification described in this appendix and with each other. Each argument may be any expression. The expression cannot contain a concatenation in which one or more of the operand lengths are specified with an asterisk.

A function reference may be used as a primary in an expression. The following example involves referencing an intrinsic function:

```
X = SQRT (B**2-4*A*C)
```

Arguments for which the result is not mathematically defined or exceeds the numeric range of the processor cause the result of the function to become undefined.

## Operational Conventions and Restrictions

For most intrinsic functions, the data type of the result of the intrinsic function is the same as the argument(s). If two or more arguments are required or permitted, then all arguments must be of the same type. An IMPLICIT statement does not change the data type of a specific or generic name of an intrinsic function.

If an intrinsic function name is used as an actual argument in an external procedure reference, the name used must be one of the specific names and must appear in an INTRINSIC statement. However, names of intrinsic functions for type conversion, for lexical relationship, and for choosing the smallest or largest value cannot be used as actual arguments.

## List of Functions

The tables starting on the next page list the available intrinsic functions. Operational conventions and restrictions (other than those already given) are listed at the end of each table.

**NOTE:** REAL\*16 intrinsic functions are not supported. The compiler issues a warning message when the name of a REAL\*16 intrinsic function is encountered; the equivalent double precision (REAL\*8) function is used instead.

Function	Number of Arguments	Generic Name	Specific Name	Type of Argument	Type of Result
Conversion to Integer	1	INT	INT <sup>1</sup>	Real	Integer
			IIFIX	Real*4	Integer*2
			JIFIX	Real*4	Integer*4
			IFIX <sup>1</sup>	Real	Integer
			IDINT	Double Complex	Integer Integer Integer
Conversion to Real	1	REAL	REAL	Integer	Real
			FLOATI	Integer*2	Real*4
			FLOATJ	Integer*4	Real*4
			FLOAT	Integer	Real
			SNGL	Double Complex Real	Real Real Real
Conversion to Double	1	DBLE	DBLE	Integer	Double
			DFLOAT	Real	Double
				Double Complex	Double Double
			DFLOTI	Integer*2	Real*8
			DFLOTJ	Integer*4	Real*8
Conversion to Complex	1,2	CMPLX	CMPLX	Integer	Complex
				Real	Complex
				Double	Complex
				Complex	Complex
				Complex*16	Complex
Conversion to Complex*16	1,2	DCMPLX	DCMPLX	Integer	Complex*16
				Real	Complex*16
				Double	Complex*16
				Complex	Complex*16
				Complex*16	Complex*16

1. INT and IFIX return result type INTEGER\*2 if the —i2 compile option is in effect; otherwise, the result type is INTEGER\*4.

Table A.1 (Part 1 of 9). Intrinsic Function

Function	Number of Arguments	Generic Name	Specific Name	Type of Argument	Type of Result
Maximum Value	2 or more	MAX	MAX0	Integer	Integer
			IMAX0	Integer*2	Integer*2
			JMAX0	Integer*4	Integer*4
			AMAX0	Integer	Real
			MAX1	Real	Integer
			AMAX1	Real	Real
		DMAX1	Double	Double	
		MAX0	IMAX0	Integer*2	Integer*2
			JMAX0	Integer*4	Integer*4
		MAX1	IMAX1	Real*4	Integer*2
			JMAX1	Real*4	Integer*4
		AMAX0	AIMAX0	Integer*2	Real*4
	AJMAX0	Integer*4	Real*4		
Minimum Value	2 or more	MIN	MIN0	Integer	Integer
			IMIN0	Integer*2	Integer*2
			JMIN0	Integer*4	Integer*4
			AMIN0	Integer	Real
			AMIN1	Real	Real
			MIN1	Real	Integer
		DMIN1	Double	Double	
		MIN0	IMIN0	Integer*2	Integer*2
			JMIN0	Integer*4	Integer*4
		MIN1	IMIN1	Real*4	Integer*2
			JMIN1	Real*4	Integer*4
		AMIN0	AIMIN0	Integer*2	Real*4
	AJMIN0	Integer*4	Real*4		

Table A.1 (Part 2 of 9). Intrinsic Functions

Function	Number of Arguments	Generic Name	Specific Name	Type of Argument	Type of Result
Truncation	1	INT	AINT	Real	Real
			DINT	Double	Double
			IINT	Real*4	Integer*2
			JINT	Real*4	Integer*4
			IIDINT	Real*8	Integer*2
			JIDINT	Real*8	Integer*4
Nearest Whole Number	1	NINT	ININT	Real*4	Integer*2
			JNINT	Real*4	Integer*4
			NINT <sup>1</sup>	Real	Integer
			IDNINT <sup>1</sup>	Double	Integer
		IDNINT	IIDNNT	Real*8	Integer*2
			JIDNNT	Real*8	Integer*4
		ANINT	ANINT	Real	Real
			DNINT	Double	Double
Zero-Extend Functions	1	ZEXT	IZEXT	Logical*1	Integer*2
				Logical*2	Integer*2
			JZEXT	Logical*1	Integer*4
				Logical*2	Integer*4
	Logical*4	Integer*2			
	Integer*2	Integer*4			

1. When NINT or IDNINT is specified as an *argument* in a subroutine call or function reference, the compiler supplies either an INTEGER\*2 or INTEGER\*4 function depending on the `-i2` command line option (see Chapter 1 of the *FORTRAN Programmer's Guide*).

Table A.1 (Part 3 of 9). Intrinsic Functions

Function	Number of Arguments	Generic Name	Specific Name	Type of Argument	Type of Result
Absolute Value	1	ABS	IABS <sup>1</sup>	Integer	Integer
			ABS	Real	Real
			DABS	Double	Double
			CABS	Complex	Real
			ZABS	Dbl Complex	Double
			IABS	Integer*2	Integer*2
			JABS	Integer*4	Integer*4
Remaindering	2	MOD	MOD <sup>1,2</sup>	Integer	Integer
			IMOD	Integer*2	Integer*2
			JMOD	Integer*4	Integer*4
			AMOD <sup>2</sup>	Real	Real
			DMOD <sup>2</sup>	Double	Double
Transfer of Sign	2	SIGN	ISIGN <sup>1,3</sup>	Integer	Integer
			IISIGN	Integer*2	Integer*2
			JISIGN	Integer*4	Integer*4
			SIGN <sup>3</sup>	Real	Real
			DSIGN <sup>3</sup>	Double	Double
Positive Difference	2	DIM	IDIM <sup>1</sup>	Integer	Integer
			IIDIM	Integer*2	Integer*2
			JIDIM	Integer*4	Integer*4
			DIM	Real	Real
			DDIM	Double	Double
Double Product	2	DPROD	DPROD	Real	Double
Length of Character Entry	1		LEN <sup>3</sup>	Character	Integer

1. The IABS, ISIGN, IDIM, and integer MOD intrinsics accept either INTEGER\*2 arguments or INTEGER\*4 arguments and the result is the same type.

2. The result for MOD, AMOD, and DMOD is undefined when the value of the second argument is zero.

3. If the value of the first argument of ISIGN, SIGN, or DSIGN is zero, the result is zero.

Table A.1 (Part 4 of 9). Intrinsic Functions

Function	Number of Arguments	Generic Name	Specific Name	Type of Argument	Type of Result
Index of a Substring	2	INDEX	INDEX <sup>1</sup>	Character	Integer
Character (returns a character of the ASCII value of the argument).	1	CHAR	CHAR	Integer	Character
Character (returns the ASCII value of a one-byte character argument).			ICHAR <sup>1</sup>	Character	Integer
Imaginary Part of a Complex Argument	1	IMAG	AIMAG DIMAG	Complex Complex*16	Real Double
Conjugate of a Complex Argument	1	CONJG	CONJG DCONJG	Complex Complex*16	Complex Complex*16
Square root	1	SQRT	SQRT <sup>2</sup> DSQRT <sup>2</sup> CSQRT <sup>2</sup> ZSQRT	Real Double Complex Complex*16	Real Double Complex Complex*16
Exponential	1	EXP	EXP DEXP CEXP ZEXP	Real Double Complex Complex*16	Real Double Complex Complex*16
Natural logarithm	1	LOG	ALOG <sup>3</sup> DLOG <sup>3</sup> CLOG <sup>3</sup> ZLOG	Real Double Complex Complex*16	Real Double Complex Complex*16

1. The result of INDEX is an integer value indicating the position in the first argument of the first substring which is identical to the second argument. The result of INDEX('ABCDEF', 'CD'), for example, would be 3. If no substring of the first argument matches the second argument, the result is zero. INDEX and ICHAR return the result type INTEGER\*2 if the `-i2` compile option is in effect; otherwise, the result type is INTEGER\*4.

2. The value of the argument of SQRT and DSQRT must be greater than or equal to zero. The result of CSQRT is the principal value with the real part greater than or equal to zero. When the real part is zero, the imaginary part is greater than or equal to zero.

3. The argument of ALOG and DLOG must be greater than zero. The argument of CLOG must not be (0.,0.). The range of the imaginary part of the result of CLOG is:  $-p < \text{imaginary part} \leq p$ .

Table A.1 (Part 5 of 9). Intrinsic Functions

Function	Number of Arguments	Generic Name	Specific Name	Type of Argument	Type of Result
Common Logarithm	1	LOG10 <sup>1</sup>	ALOG10 DLOG10	Real Double	Real Double
Sine	1	SIN <sup>2</sup>	SIN DSIN CSIN ZSIN	Real Double Complex Complex*16	Real Double Complex Complex*16
Sine (degree)	1	SIND <sup>3</sup>	SIND DSIND	Real*4 Real*8	Real*4 Real*8
Cosine	1	COS <sup>2</sup>	COS DCOS CCOS ZCOS	Real Double Complex Complex*16	Real Double Complex Complex*16
Cosine (degree)	1	COSD <sup>3</sup>	COSD DCOSD	Real*4 Real*8	Real*4 Real*8
Tangent	1	TAN <sup>2</sup>	TAN DTAN	Real Double	Real Double
Tangent (degree)	1	TAND <sup>3</sup>	TAND DTAND	Real*4 Real*8	Real*4 Real*8
Arcsine	1	ASIN <sup>4,5,6</sup>	ASIN DASIN	Real Double	Real Double
Arcsine (degree)	1	ASIND <sup>4,5</sup>	ASIND DASIND	Real*4 Real*8	Real*4 Real*8
Arc cosine	1	ACOS <sup>6</sup>	ACOS DACOS	Real Double	Real Double
Arc cosine (degree)	1	ACOSD <sup>4,5</sup>	ACOSD DACOSD	Real*4 Real*8	Real*4 Real*8

1. The absolute value of the argument for ALOG10 and DLOG10 must be greater than zero.
2. The argument for SIN, DSIN, CSIN, ZSIN, COS, DCOS, CCOS, ZCOS, TAN, or DTAN must be in radians and is treated modulo 2P.
3. The argument for SIND, COSD, or TAND must be in degrees and is treated as modulo 360.
4. The absolute value of the arguments for ASIN, DASIN, ASIND, DASIND, ACOS, DACOS, ACOSD, and DACOSD must be less than or equal to 1.
5. The range of the result for ASIN and DASIN is  $-p/2 < \text{result} \leq p/2$ ; the range of the result for DASIN is  $0 \leq \text{result} \leq p$ ; and the range of the result for ACOS and DACOS is less than or equal to one.
6. The result of ASIN, DASIN, ACOS, and DACOS is in radians.
7. The result of ASIND, DASIND, ACOS, DACOSD is in degrees.

Table A.1 (Part 6 of 9). Intrinsic Functions

Function	Number of Arguments	Generic Name	Specific Name	Type of Argument	Type of Result
Arctangent	1	ATAN <sup>1</sup>	ATAN DATAN	Real Double	Real Double
Arctangent (degree)		ATAND <sup>2</sup>	ATAND DATAND	Real*4 Real*8	Real*4 Real*8
Arctangent	2	ATAN2 <sup>1, 3</sup>	ATAN2 DATAN2	Real Double	Real Double
Arctangent (degree)		ATAN2D <sup>2, 4</sup>	ATAN2D DATAN2D	Real*4 Real*8	Real*4 Real*8
Hyperbolic Sine	1	SINH	SINH DSINH	Real Double	Real Double
Hyperbolic Cosine	1	COSH	COSH DCOSH	Real Double	Real Double
Hyperbolic Tangent	1	TANH	TANH DTANH	Real Double	Real Double
Logically Greater Than or Equal	2	LGE <sup>5</sup>	LGE	Character	Logical
Logically Greater Than	2	LGT <sup>5</sup>	LGT	Character	Logical
Logically Less Than or Equal	2	LLE <sup>5</sup>	LLE	Character	Logical
Logically Less Than	2	LLT <sup>5</sup>	LLT	Character	Logical

1. The result of ATAN, DATAN, ATAN2, and DTAN2 is in radians.

2. The result of ATAND, DATAND, ATAN2D, and DATAN2D is in degrees.

3. If the value of the first argument of ATAN2 or DATAN2 is positive, the result is positive. When the value of the first argument is zero, the result is zero if the second argument is positive and P if the second argument is negative. If the value of the first argument is negative, the result is negative. If the value of the second argument is zero, the absolute value of the result is P/2. Both arguments must not have the value zero.

4. Note 3 on this page also applies to ATAN2 and DTAN2D, except for the range of the result, which is:  $-180 \text{ degrees} < \text{result} < 180 \text{ degrees}$ .

5. The character relational intrinsics (LLT, LGT, LLE, and LGE) return result type LOGICAL\*2 if the \$log2 (Chapter 11) compile option is in effect; otherwise, the result type is LOGICAL\*4.

Table A.1 (Part 7 of 9). Intrinsic Functions



Function	Number of Arguments	Generic Name	Specific Name	Type of Argument	Type of Result
Bitwise And	2		IAND <sup>1</sup> AND	Integer Integer	Integer Integer
Bitwise Or	2		IIOR IOR <sup>1</sup> OR JIOR	Integer*2 Integer Integer Integer	Integer*2 Integer Integer Integer
Bitwise Not	1		INOT JNOT NOT <sup>1</sup>	Integer*2 Integer Integer	Integer*2 Integer Integer
Bitwise Exclusive Or	2		IIEOR JIEOR IEOR <sup>1</sup> XOR	Integer*2 Integer Integer Integer	Integer*2 Integer Integer Integer
Bitwise Shift	2		IISHFT JISHFT ISHFT <sup>1</sup> LSHIFT RSHIFT	Integer*2 Integer Integer Integer Integer	Integer*2 Integer Integer Integer Integer
Bitwise Circular Shift	2		IISHIFTC JISHIFTC ISHIFTC	Integer*2 Integer Integer	Integer*2 Integer Integer

1. The following intrinsics accept either INTEGER\*2 arguments or INTEGER\*4 arguments and the result is the same type as the following arguments:

IAND	ISHFT
IOR	NOT
IEOR	

When one of the intrinsic names listed in this note is specified as an *argument* in a subroutine call or function reference, the compiler supplies either an INTEGER\*2 or INTEGER\*4 function depending on the `-i2` command line option.

Table A.1 (Part 8 of 9). Intrinsic Functions

Function	Number of Arguments	Generic Name	Specific Name	Type of Argument	Type of Result
Bit Extraction	3		IIBITS	Integer*2	Integer*2
			JIBITS	Integer	Integer
			IBITS	Integer	Integer
Bit Set	2		IIBSET	Integer*2	Integer*2
			JIBSET	Integer	Integer
			IBSET	Integer	Integer
Bit Test	2		BITEST	Integer*2	Logical*2
			BJTEST	Integer	Logical
			BTEST	Integer	Logical
Bit Clear	2		IIBCLR	Integer*2	Integer*2
			JIBCLR	Integer	Integer
			IBCLR	Integer	Integer

Table A.1 (Part 9 of 9). Intrinsic Functions



## Symbols

\$ edit descriptor, 9–30  
 + addition, identity operator, 3–2  
 – subtraction, negation operator, 3–2  
 \* multiplication operator, 3–2  
 \*\* exponentiation operator, 3–2  
 / (slash) editing, 9–31  
 / division operator, 3–2

## A

A edit descriptor  
   general description, 9–24–9–25  
   using variable format descriptor with, 9–5  
 ABS intrinsic function, A–6  
 ACCEPT statement, 8–3  
 access methods, 7–5  
 ACCESS specifier  
   in INQUIRE statement, 8–13  
   in OPEN statement, 8–18  
 ACOS intrinsic function, A–8  
 ACOSD intrinsic function, A–8  
 aggregate, assignment statements, 5–6  
 AND (bitwise) intrinsic function, A–10  
 .AND. logical operator, 3–10, 3–13  
 ANINT intrinsic function, A–5  
 arguments  
   dummy, 10–4  
   in a function reference, 10–6  
 arithmetic  
   expressions, 3–1  
   operands, 3–3  
   relational expressions, 3–9  
 array  
   passing as an argument, 10–4  
   size, 2–17  
   subscripts, 2–18  
 array name, as format identifier, 9–1  
 arrays, 2–14  
 ASSIGN statement, 5–6  
 assignment statements  
   aggregate, 5–6  
   character, 5–5

conversion rules, 5–2  
 logical, 5–5  
 statement label, 5–6

ASSOCIATEVARIABLE specifier, in OPEN statement, 8–19

ATAN2 intrinsic function, A–9  
 ATAND intrinsic function, A–9  
 ATAND2 intrinsic function, A–9  
 AUTOMATIC, statement, 4–3

## B

BACKSPACE statement, 8–4  
 bit, constants, 2–9  
 bit clear intrinsic function, A–11  
 bit extraction intrinsic function, A–11  
 bit set intrinsic function, A–11  
 bit test intrinsic function, A–11  
 blank edit descriptors, 9–29  
 BLOCK DATA, statement, 4–5  
 BN edit descriptor, 9–29  
 BYTE type statement, 4–13  
 BZ edit descriptor, 9–29

## C

CALL statement, 6–3  
 CARRIAGECONTROL specifier  
   in INQUIRE statement, 8–14  
   in OPEN statement, 8–19  
 CHAR intrinsic function, A–7  
 character  
   assignment statements, 5–5  
   constants, 2–7  
   data type statements, 4–16  
 character edit descriptor, 9–26  
 character expressions  
   expressions, 3–6  
   relational, 3–9  
 character set, 1–1  
 characters, special, 1–1  
 cilist (control information list), 8–43  
 CLOSE statement, 8–5  
   disconnecting a unit, 7–7

\$COL120 in-line option, 11-2  
 \$COL72 in-line option, 11-2  
 colon edit descriptor, 9-29  
 comment lines, 1-4  
 COMMON, statement, 4-6  
 complex  
   constants, 2-6  
   type statements, 4-13  
 complex data editing, 9-30  
 concatenation operator, 3-7  
 CONJG intrinsic function, A-7  
 connected unit, 7-7  
 constant expressions  
   arithmetic, 3-4  
   character, 3-8  
   integer, 3-5  
 constants, 2-2—2-3, 2-4  
   bit, 2-9  
   character, 2-7  
   complex, 2-6  
   Hollerith, 2-8  
   hexadecimal integer, 2-3  
   integer, 2-3  
   logical, 2-7  
   octal integer, 2-4  
   real, 2-4, 2-5  
 continuation line, 1-6  
 CONTINUE statement, 6-5  
 control information list, 8-43  
 control characters, 1-2  
 control statements, 6-1  
 conversion rules, for assignment statements, 5-2  
 COS intrinsic function, A-8  
 COSD intrinsic function, A-8  
 COSH intrinsic function, A-9

## D

D field descriptor, 9-18  
 data initialization, 5-7  
 data transfer rules, 8-49  
 \*\*Empty\*\*, 2-2  
 data types, 2-1

DATA, statement, 4-10  
 DBLE intrinsic function, A-3  
 DCMLX intrinsic function, A-3  
 debugging lines, 1-5  
 declarators, array, 2-15  
 DECODE statement, 8-7  
 DEFAULTFILE specifier  
   in INQUIRE statement, 8-13  
   in OPEN statement, 8-20  
 DEFINE FILE statement, 8-8  
 DELETE statement, 8-9  
 %DESCR built-in function, 10-5  
 descriptors, repeatable, 9-3  
 DIM intrinsic function, A-6  
 DIMENSION, statement, 4-18, 4-33  
 direct access  
   file, 7-6  
   READ statement, 8-25  
   WRITE statement, 8-36  
 DIRECT specifier, in INQUIRE statement, 8-14  
 disconnecting a unit, 7-7  
 DISPOSE specifier  
   in CLOSE statement, 8-5  
   in OPEN statement, 8-20  
 division, integer, 3-6  
 DO statement, 6-6  
   effect of —onetrup option, 6-7  
 DO statement (implied), 5-8  
 DO WHILE statement, 6-10  
 dollar sign, edit descriptor for, 9-30  
 DOUBLE COMPLEX, type statement, 4-13  
 DOUBLE PRECISION, type statement, 4-13  
 double precision, constants, 2-5  
 DPROD intrinsic function, A-6  
 dummy arguments, 10-4

## E

E field descriptor, 9-16  
 ENTRY statement, 10-12—10-15  
 edit descriptor, 9-29  
   purpose, 9-9

reference, 9-28—9-29

ELSE IF statement, 6-13

ELSE statement, 6-11

ENCODE statement, 8-10

END DO statement, 6-16

END IF statement, 6-17

END specifier, 8-47

END statement, 6-15

end-of-file specifier, 8-47

ENDFILE statement, 8-11

endfile record, 7-2

.EQ. relational operator, 3-8

EQUIVALENCE, statement, 4-19

.EQV. logical operator, 3-10, 3-13

ERR (error) specifier, 8-46

escape sequences, 1-2

EXIST specifier, in INQUIRE statement, 8-14

EXP intrinsic function, A-7

exponentiation, 3-6

expressions

- arithmetic, 3-1
  - interpreting, 3-2
- arithmetic constant, 3-4
- arithmetic relational, 3-9
- character, 3-6
- character constant, 3-8
- character relational, 3-9
- evaluating, rules for, 3-13
- integer constant, 3-5
- logical, 3-10
  - interpreting, 3-12
- parenthesis in, interpreting, 3-14
- relational, 3-8

EXTERNAL, statement, 4-22

external files, 7-4

## F

F field descriptor, 9-14

FORMAT statement

- general rules, 9-7
- input rules, 9-8
- interaction with input/output list, 9-32

output rules, 9-8

specifications, 9-2—9-10

\$F66 in-line option, 11-2

.FALSE. relational expression, 3-8

field descriptors

- defaults, 9-10
- numeric, 9-9
- purpose, 9-9

file, access, 7-5

FILE specifier

- in INQUIRE statement, 8-13
- in OPEN statement, 8-18

files

- definition, 7-3
- external, 7-4
- internal, 7-4

FIND statement, 8-12

FMT (format) specifier, 8-44

form feed character, 1-2

FORM specifier

- in INQUIRE statement, 8-15
- in OPEN statement, 8-20

format

- (FMT) specifier, 8-44
- expressions, variable, 9-5
- specifications, purpose, 9-1
- specifier, usage, 9-3—9-5

formatted

- I/O statements, 7-2
- input/output
  - data transfer rules, 8-49
  - format identifier in, 9-1
- READ statement
  - function, 8-29
  - syntax, 8-28
- records, 7-1
- WRITE statement, function, 8-40
- WRITE statement (sequential), syntax, 8-39

FORMATTED specifier, in INQUIRE statement, 8-15

FUNCTION statement, 10-9—10-11

function, definition, 10-1

function subprogram

- definition, 10-1
- using, 10-6—10-9

functions, built-in, 10-5

## G

G field descriptor, 9-19

.GE. relational operator, 3–8

GO TO statement  
 computed, 6–19  
 symbolic name, 6–20  
 unconditional, 6–18

.GT. relational operator, 3–8

## H

H field descriptor, 9–26

Hollerith, constants, 2–8

Hollerith constant, used as an argument, 10–7

hexadecimal, constants, 2–3

## I

I field descriptor, 9–10

IDNINT intrinsic function, A–5

IF statement  
 arithmetic, 6–21  
 branch logical, 6–22  
 test conditional, 6–23

IMAG intrinsic function, A–7

IMPLICIT, statement, 4–24

implied-DO list, 8–48

\$INCLUDE in-line option, 11–3

INDEX intrinsic function, A–7

indexed  
 READ statement, 8–26  
 WRITE statement, 8–37

indexed (keyed) access, file, 7–6

initialization data, 5–7

input  
 list, contents of, 8–47  
 list directed, 9–33

input/output  
 (ios) specifier, 8–46  
 data transfer rules, 8–49  
 formatted, format identifier in, 9–1  
 list (iolist), 8–47

input/output list, interaction with FORMAT, 9–32

input/output statements  
 formatted, 7–2  
 list-directed, definition, 7–3

summary, 8–1  
 unformatted, 7–2

INQUIRE statement, 8–13

INT intrinsic function, A–3, A–5

\$INT2 in-line option, 11–3

integer  
 constant expressions, 3–5  
 division, 3–6  
 type statements, 4–13

internal  
 READ statement, 8–27  
 WRITE statement, 8–38

internal files, 7–4

INTRINSIC, statement, 4–28

intrinsic functions  
 conventions and restrictions, A–2  
 using, A–1—A–5

iolist (input/output list), 8–47

ios (input/output) specifier, 8–46

## K

KEY  
 key-field-value specifier, 8–45  
 specifier, in OPEN statement, 8–21

key value, in OPEN and READ, 7–6

BLANK specifier, 8–46  
 in INQUIRE statement, 8–14  
 in OPEN statement, 8–19

key-reference specifier, 8–46

KEYED specifier, in INQUIRE statement, 8–15

KEYID specifier, 8–46

## L

L edit descriptor, 9–23

label  
 assignment, 5–6  
 rules, 1–7

.LE. relational operator, 3–8

leyed access, file, 7–6

LGE intrinsic function, A–9

LGT intrinsic function, A–9

list-directed  
 formatting, 9–33

READ statement (internal), syntax, 8-27  
 READ statement (sequential)  
   function, 8-29  
   syntax, 8-28  
 WRITE statement (sequential)  
   function, 8-40  
   rules, 8-40—8-42  
   syntax, 8-39  
 list-directed I/O statements, I/O statements, definition, 7-3  
 list-directed READ (sequential), READ statement (sequential), rules, 8-30  
 list-directed WRITE statement (internal), syntax, 8-38  
 list-directed WRITE statement (sequential), rules, 8-41  
 lists  
   implied-do, 8-48  
   input, 8-47  
   output, 8-48  
 LLE intrinsic function, A-9  
 LLT intrinsic function, A-9  
 %LOC built-in function, 10-5  
 LOG intrinsic function, A-7  
 LOG10 intrinsic function, A-8  
 \$LOG2 in-line option, 11-3  
 logical  
   assignment statements, 5-5  
   constants, 2-7  
   type statements, 4-13  
 logical expressions, 3-10  
 .LT. relational operator, 3-8

## M

main program, 1-7  
 MAX intrinsic function, A-4  
 MAXREC specifier, in OPEN statement, 8-21  
 MIN intrinsic function, A-4  
 MOD intrinsic function, A-6

## N

NAME specifier, in INQUIRE statement, 8-15  
 NAMED specifier, in INQUIRE statement, 8-15

NAMELIST, statement, 4-29  
 namelist (NML) specifier, 8-45  
 namelist-directed  
   READ statement  
     function, 8-29  
     syntax, 8-28  
   READ statement (sequential), rules, 8-31—8-33  
   WRITE statement (sequential), syntax, 8-39  
   WRITE statement(sequential)  
     function, 8-40  
     rules, 8-42  
 names  
   array, 2-14, 2-15  
   substrings, 2-11  
   symbolic, 1-3  
 .NE. relational operator, 3-8  
 .NEQV. logical operator, 3-10, 3-13  
 new line character, 1-2  
 NEXTREC specifier, in INQUIRE statement, 8-16  
 NINT intrinsic function, A-5  
 NML (namelist) specifier, 8-45  
 NOT (bitwise) intrinsic function, A-10  
 .NOT. logical operator, 3-10, 3-13  
 null character, 1-2  
 NUMBER specifier, in INQUIRE statement, 8-16  
 numeric type statements, 4-13

## O

O field descriptor, 9-12  
 octal, constants, 2-4  
 —onetric compiler option, in Do statement, 6-7  
 OPEN statement  
   connecting to a unit, 7-7  
   description, 8-18  
   for keyed access files, 7-6  
 OPENED specifier, in INQUIRE statement, 8-16  
 operands  
   arithmetic, 3-3  
   character, 3-7  
   logical, 3-11  
   relational, 3-8  
 operators  
   arithmetic, 3-2  
   concatenation, 3-7  
   logical, 3-10



relational, 3-8  
 options, in-line, 11-2—11-4  
 OPTIONS statement, 11-1—11-2  
 OR (bitwise) intrinsic function, A-10  
 OR (exclusive bitwise) intrinsic function, A-10  
 .OR. logical operator, 3-10, 3-13  
 ORGANIZATION specifier, in INQUIRE statement, 8-16  
 output, list-directed, 9-35  
 output list, contents of, 8-48

## P

P edit descriptor, 9-21  
 PROGRAM, statement, 4-35  
 PARAMETER, statement, 4-30  
 parentheses, interpreting in expressions, 3-14  
 PAUSE statement, 6-25  
 plus sign, edit descriptor for, 9-29  
 preconnected unit, 7-7  
 PRINT statement, 8-24

## Q

Q edit descriptor, 9-27

## R

REWIND statement, 8-33  
 READ statement  
   direct access, 8-25  
   indexed, 8-26  
   internal, 8-27  
   keyed access, 7-6  
   sequential, 8-28  
 READONLY specifier, in OPEN statement, 8-22  
 real, type statements, 4-13  
 REAL intrinsic function, A-3  
 REC (record) specifier, 8-45  
 RECL specifier  
   in INQUIRE statement, 8-16  
   in OPEN statement, 8-21

RECORD, statement, 4-36

records

  definition, 7-1  
   endfile, 7-2  
   formatted, 7-1  
   unformatted, 7-1

RECORDSIZE specifier, in OPEN statement, 8-22

RECORDTYPE specifier

  in INQUIRE statement, 8-16  
   in OPEN statement, 8-22

%REF built-in function, 10-5

relational expressions, 3-8  
   arithmetic, 3-9

repeat count

  in edit descriptors, 9-25  
   interaction with input/output list, 9-32

RETURN statement, 6-26

REWRITE statement, 8-34

## S

SAVE, statement, 4-37

sequential

  file access, 7-5  
   READ statement, 8-28  
   WRITE statement, 8-39

SEQUENTIAL specifier, in INQUIRE statement, 8-17

SHARED specifier, in OPEN statement, 8-22

SHIFT (bitwise) intrinsic function, A-10

SHIFT CIRCULAR (bitwise) intrinsic function, A-10

SIGN intrinsic function, A-6

SIN intrinsic function, A-8

SIND intrinsic function, A-8

SINH intrinsic function, A-9

size, array, 2-17

slash editing, 9-31

source program, syntax rules, 1-4

SP edit descriptor, 9-29

specification statements, 4-1—4-4

SQRT intrinsic function, A-7

SS edit descriptor, 9-29

statement, 8-40

statement function  
   definition, 10-1

referencing, 10-3  
 restrictions, 10-3—10-4  
 syntax and rules, 10-2—10-4

STATIC, statement, 4-3

STATUS specifier  
 in CLOSE statement, 8-5  
 in OPEN statement, 8-22

STOP statement, 6-27

storage, of arrays, 2-17

STRUCTURE, statement, 4-39—4-43

subprogram  
 definition, 10-1  
 using, 10-6—10-9

subprograms, definition, 1-8

SUBROUTINE statement, 10-11

subroutine subprogram  
 definition, 10-1  
 using, 10-6—10-9

substrings  
 character, 2-11  
 names, 2-11  
 values, 2-12

symbols, valid names, 1-3

syntax conventions, v

## T

T edit descriptor, 9-28

tab character formatting, 1-5

TAN intrinsic function, A-8

TAND intrinsic function, A-8

TANH intrinsic function, A-9

TL edit descriptor, 9-28

TR edit descriptor, 9-28

.TRUE. relational expression, 3-8

TYPE specifier, in OPEN statement, 8-23

TYPE statement, 8-24

type statements  
 character, 4-16  
 numeric, 4-13

## U

unformatted  
 input/output, general rules, 8-49  
 READ statement  
 function, 8-29  
 rules, 8-29  
 syntax, 8-28  
 WRITE statement (sequential), syntax, 8-39

unformatted I/O statements, 7-2

unformatted records, 7-1

UNFORMATTED specifier, in INQUIRE statement, 8-17

UNION declaration  
 example, 4-42  
 syntax, 4-40

UNIT (unum) specifier, 8-44

units, 7-7

UNLOCK statement, 8-35

unum (UNIT) specifier, 8-44

## V

%VAL built-in function, 10-5

variable format expressions, 9-5

variables, definition, 2-11

VOLATILE, statement, 4-43

## W

WRITE statement  
 direct access, 8-36  
 indexed, 8-37  
 internal, 8-38  
 sequential, 8-39

## X

X edit descriptor, 9-28

.XOR. logical operator, 3-10, 3-13

## Z

Z field descriptor, 9-13

ZEXT intrinsic function, A-5



---

## Customer Response Card

Your comments, which can assist us in improving our products and our publications, are welcome.

If you wish to reply, be sure to include your name and address, *and the name and part number that appears on the first page of this manual.*

Thank you for your cooperation.

No postage necessary if mailed in the U. S. A.

After writing comments, detach this page and then fold, seal, and mail.

---

### Comments

Name of manual: \_\_\_\_\_

Part number: \_\_\_\_\_

---

MIPS may use and distribute any of the information you supply in any way it believes appropriate without incurring any obligation whatever. You may, of course, continue to use the information you supply.



NO POSTAGE  
NECESSARY  
IF MAILED  
IN THE  
UNITED  
STATES

**BUSINESS REPLY MAIL**

FIRST CLASS

PERMIT NO. 1659

SUNNYVALE, CA

POSTAGE WILL BE PAID BY ADDRESSEE:

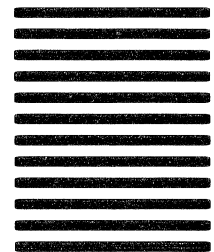

**MIPS Computer Systems  
928 Arques Avenue  
Sunnyvale, CA 94086-9756**

