

GC27 0608 1  
File No. S370/4300 20

## **Advanced Communications Function for VTAM Version 2**

### **Program Product**

### **General Information**

Program Numbers 5665-280 (MVS)  
5662-280 (OS/VS1)  
5666-280 (VSE)

The IBM logo, consisting of the letters 'IBM' in a bold, sans-serif font, with each letter formed by eight horizontal bars of varying lengths, creating a striped effect.

GC27-0608-1  
File No. S370/4300-20

# **Advanced Communications Function for VTAM Version 2**

## **Program Product**

## **General Information**

Program Numbers 5665-280 (MVS)  
5662-280 (OS/VS1)  
5666-280 (VSE)

The IBM logo, consisting of the letters 'IBM' in a bold, sans-serif font, with each letter formed by a series of horizontal bars of varying lengths, creating a striped effect.

## **Second Edition (September 1982)**

This manual applies to the Advanced Communications Function for the Virtual Telecommunications Access Method (ACF/VTAM) Version 2 program product for the OS/VS2 (MVS), OS/VS1, and VSE operating systems.

Information about the optional ACF/VTAM Encrypt/Decrypt Feature, available for OS/VS2 (MVS) and OS/VS1 only, is also included.

The information in this publication should be used for planning until ACF/VTAM Version 2 becomes available for your operating system.

It is possible that this material may contain reference to, or information about, IBM products (machines and programs) that are not announced in your country. Such references or information must not be construed to mean that IBM intends to announce such IBM products, programming or services in your country.

The program product described in this manual, and all licensed material available for it, are provided by IBM under the terms of the Agreement for IBM Licensed Programs. Your branch office can advise you on ordering procedures.

Changes are continually made to the information in IBM system publications. Before using this publication in connection with the operation of IBM systems, consult your IBM representative or the appropriate IBM system bibliography to find out which editions are applicable and current.

A form has been provided at the back of this publication for readers' comments. Address additional comments to IBM Corporation, Department 52Q, Neighborhood Road, Kingston, New York 12401. IBM may use or distribute any of the information you supply in any way it believes appropriate without incurring any obligations whatever. You may, of course, continue to use the information you supply.

## Preface

This publication provides a general description of the services provided by Advanced Communications Function for the Virtual Telecommunications Access Method (ACF/VTAM) Version 2. It is directed primarily to data processing system planners who need an overview of ACF/VTAM.

Note that throughout this book the term *ACF/VTAM* refers to ACF/VTAM Version 2 unless otherwise noted. Also note that the ACF/VTAM publications cited in this book apply only to ACF/VTAM Version 2 unless otherwise noted.

### ACF/VTAM Version 2 Enhancements

ACF/VTAM Version 2 provides significant enhancements over ACF/VTAM Version 1, VTAM Level 2, and Advanced Communications Function for the Virtual Telecommunications Access Method Entry (ACF/VTAME). Chapter 8, "Summary of ACF/VTAM," contains a list of the major ACF/VTAM Version 2 enhancements over these program products. ACF/VTAM Version 1 is described in *ACF/VTAM General Information: Introduction*, GC38-0462 (Version 1 Releases 2 and 3) and *ACF/VTAM General Information*, GC38-0254 (Version 1 Release 1). VTAM Level 2 is described in *Introduction to VTAM*, GC27-6987. ACF/VTAME is described in *ACF/VTAME General Information: Introduction*, GC27-0438.

### Major Topics in This Book

The major topics covered in this book are:

- Characteristics of ACF/VTAM
- Creating an ACF/VTAM data communication system
- Controlling an ACF/VTAM network
- ACF/VTAM application programs
- Reliability, availability, serviceability (RAS)
- ACF/VTAM Version 2 enhancements over ACF/VTAM Version 1, VTAM Level 2, and ACF/VTAME

In addition, Chapters 1 and 2 introduce the reader to the concepts and major features of ACF/VTAM and the Encrypt/Decrypt Feature. Chapters 3 through 7 provide preliminary information for installation managers and system programmers who are evaluating and planning for ACF/VTAM. Chapter 8 summarizes the major enhancements and operational considerations for ACF/VTAM and the Encrypt/Decrypt Feature.

You should be familiar with the basic concepts of data communications. For a description of the relationship between ACF/VTAM and ACF/NCP/VS and ACF/TCAM, see *Systems Network Architecture Concepts and Products*.

In this publication, the Advanced Communications Function for Network Control Program/Virtual Storage (ACF/NCP/VS) program product is often referred to as *NCP*.

Wherever this manual mentions the use of ACF/VTAM under VSE, it refers to VSE with the VSE/Advanced Functions program product. *VSE* refers to the Virtual Storage Extended operating system, comprising the DOS/VSE system control programming (SCP) code and the VSE/Advanced Functions program product.

Throughout this book, when a particular service applies to both OS/VS1 and OS/VS2 (MVS), these systems are referred to as *OS/VS*.

References to OS/VS2 (MVS) include these program products:

- MVS 3.8
- MVS 3.8 with the System Extension program product
- MVS 3.8 with the System Product Version 1 program product
- MVS 3.8 with the System Product Version 2 program product for System/370 Extended Architecture (MVS/XA)

References to the Time Sharing Option (TSO) include the TSO Extensions (TSO/E) program product.

## Related Publications

This manual is part of a library of publications that describe ACF/VTAM. Figure 1 shows the publications for ACF/VTAM. Using this figure, you will be able to decide which publications are required when performing the various tasks involved in using ACF/VTAM. Appendix B, "Library Summary," at the back of this book, contains:

- A brief summary of what each ACF/VTAM publication contains
- A chart showing the evolution of the ACF/VTAM library
- A bibliography of other publications that are referred to in this book or that contain information that might be useful to someone who is planning to install ACF/VTAM.

**Using ACF/VTAM Library**

*ACF/VTAM General Information*  
GC27-0608

*ACF/VTAM Master Index*  
GX27-0032

**Evaluation and Education**

*ACF/VTAM General Information*  
GC27-0608

**Installing ACF/VTAM**

*ACF/VTAM Planning and Installation Reference*,  
SC27-0610

*ACF/VTAM Reference Summary*,  
SX27-0027

**Writing ACF/VTAM Application Programs**

*ACF/VTAM Programming*,  
SC27-0611

*ACF/VTAM Reference Summary*,  
SX27-0027

**Operating ACF/VTAM**

*ACF/VTAM Operation*,  
SC27-0612

*ACF/VTAM Messages and Codes*,  
SC27-0614

*ACF/VTAM Reference Summary*,  
SX27-0027

**Diagnosing Problems**

*ACF/VTAM Diagnosis Guide*,  
SC27-0615 (OS/VS)  
SC27-0630 (VSE)

*ACF/VTAM Diagnosis Reference*,  
LY38-3053 (OS/VS)  
LY38-3058 (VSE)

*ACF/VTAM Data Areas*,  
LY38-3054 (OS/VS)  
LY38-3059 (VSE)

*ACF/VTAM Logic: Encrypt/Decrypt Feature*  
LY38-3055

**Figure 1. The ACF/VTAM Version 2 Library**



# Contents

## **Chapter 1. Introduction 1**

- SNA Benefits 1
- ACF/VTAM Services 1
- ACF/VTAM Encrypt/Decrypt Feature (OS/VS Only) 2
- TSO/VTAM Services (OS/VS2 [MVS] Only) 3
- Communication Adapter Services (VSE Only) 3

## **Chapter 2. Characteristics of ACF/VTAM 5**

- SNA Overview and ACF/VTAM's Relationship to SNA 5
  - Session Establishment 6
- Communication Controllers 7
- Loop Adapters (OS/VS1 and VSE Only) 8
- Communication Adapters (VSE Only) 8
- Terminals in an ACF/VTAM Network 8
  - SNA Terminals 8
    - Non-SNA Terminals 8
- ACF/VTAM Application Programs 8
  - Exit Routines for Application Programs 9
- Distribution of Functions 9
- Sharing Resources 10
- Data Flow 10
- ACF/VTAM Networks 12
  - Facilities an ACF/VTAM Network 14
    - Channel-to-Channel Connections (OS/VS Only) 15
    - Communication Adapter Connections (VSE Only) 15
    - Intermediate Routing Node Facility 15
    - Parallel Links/Transmission Groups 15
    - Extended Communication Controller Interconnection 15
    - Multiple Routes 17
    - Reliability, Availability, and Serviceability (RAS) Facilities 17
- Views of an ACF/VTAM Network 17
  - A Single-Domain Network 17
  - A Multiple-Domain Network 19

## **Chapter 3. Creating an ACF/VTAM Data Communication Network 27**

- Defining ACF/VTAM and Channel-Attached Devices to the Operating System 27
- Defining the Domain to ACF/VTAM 27
  - Defining Network Control Programs (NCPs) 28
  - Defining ACF/VTAM Application Programs 29
  - Defining Terminals on Switched Lines 29
  - Defining Channel-Attached SNA Terminals 29
  - Defining Channel-Attached Non-SNA Terminals 29
  - Defining Loop-Adapter-Attached Terminals 29
  - Defining Communication Adapter-Attached Resources (VSE Only) 29
  - Defining Channel-to-Channel Connections between Host Processors (OS/VS Only) 30
  - Defining Cross-Domain Resources (CDRSCs) 30
  - Defining Cross-Domain Resource Managers (CDRMs) 30
  - Defining Routes between Subareas 30
  - Defining Communication Network Management (CNM) Routing Tables 30
- Defining ACF/VTAM Start Options 30
- Defining Dynamic Reconfiguration of Physical Units and Logical Units 31
- Defining a Table to Change ACF/VTAM Messages 31
- Defining a Table to Change Selected ACF/VTAM Operator Commands 31
- Defining Session Establishment and Termination Procedures 32
- Coding Installation Exit Routines 33

## **Chapter 4. Controlling an ACF/VTAM Network 35**

- Operator Commands 36
- Dynamic Reconfiguration 37
- Network Communications Control Facility (NCCF) 38

## **Chapter 5. ACF/VTAM Application Programs 39**

- Identifying the Application Program to ACF/VTAM 39
- Establishing a Session 39
  - The PLU's Role in Session Establishment 39



The SLU's Role in Session Establishment	42
Requesting Data Transfer	42
Terminating a Session	43
Termination Requested by a Secondary Logical Unit	43
Termination Requested by a Primary Logical Unit	43
Session Termination Initiated by the ACF/VTAM Operator	43
Releasing and Passing a Secondary Logical Unit	43
Session Termination by ACF/VTAM	43
<b>Chapter 6. Other Telecommunication Access Methods</b>	<b>45</b>
ACF/VTAM and Other Access Methods under OS/VS	45
ACF/VTAM and BTAM-ES under VSE	46
ACF/VTAM, ACF/VTAME, and ACF/TCAM in a Multiple-Domain Network	47
<b>Chapter 7. Reliability, Availability, Serviceability</b>	<b>49</b>
ACF/VTAM's RAS Strategy	49
Diagnostic Aids	49
ACF/VTAM Trace Facilities	49
Additional Trace Facilities	50
Formatted Dumps (OS/VS Only)	51
NCP Dumps	51
TOLTEP	52
Error Recording	52
Printing Error Records	53
Link-Level 2 Test (SDLC Link Test)	53
LU Connection Test	53
Route Verification	53
Reporting of Pending Events	54
Message Module Identification	54
Recovery Aids	54
Error Recovery Procedures	54
Restart/Recovery	54
Parallel Links	55
Multiple Routes	55
Session Outage Notification	56
Resource Takeover	56
<b>Chapter 8. Summary of ACF/VTAM</b>	<b>57</b>
ACF/VTAM Version 2 Functions	57
Operating Environment	60
Machine Requirements	60
Storage Requirements	60
Programming Requirements	60
Compatibility	62
NCP	62
ACF/VTAM Application Programs	62
BTAM Application Programs	63
Related IBM Programs	63
Cross-Domain Communication	64
Conversion	65
ACF/VTAM Application Programs	65
BTAM Application Programs	65
Data Security, Auditability, and Control	65
<b>Appendix A. Supported Products</b>	<b>67</b>
Network Terminal Option (NTO)	72
Communication Controllers	72
Related IBM Programs	72
<b>Appendix B. Library Summary</b>	<b>73</b>
Organization of the Library	73
Abstracts of Publications	75
Evolution of Publications	79
Bibliography	84
Systems Network Architecture (SNA) Publications	84
NCP Publications	84
Cryptography Publications	85
Network Terminal Option (NTO) Publications	85
Network Communications Control Facility (NCCF) Publications	85

Publications on Other Access Methods 86  
OS/VS Publications 86  
TSO and TSO/VTAM Publications (MVS Only) 86  
MVS Publications 87  
    MVS/Extended Architecture Publications (When Available) 89  
VSI Publications 91  
VSE Publications 91

**Appendix C. Advanced Communications Function for VTAM Version 2: Summary 93**

Testing Period 93  
License 93  
Program Services 93  
Local Licensed Program Support 93  
Warranty 93  
Availability of Licensed Program 94

**Glossary of Terms and Abbreviations 95**

Reference Words Used in the Entries 95

**Index 115**

## Figures

1. The ACF/VTAM Version 2 Library v
2. Data Flow through an ACF/VTAM Network 11
3. A Single-Domain ACF/VTAM Network 13
4. A Multiple-Domain ACF/VTAM Network 16
5. The Physical Configuration of an ACF/VTAM Network 20
6. The Network as Viewed by the Host Operating System 21
7. The Domain as Viewed by ACF/VTAM 22
8. The Network as Viewed by ACF/VTAM A 23
9. The Network as Viewed by ACF/VTAM B 24
10. The Network as Viewed by Application Programs 25
11. Identifying an Application Program to ACF/VTAM 40
12. Establishing a Session with a Secondary Logical Unit 41
13. Establishing a Session with a Secondary Logical Unit 42
14. ACF/VTAM with Other Telecommunication Access Methods in OS/VS 45
15. ACF/VTAM with BTAM-ES in VSE 46
16. ACF/VTAM with ACF/TCAM in a Multiple Domain Network 47
17. Factors to Consider when Moving Programs from Prior Releases of ACF/VTAM 63
18. Terminal Products Supported by ACF/VTAM 68
19. Terminal Products Supported by TSO/VTAM 70
20. Related IBM Programs 72
21. Evolution of the ACF/VTAM Version 2 Library 80

## Summary of Amendments (September 10, 1982) to GC27-0608-0 by Revision GC27-0608-1

### *New Program Functions*

ACF/VTAM supports the communication adapter feature of the IBM 4331 and 4321 Processors. This feature allows devices to be link-attached to the host processor without using a communication controller.

It also supports MVS 3.8 with the System Product Version 2 for System/370 Extended Architecture (MVS/XA) and the TSO Extensions (TSO/E) program product.

In addition, ACF/VTAM supports the Network Logical Data Manager (NLDM) program product. NLDM helps a user at a central control point identify network problems relating to sessions by means of interactive display techniques. NLDM runs with the Network Communications Control Facility (NCCF) as a communication network management application program.

ACF/VTAM also supports NCP Version 2 for the IBM 3705 Communications Controller. This includes support for a new NCP trace, the generalized path information unit trace (GPT). GPT records the flow of path information units to or from an NCP and its subordinate physical and logical units.

### *New Documentation*

References to NCP now include NCP Version 2.

The MVS and TSO program products supported by ACF/VTAM are listed in the Preface.

Communication adapter services are described in Chapters 1 and 2. Chapter 2 also lists the devices that can be attached through a communication adapter.

Defining communication adapter-attached resources is described in Chapter 3. This chapter also describes the requests and responses that are routed to NLDM under defining communication network management routing tables.

Testing SDLC links to communication adapter-attached resources is discussed in Chapters 4 and 7.

The information NLDM collects is described under NCCF in Chapter 4.

References to communication adapter-attached devices are added to Figure 15 in Chapter 6.

GPT is added to the list of ACF/VTAM trace facilities in Chapter 7.

In Chapter 8, communication adapter support is added to the summary of ACF/VTAM Version 2 functions. Using a communication adapter for remote communication is described under machine requirements. Considerations for converting BTAM application programs are discussed under compatibility and conversion. Communication adapter requirements are described under compatibility. NLDM and GPT are listed under compatibility as functions that require NCP Version 2.

The devices that are or are not supported through the communication adapter are listed in Appendix A. NLDM is added to the list of supported program products.

MVS/XA, NCP Version 2, and NLDM manuals are added to the bibliography in Appendix B.

### ***Changed Documentation***

8100 processors are added to Figure 3 in Chapter 1.

3274s replace 3790s in Figures 5 and 6 in Chapter 2.

The following supported devices are added to Appendix A:

- Displaywriter
- 3232 Keyboard Printer Terminal
- 4700 Finance Communication System
- 5520 Administrative System

Additions and corrections are also in the list of supported program products in Appendix A.

In the publications abstracts in Appendix B, considerations for converting from BTAM are added to the *ACF/VTAM Planning and Installation Reference* and *ACF/VTAM Programming*. Also, corrections are made to the manual titles and form numbers in the bibliography.

## Chapter 1. Introduction

Advanced Communications Function for the Virtual Telecommunications Access Method (ACF/VTAM) controls communication between elements in a Systems Network Architecture (SNA) data communication network. SNA is a description of the logical structure, formats, protocols, and the operational sequences for transmitting information through the data communication network.

### SNA Benefits

Using SNA within the network:

- Provides a consistent and comprehensive structure for communication system growth
- Minimizes the effects of system changes
- Distributes network functions away from host processors
- Allows sharing of network resources
- Supports many different kinds of communication devices
- Extends system functions conveniently and effectively to the user
- Minimizes the user's involvement in details of system operation

### ACF/VTAM Services

To provide the following services, ACF/VTAM uses the facilities of the operating system, virtual storage, communication controllers, and the IBM Virtual Storage Access Method (VSAM).

To support communication within either a single-domain network or multiple-domain network, ACF/VTAM:

- Controls the allocation of resources in the network (such as communication lines, communication controllers, and terminals)
- Permits application programs to share resources in the network
- Permits use of resources without specific knowledge of their location
- Establishes, controls, and terminates sessions between logical units in the network, such as application programs and terminals.
- Facilitates the transfer of data between points in the network
- Permits the operation of the network to be monitored and altered by the ACF/VTAM operator

- Permits the network configuration to be changed while the network is being used
- Initiates detection and correction of problems in the operation of the network

In addition, ACF/VTAM Version 2 provides an integrated multisystem networking facility. As part of a multiple-domain networking, ACF/VTAM:

- Permits an application program in one domain to communicate with application programs and terminals in other domains
- Permits a terminal of one host processor to communicate with application programs in another host processor's domain
- Establishes, controls, and terminates sessions with application programs and terminals in other parts of the multiple-domain network
- Permits the ACF/VTAM operator to obtain information about resources in parts of the network not controlled by the ACF/VTAM domain
- Allows control of a communication controller of one host processor to be transferred to another host processor
- Permits control of the terminals of a communication controller to be divided among multiple host processors

### **ACF/VTAM Encrypt/Decrypt Feature (OS/VS Only)**

The program product ACF/VTAM Encrypt/Decrypt Feature, in combination with the Programmed Cryptographic Facility program product and the ACF/VTAM program product, provides the following services:

- Permits encryption and decryption of data during logical unit-to-logical unit sessions
- Permits single-domain and multiple-domain cryptography. When used in a multiple-domain environment, the Encrypt/Decryption is needed in each domain that uses cryptography.
- Permits ACF/VTAM application programs generally to run unaltered with the Encrypt/Decrypt Feature. (Several SNA sense codes dealing with unrecoverable errors are associated with the Encrypt/Decrypt Feature; application programs not currently using the Encrypt/Decrypt Feature might have to be changed to handle these sense codes properly.)
- Permits application programs to select encryption for particular sessions or for particular data requests within sessions.
- Allows the ACF/VTAM operator or installation management to define a logical unit as requiring session level cryptography.
- Prevents the printing of cryptographic values and enciphered (or deciphered) data in dumps or in trace records.

## **TSO/VTAM Services (OS/VS2[MVS] Only)**

TSO/VTAM services support the Time Sharing Option (TSO) through ACF/VTAM. TSO is a standard feature in OS/VS2 (MVS) that provides conversational time sharing. TSO/VTAM extends the line and terminal sharing benefits of ACF/VTAM to TSO users and provides conversational time sharing to the users of other ACF/VTAM applications such as IMS/VS, CICS/VS, and VSPC.

TSO/VTAM services can be extended to support certain non-SNA terminals by the Network Terminal Option (NTO) program product, available in conjunction with ACF/NCP/VS. See Appendix A for a description of terminals supported by TSO/VTAM.

TSO/VTAM can co-reside with TSO/TCAM in the same host processor. For more information about TSO/VTAM, refer to the OS/VS2 TSO publications listed in Appendix B in this book.

## **Communication Adapter Services (VSE Only)**

The communication adapter, an optional feature available with the IBM 4331 and 4321 Processors, allows the use of the line-attached terminals without the requirement of communication controllers (and network control programs). The communication adapter recognizes and fulfills requests from ACF/VTAM to transfer data between the host processor and a terminal attached to the communication adapter with an SDLC or BSC line or to a communication adapter (or communication controller) in another SNA access method's domain. Together, ACF/VTAM and the communication adapter provide the following services:

- Terminal addressing
- Terminal dialing
- Terminal polling
- Terminal answering
- Management of SDLC and BSC line controls
- Control of multipoint lines
- Exchange of identification sequences for terminals on switched lines
- Management of the modem/line interface
- Pacing
- Detection, recovery, and recording of temporary line errors

The communication adapter also supports the service functions of the host processor available on the IBM 4331 and 4321 Processors. The service functions of the host processor provide line-testing, line-tracing, and configuration-updating functions.





## Chapter 2. Characteristics of ACF/VTAM

This chapter describes the composition of an ACF/VTAM network<sup>1</sup> and the way the elements of the network are controlled and shared through ACF/VTAM.

### SNA Overview and ACF/VTAM's Relationship to SNA

Data communications is the process of transmitting and receiving data over communication facilities such as telephone lines. In a host-processor-based data communication system, data is passed between points in a data communication *network*. Systems Network Architecture (SNA) defines the structure and protocols (request/response rules) for such a network. ACF/VTAM provides one of the SNA-defined network components, the *System Services Control Point* (SSCP), which is used to control the network. Additionally, ACF/VTAM allows application programs running in a host processor to use the network to communicate with other network users, for example, to communicate with terminals attached to the network or to communicate with other ACF/VTAM application programs. A network may contain more than one SSCP. The network users associated with one SSCP (that is, in its *domain*) can communicate with the network users associated with other SSCPs.

A user of the network gains access to network facilities through a port called a *logical unit* (LU). For example, an ACF/VTAM application program uses ACF/VTAM macro instructions to create a logical unit; thereafter, the application program is identified with that logical unit and uses it to access the network. SNA terminals also implement logical units; for example, there is a logical unit associated with each IBM 3270 display terminal. Many cluster controllers allow the customer to run programs in them; such cluster controllers provide logical units by which those programs access the network.

In order for two logical units (for example, the logical units for an ACF/VTAM application program and a display terminal) to communicate with each other, a logical connection called a *session* must be established between these two logical units. The SSCP assists the logical units in establishing this session.

The logical unit for an application program can have more than one session at a time. These sessions can be with one or more session partners. Multiple concurrent sessions between a single pair of logical units are called *parallel sessions*. A logical unit for a terminal can have only one session at a time and therefore cannot have multiple session partners or parallel sessions.

In any given session, one end of the session is called the *primary end*, and the logical unit at that end is called the *primary logical unit* (PLU) for that session. The other end of the session and its logical unit are called the *secondary end* of the session and the *secondary logical unit* (SLU), respectively. The PLU has somewhat more responsibility in establishing the session. A logical unit may be a PLU for some of the sessions it has and an SLU for others.

Generally, ACF/VTAM application program logical units are PLUs, and terminal logical units are SLUs. However, a PLU does not have to be located in a host processor; it might be located in a communication controller (for example).

---

<sup>1</sup> In this book an ACF/VTAM network is defined as an SNA network containing one or more ACF/VTAM host processors. An ACF/VTAM network so defined may contain SNA access methods other than ACF/VTAM (such as ACF/VTAME or ACF/TCAM).

Application programs can also act as SLUs, for example, when the other logical unit in a session is another application program acting as the PLU for that session.

Every logical unit in the network is associated with a *physical unit* (PU). The physical unit works with the SSCP to do such things as manage the network configuration (that is, determine which network elements, such as links, logical units, and physical units, are currently usable). There is a physical unit supplied by ACF/VTAM in each host processor containing ACF/VTAM. There is also a physical unit in each cluster controller and in each communication controller.

Two characteristics of ACF/VTAM and its use of SNA are of primary importance. First, ACF/VTAM uses the processing capabilities of communication controllers and terminal products allowing part of the data communication control to be moved out of the host processor and into the network. Second, ACF/VTAM treats the parts of the network as shareable resources. The lines, controllers, and logical units can be shared by all the application programs that use ACF/VTAM.

### ***Session Establishment***

The logical connection between two logical units is called a *session* (as described earlier). Session establishment is the process of activating the session. Once a session has been established, each logical unit can communicate with the other.

There are many ways that a session between two logical units can be requested. For example, there are ACF/VTAM macro instructions by which an application program can request a session with another logical unit; a terminal logical unit can request a session by doing a logon to another logical unit; or the ACF/VTAM operator can request that a session be established between two logical units. In each case a *session initiation request* (for example, a logon from a terminal logical unit) is sent to the SSCP. The SSCP in turn interacts with the logical unit that will be the PLU in the requested session. The PLU in turn sends a session establishment request (a Bind Session request) to the SLU to actually activate the requested session.

Before two logical units can establish a session, they both must agree on a set of protocols that will be used for the duration of the session. This set of protocols is determined by *session parameters*. Generally, the PLU suggests the set of session parameters and the SLU either agrees to them or rejects them. If, however, the PLU indicates that the session parameters are negotiable, the SLU can return another set of session parameters to the PLU and request that these new parameters be used for this session.

If the Encrypt/Decrypt Feature is included in the system, ACF/VTAM determines whether a cryptographic session has been requested and what capability the two ends of the session have. ACF/VTAM establishes the session only if both ends of the session have compatible cryptographic requirements. ACF/VTAM does not establish the session if one end of the session requires cryptography when the other end of the session does not have cryptographic capability.

## Communication Controllers

Communication controllers such as the IBM 3705 Communications Controller can be used in an ACF/VTAM network. Communication controllers link ACF/VTAM with the remote portions of the network and control the flow of information between link-attached (remote) terminals and ACF/VTAM. In a multiple-domain network, communication controllers can be used to connect domains.

Communication controllers permit large network configurations that require few subchannel addresses. The communication controller can be attached to either a byte-multiplexer channel, a block-multiplexer channel, or a selector channel.

A communication controller and its Network Control Program (NCP) support a variety of link-attached (remote) terminals attached to the controller. The NCP, which is stored and executed within the controller, is generated from a series of macro instructions coded by the system programmer. An NCP can be generated to handle lines in either *network control mode* or *emulation mode* or both. An NCP that is generated with both kinds of functions is called an NCP with Partitioned Emulation Programming (PEP).

The following releases of the NCP can be used with ACF/VTAM Version 2:

- Advanced Communications Function for NCP (ACF/NCP) Version 2
- Advanced Communications Function for NCP/VS (ACF/NCP/VS) Version 1 Release 3
- Advanced Communications Function for NCP/VS (ACF/NCP/VS) Version 1 Release 2.1

Note that to use some of the ACF/VTAM Version 2 enhancements, the appropriate release of ACF/NCP/VS is required. Chapter 8, "Summary of ACF/VTAM," lists the functions that require a particular release of ACF/NCP/VS.

ACF/VTAM supports only the network control mode, either with or without PEP. (Emulation mode is used to emulate the IBM 2701 Data Adapter Unit and the IBM 2702 and 2703 Transmission Control Units and is not supported by ACF/VTAM.) In network control mode, the NCP allows some functions previously performed entirely by an access method (such as BTAM) to be performed primarily in the controller. Functions provided by a communication controller with an NCP include:

- Transmitting data between nodes
- Controlling lines
- Controlling buffering
- Deleting and inserting communication control characters
- Detecting permanent and temporary line errors
- Gathering line statistics
- Activating and deactivating lines
- Closing down portions of the network
- Handling recoverable line errors
- Providing error statistics to ACF/VTAM
- Testing communication links

## **Loop Adapters (OS/VS1 and VSE Only)**

The loop adapter feature of the IBM 4331 Processor increases the number of terminals and terminal types that can be attached to the 4331 processor. The loop adapter is attached to the processor by an internal channel and supports both channel-attached and link-attached device loops. The attachment of the device loops is transparent to ACF/VTAM, so all devices appear to ACF/VTAM as channel-attached terminals. The loop adapter also provides function to make certain non-SNA terminals appear to ACF/VTAM as SNA devices.

## **Communication Adapters (VSE Only)**

The communication adapter feature of the IBM 4331 and 4321 Processors allows communication lines to be attached to the processor without using a communication controller. Under ACF/VTAM, the lines can be under SDLC or BSC line control and may be divided between the two line controls in any proportion. The communication adapter can have up to two autocall interfaces to attach autocall units. With an autocall unit, ACF/VTAM can establish switched connections to terminals without operator intervention.

## **Terminals in an ACF/VTAM Network**

### ***SNA Terminals***

An SNA terminal can perform functions defined by Systems Network Architecture (SNA). These terminals may be attached to the network by a channel, a loop adapter, or a Synchronous Data Link Control (SDLC) link. SNA terminals contain logical units with which other logical units (for example, application programs) can communicate through sessions. Appendix A lists SNA (and non-SNA) terminals supported by ACF/VTAM.

### ***Non-SNA Terminals***

Non-SNA terminals supported by ACF/VTAM are Binary Synchronous Control (BSC) and channel-attached IBM 3270 Information Display Systems, and selected start-stop and BSC devices that are supported in conjunction with the Network Terminal Option (NTO) program product, which runs in a communication controller.

ACF/VTAM support of non-SNA terminals makes such terminals appear to have logical units associated with them. Therefore, an ACF/VTAM application program can in large part treat SNA and non-SNA terminals the same; for both types of terminals the application program establishes sessions with logical units.

## **ACF/VTAM Application Programs**

An ACF/VTAM application program is any program that uses ACF/VTAM macro instructions to request services from ACF/VTAM. By using ACF/VTAM macro instructions, an application program can transfer data to and from terminals or other application programs. The application program can communicate without need for complex polling or scanning techniques.

ACF/VTAM macro instructions can also be used to transfer enciphered data. The ACF/VTAM Encrypt/Decrypt Feature has the data enciphered before it is sent into the network and has incoming data deciphered for an application program residing in the host processor.

## ***Exit Routines for Application Programs***

An application program can supply a comprehensive set of exit routines that ACF/VTAM invokes under certain conditions. Exit routines may be thought of as event handlers that can be invoked under the following circumstances:

- The application program receives a request to establish or terminate a session.
- The application program loses contact with a session partner.
- The application program receives notification that a session it requested cannot be established.
- Use of an SLU currently in session with the PLU is requested by another PLU.
- A session-control request is received by the application program.
- The ACF/VTAM operator halts ACF/VTAM processing or deactivates the application program.
- ACF/VTAM detects a logical error in an application program's request for an operation, or detects a physical error while attempting to perform an operation.
- The application program receives an SNA response or certain SNA requests, and the application program specifies that it is to handle such matters in an exit routine.
- ACF/VTAM completes an operation requested by the application program and the application program has asked to be notified of the completion in an exit routine.

By using exit routines to handle certain events, an application program need not wait for completion of ACF/VTAM services or check periodically for special conditions.

## **Distribution of Functions**

ACF/VTAM uses the processing capabilities of the communication controllers and of the SNA terminals, so that many functions formerly performed in the host processor can be distributed among other network components. In general:

- ACF/VTAM allocates resources within its domain.
- The communication controllers control data flow in the network.
- ACF/VTAM application programs process data and request communication services from ACF/VTAM.
- The programmed logic of certain terminals formats data and processes local transactions.

By performing some functions outside the host:

- The host is relieved of many minor requests.
- Processing and error recovery are performed closer to the terminal user.
- Programmable terminals can perform some remote processing when no connection to the host can be made.
- Daily processing can be done by link-attached programmable terminals and then sent to the host to update a central data base.

## Sharing Resources

ACF/VTAM allows resources to be shared among users of the network. For example, an application program logical unit can communicate with many other logical units concurrently. The maximum number of concurrent LU-LU sessions that a logical unit can support is known as the *session limit* for the logical unit. For a device-type logical unit, such as an IBM 3270 display terminal, the session limit is one. ACF/VTAM application program logical units have no session limit. Some application programs can communicate with each other over two or more sessions concurrently (parallel sessions).

Resources that make up the physical paths between logical units are also shared. For example, two logical units can be associated with two displays on the same or different cluster controller on an SDLC line, and each logical unit can communicate with a different application program. When either application program requests data to be transferred, the same line is used. Thus lines may be shared among application programs and logical units.

In a multiple-domain network, data processing functions can also be distributed among resources in different domains. For example, logical units in domain A can use an application program in domain B to process one type of data and an application program in domain C to process another type of data.

## Data Flow

ACF/VTAM uses operating system facilities to manage the flow of data between itself and application programs and between the host processor and devices that are attached to the host processor by a channel or through a communication adapter. These devices include:

- Host processors attached by a channel-to-channel connection (OS/VS only)
- Host processors attached through communication adapters (VSE only)
- Communication controllers attached by a channel or through a communication adapter
- Terminals attached by a channel or through a communication adapter

Although ACF/VTAM does not actually transfer data throughout the network, it provides the information needed by other nodes in the network to route the data.

ACF/VTAM and NCP are responsible for the transfer of data between the elements in only the SNA portion of the network. Control of the data flow beyond the limits of the SNA network is the responsibility of elements at those limits.

In a network with SNA terminal systems used as work stations, for example, in the IBM 3600 Finance Communication System, some communication occurs beyond ACF/VTAM's control. Figure 2 shows the data flow for an ACF/VTAM network that has an SNA terminal system. Note that nodes in the SNA network are responsible only for the data transfer between the application program logical unit and the logical unit in the cluster controller. The logical unit in the cluster controller is responsible for the transfer of the data between itself and the work station (which is the final destination of the message).

ACF/VTAM application programs are responsible for transferring data to and from auxiliary storage devices (tape drives, disk storage units, and other external storage devices attached to the host processor). The application program can use an access method such as IBM's Virtual Storage Access Method (VSAM) to perform these input/output operations.

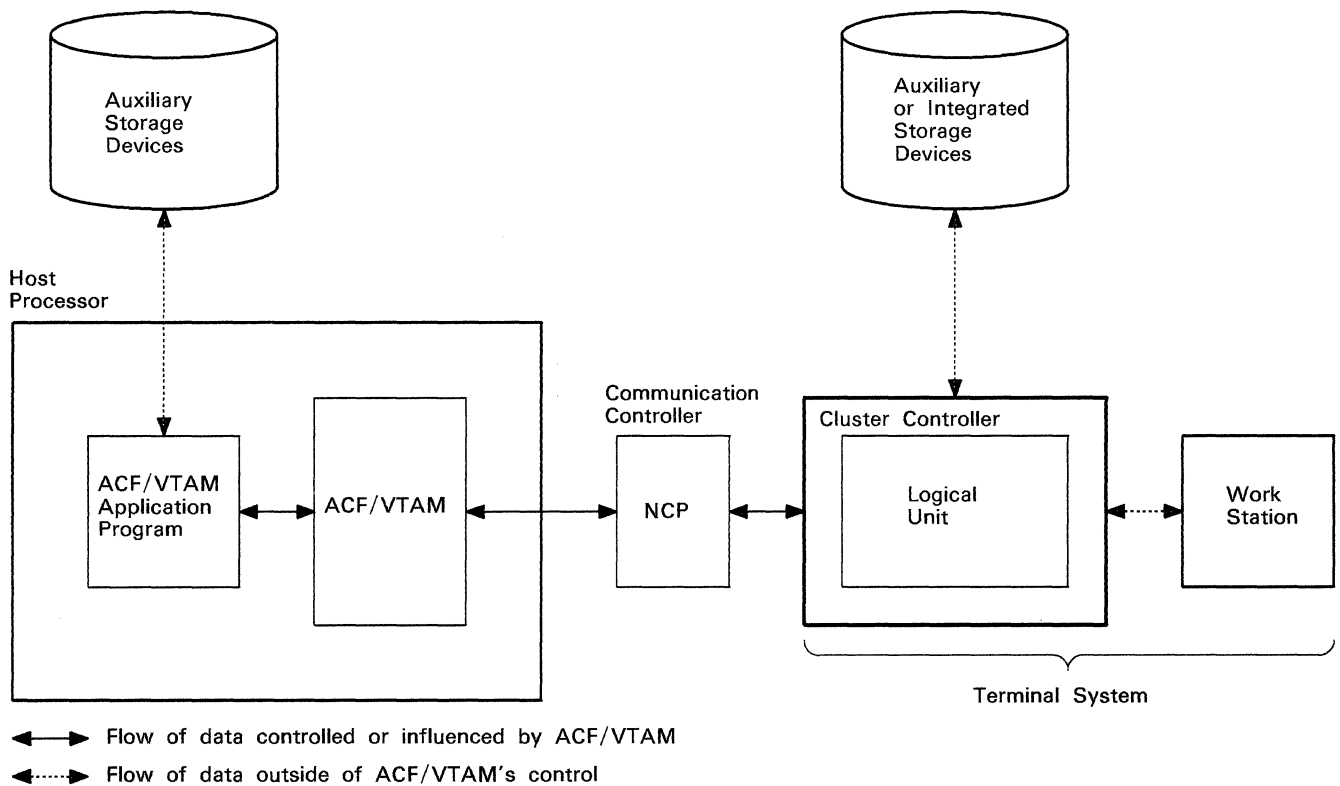

Figure 2. Data Flow through an ACF/VTAM Network



## ACF/VTAM Networks

An ACF/VTAM network consists of one or more ACF/VTAM domains. An *ACF/VTAM domain* consists of one host processor containing ACF/VTAM, and one or a combination of:

- Channel-attached communication controllers
- Link-attached communication controllers (excluding communication controllers attached through a communication adapter)
- Cluster controllers channel-attached to the host processor
- Cluster controllers attached to a 4331 processor through a loop adapter (OS/VS1 and VSE only)
- Cluster controllers attached to a 4331 or 4321 processor through a communication adapter (VSE only)
- Cluster controllers attached by SDLC links to communication controllers
- Non-SNA terminals supported in conjunction with the Network Terminal Option program product or a similar user-written program
- 3270 Display Stations attached by BSC links to a 4331 or 4321 processor through a communication adapter (VSE only)
- 3270 Display Stations attached by BSC links to communication controllers
- ACF/VTAM application programs in the host processor
- The links that connect the nodes of the network

Appendix A lists the terminal products supported by ACF/VTAM.

Each domain can be divided into parts called *subareas*. A subarea consists of one host processor or one communication controller (containing an NCP) and the associated resources. Figure 3 illustrates a possible configuration for a single-domain network.

The network in Figure 3 has four subareas. Subarea 1 contains the host processor, the ACF/VTAM application programs in the host processor, the channel-attached terminal systems, and resources attached through a communication adapter. The channel-attached terminal systems include the loop adapters and two channel-attached 3270 Information Display Systems. Subarea 2 contains a SDLC link-attached communication controller, a 3600 Finance Communication System, and a 3276 Control Unit Display Station. Subareas 3 and 4 contain the other communication controllers and their associated resources, which include 8100 Processors.

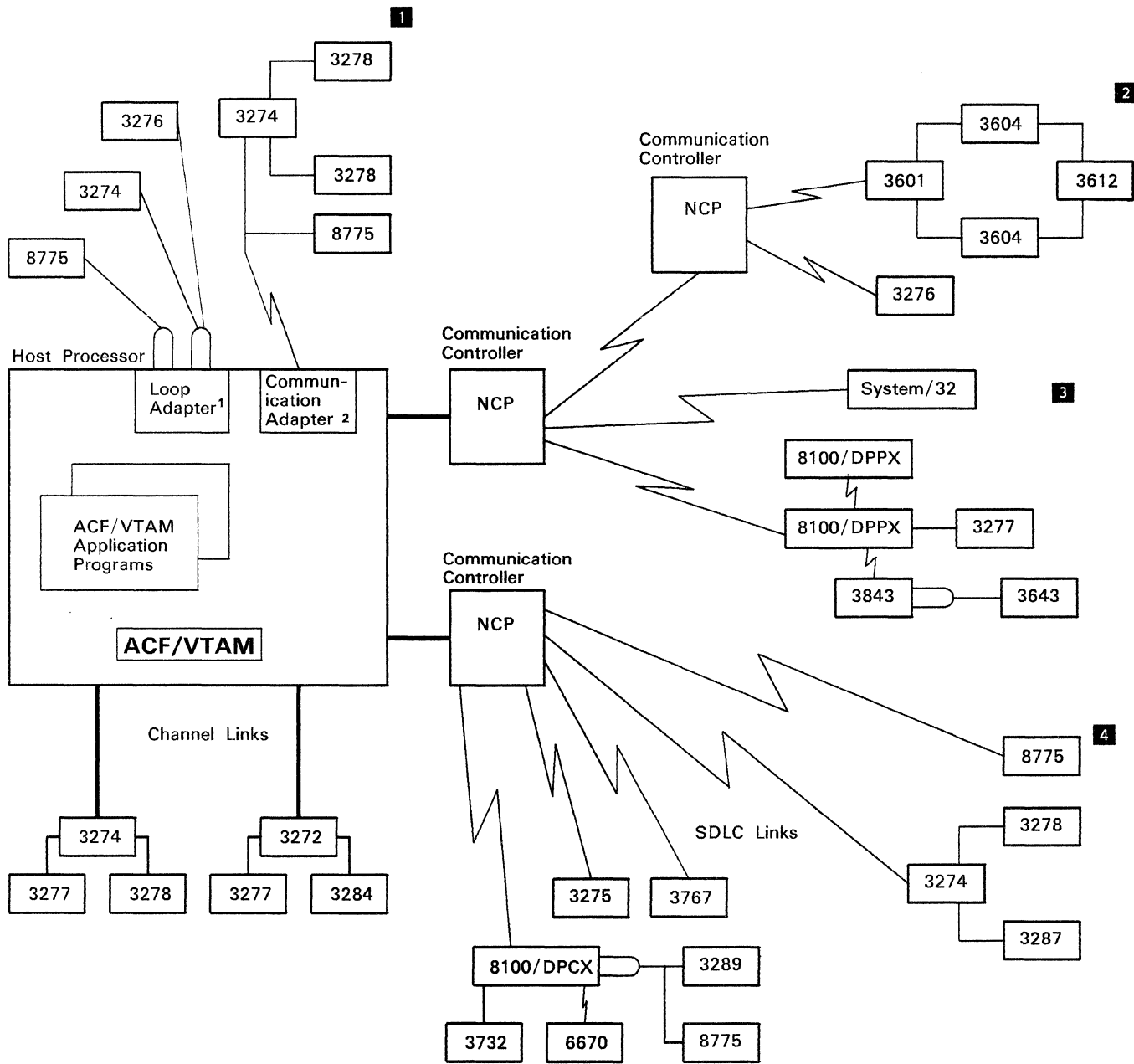

<sup>1</sup> Available for 4331 processor only.  
<sup>2</sup> Available for 4321 and 4331 processors only.

Figure 3. A Single-Domain ACF/VTAM Network

ACF/VTAM permits cross-domain communication by allowing domains to be connected by means of any or all of the following:

- A channel-to-channel connection between two host processors (OS/VS only)
- A communication adapter-to-communication adapter connection between two host processors (VSE only)
- One or more SDLC links between communication controllers
- One or more communication controllers that are channel-attached to two host processors
- A communication controller that is attached to a host processor through a communication adapter (VSE only)

In a multiple-domain network, each ACF/VTAM controls its own domain. Before a logical unit in one domain can communicate with a logical unit in another domain, both ACF/VTAMs must exchange information to establish the session. In addition, for a multiple-domain network, some of the domains can be controlled by ACF/VTAM Version 1 (with its Multisystem Networking Facility), ACF/TCAM (with its Multisystem Networking Facility), or ACF/VTAME. See Chapter 6, "Other Telecommunication Access Methods," for more information on ACF/TCAM, ACF/VTAME, and ACF/VTAM in the same network.

### ***Facilities an ACF/VTAM Network***

ACF/VTAM provides facilities that allow great flexibility in the configuration of the network, routing of messages, and network availability:

- Channel-to-channel connections between host processors (OS/VS only) provide greater communication speed and improved reliability over teleprocessing links.
- Communication adapter connections (VSE only) allow devices to be link-attached to a 4331 or 4321 processor without using a communication controller
- ACF/VTAM's intermediate routing node facility allows flexibility in network configurations.
- Parallel links and the associated transmission group function provide greater communication speed between NCPs and improved reliability of connections between communication controllers.
- Extended communication-controller interconnection allows flexible network configurations.
- Multiple routes to subareas of the network can define up to eight routes for communication between any two subareas in the network.
- Reliability, availability, and serviceability (RAS) facilities provide backup and recovery capabilities, route verification, and notification of failures in the network.
- Optional dynamic definition of cross-domain resources reduces the requirement to predefine such resources.

For additional information on ACF/VTAM Version 2 enhancements, see Chapter 8, "Summary of ACF/VTAM".

### **Channel-to-Channel Connections (OS/VS Only)**

Channel-to-channel connections between host processors (OS/VS only) provide greater communication speed and improved reliability over teleprocessing links. Any host processors that are to be connected through this facility must both contain ACF/VTAM Version 2 and an OS/VS operating system.

### **Communication Adapter Connections (VSE Only)**

Communication adapter connections allow host processors and devices to be link-attached to a 4331 or 4321 processor without using a communication controller. Two host processors can be connected through communication adapters provided both have a communication adapter and each contains the VSE operating system and either ACF/VTAM Version 2 or ACF/VTAME. Communication controllers can also be attached through a communication adapter by cross-domain links. However, they cannot be in the same domain as the host containing the communication adapter.

### **Intermediate Routing Node Facility**

ACF/VTAM's intermediate routing node facility allows flexibility in network configuration. This facility allows ACF/VTAM to receive messages destined for subareas other than its own and then route that data to the appropriate subareas.

### **Parallel Links/Transmission Groups**

In ACF/VTAM, adjacent communication controllers can be connected by one or more concurrently active SDLC links. Traffic between communication controllers can use any or all of the links. The links are activated and deactivated independently, thereby allowing increased or decreased bandwidth.

A system programmer can define up to eight logical links called *transmission groups*, each consisting of one or more SDLC links, between adjacent communication controllers. If one or more of the links in a transmission group fails, session traffic continues on the remaining links in the group without loss of data. By defining multiple transmission groups and multiple routes between subareas of the network, a system programmer can route different kinds of traffic over different transmission groups. For example, a system programmer can assign interactive sessions to routes using transmission groups providing rapid response time and batch sessions to transmission groups able to handle a large capacity of data.

In Figure 4, the transmission groups GROUP6 through GROUP11 can consist of one or many SDLC links. In addition, there can be more than one transmission group between NCPs, such as groups GROUP8 and GROUP9 between NCP3 and NCP6. Additionally, the single channel between a host processor and a channel-attached communication controller or another host processor is also defined as a transmission group. These are shown in Figure 4 as groups GROUP1 through GROUP5.

### **Extended Communication Controller Interconnection**

Communication controllers can be attached to one or more link-attached or channel-attached communication controllers or both. Figure 4 shows a possible network with two domains illustrating several examples of enhanced interconnection. For example, transmission group GROUP10 connects link-attached communication controllers NCP4 and NCP5.

Link-attached communication controllers can also be shared by different domains. In Figure 4, any of the NCPs shown could be owned by either or both of the host processors. For example, NCP5 is shared by HOST1 and HOST2. Some of the resources attached to NCP5 are part of HOST1's domain; some are part of HOST2's domain.

These connections allow additional paths for routing messages throughout the network and additional backup possibilities. In conjunction with the alternate routing abilities described later, the additional connections can improve reliability and availability of resources in the network.

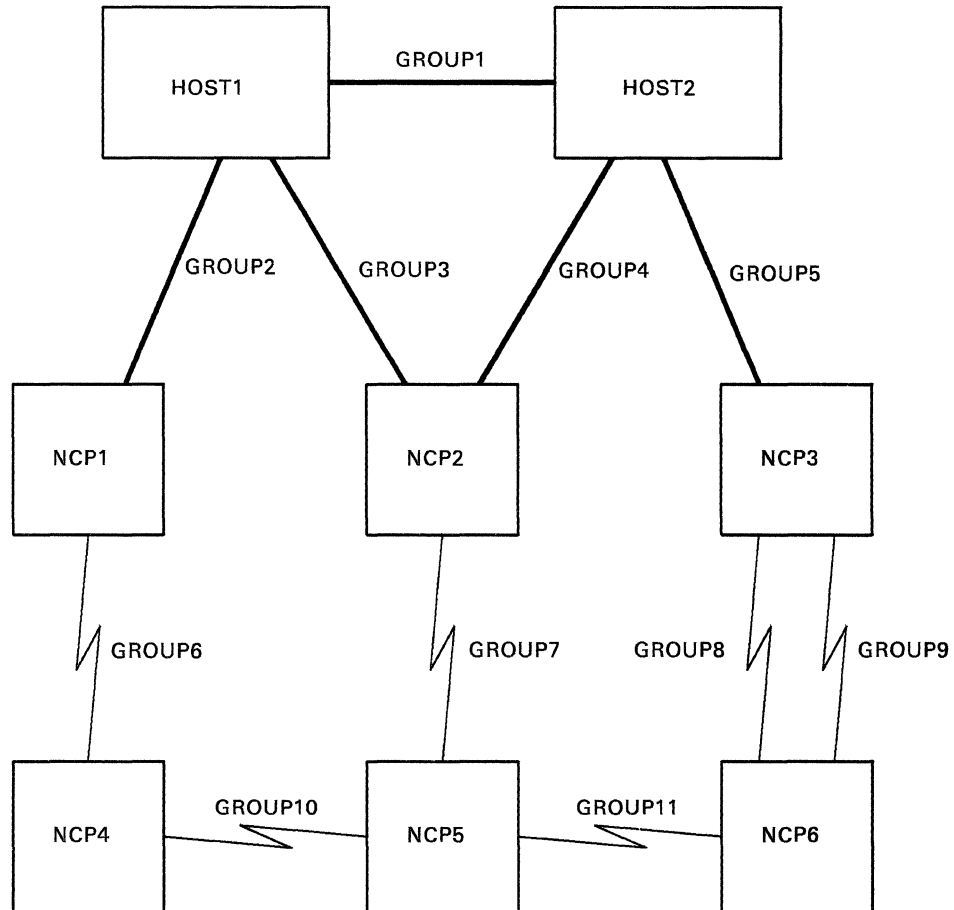

**Figure 4. A Multiple-Domain ACF/VTAM Network**

## Multiple Routes

ACF/VTAM allows a system programmer to define up to eight routes for message transmission between two host processors or between a host processor and a communication controller. When a session is initiated, one of the routes is automatically selected for the traffic. The ordered sequence of routes from which one is selected for a session is called the *class of service*. A system programmer can limit the selection to a particular route or to one of an ordered sequence of routes. Using this capability, a system programmer can distribute the traffic for different sessions among different routes.

The ordered sequence of routes, which are defined by a system programmer, defines the set of alternate routes available for session traffic. If a route becomes inoperative during a session, each end of the session is notified, and the session can be reestablished. This causes automatic selection of one of the alternate routes when a request to reestablish the session is received. The logical units can then resynchronize the session's data traffic and continue communication on the new route.

For example, in Figure 4, messages from an application program in host processor HOST1 to another application program in HOST2 can be sent over the route consisting of transmission group GROUP1; or alternatively, GROUP3, NCP2, and GROUP4; or as a third alternative, through GROUP2, NCP1, GROUP6, NCP4, GROUP10, NCP5, GROUP11, NCP6, GROUP8, NCP3, and GROUP5. Messages from an application program in host processor HOST1 to a logical unit attached to NCP5 can be sent over the route consisting of GROUP2, NCP1, GROUP6, NCP4, GROUP10, and NCP5; or alternatively, through GROUP3, NCP2, GROUP7, and NCP5. The routes mentioned here are just examples; other routes are possible.

Note that a route can pass through a host processor containing ACF/VTAM Version 2. For example, an application program in HOST1 can send a message through HOST2 to a channel-attached logical unit or to a logical unit attached to NCP3 (or any other NCP).

### Reliability, Availability, and Serviceability (RAS) Facilities

ACF/VTAM provides facilities that help maintain the reliability of the network, availability of the resources in the network, and serviceability of the components of the network. These facilities are described in Chapter 7, "Reliability, Availability, Serviceability".

### Views of an ACF/VTAM Network

When considering ACF/VTAM's place in the network, it is useful to know what the network looks like from several viewpoints. These viewpoints are described for both a single-domain network and a multiple-domain network.

#### *A Single-Domain Network*

A possible physical configuration for a single-domain ACF/VTAM network can be visualized from Figure 5, by assuming the configuration related to Host Processor A and its associated devices (excluding the link to Host Processor B's communication controller).

Such a single-domain network includes a host processor with a system console. The system console is used to enter ACF/VTAM operator commands to control

the system. Also attached to the host processor are auxiliary storage devices that contain data sets used by ACF/VTAM.

The network shown in Figure 5 also includes the following channel-attached devices and systems: a non-SNA 3270 Information Display System, a 3790 Communication System, and a 3705 Communications Controller. Attached to the 3705 is an 8140 Processor, and another 3705 Communications Controller with a 3767 Communication Terminal attached.

A network has a definite physical configuration, but its definition and uses are different for the operating system, ACF/VTAM, and application programs. The illustrations in Figure 6 through Figure 10 show these differences.

Part A of Figure 6 depicts the ACF/VTAM network as viewed by the operating system. Note that support is generated in the operating system only for channel-attached devices.

The number of auxiliary storage devices used by ACF/VTAM depends upon data requirements, which in turn are influenced by factors such as the size and complexity of the network. In general, data used by or generated by ACF/VTAM falls into one of three categories as shown in Part A of Figure 6:

*ACF/VTAM libraries*, which contain ACF/VTAM load module descriptions of the system, and operational specifications of the installation

*NCP libraries*, which contain NCP load modules, descriptions of the system, and dump records

*Reliability, availability, and serviceability (RAS) libraries*, which contain records to assist in error recording and maintenance of the ACF/VTAM system

ACF/VTAM and NCP libraries include ACF/VTAM, NCP, and operating system data sets; most of the library requirements for RAS involve operating system data sets. The composition and organization of these libraries depend upon the operating system under which ACF/VTAM is being executed.

Part A of Figure 7 depicts the SNA network as viewed by ACF/VTAM. The host processor must contain the operating system (MVS, OS/VS1, or VSE), ACF/VTAM, and one or more application programs. An application program is represented to ACF/VTAM by an access method control block (ACB). Part A of Figure 6 shows that all channel-attached devices are initially "owned" by the operating system, but, as indicated in part a of Figure 7, when ACF/VTAM is started and begins activating parts of the SNA network, ACF/VTAM acquires the use of these devices.

ACF/VTAM sees each SNA terminal product as a physical unit (PU) and one or more logical units (LUs). Note that the number of logical units in an SNA terminal system is independent of the number of attached devices. For example, a logical unit (often a program in the cluster controller) can control more than one device attached to the cluster controller.

The system console is used by ACF/VTAM but is not allocated to ACF/VTAM. The ACF/VTAM operator enters ACF/VTAM commands through this console, and ACF/VTAM sends messages to the ACF/VTAM operator at this console.

(A special application program, called a *program operator*, can also enter ACF/VTAM operator commands. This facility is described in Chapter 5.)

Part A of Figure 10 shows the network as viewed by an application program. This view results from ACF/VTAM's ownership of all elements in the network and the way ACF/VTAM allocates them. Note that the application program in this diagram will also appear as a logical unit to other ACF/VTAM application programs. ACF/VTAM establishes sessions between application program LUs and other logical units. The intermediate elements are used only for the time needed to satisfy a specific transmission request.

Application programs are not directly concerned with the system console used by the ACF/VTAM operator or with the ACF/VTAM, NCP, or RAS libraries.

### ***A Multiple-Domain Network***

The illustrations in Figure 6 through Figure 10 show a multiple-domain ACF/VTAM network as viewed in terms of physical components (Figure 5), as seen by the host operating systems (Figure 6), as seen by the ACF/VTAMs in each host processor (Figure 7, Figure 8, and Figure 9), and as seen by application programs in each host processor (Figure 10). Figure 5 shows two domains connected by an SDLC link between two communication controllers. Each domain has its own auxiliary storage devices, system console, and communication devices.

As shown in Figure 6, each operating system sees only the channel-attached devices attached to its host processor; the operating systems are not concerned with link-attached devices either in their own domain or in other domains. Operating system A and operating system B need not be of the same type as long as they support ACF/VTAM. For example, operating system A can be a VSE system and operating system B can be OS/VS2 (MVS).

Figure 7 shows how ACF/VTAM in each host processor sees its own domain. To each ACF/VTAM, its domain appears the same as a single-domain network. (See the previous section.)

The illustrations in Figure 8 and Figure 9 show the multiple-domain network as viewed by the two ACF/VTAMs. ACF/VTAM A and ACF/VTAM B see their domains in the same way as they do in a single-domain system. In addition, each sees the cross-domain resource manager (CDRM) for the other ACF/VTAM and the resources in the other domain that are available for cross-domain communication. However, they do not see the physical units associated with the cross-domain resources (logical units). A resource in the other domain is available if it has been defined properly to ACF/VTAM as a cross-domain resource, or if the CDRM in ACF/VTAM's own domain can dynamically define cross-domain resources.

Figure 10 shows the network as viewed by application programs in each host processor. The application program in host processor A identified as ACB1 sees the logical units and non-SNA terminals in its own domain and the cross-domain resources of domain B. It is not aware of whether a resource is in its own domain or in another domain. It also is not aware that ACB2 represents an application program; it sees it as a logical unit. Similarly, the application program in host processor B sees its own domain's logical units and non-SNA terminals as well as the cross-domain resources of domain A.



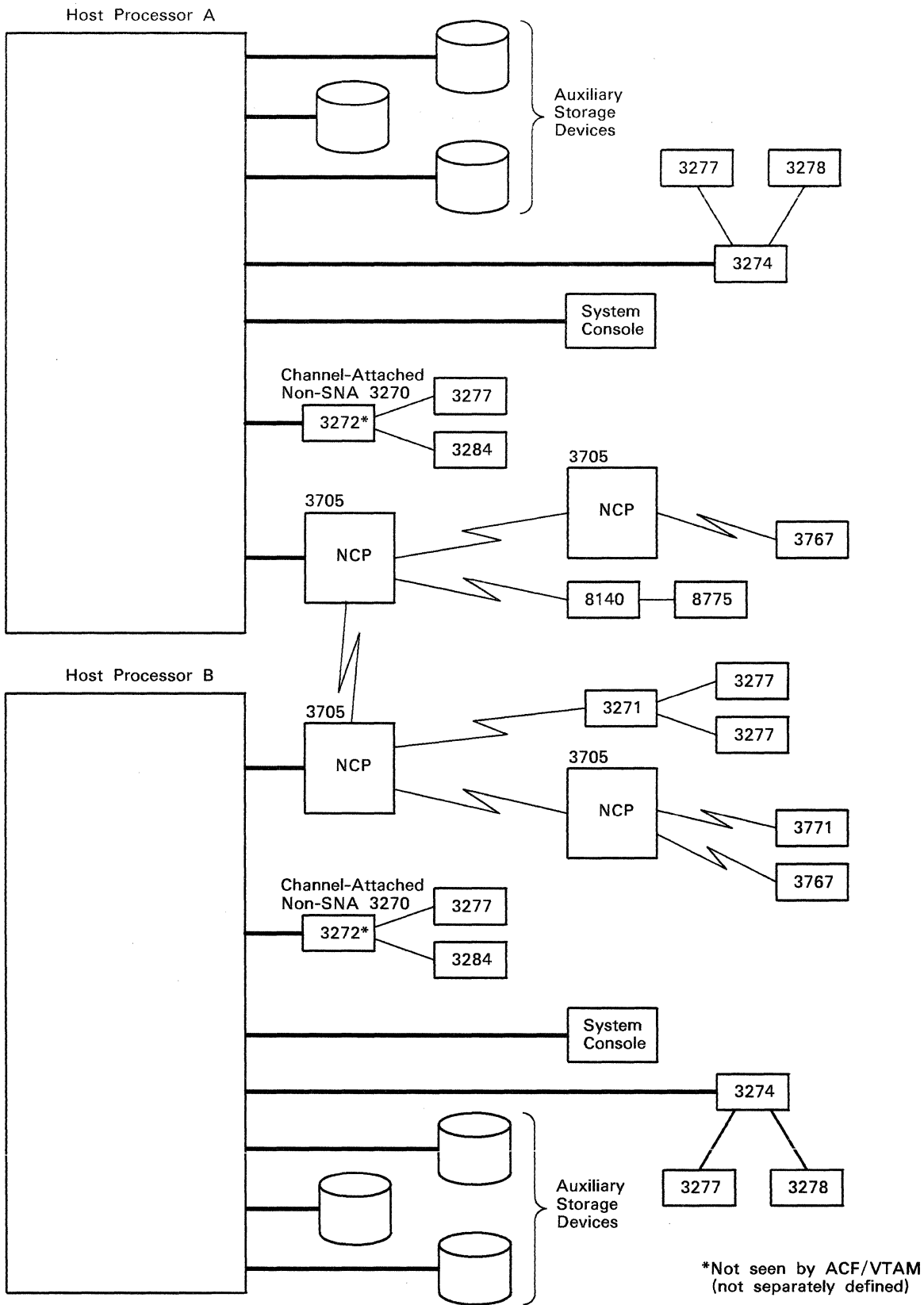
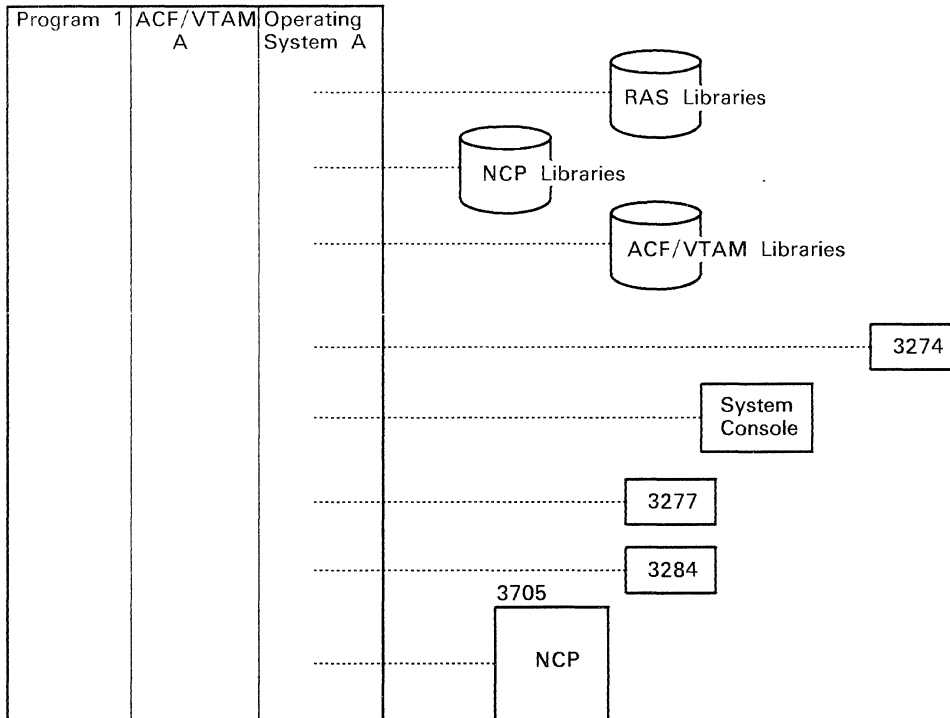
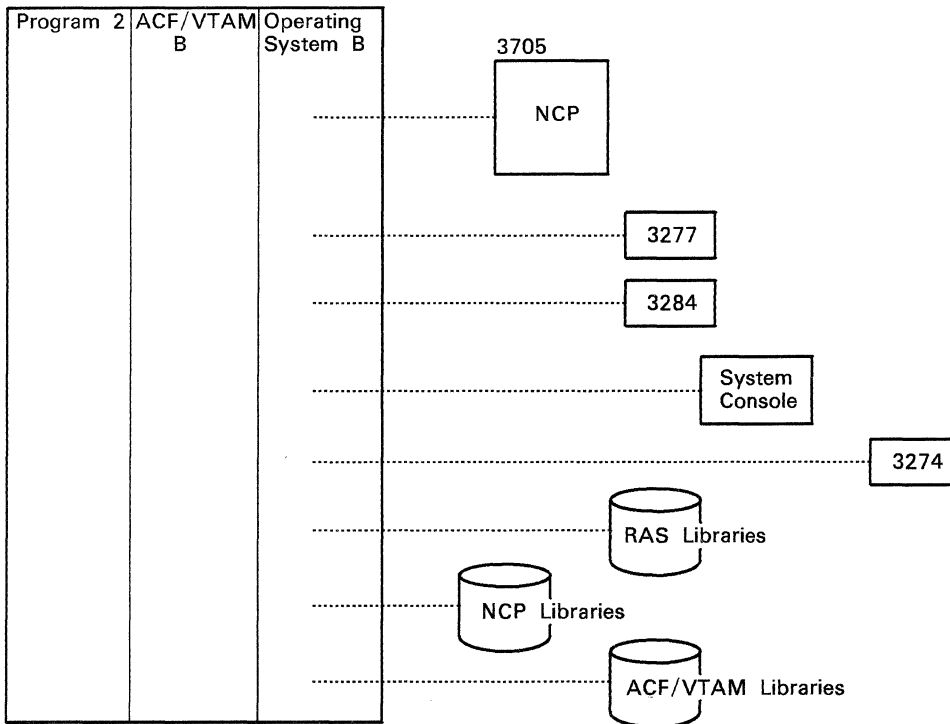

Figure 5. The Physical Configuration of an ACF/VTAM Network

**A. Operating System A's View of the Network**  
Host Processor A



**B. Operating System B's View of the Network**  
Host Processor B



**Figure 6. The Network as Viewed by the Host Operating System**

**A. ACF/VTAM A's View of its Domain**

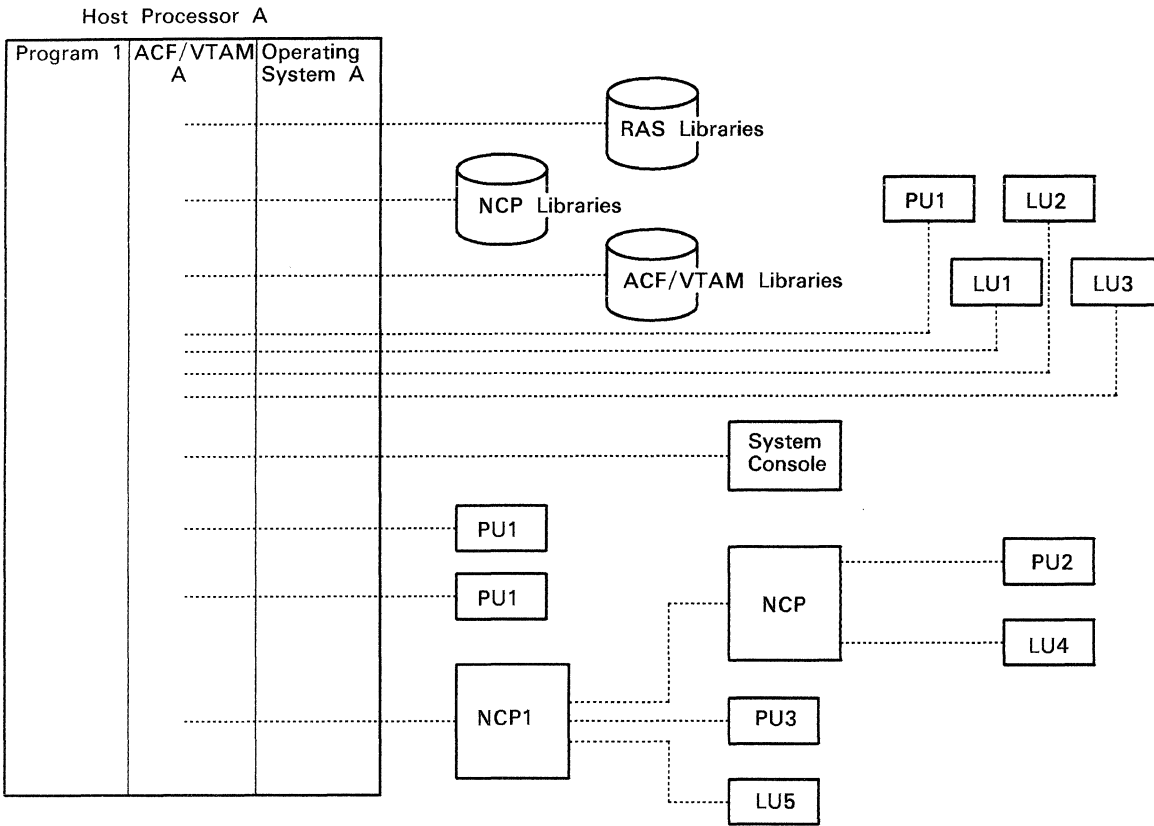

**B. ACF/VTAM B's View of its Domain**

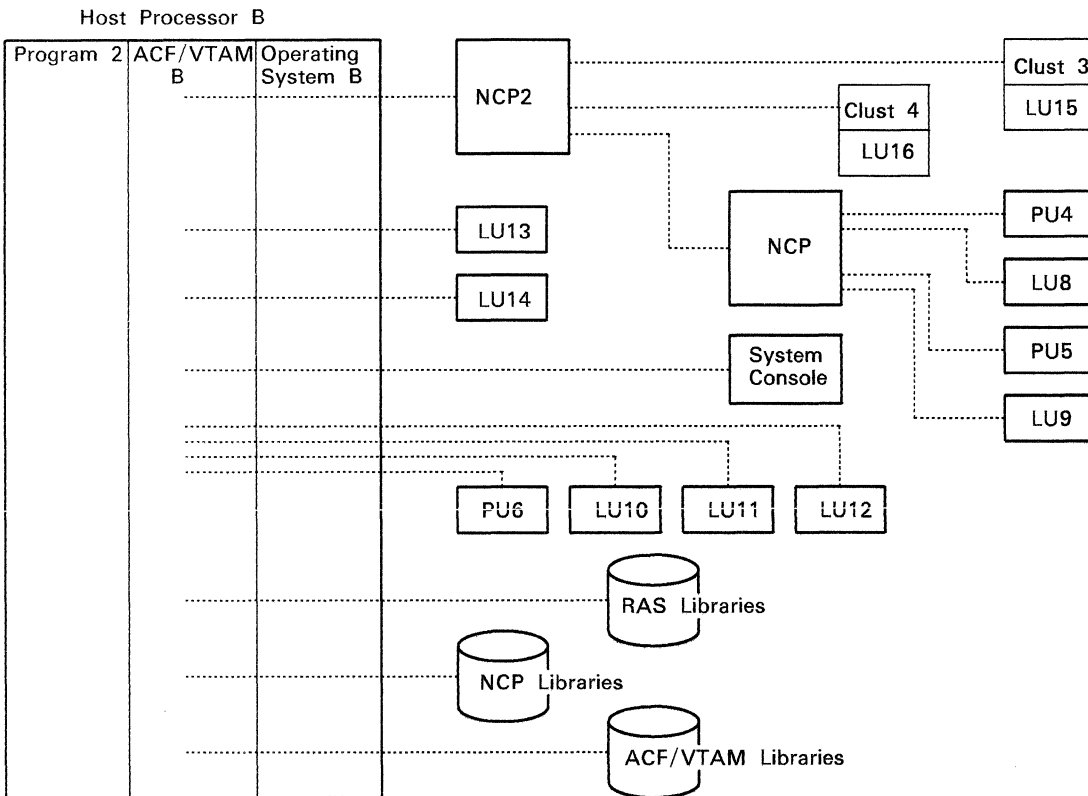

Figure 7. The Domain as Viewed by ACF/VTAM

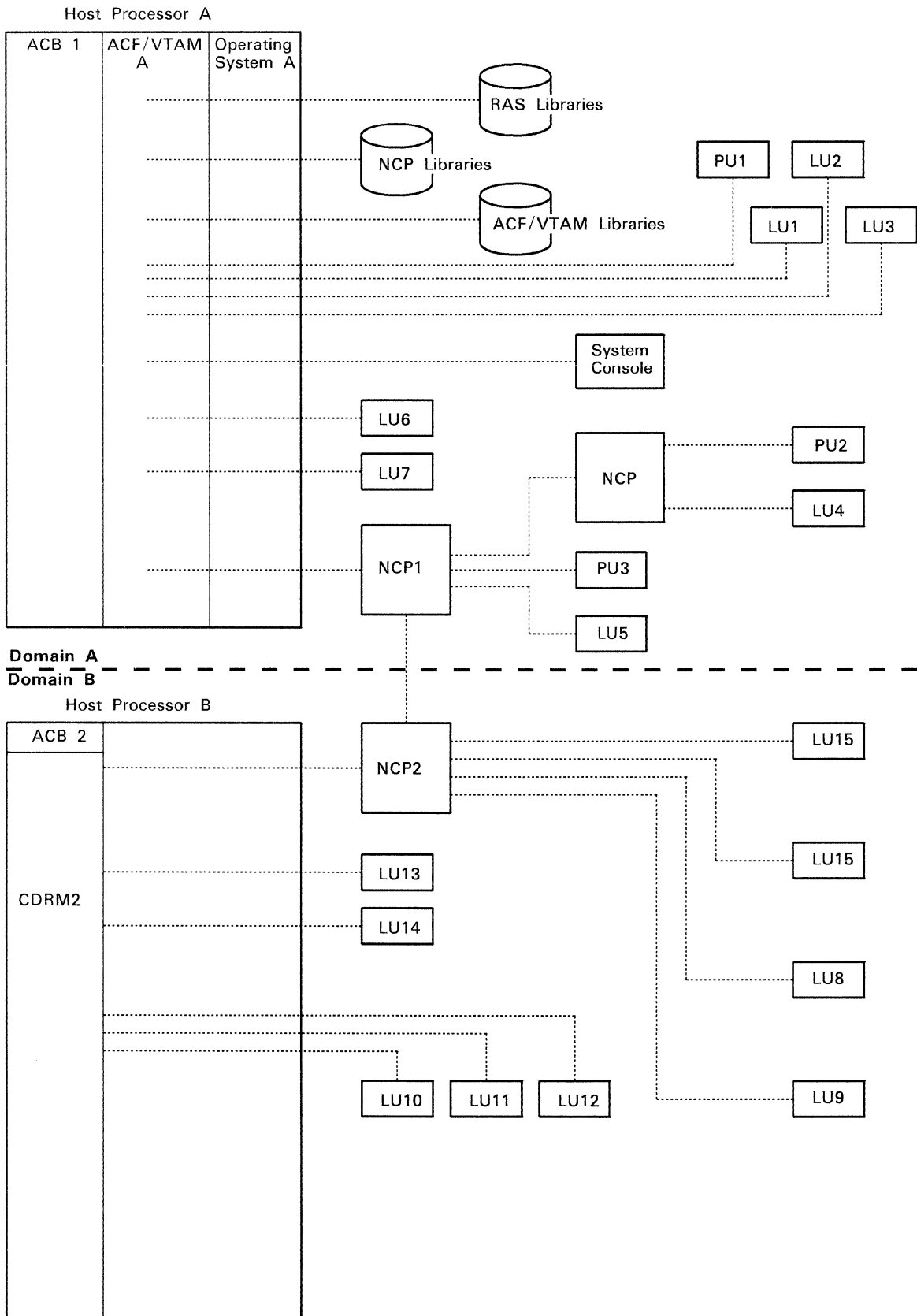

Figure 8. The Network as Viewed by ACF/VTAM A

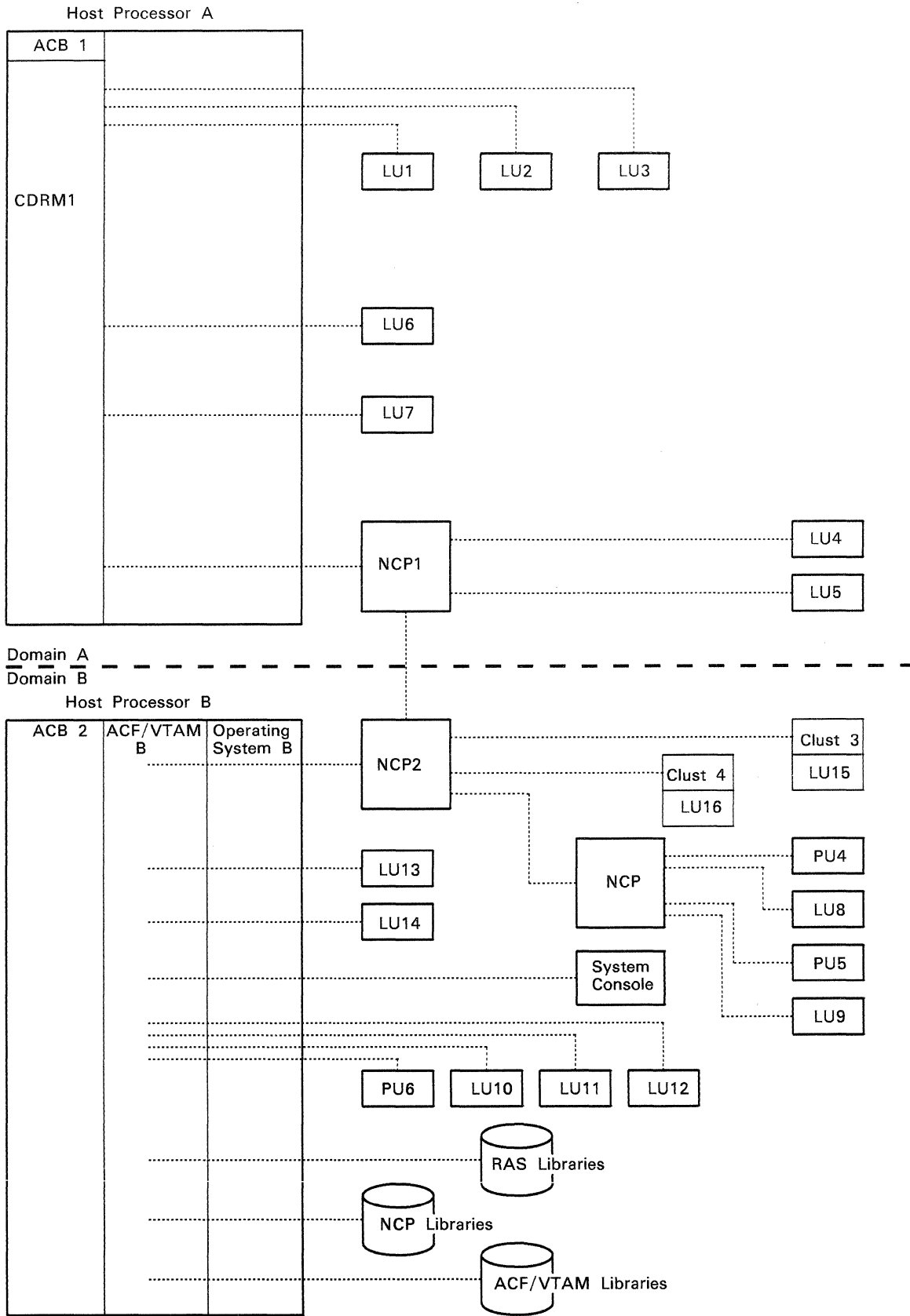
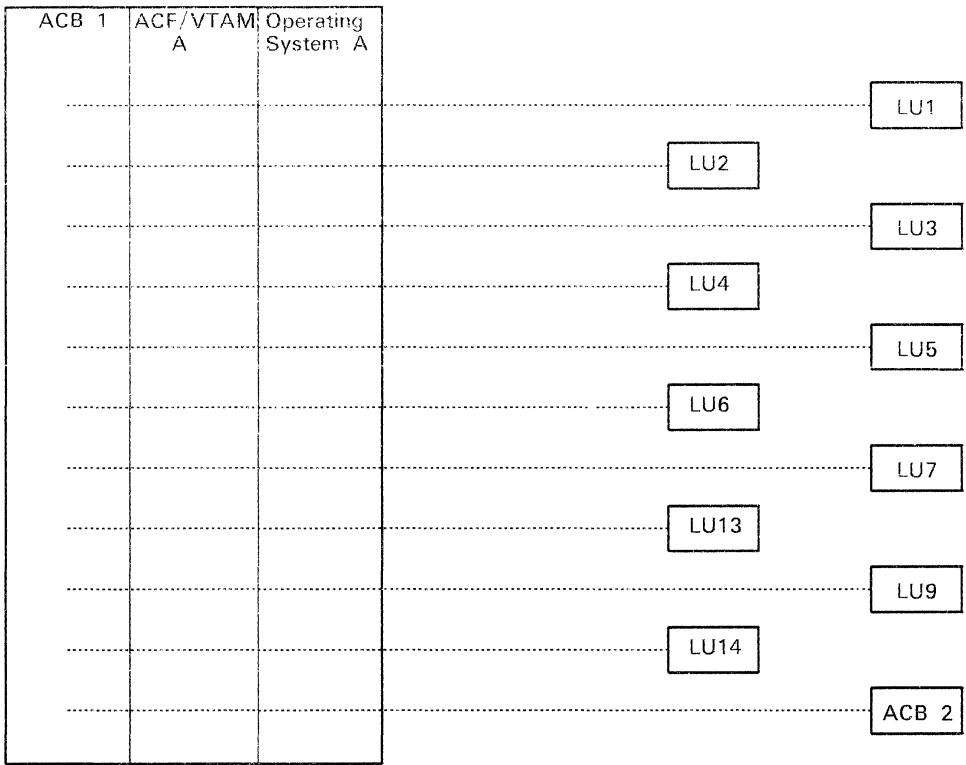
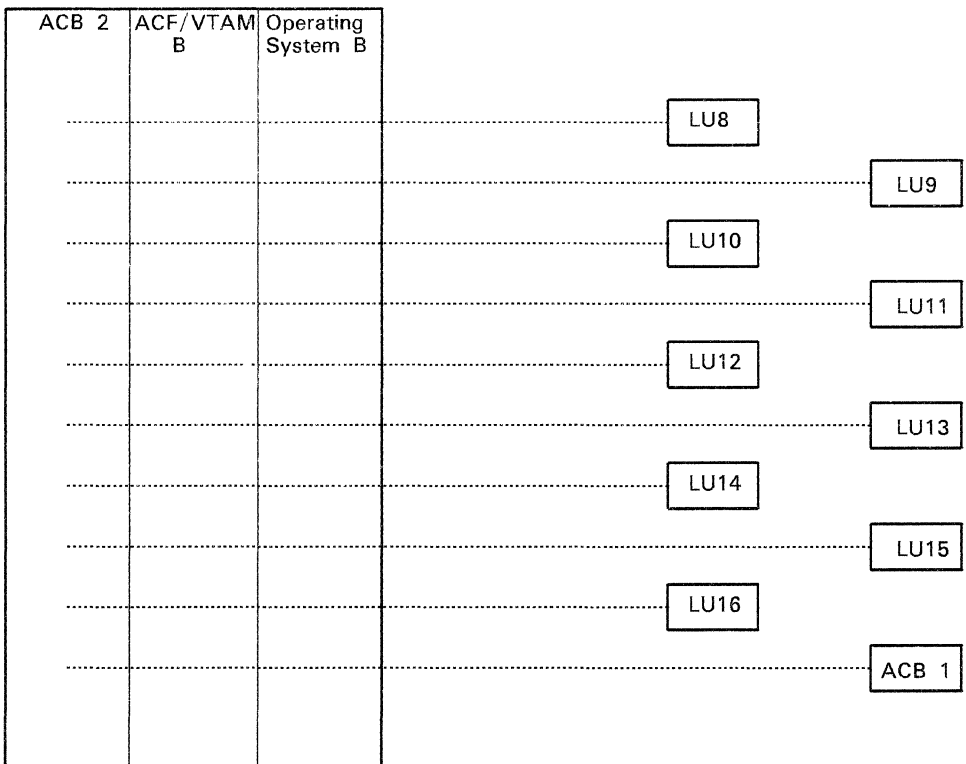

Figure 9. The Network as Viewed by ACF/VTAM B

**A. The Data Communication Network Viewed by ACF/VTAM Application Program 1**



**B. The Data Communication Network Viewed by ACF/VTAM Application Program 2**



**Figure 10. The Network as Viewed by Application Programs**



## Chapter 3. Creating an ACF/VTAM Data Communication Network

Defining an ACF/VTAM data communication network consists of defining one or more ACF/VTAM domains and coordinating the domain definitions. Four processes are involved in the creation of a domain:

- Defining ACF/VTAM and channel-attached devices to the operating system
- Defining the domain to ACF/VTAM
- Defining ACF/VTAM start options
- Coding exit routines (optional)

For more detailed information about defining an ACF/VTAM network, see the *ACF/VTAM Planning and Installation Reference*.

### Defining ACF/VTAM and Channel-Attached Devices to the Operating System

During system generation, ACF/VTAM is specified with the ACSMETH operand of the DATAMGT macro instruction in OS/VS or as an operand of the SUPVR macro instruction in VSE. At that time, channel-attached SNA and non-SNA terminals and channel-attached communication controllers are defined to the operating system. In OS/VS systems, any channel-to-channel connections between host processors are also defined to the operating system. Note that because only channel-attached terminals and communication controllers are defined to the operating system, the configuration of the link-attached terminals and communication controllers can be changed without regenerating the operating system.

### Defining the Domain to ACF/VTAM

Defining the domain to ACF/VTAM can include some or all of the following:

- Defining network control programs (NCPs). One NCP must be defined for each communication controller in the domain. (This includes defining the terminals attached to the communication controller.)
- Defining ACF/VTAM application programs
- Defining terminals on switched lines
- Defining channel-attached SNA terminals
- Defining channel-attached non-SNA terminals
- Defining loop-adapter-attached terminals
- Defining communication adapter-attached resources (VSE only)
- Defining channel-to-channel connections between host processors. (This applies only to OS/VS systems in a multiple-domain network.)
- Defining cross-domain resources (CDRSCs). (This applies only in a multiple-domain network. A CDRSC defines a resource in another domain that can be used for cross-domain communication.)



- Defining cross-domain resource managers (CDRMs). (This applies only in a multiple-domain network. A CDRM is an ACF/VTAM, ACF/VTAME, or ACF/TCAM facility used to control cross-domain communication.)
- Defining routes between subareas
- Defining communication network management (CNM) routing tables
- Defining ACF/VTAM start options
- Defining dynamic reconfiguration of physical units and logical units
- Defining a table to change ACF/VTAM messages
- Defining a table to change selected ACF/VTAM operator commands
- Defining session establishment and termination procedures
- Coding exit routines

### ***Defining Network Control Programs (NCPs)***

An NCP definition specifies the numbers, types, and configurations of terminals to be attached to a communication controller. The NCP has its own generation language, which consists of macro instructions that:

- Describe the communication controller
- Specify NCP options
- Describe the interaction of ACF/VTAM with the NCP (such as buffers and block sizes)
- Describe lines, line groups, and paths
- Describe terminals

The NCP macro instructions are assembled, verified, and used to generate the NCP. The NCP-generation source statements are used again by ACF/VTAM during ACF/VTAM's definition of the NCP.

At least one NCP must be generated for each communication controller. A communication controller can have more than one NCP generated for it; which NCP is used is determined by which NCP is activated by the ACF/VTAM operator. Each NCP must have a different symbolic name. Multiple NCPs for a communication controller are useful for installations that have varying data communication requirements. Using different NCPs for different requirements allows the system programmer to alter terminal configurations as demands on application programs change, and might make processing more efficient.

Network configurations can also be altered without disrupting network operation if the ability to dynamically reconfigure the network is specified in the NCP generation. For more information, see the section "Dynamic Reconfiguration" in Chapter 4.

## ***Defining ACF/VTAM Application Programs***

An application program is defined using the APPL definition statement. Each application program is given a unique symbolic name, and can be defined by itself or as one of a group of application programs. For example, a university might set aside a portion of each day's computing time for student use and would want to have a group of student-oriented programs in the system during that period. If defined as a group, the operator could activate these application programs in one step.

Each TSO/VTAM user and terminal control address space (TCAS) is an ACF/VTAM application program; therefore, separate definition statements must be specified for each TCAS and each user address space.

Characteristics of the application program and authorization to use special facilities are also identified.

## ***Defining Terminals on Switched Lines***

Each set of SNA terminals on switched (dial) lines is defined using ACF/VTAM definition statements. These define the characteristics of the terminals, their method of connection (manual dial-out, automatic dial-out, or dial-in) and the telephone numbers to be used.

## ***Defining Channel-Attached SNA Terminals***

ACF/VTAM provides session-establishment and data transfer services to certain SNA terminals channel-attached to the host processor (see Appendix A). Terminals attached in this way are defined using ACF/VTAM definition statements.

## ***Defining Channel-Attached Non-SNA Terminals***

ACF/VTAM provides support for channel-attached non-SNA 3270s. These devices are defined with ACF/VTAM definition statements.

## ***Defining Loop-Adapter-Attached Terminals***

ACF/VTAM provides session-establishment and data transfer services to certain terminals attached to a loop adapter on a 4331 processor (see Appendix A). Terminals attached in this way are defined using ACF/VTAM definition statements.

## ***Defining Communication Adapter-Attached Resources (VSE Only)***

ACF/VTAM provides session establishment and data transfer services to certain SNA and non-SNA devices link-attached through a communication adapter on a 4331 or 4321 processor (see Appendix A). These devices are defined using ACF/VTAM definition statements.

In a multiple-domain network, the system programmer can define a communication adapter connection between host processors or between a host processor and a communication controller. Two host processors can be connected through communication adapters provided both have a communication adapter and each contains the VSE operating system and either ACF/VTAM Version 2 or ACF/VTAME.

### ***Defining Channel-to-Channel Connections between Host Processors (OS/VS Only)***

In a multiple-domain network, the system programmer can define a channel-to-channel connection between host processors. Such a connection is defined using ACF/VTAM definition statements. The host processors to be connected must both contain ACF/VTAM Version 2 running under an OS/VS operating system.

### ***Defining Cross-Domain Resources (CDRSCs)***

In a multiple-domain network, the system programmer must define, within a domain, logical units in other domains that can be used for cross-domain communication. Only those logical units in other domains that will be involved in cross-domain sessions initiated from this domain need to be defined.

### ***Defining Cross-Domain Resource Managers (CDRMs)***

In a multiple-domain network, the system programmer must define the ACF/VTAM facilities called *cross-domain resource managers* that control the establishment of cross-domain sessions.

### ***Defining Routes between Subareas***

The system programmer must define the routes for both cross-domain and single-domain communication. Multiple routes can be defined between subareas.

### ***Defining Communication Network Management (CNM) Routing Tables***

An application program can communicate with ACF/VTAM through the communications network management (CNM) interface. In order for the application program to be authorized to receive unsolicited requests, the system programmer must define a routing table as part of the interface between ACF/VTAM and the application program. Such an application program could request and receive network error and status records, request and receive either notification of session establishment and termination or NCP session trace data, or it could receive and fulfill physical unit load requests. For more information, see *ACF/VTAM Planning and Installation Reference*.

### ***Defining ACF/VTAM Start Options***

When the system operator starts ACF/VTAM, options can be specified to define facilities according to user requirements. These options can be entered individually by the operator or can be predefined in the ACF/VTAM definition library. Start options control the following:

- The manner in which start options are specified
- ACF/VTAM's identity in the network
- Network configuration
- ACF/VTAM performance
- The gathering of tuning statistics
- ACF/VTAM operator commands and messages
- Problem determination

## Defining Dynamic Reconfiguration of Physical Units and Logical Units

The system program can supply alternate definitions for the physical units and logical units attached to a communication controller. By activating these alternate definitions, the ACF/VTAM operator can reconfigure the resources attached to that communication controller.

## Defining a Table to Change ACF/VTAM Messages

ACF/VTAM uses a table to determine what text to use for the messages that it sends to the ACF/VTAM operator. The system programmer can optionally define a supplementary table containing replacement text for any or all ACF/VTAM messages. This might be done to provide the operator with messages tailored to a particular environment or to provide messages in a language other than English.

This facility also enables the system programmer to change the message suppression level of any or all messages. This allows selected messages to be suppressed, thereby controlling the number and types of messages that can be sent to the operator.

The system programmer can also specify a separate table to be used for messages sent to a program operator. This allows a program operator to receive messages specially tailored for use by the program operator.

In OS/VS, this facility also allows the system programmer to change the message routing codes of any or all messages. This allows selected messages to be sent to a destination other than the system operator's console.

**Note:** User modification of information required for problem diagnosis, such as IBM-supplied message identifiers and message suppression levels, might impair the standard serviceability characteristics of the product and will increase the documentation requirements for reporting a problem to IBM. The IBM-supplied message CSECT should be retained for problem recreation.

## Defining a Table to Change Selected ACF/VTAM Operator Commands

For some ACF/VTAM operator commands, ACF/VTAM uses a table to determine what operands are valid for that command and what default value to use for each operand. The system programmer can optionally define a supplementary table containing replacement command operands and default values. This might be done to provide the operator with commands tailored to a particular environment.

For example, the MODIFY DUMP command, which dumps an NCP, can be redefined. The IBM-supplied MODIFY DUMP command requires that the operator specify the name of the NCP to be dumped. In a small network with only one NCP, it might be desirable to redefine the MODIFY DUMP command so that it will automatically dump that particular NCP. This eliminates the need for the operator to specify the NCP name. Other command parameters can be handled in the same way, thereby reducing both the operator's workload and the chance for error.

This facility could also be used to provide commands in a language other than English.

The commands that can be redefined in this way are listed in *ACF/VTAM Planning and Installation Reference*.

**Note:** User modification of information required for problem diagnosis, such as IBM-supplied command syntax and defaults, might impair the standard serviceability characteristics of the product and will increase the documentation requirements for reporting a problem to IBM. The IBM-supplied command CSECT should be retained for problem recreation.

## Defining Session Establishment and Termination Procedures

A logical unit can request that a session be established or terminated by sending a command to ACF/VTAM in one of two forms:

- *A field-formatted command.* This form of command can be used by logical units in programmable devices. SNA defines the format of the field-formatted commands; no system programmer action is needed to define these commands.
- *A character-coded command.* This form of command is used by programmable and nonprogrammable devices. An installation using this form of command can use either the IBM-defined format of character-coded commands (such as LOGON or LOGOFF), or, by building a definition table, can define alternate forms of the commands. The character-coded command is converted to a field-formatted command by ACF/VTAM before processing.

During the session-establishment process, the primary and secondary ends of a session establish a set of rules to be followed when communicating. These rules are specified by *session parameters*. Session parameters generally correspond to modes of operation, such as batch or interactive operation. These session parameters can specify:

- Whether operation is half-duplex or full-duplex
- Who has error-recovery responsibility
- Whether data can be chained
- Who can speak first
- What level of cryptographic session is expected

A set of session parameters can be associated with a symbolic name called a *logon mode name*. Each logon mode is defined in a *logon mode table*, which associates each logon mode name with a set of session parameters. The system programmer can build one or more logon mode tables to define a set of logon mode names and session parameters or can use the IBM-supplied logon mode table.

Implicit in the logon mode specification for an LU-to-LU session is selection of a class of service (COS); that is, each defined logon mode name will have an associated COS. The COS is a symbolic name used to select a list of virtual route numbers and transmission priorities to be used for a particular session. The system programmer can specify the COS in the logon mode table or allow it to default to a symbolic name of eight blanks.

If the primary logical unit indicates that the session parameters are negotiable, the secondary logical unit can change certain parameters.

Because TSO/VTAM uses ACF/VTAM's logon facilities, TSO/VTAM users cannot use the TSO LOGON command unless an interpret table is defined to allow logon requests to have the same format as that used by the TSO LOGON command. (An interpret table is a user-defined table that ACF/VTAM can use to convert a user-specified character string into an ACF/VTAM LOGON command.) For more information, see *ACF/VTAM Planning and Installation Reference*.

## Coding Installation Exit Routines

The system programmer can code installation exit routines that can be included as part of ACF/VTAM. These exit routines are automatically invoked by ACF/VTAM whenever an event occurs that is supervised by the routine. These exit routines are executed as part of ACF/VTAM and are not under the control of the application programs. The exit routines must be able to support a logical unit that is participating in multiple concurrent sessions (parallel sessions) with another logical unit.

The following exit routines can be included by the system programmer as part of ACF/VTAM:

- An *authorization exit routine*. To validate session-establishment requests.
- An *accounting exit routine*. To collect accounting information.
- A *logon-interpret exit routine*. To determine the appropriate application program to receive a session establishment request.
- A *virtual route selection exit routine*. To influence the selection of a set of routes to be considered for a session. The first usable route in the set will be selected for the session by ACF/VTAM.
- A *virtual route window size calculation user-replaceable module*. To calculate the minimum and maximum window sizes for a virtual route when that virtual route is activated.



## Chapter 4. Controlling an ACF/VTAM Network

ACF/VTAM provides ACF/VTAM operator functions for controlling the data communication devices and application programs. Using a subset of the operating system commands, an ACF/VTAM operator can:

- Alter the domain in response to fluctuating requirements of the user
- Minimize the impact on the domain if a domain component fails
- Assist in increasing the efficiency of the domain
- Start and stop ACF/VTAM

More specifically, the commands enable the operator to:

- Activate and deactivate resources in the domain
- Initiate requests to establish or terminate sessions between logical units
- Dynamically redefine the domain configuration
- Halt communication activities in an orderly manner
- Monitor the activity in the domain
- Test a nonswitched SDLC link between:
  - A communication controller and a cluster controller
  - Two communication controllers
  - A host processor and a cluster controller attached through a communication adapter (VSE only)
  - A host processor and a communication controller attached through a communication adapter (VSE only)
  - Two host processors attached through communication adapters (VSE only)
- Monitor application program status
- Control which domains can be used for cross-domain communication by activating and deactivating cross-domain resource managers
- Activate path definition sets that define communication routes
- Control which logical units in other domains can be used for cross-domain communication
- Display and dump NCP storage
- Test the status of a route



## Operator Commands

An ACF/VTAM operator can use the following commands:

**DISPLAY:** Displays the status of ACF/VTAM resources, such as application programs, terminals, links, routes, communication controllers, and ACF/VTAM buffers, and displays up to 256 bytes of NCP storage.

**EXEC:** Starts ACF/VTAM in a VSE system. (In OS/VS, the **START** command starts ACF/VTAM.) The ACF/VTAM operator can specify start options to define some ACF/VTAM facilities. See “Defining ACF/VTAM Start Options” in Chapter 3 for a description of start options.

**HALT:** Shuts down the domain and stops ACF/VTAM. (TSO/VTAM is stopped with the system **STOP** command.)

**MODIFY:** Enables the ACF/VTAM operator to change the operating characteristics of ACF/VTAM and of the communication controllers. Specifically, **MODIFY** allows the operator to:

- Start or stop ACF/VTAM trace facilities
- Request a dump of the NCP
- Start or stop the online testing programs
- Test a link between ACF/VTAM and a physical unit on a nonswitched SDLC link without affecting other physical units that may be on that same link
- Start and stop the recording of tuning statistics
- Modify the level at which messages are to be suppressed
- Change the owning cross-domain resource manager of cross-domain resources
- Increase the level of cryptographic session required for a logical unit
- Cause the NCP to generate maintenance data records (MDRs) for temporary errors and have these errors recorded. In OS/VS, temporary errors are recorded on SYS1.LOGREC. In VSE, temporary errors are recorded on EREP or SYSREC files.

**START:** Starts ACF/VTAM in an OS/VS system. (In VSE, the **EXEC** command starts ACF/VTAM.) The ACF/VTAM operator can specify start options to define some ACF/VTAM facilities. See “Defining ACF/VTAM Start Options” in Chapter 3 for a description of start options.

TSO/VTAM is started with the system **START** command.

VARY: Enables the ACF/VTAM operator to control the use of ACF/VTAM resources. For example, the VARY command enables the operator to:

- Redefine the domain (that is, to dynamically reconfigure an NCP, or to activate or deactivate logical units, cluster controllers, application programs, lines, NCPs, channel-to-channel connections, cross-domain resources, and cross-domain resource managers)
- Activate lines attached to a communication controller executing with PEP, and have them automatically switched from emulation mode to network control mode
- Activate, load, reconfigure or deactivate NCPs
- Activate path definition sets that define communication routes
- Acquire and release resources
- Specify that a device-type secondary logical unit (such as a terminal) is to be automatically logged on to primary logical unit (such as an application program)
- Terminate sessions

ACF/VTAM operator commands can be sent to ACF/VTAM from the system console or from an application program that has been authorized to use the SENDCMD and RCVCMD macro instructions. SENDCMD is used to send ACF/VTAM operator commands (except START and HALT) to ACF/VTAM; RCVCMD is used to receive messages from ACF/VTAM. With this facility, an application program can monitor and control a domain or a multiple-domain network. Such an application program is called a *program operator*.

ACF/VTAM operator commands (except for some DISPLAY options) are effective only for the domain in which they are entered. A program operator in one domain, however, can communicate with a program operator in another domain to request information and changes in the other domain.

For some ACF/VTAM operator commands, ACF/VTAM uses a table to determine what operands are valid for that command and what default value to use for each operand. The user can optionally define a replacement table containing replacement command operands and default values for these commands. For more information, see “Defining a Table To Change Selected ACF/VTAM Operator Commands” in Chapter 3.

## Dynamic Reconfiguration

The ACF/VTAM operator can dynamically reconfigure an NCP by using the VARY command. This reconfiguration reflects the addition or deletion of physical units and logical units attached to the NCP. With dynamic reconfiguration, domain operation is not disrupted, because there is no need to load the communication controller with a new NCP.

Dynamic reconfiguration, however, should be used only as a temporary solution for reconfiguration; a regeneration of the NCP, reflecting the new configuration, should be done as soon as time permits.

## **Network Communications Control Facility (NCCF)**

The process of controlling a network can be simplified by the addition of an IBM program product, the Network Communications Control Facility (NCCF). NCCF can be used as a program operator to control, record, and automate various operator tasks. For example, NCCF can be used to:

- Route commands (ACF/VTAM and system) to the proper domain for execution and route the responses from that domain to the issuing operator
- Provide for multiple ACF/VTAM operators, each with different responsibilities, at various locations in the network
- Permit user-written programs that react to data traffic or to user-written operands and commands
- Permit operator-to-operator communication

NCCF is also a program base upon which users can add other IBM-supplied or user-supplied programs. For example, an IBM program product, the Network Problem Determination Application (NPDA), can be used in conjunction with NCCF to identify, isolate, and monitor errors detected by communication subsystems and to record these errors in a central location. The Network Logical Data Manager (NLDM), another IBM program product that can be used with NCCF, aids in network problem determination by providing on-line information about sessions. NLDM collects data for sessions involving LUs, PUs, and SSCPs for the following types of sessions: LU-LU, SSCP-LU, SSCP-PU, and SSCP-SSCP. It also collects information about the data flows to and from BSC 3270 terminals attached to an NCP. Such terminals are treated as LUs.

## Chapter 5. ACF/VTAM Application Programs

ACF/VTAM provides macro instructions that establish or terminate sessions and that send or receive data. The application program must set up control blocks that contain information used to direct these operations. ACF/VTAM provides two methods of creating control blocks. An application program can create control blocks during assembly or during program execution. If control blocks are generated during program execution, the application program need not be reassembled if the format of a control block is changed. Many control block fields can be modified and examined using macro instructions provided for this purpose.

Control blocks are modified when sessions are established or data is transferred. Each request can change fields that apply for that operation. ACF/VTAM modifies the control blocks to provide information about the processing of the request.

### Identifying the Application Program to ACF/VTAM

During execution, an application program must identify itself to ACF/VTAM before it uses any ACF/VTAM facilities. The program identifies itself by using an *access method control block (ACB)* that indicates its symbolic name, a password for authorization, and a list of exit routines to be scheduled when certain events occur (such as receipt of a request that the application program establish a session with another logical unit). An OPEN macro instruction specifying the ACB must be issued to make the application program known to ACF/VTAM. Figure 11 shows the process of identifying an application program to ACF/VTAM.

### Establishing a Session

An application program can be the primary logical unit (PLU) or secondary logical unit (SLU) in a session. The session-establishment procedures used by the application program depend on whether it is to be the PLU or SLU in the session.

#### *The PLU's Role in Session Establishment*

It is possible to initiate a session in which an ACF/VTAM application program will act as the PLU. Such a session initiation request may come from many sources, including the application program itself (by issuing a SIMLOGON macro instruction, if it is authorized to do so). The request is sent to the SSCP, which in turn sends a request to the application program logical unit. The application program is notified of the request for a session when its LOGON exit routine is invoked. The application program can then either accept the request by issuing an OPNDST macro instruction with the ACCEPT option (this causes the session establishment procedure to continue by sending a Bind Session request to the logical unit that will act as the SLU in the session) or the application program can reject the request by issuing a CLSDST macro instruction (this causes the SSCP and then the session initiator to be notified that no session will be established). If the application program does not have a LOGON exit routine, it can still accept sessions by using OPNDST OPTCD=ACCEPT; however, this technique is less flexible than using a LOGON exit routine.

## Host Processor

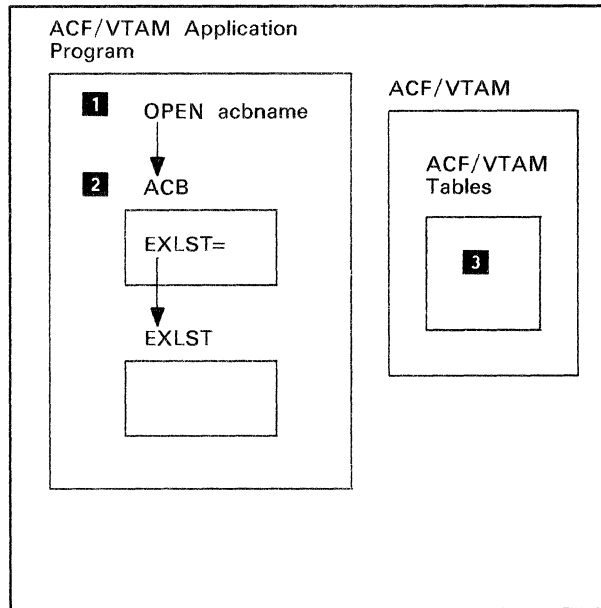

- 1** The OPEN macro instruction specifies an access method control block (ACB).
- 2** The ACB contains information about the application program and can specify a set of user-written exit routines to be invoked when specific events occur.
- 3** ACF/VTAM updates its internal tables to indicate that the application program is active and that the EXLST exit routines are eligible for scheduling.

Figure 11. Identifying an Application Program to ACF/VTAM

An alternative technique, which can be used by authorized application programs, combines into one macro instruction both the session initiation request and the session establishment request. Thus by issuing OPNDST OPTCD=ACQUIRE, the application program requests the SSCP to give permission to establish a session and then sends a Bind Session request to the SLU. No LOGON exit routine or OPNDST OPTCD=ACCEPT is required.

Whenever OPNDST is issued in any of these techniques, the OPNDST macro instruction designates a *request parameter list* (RPL), which gives parameters (such as ACCEPT or ACQUIRE) for the operation. The RPL in turn specifies a *node initialization block* (NIB). The NIB identifies the session to be established (for example, by using a *communications identifier* (CID) originally obtained in the LOGON exit routine) and also specifies parameters to be used by ACF/VTAM and by the SLU after the session has been established. At the completion of the OPNDST, ACF/VTAM has placed additional information about the session into the RPL and NIB. Figure 12 illustrates the use of control blocks for acquiring logical units.

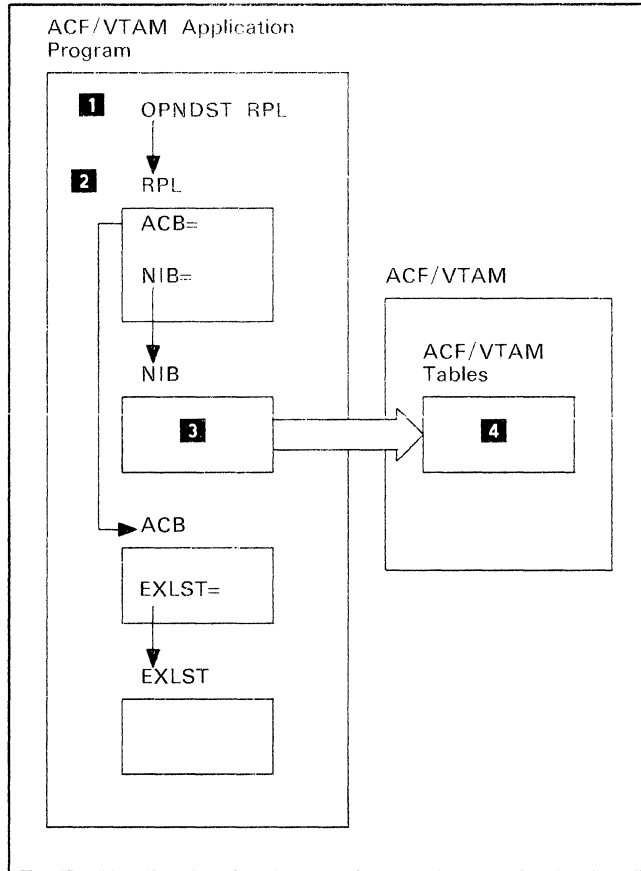

- 1** The OPNDST macro instruction specifies a request parameter list (RPL).
- 2** The RPL describes the request for session establishment and specifies one or more node initialization blocks (NIBs).
- 3** Each NIB identifies the session to be established, for example, by describing the logical unit to be the SLU in the session.
- 4** When ACF/VTAM completes the session establishment, the logical unit information from the NIBs is moved into internal ACF/VTAM tables. ACF/VTAM notifies the application program by posting an ECB or by scheduling an RPL exit routine.

**Figure 12. Establishing a Session with a Secondary Logical Unit**

## The SLU's Role in Session Establishment

It is possible to initiate a session in which an ACF/VTAM application program will act as the SLU. Such a session initiation request may come from many sources, including the application program itself (by issuing a REQSESS macro instruction). As described in the previous section, such a session initiation request is sent to the SSCP, which in turn sends a request to the PLU. If the PLU accepts the request for a session, it sends a Bind Session request to the application program, which receives the request in its SCIP exit routine. If the application program then chooses to accept the session, it issues an OPNSEC macro instruction; if it chooses to reject the session, it issues a SESSIONC macro instruction. Figure 13 shows the process of establishing a session between two application programs.

An RPL and a NIB are used with OPNSEC in the same way as they are used with OPNDST as described in the previous section.

## Requesting Data Transfer

ACF/VTAM uses data transfer macro instructions for communication on a session. An application program acting as the PLU in the session usually must request that the flow of data between itself and the SLU be allowed. This is done either when the session is established, using the OPNDST macro instruction, or after, using the SESSIONC macro instruction. When the session is established and the flow of data is allowed, data transfer can be started by either of the logical units.

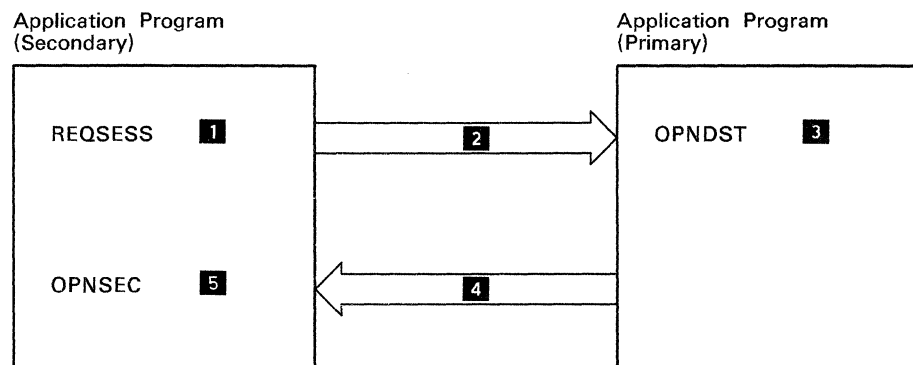

- 1** The application program that will act as the secondary end of the session (the SLU) issues a REQSESS macro instruction to request a session with an application program that will act as the primary end of the session (the PLU).
- 2** ACF/VTAM notifies the PLU that a request for a session has been received.
- 3** The PLU issues an OPNDST macro instruction to accept the request and to establish the session.
- 4** ACF/VTAM notifies the SLU that the PLU wishes to establish a session.
- 5** The SLU issues an OPNSEC macro instruction to complete the session establishment.

Figure 13. Establishing a Session with a Secondary Logical Unit

An application program (whether acting as the primary or secondary end of a session) issues a SEND macro instruction to transfer data to ACF/VTAM buffers. If a cryptographic session has been established, data will be enciphered before being sent outside of the host processor. An application program issues a RECEIVE macro instruction to transfer data from ACF/VTAM buffers to the application program's data area. If the data has been enciphered, it will be deciphered before being transferred to the application program's data area.

## **Terminating a Session**

Session termination can be requested by a primary or secondary logical unit, or by the ACF/VTAM operator. Sessions are also terminated by ACF/VTAM when a failure of the session path occurs.

### ***Termination Requested by a Secondary Logical Unit***

A secondary logical unit can request conditional or unconditional termination of a session with an application program. When session termination is requested, ACF/VTAM notifies the application program of the request by invoking an application program exit routine. For conditional termination requests, the program then has the option of terminating the session or ignoring the request. When unconditional session termination is requested, ACF/VTAM notifies the application program that the session must be terminated by invoking an exit routine.

When an application program acting as the SLU in a session wishes to end a session, it can request session termination by issuing a TERMSSESS macro instruction. If the PLU is an ACF/VTAM application program, it is notified in the same manner as previously described.

### ***Termination Requested by a Primary Logical Unit***

When an application program acting as the PLU in a session wishes to end a session, it issues a CLSDST macro instruction. This type of session termination might be the normal procedure for terminating a batch output operation.

### ***Session Termination Initiated by the ACF/VTAM Operator***

An ACF/VTAM operator can use the VARY command to terminate sessions or deactivate one or both ends of a session.

### ***Releasing and Passing a Secondary Logical Unit***

When an application program acting as the PLU in a session issues a CLSDST macro instruction, the macro instruction specifies whether the SLU in the session is to be *released* or *passed*. When a secondary logical unit is released, it is free to establish a new session with another logical unit. When the logical unit is passed, a session initiation request is generated requesting a session between the SLU and a specified PLU. This type of CLSDST can be useful when a logical unit uses a sequence of application programs.

### ***Session Termination by ACF/VTAM***

When ACF/VTAM is informed of the failure of a session path, it terminates the session and notifies the PLU or SLU application program of the session failure. (For a session between two application programs, both application programs are notified.) The notification is passed to an application program exit routine.





## Chapter 6. Other Telecommunication Access Methods

ACF/VTAM can coexist in the same host processor with BTAM, TCAM, and ACF/TCAM under OS/VS and with BTAM-ES under VSE.

### ACF/VTAM and Other Access Methods under OS/VS

In an OS/VS system, BTAM, ACF/TCAM (or TCAM), and ACF/VTAM can operate concurrently (see Figure 14).

BTAM application programs use BTAM to communicate with terminals attached to transmission control units, terminals attached to communication controllers in emulation mode, or channel-attached non-SNA terminals.

ACF/TCAM (or TCAM) application programs use ACF/TCAM (or TCAM) to communicate with terminals attached to communication controllers in network control mode, terminals attached to communication controllers in emulation mode, terminals attached to transmission control units, or channel-attached terminals.

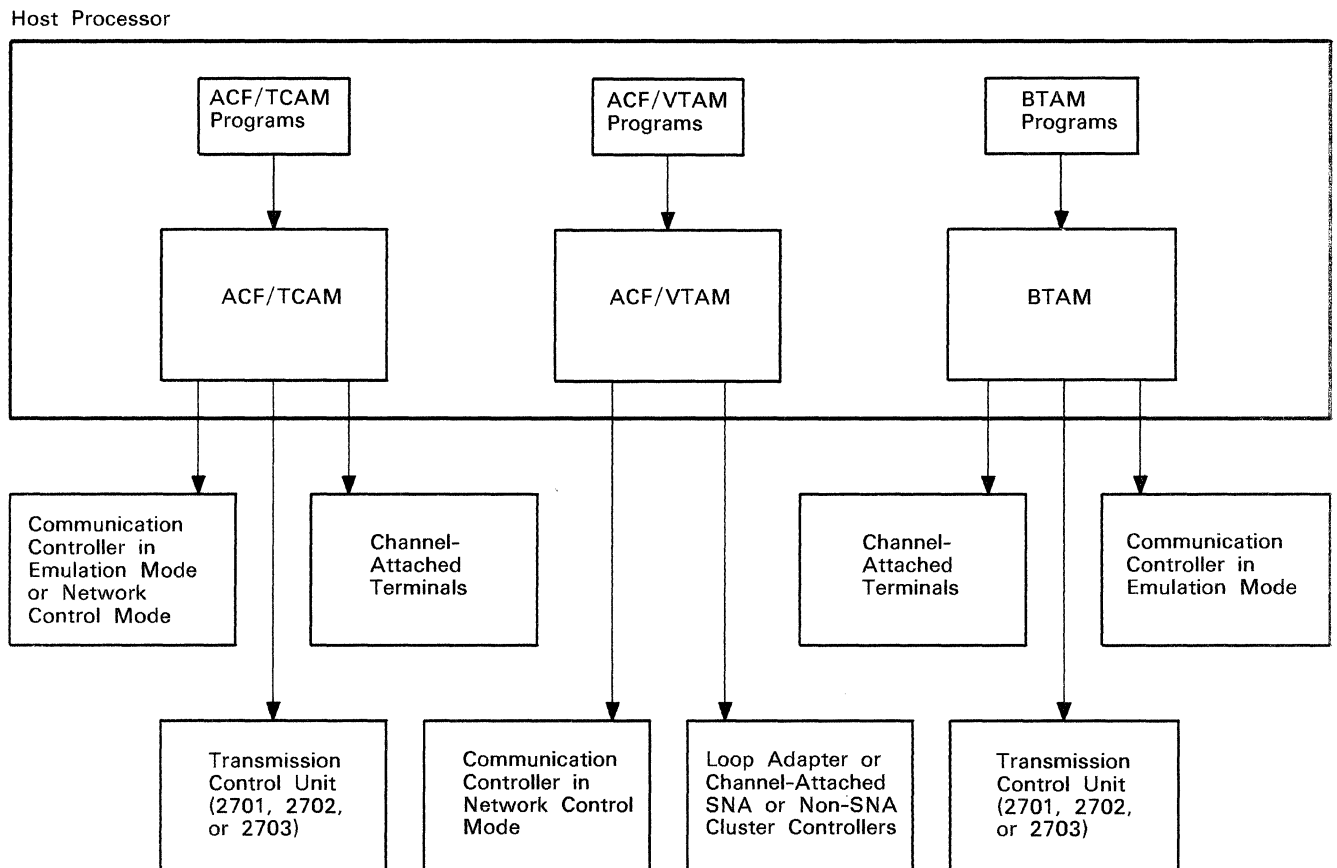

Figure 14. ACF/VTAM with Other Telecommunication Access Methods in OS/VS

ACF/VTAM application programs use ACF/VTAM to communicate with logical units attached to communication controllers in network control mode, logical units attached through a loop adapter or communication adapter, and channel-attached terminals (see Appendix A).

Lines attached to communication controllers using Partitioned Emulation Programming (PEP) can be used in either network control mode or emulation mode with an appropriate access method.

With concurrent execution of access methods, a single application program can use ACF/TCAM (or TCAM), BTAM, and ACF/VTAM to communicate with separate networks, provided that all requirements of the access methods are met.

### ACF/VTAM and BTAM-ES under VSE

In a VSE system, BTAM-ES and ACF/VTAM can operate concurrently (see Figure 15).

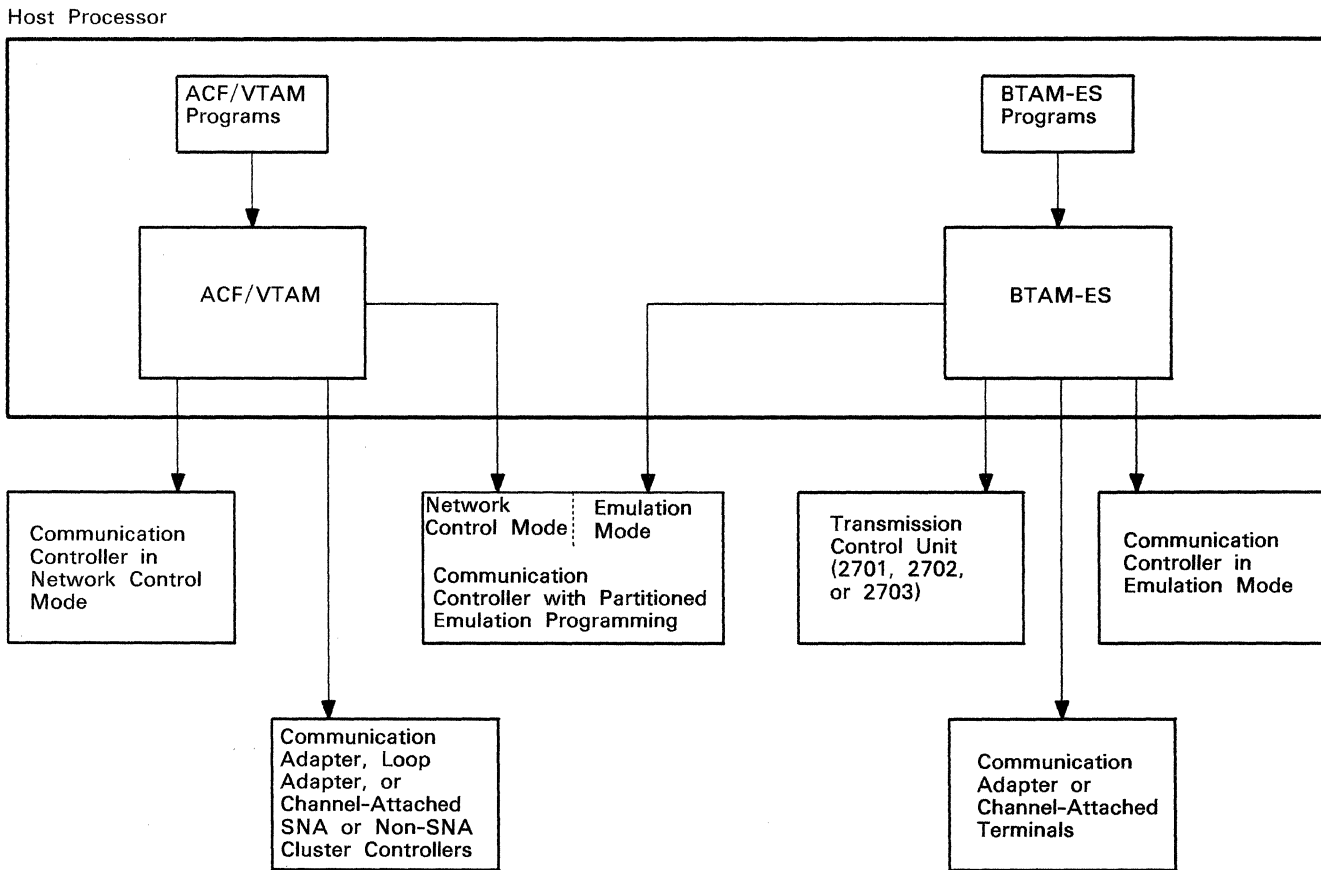

Figure 15. ACF/VTAM with BTAM-ES in VSE

BTAM-ES programs use BTAM-ES to communicate with terminals attached to transmission control units, terminals attached to communication controllers in emulation mode, or channel-attached terminals.

ACF/VTAM application programs use ACF/VTAM to communicate with logical units attached to communication controllers in network control mode, logical units attached through a loop adapter, or communication adapter, and channel-attached terminals (see Appendix A).

Lines attached to communication controllers using Partitioned Emulation Programming (PEP) can be used in either network control mode or emulation mode with an appropriate access method.

With concurrent execution of access methods, a single application program can use both BTAM-ES and ACF/VTAM to communicate with separate networks, provided that all requirements of both access methods are met.

### ACF/VTAM, ACF/VTAME, and ACF/TCAM in a Multiple-Domain Network

In a multiple-domain network, resources in an ACF/VTAM domain can communicate with resources in an ACF/TCAM or an ACF/VTAME domain, whether in the same host or different hosts, provided that all requirements for cross-domain communication of both access methods are met. Figure 16 illustrates use of ACF/VTAM and ACF/TCAM in a multiple-domain network. In addition, other access methods can operate in each host processor as described above. See *Systems Network Architecture Concepts and Products* for more information about ACF/TCAM and ACF/VTAM in a multiple-domain network.

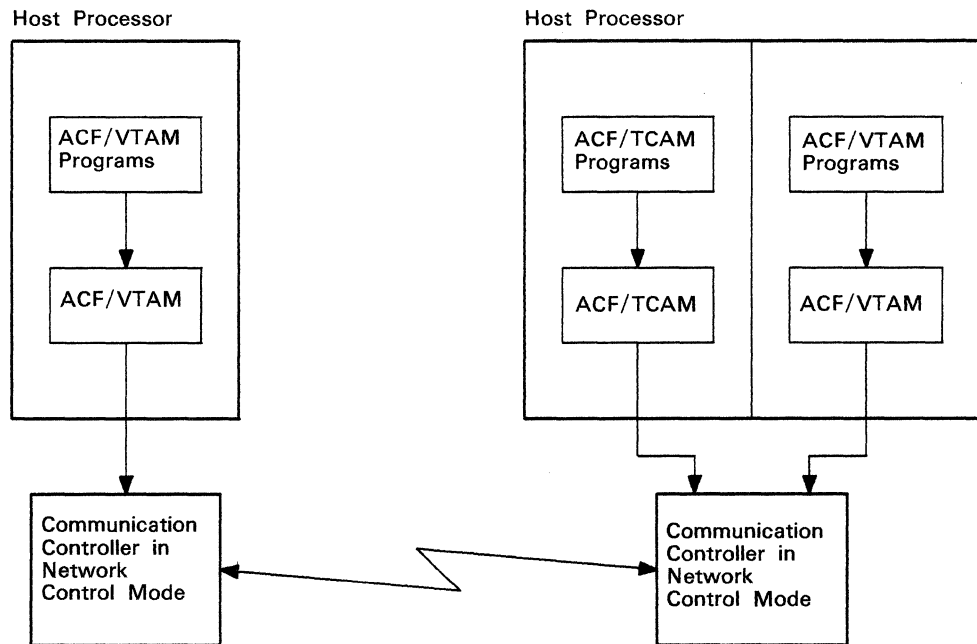

Figure 16. ACF/VTAM with ACF/TCAM in a Multiple-Domain Network



## Chapter 7. Reliability, Availability, Serviceability

### ACF/VTAM's RAS Strategy

ACF/VTAM, in conjunction with the operating system, provides a comprehensive set of reliability, availability, and serviceability (RAS) aids for the ACF/VTAM domain. These RAS aids are intended to:

- Prevent problems by detecting certain domain conditions or improper requests
- If a problem occurs, aid in the diagnosing and subsequent correction of the problem
- After the problem has been corrected, enable the ACF/VTAM domain to be recovered and restarted.

RAS aids can be divided into diagnostic aids and recovery aids. Diagnostic aids include operating system traces and dumps, device-level tests (such as the link-level 2 test and the LU connection test), and the Teleprocessing Online Test Executive Program (TOLTEP), a device diagnostic facility. ACF/VTAM processes the output from these facilities to make the results easier for users to interpret. Recovery aids include operating-system hardware and software error-recovery programs, as well as communication controller recovery aids.

### Diagnostic Aids

#### *ACF/VTAM Trace Facilities*

ACF/VTAM provides traces to record (for example) input and output activity, buffer information, activity on lines attached to the NCPs, and internal ACF/VTAM activity. More than one trace can be active concurrently. The ACF/VTAM operator can use the MODIFY command to start or stop a trace at any time and to specify trace options, where appropriate. Some traces can also be specified with ACF/VTAM start options.

In OS/VS, the trace data is collected by the Generalized Trace Facility and printed using ACF/TAP or the PRDMP utility. Any cryptographic values and any data belonging to cryptographic sessions are suppressed. In VSE, the trace data is stored in a trace file and printed using ACF/TAP or an ACF/VTAM trace print utility.

ACF/VTAM provides the following types of traces:

- The buffer content trace, which records the text that passes through ACF/VTAM buffers.
- The storage management services trace, which records how ACF/VTAM uses its buffer pools.

- The I/O trace, which records the I/O activity associated with a particular resource.
- The NCP line trace, which provides an SDLC line trace for a line attached to an NCP.
- The transmission group (TG) trace, which provides an SDLC line trace for a transmission group. (See “Parallel Links” elsewhere in this chapter.) Message traffic over a transmission group between two communication controllers can be traced as if it were a single SDLC link.
- The NCP generalized PIU trace (GPT), which traces data passing through the NCP to or from a specified resource.
- The ACF/VTAM internal trace, which keeps a record of ACF/VTAM’s resources and flow of control. Information can be recorded on a trace table in fixed storage or can be recorded externally.
- In OS/VS2 (MVS), the TSO component trace, which traces activity associated with a particular TSO user ID.

ACF/VTAM also records tuning statistics about the I/O interface between ACF/VTAM and any of the following:

- a channel-to-channel connection with an adjacent host processor
- a channel-attached communication controller
- a channel-attached SNA cluster controller

Collection of these statistics, as well as the display of these statistics at the system console, can be started or stopped with the MODIFY command.

### **Additional Trace Facilities**

The operating system provides traces that help the user to determine whether a problem is the result of a user error or system error and, in the latter case, which system component caused the error.

**OS/VS Trace Facility:** The Generalized Trace Facility (GTF) is the trace mechanism employed by OS/VS. This feature traces input/output, supervisor call instructions (SVCs), program interruptions, external interruptions, and the dispatching of tasks in the operating system as well as in ACF/VTAM. In addition, GTF records the ACF/VTAM trace data. The ACF/VTAM traces can be started or stopped any time GTF is active. The PRDMP utility is used to print GTF information. PRDMP can be used to print ACF/VTAM information.

**VSE Trace Facilities:** Trace facilities for VSE monitor fetch/load, input/output, supervisor call instructions (SVCs), and ACF/VTAM. Data collected by these traces provides a chronological record of certain ACF/VTAM activities and shows conditions that existed when an error occurred. A VSE utility program can be used to print trace data.

## ***Formatted Dumps (OS/VS Only)***

Formatted dump programs are available to ACF/VTAM users through the operating system. They are ABDUMP, SDUMP, and a service-aids dump.

***ABDUMP:*** ABDUMP is called with the operating system's ABEND or SNAP macro instruction. The dump consists of the major control blocks of the terminated task, its subtasks, and its direct callers, as well as any pages within the failing partition or region that were referred to during execution and are still allocated. Dumps of programs using ACF/VTAM are formatted by the ACF/VTAM formatted-dump programs. The formatted-dump program examines ACF/VTAM control blocks and prints diagnostic messages if control block chains are broken or invalid addresses are present.

***SDUMP:*** If an error occurs while an ACF/VTAM request is being processed, and if the user has provided an SYS1.DUMP data set, an unformatted SVC dump (SDUMP) is taken. When an SDUMP is printed by the PRDUMP utility, the ACF/VTAM formatted-dump program formats the control blocks associated with ACF/VTAM. In OS/VS2 (MVS), the system operator can request an SVC dump from the system console.

***Service-Aids Dump:*** The operating system provides a stand-alone service aid named AMDSADMP in OS/VS2 (MVS) or HMDSADMP in OS/VS1 to dump the contents of main storage to a printer or tape. This service aid does not produce formatted control blocks. For dumps that are printed by PRDUMP, however, the ACF/VTAM formatted-dump program can be invoked to format control blocks associated with ACF/VTAM application programs from the original dump.

## ***NCP Dumps***

ACF/VTAM uses the NCP dump program to dump the contents of a communication controller. An NCP dump is taken automatically if the NCP fails and an automatic dump was specified as part of the generation of that NCP. If an NCP fails and an automatic dump was not specified, the ACF/VTAM operator is notified of the failure and is given the option of requesting a dump of the NCP.

An NCP can also be dumped at the request of the ACF/VTAM operator. When requesting an NCP dump, the operator can specify either a dynamic dump or a static dump of the NCP.

For a dynamic dump, the dump takes place while the NCP is running. The dump data represents the NCP over the period of time the dump transmission takes. The storage contents of the NCP could change from the time the request is made until the time the data is transmitted, but NCP processing is not interrupted.

For a static dump, the NCP is stopped and dumped. The dump data represents the NCP at a given point in time. The storage contents of the NCP does not change while the dump is in progress, but NCP processing is interrupted and the NCP must be reloaded.



## TOLTEP

The Teleprocessing Online Test Executive Program (TOLTEP) is a test facility that oversees the execution of online testing of data communication devices. TOLTEP allows online tests to run while the data communication system continues normal operations. The online tests perform diagnostic procedures on devices and verify their operation. More than one online test can be run at a time. TOLTEP is included in the system when ACF/VTAM is generated and is started and stopped with ACF/VTAM. For more information on TOLTEP, see *ACF/VTAM Diagnosis Guide*.

## Error Recording

**Hardware Errors:** ACF/VTAM uses its own error-recovery procedures to compile information on I/O errors. These procedures interface with the operating system's recording facilities to format and write the error records to a direct-access device. In OS/VS, the outboard recorder is used to record errors that occur on channel-attached terminals, while the miscellaneous data recorder is used to record errors on link-attached terminals. In VSE, the recovery management support recorder is used to record errors that occur on both channel-attached and link-attached terminals.

For channel-attached terminals, two types of error records are written: permanent-error records and counter-overflow/end-of-day error records. A permanent-error record is written when the error-recovery procedures either encounter an undefined or unanticipated error or are unsuccessful in retrying an I/O operation. A counter-overflow/end-of-day error record is written when one of the counters updated by ACF/VTAM is ready to overflow, or when an end-of-day situation occurs. Two counters are maintained in ACF/VTAM: one counter saves the count of temporary errors (errors corrected by the error-recovery procedures) and the other saves the count of Start I/O commands issued. Other counters are maintained in the operating-system device statistics table of unit check errors by error type for each channel-attached terminal. All of the counters appear in each record; and after the record is written, the counters are reset to 0.

I/O errors on link-attached terminals attached to a channel-attached communication controller are processed by routines in the NCP in the communication controller. Information on the cause of the error is passed to ACF/VTAM for forwarding to the operating system's facilities.

The Network Problem Determination Application (NPDA) program product, when used with the NCCF program product, assists users in performing problem determination by collecting and interpreting records of errors detected within a network and by recommending possible responses. The NPDA user has access, through a terminal, to the accumulated error data and statistics. NPDA uses cross-domain communication to permit displays of errors collected in other domains that are running equivalent releases of NPDA. For more information on NPDA, see *Network Problem Determination Application: General Information*.

**Intensive Mode Error Recording:** The ACF/VTAM operator can initiate intensive mode error recording by means of the MODIFY command. This facility records error information about temporary errors over a link to a device controlled by an NCP.

**Software Errors (OS/VS Only):** The software error recording facility (SRF) is used by ACF/VTAM. Special routines receive control on abend conditions, machine checks, and unanticipated program checks. Control is then passed to SRF routines for error recording and then to retry routines.

### ***Printing Error Records***

The operating system's error recording edit and print program (EREP) can be used to select, format, and print the error records.

By using NPDA in conjunction with NCCF, detailed subsystem and communication link error records can be obtained for analyzing network problems.

### ***Link-Level 2 Test (SDLC Link Test)***

The ACF/VTAM operator can request a link test between the following resources:

- A communication controller and a cluster controller
- Two communication controllers
- A host processor and a cluster controller attached through a communication adapter (VSE only)
- A host processor and a communication controller attached through a communication adapter (VSE only)
- Two host processors attached through communication adapters (VSE only)

When the test is requested, test data is sent to the link station. If the data is received, the link station echoes the data back to the NCP or host processor that initiated the request. The results of this link test are returned to the ACF/VTAM operator.

### ***LU Connection Test***

This test allows a USS terminal user to verify that an operational path exists between the terminal and its owning ACF/VTAM. The user may, optionally, specify the test data to be sent to ACF/VTAM as well as how many times ACF/VTAM is to echo the input data back to the terminal.

### ***Route Verification***

The ACF/VTAM operator can test whether a route originating in the operator's host is operative or inoperative. A test message is sent along the route resulting in a reply that indicates whether the route is available. If the route is available, the success of the test is reported to the test originator. If the test message cannot be sent along the entire route, the reply includes information to aid in locating the inoperative part of the route. Additionally, as part of the verification, appropriate resource owners are notified when an inactive or inoperative resource is encountered on a route.

## ***Reporting of Pending Events***

Reporting of pending events provides information to the ACF/VTAM operator on events that have been pending for longer than a specified length of time.

## ***Message Module Identification***

An ACF/VTAM message can optionally contain the name of the internal ACF/VTAM programming module that issued the message.

## **Recovery Aids**

### ***Error Recovery Procedures***

***Hardware Errors:*** When an I/O error interruption occurs for a channel-attached terminal, ACF/VTAM error-recovery procedures determine the type of error from the channel status word (CSW) and sense information and then attempt to recover from the error. The method used to attempt recovery is device dependent and is described in the functional characteristics manual for each terminal. Error-recovery procedures for terminals, control units, and lines attached to the communication controller in network control mode are provided by the NCP.

***Software Errors (OS/VS Only):*** Software error-recovery procedures are closely connected with the error exit routines established by the STAE or ESTAE macro instruction. These routines are system dependent.

The general approach to software error recovery is to attempt isolation of the error and to limit its effect on other parts of the system. In certain instances, ACF/VTAM attempts to reinitialize a failing module in order to maintain the function. In other instances, ACF/VTAM terminates a failing application program, or deactivates a failing network component to allow the remaining components to continue. Where possible, ACF/VTAM reallocates resources no longer in use.

### ***Restart/Recovery***

The restart and recovery facilities safeguard the operating system and communication controller environments. The facilities allow a communication controller to be restarted and allow reestablishment of the network configuration.

***Configuration Restart:*** ACF/VTAM provides the capability to restore the domain after a failure occurs. An *immediate configuration restart* occurs as soon as an error is detected. ACF/VTAM automatically attempts to restore the status of an SNA terminal that has lost contact with ACF/VTAM or the status of a failed NCP that requires reloading.

A *delayed configuration restart* is caused by an operator command and is applicable after:

- An ACF/VTAM failure
- A host operating system or host processor failure
- A communication controller or an NCP failure from which ACF/VTAM did not immediately recover
- Deactivation of the domain (or any part of it) by the ACF/VTAM operator

When restarting ACF/VTAM and its domain, the ACF/VTAM operator can specify whether parts of the domain are to be activated to their status prior to deactivation or failure (a *warm* restart) or to be activated to their status as specified when they were defined to ACF/VTAM (a *cold* restart).

If the NCP must be reloaded during the restart, logical unit-to-logical unit sessions using that NCP will be disrupted. If reactivation of the physical units or logical units is unsuccessful, sessions are disrupted. If the reactivation is successful, and the physical units and logical units support nondisruptive recovery requests [ACTPU(ERP) and ACTLU(ERP)], sessions can continue. Consult the appropriate device publication to determine if nondisruptive recovery is supported. For ACF/NCP/VS Version 1 Release 2.1, sessions are also disrupted if physical units or associated logical units must be reactivated.

After a failure that disrupts an SSCP-SSCP session, ACF/VTAM can restart that session without disrupting LU-to-LU sessions that were not directly affected by the failure.

***Integrity of Application Program Data:*** The ACF/VTAM posting facilities, which use the CHECK macro instruction, help provide data integrity in case ACF/VTAM or an NCP fails. An application program can ask for notification when a request has been completely transmitted. If the transmission was not successful, the application program is informed. The application program is assumed to be holding the data buffer until notified of a complete transmission. If ACF/VTAM fails, application programs can disconnect from ACF/VTAM and continue with other processing until ACF/VTAM is restarted. On a communication controller permanent error, the application program should terminate sessions with the logical units associated with that communication controller, but can continue execution using other logical units.

### ***Parallel Links***

More than one SDLC link can operate concurrently between communication controllers (except when ACF/NCP/VS Version 1 Release 2.1 is installed). These links can be grouped to form a logical link called a *transmission group*. Each physical link in a transmission group is activated and deactivated individually. When messages are transmitted over a transmission group, all of the links in the group are used, thereby increasing the effective bandwidth of the group. There can also be more than one transmission group between communication controllers.

If one of the links in a transmission group fails, session traffic continues to flow on the remaining links in the group without losing messages or changing the order of the messages unless there are no remaining active links in the group. ACF/VTAM notifies the affected ACF/VTAM operators of failures involving individual links in a transmission group.

### ***Multiple Routes***

The user can define up to eight routes between two subareas (except when ACF/NCP/VS Version 1 Release 2.1 is installed). This feature improves network reliability as well as possibly increasing the through-put of messages in the network.

### ***Session Outage Notification***

If a session's message route becomes inoperative, ACF/VTAM notifies the primary and secondary logical units of the outage. The logical units can then attempt to restore the session using an alternate route.

### ***Resource Takeover***

ACF/VTAM has network definition options and ACF/VTAM operator commands that allow the user to change the configuration of the network to avoid problems in specific elements. The user can use a switched line to back up a nonswitched line or use one host processor to back up another host processor.

## Chapter 8. Summary of ACF/VTAM

ACF/VTAM is a data communication access method compatible with Systems Network Architecture (SNA). ACF/VTAM controls communication among logical units in a single-domain or multiple-domain network. The optional Encrypt/Decrypt Feature (OS/VS only), in combination with the prerequisite Programmed Cryptographic Facility Program Product, provides the ability to encipher data and thereby enables improved data security.

### ACF/VTAM Version 2 Functions

ACF/VTAM Version 2 (Program Numbers 5665-280 [MVS], 5662-280 [OS/VS1], and 5666-280 [VSE]) provides the following enhancements over ACF/VTAM Version 1 and ACF/VTAME:

- Offers a simplified packaging of the distribution medium for easier installation (by putting the basic material on one tape)
- Provides a multiple-domain network capability without the need for the Multisystem Networking Facility (MSNF) feature. The functions provided by MSNF are an integral part of ACF/VTAM Version 2.
- Permits the channel-to-channel connection of two host processors (both containing ACF/VTAM Version 2 and an OS/VS operating system).
- Permits devices and host processors to be attached to a 4331 or 4321 processor through a communication adapter (VSE only). Two host processors can be connected through communication adapters provided that both have a communication adapter and each contains either ACF/VTAM Version 2 or ACF/VTAME.
- Permits the system programmer to modify ACF/VTAM operator messages
- Permits the system programmer to modify certain ACF/VTAM operator commands
- Enables an ACF/VTAM operator to select the dump data set to be used when specifying an NCP dump
- Permits the use of a device-type logical unit that can perform the functions of a primary logical unit.
- Enables an application program to send a large message to a SNA logical unit and request that ACF/VTAM split the message into a multiple request unit (RU) chain, if necessary.
- Enables an application program to send a message using non-contiguous data buffers
- Permits an application program to define its own request header (RH) to be used with any given message
- Permits an application program to issue an exception request
- Provides an application program with a user field within the ACB

- Provides an application program with information about the level of access method support that is available to it. The following information is available:
  - That the access method is ACF/VTAM Version 2
  - Whether the ACF/VTAM Encrypt/Decrypt feature is installed
  - Which ACF/VTAM functions are available to the application program
  - The network name of the application program logical unit
  - The ACB name of the application program logical unit
- Provides improved information to the ACF/VTAM operator in the event of a TSO logon failure (MVS only)
- Provides an improved I/O trace that traces only real I/O events
- Places the latest PTF number next to the module name in a dump
- Allows a 3036 Console to be allocated as an ACF/VTAM terminal

In addition to the enhancements listed above, ACF/VTAM Version 2 provides the following enhancements over VTAM Level 2:

- Permits two application programs to communicate over an SNA session
- Allows concurrent multiple sessions between application programs
- Permits negotiable session parameters between application programs
- Provides request traffic pacing between application programs
- Provides inbound request traffic pacing from terminals that support inbound pacing
- Permits application programs in one domain to communicate with application programs and terminals in other domains
- Permits terminals attached to one host processor to communicate with application programs in other host processors
- Establishes, controls, and terminates access to application programs and SNA terminals in other parts of the multiple-host network
- Allows a communication controller of one host processor to be transferred to an adjacent host processor
- Permits the terminals of one communication controller to be shared by more than one host processor
- Provides enhanced operator control of session termination
- Provides additional ACF/VTAM operator display capabilities

- Permits dynamic reconfiguration of nonswitched SNA devices
- Provides continued support of selected non-SNA terminals in conjunction with the Network Terminal Option program product
- Enables TSO/VTAM support of selected non-SNA terminals in conjunction with the Network Terminal Option program product (MVS only)
- Allows multiple SDLC links (transmission groups) between communication controllers
- Allows multiple routes between subareas
- Permits multiple transmission priority levels
- Enables extended interconnection of communication controllers
- Provides enhanced network flow control
- Has reduced cross-domain resource definition requirements
- Provides enhanced notification of session outages
- Has enhanced recovery capabilities
- Provides route verification and error notification facilities
- Has additional tracing capabilities
- Provides enhanced link-level 2 test
- Provides a logical unit connection test
- Permits intensive mode recording of NCP SDLC data link errors
- Enables dynamic display of NCP storage
- Permits dynamic dump of NCP storage
- Provides dynamic expansion and contraction of ACF/VTAM buffer pools
- Provides dynamic collection of statistics that can be used in adjusting the network's performance characteristics
- Permits an application program, such as the Downstream Load Utility (DSLUI) program product, to use the communication network management (CNM) interface to satisfy the load requirements of certain type 2 physical units, such as the IBM 8775 (OS/VS1 and VSE only).



## Operating Environment

### *Machine Requirements*

ACF/VTAM runs in a virtual storage environment in any IBM host processor that supports the OS/VS2 (MVS), OS/VS1, or VSE operating system as specified in the "Programming Requirements" section below.

The host processor instruction set must include the Compare and Swap and the Compare Double and Swap instructions.

For remote communication, ACF/VTAM can use a 3705-I, 3705-II, or 3705-80 Communications Controller with the appropriate level of ACF/NCP/VS.

- A communication controller is required for remote communication only in OS/VS systems and in VSE systems where the host processor does not have a communication adapter.
- In VSE systems, ACF/VTAM can also use the 4331 or 4321 communication adapter for remote communication with link-attached SNA and non-SNA terminals. An SDLC, BSC, or combined SDLC-BSC communication adapter can be used, depending on the line requirements of the terminals.

See Appendix A for a list of supported terminals.

### *Storage Requirements*

Requirements for host processor storage and for disk storage for ACF/VTAM data sets can be calculated by using *ACF/VTAM Planning and Installation Reference*. Requirements for disk storage for NCP data sets can be calculated by using the appropriate NCP installation manual. (See Appendix B.)

Storage requirements for TOLTEP data sets are included as part of ACF/VTAM data set storage in the publications mentioned above, because TOLTEP is included in ACF/VTAM. Disk storage information for the online tests is provided by the IBM program support representative.

Storage requirements for communication controllers can be calculated by using the appropriate NCP installation manual. (See Appendix B.)

### *Programming Requirements*

ACF/VTAM Version 2 needs one of the following operating systems:

OS/VS1 Release 7.0

OS/VS2 Release 3.8 (MVS)

VSE/AF Release 3

ACF/VTAM will also operate with subsequent releases or modifications of these operating systems, unless otherwise stated in the announcement documentation for these releases or modifications. ACF/VTAM does not support prior releases of those operating systems.

The Time Sharing Option of ACF/VTAM (TSO/VTAM) operates only under OS/VS2 (MVS).

The use of certain ACF/VTAM facilities (such as delayed configuration restart or the ACF/VTAM Encrypt/Decrypt Feature) requires the current level of Virtual Storage Access Method (VSAM). If VSAM is to be used, ACF/VTAM requires the appropriate compatibility PTF.

The optional feature, ACF/VTAM Encrypt/Decrypt Feature, requires the Programmed Cryptographic Facility program product.

The following functions are supported when ACF/VTAM Version 2 operates with ACF/NCP/VS Version 1 Release 2.1 or 3:

- Cross-domain communication for channel-attached devices
- Simultaneous multiple sessions between application programs
- Negotiable session parameters between application programs
- Enhanced operator control of session termination
- LU connection test
- Dynamic display of NCP storage
- Dynamic dump of NCP storage
- Enhanced link-level 2 test
- Intensive mode recording of NCP SDLC link errors
- Dynamic reconfiguration of nonswitched SNA devices
- Simplified cross-domain resource definition

The following functions are supported only when ACF/VTAM Version 2 operates with ACF/NCP/VS Version 1 Release 3 or Version 2:

- Multiple routes between subareas
- Multiple SDLC links (transmission groups between adjacent NCPs)
- Extended interconnection of communication controllers
- Multiple transmission priority levels
- Enhanced notification of session outages
- Enhanced network flow control
- Route verification and error notification facilities
- Enhanced recovery capabilities

The following functions are supported only when ACF/VTAM Version 2 operates with ACF/NCP Version 2:

- Generalized PIU trace (GPT)
- Notification of session establishment and termination (through NLDM - MVS only)
- Continuous trace of PIU data passing between selected network resources (through NLDM - MVS only)

## Compatibility

### *NCP*

ACF/VTAM Version 2 operates with ACF/NCP Version 2 and with ACF/NCP/VS Version 1 Releases 2.1 and 3.

Some of the functions of ACF/VTAM Version 2 require the appropriate release of ACF/NCP/VS, as indicated in the previous section of this chapter.

Like ACF/VTAM Version 1 Releases 2 and 3, ACF/VTAM Version 2 supports only record-mode sessions. The Network Terminal Option program product (or a similar user-written program) can be used to support selected non-SNA devices in record-mode sessions.

### *ACF/VTAM Application Programs*

As each new release of ACF/VTAM was developed, new application program facilities were added, obsolete facilities were deleted, and errors were corrected. Internal changes were also made to improve performance, reliability, availability, and serviceability. In this activity, the goal was to allow application programs that ran on a prior release of VTAM to run on the new release of ACF/VTAM without modification or reassembly of the application program. However, in certain cases an application program must be modified.

The table in Figure 17 lists the factors to consider when moving an application program from a prior release of VTAM to ACF/VTAM Version 2. Each factor is discussed in detail in *ACF/VTAM Programming*.

An existing user program may require modification if it depends on the internal processing characteristics of VTAM or ACF/VTAM, such as the sequence of steps when processing an operator command or synchronous SIMLOGON macro instruction. Existing programs also may require changes to make use of the ACF/VTAM's networking capabilities.

Program operator application programs can run unchanged, provided they do not depend on the structure or content of the ACF/VTAM message table (ISTCFCMM in MVS and VSE, ISTCFAMM in OS/VS1). That is, no change is required for a program operator if it depends only on the documented program operator interface and on the content, structure, and meaning of the messages received through this interface. However, any program operator that depends on the structure or content of ISTCFCMM or ISTCFAMM might require changes.

## BTAM Application Programs

Existing application programs that use BTAM macros directly must be rewritten to operate with ACF/VTAM Version 2. BTAM application programs that use an IBM application subsystem such as CICS/VS or IMS should require few changes, if any, to run on ACF/VTAM Version 2. Consideration for converting from BTAM to ACF/VTAM are discussed in the *ACF/VTAM Planning and Installation Reference*.

## Related IBM Programs

If USS facilities are used to change ACF/VTAM messages, NCCF may need to be modified to ensure the correct routing of messages. Refer to *NCCF Installation* for more information.

Related IBM programs such as CICS/VS, IMS/VS, POWER/VS, JES1/RES, JES2/RJE, TSO, VSPC, and SSS that are compatible with VTAM Level 2 or ACF/VTAM Version 1 are compatible with ACF/VTAM Version 2 on the appropriate operating system release. Recompilation of these programs is not required.

TCAM through VTAM is not provided with ACF/VTAM. However, ACF/TCAM can exist in the same host processor as ACF/VTAM.

Programming Factors To Be Considered:	When Migrating to ACF/VTAM Version 2 From:			
	VTAM Level 2	ACF/VTAM Version 1 Release 1	ACF/VTAME or ACF/VTAM Version 1 Release 2	ACF/VTAM Version 1 Release 3
Sequence Number Dependencies for LU Type 0 3270 Terminals	●	●	●	●
Logon Mode Names for Non-SNA 3270 Terminals	●			
Search of Default Logon Mode Table	●			
Bracket Protocols for Non-SNA 3270 Terminals	●			
Reporting Segmenting Errors	●			
Removal of Basic-Mode Support	●	●		
LOSTERM Exit Reason Codes	●	●		
Reporting Failures When NIB USERFLD Is Specified	●	●		
Parallel Sessions and the Use of NIBCID	●	●		
CLEAR Not Sent Before UNBIND	●	●		
SETLOGON OPTCD=QUIESCE	●	●		
SIMLOGON OPTCD=CONALL	●	●		
COS Name and Logon Mode Name	●	●	●	
Increase of ACB Size	●	●	●	●

Figure 17. Factors to Consider when Moving Programs from Prior Releases of ACF/VTAM

## ***Cross-Domain Communication***

ACF/VTAM Version 2 can support cross-domain communication for the following types of configurations:

- Multiple host processor configurations, operating with any combination of OS/VS2 (MVS), OS/VS1, or VSE operating systems, where each host processor has a network controlled by ACF/VTAM Version 2 and ACF/NCP/VS. Optionally, some of the host processors may have networks controlled by the following currently supported access methods:
  - ACF/VTAM Version 1 Release 1, 2, or 3 with its Multisystem Networking Facility and ACF/NCP/VS
  - ACF/TCAM Version 2 Release 3 or 4 with its Multisystem Networking Facility and ACF/NCP/VS
  - ACF/VTAME
- A network controlled by a single host processor with two access methods, ACF/VTAM Version 2 and an ACF/TCAM Version 2 Release 3 or 4 with its Multisystem Networking Facility, in conjunction with ACF/NCP/VS
- Combinations of the previous types of configurations

In a multiple-domain network with both ACF/VTAM and ACF/TCAM, ACF/VTAM's access to device characteristics of the terminals controlled by ACF/TCAM is limited to those indicators defined and maintained by ACF/TCAM. In particular, ACF/VTAM cannot determine and, therefore, cannot provide to the application program the physical device address (used in the copy function) of an IBM 3271 model 11 or 12 or compatible device controlled by ACF/TCAM.

Two host processors can be attached through a channel-to-channel connection provided that both contain ACF/VTAM Version 2 and an OS/VS operating system.

Two host processors can be connected through communication adapters provided both have a communication adapter and each contains the VSE operating system and either ACF/VTAM Version 2 or ACF/VTAME.

The ACF/VTAM Encrypt/Decrypt Feature in one domain operates with an ACF/VTAM Encrypt/Decrypt Feature or ACF/TCAM Version 2 (or subsequent releases) in another domain to establish cross-domain cryptographic sessions. (Encryption/decryption is included in ACF/TCAM Version 2). The feature does not operate with VTAM, TCAM, ACF/VTAME, nor with ACF/TCAM Version 1.

## Conversion

### ***ACF/VTAM Application Programs***

User-written application programs that use the macro language and control block record-mode interface of VTAM Level 2, ACF/VTAM Version 1, or ACF/VTAME will continue to operate on the same operating system with ACF/VTAM Version 2, without changes (except those listed in Figure 17) and without recompilation, provided that these programs do not depend on the internal processing characteristics of these access methods.

Initially, host processors that are to participate in a multiple-domain network can install ACF/VTAM with single-domain networks, and the domains can be connected later with cross-domain links. This permits an existing domain to continue to operate while the multiple-domain network is being developed. It should be noted that once a feature such as the optional Encrypt/Decrypt Feature has been installed, it is difficult to remove. Removing a feature requires regenerating the system and reapplying all of the features you wish to retain.

ACF/VTAM application programs generally will not need to be changed to operate with the Encrypt/Decrypt Feature. However, several SNA sense codes that deal with unrecoverable errors associated with the Encrypt/Decrypt Feature have been introduced; existing application programs may need to be changed to handle these codes properly.

For more information about converting to ACF/VTAM, see *ACF/VTAM Planning and Installation Reference* and *ACF/VTAM Programming*.

### ***BTAM Application Programs***

User-written application programs that use BTAM macros directly must be rewritten to operate with ACF/VTAM Version 2. You may redesign these programs to use an IBM application subsystem such as CICS/VS or IMS or recode them to use ACF/VTAM macros directly. For more information about designing application programs to use an IBM application subsystem, see the appropriate subsystem programming manual. For information about coding ACF/VTAM application programs, see *ACF/VTAM Programming*. For a comparison of ACF/VTAM and BTAM macro instructions, see the *ACF/VTAM Planning and Installation Reference*.

Converting BTAM application programs that already use an IBM application subsystem should involve few changes in most cases. Refer to the appropriate subsystem programming manual for details.

## **Data Security, Auditability, and Control**

ACF/VTAM enables the installation to establish and maintain the integrity of the data communication network. The installation can control sessions between application programs and terminals. The installation can also control access to and the use of data within the system.

ACF/VTAM provides a confidential text capability. The data on sessions defined by the user to contain confidential text is not included in buffer traces. Moreover, buffers containing confidential text are cleared before being returned to the buffer pool.

User management is responsible for the selection, application, adequacy, and implementation of these features and for the appropriate application and administrative control.



## Appendix A. Supported Products

This appendix lists the programs and terminals supported by ACF/VTAM. These terminals are channel-attached, link-attached, or loop-adapter-attached. Channel-attached terminal products are attached directly to the host processor on a channel. Link-attached terminal products are attached on SDLC links or, for the BSC 3270, on BSC links, to either a channel-attached or link-attached communication controller or, in VSE, through a communication adapter on a 4331 or 4321 processor. If the Network Terminal Option program product is installed in a communication controller, selected non-SNA devices can be attached over BSC or start/stop lines. Loop-adapter-attached terminals are attached to a 4331 processor loop adapter either through channel attachments or link attachments.

Figure 18 lists the terminals supported by ACF/VTAM. These products are grouped as:

- Channel-attached SNA terminal products
- SDLC terminal products
- Channel-attached non-SNA terminal products
- BSC terminal products
- Start-stop terminal products

The figure also indicates whether the terminal can be used on switched or nonswitched lines (or both) and indicates the PU type by which the terminal or terminal subsystem is defined to ACF/VTAM and the NCP.

Terminals that are functionally equivalent to those specifically supported by ACF/VTAM may also function satisfactorily. The user is responsible for establishing equivalency.

Where Figure 18 states that a terminal is “supported as” another terminal, it means that these terminals are defined to ACF/VTAM and use ACF/VTAM facilities in the same manner. This does not mean that the terminals have similar processing capabilities or physical characteristics. For example, a 3274 Model 1B is supported as a channel-attached 3272 cluster controller. However, the data exchanged between an application program and the 3274 and the disposition of the data after it reaches the 3274 is not necessarily the same as for a 3272.

Figure 19 lists the terminals supported by TSO/VTAM.



Device or Subsystem Name	Controlling Device-Model	PU Type	Switched	Non-Switched	Notes
<b>Channel-Attached SNA</b>					
3270 Information Display System	3274-1A,21A,31A	2			
3790 Communication System	3791	2			
3730 Distributed Office Communication System	3791	2			
4331 Loop Adapter		2			
<b>Link-Attached (SDLC) SNA</b>					
3232 Keyboard Printer Terminal	3232-1	2	X	X	
3270 Information Display System	3271-11,12	1		X	Supported as a PU Type 1 3270 Not supported through a communication adapter
	3274-1C,21C,31C	2		X	
	3274-51C	2	X	X	
	3274-52C	2	X	X	
	3275-11,12	1		X	Supported as a PU Type 1 3270 Not supported through a communication adapter
	3276-1,2,3,4	2		X	With SDLC/BSC switch set to SDLC Can support cryptographic sessions
	3276-11,12,13,14	2	X	X	
3600 Finance Communication System	3601,3602 3614,3624	2 2	X	X X	
3630 Plant Communication System	3631,3632	2		X	
3650 Retail Store System	3651-A50,B50	2	X	X	
3660 Supermarket System	3651-A60,B60 3661	2 2	X X		
3680 Programmable Store System	3684	2	X	X	
3730 Distributed Office Communication System	3791	2	X	X	
3767 Communication Terminal	3767	1	X	X	Can support cryptographic sessions
3770 Data Communication System	3771,3773 3774,3775 3776,3777	2 2 2	X X X	X X X	
3790 Communication System	3791	2	X	X	
4700 Finance Communication System	4701	2	X	X	
5280 Distributed Data System	5285	2	X	X	
5520 Administrative System	5525	2	X	X	
5937-S1 Industrial Terminal	5937	1		X	Supported as a PU Type 1 3270 Not supported through a communication adapter
6670 Information Distributor	6670	1	X	X	
8100 Information System (DPCX)	8130,8140	2	X	X	
8100 Information System (DPPX)	8130,8140	2	X	X	
8775 Display Terminal	8775-11,12	2	X	X	
Displaywriter		2	X	X	

Figure 18 (Part 1 of 2). Terminal Products Supported by ACF/VTAM

Device or Subsystem Name	Controlling Device-Model	PU Type	Switched	Non-Switched	Notes
<b>Link-Attached (SDLC) SNA (con't)</b>					
Series/1	Series/1	2	X	X	
System/32	System/32	2	X	X	
System/34	System/34	2	X	X	
System/38	System/38	2	X	X	
<b>Channel-Attached Non-SNA</b>					
3036 Console	3036				Supported as a 3272-1,2
3270 Information Display System	3272-1,2 3274-1B,1D,21B, 21D,31D				Supported as a 3272-1,2
4331 Display/Printer Adapter					
<b>Link-Attached (BSC) Non-SNA</b>					
3270 Information Display System	3271-1,2 3274-1C,21C, 31C,51C 3275-1,2 3276-1,2,3,4			X X X X	Supported as a 3271-1,2 Supported as a 3271-1,2 Supported as a 3271-1,2
3780 Data Communications Terminal	3780	1		X	Supported through the Network Terminal Option Program Product
5275 Direct Numerical Control Station	5275			X	Supported as a 3275-1,2
5937-S1 Industrial Terminal	5937			X	Supported as a 3271-1,2
8100 Information System (DPPX)	8130,8140			X	Supported as a 3271-1,2
<b>Link-Attached (Start-Stop) Non-SNA</b>					
2740 Communications Terminal	2740-1	1	X	X	Start-stop non-SNA terminals are supported through the Network Terminal Option Program Product. See the Network Terminal Option General Information manual for details.
2741 Communications Terminal	2741	1	X	X	
3767 Communications Terminal	3767-1,2	1	X	X	
World Trade Teletypwriter Terminal (WTTY)	WTTY	1		X	
Western Union Teletypwriter Exchange Service Terminal	TWX Model 33/35	1	X	X	
3101 Display Terminal	3101	1	X	X	

Figure 18 (Part 2 of 2). Terminal Products Supported by ACF/VTAM

Device or Subsystem Name	Controlling Device-Model	Terminal-Model	LU Type
<b>Channel-Attached SNA</b>			
3270 Information Display System	3274-1A,21A,31A	3277-1,2 3278-1,2,3,4,5 3279-2A,2B,3A,3B	2 2 2
3790 Communication System	3791-1A,1B,1C,2A,2B 3276-12	3277-1,2 3278-2	2 2
<b>Link-Attached (SDLC) SNA</b>			
3232 Keyboard Printer Terminal	3232-1		2
3270 Information Display System	3271-11,12 3274-1C,21C,31C,51C	3277-1,2 3277-1,2 3278-1,2,3,4,5 3279-1A,1B,2A,2B	0 2 2 2
	3275-11,12 3276-11,12,13,14	3278-1,2,3,4,5 3279-2A,2B,3A,3B	0 2 2
3767 Communication Terminal	3767-1,2,3		1 1
3770 Data Communication System	3771-1,2,3 3773-1,2,3 3774-1,2 3775-1		1 1 1 2
3790 Communication System	3791-1A,1B,1C,2A,2B 3276-12	3277-1,2 3278-2	2 2
5520 Administrative System	5525		2
8775 Display Terminal	8775-11,12		2
8130 Processor	8130-A21,A22,A23,A24 3276-11,12,13,14	8775-1,2 3277-1,2 3278-1,2,3,4 3279-2A,2B,3A,3B	2 2 2 2
8140 Processor	8140-A31,A32,A33 8140-A34,A41,A42 8140-A43,A44,A51 8140-A52,A53,A54 3276-11,12,13,14	8775-1,2 3277-1,2   3278-1,2,3,4 3279-2A,2B,3A,3B	2 2 2 2 2 2
Displaywriter			2
<b>Channel-Attached Non-SNA</b>			
3036 Console	3272-1,2	3277-1,2	0
3270 Information Display System	3272-1,2 3274-1B,1D,21B,21D,31D	3277-1,2 3277-1,2 3278-1,2,3,4,5 3279-2A,2B,3A,3B	0 0 0 0
<b>Link-Attached (BSC) Non-SNA</b>			
3270 Information Display System	3271-1,2 3274-1C,21C,31C,51C	3277-1,2 3277-1,2 3278-1,2,3,4,5 3279-2A,2B,3A,3B	0 0 0 0
	3275-1,2 3276-1,2,3,4	3278-1,2,3,4 3279-2A,2B,3A,3B	0 0
8130 Processor	8130-A21,A22 8130-A23,A24 3276-11,12,13,14	8775-1,2 3277-1,2 3278-1,2,3,4,5 3279-2A,2B,3A,3B	0 0 0 0
8140 Processor	8140-A31,A32,A33 8140-A41,A42,A43 8140-A44,A51,A52 8140-A53,A54 3276-11,12,13,14	8775-1,2 3277-1,2   3278-1,2,3,4,5 3279-2A,2B,3A,3B	0 0 0 0 0 0
The Network Terminal Option allows TSO/VTAM users to communicate with selected non-SNA devices that are not supported by TSO/VTAM in VTAM Level 2 and ACF/VTAM Version 1 Release 1. These non-SNA devices are the IBM 2741, IBM 3101, WTTY, and TWX Model 33/35.			

Figure 19. Terminal Products Supported by TSO/VTAM

## Network Terminal Option (NTO)

ACF/VTAM also supports some non-SNA terminal products, other than the channel-attached and link-attached BSC 3270s, through the Network Terminal Option program product. The Network Terminal Option, which resides in the NCP, allows certain non-SNA terminals to be attached to the network as NCP logical units. Through an interface with the Network Terminal Option, ACF/VTAM supports these non-SNA terminals as SNA 3767 Communication Terminals. For information about the Network Terminal Option program product and the non-SNA terminals it supports, see *Network Terminal Option General Information*.

## Communication Controllers

ACF/VTAM supports the following IBM communication controllers:

- 3705-I Communications Controller
- 3705-II Communications Controller
- 3705-80 Communications Controller

Each communication controller must have a network control program (NCP) in network control mode either alone or with partitioned emulation programming (PEP). The communication controllers can be channel-attached or link-attached (through another communication controller). ACF/VTAM does not support either the 2701, 2702, or 2703, or the emulation mode functions of the NCP, alone or with PEP.

## Related IBM Programs

Figure 20 summarizes the IBM programs that are supported by ACF/VTAM and the operating systems indicated. Where a release or version is indicated, it is the minimum level supported by ACF/VTAM Version 2. For more information, see your IBM marketing representative.

Type	Programs	MVS	VS1	VSE
DB/DC	CICS/VS IMS/VS	• •	• •	•
Job Entry	FTP JEP JES1/RES JES2/RJE JES2/NJE JES3/RJP VSE/POWER RJE	• • • • •	• •	• • •
Interactive	IIPS/IIAS IIS TSO,TSO/E VM/VCNA VSE/ICCF <b>1</b> VSPC VS/APL <b>2</b>	• • • • • •	• • • •	• • • • •
Device Support	BTP Version 4 DSL DSX Release 2 GDDM <b>3</b> Host Command Facility Host Prep IDWS MVS/IDWS NTO Programmable Store System Host Support SSS Release 4	• • • • • • • • • • • •	• • • • • • • • • • •	• • • • • • • • • • •
Systems and Communications Network Management	Information/System <b>4</b> NCCF Release 2 NPDA Version 1 Release 2 NLDM	• • • •	• •	• • •
Distributed Data Processing	DISOSS/370 <b>5</b> DISOSS/VSE <b>1</b> VSE/OCCF <b>6</b>	•	•	• •

**Notes:**

- 1** Supported through CICS/VS
- 2** Supported through CICS/VS, TSO/VTAM, or VSPC
- 3** Supported through CICS/VS, IMS/VS, or TSO/VTAM
- 4** In MVS, supported through NCCF or TSO/VTAM.  
In VSE, supported through VSE/ICCF
- 5** Supported through CICS/VS or IMS/VS
- 6** Supported through NCCF

**Figure 20. Related IBM Programs**

## Appendix B. Library Summary

### Organization of the Library

The ACF/VTAM Version 2 library is designed as a “task-oriented” library. This means that the basic function of each book in the library is to provide the information you need to perform a specific task. Each task associated with ACF/VTAM can be performed using one or more of the books in the ACF/VTAM library.

The books in the ACF/VTAM Version 2 library are illustrated in Figure 1 in the Preface of this book, grouped according to their related tasks. The lines and arrows indicate a recommended flow of reading. Note that most of the books apply to ACF/VTAM Version 2 for both VSE and OS/VS [OS/VS1 and OS/VS2 (MVS)]. Where separate books exist for OS/VS and VSE, both form numbers are specified.

A brief description of the categories of tasks illustrated in Figure 1 follows:

#### ***Evaluation***

This task consists of evaluating the applicability of ACF/VTAM Version 2 to the requirements of your particular installation. The information you need to perform this task is provided in *ACF/VTAM General Information*.

#### ***Planning***

This task involves determining how ACF/VTAM will be installed and used at your installation. Decisions must be made on which ACF/VTAM options are to be selected and what procedures are to be followed during various other ACF/VTAM tasks (that is, installation, operation, application programming, and program service). The information you need to perform the planning task is included in *ACF/VTAM Planning and Installation Reference*.

#### ***Installing ACF/VTAM***

This task consists of many separate functions or sub-tasks, as follows: defining your network resources to ACF/VTAM; defining ACF/VTAM to your operating system; placing ACF/VTAM in your system library; adding the various facilities and options of ACF/VTAM you selected in the planning task; applying PTFs to ACF/VTAM; defining ACF/VTAM start options and procedures, and defining how ACF/VTAM is to establish and terminate sessions. The information you need to perform the installation task is contained in *ACF/VTAM Planning and Installation Reference* and summarized in *ACF/VTAM Reference Summary*.

#### ***Writing ACF/VTAM Application Programs***

This task encompasses planning for designing and coding ACF/VTAM application programs. Should your installation find it necessary to write one or more ACF/VTAM application programs, the information you need to perform this task is included in *ACF/VTAM Programming*. The ACF/VTAM macro language, which you can use to write ACF/VTAM application programs, is summarized in *ACF/VTAM Reference Summary*.

### ***Operating ACF/VTAM***

This task consists of starting and stopping ACF/VTAM, monitoring and controlling it, and reacting to abnormal events. The information you need to perform this task is included in *ACF/VTAM Operation* and *ACF/VTAM Messages and Codes*, and summarized in *ACF/VTAM Reference Summary*.

### ***Program Service***

This task consists of detecting, diagnosing, and correcting ACF/VTAM problems. It is a task performed by the ACF/VTAM user and/or IBM programming service representatives. The task includes collecting and examining problem-related facts, organizing significant facts into a problem description, bringing about a resolution to the immediate problem and, if necessary, developing a permanent correction. As a user, you will normally be involved in all but the last activity. The information you need to perform most of your program service activities is included in *ACF/VTAM Diagnosis Guide*. More detailed program service information is included in *ACF/VTAM Diagnosis Reference* and *ACF/VTAM Data Areas*. If you use the ACF/VTAM Encrypt/Decrypt Feature, you might also require *ACF/VTAM Logic: Encrypt/Decrypt Feature* for program service activities.

## Abstracts of Publications

This section summarizes the contents of each book in the ACF/VTAM Version 2 library. Each abstract applies to a single book, except in those cases where separate books are provided for OS/VS and VSE.

### *ACF/VTAM General Information (GC27-0608)*

This book provides an overview of the facilities of ACF/VTAM Version 2 and of the major tasks involved in using it. It contains detailed information on the hardware and software requirements for the use of ACF/VTAM, and other information on the use of ACF/VTAM that you can use to determine whether or not you need this product.

### *ACF/VTAM Planning and Installation Reference (SC27-0610)*

This book provides the information needed to plan for and install ACF/VTAM Version 2. It has two sections, planning and reference, which discuss planning and coding for:

- Defining the network to ACF/VTAM
- Establishing and terminating sessions
- Writing installation exit routines and replaceable modules
- Starting ACF/VTAM

It also discusses planning for:

- Testing ACF/VTAM
- Writing ACF/VTAM application programs
- Operating ACF/VTAM
- Using TSO/VTAM
- Tuning ACF/VTAM
- Operating in the same network with ACF/TCAM
- Migrating to ACF/VTAM Version 2 from ACF/VTAM Version 1, VTAM Level 2, and ACF/VTAME, and converting from BTAM

Also included is an example of a hypothetical network.

### *ACF/VTAM Programming (SC27-0611)*

This book describes how to use ACF/VTAM macro instructions to send data to and receive data from 1) a terminal in either the same or a different domain, or 2) another application program in either the same or a different domain. Also included are a dictionary of ACF/VTAM macro instructions and considerations for migrating application programs from prior releases of VTAM (VTAM Level 2, ACF/VTAME, or any release of ACF/VTAM Version 1) and for converting BTAM application programs. This book assumes that the reader is familiar with assembler language and the programming facilities of the operating system.



### *ACF/VTAM Reference Summary (SX27-0027)*

This book contains selected reference information extracted from *ACF/VTAM Programming*, SC27-0611, *ACF/VTAM Operation*, SC27-0612, and *ACF/VTAM Planning and Installation Reference*, SC27-0610. Contents include: ACF/VTAM operator commands, a summary of ACF/VTAM macro instructions, and selected SNA reference data.

### *ACF/VTAM Operation (SC27-0612)*

This book is a reference manual for operators who run an ACF/VTAM network. It is also a guide for system programmers who must supply operators with the detailed information that they need to run the ACF/VTAM network.

This book includes:

- An introduction to operating ACF/VTAM.
- A description of ACF/VTAM commands.
- A description of how to use ACF/VTAM commands to perform network control functions.

### *ACF/VTAM Messages and Codes (SC27-0614)*

This book contains, in alphanumeric order, all messages and codes issued by ACF/VTAM. These include all operator messages with 'IST' and '5' prefixes, TSO/VTAM messages, TOLTEP messages, and terminal user and ACF/VTAM operator messages issued by ACF/VTAM's Unformatted System Services (USS). This book can be inserted into the operating system messages manual, if desired, or used as a stand-alone book.

### *ACF/VTAM Diagnosis Guide (SC27-0615 for OS/VS, SC27-0630 for VSE)*

This book describes an approach to debugging ACF/VTAM. This book helps the reader determine the failing ACF/VTAM function, and develop a keyword string of symptoms that accurately describe the problem. It presents guidelines, tools, and other information that the reader can use as ACF/VTAM debugging aids. These aids can help to isolate an error or failure to ACF/VTAM, to the ACF/NCP, or to an ACF/VTAM application program or device (logical unit). This book also summarizes serviceability aids described in other books and directs the reader to detailed descriptions of these aids.

This book is intended for customer system programmers and IBM programming service representatives (PSRs) who maintain systems and application programs that use ACF/VTAM.

### *ACF/VTAM Diagnosis Reference* (LY38-3053 for OS/VS, LY38-3058 for VSE)

This book consists of five main sections of diagnosis information for ACF/VTAM. The first section contains an overview of the logic of ACF/VTAM, an overview of the control blocks of ACF/VTAM, and an overview of the components of ACF/VTAM. The second section describes the major functions of each component. It contains the input to a function, the modules and macros involved in the processing of a function, and the output from a function. The third section describes the flow of module control for each major function. The fourth section describes processing of ACF/VTAM operator commands, application program macro instructions, and request/response units (RUs). The fifth section is an alphanumeric listing of modules, a summary of the functions performed by each module, and any major input/output.

Additionally, a module directory lists all of the ACF/VTAM modules in alphanumeric order, and for each module gives its descriptive name, its load module or library, and the diagrams in which the module appears. This book also includes RU flow diagrams, explanations of ACF/VTAM channel programs, and a foldout diagram of the major ACF/VTAM control blocks.

This book contains only information about the ACF/VTAM base system (without the optional Encrypt/Decrypt Feature). For logic information about this optional features, see *ACF/VTAM Logic: Encrypt/Decrypt Feature*, LY38-3055. (The Encrypt/Decrypt Feature is available only on OS/VS systems.)

### *ACF/VTAM Data Areas* (LY38-3054 for OS/VS, LY38-3059 for VSE)

This book describes all of the data areas used by ACF/VTAM. It is intended for IBM programming service representatives and customer personnel who are diagnosing problems with ACF/VTAM.

The data maps in this book are divided into four parts for each ACF/VTAM data area. First is a reference list giving a function description of the data area, its boundary alignment, its length in bytes, a list of control blocks containing pointers to the data area, control blocks embedded within the data area, and where in storage the data area is found. Second is a diagram of the data area, showing the offsets, type, length, name, and description of each field in the data area. Third is a cross-reference list of all fields in the data area. Fourth is a list of constant fields in the data area, if any. The constants are listed by field name, value, and meaning.

Information about categories of ACF/VTAM data areas and control block relationships is included in *ACF/VTAM Diagnosis Reference*.

### *ACF/VTAM Logic: Encrypt/Decrypt Feature* (LY38-3055)

This book describes the logic of the Encrypt/Decrypt Feature of ACF/VTAM. It should be used in conjunction with *ACF/VTAM Diagnosis Reference*, LY38-3053, which describes the high-level logic of ACF/VTAM including the Encrypt-Decrypt Feature. This book is intended primarily to help IBM programming service representatives and customer system programmers to quickly locate failures in ACF/VTAM.

Included in this book are module flow diagrams that describe the logic of this feature's components and show the flow of control between modules. It also contains summaries of key information (name, function, input and output) on each module of this feature.

This information should enable the reader to determine the module that performs a particular function and how control passes to and from that module.

This book should be used along with *ACF/VTAM Data Areas*, LY38-3054 (OS/VS), which contains maps of the data areas used by ACF/VTAM, including the Encrypt/Decrypt Feature.

## Evolution of Publications

This section illustrates the relationship of each book in the ACF/VTAM Version 2 library to its predecessor books in earlier ACF/VTAM libraries. It is intended primarily to help ACF/VTAM users migrating from earlier releases of the system, by identifying the ACF/VTAM Version 2 book that contains information included in books from earlier ACF/VTAM libraries.

Figure 21 shows the titles and form numbers for the books in the libraries for ACF/VTAM Version 1 Releases 1, 2, and 3; and ACF/VTAM Version 2. The arrows between the books for each library represent the evolution of the books, that is, the movement of information from a book in one library to a book in another library.

For example, information contained in *ACF/VTAM Installation Guide*, a book in the ACF/VTAM Version 1 Release 1 library, can be found in the Version 2 book, *ACF/VTAM Planning and Installation Reference*. The Version 1 Release 2 book containing that information is *ACF/VTAM Pre-Installation Planning*.

Related information from more than one book is often combined into a single book for the convenience of the user. For example, information from three Version 1 Release 2 books is now combined in the Version 2 book, *ACF/VTAM Diagnosis Reference*. There are times, however, when information on a particular function or product is more readily usable if it is spread out among several books. Hence, information from the Version Release 1 book, *ACF/VTAM TOLTEP*, was divided between two Version 1 Release 2 books (and their Version 2 successors): *ACF/VTAM Messages and Codes*, and *ACF/VTAM Diagnostic Techniques*.

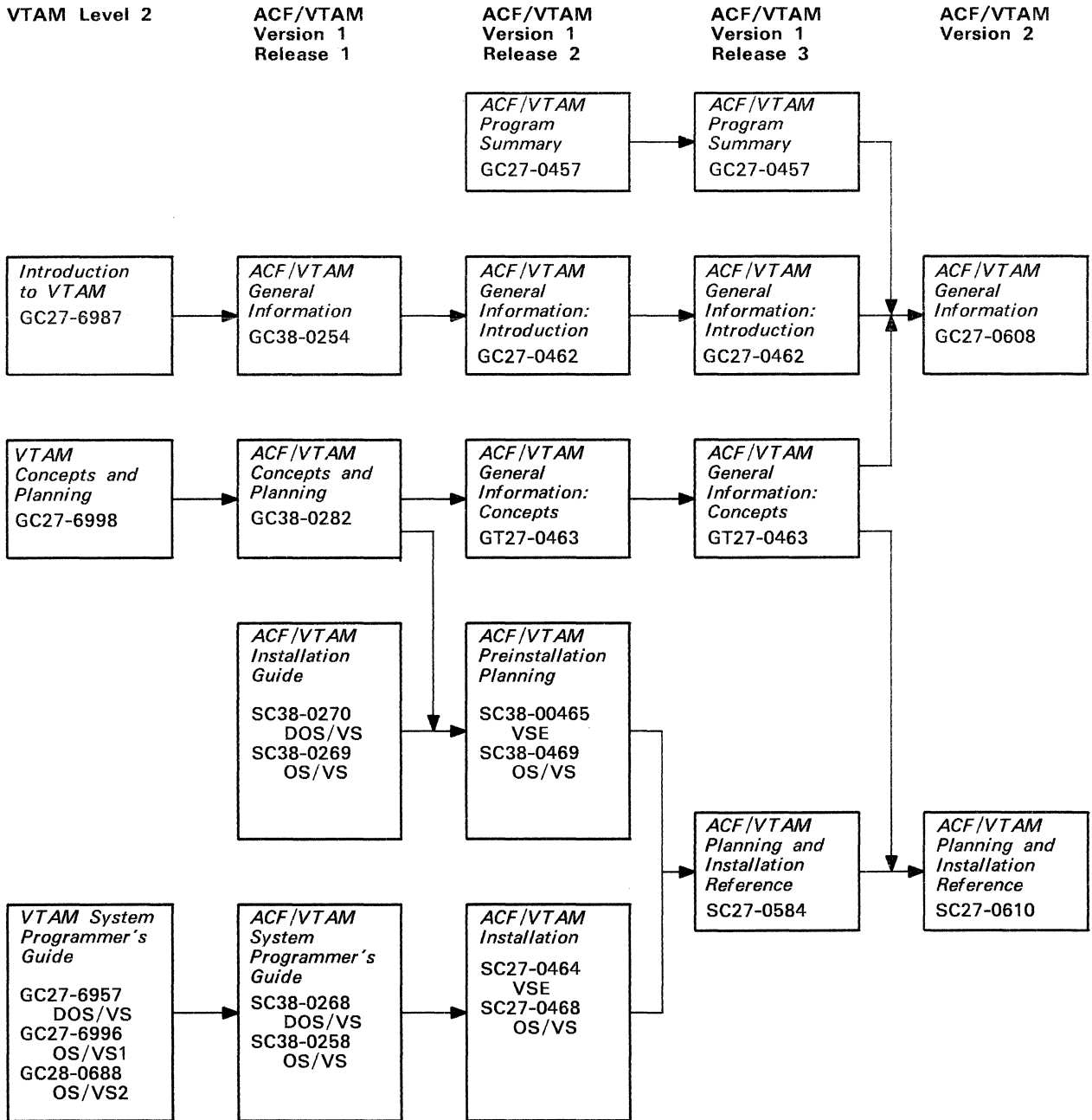

Figure 21 (Part 1 of 4). Evolution of the ACF/VTAM Version 2 Library

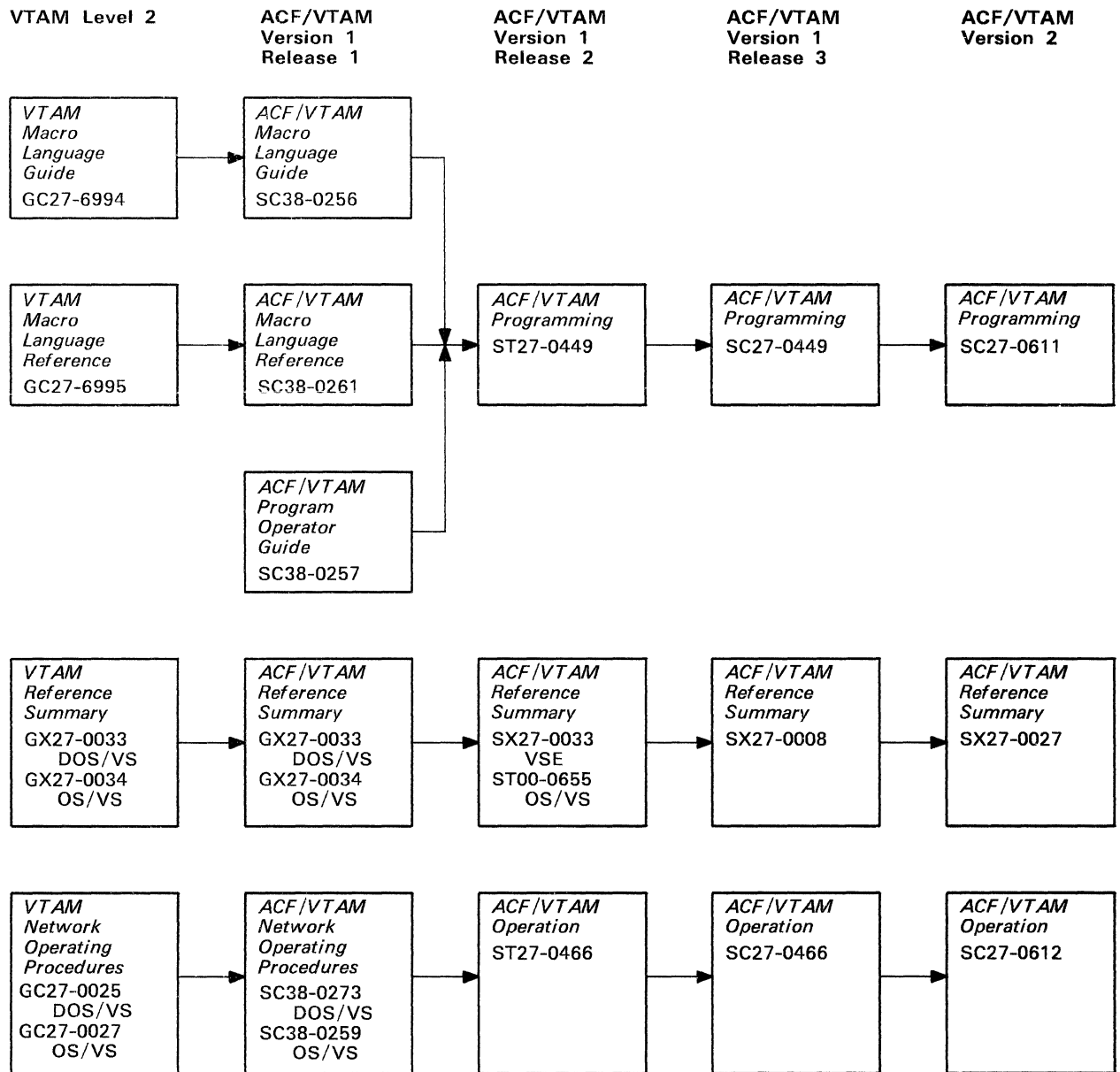

Figure 21 (Part 2 of 4). Evolution of the ACF/VTAM Version 2 Library

VTAM Level 2

ACF/VTAM  
Version 1  
Release 1

ACF/VTAM  
Version 1  
Release 2

ACF/VTAM  
Version 1  
Release 3

ACF/VTAM  
Version 2

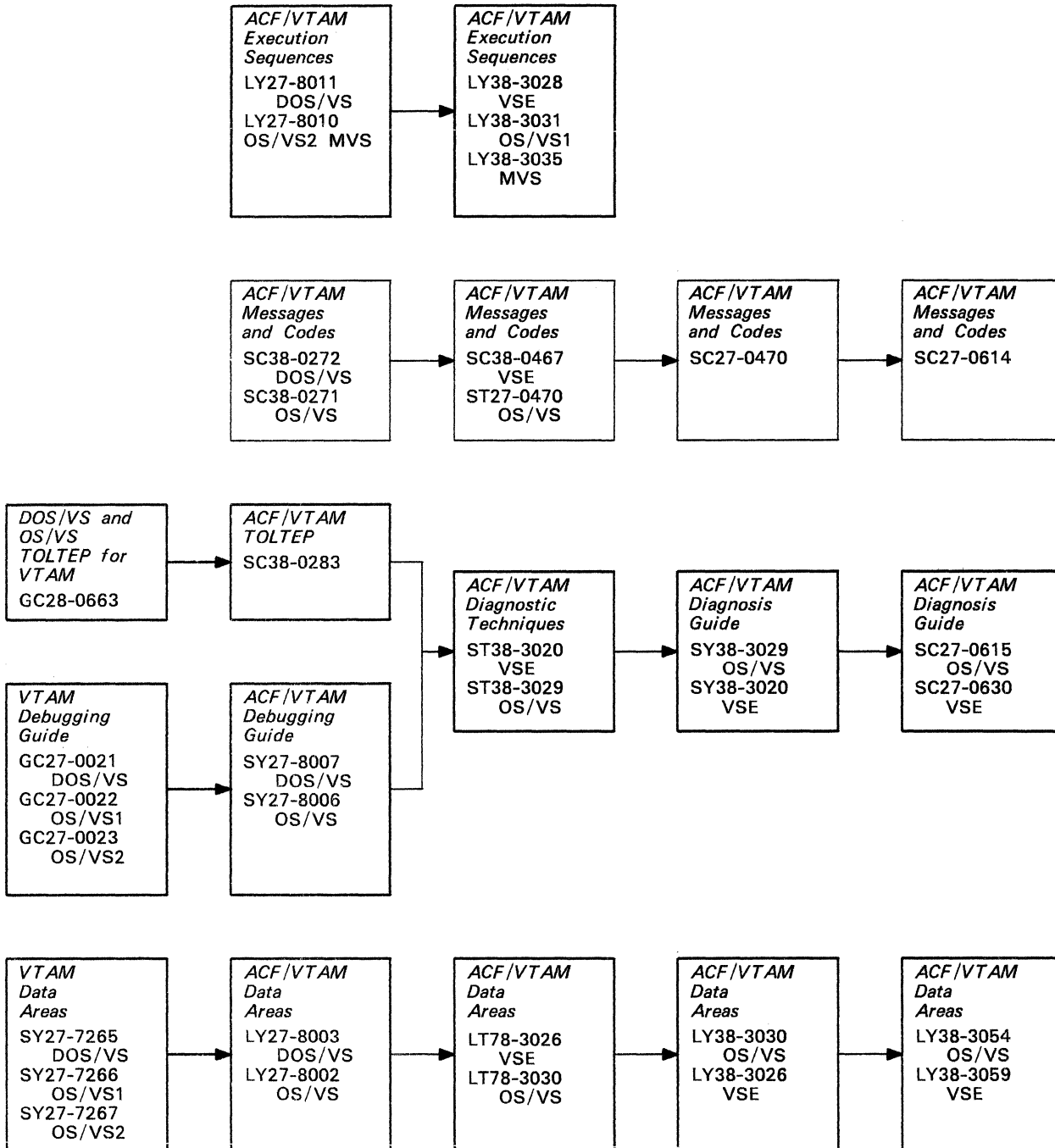

Figure 21 (Part 3 of 4). Evolution of the ACF/VTAM Version 2 Library

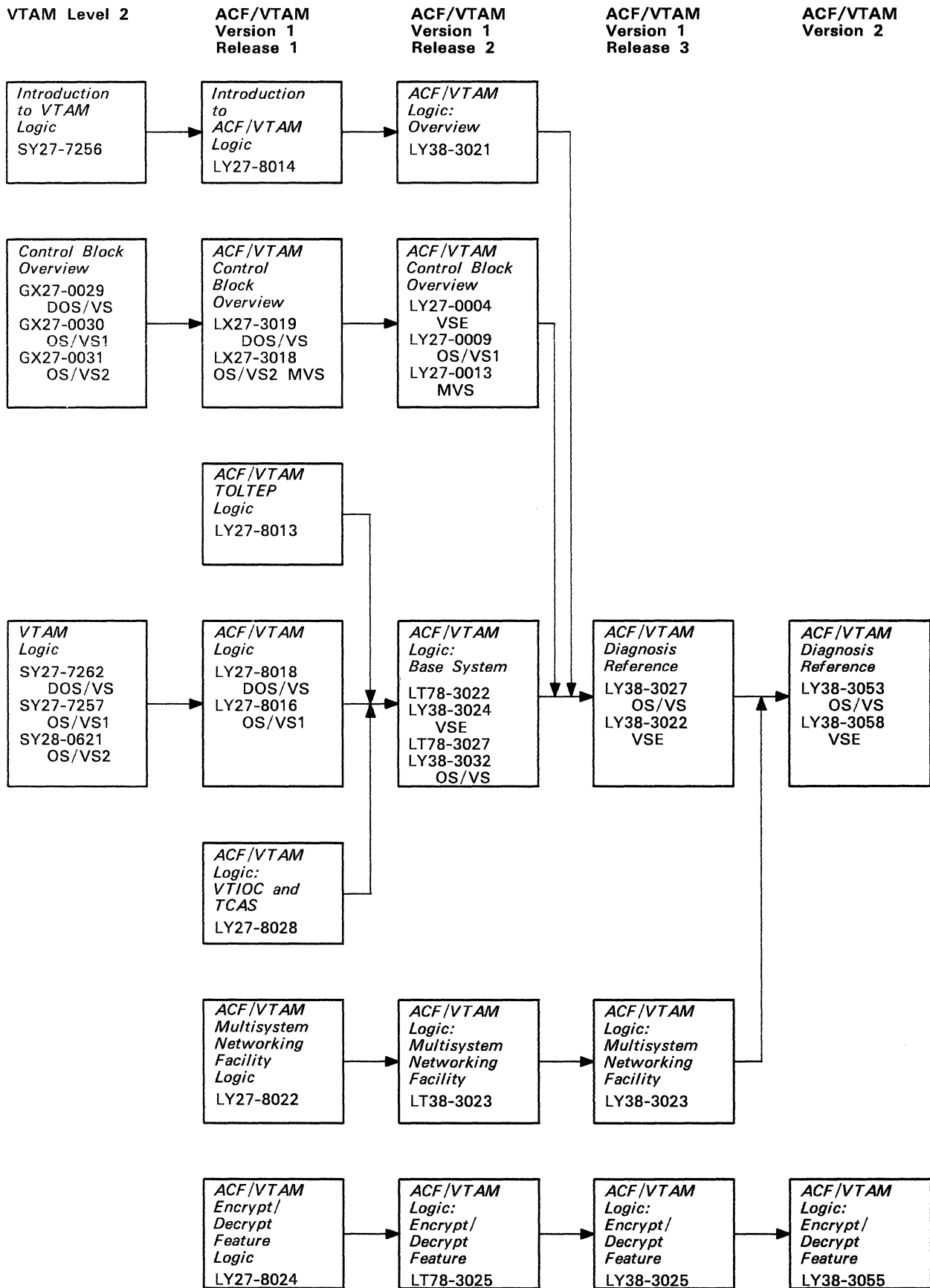

Figure 21 (Part 4 of 4). Evolution of the ACF/VTAM Version 2 Library



## Bibliography

This section provides the titles and form numbers of books containing information on products that work in conjunction with ACF/VTAM. Most of these books are listed as prerequisite or related reading in one or more of the books in the ACF/VTAM Version 2 library.

The titles and form numbers of the books listed were correct at the time this book was published. Before ordering any book listed, you should verify the accuracy of the title and form number with your IBM representative or the *IBM System/370 and 4300 Processors Bibliography*, GC20-0001.

### ***Systems Network Architecture (SNA) Publications***

<b>Title</b>	<b>Form Number</b>
<i>Systems Network Architecture Concepts and Products</i>	GC30-3072
<i>Systems Network Architecture Technical Overview</i>	GC30-3073
<i>Systems Network Architecture Reference Summary</i>	GA27-3136
<i>Systems Network Architecture Sessions Between Logical Units</i>	GC20-1868
<i>Systems Network Architecture Format and Protocol Reference Manual: Architectural Logic</i>	SC30-3112

### ***NCP Publications***

The following manuals are for NCP Version 1 Release 3:

<b>Title</b>	<b>Form Number</b>
<i>ACF/NCP/VS (Network Control Program and System Support Programs) General Information</i>	GC30-3058
<i>Advanced Communications Function for Network Control Program and System Support Programs for the IBM 3705 Installation</i>	SC30-3154
<i>Advanced Communications Function for Network Control Program and System Support Programs for the IBM 3705 Utilities</i>	SC30-3158

The following manuals are for NCP Version 2:

Title	Form Number
<i>Advanced Communications Function for Network Control Program for the IBM 3705, Advanced Communications Function for System Support Programs for the IBM 3705 General Information</i>	GC30-3058
<i>Advanced Communications Function for Network Control Program and System Support Programs Installation and Resource Definition</i>	SC30-3167
<i>Advanced Communications Function for Network Control Program and System Support Programs Utilities</i>	SC30-3168

### ***Cryptography Publications***

Title	Form Number
<i>Data Security Through Cryptography</i>	GC22-9062
<i>IBM Cryptographic Subsystem Concepts and Facilities</i>	GC22-9063
<i>OS/VS1 and OS/VS2 MVS Programmed Cryptographic Facility General Information</i>	GC28-0942
<i>OS/VS1 and OS/VS2 MVS Cryptographic Unit Support General Information</i>	GC28-1015

### ***Network Terminal Option (NTO) Publications***

Title	Form Number
<i>Network Terminal Option General Information</i>	GC38-0297
<i>Network Terminal Option Installation</i>	SC38-0298
<i>Network Terminal Option Diagnosis and Logic</i>	LY38-3018

### ***Network Communications Control Facility (NCCF) Publications***

Title	Form Number
<i>Network Communications Control Facility General Information</i>	GC27-0429
<i>Network Communications Control Facility Installation</i>	SC27-0430
<i>Network Communications Control Facility Messages</i>	SC27-0431
<i>Network Communications Control Facility Terminal Use</i>	SC27-0432

<i>Network Communications Control Facility Customization</i>	SC27-0433
<i>Network Problem Determination Application General Information (Version 1)</i>	GC34-2010
<i>Network Problem Determination Application General Information (Version 2)</i>	GC34-2061
<i>Network Logical Data Manager General Information</i>	GC30-3081
<i>Network Logical Data Manager Installation and Operation</i>	SC30-3165
<i>Network Logical Data Manager Diagnosis</i>	SC30-3166

### ***Publications on Other Access Methods***

<b>Title</b>	<b>Form Number</b>
<i>Advanced Communications Function for TCAM General Information: Introduction</i>	GC30-3057
<i>Advanced Communications Function for VTAM Entry General Information: Introduction</i>	GC27-0438
<i>Basic Telecommunications Access Method - Extended Support (BTAM-ES) General Information</i>	GC38-0292

### ***OS/VS Publications***

<b>Title</b>	<b>Form Number</b>
<i>OS/VS System Modification Program (SMP) System Programmer's Guide</i>	GC28-0673
<i>OS/VS System Modification Program (SMP) Messages and Codes</i>	GC38-1047
<i>OS/VS Linkage Editor and Loader</i>	GC26-3813

### ***TSO and TSO/VTAM Publications (MVS Only)***

<b>Title</b>	<b>Form Number</b>
<i>OS/VS2 System Programming Library: TSO</i>	GC28-0629
<i>OS/VS2 TSO Terminal User's Guide</i>	GC28-0645
<i>OS/VS2 TSO Command Language Reference</i>	GC28-0646
<i>OS/VS2 TSO Guide to Writing a Terminal Monitor Program or a Command Processor</i>	GC28-0648

<i>MVS/Extended Architecture TSO Command Language Reference (Supplement to OS/VS2 TSO Command Language Reference, GC28-0646)</i>	SD23-0259
<i>MVS/Extended Architecture TSO Guide to Writing a Terminal Monitor Program or a Command Processor (Supplement to OS/VS2 TSO Guide to Writing a Terminal Monitor Program or a Command Processor, GC28-0648)</i>	GD23-0261
<i>MVS/Extended Architecture TSO Terminal Monitor Program and Service Routines Logic (Supplement to OS/VS2 TSO Terminal Program and Service Routines Logic, SY28-0650)</i>	LY23-0262
<i>MVS/Extended Architecture TSO Command Processor Logic (Volume IV) (Supplement to OS/VS2 TSO Command Processor Logic (Volume IV) SY28-0652)</i>	LD23-0273
<i>MVS/Extended Architecture TSO Extensions TSO Command Language Reference</i>	SC28-1134
<i>MVS/Extended Architecture TSO Extensions TSO Guide to Writing a Terminal Monitor Program or a Command Processor</i>	SC28-1136
<i>MVS/Extended Architecture System Programming Library: TSO</i>	GC28-1173
<i>MVS/Extended Architecture TSO Terminal Users Guide</i>	GC28-1274

## **MVS Publications**

<b>Title</b>	<b>Form Number</b>
<i>OS/VS2 MVS/System Product Version 1 General Information Manual</i>	GC28-1025
<i>OS/VS2 System Programming Library: System Generation Reference</i>	GC26-3792
<i>OS/VS2 System Programming Library: Initialization and Tuning Guide (MVS/SP)</i>	GC28-1029
<i>OS/VS2 System Programming Library: Supervisor</i>	GC28-1046
<i>OS/VS2 System Programming Library: Service Aids</i>	GC28-0674
<i>OS/VS2 System Programming Library: Debugging Handbook (Volume 1)</i>	GC28-1047
<i>OS/VS2 System Programming Library: Debugging Handbook (Volume 2)</i>	GC28-1048
<i>OS/VS2 System Programming Library: Debugging Handbook (Volume 3)</i>	GC28-1049

<i>Operator's Library: OS/VS2 MVS System Commands</i>	GC28-1031
<i>OS/VS2 TSO Terminal Monitor Program and Service Routines Logic</i>	SY28-0650
<i>OS/VS2 TSO Command Processor Logic (Volume IV)</i>	SY28-0652
<i>OS/VS2 System Logic Library (Volume 1)</i>	SY28-0713
<i>OS/VS2 System Logic Library (Volume 2)</i>	LY28-1063
<i>OS/VS2 System Logic Library (Volume 3)</i>	LY28-1067
<i>OS/VS2 System Logic Library (Volume 4)</i>	LY28-1071
<i>OS/VS2 System Logic Library (Volume 5)</i>	LY28-1075
<i>OS/VS2 System Logic Library (Volume 6)</i>	LY28-1079
<i>OS/VS2 System Logic Library (Volume 7)</i>	LY28-1083
<i>OS/VS2 System Logic Library (Volume 8)</i>	LY28-1087
<i>OS/VS2 System Logic Library (Volume 9)</i>	LY28-1091
<i>OS/VS2 System Logic Library (Volume 10)</i>	LY28-1095
<i>OS/VS2 System Logic Library (Volume 11)</i>	LY28-1099
<i>OS/VS2 Access Method Services</i>	GC26-3841
<i>OS/VS2 MVS Utilities</i>	GC26-3902
<i>OS/VS2 System Programming Library: OLTEP</i>	GC28-0675
<i>OS/VS2 System Programming Library: Data Management</i>	GC26-3830
<i>OS/VS2 Data Management Macro Instructions</i>	GC26-3873
<i>OS/VS2 MVS Data Management Macro Services Guide</i>	GC26-3875
<i>OS/VS2 MVS Checkpoint/Restart</i>	GC26-3877
<i>OS/VS2 MVS JCL</i>	GC28-0692
<i>Installing the IBM 3790 Communication System for Use with OS/VS2</i>	GC22-9022
<i>Operator's Library: OS/VS2 MVS JES2 Commands</i>	GC23-0007
<i>Operator's Library: Network Job Entry Facility for JES2 Commands</i>	SC23-0011
<i>OS/VS Message Library: VS2 System Messages</i>	GC38-1002
<i>OS/VS Message Library: VS2 System Codes</i>	GC38-1008

## MVS/Extended Architecture Publications (When Available)

Title	Form Number
<i>MVS/System Product Version 2 General Information</i>	GC28-1118
<i>MVS/Extended Architecture Overview</i>	GC28-1146
<i>Data Facility Product General Information</i>	GC26-4007
<i>MVS/Extended Architecture: System Generation Reference</i>	GC26-4009
<i>MVS/Extended Architecture System Programming Library: Initialization and Tuning</i>	GC28-1149
<i>MVS/Extended Architecture System Programming Library: System Macros and Facilities (Volume 1)</i>	GC28-1150
<i>MVS/Extended Architecture System Programming Library: System Macros and Facilities (Volume 2)</i>	GC28-1151
<i>MVS/Extended Architecture System Programming Library: System Modifications</i>	GC28-1152
<i>MVS/Extended Architecture System Programming Library: Service Aids</i>	GC28-1159
<i>MVS/Extended Architecture Debugging Handbook (Volume 1)</i>	GC28-1164
<i>MVS/Extended Architecture Debugging Handbook (Volume 2)</i>	GC28-1165
<i>MVS/Extended Architecture Debugging Handbook (Volume 3)</i>	GC28-1166
<i>MVS/Extended Architecture Debugging Handbook (Volume 4)</i>	GC28-1167
<i>MVS/Extended Architecture Debugging Handbook (Volume 5)</i>	GC28-1168
<i>MVS/Extended Architecture System Logic Library (Volume 1)</i>	SY28-1208
<i>MVS/Extended Architecture System Logic Library (Volume 2)</i>	LY28-1210
<i>MVS/Extended Architecture System Logic Library (Volume 3)</i>	LY28-1214
<i>MVS/Extended Architecture System Logic Library (Volume 4)</i>	LY28-1218
<i>MVS/Extended Architecture System Logic Library (Volume 5)</i>	LY28-1222
<i>MVS/Extended Architecture System Logic Library (Volume 6)</i>	LY28-1226
<i>MVS/Extended Architecture System Logic Library (Volume 7)</i>	LY28-1230
<i>MVS/Extended Architecture System Logic Library (Volume 8, Part 1)</i>	LY28-1234

<i>MVS/Extended Architecture System Logic Library (Volume 8, Part 2)</i>	LY28-1235
<i>MVS/Extended Architecture System Logic Library (Volume 9)</i>	LY28-1238
<i>MVS/Extended Architecture System Logic Library (Volume 10, Part 1)</i>	LY28-1242
<i>MVS/Extended Architecture System Logic Library (Volume 10, Part 2)</i>	LY28-1243
<i>MVS/Extended Architecture System Logic Library (Volume 11)</i>	LY28-1246
<i>MVS/Extended Architecture System Logic Library (Volume 12)</i>	LY28-1250
<i>MVS/Extended Architecture System Logic Library (Volume 13)</i>	LY28-1254
<i>MVS/Extended Architecture System Logic Library (Volume 14)</i>	LY28-1258
<i>MVS/Extended Architecture System Logic Library (Volume 15)</i>	LY28-1262
<i>MVS/Extended Architecture System Logic Library (Volume 16, Part 1)</i>	LY28-1266
<i>MVS/Extended Architecture System Logic Library (Volume 16, Part 2)</i>	LY28-1267
<i>MVS/Extended Architecture System Logic Library (Volume 17)</i>	LY28-1270
<i>MVS/Extended Architecture Access Method Services Reference</i>	GC26-4019
<i>MVS/Extended Architecture Utilities</i>	GC26-4018
<i>MVS/Extended Architecture OLTEP</i>	GC28-1161
<i>MVS/Extended Architecture System Programming Library: Data Management</i>	GC26-4010
<i>MVS/Extended Architecture Data Management Macro Instructions</i>	GC26-4014
<i>MVS/Extended Architecture Data Management Services</i>	GC26-4013
<i>MVS/Extended Architecture Checkpoint/Restart</i>	GC26-4012
<i>MVS/Extended Architecture JCL</i>	GC28-1148
<i>MVS/Extended Architecture Operations: JES2 Commands</i>	SC23-0064
<i>MVS/Extended Architecture Message Library: System Messages</i>	SG28-1156
<i>MVS/Extended Architecture Message Library: System Codes</i>	SG28-1157

## ***VSI Publications***

<b>Title</b>	<b>Form Number</b>
<i>OS/VSI Planning and Use Guide</i>	GC24-5090
<i>OS/VSI Storage Estimates</i>	GC24-5094
<i>OS/VSI Service Aids</i>	GC28-0665
<i>OS/VSI Access Method Services</i>	GC26-3840
<i>OS/VSI Utilities</i>	GC26-3901
<i>OS/VSI JCL Reference</i>	GC24-5099
<i>OS/VSI JCL Services</i>	GC24-5100
<i>OS/VSI System Generation Reference</i>	GC26-3791
<i>OS/VSI System Management Facilities</i>	GC24-5115
<i>OS/VSI Debugging Guide</i>	GC24-5093
<i>OS/VSI Data Management for System Programmers</i>	GC26-3837
<i>OS/VSI Data Management Macro Instructions</i>	GC26-3872
<i>OS/VSI Data Management Services Guide</i>	GC26-3874
<i>OS/VSI Checkpoint/Restart</i>	GC26-3876
<i>Operator's Library: OS/VSI Reference</i>	GC38-0110
<i>OS/VS Message Library: VSI System Messages</i>	GC38-1001
<i>OS/VS Message Library: VSI System Codes</i>	GC38-1003
<i>OS/VS Message Library: VSI Routing and Descriptor Codes</i>	GC38-1101

## ***VSE Publications***

<b>Title</b>	<b>Form Number</b>
<i>Introduction to the VSE System</i>	GC33-6108
<i>VSE/Advanced Functions System Management Guide</i>	SC33-6094
<i>VSE/Advanced Functions System Control Statements</i>	SC33-6095
<i>VSE/Advanced Functions System Generation</i>	SC33-6096
<i>VSE/Advanced Functions Operating Procedures</i>	SC33-6097



<i>VSE/Advanced Functions Messages</i>	SC33-6098
<i>VSE/Advanced Functions Serviceability Aids and Debugging Procedures</i>	SC33-6099
<i>VSE/Advanced Functions System Utilities</i>	SC33-6100
<i>VSE/Advanced Functions Maintain System History Program (MSHP) User's Guide</i>	SC33-6101
<i>VSE/Advanced Functions Diagnosis Guide</i>	SC33-6112
<i>DOS/VSE Entry User's Guide</i>	GC33-6047
<i>Device Support Facilities User's Guide and Reference</i>	GC35-0033
<i>Environmental Recording Editing and Printing (EREP) Program</i>	GC28-0772
<i>VSE System Data Management Concepts</i>	GC24-5209
<i>VSE/Advanced Functions Macro User's Guide</i>	SC24-5210
<i>VSE/Advanced Functions Macro Reference</i>	SC24-5211

## **Appendix C. Advanced Communications Function for VTAM Version 2: Summary**

### **Testing Period**

The testing period for the base system is two months. No testing period is applicable to DSLO licenses.

The testing period for the Encrypt/Decrypt Feature is one month.

### **License**

A separate license is required for each designated machine on which the licensed program materials will be used, except as otherwise provided by IBM.

### **Program Services**

Central Service, including the IBM Support Center, will be available until discontinued by IBM upon twelve months' written notice. For DSLO licenses (DPD and A/FE), Central Service, including the IBM Support Center, will be provided only through the customer location designated for the basic license.

### **Local Licensed Program Support**

Local Licensed Program Support will be available until discontinued by IBM upon twelve months' written notice.

Local Licensed Program Support will be provided under the terms and conditions of the Agreement for Local Licensed Program Support for IBM Licensed Programs at the Monthly Licensed Program Support Charge, Monthly Additional Licensed Program Support Charge, or will be provided at the applicable hourly rate.

Local Licensed Program Support will be provided by IBM Field Engineering for DPD and by IBM Customer Engineering for E/ME/A and A/FE.

### **Warranty**

The ACF/VTAM Version 2 Licensed Program is warranted to conform to its Licensed Program Specifications when shipped to the customer if properly used in the Specified Operating Environment.

The Licensed Program Specifications may be updated from time to time and such updates may constitute a change in specifications.

Following the discontinuance of all program services, this program will be distributed on an "As Is" basis without warranty of any kind either express or implied.

## **Availability of Licensed Program**

The estimated availability date at PID (Program Information Department) for ACF/VTAM Version 2 is:

- December 1981 for OS/VS2 (MVS) (available)
- September 1982 for OS/VS1
- December 1982 for VSE

Estimated availability at EPL (European Program Library) and other WT area Program Libraries is one month later than availability at PID.

# Glossary of Terms and Abbreviations

This glossary includes terms and definitions from the *IBM Vocabulary for Data Processing, Telecommunications, and Office Systems, GC20-1699*.

## Reference Words Used in the Entries

The following reference words are used in this glossary.

*Contrast with.* Refers to a term that has an opposed or substantively different meaning.

*Deprecated term for.* Indicates that the term should not be used. It refers to a preferred term, which is defined.

*See.* Refers to multiple-word terms that have the same last word.

*See also.* Refers to related terms that have similar (but not synonymous) meanings.

*Synonym for.* Appears in the commentary of a less desirable or less specific term and identifies the preferred term that has the same meaning.

*Synonymous with.* Appears in the commentary of a preferred term and identifies less desirable or less specific terms that have the same meaning.

## A

**ACB.** Access method control block.

**ACB address space.** In ACF/VTAM, the address space in which the ACB is opened. See *associated address space* and *session address space*.

**ACB name.** (1) The name of an ACB macro instruction. (2) A name specified in the ACBNAME parameter of an APPL statement. Contrast with *network name*.

**Note:** This name allows an ACF/VTAM application program that is used in more than one domain to specify the same application program identification (pointed to by the APPLID parameter of the program's ACB statement) in each copy. ACF/VTAM knows the program by both its ACB name and its network name (the name of the APPL statement). Program users within the domain can request a session using the ACB name or the network name; program users in other domains must use the network name (which must be unique in the network).

**ACB-based macro instruction.** In ACF/VTAM, a macro instruction whose parameters are specified by the user in an access method control block.

**accept.** In an ACF/VTAM application program, to accept a CINIT request from an SSCP to establish a session with a logical unit; the application program acts as the primary end of the session. Contrast with *acquire* (1).

**Note:** The accept process causes a BIND request to be sent from the primary end of the session to the logical unit that will act as the secondary end of the session, requesting that the session be established and passing session parameters. For example, the session-initiation request that originally caused the SSCP to send the CINIT request may have resulted from a logon by the terminal operator, from a macro instruction issued by an ACF/VTAM application program, or from an ACF/VTAM operator command.

**access method.** A technique for moving data between main storage and input/output devices.

**access method control block (ACB).** A control block that links an application program to VSAM or ACF/VTAM.

**accounting exit routine.** In ACF/VTAM, an optional installation exit routine that collects statistics about session initiation and termination.

**ACF.** Advanced Communications Function.

**ACF/NCP.** Advanced Communications Function for the Network Control Program.

**ACF/TCAM.** Advanced Communications Function for the Telecommunications Access Method.

**ACF/VTAM.** Advanced Communications Function for the Virtual Telecommunications Access Method.

**ACF/VTAM application program.** A program that has opened an ACB to identify itself to ACF/VTAM and can now issue ACF/VTAM macro instructions.

**ACF/VTAM definition.** The process of defining the user application network to ACF/VTAM and modifying IBM-defined characteristics to suit the needs of the user.

**ACF/VTAM definition library.** The operating system files or data sets that contain the definition statements and start options filed during ACF/VTAM definition.

**ACF/VTAM operator.** A person or program authorized to issue ACF/VTAM operator commands. See *domain operator*, *program operator*, and *network operator* (2).

**ACF/VTAM operator command.** A command used to monitor or control an ACF/VTAM domain.

**ACF/VTAME.** Advanced Communications Function for the Virtual Telecommunications Access Method Entry.

**acquire.** (1) In ACF/VTAM, the operation in which an authorized ACF/VTAM application program initiates and establishes a session with another logical unit; the application program acts as the primary end of the session.

**Note:** The acquire process causes an Initiate request to be sent to the SSCP which causes the SSCP to return a CINIT request to the application program (the PLU); this in turn causes the PLU to send a BIND request to the SLU.

Contrast with *accept*. (2) In relation to ACF/VTAM resource control, to take over resources (communication controllers or other physical units) that were formerly controlled by a data communication access method in another domain, or to assume control of resources that were controlled by this domain but released. Contrast with *release*. See also *resource takeover*.

**active.** In ACF/VTAM, pertaining to a major or minor node for which a VARY ACT command has been issued. Also, a major or minor node in a list of major nodes to be activated when ACF/VTAM is started. Contrast with *inactive*.

**Note:** For a major node, this makes the node and its minor nodes known to ACF/VTAM. For a minor node, this generally results in the execution of an SNA protocol to make the minor node usable by the network. For an LU minor node, this indicates that the ACF/VTAM operator has given permission for the LU to participate in an LU-LU session.

**adjacent nodes.** Two nodes that are connected by one or more data links with no intervening nodes.

**adjacent subareas.** Two subareas connected by one or more links with no intervening subareas. See also *subarea*.

**Advanced Communications Function (ACF).** A group of IBM program products (principally ACF/TCAM, ACF/VTAM, ACF/VTAME, and ACF/NCP) that use the concepts of Systems Network Architecture (SNA), including distribution of function and resource sharing.

**Advanced Communications Function for the Network Control Program (ACF/NCP).** A program product that provides communication controller support for single-domain and multiple-domain networks.

**Advanced Communications Function for the Telecommunications Access Method (ACF/TCAM).** A program product that provides single-domain network, and, optionally, multiple-domain capability. ACF/TCAM runs under MVS and OS/VS1 and provides message queuing.

**Advanced Communications Function for the Virtual Telecommunications Access Method (ACF/VTAM).** A program product that provides single-domain network and, optionally, multiple-domain capability. ACF/VTAM runs under MVS, OS/VS1, and VSE and supports direct-access programs and subsystems such as Virtual Machine/VTAM Communications Application (VM/VCNA), Virtual Storage Personal Computing (VSPC), and VSE/POWER.

**Advanced Communications Function for the Virtual Telecommunications Access Method Entry (ACF/VTAME).** A program product that provides single-domain and multiple-domain network capability for 4300 systems that may include communication adapters.

**any-mode.** In ACF/VTAM: (1) The form of a RECEIVE request that obtains input from any one (unspecified) session. (2) The form of an accept request that completes the establishment of a session by accepting any one (unspecified) queued CINIT request. Contrast with *specific-mode*. See *continue-any mode*. See also *accept*.

**API.** Application program interface.

**application program exit routine.** In ACF/VTAM, a user-written exit routine that performs functions for a particular application program and is run as part of the application program. Examples are RPL exit routines, EXLST exit routines, and the TESTCB exit routine. Contrast with *installation exit routine*.

**application program identification.** The symbolic name by which an application program is identified to ACF/VTAM.

**Note:** It is specified in the APPLID parameter of the ACB macro instruction. It corresponds to the ACBNAME parameter in the APPL statement or, if ACBNAME is defaulted, to the name of the APPL statement.

**application program interface (API).** The formally-defined programming language interface between an IBM system control program or program product and its user.

**application program major node.** In ACF/VTAM, a member or book of the ACF/VTAM definition library that contains one or more APPL statements, each representing an application program.

**associated address space.** In ACF/VTAM, the address space in which RPL-based requests are issued that specify an ACB opened in another address space.

**asynchronous exit routine.** In ACF/VTAM, an RPL exit routine or an EXLST exit routine other than LERAD or SYNAD. Contrast with *inline exit routine*.

**asynchronous operation.** In ACF/VTAM, an operation, such as a request for session establishment or data transfer, in which the application program is allowed to continue execution while ACF/VTAM performs the operation. ACF/VTAM informs the program after the operation is completed. Contrast with *synchronous operation*.

**asynchronous request.** In ACF/VTAM, a request for an asynchronous operation. Contrast with *synchronous request*.

**authorization exit routine.** In ACF/VTAM, an optional installation exit routine that approves or disapproves requests for session initiation.

**authorized path.** In ACF/VTAM for MVS, a facility that enables an application program to specify that a data transfer or related operation be carried out in a privileged and more efficient manner.

**automatic activation.** In ACF/VTAM, the activation of links and link stations in adjacent subarea nodes as a result of channel device name or RNAME specifications related to an activation command naming a subarea node.

**automatic deactivation.** In ACF/VTAM, the deactivation of links and link stations in adjacent subarea nodes as a result of a deactivation request naming a subarea node.

**Note:** Automatic deactivation occurs only for automatically activated links and link stations that have not also been directly or indirectly activated.

**automatic logon.** A process by which ACF/VTAM creates a session-initiation request (logon) for a session between a secondary logical unit (other than a secondary application program) and a designated primary logical unit whenever the secondary logical unit is not in session with, or queued for a session with, another primary logical unit. See also *controlling application program, controlling logical unit*.

**Note:** Specifications for the automatic logon can be made when the secondary logical unit is defined or can be made via the VARY NET,LOGON command.

**auxiliary network address.** In ACF/VTAM, any network address, except the main network address, assigned to an LU capable of having parallel sessions. Contrast with *main network address*.

**available.** In ACF/VTAM, pertaining to a logical unit that is active, connected, enabled, and not at its session limit.

## B

**basic information unit (BIU).** In SNA, the unit of data and control information that is passed between half-sessions. It consists of a request/response header (RH) followed by a request/response unit (RU).

**basic mode.** In ACF/VTAM Version 1 Release 1 and in VTAM, a mode of data transfer in which the application program can communicate with non-SNA terminals without using SNA protocols. Contrast with *record mode*.

**basic transmission unit (BTU).** In SNA, the unit of data and control information passed between path control components. A BTU can consist of one or more path information units (PIUs). See also *blocking of PIUs*.

**begin bracket.** In SNA, the value (binary 1) of the begin-bracket indicator in the request header (RH) of the first request in the first chain of a bracket; the value denotes the start of a bracket. Contrast with *end bracket*. See also *bracket*.

**bidder.** In SNA, the LU-LU half-session defined at session activation as having to request and receive permission from the other LU-LU half-session to begin a bracket. Contrast with *first speaker*. See also *bracket protocol*.

**binary synchronous communication (BSC).** (1) Communication using binary synchronous line discipline. (2) A uniform procedure, using a standardized set of control characters and control character sequences, for synchronous transmission of binary-coded data between stations.

**BIND.** In SNA, a request to activate a session between two logical units. See also *session activation request*.

**BIU.** Basic information unit.

**BIU segment.** In SNA, the portion of a basic information unit (BIU) that is contained within a path information unit (PIU). It consists of either a request/response header (RH) followed by all or a portion of a request/response unit (RU), or only a portion of an RU.

**blocking of PIUs.** In SNA, an optional function of path control that combines multiple path information units (PIUs) into a single basic transmission unit (BTU).

**Note:** When blocking is not done, a BTU consists of one PIU.

**boundary function.** In SNA, (1) A capability of a subarea node to provide protocol support for adjacent peripheral nodes, such as: (a) transforming network addresses to local addresses, and vice versa; (b) performing session sequence numbering for low-function peripheral nodes; and (c) providing session-level pacing support. See also *path control network, network addressable unit*. (2) The component that provides these capabilities.

**boundary node.** A subarea node that performs boundary functions. See also *boundary function*.

**Note:** A subarea node may be a boundary node, an intermediate routing node, both, or neither depending on how it is used in the network.

**bracket.** In SNA, one or more chains of request units (RUs) and their responses that are exchanged between the two LU-LU half-sessions and that represent a transaction between them. A bracket must be completed before another bracket can be started. Examples of brackets are data base inquiries/replies, update transactions, and remote job entry output sequences to work stations. See also *begin bracket, end bracket*.

**bracket protocol.** In SNA, a data flow control protocol in which exchanges between the two LU-LU half-sessions are achieved through the use of brackets, with one LU designated at session activation as the first speaker and the other as the bidder. The bracket protocol involves bracket initiation and termination rules. See also *bidder, first speaker*.

**BSC.** Binary synchronous communication.

**BTU.** Basic transmission unit.

**buffer group.** In ACF/VTAM, a group of buffers associated with one or more contiguous, related entries in a buffer list. The buffers may be located in discontinuous areas of storage and may be combined into one or more request units.

**buffer list.** In ACF/VTAM, a contiguous set of control blocks (buffer list entries) that allow an application program to send function management (FM) data from a number of discontinuous buffers with a single SEND macro instruction.

**buffer list entry.** A control block within a buffer list that points to a buffer containing function management (FM) data to be sent.

## C

**cancel closedown.** A closedown in which ACF/VTAM is abnormally terminated either because of an unexpected situation or as the result of an operator command. See also *orderly closedown*, *quick closedown*.

**CDRM.** Cross-domain resource manager.

**CEB.** Conditional end bracket.

**chain.** See *RU chain*.

**change-direction protocol.** In SNA, a data flow control protocol in which the sending logical unit (LU) stops sending normal-flow requests, signals this fact to the receiving LU using the change-direction indicator (in the request header of the last request of the last chain), and prepares to receive requests.

**channel-attached.** (1) Pertaining to the attachment of devices directly by data channels (I/O channels) to a computer. Contrast with *link-attached*. (2) Pertaining to devices that are attached to a controlling unit by cables, rather than by telecommunication lines.

**character-coded.** In ACF/VTAM, pertaining to commands (such as LOGON or LOGOFF) entered by an end user and sent by a logical unit in character form. The character-coded command must be in the syntax defined in the user's unformatted system services definition table. Synonym for *unformatted*. Contrast with *field-formatted*.

**CID.** Communication identifier.

**CINIT.** A network services request sent from an SSCP to an LU requesting that LU to establish a session with another LU and to act as the primary end of the session.

**ciphertext.** Synonym for *enciphered data*.

**class of service (COS).** In SNA, a designation of the path control network characteristics, such as path security, transmission priority, and bandwidth, that apply to a particular session. The end user designates class of service at session initiation by using a symbolic name that is mapped into a list of virtual routes, any one of which can be selected for the session to provide the requested level of service.

**Cleanup.** A network services request, sent by an SSCP to an LU, that causes a particular LU-LU session with that LU to be ended immediately without requiring the participation of either the other LU or its SSCP.

**clear data.** Data that is not enciphered. Synonymous with *plaintext*.

**clear session.** A session in which only clear data is transmitted or received. Contrast with *cryptographic session*.

**closedown.** The deactivation of a device, program, or system. See *cancel closedown*, *orderly closedown*, and *quick closedown*.

**cluster controller.** A device that can control the input/output operations of more than one device connected to it. A cluster controller may be controlled by a program stored and executed in the unit; for example, the IBM 3601 Finance

Communication Controller. Or it may be controlled entirely by hardware; for example, the IBM 3272 Control Unit.

**CNM.** Communication network management.

**command.** (1) A request from a terminal for the performance of an operation or the execution of a particular program. (2) In SNA, any field set in the transmission header (TH), request header (RH), and sometimes portions of a request unit, that initiates an action or that begins a protocol; for example: (a) Bind Session (session-control request unit), a command that activates an LU-LU session, (b) the change-direction indicator in the RH of the last RU of a chain, (c) the virtual route reset window indicator in a FID4 transmission header. (3) See also *ACF/VTAM operator command*.

**communication adapter.** An optional hardware feature, available on certain processors, that permits communication lines to be attached to the processors.

**communication common carrier.** In the USA and Canada, a public data transmission service that provides the general public with transmission service facilities; for example, a telephone or telegraph company.

**communication control character.** Synonym for *transmission control character*.

**communication control unit.** A communication device that controls the transmission of data over lines in a network. Communication control units include transmission control units (such as the 2702 Transmission Control Unit) and communication controllers (such as the 3705 Communications Controller).

**communication controller.** A type of communication control unit whose operations are controlled by one or more programs stored and executed in the unit. For example, the IBM 3705 Communications Controller.

**communication identifier (CID).** In ACF/VTAM, a key for locating the control blocks that represent a session. The key is created during the session-establishment procedure and deleted when the session ends.

**communication line.** Deprecated term for *telecommunication line*, *transmission line*.

**communication macro instructions.** In ACF/VTAM, the set of RPL-based macro instructions used to communicate during a session.

**communication management configuration.** In ACF/VTAM, a technique for configuring a network that allows for the consolidation of many network management functions for the entire network in a single host processor.

**communication network management (CNM) application program.** An ACF/VTAM application program that is authorized to issue formatted management services request units containing physical-unit-related requests and to receive formatted management services request units containing information from physical units.

**communication network management (CNM) interface.** The interface that allows an application program to send Forward request units (RUs) to an access method (and to receive

responses to these RUs) and to receive Deliver request units (RUs) from an access method (and to send responses to these RUs). These request/response units contain network services request/response units (data and commands).

**conditional end bracket (CEB).** In SNA, the value (binary 1) of the conditional end bracket indicator in the request header (RH) of the last request of the last chain of a bracket; the value denotes the end of the bracket. Contrast with *end bracket*. See also *begin bracket* and *bracket*.

**configuration restart.** In ACF/VTAM, the recovery facility that can be used after a failure or deactivation of a major node, ACF/VTAM, or the host processor to restore the domain to its status at the time of the failure or deactivation.

**configuration services.** In SNA, one of the types of network services in the system services control point (SSCP) and in the physical unit (PU); configuration services activate, deactivate, and maintain the status of physical units, links, and link stations. Configuration services also shut down and restart network elements and modify path control routing tables and address-translation tables. See also *maintenance services*, *management services*, *network services*, *session services*, and *system services control point*.

**connected.** In ACF/VTAM, pertaining to a PU or LU that has an active physical path to the host processor containing the SSCP that controls the PU or LU.

**connection.** Synonym for *physical connection*.

**connection point manager.** In SNA, a component of the transmission control layer that: (1) performs session-level pacing of normal-flow requests, (2) checks sequence numbers of received request units, (3) verifies that request units do not exceed the maximum permissible size, (4) routes incoming request units to their destinations within the half-session, and (5) enciphers and deciphers FMD request units when cryptography is selected. The connection point manager coordinates the normal and expedited flows for one half-session.

**Note:** The sending connection point manager within a half-session builds the request/response header (RH) for outgoing request/response units (RUs), and the receiving connection point manager interprets the request/response headers that precede incoming request/response units.

**continue-any mode.** In ACF/VTAM, a state into which a session is placed that allows its input to satisfy a RECEIVE request issued in any-mode. While this state exists, input on the session can also satisfy RECEIVE requests issued in specific-mode. Contrast with *continue-specific mode*.

**continue-specific mode.** In ACF/VTAM, a state into which a session is placed that allows its input to satisfy only RECEIVE requests issued in specific-mode. Contrast with *continue-any mode*.

**controlling application program.** In ACF/VTAM, an application program with which a secondary logical unit (other than an application program) is automatically put in session whenever the secondary logical unit is available. See also *automatic logon*, *controlling logical unit*.

**controlling logical unit.** In ACF/VTAM, a logical unit with which a secondary logical unit (other than an application program) is automatically put in session whenever the secondary logical unit is available. A controlling logical unit can be either an application program or a device-type logical unit. See also *automatic logon*, *controlling application program*.

**converted command.** An intermediate form of a character-coded command produced by ACF/VTAM through use of an unformatted system services definition table. The format of a converted command is fixed; the unformatted system services definition table must be constructed in such a manner that the character-coded command (as entered by a logical unit) is converted into the predefined, converted command format. See also *unformatted*.

**COS.** Class of service.

**cross keys.** Synonym for *cross-domain keys*.

**cross-domain.** In SNA, pertaining to control of resources involving more than one domain.

**cross-domain keys.** In SNA, a pair of cryptographic keys used by a system services control point (SSCP) to encipher the session cryptography key that is sent to another SSCP and to decipher the session cryptography key that is received from the other SSCP during initiation of cross-domain LU-LU sessions that use session-level cryptography. Synonymous with *cross keys*.

**cross-domain link.** A link physically connecting two domains.

**cross-domain LU-LU session.** In SNA, a session between logical units (LUs) in different domains. Contrast with *same-domain LU-LU session*.

**cross-domain resource.** A resource owned by a CDRM in another domain but known by the CDRM in this domain by network name and associated cross-domain resource manager.

**cross-domain resource manager (CDRM).** In ACF/VTAM, the function in the system services control point (SSCP) that controls initiation and termination of cross-domain sessions.

**cross-subarea.** In SNA, pertaining to control of resources involving more than one subarea node.

**cross-subarea link.** A link between two adjacent subarea nodes.

**CRV.** Cryptography Verification.

**cryptographic.** Pertaining to the transformation of data to conceal its meaning. See also *encipher*, *decipher*.

**cryptographic algorithm.** A set of rules that specify the mathematical steps required to encipher and decipher data.

**cryptographic key.** In systems using the Data Encryption Standard (DES), a 64-bit value (containing 56 independent bits and 8 parity bits) provided as input to the algorithm in determining the output of the algorithm. See *cross-domain*



*keys, session cryptography key, host master key, and secondary logical unit key.*

**cryptographic session.** In SNA products, an LU-LU session in which a function management data (FMD) request may be enciphered before it is transmitted and deciphered after it is received. Contrast with *clear session*. See *required cryptographic session* and *selective cryptographic session*.

**cryptographic session key.** In SNA, deprecated term for *session cryptography key*.

**Cryptography Verification (CRV) request.** A request unit sent by the primary logical unit (PLU) to the secondary logical unit (SLU) as part of cryptographic session establishment, to allow the SLU to verify that the PLU is using the correct cryptographic session key.

## D

**data communication.** The transmission and reception of data.

**data encrypting key.** A key used to encipher and decipher data transmitted in a cryptographic session. Contrast with *key encrypting key*. See *session cryptography key*.

**Data Encryption Standard (DES) algorithm.** A cryptographic algorithm designed to encipher and decipher data using a 64-bit cryptographic key, as specified in the *Federal Information Processing Standard Publication 46*, January 15, 1977.

**data flow control (DFC).** In SNA, a request/response unit (RU) category used for requests and responses exchanged between the data flow control layer in one half-session and the data flow control layer in the session partner.

**data flow control (DFC) layer.** In SNA, the layer within a half-session that (1) controls whether the half-session can send, receive, or concurrently send and receive request units (RUs); (2) groups related RUs into RU chains; (3) delimits transactions via the bracket protocol; (4) controls the interlocking of requests and responses in accordance with control modes specified at session activation; (5) generates sequence numbers; and (6) correlates requests and responses.

**data flow control protocol.** In SNA, the sequencing rules for requests and responses by which network addressable units in a session coordinate and control data transfer and other operations. For example, see *bracket protocol*.

**data link.** In SNA, synonym for *link*.

**data link control (DLC) layer.** In SNA, the layer that consists of the link stations that schedule data transfer over a link between two nodes and perform error control for the link. Examples of data link control are SDLC for serial-by-bit link connection and data link control for the System/370 channel.

**data link control protocol.** In SNA, a set of rules used by two nodes on a data link to accomplish an orderly exchange of information. Synonymous with *line control*.

**data traffic reset state.** The state usually entered after Bind Session, if Cryptography Verification is used, and after Clear, but prior to Start Data Traffic. While a session is in this state,

requests and responses for data and data flow control cannot be sent. Only certain session control requests can be sent.

**decipher.** To convert enciphered data into clear data. Contrast with *encipher*.

**definite response.** In SNA, a value in the form-of-response-requested field of the request header. The value directs the receiver of the request to return a response unconditionally, whether positive or negative, to that request. Contrast with *exception response, no response*.

**definition statement.** In ACF/VTAM, the means of describing an element of the network.

**delayed-request mode.** In SNA, an operational mode in which the sender may continue sending request units on the normal flow after sending a definite-response request chain on that flow, without waiting to receive the response to that chain. Contrast with *immediate-request mode*.

**delayed-response mode.** In SNA, an operational mode in which the receiver of normal-flow request units can return responses to the sender in a sequence different from that in which the corresponding request units were sent. Contrast with *immediate-response mode*.

**Note:** An exception is the response to the DFC request CHASE: all responses to normal-flow request units received before CHASE must be sent before the response to CHASE is sent.

**DES.** Data Encryption Standard.

**device control character.** A control character used for the control of ancillary devices associated with a data processing system or data communication system, for example, for switching such devices on or off.

**device-type logical unit.** In ACF/VTAM, a logical unit that has a session limit of one and usually acts as the secondary end of a session. It is typically an SNA terminal (such as a logical unit for a 3270 terminal or a logical unit for a 3790 application program). It could be the primary end of a session, for example, the logical unit representing the Network Routing Facility logical unit. See also *peripheral node*.

**DFC.** Data flow control.

**DFSYN response.** In ACF/VTAM, a normal-flow response that is treated as a normal-flow request so that it may be received in order with normal-flow requests.

**direct activation.** In ACF/VTAM, the activation of a resource as a result of an activation command specifically naming the resource. Contrast with *indirect activation*.

**direct deactivation.** In ACF/VTAM, the deactivation of a resource as a result of a deactivation command specifically naming the resource. Contrast with *indirect deactivation*.

**disabled.** In ACF/VTAM, pertaining to an LU that has indicated to its SSCP that it is temporarily not ready to establish LU-LU sessions. An Initiate request for a session with a disabled LU can specify that the session be queued by

the SSCP until the LU becomes enabled. The LU can separately indicate whether this applies to its ability to act as a primary logical unit (PLU) or a secondary logical unit (SLU). See also *enabled* and *inhibited*.

**disconnection.** The termination of a physical connection.

**DLC.** Data link control.

**domain.** In SNA, a system services control point (SSCP) and the physical units (PUs), logical units (LUs), links, link stations, and all the associated resources that the SSCP has the ability to control by means of activation requests and deactivation requests.

**domain operator.** In a multiple-domain network, the person or program that controls the operation of the resources controlled by one system services control point. Contrast with *network operator* (2).

**Downstream Load Utility (DSLUI).** A program product that uses the communication network management (CNM) interface to support the load requirements of certain type 2 physical units, such as the IBM 3644 Automatic Data Unit and the IBM 8775 Display Terminal.

**DRDS.** Dynamic reconfiguration data set.

**duplex.** (1) In data communication, pertaining to a simultaneous two-way independent transmission in both directions. Synonymous with *full duplex*. (2) Contrast with *half duplex*.

**dynamic reconfiguration.** In ACF/VTAM, the process of changing the network configuration (peripheral PUs and LUs) associated with a boundary node, without regenerating the boundary node's complete configuration tables.

**dynamic reconfiguration data set (DRDS).** In ACF/VTAM, a data set used for storing definition data that can be applied to a generated communication controller configuration at the operator's request. See also *dynamic reconfiguration*.

## E

**ECB.** Event control block.

**echo check.** A check to determine the correctness of the transmission of data in which the received data are returned to the source for comparison with the originally transmitted data.

**element.** (1) A field in the network address. (2) The particular resource within a subarea identified by the element address. See also *subarea*.

**element address.** In SNA, a value in the element address field of the network address identifying a specific resource within a subarea. See *subarea address*.

**emulation mode.** The function of a network control program that enables it to perform activities equivalent to those performed by a transmission control unit. Contrast with *network control mode*.

**enabled.** In ACF/VTAM, pertaining to an LU that has indicated to its SSCP that it is now ready to establish LU-LU

sessions. The LU can separately indicate whether this prevents it from acting as a primary logical unit (PLU) or as a secondary logical unit (SLU). See also *disabled* and *inhibited*.

**encipher.** (1) To scramble data or convert it, prior to transmission, to a secret code that masks the meaning of the data to any unauthorized recipient. (2) In ACF/VTAM, to convert clear data into enciphered data. Contrast with *decipher*.

**enciphered data.** Data whose meaning is concealed from unauthorized users. Synonymous with *ciphertext*.

**end bracket.** In SNA, the value (binary 1) of the end bracket indicator in the request header (RH) of the first request of the last chain of a bracket; the value denotes the end of the bracket. Contrast with *begin bracket*. See also *bracket*.

**end user.** In SNA, the ultimate source or destination of application data flowing through an SNA network. An end user may be an application program or a terminal operator.

**ER.** Explicit route.

**event control block (ECB).** A control block used to represent the status of an event.

**exception request (EXR).** In SNA, a request that replaces another message unit in which an error has been detected.

**Note:** The exception request contains a 4-byte sense field that identifies the error in the original message unit and, except for some path errors, is sent to the destination of the original message unit; if possible, the sense data is returned in a negative response to the originator of the replaced message unit.

**exception response.** In SNA, a value in the form-of-response-requested field of a request header: the receiver is requested to return a response only if the request is unacceptable as received or cannot be processed; that is, a negative response, but not a positive one, may be returned. Contrast with *definite response*, *no response*. See also *negative response*.

**exit list (EXLST).** In VSAM and ACF/VTAM, a control block that contains the addresses of routines that receive control when specified events occur during execution; for example, routines that handle session-establishment request processing or I/O errors.

**exit routine.** Any of several types of special-purpose user-written routines. See *accounting exit routine*, *authorization exit routine*, *logon-interpret routine*, *virtual route selection exit routine*, *EXLST exit routine*, and *RPL exit routine*.

**EXLST exit routine.** In ACF/VTAM, a routine whose address has been placed in an exit list (EXLST) control block. The addresses are placed there with the EXLST macro instruction, and the routines are named according to their corresponding operand; hence DFASY exit routine, TPEND exit routine, RELREQ exit routine, and so forth. All exit list routines are coded by the ACF/VTAM application programmer. Contrast with *RPL exit routine*.

**expedited flow.** In SNA, a data flow designated in the transmission header (TH) that is used to carry network control, session control, and various data flow control request/response units (RUs); the expedited flow is separate from the normal flow (which carries primarily end-user data) and can be used for commands that affect the normal flow. Contrast with *normal flow*.

**Note:** The normal and expedited flows move in both the primary-to-secondary and secondary-to-primary directions. Requests and responses on a given flow (normal or expedited) usually are processed sequentially within the path, but the expedited flow traffic may be moved ahead of the normal-flow traffic within the path at queuing points in the half-sessions and for half-session support in boundary functions.

**explicit route (ER).** In SNA, the path control network components, including a specific set of one or more transmission groups, that connect two subarea nodes. An explicit route is identified by an origin subarea address, a destination subarea address, an explicit route number, and a reverse explicit route number. See also *path, route extension, virtual route*.

**explicit route length.** In SNA, the number of transmission groups in an explicit route.

**EXR.** Exception request.

**external domain.** The part of the network that is controlled by an SSCP other than the SSCP that controls this part.

## F

**FD.** Full duplex.

**FDX.** Full duplex.

**feedback information.** In ACF/VTAM, information that is placed in certain RPL fields when an RPL-based macro instruction is completed.

**FIC.** First-in-chain.

**FID.** Format identification.

**field-formatted.** Pertaining to a request or response that is encoded into fields, each having a specified format such as binary codes, bit-significant flags, and symbolic names. Contrast with *character-coded*.

**field-formatted request.** In SNA, a request that is encoded into fields, each having a specified format such as binary codes, binary counts, bit-significant flags, and symbolic names; a format indicator in the request/response header (RH) for the request is set to zero. Contrast with *character-coded*.

**first speaker.** In SNA, the LU-LU half-session defined at session activation as: (1) able to begin a bracket without requesting permission from the other LU-LU half-session to do so, and (2) winning contention if both half-sessions attempt to begin a bracket simultaneously. Contrast with *bidder*. See also *bracket protocol*.

**first-in-chain (FIC).** An request unit whose request header (RH) begin chain indicator is on and whose RH end chain indicator is off. See also *RU chain*.

**flow control.** In SNA, the process of managing the rate at which data traffic passes between components of the network. The purpose of flow control is to optimize the rate of flow of message units, with minimum congestion in the network; that is, to neither overflow the buffers at the receiver or at intermediate routing nodes, nor leave the receiver waiting for more message units. See also *pacing, session-level pacing, virtual route pacing*.

**FMD.** Function management data.

**FMH.** Function management header.

**format identification (FID) field.** In SNA, a field in each transmission header (TH) that indicates the format of the TH; that is, the presence or absence of certain fields. Transmission header formats differ in accordance with the types of nodes between which they pass.

**Note:** There are six FID types:

FID0, used for traffic involving non-SNA devices between adjacent subarea nodes when either or both nodes do not support explicit route and virtual route protocols.

FID1, used for traffic between adjacent subarea nodes when either or both nodes do not support explicit route and virtual route protocols.

FID2, used for traffic between a subarea node and an adjacent PU type 2 peripheral node.

FID3, used for traffic between a subarea node and an adjacent PU type 1 peripheral node.

FID4, used for traffic between adjacent subarea nodes when both nodes support explicit route and virtual route protocols.

FIDF, used for certain commands (for example, for transmission group control) sent between adjacent subarea nodes when both nodes support explicit route and virtual route protocols.

**formatted system services.** A portion of ACF/VTAM that provides certain system services as a result of receiving a field-formatted command, such as an Initiate or Terminate command. Contrast with *unformatted system services (USS)*. See also *field-formatted*.

**full duplex (FD, FDX).** Synonym for *duplex*.

**function management data (FMD).** In SNA, an RU category used for end-user data exchanged between logical units (LUs) and for requests and responses exchanged between network services components of LUs, PUs, and SSCPs.

**function management (FM) header.** In SNA, one or more headers, optionally present in the leading request units (RUs) of an RU chain, that allow one half-session in an LU-LU session to: (1) select a destination at the session partner and

control the way in which the end-user data it sends is handled at the destination, (2) change the destination or the characteristics of the data during the session, and (3) transmit between session partners status or user information about the destination (for example, a program or device).

**Note:** FM headers can be used on LU-LU session types 0, 1, 4, and 6.

**function management (FM) profile.** In SNA, a specification of various data flow control protocols (such as RU chains and data flow control requests) and FMD options (such as use of FM headers, compression, and alternate codes) supported for a particular session. Each function management profile is identified by a number.

## G

**generalized path information unit trace (GPT).** A record of the flow of path information units (PIUs) to or from an NCP and its subordinate physical and logical units.

**generic BIND.** A synonym for a session activation request.

**generic UNBIND.** A synonym for a session deactivation request.

**GPT.** Generalized path information unit trace.

## H

**half-duplex.** (1) In data communication, pertaining to an alternate, one way at a time, independent transmission. (2) Contrast with *duplex*.

**half-session.** In SNA, a component that provides FMD services, data flow control, and transmission control for one of the sessions of a network addressable unit (NAU). See also *primary half-session*, *secondary half-session*.

**host LU.** An SNA logical unit located in a host processor, for example, an ACF/VTAM application program. Contrast with *peripheral LU*.

**host master key.** In SNA, deprecated term for *master cryptography key*.

**host processor.** In a network, the processing unit in which the data communication access method resides.

## I

**ICV.** Initial chaining value.

**immediate-request mode.** In SNA, an operational mode in which the sender stops sending request units (RUs) on a given flow (normal or expedited) after sending a definite-response request chain on that flow until that chain has been responded to. Contrast with *delayed-request mode*. See also *immediate-response mode*.

**immediate-response mode.** In SNA, an operational mode in which the receiver responds to request units (RUs) on a given normal flow in the order it receives them; that is, in a first-in,

first-out sequence. Contrast with *delayed-response mode*. See also *immediate-request mode*.

**inactive.** In ACF/VTAM, pertaining to a major or minor node that has not been activated or for which the VARY INACT command has been issued. Contrast with *active*.

**indirect activation.** In ACF/VTAM, the activation of a lower-level resource of the resource hierarchy as a result of SCOPE or ISTATUS specifications related to an activation command naming a higher-level resource. Contrast with *direct activation*.

**indirect deactivation.** In ACF/VTAM, the deactivation of a lower-level resource of the resource hierarchy as a result of a deactivation command naming a higher-level resource. Contrast with *direct deactivation*.

**inhibited.** In ACF/VTAM, pertaining to an LU that has indicated to its SSCP that it is not ready to establish LU-LU sessions. An Initiate request for a session with an inhibited LU will be rejected by the SSCP. The LU can separately indicate whether this applies to its ability to act as a primary logical unit (PLU) or as a secondary logical unit (SLU). See also *enabled* and *disabled*.

**initial chaining value (ICV).** An eight-byte pseudo-random number used to verify that both ends of a session with cryptography have the same session cryptography key. The initial chaining value is also used as input to the Data Encryption Standard (DES) algorithm to encipher or decipher data in a session with cryptography. Synonymous with *session seed*.

**Initiate.** A network services request, sent from an LU to an SSCP, requesting that an LU-LU session be established.

**inline exit routine.** In ACF/VTAM, a SYNAD or LERAD exit routine. Contrast with *asynchronous exit routine*.

**INN.** Deprecated term for *intermediate routing node (IRN)*.

**installation exit routine.** In ACF/VTAM, a user-written exit routine that can perform functions related to initiation and termination of sessions and is run as part of ACF/VTAM rather than as part of an application program. Examples are the accounting, authorization, logon-interpret, and virtual route selection exit routines. Contrast with *application program exit routine*.

**intermediate routing function.** In SNA, a path control capability in a subarea node that receives and routes path information units (PIUs) that neither originate in nor are destined for network addressable units (NAUs) in the subarea node. Contrast with *boundary function*.

**intermediate routing node (IRN).** In SNA, a subarea node with intermediate routing function. A subarea node may be a boundary node, an intermediate routing node, both, or neither, depending on how it is used in the network.

**interpret table.** In ACF/VTAM, an installation-defined correlation list that translates an argument into a string of eight characters. Interpret tables can be used to translate logon data into the name of an application program for which the logon is intended.

**IRN.** Intermediate routing node.

## K

**key-encrypting key.** A key used in sessions with cryptography to encipher and decipher other keys. Contrast with *data encrypting key*.

## L

**large message performance enhancement outbound (LMPEO).** In ACF/VTAM, a facility in which ACF/VTAM reformats function management (FM) data that exceeds the maximum request unit (RU) size (as specified in the BIND) into a chain or partial chain of RUs.

**last-in-chain (LIC).** A request unit whose request header (RH) end chain indicator is on and whose RH begin chain indicator is off. See also *RU chain*.

**LERAD exit routine.** A synchronous EXLST exit routine that is entered automatically when a logic error is detected.

**LIC.** Last-in-chain.

**line.** See *communication line*.

**line control.** Synonym for *data link control protocol*.

**line group.** One or more telecommunication lines of the same type that can be activated and deactivated as a unit.

**link.** In SNA, the combination of the link connection and the link stations joining network nodes; for example: (1) a System/370 channel and its associated protocols, (2) a serial-by-bit connection under the control of Synchronous Data Link Control (SDLC). Synonymous with *data link*.

**Note:** A link connection is the physical medium of transmission; for example, a telephone wire or a microwave beam. A link includes the physical medium of transmission, the protocol, and associated communication devices and programming; it is both logical and physical.

**link connection.** In SNA, the physical equipment providing two-way communication between one link station and one or more other link stations; for example, a telecommunication line and data circuit terminating equipment (DCE).

**link level 2 test.** See *link test*.

**link station.** (1) In SNA, the combination of hardware and software that allows a node to attach to and provide control for a link. (2) In ACF/VTAM, a named resource within a subarea node representing another subarea node directly attached by a cross-subarea link. In the resource hierarchy, the link station is subordinate to the cross-subarea link.

**link test.** In SNA, a test in which one link station returns data received from another link station without changing the data in order to test the operation of the link.

**Note:** Three tests can be made; they differ in the resources that are dedicated during the test. A link test, level 0 requires a dedicated subarea node, link, and secondary link station. A link test, level 1 requires a dedicated link and secondary link station. A link test, level 2 requires only the dedicated link station.

**link-attached.** In ACF/VTAM, pertaining to devices that are physically connected by a telecommunication line. Synonymous with *remote*. Contrast with *channel-attached*.

**LMPEO.** Large message performance enhancement outbound.

**local.** (1) Synonymous with *channel-attached*. (2) Pertaining to a device that is attached to a controlling unit by cables, rather than by a telecommunication line.

**local address.** In SNA, an address used in a peripheral node in place of an SNA network address and transformed to or from an SNA network address by the boundary function in a subarea node.

**local non-SNA major node.** In ACF/VTAM, a major node whose minor nodes are channel-attached non-SNA terminals.

**local session identification (LSID).** In SNA, a field in a FID3 transmission header that contains an indication of the type of session (SSCP-PU, SSCP-LU, or LU-LU) and the local address of the peripheral logical unit (LU) or physical unit (PU).

**local SNA major node.** In ACF/VTAM, a major node whose minor nodes are channel-attached peripheral nodes.

**logic error.** In ACF/VTAM, an error condition that results from an invalid request; a program logic error.

**logical unit (LU).** In SNA, a port through which an end user accesses the SNA network in order to communicate with another end user and through which the end user accesses the functions provided by system services control points (SSCPs). An LU can support at least two sessions -- one with an SSCP and one with another LU -- and may be capable of supporting many sessions with other logical units. See also *network addressable unit*, *peripheral LU*, *physical unit*, *system services control point*, *primary logical unit*, *secondary logical unit*.

**logical unit (LU) services.** In SNA, capabilities in a logical unit to: (1) receive requests from an end user and, in turn, issue requests to the system services control point (SSCP) in order to perform the requested functions, typically for session initiation; (2) receive requests from the SSCP, for example to activate LU-LU sessions via Bind Session requests; and (3) provide session presentation and other services for LU-LU sessions. See also *physical unit (PU) services*.

**log off.** To request that a session be terminated.

**log on.** (1) To initiate a session. (2) In SNA products, to initiate a session between an application program and a logical unit.

**logoff.** In ACF/VTAM, an unformatted session-termination request.

**logon.** In ACF/VTAM, an unformatted session-initiation request for a session between two logical units. See *automatic logon* and *simulated logon*. See also *session-initiation request*.

**logon data.** In ACF/VTAM: (1) The user data portion of a field-formatted or unformatted session-initiation request. (2) The entire logon sequence or message from an LU. Synonymous with *logon message*.

**logon message.** Synonym for *logon data*.

**logon mode.** In ACF/VTAM, a subset of session parameters specified in a logon mode table for communication with a logical unit. See also *session parameters*.

**logon mode table.** In ACF/VTAM, a set of entries for one or more logon modes. Each logon mode is identified by a logon mode name.

**logon-interpret routine.** In ACF/VTAM, an installation exit routine, associated with an interpret table entry, that translates logon information. It may also verify the logon.

**loop adapter.** A feature of the 4331 Processor that supports the attachment of a variety of SNA and non-SNA devices. To ACF/VTAM, these devices appear as channel-attached type 2 physical units.

**LSID.** Local session identification.

**LU.** Logical unit.

**LU connection test.** In SNA products, a diagnostic aid that permits a terminal operator to check whether the path between a system services control point (SSCP) and a logical unit (LU) is operational.

**LU type.** In SNA, a deprecated term for *LU-LU session type*.

**LU-LU session.** In SNA, a session between two logical units in an SNA network. It provides communication between two end users, or between an end user and an LU services component.

**LU-LU session type.** In SNA, the classification of an LU-LU session in terms of the specific subset of SNA protocols and options supported by the logical units (LUs) for that session, namely:

The mandatory and optional values allowed in the session activation request.

The usage of data stream controls, FM headers, RU parameters, and sense codes.

Presentation services protocols such as those associated with FM header usage.

LU-LU session types 0, 1, 2, 3, 4, 6, and 7 are defined.

**Note:** At session activation, one LU-LU half-session selects the session type and includes or excludes optional protocols of the session type by sending the session activation request, and the other half-session concurs with the selection by sending a positive response or rejects the selection by sending a negative response. In LU-LU session types 4 and 6, the half-sessions may negotiate the optional parameters to be used. For the other session types, the primary

half-session selects the optional protocols without negotiating with the secondary half-session.

## M

**main network address.** In ACF/VTAM, the LU network address used for the SSCP-LU session and certain LU-LU sessions with the LU. Contrast with *auxiliary network address*.

**mainline program.** In ACF/VTAM, that part of the application program that issues OPEN and CLOSE macro instructions.

**maintenance services.** In SNA, one of the types of network services in system services control points (SSCPs) and physical units (PUs). Maintenance services provide facilities for testing links and nodes and for collecting and recording error information. See also *configuration services*, *management services*, *network services*, *session services*.

**major node.** In ACF/VTAM, a set of minor nodes that can be activated and deactivated as a group. See *node* and *minor node*.

**management services.** In SNA, one of the types of network services in system services control points (SSCPs) and logical units (LUs). Management services forward requests for network data, such as error statistics, and deliver the data in reply. See also *configuration services*, *maintenance services*, *network services*, *session services*.

**mandatory cryptographic session.** Synonym for *required cryptographic session*.

**master cryptography key.** In SNA, a cryptographic key used to encipher operational keys that will be used at a node.

**message.** In ACF/VTAM, the amount of FM data transferred to ACF/VTAM by the application program with one SEND request.

**message unit.** In SNA, the unit of data processed by any layer; for example, a basic information unit (BIU), a path information unit (PIU), a request/response unit (RU).

**MIC.** Middle-in-chain.

**middle-in-chain (MIC).** A request unit whose request header (RH) begin chain indicator and RH end chain indicator are both off. See also *RU chain*.

**minor node.** In ACF/VTAM, a uniquely-defined resource within a major node. See *node* and *major node*.

**modem.** (modulator-demodulator) A device that modulates and demodulates signals transmitted over data communication facilities.

**multiple-domain network.** In SNA, a network with more than one system services control point (SSCP). Contrast with *single-domain network*.

**multipoint link.** A link or circuit interconnecting several link stations. Contrast with *point-to-point line*.

**Multisystem Networking Facility.** An optional feature of ACF/TCAM and ACF/VTAM Version 1 that permits these access methods, together with ACF/NCP, to control a multiple-domain network.

**multithread application program.** An ACF/VTAM application program that processes requests for more than one session concurrently. Contrast with *single-thread application program*.

## N

**NAU.** Network addressable unit.

**NC.** Network control.

**NCCF.** Network Communications Control Facility.

**NCP.** Network control program.

**NCP major node.** In ACF/VTAM, a set of minor nodes representing resources, such as lines and peripheral nodes, controlled by a network control program. See *major node*.

**negative polling limit.** For a start-stop or BSC terminal, the maximum number of consecutive negative responses to polling that the communication controller accepts before suspending polling operations.

**negative response.** In SNA, a response indicating that a request did not arrive successfully or was not processed successfully by the receiver. Contrast with *positive response*. See *exception response*.

**negotiable BIND.** In SNA, a capability that allows two LU-LU half-sessions to negotiate the parameters of a session when the session is being activated.

**network.** In data processing, a user application network. See *path control network*, *public network*, *SNA network*, and *user application network*.

**network address.** In SNA, an address, consisting of subarea and element fields, that identifies a link, a link station, or a network addressable unit. Subarea nodes use network addresses; peripheral nodes use local addresses. The boundary function in the subarea node to which a peripheral node is attached transforms local addresses to network addresses and vice versa. See *local address*. See also *network name*.

**network addressable unit (NAU).** In SNA, a logical unit, a physical unit, or a system services control point. It is the origin or the destination of information transmitted by the path control network. See also *network name*, *network address*, and *path control network*.

**Note:** Each NAU has a network address that represents it to the path control network. (LUs may have multiple addresses for parallel LU-LU sessions.) The path control network and the NAUs collectively constitute the SNA network.

**Network Communications Control Facility (NCCF).** An IBM program product consisting of a base for command processors that can monitor, control, and improve the operation of a network.

**network configuration tables.** The tables through which the system services control point (SSCP) interprets the network configuration.

**network control (NC).** In SNA, an RU category used for requests and responses exchanged between physical units (PUs) for such purposes as activating and deactivating explicit and virtual routes and sending load modules to adjacent peripheral nodes. See also *data flow control layer* and *session control*.

**network control mode.** The functions of a network control program that enable it to direct a communication controller to perform activities such as polling, device addressing, dialing, and answering. Contrast with *emulation mode*.

**network control program (NCP).** A program, generated by the user from a library of IBM-supplied modules, that controls the operation of a communication controller.

**network control program generation.** The process, performed in a host system, of assembling and link-editing a macro instruction program to produce a network control program.

**Network Logical Data Manager (NLDM).** A program product that helps the user at a central control point identify network problems relating to sessions by means of interactive display techniques. NLDM runs with the Network Communications Control Facility (NCCF) as a CNM application program.

**network name.** (1) In SNA, the symbolic identifier by which end users refer to a network addressable unit (NAU), a link, or a link station. See also *network address*. (2) In a multiple-domain network, the name of the APPL statement defining an ACF/VTAM application program is its network name and it must be unique across domains. Contrast with *ACB name*. See *uninterpreted name*.

**network node.** Synonym for *node*.

**network operator.** (1) A person or program responsible for controlling the operation of all or part of a network. (2) The person or program that controls all the domains in a multiple-domain network. Contrast with *domain operator*.

**network operator console.** A system console or terminal in the network from which an operator controls the network.

**Network Problem Determination Application (NPDA).** A program product that assists the user in identifying network problems from a central control point using interactive display techniques.

**network services (NS).** In SNA, the services within network addressable units (NAUs) that control network operation through SSCP-SSCP, SSCP-PU, and SSCP-LU sessions. See *configuration services, maintenance services, management services, session services.*

**network services (NS) header.** In SNA, a 3-byte field in an FMD request/response unit (RU) flowing in an SSCP-LU, SSCP-PU, or SSCP-SSCP session. The network services header is used primarily to identify the network services category of the RU (for example, configuration services, session services) and the particular request code within a category.

**Network Services Procedure Error (NSPE).** A request unit that is sent by an SSCP to an LU when a procedure requested by that LU has failed.

**Network Terminal Option (NTO).** An IBM program product that extends the capabilities of the ACF/NCP to support a select group of non-SNA devices.

**networking.** In a multiple-domain network, communication among domains.

**NIB.** Node initialization block.

**NIB list.** A series of contiguous node initialization blocks.

**NLDM.** Network Logical Data Manager.

**no response.** In SNA, a value in the form-of-response-requested field of the request header (RH) indicating that no response is to be returned to the request, whether or not the request is received and processed successfully. Contrast with *definite response, exception response.*

**node.** (1) In SNA, an endpoint of a link or junction common to two or more links in a network. Nodes can be distributed to host processors, communication controllers, cluster controllers, or terminals. Nodes can vary in routing and other functional capabilities. (2) In ACF/VTAM, a point in a network defined by a symbolic name. Synonymous with *network node.* See *major node* and *minor node.*

**node initialization block (NIB).** In ACF/VTAM, a control block associated with a particular node or session that contains information used by the application program to identify the node or session and to indicate how communication requests on a session are to be handled by ACF/VTAM.

**node name.** In ACF/VTAM, the symbolic name assigned to a specific major or minor node during network definition.

**node type.** In SNA, a designation of a node according to the protocols it supports and the network addressable units (NAUs) that it can contain. Four types are defined: 1, 2, 4, and 5. Type 1 and type 2 nodes are also referred to as peripheral nodes and type 4 and type 5 nodes are also referred to as subarea nodes. See also *physical unit type.*

**non-SNA terminal.** A terminal that does not use SNA protocols.

**nonswitched line.** A telecommunication line on which connections do not have to be established by dialing. Contrast with *switched line.*

**normal flow.** In SNA, a data flow designated in the transmission header (TH) that is used primarily to carry end-user data. The rate at which requests flow on the normal flow can be regulated by session-level pacing. Contrast with *expedited flow.*

**Note:** The normal and expedited flows move in both the primary-to-secondary and secondary-to-primary directions. Requests and responses on a given flow (normal or expedited) usually are processed sequentially within the path, but the expedited-flow traffic may be moved ahead of the normal-flow traffic within the path at queuing points in the half-sessions and for half-session support in the boundary functions.

**Notify.** A network services request unit that is sent by an SSCP to an LU to inform the LU of the status of a procedure requested by the LU.

**NPDA.** Network Problem Determination Application.

**NS.** Network services.

**NSPE.** Network Services Procedure Error.

**NTO.** Network Terminal Option.

## O

**OIC.** Only-in-chain.

**only-in-chain (OIC).** A request unit whose request header (RH) begin chain indicator and RH end chain indicator are both on. See also *RU chain.*

**orderly closedown.** The orderly deactivation of ACF/VTAM and its domain. An orderly closedown does not complete until all application programs have closed their ACBs. Until then, RPL-based operations continue; however, no new sessions can be established and no new ACBs can be opened. Contrast with *cancel closedown* and *quick closedown.*

## P

**pacing.** In SNA, a technique by which a receiving component controls the rate of transmission of a sending component to prevent overrun or congestion. See *session-level pacing, send pacing, and virtual route (VR) pacing.* See also *flow control.*

**pacing group.** In SNA, (1) The path information units (PIUs) that can be transmitted on a virtual route before a virtual-route pacing response is received, indicating that the virtual route receiver is ready to receive more PIUs on the route. Synonymous with *window.* (2) The requests that can be transmitted on the normal flow in one direction on a session before a session-level pacing response is received, indicating that the receiver is ready to accept the next group of requests.



**pacing group size.** In SNA, (1) The number of path information units (PIUs) in a virtual route pacing group. The pacing group size varies according to traffic congestion along the virtual route. Synonymous with *window size*. (2) The number of requests in a session-level pacing group.

**pacing response.** In SNA, an indicator that signifies a receiving component's readiness to accept another pacing group; the indicator is carried in a response header (RH) for session-level pacing, and in a transmission header (TH) for virtual route pacing.

**parallel links.** In SNA, two or more links between adjacent subarea nodes.

**parallel sessions.** In SNA, two or more concurrently active sessions between the same two logical units (LUs) using different pairs of network addresses. Each session can have independent session parameters.

**partitioned emulation programming (PEP) extension.** A function of a network control program that enables a communication controller to operate some telecommunication lines in network control mode while simultaneously operating others in emulation mode.

**path.** (1) In SNA, the series of path control network components (path control and data link control) that are traversed by the information exchanged between two network addressable units (NAUs). A path consists of a virtual route and its route extension, if any. See also *explicit route*. (2) In defining a switched major node, a potential dial-out port that can be used to reach a physical unit.

**path control (PC) layer.** In SNA, the layer that manages the sharing of link resources of the SNA network and routes basic information units (BIUs) through it. Path control routes message units between network addressable units (NAUs) in the network and provides the paths between them. It converts the BIUs from transmission control (possibly segmenting them) into path information units (PIUs) and exchanges basic transmission units (BTUs) and one or more PIUs with data link control. See also *BIU segment*, *blocking of PIUs*, *data link control layer*, *transmission control layer*.

**Note:** The unit of control information built by the sending path control component is the transmission header (TH), attached to the BTU; the TH is interpreted by the receiving path control component. The path control layer in subarea nodes consists of explicit route control, transmission group control, virtual route control, and boundary function path control.

**path control (PC) network.** In SNA, the part of the SNA network that includes the data link control and path control layers. See *SNA network* and *user application network*.

**path information unit (PIU).** In SNA, a message unit consisting of a transmission header (TH) alone, or of a TH followed by a basic information unit (BIU) or a BIU segment. See also *transmission header*.

**PC.** Path control.

**pending active session.** In ACF/VTAM, the state of an LU-LU session recorded by the SSCP when it finds both LUs available and has sent a CINIT request to the primary logical unit (PLU) of the requested session.

**PEP.** Partitioned emulation programming.

**peripheral LU.** In SNA, a logical unit representing a peripheral node.

**peripheral node.** In SNA, a node that uses local addresses for routing and therefore is not affected by changes in network addresses. A peripheral node requires boundary function assistance from an adjacent subarea node. A peripheral node is a type 1 or type 2 node connected to a subarea node.

**peripheral PU.** In SNA, a physical unit representing a peripheral node.

**physical connection.** In ACF/VTAM, a point-to-point connection or multipoint connection.

**physical unit (PU).** In SNA, one of three types of network addressable units (NAUs); each node of an SNA network contains a physical unit (PU) that manages and monitors the resources (such as attached links) of a node, as requested by an SSCP via an SSCP-PU session. See also *peripheral PU*, *physical unit type*, *subarea PU*.

**Note:** An SSCP activates a session with the physical unit in order to indirectly manage, through the PU, resources of the node such as attached links.

**physical unit (PU) services.** In SNA, the components within a physical unit (PU) that provide configuration services and maintenance services for SSCP-PU sessions. See also *logical unit (LU) services*.

**physical unit type.** In SNA, the classification of a physical unit (PU) according to the type of node in which it resides. The PU type is the same as its node type; that is, a type 1 PU resides in a type 1 node, and so forth.

**PIU.** Path information unit.

**plaintext.** Data that is not enciphered. Synonym for *clear data*.

**PLU.** Primary logical unit.

**point-to-point link.** A link that connects a single remote link station to a node; it may be either switched or nonswitched. Contrast with *multipoint link*.

**positive response.** A response indicating that a request was received and processed. Contrast with *negative response*.

**primary application program.** In ACF/VTAM, an application program acting as the primary end of an LU-LU session.

**primary end of a session.** The end of a session that uses primary protocols. The primary end establishes the session. For an LU-LU session, the primary end of the session is the primary logical unit. Contrast with *secondary end of a session*. See *half-session*.

**primary half-session.** In SNA, the half-session that sends the session activation request. See also *primary logical unit*. Contrast with *secondary half-session*.

**primary logical unit (PLU).** In SNA, the logical unit (LU) that contains the primary half-session for a particular LU-LU session. Contrast with *secondary logical unit*.

**Note:** A particular logical unit may contain both primary and secondary half-sessions for different active LU-LU sessions.

**program operator.** An ACF/VTAM application program that is authorized to issue ACF/VTAM operator commands and receive ACF/VTAM operator awareness messages. See also *solicited messages* and *unsolicited messages*.

**protocol.** In SNA, the meanings of, and the sequencing rules for, requests and responses used for managing the network, transferring data, and synchronizing the states of network components.

**PU.** Physical unit.

**PU type.** Physical unit type.

**public network.** A network established and operated by communication common carriers or telecommunication Administrations for the specific purpose of providing circuit-switched, packet-switched, and leased-circuit services to the public. Contrast with *user-application network*.

**PU-PU flow.** In SNA, the exchange between physical units (PUs) of network control requests and responses.

## Q

**queued BIND.** In ACF/VTAM, a BIND request, sent from the primary logical unit (PLU) to the secondary logical unit (SLU), that has not yet been responded to by the SLU. This creates a pending active session at the SLU. When the SLU is an ACF/VTAM application program, it responds to a BIND by issuing an OPNSEC or SESSIONC macro instruction.

**queued CINIT.** In ACF/VTAM, a CINIT request, sent from an SSCP to an LU, that has not yet been responded to by the LU. This creates a pending active session at the LU. An ACF/VTAM application program responds to a CINIT by issuing an OPNDST ACCEPT or a CLSDST macro instruction.

**queued session.** In ACF/VTAM, pertaining to a requested LU-LU session that cannot be started because one of the LUs is not available. If the session-initiation request specified queuing, the SSCP(s) will record the request and later continue with the session-establishment procedure when both LUs become available.

**quick closedown.** In ACF/VTAM, a closedown in which any RPL-based communication macro instruction is terminated (posted complete with an error code) and no new sessions can be established and no new ACBs can be opened. See also *cancel closedown* and *orderly closedown*.

**quiesce protocol.** In ACF/VTAM, a method of communicating in one direction at a time. Either the primary logical unit (PLU) or the secondary logical unit (SLU) assumes the exclusive right to send normal-flow requests, and the other node refrains from sending such requests. When the sender wants to receive, it releases the other node from its quiesced state.

## R

**RDT.** Resource definition table.

**receive pacing.** In SNA, the pacing of message units that the component is receiving. See also *send pacing*.

**record mode.** In ACF/VTAM, the mode of data transfer in which the application program can communicate with logical units. Contrast with *basic mode*.

**release.** In ACF/VTAM resource control, to relinquish control of resources (communication controllers or physical units). See also *resource takeover*. Contrast with *acquire (2)*.

**remote.** Synonym for *link-attached*.

**request header.** In SNA, a request unit (RU) header preceding a request unit.

**request parameter list (RPL).** In ACF/VTAM, a control block that contains the parameters necessary for processing a request for data transfer, for establishing or terminating a session, or for some other operation.

**request unit (RU).** In SNA, a message unit that contains control information such as a request code or FM headers, end-user data, or both.

**request/response header (RH).** In SNA, control information, preceding a request/response unit (RU), that specifies the type of RU (request unit or response unit) and contains control information associated with that RU.

**request/response unit (RU).** In SNA, a generic term for a request unit or a response unit.

**required cryptographic session.** A cryptographic session in which all outbound data is enciphered and all inbound data is deciphered. Synonymous with *mandatory cryptographic session*. Contrast with *selective cryptographic session* and *clear session*.

**resource definition table (RDT).** In ACF/VTAM, a table that describes the characteristics of each node available to ACF/VTAM and associates each node with a network address. This is the main ACF/VTAM network configuration table.

**resource hierarchy.** In ACF/VTAM, the relationship among network resources in which some resources are subordinate to others as a result of their position in the network structure and architecture; for example, the LUs of a peripheral PU are subordinate to that PU, which, in turn, is subordinate to the link attaching it to its subarea node.

**resource takeover.** In ACF/VTAM, action initiated by a network operator to transfer control of resources from one domain to another. See also *acquire (2)* and *release*.

**responded output.** In ACF/VTAM, a type of output request that is completed when a response is returned. Contrast with *scheduled output*.

**response header (RH).** In SNA, a header, optionally followed by a response unit (RU), that indicates whether the response is positive or negative and that may contain a pacing response. See also *negative response*, *pacing response*, *positive response*.

**response unit (RU).** In SNA, a message unit that acknowledges a request unit; it may contain prefix information received in a request unit. If positive, the response unit may contain additional information (such as session parameters in response to Bind Session), or if negative, contains sense data defining the exception condition.

**REX.** Route extension.

**RH.** Request/response header.

**route.** See *explicit route*, *virtual route*.

**route extension (REX).** In SNA, the path control network components, including a peripheral link, that make up the portion of a path between a subarea node and a network addressable unit (NAU) in an adjacent peripheral node. See also *path*, *explicit route (ER)*, *virtual route (VR)*.

**RPL.** Request parameter list.

**RPL exit routine.** In ACF/VTAM, an application program exit routine whose address has been placed in the EXIT field of a request parameter list. ACF/VTAM invokes the routine to indicate that an asynchronous request has been completed. See *EXLST exit routine*.

**RPL-based macro instruction.** In ACF/VTAM, a macro instruction whose parameters are specified by the user in a request parameter list.

**RU.** Request/response unit.

**RU chain.** In SNA, a set of related request/response units (RUs) that are consecutively transmitted on a particular normal or expedited data flow. The request RU chain is the unit of recovery: if one of the RUs in the chain cannot be processed, the entire chain is discarded.

**Note:** Each RU belongs to only one chain, which has a beginning and an end indicated via control bits in request/response headers within the RU chain. Each RU can be designated as first-in-chain (FIC), last-in-chain (LIC), middle-in-chain (MIC), or only-in-chain (OIC). Response units and expedited-flow request units are always sent as only-in-chain.

## S

**same-domain LU-LU session.** In SNA, an LU-LU session between logical units (LUs) in the same domain. Contrast with *cross-domain LU-LU session*.

**SC.** Session control.

**scheduled output.** In ACF/VTAM, a type of output request that is completed, as far as the application program is concerned, when the program's output data area is free. Contrast with *responded output*.

**SCS.** SNA character string.

**SDLC.** Synchronous Data Link Control.

**secondary application program.** An application program acting as the secondary end of an LU-LU session.

**secondary end of a session.** That end of a session that uses secondary protocols. For an LU-LU session, the secondary end of the session is the secondary logical unit. Contrast with *primary end of a session*. See also *secondary logical unit* and *half-session*.

**secondary half-session.** In SNA, the half-session that receives the session-activation request. See also *secondary logical unit*. Contrast with *primary half-session*.

**secondary logical unit (SLU).** In SNA, the logical unit (LU) that contains the secondary half-session for a particular LU-LU session. Contrast with *primary logical unit*.

**Note:** A logical unit may contain secondary and primary half-sessions for different active LU-LU sessions.

**secondary logical unit (SLU) key.** A key-encrypting key used to protect a session cryptography key during its transmission to the secondary half-session.

**segmenting of BIUs.** In SNA, an optional function of path control that divides a basic information unit (BIU) received from transmission control into two or more path information units (PIUs). The first PIU contains the request header (RH) of the BIU and usually part of the RU; the remaining PIU or PIUs contain the remaining parts of the RU.

**Note:** When segmenting is not done, a PIU contains a complete BIU.

**selective cryptographic session.** A cryptographic session in which an application program is allowed to specify the request units to be enciphered. Contrast with *required cryptographic session* and *clear session*.

**send pacing.** In SNA, pacing of message units that a component is sending. See also *receive pacing*.

**session.** In SNA, a logical connection between two network addressable units (NAUs) that can be activated, tailored to provide various protocols, and deactivated, as requested. The session activation request and response can determine options relating to such things as the rate and concurrency of data exchange, the control of contention and error recovery, and the characteristics of the data stream. Sessions compete for network resources such as the links within the path control network. For routing purposes, each session is identified by

the network or local addresses of the session partners. See *half-session*, *LU-LU session*, *SSCP-LU session*, *SSCP-PU session*, *SSCP-SSCP session*. See also *LU-LU session type*, *PU-PU flow*.

**Note:** Each session is uniquely identified in a transmission header (TH) by a pair of network addresses, identifying the origin and destination NAUs of any transmissions exchanged during the session.

**session activation request.** In SNA, a request that activates a session between two network addressable units (NAUs) and specifies session parameters that control various protocols during session activity; for example, BIND and ACTPU. Synonymous with *generic BIND*. Contrast with *session deactivation request*.

**session address space.** In ACF/VTAM, an ACB address space or an associated address space in which an OPNDST or OPNSEC macro instruction is issued to establish a session. See also *ACB address space* and *associated address space*.

**session control (SC).** In SNA, (1) One of the components of transmission control. Session control is used to purge data flowing in a session after an unrecoverable error occurs, to resynchronize the data flow after such an error, and to perform cryptographic verification. (2) An RU category used for requests and responses exchanged between the session control components of a session and for session activation/deactivation requests and responses.

**session cryptography key.** In SNA, a data encrypting key used to encipher and decipher function management data (FMD) requests transmitted in an LU-LU session that uses cryptography.

**session deactivation request.** In SNA, a request that deactivates a session between two network addressable units (NAUs); for example, UNBIND and DACTPU. Synonymous with *generic UNBIND*. Contrast with *session activation request*.

**session limit.** (1) In SNA, the maximum number of concurrently active LU-LU sessions a particular logical unit can support.

**Note:** ACF/VTAM application programs acting as logical units have no session limit. Device-type logical units have a session limit of one.

(2) In the network control program, the maximum number of concurrent line-scheduling sessions on a non-SDLC, multipoint line.

**session parameters.** In SNA, the parameters that specify or constrain the protocols (such as bracket protocol and pacing) for a session between two network addressable units. See also *logon mode*.

**session partner.** In SNA, one of the two network addressable units (NAUs) having an active session.

**session seed.** Synonym for *initial chaining value*.

**session sequence number.** In SNA, a sequentially-incremented identifier that is assigned by data flow control to each request unit on a particular normal flow of a session, typically an

LU-LU session, and is checked by transmission control. The identifier is carried in the transmission header (TH) of the path information unit (PIU) and is returned in the TH of any associated response. Contrast with *virtual route sequence number*.

**session services.** In SNA, one of the types of network services in the system services control point (SSCP) and in the logical unit (LU). These services provide facilities for an LU or a network operator to request that the SSCP initiate or terminate sessions between logical units. See *configuration services* and *maintenance services*.

**session-establishment macro instructions.** In ACF/VTAM, the set of RPL-based macro instructions used to initiate, establish, or terminate LU-LU sessions.

**session-establishment request.** In ACF/VTAM, a request to an LU to establish a session. For the primary logical unit (PLU) of the requested session, the session-establishment request is the CINIT sent from the SSCP to the PLU. For the secondary logical unit (SLU) of the requested session, the session-establishment request is the BIND sent from the PLU to the SLU.

**session-initiation request.** In SNA, an Initiate or logon request from a logical unit (LU) to a system services control point (SSCP) that an LU-LU session be activated.

**session-level pacing.** In SNA, a flow control technique that permits a receiving connection point manager to control the data transfer rate (the rate at which it receives request units) on the normal flow. It is used to prevent overloading a receiver with unprocessed requests when the sender can generate requests faster than the receiver can process them. See also *pacing*, *virtual route pacing*.

**session-termination request.** In ACF/VTAM, a request that an LU-LU session be terminated.

**shadow resource.** In ACF/VTAM, an alternate representation of a network resource that is retained as a definition for possible future use.

**share limit.** In SNA, the maximum number of control points that can concurrently control a network resource.

**shared.** Pertaining to the availability of a resource to more than one use at the same time.

**simulated logon.** A session-initiation request generated when an ACF/VTAM application program issues a SIMLOGON macro instruction. The request specifies an LU with which the application program wants a session in which the requesting application program will act as the PLU.

**single-domain network.** In SNA, a network with one system services control point (SSCP). Contrast with *multiple-domain network*.

**single-thread application program.** An ACF/VTAM application program that processes requests for multiple sessions one at a time. Such a program usually requests synchronous operations from ACF/VTAM, waiting until each operation is completed before proceeding. Contrast with *multithread application program*.

**SLU.** Secondary logical unit.

**SNA.** Systems Network Architecture.

**SNA character string (SCS).** A character string composed of EBCDIC controls, optionally intermixed with end-user data, that is carried within a request/response unit.

**SNA network.** The part of a user-application network that conforms to the formats and protocols of Systems Network Architecture. It enables reliable transfer of data among end users and provides protocols for controlling the resources of various network configurations. The SNA network consists of network addressable units, boundary function components, and the path control network.

**SNA terminal.** A terminal that supports Systems Network Architecture protocols.

**SNBU.** Switched network backup.

**solicited message.** A response from ACF/VTAM to a command entered by a program operator. Contrast with *unsolicited message*.

**specific-mode.** In ACF/VTAM: (1) The form of a RECEIVE request that obtains input from one specific session. (2) The form of an accept request that completes the establishment of a session by accepting a specific queued CINIT request. (3) Contrast with *any-mode*. See *continue-specific mode*.

**SSCP.** System services control point.

**SSCP ID.** In SNA, a number that uniquely identifies a system services control point (SSCP). The SSCP ID is used in session activation requests sent to physical units (PUs) and other SSCPs.

**SSCP-LU session.** In SNA, a session between a system services control point (SSCP) and a logical unit (LU); the session enables the LU to request the SSCP to help initiate LU-LU sessions.

**SSCP-PU session.** In SNA, a session between a system services control point (SSCP) and a physical unit (PU); SSCP-PU sessions allow SSCPs to send requests to and receive status information from individual nodes in order to control the network configuration.

**SSCP-SSCP session.** In SNA, a session between the system services control point (SSCP) in one domain and the SSCP in another domain. An SSCP-SSCP session is used to initiate and terminate cross-domain LU-LU sessions.

**start option.** In ACF/VTAM, a user-specified or IBM-supplied option that determines certain conditions that are to exist during the time an ACF/VTAM system is operating. Start options can be predefined or specified when ACF/VTAM is started.

**subarea.** A portion of the SNA network consisting of a subarea node, any attached peripheral nodes, and their associated resources. Within a subarea node, all network addressable units, links, and adjacent link stations (in attached peripheral or subarea nodes) that are addressable within the subarea share a common subarea address and have distinct element addresses.

**subarea address.** In SNA, a value in the subarea field of the network address that identifies a particular subarea. See also *element address*.

**subarea LU.** In SNA, a logical unit in a subarea node. Contrast with *peripheral LU*.

**subarea node.** In SNA, a node that uses network addresses for routing and whose routing tables are therefore affected by changes in the configuration of the network. Subarea nodes can provide boundary function support for peripheral nodes. Type 4 and type 5 nodes are subarea nodes. See also *intermediate routing node*, *peripheral node*, *node type*.

**subarea PU.** In SNA, a physical unit in a subarea node.

**switched line.** A communication line in which the connection between the communication controller and a remote link station is established by dialing.

**switched major node.** In ACF/VTAM, a major node whose minor nodes are physical units and logical units attached by switched SDLC links.

**switched network backup (SNBU).** In ACF/VTAM, an optional facility that allows a user to specify, for certain types of PUs, a switched line to be used as an alternate path if the primary line becomes unavailable or unusable.

**SYNAD exit routine.** A synchronous EXLST exit routine that is entered when a physical error is detected.

**Synchronous Data Link Control (SDLC).** A discipline for managing synchronous, code-transparent, serial-by-bit information transfer over a link connection. Transmission exchanges may be duplex or half-duplex over switched or nonswitched links. The configuration of the link connection may be point-to-point, multipoint, or loop. SDLC conforms to subsets of the Advanced Data Communication Control Procedures (ADCCP) of the American National Standards Institute and High-Level Data Link Control (HDLC) of the International Standards Organization.

**synchronous operation.** In ACF/VTAM, a communication, or other operation in which ACF/VTAM, after receiving the request for the operation, does not return control to the program until the operation is completed. Contrast with *asynchronous operation*.

**synchronous request.** In ACF/VTAM, a request for a synchronous operation. Contrast with *asynchronous request*.

**system services control point (SSCP).** In SNA, a focal point within an SNA network for managing the configuration, coordinating network operator and problem determination requests, and providing directory support and other session services for end users of the network. Multiple SSCPs, cooperating as peers, can divide the network into domains of control, with each SSCP having a hierarchical control relationship to the physical units and logical units within its domain.

**Systems Network Architecture (SNA).** The description of the logical structure, formats, protocols, and operational sequences

for transmitting information units through and controlling the configuration and operation of networks.

**Note:** The purpose of the layered structure of SNA is to allow the ultimate origins and destinations of information – that is, the end users – to be independent of, and unaffected by, the way in which the specific SNA network services and facilities used for information exchange are provided.

## T

**TC.** Transmission control.

**TCAS.** Terminal Control Address Space.

**telecommunication line.** Any physical medium such as a wire or microwave beam, that is used to transmit data. Synonymous with *transmission line*.

**terminal.** A device, usually equipped with a keyboard and some kind of display, capable of sending and receiving information over a link.

**terminal component.** A separately-addressable part of a terminal that performs an input or output function, such as the display component of a keyboard-display device or a printer component of a keyboard-printer device.

**Terminal Control Address Space (TCAS).** The part of TSO/VTAM that provides logon services for TSO/VTAM users.

**Terminate.** In SNA, a request unit that is sent by an LU to its SSCP to cause the SSCP to start a procedure to end one or more designated LU-LU sessions.

**TG.** Transmission group.

**TGID.** Transmission group identifier.

**TH.** Transmission header.

**transmission control character.** Any control character used to control or facilitate transmission of data between data terminal equipment. Synonymous with *communication control character*.

**transmission control (TC) layer.** In SNA, the layer within a half-session that synchronizes and paces session-level data traffic, checks session sequence numbers of requests, and enciphers and deciphers end-user data. Transmission control has two components: the connection point manager and session control. See also *half-session*.

**transmission group (TG).** In SNA, a group of links between adjacent subarea nodes, appearing as a single logical link for routing of messages.

**Note:** A transmission group may consist of one or more SDLC links (parallel links) or of a single System/370 channel.

**transmission group identifier (TGID).** In SNA, a set of three values, unique for each transmission group, consisting of the subarea addresses of the two adjacent nodes connected by the transmission group, and the transmission group number (1-255).

**transmission header (TH).** In SNA, control information, optionally followed by a basic information unit (BIU) or a BIU segment, that is created and used by path control to route message units and to control their flow within the network. See also *path information unit*.

**transmission line.** Synonym for telecommunication line.

**transmission priority.** In SNA, a rank assigned to a path information unit (PIU) that determines its precedence for being selected by the transmission group control component of path control for forwarding to the next subarea node of the route used by the PIU.

**transmission services (TS) profile.** In SNA, a specification in a session activation request (and optionally, in the responses) of transmission control (TC) protocols (such as session-level pacing and the usage of session-level requests) to be supported by a particular session. Each defined transmission services profile is identified by a number.

**transmission subsystem component (TSC).** The component of ACF/VTAM that comprises the transmission control, path control, and data link control layers of SNA.

**TSC.** Transmission subsystem component.

**TSO/VTAM.** Time Sharing Option for the Virtual Telecommunications Access Method.

## U

**unformatted.** In ACF/VTAM, pertaining to commands (such as LOGON or LOGOFF) entered by an end user and sent by a logical unit in character form. The character-coded command must be in the syntax defined in the user's unformatted system services definition table. Synonymous with *character-coded*. Contrast with *field-formatted*.

**unformatted system services (USS).** In SNA products, a system services control point (SSCP) facility that translates a character-coded request, such as a logon or logoff request into a field-formatted request for processing by formatted system services and translates field-formatted replies and responses into character-coded requests for processing by a logical unit. Contrast with *formatted system services*. See also *converted command*.

**uninterpreted name.** In SNA, a character string that an SSCP is able to convert into the network name of an LU.

**Note:** Typically, an uninterpreted name is used in a logon or Initiate request from an SLU to identify the PLU with which the session is requested. The SSCP interprets the name into the network name of the PLU in order to set up the session. When the PLU eventually sends a BIND to the SLU, the BIND contains the original uninterpreted name.

**unsolicited message.** A message, from ACF/VTAM to a program operator, that is unrelated to any command entered by the program operator. Contrast with *solicited message*.

**user correlator.** A 4-byte value supplied to ACF/VTAM by an application program when certain macro instructions (such as REQSESS) are issued. It is returned to the application program when subsequent events occur (such as entry to a SCIP exit routine upon receipt of BIND) that result from the procedure started by the original macro instruction.

**user exit queue.** A structure built by ACF/VTAM that is used to serialize the execution of application program exit routines. Only one exit routine on each user exit queue can run at a time.

**user-application network.** A configuration of data processing products, such as processors, controllers, and terminals, established and operated by users for the purpose of data processing or information exchange, which may use services offered by communication common carriers or telecommunication Administrations. Contrast with *public network*.

**USS.** Unformatted system services.

## V

**virtual route (VR).** In SNA, a logical connection (1) between two subarea nodes that is physically realized as a particular explicit route, or (2) that is contained wholly within a subarea node for intra-node sessions. A virtual route between distinct subarea nodes imposes a transmission priority on the underlying explicit route, provides flow control through virtual-route pacing, and provides data integrity through sequence numbering of path information units (PIUs). See also *explicit route*, *path*, *route extension*.

**virtual route identifier (VRID).** In SNA, a virtual route number and a transmission priority number that, when combined with the subarea addresses for the subareas at each end of a route, identify the virtual route.

**virtual route (VR) pacing.** In SNA, a flow control technique used by the virtual route control component of path control at each end of a virtual route to control the rate at which path information units (PIUs) flow over the virtual route. VR pacing can be adjusted according to traffic congestion in any of the nodes along the route. See also *pacing*, *session-level pacing*.

**virtual route selection exit routine.** In ACF/VTAM, an optional installation exit routine that modifies the list of virtual routes associated with a particular class of service before a route is selected for a requested LU-LU session.

**virtual route sequence number.** In SNA, a sequential identifier assigned by the virtual route control component of path control to each path information unit (PIU) that flows over a virtual route. It is stored in the transmission header of the PIU. Contrast with *session sequence number*.

**VR.** Virtual route.

**VRID.** Virtual route identifier.

**VTAM Terminal I/O Coordinator (VTIIOC).** The part of TSO/VTAM that converts TSO TGET, TPUT, TPG, and terminal control macro instructions into SNA request units.

**VTIIOC.** VTAM Terminal I/O Coordinator.

## W

**window.** In SNA, synonym for *pacing group*.

**window size.** In SNA, synonym for *pacing group size*.

## X

**XID.** A data link control command and response passed between adjacent nodes that allows the two nodes to exchange identification and other information necessary for operation over the data link.

# Index

## A

abbreviations, expanded 95  
ABDUMP 51  
ACB (see access method control block)  
access method control block  
    defined 95  
    length compatibility 63  
accounting exit routine 33  
ACF/TAP 49  
ACF/TCAM  
    coexisting with ACF/VTAM 45  
    in multiple-domain network 63  
    publications 84  
    TSO/TCAM coresiding with TSO/VTAM 3  
ACF/VTAM  
    abbreviation for product name iii  
    application program  
        characteristics of 39  
        data transfer 41  
        definition of 8  
        exit routine for 9  
        function of 8  
        identifying to ACF/VTAM 39  
        integrity of data 55  
        new function in Version 2 57  
        publication 73  
    availability aids 49  
    availability of 94  
    characteristics of 5,6  
    coexisting with other access methods 45  
    commands 36  
    compatibility 62  
    configuration restart 54  
    controlling network 35  
    cryptographic services 2,8,43  
    customizing messages and commands 31  
    data flow 10  
    defined 95  
    defining to operating system 27  
    DSLO license 93  
    Encrypt/Decrypt Feature 2  
    enhancements over VTAM Level 2 57  
    error recording 52  
    evaluating 73  
    facilities used by 1  
    functions of 1  
    in network (illustration) 13,20-25  
    installing 73  
    intermediate routing node facility 15  
    license for 93  
    machine requirements 60  
    manuals for 73, 75, 79  
    multiple-domain network support 2  
    network  
        creating 27  
        facilities of 14  
        parts of 12  
        views of 17  
    new functions for Version 2 57  
    operating 35,74  
    planning for 73  
    prior releases, documentation of iii  
    program numbers for 57  
    program products supported 72  
    program service 74  
    Programmed Cryptographic Facility 2

    programming requirements 60  
    publications 73,75,79  
    RAS strategy 49  
    recovery 54  
    related program products 72  
    relationship to SNA 5  
    relationship with ACF/NCP, documentation of iii  
    relationship with ACF/TCAM, documentation of iii  
    reliability aids 49  
    security 65  
    serviceability aids 49  
    serviceability characteristics of 31  
    services of 1  
    start options, defining 30  
    storage requirements 60  
    summary of 57  
    task analysis 73  
    terminal products supported 67-69  
    terminating sessions 43  
    testing period 93  
    trace facilities 49  
    transfer of data 10  
    TSO/VTAM support 3  
    tuning statistics for 50  
    use of SNA 6  
    warranty for 93  
    writing application programs 73  
ACF/VTAM commands, customizing 31  
ACF/VTAM messages  
    customizing 31  
    issuing module 54  
ACF/VTAM Version 1  
    conversion 65  
    in multiple-domain network 64  
ACF/VTAME  
    conversion 65  
    defined 95  
    in multiple-domain network 64  
    publications 84  
acronyms, expanded 95  
ACTPU(ERP), support for 55  
AMDSADMP 51  
APPL definition statement 29  
application program  
    ACF/VTAM 8,39  
    auxiliary storage devices 11  
    conversion 64  
    data transfer 42  
    defining 29  
    Encrypt/Decrypt Feature 2  
    exit routine for 9  
    identifying to ACF/VTAM 39  
    integrity of data 55  
    migration factors 63  
    publication 73  
authorization exit routine 33  
auxiliary storage device, data flow to 11  
auxiliary storage device, in network  
    (illustration) 20-25  
availability aids 49

## B

bibliography 84  
binary synchronous control (see BSC)



BSC terminal, attachment of 8  
BTAM  
    coexisting with ACF/VTAM 45  
    converting application programs to operate with  
        ACF/VTAM Version 2 63,65  
    functions previously performed by 7  
BTAM-ES  
    coexisting with ACF/VTAM 46  
    converting application programs to operate with  
        ACF/VTAM Version 2 63,65  
    publications 86  
BTP, ACF/VTAM support for 72

## C

CDRM  
    defining 30  
    use of 28  
CDRSC  
    defining 30  
    use of 27  
channel-attached devices, defining 27  
channel-attached terminals, on loop adapter 8  
channel-to-channel connection  
    advantages of 15  
    defining 30  
    in network (illustration) 15  
    requirements for 15  
    tuning statistics for 50  
CICS/VS  
    ACF/VTAM support for 72  
    products supported through 72  
class of service  
    definition of 17  
    specified in logon mode table 32  
CLSDST macro instruction 39,43  
CNM (see communications network  
    management)  
communication adapter  
    advantages of 15  
    defining 29  
    services of 3,15  
    use of 8  
communication adapter-attached resources,  
    defining 27  
communication controller  
    defined 98  
    extended interconnection of 15  
    functions of 7  
    in network (illustration) 13,20-25  
    NCP in 7,28  
    NTO program product 8,71  
    subarea for 12  
    supported by ACF/VTAM 71  
    use of 7  
communications network management  
    application program support 72  
    defined 98  
    routing table 30  
compatibility 62  
compatibility PTF for VSAM 60  
conditional session termination 43  
configuration restart 54  
connection  
    channel-to-channel 15  
    communication adapter 15  
    of communication controllers 15  
converting application programs to operate with  
    ACF/VTAM Version 2 65  
cross-domain resource (see CDRSC)

cross-domain resource manager (see CDRM)  
cryptography 2  
    application program 8  
    data transfer 43  
    programming requirements 60,61  
    publications 85  
    session establishment 6,32

## D

data  
    encryption of 2  
    flow of 10  
data communication network, creating 27  
data communications, definition of 5  
data integrity of application program 55  
data sets  
    ACF/VTAM 17  
    NCP 17  
    RAS 17  
data transfer 42  
DATAMGT macro instruction 27  
DB/DC programs supported by ACF/VTAM 72  
definitions 95  
delayed configuration restart 54  
    programming requirements 60  
device support programs 72  
dial terminal, defining 29  
DISOSS/VSE, ACF/VTAM support for 72  
DISOSS/370, ACF/VTAM support for 72  
DISPLAY command 36  
distributed data processing programs 72  
distribution medium for ACF/VTAM 57  
distribution of functions 9  
domain  
    defining to ACF/VTAM 27  
    definition of 5,11  
    parts of 11  
domains, connection of 14  
Downstream Load Utility program product (see DSLU)  
DSLO  
    no testing period 93  
    program services 93  
DSLU  
    ACF/VTAM support for 72  
    defined 97  
    for loading PU 59  
DSX, ACF/VTAM support for 72  
dump  
    formatted 51  
    NCP 51  
    service-aid 51  
dynamic NCP dump 51  
dynamic reconfiguration, defining 31  
dynamic reconfiguration of NCP 37

## E

emulation mode, of NCP 7  
Encrypt/Decrypt Feature 2  
    conversion 65  
    session establishment 6  
    with application program 8  
EREP 53  
error recording 52  
    editing and printing 53  
    intensive mode 52  
    software 53  
    with NPDA 52  
error recovery procedures 54

EXEC command 36  
 exit routine  
   application program 9  
   defined 101  
   installation 33

**F**

facilities  
   of an ACF/VTAM network 14  
   of operating system 10  
   used by ACF/VTAM 1

field-formatted command, definition of 32  
 formatted dump 51  
 FTP, ACF/VTAM support for 72

functions  
   of application program 8  
   previously performed by BTAM 7  
   distribution of 9  
   new for Version 2 57,58  
   of ACF/VTAM 1  
   of communication controller 7  
   of NCP 7  
   provided in each release of NCP 61

**G**

GDDM, ACF/VTAM support for 72  
 Generalized Trace Facility 49,50  
 generation  
   NCP 7,28  
   system 27  
 glossary 95  
 GTF 49,50

**H**

HALT command 36  
 hardware errors, recovery from 54  
 HMDSADMP 51  
 Host Command Facility, ACF/VTAM support for 72  
 host INN (see intermediate routing node)  
 Host Prep, ACF/VTAM support for 72  
 host processor  
   defined 103  
   in network (illustration) 13,15,20-25  
   subarea for 12  
   supported by ACF/VTAM 60

**I**

IBM 3271 model 11 or 12, access to device  
   address 63  
 IDWS, ACF/VTAM support for 72  
 IIPS/IIAS, ACF/VTAM support for 72  
 IIS, ACF/VTAM support for 72  
 immediate configuration restart 54  
 IMS/VS  
   ACF/VTAM support for 72  
   products supported through 72  
 Information/System, ACF/VTAM support for 72  
 INN (see intermediate routing node)  
 installation exit routines  
   coding 33  
   defined 103  
 integrity of application program data 55  
 intensive mode error recording 52  
 interactive programs supported by ACF/VTAM 72

intermediate routing node 15  
 interpret table, for TSO logon 33  
 IRN (see intermediate routing node)

**J**

JEP, ACF/VTAM support for 72  
 JES1/RES, ACF/VTAM support for 72  
 JES2/NJE, ACF/VTAM support for 72  
 JES2/RJE, ACF/VTAM support for 72  
 JES2/RJP, ACF/VTAM support for 72  
 job entry programs supported by ACF/VTAM 72

**L**

libraries (data sets)  
   ACF/VTAM 17  
   NCP 17  
   RAS 17

license for ACF/VTAM 93  
 link-level 2 test 53  
 links, parallel 15,55  
 logical unit (see LU)  
 LOGON command, for TSO 33  
 LOGON exit routine 39  
 logon mode name, definition of 32  
 logon mode table, definition of 32  
 logon-interpret exit routine 33  
 loop adapter  
   defined 105  
   in network (illustration) 13  
   terminals attached to 8  
   use of 8

LU  
   definition of 5  
   in cluster controller 11  
   SNA terminal product 18  
 LU connection test 53

**M**

machine requirements 60  
 macro instructions  
   data transfer 42  
   for PLU 39  
   for SLU 42  
   NCP 28  
 major topics in this book iii  
 message  
   customizing 31  
   defined 105  
   issuing module 54  
 migration factors for application programs 63,64,75  
   books that discuss 64,75  
 MODIFY command 36  
 multiple routes 17,55  
 multiple-domain network  
   ACF/VTAM support 2  
   control of domains 12  
   defined 105  
   illustration of 16,20-25  
   views of 19  
 Multisystem Networking Facility  
   defined 106  
   for ACF/TCAM 12  
   for ACF/VTAM Version 1 14  
   integrated in ACF/VTAM Version 2 2,57

MVS  
  publications 86-88  
  TSO/VTAM in 3  
MVS/XA publications 87,89,90  
MVS/IDWS, ACF/VTAM support for 72

N

NCCF  
  ACF/VTAM support for 72  
  as base for other programs 38  
  as program operator 38  
  compatibility 63  
  products supported through 72  
  publications 85  
  with NPDA 52

NCP  
  abbreviation for ACF/NCP/VS iii  
  compatibility 62  
  connection of, illustration of 16  
  defining to ACF/VTAM 28  
  dumping 51  
  dynamic reconfiguration of 37  
  emulation mode 7  
  functions of 7  
  functions provided in each release 61  
  generalized PIU trace (GPT) 50  
  line trace 50  
  network control mode 7  
  operating modes supported by ACF/VTAM 7  
  publications 84  
  releases supported by ACF/VTAM 7  
  transfer of data 10  
  transmission group (TG) trace 50

network  
  ACF/VTAM, facilities of 14  
  defined 106  
  SNA portion 10

Network Communications Control Facility  
  (see NCCF)

network control mode, of NCP 7

network control program (see NCP)

Network Logical Data Manager (see NLDM)

Network Problem Determination Application  
  (see NPDA)

Network Terminal Option (see NTO)

NLDM  
  ACF/VTAM support for 72  
  as a NCCF-based program product 38

node initialization block (NIB) 40

non-SNA terminal, attachment of 8

NPDA  
  ACF/VTAM support for 72  
  as NCCF-based program product 38  
  error recording 52

NTO  
  ACF/VTAM support for 72  
  for non-SNA terminals 8,69-71  
  publications 85  
  TSO/VTAM support 3,70

O

OPEN macro instruction 39

operating ACF/VTAM 35

operating system  
  ACF/VTAM support 60  
  defining ACF/VTAM to 27

publications 86-92  
  use of facilities 10

OPNDST macro instruction 39

OPNSEC macro instruction 42

OS/VS  
  abbreviation for MVS and OS/VS1 iv  
  publications 86-91  
  trace facility for 50  
  overview of SNA 5

P

parallel links  
  advantages of 15,55  
  defined 108  
  requirements for 15,55

parallel sessions  
  definition of 5  
  session limit 10

partitioned emulation programming (see PEP)

passing an SLU 43

pending events, reporting 54

PEP  
  definition of 7  
  with other telecommunication access  
  methods 46,47

physical unit (see PU)

PLU  
  definition of 5  
  exit routine for 9  
  macro instructions for 39  
  session establishment 39  
  session termination 43

PRDMP utility 49,50

primary logical unit (see PLU)

program, user (see application program)

program operator  
  NCCF 38  
  definition of 37  
  tailoring messages for 31

Programmable Store System, ACF/VTAM support  
  for 72

Programmed Cryptographic Facility 2

programming requirements 60

PTF for VSAM compatibility 60

PU  
  definition of 6  
  SNA terminal product 24

publications  
  ACF/VTAM, illustration of library v  
  related iv

R

RAS strategy of ACF/VTAM 49

RECEIVE macro instruction 43

recovery aids 54

releasing an SLU 43

reliability aids 49

reliability availability and serviceability  
  (see RAS)

REQSESS macro instruction 42

request parameter list (RPL) 40

resource takeover 56

resources, sharing 10

restart of ACF/VTAM 54

route verification test 53

- routes
  - between subareas, defining 30
  - multiple 17,55
  - testing 53
- S**
- SDUMP 51
- secondary logical unit (see SLU)
- security, of data 65
- SEND macro instruction 43
- serviceability aids 49
- service-aid dump 51
- session
  - cryptographic 6
  - establishing 6,32,39
  - exit routine for, application program 9
  - LU-LU 5
  - outage notification 56
  - parallel 5
  - parameters for 6,32
  - primary end of 5,39
  - secondary end of 5,42
  - terminating 32,43
- session establishment procedures, defining 32
- session limit, definition of 10
- session parameters 6
  - definition of 32
  - negotiable 32
- session termination procedures, defining 32
- SESSIONC macro instruction 42
- sharing resources 10
- SIMLOGON macro instruction 39
- single-domain network
  - defined 111
  - illustration of 13, 20-25
- SLU
  - definition of 5
  - exit routine for 9
  - macro instructions for 42
  - releasing and passing 43
  - session establishment 42
  - session termination 43
- SNA
  - benefits of 1
  - definition of 1
  - overview of 5
  - publications 84
  - SNA terminals, use of LU 5
  - terminal 8
  - transfer of data 10
  - using in network 1
- SNA terminal
  - attachment of 8
  - use of LU 5
  - work station for 11
- software errors
  - recording of 53
  - recovery from 54
- SSCP, provided by ACF/VTAM 5
- SSS, ACF/VTAM support for 72
- START command 36
- start options, defining 30
- start-stop device 8
- static NCP dump 51
- storage requirements 60
- subareas
  - definition of 12
  - examples of 12
  - in network (illustration) 13
  - routes between, defining 30
  - supported products 67
  - SUPVR macro instruction 27
  - system console 18
  - system generation 27
  - Systems Network Architecture (see SNA)
  - system service control point (see SSCP)
  - systems management programs supported by ACF/VTAM 72
  - System/32, in network (illustration) 13
- T**
- tasks 73
- TCAM (see ACF/TCAM)
- TCAS, defining to ACF/VTAM 29
- telecommunication access method 45
- Teleprocessing Online Test Executive Program 52
- terminal
  - attached to communication adapter 8
  - attached to loop adapter 8
  - BSC 8
  - channel-attached, defining 29
  - communication adapter-attached, defining 29
  - defined 113
  - dial terminal, defining 29
  - in network (illustration) 13,20-25
  - loop-adapter-attached, defining 29
  - non-SNA terminal
    - defining 29
    - description 8
    - support for 67
  - NTO support for 8,69-71
  - on switched line, defining 29
  - SNA terminal
    - defining 29
    - description 8
    - support for 67
  - start-stop devices 8
  - 3270 terminal, defining 29
- terminal control address space (see TCAS)
- terms, defined 95
- TERMSESS macro instruction 43
- testing period for ACF/VTAM 93
- this book
  - abstract of 75
  - major topics in iii
  - related publications iv
- Time Sharing Option (see TSO/VTAM)
- TOLTEP 52
  - documentation of messages 76
  - storage requirements 60
- trace facilities 49
- transmission group 14
  - in network (illustration) 16
  - trace of 50
- TSO
  - ACF/VTAM support for 3,72
  - compatibility 63
  - component trace 50
  - LOGON command for 33
  - new function in Version 2 58
- TSO/E (see TSO)
- TSO/TCAM, coresiding with TSO/VTAM 3
- TSO/VTAM
  - coresiding with TSO/TCAM 3
  - defining users to ACF/VTAM 29
  - documentation of messages 76
  - halting 36
  - logon facilities 33

- products supported through 72
- programming requirements 60
- services of 3
- starting 36
- terminal products supported 70
- tuning statistics, devices for which they are recorded 50

## U

- unconditional session termination 43
- user address space, defining to ACF/VTAM 29
- user program (see application program)
- user-defined request header 57
- user-replaceable module for virtual route
  - window size calculation 33
- using
  - CDRM 28
  - CDRSC 27
  - communication adapter 8
  - communication controller 7
  - loop adapter 8
  - LU 5
  - operating system facilities 1,10
  - SNA 1,6
  - VSAM 1,60
- utility, PRDMP 49,50

## V

- VARY command 37
  - terminating sessions 43
- virtual route selection exit routine 33
- virtual route window size calculation
  - user-replaceable module 33
- Virtual Storage Access Method (see VSAM)
- VM/VCNA, ACF/VTAM support for 72
- VS APL, ACF/VTAM support for 72
- VSAM
  - programming requirements 60
  - used by ACF/VTAM 1
  - with auxiliary storage devices 11

## VSE

- abbreviation for VSE/AF iv
- publications 91
- trace facility for 50

## VSE/ICCF

- ACF/VTAM support for 72
- products supported through 72

- VSE/OCCE, ACF/VTAM support for 72
- VSE/POWER RJE, ACF/VTAM support for 72
- VSPC
  - ACF/VTAM support for 72
  - products supported through 72

## W

- warranty for ACF/VTAM 93
- work station, data flow to 10

## Numeric

- 270x Transmission Control Unit,
  - with BTAM or BTAM-ES 45,46

- 3036 Console, support for 58

- 3270 Information Display System
  - in network (illustration) 13,20-25
  - non-SNA terminal 8

- 3270 terminal, defining 29

- 3271 (see IBM 3271)

- 3600 Finance Communication System
  - data flow to 10

- in network (illustration) 13,20-25

- 3705 (see communication controller)

- 3767 Communication Terminal, in network
  - (illustration) 13,20-25

- 3790 Communication System, in network
  - (illustration) 13,20-25

- 4321 processor

- communication adapter feature of 8

- 4331 processor

- communication adapter feature 8
  - loop adapter feature of 8

- 8775 Display Terminal

- in network (illustration) 13,20-25

- loading PU 59

Advanced Communications  
Function for VTAM Version 2  
General Information

READER'S  
COMMENT  
FORM

Order No. GC27-0608-1

This manual is part of a library that serves as a reference source for systems analysts, programmers, and operators of IBM systems. This form may be used to communicate your views about this publication. They will be sent to the author's department for whatever review and action, if any, is deemed appropriate. Comments may be written in your own language; use of English is not required.

IBM may use or distribute any of the information you supply in any way it believes appropriate without incurring any obligation whatever. You may, of course, continue to use the information you supply.

Note: Copies of IBM publications are not stocked at the location to which this form is addressed. Please direct any requests for copies of publications, or for assistance in using your IBM system, to your IBM representative or to the IBM branch office serving your locality.

How did you use this publication?

- |                          |                                     |                          |                        |
|--------------------------|-------------------------------------|--------------------------|------------------------|
| <input type="checkbox"/> | As an introduction                  | <input type="checkbox"/> | As a text (student)    |
| <input type="checkbox"/> | As a reference manual               | <input type="checkbox"/> | As a text (instructor) |
| <input type="checkbox"/> | For another purpose (explain) _____ |                          |                        |

Is there anything you especially like or dislike about the organization, presentation, or writing in this manual? Helpful comments include general usefulness of the book; possible additions, deletions, and clarifications; specific errors and omissions.

Page Number:

Comment:

Note: Staples can cause problems with automated mail sorting equipment.  
Please use pressure sensitive or other gummed tape to seal this form.

What is your occupation? \_\_\_\_\_

Newsletter number of latest Technical Newsletter (if any) concerning this publication: \_\_\_\_\_

If you wish a reply, give your name and address:

IBM branch office serving you \_\_\_\_\_

Thank you for your cooperation. No postage stamp necessary if mailed in the U.S.A. (Elsewhere, an IBM office or representative will be happy to forward your comments or you may mail directly to the address in the Edition Notice on the back of the title page.)

Reader's Comment Form

Cut or Fold Along Line

Advanced Communications Function for VTAM Version 2 General Information (File No. S370/4300-20)

Printed in U.S.A.

GC27-0608-1

Fold and tape

Please Do Not Staple

Fold and tape



NO POSTAGE  
NECESSARY  
IF MAILED  
IN THE  
UNITED STATES

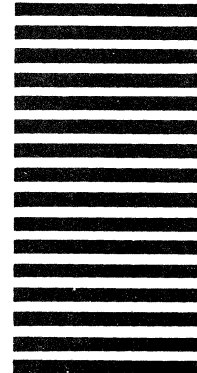

**BUSINESS REPLY MAIL**  
FIRST CLASS      PERMIT NO. 40      ARMONK, N.Y.

POSTAGE WILL BE PAID BY ADDRESSEE:

**International Business Machines Corporation  
Department 52Q  
Neighborhood Road  
Kingston, New York 12401**

Fold and tape

Please Do Not Staple

Fold and tape



