

**407**

**accounting**

**machine**

---

**IBM**

**407**

**accounting  
machine**

---

**manual of operation**

MINOR REVISION

This edition, Form 22-5765-7, is a minor revision of the preceding edition but does not obsolete Form 22-5765-6. Principal changes in this edition are:

PAGE	SUBJECT
63	Wiring (Figure 59) Item I
12-206	CO-CC (CO card cycles) 0-79, 80
95-193	Counter punch exits
105	Wiring—Summary Punching with Variable Storage Unit Read-out (Figure 95), Item 6
110	Item 6 pickup of the selector used to select all cycles to channel entry
112	Item 6 (same as Item 6 Page 110)
144	B Page Number Printing, Item 12—Card Cycles Used to Pickup Pilot Selector 15
193	Maximum Number of Entries From One Source
196-199	CO-CC 0-79,80 Item 35

Copyright 1950, 1951, 1953 by  
International Business Machines Corporation  
590 Madison Avenue, New York 22, N. Y.  
Printed in U. S. A.  
Form 22-5765-7

# CONTENTS

SECTION I	PAGE	SECTION II	PAGE
BASIC PRINCIPLES .....	5	TAPE-CONTROLLED CARRIAGE .....	118
Feed Unit .....	6	Control Tape .....	118
Print Unit .....	8	Operating Features .....	122
Operating Keys, Switches, and Signals .....	8	IBM Form Feeding Devices .....	123
Control Panel .....	11	Form Stand and Form Feed Guides .....	128
Detail Printing .....	13	Form Control .....	129
Addition .....	17	Multiple Heading Groups; Overflow Sheet Identification .....	136
Zero and Special Symbol Control .....	22	Invoice and Page Numbering .....	141
Program Control .....	27	Identifying Overflow Sheets with More than One Line .....	145
Group Printing .....	32	Variable Length Overflow .....	145
Subtraction .....	35	Inverted Form Operations .....	148
Counter Coupling .....	40	Floating Dollar Sign and Check-Protecting Asterisk .....	151
X Selection .....	42	Single Sheet Form Feeding; Selective Spacing .....	156
Digit Selection .....	45		
Character Emitter Printing .....	46		
Print Selection .....	48		
Offset Total Printing .....	51		
Group Indication .....	52		
Counting and Programming with Cycle Count .....	54		
Alteration Switches .....	56		
Field Selection .....	59		
Class Selection .....	61		
Symbol Selection .....	62		
Space Control .....	66		
Total Transfer .....	72		
Crossfooting .....	77		
Multiple X or Digit Selection .....	78		
Recognizing Negative and Zero Balances .....	81		
Stop and Automatic Stop .....	82		
Split Column Control .....	84		
Storage Units .....	85		
Summary Punching .....	94		
Special Program .....	105		
		SECTION III	
		MULTIPLE LINE READING OPERATIONS .....	159
		Address Printing .....	159
		MLR Heading Cards .....	162
		Printing More than Three Lines from One Card .....	164
		SECTION IV	
		TYPICAL APPLICATIONS .....	167
		Label and Pick Slip Writing .....	167
		Cross-Checking .....	171
		Invoice Preparation .....	173
		FORM DESIGN .....	187
		OPERATING SUGGESTIONS .....	189
		CONTROL PANEL SUMMARY .....	197
		TIMING CHARTS .....	205
		INDEX .....	208

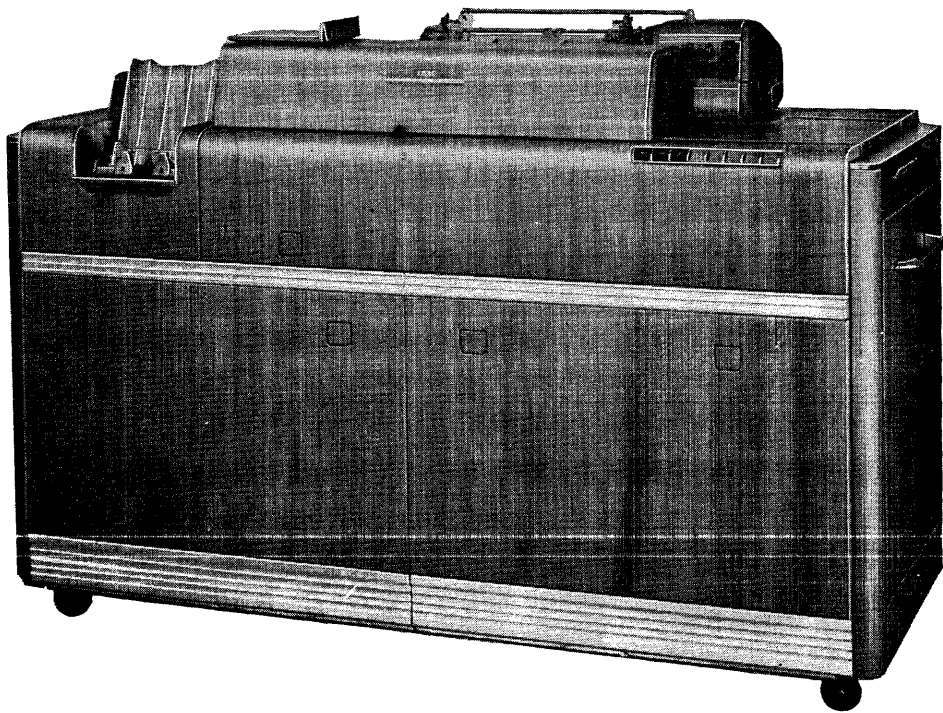

ACCOUNTING MACHINE, TYPE 407

# IBM ACCOUNTING MACHINE

## Type 407

THE TYPE 407 Accounting Machine prepares printed reports from IBM cards. The machine prints information from 120 print wheels which form a solid bank 12 inches wide. Each print wheel has 47 different characters, namely, all the letters of the alphabet, all the numbers, and 11 special characters.

The Type 407 can print 18,000 characters a minute. IBM cards are read at the rate of 150 per minute or 9,000 per hour. The same rate of speed is maintained for detail printing and group printing.

As a punched card is being read, it remains stationary at one of two stations and may be re-read as often as desired, which permits multiple line printing or crossfooting quantities and amounts from a single card.

Amounts can be added or subtracted in 112 counter positions which are arranged in 20 groups of 3, 4, 6 and 8 positions each. Numerical or alphabetic information may be stored in four storage units until ready for use.

Forms may be positioned in the machine automatically by the use of the carriage, which is set up for operation by inserting a prepunched tape in the tape control mechanism.

All summary punch wiring is included on the accounting machine control panel, thus allowing the use of selectors and other features of the machine for summary punching operations.

To describe the operation of the Type 407 Accounting Machine, this manual is divided into five sections:

1. Principles of operation of the Type 407 (except multiple line printing).
2. Principles of operation of the tape-controlled carriage.
3. Principles of multiple line printing operations.
4. Typical applications.
5. Forms Design.  
Operating Suggestions.  
Control Panel Summary.  
Timing Charts.

The functions of the machine are illustrated by examples with sample cards, reports and wiring diagrams. The control panel hubs are explained as they are first introduced.

Ready reference to the function of each control panel hub may be found in the index. Although a general description of a particular feature precedes its use in a problem, it is sometimes necessary to read a problem explanation in order to obtain more detailed information regarding its application.

The sections are arranged in order of complexity, and each is explained in terms of knowledge of features already covered in preceding sections. To learn the operation of the machine, therefore, most effective results will be obtained by reading the sections in order.

The typical applications section shows complete wiring for each example and illustrates the combined use of many of the features that have been individually explained on preceding pages.

## FEED UNIT

CARDS are placed in the hopper (Figure 1) with the 9 edge toward the throat. They feed into the machine from the bottom, under the control of the feed rolls. The hopper will hold approximately 1,000 cards. Each card in turn is positioned at the first, then at the second reading stations by means of card grippers which move horizontally as indicated by the arrows in Figure 2. The cards may be held at the reading stations for any given number of cycles, after which they move around the stacker drum into the stacker where they are held in position by a pressure plate. When the stacker becomes full, the machine stops.

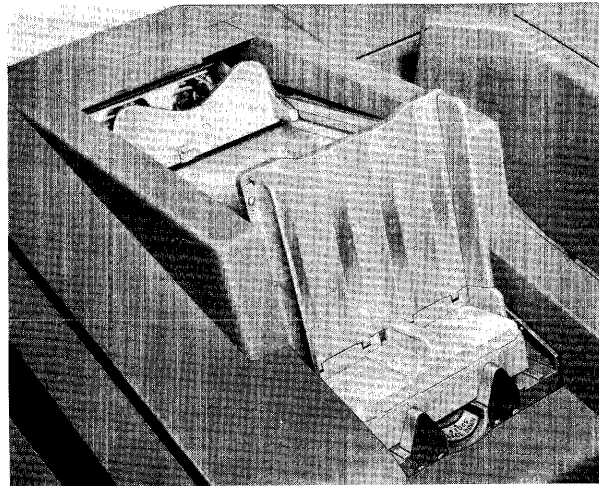

FIGURE 1. HOPPER AND STACKER

## Card Reading

As a card is positioned at a reading station, it is lined up by the card aligners so that the 960 possible punching positions (12 digit positions times 80 card columns) are directly under the 960 stationary reading brushes and directly above the 960 metal segments (labelled 9, 8, 7—12 in Fig-

ure 2). Any hole that is punched in the card allows its corresponding brush to make contact with a metal segment. The electrical impulse resulting from this contact is transmitted from the commutator as it rotates in a clockwise direction to the brushes in that position.

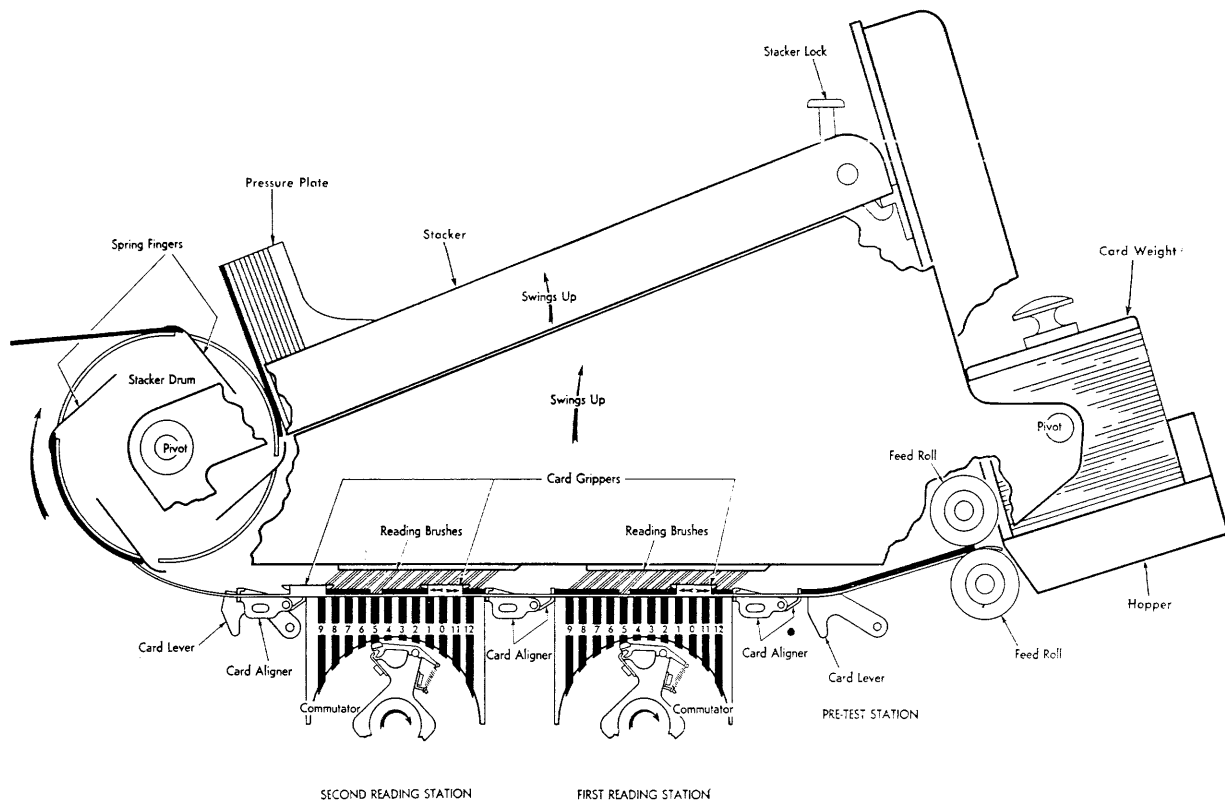

FIGURE 2. FEED UNIT SCHEMATIC

There are 80 commutators at each reading station, representing the 80 columns of the card. They rotate together, starting with the 9 position and advancing progressively to 12. These commutators transmit impulses to the brushes in their corresponding position. The brushes transmit these impulses to the control panel, where they may be used to control a specific machine function.

It may be seen that a card is read as it is standing still, and that it may easily be re-read again and again, merely by holding the card stationary.

**Card Feeding**

Normally, card feeding is continuous and automatic once the start key has been depressed, except when a card fails to feed from the hopper or when the hopper runs out of cards. A card feed failure will be recognized at the pre-test station and causes the machine to stop and the card feed stop light to turn on. Card feeding may be resumed as described under *Card Feed Stop Light*.

**Card Removal**

Access to the cards after they have left the hopper may be obtained by first depressing the

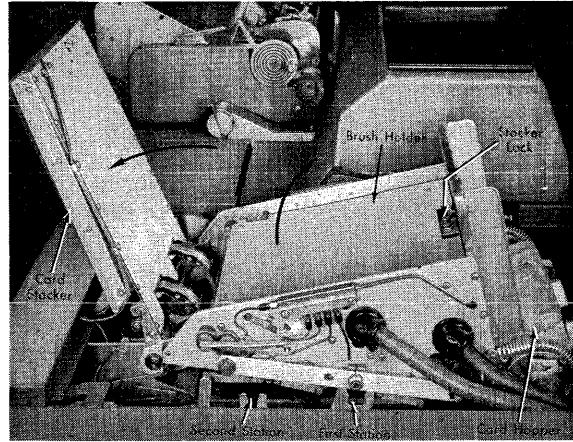

**FIGURE 3. STACKER IN RAISED POSITION**  
 stacker lock, then raising the stacker itself, which swings toward the back of the machine (Figure 3), and raising the brush holder which swings toward the front of the machine (Figure 4). The cards may then be easily removed from the machine by hand. The brushes, which normally protrude slightly below the brush holder, recede into the holder when it is in a raised position, thus preventing any possible damage to the brushes.

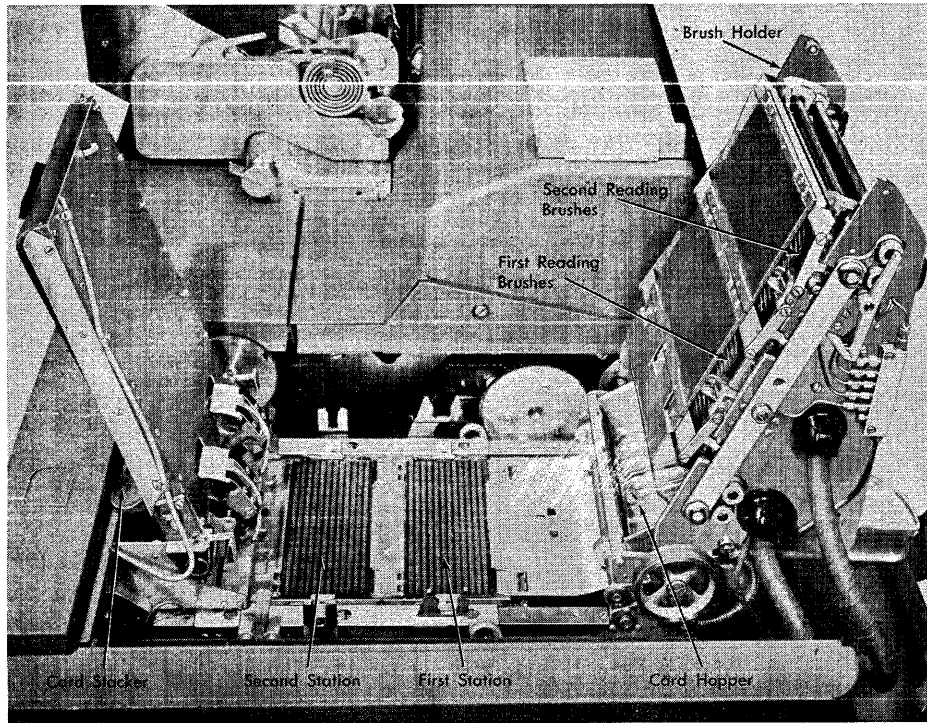

NOTE: Remove cards from the stacker and the hopper before raising the stacker and the brush holder.

**FIGURE 4. FEED UNIT BRUSHES RAISED**



PRINT UNIT

PRINTING on the Type 407 is accomplished by means of 120 print wheels arranged in a solid bank which prints within a width of 12 inches, 10 characters to the inch. Each print wheel contains the following 47 separate character positions (Figure 5):

- 10 digits: 0 through 9
- 26 letters: A through Z
- 11 special characters:  
/ \$ □ \* % @ & - # . ,

As shown in Figure 5, the print wheel is divided into twelve equal parts:

- Digits 1 through 9 9 parts
- Combination of the digits 8 and 3 in one column 1 part
- Combination of the digits 8 and 4 in one column 1 part
- Zone only 1 part

Each of the twelve parts is in turn divided into four sections:

- 0 Zone
- 11 Zone
- 12 Zone
- N (no) Zone

As shown in Figure 6, the 0, 11, and 12 zones control the printing of 26 letters, zero, and nine special characters. The N (no) zone controls the printing of nine digits and two special characters.

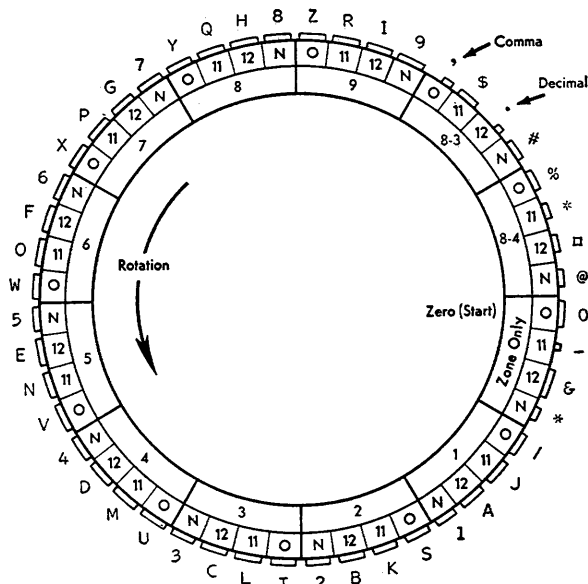

FIGURE 5. PRINT WHEEL SCHEMATIC

LOWER PUNCH	ZONE			
	12	11	0	N
1	A	J	/	1
2	B	K	S	2
3	C	L	T	3
4	D	M	U	4
5	E	N	V	5
6	F	O	W	6
7	G	P	X	7
8	H	Q	Y	8
9	I	R	Z	9
8-3	.	\$	,	#
8-4	□	'*	%	@
	ε	-	0	<sup>2</sup> *

1.Total Symbol 2.Check Protection

FIGURE 6. CHARACTER CODES

An additional special character (\*) position is provided for check protection.

The print wheels remain stationary until the digit punched in the card is read, at which time one of the twelve sections is selected. A further selection of one of the four parts within that section is made when the zone is read. The printing wheel rotates at a high rate of speed until printing time, when its speed is reduced to 25% of normal. At the actual time of printing the wheel is moved forward against the platen in a straight line motion, which produces maximum legibility. The rotary motion of the wheel at print time is compensated for by a special cam.

Although one line is printed on one cycle, the wheels print at four different times within that cycle. All of the wheels zoned for 0 print first, followed in succession by those for 11, 12 and N.

Speed

The Type 407 operates at a speed of 150 cards per minute (9,000 cards per hour). With 120 wheels for printing, the maximum printing speed is 18,000 characters per minute. The same speed is maintained for accumulating totals for group printing, total printing, crossfooting, or taking special program cycles for other operations.

OPERATING KEYS, SWITCHES, AND SIGNALS

SWITCHES and signals for controlling machine operations are shown in Figure 7.

### Main Line Switch

To operate the machine, the main line switch located on the upper left side of the machine must be turned on. This switch should not be turned off while cards are feeding or during any other machine operation.

### Start Key

The start key must be depressed to start the feeding of cards through the machine. It is also used to extinguish the form stop and the automatic stop lights.

### Stop Key

When the stop key is depressed, the machine will stop before the next card is fed. If a total cycle is in process or about to be started when the stop key is depressed, the cycle will be completed before the machine stops. The stop key is also used to extinguish the card feed stop light.

### Final Total Key

If the final total toggle switch is ON, the final total key is used to print and reset final totals manually, provided they have been wired on the control panel.

### Card Feed Stop Light

The card feed stop light will glow whenever a card fails to feed in either the accounting machine or the summary punch, and also when the summary punch runs out of cards. It will also turn on if a card fails to feed to the stacker from the second station. When the light turns on because

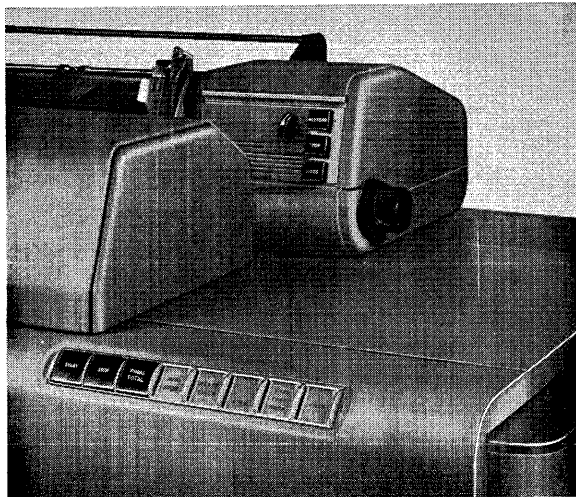

FIGURE 7. OPERATING KEYS AND SIGNAL LIGHTS

of feed failure on the accounting machine, the following procedure must be followed:

- a. Remove cards from the hopper and correct the bottom card which failed to feed.
- b. Replace cards in the hopper.
- c. Depress the stop key to turn out the light.
- d. Depress the start key to resume operation.

The cards will then feed normally without interruption of the normal control or spacing operation.

When the card feed stop light turns on because the summary punch hopper is empty, it may be turned off by (1) replenishing the hopper and (2) depressing the start key.

### Form Stop Light

The form stop light goes on and the machine stops whenever the last form is within  $13\frac{3}{8}$  inches of the platen, provided the form stop toggle switch is ON. The form stop light is turned off by (1) inserting a new form and (2) depressing the start key.

### Automatic Stop Light

The automatic stop light will go on whenever the machine stops because of an impulse received by the auto stop hub on the control panel. It may be turned off and operation may be resumed by depressing the start key.

### Fuse Light

The fuse light goes on and the machine stops whenever a fuse burns out. The fuses are located on the lower left side of the machine. The light is turned off when the fuse has been replaced, and the operation may be resumed by depressing the start key.

### Light (unlabelled)

The unlabelled light will go on when the main line switch is turned on and the machine is idling.

### Reset Check Light

The reset check circuit is designed to determine if counters reset correctly. The circuit may be made inoperative or operative by setting a reset check toggle switch to an off or on position. If the reset check switch is off, a reset check light blinks while the machine is operating, thus calling attention to the operator that the check circuit is not operative. If the reset check switch is on, the reset

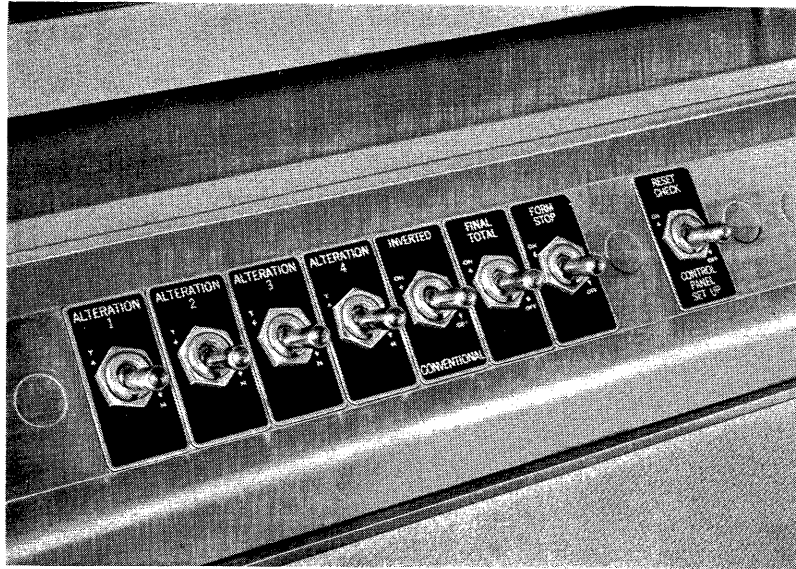

FIGURE 8. OPERATING SWITCHES

check light turns on and the machine stops only when an error is detected upon reset.

A reset error is generally caused by improper counter wiring. The steps to be taken to locate the error are described under *Operating Suggestions*. However, before errors in counter wiring can be located and corrected, cards in the machine at the time the reset check light turns on must be run out into the stacker. To do this, the following steps are necessary:

1. Remove cards from the hopper.
2. Depress the start key to run cards out of the machine. At this time re-programming occurs, and the counters reset a second time. The machine continues to run.
3. To stop the machine, depress the stop key. The reset check light may or may not turn off.
4. If the reset check light turns off, it means that all cards have run out of the machine and are in the stacker.
5. If the reset check light does not turn off, there are still some cards in the machine. To run them out, it is necessary to:
  - a. Turn off the reset check switch.
  - b. Depress the start key to run the cards out into the stacker.
  - c. Depress the stop key to stop the machine. When the machine stops, the reset check light will turn off.

#### Alteration Switches 1, 2, 3, 4 (Figure 8)

When an alteration switch is turned on, a corresponding selector on the control panel transfers. The selectors may be used to alter control panel setups.

#### Inverted Switch

This switch must be ON whenever inverted forms are being run. Inverted forms are those in which the detail cards precede the heading cards. The switch must be OFF for running conventional forms.

#### Final Total Switch

When the final total switch is ON, final totals may be manually printed and reset by depressing the final total key, provided the final total hubs on the control panel have been properly wired. It also allows the run-out final total to print automatically when the LCT (last card total) switch is on.

When the final total switch is OFF, neither final totals nor run-out final totals may be taken and the final total will remain in the machine indefinitely.

#### Form Stop Switch

When the form stop switch is ON, the end of form stop, located in the center of the carriage, is operative and will cause the machine to stop when the last form is within  $13\frac{3}{8}$ " of the print-

ing line. When the form stop switch is OFF, the end of form stop is inoperative.

#### Reset Check Switch

The purpose of the Reset Check Switch is explained under *Reset Check Light*.

### CONTROL PANEL

THE AUTOMATIC operation of the machine is obtained through a control panel (Figure 9) which directs the machine to perform various functions according to the requirements of the operation.

The machine operates from electrical impulses which result from sensing the hole in a card. The impulse travels by internal connections to the control panel located on the right side of the machine, and by means of external wires it can be directed to perform the required operation.

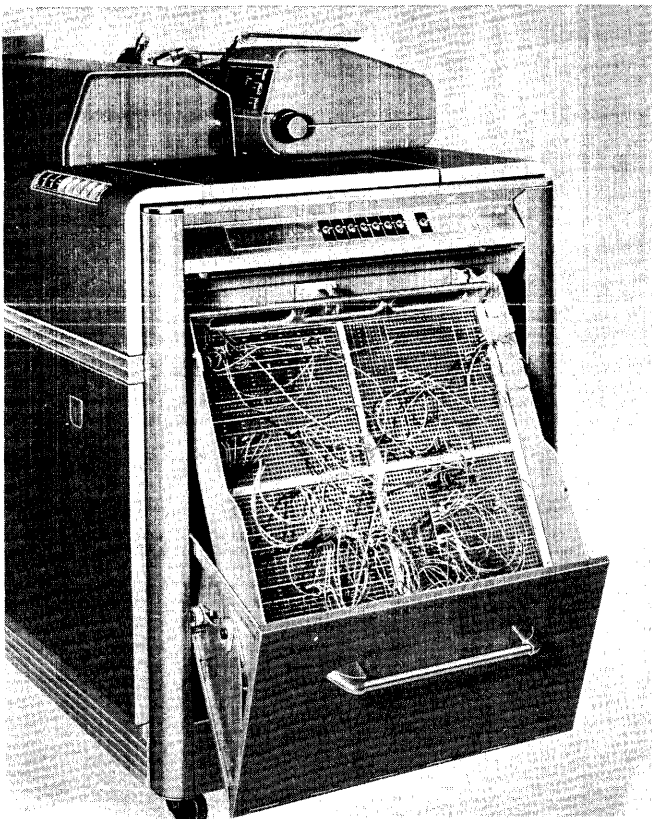
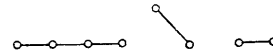

FIGURE 9. CONTROL PANEL INSERTED IN MACHINE

There are two kinds of hubs on the control panel, exits and entries. An exit is one which emits an impulse. Some exits are under the control of the hole in the card, and others result from some function previously performed, or are automatic for every card. An entry hub is one which can accept an impulse wired to it. A connection must always be made from an exit to an entry by placing one end of a wire in the exit hub and the other end in the entry hub. Which exits and entries are used will depend entirely upon the job the machine is called upon to do. The control panel may be changed to prepare each new report, thereby giving to one machine the flexibility needed to produce different types of documents or reports for many different applications.

Whenever two or more hubs are connected by lines, as shown below, these hubs are common, that is, two or more exits or entries serve the same purpose. Such an arrangement reduces the need for split wires (wires with more than two ends) since these hubs are actually connected together and serve the same purpose as split wires.



To facilitate reference to specific hubs on the control panel (Figure 10), the rows are numbered from 1 through 80 horizontally and lettered from A through BL vertically. This arrangement divides the control panel into four equal sections. Generally, *position* wiring, such as card reading, counter entry and exit, storage entry and exit, comparing, and printing, is concentrated in the upper and lower left sections, while wiring for *control* of entry, exit, adding, subtracting, and other functions is concentrated in the upper and lower right sections. Groups of hubs performing like functions are sectioned off by heavy lines. Shaded hubs indicate possible additional capacity for various features.

FIGURE 10. CONTROL PANEL DIAGRAM

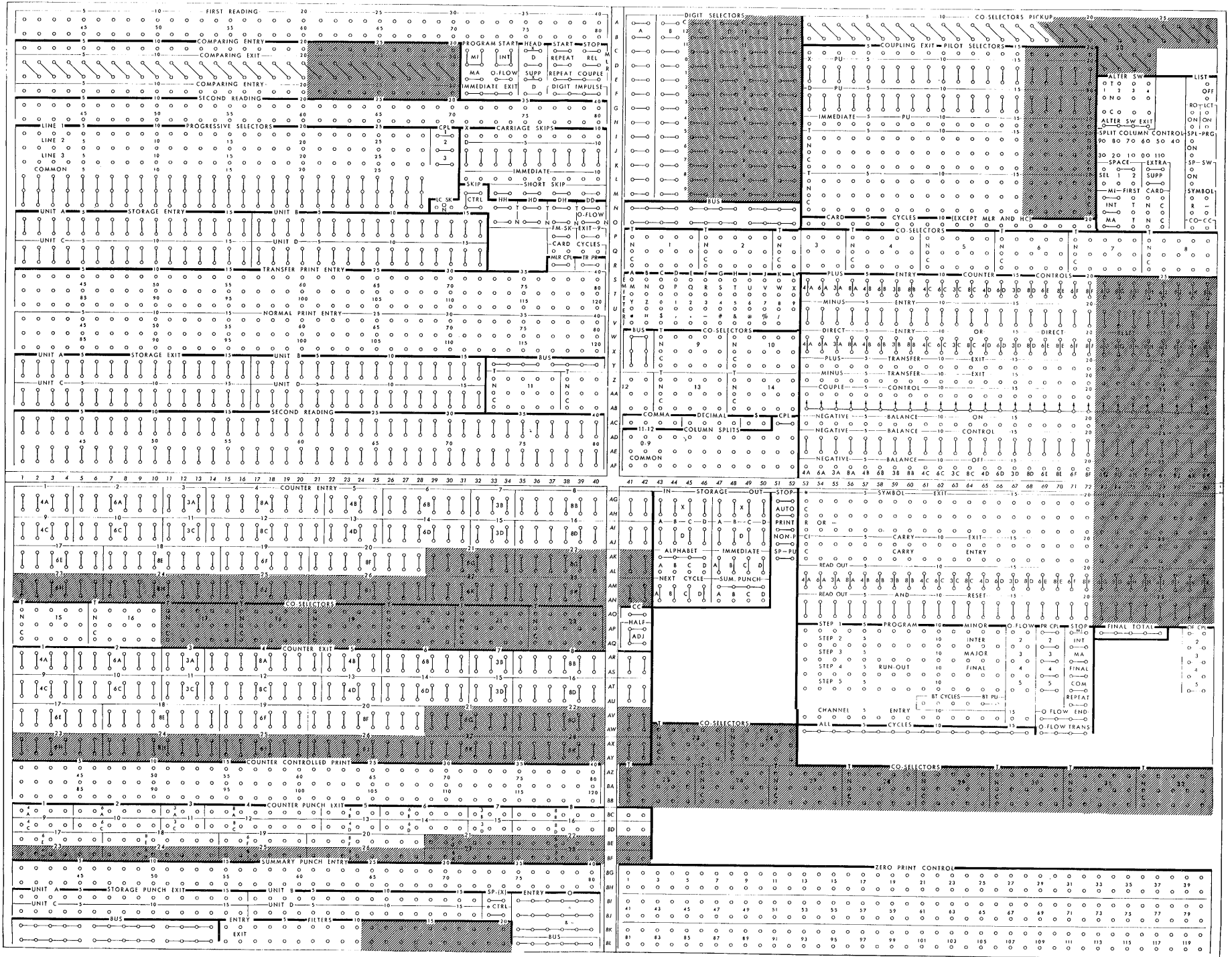

DETAIL PRINTING

THE TYPE 407 is basically a detail printing machine. Detail printing is the printing of information from each card as it passes through the machine. Figure 11 shows the codes that must be punched in the card to print digits, letters and special characters. The digits 0 through 9 are identified by single punches, while the letters and special characters are identified by combination punching. For example, the combination of 12 punches with the digits 1 through 9 are recognized by the machine as the letters A through I. Combinations of 11 punches with the digits 1 through 9 are recognized by the machine as the letters J through R. Combinations of 0 punches with the digits 2 through 9 are recognized by the machine as the letters S through Z. Eleven special characters are designated by various combinations of punches as shown in Figure 11. These are permanently assigned codes and when the control panel is properly wired, the machine will always recognize a 12-1 as the letter A, 0-4-8 as the % sign, etc.

As previously explained, each one of the 120 print wheels may be impulsed to print any one of the 47 characters shown on the card in Figure

11. Only one wire on the control panel is needed to print a number, a letter or a special character.

*Underpunching cannot be used as a means of correcting cards when they are to be processed through the 407.*

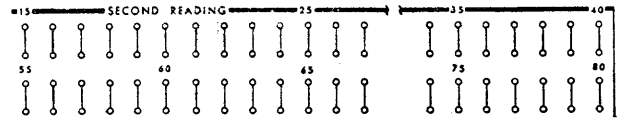

G-H, 1-40;  
AC-AF, 1-40

**Second Reading.** There are two sets of second reading hubs, one in the left center of the control panel and the other at the left top of the panel. The corresponding hubs in both sets are common and can be used interchangeably. The 80 second reading hubs represent the 80 columns on the cards and are used for all normal reading operations. In order to print information that is punched in the card, the second reading hubs corresponding to the card columns are wired to normal print entry. They may also be wired to transfer print entry or counter-controlled print as explained under the discussion of those hubs.

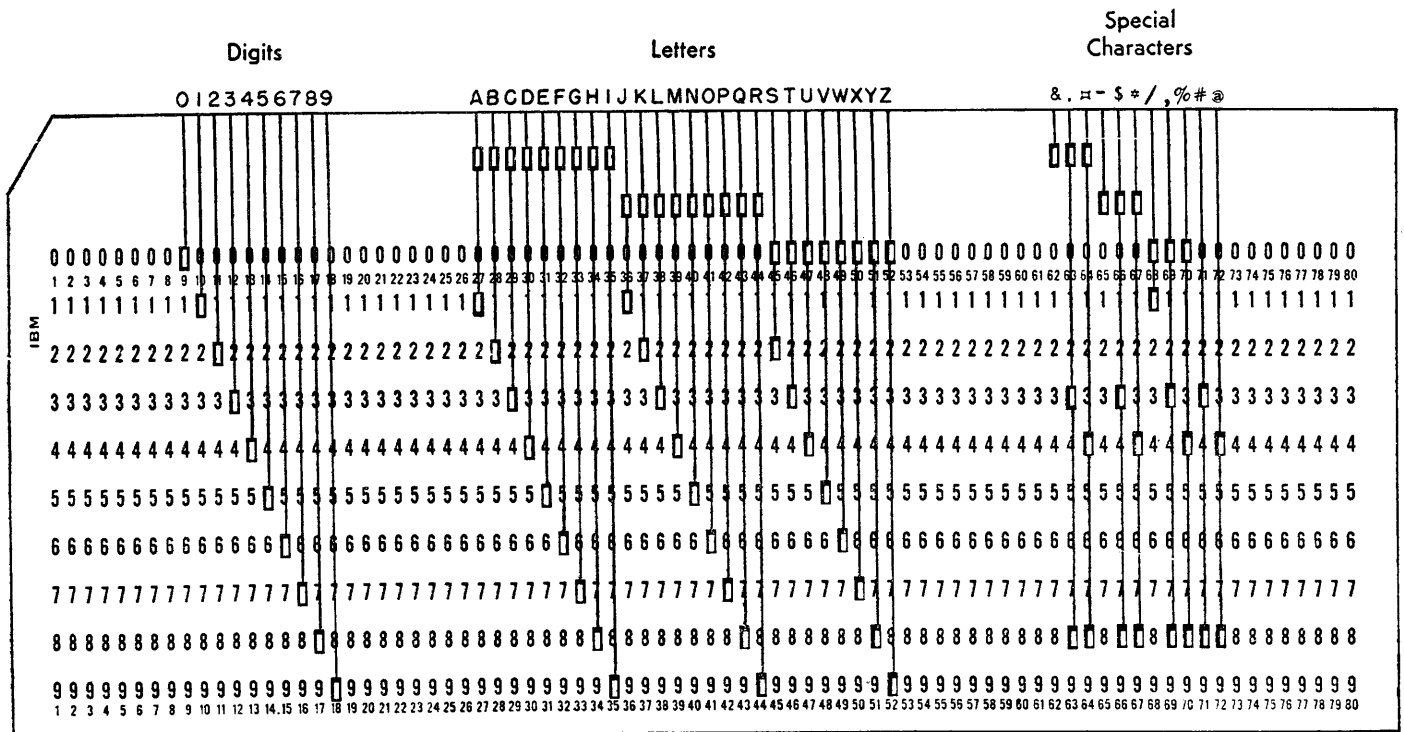
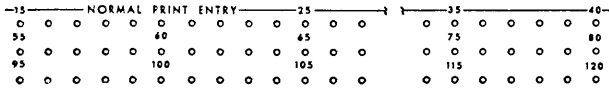

FIGURE 11. CHARACTER PUNCHING



V-X, 1-40

**Normal Print Entry.** Each print wheel has a corresponding normal print entry hub on the control panel. When a print entry hub is impulsed from a second reading hub, directly or through selectors, the print wheel prints the numerical, alphabetic or special character information that is punched in a column of the card. Only one wire is required to print any one character. If a controlling X is punched over a numerical field, that X must be filtered out by means of a column split, or the column containing the X must be wired to counter-controlled print hubs.

The normal print entry hubs may also be wired from the emitter and the comma, decimal and dollar exit hubs. In some instances they are also wired from first reading.



K-L, 74-75

**Space 1-2.** The machine will single space (6 lines to the inch) if the hub labelled 1 is connected to either of the two common exit hubs above it. The machine will double space (3 lines to the

inch) if the hub labelled 2 is connected to either of the two common exit hubs above it. Unless the carriage is used to control spacing (sel space), failure to connect either the 1 or 2 space hubs will result in continuous skipping, since the function of these hubs is to stop a skip after either one or two spaces have been taken.

**Spacing Chart**

In the report shown in Figure 13, the order number, punched in columns 1-5 of the card, must print in the order number column of the shipping schedule. Likewise the product number, schedule date, customer number and quantity must print under their respective headings.

The best way to determine which print wheels to use to print order number in the report column set aside for it is to superimpose the report itself on a spacing chart, as shown in Figure 12. The numbers across the top and bottom of the spacing chart represent print wheel positions, which are spaced 10 to the inch or the same as standard pica typewriter spacing. The large numbers represent the tens position and the small numbers the units position of the print wheel number. The numbers down the sides of the spacing chart represent line numbers.

The report may be superimposed on the spacing chart without consideration for alphabetic or numerical printing, since all print wheels print all 47 characters. If the report is positioned as shown

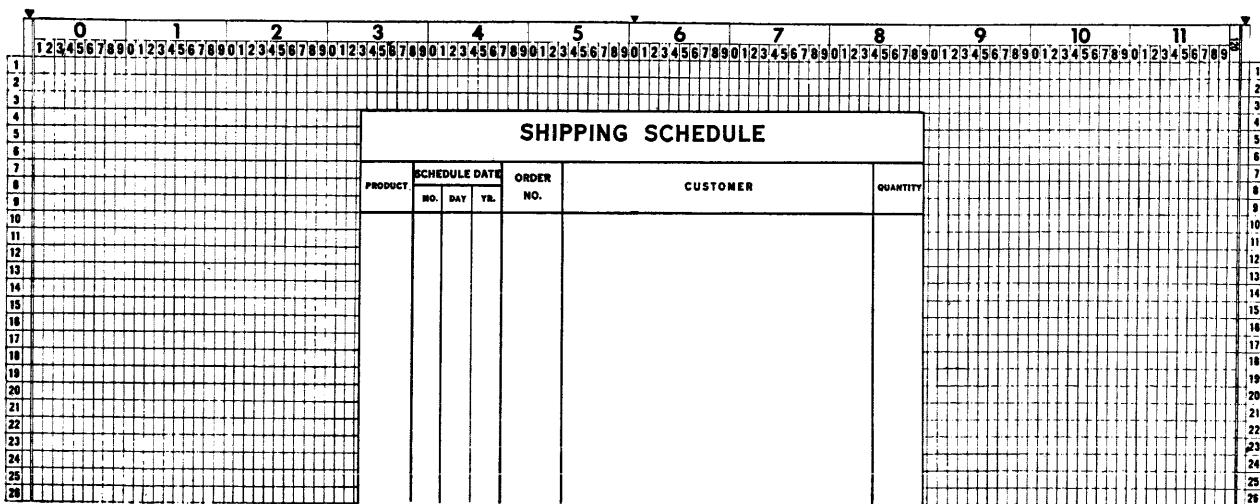

FIGURE 12. REPORT AND SPACING CHART

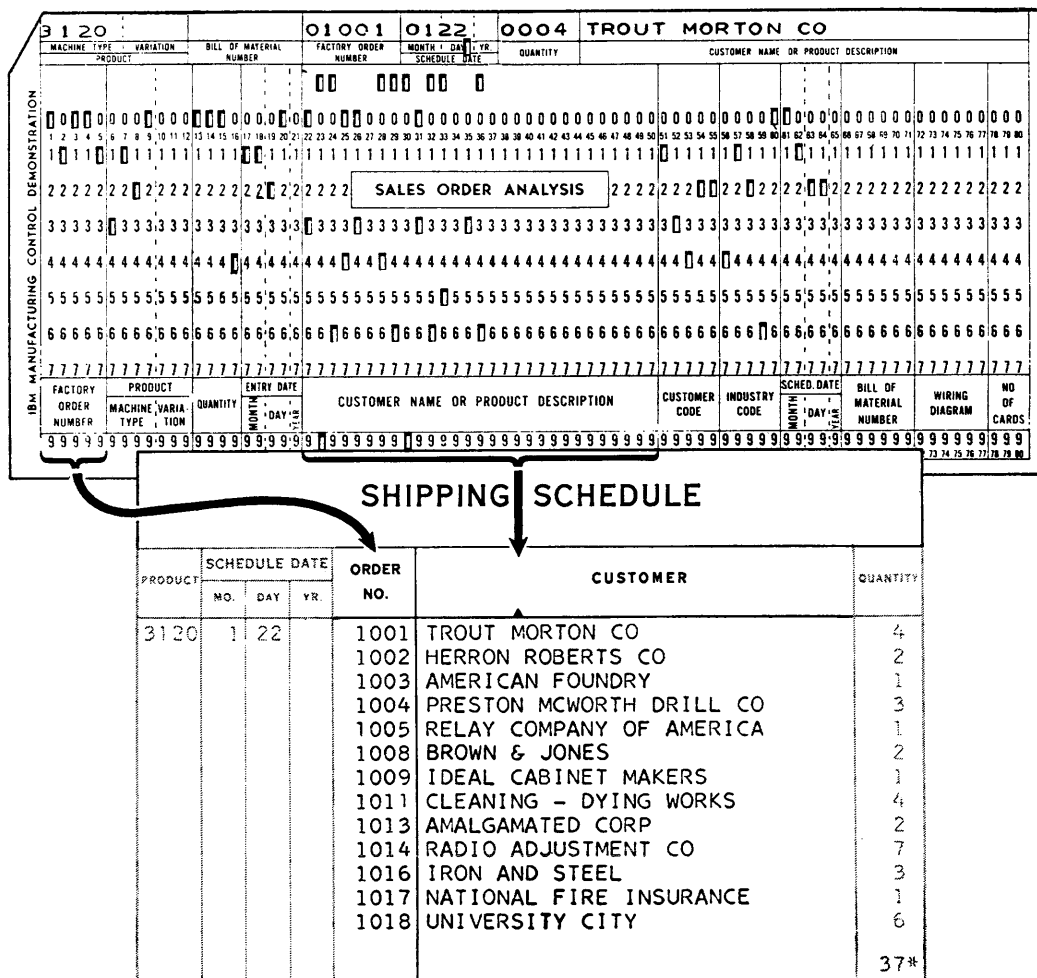

FIGURE 13

in Figure 12, then product number will be printed by print wheels 34-37, schedule date by print wheels 39-46, and order number by print wheels 48-52. In this example the report is centered, with the form alignment symbol (▲) in the center of the report lined up with print wheel 60 in the center of the spacing chart.

The printed Shipping Schedule is shown in Figure 13.

Wiring for Detail Printing (Figure 14)

1. Order number, punched in columns 1-5 of the sales order analysis card, is detail printed by wiring second reading 1-5 to normal print entry 48-52.

2. Customer name, punched in columns 22-50 of the card, is detail printed by wiring second reading 22-50 to normal print entry 54-82.

3. Since the report is to be single spaced (6 lines to the inch) space hub 1 is connected to the exit above it.

4. Zero print control positions 49-52 (representing the order number printing positions) are connected. The high order position is not wired. Zeros will print to the right of significant digits when they are punched in the card. It is necessary to connect the zero print control positions for the alphabetic field since there is interspersed special character punching. A more detailed explanation will be given under *Zero Print Control*.



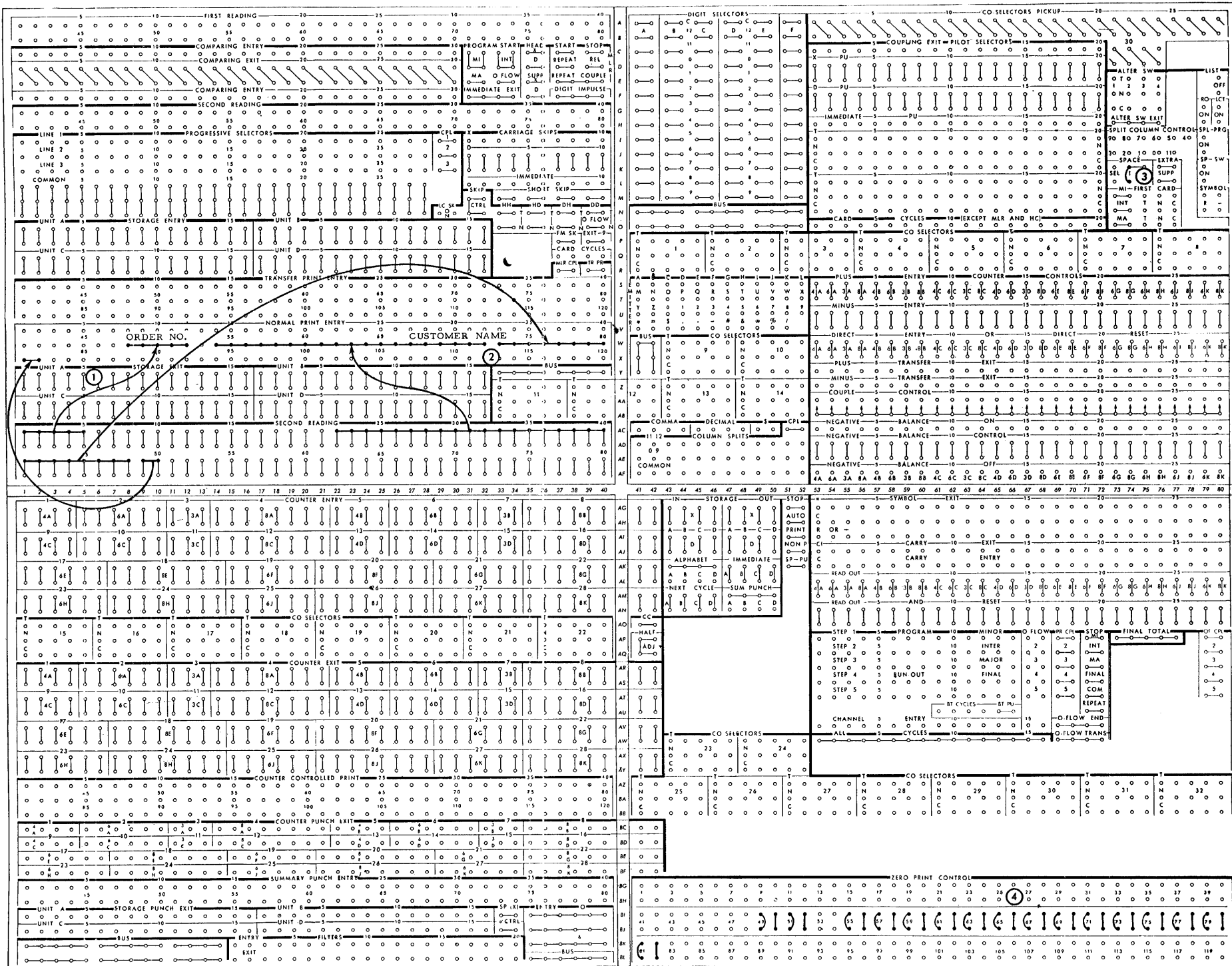

ADDITION

THE TYPE 407 machine has 112 individual accumulators, each of which can add up to 9. These single position accumulators are grouped into units called counters, which vary in size from a 3-position counter to an 8-position counter. Within each counter a single position will add up to 9 and then carry over to the next position to its left. These two counter positions in turn add up to 99 and carry over into the third position, and so on. The carry-over within each counter is automatic.

Each counter has a serial number for general identification and a number and a letter for specific identification, the number in the latter case, indicating how many positions the counter contains, and the letter its grouping. For example, counter 7 is also labelled 3B, meaning that it is a 3-position counter in the B group. There are 20 separate counters grouped as follows:

Group	A	B	C	D	E	F
Positions	4 6 3 8	4 6 3 8	4 6 3 8	4 6 3 8	6 8	6 8
Numbers	1 2 3 4	5 6 7 8	9 10 11 12	13 14 15 16	17 18	19 20

The counters may be coupled in any desired arrangement. A 6-position counter may be coupled with a 3-position counter to form a 9-position counter. An 8-position counter may be coupled with a 6-position counter to form a 14-position counter.

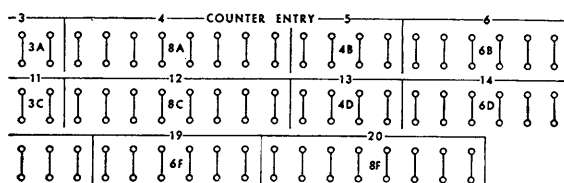

AG-AN, 1-42

**Counter Entry.** The counter entry hubs accept information to be added or subtracted. Each counter position contains a pair of common entry hubs which are normally wired from second reading. They may also be wired from other counter exits, half adjustment, cycle count or from a digit selector used as an emitter. The counters are identified by numbers from 1 to 20 and by numbers and letters to represent size and grouping.

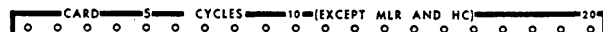

O, 53-72

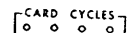

Q, 37-40

**Card Cycles.** There are two sets of card cycles hubs. One set of 20 independent hubs (O, 53-72) emit impulses as each detail card, except heading and MLR cards, is read at the second reading station. Another set of four independent hubs (Q, 37-40) emit impulses as each card, including heading and MLR cards, is read at the second reading station. They are normally wired to counter plus or minus to cause addition or subtraction, or to direct entry to suppress the counter exits.



S-T, 53-80

**Counter Control Plus.** Each counter has a corresponding plus entry which must be impulsed to cause the counter to add as the card is read at the second station. If a counter is to add from every card, a card cycles impulse is wired to the plus hubs of that counter. If only certain cards are to be added, the card cycles impulse must be selected to reach the counter plus hubs only for the particular cards to be added.

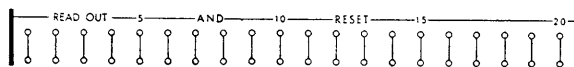

AN-AO, 53-80

**Read Out and Reset.** Each counter has a pair of common read out and reset hubs which, when impulsed, will cause the counter to read out (print the total) and reset (clear) in the same cycle. The time at which the total will print depends upon the type of impulse wired to the read out and reset hubs. Normally they are wired from a program or a final total hub. They may also be wired from card cycles to cause the counter to read out and reset for every card, or from first card minor, intermediate or

major to cause the counter to read out and reset for the first card of every minor, intermediate or major group. A counter on the 407 always resets either by adding the 9's complement of the number standing in the counter when resetting without printing, or the 9's complement of the number printed. A counter always resets to 9 rather than zero, thus leaving 9's standing in every counter position after reset.

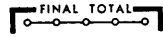

AP, 73-77

**Final Total.** The five common final total hubs emit an impulse that may be used to read out and reset counters whenever the final total key is depressed, provided the following conditions have been satisfied:

- a. The final total toggle switch is on.
- b. The last card has been run out of the machine.
- c. The machine is idling.

When the last card leaves the hopper, the machine stops. The start key must then be depressed to run out the cards remaining in the machine. The final total key is then depressed to print the total. If the final total toggle switch is off, the total cannot be cleared even though all other conditions have been satisfied; this prevents accidental clearing of the counter.

When the final total key is depressed, the carriage is restored to its home position before the total prints if the LC SK (last card skip) switch is wired on. If there is no tape in the carriage this restoration accounts for one space. Another space is taken before the total prints, thus causing a final total to print two spaces below the last printed item.

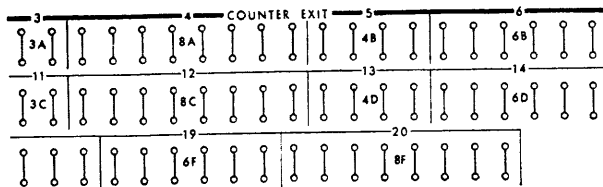

AR-AY, 1-42

**Counter Exit.** Each counter has a corresponding counter exit from which all counter detail and

total printing is obtained. These hubs must be wired to counter-controlled print if the total is to be printed and the counter is to reset at the same time. They may be wired to either normal or transfer print entry if the counter is to be read out only. The counter exits are internally tied to the corresponding counter entry hubs except when the direct entry or direct reset controls for that counter are impuised. The exit hubs may be used as entries, as they frequently are when transferring totals from one counter to another.

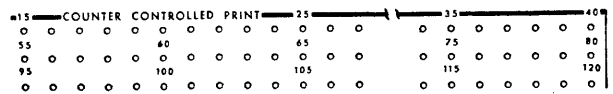

AZ-BB, 1-40

**Counter-Controlled Print.** Each print wheel has a corresponding counter-controlled print hub on the control panel, which is internally connected to either transfer or normal print entry, whichever is active. The difference between these hubs and the normal print entry hubs discussed earlier is that the counter-controlled print hubs are also exits for all amounts printed by the print wheels. A cycle on the Type 407 is divided into two parts, referred to as the first half and the second half of the cycle, as shown in Figure 15. Information read from the card reaches the counter-controlled print hubs from the counter exit in the first half of the cycle, and sets up the print wheels for printing. The information which the wheel prints is emitted from the counter-controlled print hubs in the second half of the cycle, and returns to the counter exit from which it started and to any other counter exits connected together. These are sometimes referred to as "echo" impulses.

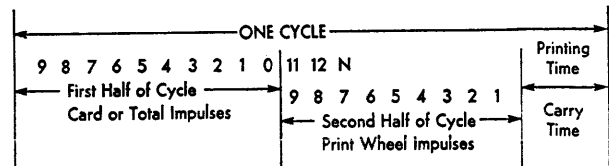

FIGURE 15. CYCLE SCHEMATIC

Counters which are controlled to add will add information returned from the print wheels through the counter exits. Counters which are controlled to reset will add or subtract the return information. Counters are then checked for a zero balance.

Counter exits must always be wired to the counter-controlled print hubs, because if a total is to be printed or transferred to another counter, the only way a counter can reset is by subtracting the total printed if it is plus, or adding the total printed if it is minus. This is done in the second half of the total cycle by impulses received from the counter-controlled print hubs. If the counter fails to balance to zero, the reset check light will turn on.

Counter-controlled print hubs may be wired directly from second reading to print numerical information, provided the same information is not wired for comparing. Alphabetic or special character information cannot be wired to counter-controlled print because these hubs do not accept 11 and 12 impulses.

gether to increase capacity, they must be coupled by wiring the CI of the counter containing the units position to the C of the coupled counter. A 10-position counter is obtained by coupling a 6-position counter with a 4-position counter. If 4A is to be coupled with 6A, and 6A contains the units position, the CI of 6A is wired to the C of 4A. The example below shows how counter coupling functions when 4 is added to 999996 in a 10-position counter.

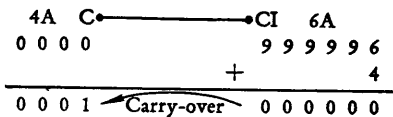

The CI and C hubs are also used to carry back from the left position of a counter to the units position of the same counter, or from CI to C. This is necessary whether a counter is impulsed to add or to subtract, to compensate for shortages that would result because of the fact that all counters reset to 9 instead of zero, and also because of the use of the 9's complement method of subtraction. In each of the examples below, the carry-back is added back into the units position because CI is wired to C of the same counter. If the carry-back wiring is omitted, positive totals would be short, and negative totals would be over, after being converted.

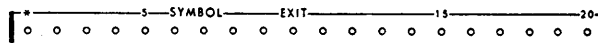

AG, 53-80

\* *Symbol Exit.* Each counter has a corresponding asterisk symbol exit hub which emits the equivalent of an 8-4-X impulse whenever the counter is impulsed to read out or to read out and reset. This is usually wired to any normal print entry hub to identify totals, or to the transfer print entry when those hubs are active. Symbol exit cannot be wired to counter-controlled print because these hubs will not accept zone impulses, which in the case of the asterisk is the X impulse.

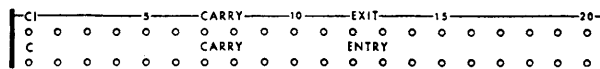

AJ-AK, 53-80

*CI Carry Exit, C Carry Entry.* These hubs have two functions, counter coupling and carry-back. If two or more counters are joined to-

POSITIVE RESULT		NEGATIVE RESULT	
PROBLEM	COUNTER ACTION	PROBLEM	COUNTER ACTION
	999999		999999
+175	000175	-175	999824
	(1)000174 → 1		(1)999823 → 1
	000175		999824
-96	999903	+96	000096
	(1)000078 → 1		999920
	000079	+102	000102
-102	999897		(1)000022 → 1
	999976		000023
+75	000075	-75	999924
	(1)000051 → 1	-52	999947
	000052		(9's complement of 52)

FIGURE 16. ADDITION

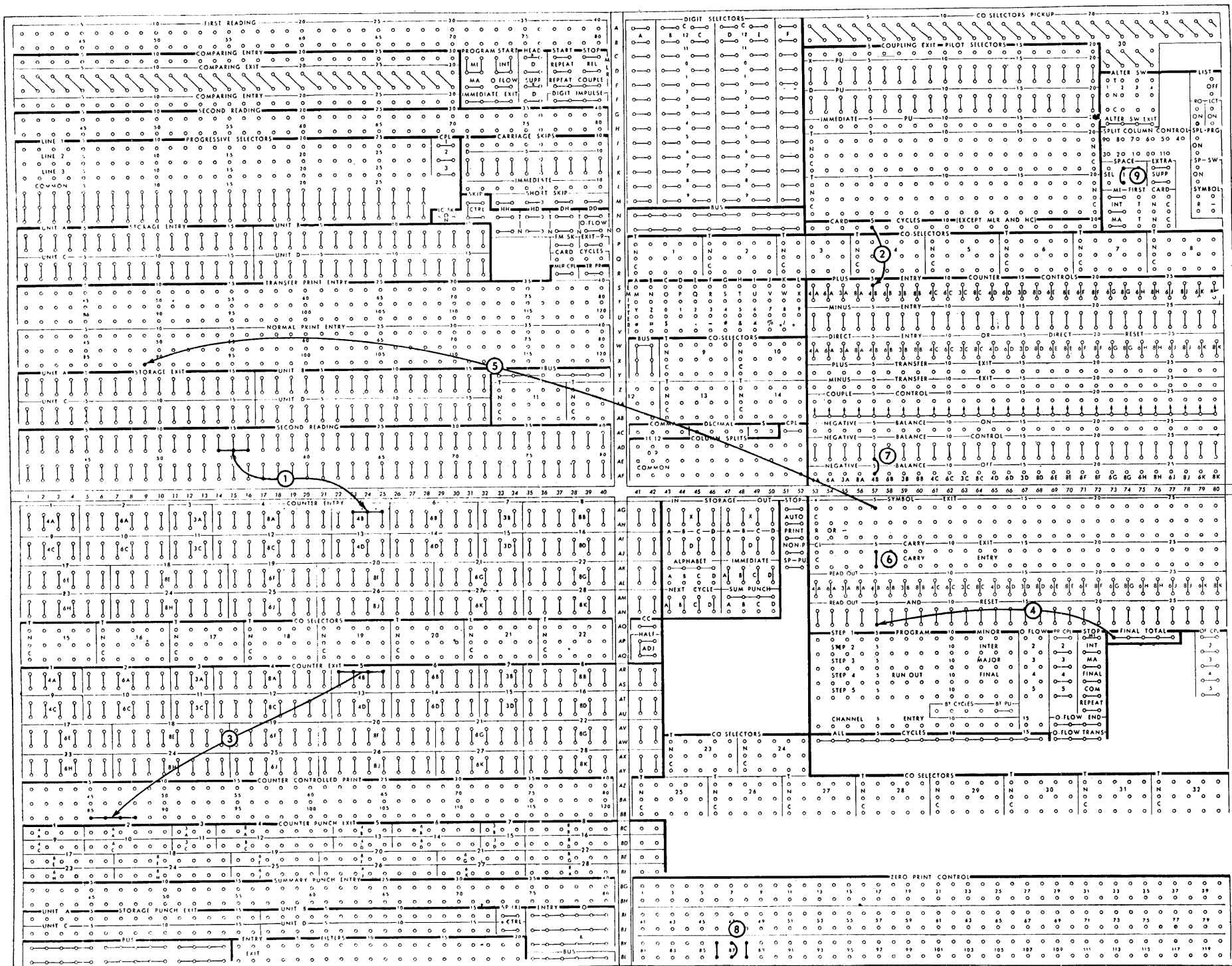

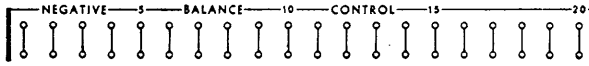

AD-AE, 53-80

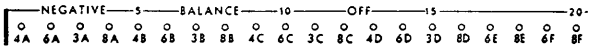

AF, 53-80

*Negative Balance Off; Negative Balance Control.*

Each counter group has a corresponding negative balance OFF hub which emits an impulse at the end of the cycle during which the counter zero-balances, and for every cycle thereafter as long as the counter remains at zero. It has two uses, to pick up selectors so that certain machine operations may be conditioned by a zero balance, and to impulse the negative balance control hubs of the same counter so that a zero balance will not print as 9's.

When counters are coupled, the negative balance control hubs must also be coupled, and when positive totals are accumulated, only the negative balance OFF of the low order counter is wired to negative balance control. This wiring works in conjunction with couple control to test all positions of the coupled counter for a zero balance.

In general, the negative balance OFF should be wired to negative balance control whenever a total to be printed from the counter is always positive.

The same card and report form for detail printing are now reconsidered for the purpose of adding quantity, as shown in Figure 17.

**Wiring, Addition (Figure 16)**

1. Columns 14-16 of the card are wired from second reading to the entry of counter 5 (4B) so that quantity may be added.

2. Counter 5 is impulsed to add the quantity from every card by wiring a card cycles impulse to counter 5 plus entry.

3. Both the detail amount and the total are printed by wiring from counter 5 exit to counter-controlled print 85-88. The reading from card columns 14-16 reaches the counter-controlled print hubs by way of the counter entry and exit during the first half of the cycle, and starts the print wheels turning. The counter-controlled print hubs then emit the impulses back into the counter by way of the counter exit during the second half of the cycle.

4. Final total is wired to counter 5 read out and reset so that the total quantity may be printed at the end of the report by depressing the final total key. The final total toggle switch must be on.

5. The asterisk symbol exit for counter 5 is wired to *normal print entry* 89, to identify the total. This impulse is the equivalent of an 8-4-X impulse and cannot be wired to counter-controlled print because these hubs do not accept zone impulses.

6. In adding, CI and C must be connected to prevent the shortage that would result from adding positive figures to 9's standing in every counter position at the beginning of an operation. All counters reset to 9.

7. Negative balance OFF (counter 5) is wired to negative balance control of the same counter.

8. Zero print control is wired for print wheels 86-88 so that zeros will print to the right of significant digits when they are punched in the card or occur in the total.

9. The report is single spaced by connecting space hub 1 to the exit hub above it.

SHIPPING SCHEDULE						
PRODUCT	SCHEDULE DATE			ORDER NO.	CUSTOMER	QUANTITY
	NO.	DAY	YR.			
3120	1	22		1001	TROUT MORTON CO	4
				1002	HERRON ROBERTS CO	2
				1003	AMERICAN FOUNDRY	1
				1004	PRESTON MCWORTH DRILL CO	3
				1005	RELAY COMPANY OF AMERICA	1
				1008	BROWN & JONES	2
				1009	IDEAL CABINET MAKERS	1
				1011	CLEANING - DYING WORKS	4
				1013	AMALGAMATED CORP	2
				1014	RADIO ADJUSTMENT CO	7
				1016	IRON AND STEEL	3
				1017	NATIONAL FIRE INSURANCE	1
				1018	UNIVERSITY CITY	6
						37*

FIGURE 17

ZERO AND SPECIAL SYMBOL CONTROL

PRINT wheels are designed to print normally only significant digits 1 to 9 and any letter or special character with a 1 to 9 combination.

The impulse, or impulses, wired to print entry must be able to reach the fuse in order to energize the print magnet and cause printing. There is an internal connection between the print magnet and the fuse at the time a digit 1 through 9 is read. However, that connection is broken after 1 time and before zero time, so that a 0, 11, and 12 cannot normally reach the fuse. A character that does not have a digit 1 to 9 will not normally reach the fuse for the same reason. Therefore zeros, whether they are read from a card or from a counter, do not normally print. For example, a number like 010050 would print as ( 1 5 ). Zero printing is controlled by use of the zero print control hubs on the control panel. These hubs will be described first, for controlling zeros, and second, for controlling the comma, decimal, dollar sign, ampersand (&), and dash (—) symbols.

Zero Print Control For Zeros

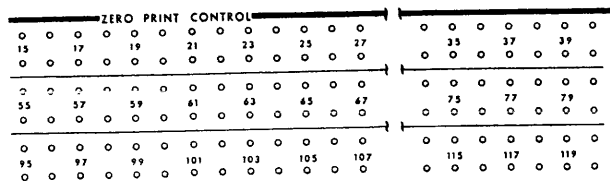

BG-BL, 41-80

*Zero Print Control.* Each print entry position has a pair of zero print control hubs diagonally arranged in two rows as illustrated in Figure 18. The hubs in the lower row are numbered from 1 to 120 on the control panel to correspond to the print entry positions. The hubs in the upper row are not numbered on the control panel, but they are associated diagonally with the hubs in the lower row.

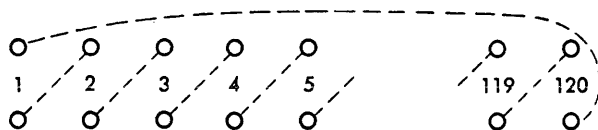

FIGURE 18

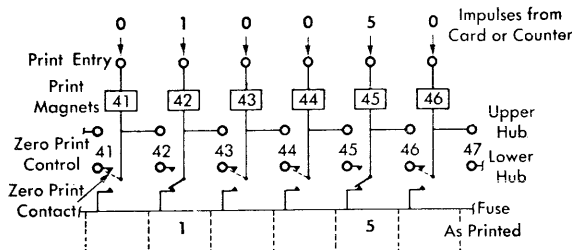

FIGURE 19

The principle of zero print control can be explained by reference to Figure 19. Six zero print positions are shown for print wheels 41 to 46. It is assumed that card columns 1 through 6 (punched 010050) are wired from second reading to normal print entry 41 through 46. Each print wheel has a corresponding print magnet, which must be energized before a zero or a significant digit will print.

When a print entry position has been impulsed with a 9 to 1 digit (print wheels 42 and 45), the zero print contacts transfer and the connection between the two diagonal hubs is broken. The upper hub and print magnet are then connected directly to the fuse for zone time (0, 11, 12).

This provides a path for a 0, 11, or 12 impulse to reach the fuse as in the case of an alphabetical character. In addition, the upper hub is connected to the fuse so that it could be used as an entry to the fuse. In positions that receive no significant digit (1 to 9) impulse, the zero print contacts do not transfer. A 0, 11, or 12 impulse entering that position would not find a path to the fuse but would be available out of the lower hub. The printing of zeros can be accomplished in the desired pattern by correctly wiring the zero print control hubs on the control panel. For example, if the lower hub

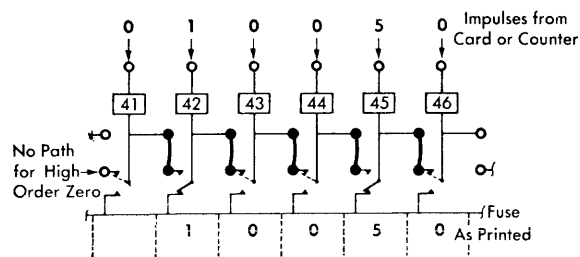

FIGURE 20

of print magnet 46 is jackplugged to the upper hub of 45, the zero impulse in position 46 would go through the normally closed zero print contact by control panel wire to the upper hub of 45, and then to the fuse. The upper hub of 45 was connected directly to the fuse because of the 5 impulse causing the zero print contact in that position to be transferred.

This arrangement affords complete flexibility in the printing of zeros. In the example above, the number may be wired to print either as 010050 or as 10050.

If zeros are to print only to the right of the significant digits, the zero print control hubs are wired for each print wheel in use except the position of the highest order, as shown in Figure 20. The zeros from hubs 43 and 44 reach the fuse over the external wires connecting 44 and 43 and the internal connection established because of the digit 1 in print wheel 42. The high-order zero cannot reach the fuse and therefore will not print.

Zeros may be printed to the left of significant digits as well as to the right by the wiring shown in Figure 21.

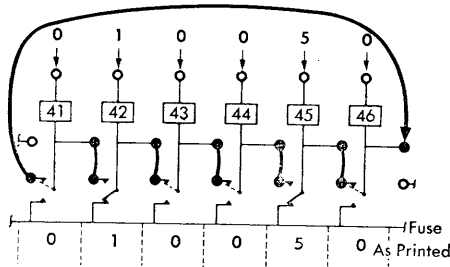
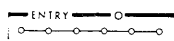

FIGURE 21

The high-order zero will print because it reaches the fuse the same way that the zero in the units position does. All zeros punched in the card or contained in a counter will print either to the left or right of a significant digit. Zeros will not print, however, unless there is a significant digit in some position.



BI, 35-40

0 Entry. These six common hubs provide a direct path to the fuse for zeros. They are normally

wired from zero print control as shown in Figure 22 to cause zeros to print regardless of significant digits. As there are no significant digits in the field, every lower zero print control hub is internally connected to its corresponding upper hub. The external wiring allows a zero anywhere in the field to reach the fuse by way of the (0) entry hubs.

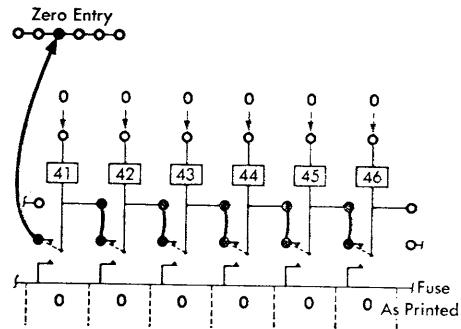

FIGURE 22

Zero print control need not be wired for alphabetic fields unless interspersed numerical or special character information is to be printed. Five of the special characters (- & . \$) are controlled from zero print control.

Zero Print Control for Dash (-) and Ampersand (&)

Because zone punches, by themselves, do not have a path to the fuse (11 for dash and 12 for ampersand) both the dash and the ampersand must be wired for zero print control and will print under the same conditions in which the zero prints. It will be seen in Figure 23 that the dash impulse reaches the fuse because of the presence of significant digits to the left. If the field were punched with all zeros, the dash would not print.

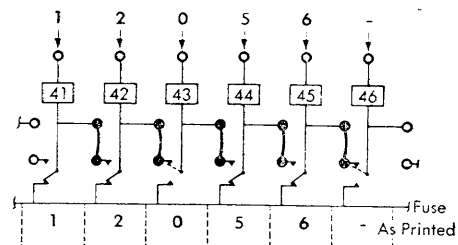

FIGURE 23



**Zero Print Control — Comma, Decimal and Dollar Sign**

There are three ways of printing commas, decimal points and dollar signs:

- a. From the card columns in which they are punched to normal or transfer print entry.
- b. From the corresponding hubs in the character emitter to normal or transfer print entry.
- c. From the comma, decimal and dollar sign exits to normal or transfer print entry.

Under method A, the symbols will print whenever they are punched, regardless of significant digits. Under method B, the symbols will print every print cycle regardless of significant digits. Under method C, the symbols are controlled by zero print control.

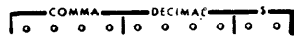

AC, 41-50

**Comma, Decimal, \$.** These hubs emit comma, decimal and dollar sign impulses every machine cycle. They are specially timed so that they can be printed only under control of the zero print hubs and in this way they differ from the comma, decimal or dollar sign impulses obtained from cards or from the emitter. They are normally wired directly to normal or transfer print entry to print the dollar sign and amount punctuation both on the detail print cycle and on the total cycle. They print with exactly the same type of control as that used for printing zeros; that is, they may be controlled to print to the right or left of significant digits by proper wiring of the zero print control hubs.

The comma, decimal and dollar sign hubs should never be split-wired directly to two or more different print entry hubs. If split-wiring is necessary, each split should be wired through a filter.

**Dollar Symbol**

The dollar symbol is normally printed to the left of significant digits. To do this, the same zero print control wiring must be used as that needed for printing zeros to the left of significant digits. Assuming that the \$ hub is wired to normal print entry 40 and the amount field to normal print entry 41-46, the dollar sign will print to

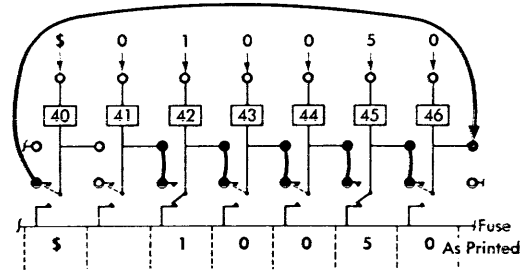

FIGURE 24

the left of significant digits by wiring lower zero print control hub 40 to the upper hub of zero print control 46 as shown in Figure 24. In this example, the dollar symbol reaches the fuse because of the digit 5. The high order zero print control hub (41) is not wired in order to prevent the printing of zeros between the dollar sign and the high order digit 1.

**Comma**

The comma is normally printed to the right of significant digits. Printing of commas requires no special wiring other than that required for printing zeros. A comma impulse does not have a path to the fuse and, therefore, its printing depends upon the presence of significant digits. The comma shown in Figure 25 reaches the fuse because of the digit 2.

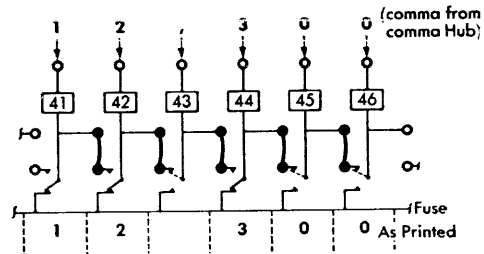

FIGURE 25

**Decimal**

There are two methods of wiring for decimal printing as illustrated in Figures 26 and 27.

The decimal point will print to the right of significant digits the same as zeros, with normal zero print control wiring. This means that for amounts of 1.00 or over, normal zero print control wiring is sufficient. A decimal impulse does not have a path to the fuse and, therefore, its printing depends upon the presence of significant digits. The decimal shown in Figure 26 reaches the fuse because of the digit 1 in the hundreds position.

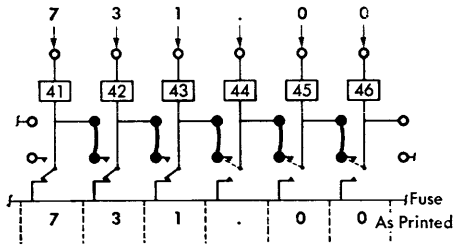

FIGURE 26

For amounts of 1 to 99 cents, however, normal wiring fails to print the zero and the decimal point to the left of the significant digits. This can be accomplished by wiring the lower hub of the decimal position back to the upper hub of the units position as shown in Figure 27. Both the zero and the decimal in this example print because of the presence of the digit 1. In order to print an amount such as 1.00, it would appear that lower hub 44 should be split-wired to upper hub 43. Although this wiring would cause zeros to print to the right of even dollar amounts, it would also cause zeros to print to the left of any amount under 1.00. Any zero to the left of the decimal could find its way to the fuse over the wiring originally intended to print decimals and zeros for amounts of from 1 to 99 cents. Although the connection shown by the dotted line in Figure 27 must be made, it cannot be made directly. To prevent zeros in the dollar columns from backing up and reaching the fuse by way of connections established by the units and tens positions, a filter is used.

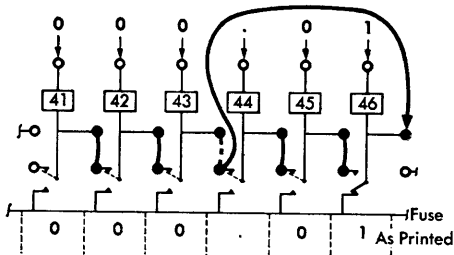
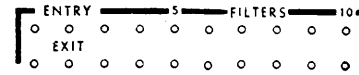

FIGURE 27

**Filter Entry - Exit.** These hubs permit the passage of an impulse in only one direction — into entry and out of exit. When any two functions are connected by split wires or through a bus, any impulse reaching one function will also



BK-BL, 15-34

reach the other. This "back circuit" can be eliminated by a filter. Ten entry and ten exit positions are standard. The exit of one filter should not be wired to the entry of another. Other suggestions for the use of filters may be found under *Operating Suggestions*.

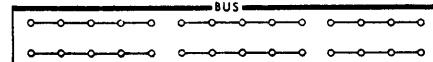

N-O, 41-52; W-Y, 41-42; Y, 33-40; BL, 35-40; BK-BL, 1-14

**Bus.** There are 16 sets of bus hubs; 10 sets have four common hubs, 4 sets have five common hubs and 2 sets have six common hubs. When an impulse is entered into one of the hubs in a set, it is available out of the remaining hubs. Bus hubs are used in place of split wires.

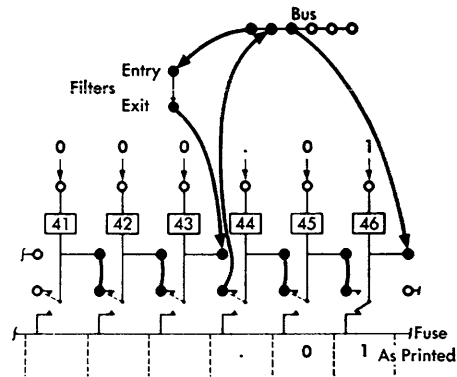

FIGURE 28

Figure 28 shows the connection between lower 44 and upper 43 made through a filter. This allows zeros and the decimal for even dollar amounts to reach the fuse because of the presence of a significant digit anywhere to the left. It will prevent zeros in 41, 42, 43 or 44 from reaching the fuse for amounts ranging from .01 to .99, since an impulse cannot pass through a filter from exit to entry. In such operations, one filter should be used for every two positions to the right of the decimal to prevent an undue load on one filter. Refer to *Load Rating Table* under *Operating Suggestions*.

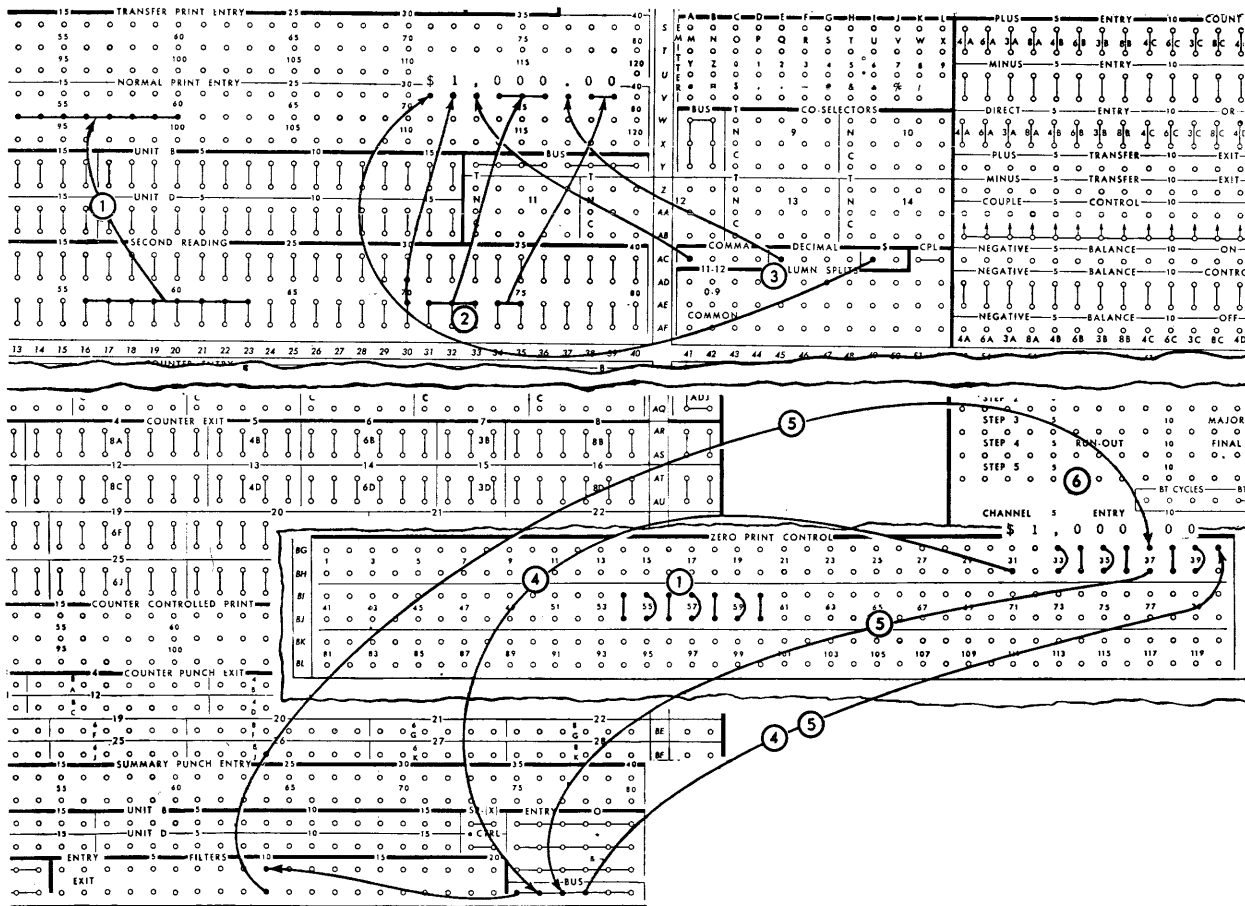

FIGURE 29. AMOUNT PUNCTUATION

**Wiring (Figure 29)**

Only that wiring is shown which concerns the printing of detail printed amounts, zeros, commas, decimals and dollar signs. The control of the symbols is the same for either detail or group printing.

1. Columns 56-63 are wired to normal print entry. Zeros will print to the right of significant digits only when they are punched in the card and when the zero print control hubs are wired. The first zero print position (53) is not wired.

2. Column 70 of the amount field is wired from second reading to normal print entry 32. Columns 71-73 are wired from second reading to normal print entry 34-46. Columns 74-75 are wired to normal print entry 38-39.

3. The comma symbol is wired to normal print entry 33, the decimal to normal print entry 37,

and the \$ symbol to normal print entry 31. Although these hubs emit impulses every machine cycle, they will print only when there are significant digits in the amount field, under the control of the zero print hubs.

4. The lower hub of zero print control 31 is wired through a set of bus hubs to the upper hub of 39. This wiring allows the printing of the dollar symbol from print wheel 31 when there are significant digits to the right. The position following the dollar symbol should be left unwired to prevent the printing of zeros to the right of the dollar sign.

5. The lower hub of zero print control 37 is wired through a set of bus hubs to two different places:

- a. To the upper hub of 39 for the purpose of printing the decimal point from print wheel

37 and a zero from 38 when there are significant digits to the right but not to the left of the decimal, as would be the case when printing ".01."

b. Through filter position 10 to the upper hub of 36 to prevent the printing of zeros to the left of the decimal for amounts of less than \$1.00.

6. The comma prints from print wheel 33 only when a significant digit appears to the left. The wiring is the same as would be required for zero control. All other positions of the amount are wired normally to control the printing of zeros.

PROGRAM CONTROL

PROGRAM CONTROL enables the machine to distinguish the cards of one classification from those of another. The cards in a single classification are referred to as a program group.

The machine can read simultaneously, by means of the first and second reading stations, the holes punched in two successive cards. Thus, each card passing through the machine is compared twice, once with the card ahead of it and once with the card following it. If the fields are the same, thus indicating that the cards are of the same program group, the machine will continue to feed cards. When the punching in one card does not compare with the punching in the card preceding it, and the control panel is properly wired, the machine will automatically start a total program cycle.

Three types of totals are possible on the Type 407: minor, intermediate, and major. They are also known as program levels 1, 2, and 3. A minor program is used for the classification representing the smallest group, intermediate program for the next group, and major program for the largest group. If totals of sales amount were to be printed by state, by city, and by customer number, customer number would be considered a minor group, city an intermediate group and state a major group. When the proper programs are used for these groups, the machine automatically

stops at the end of each group and will not start until the required number of program cycles is taken. For a minor program change only one total program cycle is required, for an intermediate program change two total program cycles are required, and for a major change, three total program cycles are required.

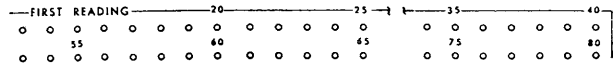

A-B, 1-40

*First Reading.* The 80 first reading hubs represent the 80 columns of the card and are used for reading information from the card as it stands at the first reading station. They are wired principally to the comparing entry and to the controlling hubs of selectors, MLR, storage units and the carriage.

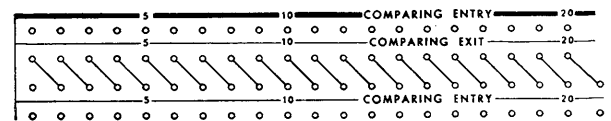

C-F, 1-30

*Comparing Unit.* Twenty positions of comparing are standard on the Type 407 and ten more are optional. Each position consists of two comparing entry hubs and two comparing exit hubs. The two common comparing exit hubs are diagonally arranged to facilitate wiring.

Comparison is accomplished by wiring the field from first reading to one row of comparing entries, and from second reading to the other row of comparing entries. Either row of comparing entries may be wired from either set of brushes, and the wiring is the same for alphabetic or numerical information. Although any hubs within a comparing entry row may be used, the corresponding hubs in the other comparing entry row must be wired. It is not possible, for example, to wire first reading to comparing entries 1 through 5 and second reading to comparing entries 6 through 10. The hubs used in both sets of entries must line up with each other.

During each card cycle the readings to both sides of the comparing entries are compared.

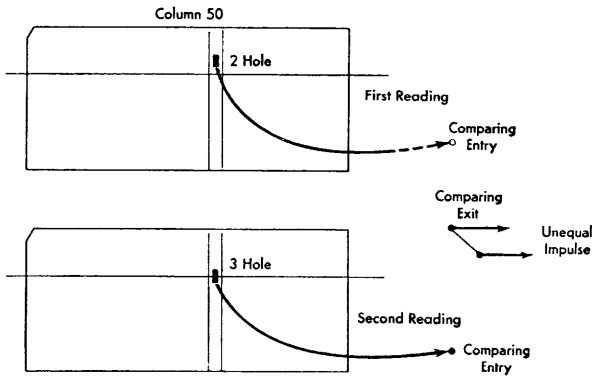
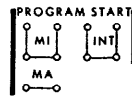

FIGURE 30. COMPARING

If the two readings for any comparing position are not identical, a comparing exit impulse is available in the two common comparing exit hubs. If the two comparing positions are identical, a comparing exit impulse is not available. The two cards shown in Figure 30 are fed to their respective reading stations at the same time. Since they are read 9's first, the 3 hole at the second reading station is read before the 2 hole at the first reading station. Therefore, the 3 impulse reaches the comparing unit before the 2 impulse, setting up an unequal condition in the unit and making an impulse available at the comparing exit. The impulse can be used to stop the feeding of cards and start programming.



C-D, 30-33;  
E, 30-31

**Program Start Minor, Inter., Major.** The minor, intermediate and major program start hubs receive comparing exit impulses from the comparing exit hubs to stop card feeding and start programming, one for minor, two for intermediate, and three for major. If intermediate program start only were wired, a minor total cycle would be forced before the intermediate total cycle. If major program start alone were wired, both a minor and an intermediate total cycle would be forced before the major total cycle.

A cycle count or a digit impulse may also be wired to program start to cause a program start on every card.

STEP	1	5	PROGRAM	10	MINOR
○	○	○	○	○	○
○	○	○	○	○	○
○	○	○	○	○	○
○	○	○	○	○	○
○	○	○	○	○	○
○	○	○	○	○	○
○	○	○	○	○	○
○	○	○	○	○	○
○	○	○	○	○	○
○	○	○	○	○	○

AP-AT, 53-66

**Program Exit Minor, Inter., Major, Run-Out Final.** Each program step has fourteen exit hubs which emit all-cycle impulses whenever the corresponding program start is impulsed. Only the minor program exit hubs become active when minor program start is impulsed; minor and intermediate program exits become active in succession when intermediate program start is impulsed; minor, intermediate and major program exits become active in succession when major program start is impulsed.

The run-out final total hubs differ from the regular final total hubs discussed earlier in that they do not depend in any way on the final total key. When they are wired directly to the read out or read out and reset of a counter, the total in the counter will clear out automatically as a final total, provided the following conditions are satisfied:

- The last card has passed through the machine.
- The final total toggle switch is ON.
- The major program start is impulsed. Without a program start all four program steps become active in turn when the LCT switch is on, as discussed later.

Each row of hubs is completely independent of the other row of hubs and only one row is active at a time.

Counters normally read out or read out and reset under the control of the program exits, after which the machine restarts automatically for the following group. Program exit hubs may also be wired to control storage units and carriage operations as described under those headings.

The fifth step shown on the diagram will be described under *Special Program*.

Run-In Reset

As the first card is fed into the machine, all programs wired are initiated, provided significant digits are punched in the control fields. Only those counters wired from normal program steps will be cleared. No printing of any kind, such as totals left standing in the machine or counter symbols, will take place on the run-in reset. This automatic feature assures that the counters to be used in an operation are cleared before the operation starts.

Final total counters must be reset manually,

that is, by turning the final total toggle switch on and by depressing the final total key.

If the LCT (last card total) switch is wired on the three normal program steps will be taken on the run-in whether or not control fields are wired. If the final total switch is also on the 4th step or run-out final will also occur on the run-in.

Detail Printing: Minor, Intermediate and Major Program

The expense distribution shown in Figure 31 is a detail printed report. The smallest group on

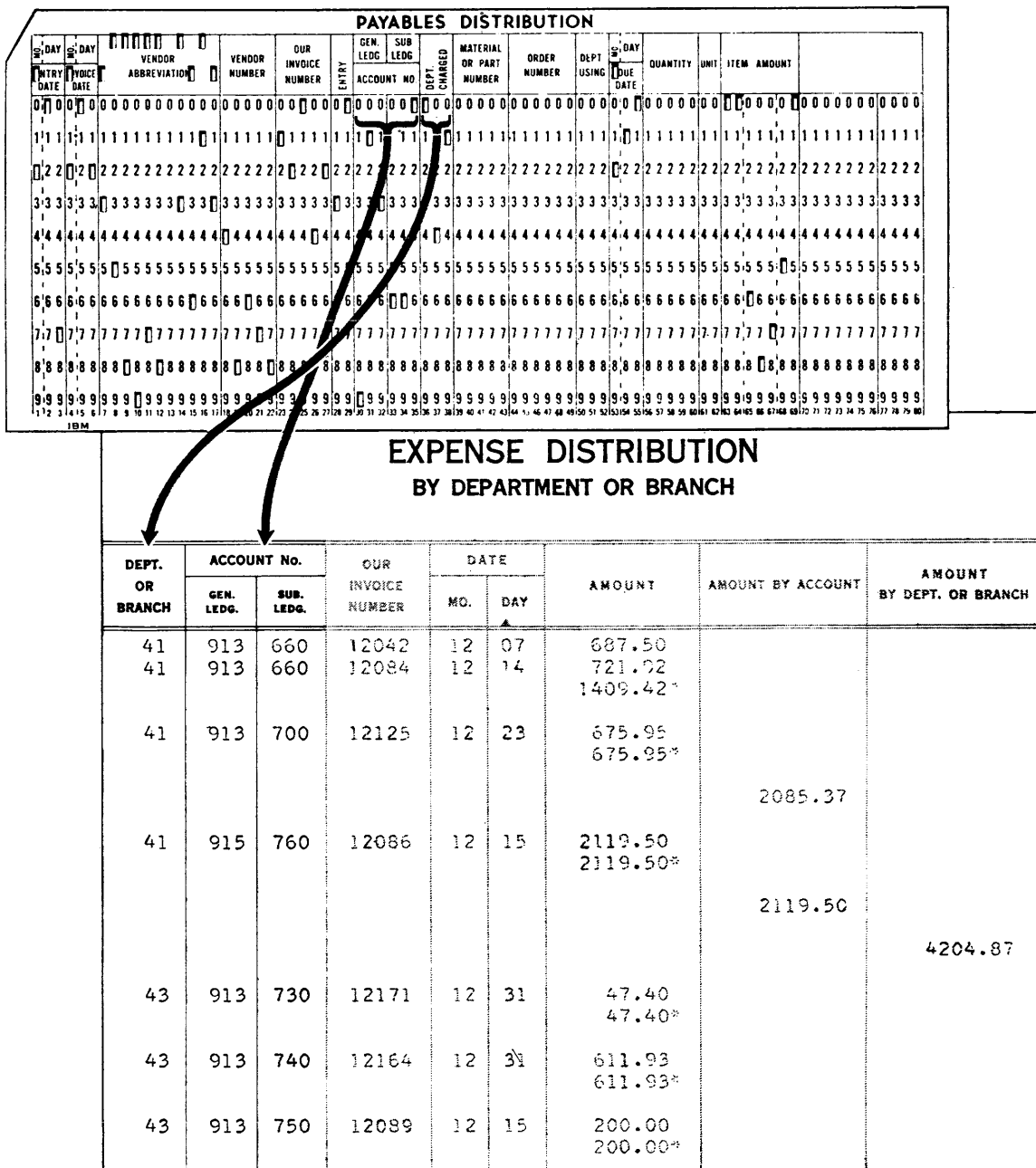
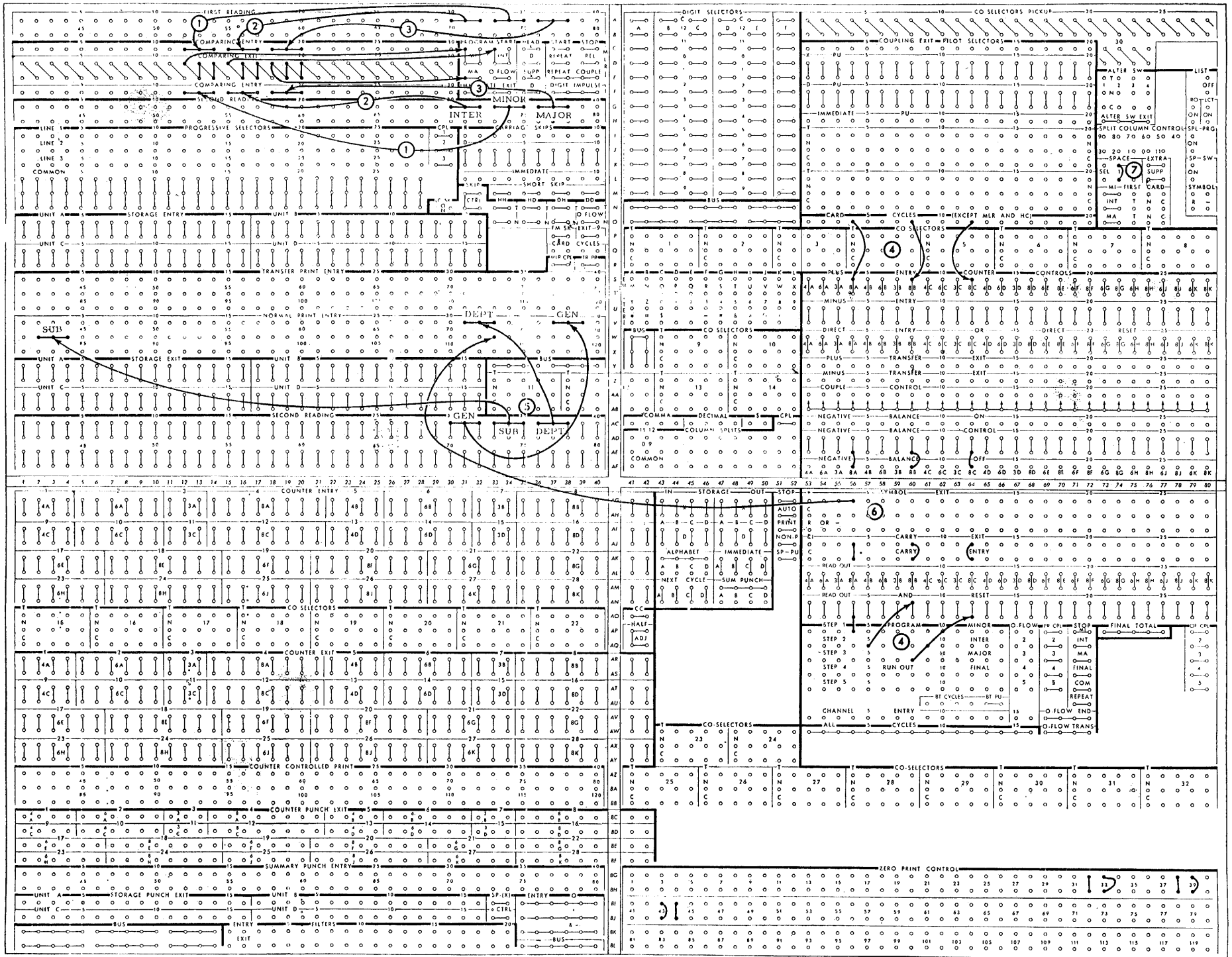

FIGURE 31



this report is subledger number and is therefore referred to as the minor group. The largest group is department and is referred to as the major group. The group in between is general ledger and is referred to as the intermediate group.

For each of the three groups mentioned, there is a corresponding total. The first minor total, \$1,409.42, was printed from one counter when the machine recognized a change from 660 to 700 in subledger number. The first intermediate total, \$2,085.37, was printed from another counter when the machine recognized a change from 913 to 915 in general ledger number. The first major total, \$4,204.87, was printed from a third counter when the machine recognized a change from 41 to 43 in department number.

Just as the three groups are known as the minor, intermediate, and major groups, the totals are known as minor, intermediate and major totals. If desired, a fourth total (run-out final) could be added and would print automatically following the last major total.

#### Wiring, Programming (Figure 32)

1. Subledger is wired from columns 33-35 of both first and second reading to comparing entry. Two jackplugs in the corresponding comparing exits make all three comparing positions common so that, if there is an unequal condition in any one of the three, a comparing exit impulse will be available either from the high or the low order position. This impulse is directed to minor program start, and causes the machine to initiate a program cycle for every change in subledger group. The minor total will print immediately below the last printed item.

2. General ledger is wired from columns 30-32 of both first and second reading to comparing entry. The comparing exit is wired to intermediate program start to initiate a second program cycle for every change in general ledger group. The intermediate total will print two lines below the minor. For detail printing, there will be an automatic space after each total.

3. Department is wired from columns 36-38 of both first and second reading to comparing entry. The comparing exit is wired to major program start to initiate a third program cycle for

every change in department group. The major total will print two lines below the intermediate total.

4. The three counters in use, namely, 4 (8A), 8 (8B), and 12 (8C), are wired to add from card cycles and read out and reset as minor, intermediate and major, respectively. They are also wired for normal carry-back and positive total printing (negative balance control off). Counter entry and exit wiring is not shown on the diagram.

5. Subledger, general ledger and department are printed for each card by wiring each of the three fields from second reading directly to normal print entry.

6. An asterisk is printed to the right of the minor totals by wiring the asterisk symbol hub of counter 4 to print wheel 73.

7. The machine is wired to single space.

#### Automatic Last Card Totals

Programs may be initiated at the end of the run to clear out final totals automatically by the use of the last card total switch. When used, the switch provides four program cycles at the end of the run.



G-H, 79-80

**RO (Run Out) ON.** Normally, the machine stops when the last card leaves the hopper. Therefore, the start key must be depressed to run the cards remaining in the machine into the stacker. When the RO switch is ON, these cards will run into the stacker automatically.

**LCT (Last Card Total) ON.** When the LCT switch is ON, three programs will be taken in succession on the run-in and as the last card is run-out to the stacker. If the final total toggle switch is also ON, a fourth program step (Run-Out Final) will be taken. The programs occur even though program start is not impulsed and regardless of the RO switch. The main purpose of both the RO and LCT switches is to allow the printing of



final totals automatically at the end of small batches of cards when it is not practical to initiate a program change for each batch.

**Wiring, Automatic Last Card Totals (Figure 33)**

1. The run out switch is wired ON to cause the last card to run into the stacker automatically. The LCT switch is wired ON to cause four program cycles on the run out: minor, intermediate, major and run-out final.

2. Counter 5 (4B) is cleared automatically after the last card runs out of the machine by the wiring of minor program to counter 5 read out

and reset. No program start wiring is necessary. Other counters would be cleared as intermediate, major and run-out final, as shown by the dotted wiring.

**GROUP PRINTING**



E-F, 80

*List Off.* The Type 407 is basically a detail printing machine. It prints from each card as it passes through the machine. When the list switch is wired OFF, printing will occur automatically for heading cards; for the first card after a control change for group indication purposes; for program cycles to print totals; and for overflow program cycles to print overflow indications. All other cards pass through the machine without printing.

When the list switch is wired OFF and neither program start nor last card total is wired, printing will take place only by depression of the final total key. If the last card total switch is wired ON, totals will be printed after the last card leaves the machine.

Figure 34B shows a group printed report using the same cards that were used in Figure 34A. It will be seen that the group printed report eliminates the printing of detail items, since there is only one printed line for each subledger or general ledger account, no matter how many cards are included within these groups. Moreover, the minor total prints on the same line with the indication. Intermediate totals print one line below the minor total, and major totals print one line below the intermediate totals when the machine is set to single space. An automatic space will occur after the intermediate total if only minor and intermediate programs are active or after the major total if all three programs are active. An automatic space never occurs after a minor total only.

The speed for group printing, as for detail printing, is 150 cycles per minute.

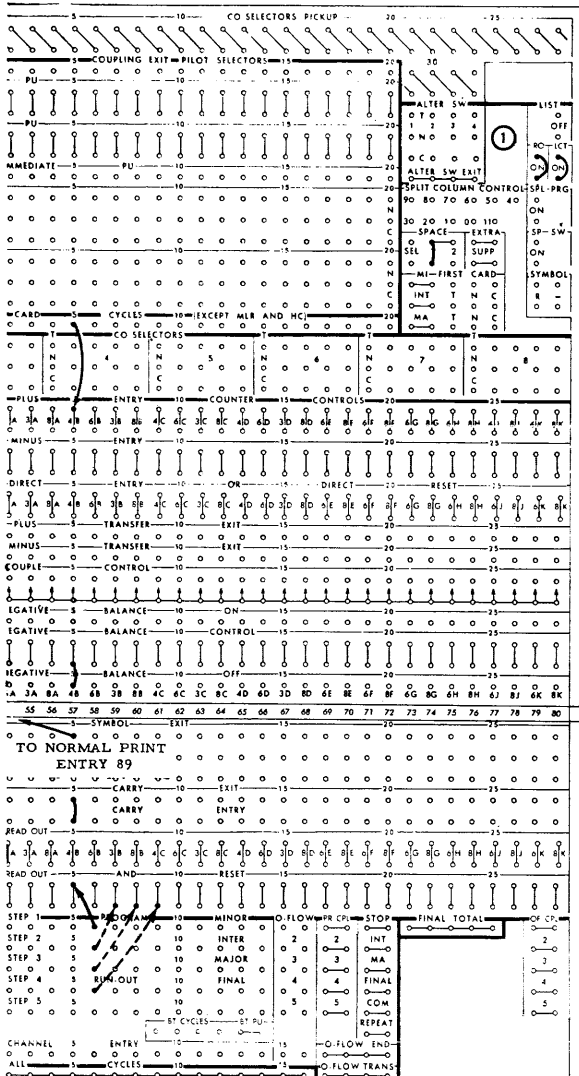

**FIGURE 33. LAST CARD TOTALS**

EXPENSE DISTRIBUTION BY DEPARTMENT OR BRANCH								
DEPT. OR BRANCH	ACCOUNT No.		OUR INVOICE NUMBER	DATE		AMOUNT	AMOUNT BY ACCOUNT	AMOUNT BY DEPT. OR BRANCH
	GEN. LEDS.	SUB. LEDS.		MO.	DAY			
82	431	112	12066	12	10	300.00		
82	431	112	12153	12	28	300.00		
						600.00*		
82	431	113	12066	12	10	150.00		
82	431	113	12066	12	10	150.00		
82	431	113	12066	12	10	125.00		
82	431	113	12153	12	28	150.00		
82	431	113	12153	12	28	150.00		
82	431	113	12153	12	28	125.00		
						850.00*		
82	431	114	12066	12	10	50.00		
82	431	114	12066	12	10	75.00		
82	431	114	12066	12	10	50.00		
82	431	114	12153	12	28	50.00		
82	431	114	12153	12	28	50.00		
82	431	114	12153	12	28	75.00		
						350.00*		
82	431	520	12149	12	28	360.43		
						360.43*		
82	431	700	12082	12	14	2.25		
						2.25*		
82	431	750	12003	12	01	100.00		
						100.00*		
82	431	810	12112	12	18	70.20		
						70.20*		
82	431	850	12043	12	07	24.75		
						24.75*		
							2357.63	
82	432	841	12151	12	28	1792.86		
						1792.86*		
							1792.86	
								4150.49

FIGURE 34A. DETAIL PRINTED REPORT

EXPENSE DISTRIBUTION BY DEPARTMENT OR BRANCH								
DEPT. OR BRANCH	ACCOUNT No.		OUR INVOICE NUMBER	DATE		AMOUNT	AMOUNT BY ACCOUNT	AMOUNT BY DEPT. OR BRANCH
	GEN. LEDS.	SUB. LEDS.		MO.	DAY			
82	431	112				600.00		
82	431	113				850.00		
82	431	114				350.00		
82	431	520				360.43		
82	431	700				2.25		
82	431	750				100.00		
82	431	810				70.20		
82	431	850				24.75		
							2357.63	
82	432	841				1792.86		
							1792.86	
								4150.49

FIGURE 34B. GROUP PRINTED REPORT

FIGURE 35. GROUP PRINTING

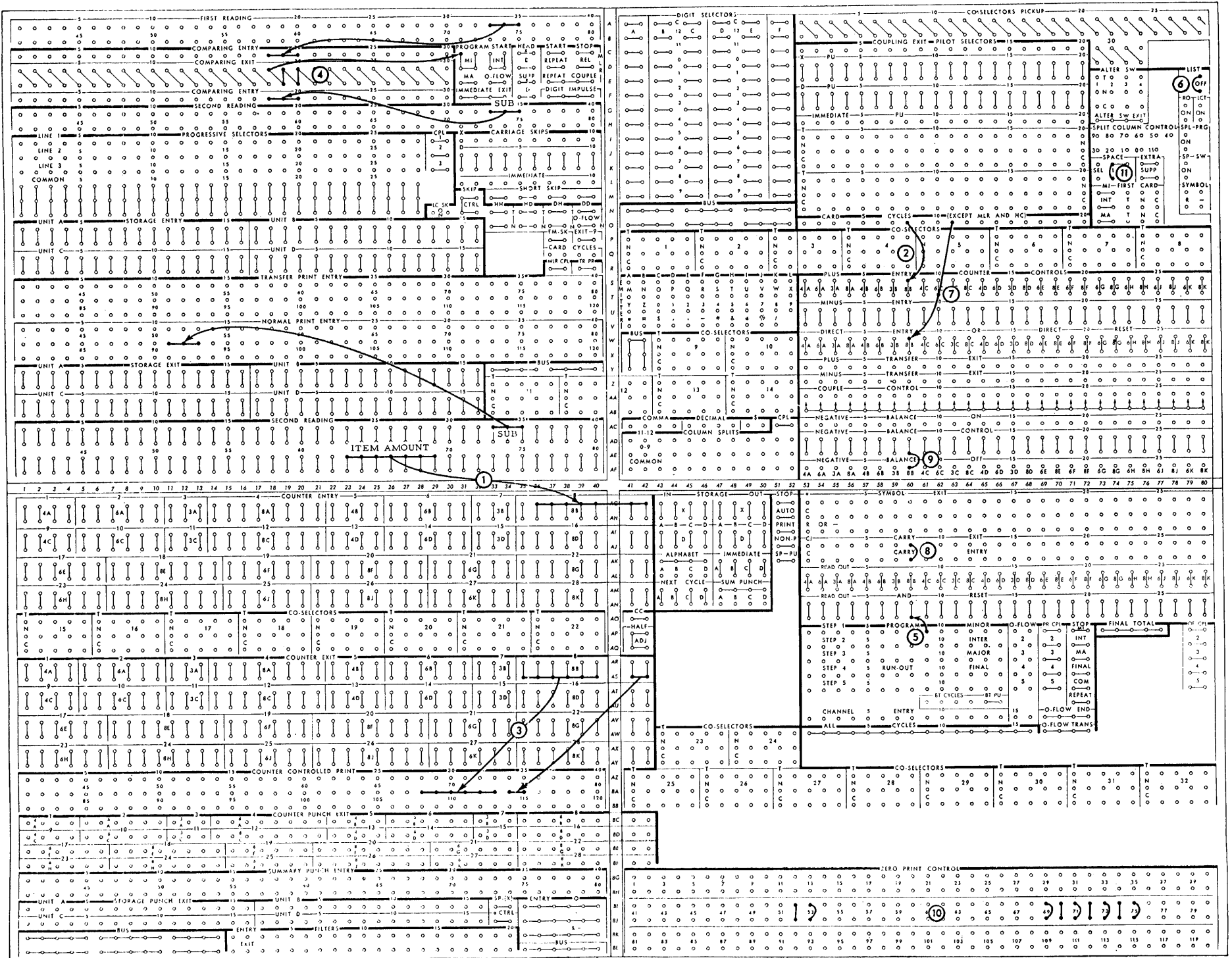

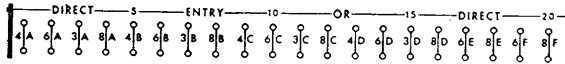

W-X, 53-80

**Direct Entry.** In group printing, the group total prints on the same line with the indication. Normally, information from the counter would print both on the indicate cycle and on the program cycle, resulting in overprinting. To suppress printing from the counter on the indicate cycle, a card cycles impulse must be wired to the direct entry hubs of the counter being used. This wiring disconnects the counter entries from the counter exits on the indicate cycle, forcing the information wired to counter entry to enter the counter directly from second reading rather than indirectly via the print wheels. This wiring also nullifies the action of the C and R or minus hubs so that credit symbols will not print on the first card of a group. When more than one direct entry hub is wired from one impulse, the corresponding read-out and reset hubs must be impulsed on the same program cycle. Otherwise, the direct entry hubs must be impulsed independently. See Direct Entry or Direct Reset under *Operating Suggestions*.

The direct entry hubs are also used for direct reset as explained under *Direct Reset*.

#### Wiring, Group Printing (Figure 35)

1. Item amount is wired from second reading to counter 8 (8B) entry.
2. Amounts are added by wiring card cycles to counter 8 plus.
3. Totals are printed by wiring counter exit 8 to counter-controlled print 68-75.
4. Subledger account is wired to comparing entry from first and second reading. The comparing exit is wired to minor program start to cause the machine to stop and take a minor program cycle for each change in subledger number. A first card indication always follows a program change when the list hub is wired off.
5. When minor program start is impulsed, the minor program exit hubs become active and are used to read out and reset counter 8.
6. The list switch is wired OFF, causing the ma-

chine to group print, that is, to indicate the group and print the total on the same line.

7. To prevent the counter from printing on the indicate cycle, a card cycles impulse is wired to direct entry, which disconnects the counter exits from the counter entry at this time and causes the item amount to enter the counter directly from second reading instead of indirectly via counter-controlled print. Because the exit hubs are inactive on the indicate cycle, amounts will not print for the first card. Only the total will print from the exits of counter 8.

Although this wiring does not allow adding from the print wheels, as each card passes through the machine, it does not in any way affect the reset check circuit for total printing. The counter still resets under control of the print wheels by adding the complement of the total printed to the total standing in the counter, and if it fails to zero balance, the reset check light will turn on.

8. CI and C are wired normally.

9. Negative balance OFF is wired to negative balance control because results will always be positive.

10. The wheels printing subledger and item amount are wired for zero print control.

11. The machine is wired to single space.

#### SUBTRACTION

SUBTRACTION on the Type 407 is accomplished by adding the 9's complement of the number. Complement results are usually converted to true figures before they are printed. Conversion of complements is done in the same cycle during which printing takes place and therefore does not require additional time. Either a CR or a minus symbol may be printed beside the converted total as well as beside each subtracted amount.

As in addition, in detail printing a counter receives the amount to be subtracted from the counter wheel, thus assuring that the counter subtracts the same figure that prints. When total printing a negative result, the counter resets by adding the true figure as printed to the complement standing in the counter. For example, a -4 would be represented in a 3-position counter as 995. When the counter is reset, +4 is added to

995, resulting in 999, which is the 9's complement of a zero balance.

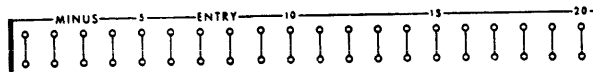

U-V, 53-80

**Counter Control Minus.** Each counter has two common minus hubs which, when wired from a card cycles impulse, cause the counter to subtract, or in other words, to add the 9's complement of the figure to be subtracted. It also makes available a C and R or minus symbol from the corresponding symbol hubs for the purpose of identifying credit items.

If a card cycles impulse were wired directly to minus, all cards would subtract. If only certain cards are to subtract, the card cycles impulse must be selected.

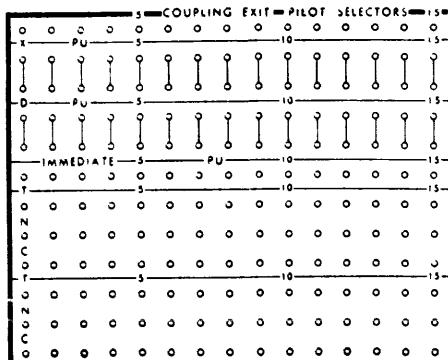

C-N, 53-72

**Pilot Selectors.** Fifteen 2-position pilot selectors are standard and five are optional. They can be used independently, or in conjunction with other selectors (co-selectors) on the control panel. The guiding function they perform when used with co-selectors gives them the name "pilot selectors."

The two positions in each selector are vertically arranged. Each position has a C (common), an N (normal) and a T (transferred) hub, and three pickup hubs, X, digit and immediate. These pickup hubs are used to control the selectors which, in turn, are used to control various machine functions, such as to add amounts from certain cards and to subtract amounts from other cards.

One of the most common methods of distinguishing one card from another is by an X punch in some column of the card. If some cards have an X punch and other cards do not, the machine can be controlled to do certain things with X cards and certain other things with cards having no X punch (NX card). If the column of the card containing the distinguishing X punch is wired to the X pickup of a pilot selector, one cycle later a card cycles impulse introduced into the C hub of that selector will be available at the T (transferred) hub. By the same token, an impulse introduced into the T hub will be available one cycle later at the C hub. If there is no X in the card, a card cycles impulse introduced into the C hub of a selector will be available at the N (normal) hub. Likewise, an impulse introduced into the N hub one cycle later will be available at the C hub. Whenever a selector is not impulsed, C and N are always connected as shown by Figure 36 (normal). Whenever a selector pickup is impulsed, C and T are temporarily connected (transferred) as shown.

A digit may also be used as a distinguishing punch to pick up a pilot selector. The column in which it is punched is wired to the digit pickup hub. If more than one digit is punched in the column wired to the D pickup, a digit selector must be used to separate the distinguishing digit from all the others. Once the digit impulse has reached the pilot selector pickup, the action of the selector is identical to that of one picked up by an X punch. The difference between the two pickups is that a D pickup will accept any impulse, whereas an X pickup will accept only X or 12 impulses.

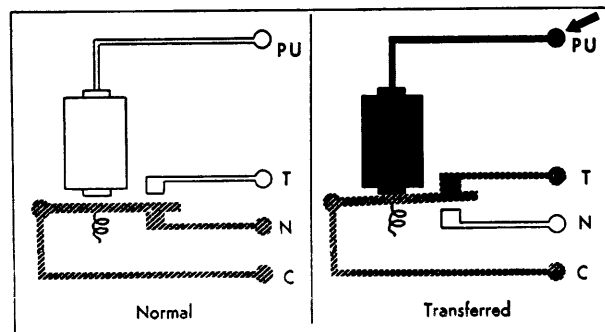
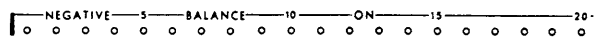

FIGURE 36. SCHEMATIC DIAGRAM OF A SELECTOR

Whenever the X or D hub of a selector is impuised, the selector transfers on the following cycle and remains transferred until the controlling card has been read at second reading. Thus, if card feeding is interrupted for any reason, such as for total printing, the selector would be transferred during the total printing cycle and the following card cycle.

The immediate pickup hubs for each selector will accept any impulse and transfer the selector immediately instead of one cycle later. If the immediate pickup is impuised during a card cycle, the selector will remain transferred only until the end of the same cycle. If the immediate pickup is impuised during a program cycle, it will remain transferred through the following card feed cycle.

Each pilot selector has a coupling exit hub, located immediately above the X pickup. This hub emits an impulse when the corresponding pilot selector is transferred and will emit this impulse once each cycle thereafter, if the selector remains transferred. These hubs are normally connected to a co-selector pickup for the purpose of expanding the pilot selector beyond two positions. Although the co-selector to which the coupling exit is wired transfers a little later than the pilot selector, the two selectors function alike for all practical purposes. This difference in transfer time need be considered only when selecting CI and C. In such cases, CI and C can be selected through the pilot selector but not through the coupled co-selector.



AC, 53-80

*Negative Balance On; Negative Balance Control.*

Each counter group has a corresponding negative balance ON hub which emits an impulse at the end of the cycle during which the counter turns negative and for every cycle thereafter as long as the counter remains negative. It has two uses, one to pick up selectors so that certain machine operations may be conditioned on a negative balance, and the other to impulse the negative balance control hubs of the same

counter so that complement totals will print as true figures.

A negative balance is signalled by a 9 in the high order position of a counter and, therefore, that position must not be used for accumulating purposes. It is the 9 in this position of the counter that causes the negative balance ON hub to emit an impulse.

The negative balance ON wired to negative balance control converts complement totals to true figures and also causes a C and R or - to be emitted from the corresponding symbol exit hubs for identifying credit balances. This wiring also supplies X-0 impulses from the highest order counter punch exit hubs, which can be used to identify credit balances punched in summary cards.

When counters are coupled, the common negative balance control hubs must also be coupled. Only the high order counter is wired for negative balance ON to control the negative balancing operations.

If negative balance ON is not wired, a negative total will print and summary punch as a 9's complement.



M-N, 79-80



AH-AI, 53-80

*Symbol Switch; C, R or Minus Symbol Exits.*

The CR symbol must print from two print wheels, the C from one and the R from another. Each counter has a corresponding C hub and a corresponding R or minus hub. Both hubs emit impulses under two conditions:

- a. When the minus hub of the counter they represent receives an impulse.
- b. When the counter they represent receives an impulse to read out or read out and reset a converted negative total. This does not include zero balances.

The R or minus symbol exit hubs are further conditioned by the setting of the symbol R

FIGURE 37. SUBTRACTION

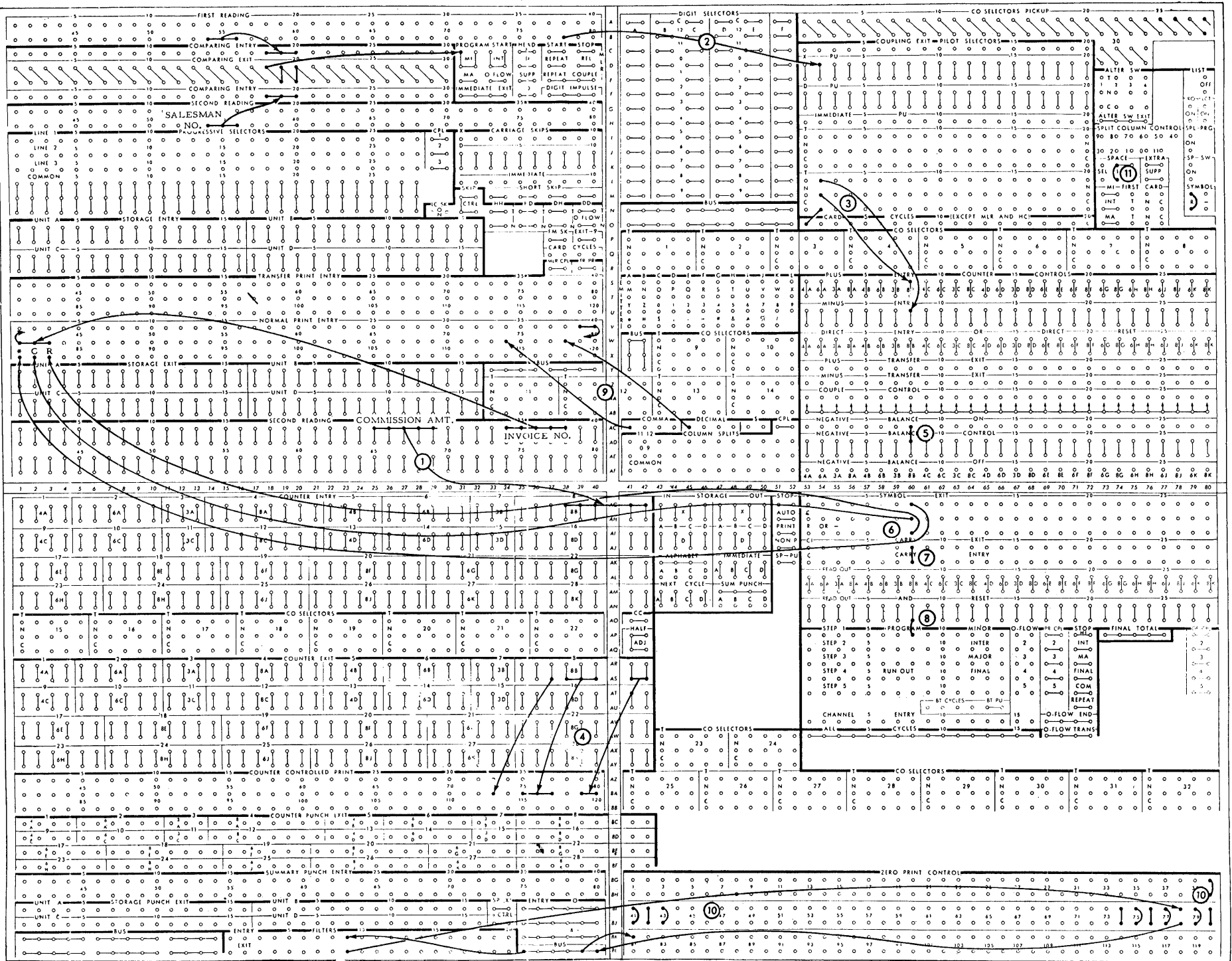

(minus) switch. If the switch is wired for R the exit hubs emit an R (X and 9) impulse. If the switch is not wired for R, the exit hubs emit a minus (-) impulse. The two minus hubs of the switch are inactive. The advantage of printing a minus sign for credit items is that it prints from a single print wheel.

If both an R and a minus are to be printed on the same line, the symbol switch should be set at R and the symbol exit impulse should be wired directly to a print wheel to print the R, and through a column split (to eliminate the 9) to the print wheel that is to print the minus sign. It is also possible to select the symbol switch so that minus signs print for negative detail items and R, together with the C from the C hubs, for negative totals.

When direct entry is impulsed, the C and R or minus symbol hubs do not emit impulses.

Symbol exit hubs can never be wired to counter-controlled print since these hubs will not accept 11 or 12 zone impulses.

Wiring, Subtraction (Figure 37)

Wiring for the shaded area shown in Figure 38 is not shown in this example. This is a detail printed report.

1. The commission amount is wired from second reading to counter 8 entry.
2. The X in column 78, identifying credit cards, is wired from the first reading station to the X pickup of pilot selector 2. The X must be read from the first station so that the pilot selector

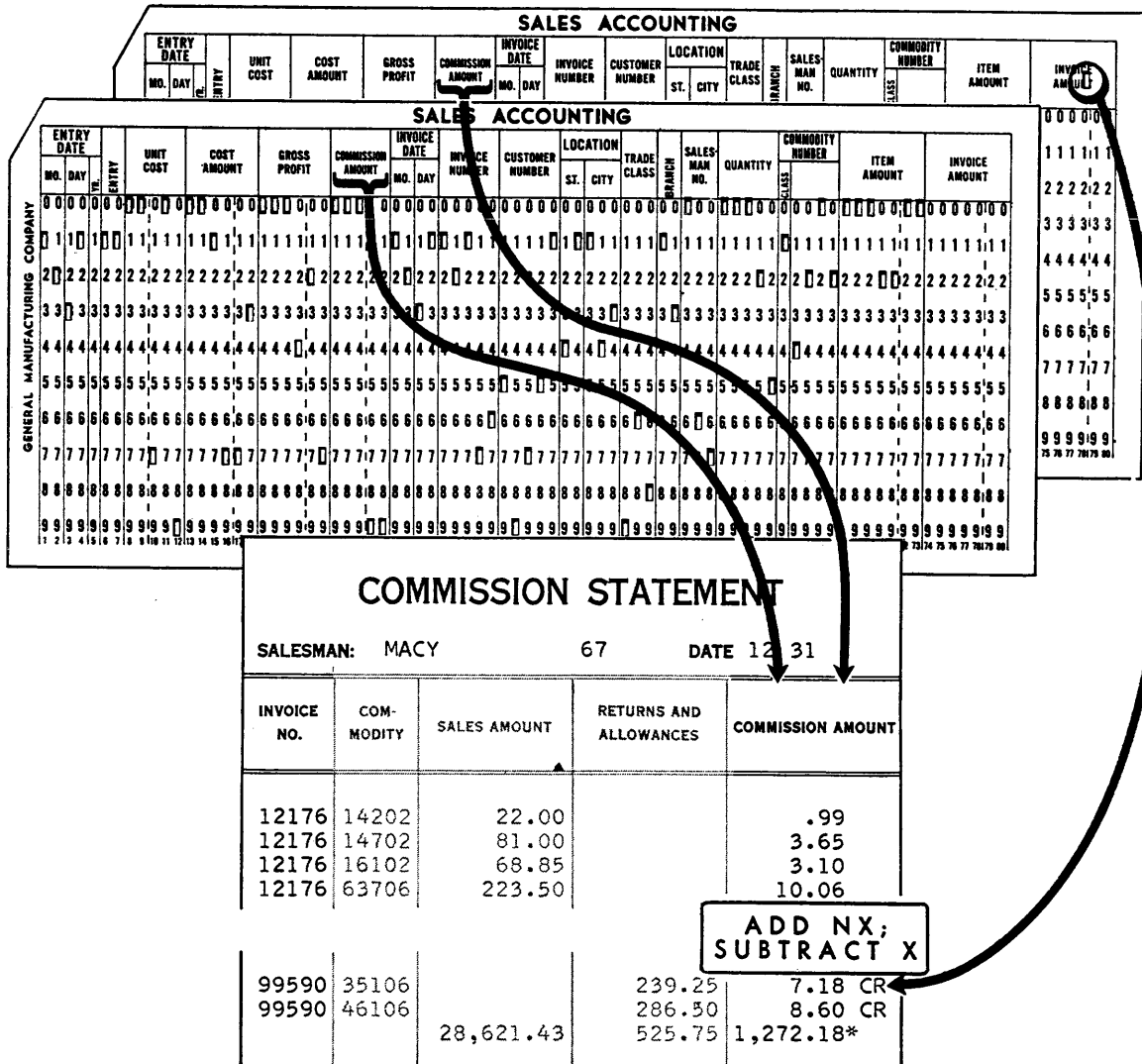

FIGURE 38. SUBTRACTION



will be transferred by the time the card reaches the second station.

3. A card cycles impulse is wired to the common of the pilot selector. An X in the card transfers the selector and the card cycles impulse controls counter 8 to subtract. The NX card does not transfer the selector and the card cycles impulse controls counter 8 to add.

4. Both detail and total amounts are printed by wiring from counter 8 exit to counter-controlled print 73-80, allowing one position for comma and one for decimal printing.

5. Negative balance ON of counter 6 is wired to negative balance control of the same counter. Negative balance ON emits an impulse whenever a 9 stands in the high order position of counter 8, indicating a negative balance. Negative balance control accepts the impulse on the total cycle to convert the complement standing in the counter to a true figure.

6. A CR symbol is printed alongside each credit item, as well as alongside a credit total, by wiring the C symbol exit hub for counter 8 to normal print entry 82 and the R or minus exit hub for counter 8 to normal print entry 83. The symbol switch is wired for printing R instead of minus.

An asterisk is printed beside every total, whether it be debit or credit, by wiring the asterisk symbol exit hub for counter 8 to normal print entry 81. Symbol exit impulses cannot be wired to counter-controlled print, since these hubs will not accept zone impulses.

7. CI and C are wired normally.

8. Minor program exit is wired to counter 8 read out and reset. The program is initiated by an impulse from the comparing exit, resulting from a change in salesman number.

9. The comma is wired to normal print entry 74 and the decimal to normal print entry 78. With these symbols under zero print control, they will print only when significant digits are present.

10. The wheels printing commission amount and invoice number are wired for zero print control. To make the decimal print when there are significant digits in the amount, the lower hub of zero print control 78 is wired through a set of bus hubs to the top hub of 81 and through a filter to the top of 78.

11. The machine is wired to single space.

### COUNTER COUPLING

COUNTER GROUPS are arranged in the following sequence: 4, 6, 3, 8; 4, 6, 3, 8; etc. This arrangement permits convenient coupling of adjacent counters to form counters of larger capacity. For example, larger capacity counters may be coupled as follows:

<u>COUNTER CAPACITY</u>	<u>COUNTER COUPLING</u>
9 positions	6 and 3
10 "	4 and 6
11 "	3 and 8
12 "	8 and 4
13 "	4, 6 and 3
14 "	6 and 8
15 "	3, 8 and 4
17 "	6, 3 and 8
18 "	8, 4 and 6

Sixteen-position counter capacity requires coupling of counters that are not adjacent. For best operation, no more than 20 counter positions should be coupled.

### CI and C for Counter Coupling

Whenever a counter is used, CI and C must be connected. When counters are coupled, the CI of the highest order counter must be wired to the C of the lowest order counter and the remaining CI and C hubs must be connected. The purpose of wiring from CI of the highest order counter to C of the lowest order counter is to carry back a 1 to the units position when adding, subtracting or group indicating. The purpose of wiring the remaining CI and C hubs is to provide a path for carryover from one counter to another.

### Negative Balance On-Off for Counter Coupling

When conversion of complements to true figures is required, the negative balance ON of only the highest order counter is wired to negative balance control of all coupled counters, since only the high order 9 can signal a credit total. When only positive totals are being printed, the negative balance OFF of the lowest order counter must be wired to negative balance control. This wiring works in conjunction with couple control to cause a zero test to be made in every coupled counter to keep the counters from printing 9's when nothing is added into the counters.

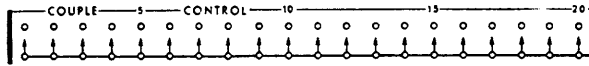

AA-AB, 53-80

**Couple Control.** Each counter has a couple control entry hub which may be connected to any one of the common hubs below it. When counters are coupled, the couple control hubs of all except the high order counter must be connected. Couple control has three main functions:

1. To insure a zero test in each coupled counter, rather than just the low order counter, when negative balance OFF is wired. This test is necessary so that 9's will not print for zero balances.

2. To eliminate the summary punching of credit X's from the coupled low order counters when amounts are negative. Unless couple control is wired, an X will summary punch from the high order position of each coupled counter, when it should punch from the high order counter only.

3. To make the corresponding negative balance ON hub inactive. Wiring of negative balance ON of coupled counters would be nullified.

**Wiring, Counter Coupling (Figure 39)**

The section of the diagram labelled A shows the wiring for coupling two adjacent counters, adding only; B shows the wiring for coupling three adjacent counters, adding and subtracting; and C shows the wiring for coupling two non-adjacent counters, adding and subtracting.

**A. COUNTER 3 COUPLED WITH COUNTER 4 TO FORM AN 11-POSITION COUNTER.**

1. A card cycles impulse is wired to plus of both counters.

2. Couple control is connected for the low order counter 4. The purpose of this wire is to insure a zero test in both counters 3 and 4.

3. The negative balance control hubs for 3 and 4 are connected. Negative balance OFF of the low order counter 4 is connected to negative balance control. This wiring works in conjunction with the couple control to zero test the whole counter.

When a counter zero balances, all positions stand at 9. With negative balance OFF wired, conversion of 9's to zeros takes place. If counter 4 couple

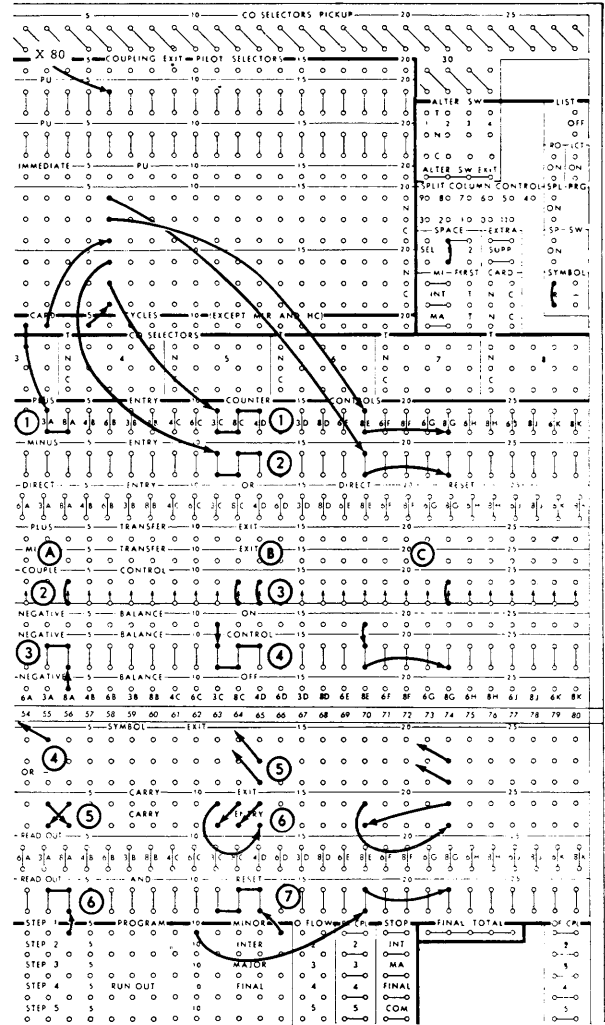

FIGURE 39. COUNTER COUPLING

control were not wired, in this example, and counter 4 contained all 9's, the 9's in counter 4 would be converted to zeros, but because the negative balance control of 3 is also connected, whatever amount stands in that counter would also be converted. Couple control prevents this from happening by allowing the test to begin with the high order position of the coupled counter and work to the low order position. It passes from one counter to another by way of the CI and C connections, so these hubs must also be wired.

4. The asterisk symbol exit of the high order counter is wired to print. The exit from the low order counter could be used.

5. When counters are coupled, the CI of the high order counter must be wired to the C of the

low order counter. The remaining CI and C hubs are then connected starting from the right and working to the left.

6. Minor program is wired to the read out and reset controls of counters 3 and 4. It is assumed that minor program start has been initiated or that the LCT switch is ON.

**B. COUNTERS 11, 12 AND 13 COUPLED  
TO FORM A 15-POSITION COUNTER.**

1. The counter control plus hubs are impulsed to add NX cards.

2. The counter control minus hubs are impulsed to subtract X cards.

3. The couple control hubs of counters 12 and 13 (low order counters) are connected.

4. The negative balance ON hub of the high order counter is wired to negative balance control of all three counters to convert complement totals to true figures, including zero balances. This wiring works in conjunction with couple control wiring to prevent the summary punching of X's from the high order positions of counters 12 and 13 when a negative result is converted. If couple control wiring were omitted, three X's would be summary punched, one from each high order position of the coupled counters. The only one needed is from the high order counter. This will be more fully discussed under *Summary Punching*.

5. The C and R or - symbol exits of the low order counter are wired to print. The low order counter must be used because the test for zero balance or negative balance starts with the high order position of the high order counter and progresses through the low order counter. Therefore, all counters coupled should be tested from high order to low order before the symbol is allowed to print. If the symbol exit were wired from the high order counter, the only time the symbols would print would be when the high order counter contained a negative result. Since it is possible for the high order counter to contain a zero result (all 9's) and the low order counter to be negative, the resulting negative total would not be identified.

6. The CI of the high order counter is wired to the C of the low order counter. The remaining CI and C hubs are connected, starting from the right and working to the left.

7. Minor program is wired to the read out and reset of counters 11, 12 and 13. It is assumed that minor program start has been initiated or that the LCT switch is ON.

**C. COUNTERS 18 AND 22 COUPLED  
TO FORM A 16-POSITION COUNTER**

Wiring principles are the same as described for wiring B.

**X SELECTION**

AMOUNTS FOR different types of transactions may be added in separate counters, even though the amount is punched in the same field of the card. This is done by means of X or digit selection. In the example shown in Figure 40, the item amount field represents sales on NX cards and the returns and allowances on X cards.

**Wiring, X Selection (Figure 41)**

In this report, the item amount is detail printed and total printed in the same amount column of the report for all NX cards, and in the returns and allowances column for all X 78 cards. Only the wiring for control of the counters is shown.

1. The item amount is wired to counter entry 18 and 20.

2. The sales amount is detail printed and total printed by wiring counter exit 18 to counter-controlled print 52-59.

3. Returns and allowances are detail printed and total printed by wiring counter exit 20 to counter-controlled print 61-68.

4. Pilot selector 5 is picked up from X78 at the first reading station.

5. For NX cards, a card cycles impulse is wired to the plus of counter 18; for X cards, it is wired to the plus of counter 20.

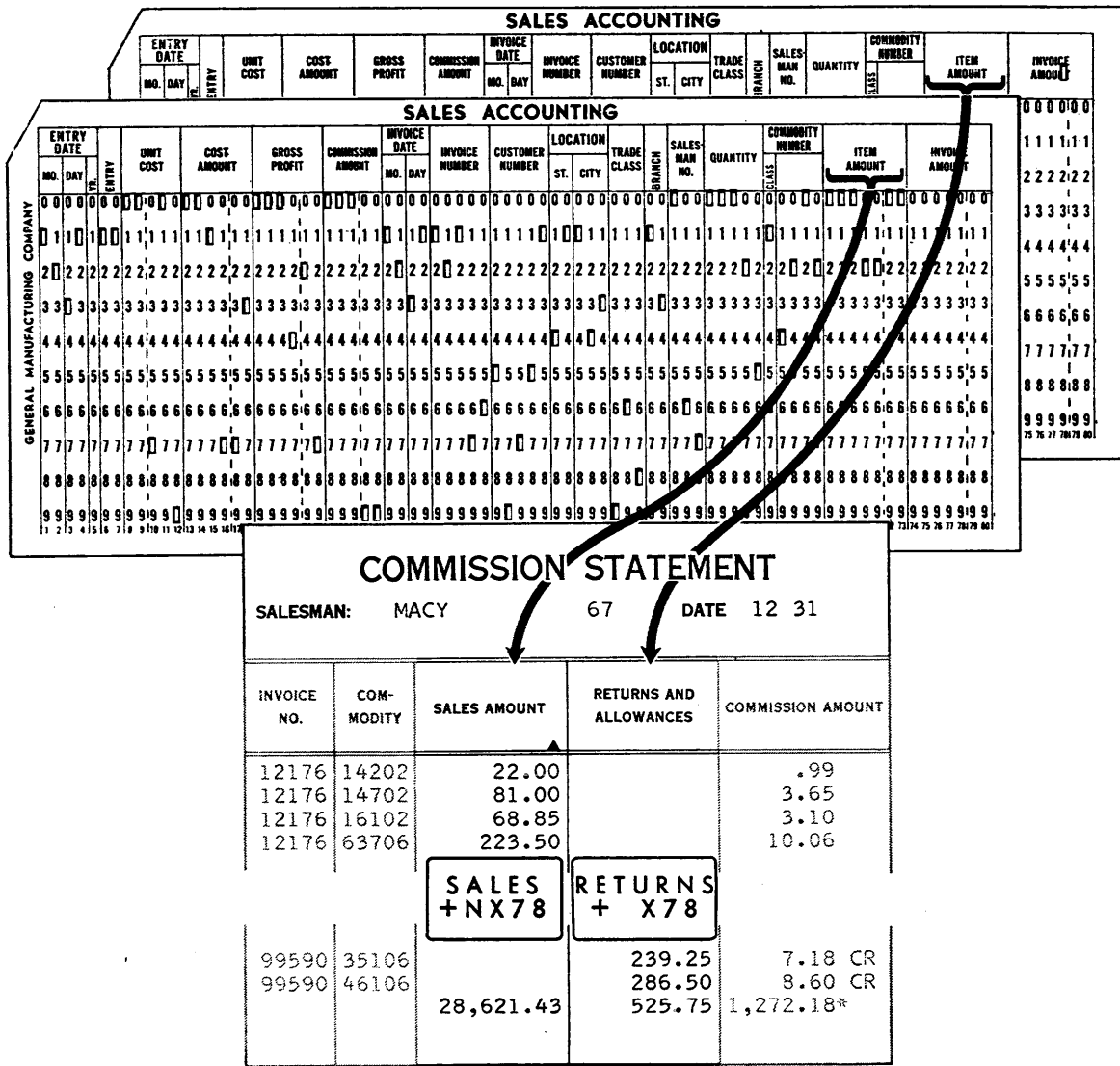

FIGURE 40

6. Negative balance OFF for each of the two counters is wired to negative balance control so that if nothing is added in the counter, complement 9's will not print.

7. The CI and C of each counter is wired normally.

8. Minor program is wired to counters 18 and 20 read out and reset so that totals will print for each salesman. Salesman number is compared and the comparing exits are wired to minor program start.

9. The machine is wired to single space.

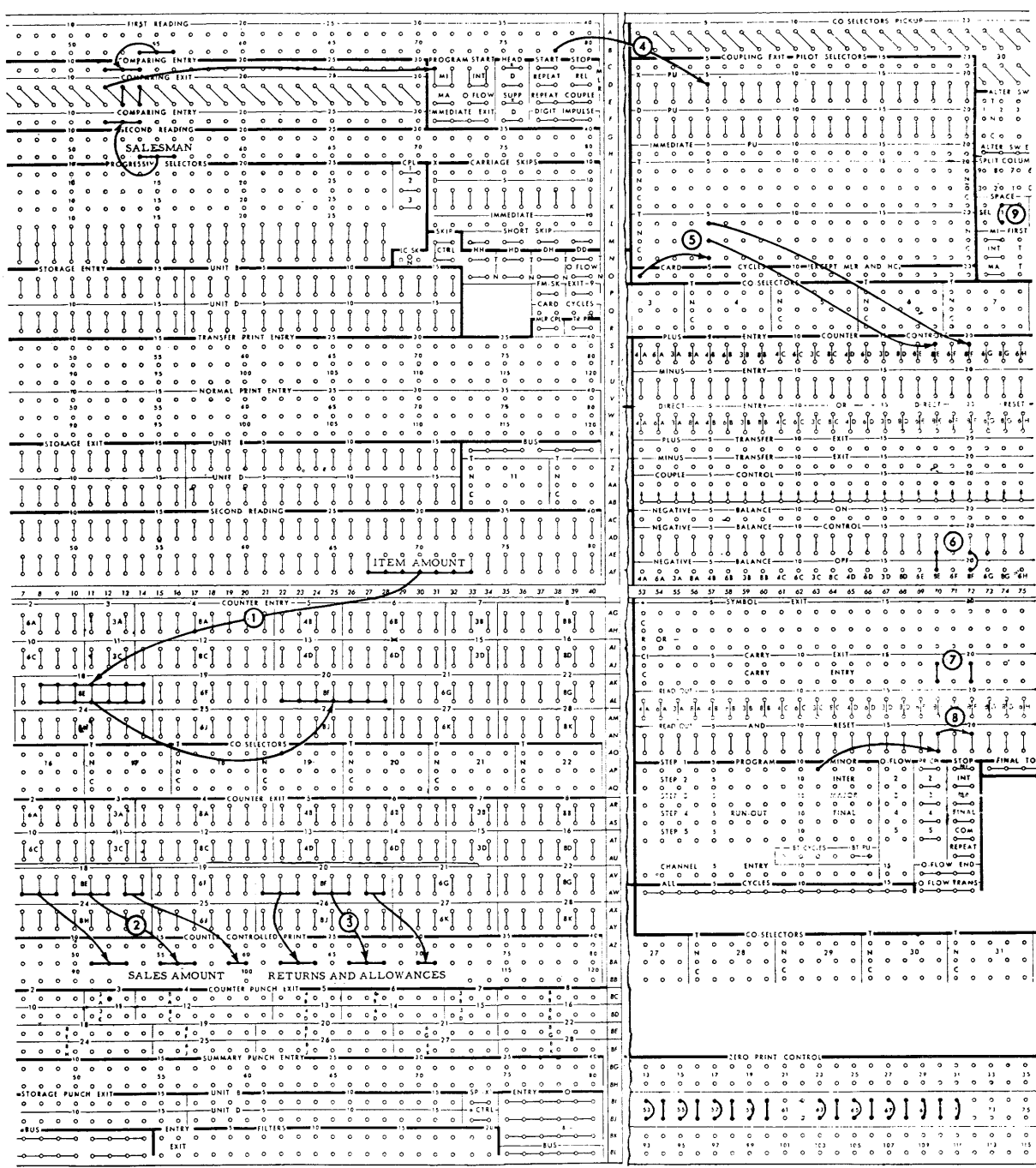
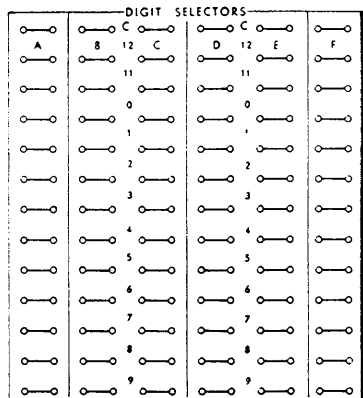

FIGURE 41. X SELECTION

DIGIT SELECTION

DIGIT PUNCHING as well as X punching may be used to control pilot selectors. If the presence of any digit in a card column is sufficient to identify a transaction, then the column containing the digit may be wired directly to the D pickup of a pilot selector. If a particular type of transaction is identified by a specific digit, then a digit selector is necessary.



A-M, 41-52

**Digit Selectors.** Two digit selectors are standard (selectors A and B) and four are optional (selectors C, D, E and F.) Each digit selector consists of a pair of C (common) hubs and twelve pairs of hubs labelled for the 12 punching positions in a column of the card. On every

machine cycle, the C hub is internally connected successively to the 9, 8, 7 . . . 12 hubs. When a column is connected to the C hub, a specific punching position can be read from the corresponding hub of the digit selector. Thus, digits may be used to pick up pilot selectors or to operate functions of the machine that may be digit controlled, such as head control, carriage skip, and many others.

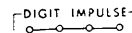

F, 37-40

**Digit Impulse.** These hubs emit digit impulses on every machine cycle. When a digit impulse is wired to the C of a digit selector, the digit selector becomes a digit emitter and may be used to print numbers, letters or special characters under proper control.

Wiring, Digit Selection (Figure 42)

The example used in explaining X selection (Figure 40) is used also for the purpose of explaining digit selection. Returns and allowances are identified by digit 5 in column 7. The wiring is shown in Figure 42.

1. Column 7 is wired from first reading to the C of digit selector A.

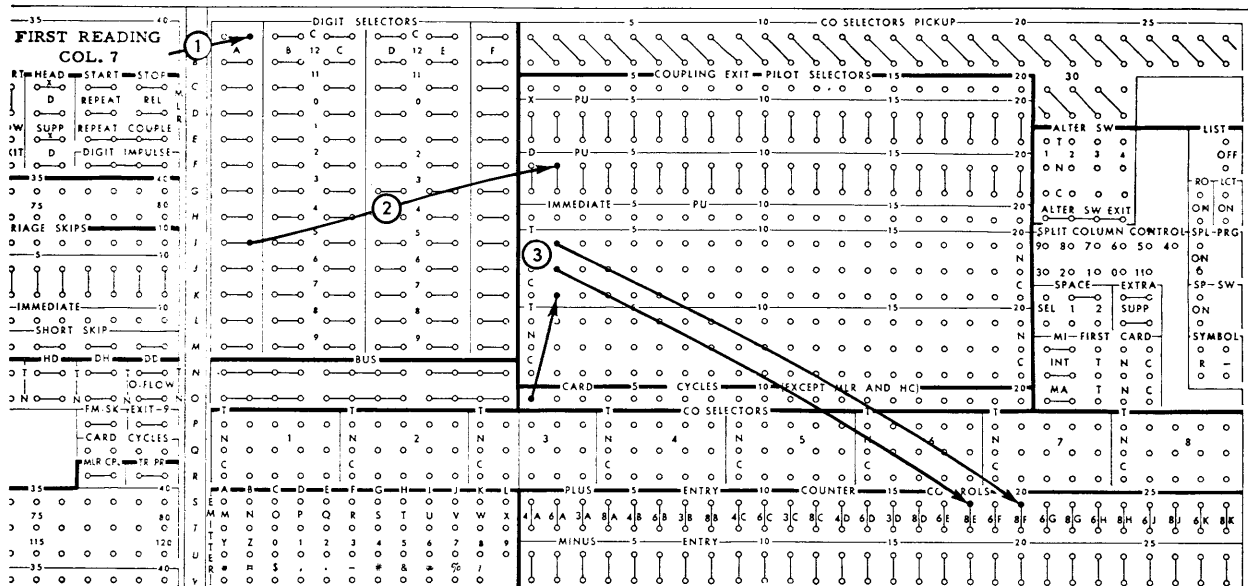

FIGURE 42. DIGIT SELECTION

2. Digit 5 is wired to the D pickup of a pilot selector.

3. A card cycles impulse is wired through the transferred side of the pilot selector to the plus of counter 20 to add returns and allowances and through the normal side to the plus of counter 18 to add sales.

**CHARACTER EMITTER PRINTING**

DIGITS, LETTERS and special characters may be printed without being punched in the card by the use of the character emitter.

	A	B	C	D	E	F	G	H	I	J	K	L
E	O	O	O	O	O	O	O	O	O	O	O	O
M	O	N	O	P	Q	R	S	T	U	V	W	X
I	O	O	O	O	O	O	O	O	O	O	O	O
T	Y	Z	0	1	2	3	4	5	6	7	8	9
R	O	H	\$	.	-	#	&	@	%	!		
O	O	O	O	O	O	O	O	O	O	O	O	O

S-V, 41-52

*Character Emitter.* All digits, letters and special characters are emitted from the character emitter hubs during every machine cycle, including run in, run out, and final total cycles. For printing, they may be wired to normal or transfer print entry directly or through selectors. For summary punching, digits may be wired to counters or summary punch entry, letters to storage units or summary punch entry, and special characters to summary punch entry. Special characters & - and / may also be wired to storage units.

	T	CO-SELECTORS				T		T
3	O	O	O	O	O	O	O	O
	N	O	O	O	O	N	O	O
	O	O	O	O	O	O	O	O
	C	O	O	O	O	C	O	O

P-R, 41-80; W-Y, 43-52; Z-AB, 33-52;  
AO-AQ, 1-40; AW-AY, 43-52; AZ-BB, 41-80

*Co-Selectors.* There are 16 standard and 16 optional co-selectors. Co-selectors are so named because they often operate in conjunction with pilot selectors. Each selector has five positions, each position having a C (common), N (normal) and a T (transferred) hub. In principle they function like pilot selectors, in that when they are transferred there is a common connection between C and T, and when they are not transferred there is a common connection between C and N.

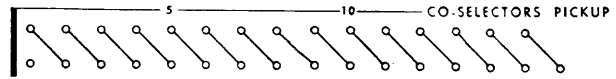

A-B, 53-80; C-D, 73, 76

Each selector has two common pickup hubs, which are diagonally arranged for convenience in jackplugging. When these hubs are impulsed, the selector transfers immediately and holds for the remainder of the cycle. When these hubs are wired from the coupling exit of a pilot selector, they transfer with the pilot selector and hold for the same length of time as the pilot selector. In other words, when a co-selector is picked up from the coupling exit of a pilot selector, the number of positions available for selection is increased from 2 to 7.

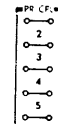

AP-AT, 69-70

*PR CPL (Program Couple).* Each of these hubs emits an impulse on a specific program step. Hub 1 emits an impulse on the minor step, hub 2 on the intermediate step, hub 3 on the major step, hub 4 on the run-out final or the fourth step, and hub 5 on the fifth step when special program is wired. These impulses are of slightly longer duration than the program exits themselves, beginning earlier and ending later. On machines that have OF CPL (overflow couple) these hubs emit on regular programs only. On machines that do not have OF CPL they emit on overflow programs as well as on regular programs.

**Wiring, Character Emitter Printing (Figure 43)**

This wiring concerns the printing of the word *total* from a character emitter on a total cycle, as shown below:

	5.19
	4.26
	3.22
TOTAL	12.67*

1. The letters that make up the word *total* are

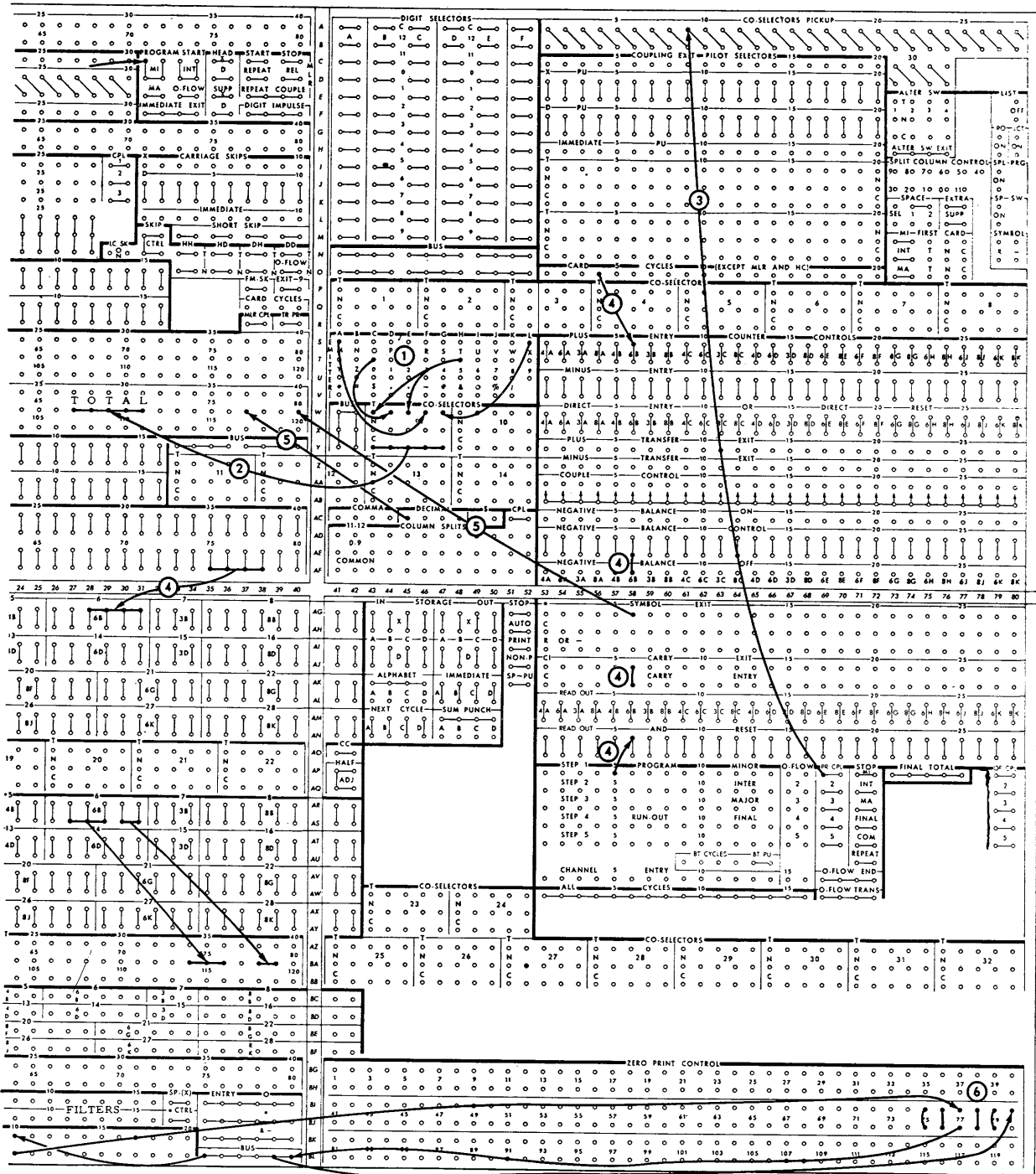

FIGURE 43. CHARACTER EMITTER PRINTING

wired from the corresponding hubs in the emitter to the transferred side of co-selector 9.

2. The common of co-selector 9 is wired to normal print entry 67-71.

3. Co-selector 9 is picked up by a minor pro-

gram couple so that the word *total* will print only on a minor program cycle. The co-selector picks up immediately on every minor program change and returns to normal at the end of the same cycle.



4. Columns 75-78 are wired to counter entry 6. The counter is impulsed to add from every card and to read out and reset on a minor program cycle. The counter exit is wired to counter-controlled print 74-76 and 78-79.

5. The decimal punctuation is wired to normal print entry 77 and the asterisk symbol to normal print entry 80.

6. Decimal and zero printing is controlled by the zero print control hubs. Three conditions must be recognized:

- a. A decimal point must print whenever an amount prints.
- b. Zeros must print to the right of dollars.
- c. Zeros for dollars, but not for cents, must be eliminated for amounts of less than \$1.

The lower hub of position 77, wired to upper 80 via bus, takes care of condition A. Normal zero print control wiring takes care of condition B. Connection of upper and lower hubs of position 77, via bus and filter, takes care of condition C.

#### PRINT SELECTION

DETAIL PRINTING and group printing in the same operation may be controlled by the use of print and non-print hubs.



AI-AJ, 51-52

*Print.* The two common print hubs accept card cycle or all cycles impulses to cause detail printing when the machine is set for group printing (list off). The cards to be detail printed must be distinguished from those to be group printed by an X or digit. An X or digit cannot be wired directly to the print hub, but is wired from first reading to pilot selector pickup. X or digit cards are printed by a card cycles impulse through the transferred side of a pilot selector, and NX or no digit cards through the normal side. The print hubs control all 120 print wheels as a unit.

*Non-P (Non-Print).* The two common non-print hubs accept card cycle, all cycles or program impulses to prevent the machine from printing and spacing regardless of the wiring to the print wheels. When the machine is detail printing, cards with distinctive punching may be prevented from printing by controlling a card cycle impulse through a pilot selector to non-print. To prevent printing and spacing on a total cycle, a program exit is wired directly to non-print. To prevent printing from the first card of a group (group indicate elimination), the minor, intermediate or major first card is wired directly to non-print. The non-print hubs control all 120 print wheels as a unit.

An X or digit cannot be wired directly to non-print.

#### Wiring, Print Selection — Group Printing (Figure 44A)

The columns to be printed are wired to normal print entry, and program start is wired normally.

1. List is wired OFF for group printing.
2. Pilot selector 2 is picked up from an X at the first reading station.
3. If X cards are to be printed, a card cycles impulse is wired through the transferred side of the pilot selector to print.
4. This eliminates printing from the first card of a group when it is NX.

In this example, if program start is not wired, overflow skipping is inoperative.

#### Wiring, Print Selection — Detail Printing (Figure 44B)

The list switch would not be wired.

5. Pilot selector 9 is picked up from an X at the first reading station.
6. Printing and spacing for X cards is suppressed by a card cycles impulse through the transferred side of the pilot selector.
7. Printing and spacing for NX cards is suppressed by a card cycles impulse through the normal side of the pilot selector, as shown by the dotted line.

In this example, overflow skipping is operative regardless of program start.

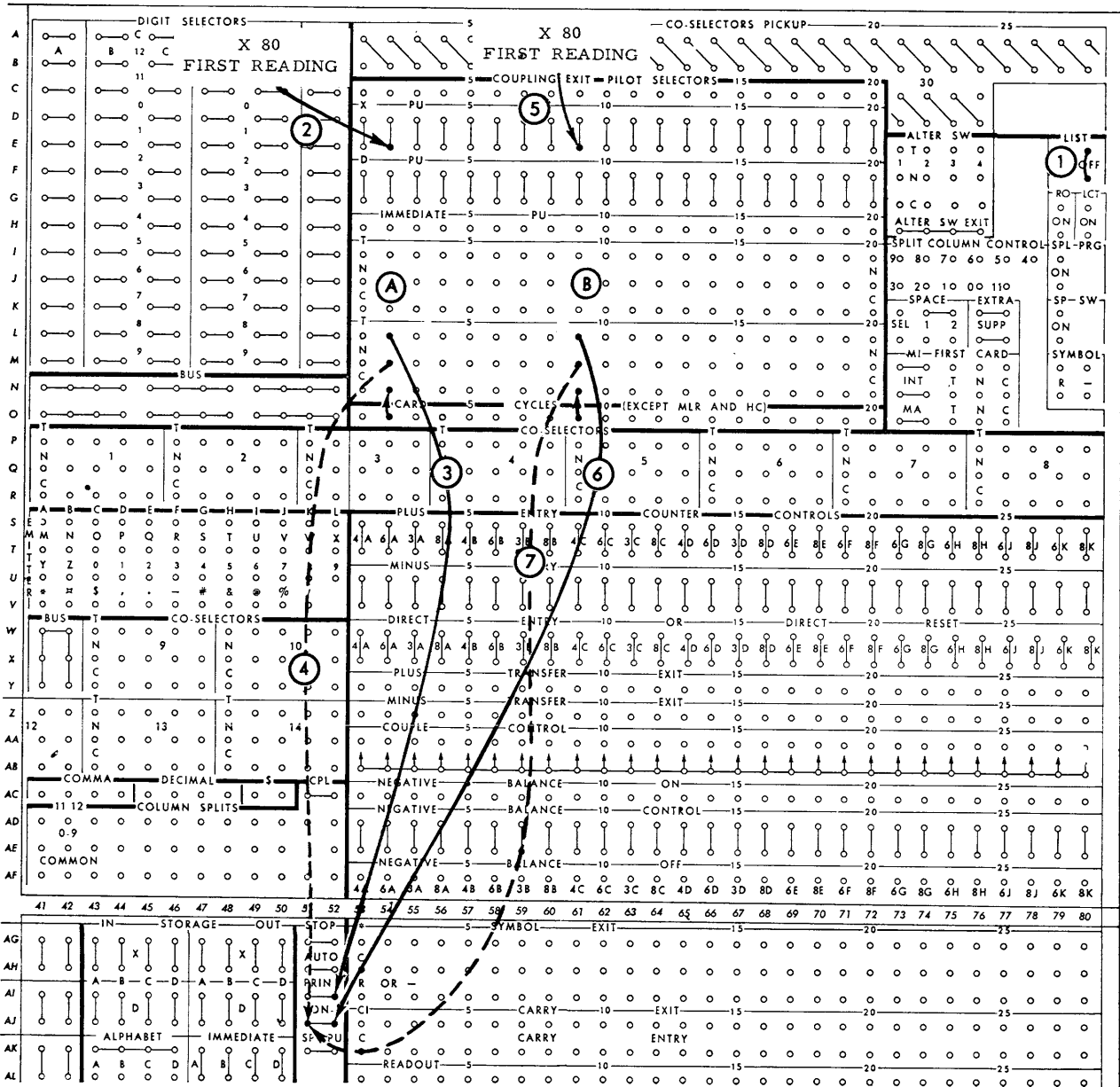

FIGURE 44. PRINT SELECTION

- A. GROUP PRINTING
- B. DETAIL PRINTING



OFFSET TOTAL PRINTING

IT IS OFTEN necessary to detail print amounts from one set of print wheels and print their total from another set of print wheels, directly beneath other printed information. In the example shown in Figure 46, the name of the insured is printed from print wheels 11-22 and the amount of insurance from print wheels 25-29.

POLICY NUMBER	NAME OF INSURED	AMOUNT OF INSURANCE	
91846702	EVELYN SMITH	1,500	
60942301	RITA GREEN	2,500	
66450398	JOHN HERRON	5,000	
138149275	DONALD GREW	2,000	
POLICIES	TRANSFERS	TOTAL AMT. INS.	REVIVALS
		11,000	

FIGURE 46. OFFSET TOTAL PRINTING

The total amount of insurance would normally print beneath the detail amounts. The total may be offset (print wheels 14-19) as shown in the illustration by wiring the counter exit through a

co-selector so that the exit impulses reach print wheels 25-29 for detail printing and print wheels 14-19 for total printing.

Wiring, Offset Total Printing (Figure 45)

1. Name of insured is wired directly to print wheels 11-22.
2. Amount of insurance is wired to counter entry 6 which is impulsed to add from card cycles.
3. The exit of counter 6 is wired through the normal side of co-selector 16 to detail print the amount of insurance from print wheels 24-29 and through the transferred side to total print from print wheels 14-19. The selector is picked up from a minor program couple.
4. Counter 6 is impulsed to read out and reset on a minor program. Minor program start is impulsed from comparing exit.
5. CI and C are wired normally.
6. Negative balance control is wired OFF, since the counter is adding only.
7. A comma is wired through co-selector 15 to normal print entry 26.
8. Co-selector 15 is picked up from minor program couple. When the selector is normal (detail printing), a comma prints from print wheel 26. When the selector is transferred (total printing), a comma prints from print wheel 16.
9. Zero print control is wired for print wheels in use.

GROUP INDICATION

THE PRINTING of information from only the first card of a group as shown in Figure 47 is called group indication. In detail printing, normally the indicative information is printed repetitively from every card in the control group. In group printing, the indicative information for minor, intermediate and major will print on the first card of every group. This repetitive printing may be suppressed by selection, by use of the transfer print hubs, or by printing from counter exits. Each

method is discussed in detail following the explanation of the hubs which are used for group indication.

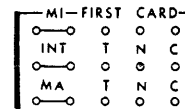

M-O, 73-77

First Card Mi, Int, Ma. The MI (minor), INT (intermediate) and MA (major) first card hubs

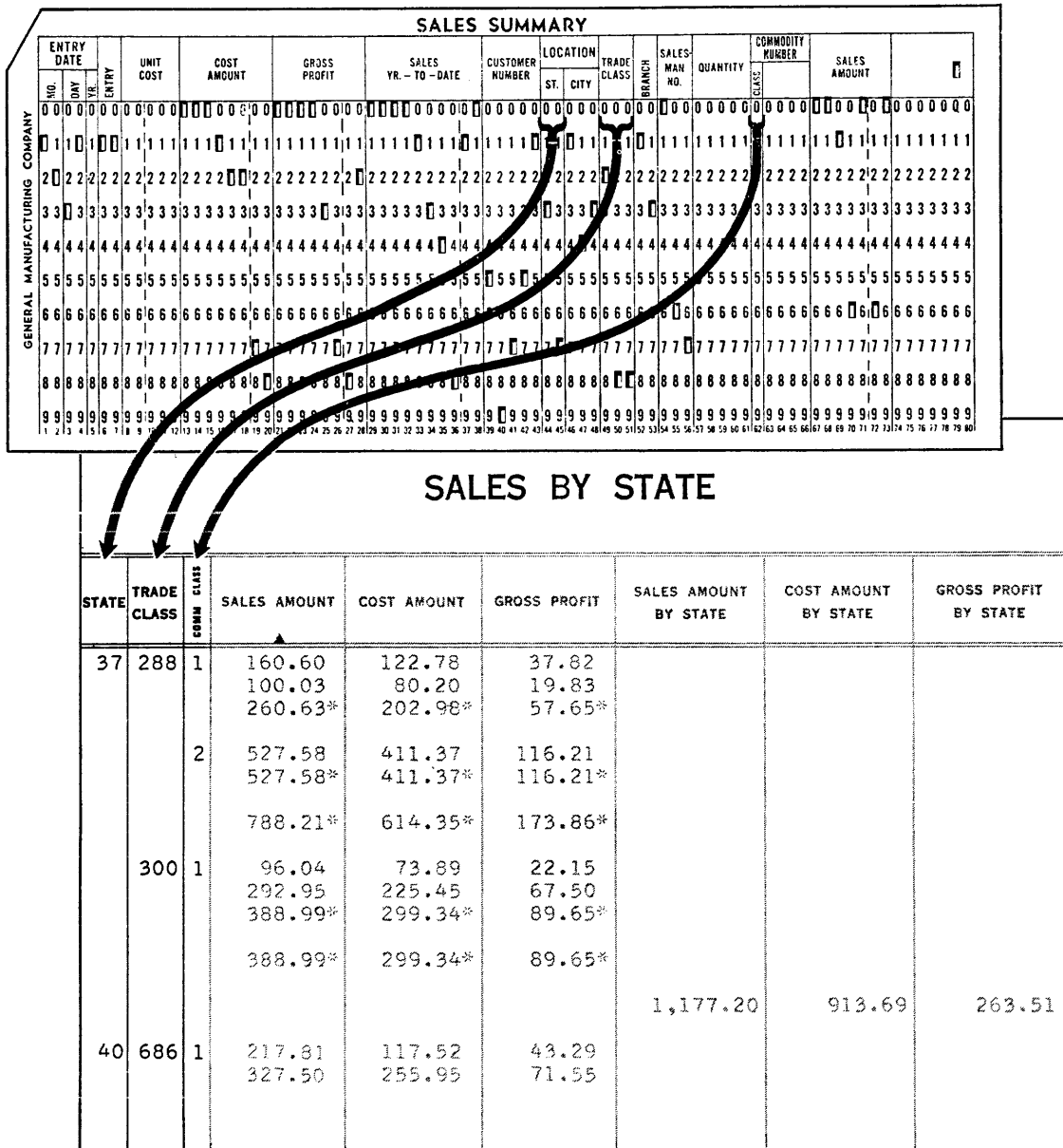

FIGURE 47

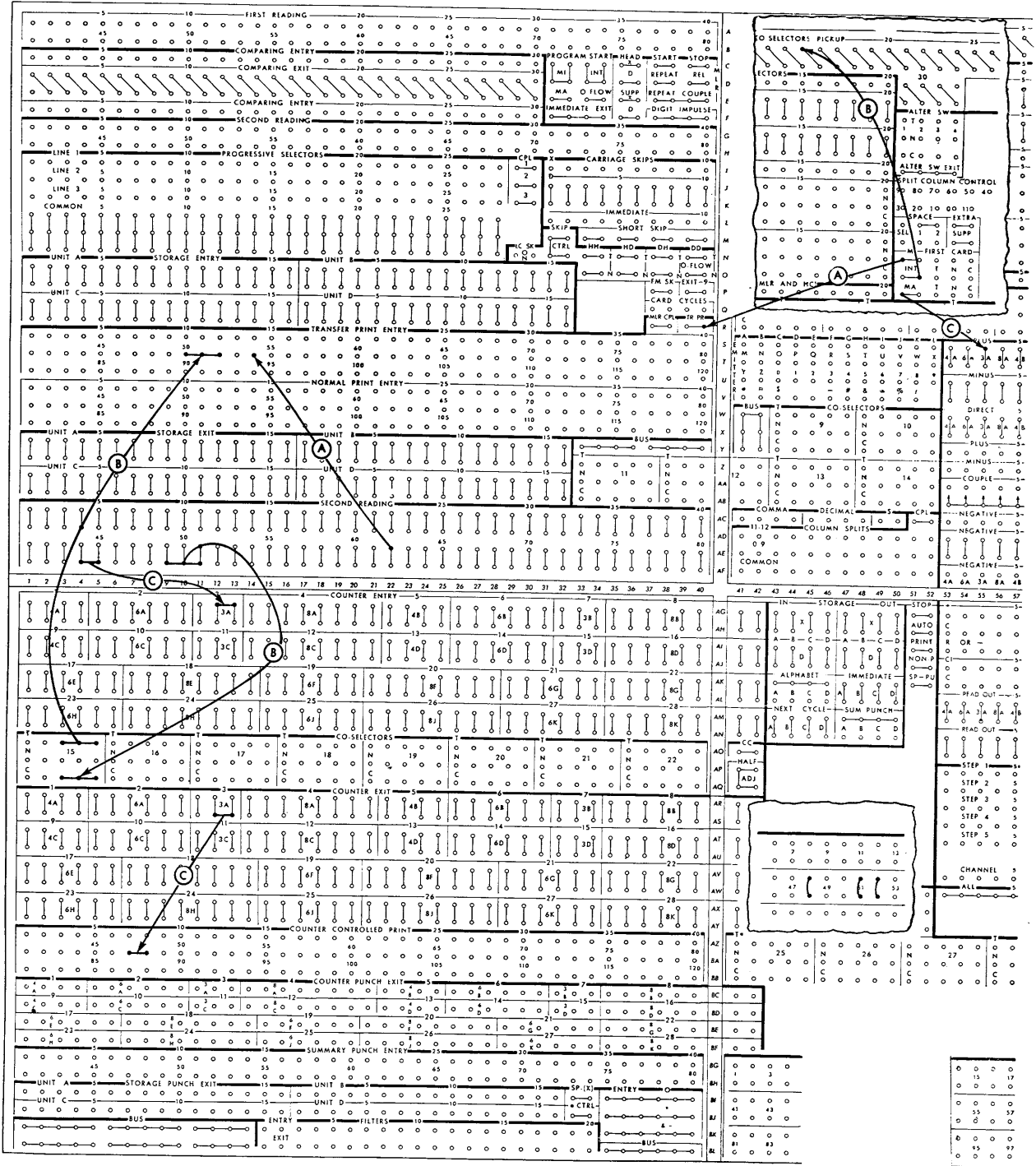
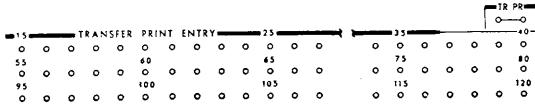

FIGURE 48. GROUP INDICATION

emit cycles impulses for the print cycle of the first card of their respective program groups, regardless of whether the first card is a detail or a heading card. In addition, the minor first card emits a cycles impulse for the first detail

card following a heading card, regardless of program change. These hubs are normally wired to counter plus to add the first card of a group, or to the pickup of a co-selector or the transfer print entry hubs for group indication.

In addition to the first card hubs, there is for each program a first card selector which transfers automatically when the corresponding first card hubs are active. These selectors are normally used to select card cycle impulses to control counters, card count impulses to enter counters on the first card of a group only, or single card columns to be group indicated.



R, 39-40; S-U, 1-40

**Transfer Print Entry.** These hubs represent another set of entries to the 120 print wheels and are active only for the duration of the impulse reaching the two common TR PR (transfer print) pickup hubs. Transfer print entry hubs are normally wired from second reading through the progressive selectors for MLR (multiple line reading) operations, or directly from second reading for non-MLR operations.

**TR PR (Transfer Print).** These common hubs represent the pickup for the 120 position transfer print entry unit. They are impulsed from any cycles impulse, such as card cycles, first card impulses, program exits, program couple, or a pilot selector coupling exit. The transfer print entry hubs remain active only for the duration of the impulse wired to TR PR. Therefore, it is not practical to impulse TR PR from digit impulses (9-12). When comma, decimal or dollar sign symbols are selected by means of transfer print entry, the TR PR must be picked up from card cycles, coupling exit of pilot selectors, or program couple.

#### Wiring, Group Indication (Figure 48)

This illustration demonstrates three methods of group indication:

**A. Transfer Print Method.** The commodity class is wired from second reading directly to transfer print entry 54. The transfer print entry

hubs are made active for the first card of each minor group by wiring minor first card to TR PR pickup.

**B. Selector Method.** The trade class is wired from second reading through the transferred side of co-selector 15 to transfer print entry 50-52. The co-selector is picked up from intermediate first card so that trade class will print only for the first card of an intermediate group. Because the minor and intermediate indications occur at the same time, the transfer print entry hubs must be used to print both if it is used to print either of them. Because transfer print entry has been impulsed, normal print entry is isolated from the print wheels.

**C. Counter Method.** The state code is wired to counter entry 3 and the major first card is wired to the plus of that counter. The counter exits are wired to counter-controlled print 47-48. The counter will add the first card of a major group. Since the counter exits are active only if the counter is impulsed, state will print once for every major group.

On the cycle following a major program change, all three indications occur together, the minor and intermediate printing from transfer print entry and the major from counter-controlled print. Counter-controlled print hubs may always be used as entries to the print wheels.

### COUNTING AND PROGRAMMING WITH CYCLE COUNT



AO, 41-42

**CC (Cycle Count).** These hubs emit a "1" impulse during every machine cycle. They may be used to count any or all machine cycles or, when properly controlled, to count cards or groups of cards or to initiate a program start.

#### Wiring (Figure 49)

**A. Card Counting.** Each card may be counted as it passes the second reading station by wiring

FIGURE 49. CYCLE COUNT — COUNTING, PROGRAMMING, AND PRINTING

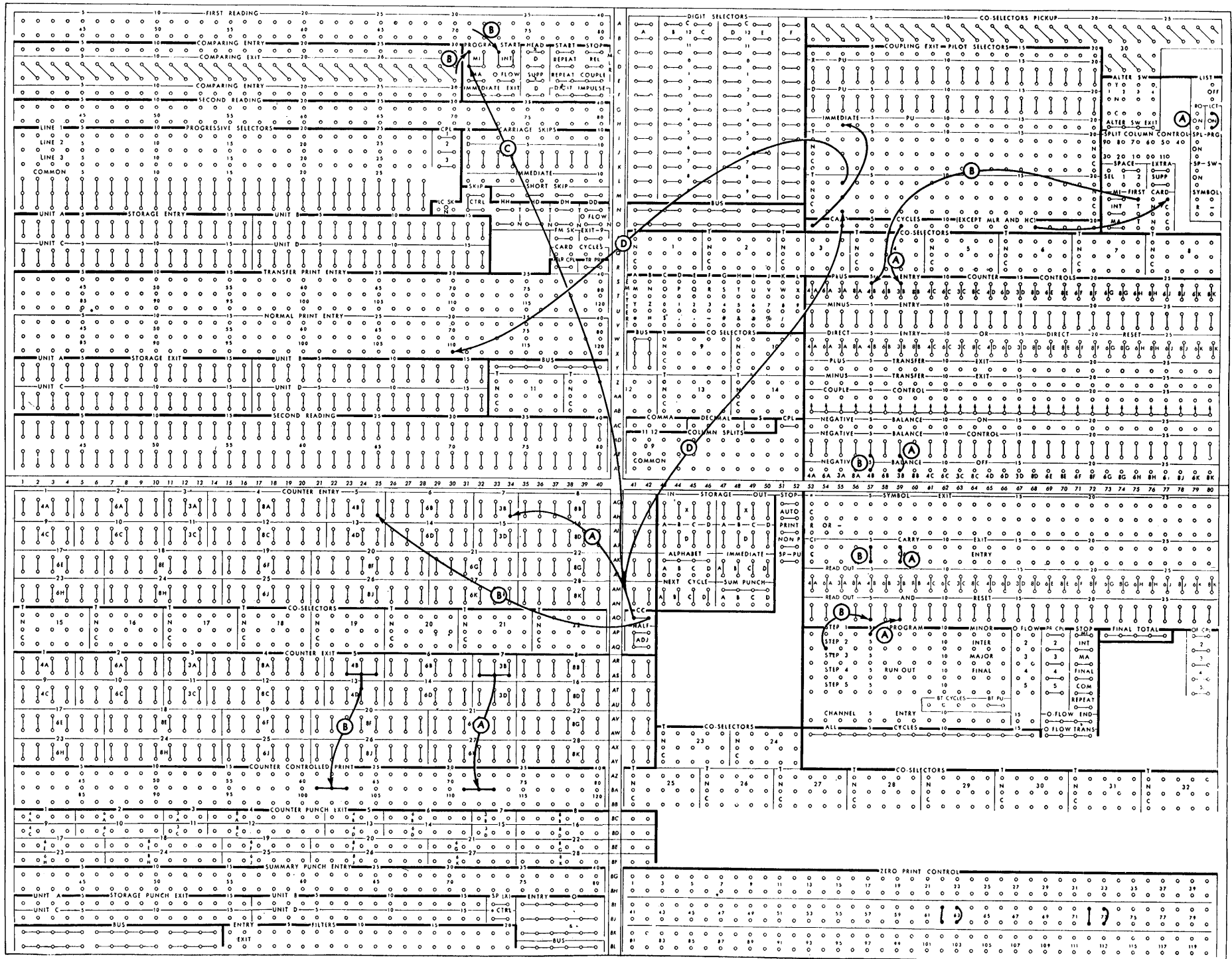



CC to a counter entry and by controlling the counter for adding and direct entry from card cycles. If only certain cards are to be counted, then the card cycles impulse must be selected. A count distribution can be made by wiring CC to several counters and by impulsing the counters to add under the control of a specific X or digit punch. With the LCT switch ON, the counter may be cleared automatically on a minor, intermediate, major or run-out final program.

**B. Group Counting.** A count of 1 may be obtained for each group of cards by wiring CC to a counter entry and by controlling the counter to add from a card cycle wired through the transferred side of the minor, intermediate or major first card selectors. If minor groups within an intermediate group are being counted, the counter is reset on an intermediate program. If minor groups within a major group are being counted the counter is reset on a major program. If all minor groups are being counted the counter is reset on run-out final. Intermediate and major groups may be counted by a corresponding change in counter controls.

**C. Impulsing Program Start from CC.** The cycle count impulse may be used to initiate a program start. If a program change is desired for every card, CC may be wired directly to minor, intermediate or major program start.

**D. Printing 1 from CC.** The digit 1 may be printed as each card reads by wiring CC through the transferred side of a selector picked up from card cycles to normal print entry, transferred print entry, or counter-controlled print. The selector is necessary to prevent printing of 1 on program cycles.

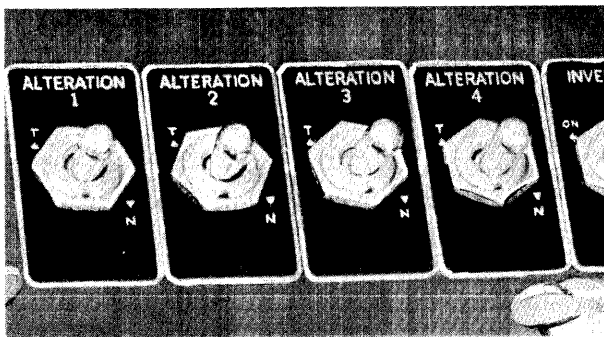
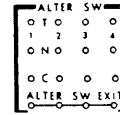

FIGURE 50. ALTERATION SWITCHES

## ALTERATION SWITCHES

WITHIN REASONABLE limitations, one control panel may be used for several different reports without any change in control panel wiring, by use of the alteration switches.



E-H, 73-76

**Alteration SW 1, 2, 3, 4.** Four alteration toggle switches are located in the switch box on the top of the machine (Figure 50). Each alteration switch controls a corresponding alteration switch selector. When the switch is on T, a common connection exists between C and T; when on N, the connection is between C and N. An alteration switch selector remains transferred as long as the corresponding toggle switch is set on T. Any impulse, including the summary punch switch, may be wired through C-N or C-T.

Pilot or co-selectors may be picked up through alteration switch selectors. In this case, one of the four alteration switch exits is wired through normal or transferred side of an alteration switch selector (depending upon the position of the switch) to the pickup of a co-selector or *the D pickup of a pilot selector*. Co-selectors can then be used to select any impulse except the summary punch switch; pilot selectors can then be used to select any impulse except a line impulse.

There are many uses for the alteration switches to vary machine functions from one report to another, such as changing from detail printing to group printing with or without summary punching, programming, print selection, or counter clearing.

### Changing from Detail Printing to Group Printing

In the example in Figure 51, the first report is detail printed; the second and third reports are group printed (list OFF). Without the alteration switches, the list OFF hubs would have to be con-

DEDUCTION REGISTER				
_____ 19__				
EMPLOYEE NAME	EMPL. No.		DEDUCT CODE	DEDUCTIONS
	DEPT.	CLOCK		
FRED ACKERLY	1	13	215	.50
FRED ACKERLY	1	13	314	.75
FRED ACKERLY	1	13	573	5.00
				6.25*
MILTON CARGIN	1	100	334	.35
MILTON CARGIN	1	100	414	.50
				.85*

DEDUCTION REGISTER				
_____ 19__				
EMPLOYEE NAME	EMPL. No.		DEDUCT CODE	DEDUCTIONS
	DEPT.	CLOCK		
FRED ACKERLY	1	13	215	6.25*
MILTON CARGIN	1	100	334	.85*
GERALD DRISCOLL	1	145	215	1.35*

DEDUCTION REGISTER				
_____ 19__				
EMPLOYEE NAME	EMPL. No.		DEDUCT CODE	DEDUCTIONS
	DEPT.	CLOCK		
FRED ACKERLY	1	13		6.25
MILTON CARGIN	1	100		.85
GERALD DRISCOLL	1	145		1.35
JOSEPH DUHLMEIER	1	150		.85
CLEMENT EDWARDS	1	170		.65
PATRICK EGGLESTON	1	175		1.00
WILLIAM FRISBIE	1	220		.85
SOCRATES GLEZEN	1	230		1.65
BERT GRAHAM	1	245		.85

FIGURE 51

FIGURE 12. CHANGING FROM DETAIL TO GROUP PRINTING

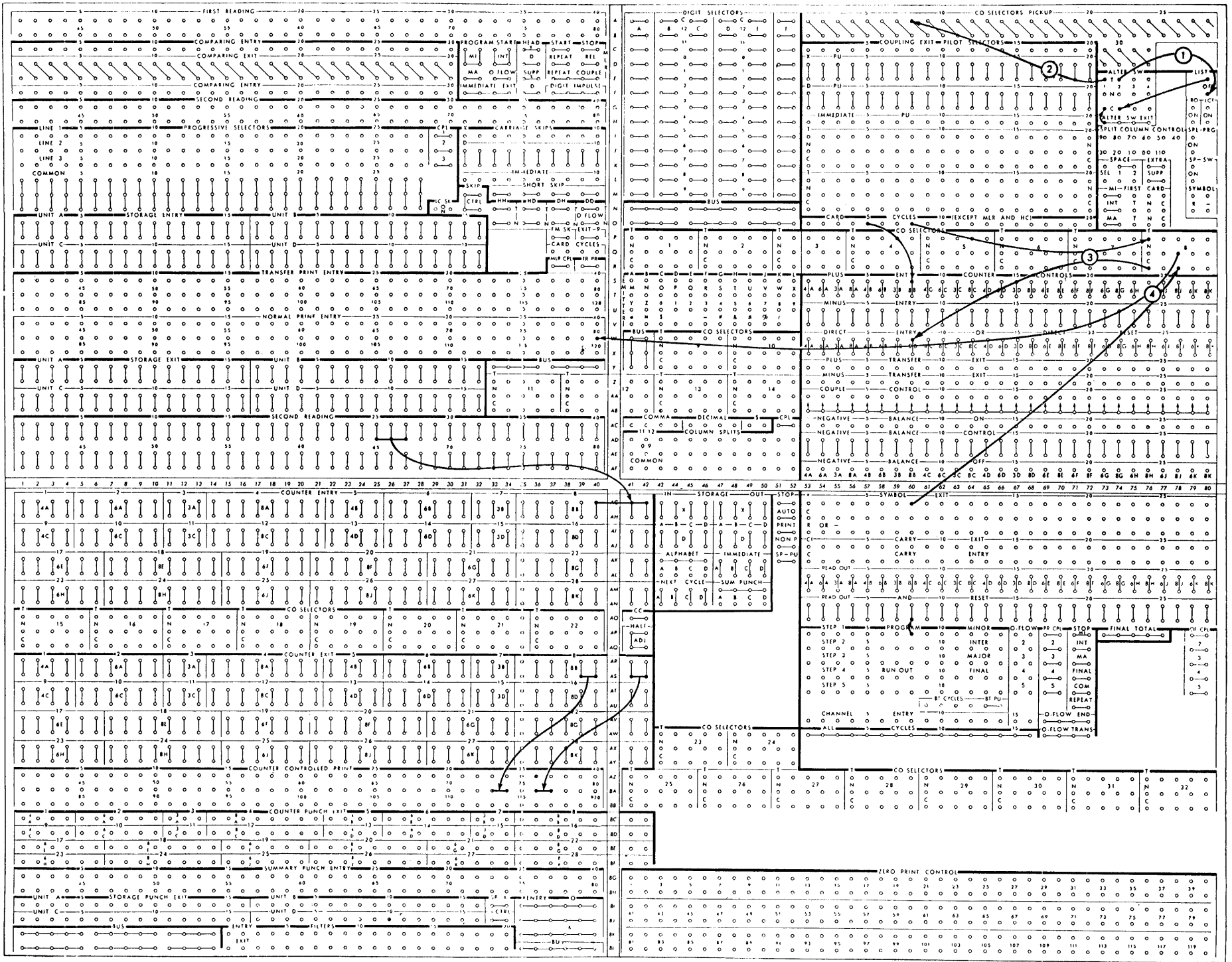

nected, and a card cycles impulse would have to be wired to direct entry of the counter being used, to eliminate overprinting as shown in the deduction column of the second report. These wiring changes can be made automatically by making use of the alteration switch feature of the machine.

**Wiring, Changing from Detail to Group Printing (Figure 52)**

1. The list exit hub is wired through the transferred side of alteration switch selector 2 to list OFF. When the alteration switch is set on N, list OFF will not be connected and the machine will detail print. When the alteration switch is set on T, list OFF will be connected and the machine will group print.

2. An alteration switch exit impulse is wired through the transferred side of alteration switch selector 1 to the pickup of co-selector 8.

3. The card cycles impulse, wired through the transferred side of the selector, reaches counter

8 direct entry when the alteration switch 1 is set on T, to prevent printing of deductions from the first card of the group.

4. The asterisk symbol exit is wired through the normal side of co-selector 8. When alteration switch 1 is set on T, the asterisk is eliminated.

More extensive changes can be made by wiring the alteration switch to one or more co-selector pickups. The extent of the changes to be made depends entirely upon the selector capacity available for making them.

**FIELD SELECTION**

WHEN A CHOICE must be made between different fields and the chosen field is to be printed from one set of print wheels or entered into one counter, field selection is necessary. Field selection can be accomplished by the use of co-selectors; transfer and normal print entry can be used under certain

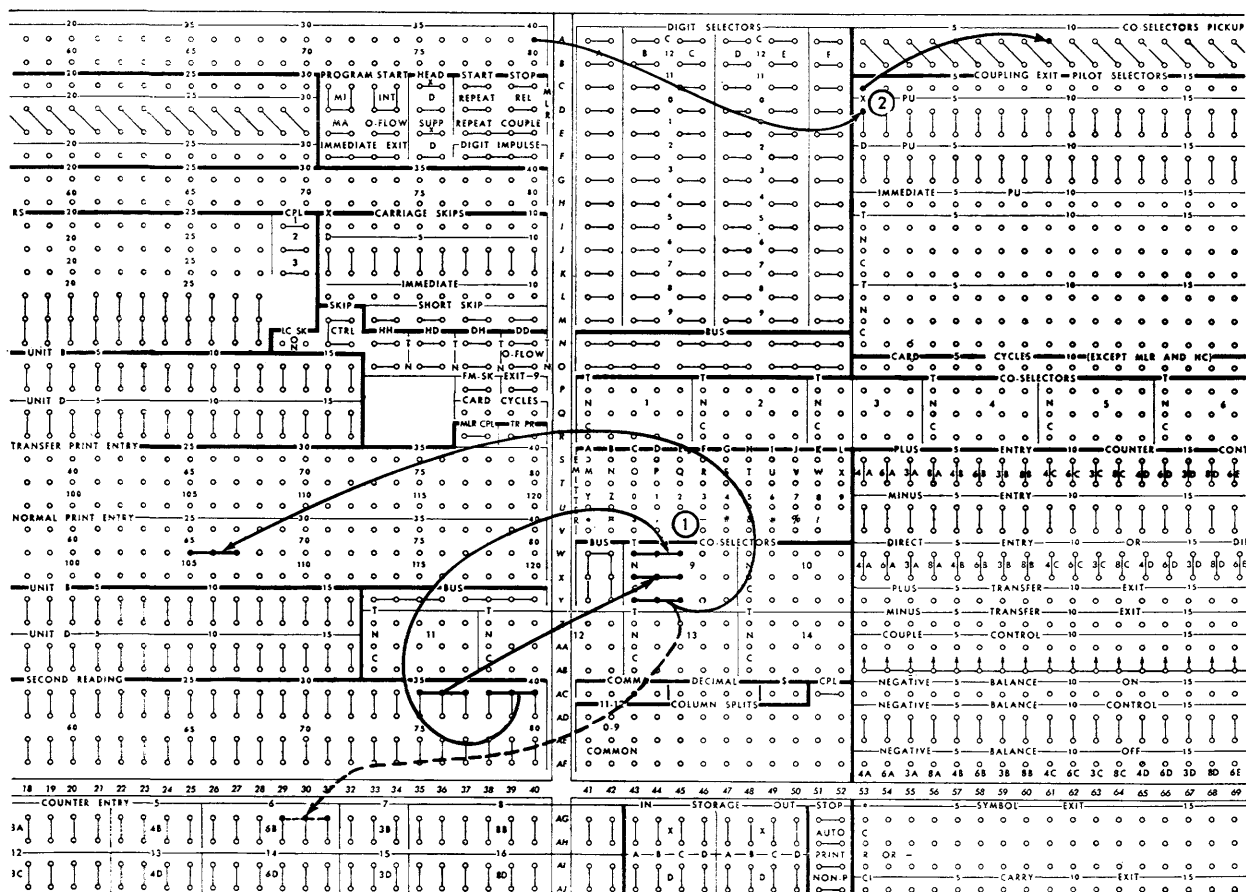

FIGURE 53. FIELD SELECTION, CO-SELECTOR METHOD

conditions. Co-selectors must be used when the selected information is to enter counters. Regardless of the purpose or method used, an X or a digit must identify one class of card to distinguish it from another. For printing purposes, the information may be numerical or alphabetic. For counter entry purposes, the information must be numerical.

**Wiring, Field Selection — Co-Selector Method (Figure 53)**

In this example, two prices are punched in the same card—the first price in columns 35-37, and the second price in columns 38-40. When the card is not X punched, the first price is selected; when the card is X punched in column 40, the second price is selected.

1. First price is wired from columns 35-37 to the normal side of co-selector 9; the second price is wired from columns 38-40 to the transferred

side. The common side is wired to normal print entry 65-67. (Dotted wiring shows entry to a counter).

2. Co-selector 9 is picked up as follows: The controlling X is wired from column 40 of first reading to the X pickup of pilot selector 1. The coupling exit of the pilot selector is wired to the pickup of co-selector 9. The co-selector will transfer with the pilot selector. First or second price passes through the selector to the print wheels according to the position of the selectors.

**Wiring, Field Selection — Normal and Transfer Print Entry (Figure 54)**

1. First price, columns 35-37, is wired to normal print entry 65-67; second price, columns 38-40, is wired to transfer print entry.

2. When pilot selector 1 transfers from an X in 40, coupling exit emits an impulse to TR PR, allowing the second price to print. When the se-

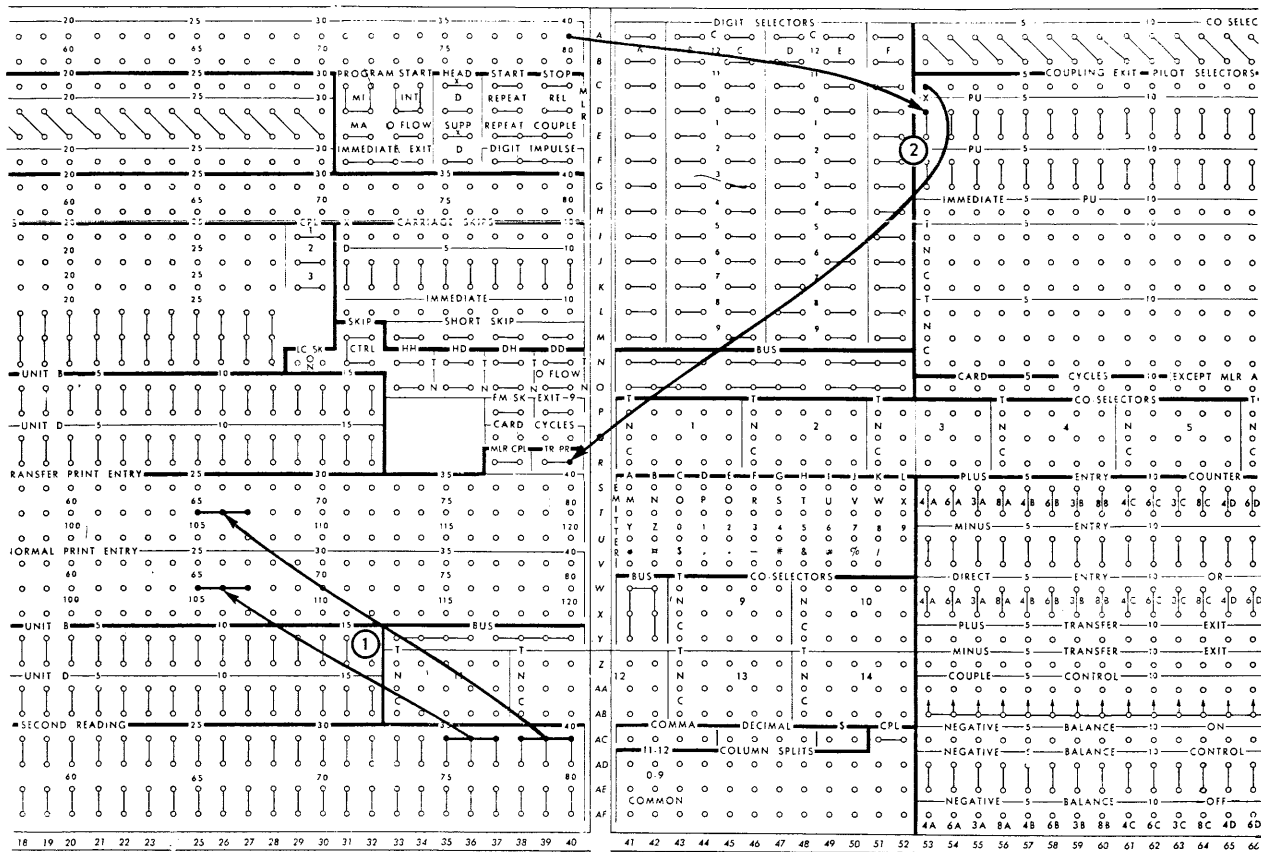

FIGURE 54. FIELD SELECTION, TRANSFER PRINT METHOD

lector does not transfer, TR PR is not impulsed, allowing the first price to print.

When this method of field selection is used, all information from the NX card must be wired to normal print entry and all information from the X card to transfer print entry. It is most practical when a great deal of field selection is necessary.

CLASS SELECTION

CLASS SELECTION is necessary whenever a choice must be made between several printing locations wired from the same field in different cards. The different classes of cards must be identified by X's or digits which are used to control selection.

The field to be selected is wired to the common side of a co-selector, the normal side to one set of print wheels, and the transferred side to another set of print wheels. The printing locations are selected under control of the X or digit.

Wiring, Class Selection — Co-Selector Method (Figure 55)

Hours, punched in columns 69-71, is wired to the common of co-selector 9. The normal side is wired to normal print entry 60-62 to print regular hours and the transferred side to normal print entry 64-66 to print overtime hours. The co-selector is coupled to a pilot selector and is transferred by an X in column 40.

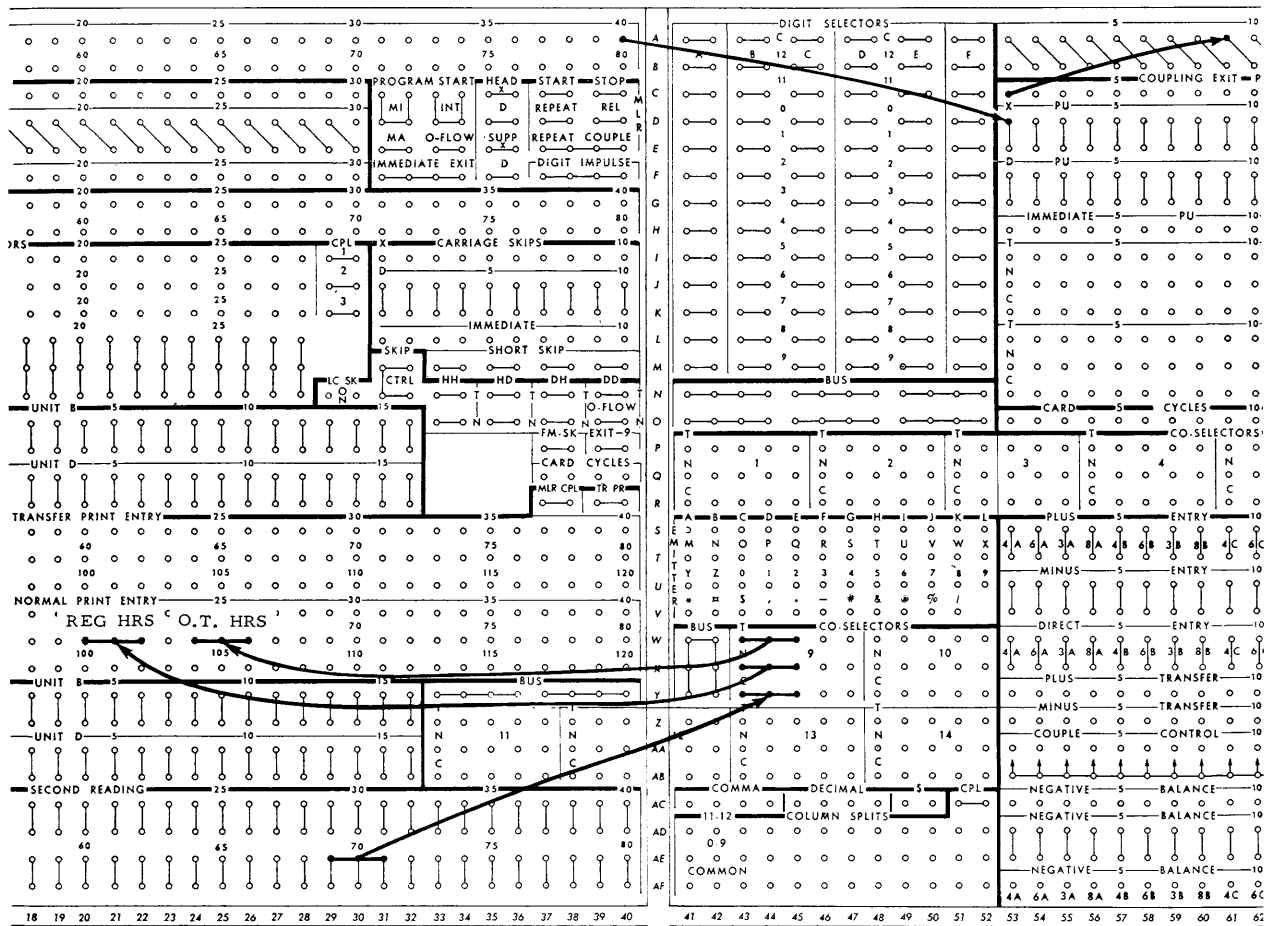

FIGURE 55. CLASS SELECTION, CO-SELECTOR METHOD

Wiring, Class Selection — Normal and Transfer Print Entry (Figure 56)

As for field selection, when this method is used all information from the NX card is wired to normal print entry and all information from the X card is wired to transfer print entry. It is most practical when a great deal of selection is necessary.

Hours, punched in columns 69-71 for all cards, is wired to normal print entry 60-62 and transfer print entry 64-66. When TR PR is impulsed from the coupling exit of pilot selector 1, overtime hours print from print wheels 64-66. When TR PR is not impulsed, regular hours print from print wheels 60-62.

SYMBOL SELECTION

SYMBOLS MOST frequently selected are amount punctuations, such as comma, decimal, and dollar sign, and amount identification, such as C, R or -. Selection is necessary when the symbols are to be printed under conditions described in the following examples.

Comma, Decimal, Dollar Symbol Selection

It is sometimes necessary to punctuate amounts on total cycles but not on card cycles, and *vice versa*. Often it may be necessary to punctuate amounts on certain card cycles identified by an X or digit, first card of minor, intermediate or major groups, etc.

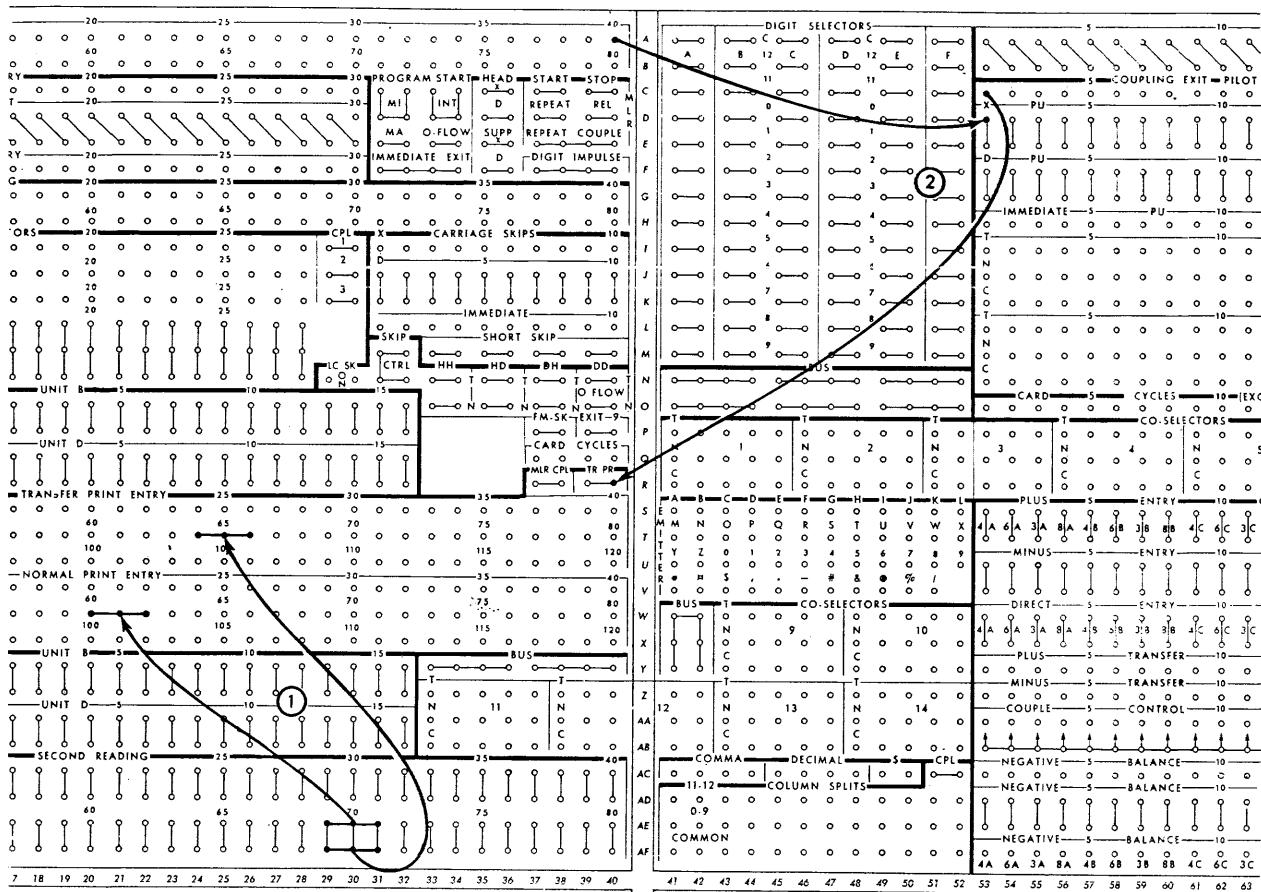

FIGURE 56. CLASS SELECTION, TRANSFER PRINT METHOD

HEADING	INVOICE NO. 12345
	AMOUNT
ITEM	625.37
ITEM	23.19
ITEM	.10
ITEM	1,742.75
	\$ 2,391.41

FIGURE 57

In Figure 57, punctuation is not required for invoice number printed from the heading card (X40). Decimals and commas are required to punctuate amounts in the body of the form. In addition, the dollar symbol is required on a total cycle but not on card cycles.

#### Wiring (Figure 58)

1. Invoice number is wired through co-selector 15 to normal print entry 21-25. The co-selector is picked up on X40 cards by wiring card cycles through the transferred side of pilot selector 1 to co-selector 15 pickup. Pilot selector 1 is picked up from an X40.

2. The amount field is wired to counter 2, controlled to add from NX40 cards. The amount is wired to counter-controlled print 18-25 with proper spacing for commas and decimals.

3. The decimal is wired to print on both detail and program cycles through the normal side of co-selector 15. The comma is wired directly to print wheel 19 and will print only when a significant digit is printed from print wheel 18.

4. Although the dollar symbol is wired directly to normal print wheel 17, it is controlled to print on total cycles only, by wiring the lower hub of zero print control 17 through the transferred side of co-selector 14 to the upper hub of 26 via the bus. The co-selector is picked up on the minor program level, thus causing print wheel 17, which is printing the dollar symbol, to be connected back to the units position of the field only on the total cycle.

The zero print control wiring must be selected and not the dollar symbol. If the zero print control wiring was direct and the dollar symbol selected, an asterisk would print on detail print cycles through a back circuit.

5. Zero print control hubs are wired normally.

#### C, R or Minus Selection, Detail and Total Printing

It is possible to select the R or - switch so that the R or - exit hubs emit an R during total cycles and a minus during detail print cycles:

$$\begin{array}{r} 1\ 2\ 3\ - \\ 1\ 4\ 7 \\ 1\ 1\ 2\ - \\ \hline 8\ 8\ C\ R\ * \end{array}$$

In the example above, 123 and 112 are recognized as negative by the minus sign. The total, 88\*, is recognized as negative by the CR symbols. The - and the C impulses to the same print wheel must therefore be selected.

#### Wiring (Figure 59)

1. The R symbol switch is wired through the normal side of co-selector 10. The minus symbol switch is always inactive. The co-selector is picked up from co-card cycles. Therefore, R can print only on total cycles and minus only on card cycles.

2. Symbol exit C of counter 5 is wired to normal print entry 114 through the normal side of co-selector 10. It will print on total cycles only.

The R or - hub for the same counter is wired through the transferred side of the selector to the same print entry as the C. When the selector is transferred on card cycles, a minus sign prints from print wheel 114, since the R symbol switch is not connected. When the selector is normal on total cycles, a C prints from print wheel 114.

3. Symbol exit R or - of counter 5 is wired to the normal print entry 115 through the normal side of co-selector 10. An R will print only on a total cycle, as the symbol switch is connected at that time.

4. The wiring for zero print control is the same for minus symbols as it is for zeros. Therefore, minus symbols will not print unless amounts are printed.



FIGURE 58. COMMA, DECIMAL, DOLLAR SYMBOL SELECTION

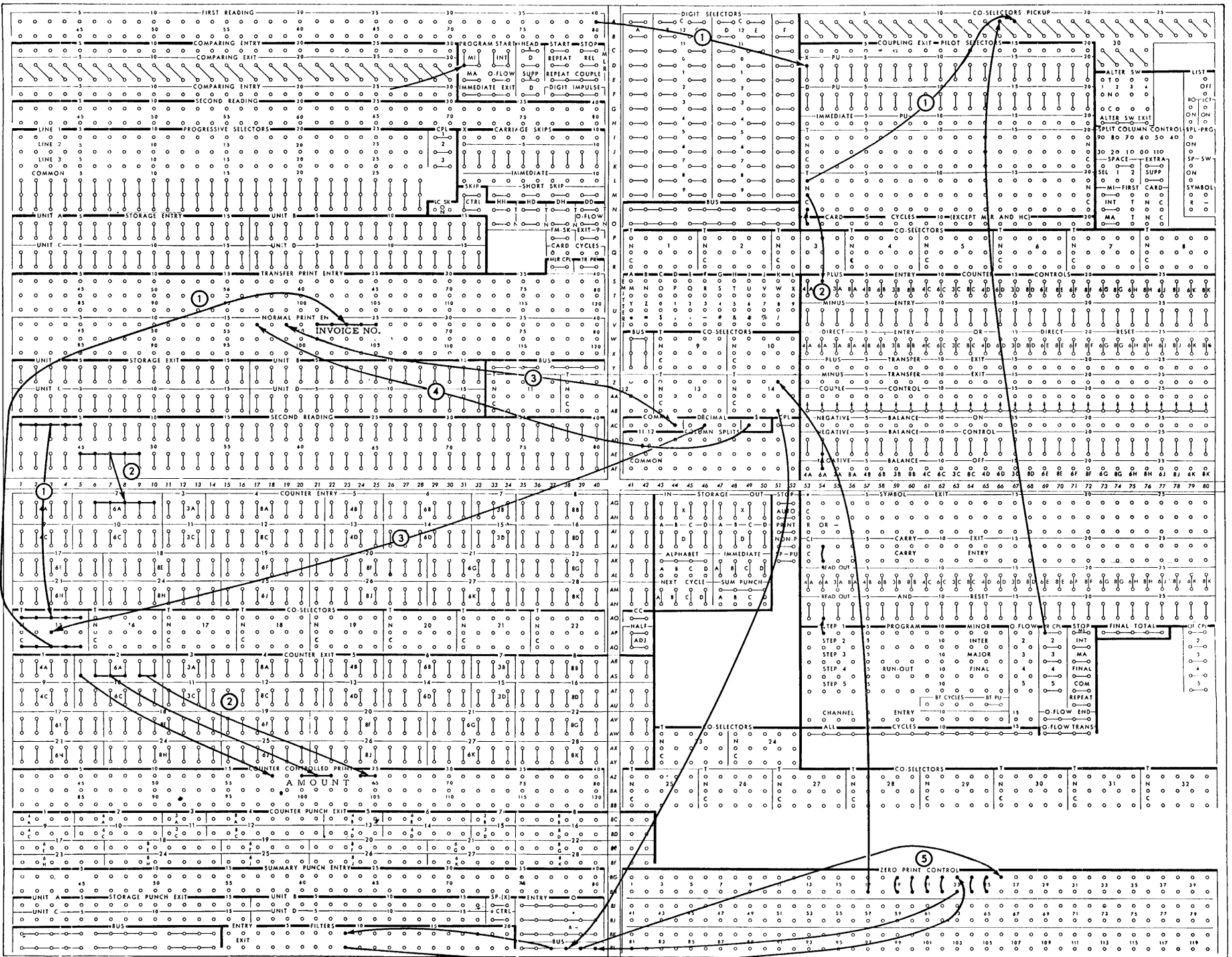

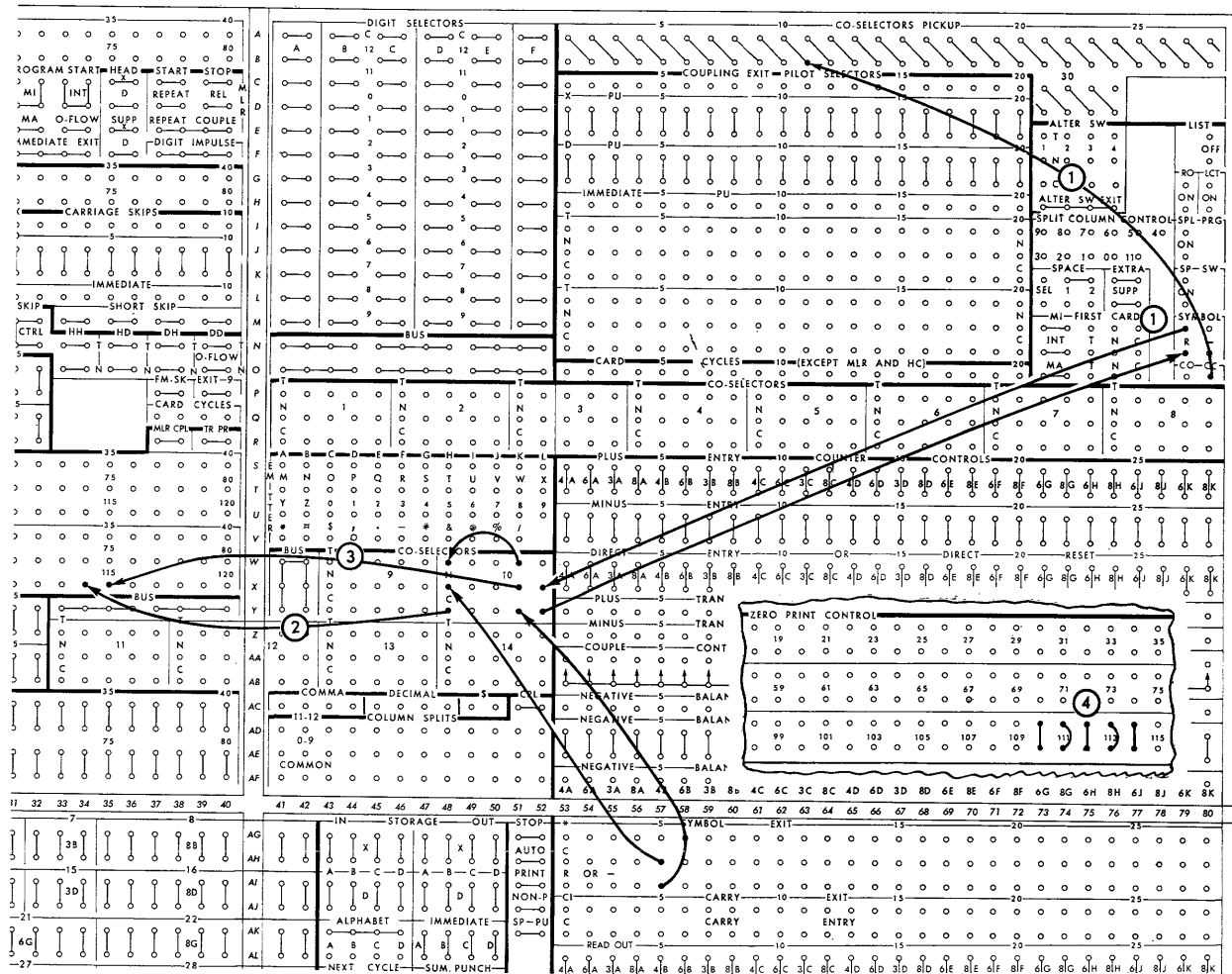

FIGURE 59. C, R OR MINUS SELECTION, DETAIL AND TOTAL PRINTING

**C, R or Minus Selection, Printing on One Line**

When several negative amounts are printed on the same line, it is possible to identify some of them with CR and some with minus signs. When the symbol switch is not wired, the R or - hubs emit an X impulse to identify negative amounts. When the R symbol switch is wired, the R or - hubs emit both an X and a 9 to identify negative amounts. The combination of these two impulses causes the printing of an R. The 9 can be eliminated by the use of a column split to print a minus when necessary.

**Column Split.** Twelve column splits are standard, each of which has three hubs; C (common), 0-9, and 11-12. They separate 11 and 12 impulses from 0-9 impulses obtained either from punching in the card or automatic impulses on the control panel. The column splits also oper-

ate for summary punching to control X punching over specific columns.

The CPL (couple) hubs are provided to pick up co-selectors in order to obtain additional column split positions. For summary punching, however, the co-selector positions cannot be used as column splits, since the co-selector will remain transferred throughout the summary punch cycle and no distinction can be made between 0-9 and 11-12. Couple hubs may be used to control functions during the second half of the cycle.

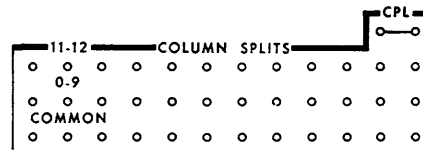

AC, 51-52, AD-AF, 41-52

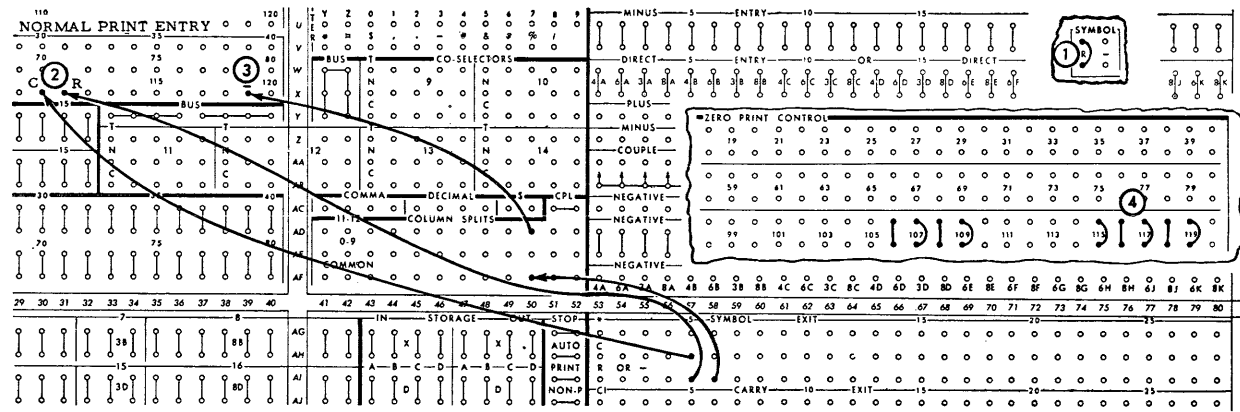

FIGURE 60. C, R OR MINUS SELECTION, PRINTING ON ONE LINE

Wiring (Figure 60)

1. The R symbol switch is connected.
2. The C and R or - hubs of counter 5 are wired to normal print entry 110-111.
3. The R or - hub of counter 6 is wired to normal print entry 119 through a column split.

CR will print from print wheels 110-111 whenever a negative amount is printed from counter 5 and a minus symbol will print from print wheel 119 whenever a negative amount is printed from counter 6. An R would print if the 9 impulse were not eliminated through the column split. Normal zero print control is wired for a minus symbol. Zero print control is not necessary when printing C and R.

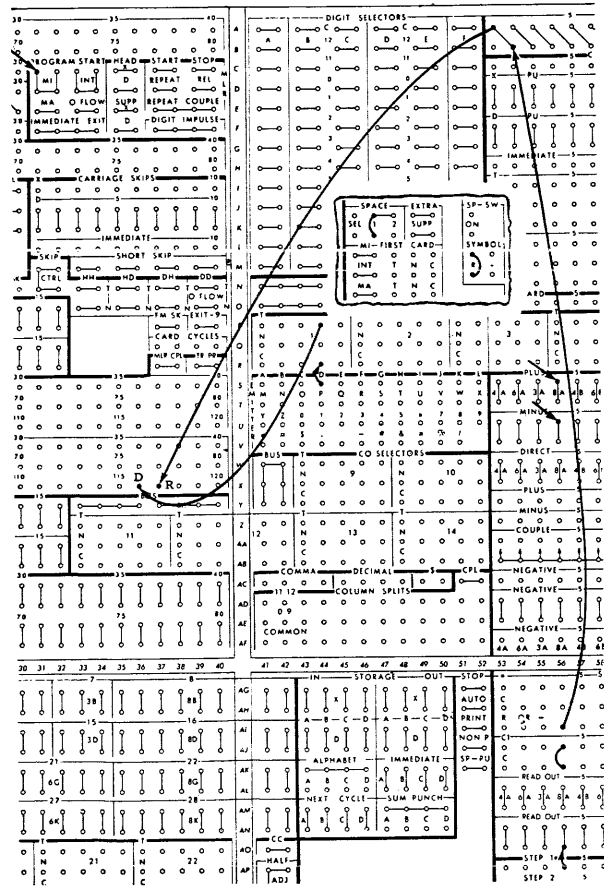

FIGURE 61. DR FOR NEGATIVE AMOUNTS

Identifying Negative Amounts with DR instead of CR

As shown in Figure 61, a D from the character emitter is wired through the transferred side of co-selector 1 to normal print entry 116. The selector is picked up from the R or - hub of counter 4. With the symbol switch wired for R, the R or - exit hub of counter 4 emits an X-9 impulse whenever the counter turns negative. The 9 picks up the selector in time to select the letter D (12-4).

The R is wired to normal print entry 117 by way of the common pickup hubs of co-selector 1.

SPACE CONTROL

ALL SPACING on the Type 407 must be wired on the control panel. As previously described, single or double spacing is accomplished by connecting the space 1 or 2 hubs. These hubs may be selected so that single and double spacing may be placed under the control of an X or digit. Triple spacing may be accomplished either by the use of the SEL hubs in conjunction with punching in the carriage

tape, or by the special wiring shown under *Operating Suggestions*.

With the machine wired for single spacing, in detail printing there will be an automatic space after each total, and in group printing there will be an automatic space after intermediate and major totals when followed by minor group indication. In group printing, both the indication and the minor total print on the same line. Examples of this spacing are shown below.

SINGLE SPACING

<u>DETAIL PRINTING</u>	<u>GROUP PRINTING</u>
.....Detail Print	.....Indicate Minor Total*
.....Detail Print	.....Indicate Minor Total*
.....Minor Total*	..... Intermediate Total**
.....	.....
.....Detail Print	.....Indicate Minor Total *
.....Detail Print	.....Indicate Minor Total *
.....Minor Total*	..... Intermediate Total**
.....	..... Major Total***
.....Intermediate Total**	.....
.....	.....Indicate Minor Total*
.....Detail Print	.....Indicate Minor Total*
.....Minor Total*	..... Indicate Minor Total*
.....	..... Etc.
..... Intermediate Total**	
.....	
.....Major Total***	
.....	
.....Detail Print	

In detail printing, double spacing occurs after each total prints. In group printing, double spacing occurs only after intermediate or major totals when followed by minor group indication.

Results of double spacing for detail and group printing are illustrated in the following example:

DOUBLE SPACING

<u>DETAIL PRINTING</u>	<u>GROUP PRINTING</u>
.....Detail Print	.....Indicate Minor Total*
.....	.....
.....Detail Print	.....Indicate Minor Total*
.....	.....
.....Minor Total*	..... Intermediate Total**
.....	.....
.....	.....
.....Detail Print	.....Indicate Minor Total*
.....	.....
.....Minor Total*	..... Intermediate Total**
.....	.....
.....	..... Major Total***
.....	.....
.....Intermediate Total**	.....
.....	.....
.....	..... Indicate Minor Total*
.....	.....
.....Major Total***	.....Indicate Minor Total*
.....	.....
.....	.....
.....Detail Print	.....

In detail printing, quadruple spacing occurs after each total prints. In group printing, quadruple spacing occurs after intermediate and major totals when followed by minor group indication.

Variations from this normal spacing may be obtained by the use of the space suppress (SUPP) or EXTRA hubs.



K-L, 76-77

**Space Suppress.** Space suppression takes precedence over all normal spacing. The space suppress hubs accept program exit impulses to suppress normal spacing before a total prints and automatic spaces after a total prints. They also accept card cycle impulses through pilot selectors to suppress normal spacing for only certain cards. When spacing is to be suppressed under the control of an X or digit in a card, the selector must be picked up from first reading. Any digit from 9 through 3 may also be used to suppress spacing on the same cycle.

**Extra Space.** When impulsed from card cycles, these hubs cause an extra space after each card prints. If single and extra space are impulsed, the result is double spacing; if double and extra space are wired, the result is quadruple spacing. The card cycles impulse may be controlled to obtain extra spacing only for certain cards.

When impulsed from program exits, these hubs cause an extra space after printing the corresponding total, except when automatic extra spaces are normal. For example, they will not cause an additional extra space after any total in detail printing, or after intermediate or major totals followed by minor group indication in group printing.

When impulsed from a first card impulse, these hubs cause an extra space after the corresponding first card prints. An X, 12, or any digit may be wired directly from first reading to cause an extra space before printing, or from second reading to cause an extra space after printing.

**Single or Double Spacing under X or D Control—  
Detail Printing (Figure 62)**

All X40 cards are double spaced by wiring one of the common space exit hubs through the transferred side of pilot selector 2 to space hub 2. All NX40 cards are single spaced by wiring the normal side of the same selector to space hub 1. The selector is picked up from an X at first reading.

If digits are used to control spacing, they must be wired to the D pickup of the pilot selector.

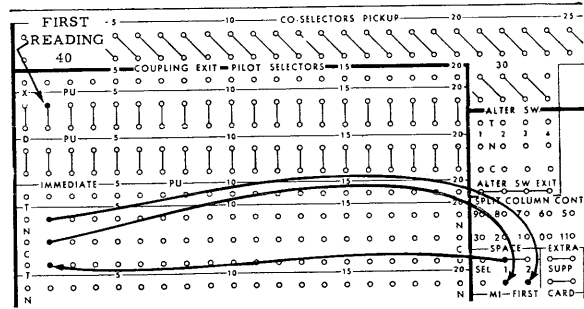

FIGURE 62. SINGLE OR DOUBLE SPACING UNDER X OR DIGIT CONTROL

**Space Suppression or Extra Space under X or D Control—Detail Printing (Figure 63)**

1. The spacing for all cards with a 3 in column 40 will be suppressed by wiring a card cycles impulse through the transferred side of pilot selector 2 to space suppress. The pilot selector is picked up by a 3 wired from the digit selector. If X's are used to control spacing, the column containing the X is wired directly from first reading to the X pickup of the selector.

2. An extra double space will be obtained after all cards with a 1 in column 40 by wiring a card cycles impulse through the transferred side of pilot selector 4 to extra space. The pilot selector is picked up by a 1 wired from the digit selector.

3. An extra double space after an X card may be obtained by wiring the X from second reading through the 11-12 side of a column split directly to EXTRA.

prints. In group printing, double spacing occurs only after intermediate and major totals when followed by minor group indication. These extra spaces are automatic.

In detail printing, with the machine wired to double space, quadruple spacing occurs after each total prints. In group printing, quadruple spacing occurs only after intermediate and major totals when followed by minor group indication.

In group printing, an extra space may be taken after all totals (except when automatic extra spaces are normal) by wiring minor, intermediate and major program exits to EXTRA.

**Extra Space—Total Printing (Figure 64A)**

In detail printing, with the machine wired to single space, double spacing occurs after each total

**Two or More Totals on the Same Line in Two or More Cycles (Figure 64B)**

Two or more program totals may be printed on the same line in as many cycles, by wiring the corresponding program exits to suppress. Spacing is suppressed before the total prints. Printing totals in this manner does not sacrifice the reset

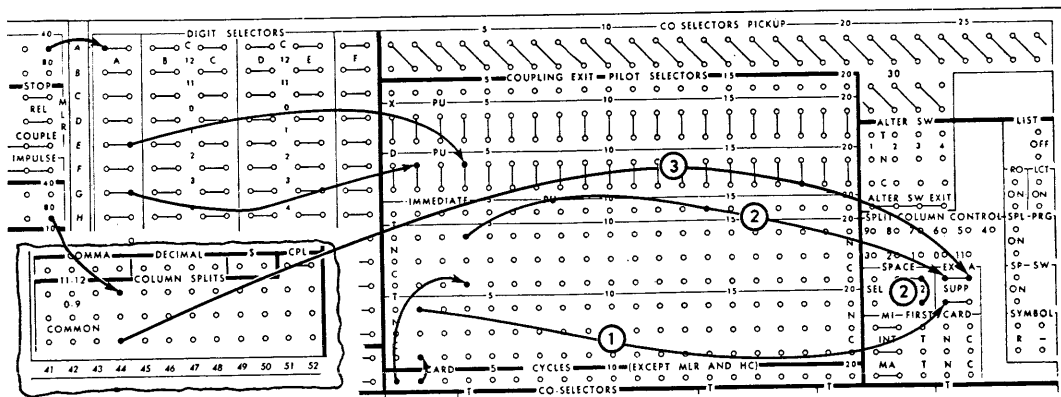

FIGURE 63. SPACE SUPPRESSION; EXTRA SPACE

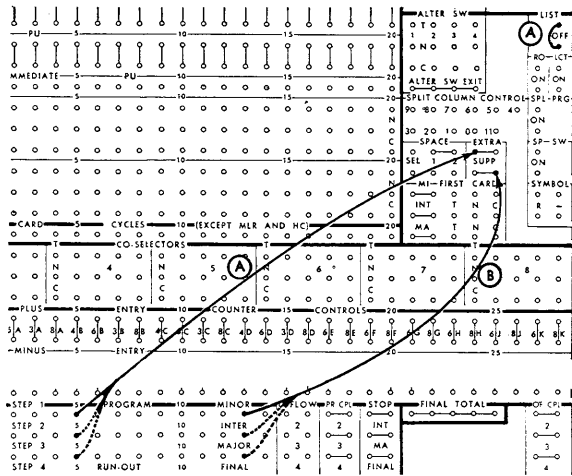

FIGURE 64.

- A. EXTRA SPACE
- B. SPACE SUPPRESSION

check feature of the machine or the ability to transfer totals from one counter to another.

Two or More Totals on the Same Line in One Cycle (Figure 65)

Minor, intermediate and major totals may be printed on the same line in one machine cycle by program couple wiring.

Two or more program totals may be made to print on the same line by joining their couple hubs, through pilot selectors. If minor and intermediate totals are to print on the same line in one cycle, a pilot selector may be picked up from the intermediate comparing exit and couple 1 joined with couple 2 through the transferred side of the selector. If minor, intermediate and major totals are to print on the same line in one cycle, two pilot selectors must be used, one picked up from the intermediate and major comparing exit and one from the major comparing exit only. The couple hubs would then be joined through these selectors. All minor totals are printed normally but when an intermediate program change is recognized, both the minor and the intermediate totals print in one cycle, instead of two, on the same line. By the same reasoning, minor, intermediate and major

totals may be printed in one cycle and on the same line upon detection of a major program change. If the couple hubs were connected directly, intermediate and major counters would clear and print each time minor totals print.

When this method of total printing is used it is not possible to transfer totals from one counter to another, because only one cycle is taken to print all totals. Therefore, the wiring must be from second reading to the counter entry of each of the counters in use, instead of from second reading to the counter entry of the minor counter and from the exits of the minor counter to the exits of the intermediate counter, and so on. The counters must be wired for direct entry and the counter plus and minus functions must be controlled on a card cycle basis. This wiring does not permit the use of additional programs beyond those that are coupled.

The wiring for printing minor, intermediate and major totals on the same line is shown in Figure 65.

1. The amount to be added is wired to the entries of 6, 8 and 16. All three counters are controlled to add from card cycles.

2. Counter 6 is read out and reset on a minor program change, counter 8 on an intermediate program change, and counter 16 on a major program change.

3. The couple hubs of all three levels are connected through pilot selectors as follows: Couple 1 and 2 are connected through the transferred side of pilot selector 5 which is picked up directly from intermediate comparing exit. This allows intermediate totals to print on the same line as the last minor total within an intermediate group. Couple 2 and 3 are connected through the transferred side of pilot selector 6 which is picked up directly from major comparing exit. This allows the major totals to print on the same line as the last intermediate total within a major group. To print the last minor total within a major group on the same line as the intermediate and major totals, it is also necessary to connect couple 1 with couple 2. Since pilot selector 5 will not pick up when there is a major comparing exit but not an intermediate (as

FIGURE 65. PRINTING THREE TOTALS ON THE SAME LINE IN ONE CYCLE

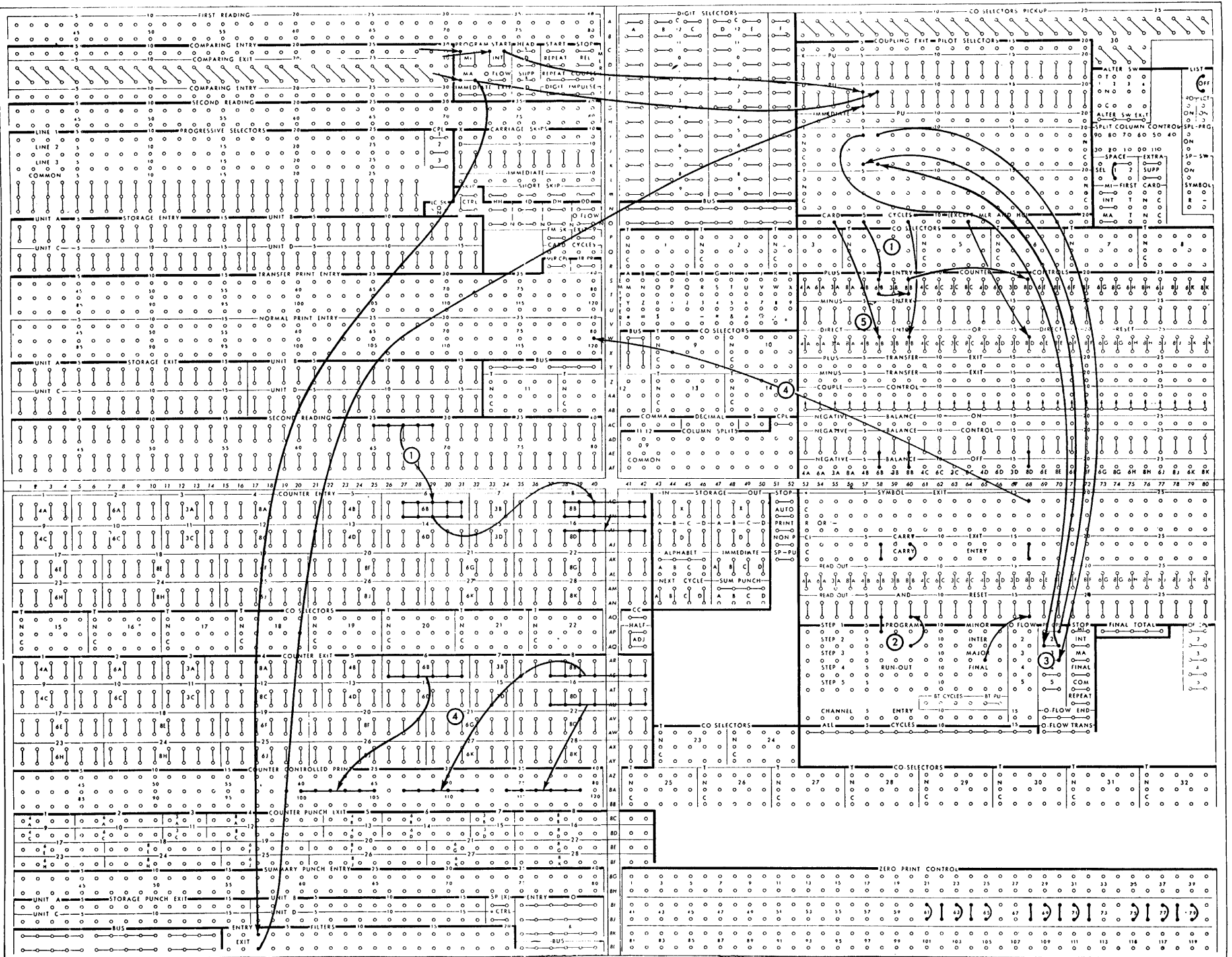

in the case of 25 major, 22 intermediate comparing with 26 major, 22 intermediate), it is necessary to pick up pilot selector 5 also with a major comparing exit through a filter.

4. Minor totals are wired to counter-controlled print 60-65. Intermediate totals are wired to counter-controlled print 67-72. Major totals are wired to counter-controlled print 74-79. The asterisk symbol for 16 is wired to normal print entry 80. The asterisk will print only for major totals.

5. Detail printing from counters 6, 8 and 16 is suppressed by wiring card cycles to the direct entry of those counters. The same card cycles impulse cannot be wired to all three direct entry hubs, since the three counters are being reset on separate program steps.

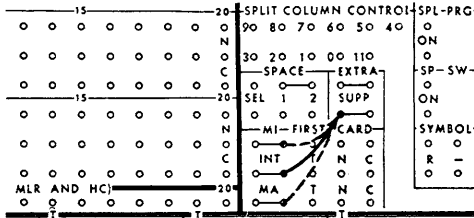

FIGURE 66. FIRST CARD SPACING

First Card Spacing (Figure 66)

Minor, intermediate or major first card hubs may be wired directly to the EXTRA or SUPP hubs.

In single spacing, the normal double space after totals can be controlled to single space by wiring first card minor, intermediate, or major to space suppress. For example:

Table with 2 columns: NORMAL and FIRST CARD SPACE SUPPRESS. It lists various print options like Detail, Minor Total, and Immediate with corresponding wiring connections.

If the first card hubs were wired to EXTRA, an extra space would be taken after the corresponding first card indication.

Expanding the Program Exits

There are 14 exits for each program level. The number of exits may be increased by controlling a co-selector from a couple exit and by wiring all cycles impulses through its transferred hubs. If

one co-selector is used the exits are expanded from 14 to 19.

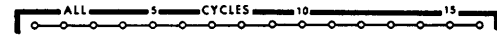

AW, 53-68

All Cycles. Sixteen common all cycles hubs emit cycle control impulses on every machine cycle. They are normally wired to channel entry to provide program exits when special program is wired, or, when properly controlled, as a substitute for card cycles or program exits. All cycles are not active during summary punch cycles or during long carriage skips.

Wiring (Figure 67)

The couple hub for the minor program is wired to the pickup of co-selector 14. All cycles impulses are wired through the transferred hubs of the co-selector to expand the minor program exits from 14 to 19. To expand intermediate, major or run out final program exits, the co-selector is picked up from the couple hubs for these levels.

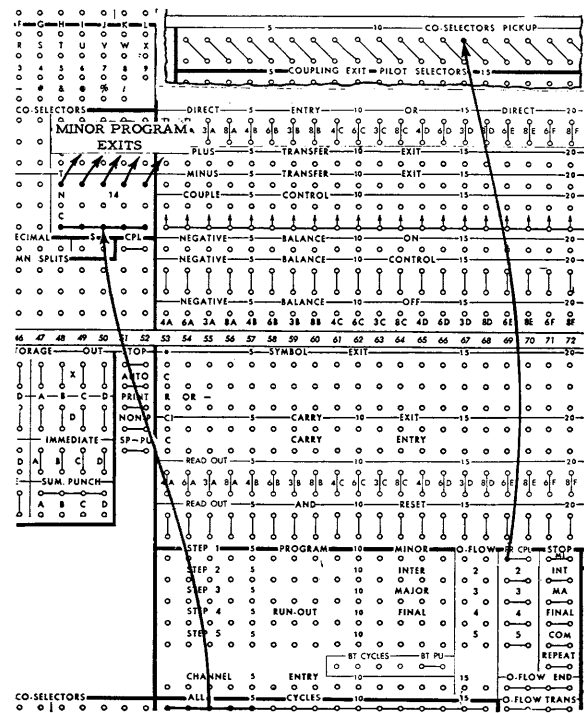

FIGURE 67. EXPANDING PROGRAM EXITS



**TOTAL TRANSFER**

**Total Printing from the Same Print Wheels**

More than one type of total may be printed from the same print wheels without the use of selectors. This operation is sometimes referred to as total transfer, and is based upon the principle of rolling totals, as they are obtained, from one counter to another.

Each total requires a separate counter. Only the minor counter adds or subtracts from the card, however. On the minor program change the minor total prints and rolls into the intermediate counter. On an intermediate program change the intermediate total prints and rolls into the major counter. On a major program change, the major total prints and rolls into a final total counter. Thus, the final total is the sum of all the major totals, the major total is the sum of all the intermediate totals, and the intermediate total is the sum of all the minor totals. This method of accumulating totals provides substantial proof that if the final total is correct, the major, intermediate, and minor totals which contribute to the final total are also correct and that all totals represent the sum of the individual items as printed on the report.

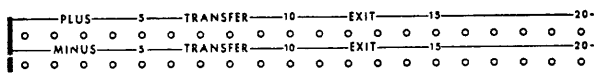

Y-Z, 53-80

**Transfer Exit, Plus and Minus.** Each counter group has transfer exit plus and minus hubs. The transfer exit plus hub emits an impulse whenever the counter is plus and is controlled to read out and reset. It is normally wired to the plus of a receiving counter. The transfer exit minus hub emits an impulse whenever the counter is minus and is controlled to read out and reset. It is normally wired to the minus of a receiving counter. Neither the transfer plus nor the transfer minus hubs will emit an impulse when the counter is controlled to read out only.

The transfer plus or minus exit of a transmitting counter cannot be wired directly to the plus or minus hubs of a receiving counter if the receiving counter hubs are also impulsed from some other source. For example, if counter 1 is

STATE	CO.	CITY	SALES	
1	1	1	500.00	} Minor Totals
		2	200.00	
		3	50.00-	
			650.00 *	} Intermediate Total
	2	1	1,082.75	} Minor Totals
		2	940.50	
		3	300.00	
			2,323.25 *	} Intermediate Total
			2,973.25 **	} Major Total

FIGURE 68

the transmitting counter and 2 is the receiving counter and 2 is wired from card cycles the transfer plus exit of 1 must be wired through a filter before reaching 2. Direct wiring between these two hubs in this instance will allow the card cycles impulse from 2 to back up into the transfer exit hub of 1 and cause 1 to subtract if it reaches transfer plus, or to add if it reaches transfer minus.

Figure 68 illustrates the printing of minor, intermediate and major totals from the same print wheels. It is a group printed report with a minor program on city, an intermediate program on county and a major program on state. All three totals are printed from the same print wheels, the intermediate total being indicated by one asterisk, and the major total by two asterisks.

**Wiring (Figure 69)**

1. Since this is a group printed report, list is wired OFF.
2. Sales amount is wired from second reading to counter entry 6.
3. Returns are identified by an X punch in column 40. This column is wired from first reading to the X pickup of pilot selector 5. A card cycles impulse is wired through the normal side of the pilot selector to the plus of counter 6 and through the transferred side to the minus of counter 6.
4. Counters 6, 8 and 16 are controlled to read out and reset on minor, intermediate and major programs, respectively.

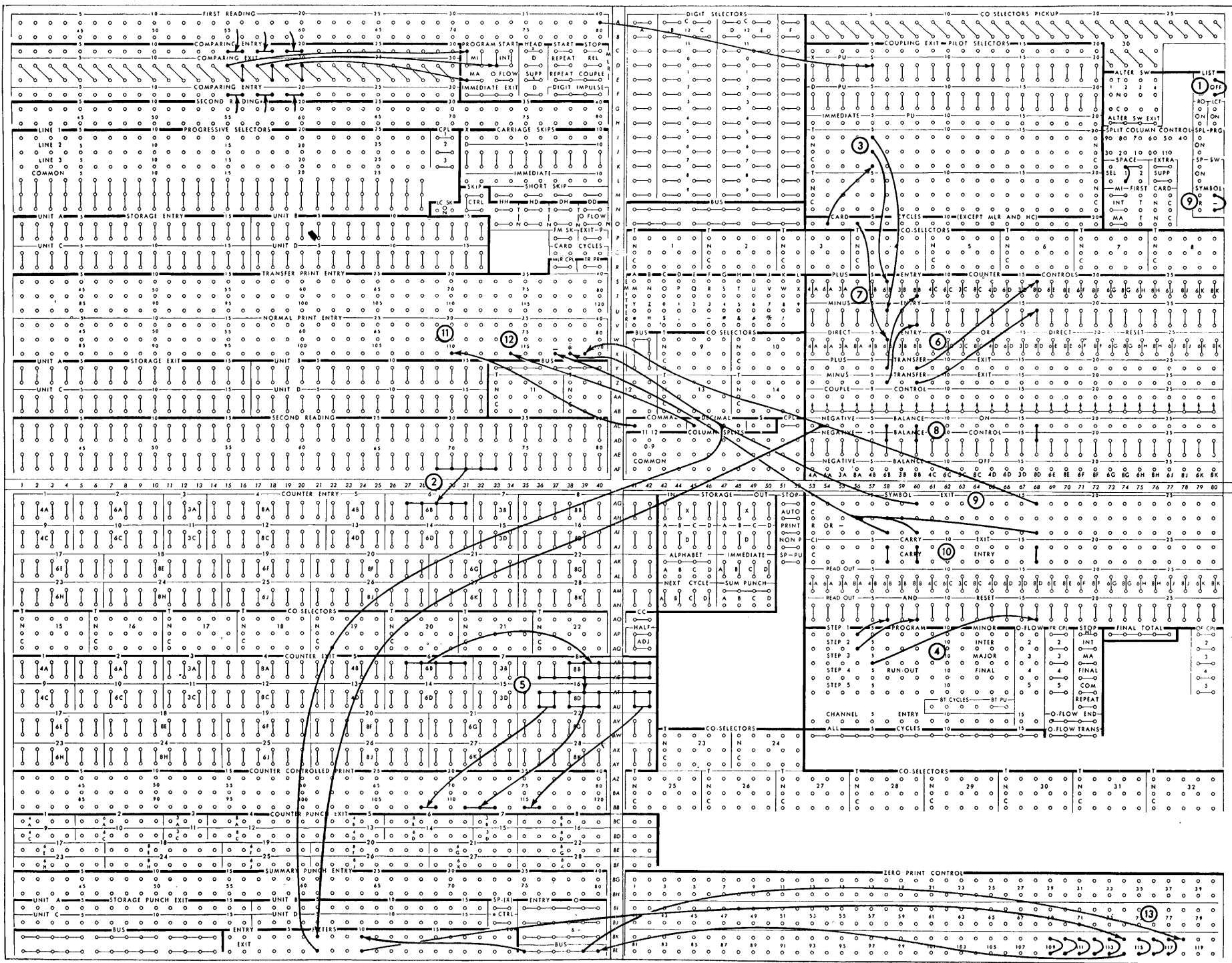

FIGURE 69. TOTAL TRANSFER, SAME PRINT WHEELS

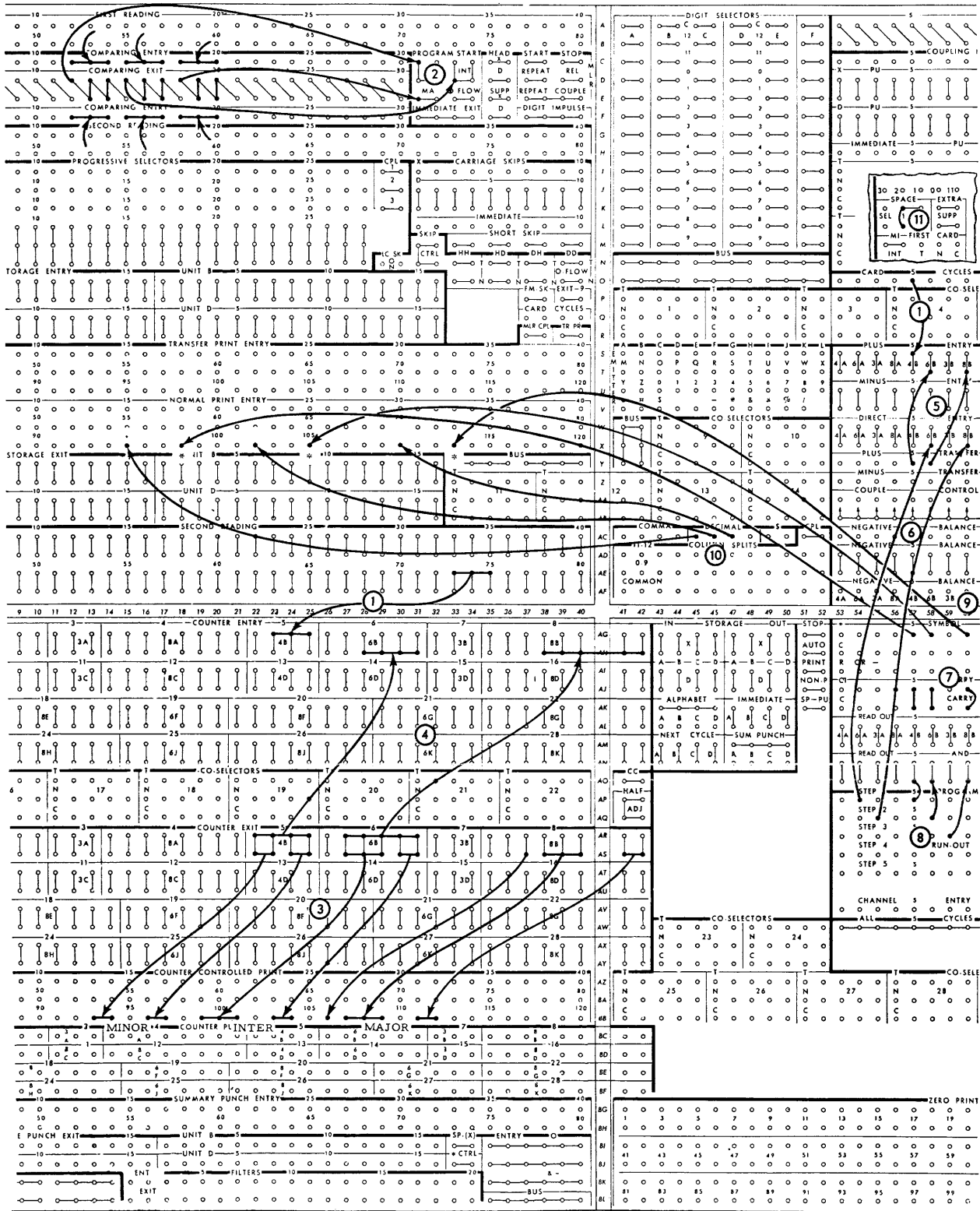

FIGURE 70. TOTAL TRANSFER, DIFFERENT PRINT WHEELS

5. The exit of counter 6 is wired to the exit of counter 8 and the exit of 8 is wired to the exit of counter 16. Counter exit 16 is also wired to counter-controlled print 108-116. Counter 6 is the only counter that will add or subtract each individual card as it passes second reading. Counters 8 and 16 will add or subtract totals only as they are transferred from one counter to the other.

On a minor program, the total prints directly from counter 6, but it also transfers to the intermediate counter 8 where it adds or subtracts according to whether it is plus or minus. The total is always converted as it reads out, so a true figure will always be transferred.

On an intermediate program the intermediate total prints from counter 8 and transfers to the major counter 16, where it will add or subtract according to whether it is plus or minus.

On a major program, the major total prints from counter 16.

Transfer between counters is made over wires connecting counter exits, when the counters are impulsed to read out and reset.

6. When minor totals are transferred from counter 6, they are either added or subtracted into counter 8 by wiring the transfer plus exit of 6 to 8 plus, and the transfer minus exit of 6 to 8 minus.

When intermediate totals are transferred from counter 8 they are either added or subtracted into 16 by wiring the transfer plus exit of 8 to 16 plus, and the transfer minus exit of 8 to 16 minus.

7. Since the report is group printed, printing from 6 exit must be suppressed during detail print cycles. This is done by wiring a card cycles impulse to the direct entry of 6, thus causing the counter exits to be disconnected from counter entry during card reading cycles. This wiring would not be necessary if the report were detail printed.

8. Negative totals of all three counters are wired for conversion.

9. A minus sign is printed from print wheel 117 for a negative minor, intermediate or major total by wiring the R or - hubs for the minor, intermediate, and major counters to normal print entry 117 which must be wired for zero print control.

These symbols will not print on the indication cycle because counter 6 is wired for direct entry. The R or - symbol switch is set for minus.

One asterisk is printed for all intermediate totals by wiring from the asterisk symbol exit of counter 8 to normal print entry 118. Two asterisks are printed for all major totals by split wiring from the asterisk symbol hubs of both 8 and 16 to normal print entry 118 through a filter and to 119 direct. The purpose of the filter is to prevent two asterisks from printing on the intermediate cycle.

10. CI and C are wired normally.

11. A comma is wired to normal print entry 110.

12. A decimal is wired to normal print entry 114.

13. Zero print control is wired for 109-117. The decimal point in 114 is printed to the left as well as the right of significant digits by wiring the lower hubs of 114 through a set of bus hubs to the upper hub of 117. It is also wired to the upper hub of 113 by way of a filter.

#### Total Printing from Different Print Wheels

Minor, intermediate and major totals can be total transferred and also total printed from different print wheels. The difference between the wiring for this and the previous example is that the counter exits of the transferring counters must be wired to counter entries of receiving counters. Wiring from exit to exit would cause detail or total printing in three places, from any one counter.

#### Wiring (Figure 70)

1. The field to be added is wired to counter 5 entry and the counter is impulsed to add.

2. Minor, intermediate and major program starts are impulsed.

3. The minor total prints from print wheels 93-97 from counter 5 exit. The intermediate total prints from print wheels 99-104 from counter 6 exit. The major total prints from print wheels 106-112 from counter 8 exit.

FIGURE 71. THREE-FIELD CROSSFOOTING

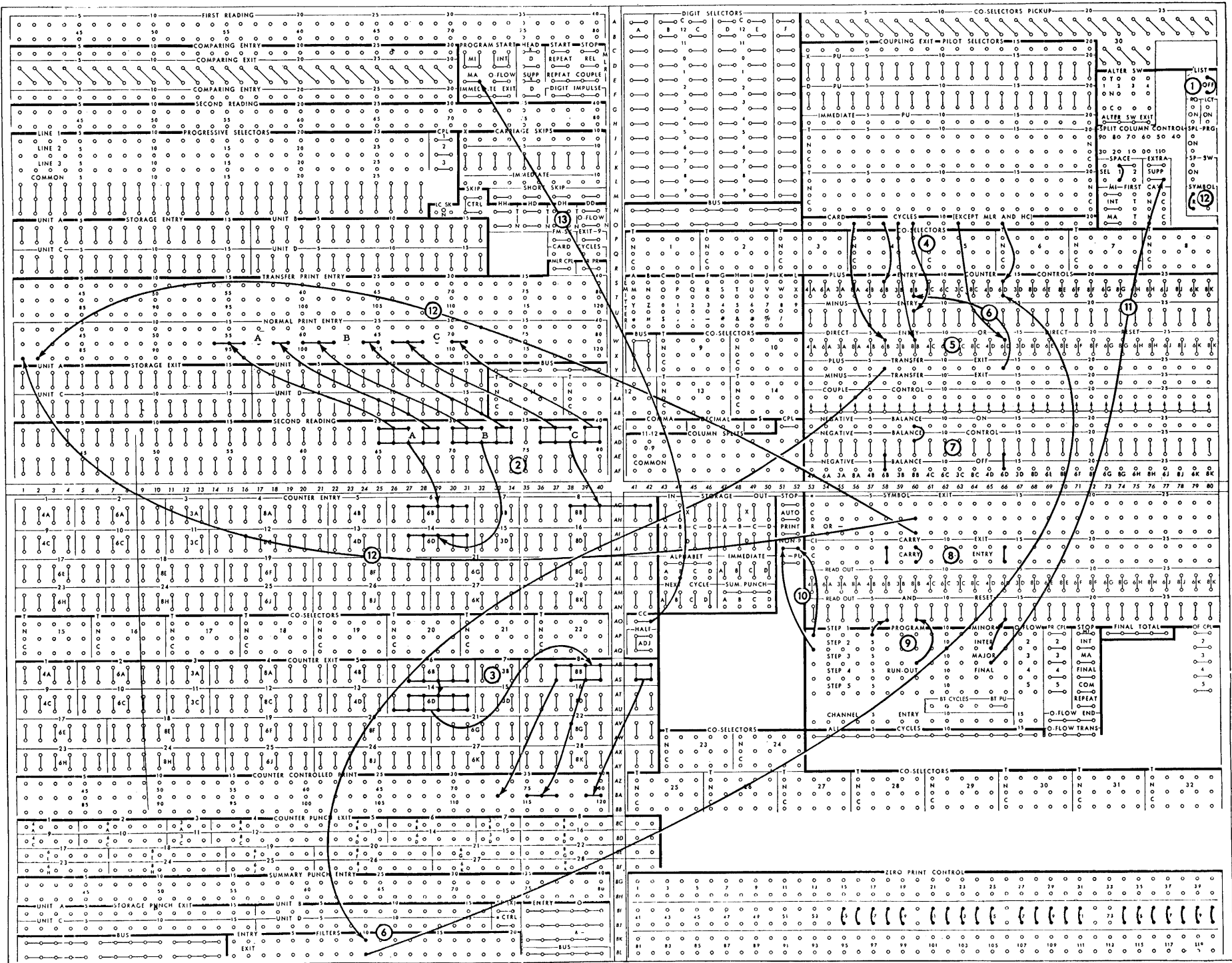

4. Counter 5 exit is wired to 6 entry so that when the minor total is read out to print it can also add in the intermediate counter 6. Counter 6 exit is wired to counter 8 entry so that when the intermediate total is read out to print it can also add in the major counter 8.

5. Transfer plus exit of counter 5 is wired to the plus of counter 6 so that minor totals will be added in the intermediate counter. Transfer plus exit of 6 is wired to the plus of 8 so that intermediate totals may be added in the major counter.

6. To prevent the printing of minor totals from the intermediate counter exits, a minor program exit is wired to the direct entry of 6. To prevent the printing of intermediate totals from the major counter exits, an intermediate program exit is wired to the direct entry of 8. This wiring disconnects the exits from entries of 6 while the minor total is being added into 6 and the exits from entries of 8 while the intermediate total is being added into 8.

7. CI and C are wired normally.

8. Counters 5, 6 and 8 are wired to read out and reset on their respective programs.

9. Asterisk symbols are wired to identify each total.

10. A decimal is wired between the tens and hundreds position of each total.

11. The single space switch is wired.

Although the zero print control wiring is not shown, it should follow the pattern previously described for the printing of zeros and decimals.

#### CROSSFOOTING

$$\pm A \pm B \pm C = \pm R$$

CROSSFOOTING may be done on the Type 407 either from individual cards or from a group of cards by rolling factors or totals from one counter to another on separate program steps. If special program is not used, three program steps are available for crossfooting. With special programming, as many steps as desired may be taken for each of the three program levels.

Three fields can be crossfooted from each card by entering the fields into three different counters as the card is read at the second reading station. The minor program is used for crossfooting the first two fields and the intermediate program for crossfooting the total of the first two fields with the third field. The major program is used to print the result.

By impulsing major program start with a cycle count, all three levels will be operative for every card. Although the counters will be cleared as the totals are rolled from one to another, printing from all except the major counter will be suppressed by the use of non-print.

Fields to be crossfooted may always be added into the receiving counter, always subtracted, or sometimes added and sometimes subtracted, under the control of a designating X or digit. This example shows three-field crossfooting, always adding two factors and always subtracting a third ( $A + B - C = R$ ).

#### Wiring (Figure 71)

1. This is a group printed report, therefore list is wired OFF.

2. Field A is entered into counter 6, field B into counter 14 and field C into counter 8. These three fields are also wired from second reading to normal print entry with spaces left for decimal printing. The decimal wiring is not shown in this example.

3. All three counter exits are connected to provide a path for rolling counters from one to the other. The exit of counter 8 is wired to print the result, allowing a space for decimal printing.

4. A card cycle impulse is wired to the plus of 6 and 14 and to the minus of 8.

5. Detail printing from all counters is prevented by wiring independent card cycle impulses to the direct entry of each counter. The same card cycle impulse cannot be wired to all three direct entry hubs, since the three counters are being reset on different program steps.

6. The transfer plus exit of 6 is wired to the plus of 14. It must be wired through a filter, how-

ever, since a card cycles impulse is already wired to 14 plus. If the transfer plus 6 were wired directly to 14, the card cycles impulse of 14 would back into the transfer plus of counter 6, and counter 6 would attempt to add and subtract simultaneously. The filter prevents this back-circuit. Transfer plus exits emit an impulse when the counter is plus, at the time the counter is read out and reset. Since 6 is read out and reset on a minor program, factor A will read out of 6 and add in 14.

The transfer plus exit of 14 is wired to the plus of 8. Since 8 is read out and reset on an intermediate program, the sum of A and B will read out of 14 and add to the minus figure in 8.

7. Because the result in counter 8 could be minus, negative balance ON is wired to negative balance control for the purpose of converting complements to true figures. Negative balance OFF is wired to 6 and 14 negative balance control to prevent the printing of 9's for possible zero balances.

8. CI and C are wired normally.

9. Counter 6 is read out and reset on a minor program, 14 on an intermediate program and 8 on a major program.

10. Both printing and spacing for the minor and intermediate program levels are suppressed by wiring the corresponding program exit hubs to non-print.

11. The major program is used to print the result from 14. To print the total on the same line as the indication, major program exit is wired to space suppress. Normally, in group printing, the minor total prints on the same line as the indication, the intermediate total one line below the indication, and the major total two lines below the indication. Since the spacing for the intermediate transfer is suppressed in this example, the cross-footed total would normally print one line below the indication.

12. Negative crossfooted totals are identified by CR symbols.

13. The cycle count impulse is wired to major program start. This wiring will force all three programs to be taken for each card, since a major program start forces both a minor and intermediate program.

Crossfooting three totals at the end of a group may be done by wiring a comparing exit impulse to major program start.

#### MULTIPLE X OR DIGIT SELECTION

WHEN A SINGLE card field is used for punching amounts or other quantitative data for different types of transactions, each transaction must be distinguished from the others by an identifying punch. In Figure 72, quantities for six different transactions are punched in the same field of the card. Five transactions are identified by significant X punches; the sixth is identified by NX. These distinguishing punches are used to control the plus or minus functions of seven counters.

A counter is required for each quantitative column on the report. Each counter adds or subtracts according to the requirements of the report columns. For example, the on hand total is determined by adding the previous balance, receipts, and returns and by subtracting requisitions. Only the X distribution and the counter coupling wiring is shown.

#### Wiring (Figure 73)

1. Pilot selector 1 is picked up from an X21 representing an old balance card, pilot selector 2 from X24 representing receipts, pilot selector 3 from X25 representing returns, pilot selector 4 from X26 representing requisitions, and pilot selector 5 from X22 representing minimum inventory. These columns are wired from first reading.

Digits as well as X's may be used to control the pilot selectors. The column containing the digit is wired from first reading to the C of a digit selector and the controlling digits to the D pickup hubs of the pilot selectors.

2. A card cycles impulse is wired through the selectors as follows: Through the transferred side of pilot selector 1 to add old balance in 2 and 3, which are coupled. Through the transferred side of pilot selector 2 to add receipts in 4. Through the transferred side of pilot selector 3 to subtract returns in 6 and 7, which are coupled. Through the transferred side of pilot selector 4 to add requisitions in 6 and 7, which are coupled, and to subtract requisitions in the on hand counter 8.

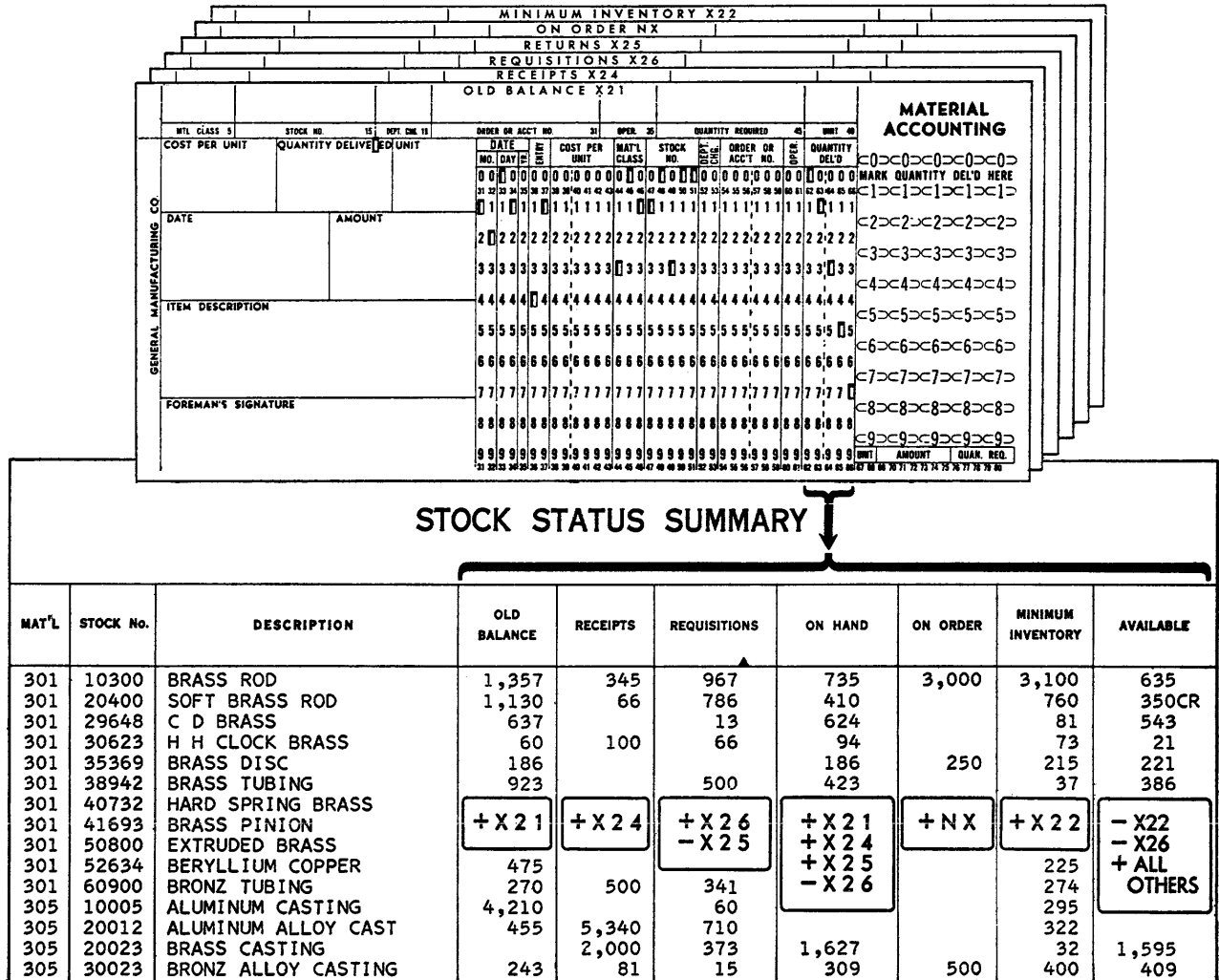

FIGURE 72

Through the transferred side of pilot selector 5 to add minimum inventory in 12.

A card cycles impulse is wired through the normal hubs of each selector and is available out of the normal side of selector 5 if a card does not contain any X punch. It is used to add on order cards in 9 and 10, which are coupled.

3. A card cycles impulse is wired through the transferred side of the first three pilot selectors to add old balance, receipts and returns in the on hand counter 8. A card cycles impulse is wired through the transferred side of the fourth and fifth selectors to subtract requisitions and minimum inventory in the available counter — 14 and 15 coupled. All other cards add in 14 and 15.

4. Couple control is connected for the low order

counter of each coupled group. The couple control has two functions:

- To allow a zero test to be made in both parts of the coupled counter.
- To prevent punching credit X's from any but the high order counter of a coupled group in summary punching.

5. All coupled counters that are subtracting (6-7 and 14-15) have the negative balance ON of the highest order counter wired to the negative balance control of both counters to convert possible negative balances to true figures.

All coupled counters that are not subtracting (2-3, 9-10) have the negative balance OFF of the



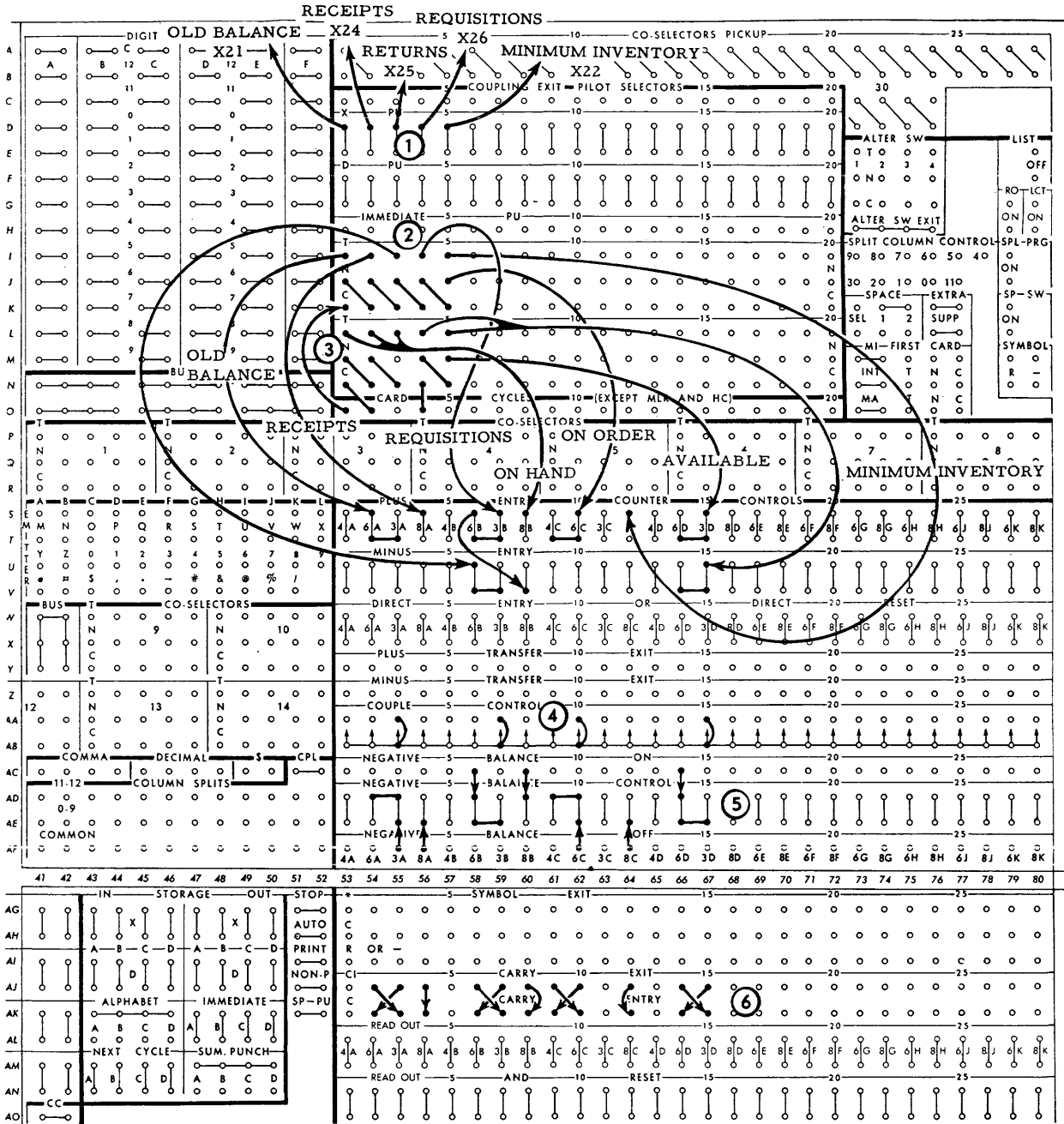

FIGURE 73. MULTIPLE X DISTRIBUTION

low order counter wired to the negative balance control of both counters to prevent the printing of 9's for zeros when nothing is added. Single counters (4 and 12) are adding only, and have their negative balance OFF hubs wired to negative balance control to prevent the printing of 9's for zeros when nothing is added.

6. Single counter 8 is adding and subtracting and has negative balance ON wired to negative balance control. For coupled counters the CI of the high order counter is connected to the C of the low order counter and all remaining CI to C hubs are connected. For single counters, CI and C of the same counter are connected.

RECOGNIZING NEGATIVE AND ZERO BALANCES

THE NEGATIVE balance ON hubs have been described previously as emitting an impulse at the end of the cycle during which the counter goes negative and for every cycle thereafter as long as the counter remains negative. The negative balance OFF hubs emit an impulse at the end of the cycle during which the counter reaches a zero balance and for every cycle thereafter as long as the counter remains at zero.

Both the ON and the OFF hubs are timed exactly alike. The ON hub is normally wired to negative balance control to cause conversion of a complement figure. The OFF hub is normally wired to negative balance control to cause a zero balance to read out as zero instead of 9's. These hubs may also be used to control such functions as:

1. Changing from detail print to group print whenever a counter changes from positive to negative or when it zero balances.
2. Changing from group print to detail print whenever a counter changes from positive to negative or when it zero balances.
3. Stopping the machine one cycle after a counter turns negative or zero balances.
4. Causing a program to be initiated one cycle after a counter turns negative or zero balances.
5. Causing information to be read out of storage when a counter turns negative or zero balances.

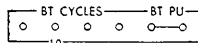

AU, 61-66

**BT (Balance Test) CYCLES — BT-PU.** A cycles impulse, such as card cycles, all cycles, program exits, etc., wired through a selector picked up from negative balance OFF or ON will damage the selector. This may be avoided by the use of BT (balance test) cycles impulses. The four independent BT cycles hubs are made active only when BT-PU is impulsed. If an all cycles im-

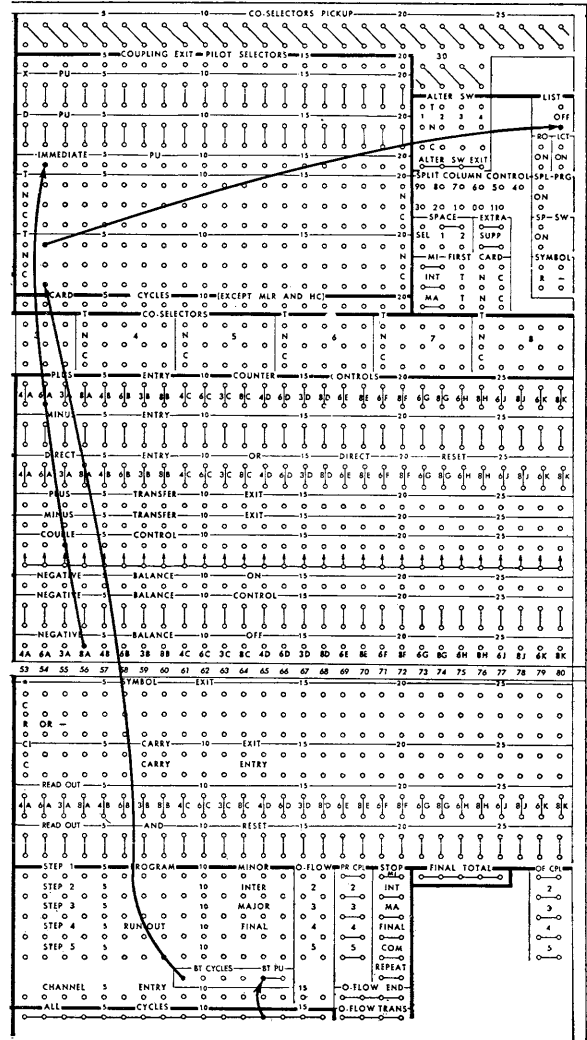

FIGURE 74. CHANGING FROM DETAIL TO GROUP PRINT ON A ZERO BALANCE

pulse is wired to BT-PU, the BT cycles hubs emit an all cycles impulse suitable for selection. If a program exit is wired to BT-PU, the BT cycles hubs emit a corresponding program cycles impulse suitable for selection.

Any digit, X or 12 may be wired to BT-PU, in which case the BT cycles will begin shortly after BT-PU is impulsed and continue for the duration of an all cycles impulse. Thus if the digit 6 were wired to BT-PU, the BT cycle would begin shortly after 6 time and continue through the second half of the cycle.

Wiring, Changing from Detail to Group Print on Zero Balance (Figure 74)

The machine may be wired to change from detail print to group print on the cycle following the detection of either a negative or a zero balance.

The negative balance OFF hub of counter 4 is wired to the I pickup of pilot selector 2. Normally, when a pilot selector is controlled from its I hub, it will pick up immediately and drop out at the end of the same cycle. The negative balance ON and OFF impulses come so late in the cycle that the selector will pick up for the following cycle and drop out at the end of that same cycle. The D pickup hubs cannot be wired from negative balance ON or OFF because the selector would pick up and drop toward the end of the same cycle and therefore would be of no use in controlling machine functions.

The lower list OFF (entry) hub is impulsed from BT cycles through the transferred side of pilot selector 2 so that the machine, which normally detail prints, will group print as long as counter 4 remains negative. The BT-PU is wired from all cycles. It is only necessary to wire from the normal side of pilot selector 2 to change from group print to detail print on a zero balance. The upper list OFF (exit) hub should not be used because it is not a properly timed impulse for selector use.

STOP AND AUTOMATIC STOP

THE TYPE 407 may be wired to stop for two different predetermined conditions during the same run of the cards, by means of control panel wiring. One of the stops may be identified by a stop light.



AG-AH, 51-52

**Stop.** The two common stop hubs receive card cycles, all cycles, comparing exit, digit, X, 12, program exit, first card impulses and skip control exits, such as HH, HD, etc., to stop all machine operation at the end of the cycle during which the impulse is received. When they receive negative balance ON or OFF impulses, the

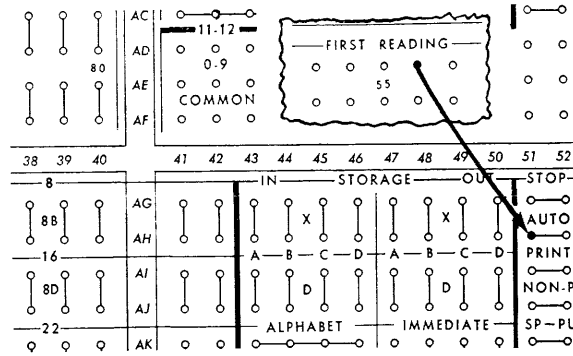

FIGURE 75. STOPPING FROM X OR DIGIT PUNCH

machine stops at the end of the following cycle. The machine is restarted by depressing the start key.

**Auto Stop.** These hubs are essentially the same as the stop hubs except that an automatic stop light turns on when the machine stops. Another exception is that when immediate exit or skip control exit, such as HH, HD, etc., is wired to auto stop, the machine stops at the end of the following cycle and not at the end of the cycle during which the impulse is received. The purpose of the light is to distinguish one stop from the other when two stops are used. The machine is restarted and the light extinguished by depressing the start key.

Stopping from an X or Digit Punch (Figure 75)

If an X or digit is wired to stop or auto stop, the machine will stop before the card prints if wired from first reading, after the card prints if wired from second reading. This would normally be

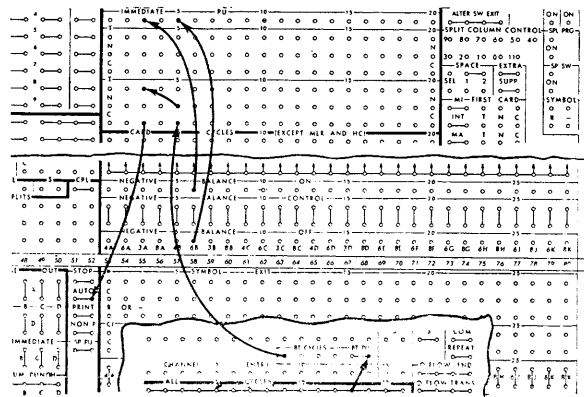

FIGURE 76. STOPPING FROM NEGATIVE BALANCE

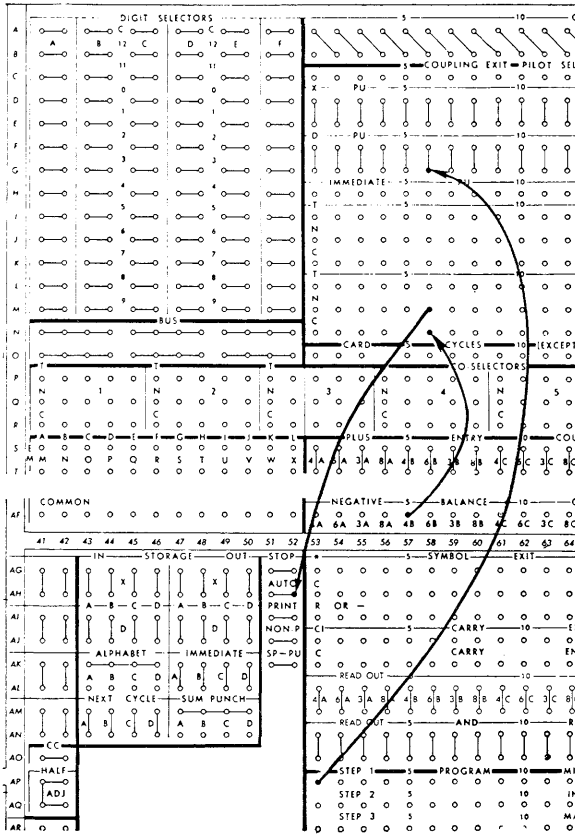

FIGURE 77. STOPPING FROM ZERO BALANCE

done through column splits or digit selectors. When auto stop is wired, the automatic stop light turns on. The machine may be restarted by depressing the start key.

Stopping from Negative Balance (Figure 76)

A negative balance is recognized by a 9 in the high order position of a counter. Because a zero balance also contains a 9 in the high order position, the negative balance ON hub cannot be wired to auto stop directly. If it were, the machine would stop both for a negative balance and for a zero balance.

Since only a negative balance stop is desired, the negative balance ON of 8 is wired to the I pickup of pilot selector 3 and the negative balance OFF of 8 is wired to the I pickup of pilot selector 5. A BT cycles impulse is wired through the normal side of selector 5 and the transferred side of se-

lector 3 to auto stop. When a zero balance occurs, selector 5 will be transferred and the BT cycles cannot reach auto stop.

When the stop hubs are impulsed from negative balance ON, the machine stops one cycle after the counter turned negative.

Stopping from Zero Balance (Figure 77)

Since a zero balance is determined by the presence of 9's in all positions of the counter being tested, the negative balance OFF of counter 5 is wired through the normal side of pilot selector 6 to auto stop. The selector is transferred by a minor program wired to its D pickup. This prevents the negative balance OFF from reaching auto stop on all zero conditions resulting from counter reset on

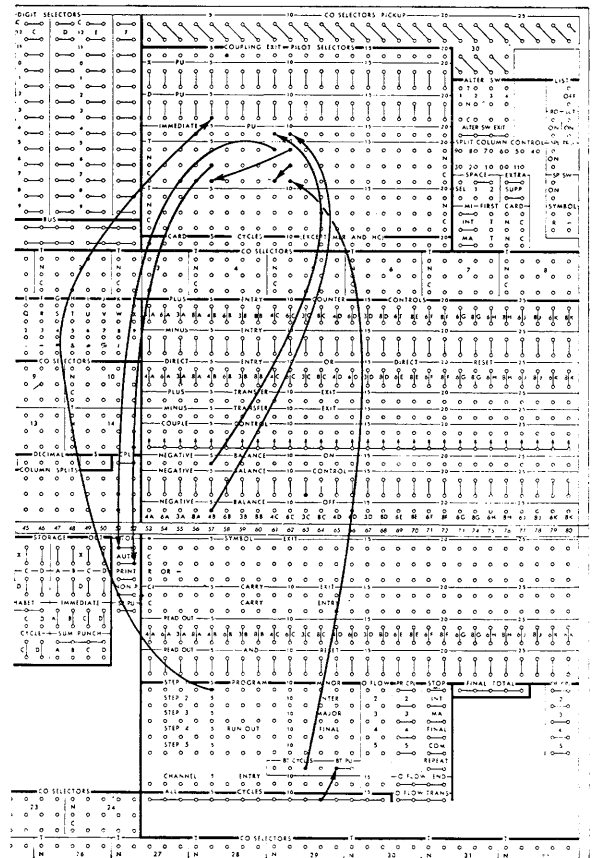

FIGURE 78. REGULAR STOP FOR NEGATIVE BALANCE, AUTO STOP FOR ZERO BALANCE

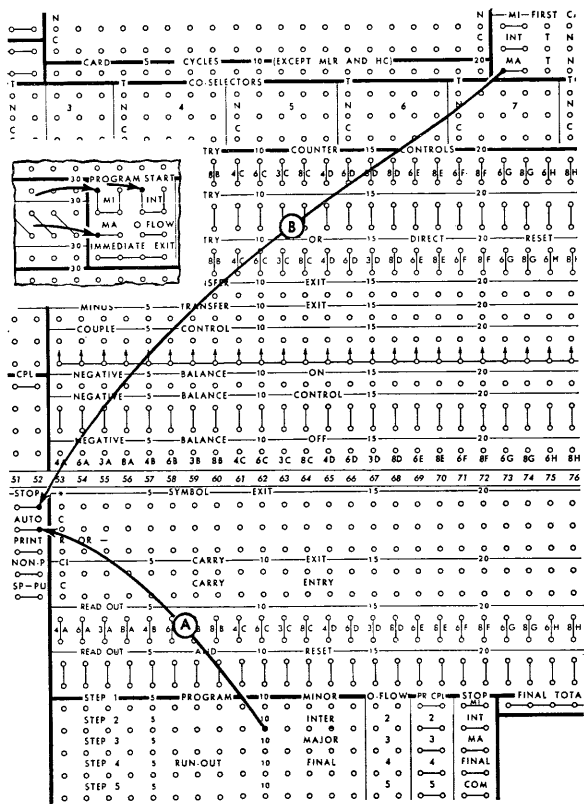

FIGURE 79 A AND B. STOPPING FROM PROGRAM EXIT OR FROM FIRST CARD

a minor, intermediate, or major program, except on the run-in.

**Regular Stop for Negative Balances and Auto Stop for Zero Balances (Figure 78)**

The immediate pickup of pilot selector 9 is wired from the negative balance ON of counter 5. The immediate pickup of pilot selector 10 is wired from the negative balance OFF of counter 5.

BT cycles is wired through the normal side of pilot selector 10 (no zero balance) and the transferred side of pilot selector 9 (negative balance) to stop. This wiring stops the machine without the stop light for negative balances only, at the end of the following cycle. BT-PU is wired from all cycles.

The D pickup of pilot selector 5 is wired from minor program. BT cycles is wired through the transferred side of pilot selector 10 (zero balance) and through the normal side of pilot selector

5 to auto stop. This wiring stops the machine and turns on the stop light for all zero balances, at the end of the following cycle.

**Stopping from a Program Exit (Figure 79A)**

When a program exit is wired to either stop or auto stop, the machine stops after the corresponding total prints. In the example shown, intermediate program exit is wired to auto stop. When an intermediate program change occurs, the machine will stop after the intermediate total prints, and the automatic stop light will turn on.

**Stopping from a First Card Impulse (Figure 79B)**

Minor, intermediate, or major first card may be wired directly to stop or auto stop. In the example shown, major first card is wired to stop, causing the machine to stop after the first card of a major group prints.

**SPLIT COLUMN CONTROL**

WITH SPLIT COLUMN control (Figures 80 and 81), multiple punching in one column can be split between any two punching positions. It differs from normal column split (which is always between 0 and X) in that the split may be between 9 and 8, 0 and X, etc. There is a hub for all the digits 9 through 0 and for 11. They emit impulses at half after the number indicated. For example, 9 emits an impulse between 9 and 8; 0 emits an impulse between 0 and 11.

The split column control hubs are normally wired to a selector pickup (immediate), making the selector operate the same as a column split de-

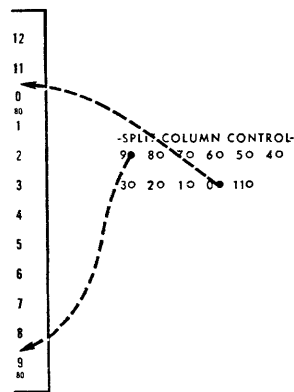

FIGURE 80. SPLIT COLUMN CONTROL

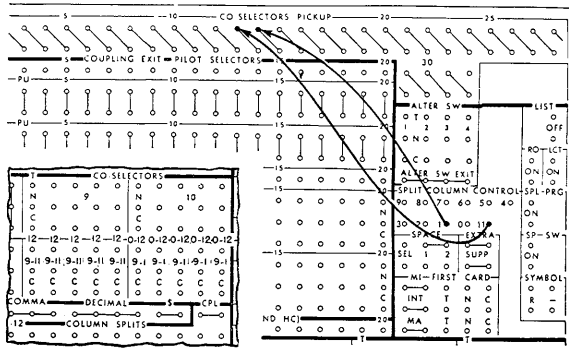

FIGURE 81. SPLIT COLUMN CONTROL

vice. For example, if a 1 is wired to a selector I (immediate) pickup, the C and N hubs of the selector are common from 9 through 1, and the C and T hubs are common from 0 through 12. Thus, zone impulses may be separated from digit impulses punched in the same column. If the 0 is wired to the selector I pickup, the C and N hubs are common from 9 through 0 and the C and T hubs are common for 11 and 12. This arrangement is the same as a normal column split. A column may be split between 11 and 12 by using the 11 hub as a pickup for the selector.

STORAGE UNITS

THE TYPE 407 provides four 16-position storage units (A, B, C, D) that allow up to 64 positions of numerical or 32 positions of alphabetic information to be stored from the card, from the emitter, or from a counter. Information may be read into or out of the storage units at will, under the control of a digit, an X punch, a card cycles impulse, a program exit and certain types of carriage impulses. Each group may store letters, digits and three of the special characters: minus (-), ampersand (&), and diagonal (/). The remaining 8 special characters include combination codes (8-3, 8-4) and, therefore, cannot be wired directly to storage units.

The storage units are used for such functions as:

- a. Storing information to be printed on sheet headings after an overflow, in order to duplicate the name and address on all subsequent forms.

- b. Increasing usable card columns for detail information by storing name, city and state which may be printed at will.
- c. Storing alphabetic or numerical information so that it may be simultaneously read out and printed line by line with the detail information from the card.
- d. Storing information to be summary punched.
- e. Storing information that is to be group indicated.
- f. Storing columnar heading information so that blank unruled forms can be headed merely by reading out of storage for each new sheet.

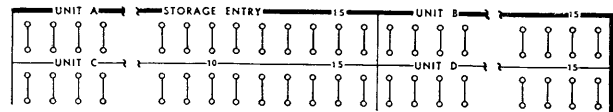

O-R, 1-32

*Storage Entry.* These hubs are the entries to the four storage units, A, B, C, and D. Each unit has 16 positions. Information may be stored from the card, a counter, or character emitter. Storage units accept information only during the first part of the cycle. Each storage unit can store 16 positions of numerical information or 8 positions of alphabetic information. Alphabetic information is always wired to the left-hand 8 positions of a storage unit. The digit impulses are stored in the first 8 positions and the zone impulses are stored in the last 8 positions.

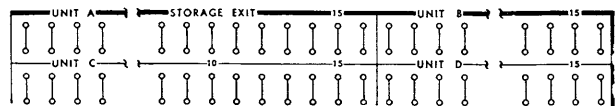

Y-AB, 1-32

*Storage Exit.* Each storage entry position has a corresponding storage exit hub. Information from the storage units may be printed from normal print entry or the transfer print entry by wiring to these hubs from storage exit. Storage exits should not be wired to counter-controlled print, since these hubs emit impulses during the second half of the cycle. Informa-

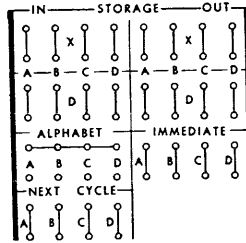

AG-AN, 43-46;  
AG-AL, 47-50

tion from storage units may be entered into counters by wiring from storage exit to counter entry. When alphabetic information is to be read out of storage, only the first 8 storage exit positions may be wired.

**Storage In, X and D.** There are two common X and two common D IN hubs for each of the four storage units. An X or digit impulse reaching these hubs causes the storage units to accept information on the following *card feed cycle*. If the X or D were wired from a card at first reading, information would be accepted by the storage unit as the same card is read at the second station, whether that information be from the emitter, a counter, or from the card itself. The D hub may also be wired from card cycles, all cycles, carriage exit, or program exit, to operate the unit on the following card feed cycle. The X hubs accept only X, 12, or carriage exit impulses. All storage units restore during the last half of the cycle in which they are impulsed. By wiring the X or D impulses from first reading, the units have time to restore before accepting new information at the second reading station.

**Storage In, Next Cycle.** There are two common hubs for each storage unit which accept digit, card cycle, all cycles or program exit impulses to cause the storage units to accept information on the following *machine cycle*. The difference between these hubs and the IN D hubs is that they cause the storage units to operate on the following *machine cycle* rather than the following *card feed cycle*. For this reason, they cannot be used if the next cycle is a summary punch or a long carriage skip cycle. They are normally wired from program exits to perform the following functions:

- a. Read in information from the first card of a group for overflow sheet identification.
- b. Read in factors to be crossfooted, thus saving counters that would normally be used for this purpose.

As for the X and D IN hubs, an impulse to next cycle causes the corresponding unit to be cleared so that new information may be entered on the following cycle.

**Storage Out, X and D.** There are two common X and two common D OUT hubs for each of the four storage units. An X or digit impulse reaching these hubs causes the storage units to read out on the following *card feed cycle*. If the X or D is wired from a card at first reading, the storage unit would read out as the same card is read at second reading, provided it is not an MLR card. Besides digits, the D hubs also accept card cycles, all cycles, carriage exit, or program exit impulses to cause a read-out on the following card feed cycle. The X hubs also accept 12 or carriage exit impulses. The storage units are not cleared on a read-out, and therefore information stored in them may be read out as often and whenever desired. Storage units clear only upon entry.

**Storage Out, Immediate.** There are two common immediate hubs for each storage unit. They accept any impulse to cause the storage units to read out immediately. They are normally wired from program exits or card cycles to cause the storage unit to read out on the same cycle. One example of their use would be to identify minor, intermediate and major totals with some descriptive information by reading this information out of the storage units on minor, intermediate, and major programs. BT cycle impulses can be controlled through the normal side of a pilot selector to immediate out so that the storage unit will not read out for zero or negative balances. The selector is picked up immediately from negative balance OFF or ON.

**Storage, Alphabet.** Whenever alphabetic information is to be stored in a storage unit, the corresponding couple entry hub (lower) must be connected to one of the four common exit hubs

above it. The exit hubs emit an impulse from 0 to 12 time.

Whenever the alphabet couple hubs of a storage unit are connected, the capacity of that unit is reduced from 16 numerical positions to 8 alphabetic positions. Wiring into or out of the storage unit must be confined to the left-hand eight positions. The right-hand positions are internally connected to accept the zone impulses directed to them by the left-hand eight positions.

#### Reading into and out of Storage under Control of an X or Digit

In the payroll register shown in Figure 82, some employees have special notes indicating what disposal is to be made of their pay checks. These notes are not punched in the employee's payroll card and therefore must be printed from some other source. One source is from the character emitter properly controlled through co-selectors. Another source is the emitter properly controlled through the storage units. Only two notations are shown, *mail* and *hold*. The word *mail* will be stored in one storage unit and the word *hold* in another. A significant X or digit for each will be punched in the employee's payroll card to cause one or the other of the storage units to read out.

#### Wiring (Figure 83, Page 88)

1. The word *hold* is wired from the emitter to

DATE			
NET PAY	CHECK NUMBER	EARNINGS TO-DATE	NOTES
4939	12208	61806	
6619	12209	76930	MAIL
5556	12210	69520	
4795	12211	40540	
8254	12212	110206	MAIL
4837	12213	70215	HOLD
5505	12214	69120	
5003	12215	49650	
6058	12216	91642	MAIL

FIGURE 82

the left-hand four positions of storage entry A, which is wired for alphabetic couple.

2. The word *mail* is wired from the emitter to the left-hand four positions of storage entry B, which is wired for alphabetic couple.

3. Entry into storage units A and B is made under the control of an X in column 80, wired from first reading to X IN of both units. This X may be punched in a leader card. Entry could also be made under the control of minor, intermediate or major first card.

4. The left-hand four positions of storage exits A and B are wired to normal print entry 111-114. One or the other will print, never both at the same time.

5. Column 40 is wired from first reading to the C of digit selector B. Whenever there is a 1 in column 40 the word *hold* will print. The 1 from digit selector B is wired to the D OUT hub of storage unit A, causing the storage unit to read out the stored information on the following cycle. This does not clear the unit, and the stored information may be read out as often as desired.

6. Whenever there is a 2 in column 40 the word *mail* will print. The 2 from the digit selector B is wired to the D OUT hub of storage unit B, causing the storage unit to read out on the following cycle. This does not clear the unit and the stored information may be read out as often as desired.

#### Storage Units as a Substitute for Counters

Although storage units can neither add nor subtract, they may be used as a substitute for counters, by storing a total that a counter has accumulated along with the sign of that total. The counter can then reset and accumulate another total, to which is added the previous total in the storage unit. The sum of the two totals, along with its sign, is then transferred back to storage and the process is repeated.

To demonstrate the principle of this operation, one counter and one storage unit will be used to print both minor and final totals. Normally two counters are required. Every minor program change requires three cycles, one cycle to print the minor total, one cycle to transfer the accumulated minor totals from storage into the counter so that the two may be added, and one cycle to transfer



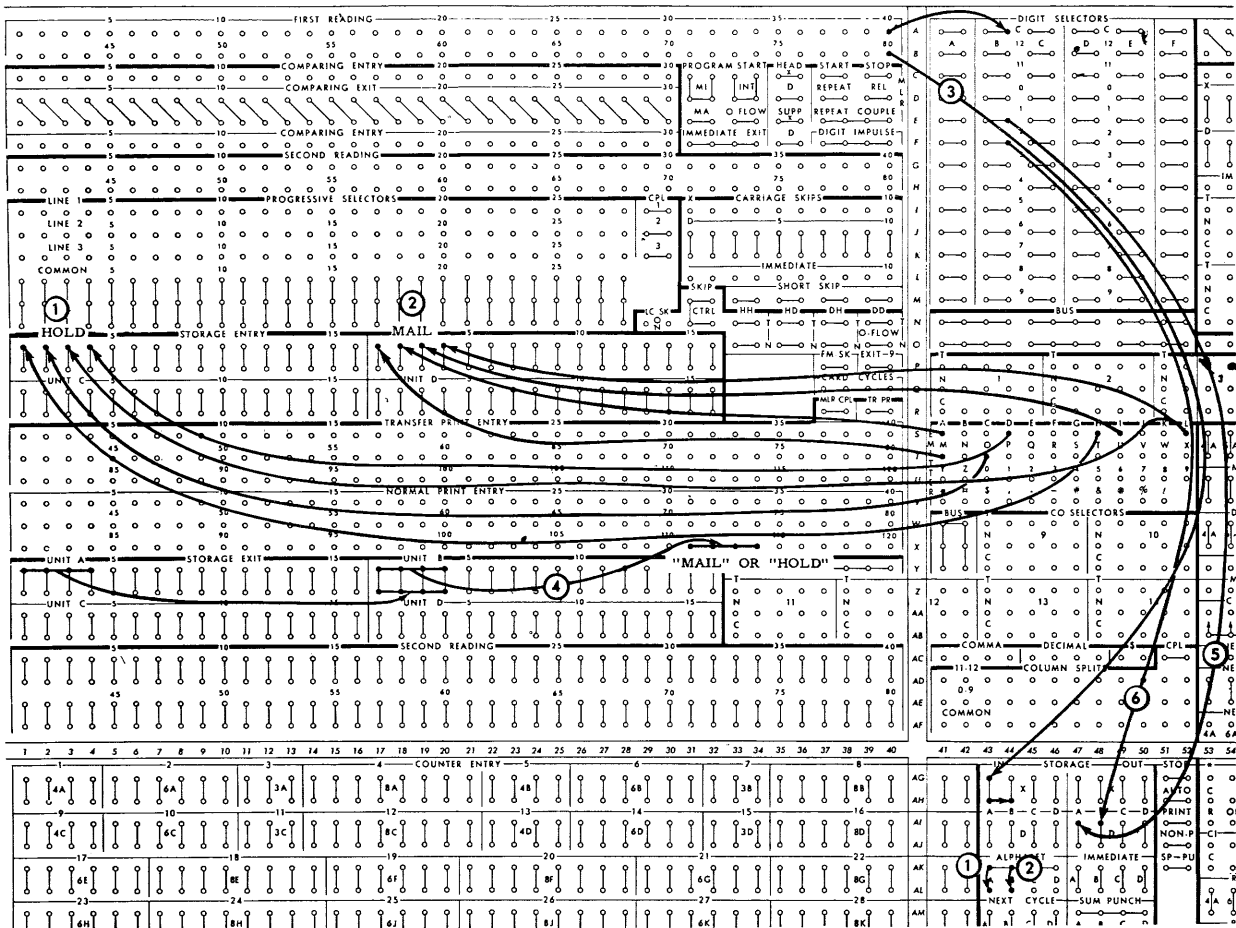
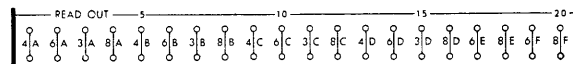

FIGURE 83. STORAGE ENTRY AND READ-OUT

the sum of the minor totals back to storage. At the end of the run, the final total will be printed from the storage unit.

Since this method of storing totals requires more cycles than the normal two-counter method, it is normally used when counters are not available. Although only two classes of total are shown, minor and final, the same principle would be used when printing minor, intermediate and major from two counters and one storage unit, or minor, intermediate, major, and final from three counters and one storage unit. Both of these operations, however, would require special program wiring, since more than three cycles would be required in each case.



AL-AM, 53-80

**Counter Control Read Out.** Each counter has a pair of common read out hubs which accept card cycle, program or all cycle impulses to read out of a counter without resetting. These hubs are normally used for progressive total printing.

**Wiring, Storage Unit as a Substitute for Counter (Adding Only; Figure 84)**

To better understand the wiring necessary to print minor and final totals by using one counter

and one storage unit, the following requirements must be kept in mind:

*Minor Program Cycle*—Read out the minor total from the counter and print.

*Intermediate Program Cycle*—Read out the accumulated minor totals from storage and add into the counter.

*Major Program Cycle*—Read out and reset the new total from the counter to storage.

*Run-Out Final Cycle*—Read out the final total from storage and print.

1. The field to be added is wired to counter entry 2 and the counter is impulsed to add every card.

2. The comparing exit of the field being compared is wired to major program start. This will cause all three program steps to be taken for every change in comparison.

3. The total is read out of counter 2 without resetting, on the first of the three programs, by wiring minor program exit to 2 read out. The counter exits of 2 are wired to counter-controlled print.

4. The sum of the accumulated minor totals, standing in storage unit B, is read out and added to the last minor total standing in the counter by the following wiring:

- a. Storage exit B to counter entry 2 by way of the normal and counter-controlled print entry hubs. Normal and counter-controlled print are connected internally.
- b. Intermediate program exit to immediate read out of storage unit B.
- c. Intermediate program exit to the plus of counter 2.

5. The accumulated minor total is read out of the counter back into storage by the following wiring:

- a. The counter exit of 2 is wired to storage entry B.
- b. The counter is read out and reset on the major program.
- c. Intermediate program exit to next cycle IN of storage unit B.

Although program 2 is wired to both the immediate read out and the next cycle read in of storage

unit B, there is no interference in the wiring because the read in occurs on the following (major) program cycle.

6. The final total is printed from storage unit B by wiring the storage exit hubs to normal print entry and by impulsing the immediate read out hubs of B from run-out final program. Since the last card total switch is ON, the run-out final program will be automatic on the run-out.

7. The storage unit is wired to read out on step 2 and the counter is read out and reset on step 3. No printing on either of these steps is desired. The non-print hubs are therefore wired from program steps 2 and 3. This wiring also suppresses spacing on these cycles.

#### Wiring, Storage Unit as a Substitute for Counter (Adding and Subtracting; Figure 85)

When subtraction is to be included in the preceding example, it will be necessary to carry the sign of the total into the storage unit on every transfer from counter to storage. One method of accomplishing this is to wire the R or - hub of the counter being used to a separate position of the storage unit. With the symbol switch set for R, the R or - hub will emit an X-9 impulse whenever the counter is impulsed to subtract or whenever the counter is negative and is impulsed to read out. The X impulse is separated from the 9 impulse through a column split.

The purpose of storing the sign of the total is to control properly the addition or subtraction of the stored total when it is transferred into the counter, and to identify a negative final total with a minus (-) symbol on the run-out final total cycle.

The wiring shown is in addition to that demonstrated in the preceding example, with the exception of the intermediate program wiring to counter 2 plus, which is changed.

1. The R or - symbol switch is wired to R. The R or - hub for counter 2 is wired through a column split to any available position in storage entry B. The impulse (part of X9 for R) will reach the storage unit whenever the counter is negative, and the storage unit is impulsed to read in.

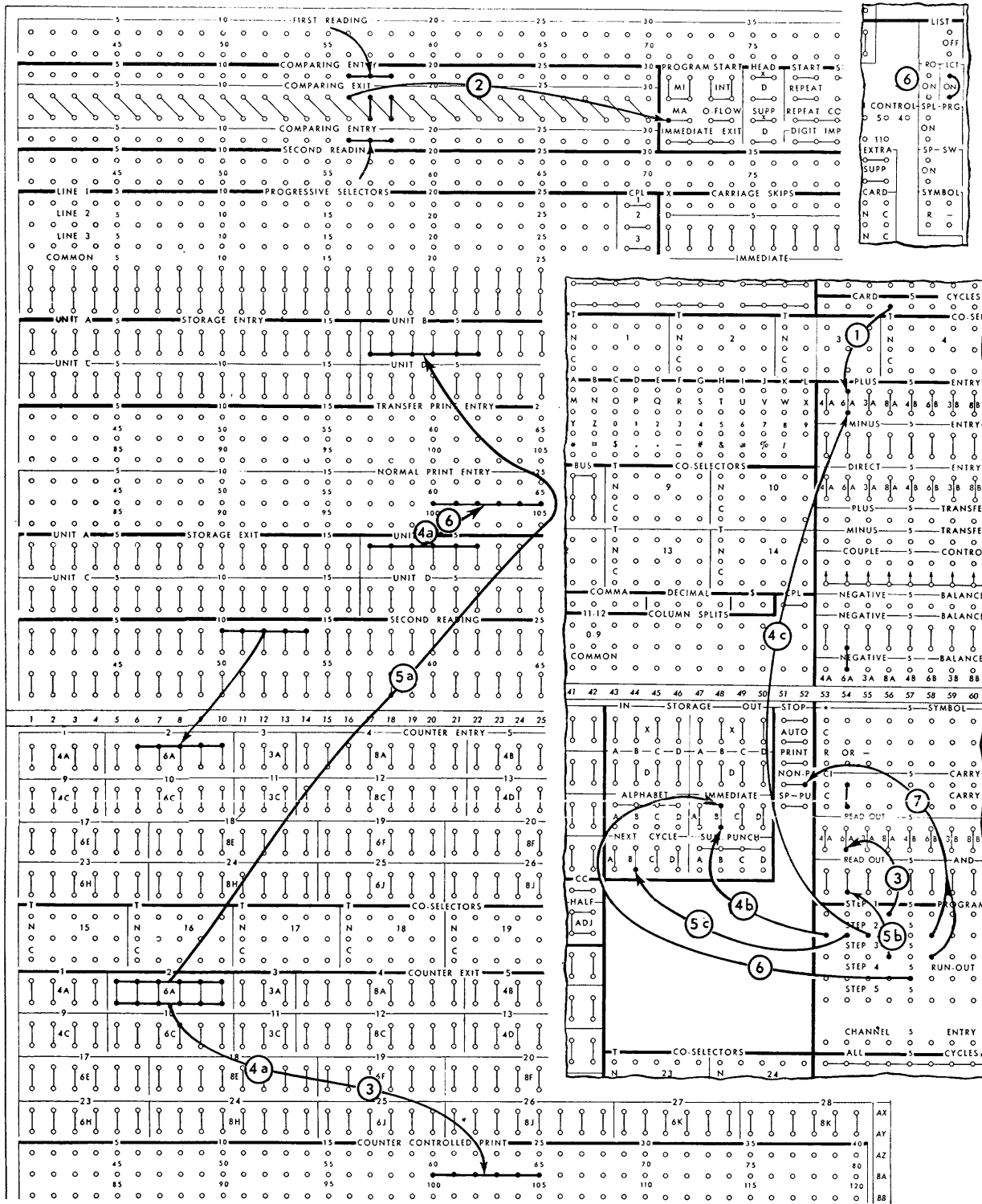

FIGURE 84. STORAGE UNIT AS SUBSTITUTE FOR COUNTER (ADDING ONLY)

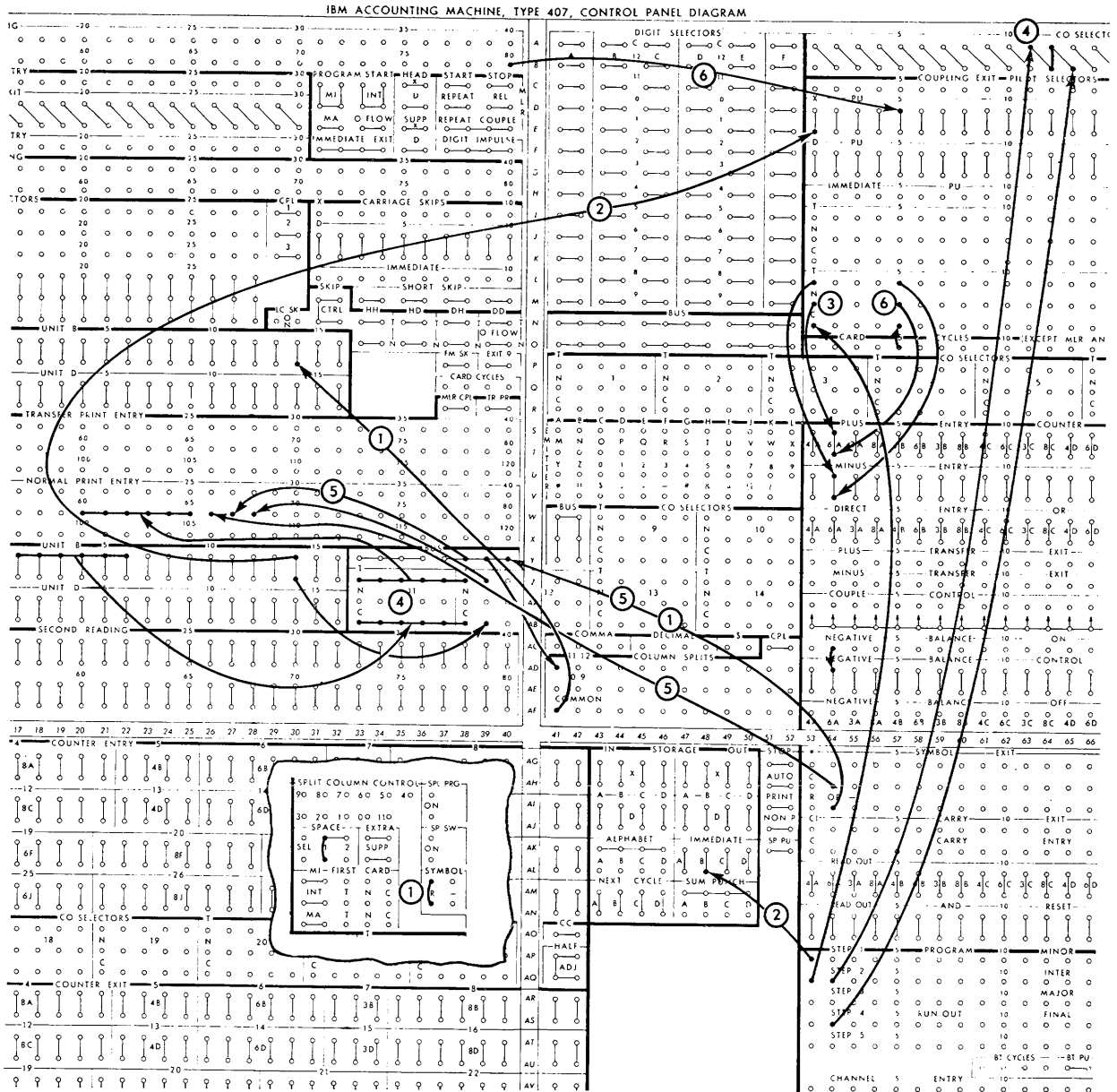

FIGURE 85. STORAGE UNIT AS SUBSTITUTE FOR COUNTER (ADDING AND SUBTRACTING)

2. The corresponding position of storage exit is wired to the pickup of pilot selector 1. The storage unit is impulsed to read out on a minor program so that the credit signal (X) will pick up pilot selector 1 in time to select the intermediate program impulse. Co-selectors 11 and 12 prevent the total in storage unit B from printing on the minor program cycle.

3. Since the transfer from storage to counter takes place on step 2, intermediate program is wired through pilot selector 1 to add or subtract in counter 2. Pilot selector 1 will be normal when

the total in storage is plus (no X in position 14), and transferred when the total in storage is minus (X in position 14).

4. The total in storage prints on the run-out final through the transferred sides of co-selectors 11 and 12. If the final total is minus, the X impulse in position 14 of the storage unit prints a minus (-) symbol from printwheel 68.

5. The CR symbols for credit minor totals are wired normally.

6. Normal counter control wiring to add NX80 and subtract X80 on card cycles.

FIGURE 86. STORING 16 ALPHABETIC CHARACTERS USING ONE STORAGE UNIT

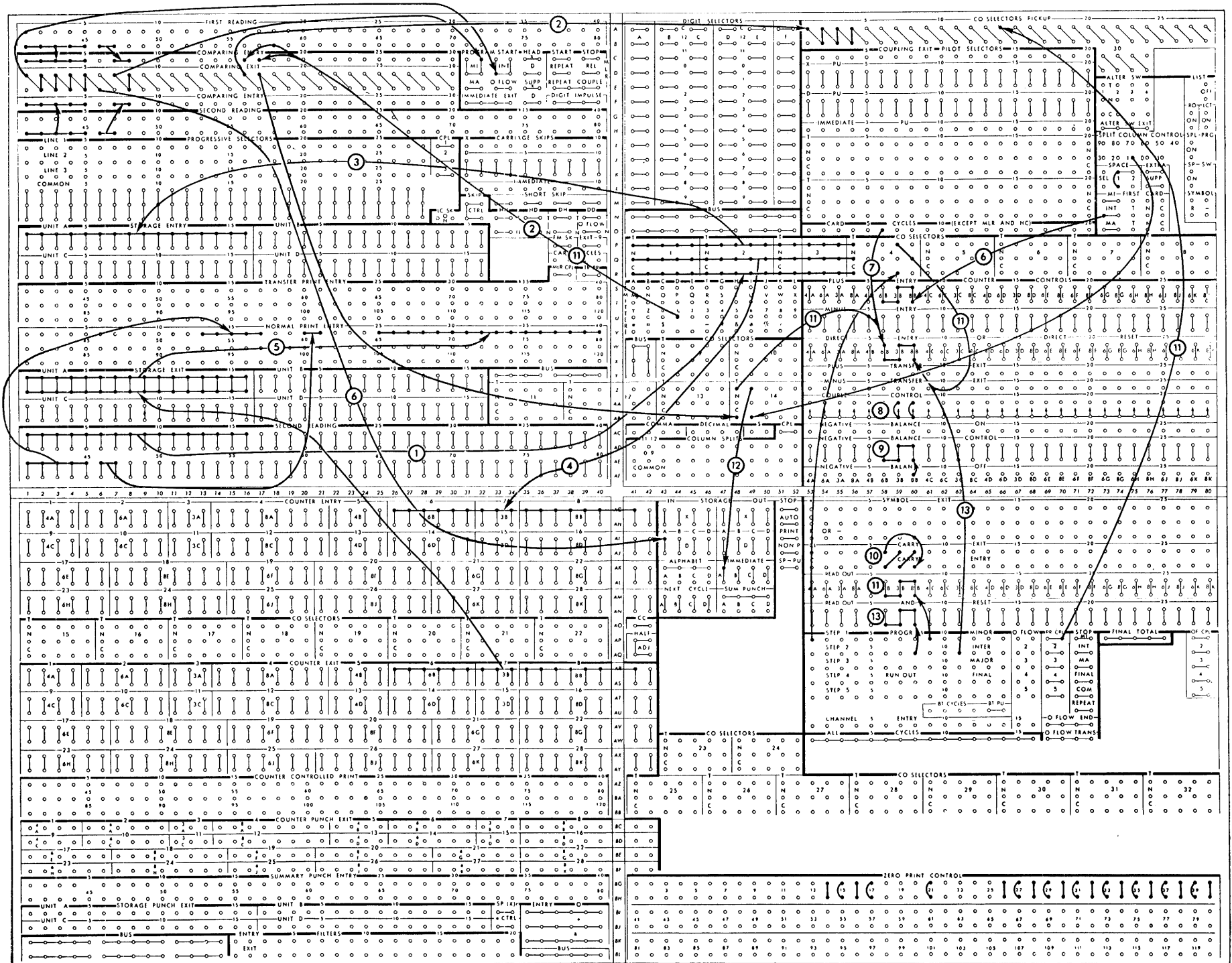

### Storing 16 Positions of Alphabetic Information, Using One Storage Unit

Normally only the left-hand eight positions of a storage unit may be used to store alphabetic information. The reason for this is that half of the unit is needed to store the digits and the other half to store the zones.

By using counters to store the digits, all positions of the storage unit can be used to store the zones. Since a storage unit will accept the first digit or zone read into it, the alphabetic field must first be wired through a selector so that only the zones enter the storage unit and only digits enter the counter. Selectors are not necessary when the information is read out to print.

It is possible to store 64 positions of alphabetic information at one time by using all four storage units to store the zones, 64 counter positions to store the digits, and 64 co-selector positions for selection of the information upon entry.

Figure 86 illustrates the printing of 16 alphabetic positions on a minor total cycle. The information printed is stored from the first card of each intermediate group. The alphabetic information prints on each succeeding minor total cycle.

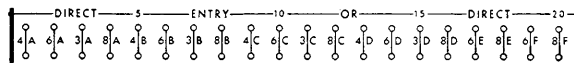

W-X, 53-80

**Direct Reset.** The hubs used for direct entry are also used for direct reset. When they are impulsed at the same time as the corresponding read out and reset hubs, the counter resets without printing. Direct reset does not allow information in the counter to reach the counter exits, and, therefore, could not be used when performing such operations as total transfer or crossfooting. It is normally used to reset counters used for such operations as summary punching or page numbering where the information in the counter should neither print nor transfer to other counters. Direct reset is not effective unless read out and reset is also wired. When more than one direct reset hub is wired

from one impulse, the corresponding plus and minus hubs must be impulsed at the same time from the same source. Otherwise, the direct reset hub must be impulsed independently. (See Direct Entry or Direct Reset under *Operating Suggestions*.)

### Wiring (Figure 86)

1. Information to be stored is wired to the common of co-selectors 1, 2, 3 and 4.

2. Co-selectors 1, 2, 3 and 4 are transferred for the reading of zones and will be normal for the reading of digits, by picking them up from a half after 1 impulse. Since split column control hub 1 is used for other purposes as described later, an equivalent impulse is made available by comparing a character emitted 1.

3. The zone impulses for the field to be stored are wired to storage A entry from the transferred side of co-selectors 1, 2, 3 and 4. These selectors will be transferred for the reading of 0, 11 and 12 impulses.

4. The digit impulses for the field to be stored are wired to counter entries 6, 7 and 8 from the normal side of co-selectors 1, 2, 3 and 4. These selectors will be normal for the reading of 1 through 9 impulses.

5. Both the zones and the digits are wired from storage exit A and counter exits 6, 7 and 8 to normal print entry 25-40.

6. Since the information to be stored is to be read from the first card of each intermediate group, the intermediate first card hub is wired to the plus of counters 6, 7 and 8 and the intermediate comparing exit hubs are wired to storage A read in D. The information is accepted by the storage unit on the following card feed cycle.

7. A card cycles impulse is wired to direct entry of 6, 7 and 8 so that the digit impulses can enter the counter directly in the first half of the cycle. This is necessary since the counter exits are not wired to counter-controlled print and since the information to be stored should not print on the indicate cycle.

8. The couple control hubs for counter 7 and 8 are connected. The high order counter is never wired for couple control.

9. Negative balance OFF of the low counter 8 is wired to negative balance control of all three counters.

10. CI of the high order counter is wired to the C of the low order counter. All remaining CI and C hubs are connected beginning at the right.

11. The counters are impulsed to read out on a minor program cycle. Only the digits 1-9 are wanted. To keep zeros from reading out and interfering with corresponding storage exits, a half after 1 impulse, made by comparing a character emitted 1, is wired to the direct entry hubs of counters 6, 7 and 8 through the transferred side of co-selector 14. Co-selector 14 is picked up from minor program couple. This suppresses the reading out of zeros on the minor program cycle.

Since the direct entry hubs hold only for the duration of the impulse wired to them, the half after 1 is supplemented by wiring minor program through the transferred side of co-selector 4 to direct entry. Co-selector 4 is picked up at half after 1.

12. The storage unit is impulsed to read out zone impulses only on a minor program by wiring split column control 1 through the transferred side of co-selector 14 to immediate OUT. This wiring prevents interference during the read out of 9-1 digits from the counters.

13. Counters 6, 7 and 8 are wired for direct reset on the intermediate program. Direct resetting

is necessary because the counter exits are not wired to counter-controlled print.

### SUMMARY PUNCHING

SUMMARY PUNCHING is the automatic preparation of one total card to replace a group of detail cards. A total or summary card contains the identification of a group and one or more totals accumulated for that group. The primary purpose of summary punching is to reduce the card volume and thus accelerate the preparation of periodic reports. When totals or balances are carried forward from one period to another, as in stock status summary or accounts receivable, the summary cards are called balance forward cards.

Summary cards are generally punched during the preparation of detail reports by a summary punch machine connected to the accounting machine by a cable, as shown in Figure 87.

Summary punch machines—Types 514, 519 and 523—may be used with the Type 407 accounting machine. The summary punch has a cable which must be connected to the receptacle provided for it on the lower left side of the accounting machine.

Up to 80 columns of information may be summary punched at one time. The only wiring required on the summary punch panel is the connecting of 80 counter exits to the 80 punch positions. No selectors are required on the summary

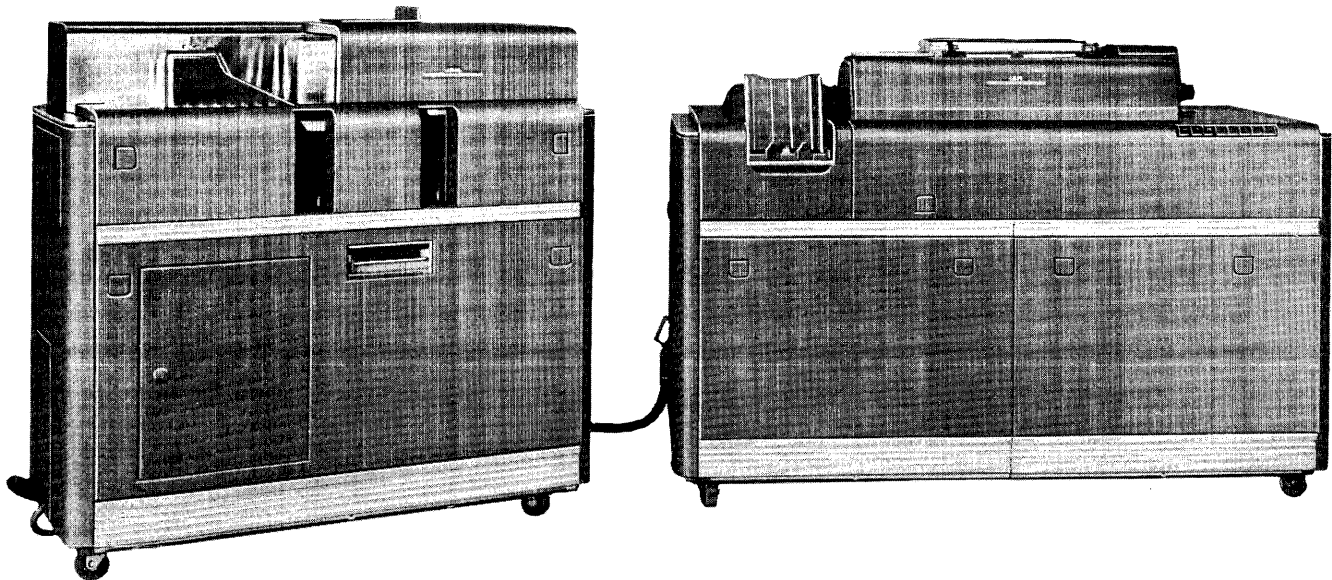
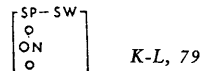

FIGURE 87. TYPE 407 ACCOUNTING MACHINE AND TYPE 514 SUMMARY PUNCH

punch, since all selected wiring is accomplished on the Type 407 control panel. All selectors that are available on the accounting machine, as well as storage units, emitters and counters, may be used for summary punch purposes.

Alphabetic as well as numerical information may be summary punched either from the storage unit or from the emitter. Special character information may also be summary punched when it is wired from the emitter.



**SP-SW (Summary Punch Switch).** This switch must be wired ON whenever any cards are to be summary punched. The purpose of the switch is to provide an interlock which delays the accounting machine while summary cards are being punched, and to stop both machines when the last card leaves the hopper of either machine. Whenever the summary punch switch is to be turned off or on for different operations, SP-SW must be wired directly through an alteration switch selector. Co-selectors or pilot selectors cannot be used.



**SP-PU (Summary Punch Pickup).** Summary punching may be initiated on any program change by impulsing the SP - PU hubs. If a program exit is wired to the pickup, summary punching will take place just before the total prints. More than one type of total may be summary punched in the same run. When summary punching is initiated, the advancement of the program will be delayed until summary punching is completed, at which time programming will continue and totals will print.

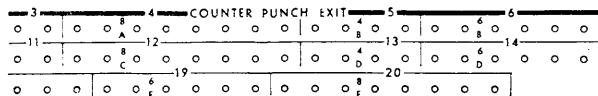

BC-BF, 1-42

**Counter Punch Exit.** For each counter position there is a corresponding counter punch exit hub.

Counter punch exits read out automatically during the first half of the cycle whatever stood in the counter on the preceding cycle. They are normally wired to summary punch entry, which accepts information from them only when the summary punch pickup is impulsed. When negative balance ON is wired, an X is emitted from the high order position of each counter punch exit whenever that counter contains a converted negative figure to be used to identify credit summary cards. The X may be punched in any column of the card by the use of the column splits. When negative balance ON or OFF is wired, an X is emitted from the high order position of each counter for zero balances.

Counter punch exits may also be wired either to transfer print entry, normal print entry, storage units, or other counter entries, even though the machine is not wired for summary punching. However, counter punch exits wired to these hubs must be selected so that they are available only when the counter is inactive, i.e., not adding, subtracting, or resetting. The only exception to this is if the counter is being direct reset, then these hubs may be used.

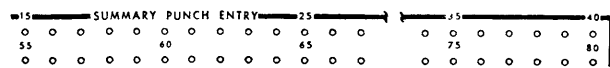

BG-BH, 1-40

**Summary Punch Entry.** The 80 summary punch entry positions represent the 80 columns of the card. Information to be summary punched must be wired to these hubs from the counter punch exits, storage punch exits, or from the emitter. Because the summary punch entry hubs are located on the accounting machine, full use may be made of the character emitter, counters and storage units.

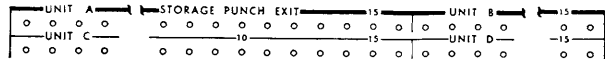

BI-BJ, 1-32

**Storage Punch Exit.** Each storage unit has a corresponding set of storage punch exit hubs. They are used for summary punching either alphabetic or numerical information from the storage units. Each unit may be individually controlled to read



FIGURE 88. SUMMARY PUNCHING MINOR TOTALS

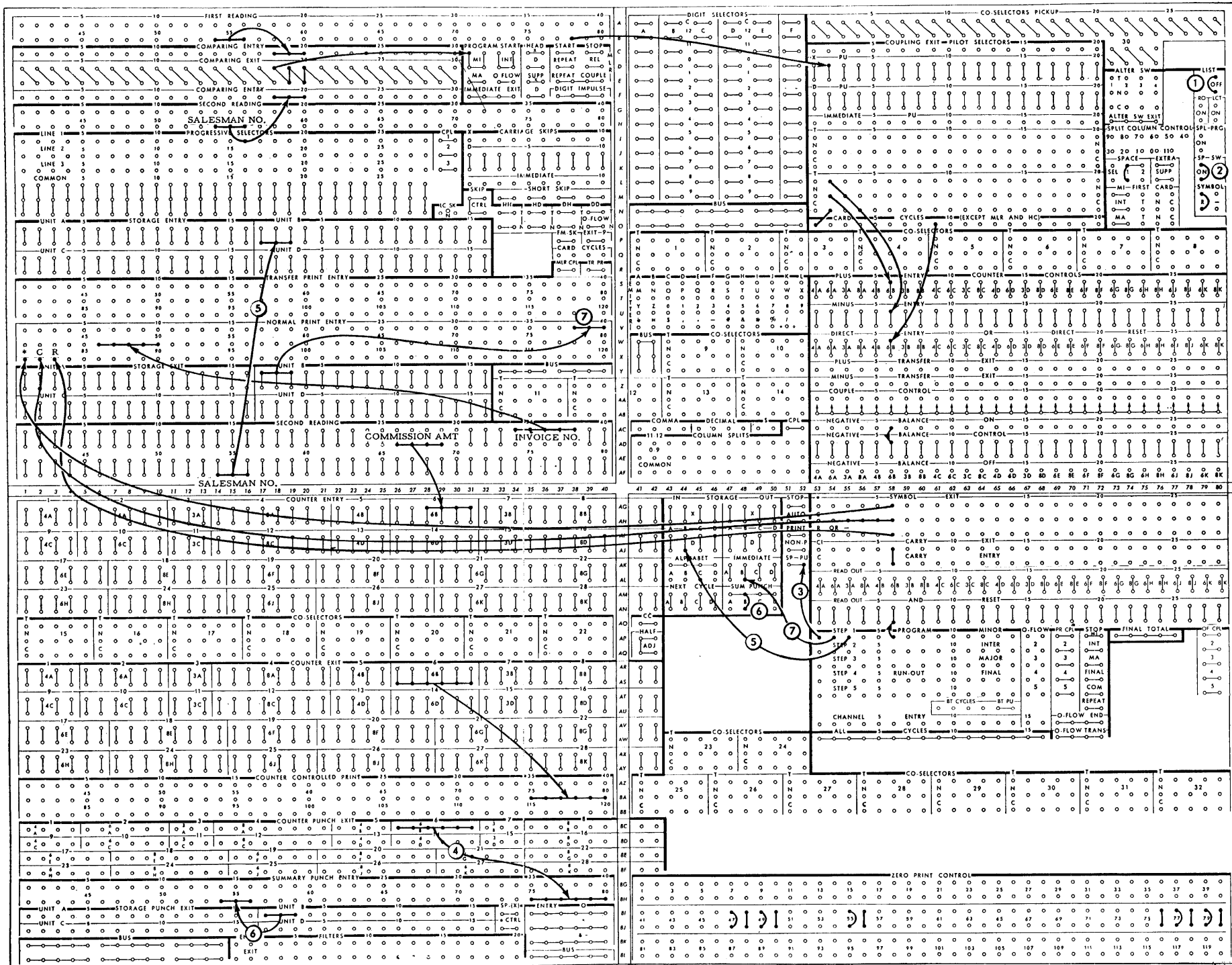

out on a specific summary punch cycle. They offer the only means of summary punching alphabetic information from the card. Since only the left-hand eight positions of a storage unit may be used for storing letters of the alphabet, only the left-hand eight positions of storage punch exit may be used for summary punching them. All sixteen positions may be used, however, for numerical information.

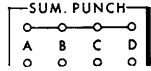

AM-AN, 47-50

**Summary Punch—Storage Out.** Each storage unit has an independent summary punch read out hub which when connected to any hub immediately above it causes the storage unit to read out on every summary punch cycle. If a storage unit is to read out only on specific summary punch cycles, the lower hub must be impulsed from a corresponding program couple.



BI, 33-34

**SP-X (Summary Punch X).** These hubs emit an X impulse every machine cycle, including all summary punch cycles. When properly controlled, through selectors, they are normally used to distinguish one type of summary card from another, such as minor from intermediate, to identify debit or credit totals punched from storage. All summary cards may be X punched by wiring SP-X directly to summary punch entry.

**Wiring, Summary Punching (Figure 88)**

All 80 counter exit positions on the summary punch should be wired position for position to the 80 punch magnet hubs. No further wiring is necessary on the summary punch control panel.

Only the summary punch wiring is explained in the following example:

1. The machine is wired for group printing.
2. The summary punch switch is turned ON.

3. The summary punch pickup is impulsed from the minor program exit. A summary card will be punched for each salesman.

4. The commission amount which has accumulated in counter 6 is summary punched into columns 76-80 by wiring the counter punch exit of 6 to summary punch entry 76-80. If the amount is negative, an X-0 will punch in column 75 from the high order position of the counter. If the amount is positive, a 0 will punch in column 75. This is an automatic function and is caused by the negative balance ON wiring to negative balance control.

5. Salesman number is summary punched from storage unit B. It is entered into the storage unit from second reading on the first card of each group, by wiring D IN from minor program exit. This wiring allows the storage unit to

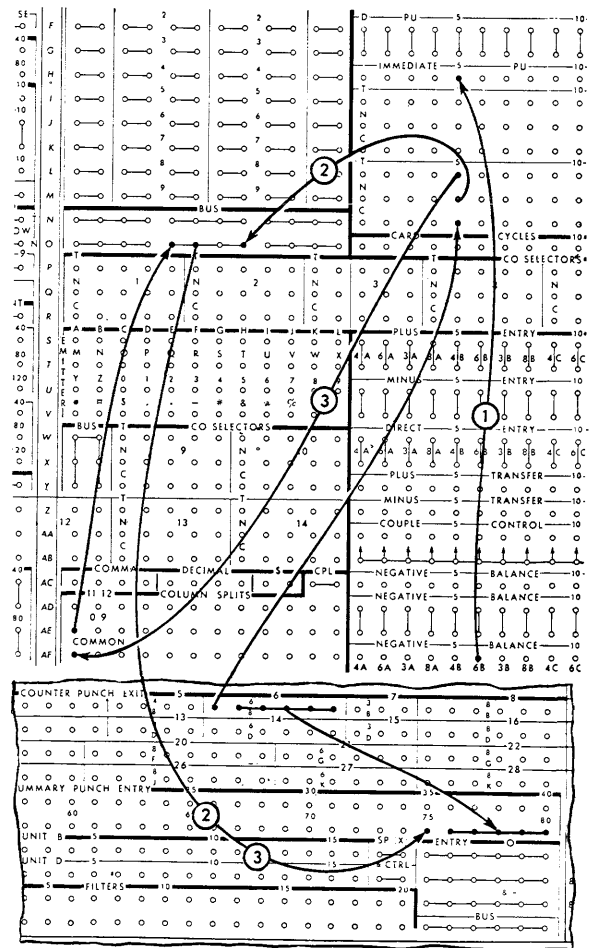

FIGURE 89. ELIMINATING X PUNCHING FOR ZERO BALANCES

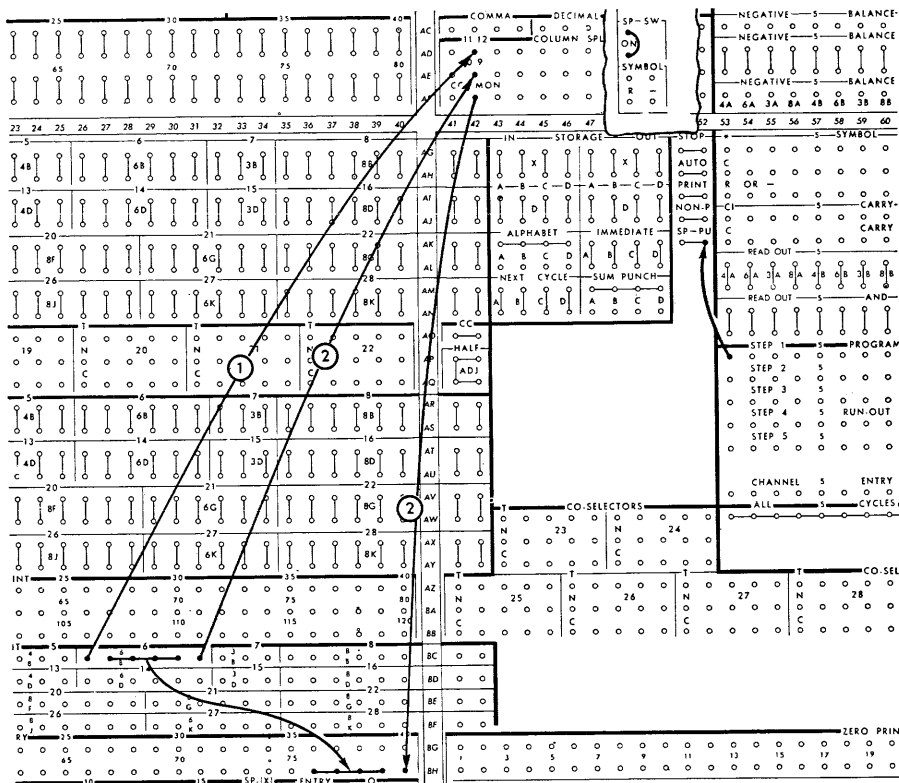

FIGURE 90. PUNCHING A CREDIT X OVER THE AMOUNT FIELD

accept information on the card feed cycle following a minor program or in other words on the first card of the next group. Next cycle IN cannot be used because entry would be made on the next machine cycle, which in the example is a summary punch cycle.

6. Salesman number is read out of storage punch exit B on a minor program to summary punch entry 54-56 on every summary punch cycle by connecting the summary punch storage out hubs for unit B and by wiring from storage punch exit B to summary punch entry.

7. Salesman number is printed on the report on the same line with the total by wiring storage exit B to normal print entry 38-40.

**Wiring, Eliminating X Punching for Zero Balances (Figure 89)**

The credit X punches from the high order position of the high order position of the counter punch exit for zero balances as well as for negative balances. If the X is not desired for zero balances it may be eliminated by the wiring shown in Figure 89. It is assumed in this example that balances will

not exceed five digits. The X-0 is punched in column 75 for negative balances and a 0 for positive or zero balances.

1. Pilot selector 5, immediate pickup, is wired from the negative balance OFF (zero balance) of counter 6.

2. The high order position of counter punch exit 6 is wired through the normal side of pilot selector 5 to summary punch entry 75. This wiring allows the high order position of counter 6 to punch X-0 in column 75.

3. The high order position of counter punch exit 6 is wired through the transferred side of pilot selector 5, through the 0-9 hubs of the column split, to summary punch entry 75. This wiring prevents the X from reaching column 75 on zero balances only.

**Wiring, Punching a Credit X over the Amount Field (Figure 90)**

The credit X punches from the high order position of the counter which must normally be reserved for detection of a negative balance. For a negative balance, this position of the counter emits

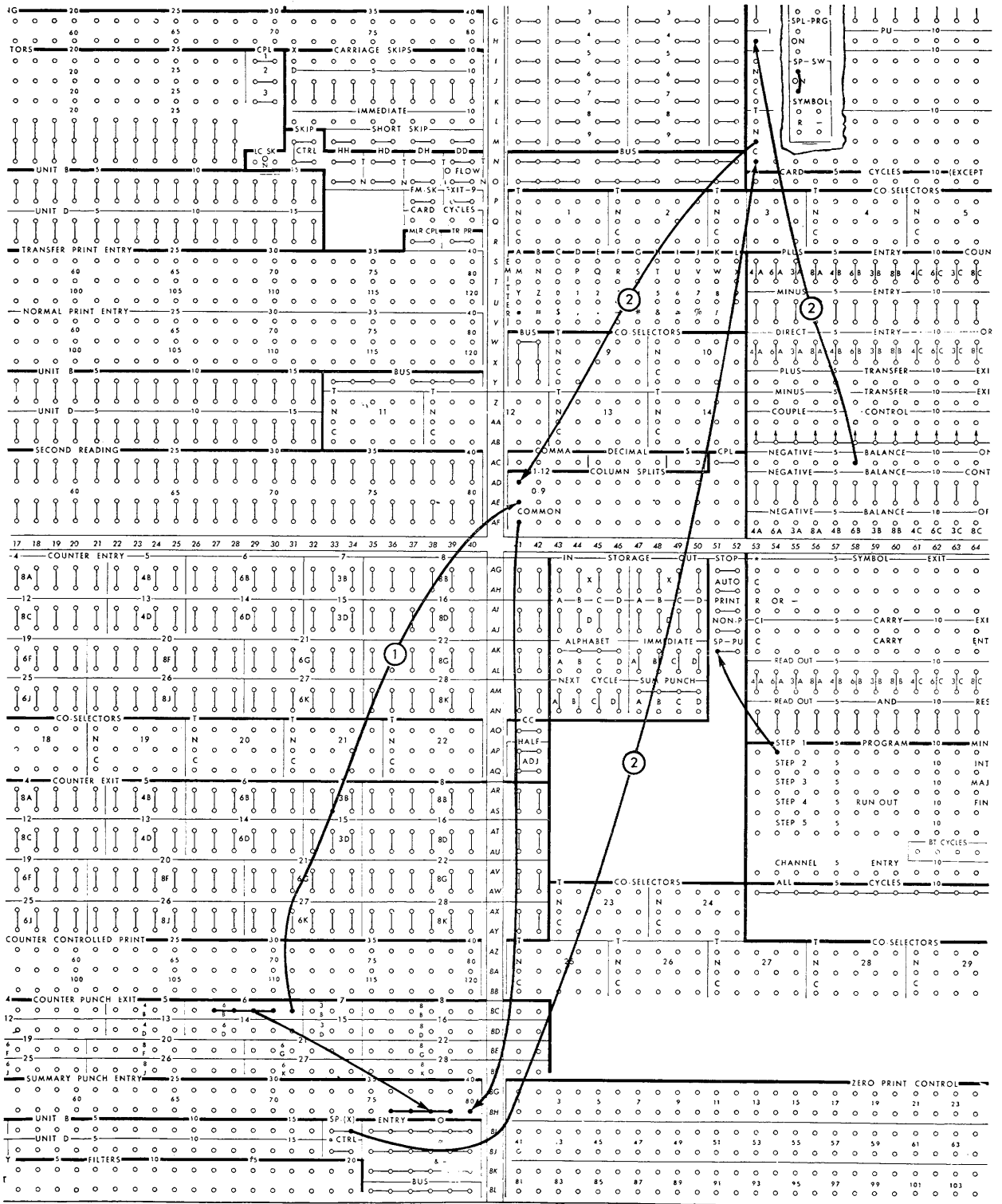

FIGURE 91. PUNCHING X'S FOR DEBIT BALANCES

an X and a 0 impulse; for a positive balance, it emits a 0 impulse. The 0 may be eliminated and the X punched anywhere in the card or over any position of the amount field by use of column splits. In this example, the X is punched over the units position.

1. The high order position of counter punch exit 6 is wired to the 11-12 hub of column split 2. The X for negative balances is available out of common.

2. The units position of counter punch exit 6 is wired to the 0-9 hub of column split 2. The X for negative balances entering the 11-12 hub of column split 2 and the units digit for all balances entering the 0-9 hub of the same column split are emitted from the C hub, which is wired to summary punch entry 80.

**Wiring, Punching X's for Debit Balances (Figure 91)**

An X may be punched to identify debit balances instead of credit balances by the use of a pilot selector. A column split is also required if the X is to be punched over a digit. In this example, the X is punched over the units digit of the amount field.

1. The units digit of the amount field is wired from counter punch exit to the 0-9 hub of a column split.

2. The summary punch X hub is wired to the common hub of a pilot selector which is picked up immediately by the negative balance ON hub of the counter. The selector will transfer for negative and zero balances, but will remain normal for positive balances. The normal hub of the selector is wired to the 11-12 hub of the column split and the common is wired to summary punch entry 80. Thus, debit balances are identified by X in column 80. Credit balances are identified as No X. The high order position of counter exit 6 which identifies credit balances is not wired and therefore a credit X is omitted.

Using the same wiring principles, a digit may be summary punched to identify debit or credit balances by using a specific digit from the character emitter instead of the SP-X.

The same wiring procedure may be used to punch the X over any other column of the field. If the X is to be punched outside the field it could

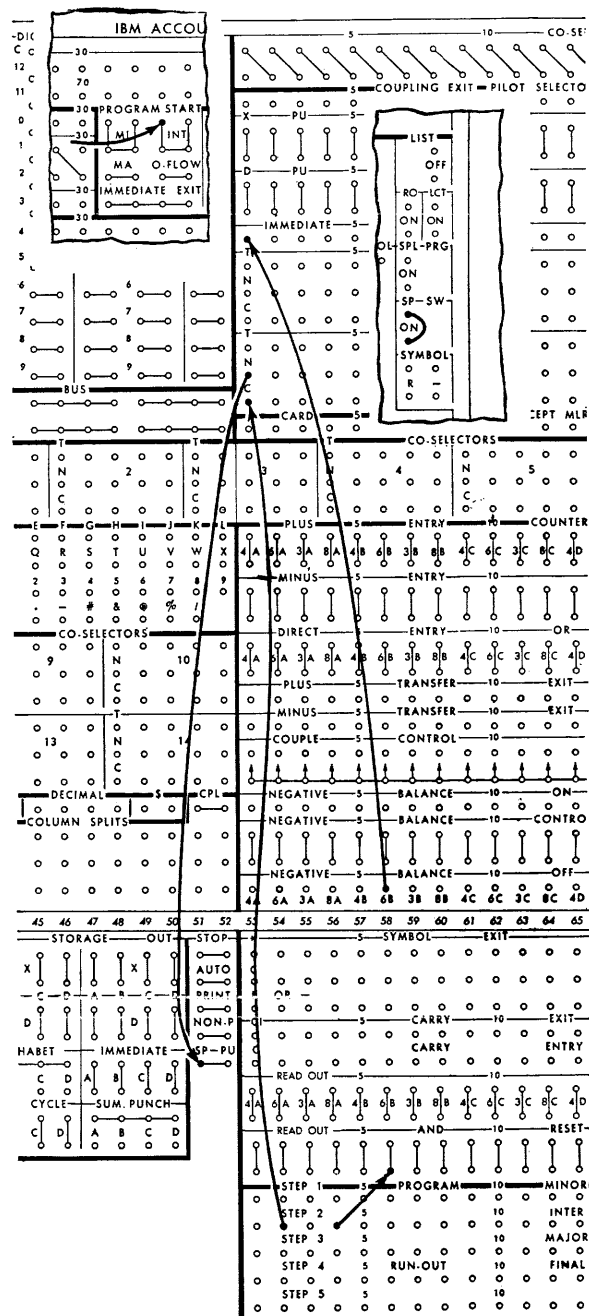

FIGURE 92. ELIMINATING ZERO BALANCE SUMMARY PUNCHING

be wired directly from the 11-12 hub of the first column split to any summary punch entry hub.

**Wiring, Eliminating Zero Balance Summary Punching (Figure 92)**

Zero balance summary punching may be eliminated by controlling the impulse wired to SP-PU through the normal side of a pilot selector picked

up from negative balance OFF. It is necessary, however, to advance the program on which summary punching is to take place one step. In other words, if the minor program would be normally used to cause summary punching, it must be changed to intermediate if zero balances are to be eliminated. All counter and storage units must read out on the program used to impulse summary punching.

The reason that an additional step is required is that the negative balance OFF hub, which is used to pick up a pilot selector through which the summary punching is controlled, emits an impulse later in the cycle than the programs it is attempting to select. Unless the pilot selector is picked up one step in advance of the program used to impulse SP-PU, the program impulse reaches SP-PU before the selector transfers and zero balance summary punching would not be eliminated.

It will be seen that because of the additional step required for this operation, three cycles (one to pick up the selector, one for summary punching, and one for total printing) instead of two will be taken every time a card is summary punched. Good judgment would dictate a study of the problem to determine if the added time required will offset the advantage gained by zero balance summary punch elimination.

#### Summary Punching More Than One Class of Total

More than one class of total may be summary punched on separate cards during the same operation. The totals to be summary punched must be selected so that they punch in turn, that is, minor first, intermediate second, and major third. Otherwise, all three totals will be punched whenever any one of them is punched. The selection is done on the Type 407 control panel.

#### Wiring, Summary Punching Minor and Intermediate Totals on Separate Cards (Figure 93)

1. The summary punch switch is wired ON.
2. Both minor and intermediate programs are wired to SP-PU.
3. Counter 6 reads out and resets on a minor program and counter 8 on an intermediate program.
4. The minor counter punch exit 6 is wired to

the normal side of co-selectors 15 and 16, and the intermediate counter punch exit 8 to the transferred side of the same selectors. The common is wired to summary punch entry 55-62.

The co-selectors are picked up from the intermediate program couple. The selectors will be normal on a minor program change, thus allowing the minor total to summary punch on one card. The selectors will be transferred on an intermediate program change, thus allowing the intermediate total to summary punch on another card.

There are two reasons for using selectors when summary punching more than one class of total:

- a. To punch minor and intermediate totals in the same field of both summary cards.
- b. Since counter punch exits emit impulses on all summary punch cycles, selection is necessary to control counter punch exits on specific program cycles.

5. The intermediate summary card is identified by an X wired from SP-X through the transferred side of co-selector 16 to summary punch entry 69.

If the minor summary card is to be identified by the X, the SP-X would be wired through the normal side of co-selector 16.

#### Wiring, Summary Punching Minor, Intermediate and Major Totals on Separate Cards (Figure 94)

1. The summary punch switch is wired ON.
2. Minor, intermediate and major programs are wired to SP-PU.
3. Counter 2 is read out and reset on a minor program, 4 on an intermediate program, and 8 on a major program.
4. Co-selectors 15-16 are picked up from the intermediate program couple and co-selectors 13-14 from the major program couple. The counter punch exits are wired through these selectors as follows:

The minor total reaches the summary punch entry hubs 60-67 through the normal side of selectors 15-16 and the normal side of 13-14.

The intermediate total reaches summary punch entry 60-67 through the transferred side of co-selectors 15-16 and the normal side of 13-14.

The major total reaches summary punch entry 60-67 through the transferred side of co-selectors 13-14.

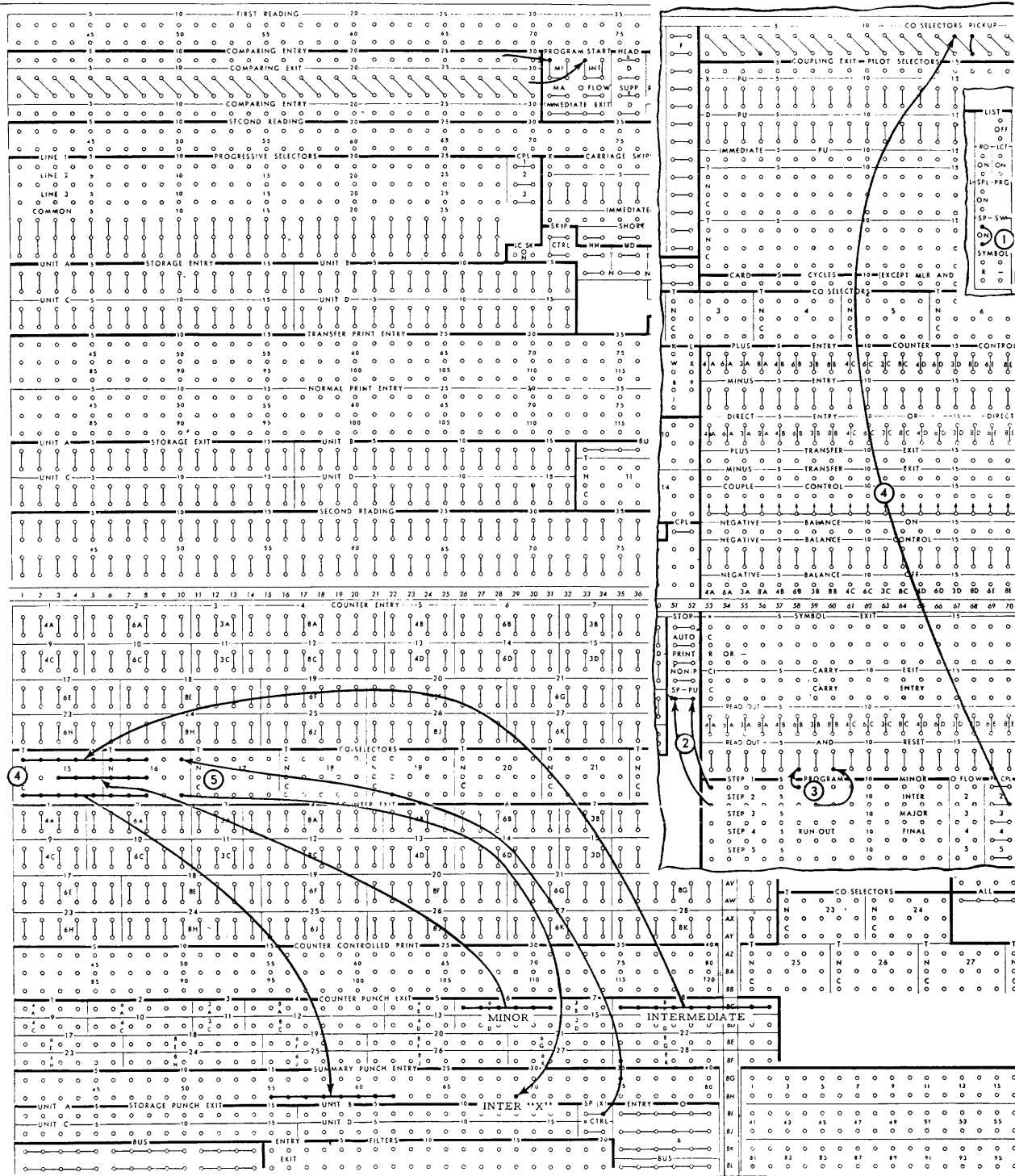

FIGURE 93. SUMMARY PUNCHING MINOR AND INTERMEDIATE TOTALS

An X is punched in column 49 to identify intermediate summary cards by wiring SP-X through the transferred side of co-selector 16 to summary punch entry 49.

An X is punched in column 53 to identify major summary cards by wiring SP-X through the transferred side of co-selector 13 to summary punch entry 53.

FIGURE 94. SUMMARY PUNCHING MINOR, INTERMEDIATE AND MAJOR TOTALS

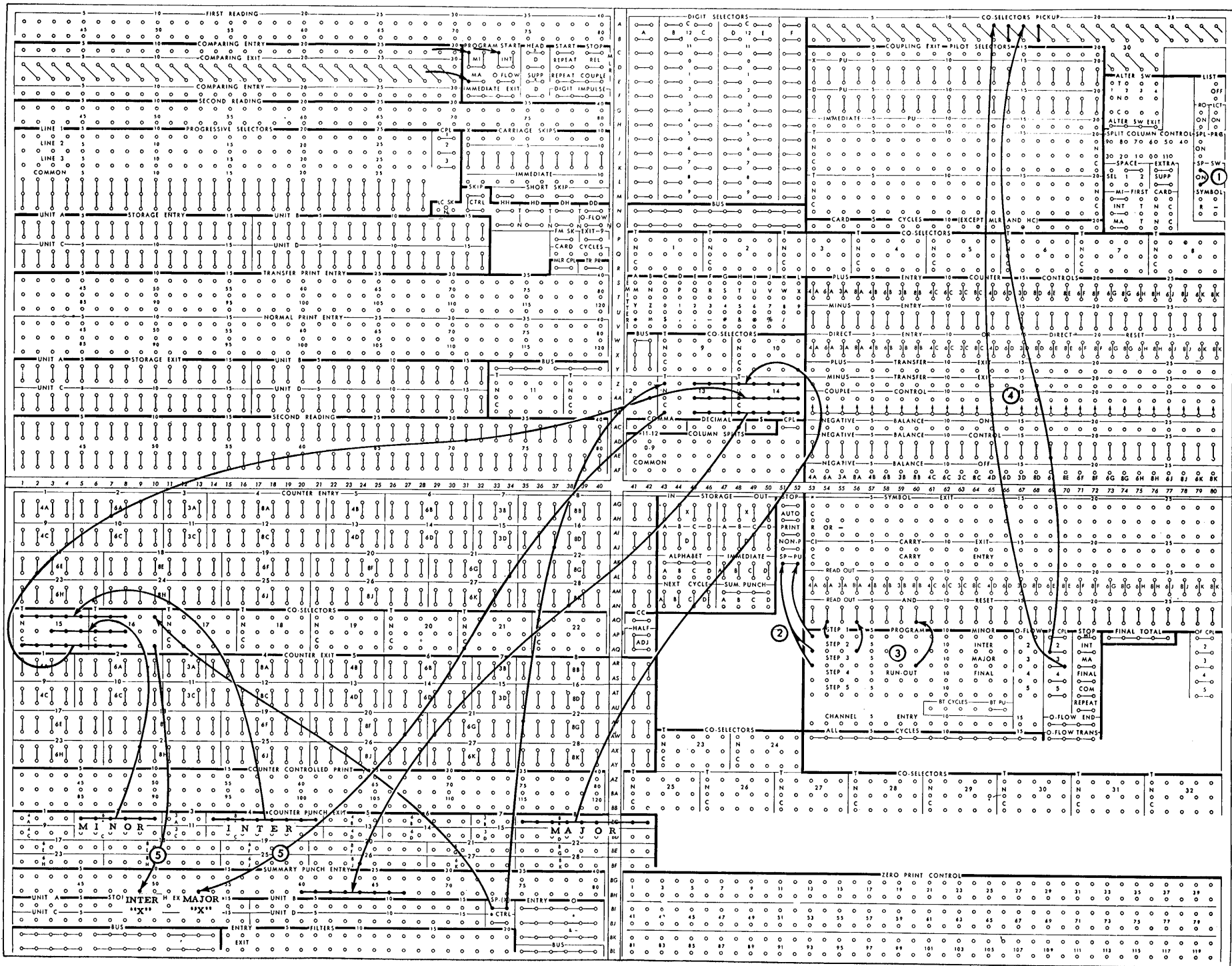
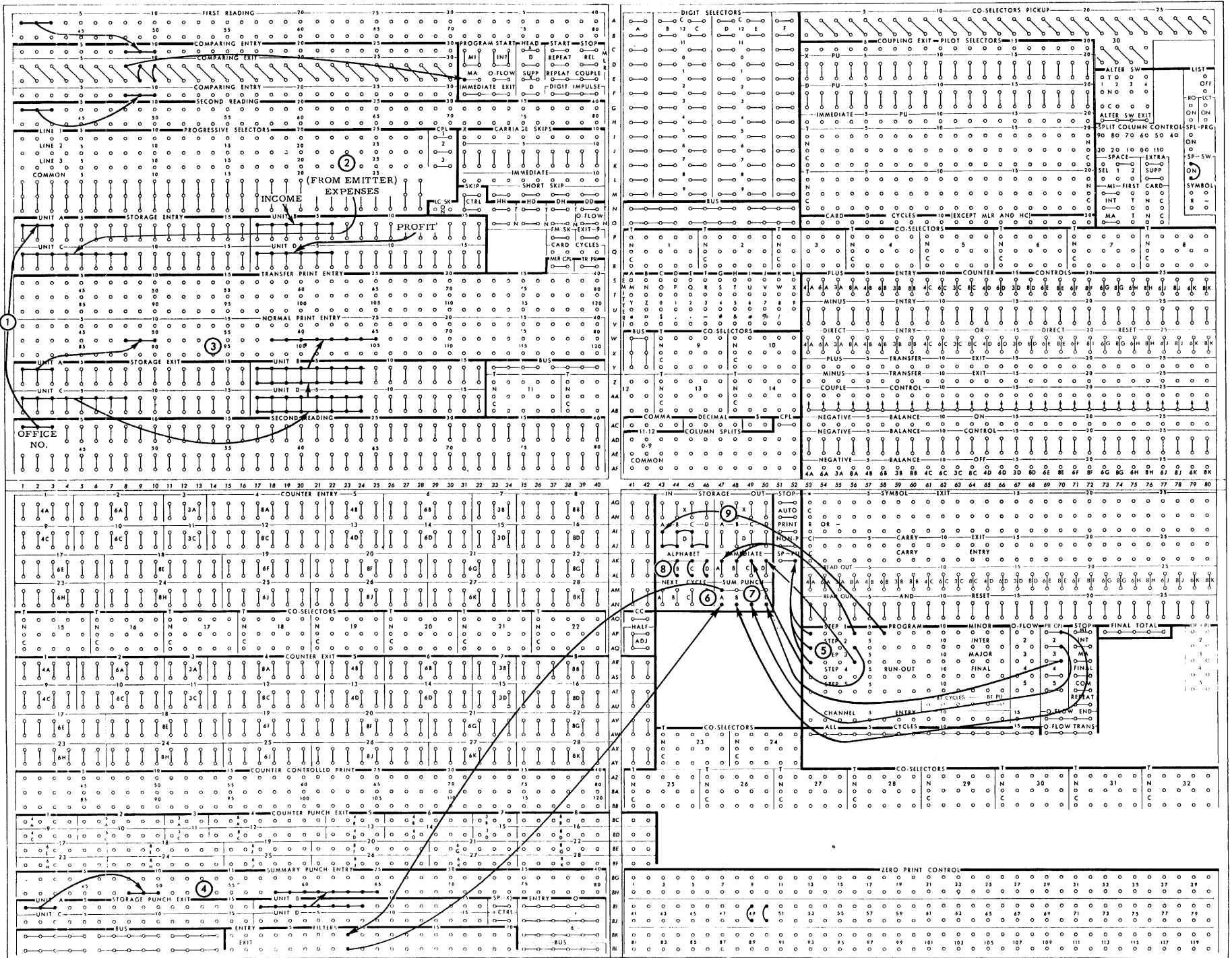



FIGURE 95. SUMMARY PUNCHING WITH VARIABLE STORAGE READ-OUT



### Wiring, Summary Punching with Variable Storage Unit Read Out (Figure 95)

This example demonstrates the use of all four storage units in a summary punch operation, each one reading out information to be punched, independently of the others. Three summary cards are desired for each change in office number, one for income (minor), a second for expenses (intermediate), and a third for profit (major). The office number is compared and the comparing exit wired to major program start. Unit A is used to store indicative information and will be controlled to read out on every summary punch cycle. Unit B is used to store the word *income* and will identify the minor total by reading out on the minor summary punch cycle only. Unit C will be used to store the word *expenses* and will identify the intermediate total by reading out on the intermediate summary punch cycle only. Unit D will be used to store the word *profit* and will identify the major total by reading out on the major summary punch cycle only.

1. Office number is entered into storage unit A from second reading.

2. The words *income*, *expense* and *profit* are entered into storage units B, C and D, respectively, from the emitter.

3. Information from all four storage units is printed by wiring the storage exits to normal print entry. The total identifications print one underneath the other.

4. The office number in storage unit A is summary punched, by wiring storage punch exit A to summary punch entry 48-50.

The information to be summary punched from storage units B, C and D may be wired out of any one of the storage punch exits to summary punch entry, since the regular exit hubs of these units are connected to the normal print entry hubs. There is an internal connection between each storage exit position and each storage punch exit position.

5. Minor, intermediate and major totals are summary punched by wiring the three levels to SP-PU.

6. The summary punch OUT hubs for unit A are connected, making the storage punch exit hubs for that unit active every summary punch cycle.

This wiring will allow the *office* code to punch in every summary card. However, when a storage unit is impulsed to punch on every summary punch cycle in this manner and at the same time some other storage unit is wired from program couple to punch on a specific cycle, the wire from summary punch to the storage entry hub must be filtered to prevent back circuits.

This wiring will allow the *office* code to punch in every summary card.

7. Storage punch exit B is controlled to punch on a minor summary punch cycle by wiring couple 1 to summary punch B.

Storage punch exit C is controlled to punch on an intermediate summary punch cycle by wiring couple 2 to summary punch C.

Storage punch exit D is controlled to punch on a major summary punch cycle by wiring couple 3 to summary punch D.

Regular programs cannot be wired to storage OUT summary punch hubs.

8. Storage units B, C and D are wired for alphabetic storage.

9. All four storage units are impulsed to read in on the card cycle following the minor program.

### SPECIAL PROGRAM

FOUR PROGRAM cycles have thus far been discussed: minor, intermediate, major and run-out final. Normally, when the minor program start is impulsed, only one program cycle is taken, when the intermediate program start is impulsed, two program cycles are taken, and when the major program start is impulsed three program cycles are taken. The run-out final program occurs only on the last card to go through the machine.

By means of special programming, any number of program cycles may be initiated for any one program start. For example, five program cycles may be initiated by a minor start for the purpose of crossfooting five minor totals or printing them one underneath the other.

SPL-PRG
o
o
o
o

*Spl. Prg. (Special Program).* When these two hubs are connected the following changes in machine function take place:

1. The normal minor, intermediate, major and run-out final programs lose their identity and become instead program steps 1, 2, 3, 4.
2. A fifth program step becomes available so that whenever any program start is initiated program steps 1, 2, 3, 4 and 5 are taken in succession.
3. Neither the regular nor the overflow program hubs will emit impulses unless channel entry is wired.
4. Automatic total spacing for both detail and group printing is altered. Instead, for each program step taken, the platen will advance uniformly, single or double space as wired.
5. Program steps 1, 2, 3, 4 and 5 are internally connected to the channel entry in succession each time a program start is initiated.

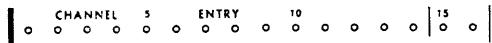

AV, 53-68

*Channel Entry.* Each vertical row of total program hubs has a corresponding channel entry hub. They are called channel entries because they accept impulses to control the activity of the hubs immediately above them. Unless the channel entry hub is impulsed, the program exit hubs above them will be inactive. When special program is not wired, each channel entry hub is internally connected with an all cycles impulse, making available program exit impulses at each of the program levels. When special program is wired, this internal connection is broken so that the channel entry does not receive an impulse unless externally wired from all cycles. This arrangement permits selection of one channel for the first five steps, another channel for the second five steps, a third channel for the next five steps, and so on.

The channel entry hubs may also be used as the common points of a selector with the five rows of program levels serving as five transferred points. After a program start has been

initiated, the five program levels are connected internally to the channel entry hubs in succession, so that information of any nature may be introduced either into the channel entry or the various program level hubs for purposes of selection.



AU, 71-72

*Repeat.* When special program is wired ON and a program start is initiated, the program succession is stopped after five program steps have been taken. If more program steps are desired, step 5 is wired to repeat, causing step 1 to be initiated on the cycle following step 5, and the automatic progression to be repeated. Any program step other than 5 may be wired to repeat and the succession of program steps will start over on the following cycle.

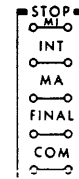

AP-AT, 71-72

*Stop Minor, Intermediate, Major, Final, Common.*

When card feeding is to be resumed following a program level other than 5, the stop hubs must be impulsed. If three steps are desired for the minor program, then step 3 is wired to minor stop. Only the intermediate stop is active on the intermediate change in program, even though a preceding step is wired to minor stop. By the same reasoning, only a major stop is active on a major change in program even though preceding steps are wired to minor and intermediate stops.

Any number of extra program steps may be taken from any one program start and only one program need be taken for the other two. For example, if five programs are desired for minor

FIGURE 96. PRINTING FIVE MINOR TOTALS FROM SAME PRINT WHEELS

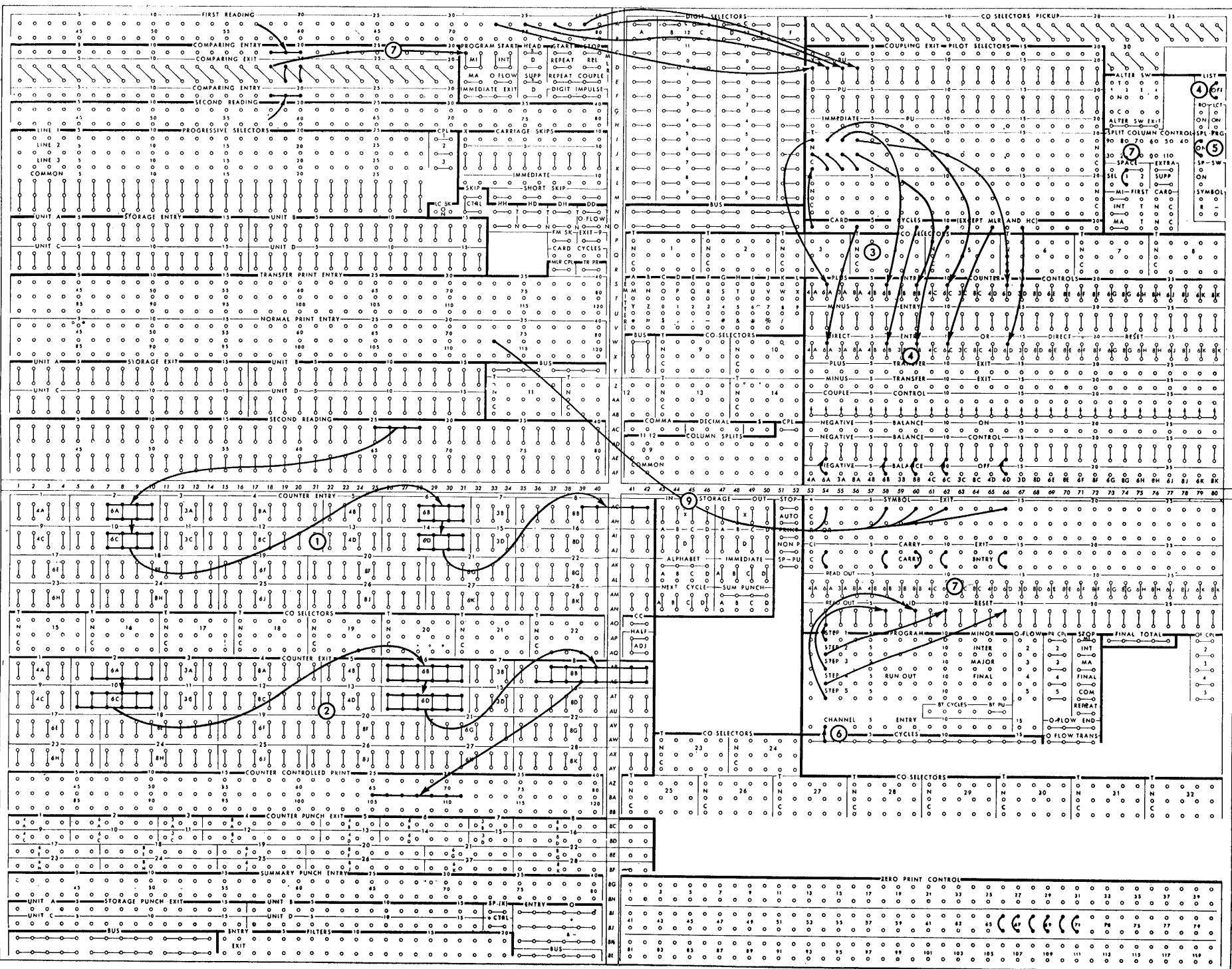

program start and one each for intermediate and major, two channels would be necessary, one for minor and the other for intermediate and major. The first channel would provide the five minor program steps. Steps 1 and 2 of the second channel would provide the intermediate and major program step. Thus, on a major program start, seven program cycles would occur, the first five for minor, the sixth for intermediate, and the seventh for major. The minor program would be stopped from step 5, the intermediate from step 6 and the major from step 7. Steps 6 and 7 are the first and second hubs of the second channel. If only five steps are desired, no stop is necessary since the machine stops automatically after the fifth step if repeat is not wired. Card feeding would then be resumed.

The common stop hub is both an entry and an exit when special program is not wired. When special program is wired, it is an entry and not an exit. As an entry, any program step wired to it will cause the program progression to stop at the end of the cycle on which it receives the impulse, regardless of other controls. As an exit it emits an all cycles impulse during the last program step of each group. It may be wired to perform special functions, such as extra spacing after the last total of each group.

The final stop is used when special program is ON, the LCT switch is ON and the final total toggle switch is ON, to stop the progression of program steps on the run-in and as the last card is run-out to the stacker. The final stop hubs may also be wired from the step following the last program step used. This extra step may be used to control a run-out final total.

#### Wiring, Printing Five Minor Totals from Same Print Wheels (Figure 96)

1. The field to be added is wired to five counters.
2. The exits of the five counters are connected and wired to counter-controlled print.
3. Counter 2 adds for X33 cards, counter 10 adds for X35 cards, counter 6 adds for X37 cards, counter 14 adds for X39 cards, and counter 8 adds for all NX cards.

4. Since the report is being group printed (list off) and counters are read out and reset on different programs, all five counters are wired for direct entry, independently.

5. The special program switch is wired ON.

6. An all cycles impulse is wired to channel entry 2.

7. The minor program start is impulsed and the machine takes five cycles before it stops. Step 1 is wired to read out and reset counter 2, step 2 to read out and reset counter 10, step 3 to read out and reset counter 6, step 4 to read out and reset counter 14, and step 5 to read out and reset counter 8. The totals will be single spaced because the space 1 hub is wired. Spacing may be altered by using space 2 or extra space.

#### Six-Field Crossfooting

Six or more fields can be crossfooted from a single card by the use of special program. The crossfooted factors may be added or subtracted.

This example demonstrates how extra cycles beyond five may be taken for minor program start. Although a cycle count is wired to minor program start so that the steps will be taken for every card, a comparing impulse can be used so that the steps can be taken for a group of cards. Thus, crossfooting may be done for every card or for a group of cards.

#### Wiring (Figure 97)

1. The six fields are wired to counters as shown. They are also wired to normal print entry.
2. A reads out of counter 2 and rolls into counter 10 to add to B. A + B reads out of counter 10 and rolls into counter 6 to add to C. A + B + C reads out of counter 6 and rolls into counter 14 to add to D. A + B + C + D reads out of counter 14 and rolls into counter 17 to add to E. A + B + C + D + E reads out of counter 17 and rolls into counter 19 to add to F. The total reads out of counter 19 to counter-controlled print.
3. All of the receiving counter plus hubs are impulsed from card cycles; therefore, transfer control plus of the transmitting counters cannot be wired directly to the plus of a receiving counter. If it is, the card cycles impulse will back up into

FIGURE 97. SIX-FIELD CROSSFOOTING

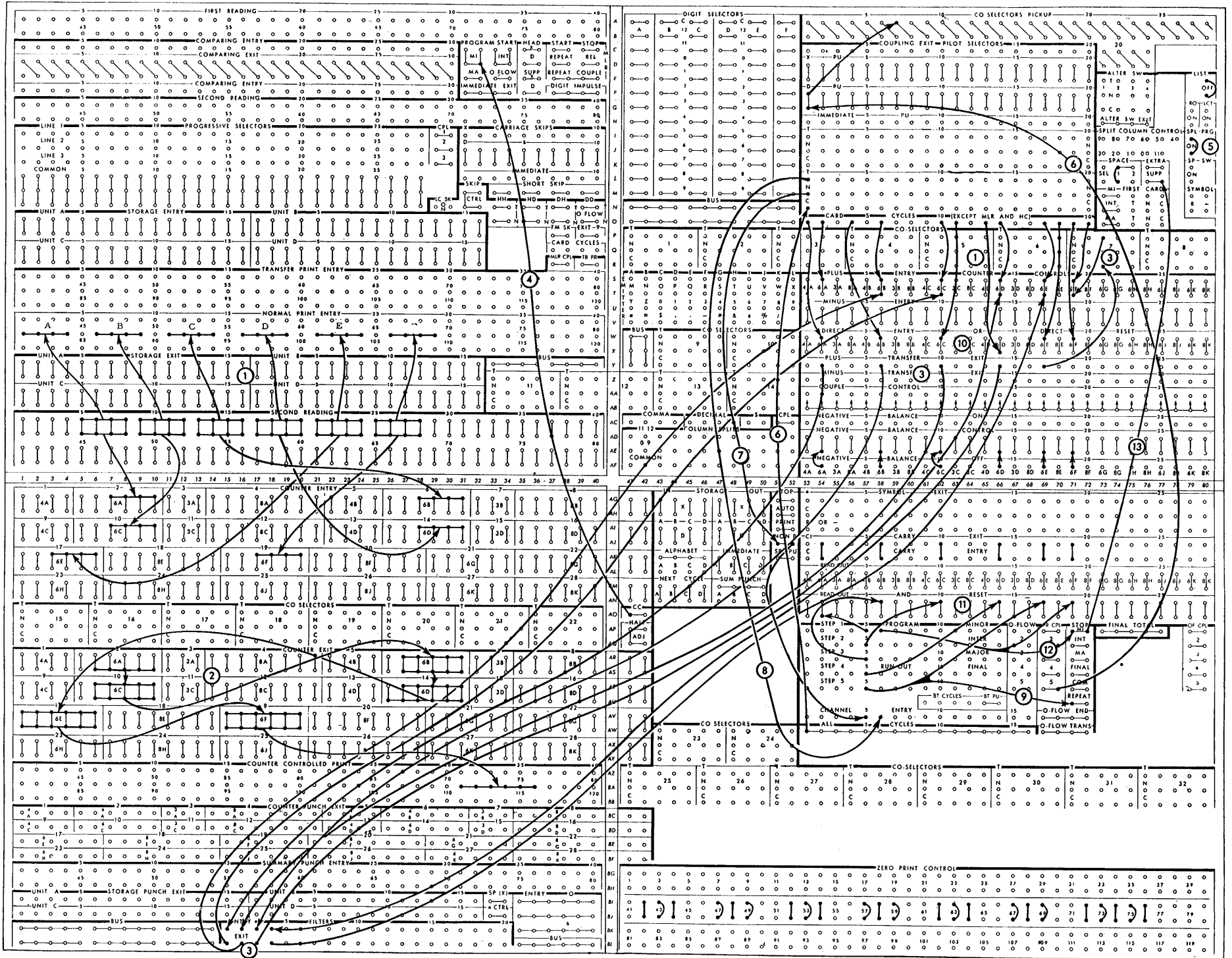

the transfer plus exit and cause the transmitting counter to subtract.

To prevent the interference, the transfer plus exit hubs of counters 2, 10, 6 and 14 are wired through filters to the plus hubs of receiving counters 10, 6, 14 and 17. The transfer plus exit of 17 is wired through the transferred side of co-selector 7 to counter 19 plus. The selector is picked up from program couple 5 and represents another method of preventing the card cycles impulse from reaching transfer plus.

4. Cycle count is wired to minor program start.

5. The special program is wired ON; therefore, once the program start is impulsed, the program levels begin stepping off until either the fifth level is reached or a stop hub is impulsed.

6. An all cycles impulse must be wired to the channel entry hub corresponding to the vertical row of program hubs to be used. If five or less cycles are desired, the all cycles impulse can be wired directly to the channel entry hub. If more than five cycles are required, as in this problem, a pilot selector must be used to select the all cycles impulse so that it reaches one channel on the first five steps and another channel on the second five steps. To do this, the couple hub of the fifth level is wired to the D pickup of a pilot selector. When the fifth minor program step is reached, the pilot selector is impulsed and transfers for the sixth cycle and through the next card feed cycle.

NOTE: If special programming is used when summary punching and more than five program levels are required, a program exit impulse should be used instead of program couple to pick the pilot selector which shifts the all cycles impulse to a different channel entry. This is required only if S.P. PU is impulsed on the last program step before the shift in the all cycles impulse takes place.

7. The pilot selector will be normal for the first five steps. An all cycles impulse wired through the normal side to non-print eliminates printing and spacing during crossfooting cycles. The all cycles impulse is also wired to the fifth channel entry. The hubs immediately above this channel entry will be active at their respective levels on the first round, or for steps 1 through 5.

8. The pilot selector will be transferred for the

sixth step and the all cycles impulse is directed to the sixth channel. The hubs immediately above this channel entry will be active for their respective levels on the second round or for steps 6 through 10.

9. Normally, programming stops and card feeding is resumed after the fifth step, if the preceding steps are not wired to stop. In the example, six steps are desired and therefore step 5 is wired to repeat. The program steps will then begin again at 1 and continue until stopped or until the 10th step is reached.

10. Since the report is being group printed and counters are read out and reset on different programs, all counters are wired for direct entry independently.

11. Counter 2 reads out and clears on step 1, counter 10 on step 2, counter 6 on step 3, counter 14 on step 4, counter 17 on step 5 and counter 19 on step 6.

12. Step 6, the last step used, is wired to minor stop. The minor stop is used because the minor program start initiated programming. Only the minor stop is active on a minor change in program.

13. The sixth program step is wired to space suppress to permit the crossfooted total to print on the same line as the indication.

#### Crossfooting Eleven Totals

For every five programs taken during a special program operation, a separate channel is required. An all cycles impulse must be wired to each channel used. It can be wired directly to channel entry if only five steps are required. For every additional five steps, a pilot selector is required to select the all cycles impulses to the channel entries in turn. When eleven cycles are required, two pilot selectors are necessary, one to control steps 6 through 10 and the other to control step 11.

The wiring shown in Figure 98 is for an 11-field group printed report. Whenever a minor program change is recognized, the totals of all eleven fields will crossfoot on ten cycles and the grand total will

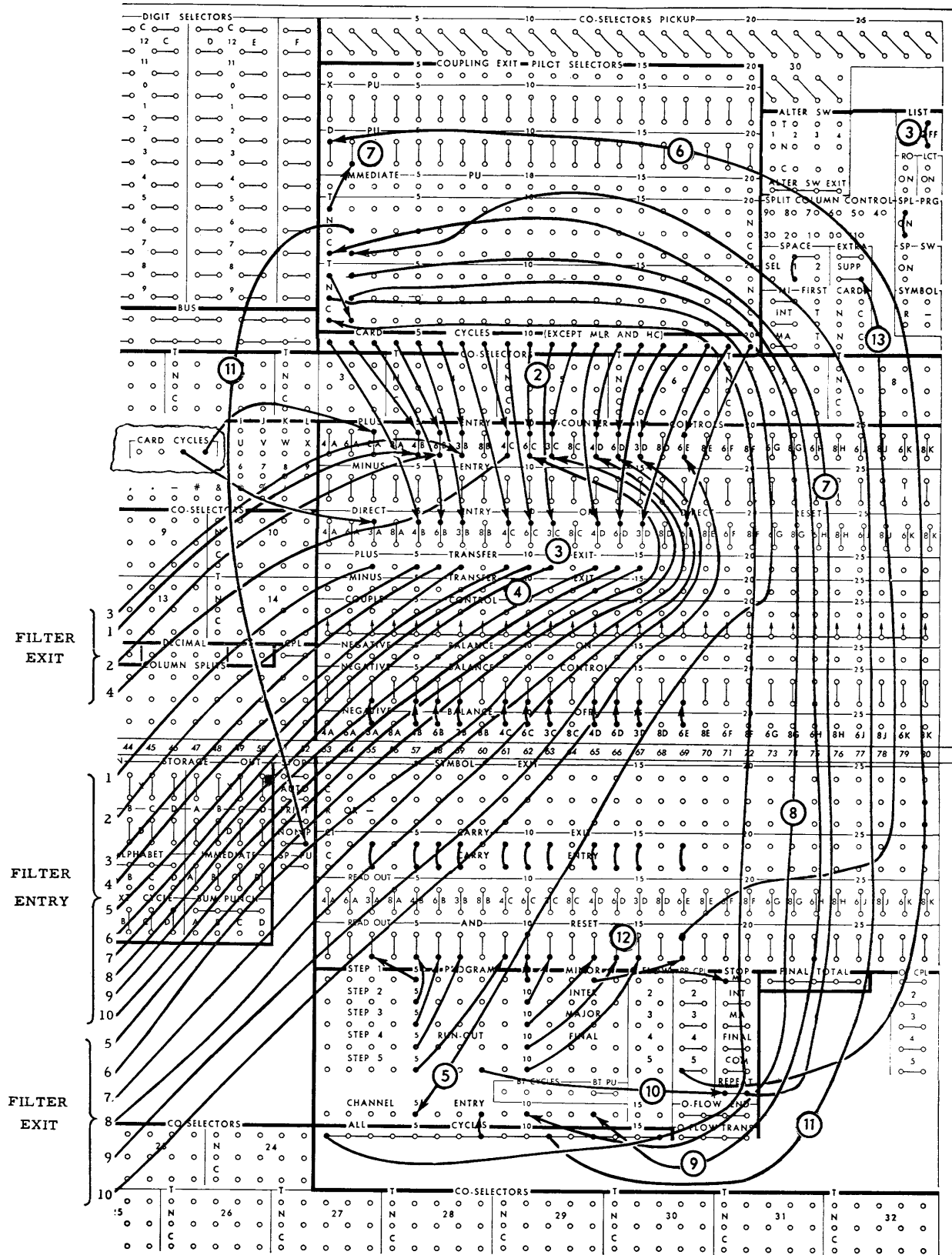

FIGURE 98. CROSSFOOTING ELEVEN TOTALS



print on the eleventh cycle before continuing with the following group. Counter entry and exit wiring is not shown, as it is the same as that shown in Figure 97. On any crossfooting or total transfer operation, however, the number of cycles may be reduced by transferring more than one counter on each step, but counter exit selection is necessary to eliminate interference.

**Wiring (Figure 98)**

1. Minor program start is wired.
2. Eleven counters are impulsed to add from card cycles.
3. Card cycles are wired independently to the direct entry hubs of each counter to suppress the printing from counters on the group indicate cycle.
4. Receiving counters are impulsed to add transferred totals by wiring the transfer control plus hubs of the transmitting counters through filters, to the plus hubs of the receiving counters. The filters are necessary to prevent the card cycles impulse from backing up into the transfer exit hubs

and thereby cause the transmitting counter to subtract erroneously.

5. An all cycles impulse is wired through the normal hubs of pilot selector 1 to channel 5. This channel will be operative for steps 1 through 5.

6. Pilot selector 1 is picked up from the couple of step 5. The selector will be normal for the first five steps and transferred for the remaining program steps through the first card of the following group. Note: See note on page 110 item 6.

7. An all cycles impulse from step 5 is wired through the transferred side of pilot selector 1 to the D pickup of pilot selector 2. On the tenth step the all cycles impulse reaches the selector pick-up and transfers the selector for step 11 and all remaining program steps through the first card of the following group.

8. An all cycles impulse is wired through the transferred side of pilot selector 1, and then through the normal side of pilot selector 2 to channel entry 10. This channel will be operative for steps 6 through 10.

9. An all cycles impulse is wired through the transferred hubs of pilot selectors 1 and 2 to chan-

<b>REPRESENTATIVE COMPANY</b> ANY CITY-ANY STATE					
INVOICE TO E C BROWN & CO		SHIPPED TO		INVOICE NUMBER      PAGE 26115      2 DATE CODE	
SHIPPED VIA		PLEASE REFER TO OUR INVOICE NUMBER WHEN REMITTING TERMS: 2% 10 DAYS. F. O. B. FACTORY			
ORDER DATE      ORDER NO.					
ITEM NUMBER	DESCRIPTION	QUANTITY & UNIT OF MEAS.	UNIT PRICE	AMOUNT	COST AND PROFIT
	INV TOT			\$ 1664.61*	1239.65-
	2% DISC			\$ 33.29CR	1664.61
	NET AMT			\$ 1631.32*	424.96

FIGURE 99. TOTAL IDENTIFICATION

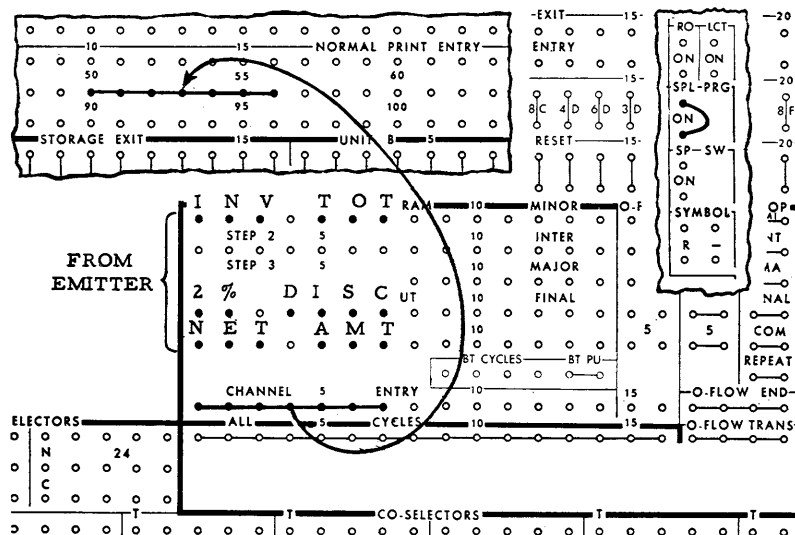

FIGURE 100. TOTAL IDENTIFICATION

nel entry 13. Pilot selector 1 is picked up for step 6 and remains transferred for all remaining program cycles. Pilot selector 2 is picked up for step 11 and remains transferred for all remaining program cycles. Channel 13 will be operative starting with step 11.

10. Since programming starts automatically after every five steps, repeat is required after steps 5 and 10. To accomplish this, an all cycles impulse is wired to channel entry 8 and the fifth step is wired to repeat. This hub will be active on every fifth program step.

11. Pilot selector 2 transfers for the eleventh and all remaining program steps through the first card of the following group. The all cycles impulse wired through the normal side will impulse non-print for steps 1 through 10, thus allowing printing only for the group indication cycle and the total print cycle.

12. The eleven counters are impulsed to read out and reset on specific program steps as shown. The last program step used (step 11) is wired to minor stop.

13. Program step 11 is also wired to SUPP so that the crossfooted total will print on the same line as the indication.

#### Printing Total Identifications from Channel Entry

When special program is wired ON, the channel entry hubs may be used as the common points of a selector with the five rows of program levels serving as five transferred points. Information wired into any or all five rows will be available out of channel entry in turn, that is, the first row on step 1, the second row on step 2, etc.

One of the uses for this type of selection would be the identification of totals as shown in Figure 99. The first total is identified as an invoice total, the second as a 2% discount total and the third as net amount. The wiring for total identification shown in this figure is illustrated in Figure 100.

#### Wiring (Figure 100)

*Inv tot* is wired to step 1, *2% disc* to step 4 and *net amt* to step 5 from the character emitter. These steps are connected progressively to the channel entry hubs which are wired to normal print entry. Steps 2 and 3 are used for the 2% discount calculation, during which non-print is impulsed.

Discount Calculation by Repeated Addition

Multiplication by repeated addition may be performed by the use of special programming. This feature often provides a practical method of performing calculations. Careful consideration should be given to each problem of this type to determine whether this method is to be preferred over other methods of calculating. In the example shown (Figure 101) two discounts are computed, one for 10% and the other for 20%. The result of each calculation is adjusted for dropped decimals and sub-

tracted from the invoice totals. The planning chart (Figure 102) illustrates this principle.



AP-AQ, 41-42

*Half Adj. (Half Adjust)*. These hubs emit a 5 impulse every machine cycle. They are normally wired to counters under selector control to adjust totals to the nearest cent. A separate program step is required for half adjusting totals.

REPRESENTATIVE COMPANY			INVOICE		
CITY, STATE			INVOICE NO.		
GENERAL RADIO CO			51-02		
SHIPPING INSTRUCTIONS			INVOICE DATE		
TERMS			MO. DAY YEAR		
SALESMAN			CUST. ORDER NO.		
CUST. ORDER DATE					
QUANTITY	UNIT	DESCRIPTION	STOCK NO.	PRICE	AMOUNT
		BROT FWD			18,868.75*
1		CABINET	T-44	56.00	56.00
1		CONSOLE	TAN	129.00	129.00
			GROSS		\$19,053.75□
			- 10%		1,905.38
					17,148.37
			- 20%		3,429.67
			NET		\$13,718.70□

FIGURE 101. DISCOUNT CALCULATION

## DISCOUNT CALCULATION PLANNING CHART

PROGRAM STEP	COUNTER 4 (NET)	COUNTER 8 (DISCOUNT)	FUNCTIONS
1.	19,053.75 RO	+1,905.375	Print accumulated total from 4. Transfer total to 8 by direct entry.
2. Non-print		$\frac{5}{1,905.380}$	$\frac{1}{2}$ adjust units position by direct entry.
3.	-1,905.38	RO	Print 10% discount from 8, dropping units position. Transfer 10% discount to 4 and subtract.
4. Non-print		*Direct reset	Direct reset 8.
5.	17,148.37 RO	1,714.837	Print first net from 4. Transfer total to 8 by direct entry.
6. Non-print	RO	$\frac{1,714.837}{3,429.674}$	Transfer total to 8 by direct entry.
7. Non-print		$\frac{5}{3,429.679}$	$\frac{1}{2}$ adjust units position by direct entry.
8.	-3,429.67	RO	Print 20% discount from 8, dropping units position. Transfer 20% discount to 4 and subtract.
9.	13,718.70 RO and reset	*Direct reset	Print final net from 4. Direct reset 8.

\*Direct reset is necessary because the units position is not wired to counter-controlled print.

FIGURE 102

## Wiring, Discount Calculation (Figure 103)

The wiring for this example can best be understood by reference to the planning chart (Figure 102) as each step is explained.

1. Counter 4 is the net counter and 8 the discount counter. The field to be accumulated is wired to 4 entry. The exit of 4 is wired to counter-controlled print and also to the entry of 8. The exit of 8 is wired to the entry of 4. This wiring facilitates the transferring of totals back and forth from one counter to another.

2. Special program is wired ON, since more than three steps are required for every minor program change.

3. Channels 2, 3, 4, 5 and 6 are made active for the first five steps by wiring all cycles through the normal side of co-selector 8 to channel entry. Channels 8, 9, 10, 11, 12 and 13 are made active for the next five steps by wiring all cycles through the transferred side of co-selector 8 to channel entry.

Co-selector 8 is picked up from the couple exit of pilot selector 3 which is picked up from the

FIGURE 103. DISCOUNT CALCULATION

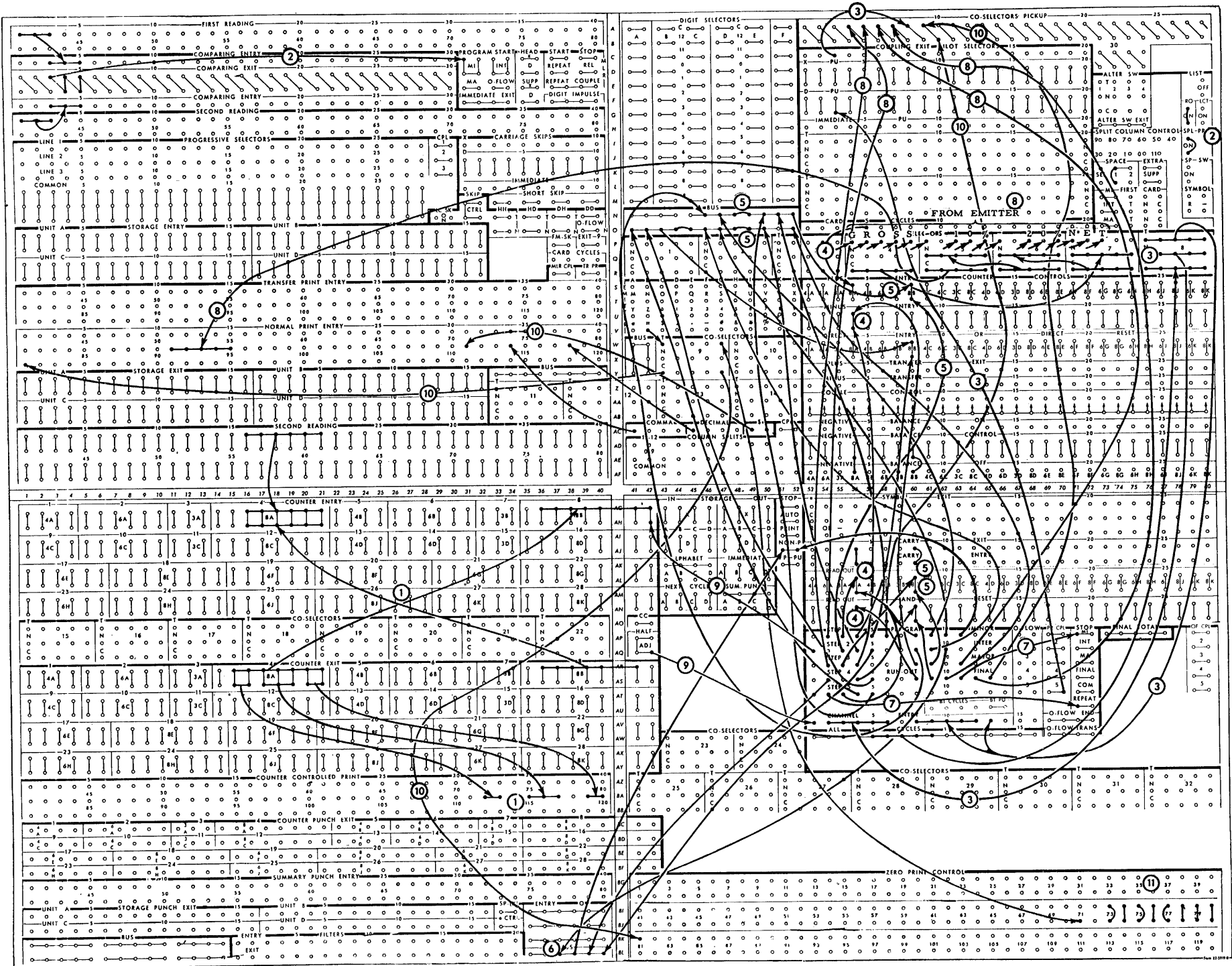

fifth program level. Both selectors will be normal for steps 1-5 and transferred for all remaining program steps through the first card of the following group.

4. The counter controls for 4 are wired as follows:

*Counter Plus:*

Card cycles to add from every card.

*Counter Minus:*

Step 3 to subtract 10% discount

Step 8 to subtract 20% discount.

*Neg. Bal. Off:*

To negative balance control.

*CI and C:*

CI to C.

*Read Out:*

Step 1 to read out gross for printing and for transmitting to 8.

Step 5 to read out first net for printing and for transmitting to 8.

Step 6 to read out for transmitting to 8.

*Read Out and Reset:*

Step 9 to read out and reset for printing net total.

5. The counter controls for 8 are wired as follows:

*Counter Plus:*

Step 1 to add gross from 4.

Step 2 to add half adjustment.

Step 5 to add first net from 4. } 20%

Step 6 to add first net from 4. } disc.

Step 7 to add half adjustment.

*Direct Entry:*

Step 1 to direct enter gross.

Step 2 to direct enter half adjustment.

Step 5 to direct enter first net. 20% }

Step 6 to direct enter first net. disc. }

Step 7 to direct enter half adjustment.

*Neg. Bal. OFF:*

To negative balance control.

*CI and C:*

CI to C.

*Read Out:*

Step 3 to read out 10% discount into 4.

Step 8 to read out 20% discount into 4.

*Read Out and Reset:*

Step 4 to direct reset and to read out and reset 10% Disc.

Step 9 to direct reset and to read out and reset 20% Disc.

6. Non print is wired to suppress printing and spacing on the following program steps:

Step 2 when 10% discount is half adjusted.

Step 4 when counter 8 is direct reset.

Step 6 when 10% is added in 8.

Step 7 when another 10% is added in 8.

7. Repeat is wired from step 5 and minor stop from the last program used, step 9.

8. Total identification is wired from the emitter as follows:

The word *net* is wired to the transferred side of co-selector 7. The selector is picked up from step 9.

—20% (discount) is wired to the transferred side of co-selector 6. The selector is picked up from step 8.

—10% (discount) is wired to the transferred side of co-selector 5. The selector is picked up from step 3.

The word *gross* is wired to the transferred side of co-selector 4. The selector is picked up from step 1. Total identification prints from print wheels 51-55.

9. Half adjustments for 10% and 20% discounts: Since both half adjustments occur at the second level (steps 2 and 7) the half adjust hub is wired to channel entry 1 and out of level 2 to the units position of counter 8 entry.

10. The dollar sign and total symbol (□) are wired to print only for gross and net totals as follows:

The dollar symbol is wired to normal print entry 71.

The total symbol is wired from the character emitter through co-selector 9.

Zero print control hub 71 is wired through the transferred side of co-selector 9 to the upper hub of 80. The selector is picked up from step 1 (gross) and step 9 (net).

11. The comma and decimal are wired to normal print entry 74 and 78 and are controlled by normal zero print control wiring.

## TAPE-CONTROLLED CARRIAGE

THE TAPE-CONTROLLED carriage controls the feeding and spacing of forms at high speed while documents or reports are being prepared on the Type 407 accounting machine. The carriage is controlled by punched holes in a narrow paper tape which exactly corresponds in length to the length of one or more forms. Holes punched in the tape stop the form when it reaches any predetermined position. One of the punched holes in the tape can be used to control the accounting machine to start overflow skipping to the next form.

The carriage will accommodate continuous forms measured in 6ths of an inch up to a maximum of 22 inches in length and  $16\frac{3}{4}$  inches in width including punched margins. While forms of any size within these limits can be handled by the carriage, forms of standard sizes available from the forms manufacturers can be obtained more quickly and economically.

Forms can be designed to permit printing in practically any desired arrangement. Skipping can be controlled to ten different sections of the form.

### Variable Line Spacing and Uniform Skipping

Single, double, or quadruple spacing can vary between lines as controlled by wiring on the control panel. For example, the heading section of a form may be single spaced and the body double spaced.

Any other spacing that is required must be controlled by the tape. Spaces up to two inches between lines can be skipped at the same rate of speed as normal spacing. This skipping is a smooth, high speed advance of the form allowing successive lines to be printed up to two inches apart at the rate of 150 lines per minute, the normal printing speed of the machine.

### Overflow Skipping

When one form is completely filled, it can be ejected and the next form can advance to the first printing line or to the first body line. This "overflow skipping" is caused by sensing a punch in a

specific position of the tape, which starts advancing the paper to the required line on the next form. If the last card of a group prints on the last available detail printing line, the total will print before skipping to the next form takes place. Overflow is slower than other skipping; therefore, it is desirable to reduce overflow skipping to a minimum.

Printing all totals on the last overflow form can be accomplished without reducing the printing space on each of the preceding forms.

### Page Totals

The overflow punch in the tape can also be used to start other operations, if desired, before ejecting the completely filled form. For example, a total may be printed at the bottom of each page before advancing to the next form.

### Overflow Sheet Identification

Several lines of numerical or alphabetic identifying information may be printed on an overflow sheet. Invoice and page numbering may also be printed on the overflow sheets.

### Predetermined Total Line

Totals can be printed on a predetermined total line, whether the form is completely filled or not. For example, although only two or three items have been printed on a form, the total of these items may be printed on a designated line of the form, instead of directly beneath the last item printed.

## CONTROL TAPE

THE CONTROL TAPE (Figure 104) has 12 columnar positions indicated by vertical lines. These positions are called channels. A maximum of 22 inches (132 lines) can be used for control of a form, although for convenience the tape blanks are slightly longer. Horizontal lines are spaced 6 to

**GLUE**

1 2 3 4 5 6 7 8 9 10 11 12 13 14 15 16 17 18 19 20 21 22 23 24 25 26 27 28 29 30 31 32

12 11 10 9 8 7 6 5 4 3 2 1

PLACE CHECK OR PAY HERE

STATEMENT  
**GENERAL MANUFACTURING CO.**  
ENDICOTT, N. Y.

IN ACCOUNT WITH

A. B. SMITH & CO.  
1025 E. MAIN ST.  
DAYTON, OHIO

CUST NO.	MO.	DAY	YR.
7756	5	01	

CODES  
1. CASH  
2. RETURN  
3. ALLOWANCE

DATE		REFERENCE	CODE	CHARGES	CREDIT
MO.	DAY				
3	12	21046		206.50	
4	2	28522		134.62	
4	10	5096	1		206.50
BALANCE DUE					134.62

128 127 126 125 124 123 122 121 120 119 118 117 116 115 114 113 112 111 110 109 108 107 106 105 104 103 102 101 100 99 98 97 96 95 94 93 92 91 90 89 88 87 86 85 84 83 82 81 80 79 78 77 76 75 74 73 72 71 70 69 68 67 66 65 64 63 62 61 60 59 58 57 56 55 54 53 52 51 50 49 48 47 46 45 44 43 42 41 40 39 38 37 36 35 34 33 32 31 30 29 28 27 26 25 24 23 22 21 20 19 18 17 16 15 14 13 12 11 10 9 8 7 6 5 4 3 2 1

PRINTED IN U.S.A.

FIGURE 104



the inch for the entire length of the tape. Round holes in the center of the tape are prepunched for a pin feed drive in a tape sensing mechanism which controls the carriage. The tape advances through the mechanism in synchronism with the movement of the printed form through the carriage. The effect is exactly the same as though the control holes were punched along the edge of each form.

Twelve brushes, one for each channel, are positioned over the tape for sensing the holes that are punched. As viewed from the front of the machine, they are numbered 1 through 12 from left to right. Brush 1 rests on channel 1, brush 2 on channel 2, and so on. A hole in the channel allows the brush to make contact with a metal roll and set up the necessary circuits that are normally used to stop skipping or to initiate an overflow.

#### Tape Channels

Tape channels are punched to control the following functions:

*First Printing Line Stop.* Channel 1 is normally punched for the first printing line of a form. This is the starting or home position.

*Normal Skip Stops.* Channels 2 through 10 are used to stop a form at one of nine positions including first body line. They may be used in any order or sequence. Digits, X's, comparing exits, skip control and program exits may be used to start skipping to any position of the form.

*Overflow Control.* The 12th channel of the tape must be punched in a position corresponding to the last printing line of a form. This punch is normally used to cause immediate overflow skipping but may also be used to initiate overflow programs which in turn can be used to print sheet identification information out of storage units and counters.

When head control is not wired, an overflow is made to the first printing line of the next form. When head control is wired, overflow skipping may be made to the first printing line if overflow page identification is to be printed; if not, the skip may be made directly to any stop used to locate the first body line.

#### Short Skip

Normally, the tape-controlled carriage stops the feeding of cards through the accounting machine

during every skip regardless of its length. The feeding of cards is resumed after the skip is completed, but at least one machine cycle is lost for every skip taken. This is sometimes referred to as interlocking, and its primary purpose is to prevent printing in flight for skips longer than two inches. If a skip is two inches or less it is called a short skip and the control panel may be wired to release the interlock and thereby cause continuous operation of the accounting machine. When the distance is more than two inches, the machine is interlocked at the start of the skip. The interlock may be released, however by impulsing short skip whenever the remaining distance to be skipped is two inches or less.

In designing forms, distances which are to be skipped frequently should, if possible, be kept within two inches for most efficient operation. These distances may or may not be between two successive sections of a form. For example, in a billing form with a section for the heading and a section for the body, the distance from the last heading line printed to the first body line should be kept within 2 inches for most efficient operation.

The interlock may be released for overflow skipping if the overflow skip is one inch or less.

#### Tape Punching

A small, compact punch (Figure 105) is provided for punching the tape. The tape is first marked in the channels in which the holes are to be punched. This can be done easily by laying the

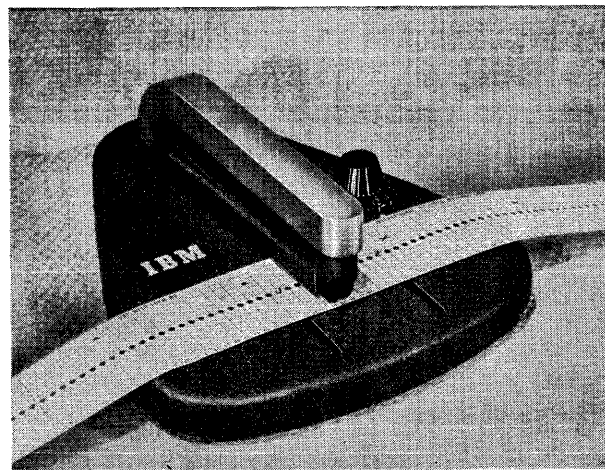

FIGURE 105. TAPE PUNCH

tape beside the left edge of the form which it is to control with the top line (immediately under the glue portion) even with the top edge of the form. A mark is then made in the first channel on the line which corresponds to the first printing line of the form. Additional marks are made in the appropriate channels for each of the other skip stops and the overflow signal required for the form.

The marking for one form should be repeated as many times as the usable length of the tape (22 inches) will allow. With the tape thus serving to control several forms in one revolution through the sensing mechanism, the life of the tape is increased. Finally, the line corresponding to the bottom edge of the last form should be marked for cutting after the tape is punched.

The tape is inserted in the punch by placing the line to be punched over a guide line on the base of the punch and placing the center feed holes of the tape over the pins projecting from the base. The dial is then turned until the arrow points at the number of the channel to be punched. Pressing on the top of the punch, toward the back, cuts a rectangular hole at the intersection of a vertical and horizontal line in the required channel of the tape.

The tape may be punched with holes in more than one channel on the same line. This is advantageous in many cases, when several skip impulses are directed to the same skip stop. Punching two holes in one channel is necessary in some instances.

After the tape is punched, it is cut and looped into a belt. *The bottom line is glued to the top line by the use of the section marked GLUE, after the glaze has been removed by an ink eraser. If the glaze is not removed, the tape ends may come apart.* The center feed holes should coincide when the two ends of the tape are glued together.

The last hole punched in the tape should not be less than four lines from the cut edge, as approximately the last half inch of the tape overlaps the glue section when the two ends are spliced. If it is necessary to punch a hole lower than four lines from the bottom of the form, the tape should be placed with the top line (immediately under the glue portion) four lines lower than the top edge of the form before marking the channels. To com-

pensate for the loss, the tape should then be cut four lines lower than the bottom edge of the form.

#### Inserting Tape in Carriage

The cover of the carriage is tilted back to gain access to the tape reading mechanism. The platen clutch is turned to a disengaged position, and the brushes are raised by moving to the left the latch located on the side of the brush holder. With the tape held so that the printed captions can be read, one end of the loop is placed over the pin feed drive wheel so that the pins engage the center drive holes. The opposite end of the loop is placed over the nearest half circle guide piece. The excess slack is removed from the tape by lifting the lever away from the notched bar and by moving the guide piece unit to the right. The tape should be just tight enough so that it will give slightly when the top and bottom portions of the loop are pressed together as shown in Figure 106. It should not fit too tightly or the pin feed holes will be damaged.

After the tape is in position, the brushes are pressed down and the cover is closed. The restore key is depressed to bring the tape to its home position and the platen clutch is turned back to its engaged position. The carriage is then ready to operate.

Tapes can be changed readily and used repeatedly over a considerable period of time.

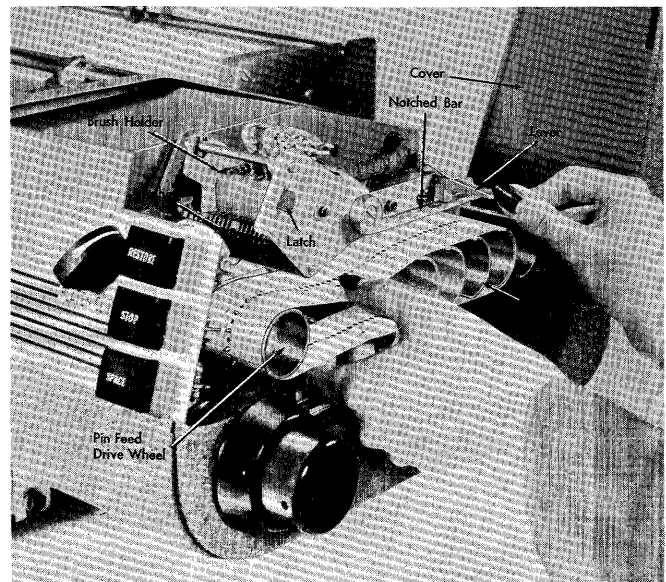

FIGURE 106. INSERTING TAPE IN CARRIAGE

## OPERATING FEATURES

### Platen Clutch

When the arrow on the platen clutch is pointing upward, as shown in Figure 107, the platen is engaged and can be turned manually only by the vernier knob. To disengage the platen from machine control, the platen clutch is turned to the right. The platen can then be turned manually by the platen knob.

### Restore Key

The carriage is set at the start or home position (channel 1) by depressing the restore key. This is done while the platen is disengaged. Restoring is necessary because the distance which each form travels through the carriage, as it is being printed, is measured by the tape. Starting from the first printing line of one form, the tape moves in synchronism with the form, until the first printing line of the next form is reached.

### Stop Key

Depression of this key stops the carriage operation instantly, and the accounting machine at the end of the cycle.

### Space Key

When the accounting machine is stopped, a form can be advanced by depressing the space key. The

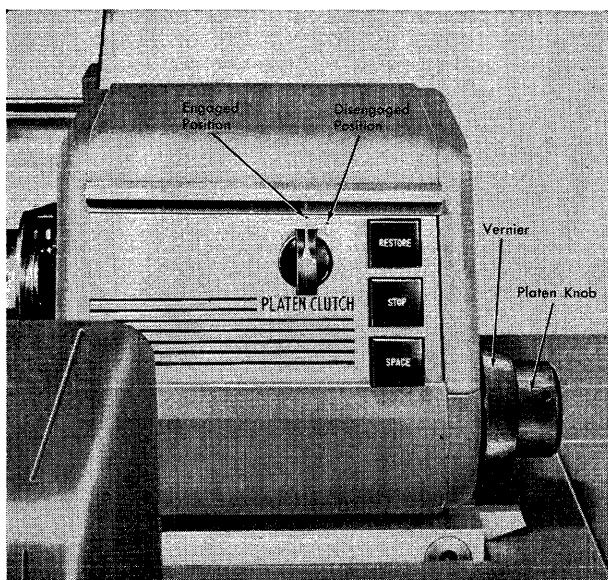

FIGURE 107. CARRIAGE FEATURES

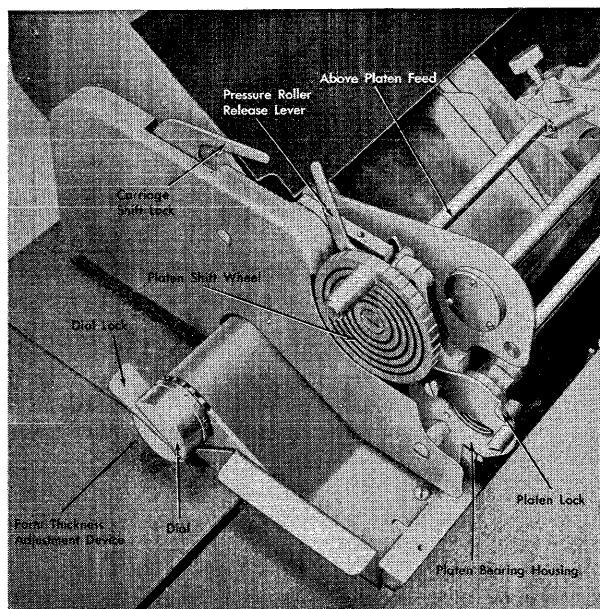

FIGURE 108. LEFT SIDE OF CARRIAGE

form advances one space for each key depression, regardless of the spacing for which the space control is wired. The first form can be fed into position by depressing the space key if the platen clutch is engaged, but the platen clutch should then be disengaged to permit restoring the tape without advancing the form.

### Platen Knob

The platen knob can be turned backward or forward to position the form only when the platen clutch is disengaged.

### Vernier Knob

The vernier knob is used to obtain exact registrations in relation to the horizontal lines. The platen advances, thus lowering the printing on the form, when the knob is turned counterclockwise. Turning the knob in a clockwise direction will cause the printing to occur higher on the form. In either case, the carriage tape is not affected and adjustments can be made while the platen is engaged or while the machine is in operation.

### Form Thickness Adjustment Device

The distance between the print wheels and the platen is adjustable, for thickness of paper stock or for varying number of copies, by the use of the form thickness adjustment device (Figure 108)

located on the left side of the carriage. This device contains seven notches numbered from 0 through 6. When the dial is in the 0 notch the print wheels are  $\frac{1}{8}$  (.125) of an inch from the platen. Each of the remaining six notches add to the  $\frac{1}{8}$  inch distance by approximately the thickness of  $1\frac{1}{2}$  cards. When the dial is set to 6 the distance is increased to approximately .178 of an inch. The dial should be set wherever the best results are obtained. To adjust for varying thicknesses, the dial lock is pulled out and the dial is turned counter-clockwise, to increase the distance between the platen and the print wheels, and clockwise to decrease the distance.

#### Pressure Release Lever

When the lever is pushed back, the feed rolls are released so that the paper can be moved freely around the platen. Pressure should always be released when the above platen feed for the Type 407 is in use. Pressure should be applied when the above platen feed is not in use.

#### Carriage Shift Lock

The purpose of the carriage shift lock is to prevent the carriage from moving laterally. When the shift lock is raised, the paper clamp bands tighten against the platen. This prevents possible damage to the paper clamp bands while moving the carriage with the platen shift wheel.

#### Platen Shift Wheel

When the carriage shift lock is raised, the platen may be shifted laterally a total of four inches by turning the platen shift wheel. For example, with the carriage in the extreme left position, the carriage may be moved four inches to the right. This adjustment should not be made while the machine is in operation.

#### End of Form Stop

The end of form stop (Figure 109) located in the center of the carriage stops the machine when the carriage runs out of paper, providing the form stop toggle switch is turned ON. The forms feed under the end of form stop and when the bottom edge of the last form passes it, the machine stops. The distance between the end of form stop and the printing line is approximately  $13\frac{3}{8}$  inches. If the end of form stop is not desired, the form stop toggle switch is turned OFF.

### IBM FORM FEEDING DEVICES

Two types of form feeding devices are available on the Type 407 machine: the IBM Above Platen Feed Device and the IBM Forms Tractor. The Forms Tractor is standard on all machines shipped after January 30, 1953.

#### IBM Above Platen Feed Device (Model A-3)

The above platen feed device is designed espe-

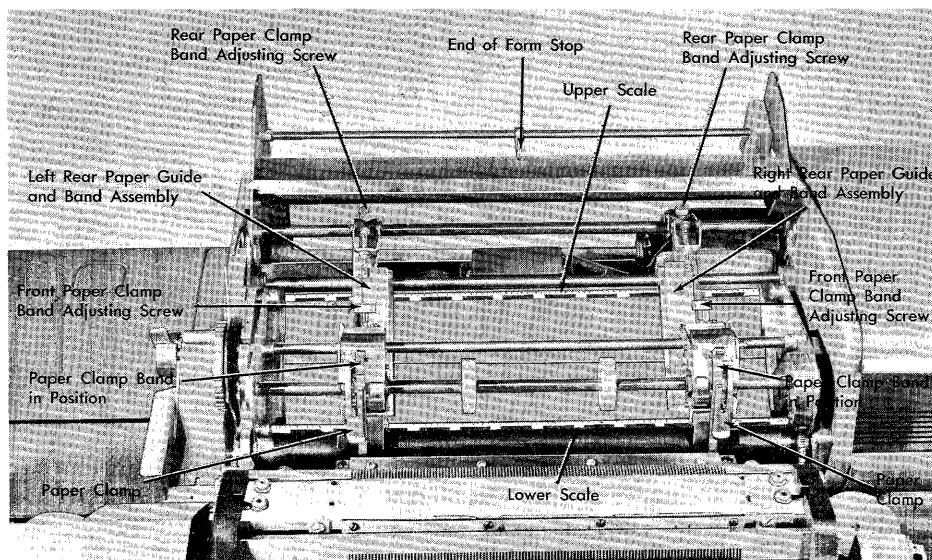

FIGURE 109

cially for the Type 407 and may be freely inserted into the carriage. It is used for feeding marginally punched continuous forms with six lines-per-inch spacing, and consists of two adjustable pin wheels with paper clamps attached. It fits into two slots on either end of the carriage and can be removed as easily as it can be inserted. It also swings back out of the way of the platen if desired.

The lower part of the feed device contains an 18 inch scale which is used in conjunction with the scale on the carriage, to assist in setting the pin wheels so that they line up with the paper guide and band assemblies. The blackened areas represent feed roll positions and need not be considered when using the above platen feed.

#### PAPER GUIDE AND BAND ASSEMBLY

To keep the paper in position and firmly against the platen during all printing cycles, the left and right paper guides (Figure 109) are equipped with metal bands, which encircle the platen and can be attached to either the above platen feed or the tear bar. The guide and band assembly may be positioned at the front and the rear along an upper and lower scale as will be explained under *Setting Paper Guides and Band Assemblies*.

The bands fit loosely around the platen when the machine is not in operation, thus allowing forms to be fed between the bands and the platen. On every print cycle the bands tighten against the platen and hold the paper firmly.

When the metal bands are disconnected from the above platen feed or the tear bar, they hang loosely over the print wheel cover on the machine.

#### PAPER GUIDE AND BAND ASSEMBLY SCALE

An 18-inch scale is permanently attached to the carriage just below the back cover. The black areas on the scale represent the location of the pressure rolls and the white areas the space between the pressure rolls. The scale is used when setting the paper guide and band assemblies.

#### TEAR BAR

The tear bar is used whenever feeding is under the control of the pressure rolls. It is a long, narrow metal instrument with a paper clamp on either end that may be set along an 18-inch scale to line up with the rear paper guide and band

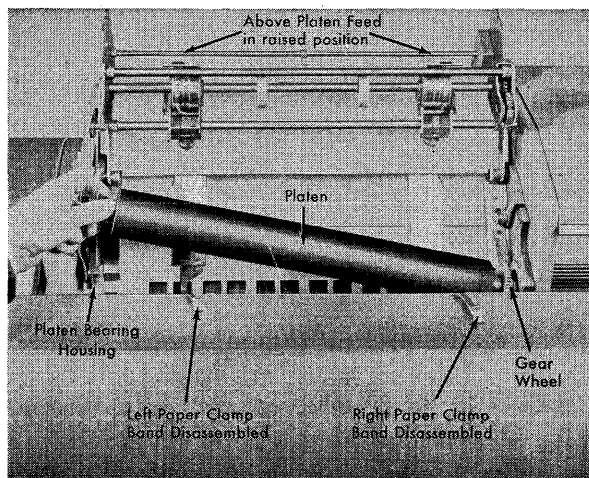

FIGURE 110. PLATEN

assembly. The scale is a permanent part of the tear bar. The blackened areas represent the location of the feed rolls and serve as a guide to prevent setting the bands on the feed rolls during pressure feeding operations.

The tear bar is generally used for single sheet operations and when roll paper is being used. It is easily inserted in the carriage by placing the ends into the forward slots on the carriage frame.

#### PLATEN

The carriage is equipped with an easily removable solid platen as a standard feature. The platen may vary in hardness with the number of parts in each form. A medium platen (90 durometer) is recommended for 6-part forms and under. A hard platen (100 durometer) is recommended for 7-part forms and over.

The platen may be removed (Figure 110) by raising the platen lock on the left side and lifting the platen from the bearing housing. When the platen is inserted, the end with the gear wheel should be placed in the slot on the right of the carriage, and the left end should be dropped into the platen bearing housing. The platen must then be moved to the right, turning it back and forth, in order to fit the platen drive key into the carriage drive mechanism. The platen lock is then closed.

Figure 110 shows the paper clamp bands disassembled and the above platen feed in a raised position.

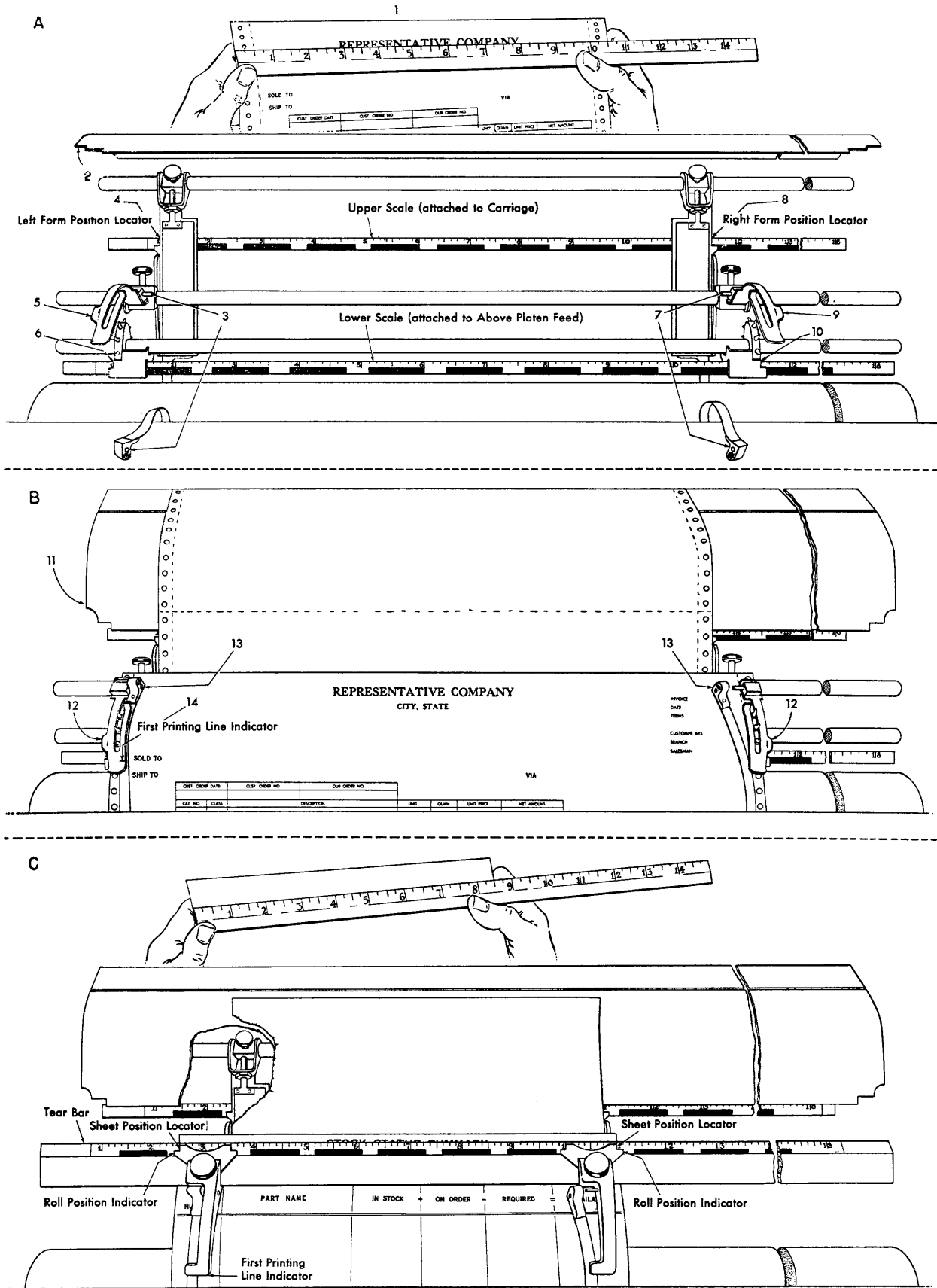

FIGURE 111

## CARRIAGE ADJUSTMENT

*Setting Paper Guides and Band Assemblies*

The best method of setting the paper guides and band assemblies is illustrated in the schematic drawings that follow. Figure 111 (A and B) shows the steps necessary for setting the guides and band assemblies when using the above platen feed and Figure 111C when using the tear bar. These instructions may be followed only for forms with  $\frac{1}{4}$  inch margins (distance from center of feed hole to edge of form), which will include the majority of forms.

The black marks on the upper and lower scale represent the location of the pressure rolls and need only be considered when pressure feeding (as described under *Tear Bar*).

*Steps in Using Above Platen Feed (Figure 111, A and B)*

1. Measure the over-all width of form ( $10\frac{1}{2}$ " in example).
2. Raise rear cover.
3. Remove left band from stud.
4. Determine the first print wheel being used and set left rear paper guide and band assembly slightly to the left of it, preferably so that the rear form position locator rests on an even  $\frac{1}{4}$ ",  $\frac{1}{2}$ " or 1" mark along the scale. (The example shows the form position locator on the 1 inch mark.)
5. Raise the paper clamp that rests on the left pin wheel.
6. Secure the left pin wheel assembly so that the lower form position locator rests at the same position on the lower scale as the rear form locator does on the upper scale. (Left pin wheel set at 1" in the example.)
7. Remove right band from stud.
8. Set right rear paper guide and band assembly so that the right rear form position locator rests on a scale reading, determined by adding the overall width of the form to the left guide reading ( $10\frac{1}{2}" + 1" = 11\frac{1}{2}"$  in example).
9. Raise the paper clamp that rests on the right pin wheel.
10. Secure right pin wheel assembly so that right lower form position indicator rests at the same position on the lower scale as the rear form

indicator does on the upper scale. (Right pin wheel set at  $11\frac{1}{2}"$  in the example.)

11. Close rear cover.
12. Insert form and close both right and left paper clamps.
13. Replace right and left bands on studs, making sure that the bands are under the paper clamps.
14. Set form so that first printing line is even with the first printing line indicator mark on paper clamp. Then, turn the paper back 11 spaces to place the form in printing position.

Adjust the carriage laterally so that the print wheels line up exactly with the printing positions on the form. The easiest way to accomplish this is to have a symbol preprinted on the form to identify print wheel 1, 60 or 120.

Figure 112 illustrates a form inserted in the carriage with an IBM Above Platen Feed Device.

*Steps in Using the Tear Bar (Figure 111, C)*

The steps necessary for positioning the paper guide band assemblies when using the tear bar are the same as those necessary when using the above platen feed, with the following exceptions:

1. The paper clamps on the tear bar replace the pin wheel assemblies. They move along the tear bar laterally when the pressure is released.

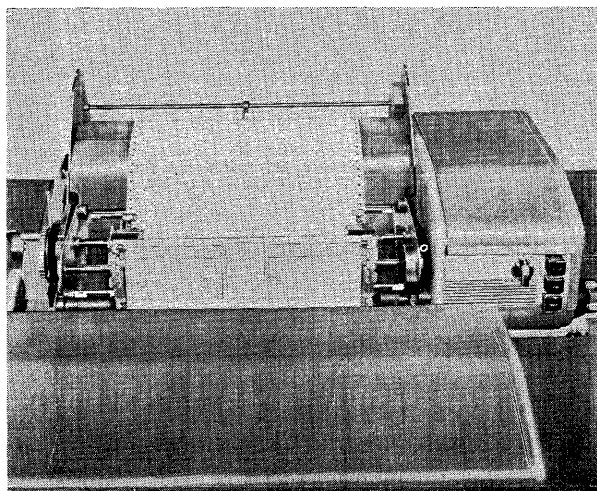

FIGURE 112. CARRIAGE READY TO OPERATE

2. When the tear bar is used, form feeding is done by pressure of the feed rolls against the paper and the platen. The band would be damaged if allowed to ride between the feed rolls and the platen. Therefore, the roll position indicators on both the paper guide and the paper clamps must never rest on a blackened area. The blackened areas represent the location of the feed rolls.

Bands being replaced must slide under the clamps before being attached to the studs.

#### IBM Forms Tractor (Model F-2)

The IBM Forms Tractor, Figure 113, is supplied on machines shipped after January 1, 1953.

This device is used for feeding marginally-punched continuous forms and has two adjustable tractor type pin feed units, one for each side of the form. It may be freely inserted in the carriage by first hooking the rear pin of the device in position and then lowering the front.

#### SIX OR EIGHT LINES PER INCH

Spacing may be set for either six or eight lines per inch. This adjustment can be made by moving the shift cam until its pointer is positioned between the two scribed lines by either the 6 or the 8 on the side frame. If the pointer cannot be positioned between the scribed lines, a tooth-on-tooth condi-

tion exists between the platen gear and the forms tractor drive gear. In this case, move the shift cam to release the pressure on the 6- or 8-line drive gear and turn the platen slightly to allow the teeth to fully engage. Single spacing at 8 lines per inch is not recommended where the accuracy of line spacing is critical.

#### STEPS IN USING THE FORMS TRACTOR

1. After the forms tractor is in position, make sure that the platen and the forms tractor can be moved freely by hand.

2. If a narrow form is to be used, remove the center paper guide which supports the form in the center.

3. Move the left lower paper guide and tractor slightly to the left of the first printing position. Place the first form between the left and right lower paper guides and move the right guide in against the edge of the form. Allow a slight clearance so that the form slides freely between both guides. Tighten both lock screws to hold the guide assemblies in place.

4. With the pressure rolls engaged, insert the form under the carriage between the round rod and the platen, and then into the pressure rolls. Turn the platen by hand (platen clutch disengaged) until the end of the form can be grasped.

5. Raise the pressure plates away from the pins.

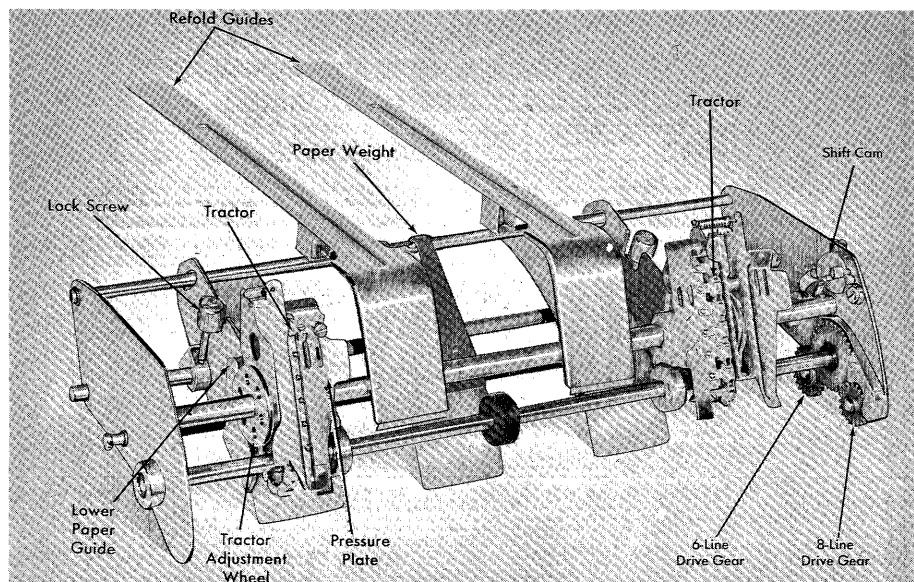

FIGURE 113. IBM FORMS TRACTOR



6. Release the pressure rolls, draw up the form, and attach the pin feed holes to the tractor pins.

7. Lower the pressure plates.

8. Set the form so that the first printing line is even with the first printing line indicator mark on the lower part of the pressure plates. Then, turn the form back 14 spaces if spacing is set for six lines per inch and 19 spaces if set for eight lines per inch.

#### TRACTOR ADJUSTMENTS

##### *Tractor Adjustment Wheels*

The tractor adjustment wheels may be turned to provide a 1/8" lateral movement of the tractors. The wheels are used to make the chain pins line up exactly with the center of the marginal holes in the paper after the paper guides have been set.

#### PAPER WEIGHT

The paper weight is non-adjustable and exerts a slight pressure on the paper as it feeds through the Forms Tractor.

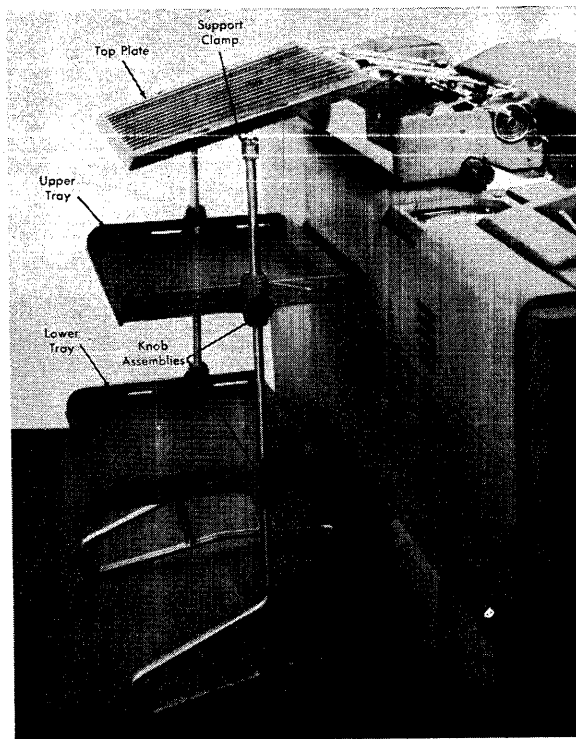

FIGURE 114

#### FORM STAND AND FORM FEED GUIDES

##### Form Stand (Figure 114)

There are two movable trays on the form stand. The upper tray holds the forms about to be fed into the machine and the lower tray receives the forms coming from the machine. For best operation, the upper tray should be set as high as possible and still allow ample room for the stack of forms feeding into the machine. This brings the paper close to the carriage and cuts down paper drag. The lower tray should be set at the extreme low position when feeding single part forms and somewhat higher when feeding multiple part forms, the exact position to be determined during actual operation.

Either tray may be moved up or down after first loosening the knob assemblies located on the side of each tray. The knobs are loosened when turned counter-clockwise.

The form stand should be placed behind the 407 with the open sides of the two trays away from the machine. The top plate should fit over the rear edges of the three form feed guides as shown in Figure 115. The stand should then be moved as close to the machine as the form feed guides will allow. The top plate may be moved up or down after first loosening the support clamps. The support clamps are loosened by turning them counter-clockwise.

##### Form Feed Guides (Figure 115)

The three form feed guides should be set equidistantly across the carriage. They are mounted at the rear on the paper roll shaft which extends through the second of two holes in the rear of each form guide. A second shaft extends through the center holes in each paper guide. A rubber grommet fits on each end of the shaft to keep it in position.

The front ends of the left and right form guides rest on the front paper clamp band adjusting screws. The front end of the center guide rests on the support bar.

FORM CONTROL

SKIPPING is started by wiring on the control panel and is stopped by holes in the tape. The following examples of control panel wiring show operating principles and are not necessarily the only arrangements of the channel punching which can be used.

Only that control panel wiring is shown which relates directly to the carriage operation.

Form to Form Skipping

Form to form skipping is required whenever continuous forms are used.

Forms of two inches or less in depth, requiring only one line of printing from single cards, can be prepared at the rate of 150 forms per minute. The rate of speed for preparing forms that are greater than two inches in depth depends on the number of lines to be printed on the form as well as the over-all depth of the form. About five inches can be skipped in two machine cycles.

The withholding statement shown in Figure 116 illustrates form to form skipping under the control of the comparing unit. A separate form is required for each employee.

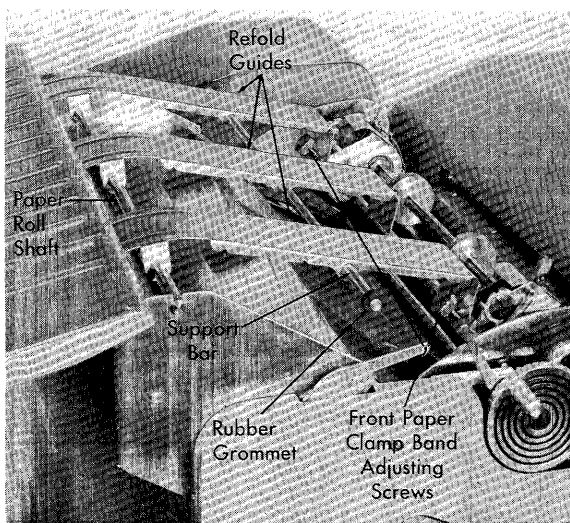
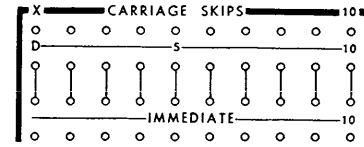

FIGURE 115



I-L, 31-40

*Carriage Skips.* There are 10 carriage skip positions representing the first ten channels on the carriage tape. Each of the 10 positions has an X, D, and immediate skip hub. If an impulse is introduced into one of these hubs and a hole is punched in the tape in the corresponding channel, a skip will take place to the position where the hole is punched in the tape. For example, if hub 3 is impulsed on the control panel and a hole is punched in channel 3 of the tape, the impulse will start the skip and the hole in the tape will stop it.

The X hubs accept X, 12 or skip control HD, HH, DH, and DD impulses, and the D hubs accept any impulse (skip control, HD, HH, DH, DD, digit, X, 12, comparing exit, etc.) to cause skipping on the following cycle. The immediate hubs accept program, all cycle, card cycle, first card or skip control impulses to cause skipping on the same cycle. When the X or D hubs are impulsed and a total intervenes, skipping takes place after the total prints. When the I hubs are impulsed and a total intervenes, skipping takes place before the total prints.

When the X or D hubs are impulsed during program or MLR (multiple line read) cycles the skip will not become effective until after all program or MLR cycles are completed. In such cases the X or D skips take precedence, and any impulse wired to I of the same channel will not be effective until after the X, D skip has been completed.

As previously described, channel 1 is normally used to identify the first printing line and channel 12 is always used to identify overflow. All other channels identify other stops within the same form and may be used interchangeably.

<p><b>GLUE</b></p> <p>10 9 8 7 6 5 4 3 2 1</p> <p>10 9 8 7 6 5 4 3 2 1</p> <p>10 9 8 7 6 5 4 3 2 1</p> <p>10 9 8 7 6 5 4 3 2 1</p>	<p><b>Form W-2</b> U. S. Treasury Department Internal Revenue Service</p>	<p><b>WITHHOLDING STATEMENT—19</b> Wages Paid and Income Tax Withheld</p>	<p><b>ORIGINAL</b> Do Not Lose This Statement</p>										
	<table border="1"> <tr> <th>Employee to whom paid (name and full address)</th> <th>MARITAL STATUS (1 SINGLE, 2 MARRIED)</th> <th>Social Security No.</th> <th>TOTAL WAGES (BEFORE PAYROLL DEDUCTIONS) PAID IN 1949</th> <th>Federal Income Tax Withheld, If Any</th> </tr> <tr> <td>A. D. STANTON 2150 SYCAMORE DRIVE TROY, PA.</td> <td style="text-align: center;">2</td> <td style="text-align: center;">312-43-5601</td> <td style="text-align: right;">3540.65</td> <td style="text-align: right;">245.00</td> </tr> </table>	Employee to whom paid (name and full address)	MARITAL STATUS (1 SINGLE, 2 MARRIED)	Social Security No.	TOTAL WAGES (BEFORE PAYROLL DEDUCTIONS) PAID IN 1949	Federal Income Tax Withheld, If Any	A. D. STANTON 2150 SYCAMORE DRIVE TROY, PA.	2	312-43-5601	3540.65	245.00	<p>APP. B.I.R. 6-7-49</p>	<p><b>NOTICE TO EMPLOYEE</b></p> <p>This statement is important!</p> <p>It must be attached to your U. S. income tax return for 19</p> <p>See instructions on other side</p>
	Employee to whom paid (name and full address)	MARITAL STATUS (1 SINGLE, 2 MARRIED)	Social Security No.	TOTAL WAGES (BEFORE PAYROLL DEDUCTIONS) PAID IN 1949	Federal Income Tax Withheld, If Any								
	A. D. STANTON 2150 SYCAMORE DRIVE TROY, PA.	2	312-43-5601	3540.65	245.00								
<p><b>EMPLOYER BY WHOM PAID</b> (Name, address, and S. S. identification No.)</p> <p style="text-align: center;"><b>GENERAL MANUFACTURING COMPANY</b> ENDICOTT, NEW YORK</p>													
<p><b>1</b></p>													
	<p><b>Form W-2</b> U. S. Treasury Department Internal Revenue Service</p>	<p><b>WITHHOLDING STATEMENT—19</b> Wages Paid and Income Tax Withheld</p>	<p><b>ORIGINAL</b> Do Not Lose This Statement</p>										
<table border="1"> <tr> <th>Employee to whom paid (name and full address)</th> <th>MARITAL STATUS (1 SINGLE, 2 MARRIED)</th> <th>Social Security No.</th> <th>TOTAL WAGES (BEFORE PAYROLL DEDUCTIONS) PAID IN 1949</th> <th>Federal Income Tax Withheld, If Any</th> </tr> <tr> <td>R. L. MORRISON 186 ELM ST. TROY, PA.</td> <td style="text-align: center;">1</td> <td style="text-align: center;">503-65-2198</td> <td style="text-align: right;">3210.86</td> <td style="text-align: right;">405.60</td> </tr> </table>	Employee to whom paid (name and full address)	MARITAL STATUS (1 SINGLE, 2 MARRIED)	Social Security No.	TOTAL WAGES (BEFORE PAYROLL DEDUCTIONS) PAID IN 1949	Federal Income Tax Withheld, If Any	R. L. MORRISON 186 ELM ST. TROY, PA.	1	503-65-2198	3210.86	405.60	<p>APP. B.I.R. 6-7-49</p>	<p><b>NOTICE TO EMPLOYEE</b></p> <p>This statement is important!</p> <p>It must be attached to your U. S. income tax return for 19</p> <p>See instructions on other side</p>	
Employee to whom paid (name and full address)	MARITAL STATUS (1 SINGLE, 2 MARRIED)	Social Security No.	TOTAL WAGES (BEFORE PAYROLL DEDUCTIONS) PAID IN 1949	Federal Income Tax Withheld, If Any									
R. L. MORRISON 186 ELM ST. TROY, PA.	1	503-65-2198	3210.86	405.60									
<p><b>EMPLOYER BY WHOM PAID</b> (Name, address, and S. S. identification No.)</p> <p style="text-align: center;"><b>GENERAL MANUFACTURING COMPANY</b> ENDICOTT, NEW YORK</p>													
<p><b>1</b></p>													
	<p><b>Form W-2</b> U. S. Treasury Department Internal Revenue Service</p>	<p><b>WITHHOLDING STATEMENT—19</b> Wages Paid and Income Tax Withheld</p>	<p><b>ORIGINAL</b> Do Not Lose This Statement</p>										
<table border="1"> <tr> <th>Employee to whom paid (name and full address)</th> <th>MARITAL STATUS (1 SINGLE, 2 MARRIED)</th> <th>Social Security No.</th> <th>TOTAL WAGES (BEFORE PAYROLL DEDUCTIONS) PAID IN 1949</th> <th>Federal Income Tax Withheld, If Any</th> </tr> <tr> <td>A. W. RENNINGER 275 WASHINGTON AVE. TROY, PA.</td> <td style="text-align: center;">2</td> <td style="text-align: center;">512-43-7102</td> <td style="text-align: right;">4920.00</td> <td style="text-align: right;">369.20</td> </tr> </table>	Employee to whom paid (name and full address)	MARITAL STATUS (1 SINGLE, 2 MARRIED)	Social Security No.	TOTAL WAGES (BEFORE PAYROLL DEDUCTIONS) PAID IN 1949	Federal Income Tax Withheld, If Any	A. W. RENNINGER 275 WASHINGTON AVE. TROY, PA.	2	512-43-7102	4920.00	369.20	<p>APP. B.I.R. 6-7-49</p>	<p><b>NOTICE TO EMPLOYEE</b></p> <p>This statement is important!</p> <p>It must be attached to your U. S. income tax return for 19</p> <p>See instructions on other side</p>	
Employee to whom paid (name and full address)	MARITAL STATUS (1 SINGLE, 2 MARRIED)	Social Security No.	TOTAL WAGES (BEFORE PAYROLL DEDUCTIONS) PAID IN 1949	Federal Income Tax Withheld, If Any									
A. W. RENNINGER 275 WASHINGTON AVE. TROY, PA.	2	512-43-7102	4920.00	369.20									
<p><b>EMPLOYER BY WHOM PAID</b> (Name, address, and S. S. identification No.)</p> <p style="text-align: center;"><b>GENERAL MANUFACTURING COMPANY</b> ENDICOTT, NEW YORK</p>													
<p><b>1</b></p>													

NOTE: This form is used to illustrate form-to-form skipping, but the design does not conform exactly to the W-2 Withholding Statement currently in use.

FIGURE 116

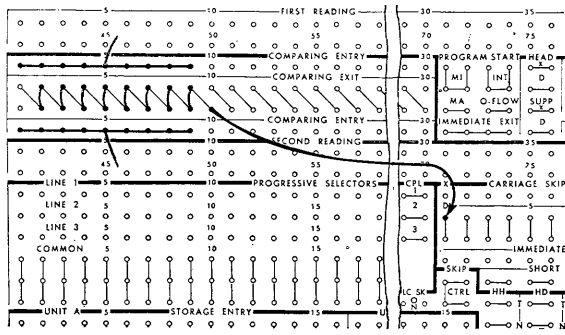

FIGURE 117. FORM TO FORM SKIPPING

**Wiring (Figure 117)**

Social security number is compared and the comparing exit wired to carriage skip 1D. It is unnecessary to initiate a program start since totals are not required. Each new group is identified by a change in social security number and the comparing exit resulting from this change will cause skipping on the following cycle or before the first card of each group. The hole in channel 1 of the tape stops the skip.

**Two Part Form Skipping — Single Heading Forms**

In any operation in which heading and detail cards are used (Figure 118) the machine can be controlled to print the heading cards in the heading section of the form and the detail cards in the body section, as well as provide for overflow.

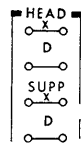

C-F, 35-36

**Head X, D.** Heading cards are usually identified by a significant punch which is normally wired from first reading to head X or D. When an impulse is received by one of these hubs it will indicate that the next card to be read is a heading card and will cause the machine to detail print during the following card feed cycle. The detail printing of heading cards will take place regardless of the setting of the list switch. These hubs also work in conjunction

with skip control to control the carriage skip D and H hubs.

When head control is impulsed, only the minor first card hubs are active during the print cycle of the first detail card following a heading card, regardless of program change or whether the program change is minor, intermediate, or major.

**Supp X, D (Suppress X, D).** An X or D impulse received by these hubs suppresses program control even though a change in group is recognized by the comparing unit. These hubs are normally wired from second reading to suppress programming between heading and body cards or between various heading cards.

Impulsing the suppress hubs does not prevent carriage skipping, however. For example, if a change in program were recognized between heading cards which have no control field and body cards which have, the program would be suspended but the activity of the HDT (heading to detail transferred) hubs would not.

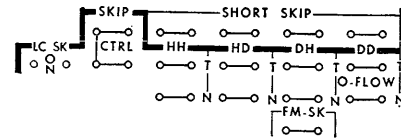

N, 29-30; M-N, 31-32; M-O, 33-40; P, 37-38

**LC SK (Last Card Skip).** This switch must be wired ON if it is desired to skip to channel 1 at the end of the run. If it is not wired, the form on which the last line printed would remain in position for final totals.

**Skip Control.** When these four common hubs receive an impulse from comparing exit and head control is wired, an internal selector system is picked up to control the HH, HD, DH and DD as described below.

**HH (Head Card to Head Card).** Whenever a heading card at the second station is followed by a heading card at the first station, an impulse is emitted from the N (normal) hubs if there is no control change (skip control not impulsed) and from the T (transferred) hubs if there is a control change.

**GLUE**

PLACE CHECK OR BILLS HERE

12	11	10	9	8	7	6	5	4	3	2	1
1	2	3	4	5	6	7	8	9	10	11	12
13	14	15	16	17	18	19	20	21	22	23	24
25	26	27	28	29	30	31	32	33	34	35	36
37	38	39	40	41	42	43	44	45	46	47	48
49	50	51	52	53	54	55	56	57	58	59	60
61	62	63	64	65	66	67	68	69	70	71	72
73	74	75	76	77	78	79	80	81	82	83	84
85	86	87	88	89	90	91	92	93	94	95	96
97	98	99	100	101	102	103	104	105	106	107	108
109	110	111	112	113	114	115	116	117	118	119	120
121	122	123	124	125	126	127	128	129	130	131	132
133	134	135	136	137	138	139	140	141	142	143	144
145	146	147	148	149	150	151	152	153	154	155	156
157	158	159	160	161	162	163	164	165	166	167	168
169	170	171	172	173	174	175	176	177	178	179	180
181	182	183	184	185	186	187	188	189	190	191	192
193	194	195	196	197	198	199	200	201	202	203	204
205	206	207	208	209	210	211	212	213	214	215	216
217	218	219	220	221	222	223	224	225	226	227	228
229	230	231	232	233	234	235	236	237	238	239	240
241	242	243	244	245	246	247	248	249	250	251	252
253	254	255	256	257	258	259	260	261	262	263	264
265	266	267	268	269	270	271	272	273	274	275	276
277	278	279	280	281	282	283	284	285	286	287	288
289	290	291	292	293	294	295	296	297	298	299	300

STATEMENT  
**GENERAL MANUFACTURING CO.**  
ENDICOTT, N. Y.

IN ACCOUNT WITH

A. B. SMITH & CO.  
1025 E. MAIN ST.  
DAYTON, OHIO

CUST NO.	MO.	DAY	YR.
7756	5	01	

CODES  
1. CASH  
2. RETURN  
3. ALLOWANCE

DATE		REFERENCE	CODE	CHARGES	CREDIT
MO.	DAY				
3	12	21046		206.50	
4	2	28522		134.62	
4	10	5096	1		206.50
BALANCE DUE					134.62

PRINTED IN U.S.A.

1	2	3	4	5	6	7	8	9	10	11	12
13	14	15	16	17	18	19	20	21	22	23	24
25	26	27	28	29	30	31	32	33	34	35	36
37	38	39	40	41	42	43	44	45	46	47	48
49	50	51	52	53	54	55	56	57	58	59	60
61	62	63	64	65	66	67	68	69	70	71	72
73	74	75	76	77	78	79	80	81	82	83	84
85	86	87	88	89	90	91	92	93	94	95	96
97	98	99	100	101	102	103	104	105	106	107	108
109	110	111	112	113	114	115	116	117	118	119	120
121	122	123	124	125	126	127	128	129	130	131	132
133	134	135	136	137	138	139	140	141	142	143	144
145	146	147	148	149	150	151	152	153	154	155	156
157	158	159	160	161	162	163	164	165	166	167	168
169	170	171	172	173	174	175	176	177	178	179	180
181	182	183	184	185	186	187	188	189	190	191	192
193	194	195	196	197	198	199	200	201	202	203	204
205	206	207	208	209	210	211	212	213	214	215	216
217	218	219	220	221	222	223	224	225	226	227	228
229	230	231	232	233	234	235	236	237	238	239	240
241	242	243	244	245	246	247	248	249	250	251	252
253	254	255	256	257	258	259	260	261	262	263	264
265	266	267	268	269	270	271	272	273	274	275	276
277	278	279	280	281	282	283	284	285	286	287	288
289	290	291	292	293	294	295	296	297	298	299	300

FIGURE 118

When the HH transferred hubs are active, detail cards are missing, since detail cards should always follow heading cards. These hubs would normally be wired to carriage skip 1 so that the heading card always starts printing on the first line of the next form.

*HD (Head Card to Detail Card).* Whenever a heading card at the second station is followed by a detail card at the first station, an impulse is emitted from the N (normal) hubs if there is no control change and from the T (transferred) hubs if there is a control change. HD normal represents heading cards followed by normal cards of the same group and is normally wired to the skip reserved for the first body line. HD transferred indicates missing detail cards of one group and missing heading cards of the following group and is usually wired to form skip (FM-SK) and to the carriage skip identifying the first body line.

*DH (Detail Card to Head Card).* Whenever a detail card at the second station is followed by a heading card at the first station an impulse is emitted from the N (normal) hubs if there is no control change and from the T (transferred) hubs if there is a control change. DH normal represents cards out of sequence when conventional forms are used and should be wired to machine stop. DH transferred represents a change from one group to another and should be wired to carriage skip 1 so that the heading card of the new group will start printing on the first line of the next form.

*DD (Detail Card to Detail Card Transferred).* Detail to detail transferred emits an impulse when there is a control change between a detail card at the second station and a detail card at the first station. DD transferred represents missing heading cards of the next group and is normally wired to skip to the first body line of the next form.

*Overflow. (Detail to Detail Normal).* These hubs emit an impulse as the last body line of a form is detail printed or as a total is group printed. The last body line is determined by a punch in

channel 12 of the tape. If heading cards are used these hubs are normally wired to the carriage skip hub assigned to the first body line. If heading cards are not used these hubs are wired to the first line of the next form, thus causing form to form ejection.

*Short Skip.* Whenever an overflow occurs and the maximum distance is one inch or less, or whenever a regular skip occurs and the maximum distance is two inches or less, the interlock may be cancelled and skipping may be done without interrupting the normal printing speed of the machine. This is done by impulsing one of the four sets of short skip hubs with the skip impulse representing the skip that is within the required distance. For example, if in form to form skipping the distance between the last printing line of one form to the first printing line of the next form is one inch or less, overflow may be wired to short skip as well as to channel 1; or if the skipping distance between the heading and body of a form is within two inches, HD normal may be wired to short skip as well as to the channel representing the first body line.

When wiring to short skip, care should be taken that these hubs are not tied in with any impulse other than the one desired.

*FM-SK (Form Skip).* A skip from the last heading line of one form to the first body line of the next form requires the carriage to skip more than one form length. The two common form skip hubs are provided for this purpose. The function of the form skip is to delay recognition of any skip stop until the corresponding position is reached on the following form. When form skip is impulsed, the ten brushes are inactive until a 12 (overflow) hole is sensed, at which time they become active again.

The impulse most frequently wired to form skip is HD transferred which represents missing detail cards of the first group and missing heading cards of the second group. Thus, the body of the first form and the heading of the second form must be skipped, preventing form spoilage and allowing the manual insertion of missing data.

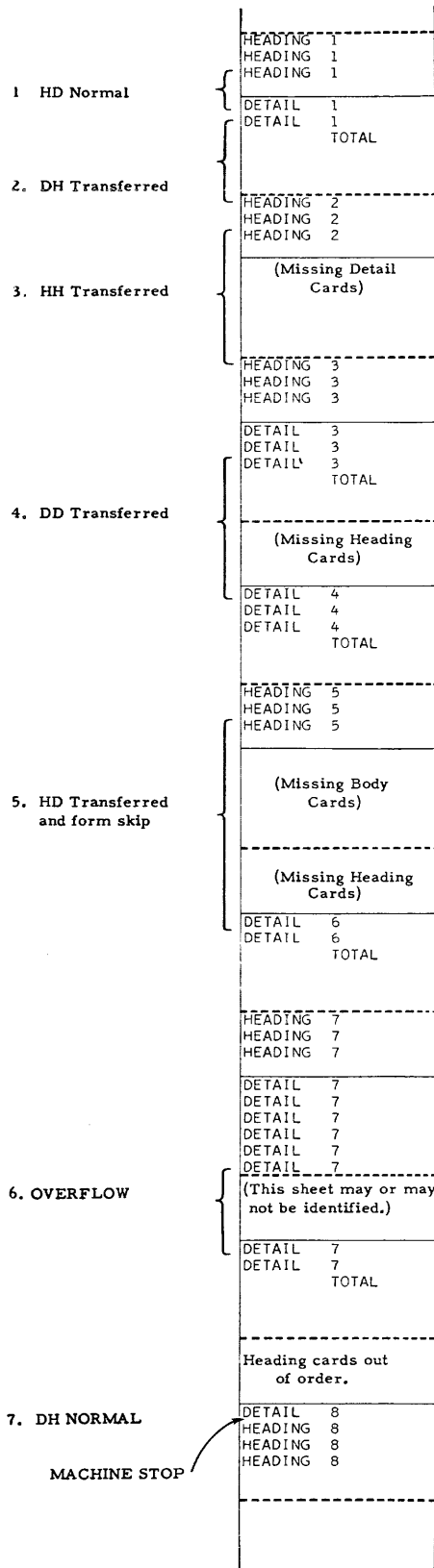

FIGURE 119

Analyzing a Form for Carriage Skip Wiring

Before any carriage skip wiring is attempted, the form itself should be analyzed to determine all the conditions under which skipping might occur. The form shown in Figure 119 would be analyzed as follows:

1. A skip is required between the heading and body of the same form. The carriage hub representing this condition is HD normal.

2. A skip to the first printing line is required after the total prints or between the detail cards of one group and the heading cards of another. DH transferred represents this condition.

3. When body cards are missing a skip from the heading of one form to the heading of the next form is required. The carriage hub representing this condition is HH transferred.

4. When heading cards are missing, a skip from the body of one form to the body of the next form is required. The carriage hub representing this condition is DD transferred.

5. When the body cards of one form and the heading cards of the next form are missing a skip from the heading of one form to the body of the following form is required. The hubs representing this condition are HD transferred and are used in conjunction with FM-SK (form skip).

6. An overflow skip is required when there are more items than one form will accommodate. The hub representing this condition is overflow. (DD normal.)

7. When heading cards follow detail cards of the same group, they are out of sequence. DH normal represents this condition.

The seven conditions described in the above analysis provide a plan for the control of carriage skipping on the basis of heading control, that is, form to form skipping and skipping to the first body line. A further skip can be initiated before total printing to permit printing of the total on a predetermined line as illustrated on Figure 118. The wiring is shown in Figure 120.

An analysis of the form should be made to determine whether the overflow skip is within the one inch limit and the regular skips are within the two inch limit. In the form shown in Figure 119, only the heading to detail skip is within that range and therefore may be wired to short skip.

Wiring (Figure 120)

1. A minor program start is wired for customer number. The comparing exit is also wired to skip control which, together with head control wiring, makes an impulse available out of the HH, HD, DH, or DD hubs for every possible combination of heading and detail cards.

2. All heading cards have an X in column 75 which is wired from first reading to head X.

3. Channel 1 has been assigned to the first printing line. The following impulses are wired to carriage skip 1D to start a skip that will be stopped at the first printing line: HH transferred to initiate a skip when detail cards are missing (condition 3 on Figure 119) and DH transferred to initiate a skip between one form and another (condition 2).

4. Channel 2 has been assigned to the first body

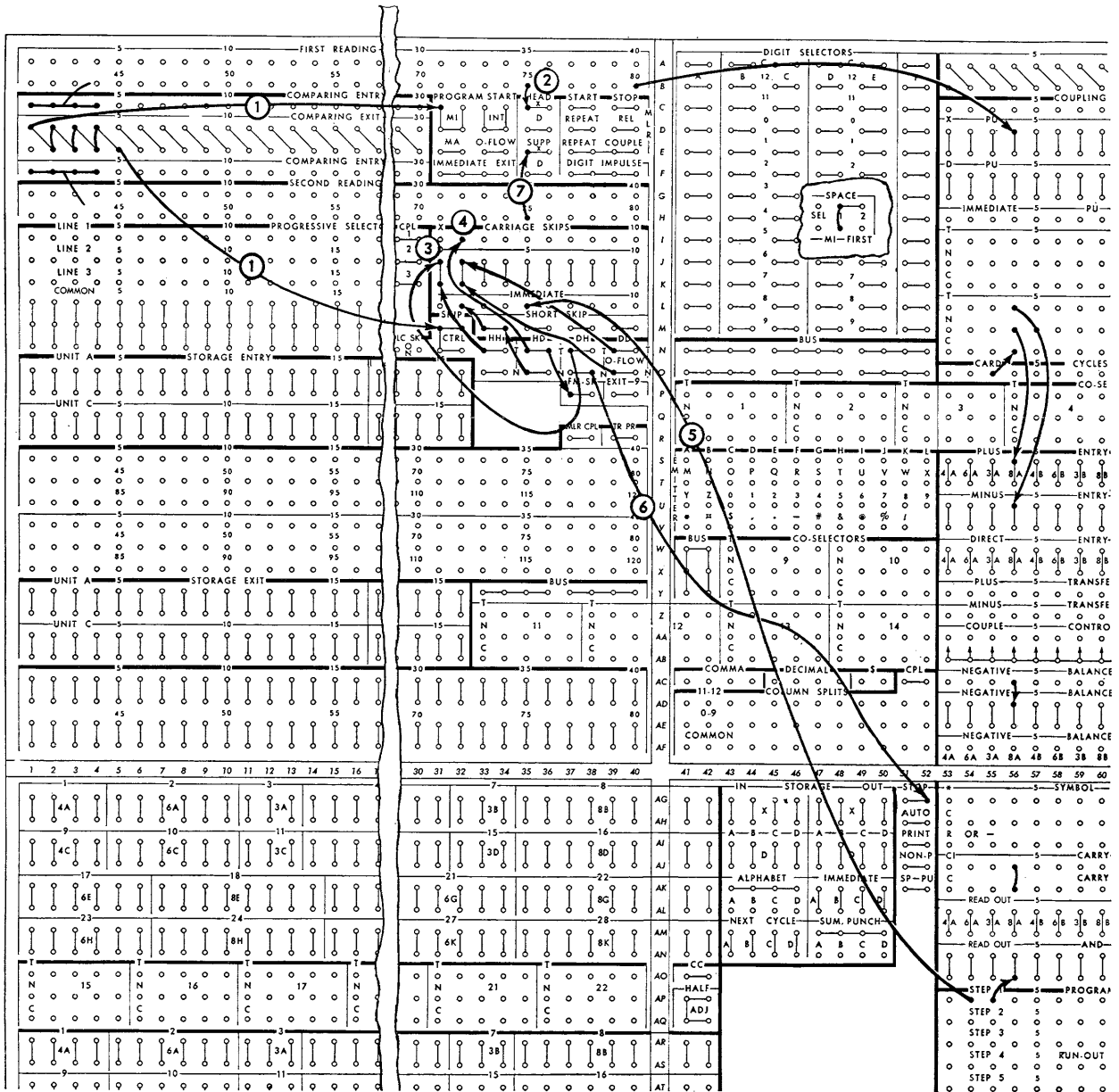

FIGURE 120. TWO PART FORM SKIPPING — SINGLE HEADING



line. The following impulses are wired to carriage skip 2X, D or I, to start a skip that will be stopped at the first body line:

HD transferred, to initiate a skip when the detail cards of one group and the heading cards of the following group are missing (condition 5). This impulse is continued to FM-SK so that the hole in channel 2 will stop the skip only on the second form. Once form skip is impulsed all 10 channel skips become inactive until an overflow punch is sensed.

DD transferred, to initiate a skip when heading cards are missing (condition 4).

Overflow, to initiate a skip when there are more detail cards than one form will accommodate (condition 6). Since the skipping distance is greater than one inch, short skip cannot be wired.

HD normal, to initiate a skip when the first body card is ready to be printed (condition 1). This impulse is continued to short skip since the distance between the heading and body is less than two inches.

Advantage has been taken of the three entries to carriage skip 2 to prevent unwanted impulses from backing up into short skip and form skip. The X, D, or I carriage skip hubs may be used interchangeably so long as program steps (not including overflow programs) do not intervene, for when they do, the X and D hubs cause skipping after the total prints and the I hub before the total prints.

5. Channel 5 has been assigned to the predetermined total line. The minor program exit is wired to carriage skip 5 I to initiate a skip before the minor total prints. If this impulse is wired to the X or D skip hubs, skipping would occur after the total prints.

6. DH normal, which represents cards out of order (condition 7), is wired to stop so that when heading cards follow detail cards of the same group, the machine stops before the card out of sequence prints. If DH normal is wired to auto stop, the machine stops after the card out of sequence prints.

7. Head suppress is wired from second reading, column 75, to suppress program changes when heading cards pass the second station.

## MULTIPLE HEADING GROUPS; OVERFLOW SHEET IDENTIFICATION

THE FLEXIBILITY of the tape-controlled carriage for controlling skipping is illustrated in Figure 121. Provision is made on the form for five sections in the heading and two sections in the body.

The first printing line is signalled by a punch in tape channel 1. The first line of the second heading is identified by a normal skip stop in channel 2. Similarly, the first lines for shipping instructions, terms, and miscellaneous data are signalled by punches in channels 3, 4 and 5, respectively.

The first body line is signalled by a punch in tape channel 6 and the predetermined total line by a punch in tape channel 7. The cards shown in the heading may all be present or any one or more may be missing. If the heading cards are identified by a common X or digit, the detail cards may be identified as No X. An identification X punched in the first card of each section causes skipping to the proper position of the form for printing in each section.

The name appearing on the first line of the first form is repeated on overflow sheets. Other information such as invoice date and number, as well as page number, shown on the first line will be discussed in the next problem. Several lines of identifying information may be printed on the overflow sheets. Storage units or counters may be used to store information to be printed on the overflow sheets.

O-FLOW |

E, 33-34

*Overflow Program Start.* The overflow program start hubs are wired from the overflow skip control hubs (DD normal) to cause overflow programs to be initiated and impulses to be made available out of the overflow program and overflow couple hubs.

*O-Flow.* There are two independent overflow hubs for each program step. When overflow program start is impulsed, the overflow program hubs become active in turn, beginning with the first step and continuing until the fifth step is reached or until stopped by the wiring of the last step

GENERAL MANUFACTURING CO.									
								INVOICE	
SM.	TER.	CUSTOMER NO.	TYPE	COPIES	PAGE	NO.	DAY	TR.	NUMBER
12	16	4218	10	6	1	10	16		21587

S EAST AND WEST R R  
O 2152 VERNOR HIGHWAY  
L DETROIT 16, MICHIGAN  
D

S EAST AND WEST R.R. STATION  
H ERIE, N. Y.  
I  
P

VIA DC&C BUFFALO  
EGW

TERMS 2/10 DAYS NET 30

NO.	DAY	YR.	CUSTOMER ORDER NUMBER	F. O. B.	S. D.	REGISTER NO.	ORIGINAL INVOICE			
10	11		2A2695D	DETROIT		502				
SERIAL NO.	CL.	CATALOGUE NUMBER AND DESCRIPTION				UNIT	QUANTITY	UNIT PRICE	NET AMOUNT	
3112	71	WD SCREWS FH STL CDM 7/8 7				GR	6	2.14	12.84	
3113	71	WD SCREWS FH STL CDM 7/8 8				GR	6	2.20	13.20	
3114	71	WD SCREWS FH STL CDM 7/8 9				GR	6	2.28	13.68	
3129	71	WD SCREWS FH STL CDM 1 6				GR	15	2.34	35.10	
3130	71	WD SCREWS FH STL CDM 1 7				GR	9	2.40	21.60	
3131	71	CRGE BLTS STL 1/4 3/4				C	20	.58	11.60	
3132	71	CRGE BLTS STL 1/4 1				C	15	.65	9.75	
3133	71	CRGE BLTS STL 1/4 1 1/4				C	30	.71	21.30	
3152	71	CRGE BLTS STL 1/4 1 1/2				C	15	.76	11.40	
3153	71	CRGE BLTS STL 1/4 2				C	15	.82	12.30	
INVOICE TOTAL										

---

GENERAL MANUFACTURING CO.									
								INVOICE	
SM.	TER.	CUSTOMER NO.	TYPE	COPIES	PAGE	NO.	DAY	TR.	NUMBER
12	16	4218				2	10	16	21587

S EAST AND WEST R R  
O  
L  
D

S  
H  
I  
P

VIA

TERMS

NO.	DAY	YR.	CUSTOMER ORDER NUMBER	F. O. B.	S. D.	REGISTER NO.	ORIGINAL INVOICE			
3155	71		MACH SCREWS BRS RH 4/40 1/4				GR	20	.36	7.20
3156	71		MACH SCREWS BRS RH 4/40 3/8				GR	6	.45	2.70
INVOICE TOTAL								172.67*		

FIGURE 121

used to overflow end. These hubs are used to control the printing of overflow indication on overflow forms by wiring them to counter or storage read out. They may also be used to

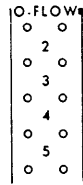

AP-AU, 67-68

control carriage skipping by wiring them to the carriage skip hubs for properly locating the form after the overflow indication.

When overflow program hubs are active, the regular program hubs are not active. When both the regular program start and the overflow program start are impulsed at the same time, the regular program exits take precedence. In such a case, the overflow programs are usually cancelled by control panel wiring.

Once the overflow program start is impulsed, progression of overflow steps will continue until stopped or until five steps have been taken, regardless of the setting of the special program switch. If more than five overflow programs are desired, the fifth overflow step is wired to repeat. Although there are only two overflow program hubs for each step, they may be expanded by wiring all cycles impulses through the transferred side of a co-selector picked up from overflow couple.

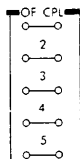

AP-AU, 79-80

**OF CPL (Overflow Couple).** Each of these hubs emits an impulse at a specific overflow program step. Hub 1 emits for overflow program 1, hub 2 for overflow program 2, and so on. The impulses are of longer duration than the overflow programs and are normally used to pick up co-

selectors for the purpose of expanding the regular overflow programs. On machines on which these hubs are inactive, overflow couple impulses are supplied by PR CPL (program couple).

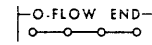

AV, 69-72

**O-Flow End.** The succession of overflow programs is stopped by wiring the last overflow program step required to overflow end. Normally, whenever an overflow program is used it is associated with either minor, intermediate or major program start. When minor program only is used, minor program exit should be wired to overflow end along with the last overflow program. This will cancel overflow steps 1 through 5, whenever both the overflow and the minor program start occur at the same time, since an overflow to the next form would not be necessary.

When overflow program is associated with intermediate program start, the intermediate program exit should be wired to overflow end along with the last overflow program. When the minor program start occurs at the same time as the overflow program start, the minor total prints, followed by a progression of overflow program steps. When the intermediate program start occurs at the same time as the overflow program start, the minor total prints, followed by the intermediate total, and all overflow programs are cancelled.

When overflow program is associated with major program start, the major program exit along with the last overflow program is wired to overflow end. A minor program occurring at the same time as overflow program would be followed by overflow program steps. Intermediate programs occurring at the same time as overflow program would cause both the minor and intermediate totals to print followed by overflow program steps. When the major program start occurs at the same time as overflow program start, the minor, intermediate and major totals print and all overflow programs are cancelled. The overflow end hubs are never ac-

tive unless overflow program start has been previously impulsed. Failure to wire overflow end hubs causes the machine to stop after the fifth program step and requires that the main line switch be turned OFF before the machine can be restarted.

#### Wiring (Figure 122)

1. All heading cards have a common X in column 80. Head X is wired from first reading, and head suppression is wired from second reading.

2. Minor and intermediate program start and skip control are wired from comparing exit, as shown.

3. In addition to the common X for all heading cards, the first card of the shipping instruction group contains an X in column 76, the first card of *via* contains an X in column 77, the terms card contains an X in column 78, and the miscellaneous data card contains an X in column 79. These X punches are necessary to cause skipping from one section of the heading to another. A skip between *sold* and *ship* is caused by wiring X76 from first reading to carriage skip 2X. A skip between *ship* and *via* is caused by wiring X77 from first reading to carriage skip 3X. A skip between *via* and *terms* is caused by wiring X78 from first reading to carriage skip 4X. A skip between *terms* and *miscellaneous data* is caused by wiring X78 from first reading to carriage skip 5X.

4. Since the skip between one section of the heading and another is never greater than two inches, short skip is wired from the X in the first card of each group. This prevents an idle cycle each time a skip is initiated in the heading.

5. Channel 1 has been assigned to the first printing line. The following impulses are wired to carriage skip 1D or I to start a skip that will be stopped at the first printing line:

Since the report is to be group printed, overflow program 1 is wired to skip to 1 I. This causes a skip to the first printing line after the last minor total on the form has been printed and before overflow program 1 is taken. If the report were to be detail printed, overflow skip (DDN) could be wired to 1 I.

DH transferred to initiate a skip to the first printing line after the intermediate total prints.

HH transferred, to initiate a skip to the first printing line when detail cards are missing.

6. Channel 6 has been assigned to the first body line. The following impulses are wired to carriage skip 6X, D or I to start a skip that will be stopped at the first body line:

HD normal, to initiate a skip from heading to body.

Overflow program 1, to initiate a skip to the first body line after the sheet identification information has been printed on an overflow sheet.

DD transferred, to initiate a skip to the first body line when heading cards are missing.

HD transferred, to initiate a skip to the first body line when there are missing detail cards of one group and missing heading cards of the following group. This impulse is continued to FM-SK so that the hole in channel 6 will be effective only after channel 12 has been sensed. The program control is suppressed by a heading X from second reading.

7. Intermediate program is wired to carriage skip 7 I to initiate a skip to the predetermined total line before the total prints.

8. An overflow program start is initiated by wiring overflow to overflow start. This wiring makes the overflow program steps active progressively from 1 to 5, every time the hole in channel 12 is sensed.

9. The name to be printed on the overflow sheet is wired into storage units A, B and C from second reading. Since alphabetic information is being stored, only the first eight positions may be used. The storage units are impulsed to accept the information by wiring X70 (first heading card) to storage IN A, B, and C. These three units are coupled for storing alphabetic information.

10. Since more than two overflow exits will be needed, they are expanded by wiring all cycles impulses through the transferred side of co-selector 4. The co-selector is picked up from overflow couple 1.

11. The overflow sheet identification is read out of storage units A, B, and C by wiring overflow program 1 to immediate read-out.

FIGURE 122. MULTIPLE HEADING GROUPS, OVERFLOW SHEET IDENTIFICATION

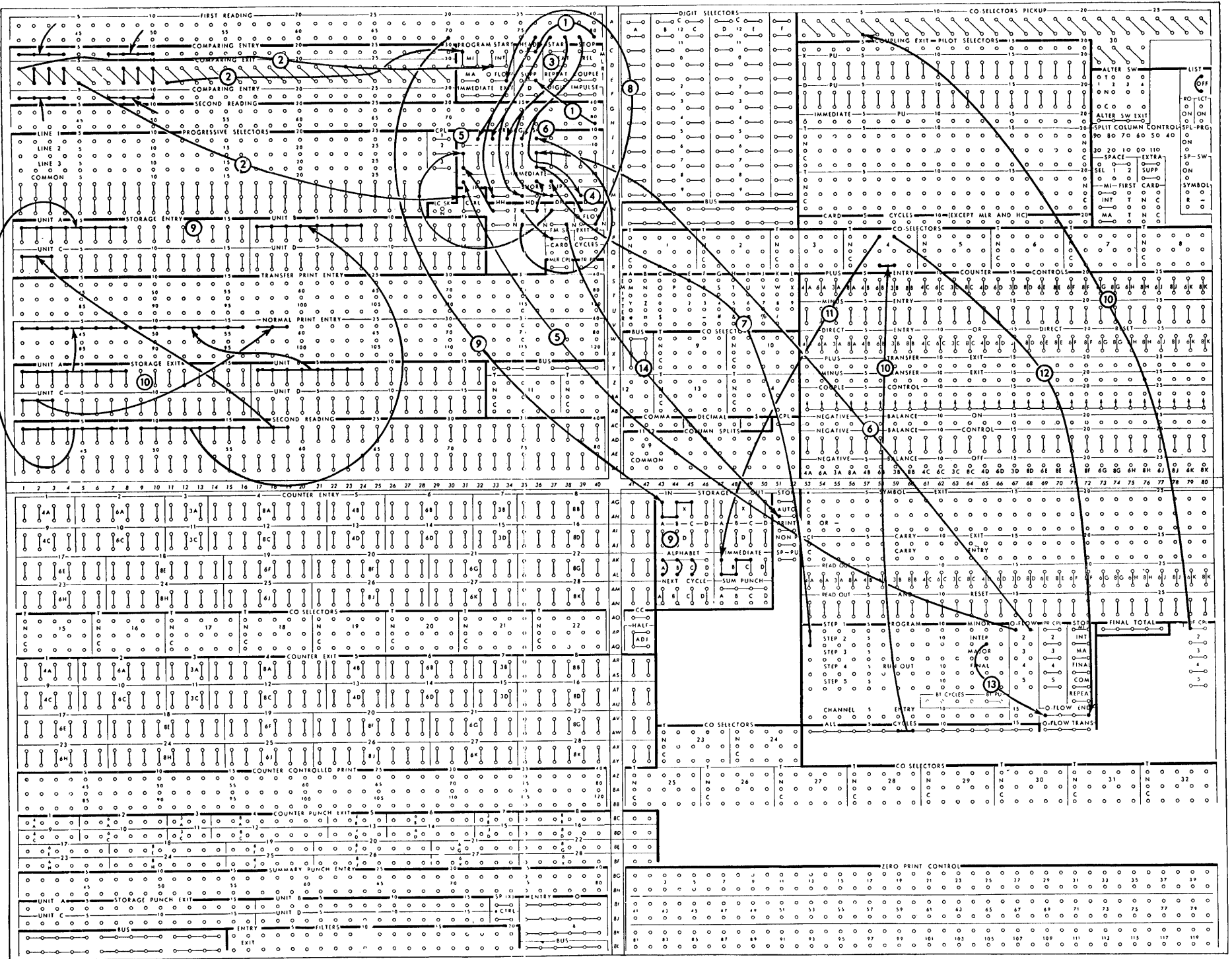

12. The last overflow program used (step 1) is wired to overflow end. Only one step is needed in this example to print the name on the first line of each overflow sheet.

13. Intermediate program is wired to overflow end, so that if the intermediate program start and the overflow program start are initiated at the same time, the normal program steps are effective and the overflow program steps are cancelled.

14. DH normal, which represents detail cards followed by heading cards of the same group (out of sequence), is wired to auto stop.

INVOICE AND PAGE NUMBERING

EVERY FORM passing through the machine may be identified by some number, usually an invoice number and a page number. Page numbers are usually printed consecutively to identify overflow sheets, while invoice numbers are printed repetitively for overflow sheets and consecutively for each invoice. The schematic analysis (Figure 123) shows both invoice and page number printed in the heading section of each form alongside the name.

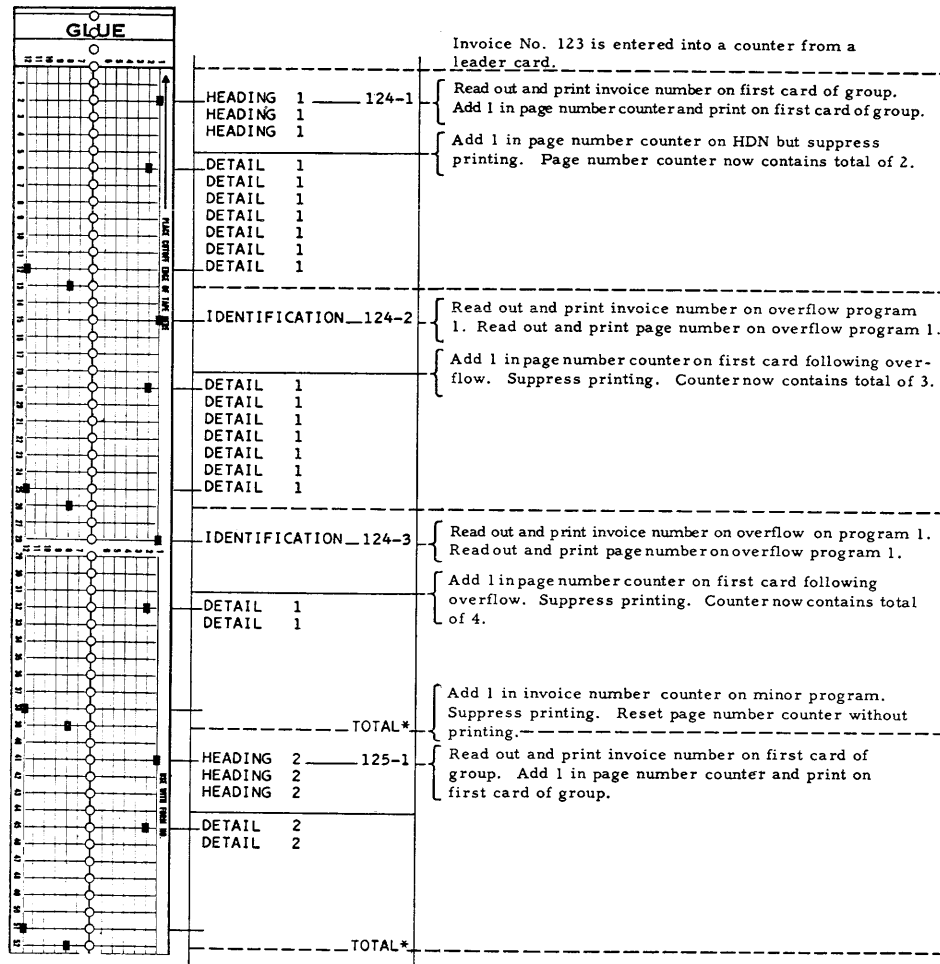
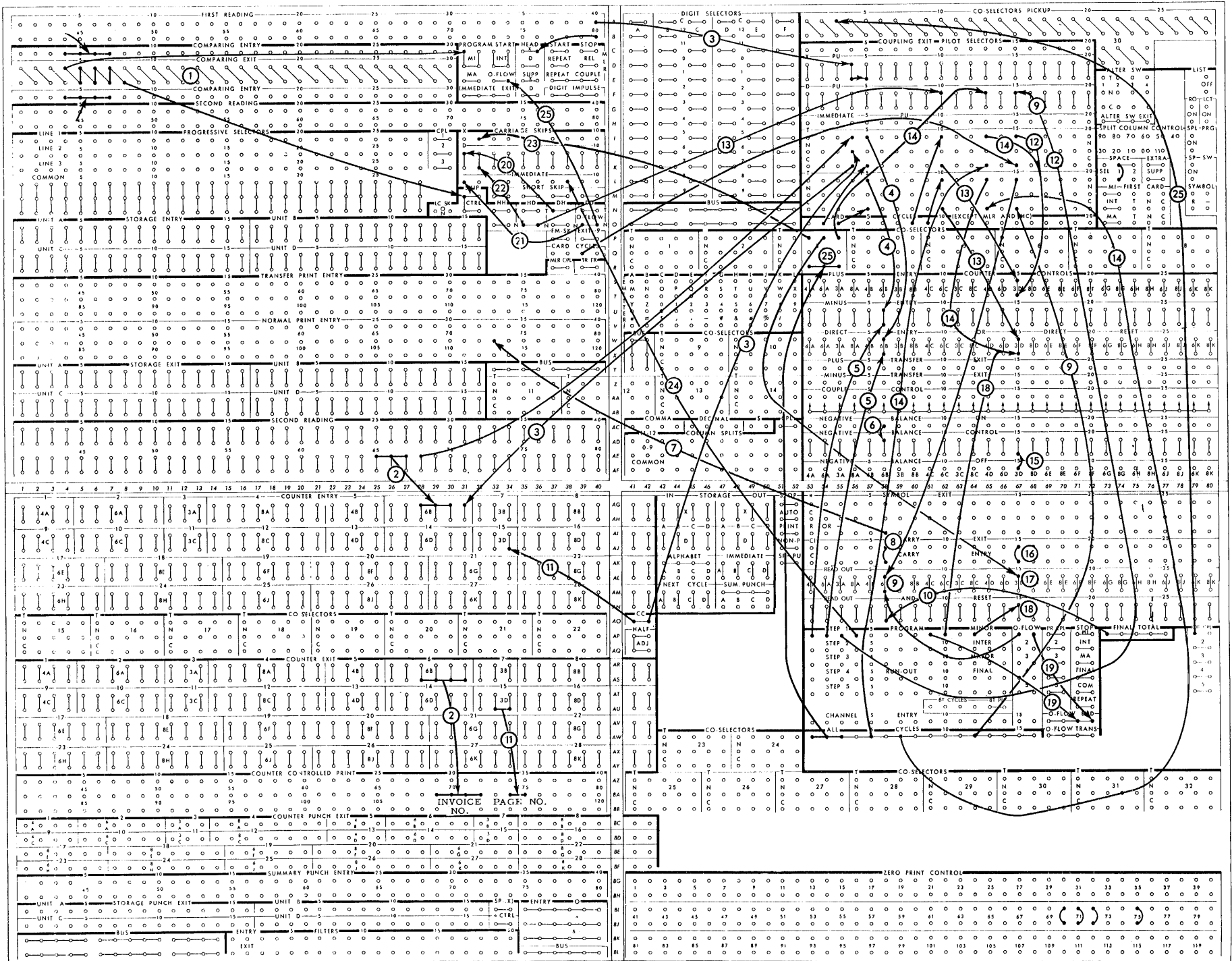

FIGURE 123

FIGURE 124. INVOICE AND PAGE NUMBERING



The functions of the carriage tape channels are as follows:

Channel 1 to locate the first printing line on which the name, invoice and page number print.

Channel 2 to locate the first body line.

Channel 8 to locate the predetermined total line.

Channel 12 to locate the overflow line.

The invoice number, which may begin with 1 or any predetermined number, is entered into a counter from a leader card punched with the last invoice number used. The invoice number is printed on the first heading line of each invoice by impulsing the invoice counter to read out on the cycle following the minor program change (first card of each group). The invoice number is printed on the first heading line of each overflow sheet by impulsing the invoice counter to read out on overflow step 1.

The invoice number is increased one on every minor program change in preparation for the next invoice to follow. The invoice number counter is reset on a final total.

The page number 1 is printed on the first heading line of each invoice by impulsing the page number counter to add 1 on the cycle following the minor program change. A 1 is added in the page number counter on a HDN condition (heading to detail normal) to increase the number to 2 in preparation for a possible overflow sheet to follow. The page number prints on the first overflow step of each overflow sheet.

A 1 is added in the page number counter on the cycle following overflow program 1, to raise the page number by 1 in preparation for a possible subsequent overflow sheet to follow. The page number counter is reset on each minor program.

#### Wiring (Figure 124)

Explanation of the wiring in this example is divided into three parts: invoice number printing, page number printing, and carriage wiring.

##### A. INVOICE NUMBER PRINTING

1. The field to be compared is wired to the comparing unit and the comparing exit is wired to minor program start and skip control.

2. The invoice number will be entered into

counter 1 from a leader card (X40). The three high order positions are wired from second reading directly to counter 6 entry.

3. The leader card X is wired from first reading to the pickup of pilot selectors 4 and 5. The units position of invoice number is wired through the transferred side of pilot selector 4 to the units position of counter 6 entry. A cycle count impulse is wired through the normal side of the selector to the units position of counter 6 entry. Thus, counter 6 is connected to column 68 for X40 (leader cards) and to the cycle count impulse on all other cycles.

4. All entries into counter 6 are subtracted so that advantage may be taken of the minus feature of the R or — hub for printing a dash between the invoice number and page number.

The number from the leader card is subtracted by wiring card cycles through the transferred side of pilot selector 5 to counter 6 minus. Card cycles is also wired through the transferred side of pilot selector 5 to the direct entry of counter 6 so that the 1 will not print at this time.

5. The invoice number is increased 1 each time a change in account is recognized, by wiring the minor program level to counter 6 minus. The program is also wired to direct entry, so that the 1 will not print at this time.

6. Negative balance ON is wired to negative balance control so that the complement invoice number will be converted to a true figure.

7. Because the R or — symbol switch is not connected, a minus sign impulse will be available out of the R or — hub of counter 6 for every print cycle. The impulse is directed to normal print entry 73 to supply a dash between the invoice and page number.

8. CI and C are connected normally.

9. The invoice number is read out of counter 6 on the cycle following the minor program change by wiring an all cycles impulse through the transferred side of pilot selector 15 to counter 6 read out. Pilot selector 15 is impulsed to pick up through its D hub from minor program. The selector transfers on the following cycle. This wiring takes care of the printing of invoice number on the first sheet of each invoice. The invoice number is also read out on the first overflow pro-



gram step for the purpose of printing invoice number on each overflow sheet.

10. The invoice number counter is cleared at the end of the run by depressing the final total key.

**B. PAGE NUMBER PRINTING**

11. The cycle count impulse is wired to counter 15 entry. Counter exit is wired to counter controlled print 74 and 75.

12. A 1 is printed and added into the page number counter on the first heading card of each group by wiring a card cycles impulse through the transferred side of pilot selector 15 to counter 15 plus. Pilot selector 15 is picked up from minor program wired to its D hub. The selector picks up on the cycle following the minor program cycle.

13. A 1 is added by direct entry into the page number counter on the cycle following a heading to body skip by wiring card cycles through the transferred side of pilot selector 10 to the plus of counter 15. This increases the page number by 1 in preparation for printing on the first overflow sheet. Card cycles is also wired through the transferred side of pilot selector 10 to the direct entry of counter 15. Pilot selector 10 is picked up by wiring HDN to the D pickup of the selector.

14. A 1 is added by direct entry into the page number counter on the cycle following overflow program 1 by wiring all cycles through the transferred side of pilot selector 13 to counter 15 plus. This increases the page number by 1 in preparation for printing on a possible second overflow sheet. All cycles is also wired through the transferred side of pilot selector 13 to the direct entry of counter 13. Pilot selector 13 is picked up by wiring overflow program 1 to the D pickup of the selector.

15. Negative balance OFF (counter 15) is wired to negative balance control.

16. CI and C are wired normally.

17. Page number is read out of counter 15 on the first overflow step for the purpose of numbering each overflow sheet.

18. The page number counter is reset without printing (direct reset) on a minor program cycle.

19. The last overflow program used (step 1) as well as the last regular program used (minor) is wired to overflow end.

**C. CARRIAGE**

20. DHT is wired to 1D to cause skipping to the first heading line of the next form, following the printing of the minor total.

21. Overflow is wired to 1 I to cause skipping to the heading identification line on an overflow.

22. Heading to body skipping is caused by wiring HDN to 2D.

23. Overflow program 1 is wired to 2X to cause skipping to the first body line after the overflow identification is printed.

24. A skip to the predetermined total line is obtained by wiring jump program to carriage skip 8 I.

25. Overflow programs are initiated by wiring overflow (DD normal) to overflow program start. Overflow program 1 is expanded through co-selector 3.

The sheet identification information could be stored in either the storage units or in counters. It would be read out for printing on the first overflow step.

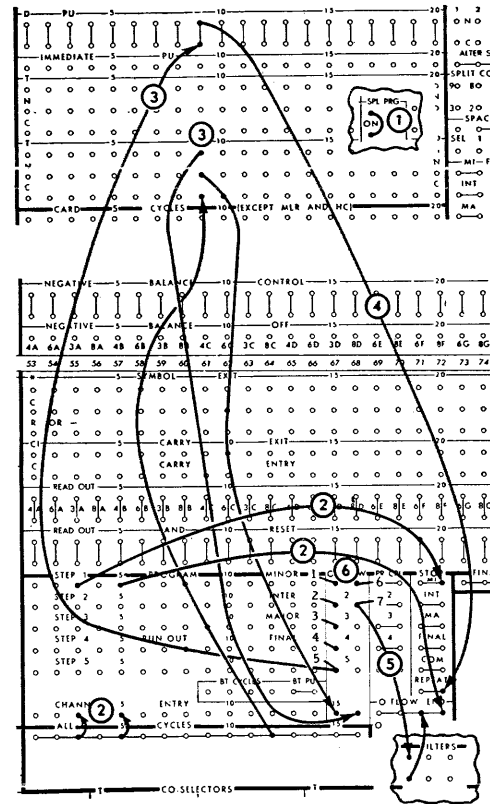

FIGURE 125. SEVEN OVERFLOW LINES

### IDENTIFYING OVERFLOW SHEETS WITH MORE THAN ONE LINE

OVERFLOW SHEETS may be identified by any number of lines within the capacity of the machine to store them. The identifying information may be alphabetic or numerical and may come from any designated card in the group or from the emitter under proper control.

This example shows the wiring required for printing seven overflow lines. Normally, overflow programs continue until stopped or until step 5 has been reached. If more than five overflow steps are required, special program must be ON and repeat must be wired.

#### Wiring, Identifying Overflow Sheets with Seven Lines (Figure 125)

1. Special program is wired ON.
  2. Only minor program start is wired. Since special program is wired ON and only one regular program step is desired, the minor program is wired to minor stop. It is also wired to overflow end, to stop the progression of overflow programs whenever both the minor and overflow program start hubs are impulsed at the same time. The channels used for these two functions are impulsed from all cycles.
  3. When special program is wired ON, the overflow program channel entries must be impulsed from all cycles. If more than five overflow steps are to be taken, as in this example, the all cycles impulse must be selected.
- Overflow step 5 is wired to the D pickup of pilot selector 9. The selector will be normal for the first five steps and transferred for the remaining overflow steps. An all cycles impulse is wired through the normal side of the selector to channel entry 15 and through the transferred side of the selector to channel entry 16.
4. Overflow step 5 is wired to repeat.
  5. Overflow step 7 is wired to overflow end to stop the progression of overflow steps.
  6. Each overflow program (1-7) would normally be wired to control read out of a different storage unit or counter.

### VARIABLE LENGTH OVERFLOW

NORMALLY, when a program change and an overflow occur at the same time, an overflow skip will not occur until all totals have been printed. In some applications, such as billing, enough space must be allowed to print the total amount of the invoice or bill, even after the overflow line has been reached. This space may vary anywhere from two to six lines and means that each form normally loses up to one inch of printing space whenever regular overflow occurs.

If a total occurs as the overflow line is reached, the overflow program steps take precedence over the regular minor, intermediate and major program steps. This allows the overflow program steps to be used for sheet identification purposes before the totals print in the body of the next form. This operation requires the use of the overflow transfer and the exit 9 hubs (tape channel 9).

EXIT-9  

P, 39-40

*Exit 9.* These hubs emit an impulse whenever a hole is read in channel 9. A hole is punched in this channel of the tape one line below the last position on the form which can be printed with detail information and still allow space for all totals. Information can be printed to the maximum capacity of the form, but should a control change occur at or below the position identified by a 9 punch, all totals will be printed on the overflow sheet. To accomplish this, the exit 9 is wired to overflow transfer through a properly controlled selector.

Channel 9 of the tape may also be used to save interlocking for the last two inches of a long skip under certain conditions. For example, in a skip of eleven inches, the interlocking time for the last two inches may occasionally be saved by punching a hole in channel 9 of the tape, two inches back from the next printing line, and by wiring exit 9 to short skip. The time that the hole in channel 9 is read will determine whether or not a cycle is saved.

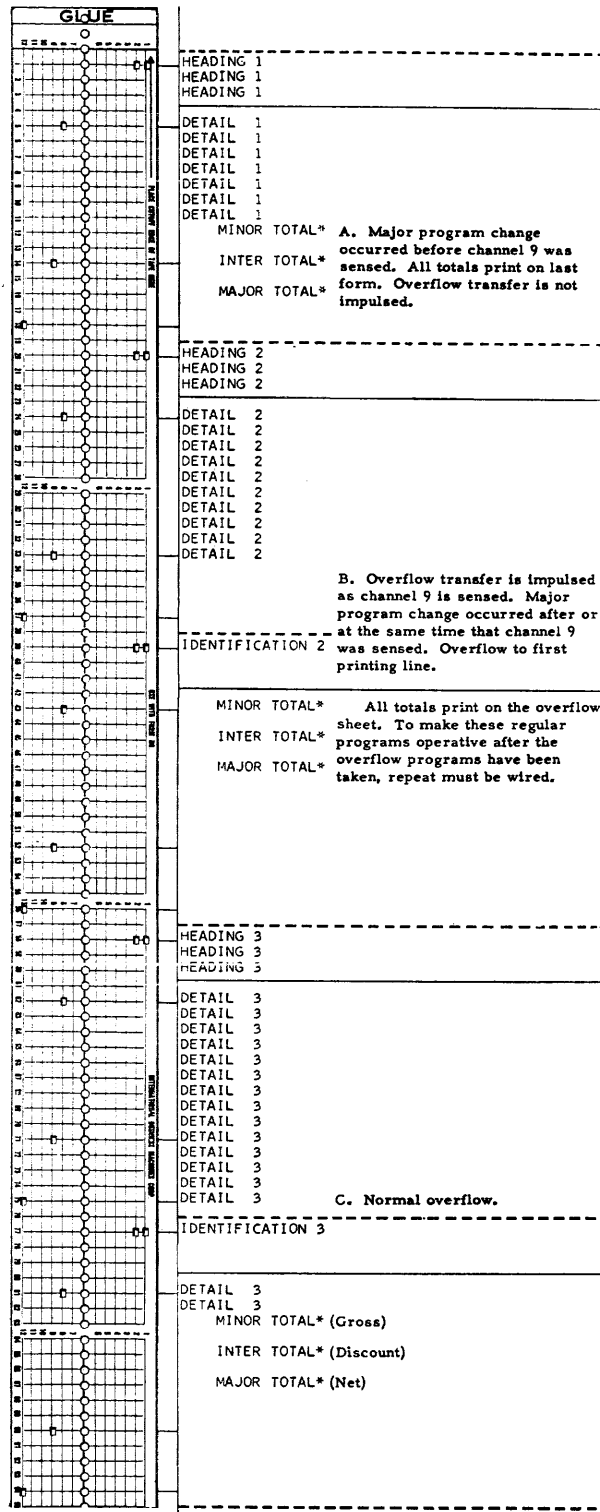

O-FLOW TRANS

AW, 69-72

**Overflow Transfer.** These hubs receive impulses from exit 9 to cause a transfer from regular to overflow programs whenever a hole in channel 9 has been sensed. This transfer takes place immediately but the overflow program exits are not effective until program start is impulsed. The normal program cycles will follow provided overflow end and program repeat are impulsed. Normally, the regular programs take precedence over overflow programs. When overflow transfer is impulsed, however, the overflow programs take precedence over the regular programs. Once overflow transfer is impulsed, it will remain active until overflow end is impulsed. The overflow transfer hubs are exits during every overflow cycle.

**Variable Length Overflow Analysis (Figure 126)**

**Channel Assignments:**

- 1 and 2 First printing line.
- 8 First body line.
- 9 Overflow transfer line.
- 12 Normal overflow.

Channel 9 is punched on the same line on which the last detail item prints within the major group. Thus, if a major program change occurs at or after the channel 9 has been sensed, all totals will be printed on the overflow form.

A. The first form identifies a major program change that occurred before channel 9 was sensed. Hence, all totals print on the same form that contains the last of the detail items for that group.

B. The second form identifies a major program change that occurred at or after the time channel 9 was sensed. This would mean that there was not enough room on the form to accommodate all the totals, so they are printed in the body of the overflow sheet. Overflow transfer is impulsed at the time channel 9 is sensed and remains active until overflow end is impulsed. This is true even though there is no program change and the regular overflow channel 12 is sensed.

FIGURE 126

Because a major program occurred at or after channel 9 was sensed, a transfer from regular to overflow programs takes place. The overflow programs are used to skip to the first printing line, where the overflow sheet is properly identified, and to skip to the first body line where the totals are printed.

In order to pick up again from step 1 (regular minor program) after having reached step 2 in the overflow programs, the last overflow step used must be wired to repeat.

C. The fourth form shows a regular overflow condition which is not in any way affected by channel 9.

Wiring, Variable Length Overflow—Detail Printing (Figure 127)

The wiring for variable length overflow shown in Figure 127 concerns detail printing only. The wiring for variable length overflow with group printing is shown in conjunction with the side by side "sold to, ship to" invoice printing described under *Invoice Preparation*.

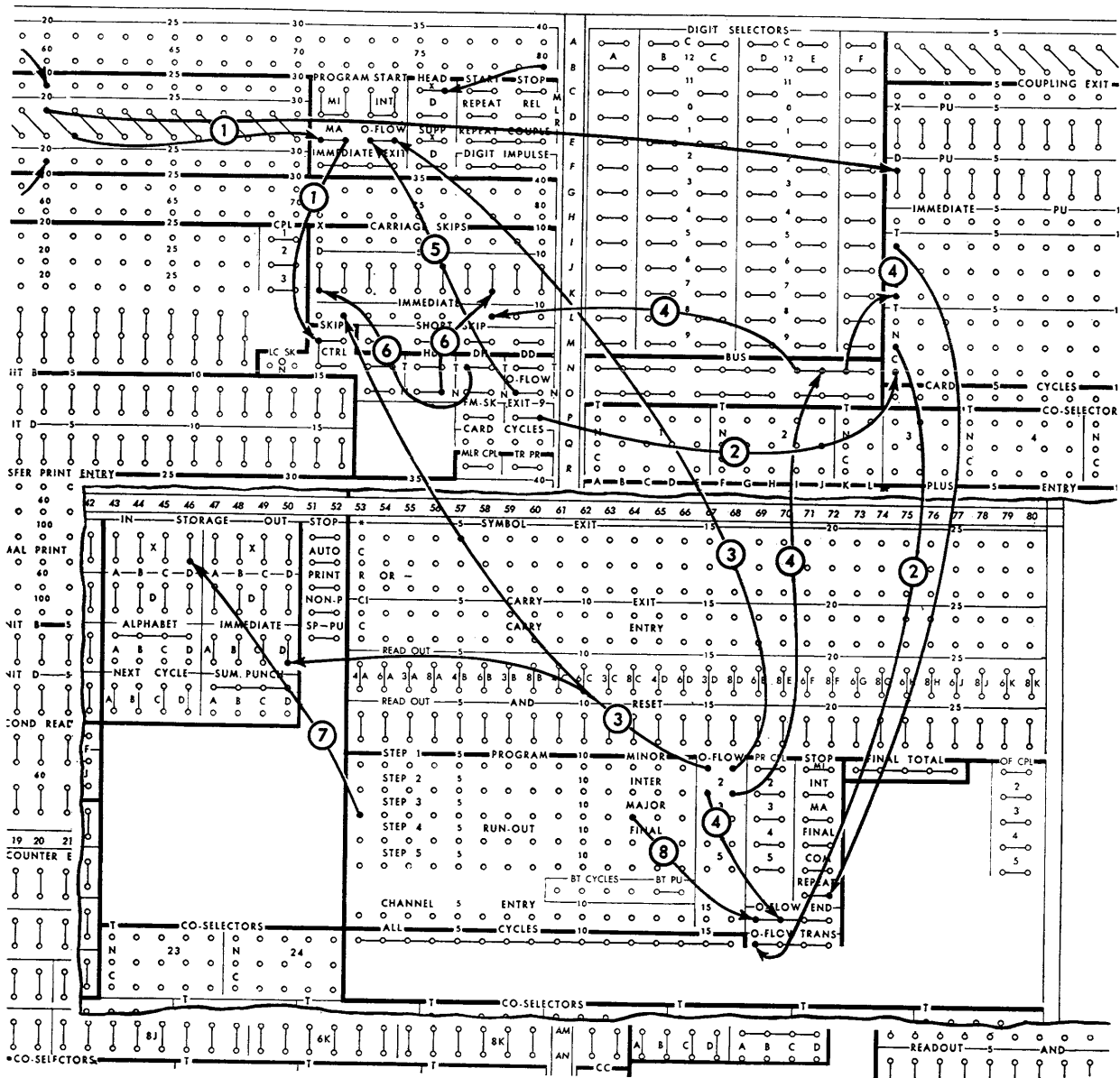

FIGURE 127. VARIABLE LENGTH OVERFLOW, DETAIL PRINTING

1. The major comparing exit hubs are wired to major program start, to skip control, and to the D pickup of pilot selector 1.

2. Exit 9 is wired through the normal side of pilot selector 1 to overflow transfer. The overflow transfer hubs will receive an impulse whenever channel 9 is sensed before or at the same time a major program change occurs.

3. If a major program change should occur any time after or at the same time that channel 9 has been sensed, the regular programs are made inactive and the overflow programs are made active. Two overflow steps are taken. Step 1 is used for the following functions:

a. To cause a skip to the first printing line of the next form by wiring to carriage skip 2 I.

b. To cause the sheet identification information to be read out of storage unit D by wiring to the immediate out of the unit.

c. To cause overflow end to be receptive to any following overflow step by impulsing overflow program start. Normally the overflow program start is impulsed from the carriage overflows hubs. In this instance the overflow channel (12) has not yet been read. Because the overflow end hubs are not receptive until the cycle following that from which overflow program start is impulsed, two overflow steps are required in this example.

4. Step 2 is used for the following functions:

a. To cause a skip to the first body line after the overflow sheet identification cycle by wiring to carriage skip 8 I.

b. To cause the regular program steps to follow the channel 9 overflow program steps by wiring to repeat, through the transferred side of pilot selector 1. The selector prevents the repeat from becoming operative on regular overflow program steps.

c. To stop the progression of overflow steps by wiring to overflow end.

5. Overflow program start is wired normally.

6. DH transferred is wired to carriage skip 1D to cause a skip to the first printing line whenever new heading cards are recognized. HD normal is wired to carriage skip 8D to cause a skip to the first body line between heading and detail cards.

7. Sheet identification information is entered into storage unit D from the first card of each group by wiring major program to storage IN X.

8. The last regular program used is wired to overflow end.

Two channels are used to locate the first printing line in this example. Channel 1 D is wired from DH transferred and channel 2 I from overflow step 1. This is necessary because when the D or X hubs are impulsed skipping is delayed until all programs have been taken.

To isolate the two types of skips, overflow and DH transferred, two separate channels are used. In this way an immediate skip wired to channel 2 will occur regardless of what channel 1 is impulsed to do.

#### INVERTED FORM OPERATIONS

VOUCHER CHECKS, such as the one illustrated in Figure 128, are known as inverted forms because detail cards are printed first, followed by heading cards. This type of operation is necessary when totals from the detail cards must be printed with heading information. In this example, check identification and amount are printed with an address on a check.

The tape for an inverted form is punched in the same manner as the tape for the conventional form. The first printing line, which is also the first body line, is identified by a hole in channel 1, the last printing line of the body (overflow) by a hole in channel 12. The predetermined total line and the first heading line are identified by holes in other channels.

Although the D and H identifications are the same (D for detail and H for heading) as for conventional operations, the normal and transferred skip control exits have different uses, in some instances, for inverted form operations. This is due to the fact that heading and detail cards are in reverse order. DH normal indicates normal change from detail to heading cards and is wired to channel 2 (first heading line). HD transferred indicates the end of one group and the beginning of another and is wired to channel 1 (first printing line).

The most noticeable difference lies in the form skip wiring and tape punching. DH transferred indicates missing heading cards of one group and missing detail cards of another. The DH transferred hub would therefore be wired to channel 2 and also to pick up a selector so that form skip may be impulsed after the intermediate total prints, to insure printing the heading cards on the next form. In conventional operations, when form skip is wired, first body line channel is not operative until the overflow punch (channel 12) has been sensed. Channel 12 cannot be used in this manner when preparing inverted forms since it precedes the channel representing the first heading line of the same form. Channel 10 is used in its place and is punched on the same line as channel

1. The tape will therefore have two holes punched on the first printing line, one in channel 1 and the other in channel 10.

The inverted form toggle switch works in conjunction with channel 10. When it is OFF (conventional forms) channel 10 operates as a normal stop. When the switch is ON (inverted forms) channel 10 can no longer be used as a stop. Instead, it is used to close the first 9 channel brush circuits which were previously opened by form skip. In other words, when form skip has been impulsed none of the remaining stops for that form will be operative. Once channel 10 has been sensed, which will take place on the next form, all channel stops will be operative. In the case of the DH transferred conditions, (missing heading

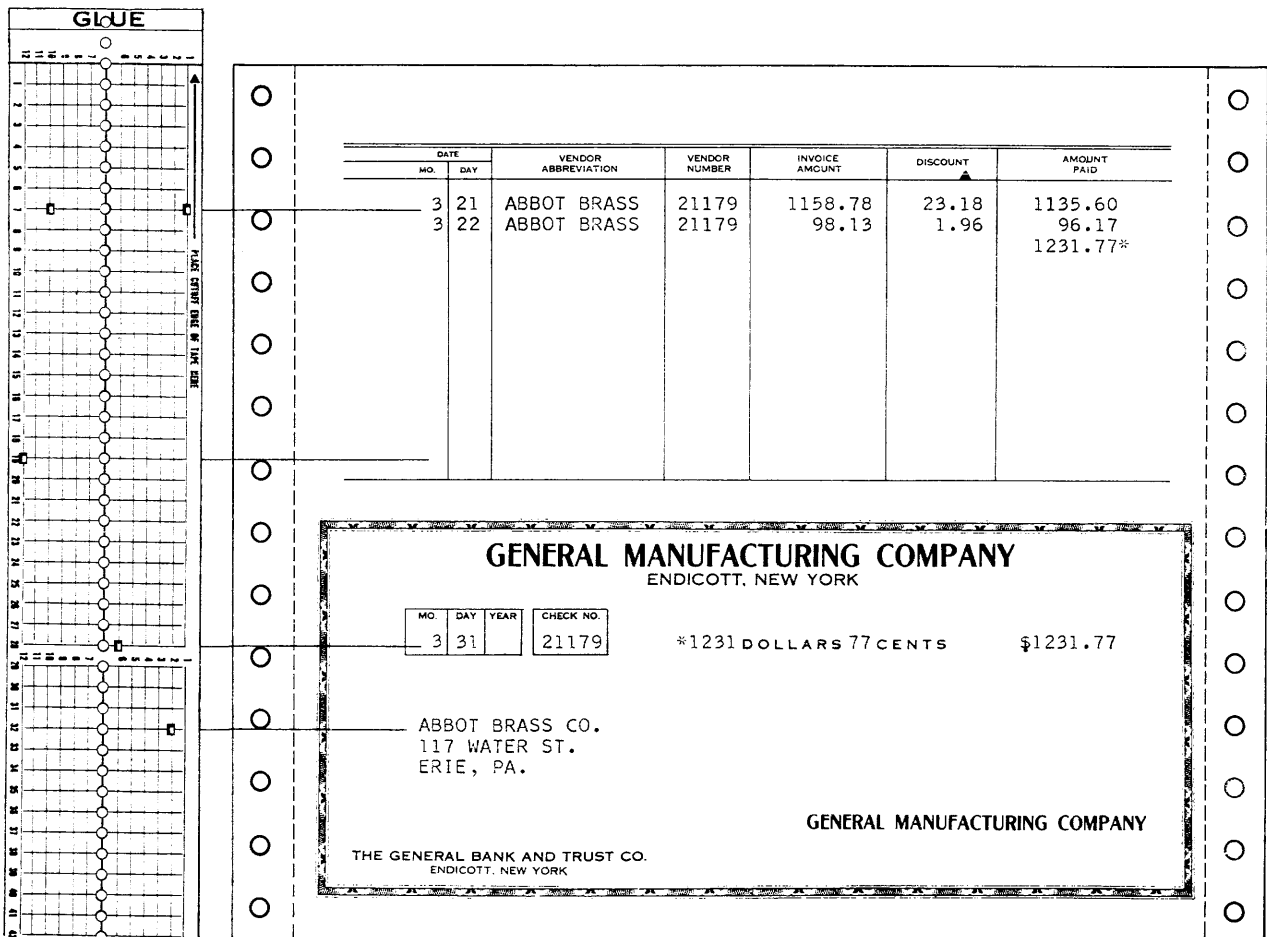
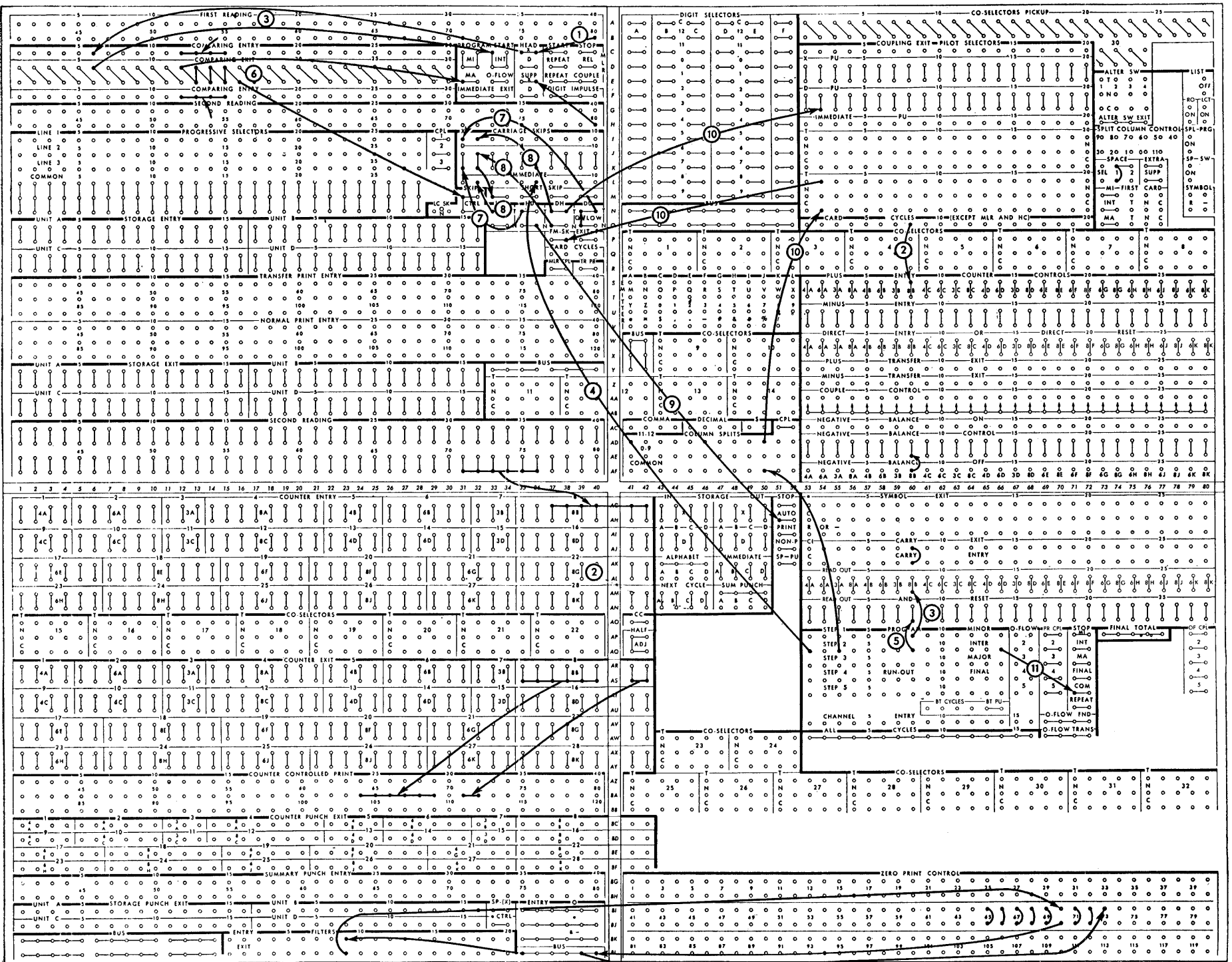

FIGURE 128

FIGURE 129. INVERTED FORM



cards of one and missing detail cards of another group) a skip will take place to the first body line of the second form instead of the first form.

#### Wiring (Figure 129)

1. All address cards have an X in column 80, which is wired from first reading to head X. It is also wired from second reading to head control suppress to suppress the program cycles on a major change.

2. The amount paid is wired from second reading to counter 8 where it is detail printed. Counter 8 is impulsed to add from card cycles, which is active for body cards only.

3. A program change is recognized between body and heading cards by the X wiring to intermediate program start. After the last body item is printed, the intermediate program start is impulsed, causing a minor and an intermediate program change. On the minor program the total of the amount paid is printed in the statement portion of the form. The minor program is wired to counter read-out so that the total will remain in the counter and print on the intermediate program. The second printing takes place on the check.

4. The intermediate program is wired to carriage skip 6 I which causes a skip to the predetermined total line (check amount) before the intermediate total is printed. The second total is identical to the first and represents the amount of the check.

5. Counter 8 is read out and reset on an intermediate program.

6. Vendor number is wired to comparing entry and the comparing exit to major program start and skip control.

7. The following impulses are wired to channel 1:

DD transferred (missing head cards)

HD transferred — skip from one form to the other after head cards print.

Overflow.

8. The following impulses are wired to channel 2:

DH transferred (missing heading cards of one group and missing detail cards of another group).

DH normal — to cause skipping to the first heading line after the check total prints on the predetermined total line. This impulse is continued to short skip, since the distance is less than two inches.

HH transferred (missing detail cards). When a program change occurs between heading cards, a skip takes place to the heading of the next form.

9. HD normal represents cards out of sequence. This impulse is wired to stop the machine.

10. DH transferred (missing heading cards of one group and missing body cards of the following group) cannot be wired directly to form skip if the totals for the detail cards are to be printed. Both the minor and the intermediate totals are printed, in the example, before the form skip becomes operative. This is accomplished by wiring DH transferred to the D pickup of pilot selector 2. The intermediate program level is then wired through the transferred side of the selector to form skip. The intermediate program impulse is further conditioned through the 11-12 side of a column split to allow only the late portion of the cycle to reach the C of the selector.

The form skip will therefore become operative after the check total prints and all channels will become inoperative until both the 1 and 10 holes are sensed. The first channel 2 after 1 and 10 will then stop the skip.

11. Although major program start is impulsed, only two programs are taken because the intermediate level is wired to common program stop. This wiring stops the progression of program steps immediately. This is possible because the major program is used exclusively to control carriage functions in this example, with no use being made of the major program level.

#### FLOATING DOLLAR SIGN AND CHECK-PROTECTING ASTERISK

THE TYPE 407 provides two methods of check protection, the floating dollar sign and the check-protecting asterisk. A dollar sign may be made to print immediately to the left of the high order significant digit. For example:



FIGURE 130. FLOATING DOLLAR SIGN, DETAIL PRINT

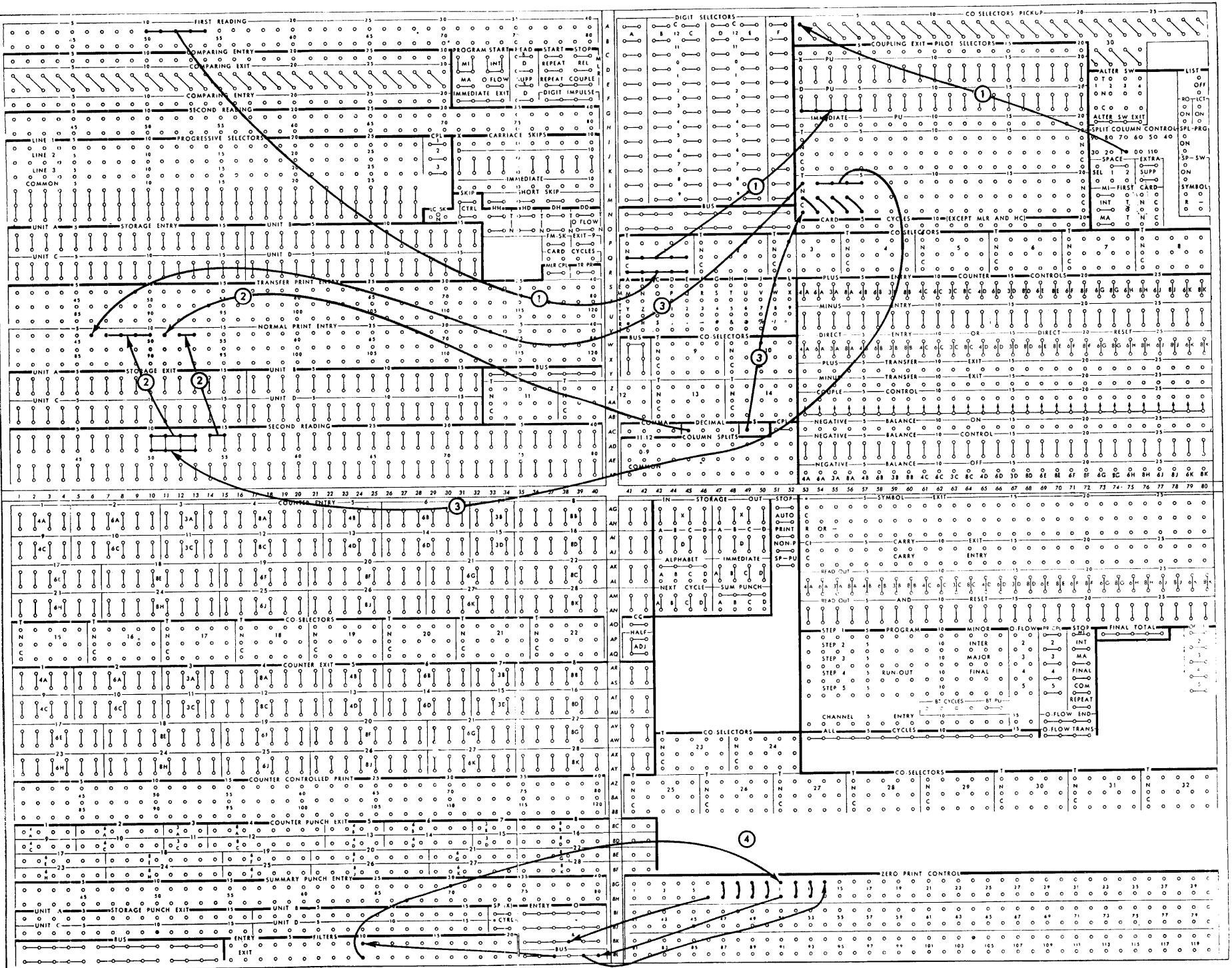

PRINT WHEELS							
6	7	8	9	10	11	12	13
\$	9	2	5	4	.	9	2
	\$	7	5	6	.	7	6
		\$	9	2	.	4	3
			\$	5	.	2	1
				\$	.	1	0

Check protection may also be accomplished by printing asterisks to the left of the high order significant digit as shown below:

PRINT WHEELS							
6	7	8	9	10	11	12	13
*	9	2	5	4	.	9	2
*	*	7	5	6	.	7	6
*	*	*	9	2	.	4	3
*	*	*	*	5	.	2	1
*	*	*	*	*	.	1	0



BJ, 33-34

*\*Ctrl.* These hubs are used primarily to control the printing of check-protecting asterisks. They are always wired to the pickup of a co-selector. All the zero print control hubs for the positions in which the asterisks are to print are connected through the normal side of the co-selector and the transferred hubs are laced from one to the other. Once a print wheel begins to turn because of the presence of a significant digit, no asterisk can print to its right. They print to the left of the high order significant digits.

Operating principles of the asterisk control feature are described below.

1. An impulse is emitted from every lower zero print control hub at no-zone time. If the no-zone impulse can reach the fuse, a check-protecting asterisk will print.

2. When a significant digit is printed, an internal connection is made from the lower zero print control position to the fuse.

3. In the schematic shown below, the no-zone impulse from zero print control position 42 can reach the fuse as follows:

- a. through the transferred side of the selector,
- b. to the transferred selector position at the right over the crosswiring,
- c. through the transferred side of the selector

to the lower zero print control hub for position 43, where it can reach the fuse over the internal path set up by the digit 8.

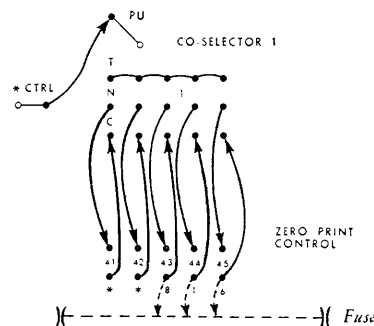

The impulse from position 41 can reach the fuse in a similar manner, by passing over two positions of the transferred side of the selector to zero print control position 43. The selector is picked up from *\*CTRL*, and is necessary so that the lower zero print control hubs will be connected at no-zone time only; at all other times they are wired to the upper hubs through the normal side of the selector.

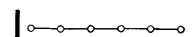

BK, 35-40

*& or -.* The six common *& or -* entry hubs are direct connections to complete the circuit for 11 or 12 impulses only. They are normally wired from the zero print control hubs to control the printing of the ampersand symbol when a 12 only is sensed and a minus symbol when the 11 only is sensed by the print wheels, regardless of the presence of significant digits. They are sometimes wired to print other symbols containing an 11 or 12 impulse, when those symbols are wired to the print wheels.

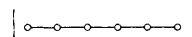

BJ, 35-40

*\*Entry.* These hubs are wired from the zero print control hubs to print asterisks to the left of high order significant digits or to print asterisks for zero balances.

Wiring, Floating Dollar Sign for Detail Print Cycle (Figure 130)

1. The dollar field, columns 10-14, is wired

from first reading through the normal side of co-selector 1 to the D pickup of the first five pilot selectors. Co-selector 1 is picked up from split column control 1 to permit pilot selector pickups to be effective only for digits 1 through 9.

2. The amount field is wired from second reading to normal print entry, along with the decimal.

3. The \$ is wired through the first five pilot selectors to normal print entry 5-10. When there

is a significant digit in column 10 the \$ reaches print wheel 6; when there is a significant digit in column 11 and not in column 10, the \$ reaches print wheel 7; and so on.

4. Lower zero print control hub 6 is wired to the & or - hubs so that the \$ will print. Normally the zero print control hub is wired back to the units zero print control and the high order position of the field is not wired. In this example,

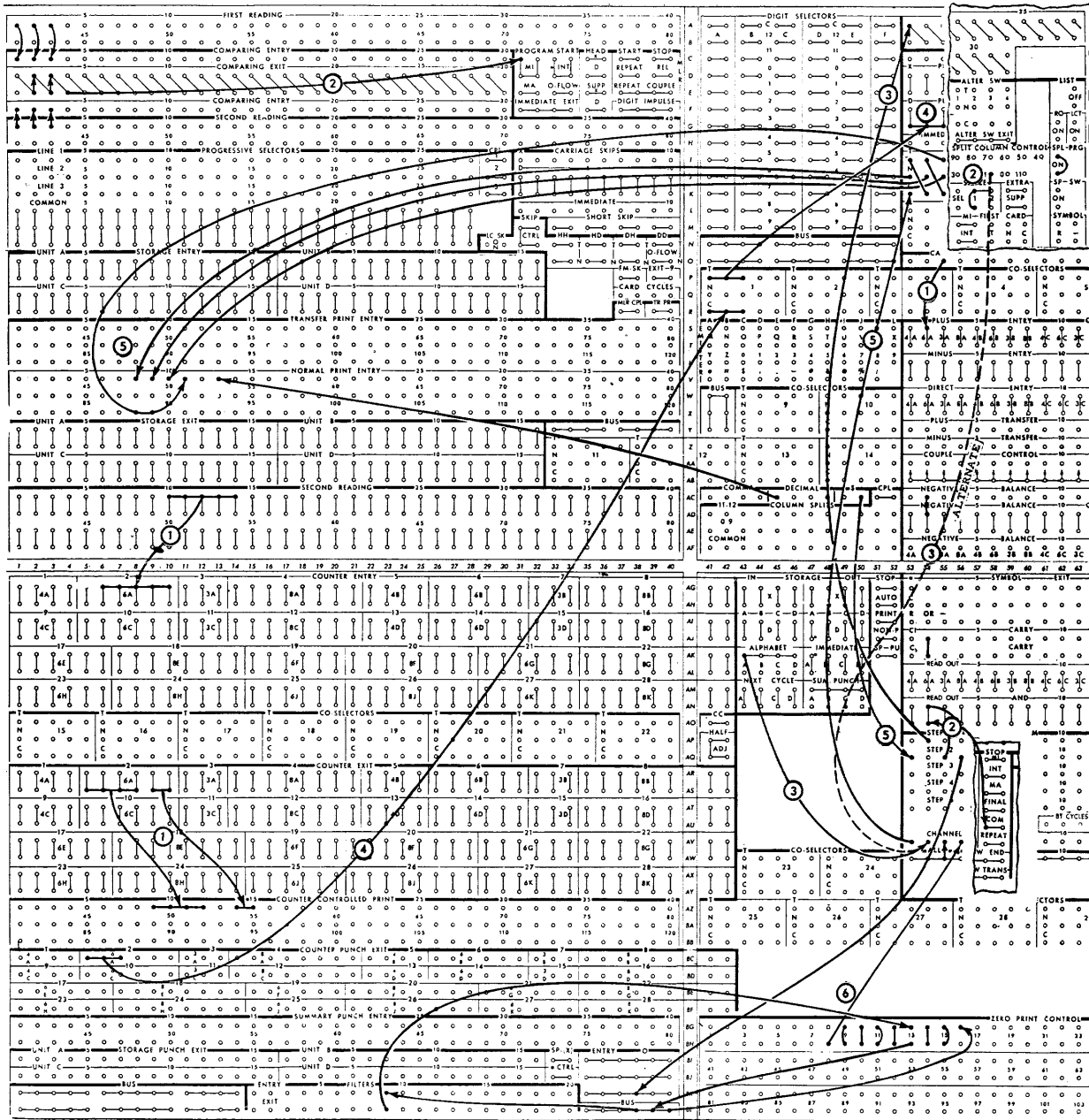

FIGURE 131. FLOATING DOLLAR SIGN, TOTAL PRINT

since the \$ might print in any position, all zero print control hubs for that field must be connected.

The & and - hubs are used because they do not accept zero impulses. They do accept 11 impulses (the zone punch for the \$), thereby allowing the dollar symbol but not the zero to print to the left of significant digits.

**Wiring, Floating Dollar Sign for Total Print Cycle (Figure 131)**

1. The amount field is wired to counter 2 which is impulsed to add for every card.

2. Minor program start is initiated and the special program switch is wired ON. An all cycles impulse is wired to channel entry 3. Counter 2 is reset and the program progression is stopped on the second level.

3. Co-selector 1 is picked up for 0, 11, 12 time on the first program level, by wiring either the storage IN alphabet exit hubs or split column control 1 through the first step of channel 2 to the selector pickup. The selector will be transferred for 0, 11, 12 and will be normal for digits 1 to 9.

4. The three high order positions (dollars) of counter punch exit 2 are wired to the D pickup of pilot selectors 1, 2 and 3 through the transferred side of co-selector 1. The counter punch exits emit both digit and zero impulses every machine cycle. The digits are filtered out on the first level through co-selector 1. On the second program level, pilot selector 1 will transfer when there is a zero in the high order position of the amount, pilot selector 2 will transfer when there is a zero in the second high order position of the amount, and so on. The selectors will be normal when there are significant digits in these corresponding positions.

5. The \$ is wired through step 2 of channel 1 to the common of pilot selector 1. It reaches normal print entry 8 when there is a significant digit in the high order position of the amount. It reaches normal print entry 9 when there is a significant digit in the second high order position of the amount but not in the high order position. It reaches normal print entry 10 when there is a significant digit in the third high order position but

not in the two high order positions. It reaches normal print entry 11 when no dollar position contains a significant digit.

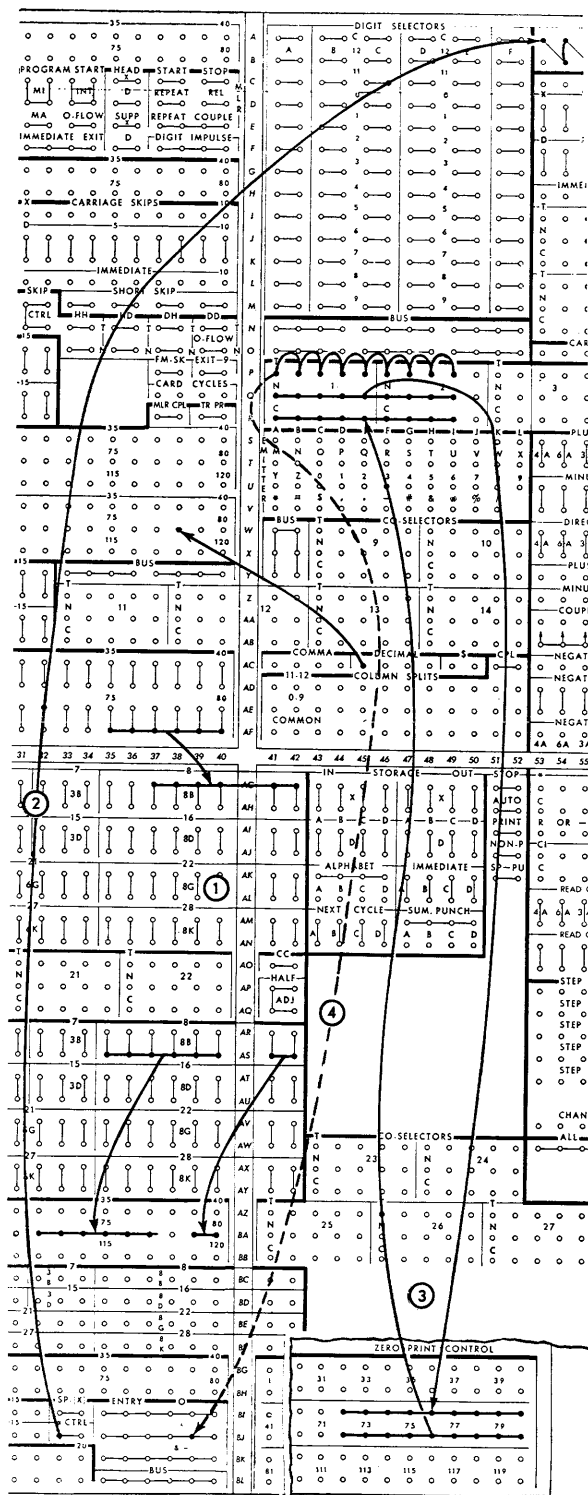

FIGURE 132. CHECK-PROTECTING ASTERISK

6. Lower zero print control hub 8 is wired through the second level of channel 4 to the & and - hubs, so that dollars and not zeros will print to the left of significant digits only on the total cycle. The remaining zero print control wiring is normal.

#### Wiring, Check-Protecting Asterisks (Figure 132)

1. The field to be accumulated is wired to counter 8 entry and from the exits to counter-controlled print.

2. Co-selectors 1 and 2 are picked up from \* control hubs. They will be normal for 9 through 12 and transferred in time to control the check-protecting asterisk.

3. Zero print control 72-80 are connected through the normal side of co-selectors 1 and 2. An asterisk will print to the left of the high order significant digit through the transferred side of these selectors which are connected together. If no significant digit is present, asterisks will not print.

4. If asterisks are also to print for zero balances, all of the transferred positions of co-selectors 1 and 2 are wired to asterisk entry.

#### SINGLE SHEET FORM FEEDING; SELECTIVE SPACING

SINGLE SHEETS can be fed into the machine by placing each form on the paper table in back of the platen. These forms must be sufficiently flexible so that they will bend around the platen without catching the leading edge of the form on the ribbon. Sufficient heading space should be allowed so that the tear bar may hold down the top of the form before printing is started. The setting of both the front and rear paper guide assemblies is the same as described under *Tear Bar*. In this operation the tear bar is substituted for the above platen feed device. Each form is placed on the paper table, and positioned automatically to the first printing line by depressing the restore key.

As shown in Figure 133, a hole must be punched in the tape four lines below the bottom edge of the form. Any available channel can be used that is not already used for other purposes. The purpose of this skip stop punch is to insure ejection of the sheet from the platen upon sensing either an overflow or a program change. The tape must

be cut 16 lines beyond the last hole punched, to compensate for the distance which a single sheet must travel around the platen before it can be advanced to the top edge of the form. Depression of the restore key feeds the single sheet from the paper table to the first printing line.

There are two different conditions under which a single sheet form can be ejected, program change or overflow. The form shown in Figure 133 does not require overflow ejection. Whether the form is ejected because of an overflow or because of a program change, it is not only necessary to stop the skip but also to stop card feeding.

Figure 133 demonstrates also the use of selective spacing, since each card always prints in a predetermined position which varies in distance from one to seven spaces apart. For this operation the SEL hubs on the control panel and channel 11 on the carriage tape are used.

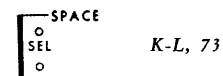

*Selective Space.* All line spacing may be controlled by the SEL hubs and a hole in channel 11 of the tape. More particularly, however, these hubs and channel 11 are used to control triple spacing or selective line spacing up to a maximum of seven lines. In some operations specific X's or digits are not available to control carriage skip, yet the cards must be printed in a particular place on the report. In such cases, the cards must be arranged in their proper order, the SEL hubs must be connected, and the carriage tape must be punched in channel 11 for every line to be printed.

When the selective space hubs are connected, the carriage is stopped by reading a hole in channel 11. The single and double space hubs normally perform this function. The printing of every card will then be under the control of the 11 punch in the tape. Whenever the desired spacing (including overflow skipping) exceeds three lines but no more than seven, both space suppress and extra must be impulsed from card cycles.

Triple spacing on the Type 407 is accomplished by connecting the SEL hubs and by punching a hole in channel 11 on every third line of the tape, including the line on which the total prints.

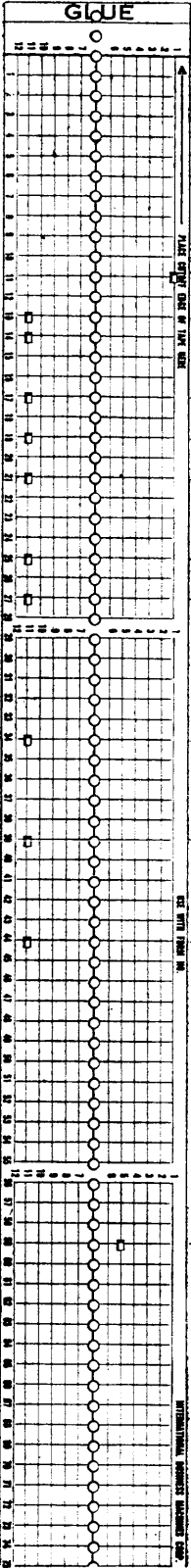

## AUTOMOBILE INSURANCE COMPANY ANY CITY AND STATE

### DECLARATIONS

ITEM 1 NAME OF ASSURED POLICY NUMBER  
 \_\_\_\_\_ JOHN DOE POLICYHOLDER 471141537

ADDRESS \_\_\_\_\_ 1025 MAPLEWOOD DRIVE  
 \_\_\_\_\_ ENDICOTT, N. Y.

ASSURED'S OCCUPATION OR BUSINESS \_\_\_\_\_  
 TYPE OF ASSURED \_\_\_\_\_ MERCHANT

PURPOSE (SEE ITEM 7)

ASSURED IS: INDIVIDUAL  CORPORATION  PARTNERSHIP  BUSINESS OR PLEASURE  COMMERCIAL

ITEM 2 POLICY PERIOD  
 FROM JUNE 2 19 TO JUNE 2 19

ITEM 3 DESCRIPTION OF AUTOMOBILE

MAKE	BODY TYPE	MODEL	YEAR	NEW	USED
BUICK	SEDAN	SUP	1947	X	
DATE PURCHASED	MOTOR NUMBER		SERIAL NUMBER	PURCHASE PRICE	
JUNE 47	7164261645		1A5431253107	2087	

ITEM 4 SCHEDULE OF COVERAGES. THE INSURANCE AFFORDED IS ONLY WITH RESPECT TO SUCH AND SO MANY OF THE FOLLOWING COVERAGES AS ARE INDICATED BY SPECIFIC PREMIUM CHARGE OR CHARGES. THE LIMIT OF THE COMPANY'S LIABILITY AGAINST EACH SUCH COVERAGE SHALL BE AS STATED HEREIN, SUBJECT TO ALL OF THE TERMS OF THIS POLICY HAVING REFERENCE THERETO.

LIMITS OF LIABILITY

BODILY INJURY	PROPERTY DAMAGE	MEDICAL PAYMENT	COMPREHENSIVE OR FIRE AND THEFT	COLLISION OR UPSET
\$100 .000 EACH PERSON	\$300 .000 EACH ACCIDENT	\$5.000 EACH ACCIDENT	\$ 5 00 EACH PERSON	CASH VALUE \$ 100 DEDUCTIBLE

PREMIUMS

BODILY INJURY OR PROP. DAM.	MEDICAL PAYMENT	COMPREHENSIVE	FIRE AND THEFT	WINDSTORM	COLLISION OR UPSET	EMERGENCY ROAD SERVICE	TOTAL
\$24.00	\$5.00	\$7.00			\$28.00		\$ 64.00

ITEM 5

THE AUTOMOBILE WILL BE PRINCIPALLY GARAGED IN THE TOWN, CITY, COUNTY AND STATE, SET FORTH IN ITEM 1 UNLESS OTHERWISE SPECIFIED HEREIN:

\_\_\_\_\_ HALLSTEAD, PA.

**AUTOMOBILE INSURANCE COMPANY**

Countersigned by \_\_\_\_\_

FIGURE 133

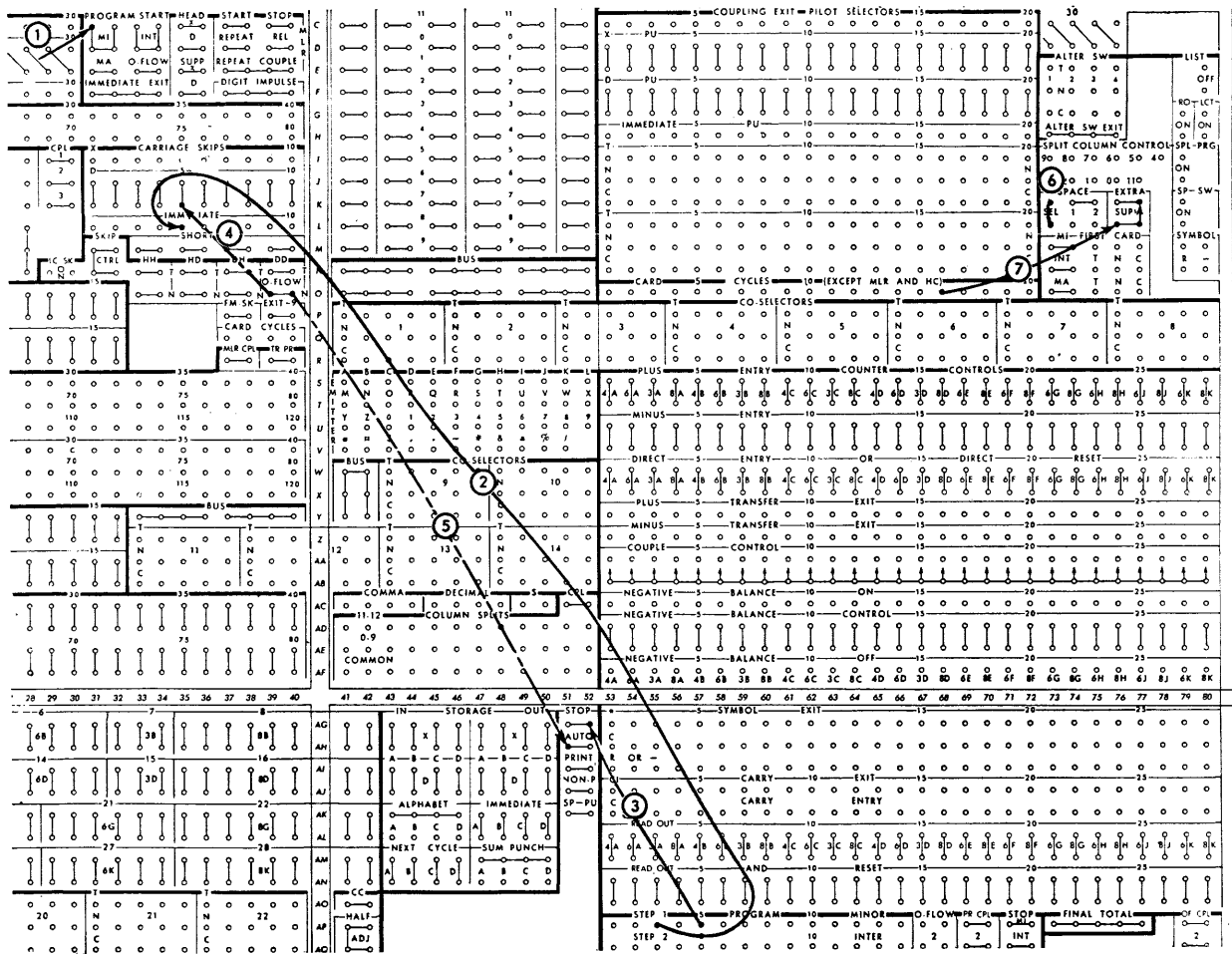

FIGURE 134. SINGLE SHEET FORM FEEDING; SELECTIVE SPACING

### Wiring, Single Sheet Form Feeding (Figure 134)

1. Minor program start is wired normally.
2. When a program change occurs, the sheet is ejected from the machine by wiring a minor program to carriage skip 5 I. A hole is punched in channel 5 of the tape four lines below the bottom edge of the form. If the report required that a total be printed before the form ejected, minor program would be wired to 5D or 5X.
3. Card feeding is stopped when skipping is caused by a minor program change, by wiring the minor program to stop.
4. For reports on which an overflow could occur, overflow is wired to carriage skip 5X, or 5D as shown by the dotted wiring.
5. Card feeding is stopped when skipping is caused by an overflow condition, by the wiring of the carriage overflow hubs to auto stop, as shown by the dotted wiring. When a new sheet is inserted in the carriage, the restore key is depressed and the sheet will automatically position

itself at the first printing line. On the run-in, the machine will stop because of the run-in reset programs, but the sheet will not be ejected. It is only necessary to press the start button to resume operations.

6. A hole is punched in channel 11 of the tape at every printing position with the exception of the first printing line. The SEL hubs are connected which causes a skip to be initiated after each line prints. The skip is stopped by channel 11.

7. Card cycles is wired to suppress and extra. The following wiring changes must be made for a group printed report:

- A. List is wired OFF.
- B. Minor and intermediate program start must be wired.
- C. Stop hubs are wired from intermediate program.
- D. Carriage skip hubs are wired from intermediate program.

## MULTIPLE LINE READING OPERATIONS

A CARD may be read more than once on the Type 407. This operation is referred to as multiple line reading. Each time the card is read, a line may be printed or a factor may be entered into a counter. There is no limitation to the number of times that a card may be read. It is only necessary to pre-determine the number of cycles desired and, by proper control panel wiring, the card will remain stationary while it is being read the required number of times.

Multiple line reading, therefore, has the advantage of printing more than one line from a single card. Figure 135 illustrates the outline of a card to be used to print these lines. It is divided into three parts, part A containing the name, part B the address, and part C the city and state. Normally 28 columns are allowed for each, but these may be expanded as explained under *Progressive Selector Expansion*.

At least one column of the card must be set aside, first, to identify the card as an MLR card, and second, to determine the number of lines to be printed from that card. This is accomplished by punching the letter A for one-line printing, B for two-line printing and C for three-line printing. In each instance the 12 punch (zone for A, B, C) is used to start MLR operations and the 1, 2, or 3 (lower punch for A, B, C) is used to stop MLR operations after one, two or three lines, respectively, have been printed. More than three lines may be printed by making use of the repeat feature, discussed under *MLR repeat*.

An MLR operation will alter other functions to provide for correct MLR operation. The operations

affected are: Pilot selector pickup, Programming, Storage Read-Out, Skipping, and Card-Cycles impulses.

### ADDRESS PRINTING

THE PRINTING of one, two or three lines of alphabetic information from a single card is illustrated in Figure 136. Each card has a 12 punched in column 80 along with a 1, 2 or 3 punch, depending on whether 1, 2 or 3 lines are to be printed. Digits 4 through 9 in the MLR control column do not affect MLR operation.

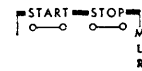

**MLR Start.** These hubs accept a 12 impulse to stop card feeding and start a series of cycles for the repeated reading of a card. The 12 impulse is normally the zone part of the letters A, B or C, although it could be an independent 12 impulse. MLR start is wired from first reading so that the repeated reading operations may begin when the MLR card reaches the second reading station. At the same time the progressive selectors become operative.

**MLR Stop.** The MLR stop hubs accept a 1, 2 or 3 impulse to stop MLR operations after 1, 2 or 3 lines have been printed and to resume card feeding. The 1, 2 or 3 punches normally represent the lower punching for the letters A, B or C although they could be punched in a separate card column. MLR stop is wired from second reading.

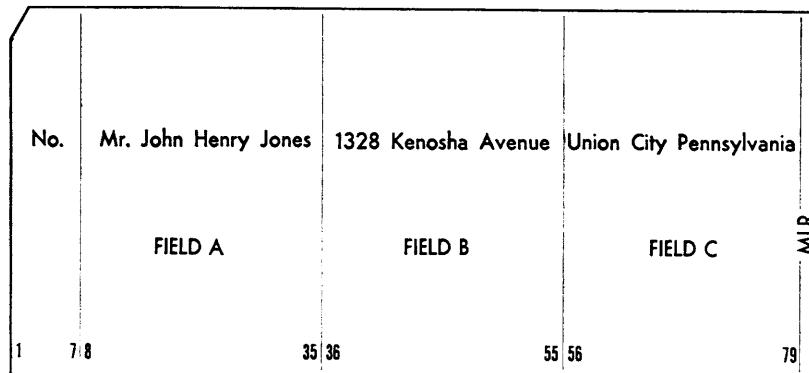
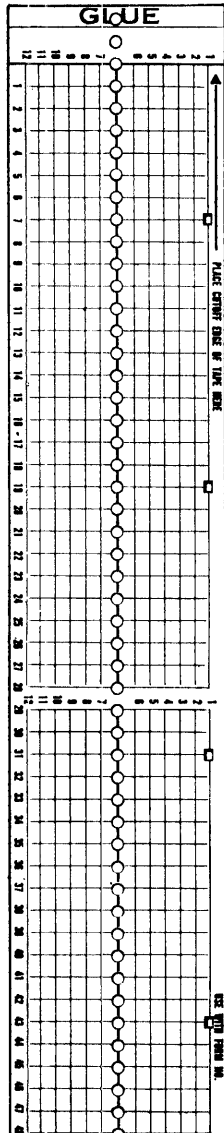

FIGURE 135





FROM REPRESENTATIVE CO. CITY, STATE		L. J. HAMMERSMITH 1465 INDIANAPOLIS ROAD INDIANAPOLIS, IND.	
DELIVER TO		L. J. HAMMERSMITH 1465 INDIANAPOLIS ROAD INDIANAPOLIS, IND.	
W. O. JOHNSON 254 DIVISION ST. FLINT 6, MICH.		L. J. HAMMERSMITH 1465 INDIANAPOLIS ROAD INDIANAPOLIS, IND.	
FROM REPRESENTATIVE CO. CITY, STATE		NYC RR TRAIN 6	
DELIVER TO		NYC RR TRAIN 6	
D. A. WORTHINGTON EVART, MICH.		D. A. WORTHINGTON EVART, MICH.	
FROM REPRESENTATIVE CO. CITY, STATE		W. O. JOHNSON 254 DIVISION ST. FLINT 6, MICH.	
DELIVER TO		NYC RR TRAIN 6	
FROM REPRESENTATIVE CO. CITY, STATE		L. J. HAMMERSMITH 1465 INDIANAPOLIS ROAD INDIANAPOLIS, IND.	
DELIVER TO		L. J. HAMMERSMITH 1465 INDIANAPOLIS ROAD INDIANAPOLIS, IND.	

IBM 5081

1 2 3 4 5 6 7 8 9 10 11 12 13 14 15 16 17 18 19 20 21 22 23 24 25 26 27 28 29 30 31 32 33 34 35 36 37 38 39 40 41 42 43 44 45 46 47 48 49 50 51 52 53 54 55 56 57 58 59 60 61 62 63 64 65 66 67 68 69 70 71 72 73 74 75 76 77 78 79 80

1 2 3 4 5 6 7 8 9 10 11 12 13 14 15 16 17 18 19 20 21 22 23 24 25 26 27 28 29 30 31 32 33 34 35 36 37 38 39 40 41 42 43 44 45 46 47 48 49 50 51 52 53 54 55 56 57 58 59 60 61 62 63 64 65 66 67 68 69 70 71 72 73 74 75 76 77 78 79 80

1 2 3 4 5 6 7 8 9 10 11 12 13 14 15 16 17 18 19 20 21 22 23 24 25 26 27 28 29 30 31 32 33 34 35 36 37 38 39 40 41 42 43 44 45 46 47 48 49 50 51 52 53 54 55 56 57 58 59 60 61 62 63 64 65 66 67 68 69 70 71 72 73 74 75 76 77 78 79 80

1 2 3 4 5 6 7 8 9 10 11 12 13 14 15 16 17 18 19 20 21 22 23 24 25 26 27 28 29 30 31 32 33 34 35 36 37 38 39 40 41 42 43 44 45 46 47 48 49 50 51 52 53 54 55 56 57 58 59 60 61 62 63 64 65 66 67 68 69 70 71 72 73 74 75 76 77 78 79 80

1 2 3 4 5 6 7 8 9 10 11 12 13 14 15 16 17 18 19 20 21 22 23 24 25 26 27 28 29 30 31 32 33 34 35 36 37 38 39 40 41 42 43 44 45 46 47 48 49 50 51 52 53 54 55 56 57 58 59 60 61 62 63 64 65 66 67 68 69 70 71 72 73 74 75 76 77 78 79 80

FIGURE 136



R, 37-38

**MLR CPL.** These common multiple line read couple hubs are active on every MLR cycle. They are normally wired to TR PR to make the transfer print entry hubs active during MLR operations. Thus, transfer print entry may be used for printing on MLR cycles, and normal print entry may be used for printing on non-MLR cycles. If MLR is not wired to TR PR, normal print entry may be used to print from MLR cards.

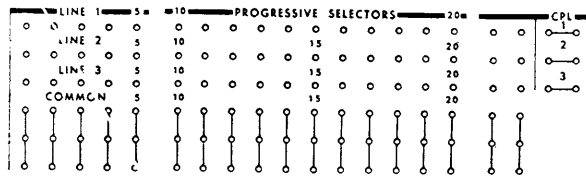

I-N, 1-30

**Progressive Selectors.** The progressive selectors consist of six rows, each row having 28 positions. The hubs labelled line 1, 2 and 3 are the transfer hubs. The line 1 hubs are internally connected to the three rows of common hubs on the first cycle after MLR start is impulsed. The line 2 hubs are internally connected to the common hubs on the second cycle after MLR start is impulsed. The line 3 hubs are internally connected to the common hubs on the third cycle after MLR start is impulsed. Only one line is active at a time. When line 2 is active, lines 1 and 3 are not active. Likewise, when line 3 is active lines 1 and 2 are not active.

An impulse entered into the line 1, 2 and 3 hubs will be available out of common on successive cycles. Also, an impulse entered into common will be available out of the corresponding line 1, 2 and 3 hubs on successive cycles.

The line 1, 2 and 3 hubs are normally wired from second reading when MLR cards are being read. The line 1 hubs are wired from the card columns representing the first printing line,

such as name, the line 2 hubs from the card columns representing the second printing line, such as address, and the line 3 hubs from the card columns representing the third printing line, such as city and state. The common may be wired to either transfer or normal print entry. If wired to transfer print entry, MLR CPL must be connected to TR PR.

**Progressive Selector Couple Hubs.** There are two common couple hubs for each line. These hubs are exits during MLR operations and are normally used to pick up co-selectors for the purpose of expanding any line beyond 28 positions. They are entry hubs, when MLR is not being used, and may be wired from a card cycle or all cycles impulse to cause the corresponding line to be connected to the common hubs for that cycle. This gives the effect of three 28-position selectors, since each line can be independently controlled when MLR is not in operation.

Each line of the progressive selector will accommodate 28 columns of the card. If more than 28 positions are desired, each line of the progressive selector may be expanded by impulsing co-selectors from the corresponding line couple. The selected data must be wired to print through the transfer side of the selector.

**Wiring (Figure 137)**

1. The MLR cards are identified by an A, B or C punch (12-1; 12-2; 12-3) in column 80 which is wired from first reading to MLR start. The 12 punch in column 80 causes card feeding to stop and MLR operations to begin.

2. Card columns 5-29, representing the name, are wired from second reading to line 1 of the progressive selector. This information reaches normal print entry on the first cycle after multiple line reading starts.

3. Card columns 30-54, representing the address, are wired from second reading to line 2 of the progressive selectors. This information reaches normal print entry on the second cycle after multiple line reading starts.

4. Card columns 55-79, representing the city

and state, are wired from second reading to line 3 of the progressive selector. This information reaches normal print entry on the third cycle after multiple line reading starts.

5. The common of the progressive selector is wired to normal print entry 48-72.

6. Column 80 is wired from second reading to MLR stop. The lower punching (1, 2 or 3) in the column determines whether one, two or three lines are to be printed before card feeding is resumed.

7. All of the cards in the operation are MLR cards. Skipping from one form to the other is accomplished by wiring column 80 from second reading to carriage skip 1D, and also short skip. Any digit punch in this column will cause the carriage to skip to the first printing line of the next form, after all the required MLR lines have been printed. Impulses reaching the D hubs of the carriage during MLR operations are not effective until completion of MLR operation for that card. The carriage becomes operative in the problem on the cycle following the printing of the last MLR line.

MLR HEADING CARDS

FIGURE 138 illustrates a statement prepared by using both MLR and normal or non-MLR cards. The MLR cards are the address cards and appear in the heading of the form. They are followed by normal cards, which appear in the body of the form.

When all heading cards including single line cards are MLR cards, the MLR code is used to control the heading operations. The heading may consist of both MLR and normal cards, but in such cases a special X must be punched in all the heading cards and that X must be wired to head control. This would also be necessary in cases where the body contained both MLR and normal cards.

Wiring (Figure 139)

1. Column 80 is wired from first reading to MLR start and also to head X. All heading cards are MLR cards and the code used to impulse MLR start is also used to impulse head control.

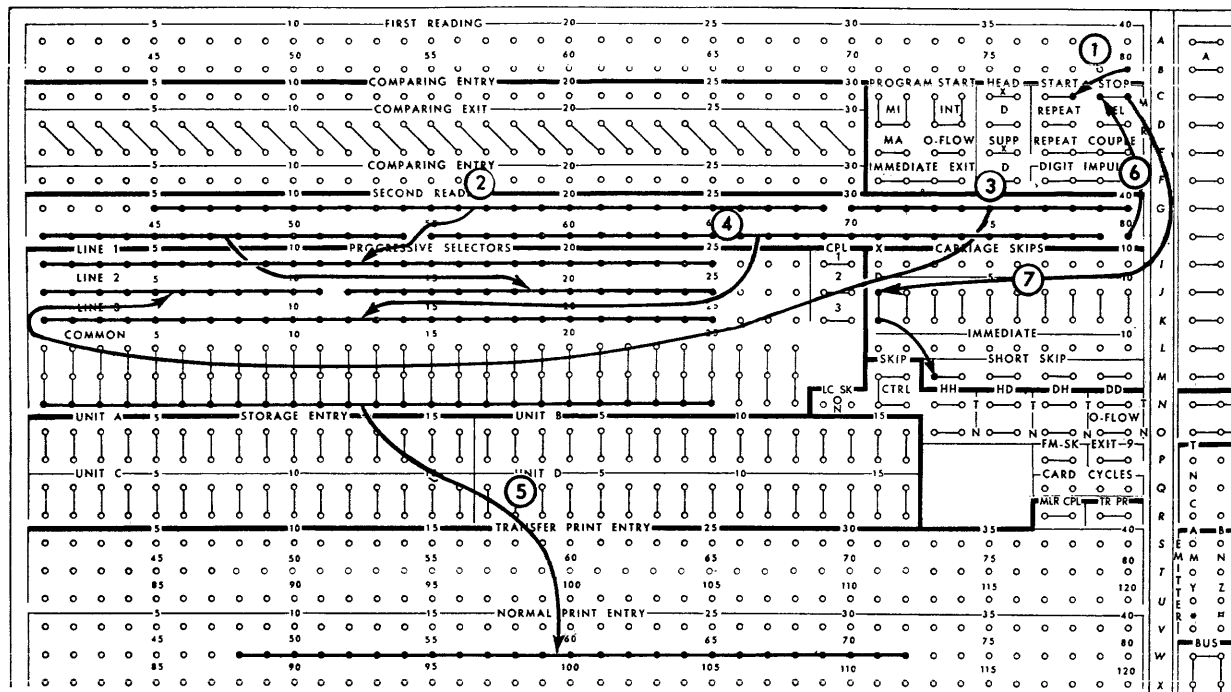

FIGURE 137. ADDRESS PRINTING

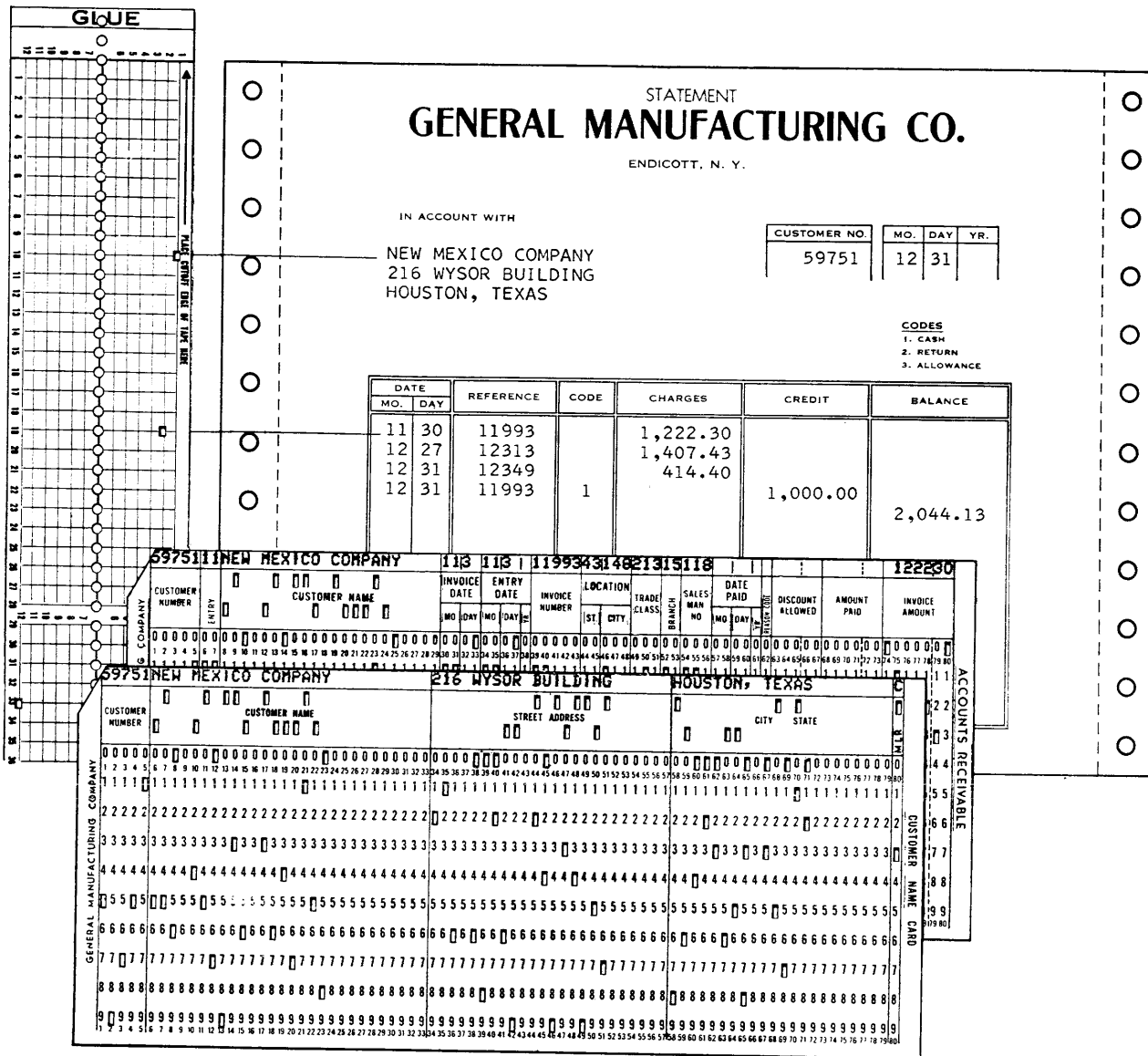

FIGURE 138

2. Column 80 is wired from second reading to MLR stop, to stop MLR operations after the number of lines printed (from one card) corresponds to the value of the lower punching in column 80 (1, 2 or 3). It is also wired to head X suppress.

3. Customer number is compared and the comparing exit is wired to minor program start and to skip control.

4. The name is wired from second reading columns 6-33 to line 1 of the progressive selector. The address is wired from second reading columns 34-57 to line 2 of the progressive selector. The city and state is wired from second reading col-

umns 58-79 to line 3 of the progressive selector. The common of the progressive selector is wired to transfer print entry 50-77 so that lines 1, 2 and 3 may print progressively. MLR CPL is connected to TR PR.

5. Channel 1 of the tape represents the first printing line. The following impulses are wired to carriage skip 1.

DH transferred to 1 D, to cause skipping to the next form for each account change. Skipping will occur after the total prints. HH transferred to 1 I, to cause skipping to the first printing line of the next form when detail cards are missing.

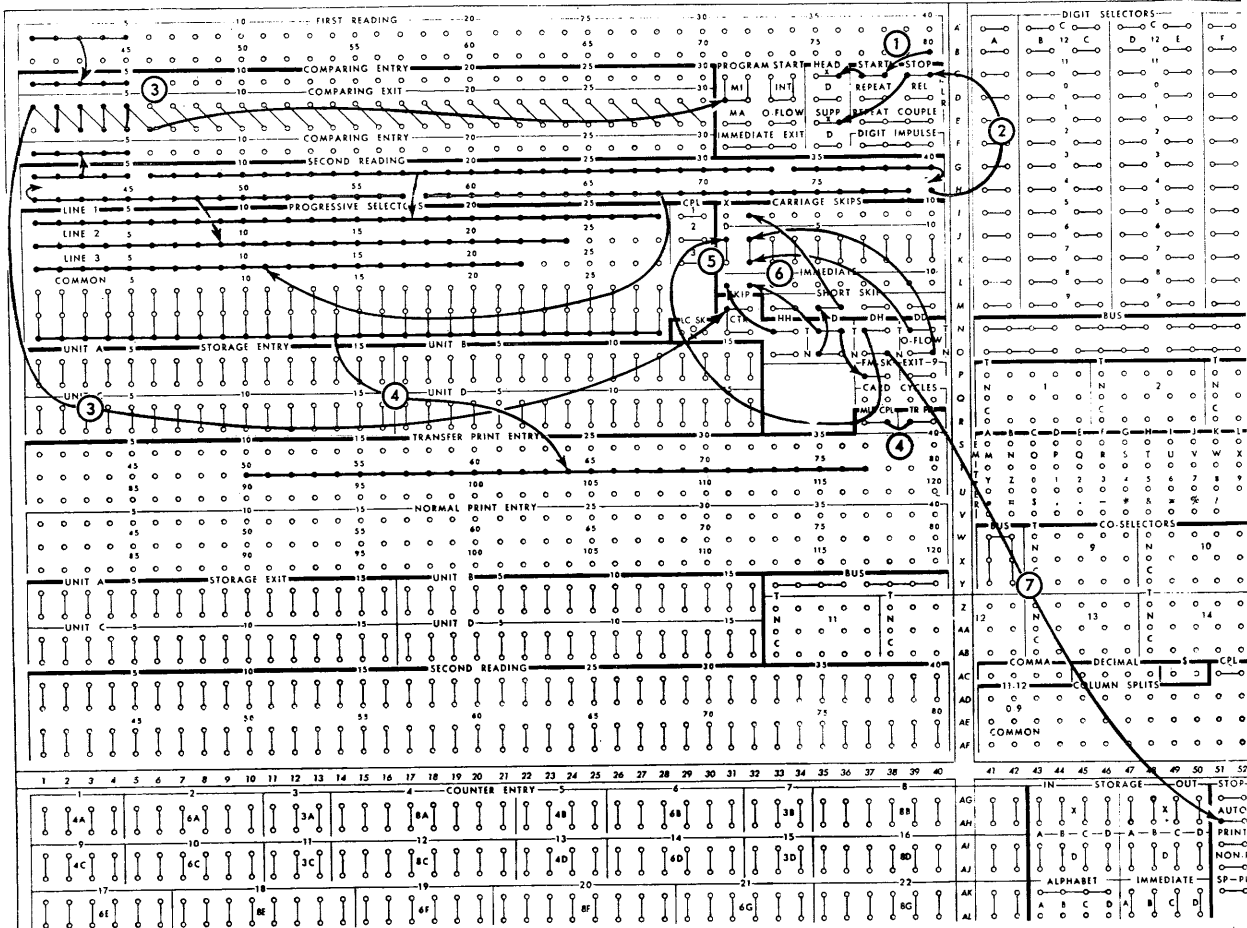

FIGURE 139. MLR HEADING CARDS

6. Channel 2 of the tape represents the first body line. The following impulses are wired to carriage skip 2:

HD transferred to 2 I, to cause skipping to the first body line when the detail cards of one group and the heading cards of the following group are missing. This impulse is continued to FM-SK so that channel 2 stop will be operative only on the second form.

DD transferred to 2 D to cause skipping to the first body line when heading cards are missing.

Overflow to 2 D to cause skipping to the first body line when there are more items in one control group than one form will accommodate. Sheet identification is not required in this example.

HD normal to 2 X to cause skipping from heading to body. This impulse is also wired

to short skip, since the distance between the heading and body is less than 2 inches.  
7. DH normal (cards out of sequence) is wired to automatic stop.

**PRINTING MORE THAN THREE LINES FROM ONE CARD**

MORE THAN three lines of information may be printed from one card as shown below. This is made possible by the fact that the progressive selectors may be made to repeat their operations as often as required. The repeating process may be done after any line, regardless of the punching in the MLR column, by impulsing the repeat hub.

R. C. DOYLE  
C/O BROADMORE INC.  
150 FRONT ST.  
DECATUR, ILL.

The information that is to be printed on more than three lines may be repetitive or may vary from one line to the next. If the information is repetitive, no selection is required. If the information varies from one line to the next, co-selectors must be used. A separate set of co-selectors will be needed for each additional line beyond three. The number of positions in each set of selectors will depend on the number of card columns being used. For example, if four lines are to be printed from one card and the first and fourth lines each contain 18 positions, 4 co-selectors will be necessary. The selectors are controlled in such a way that they will be normal for steps 1, 2 and 3 and transferred for step 4 (repeat cycle). The first line is wired through the normal and the fourth line through the transferred side of the selectors to line 1 of the progressive selector.

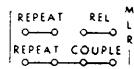

D-E. 37-40

**Repeat.** Normally, the progression of the MLR selector is stopped after 1, 2 or 3 lines depending on the lower punching in the MLR control column. Lines may be repeated, if desired, by impulsing the repeat hub with any impulse effective at 12 time. This is done by wiring an all cycles impulse through that step of the progressive selector after which the repeating operation is to take place. Repeat printing always starts with line 1. If more than three lines are to be printed through the progressive selector, an all cycles impulse is wired through line 3 of the progressive selector to repeat. If the first line is to be repeated, an all cycles impulse is wired through line 1 of the progressive selector to repeat. When repeat is wired, progression is stopped by impulsing release, since the regular stop hubs are inactive.

**Release.** Normally, MLR progression is stopped from a punch in the card (MLR control column). Progression may be stopped before the indicated number of lines have been printed by impulsing release. This is done by wiring a digit (9-1) or any cycles impulse to the common of

any unused progressive selector position and out of the proper line (1, 2, 3) to release. Then, if a C were punched in the MLR control column (3 lines) the progressive selector could be stopped after the first line by wiring all cycles through line 1 to release.

When repeat is wired, release must also be wired to stop the progressive selector after the desired line. Thus, if four lines are to be printed from one card, each one different from the other, release must be impulsed from the fourth step. This is done by wiring all cycles through the transferred side of the co-selector (picked up from repeat couple) to release. The release hub will receive the impulse to stop the progressive selectors after the fourth line has been printed.

**Repeat Couple.** Whenever repeat is impulsed, the repeat couple hubs will emit an impulse on all following cycles until the end of the cycle during which release is impulsed. When more than three MLR cycles are required, these hubs may be used to control a co-selector for the fourth and all following MLR cycles. The normal side of the selector is used to control the printing of lines 1, 2 or 3 and the transferred side to control the printing of the repeat lines 4, 5, 6, etc.

**Wiring (Figure 140)**

*Name* is punched in columns 1-18; *in care of* in columns 19-36; *street address* in columns 37-54, and *city* in columns 55-72. Only the MLR 12 punch is needed in the MLR control column 80, which will be wired to MLR start. Since repeat is wired, MLR progression is stopped by selective wiring of all cycles to release. No lower punching in the MLR column is necessary.

1. Columns 1-18 representing the name (first line) are wired from second reading to the normal side of co-selectors 1-4. Columns 55-72 representing the city (fourth line) are wired to the transferred side of co-selectors 1-4. The common is wired to line 1 of the progressive selectors.

2. Co-selectors 1-4 are picked up from repeat couple and will be transferred for all repeat MLR cycles. Repeat couple hubs emit an impulse the cycle after MLR is wired to repeat, and on all fol-

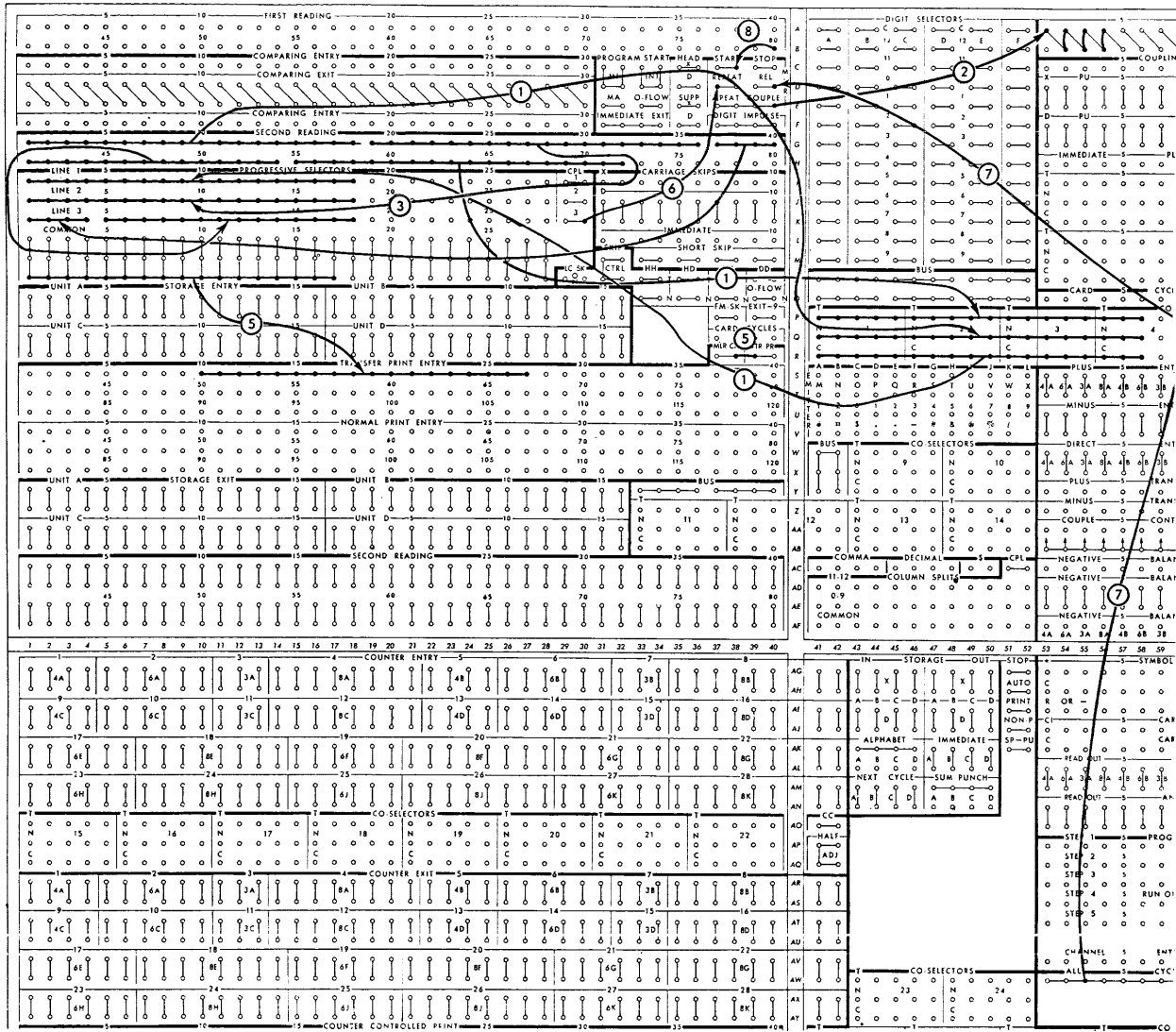

FIGURE 140. PRINTING FOUR LINES FROM ONE CARD

lowing MLR cycles. The selectors will be normal for steps 1-3 and transferred for step 4.

3. Columns 18-36 representing the *care of* line are wired direct to line 2 of the progressive selectors.

4. Columns 37-54 representing the street address are wired direct to line 3 of the progressive selectors.

5. The common hubs (1-18) of the progressive selector are wired to transfer print entry 10-28. The transfer print entry hubs are made active during MLR cycles by wiring MLR CPL to TR PR.

6. To make the progressive selectors return to line 1 after reading line 3, couple 3 is wired to repeat.

7. To stop the progression of MLR lines after line 4 has been read, an all cycles impulse is wired through the transferred side of co-selector 4 to release. Co-selector 4 will transfer for the fourth MLR line. The release will be effective after the fourth line prints. If five lines are required, the all cycles impulse must be wired through line 2 of the progressive selectors and through the transferred side of the repeat coupled selectors to release.

8. MLR start is wired from column 80 first reading. Only a 12 punch is required in the MLR control, since MLR progression is stopped by impulsing release.

## TYPICAL APPLICATIONS

### LABEL AND PICK SLIP WRITING

THIS EXAMPLE, and those to follow, demonstrate the combined use of some of the control panel hubs that have been explained independently in preceding chapters.

In the example shown in Figure 141, one shipping label is prepared for each shipping container for each customer. Only two cards are required to print any predetermined number of these labels, one card punched with the customer name and address and the other with the product contained in the package. The card containing the name and address is a normal card punched with a special identifying X or digit. The card containing the product description is an MLR card and also contains the number of labels to be printed.

The name and address is read from the normal card (X79) and stored. The product description is read from the MLR card as it is held stationary at second reading for a given number of cycles determined by the number of labels to be pre-

pared. This number from the MLR card is entered into a counter negatively and 1 is added each time a label is printed. When the counter reaches zero, the MLR card is released from the second station and the next card feeds.

This problem also demonstrates storage of 16 alphabetical characters in one storage unit as discussed under Figure 86. A maximum of 54 alphabetical characters are stored from each name card, 27 for the name and 27 for the address.

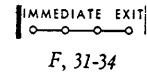

*Immediate Exit.* These hubs emit a short impulse (similar in timing to carriage skip control exits) during the second half of each machine cycle and are usually selected to control functions such as:

- a. Initiating a program for a particular digit or combination of digits punched in the card;

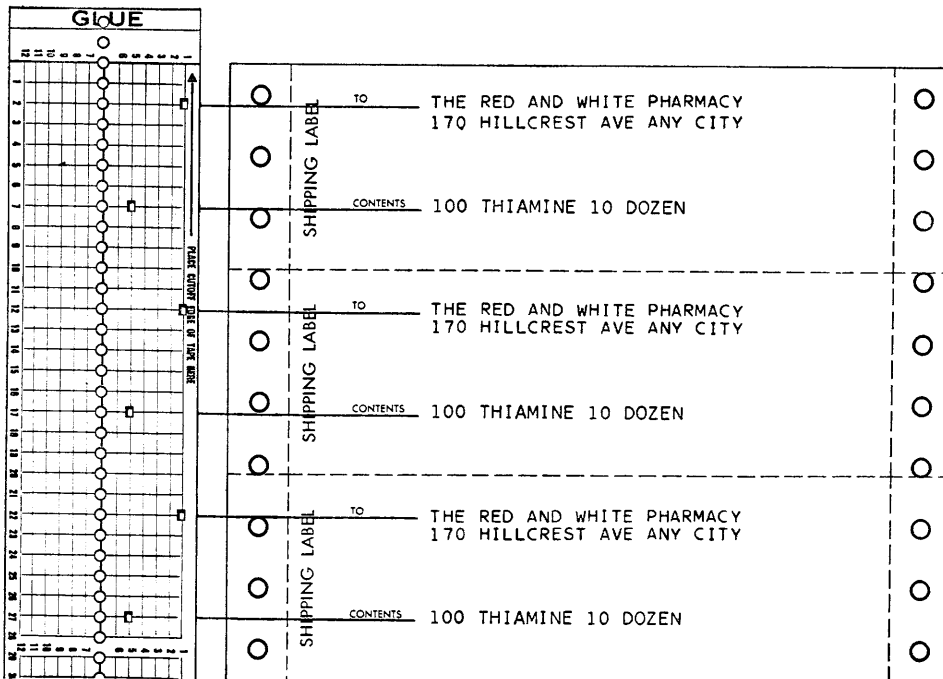
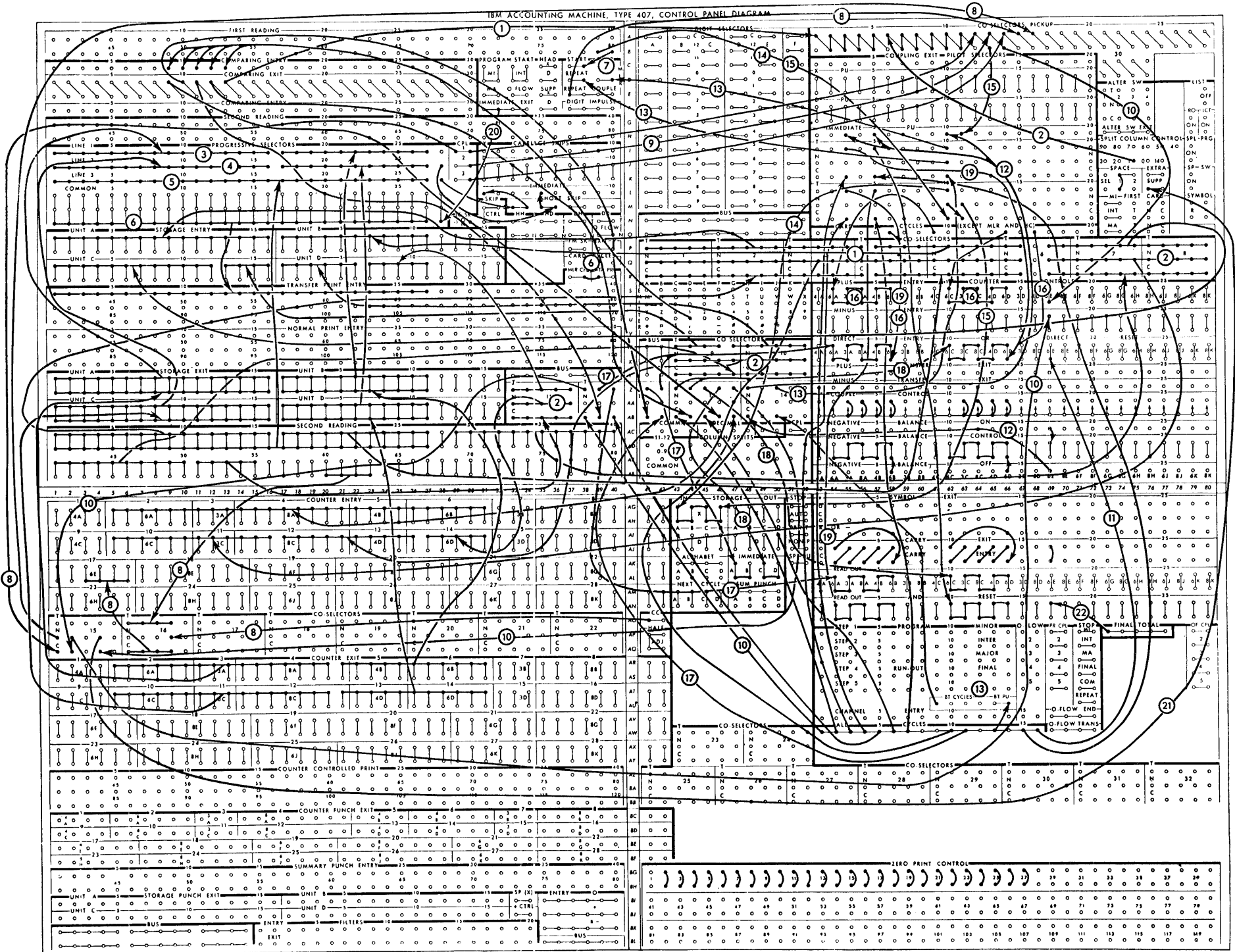

FIGURE 141. LABEL AND PICK SLIP WRITING



FIGURE 142. LABEL AND PICK SLIP WRING



- b. Initiating a program when two independent fields are equal;
- c. Initiating a skip after printing.

#### Wiring (Figure 142)

1. The name field, columns 1-27, is wired from second reading to the common of co-selectors 1, 2, 3, 4, 5 and part of 6. The selectors are picked up at half after 1 so that zone impulses in the name field may be wired out of the transferred sides to storage entry A and B and the digit impulses out of the normal sides to the entry of counters 1 to 6.

2. The address field, columns 29-55, is wired from second reading to the common of co-selectors 6, 7, 8, 9, 10 and 11. The selectors are picked up at half after 1 so that zone impulses in the address field may be wired out of the transferred sides to storage entry C and D and the digit impulses out of the normal sides to the entry of counters 10-14.

3. The exits of storage units A and B and the exits of counters 1-6 are wired directly to line 1 of the progressive selector. These units store the name.

4. The exits of storage units C and D and the exits of counters 10-14 are wired directly to line 2 of the progressive selector. These units store the address.

5. Columns 1-27, representing the contents description, are wired from second reading to line 3 of the progressive selector.

6. The common of the progressive selector is wired to transfer print entry. The name will print on the first MLR cycle, the address on the second, and the contents description on the third. MLR CPL is wired to TR PR to make the transfer print entry hubs active on MLR cycles.

7. MLR column 80 is wired from first reading to MLR start. Only the 12 punch is needed since MLR is stopped by impulsing release.

8. The field containing the number of labels to be printed is wired from second reading to counter entry 17, through the transferred side of co-selector 16. A cycle count is wired to the units position of counter 6 through the normal side of co-selector 16. Co-selector 16 is picked up from the MLR couple 1 hub, through the

normal side of co-selector 14. Selector 14 in turn is picked up from repeat couple. The purpose of selector 14 is to prevent the couple 1 impulse from picking up co-selector 15 on repeat cycles.

The number of labels to be printed will therefore enter counter 17 as the first line of the MLR card is read. A count of 1 will enter the counter on the second MLR cycle of the first and every repeat operation, or in other words, every time a label is printed.

9. Lines 1, 2 and 3 of the progressive selector are expanded by wiring couple 1, 2 and 3 to the pickup of co-selectors 12, 13, and 14, respectively.

10. The "number of labels" field is subtracted in counter 17 on the first MLR cycle by wiring an all cycles impulse through the transferred side of co-selector 12 and the normal side of co-selector 15 to counter 17 minus. Co-selector 12 allows the impulse to reach the counter minus only during the printing of line 1, and co-selector 15 keeps the counter from subtracting on all repeat line 1 operations. The counter is impulsed to add 1 on every second MLR cycle by wiring MLR couple 2 to counter 17 plus.

11. An all cycles impulse is wired to direct entry, since neither the number of labels nor the 1 is to be printed.

12. Negative balance OFF of counter 17 is wired through the transferred side of co-selector 14 to the I pickup hubs of pilot selectors 3, 5 and 10. The pilot selectors will transfer for the third line of the last label in each group to be printed. (Counter 17 zero balances at the end of line 2.)

Pilot selectors 3 and 5 are used to control the direct reset of the name and address counters on line 3 of the last label in each group. Pilot selector 10 is used to control MLR repeat and release; it is also used to control the entry of the zone impulses of the name and address field into storage.

13. An all cycles impulse is wired to BT PU. A BT cycles impulse is wired through the transferred side of co-selector 14 (line 3 selector) through the normal side of pilot selector 10 to repeat, and through the transferred side to release. As long as counter 17 is negative, the progressive selector will be impulsed to repeat and the product description card will remain at the second station.

When the counter reaches zero, release will be impulsed as the third line of the last label in each group is printed. The product description card at station 2 will be released and the next card will advance to station 2.

14. The name and address card is identified by an X in column 79. Column 79 is wired from first reading through the transferred side of pilot selector 10 to storage IN A, B, C, D (X) hubs. The X impulse reaches these hubs on MLR step 3 if counter 17 stood at zero on step 2, and conditions the storage units to accept the zone impulses from the name and address fields when the X79 card reaches second reading.

15. The name and address zone impulses for the first X79 card are stored by wiring X79 from first reading through the normal sides of both pilot selectors 10 and 11 to storage IN A, B, C, D (X) hubs. This wiring allows the storage units to be conditioned only on the first MLR cycle when counter 17 does not stand at zero (first card through the machine). Pilot selector 11 is picked up from MLR couple 1.

16. The digit impulses for the name are stored in counters 2, 3, 4, 5 and 6 and for the address in counters 10, 11, 12, 13 and 14. The counters are impulsed to add by direct entry from card cycles. Couple control, negative balance control and CI to C wiring for the two groups of counters is normal.

17. The zone impulses for the name are read out of storage units A and B on the first MLR cycle by wiring a half after 1 impulse through the transferred side of co-selector 12 (line 1) to A and B immediate OUT. The purpose of the half after 1 impulse is to cause only the zones to read out.

The digit impulses for the name are read out of counters 2, 3, 4, 5 and 6 by wiring all cycles through the transferred side of co-selector 12 (line 1) to the counter read-out hubs. To prevent zeros from reading out of blank counter positions and interfering with corresponding storage positions, a half after 1 is wired through the transferred side of co-selector 12 to direct entry. This in effect allows only digits 9-1 to read out. Since the direct entry hubs hold only for the duration of the impulse wired to them, half after 1 is supplemented by wiring all cycles through the transferred side of co-selector 12 to direct entry.

18. The zone impulses for the address are read out of storage units C and D on the second MLR cycle by wiring a half after 1 impulse through the transferred side of co-selector 13 (line 2) to C and D immediate OUT. The purpose of the half after 1 impulse is to cause only the zones to read out.

The digit impulses for the address are read out of counters 10, 11, 12, 13 and 14 by wiring all cycles through the transferred side of co-selector 13 (line 2) to the counter read-out hubs. To prevent zeros from reading out of blank counter positions and interfering with corresponding storage positions, a half after 1 is wired through the transferred side of co-selector 13 to direct entry. This in effect allows only digits 9-1 to read out. The half after 1 is supplemented by an all cycles impulse wired to direct entry through the transferred side of co-selector 13.

19. All counters are cleared by direct reset on line 3 of the last label in each group.

20. Tape channel 5 identifies the *contents*, and tape channel 1 the first printing line. A skip to channel 5 takes place after the address is printed, by wiring the immediate exit through line 2 of the progressive selector to carriage skip 5I. A skip to channel 1 takes place after the contents line is printed by wiring the immediate exit through line 3 of the progressive selector to carriage skip 1I. Both skips are wired for short skip.

The immediate exit is used instead of an all cycles impulse, because skipping is to take place after lines 2 and 3 print. All cycles would cause skipping before printing.

The X or D carriage skip hubs cannot be used in this example because, once impulsed, they hold through the remaining MLR cycles before becoming active. The use of the X and D hubs would not allow skipping between MLR lines.

21. The space occurring during the first MLR cycle following the reading from the name card is suppressed by wiring an all cycles impulse through the transferred side of co-selector 12 (line 1) and the normal side of co-selector 15 to SUPP. Co-selector 15 is transferred for all repeat cycles.

22. Counter 17 is reset from final total. This counter should be cleared before the beginning of the operation.

## CROSS-CHECKING

WHENEVER an original and a duplicate report are prepared side by side and the amounts on both are exactly the same, two methods are available for printing these amounts:

1. From a single counter, split wiring the exits to two different sets of print wheels.
2. From two counters, wiring the exits of each separately.

The first method does not offer the same checking possibilities as the second method. Under method 1, two printed amounts from one counter could differ and not be detected. The reason for this is that the counter exits are split wired and although the "echo impulses" from the counter controlled print wheels differed, the first impulse back to the counter would be accepted.

Under method 2, the two amounts are printed from two counters. If the totals disagree, the reset check circuit can be made operative by cross-checking. This is done by selecting the read back (echo impulse from counter-controlled print) of one counter into the other counter, and *vice versa*. The read back occurs in the second half of the cycle and if either counter fails to zero balance, the reset check light turns on and the machine stops.

## Wiring, Cross-Checking (Figure 143)

1. The field to be accumulated is wired to counter entry 4 and 8.

2. Special program is wired ON.

3. The couple hub of the column splits is wired through channel 1 of the program unit to pick up co-selectors 1-4. Since the couple hub emits an impulse during the second half of the cycle, co-selectors 1-4 will be normal for the first half of the cycle and transferred for the second half of the cycle.

4. The exits of counter 4 are connected to counter-controlled print 53-60 during the first half of the cycle and to counter 8 exits during the second half of the cycle, through co-selectors 1-2.

5. The exits of counter 8 are connected to counter-controlled print 68-75 during the first half of the cycle and to counter 4 exits during the second half of the cycle, through co-selectors 3-4.

On each detail print cycle, counter-controlled print 53-60 is set up from counter 4 exit and the amount adds in counter 8. Likewise, counter-controlled print 68-75 is set up from counter 8 exit and the amount adds in counter 4.

On the total cycle, the total in counter 4 is printed from print wheels 53-60 and the echo impulse carries it to counter 8 for zero balancing. Likewise the total in counter 8 is printed from print wheels 68-75 and the echo impulse carries it to counter 4 for zero balancing. If either counter fails to zero balance, the machine stops and the reset check light turns ON. Thus, whatever prints from counter 4 must also print from counter 8

FIGURE 143. CROSS-CHECKING

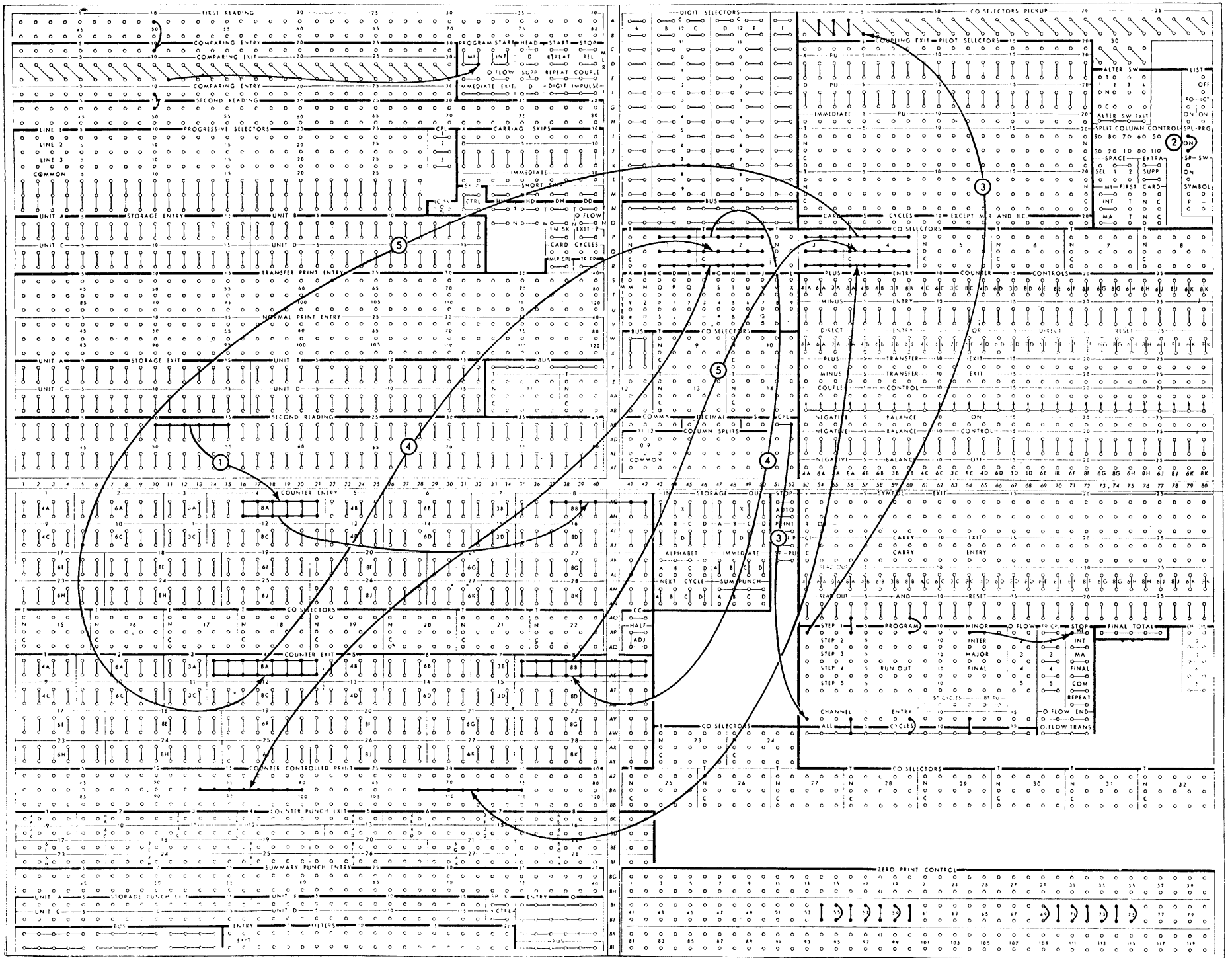

INVOICE PREPARATION

THE INVOICE shown in Figure 144B is a group printed report with a minor program on item number and an intermediate program on customer number. It demonstrates simultaneous reading from two cards, one an MLR card and the other a normal card, resulting in side by side printing of both the *invoice to* and *ship to* headings. It also demonstrates:

- Invoice and page numbering.
- Use of both MLR and normal cards in the heading.
- Alphabetic identification of the overflow sheet.
- Variable length overflow when group printing.
- Total identification.
- Crossfooting.

As shown in Figure 144A, the *invoice to* card is an MLR card with the MLR control C punched in column 1. The *ship to* card is a normal card from which the name, address and city will be read at the first station at the same time that the MLR card is being read at the second station.

The *ship via* and the *order data* cards are also normal cards. Since the heading consists of both MLR and normal cards, all of them are identified by an X in column 80. Each heading card is also punched with a card number in column 80.

The detail cards are identified as NX80 cards and have all the special characters punched in them that are shown in the item number, description and unit price columns of the invoice. They are pulled from prepunched denominating tub files and any one line may consist of more than one card.

29045	115/273	LAG SCREWS 1 X 1/2	10	5.25	525	355			
CUST. NO.	ITEM NUMBER	DESCRIPTION	QUANTITY	UNIT PRICE	AMOUNT	COST			
00	00	00 00	0	0	000	000			
29045	3/15	AK-71425 DE							
CUSTOMER NO.	ORDER DATE	ORDER NO.	SALESMAN						
00	00	00	000 00						
29045	WESTERN TRUCKERS								
CUSTOMER NO.	SHIPPED VIA								
00	00 00 00								
29045	K-Y-2 SERVICE CORP		222 WESTERN AVE		INDIANAPOLIS, IND				
CUSTOMER NO.	SHIP TO NAME		STREET ADDRESS		CITY-STATE				
00	00 00		00		000 0 000				
29045	E BROWN & CO		2364 MICHIGAN BLVD		CHICAGO 27, ILL				
CUSTOMER NO.	CUSTOMER NAME		STREET ADDRESS		CITY-STATE				
00	00 00		000000 0 0		000000 0 000000				
0	0	0	0	0	0	0	0	0	0
1	1	1	1	1	1	1	1	1	1
2	2	2	2	2	2	2	2	2	2
3	3	3	3	3	3	3	3	3	3
4	4	4	4	4	4	4	4	4	4
5	5	5	5	5	5	5	5	5	5
6	6	6	6	6	6	6	6	6	6
7	7	7	7	7	7	7	7	7	7
8	8	8	8	8	8	8	8	8	8
9	9	9	9	9	9	9	9	9	9

FIGURE 144A. CARDS FOR INVOICE PREPARATION

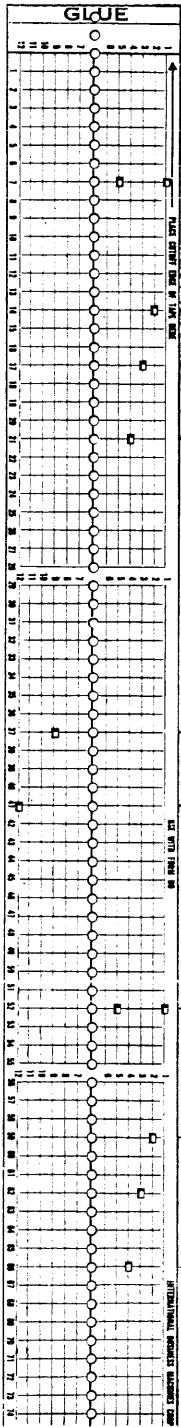

**REPRESENTATIVE COMPANY**  
ANY CITY-ANY STATE

INVOICE TO	SHIPPED TO	INVOICE
E C BROWN & CO 2364 MICHIGAN BLVD CHICAGO 27, ILL	X-Y-Z SERVICE CORP 222 WESTERN AVE INDIANAPOLIS, IND	NUMBER PAGE 26115 1 DATE DEC. 22, XX CODE 29045
SHIPPED VIA WESTERN TRUCKERS		PLEASE REFER TO OUR INVOICE NUMBER WHEN REMITTING TERMS: 2% TEN DAYS. F. O. B. FACTORY
ORDER DATE	ORDER NO.	
3/15/XX	AK-71423 DE	D NORTON

ITEM NUMBER	DESCRIPTION	QUANTITY & UNIT OF MEAS.	UNIT PRICE	AMOUNT	COST AND PROFIT
115/278	LAG SCREWS 1 X 1/2	2 C	5.25	10.50	
115/282	LAG SCREWS 3 X 1/2	5 C	5.30	26.50	
SBN- 02	HAMMER-ADZE EYE+BELL POLL,RND NECK	12 DOZ	10.50	126.00	
369-2HF	HAMMER-BALL PEEN 2/0,3/4 LB	4 DOZ	12.64	50.56	
101-224	WASHING MACHINE	8 EACH	165.00	1,320.00	
21-564	NAILS-STEEL WIRE 60-2IN	6 CWT	8.30	49.80	
21-572	NAILS-STEEL WIRE 100-3IN	4 CWT	7.80	31.20	
143-210	BRUSH, FLAT WALL 3 X 2 5/8 X 13/16	6 EACH	.95	5.70	
743D217	GROMMETS	720 EACH	.01	7.20	
143-210	BRUSH,FLAT WHITE	12 GAL	2.85	34.20	
216-418	PAINT,WALL UNDERCOAT	1 GAL	2.95	2.95	

**REPRESENTATIVE COMPANY**  
ANY CITY-ANY STATE

INVOICE TO	SHIPPED TO	INVOICE
E C BROWN & CO		NUMBER PAGE 26115 2 DATE CODE
SHIPPED VIA		PLEASE REFER TO OUR INVOICE NUMBER WHEN REMITTING TERMS: 2% TEN DAYS. F. O. B. FACTORY
ORDER DATE	ORDER NO.	

ITEM NUMBER	DESCRIPTION	QUANTITY & UNIT OF MEAS.	UNIT PRICE	AMOUNT	COST AND PROFIT
	INV TOT			\$ 1664.61*	1239.65-
	2% DISC			\$ 33.29CR	1664.61
	NET AMT			\$ 1631.32*	424.96

FIGURE 144B

	AMOUNT	2% DISC.	COST	NET TOT.	AMOUNT
Counters	8	4	17	16	12
From Card	+ Amount Direct Entry	- Amount Direct Entry	- Cost Direct Entry		+ Amount Direct Entry
Program 1	RO & Reset Print Amount			+ Amount from 8	
Program 2		- Amount From 16 = Twice Amt.	RO & Print Cost	RO & Print Invoice Total	
Program 3		RO 2% Disc. Offset Print	+ Inv. Total From 12 = Profit	- 2% Disc. from 4 = Net	RO & Reset
Program 4		Direct Reset	RO & Reset Profit	RO & Reset Print Net	

FIGURE 144C. COUNTER ANALYSIS FOR INVOICE PREPARATION

Study of the counter analysis (Figure 144C) will clarify the problem.

In addition to the counters referred to in the above chart, the following counters are also used:

- 15 Page number
- 4 Quantity
- 2 Customer code
- 6 Invoice number
- 10 Unit price group indication

Assignment of carriage tape channels, as shown in Figure 144B, is as follows:

- 1 and 5 First printing line
- 2 Shipped Via
- 3 Order data
- 4 First body line
- 9 Variable length overflow line
- 12 Overflow

The wiring for the example is complete. To make it easier to follow and understand, six wiring diagrams have been used. As nearly as it is possible to do so, each diagram is related to a few specific functions of the machine. For example, diagram A concerns the comparing unit, carriage skips, MLR control and overflow programs, diagram B concerns, for the most part, MLR printing, diagram C total identifications, and so on.

#### Wiring, Diagram A (Figure 145A)

1. MLR control column 1 is wired to MLR start

from first reading and MLR stop from second reading. The *invoice to card* is the only MLR card being used.

2. Column 80, which contains both the heading card X and the card number, is wired to head X from first reading. Since the heading cards do not contain the item number control field, column 80 is wired to head suppress from second reading. This wiring prevents a minor program change from taking place between heading and body cards. Although head suppress does not suppress the action of the carriage skip hubs, there will be no interference in this example because the skip control is wired from the comparing exit hubs of the customer number field and not the item number field.

Column 80 is also wired to digit selector A common.

3. The item number field (columns 7-13) is compared and the comparing exit is wired to minor program start. The customer number field (columns 2-6) is compared and the comparing exits are wired to intermediate program start.

4. The carriage skip control is wired from the customer number comparing exit hubs.

5. The carriage skip hubs are wired as follows:

Channel 1D—from DH transferred to cause a skip to the first printing line after the totals print, for every change in customer number. Once a channel has been impulsed through its X or D hub,



FIGURE 149A. INVOICE PREPARATION, SIDE-BY-SIDE HEADING

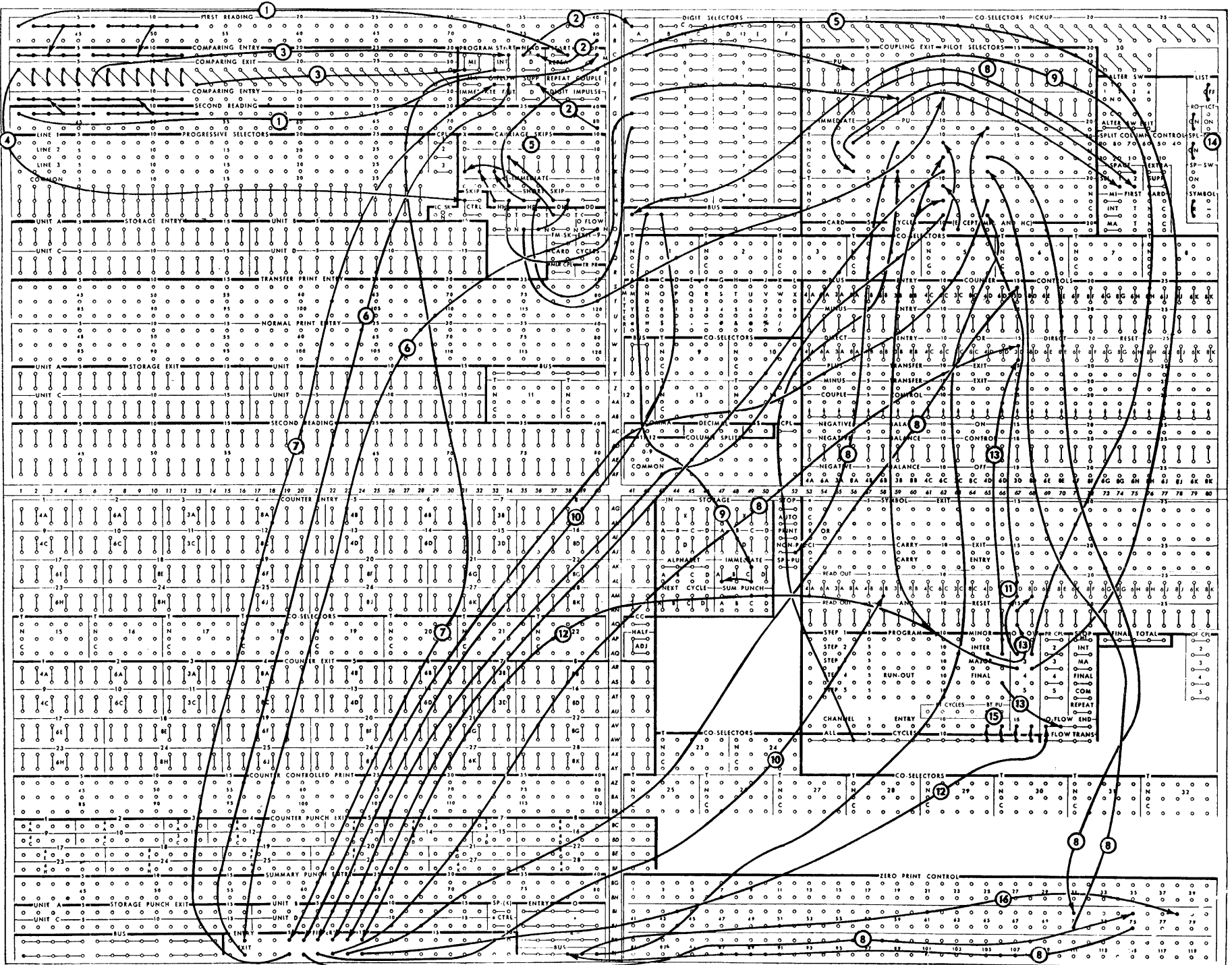

it remains effective until the skip is completed even though there may be intervening programs or MLR cycles. Until the skip is completed, an impulse to I will be ineffective; hence two channels are required for the first printing line. As will be seen on diagram E, a skip to the first printing line is required on a variable length overflow condition even though channel 1 has been previously impulsed from DH transferred. The skip is wired to channel 5, which also locates the first printing line.

Channel 2D—from a 3 in column 80 (ship via) to cause a skip to the *ship via* line in the heading. This impulse is continued to short skip since the skipping distance is less than two inches.

Channel 3D—from a 4 in column 80 (order data) to cause a skip to the order data line in the heading. This impulse is continued to short skip.

Channel 4D—from HD normal to cause a skip to the first body line, after the heading cards have been printed. The impulse is continued to short skip.

Channel 4 I—from overflow step 3 to cause a skip to the first body line after the overflow sheet identification has been printed.

6. Overflow is wired to overflow program start through a filter. This wiring initiates overflow program steps on a normal overflow.

7. Overflow program start is also wired from intermediate comparing exit through a filter. This wiring is necessary to make overflow end receptive for a variable length overflow condition. Overflow end will not function unless overflow program start has been previously impulsed.

8. The pilot selectors on diagram A are wired as follows:

Pilot selector 4—All heading cards are single spaced, and all detail cards double spaced, by wiring the space exit hub through the normal side of the selector to space 2 and through the transferred side to space 1. The selector is picked up from an X in column 80 wired through digit selector A.

Pilot selector 7—Since the *ship to* card (2 in column 80) is read and printed from the first reading station, all printing and spacing for this card are prevented as it passes the second reading station, by wiring an all cycles impulse through the transferred side of pilot selector 4 to non-print. The

selector is picked up from a 2 in column 80.

Pilot selector 10 upper—The page number counter 15 is impulsed to add 1 on the cycle following the HD normal skip by wiring a card cycles impulse through the transferred side of the selector to 15 plus. The selector is picked up from HD normal. Counter 15 is also impulsed to add 1 on the cycle following the overflow sheet identification by wiring overflow step 3 through the normal side of the selector to 15 plus.

Pilot selector 10 lower—Since the 1 added in counter 15 should not print while entering the counter, direct entry is impulsed from card cycles through the normal side of the selector and from overflow step 3 through the transferred side of the selector.

Pilot selector 13 upper—A comma, which prints after the day of the month in the heading, cannot be allowed to print on the overflow sheet identification line. This is prevented by connecting zero print control hub 71, the print wheel from which the comma prints, through the normal side of pilot selector 13. The pilot selector is picked up immediately from overflow step 2, the same overflow step that is used to cause the sheet identification information to be read out of storage.

Pilot selector 13 lower—Like the comma, the decimal which prints in the heading must be suppressed on the overflow sheet. This is done by connecting zero print control 75, from which print wheel the decimal prints, through the normal side of pilot selector 13. The pilot selector is picked up from overflow step 2.

#### OVERFLOW PROGRAMS

9. Overflow step 2 is wired to immediate read out of storage units A and C so that the *invoice to* name, which is stored in these units, will read out and print on the overflow sheet.

10. Overflow step 2 is wired to the read-out of counter 6 so that the invoice number will read out and print on the overflow sheet.

11. Overflow step 2 is wired to the read-out of counter 15 so that page number will read out and print on the overflow sheet. The wire from this step to overflow program start has been explained

FIGURE 147B. INVOICE PREPARATION, SIDE-BY-SIDE HEADING

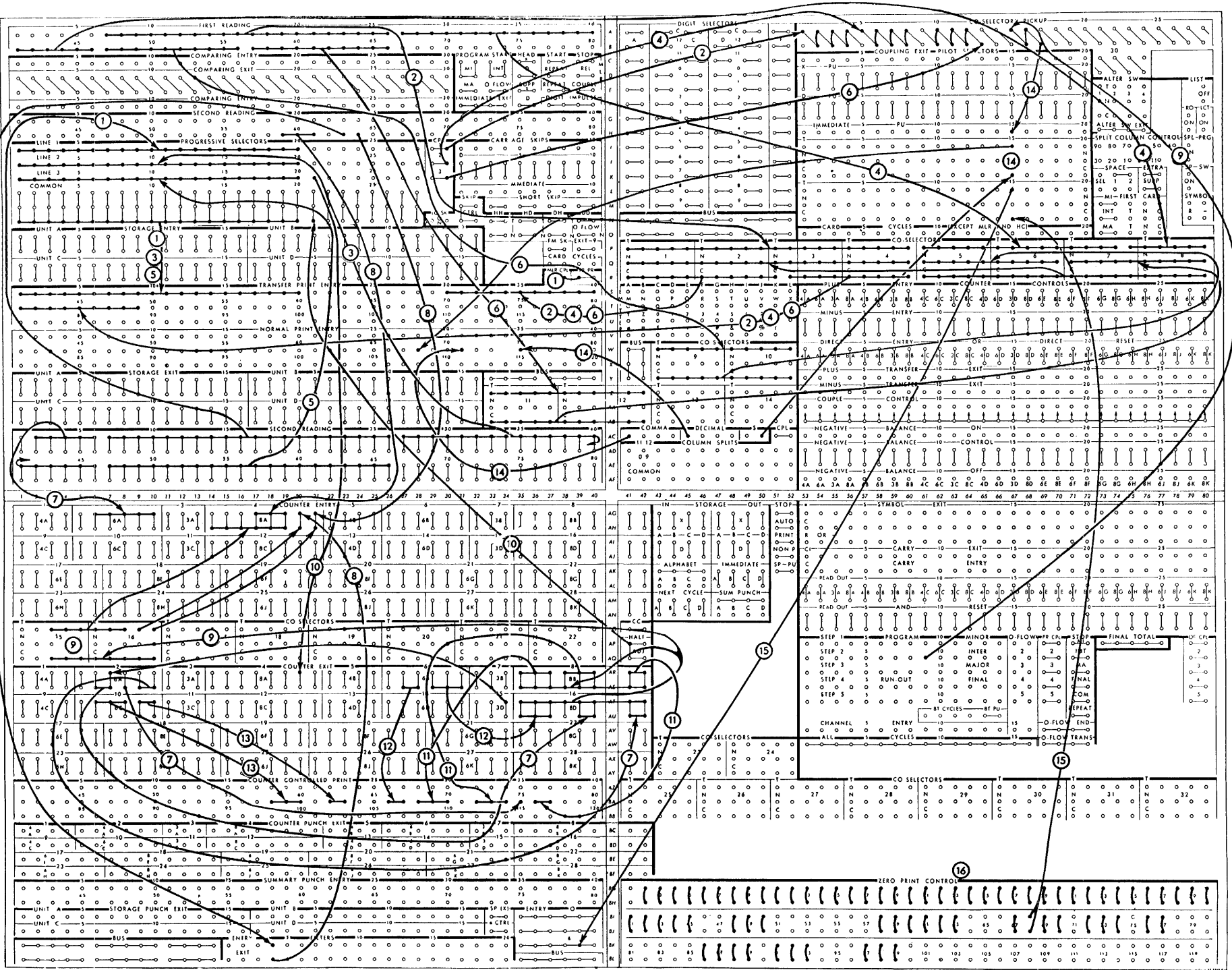

under number 7, and to the immediate pickup of pilot selector 13, under number 8.

12. Overflow step 3 is wired to overflow end. The wire from this step to counter 15 plus is explained under number 8. The wired to carriage skip 4 I is explained under number 5.

#### REGULAR PROGRAMS

13. Step 2 of the regular program is wired to direct reset the page number counter 15. It is also wired to read out and reset the 2% discount counter 16. Step 4 of the regular program is wired to overflow end.

#### SWITCHES

14. List is wired OFF, since the report is group printed. Run-out is wired ON. Special program is wired ON, since more than three program steps are required. The symbol switch is wired for printing R.

15. Because special program is wired ON, all cycles impulses are wired into both overflow channel entries and into regular channel entries.

16. The lower hub of zero print control 75 is wired back to the upper hub of 78 for decimal printing in the amount column.

Wiring, Diagram B (Figure 145B)

1. The *invoice to* information comes from an MLR card. The first line of the MLR card is printed by wiring columns 7-26 from second reading to transfer print entry 1-20 through line 1 of the progressive selectors. TR PR is picked up from MLR CPL.

2. The *ship to* information comes from a normal card. When the *invoice to* MLR card is being read at the second station, the *ship to* normal card reads at the first station. In order to print the *ship to* name at the same time that the *invoice to* name is being printed, columns 7-26 (name field) are wired from first reading through the transferred side of co-selectors 1-4 to transfer print entry 30-49. The co-selectors are picked up from couple 1 of the progressive selectors.

3. The second line of the *invoice to* MLR card is printed by wiring columns 27-46 (address field) from second reading to transfer print entry 1-20 through line 2 of the progressive selector.

4. The second line of *ship to* is printed at the same time as the second line of *invoice to* by wiring columns 27-46 (address field) from first read-

ing through the transferred side of co-selectors 5-8 to transfer print entry 30-49. The co-selectors are picked up from couple 2 of the progressive selectors.

5. The third line of the *invoice to* MLR card is printed by wiring columns 47-66 (city field) from second reading to transfer print entry 1-20 through line 3 of the progressive selectors.

6. The third line of *ship to* is printed at the same time as the third line of *invoice to* by wiring columns 47-66 from first reading through the transferred side of co-selectors 9-12 to transfer print entry 30-49. The co-selectors are picked up from couple 3 of the progressive selectors.

7. Customer code is printed beneath the date in the heading, at the same time that the third MLR line is being printed, by wiring columns 2-6 from second reading to counter entry 2. The counter exits are wired to counter-controlled print 73-77 through the common hubs of counters 8 and 16 to avoid split wires. Counter 2 is impulsed to add and print on the third MLR line and to direct reset on the first MLR line as shown in diagram 143C.

8. The unit price is entered into counter 4 from second reading. Although the unit price field covers columns 59-64, column 62 is punched with the decimal code and therefore is not wired to the counter. Counter 4 is to be used to accumulate the 2% discount amount.

9. At the end of each customer group, counter 4 contains the total amount in negative form. On program 2 it is doubled by subtracting the total amount obtained from counter 16. Counter exit 16 is wired to the entry of 4 through the transferred side of co-selectors 15 and 16. These selectors are picked up on program step 2 which allows counters 4 and 16 to be connected only on that cycle.

10. A half adjustment is entered into the tens positions of counter 4 exit on the third MLR cycle by wiring the half adjust through line 3 of the progressive selectors. The purpose of the half adjustment is to correct the 2% discount amount which is developed in counter 4. The purpose of controlling it through the MLR selectors is to save a cycle by entering it during MLR reading instead of on a program.

FIGURE 145C. INVOICE PREPARATION, SIDE-BY-SIDE HEADING

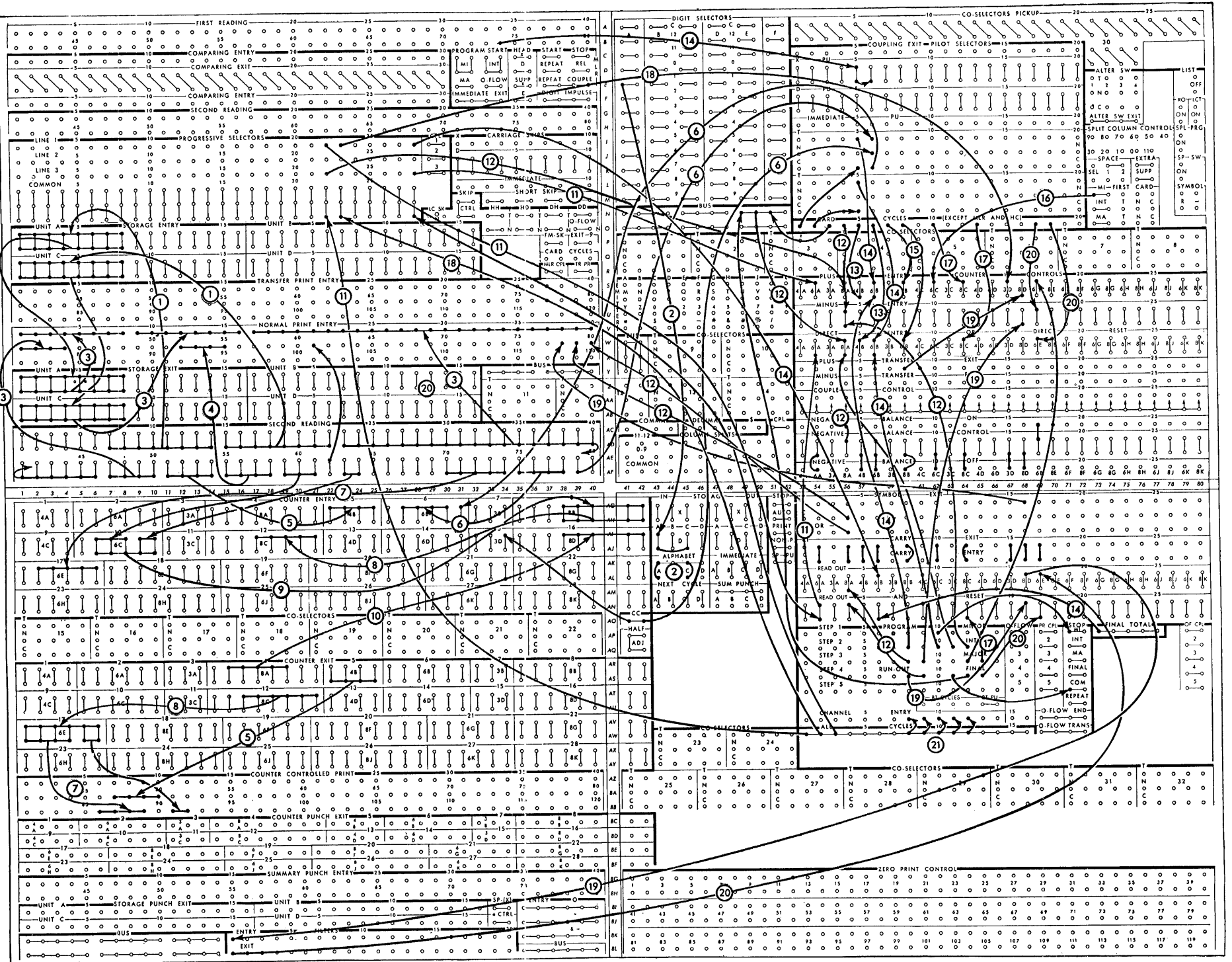

11. The exits of counters 2, 8, and 16 are wired to the same counter-controlled print hubs, with proper allowance for decimal and comma printing. Counter 2 adds customer code and is described under number 9. Counter 8 accumulates unit price for printing minor totals in the amount column in the body of the invoice. Counter 16 prints the invoice total and the net amount.

12. Counter 6 adds the beginning invoice number from a leader card. The three low order positions of this number print from the same print wheels as the three high order positions of amount, invoice total, etc. To avoid split wires, the three high order positions of counter 6 exit are wired to counter-controlled print 68-70 through the common hubs of 8 and 16. The remaining two positions of counter 6 exit are wired directly to 66-67.

13. The unit price is printed from the first card of each minor group through counter 10. The exits of this counter are wired to counter-controlled print 58-63.

14. The comma is wired to normal print entry 71 and the decimal to normal print entry 75. The dollar symbol is wired to normal print entry 68 through the transferred side of pilot selector 15. The pilot selector is picked up immediately from the intermediate program level and remains transferred for all remaining programs.

15. Zero print control hub 68 is wired normally and is also wired through the transferred side of pilot selector 15 to ampersand and minus (&-) entry. The normal wiring controls zero printing on the invoice number. The wiring through the selector allows the dollar symbol to print only on the second, third, and fourth program levels.

16. All zero print control hubs that do not require special wiring are connected as shown.

#### Wiring, Diagram C (Figure 145C)

1. The first eight columns of the name field (7-14) are wired to the entry of storage unit A. The last 8 columns of the name field (15-22) are wired to the entry of storage unit C. These two units are used to store the overflow sheet identification information.

2. The name from the *invoice to* card (1 in column 80) is entered into storage units A and C by

wiring a 1 from digit selector A to storage IN D hubs. Both storage units are wired to accept alphabetic information.

3. The item number and product description punched in the detail cards are wired from second reading to normal print entry 1-44. Entry into the first sixteen normal print hubs is obtained through the common hubs of storage units A and C to avoid split wires.

4. Unit of measure is wired from columns 55-58 to normal print entry 52-55.

5. Quantity is wired from 51-54 to counter entry 5. The exits of this counter are wired to counter-controlled print 47-50.

6. The four high order positions of invoice number are wired from second reading to the corresponding counter 6 entry positions. The units position of the invoice field is wired through the transferred side of pilot selector 6 in conjunction with the cycle count. The selector will be transferred when the leader card is read and will be normal at all other times.

7. The cost field, columns 70-74, is wired to counter entry 17. The counter exits are wired to counter-controlled print 86 to 92 with spacing for decimals.

8. Unit price is being added in counter 12 to work in conjunction with the cost counter 17. The unit cost field reached 12 entry by way of counters 10 and 8 common entry hubs. The counter exits of 12 are wired to the exits of 17 so that the invoice total may be rolled into and added to the negative cost amount in 17. Counter 12 exits are also wired to counter-controlled print 86-92, through the common hubs of 17 exit to avoid split wiring.

9. Unit price is entered into counter 8 by way of the common entry hubs of counter 10.

10. The exit of counter 4 with 2 positions dropped is wired to the entry of counter 16. This wiring carries the 2% discount amount from 4 to 16.

#### COUNTER CONTROL WIRING

11. Counter 2 (customer code) is controlled to add and print the customer code on the third MLR line and to direct reset on the first MLR line.

12. Counter 4 (2% discount) is impulsed to subtract the item amount from each card and the in-

FIGURE 145D. INVOICE PREPARATION, SIDE-BY-SIDE HEADING

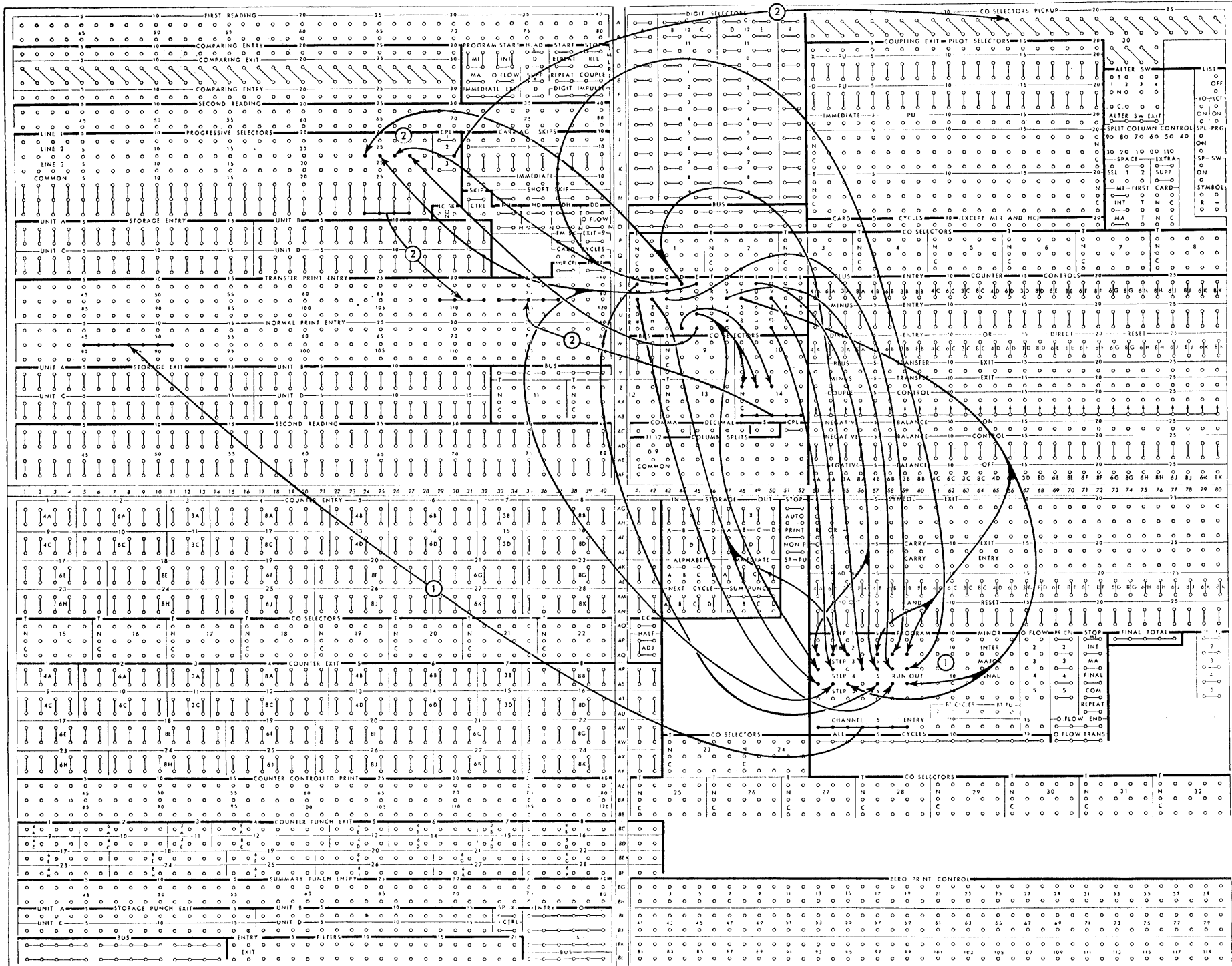

voice total on program 2, both by direct entry. It is also wired to subtract the half adjustment on the third MLR line. The counter is wired for conversion and CR symbols are wired to normal print entry. The 2% discount is read out on program 3 and the counter is wired for direct reset on program 4.

13. Counter 5 (quantity) is impulsed to add quantity from every card by direct entry. The reset of this counter is explained on diagram E.

14. Counter 6 (invoice number) is impulsed to add by direct entry the beginning invoice number from the X74 leader card, through pilot selector 5. It is also impulsed to add by direct entry a 1 on each intermediate level. The invoice number is read out of the counter and printed on the first MLR step by wiring all cycles through step 1 of the progressive selector to read out. The counter is reset on a final total.

15. Counter 8 (amount) adds the unit price from each card, by direct entry. The minor total prints on the invoice and is transferred to the net counter 16. The reset of the counter is explained on diagram E.

16. Counter 16 (group indicate unit price) is used to print the unit price from the first card of each group. It is wired to add from MI first card.

17. Counter 12 (invoice amount) adds the amount by direct entry. It prints the invoice amount in the cost column while rolling it into counter 17 (cost counter) to be added to the negative cost amount on the major program level.

18. Counter 15 (page number) is impulsed to add and print a 1 on the first MLR cycle by wiring all cycles, through line 1 of the progressive selector, to 15 plus. This represents page 1 for each invoice. The remaining wiring for 15 is explained on diagram A.

19. Counter 16 (net amount) is impulsed to add the minor totals received from counter 8 on the minor level, and to subtract the 2% discount amount on the major level. The invoice total is read out on the second program level and the net amount is read out and reset on the fourth level. The counter is reset on the fourth level. An asterisk is wired to print for all totals.

20. Counter 17 (cost). The unit cost is subtracted from every card and the counter is wired

for direct entry. The counter is wired to convert complements and print a total of the cost items on the intermediate level, add the invoice amount from 12 on the major level, and read out the profit on the fourth level.

21. Because special program is wired ON, the program channels described on the diagram are wired from all cycles.

#### Wiring, Diagram D (Figure 145D)

1. Totals are identified by wiring the total identifications from the emitter through the first seven program channels.

INV TOT is wired to level 2

2% DISC is wired to level 3

NET AMT is wired to level 4

The common hubs are wired to normal print entry 45-51.

2. The date is printed on the second MLR line by wiring from the emitter partly through the transferred side of co-selector 14 and partly through line 2 of the progressive selector to transfer print entry 69-77. The co-selector is picked up from the couple 2 hubs of the progressive selector.

#### Wiring, Diagram E (Figure 145E)

The wiring on this diagram concerns variable length overflow in group printing. The main difference between variable length overflow for group printing and a variable length overflow for detail printing is that even though a program change has occurred after channel 9 has been sensed, the minor totals that print for each change in program must print before the overflow transfer, and the resulting overflow programs are then allowed to take place.

1. Pilot selector 1 is picked up whenever the regular overflow (channel 12) has been sensed, provided it does not occur at the same time or after an intermediate program change. Overflow program 3 is wired through the normal side of this selector to repeat, making the repeat effective only on the last variable length overflow program and not on the last regular overflow program.

Overflow step 1 is also wired through the normal side of pilot selector 1 to the read out and reset of the amount counter 8 and the quantity



FIGURE 145E. INVOICE PREPARATION, SIDE-BY-SIDE HEADING

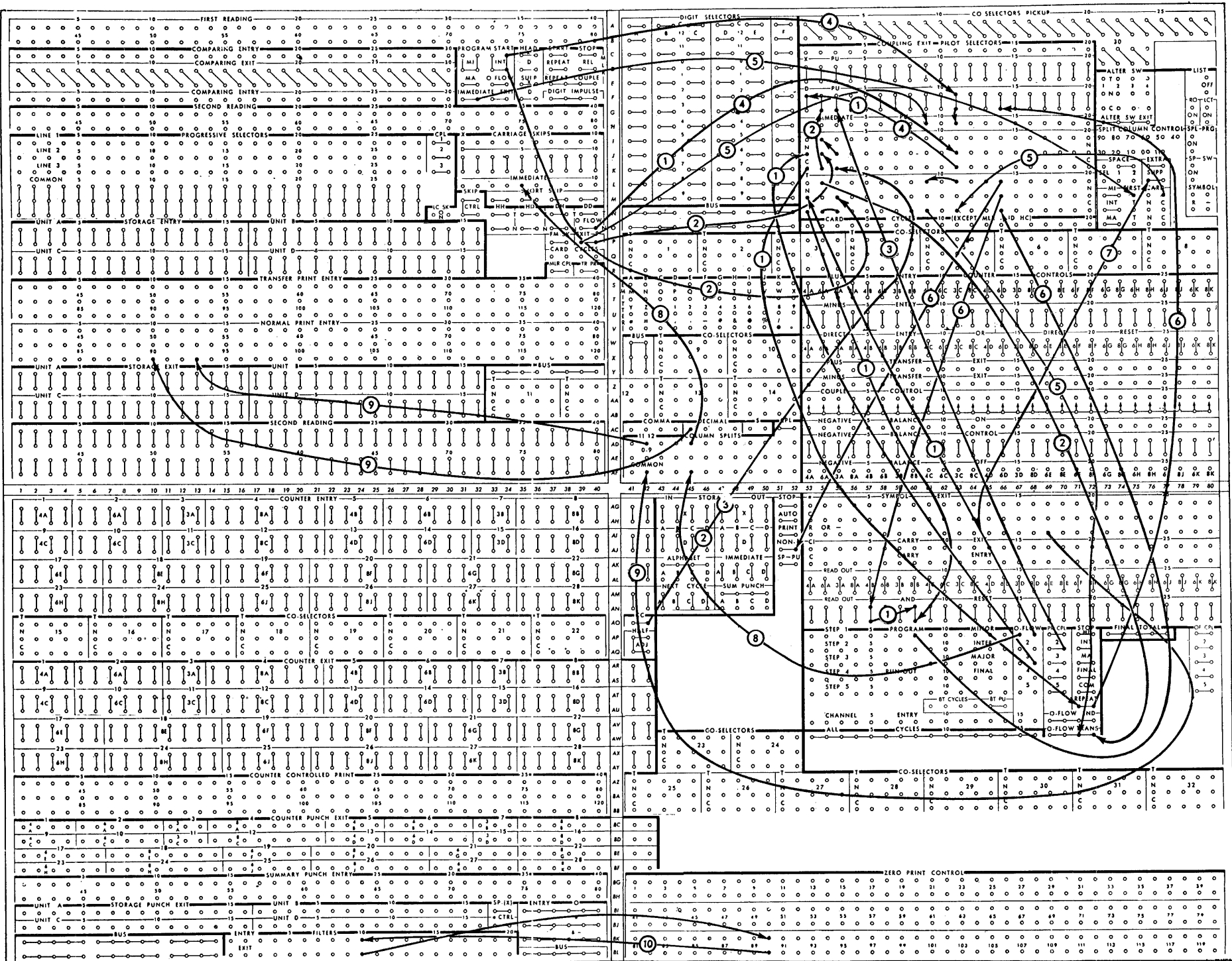

counter 5. Although these counters read out and reset normally from regular program step 1, the read out and reset on overflow step 1 is necessary when an intermediate program occurs after channel 9 is sensed, causing a shift from regular to overflow program steps.

2. Pilot selector 2 is picked up whenever channel 9 is sensed, and held up until an intermediate program occurs, by the cycle count wiring through the normal side of pilot selector 3 and the transferred side of pilot selector 2. The intermediate comparing exit is wired through the transferred side of the selector to overflow transfer, causing overflow transfer to be impulsed on the cycle following that in which channel 9 is sensed. If an intermediate program occurs before or at the same time channel 9 is sensed, no overflow will occur.

3. Pilot selector 3 is picked up from both the intermediate program level and overflow step 2 level by wiring couple 2 to the D pickup. The couple hubs emit during both regular and overflow program steps. A cycle count is wired through the normal side of the selector to transfer selector 2 until an intermediate program occurs. Selector 2 must be transferred, once channel 9 is sensed, in case an intermediate program occurs any time afterward until the end of the form is reached.

4. Pilot selector 11 is picked up from the intermediate comparing exit, both from its immediate and its D hubs. The selector is used to control the pickup of pilot selector 1 so that selector 1 will be transferred only when channel 12 is sensed prior to an intermediate change in program.

5. If the last item on the invoice is a single card group, and is recognized at the same time that channel 9 is sensed, the intermediate comparing exit cannot pass through pilot selector 2 (transferred one cycle later) and, therefore, overflow transfer will not be impulsed. To correct this condition, it is necessary first to recognize a single

card group and then to determine whether exit 9 is active at the same time.

Single card groups may be recognized when both the minor first card selector and pilot selector 11 are transferred at the same time. The presence of an exit 9 impulse is recognized when pilot selector 9 is transferred. An immediate exit impulse is wired through the transferred side of all three selectors to overflow transfer.

6. Pilot selector 14 is picked up from variable length overflow step 3. The minor program level is wired through its normal side to read out and reset 5 and 8, and through its transferred side to non-print. When variable length overflow occurs, the minor program is connected to non-print so that the program level will be ineffective for the repeat programs. Only intermediate and major are required.

7. Overflow level 1 is wired to SUPP to suppress the spacing that occurs when counters 5 and 8 are read out and reset on this step. When a normal program is wired to counter read out and reset, this spacing is internally suppressed.

8. This wiring initiates a skip to the first printing line, identified by channel 5, on the first overflow step. This is the second impulse wired to skip to the first printing line, the other being DH transferred. The overflow wiring is necessary to cause skipping to the first printing line whenever an overflow condition is sensed, whether regular or variable. This impulse is wired through a column split so that the impulse reaches the skip hubs during the second half of the cycle, thereby causing a skip after the total prints.

9. The dollar symbol is wired to normal print entry 83 and the decimal to normal print entry 90. A minus symbol from counter 17 R or - is wired to normal print entry 93.

10. Zero print control for the dollar sign, decimals and zeros for the cost field is wired as shown.

PRINTED IN U.S.A.

**IBM**  
CONTROL TAPE

Assign one printing position for each vertical column rule when designing form

# IBM ELECTRIC ACCOUNTING MACHINES

Spacing Chart 10 Characters per Inch

Lateral Form Alignment Symbols (▼) should be Embodied in Forms Design to Facilitate Ready Forms Alignment

STANDARD WIDTH FORMS (INCHES)										
OVERALL										
4¼	5¼	6½	8	8½	9½	10½	12	13¼	14¼	16¼
HOLE TO HOLE										
4¼	5¼	6	7½	8	9	10½	11½	13¼	14¾	16¼

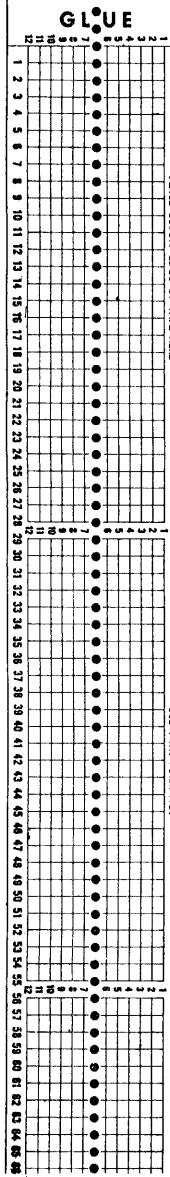

**PRINTER'S NOTE**  
This form is accurately printed, but paper is affected by atmospheric conditions which may cause slight variations in relation to actual machine spacing. Forms should be accurately scaled to the dimensions shown.

ATTACH ANOTHER CHART FOR FORMS LONGER THAN 11 INCHES

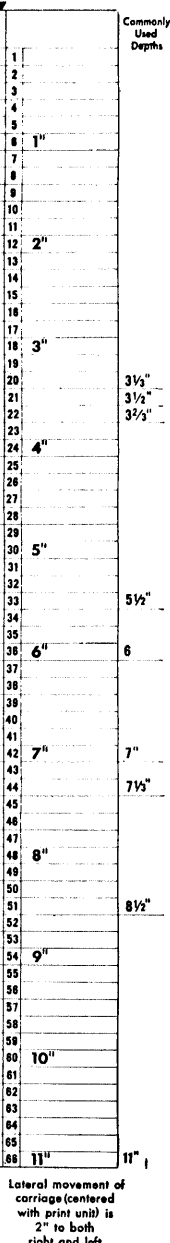
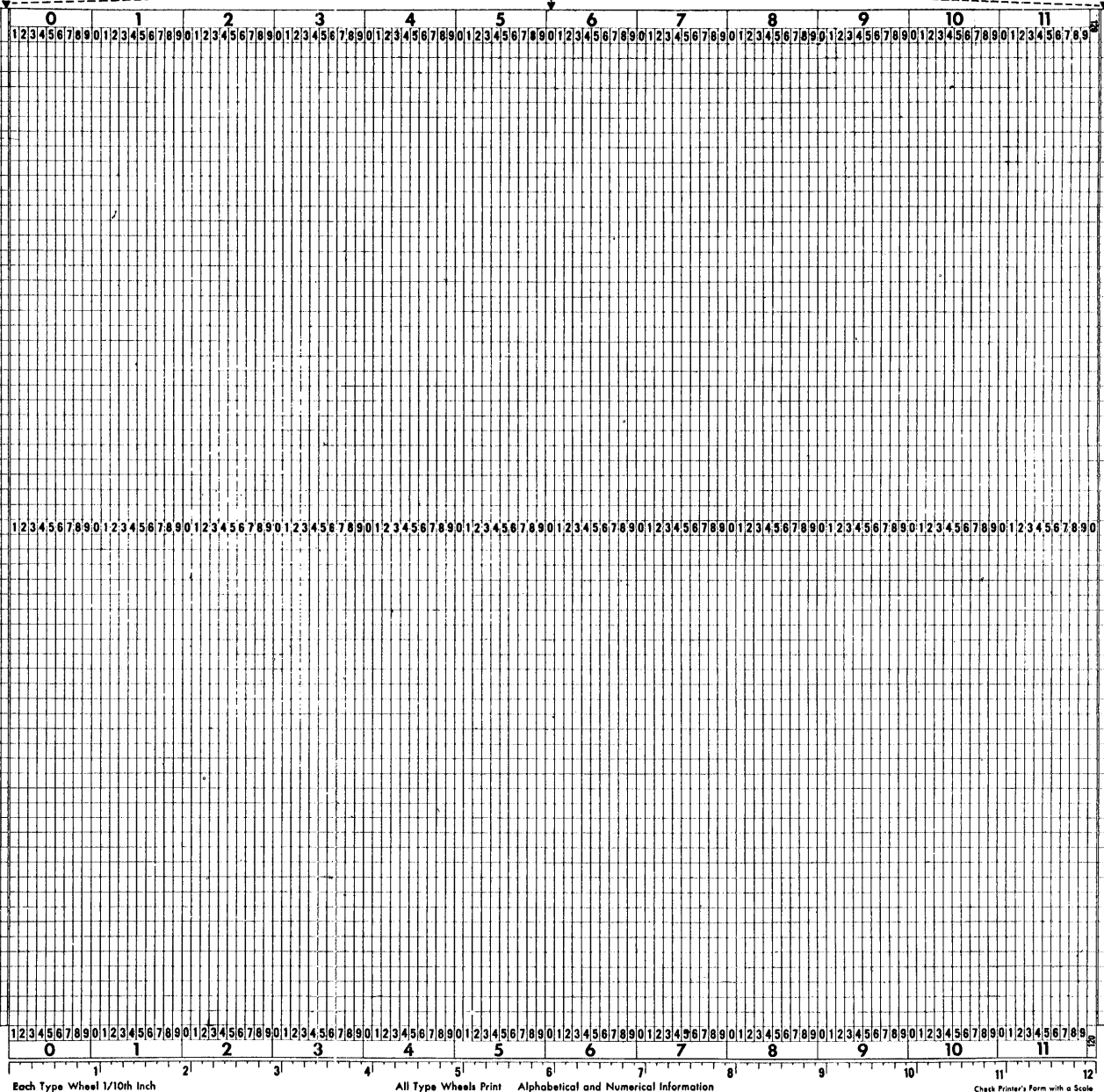

INTERNATIONAL BUSINESS MACHINES CORPORATION, 590 Madison Ave., New York 22, N. Y.  
IBM ELECTRIC ACCOUNTING MACHINE DIVISION

FORM NO. 22-58241

FIGURE 146. SPACING CHART

## FORM DESIGN

SOME OF the rules heretofore followed for designing forms should now be reconsidered in the light of the many new features introduced by the Type 407 accounting machine. It is not the purpose of the text to describe forms specifications generally, since that subject is well covered in *Recommended Specifications for Forms Used With IBM Form Feeding Platen On The Type 407 Accounting Machine* (Form 22-5799). Rather, it is the purpose of this discussion to describe the rules of form design affected by:

- A. The print unit, containing 120 print wheels in a 12-inch width, each print wheel containing all characters.
- B. Such features of the machine as character emitter, amount punctuation, overflow printing, etc.

One of the basic tools used in designing forms is the spacing chart shown in Figure 146. The numbers across the top from 0 to 11 represent the tens positions of the print wheel number, and the numbers directly beneath represent the units position of the print wheel number. Print wheel 42 may be readily located by referring first to the 4 column and then to the digit 2 within the 4 column. Print wheel 9 may be located by referring to the 0 column and then to the digit 9 within that column. The form alignment symbol ▲ locates print wheel 1, 60 or 120 and should be embodied in the form design to facilitate form alignment.

A facsimile of the carriage control tape is shown at the left for marking the control punching for a specific form. Notations have been included relative to standard form widths and depths, lateral movement of the carriage, and instructions to forms manufacturers.

### Form Design as Affected by the Print Unit

In view of the 120 print wheels and the 12-inch print unit, the following factors should be considered when designing forms to be used on the Type 407:

1. The maximum form width that may be used is  $16\frac{3}{4}$  inches and the minimum  $4\frac{3}{4}$  inches.
2. The maximum form length that may be used is 22 inches.
3. Since all print wheels contain all characters, form depth may be reduced and carbon paper eliminated by the use of side by side printing. For example, sold to and ship to names can be printed on the same line, one on the left side of the form and the other on the right.
4. Forms may be designed for printing six or eight lines to the inch. Single-space eight lines per inch printing is not recommended.
5. Forms may be designed for variable line spacing within a form.
6. It is possible to dispense with many vertical lines, since the machine can be wired to print commas, decimals, oblique lines, dashes, etc.
7. Vertical lines should *not* be printed between two adjacent printing positions, since there is an over-all maximum tolerance of only .010 inch between adjacent characters.
8. The number of legible copies that can be produced depends on the weight of the paper used for each form, the carbon coating, and the hardness of the platen. Since the striking force of the print wheels is not adjustable, paper and carbon should be tested in conjunction with a platen of the recommended durometer.
9. Because of the paper clamp bands, which hold the form in a fixed position during printing, a minimum of  $\frac{7}{16}$  of an inch must be allowed from the center of the marginal pin feed hole to the first and last character in a printed line.
10. The CR symbol prints from two print wheels while the minus sign prints from one. For this reason the minus sign is recommended as a credit symbol in lieu of the CR symbol.
11. The dollar symbol need no longer be pre-printed on a check form, since this symbol can be wired immediately to the left of significant digits.
12. The number of alphabetic positions that can be assigned in forms layout to print from storage is 32. More than 32 positions can be stored by use of counters and co-selectors in conjunction with storage as shown in Figure 86.

### Form Design as Affected by Other Features

1. The character emitter, through selectors or storage control, may be used to print report headings on blank forms and to identify the first and last line of a report with such information as *brought forward* on the first line and *carried forward* on the last line.

2. Maximum utilization of the variable length overflow feature makes it unnecessary to reserve space for multiple total lines.

3. Skips up to two inches are possible without interrupting the normal printing speed of the machine. Therefore, there is an advantage to holding forms to a size which will not require skipping of more than two inches between print cycles.

4. Zero suppression on the Type 407 is electrical and completely flexible. It is not mandatory, for example, to line up the right-hand digit of information printed in the heading, such as customer number, with the units digit within the columnar field, such as an amount field.

5. Total identification permits flexible positioning of totals.

6. When a fastening medium such as a staple is used to hold multiple part sets together, it should be kept away from the paper clamps if possible. If it is necessary to place the staples in the area covered by the paper clamp, the staples must be horizontal.

### RIBBON REPLACEMENT

THE RIBBON feeds from one spool to the other approximately one inch on each print cycle. It feeds in one direction until a metal eyelet near the end of the ribbon on either spool strikes the ribbon reversing lever, thus reversing the feed.

When a new ribbon is installed, it is important that the leading end of the ribbon is firmly hooked onto the empty spool. Enough ribbon should be wound on the empty spool so that the metal eyelet is somewhere between the spool and the ribbon reversing lever. The threading of the ribbon around the guide rollers is shown in the schematic around the guide rollers is shown in the schematic below.

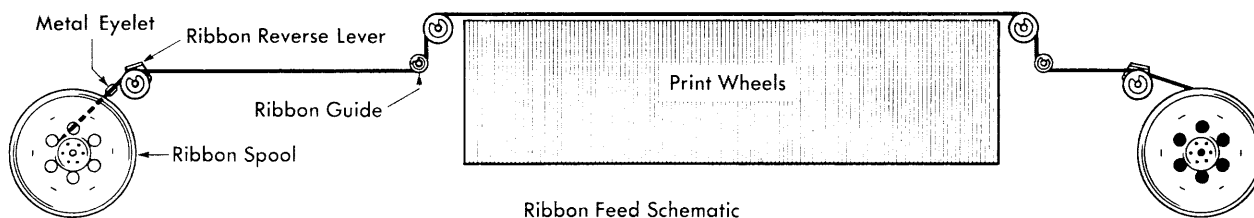

## OPERATING SUGGESTIONS

BEFORE a feature or a control panel hub was used in this manual, it was described. Because of the wide flexibility in use of hubs, however, it was not always possible to present some of the corrective measures that must be taken when a feature or a control panel hub is used in a somewhat unusual way, without complicating the basic instruction. Some of these measures are described here.

### Proper Use of Filters

It is generally assumed that a filter allows current to go in only one direction — from *entry* to *exit* — and thus may be used to eliminate back circuits. Filters, however, do not entirely eliminate back circuits. A little current passes in the opposite direction — from *exit* to *entry* — but so little that the reverse current cannot operate any feature of the machine. Also, as current passes through a filter, there is a slight loss of power.

Filters were originally installed in the Type 407 to permit flexibility in the control of zero printing and amount punctuation as well as for the control of special character printing, such as minus, ampersand, and dollar signs. To eliminate back circuits for purposes other than those for which filters were originally intended, selectors should be used whenever possible, as improper use of filters will not only cause improper machine operation but may also damage the filters.

Quite often one or more comparing positions may be used to avoid using filters; for example, digits 1 and 3 may be used to pick up two pilot selectors independently. They may also be used in combination to pick up a third selector. If digits 1 and 3 are wired to the upper and lower hub of the same comparing position, the comparing exit can become the pickup impulse for either digit. The comparing exit impulse comes from a completely independent source and, therefore, cannot in any way interfere with the proper control of the other two selectors.

Under certain conditions, filters can be used for purposes other than those for which they were

originally intended; however, special consideration must be given to the following rules when filters are so used:

1. If a given impulse must pass through a filter to operate any feature in combination with another impulse, that same impulse must pass through another filter to operate any other feature. This is shown in Figure 147, where impulse A controls pilot selectors 2 and 4, and impulse B controls selector 4. Impulse A must be wired through a filter to each of the pilot selector pickup hubs.

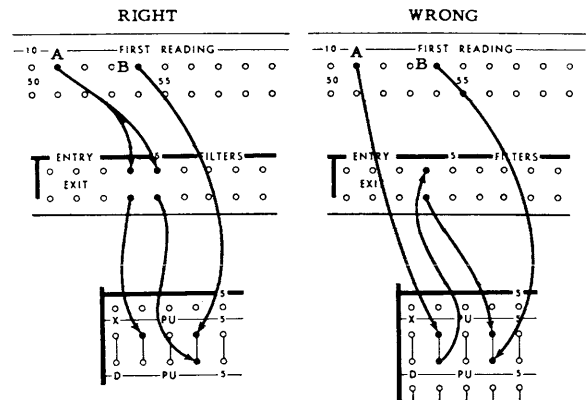

FIGURE 147

2. An impulse must not pass through more than one filter in series to control a feature; in other words, the exit of one filter must not be wired to the entry of another filter. See Figure 148.

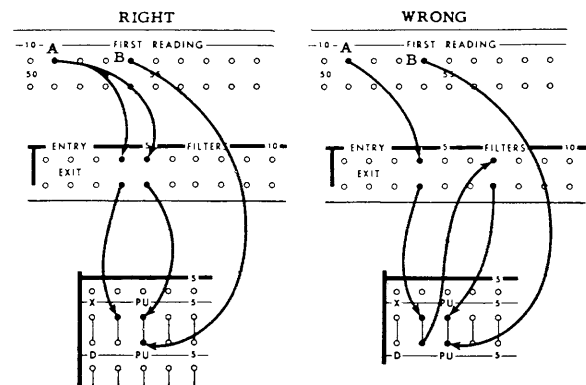

FIGURE 148

3. Split-wiring through filters should not be used when such wiring creates reverse current paths for two or more different impulses at the same time, as the combination of both reverse currents may be sufficient to operate a machine feature erroneously. In Figure 149, if the impulses at first reading 15 and 19 occur at the same time, the reverse current through filters 2 and 8 combined may be sufficient to pick up selector 2.

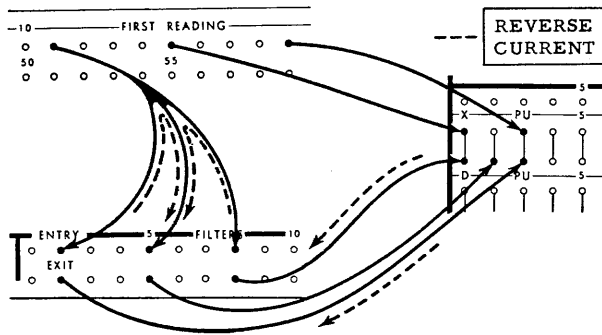

FIGURE 149

4. A filter is built to take a certain load of electricity which, if exceeded, will damage the filter and may cause the machine to operate improperly. Therefore, if one filter exit is used to control several similar or different features, reference must be made to a load rating table (Figure 151) to determine that the combined load rating does not exceed 4. For example, one filter exit can be used to pick up two co-selectors (combined rating 4) but cannot be used to pick up four co-selectors (combined rating 8). See Figure 150.

Direct Entry or Direct Reset (Figure 152)

When lacing direct entry or direct reset from one counter group to another, the following rules must be kept in mind:

1. Card cycles may be laced from one direct entry to another up to a maximum of five counter groups, provided that all corresponding counter groups are read out and reset on the same program. Example B is wrong because the three counter groups are cleared on different program cycles.

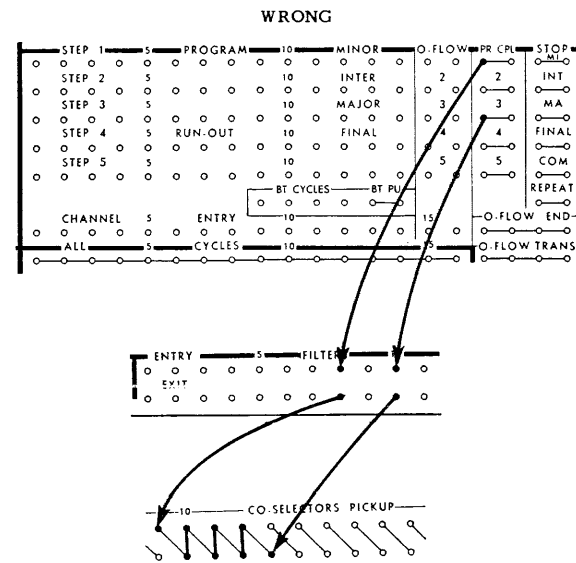
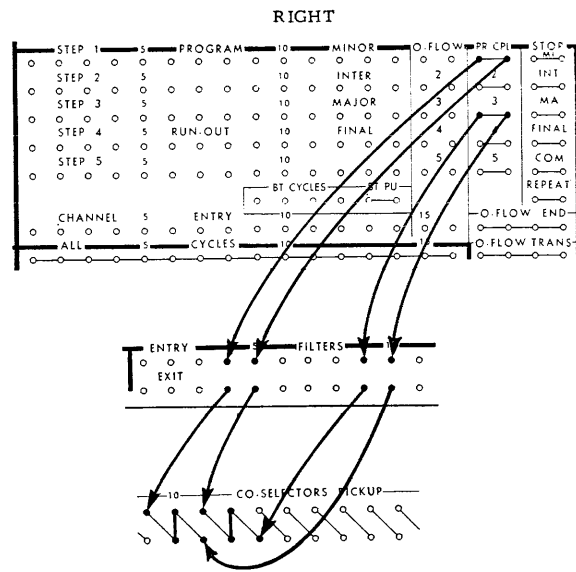

FIGURE 150

The wiring may be corrected by impulsing each direct entry position from three independent card cycles.

2. Program exits may be laced from one direct reset to another up to a maximum of five counter groups, provided that the corresponding counter groups add or subtract at the same time. Example D is wrong, because the three counter groups are impulsed to add at different times. The wiring may be corrected by impulsing each direct reset position from three independent minor program exits.

CONTROL PANEL ENTRY HUB	LOAD RATING	CONTROL PANEL ENTRY HUB	LOAD RATING	CONTROL PANEL ENTRY HUB	LOAD RATING
Auto Stop	1	Head Supp, X, D	3	Runout Switch	1
BT PU	1	Head X, D	3	Short Skip	2
Carriage Skips X, D, I	1	LC SK	*	Skip Control	3
Carry Entry	*	LCT	1	Space 1, 2, Extra, Sel.	3
Column Split Cpl	*	List Off	1	Space Supp.	3
Comparing Entry	1	MLR Release	1	Spl. Prg.	2
Co-Selector Pickup	2	MLR Repeat	1	Stop	2
Counter Control (plus, minus, read out)	1	MLR Start	1	Storage Entry	2
Counter Controlled Print	3	MLR Stop	2	Storage (SP) - Immediate	1
Ctr Control (RO and RE)	2	Neg. Bal. Control	1	Storage - In-Out, X, D, Next Cycle, Alpha.	1
Counter Couple Control	1	Non-Print	3	Storage - Summary Punch	3
Counter Entry and Exit	3	Normal Print Entry	3	Summary Punch Entry	3
Cpl Progressive Selector	3	Overflow End	2	Summary Punch Pickup	4
Dir Entry or Dir Reset	1	Overflow Trans.	2	Summary Punch Switch ON	1
FM-SK	3	Pilot Sel I, X, D Pickup	1	TR PR	*
		Program Repeat	2	Transfer Print Entry	3
		Program Start	1	Zero Print Control	#2
		Program Stop (Mi, Int, Ma, Final, Com.)	4		

\* Must not be wired through filters.  
 # When filters are necessary for zero print control, one filter must be used for every two positions to the right of the decimal.

FIGURE 151. LOAD RATING TABLE

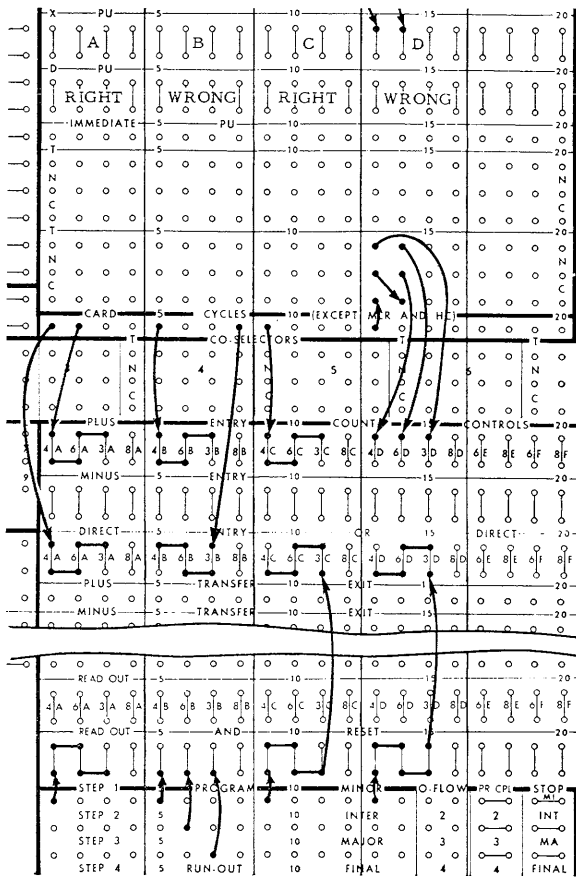

FIGURE 152. DIRECT ENTRY OR DIRECT RESET

Counter Coupling

When counters are coupled and only some of them need to be reset directly, impulses to the plus and minus hubs of the coupled counters must be isolated and not laced from one counter to the other.

In example A (Figure 153) counter 2 is used to accumulate dollar amounts and counter 3 to accumulate cents. The cents are not to be printed, so counter 3 is cleared on a minor program by direct reset. When there is a positive balance in the two counters, counter 2 is reset normally, that is, by subtracting in the second half of the cycle to reach a zero balance. The minus impulse will travel over the external wiring to counter 3 minus and cause that counter to subtract also. However, since counter 3 is cleared by direct reset, the plus hubs have already been impulsed internally. Thus, counter 3 will be adding, subtracting, reading out and resetting, all at the same time. This will cause bad counter operation in the entire machine and could give erroneous results.

To correct this condition, the minus and plus hubs of the two counters are isolated by wiring independent card cycles to the plus and minus hubs of each counter as shown in example B



(Figure 153). This prevents the internal minus impulse out of counter 10 minus hubs from reaching the minus hubs of counter 11 on the total cycle, since there is no common connection between the two.

### Wiring of X's or 12's to Print Entry

When normal or transfer print entry is wired directly from second reading, X or 12 punches in otherwise numerical fields will cause alphabetic printing. Zoning of the print wheel can be eliminated

by wiring the column in which the X or 12 is punched through the 0-9 hubs of a column split.

When the control is on a numerical field in which an X or a 12 is also punched for other purposes, the first and second reading positions must be wired through column splits to eliminate the X or 12 before wiring to comparing entry. Otherwise, the extraneous X or 12 punch will break control twice, the first time when the X or 12 is read by the first reading brush and the second time when the X or 12 is read by the second reading brush. An alternative method would be to wire the comparing exit to program start through the 0-9 hubs of a column split.

When the X or 12 is punched in each card of a group in an otherwise blank numerical control field and the X or 12 is used to function as normal control, the X or 12 cannot, of course, be eliminated. However, the column in which the X or 12 is punched must be wired to the normal or transfer print entry through the 0-9 hubs of a column split to prevent the X or 12 from spreading across the whole field through the zero print control wiring. If the X or 12 to the print wheel is not eliminated, the X or 12 back-circuits as follows:

- Internally through the zero print control wiring to the adjacent print entry positions;
- Externally from print entry to second reading;
- Internally from the lower set of second reading positions to the upper common set;
- Externally from the upper set of second reading positions to one side of the comparing entries.

Thus, each card in the group punched X or 12 breaks control as follows:

#### Comparing Entry

First Reading	X
Second Reading	X (X) (X) (X)

Example 1 below shows results obtained when the column containing the X or 12 is wired from second reading to normal or transfer print entry through a column split. Example 2 shows results obtained when the second reading position is wired directly to normal or transfer print entry.

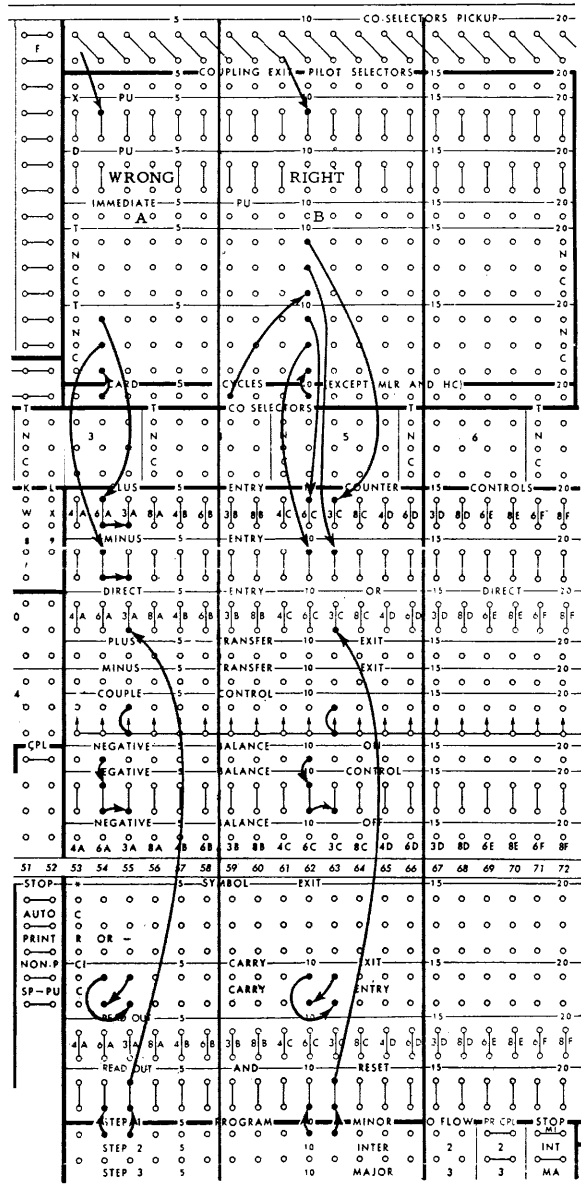

FIGURE 153. COUNTER COUPLING

<u>Example 1</u>		<u>Example 2</u>	
<i>Control</i>	<i>Amounts</i>	<i>Control</i>	<i>Amounts</i>
12345	25	12345	25
12345	50	12345	50
12345	25	12345	25
	100*		100*
(X)	75	(X)	75
(X)	25		75*
(X)	50		
	150*	(X)	25
			25*
12346	75		
12346	125	(X)	50
	200*		50*
		12346	75
(X) would not normal-		12346	125
ly print in either ex-			200*
ample.			

Note in example 2 that the three X-punched cards in the same group cause three control breaks for the reasons stated.

Since an X or 12 punch in an otherwise blank field back-circuits to the adjacent second reading positions when wired directly to normal or transfer print entry, it is obvious that any feature controlled by an X or 12 punch from any second reading position within that field will operate erroneously.

The rule, therefore, is that any X or 12 not intended for alphabetic or character printing should not be wired directly to normal or transfer print entry but should be eliminated through a column split.

**Negative Balance On-Off**

If a cycles impulse is allowed to back up into negative balance ON or OFF, the corresponding counter action could be affected, and an incorrect result obtained. Extreme care must be taken to prevent this back circuit.

**Counter Punch Exits**

Counter punch exits were primarily intended for summary punching purposes and are normally

wired to the summary punch entry hubs. They cannot be wired directly to any other set of entries, such as to the pickup hubs of pilot selectors. They must be first selected so that they reach the entries at a time when the corresponding counter is not adding, subtracting or resetting. There is one exception: counter punch exit impulses may reach entry hubs during a direct reset operation. Although the counter punch exits may function when wired directly, considerable damage is done to the machine internally.

**Maximum Number of Entries from One Source**

One source hub (such as card cycles) may be split-wired to several entry hubs. However, for safe operation one source hub should not be wired to more than five entries.

**Triple Spacing**

Triple spacing may be accomplished without the use of the SEL hubs by combination wiring of space hubs 1, 2 and EXTRA. The principle is explained by the following example:

```

PRINT SPACE BEFORE PRINTING (Wire 2)
— — SPACE AFTER PRINTING } (Wires 3 & 4)
— — SPACE AFTER PRINTING }
PRINT SPACE BEFORE PRINTING (Wire 2)
    
```

**Wiring (Figure 154)**

1. Co-selector 7 is picked up immediately from split column control 3. This wiring transfers the selector slightly before printing time. The selector remains transferred for the remainder of the cycle.

2. One space before printing is obtained by wiring the space exit hub through the transferred side of co-selector 7 to space 1.

3. Two spaces after printing are obtained by wiring the space exit hub through the normal side of co-selector 7 to space 2. This wiring works in conjunction with the extra space wiring.

4. All cycles wired to EXTRA conditions the machine to take two spaces after printing in addition to the one space before printing.

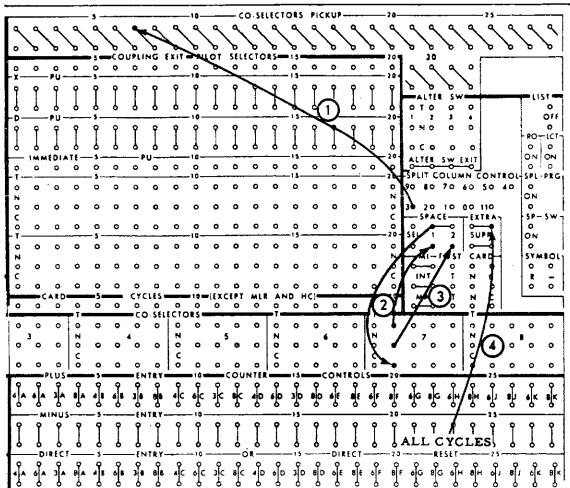

FIGURE 154. TRIPLE SPACING

### Locating Counters Causing Reset Check Light

When the reset check light turns on during the testing of a control panel, it is generally caused by improper counter wiring. Specifically, the light turns on when a counter or group of counters, wired to reset, fails to reset to 9's (zero) for one reason or another.

The most common causes, illustrated in Figure 155, are as follows:

1. When coupled counters are wired to add only, and CI is not wired to C.

This is because the normal path for the test impulse is through the CI to C wiring. If the proper connections are not made, the test impulse is not allowed to pass from the high-order counter to the low-order counter.

2. When counter exit positions are erroneously wired to normal or transfer print entry instead of to counter-controlled print.

When counter exits are wired to normal or transfer print entry, the only way that the counter can clear is by direct reset.

3. When emitted impulses, such as dollar, decimal, comma, and special characters, overlap positions wired from counter exit to counter-controlled print.

For example, a decimal is wired to normal or transfer print entry 60, and a counter exit position is wired to counter-controlled print 60. In such cases, the symbol impulse back-circuits to the counter exit position in the second half of the

reset cycle and prevents the counter from resetting to 9's.

4. When the total in a counter exceeds the number of positions wired from counter exit to counter-controlled print.

This condition may be described as "total overflow" and is more apt to occur during the preparation of a report than during the initial testing of the control panel.

When only one counter is cleared on a given program step, and the reset check light turns on, it is a simple matter to locate the counter in error and check the counter wiring for the error conditions just described.

When several counters are cleared and the reset check light turns on, the specific counter in error may be located by proceeding as follows:

1. Empty the hopper.
2. Depress the start key to run out the cards.
3. Depress the stop key to turn off the reset check light.
4. Remove the reset wire from one of the counters.
5. Run the test deck through the machine a second time. If the reset check light does not turn on, that counter is in error.
6. If the reset check light does turn on, remove the reset wiring from each remaining counter group in turn and repeat steps 1 through 5 until the machine does not indicate a reset failure. The last counter group disconnected has the faulty counter wiring.
7. If all counter wiring is correct and the reset check light turns on, the trouble is due to machine failure.

### WIRING (FIGURE 155)

1. CI to C of counter group 13-14 not wired.
2. Counter exits of counter 2 are wired to normal print entry, and the counter is wired to read out and reset normally.
3. The decimal, which is erroneously wired to normal print entry 60, should be wired to normal print entry 59. The comma, which is erroneously wired to normal print entry 56, should be wired to normal print entry 55.
4. The total in the counter contains nine significant digits. Only eight positions are wired to counter-controlled print.

FIGURE 155. COUNTERS CAUSING RESET CHECK LIGHT

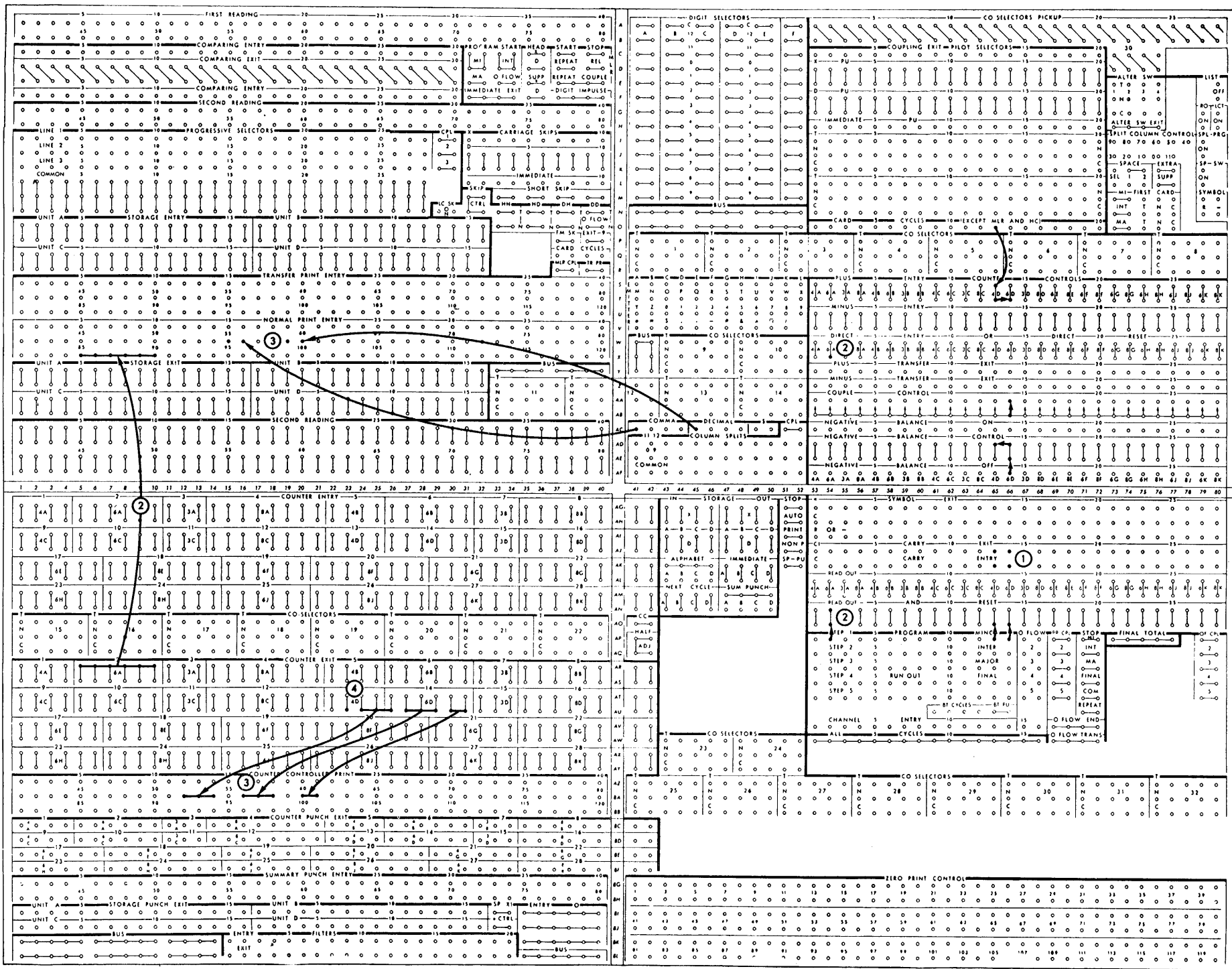
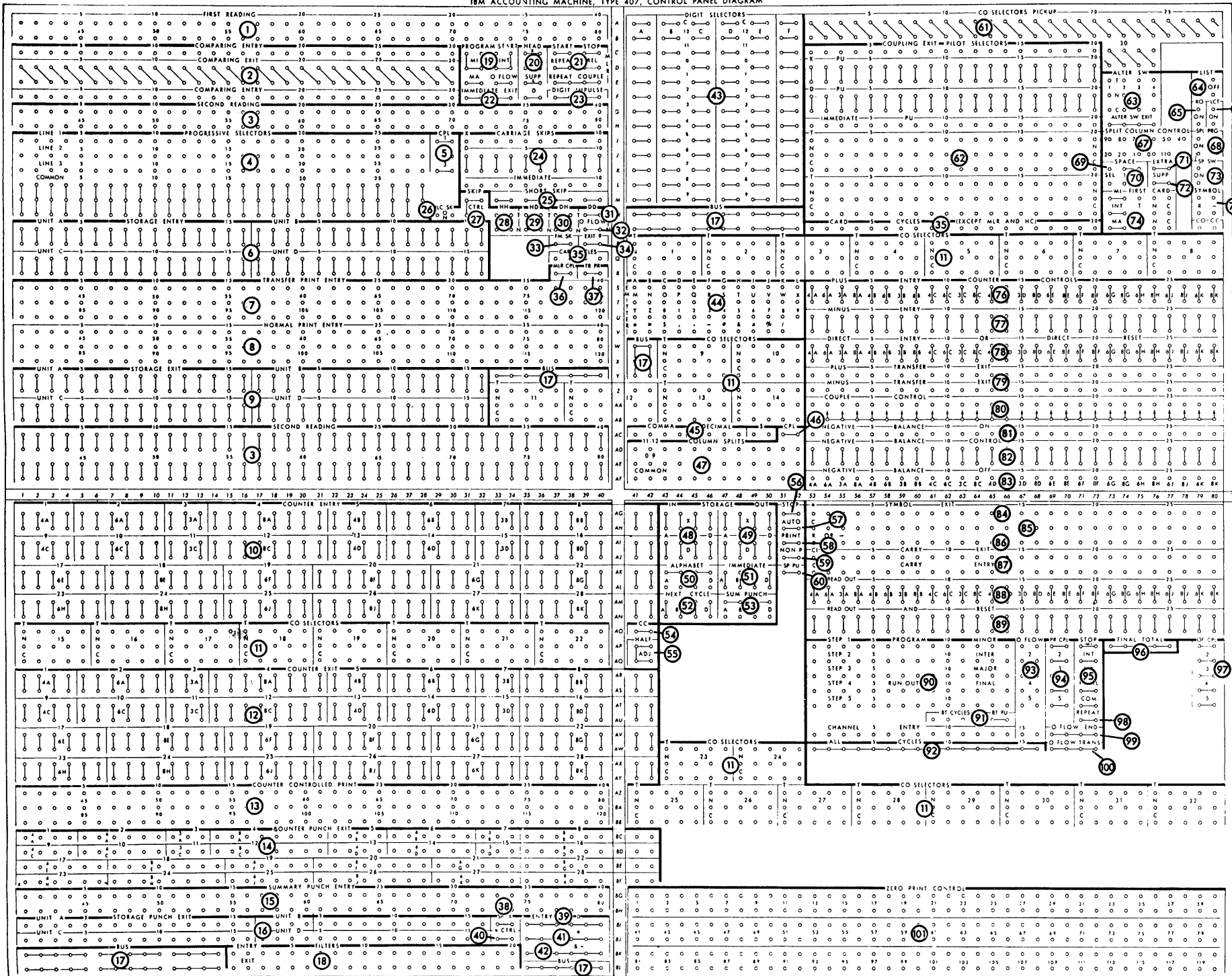

FIGURE 156. CONTROL PANEL SUMMARY



## CONTROL PANEL SUMMARY

EACH SECTION of the control panel (Figure 156) is assigned a number under which the hubs are briefly described.

1. *First Reading.* These hubs represent the 80 brushes that read the card at the first station. They are wired principally to comparing entry, MLR start, X or D storage controls, digit selectors, pilot and co-selector pickups, X or D carriage skips and heading control.

2. *Comparing Unit.* There are 20 positions of comparing on the standard machine. The comparing entry hubs are wired from first and second reading, so that classifications in two cards may be compared to determine whether or not they are alike in both cards. If the punching is alike, the cards belong to the same group; if it is unlike, the cards belong to different groups. Three different classifications can be compared at the same time to print totals for each classification.

Each vertical pair of entry hubs has a corresponding pair of common comparing exit hubs, which are diagonally arranged for convenience in jackplugging. Whenever a reading at one station does not compare with the reading at the other station, the comparing exits emit an impulse which is normally wired to program start and carriage skip control.

3. *Second Reading.* These hubs represent the 80 brushes that read the card at the second station. They appear at two locations on the control panel for convenience in wiring. The upper set of hubs is normally wired to comparing entry or to progressive selectors for multiple line reading. The lower set of hubs is normally wired to counter entry, storage entry, normal or transfer print entry, heading control suppression and MLR stop control.

4. *Progressive Selectors.* There are 28 progressive selector positions each consisting of three common and three transfer hubs. The transfer hubs labelled 1, 2, 3 are successively connected internally to the common hub during MLR operations. Information for three lines of printing can then be wired from second reading to the hubs for each line and from the common hubs to transfer print entry.

5. *Progressive Selector Couple.* Each line has a pair of couple hubs which are exits during MLR operations and normally are used to pick up co-selectors for the purpose of expanding any line beyond 28 positions. They are also entry hubs when MLR lines are not being printed, and may be wired from any cycle impulse to cause the corresponding line to be connected to the common hubs for that cycle. This gives the effect of three 28-position

selectors, since each line can be independently controlled when MLR is not in operation.

6. *Storage Entry.* These are the entries to the four storage units. Normally they are wired from second reading to store information read from a card, or from counter exits to store information accumulated in counters. Numerical information, including 11 and 12 punching, can be stored in all 16 positions. Alphabetic information must be read into the left-hand eight positions of each unit. Storage units clear when corresponding Storage IN hubs are impulsed.

7. *Transfer Print Entry.* The 120 transfer print entry hubs are one of three sets of entries to the print wheels. Like the transferred hubs of a selector, these hubs accept impulses only when they are made active by a cycle control impulse reaching TR PR.

8. *Normal Print Entry.* The 120 normal print entry hubs are one of three sets of entries to the print wheels. Normally they are wired from second reading or from storage exits to print either numerical or alphabetic information.

9. *Storage Exit.* These are the exits from the four storage units. They are normally wired to normal or transfer print entry or to counter entries. The storage exits are active any time the corresponding storage unit is impulsed to read out.

10. *Counter Entry.* There are 112 counter positions arranged in convenient groups of 4, 6, 3 and 8 positions. Counter entries are normally wired from second reading for the purpose of adding, subtracting or group indicating information read from the card. The entry of every counter group is internally connected to the corresponding counter exit positions unless direct entry for that counter group is wired. These hubs are receptive on the first half of the cycle only.

11. *Co-selector.* Sixteen co-selectors are standard. Each selector has five positions. When the pickup hubs are impulsed, the selector picks up immediately and holds to the end of the same cycle.

12. *Counter Exits.* Counter exits emit impulses for information that is detail or total printed from the counter. To detail print, the counter must be impulsed to add or subtract, at which time counter entries are internally connected to counter exits. To total print, the counter must be read out and reset and the exits must be wired to counter-controlled print. Counter exits do not emit impulses when the counter is impulsed to direct entry, at which time they are internally disconnected from counter entry. Also, counter exits do not emit impulses when direct reset is wired. Refer to paragraphs 13 and 78.

13. *Counter-Controlled Print.* These hubs are one of three sets of entries to the print wheels, the other two being normal and transfer print entry. Normally they are wired from counter exits, receiving the information from the counter during the first half of the cycle and returning it back to the counter during the second half of the cycle. The print wheels are set up for printing during the first half of the cycle. The returned information during the second half of the cycle either adds or subtracts in the counter to reach a zero balance, thus affording a check between the amounts printed on a report and the amount accumulated in the counter.

These hubs provide the only means by which a counter may be reset as the total is printed, since counter clearing is done in the second half of the cycle. Counter exit positions containing significant digits must be wired to counter-controlled print in order to reset.

Alphabetic or special character information cannot be wired to counter-controlled print, since these hubs do not accept zone impulses.

14. *Counter Punch Exit.* The counter punch exits are active on every machine cycle, emitting whatever stands in the corresponding counter. Normally they are wired to summary punch entry during summary punching operations, so that accumulated amounts or group indicated information may be punched in a summary card. The high order position of each counter punch exit emits a 0-X impulse whenever a converted negative figure or a zero balance is being punched.

15. *Summary Punch Entry.* These hubs represent the 80 punch magnets on the summary punch. Normally they are wired from counter punch exits, the character emitter, or storage punch exits for summary punching.

16. *Storage Punch Exit.* These hubs are normally wired to summary punch entry when information in the storage units is to be summary punched. They are under the control of the storage OUT summary punch hubs which may be impulsed on any summary punch cycle. The units are independently controlled.

17. *Bus.* These hubs are located in convenient sections of the control panel and are used to expand either exits or entries, thereby eliminating the need for split wires.

18. *Filters.* There are 10 filters standard, each with an entry and an exit hub. They allow an impulse to travel in only one direction (into entry, out of exit) and are used to control a circuit in one direction only.

19. *Program Start.* The program start hubs are identified as MI (minor), INT (intermediate), MA (major), and O-Flow (overflow). MI, INT and MA are normally wired from the comparing exit to cause a program change for every group or from CC (cycle count) to cause a program change for every card. The MI, INT and MA hubs accept impulses to activate the minor, intermediate and major programs.

The overflow entry is used in conjunction with the carriage and is normally wired from the overflow carriage hub to cause overflow programs to be initiated for overflow sheet identification.

An impulse into any of these program start hubs causes card feeding to stop and a series of one or more program cycles to start unless this occurs on an MLR operation in which case programming will be suspended until after the MLR operation is completed.

20. *Head X, D; Supp X, D.* Head X or D hubs are usually wired from first reading to cause heading cards to detail print regardless of the setting of the list switch. When wired, they work in conjunction with skip control, for controlling the function of the D and H carriage skip hubs.

Suppress X or D hubs normally are wired from second reading to suspend control between heading cards or between heading and body cards. They do not suspend carriage skipping.

21. *MLR Start, Stop, Repeat, Rel; Repeat Couple.* The MLR start hubs accept a 12 impulse from first reading to stop card feeding and start a series of cycles for the repeated reading of a card. The progressive selectors operate during this series of repeated cycles.

The MLR stop hubs accept a 1, 2 or 3 impulse from second reading to stop the progressive selection after 1, 2 or 3 lines have been printed. Card feeding then resumes.

The MLR repeat hubs accept the equivalent of a 12 from an all cycles impulse after an MLR operation has been started. This causes the progressive selectors to operate again starting with line 1.

The MLR release hubs must be wired whenever repeat is wired. These hubs accept the equivalent of 9 to 1 of an all cycles impulse to stop any series of MLR cycles at the end of the cycle during which release is impulsed.

Repeat couple hubs emit an impulse on every repeat MLR cycle, and normally are wired to co-selectors so that a distinction can be made between regular MLR cycles and repeat MLR cycles.

22. *Immediate Exit.* These hubs emit a short impulse during the second half of each machine cycle. Normally it is selected to control operations during the second half of the cycle, such as machine stop, for a negative balance in a counter, or to control program start.

23. *Digit Impulse.* These hubs emit impulses corresponding to the 12 punching positions in a column of the card. Normally they are wired to the C hub of digit selectors so that any required impulse can be read from the exits during one or more cycles.

24. *Carriage Skips X, D and Immediate.* These hubs correspond to channels 1 to 10 on the tape. They receive impulses to initiate skips that are to be stopped by holes in the corresponding channels of the tape.

The X hubs accept 11, 12 or skip control impulses and the D hubs accept any impulse to cause skipping on the following cycle. The I hubs accept cycle or skip control impulses to cause skipping on the same cycle.

When the X or D hubs are impulsed and a total intervenes, skipping takes place after the total prints. When the I hubs are impulsed and a total intervenes, skipping takes place before the total prints. When the X or D hubs are impulsed during program or MLR cycles, the skip will not become effective until after all program or MLR cycles are completed.

Channel 1 must be used to identify the first printing line and channel 12 the overflow line.

25. *Short Skip*. These hubs are entries and normally are wired from the skip control hubs, when the skip does not exceed two inches or the overflow one inch. When impulsed, they suppress the normal internal interlock that occurs whenever a skip is initiated, and allow the skip to take place without loss of time.

26. *LC SK (Last Card Skip)*. When the switch is wired ON, the carriage will skip to channel 1 at the end of a run. If it is not wired, a final total may be printed on the last form.

27. *Skip Control*. The four common skip control hubs normally are wired from the comparing exits and operate in conjunction with head X or D to pick up an internal selector for controlling HH, HD, DH and DD hubs.

28. *HH — Head Card to Head Card*. Whenever a heading card at the second station is followed by a heading card at the first station, an impulse is emitted from N (normal) if there is no control change and from T (transferred) if there is a control change.

When the HH T hubs are active, detail cards are missing. These hubs would normally be wired to channel 1.

29. *HD — Head Card to Detail Card*. Whenever a heading card at the second station is followed by a detail card at the first station, an impulse is emitted from HD N if there is no control change, and from HD T if there is a control change. HD N identifies heading cards followed by normal cards of the same group and usually is wired to the channel reserved for the first body line. HD T identifies missing detail cards of one group and missing heading cards of another group and normally is wired to the first body line channel and to FM-SK.

30. *DH — Detail Card to Head Card*. Whenever a detail card at the second station is followed by a heading card at the first station, an impulse is emitted from DH N if there is no control change and from DH T if there is a control change. DH N identifies cards out of sequence on a conventional form and normally is wired to stop. DH T identifies a change from one group to another on a conventional form and should be wired to carriage skip 1.

For inverted forms, DH N is wired to the carriage skip identifying the first body line and DH T to FM-SK and to the first body line carriage skip.

31. *DD T — Detail Card to Detail Card Transferred*. These hubs emit an impulse whenever two detail cards follow each other and a control change occurs. They identify missing heading cards and normally are wired to the first body line carriage skip.

32. *O-FLOW — Detail to Detail Normal*. These hubs emit an impulse as the last body line of a form is printed. The last body line of a form is determined by a punch in channel 12 of the tape. If heading cards are used, these hubs normally are wired to the first body line carriage skip hub. Without heading cards, these hubs are wired to skip to the first line of the next form.

33. *FM-SK*. When impulsed, the form skip hubs suspend the action of all skip stops until after the overflow punch has been sensed for conventional forms or a punch in channel 10 has been sensed for inverted forms. Normally it is wired from HD T for conventional forms and from DH T for inverted forms.

34. *Exit 9*. These hubs emit an impulse whenever a punch in channel 9 of the tape is sensed. They normally are wired through selectors to overflow transfer for variable length overflow operations. They are also wired to short skip to release the interlock on the last two inches of a long skip.

35. *Card Cycles*. These hubs emit a cycle control impulse on card feed cycles for controlling entry into and printing from counters. This impulse starts before the 9 position in the card is read and it continues until all adding into counters has been completed. These hubs are not active for MLR, heading card, and program cycles. The four card cycle hubs (Q, 37-40) are active on every card feed cycle, including MLR and head card cycles. The two CO-CC hubs (0-79-80) are active on every card cycle and are short impulses to be used to pick up co-selectors.

36. *MLR CPL*. These two common hubs are active on every MLR cycle. They are normally wired to TR PR to make the transfer print entry hubs active on every MLR cycle.

37. *TR PR (Transfer Print)*. These common hubs represent the pickup for the 120 position transfer print entry unit. They are normally wired from MLR CPL. These hubs may also be wired from cycles impulses as described on page 54. The transfer print unit remains transferred only for the duration of the impulse wired to TR PR.

38. *SP-X (Summary Punch X)*. These hubs emit an X impulse on every summary punch cycle and are normally wired through selectors to summary punch entry to identify different types of summary cards, such as minor and intermediate summary cards. They are also used to identify debit balance summary cards



when an NX is used to represent a credit balance summary card.

39. *0 Entry*. The zero entry hubs are direct connections to complete a circuit from any lower zero print control hub wired to them. Normally, they are wired from zero print control hubs to print zeros for zero balances.

40. *\*Ctrl (Asterisk Control)*. These hubs emit an impulse for asterisk control and are wired to co-selector pickup hubs to control zero print control hubs when check-protecting asterisks are being printed. They differ from the regular asterisk in that they print from the check-protecting asterisk impulse rather than an 8-4-11 impulse.

41. *\*Entry*. The asterisk entry hubs are direct connections to complete the circuit for printing check-protecting asterisks (N impulse). They are normally wired from zero print control.

42. *& — Entry*. The ampersand and minus entry hubs are direct connections to complete the circuit for printing an ampersand (12 only) or a minus (11 only). They are normally wired from zero print control.

43. *Digit Selectors*. Two digit selectors, A and B, are standard. These selectors are used to select specific digits from a card column or to emit digits on every machine cycle. The C hub is impulsed from a reading station if a specific digit is to be selected, or from digit impulse if the selector is to be used as an emitter.

44. *Character Emitter*. All letters, digits and special characters are emitted from the character emitter on each machine cycle. Usually they are wired through selectors to normal or transfer print entry, to counter entry (numbers only), to storage units, or to summary punch entry.

45. *Comma, Decimal, Dollar Symbol*. These symbols are emitted on every machine cycle. They differ from the same hubs in the character emitter in that they can be controlled by zero print control wiring. They are normally wired directly to normal or transfer print entry.

46. *Column Split Cpl*. The column split couple hubs are normally used to pick up selectors for the purpose of expanding column splits. They are also used as exit hubs during the second half of the cycle.

47. *Column Splits*. Twelve column splits are standard. Each one has a C (common), 0-9, and 11-12 hub. They are used to separate 11-12 punches from 0-9 punches in a card column. By wiring a cycle impulse into C and out of 11-12, the second half of the cycle can be separated from the first half.

48. *Storage In, X-D*. Each storage unit has its own storage IN X and D hubs. They accept impulses to condition the storage units to accept information on the following *card feed cycle*. The X hubs accept 11, 12 or carriage exit impulses and are normally wired from first reading. The D hubs accept digits, 11, 12, carriage exit

or cycle impulses and are normally wired from first reading or any hub emitting a cycle impulse. When the IN hubs receive an impulse, storage units clear before the next machine cycle.

49. *Storage Out, X-D*. Each storage unit has its own storage OUT X and D hubs. They accept impulses to cause the storage units to read out on the following card feed cycle, provided the pickup is not from an MLR card. The X hubs accept 11, 12 or carriage exit impulses. The D hubs accept digit, 11, 12, carriage exit or cycle impulses.

50. *Storage, Alphabet*. Each storage unit has its own alphabet couple hubs which must be connected when alphabetic information is being stored. The common hubs above are exits and emit the equivalent of a 0-11-12 impulse. The lower hubs are entries. When the alphabet couple hub for a storage unit is connected, all numbers enter the left eight positions of the unit and all zones enter the right-hand eight positions. It is necessary to wire only the left side of the storage unit when storing alphabetic information.

51. *Storage Out, Immediate*. Each storage unit has two common immediate OUT hubs. They accept any impulse to cause the storage units to read out immediately.

52. *Storage In, Next Cycle*. Each storage unit has two common next cycle hubs, which when impulsed condition the storage units to accept information on the next *machine cycle*. They are normally wired from program exits to cause the storage units to be conditioned, either for the first card of the next group or for the following program step. These hubs cannot be used if the next machine cycle is a summary punch or a long carriage skip cycle.

53. *Storage, Sum Punch*. Summary punching out of each storage unit is controlled by the summary punch hubs. The lower hubs are entries and are independent one from the other. The top hubs are common. When the lower hubs are connected to any of the top hubs, the storage punch exits will emit on every summary punch cycle. Summary punching out of a particular storage unit may be done on a specific program by wiring the program couple hub to the lower summary punch hub.

54. *CC (Cycle Count)*. The CC hub emits a 1 impulse during the first and second half of every machine cycle. Normally it is wired to counter entry to count cards or groups of cards, or to program start to cause one or more programs to be initiated for every card.

55. *Half Adj*. The half adjust hubs are exits for a 5 impulse during the first and second half of every machine cycle. These hubs normally are wired to counter entry for decimal adjusting purposes.

56. *Stop*. These hubs accept card cycle, all cycle, first card, digits, 11, 12, comparing exit impulses or skip control exits, such as HH, HD, etc., to stop the machine at the end of the same cycle. They receive negative balance ON, or negative balance OFF impulses to stop the machine at the end of the following cycle. The machine is restarted by depressing the start button.

57. *Auto*. These hubs are the same as the STOP hubs except that they also cause the automatic stop light to turn on. When immediate exits or skip control exits, such as HH, HD, etc., are wired to these hubs, the machine stops at the end of the following cycle and not at the end of the same cycle.

58. *Print*. These hubs accept card cycle or all cycles impulses to cause the machine to detail print when the list switch is wired OFF.

59. *Non-Print*. These hubs accept card cycle or all cycles impulses to prevent printing and spacing for the cycle during which non-print is impulsed.

60. *SP-PU*. The summary punch pickup hubs accept any cycle impulse to cause the machine to summary punch. They are normally wired from program levels.

61. *Co-Selector Pickup*. These are the pickup hubs for the co-selectors. When impulsed, they cause the co-selector to transfer immediately. They are normally wired from pilot selector coupling exit or from program steps.

62. *Pilot Selectors*. Fifteen pilot selectors are standard. Each selector has two positions arranged vertically, and an X, D, and immediate pick-up. When the X or D hubs are impulsed, the selector transfers on the following card or program cycle unless there is an MLR card at the second reading. When pilot selector X or D hubs are impulsed from an MLR card at first reading, the selector will transfer on the following cycle and remain transferred through all MLR cycles of that card, provided there is not an MLR card at second reading. If the X or D hubs are impulsed while an MLR card is at second reading, the selector transfers after all MLR lines of the card at second reading have been printed. When X or D hubs are impulsed during a program cycle, the selector transfers on the following cycle and remains transferred for all remaining program cycles through the first card of the following group.

When the I hubs are impulsed, the selector transfers immediately. When I is impulsed during a program cycle, the selector transfers immediately and remains transferred for all program cycles and through the first card of the following group. If the I hubs are impulsed while an MLR card is being read, the selector transfers immediately and remains transferred for all MLR cycles. Each selector also has a coupling exit which emits an impulse when the selector transfers, and continues to emit as long as the selector remains transferred. It is normally wired to a co-selector pick-up.

63. *Alter. Sw*. There are four alteration switch selectors on the control panel that correspond to the four alteration toggle switches on the machine. When the alteration toggle switches are turned on, the corresponding selector transfers. The selectors may be used independently or in conjunction with pilot or co-selectors to change machine functions under the control of a toggle switch.

64. *List*. When the switch is off, the machine group prints. When the switch is not wired, the machine de-

tail prints. The lower hub may be impulsed by a cycle impulsed wired through selectors to control detail and group printing.

65. *RO (Run Out)*. When the run out switch is ON, the last card in the machine runs out automatically into the stacker. When the switch is not wired, the last card must be run out into the stacker by depressing the start key.

66. *LCT (Last Card Total)*. When this switch is ON, three programs (minor, intermediate and major) will be taken in succession on the run-in and as the last card is run-out to the stacker. When the switch is not wired, the programs are under the control of the program start hubs. The fourth step (run-out final) is active only if the final total toggle switch is ON.

67. *Split Column Control*. These are off-time emitter hubs that emit an impulse at half after the number they represent. They are normally wired to pick up selectors which are then used as column splits.

68. *Spl. Prg*. When the special program switch is ON, a program change causes card feeding to stop and a series of program cycles to start. The cycles will continue until 5 steps have been taken (unless repeat is wired), after which time card feeding resumes. Special program ON also disconnects the internal all cycles impulse from the channel entries, permitting control panel entry to each channel. These impulses may be selected, however, so that channel 1 represents program steps 1 through 5, channel 2 program steps 6 through 10, etc.

When the special program switch is not wired, programming is normal.

69. *Sel Space*. When these hubs are connected, all spacing is under the control of channel 11 in the carriage control tape. Every space initiated after printing is stopped by a hole in channel 11, thus allowing variable spacing within any section of the form. The select space hubs and the punching in channel 11 of the control tape must be used for triple spacing.

70. *Space 1-2*. Space 1 hubs are connected for single spacing and space 2 hubs for double spacing. These hubs stop rather than cause spacing, for an automatic space is initiated before each line prints. These hubs may be selected so that single or double spacing may be placed under the control of a specific punch in the card.

71. *Extra*. These hubs accept cycle impulses to cause single or double space after printing, depending on how space 1 or 2 is wired. These impulses may be selected.

72. *Supp*. These hubs accept program impulses to suppress normal spacing before a total prints, or a card cycles impulse to suppress normal spacing for every card. These impulses may be selected. Space suppression takes precedence over all normal spacing but does not suppress extra spacing.

73. *SP-SW*. The summary punch switch must be on

for summary punching. Its function is to provide an interlock which delays the accounting machine while summary cards are being punched and to stop accounting machine operation when the last card leaves the summary punch hopper. This switch may be selected only through an alteration switch selector.

74. *First Card.* The MI, INT and MA first card hubs emit a cycle impulse for the first detail card read after a minor, intermediate or major program change. The minor first card hubs are always active for the first detail card following a heading card. They are normally wired to counter plus to add the first card of a group, to the pickup hubs of a co-selector, or to the transfer print control hubs.

Each first card hub has a corresponding single position selector which transfers during the time the first card impulse is available.

75. *Symbol.* When the symbol switch is set for R, the R or - hubs for each counter emit an R (11-9) impulse when the counter is negative. When the switch is set for minus or is not wired, the R or - hubs emit a minus (11) impulse when the counter is negative. The R symbol switch can be selected so that the R prints on detail print cycles and the minus on group print cycles, or *vice versa*.

76. *Counter Control Plus.* A card cycle, all cycles, program, or first card impulse introduced into these hubs will cause the corresponding counter to add. Transfer exit plus is also wired to counter control plus, when positive information is being transferred from another counter.

77. *Counter Control Minus.* A card cycle, all cycles, program, or first card impulse introduced into these hubs will cause the corresponding counter to subtract. Transfer exit minus is also wired to counter control minus, when minus information is being transferred from another counter. When the minus hubs are impulsed, both the C and R or - hubs for the corresponding counter are active.

78. *Direct Entry or Direct Reset.* These are direct entry hubs when the same impulse is wired to them that is also wired to the corresponding plus or minus hubs. An impulse to direct entry separates the counter entry from the counter exit. The information wired to the counter entry hubs will enter the counter directly from the card rather than from the counter-controlled print hubs. When direct entry is wired, no printing occurs. It is normally used during group printing operations to prevent overprinting and when transferring from another counter information that is not to be printed.

These are direct reset hubs when the same impulse is wired to them that is also wired to the corresponding read-out and reset hubs. An impulse to direct reset causes the total to clear out of the counter without reading out of the counter exit hubs. A counter is nor-

mally wired for direct reset whenever the counter is to be cleared without printing the total. Totals cannot be transferred from one counter to another when direct reset is wired.

79. *Transfer Plus-Minus Exit.* The transfer plus exit hubs emit an impulse when the corresponding counter read-out and reset hubs are impulsed and the counter is plus. They are wired to the plus of another (receiving) counter.

The transfer minus exit hubs emit an impulse when the corresponding counter read-out and reset hubs are impulsed and the counter is minus. They are wired to the minus of another (receiving) counter.

80. *Couple Control.* Whenever counters are coupled, the couple control hubs of all but the high order counter must be connected. This wiring insures that a zero test will be made in every coupled counter when negative balance is wired off, and prevents the punching of credit X's from any but the high order counter during summary punch operations.

81. *Negative Balance On.* These hubs emit an impulse at the end of the cycle during which the corresponding counter turns negative and for every cycle thereafter as long as the counter remains negative. Normally they are wired to negative balance control to convert complement figures or to the pickup of a selector to control other functions of the machine.

82. *Negative Balance Control.* These are entry hubs wired either from negative balance ON to convert complement results or from negative balance OFF to convert zero balance 9's to zeros.

83. *Negative Balance Off.* These hubs emit an impulse at the end of the cycle during which the corresponding counter zero balances. They are wired to negative balance control to convert zero balance 9's to zeros or to selector pickup hubs to control other functions of the machine.

84. \* *Symbol Exit.* These hubs emit the equivalent of an 8-4-11 impulse whenever the corresponding counter is impulsed to read out or to read out and reset. They are wired to normal or transfer print entry for the printing of asterisk symbols for totals. They cannot be wired to counter-controlled print since these hubs do not accept zone impulses.

85. *C Symbol Exit.* These hubs emit a C (12-3) impulse whenever the corresponding counter is impulsed to subtract. They also emit a C impulse whenever the corresponding counter is negative and is impulsed to read out or read out and reset. They are wired to normal or transfer print entry in conjunction with the R hub to identify a credit item or a credit total. They cannot be wired to counter-controlled print.

86. *R or - Symbol Exit.* If the R or - switch is wired for R, these hubs emit an R (11-9) impulse whenever the corresponding counter is impulsed to subtract or whenever that counter is impulsed to read out

or read out and reset a converted negative total. If the R switch is not wired or is wired for minus, these hubs emit a minus (11) impulse under the same condition as the R hubs. The R or - hubs are wired to normal or transfer print entry to identify credit items or credit totals. They cannot be wired to counter-controlled print.

87. *Carry Exit — Carry Entry.* The CI and C hubs must always be connected whenever a counter is in use. This is necessary because all counters reset to 9's. When counters are coupled the CI of the high order counter is wired to the C of the low order counter and the remaining CI and C hubs of the group are connected from right to left.

88. *Read Out.* These hubs accept cycle impulses to cause a counter to read out without resetting. They are normally used for progressive totalling.

89. *Read Out and Reset.* These hubs accept cycle impulses to cause a counter to read out and reset.

90. *Program.* These hubs are exits for cycle control impulses which are wired to control counters, selectors, storage units and the carriage, during program steps. Normally the first row of hubs (minor) becomes active as exits when the minor start hub receives an impulse; first and second (intermediate) rows become active in succession when the intermediate start receives an impulse; first, second and third (major) rows become active in succession when the major start receives an impulse. The run-out final row is active when the LCT switch is wired on and the final total toggle switch is on.

When the special program switch is not wired on, each channel entry is connected internally to an all cycles impulse. When the switch is on, this connection is broken and must be made by external wiring. With the switch on, any start impulse causes the program steps to become active in succession from 1 through 5, at which point they stop unless repeat is wired.

91. *BT CYCLES — BT PU.* When BT PU (balance test pickup) is wired from a cycles impulse, the BT Cycles hubs emit impulses which begin slightly later and are suitable for selection through selectors picked up immediately from Neg. Bal. ON or OFF. When BT PU is impulsed from a digit, BT cycles will emit an impulse that begins slightly after the digit and continues to the end of the cycle.

92. *All Cycles.* These common hubs emit all cycles impulses on every machine cycle except summary punch cycles or long carriage skips. They are normally used as a substitute for other cycle impulses when properly controlled, or to provide program exit impulses when special program is wired on.

93. *O-FLOW.* There are two independent overflow hubs for each program level. When overflow program start is impulsed, the overflow program hubs become active in turn, beginning with the first level and continuing until the fifth level is reached or until

stopped by impulsing overflow end. They are normally used to control counters, storage units and carriage operations for overflow sheet identification purposes. When overflow programs are active the regular programs are inactive.

94. *PR CPL.* Each program step has a pair of common couple hubs. They emit impulses that begin sooner and last longer than the regular programs and are normally used to pick up selectors for the purpose of expanding the program exits. On machines that have OF CPL these hubs emit on regular programs only. On machines that do not have OF CPL they emit on overflow programs as well as on regular programs.

95. *Stop Mi, Int, Ma, Final, Com.* When special program is wired on, the automatic stops are cancelled and the program stop must be wired. Normally the last program used is wired to stop minor, intermediate or major, depending on what program start initiated the progression. The final stop is used when special program is on, and both the run-out switch and the final total toggle switch are on, to stop the progression of program steps after the last card runs out of the machine.

When the common stop hub is impulsed, the progression of steps will stop at the end of the same cycle, regardless of other controls. It is also an exit hub, and as such, emits an all cycles impulse during the last program step of each group.

96. *Final Total.* These hubs are normally wired to counter read-out and reset when final totals are desired. They emit an impulse whenever the final total key is depressed, provided the final total toggle switch is on, the machine is idling, and there are no cards at the first and second reading stations.

97. *OF CPL (Overflow Couple).* These hubs emit impulses on their corresponding overflow program steps. The impulses begin sooner and last longer than the regular overflow programs and are normally used to pick up co-selectors for expanding overflow programs beyond two positions.

98. *Repeat.* When special program is wired on and a program start is initiated, five program steps are taken before the machine stops, if no other stops are wired. If more steps are desired, step 5 is wired to repeat, causing the automatic progression to be repeated. Any program step other than 5 can be wired to repeat and the progression of steps will start over again on the following cycle.

99. *O-Flow End.* The succession of overflow program steps is stopped by wiring the last overflow program used to overflow end. The highest program level used (minor, intermediate or major) is also wired to overflow end along with the last overflow program, to cancel the overflow steps when both the overflow and the program change occur at the same time.

100. *O-Flow Trans.* These hubs are normally wired from exit 9 through a selector to cause a transfer from regular to overflow programs whenever a program change occurs after the hole in channel 9 has been sensed. They are used in variable length overflow operations.

101. *Zero Print Control.* Each print wheel has a pair of zero print control hubs. They are jackplugged to print zeros to the right of significant digits. The high

order position of a field is always left unplugged. To print zeros, zero impulses must be received by the print wheel either from a card, from a counter, or from an emitter. Zeros may be controlled to print to the left of significant digits or for zero balances. The zero print control hubs also control the printing of commas, decimals and dollar signs as they do zeros, when these symbols are wired to print entry from the comma, decimal and dollar hubs located immediately above the column splits.

## TIMING CHARTS

THE MAIN purpose of timing charts (Figures 157 and 158) is to assist in determining whether or not doubtful control panel wiring will function without damaging the machine internally. A good working knowledge of the machine is necessary before timing charts can be used effectively. The timing charts should be used in conjunction with the control panel summary, the load rating table, and the operating suggestions.

A cycle is a period of time required for a given series of events at the completion of which the series is repeated. Since the Type 407 operates at a speed of 150 cycles per minute, one cycle requires two-fifths of a second. Each cycle is divided into 24 equal parts called points, and each point of a cycle is further divided into 15 degrees. There are 360 degrees from one given point of a cycle to the same point of the next cycle. A cycle is generally measured from 0 to 0 (0 being the same as 360). Since the functional cycle on the Type 407 begins at 322 degrees, the timing charts show a range from 322 degrees to 322 degrees.

Each cycle is also divided into two parts referred to as the first and second half of the cycle. Generally, the first half of the cycle (0 degrees to 180 degrees) is used for card reading and the second half (150 degrees to 285 degrees) for accumulating, although the latter may be done in the first half of the cycle by direct entry. Print wheels are set up from card reading or counter exits in the first half of the cycle and "echo" back to the counter in the second half.

The transfer time of pilot selectors when picked up with X or D is from approximately 292 degrees

of one card cycle to 285 degrees of the next card cycle. Thus, pilot selectors remain transferred for intervening program cycles. The 7-degree break is necessary to allow time for a transferred selector to drop back to normal between one card cycle and another. When pilot selector immediate (I) is impulsed, selectors transfer immediately and drop at 285 degrees of the same cycle. If programs intervene, the selector will hold through the next card feed cycle.

Co-selectors transfer immediately and return to normal at 285 degrees of the same cycle. When a co-selector is transferred with a coupling exit of a pilot selector, the co-selector transfers during carry (CI) time (307 degrees to 315 degrees), and for this reason pilot selectors (X or D pickup) instead of co-selectors should be used to select carry impulses.

As a general rule, an allowance of 7 degrees should be made between the immediate pickup impulse and the impulse to be selected because of the variable lag in the actual transfer of selectors. Impulses that are active during pick-up time should not be selected. For example, the chart will show that selecting an all cycles impulse through a selector picked up immediately from negative balance OFF or ON will arc the selector points. On the other hand, the chart also shows that the same result can be accomplished by selecting the balance test cycle instead of all cycles without damaging the selector points.

The timing shown applies to all Type 407 machines that are internally wired to wiring diagram number 220775G.

# TYPE 407 ACCOUNTING MACHINE TIMING CHART

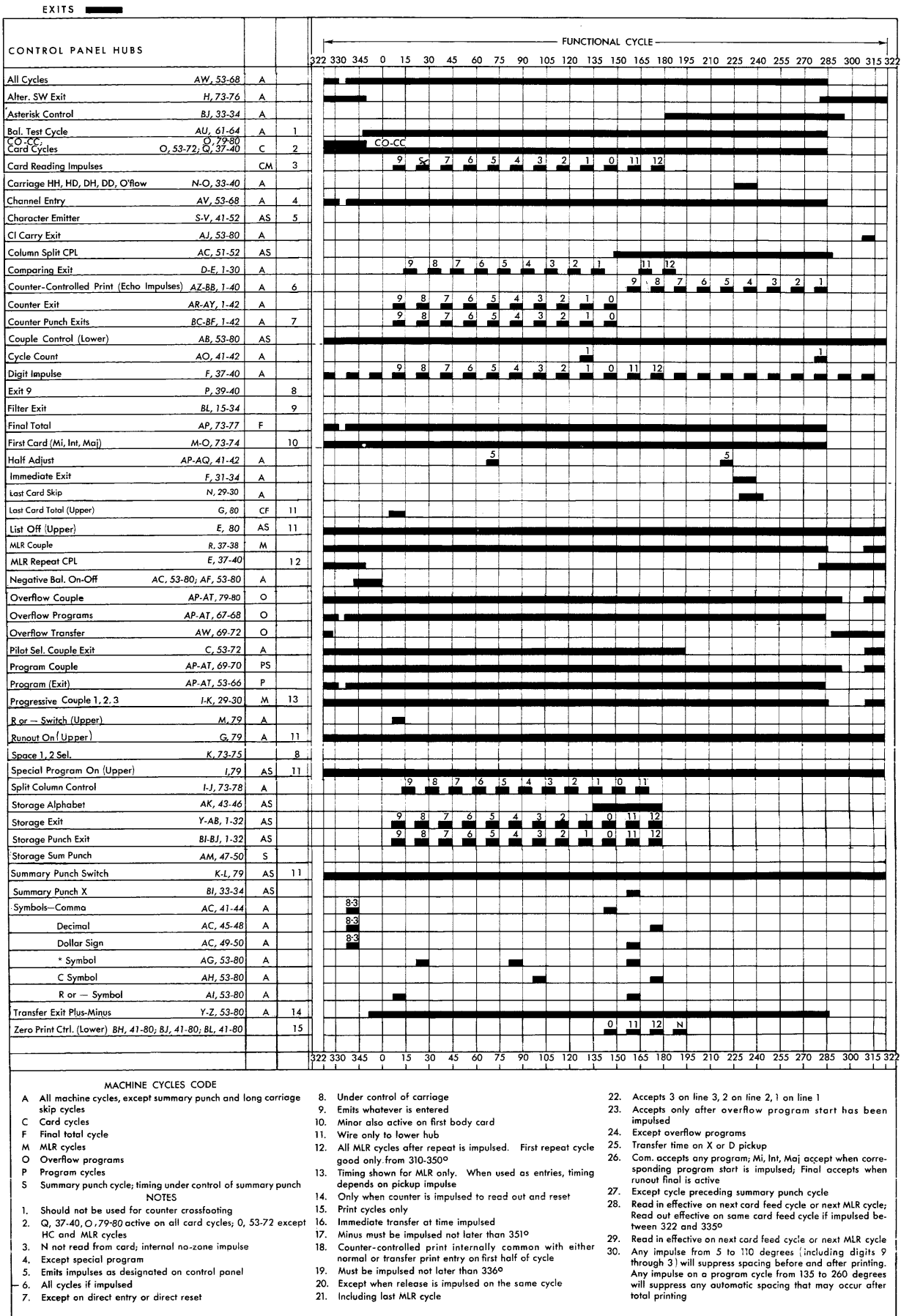

FIGURE 157. TIMING CHART, EXITS — WIRING DIAGRAM NO. 220775G

TYPE 407 ACCOUNTING MACHINE

TIMING CHART

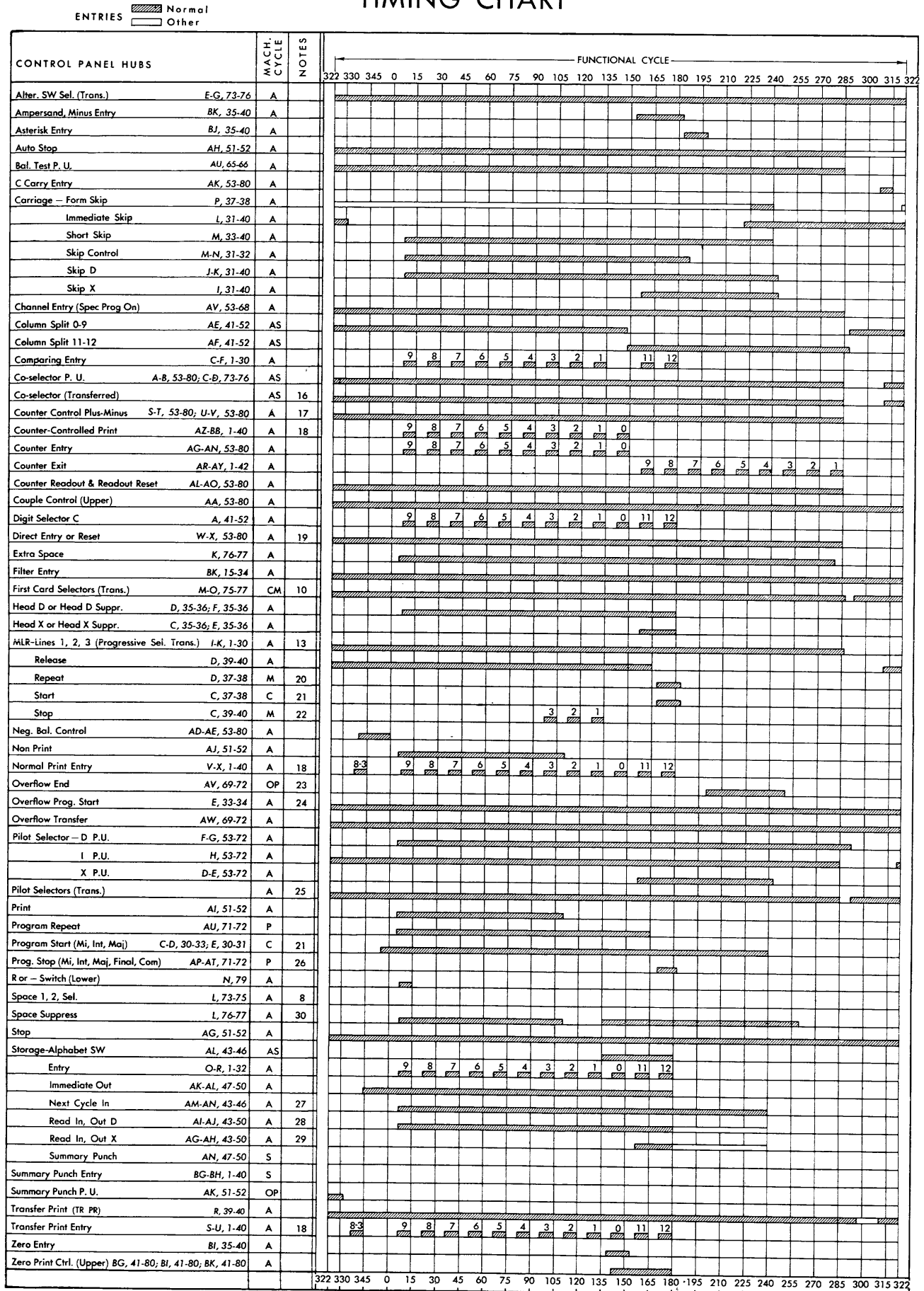

FIGURE 158. TIMING CHART, ENTRIES — WIRING DIAGRAM No. 220775G



# INDEX

Above Platen Feed Device .....	123	Crossfootting Eleven Totals .....	110
Above Platen Feed, Steps in Using .....	126	Crossfootting (Six-Field) .....	108
Addition .....	17	Cycle Count — Counting, Programming, and Printing (Figure 49) .....	55
Address Printing (MLR) .....	159	DD (Detail Card to Detail Card) .....	133, 199
All Cycles .....	71, 203	Debit Balance Summary Cards (X Punch for) .....	100
Alphabet (Storage) .....	86, 200	Decimal .....	24, 200
Alteration Switches .....	10, 56, 201	Decimal Selection .....	62
Amount Punctuation (Figure 29) .....	26	Detail Printing .....	13
Ampersand or Minus Entry .....	153, 200	Detail Printing: Minor, Intermediate and Major Program .....	29
Analyzing a Form for Carriage Skip Wiring .....	134	DH (Detail Card to Heading Card) .....	133, 199
Asterisk (Check-Protecting) .....	151	Digit Impulse .....	45, 198
Asterisk Control .....	153, 200	Digit Selection .....	45, 78
Asterisk Entry .....	153, 200	Digit Selectors .....	45, 200
Asterisk Symbol Exit .....	19, 202	Direct Entry .....	35, 190, 202
Automatic Last Card Totals .....	31	Direct Reset .....	93, 190, 202
Automatic Stop .....	82, 201	Discount Calculation by Repeated Addition .....	114
Automatic Stop Light .....	9	Dollar Sign (Floating) .....	151
Band Assembly and Paper Guide .....	124	Dollar Symbol .....	24, 200
BT (Balance Test) Cycles .....	81, 203	Dollar Symbol Selection .....	62
BT PU (Balance Test Pickup) .....	81, 203	Double Spacing .....	67
Bus .....	25, 198	DR Instead of CR for Negative Amounts .....	66
C, R or Minus Selection, Detail and Total Printing .....	63	Eight Lines per Inch .....	127
C, R or Minus Selection, Printing on One Line .....	65	Eliminating X Punching for Zero Balances (Figure 89) .....	97
C, R or Minus Symbol Exit .....	37, 202	Eliminating Zero Balance Summary Punching (Figure 92) .....	100
Card Cycles .....	17, 199	Emitter (Character) .....	46, 200
Card Feed Stop Light .....	9	End of Form Stop .....	123
Card Feeding .....	7	Exit 9 .....	145, 199
Card Reading .....	6	Expanding Program Exits .....	71
Card Removal .....	7	Extra Space .....	67, 201
Carriage Adjustment .....	126	Extra Space — Total Printing .....	68
Carriage Shift Lock .....	123	Feed Unit .....	6
Carriage Skip Wiring Analysis .....	134	Field Selection .....	59
Carriage Skips .....	129, 198	Filter Entry-Exit .....	25, 189, 198
CC (Cycle Count) .....	54, 200	Final Total .....	18, 203
Changing from Detail Printing to Group Printing .....	56	Final Total Key .....	9
Changing from Detail to Group Print on Zero Balance (Figure 74) .....	81	Final Total Switch .....	10
Channel 9 .....	145, 199	First Card Minor, Intermediate, Major .....	52, 202
Channel 10 .....	149	First Card Spacing .....	71
Channel 11 (Selective Space) .....	156, 201	First Printing Line, Above Platen Feed (Step 14) .....	126
Channel Entry (Program) .....	106, 203	First Printing Line, Forms Tractor (Step 8) .....	128
Character Codes .....	8	First Printing Line Stop .....	120
Character Emitter .....	46, 200	First Reading .....	27, 197
Character Emitter Printing .....	46	Floating Dollar Sign .....	151
Character Punching .....	13	FM-SK (Form Skip) .....	133, 199
Check-Protecting Asterisk .....	151	Form Control .....	129
CI and C for Counter Coupling .....	40	Form Design .....	187
CI Carry Exit, C Carry Entry .....	19, 203	Form Feeding Devices (IBM) .....	123
Class Selection .....	61	Form Stand and Form Feed Guides .....	128
Column Split .....	65, 200	Form Stop Light .....	9
Column Split Couple .....	65, 200	Form Stop Switch .....	10
Comma .....	24, 200	Form Thickness Adjustment Device .....	122
Comma, Decimal, Dollar Symbol .....	24, 200	Form to Form Skipping .....	129
Comma, Decimal, Dollar Symbol Selection .....	62	Forms Tractor (IBM) .....	127
Comparing Unit .....	27, 197	Fuse Light .....	9
Control Panel .....	11, 12	Group Indication .....	52
Control Panel Summary .....	197	Group Printing .....	32
Control Tape .....	118	Half Adjust .....	114, 200
Co-Selectors .....	46, 197	HD (Head Card to Detail Card) .....	133, 199
Co-Selectors Pickup .....	46, 201	Head Suppress, X, D .....	131, 198
Counter Control Minus .....	36, 202	Head X, D .....	131, 198
Counter Control Plus .....	17, 202	HH (Head Card to Head Card) .....	131, 199
Counter Control Read Out .....	88	Identifying Negative Amounts with DR Instead of CR .....	66
Counter Control Read Out and Reset .....	17, 203	Identifying Overflow Sheets with More than One Line .....	145
Counter-Controlled Print .....	18, 198	Immediate Exit .....	167, 198
Counter Coupling .....	40, 191	Immediate Out (Storage) .....	86, 200
Counter Entry .....	17, 197	Inserting Tape in Carriage .....	121
Counter Exit .....	18, 197	Introduction .....	5
Counter Punch Exit .....	95, 193, 198	Inverted Form Operations .....	148
Counting and Programming with Cycle Count .....	54	Inverted Switch .....	10
Couple Control .....	41, 202	Invoice and Page Numbering .....	141
Couple (Program) .....	46, 203	Invoice Preparation .....	173
Coupling Exit (Pilot Selectors) .....	36, 201	Label and Pick Slip Writing .....	167
Cross-Checking .....	171	LC SK (Last Card Skip) On .....	131, 199
Crossfootting .....	77	LCT (Last Card Total) On .....	31, 201

## INDEX (Continued)

Lights	9, 10	Progressive Selectors	161, 197
List Off	32, 201	Proper Use of Filters	189
Load Rating Table	191	Punching a Credit X over the Amount Field (Figure 90)	98
Locating Counters Causing Reset Check Light	194	Punching X's for Debit Balances (Figure 91)	99
Main Line Switch	9	R or Minus (Switch)	37, 202
Maximum Number of Entries from One Source	193	R or Minus Symbol Exit	37, 202
Minor, Intermediate and Major First Card	52, 202	Read Out (Counter Control)	88, 203
Minor, Intermediate and Major Program Start	28, 198	Read Out and Reset (Counter Control)	17, 203
MLR CPL	161, 199	Reading Into and Out of Storage under Control of an X or Digit	87
MLR Heading Cards	162	Recognizing Negative and Zero Balances	81
MLR Release	165, 198	Regular Stop for Negative Balances and Auto Stop for Zero Balances	84
MLR Repeat	165, 198	Release (MLR)	165, 198
MLR Repeat Couple	165, 198	Repeat Couple (MLR)	165, 198
MLR Start	159, 198	Repeat (MLR)	165, 198
MLR Stop	159, 198	Repeat (Special Program)	106, 203
Multiple Heading Groups; Overflow Sheet Identification	136	Reset Check Light	9, 194
Multiple Line Reading Operations	159	Reset Check Switch	10
Multiple X or Digit Selection	78	Restore Key	122
Multiplication by Repeated Addition	114	Ribbon Replacement	188
Negative Amounts, Identifying with DR Instead of CR	66	RO (Run Out) On	31, 201
Negative Balance Control	21, 37, 202	Run-In Reset	29
Negative Balance Off	21, 193, 202	Second Reading	13, 197
Negative Balance On	37, 193, 202	Selective Space	156, 201
Negative Balance On-Off for Counter Coupling	40	Selectors	36, 46, 197, 201
Next Cycle (Storage In)	86, 200	Setting Paper Guides and Band Assemblies	126
Non-Print	48, 201	Short Skip	120, 133, 199
Normal Print Entry	14, 197	Single Heading Forms	131
Normal Skip Stops	120	Single or Double Spacing under X or D Control-Detail Printing	68
OF CPL (Overflow Couple)	138, 203	Single Sheet Form Feeding; Selective Spacing	156
Offset Total Printing	51	Single Spacing	67
Operating Features (Tape-Controlled Carriage)	122	Six or Eight Lines per Inch	127
Operating Suggestions	189	Six Field Crossfooting	108
Operating Keys, Switches, and Signals	8	Skip Control	131, 199
Overflow Control	120	Space 1-2	14, 201
Overflow (Detail to Detail Normal)	133, 199	Space Control	66
Overflow End	138, 203	Space, Extra	67, 201
Overflow (Program)	136, 203	Space Key	122
Overflow Program Start	136, 198	Space, Selective	156, 201
Overflow Sheet Identification (More than One Line)	118, 145	Space Suppress	67, 201
Overflow Sheet Identification (Single Line)	136	Space Suppression or Extra Space under X or D Control— Detail Printing	68
Overflow Skipping	118	Spacing Chart	14, 186
Overflow Transfer	146, 204	Speed	8
Overflow, Variable Length	145	SPL PRG (Special Program)	105, 201
Page Numbering	141	Split Column Control	84, 201
Page Totals	118	SP-PU (Summary Punch Pickup)	95, 201
Paper Guide and Band Assembly	124	SP-SW (Summary Punch Switch)	95, 201
Paper Guide and Band Assembly Scale	124	SP-X (Summary Punch X)	97, 199
Paper Weight	128	Start Key	9
Pilot Selectors	36, 201	Start (MLR)	159, 198
Platen	124	Stop and Automatic Stop	82, 200
Platen Clutch	122	Stop Key	9
Platen Knob	122	Stop Key (Carriage)	122
Platen Shift Wheel	123	Stop Minor, Intermediate, Major, Final, Common	106, 203
PR CPL (Program Couple)	46, 203	Stop (MLR)	159, 198
Predetermined Total Line	118	Stopping from First Card Impulse	84
Pressure Release Lever	123	Stopping from Negative Balance	83
Print	48, 201	Stopping from Program Exit	84
Print Selection	48	Stopping from an X or Digit Punch	82
Print Unit	8	Stopping from Zero Balance	83
Print Wheel	8	Storage, Alphabet	86, 200
Printing Five Minor Totals from Same Print Wheels (Figure 96)	107	Storage Entry	85, 197
Printing More than Three Lines from One Card	164	Storage Exit	85, 197
Printing Three Totals on the Same Line in One Cycle (Figure 65)	70	Storage In, Next Cycle	86, 200
Printing Total Identifications from Channel Entry	113	Storage In, X and D	86, 200
Program Control	27	Storage Out, Immediate	86, 200
Program Exits	28, 203	Storage Out, Summary Punch	97, 200
Program Repeat (Special)	106, 203	Storage Out, X and D	86, 200
Program, Special	105, 201	Storage Punch Exit	95, 198
Program Start Minor, Inter., Major	28, 198	Storage Units	85
Program Start, Overflow	136, 198	Storage Units as a Substitute for Counters	87
Programming (Figure 32)	30	Storing 16 Positions of Alphabetic Information, Using One Storage Unit	93
Programming with Cycle Count	54	Subtraction	35
Progressive Selector Couple	161, 197		

## INDEX (Continued)

Summary Punch Entry .....	95, 198
Summary Punch (Storage Out) .....	97, 200
Summary Punching .....	94
Summary Punching More than One Class of Total .....	101
Summary Punching with Variable Storage Read Out (Figure 95) .....	104
Suppress, Space .....	67, 201
Suppress X, D (Heading) .....	131, 198
Switches .....	9, 10
Symbol Exit .....	19, 37, 202
Symbol Selection .....	62
Symbol Switch (R or Minus) .....	37, 202
Tape Channels .....	120
Tape-Controlled Carriage .....	118
Tape Punching .....	120
Tear Bar .....	124
Tear Bar, Steps in Using .....	126
Three-Field Crossfooting (Figure 71) .....	76
Timing Charts .....	205
Total Identification (Printing from Channel Entry) .....	113
Total Printing from Different Print Wheels .....	75
Total Printing from the Same Print Wheels .....	72
Total Transfer .....	72
TR PR (Transfer Print) .....	54, 199
Tractor Adjustments .....	128
Transfer Exit, Plus and Minus .....	72, 202
Transfer Print Entry .....	54, 197
Triple Spacing .....	193
Two or More Totals on the Same Line in One Cycle .....	69
Two or More Totals on the Same Line in Two or More Cycles .....	68
Two-Part Form Skipping — Single Heading Form .....	131
Typical Applications .....	167
Unlabelled Light .....	9
Using Above Platen Feed .....	126
Using Tear Bar .....	126
Variable Length Overflow .....	145
Variable Length Overflow Analysis .....	146
Variable Length Overflow (Group Printing) .....	173
Variable Line Spacing and Uniform Skipping .....	118
Vernier Knob .....	122
<b>WIRING DIAGRAMS</b>	
Addition (Figure 16) .....	20
Address Printing (Figure 137) .....	162
Amount Punctuation (Figure 29) .....	26
Automatic Last Card Totals (Figure 33) .....	32
C, R or Minus Selection, Detail and Total Printing (Figure 59) .....	65
C, R or Minus Selection, Printing on One Line (Figure 60) .....	66
Changing from Detail to Group Printing (Figure 52) .....	58
Changing from Detail to Group Print on Zero Balance (Figure 74) .....	81
Character Emitter Printing (Figure 43) .....	47
Check-Protecting Asterisk (Figure 132) .....	155
Class Selection, Co-Selector Method (Figure 55) .....	61
Class Selection, Transfer Print Method (Figure 56) .....	62
Comma, Decimal, Dollar Symbol Selection (Figure 58) .....	64
Counter Coupling (Figure 39) .....	41
Counter Coupling (Figure 153) .....	192
Counters Causing Reset Check Light (Figure 155) .....	195
Cross-Checking (Figure 143) .....	172
Crossfooting Eleven Totals (Figure 98) .....	111
Cycle Count — Counting, Programming, and Printing (Figure 49) .....	55
Detail Printing (Figure 14) .....	16
Digit Selection (Figure 42) .....	45
Direct Entry or Direct Reset (Figure 152) .....	191
Discount Calculation (Figure 103) .....	116
DR for Negative Amounts (Figure 61) .....	66
Eliminating X Punching for Zero Balances (Figure 89) .....	97
Eliminating Zero Balance Summary Punching (Figure 92) .....	100
Expanding Program Exits (Figure 67) .....	71
Extra Space; Space Suppression (Figure 64) .....	69
Field Selection, Co-Selector Method (Figure 53) .....	59
Field Selection, Transfer Print Method (Figure 54) .....	60
Filters (Figures 147-150) .....	189, 190

<b>Wiring Diagrams (continued)</b>	
First Card Spacing (Figure 66) .....	71
Floating Dollar Sign, Detail Print (Figure 130) .....	152
Floating Dollar Sign, Total Print (Figure 131) .....	154
Form to Form Skipping (Figure 117) .....	131
Group Indication (Figure 48) .....	53
Group Printing (Figure 35) .....	34
Inverted Form (Figure 129) .....	150
Invoice and Page Numbering (Figure 124) .....	142
Invoice Preparation, Side-by-Side Heading (Figure 145A, B, C, D, E,) .....	176
Label and Pick Slip Writing (Figure 142) .....	168
MLR Heading Cards (Figure 139) .....	164
Multiple Heading Groups; Overflow Sheet Identification (Figure 122) .....	140
Multiple X Distribution (Figure 73) .....	80
Offset Total Printing (Figure 45) .....	50
Print Selection (Figure 44) .....	49
Printing Five Minor Totals from Same Print Wheels (Figure 96) .....	107
Printing Four Lines from One Card (Figure 140) .....	166
Printing Three Totals on the Same Line in One Cycle (Figure 65) .....	70
Programming (Figure 32) .....	30
Punching a Credit X over the Amount Field (Figure 90) .....	98
Punching X's for Debit Balances (Figure 91) .....	99
Regular Stop for Negative Balances, Auto Stop for Zero Balances (Figure 78) .....	83
Seven Overflow Lines (Figure 125) .....	144
Single or Double Spacing under X or D Control — Detail Printing (Figure 62) .....	68
Single Sheet Form Feeding; Selective Spacing (Figure 134) .....	158
Six-Field Crossfooting (Figure 97) .....	109
Space Suppression; Extra Space (Figure 63) .....	68
Split Column Control (Figure 81) .....	85
Stopping from Negative Balance (Figure 76) .....	82
Stopping from Program Exit or from First Card (Figure 79) .....	84
Stopping from X or Digit Punch (Figure 75) .....	82
Stopping from Zero Balance (Figure 77) .....	83
Storage Entry and Read-Out (Figure 83) .....	88
Storing 16 Alphabetic Characters in One Storage Unit (Figure 86) .....	92
Storage Unit as a Substitute for Counter (Adding and Subtracting) (Figure 85) .....	91
Storage Unit as a Substitute for Counter (Adding Only) (Figure 84) .....	90
Subtraction (Figure 37) .....	38
Summary Punching Minor Totals (Figure 88) .....	96
Summary Punching Minor and Intermediate Totals (Figure 93) .....	102
Summary Punching Minor, Intermediate and Major Totals (Figure 94) .....	103
Summary Punching with Variable Storage Read Out (Figure 95) .....	104
Three-Field Crossfooting (Figure 71) .....	76
Total Identification (Figure 100) .....	113
Total Printing, Different Print Wheels (Figure 70) .....	74
Total Transfer, Same Print Wheels (Figure 69) .....	73
Triple Spacing (Figure 154) .....	194
Two Part Form Skipping — Single Heading (Figure 120) .....	135
Variable Length Overflow, Detail Printing (Figure 127) .....	147
X Selection (Figure 41) .....	44
Zero Print Control (Figures 18-28) .....	22-25
Wiring of X's or 12's to Print Entry .....	192
X Selection .....	42
Zero and Special Symbol Control .....	22
Zero Balance (Eliminating Summary Punching) (Figure 92) .....	100
Zero Balance (Eliminating X Punching) (Figure 89) .....	97
Zero Entry .....	23, 200
Zero Print Control .....	22, 204
Zero Print Control — Comma, Decimal and Dollar Sign .....	24
Zero Print Control for Dash and Ampersand .....	23
Zero Print Control for Zeros .....	22

