

IBM Systems Reference Library

IBM Remote Multiplexers and Communications Terminals Installation Manual—Physical Planning

This publication contains physical planning information for IBM remote multiplexers and communications terminals. Included are physical specifications, electrical and environmental requirements and cabling requirements for the following devices:

- IBM 1001 Data Transmission Terminal
- IBM 1013 Card Transmission Terminal
- IBM 1092 and 1093 Programmed Keyboards
- IBM 2712 Remote Multiplexer
- IBM 2740 Communications Terminal
- IBM 2741 Communications Terminal
- IBM 2760 Optical Image Unit
- IBM 2780 Data Transmission Terminal
- IBM 2845 Display Control, including
 - IBM 2265 Display Station and Keyboard
 - IBM 1053 Printer Model 4
 - IBM 3287 Printer Models 1 and 2
- IBM 3704 Communications Controller (With Remote Program Loader)
- IBM 3705 Communications Controller (With Remote Program Loader)
- IBM 3735 Programmable Buffered Terminal, including
 - IBM 5496 Data Recorder
 - IBM 3286 Printer Model 3
- IBM 3767 Communication Terminal
- IBM 3770 Data Communication System, including
 - IBM 2502 Card Reader Models A1, A2, and A3
 - IBM 3203 Printer Model 3
 - IBM 3411 Magnetic Tape Unit and Control Model 1
 - IBM 3501 Card Reader
 - IBM 3521 Card Punch
 - IBM Communication Terminal
 - 3771 Communication Terminal
 - 3773 Communication Terminal
 - 3774 Communication Terminal
 - 3775 Communication Terminal
 - 3776 Communication Terminal
 - 3777 Communication Terminal
 - IBM 3782 Card Attachment Unit Models 1 and 2
 - IBM 3784 Line Printer
- IBM 3780 Data Communication Terminal
 - IBM 3781 Card Punch
- IBM 5275 Direct Numerical Control Station

This manual presents detailed physical-planning information about stand-alone remote terminals and multiplexers. It is intended for use by those responsible for planning and preparing customer facilities and by those responsible for installing these devices upon delivery.

Installation-planning information of a general nature, applicable to all devices, is presented first, and includes such things as site preparation and location of terminals, communication facilities, and product and environmental safety. This general information is followed by detailed unit specifications (in numerical sequence by machine-type number) for each device. The Appendix includes charts showing the types of power cords and plugs referred to in the unit specification pages for individual devices, and also includes information on IBM line adapter cable terminations and telegraph line terminations.

- Addition of planning information for attaching the 3781 Card Punch to the 3780 Data Communication Terminal.
- Revision of the 3286 Printer Model 3 operating environment specifications.
- Corrections to the 3704 and 3705 cable specifications

Summary of Amendments for GA27-3006-7

This manual contains miscellaneous technical and editorial changes. A change to the text is indicated by a vertical line to the left of the change.

Eight Edition (February 1978)

This is a revision of, and obsoletes, GA27-3006-6 and Technical Newsletters GN27-3197, GN27-3201, GN27-3209, GN27-3213, GN27-3226 and GN27-3231. Refer to the "Summary of Amendments" for the changes included in this edition.

Changes are periodically made to the information herein; before using this publication in connection with the operation of IBM systems or equipment, refer to the IBM System/370 Bibliography (GC20-0001) and associated Technical Newsletters for the editions that are applicable and current.

Requests for copies of IBM publications should be made to your IBM representative or to the IBM branch office serving your locality.

This manual has been prepared by the IBM System Communications Division, Publication Center, Department E01, P.O. Box 12195, Research Triangle Park, North Carolina 27709. A form for readers' comments is provided at the back of this publication. If the form has been removed, comments may be sent to the above address. Comments become the property of IBM.



This Newsletter No. GN27-3237
Date October 27, 1978
Base Publication No. GA27-3006-7
File No. TP 15
Previous Newsletters None

IBM Remote Multiplexers and Communications Terminals Installation Manual—Physical Planning

© IBM Corp. 1968, 1972, 1973, 1977, 1978

This Technical Newsletter provides replacement pages for the subject publication. Pages to be inserted and/or removed are:

iii, iv
3287.1, 3287.2
3287.3, 3287.4
3287.5, 3287.6 (To be removed)
3289.1, blank (Added)
3770.7, 3770.8
3770.15, 3770.16
A-1, A-2 (A-2 added)
A-3, blank (Added)

A change or addition to the text or a change to an illustration is indicated by a vertical line to the left of the change.

Summary of Amendments

This Technical Newsletter contains physical planning information for the IBM 3287 Printer Models 11 and 12 and the 3289 Line Printer Model 3.

Note: Please file this cover letter at the back of the manual to provide a record of changes.



This Newsletter No. GN27-3241
Date Oct. 27, 1978
Base Publication No. GA27-3006-7
File No. TP-15
Previous Newsletters GN27-3237

IBM Remote Multiplexers and Communications Terminals Installation Manual—Physical Planning

© IBM Corp. 1968, 1972, 1973, 1977, 1978

This Technical Newsletter provides replacement pages for the subject publication. Pages to be inserted and/or removed are:

3705.3, 3705.4
3705.5, 3705.6

A change or addition to the text or a change to an illustration is indicated by a vertical line to the left of the change.

Summary of Amendments

Information is provided for the recently announced 3705 Communication Controller high speed local and duplex device.

Note: Please file this cover letter at the back of the manual to provide a record of changes.



Technical Newsletter

This Newsletter No. GN27-3250
Date April 3, 1979
Base Publication No. GA27-3006-7
System TP-15
Previous Newsletters GN27-3237
GN27-3241

IBM Remote Multiplexers and Communications Terminals Installation Manual - Physical Planning

© IBM Corp. 1968, 1972, 1973, 1976, 1977

This Technical Newsletter provides replacement pages for the subject publication. Pages to be inserted and/or removed are:

3705.3, 3705.4
3705.5, 3705.6
3705.7, blank (added)
A-1, A-2

A change to the text or to an illustration is indicated by a vertical lines to the left of the change.

Summary of Changes

Changes reflect added information on the IBM 3705, models J, K, and L.

Note: Please file this cover letter at the back of the manual to provide a record of the changes.



Technical Newsletter

This Newsletter No. GN27-3253
Date 15 Aug. 1979

Base Publication No. GA27-3006-7
File No. TP-15

Previous Newsletters GN27-3250
GN27-3241
GN27-3237

IBM Remote Multiplexers and Communication Terminals Installation Manual - Physical Planning

© IBM Corp. 1968, 1972, 1973, 1976, 1977

This Technical Newsletter provides replacement pages for the subject publication. Pages to be inserted and/or removed are:

3705.1, 3705.2
3705.5, 3705.6
3705.7, blank

A change to the text or to an illustration is indicated by vertical lines to the left of the change.

Summary of Changes

This Technical Newsletter adds information for the
Type 3HS Communication Scanner.

Note: Please file this cover letter at the back of the manual to provide a record of the changes.

IBM Corporation, Publications Development, Dept. E02, P.O. Box 12195, Research Triangle Park, N.C. 27709

© IBM Corp. 1979

Printed in U.S.A.



Technical Newsletter

This Newsletter No. GN27-3281
Date 27 Feb 1980

Base Publication No. GA27-3006-7
File No. TP-15

Previous Newsletters GN27-3253
GN27-3250
GN27-3241
GN27-3237

IBM Remote Multiplexers and Communication Terminals Installation Manual - Physical Planning

© IBM Corp. 1968, 1972, 1973, 1976, 1977

This Technical Newsletter provides replacement pages for the subject publication. Pages to be inserted and/or removed are:

3705.1, 3705.2	3770.1, 3770.2
3705.5, 3705.6	3770.3, 3770.4
3705.7, 3706.8	

A change to the text or to an illustration is indicated by a vertical line to the left of the change.

Summary of Changes

This Technical Newsletter adds information about the CCITT X.21 Interface Feature.

Note: Please file this cover letter at the back of the manual to provide a record of the changes.

Contents

Introduction	1	IBM 3287 Printer Model 1, 2, 11, and 12	3287.1
Site Preparation and Location of Terminals	3	IBM 3289 Line Printer Model 3	3289.1
Temperature and Humidity	3	IBM 3704 Communications Controller (With Remote	
Atmospheric	3	Program Loader)	3704.1
Electrical Requirements	3	Models and Configurations	3704.1
Grounding	3	3704 Communications Controller (With Remote	
Convenience Outlets	3	Program Loader) - Specifications	3704.2
Floor Planning	3	Cable Information	3704.3
Communication Facilities	5	IBM 3705 Communications Controller (With Remote	
Modulation/Demodulation Devices	5	Program Loader)	3705.1
Definitions	5	Models and Configurations	3705.1
Installation	5	3705 Communications Controller (With Remote	
IBM Line Adapters	5	Program Loader) - Specifications	3705.2
IBM Modems	5	Cable Information	3705.4
Data Sets	5	IBM 3735 Programmable Buffered Terminal, Including	
Connectors	5	IBM 5496 Data Recorder and IBM 3286 Printer Model 3—	
Product and Environmental Safety	7	Specifications	3735.1
Standard Symbols and Shipping Dimensions	9	3735 Programmable Buffered Terminal—Specifications	3735.2
IBM 1001 Data Transmission Terminal	1001.1	5496 Data Recorder (Attached to 3735)—Specifications	3735.3
Specifications	1001.1	3286 Printer Model 3 (Attached to 3735)—	
IBM 1013 Card Transmission Terminal	1013.1	Specifications	3735.4
1013 Card Transmission Terminal—Specifications	1013.2	IBM 3767 Communication Terminal	
IBM 1092 and 1093 Programmed Keyboards	1092.1	Specifications	3767.1
1092 and 1093 Programmed Keyboards—		Signal Cables and Connections	3767.2
Specifications and Configurations	1092.2	IBM 3770 Data Communication System	3770.1
IBM 2712 Remote Multiplexer	2712.1	Configurations	3770.1
Models and Configurations	2712.1	Communication Facilities	3770.1
Line Assignments	2712.1	Communication Cables for 3771, 3773, 3774, 3775,	
Communication Cables	2712.1	3776, and 3777	3770.1
2712 Remote Multiplexer, Models 1 and 2—		3770 System Environment	3770.2
Specifications	2712.2	IBM 2502 Card Reader-Specifications	3770.4
IBM 2740 Communications Terminal	2740.1	IBM 3203 Printer Model 3-Specifications	3770.5
Communications Facilities	2740.1	IBM 3411 Magnetic Tape Unit and Control	3770.6
Signal—Cable Chart	2740.1	IBM 3501 Card Reader-Specifications	3770.7
2740 Communications Terminal Model 1—Specifications	2740.2	IBM 3521 Card Punch-Specifications	3770.8
2740 Communications Terminal Model 2—Specifications	2740.3	IBM 3771 Communication Terminal-Models 1, 2, and	
IBM 2741 Communications Terminal	2741.1	3-Specifications	3770.9
Communication Facilities	2741.1	IBM 3773 Communication Terminal-Models 1, 2, 3	
Signal—Cable Chart	2741.1	and P1, P2, and P3-Specifications	3770.10
2741 Communications Terminal—Specifications	2741.2	IBM 3774 Communication Terminal-Models 1, 2, P1	
IBM 2760 Optical Image Unit	2760.1	and P2-Specifications	3770.11
2760 Optical Image (Attaches to 2740 Model 1 Only)—		IBM 3775 Models 1 or P1-Specifications	3770.12
Specifications	2760.2	IBM 3776 Communication Terminal Models 1 and 2-	
IBM 2780 Data Transmission Terminal	2780.1	Specifications	3770.13
Models and Configurations	2780.1	IBM 3777 Communication Terminal-Specifications	3770.14
Communications Facilities	2780.1	IBM 3782 Card Attachment Unit Model 1, with 3521	
Data Set Cables	2780.1	Card Punch-Specifications	3770.15
2780 Data Transmission Terminal Model 1—		IBM 3782 Card Attachment Unit Model 2, with 2502	
Specifications	2780.2	Card Reader-Specifications	3770.16
2780 Data Transmission Terminal Model 2—		IBM 3784 Line Printer-Specifications	3770.17
Specifications	2780.3	IBM 3780 Data Communication Terminal	3780.1
2780 Data Transmission Terminal Model 3—		Specifications	3780.1
Specifications	2780.4	IBM 3781 Card Punch – Specifications	3780.4
2780 Data Transmission Terminal Model 4—		IBM 5275 Direct Numerical Control Station	5275.1
Specifications	2780.5	Appendix A. Power Cord—Plug Types	A.1
IBM 2845 Display Control, Including IBM 2265 Display		Appendix B. Power Cord Types	B.1
Station and Keyboard, and IBM 1053 Printer Model 4	2845.1	Appendix C. IBM Line Adapter Cable Terminations	C.1
Cable Information	2845.1	Appendix D. Telegraph Line Terminations	D.1
2845 Display Control (For Use With IBM 2265 and		Appendix E. IBM Switched Network Line Adapter Cable	
1053 Model 4)—Specifications	2845.2	Terminations	E.1
2265 Display Station and Keyboard			
(Attached to 2845)	2845.3		
2265 Display Station and Keyboard			
(Attached to 2845)—Specifications	2845.4		
1053 Printer Model 4 (Attached to 2845)—Specifications	2845.5		

Illustrations

<i>Figure</i>	<i>Title</i>	<i>Page</i>	<i>Figure</i>	<i>Title</i>	<i>Page</i>
1001-1	IBM 1001 Data Transmission Terminal . . .	1001.1	3767	IBM 3767 Communication Terminal . . .	3767.1
1013-1	IBM 1013 Card Transmission System . . .	1013.1	3770-1	IBM 2502 Card Reader Models A1, A2 and A3	3770.4
1092-1	IBM 1092 Programmed Keyboard . . .	1092.1	3770-2	IBM 3203 Printer Model 3.	3770.5
1092-2	IBM 1093 Programmed Keyboard . . .	1092.1	3770-3	IBM 3411 Magnetic Tape Unit and control Model 1	3770.6
2712-1	IBM 2712 Model 1 Configuration . . .	2712.1	3770-4	IBM 3501 Card Reader	3770.7
2712-2	IBM 2712 Model 2 Configuration . . .	2712.1	3770-5	IBM 3521 Card Punch	3770.8
2712-3	IBM 2712 Remote Multiplexer	2712.2	3770-6	IBM 3771 Communication Terminal (with Variable with Forms Tractor) . . .	3770.9
2740-1	IBM 2740 Model 1	2740.1	3770-7	IBM 3773 Communication Terminal (with Variable width Forms Tractor) . .	3770.10
2740-2	IBM 2740 Model 2 with Document Insertion Feature	2740.1	3770-8	IBM 3774 Communication Terminal (with Variable width Forms Tractor) . .	3770.11
2741-1	IBM 2741 Communications Terminal . . .	2741.1	3770-9	IBM 3775/3776 Communication Terminal . .	3770.12
2760-1	IBM 2760 Optical Image Unit	2760.1	3770-10	IBM 3776 Communication Terminal . . .	3770.13
2780-1	IBM 2780 Data Transmission Terminal (Applies to Models 1 and 2)	2780.1	3770-11	IBM 3777 Communication Terminal (with 2502 Card Reader)	3770.14
2845-1	IBM 2845 Display Control	2845.2	3770-12	IBM 3782 Card attachment Unit Model 1 with 3521 Card Punch	3770.15
2845-2	IBM 2265 Display Station and Keyboard . .	2845.3	3770-13	IBM 3782 Card attachment Unit Model 2 with 2502 Card Reader	3770.16
2845-3	IBM 1053 Printer Model 4	2845.5	3770-14	IBM 3784 Line Printer	3770.17
3287	IBM 3287 Printer Models 1, 2, 11 and 12 . .	3287.1	3780-1	IBM 3780 Data Communication Terminal . .	3780.1
3289	IBM 3289 Line Printer Model 3	3289.1	3780-2	IBM 3781 Card Punch	3780.4
3704-1	IBM 3704 Communications Controller (With Remote Program Loader)	3704.1	C-1	Two-Wire Termination Jack	C.1
3705-1	IBM 3705 Communications Controller (With Remote Program Loader)	3705.1	C-2	Four-Wire Termination Jack	C.1
3735-1	Selectric I/O II	3735.1	C-3	Connector Attached to Cable from IBM Line Adapter Special Feature	C.1
3735-2	Control Unit	3735.1	E-1	Switched Network Line Adapter Cable	E.1
3735-3	IBM 5496 Data Recorder	3735.3	E-2	Cable Connections to the Data Access Arrangement (DAA)	E.1
3735-4	IBM 3286 Printer Model 3	3735.4			

This manual contains physical planning information for various IBM communications terminals and multiplexers. Following the text portion of the manual, specifications peculiar to each terminal and multiplexer are listed. The page number of each specification page indicates the type of information contained on the page (e. g., 2741.2 is the second page of specifications pertaining to the IBM 2741. Appendixes contain common information concerning cables, power cord plugs, and receptacles.

This manual will serve as a guide in preparing facilities for installation of IBM remote multiplexers or communications terminals. Consult IBM sales representatives and physical-planning representatives for assistance. For planning information of a more general nature, order the Com-

munication Services Systems Reference Library publication, *Planning and Installation of a Data Communications System Using IBM Line Adapters*, GA24-3435, through the local IBM sales office. Careful planning will ensure that physical and environmental requirements are satisfied. Adherence to the specifications and recommendations eliminates costly rework of the facilities when receiving the equipment, and enhances equipment performance and availability after it is operating.

When planning for the installation of IBM equipment, consider site preparation (including location of terminals) and selection of the communications facilities. These topics are expanded in the following sections.

TEMPERATURE AND HUMIDITY

Specific temperature and humidity requirements are given on the specification pages. In general, IBM communication products will work under conditions typical of most commercial environments.

ATMOSPHERIC

IBM products are designed to operate in normal commercial environments. However, in unusual cases, the effects of contamination in the air may make it necessary for the customer to provide suitable enclosures for protection from oil, grease, dirt, and corrosive gases. In some cases, filtered air may be necessary to eliminate potentially contaminating particles and gases. If in doubt, consult your IBM installation planning representative.

ELECTRICAL REQUIREMENTS

Power to IBM machines is usually provided through a separate power cord connected to each machine. Power should not be supplied from the same electrical circuit that supplies power to machines producing electrical noise. For certain small machines, power is provided from another IBM machine. See the specification page for detailed requirements for each machine. Where more than one voltage and/or more than one type of attachment cord plug (60 Hz) is indicated as being available, the required voltage and type of plug must be specified at the time the unit is ordered. See Appendix A for description of various cord plug types. Cord plugs are not supplied with 50 Hz machines; this permits customers to use locally approved plugs and receptacles.

Unless otherwise noted on individual specification pages, voltage tolerance is $\pm 10\%$, and frequency tolerance is ± 0.5 Hz of the values listed.

Grounding

A green-wire grounding conductor is supplied in each power cord. Each customer-supplied branch circuit should have an insulated wire conductor for the purpose of grounding equipment. This equipment grounding wire is a dedicated ground, not a neutral. All branch-circuit grounding wires should be tied to a common ground point at the distribution panel, and a single insulated grounding wire run from the distribution panel to the nearest suitable grounding station. Conduit must not be used as the only grounding means. See 3767 pages for unique considerations. Unless otherwise required by local codes, the grounded neutral conductor must be electrically isolated from the system grounding conductor except at the building grounding

station. IBM installation planning representatives should be consulted for further details. See Appendix B for description of various code types.

Convenience Outlets

A suitable number of grounded convenience outlets should be installed in a computer room and Customer Engineer room for use by building maintenance personnel, porter service, customer engineers, etc. A convenience outlet should be near each remote machine location for use during servicing.

FLOOR PLANNING

Efficient operation and servicing of equipment depends primarily on convenient access to the equipment by both operator and service personnel. A properly-oriented workflow pattern should be a major objective of the machine area layout. Equipment should be arranged to allow adequate space for servicing.

IBM provides templates of the units of its equipment, drawn to a scale of 1/4 inch = 1 foot (1:48; W.T., 1:50). Each template may be cut out and moved about to a number of different possible locations on a scale drawing of the proposed area. If the scale drawing is on reproducible type paper, the templates may be lightly fastened to the paper with transparent tape, and copies of the proposed floor plans can be made in many standard reproducing machines. The *Communications Terminals* template is order number X27-2900.

CUSTOMER SET-UP DESIGNATED UNITS

The 3287 and 3767 are designated customer Set-Up (CSU) units, thereby offering the customer early availability and relocation flexibility. For additional information on CSU the customer should contact his IBM Marketing Representative and obtain the 3287 Printer-Site Planning Guide, GA18-2018 or the IBM 3767 Communication Terminal Site Planning Guide, GA27-3104.

MODULATION/DEMODULATION DEVICES

Data modulation/demodulation devices are used to convert data bits to signals suitable for transmission over common-carrier or private-wire facilities. The devices (integrated modems, line adapters, modems, and data sets) are used by IBM teleprocessing equipment. The integrated modems and line adapters are supplied by IBM. The modems and data sets may be supplied by IBM, the common carrier, or the customer.

Definitions

For the purposes of this manual, the following definitions will apply.

Data set — a stand-alone, modulation/demodulation device; supplied by the common carrier or the customer. (Sometimes referred to as data modems by suppliers.)

Integrated modem or IBM Line Adapter — a modulation/demodulation device incorporated as a feature within the IBM teleprocessing equipment. In general older devices are referred to as “Line Adapters”, and the newer devices are referred to as “Integrated modems”.

Modem — a stand-alone, modulation/demodulation device supplied by IBM.

Installation

The customer must arrange for installation of non-IBM supplied communications equipment and services. IBM teleprocessing representatives will assist in defining requirements. Communications facilities must be ordered sufficiently in advance to ensure their availability when the IBM equipment is installed.

The selection of the type of communication lines to be used depends on the specifications of the terminal; type of application; specifications of line adapters, modems, and data sets; and volume of interchanged data. The types of communications lines that can be used by a particular terminal are described in the publication referenced under Communications Facilities heading on the specification page for that terminal.

IBM LINE ADAPTERS and INTEGRATED MODEMS

IBM line adapters and IBM integrated modems perform the modulation/demodulation function on a communications facility at speeds up to 2400 bits per second. When IBM line adapters or IBM integrated modems are used, common-carrier or customer supplied data sets are not required. Detailed information regarding IBM line adapters and IBM integrated modems can be found in the System Reference Library publication, *Planning and Installation*

of a Data Communications System Using IBM Line Adapters, order number GA24-3435. IBM line adapters or IBM integrated modems cannot be intermixed with other modulation/demodulation devices on the same communications lines, with the exception of the 2400 bps Integrated Modem which may be intermixed with the IBM 3872 modem.

Since the 2400 bps Integrated Modem feature is an IBM 3872 Modem which has been incorporated into the terminal, the *IBM 3872 Modem User's Guide*, order GA27-3058, will provide useful information.

IBM MODEMS

The following modems are available from IBM:

<i>IBM Type Number</i>	<i>Maximum Speed in bits per second</i>	<i>Domestic Use</i>	<i>World Trade Use</i>
3872	2400	yes	yes
3874	4800	yes	yes
3875	7200	yes	yes
3976	1200	no	yes
3977	1200	no	yes
3978	4800	no	yes

DATA SETS

Common-carrier or customer-provided data sets are used to perform the modulation/demodulation function on a common-carrier switched telecommunications network or a voice-grade, private-line data channel when IBM Integrated Modems, IBM line adapters, or IBM modems are not used. IBM telegraph adapters are used to interface directly to common-carrier telegraph lines, thereby eliminating the need for modems.

CONNECTORS

Appendixes C and E describe the connectors used between IBM Integrated Modems or IBM line adapters and the customer's or common carrier's lines. Appendix D describes the interface connections between IBM terminals and telegraph circuits.

When common-carrier or customer-supplied data sets are used, IBM supplies a cable terminated with a 25-pin data set connector that mates with the receptacle normally furnished with common-carrier or customer-supplied data sets.

Safety is a major consideration in the design of all IBM products. Whenever possible, mechanical and electrical hazards are either eliminated or carefully shielded. Extensive testing of new products further ensures that products are safe before they are shipped; all IBM machines conform to national safety codes and are listed by Underwriters' Laboratories.

Another aspect of safety—environmental safety—is the customer's responsibility. He should:

1. Abide by national and local electrical codes. Terminals described in this manual are not designed for installation in hazardous locations as described in NEC (National Electrical Code) 70, Article 500.
2. Provide the recommended service clearances, for both operating and service personnel.
3. Provide adequate portable fire suppression equipment near the units for protection from fire.
4. Provide manually-operated power-off switches for electrical circuits serving units of the equipment.
5. Train personnel in accident prevention and in appropriate measures to be followed in case of accident.

STANDARD SYMBOLS

In Plan Views



Cable Entry and Exit



Power Cord Exit (See Note)

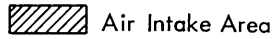

Air Intake Area



Gate Swings



Optional Equipment

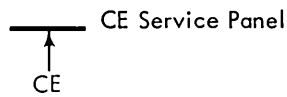

CE Service Panel

In Cabling Schematics

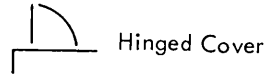
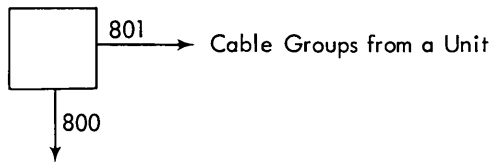

Hinged Cover

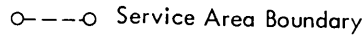

Service Area Boundary

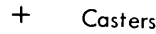

Casters

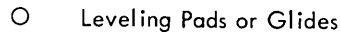

Leveling Pads or Glides



Legs



Non-Raised Floor Cable Exit

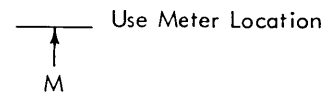

Use Meter Location

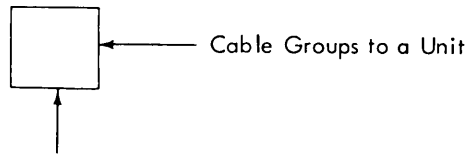

Note: Power cords are supplied in 14-foot (4,27m) lengths, unless otherwise noted on the specifications page. The length is measured from the symbol ⊕.

Shipping Dimensions

Unless otherwise noted on individual specification pages, the following statement applies: All systems components can be reduced to 29-1/2 inches by 60 inches (75 cm by 152 cm) or smaller sections for shipment.

Scale

Unless otherwise noted, plan views are to the scale of 1/4" = 1'.

IBM 1001 Data Transmission Terminal

SPECIFICATIONS

PLAN VIEW (Scale: 1/2" = 1')

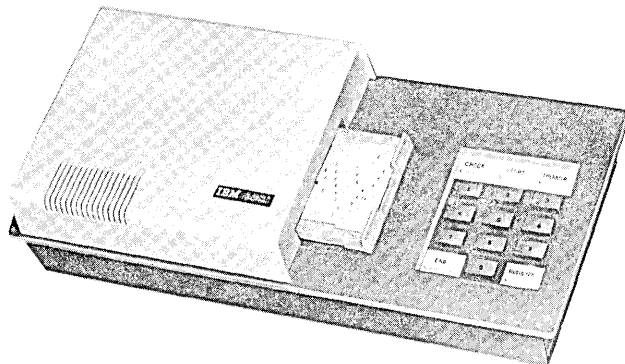
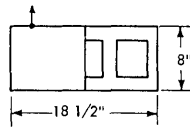

Figure 1001-1. IBM 1001 Data Transmission Terminal

Dimensions:

	Front	Side	Height
Installed inches	18-1/2	8	5
Centimeters	47,0	20,3	12,7

Service Clearances

	Front	Rear	Right	Left
Inches	0	0	0	0
Centimeters	0	0	0	0

Weight

21 lbs.	9,5 kg
---------	--------

Heat Output

—BTU/h	—kcal/h
--------	---------

Air Flow

—CFM	—m ³ /min
------	----------------------

Power Requirements

Power supplied from telephone circuit

Environment, Operating

Temp.	50 to 90°F	10 to 32.2°C
Rel. Humidity	8 to 80%	8 to 80%
Max. Wet Bulb	85°F	29.4°C

Environment, Non-operating

Temp.	30 to 110°F	-1.1 to 43°C
Rel. Humidity	8 to 90%	—
Max. Wet Bulb	85°F	29.4°C

Communication Facilities — See Product Reference Literature manual — IBM 1001 Data Transmission System, GA24-1029.

IBM 1013 Card Transmission Terminal

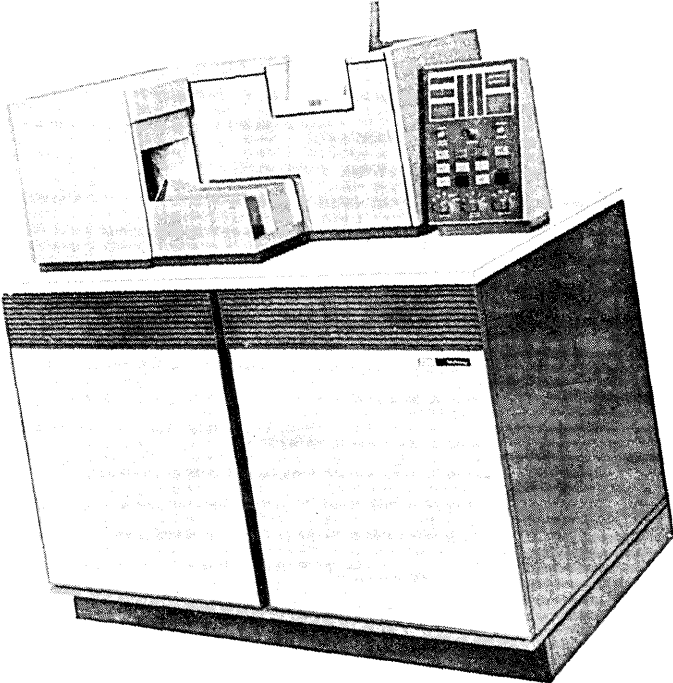
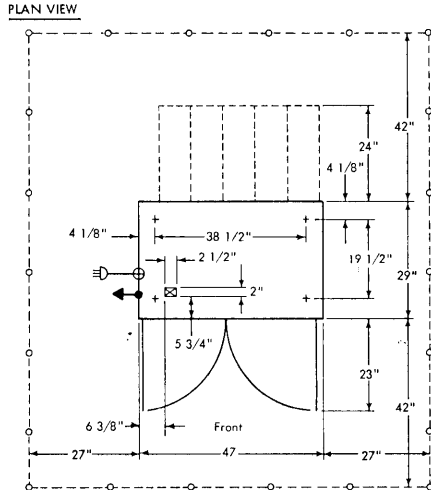

Figure 1013-1. IBM 1013 Card Transmission System

1013 CARD TRANSMISSION TERMINAL – SPECIFICATIONS



Inches	Centimeters
2	5,1
2-1/2	6,4
4-1/8	10,5
5-3/4	14,6
6-3/8	16,2
19-1/2	49,5
23	58,4
24	61,0
27	68,6
29	73,7
38-1/2	96,8
42	106,7
47	119,4

Dimensions

	Front	Side	Height
Installed inches	47	29	54
Centimeters	119,4	73,7	137,2

Service Clearances

	Front	Rear	Right	Left
Inches	42	42	27	27
Centimeters	106,7	106,7	68,6	68,6

Weight

800 lbs. 362,9 kg

Heat Output

2525 BTU/h 636,3 kcal/h

Air Flow

— CFM — m³/min

Power Requirements

	60 Hz.	50 Hz.
Volts	115	112.5/123.5
kVA	1.0	1.1
Phase	1	1
Branch Circuit (A)	15	
Max. Cont. Load (A)	8.5	8.5
Plug Type (Note 1)	H,J	None
Power Cord Style (Note 2)	—	A6
Power Cord Length	7-1/2 ft. (2.29 m)	

Environment, Operating

Temp.	50 to 90°F	10 to 32.2°C
Rel. Humidity	20 to 80%	
Max. Wet Bulb	78°F	26°C

Environment, Non-operating

Temp.	50 to 110°F	10 to 43°C
Rel. Humidity	8 to 80%	
Max. Wet Bulb	80°F	27°C

Communication Facilities – See SRL, *IBM 1013 Card Transmission Terminal*, GA21-1068.

Cable Information

Connecting Units: 1013 to Dataset
Available Length: 20 ft. (609,6 cm)

The cable is supplied with this unit. The cable is terminated with a 25-pin data set connector as described in EIA RS-232-C.

Notes:

1. Description of plug type with matching receptacles and connectors – see Appendix A.
2. Description of World Trade power cord styles – see Appendix B.
3. Chip box is accessible from the rear of the machine.

1092 AND 1093 Programmed Keyboards

PLAN VIEW (Scale: 1/2" = 1')

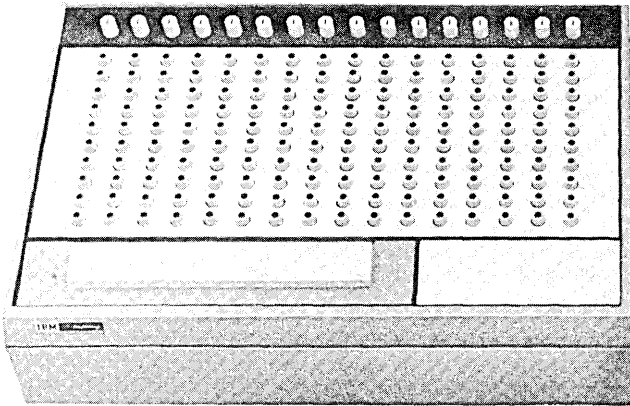
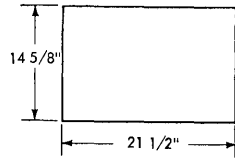

Figure 1092-1. IBM 1092 Programmed Keyboard

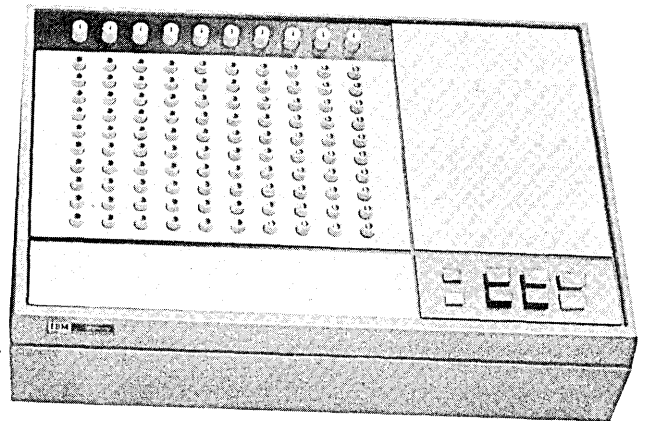
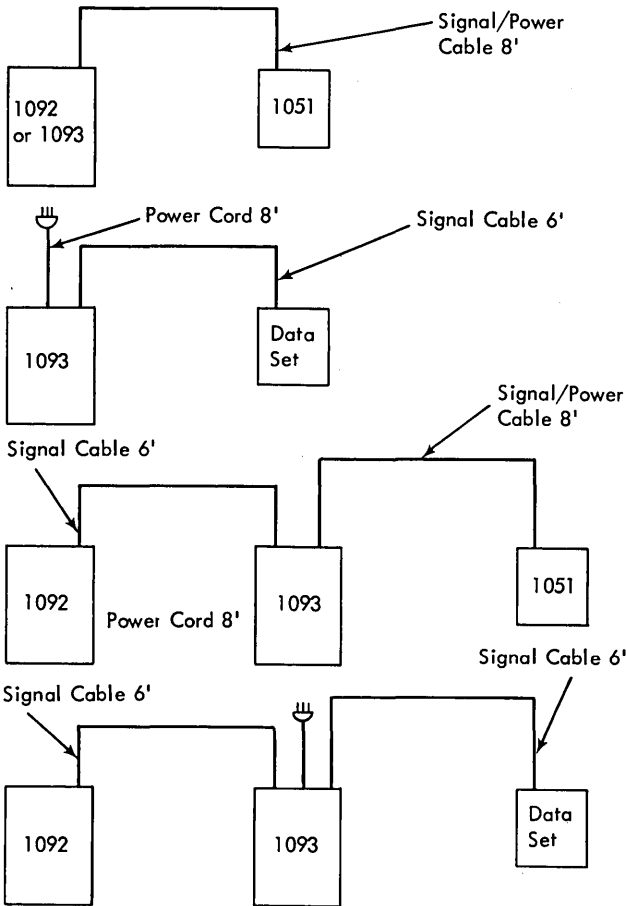

Figure 1092-2. IBM 1093 Programmed Keyboard

1092 AND 1093 PROGRAMMED KEYBOARDS – SPECIFICATIONS AND CONFIGURATIONS

TYPICAL CONFIGURATIONS



Feet	Meters
6	1.83
8	2.44

Dimensions

	Front	Side	Height
Installed inches	21-1/2	14-5/8	8-1/8
Centimeters	54,6	37,1	20,6

Service Clearances

	Front	Rear	Right	Left
Inches	Operator Clearance Only	—	—	—
Centimeters	—	—	—	—

Weight (max.)

38 lbs.	17,2 kg.
---------	----------

Heat Output

— BTU/h	— kcal/h
---------	----------

Air Flow

— CFM	— m ³ /min
-------	-----------------------

Power Requirements

	60 Hz.	50 Hz.
Volts	115	112.5/123.5 195/220/235
kVA	0.1	0.1
Phase	1	1
Branch Circuit (A)	15	
Max. Cont. Load (A)	0.9	0.9
Plug Type		
(Notes 1 and 4)	H	—
Power Cord Style	—	—
Power Cord Length		
(Note 4)	8 ft.	(2.44m)

Environment, Operating

Temp.	30 to 110°F	-1.1 to 43°C
Rel. Humidity	10 to 90%	
Max. Wet Bulb	85°F	29.4°C

Environment, Non-operating

Temp.	30 to 110°F	-1.1 to 43°C
Rel. Humidity	10 to 90%	
Max. Wet Bulb	85°F	29.4°C

Communication Facilities – See SRL, *IBM 1092 and 1093 Programmed Keyboards*, GA24-3266.

Notes:

1. Description of plug type with matching receptacles and connectors – see Appendix A.
2. Electrical requirements, except for kVA, apply only to 1093 attached to a data set. Otherwise power is provided to 1092 from 1093 or 1051, and to 1093 from 1051.
3. The effects of airborne contamination are minimized. However, in unusual cases, it may be necessary to provide additional protection.
4. 1093 only.

IBM 2712 Remote Multiplexer

MODELS AND CONFIGURATIONS

The IBM 2712 bit-multiplexes data received from remote terminals over low-speed lines and retransmits over a single high-speed line to the IBM 2702 or 2703. The 2712 Model 1 can serve a maximum of ten point-to-point or multipoint low-speed lines. Model 2 can serve a maximum of 14 telegraph lines. See Figures 2712-1 and 2712-2.

To facilitate servicing, the 2712 must be installed within sight at one of the terminals. This local terminal requires the same type of service as the other terminals on the line if it is part of a multi-drop line. If the local terminal is a 1050 and is the only one on the line, it can be connected to the 2712 Model 1 by using IBM Adapter 4630.

High-speed communication between the 2712 and the 2702 or 2703 requires four-wire full-duplex leased private-line service.

LINE ASSIGNMENTS

The assignment of line-adapter features must be shown on the Cable Order and Line Assignment Form (120-1292).

COMMUNICATION CABLES

The required length of the IBM-supplied cables from the 2712 to their termination with the communication facilities must be indicated on the Cable Order and Line Assignment Form (120-1292).

All communication cables enter the raised-floor cutout or cable channel and have a maximum length of 40 feet. (12.2m).

- Cables to data sets terminate in a 25-pin connector as described in EIA RS-232-C.
- Cables from Limited-Distance Line Adapters terminate at a four-prong pin connector P/N 341200 (Western Electric 283B plug or equivalent) supplied by IBM. See Appendix C. The customer or common carrier is responsible to provide and attach the matching socket connector (Western Electric 404B surface-mount receptacle, or 493A flush-mount receptacle, or equivalent) to the line.
- Cable to local adapter (1050 only within sight of 2712 Model 1) has IBM connector.
- Cables to telegraph terminals termination is described in Appendix D. Each telegraph cable services two telegraph lines: Line 1 – Black wire is plus (+) or “Ring”; black and orange wire is minus (-) or “Tip.” Line 2 – Black and yellow wire is plus (+) or “Ring”; black and red wire is minus (-) or “Tip.”

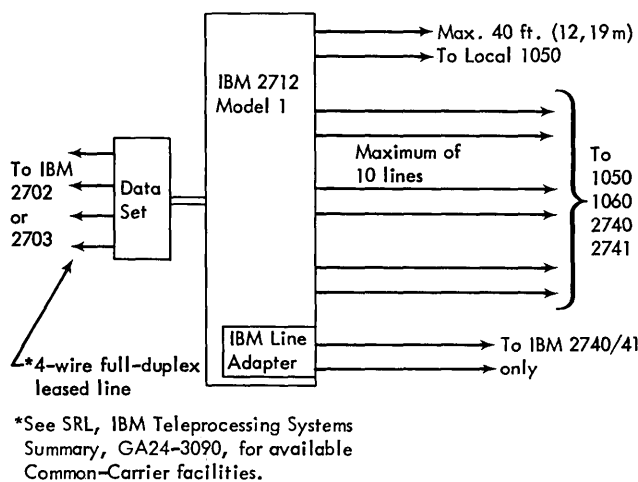

Figure 2712-1. IBM 2712 Model 1 Configuration

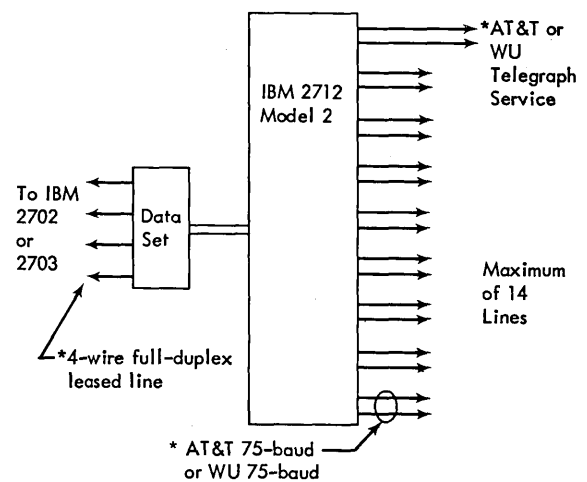
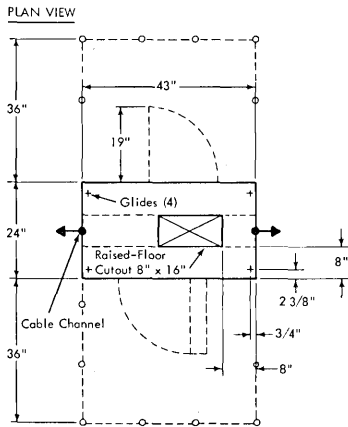

Figure 2712-2. IBM 2712 Model 2 Configuration

2712 REMOTE MULTIPLEXER, MODELS 1 AND 2 – SPECIFICATIONS



Inches	Centimeters
3/4	1,9
2-3/8	6,0
8	20,3
16	40,6
19	48,3
24	61,0
36	91,4
43	109,2

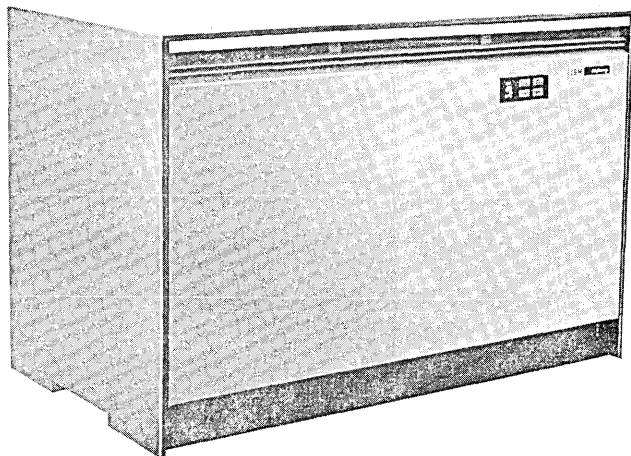

Figure 2712-3. IBM 2712 Remote Multiplexer

Dimensions

	Front	Side	Height
Installed inches	43	24	29
Centimeters	109,2	61,0	73,7

Service Clearances

	Front	Rear	Right	Left
Inches	36	36	0	0
Centimeters	91,4	91,4	0	0

Weight

400 lbs.	181,4 kg.
----------	-----------

Heat Output

Model 1:	1200 BTU/h	302,4 kcal/h
Model 2:	1350 BTU/h	340,2 kcal/h

Air Flow

50 CFM	1,4 m ³ /min
--------	-------------------------

Power Requirements

	60 Hz.	50 Hz.
Volts	115	
kVA	Model 1: 0.38 Model 2: 0.43	
Phase	1	Not Available
Branch Circuit (A)	15	
Max. Cont. Load (A)	3.3 3.7	
Plug Type (Note 1)	H,J	
Power Cord Style	—	
Power Cord Length	14 ft.	(4.27m)

Environment, Operating

Temp.	50 to 110°F	10 to 43°C
Rel. Humidity	10 to 80%	
Max. Wet Bulb	85°F	29.4°C

Environment, Non-operating

Temp.	50 to 110°F	10 to 43°C
Rel. Humidity	10 to 80%	
Max. Wet Bulb	85°F	29.4°C

Communication Facilities – See SRL, *IBM Teleprocessing Systems Summary*, GA24-3090.

Notes:

1. Description of plug type with matching receptacles and connectors – see Appendix A.

IBM 2740 Communications Terminal

COMMUNICATIONS FACILITIES

See SRL, *IBM Teleprocessing Systems Summary*, GA24-3090, for available common-carrier facilities.

SIGNAL-CABLE CHART

Signal Cable	Length	Diameter	Connector Supplied by IBM	Matching Connector Supplied by Customer
From 2740 to Data Set	8 ft. (2.44m)	3/8 in. (0,95 cm)	EIA RS-232-C or equivalent	Supplied with Data Set by Common Carrier.
From IBM Line Adapter (Special Feature) to Communications Line	8 ft. (2.44m)	3/8 in. (0,95 cm)	Western Electric 283B plug or equivalent	Western Electric 404B (or equivalent) for Surface Mounting, or Western Electric 493A (or equivalent) for Flush Mounting. See Appendix C for connections.
From Telegraph Line Adapter (IBM Special Feature) to Communications Line	8 ft. (2.44m)	5/16 in. (0,79 cm)	See Appendix D	Attaches to Common-Carrier Terminal Board.

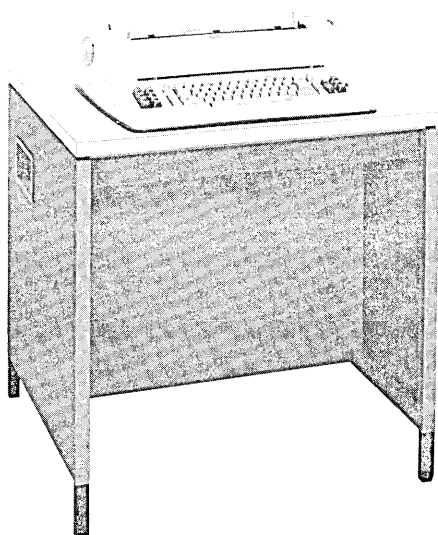

Figure 2740-1. IBM 2740 Model 1

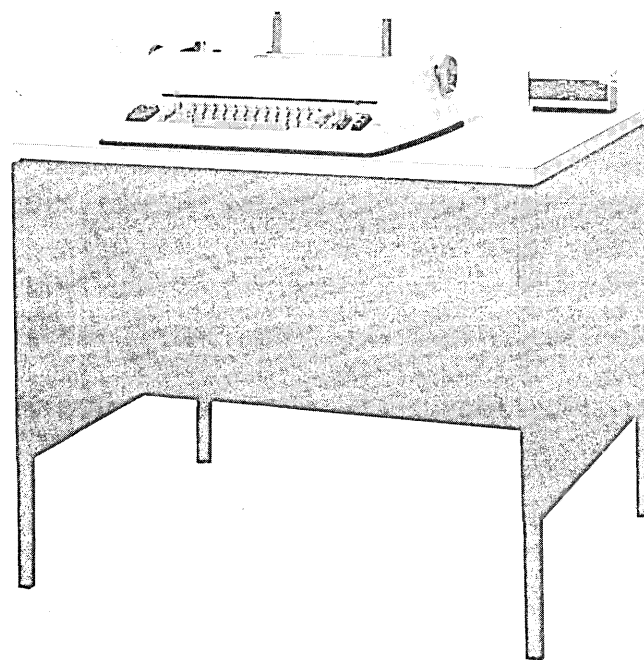
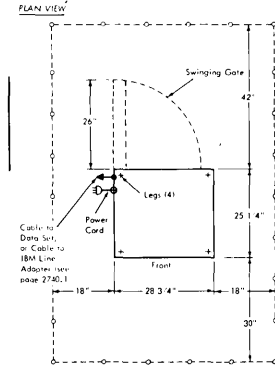

Figure 2740-2. IBM 2740 Model 2 with Document Insertion Feature

2740 COMMUNICATIONS TERMINAL MODEL 1 – SPECIFICATIONS



Inches	Centimeters
18	45,7
25-1/4	64,1
26	66
28-3/4	73
28-7/8	73,3
30	76,2
36-1/2	92,7
42	106,7

Feet	Centimeters
6	182,9
8	243,8

Dimensions

	Front	Side	Height
Installed inches	28-3/4	25-1/4	(Note 3)
Centimeters	72,7	63,8	—

Service Clearances

	Front	Rear	Right	Left
Inches	30	42	18	18
Centimeters	76,2	106,7	45,7	45,7

Weight

196 lbs.	88,9 kg
----------	---------

Heat Output

400 BTU/h	100,8 kcal/h
-----------	--------------

Air Flow

— CFM	— m ³ /min
-------	-----------------------

Power Requirements

	60 Hz.		50 Hz.	
Volts	115	208/230	112.5/123.5	195/220/235
kVA	0.2	0.3	0.3	0.2
Phase	1		1	
Branch Circuit (A)	15			
Max. Cont. Load (A)	1.6	1.3	2.4	1.1
Plug Type (Note 1)	H,J	K,L	—	

Power Cord

Style (Note 2) —	G3
------------------	----

Power

Cord Length	6 ft. (1.83m)
-------------	---------------

Environment, Operating

Temp.	50 to 110 ⁰ F	10 to 43 ⁰ C
Rel. Humidity	10 to 80%	
Max. Wet Bulb	85 ⁰ F	29.4 ⁰ C

Environment, Non-operating

Temp.	50 to 110 ⁰ F	10 to 43 ⁰ C
Rel. Humidity	10 to 80%	
Max. Wet Bulb	85 ⁰ F	29.4 ⁰ C

Communication Facilities – See SRL, *IBM Teleprocessing Systems Summary*, GA24-3090.

Notes:

1. a. Description of plug type with matching receptacles and connectors – see Appendix A.
 b. When the terminal's power supply is 208/230 volts and the terminal is to be used on a raised floor installation, plug type J should be used.
2. Description of World Trade power cord styles – see Appendix B.
3. Overall height is 36-1/2 inches (92,7 cm).
 Desk top is 28-7/8 inches (73,3 cm).

2740 COMMUNICATIONS TERMINAL MODEL 2 – SPECIFICATIONS

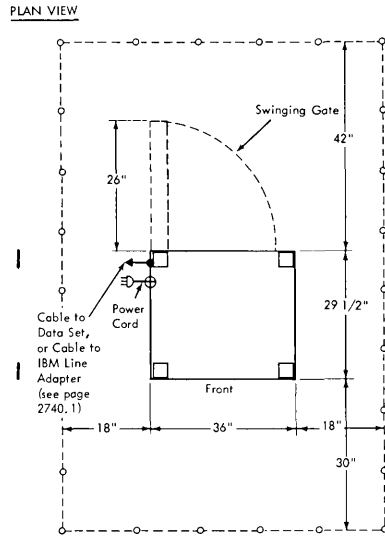

Inches	Centimeters
18	45,7
26	66
28 7/8	73,3
29 1/2	74,9
30	76,2
36	91,4
36 1/2	92,7
42	106,7

Feet	Centimeters
6	182,9
8	243,8

Dimensions

	Front	Side	Height
Installed inches	36	29-1/2	(Note 3)
Centimeters	91,4	74,9	—

Service Clearances

	Front	Rear	Right	Left
Inches	30	42	18	18
Centimeters	76,2	106,7	45,7	45,7

Weight

235 lbs.	106,6 kg
----------	----------

Heat Output

400 BTU/h	100,8 kcal/h
-----------	--------------

Air Flow

— CFM	— m ³ /min
-------	-----------------------

Power Requirements

	60 Hz.		50 Hz.	
Volts	115	208/230	112.5/123.5	195/220/235
kVA	0.2	0.3	0.3	0.2
Phase	1		1	
Branch Circuit (A)	15			
Max. Cont. Load (A)	1.6	1.3	2.4	1.4
Plug Type (Note 1)	H,J	K,L	—	
Power Cord Style (Note 2)	—		G3	
Power Cord Length	6 ft.		(1.83m)	

Environment, Operating

Temp.	50 to 110 ^o F	10 to 43 ^o C
Rel. Humidity	10 to 80%	
Max. Wet Bulb	85 ^o F	29.4 ^o C

Environment, Non-operating

Temp.	50 to 110 ^o F	10 to 43 ^o C
Rel. Humidity	10 to 80%	
Max. Wet Bulb	85 ^o F	29.4 ^o C

Communication Facilities — See SRL, *IBM Teleprocessing Systems Summary*, GA24-3090.

Notes:

- a. Description of plug type with matching receptacles and connectors — see Appendix A.
b. When terminal supply voltage is 208 or 230 and terminal is to be on a raised floor-plug type A must be used.
- Description of World Trade power cord styles — see Appendix B.
- Overall height is 36-1/2 inches (92,7 cm).
Desk top is 28-7/8 inches (73,3 cm).

IBM 2741 Communications Terminal

COMMUNICATION FACILITIES

See SRL, *IBM Teleprocessing Systems Summary*, GA24-3090.

SIGNAL-CABLE CHART

Signal Cable	Length	Diameter	Connector Supplied by IBM	Matching Connector Supplied by Customer
From 2741 to Data Set	8 ft. (2.44m)	3/8 in. (0,95 cm)	EIA RS-232-C or equivalent	Supplied with Data Set by Common Carrier.
From IBM Line Adapter (Special Feature) to Communications Line	8 ft. (2.44m)	3/8 in. (0,95 cm)	Western Electric 283B plug or equivalent	Western Electric 404B (or equivalent) for Surface Mounting or Western Electric 493A (or equivalent) for Flush Mounting.

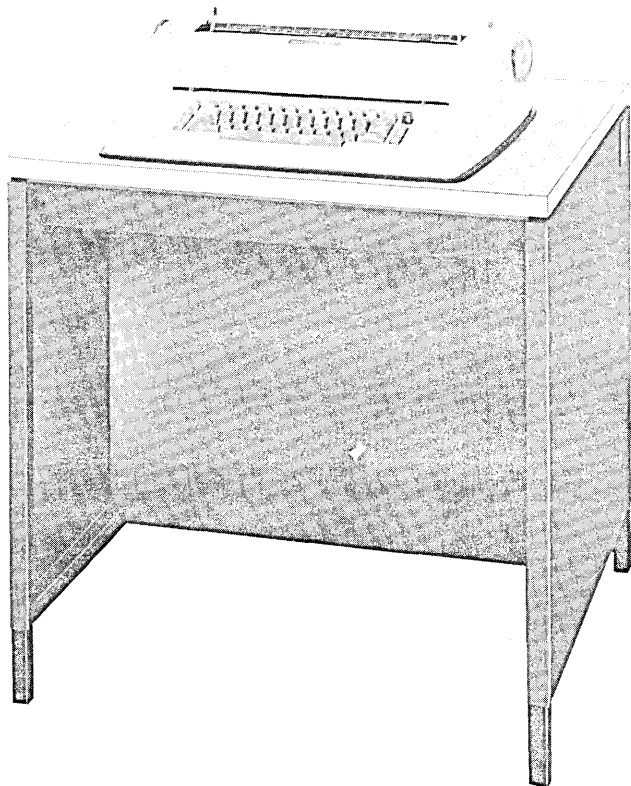
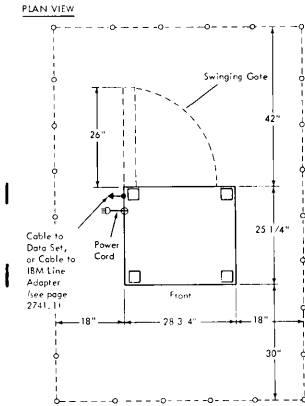

Figure 2741-1. IBM 2741 Communications Terminal

2741 COMMUNICATIONS TERMINAL – SPECIFICATIONS



Inches	Centimeters
18	45,7
25-1/4	64,1
26	66,0
28-3/4	73,0
28-7/8	73,3
30	76,2
42	106,7

Feet	Meters
6	1.83
8	2.44

Dimensions

	Front	Side	Height
Installed inches	28-3/4	25-1/4	(Note 3)
Centimeters	73	64,1	—

Service Clearances

	Front	Rear	Right	Left
Inches	30	42	18	18
Centimeters	76,2	106,7	45,7	45,7

Weight

196 lbs.	88,9 kg
----------	---------

Heat Output

400 BTU/h	100,8 kcal/h
-----------	--------------

Air Flow

— CFM	— m ³ /min
-------	-----------------------

Power Requirements

	60 Hz.		50 Hz.	
Volts	115	208/230	112.5/123.5	195/220/235
kVA	0.2	0.3	0.3	0.2
Phase	1		1	
Branch				
Circuit (A)	15			
Max. Cont. Load (A)	1.6	1.3	2.4	1.1
Plug Type (Note 1)	H,J	K,L	—	
Power Cord Style (Note 2)	—		G3	
Power Cord Length	6 ft.		(1.83m)	

Environment, Operating

Temp.	50 to 110°F	10 to 43°C
Rel. Humidity	10 to 80%	
Max. Wet Bulb	85°F	29.4°C

Environment, Non-operating

Temp.	50 to 110°F	10 to 43°C
Rel. Humidity	10 to 80%	
Max. Wet Bulb	85°F	29.4°C

Communication Facilities – See SRL, *IBM Teleprocessing Systems Summary*, GA24-3090.

Notes:

- Description of plug type with matching receptacles and connectors – see Appendix A.
When terminal supply voltage is 208 or 230 and terminal is to be on a raised floor-plug type A must be used.
- Description of World Trade power cord styles – see Appendix B.
- Overall height is 36-1/2 inches (92.7 cm).
Desk top is 28-7/8 inches (73.3 cm).

IBM 2760 Optical Image Unit

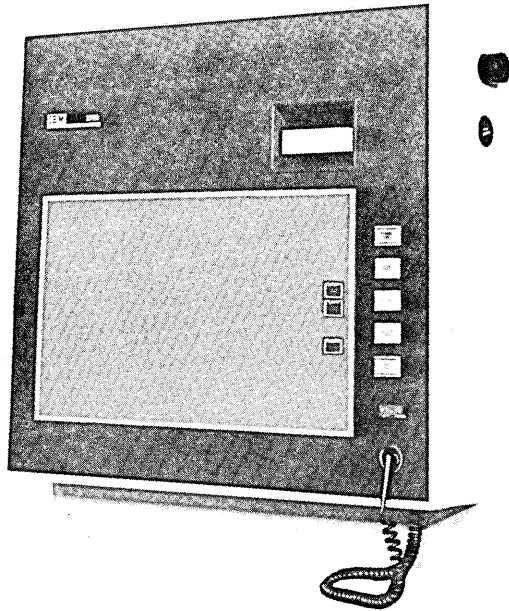
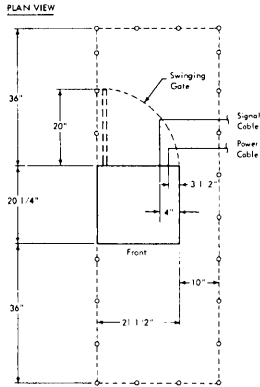

Figure 2760-1. IBM 2760 Optical Image Unit

2760 OPTICAL IMAGE (ATTACHES TO 2740 MODEL 1 ONLY) – SPECIFICATIONS



Inches	Centimeters
3-1/2	8,9
4	10,2
10	25,4
20	50,8
20-1/4	51,4
21-1/2	54,6
36	91,4

Dimensions

	Front	Side	Height (Note 1)
Installed inches	22-1/2	20-1/4	22
Centimeters	57,2	51,4	55,9

Service Clearances

	Front (Note 4)	Rear (Note 5)	Right	Left
Inches	36	36	10	0
Centimeters	91,4	91,4	25,4	0

Weight

90 lbs. 40,8 kg

Heat Output

573 BTU/h 144,4 kcal/h

Air Flow

75 CFM 2,0 m³/min

Power Requirements

	60 Hz.	50 Hz.
Volts	(Must agree with 2740)	
kVA	0.2	—
Phase	—	—
Branch Circuit (A)	(Power from 2740)	
Max. Cont. Load (A)	(Power from 2740)	
Plug Type	—	—
Power Cord Style	—	—
Power Cord Length	(Note 2)	(Note 2)

Environment, Operating

Temp.	50 to 110°F	10 to 43°C
Rel. Humidity	8 to 80%	
Max. Wet Bulb	85°F	29.4°C

Environment, Non-operating

Temp.	50 to 125°F	10 to 52°C
Rel. Humidity	8 to 80%	
Max. Wet Bulb	85°F	29.4°C

Notes:

1. Height above table top. Customer must provide table for 2760.
2. Two 8' (2,44m) cables are provided with the 2760 Optical Image Unit for connecting to the 2740 Model 1.
3. Avoid rear or overhead high intensity lighting.
4. From front edge of table.
5. From rear of unit or 24" (61 cm) from rear edge of table.

IBM 2780 Data Transmission Terminal

MODELS AND CONFIGURATIONS

The IBM 2780 is available in four models, permitting a variety of system configurations. The four models are:

- Model 1 – Card read and print
- Model 2 – Card read, card punch, and print
- Model 3 – Print only (used as a receive terminal only)
- Model 4 – Card read and card punch

COMMUNICATIONS FACILITIES

The communication facilities used by the IBM 2780 must have appropriate modulation/demodulation capability. They can be either leased common-carrier private lines, common-carrier switched telephone networks, or equivalent privately owned facilities.

When transmission speed is a primary consideration on private-line facilities, the use of a four-wire (full-duplex) private line may be advantageous because it provides the means to reduce significantly the time required to reverse the direction of transmission for control purposes. Although use of a four-wire (full-duplex) communication channel can

minimize turn-around delay, the IBM 2780 cannot receive and transmit data simultaneously; it is capable of half-duplex data transmission only. (Whether or not full-duplex charges apply depends on the local common carrier.) Transmission speed, 600, 1200, 2000, 2400, or 4800 bps (bits per second), depends on the type of communication facilities used, and must be specified at the time of ordering the IBM 2780.

The type of data set, and whether terminal is to be used on a two-wire or four-wire communication line, must be specified at the time of ordering the IBM 2780.

DATA SET CABLES

A 20-foot (6.1m) cable from the 2780 to the data set will be provided as standard unless a different length is specified at the time of the order. A maximum length up to 40 (12.2m) feet is available. Excessively long cables should be avoided. Consult your IBM sales representative for further information.

Data set cables are equipped with a connector that is compatible with the type of data set specified.

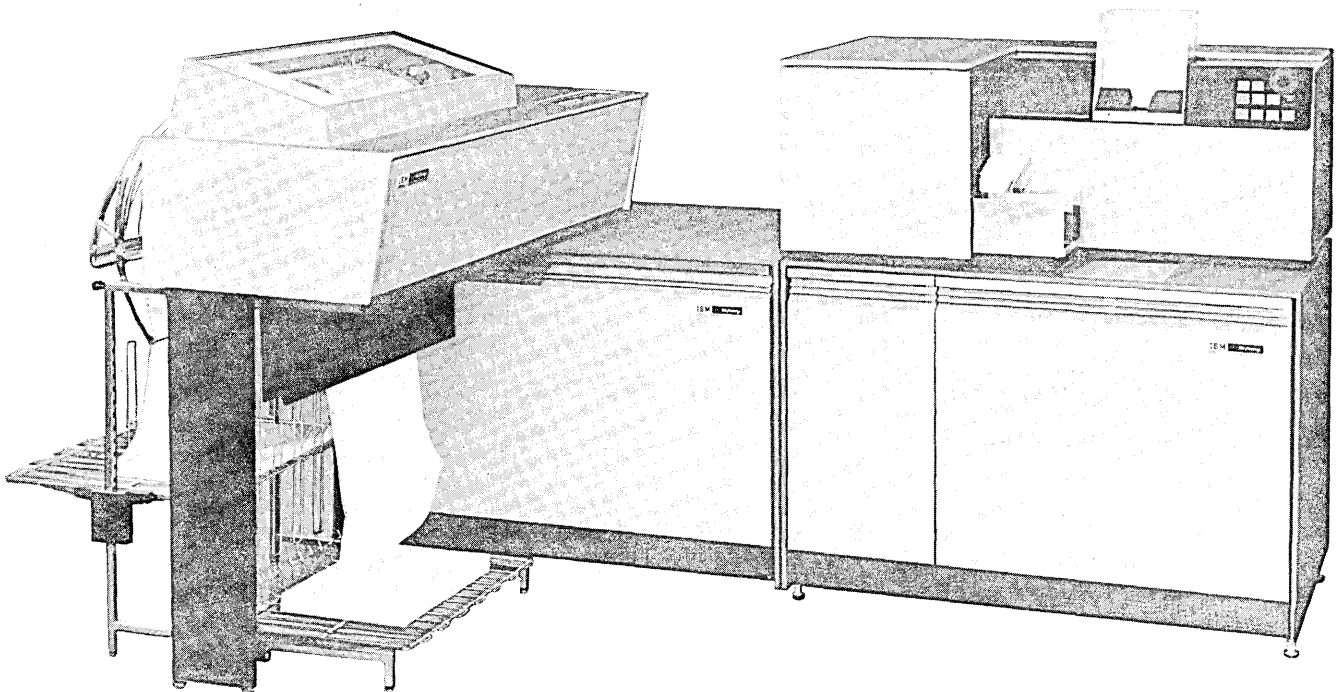
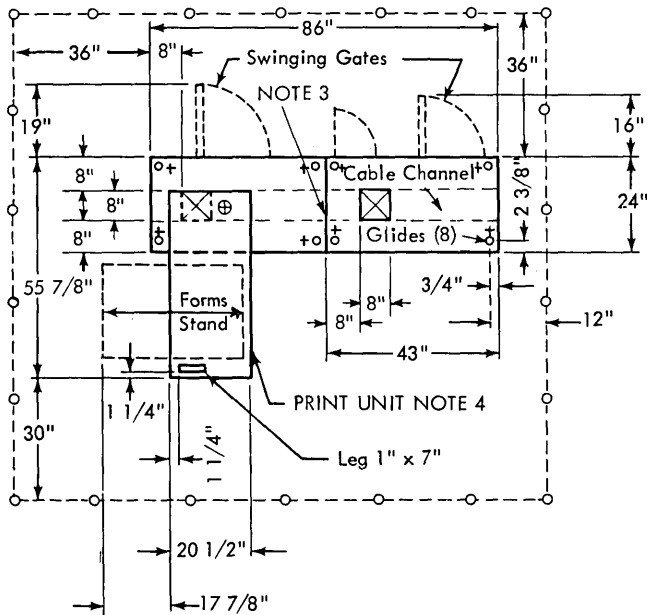

Figure 2780-1. IBM 2780 Data Transmission Terminal (Applies to Models 1 and 2)

2780 DATA TRANSMISSION TERMINAL MODEL 1 – SPECIFICATIONS

PLAN VIEW



Inches	Centimeters
3/4	1,9
1	2,5
1-1/4	3,2
2-3/8	6,0
7	17,8
16	40,6
17-7/8	45,4
19	48,3
20-1/2	52,1
24	61,0
43	109,2
55-7/8	141,9
86	218,4

Feet	Meters
14	4,27
40	12,19

Dimensions

	Front	Side	Height	
Installed inches	86	55-7/8	49	
Centimeters	218,4	141,9	124,5	
Service Clearances	Front	Rear	Right	Left
Inches	30	36	12	36
Centimeters	76,2	91,4	30,5	91,4
Weight	1650 lbs. 748 kg.			
Heat Output	4800 BTU/h 1210 kcal/h			
Air Flow	— CFM — m ³ /min			
Power Requirements				

	60 Hz.	50 Hz.
Volts	208/230	195/220/235
kVA	1.8	2.0
Phase	1	1
Branch Circuit (A)	15	
Max. Cont. Load (A)	7.8	8.3
Plug Type (Note 1)	A	—
Power Cord Style (Note 2)	—	A1
Power Cord Length	14 ft.	(4.27m)

Environment, Operating

Temp.	60 to 90°F	16 to 32°C
Rel. Humidity	8 to 80%	
Max. Wet Bulb	78°F	25°C

Environment, Non-operating

Temp.	50 to 110°F	10 to 43°C
Rel. Humidity	8 to 80%	
Max. Wet Bulb	80°F	27°C

Communication Facilities – See SRL, *IBM Teleprocessing Systems Summary*, GA24-3090.

Notes:

1. Description of plug type with matching receptacles and connectors – see Appendix A.
2. Description of World Trade power cord styles – see Appendix B.
3. Units separated for shipment. Bolt together for installation.
4. For shipment, print unit is rotated over the cabinet. Dimensions are then: 24 in. x 48-1/8 in. x 46 in. (61 cm x 122 cm x 116,8 cm)

2780 DATA TRANSMISSION TERMINAL MODEL 2 – SPECIFICATIONS

PLAN VIEW

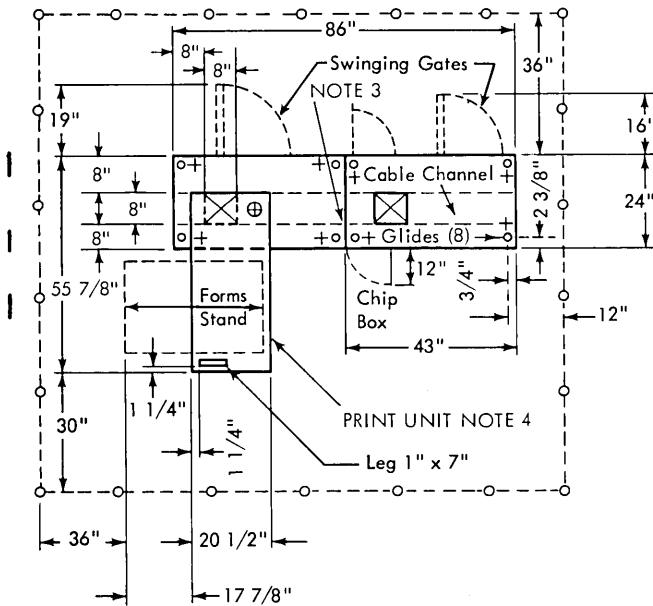

Inches	Centimeters
3/4	1,9
1	2,5
1-1/4	3,2
2-3/8	6,0
7	17,8
12	30,5
16	40,6
17-7/8	45,4
19	48,3
20-1/2	52,1
24	61,0
43	109,2
55-7/8	141,9
86	218,4

Feet	Meters
14	4,27
40	12,19

Dimensions

	Front	Side	Height
Installed inches	86	55-7/8	40
Centimeters	218,4	141,9	124,5

Service Clearances

	Front	Rear	Right	Left
Inches	30	36	12	36
Centimeters	76,2	91,4	30,5	91,4

Weight

1650 lbs. 748 kg

Heat Output

4800 BTU/h 1210 kcal/h

Air Flow

— CFM — m³/min

Power Requirements

	60 Hz.	50 Hz.
Volts	208/230	195/220/235
kVA	1.8	2.0
Phase	1	1
Branch Circuit (A)	15	
Max. Cont. Load (A)	8.0	8.7
Plug Type (Note 1)	A	—
Power Cord Style (Note 2)	—	A1
Power Cord Length	14 ft.	(4.27m)

Environment, Operating

Temp.	60 to 90 ^o F	16 to 32 ^o C
Rel. Humidity	8 to 80%	
Max. Wet Bulb	78 ^o F	25 ^o C

Environment, Non-operating

Temp.	50 to 110 ^o F	10 to 43 ^o C
Rel. Humidity	8 to 80%	
Max. Wet Bulb	80 ^o F	27 ^o C

Communication Facilities – See SRL, *IBM Teleprocessing Systems Summary*, GA24-3090.

Notes:

1. Description of plug type with matching receptacles and connectors – see Appendix A.
2. Description of World Trade power cord styles – see Appendix B.
3. Units separated for shipment. Bolt together for installation.
4. For shipment, print unit is rotated over the cabinet. Dimensions are then: 24 in. x 48-1/8 in. x 46 in. (61 cm x 122 cm x 116,8 cm)
5. See page 2780.1 for photo; Models 1 and 2 are identical in appearance.

2780 DATA TRANSMISSION TERMINAL MODEL 3 – SPECIFICATIONS

PLAN VIEW

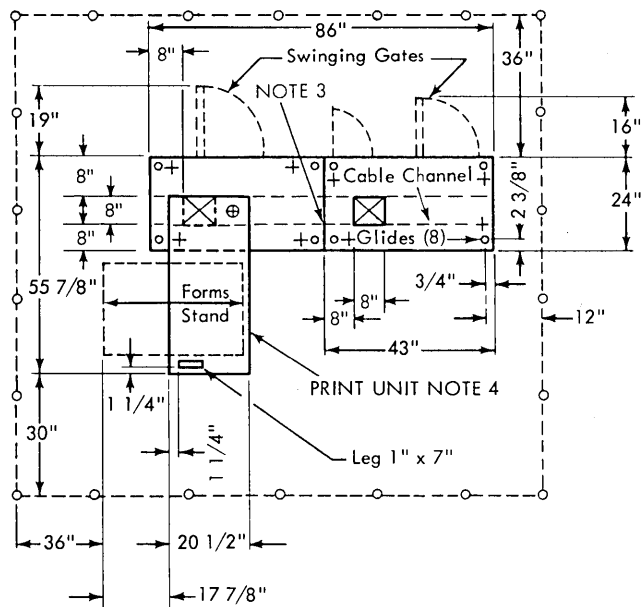

Inches	Centimeters
3/4	1,9
1	2,5
1-1/4	3,2
2-3/8	6,0
7	17,8
16	40,6
17-7/8	45,4
19	48,3
20-1/2	52,1
24	61,0
43	109,2
55-7/8	141,9
86	218,4

Feet	Meters
14	4,27
40	12,19

Dimensions

	Front	Side	Height	
Installed inches	86	55-7/8	49	
Centimeters	218,4	141,9	124,5	
Service Clearances	Front	Rear	Right	Left
Inches	30	36	12	36
Centimeters	76,2	91,4	30,5	91,4
Weight	1350 lbs. 612 kg			
Heat Output	3950 BTU/h 995,6 kcal/h			

Air Flow
 — CFM — m³/min

Power Requirements

	60 Hz.	50 Hz.
Volts	208/230	195/220/235
kVA	1.7	1.9
Phase	1	1
Branch Circuit (A)	15	
Max. Cont. Load (A)	7.4	8.1
Plug Type (Note 1)	A	—
Power Cord Style (Note 2)	—	A1
Power Cord Length	14 ft.	(4.27)

Environment, Operating

Temp.	60 to 90°F	16 to 32°C
Rel. Humidity	8 to 80%	
Max. Wet Bulb	78°F	25°C

Environment, Non-operating

Temp.	50 to 110°F	10 to 43°C
Rel. Humidity	8 to 80%	
Max. Wet Bulb	80°F	27°C

Communication Facilities – See SRL, *IBM Teleprocessing Systems Summary*, GA24-3090.

Notes:

1. Description of plug type with matching receptacles and connectors – see Appendix A.
2. Description of World Trade power cord styles – see Appendix B.
3. Units separated for shipment.
Bolt together for installation.
4. For shipment, print unit is rotated over the cabinet. Dimensions are then: 24 in. x 48-1/8 in. x 46 in. (61 cm x 122 cm x 116,8 cm)

2780 DATA TRANSMISSION TERMINAL MODEL 4 – SPECIFICATIONS

PLAN VIEW

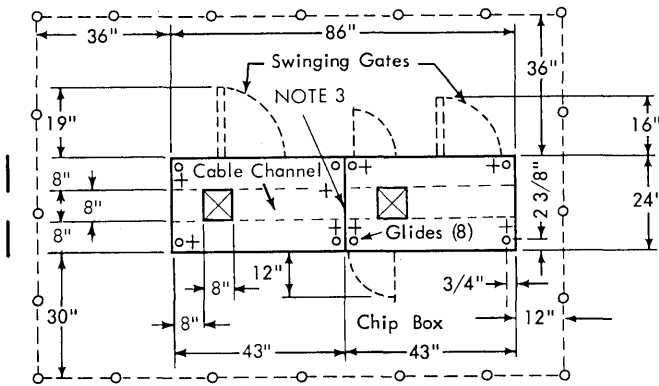

Inches	Centimeters
3/4	1,9
2-3/8	6,0
12	30,5
16	40,6
19	48,3
24	61,0
43	109,2
86	218,4

Feet	Meters
14	4,27
40	12,19

Dimensions

	Front	Side	Height
Installed inches	86	24	49
Centimeters	218,4	61,0	124,5

Service Clearances

	Front	Rear	Right	Left
Inches	30	36	12	36
Centimeters	76,2	91,4	30,5	91,4

Weight

1060 lbs.	480,8 kg
-----------	----------

Heat Output

3700 BTU/h	932 kcal/h
------------	------------

Air Flow

—CFM	—m ³ /m
------	--------------------

Power Requirements

	60 Hz.	50 Hz.
Volts	208/230	195/220/235
kVA	1.7	1.8
Phase	1	1
Branch Circuit (A)	15	
Max. Cont. Load (A)	7.2	7.8
Plug Type (Note 1)	A	—
Power Cord Style (Note 2)	—	A1
Power Cord Length	14 ft.	427 cm

Environment, Operating

Temp.	60 to 90°F	16 to 32°C
Rel. Humidity	8 to 80%	
Max. Wet Bulb	78°F	25°C

Environment, Non-operating

Temp.	50 to 110°F	10 to 43°C
Rel. Humidity	8 to 80%	
Max. Wet Bulb	80°F	27°C

Communication Facilities – See SRL, *IBM Teleprocessing Systems Summary*, GA24-3090.

Notes:

1. Description of plug type with matching receptacles and connectors – see Appendix A.
2. Description of World Trade power cord styles – see Appendix B.
3. Units separated for shipment. Bolt together for installation.

IBM 2845 Display Control, Including IBM 2265 Display Station and Keyboard, and IBM 1053 Printer Model 4

CABLE INFORMATION

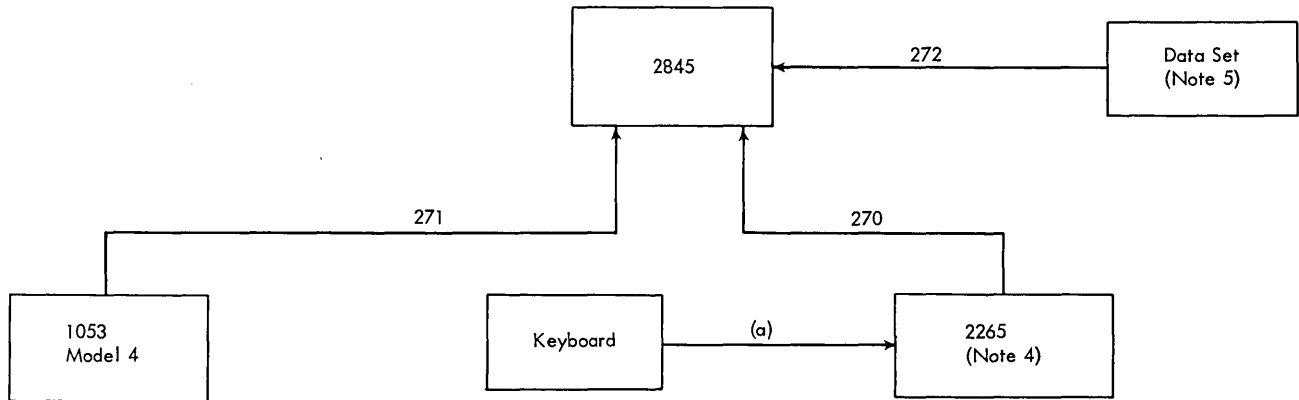

Group No.	No. of Cables	To	From	Max. Length Ft (M)	Note
(a)	1	2265	Keyboard	7 1/2 Fixed 2.28	1,3
270	1	2845	2265	40 12.19	2
271	1	2845	1053	40 12.19	2
272	1	2845	Data Set	40 12.19	2

Notes:

1. Fixed-length cable provided with Keyboard Option (SF 4766).
2. Order on System/360 Cable Order Form 120-1080.
3. Cable exits at back of 2265 but may be run under the 2265.
4. The Display Station (2265) must be in the same room with the Display Control (2845). The Display Station should be visible from the Display Control.
5. See SRL, *IBM Teleprocessing Systems Summary*, GA24-3090 for available communication facilities.

2845 DISPLAY CONTROL (FOR USE WITH IBM 2265 AND 1053 MODEL 4) – SPECIFICATIONS

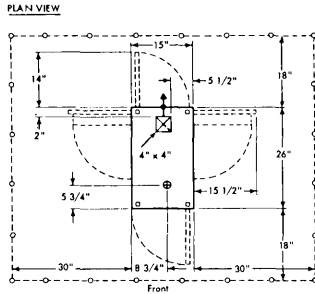

Inches	Centimeters
2	5,1
4	10,1
5-1/2	14
5-3/4	14,6
8-3/4	22,2
14	35,6
15	38,1
15-1/2	39,4
26	66

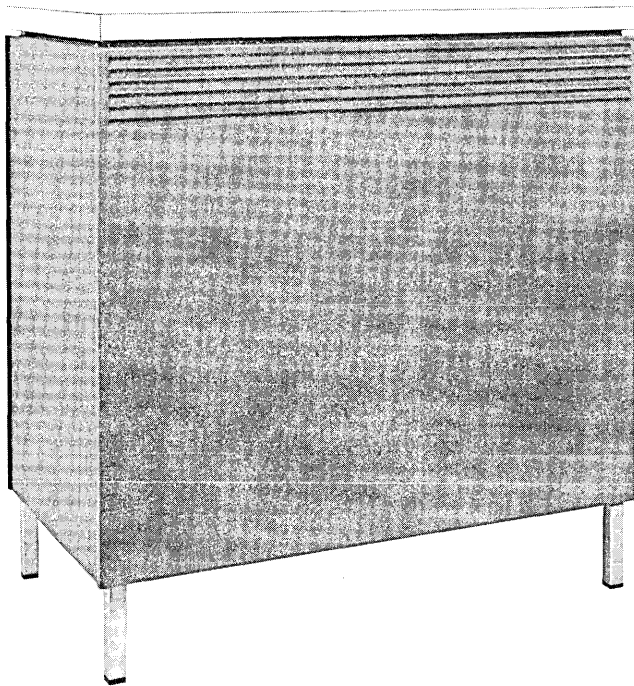

Figure 2845-1. IBM 2845 Display Control

Dimensions

	Front	Side	Height
Installed inches	15	26	27
Centimeters	38,1	66	68,6

Service Clearances

	Front	Rear	Right	Left
Inches	18	18	30	30
Centimeters	45,7	45,7	76,2	76,2

Weight

110 lbs. 49,9 kg

Heat Output

680 BTU/h 171,4 kcal/h

Air Flow

— CFM — m³/min

Power Requirements

	60 Hz.	50 Hz.	
Volts	115	112.5/123.5	195/220/235
kVA	0.4	0.4	0.5
Phase	1	1	
Branch Circuit (A)	15		
Max. Cont. Load (A)	3.0	3.0	2.0
Plug Type (Note 1)	H	—	
Power Cord			
Style (Note 2)	—	G4	
Power Cord Length	6 ft.	(1.83m)	

Environment, Operating

Temp.	50 to 110°F	10 to 43°C
Rel. Humidity	8 to 80%	
Max. Wet Bulb	85°F	29.4°C

Environment, Non-operating

Temp.	50 to 125°F	10 to 52°C
Rel. Humidity	8 to 80%	
Max. Wet Bulb	85°F	29.4°C

Cable Information – See page 2845.1

Communication Facilities – See SRL, *IBM Teleprocessing Systems Summary*, GA24-3090.

Notes:

1. Description of plug type with matching receptacles and connectors – see Appendix A.
2. Description of World Trade power cord styles – see Appendix B.

2265 DISPLAY STATION AND KEYBOARD (ATTACHED TO 2845)

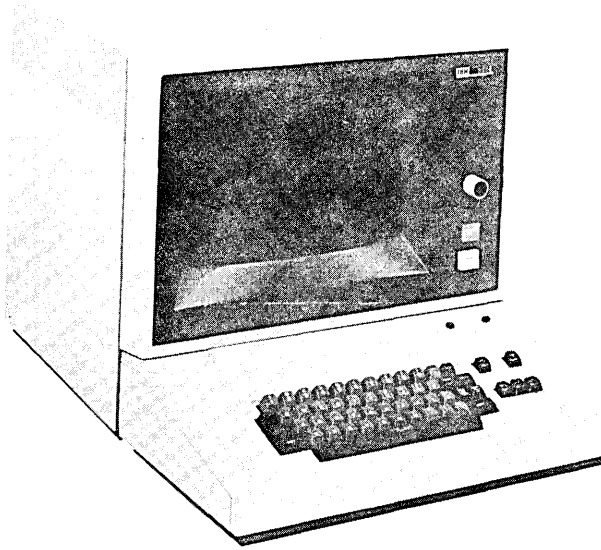
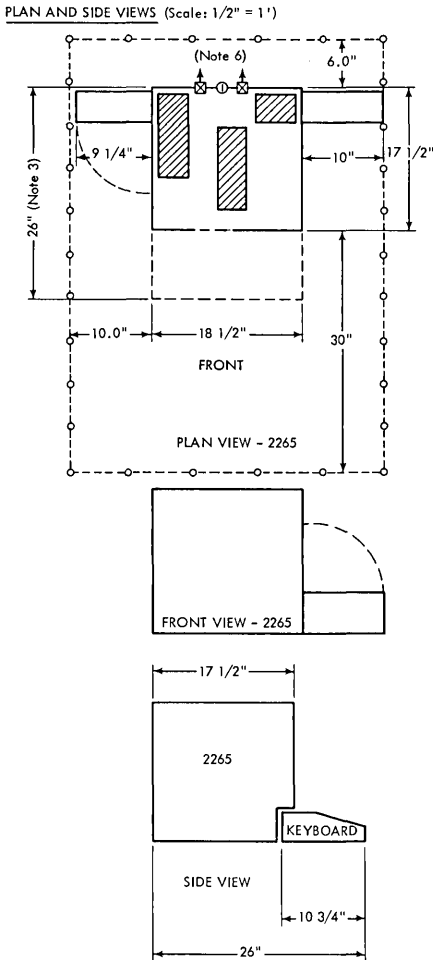

Figure 2845-2. IBM 2265 Display Station and Keyboard

2265 DISPLAY STATION AND KEYBOARD (ATTACHED TO 2845) – SPECIFICATIONS



Inches	Centimeters
9-1/4	23,5
10	25,4
10-3/4	27,3
17-1/2	44,4
18-1/2	47
26	66

Dimensions

	Front	Side	Height	
Display Station		(Note 3)	(Note 5)	
Inches	18-1/2	17-1/2	16-1/2	
Centimeters	47	44,4	41,9	
Keyboard				
Inches	18-1/2	10-3/4	4-1/4	
Centimeters	47	27,3	10,8	
Service Clearances (Note 6)				
	Front (Note 4)	Rear	Right	Left
Inches	30	6.0	10.0	10.0
Centimeters	76,2	15,2	25,4	25,4

Weight

Keyboard	15 lbs.	6,8 kg
Display	87 lbs.	39,5 kg

Heat Output

545 BTU/h	137.3 kcal/h
-----------	--------------

Air Flow

— CFM	— m ³ /min
-------	-----------------------

Power Requirements

	60 Hz.	50 Hz.	
Volts	115	112.5/123.5	195/220/235
kVA	0.2	0.2	0.2
Phase	1	1	
Branch Circuit (A)	15		
Max. Cont. Load (A)	2.0	2.0	1.0
Plug Type (Note 1)	H	—	
Power Cord			
Style (Note 2)	—	G4	
Power Cord Length	6 ft.	(1.83m)	

Environment, Operating

Temp.	50 to 110°F	10 to 43°C
Rel. Humidity	8 to 80%	
Max. Wet Bulb	85°F	29.4°C

Environment, Non-operating

Temp.	50 to 125°F	10 to 52°C
Rel. Humidity	8 to 80%	
Max. Wet Bulb	85°F	29.4°C

Cable Information – See page 2845.1

Notes:

1. Description of plug type with matching receptacles and connectors – see Appendix A.
2. Description of World Trade power cord styles – see Appendix B.
3. 26 inches (66cm) with keyboard.
4. Operator clearance.
5. Height above table top. Customer must provide table for 2265.
6. Min. top clearance – 6" (15.2cm) for air circulation.

1053 PRINTER MODEL 4 (ATTACHED TO 2845) – SPECIFICATIONS

PLAN VIEW (Scale: 1/2" = 1')

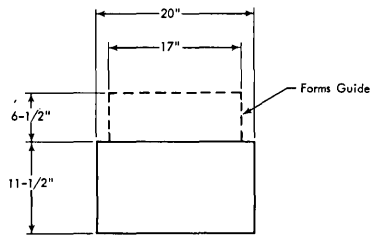

Inches	Centimeters
6-1/2	16,5
11-1/2	29,2
17	43,2
20	50,8

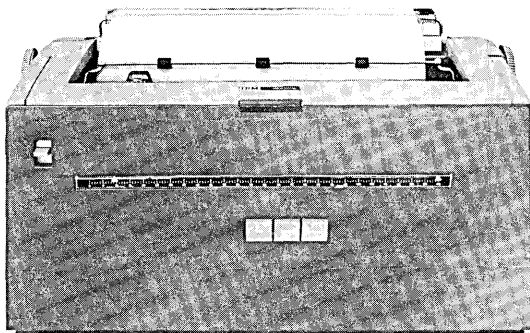

Figure 2845-3. IBM 1053 Printer Model 4

Dimensions

	Front	Side	Height	
	(Note 3)			
Installed inches	23	11-1/2	9	
Centimeters	58,4	29,2	22,9	
Service Clearances				
	Front	Rear	Right	Left
Inches	0	0	0	0
Centimeters	—	—	—	—

Weight

35 lbs. 15,9 kg

Heat Output

520 BTU/h 131 kcal/h

Air Flow

— CFM — m³/min

Power Requirements

	60 Hz.		50 Hz.				
Volts	115	208/230	112.5/123.5	195/220/235			
kVA	0.2		0.2				
Phase	1		1				
Branch	15						
Circuit (A)	15						
Max. Cont. Load (A)	1.2	0.6	1.0	0.9	0.7	0.6	0.5
Plug Type (Note 1)	H	K	—				
Power Cord Style (Note 2)	—		G2				
Power Cord Length	14 ft.		(4.27m)				

Environment, Operating

Temp.	50 to 110°F	10 to 43°C
Rel. Humidity	10 to 80%	
Max. Wet Bulb	80°F	27°C

Environment, Non-operating

Temp.	50 to 110°F	10 to 43°C
Rel. Humidity	10 to 80%	
Max. Wet Bulb	80°F	27°C

Cable Information – See page 2845.1

Notes:

1. Description of plug type with matching receptacles and connectors – see Appendix A.
2. Description of World Trade power cord styles – see Appendix B.
3. Includes 1-1/2 inches (3,8 cm) each side for platen knobs.

IBM 3287 PRINTER Model 1, 2, 11 and 12 (CUSTOMER SETUP DESIGNATED)

PLAN VIEW

Dimensions shown in millimeters
 Plan View scale drawn (1 : 25)

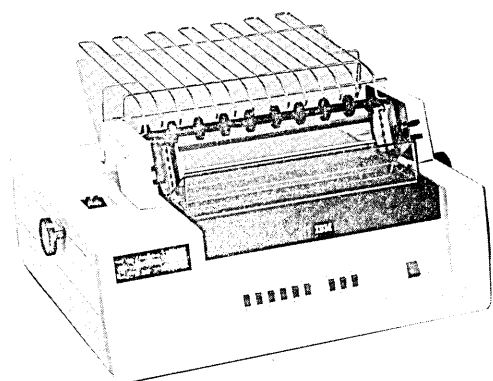
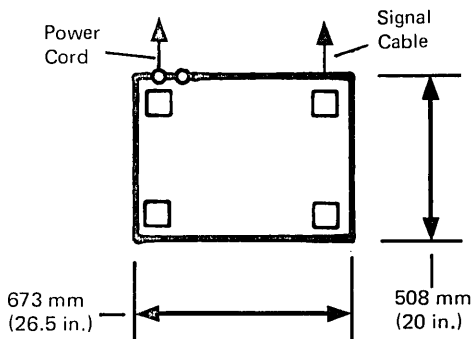

Note: The minimum distance between the 3287 and Display Terminals should be no less than 762 mm (30 in)

SPECIFICATIONS

Dimensions

	Front	Side	Height*
Millimeters	673	508	254
Inches	(26.5)	20	10

*349mm(13.75 in) with forms tractor

Service Clearances

	Front	Rear	Right	Left
Millimeters	508	508	762	762
Inches	20	20	30	30

A 1016mm(40 in) clearance above the terminal is required during servicing.
 127mm (5 in) at rear required for paper loading.

Weight

34.2kg (75-½ Lb)
 36kg (79-½ Lb) (with forms tractor)

Heat output

250w (215 kcal/hr) (853 BTU/hr)

Airflow

1.5m³/min (55cfm) Model 1
 3m³/min (105cfm) Model 1 with Blower Feature
 3m³/min (105cfm) Model 2

Power Requirements

KVA: 0.25
 Phase: 1

Environment, Operating

Temperature 10⁰ to 40.6⁰C (50⁰ to 104⁰F)
 Relative Humidity 8 to 80%
 Maximum Wet Bulb 27⁰ C (80⁰F)

* For Models 1, 2, 11 and 12, see specify feature for operation in environment above 32.2⁰C(90⁰F)

Environment, Non-Operating

Temperature 10⁰ to 51.7⁰C (50⁰ to 125⁰F)
 Relative Humidity 8% to 80%
 Maximum Wet Bulb 27⁰C (80⁰F)

Signal Cables Models 1 and 2

For attachment to System/370 model 138 or 148 see the cabling schematic pages for 370/138 or 148 for appropriate IBM cable group number. (610 meters, 2000 ft max)

● For Signal Cable Description see page 3287.2
 Signal Cables Models 11 and 12. (See next page)

Volts

	Voltage Tolerance	60Hz + 0.5Hz				50 Hz + 0.5Hz					
		100	110	120	127	100	110	200	220	230	240
US & Canada	+6% -13%			+							
Japan	± 10%	+				+		+			
American Far East	+8% -12.5%	+	+	+	+	+	+	+	+	+	+
Europe/Middle East & Africa	+8% -12.5%			+					+		+

For safety and proper machine operation each *Power Receptacle* must be grounded. To insure proper grounding a dedicated wire conductor is recommended.

CORD LENGTH: Power Cord Length, 2.8m (9 ft) supplied as standard, (optional lengths available; 1.8m (6 ft), 3.7 m (12 ft), 4.5 m (15 ft).

Plug - Power Cord - see appendix A

Power Cord Type (for those countries supplied with power cord but no plug). Outside diameter 9.0mm (0.350 in); number of conductors-3 plus drain: wire conductor size 18 AWG/stranded (1.0 mm); shield aluminum polyester tape.

SIGNAL CABLE MODELS 11 AND 12

For attachment to the signal loop via a Loop Station Connector Box, a 3 m (10 Ft.) cable and a unique plug called a Loop Device Connector is shipped with the printer. For further information refer to the Loop Installation Physical Planning Manual, Form Number GA27-2878.

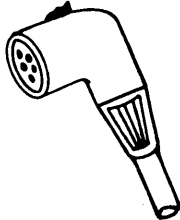

SIGNAL CABLE MODELS 1 AND 2

Type (Commerical Designation)	RG62A/U coaxial - Meeting MIL SPEC C-17D
Characteristic Impedance	93 ohms
Capacitance (Nominal)	14.5 pF/ft
Maximum Length	
When attaching via feature code 8330	610 meters (2000 feet)
When attaching via feature code 8331	1500 meters (4920 feet)

User Responsibility

The user is responsible for the procurement installation and maintenance of the signal cable (coaxial) that connects the 3287 to its associated control unit. IBM part numbers are provided for the user who wishes to purchase components or preassembled cables from IBM. RG62A/U is designated for indoor use. For outdoor cables, the RG62A/U must be designated as "modified for outdoor use"

Bulk Cable Specifications (Note 1)

Conductor	AWG Wire Size Stranding Material Coating DC Resistance	22 Solid Copper Covered Steel None 4.4 OHMS/100 Ft(Max)
Insulation	Material	Note 3
Shield	Material Type Coverage	Copper AWG 34 Note 4
Jacket	Material Color Avg Single Wall Thickness	PVC Note 1 Black 0.040 in (1.02 mm) min (outdoors) 0.031 in (0.79 mm) min (indoors)
Rating	Voltage Ambient Temperature	Note 5 60°C max
Capacitance Nominal		14.5 pF/ft
Impedance Characteristic		93±5 Ohms
Attenuation		8.0 dB/100 ft max
Velocity of Propagation		80%

Notes

1. Cable commercially designated RG62 A/U Meeting MIL Spec C-17D, is approved (non-contaminating vinyl jacket with solid conductor having 40% conductivity). Cable commercially designated RG62 A/U Meeting MIL SPEC C-17D modified for outdoor use (which includes vapor barrier and thicker jacket) is an approved substitute. Outdoor cable jacket must meet the minimum requirements for underground feeder and branch circuit cable and must be weatherproof and sunlight resistant per UL Subject 493.
2. Outer diameter (nominal)
 Indoor 6.15 mm (0.242 in)
 Outdoor 6.6 mm (0.260 in)
3. Polyethylene (outdoor); flame retardant polyethylene (indoor).
4. Seven ends, 16 carriers, 8.2 ± 10% pick per inch, 90% minimum coverage.
5. Dielectric strength test, 3,000 volts rms.

TO ORDER	SPECIFY	ON
Bulk cable (outdoor)	IBM part 5252750 and cable length	Miscellaneous equipment specification (MES) form
Bulk cable (indoor)	IBM part 323921 and cable length	MES form
Preassembled cables (outdoor)	IBM part 1833108 and cable length	MES form
Preassembled cables (indoor)	IBM part 2577672 and cable length	MES form
BNC-Type connectors (2) in kit form (outdoors). One kit per cable length	Connector group IBM part 1836419	MES form
BNC-Type connectors in kit form (indoors). One kit per cable length	Connector group IBM part 1836418	MES form
Adapter (for joining two coaxial cables)	IBM part 5252643	MES form

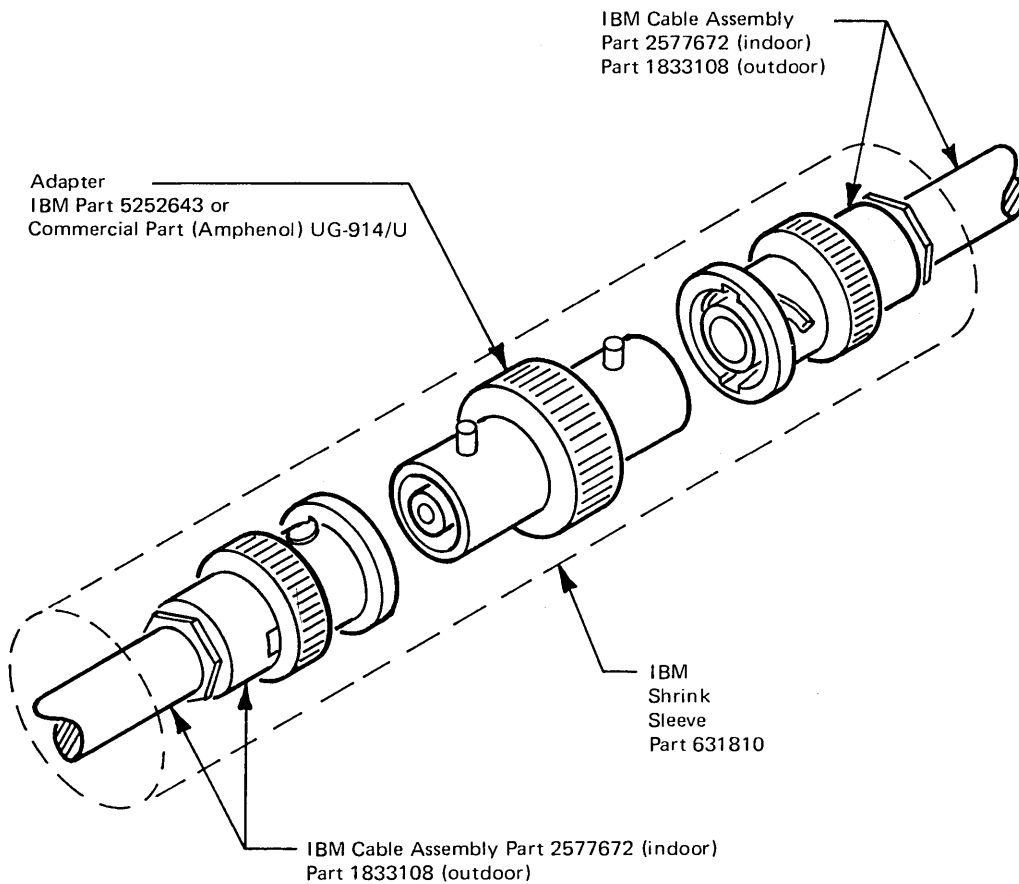

Cable Adapter for Joining Coaxial Cables

LIGHTNING STATION PROTECTORS

To protect personnel and prevent damage to IBM equipment from sudden surges of lightning energy, a station protector must be attached to the shield at each end of each coaxial cable that is run outdoors. This requirement applies to both overhead and buried cables.

The station protectors must be installed indoors as close as close as possible to where the cable enters or exits the building. Local and federal requirements must be observed when installing station protectors.

A common type of station protector is the gas-tube protector which has a useful life of approximately several hundred surges. The gas-tube protector is recommended for all geographic areas.

The following station protectors and attachment kit may be purchased from IBM on a Miscellaneous Equipment Specification (MES) form.

- Two gas-tube station protectors IBM part 1830818
- One attachment kit IBM part 1833106

Note: An attachment kit is required for each order of two station protectors. The kit contains the parts necessary to attach a station protector at each end of one coaxial cable.

3289 LINE PRINTER MODEL 3

Plan View

Scale (1 : 50)

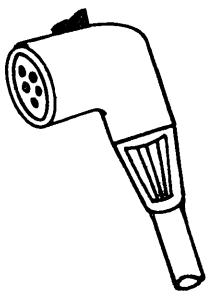
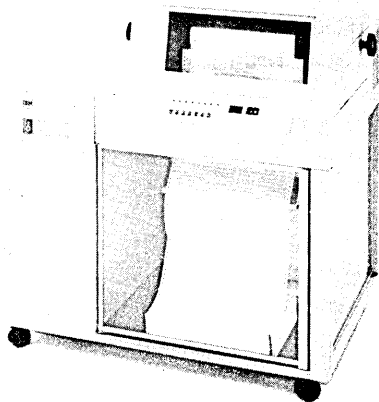
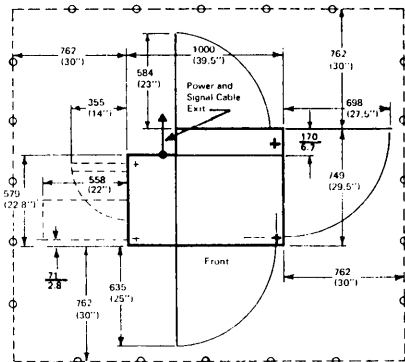

Loop Device Connector

Voltage Tolerance	Volts									
	60Hz + 0.5Hz				50Hz + 0.5Hz					
	100	110	120	127	100	110	200	220	230	240
US & Canada	+6%			+						
Japan	-13%									
American/Far East	± 10%	+			+		+			
Europe/Middle East & Africa	+8%									
	-12.5%		+	+	+	+		+	+	+
	-12.5%									+

Specifications

Dimensions:

	F	S	H
mm	1000	749	1040
(Inches)	(39.5)	(29.5)	(40.95)

Service Clearances:

	F	R	L	Rt
mm	762	762	762	762
(Inches)	(30)	(30)	(30)	(30)

Weight: 150 kg (330 lb)

Heat Output: 405w (353 kcal/hr) (1400 BTU/hr)

Airflow: Convection

Power Requirements:

kVA	0.6
Phase	1
Branch Circuit(A)	15

Environment Operating:

Temperature	10.0° to 40.6°C (50° to 105°F)
Rel Humidity	8% to 80%
Max Wet Bulb	27°C (80°F)

Environment Non-Operating:

Temperature	10.0° to 51.7°C (50° to 125°F)
Rel Humidity	8% to 80%
Max Wet Bulb	26.7°C (80°F)

Optimum paper stacking will occur in a temperature range of 15.6° - 37.8°C (60° - 100° F) and a relative humidity range of 26% - 62%.

SIGNAL CABLE

For attachment to the signal loop via a Loop Station Connector Box, a 3.05 m (10 ft) cable and a unique plug called a Loop Device Connector is shipped with the printer. For further information refer to the Loop Installation Physical Planning manual, Form Number GA27-2878.

For safety and proper machine operation each *Power Receptacle* must be grounded. To insure proper grounding, a dedicated wire conductor is recommended.

CORD LENGTH: Power Cord Length, 2.8m (9ft.) supplied as standard, (optional lengths available; 1.8m (6ft.), 3.7m (12ft.), 4.5m (15ft.).

Power Cord, plug type, see appendix A.

POWER CORD TYPE (for those countries supplied with power cord but no plug). Outside diameter 9.0 mm (0.350 in); number of conductors-3; conductor size # 18 AWG/stranded (1.0 mm), shield aluminum polyester tape plus drain wire;

IBM 3704 Communications Controller (With Remote Program Loader)

MODELS AND CONFIGURATIONS

The IBM 3704 Communications Controller (With Remote Program Loader) is a programmable transmission control unit for System/370. It communicates with the CPU through a 3704 or 3705 by means of a Type 3002 private line data channel with Type C2 conditioning, a CCITT recommended M102 data channel, or equivalent privately-supplied channel. The 3704 (With Remote Program Loader) can handle line speeds from 45.5 bps to 50000 bps. A max-

imum of 32 lines can be attached to the 3704 (With Remote Program Loader), depending upon the type of line attachments required.

The 3704 (With Remote Program Loader) is available in two models:

- Model A3 - 48K bytes of Storage
- Model A4 - 64K bytes of Storage.

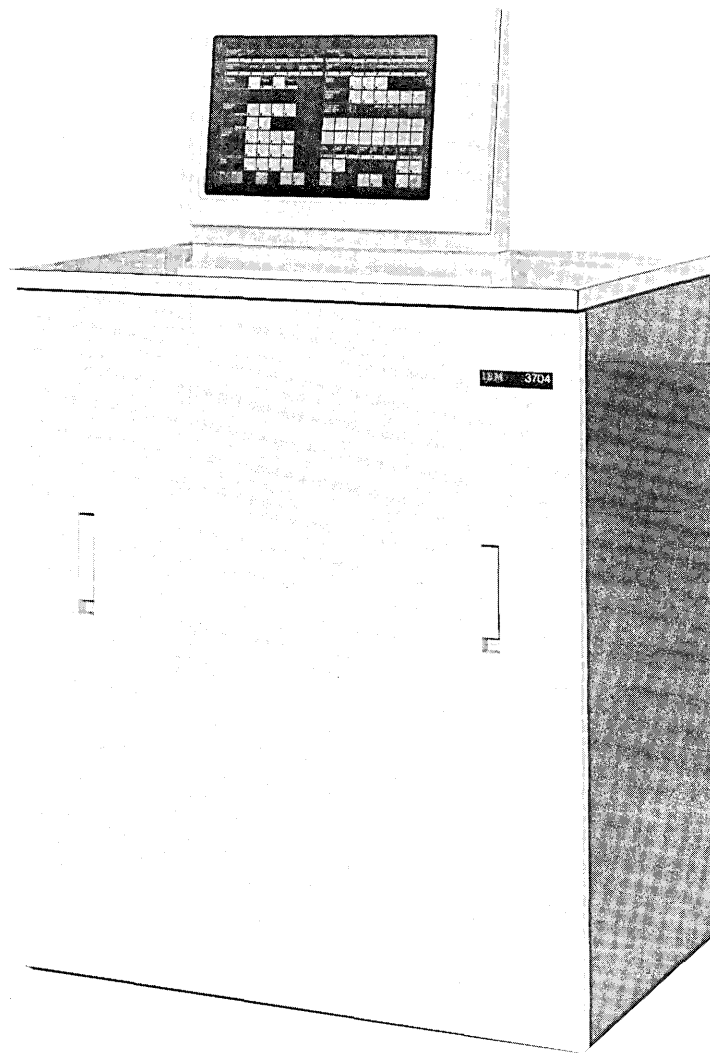
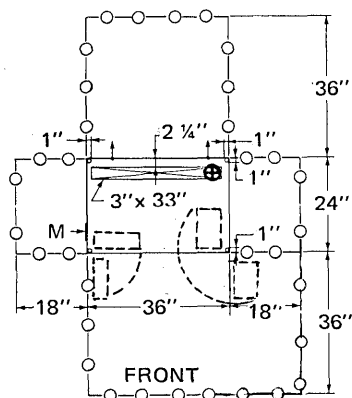

Figure 3704-1. IBM 3704 Communications Controller (With Remote Program Loader).

3704 COMMUNICATIONS CONTROLLER (WITH REMOTE PROGRAM LOADER) - SPECIFICATIONS

PLAN VIEW



Dimensions

	Front	Side	Height **
Installed inches	36	24	57
Centimeters	92	61	145

Service Clearances

	Front	Rear	Right	Left
Inches	36	36	18	18
Centimeters	92	92	46	46

Weight

390 lbs. 177 kg

Heat Output

5600 Btu/h 1450 kcal/h

Air Flow ***

500 ft³/min 14 m³/min

Environment, Operating ***

Temp. 60 to 90 °F 16 to 32 °C
 Rel. Humidity 8 to 80 %
 Max. Wet Bulb 78 °F 26 °C

Environment, Non-operating

Temp. 50 to 110 °F 10 to 43 °C
 Rel. Humidity 8 to 80 %
 Max. Wet Bulb 85 °F 29 °C

Inches	Centimeters
1	2,5
2 ¼	5,7
3	7,6
18	45,7
20	50,8
24	61,0
33	73,8
36	91,4

Power Requirements

Specifications	60 Hz				50 Hz*					
	100*	200*	208	230	100	110	123	200	220	235
Volts	100*	200*	208	230	100	110	123	200	220	235
kVA	2.2	2.2	2.2	2.2	2.2	2.2	2.2	2.2	2.2	2.2
Phase	1	1	1	1	1	1	1	1	1	1
Branch Circuit (A)	—	—	15	15	—	—	—	—	—	—
Max. Cont. Load (A)	22.0	11.0	10.6	9.6	22.0	20.0	19.5	11.0	10.0	9.3
Plug Type	—	—	A	A	—	—	—	—	—	—
Power Cord Style****	A1	A1	—	—	A1	A2	A2	A1	A2	A2
Cord Length (ft)	14'	14'	14'	14'	14'	14'	14'	14'	14'	14'
Cord Length (m)	4.27	4.27	4.27	4.27	4.27	4.27	4.27	4.27	4.27	4.27

* World Trade Only

** Counter top height 42" (105 cm)

*** Extended Environment, Operating

Temp. 50 to 100 °F 10 to 38 °C
 Air Flow 600 ft³/m 16.8 m³/m

3704 COMMUNICATIONS CONTROLLER CABLING SCHEMATIC

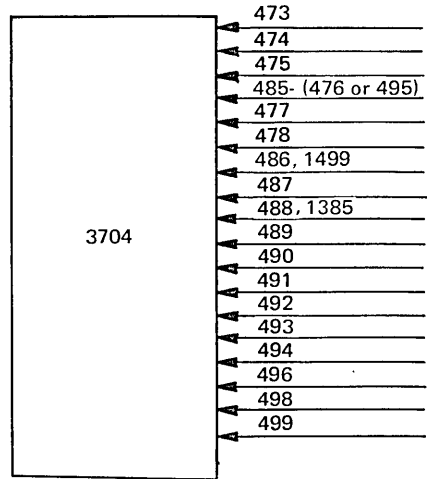

Cables for IBM and Non-IBM Devices

Group No.	Termination
473 } 492 }	1 25-Pin EIA RS-232C or CCITT Connector (Male)
474 } 490 }	2 Pair #8 Ring Lugs
475 } 477 } 478 } 485 } 486 }	2 25-Pin EIA RS-232C or CCITT Connectors (Male)
476 } 495 }	1 25-Pin EIA RS-232C Connector (Male) (See Note 3) Attaches to Group 485 8" Fixed Length (2.03 m)
487 } 488 } 1385 } 1494 }	2 25-Pin EIA RS-232C Connectors (Female)
489	12-Pin Burndy Connector for Wide-Band Modem
491 } 493 }	2 WE-283B Plugs; Customer Provides 404B Surface Mount, 493A Flush Mount, 549A Surface Mount Jacks, or Equivalent Receptacle
494 }	#8 Ring Lugs (8 for each leg)
496	1 34-Pin CCITT V.35 Connector (Male)
498	4 Pair #8 Ring Lugs
499	1 WE-283B Plug; Customer Provides 404B Surface Mount, 493A Flush Mount, 549A Surface Mount Jacks, or Equivalent Receptacle

**3704 COMMUNICATIONS CONTROLLER
CABLING SCHEMATIC**

Feature Code	Group	Line Set Type	No. of Cables	From	To	Max Length (ft)	Notes
2944	496	1K	1	Modem	3704	45	12
4709	498	LIB 9	1	Common-Carrier CBS Data Coupler	3704	45	
4711	475 or	1A	2	Two Modems	3704	45	7
-	477 or	1A	2	Two Modems	3704	45	11,12
-	478	1A	2	Two Modems	3704	45	11,12
4712	492	1B	1	One Low-Speed Duplex Modem	3704	45	
4713	487	1C	2	Two Directly Attached Terminals	3704	195	16
4714	477 or	1A/1D	2	Two Modems	3704	45	9,11,12
-	478 or	1A/1D	2	Two Modems	3704	45	9,11,12
-	485 or	1D	2	Two Modems	3704	45	3,9,10
4715	486	1E	2	Two Autocall Units	3704	45	
-	1499	1E	2	Two World Trade Autocall Units	3704	45	15
4716	488	1F	2	Two Directly Attached Terminals	3704	95	14,16
-	1385	1F	2	Two Directly Attached Terminals	3704	95	14,16
4717	489	1G	1	Wide-Band Modem	3704	45	
4718	473	1H	1	Modem	3704	45	
4719	-	1J	-	-	-	-	8
4721	474	2A	1	Common-Carrier Terminal Strip	3704	45	13
-	490	2A	1	Common-Carrier Terminal Strip	3704	45	4
4731	491	3A	1	Common-Carrier Telephone Jack	3704	45	
4732	491	3B	1	Common-Carrier Telephone Jack	3704	45	
4741	491	4A	1	Common-Carrier Telephone Jack	3704	45	
4742	491	4B	1	Common-Carrier Telephone Jack	3704	45	
4743	491	4C	1	Common-Carrier Telephone Jack	3704	45	
4751	493	1L	1	Common-Carrier Telephone Jack	3704	45	5
4752	493	1M	1	Common-Carrier Telephone Jack	3704	45	5
4754	499	1X	1	Common-Carrier Telephone Jack	3704	45	1
4755	499	1Y	1	Common-Carrier Telephone Jack	3704	45	1
4761	494	1P	2	Common-Carrier CBS Data Coupler	3704	45	6
4771	498	1Q	1	Common-Carrier CBS Data Coupler	3704	45	
4781	499	8A	1	Common-Carrier Telephone Jack	3704	45	
4782	498	8B	1	Common-Carrier CBS Data Coupler	3704	45	
4784	499	10A	1	Common-Carrier Telephone Jack	3704	45	
4785	499	8C	1	Common-Carrier Telephone Jack	3704	45	
4786	498	8D	1	Common-Carrier CBS Data Coupler	3704	45	

Notes:

1. Total cable length of 200 feet (unless modified by general control-to-channel cabling schematic) available to attach up to eight control units.
2. Sequence and control (EPO).
3. One required for each SF #4714, *except* in Germany. See Note 11. In U.S. and Canada, SF #4714 may require either cable group 476 or 495 depending on the following:
 - a. One or two of group 476 required in addition to group 485 for switched network modems that use either "Ring-Indicate" or "Coupler-Cut-Through" on pin 23. (Pin 18 is not used.)
 - b. One or two of group 495 required in addition to group 485 for modems using a contact closure interface between pins 19 and 20. Group 495 provides compatibility between 3704 25-pin EIA RS-232C voltage interface and the modem contact closure interface. Cable includes a jumper between pins 19 and 20 and removes the "Data Terminal Ready" voltage from pin 20.
4. One required for each SF #4721, *except* in Germany. See Note 13.
5. One required when two SF #4751s or #4752s are attached. Use cable group 499 when only one SF #4751 or #4752 is attached.
6. One required when two SF #4761s are attached. Use cable group 498 when one SF #4761 is attached.
7. One required for each SF #4711, *except* in Germany. See Note 11.

3704 COMMUNICATIONS CONTROLLER CABLING SCHEMATIC

Notes: (Continued)

8. External cable is not supplied for SF #4719 (Line Set Type 1J). The cable-connecting hardware is supplied for this feature. See *IBM 3704 and 3705 Communications Controllers*, OEMI, GA27-3053, for pin designations. Any customer-supplied protective conduit must *not* extend above the lower machine frame (2-1/2").
9. For SF #4714, at transmission rates above 7,200 bps, the cable length is limited to 25 feet maximum in U.S. and Canada. At rates above 4,800 bps, the length is limited to 25 feet maximum in World Trade countries.
10. For SF #4714 (Line Set Type 1D, cable group 485). If a longer cable length is desired at the higher speeds, contact the IBM DP Special Product Marketing Representative.
11. One required for each SF #4711 or #4714 in Germany depending on the following:
 - a. For IBM modems, use group 477. (Provides a shielded cable for compliance with radio-frequency-interference regulations.)
 - b. For PTT mandatory modems, use group 478. (Pins 14 and 18 are not used.)
12. For World Trade countries only.
13. One required for each SF #4721 in Germany. (Provides a shielded cable for compliance with radio-frequency-interference regulations.)
14. If attaching an IBM SNA Terminal, Group 1385 must be used, otherwise order group 488.
15. SF #4715 requires one cable group 1499 for French Caducee Automatic Calling Units, otherwise order group 486.
16. The total cable length (including any directly attached terminal cable) must not exceed 100 feet for SF 4716 nor 200 feet for SF 4713.

IBM 3705-I or 3705-II Communications Controller (With Remote Program Loader)

The IBM 3705 (With Remote Program Loader) is a programmable transmission control unit for System/370. It is attached to the CPU through a 3705 by a Type 3002 private line data channel with Type C2 conditioning, a CCITT recommended M102 data channel, or equivalent privately-supplied channel. The 3705-I (With Remote Program Loader) can handle line speeds from 45.5 bps to 64,000 bps. The 3705-II (With Remote Program Loader) can handle line speeds from 45.5 bps to 230,400 bps.

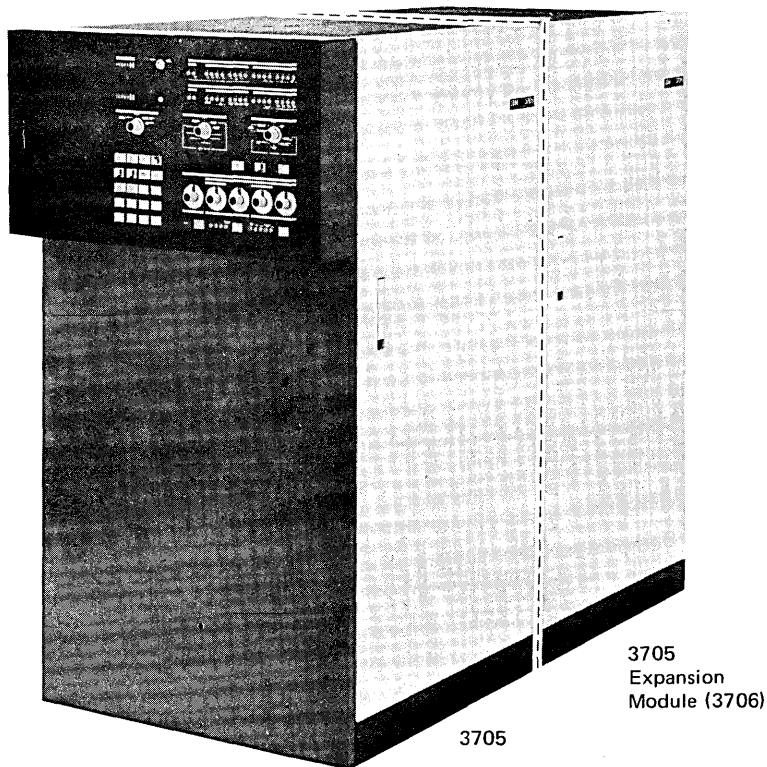
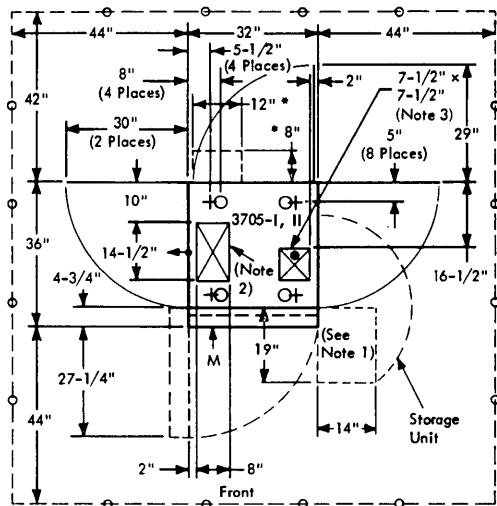

Figure 3705-1. IBM 3705 Communications Controller (With Remote Program Loader)

**3705-I or 3705-II COMMUNICATIONS CONTROLLER (WITH
REMOTE PROGRAM LOADER) - SPECIFICATIONS**

3705 (WITH REMOTE PROGRAM LOADER)

PLAN VIEW



- Notes:**
1. For full 180° swing, remove adjacent machine cover.
 2. Signal cable entry.
 3. Power cable entry.

* Storage Unit-In Last Module Only

Inches	Centimeters
2	5
4	10
4 3/4	12
5	13
5 1/2	14
7 1/2	19
8	20
10	25
14	36
14 1/2	37
16 1/2	42
18	46
27 1/4	69
29	74
30	76
31 1/4	79
32	81
36	91
42	107
44	112
129 3/4	330

**3705-I or 3705-II (WITH REMOTE PROGRAM LOADER)
MAXIMUM CONFIGURATION**

PLAN VIEW

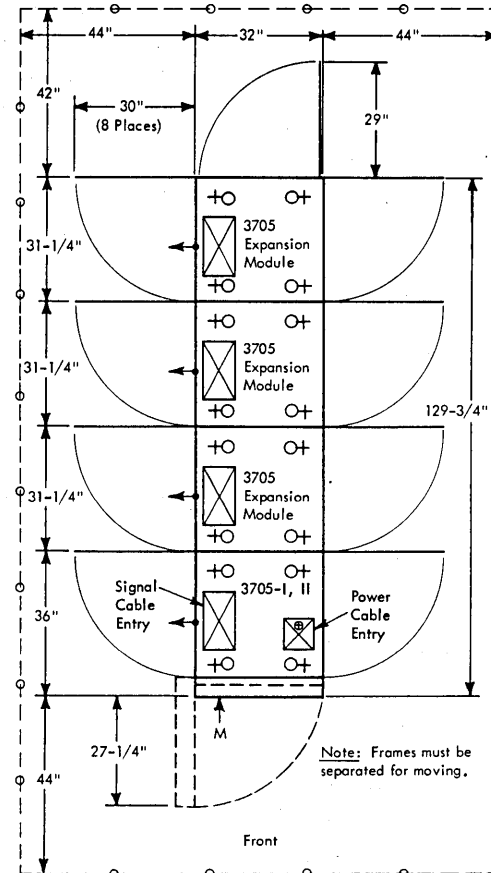

**3705 EXPANSION MODULE (WITH REMOTE PROGRAM
LOADER)**

PLAN VIEW

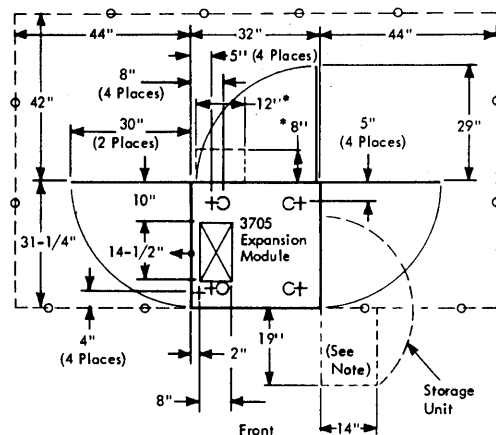

Note: For full 180° swing,
remove adjacent machine cover.

* Storage Unit-In last Module Only

**3705-I or 3705-II COMMUNICATION CONTROLLER (WITH
REMOTE PROGRAM LOADER) - SPECIFICATIONS**

Model	Dimensions* in (cm)			Service Clearance in (cm)				Weight lb (kg)
	Front	Side	Height	Front	Rear	Right	Left	
A or E	32 (81)	36 (91)	60 (152)	44 (112)	42 (107)	44 (112)	44 (112)	1010 (460)
B, F or J	32 (81)	67½ (171)	60 (152)	44 (112)	42 (107)	44 (112)	44 (112)	1920 (880)
C, G, or K	32 (81)	98½ (250)	60 (152)	44 (112)	42 (107)	44 (112)	44 (112)	2830 (1300)
D, H or L	32 (81)	129 ¼ (330)	60 (152)	44 (112)	42 (107)	44 (112)	44 (112)	3740 (1700)

*Shipping dimensions are 32" x 36" x 60" (81 cm x 91 cm x 152 cm). Removal of the covers reduces the width to 29½" (75 cm). The front panel can be removed to make the unit 29½" x 30" x 60" (75 cm x 76 cm x 152 cm).

Model	Heat Output BTU/h (Kcal/h)	
	60 Hz	50 Hz
A or E	6400 (1650)	7170 (1850)
B or F	12,800 (3250)	14,340 (3650)
C or G	19,200 (4850)	21,510 (5450)
D or H	25,600 (6500)	28,680 (7250)
J	11,300 (2850)	12,900 (3250)
K	16,900 (4300)	19,400 (4900)
L	22,500 (5700)	25,800 (6500)

Specification	Model	60 Hz			50 Hz † *				
		200*	208	230	200	220	235	380	408
Volts	All	200*	208	230	200	220	235	380	408
Phase	All	3	3	3	3	3	3	3	3
KVA	A or E	2.5	2.5	2.5	2.8	2.8	2.8	2.8	2.8
	B or F	5.0	5.0	5.0	5.6	5.6	5.6	5.6	5.6
	C or G	7.5	7.5	7.5	8.4	8.4	8.4	8.4	8.4
	D or H	10.0	10.0	10.0	11.2	11.2	11.2	11.2	11.2
	J	5.3	5.3	5.3	5.9	5.9	5.9	5.9	5.9
	K	7.9	7.9	7.9	8.9	8.9	8.9	8.9	8.9
	L	10.6	10.6	10.6	11.9	11.9	11.9	11.9	11.9
	Branch Circuit (Amp)	A or E	—	30	30	—	—	—	—
B, F, or J	—	30	30	—	—	—	—	—	
C, G, or K	—	60	60	—	—	—	—	—	
D, H, or L	—	60	60	—	—	—	—	—	
Max. Cont. Load (Amp)	A or E	11.3	10.8	9.8	13.6	12.3	11.6	4.2	3.9
	B or F	22.6	21.6	19.6	27.2	24.6	23.2	8.4	7.8
	J	23.9	22.8	21.2	28.8	26.1	24.6	8.9	8.3
	C or G	33.9	32.4	29.4	40.8	36.9	34.8	12.6	11.7
	K	35.9	34.7	31.1	43.2	39.1	36.8	13.3	12.4
	D or H	45.2	43.2	39.2	54.4	49.2	46.4	16.8	15.6
	L	47.8	45.7	41.5	57.6	52.1	49.0	17.8	16.5
	Power Cord Style**	A or E	F1	—	—	D2	D2	D2	D2
B, F, or J		F2	—	—	E1	E1	E1	D2	D2
C, D, H, K, or L		F2	—	—	E2	E2	E2	E1	E1
Plug Type	A, B, E, F, or J	—	D	D	—	—	—	—	—
	C, D, G, H, K, L	—	E	E	—	—	—	—	—
Power Cord Length (ft) Length (m)	All	14 4.27	14 4.27	14 4.27	14 4.27	14 4.27	14 4.27	14 4.27	14 4.27

*World Trade

**When Field converting to Models A,B,E,F, or J from Models C,D,G,H,K, or L a new Power Cord will not be shipped. Existing cord assembly should be used.

†For the 3705-II, 50 Hz only, the phase may be unbalanced to a ratio of 1.3 to 1.

**3705-I or 3705-II COMMUNICATION CONTROLLER
(WITH REMOTE PROGRAM LOADER) -
SPECIFICATIONS**

Air Flow

800 ft³/min (25 m³/min)

Environment, Operation

Temp.	60 to 90 °F	16 to 32 °C (3705-I)
	50 to 100 °F	10 to 38 °C (3705-II)*
Rel. Humidity	8 to 80%	
Max. Wet Bulb	78 °F	26 °C

Environment, Non-operating

Temp.	50 to 110 °F	10 to 40 °C
Rel. Humidity	8 to 80%	
Max. Wet Bulb	80 °F	26.7 °C

**Extended Environment with Internal Air Circulation
Features, Operating (3705-I only)****

Temp.	50 to 100 °F	10 to 38 °C
Air Flow	980 ft ³ /min (27.8 m ³ /min)	

* The upper temperature limit must be derated 1 °F (0.6 °C) for each 250 feet (76 m) of elevation above 3000 feet (914 m).

** An Internal Air Circulation Feature is needed with each increment of storage on 3705-I only.

**3705-I AND II COMMUNICATIONS CONTROLLER AND
 3705 EXPANSION MODULE CABLING SCHEMATIC**

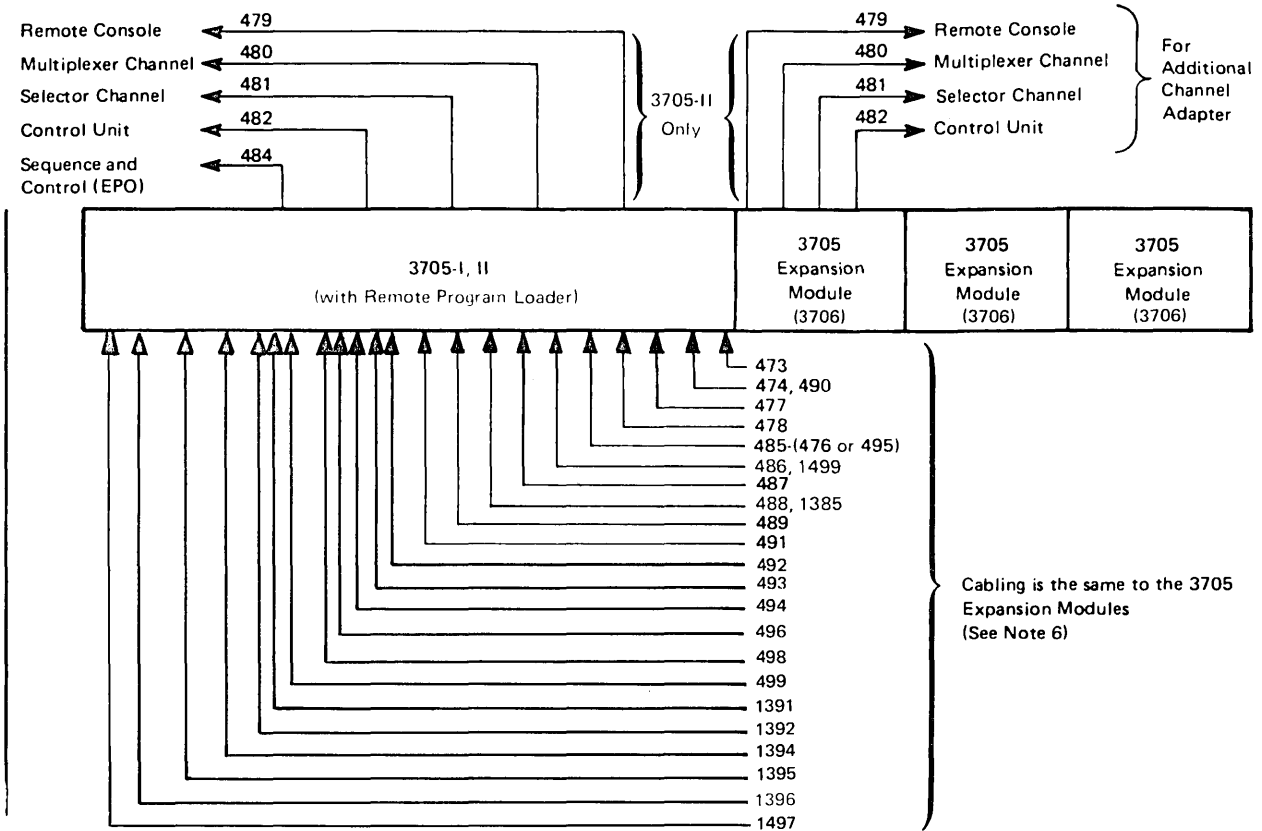

Cables for IBM and Non-IBM Devices

Group No.	Termination
473 } 492 }	1 25-Pin EIA RS-232C or CCITT Connector (Male)
474 } 490 }	2 Pair #8 Ring Lugs
476 } 495 }	1 25-Pin EIA RS-232C Connector (Male) (See Note 2)
	Attaches to Group 485
	8" Fixed Length (2.03 m)
477 } 478 } 485 } 486 }	2 25-Pin EIA RS-232C or CCITT Connectors (Male)
487 } 488 } 1385 } 1499 }	2 25-Pin EIA RS-232C or CCITT Connectors (Female)
489	12-Pin Burndy Connector for Wide-Band Modem (Male)
491 } 493 }	2 WE-283B Plugs; Customer Provides 404B Surface Mount, 493A Flush Mount, 549A Surface Mount Jacks, or Equivalent Receptacles
494	#8 Ring Lugs (8 for each leg)
496 } 1497 }	1 34-Pin Winchester or CCITT V.35 Connector (Male) or Equivalent.
498	#8 Ring Lugs (8)
499	1 WE-283B Plug; Customer Provides 404B Surface Mount, 493A Flush Mount, 549A Surface Mount Jacks, or Equivalent Receptacles
1391	1 15-Pin CCITT X.21 Connector (Male)
1392 } 1392 }	2 15-Pin CCITT X.21 Connectors (Female)
1396	1 15-Pin CCITT X.21 Connector (Male)
	Attaches to Group 1392
	24 in. Fixed Length (610mm)
1394 } 1395 }	1 34-Pin Winchester or V.35 Connector (Female) or Equivalent

**3705-I AND II COMMUNICATIONS CONTROLLER AND
 3705 EXPANSION MODULE CABLING SCHEMATIC**

Feature Code	Group No.	Line Set Type	No. of Cables	From	To	Max Length		Notes
						(ft)	Meters	
1543	479		1	3705-I, II, 3705 Expansion Module	Remote Console	150	45.7	4
-	480		2	3705-I, II, 3705 Expansion Module	Multiplexer Channel	-	-	1
-	481		2	3705-I, II, 3705 Expansion Module	Selector Channel	-	-	1
-	482		2	3705-I, II, 3705 Expansion Module	Control Unit	-	-	1
-	484		1	3705-I, II	Channel	150	45.7	15
2944	496	1K	1	One High-Speed Modem	3705-I, II or 3705 Expansion Module	45	13.7	7
4707	498	LIB 7	1	Common-Carrier CBS Data Coupler	3705-I, II or 3705 Expansion Module	45	13.7	
47i1	477 or	1A	2	Two IBM Modems	3705-I, II or 3705 Expansion Module	45	13.7	7,10
	478 or	1A	2	Two Non-IBM Modems	3705-I, II or 3705 Expansion Module	45	13.7	7,10
	485	1A	2	Two Modems	3705-I, II or 3705 Expansion Module	45	13.7	8,10
4712	492	1B	1	One Low-Speed Duplex Modem	3705-I, II or 3705 Expansion Module	45	13.7	
4713	487	1C	2	Two Directly Attached Terminals	3705-I, II or 3705 Expansion Module	195	59.4	12
4714	477 or	1D	2	Two IBM Modems	3705-I, II or 3705 Expansion Module	45	13.7	5,7,10
	478 or	1D	2	Two Non-IBM Modems	3705-I, II or 3705 Expansion Module	45	13.7	5,7,10
	485	1D	2	Two Modems	3705-I, II or 3705 Expansion Module	45	13.7	2,5,10,11
4715	486 or	1E	2	Two Autocall Units	3705-I, II or 3705 Expansion Module	45	13.7	
	1499	1E	2	Two W.T. Autocall Units	3705-I, II or 3705 Expansion Module	45	13.7	7, 14
4716	488 or	1F	2	Two Directly Attached Terminals	3705-I, II or 3705 Expansion Module	95	28.9	12
	1385	1F	2	Two Directly Attached Terminals	3705-I, II or 3705 Expansion Module	95	28.9	12,13
4717	489	1G	1	Wide-Band Modem	3705-I, II or 3705 Expansion Module	45	13.7	
4718	473	1H	1	One-Medium Speed Duplex Modem	3705-I, II or 3705 Expansion Module	45	13.7	
4719	None	1J	0					3
4720	496	1S	1	One High-Speed Modem	3705-I, II or 3705 Expansion Module	45	13.7	8
4721	490 or	2A	1	Common-Carrier Terminal Strip	3705-I, II or 3705 Expansion Module	45	13.7	8,9
	474	2A	1	Common-Carrier Terminal Strip	3705-I, II or 3705 Expansion Module	45	13.7	7,9
4722	489	1GA	1	Wide-Band Modem	3705-II or 3705 Expansion Module	45	13.7	16
4723	489	1TA	1	Wide-Band Duplex Modem	3705-II or 3705 Expansion Module	45	13.7	16
4725	489	1T	1	One Wide-Band Duplex Modem	3705-I, II or 3705 Expansion Module	45	13.7	
4726	1497	1U	1	One High-Speed Duplex Modem	3705-I, II or 3705 Expansion Module	45	13.7	
4727	1394	1W	1	One Directly Attached Device	3705-II or 3705 Expansion Module	145	44.2	
4728	1395	1Z	1	One Directly Attached Device	3705-II or 3705 Expansion Module	145	44.2	
4731	491	3A	1	Common-Carrier Telephone Jack	3705-I, II or 3705 Expansion Module	45	13.7	
4732	491	3B	1	Common-Carrier Telephone Jack	3705-I, II or 3705 Expansion Module	45	13.7	
4741	491	4A	1	Common-Carrier Telephone Jack	3705-I, II or 3705 Expansion Module	45	13.7	
4742	491	4B	1	Common-Carrier Telephone Jack	3705-I, II or 3705 Expansion Module	45	13.7	
4743	491	4C	1	Common-Carrier Telephone Jack	3705-I, II or 3705 Expansion Module	45	13.7	
4751	499	5A	1	Common-Carrier Telephone Jack	3705-I, II	45	13.7	6
4752	499	5B	1	Common-Carrier Telephone Jack	3705-I, II	45	13.7	6
4754	499	11A	1	Common-Carrier Telephone Jack	3705-I, II	45	13.7	6
4755	499	11B	1	Common-Carrier Telephone Jack	3705-I, II	45	13.7	6
4761	498	6A	1	Common-Carrier CBS Data Coupler	3705-I, II or 3705 Expansion Module	45	13.7	
4781	493	8A	1	Common-Carrier Telephone Jack	3705-I, II or 3705 Expansion Module	45	13.7	
4782	494	8B	2	Common-Carrier CBS Data Coupler	3705-I, II or 3705 Expansion Module	45	13.7	
4784	499	10A	1	Common-Carrier Telephone Jack	3705-I, II or 3705 Expansion Module	45	13.7	
4785	493	12A	1	Common-Carrier Telephone Jack	3705-I, II or 3705 Expansion Module	45	13.7	
4786	494	12B	2	Common-Carrier CBS Data Coupler	3705-I, II or 3705 Expansion Module	45	13.7	
4791	498	9A	1	Common-Carrier CBS Data Coupler	3705-I, II or 3705 Expansion Module	45	13.7	
5655	1391 or	1N	1	One Duplex W.T. DCE	3705-II or 3705 Expansion Module	45	13.7	7
	1392 &	1N	2	Two Half-Duplex W.T. DCEs	3705-II or 3705 Expansion Module	45	13.7	7, 17
	1396							
5656	1391	1R	1	One Duplex W.T. DCE	3705-II or 3705 Expansion Module	45	13.7	7

Note: Refer to the notes on the next page.

3705-I AND II COMMUNICATIONS CONTROLLER AND 3705 EXPANSION MODULE CABLING SCHEMATIC

Notes:

1. Total cable length of 200 feet (6.1m) (unless modified by general control-to-channel cabling schematic) is available to attach up to eight control units.
2. SF #4714 requires cable group 485 and may require either group 476 or 495 as specified below:
 - a. One or two of group 476 is required for switched network modems that use either "Ring-Indicate" or "Coupler-Cut-Through" on pin 23. (Pins 18 and 23 are not used.)
 - b. One or two of group 495 is required for modems using a contact closure interface between pins 19 and 20. Group 495 provides compatibility between the 3705 25-pin EIA RS-232C voltage interface and the modem contact closure interface. Cable includes a jumper between pins 19 and 20 and removes the "Data Terminal Ready" voltage from pin 20.
3. Cable-connecting hardware is supplied for SF #4719; external cable is not supplied. See *IBM 3704 and 3705 Communications Controllers, Original Equipment Manufacturer's Information, GA27-3053*, for pin designations. Any customer-supplied protective conduit must not extend above the lower machine frame 2.6" (6.6cm).
4. In addition to the two sets of channel cables chosen, one cable group 479 is required of the type 3 channel adapters interface enable/disable switch is to be placed on the remote console (3058 or 3068).
5. The maximum cable length is 25 feet (7.62m) when the rate exceeds 7,200 bps in U.S. and Canada or 4,800 bps in World Trade countries.
6. SF #4751, #4752, #4754, and #4755 do not apply to the 3705 Expansion Module.
7. For World Trade countries only.
8. For U.S. and Canada.
9. In World Trade countries *except* Germany, SF #4721 requires one cable group 490. In Germany, SF #4721 requires one cable group 474 (provides a shielded cable).
10. In World Trade countries *except* Germany, SF #4711 and SF #4714 require one cable group 485. In Germany, SF #4711 and SF #4714 require either one group 477 when using IBM modems (provides a shielded cable) or one group 478 when using PTT mandatory modems (pins 14 and 18 are not used). United States and World Trade—for SF #4714 at transmission rates above 7200 bps U.S. or 4800 bps W.T. the cable maximum length is 25 feet (7.6m).
11. For SF #4714 (Line Set Type ID, cable group 485). If a longer cable length is desired at the higher speeds, contact the IBM DP Special Products Marketing Representative.
12. The total cable length (including any directly-attached terminal cable) must not exceed 100 feet for SF #4716 nor 200 feet for SF #4713.
13. If attaching a IBM SNA Terminal, Group 1385 must be used, otherwise order group 488.
14. SF #4715 requires one group 1499 when attaching French Caducee Automatic Calling Units, otherwise order group 486.
15. Sequence and control cable (EPO).
16. Operates only with a Type 3HS Communication Scanner.
17. SF #5655 using cable group 1392 also requires one cable group 1396. Each 3705 or 3705 expansion module (3706) requires only one 1396 cable group.

IBM 3735 Programmable Buffered Terminal, Including IBM 5496 Data Recorder and IBM 3286 Printer Model 3 – Specifications

PLAN VIEW (Scale: 1/2" = 1')

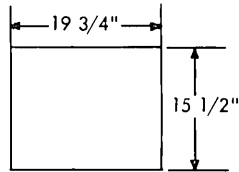

Inches	Centimeters
8 3/4	22,2
15 1/2	39,4
19 3/4	50,2
23	58,5
29	73,7
30	76,2
42	106,7

PLAN VIEW (Scale: 1/4" = 1')

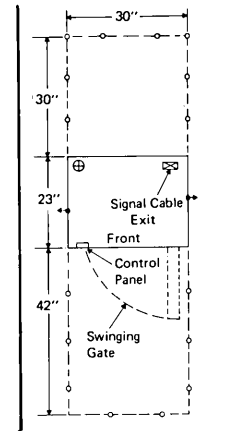

Service Area Boundary

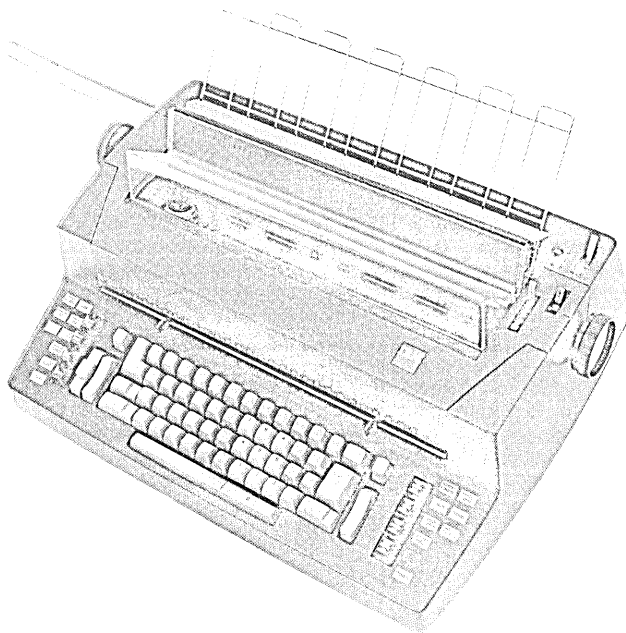

Figure 3735-1. Selectric I/O II

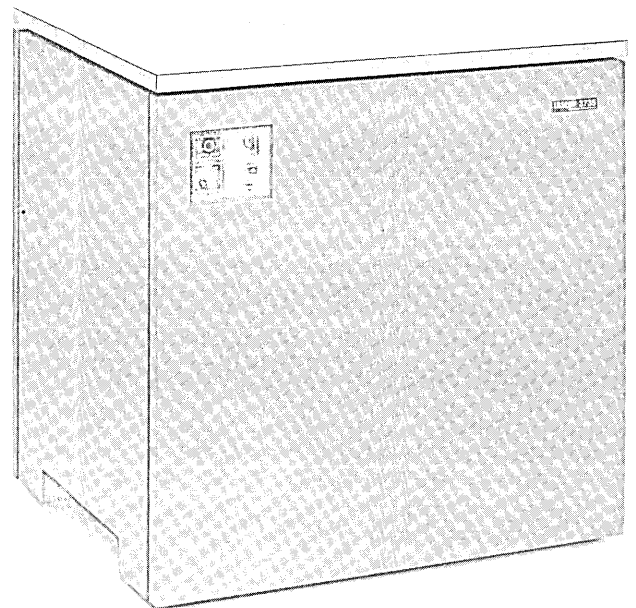

Figure 3735-2. Control Unit

3735 PROGRAMMABLE BUFFERED TERMINAL – SPECIFICATIONS

Dimensions

Selectric I/O II

	Front	Side	Height
Inches	19-3/4	15-1/2	8-3/4
Centimeters	50,2	39,4	22,2

Dimensions do not include platen knobs or paper guide.

Control Unit

	Front	Side	Height
Inches	30	23	29
Centimeters	76,2	57,2	73,7

Weight

Selectric I/O II	55 lbs.	25,0 kg
	240 lbs.	108,9 kg

Cables – IBM-Provided and shipped with unit

Selectric I/O II to Control Unit (2 cables): 8' (2,4m)

Control Unit to Communications Line: (Signal Cables)

1. Using external modem (data set)

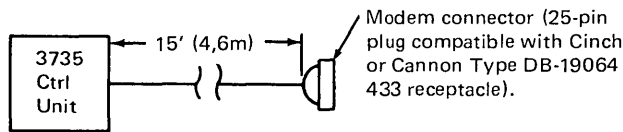

2. Using an IBM Integrated Modem feature:

a. Connecting to leased or privately owned communications line:

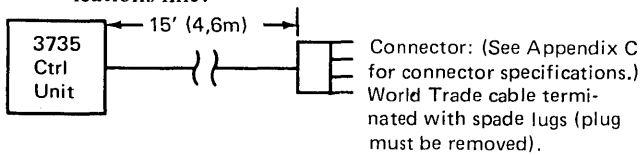

b. Connecting to common-carrier switched network through Data Access Arrangement (DAA type CBS):

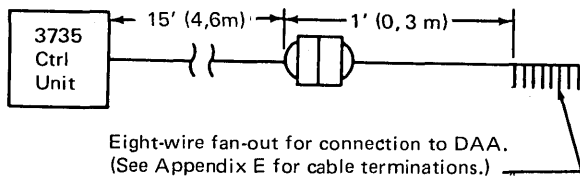

c. Connecting to common-carrier switched network through Data Access Arrangement (DAA type CDT):

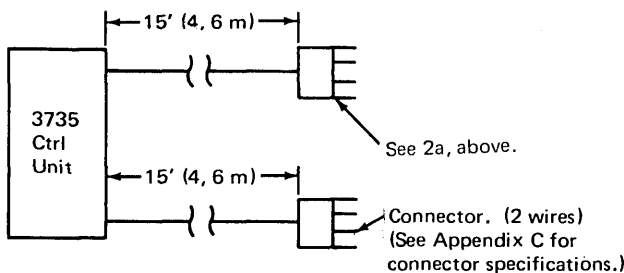

d. Connecting to CADUCEE Switched Network:

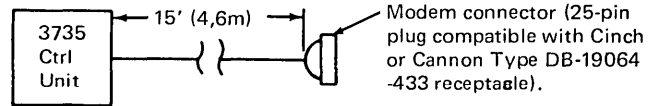

Heat Output

Both units	2000 BTU/h	504 kcal/h
------------	------------	------------

Air Flow

Control Unit	15 ft ³ /min	0,42 m ³ /min
--------------	-------------------------	--------------------------

Environment, Operating

Temp.	50 ⁰ to 110 ⁰ F	10 ⁰ to 43 ⁰ C
Rel Humidity	8 to 80%	
Max. Wet Bulb	85 ⁰ F	29,4 ⁰ C

Environment, Non-operating

Temp.	50 ⁰ to 125 ⁰ F	10 ⁰ to 52 ⁰ C
Rel Humidity	8 to 80%	
Max. Wet Bulb	85 ⁰ F	29,4 ⁰ C

Power Requirements (Control Unit*)

	60 Hz.				50 Hz.		
Volts	100/115	100	110	123.5	200	220	235
kVA	0.7	0.7	0.7	0.7	0.7	0.7	0.7
Phase	1	1	1	1	1	1	1
Branch							
Circuit (A)	15						
Max. Cont. Load (A)	6.0	6.5	6.5	5.7	3.5	3.1	3.0
Plug Type**	H,J			Power Cord Only			
Power Cord Style	—	G4	See Appendix B				
Power Cord Length	6 ft.		(18.26m)				

* Selectric I/O II power is supplied by the Control Unit.

** See Appendix A for description of power plugs.

Communications Facilities

See IBM 3735 Programmable Buffered Terminal Concept and Application, GA27-3043, for description of communication facilities.

5496 DATA RECORDER (ATTACHED TO 3735) – SPECIFICATIONS

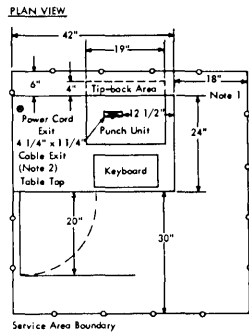

Notes:
1. Right service clearance needed above table top only.

Inches	Centimeters
1 1/4	3,2
4	10,2
4 1/4	10,8
6	15,2
12 1/2	31,8
18	45,7
19	48,3
20	50,8
24	61
30	76,2
37 1/2	95,3
42	106,7

Feet	Meters
7	2,1
15	4,6
9	2,77

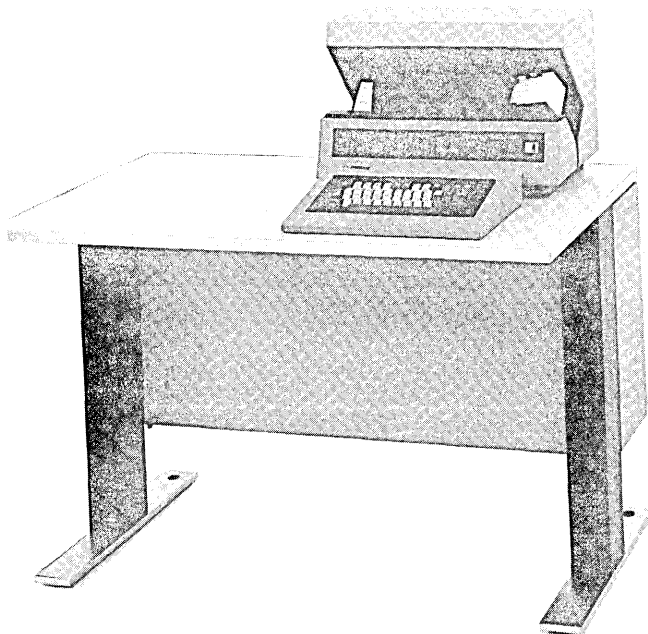

Figure 3735-3. IBM 5496 Data Recorder

Dimensions

	Front	Side	Height
Inches	42	24	37-1/2
Centimeters	106,7	61	95,3

Service Clearances

	Front	Rear	Right	Left
Inches	30	6	18	—
Centimeters	76,2	15,2	45,7	—

Weight

250 lbs 113,4 kg

Heat Output

60 hertz	850 BTU/h	214 kcal/h
50 hertz	1225 BTU/h	309 kcal/h

Air Flow

— CFM — m³/min

Signal Cable—IBM Provided and shipped with unit
5496 to Control Unit: 12 ft. (3,66 meters)

Environmental Requirements

See Page 3735.2

Power Requirements **

	60 Hz.		50 Hz.					
Volts	115	100	100	110	123.5	200	220	235
kVA	0.4	0.4	0.6	0.6	0.6	0.6	0.6	0.6
Phase	1	1	1	1	1	1	1	1
Branch								
Circuit (A)	15	15						
Max. Cont. Load (A)	3.1	3.6	5.2	4.7	4.1	2.6	2.3	2.2

Plug Type* H,J

Power

Cord Length	9 ft.	(2.77m)						
Cord Style	G4	G4	G4	G4	G4	G4	G4	G4***

* See Appendix A for description of power plugs.

** This unit is equipped with radio interference control circuitry and requires a good insulated wired earth or building ground. Total resistance of the ground conductor, measured between the receptacle and the building grounding point, may not exceed 3 ohms. For proper operation, all components of the system or systems to which this unit is attached must have the same ground reference.

*** See Appendix B for description of cord styles.

**3286 PRINTER MODEL 3 (ATTACHED TO 3735)
SPECIFICATIONS**

PLAN VIEW

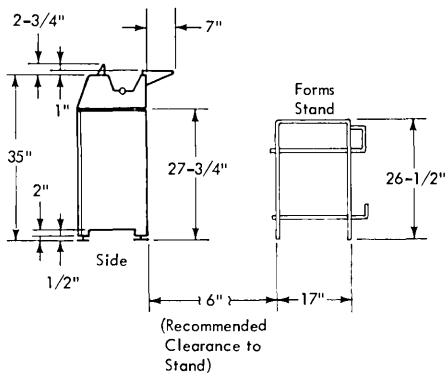
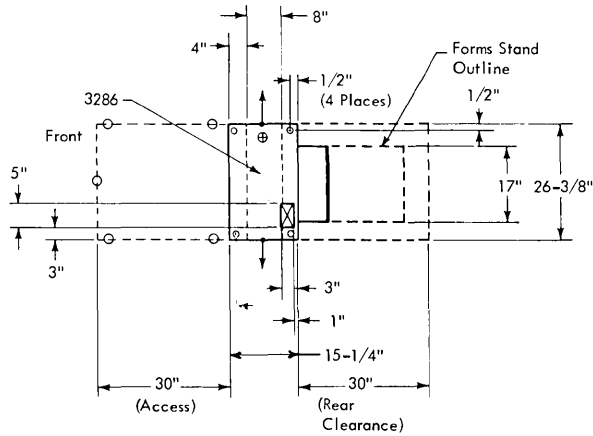

Inches	Centimeters
1/2	1
1	3
2	5
2-3/4	7
3	8
4	10
5	13
6	15
7	18

Inches	Centimeters
8	20
15-1/4	39
17	43
26-1/2	67
26-3/8	68
27-3/4	70
30	76
35	89

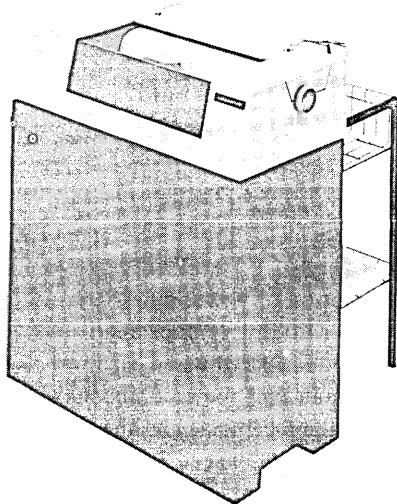

Figure 3735.4 IBM 3286 Printer Model 3

Dimensions

	Front	Side	Height
Inches	26-3/8	15-1/4	37-3/4
Centimeters	68	39	96

Service Clearances

	Front	Rear	Right	Left
Inches	30	30	0	0
Centimeters	76	76	0	0

Weight

135 lbs	62 kg
---------	-------

Heat Output

770 BTU/h	200 kcal/h
-----------	------------

Air Flow

Convection only

Signal Cable – IBM Provided and shipped with unit

3286 to Control Unit: 13 ft (3,96 meters)

Environment, Operating

Temp.	50° to 110°F	10° to 43°C
Rel Humidity (See Note)	8 to 80%	
Max. Wet Bulb	85°F	29.4°C

Note: Optimum forms feeding and stacking will be achieved in the operating range of 26 to 62% relative humidity. More frequent forms handling intervention may be required when operating in environments outside this range.

Environment, Non-operating

Temp.	50° to 125°F	10° to 52°C
Rel Humidity	8 to 80%	
Max. Wet Bulb	85°F	29.4°C

Power Requirements:

	60 Hz.		50 Hz.				
	115	100	100	110	123.5	200	235
Volts	115	100	100	110	123.5	200	235
kVA	0.26	0.26	0.26	0.26	0.26	0.26	0.26
Phase	1	1	1	1	1	1	1
Branch							
Circuit (A)	15	-	-	-	-	-	-
Max. Cont. Load (A)	2.6	2.6	2.6	2.4	2.1	1.2	1.1
Plug Type*	H,J Power Cord Only						
Power Cord Style	A9-See Appendix B						
Power Cord Length	8 ft.	2.44 m					

*See Appendix A for description of power plugs.

IBM 3767 Communication Terminal Model 1, 2 and 3 (CUSTOMER SET-UP DESIGNATED)

SPECIFICATIONS

Plan View

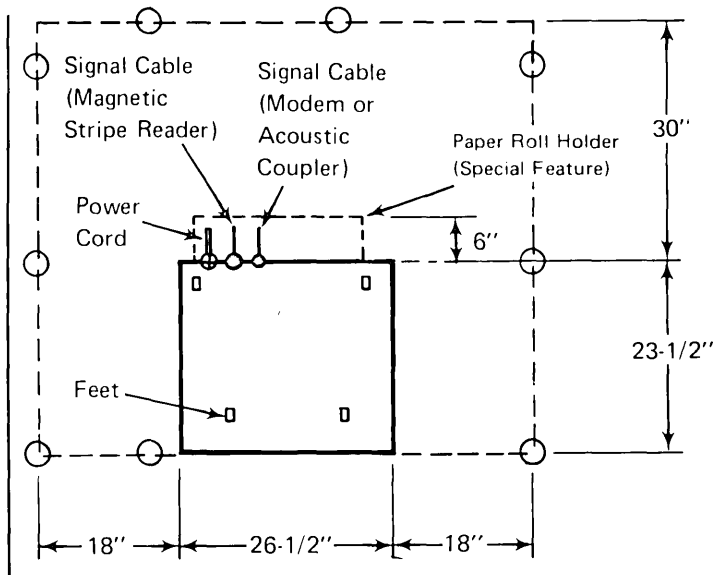

Dimensions

	Front	Side	Height*
Inches	26-1/2	23-1/2	10
Centimeters	67.3	59.7	25.4

* 11-1/2 inches (29,2 cm) with forms tractor

Service Clearances*

	Front**	Rear	Right	Left
Inches	0	20"	30"	30"
Centimeters	0	50.8	76.2	76.2

* A 50" inch (127cm) service clearance (measured from the table) above the terminal is required.

** Operator access must be provided.

Weight

78 lbs. 35.4 kg

Heat Output

853 BTU/hr. 215 kcal/hr.

Air Flow

Model 1 and 2 - 1.5m³/min (55 CFM)

Model 3 3m³/min (105 CFM)

Model 1 and 2 - 3m³/min (105CFM) order Blower Feature

Power Requirements

Volts	60 Hz.			50Hz. +				
	100	115	220	100	110	123.5	220	235
kVA	0.25	0.25	0.25	0.25	0.25	0.25	0.25*	0.25
Phase	1	1	1	1	1	1	1	1
Branch								
Circuit (A)	-	15	-	-	-	-	-	-
Max. Cont. Load (A)	2.5	2.1	1.1	2.5	2.2	2.0	1.1	1.0
Plug Type*								
Non-Locking	H	H	-	H	-	-	-	-
Locking	J	J	-	-	-	-	-	-
Power Cord Style**			G4	G4	G4	G4	G4	G4
Length***			10 ft.	(3.5m)				

*Refer to Appendix A.

**Refer to Appendix B.

***A 6-foot (1.83m) cord may be specified at the time of the order.

For safety each branch ckt must be grounded. A dedicated wire conductor or a continuous metal may be used for the purpose of grounding. The dedicated wire conductor is recommended.

+World Trade Only

Inches	Centimeters
3-1/4	8.2
4-1/4	10.8
5-1/4	13.3
6	15.2
10	25.4
10-1/4	26.1
10-13/32	26.4
11-1/2	29.2
18	45.7
23-1/2	59.7
26-1/2	67.3
30	76.2
36	91.4
90	228.6

Feet	Meters
6	1.8
10	3.5
20	6.1
25	7.6
30	9.1
35	10.6
40	12.1

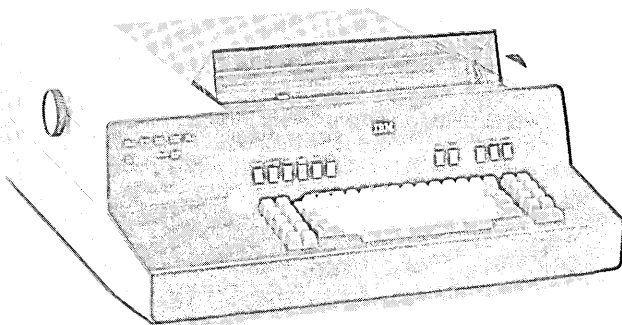

Figure 3767. IBM 3767 Communication Terminal

Operating Environment*

Temperature
 Rel. Humidity 8 to 80%
 Max. Wet Bulb 80°F 27°C
 Also see note 2.

Non-Operating Environment

Temperature 50° to 125°F 10° to 52°C
 Rel. Humidity 8 to 80%
 Max. Wet Bulb 80°F 27°C

Communications Facilities--See *IBM Teleprocessing Systems Summary*, GA24-3090.

*See sales feature for operation in environment above 90°F (32.2°C).

Notes:

1. Magnetic Stripe Reader (special feature) attaches at a rear cable exit with a 7 foot (2.13 m) provided signal cable. The reader's dimensions are: front 2 1/2 inches (6.4 cm); side 6 inches (15.2 cm); height 3 1/2 inches (6.9 cm).
2. Acoustic Coupler (special feature) attaches at a rear cable exit with a 36-inch (91.4 cm) provided signal cable. The coupler's dimensions are: front 6 inches (15.2 cm); side 10 1/2 inches (26.7 cm); height 5 3/4 inches (14.6 cm)

With the Acoustic Coupler feature attached, the ambient room noise level should not exceed 80 dBamb, with impulse noise not greater than 90dB. A normal office environment meets these criteria. When the 3767 is transmitting or receiving, avoid loud sharp noises near the Acoustic Coupler.

SIGNAL CABLES AND CONNECTORS

A 20-foot (6.1m) cable is provided as standard. Different lengths may be specified at the time of the order as follows:

25 feet (7.62m), 30 feet (9.14m), 35 feet (10.67 m), 40 feet (12.19m).

Connectors used for the various modem and line configurations are as follows:

With an External Modem

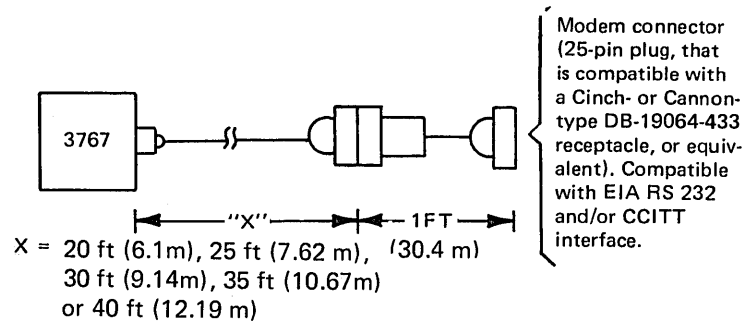

With the IBM Integrated Modem Feature

USA/Canada:

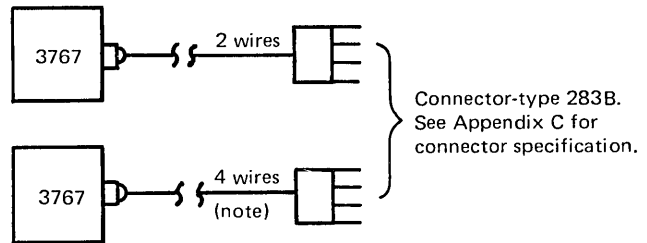

Countries except USA/Canada:

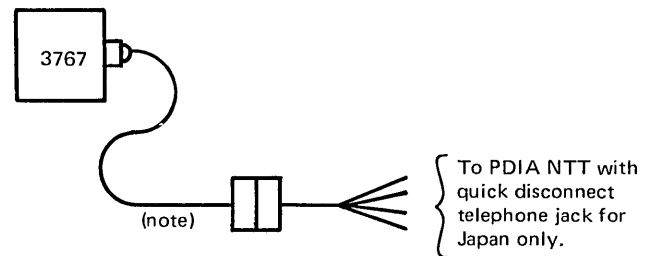
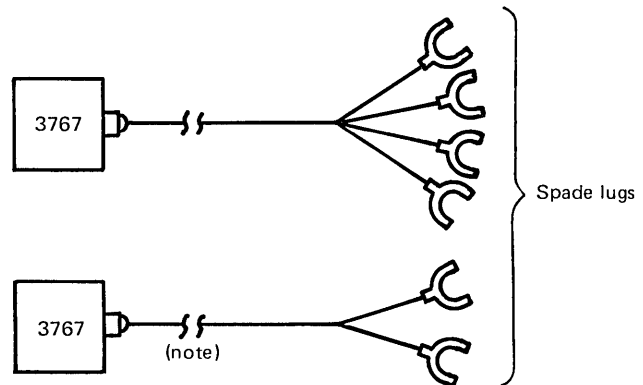

Note: Available for a leased or privately-owned communications line only.

IBM 3770 Data Communication System

CONFIGURATIONS

Machine Type	Maximum I/O Attachments		Integrated Modems		
	Machine	Feature	1200 bps	2400 bps	4800 bps
3771	1	0	Yes	No	No
3773	0	1	Yes	No	No
3774	3	3	Yes	Yes	No
3775	2	3	Yes	Yes	No
3776-1,2	2	2	No	Yes	Yes
3776-3,4	3	3	No	No	No
3777-1	2	2	No	No	No
3777-2	3	3	No	No	No
3777-3	4	3	No	No	No

* Either a 3501 or a 3521/3782-1 (not both) can be attached to the 3771.

Attachable To	I/O Machines					
	2502+ 3782-2	3521† 3782-1	3501†	3784	3203	3411
3771	No	Yes††	Yes††	No	No	No
3773	No	No	No	No	No	No
3774	Yes	Yes	Yes	Yes‡	No	No
3775	Yes	Yes	Yes	No	No	No
3776-1-2	Yes	Yes	Yes	No	No	No
3776-3-4	Yes	Yes	No	No	No	Yes
3777-1	Yes‡‡	No	No	No	Std.*	No
3777-2	Yes‡‡	Yes	No	No	Std.*	No
3777-3	Yes‡‡	Yes	No	No	Std.*	Yes

* All 3777s must have a 3203 Printer attached.

† Only one card reader can be attached. If a 2502 or 3501 Card Reader and a 3521 Card Punch with the Card Read feature are attached, the 3521 Card Read feature can be used only for punch checking.

†† Either a 3501 or a 3521/3782-1 (not both) can be attached to the 3771.

‡ A 3784 Line Printer can be attached to a 3774 Model 1 or 2 or P1 or P2 only.

‡‡ A 2502 can be attached directly to the 3777; the 3782-2 is not required. (The 3777 requires the 2502 Card Reader Attachment feature).

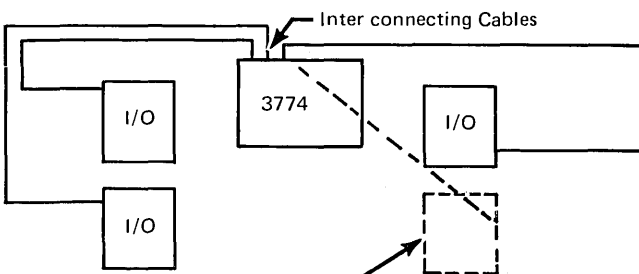

Without raised floor, I/O device should not be placed here because of restricted cable length.

The configuration shown is suggested for convenient access to the I/O devices. Any device may occupy any I/O position shown, depending on the customer's preference.

Attachable To	I/O Feature			
	1st Diskette Device	2nd Diskette Device	Display	Key Pad Numeric
3771	No	No	No	No
3773	Std.*	No	No	Yes**
3774	Yes	Yes	Yes**	Yes**
3775	Yes	Yes	Yes**	Yes**
3776-1-2	Yes	Yes	No	No
3776-3-4	Yes	Yes	Yes	No
3777-1-2	Yes	Yes	Yes	No
3777-3	Yes	Yes	Yes	No

* One diskette storage device is standard on the 3773.

** These features are available for programmable models only.

Modem Fan Out Configuration, Integrated Modem

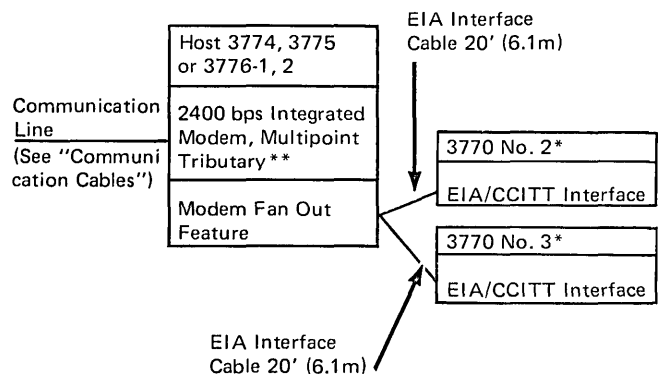

* 3771, 3773, 3774, 3775, or 3776

** Or 4800 bps Integrated Modem, Multipoint Tributary on the 3776.

Modem Fan Out with 3872 or 3874

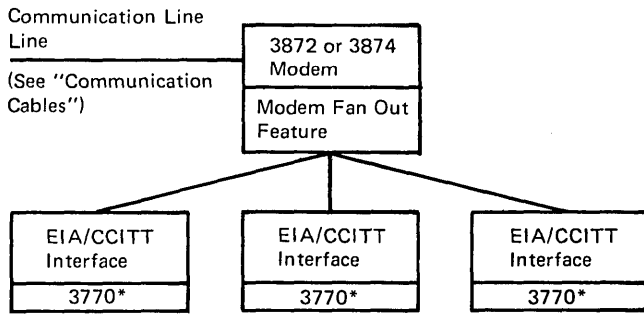

*3771, 3773, 3774, 3775, or 3776

COMMUNICATION FACILITIES

Refer to the publication *IBM 3770 Data Communication System—System Components*, GA27-3097.

COMMUNICATION CABLES FOR 3771, 3773, 3774, 3775 and 3776-1, 2

For 3777, see "Communication Cables for 3777."
 For 3776 Models 3 and 4, see "Communication Cables for 3776 Models 3 and 4."

Communication Terminal to Communication Line

- Using external modem, or (with Modem Fan Out feature) EIA/CCITT Interface connection to host terminal:

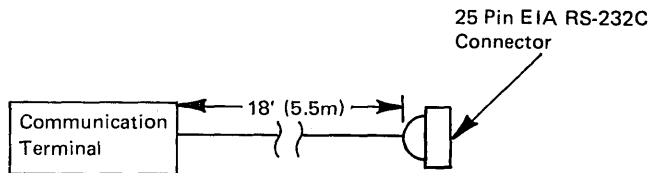

- Using an IBM Integrated Modem feature (not available on 3776-3, 4 or 3777):

- Connecting to Leased or privately owned communication lines:

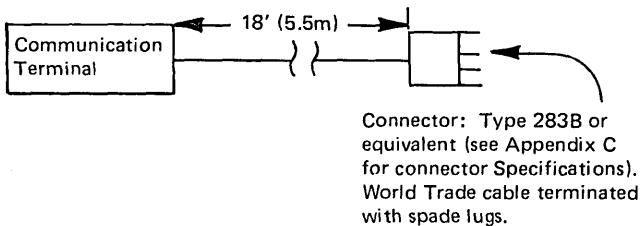

- Connecting to common-carrier switched network through Data Access Arrangement (DAA type CBS):

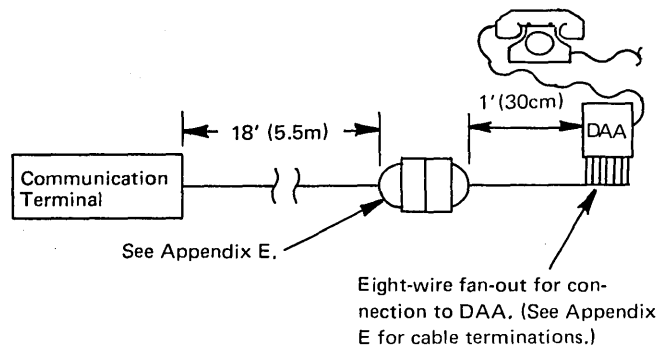

- Switched Network Backup: Connecting to common-carrier switched network through Data Access Arrangement (DAA type CDT):

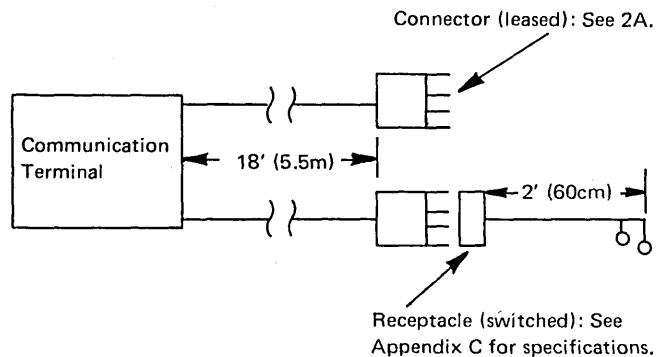

- Connecting to French CADUCEE switched network:

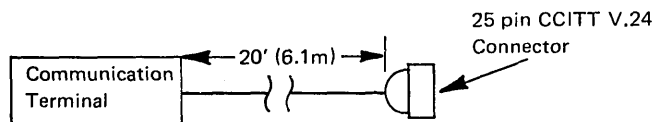

- Connecting to common-carrier switched network with manual answer through Data Access Arrangement (DAA type CDT):

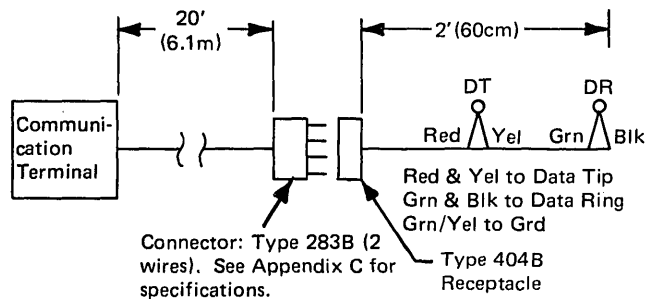

- f. Modem Fan Out feature: 2400 bps or 4800 bps Integrated Modem, Non-Switched. Cable supplied by EIA/CCITT Interface (see 1), Connector compatible with 25 pin EIA RS-232C connector.

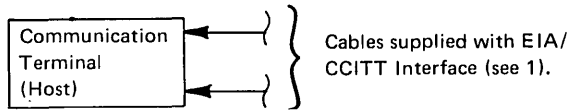

WT Switched Network (Dial) Ext Modems

- a. Business machine answer tone required
 (Modem generated if not)
- b. Modem Connection DTR
 CDSL

COMMUNICATION CABLES FOR 3776 MODELS 3 AND 4 Dataphone Digital Service Attachment

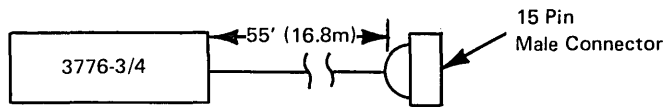

COMMUNICATION CABLES FOR 3777

3777-1 or 3777-2

Using External Modem - EIA/CCITT V.24 Interface

EIA: 2400 - 19,200 bps
 CCITT: 2400-9600 bps

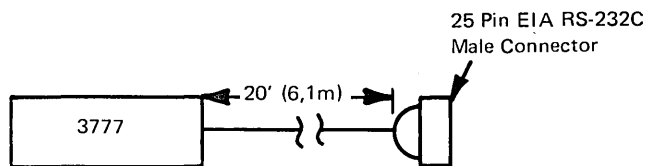

For 19,200 bps Wide Band Interface Operation

- (a) High Speed Digital Interface Connector at 19,200 bps

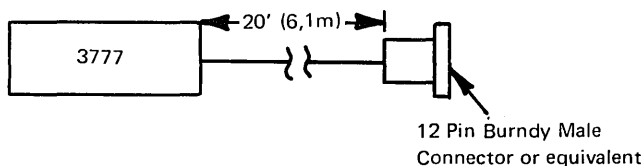

- (b) For CCITT V.35 at 20,400 bps

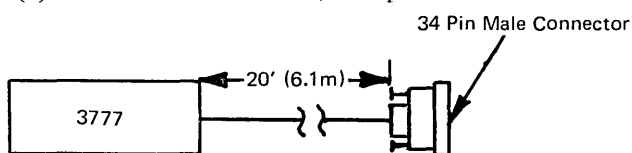

3777-3 Dataphone Digital Service Attachment

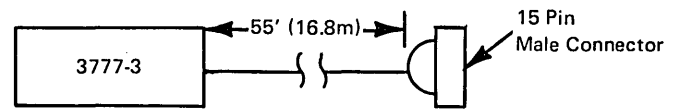

COMMUNICATION CABLE FOR CCITT X.21 FEATURE

For attachment to CCITT X.21 DCE (Data Circuit-Terminating Equipment) on a non-switched network. (3771, 3774, 3775, 3776, 3777-1, 3 using SDLC only)

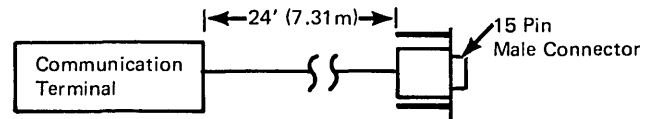

3770 SYSTEM ENVIRONMENT (except 3777/3203 or 3776/3777 with 3411)

Operating

Temperature 10° to 40.6°C (50° to 105°F)
 Relative Humidity 8% to 80%
 Maximum Wet Bulb 27°C (80°F)

Non-Operating

Temperature 10° to 52°C (50° to 125°F)
 Relative Humidity 8% to 80%
 Maximum Wet Bulb 27°C (80°F)

3777/3203 ENVIRONMENT

Operating

Temperature 16° to 38°C (60° to 100°F)
 Relative Humidity 8 - 80%
 Maximum Wet Bulb 23°C (73°F)

Non-Operating

Temperature 10° to 43°C (50° to 110°F)
 Relative Humidity 8% to 80%
 Maximum Wet Bulb 27°C (80°F)

3776 MODELS 3 and 4/3411 ENVIRONMENT

3777 MODEL 3/3411 ENVIRONMENT

Operating

Temperature 16° to 32°C (60° to 90°F)
 Relative Humidity 8 - 80%
 Maximum Wet Bulb 23°C (73°F)

Non-Operating

Temperature 10° to 43°C (50° to 110°F)
 Relative Humidity 8% to 80%
 Maximum Wet Bulb 27°C (80°F)

**IBM 2502 CARD READER MODELS A1 AND A2
(ATTACHES TO 3782 MODEL 2)
IBM 2502 CARD READER MODELS A1, A2, AND A3
(ATTACHES TO 3776 MODELS 3 AND 4 AND
3777 COMMUNICATION TERMINAL**

Plan View

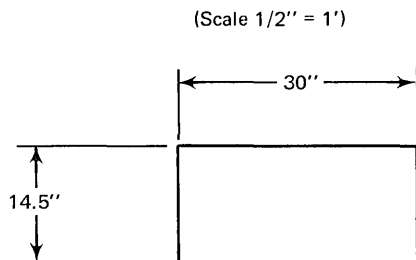

Inches	Centimeter
14.5	37
16	41
30	76

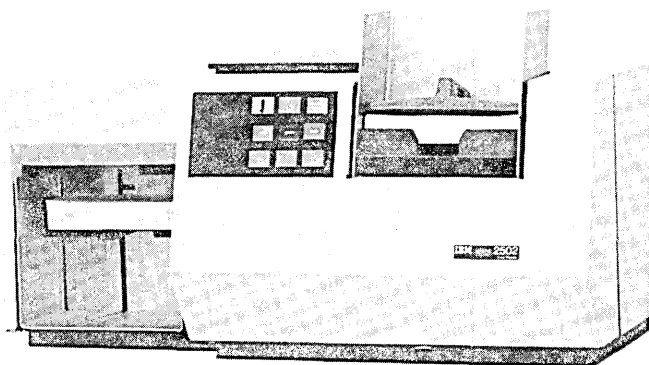

Figure 3770-1. IBM 2502 Card Reader Models A1, A2, and A3

Dimensions

	Front	Side	Height
Inches	30	14.5	16
Centimeters	76	37	41

Service Clearances

Applicable only in a system configuration. See the 3782 Card Attachment Unit Model 2 or the 3777 Communication Terminal.

Weight

110 lb (58 kg)

Heat Output

480 BTU/hr (120 kcal/hr)

Air Flow - Convection only

Environmental Requirements:

See "3770 System Environment"

Power Requirements:

	60 hertz		50 hertz
kVA*	0.2		0.2

*Power is provided from the 3782 Model 2 or the 3777. The 2502 must be ordered for 115V operation with all 60Hz 3782s or 3777s, or for 220V operation with all 50Hz 3782s or 3777s.

IBM provides cables to attach the 2502 to the 3782 Model 2 or the 3777.

3203 PRINTER MODEL 3 - SPECIFICATIONS (ATTACHES TO 3777 COMMUNICATION TERMINAL)

PLAN VIEW

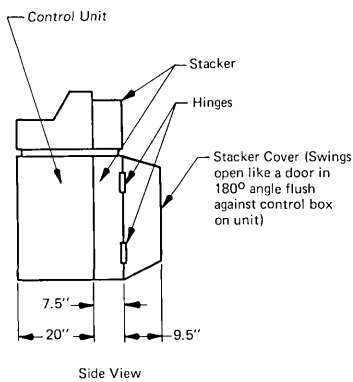
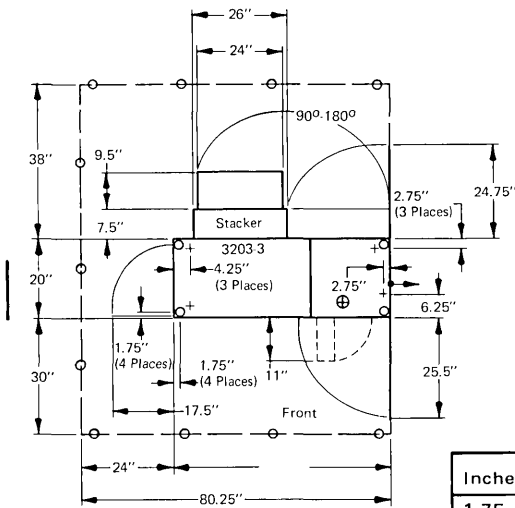

Inches	Centimeters
1.75	4,5
2.75	7
4.25	11
6.25	16
7.5	19
9.5	24
11	28
17.5	45
20	51
24	61
24.75	63
25.5	65
26	66
30	76
38	97
46.25	117
56.25	143
80.25	204

Dimensions

	Front	Side	Height
Centimeters	143	51	117
Inches	56.25	20	46.25

Service Clearances

	Front	Rear	Right	Left
Centimeters	76	97	0	61
Inches	30	38	0	24

Weight

390 kg 860 lbs.

Heat Output

1,600 kcal/hr 6200 BTU/hr

Airflow

10 m³/min 350 cfm

Environment

See "3777/3203 Environment"

Power Requirements:

Note: Different from 3777.

	60 Hz			50 Hz*				
Volts	200*	208	230	200	220	235	380	408
kVa	1.9	1.9	2.1	1.9	1.9	2.1	2.2	2.3
Phase	3	3	3	3	3	3	3	3
Branch								
Circuit(A)	-	15	15	-	-	-	-	-
Max. Cont.								
Load(a)	5.5	5.3	5.3	5.5	5.0	5.2	3.4	3.3
Plug Type†	-	B	B	-	-	-	-	-
Power Cord								
Style††	G7	-	-	G7	G7	G7	G8	G8

Power Cord Length: 14 ft. (4.27 m)

*World Trade only

† See Appendix A for power plug description.

†† See Appendix B for power cord description.

Note: Signal Cables are provided to attach the 3203 to the 3777. The cables are 20 feet long (6.1 m).

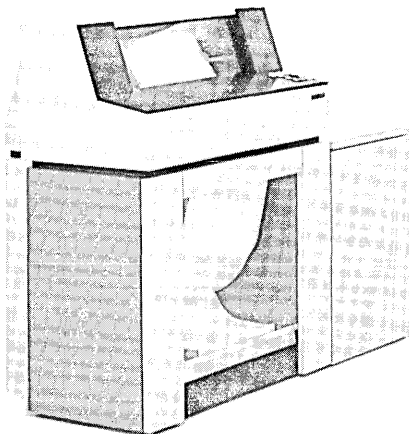

Figure 3770-2. IBM 3203 Printer Model 3

**3411 MAGNETIC TAPE UNIT AND CONTROL MODEL 1
(ATTACHES TO 3776 MODELS 3 AND 4 AND 3777
MODEL 3)**

Plan View

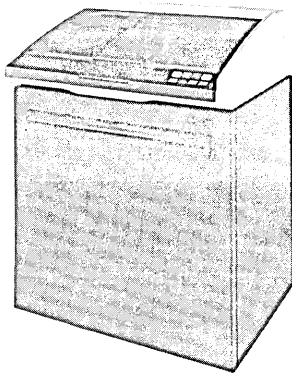
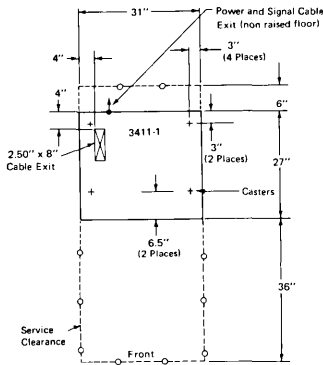

Figure 3770-3. IBM 3411 Magnetic Tape Unit and Control Model 1.

Cables and Cabling Schematic

3411 Signal and Emergency Power Off Cable order cable group 3-17 (a system/3 group) but for system 3770 usage (length variable)

Cable Group 3-17 MUST be ordered separately

Group No.	No. of Cables	From	To	Max. Length
3-17	3	3411	3776/3777	26 ft. (7.9 m)

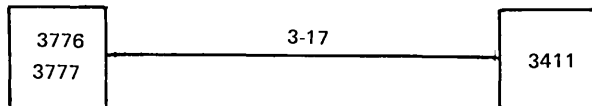

SPECIFICATIONS

Dimensions:

	Front	Side	Height
Inches	31	27	39
(cm)	(79)	(69)	(99)

Service Clearances:

	Front	Rear	Right	Left
Inches	36	6	0*	0*
(cm)	(91)	(15)	(0*)	(0*)

Weight: 325 lb (150 kg)

Heat Output: 554 kcal/hr 2200 BTU/hr

Air Flow: 200 cfm (6 m³/min)

Environment Operating

Temperature	16° to 32°C (60° to 90°F)
Relative Humidity	8-80%
Maximum Wet Bulb	23°C (73°F)

Environment Non-Operating

Temperature	10° to 43°C (50° to 110°F)
Relative Humidity	8% to 80%
Maximum Wet Bulb	27°C (80°F)

Power Requirements

	60 Hz			50 Hz		
	+++ 200	208	230	200	220	+++ 235
Volts	200	208	230	200	220	235
kVA	1.2	1.2	1.2	1.2	1.2	1.2
Phase	1	1	1	1	1	1
Branch Circuit (A)	-	15	15	-	-	-
Max. Cont. Load (A)	6	5.8	5.2	6	5.4	5.1
Plug Type +	-	C	C	-	-	-
Power Cord Style ++	A7	-	-	A7	A7	A7

Power Cord Length 11 ft. (3.4 m)

+ See Appendix A for power plug description.
++ See Appendix B for power cord description.
+++ World Trade only.

IBM 3501 CARD READER (ATTACHES TO 3289 MODEL 3, 3771, 3774, 3775 OR 3776 MODELS 1 AND 2)

Plan View

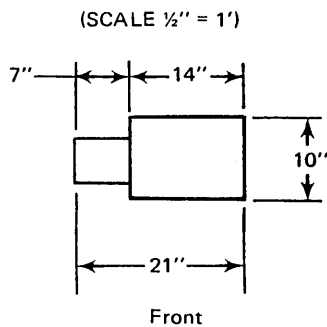

Millimeters	Inches
180	7
250	10
360	14
530	21

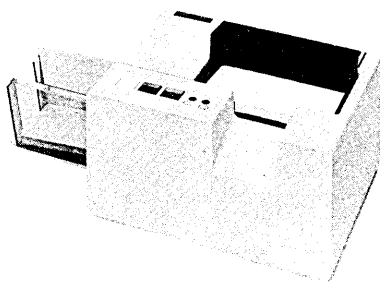

Figure 3770-4. IBM 3501 Card Reader

Dimensions

	Front	Side	Height
Millimeters	530	250	250
(Inches)	21	10	10

Service Clearances

	Front	Rear	Right	Left
Millimeters	*	*	*	*
(Inches)	*	*	*	*

Minimum of 150m (6 in) clearance recommended above and to the left of the 3501 for operator access. Unit can be moved for servicing.

Weight

11kg (25 lbs.)

Heat Output

75 kcal/hr (300 BTU/hr)

Air Flow

Negligible

Power Requirements

kVA 0.3

Phase 1

Powered from 3289 Model 3 3771, 3774, 3775, or 3776 Models 1 and 2.

The 3501 must be ordered for 115 V for operation with all 60 Hz terminals or for 220 V for operation with all 50 Hz terminals.

Operating Environment

Temperature	10° to 40.6°C (50° to 105°F)
Relative Humidity	8% to 80%
Maximum Wet Bulb	27°C (80°F)

Non-Operating

Temperature	10° to 52°C (50° to 125°F)
Relative Humidity	8% to 80%
Maximum Wet Bulb	27°C (80°F)

Cables

IBM provides signal and power cables to attach 3501 to 3289 Model 3, 3771, 3774, 3775, or 3776 Model 1 and 2. Length: 3.5 m (10 Ft.).

IBM 3521 CARD PUNCH (ATTACHED TO 3782 MODEL 1)

Plan View

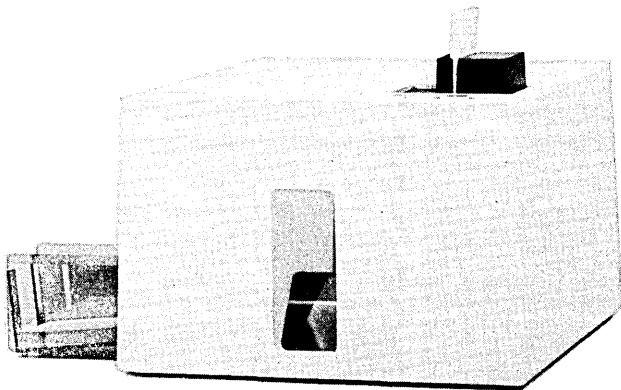
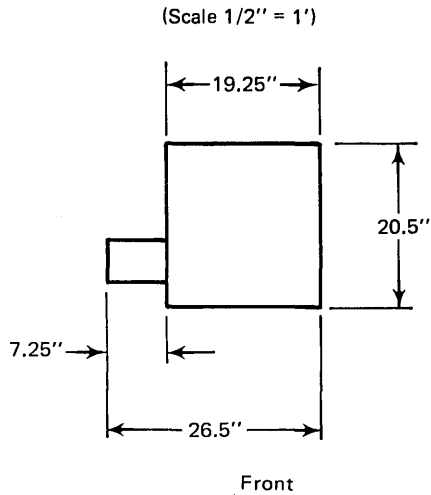

Figure 3770-5. IBM 3521 Card Punch

Dimensions

	Front	Side	Height
Millimeters	670	520	370
Inches	26.5	20.5	14.5

Service Clearances

Applicable only in a system configuration. See the 3782 Card Attachment Unit Model 1.

Weight

34 kg (75 lb)

Heat Output

230 kcal/hr. (900 BTU/hr.)

Air Flow

Environmental Requirements:

See "3770 System Environment"

Power Requirements

kVA 0.5

Power is provided from the 3782 Model 1. The 3521 must be ordered for 115 V operation with all 60 Hz 3782s, or for 220 V operation with all 50 Hz 3782s.

Cables

Cables are IBM provided for attachment of 3521 to 3782 Model 1

Millimeters	Inches
185	7.25
370	14.5
490	19.25
520	20.5
670	26.5

IBM 3771 COMMUNICATION TERMINAL MODELS 1, 2, AND 3—SPECIFICATIONS

Plan View

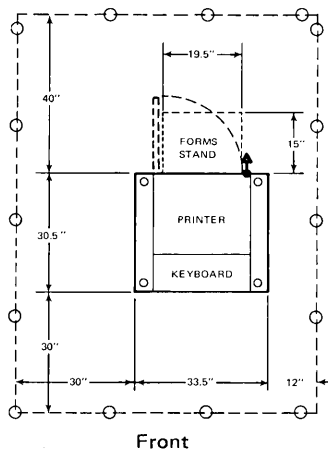

Inches	Centimeters
12	30
15	38
19.5	49
30	76
30.5	77,5
33.5	85
38.12	97
40	102

Dimensions	Front	Side**	Height
Inches	33.5	30.5	38.12
Centimeters	85	77,5	97

Service Clearances	Front	Rear	Right	Left
Inches	30	40	12	30
Centimeters	76	102	30	76

Weight	
150 lbs.	68 kg

Heat Output	
1100 BTU/hr	277 kcal/hr

Air Flow	
75 cfm	2,1 m ³ /min

Power Requirements

	+ 60 Hz +				50 Hz +					
Volts	100	115	200	220	100	110	123.5	200	220	235
kVA	0.6	0.6	0.6	0.6	0.6	0.6	0.6	0.6	0.6	0.6
Phase	1	1	1	1	1	1	1	1	1	1
Branch										
Circuit (A)	-	15	-	-	-	-	-	-	-	-
Max. Cont. Load (A)	6.0	5.4	3.0	2.7	6.0	5.5	4.9	3.0	2.7	2.6
Plug Type*	-	H,J	-	-	-	-	-	-	-	-
Power Cord Style	G6	-	G6	A1	G6	A1	A1	G6	A1	A1
Power Cord Length	8 ft. (2.44m)			2,44 m						

*See Appendix A for power plug description.

**Side dimension reduced to 29.5" (74.93 cm) by removing keyboard cover.

+ World Trade Only

Note: A mounting surface will be necessary for cord attached *Operator ID Reader*. Cord is 6 ft.

long. Unit is approximately 5¾" (14.6 cm) x 2½" (6.35 cm) x 2" (5.1 cm) high and weighs 2 lbs. (0.91 kg).

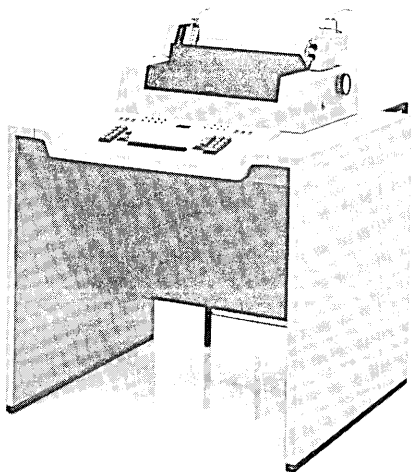
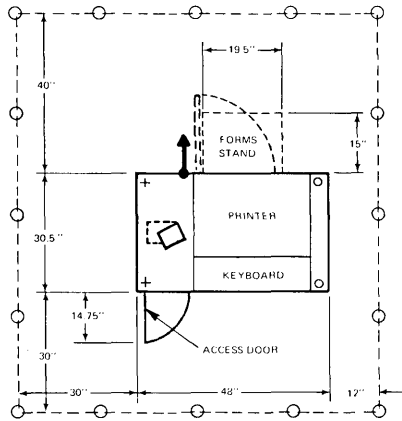

Figure 3770-6. IBM 3771 Communication Terminal (With Variable Width Forms Tractor)

IBM 3773 COMMUNICATION TERMINAL MODELS 1, 2, AND 3 AND P1, P2, AND P3 – SPECIFICATIONS

Plan View



Front

Inches	Centimeters
12	30
14.75	37
15	38
19.5	49
30	76
30.5	77,5
38.12	97
40	102
48	122
62	157

Dimensions

	Front	Side***	Height*	
Inches	48	30.5	38.12	
Centimeters	122	77,5	97	
Service Clearances				
	Front	Rear	Right	Left
Inches	30	40	12	30
Centimeters	76	102	30	76
Weight				
200 lbs.	90 kg			
Heat Output				
1050 BTU/hr	260 kcal/hr			
Air Flow				
75 cfm	2,1 m ³ /min			

Power Requirements

	60 Hz +				50 Hz +					
	100	115	200	220	100	110	123.5	200	220	235
Volts	100	115	200	220	100	110	123.5	200	220	235
kVA	0.4	0.4	0.4	0.4	0.4	0.4	0.4	0.4	0.4	0.4
Phase	1	1	1	1	1	1	1	1	1	1
Branch										
Circuit (A)	-	15	-	-	-	-	-	-	-	-
Max. Cont. Load (A)	4.0	3.3	2.0	1.8	4.0	3.6	3.2	2.0	1.8	1.7
Plug Type**	-	HJ	-	-	-	-	-	-	-	-
Power Cord Style	G6	-	G6	A1	G6	A1	A1	G6	A1	A1
Power Cord Length	8 ft. (2.44m)									

*Desk top height is 29.12" (74 cm).

**See Appendix A for power plug description.

***Side dimension reducible to 29.5" (74.93 cm) by removal of keyboard cover.

+ World Trade Only

Note: A mounting surface will be necessary for cord attached attached *Operator ID Reader*. Cord is 6 ft. long.

Unit is approximately 5¾" (14.6 cm) x 2½" (6.35 cm) x 2" (5.1 cm) high and weighs 2 lbs. (0.91 kg).

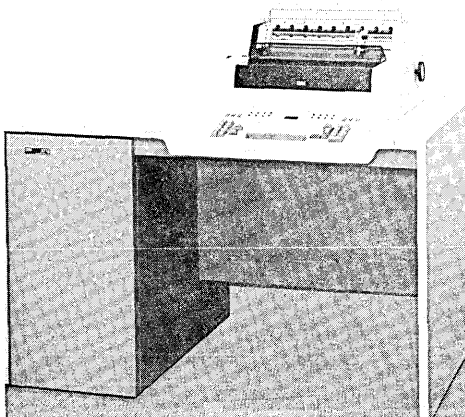
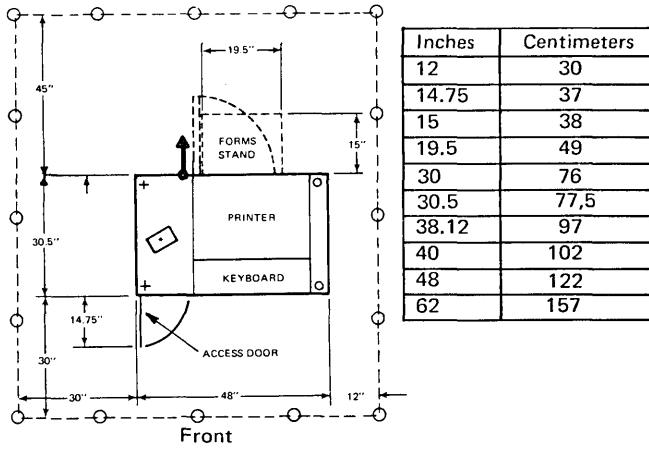

Figure 3770-7. IBM 3773 Communication Terminal (with Variable Width Forms Tractor)

**IBM 3774 COMMUNICATION TERMINAL
MODELS 1 AND 2, P1 AND P2 – SPECIFICATIONS**

Plan View



Plan View w/Second Diskette Storage

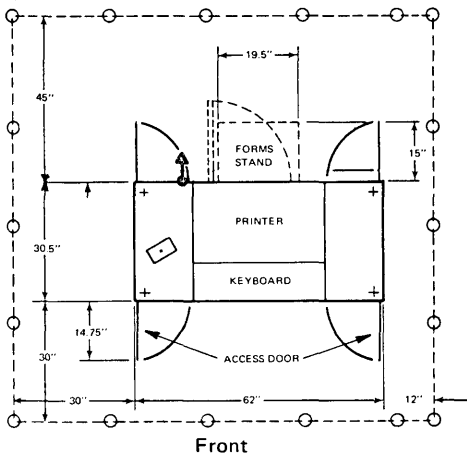

* Display on Models P1 and P2 only.

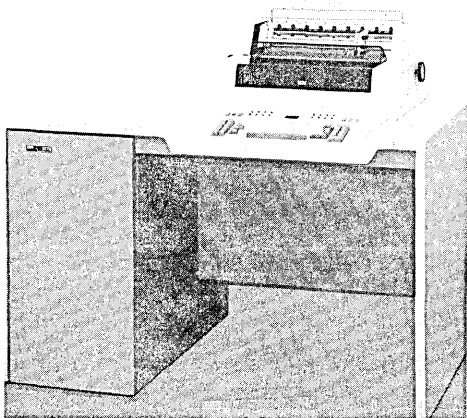

Figure 3770-8. IBM 3774 Communication Terminal (With Variable Width Forms Tractor)

Dimensions

	Front*	Side****	Height**
Inches	48	30.5	38.12
Centimeters	122	77.5	97

Service Clearances

	Front	Rear	Right	Left
Inches	30	40	12	30
Centimeters	76	102	30	76

Weight, W/Single Diskette Storage

425 lbs. 193 kg

Weight, W/Second Diskette Storage

500 lbs. 227 kg

Heat Output

2100 BTU/hr 529 kcal/hr

Air Flow

150 cfm 4.2 m³/min

Power Requirements

	60 Hz +				50 Hz +					
	100	115	200	220	100	110	123.5	200	220	235
Volts	100	115	200	220	100	110	123.5	200	220	235
kVA	1.1	1.1	1.1	1.1	1.1	1.1	1.1	1.1	1.1	1.1
Phase	1	1	1	1	1	1	1	1	1	1
Branch										
Circuit (A)	-	15	-	-	-	-	-	-	-	-
Max. Cont. Load (A)	10.7	9.3	5.8	4.8	10.7	10.0	8.5	5.8	4.8	4.5
Plug Type***	-	H,J	-	-	-	-	-	-	-	-
Power Cord Style	G6	-	G6	A1	G6	A1	A1	G6	A1	A1
Power Cord Length	8 ft. (2.44m)									

*Dimension shown is for machines without second Diskette Storage. Front dimension for machines with this feature is 62" (157 cm). The 2nd Diskette can be unbolted, if necessary, to reduce length during placement.

**Desk top height is 29.12" (74 cm).

***See Appendix A for power plug description.

****Side dimension reducible to 29.5" (74.9 cm) by removal of keyboard cover

+ World Trade Only

Note:

1. Clearance to floor is 0.75" (1,9 cm). Avoid carpet which might block air flow from bottom of machine.

**IBM 3775 COMMUNICATION TERMINAL
MODEL 1 OR P1 – SPECIFICATIONS**

Plan View

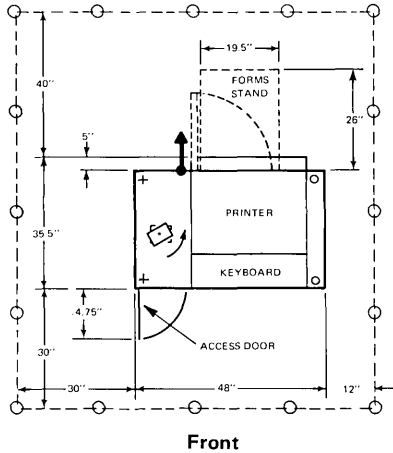

Inches	Centimeters
5	13
12	30
14.75	37
15	38
19.5	49
30	76
35.5	90
38.12	97
40	102
48	122
62	157

Front

Plan View - W/Second Diskette Storage

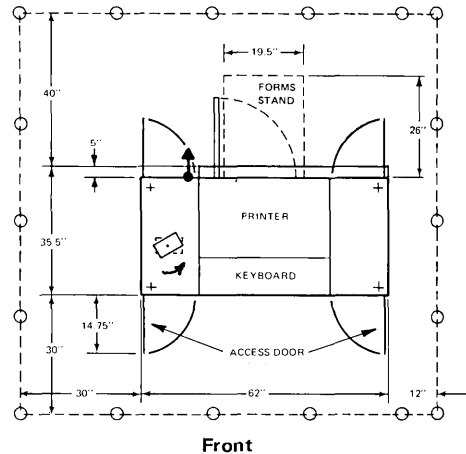

Front

* Display on 3775 Model P1 only.

Dimensions

	Front*	Side****	Height**
Inches	48	35.5	38.12
Centimeters	122	90	97

Service Clearances

	Front	Rear	Right	Left
Inches	30	40	12	30
Centimeters	76	102	30	76

Weight W/Single Diskette Storage

500 lbs. 227 kg

Weight W/Second Diskette Storage

575 lbs. 261 kg

Heat Output

2200 BTU/hr 560 kcal/hr

Air Flow

150 cfm 4.2 m³/min

Power Requirements

	60 Hz +				50 Hz +					
Volts	100	115	200	220	100	110	123.5	200	220	235
kVA	1.2	1.2	1.2	1.2	1.2	1.2	1.2	1.2	1.2	1.2
Phase	1	1	1	1	1	1	1	1	1	1
Branch										
Circuit (A)	-	15	-	-	-	-	-	-	-	-
Max. Cont. Load (A)	12.3	10.7	6.1	5.5	12.3	10.9	10.0	6.1	5.5	5.2
Plug Type***	-	H,J	-	-	-	-	-	-	-	-
Power Cord Style	G6	-	G6	A1	G6	A1	A1	G6	A1	A1
Power Cord Length	8 ft. (2.44m)									

*Dimension shown is for machines without second Diskette Storage. Front dimension for machines with this feature is 62" (158 cm). The 2nd Diskette can be unbolted, if necessary, to reduce length during placement.

**Desk top height is 29.12" (74 cm).

***See Appendix A for power plug description.

****Side dimension reducible to 29.5" (74.9 cm) by removal of keyboard cover and acoustic hood.

+ World Trade Only

Note:

Clearance to floor is 0.75" (1.9 cm). Avoid carpet which might block airflow from bottom of machine.

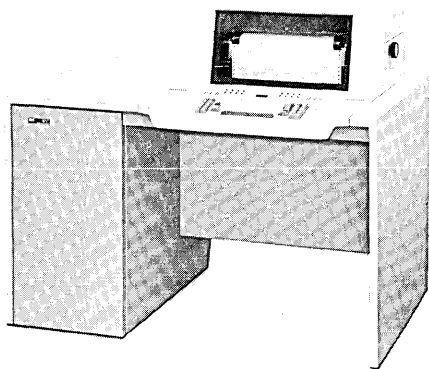
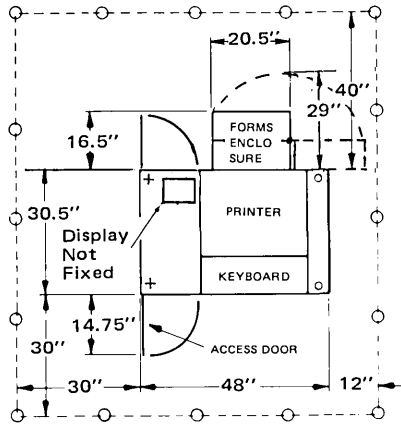

Figure 3770-9. IBM 3775/3776 Communication Terminal

IBM 3776 COMMUNICATION TERMINAL MODELS 1, 2, 3, AND 4

Plan View



Front

Inches	Centimeters
12	30
14.75	37
16.5	42
20.5	52
30	76
30.5	76
38.12	97
40	102
48	122
62	157

Plan View - W/Second Diskette Storage

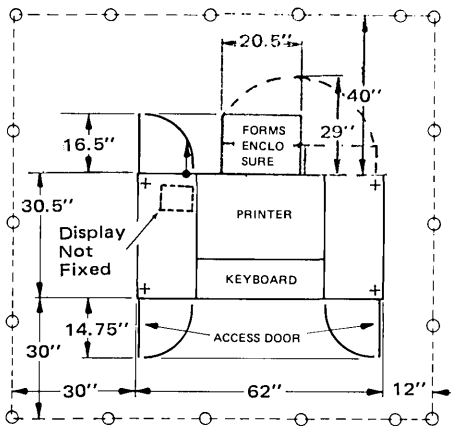

Front

Dimensions

	Front*	Side***	Height**
Inches	48	116	38.12
Centimeters	122	45.5	97

Service Clearances

	Front	Rear	Right	Left
Inches	30	40	12	30
Centimeters	76	102	30	76

Weight W/Single Diskette Storage****

500 lbs 227 kg

Weight W/Second Diskette Storage****

600 lbs. 272 kg

Heat Output

2500 BTU/hr 636 kcal/hr

Air Flow

150 cfm 4.2 m³/min

Power Requirements

	60 Hz				50 Hz					
	100	115	200	220	100	110	123.5	200	220	235
Volts	100	115	200	220	100	110	123.5	200	220	235
kVA	1.2	1.2	1.2	1.2	1.2	1.2	1.2	1.2	1.2	1.2
Phase	1	1	1	1	1	1	1	1	1	1
Branch										
Circuit(A)	-	15	-	-	-	-	-	-	-	-
Max. Cont. Load (A)	12.3	10.7	6.1	5.5	12.4	10.8	10.0	6.1	5.5	5.2
Plug Type+	-	H,J	-	-	-	-	-	-	-	-
Power Cord Style++	G6	-	G6	A1	G6	A1	A1	G6	A1	A1
Power Cord Length:	8 ft. (2.44 m)									

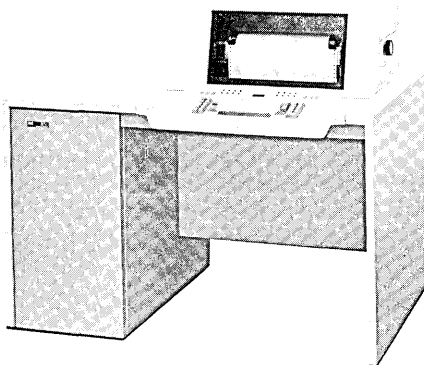

*Dimension shown is for machines with one diskette storage device. Front dimension for machines with two diskette storage devices is 157 cm (62"). The second diskette device can be unbolted, if necessary, to reduce length during placement.

**Desk top height is 74 cm (29.12")

***Side dimension reducible to 74.9 cm (29.5") by removal of keyboard cover and forms enclosure

****Excluding forms enclosure.

+See Appendix A for power plug description.

++See Appendix B for power cord description.

+++World Trade only.

Note:

Clearance to floor is 0.75" (1.9 cm). Avoid carpet which might block airflow from bottom of machine.

IBM 3777 COMMUNICATION TERMINAL MODELS 1, 2, and 3

Plan View

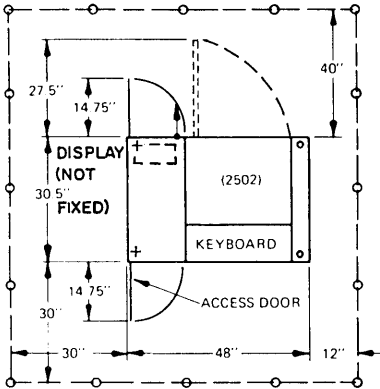

Front

Inches	Centimeters
12	30
14.75	37
15	38
27.5	70
30	76
30.5	77.5
40	102
45.12	115
45.5	116
48	122
62	157

Dimensions

	Front*	Side***	Height**
Inches	62	30.5	45.12
Centimeters	157	77.5	115

Service Clearances

	Front	Rear	Right	Left
Inches	30	40	12	30
Centimeters	76	102	30	76

‡ Weight W/Single Diskette Storage

179 kg 395 lbs.

‡ Weight W/Second Diskette Storage

220 kg 495 lbs.

Heat Output

916 kcal/hr 3600 BTU/hr****

Air Flow

5.88 m³/min 210 cfm

Environment: See "3777/3203 Environment".

Plan View - W/Second Diskette Storage

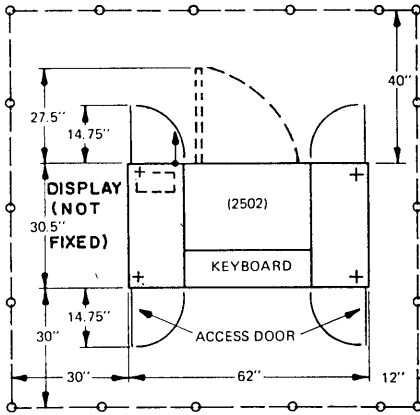

Power Requirements

Note: Different from 3203.

	††† 60 Hz ††† †††				††† 50 Hz					
	100	115	200	220	100	110	123.5	200	220	235
Volts	100	115	200	220	100	110	123.5	200	220	235
kVA	1.6	1.7	1.7	1.7	1.6	1.6	1.7	1.7	1.7	1.8
Phase	1	1	1	1	1	1	1	1	1	1
Branch										
Circuit(A) -		20	-	-	-	-	-	-	-	-
Max. Cont.										
Load(A)	16.0	14.5	8.5	7.8	16.0	15.0	13.7	8.4	7.7	7.5
Plug Type†	-	M,N	-	-	-	-	-	-	-	-
Power Cord										
Style††	A1	-	G6	G6	A1	A1	A1	G6	G6	G6

Power Cord Length: 8 ft. (2.44 m)

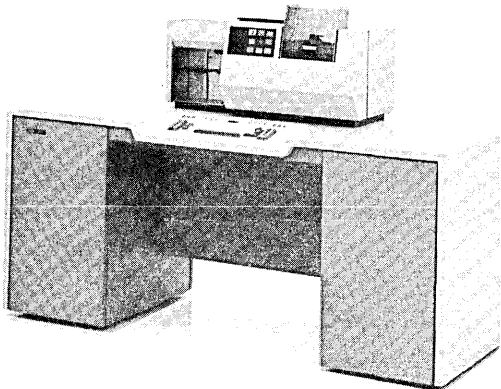

Figure 3770-11. IBM 3777 Communication Terminal (with 2502 Card Reader)

*Dimension shown is for machines with two diskette storage devices. Front dimensions for machines with one diskette. Storage device is 122 cm (48"). The second diskette device can be unbolted, if necessary to reduce length during placement.

**Dimension shown includes 2502 Card Reader (optional I/O attachment). Desk top height of the 3777 is 74 cm (29.12").

***Side dimension reducible to 74.9 cm (29.5") by removing keyboard cover.

****Heat output is 4500 BTU/hr (1135 kcal/hr with 2502).

† See Appendix A for power plug description.

†† See Appendix B for power cord description.

††† World Trade only

‡ Weight does not include the 2502 which weighs 49.9 kg (110 lbs).

Note:

Clearance to floor is 0.75" (1.9 cm). Avoid carpet which might block airflow from bottom of machine.

**IBM 3782 CARD ATTACHMENT UNIT, MODEL 1, WITH
 3521 CARD PUNCH (ATTACHES TO 3289 MODEL 3,
 3771, 3774, 3775, 3776 OR 3777 MODEL 2 AND 3**

Plan View

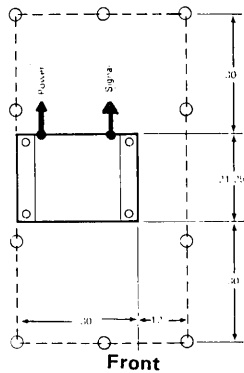

Millimeters	Inches
300	12
540	21.25
740	29.12
760	30
1100	43.5

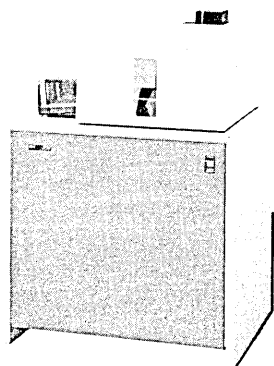

Figure 3770-12. IBM 3782 Card Attachment Unit Model 1 with 3521 Card Punch

Dimensions

	Front	Side	Height
Millimeters	760	540	1100
Inches	30	21.25	43.5

Overall height, including 3521. 3782 height is 740mm (29.12in.).

Service Clearances

	Front	Rear	Right	Left
Millimeters	760	760	300	-
Inches	30	30	12	-

Weight

61 kg (135 lbs.)

Heat Output

420 kcal/h (1650 BTU/h)

Air Flow

Operating Environment

Temperature 10° to 40.6°C (50° to 105°F)
 Relative Humidity 8% to 80%
 Maximum Wet Bulb 27°C (80°F)

Non-Operating

Temperature 10° to 52°C (50° to 125°F)
 Relative Humidity 8% to 80%
 Maximum Wet Bulb 27°C (80°F)

Power Requirements

The 3521 is powered from the 3782-1. The 3521 must be ordered for 115V for operation with 60Hz 3782 or for 220V for operation with 50Hz 3782.

	+ 60Hz + +				50Hz +					
Volts	100	115	200	220	100	110	123.5	200	220	235
kVA	0.7	0.7	0.7	0.7	0.7	0.7	0.7	0.7	0.7	0.7
Phase	1	1	1	1	1	1	1	1	1	1
Branch										
Circuit (A)	-	15	-	-	-	-	-	-	-	-
Max. Cont. Load (A)	6.9	6.0	3.5	3.2	6.9	6.3	5.6	3.5	3.2	3.0
Plug Type	-	H.J	-	-	-	-	-	-	-	-

See Appendix A for description of power plugs.

Power Cord

Style G6 - G6 A1 || G6 A1 A1 G6 A1 A1

See Appendix B for description of power cords.

Power Cord Length: 2.44 m (8 Ft.)

+World Trade Only

Signal Cables: IBM provided for attachment of 3782 to 3289

Model 3, 3771, 3774, 3775, 3776 or 3777.

Basic Machine cable length: 3.5 m (10 Ft.)

Read/Print Feature Cable length: 3.5 m (10 Ft.)

**IBM 3782 CARD ATTACHMENT UNIT, MODEL 2 WITH
 2502 CARD READER (ATTACHES TO 3289 MODEL 3,
 3774, 3775, 3776 or 3777)**

Plan View

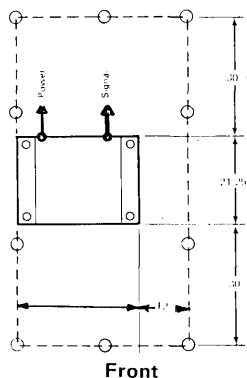

Millimeters	Inches
300	12
540	21.25
740	29.12
760	30
1150	45

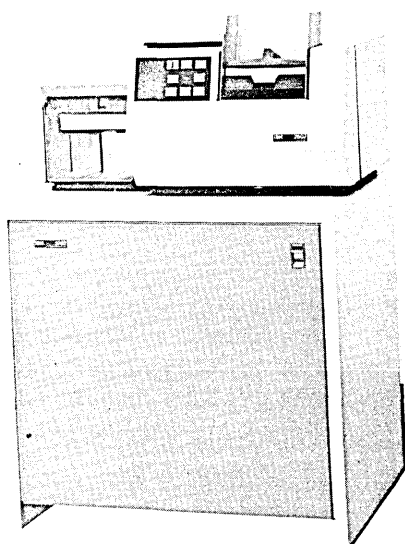

Dimensions

	Front	Side	Height*
Millimeters	760	540	1150
Inches	30	21.25	45

Overall height, including 2502. 3782 height is 740 mm (29.12 in.)

Service Clearances

	Front	Rear	Right	Left
Millimeters	760	760	300	300
Inches	30	30	12	12

Weight

84kg (185 lbs.)

Heat Output

530 kcal/hr (2100 BTU/hr)

Air Flow

Operating Environment

Temperature 10° to 40.6°C (50° to 105°F)
 Relative Humidity 8% to 80%
 Maximum Wet Bulb 27°C (80°F)

Non-Operating

Temperature 10° to 52°C (50° to 125°F)
 Relative Humidity 8% to 80%
 Maximum Wet Bulb 27°C (80°F)

Power Requirements

The 2502 is powered from the 3782-2. The 2502 must be ordered for 115V for operation with all 60Hz 3782s, or for 220V for operation with all 50Hz 3782s.

	60Hz +				50Hz +					
	100	115	200	220	100	110	123.5	200	220	235
Volts	100	115	200	220	100	110	123.5	200	220	235
kVA	0.8	0.8	0.8	0.8	0.9	0.9	0.9	0.9	0.9	0.9
Phase	1	1	1	1	1	1	1	1	1	1
Branch										
Circuit (A)	-	15	-	-	-	-	-	-	-	-
Max. Cont. Load (A)	8.0	7.5	4.0	3.6	9.0	8.2	7.3	4.5	4.1	3.8
Plug Type	-	H,J	-	-	-	-	-	-	-	-
Power Cord Style	G6	-	G6	A1	G6	A1	A1	G6	A1	A1

See Appendix A for description of power plugs.

See Appendix B for description of power cords.

Power Cord Length: 2.44 (8 Ft.)

+World Trade only

Signal Cable - IBM provided for attachment of 3782 to 3289 Model 3, 3774, 3775 or 3776. Two basic cables length 3.66 m (12 Ft.)

One OMR feature cable length 3.66 m (12 FT.) Not supported with 3289 Model 3.

Figure 3770-13. IBM 3782 Card Attachment Unit Model 2 with 2502 Card Reader

3784 LINE PRINTER (ATTACHES TO 3774 COMMUNICATION TERMINAL)

Plan View

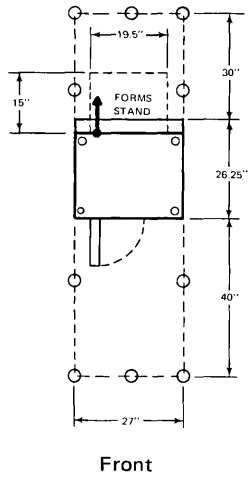

Inches	Centimeters
12	30
15	38
19.5	49
26.25	67
27	69
30	76
40	102

Dimensions

	Front	Side	Height
Inches	27	26.25	42.5
Centimeters	69	67	108

Service Clearances

	Front	Rear	Right	Left
Inches	40	30	-	-
Centimeters	102	76	-	-

Weight

275 Lbs. 125 kg

Heat Output

1380 BTU/h 348 kcal/h

Air Flow

75 CFM 2,1 m³/min

Environment

See "3770 System Environment"

Power Requirements

	60Hz +				50Hz +					
	100	115	200	220	100	110	123.5	200	220	235
Volts	100	115	200	220	100	110	123.5	200	220	235
kVA	0.6	0.6	0.6	0.6	0.6	0.6	0.6	0.6	0.6	0.6
Phase	1	1	1	1	1	1	1	1	1	1
Branch										
Circuit (A)	-	15	-	-	-	-	-	-	-	-
Max. Cont. Load (A)	5.2	4.5	2.6	2.4	5.2	4.7	4.2	2.6	2.4	2.2
Plug Type*	-	H,J	-	-	-	-	-	-	-	-
Power Cord Length	8 ft.				2,44 meters					
Power Cord Style**	G6	-	G6	A1	G6	A1	A1	G6	A1	A1

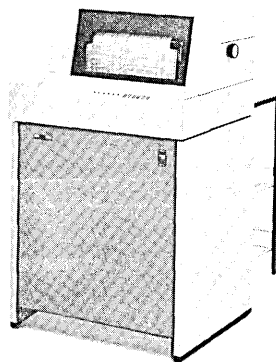

Figure 3770-14. IBM 3784 Line Printer

Signal Cables - IBM Provided with 3784: 3874 to 3774
12 ft. (3,66 meters)

*See Appendix A for description of power plugs.

**See Appendix B for description of power cords.

IBM 3780 Data Communication Terminal-Specifications

PLAN VIEW

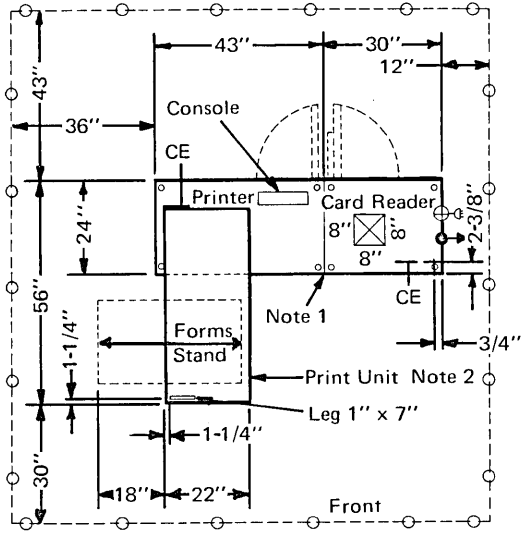

Inches	Centimeters
3/4	1,9
1	2,5
1 1/4	3,2
2 3/8	6,0
7	17,8
8	20
12	30,5
18	45,4
22	55,9

Inches	Centimeters
24	61,0
30	76,2
36	91,4
43	109,2
46	116,8
56	142,2
73	185,4

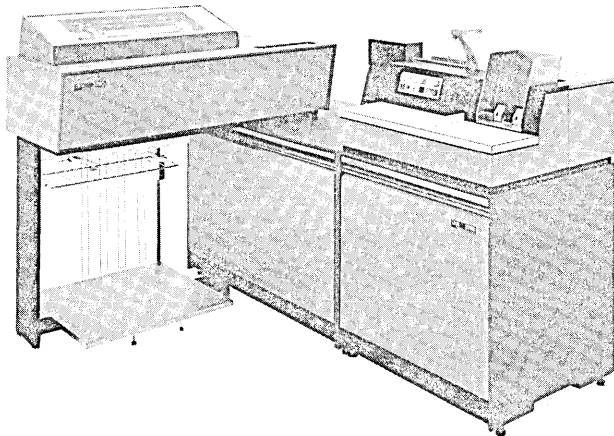

Figure 3780-1 IBM 3780 Data Communication Terminal

Dimensions

	Length	Depth	Height
Installed inches	73	56	46
Centimeters	185	142	117

Service Clearance

	Front	Left	Rear	Right
Inches	30	36	43	12
Centimeters	76	91	109	30

Weight

1275 lbs. 567 kg.

Heat Output

4916 BTU/h 1238 kcal/h

Air Flow

410CFM 11,6m³/min

Environment, Operating

Temp.	60° to 90°F	16° to 32°C
Rel. Humidity	8 to 80%	
Max. Wet Bulb	78°F	26°C

Environment, Non-Operating

Temp.	50° to 110°F	10° to 43°C
Rel. Humidity	8 to 80%	
Max. Wet Bulb	80°F	27°C

Notes:

1. Units separated for shipment. Bolt together for installation.
2. For shipment, print unit is rotated over the cabinet. Dimensions are then 24 in. x 48 in. x 46 in. (61 cm x 122 cm x 117 cm)

IBM 3780 Data Communication Terminal – Specifications

Power Requirements

	60 Hz.					50 Hz.*					
	100*	115	200*	208	230	100	110	123.5	200	220	235
Volts	100*	115	200*	208	230	100	110	123.5	200	220	235
kVa	1.8	1.8	1.8	1.8	1.8	1.8	1.8	1.8	1.8	1.8	1.8
Phase	1	1	1	1	1	1	1	1	1	1	1
Branch Circuit (A)		20		15	15						
Plug/Power Cord (Note 1)											
Locking	Power	NA	Power	A	A	Power Cord Only					
Non-Locking	Cord	M	Cord	K	K						
	Only		Only								
Power Cord Style (Note 2)	A3	–	A3	–	–	A3	G5	G5	A3	G5	G5
Power Cord Length		14 ft.	(4.27m)				14 ft.		4.3 m		

*World Trade

Notes:

1. Description of plug type with matching receptacles and connectors – see Appendix A.
2. Description of World Trade power cord styles – see Appendix B.

COMMUNICATIONS FACILITIES

The type of modem (data set) to be used must be specified at the time of ordering the IBM 3780. See SRL., *Component Information for the IBM 3780 Data Communication Terminal*, GA27-3063.

COMMUNICATIONS INTERFACE CABLE (IBM PROVIDED)

A 20-foot* (6.1m) cable from the 3780 will be provided as standard unless a different length is specified at the time of the order. Available ordering lengths are: 20, 25, 30, 35, and 40 feet (6.1, 7.22, 9.14, 10.67, 12.19m). The shortest permissible length should be used. Consult your IBM representative for further information.

*Part of total length required for gate connection. Actual available length 17 ft (5.2m) from cable exit.

Control Unit to Communications Line:

1. Using external modem (data set)

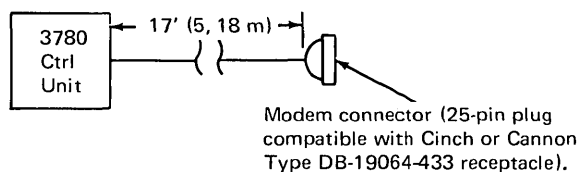

2. Using an IBM 2400/1200 bps Integrated Modem feature:

a. Connecting to leased or privately owned communications line:

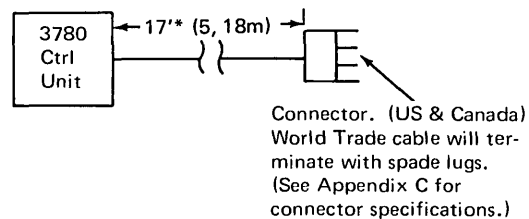

b. Connecting to common-carrier switched network through Data Access Arrangement (DAA):

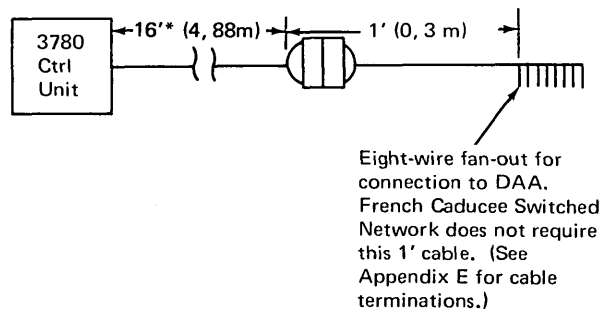

IBM 3780 Data Communication Terminal – Specifications

- c. Connecting to communication lines when the IBM 2400 bps Switched Network Backup feature is installed:

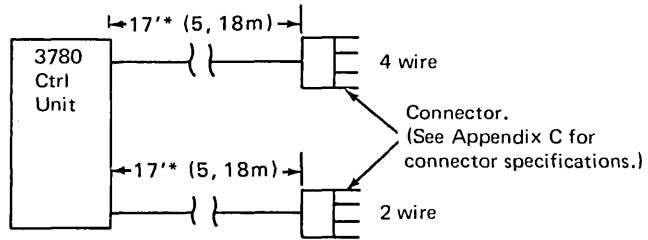

IBM 3781 Card Punch-Specifications

PLAN VIEW

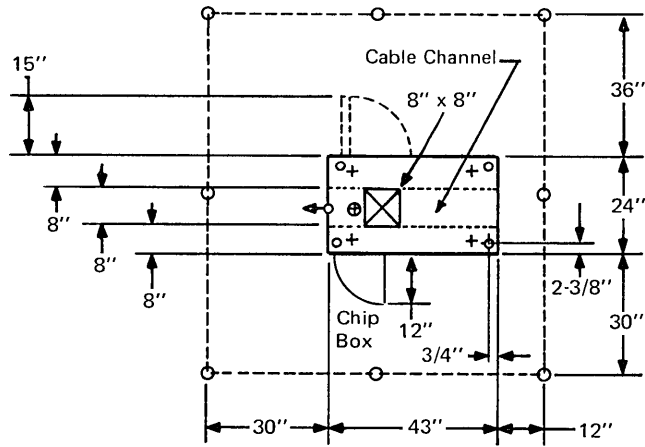

Inches	Centimeters
3/4	1,9
2-3/8	6,0
8	20
12	30,5
15	38,1
24	61,0
43	109,2

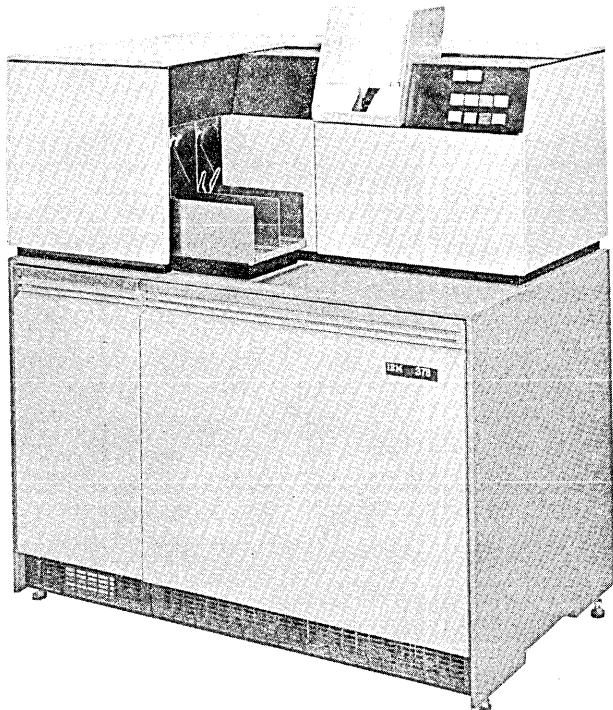

Figure 3780-2. IBM 3781 Card Punch

Dimensions

	Front	Side	Height
Installed Inches	43	24	49
Centimeters	109	61	125

Service Clearance

	Front	Rear	Right	Left
Inches	30	36	12	30
Centimeters	76	91	30	76

Weight

560 lbs. 254 kg.

Heat Output

1,700 BTU/h 430 kcal/h

Air Flow

100 CFM 3,0m³/min

Environment, Operating

Temp	60° to 90°F	(16° to 32°C)
Rel. Humidity	8 to 80%	
Max. Wet Bulb	78°F	(26°C)

Environment, Non-Operating

Temp	50° to 110°F	(10° to 43°C)
Rel. Humidity	8 to 80%	
Max. Wet Bulb	80°F	(27°C)

Interconnecting Signal Cable

17 ft. (5.2m)

Note: The signal cable (provided) is 17 feet (5.2m) from the 3781 cable exit to the 3780 cable entry.

IBM 3781 Card Punch-Specifications

Power Requirements

		60 Hz.				50 Hz. *						
Volts		100*	115	200*	208	230	100	110	123.5	200	220	235
kVa		.6	.6	.6	.6	.6	.6	.6	.6	.6	.6	.6
Phase		1	1	1	1	1	1	1	1	1	1	1
Branch Circuit (A)		—	15	—	15	15	—	—	—	—	—	—
Plug-Power Cord (Note 1)												
Locking	Power	NA		Power	A	A	Power Cord only					
Non-Locking	Cord	H		Cord	K	K						
	Only			Only								
Power Cord Style (Note 2)		A3	—	A3	—	—	A3	G5	G5	A3	G5	G5
Power Cord Length			14 ft.		(4.3 m)				14 ft.		(4.3m)	

*World Trade

Notes:

1. Description of plug type with matching receptacles and connectors - see Appendix A.
2. Description of World Trade power cord styles - see Appendix B.

5275 DIRECT NUMERICAL CONTROL STATION – SPECIFICATIONS

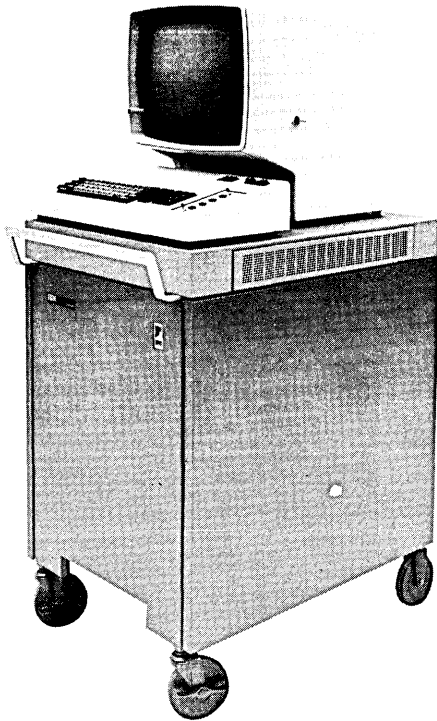

Dimensions

	Front	Side	Height
Inches	23	33	56
(mm)	(584.2)	(838.2)	(1422.4)

Service Clearances

	Front	Rear	Right	Left
Inches	30	30	30	30
(mm)	(762.0)	(762.0)	(762.0)	(762.0)

Weight

375 lb 170.9 kg

Heat Output

1700 BTU/hr (430 kcal/hr)

Airflow

Forced Air

Power Requirements

Branch Circuit Voltage	115
kVA	0.70
Phases	1
Branch Circuit (A)	15
Max. Cont. Load (A)	5.7
Power Cord Length	15 ft. (4.57 Meters)
Locking	

Plug (locking) J

Environment, Operating

Temperature	50 to 105°F (10 to 40.6°C)
Rel. Humidity	8 to 80%
Max. Wet Bulb	85°F (29°C)

Environment, Nonoperating

Temperature	50 to 125°F (10 to 52°C)
Rel. Humidity	8 to 80%
Max. Wet Bulb	85°F (29°C)

Notes:

If a convenience outlet for servicing the equipment is not available near the 5275, use NEMA 5-15R or equivalent, (Type H). See Appendix A for plug description.

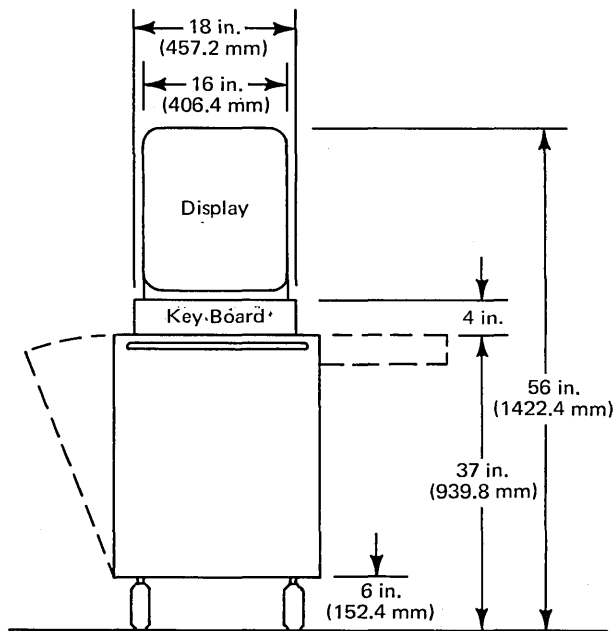

Front Elevation

5275 DIRECT NUMERICAL CONTROL STATION



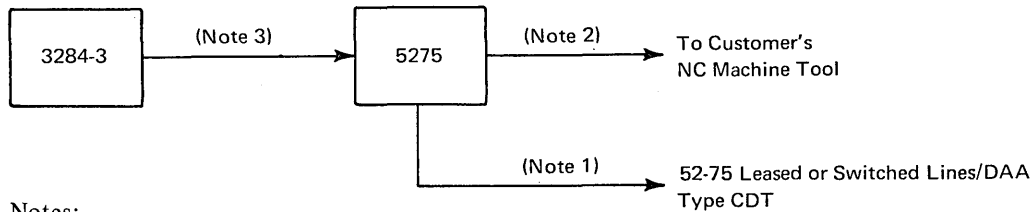
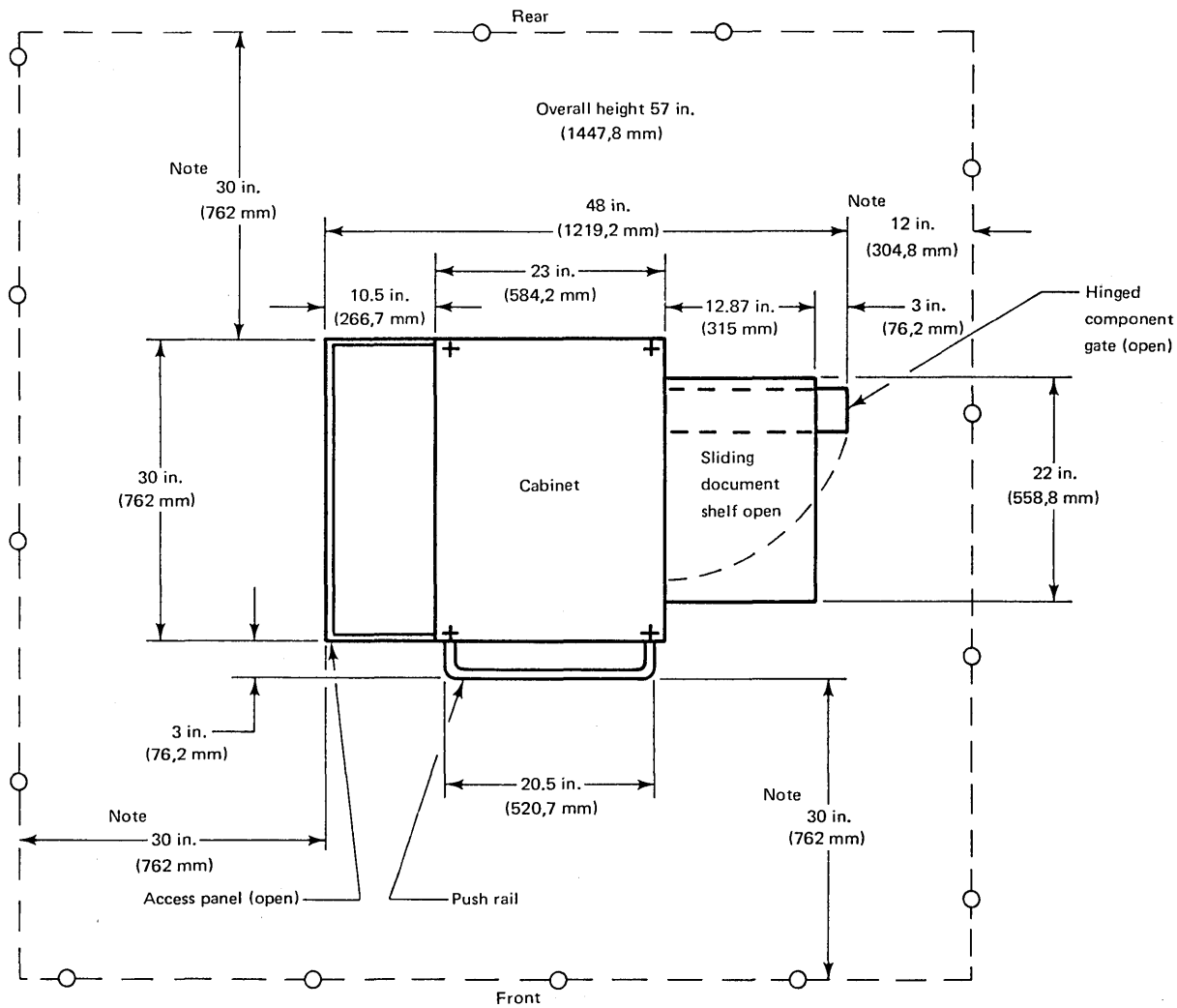









PLAN VIEW (Scale None)



Notes:

1. Cable group no. 52-75 max length 40 ft. (12.19m) connected to Leased or Switched Line/DAA Type CDT.
2. Variable cable lengths in increments of 10 ft. (3.05m) up to 100 ft. (30.48m) max. can be ordered from IBM via RPO.
3. Fixed length of 10 ft. (3.05m) supplied with 3284-3.
4. For specification on the optional 3284-3 Printer, see appropriate pages in System/370 Manual.

5275 Direct Numerical Control Station Cabling Schematic

60 Hz Power Receptacles and Plugs												
PLUG TYPE	A††	B††	C††	D††	E††	H	J†	K	L†	M	N†	R
PLUG**	(R&S) 3720	(R&S) 3730	(R&S) 3750	(R&S) 3760	(R&S) 7328	NEMA 5-15P	NEMA L5-15P	NEMA 6-15P	NEMA L6-15P	NEMA 5-20P	NEMA L5-20P	NEMA 5-30P
RECEPTACLE NEMA OR ** R&S IN-LINE	(R&S) 3743	(R&S) 3744	(R&S) 3753	(R&S) 3754	(R&S) 7324	NEMA 5-15R	NEMA L5-15R	NEMA 6-15R	NEMA L6-15R	NEMA 5-20R	NEMA L5-20R	NEMA 5-30R
	(R&S) 3913	(R&S) 3914	(R&S) 3933	(R&S) 3934	(R&S) 7428	NEMA 5-15R	NEMA L5-15R	NEMA 6-15R	NEMA L6-15R	NEMA 5-20R	NEMA L5-20R	NEMA 5-30R
SCHEMATIC— FACE OF PLUG												
SERVICE RATING AMPS VOLTS	20 208/230	15 208/230	30 208/230	30 208/230	60 208/230	15 115	15 115	15 208/230	15 208/230	20 115	20 115	30 115
PHASE	1	3	1	3	3	1	1	1	1	1	1	1
WIRES****	3	4	3	4	4	3	3	3	3	3	3	3

* These plug types (or equivalent) are supplied with the machines. Customer provides matching receptacle.

** For US and Canada Ref: NEMA = National Elect Manufacturer's Association. R&S = Russell & Stoll

*** The 3 phase receptacle must be wired for correct phase rotation; looking at the face of the receptacle and a counterclockwise direction from the ground pin, the sequence will be Φ_1, Φ_2, Φ_3 .

**** Number of wires includes one insulated equipment grounding conductor (Grn/Grn-Yel)

† Plug types J, L, and N are locking style.

†† Plug types A, B, C, D and E are watertight.

3287 MODELS 1, 2 AND 3289 MODEL 3 ONLY

POWER PLUG CHART
UNITED STATES AND CANADA
 120 Volts 1 Phase 60 Hz

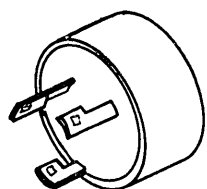

Locking
 NEMA L5-15P

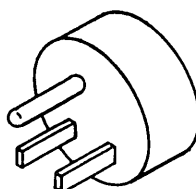

Nonlocking
 NEMA 5-15P

POWER PLUG CHART
EUROPE, MIDDLE EAST, AND AFRICA
 220 or 240 Volts 1-phase 50 Hz

Austria Bulgaria Finland Germany Iran Iceland Netherlands	Norway Portugal Poland Rumania Spain Sweden		Algeria Belgium France	Hungary Yugoslavia	
		Maximum 16 amperes			Maximum 16 amperes
Denmark			Ireland United Kingdom		
		Maximum 10 amperes			Maximum 13 amperes
Israel			South Africa		
		Maximum 16 amperes			Maximum 15 amperes
Switzerland			Other Europe, Middle East, and Africa Countries		
		Maximum 10 amperes			Maximum 16 amperes
Italy					
		Maximum 16 amperes			

3287 MODELS 1, 2 AND 3289 MODEL 3 ONLY

POWER PLUG CHART
 ASIA AND LATIN AMERICA

Argentina	New Zealand
Australia	Paraguay
Chile	Uruguay
Columbia	Venezuela

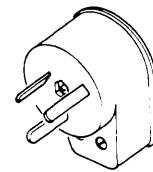

200, 220, 230, 240 volts; 1-phase; 50 Hz; maximum 10 amperes.
 For voltages lower than these, a power cord without plug is supplied.

Bahama	Honduras
Barbados	Jamaica
Bermuda	Mexico
Bolivia	Nicaragua
Brazil	Netherlands Antilles
Costa Rica	Panama
Dominican Republic	Peru
Ecuador	Philippines
El Salvador	Taiwan
Guatemala	Thailand



100, 110 volts; 1-phase; 50 Hz; maximum 15 amperes.
 100, 110, 120, 127 Volts; 1-phase; 60 Hz; maximum 15 amperes.
 For voltages higher than these, a power cord without plug is supplied.

Indonesia

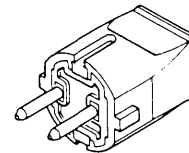

200, 240 volts; 1-phase; 50 Hz; maximum 16 amperes.
 For voltages lower than these, a power cord without plug is supplied.

Japan



Locking

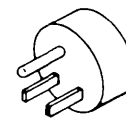

Nonlocking

100, 110 volts; 1-phase; 50 Hz; maximum 15 amperes.
 100, 110, 120, 127 volts; 1-phase; 60 Hz; maximum 15 amperes.
 For voltages higher than these, a power cord without plug is supplied.

Malaysia

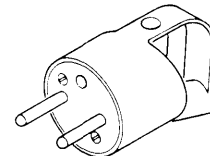

200, 240 volts; 1-phase; 50 Hz; maximum 16 amperes.
 For voltages lower than these, a power cord without plug is supplied.

Other Asian and Latin America
 Countries

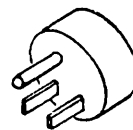

100 volts; 1-phase;
 50 or 60 Hz; maximum 15 amperes.

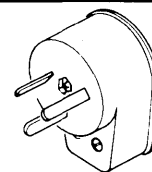

200, 240 volts; 1-phase;
 50 Hz; maximum 10 amperes.

Appendix B. Power Cord Types

Power Cord Style	Cable O D		Shield	Conductor			
	(in.)	(cm)		Quantity	Nominal O D		AWG No.
					(in.)	(cm)	
A1	0.520	1.3	1	3	0.064	0.2	14
A2	0.620	1.6	1	3	0.080	0.2	12
A3	0.571	1.5	1	3	0.102	0.3	10
A6	0.560	1.4	0	3	0.064	0.2	14
A7	0.510	1.30	1	3	0.081	0.21	12
D1	0.815	2.1	2	5	0.102	0.3	10
D2	0.750	1.9	1	5	0.102	0.3	10
E1	1.079	2.7	1	5	0.129	0.3	8
E2	1.40	4.0	0	5	0.232	0.6	4
F1	0.540	1.3	1	4	0.080	0.2	12
F2	0.920	2.3	1	4	0.102	0.3	10
F3	1.340	3.4	1	4	0.232	0.6	4
G1			0	3	0.040	0.1	18
G2	0.372	0.9	0	3	0.115	0.3	18
G3	0.365	0.9	0	3	0.051	0.1	16
G4	0.360	0.9	1	3	0.040	0.1	18
G5	0.703	1.8	1	3	0.104	0.3	10
G6	0.38	1.0	1	3	0.051	0.1	16
G7	0.420	1.1	1	4	0.051	0.1	16
G8	0.504	1.2	1	5	0.051	0.1	16

Appendix C. IBM Line Adapter/Integrated Modem Cable Terminations

Unless otherwise specified, the cable provided from the IBM Integrated Modem or the IBM Line Adapter to the customer-provided communication line is terminated with a Western Electric Type 283B Plug. The customer must provide, and make connections to, either a Western Electric Type 404B Surface Mount or a Western Electric Type 493A Flush Mount (or equivalent) Receptacle.

IBM cables as shipped from the factory are wired as shown in Figure C-1 for 2-wire systems and in Figure C-2 for 4-wire systems. This is in agreement with the

operating procedures for a majority of the common carriers; however, some companies interchange their Transmit and Receive leads. Where this condition exists, it will be necessary to secure local agreement between IBM and the common carrier. Figure C-3 shows the Western Electric type 283B connector attached to the cable from the IBM Line Adapter Feature or the IBM Integrated Modem Feature. See GA27-3435 for the required terminations for the various types of IBM line adapters or IBM integrated modems.

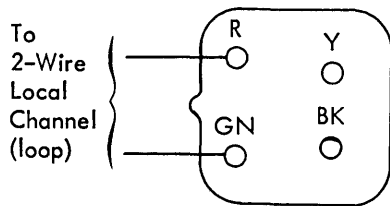

Figure C-1. Two-Wire Termination Jack

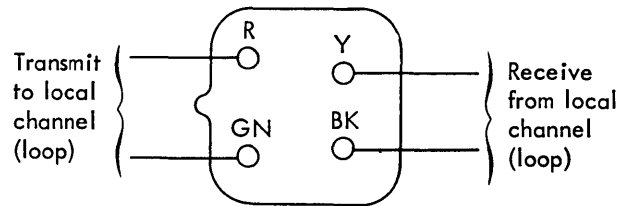

Figure C-2. Four-Wire Termination Jack

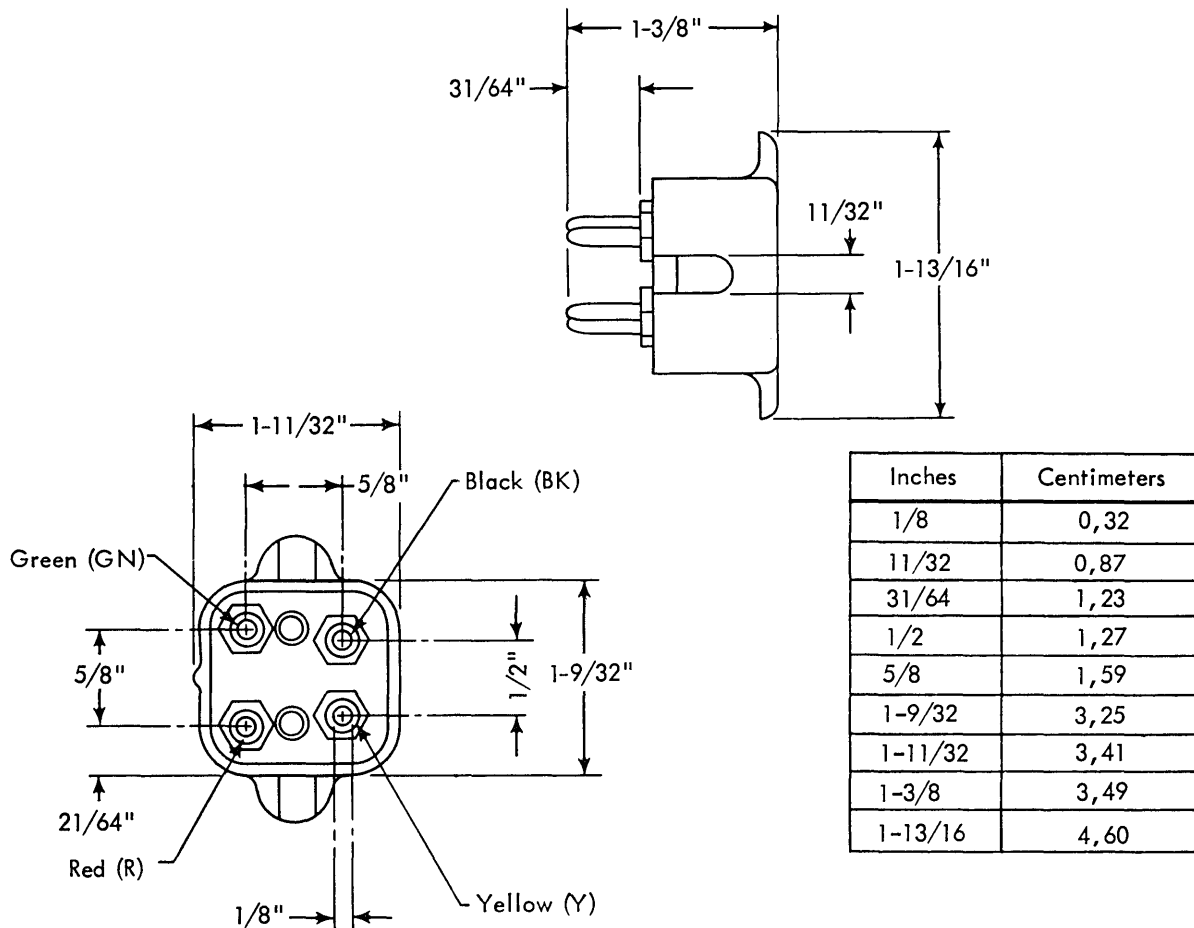

Figure C-3. Connector Attached to Cable from IBM Line Adapter/Integrated Modem Feature

Appendix D. Telegraph Line Terminations

When an IBM unit is to be connected to a common-carrier leased telegraph circuit, IBM will terminate its cable using ring lugs to fit over 8-32 screw terminals. To facilitate

servicing, the common-carrier should provide the terminal board in the same room as the IBM equipment.

Appendix E. IBM Switched Network Integrated Modem Cable Terminations

Unless otherwise specified, the cable provided from the IBM terminal to the customer-provided communications Data Access Arrangement (DAA) is terminated with eight No. 8 lugs. The customer is responsible for having this cable connected to the type CBS Data Coupler (or equivalent) of the DAA communications facility. It is also suggested that the customer secure this cable with a wall

fastener to prevent possibly serious strain at the DAA.

IBM cables as shipped from the factory are wired as shown in Figures E-1 and E-2.

The type CBS coupler must be mounted vertically.

Note: If the Integrated Modem does not have Auto Answer capability, the cable will be terminated with a 4 prong plug described in appendix C.

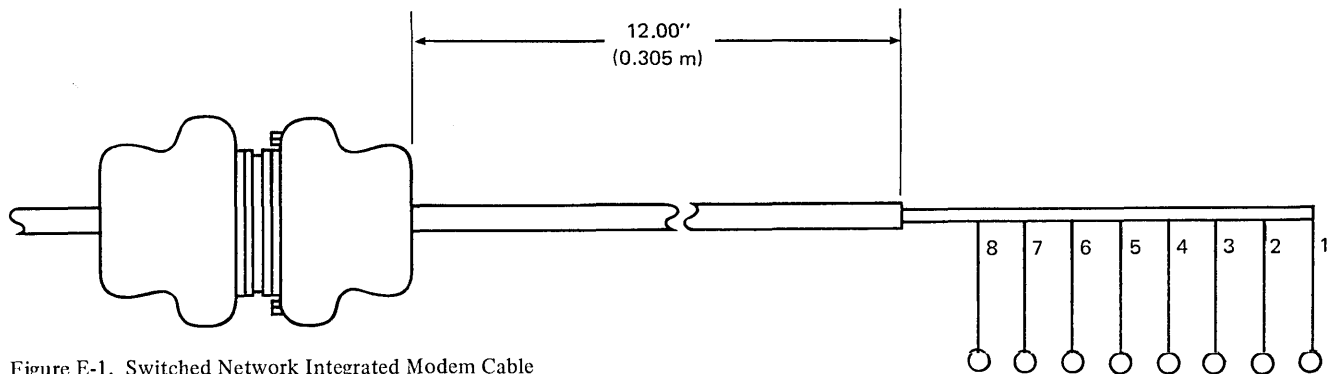

Figure E-1. Switched Network Integrated Modem Cable

Wire No.	Color	Connector Pin No.	DAA Termination
1	black	15	Data Ring (DR)
2	white	14	Data Tip (DT)
3	violet	5	Ring Indicate (RI)
4	blue	8	Off Hook (OH)
5	brown	3	Coupler Cut Through (CCT)
6	yellow	6	Data Modem Ready (DA)
7	gray	7	Signal Ground (SG)
8	red	4	Switch Hook (SH)
	shield	1	(no connection)

Figure E-2. Cable Connections to the Data Access Arrangement (DAA)

Order No. GA27-3006-7

Your comments, accompanied by answers to the following questions, help us produce better publications for your use. Each reply is carefully reviewed by the persons responsible for writing and publishing this material. Comments and suggestions become property of IBM.

Please direct *any requests for copies of publications or for assistance in using your IBM System or equipment*, to your IBM representative or to the IBM sales office serving your locality.

- Did this publication meet your needs?
- How did you use this publication?
- What is your occupation?

————— COMMENTS —————

We would appreciate your comments: please give specific page and line references when appropriate. Additional comments may be made on the other side of this form.

Cut or Fold Along This Line

If you would like a reply, complete the following (Please Print):

Your Name _____
Company Name _____
Department _____
Street Address _____
City _____ State _____ Zip Code _____

Thank you for your cooperation. No postage stamp is necessary if mailed in the U.S.A. (Elsewhere, an IBM office or representative will be happy to forward your comments.)

GA27-3006-7

ADDITIONAL COMMENTS:

Cut or Fold Along Line

Remote Multiplexers and Terminals Installation Manual — Physical Planning (File No. TP-15) Printed in U.S.A. GA27-3006-7

Fold

Fold



NO POSTAGE
NECESSARY
IF MAILED
IN THE
UNITED STATES

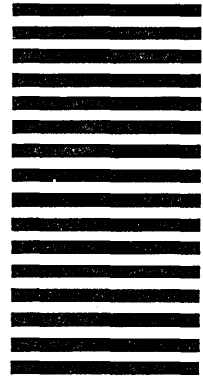

BUSINESS REPLY MAIL
FIRST CLASS PERMIT NO. 40 ARMONK, N.Y.

POSTAGE WILL BE PAID BY ADDRESSEE:

Postage will be paid by:

International Business Machines Corporation
Dept. E01
P.O. Box 12195
Research Triangle Park
North Carolina 27709

Fold

Fold



International Business Machines Corporation
Data Processing Division
1133 Westchester Avenue, White Plains, N.Y. 10604

IBM World Trade Americas/Far East Corporation
Town of Mount Pleasant, Route 9, North Tarrytown, N.Y., U.S.A. 10591

IBM World Trade Europe/Middle East/Africa Corporation
360 Hamilton Avenue, White Plains, N.Y., U.S.A. 10601



International Business Machines Corporation
Data Processing Division
1133 Westchester Avenue, White Plains, N.Y. 10604

IBM World Trade Americas/Far East Corporation
Town of Mount Pleasant, Route 9, North Tarrytown, N.Y., U.S.A. 10591

IBM World Trade Europe/Middle East/Africa Corporation
360 Hamilton Avenue, White Plains, N.Y., U.S.A. 10601