

IBM 4701 Controller Setup And Subsystem Installation Instructions

Part 1. 4701 Controller Setup Instructions

1

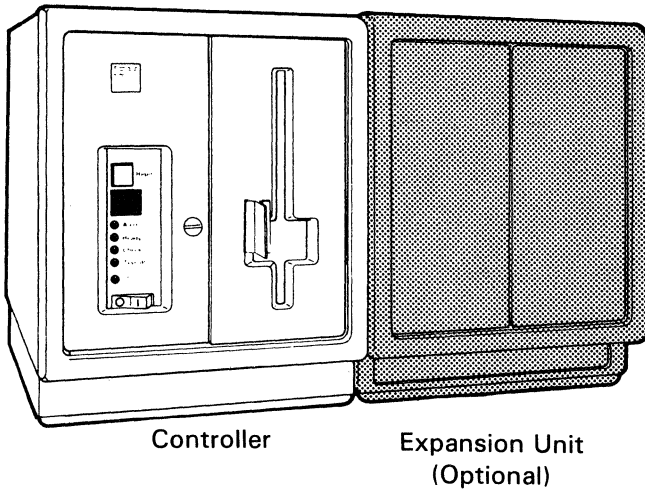

Part 2. Subsystem Installation Instructions

2

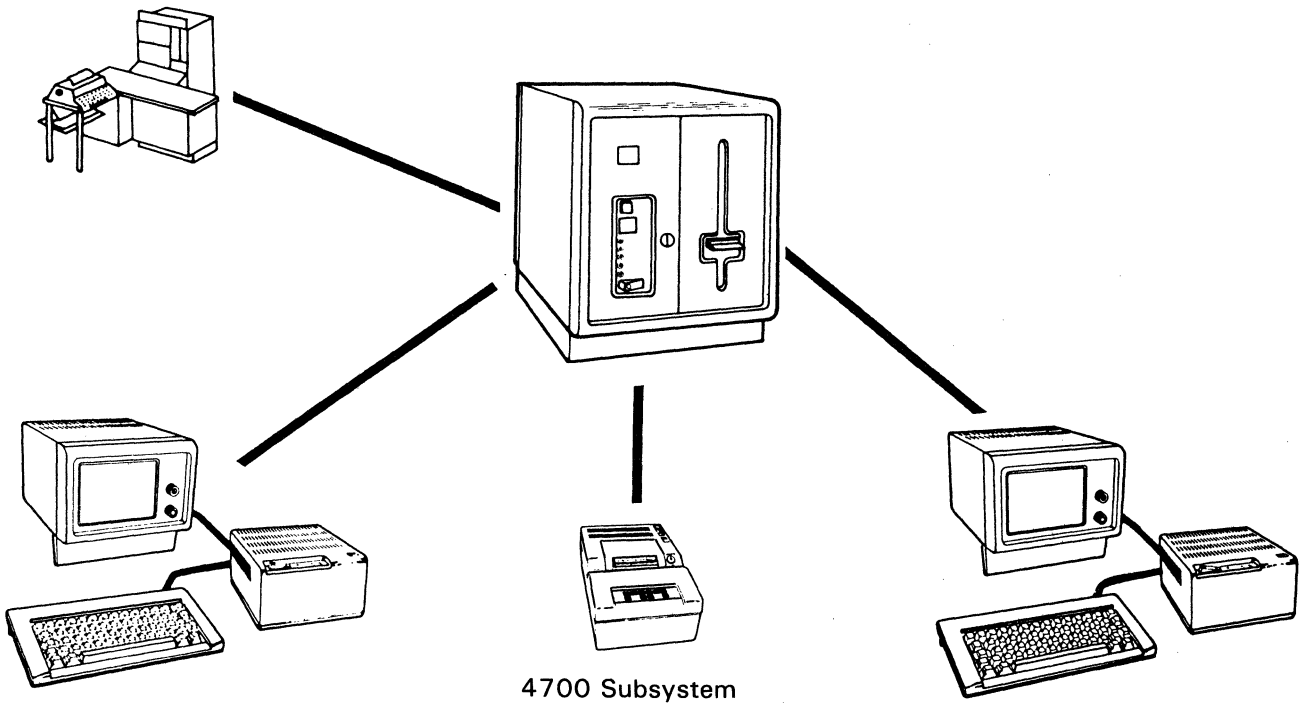

Third Edition (July 1983)

This edition, GC31-2021-2, is a major revision of GC31-2021-1 which is obsolete.

Changes occur often to the information herein; before using this publication in connection with the operation of IBM systems, consult *IBM System/370 Bibliography of Industry Systems and Application Programs*, GC20-0370, for the editions that are applicable and current.

References in this publication to IBM products, programs, or services do not imply that IBM intends to make these available in all countries in which IBM operates. Any reference to an IBM program product in this publication is not intended to state or imply that only IBM's program product may be used. Any functionally equivalent program may be used instead.

Publications are not stocked at the address given below; requests for IBM publications should be made to your IBM representative or to the IBM branch office serving your locality.

A form for reader's comments is at the back of this publication. If the form has been removed, comments may be addressed to IBM Corporation, Information Development, Department 78C, 1001 W. T. Harris Blvd., Charlotte, NC 28257, USA. IBM may use or distribute whatever information you supply in any way it believes appropriate without incurring any obligation to you.

Part 1. 4701 Controller Setup Instructions

Please follow all instructions step by step, in sequence, and mark the box as you complete each step. When you finish, keep this manual for future use.

Step 1-1.

Study the front and rear of the controller.

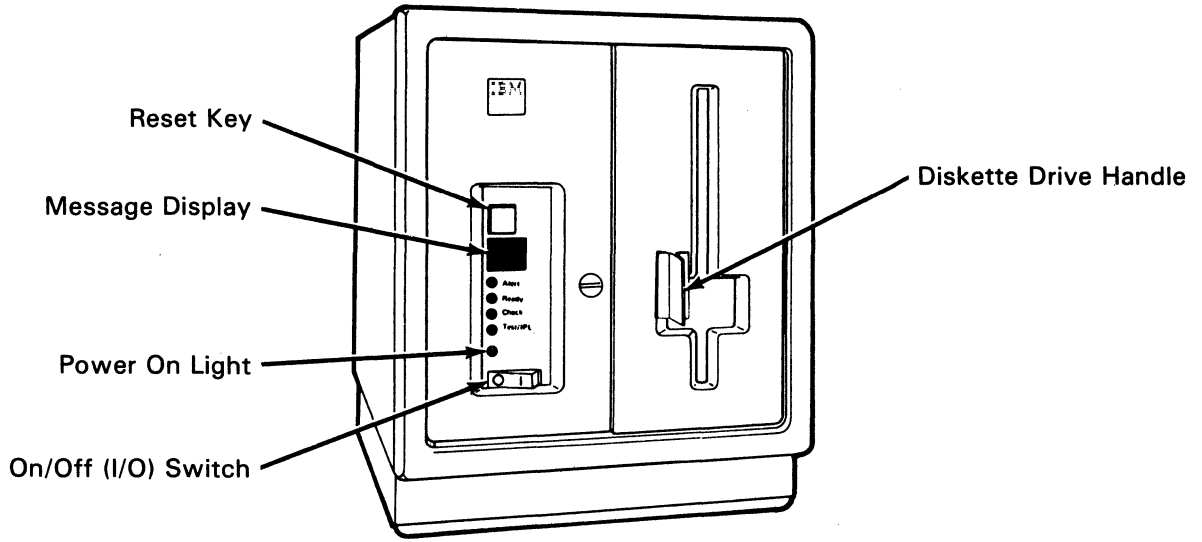

Front of Controller

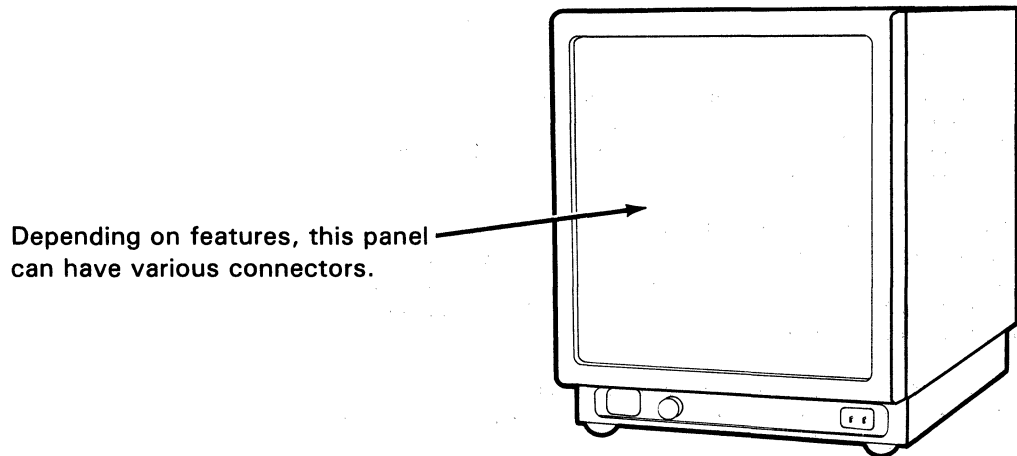

Rear of Controller

□ Step 1-2.

Some controllers can have an expansion unit (special feature shipped in a separate container). If you have an expansion unit to attach to this controller, study the front of the expansion unit.

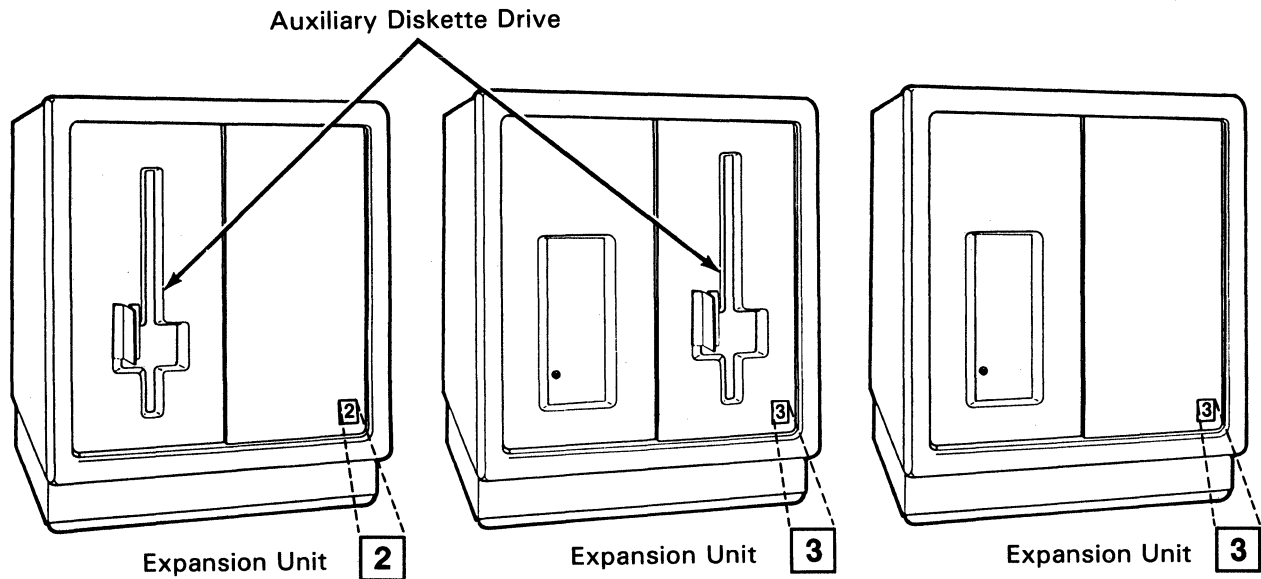

□ Step 1-3.

Check that you received the following:

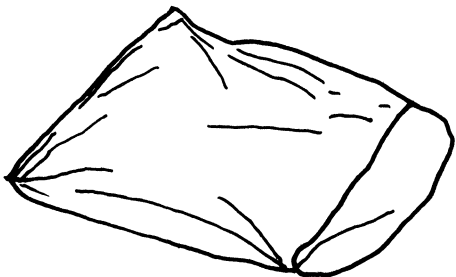

Shipping Envelope With Cables

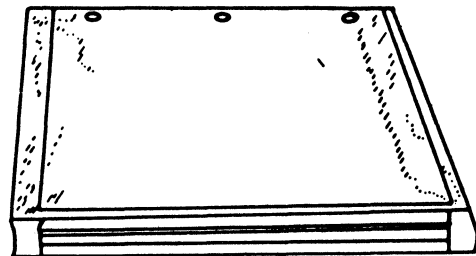

Shipping Envelope With Manuals

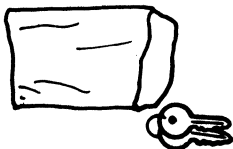

Envelope (taped to the top of the controller) containing keys.
Notify your supervisor about these keys.

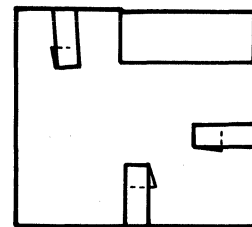

Folder With Diskettes

□ **Step 1-4.**

Remove the cables and power cord(s) from the plastic bags. Remove the cardboard protectors from the ends of each communication cable. Examine the shipping envelopes for the following:

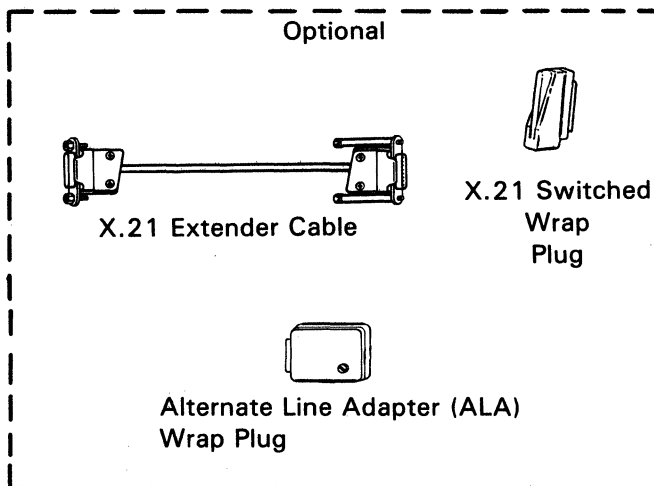
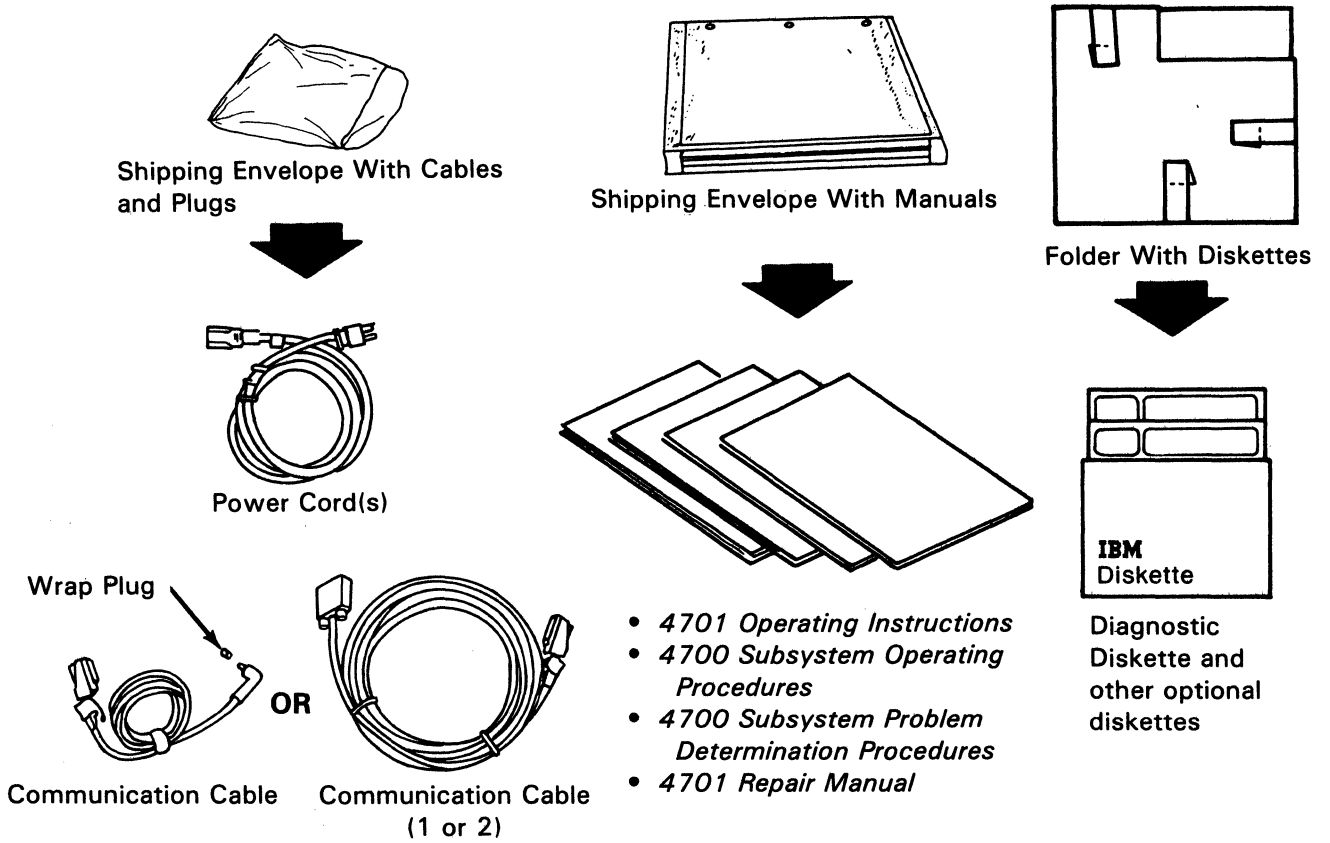

1

Step 1-5.

Press O (Off).

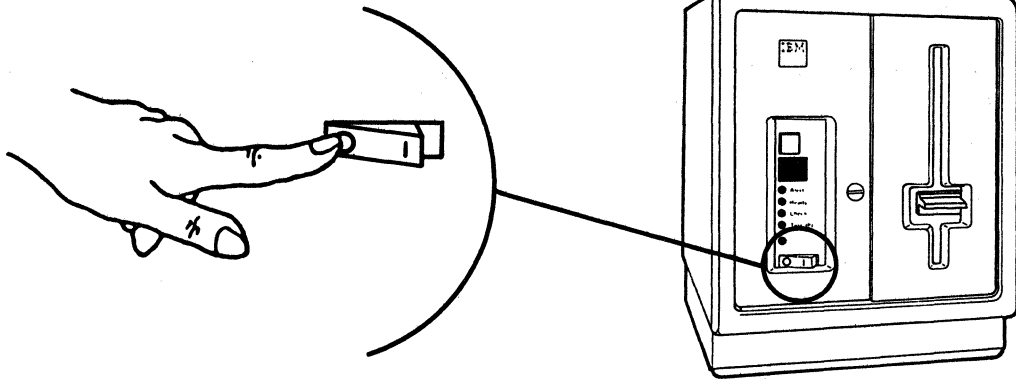

Step 1-6.

Does this controller have an expansion unit?

Yes

 Go to Step
 1-7.

No

 Go to Step
 1-16.

Step 1-7. Do this only if this controller has an expansion unit.

Which one do you have?

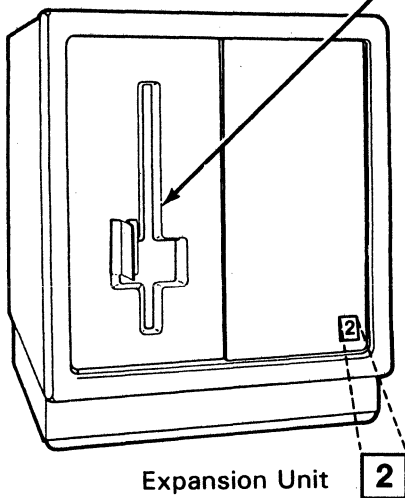
Auxiliary Diskette Drive



Expansion Unit **2**

 Go to Step
 1-8.

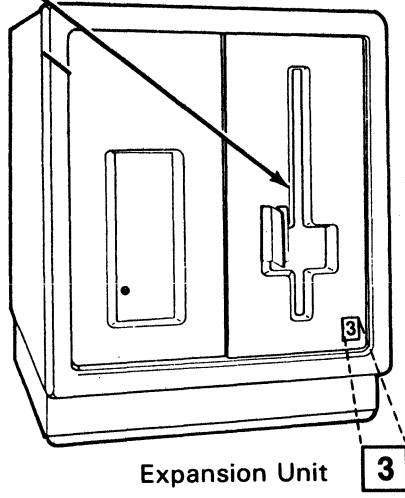

Expansion Unit **3**

 Go to Step
 1-11.

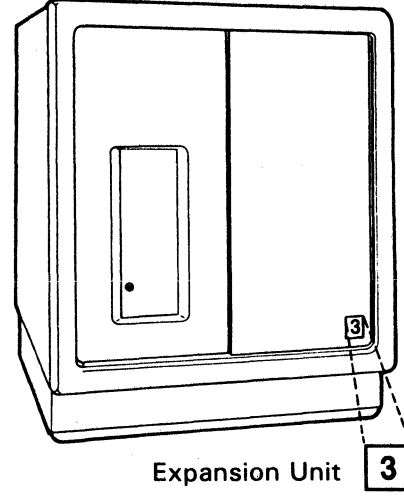

Expansion Unit **3**

 Go to Step
 1-11.

Step 1-8.

If you are setting up expansion unit 2, place the expansion unit to the right side of the controller.

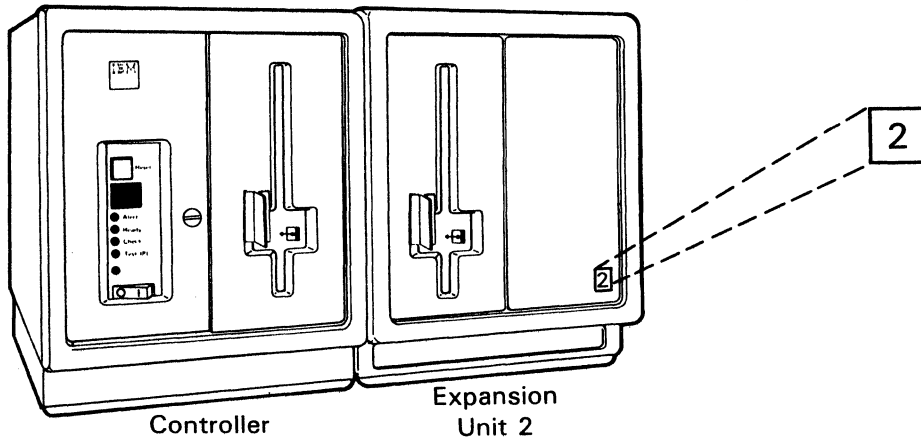

Step 1-9.

Connect the expansion unit power cord to the power socket at the rear of the controller.

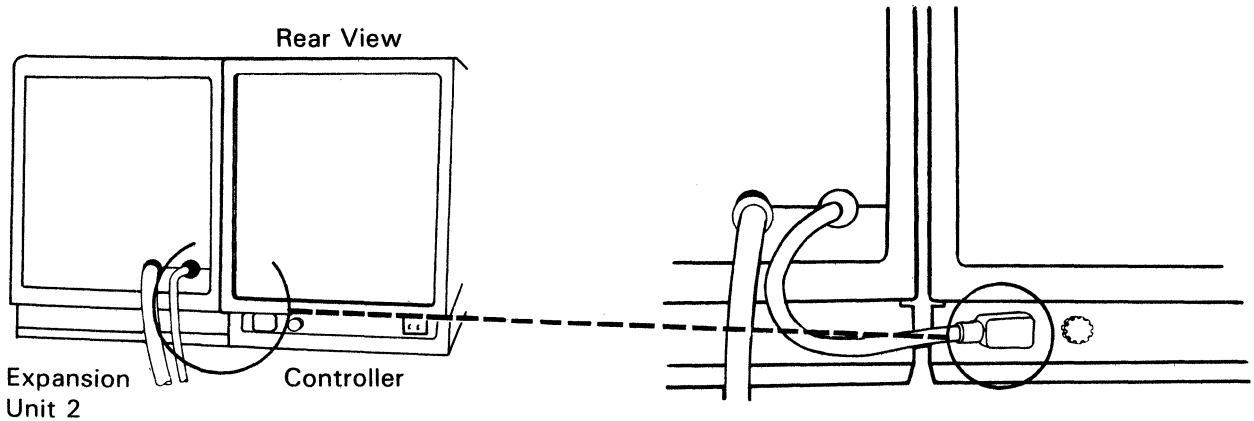

Step 1-10.

Connect the auxiliary diskette drive signal cable into panel E at the rear of the controller, tighten the thumbscrews.

Go to Step 1-16.

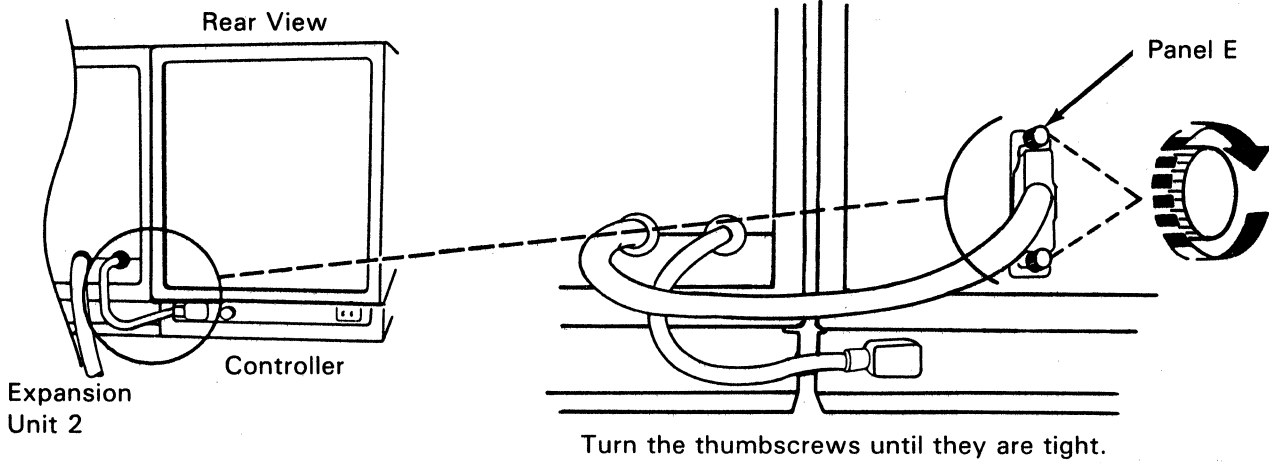

Step 1-11. You should come here from Step 1-7 if you have a disk expansion unit.

Place the expansion unit to the right side of the controller.

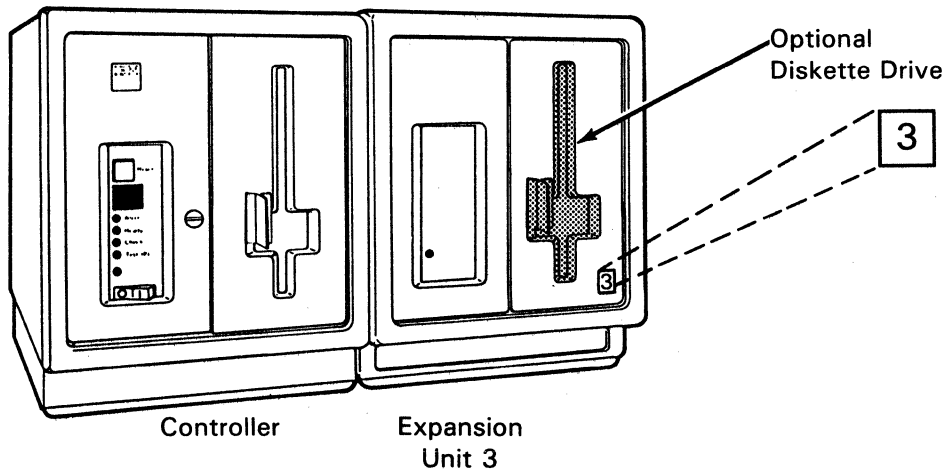

Warning: This machine must be on a level surface.

Step 1-12.

Connect the two disk expansion unit cables marked **D1** and **D2** to the **D1** and **D2** connectors on the rear of the controller. Connect **D2** first, then **D1**. Push in and tighten both thumbscrews.

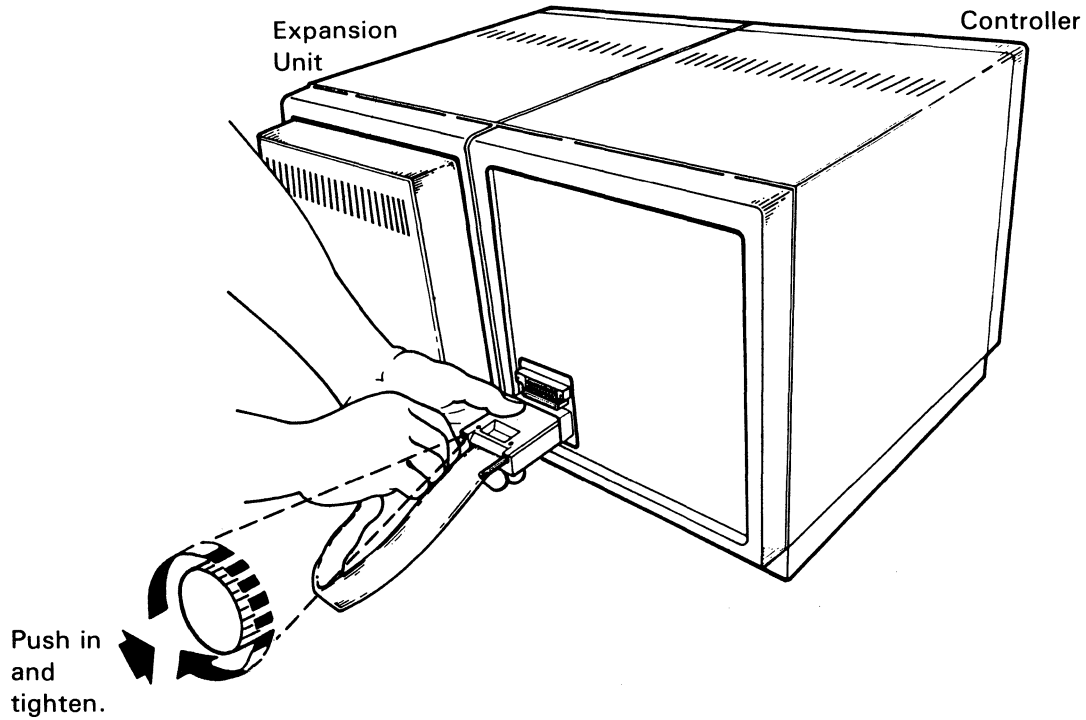

Step 1-13.

Do you have an expansion unit 3 with an auxiliary diskette drive?

Yes
↓
Go to Step 1-14.

No
↓
Go to Step 1-15.

□ Step 1-14.

Connect the auxiliary diskette drive signal cable into panel E at the rear of the controller. Tighten the thumbscrews.

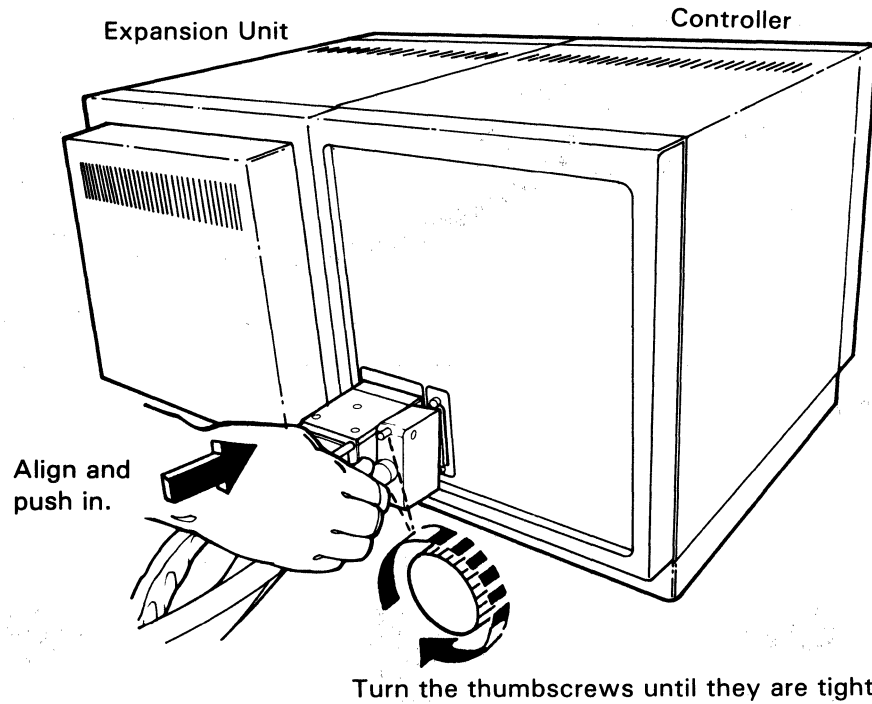

□ Step 1-15.

Get one of the power cords and connect it to the rear of expansion unit 3. Ensure that it is plugged in all the way.

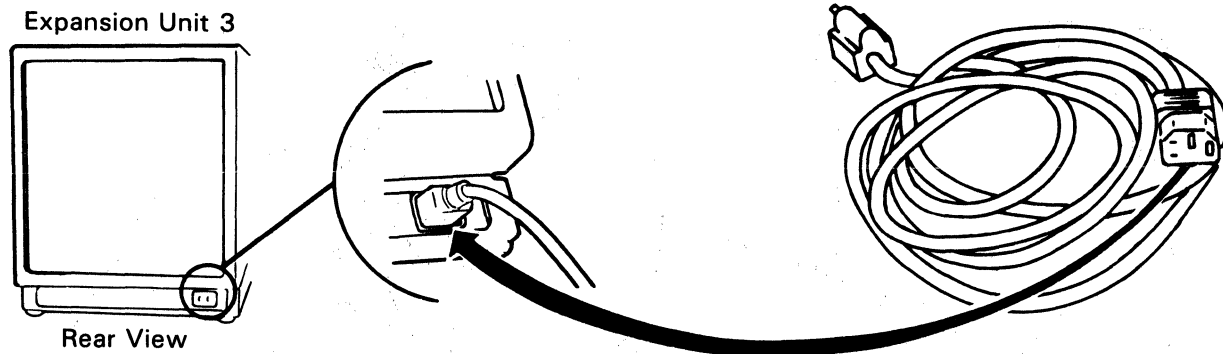

Step 1-16.

Connect the power cord to the rear of the controller. Ensure that it is plugged in all the way.

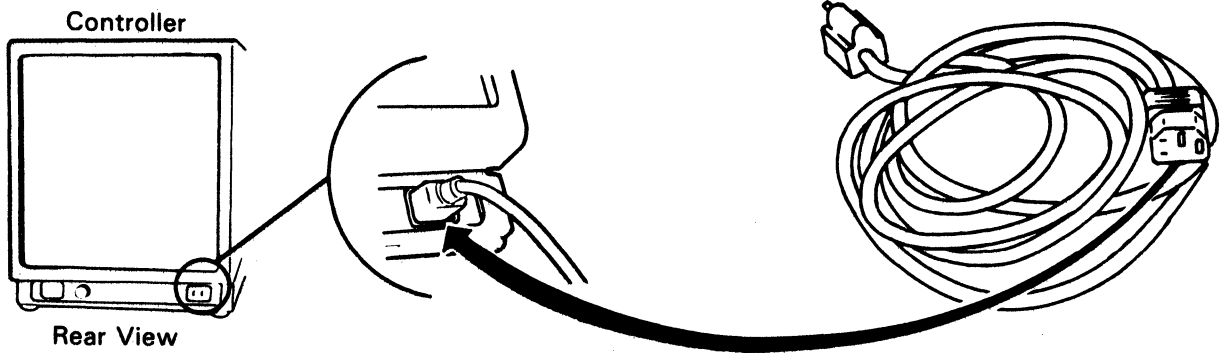

Step 1-17.

Do you have a panel G or H?

G
↓
Go to Step 1-18.

H
↓

Neither
↓
Go to Step 1-18.

Get the Alternate Line Adapter (ALA) wrap plug and plug it in any one of the sockets on panel H, at the rear of the controller.

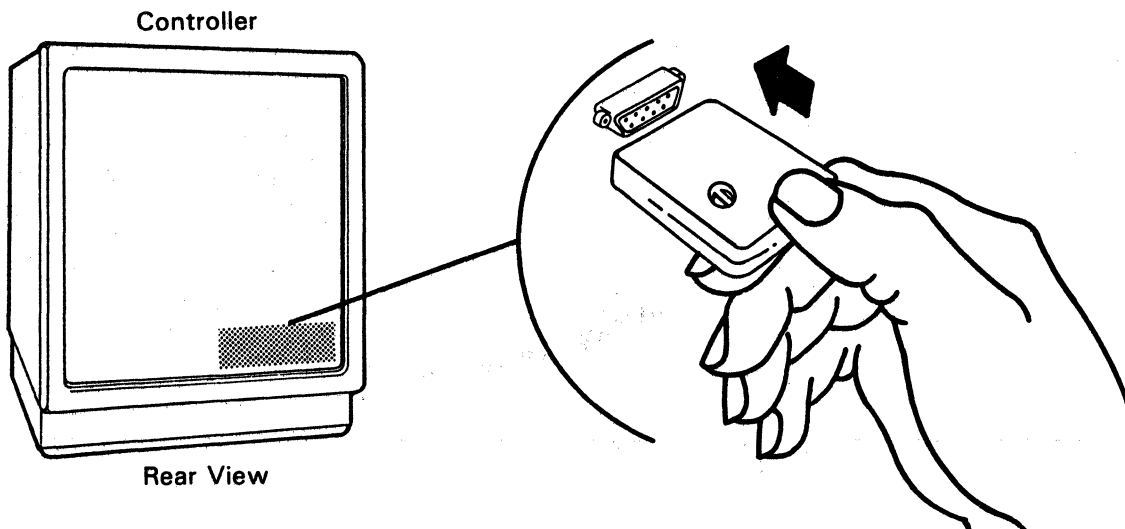

Step 1-18.

Remove and keep the wing screw (located at panel F of the controller).

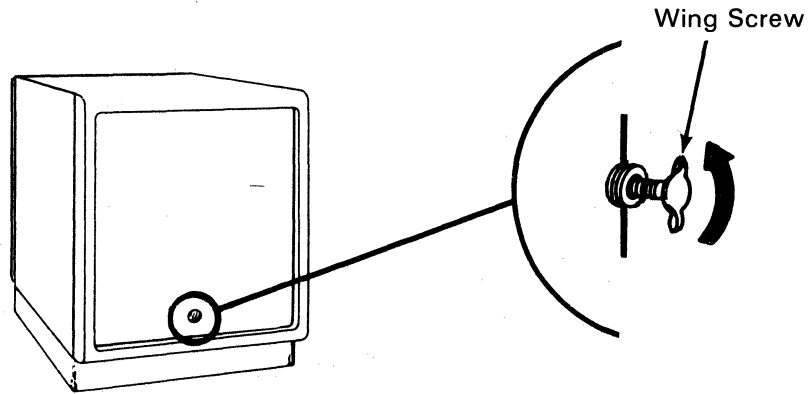

Get the communication cable(s). Insert the wing screw through the ground wires of the communication cable(s). Screw the wing screw into the threaded hole at panel F, and tighten the wing screw.

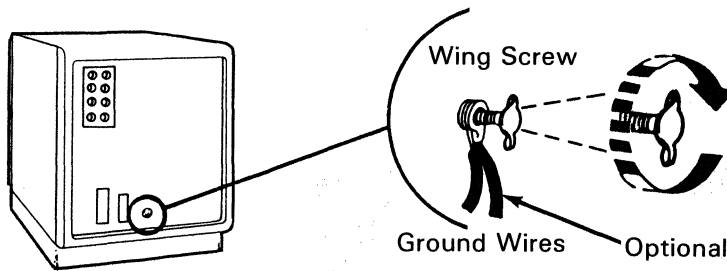

Step 1-19.

Do you have an X.21 extender cable?

Yes
↓
Go to Step 1-20.

No
↓
Go to Step 1-23.

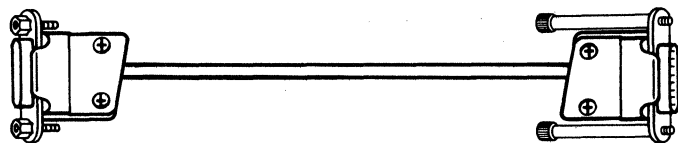

Step 1-20.

Get the X.21 extender cable and connect the end (without thumbscrews) to the other end of the communication cable. Tighten both thumbscrews.

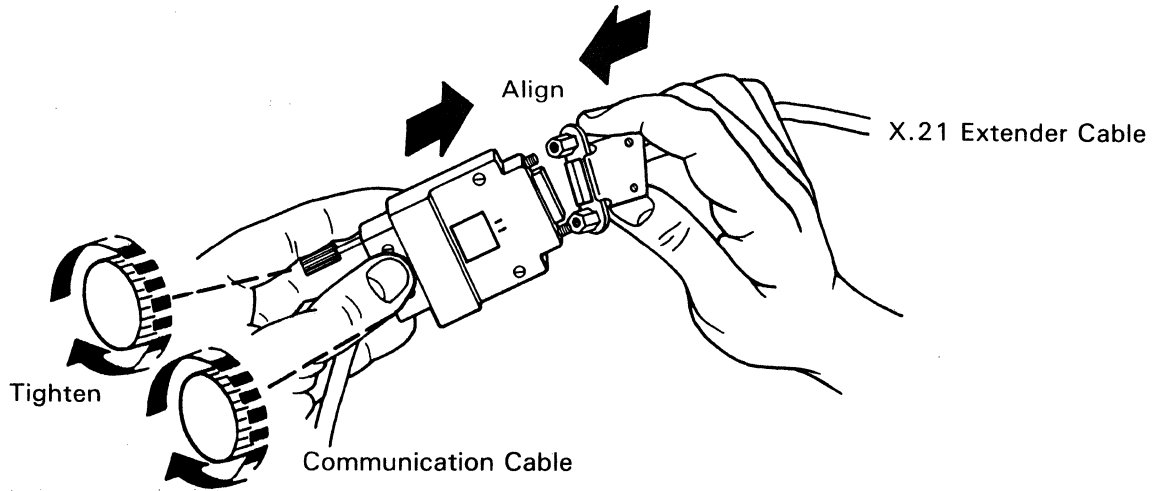

Step 1-21.

Do you have an X.21 switched wrap plug in the cable shipping envelope?



X.21 Switched Wrap Plug

Yes
↓
Go to Step 1-22.

No
↓
(You have the X.21 nonswitched feature.)
Go to Step 1-34.

Step 1-22.

Connect the X.21 switched wrap plug to the panel F connector at the rear of the controller, and swing the retainer clip over the housing. **Omit Steps 1-23 and 1-24, and go to Step 1-25.**

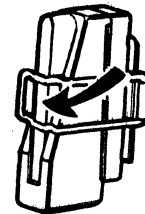
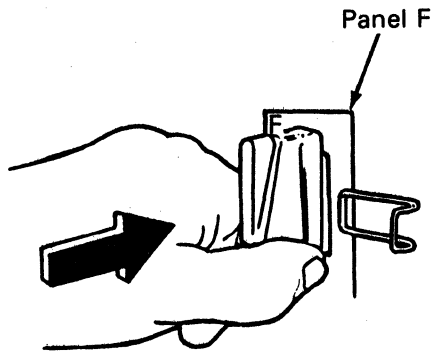

X.21 Switched Wrap Plug

Step 1-23. You should come here from Step 1-19.

Connect the communication cable(s) at panel F (and panel G, if you have panel G) on the rear of the controller. Swing the retainer clip(s) over the housing(s).

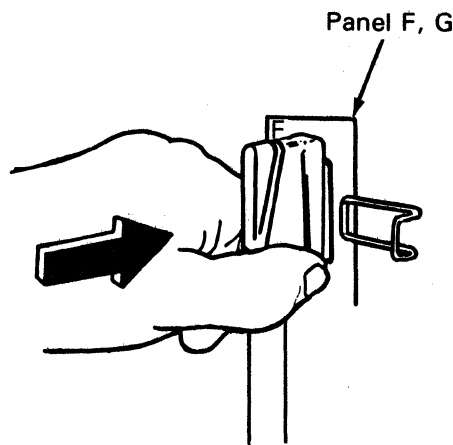

Communication Cable

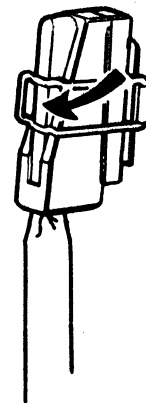

Step 1-24.

At the other end of the communication cable(s), perform the following, depending on the cable(s) you have.

- Set the TEST/OPER switch to the TEST position.
- Connect the wrap plug to the cable.

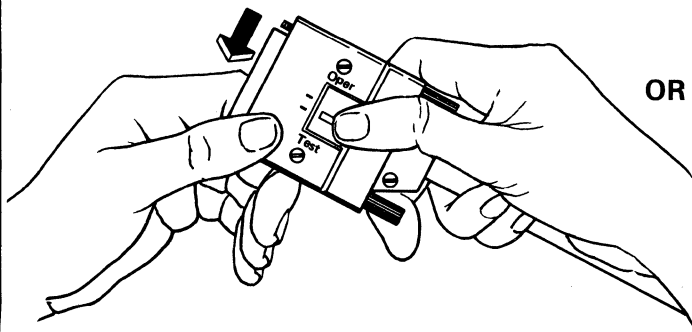

OR

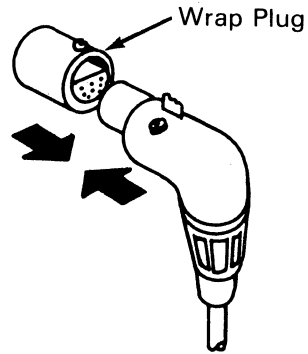

Leave this end unattached at this time.

Step 1-25.

Connect the controller power cord and if present, the expansion unit 3 power cord, to the electric outlet(s).

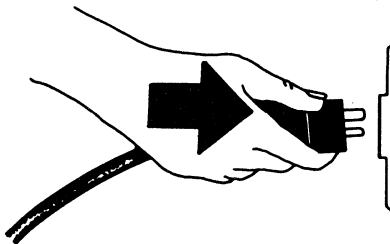

You will do the remaining steps at the front of the controller.

□ **Step 1-26.**

Open the diskette drive (if it is not already open) by turning the handle in the direction of the arrow to the vertical position.

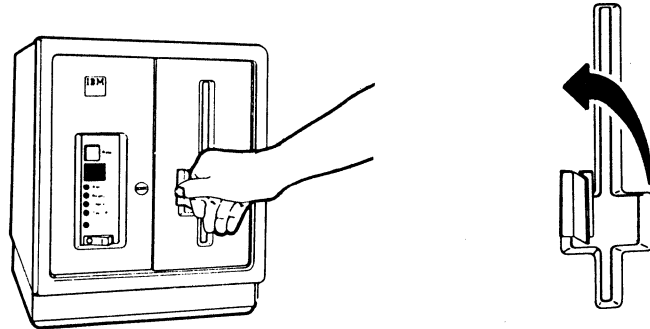

□ **Step 1-27.**

Remove the diskette labeled **Diagnostic Diskette** from its protective envelope. Save the envelope to protect the diskette after setup.

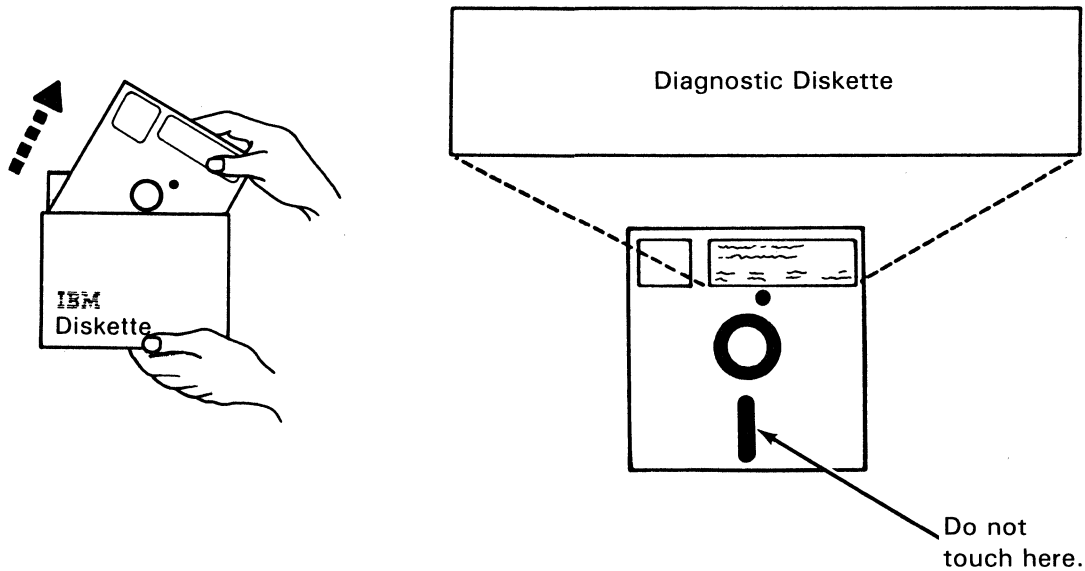

Step 1-28.

Insert the **Diagnostic Diskette** squarely into the controller diskette drive with the label facing to your left as shown.

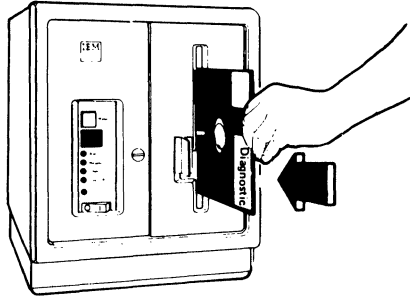

Step 1-29.

Close the diskette drive by turning the handle in the direction of the arrow to the horizontal position.

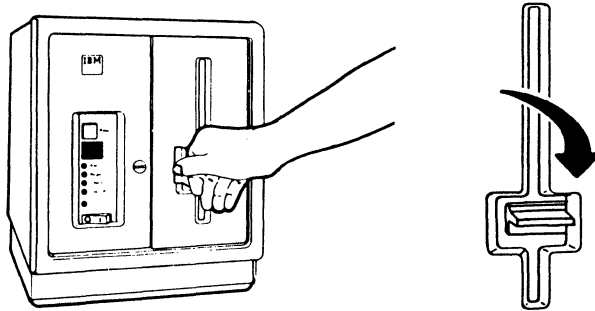

□ Step 1-30.

Press | (On).

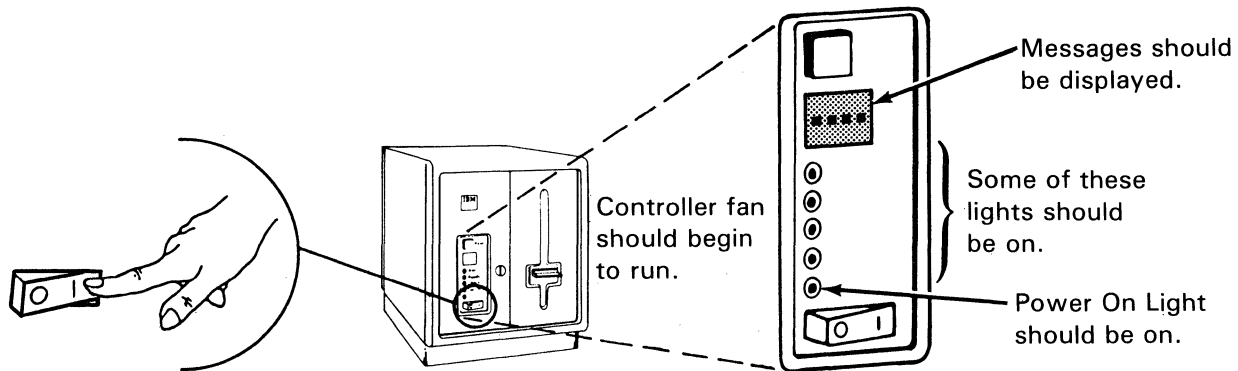

The power light(s) on the controller and disk expansion unit (if attached) **must** be on before you continue. If they are not on, **go to Step 1-53.**

Warning: Do not move the expansion unit while it is on; unit damage could occur.

□ Step 1-31.

The controller should now be running internal tests, which should run from three to fifteen minutes. Watch the display. While you are waiting for the tests to complete, read the remainder of this Step and prepare for the message that will be displayed.

If this controller has *no* auxiliary diskette drive, wait for this message.

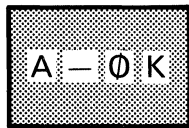

When this message is displayed, **go to Step 1-52.**

If this controller has an auxiliary diskette drive, wait for this message.

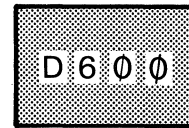

When this message is flashing, **go to Step 1-32.**

If after fifteen minutes, one of these messages is not displayed, **go to Step 1-53.**

□ **Step 1-32.** Do this (and Step 1-33) if this controller has an auxiliary diskette drive.

- Open the auxiliary diskette drive (if it is not already open) by turning the handle in the direction of the arrow to the vertical position.

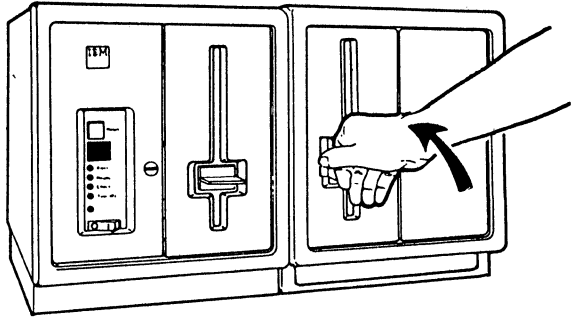

Note: On expansion unit 3, the auxiliary diskette drive will be on the right side of the expansion unit.

- Open the controller diskette drive, and remove the diskette.

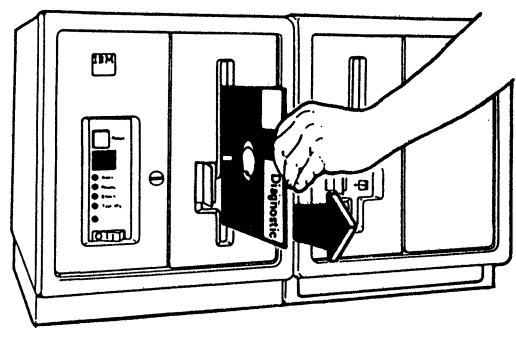
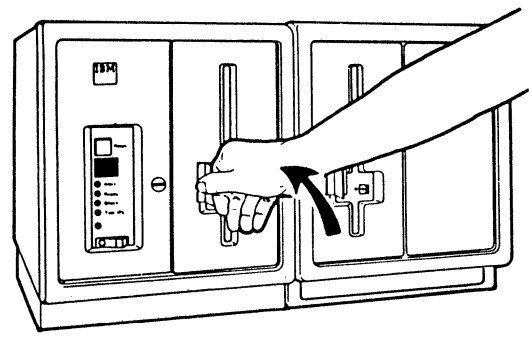

- Insert the diskette into the auxiliary diskette drive, and close the drive.

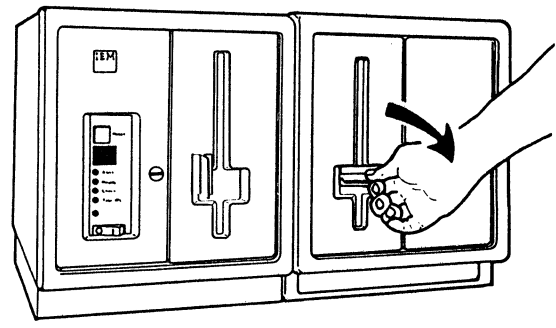
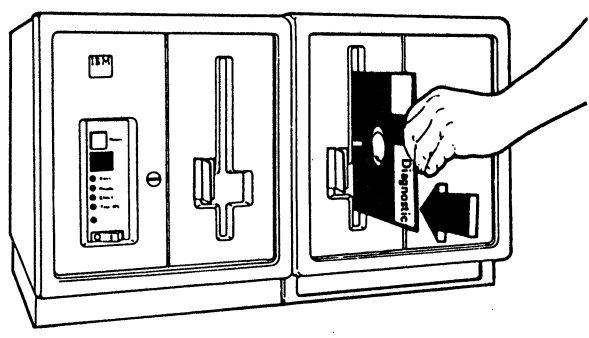

When the message **D 6 0 1** is displayed, go to **Step 1-33**.

If the message **E 6 2 0** is displayed for more than 20 seconds after closing the drive handle, go to **Step 1-53**.

If any other message is displayed, go to **Step 1-53**.

□ Step 1-33.

- Open the auxiliary diskette drive, and remove the diskette.

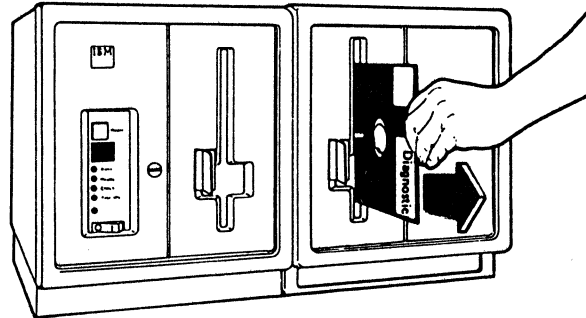
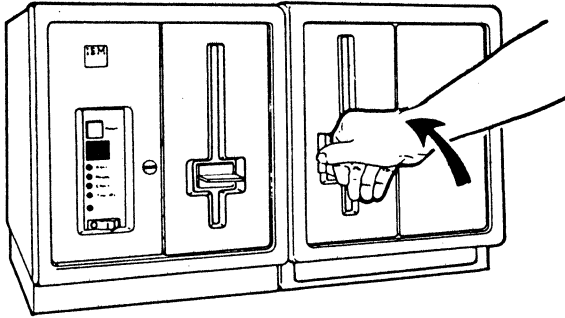

- Insert the diskette into the controller diskette drive, and close the controller diskette drive.

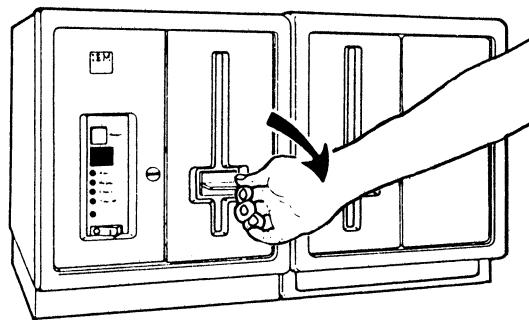
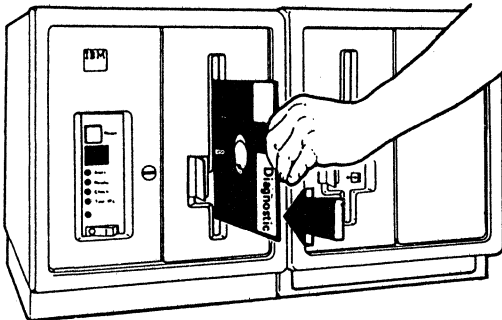

Testing should automatically resume and continue until the following message is displayed. If so, go to Step 1-52.

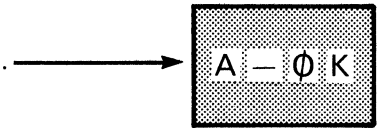

If this message is not displayed, go to Step 1-53.

Step 1-34. Do this (and Steps 1-35 through 1-51) only if this controller has the X.21 nonswitched feature (see Steps 1-19 through 1-21).

Connect the communication cable to the panel F connector at the rear of the controller, and swing the retainer clip over the housing.

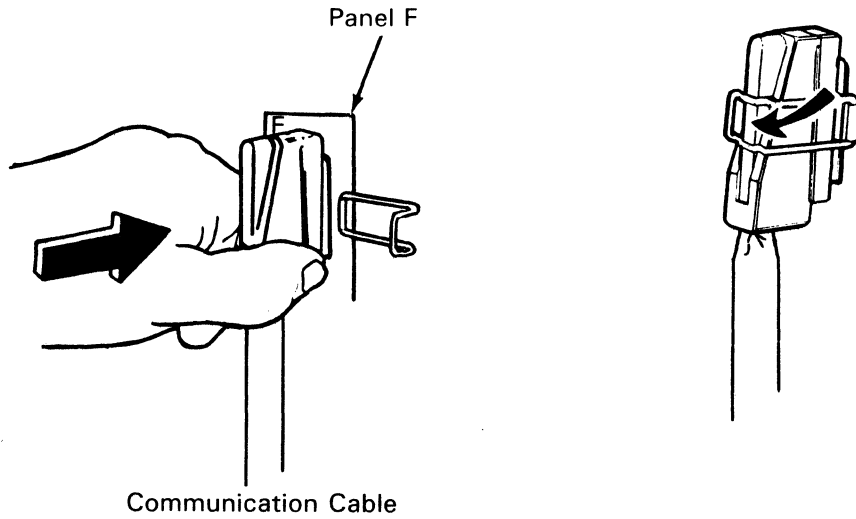

Step 1-35.

At the other end of the communication cable set the TEST/OPER switch to the test position.

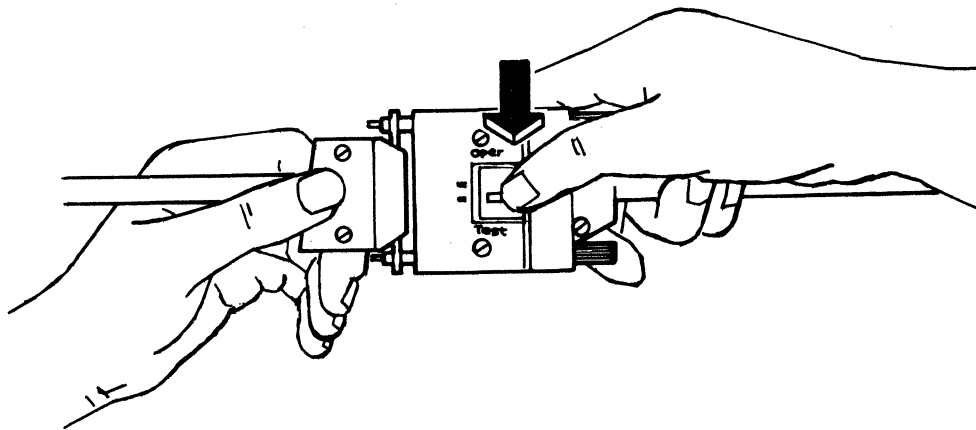

Step 1-36.

Connect the controller power cord and, if present, the expansion unit 3 power cord to the electric outlet.

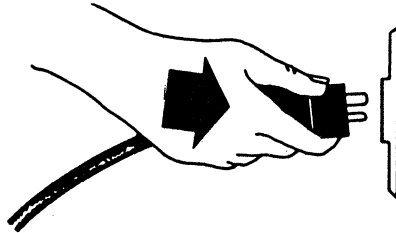
 **Step 1-37.**

Do you have a modem or Data Circuit-Terminating Equipment (DCE) to attach to this controller?

Yes
↓
Go to Step
1-38.

No
↓
Go to Step
1-40.

 Step 1-38.

Connect the end (with thumbscrews) of the X.21 extender cable to the modem or DCE, and turn the thumbscrews until they are tight.

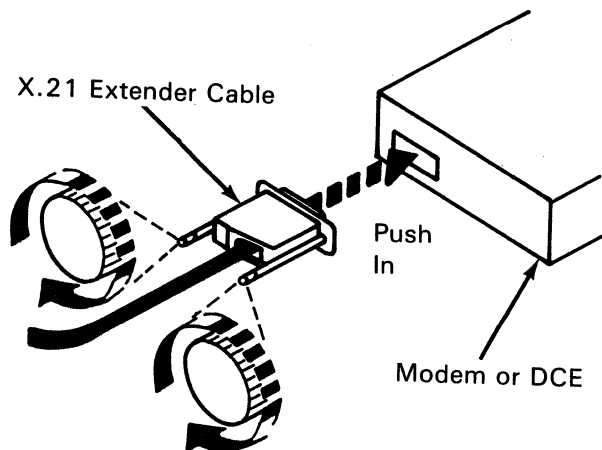

Step 1-39.

Refer to the modem manufacturer's instructions, and switch on the modem.

Step 1-40.

Open the diskette drive (if it is not already open) by turning the handle in the direction of the arrow to the vertical position.

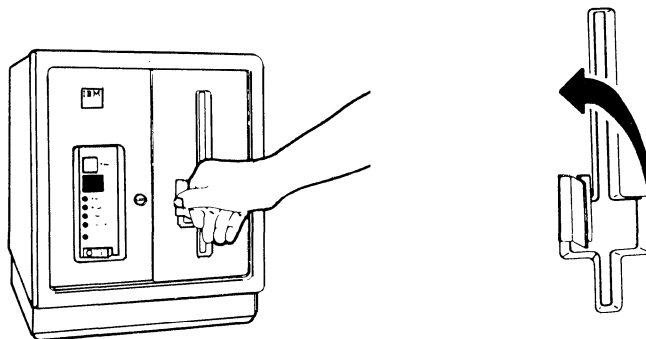

Step 1-41.

Remove the diskette labeled **Diagnostic Diskette** from its protective envelope. Retain the envelope to protect the diskette after setup.

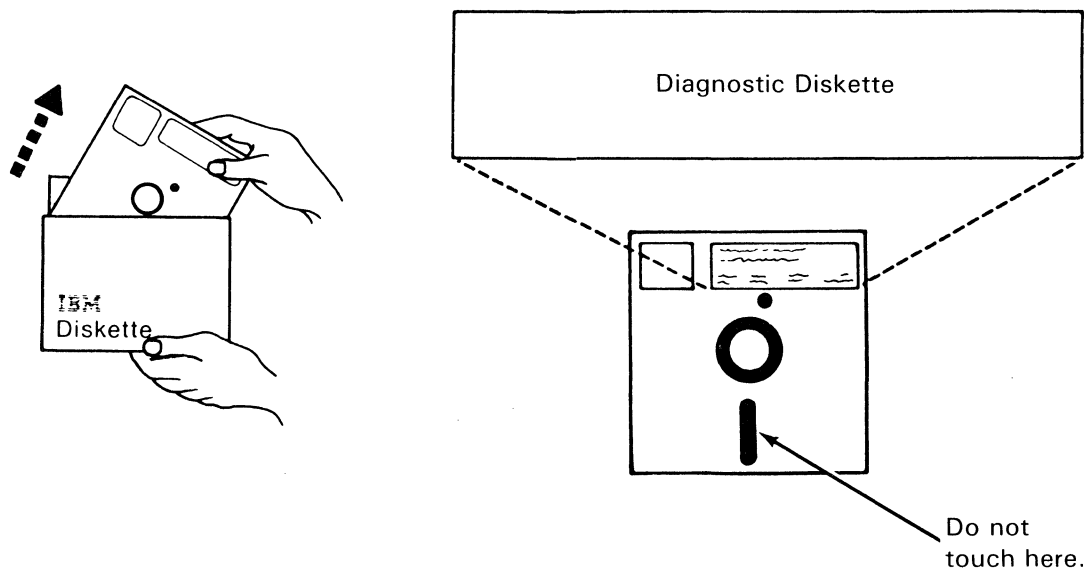

Step 1-42.

Insert the **Diagnostic Diskette** squarely into the controller diskette drive with the label facing to your left as shown.

1

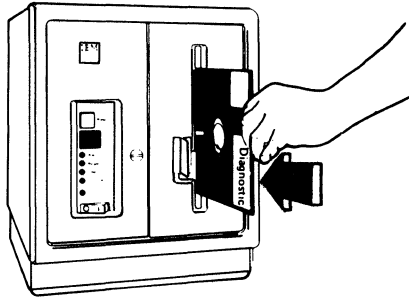

Step 1-43.

Close the diskette drive by turning the handle in the direction of the arrow to the horizontal position.

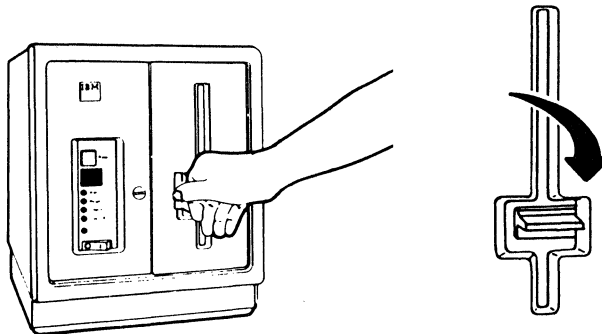

□ **Step 1-44.**

Press | (On).

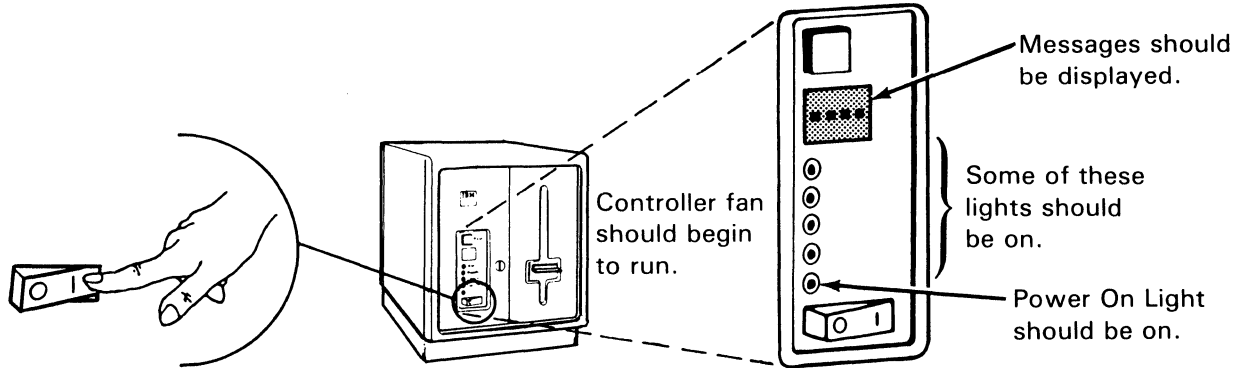

The power light(s) on the controller and disk expansion unit (if attached) **must** be on before you continue. If they are not on, **go to Step 1-53.**

Warning: Do not move the expansion unit while it is on; unit damage could occur.

□ **Step 1-45.**

The controller should now be running internal tests, which should run from three to fifteen minutes. Watch the display. While you are waiting for the tests to complete, read the remainder of this step and prepare for the message that will be displayed.

This displayed message tells you to go to a particular step as indicated below.

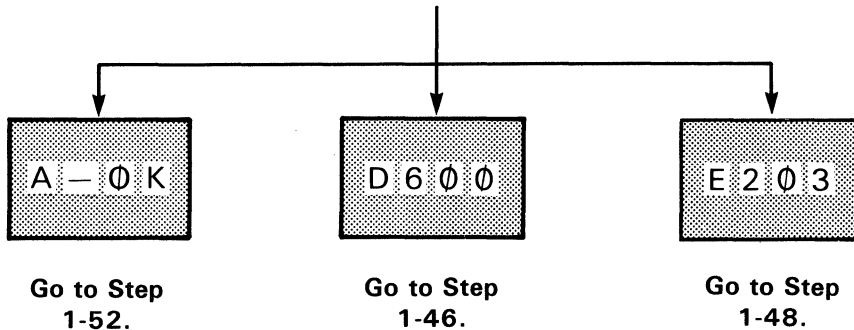

If after fifteen minutes, one of these messages is not displayed, **go to Step 1-53.**

□ **Step 1-46.** Do this (and Step 1-47) if this controller has an auxiliary diskette drive.

- Open the auxiliary diskette drive (if it is not already open) by turning the handle in the direction of the arrow.

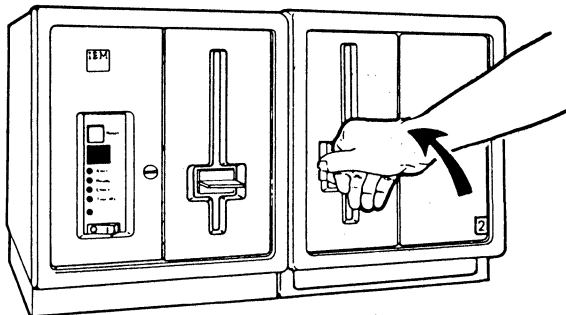

Note: On expansion unit 3, the auxiliary diskette drive is on the right side of the unit.

- Open the controller diskette drive, and remove the diskette.

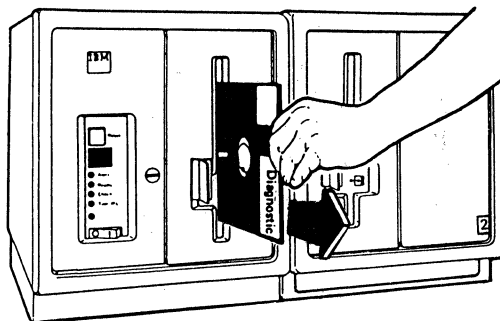
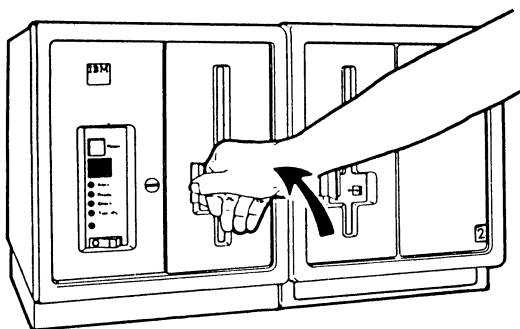

- Insert the diskette into the auxiliary diskette drive, and close the drive by turning the handle.

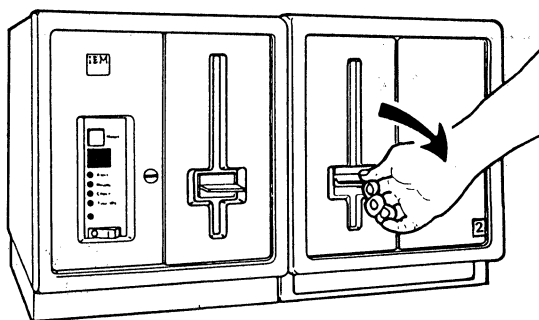
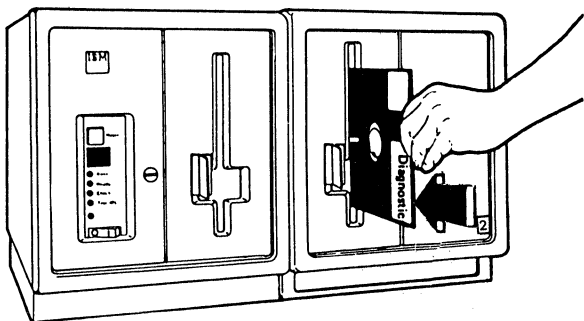

When the message **D 6 0 1** is flashed, go to **Step 1-47**.

If the message **E 6 2 0** is displayed for more than 20 seconds after closing the drive, go to **Step 1-53**.

If any other message is displayed, go to **Step 1-53**.

Step 1-47.

- Open the auxiliary diskette drive, and remove the diskette.

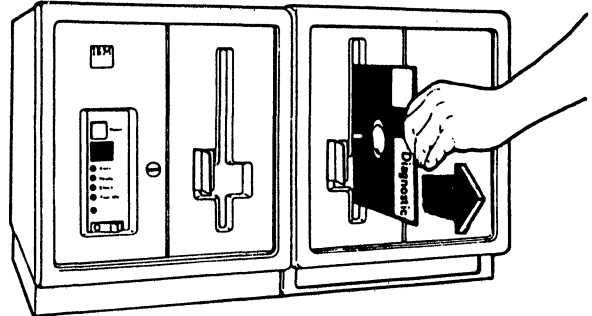
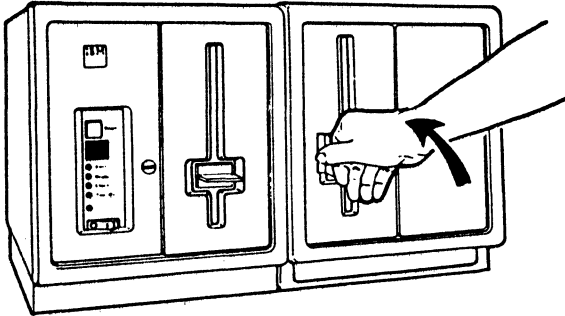

- Insert the diskette into the controller diskette drive, and close the controller diskette drive.

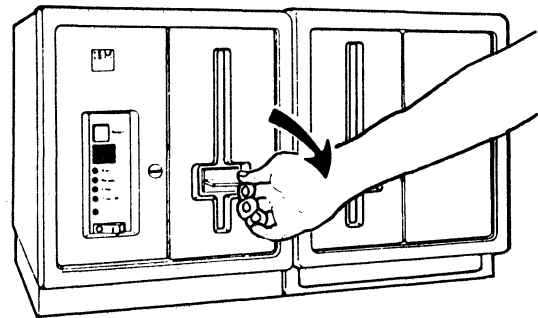
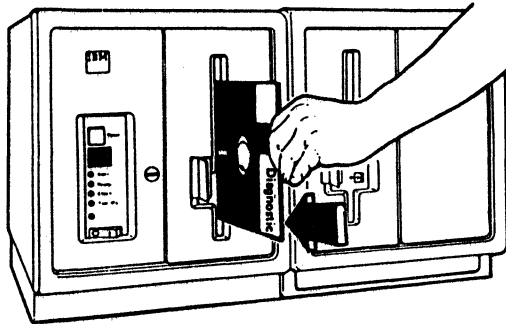

Testing should automatically resume and continue. **Go back to Step 1-45.**

Step 1-48.

Do you have a modem or DCE attached and switched on?

Yes
↓
Go to Step
1-52.

No
↓
Go to Step
1-49.

Step 1-49.

You cannot completely test the X.21 nonswitched feature without a modem or DCE attached to the controller. If you can get a modem or DCE, **go to Step 1-37** and continue. If you cannot get a modem or DCE, **go to the next step.**

Step 1-50.

At the controller, open and close the handle as shown below.

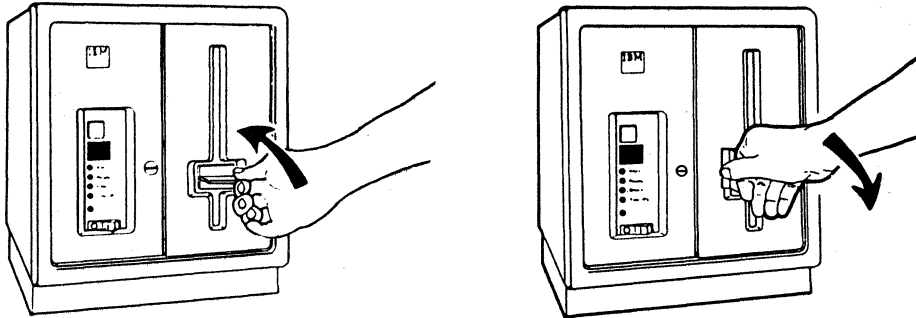

When **E:2 0 3** is displayed, open and close the handle **only one time**. (Additional opening and closing can cause misleading indications.) If **T:9 9 9** is displayed, **go to Step 1-51**; if any other message is displayed, **go to Step 1-53**.

Step 1-51.

The **T:9 9 9** message indicates that testing is complete, but not all tests were run. **Go to Step 1-52.**

Step 1-52. Controller setup is complete: Ignore Step 1-53.

For instructions on attaching the controller to the host system and terminals, see "Part 2: Subsystem Installation Instructions" later in this manual. If you are immediately going to Part 2, do not switch the units off. If you switch the power off, the disk expansion unit takes 30 seconds to go off.

Step 1-53.

- Ensure that you performed the steps exactly as you were instructed.
- If you are not sure, go through each step again.
- If the problem continues, **go to** "Problem Determination" in the *4701 Operating Instructions*.

Part 2. Subsystem Installation Instructions

These instructions describe the procedures for connecting and checking the connections between the 4701 controller, its associated terminals, and the host system.

Before you begin, ensure that the following is complete:

- All loops and coaxial cables should be installed and checked out as described in *IBM 4700 Finance Communication System Installation Planning Manual*, GC31-2018.
- All cables should be identified and marked to indicate the proper controller and terminal connections.
- All 47xx terminals should be set up as described in their setup instructions.
- 36xx terminals should not be set up or installed yet, but if you have any 3603, 3604-5, 3604-6, 3604-7, 3606, or 3608 terminals, you should have the following:

IBM 3600 Finance Communication System Financial Services Terminals: Terminal Installation Guide, GA27-2796

IBM 3604 Keyboard Display, Models 5 and 6 Setup Instructions, GA23-0037

IBM 3604 Administrative Keyboard Display Model 7 Setup Instructions, GA23-0035.

- All Device Cluster Adapter (DCA) attached terminals should be set up as described in their setup instructions. (DCA attached terminals are those that attach to the controller panels B or C by coaxial cables. See "Sample DCA and Host System Connections" on page 2-3.)
- All terminals should have power switched off.
- Any data links and modems or DCE should be installed and tested.
- You should have a copy of each Branch Equipment Inventory Work Sheet (from *IBM 4700 Finance Communication System Installation Planning Manual*, GC31-2018) for this subsystem.

Overview Diagrams

The diagrams on the following pages show examples of the connections you will be making. Study the diagrams so that you understand the connections.

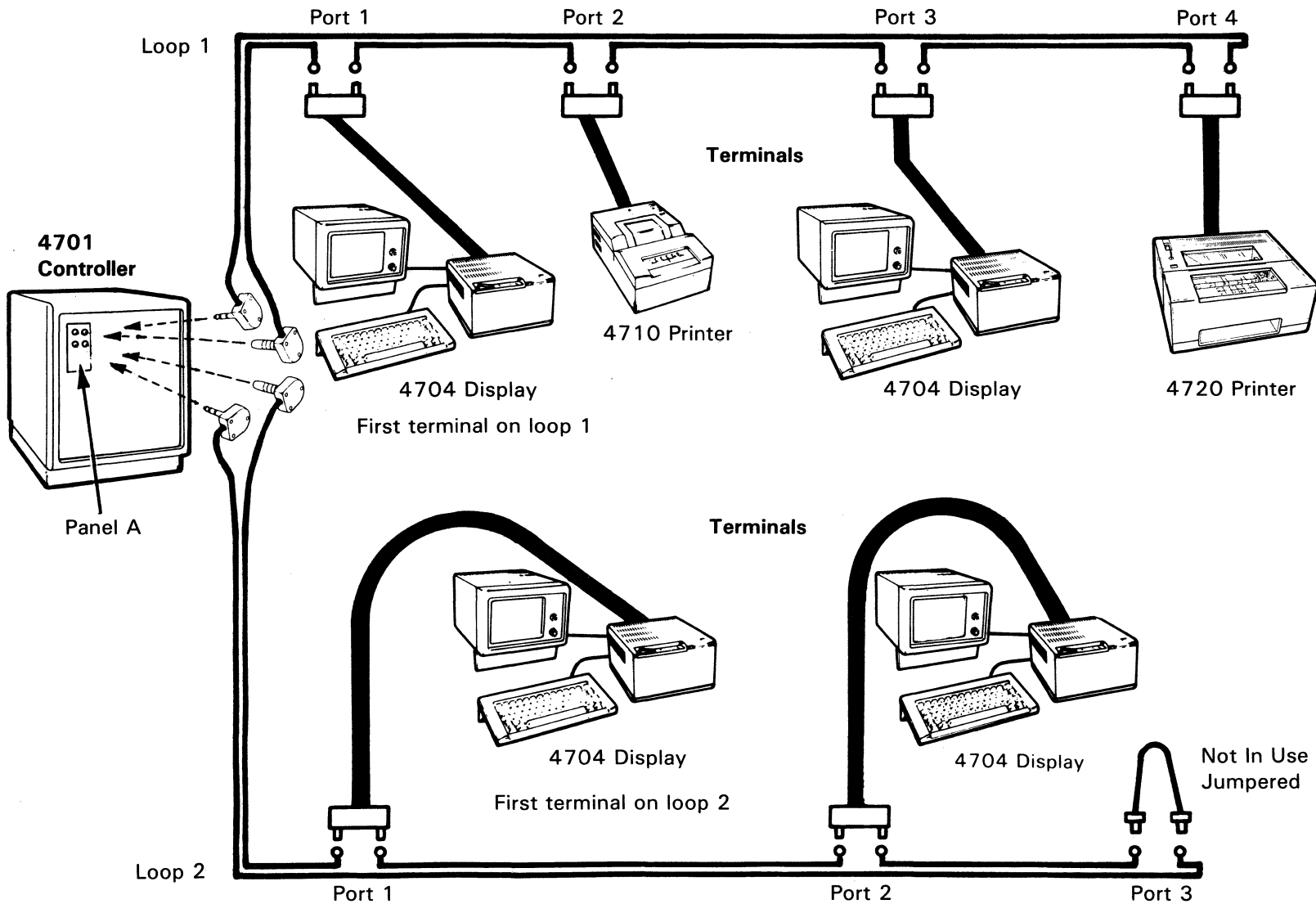

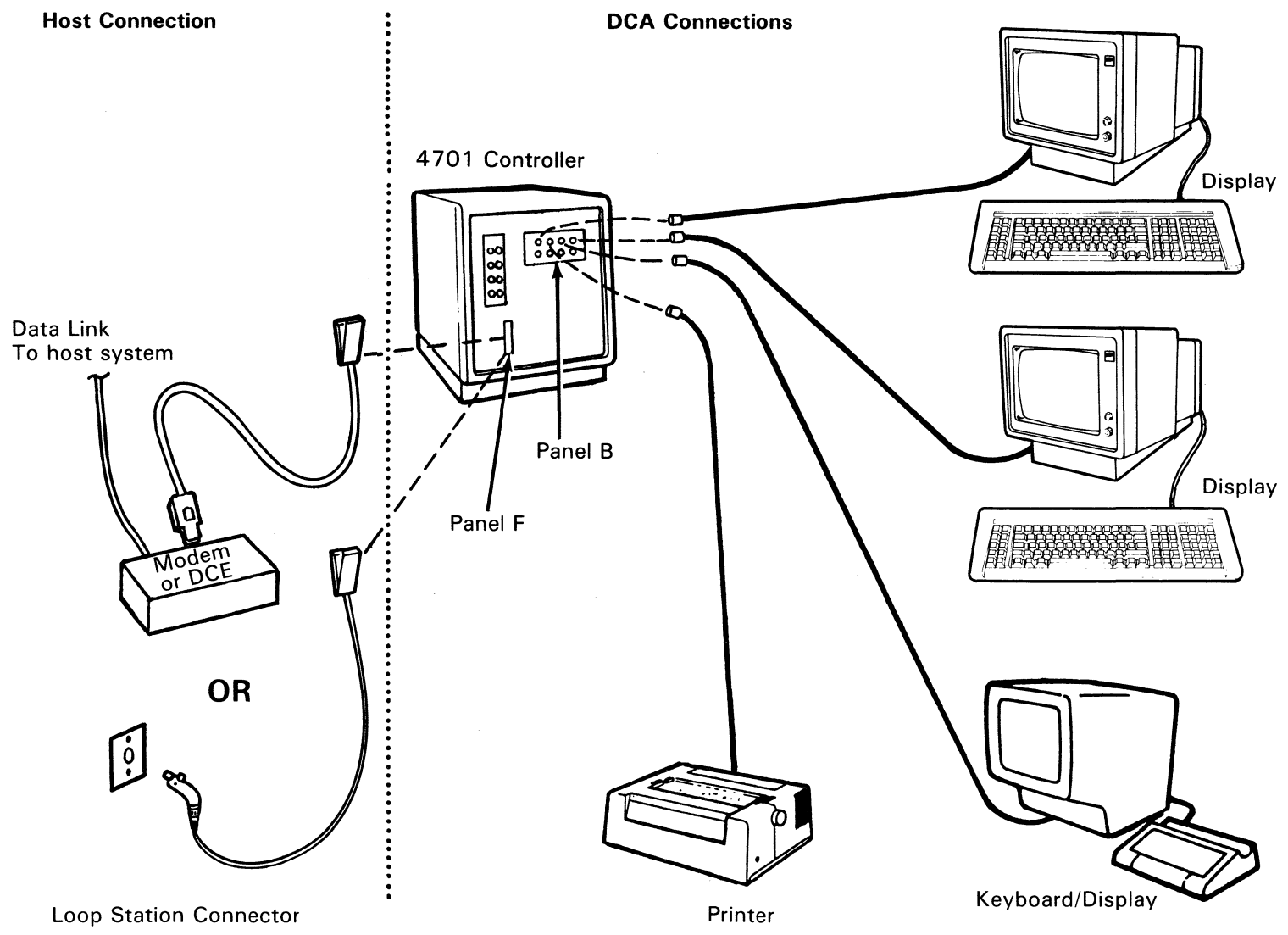

Step 2-1.

Be sure you have read the information on the three previous pages. Enter this step from Step 1-52 of Part 1 "4701 Controller Setup Instructions." The controller should be set up with **A:0K** (or **T:9:9:9**) displayed in the message display. If you have not completed controller setup, complete it before you continue.

Step 2-2.

At the controller, open and then close the diskette drive by turning the handle as shown below.

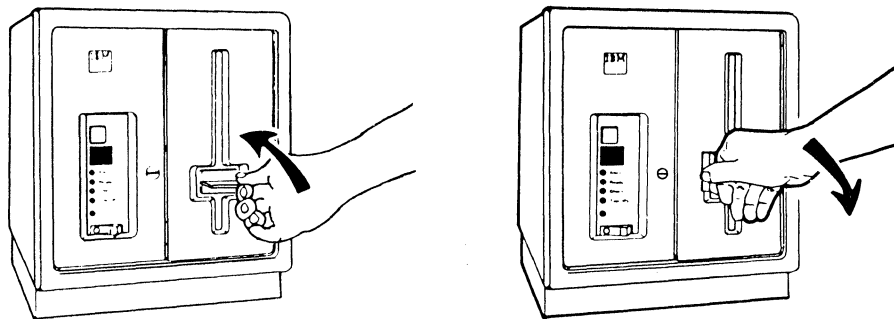

Step 2-3.

After a few seconds, the following message should be displayed.



Ignore the characters in the shaded area.

If this message is not displayed, go to **Step 2-25**.

□ **Step 2-4.**

Terminals can connect to the loop by either of these two connector types.

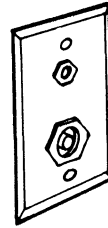

Wall-Mounted Connector

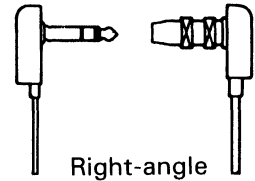

Right-angle Connectors

If you have any pairs of right-angle connectors **(except those that connect to the controller)**, go to each pair and connect them **together**.

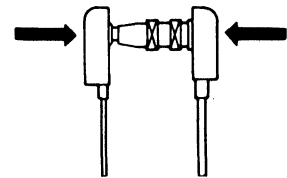

□ **Step 2-5.**

Open the operator panel door. Set the Loop 1 (L1) speed switch according to information on the Branch Equipment Inventory Work Sheet. If loops 2, 3, and 4 are installed, set these switches also **even if you are not using these loops**. Leave switch 1 OFF for each loop.

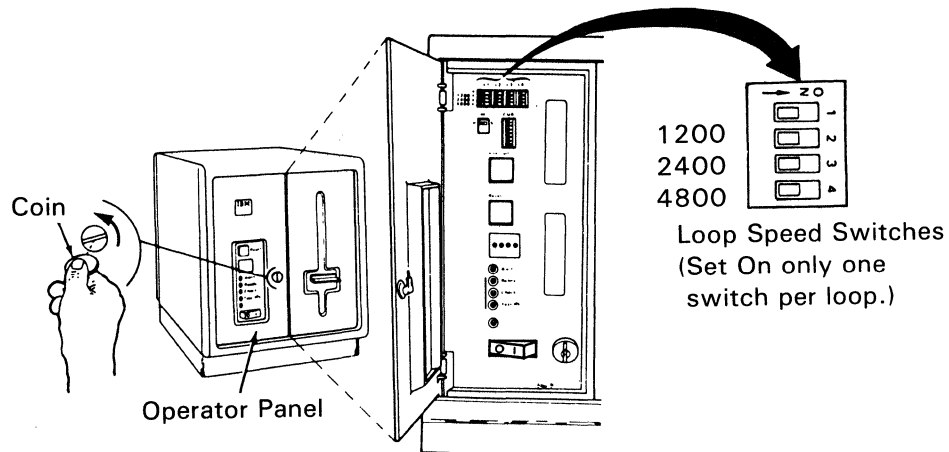

□ Step 2-6.

Observe the labels on the loop cables, and connect the loop-1 cables to the loop-1 connectors on panel A at the rear of the controller. Do not connect other loop cables at this time.

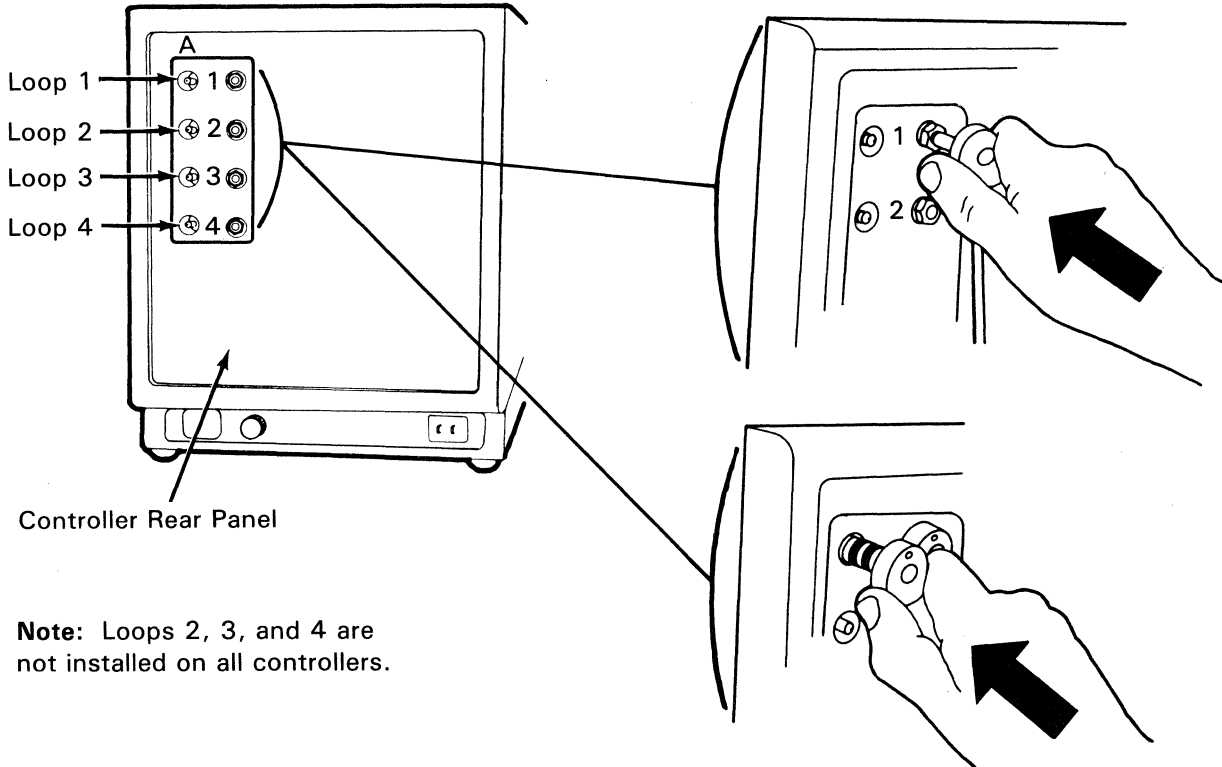

Controller Rear Panel

Note: Loops 2, 3, and 4 are not installed on all controllers.

2

□ Step 2-7.

Within about 10 seconds, the controller message display should display the following:

This message

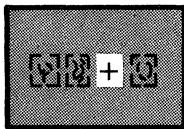

must be displayed before you continue.

If **1** is displayed:

- One or more loop connections made in Step 2-4 are not tightly connected, or
- The loop cables are not tightly connected to the Panel-A connectors, or
- Loop 1 is wired wrong.

If any other character is displayed, go to **Step 2-26**.

Step 2-8.

As you connected loop-1 cables in Step 2-6, connect any additional loop cables (loops 2, 3, and 4) if installed; within 10 seconds after you connect each loop, the following message should be displayed:

This message

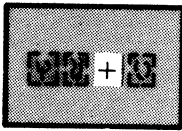

must be displayed
before you continue.

If 2 3 or 4 is displayed, the loop with that number has one of the following:

- One or more loop connections made in Step 2-4 are not tightly connected, or
- The loop cables are not tightly connected to the Panel-A connectors, or
- The loop is wired wrong.

If any character is displayed except

+ 2 , 3 , or 4 , go to Step 2-26.

Step 2-9.

Connect 47xx Loop Terminals (loop terminals are 4704, 4710, and 4720).
If you do not have 47xx loop terminals to connect, go to Step 2-14.

If you came to this step from:

1. Step 2-8, go to the first 47xx terminal on loop 1, ...
2. Step 2-12, go to the next 47xx terminal on the same loop, ...
3. Step 2-13, go to the first 47xx terminal on the next loop, ...

... and use the charts on the following pages to set the loop speed and address switches according to information on the Branch Equipment Inventory Work Sheet.

To Set the Switches on the 4704

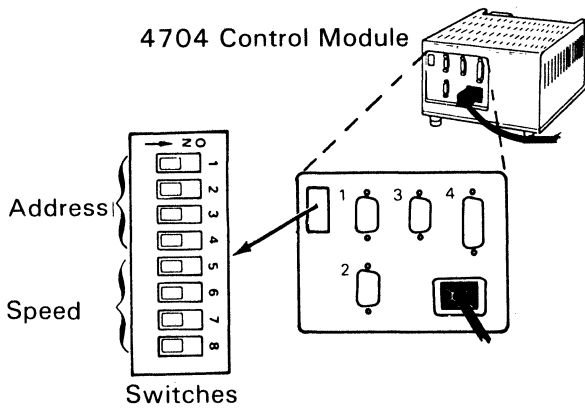

4704 Control Module
Address Switch Settings

Terminal Address	Switch	
	ON	OFF
0	—	1, 2, 3, 4
1	1	2, 3, 4
2	2	1, 3, 4
3	1, 2	3, 4
4	3	1, 2, 4
5	1, 3	2, 4
6	2, 3	1, 4
7	1, 2, 3	4
8	4	1, 2, 3
9	1, 4	2, 3
10	2, 4	1, 3
11	1, 2, 4	3
12	3, 4	1, 2
13	1, 3, 4	2
14	2, 3, 4	1
15	1, 2, 3, 4	—

4704 Control Module
Loop Speed Switch Settings

Loop Speed *	Switch	
	ON	OFF
1200	6	5, 7, 8
2400	7	5, 6, 8
4800	8	5, 6, 7

* Speed in bits-per-second

To Set the Switches on the 4710

Note: These switches may be located on the rear panel apron or they may be on the underside of the ribbon access cover.

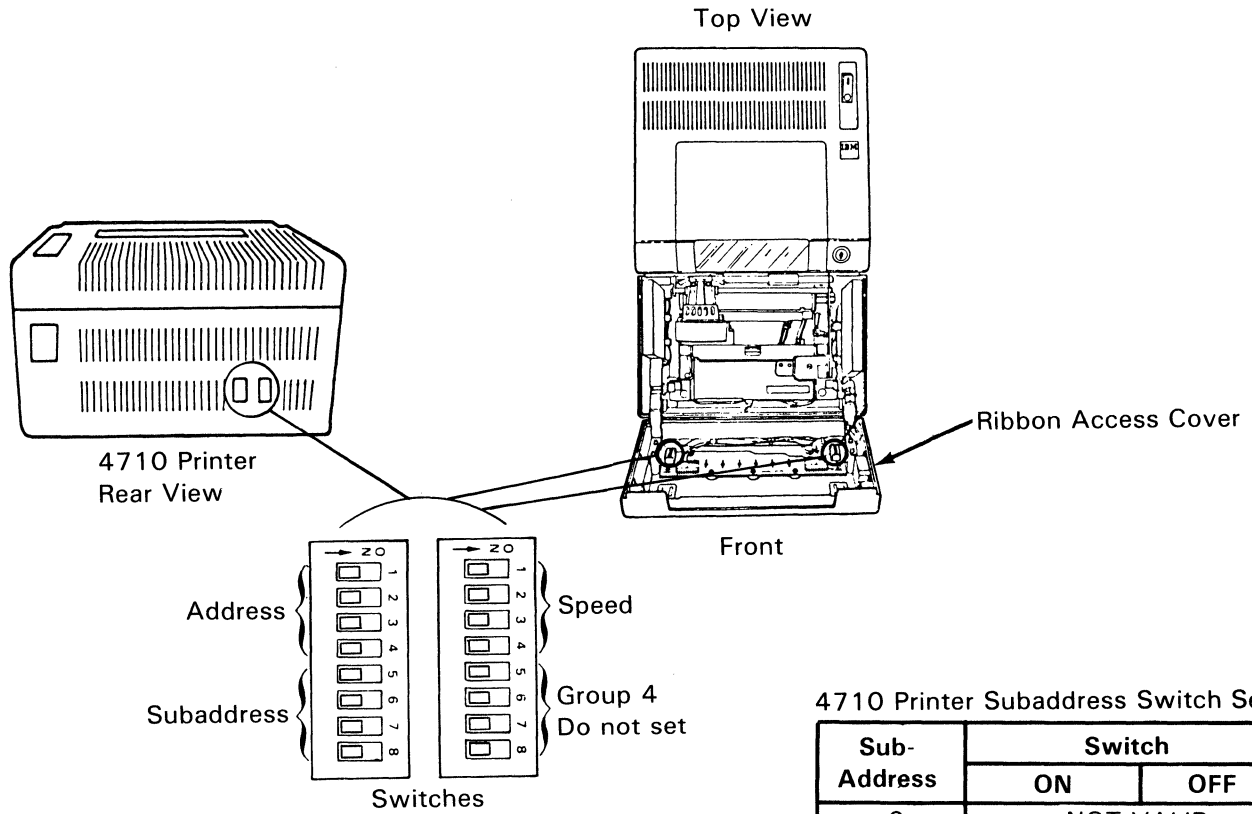

4710 Printer
Address Switch Settings

Terminal Address	Switch	
	ON	OFF
0	—	1, 2, 3, 4
1	1	2, 3, 4
2	2	1, 3, 4
3	1, 2	3, 4
4	3	1, 2, 4
5	1, 3	2, 4
6	2, 3	1, 4
7	1, 2, 3	4
8	4	1, 2, 3
9	1, 4	2, 3
10	2, 4	1, 3
11	1, 2, 4	3
12	3, 4	1, 2
13	1, 3, 4	2
14	2, 3, 4	1
15	1, 2, 3, 4	—

4710 Printer Subaddress Switch Settings

Sub-Address	Switch	
	ON	OFF
0	NOT VALID	
1	5	6, 7, 8
2	6	5, 7, 8
3	5, 6	7, 8
4	7	5, 6, 8
5	5, 7	6, 8
6	6, 7	5, 8
7	5, 6, 7	8
8	8	5, 6, 7
9	5, 8	6, 7
10	6, 8	5, 7
11	5, 6, 8	7
12	7, 8	5, 6
13	5, 7, 8	6
14	6, 7, 8	5
15	5, 6, 7, 8	—

4710 Printer
Loop Speed Switch Settings

Loop Speed *	Switch	
	ON	OFF
1200	2	1, 3, 4
2400	3	1, 2, 4
4800	4	1, 2, 3

* Speed in bits-per-second.

To Set the Switches on the 4720

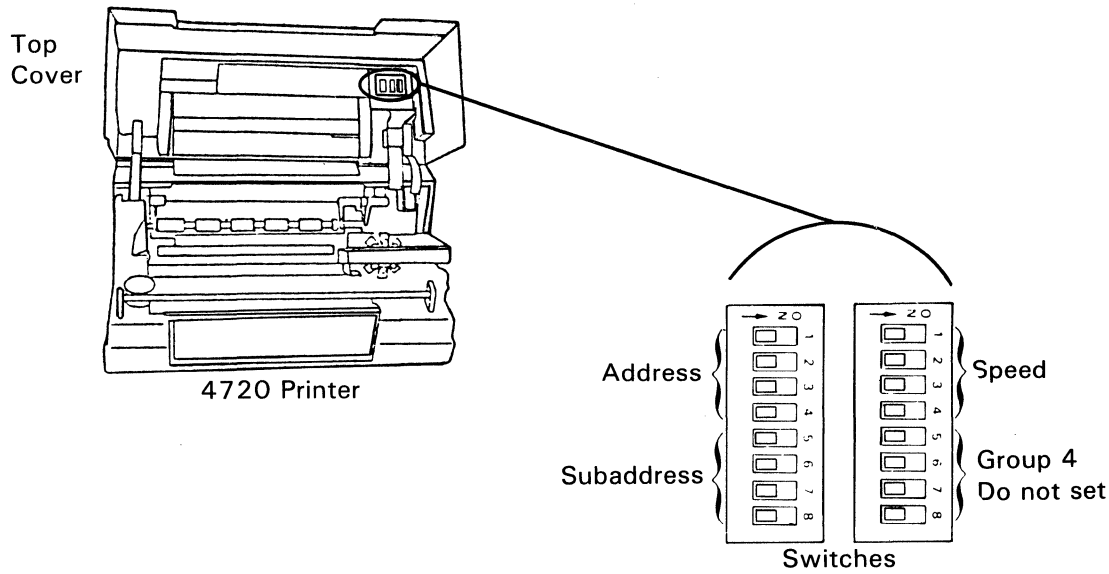

4720 Printer
Address Switch Settings

Terminal Address	Switch	
	ON	OFF
0	—	1, 2, 3, 4
1	1	2, 3, 4
2	2	1, 3, 4
3	1, 2	3, 4
4	3	1, 2, 4
5	1, 3	2, 4
6	2, 3	1, 4
7	1, 2, 3	4
8	4	1, 2, 3
9	1, 4	2, 3
10	2, 4	1, 3
11	1, 2, 4	3
12	3, 4	1, 2
13	1, 3, 4	2
14	2, 3, 4	1
15	1, 2, 3, 4	—

4720 Printer Subaddress Switch Settings

Terminal Subaddress	Switch	
	ON	OFF
2	6	5, 7, 8
4	7	5, 6, 8
6	6, 7	5, 8
8	8	5, 6, 7
10	6, 8	5, 7
12	7, 8	5, 6
14	6, 7, 8	5

4720 Printer
Loop Speed Switch Settings

Loop Speed *	Switch	
	ON	OFF
1200	2	1, 3, 4
2400	3	1, 2, 4
4800	4	1, 2, 3

*Speed in bits-per-second.

Step 2-10. Connect 47xx Loop Terminals (Continued)

Connect the terminal to the loop.

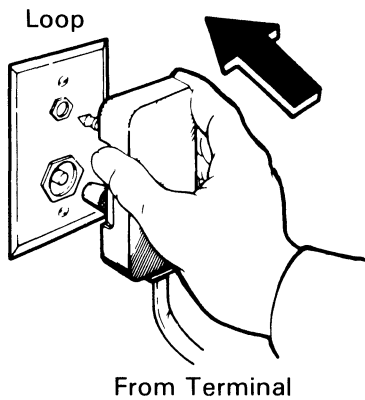

OR

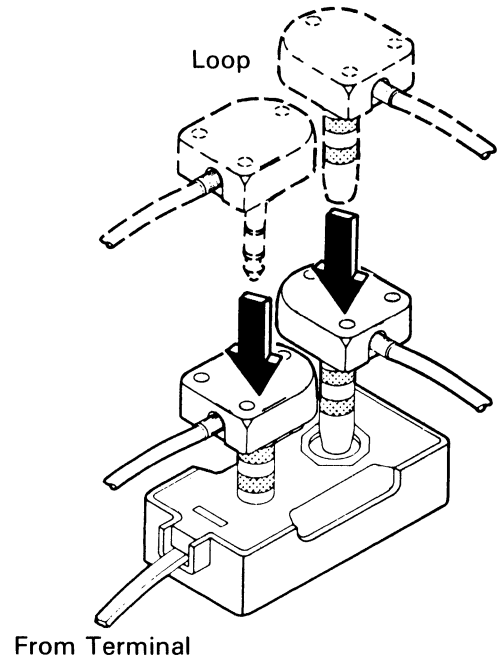

Step 2-11. Connect 47xx Loop Terminals (Continued)

Switch on the terminal, and observe the Ready light (or Loop OK indicator).

 OK 4704

 OK 4710, 4720

If the Ready light (or Loop OK indicator) is not constantly on, check the following:

- Terminal power should be on.
- The terminal loop connector should be tightly connected to the loop cable.
- The loop should be correctly wired.
- The loop speed switches on both controller and terminal should be correctly set. They should be set to the same value.

If the problem continues, go to **Step 2-26**.

Step 2-12. Connect 47xx Loop Terminals (Continued)

Repeat Steps 2-9, 2-10, and 2-11 for each 47xx terminal on the same loop. If you have connected and tested all 47xx terminals on this loop, **go to Step 2-13.**

Step 2-13. Connect 47xx Loop Terminals (Continued)

If loop 2, 3, or 4 is installed on the controller, repeat Steps 2-9 through 2-12 for each loop. When all 47xx terminals on all loops have been connected and tested, **go to Step 2-14.**

Step 2-14. Connect DCA-Attached Terminals

If you do not have DCA-attached terminals to connect, **go to Step 2-18.**

The controller message display should display the following:

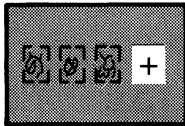

Ignore the characters
in the shaded area.

If any other character is displayed,
go to Step 2-26.

5. Connect DCA-Attached Terminals (Continued)

y if you have a DCA-attached printer to connect. Temporarily connect the DCA-cable to port 1 on panel B at the rear of the controller. Then switch on the printer.

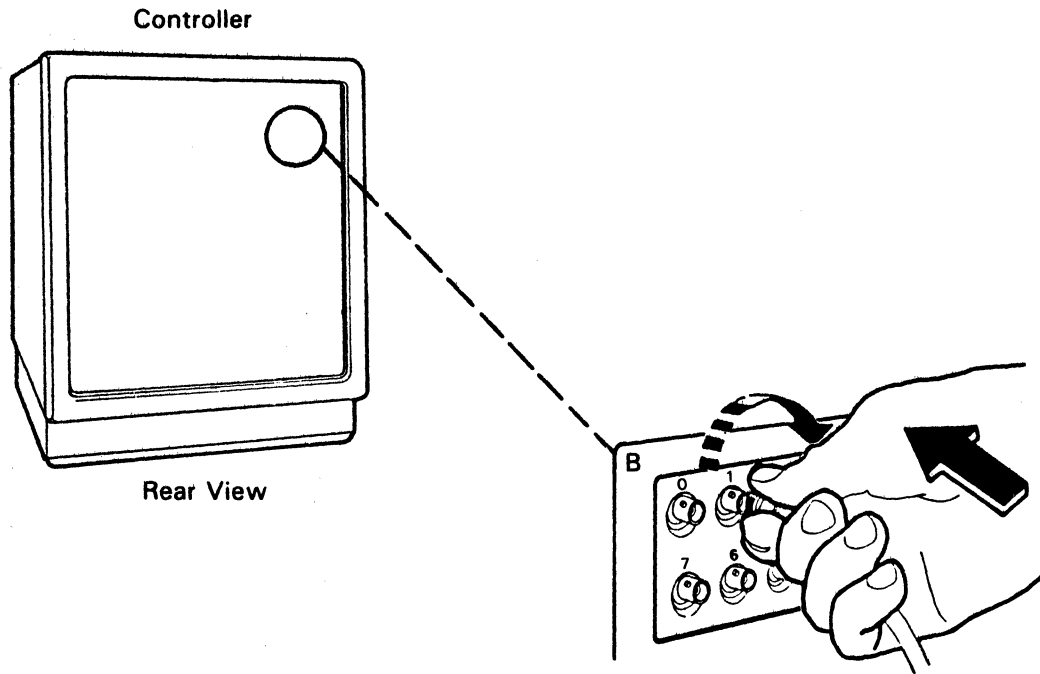

The printer Ready light should come on. If it does not, go to Step 2-26.

Note: The DCA-attached printers can be checked only one at a time. If you have more than one of these printers to connect to this controller, disconnect the cable now connected to port 1 and repeat this step for each printer.

Step 2-16. Connect DCA-Attached Terminals (Continued)

Do this step only if you have a DCA-attached display to connect. Temporarily connect it from each DCA-attached display one at a time to port 0 on panel B at the rear of the controller switch on the displays (one at a time).

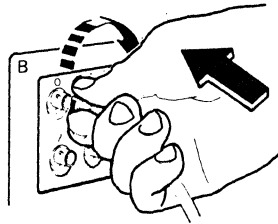

After about 20 seconds, each display should display the following message while it is connected to port 0.

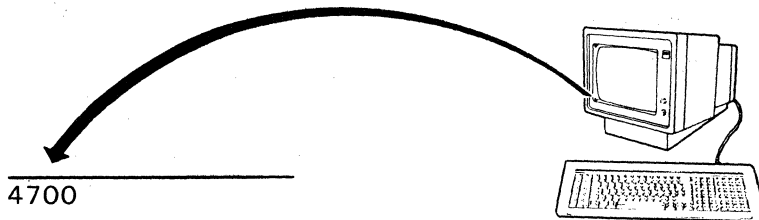

If any DCA-attached display fails to display the message, go to **Step 2-26**.

2

Step 2-17. Connect DCA-Attached Terminals (Continued)

When all DCA-attached terminals have been successfully checked out, connect the cables to their correct panel B ports (and panel C ports, if present) according to the labels on the cables.

Step 2-18. Set Up and Connect 36xx Terminals

If you do not have any of these terminals (3603, 3604-5, 3604-6, 3604-7, 3606, or 3608) connect to the 4700 loop, go to **Step 2-19**.

Refer to the Setup Instructions (3604-5, 3604-6, 3604-7) or Terminal Installation (3603, 3606, 3608) and follow the instructions. When you have successfully set up these 36xx terminals, go to **Step 2-19**. If the Ready light(s) (or Loop OK light) come on and remain constantly on, go to **Step 2-26**.

□ **Step 2-19.** Connect Host Link

Open the operator panel (if it is not open), and set the controller unit address (CUA) switches according to information on the Branch Equipment Inventory Work Sheet.

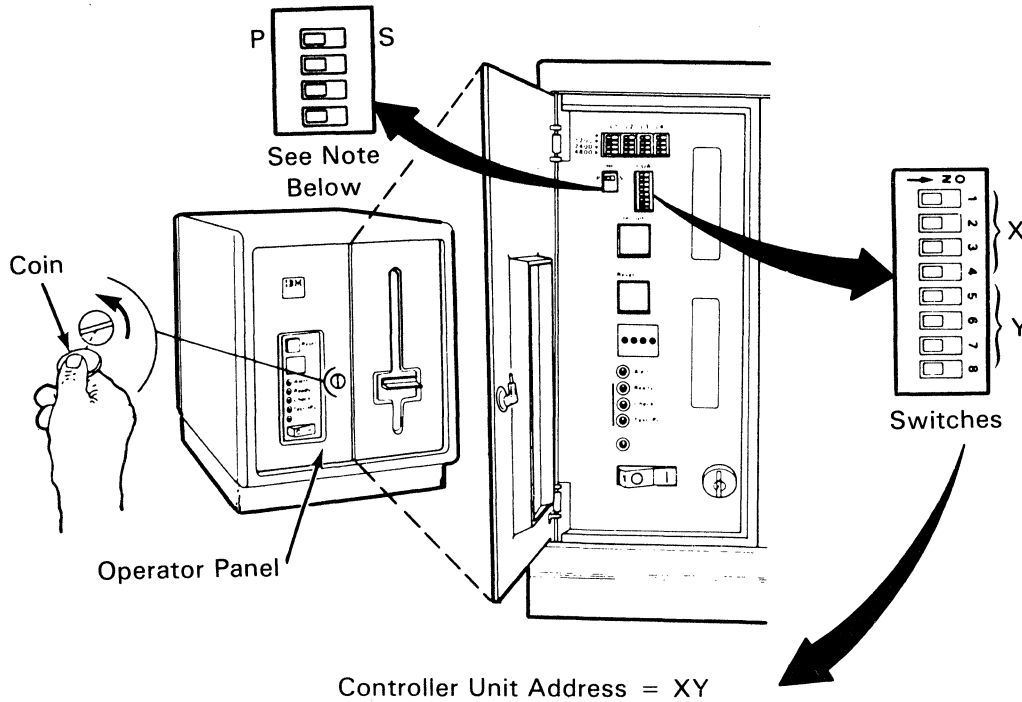

X =	Switch On	Switch Off
0	—	1, 2, 3, 4
1	4	1, 2, 3
2	3	1, 2, 4
3	3, 4	1, 2
4	2	1, 3, 4
5	2, 4	1, 3
6	2, 3	1, 4
7	2, 3, 4	1
8	1	2, 3, 4
9	1, 4	2, 3
A	1, 3	2, 4
B	1, 3, 4	2
C	1, 2	3, 4
D	1, 2, 4	3
E	1, 2, 3	4
F	1, 2, 3, 4	—

Y =	Switch On	Switch Off
0	—	5, 6, 7, 8
1	8	5, 6, 7
2	7	5, 6, 8
3	7, 8	5, 6
4	6	5, 7, 8
5	6, 8	5, 7
6	6, 7	5, 8
7	6, 7, 8	5
8	5	6, 7, 8
9	5, 8	6, 7
A	5, 7	6, 8
B	5, 7, 8	6
C	5, 6	7, 8
D	5, 6, 8	7
E	5, 6, 7	8
F	5, 6, 7, 8	—

Note: Set the Primary/Secondary (P/S) speed switch to P. If the multiuse communication loop feature is not installed, this switch has no effect.

Step 2-20. Connect Host Link (Continued)

At the opposite end of the communication cable(s), set the TEST/OPER switch to the OPER position or remove the wrap plug.

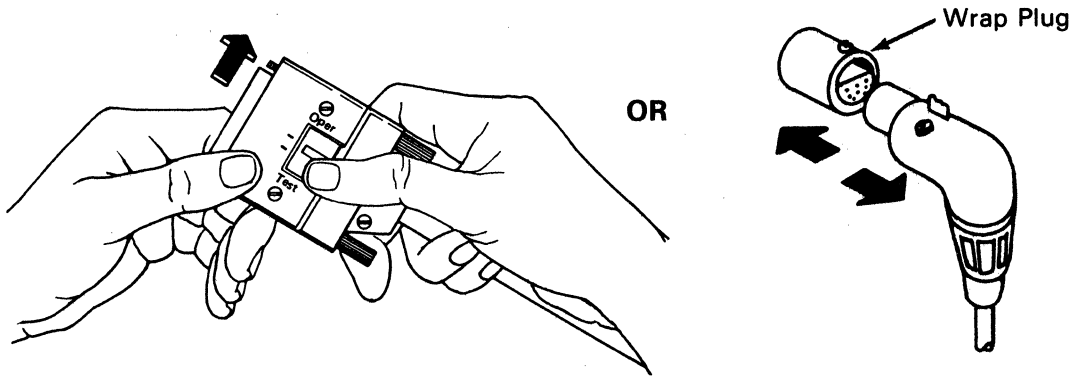

If this controller does not have an X.21 wrap plug connected to Panel F, omit Step 2-21 and go to Step 2-22.

Step 2-21. Connect Host Link (Continued)

If this controller has an X.21 switched wrap plug attached to panel F instead of a communication cable, remove the X.21 switched wrap plug from panel F, and connect the communication cable to panel F.

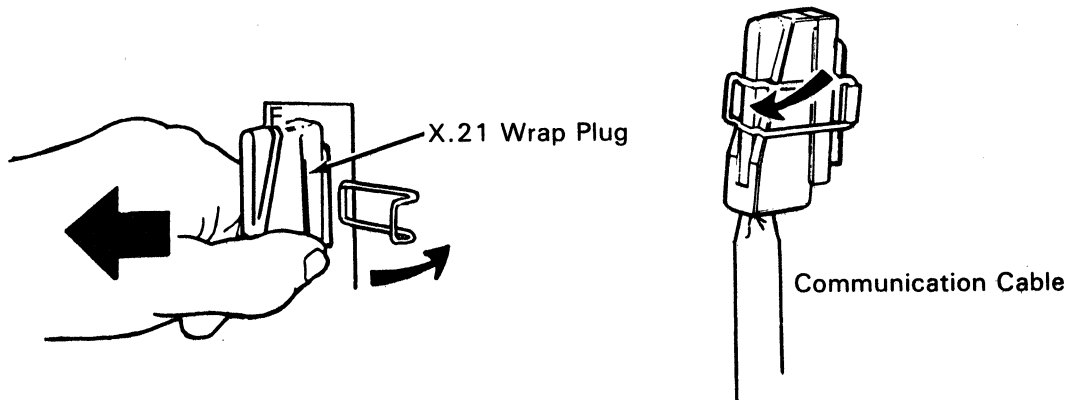

Step 2-22. Connect Host Link (Continued)

Connect the communication cable to the data link.

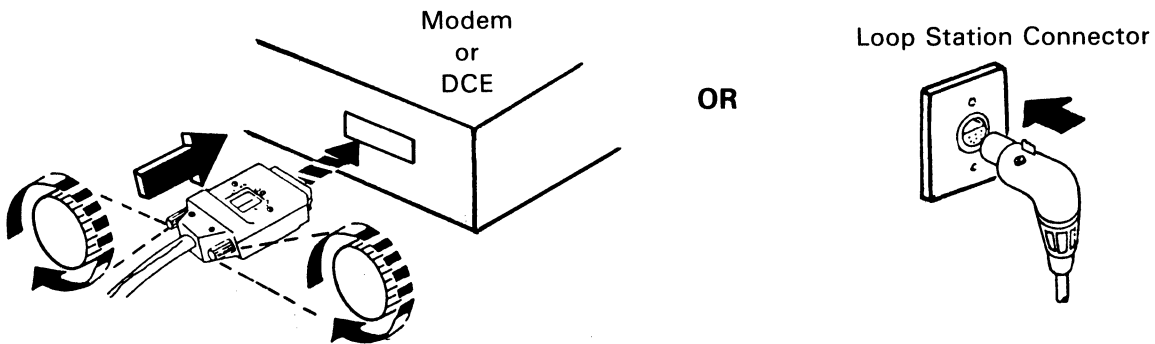

Note: If you have an X.21 extender cable attached to the communication cable, connect the X.21 extender cable to the data link.

Step 2-23. Connect Host Link (Continued)

The message display on the controller should display the following:



Ignore the characters in the shaded area.

If any other message is displayed, go to **Step 2-26.**

Step 2-24. Connect ALA (Optional)

If you have a communication cable attached to panel G, set the TEST/OPER switch at the other end of the cable to the OPER position.

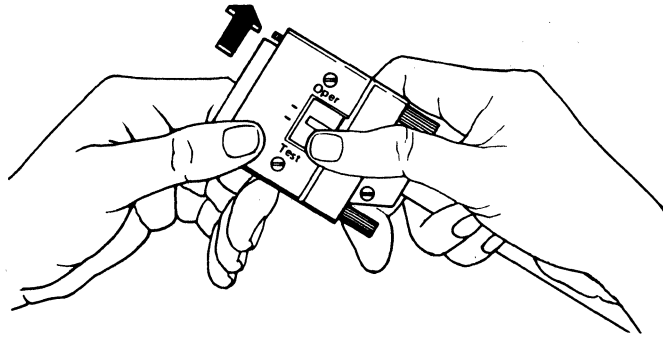

If a wrap plug is in a socket on panel H, remove the wrap plug.

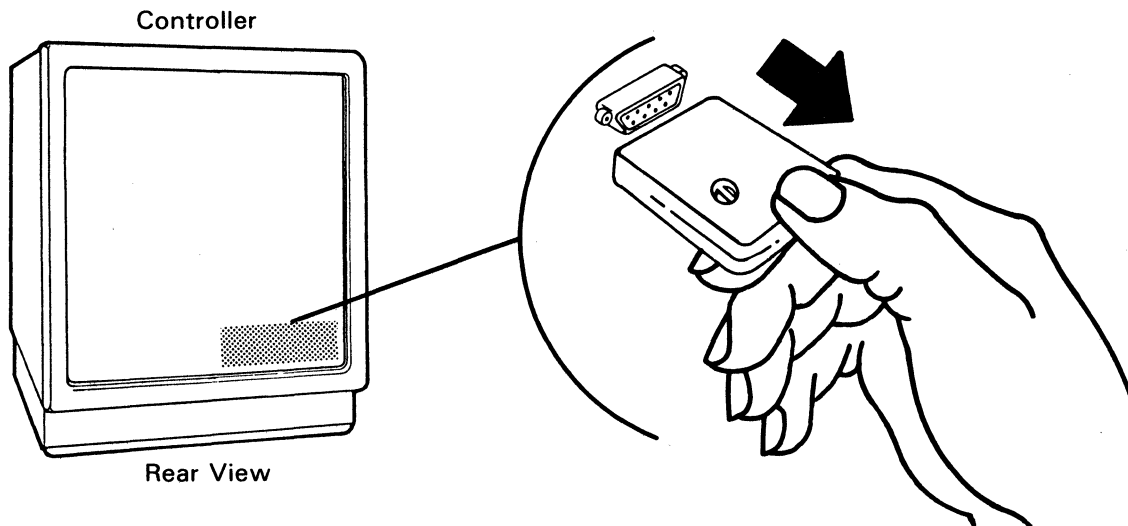

You can now attach the ALA and the unit(s) to which the ALA attaches.

Step 2-25. Subsystem Installation is Complete : Ignore Step 2-26.

Note: Inform your IBM service representative if you have any of the following 36xx terminals to be installed: 3604-1, 3604-2, 3604-3, 3604-4, 3610, 3611, 3612, 3615, 3616, 3618, 3624.

Note: If you desire, you may conduct further tests by using the system monitor. See the *IBM 4700 Finance Communication Subsystem Operating Procedures*, GC31-2032.

Step 2-26.

- Ensure that you performed each step exactly as you were instructed. If you are not sure, try the failing steps again.
- If the problem is an incorrect message on the 4701 message display, go to *IBM 4700 Subsystem Operating Procedures*, GC31-2032.
- If the problem is in communicating with a terminal or the host, go to *IBM 4700 Subsystem Problem Determination*, GC31-2033.

IBM 4701 Controller
Setup and Subsystem
Installation Instructions
Order No. GC31-2021-2

**READER'S
COMMENT
FORM**

This manual is part of a library that serves as a reference source for systems analysts, programmers, and operators of IBM systems. You may use this form to communicate your comments about this publication, its organization, or subject matter, with the understanding that IBM may use or distribute whatever information you supply in any way it believes appropriate without incurring any obligation to you.

Your comments will be sent to the author's department for whatever review and action, if any, are deemed appropriate. Comments may be written in your own language; English is not required.

Note: *Copies of IBM publications are not stocked at the location to which this form is addressed. Please direct any requests for copies of publications, or for assistance in using your IBM system, to your IBM representative or to the IBM branch office serving your locality.*

Possible topics for comment are:

Clarity Accuracy Completeness Organization Coding Retrieval Legibility

If you wish a reply, give your name, company, mailing address, and date:

What is your occupation? _____

Number of latest Newsletter associated with this publication: _____

Thank you for your cooperation. No postage stamp necessary if mailed in the U.S.A.
(Elsewhere, an IBM office or representative will be happy to forward your comments or you may mail directly to the address in the Edition Notice on the back of the title page.)

Note: Staples can cause problems with automated mail sorting equipment.
Please use pressure sensitive or other gummed tape to seal this form.

Reader's Comment Form

Fold and Tape

Please Do Not Staple

Fold and Tape



NO POSTAGE NECESSARY IF MAILED IN THE UNITED STATES

BUSINESS REPLY MAIL

FIRST CLASS PERMIT NO. 40 ARMONK, N.Y.



POSTAGE WILL BE PAID BY ADDRESSEE:

International Business Machines Corporation
Department 78C
1001 W. T. Harris Boulevard
Charlotte, NC 28257

Fold and Tape

Please Do Not Staple

Fold and Tape



