



Systems Reference Library

**IBM System/360
Disk and Tape Operating Systems
COBOL Programmer's Guide**

**Program Number 360N-CB-452
360M-CB-402**

This publication describes how to compile, linkage edit, and execute a Disk and Tape COBOL program. The text also describes the output from each of these steps. In addition, it explains options of the compiler and many available features of the operating system.



PREFACE

The purpose of this publication is to enable programmers to compile, linkage edit, and execute COBOL programs under control of IBM System/360 Disk and Tape Operating Systems. The Disk and Tape COBOL language is described in the publication IBM System/360 Disk and Tape Operating Systems: COBOL Language Specifications, Form C24-3433, which is a corequisite to this publication.

Programmers unfamiliar with the Disk and Tape Operating Systems should read the Introduction and Sections I, II, and III for detailed information about preparing COBOL programs and deck structures for processing by the system.

Programmers who are familiar with the Disk and Tape Operating Systems and wish to know how to run COBOL programs should read Section I. This section contains the control card parameters and specific options needed to prepare deck structures for processing.

Sections IV, V, and VI contain information that is intended to aid programmers in writing efficient programs and in debugging programs that do not execute properly. The remaining sections discuss optional features of the Disk and Tape Operating Systems that are available to COBOL programmers.

This revision provides a new section about using the direct-access methods of the Disk Operating System. It also provides information about the new control cards and a discussion of variable length records.

Wider and more detailed discussions of the Disk and Tape Operating System are given in the following publications:

IBM System/360 Disk and Tape Operating System: COBOL Language Specifications,
Form C24-3433.

Publications closely related to this one are:

IBM System/360 Disk Operating System: System Control and System Service Programs,
Form C24-5036.

IBM System/360 Tape Operating System: System Control and System Service Programs,
Form C24-5034.

IBM System/360 Disk Operating System: Supervisor and Input/Output Macros, Form C24-5037.

IBM System/360 Tape Operating System: Supervisor and Input/Output Macros, Form C24-5035.

IBM System/360 Disk Operating System: Data Management Concepts, Form C24-3429.

IBM System/360 Tape Operating System: Data Management Concepts, Form C24-3430.

IBM System/360 Disk Operating System: System Generation and Maintenance, Form C24-5033.

IBM System/360 Tape Operating System: System Generation and Maintenance, Form C24-5015.

IBM System/360 Principles of Operation, Form A24-6821.

The titles and abstracts of related publications are listed in the publication IBM System/360 Bibliography, Form A22-6822.

Fifth Edition

This is a major revision of, and makes obsolete, C24-5025-3 and Technical Newsletters N24-5264 and N28-0221. A new section has been added to explain the use of indexed sequential and direct file organizations for DOS. A new Appendix E has been added to describe the track formats of the 2311, 2314, and the 2321. Other changes to the text are indicated by a vertical line to the left of the change; revised illustrations are denoted by the symbol * to the left of the caption.

Significant changes or additions to the specifications contained in this publication are continually being made. When using this publication in connection with the operation of IBM equipment, check the latest SRL Newsletter for revisions or contact the local IBM branch office.

Requests for copies of IBM publications should be made to your IBM representative or to the IBM branch office serving your locality.

Address comments concerning the contents of this publication to IBM Corporation, Publications Department, 1271 Avenue of the Americas, New York, New York 10020.

TABLE OF CONTENTS

| | |
|---|----|
| INTRODUCTION | 9 |
| Data Organization | 9 |
| Executing a COBOL Program | 10 |
| Compilation | 10 |
| Linkage Editing | 10 |
| Execution | 10 |
| Libraries | 10 |
| Core Image Library | 11 |
| Source Statement Library | 11 |
| Relocatable Library | 11 |
| Multiprogramming | 11 |
| | |
| SECTION I: PREPARING COBOL PROGRAMS FOR PROCESSING | 13 |
| Input/Output Device Assignment | 13 |
| Job Control Statements | 14 |
| Sequence of Job Control Statements | 15 |
| Format of Job Control Statements | 16 |
| Continuation of Job Control Statement | 16 |
| The ASSGN Statement | 16 |
| The EXEC Statement | 18 |
| The JOB Statement | 18 |
| LBLTYP Statement | 18 |
| VOL Statement | 19 |
| TPLAB Statement | 19 |
| OPTION Statement | 19 |
| PAUSE Statement | 21 |
| DLAB Statement (DOS only) | 22 |
| XTENT Statement (DOS Only) | 22 |
| The RESET Statement | 24 |
| The End-of-Data-File Statement | 24 |
| The End-of-Job Statement | 24 |
| The Comments Statement | 24 |
| CBL Statement (COBOL Option Control Card) | 25 |
| DLBL Statement | 26 |
| TLBL Statement | 26 |
| EXTENT -- DASD Extent Information | 27 |
| The Linkage Editor | 29 |
| Linkage Editor Control Statements | 29 |
| The PHASE Statement | 30 |
| The INCLUDE Statement | 30 |
| The Autolink Feature | 30 |
| Librarian Functions | 31 |
| Cataloging Program Phases--Core Image Library | 32 |
| Cataloging Object Modules--relocatable Library | 32 |
| Cataloging Books--source Statement Library | 33 |
| Cataloging Books--User Private Library | 34 |
| Checkpointing a Program | 35 |
| | |
| SECTION II: DECK STRUCTURES FOR PROCESSING COBOL PROGRAMS IN A TAPE | |
| OPERATING SYSTEM | 37 |
| Assumed Tape Resident System Configuration | 37 |
| Examples of Processing Using Tape Configuration | 39 |
| Example 1--Compile and Punch | 39 |
| Example 2--Cataloging an Object Module in Relocatable Library | 39 |
| Example 3--COMPILE, LINKAGE EDIT, and EXECUTE | 40 |
| Example 4--Executing a Program | 41 |
| Example 5--Cataloging Source Modules to Source Statement Library | 42 |
| Example 6--COMPILE (Using Source Statement Library), LINKAGE EDIT, and EXECUTE | 43 |

| | |
|---|----|
| SECTION III: DECK STRUCTURES FOR PROCESSING COBOL PROGRAMS IN A DISK OPERATING SYSTEM | 46 |
| Assumed Disk Resident System Configuration | 47 |
| Examples of Processing Using Disk Configuration | 48 |
| Example 1--COMPILE and PUNCH | 49 |
| Example 2--Cataloging an Object Module in Relocatable Library | 49 |
| Example 3--COMPILE, LINKAGE EDIT, and EXECUTE | 49 |
| Example 4--Executing a Program | 50 |
| Example 5--Cataloging Source Modules in Source Statement Library | 50 |
| Example 6--COMPILE (Using Source Statement Library), LINKAGE EDIT, and EXECUTE | 51 |
| SECTION IV: INTERPRETING OUTPUT | 54 |
| Compiler Output | 54 |
| Source Listing (LIST) | 54 |
| Data Map (SYM) | 55 |
| Procedure mAp (LISTX) | 57 |
| Diagnostic Messages (ERRS) | 58 |
| Working with Diagnostic Messages | 59 |
| How Diagnostic Messages Are Determined | 59 |
| Examples of How Diagnostic Messages Are Generated | 60 |
| Linkage Editor Output | 60 |
| Execution Time Messages | 60 |
| Program PHASE Dumps | 61 |
| How to Use a Dump | 62 |
| Object Storage Layout | 62 |
| SECTION V: THE DEBUGGING LANGUAGE | 63 |
| TRACE Statement | 63 |
| EXHIBIT Statement | 63 |
| ON Statement | 64 |
| The Debug Packet | 64 |
| Job Control Setup For Using Debug Packets | 65 |
| SECTION VI: PROGRAMMING CONSIDERATIONS | 67 |
| Conserving Storage | 67 |
| Decimal-Point Alignment | 68 |
| Unequal-Length Fields | 68 |
| Mixed-Data Formats | 69 |
| DISPLAY to COMPUTATIONAL-3 | 69 |
| DISPLAY to COMPUTATIONAL | 70 |
| COMPUTATIONAL-3 to COMPUTATIONAL | 70 |
| COMPUTATIONAL to COMPUTATIONAL-3 | 70 |
| COMPUTATIONAL to DISPLAY | 70 |
| COMPUTATIONAL-3 to DISPLAY | 71 |
| DISPLAY to DISPLAY | 71 |
| Conversion of COMPUTATIONAL-1 or COMPUTATIONAL-2 Data | 71 |
| Sign Control | 71 |
| Conditional Statements | 72 |
| Other Considerations Using DISPLAY and COMPUTATIONAL Fields | 73 |
| DISPLAY (Non Numeric and External Decimal) Fields | 73 |
| COMPUTATIONAL-3 (Internal Decimal) Fields | 73 |
| COMPUTATIONAL Field | 73 |
| COMPUTATIONAL-1 and COMPUTATIONAL-2 Fields | 73 |
| Data Forms | 73 |
| Elementary Items | 74 |
| Group Item | 74 |
| Numeric Data Format Usage | 75 |
| Machine Representation of Data Items | 76 |
| Examples Showing Effect of Data Declarations | 78 |
| MOVE Statement | 78 |
| COMPUTATIONAL-3 Fields | 78 |
| DISPLAY Fields | 79 |
| Move DISPLAY to COMPUTATIONAL-3 | 79 |
| Move COMPUTATIONAL-3 to REPORT | 79 |
| Relationals | 79 |
| Arithmetic Computations | 80 |
| General Techniques for Coding | 80 |
| Intermediate Results In Complex Expressions | 80 |
| Alternate Method of Solution (Unexpected Intermediate Results) | 81 |

| | |
|---|-----|
| Arithmetic Suggestions | 81 |
| Arithmetic Fields | 81 |
| Exponentiation | 81 |
| Comparisons | 83 |
| Redundant Coding | 83 |
| Editing | 83 |
| Opening Files | 84 |
| ACCEPT Verb | 84 |
| Paragraph Names | 84 |
| Trailing Characters | 85 |
| Redefinition | 85 |
| Alignment and Slack Bytes | 87 |
| Variable Length Records | 89 |
| Blocking Variable Length Records | 90 |
| Processing Buffers | 91 |
| Variable Record Alignment Containing OCCURS...DEPENDING ON Clause | 91 |
| MultiVolume Input File with Standard Labels, Alternate Tape Drive Specified | 92 |
| Input/Output Error Processing Considerations | 92 |
| Sequential Tape File Organization | 92 |
| Sequential Disk File Organization | 93 |
| SECTION VII: SUBPROGRAMS AND OVERLAY STRUCTURES | 95 |
| Linkage Editor | 95 |
| Calling a Subprogram | 95 |
| Accessing Call Parameters | 98 |
| Restrictions on the Using Statement | 98 |
| Overlay structures | 98 |
| Linkage Editing without Overlay | 99 |
| Overlay Processing | 100 |
| Linkage Editing with Overlay | 101 |
| Passing Parameters to Assembler Language Routine | 106 |
| SECTION VIII: PROCESSING COBOL FILES ON DIRECT ACCESS DEVICES | 110 |
| Indexed Sequential | 111 |
| Prime Areas and Overflow Areas | 111 |
| Index Areas | 112 |
| Cobol Statements Used to Specify an Indexed Sequential File | 115 |
| Creating an Indexed Sequential File | 115 |
| OPEN Statement | 115 |
| WRITE Statement | 116 |
| CLOSE Statement | 116 |
| Sequential Retrieval of an Indexed Sequential File | 116 |
| Updating Sequentially | 117 |
| Random Retrieval of an Indexed Sequential File | 118 |
| Updating Randomly | 118 |
| Adding Randomly | 119 |
| Error Recovery Techniques for Indexed Sequential Files | 119 |
| INVALID KEY Errors | 121 |
| USE AFTER STANDARD ERROR Routines | 121 |
| Modifying the DTF Table for Indexed Sequential Organization Files | 123 |
| Example of COBOL Main Program and COBOL Subprogram Modifying DTF | 125 |
| Coding Examples Using Indexed Sequential Files | 125 |
| Creating an Indexed Sequential File | 126 |
| Random Retrieval | 128 |
| Sequential Retrieval | 130 |
| Direct Organization | 132 |
| Specifying Keys | 132 |
| A Randomizing Technique | 134 |
| Randomizing | 135 |
| Randomizing for the 2311 Disk Pack | 135 |
| Randomizing for the 2321 Data Cell | 136 |
| COBOL Statements Used to Specify Direct Organization Files | 138 |
| Creating a Direct Organization File | 138 |
| Sequential Retrieval of a Direct Organization File | 139 |
| Random Retrieval, Updating and Adding to a Direct File | 139 |
| Random Retrieval | 140 |
| Updating Randomly | 140 |

| | |
|---|------|
| Adding Randomly | .140 |
| Multiple Entry Points | .141 |
| Error Recovery Techniques for Direct Files | .143 |
| INVALID KEY | .144 |
| USE AFTER STANDARD ERROR | .144 |
| Modifying The Dtf Table for Direct Files | .145 |
| Coding Examples For Direct Organization Files | .146 |
| Creating the File | .146 |
| Random Retrieval -- Direct Organization | .150 |
| Sequential Retrieval -- Direct Organization | .152 |
| APPENDIX A: CONSIDERATIONS WHEN USING ASSEMBLER WITH COBOL FOR | |
| OVERLAYS | .154 |
| Assembler Routine for Effecting Overlays | .154 |
| Functions of Overlay Routine Instructions | .155 |
| Assembler Language Subprograms | .155 |
| Called and Calling Programs | .155 |
| Linkage Conventions | .156 |
| Register Use | .156 |
| Argument List | .157 |
| Save Area | .157 |
| Lowest Level Subprogram | .160 |
| In-Line Parameter List | .160 |
| Data Format of Arguments | .160 |
| APPENDIX B: REFERENCE FORMATS FOR DISK AND TAPE OPERATING SYSTEMS | |
| COBOL | .162 |
| APPENDIX C: STANDARD TAPE FILE LABELS | |
| | .171 |
| APPENDIX D: STANDARD DASD FILE LABELS -- FORMAT 1 | |
| | .172 |
| APPENDIX E: TRACK FORMAT FOR THE 2311, 2314, AND 2321 | |
| | .174 |
| APPENDIX F: EXAMPLES OF COBOL PROGRAMS | |
| | .176 |
| APPENDIX G: SUBROUTINES USED BY COBOL | |
| | .178 |
| APPENDIX H: DIAGNOSTIC MESSAGES | |
| Compiler Diagnostic Messages | .186 |
| Execution Time Messages | .213 |
| Debug Packet Error Messages | .214 |

FIGURES

| | | |
|------------|---|-----|
| Figure 1. | Symbolic Names, Their Function, and Permissible Device Type | 14 |
| Figure 2. | Possible Specifications for X'ss' in the ASSGN Statement | 17 |
| Figure 3. | Input/output Units Used by COBOL Program in a Tape System | 38 |
| Figure 4. | Input/output Units Used by COBOL Program in a Disk System | 46 |
| Figure 5. | Example of a COBOL Source Listing | 56 |
| Figure 6. | Example of a Data Map | 56 |
| Figure 7. | Example of a Procedure Map for a COBOL Program | 57 |
| Figure 8. | Example of Source Module Diagnostics | 58 |
| Figure 9. | Example of a Debug Packet | 66 |
| Figure 10. | Number of Bytes Required for Each Class of Elementary Item | 74 |
| Figure 11. | Characteristics of Numeric Data | 76 |
| Figure 12. | Example of a Calling Program (Part 1 of 3). | 96 |
| Figure 12. | Example of a Calling Program (Part 2 of 3). | 96 |
| Figure 13. | Storage Layout for Nonoverlay | 99 |
| Figure 14. | Example of Data Flow Logic in a Call Structure | 100 |
| Figure 15. | Storage Layout for Overlay Processing | 101 |
| Figure 16. | Flow Diagram of Overlay Logic | 105 |
| Figure 17. | Indexed Sequential File Without Overflow | 113 |
| Figure 18. | Indexed Sequential File With Overflow | 114 |
| Figure 19. | Called and Calling Programs | 156 |
| Figure 20. | Linkage Registers | 157 |
| Figure 21. | Save Area Layout and Word Contents | 158 |
| Figure 22. | Sample Linkage Routines Used with a Calling Subprogram | 159 |
| Figure 23. | Sample Linkage Routines Used with a Lowest Level Subprogram | 160 |
| Figure 24. | Sample In-line Parameter List | 161 |
| Figure 26. | Example of a Calling Program (Part 1 of 2) | 176 |
| Figure 26. | Example of a Calling Program (Part 2 of 2) | 176 |
| Figure 27. | Example of a Subprogram (Part 1 of 2) | 177 |
| Figure 27. | Example of a Subprogram (Part 2 of 2) | 177 |

TABLES

| | | |
|----------|---|-----|
| Table 1. | Error Functions | 120 |
| Table 2. | Error Indicators | 122 |
| Table 3. | Contents of Skeleton DTF Table | 124 |
| Table 4. | Linkage Editor Diagnostic Output | 142 |
| Table 5. | Error Functions | 144 |
| Table 6. | Skeleton DTF Table for Direct Organization File | 145 |

A Disk and Tape Operating Systems COBOL program is processed by the IBM System/360 Disk and Tape Operating Systems. The operating system consists of a number of processing programs and a control program. The processing programs include the COBOL compiler, service programs, and user-written programs. The control program supervises the execution of the processing programs; controls the location, storage, and retrieval of data; and schedules jobs for continuous processing.

A request to the operating system for facilities and scheduling of program execution is called a job. For example, a job could request execution of the COBOL compiler to compile a program. A job consists of one or more job steps, each of which specifies execution of a program. A programmer makes these requests to the operating system by use of job control statements that may be punched into cards.

Each job is preceded by a JOB statement that identifies the job. Each job step is preceded by an EXEC statement that names the program to be executed and calls for execution. Included in each job step and preceding the EXEC statement are other job control statements (such as ASSGN and XTENT) that describe data or request allocation of input/output devices.

The data processed by execution of any processing program must be in the form of a data file. A data file is a named, organized collection of one or more records that are logically related. Information in a data file may or may not be restricted to a specific type, purpose, or storage medium. A data file may be a source program, a library of sub-routines, or a file of data records that is to be processed by a COBOL program.

A data file resides in one or more volumes. A volume is a unit of external storage that is accessible to an input/output device. For example, a volume may be a reel of tape or a disk pack.

In the Disk and Tape Operating Systems, input/output devices are given standard symbolic names. A programmer can refer to an input/output device in his program by using the appropriate symbolic name, and the program is not dependent on an actual device address. The actual device address is supplied by a job control statement when the program is executed or at system generation time.

DATA ORGANIZATION

A data file used by a COBOL program can have one of three types of organization: sequential, indexed sequential, or direct. The first type (sequential) may be on any input/output device. All other types must be on direct-access devices.

1. A sequential data file is one in which records are organized solely on the basis of their successive physical positions, as on tape.
2. An indexed sequential data file is one in which records are arranged in logical sequence (according to a key that is part of every record) on the tracks of a direct-access device. A separate index or set of indexes maintained by the system indicates the location of each record. This permits random, as well as sequential, access to any record.

3. A direct data file in COBOL is one in which records are referred to by use of keys. An actual key specifies the actual track address. A symbolic key identifies the record on the track.

EXECUTING A COBOL PROGRAM

Three basic operations are performed to execute a COBOL program: compilation, linkage editing, and actual execution.

COMPILATION

Compilation is the process of translating a COBOL source program into a series of instructions comprehensible to the computer, i.e., machine language. In operating system terminology, the input to the compiler, the source program, is called the source module. The output from the compiler, the compiled source program, is called an object module.

LINKAGE EDITING

The linkage editor is a service program that prepares object modules for execution. It can also be used to combine two or more separately compiled object modules into a format suitable for execution as a single program. During the process of linkage editing, external references between different modules are resolved. The executable output of the linkage editor is called a program phase. The output may consist of one or more program phases.

EXECUTION

Actual execution is under supervision of the control program, which obtains a program phase from the core image library, loads it into main storage, and initiates execution of the machine language instructions contained in the program phase.

LIBRARIES

Another service program in the Disk and Tape Operating Systems is called the librarian. The librarian consists of a group of maintenance routines that service the three system libraries. The maintenance routines provide such operations as adding, deleting, or copying portions of a library.

The three system libraries are: the core image library, the source statement library, and the relocatable library.

CORE IMAGE LIBRARY

All permanent programs in the Disk and Tape Operating System must be added to the core image library. The core image library is required, and the programs are stored in the library in the form of program phases. Unless the program phase has been linkage edited in the previous job step, the core image library is searched at execution time to obtain the program phase named in the EXEC statement.

SOURCE STATEMENT LIBRARY

The source statement library is used to store portions of COBOL source programs that are to be copied into a source program when the COPY or INCLUDE clauses of the COBOL language are used. The source statement library is not required. However, use of the source statement library can reduce the amount of coding needed for each individual program, that is, if standard file descriptions are added to the source statement library, they need not be coded again.

RELOCATABLE LIBRARY

The relocatable library is used to store object modules that can be subsequently linkage edited with other object modules. Each object module may also be a complete program that can be linkage edited and then executed. The relocatable library contains the COBOL library subroutines and the input/output modules used by the COBOL compiler.

MULTIPROGRAMMING

The DOS provides the capability of simultaneously processing two or three batched job streams for systems with at least 32K of main storage. This support is referred to as fixed partitioned multiprogramming because each job stream is assigned a different area or partition of main storage. The number and size of the partitions are allocated during system generation and may be altered by the operator.

There are two types of problem programs that can be run in a multiprogramming system: batch job processing and SPI (Single Program Initiator). Batched job processing is initiated by job control from the batched-job input stream. This capability is extended to all three programming partitions (BG, F1, and F2) if sufficient storage and separate input/output devices are available. The batched-job foreground option is selected when the system is generated by specifying MPS=BJF in the supervisor macro instructions. Programs run under SPI do not execute from a stack, but are initiated by the operator from the printer-keyboard. When an SPI program completes processing, the operator must explicitly initiate the next program.

The linkage editor determines whether the program to be executed is either a background or a foreground program. Both types of programs are initiated and terminated asynchronously of the other. Neither is aware of the other's existence.

COBOL source modules must be compiled as background programs. COBOL program phases can be executed as either background or foreground programs.

In a multiprogramming environment, control always passes to the program with the highest priority. Priority is assigned according to classification of programs as follows:

1. Supervisor
2. Operator communication routine
3. Foreground-one program
4. Foreground-two program
5. Background program

The background program must be a minimum of 10K. The foreground program areas must be in increments of 2K. The maximum size of a foreground program area is 510K.

SECTION I: PREPARING COBOL PROGRAMS FOR PROCESSING

This section provides information about preparing COBOL source programs for compilation, linkage editing, and execution. Included are discussions of frequently used job control statements, linkage editor control statements, and librarian control statements. Some individual examples are given, but Sections II and III should be scrutinized for complete examples of deck setups.

A complete list of job control, linkage editor, and librarian control statements and other options can be found in the publications IBM System/360 Disk Operating System: System Control and System Service Programs and IBM System/360 Tape Operating System: System Control and System Service Programs.

INPUT/OUTPUT DEVICE ASSIGNMENT

The input/output devices used for compilation, linkage editing, and execution are referred to by a standard set of symbolic names. These symbolic names are used in COBOL programs and in job control statements instead of actual physical device addresses. This provides several advantages for the programmer. For example, a programmer uses the ASSIGN TO clause to assign a file to the appropriate symbolic name. Such a program is not dependent on the physical device address and, as such, does not have to be recompiled unless the device type changes. The symbolic names and their usage are shown in Figure 1.

The symbolic names are assigned to physical devices at system generation time, by the operator, or by means of the job control ASSGN statement.

If a programmer wishes to use the assignments made at system generation time, he need not include any ASSGN statements in his job unless he is using his own data files in the COBOL program.

| SYMBOLIC NAME | FUNCTION | PERMISSABLE DEVICE TYPES |
|------------------------|---|---|
| SYSRDR | Input unit for control statements | Card reader Magnetic tape unit Disk drive |
| SYSIPT | Input unit for programs | Card reader Magnetic tape unit Disk drive |
| SYSPCH | Main unit for punched output | Card punch Magnetic tape Disk drive |
| SYSLST | Main unit for printed output | Printer Magnetic tape Disk drive |
| SYSLOG | Operator messages and to log job control statements | Printer-keyboard Printer |
| SYSLNK | Input to the linkage editor | Disk extent Magnetic tape unit |
| SYSRES | Contains the operating system, the core image library, relocatable library, and source statement library | Tape unit or Area of a disk drive |
| SYSSSLB | The private source statement library | Magnetic tape unit Disk drive |
| SYSRLB | Private relocatable library | Magnetic tape unit Disk drive |
| SYSIN | Must be used when SYSRDR and SYSIPT are assigned to the same disk extent. May be used when they are assigned to the same card reader or magnetic tape. This name can only be specified in a job control statement. COBOL SELECT statement must use the other names. | Disk Tape Card reader |
| SYSOUT | This name must be used when SYSPCH and SYSLST are assigned to the same magnetic tape unit. It must be assigned by the operator ASSGN command. | Tape Disk Punch |
| SYS000 to SYS222 | These names are available to the programmer as work files or for storing data files. These names are called <u>programmer logical units</u> as opposed to the remaining names which are always referred to as <u>system logical units</u> . | Any unit |

• Figure 1. Symbolic Names, Their Function, and Permissible Device Type

JOB CONTROL STATEMENTS

Job control statements are read from the device identified as SYSRDR. Not all job control statements are needed by COBOL. Those required are JOB, EXEC, /*, and /&. If disk labels are used, the VOL, XTENT, and DLAB statements are required. If tape labels are used, the VOL and TPLAB statements are required. All other statements are optional.

Statements most likely to be used by the COBOL user are:

| <u>Operation</u> | <u>Meaning</u> |
|-------------------|---------------------------------------|
| JOB | Job name |
| EXEC | Execute program |
| ASSGN | Input/output assignments |
| LBLTYP | Reserve storage for label information |
| VOL | Volume information |
| DLAB (Disk only) | Disk file label information |
| DLBL | Disk file label information |
| XTENT (Disk only) | Disk file extent |
| EXTENT | Disk file extent |
| TPLAB | Tape file label information |
| TLBL | Tape file label information |
| OPTION | Option |
| PAUSE | Pause (for message to operator) |
| /* | End of data file |
| /& | End of job |
| * | Comment |

SEQUENCE OF JOB CONTROL STATEMENTS

The job control statements for a specific job always begin with a JOB statement and end with a /& (end-of-job) statement. A specific job consists of one or more job steps. Each job step is initiated by an EXEC statement. Preceding the EXEC statement are any job control statements necessary to prepare for the execution of the specific job step. The only limitation on the sequence of statements preceding the EXEC statement is that which is discussed here for the label information statements. The following statements can precede the EXEC statement for a job step and will be frequently used by COBOL programmers.

| | |
|--------|--------|
| ASSGN | DLAB |
| LBLTYP | XTENT |
| VOL | TPLAB |
| | DLBL |
| | EXTENT |
| | TLBL |
| | OPTION |
| | PAUSE |

The label statements must be in the order:

| | | |
|-------|----|--|
| VOL | or | VOL |
| TPLAB | | DLAB |
| | or | XTENT (one for each area or file in volume) |
| | | TLBL |
| | | DLBL |
| | | EXTENT (one for each area or file in a volume) |

and must immediately precede the EXEC statement to which they apply.

FORMAT OF JOB CONTROL STATEMENTS

All job control statements are free form, except for a few restrictive rules.

The general format of the job control statements is, as follows:

1. Name. Two slashes (//) identify the statement as a control statement. They must be in columns 1 and 2. The second slash must be immediately followed by at least one blank. Exceptions to these rules are:
 - a. The end-of-job statement contains /& in columns 1 and 2.
 - b. The end-of-file statement contains /* in columns 1 and 2.
 - c. The comment statement contains * in column 1 and a blank in column 2.
2. Operation. This field describes the type of control statement. It can be up to eight characters long. At least one blank follows its last character,
3. Operand. This field may be blank or may contain one or more entries separated by commas. The last term must be followed by a blank, unless its last character is in column 71.
4. Comments. Comments are permitted anywhere after the trailing blank of the operand field.

CONTINUATION OF JOB CONTROL STATEMENT

Information starts in column 1 and cannot extend past column 71. The exceptions to this are file-label statements (TPLAB and DLAB). Information for file-label statements can be specified on more than one card, in which case a continuation statement is required. Any non-blank character present in column 72 specifies that information is contained in the card image that follows. Columns 1 through 15 of the continuation statement are ignored. Begin continuation statement information in column 16.

The ASSGN Statement

The ASSGN statement is used to assign a logical device address to a physical device. The format of the ASSGN statement is as follows:

```
// ASSGN SYSxxx,device-address [ { ,X'ss' } ]
```

SYSxxx is one of the logical devices listed in Figure 1 (with the exception of SYSOUT, which cannot be assigned by means of ASSGN statements). The system permits programmer logical units in the range from SYS000 to SYS222. The number of units actually permitted in a specific installation is defined at system generation time and, normally, is less than 223. Units SYS000 through SYS009 are the minimum configuration provided by the system.

Device-address permits three different formats:

- X'cuu' where c is the channel number and uu the unit number in hexadecimal notation. The values of cuu are determined by each installation.
- UA Unassign. The job will be canceled if a file attached to this logical unit is referred to by one of the input/output statements OPEN, CLOSE, READ, WRITE, or REWRITE.
- IGN Ignore. References to this logical unit are ignored. (This does not apply to SYSRDR and SYSIPT.) This format may be used in program debugging to ignore files.

X'ss' is the device specification. It is used for specifying mode settings for 7-track and dual-density 9-track tapes. If X'ss' is not specified, the system assumes X'90' for 7-track tapes and X'C0' for 9-track tapes. The possible specifications for X'ss' are shown in Figure 2.

| ss | Bytes per inch | Parity | Translate Feature | Convert Feature |
|----|----------------|------------------------|-------------------|-----------------|
| 10 | 200 | odd | off | on |
| 20 | 200 | even | off | off |
| 28 | 200 | even | on | off |
| 30 | 200 | odd | off | off |
| 38 | 200 | odd | on | off |
| 50 | 556 | odd | off | on |
| 60 | 556 | even | off | off |
| 68 | 556 | even | on | off |
| 70 | 556 | odd | off | off |
| 78 | 556 | odd | on | off |
| 90 | 800 | odd | off | on |
| A0 | 800 | even | off | off |
| A8 | 800 | even | on | off |
| B0 | 800 | odd | off | off |
| B8 | 800 | odd | on | off |
| C0 | 800 | single-density 9-track | | |
| C0 | 1600 | dual-density 9-track | | |
| C0 | 1600 | single-density 9-track | | |
| C8 | 800 | dual-density 9-track | | |

• Figure 2. Possible Specifications for X'ss' in the ASSGN Statement

ALT indicates an alternate magnetic tape unit that is used when the capacity of the original assignment is reached. The characteristics of the alternate unit must be the same as those of the original unit. Multiple alternates may be assigned to a logical unit.

Note: All device assignments made with ASSGN statements are reset between jobs to the configuration specified at system generation time plus any modifications that may have been made by the operator (see the section "The JOB Statement").

When preparing ASSGN statements for a compilation job step, the programmer uses the system logical units (SYSIPT, etc.) to refer to input/output devices used in the system configuration. When preparing the ASSGN statement for execution time job steps, the programmer uses the programmer logical units (SYS000 through SYS222) to assign a symbolic unit to a specified physical device. For example,

```
// ASSGN SYS004,X'00C'
```

This example could be used to assign the symbolic unit SYS004 to a card reader at address X'00C'. The first digit specifies the multiplexor channel and the 0C specifies the unit number.

To specify this file in a COBOL program, the programmer writes

```
SELECT filename ASSIGN TO 'SYS004'
```

Note that only the programmer logical units (SYS000 through SYS222) can be used in a COBOL program.

The EXEC Statement

The execution of a job step is initiated by the following job control statement:

```
// EXEC name
```

Name is the name of the first phase of the program to be fetched for execution from the core-image library. Therefore, execution of a COBOL compilation would be initiated by the statement

```
// EXEC COBOL
```

The name must be omitted if a program that was processed by the linkage editor in the previous job step of the same job is to be executed from SYSLNK.

The JOB Statement

Each job begins with the following job control statement:

```
// JOB job-name
```

Job-name is a user-defined name of 1 to 8 characters, the first of which must be alphabetic.

Note: The JOB statement resets the effect of all previously issued OPTION and ASSGN statements.

LBLTYP Statement

THE LBLTYP statement is used to define the amount of main storage to be reserved at linkage edit time for processing tape and nonsequential disk-file labels in the COBOL program area of main storage. It applies to both background and foreground programs and is required if the file contains standard labels. The format of the LBLTYP statement is:

```
// LBLTYP {TAPE[(nn)]}  
          {NSD (nn) }
```

TAPEnn For the Tape Operating System, nn is used to specify the decimal number of pairs of VOL, TPLAB statements that appear immediately before the execution of the linkage edited program.

TAPE[(nn)] For the Disk Operating System, TAPE is used only if tape files requiring label information are to be processed, and no nonsequential DASD files are to be processed. nn is optional, and is present only for future expansion (it is ignored by job control).

NSD(nn) Used if any nonsequential DASD files are to be processed, (Disk only) regardless of other file types to be used. nn specifies the largest number of extents to be used for a single file.

VOL Statement

The VOL statement is used to check standard labels for tape or disk files. It is required for each file on a multiple volume file. The format of the VOL statement is:

```
// VOL SYSxxx,filename
```

SYSxxx (the first operand) is the logical unit referenced.

filename (the second operand) identifies the file for the control program.

The occurrence of two identical operands is peculiar to COBOL object modules, because SYS004 is both the filename by which the file is known to the control program, and the logical unit which is assigned to a device.

TPLAB Statement

The TPLAB statement contains file label information for tape label checking and writing and must immediately follow the VOL statement. The formats of the TPLAB statements are:

```
// TPLAB 'label fields 3-10'  
// TPLAB 'label fields 3-13'
```

TPLAB identifies the tape-label statement and can be written two ways:

1. Input labels require only one statement, and contain fields 3-10 of the standard tape file label. These are the only fields used for checking the label of an input file. Refer to Appendix C for an illustration of standard tape file labels.
2. When writing output labels, additional fields 11 through 13 may be included by use of a continuation statement. (These fields are not required for output files.) Refer to the publication IBM System/360 Disk Operating System: System Control and System Service Programs, for details about these fields.

OPTION Statement

This statement specifies one or more of the job control options available. The order in which they appear in the operand field is arbitrary. The format of the option statement is:

```
// OPTION option1 [,option2,...]
```

where the options are:

| | |
|----------------------|---|
| LOG | Causes the listing of columns 1 through 80 of all control statements on SYSLST. Control statements are not listed until a LOG option is encountered. Once a LOG option statement is read, logging continues from job-step to job-step until a NOLOG option is encountered or until either the JOB or /% control statement is encountered. |
| NOLOG | Suppresses the listing of all control statements on SYSLST except JOB and /% statements until a LOG option is encountered. |
| DUMP | Causes a dump of the registers and main storage to be printed on SYSLST in the case of an abnormal program end (such as program check). |
| NODUMP | Suppresses the DUMP option. |
| LINK | Indicates that the object module is to be linkage edited after compilation. When the LINK or CATAL option is used, the output of the compiler is written on SYSLNK. The LINK option must always precede an EXEC LNKEDT statement containing a compiler step. |
| NOLINK | Suppresses the LINK option. The compiler can also suppress the LINK option if the program contains an error that would preclude the successful execution of the program. An EXEC statement with a blank operand also suppresses the LINK option. |
| DECK | Causes the compiler to punch object modules on SYSPCH. If LINK is specified, the DECK option is ignored. |
| NODECK | Suppresses the DECK option. |
| LIST | Causes the compiler to write source statements on SYSLST. |
| NOLIST | Suppresses the LIST option. |
| LISTX | Causes the compiler to write the procedure division map in hexadecimal on SYSLST. |
| NOLISTX | Suppresses the LISTX option. |
| XREF | Causes the Assembler to write the symbolic cross-reference list on SYSLST. |
| NOXREF | Suppresses the XREF option. |
| ERRS | Causes the compiler to write the diagnostic messages related to the source program on SYSLST. |
| NOERRS | Suppresses the ERRS option. |
| CATAL | Causes the cataloging of a phase or program in the core image library at the completion of a linkage-editor run. CATAL also causes the LINK option to be set. |
| MINSYS (TOS only) | Causes the linkage editor to generate minimal modules for later runs on systems when linkage editing on systems greater than 16K. |
| GO (TOS only) | Indicates that a linkage edited program exists on SYSLNK. The program either can be cataloged in the core image library or executed. To catalog the program, specify |

GO, CATAL in the OPTION statement. To execute the program, specify GO in the OPTION statement and follow it with an EXEC statement with a blank operand. When GO is specified, job control does not open SYSLNK or check the content of SYSLNK.

STDLABEL (DOS only) Causes all disk labels submitted after this point to be written on the standard label track. Reset to USRLABEL option at end-of-job step.

USRLABEL (DOS only) Causes all disk labels submitted after this point to be written at the beginning of the user label track.

SYM Causes the compiler to print the data division map on SYSLST.

PARSTD Causes all DASD or tape labels submitted after this point to be written at the beginning of the partition standard label track. Reset to USRLABEL option at end-of-job or end-of-job step. All file definition statements submitted after this option will be available to any program in the current partition until another set of partition standard file definition statements is submitted. All file definition statements submitted after OPTION PARSTD will be included in the standard file definition set until one of the following occurs:

1. End-of-job step
2. End-of-job
3. OPTION USRLABEL is specified.
4. OPTION STDLABEL is specified.

For a given filename, the sequence of search for label information during an OPEN is the USRLABEL area, followed by the PARSTD area, followed by the STDLABEL area.

The options specified in the OPTION statement remain in effect until a contrary option is encountered or until a JOB control statement is read. In the latter case, the options are reset to the standard that was established when the system was originally generated.

Any assignment for SYSLNK, after the occurrence of the OPTION statement, cancels the LINK and CATAL options. These two options are also canceled after each occurrence of an EXEC statement with a blank operand.

PAUSE Statement

This statement can be used for operator action between jobs. Any messages to the operator can appear in the operand of a PAUSE statement. The format for the PAUSE statement is:

```
// PAUSE [comments]
```

An example of this statement is:

```
// PAUSE SAVE SYS004, SYS005, MOUNT NEW TAPES
```

This statement tells the operator to save the output tapes, and mount two new tapes.

When the PAUSE statement is encountered by job control, the printer-keyboard (IBM 1052) is unlocked for operator-message input. The end-of-communication indicator, B (B = alter code 5), causes processing to continue.

DLAB Statement (DOS only)

The disk-label statement contains file label information for disk label checking and creation. This card must immediately follow the VOL card. The DLAB statement requires (in the case of card input) two cards for completion, therefore, column 72 of the first card requires a character punch other than a blank. The disk-label is known as a FORMAT 1 disk file label. Its format is given in Appendix D. The format of the DLAB statement is:

```
// DLAB 'label fields 1-3',          C
      xxxx,yyddd,yyddd,'systemcode'[,type]
```

'label fields 1-3' are defined in Appendix D.

xxxx is the volume sequence number in field 4 of the FORMAT 1 label, and must begin in card column 16.

yyddd,yyddd is the file creation date followed by the file expiration date.

'systemcode' is ignored by Disk and Tape Operating Systems but is required by Operating System. It must be 13 characters long.

[,type] indicates the type of file label:

```
SD - sequential disk
DA - direct access
ISC - indexed sequential (used when creating a file)
ISE - indexed sequential (used when updating or retrieving a
      file)
```

XTENT Statement (DOS only)

This statement is used to define an area in a direct-access storage device (DASD). Each DASD statement requires one or more XTENT statements. There are three extent types. Each is identified by a code that informs the control program what the defined area is to be used for. The format of the XTENT statement is:

```
// XTENT type,sequence,lower,upper
      'serial no.',SYSxxx[,B2]
```

type Extent Type -- occupies 1 or 3 columns, containing:

1 = data area (no split cylinder)

2 = overflow area (for indexed sequential file)

4 = index area (for indexed sequential file)

128 = data area (split cylinder). If type 128 is specified, the lower head H₁H₂H₂ is taken from lower, and the upper head H₁H₂H₂ is taken from upper.

sequence Extent Sequence Number -- indicates the sequence number of this extent within a multi-extent file. The sequence number occupies 1 to 3 columns and contains a decimal number from 0 to 255. Extent sequence 0 is used for the master index of an indexed sequential file. If the master index is not used, the first extent of an indexed sequential file has sequence number 1. The extent sequence for all other types of files begins with 0. Direct files can have up to 5 extents. ISAM files can have up to 11 data extents (9 prime, 1 cylinder index, 1 separate overflow).

lower Lower Limit of Extent -- occupies 9 columns and contains the lowest address of the extent in the form $B_1C_1C_1C_2C_2C_2H_1H_2H_2$

where:

B_1 is the initially assigned cell number. It is equal to:

0 for 2311 and 2314
0 to 9 for 2321

C_1C_1 is the subcell number. It is equal to:

00 for 2311 and 2314
00 to 19 for 2321

$C_2C_2C_2$ is the cylinder number. It can be:

000 to 199 for 2311 and 2314
or strip number:
000 to 009 for 2321

H_1 is the head block position. It is equal to:

0 for 2311 and 2314
0 to 4 for 2321

H_2H_2 is the head number. It can be:

00 to 09 for 2311
00 to 19 for 2321 and 2314

A lower extent of all zeros is invalid.

Note: For 2321, the last 5 strips of subcell 19 are reserved for alternate tracks.

upper Upper Limit of Extent -- occupies 9 columns containing the highest address of the extent, in the same form as the lower limit.

'serial no.' Volume Serial Number -- This is a 6-byte alphanumeric character string, contained within apostrophes. The number is the same as in the volume label (volume serial number) and the format 1 label (file serial number).

SYSxxx This is the symbolic address of the DASD drive. If more than one symbolic address is to be specified on separate XTENT cards for the same file, the symbolic addresses must be in consecutive order.

B₂ Currently assigned cell number. Its value is:

0 for 2311 or 2314
0-9 for 2321

This field is optional. If missing, job control assigns B₂ = B₁.

The RESET Statement

The RESET statement resets input/output assignments to the standard assignments. The standard assignments are those specified at system generation time plus any modifications made by the operator by means of an ASSGN command (as opposed to using an ASSGN control statement) without the TEMP option. The format of the RESET statement is as follows:

```
// RESET      SYS
              PROG
              ALL
              SYSxxx
```

SYS resets all system logical units to their standard assignments.

PROG resets all programmer logical units to their standard assignments.

ALL resets all programmer and system logical units to their standard assignments.

SYSxxx resets the specified logical unit to its standard assignment.

The End-of-Data-File Statement

The end-of-data-file statement (/* in columns 1 and 2) serves as a delimiter for the input read from the device assigned to SYSIPT. Therefore, COBOL programs must be terminated by an end-of-data-file statement. This statement is also recognized on the programmer logical units that are assigned to a card reader. This causes the ENDFILE condition to be raised for a COBOL input file.

The End-of-Job Statement

The end-of-job statement (/& in columns 1 and 2) indicates that a job has been completed. If this statement is omitted, the Job Control program may skip the next job stacked on the device assigned to SYSRDR and/or SYSIPT. If SYSRDR and SYSIPT are different units, the end-of-job statement must appear on both.

The Comments Statement

A special comments statement (* in column 1 and blank in column 2, followed by the desired comments) is available for longer messages. The comments are printed on SYSLOG, but no halt is effected by this statement.

CBL Statement (COBOL Option Control Card)

Although most options for compilation are specified in the job control OPTION statement, the COBOL compiler provides an additional option statement to increase flexibility. The CBL card must be placed between the EXEC COBOL statement and the first statement in the COBOL program. The CBL card cannot be continued. However, if specification of options will continue past column 71, two CBL cards may be used. The format of this card is:

```
CBL [DMAP=h] [,PMAP=h] [,BUFFSIZ=d] [,DISPCHK=YES]
                                     NO
                                     [,INVED][,NOEXIT=([E],[C])]
```

| | |
|--------------------------|---|
| CBL | CBL must begin in column 2, be preceded and followed by at least one blank. |
| DMAP=h PMAP=h | DMAP and PMAP specify that the addresses which appear in the coding of both the data division map and the procedure division are to be incremented by the number h. This is only for the listing not for the object module. h is a hexadecimal number of from 1 to 8 digits and is assumed to be zero if one of these options is not specified. If both options are specified, the value for the last h is the value that is used. h is called a relocation factor. |
| BUFFSIZ=d | BUFFSIZ specifies the size of the compiler buffer. d is a decimal number from 170 to either 32,760 for magnetic tape or the maximum size of a track for disk. If this option is not specified, 170 is assumed for 16K systems and 1,024 is assumed on 32K or larger systems. Double buffers are always used. |
| DISPCHK=YES <u>NO</u> | DISPCHK specifies whether or not a diagnostic check is to be made at execution time for displayed items. If YES is specified, the length of all items to be displayed is checked before moving them to the buffer. If an item is too long, it is truncated, but no message is printed. If NO is specified, no check is made and items are moved directly to the buffer. If an item is too long and thus exceeds the buffer size, it will destroy the contents of the storage area following the buffer. The default value is NO. |
| INVED | INVED specifies that the roles of the characters "." and "," are to be reversed. This affects report items in the data division, value clauses in the data division, and numeric literals in the procedure division. If this option is not specified, the character "." represents a decimal point and the character "," represents an insertion character. |
| NOEXIT | If NOEXIT is specified the compiler does not generate code for program checks. If C is specified, code for program checks is suppressed for CALL coding and if E is specified coding is suppressed for ENTRY coding. Specification of this option will greatly improve the time needed for execution of the program. However, the programmer must be responsible for handling interrupts which occur for an ON SIZE ERROR condition. If this option is not specified, the compiler will handle program checks for arithmetic statements in the program. |

DLBL Statement

This statement replaces the VOL and DLAB statement combination used in previous versions of the system. It contains file label information for DASD label checking and creation. (This release of the system will continue to support the VOL, DLAB, and XTENT combinations currently in use.) The DLBL statement has the following format.

```
// DLBL      filename,['file-ID'],[date],[codes]
```

filename This can be from 1 to 7 characters and is identical to the symbolic name of the program DTF which identifies the file.

'file-ID' The name associated with the file on the volume. This can be from 1 to 44 bytes of alphanumeric data, contained within apostrophes, including file-ID and, if used, generation number and version number of generation. If fewer than 44 characters are used, the field will be left-justified and padded with blanks. If this operand is omitted, "filename" will be used.

date This can be from 1 to 6 characters indicating either the retention period of the file in the format d-dddd or the absolute expiration date of the file in the format yy/ddd. If this parameter is omitted, a 0-day retention period is assumed. If this operand is present on an input file, it is ignored.

codes This is a 2 or 3 character field indicating the type of file label, as follows:

- SD for Sequential Disk or for DTFPH with MOUNTED-SINGLE
- DA for Direct Access or for DTFPH with MOUNTED=ALL
- ISC for Indexed Sequential using Load Create
- ISE for Indexed Sequential using Load Extension, Add, or Retrieve

TLBL Statement

This statement replaces the VOL and TPLAB statement combination used in previous versions of the system. (This release will continue to support the VOL, TPLAB combination currently in use.) The TLBL statement contains file label information for tape label checking and writing. Its format follows:

```
// TLBL      filename,['file-ID'],[date],[file-serial-number], [volume-  
sequence-number],[file-sequence-number],  
[generation-number],[version-number]
```

filename This can be from 1 to 7 characters and is identical to the symbolic name of the program DTF which identifies the file.

'file-ID' One to 17 characters, contained within apostrophes, indicating the name associated with the file on the volume. This operand may contain embedded blanks. On output files, if this operand is omitted, the "filename" will be used. On input files, if the operand is omitted, no checking will be done.

| | |
|------------------------|--|
| date | Four to 6 characters, in the format yy/ddd, indicating the expiration date of the file for output or the creation date for input. (The day of the year may have from 1 to 3 characters.) For output files, a 1 to 4 character retention period (d-dddd) may be specified. If this operand is omitted, a 0 day retention period will be assumed for output files. For input files, no checking will be done if this operand is omitted or if a retention period is specified. |
| file serial number | One to 6 characters indicating the volume serial number of the first (or only) reel of the file. If less than 6 characters are specified, the field will be right-justified and padded with zeros. If this operand is omitted on output, the volume serial number of the first (or only) reel of the file will be used. If the operand is omitted on input, no checking will be done. |
| volume sequence number | One to 4 characters in ascending order for each volume of a multiple volume file. This number is incremented automatically by OPEN/CLOSE routines as required. If this operand is omitted on output, BCD 0001 will be used. If i ed i |
| file sequence number | One to 4 characters in ascending order for each file of a multiple file volume. This number is incremented automatically by OPEN/CLOSE routines as required. If omitted on output, BCD 001 will be used. If omitted on input, no checking will be done. |
| generation number | One to 4 characters that modify the file-ID. If omitted on output, BCD 0001 is used. If omitted on input, no checking will be done. |
| version number | One or 2 characters that modify the generation number. If omitted on output, BCD 01 will be used. If omitted on input, no checking will be done. |

For output files, the current date will be used as the creation date and "DOS/TOS/360" will be used as the system code.

EXTENT -- DASD Extent Information

The EXTENT command or statement defines each area, or extent, of a DASD file. One or more EXTENT commands or statements must follow each DLBL command or statement except for single volume input files for Sequential Disk or Direct Access, on either a 2311 or a 2314, for which the DEVADDR parameter has been specified in the DTF table.

This command or statement replaces the XTENT command or statement used in previous versions of the system. (Programming support for XTENT will be continued.)

```
[//] EXTENT,[symbolic-unit],[serial-number],
      [type],[sequence-number],[relative-
      track],[number-of-tracks],[split-
      cylinder-track],[B=bins]
```

Accepted by SPI

```
// EXTENT[symbolic-unit],[serial-number],
      [type],[sequence-number],[relative-
      track],[number-of-tracks],[split-
      cylinder-track],[B=bins]
```

Accepted by JC

symbolic unit A 6-character field indicating the symbolic unit (SYSxxx) of the volume for which this extent is effective. If this operand is omitted, the symbolic unit of the preceding EXTENT will be used. (This operand is not required for an IJSYSxx filename or for a file defined with the DTF DEVADDR=SYSnnn.)

serial number From 1 to 6 characters indicating the volume serial number of the volume for which this extent is effective. If fewer than 6 characters are used, the field will be right-justified and padded with zeros. If this operand is omitted, the volume serial number of the preceding EXTENT will be used. If no serial number was provided in the EXTENT command or statement, the serial number will not be checked and it will be the user's responsibility if files are destroyed due to mounting the wrong volume.

type One character indicating the type of the extent, as follows:

- 1 - data area (no split cylinder)
- 2 - overflow area (for indexed sequential file)
- 4 - index area (for indexed sequential file)
- 8 - data area (split cylinder)

If this operand is omitted, type 1 will be assumed.

sequence number One to 3 characters containing a decimal number from 0 to 255 indicating the sequence number of this extent within a multi-extent file. Extent sequence 0 is used for the master index of an indexed sequential file. If the master index is not used, the first extent of an indexed sequential file has the sequence number 1. The extent sequence number for all other types of files begins with 0. If this operand is omitted for the first extent of ISFMS files, the extent will not be accepted. For SD or DA files, this operand is not required.

relative track One to 5 characters indicating the sequential number of the track, relative to zero, where the data extent is to begin. If this field is omitted on an ISFMS file, the extent will not be accepted. This field is not required for DA input or for SD input files (the extents from the file labels will be used).

Formulas for converting actual to relative track (RT) and relative track to actual for the DASD devices follow.

Actual to Relative

- 2311 $10 \times \text{cylinder number} + \text{track number} = \text{RT}$
- 2314 $20 \times \text{cylinder number} + \text{track number} = \text{RT}$
- 2321 $1000 \times \text{subcell number} + 100 \times \text{strip number} + 20 \times \text{block number} + \text{track number} = \text{RT}$

Relative to Actual

- 2311 $\frac{\text{RT}}{10}$ = quotient is cylinder, remainder is track
- 2314 $\frac{\text{RT}}{20}$ = quotient is cylinder, remainder is track
- 2321 $\frac{\text{RT}}{1000}$ = quotient is subcell, remainder1
 $\frac{\text{remainder1}}{100}$ = quotient is strip, remainder2
 $\frac{\text{remainder2}}{20}$ = quotient is block, remainder is track

Example: Track 5, cylinder 150 on a 2311 = 1505 in relative track.

| | |
|----------------------|---|
| number of tracks | One to 5 characters indicating the number of tracks to be allotted to the file. For SD input or DA input, this field may be omitted. For split cylinders, the number of tracks must be an even multiple of the number of tracks per cylinder specified for the file. |
| split cylinder track | One or 2 characters, from 0-19, indicating the upper track number for the split cylinder in SD files. |
| bins | One or 2 characters identifying the 2321 bin that the extent was created for or on which the extent is currently located. If the field is one character, the creating bin is assumed to be zero. There is no need to specify a creating bin for SD or ISFMS files. If this operand is omitted, bin zero is assumed for both bins. If the operand is included and positional operands are omitted, only one comma is required preceding the key-word operand. (One comma for each omitted positional operand will be acceptable, but not necessary.) |

THE LINKAGE EDITOR

The linkage editor prepares an object module for execution. It can also be used to combine two or more separately compiled object modules into a format suitable for execution. The output of the linkage editor consists of one or more program phases.

If linkage editor processing is desired, the job control OPTION statement specifying the LINK or CATAL option must precede the first linkage editor control card and the first EXEC statement in the job. The linkage editor is called for processing by specifying LNKEDT in an EXEC statement. Processing by the linkage editor is suppressed if severe programming errors are detected during compilation.

Input to the linkage editor may consist of any combination of the following:

1. Object modules compiled in previous job steps (SYSLNK)
2. Object modules from the relocatable library (SYSRES) or (SYSRLB)
3. Object modules in the form of card decks (SYSIPT)

Output from the linkage editor is placed in the core image library as a permanent member if the CATAL option has been specified on the job control OPTION statement. If CATAL has not been specified, the program phase is placed in the temporary part of the core image library for DOS or on SYSLNK for TOS.

LINKAGE EDITOR CONTROL STATEMENTS

The execution of the linkage editor is initiated by linkage editor control statements read from SYSRDR. The general format of linkage editor control statements is similar to that of the job control statements except that the linkage editor control statements must have a blank in column 1 instead of // in columns 1 and 2. The PHASE card and the INCLUDE card are of special interest in preparing object modules to be linkage edited.

The PHASE Statement

The PHASE statement must be specified if the output of the linkage editor is to consist of more than one phase or if the program phase is to be cataloged in the core image library. Each object module that is to begin a phase must be preceded by a PHASE statement of the following format:

```
PHASE phase-name,origin
```

The phase-name is the name under which the program phase is to be cataloged. This name does not have to be the program-id name, and in the case of overlay it should not be the same. It must consist of 1 to 8 alphanumeric characters, the first of which must be alphabetic.

The origin indicates to the linkage editor the begin address of this specific phase. An asterisk may be used as an origin specification to indicate that this phase is to follow the previous phase or the Supervisor at the next double-word boundary. This simple format of the PHASE statement covers all applications that do not include setting up overlay structures. See Section VII: Subprograms and Overlay for information on the PHASE statement for overlay applications.

The INCLUDE Statement

The INCLUDE statement must be specified for each object module deck or object module in the relocatable library that is to be included in a program phase. The format of the INCLUDE statement is as follows:

```
INCLUDE [module-name]
```

module-name is not specified when the module to be included is in the form of a card deck being entered from SYSIPT. If the object module is being included from the relocatable library, the module-name is the name under which the module was cataloged in the library.

THE AUTOLINK FEATURE

If any references to external names are still unresolved after all modules have been read from SYSLNK, SYSIPT, and/or the relocatable library, the autolink feature of the linkage editor searches the relocatable library for module-names identical to the unresolved names and includes these modules in the program phase. This feature is required in which to include COBOL subroutines that are cataloged in the relocatable library.

Examples:

1. Linkage edit one object module compiled in a previous job step.

```

// JOB      N0123
// OPTION   LINK
// PHASE    EXAMPLE,*
// EXEC     COBOL
//          COBOL
//          source module
/*
// EXEC     LNKEDT
// EXEC     data

/*
/ε

```

2. Linkage edit three object modules and catalog the phase (one module from previous compilation, one from SYSIPT and one named R from the relocatable library).

```

// JOB
// OPTION   CATAL
// PHASE    EXAMPLE,*
// EXEC     COBOL
//          COBOL
//          source module
/*
// INCLUDE  (object module)
// INCLUDE  R
/*
// EXEC     LNKEDT
/ε

```

LIBRARIAN FUNCTIONS

The service program called the librarian takes care of all maintenance functions (such as adding, deleting, and copying or renaming) for the system libraries. Cataloging (which simply means adding) of frequently used program phases, object modules, or source language statements in one of the system libraries greatly reduces the time required for card reading and linkage editor processing. Object modules are cataloged in the relocatable library. Program phases are cataloged in the core image library. Source module statements are cataloged in the source statement library. Each sequence of source statements cataloged in the source statement library is called a book.

The name of a phase, module, or book must be unique for each library. When a phase, module or book is cataloged in a library, any module, phase, or book already contained in the respective library and having the same name is automatically deleted. This necessitates some naming conventions for each installation in order to prevent a programmer from unintentionally deleting programs that are part of the library.

A complete description of the library maintenance functions and deck set ups used to specify them is included in the publication IBM System/360 Tape or Disk Operating System: System Control and System Service Programs. The following discussions show how to catalog.

CATALOGING PROGRAM PHASES--CORE IMAGE LIBRARY

If a program is to be cataloged in the core image library, the job control statement // OPTION with the CATAL option must be given prior to linkage editor processing and it must precede the first PHASE card of the program to be cataloged in the case of compile and link edit runs. Upon successful completion of the linkage editor job step, the program phase(s) are automatically cataloged. The program phase can be executed in the next job step in the same job by specifying the // EXEC statement with a blank name field. When it is executed in a subsequent job, the EXEC statement that calls for execution must specify the name under which it has been cataloged. Note that the phase is cataloged under the name specified in the PHASE statement. The following is an example of cataloging a single phase in the core image library.

```
// JOB FOURA           // JOB FOURB
// OPTION CATAL       // OPTION CATAL
  PHASE FOURA,*      PHASE FOURB,*
  INCLUDE            INCLUDE MOD4B
                    // LBLTYP NSD(nn) or TAPE
                    // EXEC LNKEDT
                    /&
    object deck
/*
// LBLTYP NSD(nn) or TAPE
// EXEC LNKEDT
/ &
```

CATALOGING OBJECT MODULES--RELOCATABLE LIBRARY

Object modules are cataloged in the relocatable library in a job step that specifies execution of a library maintenance program. This program is called by specifying MAINT in the operand field of the EXEC statement. Each object module to be cataloged must be preceded by the CATALR control statement. The format of this statement is:

CATALR module-name

where:

module-name

must be used in the linkage editor INCLUDE statement. The module may be preceded but not followed by linkage editor control statements.

The object modules named in CATALR statements must be on SYSIPT. If a programmer wishes to compile and catalog in one job, he could assign SYSPCH to a magnetic tape drive and reassign the same drive to SYSIPT for the catalog step. This would eliminate unnecessary card handling.

Note that CATALR statements are read from SYSIPT for DOS and SYSRDR for TOS. Therefore, the CATALR statements must be put on SYSRDR in the same sequence as the object modules on SYSIPT. The following is an example of cataloging two modules in the relocatable library.

```
// JOB EIGHT
// EXEC MAINT
  CATALR MOD8A
```

object deck

```
CATALR MOD8B
```

object deck

```
/*
/ε
```

The following is an example of compiling and cataloging a module in the relocatable library.

```
// JOB NINE
// ASSGN SYSPCH,X'183' (TAPE DRIVE)
// OPTION DECK
// EXEC COBOL
```

source deck

```
/*
  CLOSE SYSPCH,X'00D' (CARD PUNCH)
// ASSGN SYSIPT,X'183' (TAPE ABOVE)
// EXEC MAINT
  CATALR MOD9
/*
/ε
```

CATALOGING BOOKS--SOURCE STATEMENT LIBRARY

Frequently used data division, environment division, and procedure division entries can be cataloged in the source statement library. A book in the source statement library might consist, for example, of a file description or a paragraph of the procedure division. Such source language statements are cataloged in the source statement library by using the library maintenance program MAINT. Each part to be entered must be preceded by a control statement of the format:

```
CATALS C.library-name
```

In addition, a control statement of the form BKEND C.library-name must precede and follow the book to be cataloged. Note that the CATALS statement is read from SYSIPT for DOS and SYSRDR for TOS but the BKEND statements are entered on SYSIPT before and after the book. The library-name must follow the rules for external-names in the COBOL language.

The following is an example of cataloging a file description in the source statement library.

```
// JOB ANYNAME
// EXEC MAINT
  CATALS C.FILEA
  BKEND C.FILEA
    BLOCK CONTAINS 13 RECORDS
    RECORD CONTAINS 120 CHARACTERS
  BKEND C.FILEA
/*
/ε
```

This file description can be included in a COBOL source module by writing the following statement:

```
FD FILEB COPY 'FILEA'
```

Note that the library entry does not include FD or the filename. It begins with the first clause that is actually to follow the filename. This is true for all options of COPY or INCLUDE. However, data entries in the library may have level numbers (01 or 77) identical to the level number of the data name that precedes the COPY clause. In this case, all information about the library data-name is copied but the library data-name and all references to it are replaced by the data-name in the program. For example, assume the following data entry is cataloged under the library name DATAR.

```
01 PAYFILE USAGE IS DISPLAY.
   02 CALC PICTURE 99.
   02 GRADE PICTURE 9
     OCCURS 1 DEPENDING ON CALC OF PAYFILE.
```

and the following statement is written in a COBOL source module

```
01 GROSS COPY 'DATAR'
```

The compiler interprets this as:

```
01 GROSS USAGE IS DISPLAY.
   02 CALC PICTURE 99.
   02 GRADE PICTURE 9
     OCCURS 1 DEPENDING ON CALC OF GROSS.
```

Note also that the library-name is used to identify the book in the library. It has no other use in the COBOL program.

For both the relocatable library and the source statement library, several library maintenance operations can be performed in one job step. Except in the case of adding, this is also true for the core image library.

CATALOGING BOOKS--USER PRIVATE LIBRARY

The procedure for cataloging books in a private library is the same as the procedure for cataloging books in the source statement library except that the logical device SYSSLB must be assigned and defined by DLBL, EXTENT or VOL, DLAB, and XTENT control statements. SYSSLB is the logical device used for private libraries.

A private library is defined by the CORGZ program. The following example defines a private library on physical unit 191.

```
// JOB PRIVLIB
// ASSGN SYSSLB,X'191'
// DLBL IJSYSSL, 'DATASET ID', DATE INFORMATION, SD
// EXTENT extent information
// EXEC CORGZ
      NEWVOL SL=cylin (tracks)
/*
/6
```

where:

```
cylin=number of cylinders allocated to the library and tracks=
      number of tracks allocated to the directory.
```

To use this private library for COPY and INCLUDE, the ASSGN, DLBL, and EXTENT job control statements which define the private library must be included in the deck structure for compilation. When these cards are present, a search for the book is made in the private library. If it is not there, the system library is searched. If the cards for the private library are not there, only the system library is searched. A programmer may create several private libraries, but only one private library can be used in a given job.

CHECKPOINTING A PROGRAM

When a program is expected to run for an extended period of time, provision should be made for taking checkpoint information periodically during the run. This information describes the status of the job and the system (main storage, input/output status, general and floating-point registers) at the time the records are written. Thus, it provides a means of restarting at a checkpoint position rather than at the beginning of the entire job, if processing is terminated for any reason before the normal end-of-job. Checkpoints are taken using the COBOL RERUN statement.

In designing a program for which checkpoints are to be taken, the user should consider the fact that, upon restarting, the program must be able to continue as though it had just reached that point in the program at which termination occurred. Hence, the user should ensure that:

1. File handling is such as to permit easy reconstruction of the status of the system as it exists at the time of each checkpoint. For example, when multifile reels are used, the operator should be informed (by message) as to which file is in use at checkpoint time. He requires this information at restart time.
2. The contents of files are not significantly altered between the time of the checkpoint and the time of the restart:
 - For sequential files, all records written on the file at checkpoint time should be unaltered at restart time.
 - For nonsequential files, care must be taken to design the program so that a restart will not duplicate work that has been completed between checkpoint time and restart time. For example, suppose that Checkpoint 5 is taken. By adding an amount representing interest due, account XYZ is updated on a direct-access file that was opened with the input/output clause. If the program is restarted from Checkpoint 5 and if the interest is recalculated and again added to account XYZ, incorrect results will be produced.

If the program is modular in design, RERUN statements must be included in all modules that handle files for which checkpoints are to be taken. (When an entry point of a module containing a RERUN statement is encountered, a COBOL subroutine -- IHD03800 -- is called. IHD03800 enters the files of the module into the list of files to be repositioned.) Repositioning to the proper record will not occur for any files that were defined in modules other than those containing RERUN statements. Moreover, a restart from any given checkpoint may not reposition other tapes on which checkpoints are stored. Note, too, that only one disk checkpoint file can be used.

Restarting a Program: If the programmer includes checkpoints in his job by means of the COBOL RERUN statement, the message

0C00I CHKPT nnnn HAS BEEN TAKEN ON SYSxxx

is given each time a checkpoint is taken. (nnnn is the 4-character identification of the checkpoint record.) To restart a job from a checkpoint, the following actions are required:

1. Replace the // EXEC statement with a // RSTRT statement whose format is:

```
// RSTRT SYSxxx,nnnn [,SYSxxx]
```

where:

SYSxxx is the symbolic name of the device on which the checkpoint records are stored

nnnn is the 4-character identification of the checkpoint record to be used for restarting

SYSxxx can be any value from SYS000 through SYS222. (If the checkpoint records are recorded on a direct-access device, SYSxxx must be repeated following the four-character identification of the checkpoint record.) All other job control statements applicable to the job step should be the same as when the job was originally run. If necessary, the channel and unit addresses for the // ASSGN statements may be changed.

2. Rewind all tapes used by the program being restarted and mount them on devices assigned to the symbolic units required by the program. (If multireel files are involved, mount (on the primary unit) the reel in use at the time that the checkpoint was taken and rewind it. If multifile reels are involved, position the reel to the start of the file referred to at the time of the checkpoint.)
3. Reposition any card file so that only cards not yet read when the checkpoint was taken are in the card reader.
4. Execute the job.

Disk and Tape Operating System COBOL provides a linkage to the system checkpoint routine and re-entry point to the COBOL program from the system restart routine. Therefore, any restrictions applying to these system routines also apply to COBOL's restart procedures except as noted above. These restrictions are outlined in the publications IBM System/360 Disk Operating System: Supervisor and Input/Output Macros and IBM System/360 Tape Operating System: Supervisor and Input/Output Macros.

SECTION II: DECK STRUCTURES FOR PROCESSING COBOL PROGRAMS IN A TAPE OPERATING SYSTEM

For each type of processing, certain combinations of job control cards are needed. The examples given illustrate typical basic types of processing within an all tape system configuration.

The examples assume a given tape system configuration, and that the COBOL Tape Compiler is used for processing.

Figure 3 is a diagram of the input/output units used by COBOL in a tape configuration, and should help the user to visualize the logical structure of a configuration. A list of the types of processing discussed, in the order they are presented, follows:

1. Compile and punch
2. Cataloging to the relocatable library
3. Compiling, linkage editing, and executing
4. Executing a previously linkage edited program
5. Cataloging to the source statement library
6. Compiling, linkage editing, and executing

Examples 3 and 6 differ in that example 3 illustrates how job control is used to link with a module cataloged to the relocatable library, while example 6 illustrates how COBOL copies source statement modules cataloged to the source statement library.

ASSUMED TAPE RESIDENT SYSTEM CONFIGURATION

The processing examples given herein assume that the following Tape Operating System was generated at system generation time:

The system includes:

- One IBM 1403 Printer
- One IBM 2540 Card/Read/Punch
- One IBM 1052 Printer-Keyboard
- Four IBM Magnetic Tape Units (excluding the resident tape drive)

Assume physical assignments at system generation time are:

- 1403 Printer assigned to physical unit X'00E'
- 2540R Reader assigned to physical unit X'00C'
- 2540P Punch assigned to physical unit X'00D'
- 1052 Printer-Keyboard assigned to physical unit X'01F'
- 2402 Magnetic Tape Unit assigned to physical unit X'180'
- 2402 Magnetic Tape Unit assigned to physical unit X'181',X'90'
- 2402 Magnetic Tape Unit assigned to physical unit X'182'
- 2402 Magnetic Tape Unit assigned to physical unit X'183'
- 2402 Magnetic Tape Unit assigned to physical unit X'184' (This unit is the resident tape drive.)

The hexadecimal 90 (X'90') in the tape assigned to X'181' determines the device specifications for a 7-track tape.

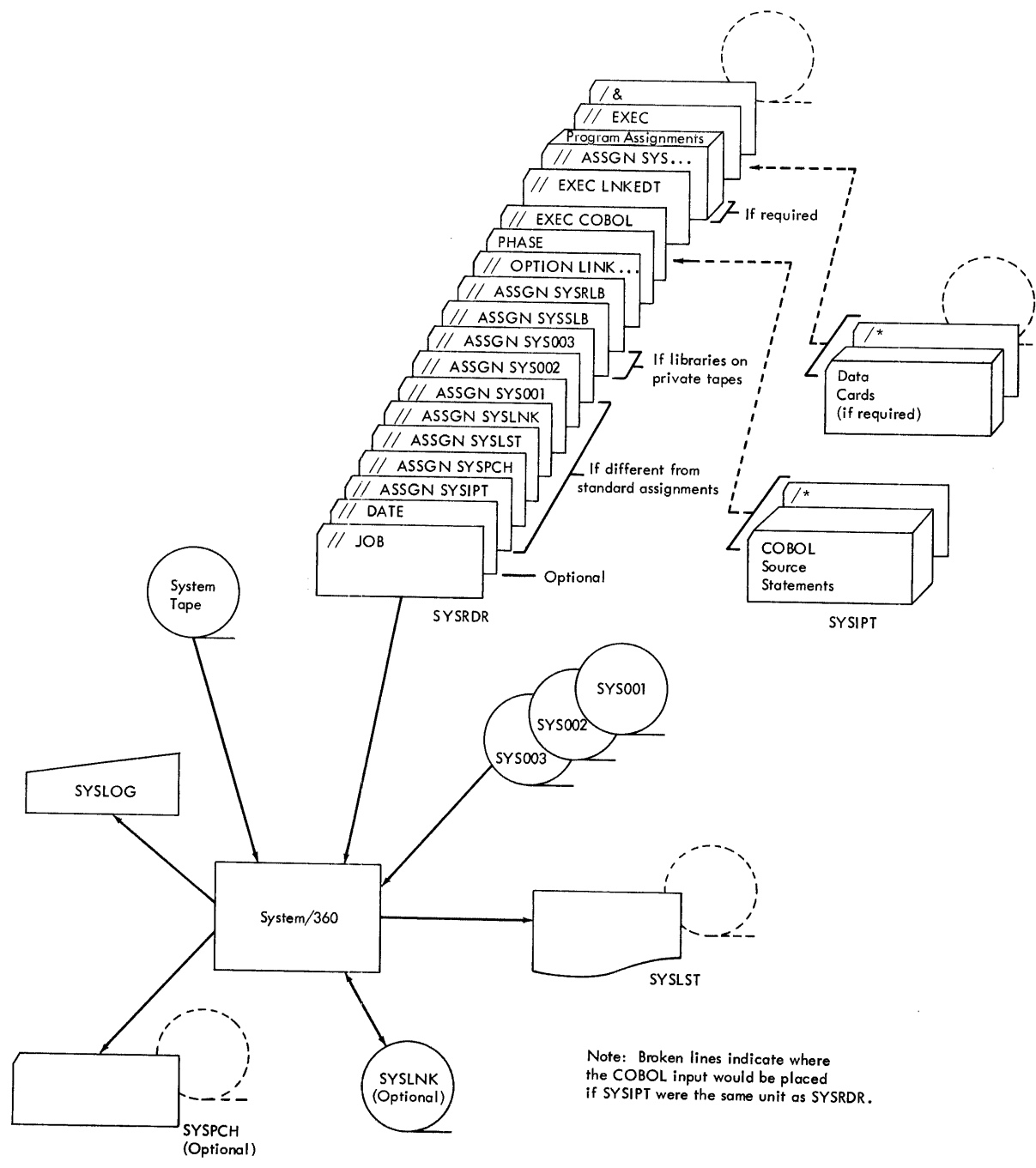

Figure 3. Input/output Units Used by COBOL Program in a Tape System

Assume logical assignments at system generation time are:

```
// ASSGN SYSIPT,X'00C'}
// ASSGN SYSRDR,X'00C'}          IBM 2540
// ASSGN SYSPCH,X'00D'
// ASSGN SYSLST,X'00E'          IBM 1403
// ASSGN SYSLOG,X'01F'          IBM 1052
// ASSGN SYSLNK,X'180'
// ASSGN SYS001,X'181',X'90' }
// ASSGN SYS002,X'182'          } IBM 2400's
// ASSGN SYS003,X'183' }
```

Notice that SYSIPT, SYSRDR, and SYSPCH are assigned to the same physical unit (they need not be), and that SYS001 is a 7-track tape. Observe also that four logical tape assignments are made. The COBOL compiler requires three logical work files to compile. The fourth can be used for compile-and-execute functions.

The user can change these assignments by the use of ASSGN cards following his JOB card. Examples of overriding assignments are given in the text that follows. In the examples that follow, whenever an optional statement is used it is identified by the words (optional card).

EXAMPLES OF PROCESSING USING TAPE CONFIGURATION

EXAMPLE 1--COMPILE AND PUNCH

Assuming that source statements are card input (SYSIPT) and job-control statements are card input (SYSRDR), the set of job-control cards required (and some helpful options) to compile and punch are:

```
// JOB SUBROTNE
// OPTION LOG,DECK,LIST,LISTX,ERRS          Input from SYSRDR
// EXEC COBOL
SUBROTNE                                     Input from SYSIPT
SOURCE STATEMENTS
/*
/ε
// PAUSE REMOVE OBJECT DECK FROM HOPPER     Input from SYSRDR
(optional card)
```

The options selected on the option card specify:

LOG -- Requests a listing of all control statements on SYSLST.
DECK -- Requests that a deck (object module) be punched on SYSPCH.
LIST -- Causes compiler to write source statements on SYSLST.
LISTX -- Causes compiler to write a procedure division map on SYSLST in hexadecimal.
ERRS -- Causes compiler to write all diagnostics related to the source program on SYSLST.

EXAMPLE 2--CATALOGING AN OBJECT MODULE IN RELOCATABLE LIBRARY

In this example, an object module generated by the compiler (see Example 1) is cataloged in the relocatable library. It is assumed that the relocatable library is on SYSRES (similarly for the source statement library). Another tape drive may be used as a private library for the relocatable library, in which case the system logical unit SYSRLB is used.

The job-control cards required to catalog an object module to an existing relocatable library are:

```
// JOB RELOCATE
// EXEC MAINT
    CATALR SUBROTNE
    (Object deck to be
    cataloged goes here.)
/*
/£
*           OBJECT MODULE 'SUBROTNE' IS NOW
*           CATALOGED TO NEW SYSRES TAPE ON
// PAUSE           SYS002
    (optional card)
```

When an object module is cataloged to the relocatable library residing on SYSRES, the following points must be considered.

1. SYS002 is the device on which the newly updated library is located (SYSRES is now outdated).
2. If SYS002 is to be established as new SYSRES, it must be mounted on the tape drive assigned to "old" SYSRES, and initial program loaded (IPL). This automatically establishes it as a "new" SYSRES. SYS002 can then be reassigned.

SYS001 is used as a work file.

EXAMPLE 3--COMPILE, LINKAGE EDIT, AND EXECUTE

This example illustrates how an object module cataloged in the relocatable library is included in a compilation, linkage edited with the main program and executed.

The job control statements required to compile, linkage edit, and execute are:

```
// JOB CALLPROG
// OPTION LINK,LIST,LISTX,ERRS
    PHASE MAIN,*
// EXEC COBOL
    {COBOL SOURCE STATEMENTS}
/*
    INCLUDE SUBROTNE {Retrieves SUBROTNE from relocatable library}
// EXEC LNKEDT
// EXEC
    {DATA DECK }
    { (if any)}
/*
/£
```

This program consists of one phase that includes the object module SUBROTNE and permits immediate execution of the program. [The name provided in the PHASE statement (main) has no relationship to the external-name given in the COBOL Program-ID statement.]

It is possible to process this program with only three work files; however, the procedure requires special instructions to the operator for making two passes through the system. In this example, such instructions are conveyed to the operator on comment cards.

The output of the first pass (Pass 1) is a punched object deck, which is used in the second pass (Pass 2). To accomplish Pass 2 (linkage edit and execute), the punched object deck must be positioned in the job

stream to precede the EXEC LNKEDT and EXEC statements. (This is done when the PAUSE statement is encountered.)

The complete job stream to accomplish both Pass 1 and Pass 2 is, as follows:

```

// JOB CALLPROG
// ASSGN SYS001,X'180' } Work
// ASSGN SYS002,X'182' } Files
// ASSGN SYS003,X'183' }
// OPTION DECK,LISTX,ERRS } Pass 1
// EXEC COBOL }

      [COBOL SOURCE STATEMENTS]

/*
// ASSGN SYS001,X'180' } Assignments
// ASSGN SYS002,X'182' } For Linkage
// ASSGN SYSLNK,X'183' } Edit and Execute
// OPTION LINK
* PLACE THE OUTPUT OF SYSPCH INTO SYSRDR.
* PLACE THE INCLUDE SUBROTNE STATEMENT
* THROUGH THE /& STATEMENT, INCLUSIVE,
* (LABELED PASS 2 IN THIS EXAMPLE)
* BEHIND THE PUNCHED OBJECT DECK JUST
* PUT INTO SYSRDR.
* CONTINUE
// PAUSE
  INCLUDE
  PHASE MAIN,*

      (The punched object deck will be
      positioned here in the job stream.)
/*
      INCLUDE SUBROTNE      { Retrieves SUBROTNE
                           { from RELOCATABLE
                           { LIBRARY
// EXEC LNKEDT
// EXEC
  { DATA DECK }
  { (if any) }
/*
/&

```

The new option card is needed to accomplish the linkage editing. The entire set of control statements and source statements from // JOB card through /& card are submitted as one job.

Note that the SYS001, SYS002, and SYSLNK units are required to execute the linkage editor.

EXAMPLE 4--EXECUTING A PROGRAM

The job control statements required simply to execute a program, assuming it is in the core image library, are:

```

// JOB CALLPROG
// ASSGN SYS006,X'00C'
// ASSGN SYS004,X'182'
// ASSGN SYS005,X'183'
// EXEC MAIN
  DATA
  DECK
/*
/ε
// PAUSE MESSAGE TO OPERATOR IF ANY.
  (optional card)

```

The example can be used for validating data, or making test runs, where many runs might be made with different sets of data decks.

EXAMPLE 5--CATALOGING SOURCE MODULES TO SOURCE STATEMENT LIBRARY

The procedural steps and the job control statements required to catalog two source statement routines in the source statement library follow.

It is assumed that a source statement library is on the system residence volume, SYSRES.

The job control statements are:

```

// JOB CATLSORC

// EXEC MAINT
  CATALS C.DATAIN
  BKEND C.DATAIN
  FILEB, DATA RECORDS ARE CAPACITOR-RECORD1,
    INDUCTOR-RECORD1,
  LABEL RECORDS ARE STANDARD, BLOCK
  CONTAINS 12 RECORDS, RECORDING MODE IS F.
  BKEND C.DATAIN
  CATALS C.INOUT
  BKEND C.INOUT
  BEGIN. OPEN INPUT FILEB, FILED OUTPUT FILEA.
  DATA. READ FILEB AT END GO TO CYCLE.
  MASTER. READ FILED AT END GO TO LABA.
    GO TO PROCESS.
  LABA. CLOSE FILEA, FILEB, FILED, STOP RUN.
  BKEND C.INOUT
/*
/ε
// PAUSE REMOVE NEW SYSRES ESTABLISHED ON X'182'.

```

The open and close routine is now cataloged in the source statement library under the name INOUT and the file description under the name DATAIN. Notice that DATAIN is cataloged before INOUT. This is because books to be cataloged must be in alphanumeric sequence.

The message is an interruption in the job stream to inform the operator to perform some task. In this example, he is instructed to remove the tape for protection.

EXAMPLE 6--COMPILE (USING SOURCE STATEMENT LIBRARY), LINKAGE EDIT, AND EXECUTE

This example illustrates:

1. How two previously written routines, that were cataloged in the source statement library, are utilized. In this example, the source statement library is on SYSRES.
2. How assignments can be made to process an inventory file with four tapes (not including SYSRES).

Assume an electronics firm stocks quantities of electrical components that are to be maintained at a minimum quantity level, and an input data file is used to check against a master file to determine stock item reorder points.

For the purposes of illustration, only two of its many components--capacitors and inductors--are treated here. They are:

| <u>CAPACITORS</u> | | | |
|--------------------|--------------|-----------------------------------|--------------------------------|
| <u>PART NUMBER</u> | <u>VALUE</u> | <u>QUANTITY</u> <u>ON HAND</u> | <u>REORDER</u> <u>POINT</u> |
| C61 | .010MFD | 47 | 50 |
| C62 | .020MFD | 60 | 50 |
| C65 | .050MFD | 50 | 50 |
| C121 | .001MMFD | 90 | 50 |
| C122 | .002MMFD | 100 | 50 |
| C125 | .005MMFD | 22 | 50 |

| <u>INDUCTORS</u> | | | |
|--------------------|--------------|-----------------------------------|--------------------------------|
| <u>PART NUMBER</u> | <u>VALUE</u> | <u>QUANTITY</u> <u>ON HAND</u> | <u>REORDER</u> <u>POINT</u> |
| L10 | .10H | 18 | 35 |
| L20 | .20H | 15 | 35 |
| L40 | .40H | 30 | 35 |
| L61 | 10.00MH | 60 | 35 |
| L62 | 20.00MH | 70 | 35 |
| L64 | 40.00MH | 69 | 35 |

Assume further, that an input update file called DATAIN (Example 5, ROUTINE 1) was created on tape and cataloged the source statement library. Assume its records are, as follows:

```
01 CAPACITOR-RECORD1.
  02 CAPACITOR OCCURS 6.
    03 PART-NUMBER PICTURE XXXX.
    03 VALUE1 PICTURE V999.
    03 VALUE2 PICTURE XXXX.
    03 QUANTITY-ON-HAND PICTURE IS S999.
    03 REORDER-PT PICTURE IS 99.
```

```
01 INDUCTOR-RECORD1.
  02 INDUCTOR OCCURS 6.
    03 PART-NUMBER PICTURE XXXX.
    03 VALUE1 PICTURE 99V99.
    03 VALUE2 PICTURE XX.
    03 QUANTITY-ON-HAND PICTURE IS S999.
    03 REORDER-PT PICTURE IS 99.
```

Also assume a program called ORDERPT (to be compiled) was written to process these records (against the master file) to reorder parts when their respective QUANTITY-ON-HAND falls below REORDER-PT.

The following source statements portray, in skeleton form, the program ORDERPT. Included is the INPUT-OUTPUT section for the program.

IDENTIFICATION DIVISION.

PROGRAM-ID, 'ORDERPT'.

·
·
·

ENVIRONMENT DIVISION.

·
·
·

INPUT-OUTPUT SECTION.

FILE-CONTROL.

SELECT FILEB ASSIGN TO 'SYS004' UTILITY 2400 UNITS.
SELECT FILEA ASSIGN TO 'SYS005' UTILITY 2400 UNITS, RESERVE NO
ALTERNATE AREA.
SELECT FILEC ASSIGN TO 'SYS006' UNIT-RECORD 1403.
SELECT FILED ASSIGN TO 'SYS007' UTILITY 2400 UNITS.

Notice that FILEC is assigned to an IBM 1403 Printer. This enables printing out the REORDER-PT, PART NUMBER of the component, and its VALUE (in MFD or MH) when the QUANTITY-ON-HAND falls below REORDER-PT.

In order to do this, a file description or FD must be written for FILEC in the data division:

DATA DIVISION.

FD FILEC....

01 REORDER.

02 REORDER-PT PICTURE IS 99 USAGE IS DISPLAY.
02 VALUE-OF-PART PICTURE IS ZZ.999.
02 PART-NUMBER PICTURE IS XXXX.
02 QUANTITY PICTURE IS 999.

Before printing out FILEC, the appropriate values are moved into REORDER-PT (50 or 35), VALUE-OF-PART (.999MFD or ZZ.999H) PART-NUMBER (CXXX or LXXX), and QUANTITY (999).

Specifically, four files are required to process this problem:

FILEA Updated master file.
FILEB Updating input file (DATAIN).
FILEC Output print file.
FILED Master file.

The control cards to compile, linkage edit, and execute the problem are:

```

// JOB INVNTORY
// OPTION LINK,LIST,DUMP
// PHASE INVNTORY,*
// EXEC COBOL
.
.
.
DATA DIVISION.          (see
FD FILEB COPY 'DATAIN'. Example 5
                        for expansion)
.
.
.
PROCEDURE DIVISION.
.
.
.
START. INCLUDE 'INOUT'. (see
                        Example 5
                        for expansion)
.
.
.
PROCESS. (Records on FILEB are processed)

/*
// LBLTYP TAPE (03)
// EXEC LNKEDT
// ASSGN SYS0004,X'181',X'90' (DATAIN)
// ASSGN SYS005,X'182' (OUTPUT FILE,NEW MASTER)
// ASSGN SYS006,X'00E' (PRINT FILE)
// ASSGN SYS007,X'183' (MASTER FILE)
* MOUNT INPUT (SYS004) ON X'181',
* OUTPUT (SYS005) ON X'182',
// PAUSE MASTER (SYS007) ON X'183'.
// VOL SYS004,SYS004
// TPLAB 'DATAIN,etc...'
// VOL SYS007,SYS007,
// TPLAB 'MASTER,etc...'
// VOL SYS005,SYS005
// TPLAB 'NEWMASTER,etc...'
// EXEC
// PAUSE SAVE SYS007 ON X'183' and SYS005 ON X'182'
/*
/6

```

Note that the program that processes the files takes advantage of two previously written routines (routine 1 and routine 2) that were cataloged to the source statement library.

Note also that the VOL and TPLAB job-control statements were used to check header records and write trailer labels on input and output files.

SECTION III: DECK STRUCTURES FOR PROCESSING COBOL PROGRAMS IN A DISK OPERATING SYSTEM

For each type of processing, certain combinations of job control cards are needed. The examples given illustrate basic types of processing within a Disk Operating System.

The examples assume a given Disk Operating System configuration that includes tape, and that the COBOL disk compiler is used for processing.

Because the COBOL disk compiler permits the use of disk or tape work files, some of the examples given in this section use tape work files while others use disk work files. Figure 4 is a diagram of the input/output units used by COBOL in a disk configuration with tape, and should help the user to visualize the logical structure of such a configuration.

Preceding the types of processing discussed is a procedure for establishing labels for COBOL disk work files and SYSLNK on the Standard Label Track. A list of the types of processing discussed, in the order they are presented, follows:

1. Compile and punch
2. Cataloging in the relocatable library
3. Compiling, linkage editing, and executing
4. Executing a previously linkage edited program
5. Cataloging in the source statement library
6. Compiling, linkage editing, and executing.

Examples 3 and 6 differ in that example 3 illustrates how job control is used to link with a module cataloged in the relocatable library, whereas example 6 illustrates how COBOL copies source statement modules cataloged to the source statement library.

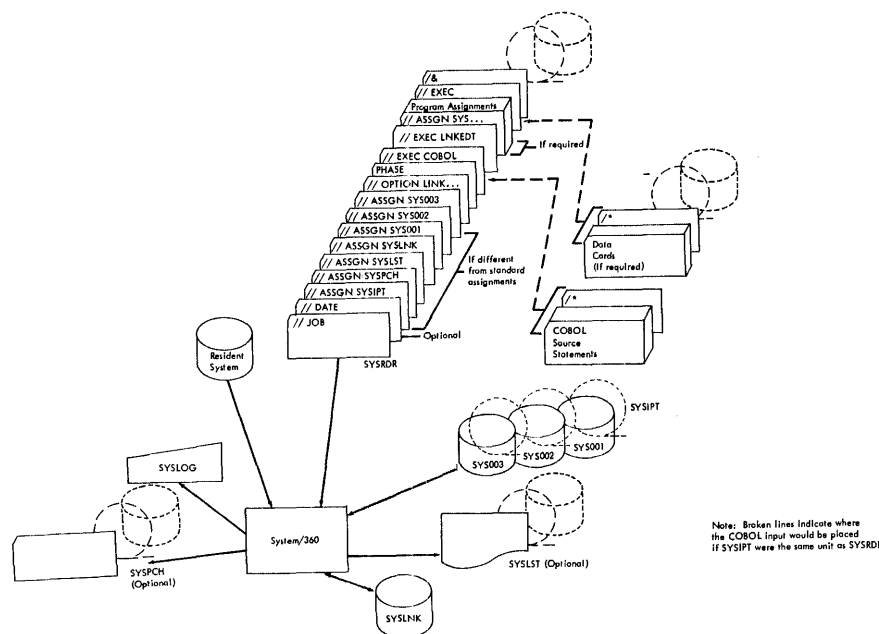

Figure 4. Input/Output Units Used by COBOL Program in a Disk System

Assumed Disk Resident System Configuration

The processing examples given here assume that the following Disk Operating System configuration with tape was generated at system generation time for the COBOL disk compiler.

The system includes:

- One IBM 2540 Card/Read/Punch
- One IBM 1052 Printer-Keyboards
- One IBM 1403 Printer
- Two IBM 2311 Disk Drives
- Four IBM 2400 Magnetic Tape Units

Assume physical assignments at system generation time are:

- 2540R Reader assigned to physical unit X'00C'
- 2540P Punch assigned to physical unit X'00D'
- 1052 Printer-keyboard assigned to physical unit X'01F'
- 1403 Printer assigned to physical unit X'00E'
- 2311 Disk pack assigned to physical unit X'190'
- 2311 Disk pack assigned to physical unit X'191'
- 2402 Magnetic tape unit assigned to physical unit X'281'
- 2402 Magnetic tape unit assigned to physical unit X'282'
- 2402 Magnetic tape unit assigned to physical unit X'283'
- 2402 Magnetic tape unit assigned to physical unit X'284', X'90'

The hexadecimal 90 (X'90') in the last tape assignment determines the device specifications for a 7-track tape.

Assume logical assignments at system generation time are:

```
// ASSGN SYSIPT,X'00C' }
// ASSGN SYSRDR,X'00C' }      IBM 2540
// ASSGN SYSPCH,X'00D' }
// ASSGN SYSLST,X'00E'      IBM 1403
// ASSGN SYSLOG,X'01F'      IBM 1052
// ASSGN SYSLNK,X'190' }
// ASSGN SYS003,X'190' }      IBM 2311's
// ASSGN SYS001,X'191' }
// ASSGN SYS002,X'191' }
```

When logical assignments are made at system generation time for the disk compiler, the following must be considered:

- SYSLNK must be assigned to disk.
- SYS001, SYS002, and SYS003 (work files) can be assigned to disk or tape, but must all be assigned to the same device type.

- When the linkage editor function is being performed, work file SYS-001 can be assigned to either disk or tape.

When tape work files are to be used instead of the given logical assignments for disk work files (SYS001, SYS002, SYS003), the user must assign tape work files at system generation time. For example:

```
// ASSGN SYS001,X'281'
// ASSGN SYS002,X'282'
// ASSGN SYS003,X'283'
```

Notice that SYSIPT, SYSRDR, and SYSPCH are assigned to the same physical unit.

The programmer can change these assignments using ASSGN cards following his JOB card. Examples of overriding assignments are given in the text that follows. In the examples that follow, whenever an optional statement is used, it is identified by the words "optional card."

EXAMPLES OF PROCESSING USING DISK CONFIGURATION

When processing programs with the COBOL disk compiler, the information provided by the VOL, DLAB, and XTENT statements for the work files SYS-001, SYS002 and SYS003 must be available for each job processed. This information can be supplied by the programmer with each job processed, or is provided for the programmer on the Standard Label Track for each job processed as required. In addition to establishing the labels required for the disk work files SYS001, SYS002, and SYS003, the labels required for SYSLNK can also be established on the Standard Label Track, where they will be available for subsequent use.

The following procedure enables setting up the Standard Label Track for COBOL disk compiler work files and SYSLNK. Once established, the labels remain in effect for use with subsequent jobs processed, until overridden.

```
// JOB BUILD STANDARD LABELS
* ALL VOL, DLAB, AND EXTENT STATEMENTS SUBMITTED IN THIS JOB
* WILL BE PERMANENTLY WRITTEN ON TRACK 0 OF THE LABEL STORAGE
* CYLINDER OF DOS SYSTEM RESIDENCE FILE SYSRES. THUS THESE
* LABELS NEED NOT BE SUBMITTED FOR EVERY JOB THAT REQUIRES
* SYSLNK AND SYS001-SYS003
// OPTION STDLABEL
// VOL SYS000,IJSYS00
// DLAB 'SYSTEM WORK FILE SYSLNK                1111111',          C
//          0001,66001,66001,'DISK OPER SYS',SD
// XTENT 1,0,000190000,000198009,'111111',SYSLNK
// VOL SYS001,IJSYS01
// DLAB 'SYSTEM WORK FILE NO. 1                1111111',          C
//          0001,66001,66001,'DISK OPER SYS',SD
// XTENT 128,0,000142000,000189003,'111111',SYS001
// VOL SYS002,IJSYS02
// DLAB 'SYSTEM WORK FILE NO. 2                02.G0000V001111111',  C
//          0001,66001,66001,'SYSTEM CODE 1',SD
// XTENT 128,0,000142004,000189007,'111111',SYS002
// VOL SYS003,IJSYS03
// DLAB 'SYSTEM WORK FILE NO. 3                02.G0000V001111111',  C
//          0001,66001,66001,'SYSTEM CODE 1',SD
// XTENT 128,0,000142008,000189009,'111111',SYS003
```

EXAMPLE 1--COMPILE AND PUNCH

Assuming that source statements are card input (SYSIPT) and job control statements are card input (SYSRDR), the job control cards required (and some helpful options) to compile and punch are:

```
// JOB SUBROTNE
// OPTION LOG,DECK,LIST,LISTX,ERRS      } Input from SYSRDR
// EXEC COBOL                             }

SUBROTNE
SOURCE STATEMENTS                       } Input from SYSIPT

/*
/ε
// PAUSE REMOVE OBJECT DECK FROM HOPPER } Input from SYSRDR
                                         (Optional card)
```

The options selected specify:

LOG -- Requests a listing of all control statements on SYSLST.
DECK -- Requests that a deck (object module) be punched on SYSPCH.
LIST -- Causes the compiler to write source statements on SYSLST.
LISTX -- Causes the compiler to write a procedure division map on SYSLST in hexadecimal.
ERRS -- Causes the compiler to write all diagnostics related to the source program on SYSLST.

EXAMPLE 2--CATALOGING AN OBJECT MODULE IN RELOCATABLE LIBRARY

In this example, an object module generated by the compiler (see Example 1) is cataloged to the relocatable library.

Note: The relocatable library is on SYSRES.

The job control cards required to catalog an object module to an existing relocatable library are:

```
// JOB RELOCATE
// EXEC MAINT
      CATALR SUBROTNE
      (Object deck to be
      cataloged goes here.)
/*
/ε
*          OBJECT MODULE 'SUBROTNE' IS
*          NOW CATALOGED TO THE RELOCATABLE
// PAUSE  LIBRARY ON SYSRES          (optional card)
```

EXAMPLE 3--COMPILE, LINKAGE EDIT, AND EXECUTE

This example illustrates how an object module cataloged to the relocatable library is included in a compilation, linkage edited with the main program, and executed.

```

// JOB CALLPROG
// OPTION LINK,LIST,LISTX,ERRS
// PHASE MAIN,*
// EXEC COBOL
// {COBOL SOURCE STATEMENTS}
/*
// INCLUDE SUBROTNE {Retrieves SUBROTNE from relocatable library}
// EXEC LNKEDT
// EXEC
// {DATA DECK}
// { (if any) }
/*
/ε

```

This program consists of one phase that includes the object module SUBROTNE and can be executed immediately. [The name provided in the PHASE statement (MAIN) has no relationship to the external-name given in

EXAMPLE 4--EXECUTING A PROGRAM

The job control statements required simply to execute a program, assuming it has been cataloged in the core image library, are:

```

// JOB CALL PROG
// ASSGN SYS006,X'00C'
// ASSGN SYS004,X'191'
// ASSGN SYS005,X'191'
// VOL SYS004,SYS004
// DLAB 'THIS IS THE JOB INPUT FILE etc,...
// XTENT Enter track specification here ...
// VOL SYS005,SYS005
// DLAB 'THIS IS THE JOB OUTPUT FILE etc,...
// XTENT Enter track specification here ...
// EXEC MAIN
// [DATA DECK]
/*
/ε
// PAUSE MESSAGE TO OPERATOR, IF ANY (optional card)

```

The example can be used for validating data, or for making test runs, where many runs might be made with different sets of data. Note that the VOL, DLAB, and XTENT statements specify areas in the disk pack (assigned to X'191') that are used by the job input and output files SYS004 and SYS005, respectively.

EXAMPLE 5--CATALOGING SOURCE MODULES IN SOURCE STATEMENT LIBRARY

The procedural steps and the job-control statements required to catalog two source statement modules in the source statement library follow.

Note: The source statement library is on the system residence volume SYSRES.

The job control statements are:

```

// JOB CATLSORC
// EXEC MAINT
CATALS C.INOUT
BKEND C.INOUT
BEGIN. OPEN INPUT FILEB, FILED OUTPUT FILEA.
DATA. READ FILEB AT END GO TO CYCLE.
MASTER. READ FILED AT END GO TO LABA.
GO TO PROCESS.
LABA. CLOSE FILEA, FILEB, FILED, STOP RUN.
BKEND C.INOUT
CATALS C.DATAIN
BKEND C.DATAIN
FILEB, DATA RECORDS ARE CAPACITOR-RECORD1,
INDUCTOR-RECORD1,
LABEL RECORDS ARE STANDARD, BLOCK
CONTAINS 12 RECORDS, RECORDING MODE IS F.
BKEND C.DATAIN
/*
/6

```

} ROUTINE 1

} ROUTINE 2

The open and close routine is now cataloged to the source statement library under the name INOUT, and the file description under the name DATAIN.

EXAMPLE 6--COMPILE (USING SOURCE STATEMENT LIBRARY), LINKAGE EDIT, AND EXECUTE

This example illustrates:

1. How two previously written routines, that were cataloged in the source statement library, are utilized. In this example, the source statement library is on SYSRES.
2. How assignments can be made to process an inventory file using direct-access storage.

Assume an electronics firm stocks quantities of electrical components that are to be maintained at a minimum quantity level, and an input data file is used to check against a master file to determine stock item reorder points.

For the purposes of illustration, only two of its many components--capacitors and inductors--are treated here. They are:

| CAPACITORS | | QUANTITY | REORDER |
|--------------------|--------------|----------------|--------------|
| <u>PART NUMBER</u> | <u>VALUE</u> | <u>ON HAND</u> | <u>POINT</u> |
| C61 | .010MFD | 47 | 50 |
| C62 | .020MFD | 60 | 50 |
| C65 | .050MFD | 50 | 50 |
| C121 | .001MMFD | 90 | 50 |
| C122 | .002MMFD | 100 | 50 |
| C125 | .005MMFD | 22 | 50 |

| INDUCTORS | | QUANTITY | REORDER |
|--------------------|--------------|----------------|--------------|
| <u>PART NUMBER</u> | <u>VALUE</u> | <u>ON HAND</u> | <u>POINT</u> |
| L10 | .10H | 18 | 35 |
| L20 | .20H | 15 | 35 |
| L40 | .40H | 30 | 35 |
| L61 | 10.00MH | 60 | 35 |
| L62 | 20.00MH | 70 | 35 |
| L64 | 40.00MH | 69 | 35 |

Assume further than an input update file called DATAIN (Example 5, ROUTINE 2), was created on disk and cataloged to the source statement library. Assume that the records are, as follows:

```

01 CAPACITOR-RECORD1.
  02 CAPACITOR OCCURS 6.
    03 PART-NUMBER PICTURE XXXX.
    03 VALUE1 PICTURE V999.
    03 VALUE2 PICTURE XXXX.
    03 QUANTITY-ON-HAND PICTURE IS S999.
    03 REORDER-PT PICTURE IS 99.

```

```

01 INDUCTOR-RECORD1.
  02 INDUCTOR OCCURS 6.
    03 PART-NUMBER PICTURE XXXX.
    03 VALUE1 PICTURE 99V99.
    03 VALUE2 PICTURE XX.
    03 QUANTITY-ON-HAND PICTURE IS S999.
    03 REORDER-PT PICTURE IS 99.

```

Also assume a program called ORDERPT (to be compiled) was written to process these records (against the master file) to reorder parts when their respective QUANTITY-ON-HAND falls below REORDER-PT.

The following source statements portray in skeleton form, the program ORDERPT. Included is the INPUT-OUTPUT section for the program.

IDENTIFICATION DIVISION.

PROGRAM-ID. 'ORDERPT'.

.

ENVIRONMENT DIVISION.

.

INPUT-OUTPUT SECTION.

FILE-CONTROL.

```

        SELECT FILEB ASSIGN TO 'SYS004' UTILITY 2400 UNITS.
        SELECT FILEA ASSIGN TO 'SYS005' UTILITY 2311 UNITS,
          RESERVE NO ALTERNATE AREA.
        SELECT FILEC ASSIGN TO 'SYS006' UNIT-RECORD 1403.
        SELECT FILED ASSIGN TO 'SYS007' UTILITY 2311 UNITS.

```

Notice that FILEC is assigned to an IBM 1403 Printer. This enables printing out the REORDER-PT, PART NUMBER of the component, and its VALUE (in MFD or MH) when the QUANTITY-ON-HAND falls below REORDER-PT.

In order to do this, a file description or FD must be written for FILEC in the data division:

DATA DIVISION.

FD FILEC....

```

01 REORDER.
  02 REORDER-PT PICTURE IS 99 USAGE IS DISPLAY.
  02 VALUE-OF-PART PICTURE IS ZZ.999.
  02 PART-NUMBER PICTURE IS XXXX.
  02 QUANTITY PICUTRE IS 999.

```

Before printing out FILEC, the appropriate values are moved into REORDER-PT (50 or 35), VALUE-OF-PART (.999 MFD or ZZ.999H) PART-NUMBER (CXXX or LXXX), and QUANTITY (999).

Specifically, four files are required to process this problem:

```

FILEA    Updated master file.
FILEB    Updating input file (DATAIN).
FILEC    Output print file.
FILED    Master file.

```

The control cards to compile, linkage edit, and execute the problem are:

```
// JOB INVTORY
// OPTION LINK,LIST,DUMP
// PHASE INVTORY,*
// EXEC COBOL
.
.
DATA DIVISION.          (see
FD FILEB COPY 'DATAIN'. Example 5
                        for expansion.)
.
.
PROCEDURE DIVISION.
.
.
START. INCLUDE 'INOUT'. (see
                        Example 5
                        for expansion.)
.
PROCESS. (Records on FILEB are processed)

/*
// LBLTYP TAPE
// EXEC LNKEDT
// ASSGN SYS004,X'284',X'90'      (DATAIN)
// ASSGN SYS005,X'190'          (OUTPUT FILE, NEW MASTER)
// ASSGN SYS006,X'00E'          (PRINT FILE)
// ASSGN SYS007,X'191'          (MASTER FILE)
*      MOUNT INPUT (SYS004) ON X'284',
// PAUSE X'90'.
// TLBL DATAIN
// DLBL SYS005, 'THIS IS THE NEW JOB MASTER FILE etc., ...'
// EXTENT Enter the track specification here ...
// DLBL SYS007, 'THIS IS THE JOB(OLD) MASTER FILE etc., ...'
// EXTENT Enter the track specification here ...
// EXEC
/*
/6
```

Note that the program that processes the files takes advantage of two previously written routines (Routines 1 and 2) that were cataloged in the source statement library.

Note also that the LBLTYP job control statement was used (for SYS004) because it is required when label information for tape files is processed.

SECTION IV: INTERPRETING OUTPUT

The compiler, linkage editor, COBOL program phases, and other system components can produce output in the form of printed listings, punched card decks, diagnostic or informative messages, and data files directed to tape or direct-access devices. This section describes the output listings that can be used to document and debug programs. Included are explanations of compiler output, a list of conditions that can cause a dump, a brief discussion of how to best use a dump, and an explanation of how diagnostic messages are determined. A complete list of diagnostic messages is contained in Appendix H.

COMPILER OUTPUT

The output of the compilation job step may include:

- A printed listing of the control statements
- A printed listing of the statements contained in the source module
- A printed listing of a data map
- A printed listing of a procedure map
- Compiler diagnostic messages
- An object module

All forms of output must be requested by means of the job control OPTION statement. For example, DECK specifies that the object module is to be punched. A complete list of the options for this statement is given in Section I. All output to be listed is printed on the device whose symbolic name is SYSLST.

SOURCE LISTING (LIST)

Figure 5 is an example of a source module listing. It is obtained when LIST is specified on the job-control OPTION statement. The listing is given on SYSLST.

GENERATED COBOL SOURCE LISTING (The heading that appears at the top of the listing is explanatory only. It does not actually appear on the listing.)

The source listing consists of:

- | | |
|------------------|---|
| LINE NO. | A compiler generated line number that is shown in the left-most column. This line number is used in diagnostic messages and LISTX references. The generated line numbers for the sample program are 1 through 39. |
| SEQ. NO | The programmer provides the statement sequence numbers. They appear in the second column. |
| SOURCE STATEMENT | All COBOL words and punctuation. Words, punctuation, and other groups of characters on each line are referenced as |

elements on the line in LISTX listings so that a specific entry may be defined.

S Sequence numbers out of order. If columns 1 through 6 of the source statement are not blank, they are sequence checked. The character S is placed beside a number not in logical ascending order. Example: assume that in the sample listing statement number 26 (generated line number) was out of sequence. The compiler would list the source statement as:

```
S26 000250 WRITE A AFTER ADVANCING 3 LINES.
```

D Debug packet card inserts. Cards inserted as part of a DEBUG packet are identified with the character D alongside the generated sequence number.

* Library cards. Cards coming from the library as a result of a COPY or INCLUDE statement are noted with an asterisk.

DATA MAP (SYM)

Figure 6 is an example of a data map. It is a portion of the data map generated for the program given in Figure 5, and is obtained when SYM is specified on the job-control OPTION statement. The data map is printed on the SYSLIST unit.

The data map shows the name of each nonprocedure name defined in the program. File-names, record-names, and condition names are identified in the column headed TYPE. (In this example, no condition names were used; therefore, none are listed.) The relative location of each entry is shown (column headed LOCATION). Linkage and file entries are relative to the level 01 or 77. Working storage is relative to 0. The addresses given are 24-bit addresses.

The column headed DATA NAME gives the names of the nonprocedure name specified in the program.

If the load address is known, it may be used as the hexadecimal offset parameter in a CBL option card parameter (DMAP=h). This would result in adjusted addresses on the listing.

GENERATED COBOL SOURCE LISTING

| LINE NO. | SEQ. NO. | SOURCE STATEMENT | D 12MAR66 04/21/66 |
|----------|----------|---|--------------------|
| 1 | 000010 | IDENTIFICATION DIVISION. | |
| 2 | 000020 | PROGRAM-ID. 'CARRRCTL'. | |
| 3 | 000030 | ENVIRONMENT DIVISION. | |
| 4 | 000040 | INPUT-OUTPUT SECTION. | |
| 5 | 000050 | FILE-CONTROL. | |
| 6 | 000060 | SELECT PRINTO ASSIGN TO 'SYS004' | |
| 7 | 000070 | UNIT-RECORD 1403 UNIT RESERVE | |
| 8 | 000080 | NO ALTERNATE AREAS. | |
| 9 | 000090 | DATA DIVISION. | |
| 10 | 000100 | FILE SECTION. | |
| 11 | 000110 | FD PRINTO RECORDING MODE F LABEL RECORDS | |
| 12 | 000120 | ARE OMITTED DATA RECORD IS A. | |
| 13 | 000130 | 01 A. | |
| 14 | 000140 | 02 C-C PICTURE X. | |
| 15 | 000150 | 02 GARB PICTURE X(20). | |
| 16 | 000160 | 02 FULLER PICTURE X(112). | |
| 17 | 000170 | WORKING-STORAGE SECTION. | |
| 18 | 000180 | 77 B PICTURE X(20) VALUE 'THIS IS A RECORD'. | |
| 19 | 000190 | 01 D PICTURE S99. | |
| 20 | 000200 | 01 E REDEFINES D. | |
| 21 | 000210 | 02 FILLER PICTURE X. | |
| 22 | 000220 | 02 F PICTURE X. | |
| 23 | 000230 | PROCEDURE DIVISION. | |
| 24 | 000240 | START. OPEN OUTPUT PRINTO. MOVE B TO GARB. | |
| 25 | 000260 | WRITE A AFTER ADVANCING 1 LINE. | |
| S26 | 000250 | WRITE A AFTER ADVANCING 3 LINES. | |
| 27 | 000270 | WRITE A AFTER ADVANCING 2 LINES. | |
| 28 | 000280 | MOVE ' ' TO C-C. WRITE A AFTER ADVANCING C-C. | |
| 29 | 000290 | MOVE '0' TO C-C. WRITE A AFTER ADVANCING C-C. | |
| 30 | 000300 | MOVE '-' TO C-C. WRITE A AFTER ADVANCING C-C. | |
| 31 | 000310 | MOVE '+' TO C-C. WRITE A AFTER ADVANCING C-C. | |
| 32 | 000320 | MOVE '1' TO C-C. WRITE A AFTER ADVANCING C-C. | |
| 33 | 000330 | MOVE 'C' TO C-C. WRITE A AFTER ADVANCING C-C. | |
| 34 | 000340 | MOVE 'TRICK COMING UP' TO FULLER. | |
| 35 | 000350 | WRITE A AFTER ADVANCING C-C. | |
| 36 | 000360 | MOVE 'EOJ' TO A. | |
| 37 | 000370 | WRITE A AFTER ADVANCING 3 LINES. | |
| 38 | 000380 | CLOSE PRINTO. | |
| 39 | 000390 | STOP RUN. | |

Figure 5. Example of a COBOL Source Listing

DATA DIVISION MAP

| TYPE | LOCATION | DATA NAME |
|------|----------|-----------|
| FILE | | PRINTO |
| REC | 0000000 | A |
| | 0000000 | C-C |
| | 0000001 | GARB |
| | 0000021 | FULLER |
| | 0000000 | B |
| REC | 0000024 | D |
| REC | 0000024 | E |
| | 0000025 | F |

Figure 6. Example of a Data Map

PROCEDURE MAP (LISTX)

Figure 7 is an example of a procedure map. It is a portion of the procedure map generated for the program given in Figure 5 and is obtained when LISTX is specified on the job-control OPTION card. The listing is printed on the SYSLST unit. The details of LISTX are given for their debugging value.

- LINE/POS** Contains the generated line number and the position of the COBOL verb on the line. (These numbers are decimal numbers.) The actual instruction(s) used to accomplish the COBOL statement is identified by the compiler-generated internal line number(s). If more than one instruction was generated, the compiler-generated line number for that COBOL statement would be repeated for each instruction listed. A look at source statement 28 shows that MOVE is the first COBOL verb on the line, hence, its location is 28 01. Counting each element in the line from left to right (for definition of an element, see "e (for definition of an element, see "Error Messages (ERRS)"), it is found that the COBOL verb WRITE occupies position 6 on the line, hence, it is location 28 06. The MOVE verb required only one System/360 machine instruction to effect its action. However, the WRITE verb required five System/360 machine instructions to effect its action. This accounts for the fact that "28 06" appears five times in the listing. It should be noted that qualified words count as one element. The line counter cannot exceed 4095. At this point, it resets to 0.
- ADDR** Contains the relative address of each instruction in the procedure division in hexadecimal. The addresses are relative to the program's load point. The address may be offset by specifying PMAP=h on the COBOL CBL option statement.
- INSTRUCTION** Contains the machine language instruction (in hexadecimal) generated for the COBOL statement.

| LINE/POS | ADDR | INSTRUCTION |
|----------|--------|-------------------|
| 00028 01 | 003270 | D2 00 5 000 4 14D |
| 00028 06 | 003276 | D2 00 5 000 5 000 |
| 00028 06 | 003270 | 41 10 4 088 |
| 00028 06 | 003280 | 58 F0 1 010 |
| 00028 06 | 003284 | 45 E0 F 00C |
| 00028 06 | 003288 | 58 50 4 088 |
| 00029 01 | 00328C | D2 00 5 000 4 14E |
| 00029 06 | 003292 | D2 00 5 000 5 000 |
| 00029 06 | 00329B | 41 10 4 088 |
| 00029 06 | 00329C | 58 F0 1 010 |
| 00029 06 | 0032A0 | 45 E0 F 00C |
| 00029 06 | 0032A4 | 58 50 4 088 |

Figure 7. Example of a Procedure Map for a COBOL Program

DIAGNOSTIC MESSAGES (ERRS)

Figure 8 is an example of a list of error messages that are obtained when ERRS is specified on the job-control OPTION card. These diagnostic messages were generated by the compiler for the program shown in Figure 5. The list is generated on SYSLST.

LINE/POS Contains the internal line numbers of the source statements, and the position of the COBOL verb or element on the line where the error was detected. An element is a word, punctuation, picture, name, literal, or any other similar unit of COBOL syntax.

When the compiler cannot locate the item in error on the line, it identifies the line at fault by generating the SEQUENCE NUMBER X-0.

When the compiler generates the line number 0-0, it is referring to an entire section (the section may be missing).

ER CODE Contains a message number and the severity level of the error:

MESSAGE NUMBER The format of the message number, and the associated message is described in Appendix H.

Severity Code

W = WARNING Explanation
This calls attention to a condition that can cause a problem, but should permit a successful run.

C = CONDITIONAL The error statement is dropped or corrective action is taken. The compilation is continued as it may have debugging value, but the statement should not execute as intended.

E = ERROR This condition seriously affects execution of the job. Execution is not attempted.

CLAUSE This column identifies either the particular COBOL clause being processed at the time the diagnostic message was discovered or the basic area that was involved, such as ALIGNMENT, FD, or similar items.

MESSAGE The actual message is given here. These messages are listed in Appendix H.

| DIAGNOSTIC MESSAGES | | | |
|---------------------|---------|-----------|--|
| LINE/POS | ER CODE | CLAUSE | MESSAGE |
| 15-1 | IJS063W | ALIGNMENT | TO ALIGN BLOCKED RECORDS ADD 3 BYTES TO THE 01 CONTAINING DATANAME FILLER. |
| 18-1 | IJS054W | ALIGNMENT | FOR PROPER ALIGNMENT, A 4 BYTE LONG FILLER ENTRY IS INSERTED PRECEDING D. |

Figure 8. Example of Source Module Diagnostics

Working with Diagnostic Messages

1. Handle the diagnostic messages in the order in which they appear on the source listing. It is possible to get compound diagnostic messages. Frequently, an earlier diagnostic indicates the reason for a later diagnostic message. For example, a missing quote for an alphabetic or alphameric literal could involve the inclusion of some clauses not intended in that particular literal. This could cause an apparently valid clause to be diagnosed as invalid because it is not complete, or because it is in conflict with something that preceded it.
2. Check for missing or extra punctuation, or other errors of this type.
3. Frequently, a seemingly meaningless message is clarified when the valid syntax or reference format is referenced. Diagnostic messages are coded directly from the reference format and are designed for use in conjunction with the particular type of reference.

How Diagnostic Messages Are Determined

The compiler scans the statement, element by element, to determine whether the words are combined in a meaningful manner. Based upon the elements that have already been scanned, there are only certain words or elements that can be correctly encountered.

If the anticipated elements are not encountered, a diagnostic message is produced. Some errors may not be uncovered until information from various sections of the program are combined and the inconsistency indicated. Errors uncovered in this manner can produce a slightly different message format than those uncovered when the actual source text is still available. The message that is made unique through that particular error may not have, for example, the actual source statement that produced the error. The position and sequence reference, however, indicates the place at which the error was uncovered.

Errors that appear to be identical are diagnosed in a slightly different manner, depending on where they were encountered by the compiler and how they fit within the context of valid syntax. For example, a period missing from the end of the working-storage section clause, is diagnosed specifically as a period required. There is no other information that can occur at that point. However, if at the end of a record description entry, an element is encountered that is not valid at that point such as the digits 02, they are diagnosed as invalid. Any clauses associated with the clause at that entry, which conflict with the entries in the previous entry (the one that had the missing period), are diagnosed. Thus, a missing period produces a different type of diagnostic message in one case than in another.

If a given compilation produces more than 25 diagnostic messages, they are presented in a batched sequence. The first 25 messages are sorted in order, followed by the second series, which is also sorted in order.

If an error occurs after the 4095 source statement, the line sequence of the source statement in error can usually be determined by adding 4095 to the sequence number given in the diagnostic message. A message frequently suggests the division of a COBOL source program in which the error occurred.

Examples of How Diagnostic Messages Are Generated

Each message has a general or skeleton form. Unique words for each message are inserted to identify the specific error that was encountered. The following two examples illustrate this form.

Example 1:

COBOL format is MOVE data-name TO data-name ...
literal

```
Error 1          MOVE FIELDA TOO FIELDB
023
                ERROR #178
                INSERT1 TO          Information
                INSERT2 TOO        passed to
                                   diagnostic
                                   out of phase I19
```

Skeleton Message #178 CSYNTAX REQUIRES WORD "Insert1".
FOUND "Insert2".

REQUIRES WORD "TO". FOUND "TOO".

Example 2:

```
Error 2          NOVE FIELDA TO FIELDB
023
                ERROR #549
                INSERT1 NOVE
```

Skeleton Message #549 E WORD INSERT1 WAS EITHER INVALID
OR SKIPPED DUE TO ANOTHER DIAGNOSTIC.

Message appears as: 23-1 IJS549E "NOVE" UNHANDLED.
WORD NOVE WAS EITHER INVALID OR SKIPPED DUE TO ANOTHER
DIAGNOSTIC.

LINKAGE EDITOR OUTPUT

The linkage editor produces diagnostic messages, console messages and a storage map. For a description of output and error messages from the linkage editor see the IBM publications IBM System/360 DOS System Control and System Service Programs and IBM System/360 TOS System Control and System Service Programs.

EXECUTION TIME MESSAGES

When an error condition that is recognized by compiler generated code occurs during execution, an error message is written on SYSLST or SYSLOG. Any messages normally written on SYSLST that result from an error

in the foreground program are written on SYS000. Messages that normally appear on SYSLOG are provided with a code indicating whether the message originated in a foreground or background program. These messages and their descriptions are listed in Appendix H.

PROGRAM PHASE DUMPS

Execution of a program phase may produce a dump as part of an abort procedure. A dump is caused by one of many errors. Several of these errors may occur at the COBOL language level while others can occur at the job-control level.

Examples of COBOL language errors that can cause a dump follow.

1. A GO TO statement with no procedure name following it may have been in properly initialized with an ALTER statement. The execution of this statement will cause an invalid branch.
2. Arithmetic calculations or moves on numeric fields that have not been properly initialized can cause an interrupt and a dump.

For example, neglecting to initialize an OCCURS...DEPENDING ON clause, or referencing data fields prior to the first read may cause an interrupt and a dump.
3. Invalid data placed in a numeric field as a result of redefinition.
4. Input/output errors that are nonrecoverable.
5. Subscripts whose values exceed the defined maximum value will, when moved into the procedure division, can destroy machine instructions in the program.
6. Attempting to execute an invalid operation code through a systems error or invalid program.
7. Generating an invalid address for an area that has address protection.
8. Subprogram linkage declarations that are not defined exactly as they are stated in the calling program.
9. Data or instructions can be modified by entering a subprogram and manipulating data incorrectly. A COBOL subprogram could acquire invalid information from the main program, e.g., a CALL using a procedure-name and an ENTRY using a data name.
10. Incorrect tape record length. Causes the compiler to generate an invalid supervisor call SVC32. This initiates the dump terminating the job.
11. An input file contains invalid data such as a blank numeric field or data incorrectly specified by its data description.

The compiler does not generate a test to check the sign position for a valid configuration before the item is used as an operand. The programmer can test for valid data by means of the numeric class test and, by use of the TRANSFORM statement, convert it to valid data under certain circumstances.

For example, if the units position of a numeric data item described as USAGE IS DISPLAY contained a blank, the blank could be transformed to a zero, thus forcing a valid sign.

HOW TO USE A DUMP

Information regarding the location of the error and the reason for an interrupt precedes the dump.

The instruction address can be compared to the Procedure Division map. Such a map is produced in the listing by the LISTX option. The load address of the module (can be obtained from the map of main storage generated by the linkage editor) must be subtracted from the instruction address to obtain the relative instruction address as shown in the procedure map. The contents of LISTX provides a relative address for each statement. By use of the error address and LISTX, the programmer can locate a specific statement appearing within a line of the source program, if the interrupt was within the COBOL program. Examination of the statement and the fields associated with it may produce information as to the specific nature of the error. A more detailed analysis would involve a deeper knowledge of Disk and Tape Operating Systems and control programs.

Object Storage Layout

The relative position, in main storage, of all the components of a COBOL program is, as follows:

- COBOL subroutines
- Working storage data items
- Edit masks
- DTF tables
- Buffers
- Procedure literals
- Work area and global table
- Instructions
- Input/output subroutines
- Subprograms

The DEBUG option in the COBOL Disk and Tape Operating Systems language allows the programmer to use three new verbs for the purpose of debugging COBOL source programs. These verbs are EXHIBIT, TRACE, and ON. They can appear anywhere in the COBOL program or in a compile-time debugging packet. Their formats and a description of their use is contained in the publication IBM System/360 DOS-TOS COBOL Language Specifications. However, this section is included in the publication to give the programmer an idea of when to use the debugging language, how to construct a debugging packet, and what job control cards are needed to use the debugging packet. A complete list of precompile error messages is included in Appendix G. These messages reflect errors in the debug packet(s) only. They are not associated with compiling.

TRACE STATEMENT

When a job does not execute properly and the diagnostic messages fail to indicate how to correct the error, a READY TRACE statement can be inserted at a point known to be prior to the trouble area. The TRACE displays each paragraph name as control is passed to that paragraph. To reduce the volume of such a trace, it is possible to turn on the trace with a READY TRACE statement and turn it off with a RESET TRACE if the area can be localized. The TRACE function can be used any number of times within the program. It would reduce the volume if RESET were issued upon entering a loop (containing a paragraph name) and READY were issued upon leaving the loop.

It is sometimes difficult to determine what the specific path of program logic is. This is especially true with a series of PERFORMS or nested conditions. A TRACE statement can be very beneficial as an aid to this problem. Also, if values are inconsistent, a TRACE statement will again aid in determining whether or not a program is actually going through a certain point.

EXHIBIT STATEMENT

To find out what specifically caused the error within the paragraph, additional data can be obtained from the fields within the specific paragraph by use of the EXHIBIT statement. The EXHIBIT statement displays the field and the source name for identification purposes. Its use may be restricted to display the field only if it has changed since the last time the program fell through that point. This permits the programmer to check on the value of the subscript name or other fields that are pertinent to a given field, and to check out logic errors. An example of the various forms of this statement follows.

DATA DIVISION.

```
77 NO-CHANGE-NAME PICTURE XX VALUE 'AB'.  
77 SUB-SCRIPT-NAME PICTURE S999 COMPUTATIONAL VALUE 30.
```

PROCEDURE DIVISION.

TEST-LOOP.

```
EXHIBIT NAMED NO-CHANGE-NAME.  
EXHIBIT CHANGED NAMED SUB-SCRIPT-NAME.  
EXHIBIT CHANGED SUB-SCRIPT-NAME.  
EXHIBIT CHANGED NO-CHANGE-NAME.
```

```
ADD 10 TO SUB-SCRIPT-NAME.  IF SUB-SCRIPT-NAME = 100 NEXT SENTENCE  
ELSE GO TO TEST-LOOP.
```

The printout for this example is:

```
NO-CHANGE-NAME =AB  
SUB-SCRIPT-NAME = 30  
30  
AB  
NO-CHANGE-NAME =AB  
SUB-SCRIPT-NAME = 40  
40  
NO-CHANGE-NAME = AB  
SUB-SCRIPT-NAME = 50  
50  
.  
.  
.  
.
```

ON STATEMENT

It is possible, where large volumes of data are involved, to sample specific portions of a program by use of the ON statement. The ON statement allows the programmer to perform a series of operations at certain times when a program passes a particular point. For example, a series of operations could be performed the 110th time through a loop and every 5th time thereafter until the 275th time. This allows the programmer to determine whether or not a given loop gets out of the expected range for a particular program.

There can be any number of these statements, and there is a compiler counter generated for each one. The counter starts at zero and is increased by one each time the path of program execution falls through that specific point. For example, if the programmer knows that the error occurs on the 500th record processed, the ON statement can be used to count records. Then a READY TRACE can be set as the counter approaches the point where the error occurred. This eliminates tracing each statement up to that point. This type of example could also have been done by a counter or a PERFORM statement, but this method is easier.

Note: An ON statement with an UNTIL or ELSE option cannot be used in an IF statement.

THE DEBUG PACKET

The debug packet can be used only in background type processing. It is a tool used for debugging COBOL object modules and is positioned in the job input stream before the COBOL source module. The packet is combined with the COBOL source module before compilation begins. Where the pack-

et is positioned within the COBOL source module is determined by the procedure division name specified in the *DEBUG card of the packet.

JOB CONTROL SETUP FOR USING DEBUG PACKETS

Debug packets for a given compilation are processed as separate job steps immediately preceding the job step that executes the COBOL compiler program.

A number of debugging packets are permitted for a program depending on the size of the machine used. In practice, the number of packets required by a programmer should not exceed Disk and Tape Operating Systems storage facilities.

Each compile-time debugging packet is headed by the control card:

```
  1 _____ 8 _____  
  *DEBUG location
```

An example of the deck setup for executing a debugging packet, including all the required job control cards is given in Figure 9.

Note that the deck setup provides for the assignment of SYSIPT (for the COBOL compilation) to the drive currently assigned to SYS004 for the packet. This is required by job control, because SYSIPT is used as the input for the COBOL program.

If a disastrous error occurs, a message followed by "RUN TERMINATED" is displayed and listed. If the job runs to completion, a message saying that SYSIPT for the COBOL compilation should be assigned to the current SYS004 is displayed and listed.

At the conclusion of a compilation, SYSIPT should be reassigned to the original device if the job stream contains additional job steps.

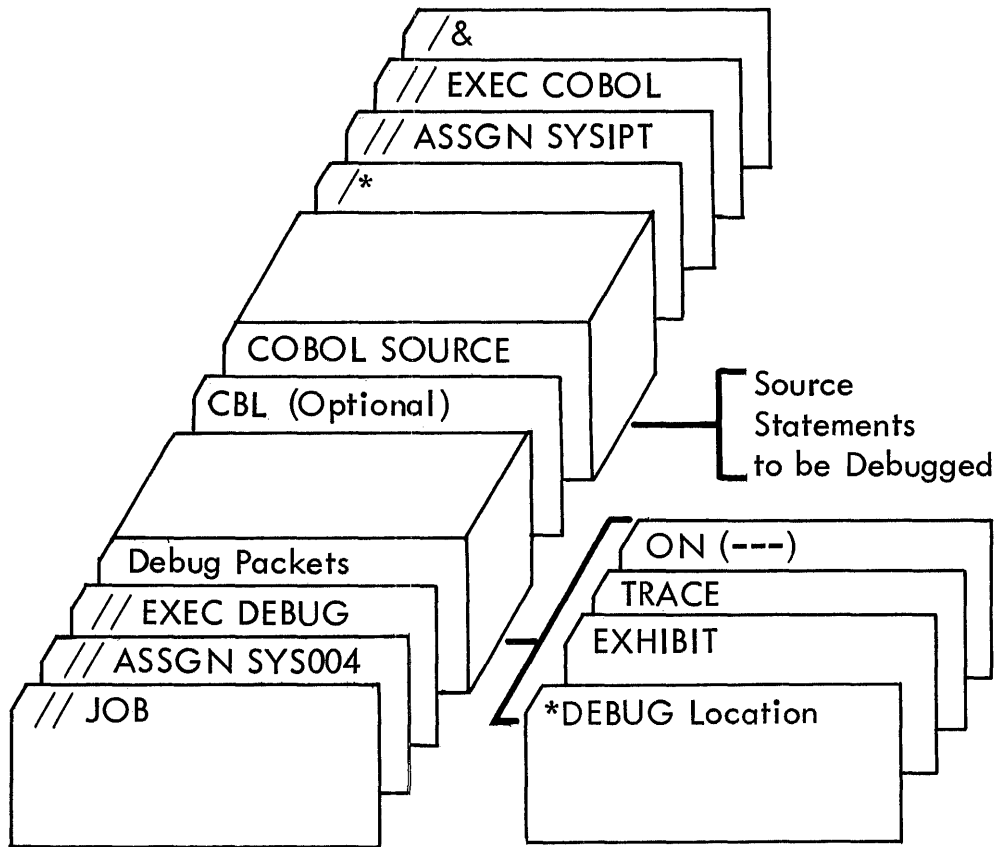

Figure 9. Example of a Debug Packet

SECTION VI: PROGRAMMING CONSIDERATIONS

This section is intended to aid the programmer in preparing efficient COBOL programs. Also included are discussions on error declaratives, variable length records, and processing buffers.

CONSERVING STORAGE

Entries in the data division can significantly affect the amount of core storage required by the program.

For example, saving one byte in the data division can cause a significant increase in the number of instructions generated in the procedure division. Conversely, a meaningful addition of one byte in the data division can result in saving 20 or more bytes of generated instructions for the procedure division. By judicious choice of such items as decimal-point alignment, sign declaration, and usage, the object code produced for the procedure division is more efficient. The compiler will resolve all of the allowable mixed data usages encountered. The required additional instructions are generated and additional storage is used.

However, if a programmer uses the methods illustrated in the following discussions, a significant amount of storage can be saved. For example, attention to decimal alignment saves storage, as follows:

1. To execute a statement, data must be aligned. Neglecting decimal alignment when defining data forces the compiler to align decimal points, which costs 18 or more bytes for each alignment procedure executed, thus using storage unnecessarily.
2. To give the programmer an idea of the effect data has on storage when data is defined without regard to optimization of data declarations, consider the following percentages and the following COBOL statements.

In a typical source statement deck, the frequency of the most common verbs written in the procedure division of a COBOL program, averaged over a number of programs, is:

```
MOVES - 50%
GO TO - 20%
IF - 15%
Miscellaneous (arithmetic calculations, input/output, PERFORMS,
etc.) - 15%
```

Assume that the number of move statements, out of a total of 250 procedural statements, is 125 and that all the sending fields and related receiving fields are defined without decimal alignment (worst case).

An example of one pair of fields is:

```
77 A PICTURE 99V9 COMPUTATIONAL-3. (sending field)
77 B PICTURE 999V99 COMPUTATIONAL-3. (receiving field)
```

Because the receiving field is one decimal position larger than the sending field, decimal alignment must be performed.

The cost in bytes of decimal alignment for these moves is: 125 moves times 18, or 2,250 bytes of storage. Each time these moves are executed 2,250 bytes of storage are used.

A programmer aware of the cost of nonalignment can conserve great amounts of storage simply by aligning decimals. Using one additional byte to align decimals in the data sending or receiving fields is small in cost, considering the savings possible in the procedure division.

The examples given in the following discussion illustrate efficient coding techniques to conserve core storage.

DECIMAL-POINT ALIGNMENT

The number of decimal positions should be the same whenever possible. If they are not, additional moves for padding, sign movement, and inserting blanks result. Statements involving fields with an unequal number of digits require intermediate operations for decimal-point alignment.

To get efficient code, the programmer should align decimal points wherever possible. If he cannot align data in the data division, he can move it to a work area. As a general rule, two or four additional instructions (12 to 18 bytes) are required in basic arithmetic statements and IF statements when decimal-point alignment is necessary to process two COMPUTATIONAL-3 fields.

Example:

```
77 A PICTURE S999V99          COMPUTATIONAL-3.  
77 B PICTURE S99V9           COMPUTATIONAL-3.
```

By adding one more decimal place to FIELD B (PICTURE S999V99), the need for alignment instructions is eliminated. No additional bytes are required for field B. (Note that System/360 hardware requires an odd number of digits for internal decimal fields. Use an odd number of nines when defining data in COMPUTATIONAL-3 format. This practice results in more efficient object code without using additional storage for the item defined.)

Example:

```
ADD 1 TO A.
```

The literal is compiled in internal decimal form, but decimal-point alignment instructions are necessary (4 instructions, 18 bytes). If instead, the literal is written 1.00, only one byte is added in the literal area. The 18 bytes required for alignment of decimal points are eliminated.

UNEQUAL-LENGTH FIELDS

Use the same number of integer digits in a field. An intermediate operation may be required when handling fields of unequal length. For example, zeros may have to be inserted in numeric fields and blanks in alphabetic or alphanumeric fields in order to pad out to the proper length. To avoid these operations, the number of integer digits in fields used together should be equal. Any increase in data field size is more than compensated for by the savings in generated object code.

For example, if data is defined as:

```
SENDFLD PICTURE S999.  
RECEIVEFLD PICTURE S99999.
```

and SENDFLD is moved to RECEIVEFLD, the cost of inserting zeros in the high-order positions (numeric fields are justified right) is 10 bytes. To eliminate these 10 bytes, SENDFLD should be defined as:

```
SENDFLD PICTURE S99999.
```

MIXED-DATA FORMATS

Do not mix data formats. When fields are used together in move, arithmetic, or relational statements, they should be in the same format whenever possible. Conversions require additional storage and longer execution time. Any operations involving data items of different formats require conversion of one of the items to a matching data format before the operation can be executed. For example, when comparing a DISPLAY field to a COMPUTATIONAL-3 field, the code generated by the COBOL processor moves the DISPLAY field to an internal work area, converting it to a COMPUTATIONAL-3 field. It then executes the comparison. This usage, although valid in COBOL, has the effect of reducing the efficiency of the program, by increasing its size. For maximum efficiency, avoid mixed data formats or use a one-time conversion; that is, move the data to a work area, thus converting it to the matching data format. By referencing the work area in procedural statements, the data is converted only once instead of for each operation.

The following example illustrates the conversions that take place when the components of a COMPUTE statement are defined:

```
A COMPUTATIONAL-1.  
B PICTURE S99V9 COMPUTATIONAL-3.  
C PICTURE S9999V9 COMPUTATIONAL-3.
```

and the following computation is specified,

```
COMPUTE C = A * B.
```

The internal decimal data (COMPUTATIONAL-3) is converted to floating-point format and then the COMPUTE is executed.

The result (which is in floating-point format) is converted to internal decimal. The required conversion routines are time consuming and use storage unnecessarily.

The following examples show what must logically be done, before the indicated operations can be performed, when working with mixed-data fields.

DISPLAY to COMPUTATIONAL-3

To Execute a MOVE: No additional code is required (if proper alignment exists) because one instruction can both move and convert the data.

To Execute a COMPARE: Before a COMPARE is executed, DISPLAY data must be converted to COMPUTATIONAL-3 format.

To Perform Arithmetic Calculations: Before arithmetics are performed, DISPLAY data is converted to COMPUTATIONAL-3 data format.

DISPLAY to COMPUTATIONAL

To Execute a MOVE: Before the MOVE is executed, DISPLAY data is converted to COMPUTATIONAL-3 data to COMPUTATIONAL data format.

To Execute a COMPARE: Before a COMPARE is executed, DISPLAY data is converted to COMPUTATIONAL-3 data format, and the COMPUTATIONAL data to COMPUTATIONAL-3 format.

To Perform Arithmetic Calculations: Before arithmetic calculations are performed, DISPLAY data is converted to COMPUTATIONAL-3 format, and then the COMPUTATIONAL-3 data to COMPUTATIONAL format.

COMPUTATIONAL-3 to COMPUTATIONAL

To Execute a MOVE: Before a MOVE is executed, COMPUTATIONAL-3 data is moved to a work field, and then converted to COMPUTATIONAL data format.

To Execute a COMPARE: Before a COMPARE is executed, COMPUTATIONAL data is converted to COMPUTATIONAL-3 data format.

To Perform Arithmetic Calculations: Before arithmetics calculations are performed, COMPUTATIONAL-3 data is converted to COMPUTATIONAL data format.

COMPUTATIONAL to COMPUTATIONAL-3

To Execute a MOVE: Before a MOVE is executed, COMPUTATIONAL data is converted to COMPUTATIONAL-3 data format.

To Execute a COMPARE: Before a COMPARE is executed COMPUTATIONAL data is converted to COMPUTATIONAL-3 data format.

To Perform Arithmetic Calculations: Before arithmetic calculations are performed, COMPUTATIONAL data is converted to COMPUTATIONAL-3 data format.

COMPUTATIONAL to DISPLAY

To Execute a MOVE: Before a MOVE is executed, COMPUTATIONAL data is converted to COMPUTATIONAL-3 data format, and then the COMPUTATIONAL-3 data to DISPLAY data format.

To Execute a COMPARE: Before a COMPARE is executed, COMPUTATIONAL data is converted to COMPUTATIONAL-3 data format, and DISPLAY data to COMPUTATIONAL-3 data format.

To Perform Arithmetic Calculations: Before arithmetic calculations are performed, COMPUTATIONAL data is converted to COMPUTATIONAL-3 data format, and DISPLAY data to COMPUTATIONAL-3 data format. The result is generated in a COMPUTATIONAL-3 work area, which is then moved to the DISPLAY result field.

COMPUTATIONAL-3 to DISPLAY

To Execute a MOVE: Before a MOVE is executed, COMPUTATIONAL-3 data is converted to DISPLAY data format.

To Execute a COMPARE: Before a COMPARE is executed, DISPLAY data is converted to COMPUTATIONAL-3 data format.

To Perform Arithmetic Calculations: Before arithmetic calculations are performed, DISPLAY data is converted to COMPUTATIONAL-3 data format. The result is generated in a COMPUTATIONAL-3 work area, which is then converted and moved to the DISPLAY result field.

DISPLAY to DISPLAY

To Perform Arithmetic Calculations: Before arithmetic calculations are performed, all DISPLAY data is converted to COMPUTATIONAL-3 data format. The result is generated in a COMPUTATIONAL-3 work area, which is then converted and moved to the DISPLAY result field.

Conversion of COMPUTATIONAL-1 or COMPUTATIONAL-2 Data

For efficient object code, use of floating-point (COMPUTATIONAL-1 or COMPUTATIONAL-2) numbers mixed with other usages should be held to a minimum. The conversion from internal to external floating point and vice versa is done by subroutines. Fields used in conjunction with a floating-point number are converted to floating-point format, causing the object program to perform conversions. For example, assume a COMPUTE is specified as:

```
COMPUTE A = B * C + D + E.
```

Assume B is COMPUTATIONAL-1 or COMPUTATIONAL-2 data and all other fields are defined as COMPUTATIONAL-3 data. Fields C, D, and E are converted to COMPUTATIONAL-1 or COMPUTATIONAL-2 data format, the calculation performed, and the result converted back from COMPUTATIONAL-1 or COMPUTATIONAL-2 data format to COMPUTATIONAL-3 data. If field B is defined as COMPUTATIONAL-3, no conversion is necessary. Use of floating-point numbers is more efficient when used in programs with computational data that is practically all COMPUTATIONAL-1 or COMPUTATIONAL-2 type. If it is necessary to use floating-point data, be careful not to mix data formats.

SIGN CONTROL

For numeric fields specified as unsigned (no S in the picture clause of decimal items), the COBOL compiler attempts to ensure that a special positive sign (F) is present so that the values are treated as absolute.

The compiler moves in a hexadecimal F whenever the possibility of the sign changing exists. Examples are: subtracting unsigned fields, moving a signed field to an unsigned field, or an arithmetic operation on signed fields where an unsigned result field is specified. The sign is not checked on input data or on group level moves. The programmer must know what type of data is being used, under those circumstances.

The use of unsigned numeric fields increases the possibility of error (an unintentional negative sign could cause invalid results) and requires additional generated code to control the sign. The use of unsigned fields should be limited to fields that are to be treated as absolute values.

Note: The hexadecimal F, while treated as a plus, does not cause the digit to be printed or punched as a signed digit.

The programmer should include a sign in numeric pictures unless absolute values are desired. The following example illustrates the additional instructions generated by the compiler each time an unsigned field is modified.

If data is defined as:

```
A PICTURE 999.  
B PICTURE S999.  
C PICTURE S999.
```

and the following moves are made,

```
MOVE B TO A.  
MOVE B TO C.
```

moving B to A causes four more bytes of storage to be used than moving B to C, because an absolute value is specified for receiving field A.

CONDITIONAL STATEMENTS

Keep arithmetic expressions out of conditional statements. Computing arithmetic values separately and then comparing them may produce more accurate results than including arithmetic statements in conditional statements. The final result of an expression included in a conditional statement is limited to an accuracy of six decimal places. The following example shows how separating computations from conditional statements can improve accuracy.

If data is defined as:

```
77 A PICTURE S9V9999 COMPUTATIONAL-3.  
77 B PICTURE S9V9999 COMPUTATIONAL-3.  
77 C PICTURE S999V99999999 COMPUTATIONAL-3.
```

and the following conditional statement is written,

```
IF A * B = C GO TO EQUALX.
```

the final result will be 99V999999. Although the receiving field for the final result (C) specifies 8 decimal positions, the final result actually obtained in this example contains 6 decimal places. For increased accuracy, define the final result field as desired, perform the computation, and then make the desired comparison, as follows.

```
77 X PICTURE IS S999V99999999 COMPUTATIONAL-3.  
COMPUTE X = A * B.  
IF X = C GO TO EQUALX.
```

OTHER CONSIDERATIONS USING DISPLAY AND COMPUTATIONAL FIELDS

DISPLAY (Non Numeric and External Decimal) Fields

Zeros and blanks are not inserted automatically by the logical instruction set. A move requires coding to insert zeros or blanks. On comparisons, the shorter item must be moved to a work area where zeros or blanks are inserted before the COMPARE statement can be executed.

COMPUTATIONAL-3 (Internal Decimal) Fields

The decimal feature provides for the automatic insertion of high-order zeros on additions, subtractions, and comparisons.

When a blank field (40) is moved into a field defined as COMPUTATIONAL-3, the sign position is not changed. Thus, the invalid sign bits of the blank field are retained. An arithmetic operation with such a field results in a program check. Before moving a blank field into a COMPUTATIONAL-3 field to be operated on, the sign position must be converted to a valid COBOL sign (F0).

COMPUTATIONAL Field

System/360 furnishes a large number of halfword and fullword instructions. Binary instructions require one of the operands to be in a register where a halfword is automatically expanded to a fullword. Therefore, handling mixed halfword and fullword fields requires no additional operations.

COMPUTATIONAL-1 and COMPUTATIONAL-2 Fields

A full set of short- and long-precision instructions is provided that enables operations involving mixed precision fields to be handled without conversion.

DATA FORMS

In order to conserve storage, the programmer must know COBOL data forms, and how they affect storage. Equally important is the way he organizes his data. The following information illustrates the various types of COBOL data forms, and their respective costs in alignment. Characteristics and requirements are described for the possible usages of numeric data, along with symbolic illustrations of what forms they take within the machine. Also included is a brief discussion of how to organize data efficiently.

Elementary Items

The number of bytes occupied by data in main storage depends on its format (or mode). Figure 10 illustrates the number of bytes required for each class of elementary items.

If files and working storage are organized so that all halfwords, fullwords, and double words are grouped together, essentially no additional storage is used. However, if these items are not grouped together properly, the amount of storage required for alignment is:

Halfword - 1 byte
Fullword - 1 to 3 bytes
Double word - 1 to 7 bytes

Group Item

Group moves of 256 or less bytes cost less than a series of single alphanumeric moves of the elementary items within the group item. Any move of a group or elementary item greater than 256 bytes in size results in a subroutine being executed.

When computational usage is specified in COBOL, slack bytes are inserted to give proper half-word, or full-word boundary alignment. This is necessary for the elementary item to be handled properly in binary arithmetic. However, using group items that include slack bytes could cause problems.

| TYPE OF ITEM | CALCULATION OF REQUIRED BYTES FROM PICTURE | |
|---------------------------------------|--|--|
| DISPLAY | | |
| Alphabetic | Bytes = Number of A's in picture | |
| Alphanumeric | Bytes = Number of X's in picture | |
| External Decimal | Bytes = Number of 9's in picture | |
| { External floating point } | Bytes = Number of characters in picture | |
| Report | Bytes = Number of characters in picture except P, V | |
| COMPUTATIONAL-3 | | |
| Internal Decimal | Bytes = (Number of 9's +1 divided by 2, rounded up) | |
| COMPUTATIONAL | | |
| | <u>Size</u> | <u>Alignment</u> |
| { Binary } Bytes = | { 2 if $1 \leq N \leq 4$ 4 if $5 \leq N \leq 9$ 8 if $10 \leq N \leq 18$ Where N=Number of 9's in picture | { Halfword Machine Address Fullword Machine Address Fullword Machine Address |
| COMPUTATIONAL-1 or COMPUTATIONAL-2 | { 4 if short- precision (computa- tional-1) 8 if long precision (computa- tional-2) | { Fullword Machine Address Double word Machine Address |
| { Internal floating point } | Bytes = | |

Figure 10. Number of Bytes Required for Each Class of Elementary Item

It is possible for two group items defined in exactly the same way to have a different number of slack bytes because they begin in different places, relative to word boundaries. Because group items use slack bytes as normal data, a move of the smaller of these to the larger can cause a loss of data. For example, assume two groups are defined, as follows:

```
Case 1      01 RECORD-1.
            02 GOLD PICTURE XX DISPLAY.
            02 MINERALS COMPUTATIONAL.
            03 OPAL PICTURE 99.
            03 QUARTZ PICTURE 99999.
```

```
Case 2      01 RECORD-1.
            02 MINERALS COMPUTATIONAL.
            03 OPAL PICTURE 99.
            03 QUARTZ PICTURE 99999.
```

Case 1 group (02 MINERALS) consists of a total of 6 bytes (it does not contain slack bytes).

Case 2 group (02 MINERALS) consists of a total of 8 bytes, including 2 slack bytes.

In case 2, 03 QUARTZ will be preceded by 2 slack bytes; thus, if case 2 group (02 MINERALS) is moved to case 1, the last 2 bytes of data will be lost.

If case 1 group (02 MINERALS) is moved to case 2 group, no data will be lost but the elementary 03 QUARTZ will be improperly aligned.

NUMERIC DATA FORMAT USAGE

Figure 11 lists the common characteristics and special characteristics of numeric data.

| Type of Data | No. of Bytes Required | Typical Usage | Converted in Arithmetic Calculation | Boundary Alignment Required | Special Characteristics |
|--|--|---|---|-----------------------------|---|
| DISPLAY (External decimal) | 1 per digit | Input from cards Output to card listings | Yes | No | May be used for numeric fields up to 18 digits long. Fields over 15 digits require extra instructions if used in computations. |
| COMPUTATIONAL-3 (Internal decimal) | 1 byte per 2 digits after the first byte for low-order digit | Input to a report item Arithmetic fields Work areas | Not normally | No | Requires less space than DISPLAY. Convenient form for decimal alignment. The natural form contains an odd number of digits. |
| COMPUTATIONAL (Binary) | 2 if $1 \leq N \leq 4$ 4 if $5 \leq N \leq 9$ 8 if $10 \leq N \leq 18$ | Subscripting Arithmetic | Yes/No--for mixed usages No--for unmixed usage | Yes | Rounding and on size error tests are cumbersome. Always must be signed. Fields of over 8 digits require more handling. |
| COMPUTATIONAL-1 COMPUTATIONAL-2 (Floating-Point) | 4 8 | Fractional exponentiation, or very large or very small values | No | Yes | Tends to produce less accuracy. COMPUTATIONAL-2 is more accurate than COMPUTATIONAL-1. Requires floating-point feature. |

Figure 11. Characteristics of Numeric Data

MACHINE REPRESENTATION OF DATA ITEMS

The following examples are machine representations of the various data items in COBOL.

Display (External Decimal)

If value is -1234, and:

S is the sign position of the number.
A 0 in the sign position indicates that the sign is plus.
A 1 in the sign position indicates that the sign is minus.

This form of data is referred to as floating point. The example is one of short precision. In long precision, the fraction length is 56 bits. For a detailed explanation of floating-point representation, refer to the publication IBM System/360 Principles of Operation listed in the preface of this manual.

EXAMPLES SHOWING EFFECT OF DATA DECLARATIONS

The specific series of instructions that are generated vary widely with the description of the data fields involved. Some examples of the range to be expected by slight differences in the data descriptions follow. The examples of possible expansions used are illustrative and should not be used for estimates of storage.

MOVE STATEMENT

Assume that data items A, B, C, and D are defined for the purpose of being moved as COMPUTATIONAL-3 fields or DISPLAY fields.

A PICTURE S99V99.
B PICTURE S99V99.
C PICTURE S99V9.
D PICTURE S99.

COMPUTATIONAL-3 Fields

If items A, B, C, and D are defined as COMPUTATIONAL-3 fields, the bytes used to:

Move A to B is: (When both integer and decimal places are equal)

6 bytes for a simple move.

Move C to B is: (The sign position must be moved, and the original sign changed.)

6 bytes for a simple move, and
18 bytes for decimal alignment.
24 bytes total

Move C to D is: (The sign requires a separate move.)

6 bytes for a simple move, and
18 bytes for decimal alignment.
24 bytes total

DISPLAY Fields

If data items A, B, C, and D are defined as DISPLAY fields, the bytes used to:

Move A to B is: (when both integer and decimal places are equal)

6 bytes for a simple move

Move C to D is:

6 bytes for a simple move, and
6 bytes for decimal alignment
12 bytes total

MOVE DISPLAY TO COMPUTATIONAL-3

The bytes used for moving DISPLAY data to a COMPUTATIONAL-3 field is:

6 bytes for conversion, and up to 24 bytes for decimal alignment.

MOVE COMPUTATIONAL-3 TO REPORT

The bytes used for moving COMPUTATIONAL-3 data to a report field is:

24 bytes for a simple move,
12 bytes for floating insertion character,
24 bytes for non-floating digit position.
18 bytes for decimal alignment,
24 bytes for trailing characters,
12 bytes for unmatched digit positions.

RELATIONALS

IF COMPUTATIONAL-3 = COMPUTATIONAL-3

The cost in bytes to execute an IF statement when all data is defined as COMPUTATIONAL-3 is:

6 bytes for the compare and branch instruction (no decimal alignment).
42 bytes for the compare and branch with decimal alignment.

IF DISPLAY = COMPUTATIONAL-3

The bytes used to execute an IF statement when data is defined as DISPLAY and COMPUTATIONAL-3 is:

18 bytes for conversion and for the compare and branch instruction,
and
18 bytes for decimal alignment.

IF COMPUTATIONAL = COMPUTATIONAL

The bytes used to execute an IF statement when all data is defined as COMPUTATIONAL is:

18 bytes for the compare and branch instruction, when the number of decimal digits is 1 to 9.

The number of bytes required to execute the IF statement is unpredictable when the number of decimal digits is from 10 to 18.

IF A * B = C * D, ETC.

For optimum use of core storage when writing an IF statement, first make all computations and then compare results.

ARITHMETIC COMPUTATIONS

ADD COMPUTATIONAL-3 TO COMPUTATIONAL-3

The bytes used to execute an ADD statement when all data is defined as computational-3 is:

6 bytes to execute the add, up to 56 bytes for alignment of decimals, and 4 bytes for blanking the sign.

GENERAL TECHNIQUES FOR CODING

The following examples illustrate how COBOL data fields can be manipulated. Some of the techniques illustrated are basic and can be used in most programs, whereas others are designed to give the programmer an insight into techniques applicable to more sophisticated programs.

INTERMEDIATE RESULTS IN COMPLEX EXPRESSIONS

The compiler can process complicated statements, but not always with the same efficiency of storage utilization as the source programmer. Because truncation may occur during computations, unexpected intermediate results may be obtained. The rules for truncation are in the publication IBM System/360 COBOL Language Specifications.

A method of avoiding unexpected intermediate results is to make critical computations by assigning maximum (or minimum) values to all fields and analyzing the results (by testing critical computations for results expected).

Because of concealed intermediate results, the final result is not always obvious.

Alternate Method of Solution (Unexpected Intermediate Results)

The necessity of computing worst case (or best case) results can be eliminated by keeping statements simple. This can be accomplished by splitting up the statement and controlling intermediate results to be sure unexpected final results are not obtained. Consider the following example:

```
COMPUTE B = (A + 3) / C + 27.600.
```

First define adequate intermediate result fields, i.e.,:

```
02 INTERMEDIATE-RESULT-A PICTURE S9(6)V999.  
02 INTERMEDIATE-RESULT-B PICTURE S9(6)V999.
```

Then, split up the expression, as follows.

```
ADD A,3 GIVING INTERMEDIATE-RESULT-A.
```

then write:

```
DIVIDE C INTO INTERMEDIATE-RESULT-A GIVING  
INTERMEDIATE-RESULT-B.
```

then, compute the final result by writing:

```
ADD INTERMEDIATE-RESULT-B, 27.600 GIVING B.
```

ARITHMETIC SUGGESTIONS

Arithmetic Fields

Initialize arithmetic fields before using them in computations. If the programmer attempts to use a field without it being initialized, the contents of the field are unpredictable: thus, invalid results might be obtained, or the job might terminate abnormally.

Exponentiation

Avoid exponentiation to a fractional power. For example:

```
V ** (P / N)
```

This requires the use of the floating-point feature. Use of floating point can be avoided by dividing the statements into separate computations. Example 1 requires the use of the floating-point feature. Example 2 restates the problem, illustrating how the use of floating point can be circumvented.

Assume data is defined:

```
DATA DIVISION.  
WORKING-STORAGE SECTION.  
77 FLD PICTURE S99V9, COMPUTATIONAL-3.  
77 EXPO PICTURE S99, COMPUTATIONAL-3.  
77 P PICTURE S99.  
77 N PICTURE S99.  
77 VALUE1 PICTURE S99.
```

Assume values used in the example were appropriately moved into their respective symbolic names, as follows:

VALUE1 = 5, P = 10, and N = 5.

Example 1:

```
COMPUTE FLD = VALUE1 ** (P / N).
```

Because $(P/N) = 10/5 = 2.00$ (with decimal places), the floating-point feature is required to solve this statement even though the exponent is an integer. The use of this type of statement involves the floating-point feature because it is not known whether decimal digits are present when the exponent is developed.

Example 2:

The statement in example 1 can be solved by writing:

```
COMPUTE EXPO = (P / N).
```

The result is truncated to two significant digits (S99), then write:

```
COMPUTE FLD = VALUE1 ** EXPO.
```

Thus, the statement written in example 1 can be solved by dividing it into two separate computations, avoiding the need for floating-point instructions.

Another occurrence that can affect final results is intermediate result truncation. For example, assume that

VALUE1 = 10, and N = 2

If $\text{COMPUTE FLD} = (\text{VALUE1} ** N) - 2$ is written, by substitution the result is:

```
FLD = (VALUE1 ** N) - 2
S99V9 = (S99 ** S99) - 2
S99V9 = (10 ** 2) - 2
S99V9 = 100.0 - 2
```

By the rule for truncation:

```
S99V9 = 100.0 - 2.
```

The most significant digit is truncated. The final result is then:

```
FLD = 00.0 - 2
```

An unexpected result could be:

```
FLD = 02.0
```

The situation can be corrected by expanding the target field (FLD), as follows:

```
77 FLD PICTURE S999V9.
```

then, when the statement is written (assuming VALUE1 = 10, and N = 2):

```
COMPUTE FLD = (VALUE1 ** N) - 2.
```

the result is:

```
FLD = (VALUE1 ** N) - 2
S999V9 = (S99 ** S99) - 2
S999V9 = (10 ** 2) - 2.
```

By the rule for truncation:

```
S999V9 = 100.0 - 2.
```

the result is,

```
FLD = 098.0
```

which is the expected result.

COMPARISONS

Numeric comparisons are usually done in COMPUTATIONAL-3 format; therefore, COMPUTATIONAL-3 is usually the most efficient data format.

Because compiler inserted slack bytes can contain meaningless data, group comparisons should not be attempted when slack bytes are within the group unless the programmer knows the contents of the slack bytes.

REDUNDANT CODING

To avoid redundant coding of usage designators, use computational designators at the group level (this does not affect the object program).

Example:

Instead of:

```
02 FULLER.
03 A COMPUTATIONAL-3 PICTURE 99V9.
03 B COMPUTATIONAL-3 PICTURE 99V9.
03 C COMPUTATIONAL-3 PICTURE 99V9.
```

write:

```
02 FULLER COMPUTATIONAL-3.
03 A PICTURE 99V9.
03 B PICTURE 99V9.
03 C PICTURE 99V9.
```

EDITING

A high-order nonfloating digit position involves more instructions than a floating digit position.

Example:

```
nonfloating      floating
999.99           vs  $$$9.99
```

The blank-when-zero is implied in certain pictures. For example:

ZZZ.ZZ

If blank-when-zero is not required for low-order characters, much more efficient coding is generated by pictures such as:

ZZZ.99

OPENING FILES

The OPEN statement does not require a work area. Less storage is used if multiple files are opened with one OPEN statement rather than specifying an OPEN statement for each file. A single OPEN requires approximately 100 bytes of additional storage for each file-name.

To conserve storage, use:

OPEN INPUT FILEA, FILEB.

rather than:

OPEN INPUT FILEA OPEN INPUT FILEB.

ACCEPT VERB

The ACCEPT verb does not provide for recognition of the last card being read from a card reader. When COBOL detects a /* card, it drops through to the next statement. Because no indication of this is given by COBOL, an end-of-file detection requires special treatment. Thus, the programmer must provide his own end card (some card other than /*) which he can test to detect an end-of-file condition.

PARAGRAPH NAMES

Paragraph names use storage when the PERFORM verb is used in the program. Use of paragraph names for comments requires more storage than the use of NOTE or a blank card. Use NOTE and/or a blank card for identifying in-line procedures where paragraph names are not required.

Example:

Avoid writing the following:

```
MOVE A TO B.  
PERFORM JOES-ROUTINE  
.  
.  
.  
JOES-ROUTINE. COMPUTE A = D + E * F.
```

The recommended coding is:

```
                MOVE A TO B.  
                PERFORM ROUTINE.  
                .  
                .  
                .  
                NOTE JOES-ROUTINE.  
ROUTINE.        COMPUTE A = D + E * F.
```

TRAILING CHARACTERS

Pictures with a trailing period or comma require that punctuation follow, otherwise the trailing picture character is treated as punctuation.

Example:

```
77A PICTURE IS 999., USAGE IS DISPLAY.
```

REDEFINITION

The results of moving a field to itself through the use of redefinition are unpredictable. To manipulate unusual data forms, use the REDEFINES clause. For example, a technique for isolating one binary byte follows.

```
02 A PICTURE S99 COMPUTATIONAL.  
02 FILLER REDEFINES A.  
   03 FILLER PICTURE X.  
   03 B PICTURE X.
```

Explanation:

COMPUTATIONAL sets up a binary halfword:

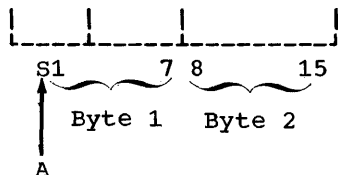

02 FILLER REDEFINES A., states that A is to be redefined as follows:

- Ignore first byte (03 FILLER PICTURE X).
- Name second byte B. (03 B PICTURE X).

Now byte B can be moved to a work area, and the assembler can perform logic operations operated on logically at the assembler level, or logical comparisons can be made by the COBOL program. It can be stored in a file, and later moved back to its point in a similarly defined field. However, using data in this manner can present problems regarding signs and numeric values. These problems require a knowledge of both System/360 and COBOL.

Another illustration of using the REDEFINES clause to manipulate data concerns the test IF NUMERIC. A field is considered numeric (under

normal language usage) if all the positions of the field are numeric with the exception of the sign position.

If a field is to be considered numeric only when it is unsigned, the sign position must be tested. A technique for relocating the sign (or "shifting") so that it can be tested as an unsigned numeric value follows.

Assume a field is defined:

```
02 IF-NUM-FIELD PICTURE X(5) VALUE '00000'.
02 CHANGE-FIELD REDEFINES IF-NUMB-FIELD.
03 REAL-FIELD, PICTURE S9(4).
03 FILLER, PICTURE X.
IF-NUM-FIELD defines a 5-byte alphanumeric field.
REAL-FIELD redefined this field to be 4 bytes numeric.
```

The fields appear in storage, as follows:

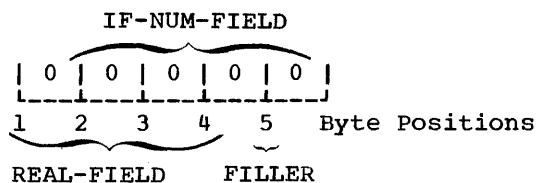

To make an IF NUMERIC test true for only unsigned fields:

1. Move the 4-byte value to be tested into REAL-FIELD. The value and its sign occupy bytes 1-4.

For example:

If +1234 is moved to REAL-FIELD, the resultant field appears in storage as follows:

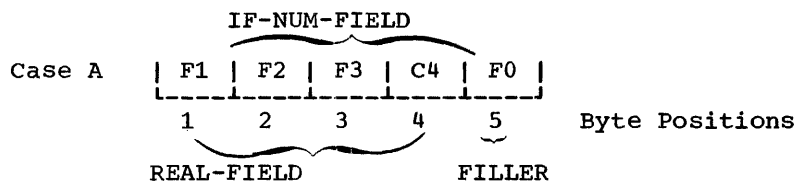

Note that the low-order byte (rightmost byte) of IF-NUM-FIELD retains its initial value of 0.

If 1234 is moved to REAL-FIELD, the resultant field appears in storage, as follows:

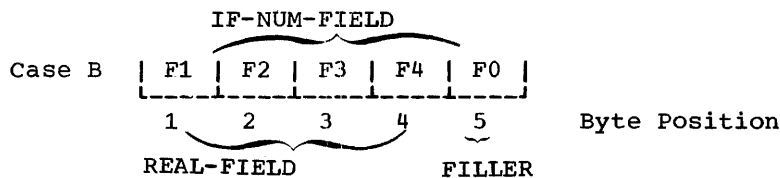

2. Test IF-NUM-FIELD FOR NUMERIC.

All four bytes of REAL-FIELD will be tested as an unsigned numeric value because the sign position was "shifted left one position," and is no longer in the units position of IF-NUM-FIELD. If the value is unsigned, a hexadecimal F appears in the sign position or fourth byte of the 4-byte field, and it appears as an unsigned numeric character.

Thus, in the preceding example, when the fourth byte is tested in case A, the numeric test fails, but when tested in case B the numeric test is satisfied.

ALIGNMENT AND SLACK BYTES

Unless binary (COMPUTATIONAL) or floating-point data (COMPUTATIONAL-1 or COMPUTATIONAL-2) is used, the programmer need not be concerned with slack bytes and alignment. Slack bytes are bytes inserted either by the programmer or the compiler in order to align data items.

Slack bytes required to align data are generated by the compiler.

Example:

```
01 RECORD.  
  02 FLD-1 PICTURE IS X(2).  
  02 FLD-2 PICTURE IS S99999 COMPUTATIONAL.
```

Because FLD-2 is binary and five digits in length, the compiler sets aside one fullword which must be aligned on a fullword boundary. In this example, two slack bytes are required. The compiler inserts them automatically.

A warning diagnostic message is given when slack bytes are inserted by the compiler.

Because COBOL aligns computational fields on output files and expects them to contain slack bytes (where required) on input files, a problem could exist when reading or writing a file.

A file that is to be read that contains computational fields without slack bytes must be coded in the same manner. That is, it must be coded with the knowledge that it does not contain slack bytes. If the file contains computational data without slack bytes, the data will not be properly aligned when read from the file, thus it cannot be processed by the compiler.

The following is a technique for manipulating computational data not containing slack bytes so that it may be processed by the compiler.

Assume a group record called RECORD-C exists on a file and consists of 2 bytes of alphanumeric data called GOLD, and 4 bytes of binary data called SILVER. The record in file would appear, as follows:

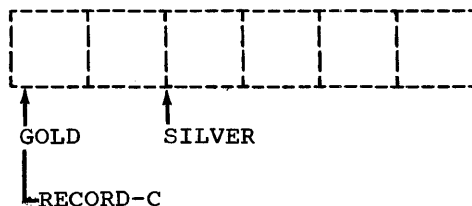

If an FD were defined:

```
01 RECORD-C.  
  02 GOLD PICTURE XX.  
  02 SILVER PICTURE S99999 COMPUTATIONAL.
```

The compiler assumes the following structure:

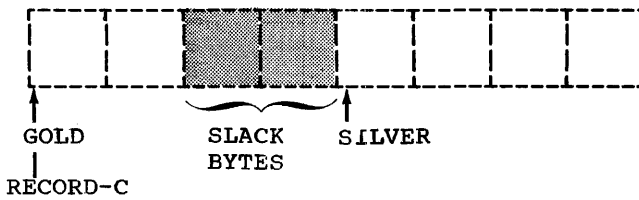

When the record on the file is read, it is placed in the area defined, left justified. The area thus contains the following:

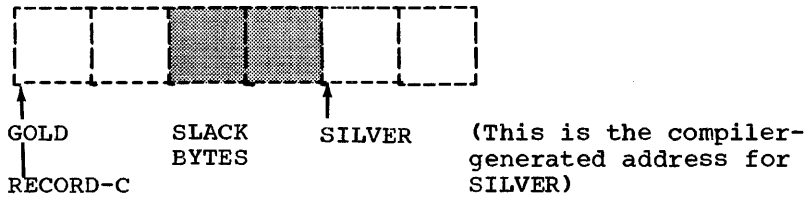

Thus, the first 2 bytes of the 02 SILVER are lost because of improper alignment. Hence, when the 02 SILVER is accessed, only the last 2 bytes are available.

To circumvent this problem, define RECORD-C, as follows:

```
02 GOLD PICTURE XX.
02 SILVER PICTURE XXXX.
```

and a GROUP item such as:

```
01 LEAD.
02 DIAMOND PICTURE S99999 COMPUTATIONAL.
```

Now, access RECORD-C. This places it in the buffer, properly aligned. Then move the 4-byte 02 SILVER (defined as alphanumeric but which is actually binary data) to the record 01 LEAD. Because the 01 LEAD is a group item, the data moved retains its original form (no data conversion takes place) and the 02 SILVER and 02 DIAMOND are properly aligned. Thus, by accessing DIAMOND, the binary data can be operated on as desired.

Assuming the same record (RECORD-C) out on the file, there is an alternate method of obtaining proper alignment when reading the record.

Define a record in an FD, as follows:

```
01 RECORD-C.
02 GOLD PICTURE XX.
02 SLIVER PICTURE XXXX.
```

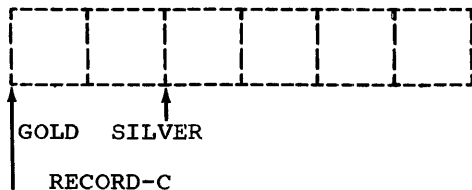

then define a record in the WORKING-STORAGE section as:

```
01 BRASS.  
  02 LEAD PICTURE XXXX.  
  02 DIAMOND REDEFINES LEAD PICTURE S99999 COMPUTATIONAL.
```

As before, when the record is accessed, it is placed properly aligned in the buffer.

Its structure in the buffer would be:

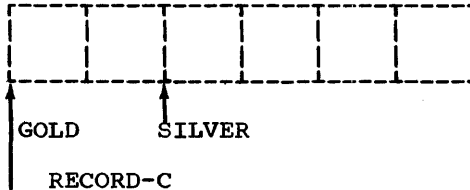

Now move the 4-byte 02 SILVER to the 02 LEAD. Because the 02 SILVER and 02 LEAD are both defined as display, the data retains its original form and are properly aligned. By accessing the REDEFINES (DIAMONDS) the binary data can be operated on as desired. The same problem could exist when reading or writing floating-point data.

For a complete discussion of slack bytes, refer to the publication IBM System/360 COBOL Language Specifications.

VARIABLE LENGTH RECORDS

Variable length records can be specified for standard sequential files only. The OCCURS...DEPENDING ON clause describes the part of the record that is to be variable. An example of specifying a variable length record is, as follows:

```
01 VARIABLE-REC.  
  05 FIXED.  
    10 A PICTURE X(46).  
    10 CONSTANT PICTURE 99.  
  05 VARIABLE-PART OCCURS 10 TIMES DEPENDING ON CONSTANT.  
    10 V-1 PICTURE X(38).  
    10 V-2 PICTURE 9(10).
```

The record consists of a fixed portion and a variable portion. The variable portion must be the last part of the record. The variable portion in the example can occur a maximum of 10 times depending on CONSTANT. In this example, CONSTANT is part of the record but it need not be. However, the programmer is always responsible for initializing and updating the value of CONSTANT before referring to data items that are part of the variable portion of the record (such as V-1 and V-2 in the example). The value of CONSTANT may be 0, in which case only the fixed portion of the record exists. However, the value of CONSTANT cannot be negative.

References to the variable portion must always be subscripted. For example, V-1 (1) refers to the first occurrence of the field in the record. If the subscript is a data-name, for example V-1 (N), the programmer must be sure that N has the appropriate value. He may wish to initialize it to 1, increment it to refer to subsequent portions of the record, and check it for maximum size.

If a subscript is represented by a literal, the location of the subscripted data item is resolved at compile time. If a subscript is represented by a data name, the location is resolved at execution time for each occurrence of the data item. Thus, if a data item subscripted by a variable is to be used frequently, it is more efficient to move the data item to a work area. It is also more efficient to define subscripts as COMPUTATIONAL with pictures of not more than five integers.

BLOCKING VARIABLE LENGTH RECORDS

When blocking variable length records, the programmer must consider how much the records will vary and the size of the buffer area. A buffer is a designated area in main storage used for input/output transactions. When file processing begins, a block is placed into a buffer where the records are directly addressed. Execution of a READ or WRITE statement directs a pointer to the appropriate record in the buffer. When writing a file, the buffer is filled and then written out as a block.

When a variable length record is written, it actually contains the record itself and a 4-byte control field indicating the record length. An additional 4-byte control field containing the block size precedes each block. The following illustration shows the layout of both blocked and unblocked records.

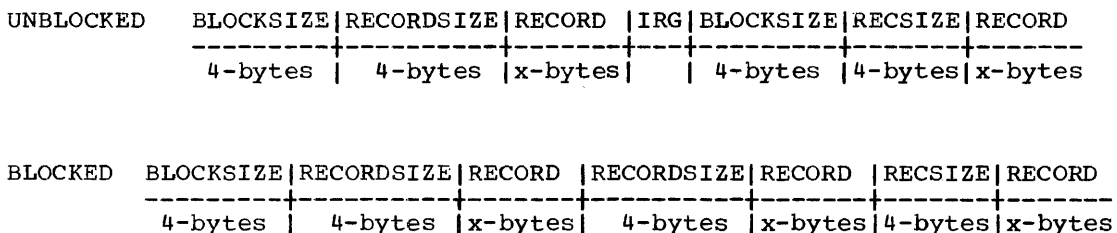

These control fields are supplied by the system and are not available to the programmer. However, they are a consideration when determining the buffer size which is specified by means of the BLOCK CONTAINS clause. If the BLOCK CONTAINS integer CHARACTERS form of the clause is used, integer must equal the size of the largest record defined for the file (RECORD CONTAINS) plus an additional 4-bytes for each record for the control field that precedes each record. (The compiler adds the 4-byte block count field. The programmer does not include this field in his count.) Note that if the file contains records with COMPUTATIONAL, COMPUTATIONAL-1, or COMPUTATIONAL-2 entries, it is the programmer's responsibility to add necessary intra-record slack bytes. These slack bytes are part of the record description and must be included in the value of the integer.

Thus, if two types of records are to be written, one of 400 characters in length and the other 200 characters in length (RECORD CONTAINS 200 TO 400 CHARACTERS), the minimum integer that can be specified is 404 (BLOCK CONTAINS 404).

However, if a record 200 characters long was placed in the block specified, there would not be enough space allocated for another record even if the next record was also 200 characters long, because the 4-byte count field preceding each variable length record could not be accommodated. Therefore, given the above facts, the programmer should at least specify BLOCK CONTAINS 408 optimum and use the APPLY WRITE-ONLY option. This option is specified to make optimum use of buffer space. When it

is specified, the length of the next record to be written is checked against the space remaining in the buffer. If the space is sufficient, the record is written. If APPLY WRITE-ONLY is not specified, the buffer is truncated and the block is written out whenever the space remaining in the buffer is not sufficient for the maximum record (400 characters in the above example) defined for the file.

The programmer can use the RECORDS option instead of the CHARACTERS option in the BLOCK CONTAINS clause to specify how many maximum size records are to fit into a block. The compiler then computes the buffer size by multiplying the length of the maximum size record by the number of records specified and adding 4 bytes for the block count field and 4 bytes for a count field for each record. This option is more efficient if the records do not vary in size considerably. However, if the following is specified:

```
RECORD CONTAINS 200 TO 400 CHARACTERS
BLOCK CONTAINS 3 RECORDS
```

the compiler reserves a buffer area of 1216 characters. Depending on the actual size of the records, more records could probably be contained in the buffer area. Given the above facts, it is possible for a block to contain five 200-character records ($5 * 204 + 4 < 1216$).

PROCESSING BUFFERS

Files can be processed using multiple buffers. Logical records are referenced in the proper block by adjusting registers (using them as pointers).

This technique eliminates the need for moving a record from the buffer area to a separate record work area, as well as the record work area itself. The record can be operated on directly in the buffer area.

When processing records in a buffer, the next read results in the previous record not being available. Because the previous record is no longer available, the technique of moving a high value to the control field of the last record (to force the processing of records remaining on the other file) cannot be used.

Here are several alternatives:

1. A GO TO statement, prior to the compare, can be altered during the AT END procedure to GO TO the low compare procedure, thus bypassing the compare.
2. A dummy record having a high value in its control field can be provided as the last logical record. This automatically causes the associated files to compare low. However, this can result in the AT END condition never occurring.
3. The control field can be moved to a separate work area following the read, and compared in the work area. The control field is then available in the work area following an AT END condition. The AT END procedure can move a high value into the control field.

VARIABLE RECORD ALIGNMENT CONTAINING OCCURS...DEPENDING ON CLAUSE

Records are processed in the file's buffer area. The first record starts on a doubleword boundary. If there is no OCCURS...DEPENDING ON

clause, a diagnostic message is given indicating the padding to be added to the record to assure proper alignment of succeeding records.

To align blocked V-type records containing an OCCURS...DEPENDING ON clause in the buffer:

1. Determine the largest alignment factor with the record.

| <u>Alignment factor is</u> | <u>For</u> |
|----------------------------|--|
| 2 | COMPUTATIONAL (1-4 digits) |
| 4 | COMPUTATIONAL-1 or COMPUTATIONAL (5-18 digits) |
| 8 | COMPUTATIONAL-2 |
| 0 | OTHER |

2. For alignment factors of four or less, pad both the fixed and the variable portions of the record to an even multiple of the alignment factor.
3. For an alignment factor of eight, move the record, as a group, to 01 in the working storage section.

MULTIVOLUME INPUT FILE WITH STANDARD LABELS, ALTERNATE TAPE DRIVE SPECIFIED

When volume switching occurs for a multivolume file with standard labels, the volume just completed will not rewind.

INPUT/OUTPUT ERROR PROCESSING CONSIDERATIONS

The USE AFTER STANDARD ERROR clause provides the programmer with a means for investigating input/output processing errors. Depending upon the presence or absence of the declarative section, IOCS provides certain error processing procedures when an input/output error occurs. The following points should be considered when the USE AFTER STANDARD ERROR clause is used with the various types of file organization.

SEQUENTIAL TAPE FILE ORGANIZATION

1. If the declarative section is not included in the program and a wrong length record occurs, the program is abnormally terminated and a storage dump is produced.

If the declarative section is not included in the program and a parity error is detected when a block of tape records is read, the tape is backspaced and reread 100 times. If the parity error persists, the tape block within which the error occurred is considered a tape error block, and the block is added to the block count found in the DTF table. IOCS indicates an input/output error (by a diagnostic message) and cancels the job.

2. If the declarative section is included in the program and a parity error is detected when a block of tape records is read (described in 1 above), the tape is backspaced and reread 100 times. If the error persists, the tape block is considered a tape error block, and the block is added to the block count found in the DTF table. However, instead of canceling the job (this occurs when a declara-

tive section is not included in the program), IOCS transfers control to the declarative section procedures to be followed on an error condition.

3. The address of the tape error block is stored by COBOL in register 3 + 192, and is accessible through an assembler subprogram.

Normal return (to the main program) from the declarative section is through the IOCS subroutine invoked, thus bringing the next sequential block into main storage and permitting continued processing of the file (the bad block is bypassed).

The programmer can interrogate the DTF table further, and display any pertinent data desired (such as block number) by using a CALL statement USING filename.

A return through the use of GO TO does not bring the next block into main storage, therefore continued processing of the file is impossible.

4. In the case of tapes, the error declarative is entered only for read errors. For write errors, IOCS automatically retries 15 times (including skips and erases) and then cancels the job.

SEQUENTIAL DISK FILE ORGANIZATION

1. If the declarative section is not included in the program and a parity error occurs when a block of records is read, the disk block is reread 10 times. If the read error persists, the disk block, within which the error occurred is considered a disk error block, and the job is terminated. If a parity error occurs when a block of records is written, IOCS attempts to write the block on an alternate track, and continued processing of the file is permitted.

If the declarative section is not included in the program and a wrong length record occurs, IOCS issues an invalid supervisor CALL of 32 which causes a storage dump.

2. If the declarative section is included in the program, and a read or write error occurs that the programmer does not want canceled, the declarative section is entered.

If a parity error occurs when a block of records is read (described in 1 above), the disk block is reread 10 times. If the read error persists, the disk block within which the error occurred is considered a disk error block and a READ operation cannot be issued to the error block. IOCS transfers control to the declarative section procedures to be followed on an error condition.

In the case of a READ operation, normal return from the declarative is to the IOCS subroutine invoked, thus bringing the next sequential block into storage and permitting continued processing of the file.

If a parity error occurs when a block of records is written, IOCS transfers control to the declarative section procedures to be followed on an error condition.

In the case of a WRITE operation, normal return from the declarative is to the next instruction in the problem program. The disk block that was to be written is bypassed.

3. In the case of a READ error, a return from the declarative through the use of GO TO does not bring the next block into main storage.

Continued processing of the file is impossible and the file must be closed.

In the case of a WRITE error, a return from the declarative through the use of GO TO permits continued processing of the file. A normal return from the declarative results in the record to be written being bypassed.

Refer to Section VIII: Processing COBOL Files on Direct Access Devices for information on error processing for other direct access organizations.

LINKAGE EDITOR

The output of a COBOL compilation is an object module. Before the program can be executed, it must be altered to a form acceptable for execution. The linkage editor edits the object module and produces a program phase. The structure of a program phase makes it suitable for execution. The COBOL program itself is produced as one control section. However, there may be external references, such as entry points to subroutines or subprograms to be resolved. The subroutines that the COBOL compiler calls for in the object program, e.g., for conversion from COMPUTATIONAL to COMPUTATIONAL-3, are obtained from the relocatable library. The subprograms that a user CALLS in his COBOL source program can be obtained from SYSIPT or from the relocatable library.

CALLING A SUBPROGRAM

Figure 12 illustrates how a subprogram is called and what data definitions are required to support the CALL.

The calling program 'CALLPROG' calls the subprogram 'PAYROLL', handing 'PAYMASTER' the address of the group item, JONES-J.

The elementary data items subordinate to JONES-J, i.e., SALARY, RATE, HOURS, can be operated on by 'PAYMASTER' through its using statement parameter, PAYOFF.

In effect, JONES-J is "equated" to PAYOFF. Any operation performed on data items subordinate to PAYOFF are really done to those items subordinate to JONES-J.

Be sure the PICTURE descriptions of equated data items are identical. There is no necessary relationship between the names of data items between calling programs and subprograms.

Notice that the PICTURES for the data items under JONES-J and PAYOFF are identical. This is good technique.

It is not required, necessarily, that the number of characters in a PICTURE of a data item be identical to its related data item, but it is required that the number of characters per record description be equal to its associated record. (The record in the calling program and the record in the called subprogram.)

Note: The entry-name (ENTRY 'PAYMASTER') must not be the same as the Program-ID ('PAYROLL').

| IBM | | COBOL PROGRAM SHEET | | | | | | | | | | Form No. X28-1464 Printed in U.S.A. | | | | | | | | | |
|---------------------------------|--------|---|-------------------------|-----------------------|--------|--------------|----|----------------|----|----------|----|--|----|----|----|----|----|----|----|----|----|
| System IBM SYSTEM/360 COBOL | | | | Punching Instructions | | | | | | Sheet of | | | | | | | | | | | |
| Program DATA PASSING SUBROUTINE | | | | Graphic | | Card Form# * | | Identification | | | | | | | | | | | | | |
| Programmer J. DOE | | Date | | Punch | | | | 73 80 | | | | | | | | | | | | | |
| SEQUENCE (PAGE) | 1 3 | 2 4 | 3 6 | 4 7 | A 8 | B 12 | 16 | 20 | 24 | 28 | 32 | 36 | 40 | 44 | 48 | 52 | 56 | 60 | 64 | 68 | 72 |
| 001 | 001 | IDENTIFICATION DIVISION. | | | | | | | | | | | | | | | | | | | |
| . | 002 | PROGRAM-ID. 'PAYROLL'. | | | | | | | | | | | | | | | | | | | |
| . | . | | | | | | | | | | | | | | | | | | | | |
| . | . | | | | | | | | | | | | | | | | | | | | |
| . | 005 | DATA DIVISION. | | | | | | | | | | | | | | | | | | | |
| . | . | | | | | | | | | | | | | | | | | | | | |
| . | 008 | 77 SALARYX PICTURE IS 9(5)V99 VALUE IS 0000000. | | | | | | | | | | | | | | | | | | | |
| . | . | | | | | | | | | | | | | | | | | | | | |
| . | 012 | LINKAGE SECTION. | | | | | | | | | | | | | | | | | | | |
| . | . | | | | | | | | | | | | | | | | | | | | |
| . | 015 | 01 | PAYOFF. | | | | | | | | | | | | | | | | | | |
| . | 016 | 02 | PAY PICTURE IS 9(5)V99. | | | | | | | | | | | | | | | | | | |
| . | 017 | 02 | RATEX PICTURE IS 9V99. | | | | | | | | | | | | | | | | | | |
| . | . | 02 | HOURS PICTURE IS 99V9. | | | | | | | | | | | | | | | | | | |
| . | 025 | PROCEDURE DIVISION. | | | | | | | | | | | | | | | | | | | |
| . | . | | | | | | | | | | | | | | | | | | | | |
| . | . | | | | | | | | | | | | | | | | | | | | |
| . | 040 | ENTER LINKAGE. | | | | | | | | | | | | | | | | | | | |
| . | 041 | ENTRY 'PAYMASTER' USING PAYOFF. | | | | | | | | | | | | | | | | | | | |
| 001 | 042 | ENTER COBOL. | | | | | | | | | | | | | | | | | | | |

A standard card form, IBM electro C61897, is available for punching source statements from this form.

Figure 12. Example of a Calling Program (Part 2 of 3).

| IBM | | COBOL PROGRAM SHEET | | | | | | | | | | Form No. X28-1464 Printed in U.S.A. | | | | | | | | | |
|---------------------------------|--------|---|--------|-----------------------|--------|--------------|----|----------------|----|----------|----|--|----|----|----|----|----|----|----|----|----|
| System IBM SYSTEM/360 COBOL | | | | Punching Instructions | | | | | | Sheet of | | | | | | | | | | | |
| Program DATA PASSING SUBROUTINE | | | | Graphic | | Card Form# * | | Identification | | | | | | | | | | | | | |
| Programmer J. DOE | | Date | | Punch | | | | 73 80 | | | | | | | | | | | | | |
| SEQUENCE (PAGE) | 1 3 | 2 4 | 3 6 | 4 7 | A 8 | B 12 | 16 | 20 | 24 | 28 | 32 | 36 | 40 | 44 | 48 | 52 | 56 | 60 | 64 | 68 | 72 |
| 002 | 044 | COMPT. COMPUTE SALARYX = HOURS * RATEX. | | | | | | | | | | | | | | | | | | | |
| . | . | | | | | | | | | | | | | | | | | | | | |
| . | 047 | MOVE SALARYX TO PAY. | | | | | | | | | | | | | | | | | | | |
| . | . | | | | | | | | | | | | | | | | | | | | |
| . | 050 | ENTER LINKAGE. | | | | | | | | | | | | | | | | | | | |
| . | 051 | RETURN. | | | | | | | | | | | | | | | | | | | |
| 002 | 052 | ENTER COBOL. | | | | | | | | | | | | | | | | | | | |

Figure 12. Example of a Calling Program (Part 3 of 3).

ACCESSING CALL PARAMETERS

When a call is issued, the address of JONES-J is passed to a special table generated by COBOL and reserved for USING statement parameters. (The user need not declare storage for this table because it is taken care of by COBOL.) Control is then transferred to the subprogram (entry point) which accesses a special register that contains the address of the generated table. The table contains all the addresses of USING statement items declared by the calling program (JONES-J). The subprogram, having obtained the address of the parameter table, can operate on any parameter (JONES-J) in the table. (Therefore, it can operate on any item subordinate to a parameter.)

Any procedural statements referencing using parameters written in the subprogram actually operate on the data items declared in the calling program as though they (data items) were located within their own data division. The subprogram makes a salary computation:

```
COMP. COMPUTE SALARYX = HOURS * RATEX
```

and moves SALARYX into the elementary item called PAY. Since JONES-J is equated to PAYOFF, then SALARY (under JONES-J) is equated to PAY, and SALARY (under JONES-J) contains the result of the computation COMP.

As illustrated, procedures previously written as subprograms can be used by employing the calling statement. This eliminates the need for repeated coding of frequently used procedures.

A programmer may want to prepare subprograms written in assembler language for use with COBOL programs. For a description of the conventions used in System/360 for preparing and using assembler language subprograms with COBOL, refer to Appendix A.

RESTRICTIONS ON THE USING STATEMENT

The maximum number of parameters permitted in a USING statement is 40. The total number of distinct paragraph names used in all the USING statements in the entire program is limited to 90. There is no upper limit to the number of data-names and file-names used throughout the program although 40 parameters per USING statement also applies to data name. Exceeding the limits specified causes diagnostic error messages.

OVERLAY STRUCTURES

The following discussion illustrates the procedures available for processing COBOL subprograms. The first technique employs the linkage editor without using the overlay facility. The second technique employs the linkage editor using the overlay facility. This technique allows the programmer to specify, at linkage edit time, the overlays required for a program. During execution of a program, overlays are performed automatically for the programmer by the control program.

Linkage Editing without Overlay

Normally, all subprograms referenced by the COBOL source program, including the main program, will fit into main storage. Therefore, the linkage editor nonoverlay technique of processing can be used to execute the entire program.

Figure 13 illustrates the storage layout for nonoverlay processing.

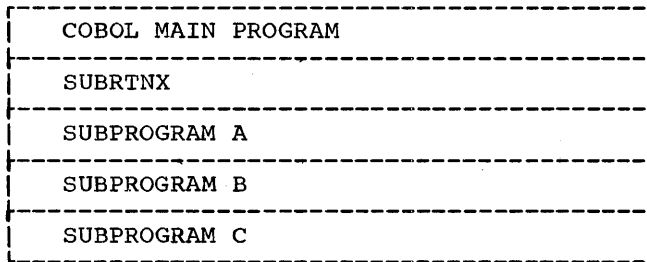

Figure 13. Storage Layout for Nonoverlay

Following is an example of the job control cards needed for the COBOL call structure without overlay. In this example, all the subprograms (including the main program NOVERLAY) fit into main storage.

Figure 14 portrays the flow of data as a result of the call structure.

```

// JOB NOVERLAY
// OPTION LINK,LIST,DUMP
ACTION MAP
  PHASE EXAMP1,*
  INCLUDE

      {Object Module A}

/*
  INCLUDE SUBRTNC
  INCLUDE SUBRTND
  INCLUDE

  SUBRTN
  OBJMOD B

/*
  ENTRY
// EXEC LNKEDT
// EXEC

      (data for program)
/*
/ε

```

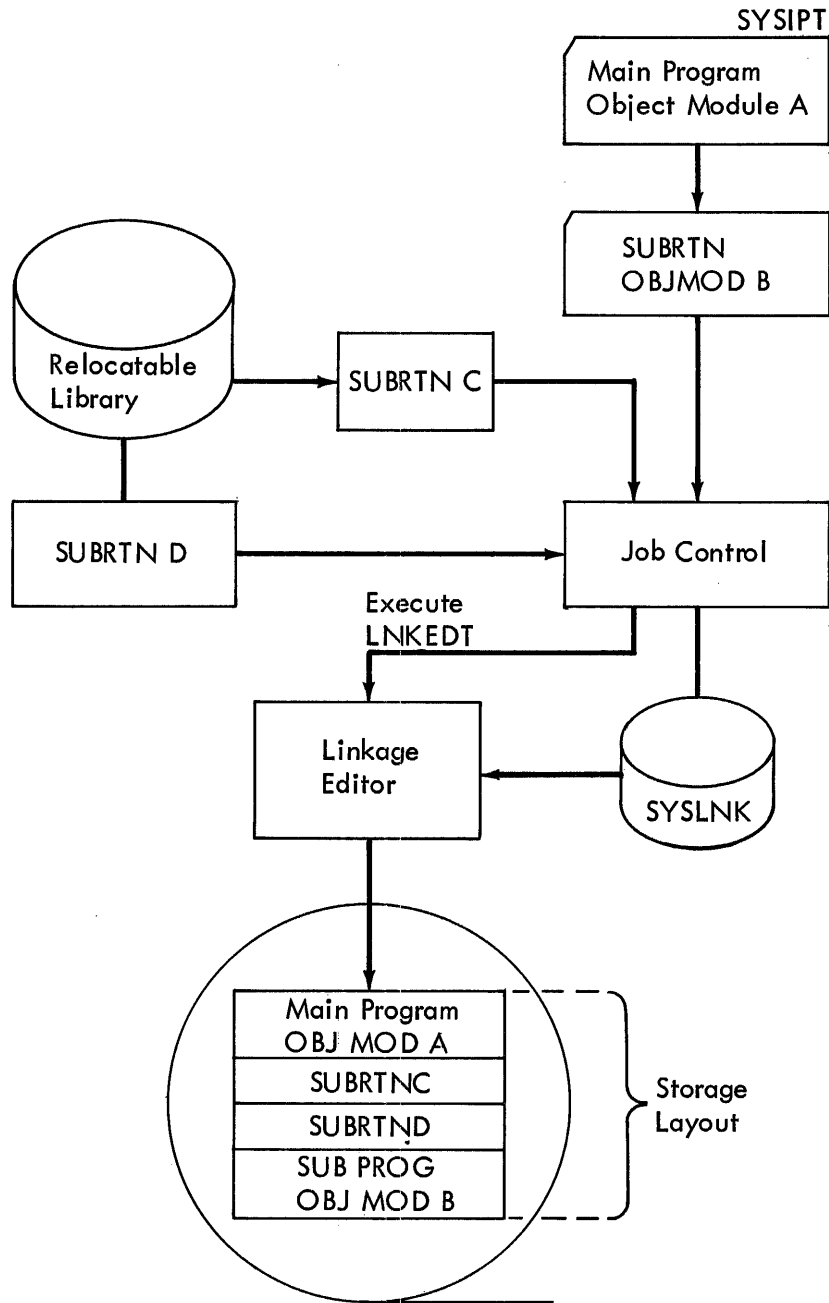

Figure 14. Example of Data Flow Logic in a Call Structure

Note: For the example given, it is assumed that SYSLNK is a standard assignment. The flow diagram illustrates how the various program segments are linkage edited into storage in a sequential arrangement.

OVERLAY PROCESSING

If the subprograms needed do not fit into main storage, it is still possible to use them. The technique that enables the programmer to use subprograms that do not fit into main storage (along with the main program) is called overlay.

Figure 15 illustrates storage layout for overlay processing.

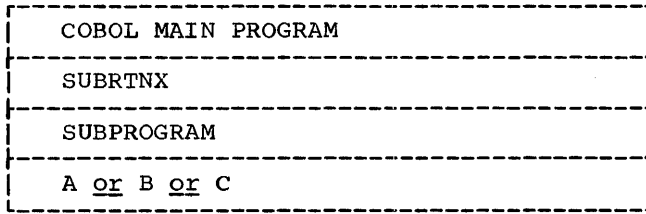

Figure 15. Storage Layout for Overlay Processing

Linkage Editing with Overlay

The linkage editor facility permits the reuse of storage locations already occupied. By judiciously segmenting a program and using the linkage editor overlay facility, the programmer can accomplish the execution of a program too large to fit into storage at one time.

In using the overlay technique, the programmer specifies, to the linkage editor, which subprograms are to overlay each other. The subprograms specified are processed, as part of the program, by the linkage editor so they can be automatically placed in main storage for execution when requested by the program. The resulting output of the linkage editor is called an overlay structure.

It is possible, at linkage edit time, to set up an overlay structure by using the COBOL source language statement `ENTER LINKAGE` and an assembler language subroutine (such as the assembler language subroutine `OVLAY`, given in Appendix A). These statements enable a user to call a subprogram that is not actually in storage. The details for setting up the linkage editor control statements for accomplishing this procedure can be found in the publication System Control and System Service listed in the preface of this manual.

In a linkage editor run, the programmer specifies the overlay points in a program by using `PHASE` statements. The linkage editor treats the entire input as one program, resolving all symbols and inserting tables into the program.

These tables are used by the control program to bring the overlay subprograms into storage automatically, when called. An example is given to illustrate how the overlay facility is used.

The intent of the overlay example given is merely to show how an overlay structure is coded; therefore, no processing of the related parameters are illustrated.

In order to process the parameters in the respective subprograms, the `USING` parameters specified therein must be appropriately defined in the pertinent working storage sections. Procedural statements can then be written in each subprogram for the respective parameters.

It is the programmer's responsibility to write the entire overlay procedure, i.e., the COBOL main (or calling) program, an assembler language subroutine that fetches and overlays the subprograms desired, and the overlay subprograms themselves. The linkage conventions for using assembler language subroutines with COBOL subprograms are given in Appendix A. A calling sequence to obtain an overlay structure between two COBOL programs follows.

COBOL Program Main (Root or Main Program):

IDENTIFICATION DIVISION.

PROGRAM-ID. 'OVERLAY'.

.

.

.

ENVIRONMENT DIVISION.

.

.

.

WORKING-STORAGE SECTION.

77 PROCESS-LABEL PICTURE IS X(8) VALUE IS 'OVERLAYB'.

77 PARAM-1 PICTURE IS X.

77 PARAM-2 PICTURE IS XX.

77 COMPUTE-TAX PICTURE IS X(8) VALUE IS 'OVERLAYC'.

01 NAMET.

02 EMPLOY-NUMB PICTURE IS 9(5).

02 SALARY PICTURE IS 9(4)V99.

02 RATE PICTURE IS 9(3)V99.

02 HOURS-REG PICTURE IS 9(3)V99.

02 HOURS-OT PICTURE IS 9(2)V99.

01 COMPUTE-SALARY PICTURE IS X(8) VALUE IS 'OVERLAYD'.

01 NAMES.

02 RATES PICTURE IS 9(6).

02 HOURS PICTURE IS 9(3)V99.

02 SALARYX PICTURE IS 9(2)V99.

.

.

.

PROCEDURE DIVISION.

.

.

.

ENTER LINKAGE.

CALL 'OVRLAY' USING PROCESS-LABEL, PARAM-1, PARAM-2.

ENTER COBOL.

.

.

.

ENTER LINKAGE.

CALL 'OVRLAY' USING COMPUTE-TAX, NAMET.

ENTER COBOL.

.

.

.

ENTER LINKAGE.

CALL 'OVRLAY' USING COMPUTE-SALARY, NAMES.

ENTER COBOL.

.

.

.

ENTER LINKAGE.

CALL 'OVRLAY' USING COMPUTE-TAX, NAMET.

ENTER COBOL.

.

.

.

COBOL Subprogram B:

```
IDENTIFICATION DIVISION.
PROGRAM-ID. 'OVERLAY1'.
.
.
ENVIRONMENT DIVISION.
.
.
DATA DIVISION.
.
.
LINKAGE SECTION.
01 PARAM-10 PICTURE IS X.
01 PARAM-20 PICTURE IS XX.
PROCEDURE DIVISION.
    ENTER LINKAGE.
    ENTRY 'OVERLAYX' USING PARAM-10, PARAM-20.
    ENTER COBOL.
.
.
    ENTER LINKAGE.
    RETURN.
    ENTER COBOL.
```

COBOL Subprogram C:

```
IDENTIFICATION DIVISION.
PROGRAM-ID 'OVERLAY2'.
.
.
ENVIRONMENT DIVISION.
.
.
DATA DIVISION.
LINKAGE SECTION.
01 NAMEX.
    02 EMPLOY-NUMBX PICTURE IS 9(5).
    02 SALARYX PICTURE IS 9(4)V99.
    02 RATEX PICTURE IS 9(3)V99.
    02 HOURS-REGX PICTURE IS 9(3)V99.
    02 HOURS-OTX PICTURE IS 9(2)V99.
PROCEDURE DIVISION,
.
.
    ENTER LINKAGE.
    ENTRY 'OVERLAYX' USING NAMEX.
    ENTER COBOL.
.
.
    ENTER LINKAGE.
    RETURN.
    ENTER COBOL.
```

COBOL Subprogram D:

```
IDENTIFICATION DIVISION.
PROGRAM-ID. 'OVERLAY3'.
.
.
ENVIRONMENT DIVISION.
.
.
DATA DIVISION.
LINKAGE SECTION.
01 NAMES.
    02 RATES PICTURE IS 9(6).
    02 HOURS PICTURE IS 9(3)V99.
    02 SALARYX PICTURE IS 9(2)V99.
PROCEDURE DIVISION.
ENTER LINKAGE.
ENTRY 'OVERLAYZ' USING NAMES.
ENTER COBOL.
.
.
ENTER LINKAGE.
RETURN.
ENTER COBOL.
```

An assembly program called OVRLAY effects the overlay. It fetches the COBOL subprogram called by the COBOL main program and puts it in the overlay area.

Appendix A contains the assembly routine that accomplishes the overlay. Figure 16 is a flow diagram of the overlay logic.

Note that if OVERLAYB were known to be in storage the CALL would be:

```
CALL 'OVERLAYX' USING PARAM-1, PARAM-2.
```

But, when using the OVRLAY subroutine, it becomes:

```
CALL 'OVRLAY' USING PROCESS-LABEL, PARAM-1, PARAM-2.
```

where PROCESS-LABEL contains the external name 'OVERLAYB' of the subprogram.

However, the ENTRY statement of the subprogram is the same for both cases, i.e., ENTRY 'OVERLAYX' USING PARAM-10, PARAM-20, whether it is called indirectly by the main program through the OVRLAY program or called directly by the main program.

Note: An ENTRY that is to be called by OVRLAY must precede the first executable statement in the subprogram.

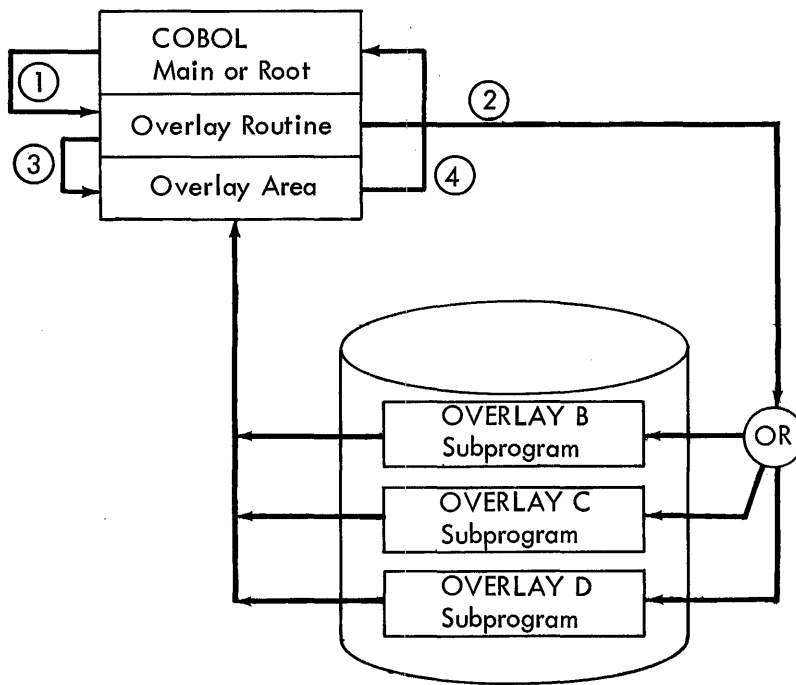

Figure 16. Flow Diagram of Overlay Logic

The job control statements required to accomplish overlay follow. The PHASE statements specify to the linkage editor that the overlay structure to be established is one in which subprograms OVERLAYB, OVERLAYC, and OVERLAYD overlay each other when called during execution.

```

// JOB OVERLAYS
// OPTION LINK
  PHASE OVERLAY,ROOT
// EXEC COBOL
  COBOL Source for
  Main Program
  'OVERLAY'
/*
// EXEC ASSEMBLY
  (source deck for OVRLAY)
/*
  PHASE OVERLAYB,*
// EXEC COBOL
  COBOL Source for
  Subprogram
  'OVERLAYB'
/*
  PHASE OVERLAYC,OVERLAYB
// EXEC COBOL
  COBOL Source for
  Subprogram
  'OVERLAYC'
/*
  PHASE OVERLAYD,OVERLAYB
// EXEC COBOL
  COBOL Source for
  Subprogram
  'OVERLAYD'
/*
// EXEC LNKEDT
// EXEC
/*
/6

```

The PHASE cards indicate the begin address of each phase. The phases OVERLAYC and OVERLAYD will have the same begin address as OVERLAYB. The sequence of events is:

1. The main program calls the overlay routine.
2. The overlay routine fetches the particular COBOL subprogram and puts it in the overlay area, and then
3. Transfers to the first instruction of the subprogram.
4. The subprogram returns to the COBOL calling program (not the overlay subroutine).

The sequence of PHASE statements given in this example causes the linkage editor to structure a module, as follows:

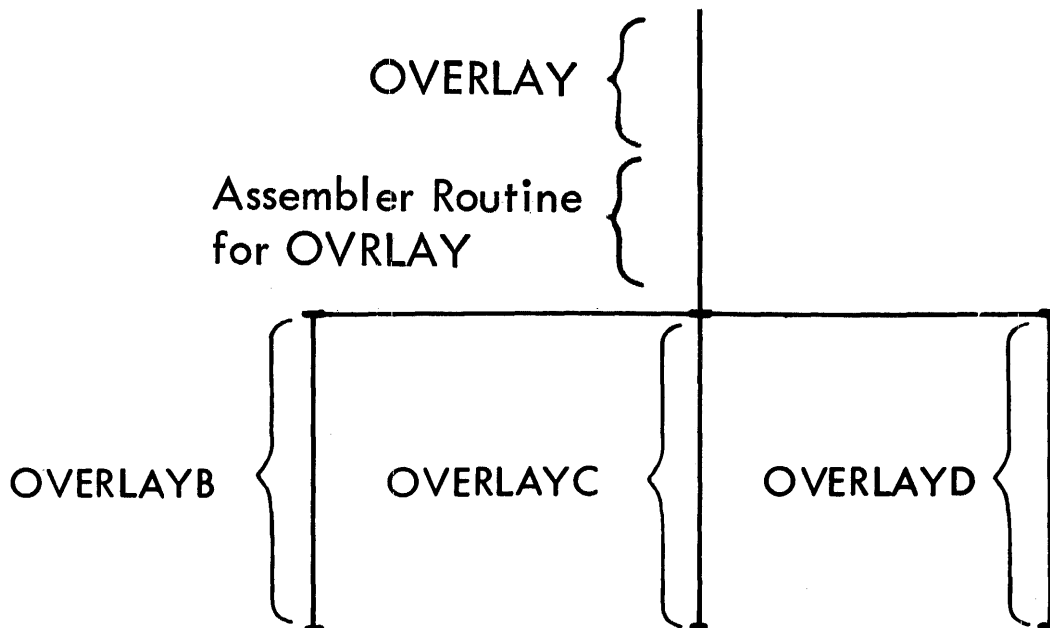

The phase name specified in the PHASE card must be the same as the value contained in the first argument for CALL 'OVRLAY', i.e., PROCESS-LABEL, COMPUTE-TAX, etc., contain OVERLAYB, OVERLAYC, respectively, which are the names given in the PHASE card. The phase name specified in the PHASE statement and the ENTRY name in the called subprogram must not be the same.

PASSING PARAMETERS TO ASSEMBLER LANGUAGE ROUTINE

A subprogram may be written in assembler language to take advantage of the system's FETCH function or other control program options not available directly through the COBOL language. Thus, a main program in COBOL may link to a subprogram in assembler language, passing a data name that contains the name of the specific entry point desired.

An example of a COBOL program passing parameters to the assembler language and the assembler language routine follow:

```
IDENTIFICATION DIVISION.  
PROGRAM-ID. 'COBOL'.  
.  
.  
DATA DIVISION.  
.  
.  
WORKING-SECTION.  
01 FIELD-1.  
02 FIELD1A PICTURE IS XXX.  
02 FIELD2A PICTURE IS XXX, VALUE IS 'ABC'.  
.  
.  
PROCEDURE DIVISION.  
MOVE 'ABC' TO FIELD1A.  
.  
.  
ENTER LINKAGE.  
CALL 'ASC' USING FIELD1A, FIELD2A.  
ENTER COBOL.  
.  
.  
.
```

```

SQRT START 0

    USING *, 15
    R14 EQU 14
    R1 EQU 1
    R2 EQU 2
    R3 EQU 3
    R0 EQU 0
    R15 EQU 15
    ENTRY ASC

    :
    :
    SAVE R14, R12

    :
    :
    L    2,0(R1)

    L    3,4(R1)

    CLC  0(3,R2),0(R3)

    :
    :
    BE   CORRECT

    :
    :
CORRECT - - -
    RETURN R14,R12

```

Note: If SQRT is in the relocatable library, an INCLUDE SQRT card must be added to the input job stream.

If the assembler program were named ASC (the same as its ENTRY point) instead of SQRT, no INCLUDE card would be needed.

In this example the COBOL program calls an assembler program, passing it two parameters (FIELD1A and FIELD2A). The assembler program compares them logically (for any reason) finds them logically equal, and then returns to the COBOL program.

The purposes of register R1, R14 and R15 are:

- Register R1 - Points to table of parameter addresses supplied by COBOL call statement.
- Register R15 - Points to first executable instruction of assembler program.
- Register R14 - Points to return statement in calling program.

The results of the assembler instructions in the SQRT routine are:

Start 0 - Informs the assembler to start assembling the program instruction, at the first available storage location for problem program.

USING *,15 - Specifies that the next instruction address be stored in the first operand (*) of this instruction.

R14 EQU 14 - Equates the Symbol R14 to the number 14 allowing user's coding to be more descriptive.

ENTRY ASC - Is the entry point into the assembler program.

SAVE R14,R12 - A macro instruction that saves the contents of all the general registers. (This protects any data the user might want to use when the COBOL program is re-entered.)

L 2,0(R1)- Loads the address of FIELD1A into register R2 (since FIELD1A is the first parameter in the table of parameters).

L 3,4(R1) - Loads the address of FIELD2A into register R3. (The second parameter in the table.)

CLC 0(3,R2),0(R3)- Compares first three characters of FIELD1A to first three characters of FIELD2A.

BE CORRECT - A conditional branch instruction that transfers to the address CORRECT if the CLC instruction proves true.

RETURN R14,R12 - Restores the general registers with their original contents (that which they contained at ENTRY time), and returns to the next statement after the CALL in the COBOL program.

SECTION VIII: PROCESSING COBOL FILES ON DIRECT ACCESS DEVICES

The data management facilities of the Disk Operating System are provided by routines that are referred to as the input/output control system (IOCS). A distinction is made between two types of routines:

1. Physical IOCS (PIOCS) -- Input/output routines that are included in the supervisor.

Physical IOCS controls the actual transfer between the external medium and main storage. It performs the functions of initiating the execution of channel commands and handling associated input/output interrupts.

2. Logical (LIOCS) -- Input/output routines that are linked with a COBOL program.

LIOCS performs those functions that a programmer needs to locate and access a logical record for processing. A logical record is one unit of information in a file of similar units -- for example, one employee's record in a master payroll file, one part-number record in an inventory file, or one customer account record in an account file. One or more logical records may be included in one physical record. LIOCS refers to the routines that perform the following functions:

- a. Blocking and deblocking records.
- b. Switching between input/output areas when two areas are specified for a file.
- c. Handling end-of-file and end-of-volume conditions.
- d. Checking and writing labels.

An understanding of how LIOCS functions may be of help to a COBOL programmer preparing files. Briefly, certain input/output statements and file description entries in the Data Division of the COBOL program such as ACCESS IS, RECORD KEY IS, etc., are used to build a unique DTF (Define the File) table for each file. The information in this table will be different based on what is stated in the COBOL program; or basically, it will contain the information particular to the file for processing input/output and a series of constants that describe the characteristics of a particular file, such as record size, block size, record format, etc.

One of the constants in the DTF table names a logic module that is to be used at execution time to process that file. A logic module is a generalized routine that modifies itself based on the constants stored in the DTF tables. It contains the coding necessary to perform data management functions required by the file such as blocking and deblocking, initiating label checking, etc.

Generally, these logic modules are separately assembled and cataloged in the relocatable library under a standard name. Then, at linkage editing time, the linkage editor searches the relocatable library using the name in the DTF table to find the logic module. The logic module is then included as part of the program phase. Note that the autolink feature of the linkage edit takes care of including the logic modules. The COBOL programmer does not specify any INCLUDE statements.

The type of DTF table prepared by the compiler depends on the data organization of the file. COBOL provides two types of data organization that are used for direct-access files only.

- Indexed Sequential -- direct-access only.
- Direct -- direct-access only.

The rest of this section provides information on preparing files with indexed sequential and direct data organizations. Included for both are general descriptions of the organization, the COBOL statements that must be specified in order to build the correct DTF tables, error recovery techniques, how to modify the DTF tables, and coding examples.

INDEXED SEQUENTIAL

Files having indexed sequential organization may be processed randomly or sequentially. Indexed sequential files may be created, added to, read from, or updated.

The records of an indexed sequential file are organized on the basis of a collating sequence determined by control fields called keys. A key precedes the data portion of a record and is from 1 to 255 bytes in length.

An indexed sequential file exists in space allocated on direct-access volumes as prime areas, overflow areas, and index areas.

Prime Areas and Overflow Areas

Prime areas are areas on a cylinder allotted for data records which consist of a key and the actual data. The track format for the 2311 or 2314 Disk Storage Drive and the 2321 Data Cell Drive shown in Appendix E may be helpful in visualizing the formats of the records for an indexed sequential file.

A new record added to an indexed sequential file is placed into a location on a track determined by the value of its key field. If records were inserted in precise physical sequence, insertion would require shifting all records of the file with keys higher than that of the one inserted. However, because an overflow area exists, indexed sequential file organization allows a record to be inserted into its proper position with only the records on the track in which the insertion is made being shifted.

Overflow areas are areas on the disk reserved to accommodate additions to the file. When a record is to be inserted, the records already on the track that are to follow the new record are written back on the track after the new record. The last record on the track is written onto an overflow track. Track index entries (see the next discussion) are adjusted to indicate records in an overflow area. The COBOL programmer may choose among three options in determining where records will be placed. They are:

1. Cylinder Overflow Area Only -- When creating an indexed sequential file two 2311 tracks or four 2314 or 2321 tracks will automatically be reserved by the COBOL compiler for cylinder overflow. These tracks will accommodate overflow records that occur within the specified cylinder. To decrease or increase the number of tracks reserved for overflow, the user must modify a DTF table entry (see

"Modifying the DTF Table" and the coding examples at the end of this section).

2. Independent Overflow Area -- An additional extent for the exclusive purpose of storing overflow records can be implemented by submitting the proper job control EXTENT cards. IOCS will then create this independent overflow area. No COBOL entry is needed to implement it. If, however, the programmer wishes an independent overflow area only (that is, no cylinder overflow area), the DTF table must be modified to specify no cylinder overflow (see "Modifying the DTF Table" and the coding examples at the end of this section).
3. Both Cylinder and Independent Overflow Areas -- In this case, the cylinder overflow will be used until it becomes full. At that time, further additions to the file will result in overflow records being placed in the independent overflow area. This option again can be implemented by specifying job control EXTENT cards.

The advantage of the cylinder overflow area is that of time. Arm motion is minimized during sequential or random retrieval and when making additions to the file.

The advantage of the independent overflow area is that of space. The number of tracks allocated to an independent overflow area may justifiably be less than the total number of tracks allocated by the cylinder overflow option. This alternative would then minimize the total disk pack area obligated for overflow records.

Index Areas

The ability to read and write records from anywhere in a file with indexed-sequential organization is provided by indexes that are part of the file itself. There are always two types of indexes: a cylinder index for the whole file, and a track index for each cylinder. A third type of index, the master index, can be created and used if desired.

Cylinder Index: For each cylinder of data, an entry is made to the cylinder index. This entry consists of the address of the track index for that cylinder and the highest key of a record on the entire cylinder.

The cylinder index will have its own extents that must be defined by job control EXTENT cards. These extents must be outside the limits of any data extents. (Note that at least two sets of extent information must be defined. They are a data extent and a cylinder index extent. If the file exceeds one disk pack, additional data extents will be provided and, at the user's option, an independent overflow area extent may be defined.) The cylinder extent must be on-line when the file is processed. It may be on the same pack as the data file, or it may be on a separate pack.

Track Index: A track index exists for each cylinder of the file. The track index always begins on track 0. For each track of data, an entry is made to the track index. The entry consists of two parts: (1) for the prime area, the entry is the address of the lowest record on that track and the highest key of a record on that track; (2) for the overflow area, the entry consists of the highest key associated with that track and the address of the lowest record in the overflow area. If no overflow entry has been made, the address is X'FF'.

Master Index: If a file occupies many cylinders, a search of the cylinder index for a key is inefficient. Thus, the user can create a master index (by specification on the EXTENT card) that indexes the cylinder index. An entry for the master index consists of the address

of the cylinder index track and the highest key of a data record on that cylinder index track. One entry is made to the master index for each track of data on the cylinder index. It is advantageous to construct a master index if the cylinder index occupies four or more tracks.

Figure 17 shows an indexed sequential file with two levels of indexing and no overflow records. The entries for track 1 of the cylinder are shown. The address of the first record on the track is track 1, record-0 at the beginning of track 1. The highest key on track 1 is 8. The address of the lowest record in the overflow area is FF because there are no overflow records. The entry to the cylinder index for track 1 shows the address of the track index and the highest key on the cylinder which is 32. The COCR (cylinder overflow control record), which is maintained in the data portion of record zero, indicates that no records are in the cylinder overflow area after loading. (Note that if the track index does not occupy all of track 0, track 0 will also contain data records).

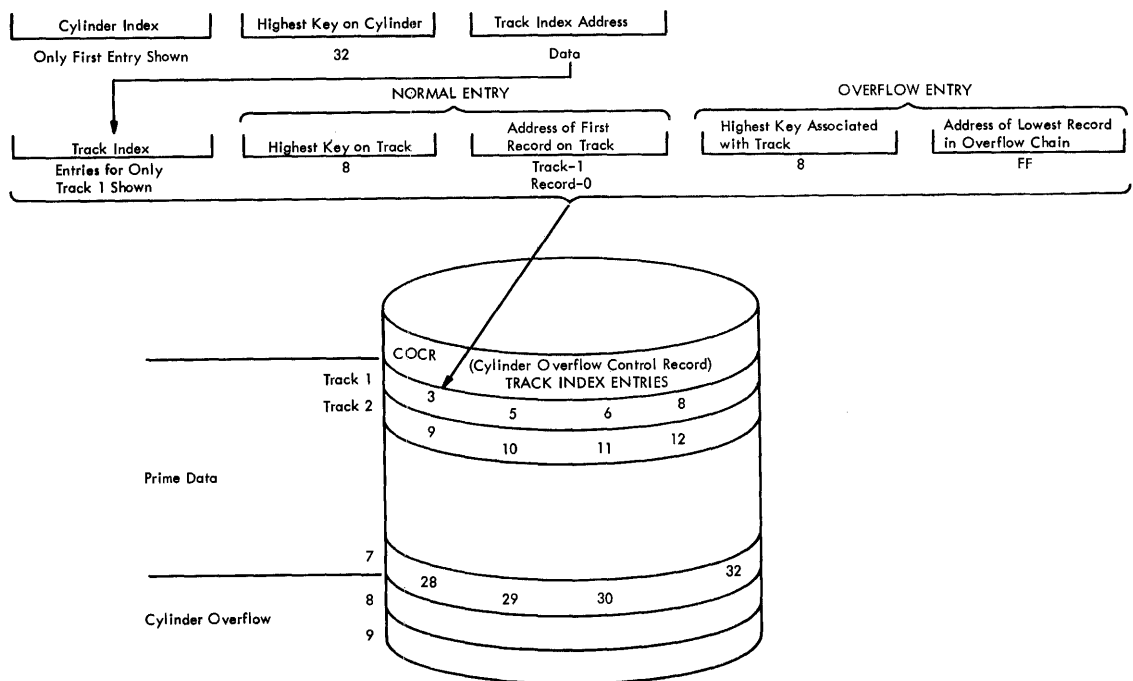

• Figure 17. Indexed Sequential File Without Overflow

Figure 18 shows what happens when another record, record 7, is added, and forces record 8 into an overflow area. In this case, the key of the normal entry is changed to 7 and the address of the overflow entry indicates the location of record 8, which is on track 8 record 1. No other changes to the indexes are required. The COCR will be updated to indicate that the last record in the cylinder overflow area is on track 8, record 1.

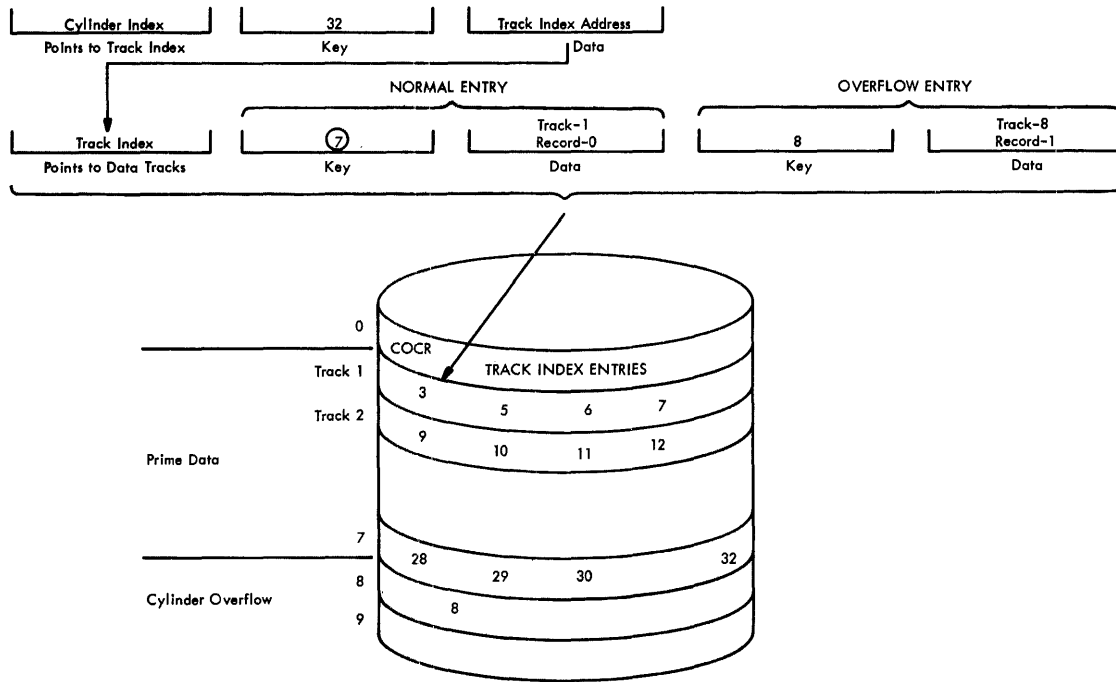

• Figure 18. Indexed Sequential File With Overflow

The indexed sequential organization enables the programmer to:

1. Read or write (in a manner similar to that for sequential organization) logical records whose keys are in ascending collating sequence.
2. Read or write individual logical records randomly.
3. Add logical records with new keys. The system locates the proper position in the file for the new record and makes all necessary adjustments to the indexes.

The important advantages are the ability to retrieve records randomly as well as sequentially, and to make additions to the file without having to sort and merge the additions while copying the entire file.

These advantages are possible because overflow areas are available to provide the additional space required when additions are made to the file, and indexes which are built and maintained by LIOCS.

COBOL STATEMENTS USED TO SPECIFY AN INDEXED SEQUENTIAL FILE

The following is a list of the COBOL statements required for creating, adding, or updating an indexed sequential file. In addition, the list is followed by a brief explanation of the functions IOCS performs as a result of executing these statements.

Creating an Indexed Sequential File

To create a sequential, indexed sequential file, the following clauses are required:

- ORGANIZATION IS INDEXED
- ACCESS IS SEQUENTIAL
- ASSIGN TO DIRECT-ACCESS
- RECORD KEY IS data-name

(The SYMBOLIC KEY may be specified.)

The programmer must then specify:

- OPEN OUTPUT file-name
- WRITE record-name [INVALID KEY]
- CLOSE file-name

OPEN Statement

The OPEN statement causes the label information for the file to be recorded in a Volume Table of Contents (VTOC). It then initiates a checking procedure that prevents writing on an existing file that might still be active. In addition, the OPEN statement establishes the area that is to be written on the disk as specified in the EXTENT statement by the LOWER and UPPER parameters. Finally, the OPEN statement initializes the cylinder and track index tables, which are eventually filled with the record keys provided by the programmer when the file is being created.

WRITE Statement

The WRITE statement enters the record keys specified by the programmer into the track and cylinder index tables and writes the actual data on the portion of the track defined by the EXTENT parameters. The records are placed on the track sequentially in the prime data area.

If the programmer specifies INVALID KEY, control is given to the invalid key routine whenever a duplicate record or a record out of sequence is detected. The programmer is responsible for writing the invalid key routine (see the coding examples).

CLOSE Statement

The CLOSE statement removes the reference to the labels in the VTOC, updates indexes (track and cylinder), and writes the end-of-file record. Once the reference to the labels is removed from the VTOC, the file must be opened again to be accessed. The index tables are updated each time a block is written out (in the case of blocked records) or each time a record is written (in the case of unblocked records). For a short block, the CLOSE statement results in truncation of the area not used in the block and in updating of the indexes with the record keys of those records in the block.

Key Handling: During the creation of an indexed sequential file, the programmer can control the RECORD KEY with certain restrictions:

- The RECORD KEY must be provided before execution of the WRITE statement. It is part of the record and identifies the particular record in the file.
- The RECORD KEY values must be given in ascending collating sequence.
- No two keys can be the same.

To extend a file previously created, the same clauses and control statements (DLBL, EXTENT) used to create the file are required, with the following exception: the parameter ISE should be used for the 'type' code in the DLBL statement instead of ISC used for creating the file.

Note that the record to be added must fit within the limits originally specified for the file by the EXTENT statement. If it does not fit, the file must be recreated.

The SYMBOLIC KEY is not required when creating an indexed sequential file.

Sequential Retrieval of an Indexed Sequential File

To retrieve an indexed sequential file sequentially, the following clauses are required:

- ORGANIZATION IS INDEXED
- ACCESS IS SEQUENTIAL
- RECORD KEY IS data-name

(The SYMBOLIC KEY may be specified.)

To simply read the file, the programmer must specify:

- OPEN INPUT file-name
- READ file-name AT END
- CLOSE file-name

OPEN Statement: The OPEN statement checks the labels of the files to be opened and initializes the VTOC to indicate an active file. It also establishes the area to be read as specified by the LOWER and UPPER limit parameters of the EXTENT statement. This initializes processing of the file, as follows:

- If the SYMBOLIC KEY is omitted, processing begins with the first record of the file, and progresses sequentially.
- If the SYMBOLIC KEY is used and binary zeros are specified therein, processing begins with the first record of the file, and progresses sequentially.
- If the SYMBOLIC KEY is used and other than binary zeros are specified, processing begins with the specified key and progresses sequentially.

READ Statement: The READ causes sequential retrieval of logical records from the file until the end-of-file record is detected. At this time, control is given to the user routine specified by the AT END statement.

CLOSE Statement: The file is reset for future use.

Updating Sequentially

To update an existing indexed sequential file, the same clauses needed to retrieve the file are required (ORGANIZATION IS INDEXED, ACCESS IS SEQUENTIAL, RECORD KEY IS) used for creating the file.

- OPEN I-O file-name
- READ file-name AT END
- REWRITE record-name [INVALID KEY]
- CLOSE file-name

The OPEN and CLOSE statements function in the same manner for updating as they do for retrieving an indexed sequential file. The READ statement also functions in the same manner (as for sequential retrieval) but must be used in conjunction with the REWRITE statement, as follows.

REWRITE Statement: The REWRITE statement writes the logical record read by a preceding READ statement back into the same physical location from which it was originally retrieved. Thus, the REWRITE statement provides the facility to update records in a file. Under no circumstances should the user modify the RECORD KEY of the record being updated. Because the

INVALID KEY check is not exercised for sequential retrieval of an indexed sequential file, results caused by modification of the RECORD KEY prior to return of the record to the file are unpredictable.

Key Handling: During sequential retrieval of a file, limited control of the SYMBOLIC KEY and RECORD KEY is permitted. Thus, the SYMBOLIC KEY can be set before the OPEN statement is executed, allowing processing to begin with any record within the file. Once the OPEN statement is completed, the SYMBOLIC KEY is not needed. The RECORD KEY, which must not be modified when updating a file, can be referred to when retrieving a record for the purpose of recognizing a particular record in the file.

Random Retrieval of an Indexed Sequential File

To retrieve, randomly update, or add to an indexed sequential file, the following clauses are required:

- ORGANIZATION IS INDEXED
- ACCESS IS RANDOM
- SYMBOLIC KEY IS data-name
- RECORD KEY IS data-name
- OPEN INPUT file-name
- READ file-name INVALID KEY
- CLOSE file-name

The OPEN and CLOSE statements function in the same manner for updating as they do for retrieving an indexed sequential file. The clauses specified allow random retrieval only. Before retrieval of each record, the SYMBOLIC KEY must be provided.

Updating Randomly

To update an indexed sequential file randomly the following clauses must be specified:

- OPEN I-O file-name
- READ file-name INVALID KEY
- REWRITE record-name [INVALID KEY]
- CLOSE file-name

The OPEN and CLOSE statements function in the same manner as for sequential retrieval of an indexed sequential file. The READ statement retrieves the record identified by the SYMBOLIC KEY. This key must be specified for every READ statement and must be within the limits of the file; otherwise, a 'NO RECORD FOUND' condition results. If this occurs, control is given to the user's INVALID KEY routine.

The REWRITE clause permits random updating of records in a file. It must be preceded by a READ, and the SYMBOLIC KEY and RECORD KEY must not be modified before the REWRITE is executed. NO INVALID KEY check is available for the update function.

Adding Randomly

To add to an indexed sequential file randomly, the same clauses as are needed to retrieve the file are required and, in addition, the programmer must specify:

- OPEN I-O file-name
- WRITE record-name [INVALID KEY]
- CLOSE file-name

The OPEN and CLOSE statements function in the same manner as for sequential retrieval of an indexed sequential file. Records can be added to an existing file by means of the WRITE statement clause. The WRITE requires that the RECORD KEY be initialized before the operation.

A duplicate key error results when a record that is being added has the same RECORD KEY value as a record already in the file. This condition causes control to be given to the programmer's INVALID KEY routine.

Key Handling: The programmer must initialize the SYMBOLIC KEY with a key value prior to every READ statement. The value must be equal to the record key within the record to be retrieved. This key must be within the file limits; otherwise, a 'NO RECORD FOUND' error condition results. The RECORD KEY can be used only for record reference during the retrieve and update functions. When adding to the file, this key must be initialized before each write.

ERROR RECOVERY TECHNIQUES FOR INDEXED SEQUENTIAL FILES

Recovery from input/output error conditions raised for an indexed sequential file may be attempted in three ways. They are:

1. The INVALID KEY clause in the COBOL program.
2. A COBOL library subroutine (IHD03500).
3. The USE AFTER STANDARD ERROR clause in the COBOL program.

The relationship among these three types of recovery attempts is shown in the flowchart that follows. If an INVALID KEY error is raised, the INVALID KEY routine is executed. If it is not, the COBOL subroutine will analyze the other error indicators. If no USE AFTER STANDARD ERROR is specified, the job is terminated after printing a message that identifies the type of error. If a user Declarative Section does exist, control is given to that routine. The COBOL programmer can prepare such a routine to make a further analysis of the DTF table to determine further information about the error status. Note that program execution can continue only if an INVALID KEY or USE AFTER STANDARD ERROR clause exists.

Table 1 summarizes the error conditions by function and indicates which errors will raise an INVALID KEY, which will be analyzed by the subroutine, and which errors could be profitably analyzed by a USE AFTER STANDARD ERROR routine (see Supervisor and Input/Output Macro Instructions for complete list of error conditions).

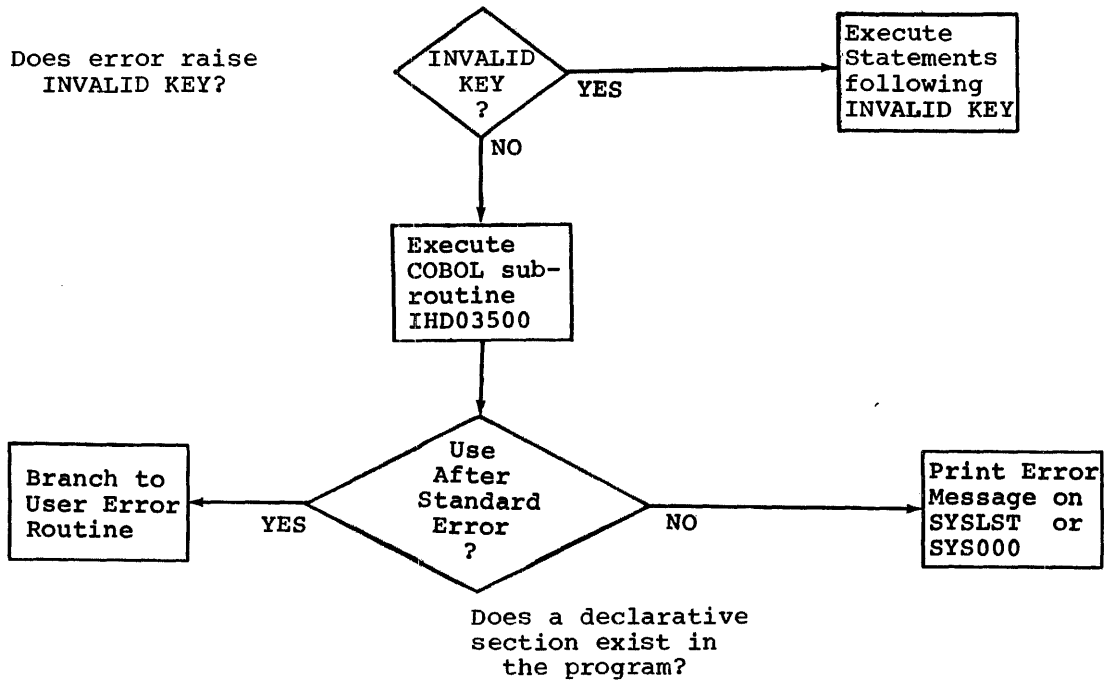

ABORT

Table 1. Error Functions

| Function Error | Create | Add | Random Retrieval | Sequential Retrieval |
|----------------------|--------------------------|--------------------------|------------------|--------------------------|
| Duplicate Record | INVALID KEY | INVALID KEY | | |
| Sequence Check | INVALID KEY | | | |
| DASD error | USE AFTER STANDARD ERROR | | | |
| Wrong length Record | USE AFTER STANDARD ERROR | | | |
| Prime data Area Full | USE AFTER STANDARD ERROR | | | |
| Cylinder Index Full | USE AFTER STANDARD ERROR | | | |
| Master Index Full | USE AFTER STANDARD ERROR | | | |
| No Record Found | | | INVALID KEY | USE AFTER STANDARD ERROR |
| Overflow Area Full | | USE AFTER STANDARD ERROR | | |
| Area Full | | | | |

INVALID KEY Errors

The invalid key is raised when:

1. A duplicate record exists (duplicate key) (WRITE).
2. When building a file, a record is out of sequence (sequence check) (WRITE).
3. No record is found during retrieval (READ).

These are the conditions from which the programmer can most logically recover. In almost all other cases, the only choice is to abort the job; therefore, most programmers should be able to handle almost all of their error recovery procedures within the INVALID KEY routines.

When creating the file, the program will execute the imperative statements following the INVALID KEY clause for either a duplicate record or sequence check. In either case the record is not added to the file. The INVALID KEY routine could identify the error record, and either close the files, or continue with the next transaction.

When adding to the file, the INVALID KEY is raised for a duplicate record. In this case, the record will not be added. The user could identify the error record and continue with the next transaction in his INVALID KEY routine.

For random retrieval, the INVALID KEY is raised if the record cannot be found on the file. The INVALID KEY routine could identify the missing record and continue with the next transaction.

During sequential retrieval no INVALID KEY IS raised. The user must specify the AT END option to branch to end-of-job steps when the end of file is encountered.

USE AFTER STANDARD ERROR Routines

When creating a file, prime data area full would be indicated if the user did not reserve a large enough extent for all data records. In this case, the user could close the file in his USE AFTER STANDARD ERROR routine. He could then submit new job control EXTENT cards reserving more room for prime data, and extend the file with the remaining data cards by resubmitting the same program.

DASD errors and wrong-length records could be bypassed, if feasible, in the USE AFTER STANDARD ERROR routine. However, in most cases, the job must be terminated.

When adding to the file, if the cylinder overflow area cannot contain the overflow record, an Overflow Area Full error will be indicated. The record will not be added. The user could continue with the next transaction in his STANDARD ERROR routine by going to a routine to read the next input transaction, since it may be possible to add records that will be located on a different cylinder. However, the best procedure would be to close the file and stop the run.

Note that a programmer may elect to start sequential retrieval at a specified key rather than at the beginning of the file. If the key specified is not in the file, and if there is no error declarative section, the COBOL subroutine will print a message indicating this and abort the job.

INVALID KEY Errors

The invalid key is raised when:

1. A duplicate record exists (duplicate key) (WRITE).
2. When building a file, a record is out of sequence (sequence check) (WRITE).
3. No record is found during retrieval (READ).

These are the conditions from which the programmer can most logically recover. In almost all other cases, the only choice is to abort the job; therefore, most programmers should be able to handle almost all of their error recovery procedures within the INVALID KEY routines.

When creating the file, the program will execute the imperative statements following the INVALID KEY clause for either a duplicate record or sequence check. In either case the record is not added to the file. The INVALID KEY routine could identify the error record, and either close the files, or continue with the next transaction.

When adding to the file, the INVALID KEY is raised for a duplicate record. In this case, the record will not be added. The user could identify the error record and continue with the next transaction in his INVALID KEY routine.

For random retrieval, the INVALID KEY is raised if the record cannot be found on the file. The INVALID KEY routine could identify the missing record and continue with the next transaction.

During sequential retrieval no INVALID KEY IS raised. The user must specify the AT END option to branch to end-of-job steps when the end of file is encountered.

USE AFTER STANDARD ERROR Routines

When creating a file, prime data area full would be indicated if the user did not reserve a large enough extent for all data records. In this case, the user could close the file in his USE AFTER STANDARD ERROR routine. He could then submit new job control EXTENT cards reserving more room for prime data, and extend the file with the remaining data cards by resubmitting the same program.

DASD errors and wrong-length records could be bypassed, if feasible, in the USE AFTER STANDARD ERROR routine. However, in most cases, the job must be terminated.

When adding to the file, if the cylinder overflow area cannot contain the overflow record, an Overflow Area Full error will be indicated. The record will not be added. The user could continue with the next transaction in his STANDARD ERROR routine by going to a routine to read the next input transaction, since it may be possible to add records that will be located on a different cylinder. However, the best procedure would be to close the file and stop the run.

Note that a programmer may elect to start sequential retrieval at a specified key rather than at the beginning of the file. If the key specified is not in the file, and if there is no error declarative section, the COBOL subroutine will print a message indicating this and abort the job.

In general, a declarative section may be included in a program in order to find out more information about an error condition that occurs. Such a routine can interrogate byte 30 of the DTF table to determine the type of error that exists. (For more information and a coding example, see "Modifying the DTF Table.") The error indicator can be passed to a subprogram by specifying the CALL statement including USING file-name. The programmer is responsible for writing the error checking subprogram. The error indicators are shown in Table 2. Normal return from the declarative is to the next sequential instruction in the program following the input/output operation. Return by means of a GO TO statement may be made to any location. Note that the programmer must realize that the record of the last input/output operation was not located.

Table 2. Error Indicators

| BYTE 30 | Add, Retrieve, or Both | Create |
|---------|----------------------------|----------------------------|
| X'80' | Direct Access Device Error | Direct Access Device Error |
| X'40' | Wrong Length Record | Wrong Length Record |
| X'20' | End of File | Prime Data Area Full |
| X'10' | No Record Found | Cylinder Index Area Full |
| X'08' | | Master Index Area Full |
| X'02' | Overflow Area Full | |

The following example illustrates a declarative routine when combining random retrieval and additions. Assuming that INVALID KEY clauses were written, control will be given to the declarative section in this example only when DASD, wrong-length record, or Overflow Area Full error indicators are raised. The purpose of the routine is to continue processing in the case of an Overflow Area Full indicator and to close the file and end the job for DASD and wrong-length record indicators.

MAIN PROGRAM

```

WORKING-STORAGE SECTION.
01 INDICATOR PICTURE 9.
.
.
.
PROCEDURE DIVISION.
DECLARATIVES.
ERR-TEST SECTION.
USE AFTER STANDARD ERROR PROCEDURE ON IS-FILE.
ENTER LINKAGE.
CALL 'ERRSUB' USING IS-FILE, INDICATOR.
ENTER COBOL.

IF INDICATOR IS EQUAL TO 1 GO TO READ-ROUTINE.
GO TO END-JOB.
END DECLARATIVES.

```

SUBPROGRAM

```

WORKING-STORAGE SECTION.
77 FULL PICTURE 9 USAGE COMPUTATIONAL VALUE 2.

LINKAGE SECTION.
01 DTF-FOR-DISK.
02 BYTE PICTURE 9 OCCURS 31 TIMES.
01 INDICATOR PICTURE 9.

```

```

PROCEDURE DIVISION.
  ENTER LINKAGE.
  ENTRY 'ERRSUB' USING DTF-FOR-DISK, INDICATOR.
  ENTER COBOL.
  MOVE LOW-VALUE TO INDICATOR.
  IF BYTE (31) IS NOT EQUAL TO FULL GO TO EXT.
  MOVE 1 TO INDICATOR.
  EXT.
  ENTER LINKAGE.
  RETURN.
  ENTER COBOL.

```

When a DASD error, wrong-length record, or Overflow Area Full error occurs on the IS-FILE, control is given to the first instruction after the USE AFTER STANDARD ERROR clause. The subprogram is called. The address of the IS-FILE DTF table and the working storage indicator are passed to the subprogram.

The subprogram sets the indicator in working storage to zeros. If byte 30 contains an X'02' indicating an Overflow Area Full error, a 1 is moved to the working storage indicator. Return is made to the main program. The main program checks to see if the indicator is a 1. If it is, a branch is made to read the next transaction. If the indicator is not a 1, a DASD error or wrong-length record error has occurred, and the program branches to the end-of-job routine to close the files and stop the run.

Note that the COBOL subroutine will also print out an error message that provides another source of information about the type of error that has occurred. (See "Modifying the DTF Table" for more information about using COBOL and assembler language subprograms to modify the DTF table.)

MODIFYING THE DTF TABLE FOR INDEXED SEQUENTIAL ORGANIZATION FILES

The DOS COBOL compiler builds a skeleton DTF table. At execution time when the file is opened, a transient routine is called to construct the complete table. The programmer may wish to change the contents of the skeleton DTF table prior to execution of the OPEN statement in order to change the overflow tracks, suppress the verify option, etc. The contents of the skeleton DTF table are shown in Table 3.

The COBOL programmer can change the contents of a certain byte in the DTF table in one of two ways, as follow:

1. By writing statements in the main COBOL program to refer to the DTF table and by writing a COBOL subprogram to change the DTF table.
2. By writing statements in the COBOL main program to refer to the DTF table and by writing an assembler language subprogram to change the DTF table.

Table 3. Contents of Skeleton DTF Table

| | | |
|--|---|-------------------------|
| COBOL TRANSIENT PREPHASE TO OPEN. THIS ROUTINE WILL BUILD THE DTFIS TABLES AT OPEN-TIME | | |
| INPUT TO THIS ROUTINE IS AS FOLLOWS SPACE MUST BE RESERVED FOR THE BIGGEST POSSIBLE TABLE THIS IS DEPENDING ONLY ON THE KEYSIZE, THE TOTAL NUMBER OF BYTES USED BY THE TABLE IS 600&KEYSIZE. THE CONTENTS OF THIS TABLE IS BEFORE THIS ROUTINE | | |
| BYTE 0 | X@00@#RANDOM | X@F0@#SEQUENTIAL |
| BYTE 1 | X@00@#2311 and 2314 | X@F0@#2321 (PRIME DATA) |
| BYTE 2 | X@00@#UNBLOCKED | X@F0@#BLOCKED |
| BYTE 3 | X@00@#NO VERIFY | X@F0@#VERIFY |
| BYTE 4-5 | RECORD SIZE | |
| BYTE 6-7 | NUMBER OF RECORDS IN BLOCK | |
| BYTE 8-9 | KEYLOCATION %FIRST BYTE IN RECORD 31 | |
| BYTE 10-11 | RECORD KEY-LENGTH | |
| BYTE 12-15 | ADDRESS OF IOAREAL | |
| BYTE 16-19 | ADDRESS OF WORKL | |
| BYTE 20 | X@00@#INDEX ON 2321 or 2314 X@F0@#INDEX ON 2311 | |
| BYTE 21 | NUMBER OF OVERFLOW-TRACKS IN CYLINDER | |
| BYTE 22-29 | FILENAME | |
| BYTE 30-31 | DUMMY | |
| BYTE 32-35 | ADDRESS OF KEYARG (SYMBOLIC KEY) | |
| THE REST OF THE TABLE MUST BE SET TO X@00@ NOTICE THAT BYTES 3,20,21 MAY BE CHANGED BY THE USER BEFORE THE OPEN STATEMENT IS EXECUTED | | |

The following are examples of the options in the DTF table that can be changed. (Note that the byte count of a DTF table begins with zero; thus, for example, byte 22 actually is the 23rd byte of the table.)

1. Byte 3 (the 4th byte) of the DTF table controls the verify option. Changing the value of the 4th byte to X'00' suppresses this option. Verification consists of IOCS checking to be sure that the record written out is correct. Suppression of the verify option can result in improved program performance.
2. The presence of a master index can be indicated by changing the value of byte 20 (the 21st byte) to X'F2' for the 2311, X'82' for the 2314, and X'02' for the 2321.
3. Byte 21 (the 22nd byte) of the DTF can be altered to change the number of overflow tracks assumed per cylinder. The number of overflow tracks assumed by the compiler is 2 for the 2311 or 4 for the 2321 or the 2314. The programmer may change this to a maximum of 8 for the 2311, 16 for the 2314, or 18 for the 2321. If the value is changed to LOW VALUE, cylinder overflow is suppressed.
4. By replacing the contents of byte 20 (the 21st byte) with X'F0' the user can locate his indexes on the 2311 or the 2314 when the prime data is on the 2321.

Example of COBOL Main Program and COBOL Subprogram Modifying DTF

In the COBOL main program, define and call the subprogram, as follows:

1. Data Division

```
FD ISFILE
```

2. Procedure Division

```
ENTER LINKAGE.  
CALL 'CHGDTF' USING ISFILE.  
ENTER COBOL.  
OPEN OUTPUT ISFILE.
```

When the call is executed, the address of the skeleton DTF is passed to the subprogram. Note that COBOL permits only data names to be passed to a COBOL subprogram. In this case, a filename is passed but only to use the address of the DTF for the file. No input/output operations can be performed on the file in the subprogram.

The subprogram could move an appropriate value into one or more bytes that the programmer wishes to modify. For example, the following subprogram will eliminate the verify option.

```
DATA DIVISION.  
LINKAGE SECTION.  
01 DTF-FOR-DISK.                                DUMMY DTF TABLE  
    02 BYTE PICTURE X OCCURS 35 TIMES.  
  
PROCEDURE DIVISION.  
    ENTER LINKAGE.  
    ENTRY 'CHGDTF' USING DTF-FOR-DISK.  
    ENTER COBOL  
    MOVE LOW-VALUE TO BYTE (4).  
    ENTER LINKAGE.  
    RETURN.  
    ENTER COBOL.
```

The LINKAGE SECTION in the subprogram defines a DTF table. Control is passed to byte 3 to eliminate the verify option and then control is returned to the main program at the OPEN statement.

Note that an assembler language subprogram can be called by using the same coding in the main COBOL program.

CODING EXAMPLES USING INDEXED SEQUENTIAL FILES

The following examples illustrate how a COBOL program can be prepared in order to create and retrieve an indexed sequential file. The job control cards specifying label information for these examples follow. They define a cylinder index located on cylinder 196, and a small prime data extent located on cylinders 197 and 198.

```
// ASSGN SYS004,X'19'  
// DLBL  SYS004,'INDEXED SEQ FILE,' 67365,ISC  
// EXTENT SYS004,111111,4,1,00010,00196  
// EXTENT SYS004,111111,1,2,00020,00197  
// EXEC
```

Creating an Indexed Sequential File

This program example shows how to create an indexed sequential file from the card reader. The file consists of records of 100 characters, 5 records in a block.

When the file is opened, the labels are checked, the track indexes are formed, and the extents are reserved for the cylinder index.

After the files are opened, cards are read and data is moved to the print file and disk file. Movement of the KEY-ID in the cards to the REC-ID of disk is mandatory since the REC-ID is the data name specified by the RECORD KEY clause.

A branch to the INVALID KEY routine will occur on sequence errors or duplicate records. This routine identifies the error type and error record, and then gets the next transaction.

The COBOL error subroutine identifies all other errors and aborts the job. If the INVALID KEY routine were not present, it would also identify and abort the job for sequence errors. It would identify the error and continue with the next sequential instruction for duplicate records.

At end-of-job, the files are closed and the job terminated.

```
01 001001 IDENTIFICATION DIVISION.
02     1 PROGRAM-ID. 'LOADIS'.
03     3 AUTHOR.
04     4 INSTALLATION.
05     5 DATE WRITTEN.
06     6 REMARKS. ILLUSTRATE CREATING OF INDEXED SEQUENTIAL FILE.
07     8 ENVIRONMENT DIVISION.
08     9 CONFIGURATION SECTION.
09     10 SOURCE-COMPUTER. IBM-360.
10     11 OBJECT-COMPUTER. IBM-360.
11 002001 INPUT-OUTPUT SECTION.
12     2 FILE-CONTROL.
13     3     SELECT IS-FILE ASSIGN TO 'SYS004' DIRECT-ACCESS 2311
14     4     ACCESS IS SEQUENTIAL ORGANIZATION IS INDEXED
15     5     RESERVE NO ALTERNATE AREA
16     7     RECORD KEY IS REC-ID.
17     10    SELECT CARD-FILE ASSIGN TO 'SYS005' UNIT-RECORD 2540R
18     11    RESERVE NO ALTERNATE AREA.
19     12    SELECT PRINT-FILE ASSIGN TO 'SYS006' UNIT-RECORD 1403
20     13    RESERVE NO ALTERNATE AREA.
21 003001 DATA DIVISION.
22     002 FILE SECTION.
23     4 FD IS-FILE      DATA RECORD IS DISK
24     5                  RECORDING MODE IS F
25     6                  LABEL RECORDS ARE STANDARD
26     7                  BLOCK CONTAINS 5 RECORDS.
27     10 01 DISK.
28     11     02 DISK-FLD1  PICTURE X(10).
29     12     02 REC-ID    PICTURE X(10).
30     13     02 DISK-NAME PICTURE X(20).
31     14     02 DISK-BAL  PICTURE 99999V99.
32     15     02 FILLER    PICTURE X(53).
33 004001 FD CARD-FILE   DATA RECORD IS CARDS
34     2                  RECORDING MODE IS F
35     3                  LABEL RECORDS ARE OMITTED.
36     5 01 CARDS.
37     6     02 KEY-ID     PICTURE X(10).
38     7     02 CD-NAME    PICTURE X(20).
39     8     02 CD-BAL     PICTURE 99999V99.
40 005001 FD PRINT-FILE  DATA RECORD IS PRINTER
41     2                  RECORDING MODE IS F
```

```

42      3          LABEL RECORDS ARE OMITTED.
43      6 01 PRINTER.
44      7 02 PRINT-ID    PICTURE  X(10).
45      8 02 FILLER      PICTURE  X(10).
46      9 02 PRINT-NAME  PICTURE  X(20).
47     10 02 FILLER      PICTURE  X(10).
48      02 PRINT-BAL    PICTURE  ZZZ,ZZZ.99-.
49 006001 PROCEDURE DIVISION.
50      3 START.
51      4 OPEN INPUT CARD-FILE PRINT-FILE OUTPUT IS-FILE.
52      6 RD.
53      7 READ CARD-FILE AT END GO TO END-JOB.
54      9 MOVE KEY-ID TO PRINT-ID REC-ID.
55     10 MOVE CD-NAME TO PRINT-NAME DISK-NAME.
56     11 MOVE CD-BAL TO PRINT-BAL DISK-BAL.
57      WRITE DISK INVALID KEY GO TO ERR.
58     13 WRITE PRINTER.
59     17 GO TO RD.
60      ERR.
61      DISPLAY 'DUPLICATE OR SEQ-ERR' UPON CONSOLE.
62      DISPLAY KEY-ID UPON CONSOLE.
63      GO TO RD.
64     19 END-JOB.
65     20 CLOSE CARD-FILE PRINT-FILE IS-FILE.
66     21 DISPLAY 'END JOB' UPON CONSOLE.
67     22 STOP RUN.

```

Random Retrieval

This program illustrates random retrieval and updating for the IS-FILE created in the previous example.

The Data Division is basically the same as in loading the file except for the ACCESS IS RANDOM clause. Both the SYMBOLIC KEY and the RECORD KEY clause are required.

The IS-FILE is opened as input. This allows both retrieval and updating. The OPEN verb does label checking, and it also stores statistic fields from the format 2 label into the DTF table.

The SYMBOLIC KEY clause data name (KEY-ID) is defined within the card read area. Reading the IS-FILE causes a search of the indexes for a record matching the KEY-ID. If the record is found, data is moved to the print-file and printed, the IS-FILE is updated, and a branch is made to the next transaction.

If a matching record is not found, the COBOL subroutine turns control to the INVALID KEY routine (No-Record). This routine identifies the error and branches to the next transaction.

If for some reason the record retrieved cannot be located again when the REWRITE verb is issued, control will be passed to ERR-ROUTINE. This condition should never occur.

The end of job routine closes the files, and terminates the job. The CLOSE verb also returns the updated statistics in the DTF table back to the format 2 label. Additions could have been made to the file in the same program if the IS-FILE were opened as I-O.

```
01 IDENTIFICATION DIVISION.
02 001002 PROGRAM-ID. 'RANDOMIS'.
03 3 AUTHOR.
04 4 INSTALLATION. 360 PROGRAMMING CENTER.
05 5 DATE WRITTEN.
06 001006 REMARKS. ILLUSTRATE RANDOM RETRIEVAL FROM IS-FILE.
07 8 ENVIRONMENT DIVISION.
08 9 CONFIGURATION SECTION.
09 10 SOURCE-COMPUTER. IBM-360.
10 11 OBJECT-COMPUTER. IBM-360.
11 002001 INPUT-OUTPUT SECTION.
12 2 FILE-CONTROL.
13 3 SELECT IS-FILE ASSIGN TO 'SYS004' DIRECT-ACCESS 2311
14 002004 ACCESS IS RANDOM ORGANIZATION IS INDEXED
15 5 RESERVE NO ALTERNATE AREA
16 6 SYMBOLIC KEY IS KEY-ID
17 7 RECORD KEY IS REC-ID.
18 10 SELECT CARD-FILE ASSIGN TO 'SYS005' UNIT-RECORD 2540R
19 11 RESERVE NO ALTERNATE AREA.
20 12 SELECT PRINT-FILE ASSIGN TO 'SYS006' UNIT-RECORD 1403
21 13 RESERVE NO ALTERNATE AREA.
22 003001 DATA DIVISION.
23 002 FILE SECTION.
24 4 FD IS-FILE DATA RECORD IS DISK
25 5 RECORDING MODE IS F
26 6 LABEL RECORDS ARE STANDARD
27 7 BLOCK CONTAINS 5 RECORDS.
28 10 01 DISK.
29 11 02 DISK-FLD1 PICTURE X(10).
30 12 02 REC-ID PICTURE X(10).
31 13 02 DISK-NAME PICTURE X(20).
32 14 02 DISK-BAL PICTURE 99999V99.
33 15 02 FILLER PICTURE X(53).
34 004001 FD CARD-FILE DATA RECORD IS CARDS
```

```

35      2          RECORDING MODE IS F
36      3          LABEL RECORDS ARE OMITTED.
37      5 01 CARDS.
38      6      02 KEY-ID          PICTURE X(10).
39      7      02 CD-NAME        PICTURE X(20).
40      8      02 CD-AMT         PICTURE 99999V99.
41 004009      02 CD-CODE        PICTURE X.
42      FD PRINT-FILE DATA RECORD IS PRINTER
43          RECORDING MODE IS F
44          LABEL RECORDS ARE OMITTED.
45 005006 01 PRINTER.
46 005007      02 PRINT-ID       PICTURE X(10).
47 005008      02 FILLER         PICTURE X(10).
48 005009      02 PRINT-NAME     PICTURE X(20).
49 002010      02 FILLER         PICTURE X(10).
50 005011      02 PRINT-BAL      PICTURE $ZZZ,999.99-.
51 005012      02 FILLER         PICTURE X(10).
52 005013      02 PRINT-AMT     PICTURE $ZZZ,ZZZ.99-.
53 005014      02 FILLER         PICTURE X(10).
54 005015      02 PRINT-NEW-BAL PCITURE $ZZZ,ZZZ.99-.
55 006001 PROCEDURE DIVISION.
56 006003 START.
57 006004      OPEN INPUT  CARD-FILE IS-FILE
58 006005          OUTPUT  PRINT-FILE.
59 006006 RD.
60 006007      READ CARD-FILE AT END GO TO END-JOB.
61 006009      READ IS-FILE  INVALID KEY GO TO NO-RECORD.
62 006010      MOVE REC-ID   TO PRINT-ID.
63 006011      MOVEDISK-NAME TO PRINT-NAME.
64 006012      MOVEDISK-BAL  TO PRINT-BAL.
65 006013      MOVECD-AMT   TO PRINT-AMT.
66 006014      ADD CD-AMT    TO DISK-BAL.
67 006015      MOVE DISK-BAL TO PRINT-NEW-BAL.
68 006017      WRITE PRINTER.
69 006019      REWRITE DISK INVALID KEY GO TO ERR-ROUTINE.
70 006021      GO TO RD.
71 007001 NO-RECORD.
72 007002      DISPLAY 'NO RECORD FOUND' UPON CONSOLE.
73 007003      DISPLAY KEY-ID UPON CONSOLE.
74 007004      GO TO RD.
75 007008 ERR-ROUTINE.
76 007009      DISPLAY 'NO UPDATE' UPON CONSOLE.
77 007010      DISPLAY KEY-ID UPON CONSOLE.
78 007011      GO TO RD.
79 007017 END-JOB.
80 007018      CLOSE CARD-FILE PRINT-FILE IS-FILE.
81 007019      DISPLAY 'END JOB' UPON CONSOLE.
82 007020      STOP RUN.

```

Sequential Retrieval

This program illustrates a sequential retrieval of the IS-FILE in order to print its contents.

The Data Division is basically the same as before. The file is opened as input. To update, it would have been opened as an INPUT-OUTPUT file.

Prior to opening the file, the program requests the operator to enter the starting key. The information he types will enter the KEY-ID data name specified by the SYMBOLIC KEY clause.

The OPEN verb will then open the file and start sequential retrieval based on the entered key. If the operator enters blanks or zeros, retrieval will start at the beginning of the file. If he enters a key that is not on the file, the COBOL error subroutine will identify the error and abort the job.

During execution of the job, the COBOL error subroutine will identify any DASD error or WLR indication and abort the job.

When the end-of-file indicator is detected, a branch is made to the END-JOB procedures.

```
01 001001 IDENTIFICATION DIVISION.
02 001002 PROGRAM-ID. 'SEQIS'.
03      3 AUTHOR.
04      4 INSTALLATION. 360 PROGRAMMING CENTER.
05      5 DATE WRITTEN.
06 001006 REMARKS. ILLUSTRATE SEQUENTIAL RETRIEVAL FROM IS-FILE.
07      8 ENVIRONMENT DIVISION.
08      9 CONFIGURATION SECTION,
09     10 SOURCE-COMPUTER. IBM-360.
10     11 OBJECT-COMPUTER. IBM-360.
11 002001 INPUT-OUTPUT SECTION.
12     2 FILE-CONTROL.
13     3     SELECT IS-FILE ASSIGN TO 'SYS004' DIRECT-ACCESS 2311
14 002004     ACCESS IS SEQUENTIAL ORGANIZATION IS INDEXED
15     5     RESERVE NO ALTERNATE AREA
16     6     SYMBOLIC KEY IS KEY-ID
17     7     RECORD KEY IS REC-ID.
18     12     SELECT PRINT-FILE ASSIGN TO 'SYS006' UNIT-RECORD 1403
19     13     RESERVE NO ALTERNATE AREA.
20 003001 DATA DIVISION.
21     002 FILE SECTION.
22     4 FD IS-FILE          DATA RECORD IS DISK
23     5                     RECORDING MODE IS F
24     6                     LABEL RECORDS ARE STANDARD
25     7                     BLOCK CONTAINS 5 RECORDS.
26     10 01 DISK.
27     11     02 DISK-FLD1   PICTURE X(10).
28     12     02 REC-ID     PICTURE X(10).
29     13     02 DISK-NAME  PICTURE X(20).
30     14     02 DISK-BAL   PICTURE 99999V99.
31     15     02 FILLER     PICTURE X(53).
32 005001 FD PRINT-FILE    DATA RECORD IS PRINTER
33     2                     RECORDING MODE IS F
34     3                     LABEL RECORDS ARE OMITTED.
35     6 01 PRINTER.
36     7     02 PRINT-ID    PICTURE X(10).
37     8     02 FILLER      PICTURE X(10).
38     9     02 PRINT-NAME  PICTURE X(20).
39     10     02 FILLER     PICTURE X(10).
40     11     02 PRINT-BAL  PICTURE $ZZZ,ZZZ.99-.
41     WORKING-STORAGE SECTION.
```

```
42      6      77 KEY-ID      PICTURE X(10).
43      PROCEDURE DIVISION.
44 001000 START.
45          DISPLAY 'ENTER STARTING KEY' UPON CONSOLE.
46          ACCEPT KEY-ID FROM CONSOLE.
47 001002
48 001003      OPEN OUTPUT PRINT-FILE
49 001004          INPUT  IS-FILE.
50 001006 RD.
51 001007      READ IS-FILE AT END GO TO END-JOB.
52 001008
53 001009      MOVE REC-ID      TO PRINT-ID.
54 001010      MOVE DISK-NAME TO PRINT-NAME.
55 001011      MOVE DISK-BAL TO PRINT-BAL.
56 001013      WRITE PRINTER.
57 001015      GO TO RD.
58 001017 END-JOB.
59 001018      CLOSE PRINT-FILE IS-FILE.
60 001019      DISPLAY 'END JOB' UPON CONSOLE.
61 001020      STOP RUN.
```

DIRECT ORGANIZATION

When files are created using direct organization, the positioning of the logical records in a file is determined by keys.

The two important characteristics of direct files are:

1. Records are stored at a physical address on disk that has some mathematical relationship to the record key (in COBOL this is supplied by the SYMBOLIC KEY clause).
2. The records are not arranged in any logical sequence by key.

Some tracks may be only partially filled, or they may have no records at all.

SPECIFYING KEYS

Both the SYMBOLIC KEY clause and the ACTUAL KEY clause must be specified for files having direct organization.

The SYMBOLIC KEY must be specified for every record and actually becomes part of that record. The ACTUAL KEY specifies the physical track address. It must be specified as an eight-byte field, and it must be defined before a record can be processed. The structure and examples of code for the 8-byte ACTUAL KEY field for both the 2311 and 2321 direct access devices follow.

The elements of the field for the 2311 are:

| | |
|-----------------------------------|--|
| M | M indicates the relative number of a disk pack. It will be 0 for the first disk pack, 1 for the second disk pack, etc. |
| | It corresponds to the symbolic address (SYS000-SYSxxx), which is specified on the EXTENT card for the file. Thus, if three EXTENT cards with SYS011, SYS012, and SYS013, respectively, are specified, M can range from 1 to 3. |
| BB | This 16-bit field will always be zero for the 2311 or 2314. It refers to the cell number when addressing the data cell (2321). |
| CC=0-199 | This 16-bit field must contain the cylinder number in binary notation. |
| HH=0-9 for 2311 =0-19 for 2314 | This 16-bit field must contain the head number in binary notation. |
| R=0 | R refers to the record number or sector number. When using COBOL, this field will always be zero. |

An example of a method of coding the 8-byte ACTUAL KEY in binary using COBOL for the 2311 disk pack is, as follows:

```
01  BINARY-KEY-RECORD
    02  MM  USAGE IS COMPUTATIONAL PICTURE IS 999 VALUE IS 0.
    02  BB  USAGE IS COMPUTATIONAL PICTURE IS 9   VALUE IS 0.
    02  CC  USAGE IS COMPUTATIONAL PICTURE IS 999 VALUE IS 10.
    02  HH  USAGE IS COMPUTATIONAL PICTURE IS 9   VALUE IS 0.
```

```

01 02 REC-R PICTURE IS X VALUE IS LOW-VALUE.
    KEY-AS-ACTUAL REDEFINES BINARY-KEY-RECORD.
    02 FILLER PICTURE IS X.
    02 THE-ACTUAL-KEY IS PICTURE IS X(8).

```

Although the ACTUAL KEY field really consists of 8 bytes, 9 bytes are defined by the given code. The 02 MM defines 2 bytes, the first byte of which is disposed of by the 02 FILLER PICTURE IS X in the redefinition statement. Thus, the code defines an 8-byte binary field named THE-ACTUAL-KEY, which is used by IOCS to access records. A pictorial structure of the THE-ACTUAL-KEY field defined by the code is, as follows:

| Pack Number (M) | Cell (BB) | | Cylinder (CC) | | Head (HH) | | Record (R) |
|-----------------------|--------------|---|------------------|----|--------------|---|---------------|
| | 1 | 2 | 3 | 4 | 5 | 6 | 7 |
| 0 | 1 | 2 | 3 | 4 | 5 | 6 | 7 |
| 0 | 0 | 0 | 0 | 10 | 0 | 0 | 0 |

The elements of the field are the same for the 2311 Data Cell except that CC (bytes 3 and 4) is divided into subcell and strip, and HH (bytes 5 and 6) is divided into headbar and head element.

An example of a method of coding the 8-byte ACTUAL KEY in binary using COBOL for the 2321 Data cell is, as follows:

```

01 BINARY-KEY-RECORD.
    02 MM USAGE IS COMPUTATIONAL PICTURE IS 999 VALUE IS 0.
    02 BB USAGE IS COMPUTATIONAL PICTURE IS 9 VALUE IS 0.
    02 CC USAGE IS COMPUTATIONAL PICTURE IS 999 VALUE IS 1.
    02 HH USAGE IS COMPUTATIONAL PICTURE IS 999 VALUE IS 0.
    02 REC-R PICTURE IS X VALUE IS LOW-VALUE.
01 KEY-AS-ACTUAL REDEFINES BINARY-KEY-RECORD.
    02 FILLER PICTURE IS X.
    02 THE-ACTUAL-KEY PICTURE IS X(8).

```

Notice that just as for the 2311, 9 bytes are defined and then redefined to eliminate the first byte, leaving 8 bytes. Thus, the code defines the ACTUAL KEY that is used by IOCS to access records. A pictorial structure of THE-ACTUAL-KEY field as defined by the code is, as follows:

| Pack Number (M) | Cell (BB) | | Cylinder (CC) | | Head (HH) | | Record (R) |
|-----------------------|--------------|---|------------------|-------|--------------|-----------------|---------------|
| | 1 | 2 | Sub Cell | Strip | Head Bar | Head Element | 7 |
| 0 | 1 | 2 | 3 | 4 | 5 | 6 | 7 |
| 0 | 0 | 0 | 0 | 1 | 0 | 0 | 0 |

As records are processed, IOCS automatically updates Record (R) (in the example, it is defined by REC-R). When the desired number of records is processed within the defined area of a strip, or no more room is available in a strip area, the next head element must be accessed in order to continue processing on that strip. When all head elements have been used, the next head bar must be accessed, thus making 20 new head elements available.

Space is allocated on the 2321, as follows:

- 256 records per head element
- 20 head elements per head bar
- 5 head bars per strip
- 10 strips per subcell
- 10 subcells per pack
- 255 packs are available

The examples in the foregoing discussion may be used to specify the fields of the actual key. Another point of consideration is how to determine what the value of the ACTUAL KEY should be and then how to update it. One method is to prepare what is called a directly addressed file. With direct addressing, every symbolic key must convert to a unique address that is used as the value of the actual key. To use this method, records must be of fixed length and the symbolic key must be a numeric character.

Direct addressing disk time when processing is random. It is also convenient when processing is sequential because the records are written in key sequence. A possible disadvantage is that there may be a large amount of unused direct-access storage because a location must be reserved for every key in the file's range even though many of the possible keys may not be used.

Another method of determining the value of the ACTUAL KEY is called indirect addressing. Indirect addressing generally is used when the range of keys for a file includes a high percentage of unused ones so that direct addressing is not feasible. For example, employee numbers may range from 0001 to 9999, but only 3000 of the possible 9999 numbers are actually assigned. Indirect addressing is also used for nonnumeric keys.

Indirect addressing means that the symbolic key is converted to a value for the actual key by use of some algorithm intended to compress the range of addresses. Such an algorithm is usually called a randomizing technique. Randomizing techniques need not produce a unique address for every record and, in fact, such techniques usually produce synonyms. Synonyms are records whose symbolic keys randomize to the same address.

Two objectives must be considered in selecting a randomizing technique:

1. Every possible key in the file must randomize to an address in the allotted range.
2. The addresses should be distributed evenly across the range so that there are as few synonyms as possible.

Note that one way to minimize synonyms is to allot more space for the file than is actually required to hold all the records. For example, the percentage of locations that are actually used might be 80%-85% of the allotted space.

A RANDOMIZING TECHNIQUE

This randomizing technique is sometimes referred to as the division/remainder method. For examples of other randomizing techniques, refer to the publication Introduction to IBM System/360 Direct Access Storage Devices and Organization Methods, Form C20-1649.

RANDOMIZING

The ACTUAL KEY field can be thought of as a "discontinuous binary address." This is important to the programmer because it describes two conditions of which he must be aware. First, the cylinder and head number must be in binary notation, so the results of the randomizing formula must be in binary format. Second, the address is "discontinuous" because a mathematical overflow from one element (e.g., head number) does not increment the adjacent element (e.g., cylinder number).

Randomizing for the 2311 Disk Pack

When randomizing to a 2311, it is possible to circumvent the discontinuous binary address, by coding the randomizing formula in decimal arithmetic, and then converting the results to binary. This can be done by setting aside a decimal field with the low-order byte reserved for head number, and the high-order bytes reserved for cylinder number. A mathematical overflow from the head number will now increment the cylinder number and produce a valid address. The low-order byte should then be converted to binary and stored in the HH field, and the high-order bytes converted to binary and stored in the CC field of the ACTUAL KEY field.

Randomizing to the 2311 should present no significant problems if the programmer using direct organization is completely aware that the cylinder and head number gives him a unique track number. To illustrate, the 2311 could be thought of as consisting of tracks numbered as follows:

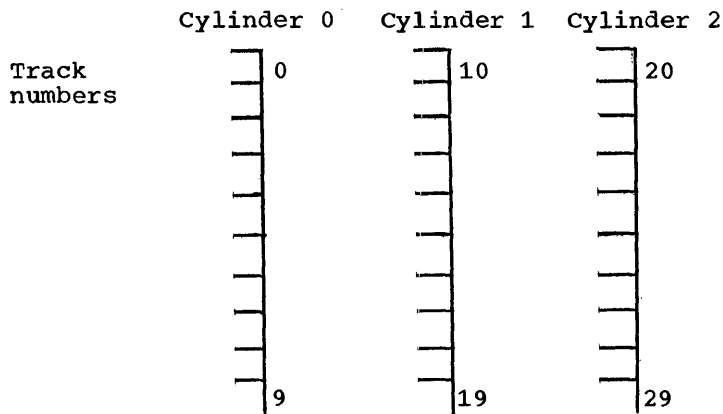

Now if the randomizing formula resulted in an address of Cylinder 001, Head 9:

| | | | |
|----------|------|---|---|
| 0 | 0 | 1 | 9 |
| Cylinder | Head | | |
| # | # | | |

this would be a reference to track 19. This fact allows the programmer to ignore the discontinuous cylinder and head number. If his formula resulted in an address of 0 0 2 0, this would result in accessing cylinder 2, head 0, and this is where track 20 is located.

The programmer can make another use of this decimal track address. He may wish to reserve the bottom track of each cylinder for synonyms. If this is the case, he is, in effect, redefining the cylinder to consist of 9 tracks rather than 10 tracks. The 2311 cylinder could then be thought of as consisting of tracks numbered, as follows:

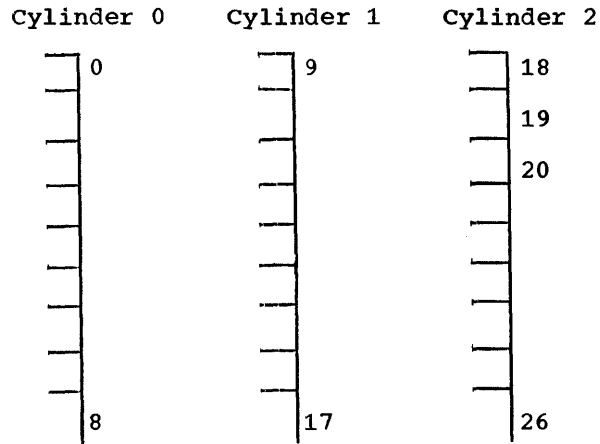

If he randomizes to relative track number 20, he can access it by dividing the track address by the number of tracks in a cylinder.

$$\begin{array}{r}
 2 = \text{Cylinder number} \\
 9 \overline{) 0020} \\
 \underline{18} \\
 2 \\
 \underline{2} \\
 0
 \end{array}$$

2=Head number

The quotient now becomes the cylinder number, and the remainder becomes the head number. As can be seen from the illustration, relative track number 20 is on cylinder 2, head 2.

To simplify randomizing, an algorithm must be developed to generate a decimal track address. This track address can then be converted to a binary cylinder number and head number. In addition, tracks can be reserved by dividing the track address by the number of tracks in a cylinder. The same concepts will hold true for devices such as the 2314. For example, an algorithm can be developed using 20 tracks per cylinder and dividing by an approximate prime number.

Randomizing for the 2321 Data Cell

The track reference field for the data cell is composed of the following discontinuous binary address:

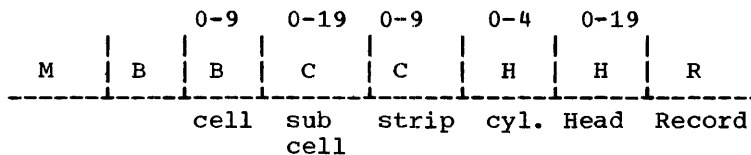

At first glance, this presents an almost impossible randomizing task, but since each strip comprises 100 tracks that are accessible through cylinder and head number, the 2321 can be considered to be composed of consecutively numbered tracks.

| Tracks | Strip |
|-----------------|-------|
| 0 99 | 0 |
| 100 → 199 | 1 |
| 900 → 999 | etc. |
| 1000 → 1099 | |
| 1900 → 1999 | |
| 10000 → 10099 | |
| 19900 → 19999 | |
| 199900 → 199999 | |

On inspection, it can be seen that relative track 20 is located on cylinder 1, head 0 of some particular strip. Its address can be calculated by dividing by 20

```

      1=Cylinder #
20 | 20
   | 20
   | 0=Head #.

```

Thus, relative track number 120 will be located on strip 1, cylinder 1, head 0 of some subcell. Note that the strip number is given by the hundreds digit, and the cylinder and head number is derived by dividing the low-order two digits by 20.

The same relationship holds true for relative track number 900. It is located on strip 9, cylinder 0, track 0. Again the hundreds digit gives the strip number, and dividing the low-order two digits by 20 results in a quotient and remainder of zero.

This relationship holds true through a relative track number of 19999, which is the number of tracks that can be contained on one cell of a data cell array. By applying the foregoing rules, an address of subcell 19, strip 9, cylinder 4, Head 19 is derived.

```

19      9      99
subcell strip      4=Cylinder #
-----
20 99
  80
  --
  19=Head #

```

Thus, by randomizing to a 5-digit decimal track number, the programmer will be able to access the 20,000 tracks (40,000,000 characters) contained in a cell.

The thousands digits would represent the subcell number, the hundreds digit, the strip number, and the quotient and remainder of the two low-order digits divided by 20 would represent the cylinder and head number. Each one of these resulting decimal digits would then be converted to binary and placed in the appropriate place in the track reference field.

There is a total of 200,000 tracks per data cell array. To derive valid addresses that cross cell boundaries, the user should randomize to a 6-digit decimal track address. The highest address possible should be 199,999. To convert this to a data cell address, similar rules apply. In this case, the user must divide the three high-order digits by 20:

```

          9=Cell
20 [---
   | 199
   | 180
   |---
   | 19=Subcell

```

The quotient becomes the cell number and the remainder becomes the subcell number. The hundreds digit is still the strip number, and the cylinder and head number can be derived as before. The resulting address would be:

| | | | | | | | |
|---|---|---|----|---|---|----|---|
| 0 | 0 | 9 | 19 | 9 | 4 | 19 | 0 |
| M | B | B | C | C | H | H | R |

cell sub strip cyl. Head
 cell

Randomizing to the data cell can be accomplished by developing an algorithm to generate decimal track addresses. The use of the foregoing rules makes it possible to convert these generated track addresses to the appropriate discontinuous binary address.

COBOL STATEMENTS USED TO SPECIFY DIRECT ORGANIZATION FILES

The following discussions show the COBOL statements required to create, retrieve, or update a direct organization file. Also included are discussions of what functions the operating system performs when each statement is executed.

Creating a Direct Organization File

To create a direct file, the following clauses are required:

- ORGANIZATION IS DIRECT
- [ACCESS IS SEQUENTIAL]
- SYMBOLIC KEY IS data-name
- ACTUAL KEY IS data-name

The programmer must then specify:

- OPEN OUTPUT file-name
- WRITE record-name [INVALID KEY]
- CLOSE file-name

OPEN Statement: The OPEN statement initializes the VTOC to indicate the presence of the labels and checks the label area for a valid output file. It also establishes the limits of the file as defined in the EXTENT statement. It checks to be sure that the file limits specified do not overlap with an existing file and completes the DTF (Define the File) table for the file that was opened. Thus, it enters the system

logical unit specified for the file into the table. In addition, the OPEN statement initializes the capacity records (R0) over the entire area of the EXTENT for the output file.

WRITE Statement: The WRITE statement transfers the record to the DASD address specified in the ACTUAL KEY. The specified SYMBOLIC KEY becomes a part of the record in the file.

Key Handling: When handling keys, the following restrictions are imposed:

1. The programmer must provide the SYMBOLIC KEY for every record loaded.
2. When creating a file, no provision is made to prevent the addition of a duplicate record.

CLOSE Statement: The CLOSE statement returns the track address of the end-of-file record to the ACTUAL KEY.

Sequential Retrieval of a Direct Organization File

To retrieve a direct file sequentially, the following clauses are required:

- ORGANIZATION IS DIRECT
- ACCESS IS SEQUENTIAL
- SYMBOLIC KEY IS data-name
- ACTUAL KEY IS data-name

The programmer must then specify:

- OPEN INPUT file-name
- READ file-name AT END
- CLOSE file-name

READ Statement: The READ statement retrieves the file sequentially beginning with the lower EXTENT.

OPEN, CLOSE Statements: The OPEN statement checks labels on the label track and initializes the VTOC. The limits of the extents are established at this time. The CLOSE statement is a no-operation.

Key Handling: During sequential retrieval of a direct field, the SYMBOLIC KEY and ACTUAL KEY are ignored.

Random Retrieval, Updating, and Adding to a Direct File

To retrieve a direct file randomly, the following clauses are required:

- ORGANIZATION IS DIRECT
- ACCESS IS RANDOM

- SYMBOLIC KEY IS data-name
- ACTUAL KEY IS data-name

The programmer must then specify:

- OPEN INPUT file-name
- READ file-name INVALID KEY
- CLOSE file-name

Random Retrieval

The READ statement retrieves a record from the information given in the SYMBOLIC KEY. The search begins at the DASD address specified in the ACTUAL KEY.

Updating Randomly

To update randomly, the programmer must specify:

- OPEN I-O file-name
- READ file-name INVALID KEY
- REWRITE record-name [INVALID KEY]
- CLOSE file-name

When updating a file, the keys must not be modified.

Adding Randomly

The WRITE statement allows new records to be added to the file. When adding records to an existing file, both the ACTUAL KEY and SYMBOLIC KEY must be supplied. The record is written into the specified location. When adding randomly to a direct file, no provision is made to prevent the addition of a duplicate record.

OPEN, CLOSE Statements: For random retrieval, the OPEN and CLOSE functions are the same as for sequential retrieval of a direct file.

Key Handling: When a file is accessed randomly, both the ACTUAL KEY and SYMBOLIC KEY must be initialized by the user before the READ or WRITE statement is specified. The ACTUAL KEY contains the DASD address and the SYMBOLIC KEY identifies the file.

MULTIPLE ENTRY POINTS

When more than one type of retrieval is specified for direct access files in a program, an indication of duplicate entry points may be given at linkage edit time. If duplicate entry points occur, the programmer must construct and include a supersettted LIOCS module that contains the individual modules.

The following example shows how (1) the module containing the duplicate entry point can be identified and (2) the supersettted module is built and included in the COBOL object module in place of the individual modules.

If a number of direct files are defined to be used by the same program, the linkage editor diagnostic messages shown in Table 4 might be obtained (they are included in the DISK LINKAGE EDITOR DIAGNOSTIC OF INPUT).

Table 4. Linkage Editor Diagnostic Output

```

JOB  CEFI1002  10/27/66  DISK LINKAGE EDITOR DIAGNOSTIC OF INPUT

ACTION TAKEN  MAP
LIST  PHASE  COMPLDGO,*
LIST  INCLUDE IHD02800  CEFI0001
LIST  INCLUDE IJJCPD1  Information supplied by COBOL compiler
LIST  INCLUDE IHD03500  CEFI0002
LIST  INCLUDE IHD03700  CEFI0003
LIST  AUTOLINK  IJFFBCZZ
LIST  AUTOLINK  IJHUARZZ  Information supplied by Linkage Editor
LINK  AUTOLINK  IJHZLZZZ
LINK  AUTOLINK  IJHZRBZZ

2143I  IS050021  ESD 404040 0010 0001 IJHZRBZZ 0 000000 0095D0 IJHZRRZZ 1 000000
      000010 IJHZRSZZ 1 000000 000001

LIST  AUTOLINK  IJHZRSZZ  Duplicate entry point
LIST  ENTRY
  
```

| 10/27/66 | PHASE | XFR-AD | LOCORE | HICORE | DSK-AD | ESD TYPE | LABEL | LOADED | REL-FR |
|----------|---|--------|--------|--------|--------|----------|----------|--------|--------|
| | COMPLDGO | 007000 | 005080 | 00A07F | 3A 7 2 | CSECT | IJJCPD1 | 005080 | 005080 |
| | | | | | | ENTRY | IJJCPD1N | 005080 | |
| | | | | | | * ENTRY | IJJCPD3 | 005080 | |
| | | | | | | CSECT | IHD02800 | 005240 | 005240 |
| | | | | | | ENTRY | IHD02801 | 005240 | |
| | | | | | | ENTRY | IHD02802 | 005270 | |
| | | | | | | CSECT | IHD03500 | 0053A8 | 0053A8 |
| | | | | | | ENTRY | IHD03501 | 0053A8 | |
| | | | | | | ENTRY | IHD03502 | 00538C | |
| | | | | | | CSECT | IHD03700 | 005680 | 005680 |
| | | | | | | ENTRY | IHD03701 | 005680 | |
| | | | | | | ENTRY | IHD03702 | 005690 | |
| | | | | | | CSECT | CEFI1002 | 0057A0 | 0057A0 |
| | | | | | | CSECT | IJFFBCZZ | 0084F0 | 0084F0 |
| | | | | | | * ENTRY | IJFFBZZZ | 0084F0 | |
| | | | | | | * ENTRY | IJFFZCZZ | 0084F0 | |
| | | | | | | * ENTRY | IJFFZZZZ | 0084F0 | |
| | | | | | | CSECT | IJHZRSZZ | 009C70 | 009C70 |
| | | | | | | CSECT | IJHZRBZZ | 0095D0 | 0095D0 |
| | Module containing duplicate entry point | | | | | CSECT | IJHUARZZ | 008820 | 008820 |
| | | | | | | ENTRY | IJHZRRZZ | 008820 | |
| | | | | | | * ENTRY | IJHUIZZZ | 008820 | |
| | | | | | | CSECT | IJHZLZZZ | 0092A0 | 0092A0 |

Note that the LIOCS modules are separately included in the program (see AUTOLINK IJ . . . entries near the top of the listing). When the modules are linkage edited with the COBOL program, an indication of a duplicate entry point may be given. The duplicate entry point is included in the line of print identified by the message number 2143I and

belongs to the module IJHZRBZZ. This message number is listed in the operating guide for the system and indicates an invalid duplication of an entry point label.

The programmer can identify the module containing the duplicate entry point and build a supersettted module, as follows:

Compare the IJH . . . (entry points) given in the line next to the message number the ENTRY points given in the LABEL column part of the listing.

In this example, the duplicate ENTRY point is ENTRY IJHZRRZZ (the second one in the 2143I line of print, and the third one from the bottom in the LABEL column listing). Thus, this duplicate entry point is in the module CSECT IJHUARZZ (see the entry just above IJHZRRZZ in the LABEL column listing). The module should also be among those given in the AUTOLIST list.

From this module (IJHUARZZ) and module IJHZRBZZ, a supersettted module must be formed, as follows:

Use the first three characters of the module name for the functions used. In this case, they would be IJH. Then use the lowest letter, between the two modules, for each of the next five character positions, as follows:

```
I J H U A R Z Z
```

```
I J H U A B Z Z      Supersettted module
```

```
I J H Z R B Z Z
```

Thus, the name of the supersettted LIOCS module that contains the individual modules (IJHUARZZ and IJHZRBZZ) is IJHUABZZ.

The supersettted module can then be included with the COBOL object module at linkage edit time instead of the individual modules (IJHUARZZ and IJHZRBZZ) by inserting an INCLUDE card before the linkage edit function, as follows:

```
INCLUDE IJHUABZZ  
  
// EXEC LNKEDT
```

ERROR RECOVERY TECHNIQUES FOR DIRECT FILES

As with indexed sequential files, error recovery may be attempted in one of three ways, as follows:

1. The INVALID KEY clause
2. COBOL error subroutine (IHD03400)
3. The USE AFTER STANDARD ERROR clause

Table 4 summarizes, by function, the conditions that cause control to be passed to the INVALID KEY, which error conditions are analyzed by the COBOL subroutine, and, optionally, those error conditions for which a USE AFTER STANDARD ERROR routine can be useful.

Table 5. Error Functions

| FUNCTION ERROR | Create or Add | Random Retrieve | Sequential Retrieve |
|------------------------|--------------------------|--------------------|------------------------|
| No Room Found | INVALID KEY | | |
| No Record Found | | INVALID KEY | |
| Wrong Length Record | USE AFTER STANDARD ERROR | | |
| Data Check | USE AFTER STANDARD ERROR | | |
| End of File | | | AT END |

INVALID KEY

When creating or adding to a file, the INVALID KEY is raised if the track does not contain room enough for the record to be written. A user routine could contain coding to place the synonym on some other track based on the randomizing technique being used.

During random retrieval, an INVALID KEY error is raised if the record is not found. Depending upon how the file was created, this condition could mean that the record may be located on some other track or cylinder, or it could mean that the record is truly missing. The INVALID KEY routine could determine this.

During sequential retrieval, there is no INVALID KEY. The AT END option after the READ statement is used to determine when the end-of-file condition is reached.

USE AFTER STANDARD ERROR

For data check and wrong-length record error conditions, the user may wish to have control passed to him by writing a USE AFTER STANDARD ERROR routine in the Declarative Section of his program. This routine can interrogate bytes 244 and 255 of the DTF in a subprogram to determine the type of error that has occurred. These error indicators are:

Byte 254

X'40' wrong-length record
X'08' no room found

Byte 255

X'80' data check in count
X'10' data check in key or data
X'08' no record found

Note that the "no room found" and the "no record found" conditions should normally be handled by INVALID KEY routines.

Normal return from the Declarative Section is to the next sequential instruction following the input/output operation (which caused the interrupt). Return by means of a GO TO statement may be made to any location within the program. It is important to remember that the last input/output operation was not completed.

Refer to the "Use After Standard Error" discussion under indexed sequential for an example showing how to interrogate the DTF table. Also, see the following discussion "Modifying the DTF Table for Direct Files."

MODIFYING THE DTF TABLE FOR DIRECT FILES

The COBOL compiler builds a skeleton DTF table for files having direct organization. When the OPEN statement is executed, a transient routine uses this information to build a complete DTF table. The contents of the skeleton DTF table are illustrated in Table 6.

Table 6. Skeleton DTF Table for Direct Organization File

| | | |
|------|-------|---|
| BYTE | 0 | -X'00'=RANDOM ACCESS X'FO'=SEQUENTIAL ACCESS |
| | 1 | -X'00'=2311 X'FO'=2321 |
| | 2 | -X'00'=RESTRICTED SEARCH X'FO'=SEARCH MULTIPLE |
| | 3 | -X'00'=NO VERIFY X'FO'=VERIFY |
| | 4-7 | -I/O AREA ADDRESS |
| | 8-11 | -SYMBOLIC KEY ADDRESS |
| | 12-15 | -ACTUAL KEY ADDRESS |
| | 16-19 | -USER LABEL |
| | 20-21 | -LENGTH OF DATA FIELD |
| | 22-29 | -SYMBOLIC FILE-NAME |
| | 30 | -SYMBOLIC KEY LENGTH |
| | 31 | -X'00'=INPUT X'FO'=OUTPUT X'FF'=I/O |
| | 32-35 | -GLOBAL TABLE ADDRESS |
| | 36 | -X'00'=FIXED LENGTH RECORDS X'FF'=UNDEFINED LENGTH RECORDS |
| | 37 | -X'FF'=USER LABELS X'00'=NO USER LABELS |

The programmer may modify the skeleton DTF table prior to execution of the OPEN statement in one of two ways.

1. By writing statements in the main COBOL program to access the DTF table and by writing a COBOL subprogram to modify the DTF table.
2. By writing statements in the COBOL main program to access the DTF table and by writing an assembler language subprogram to change the DTF table.

See the discussion "Modifying the DTF Table" under indexed sequential for an example of a COBOL main program and COBOL subprogram that modifies the DTF table.

Byte 3 (the 4th byte) can be changed to X'00' to suppress the verify option. Verification consists of IOCS checking to be sure that a record written out is correct. Suppression of the verify option could result in improved program performance.

CODING EXAMPLES FOR DIRECT ORGANIZATION FILES

The following examples illustrate how to create and retrieve, sequentially or randomly, a file with direct data organization.

The following job control cards can be used for the examples:

```
// DLBL   SYS004',DIRECT ACCESS FILE',67300,DA
// EXTENT SYS004,111111,1,1,00001,00030
// EXEC
```

Creating the File

This example illustrates how to create a direct organization file from cards. The DA-FILE is composed of unblocked 100 character records that are preceded by a 10-byte key. The key contains the customer identification and the data portion contains customer name balance.

The file control section defines the DA-FILE. The SYMBOLIC KEY clause defines the data name KEY-ID, which is a field in the CARD-FILE. This field will become the record key used by LIOCS to create the key portion of the disk record.

The ACTUAL KEY clause defines the data name address that is in working storage. This field will contain the binary disk address used by LIOCS for its track reference field.

To properly align the binary CC and HH portions of this track reference field on a half-word boundary, the data name address is preceded by a 01 FILLER. This forces FILLER to begin on a double-word boundary. The M portion of the address is not aligned, but the BB, CC, and HH portions of the address are all on half-word or full-word boundaries.

The M, BB, and R portions of the address are assigned a picture of X with a value of LOW-VALUE to cause a binary zero to be inserted in these portions of the address. The BB and R portions should always be binary zeros in 2311 applications. The M portion is always zero in this example, since the data file is contained on one disk pack.

If the data file extends over several disk packs, the M portion of the address would have to be changed to access the correct disk pack. For example, if the file required 250 cylinders, it could be contained on two disk packs. The first 199 cylinders could be located on the first pack (assuming that cylinder zero contains the VTOC). A cylinder address in excess of 199 would indicate that the record is to be located on the second disk pack. To illustrate, a cylinder address of 229 should be located on cylinder 30 of pack 2. This can be accomplished by subtracting 199 from the cylinder address. If the results are positive,

move a binary one to the M portion of the address, and to the results of the subtraction to the CC portion of the address. This results in an address, as follows:

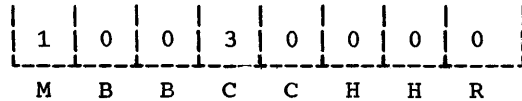

To assure that a binary one is moved to the M field, the following procedure may be used.

```

WORKING-STORAGE SECTION.
01 M-FLD PICTURE99USAGE COMPUTATIONAL.
01 M-FLD-2 REDEFINES M-FLD.
   02 FILLER PICTURE X.
   02 M-2 PICTURE.
  
```

M-FLD defines a half-word binary field. Move 1 to M-FLD. Then move M-2 to M. This will move the eight low-order bits of M-FLD to M.

If the literal 1 were moved directly to M, it would be stored there as a display item with a hexadecimal notation of 'F1'. This will produce an invalid address. The recommended procedure will cause a X'01' to be stored in M field, yielding the desired result.

The PROCEDURE DIVISION starts by opening the files. This will cause the transient open routine to construct the complete DTF table. In addition to the open functions of checking labels and creating VTOC entries, COBOL subroutine IHD03600 is entered at this time. The purpose of this subroutine is to issue the WRITE RECORD ZERO macro-instruction to all the tracks specified by the EXTENT cards for the DA-FILE. This will assure that the track is cleared and that record zero is initialized with the correct information.

This subroutine relieves the user of the responsibility of running clear disk utilities or of rerunning the Initialize Disk program.

After the card is read, the randomizing routine is entered. This routine uses division by prime number. It is assumed that this small file fits on 2 cylinders, and a prime number of 19 is used as a divisor. The results of the routine (the remainder) are stored in TRACK, giving a decimal track address. Ten is added to the track address to avoid any references to cylinder zero.

The low-order byte must now be moved to the binary HH field of the ACTUAL KEY and the three high-order bytes to the binary CC field. This is done by redefining the 4-digit track address into a 3-byte cylinder number and a 1-byte head number. The move is then accomplished by accessing the appropriate data-names.

If there is room for the record on the accessed track, the record is written, an audit trail is printed, and a branch is made to get the next transaction.

If there is no room on the track, a branch to the synonym routine is made. This synonym routine uses the "spilling" technique. It checks the HH field for 9 to determine whether or not the end of cylinder has been reached. If it has not been reached, 1 is added to the head number and the write is repeated; this time, attempting to write the synonym on the following track.

If the end of cylinder is reached without successfully writing the record, a branch is made to the end-of-cylinder routine. This routine will write synonyms on an overflow track located on cylinder 3, head 0. If the overflow track becomes full, the job is terminated. Abnormal

termination, for this reason, would indicate the need for a better randomizing formula or more track reserved for overflow.

The END-JOB routine closes the file, and terminates the run. It will also use information obtained by COBOL subroutine IHD03100 to write an end of file record. This subroutine has kept track of the last record location. It will write the EOF record on either the last track of the extent, or after the last record, whichever is greater.

```
01 001001 IDENTIFICATION DIVISION.
02     PROGRAM-ID. 'LOADDA'.
03     REMARKS.    ILLUSTRATE CREATION OF DIRECT ACCESS FILE.
04     3 AUTHOR.
05     4 INSTALLATION. 360 PROGRAMMING CENTER.
06     ENVIRONMENT DIVISION,
07     CONFIGURATION SECTION.
08     SOURCE-COMPUTER. IBM-360.
09     OBJECT-COMPUTER. IBM-360.
10 002001 INPUT-OUTPUT SECTION.
11     FILE-CONTROL.
12         SELECT DA-FILE ASSIGN TO 'SYS004' DIRECT-ACCESS 2311
13         ACCESS IS SEQUENTIAL ORGANIZATION IS DIRECT
14         RESERVE NO ALTERNATE AREA
15         SYMBOLIC KEY IS KEY-ID
16         ACTUAL KEY IS ADDRESS.
17         SELECT CARD-FILE ASSIGN TO 'SYS005' UNIT-RECORD 2540R
18         RESERVE NO ALTERNATE AREA.
19         SELECT PRINT-FILE ASSIGN TO 'SYS006' UNIT-RECORD 1403
20         RESERVE NO ALTERNATE AREA.
21 003002 DATA DIVISION.
22     FILE SECTION.
23     FD DA-FILE      DATA RECORD IS DISK
24                     RECORDING MODE IS F
25                     LABEL RECORDS ARE STANDARD.
26     01 DISK.
27         02 DISK-NAME  PICTURE X(20).
28         02 DISK-BAL   PICTURE 99999V99.
29         02 FILLER     PICTURE X(73).
30 004001 FD CARD-FILE DATA RECORD IS CARDS
31                     RECORDING MODE IS F
32                     LABEL RECORDS ARE OMITTED.
33     01 CARDS.
34         02 KEY-ID    PICTURE 9(10).
35         02 CD-NAME   PICTURE X(20).
36         02 CD-BAL    PICTURE 99999V99.
37 005001 FD PRINT-FILE DATA RECORD IS PRINTER
38                     RECORDING MODE IS F
39                     LABEL RECORDS ARE OMITTED.
40     01 PRINTER.
41         02 PRINT-ID   PICTURE X(10).
42         02 FILLER     PICTURE X(10).
43         02 PRINT-NAME PICTURE X(20).
44         02 FILLER     PICTURE X(10).
45         02 PRINT-BAL  PICTURE $ZZ,ZZ9.99-.
46     WORKING-STORAGE SECTION.
47         77 NINE       PICTURE 99      USAGE COMPUTATIONAL VALUE 09.
48         77 SAVE       PICTURE S9(10)  USAGE COMPUTATIONAL-3.
49         77 QUOTIENT   PICTURE S9999   USAGE COMPUTATIONAL-3.
50         77 PRODUCT    PICTURE S9999   USAGE COMPUTATIONAL-3.
51         01 TRACK      PICTURE S9999.
52         01 TRACK2     REDEFINES TRACK.
53             03 CYL     PICTURE 999.
54             03 HEAD    PICTURE 9.
55     01 FILLER.
56         02 FILLER     PICTURE X.
57         02 ADDRESS.
58             03 M       PICTURE X      VALUE LOW-VALUE.
```

```

59          03 BB      PICTURE XX  VALUE LOW-VALUE.
60          03 CC      PICTURE 999  USAGE COMPUTATIONAL.
61          03 HH      PICTURE 99   USAGE COMPUTATIONAL.
62          03 R       PICTURE X   VALUE LOW-VALUE.
63 006001  PROCEDURE DIVISION.
64      START.
65          OPEN INPUT  CARD-FILE
66              OUTPUT PRINT-FILE  DA-FILE.
67      RD.
68          READ CARD-FILE AT END GO TO END-JOB.
69          MOVE KEY-ID TO SAVE.
70          DIVIDE 19 INTO SAVE  GIVING QUOTIENT.
71          MULTIPLY QUOTIENT BY 19 GIVING PRODUCT.
72          SUBTRACT PRODUCT FROM SAVE GIVING TRACK.
73          ADD 10 TO TRACK.
74          MOVE HEAD TO HH.
75          MOVE CYL TO CC.
76          MOVE CD-NAME TO DISK-NAME.
77          MOVE CD-BAL  TO DISK-BAL.
78      WR.
79          WRITE DISK INVALID KEY GO TO SYNONYMN-ROUTINE.
80      PRT.
81          MOVE CD-NAME TO PRINT-NAME.
82          MOVE CD-BAL  TO PRINT-BAL.
83          MOVE KEY-ID  TO PRINT-ID.
84          WRITE PRINTER.
85          GO TO RD.
86 007001  SYNONYMN-ROUTINE.
87          IF HH IS EQUAL TO NINE GO TO END-OF-CYLINDER.
88          ADD 1 TO HH.
89          GO TO WR.
90      END-OF-CYLINDER.
91          MOVE 3 TO CC.
92          MOVE ZERO TO HH.
93          WRITE DISK INVALID KEY GO TO NO-ROOM.
94          GO TO PRT.
95      NO-ROOM.
96          DISPLAY 'CYLINDER OVERFLOW FULL' UPON CONSOLE.
97      END-JOB.
98          CLOSE  CARD-FILE  PRINT-FILE  DA-FILE
99          DISPLAY 'END JOB' UPON CONSOLE.
00          STOP RUN.

```

Random Retrieval -- Direct Organization

This coding example illustrates random retrieval from the file created in the previous example.

The Data Division contains basically the same information as that in the previous example. The DA-FILE is opened as input, which permits updating. By opening the file as INPUT-OUTPUT, additions to the file could be made in the same run, or in a separate processing program.

The same randomizing formula is used as in loading the file. The SYMBOLIC KEY data-name (KEY-ID) within the card file specifies the key of the record to be found. The READ verb starts a search for an equal key on the track specified by the ACTUAL KEY address.

If the record is found, data is printed, the disk record is updated, and the next transaction is read.

Since the search was not restricted, the record will be found if it is either on the track specified or on any following tracks of the same cylinder. Only if the record is not located prior to reaching the end of the cylinder does a "no record found" condition occur. This will cause a branch to the END-OF-CYLINDER routine.

The END-OF-CYLINDER routine initiates a search for the record on the overflow cylinder. If the record is located, a branch is made to the processing routine. If another "no record found" condition occurs, the error and error record are identified, and processing continues with the next transaction.

The END-JOB routine terminates the run.

```
01 001001 IDENTIFICATION DIVISION.
02     PROGRAM-ID.      'RANDA'.
03     REMARKS.        ILLUSTRATE RANDOM RETRIEVAL FROM DA FILE.
04     3 AUTHOR.
05     4 INSTALLATION. 360 PROGRAMMING CENTER.
06     ENVIRONMENT DIVISION.
07     CONFIGURATION SECTION.
08     SOURCE-COMPUTER. IBM-360.
09     OBJECT-COMPUTER. IBM-360.
10 002001 INPUT-OUTPUT SECTION.
11     FILE-CONTROL.
12         SELECT DA-FILE ASSIGN TO 'SYS004' DIRECT-ACCESS 2311
13         ACCESS IS RANDOM      ORGANIZATION IS DIRECT
14         RESERVE NO ALTERNATE AREA
15         SYMBOLIC KEY IS KEY-ID
16         ACTUAL KEY IS ADDRESS.
17         SELECT CARD-FILE ASSIGN TO 'SYS005' UNIT-RECORD 2540R
18         RESERVE NO ALTERNATE AREA.
19         SELECT PRINT-FILE ASSIGN TO 'SYS006' UNIT-RECORD 1403
20         RESERVE NO ALTERNATE AREA.
21 003002 DATA DIVISION.
22     FILE SECTION.
23     FD DA-FILE      DATA RECORD IS DISK
24                     RECORDING MODE IS F
25                     LABEL RECORDS ARE STANDARD.
26     01 DISK.
27         02 DISK-NAME  PICTURE  X(20).
28         02 DISK-BAL  PICTURE  99999V99.
29         02 FILLER    PICTURE  X(73).
30 004001 FD CARD-FILE DATA RECORD IS CARDS
31                     RECORDING MODE IS F
32                     LABEL RECORDS ARE OMITTED.
```

```

33      01 CARDS.
34      02 KEY-ID PICTURE 9(10).
35      02 CD-NAME PICTURE X(20).
36      02 CD-AMT PICTURE S99999V99.
37 005001 FD PRINT-FILE DATA RECORD IS PRINTER
38          RECORDING MODE IS F
39          LABEL RECORDS ARE OMITTED.
40      01 PRINTER.
41      02 PRINT-ID PICTURE X(10).
42      02 FILLER PICTURE X(10).
43      02 PRINT-NAME PICTURE X(20).
44      02 FILLER PICTURE X(10).
45      02 PRINT-BAL PICTURE $ZZ,ZZ9.99-.
46      02 FILLER PICTURE X(10).
47      02 PRINT-AMT PICTURE ZZ,ZZ9.99-.
48      02 FILLER PICTURE X(10).
49      02 PRINT-NEW-BAL PICTURE ZZ,ZZ9.99-.
50      WORKING-STORAGE SECTION.
51      77 NINE PICTURE 99 USAGE COMPUTATIONAL VALUE 09.
52      77 SAVE PICTURE S9(10) USAGE COMPUTATIONAL-3.
53      77 QUOTIENT PICTURE S9999 USAGE COMPUTATIONAL-3.
54      77 PRODUCT PICTURE S9999 USAGE COMPUTATIONAL-3.
55      01 TRACK PICTURE S9999.
56      01 TRACK2 REDEFINES TRACK.
57          03 CYL PICTURE 999.
58          03 HEAD PICTURE 9.
59      01 FILLER.
60      02 FILLER PICTURE X.
61      02 ADDRESS.
62          03 M PICTURE X VALUE LOW-VALUE.
63          03 BB PICTURE XX VALUE LOW-VALUE.
64          03 CC PICTURE 999 USAGE COMPUTATIONAL.
65          03 HH PICTURE 99 USAGE COMPUTATIONAL.
66          03 R PICTURE X VALUE LOW-VALUE.
67 006001 PROCEDURE DIVISION.
68      START.
69          OPEN INPUT CARD-FILE
70              OUTPUT PRINT-FILE
71              INPUT DA-FILE.
72      RD.
73          READ CARD-FILE AT END GO TO END-JOB.
74          MOVE KEY-ID TO SAVE.
75          DIVIDE 19 INTO SAVE GIVING QUOTIENT.
76          MULTIPLY QUOTIENT BY 19 GIVING PRODUCT.
77          SUBTRACT PRODUCT FROM SAVE GIVING TRACK.
78          ADD 10 TO TRACK.
79          MOVE HEAD TO HH.
80          MOVE CYL TO CC.
81          READ DA-FILE INVALID KEY GO TO END-OF-CYLINDER.
82      ADD.
83          MOVE DISK-BAL TO PRINT-BAL.
84          ADD CD-AMT TO DISK-BAL.
85          MOVE CD-AMT TO PRINT-AMT.
86          MOVE DISK-NAME TO PRINT-NAME.
87          MOVE DISK-BAL TO PRINT-NEW-BAL.
88          MOVE KEY-ID TO PRINT-ID.
89          WRITE PRINTER.
90          REWRITE DISK.
91          GO TO RD,
92      END-OF-CYLINDER.
93          MOVE 3 TO CC.
94          MOVE ZERO TO HH.
95          READ DA-FILE INVALID KEY GO TO NO-RECORD.
96          GO TO ADD.
97      NO-RECORD.
98          DISPLAY 'NO RECORD FOUND' UPON CONSOLE.
99          DISPLAY KEY-ID UPON CONSOLE.
00          GO TO RD.

```



```

01      END-JOB.
02      CLOSE CARD-FILE PRINT-FILE DA-FILE
03      DISPLAY 'END JOB' UPON CONSOLE.
04      STOP RUN.

```

Sequential Retrieval -- Direct Organization

This program illustrates sequential retrieval of the direct-access records in their physical sequence.

The starting disk address, Cylinder 1, Head 0, is moved to the ACTUAL KEY address.

The READ statement fetches the first record and locates the address of the next record. Both the key and data portion of the DASD record are read since the SYMBOLIC KEY clause is specified.

A listing is made of the DA-FILE. Each READ statement issued to the DA-FILE retrieves another record and locates the following record. This continues until the end-of-file record is reached, at which time the program branches to the END-JOB routine.

```

01 001001 IDENTIFICATION DIVISION.
02     PROGRAM-ID. 'SEQDA'.
03     REMARKS.      ILLUSTRATE SEQ. RETRIEVAL OF DIRECT ACCESS FILE.
04     3 AUTHOR.
05     4 INSTALLATION. 360 PROGRAMMING CENTER.
06     ENVIRONMENT DIVISION.
07     CONFIGURATION SECTION.
08     SOURCE-COMPUTER. IBM-360.
09     OBJECT-COMPUTER. IBM-360.
10 002001 INPUT-OUTPUT SECTION.
11     FILE-CONTROL.
12         SELECT CA-FILE ASSIGN TO 'SYS004' DIRECT-ACCESS 2311
13         ACCESS IS SEQUENTIAL ORGANIZATION IS DIRECT
14         RESERVE NO ALTERNATE AREA
15         SYMBOLIC KEY IS KEY-ID
16         ACTUAL KEY IS ADDRESS.
17         SELECT PRINT-FILE ASSIGN TO 'SYS006' UNIT-RECORD 1403
18         RESERVE NO ALTERNATE AREA.
19 003002 DATA DIVISION.
20     FILE SECTION.
21     FD DA-FILE      DATA RECORD IS DISK
22                     RECORDING MODE IS F
23                     LABEL RECORDS ARE STANDARD.
24     01 DISK.
25         02 DISK-NAME  PICTURE X(20).
26         02 DISK-BAL   PICTURE 99999V99.
27         02 FILLER     PICTURE X(73).
28 005001 FD PRINT-FILE DATA RECORD IS PRINTER
29                     RECORDING MODE IS F
30                     LABEL RECORDS ARE OMITTED.
31     01 PRINTER.
32         02 PRINT-ID   PICTURE X(10).
33     02 FILLER         PICTURE X(10).
34         02 PRINT-NAME PICTURE X(20).
35         02 FILLER     PICTURE X(10).
36         02 PRINT-BAL  PICTURE $ZZ,ZZ9.99-.
37     WORKING-STORAGE SECTION.
38         77 KEY-ID     PICTURE X(10).
39     01 FILLER.
40         02 FILLER     PICTURE X.
41         02 ADDRESS.
42         03 M          PICTURE X  VALUE LOW-VALUE.
43         03 BB         PICTURE XX  VALUE LOW-VALUE.

```

```

44          03 CC      PICTURE 999  USAGE COMPUTATIONAL.
45          03 HH      PICTURE 99   USAGE COMPUTATIONAL.
46          03 R       PICTURE X    VALUE LOW-VALUE.
47 006001 PROCEDURE DIVISION.
48      START.
49          MOVE ZERO TO HH.
50          MOVE 1     TO CC.
51          OPEN INPUT DA-FILE
52              OUTPUT PRINT-FILE.
53      RD.
54          READ DA-FILE AT END GO TO END-JOB.
55          MOVE DISK-NAME TO PRINT-NAME.
56          MOVE DISK-BAL  TO PRINT-BAL.
57          MOVE KEY-ID    TO PRINT-ID.
58      PRT.
59          WRITE PRINTER.
60
61          GO TO RD.
62      END-JOB.
63          DISPLAY 'END OF JOB' UPON CONSOLE.
64          CLOSE DA-FILE PRINT-FILE.
65          STOP RUN.

```

APPENDIX A: CONSIDERATIONS WHEN USING ASSEMBLER WITH COBOL FOR OVERLAYS

This appendix contains:

- An example of a printout of an assembler routine effecting overlays specified by a COBOL Disk and Tape Operating Systems program.
- Explanations of the functions performed by the assembler overlay subroutine instructions. The explanations are keyed to the instructions in the listing.
- Information needed to prepare and use subprograms written in assembler language with a main program written in COBOL.

ASSEMBLER ROUTINE FOR EFFECTING OVERLAYS

The following overlay subroutine is an example and is governed by the following restrictions:

1. The example is a suggested technique and not the only technique.
2. It can be used for assembler overlays if statement 30 is deleted and if the user has a desired entry point in his end card.
3. The subroutine cannot be used for entry points other than at the first instruction of the Procedure Division. A suggested technique for diverse entry points is a table lookup employing V-type constants.
4. Deletion of statement 30, i.e., LA 15,48(15) could result in looping or a process error in the subprogram.
5. The number of bytes of initialization generated by the compiler (i.e., the 48 in statement 30 of the example) may change in subsequent modification of the compiler.

```
STMNT  SOURCE STATEMENT
0001  OVRLAY START 0
0002      ENTRY OVRLAY
0003  * AT ENTRY TIME
0004  * . R1 = POINTER TO ADCON LIST OF USING ARGUMENTS FIRST ARGUMENT
0005  *     IS PHASE OR SUBROUTINE NAME, MUST BE 8 BYTES
0006  *     R13 = ADDRESS OF SAVE AREA
0007  *     R14 = RETURN POINT OF CALLING PROGRAM
0008  *     R15 = ENTRY POINT OF OVERLAY PROGRAM
0009  * AT EXIT
0010  *     R1 = POINTER TO SECOND ARGUMENT OF ADCON LIST OF USING ARGUMENTS
0011  *     R14 = RETURN POINT OF CALLING PROGRAM--NOT THIS PROG
0012  *     R15 = ENTRY POINT OF PHASE OR SUBPROGRAM
0013  * R0 IS DESTROYED BY THIS ROUTINE
0014      USING *,15
0015      ST 1,SAVE
0016      L 1,0(1)      R1 = ADDRESS OF PHASE NAME
0017      CLC0(8,1),CORSUBIS IT IN CORE
0018      BE SUBIN      YES
0019      MVCCORSUB(8),0(1) NO,CORSUB = PHASE NAME
0020      SR 0,0      R0 = 0
```

```

0021 *          LOAD REQUIRES R0 = 0 IF LOAD ADDRESS
0022 *          ISNT SPECIFIED, R1 = ADDRESS OF
0023 *          PHASE NAME.  R1 = PHASE ENTRY
0024 *
0025     SVC4          LOAD PHASE
0026     ST 1,ASUB     ASUB=ENTRY POINT OF PHASE
0027     SUBLN 1,SAVE  R1 = POINTER TO SECOND ADCON OF
0028     LA 1,4(1)     USING LIST--BYPASSES PHASE NAME
0029     L 15,ASUB     R15 = ENTRY POINT OF PHASE
0030     LA 15,48(15)  BYPASS COBOL INITIALIZATION IN SUBPROGRAM
0031     BR 15         BRANCH TO SUBROUTINE, RETURN WILL BE
0032 *                TO PROGRAM WHICH CALLED OVRLAY
0033     DS OF
0034     SAVDC 4X'FF'   REGISTER SAVE AREA
0035     ASUDC 4X'FF'   ADDRESS OF SUBROUTINE
0036     CORDCB8X'FF'  NAME OF SUBROUTINE IN CORE
0037     END

```

FUNCTIONS OF OVERLAY ROUTINE INSTRUCTIONS

The instructions of the overlay routine perform the following functions:

```

0015 - Saves the address of the PARAMETER LIST
0016 - Loads the address of the PARAMETER LIST
0017 - Checks to see if program is already in overlay area
0018 - If it is, OVERLAY branches directly to subprogram
0025 - OVERLAY then issues OVERLAY CALL
0026 - Saves 1st address of overlaying and subprogram
0027 - Loads address of parameter table
0028 - Indexes and loads address of first parameter
0029, 0030, 0031 - Branches to subprogram to execute procedural steps
0033,0037 - Defines storage, defines constants and end of routine
            instruction.

```

ASSEMBLER LANGUAGE SUBPROGRAMS

CALLED AND CALLING PROGRAMS

Any program referred to by another program is called subprogram. If this called subprogram refers to another subprogram, it is both a called and calling subprogram. In Figure 19, program A calls subprogram B; subprogram B calls subprogram C; therefore:

1. A is considered a calling program by B.
2. B is considered a called subprogram by A.
3. B is considered a calling subprogram by C.
4. C is considered a called subprogram by B.

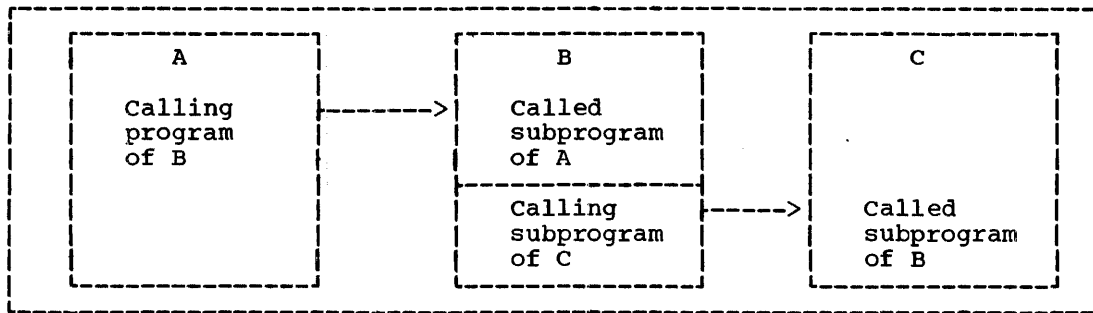

Figure 19. Called and Calling Programs

There are three basic ways to use assembler-written subprograms with a main program written in COBOL:

1. A COBOL main program or subprogram calling an assembler-written subprogram.
2. An assembler-written subprogram calling a COBOL subprogram.
3. An assembler-written subprogram calling another assembler-written subprogram.

From these combinations, more complicated structures can be formed.

The Disk and Tape Operating Systems have established certain conventions to give control to and return control from assembler-written subprograms. These conventions, called linkage conventions, are described in the following text.

LINKAGE CONVENTIONS

The save and return routines for assembler subprograms need not be written exactly the same as those generated by the COBOL compiler. However, there are basic conventions for COBOL programs to which the assembler programmer must adhere. These conventions include:

1. Using the proper registers to establish linkage.
2. Reserving, in the calling program, an area that is used by the called subprogram to refer to the argument list.
3. Reserving, in the calling program, a save area in which the registers may be saved.

Register Use

The Disk and Tape Operating Systems have assigned functions to certain registers used in linkages. The function of each linkage register is shown in Figure 20.

| REGISTER NUMBER | REGISTER NAME | FUNCTION |
|-----------------|------------------------|--|
| 1 | Argument List Register | Address of the argument list passed to the called subprogram. |
| 13 | Save Area Register | Address of the area reserved by the calling program in which the contents of certain registers are stored by the called program. |
| 14 | Return Register | Address of the location in the calling program to which control is returned after execution of the called program. |
| 15 | Entry Point Register | Address of the entry point in the called subprogram. |

Figure 20. Linkage Registers

Argument List

Every assembler-written subprogram that calls another subprogram must reserve an area of storage (argument list) in which the argument list used by the called subprogram is located. Each entry in the parameter list occupies four bytes and is on a full-word boundary.

In the first byte of each entry in the parameter list, bits 1 through 7 contain zeros. However, bit 0 may contain a 1 to indicate the last entry in the parameter area.

The last three bytes of each entry contain the 24-bit address of the argument.

Save Area

An assembler subprogram that calls another subprogram must reserve an area of storage (save area) in which certain registers (i.e., those used in the called subprogram and those used in the linkage to the called subprogram) are saved.

The maximum amount of storage reserved by the calling subprogram is 18 words. All registers are saved. Figure 21 shows the layout of the save area and the contents of each word.

| | |
|----------------------|---|
| AREA (word 1) | This word is a part of the standard linkage convention established under the disk and tape operating systems. The word must be reserved for proper addressing of the succeeding entries. However, an assembler subprogram may use the word for any desired purpose. |
| AREA+4 (word 2) | The address of the previous save area; that is, the save area of the subprogram that called this one. |
| AREA+8 (word 3) | The address of the next save area; that is, the save area of the subprogram to which this subprogram refers. |
| AREA+12 (word 4) | The contents of register 14; that is, the return address. |
| AREA+16 (word 5) | The contents of register 15; that is, the entry address. |
| AREA+20 (word 6) | The contents of register 0. |
| AREA+24 (word 7) | The contents of register 1. |
| . | . |
| . | . |
| . | . |
| AREA+68 (word 18) | The contents of register 12. |

Figure 21. Save Area Layout and Word Contents

A called COBOL subprogram does not save floating-point registers. The programmer is responsible for saving and restoring the contents of these registers in the calling program.

Example

The linkage conventions used by an assembler subprogram that calls another subprogram are shown in Figure 22. The linkage should include:

1. The calling sequence.
2. The save and return routines.
3. The out-of-line parameter list. (An in-line parameter list may be used; see "In-line Parameter List.")
4. A save area on a full-word boundary.

| | | | |
|-------------------|----------|-----------------------------------|---|
| deckname | START | 0 | |
| | ENTRY | name ₁ | |
| | EXTRN | name ₂ | |
| | USING | name ₁ ,15 | |
| * Save Routine | | | |
| name, | STM | 14,r ₁ ,12(13) | The contents of registers 14, 15, and 0 through r ₁ are stored in the save area of the calling program (previous save area). r ₁ is any number from 0 through 12. |
| * | | | |
| * | | | |
| | LR | r ₃ ,15 | |
| | DROP | 15 | |
| | USING | name ₁ ,r ₃ | where r ₃ and r ₂ have been saved |
| * | LR | r ₂ ,13 | Loads register 13, which points to the save area of the calling program, into any general register, r ₂ , except 0 and 13. |
| * | | | |
| | LA | 13,AREA | Loads the address of this program's save area into register 13. |
| * | | | |
| | ST | 13,8(0,r ₂) | Stores the address of this program's save area into word 3 of the save area of the calling program. |
| * | | | |
| | ST | r ₂ ,4(0,13) | Stores the address of the previous save area (i.e., the same area of the calling program) into word 2 of this program's save area. |
| * | | | |
| | BC | 15,prob ₁ | |
| AREA | DS | 18F | Reserves 18 words for the save area. |
| * | | | This is last statement of save routine. |
| prob ₁ | | | User-written program statements |
| / | | | Calling Sequence |
| | 1,ARGLST | | First statement in calling sequence. |
| | L | 15,ADCON | |
| | BALR | 14,15 | |
| * | | | Remainder of user-written program statements |
| * Return Routine | | | |
| | L | 13,4(0,13) | First statement in return routine. Loads the address of the previous save area back into register 13. |
| * | | | |
| | LM | 2,r ₁ ,28(13) | The contents of registers 2 through r ₁ , are restored from the previous save area |
| * | | | |
| | L | 14,12(13) | Loads the return address, which is in word 4 of the calling program's save area, into register 14. |
| * | | | |
| | MVI | 12(13),X'FF' | Sets flag FF in the save area of the calling program to indicate that control has returned to the calling program. |
| * | | | |
| | BCR | 15,14 | Last statement in-return routine. |
| ADCON | DC | A(name ₂) | contains the address of subprogram name ₂ . |
| * | | | |
| * Parameter List | | | |
| ARGLST | DC | AL4(arg ₁) | First statement in parameter area setup. |
| | DC | AL4(arg ₂) | |
| | DC | X'80' | First byte of last argument sets bit 0 to 1. |
| | DC | AL3(arg _n) | last statement in parameter area setup. |

Figure 22. Sample Linkage Routines Used with a Calling Subprogram

LOWEST LEVEL SUBPROGRAM

If an assembler subprogram does not call any other subprogram (i.e., if it is at the lowest level), the programmer should omit the save routine, calling sequence, and parameter list shown in Figure 22. If the assembler subprogram uses any registers, it must save them. Figure 23 shows the appropriate linkage conventions used by an assembler subprogram at the lowest level.

| | | |
|---------------------------------|-------|--------------|
| deckname | START | 0 |
| | ENTRY | name |
| | USING | *,15 |
| name | STM | 14,r1,12(13) |
| | . | . |
| | . | . |
| User-written program statements | | |
| | . | . |
| | . | . |
| | LM | 2,r1,28(13) |
| | MVI | 12(13),X'FF' |
| | BCR | 15, 14 |

Note: If registers 13 and/or 14 are used in the called subprogram, their contents should be saved and restored by the called subprogram.

Figure 23. Sample Linkage Routines Used with a Lowest Level Subprogram

In-Line Parameter List

The assembler programmer may establish an in-line parameter list instead of an out-of-line list. In this case, he may substitute the calling sequence and parameter list shown in Figure 24 for that shown in Figure 22.

Data Format of Arguments

Any assembler-written subprogram must be coded with a detailed knowledge of the data formats of the arguments being passed. Most coding errors will probably occur because of the data-format discrepancies of the arguments.

If one programmer writes both the main program and the subprogram, the data formats of the arguments should not present a problem when passed as parameters. However, when the programs are written by different programmers, the data-format specifications for the arguments must be clearly defined for the user.

| | | |
|--------|------|------------------------|
| ADCON | DC | A(prob ₁) |
| | . | |
| | . | |
| | LA | 14, RETURN |
| | L | 15, ADCON |
| | CNOP | 2, 4 |
| | BALR | 1, 15 |
| | DC | AL4(arg ₁) |
| | DC | AL4(arg ₂) |
| | . | |
| | . | |
| | DC | X'80' |
| | DC | AL3(arg _n) |
| RETURN | BC | 0, X'isn' |

Figure 24. Sample In-line Parameter List

APPENDIX B: REFERENCE FORMATS FOR DISK AND TAPE OPERATING SYSTEMS COBOL

IDENTIFICATION DIVISION.

PROGRAM-ID. 'program-name'.
[AUTHOR. sentence...]
[INSTALLATION. sentence...]
[DATE-WRITTEN. sentence...]
[DATE-COMPILED. sentence...]
[SECURITY. sentence...]
[REMARKS. sentence...]

ENVIRONMENT DIVISION.

CONFIGURATION SECTION.

[SOURCE-COMPUTER. IBM-360 [model-number].]
[OBJECT-COMPUTER. IBM-360 [model-number].]

INPUT-OUTPUT SECTION.

FILE-CONTROL. [COPY library-name.]
SELECT file-name [COPY library-name.]

ASSIGN TO external-name { DIRECT-ACCESS
UTILITY
UNIT-RECORD } device-number UNIT [S]

[RESERVE { NO
1 } ALTERNATE AREA[S]]

[ACCESS IS { SEQUENTIAL
RANDOM }]

[ORGANIZATION IS { INDEXED
DIRECT }]

[SYMBOLIC KEY IS data-name]
[ACTUAL KEY IS data-name]
[RECORD KEY IS data-name]

I-O-CONTROL

[SAME AREA FOR file-name-1 file-name-2 [file-name-3...].]

[RERUN ON external-name { DIRECT-ACCESS
UTILITY } device-number UNIT[S]]

EVERY integer RECORDS OF file-name

[APPLY overflow-name TO FORM-OVERFLOW ON file-name.]

[APPLY WRITE-ONLY ON file-name.....]

[APPLY RESTRICTED SEARCH OF integer TRACKS ON file-name.....]

DATA DIVISION.

FILE SECTION.

FD file-name [COPY library-name.]

[BLOCK CONTAINS integer { CHARACTERS
RECORDS }]

[RECORDING MODE IS { U
F
V }]

[RECORD CONTAINS [integer-1 TO] integer-2 CHARACTERS]

LABEL { RECORD IS } { STANDARD }
 { RECORDS ARE } { OMITTED }
 data-name

DATA { RECORDS ARE } record-name...
 { RECORD IS }

Record Description Entry.

WORKING-STORAGE SECTION.

Record Description entries

LINKAGE SECTION.

Record Description entries

level-number { data-name } [REDEFINES data-name-2] [COPY library-name.]
 { FILLER }

[PICTURE IS { alpha-form
 an-form
 numeric-form
 report-form
 fp-form }]

[OCCURS integer TIMES [DEPENDING ON data-name]]

[JUSTIFIED RIGHT]

[BLANK WHEN ZERO]

[VALUE IS literal]

[USAGE IS { DISPLAY
 COMPUTATIONAL
 COMPUTATIONAL-1
 COMPUTATIONAL-2
 COMPUTATIONAL-3 }]

PROCEDURE DIVISION

DECLARATIVES.

{ section-name SECTION. USE-SENTENCE.
 { paragraph-name. sentence... .} ... } ...

END DECLARATIVES.

USE FOR CREATING [BEGINNING
 ENDING] LABELS ON OUTPUT file-name...

USE FOR CHECKING [BEGINNING
 ENDING] LABELS ON INPUT file-name...

USE AFTER STANDARD ERROR PROCEDURE ON file-name.

Conditionals.

IF Statement.

IF condition [THEN] {statement-1...} [ELSE {statement-2...}]
 {NEXT SENTENCE} {OTHERWISE} {NEXT SENTENCE}

Relation Test.

{data-name-1
 arithmetic-expression-1
 figurative-constant-1
 literal-1} IS [NOT] {>
 <
 =
 GREATER THAN
 LESS THAN
 EQUAL TO} {data-name-2
 arithmetic
 expression-2
 figurative
 constant-2
 literal-2}

Sign Test.

{data-name
 arithmetic-expression} IS [NOT] {POSITIVE
ZERO
NEGATIVE}

Class Test.

{data-name IS [NOT] } {NUMERIC
ALPHABETIC}

Condition Name Test.

[NOT] condition-name

Overflow Test.

[NOT] overflow-name

Open and Close Statements.

OPEN {INPUT {file-name [WITH NO REWIND [REVERSED]]} ...
 [OUTPUT{file-name [WITH NO REWIND]}...]
 [I-O {file-name} ...]}
 {OUTPUT {file-name [WITH NO REWIND]}...
 [INPUT {file-name [WITH NO REWIND [REVERSED]]}...]
 [I-O {file-name} ...]}
 {I-O {file-name}...[OUTPUT{file-name [WITH NO REWIND]}...]
 [INPUT {file-name [WITH NO REWIND [REVERSED]]}...]}
CLOSE {file-name [UNIT] [REEL] [WITH {NO REWIND}]} ...

Input/Output Verbs

READ file-name RECORD [INTO data-name] AT END
 imperative statement...

READ file-name RECORD [INTO data-name]
 {AT END
INVALID KEY} imperative statement...

WRITE record-name [FROM data-name-1]
 [INVALID KEY imperative statement...]

WRITE record-name [FROM data-name-1]

[AFTER ADVANCING { data-name-2 } LINES]
 { integer }

permissible values for data-name-2

| <u>Value</u> | <u>Interpretation</u> |
|--------------|--|
| b (blank) | single spacing |
| 0 | double spacing |
| - | triple spacing |
| + | suppress spacing |
| 1 through 9 | skip to channels 1 through 9, respectively |
| A, B, C | skip to channels 10, 11, 12, respectively |
| V, W | pocket select 1 or 2, respectively on the IBM 1442, or 2540 and P1 or P2 on the IBM 2540 |

Permissible integer

0 - skip to next-page
1 - skip 1 line
2 - skip 2 lines
3 - skip 3 lines

REWRITE record-name [FROM data-name]
 [INVALID KEY imperative-statement...]

DISPLAY { data-name } ... [UPON CONSOLE]
 { literal } [UPON SYSPUNCH]

ACCEPT data-name [FROM CONSOLE]

Data Manipulation Verbs

MOVE { data-name-1 }
 { literal } TO data-name-2 ...

Option 1

EXAMINE data-name TALLYING { ALL
 { LEADING
 { UNTIL FIRST } } 'character-1'

 [REPLACING BY 'character-2']

Option 2

EXAMINE data-name REPLACING { ALL
 { LEADING
 { UNTIL FIRST
 { FIRST } } } 'character-1'

 BY 'character-2'

TRANSFORM data-name-3 CHARACTERS

FROM { figurative-constant-1 }
 { non-numeric-literal-1 } TO { figurative-constant-2 }
 data-name-1 { non-numeric literal-2 }
 data-name-2

Arithmetic Verbs

ADD { numeric-literal
floating point literal } ... { TO
GIVING } data-name-n
data-name-1

[ROUNDED] [ON SIZE ERROR imperative-statement...]

SUBTRACT { data-name-1
numeric-literal-1 } ...
floating-point-literal-1

FROM { data-name-m [GIVING data-name-n]
numeric-literal-m GIVING data-name-n }
floating-point-literal-m GIVING data-name-n

[ROUNDED] [ON SIZE ERROR imperative statement...]

MULTIPLY { data-name-1
numeric-literal-1 }
floating-point-literal-1

BY { data-name-2 [GIVING data-name-3]
numeric-literal-2 GIVING data-name-3 }
floating-point-literal-2 GIVING data-name-3

[ROUNDED] [ON SIZE ERROR imperative statement...]

DIVIDE { data-name-1
numeric-literal-1 }
floating-point-literal-1

INTO { data-name-2 [GIVING data-name-3]
numeric-literal-2 GIVING data-name-3 }
floating-point-literal-2 GIVING data-name-3

[ROUNDED] [ON SIZE ERROR imperative statement...]

COMPUTE data-name-1 [ROUNDED] = { data-name-2
numeric-literal }
floating-point-literal }
arithmetic-expression }

[ON SIZE ERROR imperative-statement...]

Procedure Branching Statements.

STOP { RUN
literal }

Option 1

GO TO [procedure-name]

Option 2

GO TO procedure-name-1 [procedure-name-2...] DEPENDING ON data-name

ALTER {procedure-name-1 TO PROCEED TO procedure-name-2} ...

Option 1

PERFORM procedure-name-1 [THRU procedure-name-2]

COPY Statement.

(within the Input-Output Section):

{ FILE-CONTROL. } COPY library-name.
{ I-O-CONTROL. }

(within the File-Control Paragraph):

SELECT file-name COPY library-name.

(within the File Section):

FD file-name COPY library-name.

(within a file, Working Storage or Linkage Section):

01 data-name COPY library-name.

(within Working Storage or Linkage Section):

77 data-name COPY library-name.

COBOL Debugging Statements.

TRACE Statement.

{ READY }
{ RESET } TRACE

EXHIBIT Statement.

EXHIBIT { NAMED
CHANGED NAME } { data-name
CHANGED } { non-numeric-literal } ...

ON (Count-Conditional) Statement

ON integer-1 [AND EVERY integer-2] [UNTIL Integer-3]

{ imperative-statement ... } [{ ELSE statement ... }]
{ NEXT SENTENCE } [{ OTHERWISE NEXT SENTENCE }]

Debug Packet Statement

1 8
*DEBUG location

PERMISSIBLE COMPARISONS

| | | SECOND OPERAND | | | | | | | | | |
|---------------|-------------------------------------|----------------|-----------------|-----------------|-----------------|-----------------|-----------------|-----------------|-----------------|-----------------|-----------------|
| | | GR | AL | AN | ED | ID | BI | EF | IF | RP | FC |
| FIRST OPERAND | Group Item (GR) | NN | NN | NN | NN | NN | NN | NN | NN | NN | NN |
| | Alphabetic Item (AL) | NN | NN | NN | | | | | | | NN ¹ |
| | Alphanumeric (non-report) Item (AN) | NN | NN | NN | NN ⁵ | | | | | NN | NN |
| | External Decimal Item (ED) | NN | | NN ⁵ | NU | NU | NU | NU | NU | | NN ³ |
| | Internal Decimal Item (ID) | NN | | | NU | NU | NU | NU | NU | | NU ² |
| | Binary Item (BI) | NN | | | NU | NU | NU | NU | NU | | NU ² |
| | External Floating-point Item (EF) | NN | | | NU | NU | NU | NU | NU | | NU ² |
| | Internal Floating-point Item (IF) | NN | | | NU | NU | NU | NU | NU | | NU ² |
| | Report Item (RP) | NN | | NN | | | | | | NN | NN ⁴ |
| | Figurative Constant (FC) | NN | NN ¹ | NN | NN ³ | NU ² | NU ² | NU ² | NU ² | NN ⁴ | |

Abbreviations for Types of Comparison

NN - Comparison as described for non-numeric items

NU - Comparison as described for numeric items

¹Permitted with the figurative constants SPACE and ALL 'character' where character must be alphabetic.

²Permitted only if figurative constant is ZERO.

³Permitted only if figurative constant is ZERO or ALL 'character' where character must be numeric.

⁴Not permitted with figurative constant QUOTE.

⁵External decimal field must consist of integers.

PERMISSIBLE MOVES

| Source Field | Receiving Field | | | | | | | | |
|---|-----------------|----|----------------|----|----|----|----|----|----|
| | GR | AL | AN | ED | ID | BI | EF | IF | RP |
| Group (GR) | Y | Y | Y | N | N | N | N | N | N |
| Alphabetic (AL) | Y | Y | Y | N | N | N | N | N | N |
| Alphanumeric (AN) | Y | Y | Y | N | N | N | N | N | N |
| External Decimal (ED) | Y | N | Y ¹ | Y | Y | Y | Y | Y | Y |
| Internal Decimal (ID) | Y | N | Y ¹ | Y | Y | Y | Y | Y | Y |
| Binary (BI) | Y | N | Y ¹ | Y | Y | Y | Y | Y | Y |
| External Floating-Point (EF) | Y | N | N | Y | Y | Y | Y | Y | Y |
| Internal Floating-Point (IF) | Y | N | N | Y | Y | Y | Y | Y | Y |
| Report (RP) | Y | N | Y | N | N | N | N | N | N |
| Zeros | Y | N | Y | Y | Y | Y | Y | Y | Y |
| Spaces | Y | Y | Y | N | N | N | N | N | N |
| ALL 'character', HIGH-VALUES, LOW-VALUES, QUOTES | Y | N | Y | N | N | N | N | N | N |
| ¹ For integers only. | | | | | | | | | |

APPENDIX C: STANDARD TAPE FILE LABELS

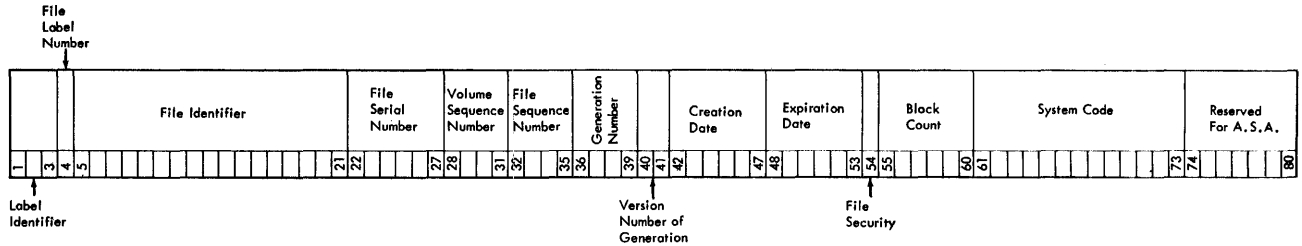

The standard tape file label format and contents are as follows:

| FIELD | NAME AND LENGTH | DESCRIPTION | FIELD | NAME AND LENGTH | DESCRIPTION | | | | | | | | | | | | |
|----------|--|---|-------|-----------------------------------|--|----------|------|---------|---|-------|------|-----|-------|------|-----|---------|-------------|
| 1. | <u>LABEL IDENTIFIER</u> 3 bytes, EBCDIC | identifies the type of label HDR = Header -- beginning of a data file EOF = End of File --- end of a set of data EOV = End of Volume -- end of the physical reel | 9. | <u>CREATION DATE</u> 6 bytes | indicates the year and the day of the year that the file was created: <table border="1"> <thead> <tr> <th>Position</th> <th>Code</th> <th>Meaning</th> </tr> </thead> <tbody> <tr> <td>1</td> <td>blank</td> <td>none</td> </tr> <tr> <td>2-3</td> <td>00-99</td> <td>Year</td> </tr> <tr> <td>4-6</td> <td>001-366</td> <td>Day of Year</td> </tr> </tbody> </table> (e.g., January 31, 1965 would be entered as 65031) | Position | Code | Meaning | 1 | blank | none | 2-3 | 00-99 | Year | 4-6 | 001-366 | Day of Year |
| Position | Code | Meaning | | | | | | | | | | | | | | | |
| 1 | blank | none | | | | | | | | | | | | | | | |
| 2-3 | 00-99 | Year | | | | | | | | | | | | | | | |
| 4-6 | 001-366 | Day of Year | | | | | | | | | | | | | | | |
| 2. | <u>FILE LABEL NUMBER</u> 1 byte, EBCDIC | Always a 1 | 10. | <u>EXPIRATION DATE</u> 6 bytes | indicates the year and the day of the year when the file may become a scratch tape. The format of this field is identical to Field 9. On a multiframe reel, processed sequentially, all files are considered to expire on the same day. | | | | | | | | | | | | |
| 3. | <u>FILE IDENTIFIER</u> 17 bytes, EBCDIC | uniquely identifies the entire file, may contain only printable characters. | 11. | <u>FILE SECURITY</u> 1 byte | indicates security status of the file. 0 = no security protection 1 = security protection. Additional identification of the file is required before it can be processed. | | | | | | | | | | | | |
| 4. | <u>FILE SERIAL NUMBER</u> 6 bytes, EBCDIC | uniquely identifies a file/volume relationship. This field is identical to the Volume Serial Number in the volume label of the first or only volume of a multi-volume file or a multi-file set. This field will normally be numeric (000001 to 999999) but may contain any six alphanumeric characters. | 12. | <u>BLOCK COUNT</u> 6 bytes | indicates the number of data blocks written on the file from the last header label to the first trailer label exclusive of tape marks. Count does not include checkpoint records. This field is used in Trailer Labels. | | | | | | | | | | | | |
| 5. | <u>VOLUME SEQUENCE NUMBER</u> 4 bytes | indicates the order of a volume in a given file or multi-file set. The first must be numbered 0001 and subsequent numbers must be in proper numeric sequence. | 13. | <u>SYSTEM CODE</u> 13 bytes | uniquely identifies the programming system. | | | | | | | | | | | | |
| 6. | <u>FILE SEQUENCE NUMBER</u> 4 bytes | assigns numeric sequence to a file within a multi-file set. The first must be numbered 0001. | 14. | <u>RESERVED</u> 7 bytes | Reserved for American Standards Association (A.S.A.). At present, should be recorded as blanks. | | | | | | | | | | | | |
| 7. | <u>GENERATION NUMBER</u> 4 bytes | uniquely identifies the various editions of the file. May be from 0001 to 9999 in proper numeric sequence. | | | | | | | | | | | | | | | |
| 8. | <u>VERSION NUMBER OF GENERATION</u> 2 bytes | indicates the version of a generation of a file. | | | | | | | | | | | | | | | |

APPENDIX D: STANDARD DASD FILE LABELS -- FORMAT 1

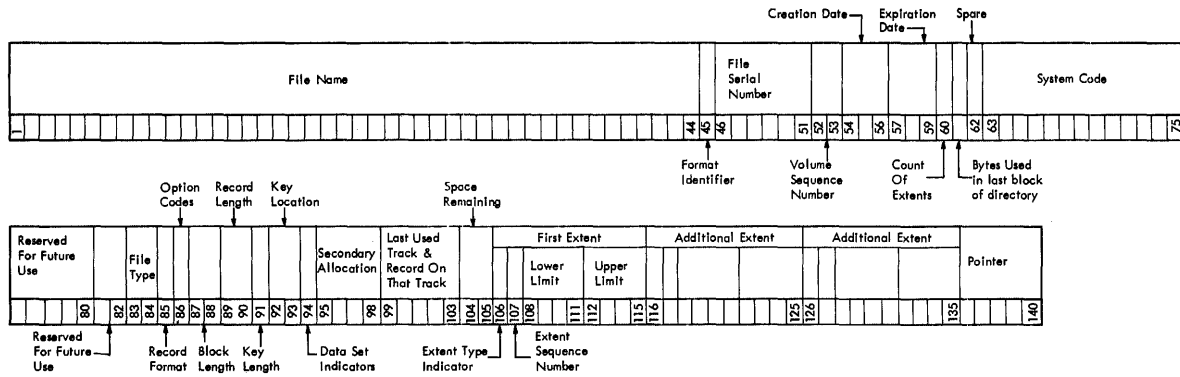

Format 1: This format is common to all data files on disk.

| FIELD | NAME AND LENGTH | DESCRIPTION | FIELD | NAME AND LENGTH | DESCRIPTION |
|-------|---|--|-------|--|--|
| 1. | FILE NAME 44 bytes, alphameric EBCDIC | This field serves as the key portion of the file label. It can consist of three sections: 1. <u>File ID</u> is an alphameric assigned by the user and identifies the file. Can be 1 - 35 bytes if generation and version numbers are used, or 1 - 44 bytes if they are not used. 2. <u>Generation Number</u> . If used, this field is separated from File ID by a period. It has the format Gnnnn, where G identifies the field as the generation number and nnnn (in decimal) identifies the generation of the file. 3. <u>Version Number of Generation</u> . If used, this section immediately follows the generation number and has the format Vnn, where V identifies the field as the version of generation number and nn (in decimal) identifies the version of generation of the file. Note: IBM System/360 Disk and Tape Operating Systems compares the entire field against the file name given in the DLAB card. The generation and version numbers are treated differently by Operating System/360. | 7 | BYTES USED IN LAST BLOCK OF DIRECTORY 1 byte, binary | Used by Operating System/360 only for partitioned (library structure) data sets. Not used by Disk and Tape Operating Systems. |
| | | | 7C | SPARE 1 byte | Reserved for future use. |
| | | | 8 | SYSTEM CODE 13 bytes | Uniquely identifies the programming system. |
| | | | 9 | RESERVED 7 bytes | This field is reserved for future use. |
| | | | 10 | FILE TYPE 2 bytes | The contents of this field uniquely identify the type of data file: Hex 4000 = Consecutive organization Hex 2000 = Direct-access organization Hex 8000 = Indexed-sequential organization Hex 0200 = Library organization Hex 0000 = Organization not defined in the file label. |

The remaining fields comprise the DATA portion of the file label:

| 2. | FORMAT IDENTIFIER 1 byte, EBCDIC numeric | 1 = Format 1 | 11 | RECORD FORMAT 1 byte | The contents of this field indicate the type of records contained in the file: <table border="1"> <thead> <tr> <th>Bit Position</th> <th>Content</th> <th>Meaning</th> </tr> </thead> <tbody> <tr> <td>0 and 1</td> <td>01</td> <td>Variable-length records</td> </tr> <tr> <td></td> <td>10</td> <td>Fixed-length records</td> </tr> <tr> <td></td> <td>11</td> <td>Undefined format</td> </tr> <tr> <td>2</td> <td>0</td> <td>No track overflow</td> </tr> <tr> <td></td> <td>1</td> <td>File is organized using track overflow (Operating System/360 only)</td> </tr> <tr> <td>3</td> <td>0</td> <td>Unblocked records</td> </tr> <tr> <td></td> <td>1</td> <td>Blocked records</td> </tr> </tbody> </table> | Bit Position | Content | Meaning | 0 and 1 | 01 | Variable-length records | | 10 | Fixed-length records | | 11 | Undefined format | 2 | 0 | No track overflow | | 1 | File is organized using track overflow (Operating System/360 only) | 3 | 0 | Unblocked records | | 1 | Blocked records |
|--------------|---|--|----|--------------------------------|--|--------------|---------|---------|---------|----|-------------------------|--|----|----------------------|--|----|------------------|---|---|-------------------|--|---|--|---|---|-------------------|--|---|-----------------|
| Bit Position | Content | Meaning | | | | | | | | | | | | | | | | | | | | | | | | | | | |
| 0 and 1 | 01 | Variable-length records | | | | | | | | | | | | | | | | | | | | | | | | | | | |
| | 10 | Fixed-length records | | | | | | | | | | | | | | | | | | | | | | | | | | | |
| | 11 | Undefined format | | | | | | | | | | | | | | | | | | | | | | | | | | | |
| 2 | 0 | No track overflow | | | | | | | | | | | | | | | | | | | | | | | | | | | |
| | 1 | File is organized using track overflow (Operating System/360 only) | | | | | | | | | | | | | | | | | | | | | | | | | | | |
| 3 | 0 | Unblocked records | | | | | | | | | | | | | | | | | | | | | | | | | | | |
| | 1 | Blocked records | | | | | | | | | | | | | | | | | | | | | | | | | | | |
| 3. | FILE SERIAL NUMBER 6 bytes, alphameric EBCDIC | Uniquely identifies a file/volume relationship. It is identical to the Volume Serial Number of the first or only volume of a multi-volume file. It is the disk pack number identification. | | | | | | | | | | | | | | | | | | | | | | | | | | | |
| 4. | VOLUME SEQUENCE NUMBER 2 bytes, binary | Identifies each volume in a multi-volume file. Each volume is relative to the first volume on which the data file resides. | | | | | | | | | | | | | | | | | | | | | | | | | | | |
| 5. | CREATION DATE 3 bytes, discontinuous binary | Indicates the year and the day of the year the file was created. It is of the form YDD, where Y signifies the year (0 - 99) and DD the day of the year (1 - 366). | | | | | | | | | | | | | | | | | | | | | | | | | | | |
| 6. | EXPIRATION DATE 3 bytes, discontinuous binary | Indicates the year and the day of the year the file may be deleted. The form of this field is identical to that of Field 5. | | | | | | | | | | | | | | | | | | | | | | | | | | | |
| 7A. | EXTENT COUNT 1 byte, binary | Contains a count of the number of extents for this file on this volume. | | | | | | | | | | | | | | | | | | | | | | | | | | | |

| <u>FIELD</u> | <u>NAME</u> | <u>DESCRIPTION</u> | <u>FIELD</u> | <u>NAME</u> | <u>DESCRIPTION</u> |
|--------------|---|--|--------------|--|---|
| | | <p>Bit Position</p> <p>4 0 No truncated records</p> <p> 1 Truncated records in file</p> <p>5 and 6 01 Control character ASA code</p> <p> 10 Control Character machine code</p> <p> 00 Control Character not stated</p> <p>7 0 Records have no keys</p> <p> 1 Records are written with keys</p> | | | |
| 12 | <u>OPTION CODES</u> 1 byte | <p>Bits within this field are used to indicate various options used in building the file.</p> <p>BIT</p> <p>0 = If on, indicates data file was created using Write Validity Check.</p> <p>1 - 7 = unused</p> | 18. | <u>SECONDARY ALLOCATION</u> 4 bytes, binary | Indicates the amount of storage to be requested for this data file at End of Extent. This field is used by Operating System/360 only. It is not used by Disk and Tape Operating Systems routines. The first byte of this field is an indication of the type of allocation request. Hex code "C2" (EBCDIC "B") indicates bytes, hex code "E3" (EBCDIC "T") indicates tracks, and hex code "C3" (EBCDIC "C") indicates cylinders. The next three bytes of this field is a binary number indicating how many bytes, tracks or cylinders are requested. |
| 13. | <u>BLOCK LENGTH</u> 2 bytes, binary | Indicates the block length for fixed length records or maximum block size for variable length blocks. | 19. | <u>LAST USED TRACK AND RECORD ON THAT TRACK</u> 5 bytes discontinuous binary | Indicates the last occupied track in a consecutive file organization data file. This field has the format CCHHR. It is all binary zeros if the last track in a consecutive data file is not on this volume or if it is not consecutive organization. |
| 14. | <u>RECORD LENGTH</u> 2 bytes, binary | Indicates the record length for fixed length records or the maximum record length for variable length records. | 20. | <u>AMOUNT OF SPACE REMAINING ON LAST TRACK USED</u> , 2 bytes, binary | A count of the number of bytes of available space remaining on the last track used by this data file on this volume. |
| 15. | <u>KEY LENGTH</u> 1 byte, binary | Indicates the length of the key-portion of the data records in the file. | 21. | <u>EXTENT TYPE INDICATOR</u> 1 byte | Indicates the type of extent with which the following fields are associated: |
| 16. | <u>KEY LOCATION</u> 2 bytes, binary | Indicates the high order position of the data record. | | | <u>HEX CODE</u> |
| 17. | <u>DATA SET INDICATORS</u> 1 byte | <p>Bits within this field are used to indicate the following:</p> <p>BIT</p> <p>0 If on, indicates that this is the last volume on which this file normally resides. This bit is used by the Disk and Tape Operating Systems DTFSR routine only. None of the other bits in this byte are used by Disk and Tape Operating Systems.</p> <p>1 If on, indicates that the data set described by this file must remain in the same absolute location on the direct access device.</p> <p>2 If on, indicates that Block Length must always be a multiple of 8 bytes.</p> <p>3 If on, indicates that this data file is security protected; a password must be provided in order to access it.</p> <p>4-7 Spare. Reserved for future use.</p> | | | <p>00 Next three fields do not indicate any extent.</p> <p>01 Prime area (indexed Sequential); or Consecutive area, etc., (i.e., the extent containing the user's data records.)</p> <p>02 Overflow area of an Indexed Sequential file.</p> <p>04 Cylinder Index or master index area of an Indexed Sequential file.</p> <p>40 User label track area</p> <p>80 Shared cylinder indicator.</p> |
| | | | 22. | <u>EXTENT SEQUENCE NUMBER</u> 1 byte, binary | Indicates the extent sequence in a multi- extent file. |
| | | | 23. | <u>LOWER LIMIT</u> 4 bytes, discontinuous binary | The cylinder and the track address specifying the starting point (lower limit) of this extent component. This field has the format CCHH. |
| | | | 24. | <u>UPPER LIMIT</u> 4 bytes | The cylinder and the track address specifying the ending point (upper limit) of this extent component. This field has the format CCHH. |
| | | | 25-28 | <u>ADDITIONAL EXTENT</u> 10 bytes | These fields have the same format as the fields 21-24 above. |
| | | | 29-32 | <u>ADDITIONAL EXTENT</u> 10 bytes | These fields have the same format as fields 21-24 above. |
| | | | 33 | <u>POINTER TO NEXT FILE LABEL WITHIN THIS LABEL SET</u> 5 bytes, discontinuous binary | The disk address (format CCHHR) of a continuation label if needed to further describe the file. If field 9 indicates Indexed Sequential organization, this field will point to a Format 2 file label within this label set. Otherwise, it points to a Format 3 file label, and then only if the file contains more than three extent segments. This field contains all binary zeros if no additional file label is pointed to. |

APPENDIX E: TRACK FORMAT FOR THE 2311, 2314, AND 2321

The track format for the 2311, 2314, and 2321 is illustrated in Figure 25. The names of the fields are described in the following discussion.

Index Marker: All tracks start with an index marker. It is a signal to the hardware indicating the beginning of the track.

Home Address: The home address, preceded by a gap, follows the index marker. The home address uniquely identifies each track by specifying the cylinder and head number.

Track Descriptor Record (Record Zero): Record zero consists of two parts: a count portion and a data portion. The count portion is the same as it is for any other record (see the following description of count for record one). The 8-byte data portion is used to record information used by LIOCS. The information in the data portion depends on the data organization (direct or indexed sequential) that is being used.

For direct organization, this portion in the form of CCHHR contains the address of the last record on the track and the number of bytes remaining on the track. This information is used to determine if there is room for another record on the track. For indexed sequential, the data portion contains the address of the last record in the cylinder overflow area and the number of tracks remaining in the cylinder overflow area. Record zero is then used as the cylinder overflow control record.

Address Marker: All records after record zero will be preceded by a 2-byte address marker. The address marker is a signal to the hardware that a record is starting.

Data Records: Data records (see R1 in Figure 25) can consist of a count and data portion for sequential organization, or a count, key, and data portion for direct and indexed sequential organizations.

1. Count Portion. The count portion contains the identification of each record, the key length, and the data length.

Identification. Each record is identified with its cylinder number, head number, or record number. The cylinder and head numbers will be the same as those of the home address. The record number will indicate which record this is on the track. That is, the first record after record zero will be record 1, followed by record 2, etc. This 5-byte binary field in the form of CCHHR is often referred to as the record ID.

Key Length. The key length is specified in an 8-bit byte; its length can range from zero to 255. This field will contain a zero if there is no key.

Data Length. The data length is specified in the 16 bits of the next 2 bytes.

Note: It is the count portion that identifies the presence or absence of a key, as well as indicates the data length. In this way, each record is unique and self formatting.

2. Key Portion. The key portion of the record is normally used to store the control field of the data record such as a man number. Direct and indexed sequential files must have a key portion.
3. Data Portion. The data portion of the record contains the data record.

APPENDIX F: EXAMPLES OF COBOL PROGRAMS

This appendix contains two sample COBOL programs. Figure 26 is a calling program, the other, Figure 27, is a subprogram which is linked by the calling program. The linkage subprogram illustrated need not be a COBOL program. However, COBOL assumes option 2 of the standard CALL, SAVE, and RETURN macros.

| SEQUENCE | | LINE | TEXT |
|----------|----------|------|---|
| (PAGE) | (SERIAL) | 1-8 | |
| 1 | 1 | 1 | IDENTIFICATION DIVISION. |
| | 2 | 1 | PROGRAM-ID. 'CALLPRGM'. |
| | 3 | 1 | REMARKS. EXAMPLE OF A CALLING PROGRAM. |
| | 4 | 1 | ENVIRONMENT DIVISION. |
| | 5 | 1 | CONFIGURATION SECTION. |
| | 6 | 1 | SOURCE-COMPUTER. IBM-360 D30. |
| | 7 | 1 | OBJECT-COMPUTER. IBM-360 D30. |
| | 8 | 1 | INPUT-OUTPUT SECTION. |
| | 9 | 1 | FILE-CONTROL. |
| | 10 | 1 | SELECT FILEA ASSIGN TO 'SYS004' UTILITY 2400 UNITS. |
| | 11 | 1 | SELECT FILEB ASSIGN TO 'SYS005' UNIT-RECORD 2540 RESERVE NO |
| | | 1 | ALTERNATE AREA. |
| | 12 | 1 | DATA DIVISION. |
| | 13 | 1 | FILE SECTION. |
| | 14 | 1 | FD FILEA DATA RECORD IS RECORD-1, LABEL RECORDS ARE STANDARD. |
| | | 1 | BLOCK CONTAINS 5 RECORDS, RECORDING MODE IS F. |
| | 15 | 1 | 01 RECORD-1. |
| | 16 | 1 | 02 SUB-FIELD A PICTURE IS X(68). |
| | 17 | 1 | 02 SUB-FIELD B PICTURE IS X(12). |
| | 18 | 1 | FD FILEB DATA RECORD IS RECORD-2, LABEL RECORDS ARE OMITTED. |
| | 19 | 1 | 01 RECORD-2 PICTURE X(80). |
| | 20 | 1 | PROCEDURE DIVISION. |
| | 21 | 1 | START. OPEN INPUT FILEB OUTPUT FILEA. |
| | 22 | 1 | START2. READ FILEB AT END GO TO LABA. |

* A standard card form, IBM electro C61897, is available for punching source statements from this form.

Figure 26. Example of a Calling Program (Part 1 of 2)

| SEQUENCE | | LINE | TEXT |
|----------|----------|------|---|
| (PAGE) | (SERIAL) | 1-8 | |
| 2 | 1 | 1 | ENTER LINKAGE. |
| | 2 | 1 | CALL 'SUBPRGM' USING RECORD-2. |
| | 3 | 1 | ENTER COBOL. |
| | 4 | 1 | NOTE SUBPROGRAM MODIFIES INFORMATION IN RECORD-2. |
| | 5 | 1 | WRITE RECORD-1 FROM RECORD-2. GO TO START2. |
| 2 | 6 | 1 | LABA. CLOSE FILEA, FILEB STOP RUN. |

Figure 26. Example of a Calling Program (Part 2 of 2)

APPENDIX G: SUBROUTINES USED BY COBOL

A table of subroutines used by COBOL to accomplish the statements or actions specified follows. The table should guide the programmer in his efforts to conserve storage and to isolate a troublespot (debugging).

| SUBROUTINE NAME | ACTION |
|---|---|
| IHD00000 Converts an external floating-point number to an internal floating-point number | Required for manipulation of external floating-point data in: MOVE - When send field is external floating point in MOVE statement. COMPUTATIONAL - When one field is external, and one field is internal floating point in computational statement. |
| IHD00100 Floating-point exponential subroutine. | Required for exponentiation to non-integer power. |
| IHD00200 Packed divides subroutine. It divides 16-byte 30-character dividend by a 16-byte 30-character divisor producing a 16-byte 30-character quotient. No registers are used. | Required for division of complex computations, COMPUTATIONAL of over 9 digits, and COMPUTATIONAL-3 of over 16 digits. |
| IHD00300 Packed multiply subroutine. It multiplies two 30-character packed fields and produces a 60-character packed product. | Required for complex computations, COMPUTATIONAL fields of over 9, or COMPUTATIONAL-3 of over 16 digits. |
| IHD00400 Error message subroutine. It generates execution time messages. | Required with floating-point and non-integer exponentiation. |
| IHD00500 Packed exponentiation subroutine. | Required for exponentiation to an integer power. [Used with IEP00700 (floating-point exponentiation) subroutine.] |
| IHD00600 Floating-point logarithm subroutine. | Required whenever floating-point conversion is needed. Used with IEP00700 (floating-point exponentiation) subroutine. |
| IHD00700 Floating-point exponentiation subroutine. | Required to set up floating-point conversion routines for nonfloating point exponentiation. |

| SUBROUTINE NAME | ACTION |
|--|--|
| <p>IHD00800</p> <p>Converts packed decimal to floating point. Conversion is accomplished by calling two other subroutines IHD01600 (TOBIN), which converts the number from packed decimal to binary, and IHD01500 (BINFL), which converts the binary number to floating point and then returns.</p> | <p>May be required when floating-point and/or non-integer exponentiation is used.</p> <p>ARITHMETIC - Required when packed and floating-point operation are in the same statement.</p> <p>MOVE - Required if the sending field is packed and the receiving field is floating point in a move statement.</p> <p>COMPUTATIONAL - Required if one field is packed, and one field is floating point in a computational statement.</p> |
| <p>IHD00900</p> <p>Converts floating-point numbers to zoned decimal numbers. Conversion is accomplished by calling two other subroutines; IHD01100 (FRFLPT), which converts the number from floating point to binary, and IHD01800 (BINZN), which converts the binary number to zoned decimal and returns.</p> | <p>ARITHMETIC - Required when there is a floating-point operand, and the receiving field is zoned in an arithmetic statement.</p> <p>MOVE - Required if the sending field is floating point, and the receiving field is zoned in a move statement.</p> |
| <p>IHD01000</p> <p>Converts a binary number to a packed decimal number. Used with IHD01300 (floating point to packed decimal) subroutine.</p> | <p>Required for:</p> <p>ARITHMETIC - Required when multiplying a binary field by a packed field or visa versa.</p> <p>- Required if multiplication is done in binary.</p> <p>MOVE - (Special Class) - If sending field is internal floating point, and receiving field is binary. The binary number must fall within the limits specified. (9 decimal digits <binary number <18 decimal digits.)</p> <p>- If sending field is binary and receiving field is binary.</p> <p>- If sending field is less than 9 and Receiving field is less than or equal to 9, or both are greater than 9 decimal digits.</p> <p>- If sending field is binary and receiving field is packed, and sending field is greater than 9 decimal digits.</p> <p>COMPUTATIONAL - If one field is binary and the other is zoned.</p> <p>- If one field is binary and the other is packed.</p> <p>- If both fields are binary and A is less than 10, and B is less than 10 and the scales of both fields are equal.</p> |

| SUBROUTINE NAME | ACTION |
|---|---|
| | <p>- If the scale of the sending field is greater than the scale of the receiving field, and the real or implied integer positions of the receiving field plus the scale of the sending field is less than 10.</p> <p>- If the scale of the sending field is less than the scale of the receiving field, and the real or implied decimal positions plus the scale of the receiving field is less than 10.</p> |
| <p>IHD01100 Converts an external floating-point number to a binary number. Used with IHD00900 (floating point to zoned decimal) subroutine, IEP01300 (floating point to packed decimal) subroutine, IHD01400 (floating point to binary) subroutine and IHD01900 (miscellaneous fields to external floating point) subroutine.</p> | <p>MOVE - Required when send field is external or internal floating point, and receiving field is external floating point.</p> |
| <p>IHD01200 Converts a zoned decimal number to a floating point number. Conversion is accomplished by calling the same subroutine used by FLPZND (IHD00900).</p> | <p>MOVE - Required when send field is zoned and receiving field is floating point. COMPUTATIONAL - Required when one field is zoned and the other field internal floating point.</p> |
| <p>IHD01300 Converts a floating point number to packed decimal format. Conversion is accomplished by calling IHD01100 (FRFLPT), which converts a floating-point number to binary, and IHD0100 (BINPK), which converts the binary number to packed decimal and then returns.</p> | <p>MOVE - Required when send field is external or internal floating point and receiving field is packed.</p> |
| <p>IHD01400 Converts an internal floating-point number to a binary format. Conversion is accomplished by calling subroutine IHD01100 (FRFLPT), which does the actual converting of the floating point number to a binary number format.</p> | <p>MOVE - Required when sending field is external or internal floating point and receiving field is binary.</p> |

| SUBROUTINE NAME | ACTION |
|--|---|
| <p>IHD01500 Converts a binary number into double precision floating point. May be required when floating-point and/or non-integer exponentiation are used. Used with IHD00800 (packed to floating point) subroutine, IHD00000 (external floating point) subroutine, IHD01200 (zoned decimal to floating point) subroutine, IHD01900 (miscellaneous field type to external floating point) subroutine.</p> | <p>MOVE - Required when sending field is binary and receiving field is floating point. ARITHMETIC - Required when one operand is binary and one operand is floating point. COMPUTATIONAL - Required when one field is binary and one is internal floating point.</p> |
| <p>IHD01600 Converts either a packed decimal or a zoned decimal number to a binary number when receiving field is greater than 9 digits.</p> | <p>Required for: MOVE - Required if the sending field is external decimal, and receiving field is packed, receiving field must be 9 decimal digits. COMPUTATIONAL - If one field is binary or zoned and one field is packed. - If both fields are binary and the following conditions are not met: • the length of the fields are unequal • A and B are both less than 10 and the scales of the fields are equal - If the scale of the sending field is greater than the scale of the receiving field and the real or implied integer positions of the receiving field plus the scale of the sending field is less than 10. - If the scale of the sending field is less than the scale of the receiving field and the real or implied decimal positions plus the scale of the receiving field is less than 10.</p> |

| SUBROUTINE NAME | ACTION |
|---|--|
| <p>IHD01700 Compares two alphabetic fields of different lengths, no restriction on maximum length, when either or both fields are greater than 255 bytes.</p> | <p>COMPUTATIONAL - Required when either or both fields are 255 bytes.</p> |
| <p>IHD01800 Converts a binary number to a zoned decimal number. Used with IHD00900 (floating-point zoned decimal) subroutine.</p> | <p>ARITHMETICS - Required when operations are performed in binary and the receiving field is zoned. MOVE - Required when sending field is binary and receiving field is zoned, zoned field is 9. MISCELLANY - Required if user displays binary item.</p> |
| <p>IHD01900 Converts a field of any of the following formats to external floating point: external decimal, internal decimal, binary, internal floating point, figurative constant of zero. Conversion is accomplished in same cases by calling IHD01100 (FRFLPT) which converts internal floating point to binary, and IHD01500 (BINFL) which converts binary to external floating point.</p> | <p>MOVE - Required when receiving field is external floating point. MISCELLANY - Required if user displays internal floating point.</p> |
| <p>IHD02000</p> | <p>Used to move group items longer than 256 bytes.</p> |
| <p>IHD02100</p> | <p>Performs the class test on alphabetic fields, as specified in the IBM publication <u>IBM System/360 Disk and Tape Operating Systems: COBOL Language Specifications</u>, Form C24-3433.</p> |

| SUBROUTINE NAME | ACTION |
|---|---|
| IHD02200 Converts a packed decimal number to a zoned decimal number. | ARITHMETIC - Required when the operations are performed in packed decimal and the receiving field is zoned. MISCELLANY - Required if user displays packed decimal format. |
| IHD02300 | This subroutine consists of three parts: 1. The first part builds a table of the beginning and end addresses of the PERFORM or nested PERFORM statements and the return address. It checks the validity of addresses. 2. The second part checks to see if the PERFORM is complete by comparing return addresses. 3. The third part deletes or eli- minates the table entries by resetting pointers and counters. Required when linkage editing a version I object deck with a ver- sion II system. |
| IHD02400 | Used to move fields when either or both fields are variable groups. Requirements: R1 points to 'sending' field R2 points to 'receiving' field WORKA is length of 'sending' field WORKA+2 is length of 'receiv- ing' field WORKA+4 is '01' if 'receiving' field is right justified. |
| IHD02500 | Used to compare two fields either or both of which are group vari- able. Used with fields defined with OCCURS...DEPENDING ON clauses. Requirements: R1 points to FIELD1. R2 points to FIELD2. WORKA is the same length as FIELD1. WORKA+2 is the same length as FIELD2. |

| SUBROUTINE NAME | ACTION |
|--------------------|--|
| IHD02600 | <p>Checks length of field to be displayed to be sure it fits into defined field, and moves DISPLAY data to an output buffer. Used if a display data fit check is specified at execution time.</p> <p>Requirements:</p> <ul style="list-style-type: none"> WORKW - must be address of byte after buffer. WORKA+4 - must be number of bytes to move minus 1. R1 - points to next available buffer byte. R2 - points to data to be moved. |
| IHD02700 | <p>Writes out display data on SYSPCH. Used when display on SYSPCH is specified.</p> |
| IHD02800 | <p>Writes out display data on SYSLST.</p> <p>Required when EXHIBIT, TRACE, or standard DISPLAY statements are used (i.e., not UPON CONSOLE or UPON SYSPCH).</p> |
| IHD02900 | <p>Reads a record from SYSIPT and moves data to the field specified by data-name.</p> <p>Required when ACCEPT is specified (not ACCEPT FROM CONSOLE).</p> |
| IHD03000 | <p>Used for display on console.</p> |
| IHD03100 | <p>Used for execution of direct-access statements.</p> <p>Required when any direct-access statement is used.</p> |
| IHD03200 | <p>If problem program has user labels, this subroutine is the linkage with the declaratives section.</p> |

| SUBROUTINE NAME | ACTION |
|--------------------|--|
| IHD03300 | If one field is divided by another and the divisor is zero, this subroutine links to the ON SIZE error routine. |
| IHD03400 | Prints out object time diagnostic messages when errors are encountered in direct-access processing. Required when IHD03100 is used. |
| IHD03500 | Produces object time diagnostic messages for indexed sequential organization of files. Required when indexed sequential data organization is indicated. |
| IHD03600 | Required to write record number zero on all tracks for an output operation when using direct-access method. |
| IHD03700 | Used for initializing tape or disk when using read and write operations. |
| IHD03800 | Used for maintaining a list of tapes to be repositioned, linking to the system's checkpoint routine, and providing a restart entry point. |
| IHD03900 | Converts internal decimal to sterling non-report. |
| IHD04000 | Converts sterling non-report to internal decimal. |
| IHD04100 | Edits internal decimal into sterling report. |

APPENDIX H: DIAGNOSTIC MESSAGES

This appendix contains a detailed description of the diagnostic messages that are generated during processing. They consist of:

- Compiler diagnostic messages
- Execution time messages
- Debug packet error messages

Certain conditions that may occur when a module is being processed will generate linkage editor diagnostic messages. For a complete description of these messages, see the publications IBM System/360 Disk Operating System, System Control and System Service Programs, Form C24-5036, and IBM System/360 Tape Operating System, System Control and System Service Programs, Form C24-5034.

COMPILER DIAGNOSTIC MESSAGES

IJS001I C LITERAL EXCEEDS 120 CHARACTERS.

System Action: The element count begins following the next quote on the line if there is one, or following the element beginning after the 120th character.

User Response: Change the length of the literal so it does not exceed the allowed maximum, or insert the missing quote, or define the literal with two statements; execute the compilation again.

IJS002I W LITERAL CONTINUATION QUOTE INVALID IN MARGIN A.

Explanation: The literal continuation quote should appear in margin B.

System Action: The continuation is allowed.

IJS003I C LITERAL IMPLY CONTINUED OR CONTINUATION QUOTE IS MISSING.

Explanation: This may be the result of a missing quote sign on the preceding line.

System Action: The non-numeric literal is truncated at the end of the preceding line. The syntax scan resumes with the first element of the next line.

User Response: Check for missing quote, column 7 continuation hyphen, or improper formation of the non-numeric literal.

IJS004I SYNTAX REQUIRES A BLANK AFTER A PERIOD OR THIS PERIOD IS INVALID DECIMAL POINT.

System Action: The inverted print edit word with the invalid decimal point is dropped, and processing continues with the next word.

User Response: Check syntax of statement in error, and try again.

IJS005I C XXX EXCEEDS 30 CHARACTERS.

Explanation: Any element that is not a non-numeric literal is truncated after 30 characters.

System Action: Normal processing continues with a literal made up of the first 30 characters.

User Response: Alter the length of the literal to conform with the specifications for this class of literal.

IJS006I C XXX REQUIRES QUALIFICATION.

Explanation: This indicates that the name is defined in more than one location, and requires qualification in order to be unique.

System Action: The first name defined is used and the compilation continues. If it is the name desired, the run compiles as desired. For further system action, see message IJS013I. It explains the handling for the procedure division statement.

User Response: Correct the procedural statements in error, or change the duplicate data names so they are unique. Execute the job again.

IJS007I C XXX HAS UNDEFINED QUALIFICATION.

Explanation: One or more of the names in the qualification hierarchy are not defined as a group containing the data-name. This may have resulted from the dropping of a data-name because of an error at its point of declaration, or because of a misspelling.

System Action: The first name defined is used. If it is the name desired, the run compiles as desired.

User Response: Check for misspelling of the data-name, or the data-name's qualifier in the hierarchy order.

IJS008I C XXX REQUIRES MORE QUALIFICATION.

Explanation: The number of qualifiers or the names are not sufficient to make the subject name unique. Another name could have the same qualification.

System Action: The first name defined is used and the compilation continues. If it is the name desired, the run compiles as desired. For further system action, see message IJS013I. It explains the handling for the procedure division statement.

IJS009I E SUBSCRIPTED 88 MUST HAVE A RIGHT PARENTHESIS. WILL BE TREATED AS A DATA NAME.

IJS010I W SYNTAX REQUIRES A BLANK AFTER A RIGHT PAREN, SEMICOLON AND OR COMMA.

Explanation: Normal processing continues.

IJS011I B XXX IS UNDEFINED.

IJS012I C XXX HAS MORE SUBSCRIPTS THAN DECLARED IN THE DATA DIVISION.

Explanation: The procedure division reference to the data-name has too many subscripts. The number of subscripts

must match the number of OCCURS...DEPENDING ON clauses in the definition hierarchy in the Data Division.

System Action: Normal processing continues with the next word.

IJS013I C RECORD NAME 'XXX' IS ASSOCIATED WITH INVALID FD ENTRY.

Explanation: The FD associated with the SELECT clause is invalid.

System Action: The error attribute for the record is generated, and normal processing continues with the next word.

User Response: Check FD entries for proper device labels, required clauses, missing period terminator, etc.

IJS023I C COPY AND INCLUDE MUST NOT BE USED WITHIN LIBRARY ENTRIES.

System Action: Words following the library name are diagnosed according to the clause being processed, up to the next required clause.

IJS024I C PERIOD MISSING FOLLOWING XXX. THE NEXT CARD MAY BE SKIPPED.

System Action: For the Data Division COPY statement -- Any other entry following the name is diagnosed as the missing period and the return is made to the phase. The phase diagnoses all entries up to the next period according to the current clause string. Normal processing continues.

For the Procedure Division INCLUDE statement -- Interrogation of the library name continues to determine its validity and whether or not it is in the library. If the library name is valid and it is found, normal processing continues.

User Response: A period should be inserted following library book name.

IJS025I C XXX IS AN INVALID LIBRARY NAME OR NOT FOUND ON LIBRARY.

Explanation: The library name may have been misspelled, not previously cataloged or not properly terminated with a quote.

System Action: Any word other than period immediately following the library name is diagnosed according to the current clause string up to the next period. This includes the current card and the next card if read.

User Response: Check for the possible causes given in the explanation.

IJS026I C FLOATING-POINTING NUMBER XXX IS BELOW OR ABOVE VALID RANGE.

System Action: The value zero is assumed.

IJS027I W NUMBER OF DECIMALS IN LITERAL XXX AND DATA ENTRY DISAGREE.

System Action: Truncation or padding is performed according to the rules governing the MOVE verb.

IJS028I C LITERAL XXX IS INVALID AND IS DROPPED.

Explanation: The value clause conflicts with the description of the entry.

System Action: The value clause is dropped.

IJS029I W LITERAL XXX AND PICTURE SIZE DISAGREE.

Explanation: This message indicates a literal that is larger than its picture.

System Action: The literal is truncated to picture size from left to right, unless right justification is specified. The scan is continued as though no error occurred.

IJS030I W LITERAL XXX WAS SIGNED, ENTRIES PICTURE WAS UNSIGNED.

Explanation: The literal encountered in this entry contains a sign, it does not appear as part of the entry because the picture is unsigned.

IJS031I W NUMBER OF INTEGERS IN LITERAL XXX AND DATA ENTRY DISAGREE.

System Action: Same as for message IJS027I.

IJS032I C LIBRARY NAME IS AN INVALID EXTERNAL NAME OR NOT IN THE LIBRARY.

Explanation: The library name may have been misspelled, not cataloged, or not properly terminated with a quote.

System Action: The invalid or not found library name is dropped and the next card is read.

IJS041I C THIS CLAUSE IGNORED AT THE 01 LEVEL IN XXX ENTRY.

Explanation: The OCCURS...DEPENDING ON clause not valid as a level 01 or level 88 entry.

System Action: The clause is dropped.

User Response: Alter the clause level number to one that is valid or remove the OCCURS...DEPENDING ON clause from the statement in error.

IJS042I C THIS CLAUSE IGNORED IN XXX ENTRY AS IT PROVIDES MORE THAN 3 LEVELS OF SUBSCRIPTING.

IJS043I C DEPENDING ON OPTION IN XXX ENTRY IS IGNORED DUE TO PRIOR USE.

IJS044I C DEPENDING ON OPTION IN XXX ENTRY IS IGNORED BECAUSE IT IS SUBORDINATE TO A PREVIOUS CLAUSE.

IJS045I C THE LEVEL OF XXX ENTRY INVALIDATES THE DEPENDING OPTION AT THE PRECEDING XXX ENTRY. THE DEPENDING OPTION IS DROPPED.

Explanation: The level number just encountered indicates that there was an OCCURS...DEPENDING ON clause that did not include the last entry within the level 01.

System Action: The OCCURS...DEPENDING ON option is dropped.

IJS046I C XXX ENTRY CONTAINS AN ILLEGAL LEVEL NUMBER OR REDEFINES CLAUSE WHICH IS IGNORED.

Explanation: A redefines clause must redefine an entry at the same level number.

System Action: The level number or the redefines clause is ignored.

User Response: Alter the level number or relocate the redefines clause to conform with the specification.

IJS047I E INTERNAL QUALIFIER TABLE OVERFLOWED WHEN HANDLING XXX.
RESTARTED QUALIFIERS WITH XXX.

Explanation: The sum of all the characters in the data-name and all its qualifiers + 4 times (the number of qualifiers + 1) must not exceed 300.

IJS048I W ENTRY PRECEDING XXX IS OF VARIABLE LENGTH.

IJS049I W XXX IS LARGER THAN ENTRY REDEFINED.

Explanation: The current entry is larger than the area redefined.

System Action: The area is assumed to be expanded.

User Response: The redefined area may be expanded.

IJS050I W XXX ENTRY PRECEDING XXX IS LARGER THAN ENTRY REDEFINED.

Explanation: Same as for message IJS049I, only for a group entry.

System Action: Same as for message IJS049I.

IJS051I W THIS CLAUSE INVALID IN XXX ENTRY AS REDEFINED AREA IS SUBSCRIPTED.

Explanation: It is invalid to redefine an area containing an OCCURS...DEPENDING ON clause.

System Action: The redefinition clause is dropped.

IJS052I C THIS CLAUSE IGNORED IN XXX ENTRY DUE TO REDEFINES OR OCCURS CLAUSE IN PRECEDING XXX LEVEL.

Explanation: A value clause cannot appear in an entry subordinate to a redefines clause.

System Action: The value clause is dropped.

IJS053I W FOR PROPER ALIGNMENT, A XXX BYTE LONG FILLER ENTRY IS INSERTED PRECEDING XXX.

Explanation: Binary or floating-point data improperly aligned for computations.

System Action: Binary and floating-point data are aligned on an appropriate boundary by the compiler. The alignment is performed by inserting an assumed filler entry preceding the item requiring alignment.

User Response: The number of slack bytes required can be reduced by the use of a different data format such as: internal decimal, grouping aligned items to the beginning of a record, or otherwise positioning them so that they will have the proper alignment within the record. A discussion of slack bytes can be found in the publication IBM System/360 Disk and Tape Operating System: COBOL Language Specifications, Form C24-3433.

IJS054I W FOR PROPER ALIGNMENT, A XXX BYTE LONG XXX FILLER ENTRY IS INSERTED PRECEDING XXX.

Explanation: Binary or floating-point data is improperly aligned for computations.

System Action: Groups are aligned according to the alignment requirements of the first elementary within that group. The level number indicated in the diagnostic message shows exactly where the implied filler entry was inserted. For further explanation, see message IJS053I.

IJS055I E XXX ENTRY PRECEDING XXX EXCEEDS MAXIMUM SIZE OF 4092 BYTES.

Explanation: The group defined at the indicated level preceding the point where this message was generated exceeded the maximum size permitted in the file or linkage section.

System Action: The compilation is continued, but execution is not attempted.

User Response: Reduce the record size to the allowable maximum size.

IJS056I W XXX ENTRY PRECEDING XXX EXCEEDS MAXIMUM LENGTH OF 32,768 BYTES.

Explanation: See message IJS055I. It applies to working-storage section.

System Action: See message IJS055I. It applies to working-storage section.

IJS057I E PROGRAM EXCEEDS 240 BASE LOCATORS MAXIMUM AT XXX.

Explanation: A base locator is assigned for each file for each level 01 or level 77 in the linkage section, and for every 4,096 bytes in the working-storage section.

System Action: The base locator counter wraps around and the results are unpredictable.

User Response: Reduce the number of base locators.

IJS058I E ERRONEOUS OR MISSING DATA DIVISION.

Explanation: No data division entries were present.

System Action: All data division entries were dropped because of errors.

IJS060I W XXX LEVEL PRECEDING XXX IS OF VARIABLE LENGTH.

Explanation: The entry, defined at the level indicated, that preceded this clause contained an OCCURS...DEPENDING ON clause.

System Action: The redefined clause is dropped because it is invalid to redefine a variable-length entry.

IJS061I C XXX ENTRY EXCEEDS MAXIMUM LENGTH FOR ITS DATA TYPE.

Explanation: The maximum permitted length of an entry depends on the type of data defined for that entry. Numeric data cannot exceed 18 digit positions, report entries cannot exceed 127 character positions.

System Action: The maximum size is used.

- IJS062I W XXX REQUIRED ALIGNMENT AND STARTS XXX BYTES PAST THE START OF THE ENTRY IT REDEFINED.
- Explanation: The entry containing the redefines clause requires alignment that differs from the alignment of the clause redefined. If alignment is required, insert a filler the size of the number of bytes indicated in the message before the item being redefined.
- IJS063I W TO ALIGN BLOCKED RECORDS ADD XXX BYTES TO THE 01 CONTAINING DATANAME XXX.
- Explanation: The first record in a buffer is aligned on a double-word boundary. All level 01 records are assumed to start on a double-word boundary. If binary or floating-point numbers are used in the record and if the records are blocked in a buffer, the succeeding records may not be properly aligned. Alignment can be obtained by padding each record by the indicated number of bytes and processing in the buffer, or by moving each record, as a group, to a level 01 record in the working-storage section before processing the computational field. The pointer to this diagnostic message indicates the last element within a record. The padding must go into the preceding level 01 record, not the level 01 record that may immediately follow the indicated data name.
- IJS064I W IF THE PRECEDING RECORD IS BLOCKED, IT MAY BE ALIGNED BY MOVING TO AN 01 IN THE WORKING-STORAGE SECTION.
- Explanation: When records are variable and blocked, only the first record can be aligned.
- IJS076I W INTEGER OPTION IS NOT PERMITTED.
- System Action: The clause is dropped.
- IJS078I C INTERNAL FILE-NAME AND DESCRIPTION TABLE OVERFLOWED. XXX NOT PROCESSED.
- Explanation: There is a fixed number of files that can be handled by a given COBOL compilation (25). If additional files must be handled, they can be processed in a subprogram and accessed via the linkage facility.
- System Action: Any files encountered after the maximum permitted are dropped. The maximum permitted is 25.
- IJS079I C RESTRICTED SEARCH INTEGER TOO LARGE ON XXX. CLAUSE DROPPED.
- IJS080I C MORE THAN THREE FORMS OVERFLOW CLAUSES. OVERFLOW-NAME XXX ENTRY IS DROPPED.
- IJS081I W XXX APPEARED PREVIOUSLY IN A 'SAME' CLAUSE. REMAINDER OF 'SAME' CLAUSE DROPPED.
- Explanation: A given filename can appear in only one same-area clause. Any duplication encountered is dropped.
- System Action: The entire same-area clause is dropped.
- User Response: Eliminate the duplicate statement.

IJS082I W INTERNAL 'SAME' TABLE OVERFLOW. ENTRIES AFTER XXX DROPPED.

Explanation: A fixed number of filenames and combinations of filenames are allowed in an internal same-area table. If reducing the number of filenames or the number of same-area clauses does not relieve the situation, it may require an entry to a subprogram to permit a large number of files to be referenced in this manner.

IJS083I W RECORD LENGTH SPECIFIED DISAGREES WITH CALCULATED MAX. RECORD LENGTH OF XXX ON XXX. CALCULATED RECORD LENGTH ASSUMED.

Explanation: The actual length of each record is calculated during compilation time by totaling all its components. If the length disagrees with the specified maximum, this warning message is given to indicate that the specified record size is ignored.

IJS084I W BLOCK SIZE FOR XXX TOO BIG. 32K ASSUMED.

Explanation: The integer specifying block size of the referenced files is too large.

System Action: The maximum size allowed is used.

IJS085I W SYMBOLIC KEY MUST BE SPECIFIED FOR XXX IF INPUT.

Note: This message is used only for a direct-access storage device.

IJS086I E ACTUAL KEY MUST BE SPECIFIED FOR XXX.

Note: This message is used only for a direct-access storage device.

IJS087I C THE XXX FILE MUST BE DESCRIBED IN A SELECT CLAUSE. CURRENT ENTRY IGNORED.

Explanation: The subject file was referenced in the Environment Division or in an FD clause. There is no select clause to define this file. The filename referenced may be an invalid entry encountered at the point that a filename was expected.

IJS088I C LABEL RECORD DATA-NAME MUST BE DEFINED IN LINKAGE SECTION.

System Action: Label records are assumed standard.

IJS089I C UNIT IS MISSING FOR XXX FILE. 2400 IS ASSUMED.

IJS090I C THE DESCRIPTION OF XXX FILE CONFLICTS ON THE FOLLOWING POINTS -- XXX.

Explanation: The description of the file referenced contains factors that conflict with each other. The factors can be in the description of the file in the Environment Division, in the FD of the file section, or in other areas such as the record description for that file.

System Action: The points in conflict are defined by the trailing clauses of the diagnostic message.

IJS091I E INDEXED ORGANIZATION ON XXX NOT VALID FOR THIS LEVEL COMPILER.

IJS092I E DIRECT ORGANIZATION ON XXX NOT VALID FOR THIS LEVEL COMPILER.

IJS093I E XXX NOT HANDLED WITH PRESENT RELEASE.

IJS094I E XXX FILE WAS NOT DEFINED BY AN FD ENTRY.
Explanation: No DTF table is built for this file, therefore, it cannot be used.

IJS096I W ONLY ONE CHECKPOINT FILE MAY BE SPECIFIED.

IJS097I E STANDARD LABELS ARE REQUIRED ON XXX FILE.

IJS098I C XXX FILE ASSUMED TO BE UTILITY.

IJS099I C XXX FILE UNIT MISSING AND ASSUMED TO BE 1403 PRINTER.

IJS100I E DIRECT-ACCESS ASSIGNED TO XXX NOT SUPPORTED IN THIS VERSION.

IJS101I C XXX FILE IS ASSIGNED TO UNIT RECORD AND MUST BE RECORDING MODE IS F.
Explanation: Unit record must be fixed length.
System Action: The largest described length is assumed.

IJS102I C A MAXIMUM OF 1 ALTERNATE AREA IS ALLOWED FOR XXX FILE.
System Action: One alternate area is reserved.

IJS103I E XXX IS NOT A VALID SYSTEM ASSIGNMENT.
Explanation: Must be SYS000 to SYS244.
System Action: SYS000 is assumed.

IJS104I E RECORD/BLOCK SIZE ON XXX GREATER THAN 3625.

IJS105I C INVALID DEVICE NUMBER SPECIFIED. DISK 2311 ASSUMED.

IJS106I W ONLY ONE AREA SUPPORTED FOR INDEXED OR DIRECT ORGANIZATION. ONE AREA ASSIGNED FOR XXX.

IJS107I C RECORD KEY REQUIRED FOR INDEX ORGANIZATION FILE XXX.

IJS108I E LENGTH OF SYMBOLIC/RECORD KEY GREATER THAN 255.

IJS109I E LENGTH OF ACTUAL KEY IS GREATER/LESS THAN 8.

IJS110I E INCORRECT DATA ITEM TYPE SPECIFIED FOR KEY.

IJS111I W TRACK AREA CLAUSE NOT SUPPORTED IN DOS.

IJS112I C SYMBOLIC AND RECORD KEY LENGTH FOR XXX DISAGREE.

IJS113I E RELATIVE ORGANIZATION ASSIGNED TO XXX NOT SUPPORTED IN THIS VERSION. COMPLETE SELECT STATEMENT DROPPED.

IJS114I E RECORD/BLOCK ON XXX IS GREATER THAN 2000.

IJS117I E SYMBOLIC KEY MUST BE SPECIFIED FOR XXX.

IJS118I W DIRECT ACTUAL KEY MUST BE SPECIFIED FOR OUTPUT FILES.

IJS176I C WORD RECORD OR RECORDS IS REQUIRED. FOUND 'XXX'.
Explanation: Syntax skips until the next clause, level number, or period at the end of the file description is encountered.

IJS177I W PERIOD REQUIRED AFTER WORD 'SECTION'.

IJS179I W 'XXX' IS AN INVALID FILE-NAME FORMAT.

Explanation: A filename must follow the format rules for data-names.

System Action: Invalid names are truncated to 30 characters and treated as valid names.

IJS180I E XXX EXCEEDS 30 CHARACTERS AND IS DROPPED.

System Action: The picture is too long and is dropped.

IJS181I W THE OPTION WORD IS MISSPELLED OR OMITTED. FOUND XXX.

System Action: The usage assumed is DISPLAY.

IJS183I C 'XXX' IS AN INVALID OR EXCESSIVE INTEGER.

Explanation: The integer indicated in this clause is determined to be invalid.

System Action: The integer is not used.

IJS184I W XXX IS AN INVALID LEVEL NUMBER.

IJS185I W LABEL RECORDS IS OMITTED. LABELS ASSUMED STANDARD.

IJS186I W SYNTAX REQUIRES DATA RECORD CLAUSE.

System Action: Syntax scanning proceeds.

IJS187I C MODE MUST BE 'V', 'F', OR 'U'. FOUND XXX.

User Response: If V, F, or U was specified, check the element number on this line for a misspelled optional word.

IJS190I W 'XXX' IS AN INVALID DATA-NAME FORMAT.

System Action: The invalid data-name(s) are truncated to 30 characters and used.

IJS191I W SD OR SA ENTRY REQUIRES F LEVEL COMPILER.

System Action: Syntax skips to next margin A entry.

IJS192I W 'XXX' IS AN INVALID RECORD-NAME FORMAT.

System Action: Invalid record names are truncated to 30 characters and treated as valid names.

IJS194I C 'XXX' IS INVALID AT THIS POINT. CHECK FOR SYNTAX ERROR ON CURRENT/PREVIOUS STATEMENT.

Explanation: While processing a given clause or sentence, an unexpected element was encountered. The clause may be valid but misplaced. This message is also given for clauses that are not valid source input to this level compiler.

User Response: Check for prior diagnostic messages, an extra or missing period, invalid continuation of non-numeric literals, or a misspelled word.

IJS196I W SYNTAX REQUIRES AN 01 LEVEL ENTRY. FOUND XXX.

IJS197I W NOT VALID FOR THIS LEVEL COMPILER.

IJS201I C XXX IS AN INVALID DATA-NAME FORMAT BUT ASSUMED VALID.

System Action: Invalid data-names are truncated to 30 characters and treated as valid names.

IJS202I C Same as diagnostic message IJS194I.

IJS203I C THIS USAGE XXX CONFLICTS WITH THE GROUP USAGE AND IS IGNORED.

IJS204I C XXX IS AN INVALID OR EXCESSIVE INTEGER.

System Action: The invalid integer is dropped.

IJS205I W XXX IS AN INVALID DATA-NAME FORMAT, BUT ASSUMED VALID.

IJS206I W WORD ZERO IS REQUIRED. FOUND XXX.

System Action: The clause is ignored.

IJS207I W WORD RIGHT IS REQUIRED. FOUND XXX.

System Action: The clause is ignored.

IJS210I C THIS ENTRY CONFLICTS WITH THE FOLLOWING DESCRIPTIONS --- XXX.

Explanation: Various clauses specified for a data entry are compared with previous specifications for the entry. If there is any factor that conflicts with the subject clause, it is listed as a trailer to this entry. Factors included that are not themselves clauses would be elementary or group item usage, specified at a group level in previous clauses. This message can appear if a period is missing at the end of a data entry or (for example) when the PICTURE clause for the second entry is encountered and automatically conflicts with the PICTURE clause for the previous entry.

IJS211I C XXX EXCEEDS 30 CHARACTERS AND IS TRUNCATED.

IJS212I C ONLY LEVELS 77 OR 01 ARE PERMITTED AT THIS POINT. FOUND XXX.

System Action: Syntax skips until a section name or level number is found.

IJS213I W THE FOLLOWING DESCRIPTIONS INVALID AT GROUP LEVEL --- XXX.

Explanation: The data entry described is determined to be a group, although the entries specified as trailers to this message are invalid at the group level. This diagnostic message can be produced by an invalid level number that was changed to a level 01, or because of a misunderstanding as to how a group is defined and what clauses are valid at the group level. A missing period can also produce this diagnostic message.

IJS214I C XXX DATA ENTRY REQUIRES A PICTURE, COMPUTATIONAL-1 OR COMPUTATIONAL-2.

Explanation: This diagnostic message can be produced by an error in the following level number that caused its level to be changed to a level 01, thereby making this entry an elementary.

System Action: Any statement in the Procedure Division containing a reference to this entry is diagnosed and dropped.

User Response: Check for missing periods or other diagnostic messages.

IJS215I W SYNTAX REQUIRES AN ENTRY IN MARGIN A. FOUND XXX IN MARGIN B.

System Action: Following certain entries in a source program, a specific clause must be encountered in margin A. If it is found in margin B, it is diagnosed but handled by the compiler.

IJS216I W SYNTAX REQUIRES AN ENTRY IN MARGIN B. FOUND XXX IN MARGIN A CHECK FOR MISSING PERIOD.

Explanation: All entries in margin A must be preceded by a period.

System Action: The compiler was in the middle of processing a clause or sentence and encountered the indicated word in margin A. Thus, a diagnostic message is issued and the word is processed as though it were valid.

IJS217I W LEVEL 77 ENTRIES MUST PRECEDE OTHER LEVELS AND ARE ASSUMED TO BE 01 LEVEL.

IJS218I W SYNTAX PERMITS ONLY LEVELS 77, 88, OR 01 AFTER A 77 LEVEL. CHANGED XXX TO 01.

IJS221I C SYNTAX FOR 'ALL' REQUIRES 'XXX' BE A SINGLE CHARACTER IN QUOTES.

System Action: The value clause is dropped.

IJS222I C PICTURE XXX WAS FOUND INVALID WHILE PROCESSING XXX. THE PICTURE IS DROPPED.

Explanation: Any element that follows the word PICTURE in a data description, other than the word that is dropped, is assumed to be a PICTURE and is passed to a later phase for analysis. The analysis proceeds from left to right on a character-by-character basis. The character identified in the message is the one processed at the time the PICTURE is determined to be invalid. The specific character itself may be invalid or may have indicated that a previous character or condition is invalid. For example, an E encountered in an external floating-point PICTURE may indicate that a preceding decimal was omitted in the mantissa.

System Action: The PICTURE is dropped and the entry identified as an error.

IJS277I W FILE SECTION OUT OF SEQUENCE.

IJS228I E SYNTAX PERMITS ONLY ONE XXX IN SOURCE PROGRAM.

System Action: Syntax proceeds.

IJS229I E WORKING STORAGE SECTION OUT OF SEQUENCE.

IJS231I E ENVIRONMENT DIVISION MISSING.

IJS233I C REPORT SECTION REQUIRES F LEVEL COMPILER.

IJS234I W WORD 'SECTION' MISSING.
IJS235I W 'PERIOD' MUST FOLLOW WORD SECTION.
IJS237I E 'XXX' IS MISPLACED.

Explanation: The statement is probably out of place in the source deck; that is, FD is working-storage.

System Action: The statement is processed as it is; however, execution may not be as desired.

User Response: Properly locate the misplaced statement.

IJS238I W 'XXX' IS AN INVALID SECTION NAME, A MISSING FD OR AN INVALID/MISPLACED LEVEL INDICATOR.

System Action: Syntax skips until a valid section-name or level number is found.

IJS239I W SYNTAX REQUIRES WORD 'DIVISION'.

IJS240I C 'UNIT' OR 'REEL' CANNOT BE SPECIFIED FOR UNIT-RECORD FILE.

IJS241I C LEVEL PRECEDING 88 MUST BE AN ELEMENTARY.

Explanation: Any level number preceding a level 88 entry must be an elementary.

System Action: If the level number preceding the level 88 entry is not an elementary, it is assumed to be one and is processed as such.

IJS242I W THE 88 ENTRY DOES NOT HAVE A VALUE, THEREFORE, IT IS DROPPED.

IJS301I W SYNTAX REQUIRES 'XXX' IN MARGIN A. FOUND 'XXX'. RESTART WITH 'XXX'.

Explanation: Syntax requires the specific entry indicated to be in margin A. If the entry is found in margin B, compilation resumes.

IJS302I C SYNTAX REQUIRES 'XXX'. FOUND 'XXX'. RESTART WITH 'XXX'. IF WORDS REQUIRED AND FOUND ARE THE SAME, THE ENTRY IS IN THE WRONG MARGIN.

System Action: Syntax scan skips to the restart clause.

IJS303I W 'XXX' IS AN INVALID CONDITION-NAME FORMAT.

Explanation: The name shown is an invalid condition name.

System Action: The name is truncated to 30 characters and processed as though it were valid.

IJS304I E 'XXX' IS AN INVALID EXTERNAL-NAME FORMAT. RESTART WITH 'XXX'.

Explanation: An external name was expected at this point in the scan of the subject clause. An external name must be enclosed in quotes. It must start with an alphabetic character, cannot contain more than eight characters, and letters and numerals are the only valid characters. A dash is not permitted.

IJS305I C SYNTAX REQUIRES SAME, RERUN, APPLY, OR 'XXX' DIVISION.
 FOUND 'XXX'. RESTART WITH 'XXX'.

User Response: Check for invalid sequence of source program cards or extra periods.

IJS306I W SYNTAX REQUIRES ENVIRONMENT OR 'XXX' DIVISION IN MARGIN A.
 FOUND 'XXX'. RESTART WITH 'XXX'.

User Response: Same as for message IJS305I.

IJS307I E SYNTAX REQUIRES I-O-CONTROL, INPUT-OUTPUT, OR 'XXX' DIVISION
 IN MARGIN A. FOUND 'XXX'. RESTART WITH 'XXX'.

User Response: Same as for message IJS305I.

IJS308I W 'XXX' IS AN INVALID DATA-NAME FORMAT. RESTART WITH 'XXX'.

Explanation: A data-name was expected at this point in the scan of the subject clause.

System Action: Invalid format is truncated to 30 characters and processed as though it were valid.

IJS309I C ENVIRONMENT PARAGRAPHS OUT OF ORDER.

System Action: Statements are handled anyway.

IJS310I W 'XXX' IS AN INVALID 360 MODEL-NUMBER. RESTART WITH 'XXX'.

System Action: Syntax scan skips to the restart clause.

IJS311I E SYNTAX REQUIRES 'FILE-CONTROL', 'XXX' OR 'DATA DIVISION' IN
 MARGIN A. FOUND 'XXX'. RESTART WITH 'XXX'.

User Response: Same as for message IJS305I.

IJS312I C 'XXX' IS AN INVALID OR EXCESSIVE INTEGER. RESTART WITH
 'XXX'.

Explanation: The syntax at this point of scan of the specified clause requires an integer.

System Action: The element found was invalid and is dropped.

IJS313I W 'XXX' IS AN INVALID FILE-NAME FORMAT. RESTART WITH 'XXX'.

Explanation: The syntax scan of the subject clause requires a file name at this point.

System Action: The element found was invalid. It was truncated to 30 characters and processed as though it were valid.

IJS314I E 'XXX' IS AN INVALID LIBRARY-NAME FORMAT. RESTART WITH
 'XXX'.

Explanation: A library name is required at this point.

System Action: The format is invalid. It is dropped.

IJS315I W MORE THAN THREE OVERFLOW OPTION CLAUSES ARE USED.

Explanation: An internal table permits a maximum of three form overflow names to be assigned in any compilation.

System Action: All form overflow names in excess of the maximum allowed (three) are dropped.

IJS316I C SYNTAX REQUIRES 'INDEXED' OR 'XXX'. FOUND 'XXX'. RESTART WITH 'XXX'.

Explanation: This message applies to a direct access storage device only.

IJS317I C SYNTAX REQUIRES 'SEQUENTIAL' OR 'XXX'. FOUND 'XXX'. RESTART WITH 'XXX'.

Explanation: This message applies to a direct access storage device only.

IJS318I W SYNTAX REQUIRES 'XXX' OR DATA DIVISION IN MARGIN A, OR SELECT IN MARGIN B. FOUND 'XXX'. RESTART WITH 'XXX'.

Explanation: The syntax for the specific clause requires specific entries at this point.

User Response: Check for misspelled words, or excessive periods.

IJS319I C SYNTAX REQUIRES 'UTILITY', 'DIRECT-ACCESS' OR 'XXX'. FOUND 'XXX'. RESTART WITH 'XXX'.

Explanation: Same as for message IJS316I.

IJS320I W 'XXX' IS AN INVALID I-O-DEVICE-NUMBER. RESTART WITH 'XXX'.

Explanation: Same as for message IJS316I.

IJS321I E NO PROCESSING OF THIS MULTIPLE SPECIFIED DIVISION OR SECTION. RESTART WITH 'XXX'.

Explanation: A section or division was encountered more than once.

System Action: The additional section or division is dropped, rather than disturb the internal sequence of the compilation.

IJS322I W FILE-NAME OR DATA-NAME EXCEEDS 30 CHARACTERS. TREATED AS 30-CHARACTER NAME.

IJS323I W SYNTAX REQUIRES 'XXX' OR CLAUSE-NAME. FOUND 'XXX'. RESTART WITH 'XXX'.

System Action: Syntax scan skips to the restart clause.

IJS324I E SYNTAX REQUIRES 'REEL' OR 'XXX'. FOUND 'XXX'. RESTART WITH 'XXX'.

System Action: Syntax scan skips to restart clause.

IJS401I C SYNTAX REQUIRES A DATA-NAME. FOUND 'XXX'.

Explanation: The syntax of the indicated clause requires a data-name. The element found was not defined as a valid data-name. The element may be indicated here, or an indication given that it was an invalid name such as, file name, condition name, figure configuration, or overflow name.

System Action: The compilation continues at the next verb or paragraph label.

User Response: Check for misspelled data-name in diagnostic messages, which would nullify the definition of a valid data-name, or the use of a COBOL word as a data-name.

IJS402I C SYNTAX REQUIRES NEXT ITEM BE 'XXX'.

Explanation: The syntax for this clause requires a specific word that was not found. The item encountered was probably a data-name. The next item indicates that the syntax requires a specific word or words. None were found.

System Action: The element found is displayed unless it was a name, in which case the word invalid name or data name is indicated. Compilation continues at the next verb or paragraph label.

User Response: The reference format for the clause specified should be consulted if the meaning of the message is not immediately clear. Also check for: missing periods, preceding diagnostic messages, invalid non-numeric literals, and COBOL words used as data-names.

IJS403I C SYNTAX REQUIRES A DATA-NAME OR NUMERIC-LITERAL. FOUND 'XXX'.

Explanation: See message IJS402I.

IJS404I C SYNTAX REQUIRES EITHER WORD 'TO', OR 'GIVING'. FOUND 'XXX'.

Explanation: See message IJS402I.

IJS405I C SYNTAX REQUIRES A SINGLE CHARACTER IN QUOTES OR A FIGCON. FOUND 'XXX'.

Explanation: See message IJS402I.

IJS406I C SYNTAX REQUIRES A FILE-NAME. FOUND 'XXX'.

Explanation: See message IJS402I.

IJS407I C SYNTAX REQUIRES DATA-NAME OR INTEGER. FOUND 'XXX'.

Explanation: See message IJS402I.

IJS408I C SYNTAX REQUIRES WORD 'INPUT', 'OUTPUT', OR 'I-3'. FOUND 'XXX'.

Explanation: See message IJS402I.

IJS409I C SYNTAX REQUIRES A PROCEDURE-NAME. FOUND 'XXX'.

Explanation: See message IJS402I.

IJS410I C SYNTAX REQUIRES A DATA-NAME OR LITERAL. FOUND 'XXX'.

Explanation: See message IJS402I.

IJS411I C SYNTAX REQUIRES WORD 'CALL', 'ENTRY', OR 'RETURN', FOUND 'XXX'.

Explanation: See message IJS402I.

IJS412I E SYNTAX REQUIRES AN EXTERNAL-NAME. FOUND 'XXX'.

Explanation: See message IJS402I.

IJS413I C SYNTAX REQUIRES '='. FOUND 'XXX'.
Explanation: See message IJS402I.

IJS414I C SYNTAX REQUIRES EXPRESSION TO BEGIN WITH EITHER A DATA-NAME, NUMERIC-LITERAL, '+', '-', OR '('. FOUND 'XXX'. TWO OPERATORS MAY NOT APPEAR ADJACENT TO ONE ANOTHER.
Explanation: See message IJS402I.

IJS415I C SYNTAX REQUIRES CALL PARAMETERS TO BE EITHER DATA-NAME, PROCEDURE-NAME OR FILE-NAME. FOUND 'XXX'.
Explanation: See message IJS402I.

IJS416I C SYNTAX REQUIRES DATA-NAME, LITERAL, FIGCON, '+', '-', '(' OR 'NOT'. FOUND 'XXX'.
Explanation: See message IJS402I.

IJS417I C SYNTAX REQUIRES ARITHMETIC OPERATOR OR RELATIONAL. FOUND 'XXX'.
Explanation: See message IJS402I.

IJS418I C SYNTAX REQUIRES A DATA-NAME, NUMERIC-LITERAL, OR '(' AFTER AN OPERATOR. FOUND 'XXX'.
Explanation: See message IJS402I.

IJS419I C SYNTAX REQUIRES A DATA-NAME, LITERAL, FIGCON, '(', '+' OR '-' AFTER A RELATIONAL. FOUND 'XXX'.
Explanation: See message IJS402I.

IJS420I C SYNTAX REQUIRES A VERB, PERIOD, 'ELSE' OR 'OTHERWISE'. FOUND 'XXX'.
Explanation: The end of a valid clause was encountered. The element that followed the valid termination of this clause is not valid.
System Action: Compilation continues at the next verb or paragraph label.
User Response: If the preceding clause had some options, check the reference format to determine whether or not the options were specified correctly. A COBOL word used as a data-name or an extra period can also produce this diagnostic message.

IJS421I C ENTRY PARAMETER MUST BE A DATA-NAME. FOUND 'XXX'.
Explanation: The only parameters that can be passed to a COBOL subprogram are data-names. The data-names must be defined in the linkage section of the subprogram.
System Action: Compilation continues at the next verb or paragraph label.

IJS422I C SYNTAX REQUIRES A RELATIONAL. FOUND XXX.
Explanation: Syntax requires that the next element be a relational.
System Action: Compilation continues at the next verb or paragraph label.

User Response: Check for invalid punching or a preceding error.

- IJS423I C SYNTAX REQUIRES WORD 'INPUT' OR 'OUTPUT'. FOUND XXX.
Explanation: See message IJS402I.
- IJS424I C SYNTAX REQUIRES WORDS 'TO PROCEED TO'. FOUND XXX.
Explanation: See message IJS402I.
- IJS425I C SYNTAX REQUIRES WORD 'CONSOLE' OR 'SYSPCH'. FOUND XXX.
Explanation: See message IJS402I.
- IJS426I E SYNTAX REQUIRES 'AT END' OR 'INVALID KEY', FOUND 'XXX'.
- IJS427I C SYNTAX REQUIRES A DATA-NAME, FIGCON OR NON-NUMERIC LITERAL.
FOUND XXX.
Explanation: See message IJS402I.
- IJS428I C SYNTAX REQUIRES A PROCEDURE-NAME AFTER 'GO TO' NOT PRECEDED
BY A PARAGRAPH-NAME. FOUND XXX.
Explanation: See message IJS402I.
- IJS429I C SYNTAX REQUIRES 'ALL', 'LEADING', 'UNTIL', OR 'FIRST'.
FOUND XXX.
Explanation: See message IJS402I.
- IJS430I C SYNTAX REQUIRES WORD 'TALLYING' OR 'REPLACING'. FOUND XXX.
Explanation: See message IJS402I.
- IJS431I C SYNTAX REQUIRES WORD 'DEPENDING ON'. FOUND XXX.
Explanation: See message IJS402I.
- IJS432I C DATA TYPE MUST BE ED, ID OR BI.
Explanation: Valid syntax for the subject verb permits
only specific data types. The data type as determined by
the definition in the Data Division is invalid for its use
here.
System Action: The statement is dropped from the point of
error.
- IJS433I C SYNTAX REQUIRES WORD 'TRACE'. FOUND XXX.
Explanation: See message IJS402I.*
- IJS434I C SYNTAX REQUIRES THAT A PERIOD OR SECTION FOLLOWS PARAGRAPH-
NAME. FOUND XXX.
Explanation: See message IJS402I.*
- IJS435I E DATA NAME AND ANY QUALIFIER MUST APPEAR WITHIN THE FIRST
SEVEN OPERANDS OF STATEMENT FOR CHANGED OPTION.
Explanation: See message IJS402I.

*Also, the entire statement from the point of error is dropped and is
not compiled.

IJS436I C SYNTAX REQUIRES A DATA-NAME, FIGCON OR LITERAL. FOUND XXX.
Explanation: See message IJS402I.*

IJS437I C SYNTAX REQUIRES A FIGCON. FOUND XXX.
Explanation: See message IJS402I.*

IJS438I C SYNTAX REQUIRES DATA-ITEM TO BE NO LONGER THAN FOUR.
Explanation: See message IJS402I.*

IJS439I C WRONG SUBSCRIPT SPECIFICATION.
Explanation: Data names and condition names can be subscripted to a depth of three. A subscript is required for each OCCURS...DEPENDING ON clause specified at the specified data-name or in groups containing that data-name.
System Action: The compilation continues at the next verb or paragraph label.
User Response: Check for fewer or more subscripts than OCCURS...DEPENDING ON clauses in the hierarchy. Subscripts must be enclosed in parentheses and separated from each other by a comma or a blank.

IJS440I C INCORRECT SPECIFICATION IN DECLARATIVE-SECTION. FOUND XXX.
Explanation: See message IJS402I.

IJS441I C SYNTAX REQUIRES AN INTEGER NOT LONGER THAN 5. FOUND XXX.
Explanation: The integer exceeds the size permitted by language specifications.
System Action: The compilation continues at the next verb or paragraph label.

IJS442I C THE DECLARATION OF THIS DATA-NAME CAUSED IT TO BE FLAGGED AS AN ERROR.
Explanation: The data-name encountered was flagged by the data division as containing an error in its declaration.
System Action: Compilation continues at the next verb or paragraph label.
User Response: Correct the declaration as indicated by the data division diagnostics and recompile.

IJS443I E SYNTAX REQUIRES A VERB. FOUND XXX.
Explanation: A point was reached where a verb was required and was missing. For example, 'IF = B.' requires a verb between the B and the period.
System Action: The statement is skipped from the point of the error.

IJS444I E SYNTAX REQUIRES A RECORD NAME. FOUND XXX.
Explanation: See message IJS402I.

 *Also, the entire statement from the point of error is dropped and is not compiled.

IJS500I W AN OPERAND'S LENGTH EXCEEDS AND IS TRUNCATED TO 256 BYTES.
Explanation: The maximum number of bytes that can be displayed is 256.
System Action: The operand is truncated to 256 bytes and displayed.

IJS501I W IF THIS VARIABLE-LENGTH ENTRY EXCEEDS 256, RESULTS WILL BE UNPREDICTABLE.
Explanation: A maximum of 256 bytes can be displayed.
System Action: The entry is truncated to 256 bytes and displayed.

IJS502I W LITERAL EXCEEDS AND IS TRUNCATED TO 72 BYTES.
System Action: In a stop-literal statement only the first 72 bytes of a longer field are typed on the console.

IJS503I W DATA EXCEEDS AND IS TRUNCATED TO 72 BYTES.
Explanation: A maximum of one line (72 bytes) can be retrieved using the ACCEPT FROM CONSOLE statement.

IJS504I W DATA EXCEEDS AND IS TRUNCATED TO 256 BYTES.
Explanation: A maximum of 256 bytes can be accepted from SYSIPT.

IJS505I C FILENAMES OR STERLING-DATA TYPE NOT ALLOWED IN COMPARE.
Explanation: See message IJS506I.

IJS506I C USAGE OF DATA-TYPES CONFLICT. THE TEST DROPPED.
Explanation: Only certain data types can be compared to each other. The types specified are invalid. Reference can be made to the compared table to determine the valid combinations. Logical comparisons of fields that are classified as invalid comparisons can often be made through a redefinition and a description of one or both of the fields as alphameric.

IJS507I W EXIT MUST BE ONLY STATEMENT IN PARAGRAPH.
System Action: Compilation continues normally.

IJS508I E THE STATEMENT CONTAINS AN UNDEFINED DATA NAME.
Explanation: See message IJS402I.

IJS509I C AN ALPHABETIC DATA-NAME CAN BE TESTED ONLY FOR ALPHABETIC OR NOT ALPHABETIC, AND NUMERIC DATA-NAME ONLY FOR NUMERIC OR NOT NUMERIC. THE TEST IS DROPPED.

IJS510I C COMPARISON OF TWO LITERALS OR FIGCONS IS INVALID.
Explanation: See message IJS506I.

IJS511I C DATA-TYPE IN ARITHMETIC STATEMENT IS NOT NUMERIC OR RECEIVING FIELD IS NOT NUMERIC OR REPORT.
Explanation: See message IJS506I.

IJS512I C DATA-NAME IN CLASS-TEST MUST BE AN, ED, OR ID.
Explanation: See message IJS506I.

IJS513I C DATA-NAME IN SIGN-TEST MUST BE NUMERIC.
Explanation: See message IJS506I.

IJS514I W DATA EXCEEDS AND IS TRUNCATED TO 72 BYTES.
System Action: If the data is longer than 72 bytes, only the first 72 bytes are printed for a DISPLAY ON CONSOLE statement.

IJS515I W DATA EXCEEDS AND IS TRUNCATED TO 120 BYTES.
System Action: If the data is longer than 120 bytes, only the first 120 bytes are printed for a DISPLAY statement.

IJS516I C OPEN 'NO REWIND' OR 'REVERSED' CANNOT BE SPECIFIED FOR A UNIT RECORD, DIRECT-ACCESS OR DISK/DATA CELL UTILITY FILE.
System Action: The options are ignored.

IJS517I C 'NO REWIND' OR 'LOCK' CANNOT BE SPECIFIED FOR A UNIT RECORD, DIRECT-ACCESS OR DISK/DATA CELL UTILITY FILE.
System Action: The options are ignored.

IJS518I E MORE THAN FORTY PARAMETERS ARE NOT ALLOWED WITH THE STATEMENT.

IJS519I C SYNTAX ALLOWS ZERO AS ONLY VALID FIGCON IN A COMPARISON WITH BI, ID, EF, AND IF.
Explanation: See message IJS506I.

IJS520I C SYNTAX ALLOWS SPACE OR ALL AS ONLY VALID FIGCONS IN COMPARISON WITH AN ALPHABETIC FIELD.
Explanation: See message IJS506I.

IJS521I C DATATYPE MUST BE ED, EF, AL, AN OR GF. FOUND XXX.
Explanation: The data types indicated are the only valid ones that can be used in the clause indicated.
System Action: Compilation continues at the next verb or paragraph label.

IJS522I C SYNTAX REQUIRES WORD RUN OR LITERAL. FOUND XXX.
System Action: The syntax scan skips the rest of the statement.

IJS523I C RECEIVING FIELDS IN PRECEDING STATEMENT IS A LITERAL.
Explanation: A Procedure Division literal cannot be changed as the result of arithmetic or a move. The statement, SUBTRACK data name FROM literal, would specify invalid action of this type.
System Action: Compilation continues at the next verb or paragraph label.

IJS524I C SYNTAX REQUIRES AT LEAST TWO OPERANDS BEFORE GIVING OPTION.
Explanation: For example, ADD A GIVING B.

System Action: The statement is skipped.

IJS525I C THE EXPRESSION HAS MORE RIGHT PARENS THAN LEFT PARENS TO THIS POINT. FOUND XXX.

Explanation: The number of right parentheses and left parentheses in a statement must agree. At no point in time can there be more right parentheses than left parentheses.

System Action: The statement is skipped from the point of the error.

User Response: Check for extra periods or missing periods, an error in a non-numeric literal, misspunched operators, or subscripted fields that are invalidly packed together without an intervening blank.

IJS526I C THE EXPRESSION HAS UNEQUAL NUMBER OF RIGHT AND LEFT PARENS.

Explanation: See message IJS525I.

IJS527I C DATA-TYPE MUST BE ED, ID, OR BI. FOUND XXX.

System Action: The statement is skipped from the point of error.

IJS528I C VARYING OPTION EXCEEDS THREE LEVELS.

Explanation: A maximum of three levels is permitted with the varying option of the PERFORM verb.

System Action: The statement is dropped from the point of error.

IJS529I C DATA-TYPE MUST BE ED, ID, BI, EE, OR IF.

Explanation: The data types shown are the only valid ones. The data-name found is not one of these types.

System Action: The statement is skipped from the point of error.

IJS530I C NUMBER OF ELSEES EXCEEDS NUMBER OF IFS.

Explanation: Number of ELSE clauses must balance out with the appropriate number of ELSE or OTHERWISE clauses.

System Action: Statement is skipped from the point of error.

User Response: Recount and make corrections.

IJS531I E INTERNAL OCCURS-DEPENDING-ON TABLE OVERFLOWED AVAILABLE CORE.

IJS532I E STATEMENT HAS TOO MANY OPERANDS.

Explanation: The statement referenced is too large or complex for the internal tables needed for compilation.

System Action: The statement is skipped from the occurrence of this condition.

User Response: The statement should be divided into more than one statement.

IJS533I E PARENTHEZING REQUIRES SAVING TOO MANY OPERANDS.
Explanation: See message IJS532I.

IJS534I E PARENTHEZING REQUIRES SAVING TOO MANY INTERNALLY
GENERATED LABELS.
Explanation: See message IJS532I.

IJS535I E PARENTHEZING REQUIRES SAVING TOO MUCH OF STATEMENT.
Explanation: See message IJS532I.

IJS536I E ARITHMETIC EXPRESSION REQUIRES MORE THAN 9 INTERMEDIATE
RESULT FIELDS.
Explanation: See message IJS532I.

IJS538I W 'OUTPUT' CANNOT BE SPECIFIED FOR INDEX/DIRECT ORGANIZATION
WITH RANDOM ACCESS. 'I-O' IS ASSUMED.

IJS539I C 'I-O' IS AN INVALID SPECIFICATION FOR DIRECT ORGANIZATION
WITH SEQUENTIAL ACCESS.

IJS540I W 'NO REWIND' CANNOT BE SPECIFIED WITH 'REVERSED' OPTION.
'REVERSED' IS ASSUMED.

IJS549I E WORD XXX WAS EITHER INVALID OR SKIPPED DUE TO ANOTHER
DIAGNOSTIC.
Explanation: The majority of these messages will probably
be caused by words skipped because of another diagnostic
message that occurred earlier in the statement. This diag-
nostic message also occurs because of misspelled words.
User Response: In the case of words skipped, correct the
previous error, or correct the current misspellings.

IJS550I C A FIGURATIVE CONSTANT IS NOT ALLOWED AS A CALL OR ENTRY
PARAMETER.
System Action: The statement is skipped from the point of
error.

IJS551I C SYNTAX REQUIRES WORD 'TO'. FOUND XXX.
System Action: Syntax scan skips the rest of the
statement.

IJS552I C RECEIVING FIELD MUST BE A DATA-NAME. FOUND XXX.
System Action: The statement is skipped from the point of
error.

IJS553I E FIGURATIVE CONSTANT IS NOT ALLOWED AS A RECEIVING FIELD.
System Action: The statement is skipped from the point of
the error.

IJS554I C THE 'XXX' DATA-TYPE IS NOT LEGAL RECEIVING FIELD.
System Action: The statement is skipped from the point of
the error.
User Response: Check the table of permissible moves in the
COBOL specification.

IJS555I C OVERFLOW NAME IS NOT A VALID SENDING FIELD.
System Action: The statement is skipped from the point of the error.

IJS556I E END DECLARATIVES IS MISSING FROM PROGRAM.
Explanation: The entire Procedure Division is treated as a declarative section.

IJS557I W FLOATING-POINT CONVERSION MAY RESULT IN TRUNCATION.
Explanation: Conversion of floating-point numbers can result in truncation of low-order digits.

IJS558I E I-O OPTION FOR FILE CONFLICTS WITH NO REWIND.
System Action: The statement is skipped from the point of the error.

IJS559I E OUTPUT OPTION FOR FILE CONFLICTS WITH REVERSED.
Explanation: The OUTPUT option conflicts with an opening of a file that has a reversed option specified.
System Action: The statement is skipped from the point of the error.

IJS560I C SYNTAX REQUIRES WORD 'NAMED', 'CHANGED', OR 'CHANGED NAMED'. FOUND XXX.
System Action: The statement is skipped from the point of error.

IJS561I C DATA TYPE MUST BE ED, ID, BI, EF, IF, RP, AL, AN, OR GF. FOUND XXX.
Explanation: A file-name, condition name, figure configuration, or variable-length group is not valid at this point.
System Action: The statement is skipped from the point of the error.

IJS562I C DATA ENTRY MUST NOT EXCEED 120 CHARACTERS.
Explanation: The data entry specified exceeds the maximum permitted for this type of output.
System Action: The statement is skipped from the point of the error.

IJS563I C DATA ENTRY MUST BE DISPLAY.
System Action: The statement is skipped from the point of the error.

IJS564I C SYNTAX REQUIRES ONE OF THE ALLOWABLE CHARACTERS. FOUND XXX.
System Action: The statement is skipped from the point of the error.

IJS565I C IF STATEMENT MUST BE TERMINATED BY A PERIOD.
Explanation: This message is obtained when the IF statement is the last statement of a paragraph and a label is detected instead of a period.

System Action: The statement is skipped from the point of error.

IJS566I C DATA TYPE MUST BE AL, AN, RP, OR GROUP.

System Action: The statement is skipped from the point of error.

IJS567I C DATA TYPE MUST BE AL, AN, FIGCON OR FIXED-LENGTH GROUP.

System Action: The statement is skipped from the point of the error.

IJS568I C DATA ITEM MUST NOT EXCEED 256 CHARACTERS.

System Action: The statement is skipped from the point of the error.

IJS569I C DATA ENTRIES MUST BE OF EQUAL LENGTH.

System Action: The statement is skipped from the point of the error.

IJS570I C THE LENGTH OF THE SECOND OPERAND MUST BE EQUAL TO THE FIRST OR A SINGLE CHARACTER.

System Action: The statement is skipped from the point of the error.

IJS571I E A RECORD NAME MUST BE ASSOCIATED WITH THIS FILE. FOUND XXX.

System Action: The statement is skipped from the point of the error.

IJS572I C ONLY ONE DATA-NAME MAY BE ASSOCIATED WITH THE CHANGED OPTION.

System Action: The statement is skipped from the point of the error.

IJS573I C DATA TYPE MUST BE ED, ID, BI, EF, IF, SN, SR, RP, AL, AN, FC, OR GROUP.

System Action: The statement is skipped from the point of error.

IJS601I W NO SIGNIFICANT POSITION MATCHES BETWEEN SENDING AND RECEIVING FIELDS IN MOVE. RECEIVING FIELD IS SET TO ZERO.

Explanation: There are no digit positions in common between the sending and receiving fields. This can be illustrated by moving a field with PICTURE 99 to a receiving field with PICTURE V99.

System Action: The receiving field is set to zero.

IJS602I W DESTINATION FIELD DOES NOT ACCEPT THE WHOLE SENDING FIELD IN MOVE.

Explanation: The sending field is larger than the receiving field in either its integer or decimal positions, or both.

System Action: The sending field is truncated.

IJS603I C AFTER ADVANCING OPTION NOT ALLOWED WITH REWRITE.

System Action: The statement is skipped from the point of the error.

IJS604I E SOURCE PROGRAM EXCEEDS INTERNAL LIMITS.

Explanation: The program is too large.

User Response: The user should do one of the following, then retry:

- Divide the program into two or more parts
- Simplify compound conditional statements.

IJS605I E PROCEDURE NAME MULTIPLY DEFINED.

Explanation: Procedure name indicated was multiply defined and was not qualified properly by the appropriate section-name when used.

IJS606I E PROCEDURE-NAME XXX NOT DEFINED.

Explanation: The name indicated was incorporated into a GO TO or a PERFORM statement, and was never defined. Procedure names must begin in columns 8 through 11 at the point where they are defined.

IJS607I E INVALID LITERAL XXX.

User Response: Check for multiple decimal points, non-numeric characters that have not been enclosed in quotes.

IJS608I E XXX IS NOT ALLOWED TO HANDLE MORE THAN 25 FILES IN ONE STATEMENT.

System Action: The rest of the statement is skipped. Only 25 files are handled.

IJS609I E PROCEDURE-NAME XXX HAS ILLEGAL CONTENT AND IS DROPPED.

IJS610I E 'CONDITION NAME' WAS EITHER NOT ALLOWED IN THIS STATEMENT OR SKIPPED DUE TO ANOTHER DIAGNOSTIC.

IJS611I E TOO MANY PARAGRAPH NAMES HAVE BEEN USED IN CALL STATEMENTS.

IJS612I W OPEN STATEMENT CONTAINS MORE THAN 9 FILENAMES. OPEN WILL SPLIT.

System Action: Handles multiple OPEN statements each containing nine filenames.

IJS613I W USING STATEMENT HAS BEEN INCORRECTLY SPECIFIED.

IJS614I E THIS CONDITIONAL HAS A MISSING RELATIONAL OPERATOR.

System Action: The statement is skipped from the point of the error.

IJS615I E READ 'AT END' REQUIRED FOR FILES WITH ACCESS SEQUENTIAL.

IJS617I E WRITE 'FROM' REQUIRED WITH APPLY WRITE ONLY.

IJS618I E REWRITE INVALID ON DIRECT OR RELATIVE SEQUENTIAL FILES.

IJS621I E OPEN 'I-O' INVALID FOR DIRECT OR RELATIVE SEQUENTIAL FILES.

IJS622I E OPEN 'OUTPUT' INVALID FOR FILES WITH ACCESS RANDOM, I-O ASSUMED.

IJS623I E OPEN 'REVERSED' VALID ONLY ON STANDARD SEQUENTIAL FILES.

IJS625I E OPEN 'REVERSED' INVALID FOR FILES WITH FORMAT V RECORDS.

IJS626I E CLOSE 'UNIT' OR 'REEL' VALID ONLY FOR STANDARD SEQUENTIAL FILES.

IJS627I E 'INVALID KEY' INVALID FOR STANDARD, DIRECT, OR RELATIVE SEQUENTIAL FILES, OR FOR REWRITE ON INDEXED SEQUENTIAL FILES.

IJS628I E OPEN 'ACTUAL KEY' REQUIRED FOR DIRECT SEQUENTIAL OUTPUT FILES.

IJS700I E SOURCE PROGRAM NOT FOUND. COMPILATION CANCELED.

IJS701I E DATA DIVISION NOT FOUND. COMPILATION CANCELED.

IJS702I E PROCEDURE DIVISION NOT FOUND. COMPILATION CANCELED.

IJS703I E SOURCE PROGRAM EXCEEDS INTERNAL LIMITS. COMPILATION CANCELED.

Explanation: The size of the assembler phase tables exceeds the core storage available for these tables.

User Response: Modify the source program to allow compilation on the source computer. There are essentially three variables that can be modified:

- The length and number of source labels could be reduced as the table for source labels must reserve 3 + L bytes per source label.
- The number of literals could be reduced as 3 bytes are reserved for each literal.
- The size of the buffer can be reduced in machines above 16K storage size.

IJS704I E DATA-NAME TABLE OVERFLOW. COMPILATION CANCELED.

IJS705I NO DIAGNOSTICS IN THIS COMPILATION.

IJS706I E EXECUTION CANCELED DUE TO E LEVEL DIAGNOSTIC.

IJS707I E CONFLICTING I/O ASSIGNMENTS.

Explanation: SYS001, SYS002, and SYS003 are not assigned to the same type of device.

System Action: Compilation is canceled.

IJS708I E STORAGE ALLOCATED TO THE COMPILER IS LESS THAN 10K. compilation canceled.

IJS708I E STORAGE ALLOCATED TO THE COMPILER IS LESS THAN 14K. COMPILATION CANCELED.

IJS709I W INCORRECT COBOL OPTION 'XXX'.

IJS710I W BUFFSIZ CANNOT BE LESS THAN 170. ASSUMED 170.

IJS711I W BUFFSIZ CANNOT BE GREATER THAN 32000. ASSUMED 32000.

IJS712I W BUFFSIZ CANNOT BE GREATER THAN 3625 (7294) FOR WORK FILES
ON DISK. ASSUMED 3625 (7294).

Explanation: 3625 for 2311
 7294 for 2314

IJS713I W BUFFSIZ IS TOO LARGE FOR SIZE OF STORAGE ALLOCATED TO THE
COMPILER. ASSUMED XXX.

EXECUTION TIME MESSAGES

A list of execution time messages follows. Most of them are self-explanatory. Where deemed necessary, examples are included to explain the message.

- #IHD901I* AN UNCORRECTABLE DASD ERROR HAS OCCURRED.
- #IHD902I* WRONG LENGTH RECORD.
- #IHD903I* NO RECORD FOUND.
- #IHD904I* ILLEGAL ID SPECIFIED.
- #IHD905I* DUPLICATE RECORD.
- #IHD906I* CYLINDER OVERFLOW AREA FULL.
- #IHD907I* PRIME DATA AREA FULL.
- #IHD908I* CYLINDER INDEX AREA FULL.
- #IHD909I* MASTER INDEX AREA FULL.
- #IHD910I* RECORD OUT OF SEQUENCE.
- #IHD911I WRONG LENGTH RECORD.
- #IHD912I NO MORE ROOM FOUND ON TRACK.
- #IHD913I DATA CHECK IN COUNT AREA.
- #IHD914I DATA CHECK WHEN READING KEY OR DATA.
- #IHD915I NO RECORD FOUND.
- #IHD993I ZERO BASE-MINUS EXPONENT-PACKED RESULT MADE ALL NINES.
- #IHD996I RESULT TOO BIG-FLOATING POINT RESULT MADE MAX FP NUMBER.
- #IHD997I ZERO BASE-MINUS EXPONENT-FLOATING POINT RESULT IS MAX FP NUMBER.
- #IHD998I ZERO BASE-PLUS EXPONENT-FLOATING POINT RESULT MADE ZERO.
- #IHD999I MINUS BASE MADE PLUS AND FLOATING POINT EXPONENTIATION CONTINUED.
- AWAITING REPLY.

*These messages pertain to indexed sequential data organization only.

DEBUG PACKET ERROR MESSAGES

The following is a complete list of precompile error messages. They apply to errors in the debugging packet only.

IJS850I TABLE OF DEBUG REQUESTS OVERFLOWED. RUN TERMINATED.

IJS851I THE FOLLOWING CARD DUPLICATES A PREVIOUS *DEBUG CARD. THIS
PACKET WILL BE IGNORED.

IJS852I THE FOLLOWING PROCEDURE DIVISION NAMES WERE NOT FOUND.
INCOMPLETE DEBUG EDIT IS NOT TERMINATED.

IJS853I THE FOLLOWING *DEBUG CARD DOES NOT CONTAIN A VALID LOCATION
FIELD. THIS PACKET WILL BE IGNORED.

IJS854I IDENTIFICATION DIVISION NOT FOUND. RUN TERMINATED.

IJS855I DEBUG EDIT RUN COMPLETE. INPUT OR COBOL COMPILATION ON
SYS004.

ACCEPT Verb 84
 Accessing Call Parameters 98
 ADDR (LISTX) 57
 Alignment and Slack Bytes 87
 Alignment, Decimal 68
 Alignment Factor, Records 92
 ALT (ASSGN Statement) 16
 Alternate Method of Solution (Intermediate Results) 81
 Apply Write Only 91
 Argument List 157
 Arithmetic Fields 81
 Arithmetic Computations 80
 Arithmetic Suggestions 81
 ASSGN Statement 16
 Assembler Language Subprograms 155
 Assembler Routines for Effecting Overlays 154
 Assumed Configuration
 Disk Resident System 47
 Tape Resident System 37
 Assumed Logical Assignments at System Generation Time
 Disk Resident System 47
 Tape Resident System 39
 Assumed Physical Assignments at System Generation Time
 Disk Resident System 47
 Tape Resident System 37
 AT END 91
 Autolink Feature 30

 Basic Types of Operations 10
 BUFFSIZ (COBOL Option) 25

 Called and Calling Programs 96,97
 Calling a Subprogram 95
 CATAL 173
 Cataloging 39,49
 Cataloging an Object Module in the Relocatable Library
 Disk 49
 Tape 39
 Cataloging Books -- Source Statement Library 33
 Cataloging Books -- User Private Library 34
 Cataloging Program Phases -- Core Image Library 32
 Cataloging Source Modules to Source Statement Library
 Disk 50
 Tape 42
 CBL Statement 25
 Checkpointing a Program 35
 COBOL Control Card 25
 COBOL Option (COBOL Control Card) 25
 COBOL Program Main (Root or Main Program) 102
 COBOL Statements Used to Specify an Indexed Sequential File 115
 COBOL Statements Used to Specify Direct Organization Files 138
 Coding Examples for Direct Organization Files 146
 Coding Examples Using Indexed Sequential Files 125
 Comments Statement 24
 Comparisons 83
 Compilation 10
 Compile and Punch
 Disk 49
 Tape 39
 Compile, Linkage Edit, and Execute
 Disk 49-50
 Tape 40

Compile (Using Source Statement), Linkage Edit, and Execute
 Disk 51
 Tape 43
 Computational (Binary) 77
 COMPUTATIONAL-1 or COMPUTATIONAL-2 (Internal Floating Point) 77-78
 COMPUTATIONAL-3 (Internal Decimal) 77
 Conditional (Severity Code) 58
 Conditional Statements 72
 Configuration, Assumed 37,47
 Conserving Storage 67
 Considerations when Using Assembler with COBOL for Overlays 154
 Continuation of Job-Control Statement 16
 Control Cards Required for Overlay 105
 Conversion of COMPUTATIONAL-1 or COMPUTATIONAL-2 Data 71
 COPY (Data Division) 34
 Core Image Library 11
 Creating a Direct Organizational File 138
 CLOSE Statement 139
 Key Handling 139
 OPEN Statement 138
 WRITE Statement 139
 Creating an Indexed Sequential File 115,126
 CLOSE Statement 116
 Key Handling 116
 OPEN Statement 115
 WRITE Statement 116
 Cylinder Index 112

 Data Area (XTENT Statement) 22
 Data Format of Arguments 160
 Data Forms 73
 DATA MAP (SYM) 55
 Data Organization 9
 Debug Packet 64,66
 Debug Packet Error Messages 214
 Debugging Language 63
 Decimal-Point Alignment 68
 DECK 20
 Deck Structures for Processing COBOL Programs
 Disk Resident System 46
 Tape Resident System 37
 Diagnostic Messages
 ERRS 58
 Examples of 60
 Sequential listing 186
 Direct Organization 132
 DISPCHK (COBOL Options) 25
 Display (Non-Numeric External Decimal) 73
 DISPLAY Fields 79
 DLAB Statement 22
 DLBL Statement 26
 DMAP (COBOL Option) 25
 Dumps 61

 Editing 83
 Elementary Items 74
 End-of-Data-File Statement 24
 End-of-Job Statement 24
 ER CODE (ERRS) 58
 Error Messages, Debug Packet 214
 Error Messages (ERRS) 58
 Error Recovery Techniques for Direct Files 143
 Error Recovery Techniques for Indexed Sequential Files 119
 Error (Severity Code) 58
 ERRS 20,58
 Examples of Processing
 Disk Configuration 48
 Tape Configuration 39

| | |
|--|----------|
| Example of Updating Actual Key | 134 |
| Example of COBOL Main Program and COBOL Subprogram Modifying DTF | 125 |
| Examples of COBOL Programs | 176 |
| Examples Showing Effective Use of of Data Declarations | 78 |
| EXEC Statement | 18 |
| Executing a COBOL Program | 10 |
| Executing a Program | |
| Disk | 50 |
| Tape | 41 |
| Execution | 10 |
| Execution Time Messages | 60 |
| EXHIBIT | 63 |
| EXIT | 25 |
| Exponentiation | 81 |
| EXTENT -- DASD Extent Information | 27 |
| Extent Sequence Number | 23 |
| Extent Type | 22 |
| Filename (VOL Statement) | 19 |
| Format of Job-Control Statement | 16 |
| Generated COBOL Source Listing | 54 |
| GO (Tape Only) | 20 |
| GO TO (DEPENDING ON) | 91 |
| Group Item | 74 |
| IF NUMERIC Test | 86 |
| IF (Relationals) | 79 |
| INCLUDE (Procedure Division) | 34 |
| INCLUDE Statement (Linkage Edit Statement) | 30 |
| In-Line Parameter List | 160 |
| Index Area (XTENT Statement) | 22 |
| Index Areas | 112 |
| Indexed Sequential File Organization | 111-131 |
| Input/Output Device Assignment | 13 |
| Insertion of Slack Bytes | 87 |
| INSTRUCTION (LISTX) | 57 |
| intermediate Results In Complex Expressions | 80 |
| Interpreting Output | 54 |
| INVALID KEY | 144 |
| INVALID KEY Errors | 121 |
| INVED (COBOL Option) | 25 |
| Input/Output Error Processing Considerations | |
| Direct (DAM) | 143-145 |
| Indexed Sequential (ISAM) | 119-127 |
| Sequential Disk | 93 |
| Sequential Tape | 92 |
| Job Control Setup for Using Debug Packets | 65 |
| Job-Control Statements | 14 |
| JOB Statement | 18 |
| Labeling Considerations | 92 |
| LBLTYP Statement | 18 |
| Librarian | 10,31 |
| Librarian Functions | 31 |
| Libraries | 10 |
| LINE/POS | |
| (ERRS) | 58 |
| (LISTX) | 57 |
| LINK | 20 |
| Linkage Conventions | 156 |
| Linkage Edit with Overlay | 101 |
| Linkage Edit without Overlay | 99 |
| Linkage Editing | 10,29,31 |
| Linkage Editor | 29,95 |
| Linkage Editor Control Statements | 29 |
| Linkage Editor Output | 60 |

LIST 20,54
LISTX 20,57
LOG 20
Lower Limit of Extent 23
Lowest Level Subprogram 160

Machine Representation of Data Items 76
Maintenance Function 31
Master Index 112
MESSAGE (ERRS) 58
Message Number (ERRS) 58
MINSYS (Tape Only) 20
Mixed Data Formats 77
 COMPUTATIONAL to COMPUTATIONAL-3 70
 COMPUTATIONAL to DISPLAY 70
 COMPUTATIONAL-3 to COMPUTATIONAL 70
 COMPUTATIONAL-3 to DISPLAY 71
 DISPLAY to COMPUTATIONAL 70
 DISPLAY to COMPUTATIONAL-3 69
 DISPLAY to DISPLAY 71
Modifying the DTF Table for Direct Files 145
Modifying the DTF Table for Indexed Sequential Organization Files 123
Move COMPUTATIONAL-3 Fields 78
 DISPLAY Fields 79
Move COMPUTATIONAL-3 to REPORT 79
Move DISPLAY to COMPUTATIONAL-3 79
MOVE Statement 78
Multiple Buffers 91
Multiple Entry Points 141
Multiprogramming 11
Multiprogramming Considerations 11,101

Name (Job Control Statement) 16
NODECK 20
NODUMP 20
NOERRS 20
NOEXIT 25
NOLINK 20
NOLIST 20
NOLISTX 20
NOLOG 20
NOTE, Use of 84
NSD (nn) (LBLTYP Statement) 18
Numeric Comparisons 83
Numeric Data Format Usage 75

OCCURS...DEPENDING ON Clause 91
ON 64
Opening Files 84
Operation (Job Control Statement) 16
Operand (Job Control Statement) 16
OPTION Statement 19
Overflow Area (XTENT Statement) 22
Overlay 105-106
Overlay Processing 100
Overlay Routine Instructions, Functions of 155
Overlay Structures 98

Paragraph Names 84
Passing Parameters to Assembler Language Routine 106
PAUSE Statement 21
Permissible Comparisons (COBOL) 169
Permissible Moves (COBOL) 170
PHASE Statement 30
PMAP (COBOL Option) 25
Prime Areas and Overflow Areas 111
Procedure for Bypassing Non-Standard Labels 92
Procedure Map (LISTX) 57

Processing Buffers 91
 Processing COBOL Files on Direct Access Devices 110
 Processing Indexed and Direct Files 110
 Program Phase Dumps 61
 Programming Considerations 67
 Punch, Compile and
 Disk 46,49
 Tape 37,39

 Randomizing 135
 Randomizing for the 2311 Disk Pack 135
 Randomizing for the 2321 Data Cell 136
 Randomizing Technique, A 134
 Random Retrieval 128
 Random Retrieval of an Indexed Sequential File 118
 Adding Randomly 119
 Key Handling 119
 Updating Randomly 118
 Random Retrieval 118
 Random Retrieval, Updating, and Adding to a Direct File 139,150
 Adding Randomly 139
 Key Handling 139
 OPEN, CLOSE 139
 Random Retrieval 140
 Updating Randomly 140
 Record Alignment 92
 Record Blocking 90
 REDEFINES 85
 Redefinition 85
 Redundant Coding 83
 Reference Formats for Disk and Tape Operating Systems COBOL 162
 Reference Work Areas for Efficiency (Mixed-Data Formats) 69
 Register Use 156
 Relationals 79
 Relocatable Library 11
 RESET Statement 24
 Restrictions on the Using Statement 98

 Save Area 157
 Sequence of Job-Control Statements 15
 Sequential Disk File Organization 93
 Sequential Retrieval 130
 Sequential Retrieval of a Direct Organization File 139,152
 Key Handling 139
 OPEN, CLOSE 139
 READ Statement 139
 Sequential Retrieval of an Indexed Sequential File or Updating an
 Indexed Sequential File 116
 Sequential Retrieval 116
 Key Handling 118
 Updating 117
 Sequential Tape File Organization 92
 Service Programs 9
 Severity Code 58
 Sign Control 71
 Slack Bytes in the Data Division 87
 Source Listing (LIST) 54
 Source Modules 10
 Specifying Keys 132
 Split Cylinder (XTENT Statement) 22
 Source Statement Library 11
 Standard DASD File Labels, Format 1 172
 Standard Tape File Labels 171
 Subprograms 95
 Subprograms and Overlay Structures 95
 Subroutines Used by COBOL 178
 SYM 21,55
 Symbolic Input/Output Assignment 14

SYSIPT 14
 SYSLNK 14
 SYSLOG 14
 SYSLST 14
 SYSPCH 14
 SYSRDR 14
 SYSRES 14
 SYSRLB 14
 SYSSLB 14
 SYS000-SYS222 14
 SYSIN 14
 SYSOUT 14
 Symbolic Units 13-14
 System Libraries 10,11
 System Service Program 9
 SYSxxx (VOL Statement) 19

 TAPE[(nn)] (LBLTYP Statement) 19
 Techniques for Coding 80
 TLBL Statement 26
 TPLAB Statement 19
 TRACE 63
 Track Format for the 2311, 2314 and 2321 174
 Track Index 112
 Trailing Characters 85

 Unequal-Length Fields 68-69
 Upper Limit of Extent 23
 Unexpected Intermediate Results 81
 USE AFTER STANDARD ERROR 144
 USE AFTER STANDARD ERROR Routines 121
 USRLABEL (Disk Only) 21

 Variable Length Records 89
 Variable Length Records, Blocking of 90
 Variable Record Alignment Containing OCCURS...DEPENDING ON Clause 91
 VOL Statement 19
 Volume Serial Number 23

 Warning (Severity Code) 58
 Working with Diagnostic Messages 59

 XTENT Statement 22
 X'SS' (ASSGN Statement) 17



