

ILLUSTRATED PARTS BREAKDOWN

HP 3000

COMPUTER SYSTEM

LIST OF EFFECTIVE PAGES

Changed pages are designated by a change date in the lower corner of the page. Original pages do not indicate a change date. Insert latest changed pages and destroy superseded pages.

PAGE NUMBER	ISSUE	PAGE NUMBER	ISSUE
Title	4 Apr 1973	2-1 thru 2-5	Original
ii	4 Apr 1973	2-6 thru 2-8	4 Apr 1973
iii	Original	2-9 thru 2-53	Original
iv Blank	Original	2-54 Blank	Original
v thru vii	Original	2-55 thru 2-117	Original
viii Blank	Original	2-118 Blank	Original
1-1	Original	Certification	Original
1-2 Blank	Original	Back Cover	Original

Section		Page
I	GENERAL INFORMATION	
	1-1. Introduction	1-1
	1-3. Scope	1-1
II	REPLACEABLE PARTS	
	2-1. Introduction	2-1
	2-3. Replaceable Parts Lists	2-1
	2-5. Index Numbered Lists	2-1
	2-9. Reference Designation Order Lists	2-1
	2-12. Ordering Information	2-2

Figure	Title	Page
2-1.	Central Processor Unit, Parts Location Diagram	2-4
2-2.	Read-Only Memory (ROM) PCA (A3), Parts Location Diagram	2-8
2-3.	Skip and Special Field (SSF) PCA (A4), Parts Location Diagram	2-12
2-4.	Arithmetic and Logic Unit (ALU) PCA (A5), Parts Location Diagram	2-16
2-5.	R-Bus PCA (A6), Parts Location Diagram	2-20
2-6.	S-Bus PCA (A7), Parts Location Diagram	2-24
2-7.	Current Instruction Register (CIR) PCA (A8), Parts Location Diagram	2-29
2-8.	Module Control Unit (MCU) PCA (A9), Parts Location Diagram	2-33
2-9.	Input Output Processor (IOP) (A10), Parts Location Diagram	2-37
2-10.	Central Data Bus Terminator PCA, Parts Location Diagram	2-39
2-11.	Input/Output Processor Bus Terminator PCA, Parts Location Diagram	2-42
2-12.	Power Bus Terminator PCA, Parts Location Diagram	2-44
2-13.	Control Assembly, Parts Location Diagram	2-46
2-14.	Universal PCA Module, Parts Location Diagram	2-48
2-15.	Memory Load PCA, Parts Location Diagram	2-53
2-16.	Memory Data and Control PCA, Parts Location Diagram	2-58
2-17.	Memory Drive and Sense PCA, Parts Location Diagram	2-67
2-18.★	Selector Channel Register PCA, Parts Location Diagram	2-69
2-19.★	Selector Channel Control PCA, Parts Location Diagram	2-71
2-20.★	Selector Channel Port PCA, Parts Location Diagram	2-73
2-21.★	Selector Channel Maintenance PCA, Parts Location Diagram	2-75
2-22.	System Clock/Console Interface PCA, Parts Location Diagram	2-79
2-23.	Multiplexer Channel PCA, Parts Location Diagram	2-83
2-24.	Multiplexer Channel Bus Terminator PCA, Parts Location Diagram	2-85
2-25.	Universal Interface (TTL) PCA, Parts Location Diagram	2-90
2-26.	Universal Interface (Differential) PCA, Parts Location Diagram	2-95
2-27.★	Universal Interface (Optical) PCA, Parts Location Diagram	2-97
2-28.	Synchronous Data Modem (201/203) IF PCA, Parts Location Diagram	2-102
2-29.	Terminal Data Interface PCA, Parts Location Diagram	2-107
2-30.	Terminal Control Interface PCA, Parts Location Diagram	2-110
2-31.	Disc File Read/Write PCA, Parts Location Diagram	2-114
2-32.	Disc File Bus PCA, Parts Location Diagram	2-121
2-33.	Disc Controller Processor PCA, Parts Location Diagram	2-125
2-34.	Disc Memory Controller PCA, Parts Location Diagram	2-129
2-35.	Disc Memory Data PCA, Parts Location Diagram	2-133
2-36.	Card Reader Interface PCA, Parts Location Diagram	2-138
2-37.	Cartridge Disc Controller PCA, Parts Location Diagram	2-143
2-38.	Magnetic Tape (9 Track) Controller PCA, Parts Location Diagram	2-148
2-39.	Magnetic Tape Controller Processor PCA, Parts Location Diagram	2-152
2-40.★	Magnetic Tape (7 Track) Controller PCA, Parts Location Diagram	2-154
2-41.	Control Panel Interface PCA, Parts Location Diagram	2-158
2-42.	Controller Maintenance Interface PCA, Parts Location Diagram	2-161
2-43.	Fan Assembly, Exploded View	2-162
2-44.	Power Supply Assembly, Exploded View	2-166
2-45.	Output Crowbar Assembly (A13), Exploded View	2-168
2-46.	Front Panel Assembly (A12), Exploded View	2-170
2-47.	Test Point Assembly (A12A1), Parts Location Diagram	2-172
2-48.	Preregulator Assembly (A9), Exploded View	2-174
2-49.	Inverter PCA (A7), Parts Location Diagram	2-176
2-50.	5V/20V Rectifier Assembly (A6), Exploded View	2-178
2-51.	Deck Assembly (A8), Parts Location Diagram	2-182
2-52.	Preregulator Control PCA (A1), Parts Location Diagram	2-185
2-53.	Inverter Driver PCA (A2), Parts Location Diagram	2-187
2-54.	20 Volt Supply PCA (A3), Parts Location Diagram	2-190
2-55.	Current Limit PCA (A4), Parts Location Diagram	2-193
2-56.	Voltage Protect PCA (A5), Parts Location Diagram	2-197

ILLUSTRATIONS (Continued)

Figure	Title	Page
2-57.	Capacitor Board PCA (A8A1), Parts Location Diagram	2-199
2-58.★	Auxiliary Control Panel, Exploded View	2-201
2-59.	Input PCA, Parts Location Diagram	2-205
2-60.	Display PCA, Parts Location Diagram	2-207
2-61.★	Hardware Maintenance Panel, Exploded View	2-209
2-62.	Input PCA, Parts Location Diagram	2-212
2-63.	Display PCA, Parts Location Diagram	2-215

★Indicates illustrations which are not available for this printing.

TABLES

Table	Title	Page
2-1.	HP 3000 Computer System	2-3
2-2.	Central Processor Unit, Replaceable Parts	2-4
2-3.	Read-Only Memory (ROM) PCA (A3), Replaceable Parts	2-5
2-4.	Skip and Special Field (SSF) PCA (A4), Replaceable Parts	2-9
2-5.	Arithmetic and Logic Unit (ALU) PCA (A5), Replaceable Parts	2-13
2-6.	R-Bus PCA (A6), Replaceable Parts	2-17
2-7.	S-Bus PCA (A7), Replaceable Parts	2-21
2-8.	Current Instruction Register (CIR) PCA (A8), Replaceable Parts	2-25
2-9.	Module Control Unit (MCU) PCA (A9), Replaceable Parts	2-30
2-10.	Input Output Processor (IOP) PCA (A10), Replaceable Parts	2-34
2-11.	Central Data Bus Terminator PCA, Replaceable Parts	2-38
2-12.	Input/Output Processor Bus Terminator PCA, Replaceable Parts	2-40
2-13.	Power Bus Terminator PCA, Replaceable Parts	2-43
2-14.	Control Assembly, Replaceable Parts	2-45
2-15.	Universal PCA Module, Replaceable Parts	2-47
2-16.	Memory Load PCA, Replaceable Parts	2-49
2-17.	Memory Data and Control PCA, Replaceable Parts	2-55
2-18.	Memory Drive and Sense PCA, Replaceable Parts	2-59
2-19.★	Selector Channel Register PCA, Replaceable Parts	2-68
2-20.★	Selector Channel Control PCA, Replaceable Parts	2-70
2-21.★	Selector Channel Port PCA, Replaceable Parts	2-72
2-22.★	Selector Channel Maintenance PCA, Replaceable Parts	2-74
2-23.	System Clock/Console Interface PCA, Replaceable Parts	2-76
2-24.	Multiplexer Channel PCA, Replaceable Parts	2-80
2-25.	Multiplexer Channel Bus Terminator PCA, Replaceable Parts	2-84
2-26.	Universal Interface (TTL) PCA, Replaceable Parts	2-86
2-27.	Universal Interface (Differential) PCA, Replaceable Parts	2-91
2-28.★	Universal Interface (Optical) PCA, Replaceable Parts	2-96
2-29.	Synchronous Data Modem (201/203) IF PCA, Replaceable Parts	2-98
2-30.	Terminal Data Interface PCA, Replaceable Parts	2-103
2-31.	Terminal Control Interface PCA, Replaceable Parts	2-108
2-32.	Disc File Read/Write PCA, Replaceable Parts	2-111
2-33.	Disc File Bus PCA, Replaceable Parts	2-115
2-34.	Disc Controller Processor PCA, Replaceable Parts	2-122
2-35.	Disc Memory Controller PCA, Replaceable Parts	2-126
2-36.	Disc Memory Data PCA, Replaceable Parts	2-130

TABLES (Continued)

Table	Title	Page
2-37.	Card Reader Interface PCA, Replaceable Parts	2-134
2-38.	Cartridge Disc Controller PCA, Replaceable Parts	2-139
2-39.	Magnetic Tape (9 Track) Controller PCA, Replaceable Parts	2-144
2-40.	Magnetic Tape Controller Processor PCA, Replaceable Parts	2-149
2-41.★	Magnetic Tape (7 Track) Controller PCA, Replaceable Parts	2-153
2-42.	Control Panel Interface PCA, Replaceable Parts	2-155
2-43.	Controller Maintenance Interface PCA, Replaceable Parts	2-159
2-44.	Fan Assembly, Replaceable Parts	2-162
2-45.	Power Supply Assembly, Replaceable Parts	2-163
2-46.	Output Crowbar Assembly (A13), Replaceable Parts	2-167
2-47.	Front Panel Assembly (A12), Replaceable Parts	2-169
2-48.	Test Point Assembly (A12A1), Replaceable Parts	2-171
2-49.	Preregulator Assembly (A9), Replaceable Parts	2-173
2-50.	Inverter PCA (A7), Replaceable Parts	2-175
2-51.	5V/20V Rectifier Assembly (A6), Replaceable Parts	2-177
2-52.	Deck Assembly (A8), Replaceable Parts	2-179
2-53.	Preregulator Control PCA (A1), Replaceable Parts	2-183
2-54.	Inverter Driver PCA, Replaceable Parts	2-186
2-55.	20 Volt Supply PCA (A3), Replaceable Parts	2-188
2-56.	Current Limit PCA (A4), Replaceable Parts	2-191
2-57.	Voltage Protect PCA (A5), Replaceable Parts	2-194
2-58.	Capacitor Board PCA (A8A1), Replaceable Parts	2-198
2-59.★	Auxiliary Control Panel, Replaceable Parts	2-200
2-60.	Input PCA, Replaceable Parts	2-202
2-61.	Display PCA, Replaceable Parts	2-206
2-62.★	Hardware Maintenance Panel, Replaceable Parts	2-208
2-63.	Input PCA, Replaceable Parts	2-210
2-64.	Display PCA, Replaceable Parts	2-213
2-65.	Reference Designations and Abbreviations	2-216
2-66.	Code List of Manufacturers	2-217

★Indicates parts lists which are not available for this printing.

1-1. INTRODUCTION.

1-2. This HP 3000 Computer System Illustrated Parts Breakdown (IPB) Manual, part no. 03000-90021, is one in a set of manuals that document the Hewlett-Packard 3000 Computer System. This manual contains replaceable parts ordering information, replaceable parts lists, exploded views, and part location diagrams.

1-3. SCOPE.

1-4. This manual is intended for use by maintenance personnel who are familiar with the maintenance procedures of the HP 3000.

1-5. Section II of this manual describes the replaceable major assemblies, subassemblies, and detailed parts for the HP 3000 Computer System. Exploded or parts location views are located adjacent to the corresponding replaceable parts lists. Where disassembly is significant, replaceable parts are listed and indexed in the order of disassembly.

2-1. INTRODUCTION.

2-2. This section contains information that enables the user to interpret the replaceable parts lists in this section, and information to order replaceable parts.

2-3. REPLACEABLE PARTS LISTS.

2-4. Replaceable parts lists in this section are in two formats; lists by order of index number and lists by order of reference designation.

2-5. INDEX NUMBERED LISTS.

2-6. The index numbered lists are used in conjunction with the exploded and parts identification views of assemblies and subassemblies. The replaceable parts are referenced to the views by index numbers which are in the order of disassembly except for attaching parts which are indexed immediately after the parts they attach.

2-7. Items in the DESCRIPTION column of the replaceable parts lists are indented to indicate item relationship. In addition, the symbol “— — x — — —” follows the last of one or more attaching parts. Indentation is as follows:

MAJOR ASSEMBLY

*Subassembly

*Attaching Parts for Subassembly

**Subassembly Parts

**Attaching Parts for Subassembly Parts

2-8. The columns in the index numbered lists provide the following information for each part:

- a. FIG. & INDEX NO. The figure and index number where the replaceable parts are shown in an exploded view.
- b. HP PART NO. The HP part number for each replaceable part.

Note: When “Coml” appears in the HP PART NO. column for a particular part, that part should be available from normal commercial sources.

- c. DESCRIPTION. The description of each replaceable part and its applicable reference designation. Also lists special applications (accessories and options) of the replaceable part. Refer to the Reference Designations and Abbreviation table at the back of this manual for an explanation of abbreviations used in the DESCRIPTION column.

- d. MFR CODE. A five digit code that denotes a typical manufacturer of the part. Refer to the Code List of Manufacturers table at the back of this manual for a list of manufacturers.

- e. MFR PART NO. The manufacturer’s part number for each replaceable part.

- f. UNITS PER ASSY. The total quantity of each part used in the assembly or subassembly to which it belongs.

2-9. REFERENCE DESIGNATION ORDER LISTS.

2-10. The lists which are in reference designation order are used in conjunction with the parts location diagrams for the printed-circuit assemblies (PCA). The replaceable parts are referenced to the parts location diagrams by reference designations which correspond to the PCA logic diagrams located in the *Detailed Logic Diagrams Manual*, part no. 03000-90023.

2-11. The columns in the reference designation order lists provide the following information for each part:

- a. REFERENCE DESIGNATION. The assembly designation and complete reference designation for each replaceable part.

- b. HP PART NUMBER. The HP part number for each replaceable part.

- c. QTY. The total quantity of a part used on the PCA is listed with the first entry for that part number.

- d. DESCRIPTION. The description of each replaceable part. Refer to the Reference Designations and Abbreviations table at the back of this manual for an explanation of abbreviations used in the DESCRIPTION column.

- e. MFR CODE. A five digit code that denotes a typical manufacturer of a part. Refer to the Code List of Manufacturers table at the back of this manual for a list of manufacturers.

- f. MFR PART NUMBER. The manufacturer’s part number for each replaceable part.

2-12. ORDERING INFORMATION.

2-13. To order replacement parts, address order or inquiry to the local Hewlett-Packard Field Office. (Refer to list at the end of this manual for addresses.) Specify the following information for each part ordered:

- a. Model and serial number.
- b. Hewlett-Packard part number for each part.
- c. Description of each part.
- d. Circuit reference designation (if applicable).

Table 2-1. HP 3000 Computer System

FIG & INDEX NO.	HP PART NO.	DESCRIPTION	MFR CODE	MFR PART NO.	UNITS PER ASSY
	30001A	CENTRAL PROCESSOR UNIT (see figure 2-1)	28480	30001A	
	30002A	UNIVERSAL PCA MODULE (see figure 2-14)	28480	30002A	
	No Number	FAN ASSEMBLY (see figure 2-43)	28480	OBD	
	30310A	POWER SUPPLY ASSEMBLY (see figure 2-44)	28480	30310A	
	30350A*	AUXILIARY CONTROL PANEL (see figure 2-58)	28480	30350A	
	30352A*	HARDWARE MAINTENANCE PANEL (see figure 2-61)	28480	30352A	
	30390A	CABINET (Refer to 30390A <i>Cabinet Maintenance Manual</i> , part no. 30390-90001.)	28480	30390A	

* Indicates parts lists and illustrations are not available for this printing.

Table 2-2. Central Processor Unit, Replaceable Parts

FIG & INDEX NO.	HP PART NO.	DESCRIPTION	MFR CODE	MFR PART NO.	UNITS PER ASSY
2-1-	30001A	CENTRAL PROCESSOR UNIT (Refer to table 2-1)			
1	30001-60001	* READ-ONLY MEMORY (ROM) PCA (A3) (see figure 2-2)	28480	30001-60001	1
2	30001-60002	* SKIP AND SPECIAL FIELD (SSF) PCA (A4) (see figure 2-3)	28480	30001-60002	1
3	30001-60003	* ARITHMETIC AND LOGIC UNIT (ALU) PCA (A5) (see figure 2-4)	28480	30001-60003	1
4	30001-60004	* R-BUS PCA (A6) (see figure 2-5)	28480	30001-60004	1
5	30001-60005	* S-BUS PCA (A7) (see figure 2-6)	28480	30001-60005	1
6	30001-60006	* CURRENT INSTRUCTION REGISTER (CIR) PCA (A8) (see figure 2-7)	28480	30001-60006	1
7	30001-60007	* MODULE CONTROL UNIT (MCU) PCA (A9) (see figure 2-8)	28480	30001-60007	1
8	30001-60008	* INPUT/OUTPUT PROCESSOR (IOP) PCA (A10) (see figure 2-9)	28480	30001-60008	1
9	No Number	* FAN ASSEMBLY (see figure 2-43)			1
10	No Number	* CARD CAGE ASSEMBLY			1
	30001-60009	* CENTRAL DATA BUS TERMINATOR PCA (not shown) (see figure 2-10)	28480	30001-60009	◆
	30001-60016	* INPUT/OUTPUT PROCESSOR BUS TERMINATOR PCA (not shown) (see figure 2-11)	28480	30001-60016	◆
	30001-60021	* POWER BUS TERMINATOR PCA (not shown) (see figure 2-12)	28480	30001-60021	◆
	30001-60010	* CONTROL ASSEMBLY (not shown) (see figure 2-13)	28480	30001-60010	◆

◆ Units per assembly depend on system configuration.

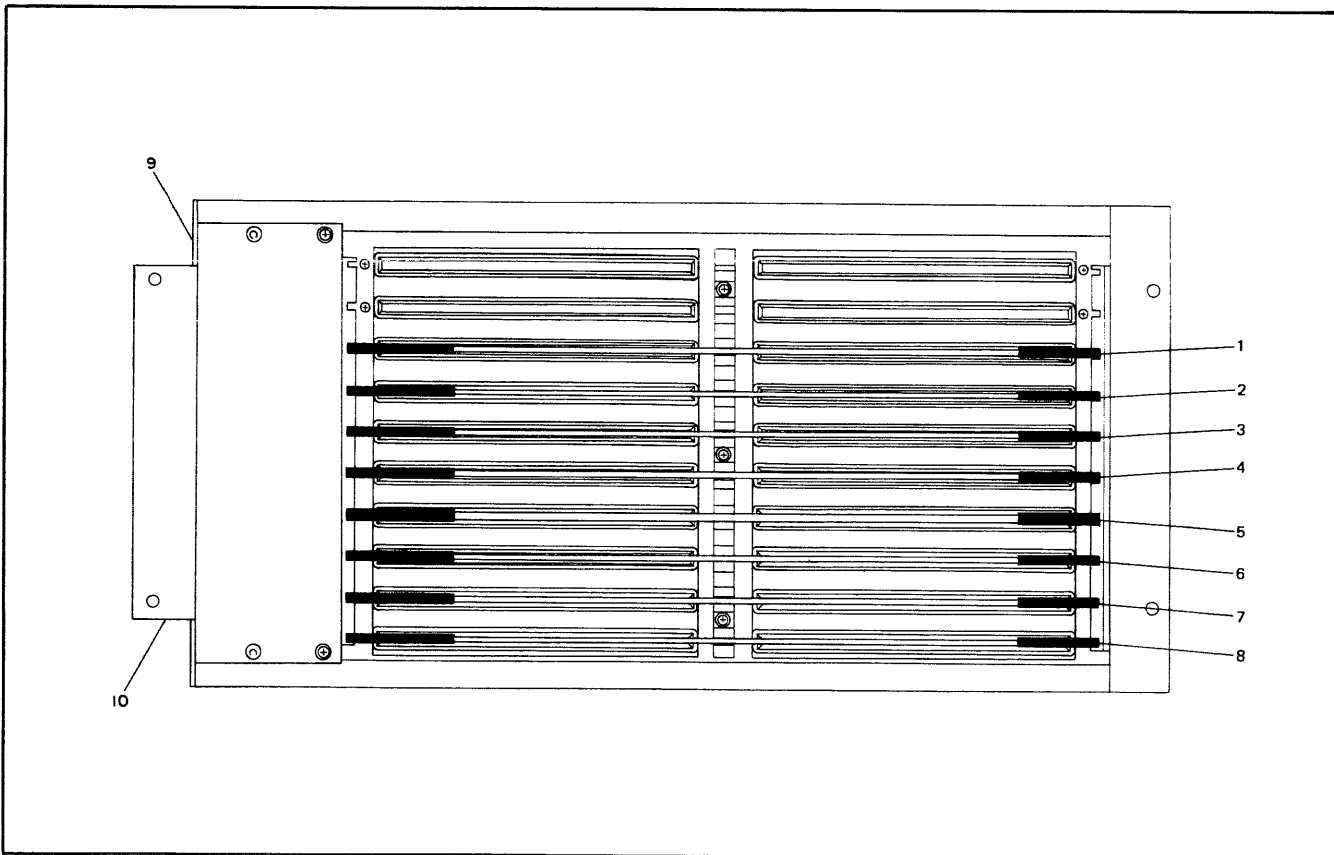

Figure 2-1. Central Processor Unit, Parts Location Diagram

Table 2-3. Read-Only Memory (ROM) PCA (A3), Replaceable Parts

Reference Designation	HP Part Number	Qty	Description	Mfr Code	Mfr Part Number
A3	30001-60001	1	READ-ONLY MEMORY (ROM) PCA	2848C	30001-60001
A3C1	0160-2055	30	C:FXD CER 0.01 UF +80-20% 100VDCW	56289	CC23F101F103ZS22-CDH
A3C2	0160-2055		C:FXD CER 0.01 UF +80-20% 100VDCW	56289	CC23F101F103ZS22-CDH
A3C3	0160-2055		C:FXD CER 0.01 UF +80-20% 100VDCW	56289	CC23F101F103ZS22-CDH
A3C4	0160-2055		C:FXD CER 0.01 UF +80-20% 100VDCW	56289	CC23F101F103ZS22-CDH
A3C5	0160-2055		C:FXD CER 0.01 UF +80-20% 100VDCW	56289	CC23F101F103ZS22-CDH
A3C6	0160-2055		C:FXD CER 0.01 UF +80-20% 100VDCW	56289	CC23F101F103ZS22-CDH
A3C7	0160-2055		C:FXD CER 0.01 UF +80-20% 100VDCW	56289	CC23F101F103ZS22-CDH
A3C8	0160-2055		C:FXD CER 0.01 UF +80-20% 100VDCW	56289	CC23F101F103ZS22-CDH
A3C9	0150-0121	8	C:FXD CER 0.1 UF +80-20% 50VDCW	56289	5C5081S-CML
A3C10	0160-0229	2			
A3C11	0160-0127	2	C:FXD CER 1.0 UF 20% 25VDCW	56289	5C13CS-CML
A3C12	0160-2055		C:FXD CER 0.01 UF +80-20% 100VDCW	56289	CC23F101F103ZS22-CDH
A3C13	0160-2055		C:FXD CER 0.01 UF +80-20% 100VDCW	56289	CC23F101F103ZS22-CDH
A3C14	0160-2055		C:FXD CER 0.01 UF +80-20% 100VDCW	56289	CC23F101F103ZS22-CDH
A3C15	0160-2055		C:FXD CER 0.01 UF +80-20% 100VDCW	56289	CC23F101F103ZS22-CDH
A3C16	0160-2055		C:FXD CER 0.01 UF +80-20% 100VDCW	56289	CC23F101F103ZS22-CDH
A3C17	0160-2055		C:FXD CER 0.01 UF +80-20% 100VDCW	56289	CC23F101F103ZS22-CDH
A3C18	0160-2055		C:FXD CER 0.01 UF +80-20% 100VDCW	56289	CC23F101F103ZS22-CDH
A3C19	0150-0121		C:FXD CER 0.1 UF +80-20% 50VDCW	56289	5C5081S-CML
A3C20	0150-0121		C:FXD CER 0.1 UF +80-20% 50VDCW	56289	5C5081S-CML
A3C21	0150-0121		C:FXD CER 0.1 UF +80-20% 50VDCW	56289	5C5081S-CML
A3C22	0160-2055		C:FXD CER 0.01 UF +80-20% 100VDCW	56289	CC23F101F103ZS22-CDH
A3C23	0160-2055		C:FXD CER 0.01 UF +80-20% 100VDCW	56289	CC23F101F103ZS22-CDH
A3C24	0160-2055		C:FXD CER 0.01 UF +80-20% 100VDCW	56289	CC23F101F103ZS22-CDH
A3C25	0160-2055		C:FXD CER 0.01 UF +80-20% 100VDCW	56289	CC23F101F103ZS22-CDH
A3C26	0160-2055		C:FXD CER 0.01 UF +80-20% 100VDCW	56289	CC23F101F103ZS22-CDH
A3C27	0160-2055		C:FXD CER 0.01 UF +80-20% 100VDCW	56289	CC23F101F103ZS22-CDH
A3C28	0160-2055		C:FXD CER 0.01 UF +80-20% 100VDCW	56289	CC23F101F103ZS22-CDH
A3C29	0160-2055		C:FXD CER 0.01 UF +80-20% 100VDCW	56289	CC23F101F103ZS22-CDH
A3C30	0160-2055		C:FXD CER 0.01 UF +80-20% 100VDCW	56289	CC23F101F103ZS22-CDH
A3C31	0160-2055		C:FXD CER 0.01 UF +80-20% 100VDCW	56289	CC23F101F103ZS22-CDH
A3C32	0160-2055		C:FXD CER 0.01 UF +80-20% 100VDCW	56289	CC23F101F103ZS22-CDH
A3C33	0160-2055		C:FXD CER 0.01 UF +80-20% 100VDCW	56289	CC23F101F103ZS22-CDH
A3C34	0150-0121		C:FXD CER 0.1 UF +80-20% 50VDCW	56289	5C5081S-CML
A3C35	0160-2055		C:FXD CER 0.01 UF +80-20% 100VDCW	56289	CC23F101F103ZS22-CDH
A3C36	0160-2055		C:FXD CER 0.01 UF +80-20% 100VDCW	56289	CC23F101F103ZS22-CDH
A3C37	0160-2055		C:FXD CER 0.01 UF +80-20% 100VDCW	56289	CC23F101F103ZS22-CDH
A3C38	0160-0127		C:FXD CER 1.0 UF 20% 25VDCW	56289	5C13CS-CML
A3C39	0160-0229				
A3R1	1810-0080	9	R:NETWORK 7 X 500 OHM 5% 0.15W EACH	2848C	1810-C080
A3R2	1810-0030	4	NETWORK:7 RESISTORS 1K OHM 5% 0.15W EA	2848C	1810-C030
A3R3	1810-0080		R:NETWORK 7 X 500 OHM 5% 0.15W EACH	2848C	1810-C080
A3R4	1810-0030		NETWORK:7 RESISTORS 1K OHM 5% 0.15W EA	2848C	1810-C030
A3R5	0757-0416	4	R:FXD MET FLM 511 OHM 1% 1/8W	2848C	0757-0416
A3R6	0757-0280	11	R:FXD MET FLM 1K OHM 1% 1/8W	2848C	0757-C280
A3R7	0757-0280		R:FXD MET FLM 1K OHM 1% 1/8W	2848C	0757-C280
A3R8	0757-0416		R:FXD MET FLM 511 OHM 1% 1/8W	2848C	0757-0416
A3R9	1810-0080		R:NETWORK 7 X 500 OHM 5% 0.15W EACH	2848C	1810-C080
A3R10	1810-0080		R:NETWORK 7 X 500 OHM 5% 0.15W EACH	2848C	1810-C080
A3R11	1810-0080		R:NETWORK 7 X 500 OHM 5% 0.15W EACH	2848C	1810-C080
A3R12	1810-0030		NETWORK:7 RESISTORS 1K OHM 5% 0.15W EA	2848C	1810-C030
A3R13	0757-0416		R:FXD MET FLM 511 OHM 1% 1/8W	2848C	0757-0416
A3R14	0757-0280		R:FXD MET FLM 1K OHM 1% 1/8W	2848C	0757-C280
A3R15	0757-0280		R:FXD MET FLM 1K OHM 1% 1/8W	2848C	0757-C280
A3R16	0757-0416		R:FXD MET FLM 511 OHM 1% 1/8W	2848C	0757-0416
A3R17	1810-0080		R:NETWORK 7 X 500 OHM 5% 0.15W EACH	2848C	1810-C080
A3R18	1810-0080		R:NETWORK 7 X 500 OHM 5% 0.15W EACH	2848C	1810-C080
A3R19	1810-0030		NETWORK:7 RESISTORS 1K OHM 5% 0.15W EA	2848C	1810-C030
A3R20	1810-0080		R:NETWORK 7 X 500 OHM 5% 0.15W EACH	2848C	1810-C080
A3R21	0757-0280		R:FXD MET FLM 1K OHM 1% 1/8W	2848C	0757-C280
A3R22	0757-0280		R:FXD MET FLM 1K OHM 1% 1/8W	2848C	0757-C280
A3R23	1810-0080		R:NETWORK 7 X 500 OHM 5% 0.15W EACH	2848C	1810-C080
A3R24	0757-0280		R:FXD MET FLM 1K OHM 1% 1/8W	2848C	0757-C280
A3R25	0757-0280		R:FXD MET FLM 1K OHM 1% 1/8W	2848C	0757-C280
A3R26	0757-0280		R:FXD MET FLM 1K OHM 1% 1/8W	2848C	0757-C280
A3R27	0757-0280		R:FXD MET FLM 1K OHM 1% 1/8W	2848C	0757-C280
A3R28	0698-0082	2	R:FXD MET FLM 464 OHM 1% 1/8W	2848C	0698-0082
A3R29	0698-0082		R:FXD MET FLM 464 OHM 1% 1/8W	2848C	0698-0082
A3R30	0757-0280		R:FXD MET FLM 1K OHM 1% 1/8W	2848C	0757-C280
A3U1	1816-0015	56	IC:ROM	2848C	1816-C015
A3U12	1816-0073	1	NOTE: QUANTITIES OF PROMS LISTED ABOVE ARE THOSE REQUIRED TO ROMS. IC:ROM 4 X 256	2848C	1816-C073

Table 2-3. Read-Only Memory (ROM) PCA (A3). Replaceable Parts (Continued)

Reference Designation	HP Part Number	Qty	Description	Mfr Code	Mfr Part Number
A3U15	1816-0075	1	IC:ROM 4 X 256	2848C	1816-0075
A3U17	1816-0077	1	IC:ROM 4 X 256	28480	1816-0077
A3U18	1816-0078	1	IC:ROM 4 X 256	2848C	1816-0078
A3U19	1816-0079	1	IC:ROM 4 X 256	28480	1816-0079
A3U21	1820-0759	4	IC:TTL LOW-POWER 8-BIT RECEIVER	2848C	1820-0759
A3U22	1816-0080	1	IC:ROM 4 X 256	2848C	1816-0080
A3U25	1816-0082	1	IC:ROM 4 X 256	2848C	1816-0082
A3U27	1816-0084	1	IC:ROM 4 X 256	2848C	1816-0084
A3U28	1816-0085	1	IC:ROM 4 X 256	2848C	1816-0085
A3U29	1816-0086	1	IC:ROM 4 X 256	28480	1816-0086
A3U32	1816-0087	1	IC:ROM 4 X 256	2848C	1816-0087
A3U35	1816-0089	1	IC:ROM 4 X 256	28480	1816-0089
A3U37	1816-0091	1	IC:ROM 4 X 256	28480	1816-0091
A3U38	1816-0092	1	IC:ROM 4 X 256	28480	1816-0092
A3U39	1816-0093	1	IC:ROM 4 X 256	2848C	1816-0093
A3U41	1820-0759		IC:TTL LOW-POWER 8-BIT RECEIVER	28480	1820-0759
A3U42	1816-0094	1	IC:ROM 4 X 256	28480	1816-0094
A3U44	1816-0280	1	IC:ROM 4 X 256	2848C	1816-0280
A3U45	1816-0096	1	IC:ROM 4 X 256	28480	1816-0096
A3U48	1816-0099	1	IC:ROM 4 X 256	2848C	1816-0099
A3U49	1816-0100	1	IC:ROM 4 X 256	28480	1816-0100
A3U51	1820-0759		IC:TTL LOW-POWER 8-BIT RECEIVER	2848C	1820-0759
A3U52	1816-0101	1	IC:ROM 4 X 256	28480	1816-0101
A3U54	1816-0281	1	IC:ROM 4 X 256	28480	1816-0281
A3U55	1816-0103	1	IC:ROM 4 X 256	28480	1816-0103
A3U57	1816-0105	1	IC:ROM 4 X 256	2848C	1816-0105
A3U59	1816-0107	1	IC:ROM 4 X 256	28480	1816-0107
A3U62	1816-0108	1	IC:ROM 4 X 256	2848C	1816-0108
A3U64	1816-0282	1	IC:ROM 4 X 256	28480	1816-0282
A3U65	1816-0110	1	IC:ROM 4 X 256	28480	1816-0110
A3U68	1816-0113	1	IC:ROM 4 X 256	2848C	1816-0113
A3U69	1816-0114	1	IC:ROM 4 X 256	2848C	1816-0114
A3U71	1820-0759		IC:TTL LOW-POWER 8-BIT RECEIVER	28480	1820-0759
A3U72	1816-0115	1	IC:ROM 4 X 256	28480	1816-0115
A3U74	1816-0283	1	IC:ROM 4 X 256	2848C	1816-0283
A3U75	1816-0117	1	IC:ROM 4 X 256	2848C	1816-0117
A3U77	1816-0119	1	IC:ROM 4 X 256	2848C	1816-0119
A3U78	1816-0120	1	IC:ROM 4 X 256	2848C	1816-0120
A3U79	1816-0121	1	IC:ROM 4 X 256	28480	1816-0121
A3U81	1820-0755	4	IC	2848C	1820-0755
A3U82	1816-0122	1	IC:ROM 4 X 256	2848C	1816-0122
A3U84	1816-0284	1	IC:ROM 4 X 256	2848C	1816-0284
A3U85	1816-0124	1	IC:ROM 4 X 256	28480	1816-0124
A3U87	1816-0126	1	IC:ROM 4 X 256	2848C	1816-0126
A3U88	1816-0127	1	IC:ROM 4 X 256	2848C	1816-0127
A3U89	1816-0128	1	IC:ROM 4 X 256	2848C	1816-0128
A3U91	1820-0373	5	IC:TTL HS DUAL 4-INPT NAND GATE	01295	SN74H20A
A3U92	1820-0755		IC	2848C	1820-0755
A3U93	1820-1033	11	IC (DS17538)	2848C	1820-1033
A3U94	1820-0690	1	IC:TTL SCHOTTKY DUAL 4-INPT NAND BUFFER	01295	SN74S40N
A3U95	1820-0140	2	IC:TTL DUAL 4-INPT AND BUFFER	04713	MC3026P
A3U96	1820-0846	6	IC:TTL DIGITAL QUAD BUFFER	1204C	DM 8094N
A3U97	1820-0846		IC:TTL DIGITAL QUAD BUFFER	1204C	DM 8094N
A3U98	1820-0846		IC:TTL DIGITAL QUAD BUFFER	1204C	DM 8094N
A3U99	1820-0886	1	IC:TTL SCHOTTKY TRIPLE 3-INPT AND GATE	01295	SN74S11N
A3U101	1820-0373		IC:TTL HS DUAL 4-INPT NAND GATE	01295	SN74H20A
A3U102	1820-1033		IC (DS17538)	28480	1820-1033
A3U103	1820-0574	9	IC:DIGITAL TTL QUAD D-F/F	1204C	DM8551N
A3U104	1820-0574		IC:DIGITAL TTL QUAD D-F/F	1204C	DM8551N
A3U105	1820-0574		IC:DIGITAL TTL QUAD D-F/F	1204C	DM8551N
A3U106	1820-0574		IC:DIGITAL TTL QUAD D-F/F	12040	DM8551N
A3U107	1820-0574		IC:DIGITAL TTL QUAD D-F/F	12040	DM8551N
A3U108	1820-0574		IC:DIGITAL TTL QUAD D-F/F	1204C	DM8551N
A3U109	1820-0846		IC:TTL DIGITAL QUAD BUFFER	1204C	DM 8094N
A3U111	1820-0373		IC:TTL HS DUAL 4-INPT NAND GATE	01295	SN74H20A
A3U112	1820-0574		IC:DIGITAL TTL QUAD D-F/F	1204C	DM8551N
A3U113	1820-0282	3	IC:TTL QUAD 2-INPT EXCL. OR GATE	01295	SN7486N
A3U114	1820-1033		IC (DS17538)	2848C	1820-1033
A3U115	1820-1033		IC (DS17538)	2848C	1820-1033
A3U116	1820-1033		IC (DS17538)	2848C	1820-1033
A3U117	1820-1033		IC (DS17538)	2848C	1820-1033
A3U118	1820-1033		IC (DS17538)	2848C	1820-1033
A3U119	1820-0574		IC:DIGITAL TTL QUAD D-F/F	1204C	DM8551N
A3U121	1820-0373		IC:TTL HS DUAL 4-INPT NAND GATE	01295	SN74H20A
A3U122	1820-0282		IC:TTL QUAD 2-INPT EXCL. OR GATE	01295	SN7486N

Table 2-3. Read-Only Memory (ROM) PCA (A3), Replaceable Parts (Continued)

Reference Designation	HP Part Number	Qty	Description	Mfr Code	Mfr Part Number
A3U123	1820-0374	3	IC:TTL HS DUAL 4-INPT AND GATE	01295	SN74H21N
A3U125	1820-0141	2	IC:TTL QUAD 2-INPT AND GATE	04713	MC3001P
A3U126	1820-1033		IC (DS17538)	2848C	1820-1033
A3U127	1820-0846		IC:TTL DIGITAL QUAD BUFFER	1204C	DM 8094N
A3U128	1820-0846		IC:TTL DIGITAL QUAD BUFFER	1204C	DM 8094N
A3U129	1820-1033		IC (DS17538)	2848C	1820-1033
A3U131	1820-0424	3	IC:TTL HS HEX INVERTER	04713	SN74HC04N
A3U132	1820-0755		IC	2848C	1820-0755
A3U133	1820-0372	1	IC:TTL TRIPLE 3-INPT AND GATE	2848C	1820-0372
A3U135	1820-0424		IC:TTL HS HEX INVERTER	04713	SN74HC04N
A3U141	1820-0239	1	IC:TTL QUAD 2-INPT NOR GATE	28480	1820-0239
A3U142	1820-0374		IC:TTL HS DUAL 4-INPT AND GATE	01295	SN74H21N
A3U143	1820-0141		IC:TTL QUAD 2-INPT AND GATE	04713	MC3001P
A3U145	1820-0373		IC:TTL HS DUAL 4-INPT NAND GATE	01295	SN74H2CN
A3U146	1820-0371	1	IC:TTL HS TRIPLE 3-INPT NAND GATE	01295	SN74H10N
A3U149	1820-1033		IC (DS17538)	2848C	1820-1033
A3U151	1820-1033		IC (DS17538)	2848C	1820-1033
A3U152	1820-0282		IC:TTL QUAD 2-INPT EXCL. OR GATE	01295	SN7486N
A3U154	1820-0374		IC:TTL HS DUAL 4-INPT AND GATE	01295	SN74H21N
A3U155	1820-0424		IC:TTL HS HEX INVERTER	04713	SN74HC04N
A3U156	1820-0837	1	IC:TTL DUAL 4-INPT NOR GATE	18324	N8815A
A3U159	1810-0037	1	RESISTOR ARRAY:1K OHM 2% 1W EACH	2848C	1810-C037
A3U161	1820-0574		IC:DIGITAL TTL QUAD D-F/F	1204C	DM8551N
A3U162	1820-0755		IC	28480	1820-0755
A3U14	1816-0199	2	IC:RCM	2848C	1816-0199
A3U14	1816-0260		IC:ROM	28480	1816-0260
A3U16	1816-0240	1	IC:ROM	28480	1816-0240
A3U24	1816-0261	1	IC:ROM	28480	1816-0261
A3U26	1816-0241	1	IC:ROM	28480	1816-0241
A3U34	1816-0262	1	IC:ROM	2848C	1816-0262
A3U36	1816-0242	1	IC:ROM	28480	1816-0242
A3U46	1816-0243	1	IC:ROM	28480	1816-0243
A3U47	1816-0228	1	IC:ROM	28480	1816-0228
A3U56	1816-0244	1	IC:ROM	28480	1816-0244
A3U58	1816-0245	1	IC:ROM	28480	1816-0245
A3U66	1816-0246	1	IC:ROM	2848C	1816-0246
A3U67	1816-0227	1	IC:ROM	2848C	1816-0227
A3U76	1816-0247	1	IC:ROM	2848C	1816-0247
A3U86	1816-0248	1	IC:ROM	2848C	1816-0248
A3U95	1820-0140		IC:TTL DUAL 4-INPT AND BUFFER	04713	MC3026P

Table 2-3. Read-Only Memory (ROM) PCA (A3), Replaceable Parts (Continued)

Reference Designation	HP Part Number	Qty	Description	Mfr Code	Mfr Part Number
A3U125	1820-0374	3	IC:TTL HS DUAL 4-INPT AND GATE	01295	SN74H21N
A3U125	1820-0141	2	IC:TTL QUAD 2-INPT AND GATE	04713	MC3001P
A3U126	1820-1033		IC (DS17538)	28480	1820-1033
A3U127	1820-0846		IC:TTL DIGITAL QUAD BUFFER	12040	DM 8054N
A3U128	1820-0846		IC:TTL DIGITAL QUAD BUFFER	12040	DM 8054N
A3U129	1820-1033		IC (DS17538)	28480	1820-1033
A3U131	1820-0424	3	IC:TTL HS HEX INVERTER	04713	SN74HC4N
A3U132	1820-0755		IC	28480	1820-C755
A3U133	1820-0372	1	IC:TTL TRIPLE 3-INPT AND GATE	28480	1820-0372
A3U135	1820-0424		IC:TTL HS HEX INVERTER	04713	SN74HC4N
A3U141	1820-0239	1	IC:TTL QUAD 2-INPT NOR GATE	28480	1820-0239
A3U142	1820-0374		IC:TTL HS DUAL 4-INPT AND GATE	01295	SN74H21N
A3U143	1820-0141		IC:TTL QUAD 2-INPT AND GATE	04713	MC3001P
A3U145	1820-0373		IC:TTL HS DUAL 4-INPT NAND GATE	01295	SN74H20N
A3U146	1820-0371	1	IC:TTL HS TRIPLE 3-INPT NAND GATE	01295	SN74H10N
A3U149	1820-1033		IC (DS17538)	28480	1820-1033
A3U151	1820-1033		IC (DS17538)	28480	1820-1033
A3U152	1820-0282		IC:TTL QUAD 2-INPT EXCL. OR GATE	01295	SN7486N
A3U154	1820-0374		IC:TTL HS DUAL 4-INPT AND GATE	01295	SN74H21N
A3U155	1820-0424		IC:TTL HS HEX INVERTER	04713	SN74HC4N
A3U156	1820-0837	1	IC:TTL DUAL 4-INPT NOR GATE	18324	N8815A
A3U159	1810-0037	1	RESISTOR ARRAY:1K OHM 2% 1W EACH	28480	1810-0037
A3U161	1820-0574		IC:DIGITAL TTL QUAD D-F/F	12040	DM8551N
A3U162	1820-0755		IC	28480	1820-C755
A3U14	1816-0277		IC:ROM	28480	1816-0277
A3U16	1816-0240	1	IC:ROM	28480	1816-0240
A3U24	1816-0278	1	IC:ROM	28480	1816-0278
A3U26	1816-0241	1	IC:ROM	28480	1816-0241
A3U34	1816-0279	1	IC:ROM	28480	1816-0279
A3U36	1816-0242	1	IC:ROM	28480	1816-0242
A3U46	1816-0243	1	IC:ROM	28480	1816-C243
A3U47	1816-0228	1	IC:ROM	28480	1816-C228
A3U56	1816-0244	1	IC:ROM	28480	1816-0244
A3U58	1816-0245	1	IC:ROM	28480	1816-0245
A3U66	1816-0246	1	IC:ROM	28480	1816-C246
A3U67	1816-0227	1	IC:ROM	28480	1816-0227
A3U76	1816-0247	1	IC:ROM	28480	1816-C247
A3U86	1816-0248	1	IC:ROM	28480	1816-C248
A3U95	1820-0140		IC:TTL DUAL 4-INPT AND BUFFER	04713	MC3026P

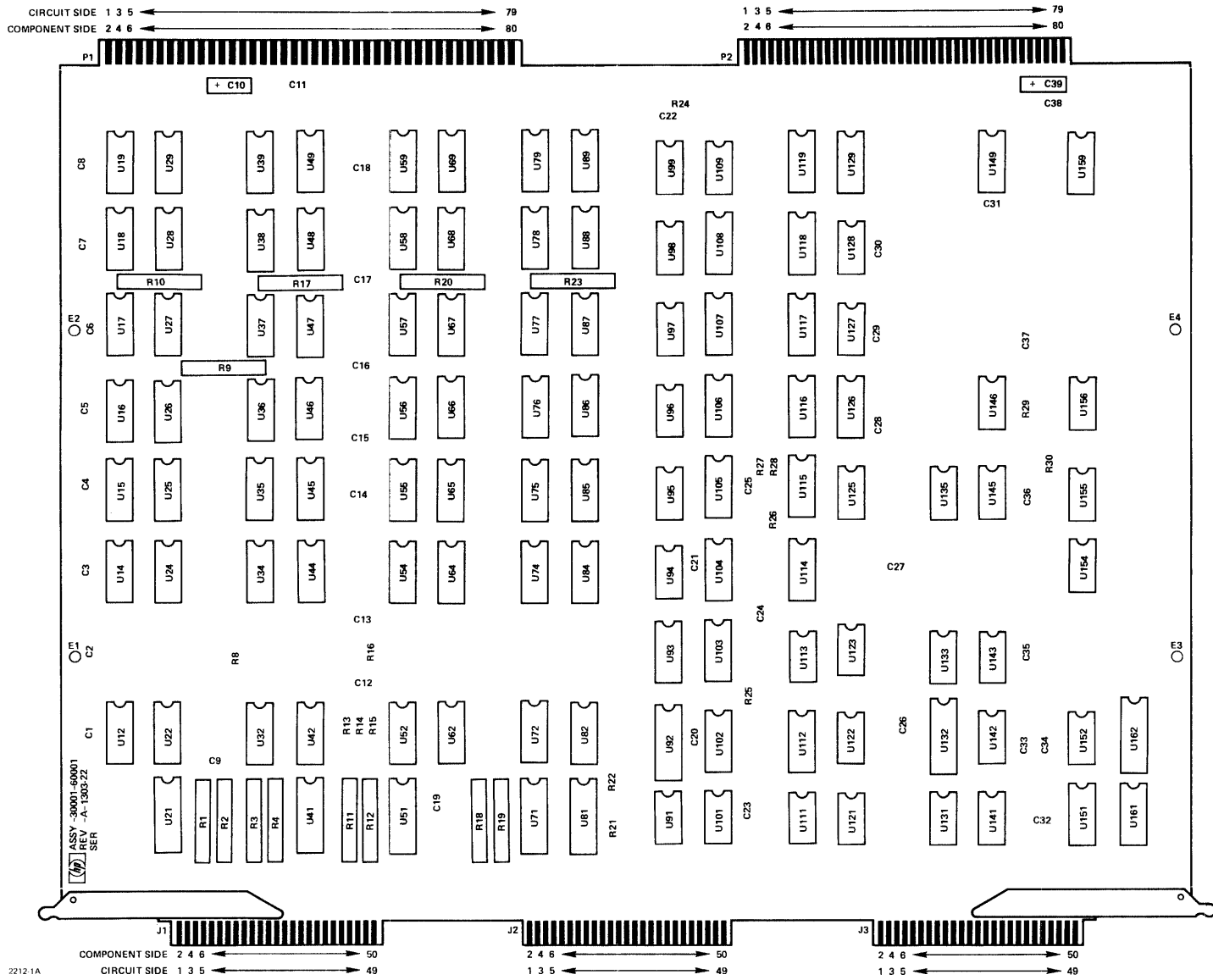

Figure 2-2. Read-Only Memory (ROM) PCA (A3), Part Location Diagram

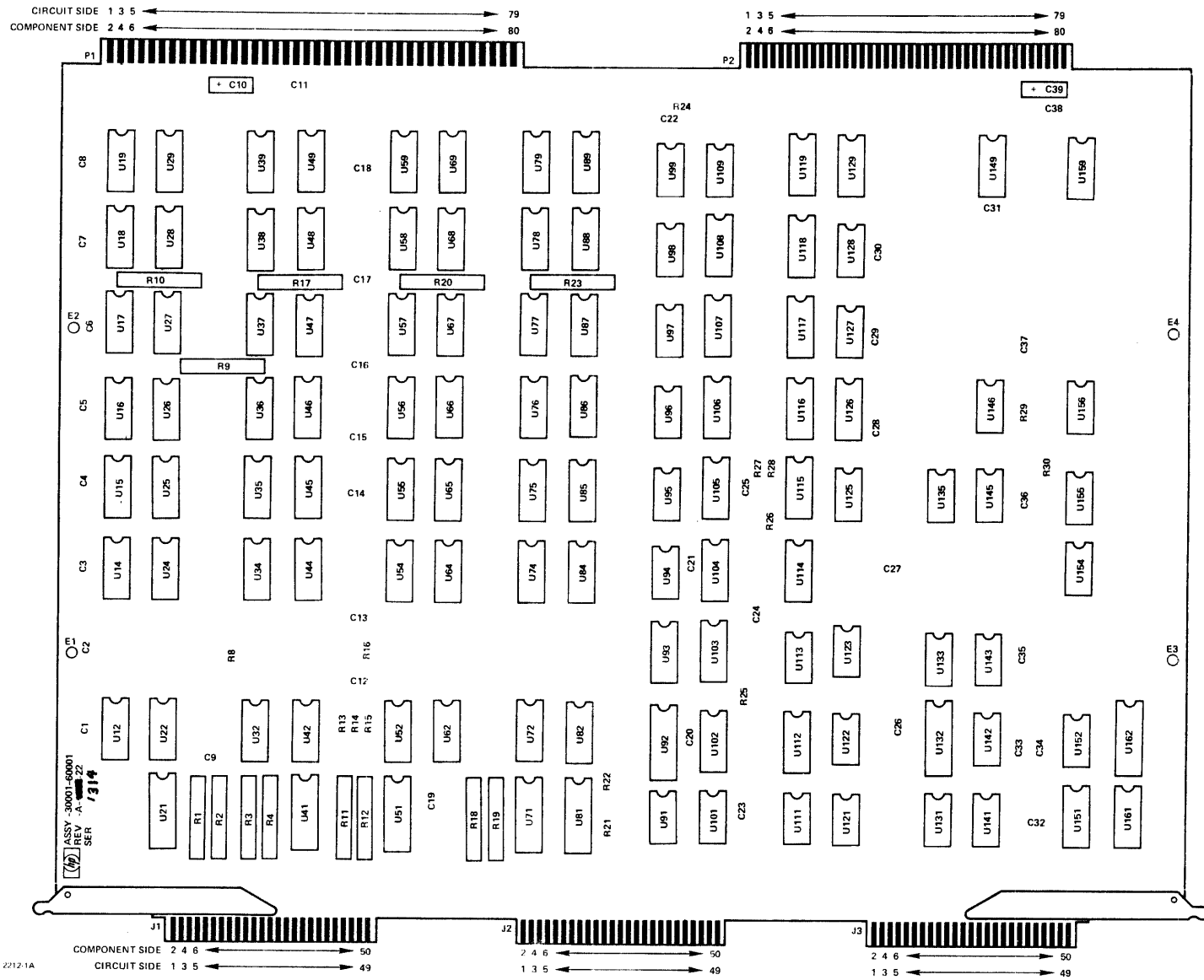

Figure 2-2. Read-Only Memory (ROM) PCA (A3), Part Location Diagram

Table 2-4. Skip and Special Field (SSF) PCA (A4), Replaceable Parts

Reference Designation	HP Part Number	Qty	Description	Mfr Code	Mfr Part Number
A4	30001-60002	1	SKIP AND SPECIAL FIELD(SSF) PCA	28480	30001-60002
A4C1	0160-2055	48	C:FXD CER 0.31 UF +80-20% 100VDCW	56289	C023F101F103ZS22-CDH
A4C2	0180-0229	3	C:FXD ELECT 33 UF 10% 10VDCW	28480	0180-0229
A4C3	0180-0229		C:FXD ELECT 33 UF 10% 10VDCW	28480	0180-0229
A4C4	0180-0291	1	C:FXD ELECT 1.0 UF 10% 35VDCW	56289	1500105X9035A2-DYS
A4C5	0160-0127	11	C:FXD CER 1.0 UF 20% 25VDCW	56289	5C13CS-CML
A4C6	0160-0127		C:FXD CER 1.0 UF 20% 25VDCW	56289	5C13CS-CML
A4C7	0180-0197	9	C:FXD ELECT 2.2 UF 10% 20VDCW	56289	1500225X9020A2-DYS
A4C8	0160-2055		C:FXD CER 0.01 UF +80-20% 100VDCW	56289	C023F101F103ZS22-CDH
A4C9	0160-2055		C:FXD CER 0.01 UF +80-20% 100VDCW	56289	C023F101F103ZS22-CDH
A4C10	0160-2055		C:FXD CER 0.01 UF +80-20% 100VDCW	56289	C023F101F103ZS22-CDH
A4C11	0160-2055		C:FXD CER 0.01 UF +80-20% 100VDCW	56289	C023F101F103ZS22-CDH
A4C12	0160-2055		C:FXD CER 0.01 UF +80-20% 100VDCW	56289	C023F101F103ZS22-CDH
A4C13	0160-2055		C:FXD CER 0.01 UF +80-20% 100VDCW	56289	C023F101F103ZS22-CDH
A4C14	0160-2101	1	C:FXD MICA 27PF 2% 300VDCW	72136	R0M15E270G3C
A4C15	0180-0197		C:FXD ELECT 2.2 UF 10% 20VDCW	56289	1500225X9020A2-DYS
A4C16	0160-0127		C:FXD CER 1.0 UF 20% 25VDCW	56289	5C13CS-CML
A4C17	0160-2055		C:FXD CER 0.01 UF +80-20% 100VDCW	56289	C023F101F103ZS22-CDH
A4C18	0160-2055		C:FXD CER 0.01 UF +80-20% 100VDCW	56289	C023F101F103ZS22-CDH
A4C19	0160-2055		C:FXD CER 0.01 UF +80-20% 100VDCW	56289	C023F101F103ZS22-CDH
A4C20	0160-2055		C:FXD CER 0.01 UF +80-20% 100VDCW	56289	C023F101F103ZS22-CDH
A4C21	0160-2055		C:FXD CER 0.01 UF +80-20% 100VDCW	56289	C023F101F103ZS22-CDH
A4C22	0160-2055		C:FXD CER 0.01 UF +80-20% 100VDCW	56289	C023F101F103ZS22-CDH
A4C23	0180-0197		C:FXD ELECT 2.2 UF 10% 20VDCW	56289	1500225X9020A2-DYS
A4C24	0180-0229		C:FXD ELECT 33 UF 10% 10VDCW	28480	0180-0229
A4C25	0160-2055		C:FXD CER 0.01 UF +80-20% 100VDCW	56289	C023F101F103ZS22-CDH
A4C26	0160-2055		C:FXD CER 0.01 UF +80-20% 100VDCW	56289	C023F101F103ZS22-CDH
A4C27	0160-2055		C:FXD CER 0.01 UF +80-20% 100VDCW	56289	C023F101F103ZS22-CDH
A4C28	0160-2055		C:FXD CER 0.01 UF +80-20% 100VDCW	56289	C023F101F103ZS22-CDH
A4C29	0160-2055		C:FXD CER 0.01 UF +80-20% 100VDCW	56289	C023F101F103ZS22-CDH
A4C30	0160-2055		C:FXD CER 0.01 UF +80-20% 100VDCW	56289	C023F101F103ZS22-CDH
A4C31	0180-0197		C:FXD ELECT 2.2 UF 10% 20VDCW	56289	1500225X9020A2-DYS
A4C32	0160-2055		C:FXD CER 0.01 UF +80-20% 100VDCW	56289	C023F101F103ZS22-CDH
A4C33	0160-2055		C:FXD CER 0.01 UF +80-20% 100VDCW	56289	C023F101F103ZS22-CDH
A4C34	0160-0127		C:FXD CER 1.0 UF 20% 25VDCW	56289	5C13CS-CML
A4C35	0160-2055		C:FXD CER 0.01 UF +80-20% 100VDCW	56289	C023F101F103ZS22-CDH
A4C36	0160-2055		C:FXD CER 0.01 UF +80-20% 100VDCW	56289	C023F101F103ZS22-CDH
A4C37	0160-2055		C:FXD CER 0.01 UF +80-20% 100VDCW	56289	C023F101F103ZS22-CDH
A4C38	0160-2055		C:FXD CER 0.01 UF +80-20% 100VDCW	56289	C023F101F103ZS22-CDH
A4C39	0160-0127		C:FXD CER 1.0 UF 20% 25VDCW	56289	5C13CS-CML
A4C40	0160-2055		C:FXD CER 0.01 UF +80-20% 100VDCW	56289	C023F101F103ZS22-CDH
A4C41	0160-0127		C:FXD CER 1.0 UF 20% 25VDCW	56289	5C13CS-CML
A4C42	0160-2055		C:FXD CER 0.01 UF +80-20% 100VDCW	56289	C023F101F103ZS22-CDH
A4C43	0160-0127		C:FXD CER 1.0 UF 20% 25VDCW	56289	5C13CS-CML
A4C44	0160-0127		C:FXD CER 1.0 UF 20% 25VDCW	56289	5C13CS-CML
A4C45	0180-0197		C:FXD ELECT 2.2 UF 10% 20VDCW	56289	1500225X9020A2-DYS
A4C46	0160-2055		C:FXD CER 0.01 UF +80-20% 100VDCW	56289	C023F101F103ZS22-CDH
A4C47	0160-2055		C:FXD CER 0.01 UF +80-20% 100VDCW	56289	C023F101F103ZS22-CDH
A4C48	0160-2055		C:FXD CER 0.01 UF +80-20% 100VDCW	56289	C023F101F103ZS22-CDH
A4C49	0160-2055		C:FXD CER 0.01 UF +80-20% 100VDCW	56289	C023F101F103ZS22-CDH
A4C50	0160-0127		C:FXD CER 1.0 UF 20% 25VDCW	56289	5C13CS-CML
A4C51	0180-0197		C:FXD ELECT 2.2 UF 10% 20VDCW	56289	1500225X9020A2-DYS
A4C52	0160-2055		C:FXD CER 0.01 UF +80-20% 100VDCW	56289	C023F101F103ZS22-CDH
A4C53	0160-2055		C:FXD CER 0.01 UF +80-20% 100VDCW	56289	C023F101F103ZS22-CDH
A4C54	0160-2055		C:FXD CER 0.01 UF +80-20% 100VDCW	56289	C023F101F103ZS22-CDH
A4C55	0160-2055		C:FXD CER 0.01 UF +80-20% 100VDCW	56289	C023F101F103ZS22-CDH
A4C56	0160-2055		C:FXD CER 0.01 UF +80-20% 100VDCW	56289	C023F101F103ZS22-CDH
A4C57	0160-2055		C:FXD CER 0.01 UF +80-20% 100VDCW	56289	C023F101F103ZS22-CDH
A4C58	0160-2055		C:FXD CER 0.01 UF +80-20% 100VDCW	56289	C023F101F103ZS22-CDH
A4C59	0160-2055		C:FXD CER 0.01 UF +80-20% 100VDCW	56289	C023F101F103ZS22-CDH
A4C60	0160-2055		C:FXD CER 0.01 UF +80-20% 100VDCW	56289	C023F101F103ZS22-CDH
A4C61	0160-2055		C:FXD CER 0.01 UF +80-20% 100VDCW	56289	C023F101F103ZS22-CDH
A4C62	0180-0197		C:FXD ELECT 2.2 UF 10% 20VDCW	56289	1500225X9020A2-DYS
A4C63	0160-2055		C:FXD CER 0.01 UF +80-20% 100VDCW	56289	C023F101F103ZS22-CDH
A4C64	0160-2055		C:FXD CER 0.01 UF +80-20% 100VDCW	56289	C023F101F103ZS22-CDH
A4C65	0160-3954	1	C:FXD 0.33 UF	28480	0160-3954
A4C66	0160-2055		C:FXD CER 0.01 UF +80-20% 100VDCW	56289	C023F101F103ZS22-CDH
A4C67	0160-2055		C:FXD CER 0.01 UF +80-20% 100VDCW	56289	C023F101F103ZS22-CDH
A4C68	0160-2055		C:FXD CER 0.01 UF +80-20% 100VDCW	56289	C023F101F103ZS22-CDH
A4C69	0160-2055		C:FXD CER 0.01 UF +80-20% 100VDCW	56289	C023F101F103ZS22-CDH
A4C70	0160-2055		C:FXD CER 0.01 UF +80-20% 100VDCW	56289	C023F101F103ZS22-CDH
A4C71	0160-0127		C:FXD CER 1.0 UF 20% 25VDCW	56289	5C13CS-CML
A4C72	0180-0197		C:FXD ELECT 2.2 UF 10% 20VDCW	56289	1500225X9020A2-DYS
A4C73	0160-0127		C:FXD CER 1.0 UF 20% 25VDCW	56289	5C13CS-CML
A4C74	0180-0197		C:FXD ELECT 2.2 UF 10% 20VDCW	56289	1500225X9020A2-DYS

Table 2-4. Skip and Special Field (SSF) PCA (A4), Replaceable Parts (Continued)

Reference Designation	HP Part Number	Qty	Description	Mfr Code	Mfr Part Number
A4C75	0160-2940	1	C:FXD MICA 470 PF 5% 300VDCM	72136	RDM15F471J3C
A4CR1	1901-0040	6	DIODE:SILICON 50 MA 30 WV	07263	FDG1088
A4CR2	1901-0040		DIODE:SILICON 50 MA 30 WV	07263	FDG1088
A4CR3	1901-0040		DIODE:SILICON 50 MA 30 WV	07263	FDG1088
A4CR4	1901-0040		DIODE:SILICON 50 MA 30 WV	07263	FDG1088
A4CR5	1901-0040		DIODE:SILICON 50 MA 30 WV	07263	FDG1088
A4CR6	1901-0040		DIODE:SILICON 50 MA 30 WV	07263	FDG1088
A4Q1	1850-0158	1	TSTR:GE PNP	80131	2N2635
A4Q2	1854-0477	1	TSTR:SI NPN	80131	2N2222A
A4R1	0757-0280	12	R:FXD MET FLM 1K OHM 1% 1/8W	28480	0757-0280
A4R2	0698-3449	2	R:FXD MET FLM 28.7K OHM 1% 1/8W	28480	0698-3449
A4R3	0698-3449		R:FXD MET FLM 28.7K OHM 1% 1/8W	28480	0698-3449
A4R4	0698-3441	1	R:FXD MET FLM 215 OHM 1% 1/8W	28480	0698-3441
A4R5	0698-3444	1	R:FXD MET FLM 316 OHM 1% 1/8W	28480	0698-3444
A4R6	0757-0280		R:FXD MET FLM 1K OHM 1% 1/8W	28480	0757-0280
A4R7	0698-4037	1	R:FXD MET FLM 46.4 OHM 1% 1/8W	28480	0698-4037
A4R8	0757-0280		R:FXD MET FLM 1K OHM 1% 1/8W	28480	0757-0280
A4R9	0757-0280		R:FXD MET FLM 1K OHM 1% 1/8W	28480	0757-0280
A4R10	0757-0280		R:FXD MET FLM 1K OHM 1% 1/8W	28480	0757-0280
A4R11	0757-1000	1	R:FXD MET FLM 51.1 OHM 1% 1/2W	28480	0757-1000
A4R12	0698-3440	2	R:FXD MET FLM 196 OHM 1% 1/8W	28480	0698-3440
A4R13	0757-0280		R:FXD MET FLM 1K OHM 1% 1/8W	28480	0757-0280
A4R14	0757-0280		R:FXD MET FLM 1K OHM 1% 1/8W	28480	0757-0280
A4R15	0698-3440		R:FXD MET FLM 196 OHM 1% 1/8W	28480	0698-3440
A4R16	0757-0280		R:FXD MET FLM 1K OHM 1% 1/8W	28480	0757-0280
A4R17	0757-0280		R:FXD MET FLM 1K OHM 1% 1/8W	28480	0757-0280
A4R18	0757-0280		R:FXD MET FLM 1K OHM 1% 1/8W	28480	0757-0280
A4R19	0757-0280		R:FXD MET FLM 1K OHM 1% 1/8W	28480	0757-0280
A4R20	0757-0280		R:FXD MET FLM 1K OHM 1% 1/8W	28480	0757-0280
A4R21	0698-4207	1	R:FXD MET FLM 44.2K OHM 1% 1/8W	28480	0698-4207
A4R22	0698-3132	1	R:FXD FLM 261 OHM 1% 1/8W	28480	0698-3132
A4U12	1820-0512	3	IC:TTL HS DUAL D F/F(35 MHZ MIN.)	01295	SN74H74N
A4U13	1820-0512		IC:TTL HS DUAL D F/F(35 MHZ MIN.)	01295	SN74H74N
A4U14	1820-0515	2	IC:TTL DUAL RE-TRIG/RE-SET MONO-MULTI	07263	U7B960259X
A4U16	1820-0142	1	INTEGRATED CIRCUIT:4INPUT,2-GR/NOR	04713	MC1004P
A4U18	1820-0697	4	IC:TTL DUAL 4-INPT LINE DRIVER	01295	SN74S140N
A4U21	1820-0370	9	IC:TTL HS QUAD 2-INPT NAND GATE	01295	SN74H00N
A4U22	1820-1033	1	IC (DS17538)	28480	1820-1033
A4U23	1820-0424	6	IC:TTL HS HEX INVERTER	04713	SN74H04N
A4U24	1820-0695	4	IC:TTL SHS DUAL J-K F/F W/PRESET	01295	SN74S113N
A4U28	1820-0697		IC:TTL DUAL 4-INPT LINE DRIVER	01295	SN74S140N
A4U32	1820-0141	5	IC:TTL QUAD 2-INPT AND GATE	04713	MC3001P
A4U32	1820-0141		IC:TTL QUAD 2-INPT AND GATE	04713	MC3001P
A4U33	1820-0739	6	IC:TTL HI-SPEED J-K F/F	01295	SN74H101N
A4U34	1820-0685	3	IC:TTL SCHOTTKY TRIPLE 3-INPT NAND GATE	01295	SN74S10N
A4U35	1820-0375	2	IC:TTL HS 8-INPT NAND GATE	01295	SN74H30N
A4U36	1820-0695	2	IC:TTL SHS DUAL J-K F/F W/PRESET	01295	SN74S113N
A4U37	1820-0681	4	IC:TTL QUAD 2-INPT NAND GATE	01295	SN74S00N
A4U38	1820-0535	1	IC:TTL DUAL PER1,2-INPT AND DRIVER	01295	SN75451P
A4U42	1820-0205	2	IC:TTL QUAD 2-INPT OR GATE	28480	1820-0205
A4U43	1820-0688	1	IC:TTL SCHOTTKY DUAL 4-INPT NAND GATE	01295	SN74S20N
A4U44	1820-0837	1	IC:TTL DUAL 4-INPT NOR GATE	18324	N8815A
A4U45	1820-0512		IC:TTL HS DUAL D F/F(35 MHZ MIN.)	01295	SN74H74N
A4U46	1820-0686	2	IC:TTL SCHOTTKY TRIPLE 3-INPT AND GATE	01295	SN74S11N
A4U47	1820-0141		IC:TTL QUAD 2-INPT AND GATE	04713	MC3001P
A4U48	1820-0370		IC:TTL HS QUAD 2-INPT NAND GATE	01295	SN74H00N
A4U52	1820-0372	2	IC:TTL TRIPLE 3-INPT AND GATE	28480	1820-0372
A4U53	1820-0239	2	IC:TTL QUAD 2-INPT NOR GATE	28480	1820-0239
A4U54	1820-0370		IC:TTL HS QUAD 2-INPT NAND GATE	01295	SN74H00N
A4U55	1820-0696	4	IC:TTL DUAL J-K F/F EDGE TRIGGERED	01295	SN74S114N
A4U56	1820-0695		IC:TTL SHS DUAL J-K F/F W/PRESET	01295	SN74S113N
A4U57	1820-0695		IC:TTL SHS DUAL J-K F/F W/PRESET	01295	SN74S113N
A4U58	1820-0376	2	IC:TTL HS DUAL 4-INPT NAND BUFFER	01295	SN74H60N
A4U63	1820-0424		IC:TTL HS HEX INVERTER	04713	SN74H04N
A4U64	1820-0724	1	IC:TTL DUAL 2-4 DECODER W/ENABLE	04713	MC4007P
A4U65	1820-0696		IC:TTL DUAL J-K F/F EDGE TRIGGERED	01295	SN74S114N
A4U66	1820-0685		IC:TTL SCHOTTKY TRIPLE 3-INPT NAND GATE	01295	SN74S10N
A4U67	1820-0759	1	IC:TTL LOW-POWER 8-BIT RECEIVER	28480	1820-0759
A4U68	1820-0697		IC:TTL DUAL 4-INPT LINE DRIVER	01295	SN74S140N
A4U72	1820-0371	8	IC:TTL HS TRIPLE 3-INPT NAND GATE	01295	SN74H10N
A4U73	1820-0371		IC:TTL HS TRIPLE 3-INPT NAND GATE	01295	SN74H10N
A4U74	1820-0424		IC:TTL HS HEX INVERTER	04713	SN74H04N
A4U75	1820-0141		IC:TTL QUAD 2-INPT AND GATE	04713	MC3001P
A4U76	1820-0686		IC:TTL SCHOTTKY TRIPLE 3-INPT AND GATE	01295	SN74S11N
A4U77	1820-0685		IC:TTL SCHOTTKY TRIPLE 3-INPT NAND GATE	01295	SN74S10N

Table 2-4. Skip and Special Field (SSF) PCA (A4), Replaceable Parts (Continued)

Reference Designation	HP Part Number	Qty	Description	Mfr Code	Mfr Part Number
A4U78	1820-0681	4	IC:TTL QUAD 2-INPT NAND GATE	01295	SN74S00N
A4U82	1820-0615		IC:TTL 8-INPT MULTIPLEXER W/COM.ENABLE	04713	FAIR 9312
A4U83	1820-0615		IC:TTL 8-INPT MULTIPLEXER W/COM.ENABLE	04713	FAIR 9312
A4U84	1820-0615		IC:TTL 8-INPT MULTIPLEXER W/COM.ENABLE	04713	FAIR 9312
A4U85	1820-0615		IC:TTL 8-INPT MULTIPLEXER W/COM.ENABLE	04713	FAIR 9312
A4U86	1820-0690	2	IC:TTL SCHOTTKY DUAL 4-INPT NAND BUFFER	01295	SN74S40N
A4U87	1820-0697		IC:TTL DUAL 4-INPT LINE DRIVER	01295	SN74S140N
A4U88	1820-0690		IC:TTL SCHOTTKY DUAL 4-INPT NAND BUFFER	01295	SN74S40N
A4U92	1820-0205		IC:TTL QUAD 2-INPT OR GATE	28480	1820-0205
A4U93	1820-0681		IC:TTL QUAD 2-INPT NAND GATE	01295	SN74S00N
A4U94	1820-0683	2	IC:TTL SCHOTTKY HEX INVERTER	01295	SN74S04N
A4U95	1820-0374		IC:TTL HS DUAL 4-INPT AND GATE	01295	SN74H21N
A4U96	1820-0683	1	IC:TTL SCHOTTKY HEX INVERTER	01295	SN74S04N
A4U102	1820-0691		IC:TTL SCHOTTKY 4 W(4-2-3-2) INPT	01295	SN74S64N
A4U103	1820-0370		IC:TTL HS QUAD 2-INPT NAND GATE	01295	SN74H00N
A4U104	1820-0370		IC:TTL HS QUAD 2-INPT NAND GATE	01295	SN74H00N
A4U105	1820-0370	IC:TTL HS QUAD 2-INPT NAND GATE	01295	SN74H00N	
A4U106	1820-0370	IC:TTL HS QUAD 2-INPT NAND GATE	01295	SN74H00N	
A4U107	1820-0370	IC:TTL HS QUAD 2-INPT NAND GATE	01295	SN74H00N	
A4U112	1820-0739	1	IC:TTL HI-SPEED J-K F/F	01295	SN74H101N
A4U113	1820-0739		IC:TTL HI-SPEED J-K F/F	01295	SN74H101N
A4U114	1820-0739		IC:TTL HI-SPEED J-K F/F	01295	SN74H101N
A4U115	1820-0739		IC:TTL HI-SPEED J-K F/F	01295	SN74H101N
A4U116	1820-0739		IC:TTL HI-SPEED J-K F/F	01295	SN74H101N
A4U117	1820-0696		IC:TTL DUAL J-K F/F EDGE TRIGGERED	01295	SN74S114N
A4U118	1820-0373		2	IC:TTL HS DUAL 4-INPT NAND GATE	01295
A4U122	1820-0370	IC:TTL HS QUAD 2-INPT NAND GATE		01295	SN74H00N
A4U123	1820-0371	IC:TTL HS TRIPLE 3-INPT NAND GATE		01295	SN74H10N
A4U124	1820-0371	IC:TTL HS TRIPLE 3-INPT NAND GATE		01295	SN74H10N
A4U125	1820-0371	IC:TTL HS TRIPLE 3-INPT NAND GATE		01295	SN74H10N
A4U126	1820-0371	1	IC:TTL HS TRIPLE 3-INPT NAND GATE	01295	SN74H10N
A4U127	1820-0373		IC:TTL HS DUAL 4-INPT NAND GATE	01295	SN74H20N
A4U128	1820-0681	4	IC:TTL QUAD 2-INPT NAND GATE	01295	SN74S00N
A4U133	1820-0696		IC:TTL DUAL J-K F/F EDGE TRIGGERED	01295	SN74S114N
A4U134	1820-0141		IC:TTL QUAD 2-INPT AND GATE	04713	MC3001P
A4U135	1820-0424		IC:TTL HS HEX INVERTER	04713	SN74H04N
A4U136	1820-0424	IC:TTL HS HEX INVERTER	04713	SN74H04N	
A4U137	1820-0424	IC:TTL HS HEX INVERTER	04713	SN74H04N	
A4U143	1820-0515	4	IC:TTL DUAL RE-TRIG/RE-SET MONO-MULTI	07263	U78960259X
A4U144	1820-0608		IC:TTL 1 OF DECODER W/ENABLE	04713	MC4006P
A4U145	1820-0608		IC:TTL 1 OF DECODER W/ENABLE	04713	MC4006P
A4U146	1820-0608		IC:TTL 1 OF DECODER W/ENABLE	04713	MC4006P
A4U147	1820-0608	1	IC:TTL 1 OF DECODER W/ENABLE	04713	MC4006P
A4U154	1820-0372		IC:TTL TRIPLE 3-INPT AND GATE	28480	1820-0372
A4U155	1820-0376		IC:TTL HS DUAL 4-INPT NAND BUFFER	01295	SN74H40N
A4U156	1820-0371	1	IC:TTL HS TRIPLE 3-INPT NAND GATE	01295	SN74H10N
A4U157	1820-0371		IC:TTL HS TRIPLE 3-INPT NAND GATE	01295	SN74H10N
A4U164	1820-0239		IC:TTL QUAD 2-INPT NOR GATE	28480	1820-0239
A4U165	1820-0375		IC:TTL HS 8-INPT NAND GATE	01295	SN74H30N
A4W1	8159-0005	1	JUMPER WIRE	28480	8159-0005
A4XY1	1200-0199	1	SOCKET:CRYSTAL	91506	8000-A69
A4Y1	0410-0472	1	CRYSTAL	28480	0410-0472

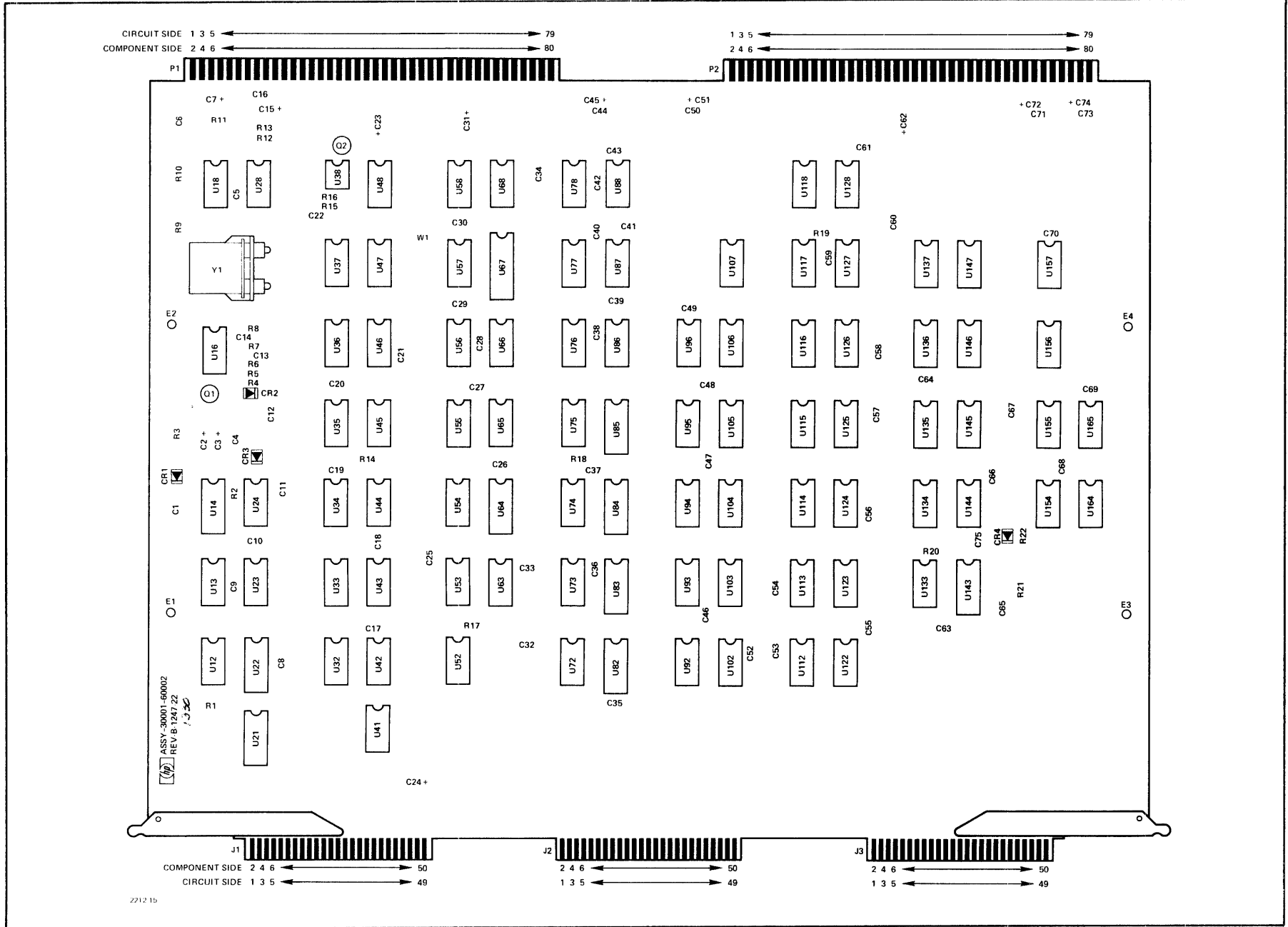

Figure 2-3. Skip and Special Field (SSF) PCA (A4), Parts Location Diagram

Table 2-5. Arithmetic and Logic Unit (ALU) PCA (A5), Replaceable Parts

Reference Designation	HP Part Number	Qty	Description	Mfr Code	Mfr Part Number
A5	30001-60003	1	ARITHMETIC AND LOGICAL UNIT(ALU) PCA	28480	30001-60003
A5C1	0150-0121	12	C:FXD CER 0.1 UF +80-20% 50VDCW	56289	5C50BIS-CML
A5C2	0150-0121		C:FXD CER 0.1 UF +80-20% 50VDCW	56289	5C50BIS-CML
A5C3	0150-0121		C:FXD CER 0.1 UF +80-20% 50VDCW	56289	5C50BIS-CML
A5C4	0150-0121		C:FXD CER 0.1 UF +80-20% 50VDCW	56289	5C50BIS-CML
A5C5	0150-0121		C:FXD CER 0.1 UF +80-20% 50VDCW	56289	5C50BIS-CML
A5C6	0160-2055	24	C:FXD CER 0.01 UF +80-20% 100VDCW	56289	C023F101F103ZS22-CDH
A5C7	0160-2055		C:FXD CER 0.01 UF +80-20% 100VDCW	56289	C023F101F103ZS22-CDH
A5C8	0160-2055		C:FXD CER 0.01 UF +80-20% 100VDCW	56289	C023F101F103ZS22-CDH
A5C9	0160-0127	3	C:FXD CER 1.0 UF 20% 25VDCW	56289	5C13CS-CML
A5C10	0180-0229	3	C:FXD ELECT 33 UF 10% 10VDCW	28480	0180-0229
A5C11	0160-2055		C:FXD CER 0.01 UF +80-20% 100VDCW	56289	C023F101F103ZS22-CDH
A5C12	0160-2055		C:FXD CER 0.01 UF +80-20% 100VDCW	56289	C023F101F103ZS22-CDH
A5C13	0150-0121		C:FXD CER 0.1 UF +80-20% 50VDCW	56289	5C50BIS-CML
A5C14	0160-2055		C:FXD CER 0.01 UF +80-20% 100VDCW	56289	C023F101F103ZS22-CDH
A5C15	0150-0121		C:FXD CER 0.1 UF +80-20% 50VDCW	56289	5C50BIS-CML
A5C16	0160-0127		C:FXD CER 1.0 UF 20% 25VDCW	56289	5C13CS-CML
A5C17	0180-0229		C:FXD ELECT 33 UF 10% 10VDCW	28480	0180-0229
A5C18	0160-2055		C:FXD CER 0.01 UF +80-20% 100VDCW	56289	C023F101F103ZS22-CDH
A5C19	0150-0121		C:FXD CER 0.1 UF +80-20% 50VDCW	56289	5C50BIS-CML
A5C20	0160-2055		C:FXD CER 0.01 UF +80-20% 100VDCW	56289	C023F101F103ZS22-CDH
A5C21	0160-2055		C:FXD CER 0.01 UF +80-20% 100VDCW	56289	C023F101F103ZS22-CDH
A5C22	0150-0121		C:FXD CER 0.1 UF +80-20% 50VDCW	56289	5C50BIS-CML
A5C23	0160-2055		C:FXD CER 0.01 UF +80-20% 100VDCW	56289	C023F101F103ZS22-CDH
A5C24	0160-2055		C:FXD CER 0.01 UF +80-20% 100VDCW	56289	C023F101F103ZS22-CDH
A5C25	0150-0121		C:FXD CER 0.1 UF +80-20% 50VDCW	56289	5C50BIS-CML
A5C26	0160-2055		C:FXD CER 0.01 UF +80-20% 100VDCW	56289	C023F101F103ZS22-CDH
A5C27	0160-2055		C:FXD CER 0.01 UF +80-20% 100VDCW	56289	C023F101F103ZS22-CDH
A5C28	0160-2055		C:FXD CER 0.01 UF +80-20% 100VDCW	56289	C023F101F103ZS22-CDH
A5C29	0160-2055		C:FXD CER 0.01 UF +80-20% 100VDCW	56289	C023F101F103ZS22-CDH
A5C30	0160-2055		C:FXD CER 0.01 UF +80-20% 100VDCW	56289	C023F101F103ZS22-CDH
A5C31	0150-0121		C:FXD CER 0.1 UF +80-20% 50VDCW	56289	5C50BIS-CML
A5C32	0160-2055		C:FXD CER 0.01 UF +80-20% 100VDCW	56289	C023F101F103ZS22-CDH
A5C33	0160-2055		C:FXD CER 0.01 UF +80-20% 100VDCW	56289	C023F101F103ZS22-CDH
A5C34	0160-2055		C:FXD CER 0.01 UF +80-20% 100VDCW	56289	C023F101F103ZS22-CDH
A5C35	0160-2055		C:FXD CER 0.01 UF +80-20% 100VDCW	56289	C023F101F103ZS22-CDH
A5C36	0160-2055		C:FXD CER 0.01 UF +80-20% 100VDCW	56289	C023F101F103ZS22-CDH
A5C37	0160-0127		C:FXD CER 1.0 UF 20% 25VDCW	56289	5C13CS-CML
A5C38	0180-0229		C:FXD ELECT 33 UF 10% 10VDCW	28480	0180-0229
A5C39	0160-2055		C:FXD CER 0.01 UF +80-20% 100VDCW	56289	C023F101F103ZS22-CDH
A5C40	0160-2055		C:FXD CER 0.01 UF +80-20% 100VDCW	56289	C023F101F103ZS22-CDH
A5C41	0160-2055		C:FXD CER 0.01 UF +80-20% 100VDCW	56289	C023F101F103ZS22-CDH
A5C42	0150-0121		C:FXD CER 0.1 UF +80-20% 50VDCW	56289	5C50BIS-CML
A5R1	0757-0280	8	R:FXD MET FLM 1K OHM 1% 1/8W	28480	0757-0280
A5R2	0757-0280		R:FXD MET FLM 1K OHM 1% 1/8W	28480	0757-0280
A5R3	0757-0280		R:FXD MET FLM 1K OHM 1% 1/8W	28480	0757-0280
A5R4	0757-0280		R:FXD MET FLM 1K OHM 1% 1/8W	28480	0757-0280
A5R5	0757-0280		R:FXD MET FLM 1K OHM 1% 1/8W	28480	0757-0280
A5R6	0757-0280		R:FXD MET FLM 1K OHM 1% 1/8W	28480	0757-0280
A5R7	0757-0280		R:FXD MET FLM 1K OHM 1% 1/8W	28480	0757-0280
A5R8	0757-0280		R:FXD MET FLM 1K OHM 1% 1/8W	28480	0757-0280
A5U13	1820-0755	16	IC	28480	1820-0755
A5U14	1820-0755		IC	28480	1820-0755
A5U15	1820-0755		IC	28480	1820-0755
A5U16	1820-0755		IC	28480	1820-0755
A5U17	1820-0755		IC	28480	1820-0755
A5U18	1820-0367	8	IC:TTL 4-BIT UP-DOWN SHIFT REGISTER	01295	SN7495N
A5U23	1820-0755		IC	28480	1820-0755
A5U24	1820-0755		IC	28480	1820-0755
A5U25	1820-0755		IC	28480	1820-0755
A5U26	1820-0755		IC	28480	1820-0755
A5U27	1820-0755		IC	28480	1820-0755
A5U28	1820-0367		IC:TTL 4-BIT UP-DOWN SHIFT REGISTER	01295	SN7495N
A5U33	1820-0371	5	IC:TTL HS TRIPLE 3-INPT NAND GATE	01295	SN74H10N
A5U34	1820-0373	6	IC:TTL HS DUAL 4-INPT NAND GATE	01295	SN74H20N
A5U36	1820-0342	1	IC:TTL HS 2 W 4-INPT AND OR INV GATE	01295	SN74H55N
A5U37	1820-0239	4	IC:TTL QUAD 2-INPT NOR GATE	28480	1820-0239
A5U38	1820-0999	1	IC:ECL QUAD-NOR 16L SHS ALU FUNCTION GENERATOR	28480	1820-0999
A5U43	1820-0683	2	IC:TTL SCHOTTKY HEX INVERTER	01295	SN74S04N
A5U44	1820-0370	5	IC:TTL HS QUAD 2-INPT NAND GATE	01295	SN74H00N
A5U46	1820-0424	2	IC:TTL HS HEX INVERTER	04713	SN74H04N
A5U47	1820-0683		IC:TTL SCHOTTKY HEX INVERTER	01295	SN74S04N
A5U49	1820-0262	4	IC:TTL 8-BIT PAR-IN SER-OUT SHIFT REG.	12040	SD9936
A5U53	1820-0695	1	IC:TTL SHS DUAL J-K F/F W/PRESET	01295	SN74S113N
A5U54	1820-0608	5	IC:TTL 1 OF DECODER W/ENABLE	04713	MC4006P

Table 2-5. Arithmetic and Logic Unit (ALU) PCA (A5), Replaceable Parts (Continued)

Reference Designation	HP Part Number	Qty	Description	Mfr Code	Mfr Part Number
A5U56	1820-0282	1	IC:TTL QUAD 2-INPT EXCL. OR GATE	01295	SN7486N
A5U57	1820-0686	3	IC:TTL SCHOTTKY TRIPLE 3-INPT AND GATE	01295	SN74S11N
A5U58	1820-0367		IC:TTL 4-BIT UP-DOWN SHIFT REGISTER	01295	SN7495N
A5U64	1820-0512	9	IC:TTL HS DUAL D F/F(35 MHZ MIN.)	01295	SN74H74N
A5U66	1820-0755		IC	28480	1820-0755
A5U67	1820-0837	4	IC:TTL DUAL 4-INPT NOR GATE	18324	N8815A
A5U68	1820-0367		IC:TTL 4-BIT UP-DOWN SHIFT REGISTER	01295	SN7495N
A5U69	1820-0262		IC:TTL 8-BIT PAR-IN SER-OUT SHIFT REG.	12040	SD9936
A5U72	1820-0512		IC:TTL HS DUAL D F/F(35 MHZ MIN.)	01295	SN74H74N
A5U73	1820-0372	2	IC:TTL TRIPLE 3-INPT AND GATE	28480	1820-0372
A5U74	1820-0686		IC:TTL SCHOTTKY TRIPLE 3-INPT AND GATE	01295	SN74S11N
A5U76	1820-0755		IC	28480	1820-0755
A5U77	1820-0688	2	IC:TTL SCHOTTKY DUAL 4-INPT NAND GATE	01295	SN74S20N
A5U78	1820-0606	3	IC:TTL ARITH. LOGIC UNIT/FUNCTION GEN.	01295	SN74181N
A5U79	1820-0686		IC:TTL SCHOTTKY TRIPLE 3-INPT AND GATE	01295	SN74S11N
A5U81	1820-0846	1	IC:TTL DIGITAL QUAD BUFFER	12040	DM 8094N
A5U83	1820-0374	2	IC:TTL HS DUAL 4-INPT AND GATE	01295	SN74H21N
A5U84	1820-0239		IC:TTL QUAD 2-INPT NOR GATE	28480	1820-0239
A5U86	1820-0755		IC	28480	1820-0755
A5U87	1820-0691	1	IC:TTL SCHOTTKY 4 W(4-2-3-2) INPT	01295	SN74S64N
A5U89	1820-0690	1	IC:TTL SCHOTTKY DUAL 4-INPT NAND BUFFER	01295	SN74S40N
A5U91	1820-0696	1	IC:TTL DUAL J-K F/F EDGE TRIGGERED	01295	SN74S114N
A5U92	1820-0535	1	IC:TTL DUAL PER1.2-INPT AND DRIVER	01295	SN75451P
A5U93	1820-0375	2	IC:TTL HS 8-INPT NAND GATE	01295	SN74H30N
A5U94	1820-0685	2	IC:TTL SCHOTTKY TRIPLE 3-INPT NAND GATE	01295	SN74S10N
A5U96	1820-0755		IC	28480	1820-0755
A5U97	1820-0611	1	IC:TTL LOOK-AHEAD CARRY GENERATOR	01295	SN74162N
A5U98	1820-0367		IC:TTL 4-BIT UP-DOWN SHIFT REGISTER	01295	SN7495N
A5U101	1820-0141	3	IC:TTL QUAD 2-INPT AND GATE	04713	MC3001P
A5U102	1820-0370		IC:TTL HS QUAD 2-INPT NAND GATE	01295	SN74H00N
A5U103	1820-0373		IC:TTL HS DUAL 4-INPT NAND GATE	01295	SN74H20N
A5U104	1820-0837		IC:TTL DUAL 4-INPT NOR GATE	18324	N8815A
A5U105	1820-0512		IC:TTL HS DUAL D F/F(35 MHZ MIN.)	01295	SN74H74N
A5U106	1820-0755		IC	28480	1820-0755
A5U107	1820-0837		IC:TTL DUAL 4-INPT NOR GATE	18324	N8815A
A5U108	1820-0367		IC:TTL 4-BIT UP-DOWN SHIFT REGISTER	01295	SN7495N
A5U111	1820-0379	3	IC:TTL HS 4W 2-2-2-3 INPT AND/OR GATE	01295	SN74H52N
A5U112	1820-0688		IC:TTL SCHOTTKY DUAL 4-INPT NAND GATE	01295	SN74S20N
A5U113	1820-0371		IC:TTL HS TRIPLE 3-INPT NAND GATE	01295	SN74H10N
A5U114	1820-0512		IC:TTL HS DUAL D F/F(35 MHZ MIN.)	01295	SN74H74N
A5U115	1820-0512		IC:TTL HS DUAL D F/F(35 MHZ MIN.)	01295	SN74H74N
A5U116	1820-0755		IC	28480	1820-0755
A5U118	1820-0606		IC:TTL ARITH. LOGIC UNIT/FUNCTION GEN.	01295	SN74181N
A5U121	1820-0205	2	IC:TTL QUAD 2-INPT OR GATE	28480	1820-0205
A5U122	1820-0141		IC:TTL QUAD 2-INPT AND GATE	04713	MC3001P
A5U123	1820-0371		IC:TTL HS TRIPLE 3-INPT NAND GATE	01295	SN74H10N
A5U124	1820-0512		IC:TTL HS DUAL D F/F(35 MHZ MIN.)	01295	SN74H74N
A5U125	1820-0512		IC:TTL HS DUAL D F/F(35 MHZ MIN.)	01295	SN74H74N
A5U126	1820-0373		IC:TTL HS DUAL 4-INPT NAND GATE	01295	SN74H20N
A5U129	1820-0262		IC:TTL 8-BIT PAR-IN SER-OUT SHIFT REG.	12040	SD9936
A5U131	1820-0370		IC:TTL HS QUAD 2-INPT NAND GATE	01295	SN74H00N
A5U132	1820-0205		IC:TTL QUAD 2-INPT OR GATE	28480	1820-0205
A5U133	1820-0608		IC:TTL 1 OF DECODER W/ENABLE	04713	MC4006P
A5U134	1820-0512		IC:TTL HS DUAL D F/F(35 MHZ MIN.)	01295	SN74H74N
A5U135	1820-0512		IC:TTL HS DUAL D F/F(35 MHZ MIN.)	01295	SN74H74N
A5U136	1820-0373		IC:TTL HS DUAL 4-INPT NAND GATE	01295	SN74H20N
A5U137	1820-0373		IC:TTL HS DUAL 4-INPT NAND GATE	01295	SN74H20N
A5U138	1820-0367		IC:TTL 4-BIT UP-DOWN SHIFT REGISTER	01295	SN7495N
A5U142	1820-0685		IC:TTL SCHOTTKY TRIPLE 3-INPT NAND GATE	01295	SN74S10N
A5U143	1820-0606		IC:TTL 1 OF DECODER W/ENABLE	04713	MC4006P
A5U144	1820-0837		IC:TTL DUAL 4-INPT NOR GATE	18324	N8815A
A5U145	1820-0239		IC:TTL QUAD 2-INPT NOR GATE	28480	1820-0239
A5U146	1820-0373		IC:TTL HS DUAL 4-INPT NAND GATE	01295	SN74H20N
A5U147	1820-0371		IC:TTL HS TRIPLE 3-INPT NAND GATE	01295	SN74H10N
A5U148	1820-0367		IC:TTL 4-BIT UP-DOWN SHIFT REGISTER	01295	SN7495N
A5U149	1820-0262		IC:TTL 8-BIT PAR-IN SER-OUT SHIFT REG.	12040	SD9936
A5U151	1820-0239		IC:TTL QUAD 2-INPT NOR GATE	28480	1820-0239
A5U152	1820-0424		IC:TTL HS HEX INVERTER	04713	SN74H04N
A5U153	1820-0608		IC:TTL 1 OF DECODER W/ENABLE	04713	MC4006P
A5U154	1820-0370		IC:TTL HS QUAD 2-INPT NAND GATE	01295	SN74H00N
A5U155	1820-0384	1	IC:TTL HS TRIPLE 3-INPT EXPANDER	01295	SN74H61N
A5U156	1820-0371		IC:TTL HS TRIPLE 3-INPT NAND GATE	01295	SN74H10N
A5U157	1820-0372		IC:TTL TRIPLE 3-INPT AND GATE	28480	1820-0372
A5U158	1820-0606		IC:TTL ARITH. LOGIC UNIT/FUNCTION GEN.	01295	SN74181N
A5U159	1820-0375		IC:TTL HS 8-INPT NAND GATE	01295	SN74H30N

Table 2-5. Arithmetic and Logic Unit (ALU) PCA (A5), Replaceable Parts (Continued)

Reference Designation	HP Part Number	Qty	Description	Mfr Code	Mfr Part Number	
A5U161	1820-0374	1	IC:TTL HS DUAL 4-INPT AND GATE	01295	SN74H21N	
A5U162	1820-0379		IC:TTL HS 4W 2-2-2-3 INPT AND/OR GATE	01295	SN74H52N	
A5U163	1820-0608		IC:TTL 1 OF DECODER W/ENABLE	04713	MC4006P	
A5U164	1820-0141		IC:TTL QUAD 2-INPT AND GATE	04713	MC3001P	
A5U165	1820-0379		IC:TTL HS 4W 2-2-2-3 INPT AND/OR GATE	01295	SN74H52N	
A5U166	1820-0376		IC:TTL HS DUAL 4-INPT NAND BUFFER	01295	SN74H40N	
A5U167	1820-0370		IC:TTL HS QUAD 2-INPT NAND GATE	01295	SN74H00N	

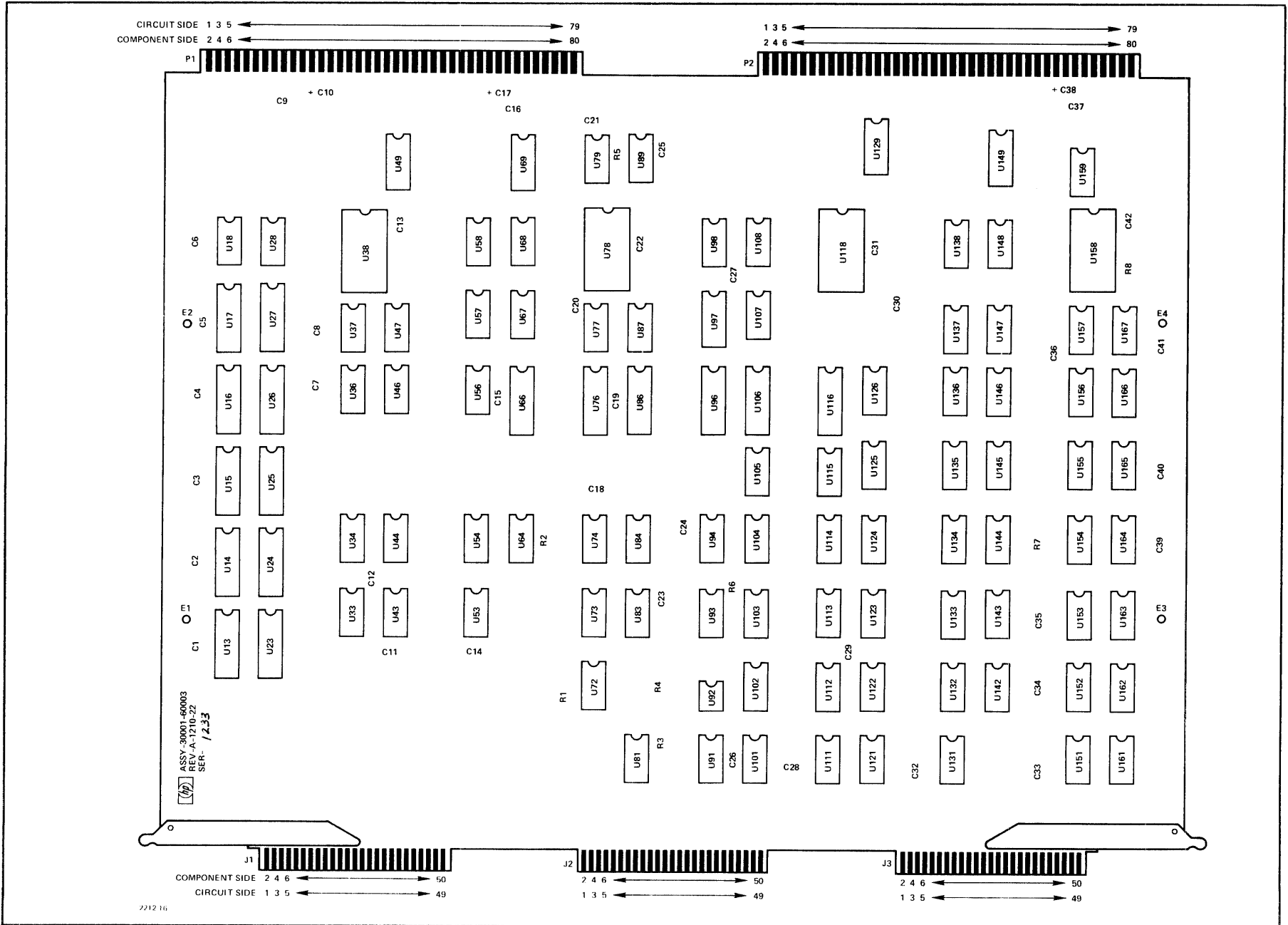

Figure 2-4. Arithmetic and Logic Unit (ALU) PCA (A5), Parts Location Diagram

Table 2-6. R-Bus PCA (A6), Replaceable Parts

Reference Designation	HP Part Number	Qty	Description	Mfr Code	Mfr Part Number
A6	30001-60004	1	R-BUS PCA	28480	30001-60004
A6C1	0160-2055	31	C:FXD CER 0.01 UF +80-20% 100VDCW	56289	C023F101F103ZS22-CDH
A6C2	0160-2055		C:FXD CER 0.01 UF +80-20% 100VDCW	56289	C023F101F103ZS22-CDH
A6C3	0150-0121	9	C:FXD CER 0.1 UF +80-20% 50VDCW	56289	5C50B1S-CML
A6C4	0160-2055		C:FXD CER 0.01 UF +80-20% 100VDCW	56289	C023F101F103ZS22-CDH
A6C5	0160-2055		C:FXD CER 0.01 UF +80-20% 100VDCW	56289	C023F101F103ZS22-CDH
A6C6	0160-2055		C:FXD CER 0.01 UF +80-20% 100VDCW	56289	C023F101F103ZS22-CDH
A6C7	0160-2055		C:FXD CER 0.01 UF +80-20% 100VDCW	56289	C023F101F103ZS22-CDH
A6C8	0160-2055		C:FXD CER 0.01 UF +80-20% 100VDCW	56289	C023F101F103ZS22-CDH
A6C9	0160-0127	4	C:FXD CER 1.0 UF 20% 25VDCW	56289	5C13CS-CML
A6C10	0180-0229	4	C:FXD ELECT 33 UF 10% 10VDCW	28480	0180-0229
A6C11	0160-2055		C:FXD CER 0.01 UF +80-20% 100VDCW	56289	C023F101F103ZS22-CDH
A6C12	0150-0121		C:FXD CER 0.1 UF +80-20% 50VDCW	56289	5C50B1S-CML
A6C13	0160-2055		C:FXD CER 0.01 UF +80-20% 100VDCW	56289	C023F101F103ZS22-CDH
A6C14	0160-2055		C:FXD CER 0.01 UF +80-20% 100VDCW	56289	C023F101F103ZS22-CDH
A6C15	0180-0229		C:FXD ELECT 33 UF 10% 10VDCW	28480	0180-0229
A6C16	0160-0127		C:FXD CER 1.0 UF 20% 25VDCW	56289	5C13CS-CML
A6C17	0160-2055		C:FXD CER 0.01 UF +80-20% 100VDCW	56289	C023F101F103ZS22-CDH
A6C18	0160-2055		C:FXD CER 0.01 UF +80-20% 100VDCW	56289	C023F101F103ZS22-CDH
A6C19	0150-0121		C:FXD CER 0.1 UF +80-20% 50VDCW	56289	5C50B1S-CML
A6C20	0160-2055		C:FXD CER 0.01 UF +80-20% 100VDCW	56289	C023F101F103ZS22-CDH
A6C21	0160-2055		C:FXD CER 0.01 UF +80-20% 100VDCW	56289	C023F101F103ZS22-CDH
A6C22	0150-0121		C:FXD CER 0.1 UF +80-20% 50VDCW	56289	5C50B1S-CML
A6C23	0160-2055		C:FXD CER 0.01 UF +80-20% 100VDCW	56289	C023F101F103ZS22-CDH
A6C24	0160-2055		C:FXD CER 0.01 UF +80-20% 100VDCW	56289	C023F101F103ZS22-CDH
A6C25	0160-2055		C:FXD CER 0.01 UF +80-20% 100VDCW	56289	C023F101F103ZS22-CDH
A6C26	0160-2055		C:FXD CER 0.01 UF +80-20% 100VDCW	56289	C023F101F103ZS22-CDH
A6C27	0160-2055		C:FXD CER 0.01 UF +80-20% 100VDCW	56289	C023F101F103ZS22-CDH
A6C28	0160-2055		C:FXD CER 0.01 UF +80-20% 100VDCW	56289	C023F101F103ZS22-CDH
A6C29	0180-0229		C:FXD ELECT 33 UF 10% 10VDCW	28480	0180-0229
A6C30	0160-2055		C:FXD CER 0.01 UF +80-20% 100VDCW	56289	C023F101F103ZS22-CDH
A6C31	0160-2055		C:FXD CER 0.01 UF +80-20% 100VDCW	56289	C023F101F103ZS22-CDH
A6C32	0160-2055		C:FXD CER 0.01 UF +80-20% 100VDCW	56289	C023F101F103ZS22-CDH
A6C33	0150-0121		C:FXD CER 0.1 UF +80-20% 50VDCW	56289	5C50B1S-CML
A6C34	0160-0127		C:FXD CER 1.0 UF 20% 25VDCW	56289	5C13CS-CML
A6C35	0160-2055		C:FXD CER 0.01 UF +80-20% 100VDCW	56289	C023F101F103ZS22-CDH
A6C36	0160-2055		C:FXD CER 0.01 UF +80-20% 100VDCW	56289	C023F101F103ZS22-CDH
A6C37	0150-0121		C:FXD CER 0.1 UF +80-20% 50VDCW	56289	5C50B1S-CML
A6C38	0160-2055		C:FXD CER 0.01 UF +80-20% 100VDCW	56289	C023F101F103ZS22-CDH
A6C39	0150-0121		C:FXD CER 0.1 UF +80-20% 50VDCW	56289	5C50B1S-CML
A6C40	0160-2055		C:FXD CER 0.01 UF +80-20% 100VDCW	56289	C023F101F103ZS22-CDH
A6C41	0180-0229		C:FXD ELECT 33 UF 10% 10VDCW	28480	0180-0229
A6C42	0160-2055		C:FXD CER 0.01 UF +80-20% 100VDCW	56289	C023F101F103ZS22-CDH
A6C43	0150-0121		C:FXD CER 0.1 UF +80-20% 50VDCW	56289	5C50B1S-CML
A6C44	0160-2055		C:FXD CER 0.01 UF +80-20% 100VDCW	56289	C023F101F103ZS22-CDH
A6C45	0150-0121		C:FXD CER 0.1 UF +80-20% 50VDCW	56289	5C50B1S-CML
A6C46	0160-2055		C:FXD CER 0.01 UF +80-20% 100VDCW	56289	C023F101F103ZS22-CDH
A6C47	0160-2055		C:FXD CER 0.01 UF +80-20% 100VDCW	56289	C023F101F103ZS22-CDH
A6C48	0160-0127		C:FXD CER 1.0 UF 20% 25VDCW	56289	5C13CS-CML
A6R1	0757-0280	8	R:FXD MET FLM 1K OHM 1% 1/8W	28480	0757-0280
A6R2	0757-0280		R:FXD MET FLM 1K OHM 1% 1/8W	28480	0757-0280
A6R3	0757-0280		R:FXD MET FLM 1K OHM 1% 1/8W	28480	0757-0280
A6R4	0757-0280		R:FXD MET FLM 1K OHM 1% 1/8W	28480	0757-0280
A6R5	0757-0280		R:FXD MET FLM 1K OHM 1% 1/8W	28480	0757-0280
A6R6	0757-0280		R:FXD MET FLM 1K OHM 1% 1/8W	28480	0757-0280
A6R7	0757-0280		R:FXD MET FLM 1K OHM 1% 1/8W	28480	0757-0280
A6R8	0757-0280		R:FXD MET FLM 1K OHM 1% 1/8W	28480	0757-0280
A6U13	1820-0370	2	IC:TTL HS QUAD 2-INPT NAND GATE	01295	SN74H00N
A6U14	1820-0755	18	IC	28480	1820-0755
A6U15	1820-0367	4	IC:TTL 4-BIT UP-DOWN SHIFT REGISTER	01295	SN7495N
A6U16	1820-1033	16	IC (DS17538)	28480	1820-1033
A6U17	1820-1033		IC (DS17538)	28480	1820-1033
A6U18	1820-1033		IC (DS17538)	28480	1820-1033
A6U19	1820-1033		IC (DS17538)	28480	1820-1033
A6U22	1820-0535	1	IC:TTL DUAL PERI. 2-INPT AND DRIVER	01295	SN75451P
A6U23	1820-0205	4	IC:TTL QUAD 2-INPT OR GATE	28480	1820-0205
A6U24	1820-0755		IC	28480	1820-0755
A6U25	1820-0755		IC	28480	1820-0755
A6U26	1820-0574	16	IC:DIGITAL TTL QUAD D-F/F	12040	DM8551N
A6U27	1820-0574		IC:DIGITAL TTL QUAD D-F/F	12040	DM8551N
A6U28	1820-0574		IC:DIGITAL TTL QUAD D-F/F	12040	DM8551N
A6U29	1820-0141	3	IC:TTL QUAD 2-INPT AND GATE	04713	MC3001P
A6U31	1820-0620	8	IC:TTL DUAL 4-INPT MULTIPLEXER	01295	SN74153N
A6U32	1820-0620		IC:TTL DUAL 4-INPT MULTIPLEXER	01295	SN74153N
A6U34	1820-0755		IC	28480	1820-0755

Table 2-6. R-Bus PCA (A6), Replaceable Parts (Continued)

Reference Designation	HP Part Number	Qty	Description	Mfr Code	Mfr Part Number
A6U35	1820-0755		IC	28480	1820-0755
A6U36	1820-0262	4	IC:TTL 8-BIT PAR-IN SER-OUT SHIFT REG.	12040	SD9936
A6U37	1820-0739	5	IC:TTL HI-SPEED J-K F/F	01295	SN74H101N
A6U38	1820-0739		IC:TTL HI-SPEED J-K F/F	01295	SN74H101N
A6U39	1820-0739		IC:TTL HI-SPEED J-K F/F	01295	SN74H101N
A6U41	1820-0574		IC:DIGITAL TTL QUAD D-F/F	12040	DM8551N
A6U42	1820-0606	4	IC:TTL ARITH. LOGIC UNIT/FUNCTION GEN.	01295	SN74181N
A6U44	1820-0755		IC	28480	1820-0755
A6U45	1820-0755		IC	28480	1820-0755
A6U46	1820-0262		IC:TTL 8-BIT PAR-IN SER-OUT SHIFT REG.	12040	SD9936
A6U47	1820-0847	2	IC:TTL DUAL CARRY/SAVE FULL ADDER	01295	74H183N
A6U48	1820-0739		IC:TTL HI-SPEED J-K F/F	01295	SN74H101N
A6U49	1820-0739		IC:TTL HI-SPEED J-K F/F	01295	SN74H101N
A6U51	1820-0620		IC:TTL DUAL 4-INPT MULTIPLEXER	01295	SN74153N
A6U52	1820-0620		IC:TTL DUAL 4-INPT MULTIPLEXER	01295	SN74153N
A6U55	1820-0367		IC:TTL 4-BIT UP-DOWN SHIFT REGISTER	01295	SN7495N
A6U56	1820-1033		IC (DS17538)	28480	1820-1033
A6U57	1820-1033		IC (DS17538)	28480	1820-1033
A6U58	1820-1033		IC (DS17538)	28480	1820-1033
A6U59	1820-1033		IC (DS17538)	28480	1820-1033
A6U61	1820-0574		IC:DIGITAL TTL QUAD D-F/F	12040	DM8551N
A6U62	1820-0606		IC:TTL ARITH. LOGIC UNIT/FUNCTION GEN.	01295	SN74181N
A6U65	1820-0755		IC	28480	1820-0755
A6U66	1820-0574		IC:DIGITAL TTL QUAD D-F/F	12040	DM8551N
A6U67	1820-0574		IC:DIGITAL TTL QUAD D-F/F	12040	DM8551N
A6U68	1820-0574		IC:DIGITAL TTL QUAD D-F/F	12040	DM8551N
A6U69	1820-0686	4	IC:TTL SCHOTTKY TRIPLE 3-INPT AND GATE	01295	SN74511N
A6U71	1820-0608	1	IC:TTL 1 OF DECODER W/ENABLE	04713	MC4006P
A6U72	1820-0239	4	IC:TTL QUAD 2-INPT NOR GATE	28480	1820-0239
A6U74	1820-0384	1	IC:TTL HS TRIPLE 3-INPT EXPANDER	01295	SN74H61N
A6U75	1820-0379	2	IC:TTL HS 4W 2-2-2-3 INPT AND/OR GATE	01295	SN74H52N
A6U76	1820-0998	4	IC	01295	SN74S153M
A6U77	1820-0998		IC	01295	SN74S153M
A6U78	1820-0998		IC	01295	SN74S153M
A6U79	1820-0998		IC	01295	SN74S153M
A6U81	1820-0141		IC:TTL QUAD 2-INPT AND GATE	04713	MC3001P
A6U82	1820-0611	1	IC:TTL LOOK-AHEAD CARRY GENERATOR	01295	SN74182N
A6U84	1820-0847		IC:TTL DUAL CARRY/SAVE FULL ADDER	01295	74H183N
A6U85	1820-0379		IC:TTL HS 4W 2-2-2-3 INPT AND/OR GATE	01295	SN74H52N
A6U86	1820-0424	3	IC:TTL HS HEX INVERTER	04713	SN74H04N
A6U87	1820-0140	1	IC:TTL DUAL 4-INPT AND BUFFER	04713	MC3026P
A6U88	1820-0205		IC:TTL QUAD 2-INPT OR GATE	28480	1820-0205
A6U89	1820-0724	3	IC:TTL DUAL 2-4 DECODER W/ENABLE	04713	MC4007P
A6U91	1820-0370		IC:TTL HS QUAD 2-INPT NAND GATE	01295	SN74H00N
A6U92	1820-0376	1	IC:TTL HS DUAL 4-INPT NAND BUFFER	01295	SN74H40N
A6U94	1820-0512	1	IC:TTL HS DUAL D F/F(35 MHZ MIN.)	01295	SN74H74N
A6U95	1820-0837	3	IC:TTL DUAL 4-INPT NOR GATE	18324	N8815A
A6U96	1820-0724		IC:TTL DUAL 2-4 DECODER W/ENABLE	04713	MC4007P
A6U97	1820-0141		IC:TTL QUAD 2-INPT AND GATE	04713	MC3001P
A6U98	1820-0690	1	IC:TTL SCHOTTKY DUAL 4-INPT NAND BUFFER	01295	SN74S40N
A6U99	1820-0755		IC	28480	1820-0755
A6U101	1820-0205		IC:TTL QUAD 2-INPT OR GATE	28480	1820-0205
A6U102	1820-0837		IC:TTL DUAL 4-INPT NOR GATE	18324	N8815A
A6U104	1820-0686		IC:TTL SCHOTTKY TRIPLE 3-INPT AND GATE	01295	SN74S11N
A6U105	1820-0686		IC:TTL SCHOTTKY TRIPLE 3-INPT AND GATE	01295	SN74S11N
A6U106	1820-0205		IC:TTL QUAD 2-INPT OR GATE	28480	1820-0205
A6U107	1820-0374	2	IC:TTL HS DUAL 4-INPT AND GATE	01295	SN74H21N
A6U108	1820-0239		IC:TTL QUAD 2-INPT NOR GATE	28480	1820-0239
A6U109	1820-0724		IC:TTL DUAL 2-4 DECODER W/ENABLE	04713	MC4007P
A6U111	1820-0620		IC:TTL DUAL 4-INPT MULTIPLEXER	01295	SN74153N
A6U112	1820-0620		IC:TTL DUAL 4-INPT MULTIPLEXER	01295	SN74153N
A6U114	1820-0755		IC	28480	1820-0755
A6U115	1820-0367		IC:TTL 4-BIT UP-DOWN SHIFT REGISTER	01295	SN7495N
A6U116	1820-0574		IC:DIGITAL TTL QUAD D-F/F	12040	DM8551N
A6U117	1820-0574		IC:DIGITAL TTL QUAD D-F/F	12040	DM8551N
A6U118	1820-0574		IC:DIGITAL TTL QUAD D-F/F	12040	DM8551N
A6U119	1820-0424		IC:TTL HS HEX INVERTER	04713	SN74H04N
A6U121	1820-0574		IC:DIGITAL TTL QUAD D-F/F	12040	DM8551N
A6U122	1820-0606		IC:TTL ARITH. LOGIC UNIT/FUNCTION GEN.	01295	SN74181N
A6U124	1820-0755		IC	28480	1820-0755
A6U125	1820-0755		IC	28480	1820-0755
A6U126	1820-1033		IC (DS17538)	28480	1820-1033
A6U127	1820-1033		IC (DS17538)	28480	1820-1033
A6U128	1820-1033		IC (DS17538)	28480	1820-1033
A6U129	1820-1033		IC (DS17538)	28480	1820-1033

Table 2-6. R-Bus PCA (A6), Replaceable Parts (Continued)

Reference Designation	HP Part Number	Qty	Description	Mfr Code	Mfr Part Number
A6U131	1820-0239		IC:TTL QUAD 2-INPT NOR GATE	28480	1820-0239
A6U132	1820-0374		IC:TTL HS DUAL 4-INPT AND GATE	01295	SN74H21N
A6U135	1820-0755		IC	28480	1820-0755
A6U136	1820-0262		IC:TTL 8-BIT PAR-IN SER-OUT SHIFT REG.	12040	SD9936
A6U137	1820-0755		IC	28480	1820-0755
A6U138	1820-0372	1	IC:TTL TRIPLE 3-INPT AND GATE	28480	1820-0372
A6U139	1820-0846	1	IC:TTL DIGITAL QUAD BUFFER	12040	DM 8094N
A6U141	1820-0371	1	IC:TTL HS TRIPLE 3-INPT NAND GATE	01295	SN74H10N
A6U142	1820-0424		IC:TTL HS HEX INVERTER	04713	SN74H04N
A6U144	1820-0755		IC	28480	1820-0755
A6U145	1820-0755		IC	28480	1820-0755
A6U146	1820-0262		IC:TTL 8-BIT PAR-IN SER-OUT SHIFT REG.	12040	SD9936
A6U147	1820-0686		IC:TTL SCHOTTKY TRIPLE 3-INPT AND GATE	01295	SN74S11N
A6U148	1820-0239		IC:TTL QUAD 2-INPT NOR GATE	28480	1820-0239
A6U149	1820-0837		IC:TTL DUAL 4-INPT NOR GATE	18324	N8815A
A6U151	1820-0620		IC:TTL DUAL 4-INPT MULTIPLEXER	01295	SN74153N
A6U152	1820-0620		IC:TTL DUAL 4-INPT MULTIPLEXER	01295	SN74153N
A6U154	1820-0755		IC	28480	1820-0755
A6U155	1820-0367		IC:TTL 4-BIT UP-DOWN SHIFT REGISTER	01295	SN7495N
A6U156	1820-0574		IC:DIGITAL TTL QUAD D-F/F	12040	DM8551N
A6U157	1820-0574		IC:DIGITAL TTL QUAD D-F/F	12040	DM8551N
A6U158	1820-0574		IC:DIGITAL TTL QUAD D-F/F	12040	DM8551N
A6U159	1820-0755		IC	28480	1820-0755
A6U161	1820-0574		IC:DIGITAL TTL QUAD D-F/F	12040	DM8551N
A6U162	1820-0606		IC:TTL ARITH. LOGIC UNIT/FUNCTION GEN.	01295	SN74181N
A6U166	1820-1033		IC (DS17538)	28480	1820-1033
A6U167	1820-1033		IC (DS17538)	28480	1820-1033
A6U168	1820-1033		IC (DS17538)	28480	1820-1033
A6U169	1820-1033		IC (DS17538)	28480	1820-1033

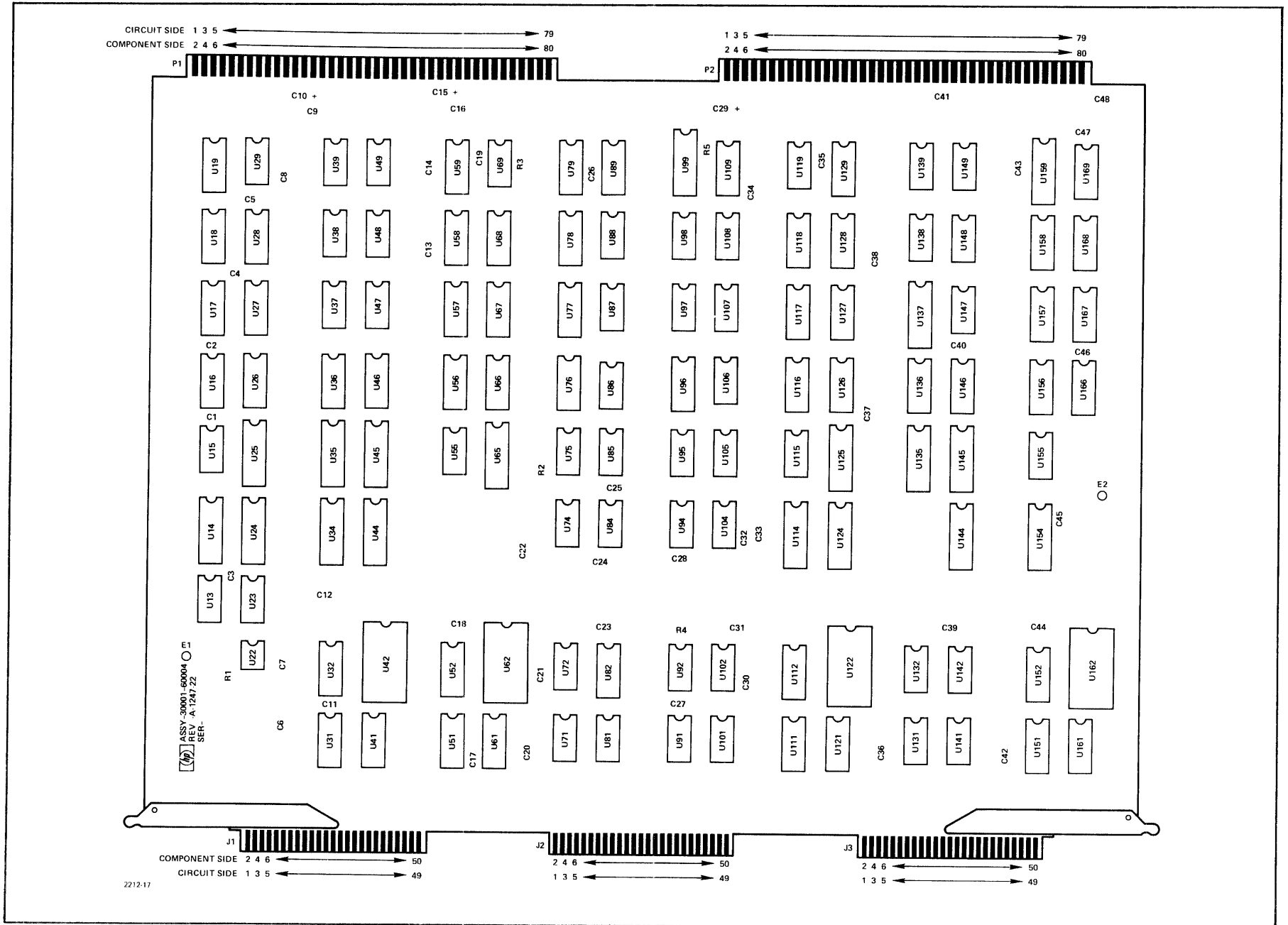

Figure 2-5. R-Bus PCA (A6), Parts Location Diagram

Table 2-7. S-Bus PCA (A7) Replaceable Parts

Reference Designation	HP Part Number	Qty	Description	Mfr Code	Mfr Part Number
A7	30001-60005	1	S-BUS PCA	28480	30001-60005
A7C1	0160-2055	24	C:FxD CER 0.01 UF +80-20% 100VDCW	56289	C023F101F103ZS22-CDH
A7C2	0150-0121	4	C:FxD CER 0.1 UF +80-20% 50VDCW	56289	5C50BIS-CML
A7C3	0160-2055		C:FxD CER 0.01 UF +80-20% 100VDCW	56289	C023F101F103ZS22-CDH
A7C4	0160-2055		C:FxD CER 0.01 UF +80-20% 100VDCW	56289	C023F101F103ZS22-CDH
A7C5	0160-2055		C:FxD CER 0.01 UF +80-20% 100VDCW	56289	C023F101F103ZS22-CDH
A7C6	0160-0127	6	C:FxD CER 1.0 UF 20% 25VDCW	56289	5C13CS-CML
A7C7	0180-0229	5	C:FxD ELECT 33 UF 10% 10VDCW	28480	0180-0229
A7C8	0160-2055		C:FxD CER 0.01 UF +80-20% 100VDCW	56289	C023F101F103ZS22-CDH
A7C9	0160-2055		C:FxD CER 0.01 UF +80-20% 100VDCW	56289	C023F101F103ZS22-CDH
A7C10	0160-2055		C:FxD CER 0.01 UF +80-20% 100VDCW	56289	C023F101F103ZS22-CDH
A7C11	0160-0127		C:FxD CER 1.0 UF 20% 25VDCW	56289	5C13CS-CML
A7C12	0160-0127		C:FxD CER 1.0 UF 20% 25VDCW	56289	5C13CS-CML
A7C13	0160-2055		C:FxD CER 0.01 UF +80-20% 100VDCW	56289	C023F101F103ZS22-CDH
A7C14	0160-0127		C:FxD CER 1.0 UF 20% 25VDCW	56289	5C13CS-CML
A7C15	0180-0229		C:FxD ELECT 33 UF 10% 10VDCW	28480	0180-0229
A7C16	0160-2055		C:FxD CER 0.01 UF +80-20% 100VDCW	56289	C023F101F103ZS22-CDH
A7C17	0180-0229		C:FxD ELECT 33 UF 10% 10VDCW	28480	0180-0229
A7C18	0160-2055		C:FxD CER 0.01 UF +80-20% 100VDCW	56289	C023F101F103ZS22-CDH
A7C19	0160-2055		C:FxD CER 0.01 UF +80-20% 100VDCW	56289	C023F101F103ZS22-CDH
A7C20	0150-0121		C:FxD CER 0.1 UF +80-20% 50VDCW	56289	5C50BIS-CML
A7C21	0160-2055		C:FxD CER 0.01 UF +80-20% 100VDCW	56289	C023F101F103ZS22-CDH
A7C22	0160-2055		C:FxD CER 0.01 UF +80-20% 100VDCW	56289	C023F101F103ZS22-CDH
A7C23	0160-2055		C:FxD CER 0.01 UF +80-20% 100VDCW	56289	C023F101F103ZS22-CDH
A7C24	0150-0121		C:FxD CER 0.1 UF +80-20% 50VDCW	56289	5C50BIS-CML
A7C25	0160-2055		C:FxD CER 0.01 UF +80-20% 100VDCW	56289	C023F101F103ZS22-CDH
A7C26	0160-2055		C:FxD CER 0.01 UF +80-20% 100VDCW	56289	C023F101F103ZS22-CDH
A7C27	0160-2055		C:FxD CER 0.01 UF +80-20% 100VDCW	56289	C023F101F103ZS22-CDH
A7C28	0150-0121		C:FxD CER 0.1 UF +80-20% 50VDCW	56289	5C50BIS-CML
A7C29	0160-0127		C:FxD CER 1.0 UF 20% 25VDCW	56289	5C13CS-CML
A7C30	0160-2055		C:FxD CER 0.01 UF +80-20% 100VDCW	56289	C023F101F103ZS22-CDH
A7C31	0160-2055		C:FxD CER 0.01 UF +80-20% 100VDCW	56289	C023F101F103ZS22-CDH
A7C32	0160-2055		C:FxD CER 0.01 UF +80-20% 100VDCW	56289	C023F101F103ZS22-CDH
A7C33	0160-0127		C:FxD CER 1.0 UF 20% 25VDCW	56289	5C13CS-CML
A7C34	0160-2055		C:FxD CER 0.01 UF +80-20% 100VDCW	56289	C023F101F103ZS22-CDH
A7C35	0180-0229		C:FxD ELECT 33 UF 10% 10VDCW	28480	0180-0229
A7C36	0160-2055		C:FxD CER 0.01 UF +80-20% 100VDCW	56289	C023F101F103ZS22-CDH
A7C37	0160-2055		C:FxD CER 0.01 UF +80-20% 100VDCW	56289	C023F101F103ZS22-CDH
A7C38	0160-2055		C:FxD CER 0.01 UF +80-20% 100VDCW	56289	C023F101F103ZS22-CDH
A7C39	0180-0229		C:FxD ELECT 33 UF 10% 10VDCW	28480	0180-0229
A7R1	0757-0280	7	R:FxD MET FLM 1K OHM 1% 1/8W	28480	0757-0280
A7R2	0757-0280		R:FxD MET FLM 1K OHM 1% 1/8W	28480	0757-0280
A7R3	0757-0280		R:FxD MET FLM 1K OHM 1% 1/8W	28480	0757-0280
A7R4	0757-0280		R:FxD MET FLM 1K OHM 1% 1/8W	28480	0757-0280
A7R5	0757-0280		R:FxD MET FLM 1K OHM 1% 1/8W	28480	0757-0280
A7R6	0757-0280		R:FxD MET FLM 1K OHM 1% 1/8W	28480	0757-0280
A7R7	0757-0280		R:FxD MET FLM 1K OHM 1% 1/8W	28480	0757-0280
A7S2	3100-2687		SWITCH:ROTARY SP5T 6 POSITION	28480	3100-2687
A7S3	3100-2687		SWITCH:ROTARY SP5T 6 POSITION	28480	3100-2687
A7S4	3100-2687		SWITCH:ROTARY SP5T 6 POSITION	28480	3100-2687
A7S5	3100-2687		SWITCH:ROTARY SP5T 6 POSITION	28480	3100-2687
A7S6	3100-2687		SWITCH:ROTARY SP5T 6 POSITION	28480	3100-2687
A7U13	1820-0685	3	IC:TTL SCHOTTKY TRIPLE 3-INPT NAND GATE	01295	SN74S10N
A7U14	1820-0608	3	IC:TTL 1 OF DECODER W/ENABLE	04713	MC4006P
A7U16	1820-0755	14	IC	28480	1820-0755
A7U17	1820-0574	36	IC:DIGITAL TTL QUAD D-F/F	12040	DM8551N
A7U18	1820-0574		IC:DIGITAL TTL QUAD D-F/F	12040	DM8551N
A7U19	1820-0755		IC	28480	1820-0755
A7U21	1820-0375	4	IC:TTL HS 8-INPT NAND GATE	01295	SN74H30N
A7U22	1820-0685		IC:TTL SCHOTTKY TRIPLE 3-INPT NAND GATE	01295	SN74S10N
A7U23	1820-0685		IC:TTL SCHOTTKY TRIPLE 3-INPT NAND GATE	01295	SN74S10N
A7U24	1820-0683	1	IC:TTL SCHOTTKY HEX INVERTER	01295	SN74S04N
A7U26	1820-0755		IC	28480	1820-0755
A7U27	1820-0755		IC	28480	1820-0755
A7U28	1820-0716	4	IC:TTL SYNC PRESET 4-BIT BINARY COUNTER	01295	SN74161N
A7U29	1820-0367	4	IC:TTL 4-BIT UP-DOWN SHIFT REGISTER	01295	SN7495N
A7U31	1820-0375		IC:TTL HS 8-INPT NAND GATE	01295	SN74H30N
A7U32	1820-0846	6	IC:TTL DIGITAL QUAD BUFFER	12040	DM 8094N
A7U33	1820-0574		IC:DIGITAL TTL QUAD D-F/F	12040	DM8551N
A7U34	1820-0608		IC:TTL 1 OF DECODER W/ENABLE	04713	MC4006P
A7U35	1820-0574		IC:DIGITAL TTL QUAD D-F/F	12040	DM8551N
A7U36	1820-0574		IC:DIGITAL TTL QUAD D-F/F	12040	DM8551N
A7U37	1820-0574		IC:DIGITAL TTL QUAD D-F/F	12040	DM8551N
A7U38	1820-0842	2	IC:TTL 8-BIT PARITY TREE	04713	MC4006P
A7U39	1820-0755		IC	28480	1820-0755

Table 2-7. S-Bus PCA (A7), Replaceable Parts (Continued)

Reference Designation	HP Part Number	Qty	Description	Mfr Code	Mfr Part Number
A7U41	1820-0375	16	IC:TTL HS 8-INPT NAND GATE	01295	SN74H30N
A7U42	1820-0574		IC:DIGITAL TTL QUAD D-F/F	12040	DM8551N
A7U43	1820-0574		IC:DIGITAL TTL QUAD D-F/F	12040	DM8551N
A7U44	1820-0608		IC:TTL 1 OF DECODER W/ENABLE	04713	MC4006P
A7U45	1820-1033		IC (DS17538)	28480	1820-1033
A7U46	1820-1033		IC (DS17538)	28480	1820-1033
A7U47	1820-1033		IC (DS17538)	28480	1820-1033
A7U48	1820-1033		IC (DS17538)	28480	1820-1033
A7U49	1820-0755		IC	28480	1820-0755
A7U51	1820-0375		IC:TTL HS 8-INPT NAND GATE	01295	SN74H30N
A7U52	1820-0373	1	IC:TTL HS DUAL 4-INPT NAND GATE	01295	SN74H20N
A7U53	1820-0205	3	IC:TTL QUAD 2-INPT OR GATE	28480	1820-0205
A7U54	1820-0367		IC:TTL 4-BIT UP-DOWN SHIFT REGISTER	01295	SN7495N
A7U55	1820-0424		1	IC:TTL HS HEX INVERTER	04713
A7U56	1820-0690	2	IC:TTL SCHOTTKY DUAL 4-INPT NAND BUFFER	01295	SN74S40N
A7U57	1820-0574	5	IC:DIGITAL TTL QUAD D-F/F	12040	DM8551N
A7U58	1820-0574		IC:DIGITAL TTL QUAD D-F/F	12040	DM8551N
A7U59	1820-0755		IC	28480	1820-0755
A7U61	1820-0239		IC:TTL QUAD 2-INPT NOR GATE	28480	1820-0239
A7U62	1820-0205		IC:TTL QUAD 2-INPT OR GATE	28480	1820-0205
A7U63	1820-0239	2	IC:TTL QUAD 2-INPT NOR GATE	28480	1820-0239
A7U65	1820-0998		IC	01295	SN74S153M
A7U66	1820-0998		IC	01295	SN74S153M
A7U68	1820-0716	1	IC:TTL SYNC PRESET 4-BIT BINARY COUNTER	01295	SN74161N
A7U69	1820-0686		IC:TTL SCHOTTKY TRIPLE 3-INPT AND GATE	01295	SN74S11N
A7U71	1820-0140	1	IC:TTL DUAL 4-INPT AND BUFFER	04713	MC3026P
A7U72	1820-0846	2	IC:TTL DIGITAL QUAD BUFFER	12040	DM 8094N
A7U73	1820-0574		IC:DIGITAL TTL QUAD D-F/F	12040	DM8551N
A7U75	1820-0574		IC:DIGITAL TTL QUAD D-F/F	12040	DM8551N
A7U76	1820-0574		IC:DIGITAL TTL QUAD D-F/F	12040	DM8551N
A7U77	1820-0574		2	IC:DIGITAL TTL QUAD D-F/F	12040
A7U78	1820-0724	IC:TTL DUAL 2-4 DECODER W/ENABLE		04713	MC4007P
A7U79	1820-0724	1	IC:TTL DUAL 2-4 DECODER W/ENABLE	04713	MC4007P
A7U81	1820-0376		IC:TTL HS DUAL 4-INPT NAND BUFFER	01295	SN74H40N
A7U82	1820-0574		IC:DIGITAL TTL QUAD D-F/F	12040	DM8551N
A7U83	1820-0574	2	IC:DIGITAL TTL QUAD D-F/F	12040	DM8551N
A7U85	1820-1033		IC (DS17538)	28480	1820-1033
A7U86	1820-1033		IC (DS17538)	28480	1820-1033
A7U87	1820-1033		IC (DS17538)	28480	1820-1033
A7U88	1820-1033		IC (DS17538)	28460	1820-1033
A7U89	1820-0755	2	IC	28480	1820-0755
A7U91	1820-0239		IC:TTL QUAD 2-INPT NOR GATE	28480	1820-0239
A7U92	1820-0370		IC:TTL HS QUAD 2-INPT NAND GATE	01295	SN74H00N
A7U93	1820-0205		IC:TTL QUAD 2-INPT OR GATE	28480	1820-0205
A7U95	1820-0239		IC:TTL QUAD 2-INPT NOR GATE	28480	1820-0239
A7U96	1820-0755	2	IC	28480	1820-0755
A7U97	1820-0574		IC:DIGITAL TTL QUAD D-F/F	12040	DM8551N
A7U98	1820-0574		IC:DIGITAL TTL QUAD D-F/F	12040	DM8551N
A7U99	1820-0755		IC	28480	1820-0755
A7U103	1820-0141		IC:TTL QUAD 2-INPT AND GATE	04713	MC3001P
A7U106	1820-0755	2	IC	28480	1820-0755
A7U107	1820-0755		IC	28480	1820-0755
A7U108	1820-0716		IC:TTL SYNC PRESET 4-BIT BINARY COUNTER	01295	SN74161N
A7U109	1820-0367		IC:TTL 4-BIT UP-DOWN SHIFT REGISTER	01295	SN7495N
A7U111	1820-0846		IC:TTL DIGITAL QUAD BUFFER	12040	DM 8094N
A7U112	1820-0846	2	IC:TTL DIGITAL QUAD BUFFER	12040	DM 8094N
A7U113	1820-0574		IC:DIGITAL TTL QUAD D-F/F	12040	DM8551N
A7U115	1820-0574		IC:DIGITAL TTL QUAD D-F/F	12040	DM8551N
A7U116	1820-0574		IC:DIGITAL TTL QUAD D-F/F	12040	DM8551N
A7U117	1820-0574		IC:DIGITAL TTL QUAD D-F/F	12040	DM8551N
A7U118	1820-0842	2	IC:TTL 8-BIT PARITY TREE	04713	MC4008P
A7U119	1820-0755		IC	28480	1820-0755
A7U122	1820-0574		IC:DIGITAL TTL QUAD D-F/F	12040	DM8551N
A7U123	1820-0574		IC:DIGITAL TTL QUAD D-F/F	12040	DM8551N
A7U125	1820-1033		IC (DS17538)	28480	1820-1033
A7U126	1820-1033	1	IC (DS17538)	28480	1820-1033
A7U127	1820-1033		IC (DS17538)	28480	1820-1033
A7U128	1820-1033		IC (DS17538)	28480	1820-1033
A7U129	1820-0574		IC:DIGITAL TTL QUAD D-F/F	12040	DM8551N
A7U131	1820-0374		IC:TTL HS DUAL 4-INPT AND GATE	01295	SN74H21N
A7U132	1820-0282	2	IC:TTL QUAD 2-INPT EXCL. OR GATE	01295	SN7486N
A7U133	1820-0574	3	IC:DIGITAL TTL QUAD D-F/F	12040	DM8551N
A7U135	1820-0620		IC:TTL DUAL 4-INPT MULTIPLEXER	01295	SN74153N
A7U136	1820-0690		IC:TTL SCHOTTKY DUAL 4-INPT NAND BUFFER	01295	SN74S40N
A7U137	1820-0574		IC:DIGITAL TTL QUAD D-F/F	12040	DM8551N

Table 2-7. S-Bus PCA (A7), Replaceable Parts (Continued)

Reference Designation	HP Part Number	Qty	Description	Mfr Code	Mfr Part Number
A7U138	1820-0574		IC:DIGITAL TTL QUAD D-F/F	12040	DM8551N
A7U139	1820-0755		IC	28480	1820-0755
A7U141	1820-0141		IC:TTL QUAD 2-INPT AND GATE	04713	MC3001P
A7U142	1820-0282		IC:TTL QUAD 2-INPT EXCL. OR GATE	01295	SN7486N
A7U143	1820-0574		IC:DIGITAL TTL QUAD D-F/F	12040	DM8551N
A7U145	1820-0620		IC:TTL DUAL 4-INPT MULTIPLEXER	01295	SN74153N
A7U146	1820-0620		IC:TTL DUAL 4-INPT MULTIPLEXER	01295	SN74153N
A7U148	1820-0716		IC:TTL SYNC PRESET 4-BIT BINARY COUNTER	01295	SN74161N
A7U149	1820-0367		IC:TTL 4-BIT UP-DOWN SHIFT REGISTER	01295	SN7495N
A7U151	1820-0846		IC:TTL DIGITAL QUAD BUFFER	12040	DM 8094N
A7U152	1820-0846		IC:TTL DIGITAL QUAD BUFFER	12040	DM 8094N
A7U153	1820-0574		IC:DIGITAL TTL QUAD D-F/F	12040	DM8551N
A7U155	1820-0574		IC:DIGITAL TTL QUAD D-F/F	12040	DM8551N
A7U156	1820-0574		IC:DIGITAL TTL QUAD D-F/F	12040	DM8551N
A7U157	1820-0574		IC:DIGITAL TTL QUAD D-F/F	12040	DM8551N
A7U159	1820-0370		IC:TTL HS QUAD 2-INPT NAND GATE	01295	SN74H00N
A7U162	1820-0574		IC:DIGITAL TTL QUAD D-F/F	12040	DM8551N
A7U163	1820-0574		IC:DIGITAL TTL QUAD D-F/F	12040	DM8551N
A7U164	1820-0239		IC:TTL QUAD 2-INPT NOR GATE	28480	1820-0239
A7U165	1820-1033		IC (DS17538)	28480	1820-1033
A7U166	1820-1033		IC (DS17538)	28480	1820-1033
A7U167	1820-1033		IC (DS17538)	28480	1820-1033
A7U168	1820-1033		IC (DS17538)	28480	1820-1033
A7U169	1820-0574		IC:DIGITAL TTL QUAD D-F/F	12040	DM8551N

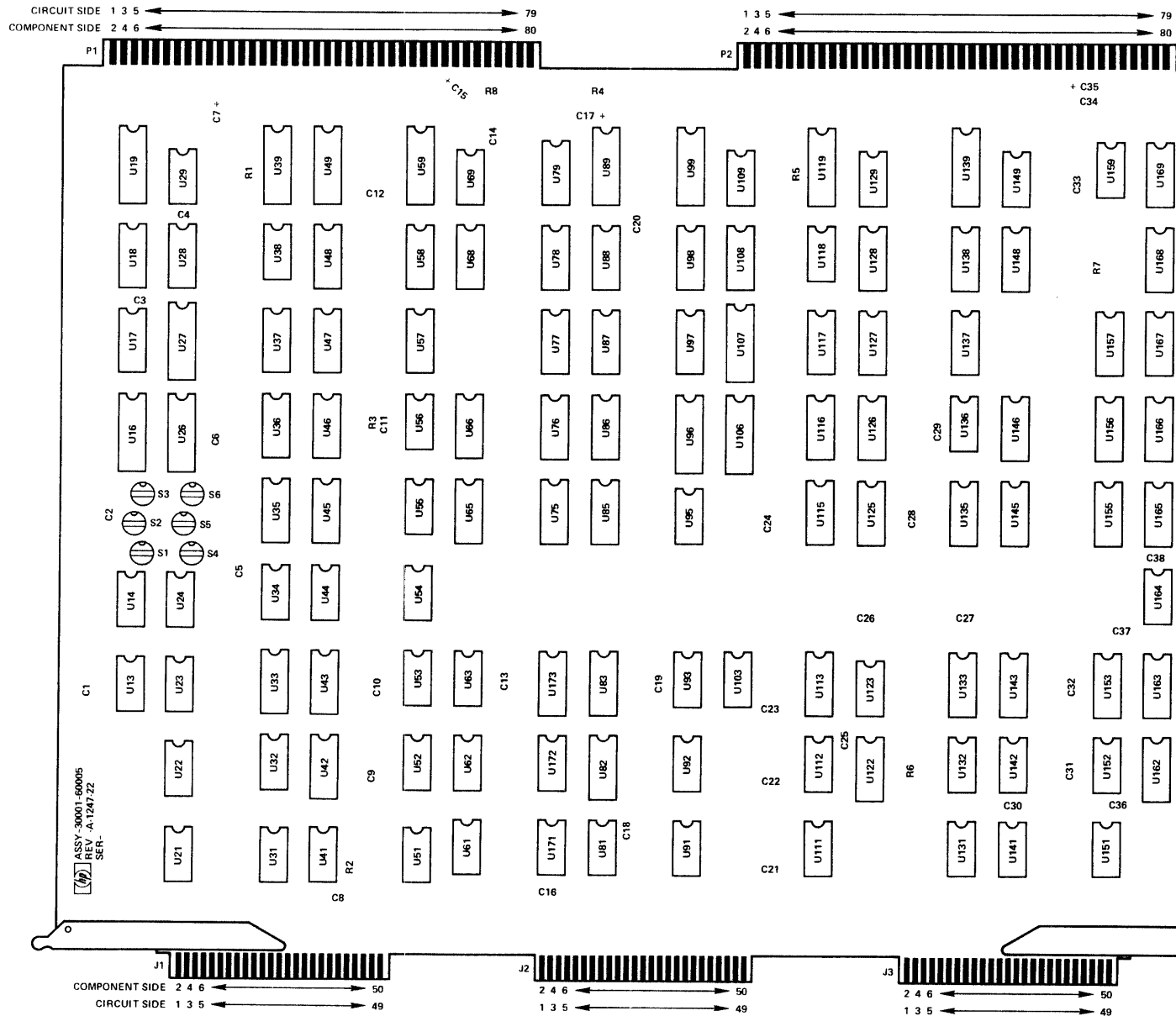

2212 18

Figure 2-6. S-Bus PCA (A7), Parts Location Diagram

Table 2-8. Current Instruction Register (CIR) PCA (A8), Replaceable Parts (Continued)

Reference Designation	HP Part Number	Qty	Description	Mfr Code	Mfr Part Number
A8C75	0160-2055		C:FXD CER 0.01 UF +80-20% 100VDCW	56289	C023F101F103ZS22-CDH
A8C76	0160-2055		C:FXD CER 0.01 UF +80-20% 100VDCW	56289	C023F101F103ZS22-CDH
A8C77	0160-2055		C:FXD CER 0.01 UF +80-20% 100VDCW	56289	C023F101F103ZS22-CDH
A8C78	0180-0229		C:FXD ELECT 33 UF 10% 10VDCW	28480	0180-0229
A8C79	0160-2055		C:FXD CER 0.01 UF +80-20% 100VDCW	56289	C023F101F103ZS22-CDH
A8C80	0160-2055		C:FXD CER 0.01 UF +80-20% 100VDCW	56289	C023F101F103ZS22-CDH
A8C81	0160-2055		C:FXD CER 0.01 UF +80-20% 100VDCW	56289	C023F101F103ZS22-CDH
A8C82	0160-2055		C:FXD CER 0.01 UF +80-20% 100VDCW	56289	C023F101F103ZS22-CDH
A8C83	0160-2055		C:FXD CER 0.01 UF +80-20% 100VDCW	56289	C023F101F103ZS22-CDH
A8C84	0160-2055		C:FXD CER 0.01 UF +80-20% 100VDCW	56289	C023F101F103ZS22-CDH
A8C85	0160-2055		C:FXD CER 0.01 UF +80-20% 100VDCW	56289	C023F101F103ZS22-CDH
A8C86	0150-0121		C:FXD CER 0.1 UF +80-20% 50VDCW	56289	5L50B1S-CML
A8C87	0160-2055		C:FXD CER 0.01 UF +80-20% 100VDCW	56289	C023F101F103ZS22-CDH
A8C88	0160-2055		C:FXD CER 0.01 UF +80-20% 100VDCW	56289	C023F101F103ZS22-CDH
A8C89	0160-2055		C:FXD CER 0.01 UF +80-20% 100VDCW	56289	C023F101F103ZS22-CDH
A8C90	0160-2055		C:FXD CER 0.01 UF +80-20% 100VDCW	56289	C023F101F103ZS22-CDH
A8C91	0160-2055		C:FXD CER 0.01 UF +80-20% 100VDCW	56289	C023F101F103ZS22-CDH
A8C92	0160-2055		C:FXD CER 0.01 UF +80-20% 100VDCW	56289	C023F101F103ZS22-CDH
A8C93	0160-2055		C:FXD CER 0.01 UF +80-20% 100VDCW	56289	C023F101F103ZS22-CDH
A8C94	0160-2055		C:FXD CER 0.01 UF +80-20% 100VDCW	56289	C023F101F103ZS22-CDH
A8C95	0160-2055		C:FXD CER 0.01 UF +80-20% 100VDCW	56289	C023F101F103ZS22-CDH
A8C96	0160-2055		C:FXD CER 0.01 UF +80-20% 100VDCW	56289	C023F101F103ZS22-CDH
A8C97	0160-2055		C:FXD CER 0.01 UF +80-20% 100VDCW	56289	C023F101F103ZS22-CDH
A8C98	0160-2055		C:FXD CER 0.01 UF +80-20% 100VDCW	56289	C023F101F103ZS22-CDH
A8C99	0160-2055		C:FXD CER 0.01 UF +80-20% 100VDCW	56289	C023F101F103ZS22-CDH
A8C100	0160-2055		C:FXD CER 0.01 UF +80-20% 100VDCW	56289	C023F101F103ZS22-CDH
A8C101	0160-2055		C:FXD CER 0.01 UF +80-20% 100VDCW	56289	C023F101F103ZS22-CDH
A8C102	0160-2055		C:FXD CER 0.01 UF +80-20% 100VDCW	56289	C023F101F103ZS22-CDH
A8R1	1810-0030	3	NETWORK:7 RESISTORS 1K OHM 5% 0.15W EA	28480	1810-0030
A8R2	1810-0030		NETWORK:7 RESISTORS 1K OHM 5% 0.15W EA	28480	1810-0030
A8R3	1810-0030		NETWORK:7 RESISTORS 1K OHM 5% 0.15W EA	28480	1810-0030
A8R4	0757-0280	2	R:FXD MET FLM 1K OHM 1% 1/8W	28480	0757-0280
A8R5	0757-0280		R:FXD MET FLM 1K OHM 1% 1/8W	28480	0757-0280
A8U1	1816-0129	3	IC: PROM	28480	1816-0129
			NOTE:		
			QUANTITIES OF PROMS LISTED ABOVE ARE THOSE REQUIRED TO MAKE ROMS.		
A8U11	1820-0370	7	IC:TTL HS QUAD 2-INPT NAND GATE	01295	SN74H00N
A8U12	1820-0696	4	IC:TTL DUAL J-K F/F EDGE TRIGGERED	01295	SN74S114N
A8U13	1820-0688	4	IC:TTL SCHOTTKY DUAL 4-INPT NAND GATE	01295	SN74S20N
A8U14	1820-0371	10	IC:TTL HS TRIPLE 3-INPT NAND GATE	01295	SN74H10N
A8U15	1820-0372	4	IC:TTL TRIPLE 3-INPT AND GATE	28480	1820-0372
A8U16	1820-0374	6	IC:TTL HS DUAL 4-INPT AND GATE	01295	SN74H21N
A8U21	1820-0691	1	IC:TTL SCHOTTKY 4 W(4-2-3-2)INPT	01295	SN74S64N
A8U22	1820-0372		IC:TTL TRIPLE 3-INPT AND GATE	28480	1820-0372
A8U23	1820-0696		IC:TTL DUAL J-K F/F EDGE TRIGGERED	01295	SN74S114N
A8U24	1820-0380	1	IC:TTL HS 4W 2-2-2-3 INPT AND/OR INV	01295	SN74H53N
A8U25	1820-0205	2	IC:TTL QUAD 2-INPT OR GATE	28480	1820-0205
A8U26	1820-0370		IC:TTL HS QUAD 2-INPT NAND GATE	01295	SN74H00N
A8U27	1820-0696		IC:TTL DUAL J-K F/F EDGE TRIGGERED	01295	SN74S114N
A8U28	1820-0696		IC:TTL DUAL J-K F/F EDGE TRIGGERED	01295	SN74S114N
A8U29	1820-0690	3	IC:TTL SCHOTTKY DUAL 4-INPT NAND BUFFER	01295	SN74S40N
A8U31	1820-0239	4	IC:TTL QUAD 2-INPT NOR GATE	28480	1820-0239
A8U32	1820-0370		IC:TTL HS QUAD 2-INPT NAND GATE	01295	SN74H00N
A8U33	1820-0239		IC:TTL QUAD 2-INPT NOR GATE	28480	1820-0239
A8U34	1820-0141	5	IC:TTL QUAD 2-INPT AND GATE	04713	MC3001P
A8U35	1820-0372		IC:TTL TRIPLE 3-INPT AND GATE	28480	1820-0372
A8U36	1820-0382	1	IC:TTL HS 2 W 4-INPT AND OR INV GATE	01295	SN74H55N
A8U37	1820-0141		IC:TTL QUAD 2-INPT AND GATE	04713	MC3001P
A8U38	1820-0695	2	IC:TTL SHS DUAL J-K F/F W/PRESET	01295	SN74S113N
A8U39	1820-0690		IC:TTL SCHOTTKY DUAL 4-INPT NAND BUFFER	01295	SN74S40N
A8U41	1820-0375	4	IC:TTL HS 8-INPT NAND GATE	01295	SN74H30N
A8U42	1820-0424	2	IC:TTL HS HEX INVERTER	04713	SN74H04N
A8U43	1820-0846	2	IC:TTL DIGITAL QUAD BUFFER	12040	DM 8094N
A8U44	1820-0755	12	IC	28480	1820-0755
A8U52	1820-0755		IC	28480	1820-0755
A8U53	1820-0755		IC	28480	1820-0755
A8U54	1820-0755		IC	28480	1820-0755
A8U56	1820-0755		IC	28480	1820-0755
A8U57	1820-0755		IC	28480	1820-0755
A8U59	1820-0686	1	IC:TTL SCHOTTKY TRIPLE 3-INPT AND GATE	01295	SN74S11N
A8U66	1820-0262	4	IC:TTL 8-BIT PAR-IN SER-OUT SHIFT REG.	12040	SD9936
A8U67	1820-0262		IC:TTL 8-BIT PAR-IN SER-OUT SHIFT REG.	12040	SD9936
A8U69	1820-0685	1	IC:TTL SCHOTTKY TRIPLE 3-INPT NAND GATE	01295	SN74S10N
A8U71	1820-0574	5	IC: DIGITAL TTL QUAD D-F/F	12040	DM8551N

Table 2-8. Current Instruction Register (CIR) PCA (A8), Replaceable Parts (Continued)

Reference Designation	HP Part Number	Qty	Description	Mfr Code	Mfr Part Number
A8U72	1820-0574	4	IC: DIGITAL TTL QUAD D-F/F	12040	DM8551N
A8U73	1820-0837		IC: TTL DUAL 4-INPT NOR GATE	18324	N8815A
A8U74	1820-0574		IC: DIGITAL TTL QUAD D-F/F	12040	DM8551N
A8U75	1820-0574		IC: DIGITAL TTL QUAD D-F/F	12040	DM8551N
A8U76	1820-0262		IC: TTL 8-BIT PAR-IN SER-OUT SHIFT REG.	12040	SD9936
A8U77	1820-0262	2	IC: TTL 8-BIT PAR-IN SER-OUT SHIFT REG.	12040	SD9936
A8U79	1820-0759		IC: TTL LOW-POWER 8-BIT RECEIVER	28480	1820-0759
A8U81	1820-0282		IC: TTL QUAD 2-INPT EXCL. OR GATE	01295	SN7486N
A8U82	1820-0282		IC: TTL QUAD 2-INPT EXCL. OR GATE	01295	SN7486N
A8U83	1820-0837		IC: TTL DUAL 4-INPT NOR GATE	18324	N8815A
A8U84	1820-0282	2	IC: TTL QUAD 2-INPT EXCL. OR GATE	01295	SN7486N
A8U85	1820-0282		IC: TTL QUAD 2-INPT EXCL. OR GATE	01295	SN7486N
A8U86	1820-0842		IC: TTL 8-BIT PARITY TREE	04713	MC4008P
A8U87	1820-0842		IC: TTL 8-BIT PARITY TREE	04713	MC4008P
A8U89	1820-0759		IC: TTL LOW-POWER 8-BIT RECEIVER	28480	1820-0759
A8U91	1820-0301	8	IC: TTL QUAD BI-STABLE D-LATCH	01295	SN7475N
A8U92	1820-0301		IC: TTL QUAD BI-STABLE D-LATCH	01295	SN7475N
A8U93	1820-0374		IC: TTL HS DUAL 4-INPT AND GATE	01295	SN74H21N
A8U94	1820-0301		IC: TTL QUAD BI-STABLE D-LATCH	01295	SN7475N
A8U95	1820-0301		IC: TTL QUAD BI-STABLE D-LATCH	01295	SN7475N
A8U96	1820-0688	1	IC: TTL SCHOTTKY DUAL 4-INPT NAND GATE	01295	SN74S20N
A8U97	1820-0683		IC: TTL SCHOTTKY HEX INVERTER	01295	SN74S04N
A8U98	1820-0681		IC: TTL QUAD 2-INPT NAND GATE	01295	SN74S00N
A8U99	1820-0141		IC: TTL QUAD 2-INPT AND GATE	04713	MC3001P
A8U101	1820-0301		IC: TTL QUAD BI-STABLE D-LATCH	01295	SN7475N
A8U102	1820-0301	1	IC: TTL QUAD BI-STABLE D-LATCH	01295	SN7475N
A8U103	1820-0375		IC: TTL HS 8-INPT NAND GATE	01295	SN74H30N
A8U104	1820-0301		IC: TTL QUAD BI-STABLE D-LATCH	01295	SN7475N
A8U105	1820-0301		IC: TTL QUAD BI-STABLE D-LATCH	01295	SN7475N
A8U106	1820-0688		IC: TTL SCHOTTKY DUAL 4-INPT NAND GATE	01295	SN74S20N
A8U107	1820-0688	1	IC: TTL SCHOTTKY DUAL 4-INPT NAND GATE	01295	SN74S20N
A8U108	1820-0690		IC: TTL SCHOTTKY DUAL 4-INPT NAND BUFFER	01295	SN74S40N
A8U109	1820-0695		IC: TTL SHS DUAL J-K F/F W/PRESET	01295	SN74S113N
A8U111	1820-0282		IC: TTL QUAD 2-INPT EXCL. OR GATE	01295	SN7486N
A8U112	1820-0371		IC: TTL HS TRIPLE 3-INPT NAND GATE	01295	SN74H10N
A8U113	1820-0376	2	IC: TTL HS DUAL 4-INPT NAND BUFFER	01295	SN74H40N
A8U114	1820-0755		IC	28480	1820-0755
A8U116	1816-0072		IC: ROM 4 X 256	28480	1816-0072
A8U118	1820-0755		IC	28480	1820-0755
A8U119	1820-0755		IC	28480	1820-0755
A8U121	1820-0239	4	IC: TTL QUAD 2-INPT NOR GATE	28480	1820-0239
A8U122	1820-0371		IC: TTL HS TRIPLE 3-INPT NAND GATE	01295	SN74H10N
A8U123	1820-0373		IC: TTL HS DUAL 4-INPT NAND GATE	01295	SN74H20N
A8U124	1820-0755		IC	28480	1820-0755
A8U126	1816-0071		IC: ROM 4 X 256	28480	1816-0071
A8U128	1820-0755	1	IC	28480	1820-0755
A8U129	1820-0755		IC	28480	1820-0755
A8U131	1820-0371		IC: TTL HS TRIPLE 3-INPT NAND GATE	01295	SN74H10N
A8U132	1820-0373		IC: TTL HS DUAL 4-INPT NAND GATE	01295	SN74H20N
A8U133	1820-0837		IC: TTL DUAL 4-INPT NOR GATE	18324	N8815A
A8U134	1820-0375	3	IC: TTL HS 8-INPT NAND GATE	01295	SN74H30N
A8U135	1820-0379		IC: TTL HS 4W 2-2-2-3 INPT AND/OR GATE	01295	SN74H52N
A8U136	1816-0070		IC: ROM 4 X 256	28480	1816-0070
A8U137	1820-0846		IC: TTL DIGITAL QUAD BUFFER	12040	DM 8094N
A8U138	1820-0424		IC: TTL HS HEX INVERTER	04713	SN74H04N
A8U139	1820-0837	1	IC: TTL DUAL 4-INPT NOR GATE	18324	N8815A
A8U141	1820-0371		IC: TTL HS TRIPLE 3-INPT NAND GATE	01295	SN74H10N
A8U142	1820-0205		IC: TTL QUAD 2-INPT OR GATE	28480	1820-0205
A8U143	1820-0370		IC: TTL HS QUAD 2-INPT NAND GATE	01295	SN74H00N
A8U144	1820-0371		IC: TTL HS TRIPLE 3-INPT NAND GATE	01295	SN74H10N
A8U145	1820-0379	1	IC: TTL HS 4W 2-2-2-3 INPT AND/OR GATE	01295	SN74H52N
A8U146	1820-0370		IC: TTL HS QUAD 2-INPT NAND GATE	01295	SN74H00N
A8U147	1820-0239		IC: TTL QUAD 2-INPT NOR GATE	28480	1820-0239
A8U148	1820-0374		IC: TTL HS DUAL 4-INPT AND GATE	01295	SN74H21N
A8U149	1820-0141		IC: TTL QUAD 2-INPT AND GATE	04713	MC3001P
A8U159	1820-0535	1	IC: TTL DUAL PERI. 2-INPT AND DRIVER	01295	SN75451P
A8U161	1820-0371		IC: TTL HS TRIPLE 3-INPT NAND GATE	01295	SN74H10N
A8U162	1820-0141		IC: TTL QUAD 2-INPT AND GATE	04713	MC3001P
A8U163	1820-0370		IC: TTL HS QUAD 2-INPT NAND GATE	01295	SN74H00N
A8U164	1820-0371		IC: TTL HS TRIPLE 3-INPT NAND GATE	01295	SN74H10N
A8U165	1820-0379	1	IC: TTL HS 4W 2-2-2-3 INPT AND/OR GATE	01295	SN74H52N
A8U166	1820-0372		IC: TTL TRIPLE 3-INPT AND GATE	28480	1820-0372
A8U167	1820-0374		IC: TTL HS DUAL 4-INPT AND GATE	01295	SN74H21N
A8U168	1820-0376		IC: TTL HS DUAL 4-INPT NAND BUFFER	01295	SN74H40N
A8U169	1820-0512		IC: TTL HS DUAL D F/F (35 MHZ MIN.)	01295	SN74H74N

Table 2-8. Current Instruction Register (CIR) PCA (A8), Replaceable Parts (Continued)

Reference Designation	HP Part Number	Qty	Description	Mfr Code	Mfr Part Number
A8U171 A8U172 A8U173 A8U174 A8U175	1820-0374 1820-0373 1820-0375 1820-0373 1820-0371		IC:TTL HS DUAL 4-INPT AND GATE IC:TTL HS DUAL 4-INPT NAND GATE IC:TTL HS 8-INPT NAND GATE IC:TTL HS DUAL 4-INPT NAND GATE IC:TTL HS TRIPLE 3-INPT NAND GATE	01295 01295 01295 01295 01295	SN74H21N SN74H20N SN74H30N SN74H20N SN74H10N
A8U176 A8U177 A8U178 A8U179	1820-0371 1820-0374 1820-0370 1820-0574		IC:TTL HS TRIPLE 3-INPT NAND GATE IC:TTL HS DUAL 4-INPT NAND GATE IC:TTL HS QUAD 2-INPT NAND GATE IC:DIGITAL TTL QUAD D-F/F	01295 01295 01295 12040	SN74H10N SN74H21N SN74H00N DM8551N

Table 2-9. Module Control Unit (MCU) PCA (A9), Replaceable Parts

Reference Designation	HP Part Number	Qty	Description	Mfr Code	Mfr Part Number
A9	30001-60007	1	MODULE CONTROL UNIT(MCU) PCA	28480	30001-60007
A9C1	0160-2055	56	C:FxD CER 0.01 UF +80-20% 100VDCW	56289	C023F101F103ZS22-CDH
A9C2	0160-2055		C:FxD CER 0.01 UF +80-20% 100VDCW	56289	C023F101F103ZS22-CDH
A9C3	0160-2055		C:FxD CER 0.01 UF +80-20% 100VDCW	56289	C023F101F103ZS22-CDH
A9C4	0160-2055		C:FxD CER 0.01 UF +80-20% 100VDCW	56289	C023F101F103ZS22-CDH
A9C5	0160-2055		C:FxD CER 0.01 UF +80-20% 100VDCW	56289	C023F101F103ZS22-CDH
A9C6	0160-2055		C:FxD CER 0.01 UF +80-20% 100VDCW	56289	C023F101F103ZS22-CDH
A9C7	0160-2055		C:FxD CER 0.01 UF +80-20% 100VDCW	56289	C023F101F103ZS22-CDH
A9C8	0180-0229	4	C:FxD ELECT 33 UF 10% 10VDCW	28480	0180-0229
A9C9	0160-2055		C:FxD CER 0.01 UF +80-20% 100VDCW	56289	C023F101F103ZS22-CDH
A9C10	0160-2055		C:FxD CER 0.01 UF +80-20% 100VDCW	56289	C023F101F103ZS22-CDH
A9C11	0160-2055		C:FxD CER 0.01 UF +80-20% 100VDCW	56289	C023F101F103ZS22-CDH
A9C12	0160-2055		C:FxD CER 0.01 UF +80-20% 100VDCW	56289	C023F101F103ZS22-CDH
A9C13	0160-2055		C:FxD CER 0.01 UF +80-20% 100VDCW	56289	C023F101F103ZS22-CDH
A9C14	0160-2055		C:FxD CER 0.01 UF +80-20% 100VDCW	56289	C023F101F103ZS22-CDH
A9C16	0150-0121	13	C:FxD CER 0.1 UF +80-20% 50VDCW	56289	5C508IS-CML
A9C17	0160-0161	2	C:FxD MY 0.01 UF 10% 200VDCW	56289	192P10392-PTS
A9C18	0160-0161		C:FxD MY 0.01 UF 10% 200VDCW	56289	192P10392-PTS
A9C19	0160-2055		C:FxD CER 0.01 UF +80-20% 100VDCW	56289	C023F101F103ZS22-CDH
A9C20	0160-2055		C:FxD CER 0.01 UF +80-20% 100VDCW	56289	C023F101F103ZS22-CDH
A9C21	0160-2055		C:FxD CER 0.01 UF +80-20% 100VDCW	56289	C023F101F103ZS22-CDH
A9C22	0160-2055		C:FxD CER 0.01 UF +80-20% 100VDCW	56289	C023F101F103ZS22-CDH
A9C23	0160-2055		C:FxD CER 0.01 UF +80-20% 100VDCW	56289	C023F101F103ZS22-CDH
A9C24	0160-2055		C:FxD CER 0.01 UF +80-20% 100VDCW	56289	C023F101F103ZS22-CDH
A9C25	0160-2055		C:FxD CER 0.01 UF +80-20% 100VDCW	56289	C023F101F103ZS22-CDH
A9C26	0160-2055		C:FxD CER 0.01 UF +80-20% 100VDCW	56289	C023F101F103ZS22-CDH
A9C27	0150-0121		C:FxD CER 0.1 UF +80-20% 50VDCW	56289	5C508IS-CML
A9C28	0160-2055		C:FxD CER 0.01 UF +80-20% 100VDCW	56289	C023F101F103ZS22-CDH
A9C29	0150-0121		C:FxD CER 0.1 UF +80-20% 50VDCW	56289	5C508IS-CML
A9C30	0160-0127	4	C:FxD CER 1.0 UF 20% 25VDCW	56289	5C13CS-CML
A9C31	0160-2055		C:FxD CER 0.01 UF +80-20% 100VDCW	56289	C023F101F103ZS22-CDH
A9C32	0160-2055		C:FxD CER 0.01 UF +80-20% 100VDCW	56289	C023F101F103ZS22-CDH
A9C33	0150-0121		C:FxD CER 0.1 UF +80-20% 50VDCW	56289	5C508IS-CML
A9C34	0160-0127		C:FxD CER 1.0 UF 20% 25VDCW	56289	5C13CS-CML
A9C35	0160-0127		C:FxD CER 1.0 UF 20% 25VDCW	56289	5C13CS-CML
A9C36	0160-2055		C:FxD CER 0.01 UF +80-20% 100VDCW	56289	C023F101F103ZS22-CDH
A9C37	0160-2055		C:FxD CER 0.01 UF +80-20% 100VDCW	56289	C023F101F103ZS22-CDH
A9C38	0160-2055		C:FxD CER 0.01 UF +80-20% 100VDCW	56289	C023F101F103ZS22-CDH
A9C39	0160-2055		C:FxD CER 0.01 UF +80-20% 100VDCW	56289	C023F101F103ZS22-CDH
A9C40	0160-2055		C:FxD CER 0.01 UF +80-20% 100VDCW	56289	C023F101F103ZS22-CDH
A9C41	0160-2055		C:FxD CER 0.01 UF +80-20% 100VDCW	56289	C023F101F103ZS22-CDH
A9C42	0160-2055		C:FxD CER 0.01 UF +80-20% 100VDCW	56289	C023F101F103ZS22-CDH
A9C43	0150-0121		C:FxD CER 0.1 UF +80-20% 50VDCW	56289	5C508IS-CML
A9C44	0180-0229		C:FxD ELECT 33 UF 10% 10VDCW	28480	0180-0229
A9C45	0160-2055		C:FxD CER 0.01 UF +80-20% 100VDCW	56289	C023F101F103ZS22-CDH
A9C46	0150-0121		C:FxD CER 0.1 UF +80-20% 50VDCW	56289	5C508IS-CML
A9C47	0180-0229		C:FxD ELECT 33 UF 10% 10VDCW	28480	0180-0229
A9C48	0160-2055		C:FxD CER 0.01 UF +80-20% 100VDCW	56289	C023F101F103ZS22-CDH
A9C49	0150-0121		C:FxD CER 0.1 UF +80-20% 50VDCW	56289	5C508IS-CML
A9C50	0160-2055		C:FxD CER 0.01 UF +80-20% 100VDCW	56289	C023F101F103ZS22-CDH
A9C51	0160-2055		C:FxD CER 0.01 UF +80-20% 100VDCW	56289	C023F101F103ZS22-CDH
A9C52	0160-2055		C:FxD CER 0.01 UF +80-20% 100VDCW	56289	C023F101F103ZS22-CDH
A9C53	0160-2055		C:FxD CER 0.01 UF +80-20% 100VDCW	56289	C023F101F103ZS22-CDH
A9C54	0150-0121		C:FxD CER 0.1 UF +80-20% 50VDCW	56289	5C508IS-CML
A9C55	0150-0121		C:FxD CER 0.1 UF +80-20% 50VDCW	56289	5C508IS-CML
A9C56	0160-2055		C:FxD CER 0.01 UF +80-20% 100VDCW	56289	C023F101F103ZS22-CDH
A9C57	0150-0121		C:FxD CER 0.1 UF +80-20% 50VDCW	56289	5C508IS-CML
A9C58	0160-2055		C:FxD CER 0.01 UF +80-20% 100VDCW	56289	C023F101F103ZS22-CDH
A9C59	0160-2055		C:FxD CER 0.01 UF +80-20% 100VDCW	56289	C023F101F103ZS22-CDH
A9C60	0160-2055		C:FxD CER 0.01 UF +80-20% 100VDCW	56289	C023F101F103ZS22-CDH
A9C61	0160-2055		C:FxD CER 0.01 UF +80-20% 100VDCW	56289	C023F101F103ZS22-CDH
A9C62	0160-2055		C:FxD CER 0.01 UF +80-20% 100VDCW	56289	C023F101F103ZS22-CDH
A9C63	0160-2055		C:FxD CER 0.01 UF +80-20% 100VDCW	56289	C023F101F103ZS22-CDH
A9C64	0160-2055		C:FxD CER 0.01 UF +80-20% 100VDCW	56289	C023F101F103ZS22-CDH
A9C65	0150-0121		C:FxD CER 0.1 UF +80-20% 50VDCW	56289	5C508IS-CML
A9C66	0160-2055		C:FxD CER 0.01 UF +80-20% 100VDCW	56289	C023F101F103ZS22-CDH
A9C67	0160-2055		C:FxD CER 0.01 UF +80-20% 100VDCW	56289	C023F101F103ZS22-CDH
A9C68	0160-2055		C:FxD CER 0.01 UF +80-20% 100VDCW	56289	C023F101F103ZS22-CDH
A9C69	0160-2055		C:FxD CER 0.01 UF +80-20% 100VDCW	56289	C023F101F103ZS22-CDH
A9C70	0160-2055		C:FxD CER 0.01 UF +80-20% 100VDCW	56289	C023F101F103ZS22-CDH
A9C71	0150-0121		C:FxD CER 0.1 UF +80-20% 50VDCW	56289	5C508IS-CML
A9C72	0160-2055		C:FxD CER 0.01 UF +80-20% 100VDCW	56289	C023F101F103ZS22-CDH
A9C73	0160-2055		C:FxD CER 0.01 UF +80-20% 100VDCW	56289	C023F101F103ZS22-CDH
A9C74	0160-2055		C:FxD CER 0.01 UF +80-20% 100VDCW	56289	C023F101F103ZS22-CDH
A9C75	0160-2055		C:FxD CER 0.01 UF +80-20% 100VDCW	56289	C023F101F103ZS22-CDH

Table 2-9. Module Control Unit (MCU) PCA (A9), Replaceable Parts (Continued)

Reference Designation	HP Part Number	Qty	Description	Mfr Code	Mfr Part Number
A9C76	0160-2055		C:FXD CER 0.01 UF +80-20% 100VDCW	56289	C023F101F103ZS22-CDH
A9C77	0160-2055		C:FXD CER 0.01 UF +80-20% 100VDCW	56289	C023F101F103ZS22-CDH
A9C78	0160-0127		C:FXD CER 1.0 UF 20% 25VDCW	56289	5C13CS-CML
A9C79	0180-0229		C:FXD ELECT 33 UF 10% 10VDCW	28480	0180-0229
A9C15	0150-0121		C:FXD CER 0.1 UF +80-20% 50VDCW	56289	5C50BIS-CML
A9R4	1810-0030	5	NETWORK:7 RESISTORS 1K OHM 5% 0.15W EA	28480	1810-0030
A9R5	1810-0030		NETWORK:7 RESISTORS 1K OHM 5% 0.15W EA	28480	1810-0030
A9R6	1810-0030		NETWORK:7 RESISTORS 1K OHM 5% 0.15W EA	28480	1810-0030
A9R7	1810-0030		NETWORK:7 RESISTORS 1K OHM 5% 0.15W EA	28480	1810-0030
A9R8	1810-0030		NETWORK:7 RESISTORS 1K OHM 5% 0.15W EA	28480	1810-0030
A9U11	1820-0685	3	IC:TTL SCHOTTKY TRIPLE 3-INPT NAND GATE	01295	SN74S10N
A9U12	1820-0685		IC:TTL SCHOTTKY TRIPLE 3-INPT NAND GATE	01295	SN74S10N
A9U13	1820-0371	5	IC:TTL HS TRIPLE 3-INPT NAND GATE	01295	SN74H10N
A9U14	1820-0686	4	IC:TTL SCHOTTKY TRIPLE 3-INPT AND GATE	01295	SN74S11N
A9U15	1820-0141	5	IC:TTL QUAD 2-INPT AND GATE	04713	MC3001P
A9U16	1820-0846	5	IC:TTL DIGITAL QUAD BUFFER	12040	DM 8094N
A9U17	1820-0846		IC:TTL DIGITAL QUAD BUFFER	12040	DM 8094N
A9U18	1820-0846		IC:TTL DIGITAL QUAD BUFFER	12040	DM 8094N
A9U21	1820-0844	1	IC:TTL DUAL 3-INPT PULSE SHAPER	04713	MC426P
A9U22	1820-0696	15	IC:TTL DUAL J-K F/F EDGE TRIGGERED	01295	SN74S114N
A9U23	1820-0696		IC:TTL DUAL J-K F/F EDGE TRIGGERED	01295	SN74S114N
A9U24	1820-0681	3	IC:TTL QUAD 2-INPT NAND GATE	01295	SN74S00N
A9U25	1820-0141		IC:TTL QUAD 2-INPT AND GATE	04713	MC3001P
A9U26	1820-0739	1	IC:TTL HI-SPEED J-K F/F	01295	SN74H101N
A9U27	1820-0574	9	IC:DIGITAL TTL QUAD D-F/F	12040	DM8551N
A9U28	1820-0755	5	IC	28480	1820-0755
A9U32	1820-0141		IC:TTL QUAD 2-INPT AND GATE	04713	MC3001P
A9U42	1820-0371		IC:TTL HS TRIPLE 3-INPT NAND GATE	01295	SN74H10N
A9U43	1820-0696		IC:TTL DUAL J-K F/F EDGE TRIGGERED	01295	SN74S114N
A9U44	1820-0424	4	IC:TTL HS HEX INVERTER	04713	SN74H04N
A9U45	1820-0696		IC:TTL DUAL J-K F/F EDGE TRIGGERED	01295	SN74S114N
A9U46	1820-0837	7	IC:TTL DUAL 4-INPT NOR GATE	18324	N8815A
A9U47	1820-0574		IC:DIGITAL TTL QUAD D-F/F	12040	DM8551N
A9U48	1820-0688	1	IC:TTL SCHOTTKY DUAL 4-INPT NAND GATE	01295	SN74S20N
A9U51	1820-0239	3	IC:TTL QUAD 2-INPT NOR GATE	28480	1820-0239
A9U52	1820-0205	3	IC:TTL QUAD 2-INPT OR GATE	28480	1820-0205
A9U53	1820-0141		IC:TTL QUAD 2-INPT AND GATE	04713	MC3001P
A9U54	1820-0691	5	IC:TTL SCHOTTKY 4 W(4-2-3-2) INPT	01295	SN74S64N
A9U55	1820-0691		IC:TTL SCHOTTKY 4 W(4-2-3-2) INPT	01295	SN74S64N
A9U57	1820-0574		IC:DIGITAL TTL QUAD D-F/F	12040	DM8551N
A9U58	1820-0686		IC:TTL SCHOTTKY TRIPLE 3-INPT AND GATE	01295	SN74S11N
A9U61	1820-0424		IC:TTL HS HEX INVERTER	04713	SN74H04N
A9U62	1820-0512	1	IC:TTL HS DUAL D F/F(35 MHZ MIN.)	01295	SN74H74N
A9U63	1820-0696		IC:TTL DUAL J-K F/F EDGE TRIGGERED	01295	SN74S114N
A9U64	1820-0374	3	IC:TTL HS DUAL 4-INPT AND GATE	01295	SN74H21N
A9U65	1820-0759	4	IC:TTL LOW-POWER 8-BIT RECEIVER	28480	1820-0759
A9U66	1820-0690	5	IC:TTL SCHOTTKY DUAL 4-INPT NAND BUFFER	01295	SN74S40N
A9U68	1820-0686		IC:TTL SCHOTTKY TRIPLE 3-INPT AND GATE	01295	SN74S11N
A9U71	1820-0608	1	IC:TTL 1 OF DECODER W/ENABLE	04713	MC4006P
A9U72	1820-0696		IC:TTL DUAL J-K F/F EDGE TRIGGERED	01295	SN74S114N
A9U73	1820-0239		IC:TTL QUAD 2-INPT NOR GATE	28480	1820-0239
A9U74	1820-0371		IC:TTL HS TRIPLE 3-INPT NAND GATE	01295	SN74H10N
A9U75	1820-0755		IC	28480	1820-0755
A9U76	1820-0690		IC:TTL SCHOTTKY DUAL 4-INPT NAND BUFFER	01295	SN74S40N
A9U77	1820-0690		IC:TTL SCHOTTKY DUAL 4-INPT NAND BUFFER	01295	SN74S40N
A9U78	1820-0681		IC:TTL QUAD 2-INPT NAND GATE	01295	SN74S00N
A9U81	1820-0683	2	IC:TTL SCHOTTKY HEX INVERTER	01295	SN74S04N
A9U82	1820-0696		IC:TTL DUAL J-K F/F EDGE TRIGGERED	01295	SN74S114N
A9U83	1820-0617	4	IC:TTL QUAD 2-INPT EXCL. NOR GATE	04713	MC3022P
A9U84	1820-0574		IC:DIGITAL TTL QUAD D-F/F	12040	DM8551N
A9U85	1820-0262	4	IC:TTL 8-BIT PAR-IN SER-OUT SHIFT REG.	12040	SD9936
A9U86	1820-0846		IC:TTL DIGITAL QUAD BUFFER	12040	DM 8094N
A9U87	1820-0842	3	IC:TTL 8-BIT PARITY TREE	04713	MC4008P
A9U88	1820-0690		IC:TTL SCHOTTKY DUAL 4-INPT NAND BUFFER	01295	SN74S40N
A9U91	1820-0371		IC:TTL HS TRIPLE 3-INPT NAND GATE	01295	SN74H10N
A9U92	1820-0696		IC:TTL DUAL J-K F/F EDGE TRIGGERED	01295	SN74S114N
A9U93	1820-0373	2	IC:TTL HS DUAL 4-INPT NAND GATE	01295	SN74H20N
A9U94	1820-0837		IC:TTL DUAL 4-INPT NOR GATE	18324	N8815A
A9U95	1820-0424		IC:TTL HS HEX INVERTER	04713	SN74H04N
A9U96	1820-0685		IC:TTL SCHOTTKY TRIPLE 3-INPT NAND GATE	01295	SN74S10N
A9U97	1820-0842		IC:TTL 8-BIT PARITY TREE	04713	MC4008P
A9U98	1820-0755		IC	28480	1820-0755
A9U101	1820-0371		IC:TTL HS TRIPLE 3-INPT NAND GATE	01295	SN74H10N
A9U102	1820-0696		IC:TTL DUAL J-K F/F EDGE TRIGGERED	01295	SN74S114N
A9U103	1820-0617		IC:TTL QUAD 2-INPT EXCL. NOR GATE	04713	MC3022P

Table 2-9. Module Control Unit (MCU) PCA (A9), Replaceable Parts (Continued)

Reference Designation	HP Part Number	Qty	Description	Mfr Code	Mfr Part Number
A9U104	1820-0205		IC:TTL QUAD 2-INPT OR GATE	28480	1820-0205
A9U105	1820-0374		IC:TTL HS DUAL 4-INPT AND GATE	01295	SN74H21N
A9U106	1820-0842		IC:TTL 8-BIT PARITY TREE	04713	MC4008P
A9U107	1820-0262		IC:TTL 8-BIT PAR-IN SER-OUT SHIFT REG.	12040	SD9936
A9U108	1820-0759		IC:TTL LOW-POWER 8-BIT RECEIVER	28480	1820-0759
A9U111	1820-0372	1	IC:TTL TRIPLE 3-INPT AND GATE	28480	1820-0372
A9U112	1820-0696		IC:TTL DUAL J-K F/F EDGE TRIGGERED	01295	SN74S114N
A9U113	1820-0373		IC:TTL HS DUAL 4-INPT NAND GATE	01295	SN74H20N
A9U114	1820-0424		IC:TTL HS HEX INVERTER	04713	SN74H04N
A9U115	1820-0623	1	IC:DIGITAL TTL 4-BIT COMPARATOR	12040	DM8200N
A9U117	1820-0617		IC:TTL QUAD 2-INPT EXCL. NOR GATE	04713	MC3022P
A9U118	1820-0755		IC	28480	1820-0755
A9U121	1820-0535	2	IC:TTL DUAL PERI.2-INPT AND DRIVER	01295	SN75451P
A9U122	1820-0846		IC:TTL DIGITAL QUAD BUFFER	12040	DM 8094N
A9U123	1820-0617		IC:TTL QUAD 2-INPT EXCL. NOR GATE	04713	MC3022P
A9U124	1820-0535		IC:TTL DUAL PERI.2-INPT AND DRIVER	01295	SN75451P
A9U125	1820-0843	3	IC:TTL DUAL DATA DISTRIBUTOR	04713	MC4002P
A9U126	1820-0691		IC:TTL SCHOTTKY 4 W(4-2-3-2)INPT	01295	SN74S64N
A9U127	1820-0262		IC:TTL 8-BIT PAR-IN SER-OUT SHIFT REG.	12040	SD9936
A9U128	1820-0759		IC:TTL LOW-POWER 8-BIT RECEIVER	28480	1820-0759
A9U131	1820-0755		IC	28480	1820-0755
A9U132	1820-0382	1	IC:TTL HS 2 W 4-INPT AND OR INV GATE	01295	SN74H55N
A9U133	1820-0696		IC:TTL DUAL J-K F/F EDGE TRIGGERED	01295	SN74S114N
A9U134	1820-0696		IC:TTL DUAL J-K F/F EDGE TRIGGERED	01295	SN74S114N
A9U135	1820-0574		IC:DIGITAL TTL QUAD D-F/F	12040	DM8551N
A9U136	1820-0682	3	IC:TTL SHS QUAD 2-INPT NAND GATE	01295	SN74S30N
A9U137	1820-0691		IC:TTL SCHOTTKY 4 W(4-2-3-2)INPT	01295	SN74S64N
A9U138	1820-0682		IC:TTL SHS QUAD 2-INPT NAND GATE	01295	SN74S30N
A9U141	1820-0370	2	IC:TTL HS QUAD 2-INPT NAND GATE	01295	SN74H00N
A9U142	1820-0693	2	IC:TTL SCHOTTKY DUAL D F/F W/PRESET	01295	SN74S74N
A9U143	1820-0374		IC:TTL HS DUAL 4-INPT AND GATE	01295	SN74H21N
A9U144	1820-0574		IC:DIGITAL TTL QUAD D-F/F	12040	DM8551N
A9U145	1820-0574		IC:DIGITAL TTL QUAD D-F/F	12040	DM8551N
A9U146	1820-0696		IC:TTL DUAL J-K F/F EDGE TRIGGERED	01295	SN74S114N
A9U147	1820-0691		IC:TTL SCHOTTKY 4 W(4-2-3-2)INPT	01295	SN74S64N
A9U148	1820-0682		IC:TTL SHS QUAD 2-INPT NAND GATE	01295	SN74S30N
A9U151	1820-0837		IC:TTL DUAL 4-INPT NOR GATE	18324	N8815A
A9U152	1820-0693		IC:TTL SCHOTTKY DUAL D F/F W/PRESET	01295	SN74S74N
A9U153	1820-0141		IC:TTL QUAD 2-INPT AND GATE	04713	MC3001P
A9U154	1820-0574		IC:DIGITAL TTL QUAD D-F/F	12040	DM8551N
A9U155	1820-0574		IC:DIGITAL TTL QUAD D-F/F	12040	DM8551N
A9U156	1820-0686		IC:TTL SCHOTTKY TRIPLE 3-INPT AND GATE	01295	SN74S11N
A9U157	1820-0843		IC:TTL DUAL DATA DISTRIBUTOR	04713	MC4002P
A9U158	1820-0843		IC:TTL DUAL DATA DISTRIBUTOR	04713	MC4002P
A9U161	1820-0837		IC:TTL DUAL 4-INPT NOR GATE	18324	N8815A
A9U162	1820-0837		IC:TTL DUAL 4-INPT NOR GATE	18324	N8815A
A9U163	1820-0696		IC:TTL DUAL J-K F/F EDGE TRIGGERED	01295	SN74S114N
A9U164	1820-0696		IC:TTL DUAL J-K F/F EDGE TRIGGERED	01295	SN74S114N
A9U165	1820-0239		IC:TTL QUAD 2-INPT NOR GATE	28480	1820-0239
A9U166	1820-0681		IC:TTL QUAD 2-INPT NAND GATE	01295	SN74S00N
A9U167	1820-0262		IC:TTL 8-BIT PAR-IN SER-OUT SHIFT REG.	12040	SD9936
A9U168	1820-0759		IC:TTL LOW-POWER 8-BIT RECEIVER	28480	1820-0759
A9U171	1820-0837		IC:TTL DUAL 4-INPT NOR GATE	18324	N8815A
A9U172	1820-0837		IC:TTL DUAL 4-INPT NOR GATE	18324	N8815A
A9U173	1820-0205		IC:TTL QUAD 2-INPT OR GATE	28480	1820-0205
A9U174	1820-0370		IC:TTL HS QUAD 2-INPT NAND GATE	01295	SN74H00N
A9U175	1820-0683		IC:TTL SCHOTTKY HEX INVERTER	01295	SN74S04N
A9U176	1820-0690		IC:TTL SCHOTTKY DUAL 4-INPT NAND BUFFER	01295	SN74S40N
A9U177	1820-0375	1	IC:TTL HS 8-INPT NAND GATE	01295	SN74H30N
A9W4	8159-0005		JUMPER WIRE	28480	8159-0005
A9W6	8159-0005		JUMPER WIRE	28480	8159-0005
A9W8	8159-0005		JUMPER WIRE	28480	8159-0005
A9W12	8159-0005		JUMPER WIRE	28480	8159-0005
A9W16	8159-0005		JUMPER WIRE	28480	8159-0005
A9XW2	1251-3322	2	PLUG:16 PIN, DIP	28480	1251-3322
A9XW10	1251-3322		PLUG:16 PIN, DIP	28480	1251-3322

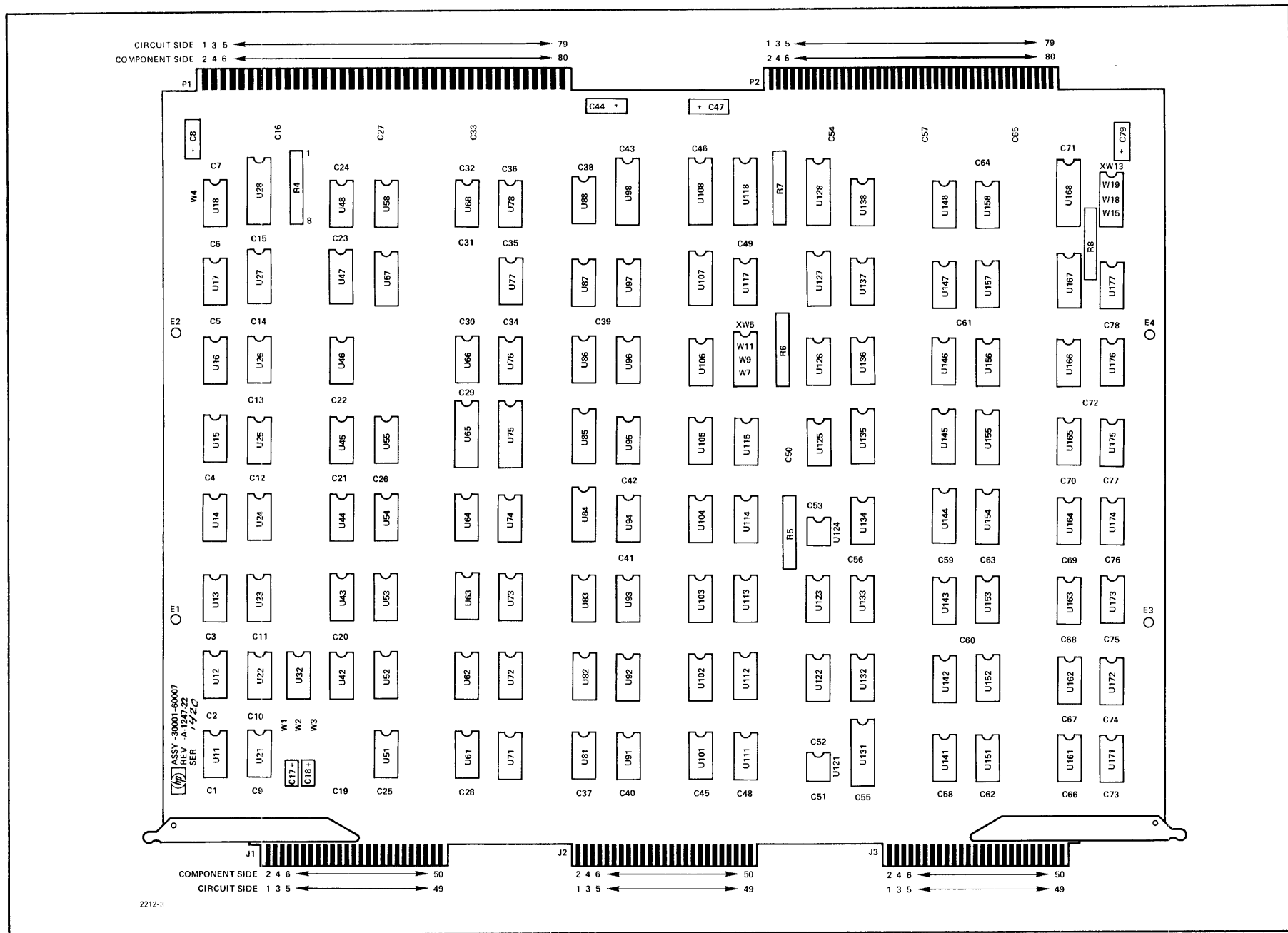

Figure 2-8. Module Control Unit (MCU) PCA (A9), Parts Location Diagram

Table 2-10. Input Output Processor (IOP) PCA (A10), Replaceable Parts

Reference Designation	HP Part Number	Qty	Description	Mfr Code	Mfr Part Number
A10	30001-60008	1	INPUT OUTPUT PROCESSOR (IOP) PCA	28480	30001-60008
A10C1	0160-2055	41	C:FxD CER 0.01 UF +80-20% 100VDCW	56289	C023F101F103ZS22-CDH
A10C2	0160-2055		C:FxD CER 0.01 UF +80-20% 100VDCW	56289	C023F101F103ZS22-CDH
A10C3	0160-2055		C:FxD CER 0.01 UF +80-20% 100VDCW	56289	C023F101F103ZS22-CDH
A10C4	0150-0121	11	C:FxD CER 0.1 UF +80-20% 50VDCW	56289	5C508IS-CML
A10C5	0180-0197	4	C:FxD ELECT 2.2 UF 10% 20VDCW	56289	1500225X9020A2-DYS
A10C6	0160-2055		C:FxD CER 0.01 UF +80-20% 100VDCW	56289	C023F101F103ZS22-CDH
A10C7	J160-2055		C:FxD CER 0.01 UF +80-20% 100VDCW	56289	C023F101F103ZS22-CDH
A10C8	0160-2055		C:FxD CER 0.01 UF +80-20% 100VDCW	56289	C023F101F103ZS22-CDH
A10C9	0150-0121		C:FxD CER 0.1 UF +80-20% 50VDCW	56289	5C508IS-CML
A10C10	0160-2055		C:FxD CER 0.01 UF +80-20% 100VDCW	56289	C023F101F103ZS22-CDH
A10C11	0160-2055		C:FxD CER 0.01 UF +80-20% 100VDCW	56289	C023F101F103ZS22-CDH
A10C12	0160-2055		C:FxD CER 0.01 UF +80-20% 100VDCW	56289	C023F101F103ZS22-CDH
A10C13	0160-2055		C:FxD CER 0.01 UF +80-20% 100VDCW	56289	C023F101F103ZS22-CDH
A10C14	0160-2055		C:FxD CER 0.01 UF +80-20% 100VDCW	56289	C023F101F103ZS22-CDH
A10C15	0160-2055		C:FxD CER 0.01 UF +80-20% 100VDCW	56289	C023F101F103ZS22-CDH
A10C16	0150-0121		C:FxD CER 0.1 UF +80-20% 50VDCW	56289	5C508IS-CML
A10C17	0160-2055		C:FxD CER 0.01 UF +80-20% 100VDCW	56289	C023F101F103ZS22-CDH
A10C18	0160-2055		C:FxD CER 0.01 UF +80-20% 100VDCW	56289	C023F101F103ZS22-CDH
A10C19	0160-2055		C:FxD CER 0.01 UF +80-20% 100VDCW	56289	C023F101F103ZS22-CDH
A10C20	0160-2055		C:FxD CER 0.01 UF +80-20% 100VDCW	56289	C023F101F103ZS22-CDH
A10C21	0160-2055		C:FxD CER 0.01 UF +80-20% 100VDCW	56289	C023F101F103ZS22-CDH
A10C22	0160-2055		C:FxD CER 0.01 UF +80-20% 100VDCW	56289	C023F101F103ZS22-CDH
A10C23	0160-2055		C:FxD CER 0.01 UF +80-20% 100VDCW	56289	C023F101F103ZS22-CDH
A10C24	0150-0121		C:FxD CER 0.1 UF +80-20% 50VDCW	56289	5C508IS-CML
A10C25	0160-2055		C:FxD CER 0.01 UF +80-20% 100VDCW	56289	C023F101F103ZS22-CDH
A10C26	0160-2055		C:FxD CER 0.01 UF +80-20% 100VDCW	56289	C023F101F103ZS22-CDH
A10C27	0160-2055		C:FxD CER 0.01 UF +80-20% 100VDCW	56289	C023F101F103ZS22-CDH
A10C28	0160-2055		C:FxD CER 0.01 UF +80-20% 100VDCW	56289	C023F101F103ZS22-CDH
A10C29	0160-2055		C:FxD CER 0.01 UF +80-20% 100VDCW	56289	C023F101F103ZS22-CDH
A10C30	0150-0121		C:FxD CER 0.1 UF +80-20% 50VDCW	56289	5C508IS-CML
A10C31	0150-0121		C:FxD CER 0.1 UF +80-20% 50VDCW	56289	5C508IS-CML
A10C32	0160-2055		C:FxD CER 0.01 UF +80-20% 100VDCW	56289	C023F101F103ZS22-CDH
A10C33	0150-0121		C:FxD CER 0.1 UF +80-20% 50VDCW	56289	5C508IS-CML
A10C34	0160-2055		C:FxD CER 0.01 UF +80-20% 100VDCW	56289	C023F101F103ZS22-CDH
A10C35	0150-0121		C:FxD CER 0.1 UF +80-20% 50VDCW	56289	5C508IS-CML
A10C36	0160-2055		C:FxD CER 0.01 UF +80-20% 100VDCW	56289	C023F101F103ZS22-CDH
A10C37	0150-0121		C:FxD CER 0.1 UF +80-20% 50VDCW	56289	5C508IS-CML
A10C38	0160-2055		C:FxD CER 0.01 UF +80-20% 100VDCW	56289	C023F101F103ZS22-CDH
A10C39	0150-0121		C:FxD CER 0.1 UF +80-20% 50VDCW	56289	5C508IS-CML
A10C40	0180-0197		C:FxD ELECT 2.2 UF 10% 20VDCW	56289	1500225X9020A2-DYS
A10C41	0160-2055		C:FxD CER 0.01 UF +80-20% 100VDCW	56289	C023F101F103ZS22-CDH
A10C42	0160-2055		C:FxD CER 0.01 UF +80-20% 100VDCW	56289	C023F101F103ZS22-CDH
A10C43	0160-2055		C:FxD CER 0.01 UF +80-20% 100VDCW	56289	C023F101F103ZS22-CDH
A10C44	0160-2055		C:FxD CER 0.01 UF +80-20% 100VDCW	56289	C023F101F103ZS22-CDH
A10C45	0160-2055		C:FxD CER 0.01 UF +80-20% 100VDCW	56289	C023F101F103ZS22-CDH
A10C46	0180-0197		C:FxD ELECT 2.2 UF 10% 20VDCW	56289	1500225X9020A2-DYS
A10C47	J160-2055		C:FxD CER 0.01 UF +80-20% 100VDCW	56289	C023F101F103ZS22-CDH
A10C48	0160-2055		C:FxD CER 0.01 UF +80-20% 100VDCW	56289	C023F101F103ZS22-CDH
A10C49	0160-2055		C:FxD CER 0.01 UF +80-20% 100VDCW	56289	C023F101F103ZS22-CDH
A10C50	0160-2055		C:FxD CER 0.01 UF +80-20% 100VDCW	56289	C023F101F103ZS22-CDH
A10C51	0160-2055		C:FxD CER 0.01 UF +80-20% 100VDCW	56289	C023F101F103ZS22-CDH
A10C52	0160-2055		C:FxD CER 0.01 UF +80-20% 100VDCW	56289	C023F101F103ZS22-CDH
A10C53	0160-2055		C:FxD CER 0.01 UF +80-20% 100VDCW	56289	C023F101F103ZS22-CDH
A10C54	0150-0121		C:FxD CER 0.1 UF +80-20% 50VDCW	56289	5C508IS-CML
A10C55	0160-2055		C:FxD CER 0.01 UF +80-20% 100VDCW	56289	C023F101F103ZS22-CDH
A10C56	0180-0197		C:FxD ELECT 2.2 UF 10% 20VDCW	56289	1500225X9020A2-DYS
A10R1	0757-0280	9	R:FxD MET FLM 1K OHM 1% 1/8W	28480	0757-0280
A10R2	0757-0416	2	R:FxD MET FLM 511 OHM 1% 1/8W	28480	0757-0416
A10R3	0757-0416		R:FxD MET FLM 511 OHM 1% 1/8W	28480	0757-0416
A10R4	0757-0280		R:FxD MET FLM 1K OHM 1% 1/8W	28480	0757-0280
A10R5	0757-0280		R:FxD MET FLM 1K OHM 1% 1/8W	28480	0757-0280
A10R8	0757-0280		R:FxD MET FLM 1K OHM 1% 1/8W	28480	0757-0280
A10R9	0757-0280		R:FxD MET FLM 1K OHM 1% 1/8W	28480	0757-0280
A10R10	0757-0280		R:FxD MET FLM 1K OHM 1% 1/8W	28480	0757-0280
A10R11	0757-0280		R:FxD MET FLM 1K OHM 1% 1/8W	28480	0757-0280
A10R12	0757-0280		R:FxD MET FLM 1K OHM 1% 1/8W	28480	0757-0280
A10R13	0757-0280		R:FxD MET FLM 1K OHM 1% 1/8W	28480	0757-0280
A10R14	0757-0401	1	R:FxD MET FLM 100 OHM 1% 1/8W	28480	0757-0401
A10S1	3100-2687	3	SWITCH:ROTARY SP5T 6 POSITION	28480	3100-2687
A10S2	3100-2687		SWITCH:ROTARY SP5T 6 POSITION	28480	3100-2687
A10S3	3100-2687		SWITCH:ROTARY SP5T 6 POSITION	28480	3100-2687
A10U11	1820-0140	5	IC:TTL DUAL 4-INPT AND BUFFER	04713	MC3026P

Table 2-10. Input Output Processor (IOP) PCA (A10), Replaceable Parts (Continued)

Reference Designation	HP Part Number	Qty	Description	Mfr Code	Mfr Part Number
A10U12	1820-0696	10	IC:TTL DUAL J-K F/F EDGE TRIGGERED	01295	SN74S114N
A10U13	1820-0205	3	IC:TTL QUAD 2-INPT OR GATE	28480	1820-0205
A10U14	1820-0695	1	IC:TTL SHS DUAL J-K F/F W/PRESET	01295	SN74S113N
A10U15	1820-0681	4	IC:TTL QUAD 2-INPT NAND GATE	01295	SN74S00N
A10U16	1820-0685	9	IC:TTL SCHOTTKY TRIPLE 3-INPT NAND GATE	01295	SN74S10N
A10U17	1820-0696		IC:TTL DUAL J-K F/F EDGE TRIGGERED	01295	SN74S114N
A10U18	1820-0535	1	IC:TTL DUAL PERI.2-INPT AND DRIVER	01295	SN74S451P
A10U19	1820-0697	1	IC:TTL DUAL 4-INPT LINE DRIVER	01295	SN74S140N
A10U21	1820-0696		IC:TTL DUAL J-K F/F EDGE TRIGGERED	01295	SN74S114N
A10U22	1820-0681		IC:TTL QUAD 2-INPT NAND GATE	01295	SN74S00N
A10U23	1820-0262	2	IC:TTL 8-BIT PAR-IN SER-OUT SHIFT REG.	12040	SD9936
A10U24	1820-0262		IC:TTL 8-BIT PAR-IN SER-OUT SHIFT REG.	12040	SD9936
A10U25	1820-0140		IC:TTL DUAL 4-INPT AND BUFFER	04713	MC3026P
A10U26	1820-0374	2	IC:TTL HS DUAL 4-INPT AND GATE	01295	SN74H21N
A10U28	1820-0690	3	IC:TTL SCHOTTKY DUAL 4-INPT NAND BUFFER	01295	SN74S40N
A10U29	1820-0690		IC:TTL SCHOTTKY DUAL 4-INPT NAND BUFFER	01295	SN74S40N
A10U31	1820-0683	3	IC:TTL SCHOTTKY HEX INVERTER	01295	SN74S04N
A10U32	1820-0691	1	IC:TTL SCHOTTKY 4 W(4-2-3-2) INPT	01295	SN74S64N
A10U33	1820-0685		IC:TTL SCHOTTKY TRIPLE 3-INPT NAND GATE	01295	SN74S10N
A10U34	1820-0681		IC:TTL QUAD 2-INPT NAND GATE	01295	SN74S00N
A10U35	1820-0685		IC:TTL SCHOTTKY TRIPLE 3-INPT NAND GATE	01295	SN74S10N
A10U36	1820-0696		IC:TTL DUAL J-K F/F EDGE TRIGGERED	01295	SN74S114N
A10U37	1820-0374		IC:TTL HS DUAL 4-INPT AND GATE	01295	SN74H21N
A10U38	1820-0756	8	IC:TTL 8-BIT DRIVER INVERTING	28480	1820-0756
A10U39	1820-0512	2	IC:TTL HS DUAL D F/F(35 MHZ MIN.)	01295	SN74H74N
A10U40	1820-0512		IC:TTL HS DUAL D F/F(35 MHZ MIN.)	01295	SN74H74N
A10U42	1820-0685		IC:TTL SCHOTTKY TRIPLE 3-INPT NAND GATE	01295	SN74S10N
A10U43	1820-0696		IC:TTL DUAL J-K F/F EDGE TRIGGERED	01295	SN74S114N
A10U44	1820-0681		IC:TTL QUAD 2-INPT NAND GATE	01295	SN74S00N
A10U45	1820-0688	2	IC:TTL SCHOTTKY DUAL 4-INPT NAND GATE	01295	SN74S20N
A10U46	1820-0696		IC:TTL DUAL J-K F/F EDGE TRIGGERED	01295	SN74S114N
A10U47	1820-0140		IC:TTL DUAL 4-INPT AND BUFFER	04713	MC3026P
A10U48	1820-0760	5	IC:TTL 8-BIT RECEIVER INVERTING	28480	1820-0760
A10U51	1820-0696		IC:TTL DUAL J-K F/F EDGE TRIGGERED	01295	SN74S114N
A10U52	1820-0696		IC:TTL DUAL J-K F/F EDGE TRIGGERED	01295	SN74S114N
A10U53	1820-0685		IC:TTL SCHOTTKY TRIPLE 3-INPT NAND GATE	01295	SN74S10N
A10U54	1820-0239	3	IC:TTL QUAD 2-INPT NOR GATE	28480	1820-0239
A10U55	1820-0760		IC:TTL 8-BIT RECEIVER INVERTING	28480	1820-0760
A10U56	1820-0756		IC:TTL 8-BIT DRIVER INVERTING	28480	1820-0756
A10U58	1820-0756		IC:TTL 8-BIT DRIVER INVERTING	28480	1820-0756
A10U61	1820-0205		IC:TTL QUAD 2-INPT OR GATE	28480	1820-0205
A10U62	1820-0696		IC:TTL DUAL J-K F/F EDGE TRIGGERED	01295	SN74S114N
A10U64	1820-0688		IC:TTL SCHOTTKY DUAL 4-INPT NAND GATE	01295	SN74S20N
A10U65	1820-0574	19	IC:DIGITAL TTL QUAD D-F/F	12040	DM8551N
A10U66	1820-0574		IC:DIGITAL TTL QUAD D-F/F	12040	DM8551N
A10U66	1820-0574		IC:DIGITAL TTL QUAD D-F/F	12040	DM8551N
A10U71	1820-0239		IC:TTL QUAD 2-INPT NOR GATE	28480	1820-0239
A10U72	1820-0140		IC:TTL DUAL 4-INPT AND BUFFER	04713	MC3026P
A10U73	1820-0574		IC:DIGITAL TTL QUAD D-F/F	12040	DM8551N
A10U74	1820-0574		IC:DIGITAL TTL QUAD D-F/F	12040	DM8551N
A10U75	1820-0574		IC:DIGITAL TTL QUAD D-F/F	12040	DM8551N
A10U76	1820-0574		IC:DIGITAL TTL QUAD D-F/F	12040	DM8551N
A10U77	1820-0574		IC:DIGITAL TTL QUAD D-F/F	12040	DM8551N
A10U78	1820-0574		IC:DIGITAL TTL QUAD D-F/F	12040	DM8551N
A10U81	1820-0140		IC:TTL DUAL 4-INPT AND BUFFER	04713	MC3026P
A10U82	1820-0239		IC:TTL QUAD 2-INPT NOR GATE	28480	1820-0239
A10U91	1820-0696		IC:TTL DUAL J-K F/F EDGE TRIGGERED	01295	SN74S114N
A10U92	1820-0637	1	IC:TTL DUAL 4-INPT NOR GATE	18324	N8815A
A10U94	1820-0755	13	IC	28480	1820-0755
A10U95	1820-0574		IC:DIGITAL TTL QUAD D-F/F	12040	DM8551N
A10U96	1820-0574		IC:DIGITAL TTL QUAD D-F/F	12040	DM8551N
A10U97	1820-0574		IC:DIGITAL TTL QUAD D-F/F	12040	DM8551N
A10U98	1820-0574		IC:DIGITAL TTL QUAD D-F/F	12040	DM8551N
A10U101	1820-0375	2	IC:TTL HS 8-INPT NAND GATE	01295	SN74H30N
A10U102	1820-0205		IC:TTL QUAD 2-INPT OR GATE	28480	1820-0205
A10U104	1820-0683		IC:TTL SCHOTTKY HEX INVERTER	01295	SN74S04N
A10U105	1820-0724	1	IC:TTL DUAL 2-4 DECODER W/ENABLE	04713	MC4007P
A10U106	1820-0756		IC:TTL 8-BIT DRIVER INVERTING	28480	1820-0756
A10U107	1820-0756		IC:TTL 8-BIT DRIVER INVERTING	28480	1820-0756
A10U108	1820-0685		IC:TTL SCHOTTKY TRIPLE 3-INPT NAND GATE	01295	SN74S10N
A10U109	1820-0686	1	IC:TTL SCHOTTKY TRIPLE 3-INPT AND GATE	01295	SN74S11N
A10U111	1820-0375		IC:TTL HS 8-INPT NAND GATE	01295	SN74H30N
A10U114	1820-0756		IC:TTL 8-BIT DRIVER INVERTING	28480	1820-0756
A10U124	1820-0756		IC:TTL 8-BIT DRIVER INVERTING	28480	1820-0756
A10U125	1820-0755		IC	28480	1820-0755

Table 2-10. Input Output Processor (IOP) PCA (A10), Replaceable Parts (Continued)

Reference Designation	HP Part Number	Qty	Description	Mfr Code	Mfr Part Number
A10U126	1820-0756		IC:TTL 8-BIT DRIVER INVERTING	28480	1820-0756
A10U128	1820-0755		IC	28480	1820-0755
A10U131	1820-0685		IC:TTL SCHOTTKY TRIPLE 3-INPT NAND GATE	01295	SN74S10N
A10U132	1820-0685		IC:TTL SCHOTTKY TRIPLE 3-INPT NAND GATE	01295	SN74S10N
A10U133	1820-0685		IC:TTL SCHOTTKY TRIPLE 3-INPT NAND GATE	01295	SN74S10N
A10U134	1820-0301	5	IC:TTL QUAD BI-STABLE D-LATCH	01295	SN7475N
A10U135	1820-0301		IC:TTL QUAD BI-STABLE D-LATCH	01295	SN7475N
A10U136	1820-0301		IC:TTL QUAD BI-STABLE D-LATCH	01295	SN7475N
A10U137	1820-0301		IC:TTL QUAD BI-STABLE D-LATCH	01295	SN7475N
A10U138	1820-0301		IC:TTL QUAD BI-STABLE D-LATCH	01295	SN7475N
A10U141	1820-0683		IC:TTL SCHOTTKY HEX INVERTER	01295	SN74S04N
A10U145	1820-0759	3	IC:TTL LOW-POWER 8-BIT RECEIVER	28480	1820-0759
A10U146	1820-0759		IC:TTL LOW-POWER 8-BIT RECEIVER	28480	1820-0759
A10U147	1820-0759		IC:TTL LOW-POWER 8-BIT RECEIVER	28480	1820-0759
A10U148	1820-0690		IC:TTL SCHOTTKY DUAL 4-INPT NAND BUFFER	01295	SN74S40N
A10U151	1820-0755		IC	28480	1820-0755
A10U152	1820-0755		IC	28480	1820-0755
A10U158	1820-0755		IC	28480	1820-0755
A10U161	1820-0755		IC	28480	1820-0755
A10U163	1820-0755		IC	28480	1820-0755
A10U164	1820-0755		IC	28480	1820-0755
A10U165	1820-0755		IC	28480	1820-0755
A10U166	1820-0842	2	IC:TTL 8-BIT PARITY TREE	04713	MC4008P
A10U167	1820-0755		IC	28480	1820-0755
A10U168	1820-0842		IC:TTL 8-BIT PARITY TREE	04713	MC4008P
A10U172	1820-0755		IC	28480	1820-0755
A10U178	1820-0755		IC	28480	1820-0755
A10U183	1820-0623	1	IC:DIGITAL TTL 4-BIT COMPARATOR	12040	DM8200N
A10U184	1820-0574		IC:DIGITAL TTL QUAD D-F/F	12040	DM8551N
A10U185	1820-0716	4	IC:TTL SYNC PRESET 4-BIT BINARY COUNTER	01295	SN74161N
A10U186	1820-0716		IC:TTL SYNC PRESET 4-BIT BINARY COUNTER	01295	SN74161N
A10U187	1820-0716		IC:TTL SYNC PRESET 4-BIT BINARY COUNTER	01295	SN74161N
A10U188	1820-0716		IC:TTL SYNC PRESET 4-BIT BINARY COUNTER	01295	SN74161N
A10U196	1820-0574		IC:DIGITAL TTL QUAD D-F/F	12040	DM8551N
A10U197	1820-0760		IC:TTL 8-BIT RECEIVER INVERTING	28480	1820-0760
A10U198	1820-0760		IC:TTL 8-BIT RECEIVER INVERTING	28480	1820-0760
A10U201	1820-0574		IC:DIGITAL TTL QUAD D-F/F	12040	DM8551N
A10U202	1820-0574		IC:DIGITAL TTL QUAD D-F/F	12040	DM8551N
A10U203	1820-0574		IC:DIGITAL TTL QUAD D-F/F	12040	DM8551N
A10U204	1820-0574		IC:DIGITAL TTL QUAD D-F/F	12040	DM8551N
A10U206	1820-0760		IC:TTL 8-BIT RECEIVER INVERTING	28480	1820-0760
A10XW1	1251-3323	1	PLUG:8 PIN, DIR	28480	1251-3323

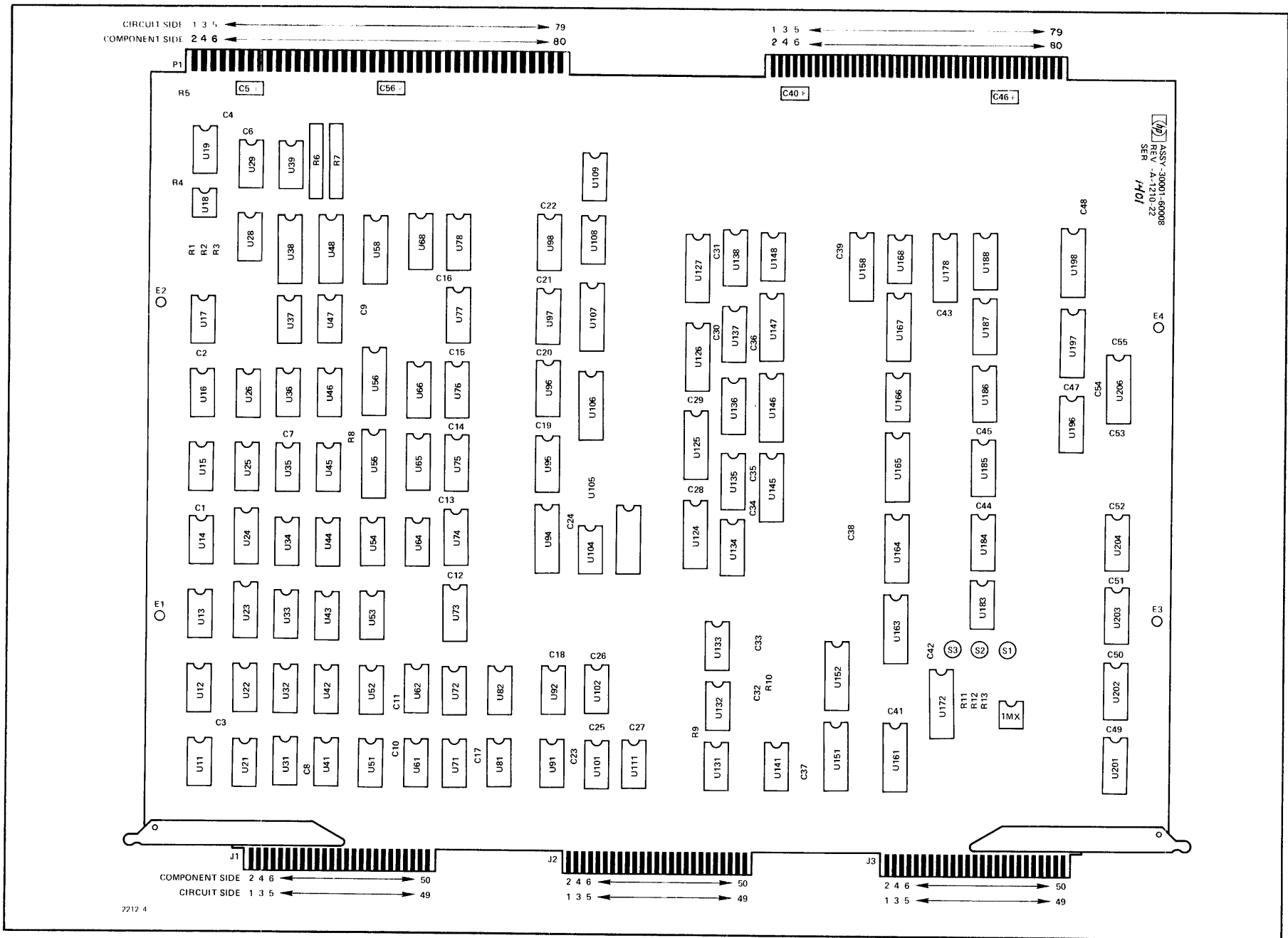

Figure 2-9. Input/Output Processor (IOP) PCA (A10), Parts Location Diagram

Table 2-11. Central Data Bus Terminator PCA, Replaceable Parts

Reference Designation	HP Part Number	Qty	Description	Mfr Code	Mfr Part Number
	30001-60009	1	CENTRAL DATA BUS TERMINATOR PCA	28480	30001-60009
C2	0180-0229	2	C:FXD ELECT 33 UF 10% 10VDCW	28480	0180-0229
C3	0180-0229		C:FXD ELECT 33 UF 10% 10VDCW	28480	0180-0229
C5	0160-0127	4	C:FXD CER 1.0 UF 20% 25VDCW	56289	5C13CS-CML
C6	0160-0127		C:FXD CER 1.0 UF 20% 25VDCW	56289	5C13CS-CML
C7	0160-0127		C:FXD CER 1.0 UF 20% 25VDCW	56289	5C13CS-CML
C8	0160-0127		C:FXD CER 1.0 UF 20% 25VDCW	56289	5C13CS-CML
R1	1810-0080	6	R:NETWORK 7 X 500 OHM 5% 0.15W EACH	28480	1810-0080
R2	1810-0123	5	RESISTIVE NETWORK:7 X 330 OHM 5% 0.15W	28480	1810-0123
R3	1810-0080		R:NETWORK 7 X 500 OHM 5% 0.15W EACH	28480	1810-0080
R4	1810-0123		RESISTIVE NETWORK:7 X 330 OHM 5% 0.15W	28480	1810-0123
R5	1810-0123		RESISTIVE NETWORK:7 X 330 OHM 5% 0.15W	28480	1810-0123
R6	1810-0080		R:NETWORK 7 X 500 OHM 5% 0.15W EACH	28480	1810-0080
R7	1810-0080		R:NETWORK 7 X 500 OHM 5% 0.15W EACH	28480	1810-0080
R8	1810-0123		RESISTIVE NETWORK:7 X 330 OHM 5% 0.15W	28480	1810-0123
R9	1810-0080		R:NETWORK 7 X 500 OHM 5% 0.15W EACH	28480	1810-0080
R10	1810-0123		RESISTIVE NETWORK:7 X 330 OHM 5% 0.15W	28480	1810-0123
R11	1810-0080		R:NETWORK 7 X 500 OHM 5% 0.15W EACH	28480	1810-0080

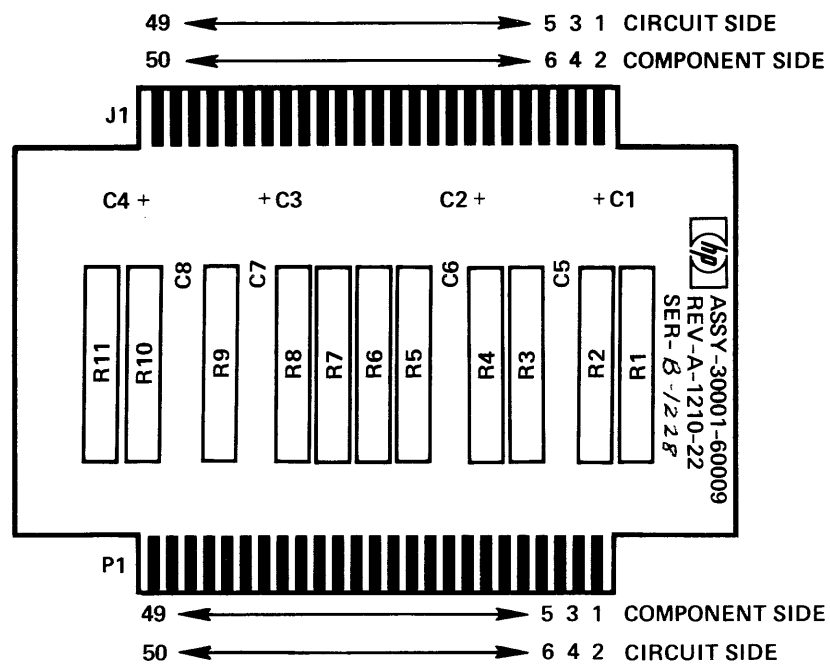

Figure 2-10. Central Data Bus Terminator PCA, Parts Location Diagram

Table 2-12. Input/Output Processor Bus Terminator PCA, Replaceable Parts

Reference Designation	HP Part Number	Qty	Description	Mfr Code	Mfr Part Number
C1	30001-60016	1	INPUT/OUTPUT PROCESSOR BUS TERMINATOR PCA	28480	30001-60016
C2	0160-2940	34	C:FXD MICA 470 PF 5% 300VDCW	72136	RDM15F471J3C
C3	0160-2940		C:FXD MICA 470 PF 5% 300VDCW	72136	RDM15F471J3C
C5	0160-2940		C:FXD MICA 470 PF 5% 300VDCW	72136	RDM15F471J3C
C7	0160-2940		C:FXD MICA 470 PF 5% 300VDCW	72136	RDM15F471J3C
C10	0150-0121	5	C:FXD CER 0.1 UF +80-20% 50VDCW	56289	5C508IS-CML
C11	0180-0197	5	C:FXD ELECT 2.2 UF 10% 20VDCW	56289	150D225X9020A2-DYS
C12	0150-0121		C:FXD CER 0.1 UF +80-20% 50VDCW	56289	5C508IS-CML
C13	0180-0197		C:FXD ELECT 2.2 UF 10% 20VDCW	56289	150D225X9020A2-DYS
C14	0150-0121		C:FXD CER 0.1 UF +80-20% 50VDCW	56289	5C508IS-CML
C15	0180-0197		C:FXD ELECT 2.2 UF 10% 20VDCW	56289	150D225X9020A2-DYS
C17	0160-2940		C:FXD MICA 470 PF 5% 300VDCW	72136	RDM15F471J3C
C19	0160-2940		C:FXD MICA 470 PF 5% 300VDCW	72136	RDM15F471J3C
C21	0160-2940		C:FXD MICA 470 PF 5% 300VDCW	72136	RDM15F471J3C
C23	0160-2940		C:FXD MICA 470 PF 5% 300VDCW	72136	RDM15F471J3C
C24	0160-2940		C:FXD MICA 470 PF 5% 300VDCW	72136	RDM15F471J3C
C25	0160-2940		C:FXD MICA 470 PF 5% 300VDCW	72136	RDM15F471J3C
C26	0160-2940		C:FXD MICA 470 PF 5% 300VDCW	72136	RDM15F471J3C
C27	0160-2940		C:FXD MICA 470 PF 5% 300VDCW	72136	RDM15F471J3C
C28	0160-2940		C:FXD MICA 470 PF 5% 300VDCW	72136	RDM15F471J3C
C29	0160-2940		C:FXD MICA 470 PF 5% 300VDCW	72136	RDM15F471J3C
C30	0160-2940		C:FXD MICA 470 PF 5% 300VDCW	72136	RDM15F471J3C
C31	0160-2940		C:FXD MICA 470 PF 5% 300VDCW	72136	RDM15F471J3C
C32	0160-2940		C:FXD MICA 470 PF 5% 300VDCW	72136	RDM15F471J3C
C33	0180-0197		C:FXD ELECT 2.2 UF 10% 20VDCW	56289	150D225X9020A2-DYS
C34	0150-0121		C:FXD CER 0.1 UF +80-20% 50VDCW	56289	5C508IS-CML
C35	0150-0121		C:FXD CER 0.1 UF +80-20% 50VDCW	56289	5C508IS-CML
C36	0180-0197		C:FXD ELECT 2.2 UF 10% 20VDCW	56289	150D225X9020A2-DYS
C37	0160-2940		C:FXD MICA 470 PF 5% 300VDCW	72136	RDM15F471J3C
C38	0160-2940		C:FXD MICA 470 PF 5% 300VDCW	72136	RDM15F471J3C
C39	0160-2940		C:FXD MICA 470 PF 5% 300VDCW	72136	RDM15F471J3C
C40	0160-2940		C:FXD MICA 470 PF 5% 300VDCW	72136	RDM15F471J3C
C41	0160-2940		C:FXD MICA 470 PF 5% 300VDCW	72136	RDM15F471J3C
C42	0160-2940		C:FXD MICA 470 PF 5% 300VDCW	72136	RDM15F471J3C
C43	0160-2940		C:FXD MICA 470 PF 5% 300VDCW	72136	RDM15F471J3C
C44	0160-2940		C:FXD MICA 470 PF 5% 300VDCW	72136	RDM15F471J3C
R1	0757-0399	34	R:FXD MET FLM 82.5 OHM 1% 1/8W	28480	0757-0399
R2	0757-0399		R:FXD MET FLM 82.5 OHM 1% 1/8W	28480	0757-0399
R3	0757-0399		R:FXD MET FLM 82.5 OHM 1% 1/8W	28480	0757-0399
R5	0757-0399		R:FXD MET FLM 82.5 OHM 1% 1/8W	28480	0757-0399
R7	0757-0399		R:FXD MET FLM 82.5 OHM 1% 1/8W	28480	0757-0399
R10	1810-0030	5	NETWORK:7 RESISTORS 1K OHM 5% 0.15W EA	28480	1810-0030
R11	1810-0080	5	R:NETWORK 7 X 500 OHM 5% 0.15W EACH	28480	1810-0080
R12	1810-0030		NETWORK:7 RESISTORS 1K OHM 5% 0.15W EA	28480	1810-0030
R13	1810-0080		R:NETWORK 7 X 500 OHM 5% 0.15W EACH	28480	1810-0080
R14	1810-0080		R:NETWORK 7 X 500 OHM 5% 0.15W EACH	28480	1810-0080
R15	1810-0030		NETWORK:7 RESISTORS 1K OHM 5% 0.15W EA	28480	1810-0030
R16	0757-0399		R:FXD MET FLM 82.5 OHM 1% 1/8W	28480	0757-0399
R18	0757-0399		R:FXD MET FLM 82.5 OHM 1% 1/8W	28480	0757-0399
R20	0757-0399		R:FXD MET FLM 82.5 OHM 1% 1/8W	28480	0757-0399
R22	0757-0399		R:FXD MET FLM 82.5 OHM 1% 1/8W	28480	0757-0399
R24	0757-0399		R:FXD MET FLM 82.5 OHM 1% 1/8W	28480	0757-0399
R25	0757-0399		R:FXD MET FLM 82.5 OHM 1% 1/8W	28480	0757-0399
R26	0757-0399		R:FXD MET FLM 82.5 OHM 1% 1/8W	28480	0757-0399
R27	0757-0399		R:FXD MET FLM 82.5 OHM 1% 1/8W	28480	0757-0399
R28	0757-0399		R:FXD MET FLM 82.5 OHM 1% 1/8W	28480	0757-0399
R29	0757-0399		R:FXD MET FLM 82.5 OHM 1% 1/8W	28480	0757-0399
R30	0757-0399		R:FXD MET FLM 82.5 OHM 1% 1/8W	28480	0757-0399

Table 2-12. Input/Output Processor Bus Terminator PCA, Replaceable Parts (Continued)

Reference Designation	HP Part Number	Qty	Description	Mfr Code	Mfr Part Number
R31	0757-0399		R:FxD MET FLM 82.5 OHM 1% 1/8W	28480	0757-0399
R32	1810-0080		R:NETWORK 7 X 500 OHM 5% 0.15W EACH	28480	1810-0080
R33	1810-0030		NETWORK:7 RESISTORS 1K OHM 5% 0.15W EA	28480	1810-0030
R34	1810-0080		R:NETWORK 7 X 500 OHM 5% 0.15W EACH	28480	1810-0080
R35	1810-0030		NETWORK:7 RESISTORS 1K OHM 5% 0.15W EA	28480	1810-0030
R36	0757-0399		R:FxD MET FLM 82.5 OHM 1% 1/8W	28480	0757-0399
R37	0757-0399		R:FxD MET FLM 82.5 OHM 1% 1/8W	28480	0757-0399
R38	0757-0399		R:FxD MET FLM 82.5 OHM 1% 1/8W	28480	0757-0399
R39	0757-0399		R:FxD MET FLM 82.5 OHM 1% 1/8W	28480	0757-0399
R40	0757-0399		R:FxD MET FLM 82.5 OHM 1% 1/8W	28480	0757-0399
R41	0757-0399		R:FxD MET FLM 82.5 OHM 1% 1/8W	28480	0757-0399
R42	0757-0399		R:FxD MET FLM 82.5 OHM 1% 1/8W	28480	0757-0399
R43	0757-0399		R:FxD MET FLM 82.5 OHM 1% 1/8W	28480	0757-0399
R44	0757-0399		R:FxD MET FLM 82.5 OHM 1% 1/8W	28480	0757-0399

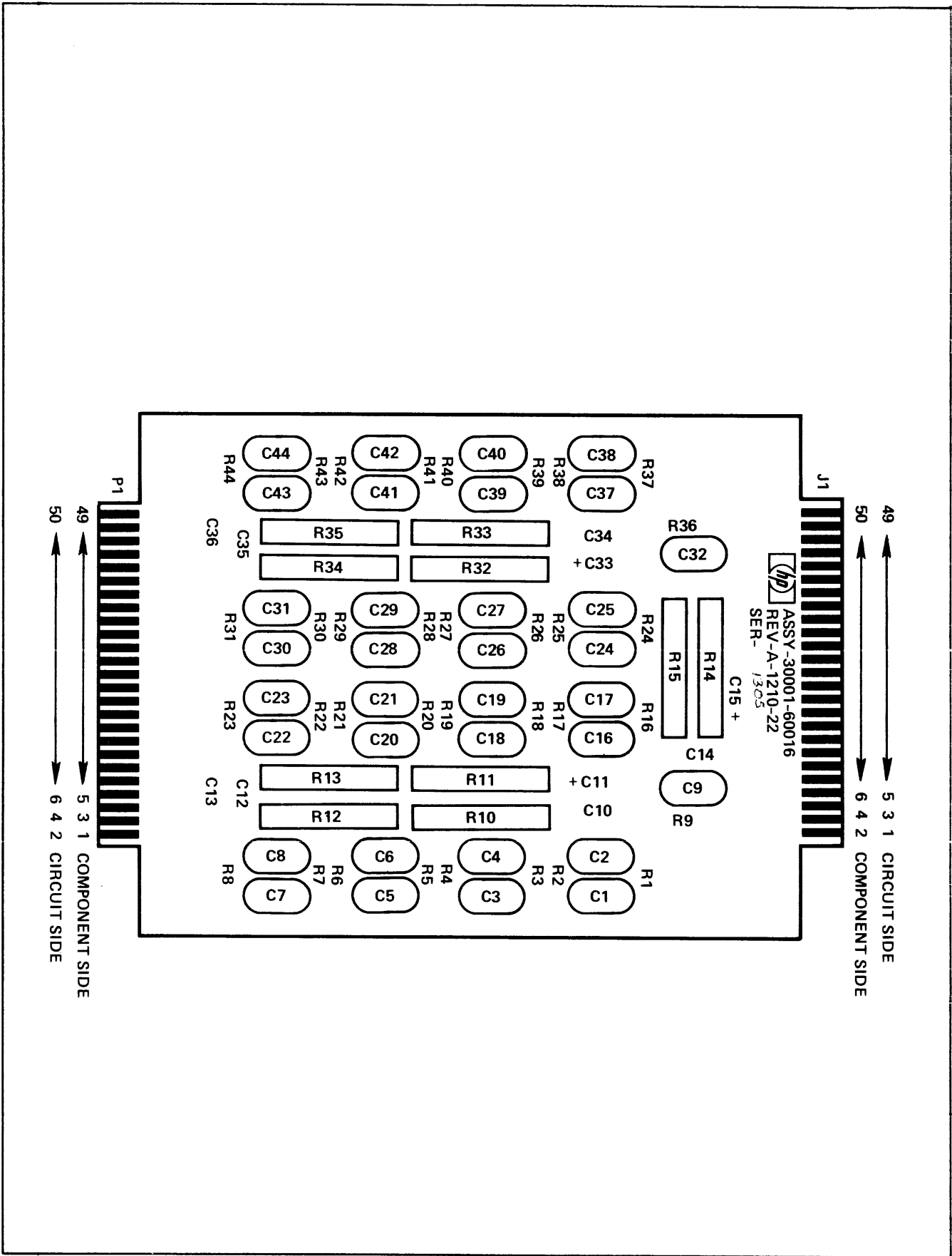

2212-20

Figure 2-11. Input/Output Processor Bus Terminator PCA, Parts Location Diagram

Table 2-13. Power Bus Terminator PCA, Replaceable Parts

Reference Designation	HP Part Number	Qty	Description	Mfr Code	Mfr Part Number
C1	30001-60021	1	POWER BUS TERMINATOR PCA	28480	30001-60021
C2	0150-0121	2	C:FxD CER 0.1 UF +80-20% 50VDCW	56289	5C5081S-CML
C3	0180-0197	1	C:FxD ELECT 2.2 UF 10% 20VDCW	56289	1500225X9020A2-DYS
C4	0160-0127	1	C:FxD CER 1.0 UF 20% 25VDCW	56289	5C13CS-CML
	0150-0121	1	C:FxD CER 0.1 UF +80-20% 50VDCW	56289	5C5081S-CML
J1	1251-3119	1	CONNECTOR:R & P, 20 CONTACT	66346	3428-2002
R1	0757-0280	2	R:FxD MET FLM 1K OHM 1% 1/8W	28480	0757-0280
R2	1810-0080	1	R:NETWORK 7 X 500 OHM 5% 0.15W EACH	28480	1810-0080
R3	1810-0030	1	NETWORK:7 RESISTORS 1K OHM 5% 0.15W EA	28480	1810-0030
R4	0757-0276	1	R:FxD MET FLM 61.9 OHM 1% 1/8W	28480	0757-0276
R5	0757-1060	1	R:FxD MET FLM 196 OHM 1% 1/2W	28480	0757-1060
R6	0757-0280	1	R:FxD MET FLM 1K OHM 1% 1/8W	28480	0757-0280
R6	0757-0198	2	R:FxD MET FLM 100 OHM 1% 1/2W	28480	0757-0198
R7	0757-0198	1	R:FxD MET FLM 100 OHM 1% 1/2W	28480	0757-0198
U1	1820-0756	1	IC:TTL 8-BIT DRIVER INVERTING	28480	1820-0756
W1	8159-0005	2	JUMPER WIRE	28480	8159-0005
W2	8159-0005	2	JUMPER WIRE	28480	8159-0005

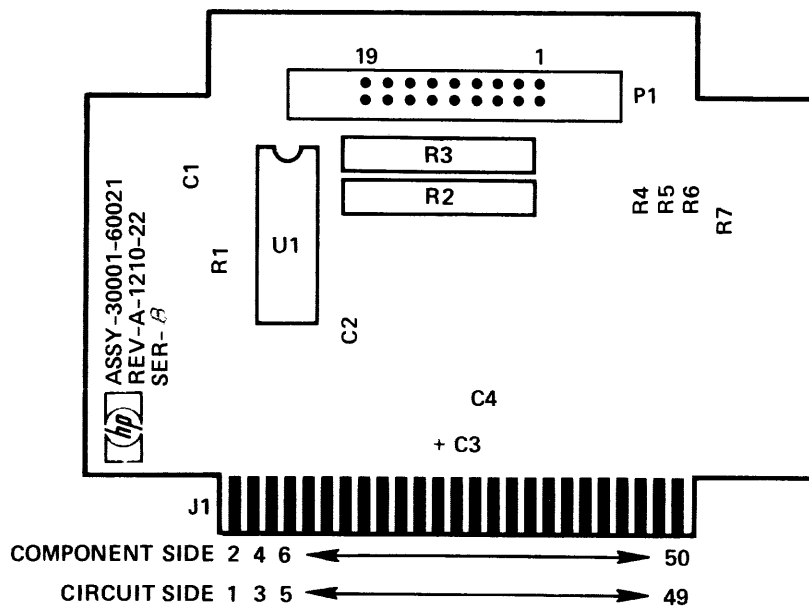

2212-21

Figure 2-12. Power Bus Terminator PCA, Parts Location Diagram

Table 2-14. Control Assembly, Replaceable Parts

Reference Designation	HP Part Number	Qty	Description	Mfr Code	Mfr Part Number
C1	30001-60010	1	CONTROL ASSY	28480	30001-60010
C2	0180-0229	9	C:FXD ELECT 33 UF 10% 10VDCW	28480	0180-0229
C3	0160-2055	15	C:FXD CER 0.01 UF +80-20% 100VDCW	56289	C023F101F103ZS22-CDH
C4	0180-0229		C:FXD CER 0.01 UF +80-20% 100VDCW	56289	C023F101F103ZS22-CDH
			C:FXD ELECT 33 UF 10% 10VDCW	28480	0180-0229
C5	0160-2055		C:FXD CER 0.01 UF +80-20% 100VDCW	56289	C023F101F103ZS22-CDH
C6	0160-2055		C:FXD CER 0.01 UF +80-20% 100VDCW	56289	C023F101F103ZS22-CDH
C7	0180-0229		C:FXD ELECT 33 UF 10% 10VDCW	28480	0180-0229
C8	0180-0229		C:FXD ELECT 33 UF 10% 10VDCW	28480	0180-0229
C9	0160-2055		C:FXD CER 0.01 UF +80-20% 100VDCW	56289	C023F101F103ZS22-CDH
C10	0160-2055		C:FXD CER 0.01 UF +80-20% 100VDCW	56289	C023F101F103ZS22-CDH
C11	0160-2055		C:FXD CER 0.01 UF +80-20% 100VDCW	56289	C023F101F103ZS22-CDH
C12	0180-0229		C:FXD ELECT 33 UF 10% 10VDCW	28480	0180-0229
C13	0160-2055		C:FXD CER 0.01 UF +80-20% 100VDCW	56289	C023F101F103ZS22-CDH
C14	0160-2055		C:FXD CER 0.01 UF +80-20% 100VDCW	56289	C023F101F103ZS22-CDH
C15	0180-0229		C:FXD ELECT 33 UF 10% 10VDCW	28480	0180-0229
C16	0160-2055		C:FXD CER 0.01 UF +80-20% 100VDCW	56289	C023F101F103ZS22-CDH
C17	0160-2055		C:FXD CER 0.01 UF +80-20% 100VDCW	56289	C023F101F103ZS22-CDH
C18	0180-0229		C:FXD ELECT 33 UF 10% 10VDCW	28480	0180-0229
C19	0160-2055		C:FXD CER 0.01 UF +80-20% 100VDCW	56289	C023F101F103ZS22-CDH
C20	0160-0127	1	C:FXD CER 1.0 UF 20% 25VDCW	56289	5C13CS-CML
C21	0160-2055		C:FXD CER 0.01 UF +80-20% 100VDCW	56289	C023F101F103ZS22-CDH
C22	0180-0229		C:FXD ELECT 33 UF 10% 10VDCW	28480	0180-0229
C23	0160-2055		C:FXD CER 0.01 UF +80-20% 100VDCW	56289	C023F101F103ZS22-CDH
C24	0180-0229		C:FXD ELECT 33 UF 10% 10VDCW	28480	0180-0229
C25	0160-2055		C:FXD CER 0.01 UF +80-20% 100VDCW	56289	C023F101F103ZS22-CDH
CR1	1990-0325	4	DIODE:VISIBLE LIGHT EMITTER	28480	1990-0325
CR2	1990-0325		DIODE:VISIBLE LIGHT EMITTER	28480	1990-0325
CR3	1990-0325		DIODE:VISIBLE LIGHT EMITTER	28480	1990-0325
CR4	1990-0325		DIODE:VISIBLE LIGHT EMITTER	28480	1990-0325
R1	1810-0030	2	NETWORK:7 RESISTORS 1K OHM 5% 0.15W EA	28480	1810-0030
R2	0757-0280	1	R:FXD MET FLM 1K OHM 1% 1/8W	28480	0757-0280
R3	1810-0030		NETWORK:7 RESISTORS 1K OHM 5% 0.15W EA	28480	1810-0030
S1	3101-0932	1	SWITCH:SLIDE DPDT	79727	G350-0002D
S2	3101-1669	17	SWITCH:TOGGLE SPDT SUB-MINIAT JADE GRAY	09353	7101C82-J4X
S3	3101-1669		SWITCH:TOGGLE SPDT SUB-MINIAT JADE GRAY	09353	7101C82-J4X
S4	3101-1669		SWITCH:TOGGLE SPDT SUB-MINIAT JADE GRAY	09353	7101C82-J4X
S5	3101-1669		SWITCH:TOGGLE SPDT SUB-MINIAT JADE GRAY	09353	7101C82-J4X
S6	3101-1669		SWITCH:TOGGLE SPDT SUB-MINIAT JADE GRAY	09353	7101C82-J4X
S7	3101-1669		SWITCH:TOGGLE SPDT SUB-MINIAT JADE GRAY	09353	7101C82-J4X
S8	3101-1669		SWITCH:TOGGLE SPDT SUB-MINIAT JADE GRAY	09353	7101C82-J4X
S9	3101-1669		SWITCH:TOGGLE SPDT SUB-MINIAT JADE GRAY	09353	7101C82-J4X
S10	3101-1669		SWITCH:TOGGLE SPDT SUB-MINIAT JADE GRAY	09353	7101C82-J4X
S11	3101-1669		SWITCH:TOGGLE SPDT SUB-MINIAT JADE GRAY	09353	7101C82-J4X
S12	3101-1669		SWITCH:TOGGLE SPDT SUB-MINIAT JADE GRAY	09353	7101C82-J4X
S13	3101-1669		SWITCH:TOGGLE SPDT SUB-MINIAT JADE GRAY	09353	7101C82-J4X
S14	3101-1669		SWITCH:TOGGLE SPDT SUB-MINIAT JADE GRAY	09353	7101C82-J4X
S15	3101-1669		SWITCH:TOGGLE SPDT SUB-MINIAT JADE GRAY	09353	7101C82-J4X
S16	3101-1669		SWITCH:TOGGLE SPDT SUB-MINIAT JADE GRAY	09353	7101C82-J4X
S17	3101-1669		SWITCH:TOGGLE SPDT SUB-MINIAT JADE GRAY	09353	7101C82-J4X
S18	3101-1670	6	SWITCH:TOGGLE SPDT SUB-MINIAT JADE GRAY	09353	7108C82-J4X
S19	3101-1670		SWITCH:TOGGLE SPDT SUB-MINIAT JADE GRAY	09353	7108C82-J4X
S20	3101-1670		SWITCH:TOGGLE SPDT SUB-MINIAT JADE GRAY	09353	7108C82-J4X
S21	3101-1670		SWITCH:TOGGLE SPDT SUB-MINIAT JADE GRAY	09353	7108C82-J4X
S22	3101-1670		SWITCH:TOGGLE SPDT SUB-MINIAT JADE GRAY	09353	7108C82-J4X
S23	3101-1669		SWITCH:TOGGLE SPDT SUB-MINIAT JADE GRAY	09353	7101C82-J4X
S24	3101-1670		SWITCH:TOGGLE SPDT SUB-MINIAT JADE GRAY	09353	7108C82-J4X
TB1	0360-1727	1	BARRIER BLOCK:2 TERMINALS	75382	699-2120-2
U1	1820-0621	4	IC:TTL QUAD 2-INPT NAND BUFFER W/OPEN C	01295	SN7438N
U2	1810-0124	4	RESISTOR ARRAY:8 X 200 OHM 2% 1-3/4W	28480	1810-0124
U3	1820-0621		IC:TTL QUAD 2-INPT NAND BUFFER W/OPEN C	01295	SN7438N
U4	1820-0621		IC:TTL QUAD 2-INPT NAND BUFFER W/OPEN C	01295	SN7438N
U5	1810-0124		RESISTOR ARRAY:8 X 200 OHM 2% 1-3/4W	28480	1810-0124
U6	1820-0621		IC:TTL QUAD 2-INPT NAND BUFFER W/OPEN C	01295	SN7438N
U7	1820-0307	8	IC:DTL HEX INVERTER	04713	MC836P
U8	1820-0307		IC:DTL HEX INVERTER	04713	MC836P
U9	1820-0307		IC:DTL HEX INVERTER	04713	MC836P
U10	1820-0307		IC:DTL HEX INVERTER	04713	MC836P
U11	1820-0307		IC:DTL HEX INVERTER	04713	MC836P
U12	1820-0307		IC:DTL HEX INVERTER	04713	MC836P
U13	1820-0307		IC:DTL HEX INVERTER	04713	MC836P
U14	1820-0307		IC:DTL HEX INVERTER	04713	MC836P
U15	1810-0124	1	RESISTOR ARRAY:8 X 200 OHM 2% 1-3/4W	28480	1810-0124
U16	1820-0424		IC:TTL HS HEX INVERTER	04713	SN74H04N
U18	1810-0124		RESISTOR ARRAY:8 X 200 OHM 2% 1-3/4W	28480	1810-0124

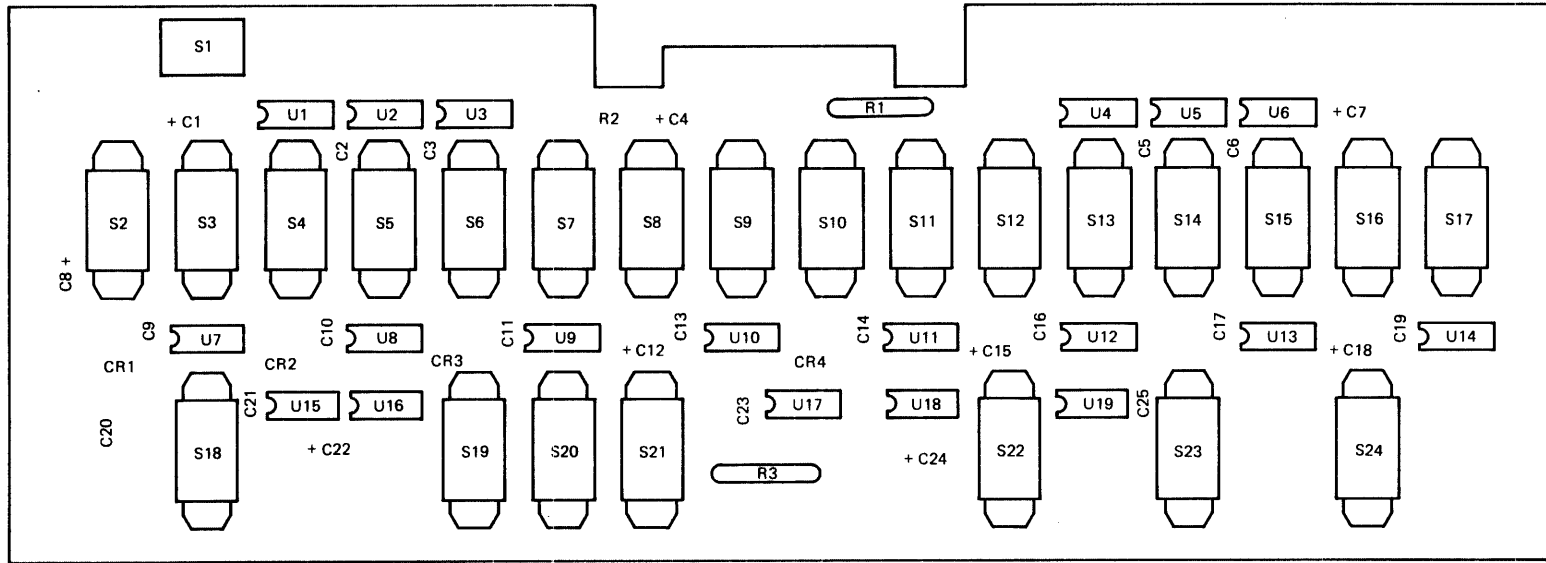

2212-36

Figure 2-13. Control Assembly, Part Location Diagram

Table 2-15. Universal PCA Module, Replaceable Parts

FIG & INDEX NO.	HP PART NO.	DESCRIPTION	MFR CODE	MFR PART NO.	UNITS PER ASSY
2-14 1	30002A	UNIVERSAL PCA MODULE (Refer to table 2-1) * PCA (TYPICAL)	28480	30002A	
	30005-60001	** MEMORY LOAD PCA (see figure 2-15)	28480	30005-60001	◆
	30005-60002	** MEMORY DATA AND CONTROL PCA (see figure 2-16)	28480	30005-60002	◆
	30006-60002	** MEMORY DRIVE AND SENSE PCA (see figure 2-17)	28480		◆
	30030-60001★	** SELECTOR CHANNEL REGISTER PCA (see figure 2-18)	28480	30030-60001	◆
	30030-60003★	** SELECTOR CHANNEL CONTROL PCA (see figure 2-19)	28480	30030-60003	◆
	30030-60005★	** SELECTOR CHANNEL PORT PCA (see figure 2-20)	28480	30030-60005	◆
	30030-60007★	** SELECTOR CHANNEL MAINTENANCE PCA (see figure 2-21)	28480	30030-60007	◆
	30031-60001	** SYSTEM CLOCK/CONSOLE INTERFACE PCA (see figure 2-22)	28480	30031-60001	◆
	30035-60001	** MULTIPLEXER CHANNEL PCA (see figure 2-23)	28480	30035-60001	◆
	30035-60003	** MULTIPLEXER CHANNEL BUS TERMINATOR PCA (see figure 2-24)			◆
	30050-60001	** UNIVERSAL INTERFACE (TTL) PCA (see figure 2-25)	28480	30050-60001	◆
	30051-60001	** UNIVERSAL INTERFACE (DIFFERENTIAL) PCA (see figure 2-26)	28480	30051-60001	◆
	30052-60001★	** UNIVERSAL INTERFACE (OPTICAL) PCA (see figure 2-27)	28480	30052-60001	◆
	30055-60001	** SYNCHRONOUS DATA MODAM (201/203) IF PCA (see figure 2-28)	28480	30055-60001	◆
	30060-60001	** TERMINAL DATA INTERFACE PCA (see figure 2-29)	28480	30060-60001	◆
	30061-60001	** TERMINAL CONTROL INTERFACE PCA (see figure 2-30)	28480	30061-60001	◆
	30202-60001	** DISC FILE READ/WRITE PCA (see figure 2-31)	28480	30202-60001	◆
	30202-60002	** DISC FILE BUS PCA (see figure 2-32)	28480	30202-60002	◆
	30202-60003	** DISC CONTROLLER PROCESSOR PCA (see figure 2-33)	28480	30202-60003	◆
	30203-60001	** DISC MEMORY CONTROLLER PCA (see figure 2-34)	28480	30203-60001	◆
	30203-60002	** DISC MEMORY DATA PCA (see figure 2-35)	28480	30203-60002	◆
	30206-60001	** CARD READER INTERFACE PCA (see figure 2-36)	28480	30206-60001	◆
	30210-60001	** CARTRIDGE DISC CONTROLLER PCA (see figure 2-37)	28480	30210-60001	◆
	30215-60001	** MAGNETIC TAPE (9 Track) CONTROLLER PCA (see figure 2-38)	28480	30215-60001	◆
	30215-60002	** MAGNETIC TAPE CONTROLLER PROCESSOR PCA (see figure 2-39)	28480	30215-60002	◆
	30217-60001★	** MAGNETIC TAPE (7 Track) CONTROLLER PCA (see figure 2-40)	28480	30217-60001	◆
	30350-60006	** CONTROL PANEL INTERFACE PCA (see figure 2-41)	28480	30350-60006	◆
	30351-60001	** CONTROLLER MAINTENANCE INTERFACE PCA (see figure 2-42)	28480	30350-60001	◆
2	30002-60001	* BACKPLANE ASSEMBLY	28480	30002-60001	◆
3	No Number	* FAN ASSEMBLY (see figure 2-43)		OBD	◆
4	No Number	* CARD CAGE ASSEMBLY		OBD	◆

◆Units per assembly depends on system configuration.
★ Indicates parts lists are not available for this printing.

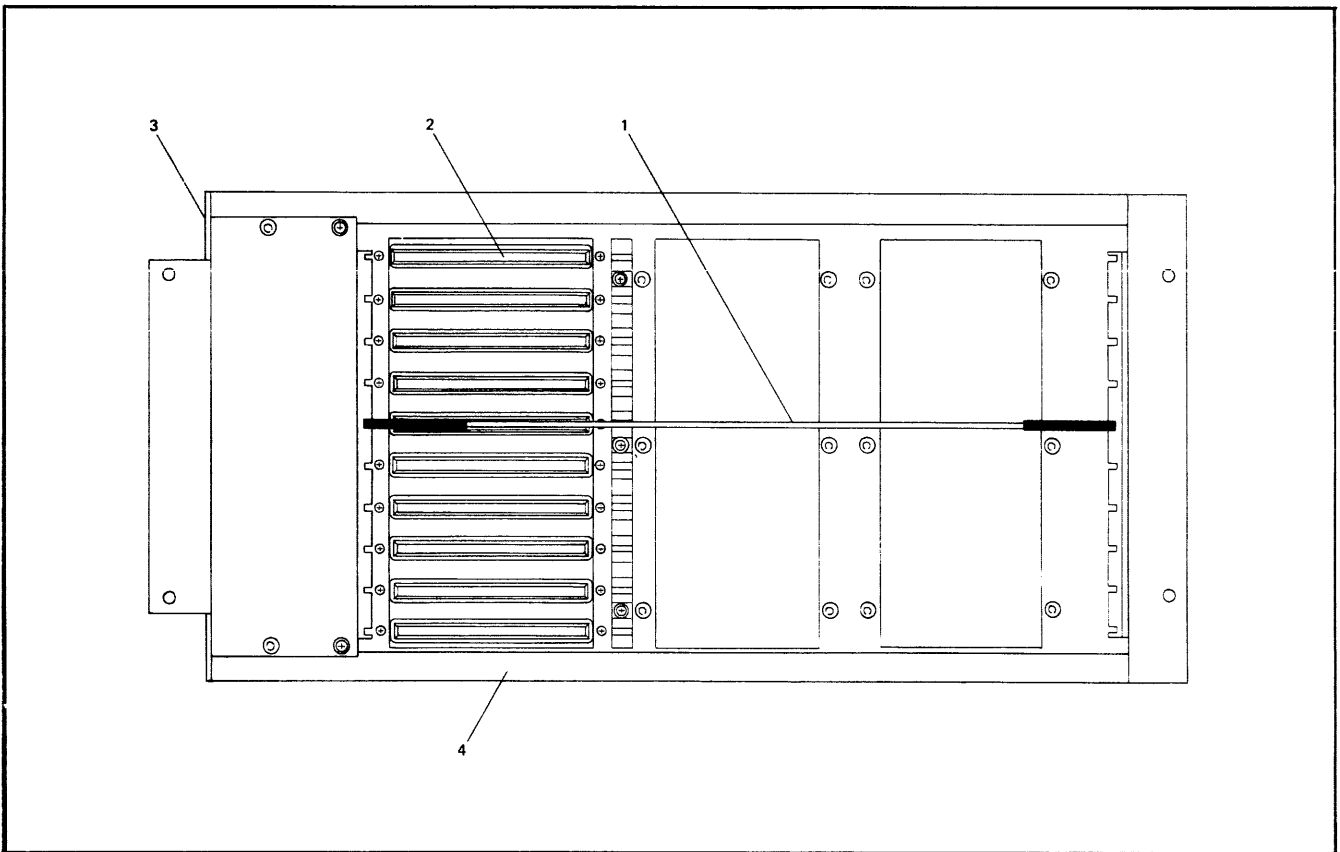

2212-27

Figure 2-14. Universal PCA Module, Parts Location Diagram

Table 2-16. Memory Load PCA, Replaceable Parts

Reference Designation	HP Part Number	Qty	Description	Mfr Code	Mfr Part Number
C1	30005-60001	1	MEMORY LOAD PCA	28480	30005-60001
C2	0160-0127	27	C:FxD CER 1.0 UF 20% 25VDCW	56289	5C13CS-CML
C3	0160-0127	17	C:FxD MICA 1600 PF 5% 100VDCW	84171	DM15F162JO
C4	0160-3710		C:FxD CER 1.0 UF 20% 25VDCW	56289	5C13CS-CML
			C:FxD MICA 1600 PF 5% 100VDCW	84171	DM15F162JO
C5	0160-3710		C:FxD MICA 1600 PF 5% 100VDCW	84171	DM15F162JO
C6	0160-0127		C:FxD CER 1.0 UF 20% 25VDCW	56289	5C13CS-CML
C7	0160-0127		C:FxD CER 1.0 UF 20% 25VDCW	56289	5C13CS-CML
C8	0160-3710		C:FxD MICA 1600 PF 5% 100VDCW	84171	DM15F162JO
C9	0160-3710		C:FxD MICA 1600 PF 5% 100VDCW	84171	DM15F162JO
C10	0160-0127		C:FxD CER 1.0 UF 20% 25VDCW	56289	5C13CS-CML
C11	0160-3710		C:FxD MICA 1600 PF 5% 100VDCW	84171	DM15F162JO
C12	0160-0127		C:FxD CER 1.0 UF 20% 25VDCW	56289	5C13CS-CML
C13	0160-0127		C:FxD CER 1.0 UF 20% 25VDCW	56289	5C13CS-CML
C14	0160-3710		C:FxD MICA 1600 PF 5% 100VDCW	84171	DM15F162JO
C15	0160-0127		C:FxD CER 1.0 UF 20% 25VDCW	56289	5C13CS-CML
C16	0160-3710		C:FxD MICA 1600 PF 5% 100VDCW	84171	DM15F162JO
C17	0160-3710		C:FxD MICA 1600 PF 5% 100VDCW	84171	DM15F162JO
C18	0160-0127		C:FxD CER 1.0 UF 20% 25VDCW	56289	5C13CS-CML
C19	0160-0127		C:FxD CER 1.0 UF 20% 25VDCW	56289	5C13CS-CML
C20	0160-3710		C:FxD MICA 1600 PF 5% 100VDCW	84171	DM15F162JO
C21	0160-3710		C:FxD MICA 1600 PF 5% 100VDCW	84171	DM15F162JO
C22	0160-0127		C:FxD CER 1.0 UF 20% 25VDCW	56289	5C13CS-CML
C23	0160-3710		C:FxD MICA 1600 PF 5% 100VDCW	84171	DM15F162JO
C24	0160-0127		C:FxD CER 1.0 UF 20% 25VDCW	56289	5C13CS-CML
C25	0160-0127		C:FxD CER 1.0 UF 20% 25VDCW	56289	5C13CS-CML
C26	0160-3710		C:FxD MICA 1600 PF 5% 100VDCW	84171	DM15F162JO
C27	0160-0127		C:FxD CER 1.0 UF 20% 25VDCW	56289	5C13CS-CML
C28	0160-3710		C:FxD MICA 1600 PF 5% 100VDCW	84171	DM15F162JO
C29	0160-3710		C:FxD MICA 1600 PF 5% 100VDCW	84171	DM15F162JO
C30	0160-0127		C:FxD CER 1.0 UF 20% 25VDCW	56289	5C13CS-CML
C31	0160-3710		C:FxD MICA 1600 PF 5% 100VDCW	84171	DM15F162JO
C32	0160-0127		C:FxD CER 1.0 UF 20% 25VDCW	56289	5C13CS-CML
C33	0160-3710		C:FxD MICA 1600 PF 5% 100VDCW	84171	DM15F162JO
C34	0160-0127		C:FxD CER 1.0 UF 20% 25VDCW	56289	5C13CS-CML
C35	0180-0094	12	C:FxD ELECT 100 UF +75-10% 25VDCW	56289	30D107G025DD2-DSM
C36	0180-0094		C:FxD ELECT 100 UF +75-10% 25VDCW	56289	30D107G025DD2-DSM
C37	0180-0094		C:FxD ELECT 100 UF +75-10% 25VDCW	56289	30D107G025DD2-DSM
C38	0180-0094		C:FxD ELECT 100 UF +75-10% 25VDCW	56289	30D107G025DD2-DSM
C39	0180-0094		C:FxD ELECT 100 UF +75-10% 25VDCW	56289	30D107G025DD2-DSM
C40	0180-0094		C:FxD ELECT 100 UF +75-10% 25VDCW	56289	30D107G025DD2-DSM
C41	0180-0094		C:FxD ELECT 100 UF +75-10% 25VDCW	56289	30D107G025DD2-DSM
C42	0180-0094		C:FxD ELECT 100 UF +75-10% 25VDCW	56289	30D107G025DD2-DSM
C43	0180-0094		C:FxD ELECT 100 UF +75-10% 25VDCW	56289	30D107G025DD2-DSM
C44	0180-0094		C:FxD ELECT 100 UF +75-10% 25VDCW	56289	30D107G025DD2-DSM
C45	0180-0094		C:FxD ELECT 100 UF +75-10% 25VDCW	56289	30D107G025DD2-DSM
C46	0180-0094		C:FxD ELECT 100 UF +75-10% 25VDCW	56289	30D107G025DD2-DSM
C47	0160-0127		C:FxD CER 1.0 UF 20% 25VDCW	56289	5C13CS-CML
C48	0160-0127		C:FxD CER 1.0 UF 20% 25VDCW	56289	5C13CS-CML
C49	0160-0127		C:FxD CER 1.0 UF 20% 25VDCW	56289	5C13CS-CML
C50	0160-0127		C:FxD CER 1.0 UF 20% 25VDCW	56289	5C13CS-CML
C51	0160-0127		C:FxD CER 1.0 UF 20% 25VDCW	56289	5C13CS-CML
C52	0160-0127		C:FxD CER 1.0 UF 20% 25VDCW	56289	5C13CS-CML
C53	0160-0127		C:FxD CER 1.0 UF 20% 25VDCW	56289	5C13CS-CML
C54	0160-0127		C:FxD CER 1.0 UF 20% 25VDCW	56289	5C13CS-CML
C55	0160-2055	2	C:FxD CER 0.01 UF +80-20% 100VDCW	56289	C023F101F103ZS22-CDH
C56	0160-2055		C:FxD CER 0.01 UF +80-20% 100VDCW	56289	C023F101F103ZS22-CDH
C57	0160-2306	1	C:FxD MICA 27 PF 5%	28480	0160-2306
C58	0160-0127		C:FxD CER 1.0 UF 20% 25VDCW	56289	5C13CS-CML
C59	0160-0127		C:FxD CER 1.0 UF 20% 25VDCW	56289	5C13CS-CML
CR1	1901-0040	18	DIODE: SILICON 50 MA 30 WV	07263	FD61088
CR2	1901-0040		DIODE: SILICON 50 MA 30 WV	07263	FD61088
CR3	1901-0620	32	DIODE BREAKDOWN	28480	1901-0620
CR4	1901-0620		DIODE BREAKDOWN	28480	1901-0620
CR5	1901-0620		DIODE BREAKDOWN	28480	1901-0620
CR6	1901-0620		DIODE BREAKDOWN	28480	1901-0620
CR7	1901-0620		DIODE BREAKDOWN	28480	1901-0620
CR8	1901-0620		DIODE BREAKDOWN	28480	1901-0620
CR9	1901-0620		DIODE BREAKDOWN	28480	1901-0620
CR10	1901-0620		DIODE BREAKDOWN	28480	1901-0620
CR11	1901-0620		DIODE BREAKDOWN	28480	1901-0620
CR12	1901-0620		DIODE BREAKDOWN	28480	1901-0620
CR13	1901-0620		DIODE BREAKDOWN	28480	1901-0620
CR14	1901-0620		DIODE BREAKDOWN	28480	1901-0620
CR15	1901-0620		DIODE BREAKDOWN	28480	1901-0620

Table 2-16. Memory Load PCA, Replaceable Parts (Continued)

Reference Designation	HP Part Number	Qty	Description	Mfr Code	Mfr Part Number
CR16	1901-0620		DIODE BREAKDOWN	28480	1901-0620
CR17	1901-0620		DIODE BREAKDOWN	28480	1901-0620
CR18	1901-0620		DIODE BREAKDOWN	28480	1901-0620
CR19	1901-0620		DIODE BREAKDOWN	28480	1901-0620
CR20	1901-0040		DIODE:SILICON 50 MA 30 WV	07263	FDG1088
CR21	1901-0040		DIODE:SILICON 50 MA 30 WV	07263	FDG1088
CR22	1901-0620		DIODE BREAKDOWN	28480	1901-0620
CR23	1901-0620		DIODE BREAKDOWN	28480	1901-0620
CR24	1901-0040		DIODE:SILICON 50 MA 30 WV	07263	FDG1088
CR25	1901-0040		DIODE:SILICON 50 MA 30 WV	07263	FDG1088
CR26	1901-0620		DIODE BREAKDOWN	28480	1901-0620
CR27	1901-0620		DIODE BREAKDOWN	28480	1901-0620
CR28	1901-0040		DIODE:SILICON 50 MA 30 WV	07263	FDG1088
CR29	1901-0040		DIODE:SILICON 50 MA 30 WV	07263	FDG1088
CR30	1901-0620		DIODE BREAKDOWN	28480	1901-0620
CR31	1901-0620		DIODE BREAKDOWN	28480	1901-0620
CR32	1901-0040		DIODE:SILICON 50 MA 30 WV	07263	FDG1088
CR33	1901-0040		DIODE:SILICON 50 MA 30 WV	07263	FDG1088
CR34	1901-0620		DIODE BREAKDOWN	28480	1901-0620
CR35	1901-0620		DIODE BREAKDOWN	28480	1901-0620
CR36	1901-0040		DIODE:SILICON 50 MA 30 WV	07263	FDG1088
CR37	1901-0040		DIODE:SILICON 50 MA 30 WV	07263	FDG1088
CR38	1901-0620		DIODE BREAKDOWN	28480	1901-0620
CR39	1901-0620		DIODE BREAKDOWN	28480	1901-0620
CR40	1901-0040		DIODE:SILICON 50 MA 30 WV	07263	FDG1088
CR41	1901-0040		DIODE:SILICON 50 MA 30 WV	07263	FDG1088
CR42	1901-0620		DIODE BREAKDOWN	28480	1901-0620
CR43	1901-0620		DIODE BREAKDOWN	28480	1901-0620
CR44	1901-0040		DIODE:SILICON 50 MA 30 WV	07263	FDG1088
CR45	1901-0040		DIODE:SILICON 50 MA 30 WV	07263	FDG1088
CR46	1901-0620		DIODE BREAKDOWN	28480	1901-0620
CR47	1901-0620		DIODE BREAKDOWN	28480	1901-0620
CR48	1901-0040		DIODE:SILICON 50 MA 30 WV	07263	FDG1088
CR49	1901-0040		DIODE:SILICON 50 MA 30 WV	07263	FDG1088
CR50	1901-0620		DIODE BREAKDOWN	28480	1901-0620
Q1	1854-0019	21	TSTR:SI NPN	28480	1854-0019
Q2	1854-0019		TSTR:SI NPN	28480	1854-0019
Q3	1854-0019		TSTR:SI NPN	28480	1854-0019
Q4	1854-0019		TSTR:SI NPN	28480	1854-0019
Q5	1854-0019		TSTR:SI NPN	28480	1854-0019
Q6	1854-0019		TSTR:SI NPN	28480	1854-0019
Q7	1853-0034	16	TSTR:SI PNP(SELECTED FROM 2N3251)	28480	1853-0034
Q9	1853-0034		TSTR:SI PNP(SELECTED FROM 2N3251)	28480	1853-0034
Q10	1854-0019		TSTR:SI NPN	28480	1854-0019
Q11	1853-0034		TSTR:SI PNP(SELECTED FROM 2N3251)	28480	1853-0034
Q12	1854-0019		TSTR:SI NPN	28480	1854-0019
Q13	1853-0034		TSTR:SI PNP(SELECTED FROM 2N3251)	28480	1853-0034
Q14	1854-0019		TSTR:SI NPN	28480	1854-0019
Q15	1853-0034		TSTR:SI PNP(SELECTED FROM 2N3251)	28480	1853-0034
Q16	1854-0019		TSTR:SI NPN	28480	1854-0019
Q17	1853-0034		TSTR:SI PNP(SELECTED FROM 2N3251)	28480	1853-0034
Q18	1854-0019		TSTR:SI NPN	28480	1854-0019
Q19	1853-0034		TSTR:SI PNP(SELECTED FROM 2N3251)	28480	1853-0034
Q20	1854-0019		TSTR:SI NPN	28480	1854-0019
Q21	1853-0034		TSTR:SI PNP(SELECTED FROM 2N3251)	28480	1853-0034
Q22	1854-0019		TSTR:SI NPN	28480	1854-0019
Q23	1853-0034		TSTR:SI PNP(SELECTED FROM 2N3251)	28480	1853-0034
Q24	1854-0019		TSTR:SI NPN	28480	1854-0019
Q25	1853-0034		TSTR:SI PNP(SELECTED FROM 2N3251)	28480	1853-0034
Q26	1854-0019		TSTR:SI NPN	28480	1854-0019
Q27	1853-0034		TSTR:SI PNP(SELECTED FROM 2N3251)	28480	1853-0034
Q28	1854-0019		TSTR:SI NPN	28480	1854-0019
Q29	1853-0034		TSTR:SI PNP(SELECTED FROM 2N3251)	28480	1853-0034
Q30	1854-0019		TSTR:SI NPN	28480	1854-0019
Q31	1853-0034		TSTR:SI PNP(SELECTED FROM 2N3251)	28480	1853-0034
Q32	1854-0019		TSTR:SI NPN	28480	1854-0019
Q33	1853-0034		TSTR:SI PNP(SELECTED FROM 2N3251)	28480	1853-0034
Q34	1854-0019		TSTR:SI NPN	28480	1854-0019
Q35	1853-0034		TSTR:SI PNP(SELECTED FROM 2N3251)	28480	1853-0034
Q36	1854-0019		TSTR:SI NPN	28480	1854-0019
Q37	1853-0034		TSTR:SI PNP(SELECTED FROM 2N3251)	28480	1853-0034
Q38	1854-0019		TSTR:SI NPN	28480	1854-0019
R1	0811-2988	17	R:FXD WW 22 OHM 1% 7W	28480	0811-2988
R2	0811-2988		R:FXD WW 22 OHM 1% 7W	28480	0811-2988
R3	0811-2988		R:FXD WW 22 OHM 1% 7W	28480	0811-2988

Table 2-16. Memory Load PCA, Replaceable Parts (Continued)

Reference Designation	HP Part Number	Qty	Description	Mfr Code	Mfr Part Number
R4	0811-2988		R:FXD WW 22 OHM 1% 7W	28480	0811-2988
R5	0811-2988		R:FXD WW 22 OHM 1% 7W	28480	0811-2988
R6	0811-2988		R:FXD WW 22 OHM 1% 7W	28480	0811-2988
R7	0811-2988		R:FXD WW 22 OHM 1% 7W	28480	0811-2988
R8	0811-2988		R:FXD WW 22 OHM 1% 7W	28480	0811-2988
R9	0811-2988		R:FXD WW 22 OHM 1% 7W	28480	0811-2988
R10	0811-2988		R:FXD WW 22 OHM 1% 7W	28480	0811-2988
R11	0811-2988		R:FXD WW 22 OHM 1% 7W	28480	0811-2988
R12	0811-2988		R:FXD WW 22 OHM 1% 7W	28480	0811-2988
R13	0811-2988		R:FXD WW 22 OHM 1% 7W	28480	0811-2988
R14	0811-2988		R:FXD WW 22 OHM 1% 7W	28480	0811-2988
R15	0811-2988		R:FXD WW 22 OHM 1% 7W	28480	0811-2988
R16	0811-2988		R:FXD WW 22 OHM 1% 7W	28480	0811-2988
R17	0811-2988		R:FXD WW 22 OHM 1% 7W	28480	0811-2988
R18	0811-2031	1	R:FXD WW 815 OHM 3% 1/4W	28480	0811-2031
R19	0757-0416	2	R:FXD MET FLM 511 OHM 1% 1/8W	28480	0757-0416
R19	0698-0085	1	R:FXD MET FLM 2.61K OHM 1% 1/8W	28480	0698-0085
R20	0757-0280	34	R:FXD MET FLM 1K OHM 1% 1/8W	28480	0757-0280
R21	0698-3443	2	R:FXD MET FLM 287 OHM 1% 1/8W	28480	0698-3443
R22	0698-3440	6	R:FXD MET FLM 196 OHM 1% 1/8W	28480	0698-3440
R23	0698-3440		R:FXD MET FLM 196 OHM 1% 1/8W	28480	0698-3440
R24	0698-3440		R:FXD MET FLM 196 OHM 1% 1/8W	28480	0698-3440
R25	0698-3440		R:FXD MET FLM 196 OHM 1% 1/8W	28480	0698-3440
R26	0698-3440		R:FXD MET FLM 196 OHM 1% 1/8W	28480	0698-3440
R27	0698-3440		R:FXD MET FLM 196 OHM 1% 1/8W	28480	0698-3440
R28	0698-3443		R:FXD MET FLM 287 OHM 1% 1/8W	28480	0698-3443
R29	0757-0280		R:FXD MET FLM 1K OHM 1% 1/8W	28480	0757-0280
R30	0757-0416		R:FXD MET FLM 511 OHM 1% 1/8W	28480	0757-0416
R31	0757-0403	16	R:FXD MET FLM 121 OHM 1% 1/8W	28480	0757-0403
R32	0757-0403		R:FXD MET FLM 121 OHM 1% 1/8W	28480	0757-0403
R33	0757-0403		R:FXD MET FLM 121 OHM 1% 1/8W	28480	0757-0403
R34	0757-0403		R:FXD MET FLM 121 OHM 1% 1/8W	28480	0757-0403
R35	0757-0403		R:FXD MET FLM 121 OHM 1% 1/8W	28480	0757-0403
R36	0757-0403		R:FXD MET FLM 121 OHM 1% 1/8W	28480	0757-0403
R37	0757-0403		R:FXD MET FLM 121 OHM 1% 1/8W	28480	0757-0403
R38	0757-0403		R:FXD MET FLM 121 OHM 1% 1/8W	28480	0757-0403
R39	0757-0403		R:FXD MET FLM 121 OHM 1% 1/8W	28480	0757-0403
R40	0757-0403		R:FXD MET FLM 121 OHM 1% 1/8W	28480	0757-0403
R41	0757-0403		R:FXD MET FLM 121 OHM 1% 1/8W	28480	0757-0403
R42	0757-0403		R:FXD MET FLM 121 OHM 1% 1/8W	28480	0757-0403
R43	0757-0403		R:FXD MET FLM 121 OHM 1% 1/8W	28480	0757-0403
R44	0757-0403		R:FXD MET FLM 121 OHM 1% 1/8W	28480	0757-0403
R45	0757-0403		R:FXD MET FLM 121 OHM 1% 1/8W	28480	0757-0403
R46	0757-0403		R:FXD MET FLM 121 OHM 1% 1/8W	28480	0757-0403
R47	0811-0939	1	R:FXD WW 100 OHM 3% 5W	28480	0811-0939
R48	0757-0280		R:FXD MET FLM 1K OHM 1% 1/8W	28480	0757-0280
R49	0698-3435	16	R:FXD MET FLM 38.3 OHM 1% 1/8W	28480	0698-3435
R50	0698-3435		R:FXD MET FLM 38.3 OHM 1% 1/8W	28480	0698-3435
R51	0757-0280		R:FXD MET FLM 1K OHM 1% 1/8W	28480	0757-0280
R52	0757-0280		R:FXD MET FLM 1K OHM 1% 1/8W	28480	0757-0280
R53	0698-3435		R:FXD MET FLM 38.3 OHM 1% 1/8W	28480	0698-3435
R54	0698-3435		R:FXD MET FLM 38.3 OHM 1% 1/8W	28480	0698-3435
R55	0757-0280		R:FXD MET FLM 1K OHM 1% 1/8W	28480	0757-0280
R56	0757-0280		R:FXD MET FLM 1K OHM 1% 1/8W	28480	0757-0280
R57	0698-3435		R:FXD MET FLM 38.3 OHM 1% 1/8W	28480	0698-3435
R58	0698-3435		R:FXD MET FLM 38.3 OHM 1% 1/8W	28480	0698-3435
R59	0757-0280		R:FXD MET FLM 1K OHM 1% 1/8W	28480	0757-0280
R60	0757-0280		R:FXD MET FLM 1K OHM 1% 1/8W	28480	0757-0280
R61	0698-3435		R:FXD MET FLM 38.3 OHM 1% 1/8W	28480	0698-3435
R62	0698-3435		R:FXD MET FLM 38.3 OHM 1% 1/8W	28480	0698-3435
R63	0757-0280		R:FXD MET FLM 1K OHM 1% 1/8W	28480	0757-0280
R64	0757-0280		R:FXD MET FLM 1K OHM 1% 1/8W	28480	0757-0280
R65	0698-3435		R:FXD MET FLM 38.3 OHM 1% 1/8W	28480	0698-3435
R66	0698-3435		R:FXD MET FLM 38.3 OHM 1% 1/8W	28480	0698-3435
R67	0757-0280		R:FXD MET FLM 1K OHM 1% 1/8W	28480	0757-0280
R68	0757-0280		R:FXD MET FLM 1K OHM 1% 1/8W	28480	0757-0280
R69	0698-3435		R:FXD MET FLM 38.3 OHM 1% 1/8W	28480	0698-3435
R70	0698-3435		R:FXD MET FLM 38.3 OHM 1% 1/8W	28480	0698-3435
R71	0757-0280		R:FXD MET FLM 1K OHM 1% 1/8W	28480	0757-0280
R72	0757-0280		R:FXD MET FLM 1K OHM 1% 1/8W	28480	0757-0280
R73	0698-3435		R:FXD MET FLM 38.3 OHM 1% 1/8W	28480	0698-3435
R74	0698-3435		R:FXD MET FLM 38.3 OHM 1% 1/8W	28480	0698-3435
R75	0757-0280		R:FXD MET FLM 1K OHM 1% 1/8W	28480	0757-0280
R76	0757-0280		R:FXD MET FLM 1K OHM 1% 1/8W	28480	0757-0280
R77	0698-3435		R:FXD MET FLM 38.3 OHM 1% 1/8W	28480	0698-3435

Table 2-16. Memory Load PCA, Replaceable Parts (Continued)

Reference Designation	HP Part Number	Qty	Description	Mfr Code	Mfr Part Number
R78	0698-3435	16	R:FXD MET FLM 38.3 OHM 1% 1/8W	28480	0698-3435
R79	0757-0280		R:FXD MET FLM 1K OHM 1% 1/8W	28480	0757-0280
R80	0757-0280		R:FXD MET FLM 1K OHM 1% 1/8W	28480	0757-0280
R81	0757-0794		R:FXD MET FLM 68.1 OHM 1% 1/2W	28480	0757-0794
R82	0757-0794		R:FXD MET FLM 68.1 OHM 1% 1/2W	28480	0757-0794
R83	0757-0280		R:FXD MET FLM 1K OHM 1% 1/8W	28480	0757-0280
R84	0757-0280		R:FXD MET FLM 1K OHM 1% 1/8W	28480	0757-0280
R85	0757-0794		R:FXD MET FLM 68.1 OHM 1% 1/2W	28480	0757-0794
R86	0757-0794		R:FXD MET FLM 68.1 OHM 1% 1/2W	28480	0757-0794
R87	0757-0280		R:FXD MET FLM 1K OHM 1% 1/8W	28480	0757-0280
R88	0757-0280		R:FXD MET FLM 1K OHM 1% 1/8W	28480	0757-0280
R89	0757-0794		R:FXD MET FLM 68.1 OHM 1% 1/2W	28480	0757-0794
R90	0757-0794		R:FXD MET FLM 68.1 OHM 1% 1/2W	28480	0757-0794
R91	0757-0280		R:FXD MET FLM 1K OHM 1% 1/8W	28480	0757-0280
R92	0757-0280		R:FXD MET FLM 1K OHM 1% 1/8W	28480	0757-0280
R93	0757-0794		R:FXD MET FLM 68.1 OHM 1% 1/2W	28480	0757-0794
R94	0757-0794	R:FXD MET FLM 68.1 OHM 1% 1/2W	28480	0757-0794	
R95	0757-0280	R:FXD MET FLM 1K OHM 1% 1/8W	28480	0757-0280	
R96	0757-0280	R:FXD MET FLM 1K OHM 1% 1/8W	28480	0757-0280	
R97	0757-0794	R:FXD MET FLM 68.1 OHM 1% 1/2W	28480	0757-0794	
R98	0757-0794	R:FXD MET FLM 68.1 OHM 1% 1/2W	28480	0757-0794	
R99	0757-0280	R:FXD MET FLM 1K OHM 1% 1/8W	28480	0757-0280	
R100	0757-0280	R:FXD MET FLM 1K OHM 1% 1/8W	28480	0757-0280	
R101	0757-0794	R:FXD MET FLM 68.1 OHM 1% 1/2W	28480	0757-0794	
R102	0757-0794	R:FXD MET FLM 68.1 OHM 1% 1/2W	28480	0757-0794	
R103	0757-0280	R:FXD MET FLM 1K OHM 1% 1/8W	28480	0757-0280	
R104	0757-0280	R:FXD MET FLM 1K OHM 1% 1/8W	28480	0757-0280	
R105	0757-0794	R:FXD MET FLM 68.1 OHM 1% 1/2W	28480	0757-0794	
R106	0757-0794	R:FXD MET FLM 68.1 OHM 1% 1/2W	28480	0757-0794	
R107	0757-0280	R:FXD MET FLM 1K OHM 1% 1/8W	28480	0757-0280	
R108	0757-0280	R:FXD MET FLM 1K OHM 1% 1/8W	28480	0757-0280	
R109	0757-0794	R:FXD MET FLM 68.1 OHM 1% 1/2W	28480	0757-0794	
R110	0757-0794	R:FXD MET FLM 68.1 OHM 1% 1/2W	28480	0757-0794	
R111	0757-0280	R:FXD MET FLM 1K OHM 1% 1/8W	28480	0757-0280	
U36	1820-0755	4	IC	28480	1820-0755
R112	0698-3438	1	R:FXD 147 OHM	28480	0698-3438
U37	1820-0756	2	IC:TTL 8-BIT DRIVER INVERTING	28480	1820-0756
U46	1820-0608	2	IC:TTL 1 OF DECODER W/ENABLE	04713	MC4006P
U48	1821-0006	4	TSTR ARRAY:SI NPN QUAD	28480	1821-0006
U49	1858-0020	4	TSTR ARRAY:SI PNP QUAD CORE DRIVERS	28480	1858-0020
U78	1821-0006	4	TSTR ARRAY:SI NPN QUAD	28480	1821-0006
U79	1858-0020		TSTR ARRAY:SI PNP QUAD CORE DRIVERS	28480	1858-0020
U87	1820-0755		IC	28480	1820-0755
U96	1820-0424	1	IC:TTL HS HEX INVERTER	04713	SN74H04N
U97	1820-0755		IC	28480	1820-0755
U108	1821-0006		TSTR ARRAY:SI NPN QUAD	28480	1821-0006
U109	1858-0020		TSTR ARRAY:SI PNP QUAD CORE DRIVERS	28480	1858-0020
U136	1820-0755		IC	28480	1820-0755
U137	1820-0756		IC:TTL 8-BIT DRIVER INVERTING	28480	1820-0756
U138	1821-0006		TSTR ARRAY:SI NPN QUAD	28480	1821-0006
U139	1858-0020		TSTR ARRAY:SI PNP QUAD CORE DRIVERS	28480	1858-0020
U156	1820-0608		IC:TTL 1 OF DECODER W/ENABLE	04713	MC4006P

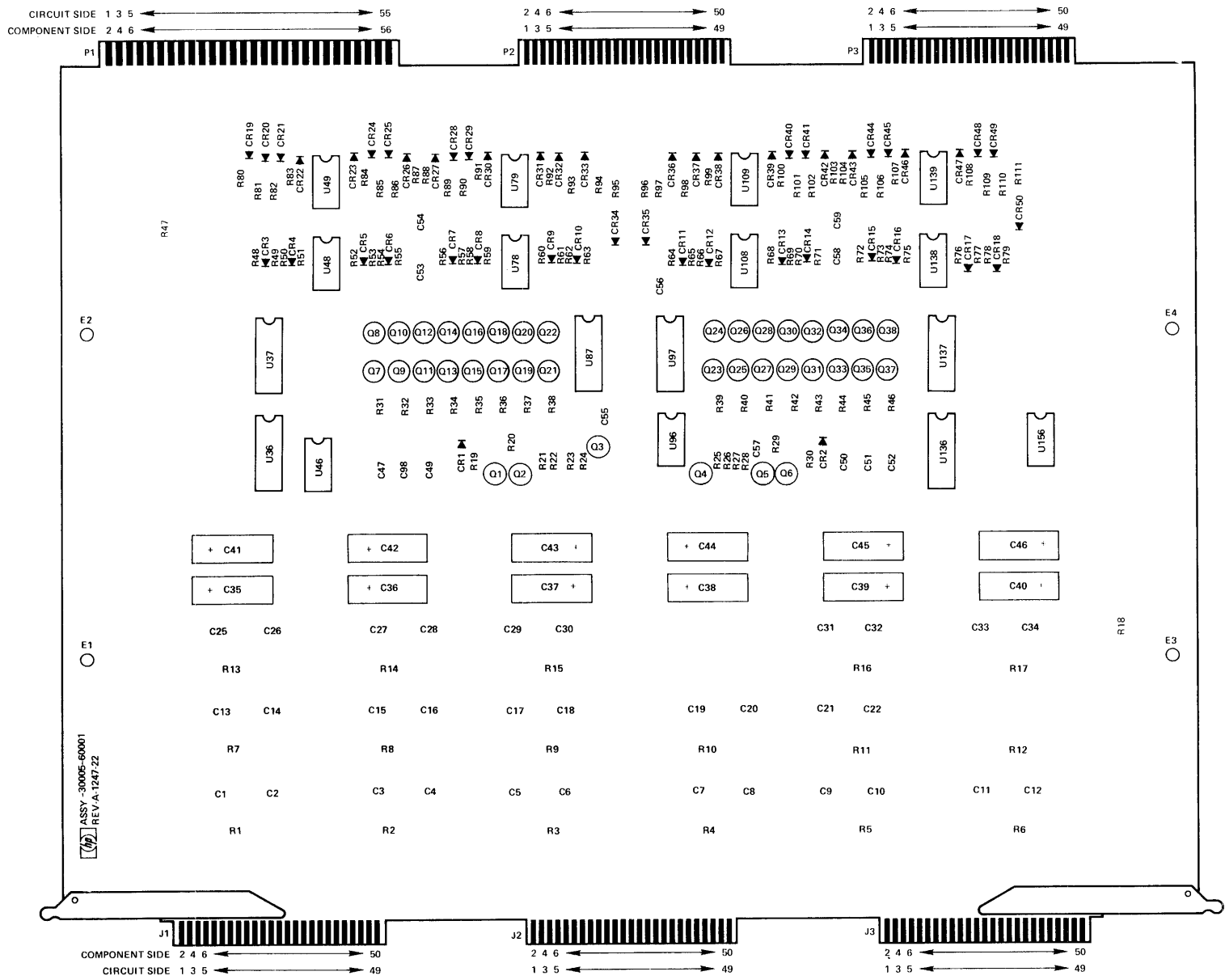

ASSY-30005-60001
REV-A-1247-22

Figure 2-15. Memory Load PCA, Parts Location Diagram

Table 2-17. Memory Data and Control PCA, Replaceable Parts

Reference Designation	HP Part Number	Qty	Description	Mfr Code	Mfr Part Number
	30005-60002	1	MEMORY DATA AND CONTROL PCA	28480	30005-60002
C1	0180-0374	2	C:FxD TANT. 10 UF 10% 20VDCW	56289	1500106X902082-DYS
C2	0160-0127	13	C:FxD CER 1.0 UF 20% 25VDCW	56289	5C13CS-CML
C3	0160-0127		C:FxD CER 1.0 UF 20% 25VDCW	56289	5C13CS-CML
C4	0160-0127		C:FxD CER 1.0 UF 20% 25VDCW	56289	5C13CS-CML
C5	0160-2055	21	C:FxD CER 0.01 UF +80-20% 100VDCW	56289	C023F101F103ZS22-CDH
C6	0160-0127		C:FxD CER 1.0 UF 20% 25VDCW	56289	5C13CS-CML
C7	0160-0127		C:FxD CER 1.0 UF 20% 25VDCW	56289	5C13CS-CML
C8	0180-0374		C:FxD TANT. 10 UF 10% 20VDCW	56289	1500106X902082-DYS
C9	0160-2055		C:FxD CER 0.01 UF +80-20% 100VDCW	56289	C023F101F103ZS22-CDH
C10	0160-2055		C:FxD CER 0.01 UF +80-20% 100VDCW	56289	C023F101F103ZS22-CDH
C11	0160-2055		C:FxD CER 0.01 UF +80-20% 100VDCW	56289	C023F101F103ZS22-CDH
C12	0160-0127		C:FxD CER 1.0 UF 20% 25VDCW	56289	5C13CS-CML
C13	0160-0127		C:FxD CER 1.0 UF 20% 25VDCW	56289	5C13CS-CML
C14	0160-2055		C:FxD CER 0.01 UF +80-20% 100VDCW	56289	C023F101F103ZS22-CDH
C15	0160-2055		C:FxD CER 0.01 UF +80-20% 100VDCW	56289	C023F101F103ZS22-CDH
C16	0160-0127		C:FxD CER 1.0 UF 20% 25VDCW	56289	5C13CS-CML
C17	0160-2055		C:FxD CER 0.01 UF +80-20% 100VDCW	56289	C023F101F103ZS22-CDH
C18	0160-2055		C:FxD CER 0.01 UF +80-20% 100VDCW	56289	C023F101F103ZS22-CDH
C19	0160-2055		C:FxD CER 0.01 UF +80-20% 100VDCW	56289	C023F101F103ZS22-CDH
C20	0160-2055		C:FxD CER 0.01 UF +80-20% 100VDCW	56289	C023F101F103ZS22-CDH
C21	0160-2055		C:FxD CER 0.01 UF +80-20% 100VDCW	56289	C023F101F103ZS22-CDH
C22	0160-2055		C:FxD CER 0.01 UF +80-20% 100VDCW	56289	C023F101F103ZS22-CDH
C23	0160-0127		C:FxD CER 1.0 UF 20% 25VDCW	56289	5C13CS-CML
C24	0160-2055		C:FxD CER 0.01 UF +80-20% 100VDCW	56289	C023F101F103ZS22-CDH
C25	0160-0127		C:FxD CER 1.0 UF 20% 25VDCW	56289	5C13CS-CML
C26	0160-2055		C:FxD CER 0.01 UF +80-20% 100VDCW	56289	C023F101F103ZS22-CDH
C27	0160-2055		C:FxD CER 0.01 UF +80-20% 100VDCW	56289	C023F101F103ZS22-CDH
C28	0160-2055		C:FxD CER 0.01 UF +80-20% 100VDCW	56289	C023F101F103ZS22-CDH
C29	0160-2055		C:FxD CER 0.01 UF +80-20% 100VDCW	56289	C023F101F103ZS22-CDH
C30	0160-2055		C:FxD CER 0.01 UF +80-20% 100VDCW	56289	C023F101F103ZS22-CDH
C31	0160-2055		C:FxD CER 0.01 UF +80-20% 100VDCW	56289	C023F101F103ZS22-CDH
C32	0160-2055		C:FxD CER 0.01 UF +80-20% 100VDCW	56289	C023F101F103ZS22-CDH
C33	0160-2055		C:FxD CER 0.01 UF +80-20% 100VDCW	56289	C023F101F103ZS22-CDH
C34	0160-0127		C:FxD CER 1.0 UF 20% 25VDCW	56289	5C13CS-CML
C35	0160-0127		C:FxD CER 1.0 UF 20% 25VDCW	56289	5C13CS-CML
C36	0160-0970	1	C:FxD MY 0.47UF 10% 80VDCW	56289	192P4749R8-PTS
C37	0160-0127		C:FxD CER 1.0 UF 20% 25VDCW	56289	5C13CS-CML
DL1	1810-0064	2	DELAY LINE:	01961	GG4
DL2	1810-0064		DELAY LINE:	01961	GG4
Q1	1854-0019	24	TSTR:SI NPN	28480	1854-0019
Q2	1854-0019		TSTR:SI NPN	28480	1854-0019
Q3	1854-0019		TSTR:SI NPN	28480	1854-0019
Q4	1854-0019		TSTR:SI NPN	28480	1854-0019
Q5	1854-0019		TSTR:SI NPN	28480	1854-0019
Q6	1854-0019		TSTR:SI NPN	28480	1854-0019
Q7	1854-0019		TSTR:SI NPN	28480	1854-0019
Q8	1854-0019		TSTR:SI NPN	28480	1854-0019
Q9	1854-0019		TSTR:SI NPN	28480	1854-0019
Q10	1854-0019		TSTR:SI NPN	28480	1854-0019
Q11	1854-0019		TSTR:SI NPN	28480	1854-0019
Q12	1854-0019		TSTR:SI NPN	28480	1854-0019
Q13	1854-0019		TSTR:SI NPN	28480	1854-0019
Q14	1854-0019		TSTR:SI NPN	28480	1854-0019
Q15	1854-0019		TSTR:SI NPN	28480	1854-0019
Q16	1854-0019		TSTR:SI NPN	28480	1854-0019
Q17	1854-0019		TSTR:SI NPN	28480	1854-0019
Q18	1854-0019		TSTR:SI NPN	28480	1854-0019
Q19	1854-0019		TSTR:SI NPN	28480	1854-0019
Q20	1854-0019		TSTR:SI NPN	28480	1854-0019
Q21	1854-0019		TSTR:SI NPN	28480	1854-0019
Q22	1854-0019		TSTR:SI NPN	28480	1854-0019
Q23	1854-0019		TSTR:SI NPN	28480	1854-0019
Q24	1854-0019		TSTR:SI NPN	28480	1854-0019
R1	0757-0280	15	R:FxD MET FLM 1K OHM 1% 1/8W	28480	0757-0280
R2	0757-0280		R:FxD MET FLM 1K OHM 1% 1/8W	28480	0757-0280
R3	0698-3150	37	R:FxD MET FLM 2.37K OHM 1% 1/8W	28480	0698-3150
R4	0698-3150		R:FxD MET FLM 2.37K OHM 1% 1/8W	28480	0698-3150
R5	0698-3150		R:FxD MET FLM 2.37K OHM 1% 1/8W	28480	0698-3150
R6	0698-3150		R:FxD MET FLM 2.37K OHM 1% 1/8W	28480	0698-3150
R7	0698-3150		R:FxD MET FLM 2.37K OHM 1% 1/8W	28480	0698-3150
R8	0698-3150		R:FxD MET FLM 2.37K OHM 1% 1/8W	28480	0698-3150
R9	0698-3150		R:FxD MET FLM 2.37K OHM 1% 1/8W	28480	0698-3150
R10	0698-3150		R:FxD MET FLM 2.37K OHM 1% 1/8W	28480	0698-3150
R11	0698-3150		R:FxD MET FLM 2.37K OHM 1% 1/8W	28480	0698-3150

Table 2-17. Memory Data and Control PCA, Replaceable Parts (Continued)

Reference Designation	HP Part Number	Qty	Description	Mfr Code	Mfr Part Number
R12	0757-0280		R:FXD MET FLM 1K OHM 1% 1/8W	28480	0757-0280
R13	0757-0280		R:FXD MET FLM 1K OHM 1% 1/8W	28480	0757-0280
R14	0757-0280		R:FXD MET FLM 1K OHM 1% 1/8W	28480	0757-0280
R15	0757-0280		R:FXD MET FLM 1K OHM 1% 1/8W	28480	0757-0280
R16	0757-0280		R:FXD MET FLM 1K OHM 1% 1/8W	28480	0757-0280
R17	0757-0280		R:FXD MET FLM 1K OHM 1% 1/8W	28480	0757-0280
R18	0757-0280		R:FXD MET FLM 1K OHM 1% 1/8W	28480	0757-0280
R19	0757-0280		R:FXD MET FLM 1K OHM 1% 1/8W	28480	0757-0280
R20	0698-3150		R:FXD MET FLM 2.37K OHM 1% 1/8W	28480	0698-3150
R21	0698-3150		R:FXD MET FLM 2.37K OHM 1% 1/8W	28480	0698-3150
R22	0698-3150		R:FXD MET FLM 2.37K OHM 1% 1/8W	28480	0698-3150
R23	0698-3150		R:FXD MET FLM 2.37K OHM 1% 1/8W	28480	0698-3150
R24	0698-3150		R:FXD MET FLM 2.37K OHM 1% 1/8W	28480	0698-3150
R25	0698-3150		R:FXD MET FLM 2.37K OHM 1% 1/8W	28480	0698-3150
R26	1810-0030	1	NETWORK:7 RESISTORS 1K OHM 5% 0.15W EA	28480	1810-0030
R27	0698-3150		R:FXD MET FLM 2.37K OHM 1% 1/8W	28480	0698-3150
R28	0698-3150		R:FXD MET FLM 2.37K OHM 1% 1/8W	28480	0698-3150
R29	0698-3150		R:FXD MET FLM 2.37K OHM 1% 1/8W	28480	0698-3150
R30	0698-3150		R:FXD MET FLM 2.37K OHM 1% 1/8W	28480	0698-3150
R31	0698-3150		R:FXD MET FLM 2.37K OHM 1% 1/8W	28480	0698-3150
R32	0698-3150		R:FXD MET FLM 2.37K OHM 1% 1/8W	28480	0698-3150
R33	0698-3150		R:FXD MET FLM 2.37K OHM 1% 1/8W	28480	0698-3150
R34	0698-3150		R:FXD MET FLM 2.37K OHM 1% 1/8W	28480	0698-3150
R35	0698-3150		R:FXD MET FLM 2.37K OHM 1% 1/8W	28480	0698-3150
R36	0698-3150		R:FXD MET FLM 2.37K OHM 1% 1/8W	28480	0698-3150
R37	0698-3150		R:FXD MET FLM 2.37K OHM 1% 1/8W	28480	0698-3150
R38	0698-3150		R:FXD MET FLM 2.37K OHM 1% 1/8W	28480	0698-3150
R39	0698-3150		R:FXD MET FLM 2.37K OHM 1% 1/8W	28480	0698-3150
R40	0698-3150		R:FXD MET FLM 2.37K OHM 1% 1/8W	28480	0698-3150
R41	0698-3150		R:FXD MET FLM 2.37K OHM 1% 1/8W	28480	0698-3150
R42	0757-0280		R:FXD MET FLM 1K OHM 1% 1/8W	28480	0757-0280
R43	0698-3150		R:FXD MET FLM 2.37K OHM 1% 1/8W	28480	0698-3150
R44	0757-0280		R:FXD MET FLM 1K OHM 1% 1/8W	28480	0757-0280
R45	0757-0280		R:FXD MET FLM 1K OHM 1% 1/8W	28480	0757-0280
R46	0698-3150		R:FXD MET FLM 2.37K OHM 1% 1/8W	28480	0698-3150
R47	0698-3150		R:FXD MET FLM 2.37K OHM 1% 1/8W	28480	0698-3150
R48	0698-3150		R:FXD MET FLM 2.37K OHM 1% 1/8W	28480	0698-3150
R49	0698-3150		R:FXD MET FLM 2.37K OHM 1% 1/8W	28480	0698-3150
R50	0698-3150		R:FXD MET FLM 2.37K OHM 1% 1/8W	28480	0698-3150
R51	0698-3150		R:FXD MET FLM 2.37K OHM 1% 1/8W	28480	0698-3150
R52	0757-0280		R:FXD MET FLM 1K OHM 1% 1/8W	28480	0757-0280
R53	0757-0280		R:FXD MET FLM 1K OHM 1% 1/8W	28480	0757-0280
R54	0698-3160	1	R:FXD MET FLM 31.6K OHM 1% 1/8W	28480	0698-3160
R55	0757-0401	4	R:FXD MET FLM 100 OHM 1% 1/8W	28480	0757-0401
R56	0757-0401		R:FXD MET FLM 100 OHM 1% 1/8W	28480	0757-0401
R57	0757-0401		R:FXD MET FLM 100 OHM 1% 1/8W	28480	0757-0401
R58	2100-2514	1	R:VAR CERMET 20K OHM 10% LIN 1/2W	28480	2100-2514
R59	0757-0401		R:FXD MET FLM 100 OHM 1% 1/8W	28480	0757-0401
S1	3100-2687	2	SWITCH:ROTARY SP5T 6 POSITION	28480	3100-2687
S2	3100-2687		SWITCH:ROTARY SP5T 6 POSITION	28480	3100-2687
U13	1820-0842	4	IC:TTL 8-BIT PARITY TREE	04713	MC4008P
U15	1820-0690	6	IC:TTL SCHOTTKY DUAL 4-INPT NAND BUFFER	01295	SN74S40N
U16	1820-0690		IC:TTL SCHOTTKY DUAL 4-INPT NAND BUFFER	01295	SN74S40N
U17	1820-0759	7	IC:TTL LOW-POWER 8-BIT RECEIVER	28480	1820-0759
U18	1820-0759		IC:TTL LOW-POWER 8-BIT RECEIVER	28480	1820-0759
U19	1820-0140	3	IC:TTL DUAL 4-INPT AND BUFFER	04713	MC3026P
U23	1820-0301	10	IC:TTL QUAD BI-STABLE D-LATCH	01295	SN7475N
U26	1820-0690		IC:TTL SCHOTTKY DUAL 4-INPT NAND BUFFER	01295	SN74S40N
U27	1820-0756	3	IC:TTL 8-BIT DRIVER INVERTING	28480	1820-0756
U28	1820-0759		IC:TTL LOW-POWER 8-BIT RECEIVER	28480	1820-0759
U29	1820-0424	2	IC:TTL HS HEX INVERTER	04713	SN74H04N
U33	1820-0301		IC:TTL QUAD BI-STABLE D-LATCH	01295	SN7475N
U36	1820-0690		IC:TTL SCHOTTKY DUAL 4-INPT NAND BUFFER	01295	SN74S40N
U37	1820-0371	2	IC:TTL HS TRIPLE 3-INPT NAND GATE	01295	SN74H10N
U38	1820-0376	5	IC:TTL HS DUAL 4-INPT NAND BUFFER	01295	SN74H40N
U39	1820-0629	5	IC:TTL SHS DUAL EDGE TRIG. J-K F/F	01295	SN74S112N
U41	1820-0756		IC:TTL 8-BIT DRIVER INVERTING	28480	1820-0756
U43	1820-0301		IC:TTL QUAD BI-STABLE D-LATCH	01295	SN7475N
U46	1820-0690		IC:TTL SCHOTTKY DUAL 4-INPT NAND BUFFER	01295	SN74S40N
U47	1820-0370	3	IC:TTL HS QUAD 2-INPT NAND GATE	01295	SN74H00N
U51	1820-0759		IC:TTL LOW-POWER 8-BIT RECEIVER	28480	1820-0759
U52	1820-0301		IC:TTL QUAD BI-STABLE D-LATCH	01295	SN7475N
U53	1820-0301		IC:TTL QUAD BI-STABLE D-LATCH	01295	SN7475N
U55	1820-0141	3	IC:TTL QUAD 2-INPT AND GATE	04713	MC3001P
U56	1820-0686	2	IC:TTL SCHOTTKY TRIPLE 3-INPT AND GATE	01295	SN74S11N

Table 2-17. Memory Data and Control PCA, Replaceable Parts (Continued)

Reference Designation	HP Part Number	Qty	Description	Mfr Code	Mfr Part Number
U57	1820-0683	2	IC:TTL SCHOTTKY HEX INVERTER	01295	SN74S04N
U58	1820-0371		IC:TTL HS TRIPLE 3-INPT NAND GATE	01295	SN74H10N
U59	1820-0755	8	IC	28480	1820-0755
U61	1820-0755		IC	28480	1820-0755
U62	1820-0301		IC:TTL QUAD BI-STABLE D-LATCH	01295	SN7475N
U63	1820-0842		IC:TTL 8-BIT PARITY TREE	04713	MC4008P
U65	1820-0140		IC:TTL DUAL 4-INPT AND BUFFER	04713	MC3026P
U69	1820-0755		IC	28480	1820-0755
U71	1820-0755		IC	28480	1820-0755
U72	1820-0301		IC:TTL QUAD BI-STABLE D-LATCH	01295	SN7475N
U73	1820-0140		IC:TTL DUAL 4-INPT AND BUFFER	04713	MC3026P
U75	1820-0629		IC:TTL SHS DUAL EDGE TRIG. J-K F/F	01295	SN74S112N
U76	1820-0239	10	IC:TTL QUAD 2-INPT NOR GATE	28480	1820-0239
U77	1820-0842		IC:TTL 8-BIT PARITY TREE	04713	MC4008P
U78	1820-0301		IC:TTL QUAD BI-STABLE D-LATCH	01295	SN7475N
U79	1820-0759		IC:TTL LOW-POWER 8-BIT RECEIVER	28480	1820-0759
U81	1820-0759		IC:TTL LOW-POWER 8-BIT RECEIVER	28480	1820-0759
U82	1820-0301		IC:TTL QUAD BI-STABLE D-LATCH	01295	SN7475N
U85	1820-0629		IC:TTL SHS DUAL EDGE TRIG. J-K F/F	01295	SN74S112N
U86	1820-0239		IC:TTL QUAD 2-INPT NOR GATE	28480	1820-0239
U87	1820-0301		IC:TTL QUAD BI-STABLE D-LATCH	01295	SN7475N
U88	1820-0370		IC:TTL HS QUAD 2-INPT NAND GATE	01295	SN74H00N
U89	1820-0755		IC	28480	1820-0755
U91	1820-0756		IC:TTL 8-BIT DRIVER INVERTING	28480	1820-0756
U92	1820-0141		IC:TTL QUAD 2-INPT AND GATE	04713	MC3001P
U95	1820-0690		IC:TTL SCHOTTKY DUAL 4-INPT NAND BUFFER	01295	SN74S40N
U96	1820-0141		IC:TTL QUAD 2-INPT AND GATE	04713	MC3001P
U97	1820-0706	2	IC:DIGITAL TTL 5-BIT COMPARATOR	04713	U78932459X
U98	1820-0629		IC:TTL SHS DUAL EDGE TRIG. J-K F/F	01295	SN74S112N
U99	1820-0842		IC:TTL 8-BIT PARITY TREE	04713	MC4008P
U102	1820-0608	2	IC:TTL 1 OF DECODER W/ENABLE	04713	MC4006P
U106	1820-0370		IC:TTL HS QUAD 2-INPT NAND GATE	01295	SN74H00N
U107	1820-0629		IC:TTL SHS DUAL EDGE TRIG. J-K F/F	01295	SN74S112N
U108	1820-0608		IC:TTL 1 OF DECODER W/ENABLE	04713	MC4006P
U109	1820-0706		IC:DIGITAL TTL 5-BIT COMPARATOR	04713	U78932459X
U112	1820-0239	3	IC:TTL QUAD 2-INPT NOR GATE	28480	1820-0239
U113	1820-0205		IC:TTL QUAD 2-INPT OR GATE	28480	1820-0205
U114	1820-0205		IC:TTL QUAD 2-INPT OR GATE	28480	1820-0205
U115	1820-0239		IC:TTL QUAD 2-INPT NOR GATE	28480	1820-0239
U116	1820-0239		IC:TTL QUAD 2-INPT NOR GATE	28480	1820-0239
U117	1820-0239		IC:TTL QUAD 2-INPT NOR GATE	28480	1820-0239
U118	1820-0376		IC:TTL HS DUAL 4-INPT NAND BUFFER	01295	SN74H40N
U122	1820-0239		IC:TTL QUAD 2-INPT NOR GATE	28480	1820-0239
U123	1820-0239		IC:TTL QUAD 2-INPT NOR GATE	28480	1820-0239
U124	1820-0239		IC:TTL QUAD 2-INPT NOR GATE	28480	1820-0239
U125	1820-0239		IC:TTL QUAD 2-INPT NOR GATE	28480	1820-0239
U126	1820-0205		IC:TTL QUAD 2-INPT OR GATE	28480	1820-0205
U128	1820-0686		IC:TTL SCHOTTKY TRIPLE 3-INPT AND GATE	01295	SN74S11N
U131	1820-0377	2	IC:TTL HS DUAL 2-WIDE 2-INPT	01295	SN74H50N
U137	1820-0683		IC:TTL SCHOTTKY HEX INVERTER	01295	SN74S04N
U138	1820-0424		IC:TTL HS HEX INVERTER	04713	SN74H04N
U139	1820-0759		IC:TTL LOW-POWER 8-BIT RECEIVER	28480	1820-0759
U141	1820-0377		IC:TTL HS DUAL 2-WIDE 2-INPT	01295	SN74H50N
U147	1820-0376		IC:TTL HS DUAL 4-INPT NAND BUFFER	01295	SN74H40N
U148	1820-0376		IC:TTL HS DUAL 4-INPT NAND BUFFER	01295	SN74H40N
U149	1820-0755		IC	28480	1820-0755
U151	1820-0207	1	IC:TTL MONOSTABLE MULTIVIBRATOR	28480	1820-0207
U159	1820-0755		IC	28480	1820-0755
U167	1820-0376		IC:TTL HS DUAL 4-INPT NAND BUFFER	01295	SN74H40N
U169	1820-0755		IC	28480	1820-0755
W2	5080-0058		CONDUCTOR ASSEMBLY:PLUG-IN JUMPER	28480	5080-0058
W3	5080-0058		CONDUCTOR ASSEMBLY:PLUG-IN JUMPER	28480	5080-0058
W4	5080-0058		CONDUCTOR ASSEMBLY:PLUG-IN JUMPER	28480	5080-0058
W5	5080-0058		CONDUCTOR ASSEMBLY:PLUG-IN JUMPER	28480	5080-0058
W6	5080-0058		CONDUCTOR ASSEMBLY:PLUG-IN JUMPER	28480	5080-0058

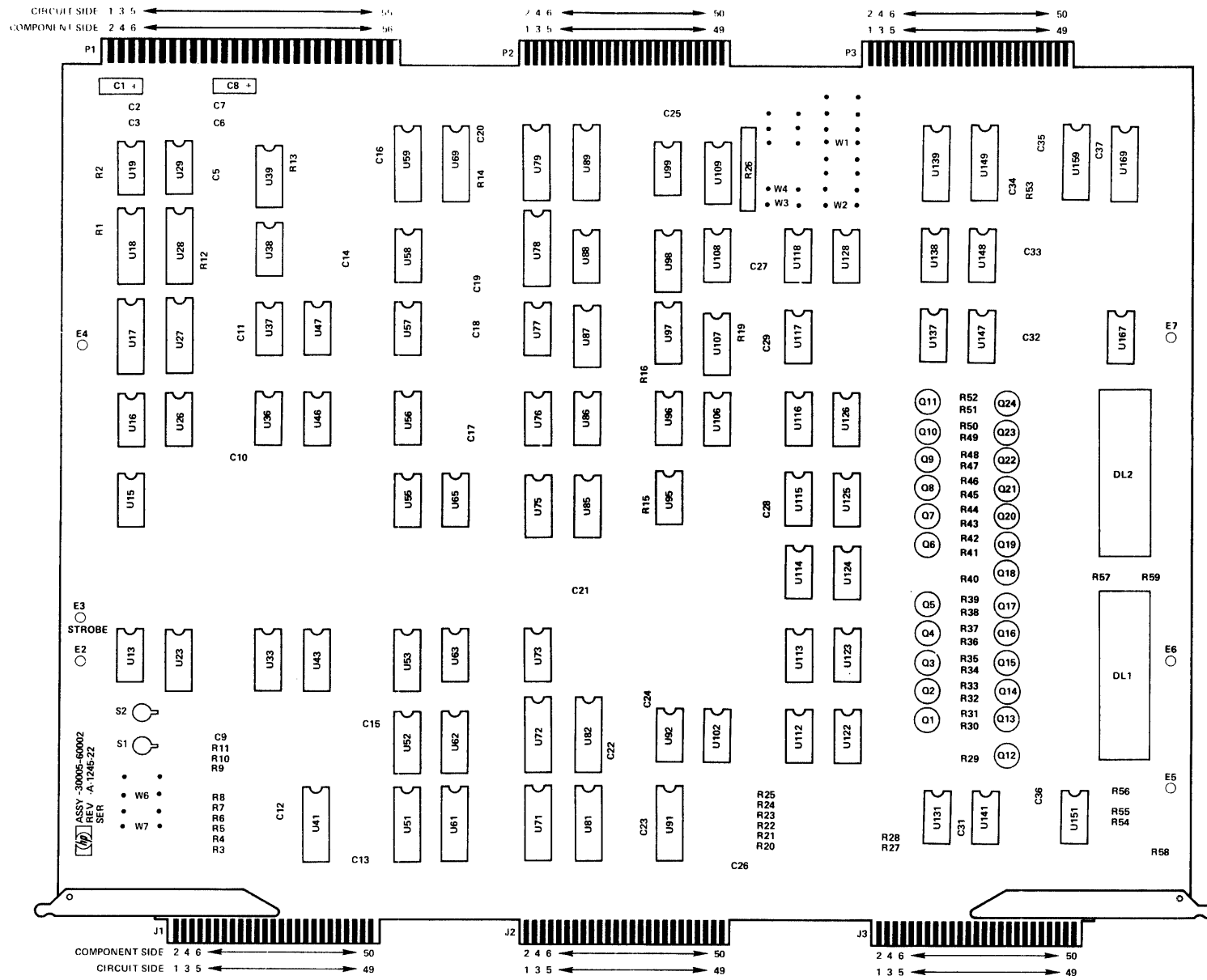

2183 26

Figure 2-16. Memory Data and Control PCA, Parts Location Diagram

Table 2-18. Memory Drive and Sense PCA, Replaceable Parts

Reference Designation	HP Part Number	Qty	Description	Mfr Code	Mfr Part Number
C1	30006-60001	1	MEMORY DRIVE AND SENSE PCA		30006-60001
C2	0160-0127	27	C:F XD CER 1.0 UF 20% 25VDCW	56289	5C13CS-CML
C3	0160-0127		C:F XD CER 1.0 UF 20% 25VDCW	56289	5C13CS-CML
C4	0160-0127		C:F XD CER 1.0 UF 20% 25VDCW	56289	5C13CS-CML
C5	0160-0127		C:F XD CER 1.0 UF 20% 25VDCW	56289	5C13CS-CML
C6	0160-0127		C:F XD CER 1.0 UF 20% 25VDCW	56289	5C13CS-CML
C7	0160-0127		C:F XD CER 1.0 UF 20% 25VDCW	56289	5C13CS-CML
C8	0160-0127		C:F XD CER 1.0 UF 20% 25VDCW	56289	5C13CS-CML
C9	0160-0127		C:F XD CER 1.0 UF 20% 25VDCW	56289	5C13CS-CML
C10	0160-0127		C:F XD CER 1.0 UF 20% 25VDCW	56289	5C13CS-CML
C11	0160-0127		C:F XD CER 1.0 UF 20% 25VDCW	56289	5C13CS-CML
C12	0160-0127		C:F XD CER 1.0 UF 20% 25VDCW	56289	5C13CS-CML
C13	0160-0127		C:F XD CER 1.0 UF 20% 25VDCW	56289	5C13CS-CML
C14	0160-0127		C:F XD CER 1.0 UF 20% 25VDCW	56289	5C13CS-CML
C15	0160-0127		C:F XD CER 1.0 UF 20% 25VDCW	56289	5C13CS-CML
C16	0160-0127		C:F XD CER 1.0 UF 20% 25VDCW	56289	5C13CS-CML
C17	0160-0127		C:F XD CER 1.0 UF 20% 25VDCW	56289	5C13CS-CML
C18	0160-0127		C:F XD CER 1.0 UF 20% 25VDCW	56289	5C13CS-CML
C19	0160-0127		C:F XD CER 1.0 UF 20% 25VDCW	56289	5C13CS-CML
C20	0160-0127		C:F XD CER 1.0 UF 20% 25VDCW	56289	5C13CS-CML
C21	0160-0127		C:F XD CER 1.0 UF 20% 25VDCW	56289	5C13CS-CML
C22	0180-0374	6	C:F XD TANT. 10 UF 10% 20VDCW	56289	1500106X902082-DYS
C23	0180-0374		C:F XD TANT. 10 UF 10% 20VDCW	56289	1500106X902082-DYS
C24	0180-0374		C:F XD TANT. 10 UF 10% 20VDCW	56289	1500106X902082-DYS
C25	0180-0374		C:F XD TANT. 10 UF 10% 20VDCW	56289	1500106X902082-DYS
C26	0180-0374		C:F XD TANT. 10 UF 10% 20VDCW	56289	1500106X902082-DYS
C27	0180-0374		C:F XD TANT. 10 UF 10% 20VDCW	56289	1500106X902082-DYS
C28	0180-0116	2	C:F XD ELECT 6.8 UF 10% 35VDCW	56289	1500685X903582-DYS
C29	0160-0127		C:F XD CER 1.0 UF 20% 25VDCW	56289	5C13CS-CML
C30	0160-0127		C:F XD CER 1.0 UF 20% 25VDCW	56289	5C13CS-CML
C31	0160-0938	3	C:F XD MICA 1000 PF 5%	72136	RDML5E102J1C
C32	0160-0938		C:F XD MICA 1000 PF 5%	72136	RDML5E102J1C
C33	0180-0116		C:F XD ELECT 6.8 UF 10% 35VDCW	56289	1500685X903582-DYS
C34	0160-0127		C:F XD CER 1.0 UF 20% 25VDCW	56289	5C13CS-CML
C35	0160-0127		C:F XD CER 1.0 UF 20% 25VDCW	56289	5C13CS-CML
C37	0160-0938		C:F XD MICA 1000 PF 5%	72136	RDML5E102J1C
C38	0140-0198	3	C:F XD MICA 200 PF 5%	72136	RDML5F201J3C
C41	0160-0127		C:F XD CER 1.0 UF 20% 25VDCW	56289	5C13CS-CML
C42	0140-0198		C:F XD MICA 200 PF 5%	72136	RDML5F201J3C
C45	0160-0127		C:F XD CER 1.0 UF 20% 25VDCW	56289	5C13CS-CML
CR1	1901-0016	2	DIODE:SILICON 1N1566	04713	1N1566
CR2	1901-0016		DIODE:SILICON 1N1566	04713	1N1566
CR3			THRU		
CR36	1901-0620	34	DIODE BREAKDOWN	28480	1901-0620
CR37	1901-0040	32	DIODE:SILICON 50 MA 30 WV	07263	FDG1088
CR38	1901-0040		DIODE:SILICON 50 MA 30 WV	07263	FDG1088
CR39	1901-0040		DIODE:SILICON 50 MA 30 WV	07263	FDG1088
CR40	1901-0040		DIODE:SILICON 50 MA 30 WV	07263	FDG1088
CR41	1901-0040		DIODE:SILICON 50 MA 30 WV	07263	FDG1088
CR42	1901-0040		DIODE:SILICON 50 MA 30 WV	07263	FDG1088
CR43	1901-0040		DIODE:SILICON 50 MA 30 WV	07263	FDG1088
CR44	1901-0040		DIODE:SILICON 50 MA 30 WV	07263	FDG1088
CR45	1901-0040		DIODE:SILICON 50 MA 30 WV	07263	FDG1088
CR46	1901-0040		DIODE:SILICON 50 MA 30 WV	07263	FDG1088
CR47	1901-0040		DIODE:SILICON 50 MA 30 WV	07263	FDG1088
CR48	1901-0040		DIODE:SILICON 50 MA 30 WV	07263	FDG1088
CR49	1901-0040		DIODE:SILICON 50 MA 30 WV	07263	FDG1088
CR50	1901-0040		DIODE:SILICON 50 MA 30 WV	07263	FDG1088
CR51	1901-0040		DIODE:SILICON 50 MA 30 WV	07263	FDG1088
CR52	1901-0040		DIODE:SILICON 50 MA 30 WV	07263	FDG1088
CR53	1901-0040		DIODE:SILICON 50 MA 30 WV	07263	FDG1088
CR54	1901-0040		DIODE:SILICON 50 MA 30 WV	07263	FDG1088
CR55	1901-0040		DIODE:SILICON 50 MA 30 WV	07263	FDG1088
CR56	1901-0040		DIODE:SILICON 50 MA 30 WV	07263	FDG1088
CR57	1901-0040		DIODE:SILICON 50 MA 30 WV	07263	FDG1088
CR58	1901-0040		DIODE:SILICON 50 MA 30 WV	07263	FDG1088
CR59	1901-0040		DIODE:SILICON 50 MA 30 WV	07263	FDG1088
CR60	1901-0040		DIODE:SILICON 50 MA 30 WV	07263	FDG1088
CR61	1901-0040		DIODE:SILICON 50 MA 30 WV	07263	FDG1088
CR62	1901-0040		DIODE:SILICON 50 MA 30 WV	07263	FDG1088
CR63	1901-0040		DIODE:SILICON 50 MA 30 WV	07263	FDG1088
CR64	1901-0040		DIODE:SILICON 50 MA 30 WV	07263	FDG1088
CR65	1901-0040		DIODE:SILICON 50 MA 30 WV	07263	FDG1088
CR66	1901-0040		DIODE:SILICON 50 MA 30 WV	07263	FDG1088

Table 2-18. Memory Drive and Sense PCA, Replaceable Parts (Continued)

Reference Designation	HP Part Number	Qty	Description	Mfr Code	Mfr Part Number
CR67	1901-0040		DIODE:SILICON 50 MA 30 WV	07263	F061088
CR68	1901-0040		DIODE:SILICON 50 MA 30 WV	07263	F061088
Q1	1854-0019	5	TSTR:SI NPN	28480	1854-0019
Q2	1854-0215	19	TSTR:SI NPN	80131	2N3904
Q3	1854-0532	34	TSTR:SI NPN	02735	2N5262
Q4	1854-0532		TSTR:SI NPN	02735	2N5262
Q5	1854-0532		TSTR:SI NPN	02735	2N5262
Q6	1854-0532		TSTR:SI NPN	02735	2N5262
Q7	1853-0036	36	TSTR:SI PNP	80131	2N3906
Q8	1853-0036		TSTR:SI PNP	80131	2N3906
Q9	1854-0215		TSTR:SI NPN	80131	2N3904
Q10	1853-0036		TSTR:SI PNP	80131	2N3906
Q11	1853-0036		TSTR:SI PNP	80131	2N3906
Q12	1854-0215		TSTR:SI NPN	80131	2N3904
Q13	1854-0532		TSTR:SI NPN	02735	2N5262
Q14	1854-0532		TSTR:SI NPN	02735	2N5262
Q15	1854-0532		TSTR:SI NPN	02735	2N5262
Q16	1854-0532		TSTR:SI NPN	02735	2N5262
Q17	1853-0036		TSTR:SI PNP	80131	2N3906
Q18	1853-0036		TSTR:SI PNP	80131	2N3906
Q19	1854-0215		TSTR:SI NPN	80131	2N3904
Q20	1853-0036		TSTR:SI PNP	80131	2N3906
Q21	1853-0036		TSTR:SI PNP	80131	2N3906
Q22	1854-0215		TSTR:SI NPN	80131	2N3904
Q23	1854-0532		TSTR:SI NPN	02735	2N5262
Q24	1854-0532		TSTR:SI NPN	02735	2N5262
Q25	1854-0532		TSTR:SI NPN	02735	2N5262
Q26	1854-0532		TSTR:SI NPN	02735	2N5262
Q27	1853-0036		TSTR:SI PNP	80131	2N3906
Q28	1853-0036		TSTR:SI PNP	80131	2N3906
Q29	1854-0215		TSTR:SI NPN	80131	2N3904
Q30	1853-0036		TSTR:SI PNP	80131	2N3906
Q31	1853-0036		TSTR:SI PNP	80131	2N3906
Q32	1854-0215		TSTR:SI NPN	80131	2N3904
Q33	1854-0532		TSTR:SI NPN	02735	2N5262
Q34	1854-0532		TSTR:SI NPN	02735	2N5262
Q35	1854-0532		TSTR:SI NPN	02735	2N5262
Q36	1854-0532		TSTR:SI NPN	02735	2N5262
Q37	1853-0036		TSTR:SI PNP	80131	2N3906
Q38	1853-0036		TSTR:SI PNP	80131	2N3906
Q39	1854-0215		TSTR:SI NPN	80131	2N3904
Q40	1853-0036		TSTR:SI PNP	80131	2N3906
Q41	1853-0036		TSTR:SI PNP	80131	2N3906
Q42	1854-0215		TSTR:SI NPN	80131	2N3904
Q43	1854-0215		TSTR:SI NPN	80131	2N3904
Q44	1853-0036		TSTR:SI PNP	80131	2N3906
Q45	1853-0036		TSTR:SI PNP	80131	2N3906
Q46	1854-0215		TSTR:SI NPN	80131	2N3904
Q47	1853-0036		TSTR:SI PNP	80131	2N3906
Q48	1853-0036		TSTR:SI PNP	80131	2N3906
Q49	1854-0532		TSTR:SI NPN	02735	2N5262
Q50	1854-0532		TSTR:SI NPN	02735	2N5262
Q51	1854-0532		TSTR:SI NPN	02735	2N5262
Q52	1854-0532		TSTR:SI NPN	02735	2N5262
Q53	1854-0215		TSTR:SI NPN	80131	2N3904
Q54	1853-0036		TSTR:SI PNP	80131	2N3906
Q55	1853-0036		TSTR:SI PNP	80131	2N3906
Q56	1854-0215		TSTR:SI NPN	80131	2N3904
Q57	1853-0036		TSTR:SI PNP	80131	2N3906
Q58	1853-0036		TSTR:SI PNP	80131	2N3906
Q59	1854-0532		TSTR:SI NPN	02735	2N5262
Q60	1854-0532		TSTR:SI NPN	02735	2N5262
Q61	1854-0532		TSTR:SI NPN	02735	2N5262
Q62	1854-0532		TSTR:SI NPN	02735	2N5262
Q63	1854-0215		TSTR:SI NPN	80131	2N3904
Q64	1853-0036		TSTR:SI PNP	80131	2N3906
Q65	1853-0036		TSTR:SI PNP	80131	2N3906
Q66	1854-0215		TSTR:SI NPN	80131	2N3904
Q67	1853-0036		TSTR:SI PNP	80131	2N3906
Q68	1853-0036		TSTR:SI PNP	80131	2N3906
Q69	1854-0532		TSTR:SI NPN	02735	2N5262
Q70	1854-0532		TSTR:SI NPN	02735	2N5262
Q71	1854-0532		TSTR:SI NPN	02735	2N5262
Q72	1854-0532		TSTR:SI NPN	02735	2N5262
Q73	1854-0215		TSTR:SI NPN	80131	2N3904

Table 2-18. Memory Drive and Sense PCA, Replaceable Parts (Continued)

Reference Designation	HP Part Number	Qty	Description	Mfr Code	Mfr Part Number
C74	1853-0036		TSTR:SI PNP	80131	2N3906
C75	1853-0036		TSTR:SI PNP	80131	2N3906
C76	1854-0215		TSTR:SI NPN	80131	2N3904
C77	1853-0036		TSTR:SI PNP	80131	2N3906
C78	1853-0036		TSTR:SI PNP	80131	2N3906
C79	1854-0532		TSTR:SI NPN	02735	2N5262
Q80	1854-0532		TSTR:SI NPN	02735	2N5262
Q81	1854-0532		TSTR:SI NPN	02735	2N5262
Q82	1854-0532		TSTR:SI NPN	02735	2N5262
Q83	1854-0215		TSTR:SI NPN	80131	2N3904
Q84	1853-0036		TSTR:SI PNP	80131	2N3906
Q85	1853-0036		TSTR:SI PNP	80131	2N3906
Q86	1854-0532		TSTR:SI NPN	02735	2N5262
Q87	1854-0532		TSTR:SI NPN	02735	2N5262
Q88	1854-0019		TSTR:SI NPN	26480	1854-0019
Q89	1853-0034	4	TSTR:SI PNP(SELECTED FROM 2N3251)	28480	1853-0034
Q90	1854-0019		TSTR:SI NPN	28480	1854-0019
Q91	1853-0034		TSTR:SI PNP(SELECTED FROM 2N3251)	28480	1853-0034
Q92	1854-0019		TSTR:SI NPN	28480	1854-0019
Q93	1853-0034		TSTR:SI PNP(SELECTED FROM 2N3251)	28480	1853-0034
Q94	1854-0019		TSTR:SI NPN	28480	1854-0019
Q95	1853-0034		TSTR:SI PNP(SELECTED FROM 2N3251)	28480	1853-0034
Q96	1854-0215		TSTR:SI NPN	80131	2N3904
Q97	1853-0036		TSTR:SI PNP	80131	2N3906
Q98	1853-0036		TSTR:SI PNP	80131	2N3906
R1	2100-2632	1	R:VAR FLM 100 OHM 10% LIN 1/2W	28480	2100-2632
R2	0757-0180	1	R:FXD MET FLM 31.6 OHM 1% 1/8W	28480	0757-0180
R3	0698-3446	1	R:FXD MET FLM 383 OHM 1% 1/8W	28480	0698-3446
R4	0757-0402	1	R:FXD MET FLM 110 OHM 1% 1/8W	28480	0757-0402
R5	0698-3440	42	R:FXD MET FLM 196 OHM 1% 1/8W	28480	0698-3440
R6	0698-3440		R:FXD MET FLM 196 OHM 1% 1/8W	28480	0698-3440
R7	0757-0394	19	R:FXD MET FLM 51.1 OHM 1% 1/8W	28480	0757-0394
R8	0698-3440		R:FXD MET FLM 196 OHM 1% 1/8W	28480	0698-3440
R9	0698-3440		R:FXD MET FLM 196 OHM 1% 1/8W	28480	0698-3440
R10	0757-0394		R:FXD MET FLM 51.1 OHM 1% 1/8W	28480	0757-0394
R11	0698-3437	2	R:FXD MET FLM 133 OHM 1% 1/8W	28480	0698-3437
R12	0757-0420	6	R:FXD MET FLM 750 OHM 1% 1/8W	28480	0757-0420
R13	0698-3437		R:FXD MET FLM 133 OHM 1% 1/8W	28480	0698-3437
R14	0757-0420		R:FXD MET FLM 750 OHM 1% 1/8W	28480	0757-0420
R15	0757-0394		R:FXD MET FLM 51.1 OHM 1% 1/8W	28480	0757-0394
R16	0757-0394		R:FXD MET FLM 51.1 OHM 1% 1/8W	28480	0757-0394
R17	0757-0403	67	R:FXD MET FLM 121 OHM 1% 1/8W	28480	0757-0403
R18	0698-3440		R:FXD MET FLM 196 OHM 1% 1/8W	28480	0698-3440
R19	0757-0403		R:FXD MET FLM 121 OHM 1% 1/8W	28480	0757-0403
R19	0757-0403		R:FXD MET FLM 121 OHM 1% 1/8W	28480	0757-0403
R20	0698-3440		R:FXD MET FLM 196 OHM 1% 1/8W	28480	0698-3440
R21	0757-0403		R:FXD MET FLM 121 OHM 1% 1/8W	28480	0757-0403
R22	0698-3440		R:FXD MET FLM 196 OHM 1% 1/8W	28480	0698-3440
R23	0757-0403		R:FXD MET FLM 121 OHM 1% 1/8W	28480	0757-0403
R24	0698-3440		R:FXD MET FLM 196 OHM 1% 1/8W	28480	0698-3440
R25	0698-7310	34	R:FXD FLM 1.65K OHM 0.25% 1/8W	28480	0698-7310
R26	0698-3445	17	R:FXD MET FLM 348 OHM 1% 1/8W	28480	0698-3445
R27	0698-7310		R:FXD FLM 1.65K OHM 0.25% 1/8W	28480	0698-7310
R28	0757-0290	17	R:FXD MET FLM 6.19K OHM 1% 1/8W	28480	0757-0290
R29	0757-0401	4	R:FXD MET FLM 100 OHM 1% 1/8W	28480	0757-0401
R30	0698-7310		R:FXD FLM 1.65K OHM 0.25% 1/8W	28480	0698-7310
R31	0698-3445		R:FXD MET FLM 348 OHM 1% 1/8W	28480	0698-3445
R32	0698-7310		R:FXD FLM 1.65K OHM 0.25% 1/8W	28480	0698-7310
R33	0757-0290		R:FXD MET FLM 6.19K OHM 1% 1/8W	28480	0757-0290
R34	0757-0401		R:FXD MET FLM 100 OHM 1% 1/8W	28480	0757-0401
R35	0757-0394		R:FXD MET FLM 51.1 OHM 1% 1/8W	28480	0757-0394
R36	0757-0394		R:FXD MET FLM 51.1 OHM 1% 1/8W	28480	0757-0394
R37	0757-0403		R:FXD MET FLM 121 OHM 1% 1/8W	28480	0757-0403
R38	0698-3440		R:FXD MET FLM 196 OHM 1% 1/8W	28480	0698-3440
R39	0757-0403		R:FXD MET FLM 121 OHM 1% 1/8W	28480	0757-0403
R40	0698-3440		R:FXD MET FLM 196 OHM 1% 1/8W	28480	0698-3440
R41	0757-0403		R:FXD MET FLM 121 OHM 1% 1/8W	28480	0757-0403
R42	0698-3440		R:FXD MET FLM 196 OHM 1% 1/8W	28480	0698-3440
R43	0757-0403		R:FXD MET FLM 121 OHM 1% 1/8W	28480	0757-0403
R44	0698-3440		R:FXD MET FLM 196 OHM 1% 1/8W	28480	0698-3440
R45	0698-7310		R:FXD FLM 1.65K OHM 0.25% 1/8W	28480	0698-7310
R46	0698-3445		R:FXD MET FLM 348 OHM 1% 1/8W	28480	0698-3445
R47	0698-7310		R:FXD FLM 1.65K OHM 0.25% 1/8W	28480	0698-7310
R48	0757-0290		R:FXD MET FLM 6.19K OHM 1% 1/8W	28480	0757-0290
R49	0757-0401		R:FXD MET FLM 100 OHM 1% 1/8W	28480	0757-0401

Table 2-18. Memory Drive and Sense PCA, Replaceable Parts (Continued)

Reference Designation	HP Part Number	Qty	Description	Mfr Code	Mfr Part Number
R50	0698-7310		R:FxD FLM 1.65K OHM 0.25% 1/8W	28480	0698-7310
R51	0698-3445		R:FxD MET FLM 348 OHM 1% 1/8W	28480	0698-3445
R52	0698-7310		R:FxD FLM 1.65K OHM 0.25% 1/8W	28480	0698-7310
R53	0757-0290		R:FxD MET FLM 6.19K OHM 1% 1/8W	28480	0757-0290
R54	0757-0401		R:FxD MET FLM 100 OHM 1% 1/8W	28480	0757-0401
R55	0757-0394		R:FxD MET FLM 51.1 OHM 1% 1/8W	28480	0757-0394
R56	0757-0394		R:FxD MET FLM 51.1 OHM 1% 1/8W	28480	0757-0394
R57	0757-0403		R:FxD MET FLM 121 OHM 1% 1/8W	28480	0757-0403
R58	0698-3440		R:FxD MET FLM 196 OHM 1% 1/8W	28480	0698-3440
R59	0757-0403		R:FxD MET FLM 121 OHM 1% 1/8W	28480	0757-0403
R60	0698-3440		R:FxD MET FLM 196 OHM 1% 1/8W	28480	0698-3440
R61	0757-0403		R:FxD MET FLM 121 OHM 1% 1/8W	28480	0757-0403
R62	0698-3440		R:FxD MET FLM 196 OHM 1% 1/8W	28480	0698-3440
R63	0757-0403		R:FxD MET FLM 121 OHM 1% 1/8W	28480	0757-0403
R64	0698-3440		R:FxD MET FLM 196 OHM 1% 1/8W	28480	0698-3440
R65	0698-7310		R:FxD FLM 1.65K OHM 0.25% 1/8W	28480	0698-7310
R66	0698-3445		R:FxD MET FLM 348 OHM 1% 1/8W	28480	0698-3445
R67	0698-7310		R:FxD FLM 1.65K OHM 0.25% 1/8W	28480	0698-7310
R68	0757-0290		R:FxD MET FLM 6.19K OHM 1% 1/8W	28480	0757-0290
R70	0698-7310		R:FxD FLM 1.65K OHM 0.25% 1/8W	28480	0698-7310
R71	0698-3445		R:FxD MET FLM 348 OHM 1% 1/8W	28480	0698-3445
R72	0698-7310		R:FxD FLM 1.65K OHM 0.25% 1/8W	28480	0698-7310
R73	0757-0290		R:FxD MET FLM 6.19K OHM 1% 1/8W	28480	0757-0290
R75	0757-0394		R:FxD MET FLM 51.1 OHM 1% 1/8W	28480	0757-0394
R76	0757-0394		R:FxD MET FLM 51.1 OHM 1% 1/8W	28480	0757-0394
R77	0757-0403		R:FxD MET FLM 121 OHM 1% 1/8W	28480	0757-0403
R78	0698-3440		R:FxD MET FLM 196 OHM 1% 1/8W	28480	0698-3440
R79	0757-0403		R:FxD MET FLM 121 OHM 1% 1/8W	28480	0757-0403
R80	0698-3440		R:FxD MET FLM 196 OHM 1% 1/8W	28480	0698-3440
R81	0757-0403		R:FxD MET FLM 121 OHM 1% 1/8W	28480	0757-0403
R82	0698-3440		R:FxD MET FLM 196 OHM 1% 1/8W	28480	0698-3440
R83	0757-0403		R:FxD MET FLM 121 OHM 1% 1/8W	28480	0757-0403
R84	0698-3440		R:FxD MET FLM 196 OHM 1% 1/8W	28480	0698-3440
R85	0698-7310		R:FxD FLM 1.65K OHM 0.25% 1/8W	28480	0698-7310
R86	0698-3445		R:FxD MET FLM 348 OHM 1% 1/8W	28480	0698-3445
R87	0698-7310		R:FxD FLM 1.65K OHM 0.25% 1/8W	28480	0698-7310
R88	0757-0290		R:FxD MET FLM 6.19K OHM 1% 1/8W	28480	0757-0290
R90	0698-7310		R:FxD FLM 1.65K OHM 0.25% 1/8W	28480	0698-7310
R91	0698-3445		R:FxD MET FLM 348 OHM 1% 1/8W	28480	0698-3445
R92	0698-7310		R:FxD FLM 1.65K OHM 0.25% 1/8W	28480	0698-7310
R93	0757-0290		R:FxD MET FLM 6.19K OHM 1% 1/8W	28480	0757-0290
R96	0757-0290		R:FxD MET FLM 6.19K OHM 1% 1/8W	28480	0757-0290
R97	0698-7310		R:FxD FLM 1.65K OHM 0.25% 1/8W	28480	0698-7310
R98	0698-3445		R:FxD MET FLM 348 OHM 1% 1/8W	28480	0698-3445
R99	0698-7310		R:FxD FLM 1.65K OHM 0.25% 1/8W	28480	0698-7310
R101	0757-0290		R:FxD MET FLM 6.19K OHM 1% 1/8W	28480	0757-0290
R102	0698-7310		R:FxD FLM 1.65K OHM 0.25% 1/8W	28480	0698-7310
R103	0698-3445		R:FxD MET FLM 348 OHM 1% 1/8W	28480	0698-3445
R104	0698-7310		R:FxD FLM 1.65K OHM 0.25% 1/8W	28480	0698-7310
R105	0698-3440		R:FxD MET FLM 196 OHM 1% 1/8W	28480	0698-3440
R106	0757-0403		R:FxD MET FLM 121 OHM 1% 1/8W	28480	0757-0403
R107	0698-3440		R:FxD MET FLM 196 OHM 1% 1/8W	28480	0698-3440
R108	0757-0403		R:FxD MET FLM 121 OHM 1% 1/8W	28480	0757-0403
R109	0698-3440		R:FxD MET FLM 196 OHM 1% 1/8W	28480	0698-3440
R110	0757-0403		R:FxD MET FLM 121 OHM 1% 1/8W	28480	0757-0403
R111	0698-3440		R:FxD MET FLM 196 OHM 1% 1/8W	28480	0698-3440
R112	0757-0403		R:FxD MET FLM 121 OHM 1% 1/8W	28480	0757-0403
R113	0757-0394		R:FxD MET FLM 51.1 OHM 1% 1/8W	28480	0757-0394
R114	0757-0394		R:FxD MET FLM 51.1 OHM 1% 1/8W	28480	0757-0394
R116	0757-0290		R:FxD MET FLM 6.19K OHM 1% 1/8W	28480	0757-0290
R117	0698-7310		R:FxD FLM 1.65K OHM 0.25% 1/8W	28480	0698-7310
R118	0698-3445		R:FxD MET FLM 348 OHM 1% 1/8W	28480	0698-3445
R119	0698-7310		R:FxD FLM 1.65K OHM 0.25% 1/8W	28480	0698-7310
R121	0757-0290		R:FxD MET FLM 6.19K OHM 1% 1/8W	28480	0757-0290
R122	0698-7310		R:FxD FLM 1.65K OHM 0.25% 1/8W	28480	0698-7310
R123	0698-3445		R:FxD MET FLM 348 OHM 1% 1/8W	28480	0698-3445
R124	0698-7310		R:FxD FLM 1.65K OHM 0.25% 1/8W	28480	0698-7310
R125	0698-3440		R:FxD MET FLM 196 OHM 1% 1/8W	28480	0698-3440
R126	0757-0403		R:FxD MET FLM 121 OHM 1% 1/8W	28480	0757-0403
R127	0698-3440		R:FxD MET FLM 196 OHM 1% 1/8W	28480	0698-3440
R128	0757-0403		R:FxD MET FLM 121 OHM 1% 1/8W	28480	0757-0403
R129	0698-3440		R:FxD MET FLM 196 OHM 1% 1/8W	28480	0698-3440
R130	0757-0403		R:FxD MET FLM 121 OHM 1% 1/8W	28480	0757-0403
R131	0698-3440		R:FxD MET FLM 196 OHM 1% 1/8W	28480	0698-3440
R132	0757-0403		R:FxD MET FLM 121 OHM 1% 1/8W	28480	0757-0403

Table 2-18. Memory Drive and Sense PCA, Replaceable Parts (Continued)

Reference Designation	HP Part Number	Qty	Description	Mfr Code	Mfr Part Number
R133	0757-0394		R:FxD MET FLM 51.1 OHM 1% 1/8W	28480	0757-0394
R134	0757-0394		R:FxD MET FLM 51.1 OHM 1% 1/8W	28480	0757-0394
R136	0757-0290		R:FxD MET FLM 6.19K OHM 1% 1/8W	28480	0757-0290
R137	0698-7310		R:FxD FLM 1.65K OHM 0.25% 1/8W	28480	0698-7310
R138	0698-3445		R:FxD MET FLM 348 OHM 1% 1/8W	28480	0698-3445
R139	0698-7310		R:FxD FLM 1.65K OHM 0.25% 1/8W	28480	0698-7310
R141	0757-0290		R:FxD MET FLM 6.19K OHM 1% 1/8W	28480	0757-0290
R142	0698-7310		R:FxD FLM 1.65K OHM 0.25% 1/8W	28480	0698-7310
R143	0698-3445		R:FxD MET FLM 348 OHM 1% 1/8W	28480	0698-3445
R144	0698-7310		R:FxD FLM 1.65K OHM 0.25% 1/8W	28480	0698-7310
R145	0698-3440		R:FxD MET FLM 196 OHM 1% 1/8W	28480	0698-3440
R146	0757-0403		R:FxD MET FLM 121 OHM 1% 1/8W	28480	0757-0403
R147	0698-3440		R:FxD MET FLM 196 OHM 1% 1/8W	28480	0698-3440
R148	0757-0403		R:FxD MET FLM 121 OHM 1% 1/8W	28480	0757-0403
R149	0698-3440		R:FxD MET FLM 196 OHM 1% 1/8W	28480	0698-3440
R150	0757-0403		R:FxD MET FLM 121 OHM 1% 1/8W	28480	0757-0403
R151	0698-3440		R:FxD MET FLM 196 OHM 1% 1/8W	28480	0698-3440
R152	0757-0403		R:FxD MET FLM 121 OHM 1% 1/8W	28480	0757-0403
R153	0757-0394		R:FxD MET FLM 51.1 OHM 1% 1/8W	28480	0757-0394
R154	0757-0394		R:FxD MET FLM 51.1 OHM 1% 1/8W	28480	0757-0394
R156	0757-0290		R:FxD MET FLM 6.19K OHM 1% 1/8W	28480	0757-0290
R157	0698-7310		R:FxD FLM 1.65K OHM 0.25% 1/8W	28480	0698-7310
R158	0698-3445		R:FxD MET FLM 348 OHM 1% 1/8W	28480	0698-3445
R159	0698-7310		R:FxD FLM 1.65K OHM 0.25% 1/8W	28480	0698-7310
R161	0757-0290		R:FxD MET FLM 6.19K OHM 1% 1/8W	28480	0757-0290
R162	0698-7310		R:FxD FLM 1.65K OHM 0.25% 1/8W	28480	0698-7310
R163	0698-3445		R:FxD MET FLM 348 OHM 1% 1/8W	28480	0698-3445
R164	0698-7310		R:FxD FLM 1.65K OHM 0.25% 1/8W	28480	0698-7310
R165	0698-3440		R:FxD MET FLM 196 OHM 1% 1/8W	28480	0698-3440
R166	0757-0403		R:FxD MET FLM 121 OHM 1% 1/8W	28480	0757-0403
R167	0698-3440		R:FxD MET FLM 196 OHM 1% 1/8W	28480	0698-3440
R168	0757-0403		R:FxD MET FLM 121 OHM 1% 1/8W	28480	0757-0403
R169	0698-3440		R:FxD MET FLM 196 OHM 1% 1/8W	28480	0698-3440
R170	0757-0403		R:FxD MET FLM 121 OHM 1% 1/8W	28480	0757-0403
R171	0698-3440		R:FxD MET FLM 196 OHM 1% 1/8W	28480	0698-3440
R172	0757-0403		R:FxD MET FLM 121 OHM 1% 1/8W	28480	0757-0403
R173	0757-0394		R:FxD MET FLM 51.1 OHM 1% 1/8W	28480	0757-0394
R174	0757-0394		R:FxD MET FLM 51.1 OHM 1% 1/8W	28480	0757-0394
R176	0757-0290		R:FxD MET FLM 6.19K OHM 1% 1/8W	28480	0757-0290
R177	0698-7310		R:FxD FLM 1.65K OHM 0.25% 1/8W	28480	0698-7310
R178	0698-3445		R:FxD MET FLM 348 OHM 1% 1/8W	28480	0698-3445
R179	0698-7310		R:FxD FLM 1.65K OHM 0.25% 1/8W	28480	0698-7310
R180	0698-3440		R:FxD MET FLM 196 OHM 1% 1/8W	28480	0698-3440
R181	0757-0403		R:FxD MET FLM 121 OHM 1% 1/8W	28480	0757-0403
R182	0698-3440		R:FxD MET FLM 196 OHM 1% 1/8W	28480	0698-3440
R183	0757-0403		R:FxD MET FLM 121 OHM 1% 1/8W	28480	0757-0403
R184	0757-0394		R:FxD MET FLM 51.1 OHM 1% 1/8W	28480	0757-0394
R185	0698-3444	16	R:FxD MET FLM 316 OHM 1% 1/8W	28480	0698-3444
R186	0757-0403		R:FxD MET FLM 121 OHM 1% 1/8W	28480	0757-0403
R187	0757-0403		R:FxD MET FLM 121 OHM 1% 1/8W	28480	0757-0403
R188	0698-3444		R:FxD MET FLM 316 OHM 1% 1/8W	28480	0698-3444
R189	0757-0403		R:FxD MET FLM 121 OHM 1% 1/8W	28480	0757-0403
R190	0757-0403		R:FxD MET FLM 121 OHM 1% 1/8W	28480	0757-0403
R191	0698-3444		R:FxD MET FLM 316 OHM 1% 1/8W	28480	0698-3444
R192	0757-0403		R:FxD MET FLM 121 OHM 1% 1/8W	28480	0757-0403
R193	0757-0403		R:FxD MET FLM 121 OHM 1% 1/8W	28480	0757-0403
R194	0698-3444		R:FxD MET FLM 316 OHM 1% 1/8W	28480	0698-3444
R195	0757-0403		R:FxD MET FLM 121 OHM 1% 1/8W	28480	0757-0403
R196	0757-0403		R:FxD MET FLM 121 OHM 1% 1/8W	28480	0757-0403
R197	0698-3435	32	R:FxD MET FLM 38.3 OHM 1% 1/8W	28480	0698-3435
R198	0698-3435		R:FxD MET FLM 38.3 OHM 1% 1/8W	28480	0698-3435
R199	0698-3435		R:FxD MET FLM 38.3 OHM 1% 1/8W	28480	0698-3435
R200	0698-3435		R:FxD MET FLM 38.3 OHM 1% 1/8W	28480	0698-3435
R201	0698-3435		R:FxD MET FLM 38.3 OHM 1% 1/8W	28480	0698-3435
R202	0698-3435		R:FxD MET FLM 38.3 OHM 1% 1/8W	28480	0698-3435
R203	0698-3435		R:FxD MET FLM 38.3 OHM 1% 1/8W	28480	0698-3435
R204	0698-3435		R:FxD MET FLM 38.3 OHM 1% 1/8W	28480	0698-3435
R205	0698-3444		R:FxD MET FLM 316 OHM 1% 1/8W	28480	0698-3444
R206	0757-0403		R:FxD MET FLM 121 OHM 1% 1/8W	28480	0757-0403
R207	0757-0403		R:FxD MET FLM 121 OHM 1% 1/8W	28480	0757-0403
R208	0698-3444		R:FxD MET FLM 316 OHM 1% 1/8W	28480	0698-3444
R209	0757-0403		R:FxD MET FLM 121 OHM 1% 1/8W	28480	0757-0403
R210	0757-0403		R:FxD MET FLM 121 OHM 1% 1/8W	28480	0757-0403
R211	0698-3444		R:FxD MET FLM 316 OHM 1% 1/8W	28480	0698-3444
R212	0757-0403		R:FxD MET FLM 121 OHM 1% 1/8W	28480	0757-0403

Table 2-18. Memory Drive and Sense PCA, Replaceable Parts (Continued)

Reference Designation	HP Part Number	Qty	Description	Mfr Code	Mfr Part Number
R213	0757-0403		R:FXD MET FLM 121 OHM 1% 1/8W	28480	0757-0403
R214	0698-3444		R:FXD MET FLM 316 OHM 1% 1/8W	28480	0698-3444
R215	0757-0403		R:FXD MET FLM 121 OHM 1% 1/8W	28480	0757-0403
R216	0757-0403		R:FXD MET FLM 121 OHM 1% 1/8W	28480	0757-0403
R217	0698-3435		R:FXD MET FLM 38.3 OHM 1% 1/8W	28480	0698-3435
R218	0698-3435		R:FXD MET FLM 38.3 OHM 1% 1/8W	28480	0698-3435
R219	0698-3435		R:FXD MET FLM 38.3 OHM 1% 1/8W	28480	0698-3435
R220	0698-3435		R:FXD MET FLM 38.3 OHM 1% 1/8W	28480	0698-3435
R221	0698-3435		R:FXD MET FLM 38.3 OHM 1% 1/8W	28480	0698-3435
R222	0698-3435		R:FXD MET FLM 38.3 OHM 1% 1/8W	28480	0698-3435
R223	0698-3435		R:FXD MET FLM 38.3 OHM 1% 1/8W	28480	0698-3435
R224	0698-3435		R:FXD MET FLM 38.3 OHM 1% 1/8W	28480	0698-3435
R225	0698-3444		R:FXD MET FLM 316 OHM 1% 1/8W	28480	0698-3444
R226	0757-0403		R:FXD MET FLM 121 OHM 1% 1/8W	28480	0757-0403
R227	0757-0403		R:FXD MET FLM 121 OHM 1% 1/8W	28480	0757-0403
R228	0698-3444		R:FXD MET FLM 316 OHM 1% 1/8W	28480	0698-3444
R229	0757-0403		R:FXD MET FLM 121 OHM 1% 1/8W	28480	0757-0403
R230	0757-0403		R:FXD MET FLM 121 OHM 1% 1/8W	28480	0757-0403
R231	0698-3444		R:FXD MET FLM 316 OHM 1% 1/8W	28480	0698-3444
R232	0757-0403		R:FXD MET FLM 121 OHM 1% 1/8W	28480	0757-0403
R233	0757-0403		R:FXD MET FLM 121 OHM 1% 1/8W	28480	0757-0403
R234	0698-3444		R:FXD MET FLM 316 OHM 1% 1/8W	28480	0698-3444
R235	0757-0403		R:FXD MET FLM 121 OHM 1% 1/8W	28480	0757-0403
R236	0757-0403		R:FXD MET FLM 121 OHM 1% 1/8W	28480	0757-0403
R237	0698-3435		R:FXD MET FLM 38.3 OHM 1% 1/8W	28480	0698-3435
R238	0698-3435		R:FXD MET FLM 38.3 OHM 1% 1/8W	28480	0698-3435
R239	0698-3435		R:FXD MET FLM 38.3 OHM 1% 1/8W	28480	0698-3435
R240	0698-3435		R:FXD MET FLM 38.3 OHM 1% 1/8W	28480	0698-3435
R241	0698-3435		R:FXD MET FLM 38.3 OHM 1% 1/8W	28480	0698-3435
R242	0698-3435		R:FXD MET FLM 38.3 OHM 1% 1/8W	28480	0698-3435
R243	0698-3435		R:FXD MET FLM 38.3 OHM 1% 1/8W	28480	0698-3435
R244	0698-3435		R:FXD MET FLM 38.3 OHM 1% 1/8W	28480	0698-3435
R245	0698-3444		R:FXD MET FLM 316 OHM 1% 1/8W	28480	0698-3444
R246	0757-0403		R:FXD MET FLM 121 OHM 1% 1/8W	28480	0757-0403
R247	0757-0403		R:FXD MET FLM 121 OHM 1% 1/8W	28480	0757-0403
R248	0698-3444		R:FXD MET FLM 316 OHM 1% 1/8W	28480	0698-3444
R249	0757-0403		R:FXD MET FLM 121 OHM 1% 1/8W	28480	0757-0403
R250	0757-0403		R:FXD MET FLM 121 OHM 1% 1/8W	28480	0757-0403
R251	0698-3444		R:FXD MET FLM 316 OHM 1% 1/8W	28480	0698-3444
R252	0757-0403		R:FXD MET FLM 121 OHM 1% 1/8W	28480	0757-0403
R253	0757-0403		R:FXD MET FLM 121 OHM 1% 1/8W	28480	0757-0403
R254	0698-3444		R:FXD MET FLM 316 OHM 1% 1/8W	28480	0698-3444
R255	0757-0403		R:FXD MET FLM 121 OHM 1% 1/8W	28480	0757-0403
R256	0757-0403		R:FXD MET FLM 121 OHM 1% 1/8W	28480	0757-0403
R257	0698-3435		R:FXD MET FLM 38.3 OHM 1% 1/8W	28480	0698-3435
R258	0698-3435		R:FXD MET FLM 38.3 OHM 1% 1/8W	28480	0698-3435
R259	0698-3435		R:FXD MET FLM 38.3 OHM 1% 1/8W	28480	0698-3435
R260	0698-3435		R:FXD MET FLM 38.3 OHM 1% 1/8W	28480	0698-3435
R261	0698-3435		R:FXD MET FLM 38.3 OHM 1% 1/8W	28480	0698-3435
R262	0698-3435		R:FXD MET FLM 38.3 OHM 1% 1/8W	28480	0698-3435
R263	0698-3435		R:FXD MET FLM 38.3 OHM 1% 1/8W	28480	0698-3435
R264	0698-3435		R:FXD MET FLM 38.3 OHM 1% 1/8W	28480	0698-3435
R265	0811-2614	4	R:FXD WW 37 OHM 1% 5W	28480	0811-2614
R266	0811-2614		R:FXD WW 37 OHM 1% 5W	28480	0811-2614
R267	0757-0397	8	R:FXD MET FLM 68.1 OHM 1% 1/8W	28480	0757-0397
R268	0698-0084	4	R:FXD MET FLM 2.15K OHM 1% 1/8W	28480	0698-0084
R269	0757-0397		R:FXD MET FLM 68.1 OHM 1% 1/8W	28480	0757-0397
R270	0698-3440		R:FXD MET FLM 196 OHM 1% 1/8W	28480	0698-3440
R271	0757-0420		R:FXD MET FLM 750 OHM 1% 1/8W	28480	0757-0420
R272	0757-0397		R:FXD MET FLM 68.1 OHM 1% 1/8W	28480	0757-0397
R273	0698-0084		R:FXD MET FLM 2.15K OHM 1% 1/8W	28480	0698-0084
R274	0757-0397		R:FXD MET FLM 68.1 OHM 1% 1/8W	28480	0757-0397
R275	0698-3440		R:FXD MET FLM 196 OHM 1% 1/8W	28480	0698-3440
R276	0757-0420		R:FXD MET FLM 750 OHM 1% 1/8W	28480	0757-0420
R277	0811-2614		R:FXD WW 37 OHM 1% 5W	28480	0811-2614
R278	0811-0563		R:FXD WW 33 OHM 1% 5W	28480	0811-0563
R279	0757-0397		R:FXD MET FLM 68.1 OHM 1% 1/8W	28480	0757-0397
R280	0698-0084		R:FXD MET FLM 2.15K OHM 1% 1/8W	28480	0698-0084
R281	0757-0397		R:FXD MET FLM 68.1 OHM 1% 1/8W	28480	0757-0397
R282	0698-3440		R:FXD MET FLM 196 OHM 1% 1/8W	28480	0698-3440
R283	0757-0420		R:FXD MET FLM 750 OHM 1% 1/8W	28480	0757-0420
R284	0757-0397		R:FXD MET FLM 68.1 OHM 1% 1/8W	28480	0757-0397
R285	0698-0084		R:FXD MET FLM 2.15K OHM 1% 1/8W	28480	0698-0084
R286	0757-0397		R:FXD MET FLM 68.1 OHM 1% 1/8W	28480	0757-0397
R287	0698-3440		R:FXD MET FLM 196 OHM 1% 1/8W	28480	0698-3440

Table 2-18. Memory Drive and Sense PCA, Replaceable Parts (Continued)

Reference Designation	HP Part Number	Qty	Description	Mfr Code	Mfr Part Number
R288	0757-0420		R:FXD MET FLM 750 OHM 1% 1/8W	28480	0757-0420
T1	0960-0111	17	BALUN MODULE	28480	0960-0111
T2	0960-0111		BALUN MODULE	28480	0960-0111
T3	0960-0111		BALUN MODULE	28480	0960-0111
T4	0960-0111		BALUN MODULE	28480	0960-0111
T5	0960-0111		BALUN MODULE	28480	0960-0111
T6	0960-0111		BALUN MODULE	28480	0960-0111
T7	0960-0111		BALUN MODULE	28480	0960-0111
T8	0960-0111		BALUN MODULE	28480	0960-0111
T9	0960-0111		BALUN MODULE	28480	0960-0111
T10	0960-0111		BALUN MODULE	28480	0960-0111
T11	0960-0111		BALUN MODULE	28480	0960-0111
T12	0960-0111		BALUN MODULE	28480	0960-0111
T13	0960-0111		BALUN MODULE	28480	0960-0111
T14	0960-0111		BALUN MODULE	28480	0960-0111
T15	0960-0111		BALUN MODULE	28480	0960-0111
T16	0960-0111		BALUN MODULE	28480	0960-0111
T17	0960-0111		BALUN MODULE	28480	0960-0111
U1	1820-0205	1	IC:TTL QUAD 2-INPT OR GATE	28480	1820-0205
U2	1820-0239	3	IC:TTL QUAD 2-INPT NOR GATE	28480	1820-0239
U4	1820-0621		IC:TTL QUAD 2-INPT NAND BUFFER W/OPEN C	01295	SN7438N
U5	1858-0001	17	TSTR ARRAY:DUAL DIFF AMPL W/CONST CUR	02735	80381
U6	1858-0001		TSTR ARRAY:DUAL DIFF AMPL W/CONST CUR	02735	80381
U7	9100-3180		TRANSFORMER	28480	9100-3180
U8	1820-0621		IC:TTL QUAD 2-INPT NAND BUFFER W/OPEN C	01295	SN7438N
U9	1858-0001		TSTR ARRAY:DUAL DIFF AMPL W/CONST CUR	02735	80381
U10	1858-0001		TSTR ARRAY:DUAL DIFF AMPL W/CONST CUR	02735	80381
U11	9100-3180		TRANSFORMER	28480	9100-3180
U12	1820-0621		IC:TTL QUAD 2-INPT NAND BUFFER W/OPEN C	01295	SN7438N
U13	1858-0001		TSTR ARRAY:DUAL DIFF AMPL W/CONST CUR	02735	80381
U14	1858-0001		TSTR ARRAY:DUAL DIFF AMPL W/CONST CUR	02735	80381
U15	9100-3180		TRANSFORMER	28480	9100-3180
U16	1820-0621		IC:TTL QUAD 2-INPT NAND BUFFER W/OPEN C	01295	SN7438N
U17	1858-0001		TSTR ARRAY:DUAL DIFF AMPL W/CONST CUR	02735	80381
U18	1858-0001		TSTR ARRAY:DUAL DIFF AMPL W/CONST CUR	02735	80381
U19	1858-0001		TSTR ARRAY:DUAL DIFF AMPL W/CONST CUR	02735	80381
U20	1858-0001		TSTR ARRAY:DUAL DIFF AMPL W/CONST CUR	02735	80381
U21	1820-0621		IC:TTL QUAD 2-INPT NAND BUFFER W/OPEN C	01295	SN7438N
U22	9100-3180		TRANSFORMER	28480	9100-3180
U23	1858-0001		TSTR ARRAY:DUAL DIFF AMPL W/CONST CUR	02735	80381
U24	1858-0001		TSTR ARRAY:DUAL DIFF AMPL W/CONST CUR	02735	80381
U25	1820-0621		IC:TTL QUAD 2-INPT NAND BUFFER W/OPEN C	01295	SN7438N
U26	9100-3180		TRANSFORMER	28480	9100-3180
U27	1858-0001		TSTR ARRAY:DUAL DIFF AMPL W/CONST CUR	02735	80381
U28	1858-0001		TSTR ARRAY:DUAL DIFF AMPL W/CONST CUR	02735	80381
U29	1820-0621		IC:TTL QUAD 2-INPT NAND BUFFER W/OPEN C	01295	SN7438N
U30	9100-3180		TRANSFORMER	28480	9100-3180
U31	1858-0001		TSTR ARRAY:DUAL DIFF AMPL W/CONST CUR	02735	80381
U32	1858-0001		TSTR ARRAY:DUAL DIFF AMPL W/CONST CUR	02735	80381
U33	1820-0621		IC:TTL QUAD 2-INPT NAND BUFFER W/OPEN C	01295	SN7438N
U34	9100-3180		TRANSFORMER	28480	9100-3180
U35	1858-0001		TSTR ARRAY:DUAL DIFF AMPL W/CONST CUR	02735	80381
U36	1820-0621		IC:TTL QUAD 2-INPT NAND BUFFER W/OPEN C	01295	SN7438N
U37	9100-3180		TRANSFORMER	28480	9100-3180
U38	1821-0006	8	TSTR ARRAY:SI NPN QUAD	28480	1821-0006
U39	9100-3130	8	TRANSFORMER:PULSE	28480	9100-3130
U40	1821-0006		TSTR ARRAY:SI NPN QUAD	28480	1821-0006
U41	9100-3130		TRANSFORMER:PULSE	28480	9100-3130
U42	1820-0756	4	IC:TTL 8-BIT DRIVER INVERTING	28480	1820-0756
U43	1820-0608	2	IC:TTL 1 OF DECODER W/ENABLE	04713	MC4006P
U44	1821-0006		TSTR ARRAY:SI NPN QUAD	28480	1821-0006
U45	9100-3130		TRANSFORMER:PULSE	28480	9100-3130
U46	1821-0006		TSTR ARRAY:SI NPN QUAD	28480	1821-0006
U47	9100-3130		TRANSFORMER:PULSE	28480	9100-3130
U48	1820-0756		IC:TTL 8-BIT DRIVER INVERTING	28480	1820-0756
U49	1820-0608		IC:TTL 1 OF DECODER W/ENABLE	04713	MC4006P
U50	1821-0006		TSTR ARRAY:SI NPN QUAD	28480	1821-0006
U51	9100-3130		TRANSFORMER:PULSE	28480	9100-3130
U52	1821-0006		TSTR ARRAY:SI NPN QUAD	28480	1821-0006
U53	9100-3130		TRANSFORMER:PULSE	28480	9100-3130
U54	1820-0756		IC:TTL 8-BIT DRIVER INVERTING	28480	1820-0756
U55	1820-0239		IC:TTL QUAD 2-INPT NOR GATE	28480	1820-0239
U56	1821-0006		TSTR ARRAY:SI NPN QUAD	28480	1821-0006
U57	9100-3130		TRANSFORMER:PULSE	28480	9100-3130
U58	1821-0006		TSTR ARRAY:SI NPN QUAD	28480	1821-0006

Table 2-18. Memory Drive and Sense PCA, Replaceable Parts (Continued)

Reference Designation	HP Part Number	Qty	Description	Mfr Code	Mfr Part Number
U59	9100-3130	3	TRANSFORMER:PULSE	28480	9100-3130
U60	1820-0756		IC:TTL 8-BIT DRIVER INVERTING	28480	1820-0756
U61	1820-0239		IC:TTL QUAD 2-INPT NOR GATE	28480	1820-0239
W1	5040-1485		CONDUCTOR ASSEMBLY:PLUG-IN JUMPER	28480	5040-1485
W2	5040-1485		CONDUCTOR ASSEMBLY:PLUG-IN JUMPER	28480	5040-1485
W3	5040-1485		CONDUCTOR ASSEMBLY:PLUG-IN JUMPER	28480	5040-1485

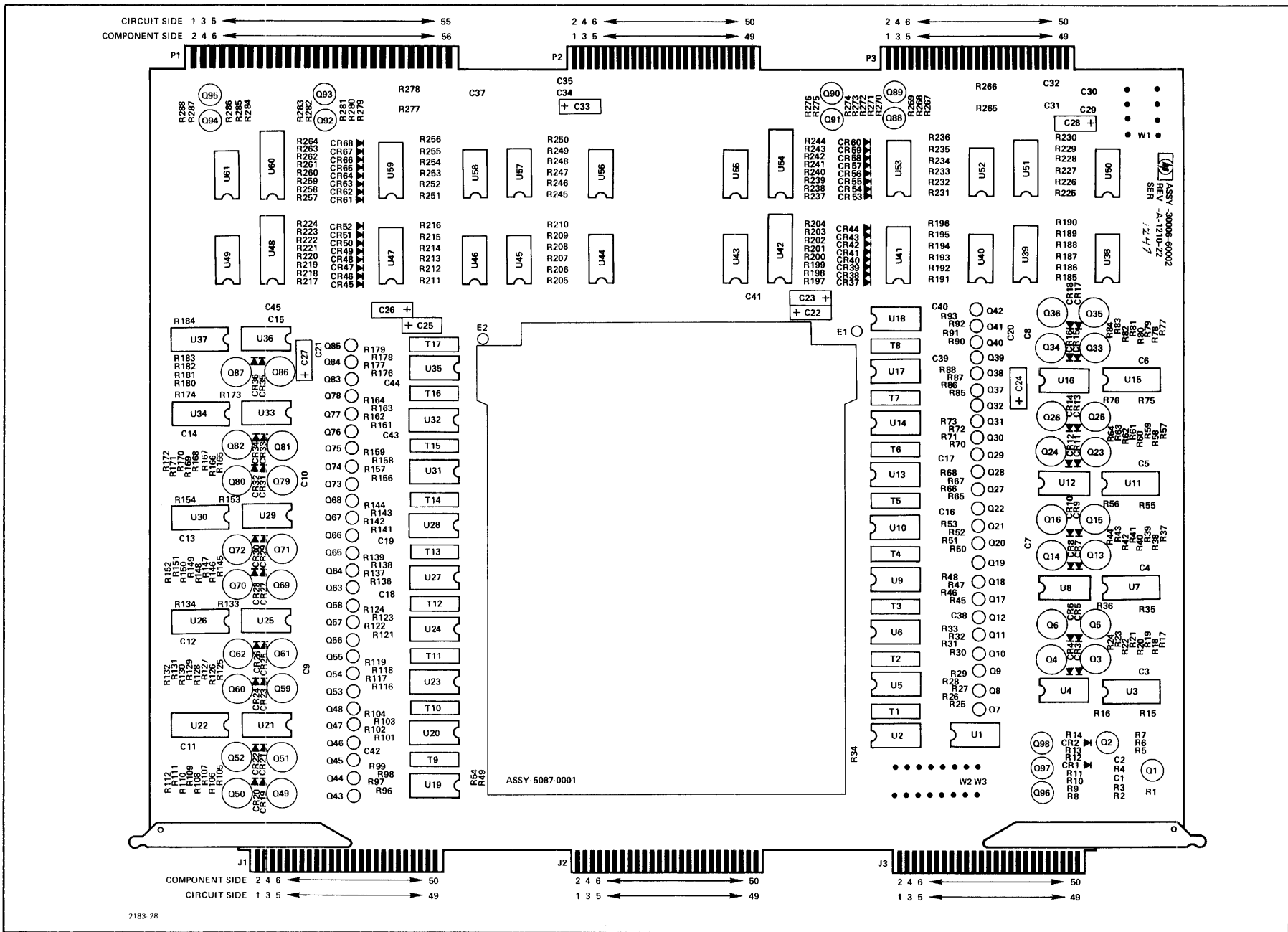

Figure 2-17. Memory Drive and Sense PCA, Parts Location Diagram

Table 2-19. Selector Channel Register PCA, Replaceable Parts

To Be Supplied

Figure 2-18. Selector Channel Register PCA, Parts Location Diagram

Table 2-20. Selector Channel Control PCA, Replaceable Parts

To Be Supplied

To Be Supplied

Figure 2-19. Selector Channel Control PCA, Parts Location Diagram

Table 2-21. Selector Channel Port PCA, Replaceable Parts

To Be Supplied

To Be Supplied

Figure 2-20. Selector Channel Port PCA, Parts Location Diagram

Table 2-22. Selector Channel Maintenance PCA, Replaceable Parts

To Be Supplied

To Be Supplied

Figure 2-21. Selector Channel Maintenance PCA, Parts Location Diagram

Table 2-23. System Clock/Console Interface PCA, Replaceable Parts

Reference Designation	HP Part Number	Qty	Description	Mfr Code	Mfr Part Number
C1	30031-60001	1	SYSTEM CLOCK/CONSOLE INTERFACE PCA	28480	30031-60001
C2	0160-2055	31	C:F XD CER 0.01 UF +80-20% 100VDCW	56289	C023F101F103ZS22-CDH
C3	0160-2055		C:F XD CER 0.01 UF +80-20% 100VDCW	56289	C023F101F103ZS22-CDH
C4	0160-0161	1	C:F XD MY 0.01 UF 10% 200VDCW	56289	192P10392-PTS
	0160-2266	1	C:F XD CER 24 PF 5% 500VDCW	72982	301-000-C0G0-240J
C5	0121-0060	10	C:VAR CER 2-8 PF NPO	72982	538-011 A 2-8
C6	0180-0197	3	C:F XD ELECT 2.2 UF 10% 20VDCW	56289	1500225X9020A2-DYS
C7	0160-2055		C:F XD CER 0.01 UF +80-20% 100VDCW	56289	C023F101F103ZS22-CDH
C8	0160-2055		C:F XD CER 0.01 UF +80-20% 100VDCW	56289	C023F101F103ZS22-CDH
C9	0160-2208	4	C:F XD MICA 330 PF 5% 300VDCW	28480	0160-2208
C10	0160-2208		C:F XD MICA 330 PF 5% 300VDCW	28480	0160-2208
C11	0160-2208		C:F XD MICA 330 PF 5% 300VDCW	28480	0160-2208
C12	0160-2055		C:F XD CER 0.01 UF +80-20% 100VDCW	56289	C023F101F103ZS22-CDH
C13	0160-2055		C:F XD CER 0.01 UF +80-20% 100VDCW	56289	C023F101F103ZS22-CDH
C14	0150-0121	7	C:F XD CER 0.1 UF +80-20% 50VDCW	56289	5C50BIS-CML
C15	0160-2055		C:F XD CER 0.01 UF +80-20% 100VDCW	56289	C023F101F103ZS22-CDH
C16	0180-0197		C:F XD ELECT 2.2 UF 10% 20VDCW	56289	1500225X9020A2-DYS
C17	0160-2940	4	C:F XD MICA 470 PF 5% 300VDCW	72136	RD15F471J3C
C18	0160-2940		C:F XD MICA 470 PF 5% 300VDCW	72136	RD15F471J3C
C19	0160-2940		C:F XD MICA 470 PF 5% 300VDCW	72136	RD15F471J3C
C20	0160-2940		C:F XD MICA 470 PF 5% 300VDCW	72136	RD15F471J3C
C21	0160-2055		C:F XD CER 0.01 UF +80-20% 100VDCW	56289	C023F101F103ZS22-CDH
C22	0160-2055		C:F XD CER 0.01 UF +80-20% 100VDCW	56289	C023F101F103ZS22-CDH
C23	0160-2055		C:F XD CER 0.01 UF +80-20% 100VDCW	56289	C023F101F103ZS22-CDH
C24	0160-2055		C:F XD CER 0.01 UF +80-20% 100VDCW	56289	C023F101F103ZS22-CDH
C25	0160-2055		C:F XD CER 0.01 UF +80-20% 100VDCW	56289	C023F101F103ZS22-CDH
C26	0160-2055		C:F XD CER 0.01 UF +80-20% 100VDCW	56289	C023F101F103ZS22-CDH
C27	0160-2055		C:F XD CER 0.01 UF +80-20% 100VDCW	56289	C023F101F103ZS22-CDH
C28	0160-2055		C:F XD CER 0.01 UF +80-20% 100VDCW	56289	C023F101F103ZS22-CDH
C29	0150-0121		C:F XD CER 0.1 UF +80-20% 50VDCW	56289	5C50BIS-CML
C30	0160-2055		C:F XD CER 0.01 UF +80-20% 100VDCW	56289	C023F101F103ZS22-CDH
C31	0150-0121		C:F XD CER 0.1 UF +80-20% 50VDCW	56289	5C50BIS-CML
C32	0160-2055		C:F XD CER 0.01 UF +80-20% 100VDCW	56289	C023F101F103ZS22-CDH
C33	0160-2055		C:F XD CER 0.01 UF +80-20% 100VDCW	56289	C023F101F103ZS22-CDH
C34	0160-2202	2	C:F XD MICA 75 PF 5%	28480	0160-2202
C35	0160-2307	1	C:F XD MICA 47 PF 5%	28480	0160-2307
C36	0160-2055		C:F XD CER 0.01 UF +80-20% 100VDCW	56289	C023F101F103ZS22-CDH
C37	0160-2202		C:F XD MICA 75 PF 5%	28480	0160-2202
C38	0150-0121		C:F XD CER 0.1 UF +80-20% 50VDCW	56289	5C50BIS-CML
C39	0160-2055		C:F XD CER 0.01 UF +80-20% 100VDCW	56289	C023F101F103ZS22-CDH
C40	0160-2055		C:F XD CER 0.01 UF +80-20% 100VDCW	56289	C023F101F103ZS22-CDH
C41	0160-2055		C:F XD CER 0.01 UF +80-20% 100VDCW	56289	C023F101F103ZS22-CDH
C42	0150-0121		C:F XD CER 0.1 UF +80-20% 50VDCW	56289	5C50BIS-CML
C43	0160-2055		C:F XD CER 0.01 UF +80-20% 100VDCW	56289	C023F101F103ZS22-CDH
C44	0160-2055		C:F XD CER 0.01 UF +80-20% 100VDCW	56289	C023F101F103ZS22-CDH
C45	0160-2055		C:F XD CER 0.01 UF +80-20% 100VDCW	56289	C023F101F103ZS22-CDH
C46	0160-2055		C:F XD CER 0.01 UF +80-20% 100VDCW	56289	C023F101F103ZS22-CDH
C47	0160-2055		C:F XD CER 0.01 UF +80-20% 100VDCW	56289	C023F101F103ZS22-CDH
C48	0160-2055		C:F XD CER 0.01 UF +80-20% 100VDCW	56289	C023F101F103ZS22-CDH
C49	0150-0121		C:F XD CER 0.1 UF +80-20% 50VDCW	56289	5C50BIS-CML
C50	0150-0121		C:F XD CER 0.1 UF +80-20% 50VDCW	56289	5C50BIS-CML
C51	0160-2055		C:F XD CER 0.01 UF +80-20% 100VDCW	56289	C023F101F103ZS22-CDH
C52	0160-2055		C:F XD CER 0.01 UF +80-20% 100VDCW	56289	C023F101F103ZS22-CDH
C53	0160-2055		C:F XD CER 0.01 UF +80-20% 100VDCW	56289	C023F101F103ZS22-CDH
C54	0160-2055		C:F XD CER 0.01 UF +80-20% 100VDCW	56289	C023F101F103ZS22-CDH
C55	0180-0197		C:F XD ELECT 2.2 UF 10% 20VDCW	56289	1500225X9020A2-DYS
CR1	1901-0158	2	DIODE:SILICON 0.75A 200 PIV	28480	1901-0158
CR2	1902-3084	2	DIODE BREAKDOWN:4.75V 10% 400MW	28480	1902-3084
CR3	1902-3084		DIODE BREAKDOWN:4.75V 10% 400MW	28480	1902-3084
CR4	1901-0158		DIODE:SILICON 0.75A 200 PIV	28480	1901-0158
L1	9100-2276	1	COIL/CHOKE 100 UH 10%	28480	9100-2276
Q1	1850-0158	1	TSTR:GE PNP	80131	2N2635
R2	0698-4037	1	R:F XD MET FLM 46.4 OHM 1% 1/8W	28480	0698-4037
R3	0698-3444	1	R:F XD MET FLM 316 OHM 1% 1/8W	28480	0698-3444
R4	0757-0280	14	R:F XD MET FLM 1K OHM 1% 1/8W	28480	0757-0280
R5	0757-0280		R:F XD MET FLM 1K OHM 1% 1/8W	28480	0757-0280
R6	0757-0280		R:F XD MET FLM 1K OHM 1% 1/8W	28480	0757-0280
R7	0757-0280		R:F XD MET FLM 1K OHM 1% 1/8W	28480	0757-0280
R8	0757-0280		R:F XD MET FLM 1K OHM 1% 1/8W	28480	0757-0280
R9	0757-0280		R:F XD MET FLM 1K OHM 1% 1/8W	28460	0757-0280
R10	0698-3155	13	R:F XD MET FLM 4.64K OHM 1% 1/8W	28480	0698-3155
R11	0757-0407	1	R:F XD MET FLM 200 OHM 1% 1/8W	28480	0757-0407
R12	1810-0030	6	NETWORK:7 RESISTORS 1K OHM 5% 0.15W EA	28480	1810-0030
R13	1810-0030		NETWORK:7 RESISTORS 1K OHM 5% 0.15W EA	28480	1810-0030
R14	1810-0030		NETWORK:7 RESISTORS 1K OHM 5% 0.15W EA	28480	1810-0030

Table 2-23. System Clock/Console Interface PCA, Replaceable Parts (Continued)

Reference Designation	HP Part Number	Qty	Description	Mfr Code	Mfr Part Number
R15	0757-0416	1	R:FXD MET FLM 511 OHM 1% 1/8W	28480	0757-0416
R16	0757-0280		R:FXD MET FLM 1K OHM 1% 1/8W	28480	0757-0280
R17	0757-0280		R:FXD MET FLM 1K OHM 1% 1/8W	28480	0757-0280
R18	0757-0280		R:FXD MET FLM 1K OHM 1% 1/8W	28480	0757-0280
R20	0757-0280		R:FXD MET FLM 1K OHM 1% 1/8W	28480	0757-0280
R21	0757-0280		R:FXD MET FLM 1K OHM 1% 1/8W	28480	0757-0280
R22	0757-0280		R:FXD MET FLM 1K OHM 1% 1/8W	28480	0757-0280
R23	0698-3155		R:FXD MET FLM 4.64K OHM 1% 1/8W	28480	0698-3155
R24	0698-3155		R:FXD MET FLM 4.64K OHM 1% 1/8W	28480	0698-3155
R25	0757-0280		R:FXD MET FLM 1K OHM 1% 1/8W	28480	0757-0280
R26	0757-0442	1	R:FXD MET FLM 10.0K OHM 1% 1/8W	28480	0757-0442
R27	0698-3155		R:FXD MET FLM 4.64K OHM 1% 1/8W	28480	0698-3155
R28	1810-0030		NETWORK:7 RESISTORS 1K OHM 5% 0.15W EA	28480	1810-0030
R29	0757-0279	2	R:FXD MET FLM 3.16K OHM 1% 1/8W	28480	0757-0279
R30	0757-0279		R:FXD MET FLM 3.16K OHM 1% 1/8W	28480	0757-0279
R31	0698-3155		R:FXD MET FLM 4.64K OHM 1% 1/8W	28480	0698-3155
R32	0698-3155		R:FXD MET FLM 4.64K OHM 1% 1/8W	28480	0698-3155
R33	0698-3155		R:FXD MET FLM 4.64K OHM 1% 1/8W	28480	0698-3155
R34	0698-3155		R:FXD MET FLM 4.64K OHM 1% 1/8W	28480	0698-3155
R35	0757-0280		R:FXD MET FLM 1K OHM 1% 1/8W	28480	0757-0280
R36	0698-3155		R:FXD MET FLM 4.64K OHM 1% 1/8W	28480	0698-3155
R37	0698-3155		R:FXD MET FLM 4.64K OHM 1% 1/8W	28480	0698-3155
R38	0698-3155		R:FXD MET FLM 4.64K OHM 1% 1/8W	28480	0698-3155
R39	1810-0030		NETWORK:7 RESISTORS 1K OHM 5% 0.15W EA	28480	1810-0030
R40	1810-0030		NETWORK:7 RESISTORS 1K OHM 5% 0.15W EA	28480	1810-0030
R41	0698-3155		R:FXD MET FLM 4.64K OHM 1% 1/8W	28480	0698-3155
R42	0698-3155		R:FXD MET FLM 4.64K OHM 1% 1/8W	28480	0698-3155
R43	1810-0125	1	RESISTIVE NETWORK:7 X 4.7K OHM 5% 0.15W	28480	1810-0125
S1	3100-3075	1	SWITCH	28480	3100-3075
U13	1820-0751	8	IC:TTL PRESETTABLE DECADE COUNTER(50MHZ	01295	SN74196N
U14	1820-0751		IC:TTL PRESETTABLE DECADE COUNTER(50MHZ	01295	SN74196N
U15	1820-0509	1	IC:DTL QUAD 1-2-2-2-INPT NAND LINE DR	04713	MC1488L
U18	1820-0755	6	IC	28480	1820-0755
U23	1820-0751		IC:TTL PRESETTABLE DECADE COUNTER(50MHZ	01295	SN74196N
U24	1820-0751		IC:TTL PRESETTABLE DECADE COUNTER(50MHZ	01295	SN74196N
U25	1820-0990	1	IC	28480	1820-0990
U28	1820-0755		IC	28480	1820-0755
U32	1820-0142	1	INTEGRATED CIRCUIT:4INPUT,2-OR/NOR	04713	MC1004P
U33	1820-0751		IC:TTL PRESETTABLE DECADE COUNTER(50MHZ	01295	SN74196N
U34	1820-0751		IC:TTL PRESETTABLE DECADE COUNTER(50MHZ	01295	SN74196N
U35	1820-0233	4	IC:TTL SYNUP-ON 4-BIT BINARY COUNTER	01295	SN74193N
U36	1820-0719	4	IC:TTL QUAD EXCLUSIVE NOR GATE	18324	N8242A
U37	1820-0742	2	IC:TTL DUAL 4-BIT LATCH	07263	U6N930859X
U43	1820-0751		IC:TTL PRESETTABLE DECADE COUNTER(50MHZ	01295	SN74196N
U44	1820-0751		IC:TTL PRESETTABLE DECADE COUNTER(50MHZ	01295	SN74196N
U45	1820-0233		IC:TTL SYNUP-ON 4-BIT BINARY COUNTER	01295	SN74193N
U46	1820-0719		IC:TTL QUAD EXCLUSIVE NOR GATE	18324	N8242A
U53	1820-0622	1	IC:TTL 8-INPT MULTIPLEXER W/ENABLE	01295	SN74151N
U54	1820-0668	2	IC:TTL HEX DRIVER W/OPEN COLL(30V)	01295	SN7407N
U58	1820-0755		IC	28480	1820-0755
U62	1820-0668		IC:TTL HEX DRIVER W/OPEN COLL(30V)	01295	SN7407N
U64	1820-0629	3	IC:TTL SHS DUAL EDGE TRIG. J-K F/F	01295	SN74S112N
U68	1820-0755		IC	28480	1820-0755
U73	1820-0755		IC	28480	1820-0755
U74	1820-0755		IC	28480	1820-0755
U75	1820-0233		IC:TTL SYNUP-ON 4-BIT BINARY COUNTER	01295	SN74193N
U76	1820-0719		IC:TTL QUAD EXCLUSIVE NOR GATE	18324	N8242A
U77	1820-0742		IC:TTL DUAL 4-BIT LATCH	07263	U6N930859X
U82	1820-0141	6	IC:TTL QUAD 2-INPT AND GATE	04713	MC3001P
U84	1820-0301	2	IC:TTL QUAD BI-STABLE D-LATCH	01295	SN7475N
U85	1820-0233		IC:TTL SYNUP-ON 4-BIT BINARY COUNTER	01295	SN74193N
U86	1820-0719		IC:TTL QUAD EXCLUSIVE NOR GATE	18324	N8242A
U91	1820-0370	5	IC:TTL HS QUAD 2-INPT NAND GATE	01295	SN74H00N
U92	1820-0141		IC:TTL QUAD 2-INPT AND GATE	04713	MC3001P
U93	1820-0512	4	IC:TTL HS DUAL D F/F(35 MHZ MIN.)	01295	SN74H74N
U94	1820-0512		IC:TTL HS DUAL D F/F(35 MHZ MIN.)	01295	SN74H74N
U95	1820-0077	2	IC:TTL DUAL D F/F	01295	SN7474N
U96	1820-0374	1	IC:TTL HS DUAL 4-INPT AND GATE	01295	SN74H21N
U97	1820-0370		IC:TTL HS QUAD 2-INPT NAND GATE	01295	SN74H00N
U99	1820-0686	1	IC:TTL SCHOTTKY TRIPLE 3-INPT AND GATE	01295	SN74S11N
U101	1820-0372	3	IC:TTL TRIPLE 3-INPT AND GATE	28480	1820-0372
U102	1820-0424	5	IC:TTL HS HEX INVERTER	04713	SN74H04N
U103	1820-0424		IC:TTL HS HEX INVERTER	04713	SN74H04N
U104	1820-0629		IC:TTL SHS DUAL EDGE TRIG. J-K F/F	01295	SN74S112N
U105	1820-0844	1	IC:TTL DUAL 3-INPT PULSE SHAPER	04713	MC426P

Table 2-23. System Clock/Console Interface PCA, Replaceable Parts (Continued)

Reference Designation	HP Part Number	Qty	Description	Mfr Code	Mfr Part Number
U106	1820-0301		IC:TTL QUAD BI-STABLE D-LATCH	01295	SN7475N
U107	1820-0491	1	IC:TTL BCD/DEC. DECODER/DRIVER	01295	SN74145N
U109	1820-0760	4	IC:TTL 8-BIT RECEIVER INVERTING	28480	1820-0760
U112	1820-0515	1	IC:TTL DUAL RE-TRIG/RE-SET MONO-MULTI	07263	U78960259X
U113	1820-0370		IC:TTL HS QUAD 2-INPT NAND GATE	01295	SN74H00N
U114	1820-0834	1	IC:TTL 1 OF 8 DECODER W/INVERT CONTROL	04713	MC4038P
U115	1820-0471	1	IC:TTL HEX INVERTER W/OPEN COLL.(30V)	01295	SN7406N
U116	1820-0424		IC:TTL HS HEX INVERTER	04713	SN74H04N
U117	1820-0141		IC:TTL QUAD 2-INPT AND GATE	04713	MC3001P
U122	1820-0077		IC:TTL DUAL D F/F	01295	SN7474N
U123	1820-0372		IC:TTL TRIPLE 3-INPT AND GATE	28480	1820-0372
U124	1820-0141		IC:TTL QUAD 2-INPT AND GATE	04713	MC3001P
U125	1820-0205	3	IC:TTL QUAD 2-INPT OR GATE	28480	1820-0205
U126	1820-0370		IC:TTL HS QUAD 2-INPT NAND GATE	01295	SN74H00N
U127	1820-0760		IC:TTL 8-BIT RECEIVER INVERTING	28480	1820-0760
U131	1820-0370		IC:TTL HS QUAD 2-INPT NAND GATE	01295	SN74H00N
U132	1820-0141		IC:TTL QUAD 2-INPT AND GATE	04713	MC3001P
U133	1820-0372		IC:TTL TRIPLE 3-INPT AND GATE	28480	1820-0372
U134	1820-0205		IC:TTL QUAD 2-INPT OR GATE	28480	1820-0205
U135	1820-0205		IC:TTL QUAD 2-INPT OR GATE	28480	1820-0205
U136	1820-0706	2	IC:DIGITAL TTL 5-BIT COMPARATOR	04713	U78932459X
U137	1820-0760		IC:TTL 8-BIT RECEIVER INVERTING	28480	1820-0760
U139	1820-0756	3	IC:TTL 8-BIT DRIVER INVERTING	28480	1820-0756
U141	1820-0371	1	IC:TTL HS TRIPLE 3-INPT NAND GATE	01295	SN74H10N
U142	1820-0239	1	IC:TTL QUAD 2-INPT NOR GATE	28480	1820-0239
U143	1820-0629		IC:TTL SHS DUAL EDGE TRIG. J-K F/F	01295	SN74S112N
U144	1820-0141		IC:TTL QUAD 2-INPT AND GATE	04713	MC3001P
U145	1820-0765	3	IC:TTL 4-BIT BINARY COUNTER	01295	SN74197N
U146	1820-0706		IC:DIGITAL TTL 5-BIT COMPARATOR	04713	U78932459X
U147	1820-0760		IC:TTL 8-BIT RECEIVER INVERTING	28480	1820-0760
U149	1820-0756		IC:TTL 8-BIT DRIVER INVERTING	28480	1820-0756
U151	1820-0231	3	IC:TTL 4-BIT SYNC BINARY COUNTER	07263	U68931659X
U152	1820-0424		IC:TTL HS HEX INVERTER	04713	SN74H04N
U153	1820-0574	2	IC:DIGITAL TTL QUAD D-F/F	12040	DM8551N
U154	1820-0574		IC:DIGITAL TTL QUAD D-F/F	12040	DM8551N
U155	1820-0512		IC:TTL HS DUAL D F/F(35 MHZ MIN.)	01295	SN74H74N
U156	1820-0424		IC:TTL HS HEX INVERTER	04713	SN74H04N
U157	1820-0262	1	IC:TTL 8-BIT PAR-IN SER-OUT SHIFT REG.	12040	SD9936
U159	1820-0756		IC:TTL 8-BIT DRIVER INVERTING	28480	1820-0756
U161	1820-0231		IC:TTL 4-BIT SYNC BINARY COUNTER	07263	U68931659X
U162	1820-0231		IC:TTL 4-BIT SYNC BINARY COUNTER	07263	U68931659X
U163	1820-0294	1	IC:TTL 8-BIT SER-IN PAR OUT SHIFT REG	12040	SD9935
U164	1820-0512		IC:TTL HS DUAL D F/F(35 MHZ MIN.)	01295	SN74H74N
U165	1820-0765		IC:TTL 4-BIT BINARY COUNTER	01295	SN74197N
U166	1820-0765		IC:TTL 4-BIT BINARY COUNTER	01295	SN74197N
U167	1820-0626	1	IC:TTL 4-BIT LATCH	07263	U78931459X
W1			THRU		
W6	8159-0005	1	JUMPER WIRE	28480	8159-0005
Y1	0410-0405	1	CRYSTAL:QUARTZ 10 MHZ	28480	0410-0405

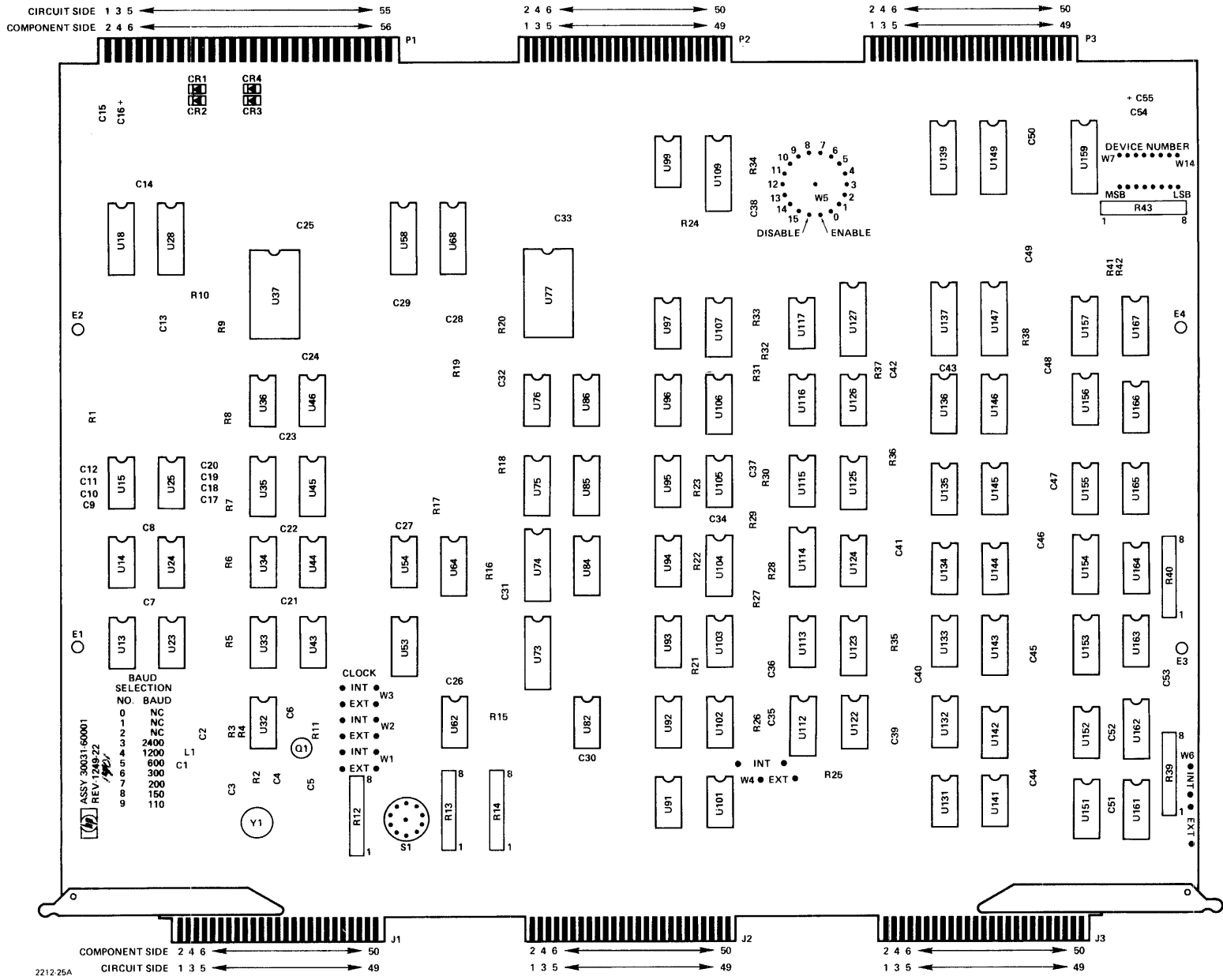

Figure 2-22. System Clock/Console Interface PCA, Parts Location Diagram

Table 2-24. Multiplexer Channel PCA, Replaceable Parts

Reference Designation	HP Part Number	Qty	Description	Mfr Code	Mfr Part Number
C1	30035-60001	1	MULTIPLEXER CHANNEL PCA	28480	30035-60001
C2	0150-0121	19	C:FxD CER 0.1 UF +80-20% 50VDCW	56289	5C50B1S-CML
C3	0150-0121		C:FxD CER 0.1 UF +80-20% 50VDCW	56289	5C50B1S-CML
C4	0150-0121		C:FxD CER 0.1 UF +80-20% 50VDCW	56289	5C50B1S-CML
C5	0180-0197	5	C:FxD ELECT 2.2 UF 10% 20VDCW	56289	150D225X9020A2-DYS
C6	0180-0197		C:FxD ELECT 2.2 UF 10% 20VDCW	56289	150D225X9020A2-DYS
C7	0180-0197		C:FxD ELECT 2.2 UF 10% 20VDCW	56289	150D225X9020A2-DYS
C8	0160-2055	1	C:FxD CER 0.01 UF +80-20% 100VDCW	56289	C023F101F103ZS2Z-CDH
C9	0160-2204	3	C:FxD MICA 100PF 5%	72136	RDML5F101J3C
C10	0180-0197		C:FxD ELECT 2.2 UF 10% 20VDCW	56289	150D225X9020A2-DYS
C11	0160-2204		C:FxD MICA 100PF 5%	72136	RDML5F101J3C
C12	0160-2204		C:FxD MICA 100PF 5%	72136	RDML5F101J3C
C13	0150-0121		C:FxD CER 0.1 UF +80-20% 50VDCW	56289	5C50B1S-CML
C14	0150-0121		C:FxD CER 0.1 UF +80-20% 50VDCW	56289	5C50B1S-CML
C15	0150-0121		C:FxD CER 0.1 UF +80-20% 50VDCW	56289	5C50B1S-CML
C16	0150-0121		C:FxD CER 0.1 UF +80-20% 50VDCW	56289	5C50B1S-CML
C17	0150-0121		C:FxD CER 0.1 UF +80-20% 50VDCW	56289	5C50B1S-CML
C18	0180-0197		C:FxD ELECT 2.2 UF 10% 20VDCW	56289	150D225X9020A2-DYS
C19	0150-0121		C:FxD CER 0.1 UF +80-20% 50VDCW	56289	5C50B1S-CML
C20	0150-0121		C:FxD CER 0.1 UF +80-20% 50VDCW	56289	5C50B1S-CML
C21	0150-0121		C:FxD CER 0.1 UF +80-20% 50VDCW	56289	5C50B1S-CML
C22	0150-0121		C:FxD CER 0.1 UF +80-20% 50VDCW	56289	5C50B1S-CML
C23	0150-0121		C:FxD CER 0.1 UF +80-20% 50VDCW	56289	5C50B1S-CML
C24	0150-0121		C:FxD CER 0.1 UF +80-20% 50VDCW	56289	5C50B1S-CML
C25	0150-0121		C:FxD CER 0.1 UF +80-20% 50VDCW	56289	5C50B1S-CML
C26	0150-0121		C:FxD CER 0.1 UF +80-20% 50VDCW	56289	5C50B1S-CML
C27	0150-0121		C:FxD CER 0.1 UF +80-20% 50VDCW	56289	5C50B1S-CML
C28	0150-0121		C:FxD CER 0.1 UF +80-20% 50VDCW	56289	5C50B1S-CML
CR1	1901-0159	2	DIODE:SILICON 0.75A 400PIV	04713	SR1358-4
CR2	1901-0159		DIODE:SILICON 0.75A 400PIV	04713	SR1358-4
R1	0698-3155	6	R:FxD MET FLM 4.64K OHM 1% 1/8W	28480	0698-3155
R2	0698-3445	1	R:FxD MET FLM 348 OHM 1% 1/8W	28480	0698-3445
R3	1810-0030	12	NETWORK:7 RESISTORS 1K OHM 5% 0.15W EA	28480	1810-0030
R4	1810-0030		NETWORK:7 RESISTORS 1K OHM 5% 0.15W EA	28480	1810-0030
R5	0698-5852	2	R:FxD MET FLM 500 OHM 1% 1/8W	28480	0698-5852
R6	0757-0280	5	R:FxD MET FLM 1K OHM 1% 1/8W	28480	0757-0280
R7	0698-5852		R:FxD MET FLM 500 OHM 1% 1/8W	28480	0698-5852
R8	0757-0280		R:FxD MET FLM 1K OHM 1% 1/8W	28480	0757-0280
R9	0698-3443	1	R:FxD MET FLM 287 OHM 1% 1/8W	28480	0698-3443
R10	0757-0420	1	R:FxD MET FLM 750 OHM 1% 1/8W	28480	0757-0420
R11	0757-0442	3	R:FxD MET FLM 10.0K OHM 1% 1/8W	28480	0757-0442
R12	0757-0442		R:FxD MET FLM 10.0K OHM 1% 1/8W	28480	0757-0442
R13	0757-0442		R:FxD MET FLM 10.0K OHM 1% 1/8W	28480	0757-0442
R14	0698-3155		R:FxD MET FLM 4.64K OHM 1% 1/8W	28480	0698-3155
R15	1810-0030		NETWORK:7 RESISTORS 1K OHM 5% 0.15W EA	28480	1810-0030
R16	1810-0030		NETWORK:7 RESISTORS 1K OHM 5% 0.15W EA	28480	1810-0030
R17	0698-3155		R:FxD MET FLM 4.64K OHM 1% 1/8W	28480	0698-3155
R18	0757-0280		R:FxD MET FLM 1K OHM 1% 1/8W	28480	0757-0280
R19	0757-0280		R:FxD MET FLM 1K OHM 1% 1/8W	28480	0757-0280
R20	1810-0030		NETWORK:7 RESISTORS 1K OHM 5% 0.15W EA	28480	1810-0030
R21	1810-0030		NETWORK:7 RESISTORS 1K OHM 5% 0.15W EA	28480	1810-0030
R22	1810-0030		NETWORK:7 RESISTORS 1K OHM 5% 0.15W EA	28480	1810-0030
R23	1810-0030		NETWORK:7 RESISTORS 1K OHM 5% 0.15W EA	28480	1810-0030
R24	0698-3155		R:FxD MET FLM 4.64K OHM 1% 1/8W	28480	0698-3155
R25	1810-0030		NETWORK:7 RESISTORS 1K OHM 5% 0.15W EA	28480	1810-0030
R26	1810-0030		NETWORK:7 RESISTORS 1K OHM 5% 0.15W EA	28480	1810-0030
R27	1810-0030		NETWORK:7 RESISTORS 1K OHM 5% 0.15W EA	28480	1810-0030
R28	1810-0030		NETWORK:7 RESISTORS 1K OHM 5% 0.15W EA	28480	1810-0030
R30	0757-0280		R:FxD MET FLM 1K OHM 1% 1/8W	28480	0757-0280
R31	0698-3155		R:FxD MET FLM 4.64K OHM 1% 1/8W	28480	0698-3155
R32	1810-0125	1	RESISTIVE NETWORK:7 X 4.7K OHM 5% 0.15W	28480	1810-0125
R33	0698-3155		R:FxD MET FLM 4.64K OHM 1% 1/8W	28480	0698-3155
U12	1820-0205	4	IC:TTL QUAD 2-INPT OR GATE	28480	1820-0205
U13	1820-0377	6	IC:TTL HS DUAL 2-WIDE 2-INPT	01295	SN74H50N
U14	1820-0380	1	IC:TTL HS 4W 2-2-2-3 INPT AND/OR INV	01295	SN74H53N
U15	1820-0370	6	IC:TTL HS QUAD 2-INPT NAND GATE	01295	SN74H00N
U16	1820-0681	3	IC:TTL QUAD 2-INPT NAND GATE	01295	SN74S00N
U17	1820-0755	2	IC	28480	1820-0755
U18	1820-0755		IC	28480	1820-0755
U21	1820-0379	3	IC:TTL HS 4W 2-2-2-3 INPT AND/OR GATE	01295	SN74H52N
U22	1820-0424	6	IC:TTL HS HEX INVERTER	04713	SN74H04N
U23	1820-0205		IC:TTL QUAD 2-INPT OR GATE	28480	1820-0205
U24	1820-0377		IC:TTL HS DUAL 2-WIDE 2-INPT	01295	SN74H50N
U25	1820-0685	2	IC:TTL SCHOTTKY TRIPLE 3-INPT NAND GATE	01295	SN74S10N

Table 2-24. Multiplexer Channel PCA, Replaceable Parts (Continued)

Reference Designation	HP Part Number	Qty	Description	Mfr Code	Mfr Part Number
U26	1820-0372	4	IC:TTL TRIPLE 3-INPT AND GATE	28480	1820-0372
U27	1820-0471	1	IC:TTL HEX INVERTER W/OPEN COLL.(30V)	01295	SN7406N
U31	1820-0377		IC:TTL HS DUAL 2-WIDE 2-INPT	01295	SN74H50N
U32	1820-0371	4	IC:TTL HS TRIPLE 3-INPT NAND GATE	01295	SN74H10N
U33	1820-0141	7	IC:TTL QUAD 2-INPT AND GATE	04713	MC3001P
U34	1820-0379		IC:TTL HS 4W 2-2-2-3 INPT AND/OR GATE	01295	SN74H52N
U35	1820-0141		IC:TTL QUAD 2-INPT AND GATE	04713	MC3001P
U37	1820-0686	3	IC:TTL SCHOTTKY TRIPLE 3-INPT AND GATE	01295	SN74S11N
U41	1820-0377		IC:TTL HS DUAL 2-WIDE 2-INPT	01295	SN74H50N
U42	1820-0141		IC:TTL QUAD 2-INPT AND GATE	04713	MC3001P
U43	1820-0379		IC:TTL HS 4W 2-2-2-3 INPT AND/OR GATE	01295	SN74H52N
U44	1820-0686		IC:TTL SCHOTTKY TRIPLE 3-INPT AND GATE	01295	SN74S11N
U45	1820-0684	2	IC:DIGITAL TTL	28480	1820-0684
U46	1820-0301	5	IC:TTL QUAD BI-STABLE D-LATCH	01295	SN7475N
U47	1820-0683	2	IC:TTL SCHOTTKY HEX INVERTER	01295	SN74S04N
U51	1820-0377		IC:TTL HS DUAL 2-WIDE 2-INPT	01295	SN74H50N
U52	1820-0693	3	IC:TTL SCHOTTKY DUAL D F/F W/PRESET	01295	SN74S74N
U53	1820-0686		IC:TTL SCHOTTKY TRIPLE 3-INPT AND GATE	01295	SN74S11N
U54	1820-0685		IC:TTL SCHOTTKY TRIPLE 3-INPT NAND GATE	01295	SN74S10N
U55	1820-0370		IC:TTL HS QUAD 2-INPT NAND GATE	01295	SN74H00N
U56	1820-0844	1	IC:TTL DUAL 3-INPT PULSE SHAPER	04713	MC426P
U57	1820-0684		IC:DIGITAL TTL	28480	1820-0684
U61	1820-0376	2	IC:TTL HS DUAL 4-INPT NAND BUFFER	01295	SN74H40N
U62	1820-0141		IC:TTL QUAD 2-INPT AND GATE	04713	MC3001P
U63	1820-0370		IC:TTL HS QUAD 2-INPT NAND GATE	01295	SN74H00N
U64	1820-0693		IC:TTL SCHOTTKY DUAL D F/F W/PRESET	01295	SN74S74N
U65	1820-0141		IC:TTL QUAD 2-INPT AND GATE	04713	MC3001P
U66	1820-0371		IC:TTL HS TRIPLE 3-INPT NAND GATE	01295	SN74H10N
U67	1820-0214	2	IC:TTL BCD TO DEC. DECODER	01295	SN7442N
U71	1820-0370		IC:TTL HS QUAD 2-INPT NAND GATE	01295	SN74H00N
U72	1820-0370		IC:TTL HS QUAD 2-INPT NAND GATE	01295	SN74H00N
U73	1820-0377		IC:TTL HS DUAL 2-WIDE 2-INPT	01295	SN74H50N
U74	1820-0140	1	IC:TTL DUAL 4-INPT AND BUFFER	04713	MC3026P
U75	1820-0681		IC:TTL QUAD 2-INPT NAND GATE	01295	SN74S00N
U77	1820-0424		IC:TTL HS HEX INVERTER	04713	SN74H04N
U78	1820-0760	2	IC:TTL 8-BIT RECEIVER INVERTING	28480	1820-0760
U81	1820-0214		IC:TTL BCD TO DEC. DECODER	01295	SN7442N
U82	1820-0424		IC:TTL HS HEX INVERTER	04713	SN74H04N
U83	1820-0424		IC:TTL HS HEX INVERTER	04713	SN74H04N
U84	1820-0424		IC:TTL HS HEX INVERTER	04713	SN74H04N
U85	1820-0681		IC:TTL QUAD 2-INPT NAND GATE	01295	SN74S00N
U91	1820-0372		IC:TTL TRIPLE 3-INPT AND GATE	28480	1820-0372
U92	1820-0371		IC:TTL HS TRIPLE 3-INPT NAND GATE	01295	SN74H10N
U93	1820-0205		IC:TTL QUAD 2-INPT OR GATE	28480	1820-0205
U94	1820-0205		IC:TTL QUAD 2-INPT OR GATE	28480	1820-0205
U95	1820-0239	1	IC:TTL QUAD 2-INPT NOR GATE	28480	1820-0239
U101	1820-0683		IC:TTL SCHOTTKY HEX INVERTER	01295	SN74S04N
U102	1820-0372		IC:TTL TRIPLE 3-INPT AND GATE	28480	1820-0372
U103	1820-0376		IC:TTL HS DUAL 4-INPT NAND BUFFER	01295	SN74H40N
U104	1820-0657	2	IC:DIGITAL TTL 8-INPT PRIORITY ENCODER	07263	U78931859X
U105	1820-0301		IC:TTL QUAD BI-STABLE D-LATCH	01295	SN7475N
U106	1820-0301		IC:TTL QUAD BI-STABLE D-LATCH	01295	SN7475N
U107	1820-0491	2	IC:TTL BCD/DEC. DECODER/DRIVER	01295	SN74145N
U108	1820-0655	2	IC:TTL DUAL INPUT NOR GATE WITH STROBE	01295	SN23684
U111	1820-0141		IC:TTL QUAD 2-INPT AND GATE	04713	MC3001P
U112	1820-0370		IC:TTL HS QUAD 2-INPT NAND GATE	01295	SN74H00N
U113	1820-0372		IC:TTL TRIPLE 3-INPT AND GATE	28480	1820-0372
U114	1820-0657		IC:DIGITAL TTL 8-INPT PRIORITY ENCODER	07263	U78931859X
U115	1820-0301		IC:TTL QUAD BI-STABLE D-LATCH	01295	SN7475N
U116	1820-0301		IC:TTL QUAD BI-STABLE D-LATCH	01295	SN7475N
U117	1820-0491		IC:TTL BCD/DEC. DECODER/DRIVER	01295	SN74145N
U118	1820-0655		IC:TTL DUAL INPUT NOR GATE WITH STROBE	01295	SN23684
U121	1820-0682	10	IC:TTL SHS QUAD 2-INPT NAND GATE	01295	SN74S30N
U122	1820-0682		IC:TTL SHS QUAD 2-INPT NAND GATE	01295	SN74S30N
U123	1820-0682		IC:TTL SHS QUAD 2-INPT NAND GATE	01295	SN74S30N
U124	1820-0682		IC:TTL SHS QUAD 2-INPT NAND GATE	01295	SN74S30N
U125	1820-0759	4	IC:TTL LOW-POWER 8-BIT RECEIVER	28480	1820-0759
U126	1820-0759		IC:TTL LOW-POWER 8-BIT RECEIVER	28480	1820-0759
U131	1820-0626	2	IC:TTL 4-BIT LATCH	07263	U78931459X
U132	1820-0233	3	IC:TTL SYNUP-ON 4-BIT BINARY COUNTER	01295	SN74193N
U135	1820-0756	10	IC:TTL 8-BIT DRIVER INVERTING	28480	1820-0756
U136	1820-0756		IC:TTL 8-BIT DRIVER INVERTING	28480	1820-0756
U137	1820-0756		IC:TTL 8-BIT DRIVER INVERTING	28480	1820-0756
U138	1820-0756		IC:TTL 8-BIT DRIVER INVERTING	28480	1820-0756
U141	1820-0626		IC:TTL 4-BIT LATCH	07263	U78931459X

Table 2-24. Multiplexer Channel PCA, Replaceable Parts (Continued)

Reference Designation	HP Part Number	Qty	Description	Mfr Code	Mfr Part Number
U142	1820-0836	1	IC:TTL DUAL 4-BIT PARITY TREE	04713	MC4010P
U143	1820-0233		IC:TTL SYNUP-DN 4-BIT BINARY COUNTER	01295	SN74193N
U144	1820-0233		IC:TTL SYNUP-DN 4-BIT BINARY COUNTER	01295	SN74193N
U145	1820-0842	4	IC:TTL 8-BIT PARITY TREE	04713	MC4008P
U146	1820-0842		IC:TTL 8-BIT PARITY TREE	04713	MC4008P
U147	1820-0756		IC:TTL 8-BIT DRIVER INVERTING	28480	1820-0756
U148	1820-0756		IC:TTL 8-BIT DRIVER INVERTING	28480	1820-0756
U151	1820-0682		IC:TTL SHS QUAD 2-INPT NAND GATE	01295	SN74530N
U152	1820-0788	1	IC:TTL HEX D-TYPE FLIP/FLOP WITH CLEAR	01295	SN35431
U155	1820-0759		IC:TTL LOW-POWER 8-BIT RECEIVER	28480	1820-0759
U156	1820-0759		IC:TTL LOW-POWER 8-BIT RECEIVER	28480	1820-0759
U161	1820-0682		IC:TTL SHS QUAD 2-INPT NAND GATE	01295	SN74530N
U162	1820-0682		IC:TTL SHS QUAD 2-INPT NAND GATE	01295	SN74530N
U163	1820-0682		IC:TTL SHS QUAD 2-INPT NAND GATE	01295	SN74530N
U164	1820-0682		IC:TTL SHS QUAD 2-INPT NAND GATE	01295	SN74530N
U175	1820-0756		IC:TTL 8-BIT DRIVER INVERTING	28480	1820-0756
U176	1820-0756		IC:TTL 8-BIT DRIVER INVERTING	28480	1820-0756
U177	1820-0756		IC:TTL 8-BIT DRIVER INVERTING	28480	1820-0756
U178	1820-0756		IC:TTL 8-BIT DRIVER INVERTING	28480	1820-0756
U181	1820-0545	4	IC:TTL SYNC 4-BIT UP-DOWN COUNTER	01295	SN74191N
U182	1820-0545		IC:TTL SYNC 4-BIT UP-DOWN COUNTER	01295	SN74191N
U183	1820-0545		IC:TTL SYNC 4-BIT UP-DOWN COUNTER	01295	SN74191N
U184	1820-0545		IC:TTL SYNC 4-BIT UP-DOWN COUNTER	01295	SN74191N
U187	1820-0706	2	IC:DIGITAL TTL 5-BIT COMPARATOR	04713	U78932459X
U188	1820-0760		IC:TTL 8-BIT RECEIVER INVERTING	28480	1820-0760
U191	1820-0742	1	IC:TTL DUAL 4-BIT LATCH	07263	U6N930859X
U192	1820-0424		IC:TTL HS HEX INVERTER	04713	SN74H04N
U193	1820-0371		IC:TTL HS TRIPLE 3-INPT NAND GATE	01295	SN74H10N
U194	1820-0682		IC:TTL SHS QUAD 2-INPT NAND GATE	01295	SN74530N
U195	1820-0842		IC:TTL 8-BIT PARITY TREE	04713	MC4008P
U196	1820-0842		IC:TTL 8-BIT PARITY TREE	04713	MC4008P
U197	1820-0706		IC:DIGITAL TTL 5-BIT COMPARATOR	04713	U78932459X
U204	1820-0693		IC:TTL SCHOTTKY DUAL D F/F W/PRESET	01295	SN74S74N
U205	1820-0141		IC:TTL QUAD 2-INPT AND GATE	04713	MC3001P

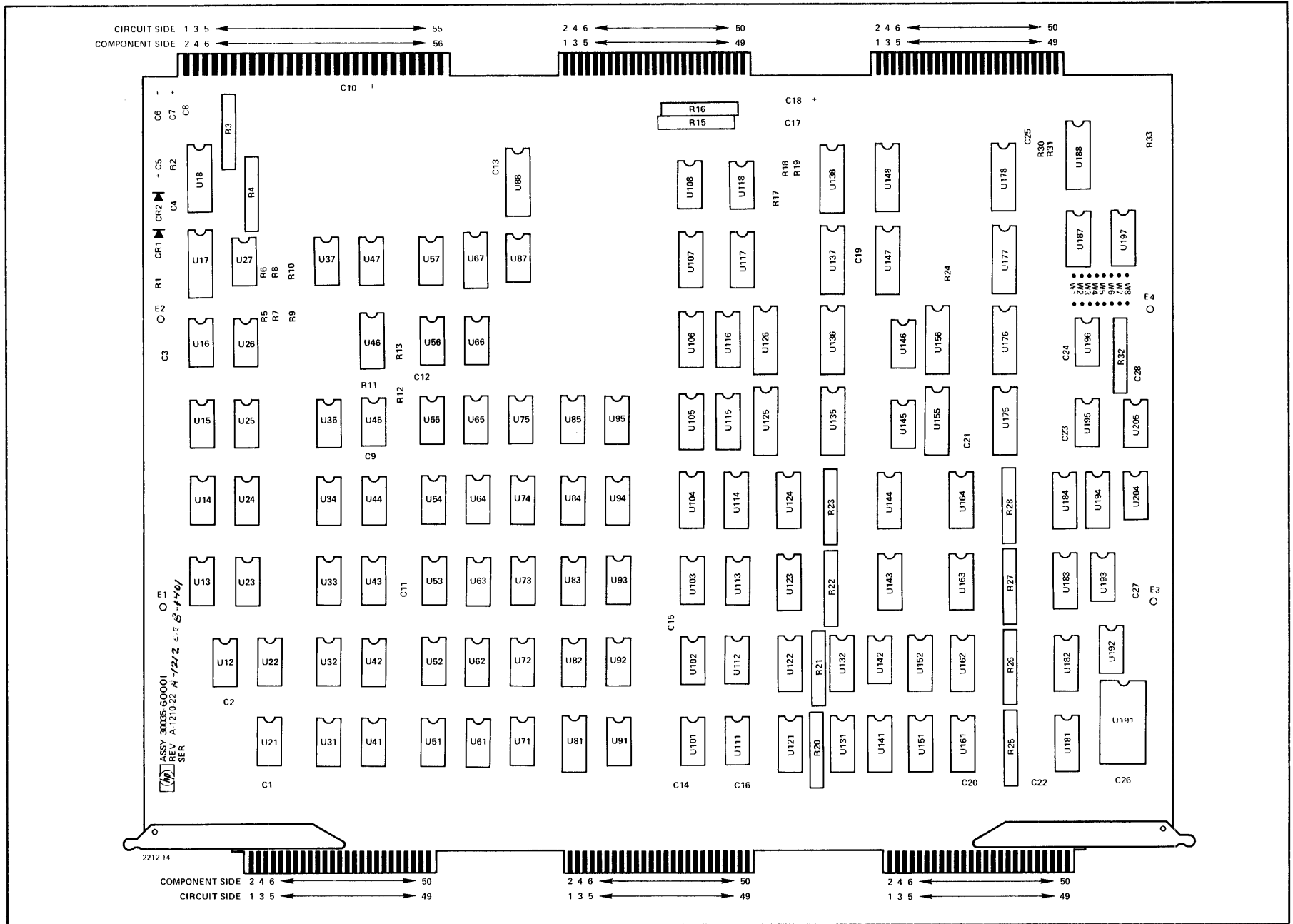

ASSY 30035-60001
 REV A 121022 A-1/2/2
 SER 2-176/1

Figure 2-23. Multiplexer Channel PCA, Parts Location Diagram

Table 2-25. Multiplexer Channel Bus Terminator PCA, Replaceable Parts

Reference Designation	HP Part Number	Qty	Description	Mfr Code	Mfr Part Number
	30035-60003	1	MULTIPLEXER CHANNEL BUS TERMINATOR PCA	28480	30035-60003
C1	0150-0121	6	C:FXD CER 0.1 UF +80-20% 50VDCW	56289	5C508IS-CML
C2	0180-0197	5	C:FXD ELECT 2.2 UF 10% 20VDCW	56289	150D225X9020A2-DYS
C3	0150-0121		C:FXD CER 0.1 UF +80-20% 50VDCW	56289	5C508IS-CML
C4	0180-0197		C:FXD ELECT 2.2 UF 10% 20VDCW	56289	150D225X9020A2-DYS
C5	0180-0197		C:FXD ELECT 2.2 UF 10% 20VDCW	56289	150D225X9020A2-DYS
C6	0150-0121		C:FXD CER 0.1 UF +80-20% 50VDCW	56289	5C508IS-CML
C7	0150-0121		C:FXD CER 0.1 UF +80-20% 50VDCW	56289	5C508IS-CML
C8	0150-0121		C:FXD CER 0.1 UF +80-20% 50VDCW	56289	5C508IS-CML
C8	0180-0197		C:FXD ELECT 2.2 UF 10% 20VDCW	56289	150D225X9020A2-DYS
C10	0180-0197		C:FXD ELECT 2.2 UF 10% 20VDCW	56289	150D225X9020A2-DYS
CR1	1901-0159	2	DIODE:SILICON 0.75A 400PIV	04713	SR1358-4
CR2	1901-0159		DIODE:SILICON 0.75A 400PIV	04713	SR1358-4
R1	0698-3443	4	R:FXD MET FLM 287 OHM 1% 1/8W	28480	0698-3443
R2	0757-0420	4	R:FXD MET FLM 750 OHM 1% 1/8W	28480	0757-C420
R3	0698-3443		R:FXD MET FLM 287 OHM 1% 1/8W	28480	0698-3443
R4	0757-0420		R:FXD MET FLM 750 OHM 1% 1/8W	28480	0757-C420
R5	0698-3443		R:FXD MET FLM 287 OHM 1% 1/8W	28480	0698-3443
R6	0757-0420		R:FXD MET FLM 750 OHM 1% 1/8W	28480	0757-C420
R7	0698-3443		R:FXD MET FLM 287 OHM 1% 1/8W	28480	0698-3443
R8	0757-0420		R:FXD MET FLM 750 OHM 1% 1/8W	28480	0757-C420
R9	0757-0416	1	R:FXD MET FLM 511 OHM 1% 1/8W	28480	0757-C416
R10	0757-0280	1	R:FXD MET FLM 1K OHM 1% 1/8W	28480	0757-0280
R11	1810-0030	2	NETWORK:7 RESISTORS 1K OHM 5% 0.15W EA	28480	1810-0030
R12	1810-0030		NETWORK:7 RESISTORS 1K OHM 5% 0.15W EA	28480	1810-0030
R13	0683-1015	1	R:FXD COMP 100 OHM 5% 1/4W	01121	C8 1015

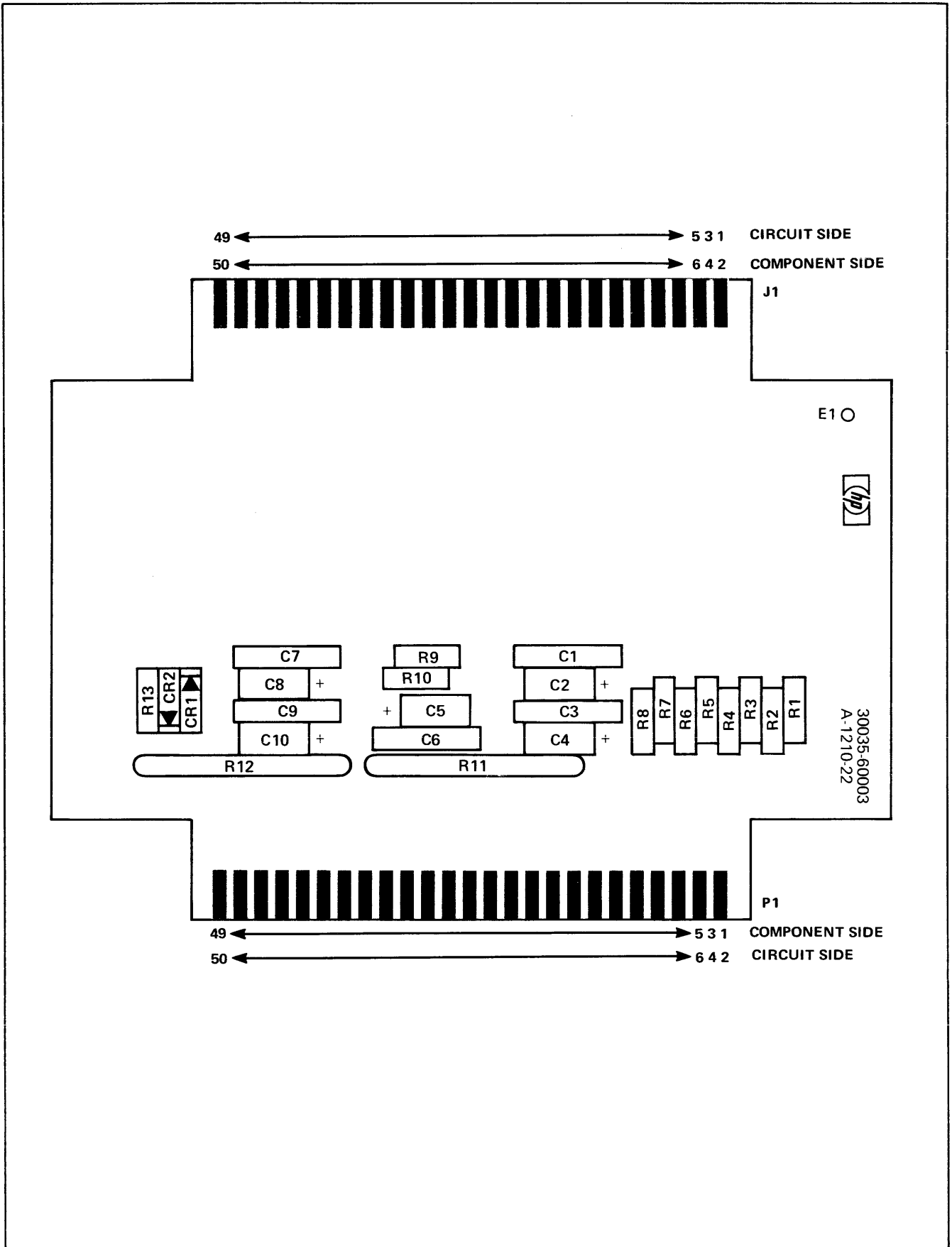

2212-22

Figure 2-24. Multiplexer Channel Bus Terminator PCA, Parts Location Diagram

Table 2-26. Universal Interface (TTL) PCA, Replaceable Parts

Reference Designation	HP Part Number	Qty	Description	Mfr Code	Mfr Part Number
C1	30050-60001	1	UNIVERSAL INTERFACE(TTL) PCA	28480	30050-60001
C2	0160-2204	14	C:FXD MICA 100PF 5%	72136	RDM15F101J3C
C3	0160-2204		C:FXD MICA 100PF 5%	72136	RDM15F101J3C
C4	0160-2055	48	C:FXD CER 0.01 UF +80-20% 100VDCW	56289	C023F101F103ZS22-CDH
C5	0180-0374	2	C:FXD TANT. 10 UF 10% 20VDCW	56289	1500106X902082-DYS
C6	0180-0374		C:FXD TANT. 10 UF 10% 20VDCW	56289	1500106X902082-DYS
C7	0160-2307	2	C:FXD MICA 47 PF 5%	28480	0160-2307
C8	0160-2307		C:FXD MICA 47 PF 5%	28480	0160-2307
C9	0160-0938	1	C:FXD MICA 1000 PF 5%	72136	RDM15E102J1C
C10	0160-2940	2	C:FXD MICA 470 PF 5% 300VDCW	72136	RDM15F471J3C
C11	0160-2055		C:FXD CER 0.01 UF +80-20% 100VDCW	56289	C023F101F103ZS22-CDH
C12	0180-0197	2	C:FXD ELECT 2.2 UF 10% 20VDCW	56289	1500225X9020A2-DYS
C13	0180-0197		C:FXD ELECT 2.2 UF 10% 20VDCW	56289	1500225X9020A2-DYS
C14	0160-2204		C:FXD MICA 100PF 5%	72136	RDM15F101J3C
C15	0160-2055		C:FXD CER 0.01 UF +80-20% 100VDCW	56289	C023F101F103ZS22-CDH
C16	0160-2204		C:FXD MICA 100PF 5%	72136	RDM15F101J3C
C17	0160-2204		C:FXD MICA 100PF 5%	72136	RDM15F101J3C
C18	0160-2204		C:FXD MICA 100PF 5%	72136	RDM15F101J3C
C19	0160-2204		C:FXD MICA 100PF 5%	72136	RDM15F101J3C
C20	0160-2055		C:FXD CER 0.01 UF +80-20% 100VDCW	56289	C023F101F103ZS22-CDH
C21	0160-2209	1	C:FXD MICA 360 PF 5%	72136	RDM15F361J3C
C22	0160-2202	3	C:FXD MICA 75 PF 5%	28480	0160-2202
C23	0160-2055		C:FXD CER 0.01 UF +80-20% 100VDCW	56289	C023F101F103ZS22-CDH
C24	0160-2055		C:FXD CER 0.01 UF +80-20% 100VDCW	56289	C023F101F103ZS22-CDH
C25	0160-2055		C:FXD CER 0.01 UF +80-20% 100VDCW	56289	C023F101F103ZS22-CDH
C26	0160-2204		C:FXD MICA 100PF 5%	72136	RDM15F101J3C
C27	0160-2940		C:FXD MICA 470 PF 5% 300VDCW	72136	RDM15F471J3C
C28	0160-2055		C:FXD CER 0.01 UF +80-20% 100VDCW	56289	C023F101F103ZS22-CDH
C29	0160-2055		C:FXD CER 0.01 UF +80-20% 100VDCW	56289	C023F101F103ZS22-CDH
C30	0160-2055		C:FXD CER 0.01 UF +80-20% 100VDCW	56289	C023F101F103ZS22-CDH
C31	0160-2055		C:FXD CER 0.01 UF +80-20% 100VDCW	56289	C023F101F103ZS22-CDH
C32	0160-2055		C:FXD CER 0.01 UF +80-20% 100VDCW	56289	C023F101F103ZS22-CDH
C33	0160-2055		C:FXD CER 0.01 UF +80-20% 100VDCW	56289	C023F101F103ZS22-CDH
C34	0160-2055		C:FXD CER 0.01 UF +80-20% 100VDCW	56289	C023F101F103ZS22-CDH
C35	0160-2055		C:FXD CER 0.01 UF +80-20% 100VDCW	56289	C023F101F103ZS22-CDH
C36	0160-2055		C:FXD CER 0.01 UF +80-20% 100VDCW	56289	C023F101F103ZS22-CDH
C37	0160-2055		C:FXD CER 0.01 UF +80-20% 100VDCW	56289	C023F101F103ZS22-CDH
C38	0150-0121	9	C:FXD CER 0.1 UF +80-20% 50VDCW	56289	5C50BIS-CML
C39	0160-2055		C:FXD CER 0.01 UF +80-20% 100VDCW	56289	C023F101F103ZS22-CDH
C40	0160-2055		C:FXD CER 0.01 UF +80-20% 100VDCW	56289	C023F101F103ZS22-CDH
C41	0160-2055		C:FXD CER 0.01 UF +80-20% 100VDCW	56289	C023F101F103ZS22-CDH
C42	0160-2055		C:FXD CER 0.01 UF +80-20% 100VDCW	56289	C023F101F103ZS22-CDH
C43	0160-2055		C:FXD CER 0.01 UF +80-20% 100VDCW	56289	C023F101F103ZS22-CDH
C44	0160-2055		C:FXD CER 0.01 UF +80-20% 100VDCW	56289	C023F101F103ZS22-CDH
C45	0160-2055		C:FXD CER 0.01 UF +80-20% 100VDCW	56289	C023F101F103ZS22-CDH
C46	0160-2055		C:FXD CER 0.01 UF +80-20% 100VDCW	56289	C023F101F103ZS22-CDH
C47	0150-0121		C:FXD CER 0.1 UF +80-20% 50VDCW	56289	5C50BIS-CML
C48	0160-2055		C:FXD CER 0.01 UF +80-20% 100VDCW	56289	C023F101F103ZS22-CDH
C49	0160-2055		C:FXD CER 0.01 UF +80-20% 100VDCW	56289	C023F101F103ZS22-CDH
C50	0150-0121		C:FXD CER 0.1 UF +80-20% 50VDCW	56289	5C50BIS-CML
C51	0160-2055		C:FXD CER 0.01 UF +80-20% 100VDCW	56289	C023F101F103ZS22-CDH
C52	0160-2055		C:FXD CER 0.01 UF +80-20% 100VDCW	56289	C023F101F103ZS22-CDH
C53	0150-0121		C:FXD CER 0.1 UF +80-20% 50VDCW	56289	5C50BIS-CML
C54	0160-2204		C:FXD MICA 100PF 5%	72136	RDM15F101J3C
C55	0160-2204		C:FXD MICA 100PF 5%	72136	RDM15F101J3C
C56	0160-2055		C:FXD CER 0.01 UF +80-20% 100VDCW	56289	C023F101F103ZS22-CDH
C57	0160-2055		C:FXD CER 0.01 UF +80-20% 100VDCW	56289	C023F101F103ZS22-CDH
C58	0160-2204		C:FXD MICA 100PF 5%	72136	RDM15F101J3C
C59	0160-2055		C:FXD CER 0.01 UF +80-20% 100VDCW	56289	C023F101F103ZS22-CDH
C60	0160-2055		C:FXD CER 0.01 UF +80-20% 100VDCW	56289	C023F101F103ZS22-CDH
C61	0160-2204		C:FXD MICA 100PF 5%	72136	RDM15F101J3C
C62	0160-2055		C:FXD CER 0.01 UF +80-20% 100VDCW	56289	C023F101F103ZS22-CDH
C63	0160-2055		C:FXD CER 0.01 UF +80-20% 100VDCW	56289	C023F101F103ZS22-CDH
C64	0160-2204		C:FXD MICA 100PF 5%	72136	RDM15F101J3C
C65	0160-2204		C:FXD MICA 100PF 5%	72136	RDM15F101J3C
C66	0160-2055		C:FXD CER 0.01 UF +80-20% 100VDCW	56289	C023F101F103ZS22-CDH
C67	0150-0121		C:FXD CER 0.1 UF +80-20% 50VDCW	56289	5C50BIS-CML
C68	0150-0121		C:FXD CER 0.1 UF +80-20% 50VDCW	56289	5C50BIS-CML
C69	0160-2055		C:FXD CER 0.01 UF +80-20% 100VDCW	56289	C023F101F103ZS22-CDH
C70	0160-2055		C:FXD CER 0.01 UF +80-20% 100VDCW	56289	C023F101F103ZS22-CDH
C71	0160-2055		C:FXD CER 0.01 UF +80-20% 100VDCW	56289	C023F101F103ZS22-CDH
C72	0150-0121		C:FXD CER 0.1 UF +80-20% 50VDCW	56289	5C50BIS-CML
C73	0160-2055		C:FXD CER 0.01 UF +80-20% 100VDCW	56289	C023F101F103ZS22-CDH
C74	0160-2055		C:FXD CER 0.01 UF +80-20% 100VDCW	56289	C023F101F103ZS22-CDH

Table 2-26. Universal Interface (TTL) PCA, Replaceable Parts (Continued)

Reference Designation	HP Part Number	Qty	Description	Mfr Code	Mfr Part Number
C75	0150-0121		C:FXD CER 0.1 UF +80-20% 50VDCW	56289	5C50BIS-CML
C76	0160-2055		C:FXD CER 0.01 UF +80-20% 100VDCW	56289	C023F101F103ZS22-CDH
C77	0160-2055		C:FXD CER 0.01 UF +80-20% 100VDCW	56289	C023F101F103ZS22-CDH
C78	0160-2055		C:FXD CER 0.01 UF +80-20% 100VDCW	56289	C023F101F103ZS22-CDH
C79	0160-2055		C:FXD CER 0.01 UF +80-20% 100VDCW	56289	C023F101F103ZS22-CDH
C80	0160-2202		C:FXD MICA 75 PF 5%	28480	0160-2202
C81	0150-0121		C:FXD CER 0.1 UF +80-20% 50VDCW	56289	5C50BIS-CML
C82	0160-2055		C:FXD CER 0.01 UF +80-20% 100VDCW	56289	C023F101F103ZS22-CDH
C83	0160-2055		C:FXD CER 0.01 UF +80-20% 100VDCW	56289	C023F101F103ZS22-CDH
C84	0160-2202		C:FXD MICA 75 PF 5%	28480	0160-2202
CR1	1990-0325	2	DIODE:VISIBLE LIGHT EMITTER	28480	1990-0325
CR2	1990-0325		DIODE:VISIBLE LIGHT EMITTER	28480	1990-0325
CR3	1901-0081	3	DIODE:SILICON 50 VOLTS WORKING	07263	FD1415
CR4	1901-0081		DIODE:SILICON 50 VOLTS WORKING	07263	FD1415
CR5	1901-0081		DIODE:SILICON 50 VOLTS WORKING	07263	FD1415
Q1	1854-0094	1	TSTR:SI NPN	80131	2N3646
R1	1810-0045	7	RESISTOR PACK:7 RES. 200 OHM 5% 0.15W	28480	1810-0045
R2	0698-3153	16	R:FXD MET FLM 3.83K OHM 1% 1/8W	28480	0698-3153
R3	0698-3153		R:FXD MET FLM 3.83K OHM 1% 1/8W	28480	0698-3153
R4	1810-0030	3	NETWORK:7 RESISTORS 1K OHM 5% 0.15W EA	28480	1810-0030
R5	0698-3440	2	R:FXD MET FLM 196 OHM 1% 1/8W	28480	0698-3440
R6	0698-3160	2	R:FXD MET FLM 31.6K OHM 1% 1/8W	28480	0698-3160
R7	0698-3160		R:FXD MET FLM 31.6K OHM 1% 1/8W	28480	0698-3160
R8	0757-0442	2	R:FXD MET FLM 10.0K OHM 1% 1/8W	28480	0757-0442
R9	0698-3158	1	R:FXD MET FLM 23.7K OHM 1% 1/8W	28480	0698-3158
R10	0757-0442		R:FXD MET FLM 10.0K OHM 1% 1/8W	28480	0757-0442
R11	0698-3153		R:FXD MET FLM 3.83K OHM 1% 1/8W	28480	0698-3153
R12	0698-3153		R:FXD MET FLM 3.83K OHM 1% 1/8W	28480	0698-3153
R13	0757-0280	22	R:FXD MET FLM 1K OHM 1% 1/8W	28480	0757-0280
R14	0698-3440		R:FXD MET FLM 196 OHM 1% 1/8W	28480	0698-3440
R15	0757-0280		R:FXD MET FLM 1K OHM 1% 1/8W	28480	0757-0280
R17	0757-0394	1	R:FXD MET FLM 51.1 OHM 1% 1/8W	28480	0757-0394
R18	0757-0280		R:FXD MET FLM 1K OHM 1% 1/8W	28480	0757-0280
R19	0698-3440		R:FXD MET FLM 196 OHM 1% 1/8W	28480	0698-3440
R20	0757-0346	1	R:FXD MET FLM 10 OHM 1% 1/8W	28480	0757-0346
R21	0757-0401	2	R:FXD MET FLM 100 OHM 1% 1/8W	28480	0757-0401
R22	0757-0280		R:FXD MET FLM 1K OHM 1% 1/8W	28480	0757-0280
R23	0698-3153		R:FXD MET FLM 3.83K OHM 1% 1/8W	28480	0698-3153
R24	0698-3153		R:FXD MET FLM 3.83K OHM 1% 1/8W	28480	0698-3153
R25	0698-3153		R:FXD MET FLM 3.83K OHM 1% 1/8W	28480	0698-3153
R26	0757-0280		R:FXD MET FLM 1K OHM 1% 1/8W	28480	0757-0280
R27	0698-3153		R:FXD MET FLM 3.83K OHM 1% 1/8W	28480	0698-3153
R28	0698-3153		R:FXD MET FLM 3.83K OHM 1% 1/8W	28480	0698-3153
R29	0698-3153		R:FXD MET FLM 3.83K OHM 1% 1/8W	28480	0698-3153
R30	1810-0045		RESISTOR PACK:7 RES. 200 OHM 5% 0.15W	28480	1810-0045
R31	1810-0045		RESISTOR PACK:7 RES. 200 OHM 5% 0.15W	28480	1810-0045
R32	1810-0030		NETWORK:7 RESISTORS 1K OHM 5% 0.15W EA	28480	1810-0030
R33	0757-0401		R:FXD MET FLM 100 OHM 1% 1/8W	28480	0757-0401
R34	0757-0280		R:FXD MET FLM 1K OHM 1% 1/8W	28480	0757-0280
R35	0698-3440	2	R:FXD MET FLM 196 OHM 1% 1/8W	28480	0698-3440
R36	0698-3440		R:FXD MET FLM 196 OHM 1% 1/8W	28480	0698-3440
R37	0757-0280		R:FXD MET FLM 1K OHM 1% 1/8W	28480	0757-0280
R38	1810-0030		NETWORK:7 RESISTORS 1K OHM 5% 0.15W EA	28480	1810-0030
R39	1810-0125	5	RESISTIVE NETWORK:7 X 4.7K OHM 5% 0.15W	28480	1810-0125
R40	0757-0280		R:FXD MET FLM 1K OHM 1% 1/8W	28480	0757-0280
R41	1810-0125		RESISTIVE NETWORK:7 X 4.7K OHM 5% 0.15W	28480	1810-0125
R42	0698-3153		R:FXD MET FLM 3.83K OHM 1% 1/8W	28480	0698-3153
R43	0698-3153		R:FXD MET FLM 3.83K OHM 1% 1/8W	28480	0698-3153
R44	0757-0280		R:FXD MET FLM 1K OHM 1% 1/8W	28480	0757-0280
R45	1810-0045		RESISTOR PACK:7 RES. 200 OHM 5% 0.15W	28480	1810-0045
R46	0698-3153		R:FXD MET FLM 3.83K OHM 1% 1/8W	28480	0698-3153
R47	0698-3153		R:FXD MET FLM 3.83K OHM 1% 1/8W	28480	0698-3153
R48	1810-0125		RESISTIVE NETWORK:7 X 4.7K OHM 5% 0.15W	28480	1810-0125
R49	0757-0280		R:FXD MET FLM 1K OHM 1% 1/8W	28480	0757-0280
R50	1810-0125		RESISTIVE NETWORK:7 X 4.7K OHM 5% 0.15W	28480	1810-0125
R51	0698-3153		R:FXD MET FLM 3.83K OHM 1% 1/8W	28480	0698-3153
R52	0698-3153		R:FXD MET FLM 3.83K OHM 1% 1/8W	28480	0698-3153
R53	0757-0280		R:FXD MET FLM 1K OHM 1% 1/8W	28480	0757-0280
R54	1810-0045		RESISTOR PACK:7 RES. 200 OHM 5% 0.15W	28480	1810-0045
R55	0757-0280		R:FXD MET FLM 1K OHM 1% 1/8W	28480	0757-0280
R56	0757-0280		R:FXD MET FLM 1K OHM 1% 1/8W	28480	0757-0280
R57	0757-0280		R:FXD MET FLM 1K OHM 1% 1/8W	28480	0757-0280
R58	0757-0280		R:FXD MET FLM 1K OHM 1% 1/8W	28480	0757-0280
R59	0757-0280		R:FXD MET FLM 1K OHM 1% 1/8W	28480	0757-0280
R60	0757-0280		R:FXD MET FLM 1K OHM 1% 1/8W	28480	0757-0280

Table 2-26. Universal Interface (TTL) PCA, Replaceable Parts (Continued)

Reference Designation	HP Part Number	Qty	Description	Mfr Code	Mfr Part Number
R61	1810-0045		RESISTOR PACK:7 RES. 200 OHM 5% 0.15W	28480	1810-0045
R62	0757-0280		R:FXD MET FLM 1K OHM 1% 1/8W	28480	0757-0280
R63	1810-0045		RESISTOR PACK:7 RES. 200 OHM 5% 0.15W	28480	1810-0045
R64	0757-0280		R:FXD MET FLM 1K OHM 1% 1/8W	28480	0757-0280
R65	0757-0280		R:FXD MET FLM 1K OHM 1% 1/8W	28480	0757-0280
R66	0698-4421	1	R:FXD FLM 249 OHM 1% 1/8W	28480	0698-4421
R67	0757-0279	2	R:FXD MET FLM 3.16K OHM 1% 1/8W	28480	0757-0279
R68	0757-0279		R:FXD MET FLM 3.16K OHM 1% 1/8W	28480	0757-0279
R69	1810-0125		RESISTIVE NETWORK:7 X 4.7K OHM 5% 0.15W	28480	1810-0125
R70	0757-0280		R:FXD MET FLM 1K OHM 1% 1/8W	28480	0757-0280
U11	1820-0424	10	IC:TTL HS HEX INVERTER	04713	SN74H04N
U12	1820-0844	9	IC:TTL DUAL 3-INPT PULSE SHAPER	04713	MC426P
U13	1820-0834	1	IC:TTL 1 OF 8 DECODER W/INVERT CONTROL	04713	MC4038P
U14	1820-0239	1	IC:TTL QUAD 2-INPT NOR GATE	28480	1820-0239
U15	1820-0515	3	IC:TTL DUAL RE-TRIG/RE-SET MONO-MULTI	07263	U78960259X
U16	1820-0515		IC:TTL DUAL RE-TRIG/RE-SET MONO-MULTI	07263	U78960259X
U17	1820-0515		IC:TTL DUAL RE-TRIG/RE-SET MONO-MULTI	07263	U78960259X
U21	1820-0844		IC:TTL DUAL 3-INPT PULSE SHAPER	04713	MC426P
U22	1820-0844		IC:TTL DUAL 3-INPT PULSE SHAPER	04713	MC426P
U23	1820-0512	14	IC:TTL HS DUAL D F/F(35 MHZ MIN.)	01295	SN74H74N
U24	1820-0844		IC:TTL DUAL 3-INPT PULSE SHAPER	04713	MC426P
U25	1820-0512		IC:TTL HS DUAL D F/F(35 MHZ MIN.)	01295	SN74H74N
U26	1820-0205	1	IC:TTL QUAD 2-INPT OR GATE	28480	1820-0205
U27	1820-0370	9	IC:TTL HS QUAD 2-INPT NAND GATE	01295	SN74H00N
U28	1820-0141	17	IC:TTL QUAD 2-INPT AND GATE	04713	MC3001P
U31	1820-0844		IC:TTL DUAL 3-INPT PULSE SHAPER	04713	MC426P
U32	1820-0141		IC:TTL QUAD 2-INPT AND GATE	04713	MC3001P
U33	1820-0512		IC:TTL HS DUAL D F/F(35 MHZ MIN.)	01295	SN74H74N
U34	1820-0424		IC:TTL HS HEX INVERTER	04713	SN74H04N
U35	1820-0141		IC:TTL QUAD 2-INPT AND GATE	04713	MC3001P
U36	1820-0141		IC:TTL QUAD 2-INPT AND GATE	04713	MC3001P
U37	1820-0629	1	IC:TTL SHS DUAL EDGE TRIG. J-K F/F	01295	SN74S112N
U38	1820-0574	1	IC:DIGITAL TTL QUAD D-F/F	12040	DM8551N
U43	1820-0512		IC:TTL HS DUAL D F/F(35 MHZ MIN.)	01295	SN74H74N
U44	1820-0375	1	IC:TTL HS 8-INPT NAND GATE	01295	SN74H30N
U45	1820-0371	4	IC:TTL HS TRIPLE 3-INPT NAND GATE	01295	SN74H10N
U46	1820-0370		IC:TTL HS QUAD 2-INPT NAND GATE	01295	SN74H00N
U47	1820-0424		IC:TTL HS HEX INVERTER	04713	SN74H04N
U48	1820-0141		IC:TTL QUAD 2-INPT AND GATE	04713	MC3001P
U51	1820-0370		IC:TTL HS QUAD 2-INPT NAND GATE	01295	SN74H00N
U52	1820-0471	4	IC:TTL HEX INVERTER W/OPEN COLL.(30V)	01295	SN7406N
U53	1820-0512		IC:TTL HS DUAL D F/F(35 MHZ MIN.)	01295	SN74H74N
U54	1820-0141		IC:TTL QUAD 2-INPT AND GATE	04713	MC3001P
U55	1820-0512		IC:TTL HS DUAL D F/F(35 MHZ MIN.)	01295	SN74H74N
U56	1820-0282	1	IC:TTL QUAD 2-INPT EXCL. OR GATE	01295	SN7486N
U57	1820-0141		IC:TTL QUAD 2-INPT AND GATE	04713	MC3001P
U58	1820-0512		IC:TTL HS DUAL D F/F(35 MHZ MIN.)	01295	SN74H74N
U61	1820-0370		IC:TTL HS QUAD 2-INPT NAND GATE	01295	SN74H00N
U62	1820-0471		IC:TTL HEX INVERTER W/OPEN COLL.(30V)	01295	SN7406N
U63	1820-0756	7	IC:TTL 8-BIT DRIVER INVERTING	28480	1820-0756
U64	1820-0371		IC:TTL HS TRIPLE 3-INPT NAND GATE	01295	SN74H10N
U65	1820-0512		IC:TTL HS DUAL D F/F(35 MHZ MIN.)	01295	SN74H74N
U66	1820-0371		IC:TTL HS TRIPLE 3-INPT NAND GATE	01295	SN74H10N
U67	1820-0377	3	IC:TTL HS DUAL 2-WIDE 2-INPT	01295	SN74H50N
U68	1820-0141		IC:TTL QUAD 2-INPT AND GATE	04713	MC3001P
U71	1820-0141		IC:TTL QUAD 2-INPT AND GATE	04713	MC3001P
U73	1820-0756		IC:TTL 8-BIT DRIVER INVERTING	28480	1820-0756
U74	1820-0141		IC:TTL QUAD 2-INPT AND GATE	04713	MC3001P
U75	1820-0141		IC:TTL QUAD 2-INPT AND GATE	04713	MC3001P
U76	1820-0424		IC:TTL HS HEX INVERTER	04713	SN74H04N
U77	1820-0377		IC:TTL HS DUAL 2-WIDE 2-INPT	01295	SN74H50N
U78	1820-0512		IC:TTL HS DUAL D F/F(35 MHZ MIN.)	01295	SN74H74N
U81	1820-0626	10	IC:TTL 4-BIT LATCH	07263	U78931459X
U82	1820-0626		IC:TTL 4-BIT LATCH	07263	U78931459X
U83	1820-0756		IC:TTL 8-BIT DRIVER INVERTING	28480	1820-0756
U84	1820-0424		IC:TTL HS HEX INVERTER	04713	SN74H04N
U86	1820-0686	2	IC:TTL SCHOTTKY TRIPLE 3-INPT AND GATE	01295	SN74S11N
U87	1820-0491	1	IC:TTL BCD/DEC. DECODER/DRIVER	01295	SN74145N
U88	1820-0760	4	IC:TTL 8-BIT RECEIVER INVERTING	28480	1820-0760
U91	1820-0616	4	IC:TTL 4-BIT 2-INPT MULTIPLEXER	07263	U78932259X
U92	1820-0616		IC:TTL 4-BIT 2-INPT MULTIPLEXER	07263	U78932259X
U93	1820-0756		IC:TTL 8-BIT DRIVER INVERTING	28480	1820-0756
U94	1820-0141		IC:TTL QUAD 2-INPT AND GATE	04713	MC3001P
U96	1820-0141		IC:TTL QUAD 2-INPT AND GATE	04713	MC3001P
U97	1820-0374	1	IC:TTL HS DUAL 4-INPT AND GATE	01295	SN74H21N

Table 2-26. Universal Interface (TTL) PCA, Replaceable Parts (Continued)

Reference Designation	HP Part Number	Qty	Description	Mfr Code	Mfr Part Number
U58	1820-0759	2	IC:TTL LOW-POWER 8-BIT RECEIVER	28480	1820-0759
U101	1820-0626		IC:TTL 4-BIT LATCH	07263	U78931459X
U102	1820-0626		IC:TTL 4-BIT LATCH	07263	U78931459X
U103	1820-0756		IC:TTL 8-BIT DRIVER INVERTING	28480	1820-0756
U111	1820-0616		IC:TTL 4-BIT 2-INPT MULTIPLEXER	07263	U78932259X
U112	1820-0616		IC:TTL 4-BIT 2-INPT MULTIPLEXER	07263	U78932259X
U113	1820-0626		IC:TTL 4-BIT LATCH	07263	U78931459X
U114	1820-0626		IC:TTL 4-BIT LATCH	07263	U78931459X
U116	1820-0424		IC:TTL HS HEX INVERTER	04713	SN74H04N
U117	1820-0715	2	IC:TTL DIGITAL HI-SPEED J-K F/F	01295	SN74H106N
U121	1820-0844		IC:TTL DUAL 3-INPT PULSE SHAPER	04713	MC426P
U122	1820-0844		IC:TTL DUAL 3-INPT PULSE SHAPER	04713	MC426P
U123	1820-0626		IC:TTL 4-BIT LATCH	07263	U78931459X
U124	1820-0626		IC:TTL 4-BIT LATCH	07263	U78931459X
U126	1820-0900	1	IC:TTL TRIPLE 3-INPT NUR GATE	28480	1820-0900
U127	1820-0715		IC:TTL DIGITAL HI-SPEED J-K F/F	01295	SN74H106N
U131	1820-J471		IC:TTL HEX INVERTER W/OPEN COLL.(30V)	01295	SN7406N
U132	1820-0424		IC:TTL HS HEX INVERTER	04713	SN74H04N
U133	1820-0626		IC:TTL 4-BIT LATCH	07263	U78931459X
U134	1820-0626		IC:TTL 4-BIT LATCH	07263	U78931459X
U136	1820-0141		IC:TTL QUAD 2-INPT AND GATE	04713	MC3001P
U137	1820-0755	2	IC	28480	1820-0755
U138	1820-0759		IC:TTL LOW-POWER 8-BIT RECEIVER	28480	1820-0759
U142	1820-0844		IC:TTL DUAL 3-INPT PULSE SHAPER	04713	MC426P
U143	1820-0512		IC:TTL HS DUAL D F/F(35 MHZ MIN.)	01295	SN74H74N
U144	1820-0512		IC:TTL HS DUAL D F/F(35 MHZ MIN.)	01295	SN74H74N
U146	1820-0370		IC:TTL HS QUAD 2-INPT NAND GATE	01295	SN74H00N
U147	1820-0760		IC:TTL 8-BIT RECEIVER INVERTING	28480	1820-0760
U148	1820-0706	2	IC:DIGITAL TTL 5-BIT COMPARATOR	04713	U78932459X
U151	1820-0471		IC:TTL HEX INVERTER W/OPEN COLL.(30V)	01295	SN7406N
U153	1820-0424		IC:TTL HS HEX INVERTER	04713	SN74H04N
U154	1820-0377		IC:TTL HS DUAL 2-WIDE 2-INPT	01295	SN74H50N
U156	1820-0371		IC:TTL HS TRIPLE 3-INPT NAND GATE	01295	SN74H10N
U158	1820-0760		IC:TTL 8-BIT RECEIVER INVERTING	28480	1820-0760
U163	1820-0370		IC:TTL HS QUAD 2-INPT NAND GATE	01295	SN74H00N
U164	1820-0141		IC:TTL QUAD 2-INPT AND GATE	04713	MC3001P
U166	1820-0372	1	IC:TTL TRIPLE 3-INPT AND GATE	28480	1820-0372
U168	1820-0706		IC:DIGITAL TTL 5-BIT COMPARATOR	04713	U78932459X
U171	1820-0370		IC:TTL HS QUAD 2-INPT NAND GATE	01295	SN74H00N
U173	1820-0141		IC:TTL QUAD 2-INPT AND GATE	04713	MC3001P
U174	1820-0761	1	IC:TTL DIGITAL	28480	1820-0761
U175	1820-0141		IC:TTL QUAD 2-INPT AND GATE	04713	MC3001P
U176	1820-0424		IC:TTL HS HEX INVERTER	04713	SN74H04N
U178	1820-0756		IC:TTL 8-BIT DRIVER INVERTING	28480	1820-0756
U181	1820-0370		IC:TTL HS QUAD 2-INPT NAND GATE	01295	SN74H00N
U183	1820-0373	1	IC:TTL HS DUAL 4-INPT NAND GATE	01295	SN74H20N
U184	1820-0512		IC:TTL HS DUAL D F/F(35 MHZ MIN.)	01295	SN74H74N
U185	1820-0686		IC:TTL SCHOTTKY TRIPLE 3-INPT AND GATE	01295	SN74S11N
U186	1820-0512		IC:TTL HS DUAL D F/F(35 MHZ MIN.)	01295	SN74H74N
U187	1820-0760		IC:TTL 8-BIT RECEIVER INVERTING	28480	1820-0760
U188	1820-0756		IC:TTL 8-BIT DRIVER INVERTING	28480	1820-0756
U191	1820-0370		IC:TTL HS QUAD 2-INPT NAND GATE	01295	SN74H00N
U193	1820-0512		IC:TTL HS DUAL D F/F(35 MHZ MIN.)	01295	SN74H74N
U194	1820-0424		IC:TTL HS HEX INVERTER	04713	SN74H04N
U195	1820-0301	1	IC:TTL QUAD BI-STABLE D-LATCH	01295	SN7475N
U196	1820-0844		IC:TTL DUAL 3-INPT PULSE SHAPER	04713	MC426P
U197	1820-0755		IC	28480	1820-0755
W2	8159-0005	4	JUMPER WIRE	28480	8159-0005
W4	8159-0005		JUMPER WIRE	28480	8159-0005
W5	8159-0005		JUMPER WIRE	28480	8159-0005
W1	8159-0005		JUMPER WIRE	28480	8159-0005

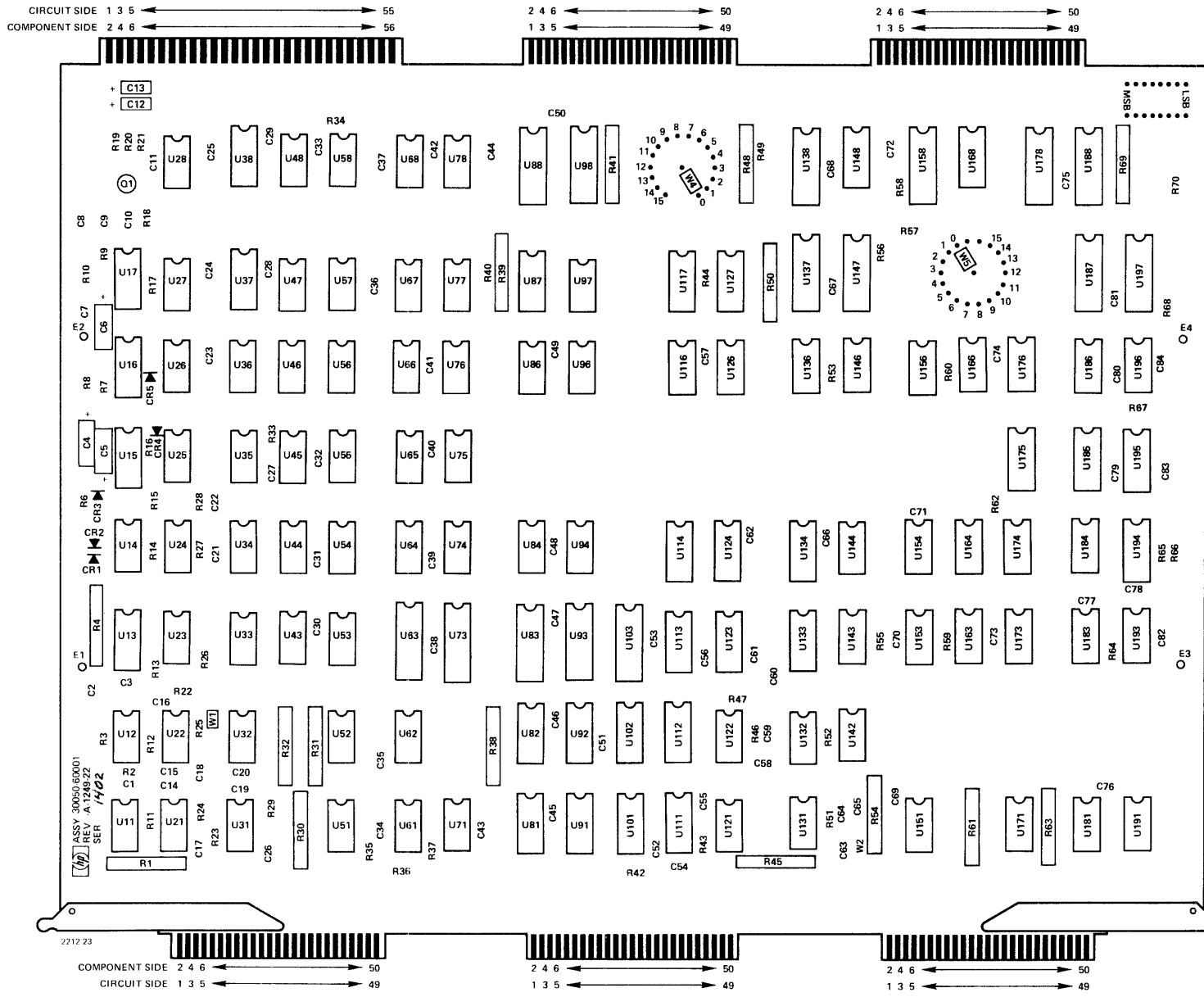

Figure 2-25. Universal Interface (TTL) PCA, Parts Location Diagram

Table 2-27. Universal Interface (Differential) PCA, Replaceable Parts

Reference Designation	HP Part Number	Qty	Description	Mfr Code	Mfr Part Number
C1	30051-60001	1	UNIVERSAL INTERFACE(DIFFERENTIAL) PCA	28480	30051-60001
C2	0160-3457	27	C:FXD DISC CER 0.002 UF 10% 250VDCW	56289	C067F251F202KS22-CDH
C3	0160-2204	27	C:FXD MICA 100PF 5%	72136	RDM15F101J3C
C4	0160-2307	2	C:FXD MICA 100PF 5%	72136	RDM15F101J3C
			C:FXD MICA 47 PF 5%	28480	0160-2307
C5	0180-0228	1	C:FXD ELECT 22 UF 10% 15VDCW	56289	150D226X9015B2-DYS
C6	0160-2940	2	C:FXD MICA 470 PF 5% 300VDCW	72136	RDM15F471J3C
C7	0160-2307		C:FXD MICA 47 PF 5%	28480	0160-2307
C8	0160-3457		C:FXD DISC CER 0.002 UF 10% 250VDCW	56289	C067F251F202KS22-CDH
C9	0160-2204		C:FXD MICA 100PF 5%	72136	RDM15F101J3C
C10	0160-2204		C:FXD MICA 100PF 5%	72136	RDM15F101J3C
C11	0160-3457		C:FXD DISC CER 0.002 UF 10% 250VDCW	56289	C067F251F202KS22-CDH
C12	0160-3457		C:FXD DISC CER 0.002 UF 10% 250VDCW	56289	C067F251F202KS22-CDH
C13	0160-2202	3	C:FXD MICA 75 PF 5%	28480	0160-2202
C14	0160-2940		C:FXD MICA 470 PF 5% 300VDCW	72136	RDM15F471J3C
C15	0160-0938	1	C:FXD MICA 1000 PF 5%	72136	RDM15E102J1C
C16	0160-2055	42	C:FXD CER 0.01 UF +80-20% 100VDCW	56289	C023F101F103ZS22-CDH
C17	0180-0197	2	C:FXD ELECT 2.2 UF 10% 20VDCW	56289	150D225X9020A2-DYS
C18	0180-0197		C:FXD ELECT 2.2 UF 10% 20VDCW	56289	150D225X9020A2-DYS
C19	0160-3457		C:FXD DISC CER 0.002 UF 10% 250VDCW	56289	C067F251F202KS22-CDH
C20	0160-3457		C:FXD DISC CER 0.002 UF 10% 250VDCW	56289	C067F251F202KS22-CDH
C21	0160-3457		C:FXD DISC CER 0.002 UF 10% 250VDCW	56289	C067F251F202KS22-CDH
C22	0160-3457		C:FXD DISC CER 0.002 UF 10% 250VDCW	56289	C067F251F202KS22-CDH
C23	0160-2204		C:FXD MICA 100PF 5%	72136	RDM15F101J3C
C24	0160-2204		C:FXD MICA 100PF 5%	72136	RDM15F101J3C
C25	0160-2204		C:FXD MICA 100PF 5%	72136	RDM15F101J3C
C26	0160-2204		C:FXD MICA 100PF 5%	72136	RDM15F101J3C
C27	0160-2055		C:FXD CER 0.01 UF +80-20% 100VDCW	56289	C023F101F103ZS22-CDH
C28	0160-2209	1	C:FXD MICA 360 PF 5%	72136	RDM15F361J3C
C29	0160-2055		C:FXD CER 0.01 UF +80-20% 100VDCW	56289	C023F101F103ZS22-CDH
C30	0160-2055		C:FXD CER 0.01 UF +80-20% 100VDCW	56289	C023F101F103ZS22-CDH
C31	0160-2055		C:FXD CER 0.01 UF +80-20% 100VDCW	56289	C023F101F103ZS22-CDH
C32	0160-3457		C:FXD DISC CER 0.002 UF 10% 250VDCW	56289	C067F251F202KS22-CDH
C33	0160-3457		C:FXD DISC CER 0.002 UF 10% 250VDCW	56289	C067F251F202KS22-CDH
C34	0160-3457		C:FXD DISC CER 0.002 UF 10% 250VDCW	56289	C067F251F202KS22-CDH
C35	0160-3457		C:FXD DISC CER 0.002 UF 10% 250VDCW	56289	C067F251F202KS22-CDH
C36	0160-2204		C:FXD MICA 100PF 5%	72136	RDM15F101J3C
C37	0160-2204		C:FXD MICA 100PF 5%	72136	RDM15F101J3C
C38	0160-2204		C:FXD MICA 100PF 5%	72136	RDM15F101J3C
C39	0160-2204		C:FXD MICA 100PF 5%	72136	RDM15F101J3C
C40	0160-2055		C:FXD CER 0.01 UF +80-20% 100VDCW	56289	C023F101F103ZS22-CDH
C41	0160-2055		C:FXD CER 0.01 UF +80-20% 100VDCW	56289	C023F101F103ZS22-CDH
C42	0160-2055		C:FXD CER 0.01 UF +80-20% 100VDCW	56289	C023F101F103ZS22-CDH
C44	0160-2055		C:FXD CER 0.01 UF +80-20% 100VDCW	56289	C023F101F103ZS22-CDH
C45	0160-2055		C:FXD CER 0.01 UF +80-20% 100VDCW	56289	C023F101F103ZS22-CDH
C46	0160-2055		C:FXD CER 0.01 UF +80-20% 100VDCW	56289	C023F101F103ZS22-CDH
C47	0160-2055		C:FXD CER 0.01 UF +80-20% 100VDCW	56289	C023F101F103ZS22-CDH
C48	0160-2055		C:FXD CER 0.01 UF +80-20% 100VDCW	56289	C023F101F103ZS22-CDH
C49	0160-2055		C:FXD CER 0.01 UF +80-20% 100VDCW	56289	C023F101F103ZS22-CDH
C50	0160-2055		C:FXD CER 0.01 UF +80-20% 100VDCW	56289	C023F101F103ZS22-CDH
C51	0150-0121	9	C:FXD CER 0.1 UF +80-20% 50VDCW	56289	5C50BIS-CML
C52	0160-2055		C:FXD CER 0.01 UF +80-20% 100VDCW	56289	C023F101F103ZS22-CDH
C53	0160-2055		C:FXD CER 0.01 UF +80-20% 100VDCW	56289	C023F101F103ZS22-CDH
C53	0160-2055		C:FXD CER 0.01 UF +80-20% 100VDCW	56289	C023F101F103ZS22-CDH
C54	0160-2055		C:FXD CER 0.01 UF +80-20% 100VDCW	56289	C023F101F103ZS22-CDH
C55	0160-2055		C:FXD CER 0.01 UF +80-20% 100VDCW	56289	C023F101F103ZS22-CDH
C56	0160-2055		C:FXD CER 0.01 UF +80-20% 100VDCW	56289	C023F101F103ZS22-CDH
C57	0150-0121		C:FXD CER 0.1 UF +80-20% 50VDCW	56289	5C50BIS-CML
C58	0160-2055		C:FXD CER 0.01 UF +80-20% 100VDCW	56289	C023F101F103ZS22-CDH
C59	0160-2055		C:FXD CER 0.01 UF +80-20% 100VDCW	56289	C023F101F103ZS22-CDH
C60	0150-0121		C:FXD CER 0.1 UF +80-20% 50VDCW	56289	5C50BIS-CML
C61	0160-2055		C:FXD CER 0.01 UF +80-20% 100VDCW	56289	C023F101F103ZS22-CDH
C62	0160-2055		C:FXD CER 0.01 UF +80-20% 100VDCW	56289	C023F101F103ZS22-CDH
C63	0160-2055		C:FXD CER 0.01 UF +80-20% 100VDCW	56289	C023F101F103ZS22-CDH
C64	0160-2055		C:FXD CER 0.01 UF +80-20% 100VDCW	56289	C023F101F103ZS22-CDH
C65	0150-0121		C:FXD CER 0.1 UF +80-20% 50VDCW	56289	5C50BIS-CML
C66	0160-2055		C:FXD CER 0.01 UF +80-20% 100VDCW	56289	C023F101F103ZS22-CDH
C67	0160-2055		C:FXD CER 0.01 UF +80-20% 100VDCW	56289	C023F101F103ZS22-CDH
C68	0160-3457		C:FXD DISC CER 0.002 UF 10% 250VDCW	56289	C067F251F202KS22-CDH
C69	0160-3457		C:FXD DISC CER 0.002 UF 10% 250VDCW	56289	C067F251F202KS22-CDH
C70	0160-2204		C:FXD MICA 100PF 5%	72136	RDM15F101J3C
C71	0160-2204		C:FXD MICA 100PF 5%	72136	RDM15F101J3C
C72	0160-2204		C:FXD MICA 100PF 5%	72136	RDM15F101J3C
C73	0160-3457		C:FXD DISC CER 0.002 UF 10% 250VDCW	56289	C067F251F202KS22-CDH
C74	0160-2055		C:FXD CER 0.01 UF +80-20% 100VDCW	56289	C023F101F103ZS22-CDH

Table 2-27. Universal Interface (Differential) PCA, Replaceable Parts (Continued)

Reference Designation	HP Part Number	Qty	Description	Mfr Code	Mfr Part Number
C75	0160-2055		C:FxD CER 0.01 UF +80-20% 100VDCW	56289	C023F101F103ZS22-CDH
C76	0160-2055		C:FxD CER 0.01 UF +80-20% 100VDCW	56289	C023F101F103ZS22-CDH
C77	0160-2055		C:FxD CER 0.01 UF +80-20% 100VDCW	56289	C023F101F103ZS22-CDH
C78	0160-2055		C:FxD CER 0.01 UF +80-20% 100VDCW	56289	C023F101F103ZS22-CDH
C79	0150-0121		C:FxD CER 0.1 UF +80-20% 50VDCW	56289	5C50BIS-CML
C80	0150-0121		C:FxD CER 0.1 UF +80-20% 50VDCW	56289	5C50BIS-CML
C81	0160-2055		C:FxD CER 0.01 UF +80-20% 100VDCW	56289	C023F101F103ZS22-CDH
C82	0160-2055		C:FxD CER 0.01 UF +80-20% 100VDCW	56289	C023F101F103ZS22-CDH
C83	0150-0121		C:FxD CER 0.1 UF +80-20% 50VDCW	56289	5C50BIS-CML
C84	0160-2055		C:FxD CER 0.01 UF +80-20% 100VDCW	56289	C023F101F103ZS22-CDH
C85	0160-2204		C:FxD MICA 100PF 5%	72136	RDM15F101J3C
C86	0160-2204		C:FxD MICA 100PF 5%	72136	RDM15F101J3C
C87	0160-2204		C:FxD MICA 100PF 5%	72136	RDM15F101J3C
C88	0160-2204		C:FxD MICA 100PF 5%	72136	RDM15F101J3C
C89	0160-2055		C:FxD CER 0.01 UF +80-20% 100VDCW	56289	C023F101F103ZS22-CDH
C90	0160-2055		C:FxD CER 0.01 UF +80-20% 100VDCW	56289	C023F101F103ZS22-CDH
C91	0160-3457		C:FxD DISC CER 0.002 UF 10% 250VDCW	56289	C067F251F202KS22-CDH
C92	0160-3457		C:FxD DISC CER 0.002 UF 10% 250VDCW	56289	C067F251F202KS22-CDH
C93	0160-3457		C:FxD DISC CER 0.002 UF 10% 250VDCW	56289	C067F251F202KS22-CDH
C94	0160-3457		C:FxD DISC CER 0.002 UF 10% 250VDCW	56289	C067F251F202KS22-CDH
C95	0160-2204		C:FxD MICA 100PF 5%	72136	RDM15F101J3C
C96	0160-2204		C:FxD MICA 100PF 5%	72136	RDM15F101J3C
C97	0160-2204		C:FxD MICA 100PF 5%	72136	RDM15F101J3C
C98	0160-2204		C:FxD MICA 100PF 5%	72136	RDM15F101J3C
C99	0150-0121		C:FxD CER 0.1 UF +80-20% 50VDCW	56289	5C50BIS-CML
C100	0160-3457		C:FxD DISC CER 0.002 UF 10% 250VDCW	56289	C067F251F202KS22-CDH
C101	0160-3457		C:FxD DISC CER 0.002 UF 10% 250VDCW	56289	C067F251F202KS22-CDH
C102	0160-3457		C:FxD DISC CER 0.002 UF 10% 250VDCW	56289	C067F251F202KS22-CDH
C103	0160-3457		C:FxD DISC CER 0.002 UF 10% 250VDCW	56289	C067F251F202KS22-CDH
C104	0160-2055		C:FxD CER 0.01 UF +80-20% 100VDCW	56289	C023F101F103ZS22-CDH
C105	0160-2055		C:FxD CER 0.01 UF +80-20% 100VDCW	56289	C023F101F103ZS22-CDH
C106	0160-2202		C:FxD MICA 75 PF 5%	28480	0160-2202
C107	0160-2202		C:FxD MICA 75 PF 5%	28480	0160-2202
C108	0150-0121		C:FxD CER 0.1 UF +80-20% 50VDCW	56289	5C50BIS-CML
C109	0160-3457		C:FxD DISC CER 0.002 UF 10% 250VDCW	56289	C067F251F202KS22-CDH
C110	0160-3457		C:FxD DISC CER 0.002 UF 10% 250VDCW	56289	C067F251F202KS22-CDH
C111	0160-3457		C:FxD DISC CER 0.002 UF 10% 250VDCW	56289	C067F251F202KS22-CDH
C112	0160-3457		C:FxD DISC CER 0.002 UF 10% 250VDCW	56289	C067F251F202KS22-CDH
C113	0160-2055		C:FxD CER 0.01 UF +80-20% 100VDCW	56289	C023F101F103ZS22-CDH
C114	0160-2204		C:FxD MICA 100PF 5%	72136	RDM15F101J3C
C115	0160-2204		C:FxD MICA 100PF 5%	72136	RDM15F101J3C
C116	0160-2204		C:FxD MICA 100PF 5%	72136	RDM15F101J3C
C117	0160-2204		C:FxD MICA 100PF 5%	72136	RDM15F101J3C
CR1	1901-0081	1	DIODE: SILICON 50 VOLTS WORKING	07263	FD1415
Q1	1854-0094	1	TSTR: SI NPN	80131	2N3646
R1	0757-0280	15	R:FxD MET FLM 1K OHM 1% 1/8W	28480	0757-0280
R2	0757-0442	2	R:FxD MET FLM 10.0K OHM 1% 1/8W	28480	0757-0442
R3	0757-0401	2	R:FxD MET FLM 100 OHM 1% 1/8W	28480	0757-0401
R4	0698-3160	1	R:FxD MET FLM 31.6K OHM 1% 1/8W	28480	0698-3160
R4	0757-0442	1	R:FxD MET FLM 10.0K OHM 1% 1/8W	28480	0757-0442
R5	0757-0280		R:FxD MET FLM 1K OHM 1% 1/8W	28480	0757-0280
R7	0757-0401		R:FxD MET FLM 100 OHM 1% 1/8W	28480	0757-0401
R8	1810-0030	8	NETWORK:7 RESISTORS 1K OHM 5% 0.15W EA	28480	1810-0030
R9	0757-0394	1	R:FxD MET FLM 51.1 OHM 1% 1/8W	28480	0757-0394
R10	0698-3158	1	R:FxD MET FLM 23.7K OHM 1% 1/8W	28480	0698-3158
R11	0698-3154	2	R:FxD MET FLM 4.22K OHM 1% 1/8W	28480	0698-3154
R12	0698-3154		R:FxD MET FLM 4.22K OHM 1% 1/8W	28480	0698-3154
R13	1810-0030		NETWORK:7 RESISTORS 1K OHM 5% 0.15W EA	28480	1810-0030
R14	0757-0280		R:FxD MET FLM 1K OHM 1% 1/8W	28480	0757-0280
R15	1810-0030		NETWORK:7 RESISTORS 1K OHM 5% 0.15W EA	28480	1810-0030
R16	0757-0280		R:FxD MET FLM 1K OHM 1% 1/8W	28480	0757-0280
R17	1810-0030		NETWORK:7 RESISTORS 1K OHM 5% 0.15W EA	28480	1810-0030
R18	1810-0030		NETWORK:7 RESISTORS 1K OHM 5% 0.15W EA	28480	1810-0030
R19	0698-3442	1	R:FxD MET FLM 237 OHM 1% 1/8W	28480	0698-3442
R20	1810-0030		NETWORK:7 RESISTORS 1K OHM 5% 0.15W EA	28480	1810-0030
R21	0757-0280		R:FxD MET FLM 1K OHM 1% 1/8W	28480	0757-0280
R22	0757-0280		R:FxD MET FLM 1K OHM 1% 1/8W	28480	0757-0280
R23	1810-0030		NETWORK:7 RESISTORS 1K OHM 5% 0.15W EA	28480	1810-0030
R24	0757-0280		R:FxD MET FLM 1K OHM 1% 1/8W	28480	0757-0280
R25	0757-0280		R:FxD MET FLM 1K OHM 1% 1/8W	28480	0757-0280
R26	0757-0280		R:FxD MET FLM 1K OHM 1% 1/8W	28480	0757-0280
R27	0757-0280		R:FxD MET FLM 1K OHM 1% 1/8W	28480	0757-0280
R28	0757-0280		R:FxD MET FLM 1K OHM 1% 1/8W	28480	0757-0280
R29	0757-0280		R:FxD MET FLM 1K OHM 1% 1/8W	28480	0757-0280
R30	1810-0030		NETWORK:7 RESISTORS 1K OHM 5% 0.15W EA	28480	1810-0030

Table 2-27. Universal Interface (Differential) PCA, Replaceable Parts (Continued)

Reference Designation	HP Part Number	Qty	Description	Mfr Code	Mfr Part Number
R31	0757-0280		R:FXD MET FLM 1K OHM 1% 1/8W	2848C	0757-0280
R32	0757-0279	2	R:FXD MET FLM 3.16K OHM 1% 1/8W	28480	0757-C279
R33	0757-0279		R:FXD MET FLM 3.16K OHM 1% 1/8W	2848C	0757-0279
R34	0757-0280		R:FXD MET FLM 1K OHM 1% 1/8W	28480	0757-C280
R35	0757-0280		R:FXD MET FLM 1K OHM 1% 1/8W	28480	0757-0280
R36	0698-3440		R:FXD MET FLM 196 OHM 1% 1/8W	28480	0698-3440
U11	1820-0721	15	IC:TTL DUAL DIFFERENT. LINE RECEIVER	12040	DM882CN
U12	1820-0721		IC:TTL DUAL DIFFERENT. LINE RECEIVER	12040	DM882CN
U13	1820-0834	1	IC:TTL 1 OF 8 DECODER W/INVERT CONTROL	04713	MC4038P
U14	1820-0239	1	IC:TTL QUAD 2-INPT NOR GATE	28480	1820-0239
U15	1820-0515	2	IC:TTL DUAL RE-TRIG/RE-SET MONO-MULTI	07263	U78960259X
U16	1820-0141	16	IC:TTL QUAD 2-INPT AND GATE	04713	MC3001P
U17	1820-0515		IC:TTL DUAL RE-TRIG/RE-SET MONO-MULTI	07263	U78960259X
U21	1820-0721		IC:TTL DUAL DIFFERENT. LINE RECEIVER	12040	DM882CN
U22	1820-0721		IC:TTL DUAL DIFFERENT. LINE RECEIVER	12040	DM882CN
U23	1820-0512	14	IC:TTL HS DUAL D F/F(35 MHZ MIN.)	01295	SN74H74N
U24	1820-0844	2	IC:TTL DUAL 3-INPT PULSE SHAPER	04713	MC426P
U25	1820-0512		IC:TTL HS DUAL D F/F(35 MHZ MIN.)	01295	SN74H74N
U26	1820-0205	1	IC:TTL QUAD 2-INPT OR GATE	28480	1820-0205
U27	1820-0370	4	IC:TTL HS QUAD 2-INPT NAND GATE	01295	SN74HCGN
U28	1820-0141		IC:TTL QUAD 2-INPT AND GATE	04713	MC3001P
U31	1820-0721		IC:TTL DUAL DIFFERENT. LINE RECEIVER	12040	DM882CN
U32	1820-0721		IC:TTL DUAL DIFFERENT. LINE RECEIVER	12040	DM882CN
U33	1820-0512		IC:TTL HS DUAL D F/F(35 MHZ MIN.)	01295	SN74H74N
U34	1820-0424	8	IC:TTL HS HEX INVERTER	04713	SN74HC4N
U35	1820-0141		IC:TTL QUAD 2-INPT AND GATE	04713	MC3001P
U36	1820-0141		IC:TTL QUAD 2-INPT AND GATE	04713	MC3001P
U37	1820-0629	1	IC:TTL SHS DUAL EDGE TRIG. J-K F/F	01295	SN74S112N
U38	1820-0574	1	IC:DIGITAL TTL QUAD D-F/F	12040	DM8551N
U43	1820-0512		IC:TTL HS DUAL D F/F(35 MHZ MIN.)	01295	SN74H74N
U44	1820-0375	1	IC:TTL HS 8-INPT NAND GATE	01295	SN74H30N
U45	1820-0371	4	IC:TTL HS TRIPLE 3-INPT NAND GATE	01295	SN74H10N
U46	1820-0370		IC:TTL HS QUAD 2-INPT NAND GATE	01295	SN74HC0N
U47	1820-0424		IC:TTL HS HEX INVERTER	04713	SN74HC4N
U48	1820-0141		IC:TTL QUAD 2-INPT AND GATE	04713	MC3001P
U51	1820-0720	11	IC:TTL DUAL DIFFERENTIAL LINE DRIVER	28480	1820-0720
U52	1820-0720		IC:TTL DUAL DIFFERENTIAL LINE DRIVER	28480	1820-0720
U53	1820-0512		IC:TTL HS DUAL D F/F(35 MHZ MIN.)	01295	SN74H74N
U54	1820-0141		IC:TTL QUAD 2-INPT AND GATE	04713	MC3001P
U55	1820-0512		IC:TTL HS DUAL D F/F(35 MHZ MIN.)	01295	SN74H74N
U56	1820-0282	1	IC:TTL QUAD 2-INPT EXCL. OR GATE	01295	SN7486N
U57	1820-0141		IC:TTL QUAD 2-INPT AND GATE	04713	MC3001P
U58	1820-0512		IC:TTL HS DUAL D F/F(35 MHZ MIN.)	01295	SN74H74N
U61	1820-0720		IC:TTL DUAL DIFFERENTIAL LINE DRIVER	28480	1820-0720
U63	1820-0756	7	IC:TTL 8-BIT DRIVER INVERTING	28480	1820-0756
U64	1820-0371		IC:TTL HS TRIPLE 3-INPT NAND GATE	01295	SN74H10N
U65	1820-0512		IC:TTL HS DUAL D F/F(35 MHZ MIN.)	01295	SN74H74N
U66	1820-0371		IC:TTL HS TRIPLE 3-INPT NAND GATE	01295	SN74H10N
U67	1820-0377	3	IC:TTL HS DUAL 2-WIDE 2-INPT	01295	SN74H50N
U68	1820-0141		IC:TTL QUAD 2-INPT AND GATE	04713	MC3001P
U71	1820-0720		IC:TTL DUAL DIFFERENTIAL LINE DRIVER	28480	1820-0720
U72	1820-0720		IC:TTL DUAL DIFFERENTIAL LINE DRIVER	28480	1820-0720
U73	1820-0756		IC:TTL 8-BIT DRIVER INVERTING	28480	1820-0756
U74	1820-0141		IC:TTL QUAD 2-INPT AND GATE	04713	MC3001P
U75	1820-0141		IC:TTL QUAD 2-INPT AND GATE	04713	MC3001P
U76	1820-0424		IC:TTL HS HEX INVERTER	04713	SN74HC4N
U77	1820-0377		IC:TTL HS DUAL 2-WIDE 2-INPT	01295	SN74H50N
U78	1820-0512		IC:TTL HS DUAL D F/F(35 MHZ MIN.)	01295	SN74H74N
U81	1820-0626	10	IC:TTL 4-BIT LATCH	07263	U78931459X
U82	1820-0626		IC:TTL 4-BIT LATCH	07263	U78931459X
U83	1820-0756		IC:TTL 8-BIT DRIVER INVERTING	28480	1820-0756
U84	1820-0424		IC:TTL HS HEX INVERTER	04713	SN74HC4N
U86	1820-0686	2	IC:TTL SCHOTTKY TRIPLE 3-INPT AND GATE	01295	SN74S11N
U87	1820-0491	1	IC:TTL BCD/DEC. DECODER/DRIVER	01295	SN74145N
U88	1820-0760	4	IC:TTL 8-BIT RECEIVER INVERTING	28480	1820-0760
U91	1820-0616	4	IC:TTL 4-BIT 2-INPT MULTIPLEXER	07263	U78932259X
U92	1820-0616		IC:TTL 4-BIT 2-INPT MULTIPLEXER	07263	U78932259X
U93	1820-0756		IC:TTL 8-BIT DRIVER INVERTING	28480	1820-0756
U94	1820-0141		IC:TTL QUAD 2-INPT AND GATE	04713	MC3001P
U96	1820-0141		IC:TTL QUAD 2-INPT AND GATE	04713	MC3001P
U97	1820-0374	1	IC:TTL HS DUAL 4-INPT AND GATE	01295	SN74H21N
U98	1820-0759	2	IC:TTL LOW-POWER 8-BIT RECEIVER	28480	1820-0759
U101	1820-0626		IC:TTL 4-BIT LATCH	07263	U78931459X
U102	1820-0626		IC:TTL 4-BIT LATCH	07263	U78931459X
U103	1820-0756		IC:TTL 8-BIT DRIVER INVERTING	28480	1820-0756
U111	1820-0616		IC:TTL 4-BIT 2-INPT MULTIPLEXER	07263	U78932259X

Table 2-27. Universal Interface (Differential) PCA, Replaceable Parts (Continued)

Reference Designation	HP Part Number	Qty	Description	Mfr Code	Mfr Part Number
U112	1820-0616	2	IC:TTL 4-BIT 2-INPT MULTIPLEXER	07263	U78932259X
U113	1820-0626		IC:TTL 4-BIT LATCH	07263	U78931459X
U114	1820-0626		IC:TTL 4-BIT LATCH	07263	U78931459X
U116	1820-0424		IC:TTL HS HEX INVERTER	04713	SN74H04N
U117	1820-0715		IC:TTL DIGITAL HI-SPEED J-K F/F	01295	SN74H106N
U121	1820-0721	1	IC:TTL DUAL DIFFERENT. LINE RECEIVER	12040	DM8820N
U122	1820-0721		IC:TTL DUAL DIFFERENT. LINE RECEIVER	12040	DM8820N
U123	1820-0626		IC:TTL 4-BIT LATCH	07263	U78931459X
U124	1820-0626		IC:TTL 4-BIT LATCH	07263	U78931459X
U126	1820-0900		IC:TTL TRIPLE 3-INPT NOR GATE	28480	1820-0900
U127	1820-0715		IC:TTL DIGITAL HI-SPEED J-K F/F	01295	SN74H106N
U131	1820-0720	2	IC:TTL DUAL DIFFERENTIAL LINE DRIVER	28480	1820-G720
U132	1820-0720		IC:TTL DUAL DIFFERENTIAL LINE DRIVER	28480	1820-0720
U133	1820-0626		IC:TTL 4-BIT LATCH	07263	U78931459X
U134	1820-0626		IC:TTL 4-BIT LATCH	07263	U78931459X
U136	1820-0141		IC:TTL QUAD 2-INPT AND GATE	04713	MC3001P
U137	1820-0755		IC	28480	1820-0755
U138	1820-0759	2	IC:TTL LOW-POWER 8-BIT RECEIVER	28480	1820-0759
U141	1820-0720		IC:TTL DUAL DIFFERENTIAL LINE DRIVER	28480	1820-0720
U142	1820-0720		IC:TTL DUAL DIFFERENTIAL LINE DRIVER	28480	1820-0720
U143	1820-0512		IC:TTL HS DUAL D F/F(35 MHZ MIN.)	01295	SN74H74N
U144	1820-0512	2	IC:TTL HS DUAL D F/F(35 MHZ MIN.)	01295	SN74H74N
U146	1820-0370		IC:TTL HS QUAD 2-INPT NAND GATE	01295	SN74H00N
U147	1820-0760		IC:TTL 8-BIT RECEIVER INVERTING	28480	1820-0760
U148	1820-0706		IC:DIGITAL TTL 5-BIT COMPARATOR	04713	U78932455X
U151	1820-0720		IC:TTL DUAL DIFFERENTIAL LINE DRIVER	28480	1820-0720
U152	1820-0720	1	IC:TTL DUAL DIFFERENTIAL LINE DRIVER	28480	1820-0720
U153	1820-0424		IC:TTL HS HEX INVERTER	04713	SN74H04N
U154	1820-0377		IC:TTL HS DUAL 2-WIDE 2-INPT	01295	SN74H50N
U156	1820-0371		IC:TTL HS TRIPLE 3-INPT NAND GATE	01295	SN74H10N
U158	1820-0760		IC:TTL 8-BIT RECEIVER INVERTING	28480	1820-0760
U163	1820-0370		IC:TTL HS QUAD 2-INPT NAND GATE	01295	SN74H00N
U164	1820-0141	1	IC:TTL QUAD 2-INPT AND GATE	04713	MC3001P
U166	1820-0372		IC:TTL TRIPLE 3-INPT AND GATE	28480	1820-0372
U168	1820-0706		IC:DIGITAL TTL 5-BIT COMPARATOR	04713	U78932455X
U171	1820-0721		IC:TTL DUAL DIFFERENT. LINE RECEIVER	12040	DM8820N
U172	1820-0721	1	IC:TTL DUAL DIFFERENT. LINE RECEIVER	12040	DM8820N
U173	1820-0141		IC:TTL QUAD 2-INPT AND GATE	04713	MC3001P
U174	1820-0761		IC:TTL DIGITAL	28480	1820-0761
U175	1820-0141		IC:TTL QUAD 2-INPT AND GATE	04713	MC3001P
U176	1820-0424		IC:TTL HS HEX INVERTER	04713	SN74H04N
U178	1820-0756	1	IC:TTL 8-BIT DRIVER INVERTING	28480	1820-0756
U181	1820-0721		IC:TTL DUAL DIFFERENT. LINE RECEIVER	12040	DM8820N
U181	1820-0721		IC:TTL DUAL DIFFERENT. LINE RECEIVER	12040	DM8820N
U182	1820-0721		IC:TTL DUAL DIFFERENT. LINE RECEIVER	12040	DM8820N
U183	1820-0373	1	IC:TTL HS DUAL 4-INPT NAND GATE	01295	SN74H20N
U184	1820-0512		IC:TTL HS DUAL D F/F(35 MHZ MIN.)	01295	SN74H74N
U185	1820-0686		IC:TTL SCHOTTKY TRIPLE 3-INPT AND GATE	01295	SN74S11N
U186	1820-0512		IC:TTL HS DUAL D F/F(35 MHZ MIN.)	01295	SN74H74N
U187	1820-0760		IC:TTL 8-BIT RECEIVER INVERTING	28480	1820-0760
U188	1820-0756		IC:TTL 8-BIT DRIVER INVERTING	28480	1820-0756
U191	1820-0721	1	IC:TTL DUAL DIFFERENT. LINE RECEIVER	12040	DM8820N
U192	1820-0721		IC:TTL DUAL DIFFERENT. LINE RECEIVER	12040	DM8820N
U193	1820-0512		IC:TTL HS DUAL D F/F(35 MHZ MIN.)	01295	SN74H74N
U194	1820-0424		IC:TTL HS HEX INVERTER	04713	SN74H04N
U195	1820-0301		IC:TTL QUAD BI-STABLE D-LATCH	01295	SN7475N
U196	1820-0844		IC:TTL DUAL 3-INPT PULSE SHAPER	04713	MC426P
U197	1820-0755	4	IC	28480	1820-0755
W1	8159-0005		JUMPER WIRE	28480	8159-0005
W2	8159-0005		JUMPER WIRE	28480	8159-0005
W3	8159-0005		JUMPER WIRE	28480	8159-0005
W4	8159-0005	JUMPER WIRE	28480	8159-0005	

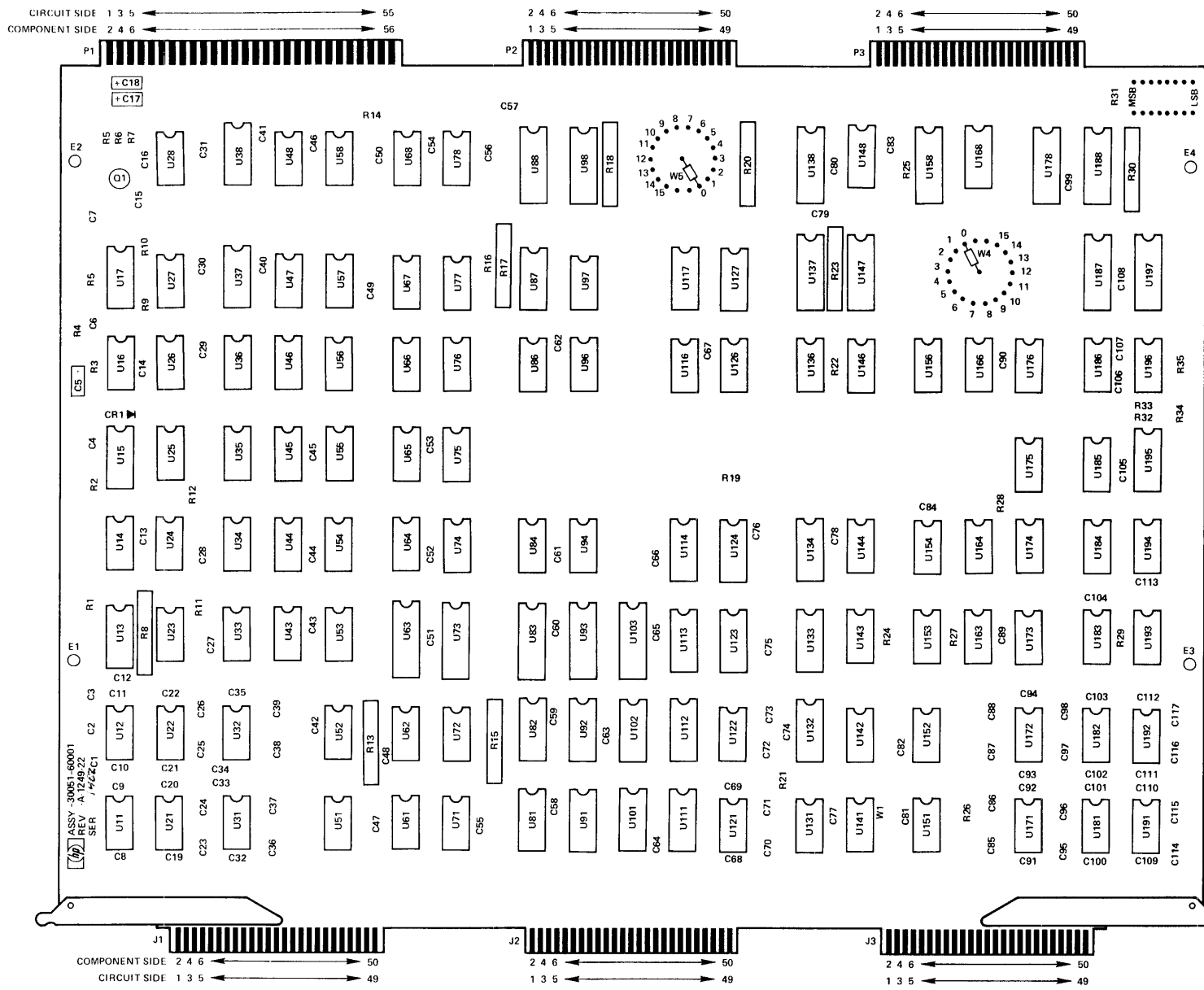

Figure 2-26. Universal Interface (Differential) PCA, Parts Location Diagram

Table 2-28. Universal Interface (Optical) PCA, Replaceable Parts

To Be Supplied

To Be Supplied

Figure 2-27. Universal Interface (Optical) PCA, Parts Location Diagram

Table 2-29. Synchronous Data Modem (201/203) IF PCA, Replaceable Parts

Reference Designation	HP Part Number	Qty	Description	Mfr Code	Mfr Part Number
	30055-60001	1	SYNCHRONOUS DATA MODAM(201/203)IF PCA	28480	30055-60001
C1	0140-0200	18	C:FXD MICA 390 PF 5%	72136	RDM15F391-J3C
C2	0180-0291	2	C:FXD ELECT 1.0 UF 10% 35VDCW	56289	1500105X9035A2-DYS
C3	0180-0291		C:FXD ELECT 1.0 UF 10% 35VDCW	56289	1500105X9035A2-DYS
C4	0160-2202	2	C:FXD MICA 75 PF 5%	28480	0160-2202
C5	0160-2202		C:FXD MICA 75 PF 5%	28480	0160-2202
C6	0160-2055	21	C:FXD CER 0.01 UF +80-20% 100VDCW	56289	C023F101F103ZS22-CDH
C7	0180-0228	1	C:FXD ELECT 22 UF 10% 15VDCW	56289	1500226X901582-DYS
C8	0140-0200		C:FXD MICA 390 PF 5%	72136	RDM15F391-J3C
C9	0140-0200		C:FXD MICA 390 PF 5%	72136	RDM15F391-J3C
C10	0140-0200		C:FXD MICA 390 PF 5%	72136	RDM15F391-J3C
C11	0140-0200		C:FXD MICA 390 PF 5%	72136	RDM15F391-J3C
C12	0140-0200		C:FXD MICA 390 PF 5%	72136	RDM15F391-J3C
C13	0140-0200		C:FXD MICA 390 PF 5%	72136	RDM15F391-J3C
C14	0140-0200		C:FXD MICA 390 PF 5%	72136	RDM15F391-J3C
C15	0140-0200		C:FXD MICA 390 PF 5%	72136	RDM15F391-J3C
C16	0140-0200		C:FXD MICA 390 PF 5%	72136	RDM15F391-J3C
C17	0140-0200		C:FXD MICA 390 PF 5%	72136	RDM15F391-J3C
C18	0140-0200		C:FXD MICA 390 PF 5%	72136	RDM15F391-J3C
C19	0140-0200		C:FXD MICA 390 PF 5%	72136	RDM15F391-J3C
C20	0140-0200		C:FXD MICA 390 PF 5%	72136	RDM15F391-J3C
C21	0140-0200		C:FXD MICA 390 PF 5%	72136	RDM15F391-J3C
C22	0140-0200		C:FXD MICA 390 PF 5%	72136	RDM15F391-J3C
C23	0140-0200		C:FXD MICA 390 PF 5%	72136	RDM15F391-J3C
C24	0160-2055		C:FXD CER 0.01 UF +80-20% 100VDCW	56289	C023F101F103ZS22-CDH
C25	0160-2055		C:FXD CER 0.01 UF +80-20% 100VDCW	56289	C023F101F103ZS22-CDH
C26	0160-2055		C:FXD CER 0.01 UF +80-20% 100VDCW	56289	C023F101F103ZS22-CDH
C27	0160-2055		C:FXD CER 0.01 UF +80-20% 100VDCW	56289	C023F101F103ZS22-CDH
C28	0160-2055		C:FXD CER 0.01 UF +80-20% 100VDCW	56289	C023F101F103ZS22-CDH
C29	0160-2055		C:FXD CER 0.01 UF +80-20% 100VDCW	56289	C023F101F103ZS22-CDH
C30	0160-2055		C:FXD CER 0.01 UF +80-20% 100VDCW	56289	C023F101F103ZS22-CDH
C31	0160-2055		C:FXD CER 0.01 UF +80-20% 100VDCW	56289	C023F101F103ZS22-CDH
C32	0160-2055		C:FXD CER 0.01 UF +80-20% 100VDCW	56289	C023F101F103ZS22-CDH
C33	0160-2055		C:FXD CER 0.01 UF +80-20% 100VDCW	56289	C023F101F103ZS22-CDH
C34	0160-2055		C:FXD CER 0.01 UF +80-20% 100VDCW	56289	C023F101F103ZS22-CDH
C35	0160-2055		C:FXD CER 0.01 UF +80-20% 100VDCW	56289	C023F101F103ZS22-CDH
C36	0160-2055		C:FXD CER 0.01 UF +80-20% 100VDCW	56289	C023F101F103ZS22-CDH
C37	0160-2055		C:FXD CER 0.01 UF +80-20% 100VDCW	56289	C023F101F103ZS22-CDH
C38	0160-2055		C:FXD CER 0.01 UF +80-20% 100VDCW	56289	C023F101F103ZS22-CDH
C39	0160-2055		C:FXD CER 0.01 UF +80-20% 100VDCW	56289	C023F101F103ZS22-CDH
C40	0160-2055		C:FXD CER 0.01 UF +80-20% 100VDCW	56289	C023F101F103ZS22-CDH
C41	0180-0137	1	C:FXD ELECT 100 UF 20% 10VDCW	56289	1500107X0010R2-DYS
C42	0160-2055		C:FXD CER 0.01 UF +80-20% 100VDCW	56289	C023F101F103ZS22-CDH
C43	0160-2055		C:FXD CER 0.01 UF +80-20% 100VDCW	56289	C023F101F103ZS22-CDH
C44	0160-2055		C:FXD CER 0.01 UF +80-20% 100VDCW	56289	C023F101F103ZS22-CDH
CR1	1902-3104	2	DIODE:BREAKDOWN 5.62V 5%	04713	SZ10939-110
CR2	1902-3104		DIODE:BREAKDOWN 5.62V 5%	04713	SZ10939-110
CR3	1901-0040	2	DIODE:SILICON 50 MA 30 WV	07263	FD61088
CR4	1901-0040		DIODE:SILICON 50 MA 30 WV	07263	FD61088
L1	9100-2265	1	COIL/CHOKE:10.0 UH 10%	28480	9100-2265
R1	0757-0278	2	R:FXD MET FLM 1.78K OHM 1% 1/8W	28480	0757-0278
R2	0757-0280	6	R:FXD MET FLM 1K OHM 1% 1/8W	28480	0757-0280
R3	0757-0278		R:FXD MET FLM 1.78K OHM 1% 1/8W	28480	0757-0278
R4	1810-0125	8	RESISTIVE NETWORK:7 X 4.7K OHM 5% 0.15W	28480	1810-0125
R5	0698-3155	34	R:FXD MET FLM 4.64K OHM 1% 1/8W	28480	0698-3155
R6	0698-3155		R:FXD MET FLM 4.64K OHM 1% 1/8W	28480	0698-3155
R7	0698-3155		R:FXD MET FLM 4.64K OHM 1% 1/8W	28480	0698-3155
R8	0757-0279	2	R:FXD MET FLM 3.16K OHM 1% 1/8W	28480	0757-0279
R9	0757-0279		R:FXD MET FLM 3.16K OHM 1% 1/8W	28480	0757-0279
R10	0757-0280		R:FXD MET FLM 1K OHM 1% 1/8W	28480	0757-0280
R11	0698-3155		R:FXD MET FLM 4.64K OHM 1% 1/8W	28480	0698-3155
R12	0698-3155		R:FXD MET FLM 4.64K OHM 1% 1/8W	28480	0698-3155
R13	0698-3155		R:FXD MET FLM 4.64K OHM 1% 1/8W	28480	0698-3155
R14	0698-3155		R:FXD MET FLM 4.64K OHM 1% 1/8W	28480	0698-3155
R15	0698-3155		R:FXD MET FLM 4.64K OHM 1% 1/8W	28480	0698-3155
R16	0757-0280		R:FXD MET FLM 1K OHM 1% 1/8W	28480	0757-0280
R17	0698-3155		R:FXD MET FLM 4.64K OHM 1% 1/8W	28480	0698-3155
R18	1810-0030	3	NETWORK:7 RESISTORS 1K OHM 5% 0.15W EA	28480	1810-0030
R19	0698-3155		R:FXD MET FLM 4.64K OHM 1% 1/8W	28480	0698-3155
R20	0698-3155		R:FXD MET FLM 4.64K OHM 1% 1/8W	28480	0698-3155
R21	0698-3155		R:FXD MET FLM 4.64K OHM 1% 1/8W	28480	0698-3155
R22	0698-3155		R:FXD MET FLM 4.64K OHM 1% 1/8W	28480	0698-3155

Table 2-29. Synchronous Data Modem (201/203) IF PCA, Replaceable Parts (Continued)

Reference Designation	HP Part Number	Qty	Description	Mfr Code	Mfr Part Number
R23	0698-3155		R:FXD MET FLM 4.64K OHM 1% 1/8W	28480	0698-3155
R24	0698-3155		R:FXD MET FLM 4.64K OHM 1% 1/8W	28480	0698-3155
R25	0698-3155		R:FXD MET FLM 4.64K OHM 1% 1/8W	28480	0698-3155
R26	0698-3155		R:FXD MET FLM 4.64K OHM 1% 1/8W	28480	0698-3155
R27	0698-3155		R:FXD MET FLM 4.64K OHM 1% 1/8W	28480	0698-3155
R28	0757-0280		R:FXD MET FLM 1K OHM 1% 1/8W	28480	0757-0280
R29	1810-0125		RESISTIVE NETWORK:7 X 4.7K OHM 5% 0.15W	28480	1810-0125
R30	0698-4421	1	R:FXD FLM 249 OHM 1% 1/8W	28480	0698-4421
R31	1810-0030		NETWORK:7 RESISTORS 1K OHM 5% 0.15W EA	28480	1810-0030
R32	1810-0030		NETWORK:7 RESISTORS 1K OHM 5% 0.15W EA	28480	1810-0030
R33	0757-0280		R:FXD MET FLM 1K OHM 1% 1/8W	28480	0757-0280
R34	1810-0125		RESISTIVE NETWORK:7 X 4.7K OHM 5% 0.15W	28480	1810-0125
R35	0698-3155		R:FXD MET FLM 4.64K OHM 1% 1/8W	28480	0698-3155
R36	1810-0125		RESISTIVE NETWORK:7 X 4.7K OHM 5% 0.15W	28480	1810-0125
R37	1810-0125		RESISTIVE NETWORK:7 X 4.7K OHM 5% 0.15W	28480	1810-0125
R38	0757-0280		R:FXD MET FLM 1K OHM 1% 1/8W	28480	0757-0280
R39	0698-3155		R:FXD MET FLM 4.64K OHM 1% 1/8W	28480	0698-3155
R40	0698-3155		R:FXD MET FLM 4.64K OHM 1% 1/8W	28480	0698-3155
R41	1810-0125		RESISTIVE NETWORK:7 X 4.7K OHM 5% 0.15W	28480	1810-0125
R42	0698-3155		R:FXD MET FLM 4.64K OHM 1% 1/8W	28480	0698-3155
R43	0698-3155		R:FXD MET FLM 4.64K OHM 1% 1/8W	28480	0698-3155
R44	0698-3155		R:FXD MET FLM 4.64K OHM 1% 1/8W	28480	0698-3155
R45	0698-3155		R:FXD MET FLM 4.64K OHM 1% 1/8W	28480	0698-3155
R46	0698-3155		R:FXD MET FLM 4.64K OHM 1% 1/8W	28480	0698-3155
R47	0698-3155		R:FXD MET FLM 4.64K OHM 1% 1/8W	28480	0698-3155
R48	0698-3155		R:FXD MET FLM 4.64K OHM 1% 1/8W	28480	0698-3155
R49	0698-3155		R:FXD MET FLM 4.64K OHM 1% 1/8W	28480	0698-3155
R50	0698-3155		R:FXD MET FLM 4.64K OHM 1% 1/8W	28480	0698-3155
R51	0698-3155		R:FXD MET FLM 4.64K OHM 1% 1/8W	28480	0698-3155
R52	0698-3155		R:FXD MET FLM 4.64K OHM 1% 1/8W	28480	0698-3155
R53	0698-3155		R:FXD MET FLM 4.64K OHM 1% 1/8W	28480	0698-3155
R54	1810-0125		RESISTIVE NETWORK:7 X 4.7K OHM 5% 0.15W	28480	1810-0125
R55	0698-3155		R:FXD MET FLM 4.64K OHM 1% 1/8W	28480	0698-3155
R56	1810-0125		RESISTIVE NETWORK:7 X 4.7K OHM 5% 0.15W	28480	1810-0125
U12	1820-0054	4	IC:TTL QUAD 2-INPT NAND GATE	01295	SN7400N
U13	1820-0617	2	IC:TTL QUAD 2-INPT EXCL. NOR GATE	04713	MC3022P
U14	1820-0077	10	IC:TTL DUAL D F/F	01295	SN7474N
U15	1820-0715	9	IC:TTL DIGITAL HI-SPEED J-K F/F	01295	SN74H106N
U16	1820-0077		IC:TTL DUAL D F/F	01295	SN7474N
U17	1820-0512	2	IC:TTL HS DUAL D F/F(35 MHZ MIN.)	01295	SN74H74N
U18	1820-0371	2	IC:TTL HS TRIPLE 3-INPT NAND GATE	01295	SN74H10N
U19	1820-0141	10	IC:TTL QUAD 2-INPT AND GATE	04713	MC3001P
U21	1820-0509	2	IC:DTL QUAD 1-2-2-2-INPT NAND LINE DR	04713	MC1488L
U22	1820-0990	2	IC	28480	1820-0990
U23	1820-0990		IC	28480	1820-0990
U24	1820-0077		IC:TTL DUAL D F/F	01295	SN7474N
U25	1820-0715		IC:TTL DIGITAL HI-SPEED J-K F/F	01295	SN74H106N
U26	1820-0239		IC:TTL QUAD 2-INPT NOR GATE	28480	1820-0239
U27	1820-0077	3	IC:TTL DUAL D F/F	01295	SN7474N
U28	1820-0512		IC:TTL HS DUAL D F/F(35 MHZ MIN.)	01295	SN74H74N
U29	1820-0844	1	IC:TTL DUAL 3-INPT PULSE SHAPER	04713	MC426P
U35	1820-0509		IC:DTL QUAD 1-2-2-2-INPT NAND LINE DR	04713	MC1488L
U38	1820-0372	3	IC:TTL TRIPLE 3-INPT AND GATE	28480	1820-0372
U39	1820-0686	1	IC:TTL SCHOTTKY TRIPLE 3-INPT AND GATE	01255	SN74S11N
U41	1820-0845	6	IC:TTL 8-BIT CONTENT ADDRESSABLE MEMORY	28480	1820-0845
U42	1820-0845		IC:TTL 8-BIT CONTENT ADDRESSABLE MEMORY	28480	1820-0845
U43	1820-0239		IC:TTL QUAD 2-INPT NOR GATE	28480	1820-0239
U44	1820-0077		IC:TTL DUAL D F/F	01295	SN7474N
U45	1820-0099	2	IC:TTL 4-BIT BINARY COUNTER	01295	SN7493N
U46	1820-0637	4	IC:TTL TRIPLE 3-INPT NOR GATE	18324	N8875A
U47	1820-0372		IC:TTL TRIPLE 3-INPT AND GATE	28480	1820-0372
U48	1820-0077		IC:TTL DUAL D F/F	01295	SN7474N
U49	1820-0372		IC:TTL TRIPLE 3-INPT AND GATE	28480	1820-0372
U51	1820-0845		IC:TTL 8-BIT CONTENT ADDRESSABLE MEMORY	28480	1820-0845
U52	1820-0845		IC:TTL 8-BIT CONTENT ADDRESSABLE MEMORY	28480	1820-0845
U53	1820-0141		IC:TTL QUAD 2-INPT AND GATE	04713	MC3001P
U54	1820-0205	4	IC:TTL QUAD 2-INPT OR GATE	28480	1820-0205
U55	1820-0141		IC:TTL QUAD 2-INPT AND GATE	04713	MC3001P
U56	1820-0715		IC:TTL DIGITAL HI-SPEED J-K F/F	01295	SN74H106N
U57	1820-0715		IC:TTL DIGITAL HI-SPEED J-K F/F	01295	SN74H106N
U58	1820-0424	9	IC:TTL HS HEX INVERTER	04713	SN74H04N
U59	1820-0301	1	IC:TTL QUAD BI-STABLE D-LATCH	01295	SN7475N
U68	1820-0424		IC:TTL HS HEX INVERTER	04713	SN74H04N
U69	1820-0900	1	IC:TTL TRIPLE 3-INPT NOR GATE	28480	1820-0900
U71	1820-0845		IC:TTL 8-BIT CONTENT ADDRESSABLE MEMORY	28480	1820-0845

Table 2-29. Synchronous Data Modem (201/203) IF PCA, Replaceable Parts (Continued)

Reference Designation	HP Part Number	Qty	Description	Mfr Code	Mfr Part Number
U72	1820-0845	3	IC:TTL 8-BIT CONTENT ADDRESSABLE MEMORY	28480	1820-0845
U73	1820-0239		IC:TTL QUAD 2-INPT NOR GATE	28480	1820-0239
U74	1820-0906		IC:DIGITAL TTL DUAL 4-INPT MULTIPLEXER	12040	DM8214N
U75	1820-0906		IC:DIGITAL TTL DUAL 4-INPT MULTIPLEXER	12040	DM8214N
U76	1820-0715		IC:TTL DIGITAL HI-SPEED J-K F/F	01295	SN74H106N
U77	1820-0655	1	IC:TTL DUAL INPUT NOR GATE WITH STROBE	01295	SN23684
U78	1820-0370	1	IC:TTL HS QUAD 2-INPT NAND GATE	01295	SN74H00N
U79	1820-0141	1	IC:TTL QUAD 2-INPT AND GATE	04713	MC3001P
U81	1820-0424		IC:TTL HS HEX INVERTER	04713	SN74H04N
U83	1820-0637		IC:TTL TRIPLE 3-INPT NOR GATE	18324	N8875A
U83	1820-0788	7	IC:TTL HEX D-TYPE FLIP/FLOP WITH CLEAR	01295	SN35431
U84	1820-0205		IC:TTL QUAD 2-INPT OR GATE	28480	1820-0205
U85	1820-0839	4	IC:TTL QUAD D-TYPE F/F	01295	SN74175N
U86	1820-0715		IC:TTL DIGITAL HI-SPEED J-K F/F	01295	SN74H106N
U87	1820-0141		IC:TTL QUAD 2-INPT AND GATE	04713	MC3001P
U88	1820-0715		1	IC:TTL DIGITAL HI-SPEED J-K F/F	01295
U89	1820-0761	IC:TTL DIGITAL		28480	1820-0761
U91	1820-0834	2	IC:TTL 1 OF 8 DECODER W/INVERT CONTROL	04713	MC4038P
U101	1820-0141		IC:TTL QUAD 2-INPT AND GATE	04713	MC3001P
U102	1820-0574	8	IC:DIGITAL TTL QUAD D-F/F	12040	DM8551N
U103	1820-0574		IC:DIGITAL TTL QUAD D-F/F	12040	DM8551N
U104	1820-0759	5	IC:TTL LOW-POWER 8-BIT RECEIVER	28480	1820-0759
U105	1820-0374		IC:TTL HS DUAL 4-INPT AND GATE	01295	SN74H21N
U106	1820-0839	3	IC:TTL QUAD D-TYPE F/F	01295	SN74175N
U107	1820-0282		IC:TTL QUAD 2-INPT EXCL. OR GATE	01295	SN7486N
U108	1820-0715	1	IC:TTL DIGITAL HI-SPEED J-K F/F	01295	SN74H106N
U109	1820-0424		IC:TTL HS HEX INVERTER	04713	SN74H04N
U111	1820-0839	1	IC:TTL QUAD D-TYPE F/F	01295	SN74175N
U112	1820-0574		IC:DIGITAL TTL QUAD D-F/F	12040	DM8551N
U113	1820-0574		IC:DIGITAL TTL QUAD D-F/F	12040	DM8551N
U114	1820-0759	1	IC:TTL LOW-POWER 8-BIT RECEIVER	28480	1820-0759
U115	1820-0077		IC:TTL DUAL D F/F	01295	SN7474N
U116	1820-0424	1	IC:TTL HS HEX INVERTER	04713	SN74H04N
U117	1820-0141		IC:TTL QUAD 2-INPT AND GATE	04713	MC3001P
U118	1820-0141	1	IC:TTL QUAD 2-INPT AND GATE	04713	MC3001P
U119	1820-0759	1	IC:TTL LOW-POWER 8-BIT RECEIVER	28480	1820-0759
U121	1820-0738		IC:DIGITAL DUAL 2-4 LINE DECODER	01295	SN74155N
U123	1820-0906	6	IC:DIGITAL TTL DUAL 4-INPT MULTIPLEXER	12040	DM8214N
U124	1820-0231		IC:TTL 4-BIT SYNC BINARY COUNTER	07263	U68931659X
U125	1820-0424		IC:TTL HS HEX INVERTER	04713	SN74H04N
U126	1820-0054		IC:TTL QUAD 2-INPT NAND GATE	01295	SN7400N
U128	1820-0374	1	IC:TTL HS DUAL 4-INPT AND GATE	01295	SN74H21N
U131	1820-0759		IC:TTL LOW-POWER 8-BIT RECEIVER	28480	1820-0759
U133	1820-0839	1	IC:TTL QUAD D-TYPE F/F	01295	SN74175N
U134	1820-0231		IC:TTL 4-BIT SYNC BINARY COUNTER	07263	U68931659X
U135	1820-0231	1	IC:TTL 4-BIT SYNC BINARY COUNTER	07263	U68931659X
U136	1820-0834		IC:TTL 1 OF 8 DECODER W/INVERT CONTROL	04713	MC4038P
U138	1820-0760	5	IC:TTL 8-BIT RECEIVER INVERTING	28480	1820-0760
U141	1820-0760		IC:TTL 8-BIT RECEIVER INVERTING	28480	1820-0760
U143	1820-0788		IC:TTL HEX D-TYPE FLIP/FLOP WITH CLEAR	01295	SN35431
U146	1820-0788	1	IC:TTL HEX D-TYPE FLIP/FLOP WITH CLEAR	01295	SN35431
U148	1820-0491		IC:TTL BCD/DEC. DECODER/DRIVER	01295	SN74145N
U149	1820-0759	1	IC:TTL LOW-POWER 8-BIT RECEIVER	28480	1820-0759
U151	1820-0205		IC:TTL QUAD 2-INPT OR GATE	28480	1820-0205
U153	1820-0788	1	IC:TTL HEX D-TYPE FLIP/FLOP WITH CLEAR	01295	SN35431
U154	1820-0788	1	IC:TTL HEX D-TYPE FLIP/FLOP WITH CLEAR	01295	SN35431
U155	1820-0788		IC:TTL HEX D-TYPE FLIP/FLOP WITH CLEAR	01295	SN35431
U156	1820-0788	1	IC:TTL HEX D-TYPE FLIP/FLOP WITH CLEAR	01295	SN35431
U159	1820-0141		IC:TTL QUAD 2-INPT AND GATE	04713	MC3001P
U169	1820-0760	1	IC:TTL 8-BIT RECEIVER INVERTING	28480	1820-0760
U171	1820-0424	1	IC:TTL HS HEX INVERTER	04713	SN74H04N
U172	1820-0231		IC:TTL 4-BIT SYNC BINARY COUNTER	07263	U68931659X
U174	1820-0574	1	IC:DIGITAL TTL QUAD D-F/F	12040	DM8551N
U175	1820-0574		IC:DIGITAL TTL QUAD D-F/F	12040	DM8551N
U176	1820-0424	1	IC:TTL HS HEX INVERTER	04713	SN74H04N
U178	1820-0760	2	IC:TTL 8-BIT RECEIVER INVERTING	28480	1820-0760
U179	1820-0755		IC	28480	1820-0755
U181	1820-0231	1	IC:TTL 4-BIT SYNC BINARY COUNTER	07263	U68931659X
U182	1820-0231		IC:TTL 4-BIT SYNC BINARY COUNTER	07263	U68931659X
U183	1820-0141	1	IC:TTL QUAD 2-INPT AND GATE	04713	MC3001P
U184	1820-0574	1	IC:DIGITAL TTL QUAD D-F/F	12040	DM8551N
U185	1820-0574		IC:DIGITAL TTL QUAD D-F/F	12040	DM8551N
U186	1820-0205	1	IC:TTL QUAD 2-INPT OR GATE	28480	1820-0205
U187	1820-0054		IC:TTL QUAD 2-INPT NAND GATE	01295	SN7400N
U188	1820-0755	1	IC	28480	1820-0755

Table 2-29. Synchronous Data Modem (201/203) IF PCA, Replaceable Parts (Continued)

Reference Designation	HP Part Number	Qty	Description	Mfr Code	Mfr Part Number
U185	1820-0756	2	IC:TTL 8-BIT DRIVER INVERTING	28480	1820-0756
U191	1820-0616	1	IC:TTL 4-BIT 2-INPT MULTIPLEXER	07263	U78932259X
U198	1820-0706	2	IC:DIGITAL TTL 5-BIT COMPARATOR	04713	U78932459X
U201	1820-0077		IC:TTL DUAL D F/F	01295	SN7474N
U202	1820-0077		IC:TTL DUAL D F/F	01295	SN7474N
U203	1820-0099		IC:TTL 4-BIT BINARY COUNTER	01295	SN7493N
U204	1820-0424		IC:TTL HS HEX INVERTER	04713	SN74H04N
U205	1820-0368	2	IC:TTL 5-BIT SHIFT REGISTER	01295	SN7496N
U206	1820-0368		IC:TTL 5-BIT SHIFT REGISTER	01295	SN7496N
U207	1820-0637		IC:TTL TRIPLE 3-INPT NOR GATE	18324	N8875A
U208	1820-0706		IC:DIGITAL TTL 5-BIT COMPARATOR	04713	U78932459X
U209	1820-0756		IC:TTL 8-BIT DRIVER INVERTING	28480	1820-0756
U211	1820-0077		IC:TTL DUAL D F/F	01295	SN7474N
U212	1820-0371		IC:TTL HS TRIPLE 3-INPT NAND GATE	01295	SN74H10N
U213	1820-0054		IC:TTL QUAD 2-INPT NAND GATE	01295	SN7400N
U214	1820-0617		IC:TTL QUAD 2-INPT EXCL. NOR GATE	04713	MC3022P
U215	1820-0715		IC:TTL DIGITAL HI-SPEED J-K F/F	01295	SN74H106N
U216	1820-0637		IC:TTL TRIPLE 3-INPT NOR GATE	18324	N8875A
U217	1820-0374		IC:TTL HS DUAL 4-INPT AND GATE	01295	SN74H21N
U219	1820-0760		IC:TTL 8-BIT RECEIVER INVERTING	28480	1820-0760
W1	8159-0005	4	JUMPER WIRE	28480	8159-0005
W2	8159-0005		JUMPER WIRE	28480	8159-0005
W3	8159-0005		JUMPER WIRE	28480	8159-0005
W4	8159-0005		JUMPER WIRE	28480	8159-0005
XY1	1200-0199	1	SOCKET:CRYSTAL	91506	8000-AG9
Y1	0410-0453	1	CRYSTAL:QUARTZ	28480	0410-0453

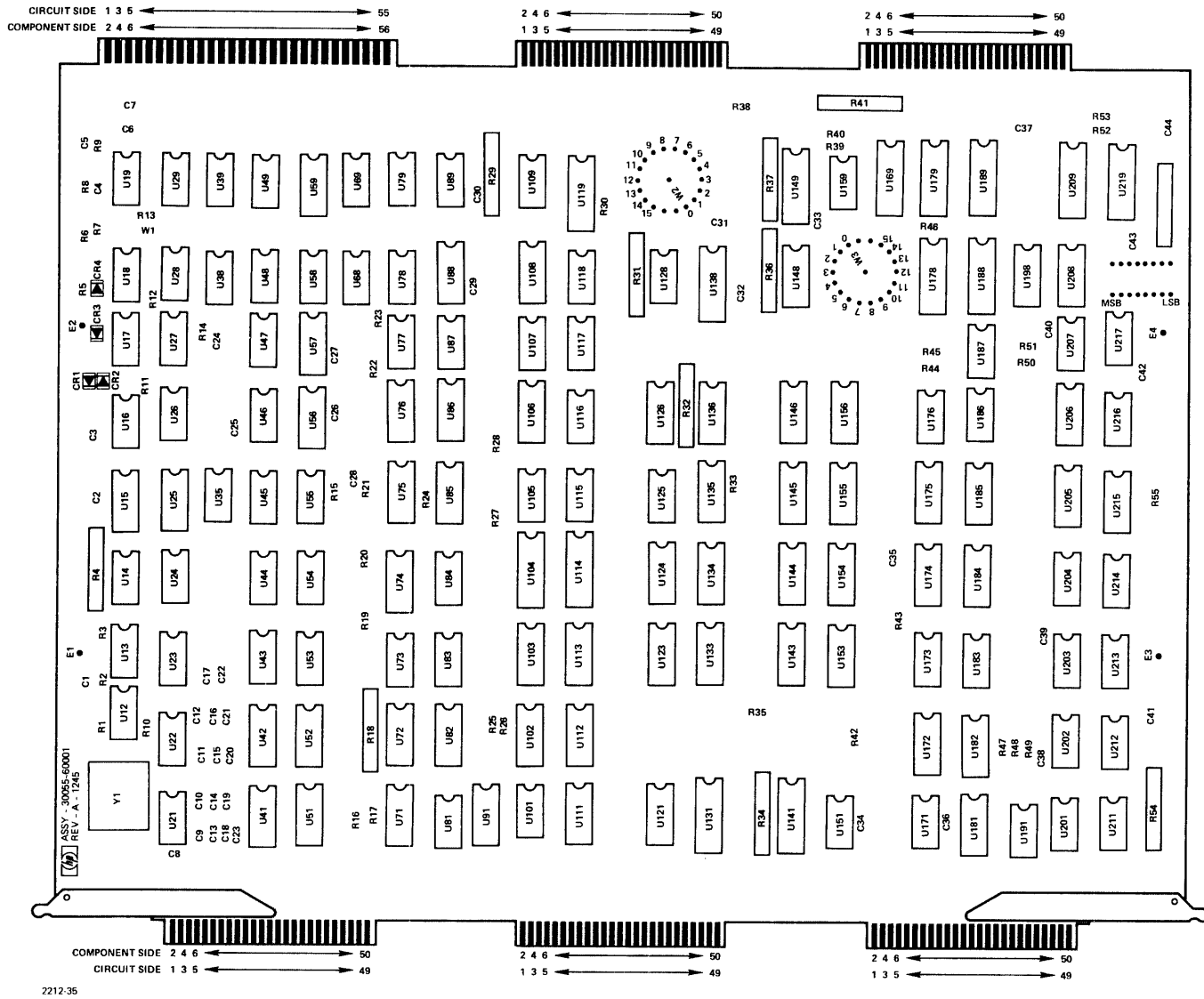

Figure 2-28. Synchronous Data Modem (201/203) IF PCA, Parts Location Diagram

Table 2-30. Terminal Data Interface PCA, Replaceable Parts

Reference Designation	HP Part Number	Qty	Description	Mfr Code	Mfr Part Number
C1	30060-60001	1	TERMINAL DATA INTERFACE PCA	28480	30060-60001
C2	0160-2055	55	C:FxD CER 0.01 UF +80-20% 100VDCW	56289	C023F101F103ZS22-CDH
C3	0160-2055		C:FxD CER 0.01 UF +80-20% 100VDCW	56289	C023F101F103ZS22-CDH
C4	0160-2055		C:FxD CER 0.01 UF +80-20% 100VDCW	56289	C023F101F103ZS22-CDH
C5	0160-2055		C:FxD CER 0.01 UF +80-20% 100VDCW	56289	C023F101F103ZS22-CDH
C6	0160-2055		C:FxD CER 0.01 UF +80-20% 100VDCW	56289	C023F101F103ZS22-CDH
C7	0180-0197	13	C:FxD ELECT 2.2 UF 10% 20VDCW	56289	1500225X9020A2-DYS
C8	0160-2055		C:FxD CER 0.01 UF +80-20% 100VDCW	56289	C023F101F103ZS22-CDH
C9	0160-2055		C:FxD CER 0.01 UF +80-20% 100VDCW	56289	C023F101F103ZS22-CDH
C10	0180-0197	16	C:FxD ELECT 2.2 UF 10% 20VDCW	56289	1500225X9020A2-DYS
C11	0160-3456		C:FxD CER 1000 PF 10% 250VDCW	56289	C067F251F102KS22-CDH
C12	0160-3456		C:FxD CER 1000 PF 10% 250VDCW	56289	C067F251F102KS22-CDH
C13	0160-3456		C:FxD CER 1000 PF 10% 250VDCW	56289	C067F251F102KS22-CDH
C14	0160-3456		C:FxD CER 1000 PF 10% 250VDCW	56289	C067F251F102KS22-CDH
C15	0160-3456		C:FxD CER 1000 PF 10% 250VDCW	56289	C067F251F102KS22-CDH
C16	0160-3456		C:FxD CER 1000 PF 10% 250VDCW	56289	C067F251F102KS22-CDH
C17	0160-3456		C:FxD CER 1000 PF 10% 250VDCW	56289	C067F251F102KS22-CDH
C18	0160-3456		C:FxD CER 1000 PF 10% 250VDCW	56289	C067F251F102KS22-CDH
C19	0160-2055		C:FxD CER 0.01 UF +80-20% 100VDCW	56289	C023F101F103ZS22-CDH
C20	0160-2307	1	C:FxD MICA 47 PF 5%	28480	0160-2307
C21	0140-0198	1	C:FxD MICA 200 PF 5%	72136	RD15F201J3C
C22	0160-2055		C:FxD CER 0.01 UF +80-20% 100VDCW	56289	C023F101F103ZS22-CDH
C23	0160-2055		C:FxD CER 0.01 UF +80-20% 100VDCW	56289	C023F101F103ZS22-CDH
C24	0180-0197		C:FxD ELECT 2.2 UF 10% 20VDCW	56289	1500225X9020A2-DYS
C25	0160-2055		C:FxD CER 0.01 UF +80-20% 100VDCW	56289	C023F101F103ZS22-CDH
C26	0180-0197		C:FxD ELECT 2.2 UF 10% 20VDCW	56289	1500225X9020A2-DYS
C27	0180-0197		C:FxD ELECT 2.2 UF 10% 20VDCW	56289	1500225X9020A2-DYS
C28	0160-3456		C:FxD CER 1000 PF 10% 250VDCW	56289	C067F251F102KS22-CDH
C29	0160-3456		C:FxD CER 1000 PF 10% 250VDCW	56289	C067F251F102KS22-CDH
C30	0160-3456		C:FxD CER 1000 PF 10% 250VDCW	56289	C067F251F102KS22-CDH
C31	0160-3456		C:FxD CER 1000 PF 10% 250VDCW	56289	C067F251F102KS22-CDH
C32	0160-3456		C:FxD CER 1000 PF 10% 250VDCW	56289	C067F251F102KS22-CDH
C33	0160-3456		C:FxD CER 1000 PF 10% 250VDCW	56289	C067F251F102KS22-CDH
C34	0160-3456		C:FxD CER 1000 PF 10% 250VDCW	56289	C067F251F102KS22-CDH
C35	0160-3456		C:FxD CER 1000 PF 10% 250VDCW	56289	C067F251F102KS22-CDH
C36	0160-2055		C:FxD CER 0.01 UF +80-20% 100VDCW	56289	C023F101F103ZS22-CDH
C37	0180-0197		C:FxD ELECT 2.2 UF 10% 20VDCW	56289	1500225X9020A2-DYS
C38	0160-2055		C:FxD CER 0.01 UF +80-20% 100VDCW	56289	C023F101F103ZS22-CDH
C39	0160-2055		C:FxD CER 0.01 UF +80-20% 100VDCW	56289	C023F101F103ZS22-CDH
C40	0160-2055		C:FxD CER 0.01 UF +80-20% 100VDCW	56289	C023F101F103ZS22-CDH
C41	0160-2055		C:FxD CER 0.01 UF +80-20% 100VDCW	56289	C023F101F103ZS22-CDH
C42	0180-0197		C:FxD ELECT 2.2 UF 10% 20VDCW	56289	1500225X9020A2-DYS
C43	0160-2055		C:FxD CER 0.01 UF +80-20% 100VDCW	56289	C023F101F103ZS22-CDH
C44	0160-2055		C:FxD CER 0.01 UF +80-20% 100VDCW	56289	C023F101F103ZS22-CDH
C45	0160-2055		C:FxD CER 0.01 UF +80-20% 100VDCW	56289	C023F101F103ZS22-CDH
C46	0160-2055		C:FxD CER 0.01 UF +80-20% 100VDCW	56289	C023F101F103ZS22-CDH
C47	0160-2055		C:FxD CER 0.01 UF +80-20% 100VDCW	56289	C023F101F103ZS22-CDH
C48	0160-2055		C:FxD CER 0.01 UF +80-20% 100VDCW	56289	C023F101F103ZS22-CDH
C49	0160-2055		C:FxD CER 0.01 UF +80-20% 100VDCW	56289	C023F101F103ZS22-CDH
C50	0160-2055	2	C:FxD CER 0.01 UF +80-20% 100VDCW	56289	C023F101F103ZS22-CDH
C51	0160-2202		C:FxD MICA 75 PF 5%	28480	0160-2202
C52	0160-2055		C:FxD CER 0.01 UF +80-20% 100VDCW	56289	C023F101F103ZS22-CDH
C53	0160-2055		C:FxD CER 0.01 UF +80-20% 100VDCW	56289	C023F101F103ZS22-CDH
C54	0160-2055		C:FxD CER 0.01 UF +80-20% 100VDCW	56289	C023F101F103ZS22-CDH
C55	0160-2055		C:FxD CER 0.01 UF +80-20% 100VDCW	56289	C023F101F103ZS22-CDH
C56	0160-2055		C:FxD CER 0.01 UF +80-20% 100VDCW	56289	C023F101F103ZS22-CDH
C57	0160-2055		C:FxD CER 0.01 UF +80-20% 100VDCW	56289	C023F101F103ZS22-CDH
C58	0160-2055		C:FxD CER 0.01 UF +80-20% 100VDCW	56289	C023F101F103ZS22-CDH
C59	0160-2202		C:FxD MICA 75 PF 5%	28480	0160-2202
C60	0160-2055		C:FxD CER 0.01 UF +80-20% 100VDCW	56289	C023F101F103ZS22-CDH
C61	0160-2055		C:FxD CER 0.01 UF +80-20% 100VDCW	56289	C023F101F103ZS22-CDH
C62	0160-2055		C:FxD CER 0.01 UF +80-20% 100VDCW	56289	C023F101F103ZS22-CDH
C63	0160-2055		C:FxD CER 0.01 UF +80-20% 100VDCW	56289	C023F101F103ZS22-CDH
C64	0160-2055		C:FxD CER 0.01 UF +80-20% 100VDCW	56289	C023F101F103ZS22-CDH
C65	0160-2055		C:FxD CER 0.01 UF +80-20% 100VDCW	56289	C023F101F103ZS22-CDH
C66	0160-2055		C:FxD CER 0.01 UF +80-20% 100VDCW	56289	C023F101F103ZS22-CDH
C67	0160-2055		C:FxD CER 0.01 UF +80-20% 100VDCW	56289	C023F101F103ZS22-CDH
C68	0160-2055		C:FxD CER 0.01 UF +80-20% 100VDCW	56289	C023F101F103ZS22-CDH
C69	0160-2055		C:FxD CER 0.01 UF +80-20% 100VDCW	56289	C023F101F103ZS22-CDH
C70	0160-2055		C:FxD CER 0.01 UF +80-20% 100VDCW	56289	C023F101F103ZS22-CDH
C71	0160-2055		C:FxD CER 0.01 UF +80-20% 100VDCW	56289	C023F101F103ZS22-CDH
C72	0160-2055		C:FxD CER 0.01 UF +80-20% 100VDCW	56289	C023F101F103ZS22-CDH
C73	0160-2055		C:FxD CER 0.01 UF +80-20% 100VDCW	56289	C023F101F103ZS22-CDH
C74	0160-2055		C:FxD CER 0.01 UF +80-20% 100VDCW	56289	C023F101F103ZS22-CDH

Table 2-30. Terminal Data Interface PCA, Replaceable Parts (Continued)

Reference Designation	HP Part Number	Qty	Description	Mfr Code	Mfr Part Number
C75	0180-0197	2	C:FXD ELECT 2.2 UF 10% 20VDCW	56289	1500225X9020A2-DYS
C76	0160-2055		C:FXD CER 0.01 UF +80-20% 100VDCW	56289	C023F101F103ZS22-CDH
C77	0180-0197		C:FXD ELECT 2.2 UF 10% 20VDCW	56289	1500225X9020A2-DYS
C78	0140-0192		C:FXD MICA 68 PF 5%	28480	0140-0192
C79	0140-0192		C:FXD MICA 68 PF 5%	28480	0140-0192
C80	0160-2055	1	C:FXD CER 0.01 UF +80-20% 100VDCW	56289	C023F101F103ZS22-CDH
C81	0160-2055		C:FXD CER 0.01 UF +80-20% 100VDCW	56289	C023F101F103ZS22-CDH
C82	0180-0374		C:FXD TANT. 10 UF 10% 20VDCW	56289	1500106X9020B2-DYS
C83	0180-0197		C:FXD ELECT 2.2 UF 10% 20VDCW	56289	1500225X9020A2-DYS
C84	0160-2055		C:FXD CER 0.01 UF +80-20% 100VDCW	56289	C023F101F103ZS22-CDH
C85	0180-0197	1	C:FXD ELECT 2.2 UF 10% 20VDCW	56289	1500225X9020A2-DYS
C86	0160-2055		C:FXD CER 0.01 UF +80-20% 100VDCW	56289	C023F101F103ZS22-CDH
C87	0180-0197		C:FXD ELECT 2.2 UF 10% 20VDCW	56289	1500225X9020A2-DYS
C88	0160-2055		C:FXD CER 0.01 UF +80-20% 100VDCW	56289	C023F101F103ZS22-CDH
C89	0160-2055		C:FXD CER 0.01 UF +80-20% 100VDCW	56289	C023F101F103ZS22-CDH
C90	0160-2055	1	C:FXD CER 0.01 UF +80-20% 100VDCW	56289	C023F101F103ZS22-CDH
C91	0180-0197		C:FXD ELECT 2.2 UF 10% 20VDCW	56289	1500225X9020A2-DYS
CR1	1902-3070		DIODE: BREAKDOWN 4.22V 5%	04713	SZ10939-74
CR2	1902-0579		DIODE BREAKDOWN: 5.11V	28480	1902-0579
CR3	1901-0159		DIODE: SILICON 0.75A 400PIV	04713	SR1358-4
CR4	1902-0579	1	DIODE BREAKDOWN: 5.11V	28480	1902-0579
CR5	1901-0159		DIODE: SILICON 0.75A 400PIV	04713	SR1358-4
CR6	1902-3036		DIODE: BREAKDOWN 3.16V 5%	04713	SZ10939-38
R1	0698-3402		R:FXD MET FLM 316 OHM 1% 1/2W	28480	0698-3402
R2	0698-3402		R:FXD MET FLM 316 OHM 1% 1/2W	28480	0698-3402
R3	0757-1094	16	R:FXD MET FLM 1.47K OHM 1% 1/8W	28480	0757-1094
R4	0698-3400		R:FXD MET FLM 147 OHM 1% 1/2W	28480	0698-3400
R5	0757-1094	2	R:FXD MET FLM 1.47K OHM 1% 1/8W	28480	0757-1094
R6	0757-0278		R:FXD MET FLM 1.78K OHM 1% 1/8W	28480	0757-0278
R7	0757-0280	3	R:FXD MET FLM 1K OHM 1% 1/8W	28480	0757-0280
R8	0757-0280	19	R:FXD MET FLM 1K OHM 1% 1/8W	28480	0757-0280
R9	0757-0278		R:FXD MET FLM 1.78K OHM 1% 1/8W	28480	0757-0278
R10	0757-0279		R:FXD MET FLM 3.16K OHM 1% 1/8W	28480	0757-0279
R11	0698-3400		R:FXD MET FLM 147 OHM 1% 1/2W	28480	0698-3400
R12	0757-1094		R:FXD MET FLM 1.47K OHM 1% 1/8W	28480	0757-1094
R13	0757-1094		R:FXD MET FLM 1.47K OHM 1% 1/8W	28480	0757-1094
R14	0757-1094		R:FXD MET FLM 1.47K OHM 1% 1/8W	28480	0757-1094
R15	0757-0280		R:FXD MET FLM 1K OHM 1% 1/8W	28480	0757-0280
R16	0757-1094		R:FXD MET FLM 1.47K OHM 1% 1/8W	28480	0757-1094
R17	0757-1094		R:FXD MET FLM 1.47K OHM 1% 1/8W	28480	0757-1094
R18	0757-1094		R:FXD MET FLM 1.47K OHM 1% 1/8W	28480	0757-1094
R19	0757-1094		R:FXD MET FLM 1.47K OHM 1% 1/8W	28480	0757-1094
R20	0757-1094	R:FXD MET FLM 1.47K OHM 1% 1/8W	28480	0757-1094	
R21	0757-1094	R:FXD MET FLM 1.47K OHM 1% 1/8W	28480	0757-1094	
R22	0757-0279	R:FXD MET FLM 3.16K OHM 1% 1/8W	28480	0757-0279	
R23	0757-0279	3	R:FXD MET FLM 3.16K OHM 1% 1/8W	28480	0757-0279
R24	1810-0020		RESISTOR NETWORK: MET FLM (7 RES)	28480	1810-0020
R25	0757-0279		R:FXD MET FLM 3.16K OHM 1% 1/8W	28480	0757-0279
R26	0757-0279		R:FXD MET FLM 3.16K OHM 1% 1/8W	28480	0757-0279
R28	0757-0279		R:FXD MET FLM 3.16K OHM 1% 1/8W	28480	0757-0279
R29	0757-0279	1	R:FXD MET FLM 3.16K OHM 1% 1/8W	28480	0757-0279
R30	0757-0279		R:FXD MET FLM 3.16K OHM 1% 1/8W	28480	0757-0279
R31	0757-0279		R:FXD MET FLM 3.16K OHM 1% 1/8W	28480	0757-0279
R32	0757-0279		R:FXD MET FLM 3.16K OHM 1% 1/8W	28480	0757-0279
R33	0757-1094		R:FXD MET FLM 1.47K OHM 1% 1/8W	28480	0757-1094
R34	0757-1094		R:FXD MET FLM 1.47K OHM 1% 1/8W	28480	0757-1094
R35	0757-0279		R:FXD MET FLM 3.16K OHM 1% 1/8W	28480	0757-0279
R36	0757-0279	R:FXD MET FLM 3.16K OHM 1% 1/8W	28480	0757-0279	
R37	0757-0279	R:FXD MET FLM 3.16K OHM 1% 1/8W	28480	0757-0279	
R37	0757-0279	R:FXD MET FLM 3.16K OHM 1% 1/8W	28480	0757-0279	
R38	0757-0279	1	R:FXD MET FLM 3.16K OHM 1% 1/8W	28480	0757-0279
R39	0757-0279		R:FXD MET FLM 3.16K OHM 1% 1/8W	28480	0757-0279
R40	0757-0279		R:FXD MET FLM 3.16K OHM 1% 1/8W	28480	0757-0279
R41	0757-0279		R:FXD MET FLM 3.16K OHM 1% 1/8W	28480	0757-0279
R42	0757-0279		R:FXD MET FLM 3.16K OHM 1% 1/8W	28480	0757-0279
R43	0757-1094		R:FXD MET FLM 1.47K OHM 1% 1/8W	28480	0757-1094
R44	1810-0020		RESISTOR NETWORK: MET FLM (7 RES)	28480	1810-0020
R45	1810-0020	RESISTOR NETWORK: MET FLM (7 RES)	28480	1810-0020	
R46	0757-1094	R:FXD MET FLM 1.47K OHM 1% 1/8W	28480	0757-1094	
R47	0757-0180	2	R:FXD MET FLM 31.6 OHM 1% 1/8W	28480	0757-0180
R48	0757-0180	2	R:FXD MET FLM 31.6 OHM 1% 1/8W	28480	0757-0180
R49	0698-3407		R:FXD MET FLM 1.96K OHM 1% 1/2W	28480	0698-3407
R50	0757-0416	2	R:FXD MET FLM 511 OHM 1% 1/8W	28480	0757-0416
R51	0757-0416		R:FXD MET FLM 511 OHM 1% 1/8W	28480	0757-0416
R52	0698-3407		R:FXD MET FLM 1.96K OHM 1% 1/2W	28480	0698-3407

Table 2-30. Terminal Data Interface PCA, Replaceable Parts (Continued)

Reference Designation	HP Part Number	Qty	Description	Mfr Code	Mfr Part Number
R53	0757-0427	1	R:FXD MET FLM 1.5K OHM 1% 1/8W	28480	0757-0427
R54	0757-1094		R:FXD MET FLM 1.47K OHM 1% 1/8W	28480	0757-1094
U11	1820-0616	12	IC:TTL 4-BIT 2-INPT MULTIPLEXER	07263	U78932259X
U12	1820-0063	3	IC:TTL DUAL 2W 2-INPT AND OR INV GATE	04713	SN7451N
U13	1820-0424	5	IC:TTL HS HEX INVERTER	04713	SN74H04N
U14	1820-0371	2	IC:TTL HS TRIPLE 3-INPT NAND GATE	01295	SN74H10N
U15	1820-0141	6	IC:TTL QUAD 2-INPT AND GATE	04713	MC3001P
U17	1820-0715	3	IC:TTL DIGITAL HI-SPEED J-K F/F	01295	SN74H106N
U18	1820-0327	6	IC:TTL QUAD 2-INPT NAND GATE	04713	SN7401N
U19	1820-0141		IC:TTL QUAD 2-INPT AND GATE	04713	MC3001P
U21	1820-0077	3	IC:TTL DUAL D F/F	01295	SN7474N
U22	1820-0376	5	IC:TTL HS DUAL 4-INPT NAND BUFFER	01295	SN74H40N
U23	1820-0294	2	IC:TTL 8-BIT SER-IN PAR OUT SHIFT REG	12040	SD9935
U24	1820-0294		IC:TTL 8-BIT SER-IN PAR OUT SHIFT REG	12040	SD9935
U25	1820-0140	4	IC:TTL DUAL 4-INPT AND BUFFER	04713	MC3026P
U27	1820-0424		IC:TTL HS HEX INVERTER	04713	SN74H04N
U28	1820-0370	8	IC:TTL HS QUAD 2-INPT NAND GATE	01295	SN74H00N
U29	1820-0370		IC:TTL HS QUAD 2-INPT NAND GATE	01295	SN74H00N
U31	1820-0509	4	IC:DTL QUAD 1-2-2-2-INPT NAND LINE DR	04713	MC1488L
U32	1820-0509		IC:DTL QUAD 1-2-2-2-INPT NAND LINE DR	04713	MC1488L
U33	1820-0301	15	IC:TTL QUAD 8I-STABLE D-LATCH	01295	SN7475N
U34	1820-0301		IC:TTL QUAD 8I-STABLE D-LATCH	01295	SN7475N
U35	1820-0261	1	IC:TTL MONO-STABLE MULTIVIBRATOR	01295	SN74121N
U36	1820-0127	1	IC:TTL QUAD 2-INPT NAND GATE	07263	U6A900259X
U37	1820-0328	3	IC:TTL QUAD 2-INPT NOR GATE	04713	SN7402N
U38	1820-0140		IC:TTL DUAL 4-INPT AND BUFFER	04713	MC3026P
U39	1820-0301		IC:TTL QUAD 8I-STABLE D-LATCH	01295	SN7475N
U41	1820-0509		IC:DTL QUAD 1-2-2-2-INPT NAND LINE DR	04713	MC1488L
U42	1820-0509		IC:DTL QUAD 1-2-2-2-INPT NAND LINE DR	04713	MC1488L
U43	1820-0301		IC:TTL QUAD 8I-STABLE D-LATCH	01295	SN7475N
U44	1820-0301		IC:TTL QUAD 8I-STABLE D-LATCH	01295	SN7475N
U45	1820-0076	1	IC:TTL DUAL J-K F/F W/PRESET CLOCK	01295	SN7476N
U46	1820-0715		IC:TTL DIGITAL HI-SPEED J-K F/F	01295	SN74H106N
U47	1820-0370		IC:TTL HS QUAD 2-INPT NAND GATE	01295	SN74H00N
U48	1820-0301		IC:TTL QUAD 8I-STABLE D-LATCH	01295	SN7475N
U49	1820-0327		IC:TTL QUAD 2-INPT NAND GATE	04713	SN7401N
U51	1820-0990	4	IC	28480	1820-0990
U52	1820-0990		IC	28480	1820-0990
U53	1820-0640	1	IC:TTL DATA SELECTOR/MULTIPLEXER	01295	SN74150N
U55	1820-0376		IC:TTL HS DUAL 4-INPT NAND BUFFER	01295	SN74H40N
U56	1820-0250	1	INTEGRATED CIRCUIT:TTL 6 BIT COMP	28480	1820-0250
U57	1820-0301		IC:TTL QUAD 8I-STABLE D-LATCH	01295	SN7475N
U58	1820-0301		IC:TTL QUAD 8I-STABLE D-LATCH	01295	SN7475N
U59	1820-0374	1	IC:TTL HS DUAL 4-INPT AND GATE	01295	SN74H21N
U61	1820-0990		IC	28480	1820-0990
U62	1820-0990		IC	28480	1820-0990
U63	1820-0376		IC:TTL HS DUAL 4-INPT NAND BUFFER	01295	SN74H40N
U64	1820-0377		IC:TTL DUAL D F/F	01295	SN7474N
U65	1820-0231	5	IC:TTL 4-BIT SYNC BINARY COUNTER	07263	U68931659X
U66	1820-0231		IC:TTL 4-BIT SYNC BINARY COUNTER	07263	U68931659X
U67	1820-0327		IC:TTL QUAD 2-INPT NAND GATE	04713	SN7401N
U68	1820-0327		IC:TTL QUAD 2-INPT NAND GATE	04713	SN7401N
U69	1820-0141		IC:TTL QUAD 2-INPT AND GATE	04713	MC3001P
U71	1820-0141		IC:TTL QUAD 2-INPT AND GATE	04713	MC3001P
U72	1820-0063		IC:TTL DUAL 2W 2-INPT AND OR INV GATE	04713	SN7451N
U73	1820-0616		IC:TTL 4-BIT 2-INPT MULTIPLEXER	07263	U78932259X
U74	1820-0231		IC:TTL 4-BIT SYNC BINARY COUNTER	07263	U68931659X
U75	1820-0063		IC:TTL DUAL 2W 2-INPT AND OR INV GATE	04713	SN7451N
U76	1820-0616		IC:TTL 4-BIT 2-INPT MULTIPLEXER	07263	U78932259X
U77	1820-0301		IC:TTL QUAD 8I-STABLE D-LATCH	01295	SN7475N
U78	1820-0077		IC:TTL DUAL D F/F	01295	SN7474N
U79	1820-0214	1	IC:TTL BCD TO DEC. DECODER	01295	SN7442N
U81	1820-0370		IC:TTL HS QUAD 2-INPT NAND GATE	01295	SN74H00N
U82	1820-0616		IC:TTL 4-BIT 2-INPT MULTIPLEXER	07263	U78932259X
U83	1820-0839	8	IC:TTL QUAD D-TYPE F/F	01295	SN74175N
U84	1820-0616		IC:TTL 4-BIT 2-INPT MULTIPLEXER	07263	U78932259X
U85	1820-0435	2	IC:TTL 8-BIT ODD/EVEN GEN./CHECKER	01295	SN74180N
U86	1820-0839		IC:TTL QUAD D-TYPE F/F	01295	SN74175N
U87	1820-0301		IC:TTL QUAD 8I-STABLE D-LATCH	01295	SN7475N
U88	1820-0686	1	IC:TTL SCHOTTKY TRIPLE 3-INPT AND GATE	01295	SN74511N
U89	1820-0760	4	IC:TTL 8-BIT RECEIVER INVERTING	28480	1820-0760
U91	1820-0370		IC:TTL HS QUAD 2-INPT NAND GATE	01295	SN74H00N
U92	1820-0370		IC:TTL HS QUAD 2-INPT NAND GATE	01295	SN74H00N
U93	1820-0231		IC:TTL 4-BIT SYNC BINARY COUNTER	07263	U68931659X
U94	1820-0839		IC:TTL QUAD D-TYPE F/F	01295	SN74175N

Table 2-30. Terminal Data Interface PCA, Replaceable Parts (Continued)

Reference Designation	HP Part Number	Qty	Description	Mfr Code	Mfr Part Number
U95	1820-0616		IC:TTL 4-BIT 2-INPT MULTIPLEXER	07263	U78932259X
U96	1820-0616		IC:TTL 4-BIT 2-INPT MULTIPLEXER	07263	U78932259X
U97	1820-0301		IC:TTL QUAD BI-STABLE D-LATCH	01295	SN7475N
U98	1820-0844	1	IC:TTL DUAL 3-INPT PULSE SHAPER	04713	MC426P
U99	1820-0755	2	IC	28480	1820-0755
U101	1820-0328		IC:TTL QUAD 2-INPT NOR GATE	04713	SN7402N
U102	1820-0424		IC:TTL HS HEX INVERTER	04713	SN74H04N
U103	1820-0328		IC:TTL QUAD 2-INPT NOR GATE	04713	SN7402N
U104	1820-0616		IC:TTL 4-BIT 2-INPT MULTIPLEXER	07263	U78932259X
U105	1820-0367	3	IC:TTL 4-BIT UP-DOWN SHIFT REGISTER	01295	SN7495N
U106	1820-0367		IC:TTL 4-BIT UP-DOWN SHIFT REGISTER	01295	SN7495N
U107	1820-0301		IC:TTL QUAD BI-STABLE D-LATCH	01295	SN7475N
U108	1820-0301		IC:TTL QUAD BI-STABLE D-LATCH	01295	SN7475N
U109	1820-0760		IC:TTL 8-BIT RECEIVER INVERTING	28480	1820-0760
U111	1820-0424		IC:TTL HS HEX INVERTER	04713	SN74H04N
U112	1820-0141		IC:TTL QUAD 2-INPT AND GATE	04713	MC3001P
U113	1820-0733	2	IC:DIGITAL QUAD 256-BIT SHIFT REGISTER	28480	1820-0733
U114	1820-0231		IC:TTL 4-BIT SYNC BINARY COUNTER	07263	U68931659X
U115	1820-0839		IC:TTL QUAD D-TYPE F/F	01295	SN74175N
U116	1820-0839		IC:TTL QUAD D-TYPE F/F	01295	SN74175N
U117	1820-0140		IC:TTL DUAL 4-INPT AND BUFFER	04713	MC3026P
U118	1820-0424		IC:TTL HS HEX INVERTER	04713	SN74H04N
U121	1820-0371		IC:TTL HS TRIPLE 3-INPT NAND GATE	01295	SN74H10N
U122	1820-0141		IC:TTL QUAD 2-INPT AND GATE	04713	MC3001P
U123	1820-0616		IC:TTL 4-BIT 2-INPT MULTIPLEXER	07263	U78932259X
U124	1820-0616		IC:TTL 4-BIT 2-INPT MULTIPLEXER	07263	U78932259X
U125	1820-0616		IC:TTL 4-BIT 2-INPT MULTIPLEXER	07263	U78932259X
U126	1820-0435		IC:TTL 8-BIT ODD/EVEN GEN./CHECKER	01295	SN74180N
U127	1820-0140		IC:TTL DUAL 4-INPT AND BUFFER	04713	MC3026P
U128	1820-0370		IC:TTL HS QUAD 2-INPT NAND GATE	01295	SN74H00N
U129	1820-0760		IC:TTL 8-BIT RECEIVER INVERTING	28480	1820-0760
U131	1820-0370		IC:TTL HS QUAD 2-INPT NAND GATE	01295	SN74H00N
U132	1820-0205	1	IC:TTL QUAD 2-INPT OR GATE	28480	1820-0205
U133	1820-0839		IC:TTL QUAD D-TYPE F/F	01295	SN74175N
U134	1820-0839		IC:TTL QUAD D-TYPE F/F	01295	SN74175N
U135	1820-0367		IC:TTL 4-BIT UP-DOWN SHIFT REGISTER	01295	SN7495N
U136	1820-0327		IC:TTL QUAD 2-INPT NAND GATE	04713	SN7401N
U137	1820-0327		IC:TTL QUAD 2-INPT NAND GATE	04713	SN7401N
U138	1820-0761	1	IC:TTL DIGITAL	28480	1820-0761
U139	1820-0755		IC	28480	1820-0755
U141	1820-0376		IC:TTL HS DUAL 4-INPT NAND BUFFER	01295	SN74H40N
U142	1820-0376		IC:TTL HS DUAL 4-INPT NAND BUFFER	01295	SN74H40N
U143	1820-0733		IC:DIGITAL QUAD 256-BIT SHIFT REGISTER	28480	1820-0733
U144	1820-0616		IC:TTL 4-BIT 2-INPT MULTIPLEXER	07263	U78932259X
U145	1820-0839		IC:TTL QUAD D-TYPE F/F	01295	SN74175N
U146	1820-0301		IC:TTL QUAD BI-STABLE D-LATCH	01295	SN7475N
U147	1820-0301		IC:TTL QUAD BI-STABLE D-LATCH	01295	SN7475N
U148	1820-0706	2	IC:DIGITAL TTL 5-BIT COMPARATOR	04713	U78932459X
U149	1820-0760		IC:TTL 8-BIT RECEIVER INVERTING	28480	1820-0760
U153	1820-0832	2	IC:TTL TO MOS TRANSLATOR/CLOCK DRIVER	12040	NH0007C
U155	1820-0715		IC:TTL DIGITAL HI-SPEED J-K F/F	01295	SN74H106N
U159	1820-0756	1	IC:TTL 8-BIT DRIVER INVERTING	28480	1820-0756
U163	1820-0832		IC:TTL TO MOS TRANSLATOR/CLOCK DRIVER	12040	NH0007C
U169	1820-0706		IC:DIGITAL TTL 5-BIT COMPARATOR	04713	U78932459X
W2	8159-0005		JUMPER WIRE	28480	8159-0005
W3	8159-0005		JUMPER WIRE	28480	8159-0005
W4	8159-0005		JUMPER WIRE	28480	8159-0005
W5	8159-0005		JUMPER WIRE	28480	8159-0005
W6	8159-0005		JUMPER WIRE	28480	8159-0005
W7	8159-0005		JUMPER WIRE	28480	8159-0005
W8	8159-0005		JUMPER WIRE	28480	8159-0005
W9	8159-0005		JUMPER WIRE	28480	8159-0005
W10	8159-0005		JUMPER WIRE	28480	8159-0005
X1	1200-0199	1	SOCKET:CRYSTAL	91506	8000-AG9
Y1	0410-0459	1	CRYSTAL:QUARTZ	28480	0410-0459

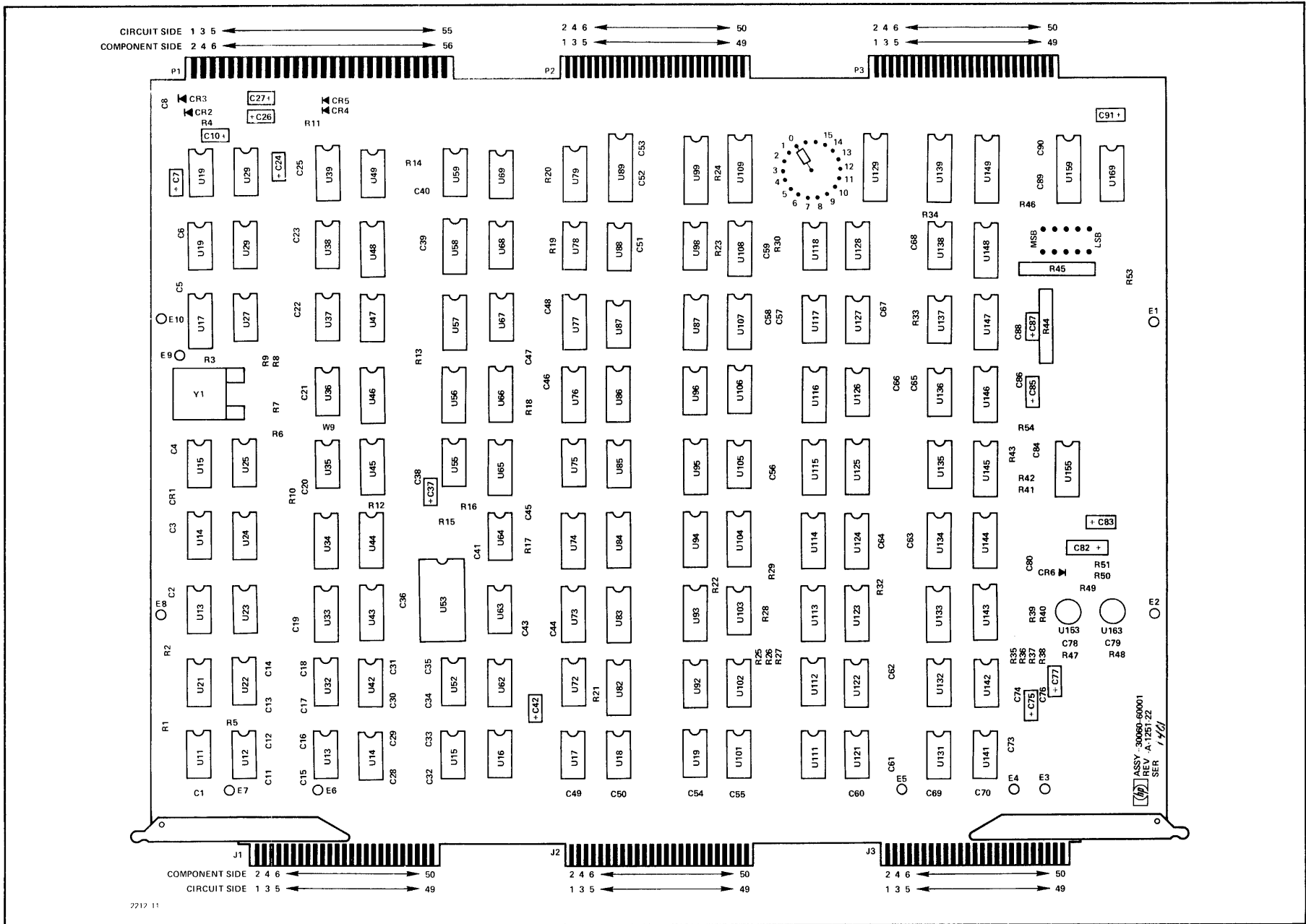

Figure 2-29. Terminal Data Interface PCA, Parts Location Diagram

Table 2-31. Terminal Control Interface PCA, Replaceable Parts

Reference Designation	HP Part Number	Qty	Description	Mfr Code	Mfr Part Number
C1	30061-60001	1	TERMINAL CONTROL INTERFACE PCA THRU	28480	30061-60001
C1			THRU		
C64	0160-2940	15	C:FXD MICA 470 PF 5% 300VDCW	72136	RDM15F471J3C
C66	0160-2055		C:FXD CER 0.01 UF +80-20% 100VDCW	56289	C023F101F103ZS22-CDH
C67	0180-0197	8	C:FXD ELECT 2.2 UF 10% 20VDCW	56289	150D225X9020A2-DYS
C68	0180-0197		C:FXD ELECT 2.2 UF 10% 20VDCW	56289	150D225X9020A2-DYS
C69	0160-2055		C:FXD CER 0.01 UF +80-20% 100VDCW	56289	C023F101F103ZS22-CDH
C70	0180-0197		C:FXD ELECT 2.2 UF 10% 20VDCW	56289	150D225X9020A2-DYS
C71	0160-2055		C:FXD CER 0.01 UF +80-20% 100VDCW	56289	C023F101F103ZS22-CDH
C72	0180-0197		C:FXD ELECT 2.2 UF 10% 20VDCW	56289	150D225X9020A2-DYS
C73	0180-0197		C:FXD ELECT 2.2 UF 10% 20VDCW	56289	150D225X9020A2-DYS
C74	0160-2055		C:FXD CER 0.01 UF +80-20% 100VDCW	56289	C023F101F103ZS22-CDH
C75	0160-2055		C:FXD CER 0.01 UF +80-20% 100VDCW	56289	C023F101F103ZS22-CDH
C76	0160-2055		C:FXD CER 0.01 UF +80-20% 100VDCW	56289	C023F101F103ZS22-CDH
C77	0180-0197		C:FXD ELECT 2.2 UF 10% 20VDCW	56289	150D225X9020A2-DYS
C78	0160-2055		C:FXD CER 0.01 UF +80-20% 100VDCW	56289	C023F101F103ZS22-CDH
C79	0160-2055		C:FXD CER 0.01 UF +80-20% 100VDCW	56289	C023F101F103ZS22-CDH
C80	0160-2202	2	C:FXD MICA 75 PF 5%	28480	0160-2202
C81	0160-2202		C:FXD MICA 75 PF 5%	28480	0160-2202
C82	0160-2055		C:FXD CER 0.01 UF +80-20% 100VDCW	56289	C023F101F103ZS22-CDH
C83	0160-2055		C:FXD CER 0.01 UF +80-20% 100VDCW	56289	C023F101F103ZS22-CDH
C84	0160-2055		C:FXD CER 0.01 UF +80-20% 100VDCW	56289	C023F101F103ZS22-CDH
C85	0160-2055		C:FXD CER 0.01 UF +80-20% 100VDCW	56289	C023F101F103ZS22-CDH
C86	0180-0197		C:FXD ELECT 2.2 UF 10% 20VDCW	56289	150D225X9020A2-DYS
C87	0160-2055		C:FXD CER 0.01 UF +80-20% 100VDCW	56289	C023F101F103ZS22-CDH
C88	0160-2055		C:FXD CER 0.01 UF +80-20% 100VDCW	56289	C023F101F103ZS22-CDH
C89	0180-0197		C:FXD ELECT 2.2 UF 10% 20VDCW	56289	150D225X9020A2-DYS
C90	0160-2055		C:FXD CER 0.01 UF +80-20% 100VDCW	56289	C023F101F103ZS22-CDH
C91	0160-2055		C:FXD CER 0.01 UF +80-20% 100VDCW	56289	C023F101F103ZS22-CDH
C92	0160-2055		C:FXD CER 0.01 UF +80-20% 100VDCW	56289	C023F101F103ZS22-CDH
C93	0160-2055		C:FXD CER 0.01 UF +80-20% 100VDCW	56289	C023F101F103ZS22-CDH
CR1	1902-0579	2	DIODE BREAKDOWN:5.11V	28480	1902-0579
CR2	1901-0159	2	DIODE:SILICON 0.75A 400PIV	04713	SR1358-4
CR3	1902-0579		DIODE BREAKDOWN:5.11V	28480	1902-0579
CR4	1901-0159		DIODE:SILICON 0.75A 400PIV	04713	SR1358-4
R1	0683-1025	2	R:FXD COMP 1000 OHM 5% 1/4W	01121	CB 1025
R2	0683-1025		R:FXD COMP 1000 OHM 5% 1/4W	01121	CB 1025
R3	0698-3622	2	R:FXD MET OX 120 OHM 5% 2W	28480	0698-3622
R4	0698-3622		R:FXD MET OX 120 OHM 5% 2W	28480	0698-3622
R5	1810-0125	3	RESISTIVE NETWORK:7 X 4.7K OHM 5% 0.15W	28480	1810-0125
R6	0757-0279	2	R:FXD MET FLM 3.16K OHM 1% 1/8W	28480	0757-0279
R7	0698-3155	4	R:FXD MET FLM 4.64K OHM 1% 1/8W	28480	0698-3155
R8	0757-0279		R:FXD MET FLM 3.16K OHM 1% 1/8W	28480	0757-0279
R9	0698-3155		R:FXD MET FLM 4.64K OHM 1% 1/8W	28480	0698-3155
R10	0698-3155		R:FXD MET FLM 4.64K OHM 1% 1/8W	28480	0698-3155
R11	0698-3155		R:FXD MET FLM 4.64K OHM 1% 1/8W	28480	0698-3155
R12	1810-0125		RESISTIVE NETWORK:7 X 4.7K OHM 5% 0.15W	28480	1810-0125
R13	1810-0125		RESISTIVE NETWORK:7 X 4.7K OHM 5% 0.15W	28480	1810-0125
U18	1820-0760	4	IC:TTL 8-BIT RECEIVER INVERTING	28480	1820-0760
U22	1820-0509	8	IC:DTL QUAD 1-2-2-2-INPT NAND LINE DR	04713	MC1488L
U23	1820-0509		IC:DTL QUAD 1-2-2-2-INPT NAND LINE DR	04713	MC1488L
U24	1820-0833	4	IC:DIGITAL TTL 8-BIT ADDRESSABLE LATCH	07263	U7B933459X
U26	1820-0076	2	IC:TTL DUAL J-K F/F W/PRESET CLOCK	01295	SN7476N
U28	1820-0374	1	IC:TTL HS DUAL 4-INPT AND GATE	01295	SN74H21N
U32	1820-0509		IC:DTL QUAD 1-2-2-2-INPT NAND LINE DR	04713	MC1488L
U33	1820-0509		IC:DTL QUAD 1-2-2-2-INPT NAND LINE DR	04713	MC1488L
U34	1820-0833		IC:DIGITAL TTL 8-BIT ADDRESSABLE LATCH	07263	U7B933459X
U35	1820-0141	3	IC:TTL QUAD 2-INPT AND GATE	04713	MC3001P
U36	1820-0715	1	IC:TTL DIGITAL HI-SPEED J-K F/F	01295	SN74H106N
U38	1820-0141		IC:TTL QUAD 2-INPT AND GATE	04713	MC3001P
U42	1820-0990	8	IC	28480	1820-0990
U46	1820-0141		IC:TTL QUAD 2-INPT AND GATE	04713	MC3001P
U48	1820-0077	1	IC:TTL DUAL D F/F	01295	SN7474N
U52	1820-0990		IC	28480	1820-0990
U56	1820-0370	3	IC:TTL HS QUAD 2-INPT NAND GATE	01295	SN74H00N
U58	1820-0214	1	IC:TTL BCD TO DEC. DECODER	01295	SN7442N
U62	1820-0990		IC	28480	1820-0990
U63	1820-0640	2	IC:TTL DATA SELECTOR/MULTIPLEXER	01295	SN74150N
U65	1820-0839	3	IC:TTL QUAD D-TYPE F/F	01295	SN74175N
U66	1820-0371	1	IC:TTL HS TRIPLE 3-INPT NAND GATE	01295	SN74H10N
U68	1820-0424	3	IC:TTL HS HEX INVERTER	04713	SN74H04N
U72	1820-0990		IC	28480	1820-0990
U75	1820-0839		IC:TTL QUAD D-TYPE F/F	01295	SN74175N
U76	1820-0424		IC:TTL HS HEX INVERTER	04713	SN74H04N

Table 2-31. Terminal Control Interface PCA, Replaceable Parts (Continued)

Reference Designation	HP Part Number	Qty	Description	Mfr Code	Mfr Part Number
U78	1820-0370		IC:TTL HS QUAD 2-INPT NAND GATE	01295	SN74H00N
U82	1820-0990		IC	28480	1820-0990
U83	1820-0640		IC:TTL DATA SELECTOR/MULTIPLEXER	01295	SN74150N
U86	1820-0370		IC:TTL HS QUAD 2-INPT NAND GATE	01295	SN74H00N
U88	1820-0686	1	IC:TTL SCHOTTKY TRIPLE 3-INPT AND GATE	01295	SN74S11N
U92	1820-0990		IC	28480	1820-0990
U96	1820-0844	1	IC:TTL DUAL 3-INPT PULSE SHAPER	04713	MC426P
U98	1820-0301	1	IC:TTL QUAD BI-STABLE D-LATCH	01295	SN7475N
U102	1820-0990		IC	28480	1820-0990
U105	1820-0076		IC:TTL DUAL J-K F/F W/PRESET CLOCK	01295	SN7476N
U108	1820-0760		IC:TTL 8-BIT RECEIVER INVERTING	28480	1820-0760
U112	1820-0990		IC	28480	1820-0990
U114	1820-0205	1	IC:TTL QUAD 2-INPT OR GATE	28480	1820-0205
U118	1820-0756	3	IC:TTL 8-BIT DRIVER INVERTING	28480	1820-0756
U122	1820-0509		IC:DTL QUAD 1-2-2-2-INPT NAND LINE DR	04713	MC1488L
U123	1820-0509		IC:DTL QUAD 1-2-2-2-INPT NAND LINE DR	04713	MC1488L
U124	1820-0833		IC:DIGITAL TTL 8-BIT ADDRESSABLE LATCH	07263	U7B933459X
U125	1820-0765	1	IC:TTL 4-BIT BINARY COUNTER	01295	SN74197N
U128	1820-0760		IC:TTL 8-BIT RECEIVER INVERTING	28480	1820-0760
U132	1820-0509		IC:DTL QUAD 1-2-2-2-INPT NAND LINE DR	04713	MC1488L
U133	1820-0509		IC:DTL QUAD 1-2-2-2-INPT NAND LINE DR	04713	MC1488L
U134	1820-0833		IC:DIGITAL TTL 8-BIT ADDRESSABLE LATCH	07263	U7B933459X
U135	1820-0839		IC:TTL QUAD D-TYPE F/F	01295	SN74175N
U144	1820-0494	1	IC:TTL 64-BIT RANDOM ACCESS MEMORY W	28480	1820-0494
U144	1820-0628	1	IC:DIGITAL TTL 64-BIT R/W MEMORY	01295	SN7489N
U145	1820-0424		IC:TTL HS HEX INVERTER	04713	SN74H04N
U146	1820-0706	2	IC:DIGITAL TTL 5-BIT COMPARATOR	04713	U7B932459X
U148	1820-0760		IC:TTL 8-BIT RECEIVER INVERTING	28480	1820-0760
U154	1820-0617	1	IC:TTL QUAD 2-INPT EXCL. NOR GATE	04713	MC3022P
U156	1820-0706		IC:DIGITAL TTL 5-BIT COMPARATOR	04713	U7B932459X
U158	1820-0756		IC:TTL 8-BIT DRIVER INVERTING	28480	1820-0756
U164	1820-0239	1	IC:TTL QUAD 2-INPT NOR GATE	28480	1820-0239
U166	1820-0761	1	IC:TTL DIGITAL	28480	1820-0761
U168	1820-0756		IC:TTL 8-BIT DRIVER INVERTING	28480	1820-0756
W1	8159-0005	8	JUMPER WIRE	28480	8159-0005
W2	8159-0005		JUMPER WIRE	28480	8159-0005
W3	8159-0005		JUMPER WIRE	28480	8159-0005
W4	8159-0005		JUMPER WIRE	28480	8159-0005
W5	8159-0005		JUMPER WIRE	28480	8159-0005
W6	8159-0005		JUMPER WIRE	28480	8159-0005
W7	8159-0005		JUMPER WIRE	28480	8159-0005
W8	8159-0005		JUMPER WIRE	28480	8159-0005

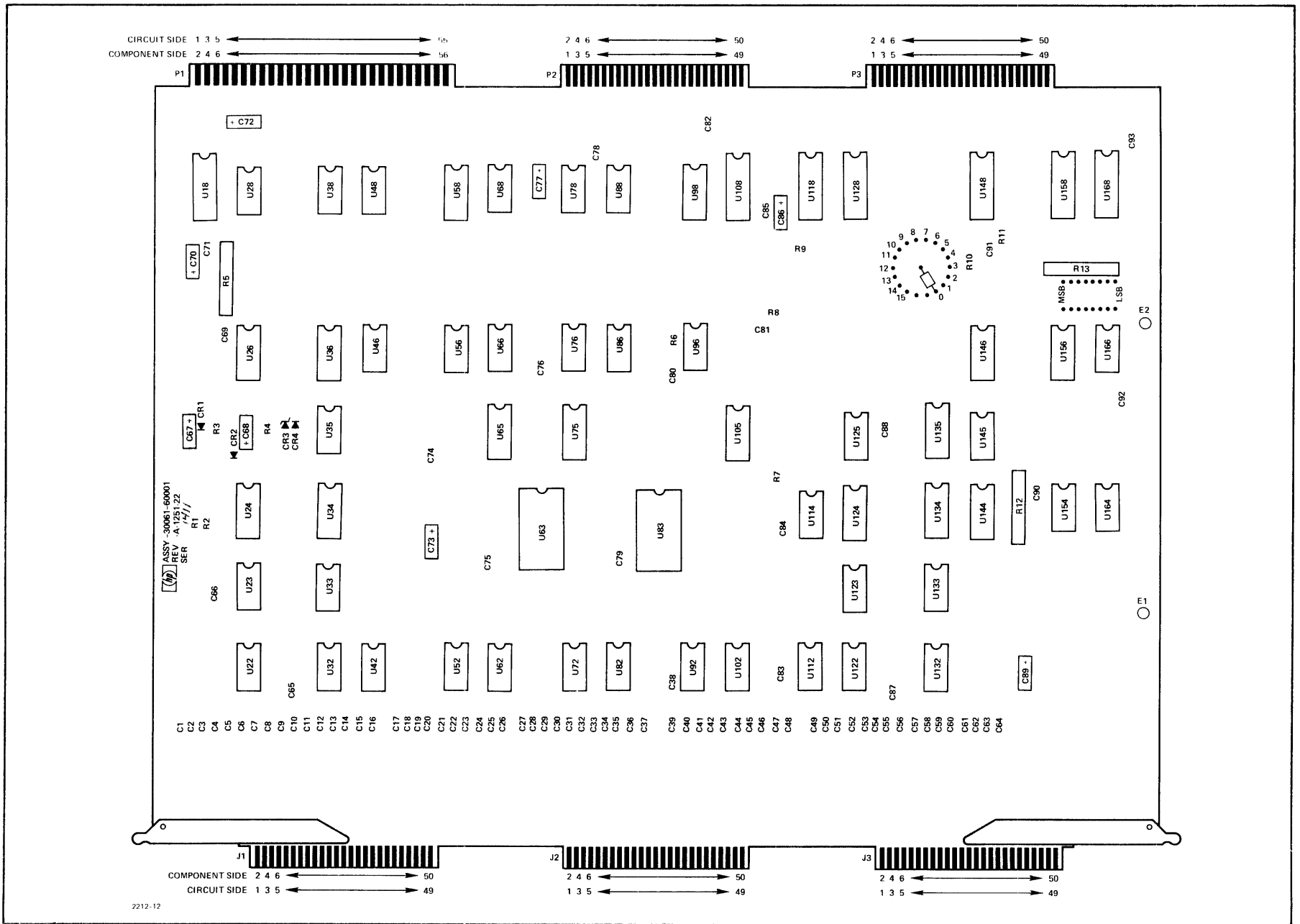

Figure 2-30. Terminal Control Interface PCA, Parts Location Diagram

Table 2-32. Disc File Read/Write PCA, Replaceable Parts

Reference Designation	HP Part Number	Qty	Description	Mfr Code	Mfr Part Number
C1	30202-60001	1	DISC FILE READ WRITE CARD	28480	30202-60001
C2	0160-2307	1	C:F XD MICA 47 PF 5%	28480	0160-2307
C3	0160-2055	17	C:F XD CER 0.01 UF +80-20% 100VDCW	56289	C023F101F103ZS22-CDH
C4	0180-0197	1	C:F XD ELECT 2.2 UF 10% 20VDCW	56289	1500225X9020A2-DYS
	0160-2055		C:F XD CER 0.01 UF +80-20% 100VDCW	56289	C023F101F103ZS22-CDH
C5	0160-2055		C:F XD CER 0.01 UF +80-20% 100VDCW	56289	C023F101F103ZS22-CDH
C6	0160-2055		C:F XD CER 0.01 UF +80-20% 100VDCW	56289	C023F101F103ZS22-CDH
C7	0160-2055		C:F XD CER 0.01 UF +80-20% 100VDCW	56289	C023F101F103ZS22-CDH
C8	0160-2055		C:F XD CER 0.01 UF +80-20% 100VDCW	56289	C023F101F103ZS22-CDH
C9	0160-2055		C:F XD CER 0.01 UF +80-20% 100VDCW	56289	C023F101F103ZS22-CDH
C10	0160-2204	1	C:F XD MICA 100PF 5%	72136	RDH15F101J3C
C11	0160-2055		C:F XD CER 0.01 UF +80-20% 100VDCW	56289	C023F101F103ZS22-CDH
C12	0160-2055		C:F XD CER 0.01 UF +80-20% 100VDCW	56289	C023F101F103ZS22-CDH
C13	0150-0121	9	C:F XD CER 0.1 UF +80-20% 50VDCW	56289	5C50BIS-CML
C14	0160-2055		C:F XD CER 0.01 UF +80-20% 100VDCW	56289	C023F101F103ZS22-CDH
C15	0150-0121		C:F XD CER 0.1 UF +80-20% 50VDCW	56289	5C50BIS-CML
C16	0160-2055		C:F XD CER 0.01 UF +80-20% 100VDCW	56289	C023F101F103ZS22-CDH
C17	0150-0121		C:F XD CER 0.1 UF +80-20% 50VDCW	56289	5C50BIS-CML
C18	0160-2055		C:F XD CER 0.01 UF +80-20% 100VDCW	56289	C023F101F103ZS22-CDH
C19	0150-0121		C:F XD CER 0.1 UF +80-20% 50VDCW	56289	5C50BIS-CML
C20	0150-0121		C:F XD CER 0.1 UF +80-20% 50VDCW	56289	5C50BIS-CML
C21	0160-2055		C:F XD CER 0.01 UF +80-20% 100VDCW	56289	C023F101F103ZS22-CDH
C22	0150-0121		C:F XD CER 0.1 UF +80-20% 50VDCW	56289	5C50BIS-CML
C23	0160-2055		C:F XD CER 0.01 UF +80-20% 100VDCW	56289	C023F101F103ZS22-CDH
C24	0160-2202	2	C:F XD MICA 75 PF 5%	28480	0160-2202
C25	0160-2202		C:F XD MICA 75 PF 5%	28480	0160-2202
C26	0150-0121		C:F XD CER 0.1 UF +80-20% 50VDCW	56289	5C50BIS-CML
C27	0150-0121		C:F XD CER 0.1 UF +80-20% 50VDCW	56289	5C50BIS-CML
C28	0150-0121		C:F XD CER 0.1 UF +80-20% 50VDCW	56289	5C50BIS-CML
C29	0160-2055		C:F XD CER 0.01 UF +80-20% 100VDCW	56289	C023F101F103ZS22-CDH
C30	0160-2055		C:F XD CER 0.01 UF +80-20% 100VDCW	56289	C023F101F103ZS22-CDH
C31	0160-2055		C:F XD CER 0.01 UF +80-20% 100VDCW	56289	C023F101F103ZS22-CDH
CR1	1901-0040	1	DIODE:SILICON 50 MA 30 WV	07263	FDG1088
R1	0757-0439	2	R:F XD MET FLM 6.81K OHM 1% 1/8W	28480	0757-0439
R2	0757-0416	3	R:F XD MET FLM 511 OHM 1% 1/8W	28480	0757-0416
R3	0698-3438	1	R:F XD MET FLM 147 OHM 1% 1/8W	28480	0698-3438
R4	0757-0439		R:F XD MET FLM 6.81K OHM 1% 1/8W	28480	0757-0439
R5	0757-0458	1	R:F XD MET FLM 51.1K OHM 1% 1/8W	28480	0757-0458
R6	1810-0030	7	NETWORK:7 RESISTORS 1K OHM 5% 0.15W EA	28480	1810-0030
R7	1810-0125	8	RESISTIVE NETWORK:7 X 4.7K OHM 5% 0.15W	28480	1810-0125
R8	0698-3441	1	R:F XD MET FLM 215 OHM 1% 1/8W	28480	0698-3441
R9	1810-0030		NETWORK:7 RESISTORS 1K OHM 5% 0.15W EA	28480	1810-0030
R10	0757-0280	1	R:F XD MET FLM 1K OHM 1% 1/8W	28480	0757-0280
R11	0757-0401	1	R:F XD MET FLM 100 OHM 1% 1/8W	28480	0757-0401
R12	1810-0125		RESISTIVE NETWORK:7 X 4.7K OHM 5% 0.15W	28480	1810-0125
R13	1810-0030		NETWORK:7 RESISTORS 1K OHM 5% 0.15W EA	28480	1810-0030
R14	1810-0125		RESISTIVE NETWORK:7 X 4.7K OHM 5% 0.15W	28480	1810-0125
R15	1810-0125		RESISTIVE NETWORK:7 X 4.7K OHM 5% 0.15W	28480	1810-0125
R16	0698-3155	8	R:F XD MET FLM 4.64K OHM 1% 1/8W	28480	0698-3155
R17	1810-0030		NETWORK:7 RESISTORS 1K OHM 5% 0.15W EA	28480	1810-0030
R18	0698-3132	1	R:F XD FLM 261 OHM 1% 1/8W	28480	0698-3132
R19	0698-3155		R:F XD MET FLM 4.64K OHM 1% 1/8W	28480	0698-3155
R20	0698-3155		R:F XD MET FLM 4.64K OHM 1% 1/8W	28480	0698-3155
R21	1810-0030		NETWORK:7 RESISTORS 1K OHM 5% 0.15W EA	28480	1810-0030
R22	0698-3155		R:F XD MET FLM 4.64K OHM 1% 1/8W	28480	0698-3155
R23	0698-3155		R:F XD MET FLM 4.64K OHM 1% 1/8W	28480	0698-3155
R24	1810-0125		RESISTIVE NETWORK:7 X 4.7K OHM 5% 0.15W	28480	1810-0125
R25	0757-0416		R:F XD MET FLM 511 OHM 1% 1/8W	28480	0757-0416
R26	0698-3155		R:F XD MET FLM 4.64K OHM 1% 1/8W	28480	0698-3155
R27	0757-0279	2	R:F XD MET FLM 3.16K OHM 1% 1/8W	28480	0757-0279
R28	0757-0279		R:F XD MET FLM 3.16K OHM 1% 1/8W	28480	0757-0279
R29	1810-0125		RESISTIVE NETWORK:7 X 4.7K OHM 5% 0.15W	28480	1810-0125
R30	1810-0125		RESISTIVE NETWORK:7 X 4.7K OHM 5% 0.15W	28480	1810-0125
R31	0698-3155		R:F XD MET FLM 4.64K OHM 1% 1/8W	28480	0698-3155
R32	1810-0125		RESISTIVE NETWORK:7 X 4.7K OHM 5% 0.15W	28480	1810-0125
R33	0698-3155		R:F XD MET FLM 4.64K OHM 1% 1/8W	28480	0698-3155
R42	0757-0416		R:F XD MET FLM 511 OHM 1% 1/8W	28480	0757-0416
U11	1820-0495	1	IC:TTL 1 OF 16 DECODER	01295	SN74154N
U12	1820-0715	6	IC:TTL DIGITAL HI-SPEED J-K F/F	01295	SN74H106N
U13	1820-0715		IC:TTL DIGITAL HI-SPEED J-K F/F	01295	SN74H106N
U14	1820-0371	6	IC:TTL HS TRIPLE 3-INPT NAND GATE	01295	SN74H10N
U15	1820-0054	2	IC:TTL QUAD 2-INPT NAND GATE	01295	SN7400N
U16	1820-0511	2	IC:TTL QUAD 2-INPT AND GATE	01295	SN7408N
U17	1820-0371		IC:TTL HS TRIPLE 3-INPT NAND GATE	01295	SN74H10N
U18	1820-0370	6	IC:TTL HS QUAD 2-INPT NAND GATE	01295	SN74H00N

Table 2-32. Disc File Read/Write PCA, Replaceable Parts (Continued)

Reference Designation	HP Part Number	Qty	Description	Mfr Code	Mfr Part Number
U22	1820-0054		IC:TTL QUAD 2-INPT NAND GATE	01295	SN7400N
U23	1820-0077	4	IC:TTL DUAL D F/F	01295	SN7474N
U24	1820-0424	6	IC:TTL HS HEX INVERTER	04713	SN74HC4N
U25	1820-0141	8	IC:TTL QUAD 2-INPT AND GATE	04713	MC3001P
U26	1820-0902	1	IC:TTL DUAL 2-INPT AND DRIVER	01295	SN75450AN
U27	1820-0141		IC:TTL QUAD 2-INPT AND GATE	04713	MC3001P
U28	1820-0141		IC:TTL QUAD 2-INPT AND GATE	04713	MC3001P
U31	1820-0424		IC:TTL HS HEX INVERTER	04713	SN74HC4N
U32	1820-0424		IC:TTL HS HEX INVERTER	04713	SN74HC4N
U41	1820-0239	2	IC:TTL QUAD 2-INPT NOR GATE	28480	1820-0239
U42	1820-0077		IC:TTL DUAL D F/F	01295	SN7474N
U43	1820-0511		IC:TTL QUAD 2-INPT AND GATE	01295	SN7408N
U44	1820-0371		IC:TTL HS TRIPLE 3-INPT NAND GATE	01295	SN74H10N
U45	1820-0373	1	IC:TTL HS DUAL 4-INPT NAND GATE	01295	SN74H20N
U46	1820-0371		IC:TTL HS TRIPLE 3-INPT NAND GATE	01295	SN74H10N
U47	1820-0715		IC:TTL DIGITAL HI-SPEED J-K F/F	01295	SN74H106N
U48	1820-0077		IC:TTL DUAL D F/F	01295	SN7474N
U52	1816-0230	1	IC:ROM	28480	1816-0230
U53	1820-0512	4	IC:TTL HS DUAL D F/F(35 MHZ MIN.)	01295	SN74H74N
U54	1820-0512		IC:TTL HS DUAL D F/F(35 MHZ MIN.)	01295	SN74H74N
U55	1820-0141		IC:TTL QUAD 2-INPT AND GATE	04713	MC3001P
U56	1820-0512		IC:TTL HS DUAL D F/F(35 MHZ MIN.)	01295	SN74H74N
U57	1820-0715		IC:TTL DIGITAL HI-SPEED J-K F/F	01295	SN74H106N
U58	1820-0686	2	IC:TTL SCHOTTKY TRIPLE 3-INPT AND GATE	01295	SN74S11N
U62	1816-0231	1	IC:ROM	28480	1816-0231
U65	1820-0231	1	IC:TTL 4-BIT SYNC BINARY COUNTER	07263	U68931659X
U73	1820-0715		IC:TTL DIGITAL HI-SPEED J-K F/F	01295	SN74H106N
U74	1820-0512		IC:TTL HS DUAL D F/F(35 MHZ MIN.)	01295	SN74H74N
U82	1816-0232	1	IC:ROM	28480	1816-0232
U85	1820-0379	1	IC:TTL HS 4W 2-2-2-3 INPT AND/OR GATE	01295	SN74H52N
U86	1820-0239		IC:TTL QUAD 2-INPT NOR GATE	28480	1820-0239
U87	1820-0370		IC:TTL HS QUAD 2-INPT NAND GATE	01295	SN74H00N
U88	1820-0424		IC:TTL HS HEX INVERTER	04713	SN74HC4N
U93	1820-0715		IC:TTL DIGITAL HI-SPEED J-K F/F	01295	SN74H106N
U94	1820-0370		IC:TTL HS QUAD 2-INPT NAND GATE	01295	SN74H00N
U102	1816-0233	1	IC:ROM	28480	1816-0233
U105	1820-0205	3	IC:TTL QUAD 2-INPT OR GATE	28480	1820-0205
U106	1820-0141		IC:TTL QUAD 2-INPT AND GATE	04713	MC3001P
U107	1820-0370		IC:TTL HS QUAD 2-INPT NAND GATE	01295	SN74H00N
U108	1820-0761	2	IC:TTL DIGITAL	28480	1820-0761
U112	1816-0234	1	IC:ROM	28480	1816-0234
U113	1820-0205		IC:TTL QUAD 2-INPT OR GATE	28480	1820-0205
U114	1820-0141		IC:TTL QUAD 2-INPT AND GATE	04713	MC3001P
U122	1816-0235	1	IC:ROM	28480	1816-0235
U123	1820-0205		IC:TTL QUAD 2-INPT OR GATE	28480	1820-0205
U124	1820-0755	9	IC	28480	1820-0755
U126	1820-0371		IC:TTL HS TRIPLE 3-INPT NAND GATE	01295	SN74H10N
U127	1820-0141		IC:TTL QUAD 2-INPT AND GATE	04713	MC3001P
U128	1820-0759	4	IC:TTL LOW-POWER 8-BIT RECEIVER	28480	1820-0759
U132	1816-0236	1	IC:ROM	28480	1816-0236
U133	1820-0742	9	IC:TTL DUAL 4-BIT LATCH	07263	U6N930859X
U134	1820-0756	5	IC:TTL 8-BIT DRIVER INVERTING	28480	1820-0756
U136	1820-0424		IC:TTL HS HEX INVERTER	04713	SN74HC4N
U137	1820-0370		IC:TTL HS QUAD 2-INPT NAND GATE	01295	SN74H00N
U138	1820-0759		IC:TTL LOW-POWER 8-BIT RECEIVER	28480	1820-0759
U142	1816-0237	1	IC:ROM	28480	1816-0237
U143	1820-0756		IC:TTL 8-BIT DRIVER INVERTING	28480	1820-0756
U144	1820-0742		IC:TTL DUAL 4-BIT LATCH	07263	U6N930859X
U146	1820-0755		IC	28480	1820-0755
U147	1820-0755		IC	28480	1820-0755
U152	1816-0238	1	IC:ROM	28480	1816-0238
U153	1820-0756		IC:TTL 8-BIT DRIVER INVERTING	28480	1820-0756
U156	1820-0760	4	IC:TTL 8-BIT RECEIVER INVERTING	28480	1820-0760
U157	1820-0759		IC:TTL LOW-POWER 8-BIT RECEIVER	28480	1820-0759
U162	1816-0239	1	IC:ROM	28480	1816-0239
U164	1820-0742		IC:TTL DUAL 4-BIT LATCH	07263	U6N930859X
U173	1820-0742		IC:TTL DUAL 4-BIT LATCH	07263	U6N930859X
U174	1820-0755		IC	28480	1820-0755
U175	1820-0761		IC:TTL DIGITAL	28480	1820-0761
U177	1820-0760		IC:TTL 8-BIT RECEIVER INVERTING	28480	1820-0760
U178	1820-0759		IC:TTL LOW-POWER 8-BIT RECEIVER	28480	1820-0759
U181	1820-0742		IC:TTL DUAL 4-BIT LATCH	07263	U6N930859X
U184	1820-0755		IC	28480	1820-0755
U185	1820-0370		IC:TTL HS QUAD 2-INPT NAND GATE	01295	SN74H00N
U187	1820-0755		IC	28480	1820-0755

Table 2-32. Disc File Read/Write PCA, Replaceable Parts (Continued)

Reference Designation	HP Part Number	Qty	Description	Mfr Code	Mfr Part Number
U188	1820-0755		IC	28480	1820-0755
U191	1810-0030		NETWORK:7 RESISTORS 1K OHM 5% 0.15W EA	28480	1810-0030
U193	1810-0030		NETWORK:7 RESISTORS 1K OHM 5% 0.15W EA	28480	1810-0030
U194	1820-0755		IC	28480	1820-0755
U195	1820-0077		IC:TTL DUAL D F/F	01295	SN7474N
U196	1820-0141		IC:TTL QUAD 2-INPT AND GATE	04713	MC3001P
U197	1820-0760		IC:TTL 8-BIT RECEIVER INVERTING	28480	1820-0760
U198	1820-0760		IC:TTL 8-BIT RECEIVER INVERTING	28480	1820-0760
U201	1820-0175	3	IC:TTL HEX INVERTER,OPEN COLL.	01295	SN7405N
U202	1820-0175		IC:TTL HEX INVERTER,OPEN COLL.	01295	SN7405N
U203	1820-0175		IC:TTL HEX INVERTER,OPEN COLL.	01295	SN7405N
U204	1820-0755		IC	28480	1820-0755
U205	1820-0686		IC:TTL SCHOTTKY TRIPLE 3-INPT AND GATE	01295	SN74S11N
U206	1820-0424		IC:TTL HS HEX INVERTER	04713	SN74H04N
U207	1820-0491	1	IC:TTL BCD/DEC. DECODER/DRIVER	01295	SN74145N
U208	1820-0756		IC:TTL 8-BIT DRIVER INVERTING	28480	1820-0756
U211	1820-0742		IC:TTL DUAL 4-BIT LATCH	07263	U6N930859X
U213	1820-0742		IC:TTL DUAL 4-BIT LATCH	07263	U6N930859X
U214	1820-0742		IC:TTL DUAL 4-BIT LATCH	07263	U6N930859X
U215	1820-0844	1	IC:TTL DUAL 3-INPT PULSE SHAPER	04713	MC426P
U216	1820-0371		IC:TTL HS TRIPLE 3-INPT NAND GATE	01295	SN74H10N
U217	1820-0756		IC:TTL 8-BIT DRIVER INVERTING	28480	1820-0756
U218	1820-0706	2	IC:DIGITAL TTL 5-BIT COMPARATOR	04713	U78932459X
U221	1820-0726	2	IC:TTL 8-BIT SHIFT REG. PAR IN/OUT	01295	SN74199
U223	1820-0726		IC:TTL 8-BIT SHIFT REG. PAR IN/OUT	01295	SN74199
U224	1820-0742		IC:TTL DUAL 4-BIT LATCH	07263	U6N930859X
U225	1820-0301	1	IC:TTL QUAD BI-STABLE D-LATCH	01295	SN7475N
U226	1820-0374	1	IC:TTL HS DUAL 4-INPT AND GATE	01295	SN74H21N
U228	1820-0706		IC:DIGITAL TTL 5-BIT COMPARATOR	04713	U78932459X
W15	8159-0005		JUMPER WIRE	28480	8159-0005

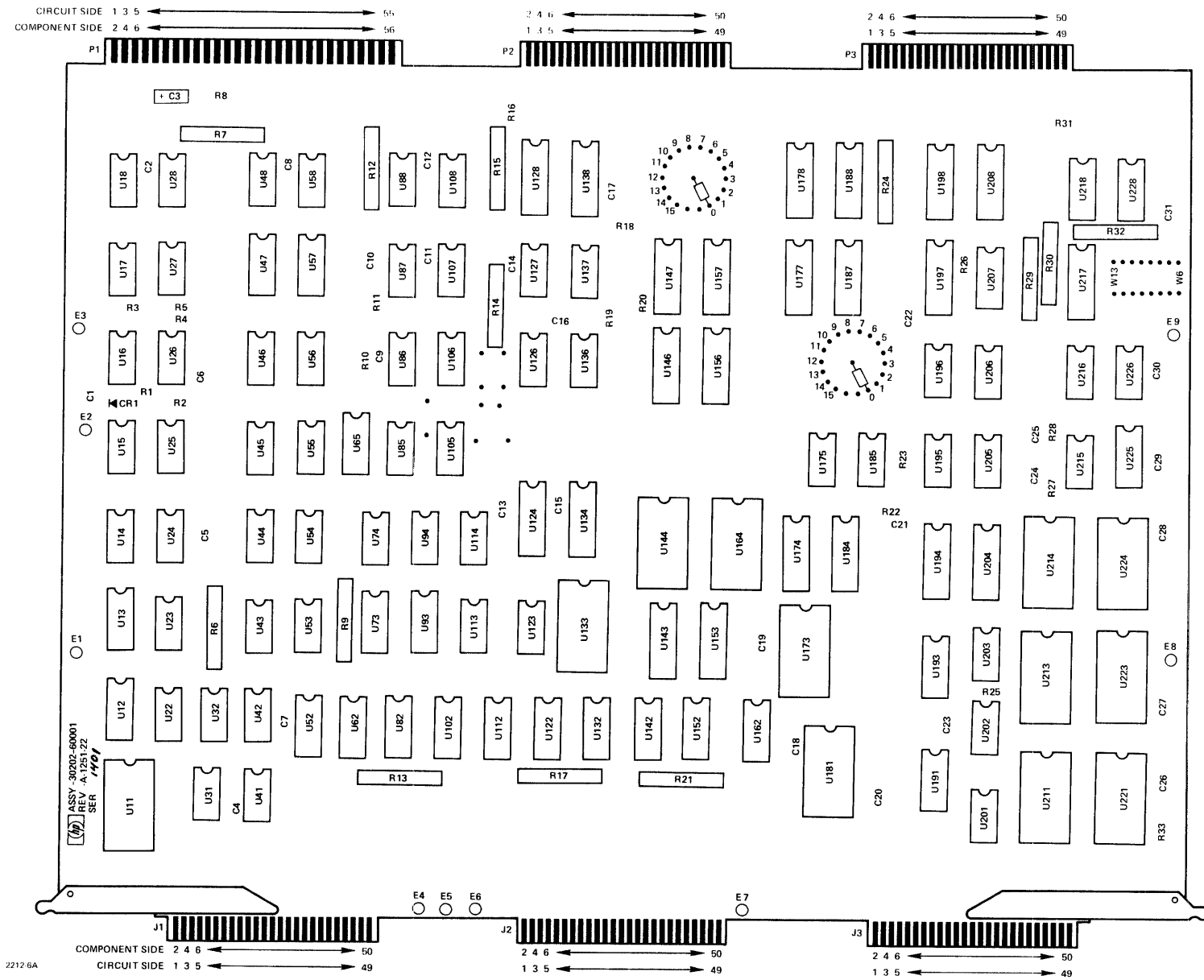

2212-6A

Figure 2-31. Disc File Read/Write PCA, Parts Location Diagram

Table 2-33. Disc File Bus PCA, Replaceable Parts

Reference Designation	HP Part Number	Qty	Description	Mfr Code	Mfr Part Number
C1	30202-60002	46	DISC FILE BUS PCA	28480	30202-60002
C2	0160-2055	2	C:FXD CER 0.01 UF +80-20% 100VDCW	56289	C023F101F103ZS22-CDH
C4	0160-0134	5	C:FXD MICA 220PF 5% 300VDCW	14655	RDM15F221J3C
C5	0121-0046	3	C:VARI CER 9-35 PF	28480	0121-0046
C6	0130-3303				
C6	0180-0197	9	C:FXD ELECT 2.2 UF 10% 20VDCW	56289	1500225X9020A2-DYS
C7	0180-0197		C:FXD ELECT 2.2 UF 10% 20VDCW	56289	1500225X9020A2-DYS
C8	0180-0197		C:FXD ELECT 2.2 UF 10% 20VDCW	56289	1500225X9020A2-DYS
C9	0160-2055		C:FXD CER 0.01 UF +80-20% 100VDCW	56289	C023F101F103ZS22-CDH
C10	0160-2055		C:FXD CER 0.01 UF +80-20% 100VDCW	56289	C023F101F103ZS22-CDH
C11	0130-3303				
C12	0130-3303				
C13	0121-0046		C:VARI CER 9-35 PF	28480	0121-0046
C14	0121-0046		C:VARI CER 9-35 PF	28480	0121-0046
C15	0160-2202	2	C:FXD MICA 75 PF 5%	28480	0160-2202
C16	0180-0197		C:FXD ELECT 2.2 UF 10% 20VDCW	56289	1500225X9020A2-DYS
C17	0160-2055		C:FXD CER 0.01 UF +80-20% 100VDCW	56289	C023F101F103ZS22-CDH
C18	0160-2202		C:FXD MICA 75 PF 5%	28480	0160-2202
C19	0160-2055		C:FXD CER 0.01 UF +80-20% 100VDCW	56289	C023F101F103ZS22-CDH
C20	0160-2306	2	C:FXD MICA 27 PF 5%	28480	0160-2306
C21	0160-0938	1	C:FXD MICA 1000 PF 5%	72136	RDM15E102J1C
C22	0160-3045	2	C:FXD MICA 53.8 PF 1% 100VDCW	28480	0160-3045
C23	0121-0046		C:VARI CER 9-35 PF	28480	0121-0046
C24	0160-2055		C:FXD CER 0.01 UF +80-20% 100VDCW	56289	C023F101F103ZS22-CDH
C25	0140-0198	2	C:FXD MICA 200 PF 5%	72136	RDM15F201J3C
C26	0180-0197		C:FXD ELECT 2.2 UF 10% 20VDCW	56289	1500225X9020A2-DYS
C27	0160-2306		C:FXD MICA 27 PF 5%	28480	0160-2306
C28	0160-2055		C:FXD CER 0.01 UF +80-20% 100VDCW	56289	C023F101F103ZS22-CDH
C29	0160-3045		C:FXD MICA 53.8 PF 1% 100VDCW	28480	0160-3045
C30	0160-2055		C:FXD CER 0.01 UF +80-20% 100VDCW	56289	C023F101F103ZS22-CDH
C31	0121-0046		C:VARI CER 9-35 PF	28480	0121-0046
C32	0150-0121	7	C:FXD CER 0.1 UF +80-20% 50VDCW	56289	5C50BIS-CML
C33	0140-0198		C:FXD MICA 200 PF 5%	72136	RDM15F201J3C
C34	0160-2453	1	C:FXD HY 0.22 UF 10% 80VDCW	56289	192P2249R8-PTS
C35	0160-2207	1	C:FXD MICA 300 PF 5%	28480	0160-2207
C36	0160-2201	1	C:FXD MICA 51 PF 5%	72136	RDM15E510J1C
C37	0160-0134		C:FXD MICA 220PF 5% 300VDCW	14655	RDM15F221J3C
C38	0160-2197	1	C:FXD MICA 10 PF 5%	72136	RDM15C100J3C
C39	0180-0197		C:FXD ELECT 2.2 UF 10% 20VDCW	56289	1500225X9020A2-DYS
C41	0180-0197		C:FXD ELECT 2.2 UF 10% 20VDCW	56289	1500225X9020A2-DYS
C42	0160-2055		C:FXD CER 0.01 UF +80-20% 100VDCW	56289	C023F101F103ZS22-CDH
C43	0160-2055		C:FXD CER 0.01 UF +80-20% 100VDCW	56289	C023F101F103ZS22-CDH
C44	0160-2055		C:FXD CER 0.01 UF +80-20% 100VDCW	56289	C023F101F103ZS22-CDH
C45	0160-2055		C:FXD CER 0.01 UF +80-20% 100VDCW	56289	C023F101F103ZS22-CDH
C46	0160-2055		C:FXD CER 0.01 UF +80-20% 100VDCW	56289	C023F101F103ZS22-CDH
C47	0160-2055		C:FXD CER 0.01 UF +80-20% 100VDCW	56289	C023F101F103ZS22-CDH
C48	0160-2055		C:FXD CER 0.01 UF +80-20% 100VDCW	56289	C023F101F103ZS22-CDH
C49	0160-2055		C:FXD CER 0.01 UF +80-20% 100VDCW	56289	C023F101F103ZS22-CDH
C50	0180-0197		C:FXD ELECT 2.2 UF 10% 20VDCW	56289	1500225X9020A2-DYS
C51	0160-2055		C:FXD CER 0.01 UF +80-20% 100VDCW	56289	C023F101F103ZS22-CDH
C52	0160-2055		C:FXD CER 0.01 UF +80-20% 100VDCW	56289	C023F101F103ZS22-CDH
C53	0140-0205	1	C:FXD MICA 62 PF 5% 300VDCW	00853	RDM15E620J3C
C54	0160-2055		C:FXD CER 0.01 UF +80-20% 100VDCW	56289	C023F101F103ZS22-CDH
C55	0150-0121		C:FXD CER 0.1 UF +80-20% 50VDCW	56289	5C50BIS-CML
C56	0160-2055		C:FXD CER 0.01 UF +80-20% 100VDCW	56289	C023F101F103ZS22-CDH
C57	0160-2055		C:FXD CER 0.01 UF +80-20% 100VDCW	56289	C023F101F103ZS22-CDH
C58	0160-2055		C:FXD CER 0.01 UF +80-20% 100VDCW	56289	C023F101F103ZS22-CDH
C59	0160-2055		C:FXD CER 0.01 UF +80-20% 100VDCW	56289	C023F101F103ZS22-CDH
C60	0160-2055		C:FXD CER 0.01 UF +80-20% 100VDCW	56289	C023F101F103ZS22-CDH
C61	0160-2055		C:FXD CER 0.01 UF +80-20% 100VDCW	56289	C023F101F103ZS22-CDH
C62	0180-0197		C:FXD ELECT 2.2 UF 10% 20VDCW	56289	1500225X9020A2-DYS
C63	0160-2055		C:FXD CER 0.01 UF +80-20% 100VDCW	56289	C023F101F103ZS22-CDH
C64	0160-2055		C:FXD CER 0.01 UF +80-20% 100VDCW	56289	C023F101F103ZS22-CDH
C65	0160-2055		C:FXD CER 0.01 UF +80-20% 100VDCW	56289	C023F101F103ZS22-CDH
C66	0160-2055		C:FXD CER 0.01 UF +80-20% 100VDCW	56289	C023F101F103ZS22-CDH
C67	0160-2055		C:FXD CER 0.01 UF +80-20% 100VDCW	56289	C023F101F103ZS22-CDH
C68	0150-0121		C:FXD CER 0.1 UF +80-20% 50VDCW	56289	5C50BIS-CML
C69	0160-2055		C:FXD CER 0.01 UF +80-20% 100VDCW	56289	C023F101F103ZS22-CDH
C70	0160-2055		C:FXD CER 0.01 UF +80-20% 100VDCW	56289	C023F101F103ZS22-CDH
C71	0160-2055		C:FXD CER 0.01 UF +80-20% 100VDCW	56289	C023F101F103ZS22-CDH
C72	0140-0196	7	C:FXD MICA 150 PF 5%	72136	RDM15F151J3C
C73	0160-2055		C:FXD CER 0.01 UF +80-20% 100VDCW	56289	C023F101F103ZS22-CDH
C74	0160-2055		C:FXD CER 0.01 UF +80-20% 100VDCW	56289	C023F101F103ZS22-CDH
C75	0160-2055		C:FXD CER 0.01 UF +80-20% 100VDCW	56289	C023F101F103ZS22-CDH
C76	0160-2055		C:FXD CER 0.01 UF +80-20% 100VDCW	56289	C023F101F103ZS22-CDH

Table 2-33. Disc File Bus PCA, Replaceable Parts (Continued)

Reference Designation	HP Part Number	Qty	Description	Mfr Code	Mfr Part Number
C77	0150-0121		C:FxD CER 0.1 UF +80-20% 50VDCW	56289	5C50BIS-CML
C78	0150-0121		C:FxD CER 0.1 UF +80-20% 50VDCW	56289	5C50BIS-CML
C79	0140-0196		C:FxD MICA 150 PF 5%	72136	RDM15F151J3C
C80	0140-0196		C:FxD MICA 150 PF 5%	72136	RDM15F151J3C
C81	0140-0196		C:FxD MICA 150 PF 5%	72136	RDM15F151J3C
C82	0160-2055		C:FxD CER 0.01 UF +80-20% 100VDCW	56289	C023F101F103ZS22-CDH
C83	0160-2055		C:FxD CER 0.01 UF +80-20% 100VDCW	56289	C023F101F103ZS22-CDH
C84	0160-2055		C:FxD CER 0.01 UF +80-20% 100VDCW	56289	C023F101F103ZS22-CDH
C85	0150-0121		C:FxD CER 0.1 UF +80-20% 50VDCW	56289	5C50BIS-CML
C86	0140-0196		C:FxD MICA 150 PF 5%	72136	RDM15F151J3C
C87	0140-0196		C:FxD MICA 150 PF 5%	72136	RDM15F151J3C
C88	0160-2055		C:FxD CER 0.01 UF +80-20% 100VDCW	56289	C023F101F103ZS22-CDH
C89	0160-2055		C:FxD CER 0.01 UF +80-20% 100VDCW	56289	C023F101F103ZS22-CDH
C90	0140-0196		C:FxD MICA 150 PF 5%	72136	RDM15F151J3C
C91	0160-2055		C:FxD CER 0.01 UF +80-20% 100VDCW	56289	C023F101F103ZS22-CDH
C92	0160-2055		C:FxD CER 0.01 UF +80-20% 100VDCW	56289	C023F101F103ZS22-CDH
C93	0160-2055		C:FxD CER 0.01 UF +80-20% 100VDCW	56289	C023F101F103ZS22-CDH
C94	0160-2055		C:FxD CER 0.01 UF +80-20% 100VDCW	56289	C023F101F103ZS22-CDH
C95	0150-0121		C:FxD CER 0.1 UF +80-20% 50VDCW	56289	5C50BIS-CML
CR1	1902-3024	1	DIODE: BREAKDOWN 2.87V 5%	04713	SZ10939-26
CR2	1901-0033	1	DIODE: SILICON 100MA 180WV	07263	FD3369
CR3	1902-3119	2	DIODE: BREAKDOWN 6.49V 2%	04713	SZ10939-129
CR4	1901-0040	2	DIODE: SILICON 50 MA 30 WV	07263	FDG1088
CR5	1902-3049	1	DIODE: SILICON 3.48V 2% 400MW	04713	SZ10939-51
CR6	1902-3119		DIODE: BREAKDOWN 6.49V 2%	04713	SZ10939-129
CR7	1901-0040		DIODE: SILICON 50 MA 30 WV	07263	FDG1088
CR38	1990-0310	1	DIODE: VISIBLE LIGHT EMITTER	28480	1990-0310
Q1	1853-0075	2	TSTR: SI PNP	28480	1853-0075
Q2	1853-0075		TSTR: SI PNP	28480	1853-0075
Q3	1853-0018	3	TSTR: SI PNP (SELECTED FROM 2N4260)	28480	1853-0018
Q4	1853-0018		TSTR: SI PNP (SELECTED FROM 2N4260)	28480	1853-0018
Q5	1853-0018		TSTR: SI PNP (SELECTED FROM 2N4260)	28480	1853-0018
Q6	1854-0094	9	TSTR: SI NPN	80131	2N3646
Q7	1854-0071	1	TSTR: SI NPN (SELECTED FROM 2N3704)	28480	1854-0071
Q8	1854-0094		TSTR: SI NPN	80131	2N3646
Q9	1854-0094		TSTR: SI NPN	80131	2N3646
Q10	1854-0094		TSTR: SI NPN	80131	2N3646
Q11	1854-0094		TSTR: SI NPN	80131	2N3646
Q12	1854-0094		TSTR: SI NPN	80131	2N3646
Q13	1854-0094		TSTR: SI NPN	80131	2N3646
Q14	1854-0094		TSTR: SI NPN	80131	2N3646
Q15	1854-0094		TSTR: SI NPN	80131	2N3646
R1	0757-0416	5	R:FxD MET FLM 511 OHM 1% 1/8W	28480	0757-0416
R2	0757-0280	18	R:FxD MET FLM 1K OHM 1% 1/8W	28480	0757-0280
R3	0698-3441	11	R:FxD MET FLM 215 OHM 1% 1/8W	28480	0698-3441
R4	0757-0280		R:FxD MET FLM 1K OHM 1% 1/8W	28480	0757-0280
R5	0757-0438	6	R:FxD MET FLM 5.11K OHM 1% 1/8W	28480	0757-0438
R6	0757-0438		R:FxD MET FLM 5.11K OHM 1% 1/8W	28480	0757-0438
R7	0757-0280		R:FxD MET FLM 1K OHM 1% 1/8W	28480	0757-0280
R8	0698-0085	2	R:FxD MET FLM 2.61K OHM 1% 1/8W	28480	0698-0085
R9	0698-0085		R:FxD MET FLM 2.61K OHM 1% 1/8W	28480	0698-0085
R10	0757-0438		R:FxD MET FLM 5.11K OHM 1% 1/8W	28480	0757-0438
R11	0757-0438		R:FxD MET FLM 5.11K OHM 1% 1/8W	28480	0757-0438
R12	0698-3395	2	R:FxD MET FLM 34.8 OHM 1% 1/2W	28480	0698-3395
R13	2100-1773	1	R:VAR WW 1K OHM 5% TYPE H 1W	28480	2100-1773
R14	0757-0280		R:FxD MET FLM 1K OHM 1% 1/8W	28480	0757-0280
R15	0757-0280		R:FxD MET FLM 1K OHM 1% 1/8W	28480	0757-0280
R16	0698-3155	5	R:FxD MET FLM 4.64K OHM 1% 1/8W	28480	0698-3155
R17	0698-3155		R:FxD MET FLM 4.64K OHM 1% 1/8W	28480	0698-3155
R18	0698-3153	7	R:FxD MET FLM 3.83K OHM 1% 1/8W	28480	0698-3153
R19	0698-3153		R:FxD MET FLM 3.83K OHM 1% 1/8W	28480	0698-3153
R20	0757-0814	1	R:FxD MET FLM 511 OHM 1% 1/2W	28480	0757-0814
R21	0698-3395		R:FxD MET FLM 34.8 OHM 1% 1/2W	28480	0698-3395
R22	0698-3446	8	R:FxD MET FLM 383 OHM 1% 1/8W	28480	0698-3446
R23	0757-0280		R:FxD MET FLM 1K OHM 1% 1/8W	28480	0757-0280
R24	0698-3438	25	R:FxD MET FLM 147 OHM 1% 1/8W	28480	0698-3438
R25	0698-3442	2	R:FxD MET FLM 237 OHM 1% 1/8W	28480	0698-3442
R26	0698-3156	1	R:FxD MET FLM 14.7K OHM 1% 1/8W	28480	0698-3156
R27	0698-3155		R:FxD MET FLM 4.64K OHM 1% 1/8W	28480	0698-3155
R28	0698-0083	1	R:FxD MET FLM 1.96K OHM 1% 1/8W	28480	0698-0083
R29	0757-0280		R:FxD MET FLM 1K OHM 1% 1/8W	28480	0757-0280
R30	0698-3155		R:FxD MET FLM 4.64K OHM 1% 1/8W	28480	0698-3155
R31	0757-0442	2	R:FxD MET FLM 10.0K OHM 1% 1/8W	28480	0757-0442
R32	0757-0442		R:FxD MET FLM 10.0K OHM 1% 1/8W	28480	0757-0442
R33	0757-0441	2	R:FxD MET FLM 8.25K OHM 1% 1/8W	28480	0757-0441

Table 2-33. Disc File Bus PCA, Replaceable Parts (Continued)

Reference Designation	HP Part Number	Qty	Description	Mfr Code	Mfr Part Number
R34	0757-0441		R:FXD MET FLM 8.25K OHM 1% 1/8W	28480	0757-0441
R35	0698-3153		R:FXD MET FLM 3.83K OHM 1% 1/8W	28480	0698-3153
R36	0698-3442		R:FXD MET FLM 237 OHM 1% 1/8W	28480	0698-3442
R37	0698-3153		R:FXD MET FLM 3.83K OHM 1% 1/8W	28480	0698-3153
R38	0757-0280		R:FXD MET FLM 1K OHM 1% 1/8W	28480	0757-0280
R39	0757-0416		R:FXD MET FLM 511 OHM 1% 1/8W	28480	0757-0416
R40	0757-0416		R:FXD MET FLM 511 OHM 1% 1/8W	28480	0757-0416
R41	0698-3153		R:FXD MET FLM 3.83K OHM 1% 1/8W	28480	0698-3153
R41	0698-3153		R:FXD MET FLM 3.83K OHM 1% 1/8W	28480	0698-3153
R42	0757-0438		R:FXD MET FLM 5.11K OHM 1% 1/8W	28480	0757-0438
R43	0757-0440	1	R:FXD MET FLM 7.50K OHM 1% 1/8W	28480	0757-0440
R44	0698-3438		R:FXD MET FLM 147 OHM 1% 1/8W	28480	0698-3438
R45	0698-3150	3	R:FXD MET FLM 2.37K OHM 1% 1/8W	28480	0698-3150
R46	0757-0416		R:FXD MET FLM 511 OHM 1% 1/8W	28480	0757-0416
R47	0757-0280		R:FXD MET FLM 1K OHM 1% 1/8W	28480	0757-0280
R48	0698-4037	1	R:FXD MET FLM 46.4 OHM 1% 1/8W	28480	0698-4037
R49	0757-0280		R:FXD MET FLM 1K OHM 1% 1/8W	28480	0757-0280
R50	0757-0438		R:FXD MET FLM 5.11K OHM 1% 1/8W	28480	0757-0438
R51	0698-3438		R:FXD MET FLM 147 OHM 1% 1/8W	28480	0698-3438
R52	0757-0280		R:FXD MET FLM 1K OHM 1% 1/8W	28480	0757-0280
R53	0698-3150		R:FXD MET FLM 2.37K OHM 1% 1/8W	28480	0698-3150
R54	0698-3153		R:FXD MET FLM 3.83K OHM 1% 1/8W	28480	0698-3153
R55	0698-3150		R:FXD MET FLM 2.37K OHM 1% 1/8W	28480	0698-3150
R56	0698-3398	2	R:FXD MET FLM 46.4 OHM 1% 1/2W	28480	0698-3398
R57	0698-3398		R:FXD MET FLM 46.4 OHM 1% 1/2W	28480	0698-3398
R58	0757-0416		R:FXD MET FLM 511 OHM 1% 1/8W	28480	0757-0416
R59	0698-3441		R:FXD MET FLM 215 OHM 1% 1/8W	28480	0698-3441
R60	0698-3438		R:FXD MET FLM 147 OHM 1% 1/8W	28480	0698-3438
R61	0698-3441		R:FXD MET FLM 215 OHM 1% 1/8W	28480	0698-3441
R62	0698-3445	8	R:FXD MET FLM 348 OHM 1% 1/8W	28480	0698-3445
R63	0757-0420	8	R:FXD MET FLM 750 OHM 1% 1/8W	28480	0757-0420
R64	0698-3438		R:FXD MET FLM 147 OHM 1% 1/8W	28480	0698-3438
R65	0757-0405	35	R:FXD MET FLM 162 OHM 1% 1/8W	28480	0757-0405
R66	0698-3132	35	R:FXD FLM 261 OHM 1% 1/8W	28480	0698-3132
R67	0698-3438		R:FXD MET FLM 147 OHM 1% 1/8W	28480	0698-3438
R68	0698-3441		R:FXD MET FLM 215 OHM 1% 1/8W	28480	0698-3441
R69	0698-3445		R:FXD MET FLM 348 OHM 1% 1/8W	28480	0698-3445
R70	0757-0420		R:FXD MET FLM 750 OHM 1% 1/8W	28480	0757-0420
R71	0698-3438		R:FXD MET FLM 147 OHM 1% 1/8W	28480	0698-3438
R72	0757-0405		R:FXD MET FLM 162 OHM 1% 1/8W	28480	0757-0405
R73	0698-3132		R:FXD FLM 261 OHM 1% 1/8W	28480	0698-3132
R74	0698-3438		R:FXD MET FLM 147 OHM 1% 1/8W	28480	0698-3438
R75	0698-3441		R:FXD MET FLM 215 OHM 1% 1/8W	28480	0698-3441
R76	0698-3445		R:FXD MET FLM 348 OHM 1% 1/8W	28480	0698-3445
R77	0757-0420		R:FXD MET FLM 750 OHM 1% 1/8W	28480	0757-0420
R78	0698-3438		R:FXD MET FLM 147 OHM 1% 1/8W	28480	0698-3438
R79	0757-0405		R:FXD MET FLM 162 OHM 1% 1/8W	28480	0757-0405
R80	0698-3132		R:FXD FLM 261 OHM 1% 1/8W	28480	0698-3132
R81	0698-3438		R:FXD MET FLM 147 OHM 1% 1/8W	28480	0698-3438
R82	0698-3441		R:FXD MET FLM 215 OHM 1% 1/8W	28480	0698-3441
R83	0698-3445		R:FXD MET FLM 348 OHM 1% 1/8W	28480	0698-3445
R84	0757-0420		R:FXD MET FLM 750 OHM 1% 1/8W	28480	0757-0420
R85	0698-3438		R:FXD MET FLM 147 OHM 1% 1/8W	28480	0698-3438
R86	0757-0405		R:FXD MET FLM 162 OHM 1% 1/8W	28480	0757-0405
R87	0698-3132		R:FXD FLM 261 OHM 1% 1/8W	28480	0698-3132
R88	0698-3438		R:FXD MET FLM 147 OHM 1% 1/8W	28480	0698-3438
R89	0698-3441		R:FXD MET FLM 215 OHM 1% 1/8W	28480	0698-3441
R90	0698-3445		R:FXD MET FLM 348 OHM 1% 1/8W	28480	0698-3445
R91	0757-0420		R:FXD MET FLM 750 OHM 1% 1/8W	28480	0757-0420
R92	0698-3438		R:FXD MET FLM 147 OHM 1% 1/8W	28480	0698-3438
R93	0757-0405		R:FXD MET FLM 162 OHM 1% 1/8W	28480	0757-0405
R94	0698-3132		R:FXD FLM 261 OHM 1% 1/8W	28480	0698-3132
R95	0698-3438		R:FXD MET FLM 147 OHM 1% 1/8W	28480	0698-3438
R96	0698-3441		R:FXD MET FLM 215 OHM 1% 1/8W	28480	0698-3441
R97	0698-3445		R:FXD MET FLM 348 OHM 1% 1/8W	28480	0698-3445
R98	0757-0420		R:FXD MET FLM 750 OHM 1% 1/8W	28480	0757-0420
R99	0698-3438		R:FXD MET FLM 147 OHM 1% 1/8W	28480	0698-3438
R100	0757-0405		R:FXD MET FLM 162 OHM 1% 1/8W	28480	0757-0405
R101	0698-3132		R:FXD FLM 261 OHM 1% 1/8W	28480	0698-3132
R102	0698-3438		R:FXD MET FLM 147 OHM 1% 1/8W	28480	0698-3438
R103	0698-3441		R:FXD MET FLM 215 OHM 1% 1/8W	28480	0698-3441
R104	0698-3445		R:FXD MET FLM 348 OHM 1% 1/8W	28480	0698-3445
R105	0757-0420		R:FXD MET FLM 750 OHM 1% 1/8W	28480	0757-0420
R106	0698-3438		R:FXD MET FLM 147 OHM 1% 1/8W	28480	0698-3438
R107	0757-0405		R:FXD MET FLM 162 OHM 1% 1/8W	28480	0757-0405

Table 2-33. Disc File Bus PCA Replaceable Parts (Continued)

Reference Designation	HP Part Number	Qty	Description	Mfr Code	Mfr Part Number
R108	0698-3132		R:FXD FLM 261 OHM 1% 1/8W	28480	0698-3132
R109	0698-3438		R:FXD MET FLM 147 OHM 1% 1/8W	28480	0698-3438
R110	0698-3441		R:FXD MET FLM 215 OHM 1% 1/8W	28480	0698-3441
R111	0698-3445		R:FXD MET FLM 348 OHM 1% 1/8W	28480	0698-3445
R112	0757-0420		R:FXD MET FLM 750 OHM 1% 1/8W	28480	0757-0420
R113	0698-3438		R:FXD MET FLM 147 OHM 1% 1/8W	28480	0698-3438
R114	0757-0405		R:FXD MET FLM 162 OHM 1% 1/8W	28480	0757-0405
R115	0698-3132		R:FXD FLM 261 OHM 1% 1/8W	28480	0698-3132
R116	0698-3438		R:FXD MET FLM 147 OHM 1% 1/8W	28480	0698-3438
R117	0698-3438		R:FXD MET FLM 147 OHM 1% 1/8W	28480	0698-3438
R118	0698-3441		R:FXD MET FLM 215 OHM 1% 1/8W	28480	0698-3441
R119	0698-3438		R:FXD MET FLM 147 OHM 1% 1/8W	28480	0698-3438
R120	0698-3438		R:FXD MET FLM 147 OHM 1% 1/8W	28480	0698-3438
R121	0698-3438		R:FXD MET FLM 147 OHM 1% 1/8W	28480	0698-3438
R123	0698-3438		R:FXD MET FLM 147 OHM 1% 1/8W	28480	0698-3438
R124	0757-0280		R:FXD MET FLM 1K OHM 1% 1/8W	28480	0757-0280
R125	0757-0280		R:FXD MET FLM 1K OHM 1% 1/8W	28480	0757-0280
R126	0698-3446		R:FXD MET FLM 383 OHM 1% 1/8W	28480	0698-3446
R127	0757-0280		R:FXD MET FLM 1K OHM 1% 1/8W	28480	0757-0280
R128	0698-3155		R:FXD MET FLM 4.64K OHM 1% 1/8W	28480	0698-3155
R129	0698-3446		R:FXD MET FLM 383 OHM 1% 1/8W	28480	0698-3446
R130	1810-0030	3	NETWORK:7 RESISTORS 1K OHM 5% 0.15W EA	28480	1810-0030
R131	181J-0030		NETWORK:7 RESISTORS 1K OHM 5% 0.15W EA	28480	1810-0030
R132	1810-0030		NETWORK:7 RESISTORS 1K OHM 5% 0.15W EA	28480	1810-0030
R133	0698-3446		R:FXD MET FLM 383 OHM 1% 1/8W	28480	0698-3446
R134	0757-0280		R:FXD MET FLM 1K OHM 1% 1/8W	28480	0757-0280
R135	0698-3446		R:FXD MET FLM 383 OHM 1% 1/8W	28480	0698-3446
R136	0757-0280		R:FXD MET FLM 1K OHM 1% 1/8W	28480	0757-0280
R137	0698-3446		R:FXD MET FLM 383 OHM 1% 1/8W	28480	0698-3446
R138	0698-3446		R:FXD MET FLM 383 OHM 1% 1/8W	28480	0698-3446
R139	0698-3446		R:FXD MET FLM 383 OHM 1% 1/8W	28480	0698-3446
R140	0757-0280		R:FXD MET FLM 1K OHM 1% 1/8W	28480	0757-0280
R141	0698-3132		R:FXD FLM 261 OHM 1% 1/8W	28480	0698-3132
R142	0698-3132		R:FXD FLM 261 OHM 1% 1/8W	28480	0698-3132
R143	0698-3132		R:FXD FLM 261 OHM 1% 1/8W	28480	0698-3132
R144	0698-3132		R:FXD FLM 261 OHM 1% 1/8W	28480	0698-3132
R145	0698-3132		R:FXD FLM 261 OHM 1% 1/8W	28480	0698-3132
R146	0698-3132		R:FXD FLM 261 OHM 1% 1/8W	28480	0698-3132
R147	0698-3132		R:FXD FLM 261 OHM 1% 1/8W	28480	0698-3132
R148	0698-3132		R:FXD FLM 261 OHM 1% 1/8W	28480	0698-3132
R149	0698-3132		R:FXD FLM 261 OHM 1% 1/8W	28480	0698-3132
R150	0698-3132		R:FXD FLM 261 OHM 1% 1/8W	28480	0698-3132
R151	0698-3132		R:FXD FLM 261 OHM 1% 1/8W	28480	0698-3132
R152	0698-3132		R:FXD FLM 261 OHM 1% 1/8W	28480	0698-3132
R153	0698-3132		R:FXD FLM 261 OHM 1% 1/8W	28480	0698-3132
R154	0698-3132		R:FXD FLM 261 OHM 1% 1/8W	28480	0698-3132
R155	0698-3132		R:FXD FLM 261 OHM 1% 1/8W	28480	0698-3132
R156	0698-3132		R:FXD FLM 261 OHM 1% 1/8W	28480	0698-3132
R157	0698-3132		R:FXD FLM 261 OHM 1% 1/8W	28480	0698-3132
R158	0698-3132		R:FXD FLM 261 OHM 1% 1/8W	28480	0698-3132
R159	0698-3132		R:FXD FLM 261 OHM 1% 1/8W	28480	0698-3132
R160	0698-3132		R:FXD FLM 261 OHM 1% 1/8W	28480	0698-3132
R161	0698-3132		R:FXD FLM 261 OHM 1% 1/8W	28480	0698-3132
R162	0698-3132		R:FXD FLM 261 OHM 1% 1/8W	28480	0698-3132
R163	0698-3132		R:FXD FLM 261 OHM 1% 1/8W	28480	0698-3132
R164	0698-3132		R:FXD FLM 261 OHM 1% 1/8W	28480	0698-3132
R165	0698-3132		R:FXD FLM 261 OHM 1% 1/8W	28480	0698-3132
R166	0698-3132		R:FXD FLM 261 OHM 1% 1/8W	28480	0698-3132
R167	0698-3132		R:FXD FLM 261 OHM 1% 1/8W	28480	0698-3132
R168	0757-0405		R:FXD MET FLM 162 OHM 1% 1/8W	28480	0757-0405
R169	0757-0405		R:FXD MET FLM 162 OHM 1% 1/8W	28480	0757-0405
R170	0757-0405		R:FXD MET FLM 162 OHM 1% 1/8W	28480	0757-0405
R171	0757-0405		R:FXD MET FLM 162 OHM 1% 1/8W	28480	0757-0405
R172	0757-0405		R:FXD MET FLM 162 OHM 1% 1/8W	28480	0757-0405
R173	0757-0405		R:FXD MET FLM 162 OHM 1% 1/8W	28480	0757-0405
R174	0757-0405		R:FXD MET FLM 162 OHM 1% 1/8W	28480	0757-0405
R175	0757-0405		R:FXD MET FLM 162 OHM 1% 1/8W	28480	0757-0405
R176	0757-0405		R:FXD MET FLM 162 OHM 1% 1/8W	28480	0757-0405
R177	0757-0405		R:FXD MET FLM 162 OHM 1% 1/8W	28480	0757-0405
R178	0757-0405		R:FXD MET FLM 162 OHM 1% 1/8W	28480	0757-0405
R179	0757-0405		R:FXD MET FLM 162 OHM 1% 1/8W	28480	0757-0405
R180	0757-0405		R:FXD MET FLM 162 OHM 1% 1/8W	28480	0757-0405
R181	0757-0405		R:FXD MET FLM 162 OHM 1% 1/8W	28480	0757-0405
R182	0757-0405		R:FXD MET FLM 162 OHM 1% 1/8W	28480	0757-0405
R183	0757-0405		R:FXD MET FLM 162 OHM 1% 1/8W	28480	0757-0405

Table 2-33. Disc File Bus PCA. Replaceable Parts (Continued)

Reference Designation	HP Part Number	Qty	Description	Mfr Code	Mfr Part Number
R184	0757-0405		R:FXD MET FLM 162 OHM 1% 1/8W	28480	0757-0405
R185	0757-0405		R:FXD MET FLM 162 OHM 1% 1/8W	28480	0757-0405
R186	0757-0405		R:FXD MET FLM 162 OHM 1% 1/8W	28480	0757-0405
R187	0757-0405		R:FXD MET FLM 162 OHM 1% 1/8W	28480	0757-0405
R188	0757-0405		R:FXD MET FLM 162 OHM 1% 1/8W	28480	0757-0405
R189	0757-0405		R:FXD MET FLM 162 OHM 1% 1/8W	28480	0757-0405
R190	0757-0405		R:FXD MET FLM 162 OHM 1% 1/8W	28480	0757-0405
R191	0757-0405		R:FXD MET FLM 162 OHM 1% 1/8W	28480	0757-0405
R192	0757-0405		R:FXD MET FLM 162 OHM 1% 1/8W	28480	0757-0405
R193	0757-0405		R:FXD MET FLM 162 OHM 1% 1/8W	28460	0757-0405
R194	0757-0405		R:FXD MET FLM 162 OHM 1% 1/8W	28480	0757-0405
R195	0757-0280		R:FXD MET FLM 1K OHM 1% 1/8W	28480	0757-0280
U11	1820-0424	2	IC:TTL HS HEX INVERTER	04713	SN74H04N
U12	1820-0368	1	IC:TTL 5-BIT SHIFT REGISTER	01295	SN7496N
U13	1820-0077	3	IC:TTL DUAL D F/F	01295	SN7474N
U15	1820-0515	3	IC:TTL DUAL RE-TRIG/RE-SET MONO-MULTI	07263	U7B960259X
U17	1858-0021	8	TSTR ARRAY:5 HI-CURRENT NPN TSTR	02735	CA3083
U18	1858-0021		TSTR ARRAY:5 HI-CURRENT NPN TSTR	02735	CA3083
U21	1820-0231	1	TSTR ARRAY:5 HI-CURRENT NPN TSTR	07263	U6B931659X
U22	1820-0613	6	IC:HS HEX INVERTER W/OPEN COLL.	01295	SN74H05N
U23	1820-0370	4	IC:TTL HS QUAD 2-INPT NAND GATE	01295	SN74H00N
U25	1820-0077		IC:TTL DUAL D F/F	01295	SN7474N
U27	1858-0021		TSTR ARRAY:5 HI-CURRENT NPN TSTR	02735	CA3083
U28	1858-0021		TSTR ARRAY:5 HI-CURRENT NPN TSTR	02735	CA3083
U29	1820-0429	1	IC:LIN VOLTAGE REGULATOR (5V)	28480	1820-0429
U32	1820-0515		IC:TTL DUAL RE-TRIG/RE-SET MONO-MULTI	07263	U7B960259X
U33	1820-0619	1	IC:TTL HS DUAL 4-INPT NAND GATE(OPEN C)	01295	SN74H22N
U35	1820-0515		IC:TTL DUAL RE-TRIG/RE-SET MONO-MULTI	07263	U7B960259X
U37	1858-0021		TSTR ARRAY:5 HI-CURRENT NPN TSTR	02735	CA3083
U38	1858-0001	1	TSTR ARRAY:DUAL DIFF AMPL W/CONST CUR	02735	80381
U45	1820-0239	1	IC:TTL QUAD 2-INPT NOR GATE	28480	1820-0239
U46	1820-0205	1	IC:TTL QUAD 2-INPT OR GATE	28480	1820-0205
U47	1858-0021		TSTR ARRAY:5 HI-CURRENT NPN TSTR	02735	CA3083
U48	1858-0021		TSTR ARRAY:5 HI-CURRENT NPN TSTR	02735	CA3083
U55	1820-0077		IC:TTL DUAL D F/F	01295	SN7474N
U56	1820-0424		IC:TTL HS HEX INVERTER	04713	SN74H04N
U58	1858-0021		TSTR ARRAY:5 HI-CURRENT NPN TSTR	02735	CA3083
U62	1820-0174	7	IC:TTL HEX INVERTER	01295	SN7404N
U65	1820-0616	1	IC:TTL 4-BIT 2-INPT MULTIPLEXER	07263	U78932259X
U67	1820-0742	3	IC:TTL DUAL 4-BIT LATCH	07263	U6N930859X
U68	1820-0902	4	IC:TTL DUAL 2-INPT AND DRIVER	01295	SN75450AN
U69	1820-0902		IC:TTL DUAL 2-INPT AND DRIVER	01295	SN75450AN
U72	1820-0535	11	IC:TTL DUAL PERI.2-INPT AND DRIVER	01295	SN75451P
U73	1820-0370		IC:TTL HS QUAD 2-INPT NAND GATE	01295	SN74H00N
U75	1820-0174		IC:TTL HEX INVERTER	01295	SN7404N
U77	1820-0111	1	IC:TTL 1 OUT OF 10 DECODER	07263	U6B930159X
U78	1820-0902		IC:TTL DUAL 2-INPT AND DRIVER	01295	SN75450AN
U79	1820-0902		IC:TTL DUAL 2-INPT AND DRIVER	01295	SN75450AN
U82	1820-0605	2	IC:TTL HS QUAD 2-INPT NAND GATE	01295	SN74H01N
U92	1820-0535		IC:TTL DUAL PERI.2-INPT AND DRIVER	01295	SN75451P
U93	1820-0141	1	IC:TTL QUAD 2-INPT AND GATE	04713	MC3001P
U98	1820-0742		IC:TTL DUAL 4-BIT LATCH	07263	U6N930859X
U100	1820-0535		IC:TTL DUAL PERI.2-INPT AND DRIVER	01295	SN75451P
U102	1820-0174		IC:TTL HEX INVERTER	01295	SN7404N
U103	1820-0370		IC:TTL HS QUAD 2-INPT NAND GATE	01295	SN74H00N
U106	1820-0511	2	IC:TTL QUAD 2-INPT AND GATE	01295	SN7408N
U108	1820-0174		IC:TTL HEX INVERTER	01295	SN7404N
U109	1820-0535		IC:TTL DUAL PERI.2-INPT AND DRIVER	01295	SN75451P
U110	1820-0535		IC:TTL DUAL PERI.2-INPT AND DRIVER	01295	SN75451P
U112	1820-0174		IC:TTL HEX INVERTER	01295	SN7404N
U113	1820-0370		IC:TTL HS QUAD 2-INPT NAND GATE	01295	SN74H00N
U119	1820-0535		IC:TTL DUAL PERI.2-INPT AND DRIVER	01295	SN75451P
U120	1820-0535		IC:TTL DUAL PERI.2-INPT AND DRIVER	01295	SN75451P
U122	1820-0535		IC:TTL DUAL PERI.2-INPT AND DRIVER	01295	SN75451P
U123	1820-0657	3	IC:DIGITAL TTL 8-INPT PRIORITY ENCODER	07263	U7B931859X
U124	1820-0657		IC:DIGITAL TTL 8-INPT PRIORITY ENCODER	07263	U7B931859X
U126	1820-0328	1	IC:TTL QUAD 2-INPT NOR GATE	04713	SN7402N
U128	1820-0742		IC:TTL DUAL 4-BIT LATCH	07263	U6N930859X
U129	1820-0535		IC:TTL DUAL PERI.2-INPT AND DRIVER	01295	SN75451P
U130	1820-0535		IC:TTL DUAL PERI.2-INPT AND DRIVER	01295	SN75451P
U132	1820-0605		IC:TTL HS QUAD 2-INPT NAND GATE	01295	SN74H01N
U142	1820-0535		IC:TTL DUAL PERI.2-INPT AND DRIVER	01295	SN75451P
U143	1820-0282	3	IC:TTL QUAD 2-INPT EXCL. OR GATE	01295	SN7486N
U146	1820-0174		IC:TTL HEX INVERTER	01295	SN7404N
U148	1820-0657		IC:DIGITAL TTL 8-INPT PRIORITY ENCODER	07263	U7B931859X

Table 2-33. Disc File Bus PCA, Replaceable Parts (Continued)

Reference Designation	HP Part Number	Qty	Description	Mfr Code	Mfr Part Number
U152	1820-0174		IC:TTL HEX INVERTER	01295	SN7404N
U153	1820-0374	2	IC:TTL HS DUAL 4-INPT AND GATE	01295	SN74H21N
U154	1820-0372	1	IC:TTL TRIPLE 3-INPT AND GATE	28480	1820-0372
U155	1820-0374		IC:TTL HS DUAL 4-INPT AND GATE	01295	SN74H21N
U156	1820-0282		IC:TTL QUAD 2-INPT EXCL. OR GATE	01295	SN7486N
U158	1820-0755	5	IC	28480	1820-0755
U163	1820-0726	4	IC:TTL 8-BIT SHIFT REG. PAR IN/OUT	01295	SN74199
U164	1820-0726		IC:TTL 8-BIT SHIFT REG. PAR IN/OUT	01295	SN74199
U166	1820-0726		IC:TTL 8-BIT SHIFT REG. PAR IN/OUT	01295	SN74199
U168	1820-0755		IC	28480	1820-0755
U173	1820-0613		IC:MS HEX INVERTER W/OPEN COLL.	01295	SN74H05N
U174	1820-0613		IC:MS HEX INVERTER W/OPEN COLL.	01295	SN74H05N
U175	1820-0613		IC:MS HEX INVERTER W/OPEN COLL.	01295	SN74H05N
U176	1820-0613		IC:MS HEX INVERTER W/OPEN COLL.	01295	SN74H05N
U178	1820-0755		IC	28480	1820-0755
U184	1820-0282		IC:TTL QUAD 2-INPT EXCL. OR GATE	01295	SN7486N
U185	1820-0715	2	IC:TTL DIGITAL HI-SPEED J-K F/F	01295	SN74H106N
U186	1820-0715		IC:TTL DIGITAL HI-SPEED J-K F/F	01295	SN74H106N
U188	1820-0755		IC	28480	1820-0755
U193	1820-0726		IC:TTL 8-BIT SHIFT REG. PAR IN/OUT	01295	SN74199
U194	1820-0613		IC:MS HEX INVERTER W/OPEN COLL.	01295	SN74H05N
U195	1820-0511		IC:TTL QUAD 2-INPT AND GATE	01295	SN7408N
U196	1820-0705	1	IC:TTL SYNC PRESET DECADE COUNTER	07263	U7B931059X
U198	1820-0755		IC	28480	1820-0755

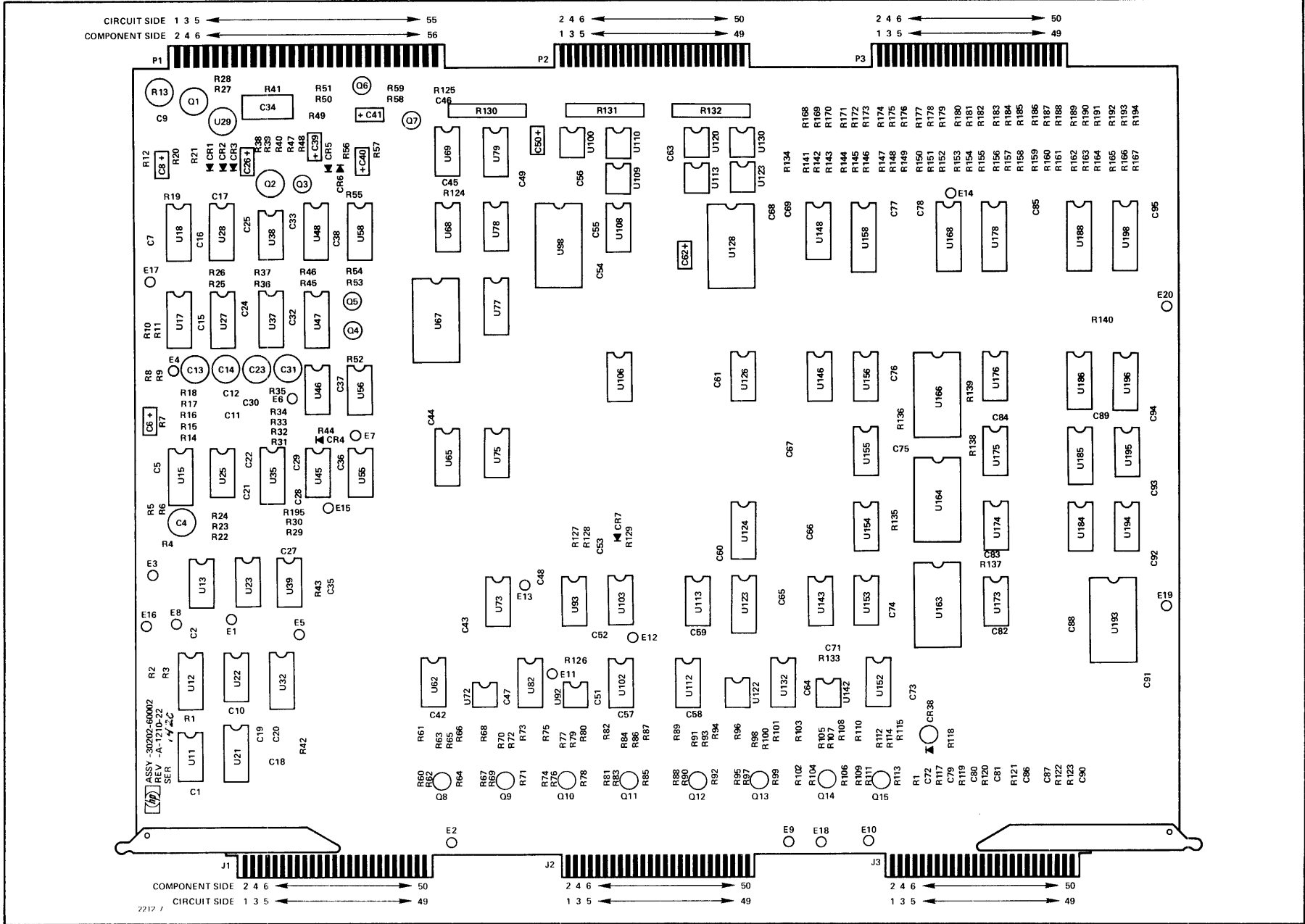

Figure 2-32. Disc File Bus PCA, Parts Location Diagram

Table 2-34. Disc Controller Processor PCA, Replaceable Parts

Reference Designation	HP Part Number	Qty	Description	Mfr Code	Mfr Part Number
C1	30202-60003 0160-2101	1	DISC CONTROLLER PROCESSOR PCA C:FXD MICA 27PF 2% 300VDCW	28480 72136	30202-60003 RDM15E27063C
C2			THRU		
C8	0160-2055		C:FXD CER 0.01 UF +80-20% 100VDCW	56289	C023F101F103ZS22-CDH
C6	0160-2055		C:FXD CER 0.01 UF +80-20% 100VDCW	56289	C023F101F103ZS22-CDH
C9	0180-0197	2	C:FXD ELECT 2-2 UF 10% 20VDCW	56289	150D225X9020A2-DYS
C10	0180-0197		C:FXD ELECT 2-2 UF 10% 20VDCW	56289	150D225X9020A2-DYS
C11	0160-2140	2	C:FXD CER 470 PF +80-20% 1000VDCW	91418	TYPE B
C12	0160-2140		C:FXD CER 470 PF +80-20% 1000VDCW	91418	TYPE B
C13	0160-2055		C:FXD CER 3.01 UF +80-20% 100VDCW	56289	C023F101F103ZS22-CDH
C14	0160-2055		C:FXD CER 0.01 UF +80-20% 100VDCW	56289	C023F101F103ZS22-CDH
C15	0160-2055		C:FXD CER 0.01 UF +80-20% 100VDCW	56289	C023F101F103ZS22-CDH
C16	0160-2055		C:FXD CER 0.01 UF +80-20% 100VDCW	56289	C023F101F103ZS22-CDH
C17			THRU		
C79	0160-2055		C:FXD CER 0.01 UF +80-20% 100VDCW	56289	C023F101F103ZS22-CDH
C80			THRU		
C91	0160-2055		C:FXD CER 0.01 UF +80-20% 100VDCW	56289	C023F101F103ZS22-CDH
CR1	1901-0040	1	DIODE:SILICON 50 MA 30 MV	07263	FDG1088
Q1	1850-0158	1	TSTR:GE PNP	80131	2N2635
R1	0698-3444	1	R:FXD MET FLM 316 OHM 1% 1/8W	28480	0698-3444
R2	1810-0030	5	NETWORK:7 RESISTORS 1K OHM 5% 0.15W EA	28480	1810-0030
R3	0698-3441	1	R:FXD MET FLM 215 OHM 1% 1/8W	28480	0698-3441
R4	0757-0280	11	R:FXD MET FLM 1K OHM 1% 1/8W	28480	0757-0280
R5	0698-4037	1	R:FXD MET FLM 46.4 OHM 1% 1/8W	28480	0698-4037
R6	0757-0280		R:FXD MET FLM 1K OHM 1% 1/8W	28480	0757-0280
R7	0757-0280		R:FXD MET FLM 1K OHM 1% 1/8W	28480	0757-0280
R8	0757-0280		R:FXD MET FLM 1K OHM 1% 1/8W	28480	0757-0280
R9	0757-0280		R:FXD MET FLM 1K OHM 1% 1/8W	28480	0757-0280
R10	0757-0280		R:FXD MET FLM 1K OHM 1% 1/8W	28480	0757-0280
R11	1810-0030		NETWORK:7 RESISTORS 1K OHM 5% 0.15W EA	28480	1810-0030
R12	1810-0030		NETWORK:7 RESISTORS 1K OHM 5% 0.15W EA	28480	1810-0030
R13	0757-0280		R:FXD MET FLM 1K OHM 1% 1/8W	28480	0757-0280
R14	0757-0280		R:FXD MET FLM 1K OHM 1% 1/8W	28480	0757-0280
R15	0757-0280		R:FXD MET FLM 1K OHM 1% 1/8W	28480	0757-0280
R16	1810-0030		NETWORK:7 RESISTORS 1K OHM 5% 0.15W EA	28480	1810-0030
R17	0757-0280		R:FXD MET FLM 1K OHM 1% 1/8W	28480	0757-0280
R18	1810-0030		NETWORK:7 RESISTORS 1K OHM 5% 0.15W EA	28480	1810-0030
R19	0757-0280		R:FXD MET FLM 1K OHM 1% 1/8W	28480	0757-0280
R20	0757-0401	1	R:FXD MET FLM 100 OHM 1% 1/8W	28480	0757-0401
U11	1820-0377	2	IC:TTL HS DUAL 2-WIDE 2-INPT	01295	SN74H50N
U14	1820-0788	7	IC:TTL HEX D-TYPE FLIP/FLOP WITH CLEAR	01295	SN35431
R21	0757-0280		R:FXD MET FLM 1K OHM 1% 1/8W	28480	0757-0280
U15	1820-0424	3	IC:TTL HS HEX INVERTER	04713	SN74H04N
U16	1820-0538	1	IC:TTL QUAD 2-INPT NAND BUFFER	01295	SN7437N
U17	1820-0512	3	IC:TTL HS DUAL D F/F(35 MHZ MIN.)	01295	SN74H74N
U18	1820-0205	6	IC:TTL QUAD 2-INPT OR GATE	28480	1820-0205
U19	1820-0239	1	IC:TTL QUAD 2-INPT NOR GATE	28480	1820-0239
U21	1820-0142	1	INTEGRATED CIRCUIT:4INPUT,2-OR/NOR	04713	MC1004P
U24	1820-0371	5	IC:TTL HS TRIPLE 3-INPT NAND GATE	01295	SN74H10N
U25	1820-0370	1	IC:TTL HS QUAD 2-INPT NAND GATE	01295	SN74H00N
U26	1820-0376	3	IC:TTL HS DUAL 4-INPT NAND BUFFER	01295	SN74H40N
U27	1820-0424		IC:TTL HS HEX INVERTER	04713	SN74H04N
U28	1820-0376		IC:TTL HS DUAL 4-INPT NAND BUFFER	01295	SN74H40N
U29	1820-0535	1	IC:TTL DUAL PERI.2-INPT AND DRIVER	01295	SN75451P
U31	1820-0379	12	IC:TTL HS 4W 2-2-2-3 INPT AND/OR GATE	01295	SN74H52N
U32	1820-0379		IC:TTL HS 4W 2-2-2-3 INPT AND/OR GATE	01295	SN74H52N
U33	1820-0379		IC:TTL HS 4W 2-2-2-3 INPT AND/OR GATE	01295	SN74H52N
U34	1820-0140	4	IC:TTL DUAL 4-INPT AND BUFFER	04713	MC3026P
U34	1820-0512		IC:TTL HS DUAL D F/F(35 MHZ MIN.)	01295	SN74H74N
U35	1820-0384	1	IC:TTL HS TRIPLE 3-INPT EXPANDER	01295	SN74H61N
U36	1820-0371		IC:TTL HS TRIPLE 3-INPT NAND GATE	01295	SN74H10N
U37	1820-0141	1	IC:TTL QUAD 2-INPT AND GATE	04713	MC3001P
U38	1820-0140		IC:TTL DUAL 4-INPT AND BUFFER	04713	MC3026P
U41	1820-0379		IC:TTL HS 4W 2-2-2-3 INPT AND/OR GATE	01295	SN74H52N
U42	1820-0379		IC:TTL HS 4W 2-2-2-3 INPT AND/OR GATE	01295	SN74H52N
U43	1820-0379		IC:TTL HS 4W 2-2-2-3 INPT AND/OR GATE	01295	SN74H52N
U44	1820-0140		IC:TTL DUAL 4-INPT AND BUFFER	04713	MC3026P
U45	1820-0495	2	IC:TTL 1 OF 16 DECODER	01295	SN74154N
U47	1820-0495		IC:TTL 1 OF 16 DECODER	01295	SN74154N
U48	1820-0372	3	IC:TTL TRIPLE 3-INPT AND GATE	28480	1820-0372
U49	1820-0377		IC:TTL HS DUAL 2-WIDE 2-INPT	01295	SN74H50N
U59	1820-0371		IC:TTL HS TRIPLE 3-INPT NAND GATE	01295	SN74H10N
U61	1820-0379		IC:TTL HS 4W 2-2-2-3 INPT AND/OR GATE	01295	SN74H52N
U62	1820-0379		IC:TTL HS 4W 2-2-2-3 INPT AND/OR GATE	01295	SN74H52N
U63	1820-0379		IC:TTL HS 4W 2-2-2-3 INPT AND/OR GATE	01295	SN74H52N
U64	1820-0424		IC:TTL HS HEX INVERTER	04713	SN74H04N
U65	1820-0371		IC:TTL HS TRIPLE 3-INPT NAND GATE	01295	SN74H10N

Table 2-34. Disc Controller Processor PCA, Replaceable Parts (Continued)

Reference Designation	HP Part Number	Qty	Description	Mfr Code	Mfr Part Number
U66	1820-0372	1	IC:TTL TRIPLE 3-INPT AND GATE	28480	1820-0372
U67	1820-0375		IC:TTL HS 8-INPT NAND GATE	01295	SN74H30N
U68	1820-0205		IC:TTL QUAD 2-INPT OR GATE	28480	1820-0205
U69	1820-0376		IC:TTL HS DUAL 4-INPT NAND BUFFER	01295	SN74H40N
U71	1820-0379		IC:TTL HS 4W 2-2-2-3 INPT AND/OR GATE	01295	SN74H52N
U72	1820-0379	21	IC:TTL HS 4W 2-2-2-3 INPT AND/OR GATE	01295	SN74H52N
U73	1820-0379		IC:TTL HS 4W 2-2-2-3 INPT AND/OR GATE	01295	SN74H52N
U74	1820-0512		IC:TTL HS DUAL D F/(35 MHZ MIN.)	01295	SN74H74N
U75	1820-0788		IC:TTL HEX D-TYPE FLIP/FLOP WITH CLEAR	01295	SN35431
U76	1820-0759		IC:TTL LOW-POWER 8-BIT RECEIVER	28480	1820-0759
U77	1820-0205		1	IC:TTL QUAD 2-INPT OR GATE	28480
U78	1820-0282	IC:TTL QUAD 2-INPT EXCL. OR GATE		01295	SN7486N
U79	1820-0140	IC:TTL DUAL 4-INPT AND BUFFER		04713	MC3026P
U81	1820-0788	IC:TTL HEX D-TYPE FLIP/FLOP WITH CLEAR		01295	SN35431
U82	1820-0759	IC:TTL LOW-POWER 8-BIT RECEIVER		28480	1820-0759
U84	1820-0759	3	IC:TTL LOW-POWER 8-BIT RECEIVER	28480	1820-0759
U85	1820-0371		IC:TTL HS TRIPLE 3-INPT NAND GATE	01295	SN74H10N
U86	1820-0843		IC:TTL DUAL DATA DISTRIBUTOR	04713	MC4002P
U87	1820-0843		IC:TTL DUAL DATA DISTRIBUTOR	04713	MC4002P
U88	1820-0205		IC:TTL QUAD 2-INPT OR GATE	28480	1820-0205
U89	1820-0372	1	IC:TTL TRIPLE 3-INPT AND GATE	28480	1820-0372
U91	1820-0788		IC:TTL HEX D-TYPE FLIP/FLOP WITH CLEAR	01295	SN35431
U92	1820-0788		IC:TTL HEX D-TYPE FLIP/FLOP WITH CLEAR	01295	SN35431
U93	1820-0788		IC:TTL HEX D-TYPE FLIP/FLOP WITH CLEAR	01295	SN35431
U94	1820-0759		IC:TTL LOW-POWER 8-BIT RECEIVER	28480	1820-0759
U95	1820-0843	1	IC:TTL DUAL DATA DISTRIBUTOR	04713	MC4002P
U96	1820-0788		IC:TTL HEX D-TYPE FLIP/FLOP WITH CLEAR	01295	SN35431
U97	1820-0205		IC:TTL QUAD 2-INPT OR GATE	28480	1820-0205
U98	1820-0759		IC:TTL LOW-POWER 8-BIT RECEIVER	28480	1820-0759
U99	1820-0608		IC:TTL 1 OF DECODER W/ENABLE	04713	MC4006P
U101	1820-0545	7	IC:TTL SYNC 4-BIT UP-DOWN COUNTER	01295	SN74191N
U103	1820-0742	14	IC:TTL DUAL 4-BIT LATCH	07263	U6N930859X
U104	1820-0759	7	IC:TTL LOW-POWER 8-BIT RECEIVER	28480	1820-0759
U105	1820-0755		IC	28480	1820-0755
U107	1820-0742		IC:TTL DUAL 4-BIT LATCH	07263	U6N930859X
U108	1820-0759	1	IC:TTL LOW-POWER 8-BIT RECEIVER	28480	1820-0759
U109	1820-0742		IC:TTL DUAL 4-BIT LATCH	07263	U6N930859X
U111	1820-0545		IC:TTL SYNC 4-BIT UP-DOWN COUNTER	01295	SN74191N
U114	1820-0759		IC:TTL LOW-POWER 8-BIT RECEIVER	28480	1820-0759
U115	1820-0755		IC	28480	1820-0755
U118	1820-0759	4	IC:TTL LOW-POWER 8-BIT RECEIVER	28480	1820-0759
U121	1820-0545		IC:TTL SYNC 4-BIT UP-DOWN COUNTER	01295	SN74191N
U123	1820-0742		IC:TTL DUAL 4-BIT LATCH	07263	U6N930859X
U127	1820-0606		IC:TTL ARITH. LOGIC UNIT/FUNCTION GEN.	01295	SN74181N
U129	1820-0742		IC:TTL DUAL 4-BIT LATCH	07263	U6N930859X
U131	1820-0205	1	IC:TTL QUAD 2-INPT OR GATE	28480	1820-0205
U134	1820-0759		IC:TTL LOW-POWER 8-BIT RECEIVER	28480	1820-0759
U135	1820-0755		IC	28480	1820-0755
U137	1820-0606		IC:TTL ARITH. LOGIC UNIT/FUNCTION GEN.	01295	SN74181N
U138	1820-0759		IC:TTL LOW-POWER 8-BIT RECEIVER	28480	1820-0759
U141	1820-0640	1	IC:TTL DATA SELECTOR/MULTIPLEXER	01295	SN74150N
U143	1820-0742		IC:TTL DUAL 4-BIT LATCH	07263	U6N930859X
U144	1820-0759		IC:TTL LOW-POWER 8-BIT RECEIVER	28480	1820-0759
U145	1820-0755		IC	28480	1820-0755
U147	1820-0611	1	IC:TTL LOOK-AHEAD CARRY GENERATOR	01295	SN74182N
U148	1820-0759	1	IC:TTL LOW-POWER 8-BIT RECEIVER	28480	1820-0759
U149	1820-0742		IC:TTL DUAL 4-BIT LATCH	07263	U6N930859X
U151	1820-0545		IC:TTL SYNC 4-BIT UP-DOWN COUNTER	01295	SN74191N
U153	1820-0742		IC:TTL DUAL 4-BIT LATCH	07263	U6N930859X
U154	1820-0759		IC:TTL LOW-POWER 8-BIT RECEIVER	28480	1820-0759
U155	1820-0755	1	IC	28480	1820-0755
U158	1820-0759		IC:TTL LOW-POWER 8-BIT RECEIVER	28480	1820-0759
U159	1820-0742		IC:TTL DUAL 4-BIT LATCH	07263	U6N930859X
U161	1820-0545		IC:TTL SYNC 4-BIT UP-DOWN COUNTER	01295	SN74191N
U164	1820-0759		IC:TTL LOW-POWER 8-BIT RECEIVER	28480	1820-0759
U165	1820-0755	1	IC	28480	1820-0755
U167	1820-0606		IC:TTL ARITH. LOGIC UNIT/FUNCTION GEN.	01295	SN74181N
U168	1820-0759		IC:TTL LOW-POWER 8-BIT RECEIVER	28480	1820-0759
U171	1820-0374		IC:TTL HS DUAL 4-INPT AND GATE	01295	SN74H21N
U173	1820-0742		IC:TTL DUAL 4-BIT LATCH	07263	U6N930859X
U177	1820-0606	1	IC:TTL ARITH. LOGIC UNIT/FUNCTION GEN.	01295	SN74181N
U179	1820-0742		IC:TTL DUAL 4-BIT LATCH	07263	U6N930859X
U181	1820-0545		IC:TTL SYNC 4-BIT UP-DOWN COUNTER	01295	SN74191N
U184	1820-0759		IC:TTL LOW-POWER 8-BIT RECEIVER	28480	1820-0759
U188	1820-0759		IC:TTL LOW-POWER 8-BIT RECEIVER	28480	1820-0759

Table 2-34. Disc Controller Processor PCA, Replaceable Parts (Continued)

Reference Designation	HP Part Number	Qty	Description	Mfr Code	Mfr Part Number
U191	1820-0545		IC:TTL SYNC 4-BIT UP-DOWN COUNTER	01295	SN74191N
U193	1820-0742		IC:TTL DUAL 4-BIT LATCH	07263	U6N930859X
U194	1820-0759		IC:TTL LOW-POWER 8-BIT RECEIVER	28480	1820-0759
U195	1820-0755		IC	28480	1820-0755
U197	1820-0742		IC:TTL DUAL 4-BIT LATCH	07263	U6N930859X
U198	1820-0759		IC:TTL LOW-POWER 8-BIT RECEIVER	28480	1820-0759
U199	1820-0742		IC:TTL DUAL 4-BIT LATCH	07263	U6N930859X
Y1	0410-0452		CRYSTAL:QUARTZ 10 MH	28480	0410-0452

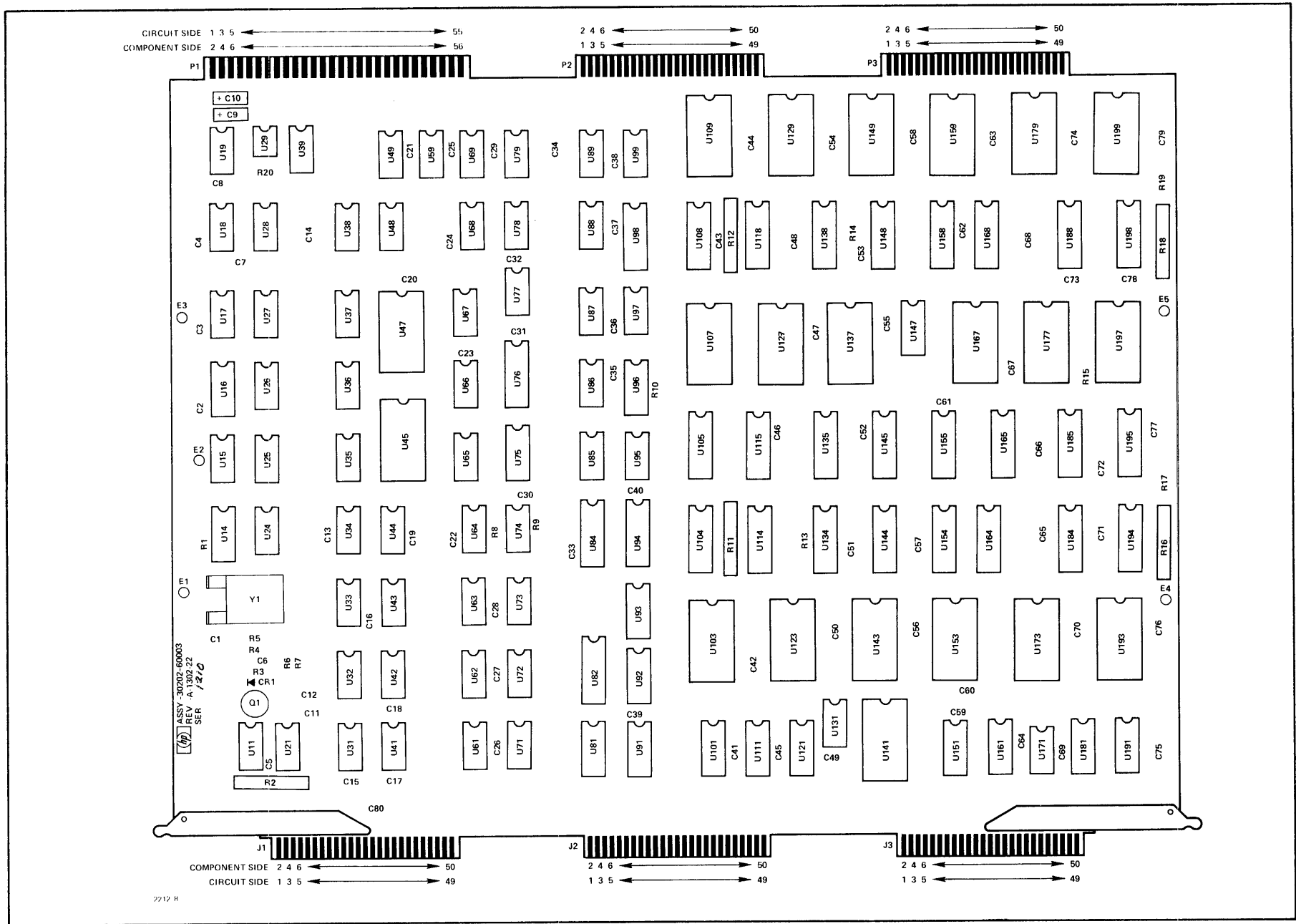

Figure 2-33. Disc Controller Processor PCA, Parts Location Diagram

Table 2-35. Disc Memory Controller PCA, Replaceable Parts

Reference Designation	HP Part Number	Qty	Description	Mfr Code	Mfr Part Number
	30203-60001	1	DISC MEMORY CONTROLLER PCA	28480	30203-60001
C1	0160-2055	58	C:FxD CER 0.01 UF +80-20% 100VDCW	56289	C023F101F103ZS22-CDH
C2	0160-2055		C:FxD CER 0.01 UF +80-20% 100VDCW	56289	C023F101F103ZS22-CDH
C3	0160-2055		C:FxD CER 0.01 UF +80-20% 100VDCW	56289	C023F101F103ZS22-CDH
C4	0160-2055		C:FxD CER 0.01 UF +80-20% 100VDCW	56289	C023F101F103ZS22-CDH
C5	0160-2055		C:FxD CER 0.01 UF +80-20% 100VDCW	56289	C023F101F103ZS22-CDH
C6	0160-2202	2	C:FxD MICA 75 PF 5%	28480	0160-2202
C7	0160-2055		C:FxD CER 0.01 UF +80-20% 100VDCW	56289	C023F101F103ZS22-CDH
C8	0160-2202		C:FxD MICA 75 PF 5%	28480	0160-2202
C9	0160-2055		C:FxD CER 0.01 UF +80-20% 100VDCW	56289	C023F101F103ZS22-CDH
C10	0160-2055		C:FxD CER 0.01 UF +80-20% 100VDCW	56289	C023F101F103ZS22-CDH
C11	0160-2055		C:FxD CER 0.01 UF +80-20% 100VDCW	56289	C023F101F103ZS22-CDH
C12	0160-2055		C:FxD CER 0.01 UF +80-20% 100VDCW	56289	C023F101F103ZS22-CDH
C13	0160-2055		C:FxD CER 0.01 UF +80-20% 100VDCW	56289	C023F101F103ZS22-CDH
C14	0160-2055		C:FxD CER 0.01 UF +80-20% 100VDCW	56289	C023F101F103ZS22-CDH
C15	0160-2055		C:FxD CER 0.01 UF +80-20% 100VDCW	56289	C023F101F103ZS22-CDH
C16	0160-2055		C:FxD CER 0.01 UF +80-20% 100VDCW	56289	C023F101F103ZS22-CDH
C17	0160-2055		C:FxD CER 0.01 UF +80-20% 100VDCW	56289	C023F101F103ZS22-CDH
C18	0160-2055		C:FxD CER 0.01 UF +80-20% 100VDCW	56289	C023F101F103ZS22-CDH
C19	0160-2055		C:FxD CER 0.01 UF +80-20% 100VDCW	56289	C023F101F103ZS22-CDH
C20	0160-2055		C:FxD CER 0.01 UF +80-20% 100VDCW	56289	C023F101F103ZS22-CDH
C21	0160-2055		C:FxD CER 0.01 UF +80-20% 100VDCW	56289	C023F101F103ZS22-CDH
C22	0160-2055		C:FxD CER 0.01 UF +80-20% 100VDCW	56289	C023F101F103ZS22-CDH
C23	0160-2055		C:FxD CER 0.01 UF +80-20% 100VDCW	56289	C023F101F103ZS22-CDH
C24	0160-2055		C:FxD CER 0.01 UF +80-20% 100VDCW	56289	C023F101F103ZS22-CDH
C25	0160-2055		C:FxD CER 0.01 UF +80-20% 100VDCW	56289	C023F101F103ZS22-CDH
C26	0160-2055		C:FxD CER 0.01 UF +80-20% 100VDCW	56289	C023F101F103ZS22-CDH
C27	0160-2055		C:FxD CER 0.01 UF +80-20% 100VDCW	56289	C023F101F103ZS22-CDH
C28	0160-2055		C:FxD CER 0.01 UF +80-20% 100VDCW	56289	C023F101F103ZS22-CDH
C29	0160-2055		C:FxD CER 0.01 UF +80-20% 100VDCW	56289	C023F101F103ZS22-CDH
C30	0160-2055		C:FxD CER 0.01 UF +80-20% 100VDCW	56289	C023F101F103ZS22-CDH
C31	0160-2055		C:FxD CER 0.01 UF +80-20% 100VDCW	56289	C023F101F103ZS22-CDH
C32	0160-2204	3	C:FxD MICA 100PF 5%	72136	RDM15F101J3C
C48	0160-2055		C:FxD CER 0.01 UF +80-20% 100VDCW	56289	C023F101F103ZS22-CDH
C49	0160-2199	1	C:FxD MICA 30 PF 5% 300VDCW	28480	0160-2199
C50	0160-2055		C:FxD CER 0.01 UF +80-20% 100VDCW	56289	C023F101F103ZS22-CDH
C51	0160-2055		C:FxD CER 0.01 UF +80-20% 100VDCW	56289	C023F101F103ZS22-CDH
C52	0160-2055		C:FxD CER 0.01 UF +80-20% 100VDCW	56289	C023F101F103ZS22-CDH
C53	0160-2055		C:FxD CER 0.01 UF +80-20% 100VDCW	56289	C023F101F103ZS22-CDH
C54	0160-2055		C:FxD CER 0.01 UF +80-20% 100VDCW	56289	C023F101F103ZS22-CDH
C55	0160-2204		C:FxD MICA 100PF 5%	72136	RDM15F101J3C
C56	0160-2055		C:FxD CER 0.01 UF +80-20% 100VDCW	56289	C023F101F103ZS22-CDH
C57	0160-2055		C:FxD CER 0.01 UF +80-20% 100VDCW	56289	C023F101F103ZS22-CDH
C58	0160-2055		C:FxD CER 0.01 UF +80-20% 100VDCW	56289	C023F101F103ZS22-CDH
C59	0160-2055		C:FxD CER 0.01 UF +80-20% 100VDCW	56289	C023F101F103ZS22-CDH
C60	0160-2055		C:FxD CER 0.01 UF +80-20% 100VDCW	56289	C023F101F103ZS22-CDH
C61	0160-2204		C:FxD MICA 100PF 5%	72136	RDM15F101J3C
C62	0160-2055		C:FxD CER 0.01 UF +80-20% 100VDCW	56289	C023F101F103ZS22-CDH
C63	0160-2055		C:FxD CER 0.01 UF +80-20% 100VDCW	56289	C023F101F103ZS22-CDH
C64	0160-2055		C:FxD CER 0.01 UF +80-20% 100VDCW	56289	C023F101F103ZS22-CDH
C65	0160-2055		C:FxD CER 0.01 UF +80-20% 100VDCW	56289	C023F101F103ZS22-CDH
C66	0160-2055		C:FxD CER 0.01 UF +80-20% 100VDCW	56289	C023F101F103ZS22-CDH
C67	0160-2055		C:FxD CER 0.01 UF +80-20% 100VDCW	56289	C023F101F103ZS22-CDH
C68	0160-2055		C:FxD CER 0.01 UF +80-20% 100VDCW	56289	C023F101F103ZS22-CDH
C69	0160-2055		C:FxD CER 0.01 UF +80-20% 100VDCW	56289	C023F101F103ZS22-CDH
C70	0160-2055		C:FxD CER 0.01 UF +80-20% 100VDCW	56289	C023F101F103ZS22-CDH
C71	0160-2055		C:FxD CER 0.01 UF +80-20% 100VDCW	56289	C023F101F103ZS22-CDH
C72	0160-2055		C:FxD CER 0.01 UF +80-20% 100VDCW	56289	C023F101F103ZS22-CDH
C73	0160-2055		C:FxD CER 0.01 UF +80-20% 100VDCW	56289	C023F101F103ZS22-CDH
C74	0160-2055		C:FxD CER 0.01 UF +80-20% 100VDCW	56289	C023F101F103ZS22-CDH
C75	0160-2055		C:FxD CER 0.01 UF +80-20% 100VDCW	56289	C023F101F103ZS22-CDH
C76	0160-2055		C:FxD CER 0.01 UF +80-20% 100VDCW	56289	C023F101F103ZS22-CDH
C77	0160-2055		C:FxD CER 0.01 UF +80-20% 100VDCW	56289	C023F101F103ZS22-CDH
R1	0698-3155	5	R:FxD MET FLN 4.64K OHM 1% 1/8W	28480	0698-3155
R2	0757-0279	2	R:FxD MET FLN 3.16K OHM 1% 1/8W	28480	0757-0279
R3	0757-0279		R:FxD MET FLN 3.16K OHM 1% 1/8W	28480	0757-0279
R4	0698-3155		R:FxD MET FLN 4.64K OHM 1% 1/8W	28480	0698-3155
R5	0698-4421	1	R:FxD FLN 249 OHM 1% 1/8W	28480	0698-4421
R6	0757-0280	1	R:FxD MET FLN 1K OHM 1% 1/8W	28480	0757-0280
R7	0698-3155	1	R:FxD MET FLN 4.64K OHM 1% 1/8W	28480	0698-3155
R8	0757-0401	1	R:FxD MET FLN 100 OHM 1% 1/8W	28480	0757-0401
R9	1810-0125	2	RESISTIVE NETWORK:7 X 4.7K OHM 5% 0.15W	28480	1810-0125

Table 2-35. Disc Memory Controller PCA, Replaceable Parts (Continued)

Reference Designation	HP Part Number	Qty	Description	Mfr Code	Mfr Part Number
R10	1810-0125		RESISTIVE NETWORK:7 X 4.7K OHM 5% 0.15W	28480	1810-0125
R11	0757-0442	2	R:FXD MET FLM 10.0K OHM 1% 1/8W	28480	0757-0442
R12	0757-0442		R:FXD MET FLM 10.0K OHM 1% 1/8W	28480	0757-0442
R13	0698-3155		R:FXD MET FLM 4.64K OHM 1% 1/8W	28480	0698-3155
R14	0698-3155		R:FXD MET FLM 4.64K OHM 1% 1/8W	28480	0698-3155
U25	1820-0844	1	IC:TTL DUAL 3-INPT PULSE SHAPER	04713	MC426P
U27	1820-0301	3	IC:TTL QUAD BI-STABLE D-LATCH	01295	SN7475N
U31	1820-0715	7	IC:TTL DIGITAL HI-SPEED J-K F/F	01295	SN74H106N
U32	1820-0205	3	IC:TTL QUAD 2-INPT OR GATE	28480	1820-0205
U33	1820-0068	2	IC:TTL TRIPLE 3-INPT POS NAND GATE	12040	SN7410N
U34	1820-0077	7	IC:TTL DUAL D F/F	01295	SN7474N
U35	1820-0205		IC:TTL QUAD 2-INPT OR GATE	28480	1820-0205
U36	1820-0239	1	IC:TTL QUAD 2-INPT NOR GATE	28480	1820-0239
U37	1820-0782	2	IC:TTL TRIPLE 3-INPT NOR GATE	01295	SN7427N
U38	1820-0077		IC:TTL DUAL D F/F	01295	SN7474N
U41	1820-0077		IC:TTL DUAL D F/F	01295	SN7474N
U42	1820-0054	5	IC:TTL QUAD 2-INPT NAND GATE	01295	SN7400N
U43	1820-0141	6	IC:TTL QUAD 2-INPT AND GATE	04713	MC3001P
U44	1820-0424	2	IC:TTL HS HEX INVERTER	04713	SN74H04N
U45	1820-0370	4	IC:TTL HS QUAD 2-INPT NAND GATE	01295	SN74H00N
U46	1820-0141		IC:TTL QUAD 2-INPT AND GATE	04713	MC3001P
U47	1820-0141		IC:TTL QUAD 2-INPT AND GATE	04713	MC3001P
U48	1820-0686	1	IC:TTL SCHOTTKY TRIPLE 3-INPT AND GATE	01295	SN74S11N
U51	1820-0174	2	IC:TTL HEX INVERTER	01295	SN7404N
U52	1820-0328	4	IC:TTL QUAD 2-INPT NOR GATE	04713	SN7402N
U53	1820-0054		IC:TTL QUAD 2-INPT NAND GATE	01295	SN7400N
U54	1820-0372	3	IC:TTL TRIPLE 3-INPT AND GATE	28480	1820-0372
U55	1820-0328		IC:TTL QUAD 2-INPT NOR GATE	04713	SN7402N
U56	1820-0374	2	IC:TTL HS DUAL 4-INPT AND GATE	01295	SN74H21N
U57	1820-0077		IC:TTL DUAL D F/F	01295	SN7474N
U58	1820-0761	2	IC:TTL DIGITAL	28480	1820-0761
U61	1820-0372		IC:TTL TRIPLE 3-INPT AND GATE	28480	1820-0372
U62	1820-0054		IC:TTL QUAD 2-INPT NAND GATE	01295	SN7400N
U63	1820-0715		IC:TTL DIGITAL HI-SPEED J-K F/F	01295	SN74H106N
U64	1820-0077		IC:TTL DUAL D F/F	01295	SN7474N
U65	1820-0174		IC:TTL HEX INVERTER	01295	SN7404N
U66	1820-0424		IC:TTL HS HEX INVERTER	04713	SN74H04N
U67	1820-0214	1	IC:TTL BCD TO DEC. DECODER	01295	SN7442N
U68	1820-0760	1	IC:TTL 8-BIT RECEIVER INVERTING	28480	1820-0760
U76	1820-0371	2	IC:TTL HS TRIPLE 3-INPT NAND GATE	01295	SN74H10N
U77	1820-0715		IC:TTL DIGITAL HI-SPEED J-K F/F	01295	SN74H106N
U78	1820-0759	2	IC:TTL LOW-POWER 8-BIT RECEIVER	28480	1820-0759
U86	1820-0141		IC:TTL QUAD 2-INPT AND GATE	04713	MC3001P
U87	1820-0715		IC:TTL DIGITAL HI-SPEED J-K F/F	01295	SN74H106N
U88	1820-0759		IC:TTL LOW-POWER 8-BIT RECEIVER	28480	1820-0759
U96	1820-0370		IC:TTL HS QUAD 2-INPT NAND GATE	01295	SN74H00N
U97	1820-0141		IC:TTL QUAD 2-INPT AND GATE	04713	MC3001P
U106	1820-0370		IC:TTL HS QUAD 2-INPT NAND GATE	01295	SN74H00N
U107	1820-0373	1	IC:TTL HS DUAL 4-INPT NAND GATE	01295	SN74H20N
U111	1820-0437	2	IC:TTL QUAD D F/F	04713	MC4015P
U112	1820-0437		IC:TTL QUAD D F/F	04713	MC4015P
U113	1820-0782		IC:TTL TRIPLE 3-INPT NOR GATE	01295	SN7427N
U114	1820-0617	1	IC:TTL QUAD 2-INPT EXCL. NOR GATE	04713	MC3022P
U115	1820-0610	1	IC:TTL DUAL 4-INPT MULTIPLEXER	07263	U68930959X
U116	1820-0301		IC:TTL QUAD BI-STABLE D-LATCH	01295	SN7475N
U117	1820-0077		IC:TTL DUAL D F/F	01295	SN7474N
U118	1820-0515	2	IC:TTL DUAL RE-TRIG/RE-SET MONO-MULTI	07263	U78960259X
U121	1820-0376	1	IC:TTL HS DUAL 4-INPT NAND BUFFER	01295	SN74H40N
U122	1820-0374		IC:TTL HS DUAL 4-INPT AND GATE	01295	SN74H21N
U123	1820-0515		IC:TTL DUAL RE-TRIG/RE-SET MONO-MULTI	07263	U78960259X
U124	1820-0328		IC:TTL QUAD 2-INPT NOR GATE	04713	SN7402N
U125	1820-0371		IC:TTL HS TRIPLE 3-INPT NAND GATE	01295	SN74H10N
U126	1820-0715		IC:TTL DIGITAL HI-SPEED J-K F/F	01295	SN74H106N
U127	1820-0068		IC:TTL TRIPLE 3-INPT POS NAND GATE	12040	SN7410N
U128	1820-0761		IC:TTL DIGITAL	28480	1820-0761
U131	1820-0054		IC:TTL QUAD 2-INPT NAND GATE	01295	SN7400N
U132	1820-0205		IC:TTL QUAD 2-INPT OR GATE	28480	1820-0205
U133	1820-0301		IC:TTL QUAD BI-STABLE D-LATCH	01295	SN7475N
U134	1820-0141		IC:TTL QUAD 2-INPT AND GATE	04713	MC3001P
U135	1820-0372		IC:TTL TRIPLE 3-INPT AND GATE	28480	1820-0372
U136	1820-0715		IC:TTL DIGITAL HI-SPEED J-K F/F	01295	SN74H106N
U137	1820-0370		IC:TTL HS QUAD 2-INPT NAND GATE	01295	SN74H00N
U141	1820-0231	2	IC:TTL 4-BIT SYNC BINARY COUNTER	07263	U68931659X
U142	1820-0231		IC:TTL 4-BIT SYNC BINARY COUNTER	07263	U68931659X
U143	1820-0077		IC:TTL DUAL D F/F	01295	SN7474N

Table 2-35. Disc Memory Controller PCA, Replaceable Parts (Continued)

Reference Designation	HP Part Number	Qty	Description	Mfr Code	Mfr Part Number
U144 U145 U146 W6	1820-0054 1820-0715 1820-0328 8159-0005		IC:TTL QUAD 2-INPT NAND GATE IC:TTL DIGITAL HI-SPEED J-K F/F IC:TTL QUAD 2-INPT NOR GATE JUMPER WIRE	01295 01295 04713 28480	SN7400N SN74H106N SN7402N 8159-0005

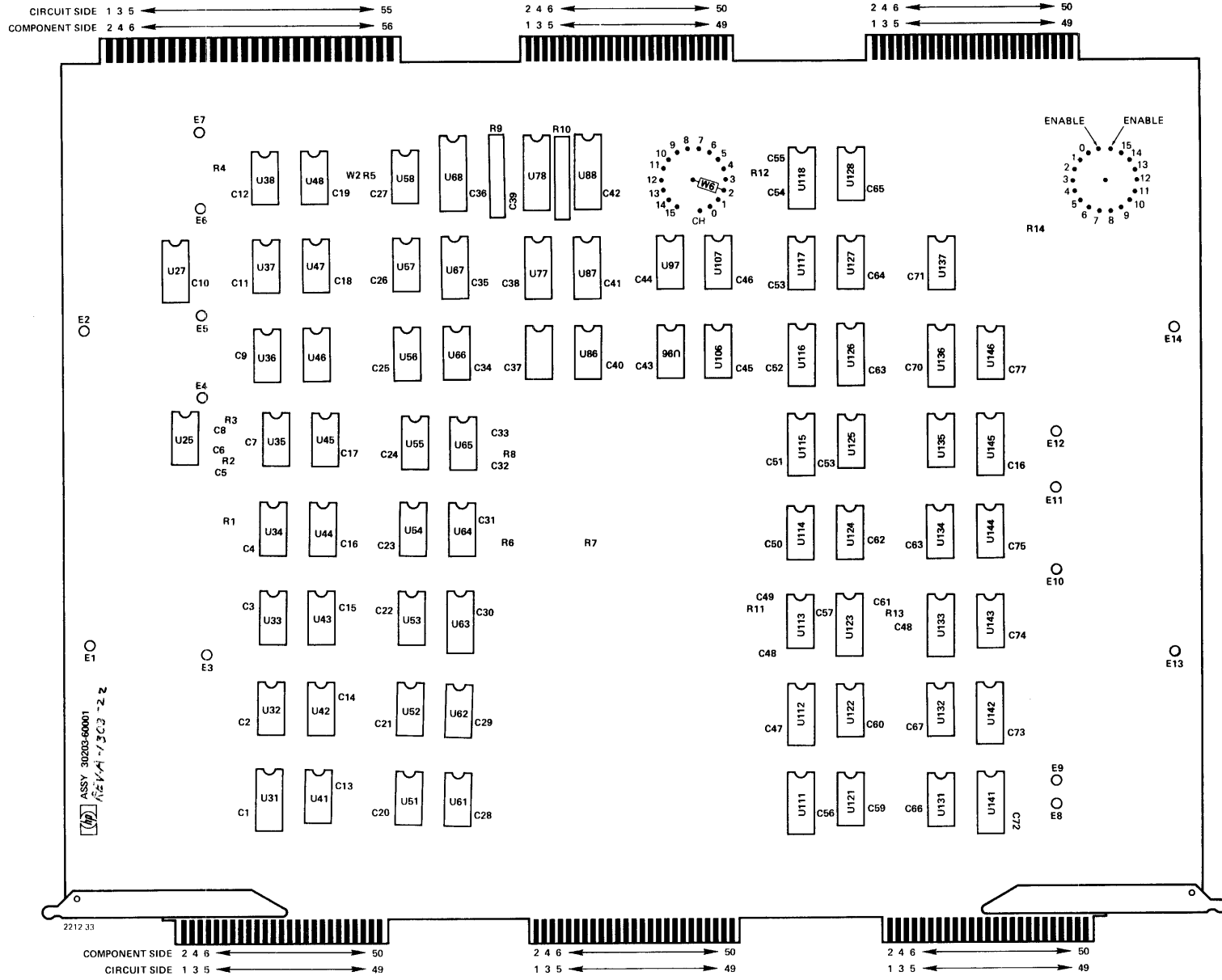

Figure 2-34. Disc Memory Controller PCA, Parts Location Diagram

Table 2-36. Disc Memory Data PCA, Replaceable Parts

Reference Designation	HP Part Number	Qty	Description	Mfr Code	Mfr Part Number
	30203-60002	1	DISC MEMORY DATA PCA	28480	30203-60002
C1	0160-2143	19	C:FXD CER 2000 PF +80-20% 1000VDCW	91418	TYPE B
C2	0160-2143	38	C:FXD CER 2000 PF +80-20% 1000VDCW	91418	TYPE B
C3	0160-2055		C:FXD CER 0.01 UF +80-20% 100VDCW	56289	C023F101F103ZS22-CDH
C4	0160-2055		C:FXD CER 0.01 UF +80-20% 100VDCW	56289	C023F101F103ZS22-CDH
C5	0160-2055		C:FXD CER 0.01 UF +80-20% 100VDCW	56289	C023F101F103ZS22-CDH
C6	0160-2055		C:FXD CER 0.01 UF +80-20% 100VDCW	56289	C023F101F103ZS22-CDH
C7	0160-2143		C:FXD CER 2000 PF +80-20% 1000VDCW	91418	TYPE B
C8	0160-2055	C:FXD CER 0.01 UF +80-20% 100VDCW	56289	C023F101F103ZS22-CDH	
C9	0160-2055	C:FXD CER 0.01 UF +80-20% 100VDCW	56289	C023F101F103ZS22-CDH	
C10	0160-2055	C:FXD CER 0.01 UF +80-20% 100VDCW	56289	C023F101F103ZS22-CDH	
C11	0160-2143	C:FXD CER 2000 PF +80-20% 1000VDCW	91418	TYPE B	
C12	0160-2143	C:FXD CER 2000 PF +80-20% 1000VDCW	91418	TYPE B	
C13	0160-2143	C:FXD CER 2000 PF +80-20% 1000VDCW	91418	TYPE B	
C14	0160-2143	C:FXD CER 2000 PF +80-20% 1000VDCW	91418	TYPE B	
C15	0160-2055	C:FXD CER 0.01 UF +80-20% 100VDCW	56289	C023F101F103ZS22-CDH	
C16	0160-2143	C:FXD CER 2000 PF +80-20% 1000VDCW	91418	TYPE B	
C17	0160-2143	C:FXD CER 2000 PF +80-20% 1000VDCW	91418	TYPE B	
C18	0160-2143	C:FXD CER 2000 PF +80-20% 1000VDCW	91418	TYPE B	
C19	0160-2143	C:FXD CER 2000 PF +80-20% 1000VDCW	91418	TYPE B	
C20	0160-2055	C:FXD CER 0.01 UF +80-20% 100VDCW	56289	C023F101F103ZS22-CDH	
C21	0160-2055	C:FXD CER 0.01 UF +80-20% 100VDCW	56289	C023F101F103ZS22-CDH	
C22	0160-2143	C:FXD CER 2000 PF +80-20% 1000VDCW	91418	TYPE B	
C23	0160-2143	C:FXD CER 2000 PF +80-20% 1000VDCW	91418	TYPE B	
C24	0160-2143	C:FXD CER 2000 PF +80-20% 1000VDCW	91418	TYPE B	
C25	0160-2143	C:FXD CER 2000 PF +80-20% 1000VDCW	91418	TYPE B	
C26	0160-2055	C:FXD CER 0.01 UF +80-20% 100VDCW	56289	C023F101F103ZS22-CDH	
C27	0160-2055	C:FXD CER 0.01 UF +80-20% 100VDCW	56289	C023F101F103ZS22-CDH	
C28	0160-2143	C:FXD CER 2000 PF +80-20% 1000VDCW	91418	TYPE B	
C29	0160-2055	C:FXD CER 0.01 UF +80-20% 100VDCW	56289	C023F101F103ZS22-CDH	
C30	0160-2143	C:FXD CER 2000 PF +80-20% 1000VDCW	91418	TYPE B	
C31	0160-2143	C:FXD CER 2000 PF +80-20% 1000VDCW	91418	TYPE B	
C32	0160-2143	C:FXD CER 2000 PF +80-20% 1000VDCW	91418	TYPE B	
C33	0160-2055	C:FXD CER 0.01 UF +80-20% 100VDCW	56289	C023F101F103ZS22-CDH	
C34	0160-2055	C:FXD CER 0.01 UF +80-20% 100VDCW	56289	C023F101F103ZS22-CDH	
C35	0160-2055	C:FXD CER 0.01 UF +80-20% 100VDCW	56289	C023F101F103ZS22-CDH	
C36	0160-2055	C:FXD CER 0.01 UF +80-20% 100VDCW	56289	C023F101F103ZS22-CDH	
C37	0160-2055	C:FXD CER 0.01 UF +80-20% 100VDCW	56289	C023F101F103ZS22-CDH	
C38	0160-2055	C:FXD CER 0.01 UF +80-20% 100VDCW	56289	C023F101F103ZS22-CDH	
C39	0160-2055	C:FXD CER 0.01 UF +80-20% 100VDCW	56289	C023F101F103ZS22-CDH	
C40	0160-2055	C:FXD CER 0.01 UF +80-20% 100VDCW	56289	C023F101F103ZS22-CDH	
C41	0160-2055	C:FXD CER 0.01 UF +80-20% 100VDCW	56289	C023F101F103ZS22-CDH	
C42	0160-2055	C:FXD CER 0.01 UF +80-20% 100VDCW	56289	C023F101F103ZS22-CDH	
C43	0160-2055	C:FXD CER 0.01 UF +80-20% 100VDCW	56289	C023F101F103ZS22-CDH	
C44	0160-2055	C:FXD CER 0.01 UF +80-20% 100VDCW	56289	C023F101F103ZS22-CDH	
C45	0160-2055	C:FXD CER 0.01 UF +80-20% 100VDCW	56289	C023F101F103ZS22-CDH	
C46	0160-2055	C:FXD CER 0.01 UF +80-20% 100VDCW	56289	C023F101F103ZS22-CDH	
C47	0160-2055	C:FXD CER 0.01 UF +80-20% 100VDCW	56289	C023F101F103ZS22-CDH	
C48	0160-2055	C:FXD CER 0.01 UF +80-20% 100VDCW	56289	C023F101F103ZS22-CDH	
C49	0160-2055	C:FXD CER 0.01 UF +80-20% 100VDCW	56289	C023F101F103ZS22-CDH	
C50	0160-2055	C:FXD CER 0.01 UF +80-20% 100VDCW	56289	C023F101F103ZS22-CDH	
C51	0160-2055	C:FXD CER 0.01 UF +80-20% 100VDCW	56289	C023F101F103ZS22-CDH	
C52	0160-2055	C:FXD CER 0.01 UF +80-20% 100VDCW	56289	C023F101F103ZS22-CDH	
C53	0160-2055	C:FXD CER 0.01 UF +80-20% 100VDCW	56289	C023F101F103ZS22-CDH	
C54	0160-2055	C:FXD CER 0.01 UF +80-20% 100VDCW	56289	C023F101F103ZS22-CDH	
C55	0160-2055	C:FXD CER 0.01 UF +80-20% 100VDCW	56289	C023F101F103ZS22-CDH	
CR1	1902-0624	1	DIODE:ZENER 3.6V 10%	12040	LM103 3.6V
Q1	1854-0477	1	TSTR:SI NPN	80131	2N2222A
R1	0698-3439	1	R:FXD MET FLM 178 OHM 1% 1/8W	28480	0698-3439
R2	0757-0401	1	R:FXD MET FLM 100 OHM 1% 1/8W	28480	0757-0401
R3	0698-3441	1	R:FXD MET FLM 215 OHM 1% 1/8W	28480	0698-3441
R4	0757-0397	1	R:FXD MET FLM 68.1 OHM 1% 1/8W	28480	0757-0397
R5	0757-0180	1	R:FXD MET FLM 31.6 OHM 1% 1/8W	28480	0757-0180
R6	0698-3432	1	R:FXD MET FLM 26.1 OHM 1% 1/8W	28480	0698-3432
R7	1810-0125	5	RESISTIVE NETWORK:7 X 4.7K OHM 5% 0.15W	28480	1810-0125
R8	1810-0125		RESISTIVE NETWORK:7 X 4.7K OHM 5% 0.15W	28480	1810-0125
R9	1810-0125		RESISTIVE NETWORK:7 X 4.7K OHM 5% 0.15W	28480	1810-0125
R10	1810-0125		RESISTIVE NETWORK:7 X 4.7K OHM 5% 0.15W	28480	1810-0125
R11	1810-0125		RESISTIVE NETWORK:7 X 4.7K OHM 5% 0.15W	28480	1810-0125
U11	1820-0424	3	IC:TTL HS HEX INVERTER	04713	SN74HC4N
U13	1820-0071	2	IC:TTL DUAL 4-INPUT NAND BUFFER	01295	SN7440N
U14	1820-0721	10	IC:TTL DUAL DIFFERENT. LINE RECEIVER	12040	DM8820N

Table 2-36. Disc Memory Data PCA. Replaceable Parts (Continued)

Reference Designation	HP Part Number	Qty	Description	Mfr Code	Mfr Part Number
U17	1820-0538	3	IC:TTL QUAD 2-INPT NAND BUFFER	01295	SN7437N
U18	1820-0836	5	IC:TTL DUAL 4-BIT PARITY TREE	04713	MC4010P
U21	1820-0720	1	IC:TTL DUAL DIFFERENTIAL LINE DRIVER	28480	1820-0720
U22	1820-0376	1	IC:TTL HS DUAL 4-INPT NAND BUFFER	01295	SN74H40N
U23	1820-0721		IC:TTL DUAL DIFFERENT. LINE RECEIVER	12040	DM8820N
U24	1820-0424		IC:TTL HS HEX INVERTER	04713	SN74HC4N
U25	1820-0839	1	IC:TTL QUAD D-TYPE F/F	01295	SN74175N
U26	1820-0071		IC:TTL DUAL 4-INPUT NAND BUFFER	01295	SN7440N
U27	1820-0617	3	IC:TTL QUAD 2-INPT EXCL. NOR GATE	04713	MC3022P
U28	1820-0836		IC:TTL DUAL 4-BIT PARITY TREE	04713	MC4010P
U31	1820-0721		IC:TTL DUAL DIFFERENT. LINE RECEIVER	12040	DM8820N
U32	1820-0721		IC:TTL DUAL DIFFERENT. LINE RECEIVER	12040	DM8820N
U33	1820-0721		IC:TTL DUAL DIFFERENT. LINE RECEIVER	12040	DM8820N
U34	1820-0721		IC:TTL DUAL DIFFERENT. LINE RECEIVER	12040	DM8820N
U35	1820-0788	3	IC:TTL HEX D-TYPE FLIP/FLOP WITH CLEAR	01295	SN35431
U36	1820-0538		IC:TTL QUAD 2-INPT NAND BUFFER	01295	SN7437N
U37	1820-0617		IC:TTL QUAD 2-INPT EXCL. NOR GATE	04713	MC3022P
U38	1820-0836		IC:TTL DUAL 4-BIT PARITY TREE	04713	MC4010P
U41	1820-0780	8	IC:TTL TRI-STATE QUAD LINE DRIVER	28480	1820-0780
U42	1820-0780		IC:TTL TRI-STATE QUAD LINE DRIVER	28480	1820-0780
U43	1820-0780		IC:TTL TRI-STATE QUAD LINE DRIVER	28480	1820-0780
U44	1820-0780		IC:TTL TRI-STATE QUAD LINE DRIVER	28480	1820-0780
U45	1820-0788		IC:TTL HEX D-TYPE FLIP/FLOP WITH CLEAR	01295	SN35431
U48	1820-0836		IC:TTL DUAL 4-BIT PARITY TREE	04713	MC4010P
U51	1820-0721		IC:TTL DUAL DIFFERENT. LINE RECEIVER	12040	DM8820N
U52	1820-0721		IC:TTL DUAL DIFFERENT. LINE RECEIVER	12040	DM8820N
U53	1820-0721		IC:TTL DUAL DIFFERENT. LINE RECEIVER	12040	DM8820N
U54	1820-0721		IC:TTL DUAL DIFFERENT. LINE RECEIVER	12040	DM8820N
U55	1820-0610	8	IC:TTL DUAL 4-UNPT MULTIPLEXER	07263	U68930959X
U58	1820-0836		IC:TTL DUAL 4-BIT PARITY TREE	04713	MC4010P
U61	1820-0780		IC:TTL TRI-STATE QUAD LINE DRIVER	28480	1820-0780
U62	1820-0780		IC:TTL TRI-STATE QUAD LINE DRIVER	28480	1820-0780
U63	1820-0780		IC:TTL TRI-STATE QUAD LINE DRIVER	28480	1820-0780
U64	1820-0780		IC:TTL TRI-STATE QUAD LINE DRIVER	28480	1820-0780
U65	1820-0610		IC:TTL DUAL 4-UNPT MULTIPLEXER	07263	U68930959X
U66	1820-0617		IC:TTL QUAD 2-INPT EXCL. NOR GATE	04713	MC3022P
U71	1820-0765	4	IC:TTL 4-BIT BINARY COUNTER	01295	SN74197N
U74	1820-0610		IC:TTL DUAL 4-UNPT MULTIPLEXER	07263	U68930959X
U75	1820-0610		IC:TTL DUAL 4-UNPT MULTIPLEXER	07263	U68930959X
U81	1820-0765		IC:TTL 4-BIT BINARY COUNTER	01295	SN74197N
U82	1820-0610		IC:TTL DUAL 4-UNPT MULTIPLEXER	07263	U68930959X
U83	1820-0765		IC:TTL 4-BIT BINARY COUNTER	01295	SN74197N
U84	1820-0610		IC:TTL DUAL 4-UNPT MULTIPLEXER	07263	U68930959X
U85	1820-0610		IC:TTL DUAL 4-UNPT MULTIPLEXER	07263	U68930959X
U86	1820-0742	4	IC:TTL DUAL 4-BIT LATCH	07263	U6N930859X
U88	1820-0742		IC:TTL DUAL 4-BIT LATCH	07263	U6N930859X
U91	1820-0301	2	IC:TTL QUAD BI-STABLE D-LATCH	01295	SN7475N
U95	1820-0054	1	IC:TTL QUAD 2-INPT NAND GATE	01295	SN7400N
U102	1820-0424		IC:TTL HS HEX INVERTER	04713	SN74HC4N
U103	1820-0610		IC:TTL DUAL 4-UNPT MULTIPLEXER	07263	U68930959X
U106	1820-0742		IC:TTL DUAL 4-BIT LATCH	07263	U6N930859X
U108	1820-0742		IC:TTL DUAL 4-BIT LATCH	07263	U6N930859X
U112	1820-0068	1	IC:TTL TRIPLE 3-INPUT POS NAND GATE	12040	SN7410N
U113	1820-0765		IC:TTL 4-BIT BINARY COUNTER	01295	SN74197N
U117	1820-0437	4	IC:TTL QUAD D F/F	04713	MC4015P
U118	1820-0437		IC:TTL QUAD D F/F	04713	MC4015P
U121	1820-0706	5	IC:DIGITAL TTL 5-BIT COMPARATOR	04713	U7B932459X
U122	1820-0545	3	IC:TTL SYNC 4-BIT UP-DOWN COUNTER	01295	SN74191N
U123	1820-0301		IC:TTL QUAD BI-STABLE D-LATCH	01295	SN7475N
U125	1820-0760	3	IC:TTL 8-BIT RECEIVER INVERTING	28480	1820-0760
U126	1820-0761	1	IC:TTL DIGITAL	28480	1820-0761
U127	1820-0437		IC:TTL QUAD D F/F	04713	MC4015P
U128	1820-0437		IC:TTL QUAD D F/F	04713	MC4015P
U131	1820-0706		IC:DIGITAL TTL 5-BIT COMPARATOR	04713	U7B932459X
U132	1820-0545		IC:TTL SYNC 4-BIT UP-DOWN COUNTER	01295	SN74191N
U133	1820-0250	1	INTEGRATED CIRCUIT:TTL 6 BIT COMP	28480	1820-0250
U135	1820-0756	2	IC:TTL 8-BIT DRIVER INVERTING	28480	1820-0756
U136	1820-0706		IC:DIGITAL TTL 5-BIT COMPARATOR	04713	U7B932459X
U137	1820-0760		IC:TTL 8-BIT RECEIVER INVERTING	28480	1820-0760
U138	1820-0759	2	IC:TTL LOW-POWER 8-BIT RECEIVER	28480	1820-0759
U141	1820-0706		IC:DIGITAL TTL 5-BIT COMPARATOR	04713	U7B932459X
U142	1820-0545		IC:TTL SYNC 4-BIT UP-DOWN COUNTER	01295	SN74191N
U143	1820-0788		IC:TTL HEX D-TYPE FLIP/FLOP WITH CLEAR	01295	SN35431
U145	1820-0756		IC:TTL 8-BIT DRIVER INVERTING	28480	1820-0756
U146	1820-0706		IC:DIGITAL TTL 5-BIT COMPARATOR	04713	U7B932459X

Table 2-36. Disc Memory Data PCA, Replaceable Parts (Continued)

Reference Designation	HP Part Number	Qty	Description	Mfr Code	Mfr Part Number
U147	1820-0755	4	IC	28480	1820-0755
U148	1820-0755		IC	28480	1820-0755
U151	1820-0141	1	IC:TTL QUAD 2-INPT AND GATE	04713	MC3001P
U152	1820-0538		IC:TTL QUAD 2-INPT NAND BUFFER	01295	SN7437N
U153	1820-0506	2	IC:DIGITAL 2-INPT,4-BIT MULTIPLEXER	18324	N8266B
U157	1820-0760		IC:TTL 8-BIT RECEIVER INVERTING	28480	1820-0760
U158	1820-0759		IC:TTL LOW-POWER 8-BIT RECEIVER	28480	1820-0759
U161	1820-0835	2	IC:TTL 2-INPT 4-BIT DIGITAL MULTIPLIER	18324	N8267B
U162	1820-0835		IC:TTL 2-INPT 4-BIT DIGITAL MULTIPLIER	18324	N8267B
U164	1820-0506		IC:DIGITAL 2-INPT,4-BIT MULTIPLEXER	18324	N8266B
U167	1820-0755		IC	28480	1820-0755
U168	1820-0755		IC	28480	1820-0755

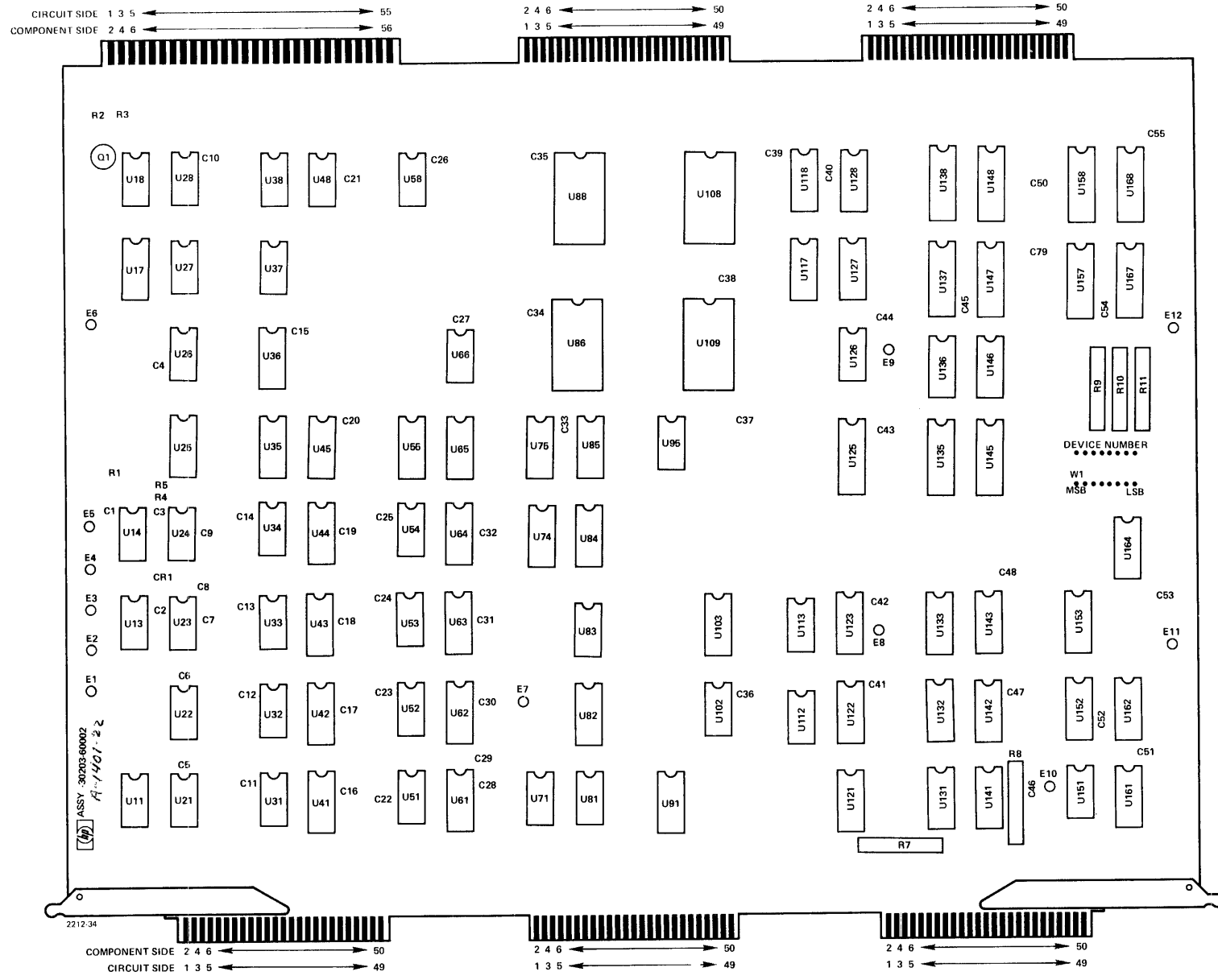

Figure 2-35. Disc Memory Data PCA, Parts Location Diagram

Table 2-37. Card Reader Interface PCA, Replaceable Parts

Reference Designation	HP Part Number	Qty	Description	Mfr Code	Mfr Part Number
	30206-60001	1	CARD READER INTERFACE PCA	28480	30206-60001
C1	0160-2055	46	C:FXD CER 0.01 UF +80-20% 100VDCW	56289	C023F101F103ZS22-CDH
C2	0160-2055		C:FXD CER 0.01 UF +80-20% 100VDCW	56289	C023F101F103ZS22-CDH
C3	0160-2055		C:FXD CER 0.01 UF +80-20% 100VDCW	56289	C023F101F103ZS22-CDH
C4	0160-2055		C:FXD CER 0.01 UF +80-20% 100VDCW	56289	C023F101F103ZS22-CDH
C5	0160-2204	21	C:FXD MICA 100PF 5%	72136	RDM15F101J3C
C6	0160-2204		C:FXD MICA 100PF 5%	72136	RDM15F101J3C
C7	0160-2055		C:FXD CER 0.01 UF +80-20% 100VDCW	56289	C023F101F103ZS22-CDH
C8	0160-3457	21	C:FXD DISC CER 0.002 UF 10% 250VDCW	56289	C067F251F202KS22-CDH
C9	0160-3457		C:FXD DISC CER 0.002 UF 10% 250VDCW	56289	C067F251F202KS22-CDH
C10	0160-2204		C:FXD MICA 100PF 5%	72136	RDM15F101J3C
C11	0160-2204		C:FXD MICA 100PF 5%	72136	RDM15F101J3C
C12	0160-2204		C:FXD MICA 100PF 5%	72136	RDM15F101J3C
C13	0160-2055		C:FXD CER 0.01 UF +80-20% 100VDCW	56289	C023F101F103ZS22-CDH
C14	0160-3457		C:FXD DISC CER 0.002 UF 10% 250VDCW	56289	C067F251F202KS22-CDH
C15	0160-3457		C:FXD DISC CER 0.002 UF 10% 250VDCW	56289	C067F251F202KS22-CDH
C16	0160-3457		C:FXD DISC CER 0.002 UF 10% 250VDCW	56289	C067F251F202KS22-CDH
C17	0180-0159	1	C:FXD ELECT 220 UF 20% 10VDCW	28480	0180-0159
C18	0160-2202	2	C:FXD MICA 75 PF 5%	28480	0160-2202
C19	0160-2202		C:FXD MICA 75 PF 5%	28480	0160-2202
C20	0160-2055		C:FXD CER 0.01 UF +80-20% 100VDCW	56289	C023F101F103ZS22-CDH
C21	0160-2055		C:FXD CER 0.01 UF +80-20% 100VDCW	56289	C023F101F103ZS22-CDH
C22	0160-2055		C:FXD CER 0.01 UF +80-20% 100VDCW	56289	C023F101F103ZS22-CDH
C23	0160-2055		C:FXD CER 0.01 UF +80-20% 100VDCW	56289	C023F101F103ZS22-CDH
C24	0160-2055		C:FXD CER 0.01 UF +80-20% 100VDCW	56289	C023F101F103ZS22-CDH
C25	0160-2055		C:FXD CER 0.01 UF +80-20% 100VDCW	56289	C023F101F103ZS22-CDH
C26	0160-2204		C:FXD MICA 100PF 5%	72136	RDM15F101J3C
C27	0160-2204		C:FXD MICA 100PF 5%	72136	RDM15F101J3C
C28	0160-3457		C:FXD DISC CER 0.002 UF 10% 250VDCW	56289	C067F251F202KS22-CDH
C29	0160-3457		C:FXD DISC CER 0.002 UF 10% 250VDCW	56289	C067F251F202KS22-CDH
C30	0160-2204		C:FXD MICA 100PF 5%	72136	RDM15F101J3C
C31	0160-2204		C:FXD MICA 100PF 5%	72136	RDM15F101J3C
C32	0160-2055		C:FXD CER 0.01 UF +80-20% 100VDCW	56289	C023F101F103ZS22-CDH
C33	0160-3457		C:FXD DISC CER 0.002 UF 10% 250VDCW	56289	C067F251F202KS22-CDH
C34	0160-3457		C:FXD DISC CER 0.002 UF 10% 250VDCW	56289	C067F251F202KS22-CDH
C35	0160-2204		C:FXD MICA 100PF 5%	72136	RDM15F101J3C
C36	0160-2204		C:FXD MICA 100PF 5%	72136	RDM15F101J3C
C37	0160-3457		C:FXD DISC CER 0.002 UF 10% 250VDCW	56289	C067F251F202KS22-CDH
C38	0160-3457		C:FXD DISC CER 0.002 UF 10% 250VDCW	56289	C067F251F202KS22-CDH
C39	0160-2204		C:FXD MICA 100PF 5%	72136	RDM15F101J3C
C40	0160-2204		C:FXD MICA 100PF 5%	72136	RDM15F101J3C
C41	0160-2055		C:FXD CER 0.01 UF +80-20% 100VDCW	56289	C023F101F103ZS22-CDH
C42	0160-3457		C:FXD DISC CER 0.002 UF 10% 250VDCW	56289	C067F251F202KS22-CDH
C43	0160-3457		C:FXD DISC CER 0.002 UF 10% 250VDCW	56289	C067F251F202KS22-CDH
C44	0160-2055		C:FXD CER 0.01 UF +80-20% 100VDCW	56289	C023F101F103ZS22-CDH
C48	0160-2055		C:FXD CER 0.01 UF +80-20% 100VDCW	56289	C023F101F103ZS22-CDH
C49	0160-2204		C:FXD MICA 100PF 5%	72136	RDM15F101J3C
C50	0160-2204		C:FXD MICA 100PF 5%	72136	RDM15F101J3C
C51	0160-3457		C:FXD DISC CER 0.002 UF 10% 250VDCW	56289	C067F251F202KS22-CDH
C52	0160-3457		C:FXD DISC CER 0.002 UF 10% 250VDCW	56289	C067F251F202KS22-CDH
C53	0160-2204		C:FXD MICA 100PF 5%	72136	RDM15F101J3C
C54	0160-2204		C:FXD MICA 100PF 5%	72136	RDM15F101J3C
C55	0160-2055		C:FXD CER 0.01 UF +80-20% 100VDCW	56289	C023F101F103ZS22-CDH
C56	0160-3457		C:FXD DISC CER 0.002 UF 10% 250VDCW	56289	C067F251F202KS22-CDH
C57	0160-3457		C:FXD DISC CER 0.002 UF 10% 250VDCW	56289	C067F251F202KS22-CDH
C58	0160-2204		C:FXD MICA 100PF 5%	72136	RDM15F101J3C
C59	0160-2204		C:FXD MICA 100PF 5%	72136	RDM15F101J3C
C60	0160-3457		C:FXD DISC CER 0.002 UF 10% 250VDCW	56289	C067F251F202KS22-CDH
C61	0160-3457		C:FXD DISC CER 0.002 UF 10% 250VDCW	56289	C067F251F202KS22-CDH
C62	0160-2204		C:FXD MICA 100PF 5%	72136	RDM15F101J3C
C63	0160-2204		C:FXD MICA 100PF 5%	72136	RDM15F101J3C
C64	0160-2055		C:FXD CER 0.01 UF +80-20% 100VDCW	56289	C023F101F103ZS22-CDH
C65	0160-3457		C:FXD DISC CER 0.002 UF 10% 250VDCW	56289	C067F251F202KS22-CDH
C66	0160-3457		C:FXD DISC CER 0.002 UF 10% 250VDCW	56289	C067F251F202KS22-CDH
C67	0160-2055		C:FXD CER 0.01 UF +80-20% 100VDCW	56289	C023F101F103ZS22-CDH
C68	0160-2055		C:FXD CER 0.01 UF +80-20% 100VDCW	56289	C023F101F103ZS22-CDH
C69	0160-2055		C:FXD CER 0.01 UF +80-20% 100VDCW	56289	C023F101F103ZS22-CDH
C70	0160-2055		C:FXD CER 0.01 UF +80-20% 100VDCW	56289	C023F101F103ZS22-CDH
C71	0160-2055		C:FXD CER 0.01 UF +80-20% 100VDCW	56289	C023F101F103ZS22-CDH
C72	0160-2055		C:FXD CER 0.01 UF +80-20% 100VDCW	56289	C023F101F103ZS22-CDH
C73	0160-2055		C:FXD CER 0.01 UF +80-20% 100VDCW	56289	C023F101F103ZS22-CDH
C74	0160-2055		C:FXD CER 0.01 UF +80-20% 100VDCW	56289	C023F101F103ZS22-CDH
C75	0150-0121	7	C:FXD CER 0.1 UF +80-20% 50VDCW	56289	5C50BIS-CML
C76	0160-2055		C:FXD CER 0.01 UF +80-20% 100VDCW	56289	C023F101F103ZS22-CDH
C77	0160-2055		C:FXD CER 0.01 UF +80-20% 100VDCW	56289	C023F101F103ZS22-CDH

Table 2-37. Card Reader Interface PCA, Replaceable Parts (Continued)

Reference Designation	HP Part Number	Qty	Description	Mfr Code	Mfr Part Number
C78	0160-2055		C:FXD CER 0.01 UF +80-20% 100VDCW	56289	C023F101F103ZS22-CDH
C79	0160-2055		C:FXD CER 0.01 UF +80-20% 100VDCW	56289	C023F101F103ZS22-CDH
C80	0160-2055		C:FXD CER 0.01 UF +80-20% 100VDCW	56289	C023F101F103ZS22-CDH
C81	0160-2055		C:FXD CER 0.01 UF +80-20% 100VDCW	56289	C023F101F103ZS22-CDH
C82	0160-2055		C:FXD CER 0.01 UF +80-20% 100VDCW	56289	C023F101F103ZS22-CDH
C83	0160-2055		C:FXD CER 0.01 UF +80-20% 100VDCW	56289	C023F101F103ZS22-CDH
C84	0160-2055		C:FXD CER 0.01 UF +80-20% 100VDCW	56289	C023F101F103ZS22-CDH
C85	0160-2055		C:FXD CER 0.01 UF +80-20% 100VDCW	56289	C023F101F103ZS22-CDH
C86	0150-0121		C:FXD CER 0.1 UF +80-20% 50VDCW	56289	5C50BIS-CML
C87	0160-2055		C:FXD CER 0.01 UF +80-20% 100VDCW	56289	C023F101F103ZS22-CDH
C88	0160-2055		C:FXD CER 0.01 UF +80-20% 100VDCW	56289	C023F101F103ZS22-CDH
C89	0160-2055		C:FXD CER 0.01 UF +80-20% 100VDCW	56289	C023F101F103ZS22-CDH
C90	0160-2055		C:FXD CER 0.01 UF +80-20% 100VDCW	56289	C023F101F103ZS22-CDH
C91	0150-0121		C:FXD CER 0.1 UF +80-20% 50VDCW	56289	5C50BIS-CML
C92	0160-2055		C:FXD CER 0.01 UF +80-20% 100VDCW	56289	C023F101F103ZS22-CDH
C93	0150-0121		C:FXD CER 0.1 UF +80-20% 50VDCW	56289	5C50BIS-CML
C94	0150-0121		C:FXD CER 0.1 UF +80-20% 50VDCW	56289	5C50BIS-CML
C95	0160-2055		C:FXD CER 0.01 UF +80-20% 100VDCW	56289	C023F101F103ZS22-CDH
C96	0160-2055		C:FXD CER 0.01 UF +80-20% 100VDCW	56289	C023F101F103ZS22-CDH
C97	0160-2055		C:FXD CER 0.01 UF +80-20% 100VDCW	56289	C023F101F103ZS22-CDH
C98	0160-2055		C:FXD CER 0.01 UF +80-20% 100VDCW	56289	C023F101F103ZS22-CDH
C99	0160-2055		C:FXD CER 0.01 UF +80-20% 100VDCW	56289	C023F101F103ZS22-CDH
C100	0150-0121		C:FXD CER 0.1 UF +80-20% 50VDCW	56289	5C50BIS-CML
C101	0150-0121		C:FXD CER 0.1 UF +80-20% 50VDCW	56289	5C50BIS-CML
C102	0160-0127	2	C:FXD CER 1.0 UF 20% 25VDCW	56289	5C13CS-CML
C106	0150-0121		C:FXD CER 0.1 UF +80-20% 50VDCW	56289	5C50BIS-CML
C103	0180-0229	2	C:FXD ELECT 33 UF 10% 10VDCW	28480	0180-0229
C104	0160-0127		C:FXD CER 1.0 UF 20% 25VDCW	56289	5C13CS-CML
C105	0180-0229		C:FXD ELECT 33 UF 10% 10VDCW	28480	0180-0229
CR1	1901-0081	1	DIODE:SILICON 50 VOLTS WORKING	07263	F01415
R1	0698-0084	1	R:FXD MET FLM 2.15K OHM 1% 1/8W	28480	0698-0084
R2	0757-0280	3	R:FXD MET FLM 1K OHM 1% 1/8W	28480	0757-0280
R3	0757-0442	1	R:FXD MET FLM 10.0K OHM 1% 1/8W	28480	0757-0442
R4	0698-3155	5	R:FXD MET FLM 4.64K OHM 1% 1/8W	28480	0698-3155
R5	0698-3155		R:FXD MET FLM 4.64K OHM 1% 1/8W	28480	0698-3155
R6	0757-0279	2	R:FXD MET FLM 3.16K OHM 1% 1/8W	28480	0757-0279
R7	0757-0279		R:FXD MET FLM 3.16K OHM 1% 1/8W	28480	0757-0279
R8	0698-3155		R:FXD MET FLM 4.64K OHM 1% 1/8W	28480	0698-3155
R9	0698-4421	1	R:FXD FLM 249 OHM 1% 1/8W	28480	0698-4421
R10	0757-0280		R:FXD MET FLM 1K OHM 1% 1/8W	28480	0757-0280
R11	1810-0125	6	RESISTIVE NETWORK:7 X 4.7K OHM 5% 0.15W	28480	1810-0125
R12	1810-0055	1	RESISTIVE NETWORK:8 ALL 10K OHM 5%	28480	1810-0055
R13	0757-0280		R:FXD MET FLM 1K OHM 1% 1/8W	28480	0757-0280
R14	0757-0427	1	R:FXD MET FLM 1.5K OHM 1% 1/8W	28480	0757-0427
R15	0698-3153	1	R:FXD MET FLM 3.83K OHM 1% 1/8W	28480	0698-3153
R16	1810-0125		RESISTIVE NETWORK:7 X 4.7K OHM 5% 0.15W	28480	1810-0125
R17	1810-0125		RESISTIVE NETWORK:7 X 4.7K OHM 5% 0.15W	28480	1810-0125
R18	0698-3155		R:FXD MET FLM 4.64K OHM 1% 1/8W	28480	0698-3155
R19	0698-3155		R:FXD MET FLM 4.64K OHM 1% 1/8W	28480	0698-3155
R20	1810-0125		RESISTIVE NETWORK:7 X 4.7K OHM 5% 0.15W	28480	1810-0125
R21	1810-0125		RESISTIVE NETWORK:7 X 4.7K OHM 5% 0.15W	28480	1810-0125
R23	0757-0280		R:FXD MET FLM 1K OHM 1% 1/8W	28480	0757-0280
R22	1810-0125		RESISTIVE NETWORK:7 X 4.7K OHM 5% 0.15W	28480	1810-0125
U13	1820-0720	2	IC:TTL DUAL DIFFERENTIAL LINE DRIVER	28480	1820-0720
U14	1820-0207	1	IC:TTL MONOSTABLE MULTIVIBRATOR	28480	1820-0207
U21	1820-0720		IC:TTL DUAL DIFFERENTIAL LINE DRIVER	28480	1820-0720
U22	1820-0721	11	IC:TTL DUAL DIFFERENT. LINE RECEIVER	12040	DM8820N
U15	1820-0207		IC:TTL MONOSTABLE MULTIVIBRATOR	28480	1820-0207
U23	1820-0174	7	IC:TTL HEX INVERTER	01295	SN7404N
U24	1820-0715	7	IC:TTL DIGITAL HI-SPEED J-K F/F	01295	SN74H106N
U31	1820-0721		IC:TTL DUAL DIFFERENT. LINE RECEIVER	12040	DM8820N
U32	1820-0721		IC:TTL DUAL DIFFERENT. LINE RECEIVER	12040	DM8820N
U33	1820-0239	2	IC:TTL QUAD 2-INPT NOR GATE	28480	1820-C239
U34	1820-0715		IC:TTL DIGITAL HI-SPEED J-K F/F	01295	SN74H106N
U35	1820-0141	10	IC:TTL QUAD 2-INPT AND GATE	04713	MC3001P
U36	1820-0141		IC:TTL QUAD 2-INPT AND GATE	04713	MC3001P
U37	1820-0141		IC:TTL QUAD 2-INPT AND GATE	04713	MC3001P
U38	1820-0844	1	IC:TTL QUAD 3-INPT PULSE SHAPER	04713	MC426P
U41	1820-0721		IC:TTL DUAL DIFFERENT. LINE RECEIVER	12040	DM8820N
U42	1820-0721		IC:TTL DUAL DIFFERENT. LINE RECEIVER	12040	DM8820N
U43	1820-0174		IC:TTL HEX INVERTER	01295	SN7404N
U44	1820-0715		IC:TTL DIGITAL HI-SPEED J-K F/F	01295	SN74H106N
U45	1820-0372	2	IC:TTL TRIPLE 3-INPT AND GATE	28480	1820-0372
U46	1820-0301	1	IC:TTL QUAD BI-STABLE D-LATCH	01295	SN7475N
U47	1820-0077	2	IC:TTL DUAL D F/F	01295	SN7474N
U48	1820-0689	1	IC	28480	1820-C689
U51	1820-0721		IC:TTL DUAL DIFFERENT. LINE RECEIVER	12040	DM8820N
U52	1820-0721		IC:TTL DUAL DIFFERENT. LINE RECEIVER	12040	DM8820N

Table 2-37. Card Reader Interface PCA Replaceable Parts (Continued)

Reference Designation	HP Part Number	Qty	Description	Mfr Code	Mfr Part Number
U53	1820-0141		IC:TTL QUAD 2-INPT AND GATE	04713	MC3001P
U55	1820-0141		IC:TTL QUAD 2-INPT AND GATE	04713	MC3001P
U56	1820-0424	3	IC:TTL HS HEX INVERTER	04713	SN74HC4N
U57	1820-0371	1	IC:TTL HS TRIPLE 3-INPT NAND GATE	01295	SN74H10N
U58	1820-0077		IC:TTL DUAL D F/F	01295	SN7474N
U61	1820-0721		IC:TTL DUAL DIFFERENT. LINE RECEIVER	12040	DM8820N
U62	1820-0721		IC:TTL DUAL DIFFERENT. LINE RECEIVER	12040	DM8820N
U63	1820-0054		IC:TTL QUAD 2-INPT NAND GATE	01295	SN7400N
U66	1820-0071	2	IC:TTL DUAL 4-INPUT NAND BUFFER	01295	SN7440N
U67	1820-0141		IC:TTL QUAD 2-INPT AND GATE	04713	MC3001P
U68	1820-0370	1	IC:TTL HS QUAD 2-INPT NAND GATE	01295	SN74HC0N
U71	1820-0721		IC:TTL DUAL DIFFERENT. LINE RECEIVER	12040	DM8820N
U72	1820-0721		IC:TTL DUAL DIFFERENT. LINE RECEIVER	12040	DM8820N
U73	1820-0610	9	IC:TTL DUAL 4-UNPT MULTIPLEXER	07263	U68930959X
U75	1820-0715		IC:TTL DIGITAL HI-SPEED J-K F/F	01295	SN74H106N
U76	1820-0900	1	IC:TTL TRIPLE 3-INPT NOR GATE	28480	1820-0900
U77	1820-0424		IC:TTL HS HEX INVERTER	04713	SN74HC4N
U78	1820-0761	1	IC:TTL DIGITAL	28480	1820-0761
U81	1820-0054		IC:TTL QUAD 2-INPT NAND GATE	01295	SN7400N
U82	1820-0141		IC:TTL QUAD 2-INPT AND GATE	04713	MC3001P
U83	1820-0076	2	IC:TTL DUAL J-K F/F W/PRESET CLOCK	01295	SN7476N
U85	1820-0174		IC:TTL HEX INVERTER	01295	SN7404N
U86	1820-0141		IC:TTL QUAD 2-INPT AND GATE	04713	MC3001P
U87	1820-0715		IC:TTL DIGITAL HI-SPEED J-K F/F	01295	SN74H106N
U88	1820-0759	2	IC:TTL LOW-POWER 8-BIT RECEIVER	28480	1820-0759
U91	1820-0205	2	IC:TTL QUAD 2-INPT OR GATE	28480	1820-0205
U92	1818-2102	1	IC:ROM	28480	1818-2102
U93	1820-0174		IC:TTL HEX INVERTER	01295	SN7404N
U95	1820-0239		IC:TTL QUAD 2-INPT NOR GATE	28480	1820-0239
U96	1820-0372		IC:TTL TRIPLE 3-INPT AND GATE	28480	1820-0372
U97	1820-0715		IC:TTL DIGITAL HI-SPEED J-K F/F	01295	SN74H106N
U101	1820-0084	2	IC:TTL 4W 2-INPT AND/OR GATE	01295	SN7453N
U103	1820-0174		IC:TTL HEX INVERTER	01295	SN7404N
U105	1820-0054		IC:TTL QUAD 2-INPT NAND GATE	01295	SN7400N
U106	1820-0374	1	IC:TTL HS DUAL 4-INPT AND GATE	01295	SN74H21N
U107	1820-0424		IC:TTL HS HEX INVERTER	04713	SN74HC4N
U111	1820-0282	1	IC:TTL QUAD 2-INPT EXCL. OR GATE	01295	SN7486N
U112	1820-0616	4	IC:TTL 4-BIT 2-INPT MULTIPLEXER	07263	U78932259X
U113	1820-0437	6	IC:TTL QUAD D F/F	04713	MC4015P
U115	1820-0782	1	IC:TTL TRIPLE 3-INPT NOR GATE	01295	SN7427N
U116	1820-0054		IC:TTL QUAD 2-INPT NAND GATE	01295	SN7400N
U117	1820-0491	1	IC:TTL BCD/DEC. DECODER/DRIVER	01295	SN74145N
U118	1820-0759		IC:TTL LOW-POWER 8-BIT RECEIVER	28480	1820-0759
U121	1820-0084		IC:TTL 4W 2-INPT AND/OR GATE	01295	SN7453N
U122	1820-0174		IC:TTL HEX INVERTER	01295	SN7404N
U123	1820-0437		IC:TTL QUAD D F/F	04713	MC4015P
U125	1820-0715		IC:TTL DIGITAL HI-SPEED J-K F/F	01295	SN74H106N
U126	1820-0076		IC:TTL DUAL J-K F/F W/PRESET CLOCK	01295	SN7476N
U128	1820-0760	4	IC:TTL 8-BIT RECEIVER INVERTING	28480	1820-0760
U131	1820-0071		IC:TTL DUAL 4-INPUT NAND BUFFER	01295	SN7440N
U132	1820-0616		IC:TTL 4-BIT 2-INPT MULTIPLEXER	07263	U78932259X
U133	1820-0437		IC:TTL QUAD D F/F	04713	MC4015P
U134	1820-0610		IC:TTL DUAL 4-UNPT MULTIPLEXER	07263	U68930959X
U135	1820-0610		IC:TTL DUAL 4-UNPT MULTIPLEXER	07263	U68930959X
U136	1820-0756	4	IC:TTL 8-BIT DRIVER INVERTING	28480	1820-0756
U137	1820-0760		IC:TTL 8-BIT RECEIVER INVERTING	28480	1820-0760
U138	1820-0760		IC:TTL 8-BIT RECEIVER INVERTING	28480	1820-0760
U141	1820-0141		IC:TTL QUAD 2-INPT AND GATE	04713	MC3001P
U142	1820-0616		IC:TTL 4-BIT 2-INPT MULTIPLEXER	07263	U78932259X
U143	1820-0437		IC:TTL QUAD D F/F	04713	MC4015P
U144	1820-0610		IC:TTL DUAL 4-UNPT MULTIPLEXER	07263	U68930959X
U145	1820-0610		IC:TTL DUAL 4-UNPT MULTIPLEXER	07263	U68930959X
U146	1820-0756		IC:TTL 8-BIT DRIVER INVERTING	28480	1820-0756
U147	1820-0755	2	IC	28480	1820-0755
U148	1820-0755		IC	28480	1820-0755
U151	1820-0205		IC:TTL QUAD 2-INPT OR GATE	28480	1820-0205
U152	1820-0174		IC:TTL HEX INVERTER	01295	SN7404N
U153	1820-0437		IC:TTL QUAD D F/F	04713	MC4015P
U154	1820-0610		IC:TTL DUAL 4-UNPT MULTIPLEXER	07263	U68930959X
U155	1820-0610		IC:TTL DUAL 4-UNPT MULTIPLEXER	07263	U68930959X
U156	1820-0706	2	IC:DIGITAL TTL 5-BIT COMPARATOR	04713	U78932459X
U157	1820-0756		IC:TTL 8-BIT DRIVER INVERTING	28480	1820-0756
U158	1820-0756		IC:TTL 8-BIT DRIVER INVERTING	28480	1820-0756
U161	1820-0141		IC:TTL QUAD 2-INPT AND GATE	04713	MC3001P
U162	1820-0616		IC:TTL 4-BIT 2-INPT MULTIPLEXER	07263	U78932259X

Table 2-37. Card Reader Interface PCA, Replaceable Parts (Continued)

Reference Designation	HP Part Number	Qty	Description	Mfr Code	Mfr Part Number
U163 U164 U165 U167 U168	1820-0437 1820-0610 1820-0610 1820-0706 1820-0760		IC:TTL QUAD D F/F IC:TTL DUAL 4-UNPT MULTIPLEXER IC:TTL DUAL 4-UNPT MULTIPLEXER IC:DIGITAL TTL 5-BIT COMPARATOR IC:TTL 8-BIT RECEIVER INVERTING	04713 07263 07263 04713 28480	MC4015P U68930555X U68930959X U78932455X 1820-0760
W2	8159-0005		JUMPER WIRE	28480	8159-0005

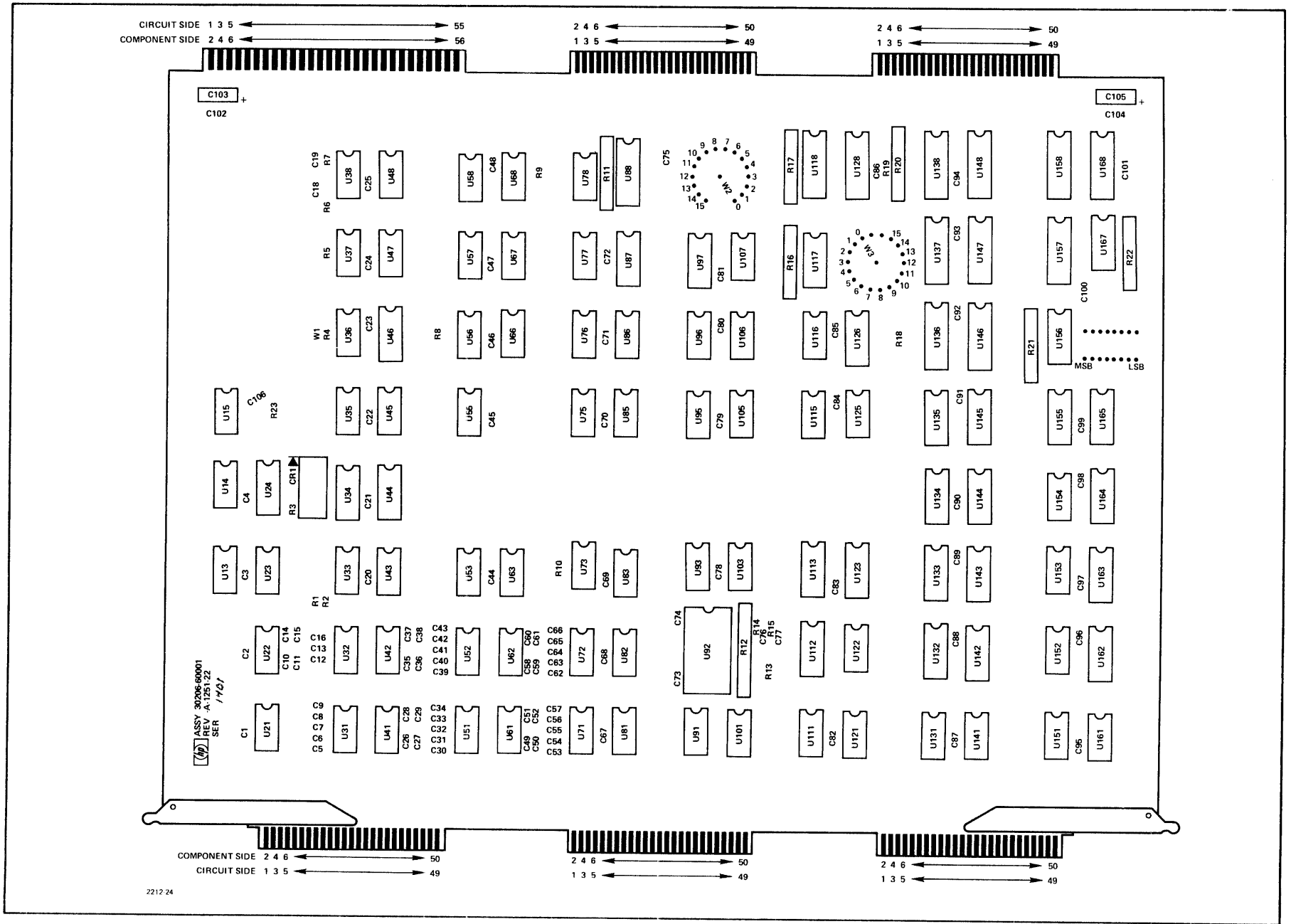

Figure 2-36. Card Reader Interface PCA, Parts Location Diagram

Table 2-38. Cartridge Disc Controller PCA Replaceable Parts

Reference Designation	HP Part Number	Qty	Description	Mfr Code	Mfr Part Number
	30210-60001	1	CARTRIDGE DISC CONTROLLER PCA	28480	30210-60001
C1	0160-2204	1	C:FXD MICA 100PF 5%	72136	RD15F101J3C
C2	0121-0046	1	C:VARI CER 9-35 PF	28480	0121-0046
C3	0150-0121	8	C:FXD CER 0.1 UF +80-20% 50VDCW	56289	5C50B1S-CML
C4	0160-2055	64	C:FXD CER 0.01 UF +80-20% 100VDCW	56289	C023F101F103ZS22-CDH
C5	0160-2055		C:FXD CER 0.01 UF +80-20% 100VDCW	56289	C023F101F103ZS22-CDH
C6	0160-2055		C:FXD CER 0.01 UF +80-20% 100VDCW	56289	C023F101F103ZS22-CDH
C7	0150-0121		C:FXD CER 0.1 UF +80-20% 50VDCW	56289	5C50B1S-CML
C8	0150-0121		C:FXD CER 0.1 UF +80-20% 50VDCW	56289	5C50B1S-CML
C9	0150-0121		C:FXD CER 0.1 UF +80-20% 50VDCW	56289	5C50B1S-CML
C10	0160-2055		C:FXD CER 0.01 UF +80-20% 100VDCW	56289	C023F101F103ZS22-CDH
C11	0150-0121		C:FXD CER 0.1 UF +80-20% 50VDCW	56289	5C50B1S-CML
C12	0150-0121		C:FXD CER 0.1 UF +80-20% 50VDCW	56289	5C50B1S-CML
C13	0160-2055		C:FXD CER 0.01 UF +80-20% 100VDCW	56289	C023F101F103ZS22-CDH
C14	0160-2055		C:FXD CER 0.01 UF +80-20% 100VDCW	56289	C023F101F103ZS22-CDH
C15	0180-0197	1	C:FXD ELECT 2.2 UF 10% 20VDCW	56289	1500225X9020A2-DYS
C16	0160-0161	2	C:FXD MY 0.01 UF 10% 200VDCW	56289	192P10392-PTS
C17	0160-0161		C:FXD MY 0.01 UF 10% 200VDCW	56289	192P10392-PTS
C18	0160-0938	4	C:FXD MICA 1000 PF 5%	72136	RD15E102J1C
C19	0160-2055		C:FXD CER 0.01 UF +80-20% 100VDCW	56289	C023F101F103ZS22-CDH
C20	0150-0121		C:FXD CER 0.1 UF +80-20% 50VDCW	56289	5C50B1S-CML
C21	0160-2055		C:FXD CER 0.01 UF +80-20% 100VDCW	56289	C023F101F103ZS22-CDH
C22	0160-2055		C:FXD CER 0.01 UF +80-20% 100VDCW	56289	C023F101F103ZS22-CDH
C23	0160-2055		C:FXD CER 0.01 UF +80-20% 100VDCW	56289	C023F101F103ZS22-CDH
C24	0160-0300	1	C:FXD MY 0.0027 UF 200VDCW	56289	192P27292-PTS
C25	0160-2198	1	C:FXD MICA 20 PF 5%	72136	RD15C200J3C
C26	0150-0121		C:FXD CER 0.1 UF +80-20% 50VDCW	56289	5C50B1S-CML
C27	0160-2055		C:FXD CER 0.01 UF +80-20% 100VDCW	56289	C023F101F103ZS22-CDH
C28	0160-2202	2	C:FXD MICA 75 PF 5%	28480	0160-2202
C30	0160-2055		C:FXD CER 0.01 UF +80-20% 100VDCW	56289	C023F101F103ZS22-CDH
C31	0160-2055		C:FXD CER 0.01 UF +80-20% 100VDCW	56289	C023F101F103ZS22-CDH
C32	0160-2202		C:FXD MICA 75 PF 5%	28480	0160-2202
C33	0160-2055		C:FXD CER 0.01 UF +80-20% 100VDCW	56289	C023F101F103ZS22-CDH
C34	0160-2055		C:FXD CER 0.01 UF +80-20% 100VDCW	56289	C023F101F103ZS22-CDH
C35	0160-2055		C:FXD CER 0.01 UF +80-20% 100VDCW	56289	C023F101F103ZS22-CDH
C36	0160-2055		C:FXD CER 0.01 UF +80-20% 100VDCW	56289	C023F101F103ZS22-CDH
C37	0160-2055		C:FXD CER 0.01 UF +80-20% 100VDCW	56289	C023F101F103ZS22-CDH
C38	0160-2055		C:FXD CER 0.01 UF +80-20% 100VDCW	56289	C023F101F103ZS22-CDH
C39	0160-2055		C:FXD CER 0.01 UF +80-20% 100VDCW	56289	C023F101F103ZS22-CDH
C40	0160-2055		C:FXD CER 0.01 UF +80-20% 100VDCW	56289	C023F101F103ZS22-CDH
C41	0160-2055		C:FXD CER 0.01 UF +80-20% 100VDCW	56289	C023F101F103ZS22-CDH
C42	0160-2055		C:FXD CER 0.01 UF +80-20% 100VDCW	56289	C023F101F103ZS22-CDH
C43	0160-2055		C:FXD CER 0.01 UF +80-20% 100VDCW	56289	C023F101F103ZS22-CDH
C44	0160-0938		C:FXD MICA 1000 PF 5%	72136	RD15E102J1C
C45	0160-0938		C:FXD MICA 1000 PF 5%	72136	RD15E102J1C
C46	0160-0938		C:FXD MICA 1000 PF 5%	72136	RD15E102J1C
C47	0160-2055		C:FXD CER 0.01 UF +80-20% 100VDCW	56289	C023F101F103ZS22-CDH
C48	0160-2055		C:FXD CER 0.01 UF +80-20% 100VDCW	56289	C023F101F103ZS22-CDH
C49	0160-2055		C:FXD CER 0.01 UF +80-20% 100VDCW	56289	C023F101F103ZS22-CDH
C50	0160-2055		C:FXD CER 0.01 UF +80-20% 100VDCW	56289	C023F101F103ZS22-CDH
C51	0160-2055		C:FXD CER 0.01 UF +80-20% 100VDCW	56289	C023F101F103ZS22-CDH
C52	0160-2055		C:FXD CER 0.01 UF +80-20% 100VDCW	56289	C023F101F103ZS22-CDH
C53	0160-2055		C:FXD CER 0.01 UF +80-20% 100VDCW	56289	C023F101F103ZS22-CDH
C54	0160-2055		C:FXD CER 0.01 UF +80-20% 100VDCW	56289	C023F101F103ZS22-CDH
C55	0160-2055		C:FXD CER 0.01 UF +80-20% 100VDCW	56289	C023F101F103ZS22-CDH
C56	0160-2055		C:FXD CER 0.01 UF +80-20% 100VDCW	56289	C023F101F103ZS22-CDH
C57	0160-2055		C:FXD CER 0.01 UF +80-20% 100VDCW	56289	C023F101F103ZS22-CDH
C58	0160-2055		C:FXD CER 0.01 UF +80-20% 100VDCW	56289	C023F101F103ZS22-CDH
C59	0160-2055		C:FXD CER 0.01 UF +80-20% 100VDCW	56289	C023F101F103ZS22-CDH
C60	0160-2055		C:FXD CER 0.01 UF +80-20% 100VDCW	56289	C023F101F103ZS22-CDH
C61	0160-2055		C:FXD CER 0.01 UF +80-20% 100VDCW	56289	C023F101F103ZS22-CDH
C62	0160-2055		C:FXD CER 0.01 UF +80-20% 100VDCW	56289	C023F101F103ZS22-CDH
C63	0160-2055		C:FXD CER 0.01 UF +80-20% 100VDCW	56289	C023F101F103ZS22-CDH
C64	0160-2055		C:FXD CER 0.01 UF +80-20% 100VDCW	56289	C023F101F103ZS22-CDH
C65	0160-2055		C:FXD CER 0.01 UF +80-20% 100VDCW	56289	C023F101F103ZS22-CDH
C67	0160-2055		C:FXD CER 0.01 UF +80-20% 100VDCW	56289	C023F101F103ZS22-CDH
C68	0160-2055		C:FXD CER 0.01 UF +80-20% 100VDCW	56289	C023F101F103ZS22-CDH
C69	0160-2055		C:FXD CER 0.01 UF +80-20% 100VDCW	56289	C023F101F103ZS22-CDH
C70	0160-2055		C:FXD CER 0.01 UF +80-20% 100VDCW	56289	C023F101F103ZS22-CDH
C71	0160-2055		C:FXD CER 0.01 UF +80-20% 100VDCW	56289	C023F101F103ZS22-CDH
C72	0160-2055		C:FXD CER 0.01 UF +80-20% 100VDCW	56289	C023F101F103ZS22-CDH
C73	0160-2055		C:FXD CER 0.01 UF +80-20% 100VDCW	56289	C023F101F103ZS22-CDH
C74	0160-2055		C:FXD CER 0.01 UF +80-20% 100VDCW	56289	C023F101F103ZS22-CDH
C75	0160-2055		C:FXD CER 0.01 UF +80-20% 100VDCW	56289	C023F101F103ZS22-CDH
C76	0160-2055		C:FXD CER 0.01 UF +80-20% 100VDCW	56289	C023F101F103ZS22-CDH

Table 2-38. Cartridge Disc Controller PCA, Replaceable Parts (Continued)

Reference Designation	HP Part Number	Qty	Description	Mfr Code	Mfr Part Number
C77	0160-2055		C:FXD CER 0.01 UF +80-20% 100VDCW	56289	C023F101F103ZS22-CDH
C78	0160-2055		C:FXD CER 0.01 UF +80-20% 100VDCW	56289	C023F101F103ZS22-CDH
C79	0160-2055		C:FXD CER 0.01 UF +80-20% 100VDCW	56289	C023F101F103ZS22-CDH
C80	0160-2055		C:FXD CER 0.01 UF +80-20% 100VDCW	56289	C023F101F103ZS22-CDH
C81	0160-2055		C:FXD CER 0.01 UF +80-20% 100VDCW	56289	C023F101F103ZS22-CDH
C82	0160-2055		C:FXD CER 0.01 UF +80-20% 100VDCW	56289	C023F101F103ZS22-CDH
C83	0160-2055		C:FXD CER 0.01 UF +80-20% 100VDCW	56289	C023F101F103ZS22-CDH
C84	0160-2055		C:FXD CER 0.01 UF +80-20% 100VDCW	56289	C023F101F103ZS22-CDH
C85	0160-2055		C:FXD CER 0.01 UF +80-20% 100VDCW	56289	C023F101F103ZS22-CDH
C86	0160-2055		C:FXD CER 0.01 UF +80-20% 100VDCW	56289	C023F101F103ZS22-CDH
C88	0140-0196		C:FXD MICA 150 PF 5%	72136	RDM15F151J3C
C87	0160-2055		C:FXD CER 0.01 UF +80-20% 100VDCW	56289	C023F101F103ZS22-CDH
CR1	1902-0029	1	DIODE:BREAKDOWN 12.1V 5% 1W	28480	1902-0029
Q1	1854-0477	4	TSTR:SI NPN	80131	2N2222A
Q2	1854-0477		TSTR:SI NPN	80131	2N2222A
Q3	1854-0477		TSTR:SI NPN	80131	2N2222A
Q4	1854-0477		TSTR:SI NPN	80131	2N2222A
R1	0757-0280	23	R:FXD MET FLM 1K OHM 1% 1/8W	28480	0757-0280
R2	0757-0280		R:FXD MET FLM 1K OHM 1% 1/8W	28480	0757-0280
R3	0757-0416	9	R:FXD MET FLM 511 OHM 1% 1/8W	28480	0757-0416
R4	0757-0416		R:FXD MET FLM 511 OHM 1% 1/8W	28480	0757-0416
R5	0698-6256	3	R:FXD FLM 3.16K OHM 0.1% 1/8W	28480	0698-6256
R6	0757-0416		R:FXD MET FLM 511 OHM 1% 1/8W	28480	0757-0416
R7	0698-3154	2	R:FXD MET FLM 4.22K OHM 1% 1/8W	28480	0698-3154
R8	0757-0416		R:FXD MET FLM 511 OHM 1% 1/8W	28480	0757-0416
R9	0757-0280		R:FXD MET FLM 1K OHM 1% 1/8W	28480	0757-0280
R10	0698-3154		R:FXD MET FLM 4.22K OHM 1% 1/8W	28480	0698-3154
R11	0757-0416		R:FXD MET FLM 511 OHM 1% 1/8W	28480	0757-0416
R12	0757-0416		R:FXD MET FLM 511 OHM 1% 1/8W	28480	0757-0416
R13	0757-0416		R:FXD MET FLM 511 OHM 1% 1/8W	28480	0757-0416
R14	0698-3446	2	R:FXD MET FLM 383 OHM 1% 1/8W	28480	0698-3446
R15	0698-3446		R:FXD MET FLM 383 OHM 1% 1/8W	28480	0698-3446
R16	0757-0280		R:FXD MET FLM 1K OHM 1% 1/8W	28480	0757-0280
R17	0757-0416		R:FXD MET FLM 511 OHM 1% 1/8W	28480	0757-0416
R18	0757-0280		R:FXD MET FLM 1K OHM 1% 1/8W	28480	0757-0280
R19	0698-3132	10	R:FXD FLM 261 OHM 1% 1/8W	28480	0698-3132
R20	0698-3132		R:FXD FLM 261 OHM 1% 1/8W	28480	0698-3132
R21	0698-3132		R:FXD FLM 261 OHM 1% 1/8W	28480	0698-3132
R22	0698-3132		R:FXD FLM 261 OHM 1% 1/8W	28480	0698-3132
R23	0698-3132		R:FXD FLM 261 OHM 1% 1/8W	28480	0698-3132
R24	0698-3132		R:FXD FLM 261 OHM 1% 1/8W	28480	0698-3132
R25	0698-3132		R:FXD FLM 261 OHM 1% 1/8W	28480	0698-3132
R26	0698-3132		R:FXD FLM 261 OHM 1% 1/8W	28480	0698-3132
R27	0698-3132		R:FXD FLM 261 OHM 1% 1/8W	28480	0698-3132
R28	0698-3132		R:FXD FLM 261 OHM 1% 1/8W	28480	0698-3132
R29	0757-0458	1	R:FXD MET FLM 51.1K OHM 1% 1/8W	28480	0757-0458
R30	0698-6256		R:FXD FLM 3.16K OHM 0.1% 1/8W	28480	0698-6256
R31	0757-0438	1	R:FXD MET FLM 5.11K OHM 1% 1/8W	28480	0757-0438
R32	0698-3440	1	R:FXD MET FLM 196 OHM 1% 1/8W	28480	0698-3440
R33	0698-3447	10	R:FXD MET FLM 422 OHM 1% 1/8W	28480	0698-3447
R34	0698-3447		R:FXD MET FLM 422 OHM 1% 1/8W	28480	0698-3447
R35	0698-3447		R:FXD MET FLM 422 OHM 1% 1/8W	28480	0698-3447
R36	0698-3447		R:FXD MET FLM 422 OHM 1% 1/8W	28480	0698-3447
R37	0698-3447		R:FXD MET FLM 422 OHM 1% 1/8W	28480	0698-3447
R38	0698-3447		R:FXD MET FLM 422 OHM 1% 1/8W	28480	0698-3447
R39	0698-3447		R:FXD MET FLM 422 OHM 1% 1/8W	28480	0698-3447
R40	0698-3447		R:FXD MET FLM 422 OHM 1% 1/8W	28480	0698-3447
R41	0698-3447		R:FXD MET FLM 422 OHM 1% 1/8W	28480	0698-3447
R42	0698-3447		R:FXD MET FLM 422 OHM 1% 1/8W	28480	0698-3447
R43	0757-0280		R:FXD MET FLM 1K OHM 1% 1/8W	28480	0757-0280
R44	0757-0280		R:FXD MET FLM 1K OHM 1% 1/8W	28480	0757-0280
R45	0698-6256		R:FXD FLM 3.16K OHM 0.1% 1/8W	28480	0698-6256
R46	0757-1002	1	R:FXD MET FLM 61.9 OHM 1% 1/2W	28480	0757-1002
R47	0757-0401	1	R:FXD MET FLM 100 OHM 1% 1/8W	28480	0757-0401
R48	0757-0280		R:FXD MET FLM 1K OHM 1% 1/8W	28480	0757-0280
R49	0757-0346	1	R:FXD MET FLM 10 OHM 1% 1/8W	28480	0757-0346
R50	0698-0084	1	R:FXD MET FLM 2.15K OHM 1% 1/8W	28480	0698-0084
R51	0757-0280		R:FXD MET FLM 1K OHM 1% 1/8W	28480	0757-0280
R52	0757-0403	1	R:FXD MET FLM 121 OHM 1% 1/8W	28480	0757-0403
R53	0757-0416		R:FXD MET FLM 511 OHM 1% 1/8W	28480	0757-0416
R54	0757-0290	1	R:FXD MET FLM 6.19K OHM 1% 1/8W	28480	0757-0290
R55	0757-0280		R:FXD MET FLM 1K OHM 1% 1/8W	28480	0757-0280
R56	0757-0280		R:FXD MET FLM 1K OHM 1% 1/8W	28480	0757-0280
R57	0757-0280		R:FXD MET FLM 1K OHM 1% 1/8W	28480	0757-0280
R58	0757-0417	2	R:FXD MET FLM 562 OHM 1% 1/8W	28480	0757-0417
R59	0757-0398	2	R:FXD MET FLM 75 OHM 1% 1/8W	28480	0757-0398

Table 2-38. Cartridge Disc Controller PCA, Replaceable Parts (Continued)

Reference Designation	HP Part Number	Qty	Description	Mfr Code	Mfr Part Number
R60	0757-0398		R:FXD MET FLM 75 OHM 1% 1/8W	28480	0757-0398
R61	0757-0417		R:FXD MET FLM 562 OHM 1% 1/8W	28480	0757-0417
R62	0757-0280		R:FXD MET FLM 1K OHM 1% 1/8W	28480	0757-0280
R63	0757-0280		R:FXD MET FLM 1K OHM 1% 1/8W	28480	0757-0280
R64	0757-0280		R:FXD MET FLM 1K OHM 1% 1/8W	28480	0757-0280
R65	1810-0030	9	NETWORK:7 RESISTORS 1K OHM 5% 0.15W EA	28480	1810-0030
R66	1810-0030		NETWORK:7 RESISTORS 1K OHM 5% 0.15W EA	28480	1810-0030
R67	0757-0280		R:FXD MET FLM 1K OHM 1% 1/8W	28480	0757-0280
R68	1810-0030		NETWORK:7 RESISTORS 1K OHM 5% 0.15W EA	28480	1810-0030
R69	1810-0030		NETWORK:7 RESISTORS 1K OHM 5% 0.15W EA	28480	1810-0030
R70	0757-0280		R:FXD MET FLM 1K OHM 1% 1/8W	28480	0757-0280
R71	0698-3442	1	R:FXD MET FLM 237 OHM 1% 1/8W	28480	0698-3442
R72	1810-0030		NETWORK:7 RESISTORS 1K OHM 5% 0.15W EA	28480	1810-0030
R74	1810-0030		NETWORK:7 RESISTORS 1K OHM 5% 0.15W EA	28480	1810-0030
R75	0757-0280		R:FXD MET FLM 1K OHM 1% 1/8W	28480	0757-0280
R76	0757-0280		R:FXD MET FLM 1K OHM 1% 1/8W	28480	0757-0280
R77	1810-0030		NETWORK:7 RESISTORS 1K OHM 5% 0.15W EA	28480	1810-0030
R78	0757-0280		R:FXD MET FLM 1K OHM 1% 1/8W	28480	0757-0280
R79	0757-0280		R:FXD MET FLM 1K OHM 1% 1/8W	28480	0757-0280
R80	1810-0030		NETWORK:7 RESISTORS 1K OHM 5% 0.15W EA	28480	1810-0030
R84	0757-0403		R:FXD MET FLM 121 OHM 1% 1/8W	28480	0757-0403
R81	0757-0280		R:FXD MET FLM 1K OHM 1% 1/8W	28480	0757-0280
R82	1810-0030		NETWORK:7 RESISTORS 1K OHM 5% 0.15W EA	28480	1810-0030
R83	0757-0280		R:FXD MET FLM 1K OHM 1% 1/8W	28480	0757-0280
U14	1826-0047	1	IC:PHASE LOCK LOOP F=MAX. 15MHZ	18324	NE5628
U18	1820-0424	10	IC:TTL HS HEX INVERTER	04713	SN74HC4N
U27	1820-0301	1	IC:TTL QUAD BI-STABLE D-LATCH	01295	SN7475N
U28	1820-0077	10	IC:TTL DUAL D F/F	01295	SN7474N
U33	1820-0077		IC:TTL DUAL D F/F	01295	SN7474N
U34	1820-0282	2	IC:TTL QUAD 2-INPT EXCL. OR GATE	01295	SN7486N
U35	1820-0715	9	IC:TTL DIGITAL HI-SPEED J-K F/F	01295	SN74HC6N
U37	1820-0141	7	IC:TTL QUAD 2-INPT AND GATE	04713	MC3001P
U38	1820-0686	1	IC:TTL SCHOTTKY TRIPLE 3-INPT AND GATE	01295	SN74S11N
U43	1820-0515	2	IC:TTL DUAL RE-TRIG/RE-SET MONO-MULTI	07263	U7B960259X
U44	1820-0515		IC:TTL DUAL RE-TRIG/RE-SET MONO-MULTI	07263	U7B960259X
U45	1820-0370	7	IC:TTL HS QUAD 2-INPT NAND GATE	01295	SN74HC0N
U47	1820-0371	3	IC:TTL HS TRIPLE 3-INPT NAND GATE	01295	SN74H10N
U48	1820-0844	1	IC:TTL DUAL 3-INPT PULSE SHAPER	04713	MC426P
U53	1820-0077		IC:TTL DUAL D F/F	01295	SN7474N
U55	1820-0424		IC:TTL HS HEX INVERTER	04713	SN74HC4N
U57	1820-0424		IC:TTL HS HEX INVERTER	04713	SN74HC4N
U58	1820-0370		IC:TTL HS QUAD 2-INPT NAND GATE	01295	SN74HC0N
U61	1820-0368	1	IC:TTL 5-BIT SHIFT REGISTER	01295	SN7496N
U62	1820-0613	3	IC:HS HEX INVERTER W/OPEN COLL.	01295	SN74H05N
U63	1820-0141		IC:TTL QUAD 2-INPT AND GATE	04713	MC3001P
U64	1820-0373	1	IC:TTL HS DUAL 4-INPT NAND GATE	01295	SN74H20N
U65	1820-0616	2	IC:TTL 4-BIT 2-INPT MULTIPLEXER	07263	U78932259X
U67	1820-0372	4	IC:TTL TRIPLE 3-INPT AND GATE	28480	1820-0372
U68	1820-0141		IC:TTL QUAD 2-INPT AND GATE	04713	MC3001P
U71	1820-0726	3	IC:TTL 8-BIT SHIFT REG. PAR IN/OUT	01295	SN74199
U72	1820-0613		IC:HS HEX INVERTER W/OPEN COLL.	01295	SN74HC5N
U73	1820-0077		IC:TTL DUAL D F/F	01295	SN7474N
U74	1820-0371		IC:TTL HS TRIPLE 3-INPT NAND GATE	01295	SN74H10N
U75	1820-0722	1	IC:TTL DUAL LINE DRIVER	01295	SN75109N
U77	1820-0374	2	IC:TTL HS DUAL 4-INPT AND GATE	01295	SN74H21N
U78	1820-0761	1	IC:TTL DIGITAL	28480	1820-0761
U82	1820-0613		IC:HS HEX INVERTER W/OPEN COLL.	01295	SN74H05N
U83	1820-0282		IC:TTL QUAD 2-INPT EXCL. OR GATE	01295	SN7486N
U84	1820-0755	7	IC	28480	1820-0755
U87	1820-0424		IC:TTL HS HEX INVERTER	04713	SN74HC4N
U88	1820-0141		IC:TTL QUAD 2-INPT AND GATE	04713	MC3001P
U91	1816-0069	1	IC:ROM	28480	1816-0069
U92	1816-0064	1	IC:ROM	28480	1816-0064
U93	1820-0077		IC:TTL DUAL D F/F	01295	SN7474N
U94	1820-0715		IC:TTL DIGITAL HI-SPEED J-K F/F	01295	SN74HC6N
U95	1820-0723	1	IC:TTL DUAL LINE RECEIVER W/STROBES	01295	SN75107N
U96	1820-0372		IC:TTL TRIPLE 3-INPT AND GATE	28480	1820-0372
U97	1820-0491	1	IC:TTL BCD/DEC. DECODER/DRIVER	01295	SN74145N
U98	1820-0760	4	IC:TTL 8-BIT RECEIVER INVERTING	28480	1820-0760
U101	1816-0061	1	IC:ROM	28480	1816-0061
U102	1816-0066	1	IC:ROM	28480	1816-0066
U103	1820-0205	3	IC:TTL QUAD 2-INPT OR GATE	28480	1820-0205
U104	1820-0370		IC:TTL HS QUAD 2-INPT NAND GATE	01295	SN74HC0N
U105	1820-0239	2	IC:TTL QUAD 2-INPT NOR GATE	28480	1820-0239
U106	1820-0141		IC:TTL QUAD 2-INPT AND GATE	04713	MC3001P
U107	1820-0715		IC:TTL DIGITAL HI-SPEED J-K F/F	01295	SN74HC6N

Table 2-38. Cartridge Disc Controller PCA, Replaceable Parts (Continued)

Reference Designation	HP Part Number	Qty	Description	Mfr Code	Mfr Part Number
U108	1820-0759	2	IC:TTL LOW-POWER 8-BIT RECEIVER	28480	1820-0759
U111	1816-0063	1	IC:ROM	28480	1816-0063
U112	1816-0065	1	IC:ROM	28480	1816-0065
U113	1820-0077		IC:TTL DUAL D F/F	01295	SN7474N
U114	1820-0424		IC:TTL HS HEX INVERTER	04713	SN74HC4N
U116	1820-0370		IC:TTL HS QUAD 2-INPT NAND GATE	01295	SN74H00N
U117	1820-0715		IC:TTL DIGITAL HI-SPEED J-K F/F	01295	SN74H106N
U121	1816-0060	1	IC:ROM	28480	1816-0060
U122	1816-0067	1	IC:ROM	28480	1816-0067
U123	1820-0715		IC:TTL DIGITAL HI-SPEED J-K F/F	01295	SN74H106N
U124	1820-0372		IC:TTL TRIPLE 3-INPT AND GATE	28480	1820-0372
U125	1820-0077		IC:TTL DUAL D F/F	01295	SN7474N
U126	1820-0715		IC:TTL DIGITAL HI-SPEED J-K F/F	01295	SN74H106N
U127	1820-0370		IC:TTL HS QUAD 2-INPT NAND GATE	01295	SN74H00N
U131	1816-0068	1	IC:ROM	28480	1816-0068
U132	1816-0062	1	IC:ROM	28480	1816-0062
U133	1820-0715		IC:TTL DIGITAL HI-SPEED J-K F/F	01295	SN74H106N
U134	1820-0077		IC:TTL DUAL D F/F	01295	SN7474N
U135	1820-0077		IC:TTL DUAL D F/F	01295	SN7474N
U136	1820-0371		IC:TTL HS TRIPLE 3-INPT NAND GATE	01295	SN74H10N
U137	1820-0141		IC:TTL QUAD 2-INPT AND GATE	04713	MC3001P
U138	1820-0759		IC:TTL LOW-POWER 8-BIT RECEIVER	28480	1820-0759
U141	1820-0239		IC:TTL QUAD 2-INPT NOR GATE	28480	1820-0239
U142	1820-0370		IC:TTL HS QUAD 2-INPT NAND GATE	01295	SN74H00N
U143	1820-0715		IC:TTL DIGITAL HI-SPEED J-K F/F	01295	SN74H106N
U144	1820-0374		IC:TTL HS DUAL 4-INPT AND GATE	01295	SN74H21N
U145	1820-0205		IC:TTL QUAD 2-INPT OR GATE	28480	1820-0205
U146	1820-0372		IC:TTL TRIPLE 3-INPT AND GATE	28480	1820-0372
U147	1820-0370		IC:TTL HS QUAD 2-INPT NAND GATE	01295	SN74H00N
U151	1820-0141		IC:TTL QUAD 2-INPT AND GATE	04713	MC3001P
U152	1820-0424		IC:TTL HS HEX INVERTER	04713	SN74HC4N
U153	1820-0715		IC:TTL DIGITAL HI-SPEED J-K F/F	01295	SN74H106N
U154	1820-0099	1	IC:TTL 4-BIT BINARY COUNTER	01295	SN7493N
U155	1820-0205		IC:TTL QUAD 2-INPT OR GATE	28480	1820-0205
U156	1820-0616		IC:TTL 4-BIT 2-INPT MULTIPLEXER	07263	U78932259X
U157	1820-0706	2	IC:DIGITAL TTL 5-BIT COMPARATOR	04713	U78932459X
U161	1820-0608	1	IC:TTL 1 OF DECODER W/ENABLE	04713	MC4006P
U162	1820-0077		IC:TTL DUAL D F/F	01295	SN7474N
U163	1820-0726		IC:TTL 8-BIT SHIFT REG. PAR IN/OUT	01295	SN74199
U165	1820-0742	5	IC:TTL DUAL 4-BIT LATCH	07263	U6N930859X
U166	1820-0742		IC:TTL DUAL 4-BIT LATCH	07263	U6N930859X
U167	1820-0760		IC:TTL 8-BIT RECEIVER INVERTING	28480	1820-0760
U168	1820-0760		IC:TTL 8-BIT RECEIVER INVERTING	28480	1820-0760
U171	1820-0755		IC	28480	1820-0755
U172	1820-0424		IC:TTL HS HEX INVERTER	04713	SN74HC4N
U173	1820-0756	6	IC:TTL 8-BIT DRIVER INVERTING	28480	1820-0756
U175	1820-0756		IC:TTL 8-BIT DRIVER INVERTING	28480	1820-0756
U176	1820-0756		IC:TTL 8-BIT DRIVER INVERTING	28480	1820-0756
U177	1820-0706		IC:DIGITAL TTL 5-BIT COMPARATOR	04713	U78932459X
U178	1820-0760		IC:TTL 8-BIT RECEIVER INVERTING	28480	1820-0760
U182	1820-0424		IC:TTL HS HEX INVERTER	04713	SN74HC4N
U191	1820-0742		IC:TTL DUAL 4-BIT LATCH	07263	U6N930859X
U192	1820-0424		IC:TTL HS HEX INVERTER	04713	SN74HC4N
U193	1820-0726		IC:TTL 8-BIT SHIFT REG. PAR IN/OUT	01295	SN74199
U195	1820-0742		IC:TTL DUAL 4-BIT LATCH	07263	U6N930859X
U196	1820-0742		IC:TTL DUAL 4-BIT LATCH	07263	U6N930859X
U197	1820-0756		IC:TTL 8-BIT DRIVER INVERTING	28480	1820-0756
U198	1820-0755		IC	28480	1820-0755
U201	1820-0755		IC	28480	1820-0755
U202	1820-0424		IC:TTL HS HEX INVERTER	04713	SN74HC4N
U203	1820-0756		IC:TTL 8-BIT DRIVER INVERTING	28480	1820-0756
U205	1820-0755		IC	28480	1820-0755
U206	1820-0755		IC	28480	1820-0755
U207	1820-0756		IC:TTL 8-BIT DRIVER INVERTING	28480	1820-0756
U208	1820-0755		IC	28480	1820-0755

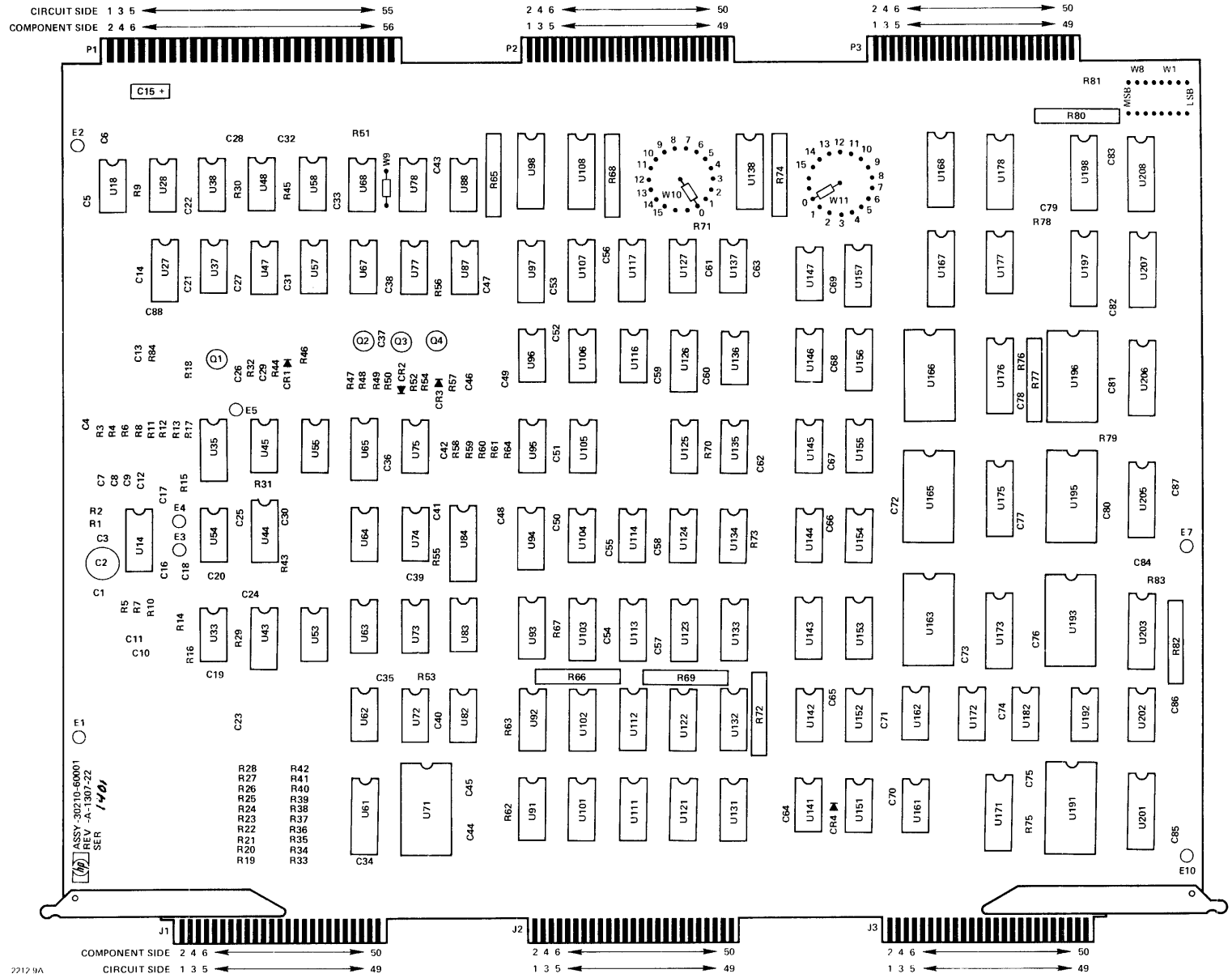

Figure 2-37. Cartridge Disc Controller PCA, Parts Location Diagram

Table 2-39. Magnetic Tape (9 Track) Controller PCA, Replaceable Parts (Continued)

Reference Designation	HP Part Number	Qty	Description	Mfr Code	Mfr Part Number
C75	0160-2055	2	C:FXD CER 0.01 UF +80-20% 100VDCW	56289	C023F101F103ZS22-CDH
C76	0160-2055		C:FXD CER 0.01 UF +80-20% 100VDCW	56289	C023F101F103ZS22-CDH
C77	0140-0208		C:FXD MICA 680 PF 5%	72136	RDH15F681J3C
C78	0140-0208		C:FXD MICA 680 PF 5%	72136	RDH15F681J3C
C79	0160-2055		C:FXD CER 0.01 UF +80-20% 100VDCW	56289	C023F101F103ZS22-CDH
C80	0160-2055		C:FXD CER 0.01 UF +80-20% 100VDCW	56289	C023F101F103ZS22-CDH
C81	0160-2055		C:FXD CER 0.01 UF +80-20% 100VDCW	56289	C023F101F103ZS22-CDH
C82	0160-2055		C:FXD CER 0.01 UF +80-20% 100VDCW	56289	C023F101F103ZS22-CDH
C83	0160-2055		C:FXD CER 0.01 UF +80-20% 100VDCW	56289	C023F101F103ZS22-CDH
C84	0160-2055		C:FXD CER 0.01 UF +80-20% 100VDCW	56289	C023F101F103ZS22-CDH
C85	0160-2055		C:FXD CER 0.01 UF +80-20% 100VDCW	56289	C023F101F103ZS22-CDH
C86	0160-2055		C:FXD CER 0.01 UF +80-20% 100VDCW	56289	C023F101F103ZS22-CDH
C87	0160-2055		C:FXD CER 0.01 UF +80-20% 100VDCW	56289	C023F101F103ZS22-CDH
C88	0160-2055		C:FXD CER 0.01 UF +80-20% 100VDCW	56289	C023F101F103ZS22-CDH
C89	0160-2055		C:FXD CER 0.01 UF +80-20% 100VDCW	56289	C023F101F103ZS22-CDH
C90	0160-2055		C:FXD CER 0.01 UF +80-20% 100VDCW	56289	C023F101F103ZS22-CDH
C91	0160-2055		C:FXD CER 0.01 UF +80-20% 100VDCW	56289	C023F101F103ZS22-CDH
C92	0160-2055		C:FXD CER 0.01 UF +80-20% 100VDCW	56289	C023F101F103ZS22-CDH
C93	0160-2055		C:FXD CER 0.01 UF +80-20% 100VDCW	56289	C023F101F103ZS22-CDH
C94	0160-2055		C:FXD CER 0.01 UF +80-20% 100VDCW	56289	C023F101F103ZS22-CDH
C95	0160-2055		C:FXD CER 0.01 UF +80-20% 100VDCW	56289	C023F101F103ZS22-CDH
C96	0160-2055		C:FXD CER 0.01 UF +80-20% 100VDCW	56289	C023F101F103ZS22-CDH
C97	0160-2055		C:FXD CER 0.01 UF +80-20% 100VDCW	56289	C023F101F103ZS22-CDH
C98	0160-2055		C:FXD CER 0.01 UF +80-20% 100VDCW	56289	C023F101F103ZS22-CDH
C99	0160-2055		C:FXD CER 0.01 UF +80-20% 100VDCW	56289	C023F101F103ZS22-CDH
C100	0160-2055		C:FXD CER 0.01 UF +80-20% 100VDCW	56289	C023F101F103ZS22-CDH
C101	0160-2055		C:FXD CER 0.01 UF +80-20% 100VDCW	56289	C023F101F103ZS22-CDH
C102	0160-2055		C:FXD CER 0.01 UF +80-20% 100VDCW	56289	C023F101F103ZS22-CDH
C103	0160-2055		C:FXD CER 0.01 UF +80-20% 100VDCW	56289	C023F101F103ZS22-CDH
C104	0160-2055		C:FXD CER 0.01 UF +80-20% 100VDCW	56289	C023F101F103ZS22-CDH
C105	0160-2055		C:FXD CER 0.01 UF +80-20% 100VDCW	56289	C023F101F103ZS22-CDH
C106	0160-2055		C:FXD CER 0.01 UF +80-20% 100VDCW	56289	C023F101F103ZS22-CDH
C107	0160-2055		C:FXD CER 0.01 UF +80-20% 100VDCW	56289	C023F101F103ZS22-CDH
C108	0160-2055		C:FXD CER 0.01 UF +80-20% 100VDCW	56289	C023F101F103ZS22-CDH
C109	0180-0197		C:FXD ELECT 2.2 UF 10% 20VDCW	56289	150D225X9020A2-DYS
C110	0180-0197	2	C:FXD ELECT 2.2 UF 10% 20VDCW	56289	150D225X9020A2-DYS
CR1	1901-0049		DIODE:SILICON 50PIV	28480	1901-0049
CR2	1901-0049	8	DIODE:SILICON 50PIV	28480	1901-0049
CR3	1901-0081		DIODE:SILICON 50 VOLTS WORKING	07263	FD1415
CR4	1901-0081		DIODE:SILICON 50 VOLTS WORKING	07263	FD1415
CR5	1901-0081		DIODE:SILICON 50 VOLTS WORKING	07263	FD1415
CR6	1901-0081		DIODE:SILICON 50 VOLTS WORKING	07263	FD1415
CR7	1901-0081		DIODE:SILICON 50 VOLTS WORKING	07263	FD1415
CR8	1901-0081		DIODE:SILICON 50 VOLTS WORKING	07263	FD1415
CR9	1901-0081		DIODE:SILICON 50 VOLTS WORKING	07263	FD1415
CR10	1901-0081	6	DIODE:SILICON 50 VOLTS WORKING	07263	FD1415
Q1	1854-0477		TSTR:SI NPN	80131	2N2222A
Q2	1854-0477		TSTR:SI NPN	80131	2N2222A
Q3	1854-0477		TSTR:SI NPN	80131	2N2222A
Q4	1854-0477	TSTR:SI NPN	80131	2N2222A	
Q5	1854-0477		TSTR:SI NPN	80131	2N2222A
Q6	1854-0477		TSTR:SI NPN	80131	2N2222A
R1	0757-0280	22	R:FXD MET FLM 1K OHM 1% 1/8W	28480	0757-0280
R2	0757-0442		R:FXD MET FLM 10.0K OHM 1% 1/8W	28480	0757-0442
R3	0757-0442		R:FXD MET FLM 10.0K OHM 1% 1/8W	28480	0757-0442
R4	0698-3445	1	R:FXD MET FLM 348 OHM 1% 1/8W	28480	0698-3445
R5	0757-0280		R:FXD MET FLM 1K OHM 1% 1/8W	28480	0757-0280
R6	0757-0280	2	R:FXD MET FLM 1K OHM 1% 1/8W	28480	0757-0280
R7	0757-0279		R:FXD MET FLM 3.16K OHM 1% 1/8W	28480	0757-0279
R8	0698-0084		R:FXD MET FLM 2.15K OHM 1% 1/8W	28480	0698-0084
R9	0757-0280	1	R:FXD MET FLM 1K OHM 1% 1/8W	28480	0757-0280
R10	0757-0346		R:FXD MET FLM 10 OHM 1% 1/8W	28480	0757-0346
R11	0757-0401		R:FXD MET FLM 100 OHM 1% 1/8W	28480	0757-0401
R12	0757-0280		R:FXD MET FLM 1K OHM 1% 1/8W	28480	0757-0280
R13	0757-0280		R:FXD MET FLM 1K OHM 1% 1/8W	28480	0757-0280
R14	0757-0280		R:FXD MET FLM 1K OHM 1% 1/8W	28480	0757-0280
R15	0757-0280		R:FXD MET FLM 1K OHM 1% 1/8W	28480	0757-0280
R16	0757-0279		R:FXD MET FLM 3.16K OHM 1% 1/8W	28480	0757-0279
R17	0757-0442		R:FXD MET FLM 10.0K OHM 1% 1/8W	28480	0757-0442
R18	0757-0442		R:FXD MET FLM 10.0K OHM 1% 1/8W	28480	0757-0442
R19	0757-0442	3	R:FXD MET FLM 10.0K OHM 1% 1/8W	28480	0757-0442
R20	0757-0442		R:FXD MET FLM 10.0K OHM 1% 1/8W	28480	0757-0442
R21	1810-0045		RESISTOR PACK:7 RES. 200 OHM 5% 0.15W	28480	1810-0045
R22	0757-0280		R:FXD MET FLM 1K OHM 1% 1/8W	28480	0757-0280
R23	0757-0280		R:FXD MET FLM 1K OHM 1% 1/8W	28480	0757-0280

Table 2-39. Magnetic Tape (9 Track) Controller PCA, Replaceable Parts (Continued)

Reference Designation	HP Part Number	Qty	Description	Mfr Code	Mfr Part Number
R24	0757-0280		R:FXD MET FLM 1K OHM 1% 1/8W	28480	0757-0280
R25	0757-0280		R:FXD MET FLM 1K OHM 1% 1/8W	28480	0757-0280
R26	1810-0045		RESISTOR PACK:7 RES. 200 OHM 5% 0.15W	28480	1810-0045
R27	1810-0045		RESISTOR PACK:7 RES. 200 OHM 5% 0.15W	28480	1810-0045
R28	0757-0280		R:FXD MET FLM 1K OHM 1% 1/8W	28480	0757-0280
R29	1810-0125	6	RESISTIVE NETWORK:7 X 4.7K OHM 5% 0.15W	28480	1810-0125
R30	1810-0125		RESISTIVE NETWORK:7 X 4.7K OHM 5% 0.15W	28480	1810-0125
R31	0757-0280		R:FXD MET FLM 1K OHM 1% 1/8W	28480	0757-0280
R32	0757-0280		R:FXD MET FLM 1K OHM 1% 1/8W	28480	0757-0280
R33	1810-0125		RESISTIVE NETWORK:7 X 4.7K OHM 5% 0.15W	28480	1810-0125
R34	1810-0125		RESISTIVE NETWORK:7 X 4.7K OHM 5% 0.15W	28480	1810-0125
R35	0757-0280		R:FXD MET FLM 1K OHM 1% 1/8W	28480	0757-0280
R36	0757-0280		R:FXD MET FLM 1K OHM 1% 1/8W	28480	0757-0280
R37	0698-3132	1	R:FXD FLM 261 OHM 1% 1/8W	28480	0698-3132
R38	1810-0125		RESISTIVE NETWORK:7 X 4.7K OHM 5% 0.15W	28480	1810-0125
R39	1810-0030	4	NETWORK:7 RESISTORS 1K OHM 5% 0.15W EA	28480	1810-0030
R40	1810-0125		RESISTIVE NETWORK:7 X 4.7K OHM 5% 0.15W	28480	1810-0125
R41	0757-0280		R:FXD MET FLM 1K OHM 1% 1/8W	28480	0757-0280
R42	0757-0280		R:FXD MET FLM 1K OHM 1% 1/8W	28480	0757-0280
R43	0757-0442		R:FXD MET FLM 10.0K OHM 1% 1/8W	28480	0757-0442
R44	0757-0442		R:FXD MET FLM 10.0K OHM 1% 1/8W	28480	0757-0442
R45	1810-0030		NETWORK:7 RESISTORS 1K OHM 5% 0.15W EA	28480	1810-0030
R46	0757-0280		R:FXD MET FLM 1K OHM 1% 1/8W	28480	0757-0280
R47	1810-0030		NETWORK:7 RESISTORS 1K OHM 5% 0.15W EA	28480	1810-0030
R48	0757-0280		R:FXD MET FLM 1K OHM 1% 1/8W	28480	0757-0280
R49	0757-0280		R:FXD MET FLM 1K OHM 1% 1/8W	28480	0757-0280
R50	0698-3440	1	R:FXD MET FLM 196 OHM 1% 1/8W	28480	0698-3440
R51	1810-0030		NETWORK:7 RESISTORS 1K OHM 5% 0.15W EA	28480	1810-0030
U11	1820-0755	6	IC	28480	1820-0755
U13	1820-0756	11	IC:TTL 8-BIT DRIVER INVERTING	28480	1820-0756
U14	1820-0141	8	IC:TTL QUAD 2-INPT AND GATE	04713	MC3001P
U15	1820-0424	8	IC:TTL HS HEX INVERTER	04713	SN74H04N
U16	1820-0900	1	IC:TTL TRIPLE 3-INPT NOR GATE	28480	1820-0900
U17	1820-0724	3	IC:TTL DUAL 2-4 DECODER W/ENABLE	04713	MC4007P
U21	1820-0742	6	IC:TTL DUAL 4-BIT LATCH	07263	U6N930859X
U22	1820-0515	2	IC:TTL DUAL RE-TRIG/RE-SET MONO-MULTI	07263	U7B960259X
U23	1820-0756		IC:TTL 8-BIT DRIVER INVERTING	28480	1820-0756
U24	1820-0626	1	IC:TTL 4-BIT LATCH	07263	U7B931459X
U25	1820-0844	1	IC:TTL DUAL 3-INPT PULSE SHAPER	04713	MC426P
U26	1820-0077	4	IC:TTL DUAL D F/F	01295	SN7474N
U27	1820-0613	2	IC:HS HEX INVERTER W/OPEN COLL.	01295	SN74H05N
U31	1820-0435	2	IC:TTL 8-BIT ODD/EVEN GEN./CHECKER	01295	SN74180N
U32	1820-0435		IC:TTL 8-BIT ODD/EVEN GEN./CHECKER	01295	SN74180N
U33	1820-0756		IC:TTL 8-BIT DRIVER INVERTING	28480	1820-0756
U34	1820-0424		IC:TTL HS HEX INVERTER	04713	SN74H04N
U35	1820-0686	1	IC:TTL SCHOTTKY TRIPLE 3-INPT AND GATE	01295	SN74S11N
U36	1820-0372	2	IC:TTL TRIPLE 3-INPT AND GATE	28480	1820-0372
U37	1820-0141		IC:TTL QUAD 2-INPT AND GATE	04713	MC3001P
U42	1816-0251	1	IC:ROM	28480	1816-0251
U44	1820-0378	1	IC:TTL HS 2-WIDE 2-INPT	01295	SN74H51N
U45	1820-0141	1	IC:TTL QUAD 2-INPT AND GATE	04713	MC3001P
U46	1820-0424		IC:TTL HS HEX INVERTER	04713	SN74H04N
U47	1820-0491	1	IC:TTL BCD/DEC. DECODER/DRIVER	01295	SN74145N
U51	1816-0220	1	IC:ROM	28480	1816-0220
U52	1816-0206	1	IC:ROM	28480	1816-0206
U53	1820-1105		IC:	28480	1820-1105
U54	1820-0141		IC:TTL QUAD 2-INPT AND GATE	04713	MC3001P
U55	1820-0077		IC:TTL DUAL D F/F	01295	SN7474N
U56	1820-0374	1	IC:TTL HS DUAL 4-INPT AND GATE	01295	SN74H21N
U57	1820-0760	4	IC:TTL 8-BIT RECEIVER INVERTING	28480	1820-0760
U61	1816-0222	1	IC:ROM	28480	1816-0222
U62	1816-0229	1	IC:ROM	28480	1816-0229
U63	1820-0372		IC:TTL TRIPLE 3-INPT AND GATE	28480	1820-0372
U64	1820-0424		IC:TTL HS HEX INVERTER	04713	SN74H04N
U65	1820-0141		IC:TTL QUAD 2-INPT AND GATE	04713	MC3001P
U66	1820-0370	4	IC:TTL HS QUAD 2-INPT NAND GATE	01295	SN74H00N
U67	1820-0761	1	IC:TTL DIGITAL	28480	1820-0761
U71	1816-0223	1	IC:ROM	28480	1816-0223
U72	1816-0253	1	IC:ROM	28480	1816-0253
U73	1810-0037	3	RESISTOR ARRAY:1K OHM 2% 1W EACH	28480	1810-0037
U74	1820-0715	16	IC:TTL DIGITAL HI-SPEED J-K F/F	01295	SN74H106N
U75	1820-0424		IC:TTL HS HEX INVERTER	04713	SN74H04N
U76	1820-0371	2	IC:TTL HS TRIPLE 3-INPT NAND GATE	01295	SN74H10N
U77	1820-0424		IC:TTL HS HEX INVERTER	04713	SN74H04N
U81	1816-0252	1	IC:ROM	28480	1816-0252

Table 2-39. Magnetic Tape (9 Track) Controller PCA, Replaceable Parts (Continued)

Reference Designation	HP Part Number	Qty	Description	Mfr Code	Mfr Part Number
U82	1816-0212	1	IC:ROM	28480	1816-0212
U83	1820-0077		IC:TTL DUAL D F/F	01295	SN7474N
U84	1820-0715		IC:TTL DIGITAL HI-SPEED J-K F/F	01295	SN74H106N
U85	1820-0141		IC:TTL QUAD 2-INPT AND GATE	04713	MC3001P
U86	1820-0715		IC:TTL DIGITAL HI-SPEED J-K F/F	01295	SN74H106N
U87	1820-0759	2	IC:TTL LOW-POWER 8-BIT RECEIVER	28480	1820-0759
U91	1820-0755		IC	28480	1820-0755
U92	1816-0226	1	IC:ROM	28480	1816-0226
U93	1810-0037		RESISTOR ARRAY:1K OHM 2% 1W EACH	28480	1810-0037
U94	1820-0715		IC:TTL DIGITAL HI-SPEED J-K F/F	01295	SN74H106N
U95	1820-0371		IC:TTL HS TRIPLE 3-INPT NAND GATE	01295	SN74H10N
U96	1820-0715		IC:TTL DIGITAL HI-SPEED J-K F/F	01295	SN74H106N
U97	1820-0759		IC:TTL LOW-POWER 8-BIT RECEIVER	28480	1820-0759
U101	1816-0214	1	IC:RGM	28480	1816-0214
U102	1816-0215	1	IC:ROM	28480	1816-0215
U103	1820-0724		IC:TTL DUAL 2-4 DECODER W/ENABLE	04713	MC4007P
U104	1820-0613		IC:HS HEX INVERTER W/OPEN COLL.	01295	SN74H05N
U105	1820-0370		IC:TTL HS QUAD 2-INPT NAND GATE	01295	SN74H00N
U111	1816-0218	1	IC:ROM	28480	1816-0218
U112	1816-0203	1			
U113	1816-0219	1	IC:ROM	28480	1816-0219
U114	1820-0077		IC:TTL DUAL D F/F	01295	SN7474N
U116	1820-0756		IC:TTL 8-BIT DRIVER INVERTING	28480	1820-0756
U121	1820-0424		IC:TTL HS HEX INVERTER	04713	SN74H04N
U122	1810-0037		RESISTOR ARRAY:1K OHM 2% 1W EACH	28480	1810-0037
U123	1820-0370		IC:TTL HS QUAD 2-INPT NAND GATE	01295	SN74H00N
U124	1820-0424		IC:TTL HS HEX INVERTER	04713	SN74H04N
U125	1820-0756		IC:TTL 8-BIT DRIVER INVERTING	28480	1820-0756
U126	1820-0706	2	IC:DIGITAL TTL 5-BIT COMPARATOR	04713	U78932459X
U127	1820-0760		IC:TTL 8-BIT RECEIVER INVERTING	28480	1820-0760
U131	1820-0141		IC:TTL QUAD 2-INPT AND GATE	04713	MC3001P
U132	1820-0756		IC:TTL 8-BIT DRIVER INVERTING	28480	1820-0756
U133	1820-0661	1	IC:TTL QUAD 2-INPT OR GATE	01295	SN7432N
U134	1820-0370		IC:TTL HS QUAD 2-INPT NAND GATE	01295	SN74H00N
U135	1820-0742		IC:TTL DUAL 4-BIT LATCH	07263	U6N930859X
U136	1820-0706		IC:DIGITAL TTL 5-BIT COMPARATOR	04713	U78932459X
U137	1820-0756		IC:TTL 8-BIT DRIVER INVERTING	28480	1820-0756
U141	1820-0141		IC:TTL QUAD 2-INPT AND GATE	04713	MC3001P
U142	1820-0715		IC:TTL DIGITAL HI-SPEED J-K F/F	01295	SN74H106N
U143	1820-0515		IC:TTL DUAL RE-TRIG/RE-SET MONO-MULTI	07263	U78960259X
U144	1820-0756		IC:TTL 8-BIT DRIVER INVERTING	28480	1820-0756
U146	1820-0760		IC:TTL 8-BIT RECEIVER INVERTING	28480	1820-0760
U147	1820-0760		IC:TTL 8-BIT RECEIVER INVERTING	28480	1820-0760
U151	1820-0715		IC:TTL DIGITAL HI-SPEED J-K F/F	01295	SN74H106N
U152	1820-0715		IC:TTL DIGITAL HI-SPEED J-K F/F	01295	SN74H106N
U153	1820-0715		IC:TTL DIGITAL HI-SPEED J-K F/F	01295	SN74H106N
U154	1820-0724		IC:TTL DUAL 2-4 DECODER W/ENABLE	04713	MC4007P
U156	1820-0755		IC	28480	1820-0755
U157	1820-0755		IC	28480	1820-0755
U161	1820-0715		IC:TTL DIGITAL HI-SPEED J-K F/F	01295	SN74H106N
U162	1820-0715		IC:TTL DIGITAL HI-SPEED J-K F/F	01295	SN74H106N
U163	1820-0657	1	IC:DIGITAL TTL 8-INPT PRIORITY ENCODER	07263	U78931859X
U165	1820-0742		IC:TTL DUAL 4-BIT LATCH	07263	U6N930859X
U166	1820-0756		IC:TTL 8-BIT DRIVER INVERTING	28480	1820-0756
U167	1820-0756		IC:TTL 8-BIT DRIVER INVERTING	28480	1820-0756
U171	1820-0715		IC:TTL DIGITAL HI-SPEED J-K F/F	01295	SN74H106N
U172	1820-0715		IC:TTL DIGITAL HI-SPEED J-K F/F	01295	SN74H106N
U173	1820-0715		IC:TTL DIGITAL HI-SPEED J-K F/F	01295	SN74H106N
U174	1820-0756		IC:TTL 8-BIT DRIVER INVERTING	28480	1820-0756
U176	1820-0755		IC	28480	1820-0755
U177	1820-0755		IC	28480	1820-0755
U181	1820-0715		IC:TTL DIGITAL HI-SPEED J-K F/F	01295	SN74H106N
U182	1820-0715		IC:TTL DIGITAL HI-SPEED J-K F/F	01295	SN74H106N
U184	1820-0742		IC:TTL DUAL 4-BIT LATCH	07263	U6N930859X
U186	1820-0742		IC:TTL DUAL 4-BIT LATCH	07263	U6N930859X
W2	8159-0005		JUMPER WIRE	28480	8159-0005

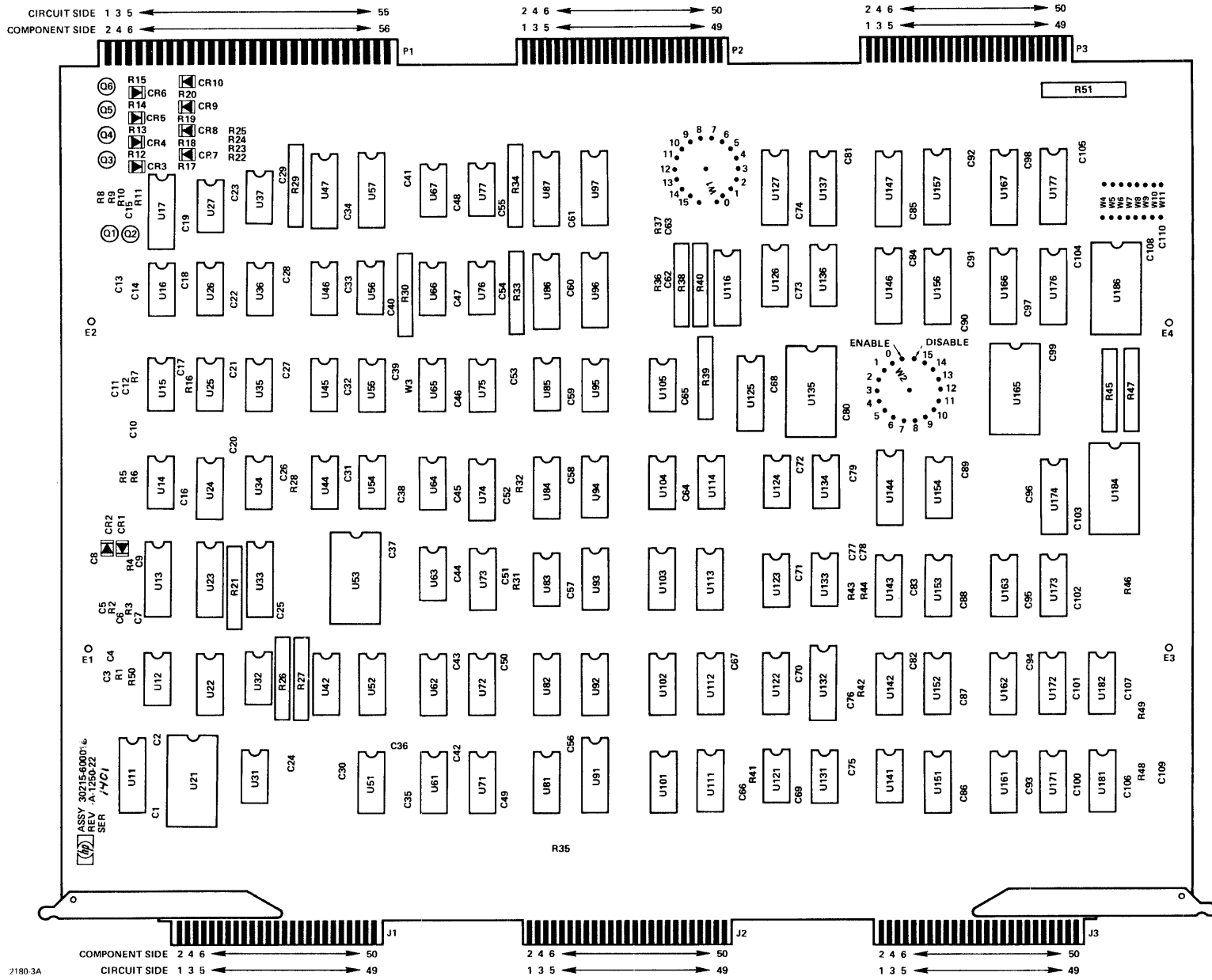

Figure 2-38. Magnetic Tape (9 Track) Controller PCA, Parts Location Diagram

Table 2-40. Magnetic Tape Controller Processor PCA, Replaceable Parts

Reference Designation	HP Part Number	Qty	Description	Mfr Code	Mfr Part Number
	30215-60002		MAGNETIC TAPE CONTROLLER PROCESSOR PCA	28480	30215-60002
C1	0160-2101	1	C:FxD MICA 27PF 2% 300VDCW	72136	RD15E270G3C
C2	0160-2055	7	C:FxD CER 0.01 UF +80-20% 100VDCW	56289	C023F101F103ZS22-CDH
C3	0160-2055		C:FxD CER 0.01 UF +80-20% 100VDCW	56289	C023F101F103ZS22-CDH
C4	0160-2055		C:FxD CER 0.01 UF +80-20% 100VDCW	56289	C023F101F103ZS22-CDH
C5	0160-2055		C:FxD CER 0.01 UF +80-20% 100VDCW	56289	C023F101F103ZS22-CDH
C6	0160-2055		C:FxD CER 0.01 UF +80-20% 100VDCW	56289	C023F101F103ZS22-CDH
C7	0160-2055		C:FxD CER 0.01 UF +80-20% 100VDCW	56289	C023F101F103ZS22-CDH
C8	0160-2055		C:FxD CER 0.01 UF +80-20% 100VDCW	56289	C023F101F103ZS22-CDH
C9	0180-0197	2	C:FxD ELECT 2.2 UF 10% 20VDCW	56289	1500225X9020A2-DYS
C10	0180-0197		C:FxD ELECT 2.2 UF 10% 20VDCW	56289	1500225X9020A2-DYS
C11	0160-2140	2	C:FxD CER 470 PF +80-20% 100VDCW	91418	TYPE B
C12	0160-2140		C:FxD CER 470 PF +80-20% 100VDCW	91418	TYPE B
C16	0160-2055	4	C:FxD CER 0.01 UF +80-20% 100VDCW	56289	C023F101F103ZS22-CDH
C17			THRU		
C18	0150-0050		C:FxD CER 1000 PF +80-20% 100VDCW	56289	C067B102E102ZS26-CDH
C80			THRU		
C91	0160-2055		C:FxD CER 0.01 UF +80-20% 100VDCW	56289	C023F101F103ZS22-CDH
CR1	1901-0040	1	DIODE:SILICON 50 MA 30 WV	07263	FDGL088
Q1	1850-0158	1	TSTR:GE PNP	80131	2N2635
R1	0698-3444	1	R:FxD MET FLM 316 OHM 1% 1/8W	28480	0698-3444
R2	1810-0030	5	NETWORK:7 RESISTORS 1K OHM 5% 0.15W EA	28480	1810-0030
R3	0698-3444	1	R:FxD MET FLM 215 OHM 1% 1/8W	28480	0698-3444
R4	0757-0280	11	R:FxD MET FLM 1K OHM 1% 1/8W	28480	0757-0280
R5	0698-4037	1	R:FxD MET FLM 46.4 OHM 1% 1/8W	28480	0698-4037
R6	0757-0280		R:FxD MET FLM 1K OHM 1% 1/8W	28480	0757-0280
R7	0757-0280		R:FxD MET FLM 1K OHM 1% 1/8W	28480	0757-0280
R8	0757-0280		R:FxD MET FLM 1K OHM 1% 1/8W	28480	0757-0280
R9	0757-0280		R:FxD MET FLM 1K OHM 1% 1/8W	28480	0757-0280
R10	0757-0280		R:FxD MET FLM 1K OHM 1% 1/8W	28480	0757-0280
R11	1810-0030		NETWORK:7 RESISTORS 1K OHM 5% 0.15W EA	28480	1810-0030
R12	1810-0030		NETWORK:7 RESISTORS 1K OHM 5% 0.15W EA	28480	1810-0030
R13	0757-0280		R:FxD MET FLM 1K OHM 1% 1/8W	28480	0757-0280
R14	0757-0280		R:FxD MET FLM 1K OHM 1% 1/8W	28480	0757-0280
R15	0757-0280		R:FxD MET FLM 1K OHM 1% 1/8W	28480	0757-0280
R16	1810-0030		NETWORK:7 RESISTORS 1K OHM 5% 0.15W EA	28480	1810-0030
R17	0757-0280		R:FxD MET FLM 1K OHM 1% 1/8W	28480	0757-0280
R18	1810-0030		NETWORK:7 RESISTORS 1K OHM 5% 0.15W EA	28480	1810-0030
R19	0757-0280		R:FxD MET FLM 1K OHM 1% 1/8W	28480	0757-0280
R20	0757-0401	1	R:FxD MET FLM 100 OHM 1% 1/8W	28480	0757-0401
U11	1820-0377	2	IC:TTL HS DUAL 2-WIDE 2-INPT	01295	SN74H50N
U14	1820-0786	7	IC:TTL HEX D-TYPE FLIP/FLCP WITH CLEAR	01295	SN55431
R21	0757-0280		R:FxD MET FLM 1K OHM 1% 1/8W	28480	0757-0280
U15	1820-0424	3	IC:TTL HS HEX INVERTER	04713	SN74H04N
U16	1820-0538	1	IC:TTL QUAD 2-INPT NAND BUFFER	01295	SN7437N
U17	1820-0512	3	IC:TTL HS DUAL D F/F(35 MHZ MIN.)	01295	SN74H74N
U18	1820-0205	6	IC:TTL QUAD 2-INPT OR GATE	28480	1820-0205
U19	1820-0239	1	IC:TTL QUAD 2-INPT NOR GATE	28480	1820-0239
U21	1820-0142	1	INTEGRATED CIRCUIT:4INPUT,2-OR/NOR	04713	MC1004P
U24	1820-0371	5	IC:TTL HS TRIPLE 3-INPT NAND GATE	01295	SN74H10N
U25	1820-0370	1	IC:TTL HS QUAD 2-INPT NAND GATE	01295	SN74H00N
U26	1820-0376	3	IC:TTL HS DUAL 4-INPT NAND BUFFER	01295	SN74H40N
U27	1820-0424		IC:TTL HS HEX INVERTER	04713	SN74H04N
U28	1820-0376		IC:TTL HS DUAL 4-INPT NAND BUFFER	01295	SN74H40N
U29	1820-0535	1	IC:TTL DUAL PERI.2-INPT AND DRIVER	01295	SN75451P
U31	1820-0379	12	IC:TTL HS 4W 2-2-2-3 INPT AND/OR GATE	01295	SN74H52N
U32	1820-0379		IC:TTL HS 4W 2-2-2-3 INPT AND/OR GATE	01295	SN74H52N
U33	1820-0379		IC:TTL HS 4W 2-2-2-3 INPT AND/OR GATE	01295	SN74H52N
U34	1820-0140	4	IC:TTL DUAL 4-INPT AND BUFFER	04713	MC3026P
U35	1820-0384	1	IC:TTL HS TRIPLE 3-INPT EXPANDER	01295	SN74H61N
U36	1820-0371		IC:TTL HS TRIPLE 3-INPT NAND GATE	01295	SN74H10N
U37	1820-0141	1	IC:TTL QUAD 2-INPT AND GATE	04713	MC3001P
U38	1820-0140		IC:TTL DUAL 4-INPT AND BUFFER	04713	MC3026P
U39	1820-0512		IC:TTL HS DUAL D F/F(35 MHZ MIN.)	01295	SN74H74N
U41	1820-0379		IC:TTL HS 4W 2-2-2-3 INPT AND/OR GATE	01295	SN74H52N
U42	1820-0379		IC:TTL HS 4W 2-2-2-3 INPT AND/OR GATE	01295	SN74H52N
U43	1820-0379		IC:TTL HS 4W 2-2-2-3 INPT AND/OR GATE	01295	SN74H52N
U44	1820-0140		IC:TTL DUAL 4-INPT AND BUFFER	04713	MC3026P
U45	1820-0495	2	IC:TTL 1 OF 16 DECODER	01295	SN74154N
U47	1820-0495		IC:TTL 1 OF 16 DECODER	01295	SN74154N
U48	1820-0372	3	IC:TTL TRIPLE 3-INPT AND GATE	28480	1820-0372
U49	1820-0377		IC:TTL HS DUAL 2-WIDE 2-INPT	01295	SN74H50N
U59	1820-0371		IC:TTL HS TRIPLE 3-INPT NAND GATE	01295	SN74H10N
U61	1820-0379		IC:TTL HS 4W 2-2-2-3 INPT AND/OR GATE	01295	SN74H52N
U62	1820-0379		IC:TTL HS 4W 2-2-2-3 INPT AND/OR GATE	01295	SN74H52N
U63	1820-0379		IC:TTL HS 4W 2-2-2-3 INPT AND/OR GATE	01295	SN74H52N
U64	1820-0424		IC:TTL HS HEX INVERTER	04713	SN74H04N
U65	1820-0371		IC:TTL HS TRIPLE 3-INPT NAND GATE	01295	SN74H10N

Table 2-40. Magnetic Tape Controller Processor PCA, Replaceable Parts (Continued)

Reference Designation	HP Part Number	Qty	Description	Mfr Code	Mfr Part Number
U66	1820-0372	1	IC:TTL TRIPLE 3-INPT AND GATE	28480	1820-0372
U67	1820-0375		IC:TTL HS 8-INPT NAND GATE	01295	SN74H30N
U68	1820-0205		IC:TTL QUAD 2-INPT OR GATE	28480	1820-0205
U69	1820-0376		IC:TTL HS DUAL 4-INPT NAND BUFFER	01295	SN74H40N
U71	1820-0379		IC:TTL HS 4W 2-2-2-3 INPT AND/OR GATE	01295	SN74H52N
U72	1820-0379	21	IC:TTL HS 4W 2-2-2-3 INPT AND/OR GATE	01295	SN74H52N
U73	1820-0379		IC:TTL HS 4W 2-2-2-3 INPT AND/OR GATE	01295	SN74H52N
U74	1820-0512		IC:TTL HS DUAL D F/F(35 MHZ MIN.)	01295	SN74H74N
U75	1820-0788		IC:TTL HEX D-TYPE FLIP/FLOP WITH CLEAR	01295	SN35431
U76	1820-0759		IC:TTL LOW-POWER 8-BIT RECEIVER	28480	1820-0759
U77	1820-0205		1	IC:TTL QUAD 2-INPT OR GATE	28480
U78	1820-0282	IC:TTL QUAD 2-INPT EXCL. OR GATE		01295	SN7486N
U79	1820-0140	IC:TTL DUAL 4-INPT AND BUFFER		04713	MC3026P
U81	1820-0788	IC:TTL HEX D-TYPE FLIP/FLOP WITH CLEAR		01295	SN35431
U82	1820-0759	IC:TTL LOW-POWER 8-BIT RECEIVER		28480	1820-0759
U84	1820-0759	3	IC:TTL LOW-POWER 8-BIT RECEIVER	28480	1820-0759
U85	1820-0371		IC:TTL HS TRIPLE 3-INPT NAND GATE	01295	SN74H10N
U86	1820-0843		IC:TTL DUAL DATA DISTRIBUTOR	04713	MC4002P
U87	1820-0843		IC:TTL DUAL DATA DISTRIBUTOR	04713	MC4002P
U88	1820-0205		IC:TTL QUAD 2-INPT OR GATE	28480	1820-0205
U89	1820-0372	1	IC:TTL TRIPLE 3-INPT AND GATE	28480	1820-0372
U91	1820-0788		IC:TTL HEX D-TYPE FLIP/FLOP WITH CLEAR	01295	SN35431
U92	1820-0788		IC:TTL HEX D-TYPE FLIP/FLOP WITH CLEAR	01295	SN35431
U93	1820-0788		IC:TTL HEX D-TYPE FLIP/FLOP WITH CLEAR	01295	SN35431
U94	1820-0759		IC:TTL LOW-POWER 8-BIT RECEIVER	28480	1820-0759
U95	1820-0843	1	IC:TTL DUAL DATA DISTRIBUTOR	04713	MC4002P
U96	1820-0788		IC:TTL HEX D-TYPE FLIP/FLOP WITH CLEAR	01295	SN35431
U97	1820-0205		IC:TTL QUAD 2-INPT OR GATE	28480	1820-0205
U98	1820-0759		IC:TTL LOW-POWER 8-BIT RECEIVER	28480	1820-0759
U99	1820-0608		IC:TTL 1 OF DECODER W/ENABLE	04713	MC4006P
U101	1820-0545	7	IC:TTL SYNC 4-BIT UP-DOWN COUNTER	01295	SN74191N
U103	1820-0742		IC:TTL DUAL 4-BIT LATCH	07263	U6N930859X
U104	1820-0759	8	IC:TTL LOW-POWER 8-BIT RECEIVER	28480	1820-0759
U105	1820-0755		IC	28480	1820-0755
U107	1820-0742		IC:TTL DUAL 4-BIT LATCH	07263	U6N930859X
U106	1820-0759		IC:TTL LOW-POWER 8-BIT RECEIVER	28480	1820-0759
U109	1820-0742	4	IC:TTL DUAL 4-BIT LATCH	07263	U6N930859X
U111	1820-0545		IC:TTL SYNC 4-BIT UP-DOWN COUNTER	01295	SN74191N
U114	1820-0759		IC:TTL LOW-POWER 8-BIT RECEIVER	28480	1820-0759
U115	1820-0755		IC	28480	1820-0755
U116	1820-0759		IC:TTL LOW-POWER 8-BIT RECEIVER	28480	1820-0759
U121	1820-0545	4	IC:TTL SYNC 4-BIT UP-DOWN COUNTER	01295	SN74191N
U123	1820-0742		IC:TTL DUAL 4-BIT LATCH	07263	U6N930859X
U127	1820-0606		IC:TTL ARITH. LOGIC UNIT/FUNCTION GEN.	01295	SN74181N
U129	1820-0742		IC:TTL DUAL 4-BIT LATCH	07263	U6N930859X
U131	1820-0205		IC:TTL QUAD 2-INPT OR GATE	28480	1820-0205
U134	1820-0759	1	IC:TTL LOW-POWER 8-BIT RECEIVER	28480	1820-0759
U135	1820-0755		IC	28480	1820-0755
U137	1820-0606		IC:TTL ARITH. LOGIC UNIT/FUNCTION GEN.	01295	SN74181N
U138	1820-0759		IC:TTL LOW-POWER 8-BIT RECEIVER	28480	1820-0759
U141	1820-0640		1	IC:TTL DATA SELECTOR/MULTIPLEXER	01295
U143	1820-0742	IC:TTL DUAL 4-BIT LATCH		07263	U6N930859X
U144	1820-0759	IC:TTL LOW-POWER 8-BIT RECEIVER		28480	1820-0759
U145	1820-0755	IC		28480	1820-0755
U147	1820-0611	1	IC:TTL LOOK-AHEAD CARRY GENERATOR	01295	SN74182N
U148	1820-0759	1	IC:TTL LOW-POWER 8-BIT RECEIVER	28480	1820-0759
U149	1820-0742		IC:TTL DUAL 4-BIT LATCH	07263	U6N930859X
U151	1820-0545		IC:TTL SYNC 4-BIT UP-DOWN COUNTER	01295	SN74191N
U153	1820-0742		IC:TTL DUAL 4-BIT LATCH	07263	U6N930859X
U154	1820-0759		IC:TTL LOW-POWER 8-BIT RECEIVER	28480	1820-0759
U155	1820-0755	1	IC	28480	1820-0755
U158	1820-0759		IC:TTL LOW-POWER 8-BIT RECEIVER	28480	1820-0759
U159	1820-0742		IC:TTL DUAL 4-BIT LATCH	07263	U6N930859X
U161	1820-0545		IC:TTL SYNC 4-BIT UP-DOWN COUNTER	01295	SN74191N
U164	1820-0759		IC:TTL LOW-POWER 8-BIT RECEIVER	28480	1820-0759
U165	1820-0755	1	IC	28480	1820-0755
U167	1820-0606		IC:TTL ARITH. LOGIC UNIT/FUNCTION GEN.	01295	SN74181N
U168	1820-0759		IC:TTL LOW-POWER 8-BIT RECEIVER	28480	1820-0759
U171	1820-0374		IC:TTL HS DUAL 4-INPT AND GATE	01295	SN74H21N
U173	1820-0742		IC:TTL DUAL 4-BIT LATCH	07263	U6N930859X
U177	1820-0606	1	IC:TTL ARITH. LOGIC UNIT/FUNCTION GEN.	01295	SN74181N
U178	1820-0742		IC:TTL DUAL 4-BIT LATCH	07263	U6N930859X
U181	1820-0545		IC:TTL SYNC 4-BIT UP-DOWN COUNTER	01295	SN74191N
U184	1820-0759		IC:TTL LOW-POWER 8-BIT RECEIVER	28480	1820-0759
U185	1820-0755		IC	28480	1820-0755

Table 2-40. Magnetic Tape Controller Processor PCA, Replaceable Parts (Continued)

Reference Designation	HP Part Number	Qty	Description	Mfr Code	Mfr Part Number
U188	1820-0759		IC:TTL LOW-POWER 8-BIT RECEIVER	28480	1820-0759
U191	1820-0545		IC:TTL SYNC 4-BIT UP-DOWN COUNTER	01295	SN74191N
U193	1820-0742		IC:TTL DUAL 4-BIT LATCH	07263	U6N930859X
U194	1820-0759		IC:TTL LOW-POWER 8-BIT RECEIVER	28480	1820-0759
U195	1820-0755		IC	28460	1820-0755
U197	1820-0742		IC:TTL DUAL 4-BIT LATCH	07263	U6N930859X
U198	1820-0759		IC:TTL LOW-POWER 8-BIT RECEIVER	28480	1820-0759
U199	1820-0742		IC:TTL DUAL 4-BIT LATCH	07263	U6N930859X
Y1	0410-0475		CRYSTAL:QUARTZ	28480	0410-0475
				28480	0410-0475

Table 2-41. Magnetic Tape (7 Track) Controller PCA, Replaceable Parts

To Be Supplied

To Be Supplied

Figure 2-40. Magnetic Tape (7 Track) Controller PCA, Parts Location Diagram

Table 2-42. Control Panel Interface PCA, Replaceable Parts

Reference Designation	HP Part Number	Qty	Description	Mfr Code	Mfr Part Number
C1	30350-60006	1	CONTROL PANEL INTERFACE PCA	28480	30350-60006
C2	0180-0229	4	C:FxD ELECT 33 UF 10% 10VDCW	28480	0180-0229
C3	0160-2055	80	C:FxD CER 0.01 UF +80-20% 100VDCW	56289	C023F101F103ZS22-CDH
C4	0160-2055		C:FxD CER 0.01 UF +80-20% 100VDCW	56289	C023F101F103ZS22-CDH
C5	0160-2055		C:FxD CER 0.01 UF +80-20% 100VDCW	56289	C023F101F103ZS22-CDH
C6	0160-2055		C:FxD CER 0.01 UF +80-20% 100VDCW	56289	C023F101F103ZS22-CDH
C7	0160-2055		C:FxD CER 0.01 UF +80-20% 100VDCW	56289	C023F101F103ZS22-CDH
C8	0160-2055		C:FxD CER 0.01 UF +80-20% 100VDCW	56289	C023F101F103ZS22-CDH
C9	0160-2055		C:FxD CER 0.01 UF +80-20% 100VDCW	56289	C023F101F103ZS22-CDH
C10	0160-2055		C:FxD CER 0.01 UF +80-20% 100VDCW	56289	C023F101F103ZS22-CDH
C11	0160-2055		C:FxD CER 0.01 UF +80-20% 100VDCW	56289	C023F101F103ZS22-CDH
C12	0160-2055		C:FxD CER 0.01 UF +80-20% 100VDCW	56289	C023F101F103ZS22-CDH
C13	0160-2055		C:FxD CER 0.01 UF +80-20% 100VDCW	56289	C023F101F103ZS22-CDH
C14	0160-2055		C:FxD CER 0.01 UF +80-20% 100VDCW	56289	C023F101F103ZS22-CDH
C15	0150-0121	11	C:FxD CER 0.1 UF +80-20% 50VDCW	56289	5C50BIS-CML
C16			THRU		
C36	0160-2055		C:FxD CER 0.01 UF +80-20% 100VDCW	56289	C023F101F103ZS22-CDH
C37	0150-0121		C:FxD CER 0.1 UF +80-20% 50VDCW	56289	5C50BIS-CML
C38	0160-2055		C:FxD CER 0.01 UF +80-20% 100VDCW	56289	C023F101F103ZS22-CDH
C39	0150-0121		C:FxD CER 0.1 UF +80-20% 50VDCW	56289	5C50BIS-CML
C40	0160-2055		C:FxD CER 0.01 UF +80-20% 100VDCW	56289	C023F101F103ZS22-CDH
C41	0160-2055		C:FxD CER 0.01 UF +80-20% 100VDCW	56289	C023F101F103ZS22-CDH
C42	0150-0121		C:FxD CER 0.1 UF +80-20% 50VDCW	56289	5C50BIS-CML
C43	0160-2055		C:FxD CER 0.01 UF +80-20% 100VDCW	56289	C023F101F103ZS22-CDH
C44	0160-2055		C:FxD CER 0.01 UF +80-20% 100VDCW	56289	C023F101F103ZS22-CDH
C45	0160-2055		C:FxD CER 0.01 UF +80-20% 100VDCW	56289	C023F101F103ZS22-CDH
C46	0180-0228	2	C:FxD ELECT 22 UF 10% 15VDCW	56289	150D226X9015B2-DYS
C47	0150-0121		C:FxD CER 0.1 UF +80-20% 50VDCW	56289	5C50BIS-CML
C48	0160-2055		C:FxD CER 0.01 UF +80-20% 100VDCW	56289	C023F101F103ZS22-CDH
C49	0160-2055		C:FxD CER 0.01 UF +80-20% 100VDCW	56289	C023F101F103ZS22-CDH
C50	0160-2055		C:FxD CER 0.01 UF +80-20% 100VDCW	56289	C023F101F103ZS22-CDH
C51	0180-0228		C:FxD ELECT 22 UF 10% 15VDCW	56289	150D226X9015B2-DYS
C52	0160-2055		C:FxD CER 0.01 UF +80-20% 100VDCW	56289	C023F101F103ZS22-CDH
C53	0160-2055		C:FxD CER 0.01 UF +80-20% 100VDCW	56289	C023F101F103ZS22-CDH
C54	0160-2055		C:FxD CER 0.01 UF +80-20% 100VDCW	56289	C023F101F103ZS22-CDH
C55	0160-2055		C:FxD CER 0.01 UF +80-20% 100VDCW	56289	C023F101F103ZS22-CDH
C56	0160-2055		C:FxD CER 0.01 UF +80-20% 100VDCW	56289	C023F101F103ZS22-CDH
C57	0160-2055		C:FxD CER 0.01 UF +80-20% 100VDCW	56289	C023F101F103ZS22-CDH
C58	0180-0229		C:FxD ELECT 33 UF 10% 10VDCW	28480	0180-0229
C59	0160-2055		C:FxD CER 0.01 UF +80-20% 100VDCW	56289	C023F101F103ZS22-CDH
C60	0160-2055		C:FxD CER 0.01 UF +80-20% 100VDCW	56289	C023F101F103ZS22-CDH
C61	0160-2055		C:FxD CER 0.01 UF +80-20% 100VDCW	56289	C023F101F103ZS22-CDH
C62	0160-2055		C:FxD CER 0.01 UF +80-20% 100VDCW	56289	C023F101F103ZS22-CDH
C63	0160-2055		C:FxD CER 0.01 UF +80-20% 100VDCW	56289	C023F101F103ZS22-CDH
C64	0160-2055		C:FxD CER 0.01 UF +80-20% 100VDCW	56289	C023F101F103ZS22-CDH
C65	0180-0229		C:FxD ELECT 33 UF 10% 10VDCW	28480	0180-0229
C66			THRU		
C85	0160-2055		C:FxD CER 0.01 UF +80-20% 100VDCW	56289	C023F101F103ZS22-CDH
C86	0150-0121		C:FxD CER 0.1 UF +80-20% 50VDCW	56289	5C50BIS-CML
C87	0160-2055		C:FxD CER 0.01 UF +80-20% 100VDCW	56289	C023F101F103ZS22-CDH
C88	0160-2055		C:FxD CER 0.01 UF +80-20% 100VDCW	56289	C023F101F103ZS22-CDH
C89	0160-2055		C:FxD CER 0.01 UF +80-20% 100VDCW	56289	C023F101F103ZS22-CDH
C90	0160-2055		C:FxD CER 0.01 UF +80-20% 100VDCW	56289	C023F101F103ZS22-CDH
C91	0160-2055		C:FxD CER 0.01 UF +80-20% 100VDCW	56289	C023F101F103ZS22-CDH
C92	0150-0121		C:FxD CER 0.1 UF +80-20% 50VDCW	56289	5C50BIS-CML
C93	0160-2055		C:FxD CER 0.01 UF +80-20% 100VDCW	56289	C023F101F103ZS22-CDH
C94	0160-2055		C:FxD CER 0.01 UF +80-20% 100VDCW	56289	C023F101F103ZS22-CDH
C95	0160-2055		C:FxD CER 0.01 UF +80-20% 100VDCW	56289	C023F101F103ZS22-CDH
C96	0160-2055		C:FxD CER 0.01 UF +80-20% 100VDCW	56289	C023F101F103ZS22-CDH
C97	0160-2055		C:FxD CER 0.01 UF +80-20% 100VDCW	56289	C023F101F103ZS22-CDH
C98	0160-2055		C:FxD CER 0.01 UF +80-20% 100VDCW	56289	C023F101F103ZS22-CDH
C99	0160-2055		C:FxD CER 0.01 UF +80-20% 100VDCW	56289	C023F101F103ZS22-CDH
C100	0160-2055		C:FxD CER 0.01 UF +80-20% 100VDCW	56289	C023F101F103ZS22-CDH
C101	0160-2055		C:FxD CER 0.01 UF +80-20% 100VDCW	56289	C023F101F103ZS22-CDH
C102	0150-0121		C:FxD CER 0.1 UF +80-20% 50VDCW	56289	5C50BIS-CML
C103	0160-2055		C:FxD CER 0.01 UF +80-20% 100VDCW	56289	C023F101F103ZS22-CDH
C104	0160-2055		C:FxD CER 0.01 UF +80-20% 100VDCW	56289	C023F101F103ZS22-CDH
C105	0150-0121		C:FxD CER 0.1 UF +80-20% 50VDCW	56289	5C50BIS-CML
C106	0160-2055		C:FxD CER 0.01 UF +80-20% 100VDCW	56289	C023F101F103ZS22-CDH
C107	0160-2055		C:FxD CER 0.01 UF +80-20% 100VDCW	56289	C023F101F103ZS22-CDH
C108	0160-2055		C:FxD CER 0.01 UF +80-20% 100VDCW	56289	C023F101F103ZS22-CDH
C109	0160-2055		C:FxD CER 0.01 UF +80-20% 100VDCW	56289	C023F101F103ZS22-CDH
C110	0160-2055		C:FxD CER 0.01 UF +80-20% 100VDCW	56289	C023F101F103ZS22-CDH
C111	0160-2055		C:FxD CER 0.01 UF +80-20% 100VDCW	56289	C023F101F103ZS22-CDH

Table 2-42. Control Panel Interface PCA, Replaceable Parts (Continued)

Reference Designation	HP Part Number	Qty	Description	Mfr Code	Mfr Part Number
C112	0160-2055	2	C:FXD CER 0.01 UF +80-20% 100VDCW	56289	C023F101F103ZS22-CDH
C113	0150-0121		C:FXD CER 0.1 UF +80-20% 50VDCW	56289	5C508IS-CML
C114	0160-2055		C:FXD CER 0.01 UF +80-20% 100VDCW	56289	C023F101F103ZS22-CDH
C115	0180-0229		C:FXD ELECT 33 UF 10% 10VDCW	28480	0180-0229
CR1	1901-0033		DIODE:SILICON 100MA 180WV	07263	F03369
CR2	1901-0033	4	DIODE:SILICON 100MA 180WV	07263	F03369
R1	1810-0030		NETWORK:7 RESISTORS 1K OHM 5% 0.15W EA	28480	1810-0030
R2	1810-0045		RESISTOR PACK:7 RES. 200 OHM 5% 0.15W	28480	1810-0045
R3	1810-0045		RESISTOR PACK:7 RES. 200 OHM 5% 0.15W	28480	1810-0045
R4	1810-0030		NETWORK:7 RESISTORS 1K OHM 5% 0.15W EA	28480	1810-0030
R5	1810-0045	4	RESISTOR PACK:7 RES. 200 OHM 5% 0.15W	28480	1810-0045
R6	0757-0280		R:FXD MET FLM 1K OHM 1% 1/8W	28480	0757-0280
R7	1810-0030		NETWORK:7 RESISTORS 1K OHM 5% 0.15W EA	28480	1810-0030
R8	1810-0030		NETWORK:7 RESISTORS 1K OHM 5% 0.15W EA	28480	1810-0030
R9	0757-0280		R:FXD MET FLM 1K OHM 1% 1/8W	28480	0757-0280
R10	0698-3159	2	R:FXD MET FLM 26.1K OHM 1% 1/8W	28480	0698-3159
R11	0698-3159		R:FXD MET FLM 26.1K OHM 1% 1/8W	28480	0698-3159
R12	0757-0280		R:FXD MET FLM 1K OHM 1% 1/8W	28480	0757-0280
R13	0757-0280		R:FXD MET FLM 1K OHM 1% 1/8W	28480	0757-0280
S1	3101-1213		SWITCH:TOGGLE DPST-DB SUB-MINIATURE	81640	T8001
U11	1820-0615	2	IC:TTL 8-INPT MULTIPLEXER W/COM.ENABLE	04713	FAIR 9312
U12	1820-0615		IC:TTL 8-INPT MULTIPLEXER W/COM.ENABLE	04713	FAIR 9312
U14	1820-0657		IC:DIGITAL TTL 8-INPT PRIORITY ENCODER	07263	U78931859X
U15	1820-0657		IC:DIGITAL TTL 8-INPT PRIORITY ENCODER	07263	U78931859X
U17	1820-0371		IC:TTL HS TRIPLE 3-INPT NAND GATE	01295	SN74H10N
U18	1820-0262	18	IC:TTL 8-BIT PAR-IN SER-OUT SHIFT REG.	12040	SD9936
U21	1820-0424		IC:TTL HS HEX INVERTER	04713	SN74H04N
U22	1820-0262		IC:TTL 8-BIT PAR-IN SER-OUT SHIFT REG.	12040	SD9936
U24	1820-0657		IC:DIGITAL TTL 8-INPT PRIORITY ENCODER	07263	U78931859X
U25	1820-0371		IC:TTL HS TRIPLE 3-INPT NAND GATE	01295	SN74H10N
U26	1820-0424	7	IC:TTL HS HEX INVERTER	04713	SN74H04N
U27	1820-0370		IC:TTL HS QUAD 2-INPT NAND GATE	01295	SN74H00N
U28	1820-0262		IC:TTL 8-BIT PAR-IN SER-OUT SHIFT REG.	12040	SD9936
U31	1820-0535		IC:TTL DUAL PERI.2-INPT AND DRIVER	01295	SN75451P
U32	1820-0262		IC:TTL 8-BIT PAR-IN SER-OUT SHIFT REG.	12040	SD9936
U33	1820-0495	2	IC:TTL 1 OF 16 DECODER	01295	SN74154N
U34	1820-0657		IC:DIGITAL TTL 8-INPT PRIORITY ENCODER	07263	U78931859X
U35	1820-0375		IC:TTL HS 8-INPT NAND GATE	01295	SN74H30N
U36	1820-0141		IC:TTL QUAD 2-INPT AND GATE	04713	MC3001P
U37	1820-0370		IC:TTL HS QUAD 2-INPT NAND GATE	01295	SN74H00N
U38	1820-0262	4	IC:TTL 8-BIT PAR-IN SER-OUT SHIFT REG.	12040	SD9936
U41	1820-0535		IC:TTL DUAL PERI.2-INPT AND DRIVER	01295	SN75451P
U42	1820-0262		IC:TTL 8-BIT PAR-IN SER-OUT SHIFT REG.	12040	SD9936
U43	1820-0495		IC:TTL 1 OF 16 DECODER	01295	SN74154N
U44	1820-0657		IC:DIGITAL TTL 8-INPT PRIORITY ENCODER	07263	U78931859X
U45	1820-0657	3	IC:DIGITAL TTL 8-INPT PRIORITY ENCODER	07263	U78931859X
U46	1820-0371		IC:TTL HS TRIPLE 3-INPT NAND GATE	01295	SN74H10N
U47	1820-0846		IC:TTL DIGITAL QUAD BUFFER	12040	DM 8094N
U48	1820-0262		IC:TTL 8-BIT PAR-IN SER-OUT SHIFT REG.	12040	SD9936
U51	1820-0535		IC:TTL DUAL PERI.2-INPT AND DRIVER	01295	SN75451P
U52	1820-0262	3	IC:TTL 8-BIT PAR-IN SER-OUT SHIFT REG.	12040	SD9936
U55	1820-0373		IC:TTL HS DUAL 4-INPT NAND GATE	01295	SN74H20N
U56	1820-0370		IC:TTL HS QUAD 2-INPT NAND GATE	01295	SN74H00N
U57	1820-0846		IC:TTL DIGITAL QUAD BUFFER	12040	DM 8094N
U58	1820-0262		IC:TTL 8-BIT PAR-IN SER-OUT SHIFT REG.	12040	SD9936
U61	1820-0535	1	IC:TTL DUAL PERI.2-INPT AND DRIVER	01295	SN75451P
U62	1820-0424		IC:TTL HS HEX INVERTER	04713	SN74H04N
U63	1820-0233		IC:TTL SYNUP-ON 4-BIT BINARY COUNTER	01295	SN74193N
U64	1820-0373		IC:TTL HS DUAL 4-INPT NAND GATE	01295	SN74H20N
U66	1820-0755		IC	28480	1820-0755
U67	1820-0574	3	IC:DIGITAL TTL QUAD D-F/F	12040	DM8551N
U68	1820-0262		IC:TTL 8-BIT PAR-IN SER-OUT SHIFT REG.	12040	SD9936
U73	1820-0370		IC:TTL HS QUAD 2-INPT NAND GATE	01295	SN74H00N
U76	1820-0755		IC	28480	1820-0755
U77	1820-0574		IC:DIGITAL TTL QUAD D-F/F	12040	DM8551N
U78	1820-0262	2	IC:TTL 8-BIT PAR-IN SER-OUT SHIFT REG.	12040	SD9936
U84	1820-0207		IC:TTL MONOSTABLE MULTIVIBRATOR	28480	1820-0207
U86	1820-0755		IC	28480	1820-0755
U87	1820-0574		IC:DIGITAL TTL QUAD D-F/F	12040	DM8551N
U88	1820-0262		IC:TTL 8-BIT PAR-IN SER-OUT SHIFT REG.	12040	SD9936
U94	1820-0207	1	IC:TTL MONOSTABLE MULTIVIBRATOR	28480	1820-0207
U96	1820-0141		IC:TTL QUAD 2-INPT AND GATE	04713	MC3001P
U97	1820-0371		IC:TTL HS TRIPLE 3-INPT NAND GATE	01295	SN74H10N
U98	1820-0370		IC:TTL HS QUAD 2-INPT NAND GATE	01295	SN74H00N
U105	1820-0239		IC:TTL QUAD 2-INPT NOR GATE	26480	1820-0239

Table 2-42. Control Panel Interface PCA, Replaceable Parts (Continued)

Reference Designation	HP Part Number	Qty	Description	Mfr Code	Mfr Part Number
U106	1820-0141		IC:TTL QUAD 2-INPT AND GATE	04713	MC3001P
U107	1820-0695	5	IC:TTL SHS DUAL J-K F/F W/PRESET	01295	SN74S113N
U108	1820-0372	2	IC:TTL TRIPLE 3-INPT AND GATE	28480	1820-0372
U114	1820-0370		IC:TTL HS QUAD 2-INPT NAND GATE	01295	SN74H00N
U115	1820-0141		IC:TTL QUAD 2-INPT AND GATE	04713	MC3001P
U116	1820-0695		IC:TTL SHS DUAL J-K F/F W/PRESET	01295	SN74S113N
U117	1820-0512	2	IC:TTL HS DUAL D F/F(35 MHZ MIN.)	01295	SN74H74N
U118	1820-0695		IC:TTL SHS DUAL J-K F/F W/PRESET	01295	SN74S113N
U123	1820-0294	2	IC:TTL 8-BIT SER-IN PAR OUT SHIFT REG	12040	SD9935
U124	1820-0695		IC:TTL SHS DUAL J-K F/F W/PRESET	01295	SN74S113N
U125	1820-0371		IC:TTL HS TRIPLE 3-INPT NAND GATE	01295	SN74H10N
U126	1820-0294		IC:TTL 8-BIT SER-IN PAR OUT SHIFT REG	12040	SD9935
U127	1820-0512		IC:TTL HS DUAL D F/F(35 MHZ MIN.)	01295	SN74H74N
U128	1820-0372		IC:TTL TRIPLE 3-INPT AND GATE	28480	1820-0372
U132	1820-0695		IC:TTL SHS DUAL J-K F/F W/PRESET	01295	SN74S113N
U134	1820-0374	3	IC:TTL HS DUAL 4-INPT AND GATE	01295	SN74H21N
U135	1820-0424		IC:TTL HS HEX INVERTER	04713	SN74H04N
U138	1820-0370		IC:TTL HS QUAD 2-INPT NAND GATE	01295	SN74H00N
U142	1820-0371		IC:TTL HS TRIPLE 3-INPT NAND GATE	01295	SN74H10N
U143	1820-0742	8	IC:TTL DUAL 4-BIT LATCH	07263	U6N930859X
U144	1820-0374		IC:TTL HS DUAL 4-INPT AND GATE	01295	SN74H21N
U145	1820-0617	3	IC:TTL QUAD 2-INPT EXCL. NOR GATE	04713	MC3022P
U146	1820-0742		IC:TTL DUAL 4-BIT LATCH	07263	U6N930859X
U148	1820-0373		IC:TTL HS DUAL 4-INPT NAND GATE	01295	SN74H20N
U152	1820-0424		IC:TTL HS HEX INVERTER	04713	SN74H04N
U153	1820-0742		IC:TTL DUAL 4-BIT LATCH	07263	U6N930859X
U154	1820-0374		IC:TTL HS DUAL 4-INPT AND GATE	01295	SN74H21N
U155	1820-0617		IC:TTL QUAD 2-INPT EXCL. NOR GATE	04713	MC3022P
U156	1820-0742		IC:TTL DUAL 4-BIT LATCH	07263	U6N930859X
U157	1820-0755		IC	28480	1820-0755
U164	1820-0617		IC:TTL QUAD 2-INPT EXCL. NOR GATE	04713	MC3022P
U168	1820-0262		IC:TTL 8-BIT PAR-IN SER-CUT SHIFT REG.	12040	SD9936
U172	1820-0262		IC:TTL 8-BIT PAR-IN SER-OUT SHIFT REG.	12040	SD9936
U173	1820-0742		IC:TTL DUAL 4-BIT LATCH	07263	U6N930859X
U174	1820-0846		IC:TTL DIGITAL QUAD BUFFER	12040	DM 8094N
U178	1820-0262		IC:TTL 8-BIT PAR-IN SER-OUT SHIFT REG.	12040	SD9936
U182	1820-0262		IC:TTL 8-BIT PAR-IN SER-OUT SHIFT REG.	12040	SD9936
U183	1820-0742		IC:TTL DUAL 4-BIT LATCH	07263	U6N930859X
U184	1820-0755		IC	28480	1820-0755
U186	1820-0742		IC:TTL DUAL 4-BIT LATCH	07263	U6N930859X
U188	1820-0262		IC:TTL 8-BIT PAR-IN SER-OUT SHIFT REG.	12040	SD9936
U192	1820-0384	1	IC:TTL HS TRIPLE 3-INPT EXPANDER	01295	SN74H61N
U195	1820-0608	1	IC:TTL 1 OF DECODER W/ENABLE	04713	MC4006P
U198	1820-0262		IC:TTL 8-BIT PAR-IN SER-OUT SHIFT REG.	12040	SD9936
U202	1820-0379	1	IC:TTL HS 4W 2-2-2-3 INPT AND/OR GATE	01295	SN74H52N
U203	1820-0742		IC:TTL DUAL 4-BIT LATCH	07263	U6N930859X
U204	1820-0424		IC:TTL HS HEX INVERTER	04713	SN74H04N
U206	1820-0755		IC	28480	1820-0755
U208	1820-0535		IC:TTL DUAL PERI.2-INPT AND DRIVER	01295	SN75451P

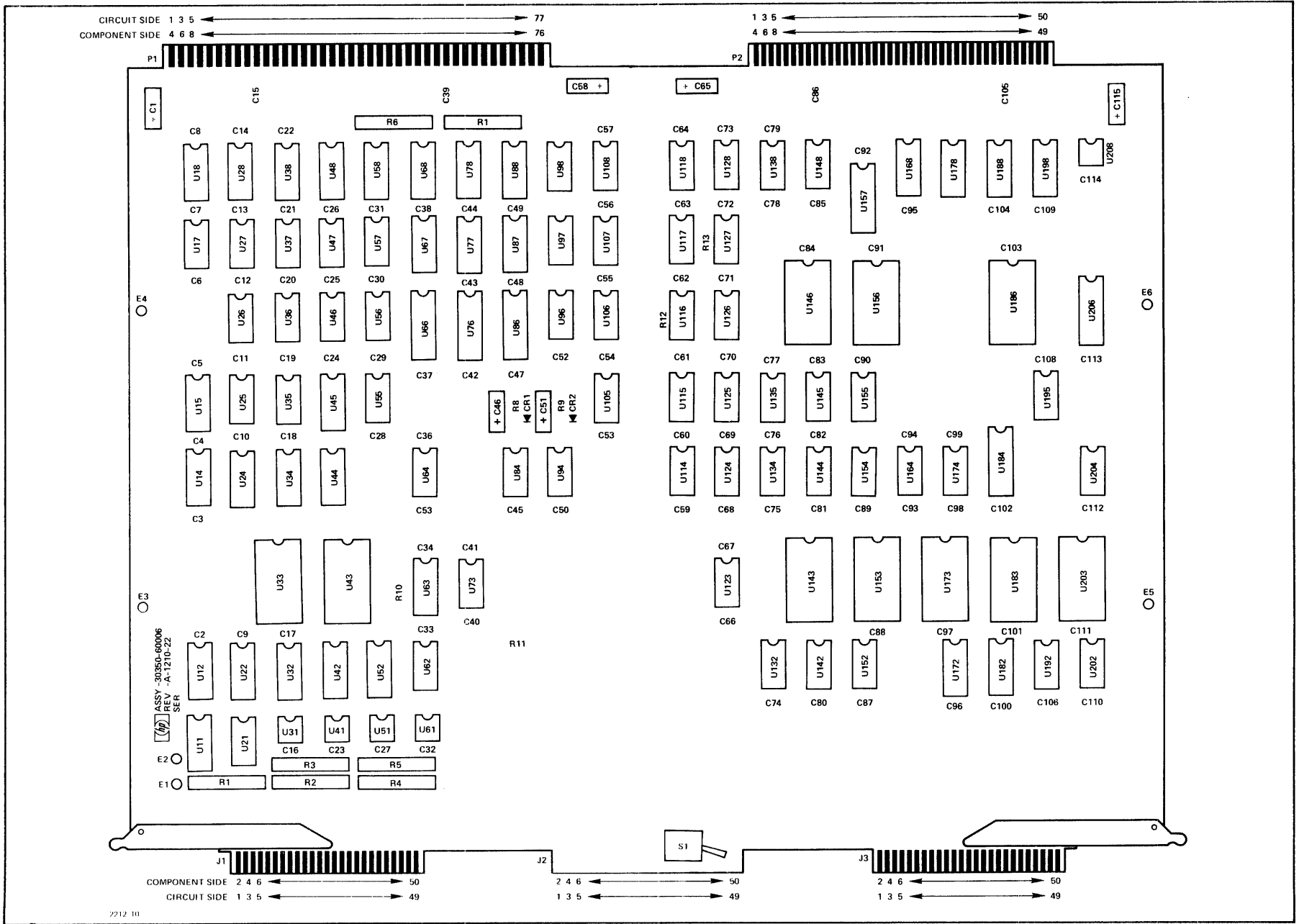

Figure 2-41. Control Panel Interface PCA, Parts Location Diagram

Table 2-43. Controller Maintenance Interface PCA, Replaceable Parts

Reference Designation	HP Part Number	Qty	Description	Mfr Code	Mfr Part Number
C1	30351-60001	1	CONTROLLER MAINTENANCE INTERFACE PCA	28480	30351-60001
C2	0160-2055	23	C:FxD CER 0.01 UF +80-20% 100VDCW	56289	C023F101F103ZS22-CDH
C3	0180-0197	6	C:FxD ELECT 2.2 UF 10% 20VDCW	56289	150D225X9020A2-DYS
C4	0160-2055		C:FxD CER 0.01 UF +80-20% 100VDCW	56289	150D225X9020A2-DYS
C5	0160-2055		C:FxD CER 0.01 UF +80-20% 100VDCW	56289	C023F101F103ZS22-CDH
C6	0160-2055		C:FxD CER 0.01 UF +80-20% 100VDCW	56289	C023F101F103ZS22-CDH
C7	0160-2055		C:FxD CER 0.01 UF +80-20% 100VDCW	56289	C023F101F103ZS22-CDH
C8	0160-2055		C:FxD CER 0.01 UF +80-20% 100VDCW	56289	C023F101F103ZS22-CDH
C9	0180-0197		C:FxD ELECT 2.2 UF 10% 20VDCW	56289	150D225X9020A2-DYS
C10	0160-2055		C:FxD CER 0.01 UF +80-20% 100VDCW	56289	C023F101F103ZS22-CDH
C11	0160-2055		C:FxD CER 0.01 UF +80-20% 100VDCW	56289	C023F101F103ZS22-CDH
C12	0160-2055		C:FxD CER 0.01 UF +80-20% 100VDCW	56289	C023F101F103ZS22-CDH
C13	0160-2055		C:FxD CER 0.01 UF +80-20% 100VDCW	56289	C023F101F103ZS22-CDH
C14	0160-2055		C:FxD CER 0.01 UF +80-20% 100VDCW	56289	C023F101F103ZS22-CDH
C15	0160-2055		C:FxD CER 0.01 UF +80-20% 100VDCW	56289	C023F101F103ZS22-CDH
C16	0160-2055		C:FxD CER 0.01 UF +80-20% 100VDCW	56289	C023F101F103ZS22-CDH
C17	0160-2055		C:FxD CER 0.01 UF +80-20% 100VDCW	56289	C023F101F103ZS22-CDH
C18	0160-2055		C:FxD CER 0.01 UF +80-20% 100VDCW	56289	C023F101F103ZS22-CDH
C19	0160-2055		C:FxD CER 0.01 UF +80-20% 100VDCW	56289	C023F101F103ZS22-CDH
C20	0160-2055		C:FxD CER 0.01 UF +80-20% 100VDCW	56289	C023F101F103ZS22-CDH
C21	0160-2055		C:FxD CER 0.01 UF +80-20% 100VDCW	56289	C023F101F103ZS22-CDH
C22	0160-2055		C:FxD CER 0.01 UF +80-20% 100VDCW	56289	C023F101F103ZS22-CDH
C23	0160-3456	7	C:FxD CER 1000 PF 10% 250VDCW	56289	C067F251F102KS22-CDH
C24	0160-3456		C:FxD CER 1000 PF 10% 250VDCW	56289	C067F251F102KS22-CDH
C25	0160-3456		C:FxD CER 1000 PF 10% 250VDCW	56289	C067F251F102KS22-CDH
C26	0160-3456		C:FxD CER 1000 PF 10% 250VDCW	56289	C067F251F102KS22-CDH
C27	0160-2055		C:FxD CER 0.01 UF +80-20% 100VDCW	56289	C023F101F103ZS22-CDH
C28	0180-0197		C:FxD ELECT 2.2 UF 10% 20VDCW	56289	150D225X9020A2-DYS
C29	0180-0197		C:FxD ELECT 2.2 UF 10% 20VDCW	56289	150D225X9020A2-DYS
C30	0160-2055		C:FxD CER 0.01 UF +80-20% 100VDCW	56289	C023F101F103ZS22-CDH
C31	0160-2055		C:FxD CER 0.01 UF +80-20% 100VDCW	56289	C023F101F103ZS22-CDH
C32	0180-0197		C:FxD ELECT 2.2 UF 10% 20VDCW	56289	150D225X9020A2-DYS
C33	0160-2055		C:FxD CER 0.01 UF +80-20% 100VDCW	56289	C023F101F103ZS22-CDH
C34	0160-3456		C:FxD CER 1000 PF 10% 250VDCW	56289	C067F251F102KS22-CDH
C35	0160-3456		C:FxD CER 1000 PF 10% 250VDCW	56289	C067F251F102KS22-CDH
C36	0160-3456		C:FxD CER 1000 PF 10% 250VDCW	56289	C067F251F102KS22-CDH
J1	1251-3141	2			
J2	1251-3141				
O1	1854-0071	1	TSTR:SI NPN(SELECTED FROM 2N3704)	28480	1654-0071
R1	0757-0280	21	R:FxD MET FLM 1K OHM 1% 1/8W	28480	0757-0280
R2	0757-0280		R:FxD MET FLM 1K OHM 1% 1/8W	28480	0757-0280
R3	0757-0407	3	R:FxD MET FLM 200 OHM 1% 1/8W	28480	0757-0407
R4	0757-0280		R:FxD MET FLM 1K OHM 1% 1/8W	28480	0757-0280
R5	0757-0280		R:FxD MET FLM 1K OHM 1% 1/8W	28480	0757-0280
R6	0757-0403	4	R:FxD MET FLM 121 OHM 1% 1/8W	28480	0757-0403
R7	0757-0403		R:FxD MET FLM 121 OHM 1% 1/8W	28480	0757-0403
R8	0757-0280		R:FxD MET FLM 1K OHM 1% 1/8W	28480	0757-0280
R9	0757-0280		R:FxD MET FLM 1K OHM 1% 1/8W	28480	0757-0280
R10	0757-0280		R:FxD MET FLM 1K OHM 1% 1/8W	28480	0757-0280
R11	0757-0403	2	R:FxD MET FLM 121 OHM 1% 1/8W	28480	0757-0403
R12	0757-0403		R:FxD MET FLM 121 OHM 1% 1/8W	28480	0757-0403
R13	0698-0082		R:FxD MET FLM 464 OHM 1% 1/8W	28480	0698-0082
R14	0698-0082		R:FxD MET FLM 464 OHM 1% 1/8W	28480	0698-0082
R15	0757-0280		R:FxD MET FLM 1K OHM 1% 1/8W	28480	0757-0280
R16	0757-0280		R:FxD MET FLM 1K OHM 1% 1/8W	28480	0757-0280
R17	0757-0280		R:FxD MET FLM 1K OHM 1% 1/8W	28480	0757-0280
R18	0757-0280		R:FxD MET FLM 1K OHM 1% 1/8W	28480	0757-0280
R19	0757-0280		R:FxD MET FLM 1K OHM 1% 1/8W	28480	0757-0280
R20	0757-0280		R:FxD MET FLM 1K OHM 1% 1/8W	28480	0757-0280
R21	0757-0407		R:FxD MET FLM 200 OHM 1% 1/8W	28480	0757-0407
R22	0757-0407		R:FxD MET FLM 200 OHM 1% 1/8W	28480	0757-0407
R23	0757-0280		R:FxD MET FLM 1K OHM 1% 1/8W	28480	0757-0280
R24	0757-0280		R:FxD MET FLM 1K OHM 1% 1/8W	28480	0757-0280
R25	0757-0280		R:FxD MET FLM 1K OHM 1% 1/8W	28480	0757-0280
R26	0757-0280		R:FxD MET FLM 1K OHM 1% 1/8W	28480	0757-0280
R27	0757-0280		R:FxD MET FLM 1K OHM 1% 1/8W	28480	0757-0280
R28	0757-0280		R:FxD MET FLM 1K OHM 1% 1/8W	28480	0757-0280
R29	1810-0125	2	RESISTIVE NETWORK:7 X 4.7K OHM 5% 0.15W	28480	1810-0125
R30	0698-3155	2	R:FxD MET FLM 4.64K OHM 1% 1/8W	28480	0698-3155
R31	1810-0125		RESISTIVE NETWORK:7 X 4.7K OHM 5% 0.15W	28480	1810-0125
R32	0698-3155		R:FxD MET FLM 4.64K OHM 1% 1/8W	28480	0698-3155
R33	0757-0280		R:FxD MET FLM 1K OHM 1% 1/8W	28480	0757-0280
R34	0757-0280		R:FxD MET FLM 1K OHM 1% 1/8W	28480	0757-0280
U13	1820-0141	2	IC:TTL QUAD 2-INPT AND GATE	04713	MC3001P

Table 2-43. Controller Maintenance Interface PCA, Replaceable Parts (Continued)

Reference Designation	HP Part Number	Qty	Description	Mfr Code	Mfr Part Number
U23	1820-0615	1	IC:TTL 8-INPT MULTIPLEXER W/COM.ENABLE	04713	FAIR 9312
U24	1820-0239	1	IC:TTL QUAD 2-INPT NOR GATE	28480	1820-0239
U27	1820-0535	2	IC:TTL DUAL PERI.2-INPT AND DRIVER	01295	SN75451P
U33	1820-0140	3	IC:TTL DUAL 4-INPT AND BUFFER	04713	MC3026P
U43	1820-0424	2	IC:TTL HS HEX INVERTER	04713	SN74H04N
U44	1820-0140		IC:TTL DUAL 4-INPT AND BUFFER	04713	MC3026P
U46	1820-0054	2	IC:TTL QUAD 2-INPT NAND GATE	01295	SN7400N
U53	1820-0759	4	IC:TTL LOW-POWER 8-BIT RECEIVER	28480	1820-0759
U54	1820-0077	7	IC:TTL DUAL D F/F	01295	SN7474N
U55	1820-0141		IC:TTL QUAD 2-INPT AND GATE	04713	MC3001P
U56	1820-0233	1	IC:TTL SYNUP-ON 4-BIT BINARY COUNTER	01295	SN74193N
U57	1820-0372	1	IC:TTL TRIPLE 3-INPT AND GATE	28480	1820-0372
U61	1820-0759		IC:TTL LOW-POWER 8-BIT RECEIVER	28480	1820-0759
U62	1820-0301	6	IC:TTL QUAD BI-STABLE D-LATCH	01295	SN7475N
U63	1820-0301		IC:TTL QUAD BI-STABLE D-LATCH	01295	SN7475N
U64	1820-0077		IC:TTL DUAL D F/F	01295	SN7474N
U65	1820-0077		IC:TTL DUAL D F/F	01295	SN7474N
U66	1820-0424		IC:TTL HS HEX INVERTER	04713	SN74H04N
U67	1820-0715	1	IC:TTL DIGITAL HI-SPEED J-K F/F	01295	SN74H106N
U71	1820-0262	14	IC:TTL 8-BIT PAR-IN SER-OUT SHIFT REG.	12040	SD9936
U72	1820-0301		IC:TTL QUAD BI-STABLE D-LATCH	01295	SN7475N
U73	1820-0294	2	IC:TTL 8-BIT SER-IN PAR OUT SHIFT REG	12040	SD9935
U74	1820-0301		IC:TTL QUAD BI-STABLE D-LATCH	01295	SN7475N
U75	1820-0262		IC:TTL 8-BIT PAR-IN SER-OUT SHIFT REG.	12040	SD9936
U76	1820-0608	1	IC:TTL 1 OF DECODER W/ENABLE	04713	MC4006P
U77	1820-0054		IC:TTL QUAD 2-INPT NAND GATE	01295	SN7400N
U81	1820-0262		IC:TTL 8-BIT PAR-IN SER-OUT SHIFT REG.	12040	SD9936
U82	1820-0262		IC:TTL 8-BIT PAR-IN SER-OUT SHIFT REG.	12040	SD9936
U83	1820-0301		IC:TTL QUAD BI-STABLE D-LATCH	01295	SN7475N
U84	1820-0294		IC:TTL 8-BIT SER-IN PAR OUT SHIFT REG	12040	SD9935
U85	1820-0077		IC:TTL DUAL D F/F	01295	SN7474N
U86	1820-0068	1	IC:TTL TRIPLE 3-INPUT POS NAND GATE	12040	SN7410N
U87	1820-0077		IC:TTL DUAL D F/F	01295	SN7474N
U91	1820-0262		IC:TTL 8-BIT PAR-IN SER-OUT SHIFT REG.	12040	SD9936
U92	1820-0617	3	IC:TTL QUAD 2-INPT EXCL. NOR GATE	04713	MC3022P
U93	1820-0617		IC:TTL QUAD 2-INPT EXCL. NOR GATE	04713	MC3022P
U94	1820-0301		IC:TTL QUAD BI-STABLE D-LATCH	01295	SN7475N
U95	1820-0077		IC:TTL DUAL D F/F	01295	SN7474N
U96	1820-0077		IC:TTL DUAL D F/F	01295	SN7474N
U101	1820-0262		IC:TTL 8-BIT PAR-IN SER-OUT SHIFT REG.	12040	SD9936
U102	1820-0374	2	IC:TTL HS DUAL 4-INPT AND GATE	01295	SN74H21N
U103	1820-0374		IC:TTL HS DUAL 4-INPT AND GATE	01295	SN74H21N
U104	1820-0617		IC:TTL QUAD 2-INPT EXCL. NOR GATE	04713	MC3022P
U105	1820-0262		IC:TTL 8-BIT PAR-IN SER-OUT SHIFT REG.	12040	SD9936
U112	1820-0535		IC:TTL DUAL PERI.2-INPT AND DRIVER	01295	SN75451P
U113	1820-0140		IC:TTL DUAL 4-INPT AND BUFFER	04713	MC3026P
U114	1820-0262		IC:TTL 8-BIT PAR-IN SER-OUT SHIFT REG.	12040	SD9936
U133	1820-0759		IC:TTL LOW-POWER 8-BIT RECEIVER	28480	1820-0759
U134	1820-0262		IC:TTL 8-BIT PAR-IN SER-OUT SHIFT REG.	12040	SD9936
U135	1820-0205	1	IC:TTL QUAD 2-INPT OR GATE	28480	1820-0205
U143	1820-0756	2	IC:TTL 8-BIT DRIVER INVERTING	28480	1820-0756
U144	1820-0262		IC:TTL 8-BIT PAR-IN SER-OUT SHIFT REG.	12040	SD9936
U145	1820-0262		IC:TTL 8-BIT PAR-IN SER-OUT SHIFT REG.	12040	SD9936
U153	1820-0759		IC:TTL LOW-POWER 8-BIT RECEIVER	28480	1820-0759
U154	1820-0262		IC:TTL 8-BIT PAR-IN SER-OUT SHIFT REG.	12040	SD9936
U163	1820-0756		IC:TTL 8-BIT DRIVER INVERTING	28480	1820-0756
U164	1820-0262		IC:TTL 8-BIT PAR-IN SER-OUT SHIFT REG.	12040	SD9936
U165	1820-0262		IC:TTL 8-BIT PAR-IN SER-OUT SHIFT REG.	12040	SD9936
W1	5040-1485	1	CONDUCTOR ASSEMBLY:PLUG-IN JUMPER	28480	5040-1485

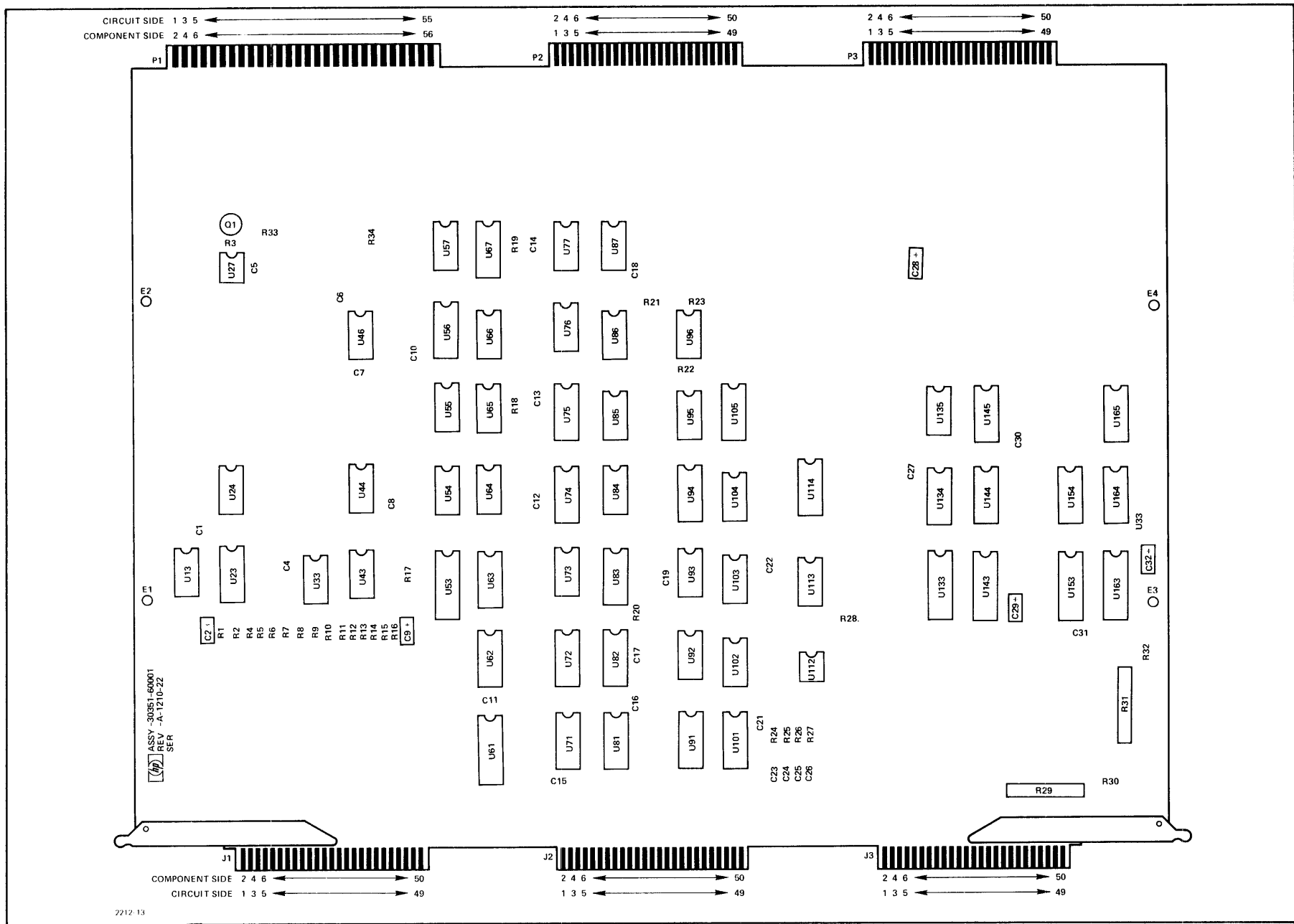
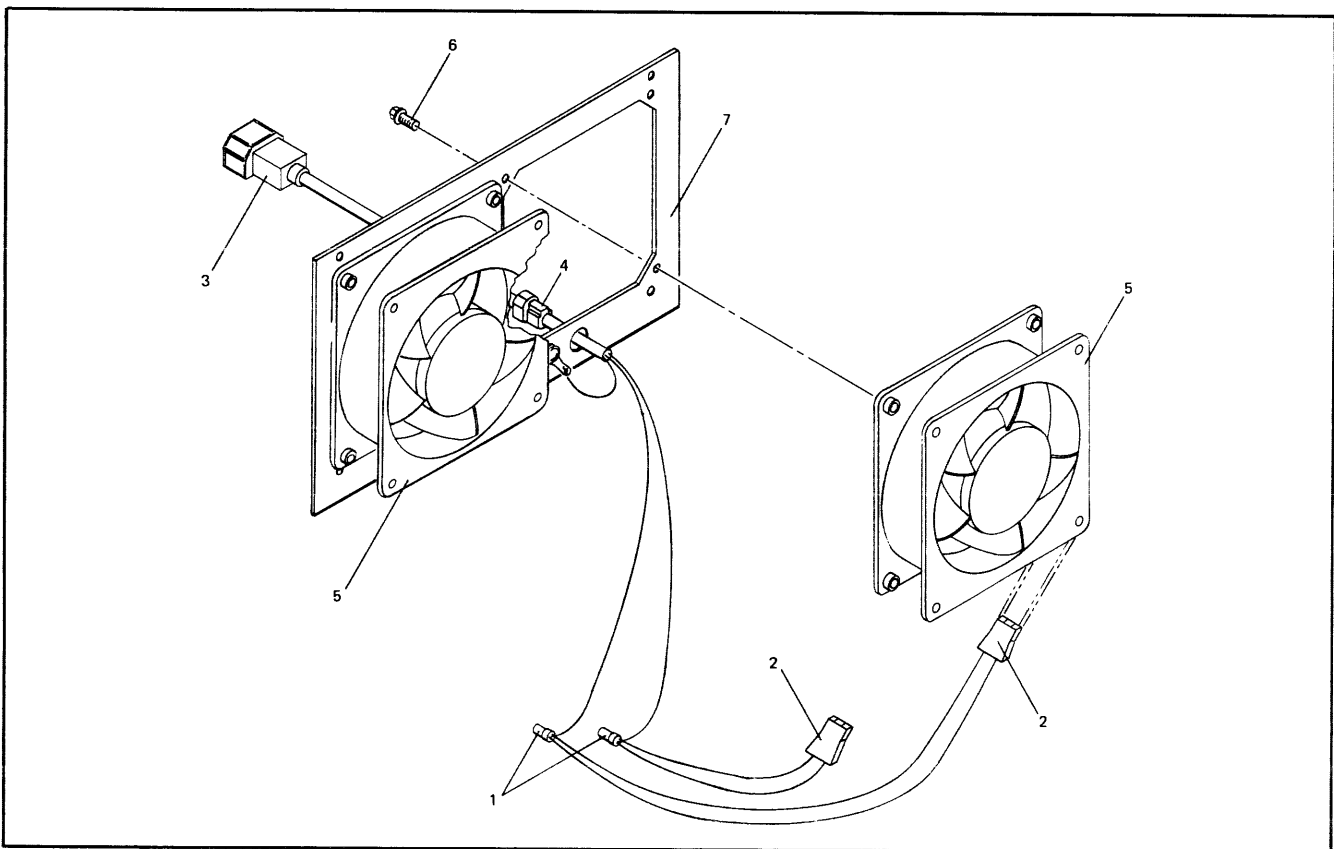

Figure 2-42. Controller Maintenance Interface PCA, Parts Location Diagram

Table 2-44. Fan Assembly, Replaceable Parts

FIG & INDEX NO.	HP PART NO.	DESCRIPTION	MFR CODE	MFR PART NO.	UNITS PER ASSY
2-43-	No Number	FAN ASSEMBLY (Refer to table 2-1)			
1	0362-0341	* TERMINAL SPLICE	00000	OBD	2
2	8120-1478	* CONNECTOR, receptacle (J1, J2)	28480	8120-1478	2
3	8120-1861	* CABLE ASSEMBLY	28480	8120-1861	1
4	0400-0083	* BUSHING, cable	28480	0400-0083	1
5	3160-0257	* FAN, tube axial (B1, B2) (Attaching Parts)	28480	3160-0257	2
6	Coml	* SCREW, machine, no. 8-32, 0.750 in, pan head --- x ---			4
7	30001-00019	* PLATE, fan mounting	28480	30001-00019	1



2212-28

Figure 2-43. Fan Assembly, Exploded View

Table 2-45. Power Supply Assembly, Replaceable Parts

FIG & INDEX NO.	HP PART NO.	DESCRIPTION	MFR CODE	MFR PART NO.	UNITS PER ASSY
2-44-1	30310A 30310-00023	POWER SUPPLY ASSEMBLY (Refer to table 2-1) * COVER, top (Attaching Parts)	28480 28480	30310A 30310-00023	1
2	Coml	* SCREW, machine, no. 4-40, 0.250 in, pan head			6
3	Coml	* WASHER, split lock, no. 4 ---- x ----			6
4	30310-60006	* VOLTAGE PROTECT PCA (A5) (see figure 2-56)	28480	30310-60006	1
5	30310-60005	* CURRENT LIMIT PCA (A4) (see figure 2-55)	28480	30310-60005	1
6	30310-60004	* 20 VOLT SUPPLY PCA (A3) (see figure 2-54)	28480	30310-60004	1
7	30310-60003	* INVERTER DRIVER PCA (A2) (see figure 2-53)	28480	30310-60003	1
8	30310-60002	* PREREGULATOR CONTROL PCA (A1) (see figure 2-52)	28480	30310-60002	1
9	30310-00003	* SPACER, hinge (Attaching Parts)	28480	30310-00003	1
10	Coml	* SCREW, machine, no. 10-32, 0.375 in, pan head			4
11	Coml	* NUT, assembled washer, ext-tooth, no. 10-32 ---- x ----			4
12	3110-0085	* HINGE (Attaching Parts)	28480	3110-0085	1
13	Coml	* SCREW, machine, no. 8-32, 0.500 in, pan head			4
14	Coml	* WASHER, split lock, no. 8 ---- x ----			4
15	30310-00024	* COVER, bottom (Attaching Parts)	28480	30310-00024	1
16	Coml	* SCREW, machine, no. 4-40, 0.500 in, pan head			3
17	Coml	* WASHER, split lock, no. 4 ---- x ----			3
18	Coml	* SCREW, machine, no. 6-32, 0.375 in, pan head			6
19	Coml	* WASHER, split lock, no. 6			6
20	Coml	* SCREW, machine, no. 8-32, 0.375 in, pan head			8
21	Coml	* WASHER, split lock, no. 8			8
22	30310-60015	* OUTPUT CROWBAR ASSEMBLY (A13) (see figure 2-45) (Attaching Parts)	28480	30310-60015	1
23	Coml	* SCREW, machine, no. 6-32, 0.250 in, pan head			2
24	Coml	* WASHER, split lock, no. 6 ---- x ----			2
25	30310-60013 No Number	* FRONT PANEL ASSEMBLY (A12) (see figure 2-46) * RIGHT SIDE ASSEMBLY (Attaching Parts)	28480	30310-60013	1 1
26	Coml	* SCREW, machine, no. 8-32, 0.375 in, pan head			6
27	Coml	* WASHER, split lock, no. 8			6
28	Coml	* SCREW, machine, no. 6-32, 0.375 in, pan head			2
29	Coml	* WASHER, split lock, no. 6 ---- x ----			2
30	9100-2939 Coml Coml	** TRANSFORMER, power (Attaching Parts) ** SCREW, machine, no. 6-32, 0.500 in, pan head ** NUT, plain, hexagon, no. 6-32 ---- x ----	28480	9100-2939	1 4 4
31	3160-0257 Coml	** FAN, tube axial 50/60 Hz (B1) (Attaching Parts) ** SCREW, machine, no. 6-32, 0.750 in, pan head	99743	WS2107FL-531	1 4

Table 2-45. Power Supply Assembly, Replaceable Parts (Continued)

FIG & INDEX NO.	HP PART NO.	DESCRIPTION	MFR CODE	MFR PART NO.	UNITS PER ASSY
2-44-	Coml	** WASHER, split lock, no. 6			4
	Coml	** NUT, plain, hexagon, no. 6-32 ---- x ----			4
32	5000-8015	** GUARD, fan	28480	5000-8015	1
33	0360-1729	** TERMINAL BLOCK (TB2) (Attaching Parts)	00000	OBD	1
	Coml	** SCREW, machine, no. 6-32, 0.625 in, pan head			4
	Coml	** WASHER, split lock, no. 6			4
	Coml	** NUT, plain, hexagon, no. 6-32 ---- x ----			4
34	30310-20004	** SUPPORT BLOCK (Attaching Parts)	28480	30310-20004	2
	Coml	** SCREW, machine, no. 6-32, 0.875 in, pan head			1
	Coml	** NUT, assembled washer, no. 6-32 ---- x ----			1
35	0360-1757	** TERMINAL BLOCK (TB1)	00000	OBD	1
36	30310-00015	** PANEL, right side	28480	30310-00015	1
	No Number	* PCA CAGE ASSEMBLY (Attaching Parts)			
37	Coml	* SCREW, machine, no. 6-32, 0.250 in, pan head			6
38	Coml	* WASHER, split lock, no. 6 ---- x ----			6
39	30310-00012	** PANEL, left side (Attaching Parts)	28480	30310-00012	1
	Coml	** SCREW, machine, no. 6-32, 0.312 in, pan head			2
	Coml	** WASHER, split lock, no. 6 ---- x ----			2
40	30310-00013	** PANEL, right side (Attaching Parts)	28480	30310-00013	1
	Coml	** SCREW, machine, no. 6-32, 0.312 in, pan head			2
	Coml	** WASHER, split lock, no. 6 ---- x ----			2
41	30310-60012	** CONNECTOR PANEL ASSEMBLY	28480	30310-60012	1
	No Number	* REAR PANEL ASSEMBLY (Attaching Parts)			1
42	Coml	* SCREW, machine, no. 8-32, 0.375 in, pan head			8
43	Coml	* WASHER, split lock, no. 8 ---- x ----			8
44	Coml	** SCREW, machine, no. 6-32, 0.375 in, pan head			1
45	Coml	** WASHER, lock, ext-tooth, no. 6			1
46	Coml	** NUT, assembled washer, no. 6-32			1
47	30310-60010	** PREREGULATOR ASSEMBLY (A9) (see figure 2-48) (Attaching Parts)	28480	30310-60010	1
	Coml	** SCREW, machine, no. 6-32, 0.375 in, pan head			4
	Coml	** WASHER, split lock, no. 6 ---- x ----			4
48	0360-1254	** TERMINAL BLOCK, 6 terminal (TB3) (Attaching Parts)	00000	OBD	1
	Coml	** SCREW, machine, no. 6-32, 0.500 in, pan head			2
	Coml	** WASHER, split lock, no. 6			4
	Coml	** NUT, plain, hexagon, no. 6-32 ---- x ----			2
49	30310-00017	** REAR PANEL	28480	30310-00017	1
50	30310-60007	* INVERTER PCA (A7) (see figure 2-49) (Attaching Parts)	28480	30310-60007	1

Table 2-45. Power Supply Assembly, Replaceable Parts (Continued)

FIG & INDEX NO.	HP PART NO.	DESCRIPTION	MFR CODE	MFR PART NO.	UNITS PER ASSY
2-44-					
51	Coml	* SCREW, machine, no. 6-32, 0.375 in, pan head			4
52	Coml	* WASHER, split lock, no. 6			4
53	Coml	* WASHER, flat, no. 6 --- x ---			4
54	30310-00022	* INVERTER BRACKET	28480	30310-00022	1
55	30310-00019	* PAD, capacitor	28480	30310-00019	1
56	9100-2938	* TRANSFORMER, pulse (T1, T2) (Attaching Parts)	28480	9100-2938	2
	Coml	* SCREW, machine, no. 6-32, 0.375 in, pan head			4
	Coml	* WASHER, split lock, no. 6			4
	Coml	* WASHER, flat, no. 6 --- x ---			4
57	30310-60011	* 5V/20V RECTIFIER ASSEMBLY (A6) (see figure 2-50) (Attaching Parts)	28480	30310-60011	1
	Coml	* SCREW, machine, no. 6-32, 0.375 in, pan head			4
	Coml	* WASHER, split lock, no. 6 --- x ---			4
58	30310-20003	* STANDOFF (Attaching Parts)	28480	30310-20003	4
	Coml	* SCREW, machine, no. 6-32, 0.375 in, pan head			4
	Coml	* WASHER, split lock, no. 6 --- x ---			4
59	30310-00001	* HEAT SINK BRACKET	28480	30310-00001	1
	Coml	* SCREW, machine, no. 6-32, 0.375 in, pan head			2
	Coml	* WASHER, split lock, no. 6 --- x ---			2
60	30310-00011	* TRANSFORMER BRACKET (Attaching Parts)	28480	30310-00011	1
	Coml	* SCREW, machine, no. 6-32, 0.375 in, pan head			2
	Coml	* WASHER, split lock, no. 6 --- x ---			2
61	30310-60014	* DECK ASSEMBLY (A8) (see figure 2-51)	28480	30310-60014	1

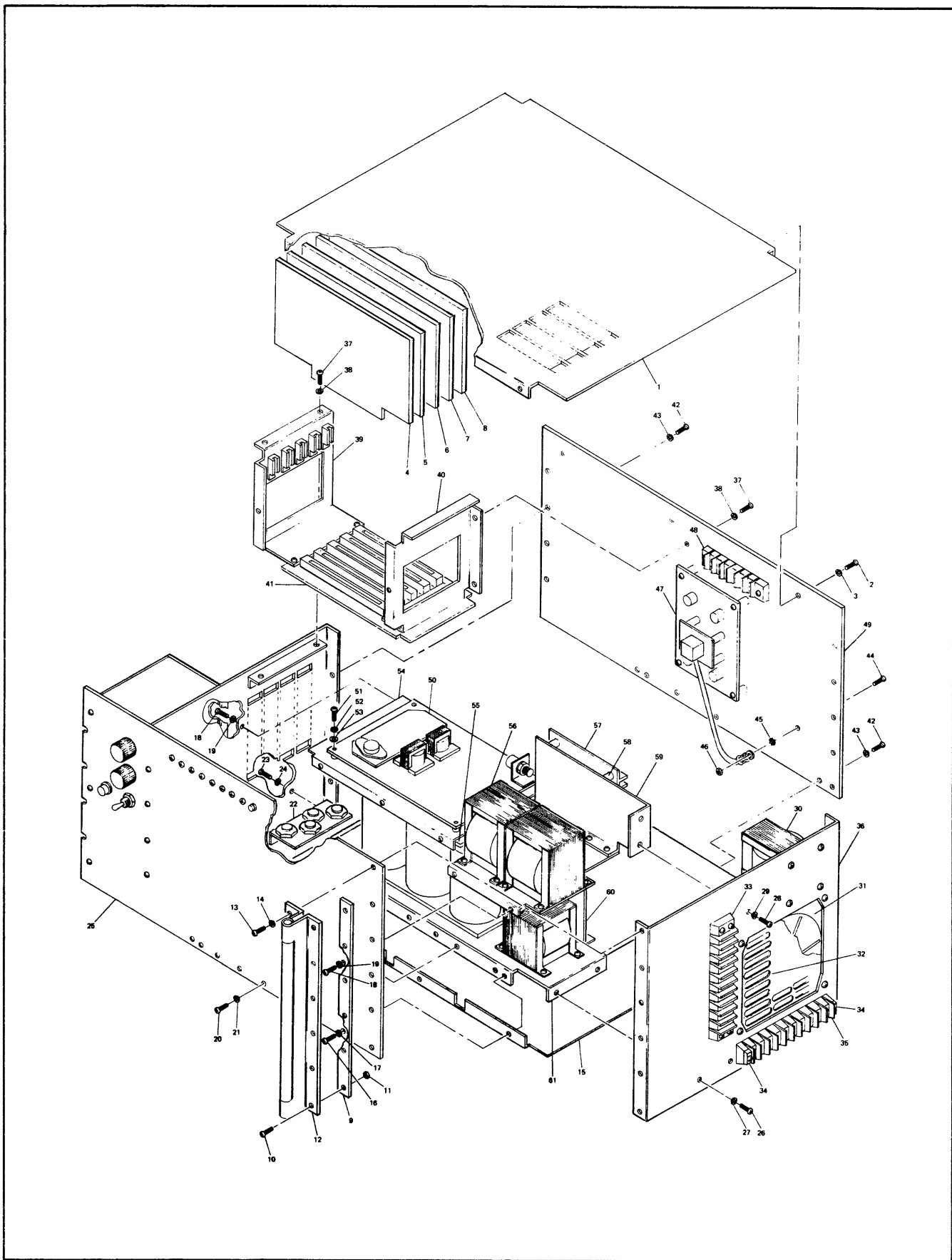
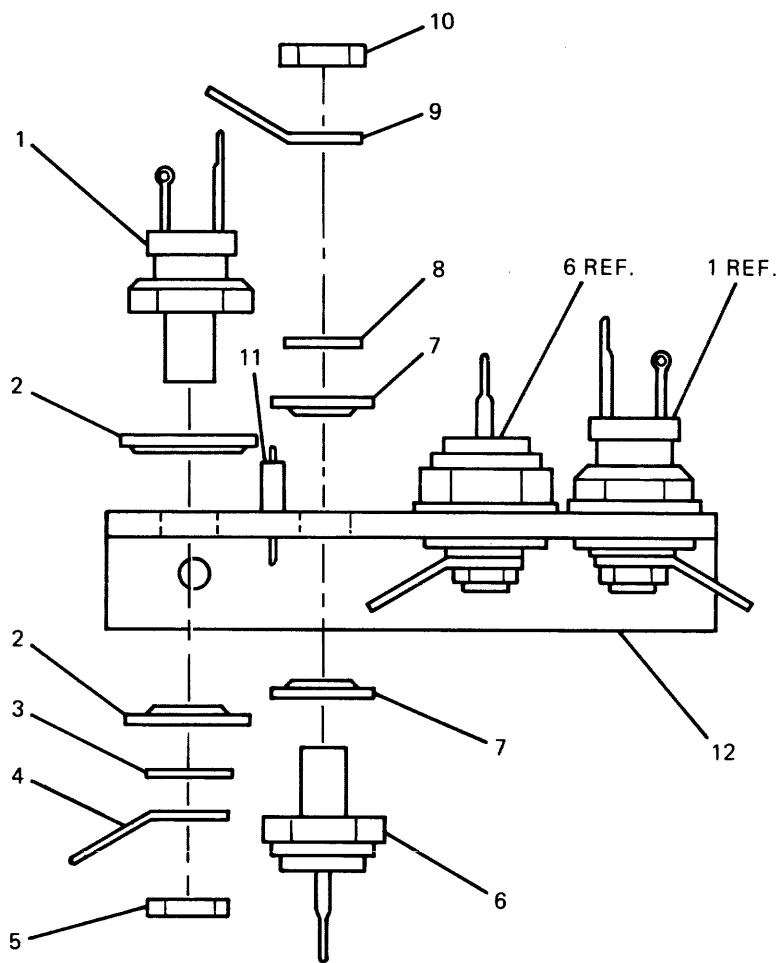

Figure 2-44. Power Supply Assembly, Exploded View

Table 2-46. Output Crowbar Assembly (A13), Replaceable Parts

FIG & INDEX NO.	HP PART NO.	DESCRIPTION	MFR CODE	MFR PART NO.	UNITS PER ASSY
2-45-1	30310-60015	OUTPUT CROWBAR ASSEMBLY (A13) (22, figure 2-44)	28480	30310-60015	1
	1884-0208	* THYRISTOR, 35A, 100V (Q1, Q2) (Attaching Parts)	12040	NL570A	2
2	1200-0088	* HEAT INSULATOR	28480	1200-0088	2
3	Coml	* WASHER, flat, 0.250 ID			1
4	Coml	* SOLDER LUG, 0.250 ID			1
5	Coml	* NUT, plain, hexagon, 1/4-28 --- X ---			1
6	1901-0315	* DIODE, Si, 50 prv, 40A (CR1, CR2) (Attaching Parts)	80131	IN1183A	2
7	1200-0088	* HEAT INSULATOR	28480	1200-0088	2
8	Coml	* WASHER, flat, 0.250 ID			1
9	Coml	* SOLDER LUG, 0.250 ID			1
10	Coml	* NUT, plain, hexagon, 1/4-28 --- X ---			1
11	0340-0077	* INSULATOR, feed thru	28480	0340-0077	1
12	30310-00006	* BRACKET, crowbar	28480	30310-00006	1



2208-36

Figure 2-45. Output Crowbar Assembly (A13), Exploded View

2-168

Table 2-47. Front Panel Assembly (A12), Replaceable Parts

FIG & INDEX NO.	HP PART NO.	DESCRIPTION	MFR CODE	MFR PART NO.	UNITS PER ASSY
2-46-	30310-60013	FRONT PANEL ASSEMBLY (A12), (25, figure 2-44)	28480	30310-60013	1
1	1251-0367	* JACK, tip (J1 thru J8)	28499	69003-1165	8
2	30310-60001	* TEST POINT ASSEMBLY (A1) (see figure 2-47)	28480	30310-60001	1
3	1251-2357	* RECEPTACLE, power, 3 pin (J9) (Attaching Parts)	82389	EAC-301	1
	Coml	* SCREW, machine, no. 6-32, 0.375in, pan head			2
	Coml	* WASHER, split lock, no. 6			2
	Coml	* NUT, plain, hexagon, no. 6-32 ---- x ----			2
4	30310-00010	* COVER, side, power input (Attaching Parts)	28480	30310-00010	1
	Coml	* SCREW, machine, no. 6-32, 0.375 in, pan head			4
	Coml	* WASHER, split lock, no. 6			4
	Coml	* NUT, plain, hexagon, no. 6-32 ---- x ----			2
5	1400-0189	* CLAMP, capacitor (Attaching Parts)	24446	128A2244621	1
	Coml	* SCREW, machine, no. 8-32, 0.375 in, pan head			2
	Coml	* WASHER, split lock, no. 8 ---- x ----			2
6	0160-3898	* CAPACITOR, fxd, dielectric, 1 μ F, 440 Vacw (C1)	56289	200P 1449	1
7	2110-0001	* FUSE, 1A (F2)	00000	OBD	1
8	2110-0010	* FUSE, 5A (F1)	00000	OBD	1
9	1400-0084	* FUSEHOLDER (XF1, XF2)	00000	OBD	2
10	0811-1854	* RESISTOR, fxd, ww, 50 ohms, 5%, 5W (R1)	56289	243E	1
11	1450-0755	* LAMP (DS1)			
12	3101-0056	* SWITCH, toggle, DPDT (S1)	27191	8926K316	1
13	0160-0904	* CAPACITOR, fxd, cer, 0.05 μ F, +20%, 1000 Vdcw (C2)	56289	10B1	1
14	9100-3174	* LINE FILTER, 10A, 115/230V (FL1) (Attaching Parts)	26364	10B1	1
	Coml	* SCREW, machine, no. 6-32, 0.375 in, pan head			2
	Coml	* WASHER, split lock, no. 6			2
	Coml	* NUT, plain, hexagon, no. 6 ---- x ----			2
15	30310-00016	* PANEL, left side (Attaching Parts)	28480	30310-00016	1
	Coml	* SCREW, machine, no. 8-32, 0.375 in, pan head			4
	Coml	* WASHER, split lock, no. 8 ---- x ----			4
16	1990-0332	* LAMP, VF = 1.8 to 3.5V (DS2)	72765	6039-004-304	1
17	30310-00014	* PANEL, front	28480	30310-00014	1

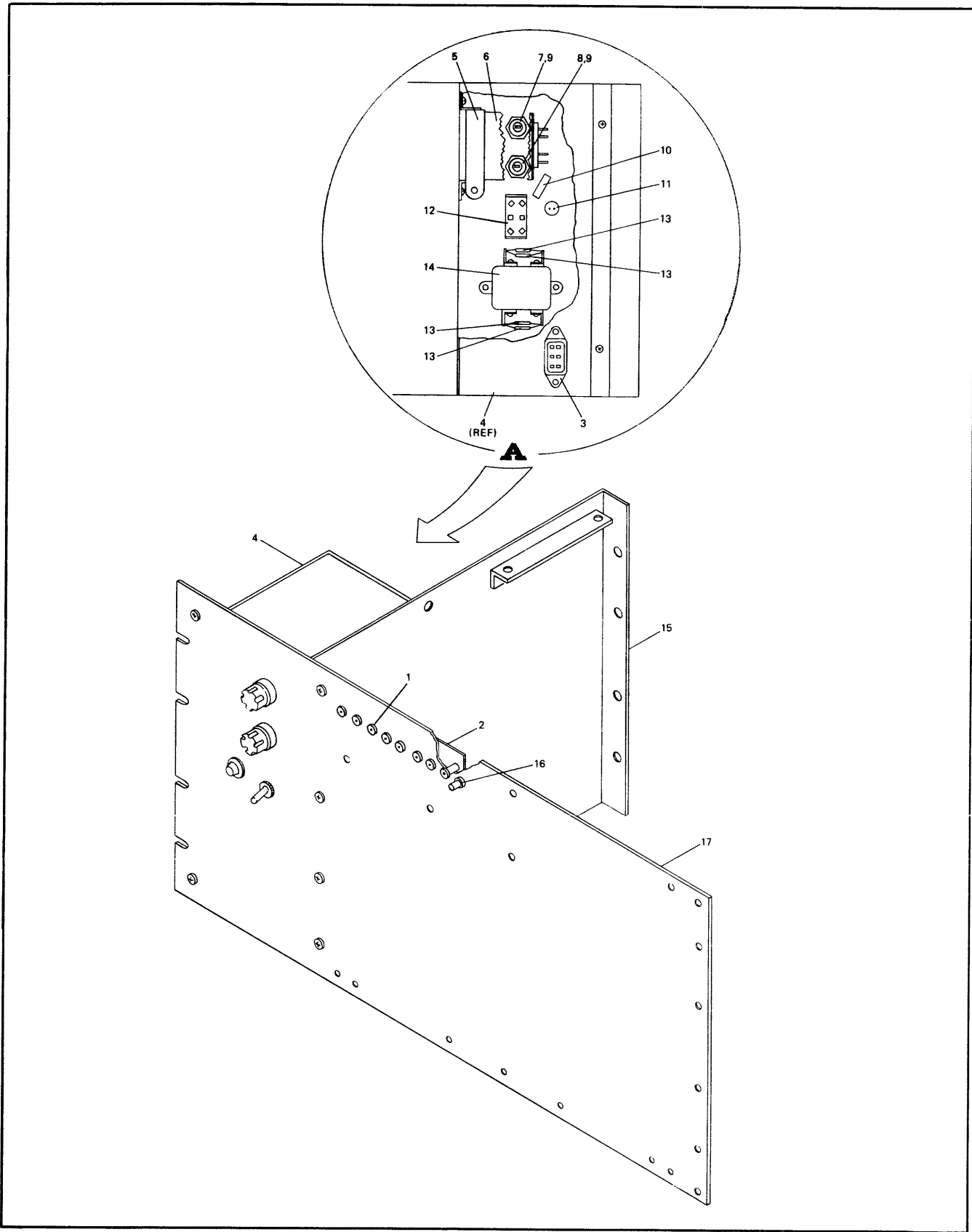

2208-37

Figure 2-46. Front Panel Assembly (A12), Exploded View

Table 2-48. Test Point Assembly (A12A1), Replaceable Parts

FIG & INDEX NO.	HP PART NO.	DESCRIPTION	MFR CODE	MFR PART NO.	UNITS PER ASSY
2-47-	30310-60001	TEST POINT ASSEMBLY (A12A1) (2, figure 2-46)	28480	30310-60001	1
1	0698-3444	* RESISTOR, fxd, flm, 316 ohms, 1%, 1/8W (R1)	28480	0698-3444	1
2	0757-1000	* RESISTOR, fxd, flm, 51.1 ohms, 1%, 1/2W (R2, R3)	28480	0757-1000	2
3	0698-0090	* RESISTOR, fxd, flm, 464 ohms, 1%, 1/2W (R4, R5)	28480	0698-0090	2
4	0757-0818	* RESISTOR, fxd, flm, 825 ohms, 1%, 1/2W (R6, R7)	28480	0757-0818	2
5	0698-0089	* RESISTOR, fxd, flm, 1780 ohms, 1%, 1/2W (R8)	28480	0698-0089	1

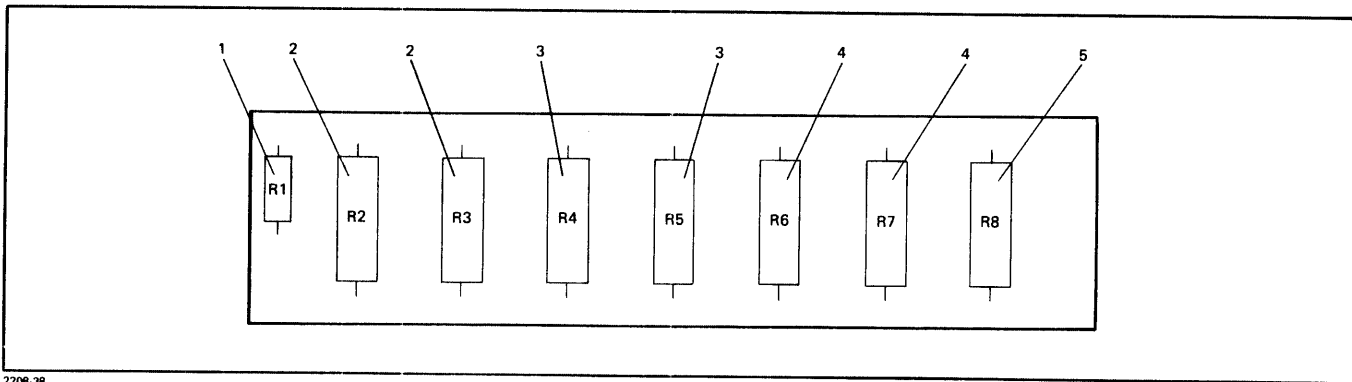

2208-38

Figure 2-47. Test Point Assembly (A12A1), Parts Location Diagram

Table 2-49. Preregulator Assembly (A9), Replaceable Parts

FIG & INDEX NO.	HP PART NO.	DESCRIPTION	MFR CODE	MFR PART NO.	UNITS PER ASSY
2-48-1	30310-60010	PREREGULATOR ASSEMBLY (A9), (57, figure 2-44)	28480	30310-60010	1
	30310-60009	* PREREGULATOR DRIVER ASSEMBLY (Attaching Parts)	28480	30310-60009	1
2	Coml	* SCREW, machine, no. 4-40, 0.500 in, pan head			4
3	Coml	* WASHER, split lock, no. 4			4
4	Coml	* WASHER, flat, no. 4			4
5	0380-0019	* SPACER ---- x ----	28480	0380-0019	4
6	0757-0316	** RESISTOR, fxd, flm, 42.2 ohms, 1%, 1/8W (R1, R4)	28480	0757-0316	2
7	1901-0159	** DIODE, Si, 0.75A, 400 prv (CR1, CR2)	04713	SR1358-4	2
8	0757-0401	** RESISTOR, fxd, flm, 100 ohms, 1%, 1/8W (R2, R3)	28480	0757-0401	2
9	9100-2942	** TRANSFORMER, pulse (T1)	28480	9100-2942	1
10	30310-80009	** BLANK BOARD	28480	30310-80009	1
11	9100-2928	* CHOKE, filter, 5A, 0.012 ohms (T1)	28480	9100-2928	1
12	1901-1061	* DIODE, rectifier, 12A, 600V (CR3, CR4) (Attaching Parts)	04713	MR886	2
13	2190-0498	* INSULATOR-MICA	28480	1200-0080	2
14	Coml	* WASHER, flat, no. 10			1
15	Coml	* SOLDER LUG, no. 10			2
16	Coml	* NUT, plain, hexagon, no. 10 ---- x ----			1
17	1884-0219	* THYRISTOR (Q1, Q2) (Attaching Parts)	28480	1884-0219	2
18	3050-0591	* INSULATOR-MICA	28480	1200-0088	2
19	Coml	* WASHER, flat, 1/4 in. ID			1
20	Coml	* SOLDER LUG, 1/4 in. ID			2
21	Coml	* NUT, plain, hexagon, 1/4-28 ---- x ----			1
22	0764-0015	* RESISTOR, fxd, flm, 560 ohms, 5%, 2W (R5)	28480	0764-0015	1
23	0160-0904	* CAPACITOR, fxd, cer, 0.05 μ F, 20%, 1000 Vdcw (C1)	56289	41C169A4-CDH	1
24	0340-0077	* TERMINAL	28480	0340-0077	6
25	30310-20003	* SPACER (Attaching Parts)	28480	30310-20003	4
26	Coml	* SCREW, machine, no. 6-32, 0.375 in, pan head			1
27	Coml	* WASHER, split lock, no. 6 ---- x ----			1
28	30310-20002	* HEAT SINK	28480	30310-20002	1
29	0340-0507	* TEFLON SPACER	28480	0340-0507	2
30	0340-0508	* TEFLON SPACER	28480	0340-0508	2

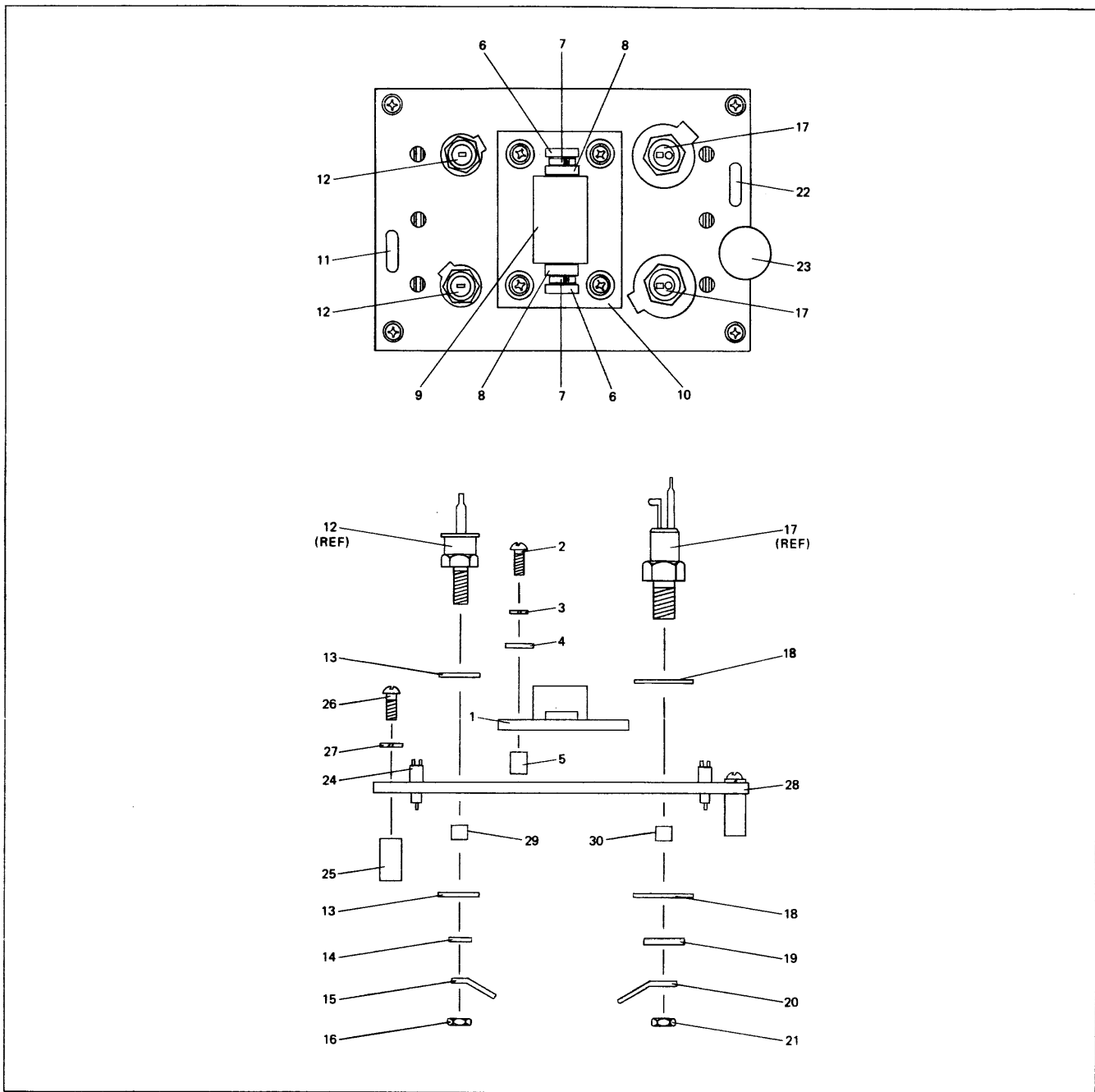

2208-39

Figure 2-48. Preregulator Assembly (A9), Exploded View

Table 2-50. Inverter PCA (A7), Replaceable Parts

FIG & INDEX NO.	HP PART NO.	DESCRIPTION	MFR CODE	MFR PART NO.	UNITS PER ASSY
2-49-1	30310-60007	INVERTER PCA (A7) (50, figure 2-44)	28480	30310-60007	1
	1854-0572	* TRANSISTOR, Si, NPN (Q1 thru Q4) (Attaching Parts)	02735	2N5805	4
2	Coml	* SCREW, machine, no. 6-32, 0.250 in, pan head			2
	Coml	* WASHER, split lock, no. 6 --- x ---			2
3	30310-00007	* HEAT SINK (Attaching Parts)	28480	30310-00007	1
	Coml	* SCREW, machine, no. 6-32, 0.375 in, pan head			4
4	Coml	* WASHER, split lock, no. 6			4
	0380-1030	* STANDOFF --- x ---	28480	0380-1030	4
5	0160-0174	* CAPACITOR, fxd, cer, 0.47 μ F, -20 +80%, 25 Vdcw (C1 thru C4)	56289	C11B7S-CML	4
6	9100-2945	* TRANSFORMER, pulse (T1, T2)	28480	9100-2945	2
7	0811-3108	* RESISTOR, fxd, ww, 2 ohms, 10% (R1)	28480	0811-3108	1
8	1902-0661	* DIODE, zener, 75V +5% (CR1, CR2)	04713	SZ11213-392	2
9	0757-0316	* RESISTOR, fxd, flm, 42.2 ohms, 1%, 1/8W (R2, R4)	28480	0757-0316	2
10	0180-0269	* CAPACITOR, fxd, elect, 1.0 μ F, -10 +50%, 150 Vdcw (C7)	56289	30D105F150BA2-DSM	1
11	1884-0219	* THYRISTOR (Q5)	28480	1884-0219	1
	30310-0000	* SCR BRACKET (Attaching Parts)			1
12	Coml	* SCREW, machine, no. 6-32, 0.375 in, pan head			2
	Coml	* WASHER, flat, no. 6			2
13	Coml	* WASHER, split lock, no. 6			2
	Coml	* NUT, plain, hexagon, no. 6-32			2
14	0757-0401	* RESISTOR, fxd, flm, 100 ohms, 1%, 1/8W (R3)	28480	0757-0401	1
15	1901-0159	* DIODE, Si, 0.75A, 400 prv (CR3 thru CR19)	04713	SR1358-4	17
16	2110-0003	* FUSE, 3A, 3AG (F1, F2)	75915	312.002	2
17	0160-0168	* CAPACITOR, fxd, my, 0.1 μ F, 10%, 200 Vdcw (C5, C6)	56289	192P10492-PTS	2
18	0757-0367	* RESISTOR, fxd, flm, 100k ohms, 1%, 1/2W (R5, R6)	28480	0757-0367	2
19	30310-80007	* BLANK BOARD	28480	30310-80007	1

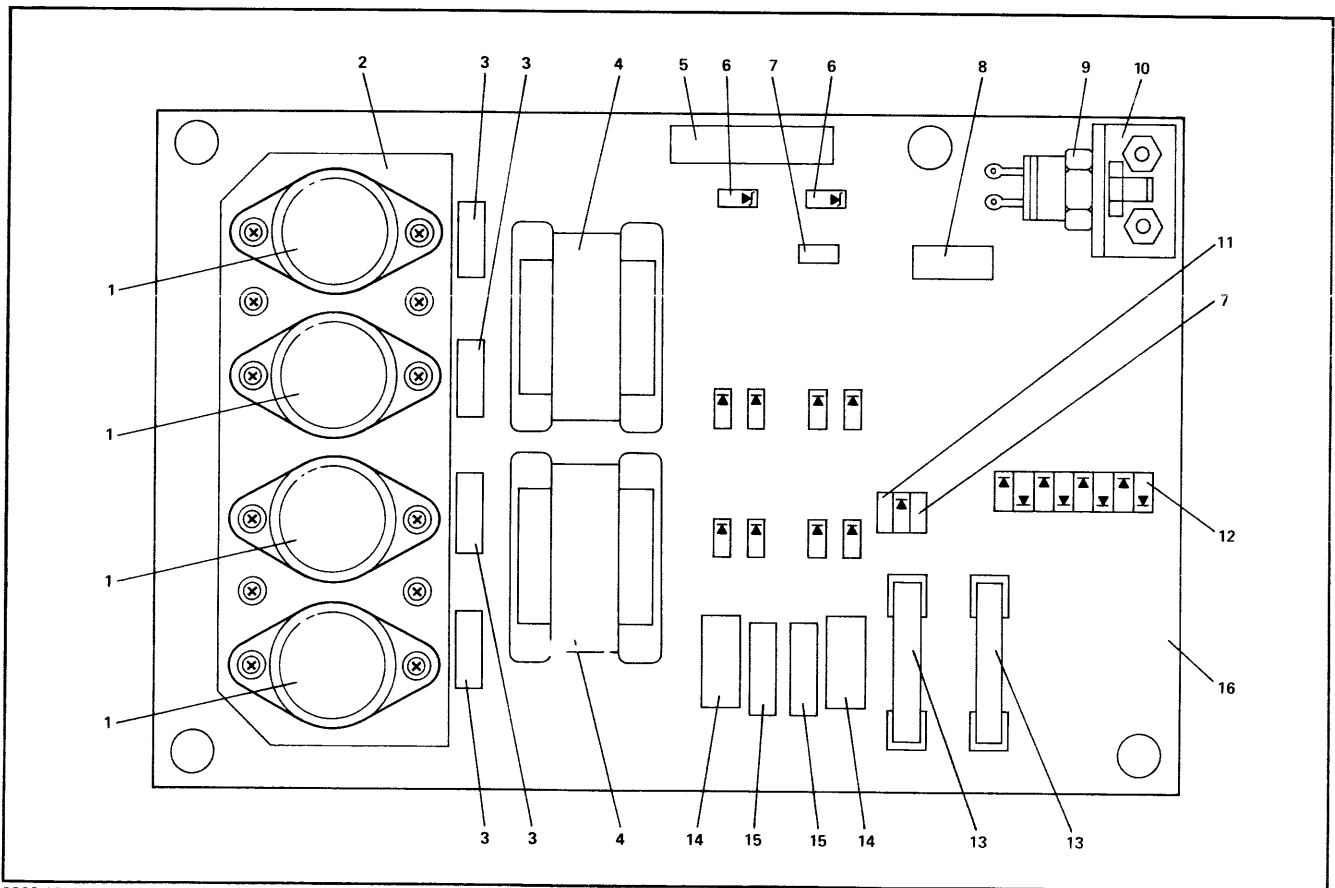

2208-40

Figure 2-49. Inverter PCA (A7), Parts Location Diagram

Table 2-51. 5V/20V Rectifier Assembly (A6), Replaceable Parts

FIG & INDEX NO.	HP PART NO.	DESCRIPTION	MFR CODE	MFR PART NO.	UNITS PER ASSY
2-50-1	30310-60011	5V/20V RECTIFIER ASSEMBLY (A6), (57, figure 2-44)	28480	30310-60011	1
	1902-0202	* DIODE, breakdown, 15.0V, 5%, 1W (CR9, CR12, CR13, CR16)	28480	1902-0202	4
2	0150-0121	* CAPACITOR, fxd, cer, 0.1 μ F, -20 +80%, 50 Vdcw (C1 thru C4)	56289	SC50BIS-CML	4
3	Coml	* SOLDER LUG, no. 6 (Attaching Parts)			2
4	Coml	* SCREW, machine, no. 6-32, 0.312 in, pan head			1
5	Coml	* WASHER, split lock, no. 6 ---- x ----			1
6	3103-0015	* THERMAL SWITCH 75°C (S1) (Attaching Parts)	14604	3001T125B211-3/8	1
	Coml	* WASHER, split lock, no. 6			1
	Coml	* NUT, plain, hexagon, no. 6-32 ---- x ----			1
7	1901-0661	* DIODE, Schottky barrier (CR9, CR12, CR13, CR16) (Attaching Parts)	04713	SBD5033K	4
	Coml	* WASHER, lock, ext-tooth, no. 10			1
	Coml	* NUT, plain, hexagon, no. 10-32 ---- x ----			1
8	1901-1035	* DIODE, fxd, 100V, 12A (CR5 thru CR8) (Attaching Parts)	28480	1901-1035	4
9	1200-0080	* INSULATOR	28480	1200-0080	2
10	Coml	* WASHER, flat, no. 10			1
11	30310-00021	* STRAP, diode	28480	30310-00021	1
12	Coml	* NUT, plain, hexagon, no. 10-32 ---- x ----			1
13	1901-1036	* DIODE, rectifier, 12A, 100V (CR1 thru CR4) (Attaching Parts)	04713	MR881	4
	1200-0080	* INSULATOR	28480	1200-0080	2
	Coml	* WASHER, flat, no. 10			1
	30310-00021	* STRIP, diode	28480	30310-00021	1
	Coml	* NUT, plain, hexagon, no. 10-32 ---- x ----			1
14	30310-20001	* HEAT SINK	28480	30310-20001	1

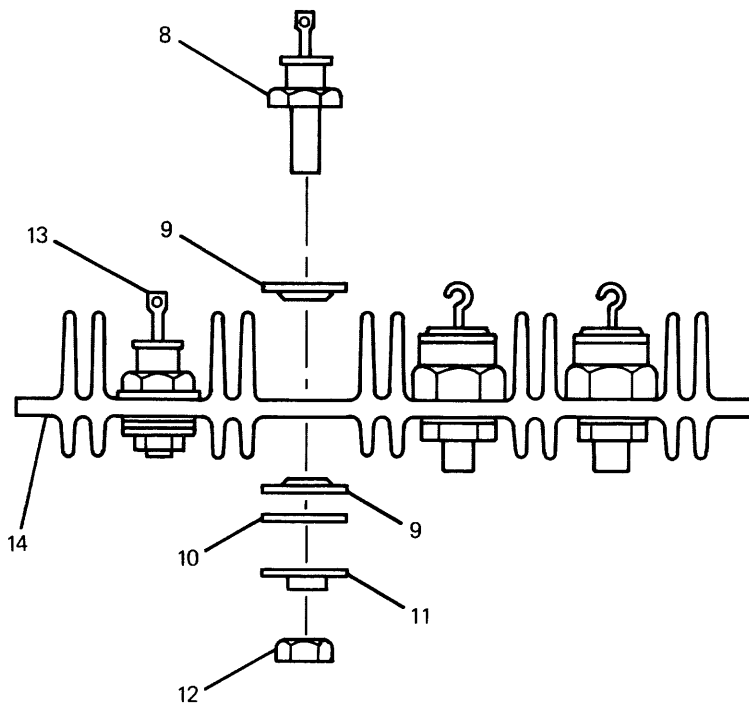
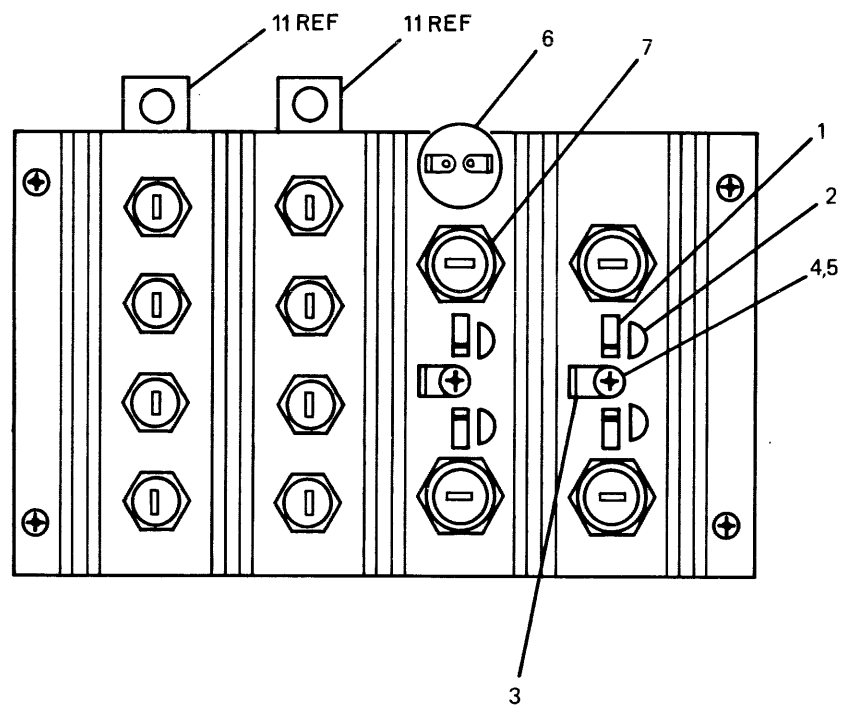

2208-41

Figure 2-50. 5V/20V Rectifier Assembly (A6), Exploded View

Table 2-52. Deck Assembly (A8), Replaceable Parts

FIG & INDEX NO.	HP PART NO.	DESCRIPTION	MFR CODE	MFR PART NO.	UNITS PER ASSY
2-51-1	30310-60014	DECK ASSEMBLY (A8) (61, figure 2-44)	28480	30310-60014	1
	9100-2944	* CHOKE, filter (L1) (Attaching Parts)	28480	9100-2944	1
	Coml	* SCREW, machine, no. 8-32, 0.500 in, pan head			4
	Coml	* WASHER, flat, no. 8			4
	Coml	* WASHER, split lock, no. 8			4
2	0811-3147	* NUT, plain, hexagon, no. 8-32 ---- x ----			4
		* RESISTOR, fxd, ww, 1.8 ohms, $\pm 3\%$ (R1) (Attaching Parts)	91637	RH25	1
		* SCREW, machine, no. 6-32, 0.375 in, pan head			2
		* WASHER, split lock, no. 6			2
		* NUT, plain, hexagon, no. 6-32 ---- x ----			2
3	30310-00020	* STRAP, copper, 125V (Attaching Parts)	28480	30310-00020	1
		* SCREW, machine, no. 10-32, 0.500 in, pan head			2
		* WASHER, split lock, no. 10 ---- x ----			2
4	30310-00020	* STRAP, copper, 125V (Attaching Parts)	28480	30310-00020	1
		* SETSCREW, no. 10-32, 0.750 in.			2
		* WASHER, split lock, no. 10			2
		* NUT, plain, hexagon, no. 10-32 ---- x ----			2
5	0180-2494*	* CAPACITOR, fxd, elect. 7800 μ F, -10 +50%, 150 Vdcw (C4, C5)	56289	36D782F150DF2ADQB	2
6	0180-2404*	* CAPACITOR, fxd, elect. 13,000 μ F, -10 +75F, 40 Vdcw (C2, C3) (Attaching Parts)	56289	602D1936040BF2A	2
		* SCREW, machine, no. 10-32, 0.375 in, pan head			1
		* WASHER, split lock, no. 10			2
		* SETSCREW, no. 10-32, 0.750 in.			1
		* NUT, plain, hexagon, no. 10-32 ---- x ----			1
7	30310-00002	* STRAP, copper, 5V (Attaching Parts)	28480	30310-00002	1
		* SCREW, machine, no. 10-32, 0.500 in, pan head			1
		* WASHER, split lock, no. 10			2
		* SETSCREW, no. 10-32, 0.750 in.			1
		* NUT, plain, hexagon, no. 10 ---- x ----			1
8	0180-2411*	* CAPACITOR, fxd, elect. 22,000 μ F, -10 +75%, 10 Vdcw (C7) (Attaching Parts)	28480	602D2236010AF2A	1
		* SCREW, machine, no. 10-32, 0.500 in, pan head			1
		* WASHER, split lock, no. 10 ---- x ----			1
9	0180-2402*	* CAPACITOR, fxd, elect. 55,000 μ F, -10 +75%, 10 Vdcw (C6) (Attaching Parts)	56289	602D5536010BF2A	1
		* SETSCREW, no. 10-32, 0.750 in.			1
		* WASHER, split lock, no. 10			1
		* NUT, plain, hexagon, no. 10 ---- x ----			1
10	0180-2413*	* CAPACITOR, fxd, elect. 7500 μ F, -10 +75%, 15 Vdcw (C8) (Attaching Parts)	56289	36D752G015AA2A	1
		* SCREW, machine, no. 10-32, 0.375 in, pan head			1
		* WASHER, split lock, no. 10			2
		* SETSCREW, no. 10-32, 0.750 in.			1
		* NUT, plain, hexagon, no. 10-32 ---- x ----			1

*These components are considered part of 30310-60014 assembly for reference purposes but must be ordered separately.

Table 2-52. Deck Assembly (A8), Replaceable Parts (Continued)

FIG & INDEX NO.	HP PART NO.	DESCRIPTION	MFR CODE	MFR PART NO.	UNITS PER ASSY		
2-51-11	30310-00004	* STRAP, copper, 20V (Attaching Parts)	28480	30310-00004	1		
	Coml	* SCREW, machine, no. 10-32, 0.375 in, pan head			1		
	Coml	* WASHER, split lock, no. 10			2		
	Coml	* SETSCREW, no. 10-32, 0.750 in.			1		
	Coml	* NUT, plain, hexagon, no. 10-32 ---- x ----			1		
12	0180-2403*	* CAPACITOR, fxd, elect, 19,000 μ F, -10 +75%, 40 Vdcw (C9) (Attaching Parts)	56289	602D193G040DF2A	1		
	Coml	* SETSCREW, no. 10			1		
	Coml	* WASHER, split lock, no. 10			1		
	Coml	* NUT, plain, hexagon, no. 10-32 ---- x ----			1		
13	0180-2541*	* CAPACITOR, fxd, elect, 1800 μ F, -10 +75%, 40 Vdcw (C14) (Attaching Parts)	56289	602D182G040AA2A	1		
	Coml	* SCREW, machine, no. 10-32, 0.375 in, pan head			1		
	Coml	* WASHER, split lock, no. 10			2		
	Coml	* SETSCREW, no. 10-32, 0.750 in.			1		
	Coml	* NUT, plain, hexagon, no. 10-32 ---- x ----			1		
14	0180-2414*	* CAPACITOR, fxd, elect, 2900 μ F, -10 +75%, 40 Vdcw (C12) (Attaching Parts)	56289	36D292G040AA2A	1		
	Coml	* SCREW, machine, no. 10-32, 0.375 in, pan head			1		
	Coml	* WASHER, split lock, no. 10			2		
	Coml	* SETSCREW, no. 10-32, 0.750 in.			1		
	Coml	* NUT, plain, hexagon, no. 10-32 ---- x ----			1		
15	0180-2416*	* CAPACITOR, fxd, elect, 9900 μ F, -10 +75%, 30 Vdcw (C11) (Attaching Parts)	56289	602D992G030AF2A	1		
	Coml	* SCREW, machine, no. 10-32, 0.375 in, pan head			1		
	Coml	* WASHER, split lock, no. 10 ---- x ----			1		
16	30310-60008*	* CAPACITOR BOARD ASSEMBLY (A1) (see figure 2-57) (Attaching Parts)	28480	30310-60008	1		
	Coml	* SCREW, machine, no. 6-32, 0.375 in, pan head ---- x ----			12		
17	1901-1035	* DIODE, fxd, 100V, 12A (CR1) (Attaching Parts)	28480	1901-1035	1		
	1200-0080	* INSULATOR			28480	1200-0080	2
	Coml	* WASHER, flat, no. 8					1
	Coml	* SOLDER LUG, no. 8					1
	Coml	* NUT, plain, hexagon, no. 8-32 ---- x ----					1
18	1853-0310	* TRANSISTOR, Si, PNP (Q1, Q2) (Attaching Parts)	04713	2N4398	2		
	Coml	* SCREW, machine, no. 6-32, 0.625 in, pan head			2		
	Coml	* SOLDER LUG, no. 6			1		
	1200-0043	* INSULATOR			28480	1200-0043	1
19	1200-0452	* SOCKET, transistor (XA1, XQ2) (Attaching Parts)	28480	1200-0452	2		
	Coml	* SCREW, machine, no. 4-40, 0.500 in, flat head			2		
	Coml	* WASHER, flat, no. 4			2		
	Coml	* WASHER, split lock, no. 4			2		
	Coml	* NUT, plain, hexagon, no. 4-40 ---- x ----			2		

* These components are considered part of 30310-60014 assembly for reference purposes but must be ordered separately.

Table 2-52. Deck Assembly (A8), Replaceable Parts (Continued)

FIG & INDEX NO.	HP PART NO.	DESCRIPTION	MFR CODE	MFR PART NO.	UNITS PER ASSY
2-51-20	9100-2943	* CHOKE, filter (L2) (Attaching Parts)	28480	9100-2943	1
	Coml	* SCREW, machine, no. 10-32, 0.375 in, pan head			1
	Coml	* WASHER, split, lock, no. 10 - - - x - - -			1
21	30310-00018	* DECK, power supply	28480	30310-00018	1

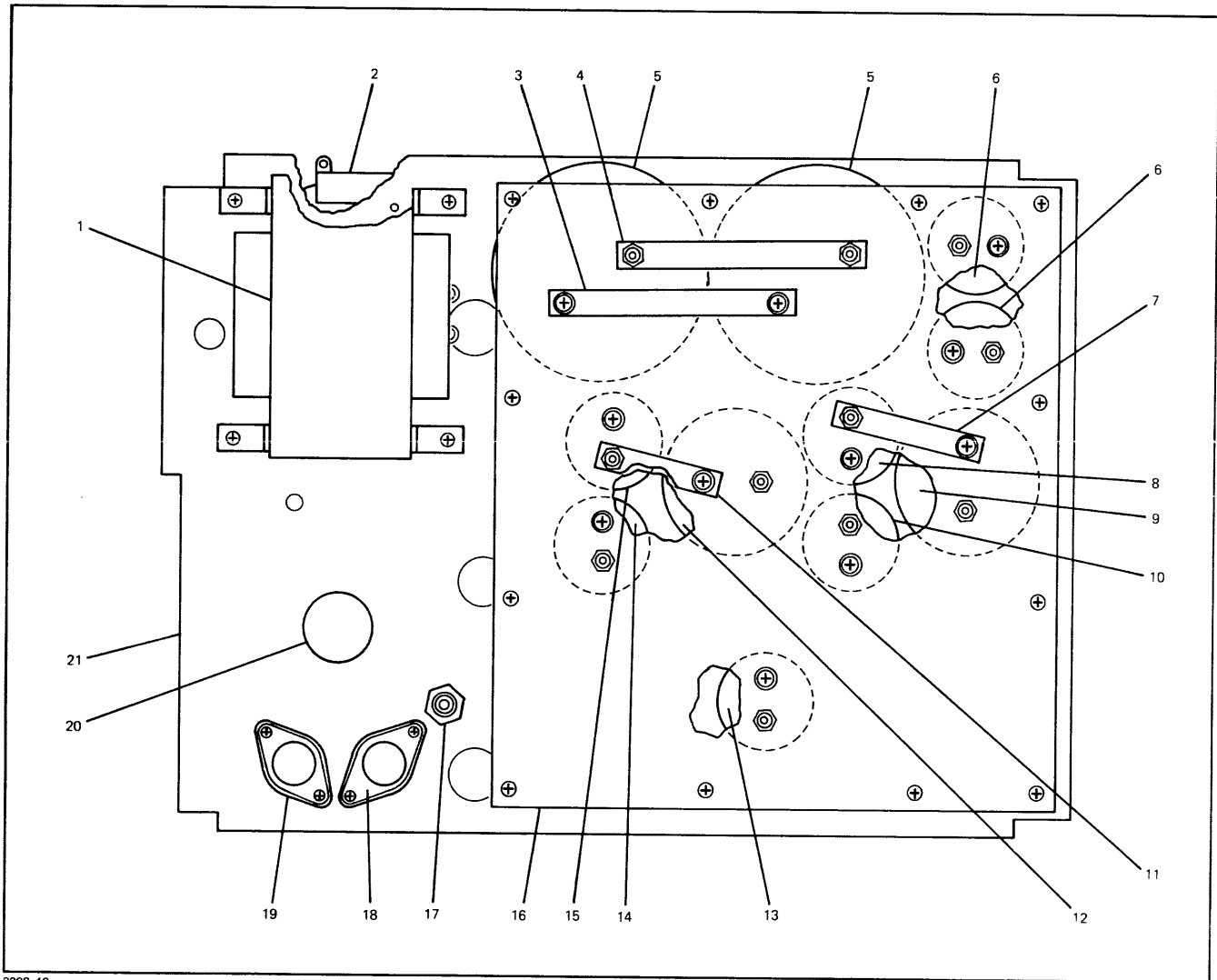

2208-42

Figure 2-51. Deck Assembly (A8), Parts Location Diagram

Table 2-53. Preregulator Control PCA (A1), Replaceable Parts

Reference Designation	HP Part Number	Qty	Description	Mfr Code	Mfr Part Number
A1	30310-60002	1	PREREGULATOR CONTROL PCA	28480	30310-60002
A1C1	0160-0157	1	C:FXD MY 0.0047 UF 10% 200VDCW	56289	192P47292-PTS
A1C2	0180-0291	4	C:FXD ELECT 1.0 UF 10% 35VDCW	56289	150D105X9035A2-DYS
A1C3	0180-0195	1	C:FXD ELECT 0.33 UF 20% 35VDCW	56289	150D334X0035A2-DYS
A1C4	0180-0291	1	C:FXD ELECT 1.0 UF 10% 35VDCW	56289	150D105X9035A2-DYS
A1C5	0160-0153	3	C:FXD MY 0.001 UF 10% 200VDCW	56289	192P10292-PTS
A1C6	0160-2204	1	C:FXD MICA 100PF 5%	72136	RDML5F101J3C
A1C7	0180-0097	4	C:FXD TANT. 47 UF 10% 35VDCW	56289	150D476X9035S2-DYS
A1C8	0180-0049	3	C:FXD ELECT 20 UF +75-10% 50VDCW	56289	30D206G050CCZ-DSM
A1C9	0160-0153	3	C:FXD MY 0.001 UF 10% 200VDCW	56289	192P10292-PTS
A1C10	0180-0197	6	C:FXD ELECT 2.2 UF 10% 20VDCW	56289	150D225X9020A2-DYS
A1C11	0180-0197	6	C:FXD ELECT 2.2 UF 10% 20VDCW	56289	150D225X9020A2-DYS
A1C12	0160-2940	1	C:FXD MICA 470 PF 5% 300VDCW	72136	RDML5F471J3C
A1C13	0180-0197	6	C:FXD ELECT 2.2 UF 10% 20VDCW	56289	150D225X9020A2-DYS
A1C14	0180-0373	1	C:FXD ELECT 0.68 UF 10% 35VDCW	56289	150D684X9035A2-DYS
A1C15	0150-0121	4	C:FXD CER 0.1 UF +80-20% 50VDCW	56289	5C50BIS-CML
A1C16	0150-0121	4	C:FXD CER 0.1 UF +80-20% 50VDCW	56289	5C50BIS-CML
A1C17	0180-1743	1	C:FXD ELECT 0.1 UF 10% 35VDCW	56289	150D104X9035A2-DYS
A1C18	0160-0162	1	C:FXD MY 0.022 UF 10% 200VDCW	56289	192P22392-PTS
A1C19	0160-0161	3	C:FXD MY 0.01 UF 10% 200VDCW	56289	192P10392-PTS
A1C20	0180-0097	4	C:FXD TANT. 47 UF 10% 35VDCW	56289	150D476X9035S2-DYS
A1C21	0180-0098	1	C:FXD ELECT 100 UF 20% 20VDCW	56289	150D107X0020S2-DYS
A1CR1	1901-0033	70	DIODE:SILICON 100MA 180WV	07263	F03369
A1CR2	1901-0033	70	DIODE:SILICON 100MA 180WV	07263	F03369
A1CR3	1901-0033	70	DIODE:SILICON 100MA 180WV	07263	F03369
A1CR4	1901-0033	2	DIODE:SILICON 100MA 180WV	07263	F03369
A1CR5	1901-0460	2	DIODE:SILICON 3-JUNCTION STABISTOR	03508	STB523
A1CR6	1902-3171	2	DIODE BREAKDOWN:11.0V 5%	28480	1902-3171
A1CR7	1902-3171	2	DIODE BREAKDOWN:11.0V 5%	28480	1902-3171
A1CR8	1901-0033	2	DIODE:SILICON 100MA 180WV	07263	F03369
A1CR9	1902-3139	2	DIODE:BREAKDOWN 8.25V 5%	04713	SZ10939-158
A1CR10	1901-0033	2	DIODE:SILICON 100MA 180WV	07263	F03369
A1CR11	1901-0159	18	DIODE:SILICON 0.75A 400PIV	04713	SR1358-4
A1CR12	1901-0159	18	DIODE:SILICON 0.75A 400PIV	04713	SR1358-4
A1CR13	1901-0033	18	DIODE:SILICON 100MA 180WV	07263	F03369
A1Q1	1854-0072	2	TSTR:SI NPN	80131	2N3054
A1Q2	1853-0052	2	TSTR:SI PNP	80131	2N374C
A1Q3	1854-0072	2	TSTR:SI NPN	80131	2N3054
A1Q4	1853-0281	21	TSTR:SI PNP	80131	2N2907A
A1Q5	1854-0477	23	TSTR:SI NPN	80131	2N2222A
A1Q6	1854-0477	12	TSTR:SI NPN	80131	2N2222A
A1Q7	1854-0039	12	TSTR:SI NPN	80131	2N3053
A1Q8	1854-0477	12	TSTR:SI NPN	80131	2N2222A
A1Q9	1854-0477	12	TSTR:SI NPN	80131	2N2222A
A1Q10	1853-0281	12	TSTR:SI PNP	80131	2N2907A
A1R1	2100-1760	2	R:VAR WW 5K OHM 5% TYPE V 1W	28480	2100-1760
A1R2	0757-0458	1	R:FXD MET FLM 51.1K OHM 1% 1/8W	28480	0757-0458
A1R3	0757-0416	1	R:FXD MET FLM 511 OHM 1% 1/8W	28480	0757-0416
A1R4	0757-0443	3	R:FXD MET FLM 11.0K OHM 1% 1/8W	28480	0757-0443
A1R5	0757-0279	6	R:FXD MET FLM 3.16K OHM 1% 1/8W	28480	0757-0279
A1R6	0683-5655	1	R:FXD COMP 5.6 MEGOHM 5% 1/4W	01121	CB 5655
A1R7	0757-0444	1	R:FXD MET FLM 12.1K OHM 1% 1/8W	28480	0757-0444
A1R8	0757-0279	1	R:FXD MET FLM 3.16K OHM 1% 1/8W	28480	0757-0279
A1R9	0757-0442	27	R:FXD MET FLM 10.0K OHM 1% 1/8W	28480	0757-0442
A1R10	0757-0465	7	R:FXD MET FLM 100K OHM 1% 1/8W	28480	0757-0465
A1R11	0757-0440	1	R:FXD MET FLM 7.50K OHM 1% 1/8W	28480	0757-0440
A1R12	0698-3452	4	R:FXD MET FLM 147K OHM 1% 1/8W	28480	0698-3452
A1R13	0757-0459	1	R:FXD MET FLM 56.2K OHM 1% 1/8W	28480	0757-0459
A1R14	0698-3155	12	R:FXD MET FLM 4.64K OHM 1% 1/8W	28480	0698-3155
A1R16	0698-3155	12	R:FXD MET FLM 4.64K OHM 1% 1/8W	28480	0698-3155
A1R17	0757-0447	3	R:FXD MET FLM 16.2K OHM 1% 1/8W	28480	0757-0447
A1R18	0698-3160	1	R:FXD MET FLM 31.6K OHM 1% 1/8W	28480	0698-3160
A1R19	0757-0442	1	R:FXD MET FLM 10.0K OHM 1% 1/8W	28480	0757-0442
A1R20	0757-0394	2	R:FXD MET FLM 51.1 OHM 1% 1/8W	28480	0757-0394
A1R21	0757-0279	2	R:FXD MET FLM 3.16K OHM 1% 1/8W	28480	0757-0279
A1R22	0757-0401	8	R:FXD MET FLM 100 OHM 1% 1/8W	28480	0757-0401
A1R23	0757-0394	8	R:FXD MET FLM 51.1 OHM 1% 1/8W	28480	0757-0394
A1R24	0757-0401	8	R:FXD MET FLM 100 OHM 1% 1/8W	28480	0757-0401
A1R25	0757-0274	5	R:FXD MET FLM 1.21K OHM 1% 1/8W	28480	0757-0274
A1R26	0757-0274	5	R:FXD MET FLM 1.21K OHM 1% 1/8W	28480	0757-0274
A1R27	0683-0275	4	R:FXD COMP 2.7 OHM 5% 1/4W	01121	CB 2765
A1R28	0698-3155	4	R:FXD MET FLM 4.64K OHM 1% 1/8W	28480	0698-3155
A1R29	0698-3155	4	R:FXD MET FLM 4.64K OHM 1% 1/8W	28480	0698-3155
A1R30	0698-3155	4	R:FXD MET FLM 4.64K OHM 1% 1/8W	28480	0698-3155
A1R31	0757-0438	5	R:FXD MET FLM 5.11K OHM 1% 1/8W	28480	0757-0438

Table 2-53. Preregulator Control PCA (A1), Replaceable Parts (Continued)

Reference Designation	HP Part Number	Qty	Description	Mfr Code	Mfr Part Number
A1R32	0683-0275		R:FXD COMP 2.7 OHM 5% 1/4W	01121	CB 27G5
A1R33	0683-0275		R:FXD COMP 2.7 OHM 5% 1/4W	01121	CB 27G5
A1R34	0683-0275		R:FXD COMP 2.7 OHM 5% 1/4W	01121	CB 27G5
A1R35	0757-0279		R:FXD MET FLM 3.16K OHM 1% 1/8W	28480	0757-0279
A1R36	0757-0288	1	R:FXD MET FLM 9.09K OHM 1% 1/8W	28480	0757-0288
A1R37	0757-0442		R:FXD MET FLM 10.0K OHM 1% 1/8W	28480	0757-0442
A1R38	0757-0279		R:FXD MET FLM 3.16K OHM 1% 1/8W	28480	0757-0279
A1R39	0698-0083	11	R:FXD MET FLM 1.96K OHM 1% 1/8W	28480	0698-0083
A1R40	0757-0442		R:FXD MET FLM 10.0K OHM 1% 1/8W	28480	0757-0442
A1R41	0757-0465		R:FXD MET FLM 100K OHM 1% 1/8W	28480	0757-0465
A1R42	0698-0083		R:FXD MET FLM 1.96K OHM 1% 1/8W	28480	0698-0083
A1U1	1826-0069	5	IC:LINEAR OPER. AMPL.	12040	LM301AD
A1U2	1826-0069		IC:LINEAR OPER. AMPL.	12040	LM301AD
A1U3	1826-0049	1	IC:VOLTAGE REGULATOR PROGRAMMABLE	07263	U6A7723393
A1U4	1826-0070	3	IC:LINEAR OPER. AMPL.	07263	U6A7741393
A1U5	1826-0069		IC:LINEAR OPER. AMPL.	12040	LM301AD

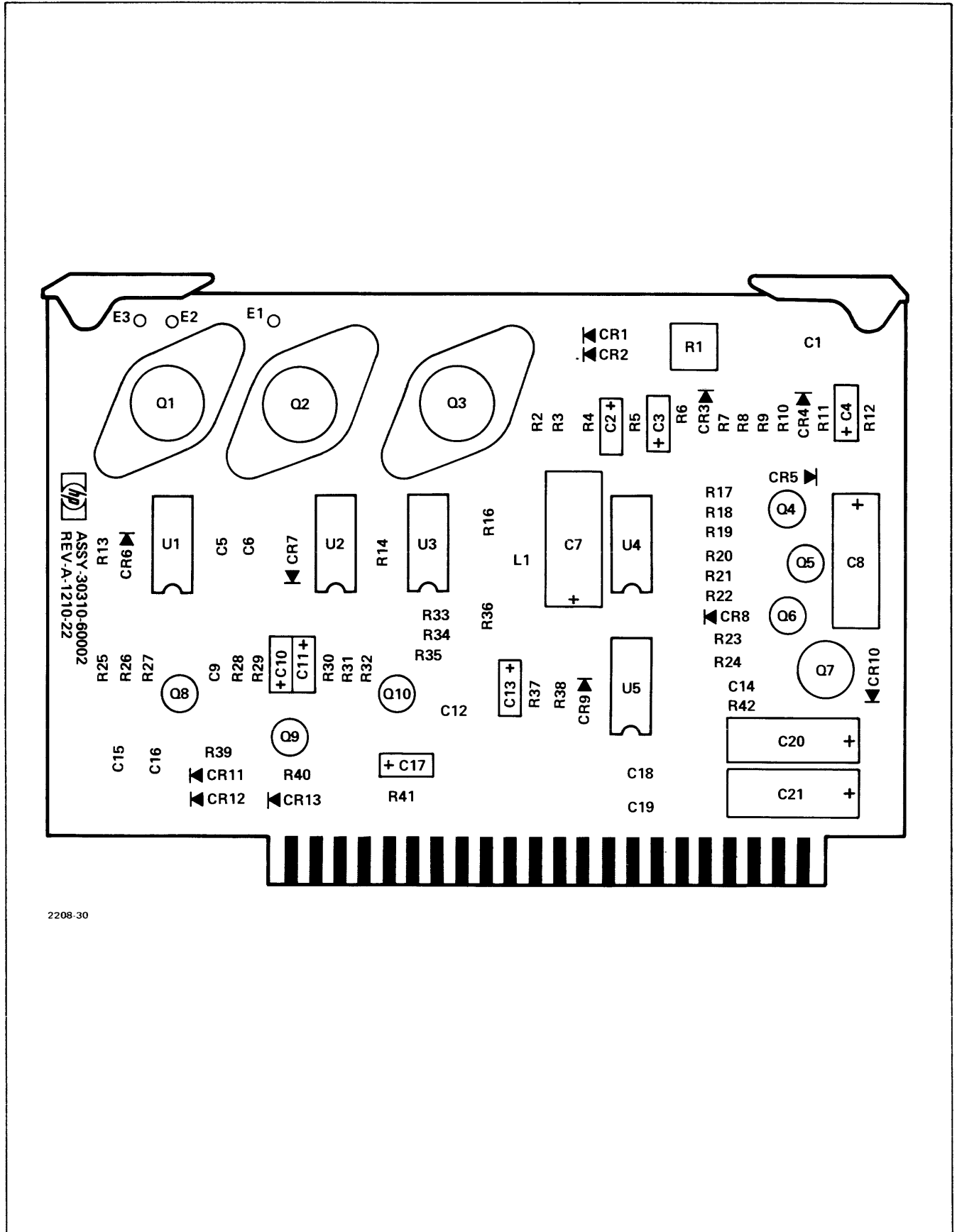

2208-30

Figure 2-52. Preregulator Control PCA (A1), Parts Location Diagram

Table 2-54. Inverter Driver PCA (A2), Replaceable Parts

Reference Designation	HP Part Number	Qty	Description	Mfr Code	Mfr Part Number
A2	30310-60003	1	INVERTER DRIVER PCA	28480	30310-60003
A2C1	0160-0194	4	C:FXD MY 0.015 UF 10%	56289	192P15392-PTS
A2C2	0160-0194		C:FXD MY 0.015 UF 10%	56289	192P15392-PTS
A2C3	0160-0161		C:FXD MY 0.01 UF 10% 200VDCW	56289	152P10392-PTS
A2C4	0180-0100	7	C:FXD ELECT 4.7 UF 10% 35VDCW	56289	150D475X903582-DYS
A2C5	0180-1746	7	C:FXD ELECT 15 UF 10% 20VDCW	28480	0180-1746
A2C6	0180-1746		C:FXD ELECT 15 UF 10% 20VDCW	28480	0180-1746
A2C7	0180-1746		C:FXD ELECT 15 UF 10% 20VDCW	28480	0180-1746
A2C8	0180-1746		C:FXD ELECT 15 UF 10% 20VDCW	28480	0180-1746
A2CR1	1901-0033		DIODE:SILICON 100MA 180WV	07263	FD3369
A2CR2	1901-0033		DIODE:SILICON 100MA 180WV	07263	FD3369
A2CR3	1901-0033		DIODE:SILICON 100MA 180WV	07263	FD3369
A2CR4	1901-0033		DIODE:SILICON 100MA 180WV	07263	FD3369
A2CR5	1901-0033		DIODE:SILICON 100MA 180WV	07263	FD3369
A2CR6	1901-0033		DIODE:SILICON 100MA 180WV	07263	FD3369
A2CR7	1901-0033		DIODE:SILICON 100MA 180WV	07263	FD3369
A2CR8	1901-0033		DIODE:SILICON 100MA 180WV	07263	FD3369
A2CR9	1901-0033		DIODE:SILICON 100MA 180WV	07263	FD3369
A2Q1	1854-0477		TSTR:SI NPN	80131	2N2222A
A2Q2	1854-0477		TSTR:SI NPN	80131	2N2222A
A2Q3	1854-0039		TSTR:SI NPN	80131	2N3053
A2Q4	1854-0039		TSTR:SI NPN	80131	2N3053
A2Q5	1854-0039		TSTR:SI NPN	80131	2N3053
A2Q6	1854-0039		TSTR:SI NPN	80131	2N3053
A2Q7	1854-0039		TSTR:SI NPN	80131	2N3053
A2Q8	1854-0039		TSTR:SI NPN	80131	2N3053
A2Q9	1854-0039		TSTR:SI NPN	80131	2N3053
A2Q10	1854-0039		TSTR:SI NPN	80131	2N3053
A2R1	0757-0397	2	R:FXD MET FLM 68.1 OHM 1% 1/8W	28480	0757-0397
A2R2	0698-3155		R:FXD MET FLM 4.64K OHM 1% 1/8W	28480	0698-3155
A2R3	0698-0085	2	R:FXD MET FLM 2.61K OHM 1% 1/8W	28480	0698-0085
A2R4	0757-0280	21	R:FXD MET FLM 1K OHM 1% 1/8W	28480	0757-0280
A2R5	0698-3449	5	R:FXD MET FLM 28.7K OHM 1% 1/8W	28480	0698-3449
A2R6	0757-0438		R:FXD MET FLM 5.11K OHM 1% 1/8W	28480	0757-0438
A2R7	0757-0280		R:FXD MET FLM 1K OHM 1% 1/8W	28480	0757-0280
A2R8	0757-0280		R:FXD MET FLM 1K OHM 1% 1/8W	28480	0757-0280
A2R9	0757-0397		R:FXD MET FLM 68.1 OHM 1% 1/8W	28480	0757-0397
A2R10	0698-3438	4	R:FXD MET FLM 147 OHM 1% 1/8W	28480	0698-3438
A2R11	0698-3438		R:FXD MET FLM 147 OHM 1% 1/8W	28480	0698-3438
A2R12	0698-3438		R:FXD MET FLM 147 OHM 1% 1/8W	28480	0698-3438
A2R13	0757-0280		R:FXD MET FLM 1K OHM 1% 1/8W	28480	0757-0280
A2R14	0698-3438		R:FXD MET FLM 147 OHM 1% 1/8W	28480	0698-3438
A2R15	0698-3402	8	R:FXD MET FLM 316 OHM 1% 1/2W	28480	0698-3402
A2R16	0698-3402		R:FXD MET FLM 316 OHM 1% 1/2W	28480	0698-3402
A2R17	0698-3402		R:FXD MET FLM 316 OHM 1% 1/2W	28480	0698-3402
A2R18	0698-3402		R:FXD MET FLM 316 OHM 1% 1/2W	28480	0698-3402
A2R19	0757-0280		R:FXD MET FLM 1K OHM 1% 1/8W	28480	0757-0280
A2R20	0698-3402		R:FXD MET FLM 316 OHM 1% 1/2W	28480	0698-3402
A2R21	0698-3402		R:FXD MET FLM 316 OHM 1% 1/2W	28480	0698-3402
A2R22	0757-0280		R:FXD MET FLM 1K OHM 1% 1/8W	28480	0757-0280
A2R23	0698-3402		R:FXD MET FLM 316 OHM 1% 1/2W	28480	0698-3402
A2R24	0698-3402		R:FXD MET FLM 316 OHM 1% 1/2W	28480	0698-3402
A2R25	0757-0280		R:FXD MET FLM 1K OHM 1% 1/8W	28480	0757-0280
A2U1	1820-0141	1	IC:TTL QUAD 2-INPT AND GATE	04713	MC3001P
A2U2	1820-0077	1	IC:TTL DUAL D F/F	01295	SN7474N
A2U3	1820-0054	1	IC:TTL QUAD 2-INPT NAND GATE	01295	SN7400N
A2U4	1820-0256	1	IC:DTL QUAD 2-INPUT POWER GATE	04713	MC858P

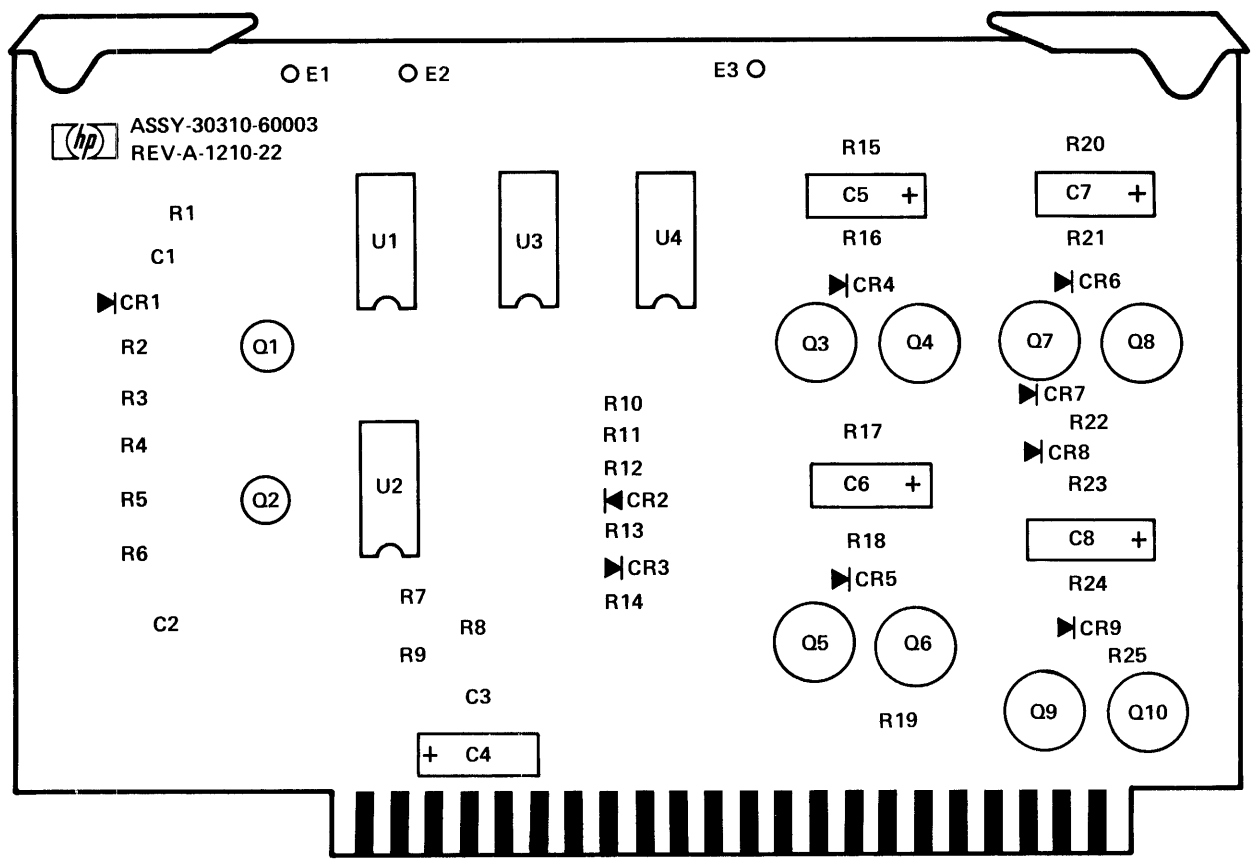

Figure 2-53. Inverter Driver PCA (A2), Parts Location Diagram

Table 2-55. 20 Volt Supply PCA (A3), Replaceable Parts

Reference Designation	HP Part Number	Qty	Description	Mfr Code	Mfr Part Number
A3	30310-60004	1	20 VOLT SUPPLY PCA	28480	30310-60004
A3C1	0160-0298	1	C:FXD MY 0.0015 UF 10% 200VDCW	56289	192P15292-PTS
A3C2	0180-0141	3	C:FXD ELECT 50 UF +75-10% 50VDCW	56289	30D506G0500D2-DSM
A3C3	0180-0197		C:FXD ELECT 2.2 UF 10% 20VDCW	56289	150D225X9020A2-DYS
A3C4	0180-0197		C:FXD ELECT 2.2 UF 10% 20VDCW	56289	150D225X9020A2-DYS
A3C5	0160-0153		C:FXD MY 0.001 UF 10% 200VDCW	56289	192P10292-PTS
A3C6	0180-0291		C:FXD ELECT 1.0 UF 10% 35VDCW	56289	150D105X5035A2-DYS
A3C7	0160-0134	2	C:FXD MICA 220PF 5% 300VDCW	14655	RDH15F221J3C
A3C8	0160-2199	1	C:FXD MICA 30 PF 5% 300VDCW	28480	0160-2159
A3C9	0160-2055	21	C:FXD CER 0.01 UF +80-20% 100VDCW	56289	C023F101F103J522-CDH
A3C10	0160-0194		C:FXD MY 0.015 UF 10%	56289	192P15392-PTS
A3C11	0180-1746		C:FXD ELECT 15 UF 10% 20VDCW	28480	0180-1746
A3C12	0180-0100		C:FXD ELECT 4.7 UF 10% 35VDCW	56289	150D475X5035B2-DYS
A3C14	0160-0194		C:FXD MY 0.015 UF 10%	56289	192P15392-PTS
A3C15	0160-0134		C:FXD MICA 220PF 5% 300VDCW	14655	RDH15F221J3C
A3C16	0160-0161		C:FXD MY 0.01 UF 10% 200VDCW	56289	192P10392-PTS
A3C18	0180-1746		C:FXD ELECT 15 UF 10% 20VDCW	28480	0180-1746
A3C19	0180-1746		C:FXD ELECT 15 UF 10% 20VDCW	28480	0180-1746
A3CR1	1901-0033		DIODE:SILICON 100MA 180WV	07263	FD3369
A3CR2	1902-3139		DIODE:BREAKDOWN 8.25V 5%	04713	SZ10939-158
A3CR3	1901-0033		DIODE:SILICON 100MA 180WV	07263	FD3369
A3CR4	1901-0033		DIODE:SILICON 100MA 180WV	07263	FD3369
A3CR5	1901-0033		DIODE:SILICON 100MA 180WV	07263	FD3369
A3CR6	1901-0033		DIODE:SILICON 100MA 180WV	07263	FD3369
A3CR7	1901-0033		DIODE:SILICON 100MA 180WV	07263	FD3369
A3CR8	1901-0033		DIODE:SILICON 100MA 180WV	07263	FD3369
A3CR9	1901-0033		DIODE:SILICON 100MA 180WV	07263	FD3369
A3CR10	1901-0033		DIODE:SILICON 100MA 180WV	07263	FD3369
A3L2	9100-1665	1	COIL/CHOKE 3300 UH 5%	28480	9100-1665
A3Q1	1853-0281		TSTR:SI PNP	80131	2N2907A
A3Q2	1854-0477		TSTR:SI NPN	80131	2N2222A
A3Q3	1854-0039		TSTR:SI NPN	80131	2N3053
A3Q4	1853-0281		TSTR:SI PNP	80131	2N2907A
A3Q5	1854-0477		TSTR:SI NPN	80131	2N2222A
A3Q6	1853-0281		TSTR:SI PNP	80131	2N2907A
A3Q6	1853-0281		TSTR:SI PNP	80131	2N2907A
A3Q7	1853-0281		TSTR:SI PNP	80131	2N2907A
A3Q8	1854-0477		TSTR:SI NPN	80131	2N2222A
A3Q9	1854-0039		TSTR:SI NPN	80131	2N3053
A3Q10	1853-0281		TSTR:SI PNP	80131	2N2907A
A3Q11	1854-0477		TSTR:SI NPN	80131	2N2222A
A3Q12	1853-0052		TSTR:SI PNP	80131	2N374C
A3Q13	1853-0281		TSTR:SI PNP	80131	2N2907A
A3Q14	1854-0477		TSTR:SI NPN	80131	2N2222A
A3Q15	1854-0477		TSTR:SI NPN	80131	2N2222A
A3R1	0757-0465		R:FXD MET FLM 100K OHM 1% 1/8W	28480	0757-0465
A3R2	2100-1757	1	R:VAR WW 500 OHM 5% TYPE V 1W	28480	2100-1757
A3R3	0698-3156	6	R:FXD MET FLM 14.7K OHM 1% 1/8W	28480	0698-3156
A3R4	0757-0465		R:FXD MET FLM 100K OHM 1% 1/8W	28480	0757-0465
A3R5	0698-0084	7	R:FXD MET FLM 2.15K OHM 1% 1/8W	28480	0698-0084
A3R6	0757-0442		R:FXD MET FLM 10.0K OHM 1% 1/8W	28480	0757-0442
A3R7	0757-0442		R:FXD MET FLM 10.0K OHM 1% 1/8W	28480	0757-0442
A3R8	0757-0346		R:FXD MET FLM 10 OHM 1% 1/8W	28480	0757-0346
A3R9	0757-0280		R:FXD MET FLM 1K OHM 1% 1/8W	28480	0757-0280
A3R10	0757-0407	1	R:FXD MET FLM 200 OHM 1% 1/8W	28480	0757-0407
A3R11	0757-0416		R:FXD MET FLM 511OHM 1% 1/8W	28480	0757-0416
A3R12	0757-0278	1	R:FXD MET FLM 1.78K OHM 1% 1/8W	28480	0757-0278
A3R13	0698-3153	3	R:FXD MET FLM 3.83K OHM 1% 1/8W	28480	0698-3153
A3R14	0698-3153		R:FXD MET FLM 3.83K OHM 1% 1/8W	28480	0698-3153
A3R15	0757-0443		R:FXD MET FLM 11.0K OHM 1% 1/8W	28480	0757-0443
A3R16	0698-3446	3	R:FXD MET FLM 383 OHM 1% 1/8W	28480	0698-3446
A3R17	0757-0279		R:FXD MET FLM 3.16K OHM 1% 1/8W	28480	0757-0279
A3R18	0698-3154	13	R:FXD MET FLM 4.22K OHM 1% 1/8W	28480	0698-3154
A3R19	0698-3155		R:FXD MET FLM 4.64K OHM 1% 1/8W	28480	0698-3155
A3R20	0757-0442		R:FXD MET FLM 10.0K OHM 1% 1/8W	28480	0757-0442
A3R21	0757-0442		R:FXD MET FLM 10.0K OHM 1% 1/8W	28480	0757-0442
A3R22	0757-0439	3	R:FXD MET FLM 6.81K OHM 1% 1/8W	28480	0757-0439
A3R23	0698-3155		R:FXD MET FLM 4.64K OHM 1% 1/8W	28480	0698-3155
A3R24	0757-0442		R:FXD MET FLM 10.0K OHM 1% 1/8W	28480	0757-0442
A3R25	0698-3156		R:FXD MET FLM 14.7K OHM 1% 1/8W	28480	0698-3156
A3R26	0757-0442		R:FXD MET FLM 10.0K OHM 1% 1/8W	28480	0757-0442
A3R27	0757-0442		R:FXD MET FLM 10.0K OHM 1% 1/8W	28480	0757-0442
A3R28	0698-7398	2	R:FXD FLM 6.124K OHM 0.1% 1/8W	28480	0698-7398
A3R29	0698-7398		R:FXD FLM 6.124K OHM 0.1% 1/8W	28480	0698-7398
A3R30	0757-0465		R:FXD MET FLM 100K OHM 1% 1/8W	28480	0757-0465

Table 2-55. 20 Volt Supply PCA (A3), Replaceable Parts (Continued)

Reference Designation	HP Part Number	Qty	Description	Mfr Code	Mfr Part Number
A3R31	0757-0442		R:FXD MET FLM 10.0K OHM 1% 1/8W	28480	0757-0442
A3R32	0698-0084		R:FXD MET FLM 2.15K OHM 1% 1/8W	28480	0698-0084
A3R33	0757-0439		R:FXD MET FLM 6.81K OHM 1% 1/8W	28480	0757-0439
A3R34	0757-0442		R:FXD MET FLM 10.0K OHM 1% 1/8W	28480	0757-0442
A3R35	0757-0346	1	R:FXD MET FLM 10 OHM 1% 1/8W	28480	0757-0346
A3R36	0683-1065	1	R:FXD COMP 10M OHM 5% 1/4W	01121	CB 1065
A3R37	0811-2071	1	R:FXD WW 453 OHM 1% 3W	28480	0811-2071
A3R38	0757-0274		R:FXD MET FLM 1.21K OHM 1% 1/8W	28480	0757-0274
A3R39	0811-1068	1			
A3R41	0698-3155		R:FXD MET FLM 4.64K OHM 1% 1/8W	28480	0698-3155
A3R42	0698-3155		R:FXD MET FLM 4.64K OHM 1% 1/8W	28480	0698-3155
A3R43	0698-3132	1	R:FXD FLM 261 OHM 1% 1/8W	28480	0698-3132
A3R44	0698-0084		R:FXD MET FLM 2.15K OHM 1% 1/8W	28480	0698-0084
A3U1	1826-0069		IC:LINEAR OPER. AMPL.	1204C	LM301AD
A3U5	1826-0069		IC:LINEAR OPER. AMPL.	12040	LM301AD

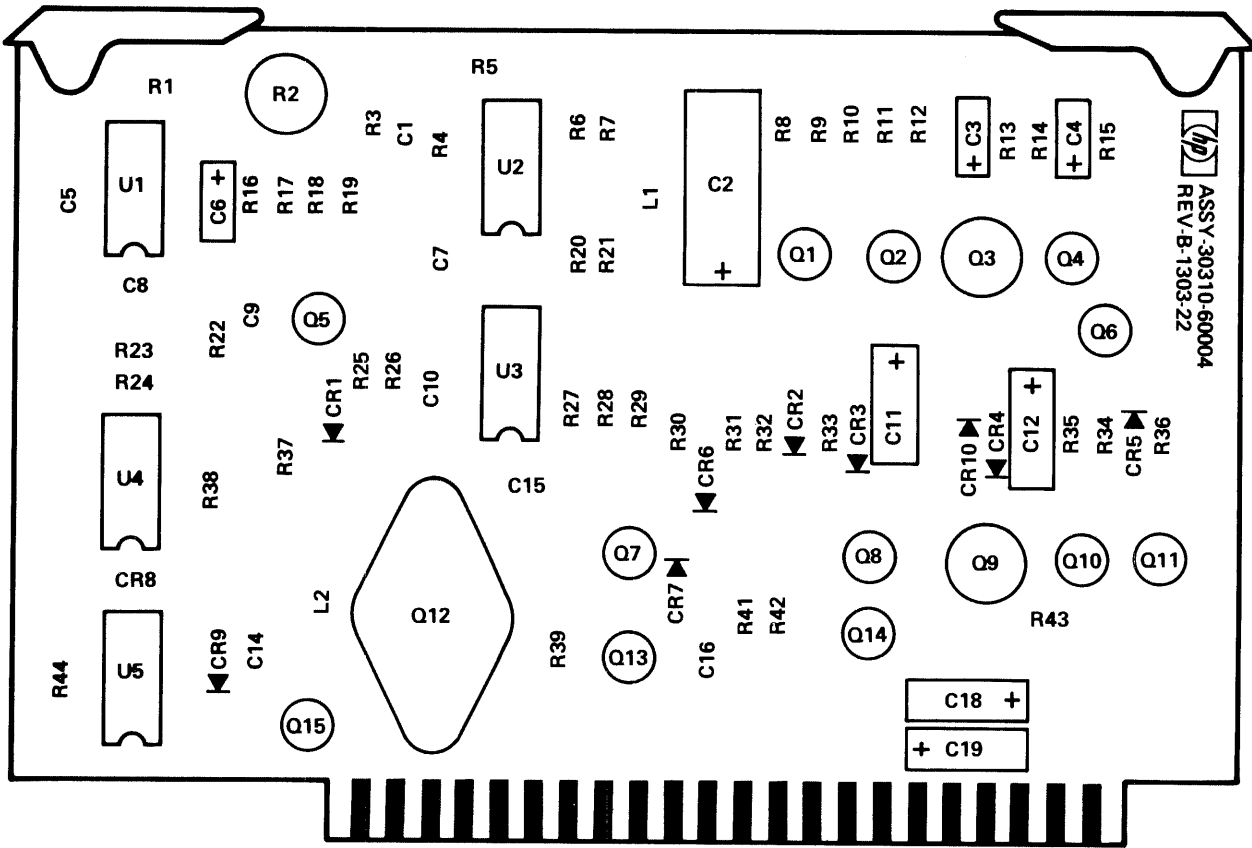

2208-32

Figure 2-54. 20 Volt Supply PCA (A3), Parts Location Diagram

Table 2-56. Current Limit PCA (A4), Replaceable Parts

Reference Designation	HP Part Number	Qty	Description	Mfr Code	Mfr Part Number
A4	30310-60005	1	CURRENT LIMIT PCA	28480	30310-60005
A4C1	0160-2055		C:FXD CER 0.01 UF +80-20% 100VDCW	56289	C023F101F103ZS22-CDH
A4C2	0160-0128	4	C:FXD CER 2.2 UF 20% 25VDCW	56289	5C152C2S-CML
A4C3	0160-2055		C:FXD CER 0.01 UF +80-20% 100VDCW	56289	C023F101F103ZS22-CDH
A4C4	0160-2055		C:FXD CER 0.01 UF +80-20% 100VDCW	56289	C023F101F103ZS22-CDH
A4C5	0160-0128		C:FXD CER 2.2 UF 20% 25VDCW	56289	5C152C2S-CML
A4C6	0180-0374	3	C:FXD TANT. 10 UF 10% 20VDCW	56289	150D106X902082-DYS
A4C7	0160-2055		C:FXD CER 0.01 UF +80-20% 100VDCW	56289	C023F101F103ZS22-CDH
A4C8	0160-2055		C:FXD CER 0.01 UF +80-20% 100VDCW	56289	C023F101F103ZS22-CDH
A4C9	0180-0097		C:FXD TANT. 47 UF 10% 35VDCW	56289	150D476X9035S2-DYS
A4C10	0160-0128		C:FXD CER 2.2 UF 20% 25VDCW	56289	5C152C2S-CML
A4C11	0160-2055		C:FXD CER 0.01 UF +80-20% 100VDCW	56289	C023F101F103ZS22-CDH
A4C12	0160-0128		C:FXD CER 2.2 UF 20% 25VDCW	56289	5C152C2S-CML
A4C13	0180-0049		C:FXD ELECT 20 UF +75-10% 50VDCW	56289	30D206G050CC2-DSM
A4C14	0180-0049		C:FXD ELECT 20 UF +75-10% 50VDCW	56289	30D206G050CC2-DSM
A4C15	0180-0374		C:FXD TANT. 10 UF 10% 20VDCW	56289	150D106X902082-DYS
A4C16	0180-0374		C:FXD TANT. 10 UF 10% 20VDCW	56289	150D106X902082-DYS
A4C17	0180-0376	4	C:FXD ELECT 0.47 UF 10% 35VDCW	56289	150D474X9035A2-DYS
A4C18	0160-2055		C:FXD CER 0.01 UF +80-20% 100VDCW	56289	C023F101F103ZS22-CDH
A4C19	0180-0376		C:FXD ELECT 0.47 UF 10% 35VDCW	56289	150D474X9035A2-DYS
A4C20	0180-0376		C:FXD ELECT 0.47 UF 10% 35VDCW	56289	150D474X9035A2-DYS
A4C21	0160-2055		C:FXD CER 0.01 UF +80-20% 100VDCW	56289	C023F101F103ZS22-CDH
A4C22	0180-0376		C:FXD ELECT 0.47 UF 10% 35VDCW	56289	150D474X9035A2-DYS
A4CR1	1902-3290	2	DIODE BREAKDOWN:SILICON 31.6V 5%	28480	1902-3290
A4CR2	1901-0033		DIODE:SILICON 100MA 180WV	07263	F03369
A4CR3	1901-0033		DIODE:SILICON 100MA 180WV	07263	F03369
A4CR4	1901-0033		DIODE:SILICON 100MA 180WV	07263	F03369
A4CR5	1901-0033		DIODE:SILICON 100MA 180WV	07263	F03369
A4CR6	1902-0072	1	DIODE:BREAKDOWN 2% 7.87V 400MW	28480	1902-0072
A4CR7	1990-0327	1	DIODE:LIGHT EMITTER	28480	1990-0327
A4CR8	1901-0033		DIODE:SILICON 100MA 180WV	07263	F03369
A4CR9	1901-0033		DIODE:SILICON 100MA 180WV	07263	F03369
A4CR10	1902-3290		DIODE BREAKDOWN:SILICON 31.6V 5%	28480	1902-3290
A4CR11	1901-0033		DIODE:SILICON 100MA 180WV	07263	F03369
A4CR12	1901-0033		DIODE:SILICON 100MA 180WV	07263	F03369
A4CR13	1901-0033		DIODE:SILICON 100MA 180WV	07263	F03369
A4CR14	1901-0033		DIODE:SILICON 100MA 180WV	07263	F03369
A4CR15	1901-0033		DIODE:SILICON 100MA 180WV	07263	F03369
A4CR16	1901-0033		DIODE:SILICON 100MA 180WV	07263	F03369
A4CR17	1901-0033		DIODE:SILICON 100MA 180WV	07263	F03369
A4CR18	1901-0033		DIODE:SILICON 100MA 180WV	07263	F03369
A4CR19	1901-0033		DIODE:SILICON 100MA 180WV	07263	F03369
A4CR20	1902-3149	1	DIODE BREAKDOWN:9.09V 5%	28480	1902-3149
A4CR21	1901-0033		DIODE:SILICON 100MA 180WV	07263	F03369
A4L1	9140-0131	3	COIL:FXD RF 10 MH	28480	9140-0131
A4L2	9140-0131		COIL:FXD RF 10 MH	28480	9140-0131
A4Q1	1853-0281		TSTR:SI PNP	80131	2N2907A
A4Q2	1854-0477		TSTR:SI NPN	80131	2N2222A
A4Q3	1854-0477		TSTR:SI NPN	80131	2N2222A
A4Q4	1854-0477		TSTR:SI NPN	80131	2N2222A
A4Q5	1853-0281		TSTR:SI PNP	80131	2N2907A
A4Q6	1854-0477		TSTR:SI NPN	80131	2N2222A
A4Q7	1854-0477		TSTR:SI NPN	80131	2N2222A
A4Q8	1853-0281		TSTR:SI PNP	80131	2N2907A
A4R1	0757-0442		R:FXD MET FLM 10.0K OHM 1% 1/8W	28480	0757-0442
A4R2	0757-0466	2	R:FXD MET FLM 110K OHM 1% 1/8W	28480	0757-0466
A4R3	0757-0464	8	R:FXD MET FLM 90.9K OHM 1% 1/8W	28480	0757-0464
A4R4	0698-0084		R:FXD MET FLM 2.15K OHM 1% 1/8W	28480	0698-0084
A4R5	0698-0085		R:FXD MET FLM 2.61K OHM 1% 1/8W	28480	0698-0085
A4R6	0757-0418	1	R:FXD MET FLM 619 OHM 1% 1/8W	28480	0757-0418
A4R7	0698-3447	1	R:FXD MET FLM 422 OHM 1% 1/8W	28480	0698-3447
A4R8	0698-3162	3	R:FXD MET FLM 46.4K OHM 1% 1/8W	28480	0698-3162
A4R9	0698-3157	1	R:FXD MET FLM 19.6K OHM 1% 1/8W	28480	0698-3157
A4R10	0698-3136	2	R:FXD MET FLM 17.8K OHM 1% 1/8W	28480	0698-3136
A4R11	0698-3162		R:FXD MET FLM 46.4K OHM 1% 1/8W	28480	0698-3162
A4R12	2100-1760		R:VAR WW 5K OHM 5% TYPE V 1W	28480	2100-1760
A4R13	0698-3456	1	R:FXD MET FLM 287K OHM 1% 1/8W	28480	0698-3456
A4R14	0757-0405	1	R:FXD MET FLM 162 OHM 1% 1/8W	28480	0757-0405
A4R15	0757-0464		R:FXD MET FLM 90.9K OHM 1% 1/8W	28480	0757-0464
A4R16	0698-3460	1	R:FXD MET FLM 422K OHM 1% 1/8W	28480	0698-3460
A4R17	0698-3451	2	R:FXD MET FLM 133K OHM 1% 1/8W	28480	0698-3451
A4R18	0757-0461	8	R:FXD MET FLM 68.1K OHM 1% 1/8W	28480	0757-0461

Table 2-56. Current Limit PCA (A4), Replaceable Parts (Continued)

Reference Designation	HP Part Number	Qty	Description	Mfr Code	Mfr Part Number
A4R19	0757-0464		R:FXD MET FLM 90.9K OHM 1% 1/8W	28480	0757-0464
A4R20	0757-0465		R:FXD MET FLM 100K OHM 1% 1/8W	28480	0757-0465
A4R21	0757-0464		R:FXD MET FLM 90.9K OHM 1% 1/8W	28480	0757-0464
A4R22	0757-0442		R:FXD MET FLM 10.0K OHM 1% 1/8W	28480	0757-0442
A4R23	0698-3156		R:FXD MET FLM 14.7K OHM 1% 1/8W	28480	0698-3156
A4R24	0698-3153		R:FXD MET FLM 3.83K OHM 1% 1/8W	28480	0698-3153
A4R25	0698-3156		R:FXD MET FLM 14.7K OHM 1% 1/8W	28480	0698-3156
A4R26	0698-3453	2	R:FXD MET FLM 196K OHM 1% 1/8W	28480	0698-3453
A4R27	0698-3453		R:FXD MET FLM 196K OHM 1% 1/8W	28480	0698-3453
A4R28	0698-0084		R:FXD MET FLM 2.15K OHM 1% 1/8W	28480	0698-0084
A4R29	0698-0084		R:FXD MET FLM 2.15K OHM 1% 1/8W	28480	0698-0084
A4R30	0757-0873	1	R:FXD MET FLM 1.62K OHM 1% 1/2W	28480	0757-0873
A4R31	0757-0442		R:FXD MET FLM 10.0K OHM 1% 1/8W	28480	0757-0442
A4R32	0757-0442		R:FXD MET FLM 10.0K OHM 1% 1/8W	28480	0757-0442
A4R33	0757-0442		R:FXD MET FLM 10.0K OHM 1% 1/8W	28480	0757-0442
A4R34	0698-3162		R:FXD MET FLM 46.4K OHM 1% 1/8W	28480	0698-3162
A4R35	0757-0466		R:FXD MET FLM 110K OHM 1% 1/8W	28480	0757-0466
A4R36	0757-0464		R:FXD MET FLM 90.9K OHM 1% 1/8W	28480	0757-0464
A4R37	0698-3150	1	R:FXD MET FLM 2.37K OHM 1% 1/8W	28480	0698-3150
A4R38	0698-3451		R:FXD MET FLM 133K OHM 1% 1/8W	28480	0698-3451
A4R39	0757-0464		R:FXD MET FLM 90.9K OHM 1% 1/8W	28480	0757-0464
A4R40	0698-3243	1	R:FXD MET FLM 178K OHM 1% 1/8W	28480	0698-3243
A4R41	0757-0442		R:FXD MET FLM 10.0K OHM 1% 1/8W	28480	0757-0442
A4R42	0757-0467	2	R:FXD MET FLM 121K OHM 1% 1/8W	28480	0757-0467
A4R43	0757-0464		R:FXD MET FLM 90.9K OHM 1% 1/8W	28480	0757-0464
A4R44	0757-0461		R:FXD MET FLM 68.1K OHM 1% 1/8W	28480	0757-0461
A4R45	0698-3260	6	R:FXD MET FLM 464K OHM 1% 1/8W	28480	0698-3260
A4R46	0757-0465		R:FXD MET FLM 100K OHM 1% 1/8W	28480	0757-0465
A4R47	0757-0464		R:FXD MET FLM 90.9K OHM 1% 1/8W	28480	0757-0464
A4R48	0757-0460	1	R:FXD MET FLM 61.9K OHM 1% 1/8W	28480	0757-0460
A4R49	0757-0467		R:FXD MET FLM 121K OHM 1% 1/8W	28480	0757-0467
A4R50	0757-0280		R:FXD MET FLM 1K OHM 1% 1/8W	28480	0757-0280
A4R51	0757-0280		R:FXD MET FLM 1K OHM 1% 1/8W	28480	0757-0280
A4R52	0698-0084		R:FXD MET FLM 2.15K OHM 1% 1/8W	28480	0698-0084
A4R53	0757-0461		R:FXD MET FLM 68.1K OHM 1% 1/8W	28480	0757-0461
A4R54	0757-0280		R:FXD MET FLM 1K OHM 1% 1/8W	28480	0757-0280
A4R55	0757-0280		R:FXD MET FLM 1K OHM 1% 1/8W	28480	0757-0280
A4R56	0757-0199	1	R:FXD MET FLM 21.5K OHM 1% 1/8W	28480	0757-0199
A4R57	0757-0280		R:FXD MET FLM 1K OHM 1% 1/8W	28480	0757-0280
A4R58	0757-0280		R:FXD MET FLM 1K OHM 1% 1/8W	28480	0757-0280
A4R59	0811-2031	2	R:FXD WM 815 OHM 3% 1/4W	28480	0811-2031
A4R60	0811-2031		R:FXD WM 815 OHM 3% 1/4W	28480	0811-2031
A4R61	0698-3446	3	R:FXD MET FLM 383 OHM 1% 1/8W	28480	0698-3446
A4R62	0698-3446		R:FXD MET FLM 383 OHM 1% 1/8W	28480	0698-3446
A4S1	3101-1819	1	SWITCH:PUSHBUTTON	28480	3101-1819
A4U1	1826-0070		IC:LINEAR OPER. AMPL.	07263	U6A7741393
A4U2	1826-0070		IC:LINEAR OPER. AMPL.	07263	U6A7741393
A4U3	1826-0100	6	OPERATIONAL AMPLIFIER, DUAL	28480	1826-0100
A4U4	1826-0100		OPERATIONAL AMPLIFIER, DUAL	28480	1826-0100
A4U5	1826-0100		OPERATIONAL AMPLIFIER, DUAL	28480	1826-0100

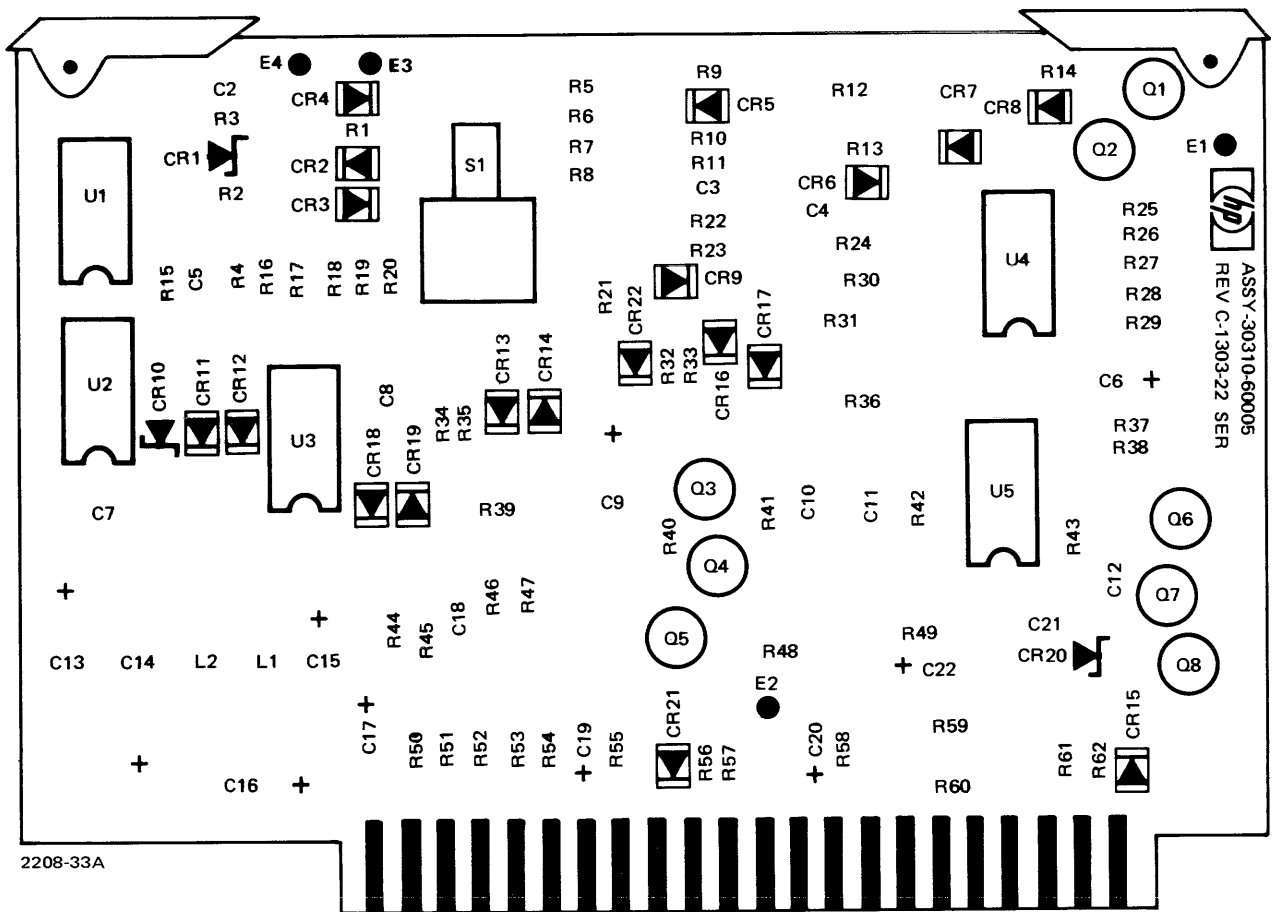

Figure 2-55. Current Limit PCA (A4), Parts Location Diagram

Table 2-57. Voltage Protect PCA (A5), Replaceable Parts

Reference Designation	HP Part Number	Qty	Description	Mfr Code	Mfr Part Number
A5	30310-60006	1	VOLTAGE PROTECT PCA	28480	30310-60006
A5C1	0180-0100		C:FXD ELECT 4.7 UF 10% 35VDCW	56289	1500475X903582-DYS
A5C2	0180-0100		C:FXD ELECT 4.7 UF 10% 35VDCW	56289	1500475X903582-DYS
A5C3	0160-2055		C:FXD CER 0.01 UF +80-20% 100VDCW	56289	C023F101F103ZS22-CDH
A5C4	0160-2143	1	C:FXD CER 2000 PF +80-20% 100VDCW	91418	TYPE B
A5C5	0160-2147	1	C:FXD CER 0.025 UF +80-20% 100VDCW	91418	TA
A5C6	0180-0197		C:FXD ELECT 2.2 UF 10% 20VDCW	56289	1500225X9020A2-DYS
A5C7	0180-0100		C:FXD ELECT 4.7 UF 10% 35VDCW	56289	1500475X903582-DYS
A5C8	0170-0040	1	C:FXD MY 0.047 UF 10% 200VDCW	56289	192P47392-PTS
A5C9	0180-0097		C:FXD TANT. 47 UF 10% 35VDCW	56289	1500476X9035S2-DYS
A5C10	0180-0161	1	C:FXD ELECT 3.3 UF 20% 35VDCW	56289	1500335X003582-DYS
A5C11	0160-2055		C:FXD CER 0.01 UF +80-20% 100VDCW	56289	C023F101F103ZS22-CDH
A5C12	0180-0291		C:FXD ELECT 1.0 UF 10% 35VDCW	56289	1500105X9035A2-DYS
A5C13	0160-2055		C:FXD CER 0.01 UF +80-20% 100VDCW	56289	C023F101F103ZS22-CDH
A5C14	0160-2055		C:FXD CER 0.01 UF +80-20% 100VDCW	56289	C023F101F103ZS22-CDH
A5C15	0180-0100		C:FXD ELECT 4.7 UF 10% 35VDCW	56289	1500475X903582-DYS
A5C16	0160-2055		C:FXD CER 0.01 UF +80-20% 100VDCW	56289	C023F101F103ZS22-CDH
A5C17	0160-2055		C:FXD CER 0.01 UF +80-20% 100VDCW	56289	C023F101F103ZS22-CDH
A5C18	0180-0100		C:FXD ELECT 4.7 UF 10% 35VDCW	56289	1500475X903582-DYS
A5C19	0160-2055		C:FXD CER 0.01 UF +80-20% 100VDCW	56289	C023F101F103ZS22-CDH
A5C20	0160-2055		C:FXD CER 0.01 UF +80-20% 100VDCW	56289	C023F101F103ZS22-CDH
A5C21	0160-2055		C:FXD CER 0.01 UF +80-20% 100VDCW	56289	C023F101F103ZS22-CDH
A5C22	0160-2055		C:FXD CER 0.01 UF +80-20% 100VDCW	56289	C023F101F103ZS22-CDH
A5C23	0160-2055		C:FXD CER 0.01 UF +80-20% 100VDCW	56289	C023F101F103ZS22-CDH
A5C24	0160-2055		C:FXD CER 0.01 UF +80-20% 100VDCW	56289	C023F101F103ZS22-CDH
A5CR1	1901-0033		DIODE:SILICON 100MA 180WV	07263	FD3369
A5CR2	1901-0033		DIODE:SILICON 100MA 180WV	07263	FD3369
A5CR3	1902-0033	1	DIODE: BREAKDOWN 6.2V	04713	1N823
A5CR4	1902-3070	1	DIODE: BREAKDOWN 4.22V 5%	04713	SZ10939-74
A5CR5	1902-3193	2	DIODE BREAKDOWN:13.3V 5%	28480	1902-3193
A5CR6	1902-3193		DIODE BREAKDOWN:13.3V 5%	28480	1902-3193
A5CR7	1901-0033		DIODE:SILICON 100MA 180WV	07263	FD3369
A5CR8	1902-0025	1	DIODE, BREAKDOWN:10.0V 5% 400 MW	28480	1902-0025
A5CR9	1901-0033		DIODE:SILICON 100MA 180WV	07263	FD3369
A5CR10	1901-0050	1	DIODE:SI 200 MA AT 1V	07263	FDA 6308
A5CR11	1901-0033		DIODE:SILICON 100MA 180WV	07263	FD3369
A5CR12	1901-0033		DIODE:SILICON 100MA 180WV	07263	FD3369
A5CR13	1901-0033		DIODE:SILICON 100MA 180WV	07263	FD3369
A5CR14	1901-0033		DIODE:SILICON 100MA 180WV	07263	FD3369
A5CR15	1901-0033		DIODE:SILICON 100MA 180WV	07263	FD3369
A5CR16	1901-0033		DIODE:SILICON 100MA 180WV	07263	FD3369
A5CR17	1901-0033		DIODE:SILICON 100MA 180WV	07263	FD3369
A5CR18	1901-0033		DIODE:SILICON 100MA 180WV	07263	FD3369
A5CR19	1901-0033		DIODE:SILICON 100MA 180WV	07263	FD3369
A5CR20	1901-0033		DIODE:SILICON 100MA 180WV	07263	FD3369
A5CR21	1902-3245	1	DIODE BREAKDOWN:SILICON 21.5V 5%	28480	1902-3245
A5CR22	1901-0033		DIODE:SILICON 100MA 180WV	07263	FD3369
A5CR23	1901-0033		DIODE:SILICON 100MA 180WV	07263	FD3369
A5CR24	1901-0033		DIODE:SILICON 100MA 180WV	07263	FD3369
A5CR25	1901-0033		DIODE:SILICON 100MA 180WV	07263	FD3369
A5CR26	1901-0033		DIODE:SILICON 100MA 180WV	07263	FD3369
A5CR27	1901-0033		DIODE:SILICON 100MA 180WV	07263	FD3369
A5CR28	1901-0033		DIODE:SILICON 100MA 180WV	07263	FD3369
A5CR29	1901-0033		DIODE:SILICON 100MA 180WV	07263	FD3369
A5CR30	1901-0033		DIODE:SILICON 100MA 180WV	07263	FD3369
A5CR31	1901-0033		DIODE:SILICON 100MA 180WV	07263	FD3369
A5CR32	1901-0033		DIODE:SILICON 100MA 180WV	07263	FD3369
A5CR33	1901-0033		DIODE:SILICON 100MA 180WV	07263	FD3369
A5CR34	1901-0033		DIODE:SILICON 100MA 180WV	07263	FD3369
A5CR35	1901-0460		DIODE:SILICON 3-JUNCTION STABISTOR	03508	ST8523
A5CR36	1901-0159		DIODE:SILICON 0.75A 400PIV	04713	SR1358-4
A5CR37	1901-0159		DIODE:SILICON 0.75A 400PIV	04713	SR1358-4
A5CR38	1901-0033		DIODE:SILICON 100MA 180WV	07263	FD3369
A5Q1	1853-0281		TSTR:SI PNP	80131	2N2907A
A5Q2	1853-0281		TSTR:SI PNP	80131	2N2907A
A5Q3	1854-0477		TSTR:SI NPN	80131	2N2222A
A5Q4	1853-0281		TSTR:SI PNP	80131	2N2907A
A5Q5	1854-0477		TSTR:SI NPN	80131	2N2222A
A5Q6	1854-0477		TSTR:SI NPN	80131	2N2222A
A5Q7	1853-0281		TSTR:SI PNP	80131	2N2907A
A5Q8	1854-0477		TSTR:SI NPN	80131	2N2222A
A5Q9	1853-0281		TSTR:SI PNP	80131	2N2907A
A5Q10	1853-0281		TSTR:SI PNP	80131	2N2907A
A5Q11	1853-0281		TSTR:SI PNP	80131	2N2907A
A5Q12	1853-0281		TSTR:SI PNP	80131	2N2907A

Table 2-57. Voltage Protect PCA (A5), Replaceable Parts (Continued)

Reference Designation	HP Part Number	Qty	Description	Mfr Code	Mfr Part Number
A5Q13	1854-0477		TSTR:SI NPN	80131	2N2222A
A5Q14	1853-0281		TSTR:SI PNP	80131	2N2907A
A5Q15	1854-0477		TSTR:SI NPN	80131	2N2222A
A5Q16	1854-0039		TSTR:SI NPN	80131	2N3053
A5R1	2100-2522	1	R:VAR CERMET 10K OHM 10% LIN 1/2W	28480	2100-2522
A5R2	2100-2574	1	R:VAR CERMET 500 OHM 10% LIN 1/2W	28480	2100-2574
A5R2	06	1			
A5R3	0698-3161	3	R:FXD MET FLM 38.3K OHM 1% 1/8W	28480	0698-3161
A5R4	0698-3440	1	R:FXD MET FLM 196 OHM 1% 1/8W	28480	0698-3440
A5R5	0698-0083		R:FXD MET FLM 1.96K OHM 1% 1/8W	28480	0698-0083
A5R6	0757-0442		R:FXD MET FLM 10.0K OHM 1% 1/8W	28480	0757-0442
A5R7	0698-0083		R:FXD MET FLM 1.96K OHM 1% 1/8W	28480	0698-0083
A5R8	0698-3446		R:FXD MET FLM 383 OHM 1% 1/8W	28480	0698-3446
A5R9	0757-0442		R:FXD MET FLM 10.0K OHM 1% 1/8W	28480	0757-0442
A5R10	0757-0485	1	R:FXD MET FLM 681K OHM 1% 1/8W	28480	0757-0485
A5R11	0757-0442		R:FXD MET FLM 10.0K OHM 1% 1/8W	28480	0757-0442
A5R12	0757-0461		R:FXD MET FLM 68.1K OHM 1% 1/8W	28480	0757-0461
A5R13	0698-3449		R:FXD MET FLM 28.7K OHM 1% 1/8W	28480	0698-3449
A5R14	0757-0442		R:FXD MET FLM 10.0K OHM 1% 1/8W	28480	0757-0442
A5R15	0698-3154		R:FXD MET FLM 4.22K OHM 1% 1/8W	28480	0698-3154
A5R16	0757-0442		R:FXD MET FLM 10.0K OHM 1% 1/8W	28480	0757-0442
A5R17	0698-0083		R:FXD MET FLM 1.96K OHM 1% 1/8W	28480	0698-0083
A5R18	0698-0082	1	R:FXD MET FLM 464 OHM 1% 1/8W	28480	0698-0082
A5R19	0757-0280		R:FXD MET FLM 1K OHM 1% 1/8W	28480	0757-0280
A5R20	0757-0280		R:FXD MET FLM 1K OHM 1% 1/8W	28480	0757-0280
A5R21	0757-0280		R:FXD MET FLM 1K OHM 1% 1/8W	28480	0757-0280
A5R22	0757-0442		R:FXD MET FLM 10.0K OHM 1% 1/8W	28480	0757-0442
A5R23	0698-3154		R:FXD MET FLM 4.22K OHM 1% 1/8W	28480	0698-3154
A5R24	0698-0083		R:FXD MET FLM 1.96K OHM 1% 1/8W	28480	0698-0083
A5R25	0757-0438		R:FXD MET FLM 5.11K OHM 1% 1/8W	28480	0757-0438
A5R26	0757-0421	1	R:FXD MET FLM 825 OHM 1% 1/8W	28480	0757-0421
A5R27	0698-0083		R:FXD MET FLM 1.96K OHM 1% 1/8W	28480	0698-0083
A5R28	0698-3444		R:FXD MET FLM 316 OHM 1% 1/8W	28480	0698-3444
A5R29	0698-0083		R:FXD MET FLM 1.96K OHM 1% 1/8W	28480	0698-0083
A5R30	0757-0439		R:FXD MET FLM 6.81K OHM 1% 1/8W	28480	0757-0439
A5R31	0698-0083		R:FXD MET FLM 1.96K OHM 1% 1/8W	28480	0698-0083
A5R32	0698-3155		R:FXD MET FLM 4.64K OHM 1% 1/8W	28480	0698-3155
A5R33	0757-0442		R:FXD MET FLM 10.0K OHM 1% 1/8W	28480	0757-0442
A5R34	0757-0401		R:FXD MET FLM 100 OHM 1% 1/8W	28480	0757-0401
A5R35	0757-0401		R:FXD MET FLM 100 OHM 1% 1/8W	28480	0757-0401
A5R36	0757-0274		R:FXD MET FLM 1.21K OHM 1% 1/8W	28480	0757-0274
A5R37	0757-0401		R:FXD MET FLM 100 OHM 1% 1/8W	28480	0757-0401
A5R38	0698-0083		R:FXD MET FLM 1.96K OHM 1% 1/8W	28480	0698-0083
A5R39	0698-3457	1	R:FXD MET FLM 316K OHM 1% 1/8W	28480	0698-3457
A5R40	0757-0461		R:FXD MET FLM 68.1K OHM 1% 1/8W	28480	0757-0461
A5R41	0698-3449		R:FXD MET FLM 28.7K OHM 1% 1/8W	28480	0698-3449
A5R42	0698-3156		R:FXD MET FLM 14.7K OHM 1% 1/8W	28480	0698-3156
A5R43	0698-3260		R:FXD MET FLM 464K OHM 1% 1/8W	28480	0698-3260
A5R44	0698-3161		R:FXD MET FLM 38.3K OHM 1% 1/8W	28480	0698-3161
A5R45	0757-0461		R:FXD MET FLM 68.1K OHM 1% 1/8W	28480	0757-0461
A5R46	0757-0461		R:FXD MET FLM 68.1K OHM 1% 1/8W	28480	0757-0461
A5R47	0698-3452		R:FXD MET FLM 147K OHM 1% 1/8W	28480	0698-3452
A5R48	0698-3260		R:FXD MET FLM 464K OHM 1% 1/8W	28480	0698-3260
A5R49	0698-3260		R:FXD MET FLM 464K OHM 1% 1/8W	28480	0698-3260
A5R50	0757-0280		R:FXD MET FLM 1K OHM 1% 1/8W	28480	0757-0280
A5R51	0698-3452		R:FXD MET FLM 147K OHM 1% 1/8W	28480	0698-3452
A5R52	0757-0461		R:FXD MET FLM 68.1K OHM 1% 1/8W	28480	0757-0461
A5R53	0698-3449		R:FXD MET FLM 28.7K OHM 1% 1/8W	28480	0698-3449
A5R54	0698-3449		R:FXD MET FLM 28.7K OHM 1% 1/8W	28480	0698-3449
A5R55	0698-3260		R:FXD MET FLM 464K OHM 1% 1/8W	28480	0698-3260
A5R56	0698-3260		R:FXD MET FLM 464K OHM 1% 1/8W	28480	0698-3260
A5R57	0698-3452		R:FXD MET FLM 147K OHM 1% 1/8W	28480	0698-3452
A5R58	0757-0280		R:FXD MET FLM 1K OHM 1% 1/8W	28480	0757-0280
A5R59	0757-0462	1	R:FXD MET FLM 75.0K OHM 1% 1/8W	28480	0757-0462
A5R60	0698-0083		R:FXD MET FLM 1.96K OHM 1% 1/8W	28480	0698-0083
A5R61	0698-3158	3	R:FXD MET FLM 23.7K OHM 1% 1/8W	28480	0698-3158
A5R62	0698-3151	2	R:FXD MET FLM 2.87K OHM 1% 1/8W	28480	0698-3151
A5R63	0698-3154		R:FXD MET FLM 4.22K OHM 1% 1/8W	28480	0698-3154
A5R64	0757-0442		R:FXD MET FLM 10.0K OHM 1% 1/8W	28480	0757-0442
A5R65	0757-0443		R:FXD MET FLM 11.0K OHM 1% 1/8W	28480	0757-0443
A5R66	0698-3154		R:FXD MET FLM 4.22K OHM 1% 1/8W	28480	0698-3154
A5R67	0698-3154		R:FXD MET FLM 4.22K OHM 1% 1/8W	28480	0698-3154
A5R68	0698-3136		R:FXD MET FLM 17.8K OHM 1% 1/8W	28480	0698-3136
A5R69	0698-3156		R:FXD MET FLM 14.7K OHM 1% 1/8W	28480	0698-3156
A5R70	0698-3154		R:FXD MET FLM 4.22K OHM 1% 1/8W	28480	0698-3154

Table 2-57. Voltage Protect PCA (A5), Replaceable Parts (Continued)

Reference Designation	HP Part Number	Qty	Description	Mfr Code	Mfr Part Number
A5R71	0698-3154	1	R:FXD MET FLM 4.22K OHM 1% 1/8W	28480	0698-3154
A5R72	0698-3158		R:FXD MET FLM 23.7K OHM 1% 1/8W	28480	0698-3158
A5R73	0757-0447		R:FXD MET FLM 16.2K OHM 1% 1/8W	28480	0757-0447
A5R74	0698-3154		R:FXD MET FLM 4.22K OHM 1% 1/8W	28480	0698-3154
A5R75	0698-3154		R:FXD MET FLM 4.22K OHM 1% 1/8W	28480	0698-3154
A5R76	0757-0200	1	R:FXD MET FLM 5.62K OHM 1% 1/8W	28480	0757-0200
A5R77	0698-3155		R:FXD MET FLM 4.64K OHM 1% 1/8W	28480	0698-3155
A5R78	0698-3154		R:FXD MET FLM 4.22K OHM 1% 1/8W	28480	0698-3154
A5R79	0757-0438		R:FXD MET FLM 5.11K OHM 1% 1/8W	28480	0757-0438
A5R80	0757-0401		R:FXD MET FLM 100 OHM 1% 1/8W	28480	0757-0401
A5R81	0757-0438		R:FXD MET FLM 5.11K OHM 1% 1/8W	28480	0757-0438
A5R82	0698-3151		R:FXD MET FLM 2.87K OHM 1% 1/8W	28480	0698-3151
A5R83	0698-3154		R:FXD MET FLM 4.22K OHM 1% 1/8W	28480	0698-3154
A5R84	0757-0274		R:FXD MET FLM 1.21K OHM 1% 1/8W	28480	0757-0274
A5R85	0698-3444		R:FXD MET FLM 316 OHM 1% 1/8W	28480	0698-3444
A5R86	0698-3154		R:FXD MET FLM 4.22K OHM 1% 1/8W	28480	0698-3154
A5R87	0757-0447		R:FXD MET FLM 16.2K OHM 1% 1/8W	28480	0757-0447
A5R88	0698-3158		R:FXD MET FLM 23.7K OHM 1% 1/8W	28480	0698-3158
A5R89	0698-3158		R:FXD MET FLM 23.7K OHM 1% 1/8W	28480	0698-3158
A5R90	0698-3161		R:FXD MET FLM 38.3K OHM 1% 1/8W	28480	0698-3161
A5U1	1826-0100	1	OPERATIONAL AMPLIFIER, DUAL	28480	1826-0100
A5U2	1826-0100		OPERATIONAL AMPLIFIER, DUAL	28480	1826-0100
A5U3	1826-0100		OPERATIONAL AMPLIFIER, DUAL	28480	1826-0100
A5U4	18201016				

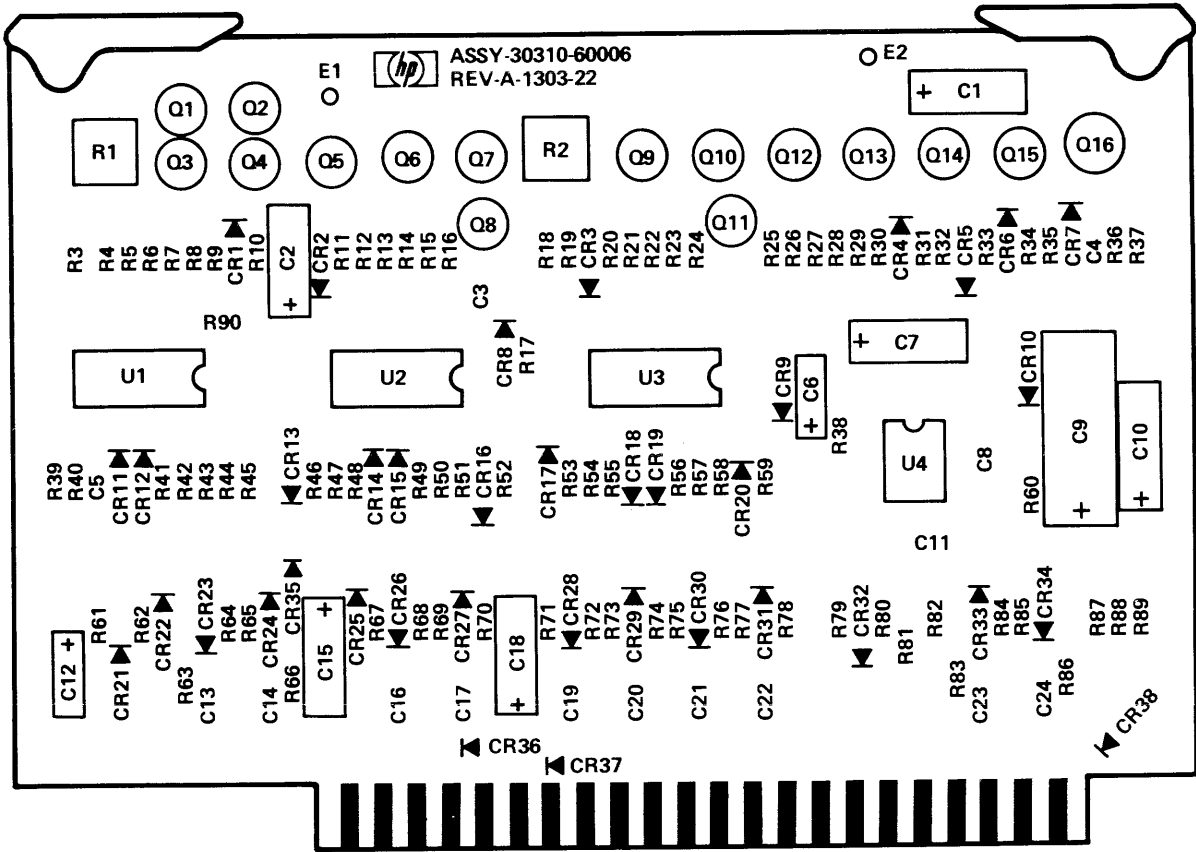

2208-34A

Figure 2-56. Voltage Protect PCA (A5), Parts Location Diagram

Table 2-58. Capacitor Board PCA (A8A1), Replaceable Parts

Reference Designation	HP Part Number	Qty	Description	Mfr Code	Mfr Part Number
A8A1	30310-60008	1	CAPACITOR BOARD, PCA	28480	30310-60008
A8A1C10	0180-2415	1	C:F XD AL ELECT 200 UF +75-10% 40VDCW	56289	390207G040EL4
A8A1C13	0160-3626	1	C:F XD CER 5000 PF 20% 2K VDCW	56289	29C231A
A8A1C15	0180-0141		C:F XD ELECT 50 UF +75-10% 50VDCW	56289	300506G050DD2-DSM
A6A1C16	0160-0141		C:F XD ELECT 50 UF +75-10% 50VDCW	56289	300506G050DD2-DSM
A8A1CR1	1901-0159		DIODE:SILICON 0.75A 400PIV	04713	SR1358-4
A8A1CR2	1901-0159		DIODE:SILICON 0.75A 400PIV	04713	SR1358-4
A8A1CR3	1901-0159		DIODE:SILICON 0.75A 400PIV	04713	SR1358-4
A8A1CR4	1901-0159		DIODE:SILICON 0.75A 400PIV	04713	SR1358-4
A8A1CR5	1901-0159		DIODE:SILICON 0.75A 400PIV	04713	SR1358-4
A8A1CR6	1901-0159		DIODE:SILICON 0.75A 400PIV	04713	SR1358-4
A8A1CR7	1901-0159		DIODE:SILICON 0.75A 400PIV	04713	SR1358-4
A8A1CR8	1901-0159		DIODE:SILICON 0.75A 400PIV	04713	SR1358-4
A8A1CR9	1901-0159		DIODE:SILICON 0.75A 400PIV	04713	SR1358-4
A8A1CR10	1901-0159		DIODE:SILICON 0.75A 400PIV	04713	SR1358-4
A8A1CR11	1901-0159		DIODE:SILICON 0.75A 400PIV	04713	SR1358-4
A8A1CR12	1901-0159		DIODE:SILICON 0.75A 400PIV	04713	SR1358-4
A8A1CR13	1901-0159		DIODE:SILICON 0.75A 400PIV	04713	SR1358-4
A8A1CR14	1901-0164	2	DIODE:SILICON 200PIV 3A	04713	1N4721
A8A1CR15	1901-0164		DIODE:SILICON 200PIV 3A	04713	1N4721
A8A1CR16	1901-0159		DIODE:SILICON 0.75A 400PIV	04713	SR1358-4
A8A1L1	9100-2940	2	CHOKE:100 UH	28480	9100-2940
A8A1L1	9140-0131	1	COIL:F XD RF 10 MH	28480	9140-0131
A8A1L2	9100-2937	1	CHOKE:50 UH	28480	9100-2937
A8A1L3	9100-2940		CHOKE:100 UH	28480	9100-2940
A8A1L4	9100-2928	3	INDUCTOR:4 UH	28480	9100-2928
A8A1L5	9100-2928		INDUCTOR:4 UH	28480	9100-2928
A8A1L6	9100-2928		INDUCTOR:4 UH	28480	9100-2928
A8A1L7	9100-2941	1	CHOKE:200 UH	28480	9100-2941
A8A1R1	0698-3609	2	R:F XD MET OX 22 OHM 5% 2W	28480	0698-3609
A6A1R2	0698-3605	2	R:F XD MET OX 15 OHM 5% 2W	28480	0698-3605
A8A1R3	0698-3605		R:F XD MET OX 15 OHM 5% 2W	28480	0698-3605
A8A1R4	0698-3624	2	R:F XD MET OX 150 OHM 5% 2W	28480	0698-3624
A8A1R5	0698-3624		R:F XD MET OX 150 OHM 5% 2W	28480	0698-3624
A8A1R6	0757-0316	2	R:F XD MET FLM 42.2 OHM 1% 1/8W	28480	0757-0316
A8A1R7	0757-0401		R:F XD MET FLM 100 OHM 1% 1/8W	28480	0757-0401
A8A1R8	0811-1885	1	R:F XD WW 0.025 OHM 5% 10W	28480	0811-1885
A8A1R9	0757-0316		R:F XD MET FLM 42.2 OHM 1% 1/8W	28480	0757-0316
A8A1R10	0757-0401		R:F XD MET FLM 100 OHM 1% 1/8W	28480	0757-0401
A8A1R11	0811-0040	1	R:F XD WW 1 OHM 1% 5W	28480	0811-0040
A8A1R12	0698-3633	2	R:F XD MET OX 390 OHM 5% 2W	28480	0698-3633
A8A1R13	0698-3633		R:F XD MET OX 390 OHM 5% 2W	28480	0698-3633
A8A1R14	0698-3609		R:F XD MET OX 22 OHM 5% 2W	28480	0698-3609
A8A1T1	9100-2942	1	TRANSFORMER	28480	9100-2942

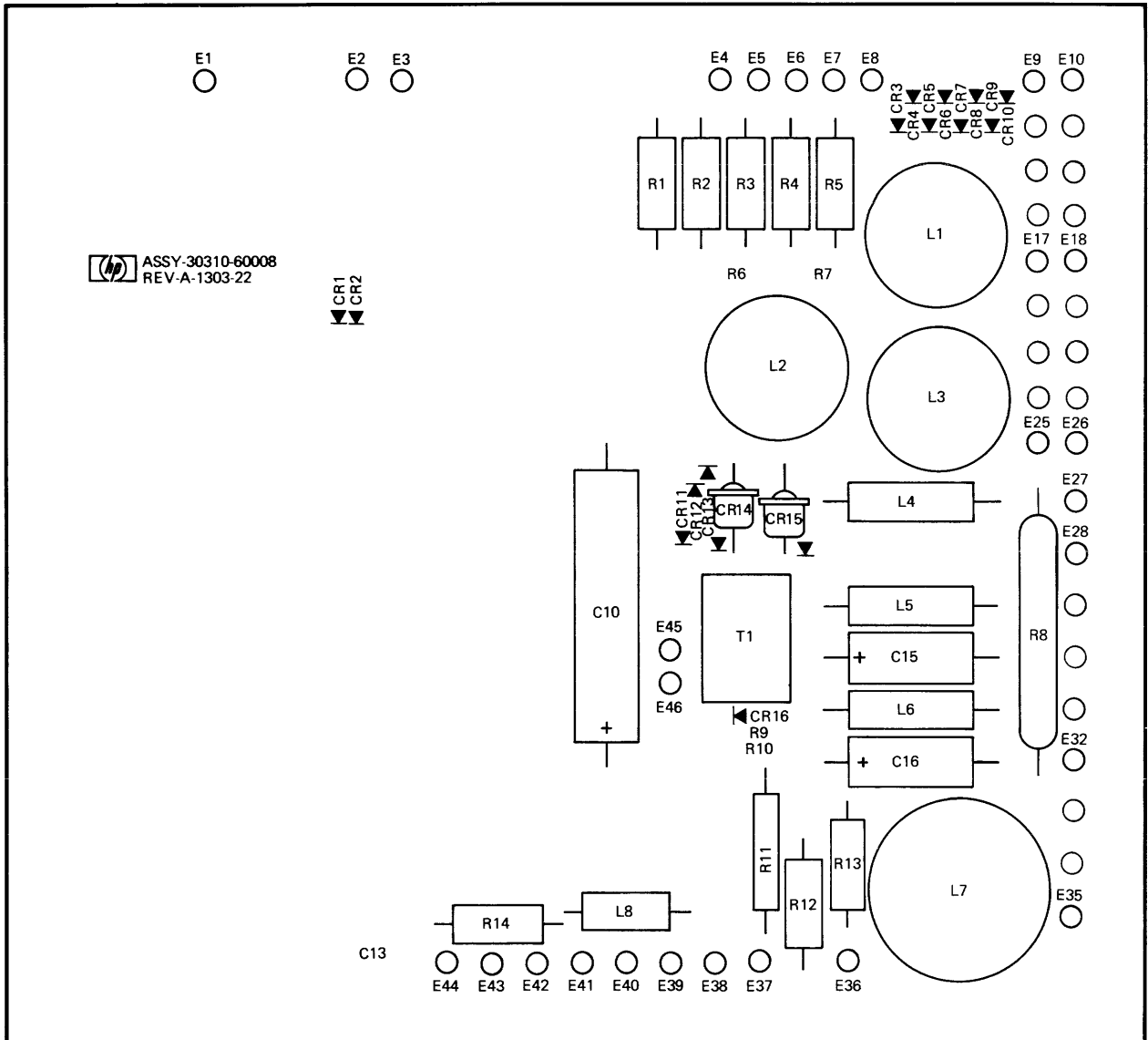

2206-43

Figure 2-57. Capacitor Board PCA (A8A1), Parts Location Diagram

Table 2-59. Auxiliary Control Panel, Replaceable Parts

To Be Supplied

To Be Supplied

Figure 2-58. Auxiliary Control Panel, Exploded View

Table 2-60. Input PCA, Replaceable Parts

Reference Designation	HP Part Number	Qty	Description	Mfr Code	Mfr Part Number
	30350-60001	1	INPUT PCA	28480	30350-60001
C1	0180-0229	7	C:FXD ELECT 33 UF 10% 10VDCW	28480	0180-C229
C2	0160-2055	35	C:FXD CER 0.01 UF +80-20% 100VDCW	56289	C023F101F103ZS22-CDH
C3	0160-2055		C:FXD CER 0.01 UF +80-20% 100VDCW	56289	C023F101F103ZS22-CDH
C4	0160-2055		C:FXD CER 0.01 UF +80-20% 100VDCW	56289	C023F101F103ZS22-CDH
C5	0160-2055		C:FXD CER 0.01 UF +80-20% 100VDCW	56289	C023F101F103ZS22-CDH
C6	0160-2055		C:FXD CER 0.01 UF +80-20% 100VDCW	56289	C023F101F103ZS22-CDH
C7	0160-2055		C:FXD CER 0.01 UF +80-20% 100VDCW	56289	C023F101F103ZS22-CDH
C8	0160-2055		C:FXD CER 0.01 UF +80-20% 100VDCW	56289	C023F101F103ZS22-CDH
C10	0160-2055		C:FXD CER 0.01 UF +80-20% 100VDCW	56289	C023F101F103ZS22-CDH
C11	0160-2055		C:FXD CER 0.01 UF +80-20% 100VDCW	56289	C023F101F103ZS22-CDH
C12	0160-2055		C:FXD CER 0.01 UF +80-20% 100VDCW	56289	C023F101F103ZS22-CDH
C13	0160-2055		C:FXD CER 0.01 UF +80-20% 100VDCW	56289	C023F101F103ZS22-CDH
C14	0160-2055		C:FXD CER 0.01 UF +80-20% 100VDCW	56289	C023F101F103ZS22-CDH
C15	0180-0229		C:FXD ELECT 33 UF 10% 10VDCW	28480	0180-0229
C16	0180-0229		C:FXD ELECT 33 UF 10% 10VDCW	28480	0180-C229
C17	0160-2055		C:FXD CER 0.01 UF +80-20% 100VDCW	56289	CC23F101F103ZS22-CDH
C18	0160-2055		C:FXD CER 0.01 UF +80-20% 100VDCW	56289	C023F101F103ZS22-CDH
C19	0160-2055		C:FXD CER 0.01 UF +80-20% 100VDCW	56289	C023F101F103ZS22-CDH
C20	0160-2055		C:FXD CER 0.01 UF +80-20% 100VDCW	56289	C023F101F103ZS22-CDH
C21	0160-2055		C:FXD CER 0.01 UF +80-20% 100VDCW	56289	C023F101F103ZS22-CDH
C22	0160-2055		C:FXD CER 0.01 UF +80-20% 100VDCW	56289	C023F101F103ZS22-CDH
C23	0160-2055		C:FXD CER 0.01 UF +80-20% 100VDCW	56289	C023F101F103ZS22-CDH
C24	0160-2055		C:FXD CER 0.01 UF +80-20% 100VDCW	56289	C023F101F103ZS22-CDH
C25	0180-0229		C:FXD ELECT 33 UF 10% 10VDCW	28480	0180-0229
C26	0160-2055		C:FXD CER 0.01 UF +80-20% 100VDCW	56289	C023F101F103ZS22-CDH
C27	0160-2055		C:FXD CER 0.01 UF +80-20% 100VDCW	56289	C023F101F103ZS22-CDH
C28	0160-2055		C:FXD CER 0.01 UF +80-20% 100VDCW	56289	C023F101F103ZS22-CDH
C29	0160-2055		C:FXD CER 0.01 UF +80-20% 100VDCW	56289	C023F101F103ZS22-CDH
C30	0160-2055		C:FXD CER 0.01 UF +80-20% 100VDCW	56289	C023F101F103ZS22-CDH
C31	0180-0229		C:FXD ELECT 33 UF 10% 10VDCW	28480	0180-0229
C32	0160-2055		C:FXD CER 0.01 UF +80-20% 100VDCW	56289	C023F101F103ZS22-CDH
C33	0160-2055		C:FXD CER 0.01 UF +80-20% 100VDCW	56289	C023F101F103ZS22-CDH
C34	0160-2055		C:FXD CER 0.01 UF +80-20% 100VDCW	56289	C023F101F103ZS22-CDH
C35	0180-0229		C:FXD ELECT 33 UF 10% 10VDCW	28480	0180-0229
C36	0180-0229		C:FXD ELECT 33 UF 10% 10VDCW	28480	0180-0229
C37	0160-2055		C:FXD CER 0.01 UF +80-20% 100VDCW	56289	C023F101F103ZS22-CDH
C38	0160-2055		C:FXD CER 0.01 UF +80-20% 100VDCW	56289	C023F101F103ZS22-CDH
C39	0160-2055		C:FXD CER 0.01 UF +80-20% 100VDCW	56289	C023F101F103ZS22-CDH
C40	0160-0127	6	C:FXD CER 1.0 UF 20% 25VDCW	56289	5C13CS-CML
C41	0160-0127		C:FXD CER 1.0 UF 20% 25VDCW	56289	5C13CS-CML
C42	0160-0127		C:FXD CER 1.0 UF 20% 25VDCW	56289	5C13CS-CML
C43	0160-0127		C:FXD CER 1.0 UF 20% 25VDCW	56289	5C13CS-CML
C44	0160-2055		C:FXD CER 0.01 UF +80-20% 100VDCW	56289	C023F101F103ZS22-CDH
C45	0160-0127		C:FXD CER 1.0 UF 20% 25VDCW	56289	5C13CS-CML
C46	0160-0127		C:FXD CER 1.0 UF 20% 25VDCW	56289	5C13CS-CML
C47	0160-2055		C:FXD CER 0.01 UF +80-20% 100VDCW	56289	C023F101F103ZS22-CDH
C48	0160-2055		C:FXD CER 0.01 UF +80-20% 100VDCW	56289	C023F101F103ZS22-CDH
C49	0160-0153	2	C:FXD MY 0.001 UF 10% 200VDCW	56289	192P10292-PTS
C50	0160-0153		C:FXD MY 0.001 UF 10% 200VDCW	56289	192P10292-PTS
C9	0160-2055		C:FXD CER 0.01 UF +80-20% 100VDCW	56289	C023F101F103ZS22-CDH
CR1	1990-0325	4	DIODE:VISIBLE LIGHT EMITTER	28480	1990-0325
CR2	1990-0325		DIODE:VISIBLE LIGHT EMITTER	28480	1990-0325
CR3	1990-0325		DIODE:VISIBLE LIGHT EMITTER	28480	1990-0325
CR4	1990-0325		DIODE:VISIBLE LIGHT EMITTER	28480	1990-0325
P1	1251-3090	2	CONNECTOR:R & P 50 MALE CONTACT	66346	3433-2002
P2	1251-3090		CONNECTOR:R & P 50 MALE CONTACT	66346	3433-2002
R1	1810-0030	4	NETWORK:7 RESISTORS 1K OHM 5% 0.15W EA	28480	1810-0030
R2	1810-0045	4	RESISTOR PACK:7 RES. 200 OHM 5% 0.15W	28480	1810-0045
R3	0757-0407	4	R:FXD MET FLM 200 OHM 1% 1/8W	28480	0757-0407
R4	0757-0407		R:FXD MET FLM 200 OHM 1% 1/8W	28480	0757-0407
R5	0757-0407		R:FXD MET FLM 200 OHM 1% 1/8W	28480	0757-0407
R6	1810-0030		NETWORK:7 RESISTORS 1K OHM 5% 0.15W EA	28480	1810-0030
R7	1810-0045		RESISTOR PACK:7 RES. 200 OHM 5% 0.15W	28480	1810-0045
R8	0757-0407		R:FXD MET FLM 200 OHM 1% 1/8W	28480	0757-0407
R9	1810-0045		RESISTOR PACK:7 RES. 200 OHM 5% 0.15W	28480	1810-0045
R10	0757-0198	13	R:FXD MET FLM 100 OHM 1% 1/2W	28480	0757-0198
R11	0757-0198		R:FXD MET FLM 100 OHM 1% 1/2W	28480	0757-0198
R12	0757-0198		R:FXD MET FLM 100 OHM 1% 1/2W	28480	0757-0198
R13	0757-0198		R:FXD MET FLM 100 OHM 1% 1/2W	28480	0757-0198
R14	0757-0198		R:FXD MET FLM 100 OHM 1% 1/2W	28480	0757-0198
R15	0757-0198		R:FXD MET FLM 100 OHM 1% 1/2W	28480	0757-0198
R16	0757-0198		R:FXD MET FLM 100 OHM 1% 1/2W	28480	0757-0198
R17	0757-0198		R:FXD MET FLM 100 OHM 1% 1/2W	28480	0757-0198
R18	0757-0198		R:FXD MET FLM 100 OHM 1% 1/2W	28480	0757-0198

Table 2-60. Input PCA, Replaceable Parts (Continued)

Reference Designation	HP Part Number	Qty	Description	Mfr Code	Mfr Part Number
R19	0757-0198		R:FXD MET FLM 100 OHM 1% 1/2W	28480	0757-0198
R20	0757-0198		R:FXD MET FLM 100 OHM 1% 1/2W	28480	0757-0198
R21	0757-0198		R:FXD MET FLM 100 OHM 1% 1/2W	28480	0757-0198
R22	0757-0198		R:FXD MET FLM 100 OHM 1% 1/2W	28480	0757-0198
R23	1810-0030		NETWORK:7 RESISTORS 1K OHM 5% 0.15W EA	28480	1810-0030
R24	0698-3159	2	R:FXD MET FLM 26.1K OHM 1% 1/8W	28480	0698-3159
R25	0698-3159		R:FXD MET FLM 26.1K OHM 1% 1/8W	28480	0698-3159
R26	1810-0045		RESISTOR PACK:7 RES. 200 OHM 5% 0.15W	28480	1810-0045
R27	1810-0030		NETWORK:7 RESISTORS 1K OHM 5% 0.15W EA	28480	1810-0030
S1	3101-1670	16	SWITCH:TOGGLE SPDT SUB-MINIAT JADE GRAY	09353	7108C82-J4X
S2	3101-1670		SWITCH:TOGGLE SPDT SUB-MINIAT JADE GRAY	09353	7108C82-J4X
S3	3101-1670		SWITCH:TOGGLE SPDT SUB-MINIAT JADE GRAY	09353	7108C82-J4X
S4	3101-1670		SWITCH:TOGGLE SPDT SUB-MINIAT JADE GRAY	09353	7108C82-J4X
S5	3101-1670		SWITCH:TOGGLE SPDT SUB-MINIAT JADE GRAY	09353	7108C82-J4X
S6	3101-1670		SWITCH:TOGGLE SPDT SUB-MINIAT JADE GRAY	09353	7108C82-J4X
S7	3101-1670		SWITCH:TOGGLE SPDT SUB-MINIAT JADE GRAY	09353	7108C82-J4X
S8	3101-1670		SWITCH:TOGGLE SPDT SUB-MINIAT JADE GRAY	09353	7108C82-J4X
S9	3101-1669	21	SWITCH:TOGGLE SPDT SUB-MINIAT JADE GRAY	09353	7101C82-J4X
S10	3101-1669		SWITCH:TOGGLE SPDT SUB-MINIAT JADE GRAY	09353	7101C82-J4X
S11	3101-1669		SWITCH:TOGGLE SPDT SUB-MINIAT JADE GRAY	09353	7101C82-J4X
S12	3101-1668	18	SWITCH:TOGGLE SPDT SUB-MINIATURE	09353	7101 C8E-J4
S13	3101-1668		SWITCH:TOGGLE SPDT SUB-MINIATURE	09353	7101 C8E-J4
S14	3101-1668		SWITCH:TOGGLE SPDT SUB-MINIATURE	09353	7101 C8E-J4
S15	3101-1669		SWITCH:TOGGLE SPDT SUB-MINIAT JADE GRAY	09353	7101C82-J4X
S16	3101-1669		SWITCH:TOGGLE SPDT SUB-MINIAT JADE GRAY	09353	7101C82-J4X
S17	3101-1669		SWITCH:TOGGLE SPDT SUB-MINIAT JADE GRAY	09353	7101C82-J4X
S18	3101-1668		SWITCH:TOGGLE SPDT SUB-MINIATURE	09353	7101 C8E-J4
S19	3101-1668		SWITCH:TOGGLE SPDT SUB-MINIATURE	09353	7101 C8E-J4
S20	3101-1668		SWITCH:TOGGLE SPDT SUB-MINIATURE	09353	7101 C8E-J4
S21	3101-1669		SWITCH:TOGGLE SPDT SUB-MINIAT JADE GRAY	09353	7101C82-J4X
S22	3101-1669		SWITCH:TOGGLE SPDT SUB-MINIAT JADE GRAY	09353	7101C82-J4X
S23	3101-1669		SWITCH:TOGGLE SPDT SUB-MINIAT JADE GRAY	09353	7101C82-J4X
S24	3101-1668		SWITCH:TOGGLE SPDT SUB-MINIATURE	09353	7101 C8E-J4
S25	3101-1668		SWITCH:TOGGLE SPDT SUB-MINIATURE	09353	7101 C8E-J4
S26	3101-1668		SWITCH:TOGGLE SPDT SUB-MINIATURE	09353	7101 C8E-J4
S27	3101-1669		SWITCH:TOGGLE SPDT SUB-MINIAT JADE GRAY	09353	7101C82-J4X
S28	3101-1668		SWITCH:TOGGLE SPDT SUB-MINIATURE	09353	7101 C8E-J4
S29	3101-1668		SWITCH:TOGGLE SPDT SUB-MINIATURE	09353	7101 C8E-J4
S30	3101-1668		SWITCH:TOGGLE SPDT SUB-MINIATURE	09353	7101 C8E-J4
S31	3101-1669		SWITCH:TOGGLE SPDT SUB-MINIAT JADE GRAY	09353	7101C82-J4X
S32	3101-1669		SWITCH:TOGGLE SPDT SUB-MINIAT JADE GRAY	09353	7101C82-J4X
S33	3101-1669		SWITCH:TOGGLE SPDT SUB-MINIAT JADE GRAY	09353	7101C82-J4X
S34	3101-1668		SWITCH:TOGGLE SPDT SUB-MINIATURE	09353	7101 C8E-J4
S35	3101-1668		SWITCH:TOGGLE SPDT SUB-MINIATURE	09353	7101 C8E-J4
S36	3101-1668		SWITCH:TOGGLE SPDT SUB-MINIATURE	09353	7101 C8E-J4
S37	3101-1669		SWITCH:TOGGLE SPDT SUB-MINIAT JADE GRAY	09353	7101C82-J4X
S38	3101-1669		SWITCH:TOGGLE SPDT SUB-MINIAT JADE GRAY	09353	7101C82-J4X
S39	3101-1669		SWITCH:TOGGLE SPDT SUB-MINIAT JADE GRAY	09353	7101C82-J4X
S40	3101-1668		SWITCH:TOGGLE SPDT SUB-MINIATURE	09353	7101 C8E-J4
S41	3101-1668		SWITCH:TOGGLE SPDT SUB-MINIATURE	09353	7101 C8E-J4
S42	3101-1668		SWITCH:TOGGLE SPDT SUB-MINIATURE	09353	7101 C8E-J4
S43	3101-1669		SWITCH:TOGGLE SPDT SUB-MINIAT JADE GRAY	09353	7101C82-J4X
S44	3101-1669		SWITCH:TOGGLE SPDT SUB-MINIAT JADE GRAY	09353	7101C82-J4X
S45	3101-1669		SWITCH:TOGGLE SPDT SUB-MINIAT JADE GRAY	09353	7101C82-J4X
S46	3101-1670		SWITCH:TOGGLE SPDT SUB-MINIAT JADE GRAY	09353	7108C82-J4X
S47	3101-1669		SWITCH:TOGGLE SPDT SUB-MINIAT JADE GRAY	09353	7101C82-J4X
S48	3101-1669		SWITCH:TOGGLE SPDT SUB-MINIAT JADE GRAY	09353	7101C82-J4X
S49	3101-1670		SWITCH:TOGGLE SPDT SUB-MINIAT JADE GRAY	09353	7108C82-J4X
S50	3101-1670		SWITCH:TOGGLE SPDT SUB-MINIAT JADE GRAY	09353	7108C82-J4X
S51	3101-1670		SWITCH:TOGGLE SPDT SUB-MINIAT JADE GRAY	09353	7108C82-J4X
S52	3101-1670		SWITCH:TOGGLE SPDT SUB-MINIAT JADE GRAY	09353	7108C82-J4X
S53	3101-1670		SWITCH:TOGGLE SPDT SUB-MINIAT JADE GRAY	09353	7108C82-J4X
S54	3101-1670		SWITCH:TOGGLE SPDT SUB-MINIAT JADE GRAY	09353	7108C82-J4X
S55	3101-1670		SWITCH:TOGGLE SPDT SUB-MINIAT JADE GRAY	09353	7108C82-J4X
S56	3101-0973	1	SWITCH:SLIDE DPDT 0.5A 125V AC/DC	79727	6126-0018
TB1	0360-1735	1	BARRIER BLOCK:4 TERMINALS 6-32 SCREW	98410	45004-3515
U2	1820-0262	5	IC:TTL 8-BIT PAR-IN SER-OUT SHIFT REG.	12040	SD9936
U3	1820-0370	2	IC:TTL HS QUAD 2-INPT NAND GATE	01295	SN74HC00
U4	1820-0615	21	IC:TTL 8-INPT MULTIPLEXER W/COM.ENABLE	04713	FAIR 9312
U5	1820-0141	2	IC:TTL QUAD 2-INPT AND GATE	04713	MC3001P
U6	1820-0621	15	IC:TTL QUAD 2-INPT NAND BUFFER W/OPEN C	01295	SN7438N
U7	1820-0621		IC:TTL QUAD 2-INPT NAND BUFFER W/OPEN C	01295	SN7438N
U8	1820-0615		IC:TTL 8-INPT MULTIPLEXER W/COM.ENABLE	04713	FAIR 9312
U8	1820-0424	2	IC:TTL HS HEX INVERTER	04713	SN74HC4N
U9	1820-0615		IC:TTL 8-INPT MULTIPLEXER W/COM.ENABLE	04713	FAIR 9312

Table 2-60. Input PCA, Replaceable Parts (Continued)

Reference Designation	HP Part Number	Qty	Description	Mfr Code	Mfr Part Number
U10	1820-0535	6	IC:TTL DUAL PERI.2-INPT AND DRIVER	01295	SN75451P
U11	1820-0535		IC:TTL DUAL PERI.2-INPT AND DRIVER	01295	SN75451P
U12	1820-0615		IC:TTL 8-INPT MULTIPLEXER W/COM.ENABLE	04713	FAIR 9312
U13	1820-0615		IC:TTL 8-INPT MULTIPLEXER W/COM.ENABLE	04713	FAIR 9312
U14	1820-0615		IC:TTL 8-INPT MULTIPLEXER W/COM.ENABLE	04713	FAIR 9312
U15	1820-0615		IC:TTL 8-INPT MULTIPLEXER W/COM.ENABLE	04713	FAIR 9312
U16	1820-0615		IC:TTL 8-INPT MULTIPLEXER W/COM.ENABLE	04713	FAIR 9312
U17	1820-0615		IC:TTL 8-INPT MULTIPLEXER W/COM.ENABLE	04713	FAIR 9312
U18	1820-0615		IC:TTL 8-INPT MULTIPLEXER W/COM.ENABLE	04713	FAIR 9312
U19	1820-0621		IC:TTL QUAD 2-INPT NAND BUFFER W/OPEN C	01295	SN7438N
U20	1820-0621		IC:TTL QUAD 2-INPT NAND BUFFER W/OPEN C	01295	SN7438N
U21	1820-0621		IC:TTL QUAD 2-INPT NAND BUFFER W/OPEN C	01295	SN7438N
U22	1820-0621		IC:TTL QUAD 2-INPT NAND BUFFER W/OPEN C	01295	SN7438N
U23	1820-0621		IC:TTL QUAD 2-INPT NAND BUFFER W/OPEN C	01295	SN7438N
U24	1820-0621		IC:TTL QUAD 2-INPT NAND BUFFER W/OPEN C	01295	SN7438N
U25	1820-0621		IC:TTL QUAD 2-INPT NAND BUFFER W/OPEN C	01295	SN7438N
U26	1820-0621		IC:TTL QUAD 2-INPT NAND BUFFER W/OPEN C	01295	SN7438N
U27	1820-0262		IC:TTL 8-BIT PAR-IN SER-OUT SHIFT REG.	12040	SD9936
U28	1820-0262		IC:TTL 8-BIT PAR-IN SER-OUT SHIFT REG.	12040	SD9936
U29	1820-0615		IC:TTL 8-INPT MULTIPLEXER W/COM.ENABLE	04713	FAIR 9312
U30	1820-0615		IC:TTL 8-INPT MULTIPLEXER W/COM.ENABLE	04713	FAIR 9312
U31	1820-0615		IC:TTL 8-INPT MULTIPLEXER W/COM.ENABLE	04713	FAIR 9312
U32	1820-0615		IC:TTL 8-INPT MULTIPLEXER W/COM.ENABLE	04713	FAIR 9312
U33	1820-0615		IC:TTL 8-INPT MULTIPLEXER W/COM.ENABLE	04713	FAIR 9312
U34	1820-0262		IC:TTL 8-BIT PAR-IN SER-OUT SHIFT REG.	12040	SD9936
U35	1820-0615		IC:TTL 8-INPT MULTIPLEXER W/COM.ENABLE	04713	FAIR 9312
U36	1820-0615		IC:TTL 8-INPT MULTIPLEXER W/COM.ENABLE	04713	FAIR 9312
U37	1820-0615		IC:TTL 8-INPT MULTIPLEXER W/COM.ENABLE	04713	FAIR 9312
U38	1820-0615		IC:TTL 8-INPT MULTIPLEXER W/COM.ENABLE	04713	FAIR 9312
U39	1820-0615		IC:TTL 8-INPT MULTIPLEXER W/COM.ENABLE	04713	FAIR 9312
U40	1820-0621		IC:TTL QUAD 2-INPT NAND BUFFER W/OPEN C	01295	SN7438N
U41	1820-0374	1	IC:TTL HS DUAL 4-INPT AND GATE	01295	SN74H21N
U42	1820-0512	2	IC:TTL HS DUAL D F/F(35 MHZ MIN.)	01295	SN74H74N
U43	1820-0695	1	IC:TTL SHS DUAL J-K F/F W/PRESET	01295	SN74S113N
U44	1820-0621		IC:TTL QUAD 2-INPT NAND BUFFER W/OPEN C	01295	SN7438N
U45	1820-0262		IC:TTL 8-BIT PAR-IN SER-OUT SHIFT REG.	12040	SD9936
U46	1820-0621		IC:TTL QUAD 2-INPT NAND BUFFER W/OPEN C	01295	SN7438N
U47	1820-0621		IC:TTL QUAD 2-INPT NAND BUFFER W/OPEN C	01295	SN7438N
U48	1820-0233	2	IC:TTL SYNUP-ON 4-BIT BINARY COUNTER	01295	SN74193N
U49	1820-0233		IC:TTL SYNUP-ON 4-BIT BINARY COUNTER	01295	SN74193N
U50	1820-0512		IC:TTL HS DUAL D F/F(35 MHZ MIN.)	01295	SN74H74N
U51	1820-0424		IC:TTL HS HEX INVERTER	04713	SN74HC4N
U52	1820-0207	2	IC:TTL MONOSTABLE MULTIVIBRATOR	28480	1820-0207
U53	1820-0535		IC:TTL DUAL PERI.2-INPT AND DRIVER	01295	SN75451P
U54	1820-0535		IC:TTL DUAL PERI.2-INPT AND DRIVER	01295	SN75451P
U55	1820-0535		IC:TTL DUAL PERI.2-INPT AND DRIVER	01295	SN75451P
U56	1820-0535		IC:TTL DUAL PERI.2-INPT AND DRIVER	01295	SN75451P
U57	1820-0370		IC:TTL HS QUAD 2-INPT NAND GATE	01295	SN74H00N
U58	1820-0141		IC:TTL QUAD 2-INPT AND GATE	04713	MC3001P
U59	1820-0207		IC:TTL MONOSTABLE MULTIVIBRATOR	28480	1820-0207
U60	1820-0615		IC:TTL 8-INPT MULTIPLEXER W/COM.ENABLE	04713	FAIR 9312
U61	1820-0621		IC:TTL QUAD 2-INPT NAND BUFFER W/OPEN C	01295	SN7438N
W2	8159-0005		JUMPER WIRE	28480	8159-0005

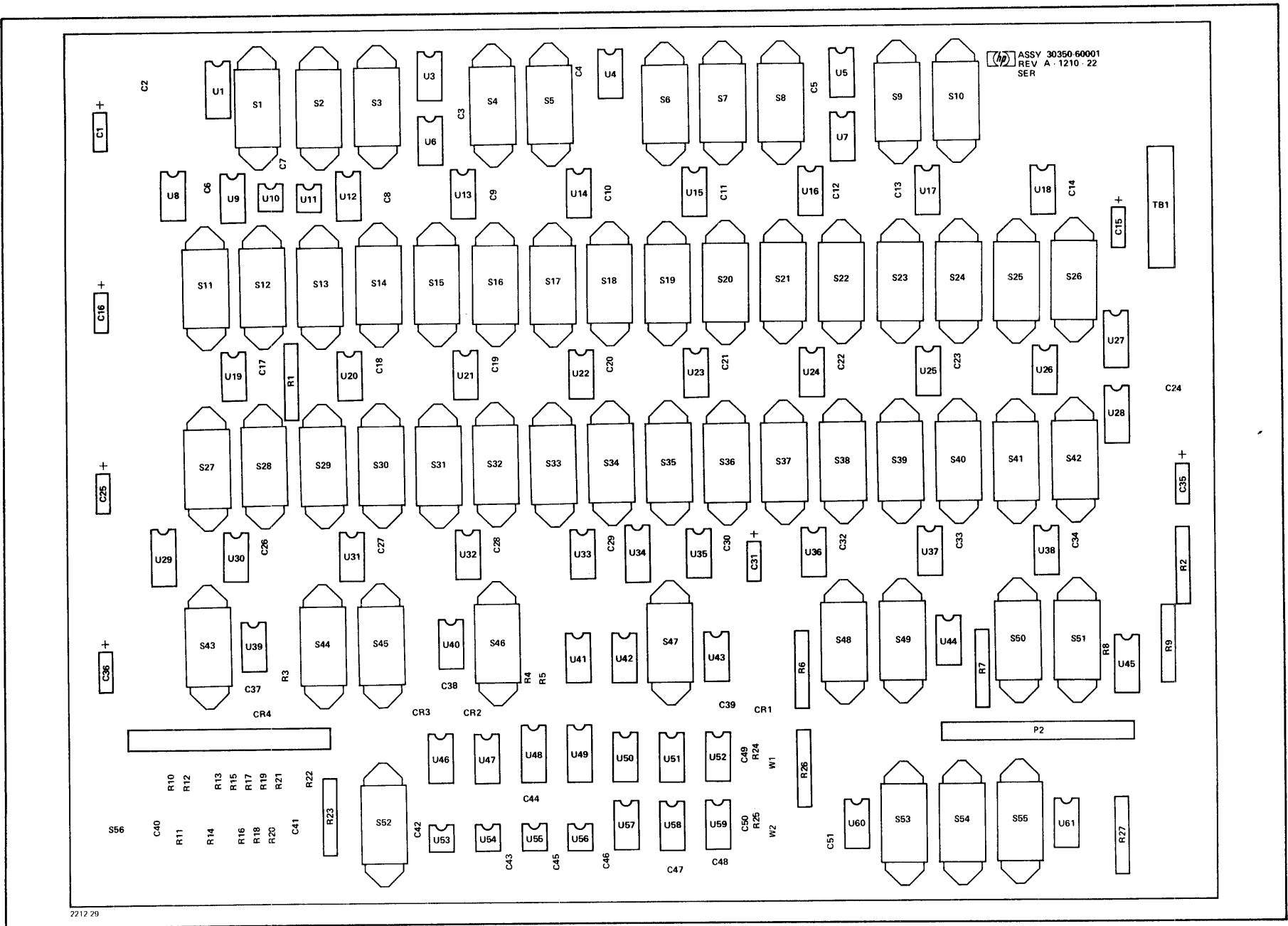

Figure 2-59. Input PCA, Parts Location Diagram

Table 2-61. Display PCA, Replaceable Parts

Reference Designation	HP Part Number	Qty	Description	Mfr Code	Mfr Part Number
	30350-60002		DISPLAY PCA	28480	30350-60002
C1	0180-0229	9	C:FxD ELECT 33 UF 10% 10VDCW	28480	0180-0229
C2	0180-0229		C:FxD ELECT 33 UF 10% 10VDCW	28480	0180-0229
C3	0180-0229		C:FxD ELECT 33 UF 10% 10VDCW	28480	0180-0229
C4	0180-0229		C:FxD ELECT 33 UF 10% 10VDCW	28480	0180-0229
C5	0160-2055	21	C:FxD CER 0.01 UF +80-20% 100VDCW	56289	C023F101F103ZS22-CDH
C6	0160-2055		C:FxD CER 0.01 UF +80-20% 100VDCW	56289	C023F101F103ZS22-CDH
C7	0160-2055		C:FxD CER 0.01 UF +80-20% 100VDCW	56289	C023F101F103ZS22-CDH
C8	0160-2055		C:FxD CER 0.01 UF +80-20% 100VDCW	56289	C023F101F103ZS22-CDH
C9	0160-2055		C:FxD CER 0.01 UF +80-20% 100VDCW	56289	C023F101F103ZS22-CDH
C10	0160-2055		C:FxD CER 0.01 UF +80-20% 100VDCW	56289	C023F101F103ZS22-CDH
C11	0160-2055		C:FxD CER 0.01 UF +80-20% 100VDCW	56289	C023F101F103ZS22-CDH
C12	0160-2055		C:FxD CER 0.01 UF +80-20% 100VDCW	56289	C023F101F103ZS22-CDH
C13	0160-2055		C:FxD CER 0.01 UF +80-20% 100VDCW	56289	C023F101F103ZS22-CDH
C14	0160-2055		C:FxD CER 0.01 UF +80-20% 100VDCW	56289	C023F101F103ZS22-CDH
C15	0160-2055		C:FxD CER 0.01 UF +80-20% 100VDCW	56289	C023F101F103ZS22-CDH
C16	0160-2055		C:FxD CER 0.01 UF +80-20% 100VDCW	56289	C023F101F103ZS22-CDH
C17	0160-2055		C:FxD CER 0.01 UF +80-20% 100VDCW	56289	C023F101F103ZS22-CDH
C18	0160-2055		C:FxD CER 0.01 UF +80-20% 100VDCW	56289	C023F101F103ZS22-CDH
C19	0160-2055		C:FxD CER 0.01 UF +80-20% 100VDCW	56289	C023F101F103ZS22-CDH
C20	0160-2055		C:FxD CER 0.01 UF +80-20% 100VDCW	56289	C023F101F103ZS22-CDH
C21	0160-2055		C:FxD CER 0.01 UF +80-20% 100VDCW	56289	C023F101F103ZS22-CDH
C22	0160-2055		C:FxD CER 0.01 UF +80-20% 100VDCW	56289	C023F101F103ZS22-CDH
C23	0180-0229		C:FxD ELECT 33 UF 10% 10VDCW	28480	0160-0229
C24	0180-0229		C:FxD ELECT 33 UF 10% 10VDCW	28480	0180-0229
C25	0180-0229		C:FxD ELECT 33 UF 10% 10VDCW	28480	0180-0229
C26	0180-0229		C:FxD ELECT 33 UF 10% 10VDCW	28480	0180-0229
C27	0180-0229		C:FxD ELECT 33 UF 10% 10VDCW	28480	0180-0229
C28	0160-2055		C:FxD CER 0.01 UF +80-20% 100VDCW	56289	C023F101F103ZS22-CDH
CR1			THRU		
CR64	1990-0325	64	DIODE:VISIBLE LIGHT EMITTER	28480	1990-0325
P1	1251-3090	1	CONNECTOR:R & P 50 MALE CONTACT	66346	3433-2002
T81	0360-1735	1	BARRIER BLOCK:4 TERMINALS 6-32 SCREW	98410	45004-3515
U1	1810-0037	2	RESISTOR ARRAY:1K OHM 2% 1W EACH	28480	1810-0037
U2	1810-0124	8	RESISTOR ARRAY:8 X 200 OHM 2% 1-3/4W	28480	1810-0124
U3	1820-0742	8	IC:TTL DUAL 4-BIT LATCH	07263	U6N930859X
U4	1810-0124		RESISTOR ARRAY:8 X 200 OHM 2% 1-3/4W	28480	1810-0124
U5	1820-0742		IC:TTL DUAL 4-BIT LATCH	07263	U6N930859X
U6	1810-0124		RESISTOR ARRAY:8 X 200 OHM 2% 1-3/4W	28480	1810-0124
U7	1820-0742		IC:TTL DUAL 4-BIT LATCH	07263	U6N930859X
U8	1810-0124		RESISTOR ARRAY:8 X 200 OHM 2% 1-3/4W	28480	1810-0124
U9	1820-0742		IC:TTL DUAL 4-BIT LATCH	07263	U6N930859X
U10	1820-0424	1	IC:TTL HS HEX INVERTER	04713	SN74H04N
U11	1820-0373	2	IC:TTL HS DUAL 4-INPT NAND GATE	01295	SN74H20N
U12	1820-0141	4	IC:TTL QUAD 2-INPT AND GATE	04713	MC3001P
U13	1820-0294	2	IC:TTL 8-BIT SER-IN PAR OUT SHIFT REG	12040	SD9935
U14	1820-0141		IC:TTL QUAD 2-INPT AND GATE	04713	MC3001P
U15	1820-0141		IC:TTL QUAD 2-INPT AND GATE	04713	MC3001P
U16	1820-0294		IC:TTL 8-BIT SER-IN PAR OUT SHIFT REG	12040	SD9935
U17	1820-0141		IC:TTL QUAD 2-INPT AND GATE	04713	MC3001P
U18	1820-0373		IC:TTL HS DUAL 4-INPT NAND GATE	01295	SN74H20N
U19	1820-0535	1	IC:TTL DUAL PERI.2-INPT AND DRIVER	01295	SN75451P
U20	1810-0124		RESISTOR ARRAY:8 X 200 OHM 2% 1-3/4W	28480	1810-0124
U21	1820-0742		IC:TTL DUAL 4-BIT LATCH	07263	U6N930859X
U22	1810-0124		RESISTOR ARRAY:8 X 200 OHM 2% 1-3/4W	28480	1810-0124
U23	1820-0742		IC:TTL DUAL 4-BIT LATCH	07263	U6N930859X
U24	1810-0124		RESISTOR ARRAY:8 X 200 OHM 2% 1-3/4W	28480	1810-0124
U25	1820-0742		IC:TTL DUAL 4-BIT LATCH	07263	U6N930859X
U26	1810-0124		RESISTOR ARRAY:8 X 200 OHM 2% 1-3/4W	28480	1810-0124
U27	1820-0742		IC:TTL DUAL 4-BIT LATCH	07263	U6N930859X
U28	1810-0037		RESISTOR ARRAY:1K OHM 2% 1W EACH	28480	1810-0037

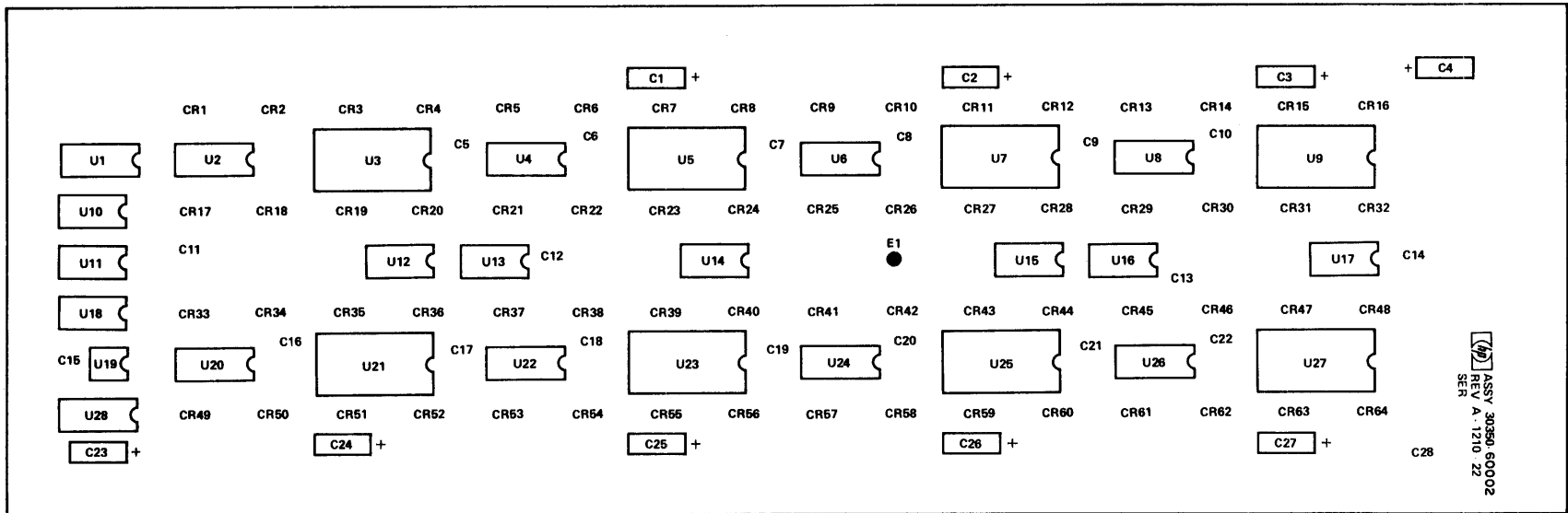

Figure 2-60. Display PCA, Parts Location Diagram

Table 2-62. Hardware Maintenance Panel, Replaceable Parts

To Be Supplied

To Be Supplied

Figure 2-61. Hardware Maintenance Panel, Exploded View

Table 2-63. Input PCA, Replaceable Parts

Reference Designation	HP Part Number	Qty	Description	Mfr Code	Mfr Part Number
C1	30352-60001	1	INPUT PCA	28480	30352-60001
C2	0160-2055	16	C:FXD CER 0.01 UF +80-20% 100VDCW	56289	C023F101F103ZS22-CDH
C3	0160-2055		C:FXD CER 0.01 UF +80-20% 100VDCW	56289	C023F101F103ZS22-CDH
C4	0180-0229	5	C:FXD ELECT 33 UF 10% 10VDCW	28480	0180-0229
	0160-2055		C:FXD CER 0.01 UF +80-20% 100VDCW	56289	C023F101F103ZS22-CDH
C5	0160-2055		C:FXD CER 0.01 UF +80-20% 100VDCW	56289	C023F101F103ZS22-CDH
C6	0160-2055		C:FXD CER 0.01 UF +80-20% 100VDCW	56289	C023F101F103ZS22-CDH
C7	0160-2055		C:FXD CER 0.01 UF +80-20% 100VDCW	56289	C023F101F103ZS22-CDH
C8	0160-2055		C:FXD CER 0.01 UF +80-20% 100VDCW	56289	C023F101F103ZS22-CDH
C9	0180-0229		C:FXD ELECT 33 UF 10% 10VDCW	28480	0180-0229
C10	0180-0229		C:FXD ELECT 33 UF 10% 10VDCW	28480	0180-0229
C11	0160-2055		C:FXD CER 0.01 UF +80-20% 100VDCW	56289	C023F101F103ZS22-CDH
C12	0180-0229		C:FXD ELECT 33 UF 10% 10VDCW	28480	0180-0229
C13	0160-2055		C:FXD CER 0.01 UF +80-20% 100VDCW	56289	C023F101F103ZS22-CDH
C14	0160-2055		C:FXD CER 0.01 UF +80-20% 100VDCW	56289	C023F101F103ZS22-CDH
C15	0160-2055		C:FXD CER 0.01 UF +80-20% 100VDCW	56289	C023F101F103ZS22-CDH
C16	0160-2055		C:FXD CER 0.01 UF +80-20% 100VDCW	56289	C023F101F103ZS22-CDH
C17	0160-2055		C:FXD CER 0.01 UF +80-20% 100VDCW	56289	C023F101F103ZS22-CDH
C18	0160-2055		C:FXD CER 0.01 UF +80-20% 100VDCW	56289	C023F101F103ZS22-CDH
C19	0180-0229		C:FXD ELECT 33 UF 10% 10VDCW	28480	0180-0229
C20	0160-2055		C:FXD CER 0.01 UF +80-20% 100VDCW	56289	C023F101F103ZS22-CDH
C21	0160-2055		C:FXD CER 0.01 UF +80-20% 100VDCW	56289	C023F101F103ZS22-CDH
P1	125103090	1			
R1	0757-1000	1	R:FXD MET FLM 51.1 OHM 1% 1/2W	28480	0757-1000
R2	1810-0030	2	NETWORK:7 RESISTORS 1K OHM 5% 0.15W EA	28480	1810-0030
R3	1810-0030		NETWORK:7 RESISTORS 1K OHM 5% 0.15W EA	28480	1810-0030
S1	3101-1669	18	SWITCH:TOGGLE SPDT SUB-MINIAT JADE GRAY	09353	7101CB2-J4X
S2	3101-1669		SWITCH:TOGGLE SPDT SUB-MINIAT JADE GRAY	09353	7101CB2-J4X
S3	3101-1669		SWITCH:TOGGLE SPDT SUB-MINIAT JADE GRAY	09353	7101CB2-J4X
S4	3101-1668	12	SWITCH:TOGGLE SPDT SUB-MINIATURE	09353	7101 CBE-J4
S5	3101-1668		SWITCH:TOGGLE SPDT SUB-MINIATURE	09353	7101 CBE-J4
S6	3101-1668		SWITCH:TOGGLE SPDT SUB-MINIATURE	09353	7101 CBE-J4
S7	3101-1669		SWITCH:TOGGLE SPDT SUB-MINIAT JADE GRAY	09353	7101CB2-J4X
S8	3101-1669		SWITCH:TOGGLE SPDT SUB-MINIAT JADE GRAY	09353	7101CB2-J4X
S9	3101-1669		SWITCH:TOGGLE SPDT SUB-MINIAT JADE GRAY	09353	7101CB2-J4X
S10	3101-1668		SWITCH:TOGGLE SPDT SUB-MINIATURE	09353	7101 CBE-J4
S11	3101-1668		SWITCH:TOGGLE SPDT SUB-MINIATURE	09353	7101 CBE-J4
S12	3101-1668		SWITCH:TOGGLE SPDT SUB-MINIATURE	09353	7101 CBE-J4
S13	3101-1669		SWITCH:TOGGLE SPDT SUB-MINIAT JADE GRAY	09353	7101CB2-J4X
S14	3101-1669		SWITCH:TOGGLE SPDT SUB-MINIAT JADE GRAY	09353	7101CB2-J4X
S16	3101-1669		SWITCH:TOGGLE SPDT SUB-MINIAT JADE GRAY	09353	7101CB2-J4X
S17	3101-1669		SWITCH:TOGGLE SPDT SUB-MINIAT JADE GRAY	09353	7101CB2-J4X
S18	3101-1669		SWITCH:TOGGLE SPDT SUB-MINIAT JADE GRAY	09353	7101CB2-J4X
S19	3101-1668		SWITCH:TOGGLE SPDT SUB-MINIATURE	09353	7101 CBE-J4
S20	3101-1668		SWITCH:TOGGLE SPDT SUB-MINIATURE	09353	7101 CBE-J4
S21	3101-1668		SWITCH:TOGGLE SPDT SUB-MINIATURE	09353	7101 CBE-J4
S22	3101-1669		SWITCH:TOGGLE SPDT SUB-MINIAT JADE GRAY	09353	7101CB2-J4X
S23	3101-1669		SWITCH:TOGGLE SPDT SUB-MINIAT JADE GRAY	09353	7101CB2-J4X
S24	3101-1669		SWITCH:TOGGLE SPDT SUB-MINIAT JADE GRAY	09353	7101CB2-J4X
S25	3101-1668		SWITCH:TOGGLE SPDT SUB-MINIATURE	09353	7101 CBE-J4
S26	3101-1668		SWITCH:TOGGLE SPDT SUB-MINIATURE	09353	7101 CBE-J4
S27	3101-1668		SWITCH:TOGGLE SPDT SUB-MINIATURE	09353	7101 CBE-J4
S28	3101-1670		SWITCH:TOGGLE SPDT SUB-MINIAT JADE GRAY	09353	7108CB2-J4X
S29	3101-1669		SWITCH:TOGGLE SPDT SUB-MINIAT JADE GRAY	09353	7101CB2-J4X
S30	3101-1669		SWITCH:TOGGLE SPDT SUB-MINIAT JADE GRAY	09353	7101CB2-J4X
S31	3101-1670		SWITCH:TOGGLE SPDT SUB-MINIAT JADE GRAY	09353	7108CB2-J4X
S32	3101-1669		SWITCH:TOGGLE SPDT SUB-MINIAT JADE GRAY	09353	7101CB2-J4X
S33	3101-1670		SWITCH:TOGGLE SPDT SUB-MINIAT JADE GRAY	09353	7108CB2-J4X
S34	3101-1669		SWITCH:TOGGLE SPDT SUB-MINIAT JADE GRAY	09353	7101CB2-J4X
S35	3101-1670		SWITCH:TOGGLE SPDT SUB-MINIAT JADE GRAY	09353	7108CB2-J4X
S36	3101-1670		SWITCH:TOGGLE SPDT SUB-MINIAT JADE GRAY	09353	7108CB2-J4X
U1	1820-0307	12	IC:DTL HEX INVERTER	04713	MC836P
U2	1820-0307		IC:DTL HEX INVERTER	04713	MC836P
U3	1820-0307		IC:DTL HEX INVERTER	04713	MC836P
U4	1820-0262	5	IC:TTL 8-BIT PAR-IN SER-OUT SHIFT REG.	12040	SD9936
U5	1820-0307		IC:DTL HEX INVERTER	04713	MC836P
U6	1820-0307		IC:DTL HEX INVERTER	04713	MC836P
U7	1820-0307		IC:DTL HEX INVERTER	04713	MC836P
U8	1820-0307		IC:DTL HEX INVERTER	04713	MC836P
U9	1820-0262		IC:TTL 8-BIT PAR-IN SER-OUT SHIFT REG.	12040	SD9936
U10	1820-0307		IC:DTL HEX INVERTER	04713	MC836P
U11	1820-0307		IC:DTL HEX INVERTER	04713	MC836P
U12	1820-0262		IC:TTL 8-BIT PAR-IN SER-OUT SHIFT REG.	12040	SD9936
U13	1820-0262		IC:TTL 8-BIT PAR-IN SER-OUT SHIFT REG.	12040	SD9936
U14	1820-0307		IC:DTL HEX INVERTER	04713	MC836P

Table 2-63. Input PCA, Replaceable Parts (Continued)

Reference Designation	HP Part Number	Qty	Description	Mfr Code	Mfr Part Number
U15	1820-0262		IC:TTL 8-BIT PAR-IN SER-OUT SHIFT REG.	12040	5D9936
U16	1820-0307		IC:DTL HEX INVERTER	04713	MC836P
U17	1820-0535	2	IC:TTL DUAL PERI.2-INPT AND DRIVER	01295	SN75451P
U18	1820-0307		IC:DTL HEX INVERTER	04713	MC836P
U19	1820-0621	1	IC:TTL QUAD 2-INPT NAND BUFFER W/OPEN C	01295	SN7438N
U20	1820-0373	2	IC:TTL HS DUAL 4-INPT NAND GATE	01295	SN74H20N
U21	1820-0535		IC:TTL DUAL PERI.2-INPT AND DRIVER	01295	SN75451P
U22	1820-0424	1	IC:TTL HS HEX INVERTER	04713	SN74H04N
U23	1820-0373		IC:TTL HS DUAL 4-INPT NAND GATE	01295	SN74H20N

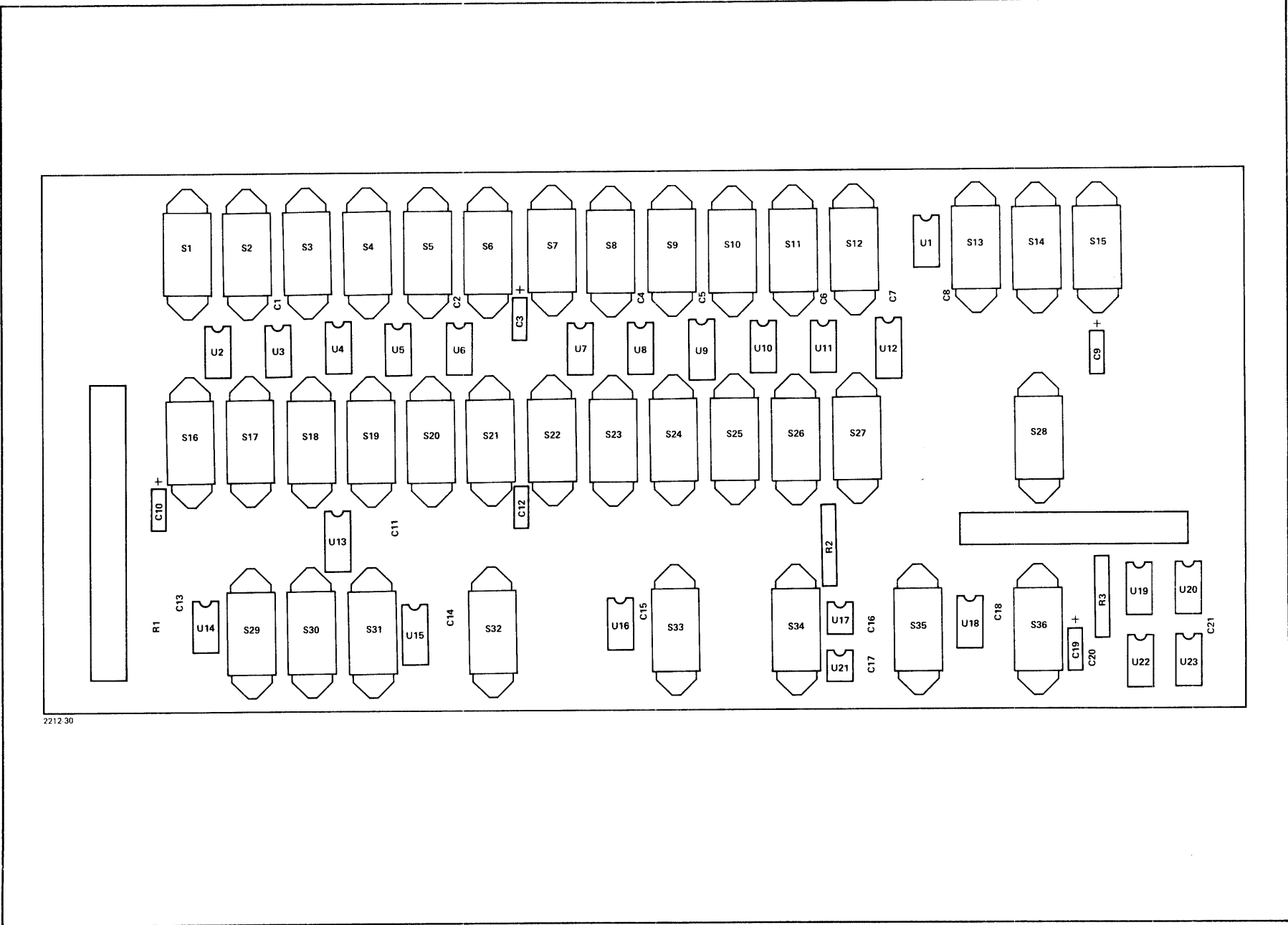

Figure 2-62. Input PCA, Parts Location Diagram

Table 2-64. Display PCA, Replaceable Parts

Reference Designation	HP Part Number	Qty	Description	Mfr Code	Mfr Part Number
	30352-60002		DISPLAY PCA	28480	30352-60002
C1	0180-0229	9	C:FXD ELECT 33 UF 10% 10VDCW	28480	0180-0229
C2	0160-2055	31	C:FXD CER 0.01 UF +80-20% 100VDCW	56289	C023F101F103ZS22-CDH
C3	0160-2055		C:FXD CER 0.01 UF +80-20% 100VDCW	56289	C023F101F103ZS22-CDH
C4	0160-2055		C:FXD CER 0.01 UF +80-20% 100VDCW	56289	C023F101F103ZS22-CDH
C5	0160-2055		C:FXD CER 0.01 UF +80-20% 100VDCW	56289	C023F101F103ZS22-CDH
C6	0160-2055		C:FXD CER 0.01 UF +80-20% 100VDCW	56289	C023F101F103ZS22-CDH
C7	0180-0229		C:FXD ELECT 33 UF 10% 10VDCW	28480	0180-0229
C8	0160-2055		C:FXD CER 0.01 UF +80-20% 100VDCW	56289	C023F101F103ZS22-CDH
C9	0180-0229		C:FXD ELECT 33 UF 10% 10VDCW	28480	0180-0229
C10	0180-0229		C:FXD ELECT 33 UF 10% 10VDCW	28480	0180-0229
C11	0160-2055		C:FXD CER 0.01 UF +80-20% 100VDCW	56289	C023F101F103ZS22-CDH
C12	0180-0229		C:FXD ELECT 33 UF 10% 10VDCW	28480	0180-0229
C13	0180-0229		C:FXD ELECT 33 UF 10% 10VDCW	28480	0180-0229
C14	0160-2055		C:FXD CER 0.01 UF +80-20% 100VDCW	56289	C023F101F103ZS22-CDH
C15	0160-2055		C:FXD CER 0.01 UF +80-20% 100VDCW	56289	C023F101F103ZS22-CDH
C16	0160-2055		C:FXD CER 0.01 UF +80-20% 100VDCW	56289	C023F101F103ZS22-CDH
C17	0160-2055		C:FXD CER 0.01 UF +80-20% 100VDCW	56289	C023F101F103ZS22-CDH
C18	0160-2055		C:FXD CER 0.01 UF +80-20% 100VDCW	56289	C023F101F103ZS22-CDH
C19	0160-2055		C:FXD CER 0.01 UF +80-20% 100VDCW	56289	C023F101F103ZS22-CDH
C20	0160-2055		C:FXD CER 0.01 UF +80-20% 100VDCW	56289	C023F101F103ZS22-CDH
C21	0160-2055		C:FXD CER 0.01 UF +80-20% 100VDCW	56289	C023F101F103ZS22-CDH
C22	0160-2055		C:FXD CER 0.01 UF +80-20% 100VDCW	56289	C023F101F103ZS22-CDH
C23	0160-2055		C:FXD CER 0.01 UF +80-20% 100VDCW	56289	C023F101F103ZS22-CDH
C24	0160-2055		C:FXD CER 0.01 UF +80-20% 100VDCW	56289	C023F101F103ZS22-CDH
C25	0180-0229		C:FXD ELECT 33 UF 10% 10VDCW	28480	0180-0229
C26	0160-2055		C:FXD CER 0.01 UF +80-20% 100VDCW	56289	C023F101F103ZS22-CDH
C27	0160-2055		C:FXD CER 0.01 UF +80-20% 100VDCW	56289	C023F101F103ZS22-CDH
C28	0160-2055		C:FXD CER 0.01 UF +80-20% 100VDCW	56289	C023F101F103ZS22-CDH
C29	0160-2055		C:FXD CER 0.01 UF +80-20% 100VDCW	56289	C023F101F103ZS22-CDH
C30	0160-2055		C:FXD CER 0.01 UF +80-20% 100VDCW	56289	C023F101F103ZS22-CDH
C31	0160-2055		C:FXD CER 0.01 UF +80-20% 100VDCW	56289	C023F101F103ZS22-CDH
C32	0160-2055		C:FXD CER 0.01 UF +80-20% 100VDCW	56289	C023F101F103ZS22-CDH
C33	0180-0229		C:FXD ELECT 33 UF 10% 10VDCW	28480	0180-0229
C34	0180-0229		C:FXD ELECT 33 UF 10% 10VDCW	28480	0180-0229
CR1			THRU		
CR140	1990-0325	14	DIODE:VISIBLE LIGHT EMITTER	28480	1990-0325
P1	1251-3090	1	CONNECTOR:R & P 50 MALE CONTACT	66346	3433-2002
T81	0360-1735	1	BARRIER BLOCK:4 TERMINALS 6-32 SCREW	98410	45004-3515
U1	1810-0124	18	RESISTOR ARRAY:8 X 200 OHM 2% 1-3/4W	28480	1810-0124
U2	1820-0742	18	IC:TTL DUAL 4-BIT LATCH	07263	U6N930859X
U3	1810-0124		RESISTOR ARRAY:8 X 200 OHM 2% 1-3/4W	28480	1810-0124
U4	1820-0742		IC:TTL DUAL 4-BIT LATCH	07263	U6N930859X
U5	1810-0124		RESISTOR ARRAY:8 X 200 OHM 2% 1-3/4W	28480	1810-0124
U6	1820-0742		IC:TTL DUAL 4-BIT LATCH	07263	U6N930859X
U7	1810-0124		RESISTOR ARRAY:8 X 200 OHM 2% 1-3/4W	28480	1810-0124
U8	1820-0742		IC:TTL DUAL 4-BIT LATCH	07263	U6N930859X
U9	1810-0037	4	RESISTOR ARRAY:1K OHM 2% 1W EACH	28480	1810-0037
U10	1820-0424	1	IC:TTL HS HEX INVERTER	04713	SN74H04N
U11	1820-0535	9	IC:TTL DUAL PERI.2-INPT AND DRIVER	01295	SN75451P
U12	1820-0535		IC:TTL DUAL PERI.2-INPT AND DRIVER	01295	SN75451P
U13	1820-0294	2	IC:TTL 8-BIT SER-IN PAR OUT SHIFT REG	12040	SD9935
U14	1820-0535		IC:TTL DUAL PERI.2-INPT AND DRIVER	01295	SN75451P
U15	1820-0535		IC:TTL DUAL PERI.2-INPT AND DRIVER	01295	SN75451P
U16	1820-0535		IC:TTL DUAL PERI.2-INPT AND DRIVER	01295	SN75451P
U17	1820-0535		IC:TTL DUAL PERI.2-INPT AND DRIVER	01295	SN75451P
U18	1820-0294		IC:TTL 8-BIT SER-IN PAR OUT SHIFT REG	12040	SD9935
U19	1820-0535		IC:TTL DUAL PERI.2-INPT AND DRIVER	01295	SN75451P
U20	1820-0535		IC:TTL DUAL PERI.2-INPT AND DRIVER	01295	SN75451P
U21	1820-0373	1	IC:TTL HS DUAL 4-INPT NAND GATE	01295	SN74H20N
U22	1810-0124		RESISTOR ARRAY:8 X 200 OHM 2% 1-3/4W	28480	1810-0124
U23	1820-0742		IC:TTL DUAL 4-BIT LATCH	07263	U6N930859X
U24	1810-0124		RESISTOR ARRAY:8 X 200 OHM 2% 1-3/4W	28480	1810-0124
U25	1820-0742		IC:TTL DUAL 4-BIT LATCH	07263	U6N930859X
U26	1810-0124		RESISTOR ARRAY:8 X 200 OHM 2% 1-3/4W	28480	1810-0124
U27	1820-0742		IC:TTL DUAL 4-BIT LATCH	07263	U6N930859X
U28	1810-0124		RESISTOR ARRAY:8 X 200 OHM 2% 1-3/4W	28480	1810-0124
U29	1820-0742		IC:TTL DUAL 4-BIT LATCH	07263	U6N930859X
U30	1820-0608	1	IC:TTL 1 OF DECODER W/ENABLE	04713	MC4006P
U31	1810-0124		RESISTOR ARRAY:8 X 200 OHM 2% 1-3/4W	28480	1810-0124
U32	1820-0742		IC:TTL DUAL 4-BIT LATCH	07263	U6N930859X
U33	1810-0124		RESISTOR ARRAY:8 X 200 OHM 2% 1-3/4W	28480	1810-0124
U34	1820-0742		IC:TTL DUAL 4-BIT LATCH	07263	U6N930859X
U35	1810-0124		RESISTOR ARRAY:8 X 200 OHM 2% 1-3/4W	28480	1810-0124
U36	1820-0742		IC:TTL DUAL 4-BIT LATCH	07263	U6N930859X
U37	1810-0124		RESISTOR ARRAY:8 X 200 OHM 2% 1-3/4W	28480	1810-0124

Table 2-64. Display PCA, Replaceable Parts (Continued)

Reference Designation	HP Part Number	Qty	Description	Mfr Code	Mfr Part Number
U38	1820-0742		IC:TTL DUAL 4-BIT LATCH	07263	U6N930859X
U39	1820-0535		IC:TTL DUAL PERI.2-INPT AND DRIVER	01295	SN75451P
U40	1810-0037		RESISTOR ARRAY:1K OHM 2% 1W EACH	28480	1810-0037
U41	1810-0124		RESISTOR ARRAY:8 X 200 OHM 2% 1-3/4W	28480	1810-0124
U42	182J-0742		IC:TTL DUAL 4-BIT LATCH	07263	U6N930859X
U43	1810-0124		RESISTOR ARRAY:8 X 200 OHM 2% 1-3/4W	28480	1810-0124
U44	1820-0742		IC:TTL DUAL 4-BIT LATCH	07263	U6N930859X
U45	1820-0742		IC:TTL DUAL 4-BIT LATCH	07263	U6N930859X
U46	1820-0742		IC:TTL DUAL 4-BIT LATCH	07263	U6N930859X
U47	1810-0124		RESISTOR ARRAY:8 X 200 OHM 2% 1-3/4W	28480	1810-0124
U48	1820-0742		IC:TTL DUAL 4-BIT LATCH	07263	U6N930859X
U49	1810-0037		RESISTOR ARRAY:1K OHM 2% 1W EACH	28480	1810-0037
U50	1810-0124		RESISTOR ARRAY:8 X 200 OHM 2% 1-3/4W	28480	1810-0124
U51	1810-0124		RESISTOR ARRAY:8 X 200 OHM 2% 1-3/4W	28480	1810-0124
U52	1820-0742		IC:TTL DUAL 4-BIT LATCH	07263	U6N930859X
U53	1810-0037		RESISTOR ARRAY:1K OHM 2% 1W EACH	28480	1810-0037
U54	1810-0124		RESISTOR ARRAY:8 X 200 OHM 2% 1-3/4W	28480	1810-0124

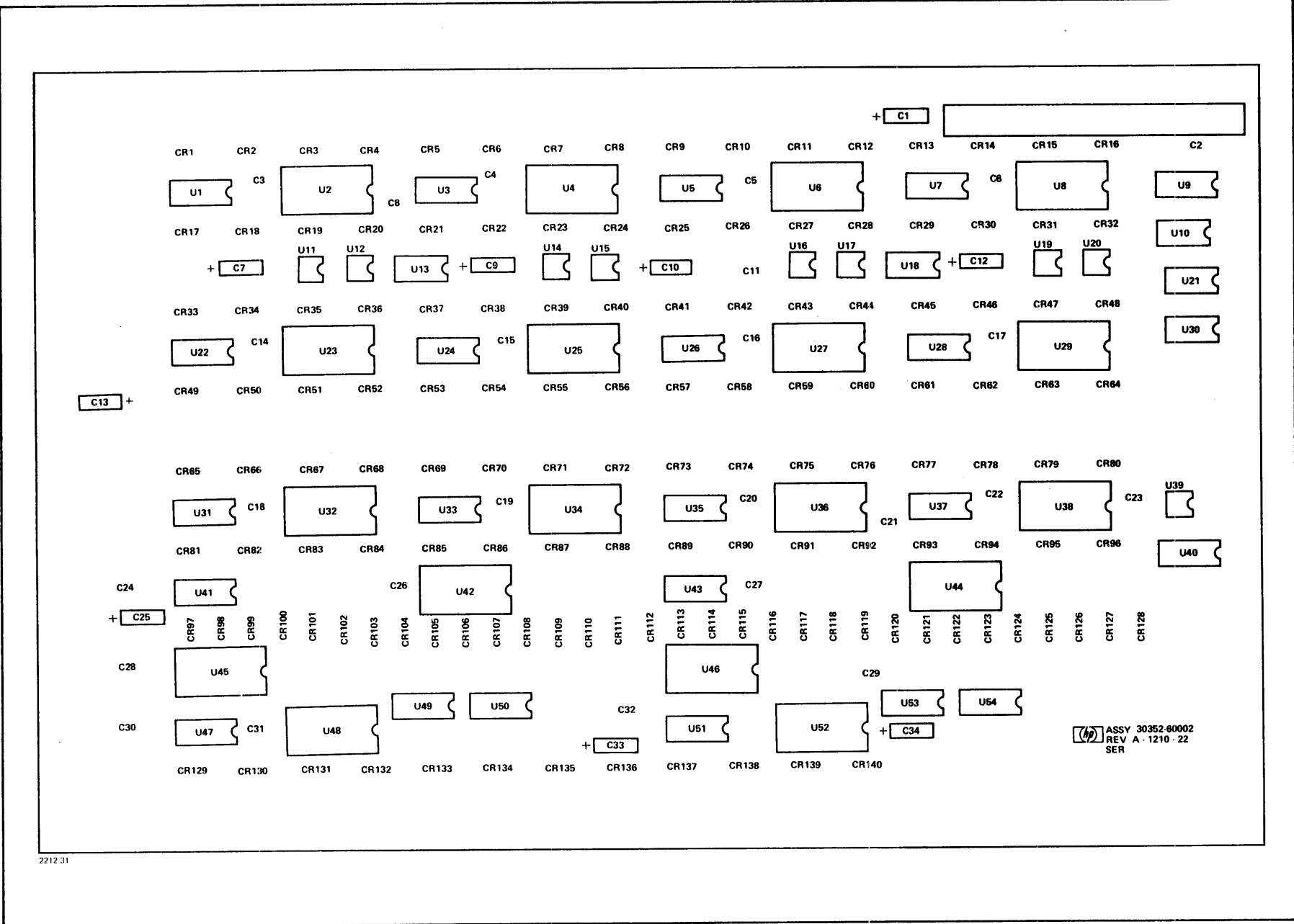

ASSY 30352-60002
REV A - 1210 - 22
SER

Figure 2-63. Display PCA, Parts Location Diagram

2212 31

Table 2-65. Reference Designations and Abbreviations

REFERENCE DESIGNATIONS		
<p>A = assembly B = motor, synchro BT = battery C = capacitor CB = circuit breaker CR = diode DL = delay line DS = indicator E = Misc electrical parts F = fuse FL = filter J = receptacle connector</p>	<p>K = relay L = inductor M = meter P = plug connector Q = semiconductor device other than diode or integrated circuit R = resistor RT = thermistor S = switch T = transformer</p>	<p>TB = terminal board TP = test point U = integrated circuit, non-repairable assembly V = vacuum tube, photocell, etc. VR = voltage regulator W = jumper wire X = socket Y = crystal Z = tuned cavity, network</p>
ABBREVIATIONS		
<p>A = amperes ac = alternating current Ag = silver Al = aluminum ar = as required adj = adjust assy = assembly b = base bp = bandpass bpi = bits per inch blk = black blu = blue brn = brown brs = brass Btu = British thermal unit Be Cu = beryllium copper cp = characters per inch coll = collector cw = clockwise ccw = counterclockwise cer = ceramic com = common crt = cathode-ray tube CTL = complementary-transistor logic cath = cathode Cd pl = cadmium plate comp = composition conn = connector compi = complete dc = direct current dr = drive DTL = diode-transistor logic depc = deposited carbon dpdt = double-pole, double-throw dpst = double-pole, single-throw em = emitter ECL = emitter-coupled logic ext = external encap = encapsulated elctlt = electrolytic F = farads FF = flip-flop flh = flat head flm = film fxd = fixed filh = fillister head G = giga (10^9) Ge = germanium gl = glass gnd = ground(ed)</p>	<p>gra = gray grn = green H = henries Hg = mercury hr = hour(s) Hz = hertz hdw = hardware hex = hexagon, hexagonal ID = inside diameter IF = intermediate frequency in. = inch, inches I/O = input/output int = internal incl = include(s) insul = insulation, insulated impgrg = impregnated incand = incandescent ips = inches per second k = kilo (10^3), kilohm lp = low pass m = milli (10^{-3}) M = mega (10^6), megohm My = Mylar mfr = manufacturer mom = momentary mtg = mounting misc = miscellaneous met. ox. = metal oxide mintr = miniature n = nano (10^{-9}) nc = normally closed or no connection Ne = neon no. = number n.o. = normally open np = nickel plated NPN = negative-positive-negative NPO = negative-positive zero (zero temperature coefficient) NSR = not separately replaceable NRFR = not recommended for field replacement OD = outside diameter OBD = order by description orn = orange ovh = oval head oxd = oxide p = pico (10^{-12}) PC = printed circuit</p>	<p>PCA = printed-circuit assembly PWB = printed-wiring board ph = phillips head pk = peak p-p = peak-to-peak pt = point prv = peak inverse voltage PNP = positive-negative-positive pwv = peak working voltage porc = porcelain posn = position(s) pozi = pozidrive rf = radio frequency rdh = round head rms = root-mean-square rww = reverse working voltage rect = rectifier r/min = revolutions per minute RTL = resistor-transistor logic s = second SB, TT = slow blow Se = selenium Si = silicon scr = silicon controlled rectifier sst = stainless steel stl = steel spcl = special spdt = single-pole, double-throw spst = single-pole, single-throw Ta = tantalum td = time delay Ti = titanium tgl = toggle thd = thread tol = tolerance TTL = transistor transistor logic U(μ) = micro (10^{-6}) V = volt(s) var = variable vio = violet Vdew = direct current working volts W = watts ww = wirewound wht = white WIV = working inverse voltage yel = yellow</p>

Table 2-66. Code List of Manufacturers

The following code numbers are from the Federal Supply Code for Manufacturers Cataloging Handbooks H4-1 and H4-2, and the latest supplements.					
Code No.	Manufacturer	Address	Code No.	Manufacturer	Address
00853	Sangamo Electric Co., Pickens Division	Pickens, S.C.	66346	Minnesota Mining & Mfg. Co. Revere Mincom Div.	St. Paul, Minn.
01121	Allen Bradley Co.	Milwaukee, Wis.	72136	Electro Motive Mfg. Co., Inc.	Willimantic, Conn.
01295	Texas Instruments, Inc. Transistor Products Div.	Dallas, Texas	72982	Erie Technological Products, Inc.	Erie, Pa.
02735	Radio Corp. of America, Semi- conductor and Materials Division	Somerville, N.J.	75382	Kulka Electric Corp.	Mt. Vernon, N. Y.
04713	Motorola Inc. Semiconductor Prod. Div	Phoenix, Arizona	79727	Continental-Wirt Electronics Corp.	Philadelphia, Pa.
09353	C & K Components Inc.	Newton, Mass.	80131	Electronic Industries Association, Standard tube or semi-conductor device, any manufacturer	
12040	National Semiconductor Corp.	Danbury, Conn.	81640	Controls Co. of America Control Switch Division	Folcroft, Pa.
18324	Signetics Corp.	Sunnyvale, Cal.	84171	Arco Electronics Inc.	Great Neck, N.Y.
28480	Hewlett-Packard Co.	Palo Alto, Cal.	91418	Radio Materials Co.	Chicago, Ill.
56289	Sprague Electric Co.	North Adams, Mass.	91508	Augat Inc.	Attleboro, Mass.
			98410	Etc Inc.	Cleveland, Ohio

CERTIFICATION

The Hewlett-Packard Company certifies that this instrument was thoroughly tested and inspected and found to meet its published specifications when it was shipped from the factory. The Hewlett-Packard Company further certifies that its calibration measurements are traceable to the U.S. National Bureau of Standards to the extent allowed by the Bureau's calibration facility.



MANUAL PART NO. 03000-90021
MICROFICHE PART NO. 03000-90042

PRINTED IN U.S.A.