

# HP 1000 System Designers Guide

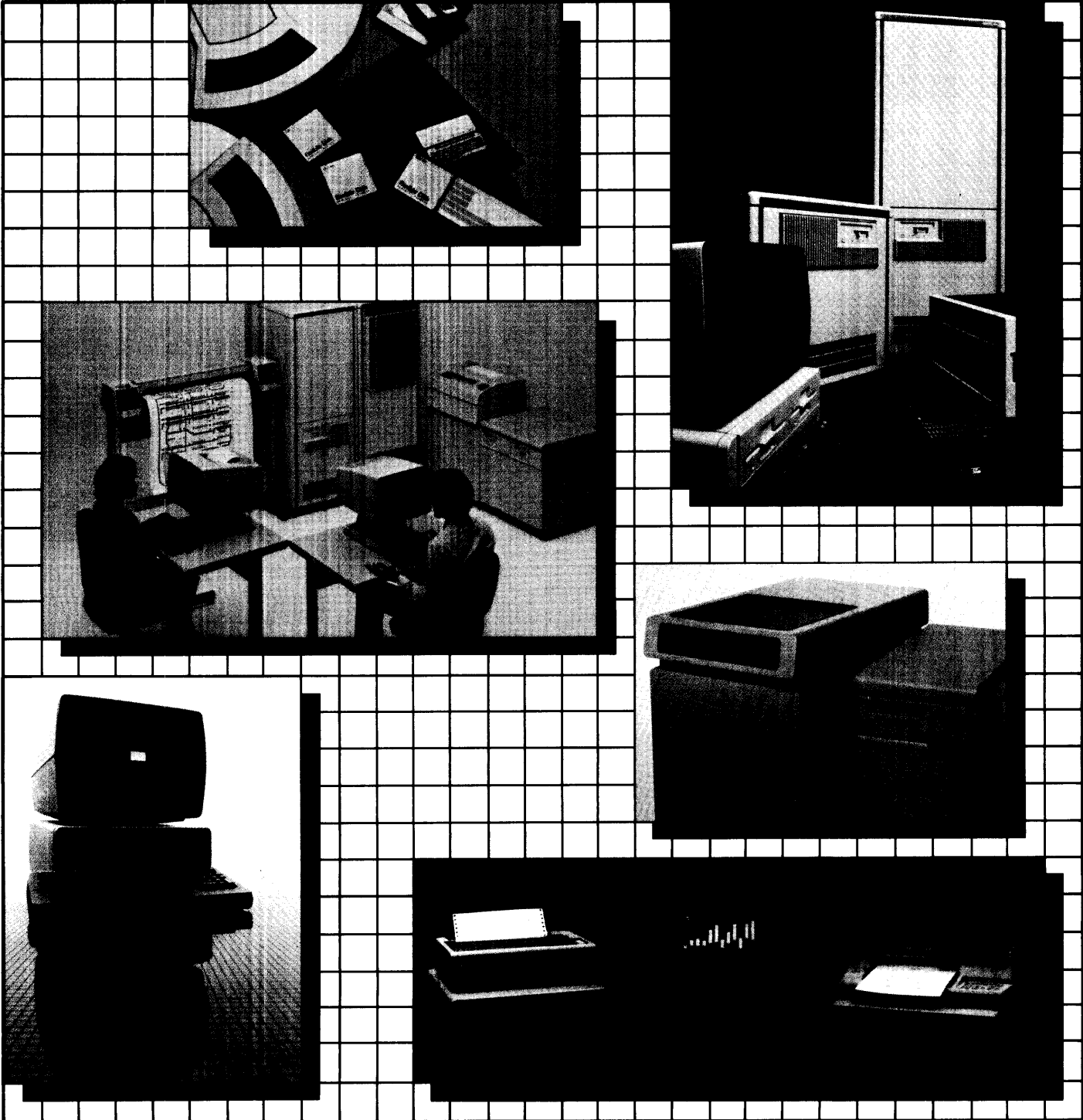

# HP 1000

## System Designer's Guide



# Printing History

The Printing History below identifies the Edition of this Manual and any Updates that are included. Periodically, Update packages are distributed which contain replacement pages to be merged into the manual, including an updated copy of this Printing History page. Also, the update may contain write-in instructions.

Each reprinting of this manual will incorporate all past Updates, however, no new information will be added. Thus, the reprinted copy will be identical in content to prior printings of the same edition with its user-inserted update information. New editions of this manual will contain new information, as well as all Updates.

To determine what software manual edition and update is compatible with your current software revision code, refer to the appropriate Software Numbering Catalog, Software Product Catalog, or Diagnostic Configurator Manual.

First Edition .....	Jun 1983
Update 1 .....	Nov 1983
Second Edition .....	Aug 1984
Third Edition .....	May 1985

## NOTICE

The information contained in this document is subject to change without notice.

HEWLETT-PACKARD MAKES NO WARRANTY OF ANY KIND WITH REGARD TO THIS MATERIAL, INCLUDING, BUT NOT LIMITED TO, THE IMPLIED WARRANTIES OF MERCHANTABILITY AND FITNESS FOR A PARTICULAR PURPOSE. Hewlett-Packard shall not be liable for errors contained herein or for incidental or consequential damages in connection with the furnishing, performance or use of this material.

Hewlett-Packard assumes no responsibility for the use or reliability of its software on equipment that is not furnished by Hewlett-Packard.

This document contains proprietary information which is protected by copyright. All rights are reserved. No part of this document may be photocopied, reproduced or translated to another program language without the prior written consent of Hewlett-Packard Company.

## List of Effective Pages

Pages	Effective Date
i through iv .....	May 1985
1-1 through 1-15/1-16 ...	May 1985
2.1-1 through 2.1-14 ....	May 1985
2.2-1 through 2.2-6 .....	May 1985
2.3-1 through 2.3-5/2.3-6	May 1985
2.4-1 through 2.4-12 ....	May 1985
3-1 through 3-4 .....	May 1985
3.1-1 through 3.1-7/3.1-8	May 1985
3.2-1 and 3.2-2 .....	May 1985
3.3-1 and 3.3-2 .....	May 1985
3.4-1 and 3.4-2 .....	May 1985
4-1 through 4-8 .....	May 1985
5.1-1 through 5.1-4 .....	May 1985
5.2-1 through 5.2-8 .....	May 1985
5.3-1 through 5.3-14 ....	May 1985
5.4-1 through 5.4-4 .....	May 1985
5.5-1 through 5.5-5/5.5-6	May 1985
5.6-1 through 5.6-12 ....	May 1985
6.1-1 through 6.1-9/6.1-10	May 1985
6.2-1 and 6.2-2 .....	May 1985
6.3-1 and 6.3-2 .....	May 1985
6.4-1 through 6.4-20 ....	May 1985



# Product Number Index

PROD. NO.	PAGE	PROD. NO.	PAGE	PROD. NO.	PAGE	PROD. NO.	PAGE
10833A-C	2.1-11 & 2.4-10	12790A	2.1-9, 3.1-6 & 5.6-7	2436A/E	5.2-1, -5	7933H	2.4-3, 5.1-3 & 5.4-4
12005B	2.1-5 & 5.3-4	12791A	5.6-4	2437A	5.2-1, -6	7935H	2.4-3, 5.1-3 & 5.4-4
12006A	5.3-7	12792C	2.1-6, -7, -8, -14	2439A	5.2-1, -7	7941A/45A	2.4-3 & 5.1-3
12007B	3.1-5 & 5.3-5	12793B	2.2-6, 2.3-5 & 5.6-6	24602A	5.3-6 & 5.6-7	7942A/46A	2.4-3 & 5.1-3
12008A	5.3-4	12794B	3.1-5 & 5.6-6	2486A	5.1-1, -4	7970B	2.4-10, -12
12009A	2.2-2, -3, -6, 2.3-5, 2.4-5, -6, -8, -10, & 5.3-4	12821A	2.2-6, 2.3-5, 2.4-5, -8 & 5.6-8	2487A	5.1-1, -4	7970E	2.4-9, -10, -12
12010A	5.3-7	12824A	5.6-4	2489A	5.1-1, -4	7971A	2.4-9, -10, -12
12011A	5.3-4	12825A	3.1-5 & 5.6-6	2563A-66A	2.2-5, -6 & 2.3-2, -5	7974A	2.4-9
12012A	5.3-4	12826B	5.6-7	2601A/02A	2.1-11	7978A	2.4-9
12013A	5.3-4	12829A	5.6-4	26099A	2.3-4, -5 & 5.6-8	82905B	2.1-11 & 2.3-2, -5
12025A/B	5.3-3, -11	12830A	3.1-6 & 5.6-6	2623A	2.1-2, 2.2-1, 5.1-2, 5.2-4, 5.4-3 & 5.5-4	82906A	2.1-11, 2.2-5, & 2.3-2, -5
12038A-D	5.3-1 & 5.3-2	12834A	3.1-5 & 5.6-6	2624B	2.1-2, 5.1-2 & 5.2-4	88140LC	2.4-3
12040B	2.1-6, -7, -8, -14, 2.2-6, 2.3-5 & 5.3-5	12845B	5.6-8	2625A	2.1-2, 2.2-1, 5.1-2, 5.2-4, 5.4-3 & 5.5-4	91000A	5.6-9
12041A	3.4-2 & 5.3-6	12892B	5.6-1	2626A	2.1-3, 5.1-2, 5.2-4, 5.4-3 & 5.5-4	9111A	2.2-2 & -3
12042B	5.3-6	12897B	5.6-5	2627A	2.1-3, 2.2-1, 5.1-2, 5.2-4, 5.4-3 & 5.5-4	91200B	5.6-9
12043A	3.2-2 & 5.3-6	12898B	5.6-5	2628A	2.1-2, 2.2-1, 5.1-2, 5.2-4, 5.4-3 & 5.5-4	9122D	2.4-4
12044A	3.1-5 & 5.3-5	12930A	5.6-9	2671A	2.1-11 & 2.3-3, -5	9133D	2.4-4
12060B	5.3-6	12940A	2.4-4	2671G/73A	2.1-11, 2.2-5 & 2.3-3, -4, -5	9144A	2.4-9
12060BC-12064A	5.3-7	12940B	5.6-5	2686A	2.3-3, -5	91712A-14A	3.1-5
12065A	2.2-2 & 5.3-7	12944B	5.6-5	2687A	2.3-3, -5	91730A	4-5
12072A	3.1-6 & 5.3-5	12966A	2.1-5 & 5.6-5	2932A/34A	2.1-11, 2.2-5 & 2.3-2, -5	91732A	4-5
12073A	3.1-5 & 5.3-5	12979C	5.6-5, -10	29429A	5.3-10	91745A/47A	4-4, 7
12075A	3.1-7, 3.3-2 & 5.3-6	12991B	5.5-5 & 5.6-5	29431G	5.3-10, -11, -12, -13 & 5.6-10, -11	91750A	3.1-1 & 4-5
12082A	3.1-5 & 5.3-5	12992B-K	5.6-4	30062B	2.1-6	91751A	3.1-3, 3.3-1 & 4-5
12092A	2.1-9, 2.3-5, 3.1-6 & 5.3-6	13013D/213D	2.4-6, -7	3074A	2.3-4 & 3.1-6	91781A-84A	3.2-1, -2 & 4-5
12103C/D	5.3-1 & 5.3-2	13037U	2.4-6	3081A	2.1-13, -14	92045A/49A	4-3
12104A	5.3-2	13175D/78D	2.4-7 & 5.6-8	37203A	5.6-5	92061A	4-3
12110A/B	5.3-1	13181A/83A	2.4-11	37203L	5.3-4	92068A	4-2
12111A-C	5.3-1 & 5.3-2	13197A	5.6-4	37213A-16A	2.1-7	92069A	4-3, -7
12153A/55A/56A	5.3-3	13222N	2.1-5, -6, -7, -8	37222A	2.1-5 & 2.1-10	92076A	4-2
12154A/57A	5.3-4	13232R/U	2.1-9	39301A	2.1-8	92077A	4-2
12158A/59A	5.3-4	13242G	2.1-11	39800A/01A	2.1-13	92078A	4-2
12205A	5.3-3	13242N	2.3-5	40025A	5.1-0 & 5.3-3	92081A	4-3, -7
12220A	5.3-2	13264A	3.1-6	40242D/G	2.1-11	92083A	4-3, -7
12221A	5.3-2	13265A	2.1-5, -6, -7	40242M	2.1-5, -6, -7, -8	92084A	4-2
12222A-H	5.3-2	13267A/88A	2.1-9	45610B	2.1-2, 2.2-1, 5.1-2, 5.2-4, 5.4-3 & 5.5-4	92101A	4-2
12250A	3.1-7, 3.3-2 & 5.6-7	13279B	2.2-1, -2	59310B	2.2-2, -3 & 5.6-5	92121A	4-6
12260A	3.2-1 & 5.6-7	13306B	5.6-4	7470A/75A	2.2-4	92131A	4-6
12261A	5.6-7	13356A	2.4-4	7550A	2.2-4	92191A/95A	2.4-4
12531C/D	5.6-8	13394A	2.4-4	7580B/85B/86B	2.2-4	92218A	2.1-14
12539C	5.5-5	15561A	2.1-5, -7	7906M/MR/S/SR	2.4-4 & 5.4-4	92219G	2.2-6 & 2.3-5
12551B/54A/56B	5.6-9	15564A	2.1-7	7911P/R	2.4-3, 5.1-3 & 5.4-4	92832A-36A	4-2
12566C	5.6-9	17623A	2.2-2, -3	7912P/R	2.4-3, 5.1-3 & 5.4-4	92841A/42A/43X	4-5 & 4-7
12597A	5.6-9	2102B-H	5.6-1	7914P/R	2.4-3, 5.1-3 & 5.4-4	92857A	4-2
12618A	5.6-8	2106BK	5.2-1	7914CT	2.4-3, 5.1-3 & 5.4-4	92860A	4-2
12620A	5.5-5, -9	2109E	5.5-1, -2	7914ST	2.4-3, -9 & 5.1-3	92861A/62A	4-4 & 4-7
12666H	5.6-2 & 5.6-3	2109EK	5.5-1	7914TD	2.4-3, -9, -10, 5.1-3 & 5.4-4	92905A	2.3-4
12699H	5.6-1, -2 & 5.6-3	2113E	5.5-1, -2, -3	7920M/S	2.4-4	92911A/15A	2.1-13
12731A	5.6-1	2117F	5.5-1, -2, -3	7925M/S	2.4-4 & 5.4-4	92922A	2.1-14
12745D	2.4-6	2137A	5.2-1, -2, -3	94200A	4-5	94250A	4-6
12746H	5.6-2	2139A	5.2-1, -2, -3, -4	9895A	2.4-4		
12747H/49H	5.6-2 & 5.6-3	2156B	5.2-1, -2				
12771A	5.6-6	2176E/77F	5.4-1, -4				
12773A	5.6-7	2178C/79C	5.4-1, -4				
12777A	5.6-5	2196C/D	5.1-1, -4				
12779H/80H	5.6-1, -2 & 5.6-3	2197C/D	5.1-1, -4				
12781A	5.6-5	2199C/D	5.1-1, -4				
12786A-C	5.6-1	2225C	2.1-11				
12787A-D	5.6-1	2392A	2.1-2, 5.1-2, 5.2-4, 5.4-3 & 5.5-4				
12788A/BB/E-H	5.6-1						
12789E/J-K	5.6-1						

# Designing HP 1000 Computer Systems -- Contents

1-1	Introduction . . . . .	1-1
1-2	HP 1000 General Information . . . . .	1-1
1-3	The HP 1000 System Design Process . . . . .	1-6
1-4	Selecting the I/O Architecture . . . . .	1-7
1-5	Selecting the Processor . . . . .	1-7
1-6	Selecting the HP 1000 Product to Use as the Basis for Your System . . . . .	1-7
1-7	Outlining Your System's Capabilities . . . . .	1-9
1-8	Completing Your System Design . . . . .	1-9

# Section 1

## Designing HP 1000 Computer Systems

### 1-1 Introduction

This section contains HP 1000 general information and overall instructions for design of HP 1000 Computer Systems. If you are a first-time user of the HP 1000 System Designer's Guide, you will find it helpful to study the General Information which follows this paragraph to become familiar with the HP 1000 processors and operating systems before attempting to design an HP 1000 System.

### 1-2 HP 1000 General Information

HP 1000 Computer Systems are open, modular hardware-software systems that are designed for real-time, multiprogramming, multi-user applications in manufacturing, research, and other fields that require real-time response. A choice of I/O architectures and processors (Table 1-1) as well as a wide variety of interfaces and software enables HP 1000 systems to effectively solve many different application problems. Typical applications include automatic testing, machine and process control, and supervisory control of programmable controllers, to name just a few. For more detailed information, see the HP 1000 A-Series and E/F-Series Hardware Technical Data books and the HP 1000 Software Technical Data book, Volume I, which are available through Hewlett-Packard Sales Representatives.

#### Hardware Designed for Real-Time Use

Systems which are used to monitor, collect data from, interact with, and control, operations and processes require the following key processor features to achieve true real-time response.

**Fast, Efficient Handling of I/O.** The "eyes" and "ears" of a real-time computer system -- external sensors, measuring instruments, and other I/O devices -- connect to it via I/O interfaces and its I/O system. The HP 1000 I/O system is designed to quickly recognize and receive new or updated information, using multi-level vectored hardware

interrupt. Each HP 1000 I/O channel has its own interrupt priority level. An interrupt directly initiates the appropriate service program (Figure 1-1); no time is wasted in polling I/O channels. Direct memory access (Figure 1-2) speeds data transfers to/from memory with minimal involvement of the CPU.

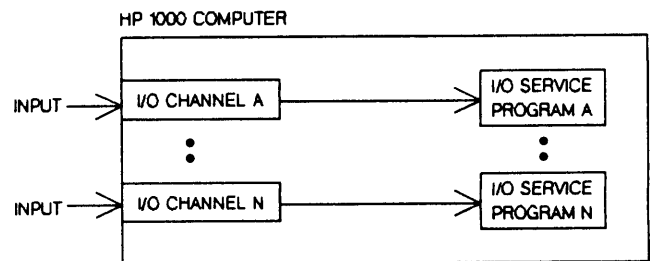

Figure 1-1. HP 1000 Vectored Hardware Interrupt

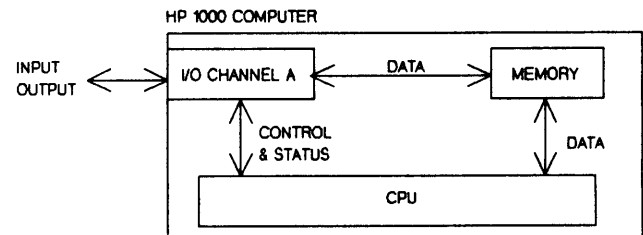

Figure 1-2. HP 1000 Direct Memory Access

**Fast Processing of Data.** HP 1000 Systems offer a choice of processing power levels, with base instruction rates to 3 MIPS (fastest instruction) and floating point processing speeds up to 500,000 FLOPs (Figure 1-3). This shortens the time required to process input data, get results, and process the next instruction.

**Operations Timing.** HP 1000 Systems include a time base generator that provides precisely-timed interrupts for maintaining a real-time clock and other system timing services.

**Large Main Memory Capacity.** Fastest response to real-time events is achieved when all or nearly all critical programs can be resident in memory to avoid the delays inherent in moving programs to and from disc. In larger applications, making most critical programs resident can require considerable

main memory capacity. HP 1000 Systems can have up to 24 megabytes of main memory (Figure 1-4) to accommodate many resident real-time programs simultaneously.

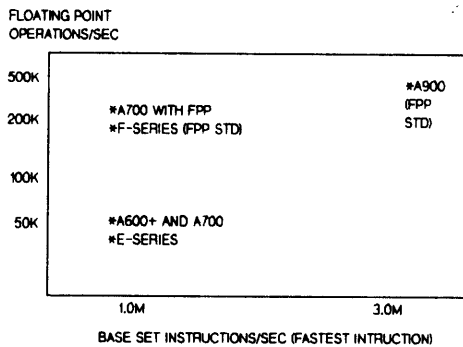

Figure 1-3. Relative Performance of HP 1000 Processors

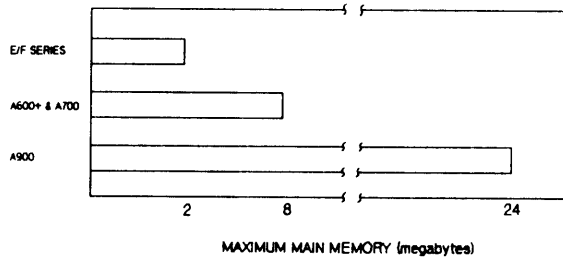

Figure 1-4. Relative Main Memory Capacities of HP 1000 Processors

In addition, it has proven practical and most effective to standardize such aspects of real-time programming as program scheduling and program development support, and bundle them into real-time software operating systems developed by the computer manufacturer, such as the Real-Time Executive (RTE) operating system used in HP 1000 Computer Systems.

The RTE system is a set of closely-coupled programs that execute in and interact with the computer (Figure 1-5) to support multiprogramming, program development, and other services as discussed below. Although different version of RTE are used to accommodate differences in the details of architecture between HP 1000 processors, the same principles and programming interface are common to all RTE systems.

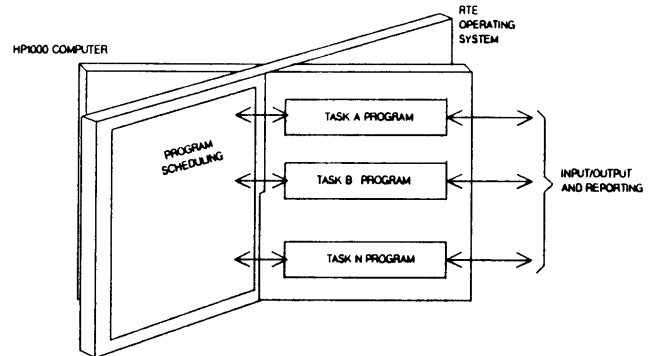

Figure 1-5.  
HP 1000/RTE Multiprogramming

### Real-Time Operating Software

**Multiprogramming.** Programming of real-time applications is very complex. The computer system must collect data from the external environment, process that data and evaluate it against limits or other criteria, and generate appropriate control outputs, operator messages, reports, or other displays. This must all be accomplished in a timely, orderly fashion so that the system maintains effective control of the external environment.

To keep the otherwise sizable effort of real-time programming manageable, it has proven to be most effective to prepare *multiple* programs to deal with the various tasks involved in real-time applications.

**Event Interrupt Scheduling** is the core of RTE's real-time program scheduling capability. Event interrupts from external devices, connected via I/O interfaces, are processed by central interrupt control programs. Central interrupt control initiates the execution of appropriate application programs and the standard RTE driver routines which control the exchange of data between main memory and external devices.

**Time Scheduling** is an extension of event interrupt scheduling in that the time "ticks" from the time base generator in the computer are treated as event interrupts which periodically schedule a real-time clock program for updating the time of day. With the real-time clock, it is possible to schedule programs to run at a user-specified time of day or at

user-specified intervals. Programs to be executed at specific times or intervals are entered into a "time" list that the RTE system checks after each clock updating. Two services supported with time scheduling are I/O timeout and time-slicing allocation of execution time among programs.

**Program-to-Program Scheduling** is supported via EXEC calls that enable one program to initiate execution of another.

**Operator Scheduling.** The operator is necessarily given overall control of the RTE system, control that includes the ability to schedule the execution of any program in the system.

**Priority Control** grants execution time to simultaneously scheduled programs in the order of the relative importance assigned to them. RTE provides 32767 levels for assignment of program priorities.

**Multi-User Program Development.** Because real-time applications development is a big job, it is often necessary to have several programmers working on different tasks at the same time. The RTE systems accommodate multiple users with log-on access control and protected user environments. Individually-identified copies of the editor, compilers or assembler, program linker, and symbolic debugger can be used for program development by different users at the same time.

**Program and Data Space Management.** Fastest dispatch and execution of real-time tasks is achieved with programs that are resident in main memory, because that avoids the millisecond-level delays involved in pulling programs from the disc. The improved responsiveness with resident programs that can be crucial to real-time applications is also greatly appreciated by multiple users during program development and other operations that involve access to the system. Most of the RTE systems support from 64 to 255 or more program partitions, working with the dynamic mapping system hardware and firmware that are built into HP 1000 Computers. The dynamic mapping system supports up to 2 megabytes of physical memory in HP 1000 E and F-Series computers and up to 24 megabytes in HP 1000 A900 computers (Figure 1-4).

In real-time applications, it can be even more important to have fast access to the data to be processed than it is to have fast dispatch of programs. For this reason, in addition to managing the user's allocation of user-available memory among program partitions, the RTE systems support Extended Memory Areas (EMAs) for main memory resident data up to 1.998 megabytes. Larger memory requirements for data in RTE-A and RTE-6/VM are accommodated by the Virtual Memory Area (VMA), up to 128 megabytes in main memory and on disc.

**Large Program Support.** RTE systems support large programs through the technique of segmentation. RTE-6/VM provides a Multilevel Segmentation, Load-On-Call facility that simplifies the development or conversion, loading, and execution of programs with large memory requirements. Segments can reside in available main memory (up to 1.8 megabytes), on disc, or in both. The Virtual Code+ (VC+) extension to RTE-A breaks up large programs into code segments transparently and automatically. This effectively gives the user up to 7.75 megabytes of code space, with the only concern being that no subroutine can be longer than 62 kilobytes.

#### Additional Software Supported Capabilities

**Graphics** is often important to the quick, effective understanding of real-time system outputs by operators and process supervisors. At the same time, graphics software must be designed to execute quickly and make efficient use of system memory. These requirements are met for general graphics uses in HP 1000 Systems by the Graphics/1000-II Version 2.0 Device-Independent Graphics Library, an extensive set of graphics subroutines and device handler modules that become part of user's application programs. Interactive and three-dimensional graphics are supported by the Advanced Graphics Package, which works with the Device-Independent Graphics Library.

**Data Base Management** provides a means for consolidating large quantities of data into a single, interrelated data base that can be shared by many different users for a wide variety of purposes. On-line Query capability supports interactive access and the printout of reports. Two systems are available for data base management, one of which provides extensive data base recovery features for protection from loss of data.

**Communication** with other systems facilitates the sharing of results, data processing workloads, and peripheral devices. HP 1000 Systems can communicate with other HP 1000 Systems, HP 3000 Systems, other systems via X.25 Packet Switching Networks, and certain IBM or plug-compatible systems. Capabilities include program-to-program communications, remote program scheduling, remote file access, remote data base access, and I/O with remote peripheral devices.

**Coordination of Programmable Controllers.** Programmable Controllers (PCs) provide essential local control of the individual stages of manufacturing processes on the factory floor. The communication needed to assure effective coordination of a plant's PCs is supported by Programmable Controller Interface/1000 (PCIF/1000) software in HP 1000 A-Series Systems.

PCIF/1000 supports communication with over 200 Allen-Bradley PCs. Via the PCs, the HP 1000 System controls distributed manufacturing processes. User's application programs in the system, communicating via PCIF/1000, maintain centralized control of PC programs and the flow of material and monitor the health of processes. The result is more efficient operation and increased productivity.

**Process Monitoring and Control** is supported by HP Process Monitoring and Control/1000 (PMC/1000) software in HP 1000 A-Series Systems. The PMC/1000 system, working with an HP 2250 or other measurement and control system and process sensors, measures temperatures, pressures, flow rates, and other process conditions. It computes engineering conversions and control algorithms. The system also displays status, signals alarms if appropriate, and keeps a process log for later analysis.

A fill-in-the-blanks process simplifies specification of process parameters (sensor and actuator point names, engineering unit conversions, etc.). This procedure makes it easy for process engineers without computer programming experience to use PMC/1000 effectively.

**Quality Management** pays off by minimizing the sizable costs of rework and maintenance under warranty. Quality management can be systematized by adding the HP Quality Decision Management/1000 (QDM/1000) software package to HP 1000 A-Series Systems.

QDM/1000 captures and analyzes data statistically. It also provides graphical output to help quality assurance people and process engineers isolate product quality deviations and their causes. Test and process data can be logged systematically to meet requirements of regulatory agencies or customers.

Menu-driven, fill-in-the-blanks configuration helps with design of data collection transactions and report and graph formats. Data archiving and system maintenance are also simplified by fill-in-the-blanks configuration.

By helping with identification of problems and their relationships to the process, materials, workmanship, and product defects, QDM/1000 equips users to fix the process. This leads to substantial improvements in yield, quality, and productivity.

## 1-3 The HP 1000 System Design Process

To design an HP 1000 Computer System, use the following procedure:

1. Select the I/O architecture and processor.
2. Select the specific product (System Processor Unit, Box Computer, or Board Computer) on which your system is to be based.
3. Summarize the peripheral, software, and communications capabilities you want the system to have.

4. For each capability listed in 3, above, make a specific selection of software, peripheral device, and communications link, using the information in the Software and Peripherals and Communications sections.
5. Summarize the overall system, using the aids in the system design summary section.

## 1-4 Selecting the I/O Architecture

For maximum I/O efficiency, especially in new applications, the Distributed Intelligence I/O architecture embodied in the A-Series processors should be selected over the Centralized Intelligence I/O architecture used in F-Series and E-Series processors. With Distributed Intelligence I/O, every I/O channel can access memory directly vs only two I/O channels at a time with Centralized Intelligence I/O. Because of its relative inefficiency, processors using Centralized Intelligence I/O should be specified only for applications in which their use is currently well accepted.

## 1-5 Selecting the Processor

Within a particular I/O architecture, the processor should be chosen on the basis of its ability to support the application, as indicated by the criteria in Table 1-1. For example, the A900 processor should be selected for applications requiring maximum computation speed and/or main memory in excess of 8 megabytes. The A600+ processor should be selected for uses in which its relatively slow floating point calculation speed is expected to be adequate.

## 1-6 Selecting the HP 1000 Product to Use as the Basis of Your System

### Choosing the Level of Integration.

**System Processor Units (SPUs)** offer the highest level of integration of all HP 1000 products. As shown in Figure 1-6, the SPU includes the box

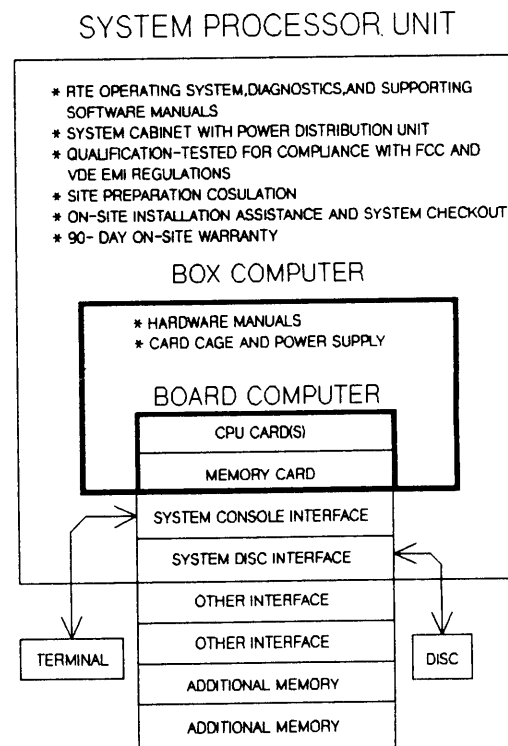

Figure 1-6. HP 1000 Integration levels

computer, interfaces to the system console and system disc, the operating system and diagnostics, the system cabinet, site prep consultation and installation/checkout services, and 90-day on-site warranty. The high level of integration of the SPU simplifies design, ordering, and implementation of systems that use a system console and a system disc, both of which are ordered separately. The SPU also complies with FCC and VDE EMI regulations, which gives OEMs a head start on EMI compliance of their HP 1000 processor-based systems.

**Box Computers** incorporate the CPU card(s) and memory in a fully-powered card cage that can be installed in a rack cabinet. Because system console and system discs are not prerequisites to purchase, the HP 1000 box computer offers OEMs and end users more configuration flexibility than the SPU. For example, the box computer can be configured to function as a remote distributed systems node without a system console for local operator communication. The operating system, diagnostics, interface cards and peripheral devices required to

complete a usable system are ordered separately. Only Micro/1000 packaged box computers comply with EMI regulations.

**Board Computers** are offered principally to OEMs whose system design requires their own custom integration to fit into a particular physical package and/or to meet cost requirements. Integration accessories, such as card cages, are available to assist OEMs with implementation of HP 1000 board computer based applications. However, because of the special nature of demand for board computers, they are available only with A600+ and E-Series processors.

### Choosing the Package

After you've chosen the level of integration to use, the final step in selecting the product to serve as the basis of your system is a choice of package. Use

the memory and I/O channel capacity information in Table 1-2 to help you match your choice of package to the anticipated capacity needs of the application.

**The Micro/1000 Package** is an excellent choice for small-to-medium sized systems because of its compactness and versatility. This package can be used atop a table, desk, or workbench, installed in a rack mounting cabinet, or placed in a vertical floor mount that combines convenient under-desk or deskside placement with rollabout mobility on its own casters. The Micro/1000 package is available at both the SPU and box computer levels of integration, and complies with EMI regulations at both levels.

**Rack Mounted SPUs** combine about 60% greater I/O channel capacity than the Micro/1000 based SPUs with rack space in an upper compartment of the 219xC SPU cabinet for additional equipment. The

Table 1-2. Memory and I/O Channel Capacities of HP 1000 System Processor Units and Computers

PROCESSOR	SYSTEM MODEL	PRODUCT NUMBER	NAME	BASE MEMORY CONFIG.		MAX. MEMORY CONFIG.	
				MAIN MEMORY	AV I/O CHANNELS	MAIN MEMORY	AV I/O CHANNELS
A900	Model 29 Micro 29	2199C/D 2489A	System Processor Unit Micro/1000 System Processor Unit	768 kB 768 kB	13 9*	24 MB 6 MB	6 8*
	n/a	2139A 2439A	Box Computer Micro/1000 Box Computer	768 kB 768 kB	15 11*	24 MB 6 MB	8 10*
A700	Model 27 Micro 27	2197C/D 2487A	System Processor Unit Micro/1000 System Processor Unit	512 kB 512 kB	13 10*	4 MB 4 MB**	10 7*
	n/a	2137A 2437A	Box Computer Micro/1000 Box Computer	128 kB# 128 kB#	16 12*	8 MB 8 MB**	13 9*
A600+	Model 26 Micro 26	2196C/D 2486A	System Processor Unit Micro/1000 System Processor Unit	512 kB 512 kB	16 12*	8 MB 8 MB	13 9*
	n/a	2156B	Box Computer	128 kB#	18	8 MB	15
	n/a	2436A	Micro/1000 Box Computer	128 kB#	14*	8 MB	11*
	n/a	2436E 2106BK	Micro/1000 Box Computer Board Computer	512 kB 128 kB#	14* n/a	8 MB 6 MB	11* n/a
F-Series	Model 85 Model 45	2179C 2177F	System Processor Unit System Processor Unit	256 kB# 256 kB	10 10	2 MB 2 MB	10 10
	n/a	2117F	Box Computer	128 kB#	13	2 MB	13
E-Series	Model 60 Model 40	2178C 2176E	System Processor Unit System Processor Unit	256 kB# 256 kB	10 10	2 MB 2 MB	10 10
	n/a	2109E	Box Computer	64 kB#	8	2 MB	8
	n/a	2113E 2109EK	Box Computer Board Computer	128 kB# 64 kB#	13 n/a	2 MB 2 MB	13 n/a

\* 12159A Battery Backup for memory physically occupies two of these I/O channels.

\*\* 12156A Floating Point Processor, 12153A Writable Control Store, and/or 12155A PROM Control Store each reduce maximum memory capacity by 2 MB.

# RTE-A and RTE-6/VM primary systems require at least 512 kB of main memory; RTE-IVB primary system requires at least 256 kB of main memory.



rack-mounted SPUs are thus the best choice for medium-to-large systems. The 219xC/D SPUs incorporate the 2137A, 2139A, or 2156B Computer and the 217xC/E/F SPUs incorporate the 2117F or 2113E Computer.

## 1-7 Outlining Your System's Capabilities

Now that you've selected the HP 1000 product on which your system will be based, it's time to summarize the capabilities you want your system to have. To help you with this, make a copy of this page and other pages on which Table 1-3 appears. Then use your copy of Table 1-3 as a capabilities checklist, entering quantity of one or more beside each desired capability, as appropriate.

## 1-8 Completing Your System Design

With your copy of the HP 1000 System Capabilities Checklist (Table 1-3), also copy the HP 1000 System Interfacing Summary (Table 1-4), and refer to the

appropriate sections behind the peripherals, communications, and software tabs. Worksheets in each section will help you to select the appropriate product (and interface and cable for peripherals and communications). On your copy of Table 1-4, list the product numbers of the peripherals being interfaced and the cables used to connect them to determine the number of each interface and cable that will be required. With respect to software, Table 4-1 in section 4 will help you to estimate main and disc memory requirements for support of your system's applications. A copy of Table 1-5 in this section provides a convenient means of summarizing your system hardware other than I/O interfaces and cables. Together, tables 1-3, 1-4, 1-5, and 4-1 provide a complete specification of your entire system, from the SPU or computer and system disc down to all required cables, interfaces, and options.

*NOTE: If this is your first HP 1000 System design, you may want to have it checked by a Hewlett-Packard Systems Engineer to confirm that it is complete.*

Table 1-3. HP 1000 System Capabilities Checklist

DESIRED CAPABILITY	SUPPORT (S) OR NON-SUPPORT (N) BY SPU; I = INCLUDED IN SPU				
	2196C/D or 2486A	2197C/D or 2487A	2199C/D or 2439A	2178C or 2179C	2176E or 2177F
INTERACTIVE USER COMMUNICATION WITH SYSTEM (For terminal selection and interfacing, see section 2.1)					
___ Display terminals (2392A or 262xA/B) for users developing programs, editing copy, or accessing a data base	S	S	S	S	S
___ Industrial terminals (3081A) for factory data entry	S	S	S	N	N
___ Bar code readers (3980xA/9291xA) for bar code data entry	S	S	S	S	S
GRAPHICS (For graphics device selection and interfacing, see section 2.2; for graphics software selection and memory and disc memory requirements, see section 4)					
___ Color TV monitors (13729B) for color graphics display	S	S	S	N	N
___ Monochrome graphics display terminals (2623A, 2625A+523, 2628A+523, or 45610B)	S	S	S	S	S
___ Color graphics display terminals (2627A)	S	S	S	S	S
___ Graphics tablets (17263A or 9111A) for graphics input	S	S	S	S	S
___ Eight-pen plotters to 36x46 in., sheet fed (7585B)	S	S	S	S	S
___ Eight-pen plotters to 36x46 in., roll fed (7586B)	S	S	S	S	S

Table 1-3. HP 1000 System Capabilities Checklist, continued

DESIRED CAPABILITY	SUPPORT (S) OR NON-SUPPORT (N) BY SPU; I = INCLUDED IN SPU				
	2196C/D or 2486A	2197C/D or 2487A	2199C/D or 2439A	2178C or 2179C	2176E or 2177F

GRAPHICS, continued

___ Eight-pen plotters to 26x46 in., sheet fed (7580B)	S	S	S	S	S
___ Eight-pen plotters to 11x17 in., auto sheet feed (7550A)	S	S	S	S	N
___ Six-pen plotters to 11x17 in. (7475A)	S	S	S	S	N
___ Two-pen plotters to 8.5x11 in. (7470A)	S	S	S	S	S
___ Raster graphics dot-matrix line printers (256xA)	S	S	S	S	N
___ Raster graphics dot-matrix serial printers (293xA)	S	S	S	N	N
[ ] Library for general graphics use (92861A/92841A*)	S	S	S	S	S*
[ ] Interactive/3-D graphics software (92862A)	S	S	S	S	N

\* Graphics in 2176E/2177F is supported by the 92841A Graphics/1000-II Version 1.0 (MATURE) Device Independent Graphics Library.

ALPHANUMERIC HARD COPY OUTPUT (For printer selection and interfacing, see section 2.3.)

___ 80-column serial thermal printers (2671A/G and 2673A)	S	S	S	N	N
___ 80-column serial impact printers (82905B and 82906A)	S	S	S	N	N
___ 132-column general-purpose serial impact printer (2932A)	S	S	S	S	S
___ 132-column serial impact printer with letter-quality and bar code printing capabilities (2934A)	S	S	S	S	S
___ 132-col, 300 lines/minute impact line printer (2563A)	S	S	S	S	S
___ 132-col, 600 lines/minute impact line printer (2565A)	S	S	S	S	S
___ 132-col, 880 lines/minute impact line printer (2566A)	S	S	S	S	S
___ 80/106-col, 8 pages/minute Laserjet printer (2686A)	S	S	S	N	N
___ 80/107-col, 12 pages/minute Laser page printer (2687A)	S	S	S	N	N

FAST-ACCESS MASS STORAGE NOTE: At least one system disc is required (interface is included in the SPU). Final choice of disc memory will depend upon capacity requirements of the system, its software, and data base (if any). For disc selection and interfacing, see section 2.4.

___ 14.5 MB fixed hard disc and 270 kB microfloppy disc (248xA Opt III, maximum of one per SPU)	S	S	S	N	N
___ 23.8 MB fixed discs* (7941A)	S	S	S	N	N
___ 23.8 MB disc*/tape drives (7942A)	S	S	S	N	N
___ 28.1 MB disc*/tape drives (7911P/R)	S	S	S	S	N
___ 55.5 MB fixed discs* (7945A)	S	S	S	N	N
___ 55.5 MB disc*/tape drives (7946A)	S	S	S	N	N
___ 65.6 MB disc*/tape drives (7912P/R)	S	S	S	S	N
___ 132.1 MB disc*/tape drives (7914P/R/CT)	S	S	S	S	N
___ 132.1 MB disc*/1600 bpi streaming mag tape subsystems (7914ST)	S	S	S	N	N
___ 132.1 MB disc*/1600 bpi start-stop mag tape subsystems (7914TD)	S	S	S	S	N
___ 404 MB CS/80 Fixed Discs* (7933H); use as system disc requires a magnetic tape unit for software installation, system bootup, and system backup	S	S	S	S	N
___ 404 MB CS/80 Removable Media Discs* (7935H); use as system disc requires a magnetic tape unit for software installation, system bootup, and system backup	S	S	S	S	N

\* Maximum of four of these discs per interface.

Table 1-3. HP 1000 System Capabilities Checklist, continued

DESIRED CAPABILITY	SUPPORT (S) OR NON-SUPPORT (N) BY SPU; I = INCLUDED IN SPU				
	2196C/D or 2486A	2197C/D or 2487A	2199C/D or 2439A	2178C or 2179C	2176E or 2177F

FAST-ACCESS MASS STORAGE, continued

___ 19.6 MB MAC Master Cartridge Disc (7906M) with multi-CPU access and capacity for up to seven MAC slave discs	S#	S#	S#	S	S
___ 50 MB MAC Master Disc (7920M) with multi-CPU access and capacity for up to seven MAC slave discs; use as system disc (217xC/E/F SPU only) requires a second 50 MB (MAC slave) disc or a mag tape unit for RTE system backup	S#	S#	S#	S	S
___ 120 MB MAC Master Disc (7925M) with multi-CPU access and capacity for up to seven MAC slave discs; use as system disc (217xC/E/F SPU only) requires a second 120 MB (MAC slave) disc or a mag tape unit for RTE system backup	S#	S#	S#	S	S
___ 19.6 MB MAC Slave Cartridge Discs (7906S)	S	S	S	S	S
___ 50 MB MAC Slave Discs (7920S)	S	S	S	S	S
___ 120 MB MAC Slave Discs (7925S)	S	S	S	S	S
___ Dual 710 kB microfloppy disc* (9122D) HP 1000 Software is NOT available on 710 kB microfloppy disc media)	S	S	S	S	N
___ 14.8 MB Winchester and 710 kB microfloppy discs (9133D) HP 1000 software is NOT available on 710 kB microfloppy disc media)	S	S	S	N	N
___ Dual 1.2 MB flexible disc subsystem (9895A)	S	S	S	S	S

\* MAC discs are supported in 219xC/D and 248xA SPU only as peripheral discs, NOT as system discs.

\* Maximum of two of these discs per interface

ARCHIVAL STORAGE AND FAST BACKUP OF LARGE DISCS (For selection and interfacing, see section 2.4.)

___ 6250/1600 bpi dual-density, 75 ips Streaming Magnetic Tape Units (7978A)	S	S	S	N	N
___ 1600 bpi, 50/100 ips start-stop/streaming Magnetic Tape Units (7974A)	S	S	S	N	N
___ 1600 bpi, 45 ips, start-stop Mag Tape Unit (7970E/7971A)	S	S	S	S	S
___ 800 bpi, 45 ips, start-stop Mag Tape Unit (7970B/7971A)	N	N	N	S	S
___ 10000 bpi, 60 ips, Tape Cartridge Subsystem (9144A)	S	S	S	S	N

PROGRAM DEVELOPMENT (For product selection and memory, disc memory, and other requirements, see section 4.)

[ ] FORTRAN Programming (92836A/92834A)	S	S	S	S	S
[ ] Pascal Programming (92833A/92832A)	S	S	S	S	S
[ ] BASIC Programming (Interpreter only)(92076A/92101A)	S	S	S	S	S
[ ] BASIC Programming (Interpreter and Compiler)(92857A)	S	S	S	S	N
[ ] Program Debugging (92860A, except in 2176E/2177F)	S	S	S	S	I
[ ] Program Activity Profiling (92860A, except in 2176E/2177F, or 92083A, except in 219xC/D or 248xA)	S	S	S	S	S
[ ] Microprogramming Support Software (92045A/92049A/92061A)	N	S	S	S	S
___ Writable control store cards (12153A/12205A/13197A)	N	S	S	S	S

DATA BASE MANAGEMENT (For product selection and memory, disc memory, and other requirements, see section 4.)

[ ] Data Base Management System with Query access (92069A)	S	S	S	S	S
[ ] Data Base Management System with Query access and extensive data base recovery features (92081A)	S	S	S	S	N

Table 1-3. HP 1000 System Capabilities Checklist, continued

DESIRED CAPABILITY	SUPPORT (S) OR NON-SUPPORT (N) BY SPU; I = INCLUDED IN SPU				
	2196C/D or 2486A	2197C/D or 2487A	2199C/D or 2439A	2178C or 2179C	2176E or 2177F
<b>MEASUREMENT AND CONTROL</b>					
— +/-1 28V fs to +/-10.23V fs Analog Input Channels (12060B for first eight channels in computer, 12061B for additional 32 channels in computer, maximum of 40)	S	S	S	N	N
— +/-1 28V fs to +/-10.23V fs Analog Input Channels (25501B for first 16 channels in 2250A/R or 2251B, 25502B for 32 additional channels in 2250A/H or 2251B, maximum of seven 25502Bs per 25501B)	S	S	S	N#	N#
— +/-12.5 mV to +/-10V fs Analog Input Channels (25503B for 32 channels in 2250A/H or 2251B, maximum of seven 25503Bs per 25501B)	S	S	S	N#	N#
— +/-12.5 mV to +/-100V fs Analog Input Channels (25504B for 16 floated and guarded channels in 2250A/H or 2251B, maximum of seven 25504Bs per 25501B)	S	S	S	N#	N#
— +/-10.23V fs Analog Output Voltage Channels (12062A for four output channels in computer)	S	S	S	N	N
— +/-10.23V fs Analog Output Voltage Channels (25510B for four output channels in 2250A/H or 2251B*)	S	S	S	N#	N#
— 20 mA fs Analog Output Voltage Channels (25510B for four output channels in 2250A/H or 2251B*)	S	S	S	N#	N#
— Isolated Event-Sense Digital Input Channels (12063A for 16 opto-isolated digital inputs and 16 relay contact closure output channels in computer)	S	S	S	N	N
— Isolated Relay Contact Closure Outputs (12063A for 16 relay contact closure outputs and 16 opto-isolated digital inputs in computer)	S	S	S	N	N
— Event-Sense Digital Input Channels (25511B for 32 digital inputs in 2250A/H or 2251B*)	S	S	S	N#	N#
— Counter Input Channels (25512B for four independent, full-function counter channels or 25516B for 16 pre-scale/totalize counter channels** in 2250A/H or 2251B*)	S	S	S	N#	N#
— Digital Output Channels (25513B for 32 digital outputs or 25515A for 16 digital outputs** in 2250A/H or 2251B*)	S	S	S	N#	N#
— Relay Output Channels (25514B for 16 isolated contact closure outputs in 2250A/H or 2251B*)	S	S	S	N#	N#
— Pulse Generator Output Channels (25515B for four independent pulse output channels in 2250A/H or 2251B*)	S	S	S	N#	N#
[ ] Measurement and Control Software (91823A)	S	S	S	N	N
* Maximum of eight 2551xBs per 2251B, maximum of two 2251Bs per 2250A/H.					
# 2250A/R can be interfaced to 217xC/E/F SPUs with basic interface driver software support, but high-level HP software is not available to support programming of measurement and control applications in 217xC/E/F SPUs.					
** The 25516B is a multifunction digital I/O card with 16 inputs, all of which can be prescaled and totalized, and 16 digital outputs.					
<b>MANUFACTURING APPLICATIONS SOFTWARE (For product selection, memory, disc, and other requirements, see section 4.)</b>					
[ ] Process monitoring and control (92121A)	S	S	S	N	N
[ ] Quality Data Management (92131A)	S	S	S	N	N
[ ] Forms data entry (94250A)	S	S		Y	N

Table 1-3. HP 1000 System Capabilities Checklist, continued

DESIRED CAPABILITY	SUPPORT (S) OR NON-SUPPORT (N) BY SPU; I = INCLUDED IN SPU				
	2196C/D or 2486A	2197C/D or 2487A	2199C/D or 2439A	2178C or 2179C	2176E or 2177F
COMMUNICATION WITH OTHER SYSTEMS (For interfaces, connections, and software and main memory and disc memory requirements, see sections 3 and 4)					
— Direct-connect point-to-point communications links to other HP 1000 Computer Systems (12044A or 12825A) (maximum cable length is 2.2 km/7,218 ft)	S	S	S	S	S
— Point-to-point communications links via modem to other HP 1000 Computer Systems (12007B or 12794B)	S	S	S	S	S
— Direct-connect point-to-point communications links to HP 3000 Computer Systems (12082A or 12834A) (maximum cable length is 1.0 km/3,281 ft)	S	S	S	S	S
— Point-to-point communications links via modem to HP 3000 Computer Systems (12073A or 12793B)	S	S	S	S	S
— Master Connections to one Data Link for communication with other HP (slave) Systems on the link (12092A or 12790A)	S*	S*	S*	S	S
— Slave Connections to Data Links from other (master) HP 1000 Computer Systems (12072A or 12830A)	S	S	S	S	S
[ ] Data Link/Multipoint master software (91732A or 91730A)	S*	S*	S*	S	S
[ ] DS/1000-IV Network software for HP 1000-to-HP 1000 or HP 1000-to-HP 3000 communications, via point-to-point or data link interface (91750A)	S	S	S	S	S
— Connection to IBM 360/370 or plug-compatible system via modem (12043A or 12260A)	S	S	S	S	S
[ ] Remote Job Entry to IBM 360/370 or plug-compatible system (91781A)	S	S	S	S	N
[ ] Multileaving Remote Job Entry to IBM 360/370 or plug-compatible system (91782A)	S	S	S	S	N
[ ] Program-to-Program Communication with IBM 360/370 or plug-compatible system (91784A)	S	S	S	S	N
— Connections to X.25 Packet Switching networks via modem (12075A or 12250A)	S	S	S	S	S
[ ] X.25 packet-switching communications software (91751A)	S	S	S	S	S
— Connections to programmable controller communications buses (eight per 12041A)	S	S	S	N	N
[ ] Communication with Programmable Controllers on the factory floor (94200A)	S	S	S	N	N
* 12092A HP 1000 A-Series Data Link Master Interface and 91732A Data Link software does NOT support HP 1000 E/F-Series Slave systems on the data link.					

Table 1-4. HP 1000 System Interfacing Summary

PRODUCT AND OPT NOS. OF INTER-FACED DEVICES	QTY	VIA A-SERIES INTERFACE AND CABLE PRODUCT NOS.		VIA E/F-SERIES INTERFACE AND CABLE PRODUCT NOS.		COMMENTS OR OTHER CONNECTION REQUIREMENTS (PRODUCT AND OPTION NUMBERS)
SYSTEM CONSOLE INTERFACE	1	12005B (Standard in SPU)	12040B (With Opt 008*)	12966A (Standard in SPU)		(Max. of eight terminals per 12040B, one terminal per 12005B or 12966A)
SYSTEM DISC INTERFACE	1	12009A (Std in SPU, except w/248xA Opt 111)		12821A (w/SPU Opt 022, 060, or 061)	13175D (w/SPU Opt 031 or 033)	(Max. of four discs per 12009A or 12821A, one MAC Master Disc and up to seven MAC Slave Discs per 13175D)
MULTIPLEXER INTERFACE		12040B		12792B		Eight ports for terminals or printers
HP-IB INTERFACE		12009A		59310B		Max. of 14 devices per interface.
MULTIPOINT/DATA LINK INTERFACE		12092A		12790A		Max. of 32 terminals or other devices per interface.
OTHER INTERFACE						
OTHER INTERFACE						
OTHER INTERFACE						
OTHER INTERFACE						

\* A-Series SPU Option 008 deletes the 12005B system console interface, which MUST be replaced by ordering the 12040B Eight-Channel Multiplexer with appropriate cable to function as the system console interface.

Table 1-5. Summary of HP 1000 Base System Hardware

NOTE: Also use Tables 1-3, 1-4, and 4-1 to summarize overall system capabilities, interfacing, and software and main memory and disc memory requirements.

ITEM	PRODUCT OR OPTION NUMBER AND NAME	QTY	COMMENTS
SPU OR COMPUTER	_____	___	_____
FLOATING POINT PROCESSOR (2137A, 2437A, or 2487A only)	_____	___	_____
SYSTEM CONSOLE CONNECTION (Also see Table 1-4.)	_____	___	_____
MEMORY CHANGE TO _____ kB -- Delete standard memory -- Products required for desired memory  -- Required memory connector	_____ _____ _____ _____	___ ___ ___ ___	_____ _____ _____ _____  Required only for A-Series memory chgs
SPU/COMPUTER OPERATION FROM 230V/50 Hz POWER	_____	___	_____
SYSTEM SOFTWARE MEDIA OPTION	_____	___	Also selects system disc interface in 2178C or 2179C SPU
INTEGRAL SYSTEM DISC	_____	___	243xA/E or 248xA only.
BATTERY BACKUP	_____	___	Included in 217xC/E/F SPUs
25 kHz POWER	_____	___	Applicable only to HP 1000 A-Series
DUAL-CHANNEL PORT CTRLR	_____	___	E/F-Series only; incl. in 217xC/E/F SPU
CONTROL STORE	_____	___	_____
I/O EXTENDER	_____	___	_____
VERTICAL FLOOR MOUNT	_____	___	243xA/E or 248xA only
CABINET AND/OR CABINET OPT	_____ _____ _____	___ ___ ___	_____ _____ _____
OTHER PLUG-IN ACCESSORIES	_____ _____ _____ _____ _____	___ ___ ___ ___ ___	_____ _____ _____ _____ _____

# Peripherals -- Contents

## Section 2.1 Terminal Selection and Interfacing

2.1-1	Introduction . . . . .	2.1-1
2.1-2	System Console Selection . . . . .	2.1-1
2.1-3	Display Terminal Selection . . . . .	2.1-1
2.1-4	Display Terminal Interfacing . . . . .	2.1-4
2.1-5	Auxilliary Printers . . . . .	2.1-11
2.1-6	Bar Code Reader Input . . . . .	2.1-12
2.1-7	Industrial Workstation Terminal . . . . .	2.1-14

## Section 2.2 Selection and Interfacing of Graphics Devices

2.2-1	Introduction . . . . .	2.2-1
2.2-2	Graphics Display . . . . .	2.2-1
2.2-3	Graphics Input . . . . .	2.2-2
2.2-4	Graphics Hardcopy Output . . . . .	2.2-3

## Section 2.3 Printer Selection and Interfacing

2.3-1	Introduction . . . . .	2.3-1
2.3-2	Types of Printers . . . . .	2.3-1
2.3-3	Printer Selection . . . . .	2.3-1
2.3-4	Printer Interfacing . . . . .	2.3-4

## Section 2.4 Selection and Interfacing of Mass Storage Devices

2.4-1	Introduction . . . . .	2.4-1
2.4-2	System Functions of Mass Storage Devices . . . . .	2.4-1
2.4-3	Disc Selection . . . . .	2.4-1
2.4-4	Disc Interfacing . . . . .	2.4-5
2.4-5	Magnetic Tape Unit Selection . . . . .	2.4-8
2.4-6	Magnetic Tape Unit Interfacing . . . . .	2.4-9



# Section 2.1

## Terminal Selection and Interfacing

### 2.1-1 Introduction

This peripherals section contains information on the selection and interfacing of system consoles, additional display terminals, and industrial terminals for HP 1000 Computer Systems.

### 2.1-2 System Console Selection

A display terminal must be provided for operator communication with HP 1000 Computer Systems:

1. in any HP 1000 Computer System based on a 217xC/E/F, 219xC/D, or 248xA SPU;
2. in any HP 1000 System based on a box or board computer that is not connected in a DS/1000-IV Distributed Systems network.

Any of the display terminals listed in this section can be used as the system console. However, you should specify a minimum-capability terminal for the system console, since extra capability, such as graphics, usually can't be put to good use. The other main consideration in selecting a system console is to specify one that uses the same type of cable as most of the other terminals in the system to facilitate connection of another terminal to the system console interface if the system console fails. An industrial terminal cannot be used as a system console.

### 2.1-3 Display Terminal Selection

All display terminals for HP 1000 Computer Systems have an 80 character by 24 line screen. All of the display terminals support character and block modes and display enhancements, such as underline, inverse video, and blink. Table 2.1-1 summarizes other factors that distinguish the various display

terminals which are supported in HP 1000 Computer Systems to help you make the best choice of display terminals for your application. The various factors listed in Table 2.1-1 are:

**Max Data Rate:** The maximum system-to-display transfer rate that has been tested in HP 1000 Systems (the HP 2625A, 2628A, and 45610B all have maximum data rates of 1920 characters per second (cps), but have been tested in HP 1000 Systems at a maximum rate of 960 cps).

**Ergonomic Adjustments** specifies the availability of display tilt and swivel adjustments for operator comfort.

**Line Drawing Set** specifies the availability of a line drawing character set for generating forms on the screen for data entry.

**Other Avail Char Sets** lists math or other character sets that are either standard or optionally available in the terminal. Table 2.1-2 summarizes character set availability and options.

**Display Area** is the display screen size.

**Disp. Memory** specifies character storage capacity. In certain terminals, the display memory also stores control characters, display enhancements, forms, and security fields, reducing the capacity available for screen-displayable characters.

**I/O Ports** helps you to determine if the terminal will support external devices, such as printers, that you may require for your application.

**Comments** provides additional information for selection guidance that isn't covered in the other columns of Table 2.1-1.

Terminal Selection  
and Interfacing

Table 2.1-1 Display Terminals Selection Guide

NOTE: The terminals are listed in order of increasing price.

TERMINAL PRODUCT NUMBER AND NAME	MAXIMUM DATA RATE IN HP 1000 SYSTEM	ERGONOMIC ADJUST- MENTS	LINE DRAW- ING SET	OTHER AVAIL CHAR SETS	DISPLAY AREA		DISP. MEMORY	I/O PORTS	COMMENTS
					mm	In.			
2392A Display Terminal	1920 char per sec via 12005B I/F; other- wise 960 char per sec	Tilt and swivel are standard	Std	Nat'l chars#	150 x 215	6.0 x 8.5	7680 char* exp to 15360 char*	One 25-pin RS232C/HP422 port; second RS232C port or 8-bit parallel Centronics port is optional	Best price/performance in low-priced terminal; ANSI operation for use with non-HP systems as well as HP 1000 is Opt 049. Block mode and soft-keys not tested in HP 1000.
45610B HP Touch- screen Terminal	960 char per sec	Tilt with 92240A, swivel with 92240B	Std	Math & Nat'l chars#	114 x 162	4.5 x 6.4	3890 char	Two 25-pin RS232C/HP422 ports and one HP-IB port	Compact terminal that sup- ports graphics@ and con- verts to HP Touchscreen Personal Computer with addition of a disc; HP Touchscreen block mode not tested w/HP 1000 systems.
2624B Display Station	960 char per sec	Tilt and swivel with Opt. 401	Std	Math, Large Char, and Nat'l Chars#	164 x 215	6.5 x 8.5	7680 char* exp to 17280 char*	One 50-pin RS-232-C port and one 25-pin RS-232-C port	Terminal with forms cache and advanced edit checks. Opt 050 printer gives hard copy of display. Multi- point interfacing is supported in HP 1000.
2628A Word Process- ing Terminal	960 char per sec	Tilt and swivel with Opt. 401	Std	Nat'l chars#	164 x 215	6.5 x 8.5	11520 char*	Two 25-pin RS232C/HP422 ports or one 25-pin RS232C/ HP422 port and one HP-IB port (available only with graphics)	Terminal supports HPWORD on HP 3000 when not in use on HP 1000; Opt 050 prin- ter gives hard copy of the display; Opt 523 adds graph- ics capability@. Inter- face via data link or multipoint not tested in HP 1000.
2623A Graphics Terminal@	960 char per sec	Tilt and swivel with Opt. 401	Opt. 202	Nat'l Chars#	164 x 215	6.5 x 8.5	3890 char	One 50-pin RS-232-C port and one 25-pin RS-232-C port for external printer or other device.	Terminal provides graphics capability. Opt 050 prin- ter gives hard copy of the display. ANSI operation for use with non-HP sys- tems as well as HP 1000 is Opt F17.
2625A Dual System Display Terminal	960 char per sec	Tilt and swivel with Opt. 401	Std	Math & Nat'l chars#	164 x 215	6.5 x 8.5	11520 char*	One 25-pin RS232C/HP422 port and one one IBM ter- minal port are standard. HP-IB printer/ plotter port is available only with graphics	Terminal usable with IBM system (emulates IBM 3276/ 3278 Display Station) when not used with HP 1000. Opt 050 printer gives hard copy of display. Opt 523 adds graphics capability@. Opt 528 adds HPWORD sup- port (see 2628A, above). Interface via data link or multipoint not tested in HP 1000.

\* The amount of memory actually usable for displayable characters depends upon how much memory is used for storage of control characters, display enhancements, forms, and/or security video fields.

# National characters are optionally available to customize the terminal for display in any of at least six different national languages. For national language options, see Table 2.1-2 on page 2.1-4.

@ Graphics capabilities of graphics terminals are compared in Table 2.2-1 on page 2.2-2.

Table 2.1-1 Display Terminals Selection Guide, continued

NOTE: The terminals are listed in order of increasing price.

TERMINAL PRODUCT NUMBER AND NAME	MAXIMUM DATA RATE IN HP 1000 SYSTEM	ERGONOMIC ADJUST- MENTS	LINE DRAW- ING SET	OTHER AVAIL CHAR SETS	DISPLAY AREA		DISP. MEMORY	I/O PORTS	COMMENTS
					mm	In.			
2626A Display Station	960 cps	Tilt and swivel with Opt. 401	Std	Math, Large Chars, and Nat'l Chars#	150 x 215	6.0 x 8.5	8560 char	One 50-pin RS-232-C port and one 25-pin RS-232-C port	Terminal with interactive forms design, horizontal scrolling of up to 160 character line, and multi- ple workspaces and split- screen capabilities avail- able to the applications programmer. Opt 050 40/80/132 col printer gives hard copy of display memory. Multipoint inter- facing is supported in HP 1000 systems.
2627A Color Graphics Terminal@	960 char per sec	Swivel with 92171T Turntable	Std	Nat'l chars#	164 x 215	6.5 x 8.5	3890 char	One 50-pin RS-232-C port and one 25-pin port for prin- ter or other device	Terminal provides color graphics capability. RGB Interface for video output to external monitor or camera is Opt 087. ANSI operation for use with non-HP systems as well as HP 1000 is Opt F17.

\* The amount of memory actually usable for displayable characters depends upon how much memory is used for storage of control characters, display enhancements, forms, and/or security video fields.

# National characters are optionally available to customize the terminal for display in any of at least six different national languages. For national language options, see Table 2.1-2 on page 2.1-4.

@ Graphics capabilities of graphics terminals are compared in Table 2.2-1 on page 2.2-2.

Table 2.1-2 Character Set Availability by Terminal

CHARACTER SET	AVAILABILITY BY TERMINAL PRODUCT AND OPTION NUMBERS				
	2392A OPTION	2623A 2627A OPTION	2624B 2626A OPTION	2625A 2628A OPTION	45610 SUFFIX

NATIONAL CHARACTER SETS

(These character sets are built into the terminal's firmware; the option provides appropriate keyboard)

U.S. English	Std	Std	Std	Std	B
Swedish/Finnish	s/b	001*	001#	s/b	s/b
Swedish	101	s/a	s/a	001	BS
Norwegian/Danish	s/b	002*	002#	s/b	s/b
Norwegian	102	s/a	s/a	002	BN
French	103	003*	003#	008	BF
German	104	004*	004#	004	BD
U.K. English	105	005*	005#	005	BU
European Spanish	106	006*	006#	006	BE
Canadian French	107	n/a	n/a	007	BC
Canadian English	108	n/a	n/a	n/a	BL
Italian	109	n/a	n/a	009	BZ
Dutch	110	n/a	n/a	010	BH
Finnish	111	s/a	s/a	011	BX
Danish	112	s/a	s/a	012	BY
Swiss German	113	n/a	n/a	n/a	BR
Swiss French	114	n/a	n/a	n/a	BQ
Latin Spanish	115	n/a	n/a	n/a	BM
Flemish	116	n/a	n/a	n/a	BW

OTHER CHARACTER SETS

Math	n/a	n/a	201	n/a	Std
Large Characters	n/a	n/a	201	n/a	n/a
Line Drawing	Std	202	Std	Std	Std

\* In HP 2623A, this national language option also includes the Line Drawing Set.

# In HP 2626A, this national language option also includes the Math and Large Character sets.

n/a = not available

s/b = see below; each option supports one language on this terminal.

s/a = see above; a single option supports this language and another language.

## 2.1-4 Display Terminal Interfacing

### A choice of Interfaces

Display terminals can be connected to HP 1000 Computer Systems via:

1. Point-to-point, single-terminal interface (usable for system console).
2. Eight-channel multiplexer interface (usable for system console in A-Series systems, but not in E/F-Series systems)
3. Data link/multipoint interface (not usable for system console).
4. X.25 interface for connection to remote terminals via modem and packet-switching network (not usable for system console).

Each of these interfacing choices is discussed in the following paragraphs.

**Point-to-Point Interface.** A point-to-point interface (the 12005B interface or 37222A\* integral modem interface in A-Series, 12966B interface in E/F-Series) connects one terminal to the system via one I/O channel. Point-to-point interfacing supports data rates up to 1920 characters per second. This interfacing mode and the various interface and cable choices associated with it are summarized in Figure 2.1-1.

\* The 37222A is not supported as a system console interface.

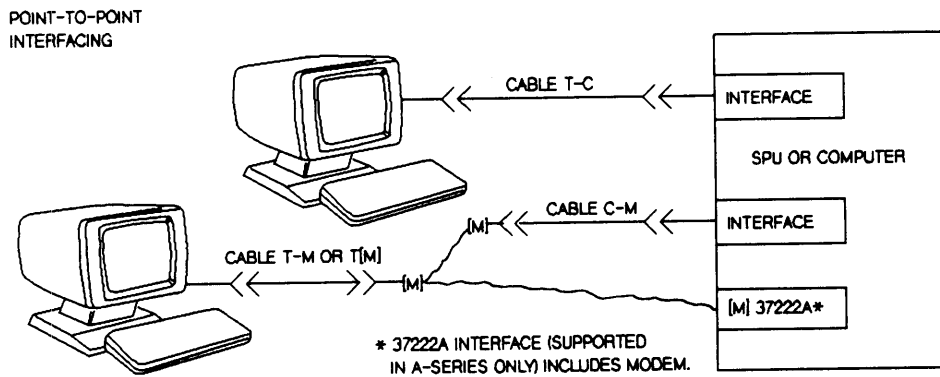

Point-to-Point Connections Summary

FROM SERIES	TO TERMINAL PRODUCT NUMBERS	FOR CONN VIA	USE					
			CABLE DESIG	INTERFACE AND CABLE OPTION	CABLE PRODUCT NO.	CABLE PART NUMBER	LENGTH (m/ft)	
A	2392A, 2625A, 2628A, 45610A, 2624B Port 2, or 2626A Port 2	Cable	T-C	12005B+002	n/a	5061-6605	5/16.7	
			C-M	12005B+003 or 37222A	n/a 15561A*	12005-60004 15561-60001	5/16.7 2.1/7	
		Modem	T-M	n/a	40242M	40242-60004	5/16.7	
			T-M or T[M]	n/a	n/a	n/a	n/a	n/a
	2623A, 2624B Port 1, 2626A Port 1, or 2627A	Cable	T-C	12005B+001 or 12005B+005#	n/a n/a	5061-6604 5061-5798 & 5061-5800	5/16.7 15/49	
			Modem	C-M	12005B+003 or 37222A*	n/a 15561A*	12005-60004 15661-60001	5/16.7 2.1/7
		T-M or T[M]		n/a	13222N or 13265A@	13222-60001	5/16.7	
			n/a	n/a	n/a	n/a	1/3.28	
E/F	2392A, 2625A, 2628A, 45610A, 2624B Port 2, or 2626A Port 2	Cable	T-C	12966A+106	n/a	12966-60015	5/16.7	
			Modem	C-M	12966A+002	n/a	12966-60006	15.2/50
				T-M	n/a	40242M	40242-60004	5/16.7
	2623A, 2624B Port 1, 2626A Port 1, or 2627A	Cable	T-C	12966A+105	n/a	12966-60014	5/16.7	
Modem			C-M	12966A+002	n/a	12966-60006	15.2/50	
			T-M or T[M]	n/a	13222N or 13265A@	13222-60001	5/16.7	
			n/a	n/a	n/a	n/a	1/3.28	

\* The 37222A interface includes a 300/1200 baud integral modem that is compatible with Bell 212A/103 type modems; the 15561A cable connects to a Bell modular telephone jack, not to a modem at the computer/SPU end of the line.

# The 12005B+005 provides a fiber optic connection instead of an electrical connection.

@ The 13265A is a pod-connector 300 baud (30 cps) modem that connects the terminal to a Bell telephone jack.

Figure 2.1-1 Point-to-Point Interfacing in HP 1000 Computer Systems

**Multiplexer Interface.** A multiplexer interface (the 12040B in A-Series, 12792C interface in E/F-Series) can be used to connect up to eight terminals to the system via a single I/O channel. In addition to making more efficient use of the system's available I/O channel capacity, the multiplexer provides interfacing at a lower cost per

channel than point to point interfacing whenever more than two terminals are to be connected. Data rates to 960 characters per second are supported, but all terminals must operate at the same rate.

The 12040B multiplexer can be used for interfacing the system console in HP 1000 A-Series Computer

## Terminal Selection and Interfacing

Systems at the lower multiplexer cost per channel rather than the point-to-point interface cost per channel. The HP 219xC/D and 248xA System Processor Units have an option (008) that deletes the 12005B interface to permit its replacement with the 12040B Multiplexer and the appropriate cable. Multiplexer interfacing of the system console is not supported in HP 1000 E/F-Series Systems.

Basic interfacing via multiplexer and the eight-port connection panel included with it is summarized in Figure 2.1-2. For modem connection to remote terminals, the 12040B/12792C multiplexer should be used with the 37214A Systems Modem as shown in Figure 2.1-3, especially if program control of modem operation is desired.

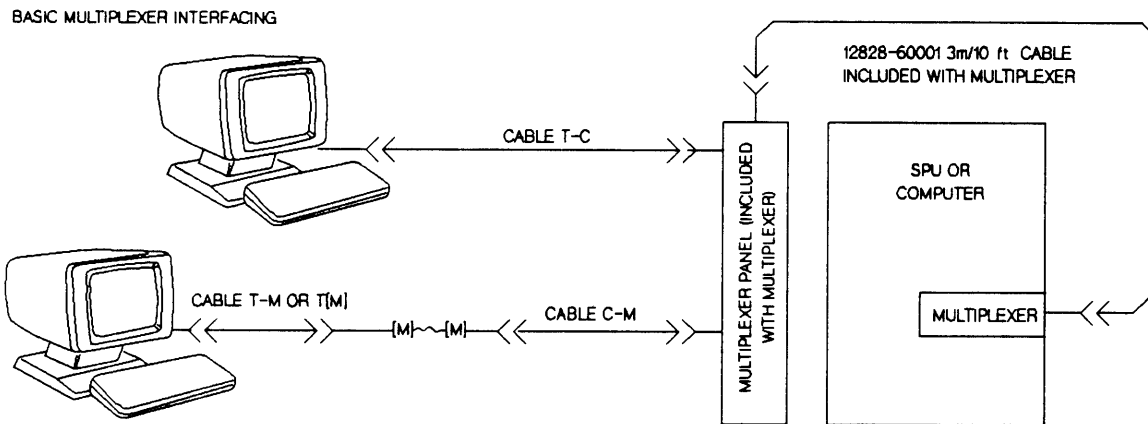

Basic Multiplexer Interfacing Summary

FROM SPU OR COMPUTER TO TERMINAL PRODUCT NUMBERS	USE							
	MULTIPLEXER PRODUCT NUMBER FOR		FOR CONN VIA	CABLE DESIG	CABLE PRODUCT NUMBER	CABLE PART NUMBER	LENGTH (m/ft)	
	A-SERIES	E/F-SERIES						
2392A, 2625A, 2628A, 45610A, 2624B Port 2, or 2626A Port 2	12040B	12792C	Cable	T-C	40242M	40242-60004	5/16.7	
				Modem	C-M	30062B	30062-60022	7.6/25
					T-M	40242M	40242-60004	5/16.7
2623A, 2624B Port 1, 2626A Port 1, or 2627A	12040B	12792C	Cable	T-C	13222N	13222-60001	5/16.7	
				Modem	C-M	30062B	30062-60022	7.6/25
					T-M or T[M]	13222N or 13265A*	13222-60001	5/16.7
							n/a	1/3.28

\* The 13265A is a pod-connector 300 baud (30 cps) modem that connects the terminal to a Bell telephone jack

Figure 2.1-2 Basic Multiplexer Interfacing in HP 1000 Computer Systems

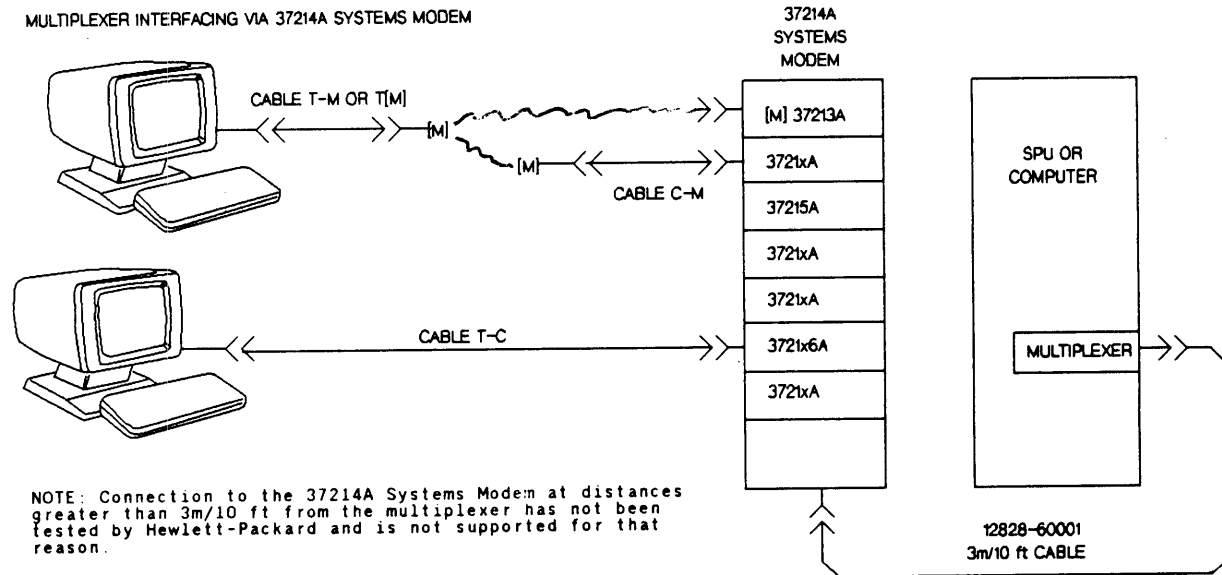

Multiplexer Interfacing Via 37214A Systems Modem

FROM SPU OR COMPUTER TO TERMINAL PRODUCT NUMBER	USE							
	MULTIPLEXER PRODUCT AND OPTION NUMBERS FOR		FOR CONN VIA	CABLE DESIG	37214A MODULE PRODUCT NUMBER	CABLE PRODUCT NUMBER	CABLE PART NUMBER	LENGTH (m/ft)
	A-SERIES	E/F-SERIES						
2392A, 2625A, 2628A, 4561CB, 2624A Port 2, or 2626A Port 2	12040B+002	12792C+002	Modem	C-M	37213A or 37215A	15561A* or 15564A	15561-60001	2.1/7
				T-M	n/a	40242M	40242-60004	5/16.4
			Cable	T-C	37216A	40242M	40242-60004	5/16.7
2623A, 2624B Port 1, 2626A Port 1, or 2627A	12040B+002	12792C+002	Modem	C-M	37213A or 37215A	15561A* or 15564A	15561-60001	2.1/7
				T-M or T[M]	n/a	13222N	13222-60001	5/16.7
			Cable	T-C	37216A	13222N	13222-60001	5/16.7

\* The 15561A cable connects to a Bell modular telephone jack, not to a modem, at the computer/SPU end of the line.

# The 13265A is a pod-connector 300 baud (30 cps) modem that connects the terminal to a Bell telephone jack.

Figure 2.1-3 Multiplexer Interfacing Via 37214A Systems Modem in HP 1000 Computer Systems

Use with 39301A Fiber Optic Multiplexers, shown in Figure 2.1-4, can be used to extend transmission distance between the SPU and terminals to 1 km (3281 feet). The use of an optical circuit instead of an electrical circuit permits connection between buildings without concern for lightning hazards. The 39301A Fiber Optic Multiplexer can support up to 16 terminals (capacity of two 12040B or 12792C multiplexers).

**Multipoint Interface.** A multipoint interface (12092A in A-Series/12790A in E/F-Series) supports daisy-chain connection of multiple terminals to the system via a single I/O channel (see Figure 2.1-5). Multipoint interfacing offers the following advantages over multiplexer interfacing:

1. Supports more terminals per interface (up to 32 vs 8 per multiplexer interface).

## Terminal Selection and Interfacing

2. Lower line costs for remote terminals (daisy chain to a group of remote terminals requires only one set of modems and one telephone line, vs two modems and a telephone line for each multiplexer-connected remote terminal).
3. Common messages are easily broadcast to all terminals on a multipoint line.

Disadvantages of multipoint interfacing are:

1. All terminals share the same daisy-chain line, at a maximum line speed of 960 char/sec, which can result in considerably higher response delays than with multiplexer-connected terminals, especially if many terminals are in use on the same line at the same time. This compares to 960 cps per terminal via the multiplexer interface.

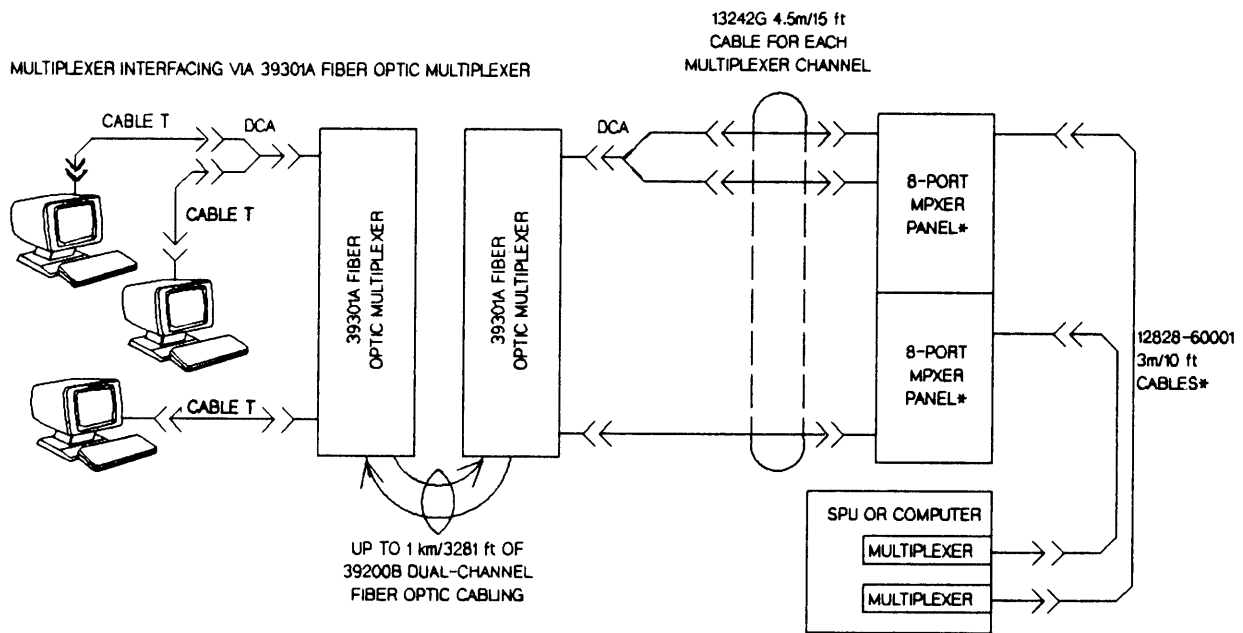

DCA = 8120-3569 Dual-Channel RS-232-C/V.24 Adapter that can be used to connect two multiplexer channels via one 39301A connector, using the primary and secondary channels of the 39301A connectors. The Adapter thus effectively doubles the usable capacity of each 39301A connector on which it is used.

Multiplexer Interfacing Via 39301A Fiber Optic Multiplexer

FOR FIBER OPTIC MULTIPLEXER TO TERMINAL PRODUCT NUMBERS	CONNECT USING CABLE PRODUCT NO.	CABLE PART NUMBER	LENGTH
2392A, 2625A, 2628A, 45610A, 2624B Port 2, or 2626A Port 2	40242M	40242-60004	5m/16.7 ft
2623A, 2624B Port 1, 2626A Port 1, or 2627A	13222N	13222-60001	5m/16.7 ft

Figure 2.1-4 Multiplexer Interfacing Via 39301A Fiber Optic Multiplexers in HP 1000 Systems



2. Graphics/1000-II is not supported via multi-point.
3. The screen mode of Edit/1000 is not supported via multipoint.
4. Additional software is required (91732A in A-Series, 91730A in E/F-Series).

**X.25 Interface.** An X.25 interface (12075A in A-Series, 12250A in E/F-Series) supports connection to remote terminals via modem, packet switching network, and an HP 2334A Multimux, which functions as a packet assembler/disassembler for up to 16 terminals. Terminals connect to the remote HP 2334A with the same cable that would be used to connect to the multiplexer panel (see Figure 2.1-2). For other information on configuration of the X.25 link to the HP 2334A, see the HP 2334A Multimux data sheet, 5953-5963 or later revision.

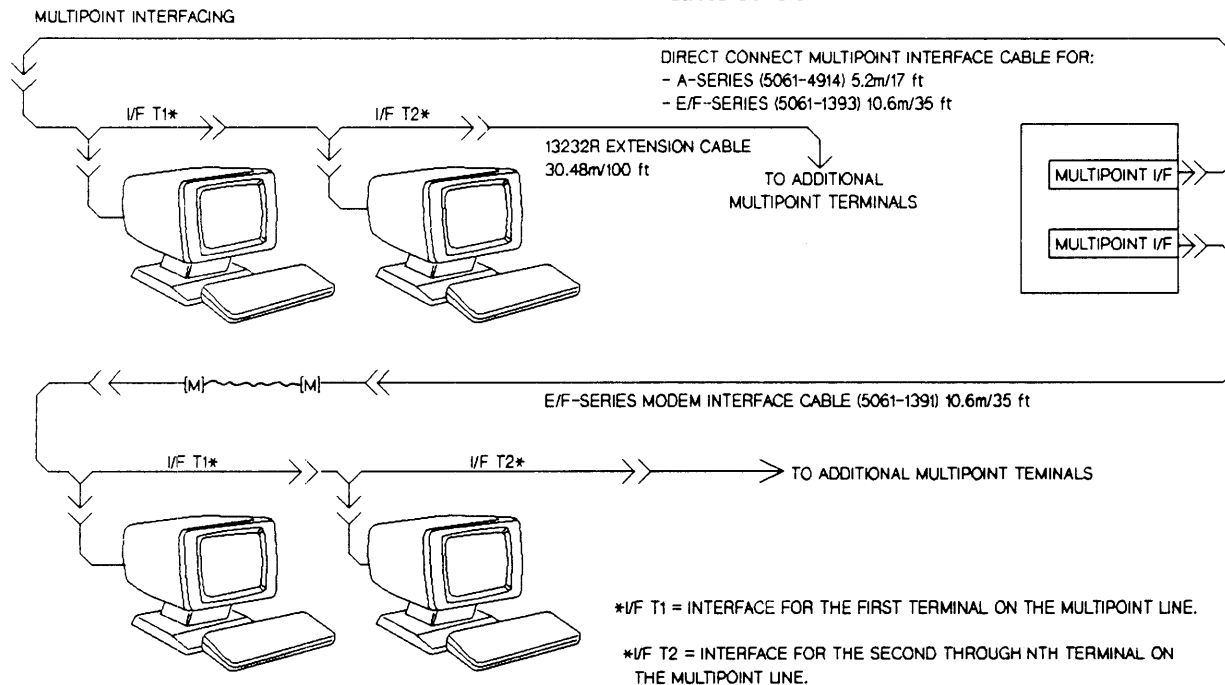

Multipoint Interfacing

FROM SPU OR COMPUTER TO MULTIPOINT TERMINAL PRODUCT NUMBERS	FOR CONN VIA	USE				
		MULTIPOINT INTERFACE PRODUCT NUMBER FOR		I/F OR CABLE DESIG	TERMINAL INTERFACE PRODUCT NUMBER	CABLE LENGTH
		A-SERIES	E/F-SERIES			
2624B or 2626A	Cable	12092A	12790A+001	T1	13232U and 13267A	1.5m/5 ft 10m/32.8 ft
				T2	13268A	10m/32.8 ft
	Modem	Not Supported	12790A+001	T1	13267A or 13267A+001	10m/32.8 ft
				T2	13268A or 13268A+001	10m/32.8 ft

Figure 2.1-5 Multipoint Interfacing in HP 1000 Computer Systems

## Terminal Selection and Interfacing

Packet switching connection to terminals offers the advantage of transmission charges that are proportional to actual message traffic, not connect time. The disadvantages of packet-switching connection are:

1. Only character mode operation is supported, which may preclude use with some software packages.
2. Additional software is required (91751A).

## Modems for Linking to Remote Terminals

Communication with terminals over considerable distances usually requires a modem-telephone line link. This link consists of two compatible modems, one interfaced to the computer, the other connected to the terminal. The modems convert the bit streams exchanged between the computer and terminal to a modulated audio signal, which is transmitted over a dial-up telephone connection or a dedicated line leased from the telephone company. The different modems that can be used for connecting remote terminals to HP 1000 Computer Systems are listed in Table 2.1-3.

Table 2.1-3 Modems Usable for HP 1000 Links to Remote Terminals

COMPUTER INTERFACE			DATA RATE (bits per sec)	MODEM AT INTERFACE	SUPPORTED TERMINALS	MODEM AT TERMINAL OR HP 2334A MULTIMUX (X 25 PACKET ASSEMBLER/DISASSEMBLER)	
TYPE	A-SERIES PRODUCT NO.	E/F-SERIES PRODUCT NO.					
Point-to-Point	12005B+003	12966A+002	300	HP 92205A*, Bell Type 103, or Vadic VA3400	2623A, 2624B Port 1, 2625A+022, 2626A Port 1, 2627A, or 2628A+022	HP 13265A	
	37222A	Not avail.		Integral with 37222A			
	12005B+003	12966A+002	1200	HP 92205A*, Bell Type 212, or Vadic VA3400	2392A, 2623A, 2624B, 2625A, 2626A, 2627A, 2628A, or 45610B	HP 92205A*, Bell Type 212, or Vadic VA3400	
	37222A	Not avail.		Integral with 37222A			
Multi-plexer	12040B+002	12792C+002	1200	HP 37214A plus 37213A per channel			
Multi-point	Multipoint communication via modem is not supported in A-Series	12790A+001	1200 Async	HP 92205A*, Bell Type 212A, or Vadic VA3400	2624B or 2626A with 13267A or 13268A	HP 92205A*, Bell Type 212A, or Vadic VA3400	
			1200 Sync	Bell Type 202T for dial-up or leased lines (1800 bps via leased lines)			Bell Type 202T for dial-up or leased lines (1800 bps via leased lines)
			2000 Sync	Bell Type 201A3 for dial-up or leased lines			Bell Type 201A3 for dial-up or leased lines
			4800 Sync	Bell Type 208B (208A for leased lines)			Bell Type 208B (208A for leased lines)
			9600 Sync	Bell Type 209A for leased lines only			Bell Type 209A for leased lines only
X.25	12075A	12250A	1200	Bell Type 212A	2392A, 2623A, 2624B, 2625A, 2626A, 2627A, 2628A, or 45610B	Bell Type 212A	
			2400	Bell Type 201C		Bell Type 201C	
			4800	Bell Type 208C		Bell Type 208C	
			9600	Bell Type 209A		Bell Type 209A	
			19200	Supplied by Public Packet Switched Network		Supplied by Public Packet Switched Network	

\* HP 92205A is for use in the United States only; order HP 92205C for use in Canada.

## 2.1-5 Auxiliary Printers

An extensive choice of auxiliary printers can be connected to most HP 1000 compatible display terminals to provide local hard copy output, as shown in Figure 2.1-6. In addition to the external

auxiliary printers listed in the table of Figure 2.1-6, a 120 cps, 80 column integral auxiliary thermal printer is optional (Option 050) on all 262x terminals except the 2627A. An HP 2674A 120 cps, 80/132 column integral printer can also be added to the 45610B terminal.

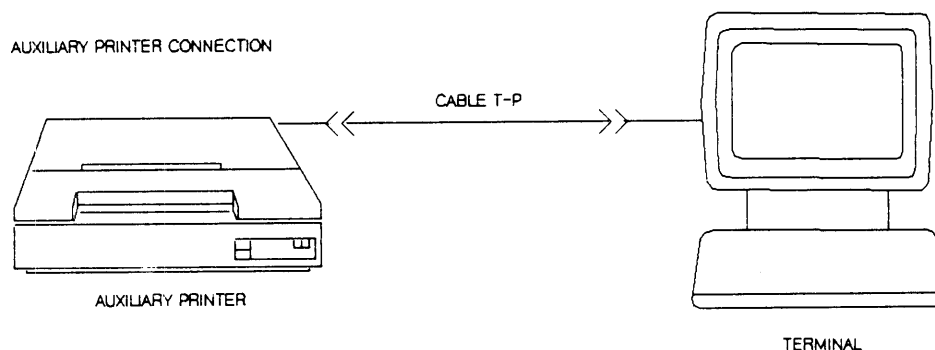

Auxiliary Printer Connections to HP Display Terminals

CONNECT TERMINAL		TO AUXILIARY PRINTER PRODUCT NUMBER AND NAME	USING TERMINAL-TO-PRINTER CABLE	
PRODUCT NUMBER	PORT		PRODUCT NUMBER	LENGTH
2392A+092	2	2601A 40 cps, 132 col Daisywheel Printer 2602A 25 cps, 132 col Daisywheel Printer  2671A+040 120 cps, 80/132 col (thermal) Printer 2671G+040 120 cps, 80/132 col Graphics Printer 2673A+040 Intelligent Graphics Printer  2932A 200 cps, 132 col General-Purpose Printer 2934A 200/100/50 cps, 132 col Office Printer	40242G	5m/16 ft
2392A+093	2	2225C 150 cps, 40/80/142 col Thinkjet Printer  2671A+042 120 cps, 80/132 col (thermal) Printer 2671G+042 120 cps, 80/132 col Graphics Printer 2673A+042 Intelligent Graphics Printer  2932A+042 200 cps, 132 col General-Purpose Printer 2934A+042 200/100/50 cps, 132 col Office Printer	40242D	1m/3 ft
2623A 2624B 2626A 2627A 2628A 45610B	2	2601A 40 cps, 132 col Daisywheel Printer 2602A 25 cps, 132 col Daisywheel Printer  2671A+040 120 cps, 80/132 col (thermal) Printer 2671G+040 120 cps, 80/132 col Graphics Printer 2673A+040 Intelligent Graphics Printer  2932A 200 cps, 132 col General-Purpose Printer 2934A 200/100/50 cps, 132 col Office Printer	13242G	5m/16 ft
2625A+026,523 2628A+026,523 45610B	HPiB	2602A+046 20 cps, 132 col Daisywheel Printer  2671A 120 cps, 80/132 col (thermal) Printer 2671G 120 cps, 80/132 col Graphics Printer 2673A Intelligent Graphics Printer  2932A+046 200 cps, 132 col General-Purpose Printer 2934A+046 200/100/50 cps, 132 col Office Printer  82905B+00x 80 cps/80 col Impact Printer 82906A+00x 160 cps/80 col Dot-Matrix Printer	10833A 10833B 10833C	1m/3.2 ft 2m/6.5 ft 4m/13 ft

Figure 2.1-6 Auxiliary Printer Connections to Display Terminals

## 2.1-6 Bar Code Reader Input

Manually keystroked entry of data can be time-consuming as well as being subject to typographical errors. Fortunately, the time and error potential in the entry of routine data can be minimized by using of bar coded labels, tags, badges, or cards. Information as diverse as product part or stock numbers, patient identification numbers for hospital records, personal identification numbers on employee badges, and property identification numbers on machines, instruments, or office equipment can be imprinted in an appropriate bar code. Thereafter, the single sweep of a wand or slot reader can scan and enter the encoded data in about a third of the time required for keystroked entry by a skilled operator, and with monotonous accuracy.

Recognizing the time savings and accuracy gains accruing to applications that can use bar codes for data entry, Hewlett-Packard offers printers that can print bar coded labels as well as bar code readers to provide a complete hardware solution to information transfer via bar code media.

Bar code printing is optional on the HP 2563A, 2565A, and 2566A Line Printers and standard on the 2934A Printer. Bar code readers can be interfaced to HP 1000 Computer Systems in two ways. HP 92911A and 92915A Bar Code Readers connect between the keyboard and the display of an HP 262xA/B or 2392A display terminal that is interfaced to an HP 1000 Computer System.

The HP 9291xA Bar Code Readers emulate the terminal keyboard in that the bar coded characters it reads are sent to the display and the computer as if they had been keystroked. HP 39800A and 39801A Bar Code Readers support eavesdrop connection between a terminal and an HP 1000 Computer System, but the terminal is not necessary to successful operation of the 3980xA Bar Code Readers. Connection of these readers to HP 1000 Computer Systems and the bar codes they can read are summarized in Figure 2.1-7.

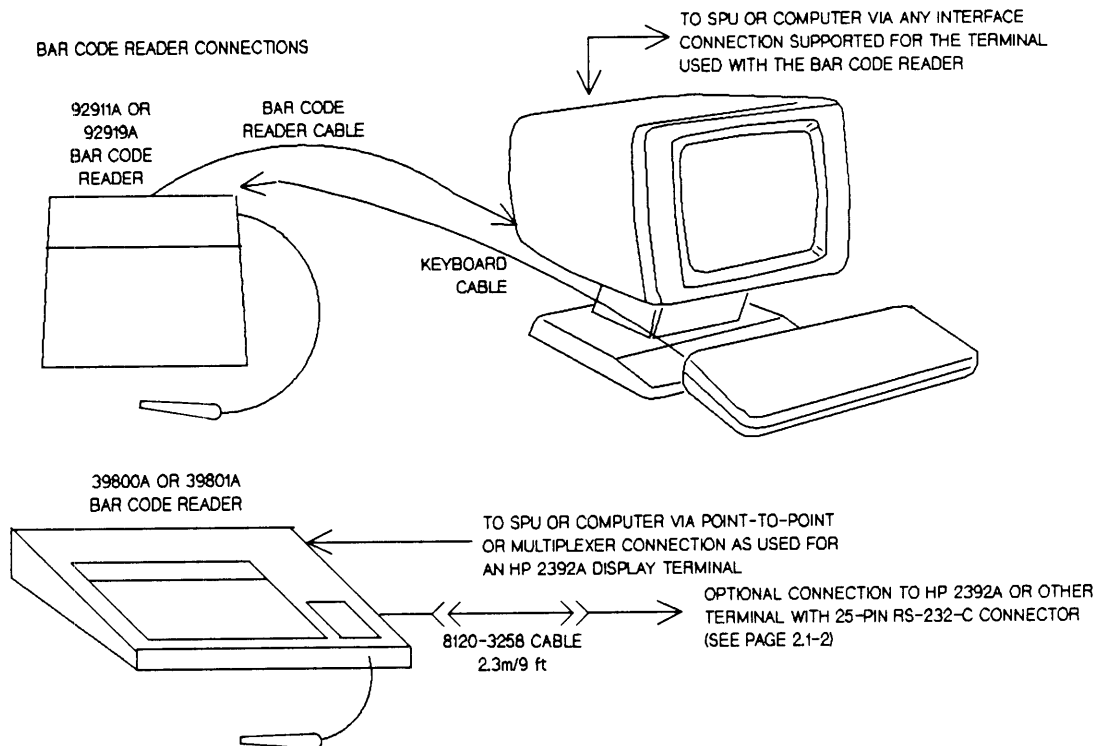

Bar Code Reader Interfacing to HP 1000 Systems

TERMINAL PRODUCT NUMBER	BAR CODE READER PRODUCT NUMBER	BAR CODE CHOICES (S = Supported, N = Not supported, Option Number to be ordered to support an optional code)					COMMENTS
		3 OF 9	INTERLEAVED 2 OF 5	INDUSTRIAL 2 OF 5	CODABAR	UPC/EAN/JAN	
2392A 45610B	92915A	S	S	N	S	S	
2623A 2624B 2626A 2627A	92911A	S	S	N	OPT. 060	N	
NOT REQUIRED	39800A	S	S	S*	OPT. 002*	OPT. 001*	Programmable reader.
	39801A	S	S	S*	OPT. 002*	OPT. 001*	Non-programmable reader.
NOT REQUIRED	3081A+ 05x	S	S	N	N	N	Bar code reader is optional addition to 3081A Industrial Workstation Terminal (see Figure 2.1-8 for connections)

\* Optional code furnished with 39800A/39801A Option 001 or 002 replaces Industrial 2 of 5 code.

Figure 2.1-7 Bar Code Reader Connections to HP 1000 Systems

## 2.1-7 Industrial Workstation Terminal

For data collection in factory environments, HP offers the HP 3081A Industrial Workstation Terminal. The HP 3081A is a compact, rugged, low-priced terminal with 32-character display and numeric keyboard. Full alphanumeric keyboard and bar code reader are optional. The bar code reader can be equipped with six different input options, including a slot reader, which uses infrared light to read "black on black" codes on badges for security applications. For details, see the HP 3081A Industrial Workstation Terminal data sheet, which is available from local HP Field Sales Offices. HP 3081A Terminal connection to HP 1000 Computer Systems is shown in Figure 2.1-8.

HP 3081A CONNECTIONS

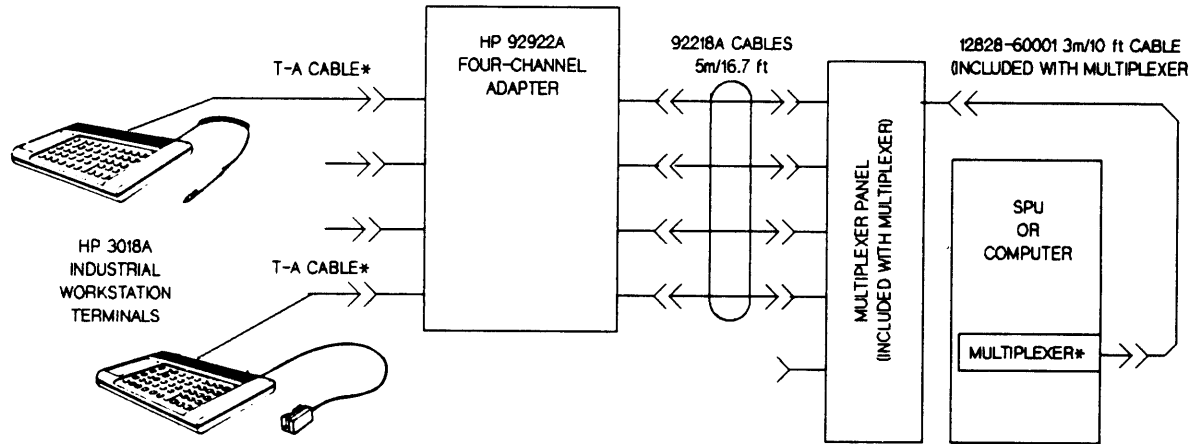

\* T-A Cables are made up by the user from 300m/984 ft reels of cabling and connectors from connector kits supplied with the HP 92922A Four Channel Adapter. Two different T-A cabling products are available. These differ with respect to their maximum usable cut length per terminal because of wire size and resistance per foot, as follows:

92920A Communications/dc power cabling, maximum length 60m/196 ft.

92921A Communications/dc power cabling, maximum length 120m/393 ft.

Figure 2.1-8 HP 3081A Industrial Workstation Terminal Connections to HP 1000 Systems

# Section 2.2

## Selection and Interfacing of Graphics Devices

### 2.2-1 Introduction

This peripherals section contains information on the selection and connection of graphics display, input, and output devices that are supported under the HP 92861A Device-Independent Graphics Library (DGL).

### 2.2-2 Graphics Display

Most graphics applications involve interaction, at least during their development. This requires display of a picture with which the user can interact.

In addition, displays can simplify complex real-time data relationships, such as those involved in process control, for better operator apprehension and response.

For graphics display on HP 1000 systems, Hewlett-Packard offers a variety of monochrome and color graphics terminals and a color monitor. The overall capabilities of graphics displays for HP 1000 Computer Systems are summarized in Table 2.2-1. Connection of graphics terminals is covered in Figures 2.1-1 through 2.1-4 (pages 2.1-5 through 2.1-8) in the previous section. Color monitors are connected to HP 1000 A-Series systems as shown in Figure 2.2-1.

*Table 2.2-1 Graphics Displays Selection Guide*

DISPLAY PRODUCT NUMBER AND NAME	DISPLAY AREA	ADDRESSABLE RESOLUTION	GRAPHICS SPEED		GRAPHICS FEATURES	COMMENTS
			VECTORS/SEC	CHAR/SEC		
GRAPHICS TERMINALS (See Figures 2.1-1 through 2.1-4, pages 2.1-5 through 2.1-8, for interfacing to HP 1000 Systems.)						
2623A Graphics Terminal	164 x 215 mm (6.5 x 8.5 inches)	390 x 512 displayable points	210 under Graphics/1000-II DGL or AGP	Not Spec'd	Rectangular area shading and Tektronix 4010 compatibility mode	Option 050 Integral printer prints hard copy of graphics display on roll-fed thermal paper (30 sec for a full screen)
2625A+523 Dual-System Display Terminal 2628A+523 Word Processing Terminal	164 x 215 mm (6.5 x 8.5 inches)	390 x 512 displayable points			Polygon area fill and Tektronix 4014 compatibility mode	
2627A Color Graphics Terminal	164 x 201 mm (6.5 x 8.0 inches)	390 x 512 displayable points			Eight user-definable colors, polygon area fill, and Tektronix 4010 compatibility mode	Non-interlaced RGB video output with separate sync is Optional (Option 087)
45610B HP Touchscreen Terminal	120 x 160 mm (4.7 x 6.3 inches)	390 x 512 displayable points			Polygon area fill and Tektronix 4014 compatibility mode	In graphics mode, the 45610B emulates the 2623A Graphics Terminal with a smaller display. Optional 2674A integral printer prints hard copy of graphics display on roll-fed thermal paper (30 sec for a full screen)
MONITOR (See Figure 2.2-2 for connection to HP 1000 Systems.)						
13279B 19-Inch Color Monitor, connected via 12065A Color Video Output Interface	251 x 335 mm (9.71x12.96 inches)	809 x 1080 displayable points	150 for 450 pixel vector, 1500 for 50 pixel vector	100 to 450 depending upon type of char	Polygon area fill, flash fill and modes, scrolling, 4 planes usable for 8 colors from 4096 plus overlay or 16 colors from 4096 without overlay.	Up to five 13279B monitors can be connected to one 12065A Color Video Output Interface. The HP 13279B complies with FCC RFI regulations.

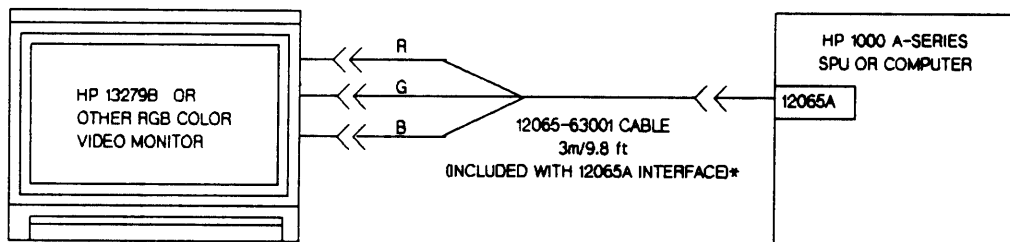

\* Usable length can be up to 152m/500 ft with RG-11/U (Belden #9212) coaxial cabling. 76m/250 ft with RG-59/U (Belden #9259) coaxial cabling.

Figure 2.2-1 Color Monitor Connection to HP 1000 A-Series Computer Systems

### 2.2-3 Graphics Input

The Device-Independent Graphics Library supports two principal methods of entering graphics information into HP 1000 Systems. A picture can be drawn on a graphics terminal using the graphics cursor control keys and stored in the system, but a better means of graphics input is to use a graphics tablet to trace the picture. This can be done in a

continuous mode or at line segment end points. With either method, the traced picture is displayed to provide feedback to the person working on it.

Graphics tablets are connected to HP 1000 Computer Systems as shown in Figure 2.2-2 and their specifications are listed in Table 2.2-2.

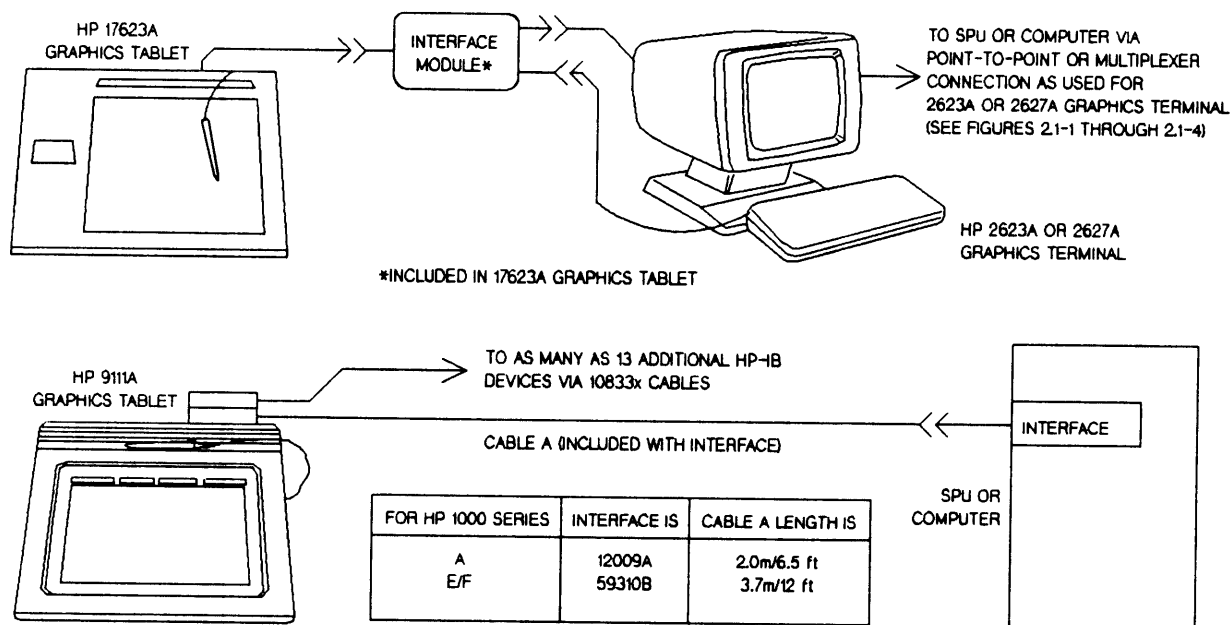

Figure 2.2-2 Graphics Tablet Connections to HP 1000 Computer Systems



Table 2.2-2 Graphics Tablets Selection Guide

PRODUCT NUMBER AND NAME	ACTIVE DIGITIZING AREA	USABLE RESOLUTION	TRANSFER RATE (Coordinate Pairs/Sec)*	COMMENTS
17623A Graphics Tablet	217 x 295 mm (8.5 x 11.6 inches)	390 x 512 points	15 at 2400 Baud, 60 at 9600 Baud; local cursor tracking rate is 30	Connects to a 2623A Graphics Terminal (which may require a firmware upgrade and will require a power supply upgrade if it doesn't include a printer; contact HP Sales Rep for more information) or a 2627A Color Graphics Terminal (see Figure 2.2-2 for connections).
9111A Graphics Tablet	218 x 300 mm (8.6 x 11.8 inches)	0.001 mm (0.00394 inches)	1 to 60, programmable	Usable with any display supported under the HP 92861A Graphics/1000-II Device-Independent Graphics Library. See Figure 2.2-2 for connections. Accuracy is +/- 0.600 mm (0.0236 in.) at 20 degrees C for each measured point +/- 0.004 mm (0.00016 in.) per degree C above or below 20 degrees C.

\* Provided that other system activity is not affecting the rate at which I/O accesses can be made available for input from the graphics tablet.

## 2.2-4 Graphics Hardcopy Output

### Graphics Plotters

Graphics plotters provide the most precise hardcopy output. In addition, they offer the only means of producing output in multiple colors or on transparent media for projection.

Plotter connection to HP 1000 Computer Systems is shown in Figure 2.2-3, below, and plotter capabilities supported under the HP 92861A Device-Independent Graphics Library are listed in Table 2.2-3.

### Graphics Printers

Most of the dot-matrix printers supported on HP 1000 Computer Systems can be used to print graphics as well as alphanumeric output. In applications for which monochrome graphics output is satisfactory and precision is relatively unimportant, a printer with graphics capability may provide adequate graphics hardcopy.

There are two different types of graphics printing. The first type is a printer that prints a "raster dump" copy of a graphics terminal's graphics display. Interfacing is simple, as shown in Figure 2.2-4 and no system overhead is incurred to get the hard copy output.

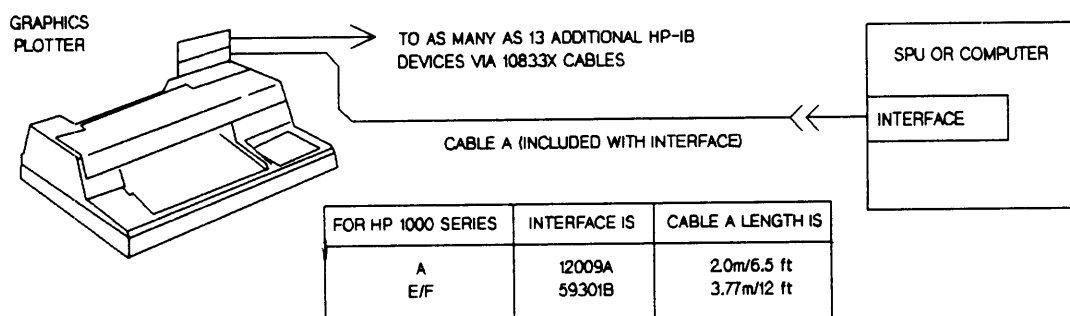

Figure 2.2-3 Graphics Plotter Connection to HP 1000 Computer Systems

Selection and Interfacing  
of Graphics Devices

Table 2.2-3 Graphics Plotters Selection Guide

PRODUCT NUMBER AND NAME	NO. OF PENS	PAPER SIZES	MAXIMUM PLOTTING AREA		RESOLUTION		REPEATABILITY WITH A GIVEN PEN		MAX. PROGR. PEN VELOCITY (PEN DOWN)		COMMENTS
			mm	INCHES	mm	IN.	mm	IN.	Cm/S	IN./S	
7470A+002 Graphics Plotter	2	A A4	191x258 191x272	7.5x10.2 7.5x10.7	0.25	0.001	0.1	0.004	38	15	Low-priced plotter for A/A4-sized plots. Has five character sets, including ANSI ASCII, French/German, Scandinavian, and Spanish/Latin American.
7475A+002 Graphics Plotter	6	A A4 B A3	198x258 192x275 414x258 402x275	7.8x10.2 7.6x10.8 16.3x10.2 15.8x10.8	0.25	0.001	0.1	0.004	38	15	Multicolor plotter for A/A4/B/A3-sized plots. Includes all 7470A char sets plus JIS ASCII, Roman 8 Extensions, Katakana, and ISO sets for Swedish, Danish/Norwegian, German, French, United Kingdom, Italian, Spanish, & Portuguese.
7550A 8-Pen Graphics Plotter	8	A A4 B A3	196x253 190x272 411x253 399x272	7.7x9.97 7.5x10.7 16.2x9.97 15.7x10.7	0.25	0.001	0.1	0.004	80	31.5	Ultra-fast plotter for A/A4/B/A3-sized media, with automatic sheet feeder for A/A4 media, HP-IB & RS-232-C interfaces, 12k byte buffer, and all character sets provided in the 7475A.
7580B Drafting Plotter	8	A/A4 to D/A1	267x203 to 622x1232	10.5x8.00 to 24.5x48.5	0.25	0.001	0.1	0.004	60	24	Drafting plotter for A/A4 thru D/A1-sized media, w/both HP-IB & RS-232-C interfaces, 18k byte buffer, & all character sets provided in 7475A.
7585B Drafting Plotter	8	A/A4 to E/A0	267x203 to 927x1232	10.5x8.00 to 36.5x48.5	0.25	0.001	0.1	0.004	60	24	Drafting plotter for A/A4 thru E/A0-sized media, with all other capabilities the same as the 7580B.
7586B Roll-Feed Drafting Plotter	8	A/A4 to E/A0	267x203 to 927x1232	10.5x8.00 to 36.5x48.5	0.25	0.001	0.1	0.004	60	24	Drafting plotter for A/A4 thru E/A0-sized sheets, or continuous rolls in widths to 919 mm/36.2 in., with all other capabilities the same as the 7580B.

The second type of graphics printing uses a vector-to-raster conversion routine from the HP 92861A Device-Independent Graphics Library to generate the raster graphics output for a printer that is connected to the HP 1000 Computer System. Because the graphics data can be processed prior to output, this type of graphics printing provides more control of size and aspect ratio than a simple raster dump from a terminal. Type 2 graphics printers are compared in Table 2.2-4 and connect to HP 1000 systems as shown in Figure 2.2-5.

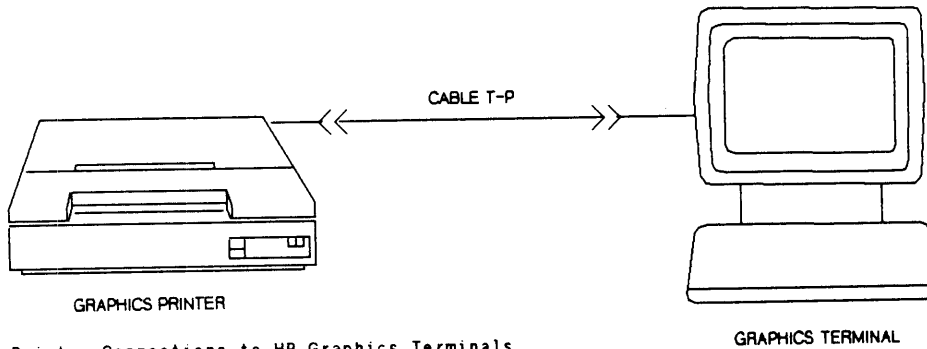

Graphics Printer Connections to HP Graphics Terminals

CONNECT TERMINAL		TO GRAPHICS PRINTER PRODUCT NUMBER AND NAME	USING CABLE PRODUCT NUMBER	LENGTH
PRODUCT NO.	PORT			
2623A 2627A 45610B	Prtr	2671G+040 120 cps, 80/132 col Graphics Printer 2673A+040 Intelligent Graphics Printer 2932A 200 cps, 132 col General-Purpose Printer 2934A 200/67/40 cps, 132 col Office Printer	13242G	5m/16.7 ft
2625A+ 026,523 2628A+ 026,523 45610B	HPIB	2671G 120 cps, 80/132 col Graphics (thermal) Prtr 2673A Intelligent Graphics (thermal) Printer 2932A+046 200 cps, 132 col General-Purpose Printer 2934A+046 200/100/50 cps, 132 col Office Printer 82906A+00x 160 cps/80 col Dot-Matrix Printer	10833A or 10833B or 10833C	1m/3.2 ft 2m/6.5 ft 4m/13 ft

Figure 2.2-4 Graphics Printer Connection to Graphics Terminals

Table 2.2-4 Graphics/1000-II DGL-Supported Graphics Printers Selection Guide

PRODUCT NUMBER AND NAME	MAXIMUM GRAPHICS PRINT RATE#	MAXIMUM PAPER WIDTH		MAXIMUM IMAGE AREA (WIDTH* x HEIGHT)		RESOLUTION (DOTS/IN.)	COMMENTS
		mm	IN.	MILLIMETERS	INCHES		
2563A Line Printer	29 inches per minute	424	16.7	1082.68x335.28	42.6x13.2	70 x 72	300 Lines per minute printer with graphics capability
2565A Line Printer	66 inches per minute	457	18.0	1082.68x335.28	42.6x13.2	70 x 72	600 Lines per minute printer with graphics capability
2566A Line Printer	50 inches per minute	457	18.0	1082.68x335.28	42.6x13.2	70 x 72	880 Lines per minute printer with graphics capability
2932A or 2934A Printer	8 inches per minute for 11.3-inch print width	400	15.75	1082.6 x289	42.6x11.3	90 x 90	200 char per sec serial printers with graphics capability

\* Provided that other system activity is not affecting the rate at which I/O accesses can be made available for output to the graphics printer.

\* The maximum width dimension, set by the Device-Independent Graphics Library, can extend along as many as four successive pages; the maximum height dimension is set to fit into the maximum width of the paper that can be used in the printer.

# Selection and Interfacing of Graphics Devices

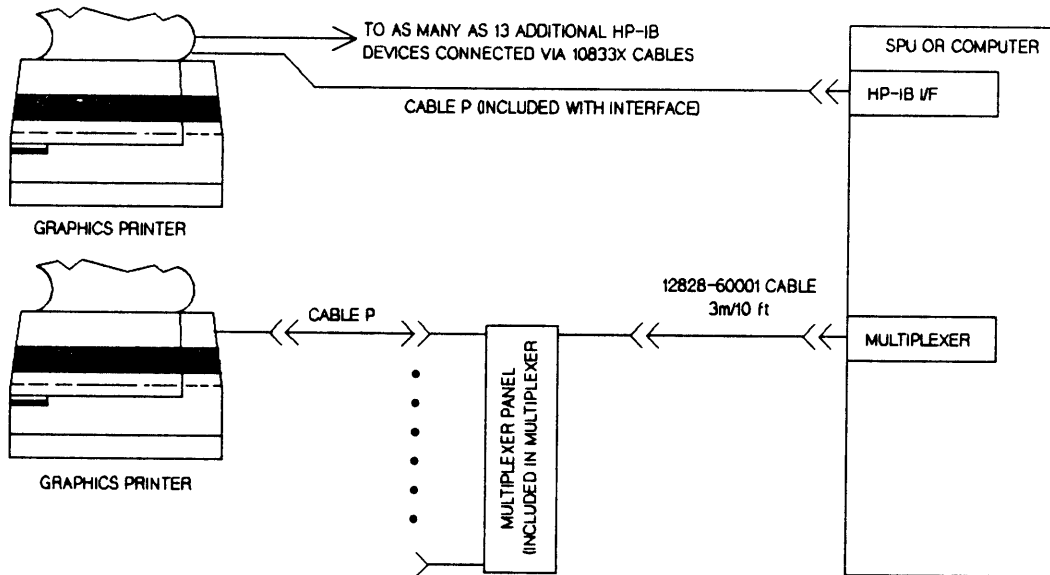

Graphics Printer Connections Summary

FROM SERIES	TO GRAPHICS PRINTER PRODUCT AND OPTION NUMBERS AND NAMES	CONNECT USING			COMMENTS
		INTERFACE PRODUCT NO.	CABLE PRODUCT OR PART NO.	LENGTH (m/ft)	
A	2563A+214 300 LPM Line Printer 2565A+214 600 LPM Line Printer 2566A+214 880 LPM Line Printer	12009A+001 (HP-IB)	12009-60008 is included w/12009A+001	4/13	Max. of two 256xA+214 Line Printers per 12009A interface
	2932A General-Purpose Printer 2934A Office Printer	12040B (Multiplexer)	92219G	3.8/12.5	
E/F	2563A+210 300 LPM Line Printer 2565A+210 600 LPM Line Printer 2566A+210 880 LPM Line Printer	12821A+001 (HP-IB)	59310-60002 is included w/12821A+001	3.69/12	Maximum of one 256xA+210 per 12821A+001 interface.

Figure 2.2-5 Graphics Printer Connections to HP 1000 Computer Systems

# Section 2.3

## Printer Selection and Interfacing

### 2.3-1 Introduction

This peripherals section contains information on the selection and connection of printers for HP 1000 Computer Systems.

### 2.3-2 Types of Printers

Four types of printers, listed in Table 2.3-1, are supported in HP 1000 Computer Systems, making it easy to get the right type of printer for your application. These printers are compared with respect to relative cost, print speed, noise level, relative paper cost, and estimated print quality.

**Dot-matrix serial impact printers** combine versatility with low cost and good print speed. Versatility can include graphics image and bar code printing and the ability to trade print speed for better print quality. Good print speed means that a dot-matrix serial impact printer can be used as the only printer on a system with modest-to-average printing requirements.

**Dot-matrix impact line printers** offer versatility similar to dot-matrix serial impact printers at faster print speeds and higher prices. A dot-matrix impact line printer should be selected for uses with large printing requirements.

**Laser printers** combine excellent print quality with print speed a bit faster than the fastest dot-matrix serial printers at higher cost. Laser printers are also the quietest supported in HP 1000 Computer Systems. They are recommended for systems with average printing workload in which high print quality is important and the lack of multipart forms print capability is irrelevant.

**Dot-matrix serial thermal printers** offer low price, reasonably fast print speed, and quieter operation than impact printers. The principal disadvantages of thermal printers are the high cost of thermal paper, over 30 times more per page for paper than the other printers, and relatively poor print quality. This type of printer is useful mainly as a low-cost, light-workload, workstation printer. It should never be considered for use as the only printer in a system.

### 2.3-3 Printer Selection

All of the printers currently supported on HP 1000 Computer Systems are compared in Printer Selection Guide Table 2.3-2 with respect to available character sets, matrix size, maximum print rate, paper type, and characters per line.

*Table 2.3-1 Types of Printers Supported on HP 1000 Systems*

TYPE OF PRINTER	COMPARISON FACTORS				
	RELATIVE COST OF HP PRINTERS* (Lowest priced printer equals 1.0)	PRINT SPEED (Char/sec or equivalent char/sec)	NOISE LEVEL	RELATIVE PAPER COST (8.5x11 non-thermal printer paper = 1.0)	ESTIMATED PRINT QUALITY
Dot-Matrix Serial Impact (A)	1.0	80 to 160	Not Spec'd	1.0 to 1.3	C
Dot-Matrix Serial Impact (B)	2.7 to 3.1	40 to 200	63 dB(A)	1.0 to 1.3	B to A
Dot-Matrix Line Impact	5.8 to 22.2	660 to 1920	65 dB(A)	1.0 to 1.3	C to B
Laser	3.6 to 12.6	165 to 250	53 dB(A)	1.0	A
Dot-Matrix Serial Thermal	1.4 to 2.4	120	60 dB(A)	31.2	D

\* Relative cost of HP printers is cost as interfaced to system and is derived from pricing information in the HP Corporate Price List.

Printer Selection  
and Interfacing

Table 2.3-2 Printers Selection Guide

PRINTER PRODUCT NUMBER & NAME	AVAILABLE CHARACTER SETS	MATRIX SIZE	MAX. SYSTEM PRINT RATE	PAPER TYPE	MAX CHAR PER LINE			COMMENTS	
					NORM	EXP	COM		
DOT-MATRIX SERIAL IMPACT PRINTERS									
2932A General Purpose Printer	128 USASCII, French, Spanish, German, Italian, U.K., Norwegian/ Danish, Swedish/ Finnish, JASCII, Katakana, Line Drawing, and Math Symbols	9x12	200 cps, bi- directional, with optimized path	Up to 400 mm/ 15.75 in. wide std fan-fold paper, up to six-part forms.	136	68	223	Usable in all HP 1000 Systems. For use as graphics printer, see page 2.2-5.	
2934A Office Printer	Same as 2932A, above, plus bar codes and large characters (up to 28X magnifi- cation).	9x12 36x24	200 cps (memo quality) or 67 or 40 cps (let- ter quality), bidirectional with optimized path. Bar codes at 650 labels per hour for 10-char code.						
82905B Impact Printer	USASCII	9x9	80 cps, bi- directional	Up to 254 mm/ 10 in. wide std fan-fold paper, up to three- part forms.	80	40 or 66	132	Usable in HP 1000 A-Series only; graphics use not supported.	
82906A Dot- Matrix Printer			160 cps, bi- directional						
DOT-MATRIX IMPACT LINE PRINTERS									
2563A Line Printer	128 USASCII, Danish, Dutch, Finnish, French, German, Italian, Norwegian, Por- tuguese, Spanish, and Swedish. Options offer Drawing, Math Symbols, Large Characters, JASCII and Kata- kana instead of std char set, high density, OCR chars, and Bar codes.	5x7 or 6x14*	300/233 LPM or 150/117 LPM for upper/lower case. Bar codes print at 14.5 inches/minute.	Up to 424 mm/ 16.7 in wide std fan-fold paper, up to six-part forms.	132	66	220	Usable in all HP 1000 Systems.  For use as graphics printer, see page 2.2-5.	
2565A Line Printer		5x7 or 7x14*	600/480 LPM or 166/130 LPM for upper/lower case. Bar codes print at 33 inches/minute.						Up to 457 mm/ 18 in. wide std fan-fold paper, up to six-part forms.
2566A Line Printer		5x7 or 7x14*	880/720 LPM or 248/195 LPM for upper/lower case. Bar codes print at 50 inches/minute.						

\* High density printing is optional in 2563A, 2565A, or 2566A Line Printer.

N/A = Not Applicable. cps = characters per second cpi = characters per inch LPM = Lines Per Minute

Table 2.3-2 Printers Selection Guide, continued

PRINTER PRODUCT NUMBER & NAME	AVAILABLE CHARACTER SETS	MATRIX SIZE	MAX. SYSTEM PRINT RATE	PAPER TYPE	MAX CHAR PER LINE			COMMENTS
					NORM	EXP	COM	
LASER PRINTERS (Supported only in HP 1000 A-Series Systems.)								
2686A Laser- jet Printer	USASCII and roman extension characters for international use	300 x 300	2 to 8 pages per minute	8.5x11 in. or A4 (210x297 mm) high-quality copier bond paper in 100- sheet input tray	80*  (10 cpi)	N/A	96* or 127*  (12 or 16.7 cpi)	Font changes in copy and change of copy orientation on the page are software selectable.
2687A Desktop Laser Page Printer	USASCII French, U.K., Kana, and Scien- tific	300 x 300	3 to 12 pages per minute	8.5x11 in. or A4 (210x297 mm) high-quality copier bond paper in 250- sheet input tray	80*  (10 cpi)	N/A	96* or 120* (12 or 15 cpi)	Font changes in copy, support of propor- tional spacing, and change of copy orientation on the page are controlled by escape characters embedded in the out- put to the 2687A.
DOT-MATRIX SERIAL THERMAL PRINTERS (Supported only in HP 1000 A-Series Systems.)								
2671A Printer	128 USASCII plus Roman Extension characters for international use and line drawing char. for forms.	7x11	120 cps, bi- directional, with optimized path	216 mm/8.5 in. wide fan-fold or roll-fed thermal paper, page perforated or continuous.	80  (10 cpi)	N/A	132  (16.7 cpi)	Graphics capability is not supported by Graphics/1000-II software.
2671G Graphics Printer								
2673G Intelli- gent Graphics Printer								
	Same as 2671A/G, above, plus JASCII, and ISO Norwegian/Danish, Swedish/Finnish, French, German, U.K., & Spanish.					40  (5 cpi)		

N/A = Not Applicable. cps = characters per second cpi = characters per inch LPM = Lines Per Minute

\* Characters per line with portrait orientation; landscape orientation on an 8-1/2 x 11 page supports approximately 32% more characters per line.

### 2.3-4 Printer Interfacing

Printer connection is illustrated in Figure 2.3-1 and summarized with respect to interface and cable used for the various printers in Table 2.3-3.

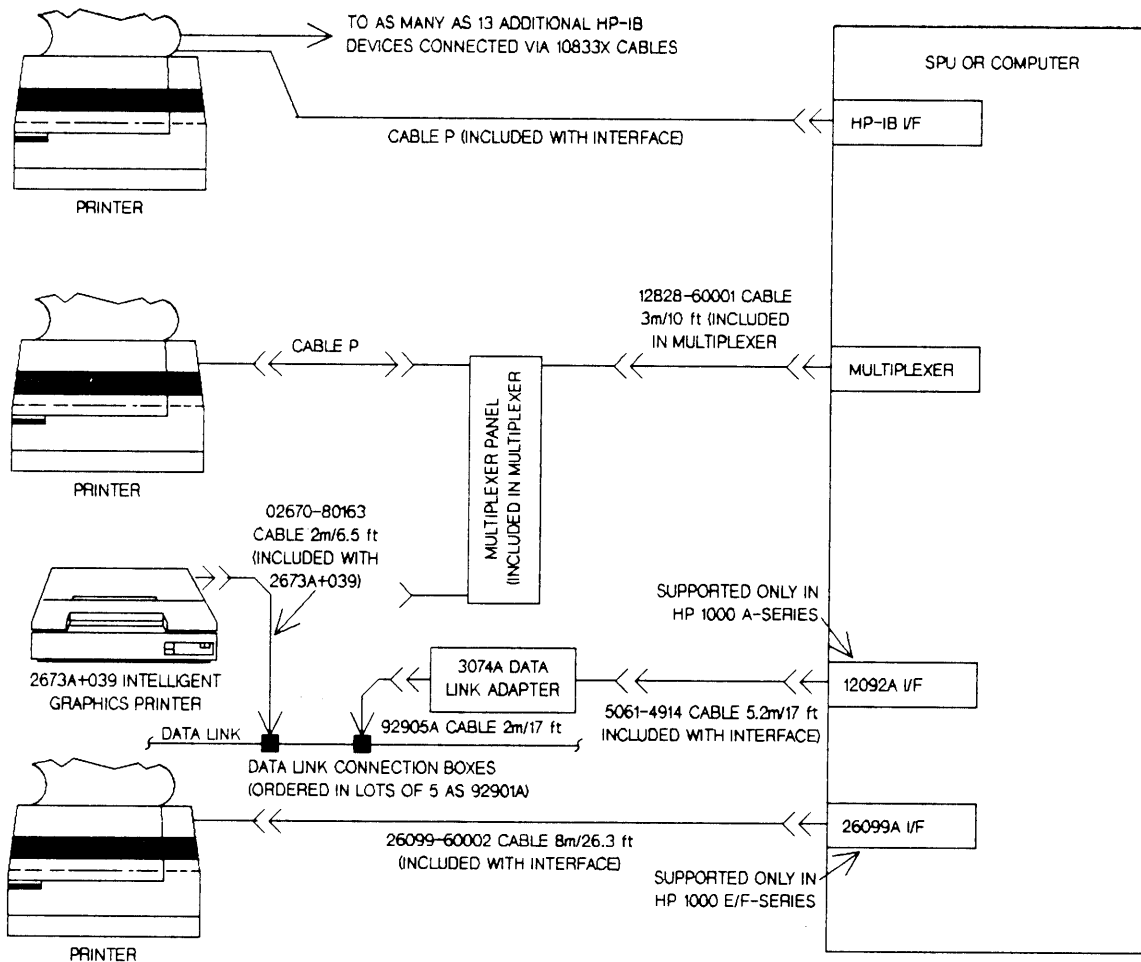

Figure 2.3-1 Printer Connections in HP 1000 Systems



Table 2.3-3 Printer Interfacing Summary

FROM SERIES	TO PRINTER PRODUCT AND OPTION NUMBERS AND NAMES	CONNECT USING			COMMENTS					
		INTERFACE PRODUCT NO.	CABLE PRODUCT OR PART NO.	LENGTH (m/ft)						
A	2563A+214 300 LPM Line Printer 2565A+214 600 LPM Line Printer 2566A+214 880 LPM Line Printer	12009A+001 (HP-IB)	12009-80008 is included w/12009A+001	4/13	HP 1000 A-Series only; max. of two 256xA Line Printers per 12009A interface.					
	2671A (120 cps thermal) Printer 2671G (thermal) Graphics Printer 2673G Intell. Graphics Printer 2932A+046 Gen'l-Purpose Printer 2934A+046 Office Printer 82905B+00x Impact Printer 82906A+00x Dot-Matrix									
	2563A+049 300 LPM Line Printer					12040B (Multi-plexer)	92219G	3.8/12.5	HP 1000 A-Series only.	
	2565A+049 600 LPM Line Printer 2566A+049 750 LPM Line Printer									
	2686A Laserjet Printer						13242N	5/16.7	HP 1000 A-Series only.	
	2687A Desktop Laser Page Printer						92219G	3.8/12.5		
	2932A General-Purpose Printer 2934A Office Printer									
	2673A+039 Intelligent Graphics Printer					12092A	02670-80163, included with 2673A Opt 039.	2/6.5	HP 1000 A-Series only; also requires HP 91732A Data Link software.	
	E/F					2563A+100 300 LPM Line Printer 2565A+100 600 LPM Line Printer 2566A+100 880 LPM Line Printer	26099A (para. diff.)	26099-60002, included with 26099A.	8/26.3	Parallel differential interfacing is same as formerly used for 2608A Line Printer.
						2563A+210 300 LPM Line Printer 2565A+210 600 LPM Line Printer 2566A+210 880 LPM Line Printer	12821A+001 (HP-IB)	59310-80002, included with 12821A+001.	3.69/12	Max. of one 256xA+210 Line Printer per 12821A interface.
2563A+049 300 LPM Line Printer		12792B (Multi-plexer)	92219G	3.8/12.5	Max. print speed requires 19.2k baud multiplexer data rate.					
2565A+049 600 LPM Line Printer 2566A+049 750 LPM Line Printer										
2932A General-Purpose Printer 2934A Office Printer										

# Section 2.4

## Selection and Interfacing of Mass Storage Devices

### 2.4-1 Introduction

This peripherals section contains information on the selection and connection of mass storage devices (discs, flexible discs, and cartridge and reel-to-reel-magnetic tape units) for HP 1000 Computer Systems.

### 2.4-2 System Functions of Mass Storage Devices

Mass storage devices provide for the installation, storage, and backup of the operating system, programs, and data for HP 1000 Computer Systems.

#### System Bootup

Each system must include a mass storage device that supports bootup\* to initiate operation of a particular generation or configuration of the operating system. The system bootup function is supported by all HP 1000-compatible magnetic tape units and by most, but not all, HP 1000-compatible discs. If the bootup device is a disc, it is called a system disc.

*\* A boot-up device is required for any system that does not boot-up from another system via a communications link.*

#### Hard Discs for Fast Access Storage

Hard discs with moving read/write heads are used to provide fast-access storage of programs and data for these reasons:

1. The hard disc media has a dimensional stability which makes possible writing and reading of magnetic patterns of very high density.
2. The hard disc can be made with enough strength and balance to be rotated at high speeds, which:
  - a. Minimizes the rotational delay in accessing data in any particular disc sector.
  - b. Maximizes the rate at which data passes beneath the read/write heads, which determines the maximum data transfer rate.

Hard discs with removable media can also be used for input and backup of programs and data. However, the relatively high cost of disc cartridges and disc packs precludes the distribution of most software via removable disc media. Software is usually provided on magnetic tape or flexible disc media.

#### Magnetic Tape Units for Software/Data Input and Backup

Magnetic Tape Units are used for software/data input and backup for these reasons:

1. Magnetic tape is the lowest-cost, high-density recording medium available and is easily mounted, dismounted, and stored.
2. A cartridge or reel of magnetic tape has high capacity (10-40 times the capacity of a flexible disc), which is essential for backing up large volumes of disc storage.
3. High sequential read-write access rates of magnetic tape drives (equalling or exceeding those of flexible disc drives), which is also necessary for backing up large volumes of disc storage.

#### Flexible Discs for Software Input and Limited-Volume Backup

Flexible discs are an excellent medium for input and backup of individual programs. However, the limited storage capacity of each disc makes it impractical to use flexible discs for input or backup of any but small systems or data bases. This same capacity limitation makes flexible discs cumbersome for the installation of large software products from Hewlett-Packard or other vendors.

### 2.4-3 Disc Selection

#### Types of discs

Three principal types of discs are supported on HP 1000 Computer Systems. These are discussed below and compared with respect to capacity and performance in Table 2.4-1.

## Selection and Interfacing of Mass Storage Devices

**CS/80 and SS/80 Discs** with capacity to 132 MB use Winchester technology wherein the disc is sealed off from environmental contamination. This protection makes possible very high data density, with high capacity in a small space at very low cost per data byte. However, the sealed disc cannot be removed from its drive to lock it up for security or to move it to another system.

CS/80 discs with 404 MB capacity are available with media that can be removed for security or use on another system.

Built-in intelligence and the Command Set/80 or SubSet/80 command set in these discs simplifies interfacing of discs of various capacities. This facilitates upgrading of disc capacity to satisfy changing system requirements.

All CS/80 discs are supported under RTE-A and RTE-6/VM. SS/80 discs are supported under RTE-A. However, CS/80 and SS/80 discs are NOT supported under RTE-IVB. For connections, see Figure 2.4-1.

**Multi-Access Controller (MAC) Discs** accommodate multi-system access to a common storage facility. Up to three A-Series computers or eight E/F-Series computers can be connected to one MAC master disc. Multi-computer compatibility is supported by the RTE-A, RTE-6/VM, and RTE-IVB operating systems and file managers for computers that access their own exclusive disc spaces on one or more MAC disc drives. Shared access to the **same** file spaces by up to four HP 1000 E/F-Series computers is supported under RTE-6/VM by the 91747A Data-share/1000 extended file manager.

All of the MAC discs also incorporate removable media for applications which require that capability.

*NOTE: MAC discs do not support bootup of RTE-A systems, hence are usable only as peripheral discs in systems operating under RTE-A.*

For MAC disc connections to HP 1000 A-Series and E/F-Series computers, see Figures 2.4-2 and 2.4-3, respectively.

**Other Discs** supported under HP 1000 Computer Systems include small fixed hard disc-microfloppy disc packages, 3.5-inch microfloppy discs, and 8-inch flexible discs. The hard disc-microfloppy disc packages are intended for use in small systems in which small size and low cost are overriding considerations. The microfloppy and flexible discs offer a convenient means of loading software into the system and providing copies of software for transportation to other HP 1000 Systems. For connection of other discs to HP 1000 Computer Systems, see Figure 2.4-4.

### Performance Considerations

Capacity, access time, and transfer rates of the discs that are supported on HP 1000 Computer Systems are compared in Table 2.4-1. The significance of these performance factors is discussed in the following paragraphs.

**Capacity.** The disc(s) selected must provide enough storage capacity to accommodate the operating system, storage and working space for program development software, space for data bases, and space for other software and data. For help in determining disc storage capacity requirements, see section 4, behind the Software tab.

In systems with very large disc storage needs, it may be necessary to connect multiple disc drives to one or more interfaces. The RTE primary systems support up to two disc interfaces, up to 3.2 gigabytes of disc storage using eight 7933H or 7935H 404 megabyte discs, four per interface. However, it is possible to generate an RTE system that supports more interfaces to increase disc capacity, up to about 20 gigabytes, limited mainly by card cage spaces available for disc interfaces and the capacity of supported disc memories.

**Access time** is the time required for the moving read/write head to reach the area on the disc that is to be accessed. This includes the average time (including controller overhead) that is required for the head to reach the desired track plus the time required for the desired disc sector to come under the read/write head (this time is half that required for one revolution of the disc).

Table 2.4-1 Disc Memories Capacity and Performance Summary

DISC PRODUCT NUMBER AND NAME	CAPACITY		TOTAL AVG. ACC. TIME* (ms)	AVG. BURST TRANSFER RATE (kB/s)	SUPPORT OF SYSTEM BOOT-UP IN			ADDITIONAL MEDIA	COMMENTS
	MB PER DISC	DISCS PER INTERFACE			RTE-A	RTE-6/VM	RTE-IVB		

CS/80 DISCS FOR A/E/F-SERIES SYSTEMS OPERATING UNDER RTE-A OR RTE-6/VM  
See Figure 2.4-1 for connections. (NOTE A)

7911P/R Fixed Disc	28.1	Up to 4	35	983	Yes	Yes	Not Supported at all	88140LC Pack of five Tape Cartridges	Includes integral cartridge tape drive w/67 MB cartridge, for one-cartridge backup of 7911 or 7912 disc, two-cartridge backup of 7914 disc. HP 79xxP/CT discs are for standalone use and 79xxR discs are for rack mounting.
7912P/R Fixed Disc	65.6		36						
7914P/R/CT Fixed Disc	132.1		36						
7914ST Disc-Tape Subsystem	132.1	Up to 4	36	983	Yes	No	Not Supported at all	N/A	Subsystem with one 7914R+140 disc (without cartridge tape drive) and one 7974A Mag Tape Unit in rack cabinet. Supported only in HP 1000 A-Series.
7914TD Disc-Tape Subsystem	132.1	Up to 4	36	983	Yes	No		N/A	Subsystem with one 7914R+140 disc (without cartridge tape drive) and one 7970E+140 Mag Tape Unit in rack cabinet. Supported only in HP 1000 A-Series.
7914TD+236 Disc-Tape Subsystem	132.1	Up to 4	36	983	No	Yes		N/A	Subsystem with one 7914R+140 disc (without cartridge tape drive) and one 7970E+236 Mag Tape Unit in rack cabinet. Supported only in HP 1000 E/F-Series only under RTE-6/VM.
7933H Fixed Disc	404	Up to 4	35.1	1,200	Yes	Yes		N/A	These discs require an HP 797xA/B/E Magnetic Tape Unit for software input and for system or data base backup and copying.
7935H Removable Media Disc									

SS/80 DISCS FOR A-SERIES SYSTEMS OPERATING UNDER RTE-A

See Figure 2.4-1 for connections.

7941A Fixed Disc	23.8	Up to 4	48.4	625	Yes	No	No	N/A	These discs require an HP 9144A Cartridge Tape Subsystem or an HP 797xA/B/E Magnetic Tape Unit for software input and for system or data base backup and copying.
7945A Fixed Disc	55.5								
7942A Disc-Tape Drive	23.8	Up to 4	48.4	625	Yes	No	No	88140LC Pack of five Tape Cartridges	These mass storage units include an HP 9144A read-after-write cartridge tape drive for software input and for system or data base backup and copying.
7946A Disc-Tape Drive	55.5								

\* Total average access time is the sum of average head seek time plus average rotational delay plus controller overhead if applicable.

NOTE A: One CS/80 disc and one MAC Master disc (next page) can be connected to an A-Series system via a single 12009A interface. However, performance of the discs may be degraded because of contention between the different types of discs on the same bus.

N/A = Not Applicable.

# Selection and Interfacing of Mass Storage Devices

*Table 2.4-1 Disc Memories Capacity and Performance Summary, continued*

DISC PRODUCT NUMBER AND NAME	CAPACITY		TOTAL AVG. ACC. TIME* (ms)	AVG. BURST TRANSFER RATE (kB/s)	SUPPORT OF SYSTEM BOOT-UP IN			ADDITIONAL MEDIA	COMMENTS
	MB PER DISC	DISCS PER INTERFACE			RTE-A	RTE-6/VM	RTE-IVB		

MULTI-ACCESS CONTROLLER DISCS FOR HP 1000 A/E/F-SERIES SYSTEMS OPERATING UNDER RTE-A, RTE-6/VM, OR RTE-IVB.

See Figures 2.4-2 and 2.4-3 for connections to HP 1000 A-Series and E/F-Series, respectively. (NOTE A)

7906M Master Disc and 7906S Slave Disc	19.6	One 79xxM/MR Master Disc and up to five 79xxS Slave Discs with A-Series, up to seven 79xxS Slave Discs with E/F-Series, which can be inter-mixed	33.3	740	No	Yes	Yes	12940A Disc Cartridge	Approximately half of the storage capacity of this disc is on a removable cartridge. HP 7906M and 7906S are stand-alone discs; HP 7906MR+025 is a rack mounting disc.
7906MR+025 Master Disc									
7920M Master Disc and 7920S Slave Disc	50.1		33.3	740	No	Yes	Yes	13394A Disc Pack	HP 7920M and 7925M are stand-alone with all storage capacity on removable disc packs. An HP 797xA/B/E Mag Tape Unit or a 7920S/7925S with the same capacity as the master disc is required to provide backup and copy capability for the master. This requirement can be satisfied by a second system with same capacity master disc with appropriate backup at the same operating site.
7925M Master Disc and 7925S** Slave Disc	120.2		36.1	740	No	Yes	Yes	13356A Disc Pack	

OTHER DISCS FOR A/E/F-SERIES SYSTEMS OPERATING UNDER RTE-A, RTE-6/VM, OR RTE-IVB

For connections, except 243xA/E or 248xA Option 111, see Figure 2.4-4.

243xA/E or 248xA Option 111 Integral Fixed and Microfloppy Discs	14.5 and 0.27	One	85** 430	230** 17	Yes	Not Supported at all	Not Supported at all	92191A Ten-disc kit	Supported only in Micro/1000 Systems.
9122D Dual Microfloppy Disc	1.42	Up to 2	485	18	No	No			For desk or tabletop use. E/F-Series.
9133D Fixed and Microfloppy Discs	14.8 and 0.71		171** 485	44** 18	Yes	Not Supported at all			For desk or tabletop use. Not supported in HP 1000 E/F-Series.
9895A Dual Flexible Disc	2.3		174	23	No	No	No	92195A Ten-disc kit	For desk or tabletop use or rack mounting.
9895A+010 Single Flexible Disc	1.15								

\* Total average access time is the sum of average head seek time plus average rotational delay plus controller overhead if applicable.

\*\* A MAC Master disc controller is compatible with 7925S Slave Discs, but if a 7925S is being added to an older system for the first time, the master disc controller may require a 7925S option 250 upgrade kit to establish compatibility. Check with your Hewlett-Packard Sales Representative if adding a 7925S disc to an HP 79xxM Master Disc that was purchased prior to 1980.

NOTE A: One CS/80 disc and one MAC Master disc can be connected to an A-Series system via a single 12009A interface. However, performance of the discs may be degraded because of contention between the different types of discs on the same bus.

\*\* Applies to Mini Winchester disc

Minimizing access time is most important in real-time applications that are heavily dependent upon disc accesses, such as processing of Virtual Memory Area data arrays for simulation or interactive graphics. Frequent access to data base information is another situation in which it is particularly desirable to minimize disc access time.

**Transfer rate** is a function of recording density and speed of disc rotation. Fast transfers are most important in applications that involve transfers of large files between systems or frequent overlaying of program segments.

**Multi-Interface Access to Discs** may be necessary because the required disc capacity cannot be connected to the system via a single interface. However, multi-interface access may also be used to provide parallel paths that permit multiple disc accesses to take place concurrently, thereby speeding up overall throughput.

Although multi-interface access can be used to speed up overall throughput, the extent to which it is usable for that purpose is limited by the I/O bandwidth of the computer. The aggregate data

rate of all concurrent disc transfers and other concurrent transfers cannot exceed the I/O bandwidth of the computer and may not quite reach it. Attempts to exceed the computer's I/O bandwidth can even result in loss of data. With MAC discs, which are less intelligent than the CS/80 and SS/80 discs, and HP 1000 E-Series Computers having standard performance memory, attempts at simultaneous disc access via two interfaces have exceeded I/O bandwidth and actually resulted in loss of data. For I/O bandwidths of the various HP 1000 Computers, see Table 1-1 on page 1-3.

## 2.4-4 Disc Interfacing

Connection of discs to HP 1000 Computer Systems is illustrated in Figures 2.4-1 through 2.4-4.

*NOTE: One CS/80 disc can be connected to the same 12009A interface as one MAC Master disc. A maximum of five 79xxS slave discs can be connected to a MAC master disc in A-Series systems. Performance may be degraded because of contention between the two different types of discs on the same HP-IB bus.*

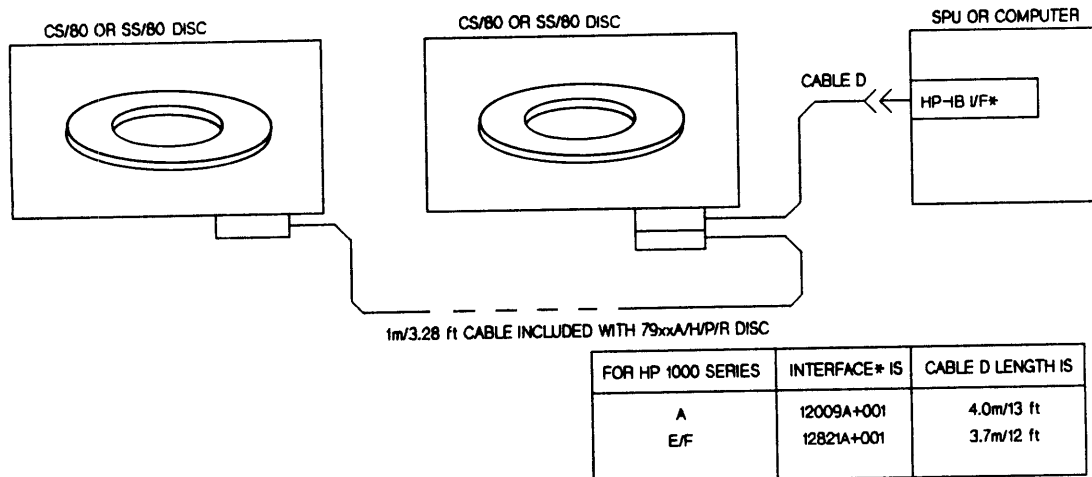

\*12009A OR 12821A INTERFACE IS INCLUDED IN HP 1000 SPU WITH CS/80 CONNECT OPTION; MUST BE ORDERED FOR COMPUTER

Figure 2.4-1 CS/80 and SS/80 Disc Connections to HP 1000 Computer Systems

# Selection and Interfacing of Mass Storage Devices

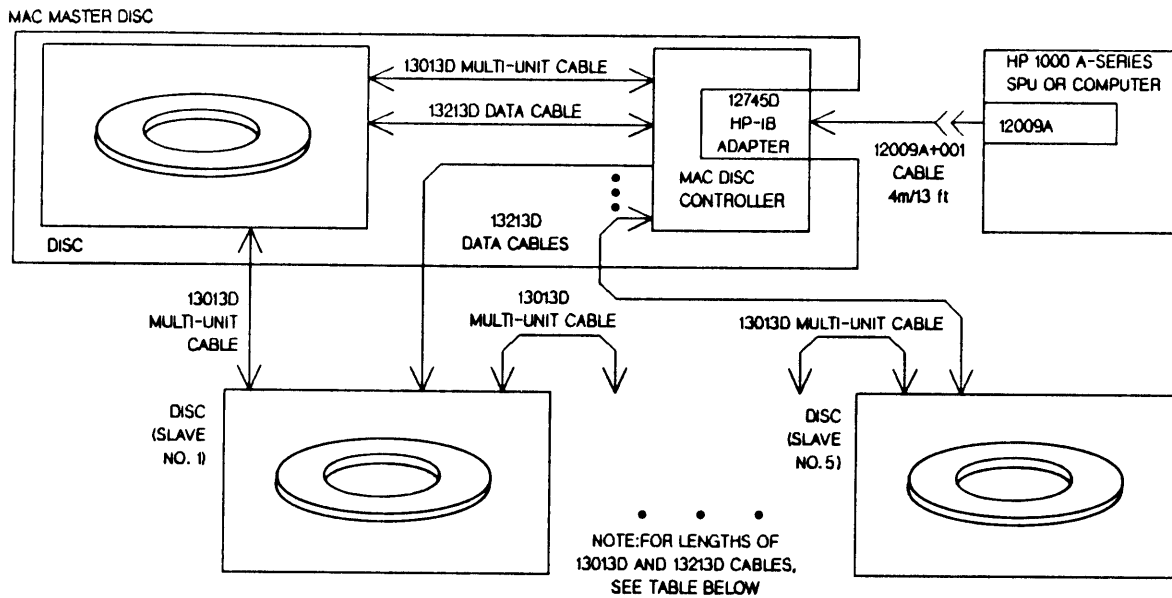

CABLE PRODUCT AND OPTION NUMBERS AND NAME	CABLE LENGTH	COMMENTS
13013D MULTI-UNIT CABLE	3.65m / 12 ft	SUPPLIED WITH 7906MR/SR
13013D+001 MULTI-UNIT CABLE	1.82m / 6 ft	SUPPLIED WITH 7906M/7920M/7925M
13013D+002 MULTI-UNIT CABLE	5.4m / 18 ft	AVAILABLE FOR SEPARATE PURCHASE
13013D+003 MULTI-UNIT CABLE	2.43m / 8 ft	SUPPLIED WITH 7906S/7920S/7925S
13213D DATA CABLE	3.04m / 10 ft	SUPPLIED WITH 7906MR/SR
13213D+001 DATA CABLE	7.6m / 25 ft	AVAILABLE FOR SEPARATE PURCHASE
13213D+002 DATA CABLE	15.2m / 50 ft	SUPPLIED WITH 7906S/7920S/7925S
13213D+003 DATA CABLE	22.8m / 75 ft	AVAILABLE FOR SEPARATE PURCHASE
13213D+004 DATA CABLE	1.82m / 6 ft	SUPPLIED WITH 7906M/7920M/7925M

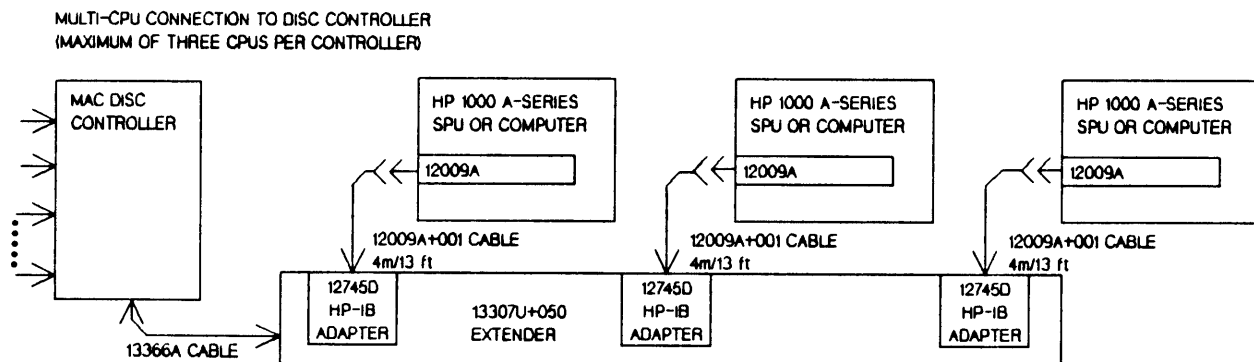
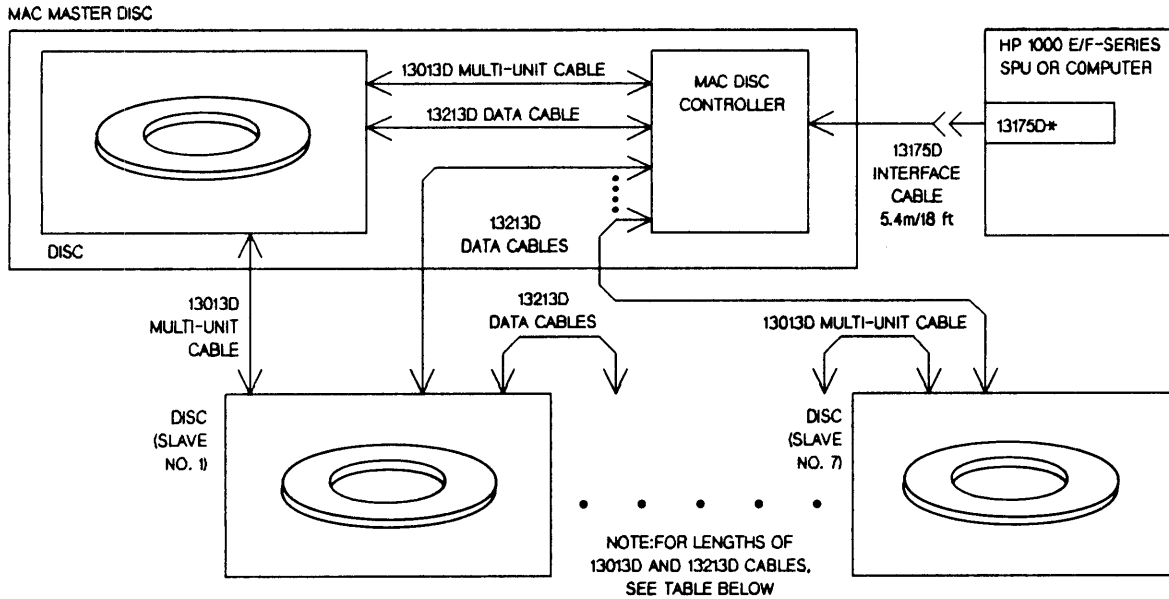

Figure 2.4-2 MAC Disc Connections to HP 1000 A-Series Computer Systems



CABLE PRODUCT AND OPTION NUMBERS AND NAME	CABLE LENGTH	COMMENTS
13013D MULTI-UNIT CABLE	3.65m/12 ft	SUPPLIED WITH 7906MR/SR
13013D*001 MULTI-UNIT CABLE	1.82m/ 6 ft	SUPPLIED WITH 7906M/7920M/7925M
13013D*002 MULTI-UNIT CABLE	5.4m /18 ft	AVAILABLE FOR SEPARATE PURCHASE
13013D*003 MULTI-UNIT CABLE	2.43m/ 8 ft	SUPPLIED WITH 7906S/7920S/7925S
13213D DATA CABLE	3.04m/10 ft	SUPPLIED WITH 7906MR/SR
13213D*001 DATA CABLE	7.6m /25 ft	AVAILABLE FOR SEPARATE PURCHASE
13213D*002 DATA CABLE	15.2m/50 ft	SUPPLIED WITH 7906S/7920S/7925S
13213D*003 DATA CABLE	22.8m/75 ft	AVAILABLE FOR SEPARATE PURCHASE
13213D*004 DATA CABLE	1.82m/ 6 ft	SUPPLIED WITH 7906M/7920M/7925M

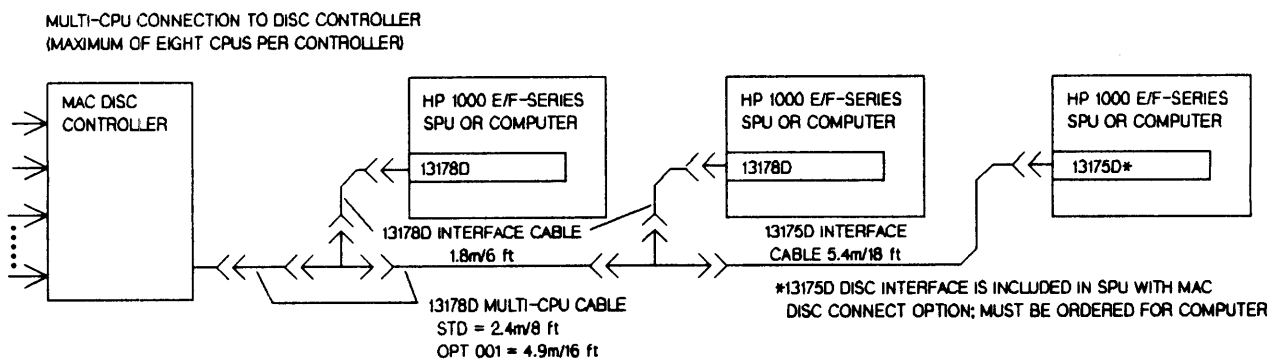
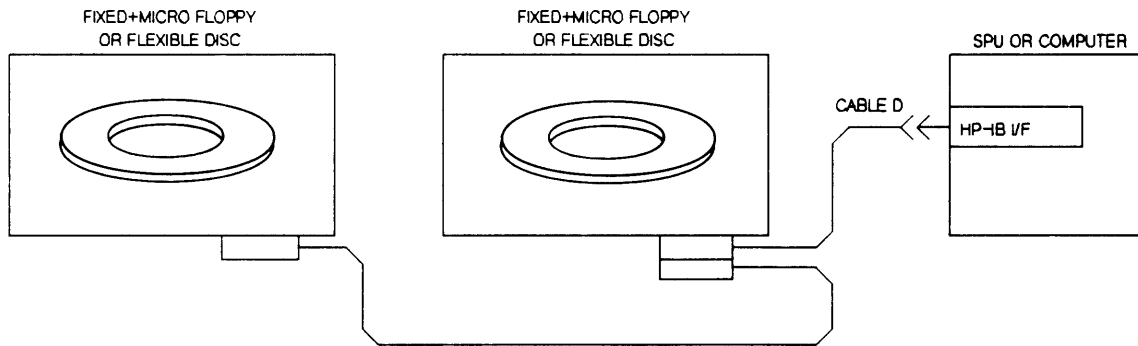

Figure 2.4-3 MAC Disc Connections to HP 1000 E/F-Series Computer Systems



## Selection and Interfacing of Mass Storage Devices



DISC-TO-DISC  
CABLE CHOICES:

10833A 1m/3.28 ft  
10833B 2m/6.5 ft  
10833C 4m/13 ft  
10833D 0.5m/1.64 ft

FOR HP 1000 SERIES	INTERFACE IS	CABLE D LENGTH IS
A	12009A+001	4.0m/13 ft
E/F *	12821A+001	3.7m/12 ft

\* NOTE: ONLY THE 9122D AND 9895A FLEXIBLE DISCS ARE SUPPORTED IN HP 1000 E/F-SERIES SYSTEMS

Figure 2.4-4 Connection of Other Discs to HP 1000 Computer Systems

### 2.4-5 Magnetic Tape Unit Selection

#### Performance Considerations

A magnetic tape unit must provide a transfer rate and capacity adequate to the job it has to perform. These, in turn, depend upon recording density, operating mode, and tape speed, as summarized for the various HP 1000-supported magnetic tape units in Table 2.4-2.

**Transfer rate** becomes increasingly important as the size of the system or data base to be backed up increases. Backup of a very large system or data base can easily require multiple tapes and one to several hours to complete. A tape unit with a fast transfer rate will get the job done in proportionately less time than a slower tape unit.

**Capacity per reel of tape** is another performance factor whose importance increases with the volume of data to be backed up or stored. With a multi-tape backup of a system or a data base, tapes will have to be changed less often on a tape unit recording at a high density that maximizes the data packed on each reel of tape. Tape storage space is also less with higher capacity because fewer reels of tape are needed to store a given volume of data.

#### Compatibility Considerations

Where a library of tapes already exists, ability of the magnetic tape unit to read those tapes can be very important. A magnetic tape recorded at 800 cpi can only be read on a tape unit at that density. If only one tape unit can be provided for the system, the need for compatibility with existing tapes may conflict to some extent with the need for high performance.

#### Operational Modes

**Start-stop** is the traditional mode of magnetic tape unit operation. The magnetic tape unit starts the tape and reads or writes a record of  $n$  bytes, stops, starts and reads or writes a record, etc., until an end of file mark is reached. The starting and stopping of the tape necessarily slows down the data transfer process. This inefficiency is particularly disadvantageous for system or data base backup, where very large volumes of data must be saved on tape.

**Streaming mode** tape motion is continuous, which typically increases the data transfer rate as compared to start-stop mode. Streaming mode magnetic tape units are supported in A-Series systems, effective with RTE-A revision code 2440. Magnetic tape units with streaming mode capability are supported in HP 1000 E/F-Series Systems only as a special.

### Appearance Considerations

The 7974A and 7978A Magnetic Tape Units are housed in cabinets that differ from HP 1000 System Processor Unit cabinets and from each other with respect to cabinet height, color of finish, and means of unlatching the front door of the cabinet. Customers who regard uniformity of appearance of their computer system installation as highly important should compare the 7974A/7978A and the HP 1000 System Processor Unit side by side before deciding on a tape unit.

## 2.4-6 Magnetic Tape Unit Interfacing

### Interfacing in HP 1000 A-Series Systems

Connection of magnetic tape units to HP 1000 A-Series Computer Systems is illustrated in Figure 2.4-5. Magnetic tape units are connected to A-Series systems via the 12009A HP-IB interface. One 12009A interface can support two HP 797xA

Table 2.4-2 Magnetic Tape Units Performance Summary

MAGNETIC TAPE UNIT PRODUCT NUMBER & NAME	RECORDING DENSITY (char per inch)	OPERATING MODE	TAPE SPEED (ips)	TRANSFER RATE (kB/sec)	APPROX. CAPACITY (MB on 2400 ft tape)	COMMENTS
MAGNETIC TAPE UNITS FOR HP 1000 A-SERIES SYSTEMS						
7914ST Disc-Tape Subsystem	1600/800*	Start-stop	50	80/40	40/20	HP 7974A Mag Tape Unit in 7914ST requires a 12009A HP-IB interface@, ordered separately, or as 219xC Option 070, which deletes the HP 1000 Model 26, 27, or 29 SPU cabinet and adds the 12009A interface for the MTU.
		Streaming#	100	160/80	40/20	
7914TD Disc-Tape Subsystem	1600	Start-stop only	45	72	40	HP 7971A+140 Mag Tape Unit in 7914TD requires a 12009A HP-IB interface@, ordered separately or as 219xC Option 070, which deletes the HP 1000 Model 26, 27, or 29 SPU cabinet and adds the 12009A interface for the MTU. NOT RECOMMENDED FOR NEW APPLICATIONS.
7970E+626 or 7971A+140/144 Magnetic Tape Unit(s)	1600	Start-stop only	45	72	40	Requires a 12009A HP-IB interface@, ordered separately. 7971A Option 144 provides two magnetic tape units in a tall cabinet. NOT RECOMMENDED FOR NEW APPLICATIONS.
7974A Magnetic Tape Unit	1600/800*	Start-stop	50	80/40	40/20	Requires a 12009A HP-IB interface@, ordered separately.
		Streaming#	100	160/80	80/40	
7978A Magnetic Tape Unit#	6250/1600	Streaming only	75	468/120	140/40 (for- matted cap.)	Requires a 12009A HP-IB interface@, ordered separately.
TAPE CARTRIDGE SUBSYSTEM FOR A-SERIES SYSTEMS OR E/F-SERIES SYSTEMS OPERATIING UNDER RTE-6/VM						
9144A Tape Cartridge Subsystem	10,000	Streaming	60	34	67 MB on 88140L Cart- ridge	Requires 1/4 of 12009A HP-IB interface (A-Series) or 12821A interface (E/F-Series), ordered separately. Compatible with tape cartridge units built into HP 791xP/R/CT or HP 7942A/7946A Discs. Easy-to-use cartridge tape is recommended for backup of discs of up to 132M bytes capacity.

\* 800 cpi density in addition to 1600 cpi is ordered as 7914ST or 7974A Option 800.

# Streaming mode in the 7914ST or 7974A and the 7978A Magnetic Tape Unit is supported in A-Series systems, effective with the RTE-A revision code 2440.

@ The 12009A HP-IB interface can support two 797xA/E Magnetic Tape Units. Although 797xA/E Magnetic Tape Units can function on the same HP-IB bus as the system disc, a separate 12009A interface for Magnetic Tape Units is required to assure satisfactory performance.

Table 2.4-2 Magnetic Tape Units Performance Summary, continued

MAGNETIC TAPE UNIT PRODUCT NUMBER & NAME	RECORDING DENSITY (char per inch)	OPERATING MODE	TAPE SPEED (ips)	TRANSFER RATE (kB/sec)	APPROX. CAPACITY (MB on 2400 ft tape)	COMMENTS
--	--------------------------------------	----------------	---------------------	---------------------------	--	----------

MAGNETIC TAPE SUBSYSTEMS FOR HP 1000 E/F-SERIES SYSTEMS

The 13181B/13183B interfaces that are included in the subsystems listed below can support up to four Magnetic Tape Units (MTUs)

7914TD+236 Disc-Tape Subsystem	1600	Start-stop only	45	72	40	HP 7971A+260 Mag Tape Unit in 7914TD+236 includes a two-card 13183B Magnetic Tape interface.
7970B+226 or 7971A+250/251 Magnetic Tape Subsystem	800	Start-stop only	45	36	20	7970B Option 226 or 7971A Option 250 or 251 includes a two card 13181B Magnetic Tape interface. 7971A Option 251 provides two 800 cpi magnetic tape units in a tall cabinet. 7971A+210 provides a single add-on 800 cpi unit in a tall cabinet and 7971A+211 provides two add-on 800 cpi units in a tall cabinet.
7970E+226 or 7971A+260/262 Magnetic Tape Subsystem	1600	Start-stop only	45	72	40	7970E Option 226 or 7971A Option 260 or 262 includes a two card 13183B Magnetic Tape interface. 7971A Option 262 provides two 1600 cpi magnetic tape units in a tall cabinet. 7971A+220/230 provides a single add-on 1600 cpi master/slave unit in a tall cabinet and 7971A+222/233 provides two add-on 1600 cpi master/slave units in a tall cabinet.
7971A+256 800 and 1600 cpi Mag Tape Subsystems	800	Start-stop only	45	36	20	7971A Option 256 includes 800 and 1600 cpi magnetic tape units in a tall cabinet and the corresponding two-card magnetic tape unit interfaces (13181B for the 800 cpi MTU, 13183B for the 1600 cpi MTU). 7971A+212 provides one 800 cpi add-on MTU and one 1600 cpi add-on MTU in a tall cabinet.
	1600			72	40	

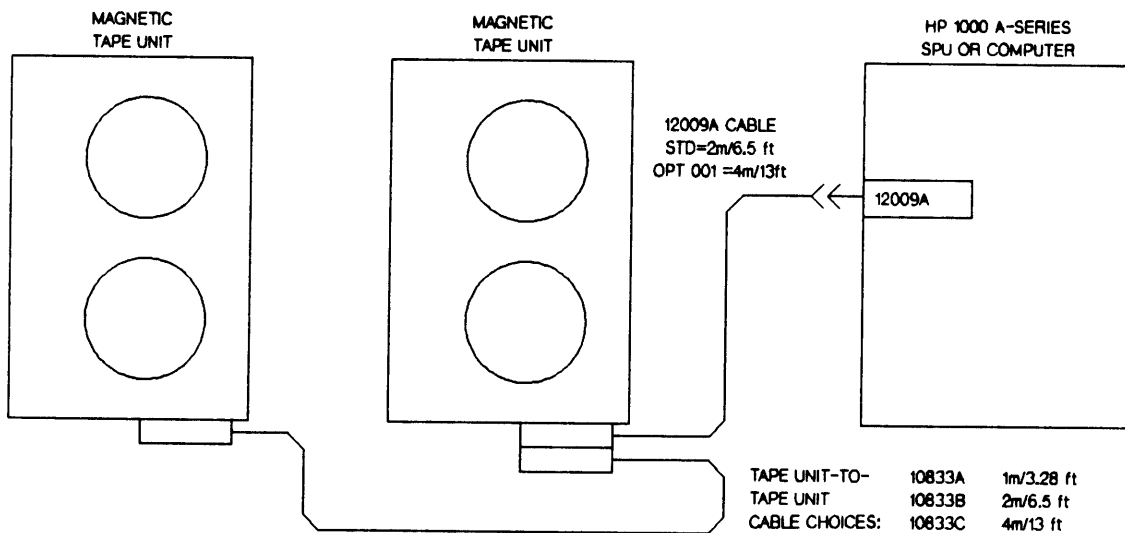

Figure 2.4-5 Connection of Magnetic Tape Units to HP 1000 A-Series Computer Systems

Magnetic Tape Units, which can be different units, such as one 7974A and one 7978A. However, the 9144A Tape Cartridge Subsystem has the same limit as CS/80 or SS/80 discs, up to four drives per 12009A interface, which can be 9144As, 791xP/R, 793xH, and/or 794xA discs.

1600 cpi Phase-Encoded units) interfaces, which are included in a subsystem option to the respective 797xA/B/E tape unit (see Table 2.4-3 for the various subsystem option numbers). Because the magnetic tape unit interface supports a specific recording mode and recording density, tape units with different recording densities must be connected via different interfaces. Each two-card interface can support up to four magnetic tape units.

### Interfacing in HP 1000 E/F-Series Systems

Connection of magnetic tape units to HP 1000 E/F-Series Computer Systems is shown in Figure 2.4-6. Magnetic tape units are connected via 13181B (for 800 cpi NRZI units) or 13183B (for

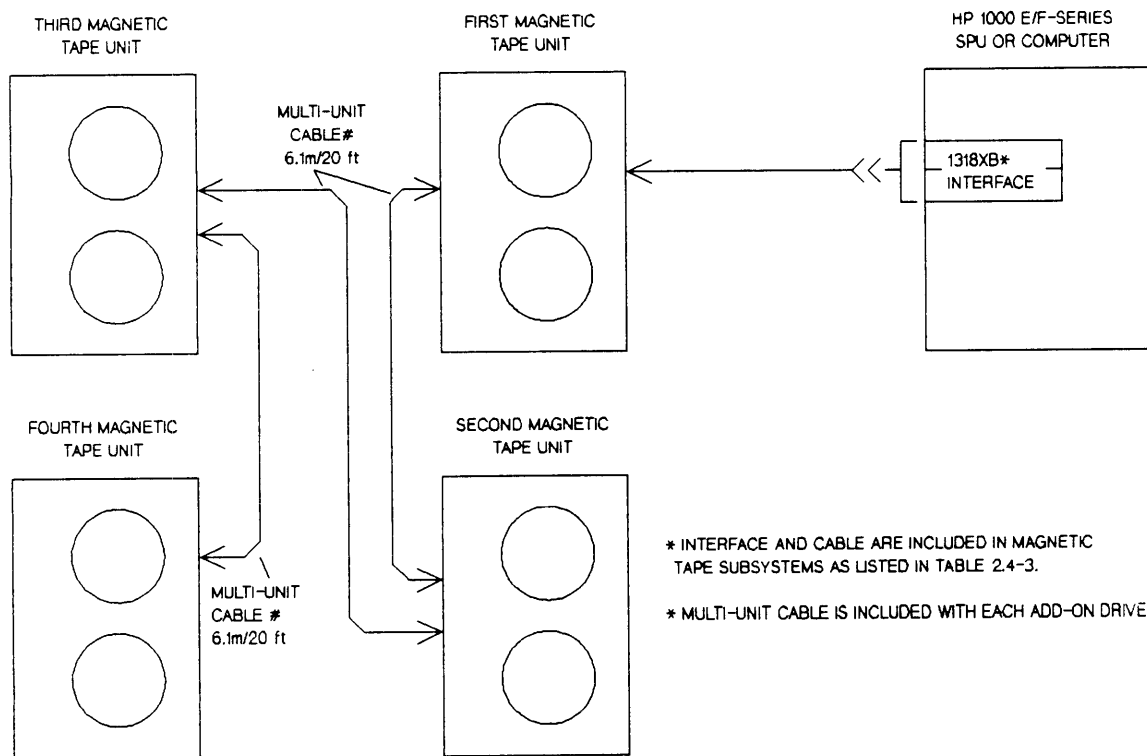

Figure 2.4-6 Connection of Magnetic Tape Units to HP 1000 E/F-Series Computer Systems

Selection and Interfacing  
of Mass Storage Devices

Table 2.4-3 Magnetic Tape Unit Configurations for HP 1000 E/F-Series Computer Systems

PRODUCT AND OPTION NUMBERS	MAGNETIC TAPE UNITS PER CABINET		CABINET STYLE	COMMENTS
	800 CPI UNITS	1600 CPI UNITS		
7970B+226	One	None	Low-boy	Is subsystem in low-boy cabinet that includes 13181B two-card 800 cpi, NRZI interface
7971A+250	One	None	Tall	Is subsystem in tall cabinet that includes 13181B two-card 800 cpi, NRZI interface
7971A+251	Two			
7971A+210	One	None	Tall	Provides add-on drive(s) in tall cabinet.
7971A+211	Two			
7914TD+236	None	One	Tall	Is subsystem in tall cabinet with 7914R+140 CS/80 Disc. Includes 13183B two-card 1600 cpi, Phase Encoded interface
7970E+226			Low-boy	Is subsystem in low-boy cabinet that includes 13183B two-card 1600 cpi, Phase-Encoded interface
7971A+260	None	One	Tall	Is subsystem in tall cabinet that includes 13183B two-card 1600 cpi, Phase-Encoded interface
7971A+262		Two		
7971A+220	None	One	Tall	Provides add-on master drive(s) in tall cabinet.
7971A+222		Two		
7971A+230	None	One	Tall	Provides add-on slave drive(s) in tall cabinet.
7971A+233		Two		
7971A+256	One	One	Tall	Is two subsystems in tall cabinet, each including its appropriate two-card interface (13181B 800 cpi, NRZI and 13183B 1600 cpi, Phase-Encoded).
7971A+212				Provides add-on 800 cpi NRZI and 1600 cpi Phase-Encoded Master Units in tall cabinet

# Communications -- Contents

## Section 3 HP 1000 Communications Overview

3-1	Introduction . . . . .	3-1
3-2	Communications Capabilities . . . . .	3-1
3-3	Communications Functions . . . . .	3-2
3-4	Communications Interfacing and Software . . . . .	3-4

## Section 3.1 Communication with Other HP Systems

3.1-1	Introduction . . . . .	3.1-1
3.1-2	Connection Modes . . . . .	3.1-1
3.1-3	Access Methods . . . . .	3.1-3
3.1-4	Capabilities . . . . .	3.1-3
3.1-5	Interfacing . . . . .	3.1-3

## Section 3.2 Communication with IBM and Plug-Compatible Systems

3.2-1	Introduction . . . . .	3.2-1
3.2-2	Communications Packages . . . . .	3.2-1
3.2-3	Interfacing . . . . .	3.2-1

## Section 3.3 Communication via X.25 Packet-Switching Networks

3.3-1	Introduction . . . . .	3.3-1
3.3-2	HP 1000 X.25 Communication . . . . .	3.3-1
3.3-3	Interfacing . . . . .	3.3-1

## Section 3.4 Communication with Programmable Controllers

3.4-1	Introduction . . . . .	3.4-1
3.4-2	Programmable Controller Communications Capabilities . . . . .	3.4-1
3.4-3	Interfacing . . . . .	3.4-2

# Section 3

## HP 1000 Communications Overview

### 3-1 Introduction

HP 1000 Systems can communicate with other systems to provide access to widely distributed data files and data bases, greatly adding to the scope and depth of information available for managerial decision-making. In computer-integrated manufacturing, communication makes possible the coordination of computer systems used for control of production processes, inventory and warehouse management, and evaluation of product quality, to name just a few. In support of these and other uses of system-to-system communication, HP 1000

systems can communicate with any of the systems shown in Figure 3-1. The numbers in parenthesis associated with each system refer to the communications section which contains information on connection to that system.

### 3-2 Communications Capabilities

HP 1000 systems communications capabilities are summarized in Table 3-1, on the next page.

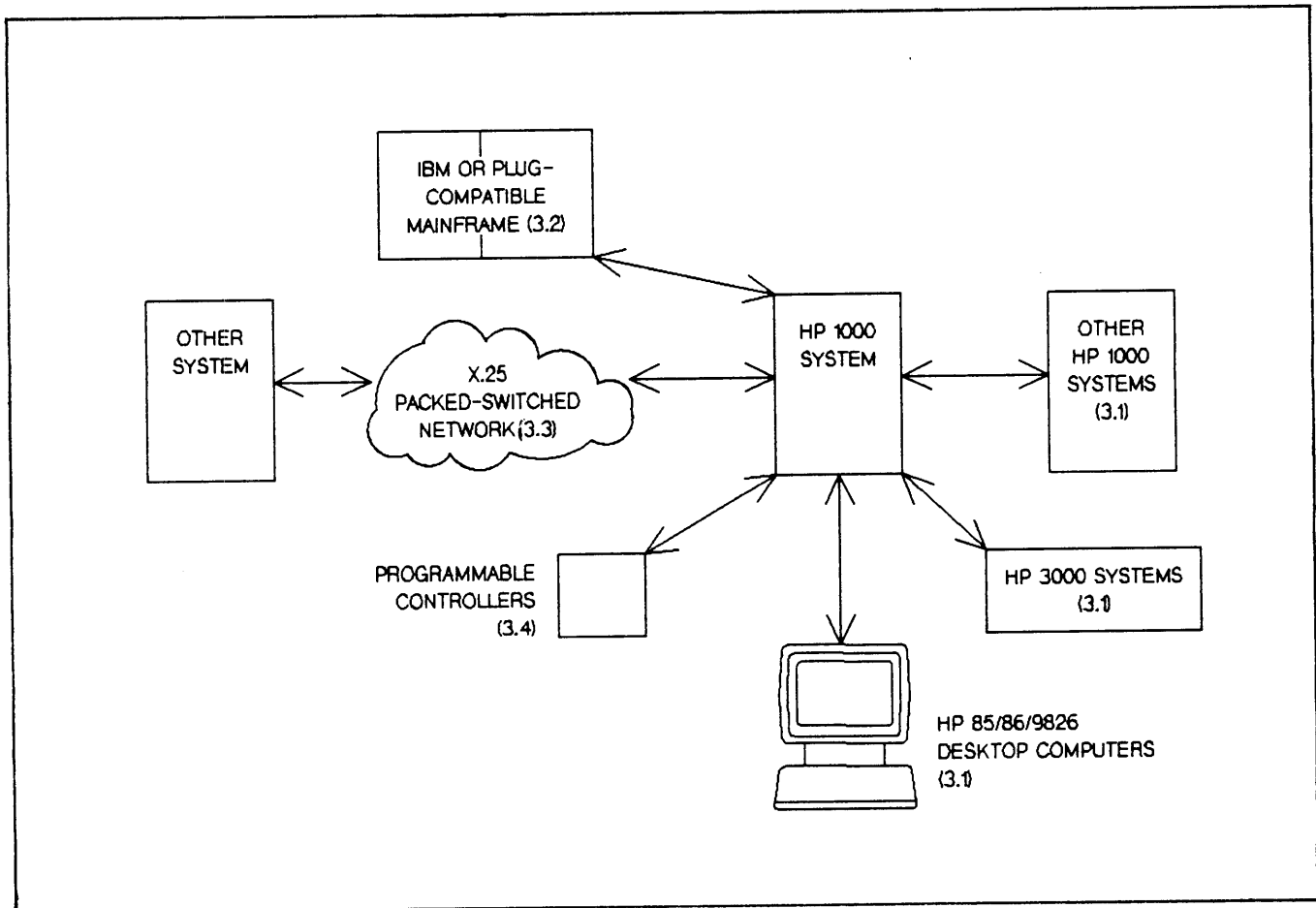

Figure 3-1. Supported HP 1000 System Connections

Table 3-1. Communications Capabilities Overview

COMMUNICATIONS CAPABILITIES - SUPPORTED FOR HP 1000 COMM. WITH >	HP 1000 SYSTEMS	HP 3000 SYSTEMS	HP 85/86 AND 9826A DESKTOP COMPUTERS	IBM* SYSTEMS	PROGR. CONT-ROLLERS
FROM LOCAL HP 1000 SYSTEM:					
User can open, read, write, update, and close program/data files on remote system.	Yes	Yes	No	Yes@	No
User can access data base on remote system.	Yes	Yes#	No	Yes@	No
User can transfer complete files from/to remote system.	Yes	Yes	No	Yes**	No
User can request actions at remote system, such as running application programs, compilers, etc.	Yes	Yes	No	Yes@	Yes
Program can open, read, write, and close files on remote system.	Yes	Yes	No	Yes@	No
Program can access data base on remote system.	Yes	No	No	Yes@	No
Program can transfer complete files to/from remote system.	Yes	Yes	No	Yes@	Yes
Program can request actions at remote system, such as running other programs or return of status information.	Yes	No	No	Yes@	Yes
Program can communicate with program(s) in remote system.	Yes	Yes	No	Yes@	No
FROM REMOTE SYSTEM:					
User can open, read, write, update, and close program/data files on local HP 1000 system.	Yes	Yes	No	Yes@	No
User can access data base on local HP 1000 system.	Yes	No	No	Yes@	No
User can transfer complete files to/from local HP 1000 system.	Yes	No	No	Yes@	No
User can request actions at local HP 1000 system, such as running application programs, compilers, etc.	Yes	Yes##	Yes##	Yes@	No
Program can open, read, write, and close files on local HP 1000 system.	Yes	Yes	No	Yes@	No
Program can access data base on local HP 1000 system.	Yes	No	No	Yes@	No
Program can transfer files to/from local HP 1000 system.	Yes	Yes	Yes	Yes**	Yes
Program can request actions at local HP 1000 system, such as running other programs or return of status information.	Yes	Yes	No	Yes@	Yes
Program can communicate with programs in local HP 1000 system.	Yes	Yes	No	Yes@	No

\* Or plug-compatible system. # By log-on to remote account which has access to Image/3000 data base.

@ Supportable via PMF/1000 and user-written programs.

\*\* As part of remote job entry to the IBM or plug-compatible system.

## Except for interactive running of RTE subsystems, such as FMGR and EDIT.

### 3-3 Communications Functions

Communications functions are typically organized in a layered hierarchy like that shown in Figure 3-2. The respective functions are described in the following paragraphs.

#### User/Program Interface

Communications software often includes a high-level user/program interface that interacts with the operating system and file management and data base management software to carry out user or program requests. This software typically supports high-level requests for access to files or data bases

on remote systems, requests for execution of commands or programs by remote systems, and requests for transfers of data between programs at the local system and those at the remote system.

In supporting high-level requests, the user/program interface software may emulate similar local-only requests which are sent via the appropriate communications management software routines. To the extent that a communication capability is reciprocal (i.e., can be requested or responded to by either system in a linked pair), the user/program interface software in both systems includes routines to support both requests and responses to requests.



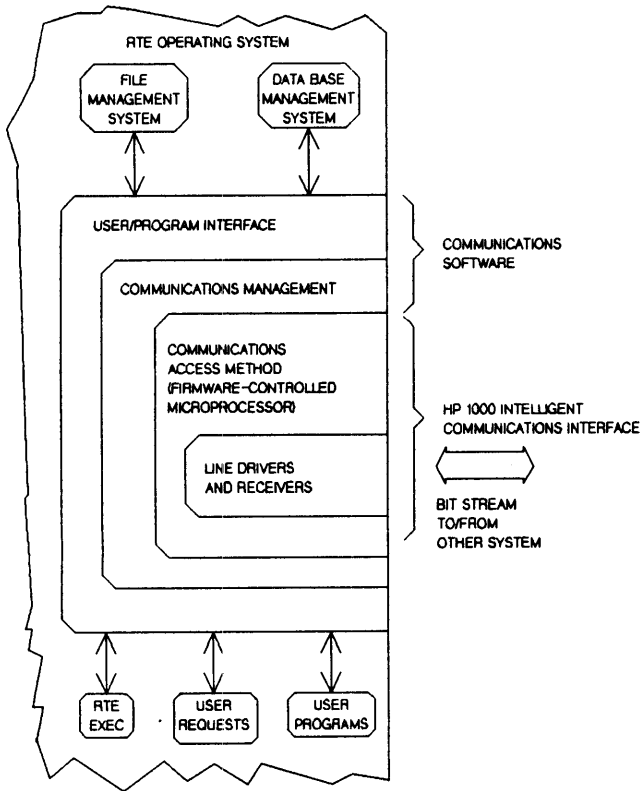

Figure 3-2. Communications functions

### Communications Management

Communications management is also a software function, consisting of routines that execute the secondary requests originated by the user/program interface software. In addition to I/O driver control and data transfer communication with the interface, communications management can also include:

1. Management of store-and-forward operations through intervening nodes (systems) of a network and dynamic message rerouting via alternate communication paths to maximize network flexibility and integrity.
2. Message accounting to ensure that a message is received at the target system once and only once.
3. Transaction logging to assist with optimization of network traffic and/or fault isolation.

### Data Transmission and Reception

**Communications Access Method (CAM)** comprises the protocol and error detection and correction methods defined for a particular type of communications link. Built-in microprocessors give HP 1000 communications interfaces extensive intelligence -- intelligence that is directed by firmware on the card to control all aspects of the CAM for the communications link being served.

For data transmission, CAM control includes addition of appropriate bits to mark the start and end of sets or blocks of data. CAM control may also include bits added to facilitate checking for transmission errors and control characters for modem synchronization. Hardware line drivers send outgoing bit streams from the microprocessor to a counterpart interface at the other end of the communications link, via direct-connect cable or via modems and switched or leased telephone lines.

Line receivers pass incoming bit streams to the microprocessor for protocol recognition and error checking. If an error is detected, the CAM firmware in the interface automatically requests a retransmission, independently of the interface's host system, which minimizes communications overhead. After a received message has passed error check, the interface deletes CAM-related bits and characters and passes the message to the communications management and user/program interface software.

### 3-4 Communications Interfacing and Software

Interfacing and software for system-to-system communication are described in the remaining sections on communications, as listed in the following table.

FOR HP 1000 COMMUNICATION WITH:	SEE SECTION
Other HP Systems, including: -- Other HP 1000 Systems -- HP 3000 Systems -- HP 85/86/9826 Desktop Computers	3.1
IBM and Plug-Compatible Systems	3.2
Other Systems via X.25 Packet-Switched Networks	3.3
Programmable Controllers	3.4

# Section 3.1

## Communication with Other HP Systems

### 3.1-1 Introduction

HP 1000 Computer Systems can communicate with other HP 1000 Systems, HP 3000 Systems, and HP 9826A and HP 85/86 Desktop Computers. This section describes the various types of network connection modes and capabilities that are supported under 91750A DS/1000-IV Distributed Systems Network software, which is the basis of all HP 1000 System communication with other HP systems. Connection information is summarized for all supported system-to-system links.

### 3.1-2 Connection Modes

Three principal types of network connection modes are supported under DS/1000-IV. (See Figure 3.1-1.) Table 3.1-1 provides selection guidance.

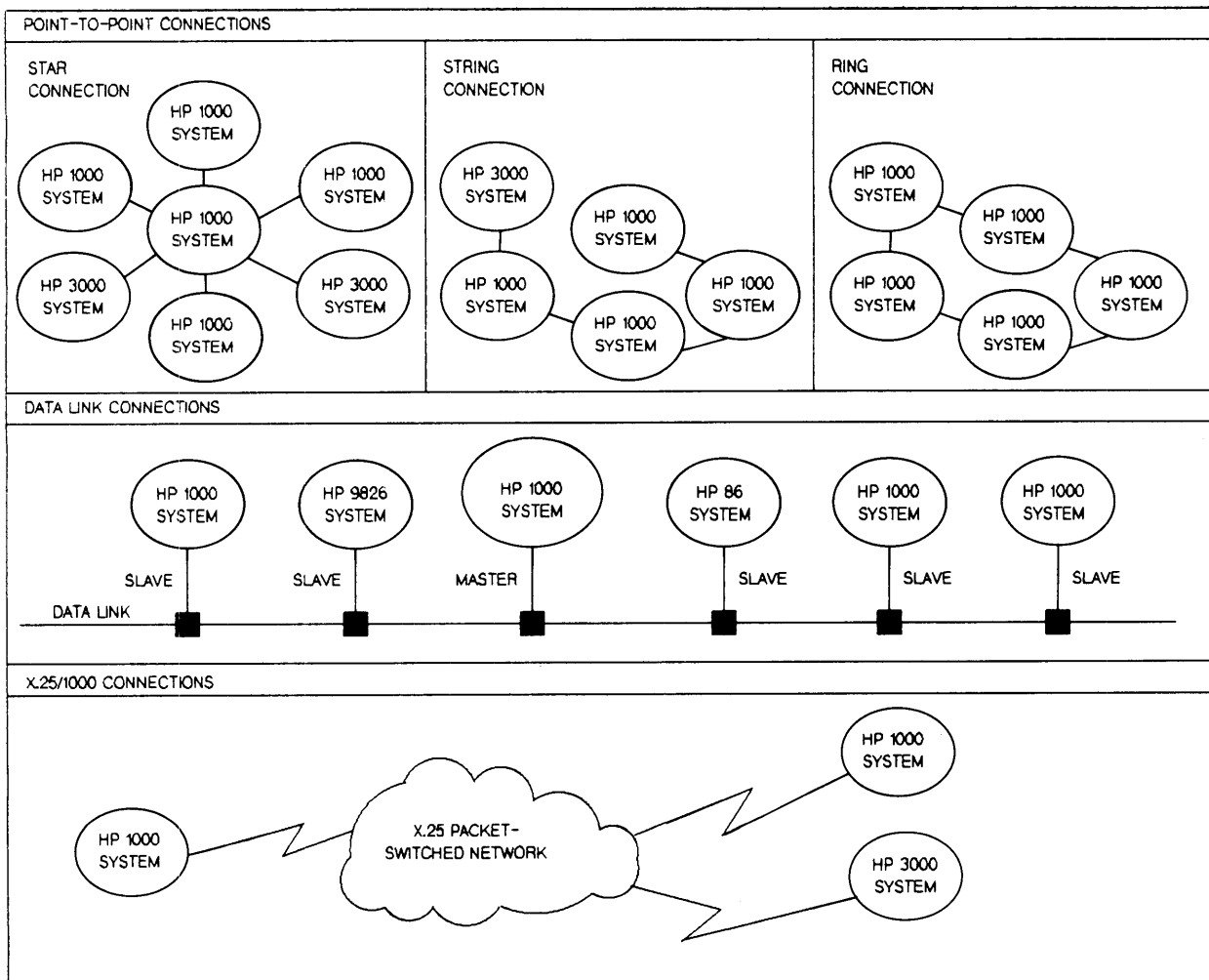

*Figure 3.1-1. HP 1000 Network Connection Modes*

Communication with  
Other HP Systems

Table 3.1-1. Network Connection Mode Selection Guide

SELECTION CRITERIA	POINT-TO-POINT CONNECTION	MULTIDROP DATA LINK CONNECTION	X.25 PACKET-SWITCHED NETWORK CONNECTION
	For applications that require maximum communication speed between systems.	For lowest overall interface hardware cost.	For the low line charges and communications reliability of packet-switched network communications.
HP SYSTEMS SUPPORTED	HP 1000 and HP 3000	HP 1000, HP 85/86, and HP 9826A	HP 1000 and HP 3000
COMM LINE DATA RATE	To 230,000 bits/second, not shared with other systems.	To 19,200 bits/second, shared with other systems on the link.	To 19,200 bits/second, not shared with other systems.
DATA THROUGHPUT RATE	To 20 kB/sec per connection for 8 kB transfers	To 1.6 kB/sec (96 kB/min) aggregate total for the data link for 8 kB transfers. Three slaves can each have an effective continuous throughput of 533 bytes/sec.	To 1.6 kB/sec per connection for 8 kB transfers.
RESPONSIVENESS	Servicing of crucial links can be given high priority. However, time required for store-and-forward transmission* via an intervening system adds to delay of receipt of a message at the addressed system.	Polling and servicing delays depend on the number of systems on the link and the amount of servicing required by each system.	Servicing of crucial links can be given high priority.
NETWORK HARDWARE REQUIREMENTS	Two interfaces and a separate communications link are required for each system-system connection.	Two interfaces and data link cables for first system-system connection, one interface and connection to data link for each additional system.	One interface and connection to a packet-switched network are required for each system-to-system connection.
NETWORK FLEXIBILITY	Network can use any of the types of connection shown in Figure 3.1-1 -- Star connection for fastest communication, string connection for lowest interfacing cost between systems at the sacrifice of store-and-forward* transmission delays, or ring connection (a string closed to provide an alternate path for maximum communication reliability). A system must be powered down to install an interface for connection of a new system link.	Master and slave system can be tapped into the data link at any connection box without disturbing link communications.	Any HP 1000 or HP 3000 system connected to the same packet-switched network can communicate with any other HP 1000 or HP 3000 system connected to the same network. Addition of a new system does not affect communications between other systems.
NETWORK RELIABILITY	Depends upon connection, as follows: 1. Star connection is critically dependent upon the central system. 2. Communication from one end of a string to the other end depends upon the intervening systems*. 3. Ring connection closes the string connection, providing a backup communications path* at the cost of two additional interfaces and the link between them.	Network reliability is critically dependent upon the master system. Except for the crucial role of the master, communication between other systems on the link depends only on the integrity of the link cable and the sending and receiving systems.	Depends upon availability of alternate paths in the packet-switched network.

\* Store-and-forward capability for communication via intervening string-connected or ring-connected systems is supported only by HP 1000 Systems, not by HP 3000 Systems.

### 3.1-3 Access Methods

The following access methods are used for communication under DS/1000-IV network software:

- \* **DS/1000-IV HDLC** (High-Level Data Link Control) for point-to-point communication between HP 1000 Systems.
- \* **DS/1000-IV Bisync** for point-to-point communication with HP 3000 Systems that have 32190A DS/3000 Network software.
- \* **Data Link (multipoint terminal) Bisync** for multipoint communication with other HP 1000 Systems and HP 9826A or HP 85/86 Desktop Computers. HP 1000 System communication as data link master also requires 91730A E/F-Series Multipoint Software or 91732A A-Series Data Link Software.
- \* **X.25 LAP-B** for communication with other HP 1000 Systems and/or HP 3000 Systems via X.25 Packet-Switched Networks. This communications access method also requires 91751A X.25 Communications Software. Remote HP 3000 Systems using this access method must have 32190A DS/3000 Network Software and 32191A X.25 Packet-Switched Network Access Software.

### 3.1-4 Capabilities

The communications capabilities supported between HP 1000 systems and other HP systems are listed in Table 3.1-2. Availability of capabilities depends upon their support by the software in each system. HP 1000-to-HP 1000 communication offers the most possibilities because all potential capabilities are supported by DS/1000-IV software in both systems. To the extent that the DS software used in other systems does not support some features of DS/1000-IV, communication with those systems will be limited. For example, store-and-forward transmission via intervening string-connected or ring-connected systems is not usable via HP 3000 nodes because it is not supported by DS/3000 Network software.

### 3.1-5 Interfacing

Interfacing for HP 1000 communication with other HP 1000 Systems, HP 3000 Systems, and HP 9826A and HP 85/86 Desktop Computers is illustrated in Figures 3.1-2 through 3.1-4. Compatible modems are listed in Table 3.1-3.

Communication with  
Other HP Systems

Table 3.1-2. HP 1000 Communications Capabilities Summary

COMMUNICATIONS CAPABILITIES - SUPPORTED FOR HP 1000 COMMUNICATION WITH >	HP 1000 SYSTEMS (PT-PT, D-L, or X.25)	HP 3000 SYSTEMS (PT-PT or X.25)	HP 9826A DESKTOP COMPUTER (D-L)	HP 85/86 DESKTOP COMPUTER (D-L)
FROM LOCAL HP 1000 SYSTEM:				
User can open, read, write, update, and close program/data files on remote system.	Yes	Yes	No	No
User can access data base on remote system.	Yes	Yes*	No	No
User can transfer complete files from/to remote system.	Yes	Yes	No	No
User can request actions at remote system, such as running application programs, compilers, etc.	Yes	Yes	No	No
Program can open, read, write, and close files on remote system.	Yes	Yes	No	No
Program can access data base on remote system.	Yes	No	No	No
Program can transfer complete files to/from remote system.	Yes	Yes	No	No
Program can request actions at remote system, such as running other programs or return of status information.	Yes	No	No	No
Program can communicate with program(s) in remote system.	Yes	Yes	No	No
Message can be sent to a unit record device at any other node in the network (Remote I/O mapping).	Yes	No	No	No
Transactions can be logged and reported to assist with optimization of the network or to isolate faults.	Yes	Yes	No	No
Nodal addressing with store-and-forward capability supports access to remote systems via intervening systems with optional dynamic message rerouting via alternate path.	Yes	No	No	No
Message accounting assures receipt of messages.	Yes	No	No	No
Remote access to virtual control panel in HP 1000 A-Series system.	Yes#	No	No	No
FROM REMOTE SYSTEM				
User can open, read, write, update, and close program/data files on local HP 1000 system.	Yes	Yes	No	No
User can access data base on local HP 1000 system.	Yes	No	No	No
User can transfer complete files to/from local HP 1000 system.	Yes	No	Yes	Yes
User can request actions at local HP 1000 system, such as running application programs, compilers, etc.	No	Yes**	Yes**	Yes**
Program can open, read, write, and close files on local HP 1000 system.	Yes	Yes	No	No
Program can access data base on local HP 1000 system.	Yes	Yes	No	No
Program can transfer complete files to/from local HP 1000 system.	Yes	Yes	Yes	Yes
Program can request actions at local HP 1000 system, such as running other programs or return of status information.	Yes	Yes	No	No
Program can communicate with program(s) in local HP 1000 system.	Yes	Yes	Yes	Yes
Program can write to peripheral device at local HP 1000 system.	Yes	No	No	No

\* By log-on to remote account which has access to Image/3000 data base.

# Supported only via point-to-point interface from adjacent system, not via data link or X.25 network.

\*\* Except for interactive running of RTE subsystems, such as FMGR and EDIT.

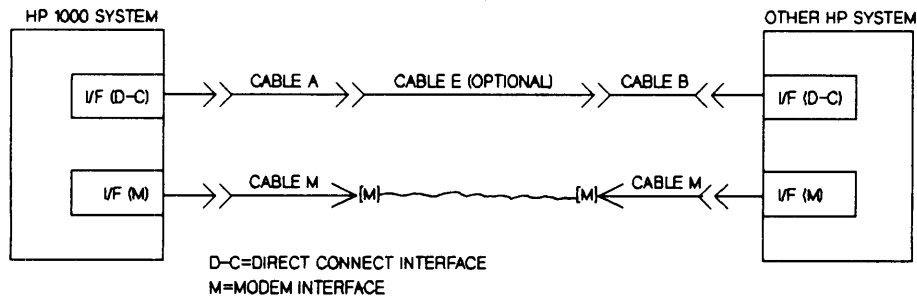

Point-to-Point Connections Summary

INTERFACE OR CABLE PRODUCT NUMBER	CONNECTION			MAXIMUM DATA RATE (kilobits per sec)	MAXIMUM COMM. DISTANCE (km/ft)	INTERFACE OR CABLE PRODUCT INCLUDES OR PROVIDES
	FROM	TO	VIA			
12007B	HP 1000 A-Series	HP 1000	Modem (M) and telephone lines	230.0@	No Limit	CABLE M, Part No. 5061-4914, 5m/16.4 ft
12794A	HP 1000 E/F-Series					
12073A	HP 1000 A-Series	HP 3000				
12793B	HP 1000 E/F-Series					
30020B	HP 3000 Ser 3x/4x/6x	HP 1000				
				57.6@		
				57.6@		MUST ORDER CABLE M, Product No. 30221A, 10m/33 ft, SEPARATELY
12044A*	HP 1000 A-Series	HP 1000	Direct-Connection (D-C)	230.0	1.0/3281	CABLE A, Part No. 5061-4914, 5m/16.4 ft, AND CABLE B, Part No. 5061-3422, 5m/16.4 ft
12825A*	HP 1000 E/F-Series			57.6	2.2/7218	
12082A	HP 1000 A-Series	HP 3000		57.6	1.0/3281	CABLE A, Part No. 5061-4914, 5m/16.4 ft
12834A	HP 1000 E/F-Series					
30220B	HP 3000 Ser 3x/4x/6x	HP 1000		57.6	1.0/3281	MUST ORDER CABLE B, Product No. 30221F, 10m/33 ft, SEPARATELY
91712A	CABLE A	CABLE B		n/a	n/a	75m/255 ft Ext. Cable (CABLE E).
91713A**						Male and female connectors for user-fabricated extension cable (CABLE E).
91714A						300m/1020 ft cable kit for user-fabricated ext. cable (CABLE E).

\* Because each 12044A/12825A interface includes all the cables needed to connect TWO interfaces, every second 12044A/12825A interface should be ordered with Option 002 to delete the unneeded second set of cables A and B.

@ Data rate depends on the selection of modem and telephone line link.

\*\* 91713A Option 001 provides edge connectors to the 12044A/12825A interface directly instead of connectors to cables A and B.

Figure 3.1-2. HP 1000 Point-to-Point Connections to Other HP Systems

Communication with  
Other HP Systems

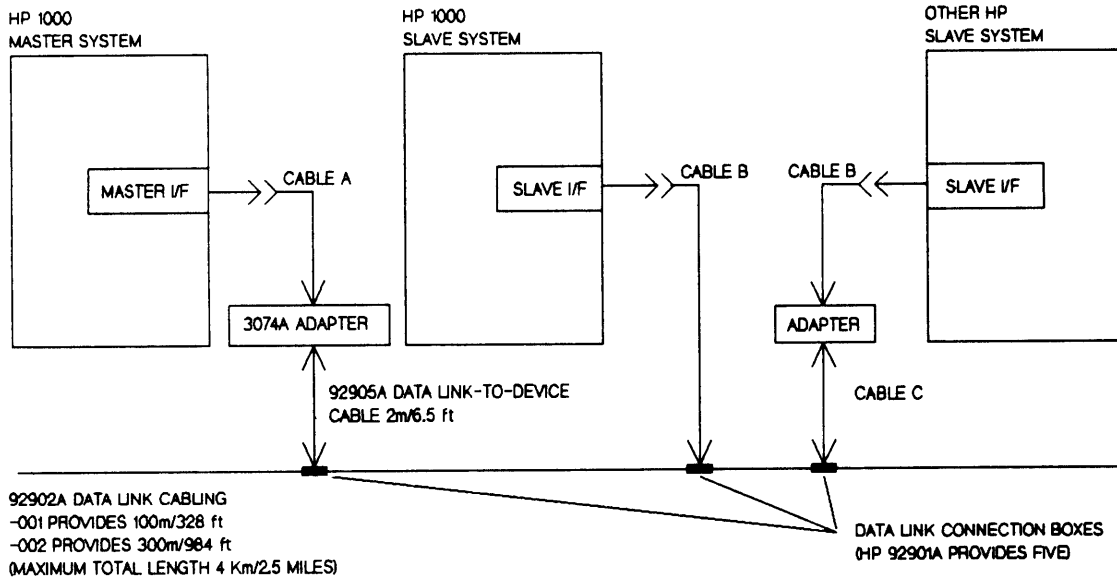

Multidrop Data Link Connections Summary

INTERFACE PRODUCT NUMBER	ADAPTER PRODUCT NUMBER	CONNECTION TO DATA LINK FROM	MAXIMUM DATA RATE (kilobits per sec)	INTERFACE OR ADAPTER INCLUDES OR PROVIDES	COMMENTS
12092A	3074A	HP 1000 A-Series Master System	19.2	CABLE A, Part No. 5061-4914, 5m/16.4 ft	HP 1000 E/F-Series and 9826A Slave Systems are NOT SUPPORTED by the A-Series Master System. The A-Series Master System requires both 91750A DS/1000-IV Network Software and 91732A Data Link Software.
12790A+001	3074A*	HP 1000 E/F-Series Master System	19.2	CABLE A, Part No. 5061-1391, 7.6m/25 ft	The E/F-Series Master System requires both 91750A DS/1000-IV Network Software and 91730A Multipoint Software.
12072A	Not Needed	HP 1000 A-Series Slave System	19.2	CABLE B, Part No. 5061-4903	The A-Series Slave System requires only 91750A DS/1000-IV Network Software.
12830A	Not Needed	HP 1000 E/F-Series Slave System	19.2	CABLE B, Part No. 5061-4903	Communication with E/F-Series Slave System is NOT SUPPORTED by the HP 1000 A-Series Master System. The E/F-Series Slave System requires only 91750A Network Software.
82966A	3074A	HP 85/86 Personal Computer	9.6	CABLE B is integral to 82966A interface; CABLE C is 92905A Data Link-to-Device Cable, 2m/6.5 ft.	HP 85 also requires 00085-15003 ROM and 82936A ROM Drawer. HP 86 also requires 00087-15003 ROM and 82936A ROM Drawer.
98628A+001	13264A	HP 9826A Desktop Computer	19.2	CABLES B and C are included with the 13264A Data Link Adapter.	HP 9826A also requires 09826-10030 Basic Binary Enhancement Software.

\* HP 1000 E/F-Series Master System can also connect to the data link via modems and four-wire telephone line, using a 3074M adapter and a 30062C cable, 7.6m/25 ft, in addition to CABLE A.

Figure 3.1-3. HP 1000 Multidrop Data Link Connections to Other HP Systems



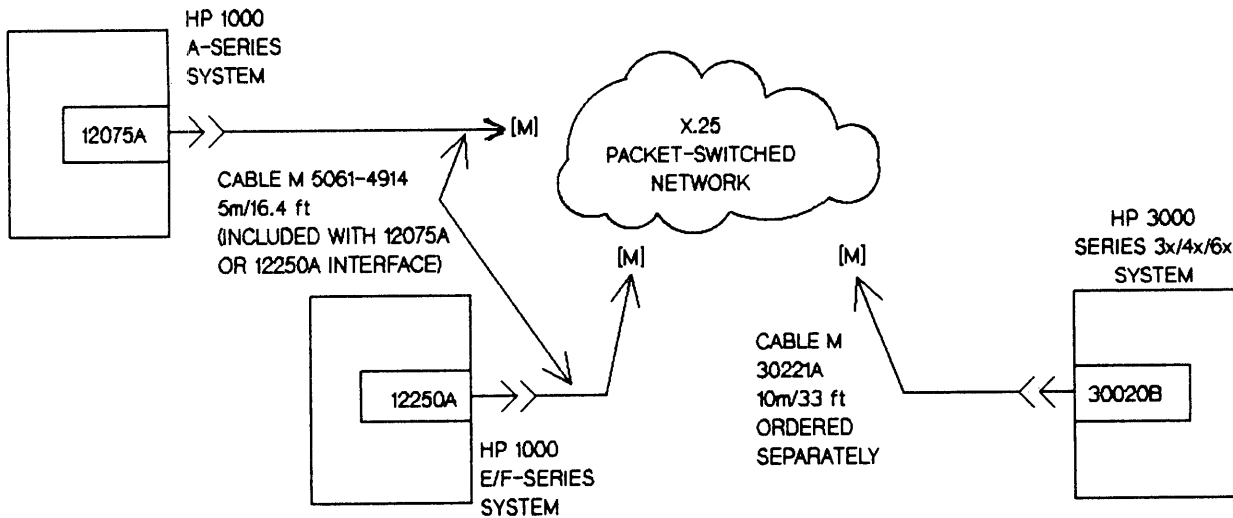

Figure 3.1-4. HP 1000 X.25 Connections to Other HP Systems

Table 3.1-3. Modems For HP 1000 Communication with Other HP Systems

ITEM	MODEM SUPPORT FOR HP 1000 COMMUNICATIONS ACCESS METHODS			
	DS/1000-IV HDLC	DS/1000-IV BISYNC	DATA LINK	X.25
<b>SUPPORTED INTERFACES</b> -- HP 1000 A-Series -- HP 1000 E/F-Series	12007B 12794B	12073A 12793B	None with A-Series 12790A+001	12075A 12250A
<b>MODEMS FOR USE WITH DIAL-UP TELEPHONE LINES</b> -- Up to 1200 bits/sec -- Up to 2400 bits/sec -- Up to 4800 bits/sec	Bell 212A GDC 212A	Bell 201C Bell 208B	Bell 202T or 212A Vadic VA3400	Bell 212A Bell 201C Bell 201C
<b>MODEMS FOR USE WITH LEASED OR PRIVATE LINES</b> -- Up to 1800 bits/sec -- Up to 2000 bits/sec -- Up to 2400 bits/sec -- Up to 4800 bits/sec -- Up to 9600 bits/sec -- Up to 19200 bits/sec	Bell 201C Bell 208A Bell 209A	Bell 201C Bell 208A Bell 209A HP 37230A	Bell 202T Bell 201A3 Gandalf LDS 120	Bell 201C Bell 208A Bell 209A RS-232-C Compatible Modems supplied by Public Packet Switched Networks

# Section 3.2

## Communication with IBM and Plug-Compatible Systems

### 3.2-1 Introduction

HP 1000 Computer Systems can communicate with IBM and IBM plug-compatible systems using any of three different communications packages. This section provides selection guidance and connection information.

the IBM or plug-compatible system by emulating a particular type of IBM workstation or communications controller. They are compatible with specific job entry or interactive communication subsystems. Selection guidance and compatibility information are given in Table 3.2-1.

### 3.2-2 Communications Packages

Two remote job entry packages and one program-to-program communications package are available for HP 1000 system communication with IBM and plug-compatible systems. These packages "talk" to

### 3.2-3 Interfacing

HP 1000 connection to IBM and plug-compatible systems is shown in Figure 3.2-1. Compatible modems are listed in Table 3.2-2.

*Table 3.2-1. IBM Communications Package Selection Guide*

COMMUNICATIONS PACKAGE	91781A RJE/1000-II REMOTE JOB ENTRY PACKAGE	91782A MRJE/1000 MULTILEAVING REMOTE JOB ENTRY PACKAGE	91784A PMF/1000 PROGRAMMATIC MAINFRAME FACILITY PACKAGE
PURPOSE	For remote job entry using a maximum of three logical devices. Relative simplicity minimizes CPU utilization, as compared to MRJE/1000.	For multileaving remote job entry using a maximum of 15 concurrently-active logical devices, with the ability to monitor flow of multiple jobs at a console.	For programmatic communication with an IBM or plug-compatible mainframe host system through 3270 data streams.
PACKAGE EMULATES	IBM 2780 and 3780 Workstations	Workstations that are compatible with job entry subsystems listed below.	IBM 3271 (Models 1 & 2), 3274 (Model 1c), and 3276 (Models 1, 2, 3, & 4) Cluster Controllers.
COMPATIBLE HOST SUBSYSTEMS	JES2, JES3, HASP II (job entry)	JES2, JES3, HASP II (Version 4 or later) (job entry)	CICS, IMS, TSO, CMS
REQUIRED HOST COMMUNICATIONS ACCESS METHOD	Any access method compatible with the job entry subsystem	Any access method compatible with the job entry subsystem	VTAM, BTAM, or TCAM
MAXIMUM DATA RATE	19,200 bits per second	9,600 bits per second	9,600 bits per second
CPU UTILIZATION AT 4800 BPS RATE	Less than 2%	Approximately 20%	Typically 6% to 8% per user
USE WITH OTHER THAN IBM OR PLUG-COMPATIBLE SYSTEMS	RJE/1000-II can be used to transfer files with other systems, such as the HP 3000 with RJE or another HP 1000 with RJE/1000-II, that have accurately implemented the 2780/3780 protocol.	Not applicable	Not applicable

# Communication with IBM and Plug-Compatible Systems

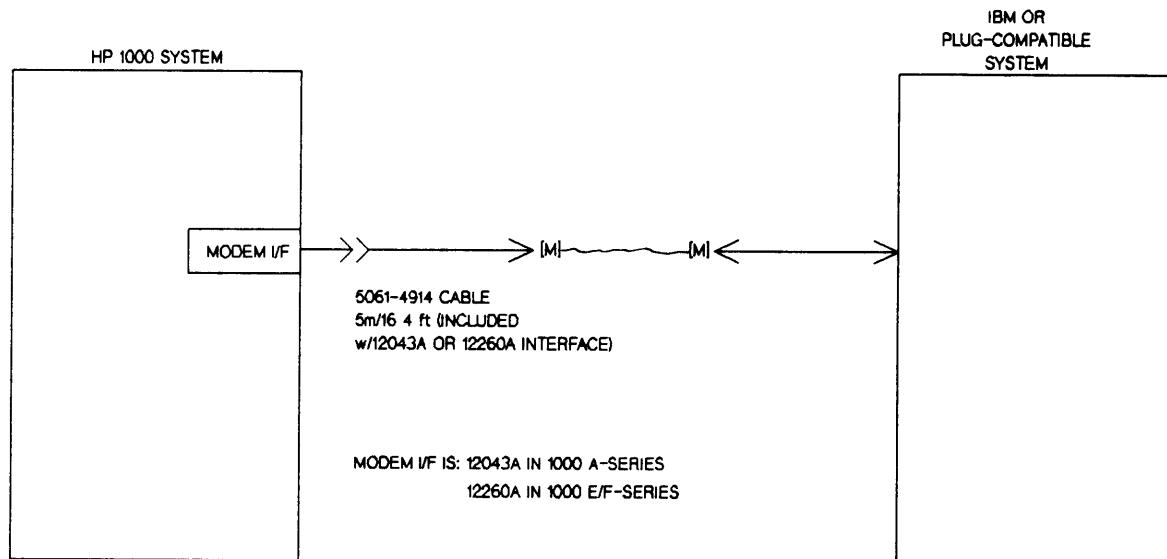

Figure 3.2-1. HP 1000 Connection to IBM or Plug-Compatible Systems

Table 3.2-2. Modems For HP 1000 Communication with IBM and Plug-Compatible Systems

ITEM	MODEM SUPPORT FOR IBM COMMUNICATIONS PACKAGES		
	91781A RJE/1000-II	91782A MRJE/1000	91784A PMF/1000
MODEMS FOR USE WITH DIAL-UP TELEPHONE LINES			IBM does not support use of dial-up lines for bisync 3270s.
-- Up to 2400 bits/sec	Bell 201C or Dataphone II 2024*	Bell 201C or Dataphone II 2024*	
-- Up to 4800 bits/sec	Bell 208B or Dataphone II 2048*	Bell 208B or Dataphone II 2048*	
MODEMS FOR USE WITH LEASED OR PRIVATE LINES			
-- Up to 2400 bits/sec	Bell 201C or Dataphone II 2024*	Bell 201C or Dataphone II 2024*	Bell 201C or Dataphone II 2024*
-- Up to 4800 bits/sec	Bell 208A or Dataphone II 2048*	Bell 208A or Dataphone II 2048*	Bell 208A or Dataphone II 2048*
-- Up to 9600 bits/sec	Bell Dataphone II 2096*	Bell 209A or Dataphone II 2096*	Bell Dataphone II 2096* or HP 37230A

\* Bell Dataphone II 2024, 2048, and 2096 are RS-449 modems that require 12043A Option 002 or 12260A Option 002 RS-449 interface cable (5061-4923; 5m/16.4 ft) instead of the RS-232-C cable (5061-4914) that is supplied with the standard 12073A/12260A interface.

# Section 3.3

## Communication via X.25 Packet-Switching Networks

### 3.3-1 Introduction

Charges for dial-up or leased telephone lines are the most significant cost of communications. In the case of dial-up lines, the user is charged for the time the line is connected. However, data is actually being transmitted over the line for only a relatively small fraction of the time that the line is connected. Packet switching, in which different data transmissions are multiplexed onto the same transmission channel and demultiplexed at the receiving end, can be used to make maximum use of available transmission time, lowering costs.

The economies afforded by packet-switched communications are offered by various public networks that charge for the amount of data transmitted. The public networks include:

1. Telenet and Tymnet in the U.S.A.
2. RTT in Belgium
3. Datapac in Canada
4. PSS in the United Kingdom
5. Transpac in France

### 3.3-2 HP 1000 X.25 Communication

X.25 Packet-Switched communication on HP 1000 systems is supported by the HP 91751A X.25 Communications Software package and the 12075A (HP 1000 A-Series) or 12250A (HP 1000 E/F-Series) LAP-B Modem interface card. This combination supports the following types of communications:

1. X.25 Synchronous host-to-network connections.

2. Asynchronous terminal connections to remote X.25 hosts via a CCITT X.3, X.28, or X.29-compatible Packet Assembler/Disassembler (PAD), such as the HP 2334A Multimux, and the X.25 network. This is supported in character mode for terminal-to-host connections. Host-to-terminal connection is not supported.

Packet-switching may be used for 91750A DS/1000-IV communication between HP 1000 systems and between HP 1000 and HP 3000 systems. The network capabilities available via the X.25 connection are listed in Table 3.1-2 on page 3.1-4. HP 1000 system communication with other systems may involve user-implemented upper-level communications software. However, it is important to understand that packet-switching communication with HP 85/86 Personal Computers or HP 9826A Desktop Computers is not supported in HP 1000 Computer Systems.

### 3.3-3 Interfacing

HP 1000 connection to X.25 networks is shown in Figure 3.3-1. Compatible modems are listed in Table 3.3-1.

*Table 3.3-1. Modems For HP 1000 Communication with X.25 Networks*

DATA RATE (BITS/SEC)	MODEMS FOR DIAL-UP LINES	MODEMS FOR LEASED LINES
1200	Bell 212A	
2400		Bell 201C
4800		Bell 208C
9600		Bell 209A
19200		RS-232-C Modems supplied by Public Packet-Switched Networks

Communication via X.25  
Packet-Switching Networks

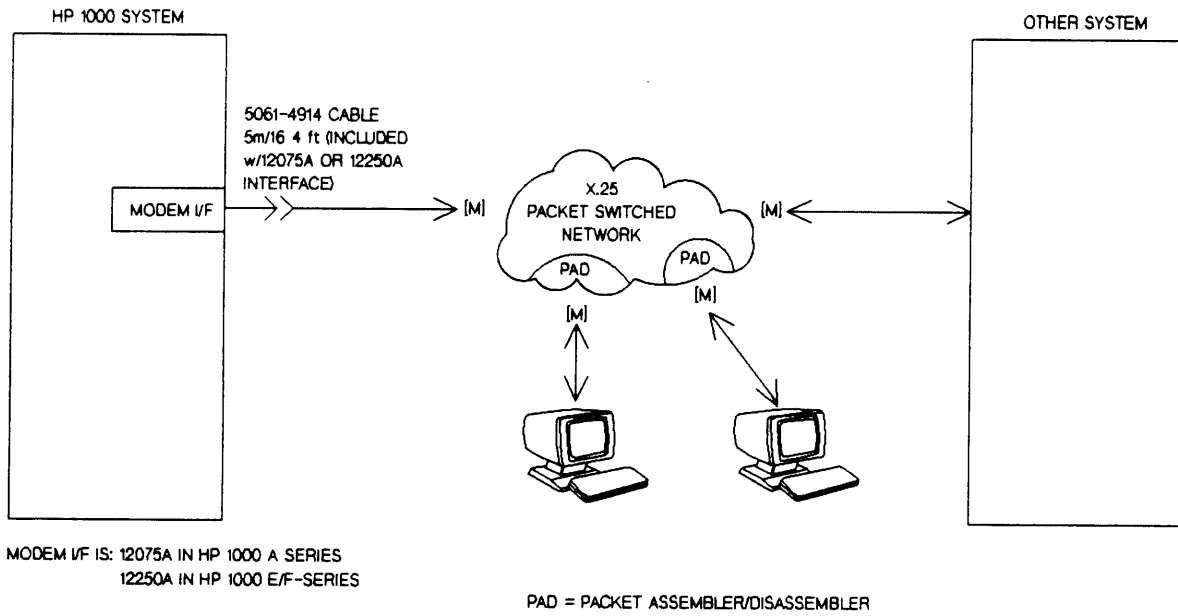

Figure 3.3-1. HP 1000 Connection to X.25 Networks

# Section 3.4

## Communication with Programmable Controllers

### 3.4-1 Introduction

Programmable controllers provide essential local control of the individual stages of manufacturing operations on the factory floor. At the next higher level of control, coordination of the operations of programmable controllers and processing and display of the information they provide is equally essential and requires the establishment of communication between the coordinating system(s) and the programmable controllers. This section summarizes the programmable controller communications capabilities available in HP 1000 systems and connection information.

### 3.4-2 Programmable Controller Communications Capabilities

HP 1000 A-Series computer systems can communicate with Allen-Bradley PLC and PLC-2 Programmable Controllers (PCs). This communication requires HP 94200A Programmable Controller Interface/1000 (PCIF/1000) software, the HP 12041A Multi-Use 8-Channel Multiplexer, and the HP 12828A Multiplexer Panel. The following capabilities are supported:

#### PC Communication Requests

The following PCIF requests support HP 1000 A-Series communication with PCs:

**PCIF-OPEN/CLOSE** -- Initiates/Terminates a dialog between an application program and PCIF/1000.

**PC-CONNECT/DISCONNECT** -- Establishes/Breaks a link between a PC and PCIF/1000.

**PC-READD** -- Reads data from PC memory.

**PC-WRITED** -- Downloads data into PC memory.

**PC-READP** -- Reads program(s) from PC memory.

**PC-WRITEP** -- Downloads program(s) into PC memory.

**PC-LOCK** -- Restricts PC access to a specific application program.

**PC-UNLOCK** -- Frees access to a LOCKed PC.

**PC-PCSTAT** -- Requests the physical status (run, program, or test mode) of a PC.

**PC-SYSTAT** -- Provides the logical status of the system, relative to a PC.

**PC-CANCEL** -- Cancels one or all requests sent previously to a PC and not yet terminated.

**PC-START/STOP** -- Starts/Stops a PC program (not supported by all PCs).

**PC-ENQUIRY** -- Retrieves data from requests made without wait or from unsolicited messages from PCs.

**PC-GETKEY/RELKEY** -- Obtains/releases system resources needed for managing asynchronous requests (requests made without wait) from application programs.

**PC-ENUNSOL/DIUNSOL** -- Enables/disables receipt by application program of unsolicited messages from a PC.

**PC-TRANS** -- Accesses PC without using the standard functions of PCIF/1000.

#### Capacity

**PCs per data highway:** Up to 63.

**Multiplexers per system:** Up to three.

**Data Highways per multiplexer:** Up to eight.

LUs per multiplexer channel: Two.

Number of PCs per system: Up to 256 if not constrained by operating system table space or system performance considerations.

**Supported PCs**

Allen-Bradley Mini-PLC-2, PLC-2, PLC-2/15, PLC-2/20, PLC-2/30, and PLC

**3.4-3. Interfacing**

HP 1000 connection to Allen-Bradley PCs is shown in Figure 3.4-1.

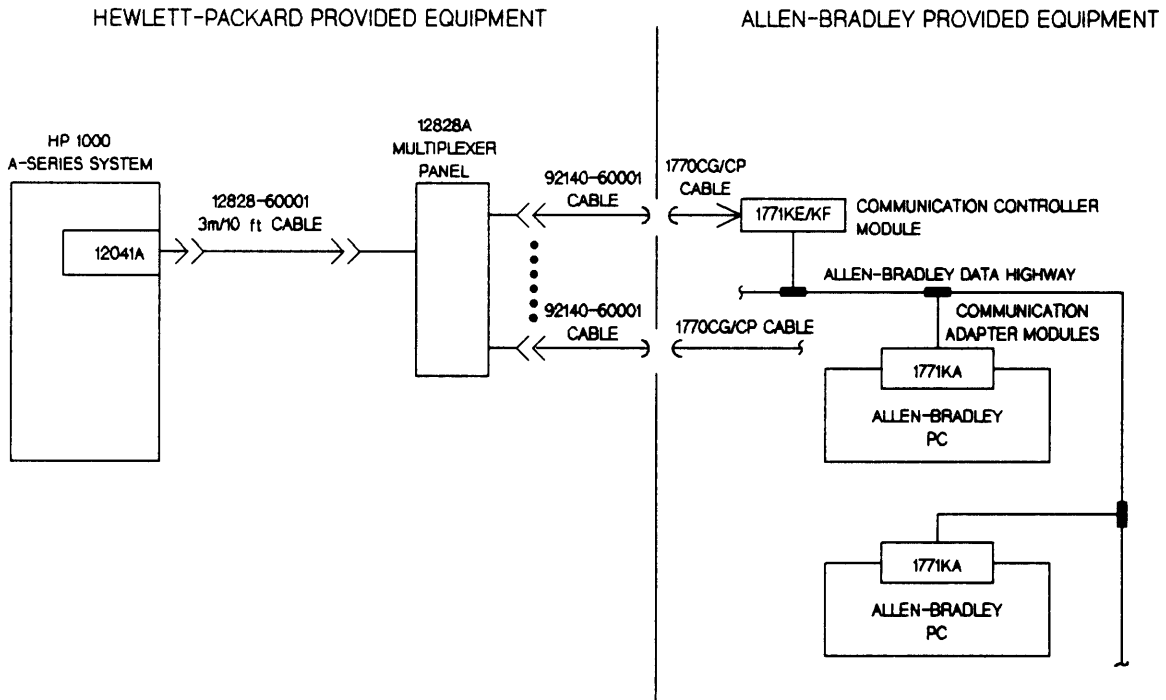

Figure 3.4-1. HP 1000 Connection to Allen-Bradley Programmable Controllers

## **Software -- Contents**

4-1	Introduction . . . . .	4-1
4-2	Software and Requirements . . . . .	4-1



# Section 4

## Software

### 4-1 Introduction

Software is the basis of all HP 1000 Computer System functions because it provides the instructions that are needed to put the hardware to work. Over thirty different Hewlett-Packard software products available for HP 1000 Computer Systems are summarized in Table 4-1, pages 4-2 through 4-6.

### 4-2 Software and Requirements

In addition to its function as a list of software, keyed according to usability by operating system, Table 4-1 provides information on requirements for Hewlett-Packard software. Hardware requirements for the use of software include main memory needed for storage during execution or in anticipation of execution. Disc memory is required for storage of software in executable and source code form and for data base storage. Certain software requires the hardware items it is designed to work with or hardware items that perform an application-related function, such as printing of program listings or reports or backup of a data base.

#### Using Table 4-1 as a Worksheet to Estimate Main and Disc Memory Requirements

**Copy Table 4-1.** Table 4-1 is designed to be a photo-copyable worksheet for determining how much main memory and disc memory will be required to support any configuration of Hewlett-Packard software. The other system hardware requirements listed in Table 4-1 provide a check to assure that essential peripheral devices or interfaces are not forgotten.

**Mark up Table 4-1.** The copy of Table 4-1 is used by circling the software to be included in the system and also circling the relevant main and disc memory requirements. Spaces are provided for calculating multi-user and data base data set requirements.

**Add up the memory requirements.** Addition of all circled items in the main and disc memory columns with the aid of the subtotal and subtotal forward lines on each page gives total main and disc memory required for support of the HP software in the system.

**Factor in application requirements.** The main and disc memory totals should be multiplied by a factor of from 1.5 to 3 to provide additional storage for user's application program code and data to determine the actual amount of main memory and hard disc memory to be provided for the system. The system designer should select a factor whose size is commensurate with the scope and complexity of the application that the system is designed to support and the proportion of the support which is to be programmed by the user.

#### Operating System Software

The operating system software, known in HP 1000 systems as the Real Time Executive (RTE), provides the basis for over-all management of system operations. These include program scheduling, input/output, and management of resources, such as main and disc memory.

The memory requirement of RTE software is highly dependent upon the system configuration. To provide a consistent base requirement, the main and disc memory needed to support the respective RTE primary systems are the figures listed in Table 4-1. The primary system in each instance includes a completely functional generated system, with system console and disc drivers, that can be booted up, function with good performance, and be used as a foundation for on-line generation of other system configurations.

It is possible to generate RTE systems in such a way that some modules which are main memory resident in the primary system are made disc resident. In this way, the RTE systems can be fitted into less main memory but at the expense of slower response and lower throughput. The disc memory capacity requirement includes storage of the generated system and relocatables.

Table 4-1. Software and Software Requirements Summary

SOFTWARE PRODUCT NUMBER AND NAME	USABLE IN			MEMORY REQUIREMENT EXPLANATION	SOFTWARE REQUIREMENTS		
	RTE-A	RTE-6/VM	RTE-IVB		MAIN MEMORY (KB)	DISC MEMORY (MB)	OTHER SYSTEM HARDWARE REQUIREMENTS
<b>OPERATING SYSTEM SOFTWARE</b>							
92077A RTE-A Operating System	Y	N	N	Primary system	368	11.5	System console terminal, system disc, and software loading/backup device*, all interfaced to system
92078A VC+ Enhancement to RTE-A	Y	N	N	Additional requirement	2	n/s	None
92084A RTE-6/VM Operating System	N	Y	N	Primary system	512	9.95	System console terminal, system disc, and software loading/backup device*, all interfaced to system, and 12539C Time Base Generator and 12897B Dual-Channel Port Controller
92068A RTE-IVB# Operating System	N	N	Y	Primary system	262	7.25	
<b>PROGRAM DEVELOPMENT SOFTWARE (SUPPORTED ONLY IN DISC-BASED SYSTEMS)</b>							
92836A FORTRAN 77	Y	Y	N	See multi-user partition requirements, below.	Spec'd below	0.17	256xA Printer for compiler output listings
92834A FORTRAN 4X	N	Y	Y			0.1	
92833A Pascal/1000	Y	Y	N	See multi-user partition requirements on next page.	Spec'd on next page	4.69	
92832A Pascal/1000#	N	N	Y			n/s	
92857A BASIC/1000C	Y	Y	N	Compiler Interpreter Other Also see multi-user partition requirements on next page.	Spec'd on next page	1.51 2.43 0.53	
92076A BASIC/1000L#	Y	N	N	See multi-user partition requirements, below		n/s	None
92101A BASIC/1000D#	N	Y	Y			n/s	
92860A Symbolic Debug/1000	Y	Y	N	See multi-user partition requirements, below.	Spec'd below	0.21	None
MULTI-USER PARTITION REQUIREMENTS	Y	Y	Y	— Users x 64 kB** entering, editing, compiling (except in FORTRAN 77, Pascal/1000, or BASIC/1000C), installing, and debugging programs =			One terminal per active user.
	Y	Y	N	— Users x 64 kB - 128 kB, depending on program size for FORTRAN 77 compilation =			
SUBTOTALS							

\* RTE-A and RTE-IVE (memory-based version of RTE-IVB) systems can be used without system console or disc in a memory-based configuration that is supported by an adjacent HP 1000 host system which communicates with the memory-based system via DS/1000-IV interface and 91750A DS/1000-IV Network software.

# = Mature product that is not recommended for new applications.

\*\* = 56 kB in RTE-IVB. n/s = Not Specified.

Table 4-1. Software and Software Requirements Summary, continued

SOFTWARE PRODUCT NUMBER AND NAME	USABLE IN			MEMORY REQUIREMENT EXPLANATION	SOFTWARE REQUIREMENTS		
	RTE-A	RTE-6/VM	RTE-IVB		MAIN MEMORY (kB)	DISC MEMORY (MB)	OTHER SYSTEM HARDWARE REQUIREMENTS
SUBTOTALS FORWARD					_____	_____	

## PROGRAM DEVELOPMENT SOFTWARE, continued

MULTI-USER PARTITION REQUIREMENTS, continued	Y	Y	Y	— Users x 122 kB (min.) or x 474 kB (max. speed) for Pascal/1000 compilation =	_____		
	Y	Y	N	— Users x 64 kB for BASIC/1000C Interpreter editing =	_____		
				— Users x 396 kB (RTE-A) or x 352 kB (RTE-6/VM) for BASIC/1000C Interpreter execution =	_____		
				— Users x 280 kB (RTE-A) or x 240 kB (RTE-6/VM) for BASIC/1000C Compilation =	_____		

## PERFORMANCE ENHANCEMENT SOFTWARE (SUPPORTED ONLY IN DISC-BASED SYSTEMS)

92083A RTE Profile Monitor	N	Y	Y	One user x 30 kB =	_____	n/s	256xA Line Printer for printing program activity profiles
Profile monitor in 92860A Symbolic Debug/1000	Y	Y	N	— Users x 64 kB =	_____		One terminal per user
92045A RTE Micro-programming Package for A700 Processors	Y	N	N	See multi-user partition requirements, below.		n/s	12153A Writable Control Store Card
92049A RTE Micro-programming Package for A900 Processors	Y	N	N	See multi-user partition requirements, below.		n/s	12205A Control Store Board
92061A RTE Micro-programming Package for E/F-Series Processors#	N	Y	Y	See multi-user partition requirements, below.		n/s	13197A Writable Control Store Board
MULTI-USER PARTITION REQUIREMENTS	Y	Y	Y	— Users x 64 kB for micro-program development	_____		One terminal per user

## DATA BASE MANAGEMENT SOFTWARE (SUPPORTED ONLY IN DISC-BASED SYSTEMS)

92081A Image/1000-II Data Base Management System	Y	Y	N	Additional base requirement; also see multi-user partition requirements and data base disc storage requirements on next page.	512	5.25	A 797xA/E Magnetic Tape Unit or a second disc with removable media for data base backup and a 256xA Line Printer for printing reports
92069A Image/1000 Data Base Management System	Y	Y	Y	Additional base requirement; also see multi-user partition requirements and data base disc storage requirements on next page.	84	0.61	
SUBTOTALS					_____	_____	

# = Mature product that is not recommended for new applications. n/s = Not Supported

Table 4-1. Software and Software Requirements Summary, continued

SOFTWARE PRODUCT NUMBER AND NAME	USABLE IN			MEMORY REQUIREMENT EXPLANATION	SOFTWARE REQUIREMENTS		
	RTE-A	RTE-6/VM	RTE-IVB		MAIN MEMORY (kB)	DISC MEMORY (MB)	OTHER SYSTEM HARDWARE REQUIREMENTS
SUBTOTALS FORWARD							
DATA BASE MANAGEMENT SOFTWARE, continued							
MULTI-USER PARTITION REQUIREMENTS	Y	Y	Y	— Users x 64 kB for local Query access to data base = _____ — Remote Users x 48 kB for remote Query access to data base = _____	_____	_____	One terminal per user
DATA BASE DISC STORAGE REQUIREMENTS	Y	Y	Y	— Data sets x _____ entries (records) per data set x _____ bytes (characters) per record x 0.000001 = _____ — Data sets x _____ entries (records) per data set x _____ bytes (characters) per record x 0.000001 = _____ — Data sets x _____ entries (records) per data set x _____ bytes (characters) per record x 0.000001 = _____ — Data sets x _____ entries (records) per data set x _____ bytes (characters) per record x 0.000001 = _____	_____	_____	None
RELIABILITY ENHANCEMENT SOFTWARE							
91745A Datasafe/1000 (for duplicate recording of discs to protect data)	N	Y	N	Additional requirement	46	n/s	A second disc with the same number of sectors per track as the system disc
91747A Datashare/1000 (for sharing of the same disc space by redundant computers)	N	Y	N	Additional requirement	n/s	n/s	System disc must be 79xxM Multi-Access Controller (MAC) disc
GRAPHICS SOFTWARE							
92861A Graphics/1000-II Version 2.0 Device-Independent Graphics Library	Y	Y	N	Graphics library subroutines are incorporated into user's application programs, do not impose any independent main memory requirement.	_____	2.5	One or more graphics devices interfaced to system (see Section 2.2).
92862A Graphics/1000-II Version 2.0 Advanced Graphics Package (REQUIRES 92861A)	Y	Y	N	Workstations monitoring — Non-CDS Workstations x 64 kB = _____ — CDS Workstations x 56 kB code + 38 kB data = _____	16	1.0*	One or more graphics devices interfaced to system (see Section 2.2).
SUBTOTALS							

\* 2.5 MB will also be required for the 92861A product. n/s = Not Supported.

Table 4-1. Software and Software Requirements Summary, continued

SOFTWARE PRODUCT NUMBER AND NAME	USABLE IN			MEMORY REQUIREMENT EXPLANATION	SOFTWARE REQUIREMENTS		
	RTE-A	RTE-6/VM	RTE-IVB		MAIN MEMORY (kB)	DISC MEMORY (MB)	OTHER SYSTEM HARDWARE REQUIREMENTS
SUBTOTALS FORWARD							
GRAPHICS SOFTWARE, continued							
92841A Graphics/1000-II Version 1.0 Device-Independent Graphics Library#	Y	Y	Y	Graphics library subroutines are incorporated into user's application programs and do not impose any independent main memory requirement.		n/s	One or more graphics devices interfaced to system (see Section 2.2).
92842A Graphics/1000-II Version 1.0 Advanced Graphics Package# (REQUIRES 92841A#)	Y	Y	N	Workstations monitoring __ Workstations x 64 kB =	16	n/s	One or more graphics devices interfaced to system (see Section 2.2).
COMMUNICATIONS SOFTWARE							
91730A Multipoint Terminal Interface/Multidrop Data Link Software	N	Y	Y	Additional base requirement Partition for system exerciser program (4.2 kB) or system status program (2.5 kB) =	3.3	n/s	12790A Multipoint interface and appropriate cables and terminals or systems (see Fig. 2.1-5 on page 2.1-10 or Fig. 3.1-3 on page 3.1-6)
91732A Data Link Software	Y	N	N	Auto restart (10 kB) = Partition for configuration reporting (30 kB), data link verification (10 kB), dynamic status reporting (32 kB), or terminal exerciser (14 kB) =		n/s	12092A Data Link Master interface and appropriate cables and terminals, printers, or systems (see Fig. 2.1-5 on page 2.1-10, Fig. 2.3-1 on page 2.3-5, or Fig. 3.1-3 on page 3.1-6)
91750A DS/1000-IV Network Software (Data link master communication also requires 91730A or 91732A software; X.25 communication also requires 91751A software.)	Y	Y	Y	Comm w/HP 1000 only (128 kB) = Comm w/HP 3000 only (128 kB) = Comm w/HP 1000 and HP 3000 (192 kB) =		1.3	One or more DS/1000-IV point-to-point, data link, or DSN/X.25 interfaces to other HP systems (see Fig. 3.1-2, 3.1-3, and 3.1-4 on pages 3.1-5 through 3.1-7).
91751A X.25 Communications Software	Y	Y	N	Additional base requirement	128	0.6	12075A (A-Series) or 12250A (E/F-Series) interface connected via modem to an X.25 Packet-Switching Network.
91781A RJE/1000-II Remote Job Entry Package	Y	Y	N	Additional base requirement __ Concurrent Users x 16 kB =	66	0.35	12043A (A-Series) or 12260A (E/F-Series) interface connected via modem to remote IBM or IBM plug-compatible system.
91782A MRJE/1000 Multileaving Remote Job Entry Package	Y	Y	N	Additional base requirement __ Concurrent Users x 16 kB =	346	1.68	
91784A PMF/1000 Programmatic Mainframe Facility	Y	Y	N	Additional base requirement __ Concurrent Users x 16 kB =	510	0.55	
94200A PCIF/1000 Programmable Controller Interface Software	Y	N	N	Additional base requirement __ Data highways x 1.8 kB = __ PCs x 1.5 kB =	116	7.0	12041A (A-Series) 8-channel Multiplexer and 12828A Multiplexer Panel connected to Allen-Bradley Programmable Controllers as shown in Fig. 3.4-1 on page 3.4-2.
SUBTOTALS							

\* = This product is not recommended for new applications.

Table 4-1. Software and Software Requirements Summary, continued

SOFTWARE PRODUCT NUMBER AND NAME	USABLE IN			MEMORY REQUIREMENT EXPLANATION	SOFTWARE REQUIREMENTS		
	RTE-A	RTE-6/VM	RTE-IVB		MAIN MEMORY (kB)	DISC MEMORY (MB)	OTHER SYSTEM HARDWARE REQUIREMENTS
SUBTOTALS FORWARD					_____	_____	
FACTORY AUTOMATION SOFTWARE							
92121A PMC/1000 Process Monitoring and Control/1000 Software (Also requires 92861A Graphics/1000-II Version 2.0 Device-Independent Graphics Library.)	Y	N	N	Minimum base requirements (one terminal, 800 blocks, and 1,600 I/O points) Up to 7 additional terminals Up to 2,700 additional blocks Up to 20,000 additional input points	1024 512 512 512	n/s	> 12156A Floating Point Processor in A700 > 2627A Color Graphics Terminal > 256xA or 293xA Printer > 3497A Data Acquisition/Control Unit or 2250A/H/L Measurement and Control System
92131A QDM/1000 Quality Decision Management Software (Also requires 92069A Image/1000 Data Base Management System and 92861A Graphics/1000-II Version 2.0 Device Independent Graphics Library)	Y	N	N	Minimum additional base requirement (up to 7 devices) — additional devices x _____ kB	512 _____ _____	n/s	> 2623A Graphics Terminal or 2627A Color Graphics Terminal as system console > 256xA or 293xA Printer or 747xA, 7550A, or 758xB Plotter > 797xA Mag Tape Subsystem
OTHER HEWLETT-PACKARD SOFTWARE							
94250A F/1000 Forms Package	Y	Y	N	Forms monitor with non-integral Forms Access Library Interactive Forms Builder Integral Forms Access Library	54 84 24	1.03	262xA/B Terminal, except 2621A/B/P.
TOTALS					_____	_____	
MULTIPLY BY APPLICATION REQUIREMENTS FACTOR					x _____	x _____	
TO DETERMINE HOW MUCH MAIN MEMORY AND DISC MEMORY TO PROVIDE					_____	_____	

**Program Development Software**

Program development software includes editor, assembler, and program installation utility software that comes with the RTE system, in addition to the separately-purchasable program development software products that are listed in Table 4-1. Since the RTE systems provide multiple copies of the editor, compilers, debugger, etc., for support of multiple users, main memory usage for program development depends upon how many users are expected to be developing programs at the same

time. Per-user main memory requirements are listed for the general category of program development but separately for FORTRAN 77, Pascal/1000, and BASIC/1000C, which require more main memory per user. Disc memory requirements are for storage of all software modules supplied with the product.

## Performance Enhancement Software

**Program activity profiling** provides a means of determining which parts of a program are the most active. Because they use the most execution time, the most active parts of a program offer the greatest opportunities for performance enhancement, either by recoding for more efficient execution or by conversion to microcode. Program activity profiling is supported for single users on E/F-Series computers by the 92083A RTE Profile Monitor and for multiple users on A/E/F-Series computers by the profile monitor in the 92860A Symbolic Debug/1000 package.

**Development of microprograms** for installation in control store is supported for multiple users on HP 1000 A700, A900, and E/F-Series computers. Microprograms enhance performance because they typically execute 3 to 10 times faster from control store than corresponding software routines execute from main memory. User microprogram space availability is specified in Table 1-1 on page 1-3.

## Data Base Management Software

Data base management offers a means of consolidating large quantities of data into a single inter-related data base that can be shared by many different users. Two different data base management systems are available for HP 1000 Systems.

The basic data base management function, including interactive Query access, is supported by the 92069A Image/1000 Data Base Management System. The 92081A Image/1000-II Data Base Management System supports all functions of 92069A Image/1000 plus provisions for decreasing the number of disc accesses, protection of data, and data base integrity. Image/1000-II should be preferred over Image/1000 for applications that cannot tolerate data loss.

In addition to base requirements for main memory storage of active Image software and disc storage of all Image software, data base management imposes main memory requirements for support of

local and/or remote Query access by multiple users and disc memory requirements for data set data storage. The basis for calculating these requirements is in Table 4-1, on page 4-4.

## Reliability Enhancement Software

**HP 91745A Datasafe/1000** supports configuration of discs in mirrored pairs. With this arrangement, write accesses record the same data on both discs of the mirrored pair. Because all data is duplicated in what is effectively a continuous on-line, real-time backup operation, data is safeguarded from a failure of either disc.

**HP 91747A Datashare/1000** supports sharing of the same data spaces on a 79xxM Multi-Access Controller (MAC) disc(s) by up to four different computers. This sharability of data facilitates implementation of systems that use multiple computers to improve processor availability. Datasafe/1000 can be used with Datashare/1000 to improve availability of data as well as processors.

## Graphics software

**The Device-Independent Graphics Library (DGL)** is an extensive library of subroutines for simplification of graphics application programming. The 92861A Graphics/1000-II Version 2.0 DGL should be selected for all new applications. The 92841A Graphics/1000-II Version 1.0 DGL is the only graphics library that is usable under RTE-IVB. It is also the only graphics library to which can be added handlers for non-supported graphics devices, which may be developed with the aid of the 92843X Skeleton Device Handler.

**The Advanced Graphics Package (AGP)** works with the Device-Independent Graphics Library (DGL) to provide support of interactive graphics workstations and the development of three-dimensional graphics. The 92862A Graphics/1000-II Version 2.0 AGP must be used with the 92861A Version 2.0 DGL and the 92842A Graphics/1000-II Version 1.0 AGP must be used with the 92841A Version 1.0 DGL.

### Communications software

**Multipoint/Data Link Software** supports multipoint and multi-drop data link connections to terminals, printers, and data link slave systems. Main memory requirements depend upon which routines from the respective 9173xA software packages are to be used in the system.

**DS/1000-IV Network Software** supports high-level communication with other HP systems, including the capabilities that are summarized in Section 3.1. Main memory requirements depend upon what links are supported, as shown in Table 4-1 on page 4-5.

Disc memory requirements in Table 4-1 apply only to the main development host HP 1000 system in the network; software for the other memory-based or disc-based HP 1000 nodes in the network can be downloaded from the HP 1000 host system.

**X.25 Software** supports HP 1000 communication with public or private packet-switched networks. This includes DS/1000-IV communication between HP 1000 systems and between HP 1000 and HP 3000 systems when routed via a packet-switching network.

**Communication with IBM and Plug-Compatible Systems** is supported by three different packages, which are compared in Section 3.2.

**Communication with Programmable Controllers** is supported in A-Series systems to facilitate overall coordination of discrete manufacturing processes, as discussed in Section 3.4.

### Factory automation software

**Process Monitoring and Control** is supported in A-Series systems by the 92121A PMC/1000 package. The process monitoring and control function places extensive demands on system resources, so few if any other functions should be added to a system running PMC/1000.

**Quality Decision Management** is supported in A-Series systems by the 92131A QDM/1000 package. The quality decision management function and related data capture operations place extensive demands on system resources, so few if any other functions should be added to a system running QDM/1000.

### Other Hewlett-Packard software

**Data entry via CRT-displayed forms** is supported in A-Series systems by the 94250A F/1000 package. Main memory usage depends upon which modules of F/1000 are selected to be memory resident.



# HP 1000 Computer Systems -- Contents

## Section 5.1 A-Series Systems Based on System Processor Units

5.1-1	System Processor Unit (SPU) Description . . . . .	5.1-1
5.1-2	SPU Selection . . . . .	5.1-1
5.1-3	System Console Requirements . . . . .	5.1-2
5.1-4	System Disc Requirement . . . . .	5.1-3
5.1-5	Other SPU Additions and Changes . . . . .	5.1-4
5.1-6	System Size Constraints . . . . .	5.1-4
5.1-7	Computer Card Cage Organization . . . . .	5.1-4
5.1-8	SPU Racking . . . . .	5.1-4

## Section 5.2 A-Series Systems Based on Computers and Board Computers

5.2-1	Computer Descriptions . . . . .	5.2-1
5.2-2	Computer Selection . . . . .	5.2-1
5.2-3	Operational Requirements . . . . .	5.2-3
5.2-4	Additions and Changes . . . . .	5.2-6
5.2-5	System Size Constraints . . . . .	5.2-7
5.2-6	System Racking . . . . .	5.2-8

## Section 5.3 A-Series Systems Expansion and Cabinet Racking

5.3-1	Memory Changes and Expansion . . . . .	5.3-1
5.3-2	Accessories and Interfaces . . . . .	5.3-3
5.3-3	System Size Constraints . . . . .	5.3-8
5.3-4	I/O Expansion . . . . .	5.3-10
5.3-5	System Racking . . . . .	5.3-10
5.3-6	System Summarization . . . . .	5.3-10

## Section 5.4 E/F-Series Systems Based on System Processor Units

5.4-1	System Processor Unit (SPU) Description . . . . .	5.4-1
5.4-2	SPU Selection . . . . .	5.4-1
5.4-3	System Console Requirements . . . . .	5.4-3
5.4-4	System Disc Requirement . . . . .	5.4-3
5.4-5	Other SPU Additions and Changes . . . . .	5.4-3
5.4-6	Computer Card Cage Organization . . . . .	5.4-4
5.4-7	System Racking . . . . .	5.4-4

## Section 5.5 E/F-Series Systems Based on Computers and Board Computers

5.5-1	Computer Descriptions . . . . .	5.5-1
5.5-2	Computer Selection . . . . .	5.5-1
5.5-3	Operational Requirements . . . . .	5.5-4
5.5-4	Additions and Changes . . . . .	5.5-5
5.5-5	System Racking . . . . .	5.5-5

## Section 5.6 E/F-Series Systems Expansion and Cabinet Racking

5.6-1	Memory Changes and Expansion . . . . .	5.6-1
5.6-2	Accessories and Interfaces . . . . .	5.6-4
5.6-3	I/O Expansion . . . . .	5.6-10
5.6-4	System Racking . . . . .	5.6-10
5.6-5	System Summarization . . . . .	5.6-12

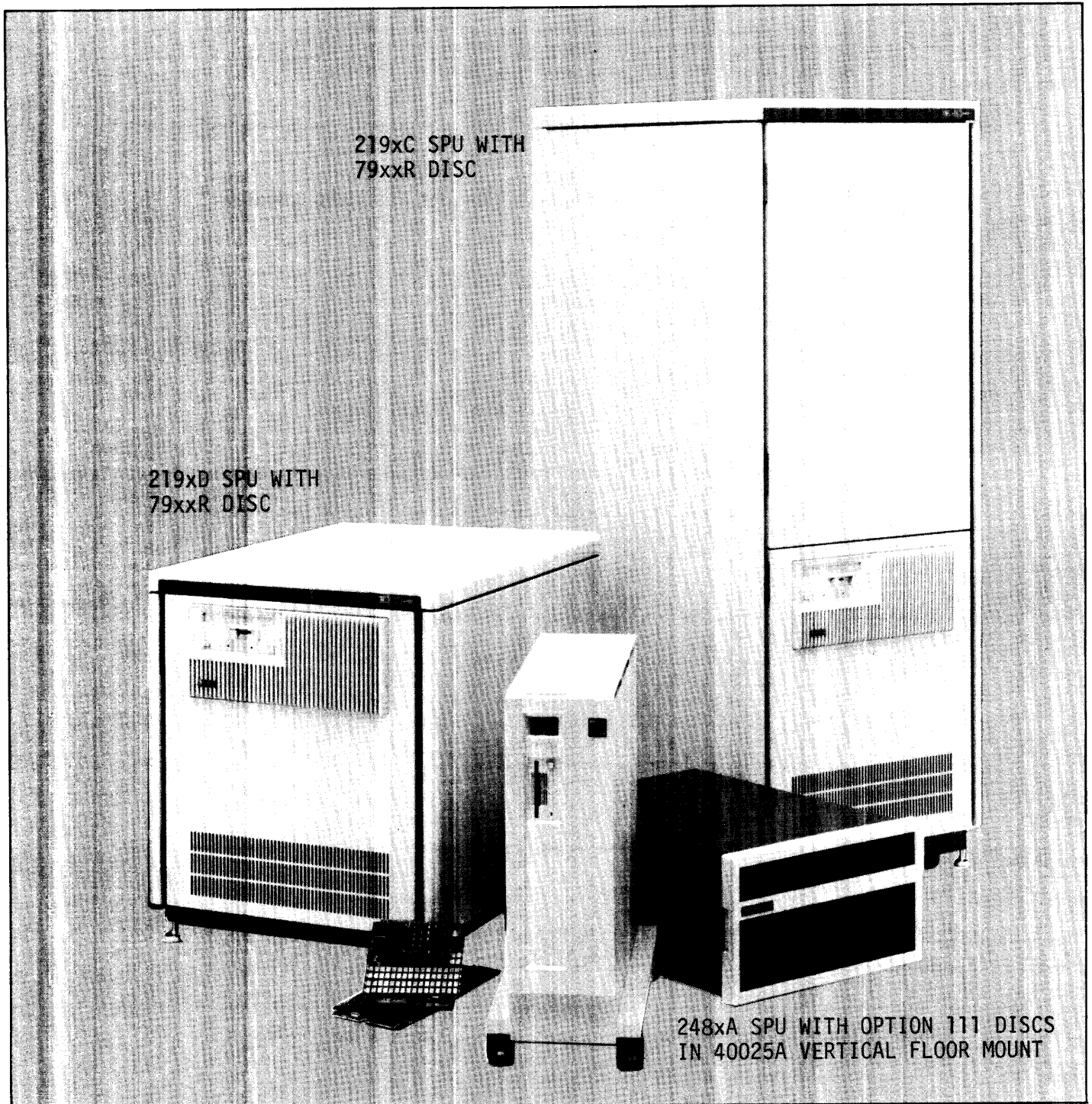

Figure 5.1-1. HP 1000 A-Series SPUs

# Section 5.1

## A-Series Systems Based on System Processor Units

### 5.1-1 System Processor Unit (SPU) Description

Standard HP 1000 A-Series System Processor Unit (SPU) hardware consists of an A600+, A700, or A900 computer with 512 or 768 kB memory and interfaces for system console and system disc. Depending upon the selection of computer and SPU package, 7 to 16 card cage slots are available for additional memory, control store card(s) in the A700 or A900 computer, and I/O cards. The SPU also includes the RTE-A Real-Time Executive operating system, hardware and software manuals, site preparation consultation, on-site installation assistance and system checkout, and 90-day on-site warranty.

### 5.1-2 SPU Selection

Nine different HP 1000 A-Series SPU products are available, as summarized in Table 5.1-1, below. Their physical configurations are shown in Figure 5.1-1.

#### Rack Mounted 219xC/D SPUs

Rack-mounted 219xC/D SPUs provide maximum card cage capacity for expansion of memory and I/O. Within the 219x group, the 219xC SPU cabinet (at right in Figure 5.1-1) provides an upper compartment for rack mounting equipment that is in addition to the computer and separately-purchased rack mountable disc in the lower part of the cabinet. The 219xD SPU cabinet (at left in Figure 5.1-1) houses only the computer and a rack mountable disc.

#### Micro/1000-Packaged 248xA SPUs

For applications that do not require the card cage capacity of the 219xC/D SPU, the 248xA SPUs offer the compactness, versatility, and lower cost of Micro/1000 packaging. In its small compass, the Micro/1000 SPU provides a 14-slot card cage (12 slots if battery backup is used) and space for an optional hard disc with microfloppy disc. The Micro/1000 SPU can be placed on a table or bench, installed in a standard 19-inch EIA rack cabinet, or used in a convenient desk-side or under-table floor mounting accessory, as shown center-front in Figure 5.1-1.

*Table 5.1-1. HP 1000 A-Series System Processor Unit Selection Guide*

SPU PRODUCT NUMBER SYSTEM MODEL NUMBER	2196C/D 26	2197C/D 27	2199C/D 29	2486A Micro 26	2487A Micro 27	2489A Micro 29
PHYSICAL CONFIGURATION	219xC SPU is rack mounted in a tall cabinet with upper compartment for additional equipment; 219xD SPU is rack mounted in a short cabinet without the upper compartment			Compact, versatile Micro/1000 package with space for integral fixed and microfloppy discs		
COMPUTER	A600+	A700	A900	A600+	A700	A900
CAPACITY -- Standard Memory	0.5 MB	0.5 MB	0.75 MB	0.5 MB	0.5 MB	0.75 MB
-- Maximum Memory	8.0 MB	8.0 MB	24.00 MB	8.0 MB	8.0 MB*	6.00 MB
-- I/O Chan Available With Std Memory	16	13	13	10#	8#	7#
-- I/O Chan Available With Max Memory	12	10	6	6#	5#	6#
PERFORMANCE -- Fastest Instruction (MIPS)	1	1	3	1	1	3
-- Floating Pt Computation (KFLOPS)	64	204	500	64	54.4**	500
-- User Microprogrammability	No	Yes	Yes	No	Yes*	Yes

\* The floating point processor card and/or control store cards each reduces the maximum memory capacity in the 2487A Micro 27 SPU by 2 megabytes.

# Battery backup in the 2486A, 2487A, or 2489A occupies two I/O slots, reducing this number by two.

\*\* With hardware floating point processor, optional in the 2487A, this figure is 204 KFLOPS.

### Computer Choices

Within the respective 219xC/D and 248xA physical configuration groupings are computer choices that determine computational performance.

**Base Instruction Set Performance** of the A600+ and A700 computers is comparable at 1 MIPS for the fastest instruction. The A900 is 3 times faster at 3 MIPS for the fastest instruction.

**Floating Point Performance** of the A700 computer with hardware floating point processor (standard in 2197C/D SPUs, optional in the 2487A SPU) is about 3 times faster than the firmware-based floating point performance of the A600+ computer. A900 floating point performance is nearly 2.5 times faster than the A700 with hardware floating point processor.

**User Microprogrammability** of the A700 and A900 computers facilitates optimization of performance by converting frequently-used or especially time-consuming software routines to faster-executing microcode. Microprogramming can also be used to create completely new machine instructions for special purposes.

### 5.1-3 System Console Requirements

HP 1000 A-Series SPUs must be equipped with a system console terminal for operator-system communication. This requires:

1. Selection of a separately-ordered system console terminal.
2. Selection of the SPU system console connect option that is appropriate for the selected system console terminal.

#### System Console Terminal Selection

The system console must be selected from those listed in Table 5.1-2. Terminal selection criteria are provided in Peripherals section 2.1, on pages 2.1-1 through 2.1-3.

Table 5.1-2. Supported System Consoles and SPU Connect Options

SUPPORTED SYSTEM CONSOLE TERMINALS	CORRESPONDING SPU CONNECT OPTIONS		
	005	006	008* PLUS 12040B MULTIPLEXER AND CABLE PRODUCT NO:
2392A Display Terminal	No	Yes	40242M
2623A Graphics Terminal	Yes	No	13222N
2624B Display Terminal	Yes	No	13222N
2625A Dual System Display Terminal	No	Yes	40242M
2626A Display Station	Yes	No	13222N
2627A Color Graphics Terminal	Yes	No	13222N
2628A Word Processing Terminal	No	Yes	40242M
45610B HP Touchscreen Terminal	No	Yes	40242M

\* SPU Option 008 and use of the 12040B 8-Channel Multiplexer for system console connection is not supported in the 2489A SPU because of excessive RFI.

### System Console Connection

The system console can be connected via the single-channel interface that is included in all A-Series SPUs or it can be connected via channel 1 of a 12040B 8-Channel Asynchronous Multiplexer. This latter choice saves card cage space and reduces overall cost of connecting more than two terminals to the system. However, it cannot be used with the 2489A SPU because of excessive RFI.

**For system console connection via the standard single-channel interface,** SPU connect (cable) option 005 or 006 must be ordered with the SPU. Table 5.1-2 indicates which of connect options 005 or 006 is appropriate for each of the supported system console terminals.

**For system console connection via the 8-channel multiplexer,** SPU option 008 must be ordered to delete the standard system console interface. In addition, a 12040B 8-Channel Multiplexer and an appropriate multiplexer panel-to-terminal cable must be ordered for connection of the system console. Table 5.1-2 indicates the appropriate cable product number for connection of each of the supported system consoles.

## 5.1-4. System Disc Requirement

HP 1000 A-Series SPUs must be equipped with a system disc for operating system and program development support. The system disc is a disc, or disc-tape combination, for which operating system software media is orderable and which will support bootup of the RTE operating system. The system discs supported for HP 1000 A-Series SPUs are listed in Table 5.1-3 along with SPU software media options and other SPU options that correspond to a particular system disc choice.

The system disc selected for the system must have enough capacity, by itself or in conjunction with additional discs, to satisfy disc memory requirements of the system as determined in the Software section on pages 4-1 through 4-6. For other disc memory selection criteria, see Peripherals section 2.4 on pages 2.4-1 through 2.4-5.

Table 5.1-3. Supported System Discs

DISC PRODUCT NUMBER	TYPE	DISC CAP. (MB)	AVG TRANS RATE* (kB/s)	AVG ACC TIME (ms)	CORRESPONDING SPU OPTIONS	
					OPTION NO.	DESCRIPTION
248xA+111 (248x SPU only)	Hard fixed disc & microfloppy disc (integral discs)	14.5 0.27	230 17	85 430	248xA+044	Software on Microfloppy Discs
7911P/R# 7912P/R# 7914P/R#	Hard, fixed with CS/80 cartridge tape drive for loading & backup	28.1 65.6 131.2	983	35 35 36	SPU Opt 022	Software on CS/80 or 9144A Cartridge Tape
7914CT	Standalone, hard, fixed with 9144A cartridge tape drive for loading and backup	131.2	983	36	SPU Opt 022 and 219xC/D+053	Software on CS/80 or 9144A Cartridge Tape Cabinet door without cutout
7914ST or 7914TD	Hard, fixed with 1600 bpi mag tape unit	131.2	983	36	SPU Opt 061 and 219xC+070	Software on 1600 bpi magnetic tape Deletes 219xC SPU cabinet (NOTE A) and adds 12009A interface to mag tape unit of 7914ST or 7914TD.
7933H** 7935H**	Hard, fixed Hard, removable	404.4	1000	32	SPU Opt 061, 219xC +050, and 219xC/D+053	Software on 1600 bpi magnetic tape Mag tape trim for upper compartment of system cabinet Cabinet door without cutout
7941A## 7945A##	Hard, fixed	23.8 55.5	625	49	SPU Opt 022 and 219xC/D+053	Software on CS/80 or 9144A cartridge tape Cabinet door without cutout
7942A 7946A	Hard, fixed with 9144A cartridge tape drive for loading & backup	23.8 55.5	625	49	SPU Opt 022 and 219xC/D+053	Software on CS/80 or 9144A cartridge tape Cabinet door without cutout (NOTE B)

NOTE A: Computer mounts in 7914ST/TD cabinet. The appearance of the 7914ST cabinet differs significantly from the appearance of the 219xC cabinet; this should be considered carefully prior to ordering 219xC Option 070.

NOTE B: The 7942A/7946A Disc can be installed in the racking position of the 791xR Disc, with access to its tape drive gained by opening the lower door. Alternatively, the 7942A/7946A Disc can be rack mounted in the upper compartment of the 219xC SPU, which requires SPU option 051 to delete the upper door for proper ventilation air flow. For information on racking equipment in the upper compartment, see page 5.3-10.

\* Average transfer rate is based on the minimum time required to transfer one track without overrun.

# For 219xC/D SPU, order the 79xxR rack mounting disc, NOT the 79xxP standalone disc.

\*\* This disc requires a separate program/data entry/backup device, such as a 797xA/E mag tape unit.

## This disc requires a separate program/data entry/backup device, such as a 9144A tape cartridge subsystem.

## 5.1-5 Other SPU Additions and Changes

### Providing More than Standard Memory

Your HP 1000 A-Series system may require more than the 512 or 768 kB of memory that is standard. How much main memory should be obtained can be determined using the information in the Software section on pages 4-1 through 4-6.

If more than 512 or 768 kB of memory is needed, SPU option 014 can be ordered to delete the standard memory, to make room for replacing it with more memory. The choices for A-Series memory changes and expansion are summarized in section 5.3, on pages 5.3-1 through 5.3-3.

### Additional Peripheral Devices and Interfaces

Your initial work on system design, using a copy of HP 1000 System Capabilities Checklist, Table 1-3, provided an initial overview of the peripheral devices to be included in the system. By using Table 1-3 with information in Peripherals sections 2.1 through 2.4, you can complete on one or more copies of Table 1-4 a detailed summary of the peripherals, interfaces, and cables to be added to your SPU to provide all the functions needed for your HP 1000 A-Series system.

## 5.1-6 System Size Constraints

### RTE-A System Memory Limitations

The RTE-A system and system tables are limited to 64k bytes of memory. The operating system will use 1/2 to 2/3 of the available memory, leaving 1/2 to 1/3 for system tables. Table space is required to support each I/O card, device, and program in the system. System size and table space are specified during system generation.

### RTE-A Device, I/O Card, and Program Support

The operating system can distinguish 255 devices, 48 I/O cards, and 255 concurrent programs. However, limited space for system tables may markedly limit the actual capacity of a particular system.

A worksheet (Table 5.3-5, pages 5.3-8 through 5.3-10) may be copied to check the size of a particular system and its required table space. This should be done for any system with more than 16 I/O interfaces or more than 24 terminals.

## 5.1-7 Computer Card Cage Organization

The HP 1000 A-Series SPUs use six different computers. The arrangement of computer and memory cards in these computers is shown in Figures 5.2-2 through 5.2-7, which relate to the respective SPUs and computers as listed below.

FOR SPU	COMPUTER IS	SEE FIGURE
2196C/D	2156B	5.2-2
2197C/D	2137A	5.2-3
2199C/D	2139A	5.2-4
2486A	2436A	5.2-5
2487A	2437A	5.2-6
2489A	2439A	5.2-7

## 5.1-8 System Racking

For information on rack mounting of HP 1000 A-Series systems, see paragraph 5.3-4, page 5.3-10.

# Section 5.2

## A-Series Systems Based on Computers and Board Computers

### 5.2-1 Computer Descriptions

#### Box Computer

The box computer consists of A600+, A700, or A900 computer cards with 128 or 768 kB memory in a card cage with power supply. The box computer lends itself well to applications whose requirements are not satisfied by SPUs, which are designed as disc-based packages. This includes use for memory-based systems, distributed system nodes with or without system console or disc, and systems configured with multiple computers for improved availability.

#### Board Computer

The A600+ computer is available as a two-board set with 128 kB memory for users who want to do their own card cage connections and power supply. Two different card cages are offered to assist users with integration of the board computer.

### 5.2-2. Computer selection

Seven different HP 1000 A-Series computer products are available, as summarized in Table 5.2-1, below. Their physical configurations are shown in Figure 5.2-1.

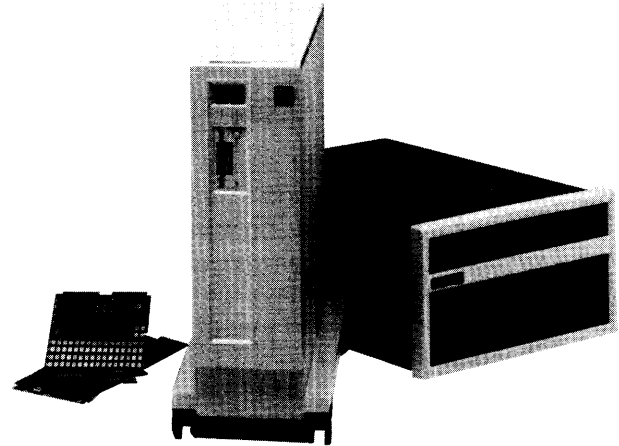

*Figure 5.2-1. HP 1000 A-Series Computers*

*Table 5.2-1. HP 1000 A-Series Computers Selection Guide*

COMPUTER PRODUCT NUMBER	2106BK	2156B	2137A	2139A	2436A/E	2437A	2439A
PHYSICAL CONFIGURATION	Board Computer	Box computer in 20-slot card cage			Box computer in compact, versatile Micro/1000 package with space for integral fixed and microfloppy discs		
PROCESSOR TYPE	A600+	A600+	A700	A900	A600+	A700	A900
CAPACITY -- Standard Memory (kB)	128	128	128	768	128/512	128	768
-- Maximum Memory (MB)	6.0*	8.0	8.0	24.0	8.0	8.0#	6.0
-- I/O Chan Av. w/Std Memory	8*	18	16	15	12**	10**	9**
-- I/O Chan Av. w/Max Memory	5*	14	12	11	8**	6**	8**
PERFORMANCE -- Fastest Instr. (MIPS)	1	1	1	3	1	1	3
-- Floating Pt (KFLOPS)	64	64	54.4##	500	64	54.4##	500
-- User Microprogrammable	No	No	Yes	Yes	No	Yes#	Yes

\* Based on use of the 2106BK Board Computer in a 12030A 10-slot card cage.

# The floating point processor card and/or control store cards each reduces the maximum memory capacity in the 2437A Micro 27 Computer by 2 megabytes.

\*\* Battery backup in the 2436A/E, 2437A, or 2439A occupies two I/O slots, reducing this number by two.

## With 2137A/2437A Option 001 hardware floating point processor, this figure is 204 KFLOPS.

### Computers in 20-Slot Box

The 2156B, 2137A, and 2139A Computers are housed in a 20-slot box (at right in Figure 5.2-1) that provides maximum capacity for expansion of memory and I/O. The arrangements of computer and memory cards in the respective computers are shown in Figures 5.2-2 through 5.2-4.

### Computers in Micro/1000 Package

For applications that do not require the card cage capacity of the 20-slot box, the 243xA Computers offer the compactness, versatility, and lower cost of Micro/1000 packaging. In its small compass, the Micro/1000 package provides a 14-slot card cage (12 slots if battery backup is used) and space for an optional hard disc with microflop disc. The Micro/1000 computer can be placed on a table or

bench, installed in a 19-inch EIA rack cabinet, or used in a convenient desk-side or under-table floor mounting accessory, as shown in Figure 5.2-1. The arrangements of computer and memory cards in the respective computers are shown in Figures 5.2-5 through 5.2-7.

### Choices of Processor Type

Within the respective 20-slot and Micro/1000 computer groupings are processor type choices that determine computational performance.

**Base Instruction Set Performance of the A600+ and A700 Processors** is comparable at 1 MIPS for the fastest instruction. The A900 is 3 times faster at 3 MIPS for the fastest instruction.

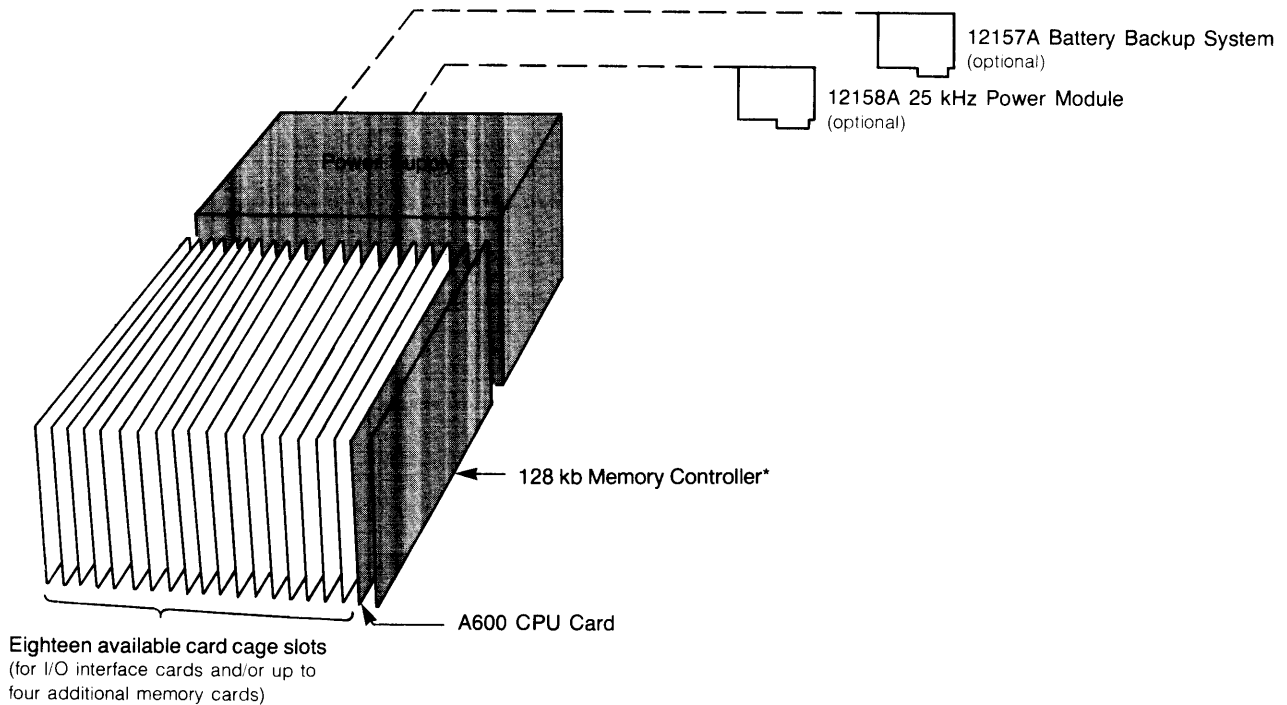

\* 512 kb or 1 Mb Memory Controller may be substituted and additional memory array cards can plug into space immediately to the right of the Memory Controller card.

Figure 5.2-2. HP 2156B A600+ Computer Card Cage Arrangement (rear view)



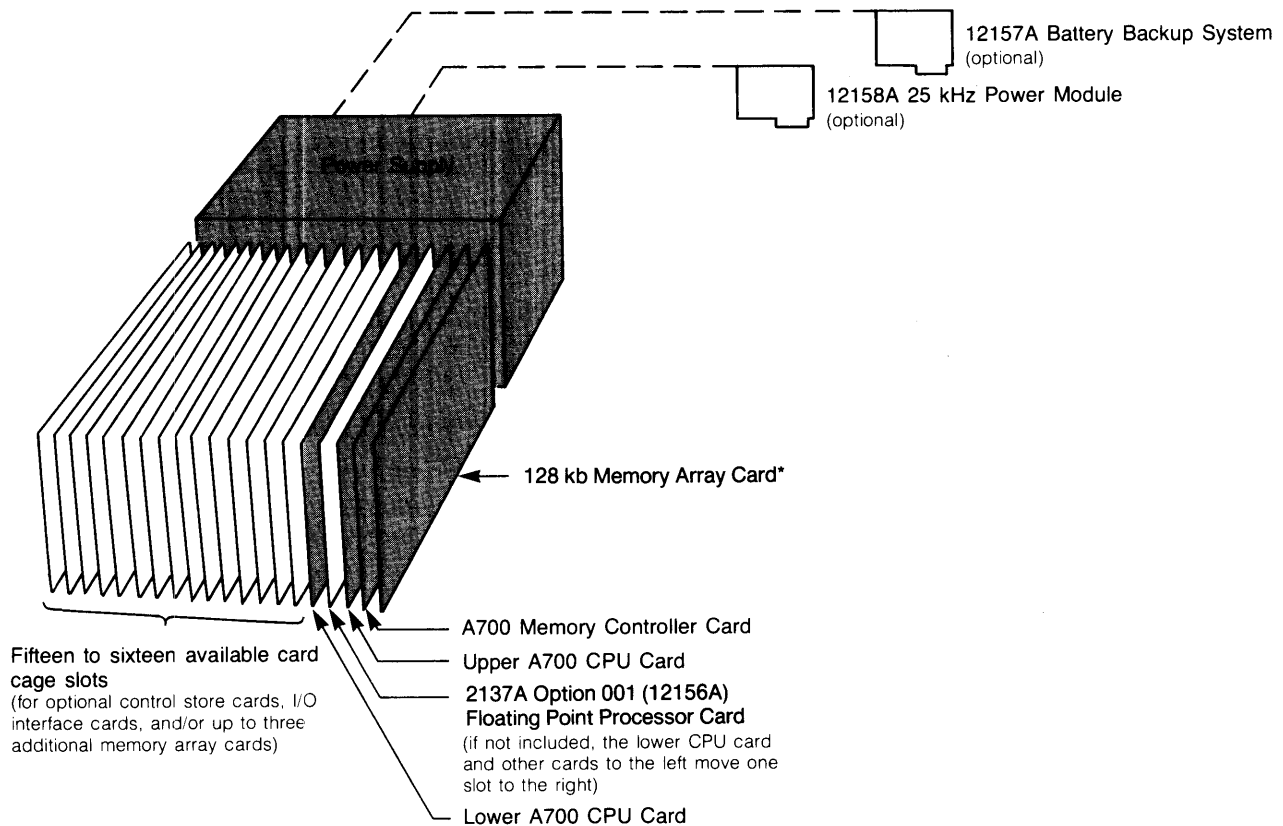

\* 512 kb, 1 Mb, or 2 Mb array card can be substituted; additional memory array cards plug into space immediately to the right of the Memory Controller card, moving all card positions to the left.

Figure 5.2-3. HP 2137A A700 Computer Card Cage Arrangement (rear view)

**Floating Point Performance of the A700 Computer** can be made about 3 times faster than the firmware-based floating point performance of the A600+ Computer by adding the 2137A/2437A option 001 hardware floating point processor. A900 floating point performance is nearly 2.5 times that of the A700 with hardware floating point processor.

**User Microprogrammability of the A700 and A900 computers** facilitates optimization of performance by converting frequently-used or especially time-consuming software routines to faster-executing microcode. Microprogramming can also be used to create completely new machine instructions for special purposes.

## 5.2-3 Operational Requirements

### Basic Requirements

For operation, HP 1000 A-Series computers must be equipped to satisfy the following minimum basic requirements:

1. Operator communication with the computer for system bootup and maintenance:
  - a. Directly via one of the system console terminal-interface-cable combinations listed in Table 5.2-2, OR

- b. Remotely from a terminal at an adjacent host system connected via one of these DS/1000-IV links:
    - 12007B DS/1000-IV Modem Interface and a modem and telephone lines OR
    - 12044A DS/1000-IV Direct-Connect Interface
2. A source for entry of the programs to be run by the computer, selected from those listed in Table 5.2-3.

Table 5.2-2. Supported Terminal-Interface-Cable Configurations for Local Boot-Up/Maintenance Console

SUPPORTED SYSTEM CONSOLE TERMINALS	CONNECT TO COMPUTER VIA	
	12005B INTERFACE WITH CABLE OPTION NUMBER	OR 12040B MULTIPLEXER WITH CABLE PRODUCT NUMBER
2392A Display Terminal	006	40242M
2623A Graphics Terminal	005	13222N
2624B Display Terminal	005	13222N
2625A Dual System Display Terminal	006	40242M
2626A Display Station	005	13222N
2627A Color Graphics Terminal	005	13222N
2628A Word Processing Terminal	006	40242M
45610B HP Touchscreen Terminal	006	40242M

\* Use of the 12040B 8-Channel Multiplexer for system console connection is not supported in the 2439A Computer because of excessive RFI.

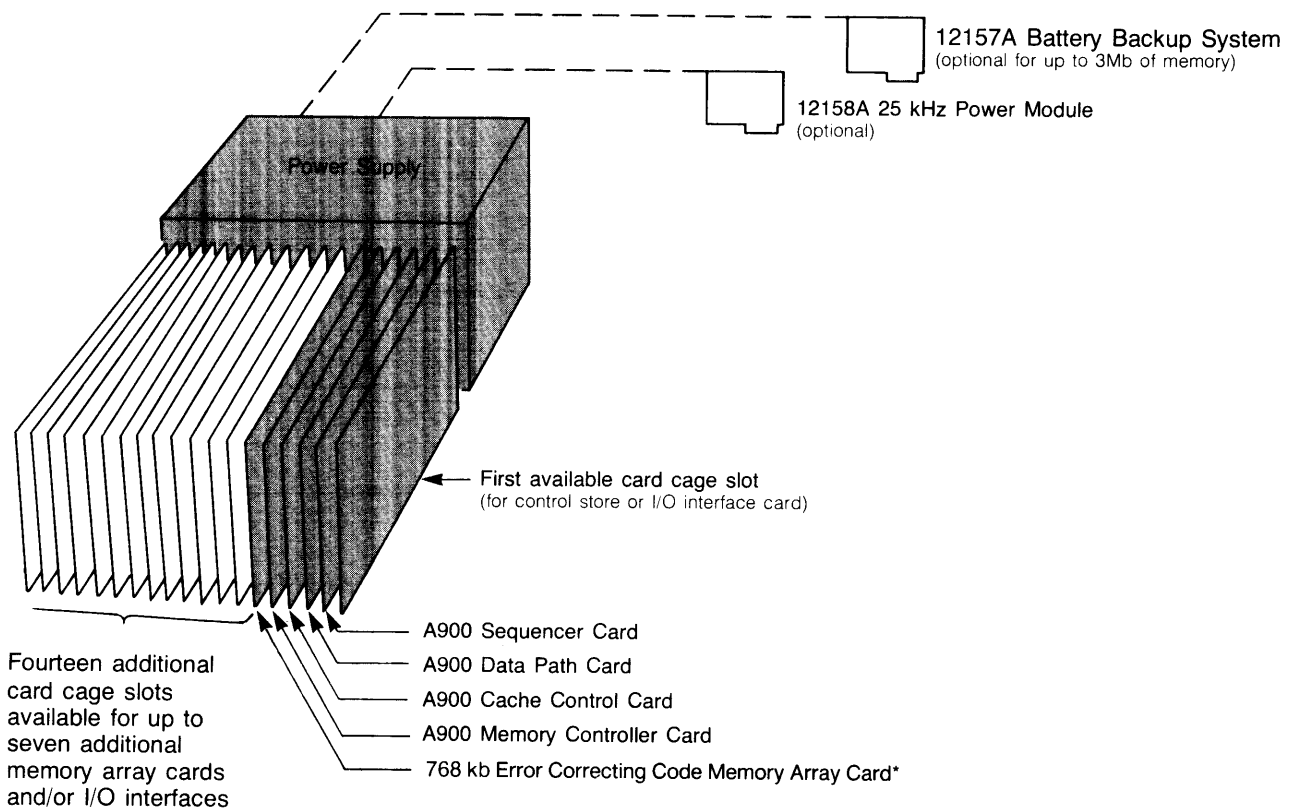

\* 3 Mb memory array card may be substituted; additional memory array card plug into space immediately to the left of the Memory Controller card, moving all card positions to the left.

Figure 5.2-4. HP 2139A A900 Computer Card Cage Arrangement (rear view)

Table 5.2-3. Supported Software Entry Sources

SUPPORTED SOFTWARE SOURCES	REQUIRED INTERFACES
1. ANY OF THE FOLLOWING DISC, DISC-TAPE, OR TAPE UNITS: -- 243xA Option 111 Integral Discs* -- 79xxP/R Disc w/Cartridge Tape Dr. -- 7942H Disc w/Cartridge Tape Drive -- 7946H Disc w/Cartridge Tape Drive -- 797xA/E Magnetic Tape Unit -- 9121D Dual Microfloppy Disc -- 9144A Cartridge Tape Subsystem	12009A HP-IB interface
2. AN ADJACENT HP 1000 SYSTEM IN A DS/1000-IV NETWORK (software downloads from host; same DS/1000-IV interface supports both operator communication and software download)  Requires 92077A/R/E RTE-A and 91750A/R DS/1000-IV Network Software.	12007B Modem I/F OR 12044A Dir Conn I/F
3. 12008A PROM STORAGE MODULE with software burned into PROMs loaded on the board.  12008A storage capacity is not sufficient to support an RTE-A based system.	Integral to 12008A

\* The 243xA Option 111 Integral Fixed and Microfloppy discs include the disc interface, so the 12009A interface is not required with that software source.

### Operating System

Any computer system will require some basis for management of overall operations. For simple uses, an OEM may find it necessary or desirable to create a stripped-down, application-specific operating system to minimize main memory requirements or to minimize operating system overhead or both. However, most users will find use of the 92077A RTE-A operating system, with or without the 92078A VC+ enhancement, more cost effective than creating their own system. Right-to-copy and right-to-execute licenses are available at 50% and 25% of first copy price for each multiple use of the basic software, significantly lowering the per-system cost of RTE-A or RTE-A/VC+ operating software.

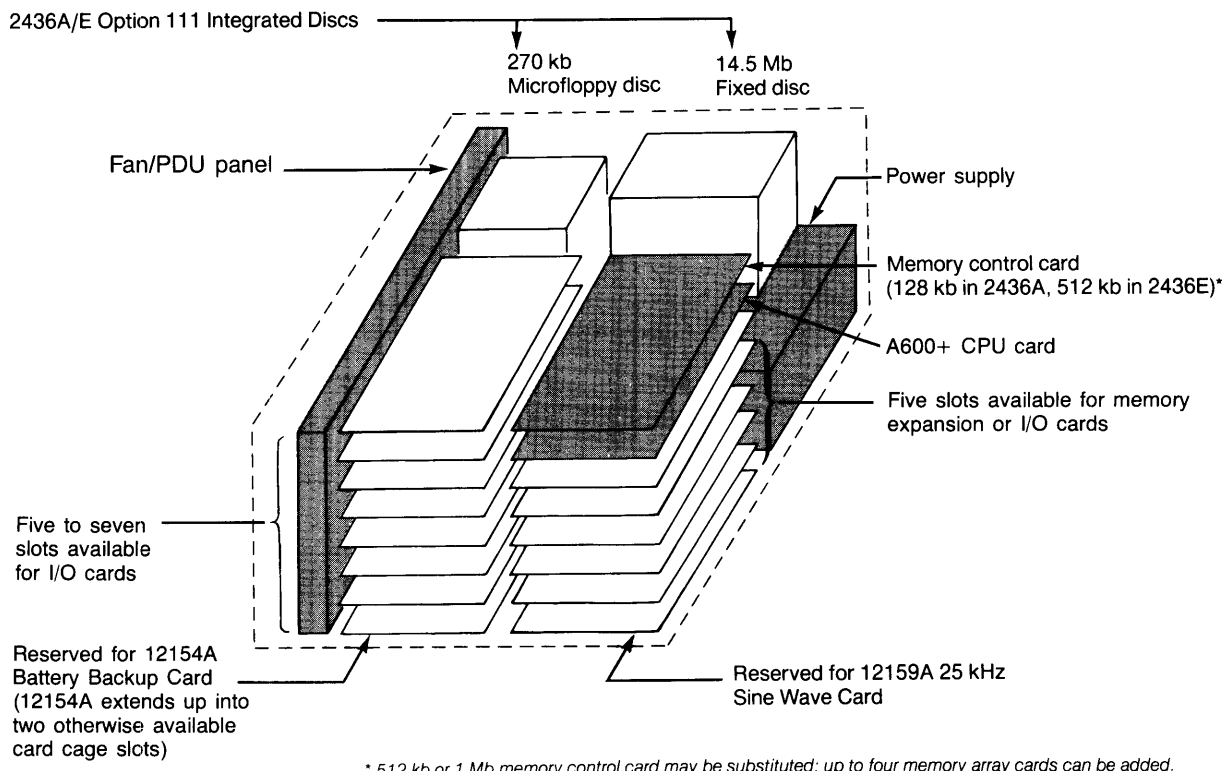

Figure 5.2-5. HP 2436A/E A600+ Micro 26 Computer Card Cage Arrangement (rear view)

The decision to use RTE-A makes it possible to project additional requirements. For example, main memory requirements for RTE-A and additional software can be projected using the information in the Software section on pages 4-1 through 4-6. Information on these same pages can be used to estimate the capacity required for a local hard disc used to support a disc-based configuration of RTE-A, if software is not going to be downloaded from an adjacent DS/1000-IV network host system.

## 5.2-4 Additions and Changes

### Providing More than Standard Memory

Your HP 1000 A-Series system may require more than the 128 or 768 kB of memory that is standard in A-Series computers. How much main memory should be obtained can be determined using the information in the Software section on pages 4-1 through 4-6.

If more than standard memory is needed, computer option 014 can be ordered to delete the standard memory, to make room for replacing it with more memory. The choices for A-Series memory changes and expansion are summarized in section 5.3, on pages 5.3-1 through 5.3-3.

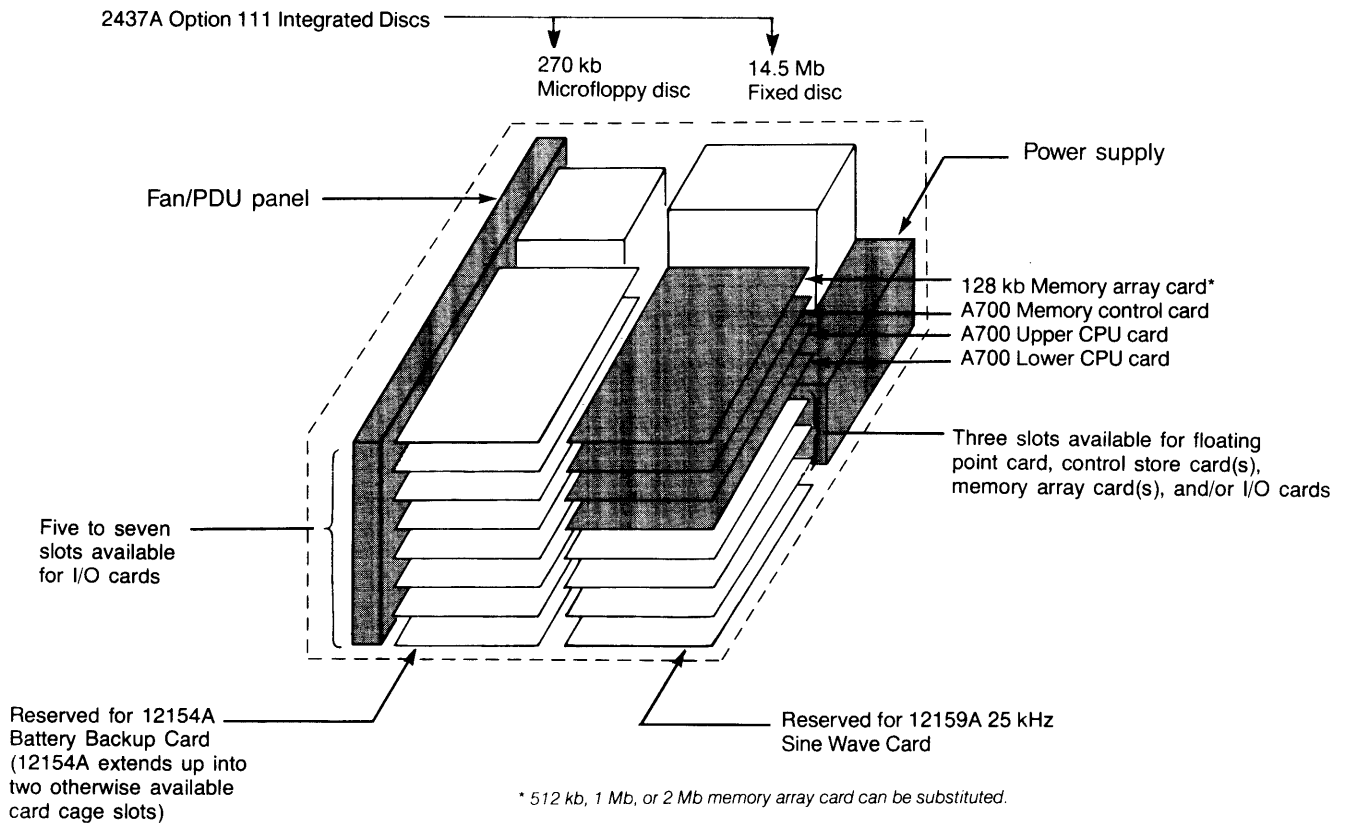

Figure 5.2-6. HP 2437A A700 Micro 27 Computer Card Cage Arrangement (rear view)

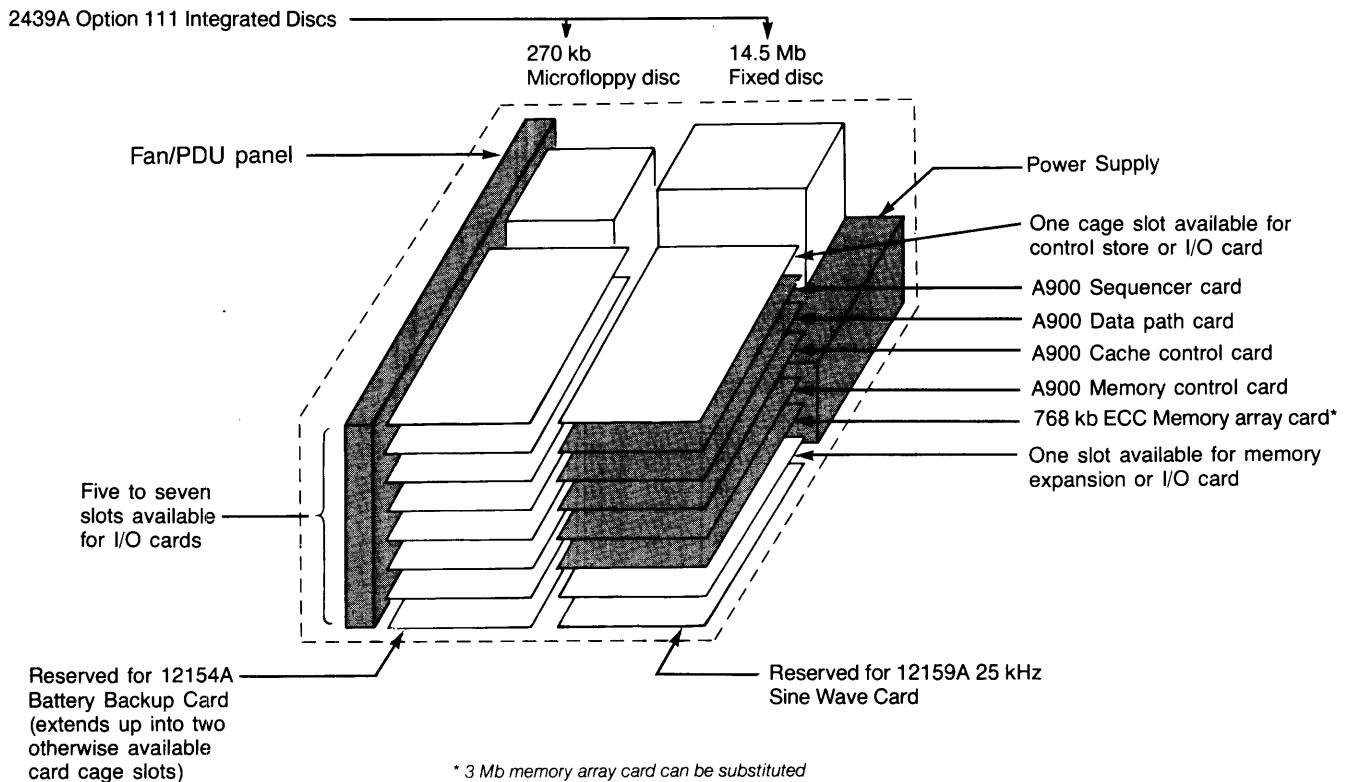

Figure 5.2-7. HP 2439A A900 Micro 29 Computer Card Cage Arrangement (rear view)

### Additional Peripheral Devices and Interfaces

Your initial work on system design, using a copy of HP 1000 System Capabilities Checklist, Table 1-3, provided an initial overview of the peripheral devices to be included in the system. By using Table 1-3 with information in Peripherals sections 2.1 through 2.4, you can complete on one or more copies of Table 1-4 a detailed summary of the peripherals, interfaces, and cables to be added to your computer to provide all the functions needed for your HP 1000 A-Series system.

## 5.2-5 System Size Constraints

### RTE-A System Memory Limitations

The RTE-A system and system tables are limited to 64k bytes of memory. The operating system will use 1/2 to 2/3 of the available memory, leaving 1/2 to 1/3 for system tables. Table space is required to support each I/O card, device, and program in the system. System size and table space are specified during system generation.

### **RTE-A Device, I/O Card, and Program Support**

The operating system can distinguish 255 devices, 48 I/O cards, and 255 concurrent programs. However, limited space for system tables may markedly limit the actual capacity of a particular system.

A worksheet (Table 5.3-5, pages 5.3-8 through 5.3-10) may be copied to use in determining the size of a particular system and its required table space. This should be done for any system with more than 16 I/O interfaces or more than 24 terminals.

## **5.2-6 System Racking**

For information on rack mounting of HP 1000 A-Series systems, see paragraph 5.3-4, page 5.3-10.

# Section 5.3

## A-Series Systems Expansion and Cabinet Racking

### 5.3-1. Memory Changes and Expansion

#### Changes on Initial Order for an SPU or Computer

To obtain memory capacity larger than the standard capacity supplied with HP 1000 A-Series SPUs or computers:

1. Order SPU or computer option 014 to delete the standard memory.
2. Using one of Tables 5.3-1 through 5.3-3 as a guide, order the memory card(s) and array connector that will provide the desired memory capacity.

#### Change from Parity Memory to ECC Memory in an A600+ System

To change to ECC memory in an A600+ system, replace the parity memory controller with a 12110A/B 512 kB or 1 MB ECC Memory Controller. The 12110A/B ECC Memory Controller can support up to four 12111x ECC memory array cards and/or existing 12103x parity memory array cards. Note, however, that the 12104A A700 ECC Memory Array card cannot be used with the 12110A/B ECC Memory Controller.

The capacity of any added memory array card cannot exceed the memory already installed and must be an integer multiple of the memory already installed. For example, a 1 MB array card can be added to the 1 MB memory controller. Then a 2 MB array card can be added to the 2 MB provided by the 1 MB controller and the 1 MB memory array.

*Table 5.3-1. A600+ Memory Configurations for 2106BK, 2156B, 2196C/D, 2436A/E, and 2486A*

MEMORY SIZE	512 kB	1.0 MB	1.5 MB	2 MB	3 MB	4 MB	5 MB	6 MB	7 MB	8 MB
<small>PARITY MEMORY (All configurations are based on use of the 12102B 512 kB parity memory controller, which is standard in 2196C/D, 2436E, and 2486A. For 2106BK, 2156B, and 2436A, must order computer option 014 and the 12102B 512 kB parity memory controller.)</small>										
12103C 512 kB ARRAY CARD	0	1	2	1	1	1	n/s	n/s	n/s	n/s
12103D 1.0 MB ARRAY CARD	0	0	0	1	2	3	n/s	n/s	n/s	n/s
MEMORY CONNECTOR	n/r	12038A	12038B	12038B	12038C	12038D	n/s	n/s	n/s	n/s

ECC MEMORY (Must order SPU or computer Option 014 to delete the standard parity memory controller.)

NOTE: ECC and parity memory array cards can be used together, within the limitation of a maximum of four array cards, to provide other memory sizes than those shown here. For more information, see the paragraph above on Change from Parity Memory to ECC Memory in an A600+ System.

SPU OR COMPUTER OPTION	014	014	014	014	014	014	014	014	014	014
12110A 512 kB MEM CONTROL	1	0	0	0	0	0	0	0	0	0
12110B 1.0 MB MEM CONTROL	0	1	1	1	1	1	1	1	1	1
12111A 512 kB ARRAY CARD	0	0	1	0	0	0	0	0	0	0
12111B 1.0 MB ARRAY CARD	0	0	0	1	2	1	2	1	2	1
12111C 2.0 MB ARRAY CARD	0	0	0	0	0	1	1	2	2	3
MEMORY CONNECTOR	n/r	n/r	12038A	12038A	12038B	12038B	12038C	12038C	12038D	12038D

n/s = Not Supported    n/r = Not Required

Table 5.3-2. A700 Memory Configurations for 2137A, 2197C/D, 2437A, and 2487A

NOTE: Within the limitation of a maximum of four memory array cards, ECC and parity memory array cards can be used together in the same system and other memory sizes than those listed here can be supported.

MEMORY SIZE	512 kB	1.0 MB	1.5 MB	2 MB	3 MB	4 MB	5 MB	6 MB	7 MB	8 MB
PARITY MEMORY										
2137A or 2437A OPTION	014	014	014	014	014	014	n/s	n/s	n/s	n/s
2197C/D or 2487A OPTION	Std	014	014	014	014	014	n/s	n/s	n/s	n/s
12103C 512 kB ARRAY CARD	1*	0	1	0	0	0	n/s	n/s	n/s	n/s
12103D 1.0 MB ARRAY CARD	0	1	1	2	3	4	n/s	n/s	n/s	n/s
MEMORY CONNECTOR	12038A*	12038A	12038B	12038B	12038C	12038D	n/s	n/s	n/s	n/s

ECC MEMORY

OPTION	014	014	014	014	014	014	014	014	014	014
12111A 512 kB ARRAY CD**	1	0	1	0	0	0	0	0	0	0
12111B 1.0 MB ARRAY CARD	0	1	1	0	1	0	1	0	1	0
12111C 2.0 MB ARRAY CARD	0	0	0	1	1	2	2	3	3	4
MEMORY CONNECTOR	12038A	12038A	12038B	12038A	12038B	12038B	12038C	12038C	12038D	12038D

\* Optional floating point processor card and/or control store card each reduces available memory capacity of the 2437A or 2487A Micro 27 Computer or SPU by one card.

\* Applies only to ordering 512 kB memory for 2137A or 2437A Computer.

\*\* The 12111A 512 kB ECC Memory Array Card is recommended; however, the 12104A 512 kB ECC Memory Array Card may be substituted for the 12111A Array Card.

n/s = Not Supported

Table 5.3-3. A900 Memory Configurations for 2139A, 2199C/D, 2439A, and 2489A

NOTE: Within the maximum number of array cards permitted in the particular SPU or computer, other memory sizes than those listed can be supported, using combinations of 3 MB and 768 kB memory array cards.

MEMORY SIZE	768 kB	1.5 MB	3 MB	6 MB	9 MB*	12 MB*	15 MB#	18 MB#	21 MB#	24 MB#
SPU OR COMPUTER OPTION	Std	014	014	014	014	014	014	014	014	014
12220A 768 kB ARRAY CARD	0	2	0	0	0	0	0	0	0	0
12221A 3 MB ARRAY CARD	0	0	1	2	3*	4*	5#	6#	7#	8#
MEMORY CONNECTOR	Incl.	12222B	12222A	12222B	12222C	12222D	12222E	12222F	12222G	12222H

\* This configuration exceeds the memory array card capacity of the 2439A or 2489A Computer or SPU.

# This configuration cannot be supported by the 12157A Battery Backup Module in the 2199C/D SPU and exceeds the memory array card capacity of the 2439A or 2489A Computer or SPU.

High density memory array cards must be installed between the 12110x controller and any parity memory array cards to be used. An appropriate 12038x Memory Connector must also be ordered if the number of array cards in the system is changed.

### Adding High Density Memory Array Cards to an A700 System

High density 12111x memory array cards can be added to parity or ECC memory in an A700 system. The 12111x cards should be installed between the A700 memory controller and the other memory



cards to provide ECC protection to the lower memory space used for the RTE-A operating system. An appropriate 12038x connector must be provided for the number of array cards in the system (up to four) if that number is changed.

*NOTE: Do not order a larger 12222x Array Connector than needed because it will interfere with use of other cards next to the memory cards.*

### Adding 12221A 3 MB Memory Array Cards to an A900 System

High density 12221A 3 MB ECC memory array cards can be added to existing ECC memory in an A900 system. The 12221A cards must be installed between existing 12220A cards, if used, and the A900 memory control card. An appropriate 12222x connector must be provided for the number of array cards in the system (up to eight in 2199C/D or 2139A; up to two in 2489A or 2439A) if that number is changed.

## 5.3-2 Accessories and Interfaces

See Table 5.3-4.

*Table 5.3-4. HP 1000 A-Series Accessories and Interfaces*

ACCESSORY/INTERFACE PRODUCT NUMBER AND NAME	PURPOSE	PREREQUISITES
<b>I/O EXTENDERS</b>		
12025A I/O EXTENDER	Adds 12 I/O channels in Micro/1000 package.	Any A-Series Computer or SPU
12025B I/O EXTENDER	Adds 18 I/O channels in 20-slot card cage (17 I/O channels in second 12025B)	Any A-Series Computer or SPU
<b>VERTICAL FLOOR MOUNT FOR MICRO/1000-PACKAGED SPUS, COMPUTERS, OR 12025A I/O EXTENDER</b>		
40025A VERTICAL FLOOR MOUNT	Convenient, vertical mounting of Micro/1000-packaged computer, SPU, or I/O Extender with roll-about mobility	243xA/E Computer, 248xA System Processor Unit, or 12025A I/O Extender
<b>CONTROL STORE AND A700 FLOATING POINT PROCESSOR CARDS</b>		
(Each uses one card cage slot -- max. of three A700 control store cards per computer or SPU; max. of one 12205A control store card per A900 computer or SPU)		
12153A WRITABLE CONTROL STORE CARD for A700 Processor	Dynamic, overlayable control store for 4k words of user's microcode	2137A, 2197C/D, 2437A, or 2487A Computer or SPU operating under RTE-A with 92045A RTE Microprogramming Package
12155A PROM CONTROL STORE CARD for A700 Processor	Mounting for non-volatile storage of 2k words of user's microcode	2137A, 2197C/D, 2437A, or 2487A Computer or SPU
12205A CONTROL STORE CARD for A900 Processor	4k words of dynamic, overlayable control store for user's microcode and mounting for 2k words of non-volatile storage of user's microcode	2139A, 2199C/D, 2439A, or 2489A Computer or SPU operating under RTE-A with 92049A RTE Microprogramming Package
12156A (or 2137A/2437A/2487A Option 001) Hardware FLOATING POINT PROCESSOR for A700	Nearly four-fold speed-up of floating point computations compared to firmware-based floating point speed of A700 computer without the 12156A plus mounting for 2k words of non-volatile storage of user's microcode (Counts as a control store card)	2137A or 2439A Computer or 2487A SPU (IS INCLUDED IN 2197C/D SPU)

**A-Series Systems  
Expansion and Racking**

*Table 5.3-4. HP 1000 A-Series Accessories and Interfaces, continued*

ACCESSORY/INTERFACE PRODUCT NUMBER AND NAME	PURPOSE	PREREQUISITES
<b>MISCELLANEOUS MAINFRAME PLUG-INS (Each uses one card cage slot)</b>		
12008A PROM STORAGE MODULE	Mounting for up to 64k bytes of PROMs for non-volatile program storage	Any A-Series Computer or SPU
12011A EXTENDER CARD	Out-of-card cage service access to system-connected A-Series plug-ins, except A900 CPU boards	Any A-Series Computer or SPU
12012A PRIORITY JUMPER CARD	Continuity of hardware priority chain through an unused card cage slot	Any A-Series Computer or SPU
12013A BATTERY BACKUP CARD	Sustains memory on memory controller during power outages and signals battery condition	2106BK Board Computer.
<b>POWER SUPPLY ENHANCEMENTS</b>		
12154A BATTERY BACKUP CARD	Sustains memory during power outages for a maximum of four memory array cards	Two available card cage slots in 243xA Computer or 248xA SPU
12157A BATTERY BACKUP SYSTEM	Sustains memory during power outages for a maximum of four memory array cards (three memory array cards in 2156B or 2196C/D)	213xA or 2156B Computer or 219xC/D SPU
12158A 25 kHz POWER MODULE	Provides up to 50W of 39V rms (two phases) at 25 kHz for powering certain interfaces	213xA or 2156B Computer or 219xC/D SPU
12159A 25 kHz SINE WAVE CARD	Provides up to 30W of 39V rms (two phases) at 25 kHz for powering certain interfaces	243xA Computer or 248xA SPU
<b>HP-IB INTERFACE AND HP-IB EXTENDER</b>		
12009A HP-IB INTERFACE CARD with 2m/6.5 ft cable	Connection of up to 14 "fast" or 14 "slow" HP-IB devices, such as discs, tape units, printers, graphics devices, etc.	Any A-Series Computer or SPU operating under RTE-A; 12009A interface for disc is included in 219xC/D and 248xA SPUs
-001 4m/13 ft cable in place of 2m cable	NOTE: Mixed connection of different types of devices on the HP-IB bus requires careful consideration of effect on overall response and response of individual devices.	
37203L HP-IB EXTENDER CARD	Extension of HP-IB communication with other HP 37203A/L Extender up to 1 km/3281 ft via coaxial cable	213xA or 2156B Computer or 219xC/D SPU with 12158A 25 kHz Power Module or 243xA Computer or 248xA SPU with 12159A 25 kHz Sine Wave Card
-001 Adds fiber optic channel	Fiber optic cable communication (same maximum distance as standard 37203L); 37203A/L option 001 is also required at remote HP-IB extender	Any A-Series Computer or SPU (25 kHz power is NOT required for fiber optic communication using the 37203L Opt 001)
<b>RECOMMENDED TERMINAL INTERFACES (Each uses one card cage slot)</b>		
12005B ASYNCHRONOUS SERIAL INTERFACE with electrical and fiber optic connectors	Single-channel, point-to-point communication with display terminals/modems, at rates to 1920 cps, as follows:	Any A-Series Computer or SPU operating under RTE-A; 219xC/D and 248xA SPUs include one 12005B interface with appropriate electrical or fiber optic connection
-001 Filtered cable	Connection to 2623A, 2624B, 2626A, or 2627A Terminal, 5m/16.4 ft cable length	
-002 Filtered cable	Connection to 2392A, 2625A, 2628A, or 45610B Terminal, 5m/16.4 ft cable length	
-003 Modem cable	Connection to RS-232-C Modem, 4.9m/16.2 ft cable length	
-004 Filtered cable	Connection to 264x terminal, 5.3m/17 ft cable length	
-005 Fiber optic adapter pod	Connection to 2623A, 2624B, 2626A, or 2627A terminal, 15m/49 ft fiber optic cable length	

Table 5.3-4. HP 1000 A-Series Accessories and Interfaces, continued

ACCESSORY/INTERFACE PRODUCT NUMBER AND NAME	PURPOSE	PREREQUISITES
RECOMMENDED TERMINAL INTERFACES, continued		
12040B 8-CHANNEL ASYNC MULTIPLEXER with RS-232-C connec- tor panel  -001 Upgrade firmware  -002 Delete connector panel  -003 Edge connector kit in place of connector panel and cable to it	Multi-channel, point-to-point communication with display terminals/modems, via a single computer I/O channel at rates to 1920 cps. Channel 0 is usable for system console.  Upgrade of 12040A to 12040B  Use with 37214A Systems Modem, which does not require connector panel  User-designed connections to multiplexer	Any A-Series Computer or SPU operating under RTE-A, EXCEPT 2439A Computer or 2489A SPU, which are NOT supported because of excessive RFI, and appropriate cable(s) for connection to terminals or modems  37214A Systems Modem
37222A INTEGRAL MODEM INTERFACE	Single-channel modem connection to dial-up telephone lines with auto dial and auto an- swer for communication with remote terminal	Any A-Series Computer or SPU operating under RTE-A, a 1556xA cable to the tele- phone circuit, and an appropriate modem and cable to remote terminal
DS/1000-IV INTERFACES (Each uses one card cage slot)		
12007B HDLC NETWORK MODEM INTERFACE with 5m/16.4 ft RS-232-C cable  -001 Firmware only  -002 RS-449 Cable*	Single-channel point-to-point communication with remote HP 1000 System via RS-232-C modems and telephone lines  Upgrades interface firmware for user not on 91750x opt x71 Firmware Update Service  Communication via RS-449 modems	Any A-Series Computer or SPU operating under RTE-A, with 91750A DS/1000-IV Net- work Software, suitable modems and tele- phone line, and remote HP 1000 system
12044A HDLC DIRECT CONNECT NETWORK INTERFACE with 5m/16.4 ft male & female cables and verifier hoods  -001 Firmware only  -002 Deletes cables & verifier hoods	Single-channel point-to-point communication with remote HP 1000 System via direct- connect cables  Upgrades interface firmware for user not on 91750x opt x71 Firmware Update Service  Elimination of cables and verifier hoods not needed for second direct connect interface	Any A-Series Computer or SPU operating under RTE-A, with 91750A DS/1000-IV Net- work Software, 91712A, 91713A, or 91714A Extension cable products as required, and remote HP 1000 system
12073A BISYNC NETWORK MODEM INTERFACE with 5m/16.4 ft RS-232-C cable  -001 Firmware only  -002 RS-449 Cable*	Single-channel point-to-point communication with remote HP 3000 System via RS-232-C modems and telephone lines  Upgrades interface firmware for user not on 91750x opt x81 Firmware Update Service  Communication via RS-449 modems	Any A-Series Computer or SPU operating under RTE-A, with 91750A DS/1000-IV Net- work Software, suitable modems and tele- phone line, and remote HP 3000 system
12082A DIRECT CONNECT BISYNC NETWORK INTERFACE with 5m/16.4 ft male cable  -001 Firmware only	Single-channel point-to-point communication with remote HP 3000 System via direct- cables  Upgrades interface firmware for user not on 91750x opt x81 Firmware Update Service	Any A-Series Computer or SPU operating under RTE-A, with 91750A DS/1000-IV Net- work Software, 91712A, 91713A, or 91714A Extension cable products as required, and remote HP 3000 system
12072A DATA LINK SLAVE INTERFACE with 5m/16.4 ft cable to 92901A connec- tion box  -001 Firmware only	Connection of HP 1000 system to DS/1000-IV data link as a slave system  Upgrades interface firmware	Any A-Series Computer or SPU operating under RTE-A, with 91750A DS/1000-IV Net- work software, and remote HP 1000 system functioning as data link master system

\* Instead of RS-232-C cable; RS-449 cable length is same as RS-232-C cable.

A-Series Systems  
Expansion and Racking

Table 5.3-4. HP 1000 A-Series Accessories and Interfaces, continued

ACCESSORY/INTERFACE PRODUCT NUMBER AND NAME	PURPOSE	PREREQUISITES
X.25 INTERFACE TO PACKET-SWITCHING NETWORKS (Uses one card cage slot)		
12075A X.25 NETWORK (modem) INTERFACE with 5m/16.4 ft RS-232-C cable	Communication with remote systems or terminals via RS-232-C modem and packet-switching network. Compatible with DS/1000-IV Network software for communication between HP 1000 systems and between HP 1000 and HP 3000 systems.	Any A-Series Computer or SPU operating under RTE-A, with 91751A X.25 Communications software, suitable modems and connection to packet-switching network.
-001 Firmware only	Upgrades interface firmware for user not on 91751x opt x91 Firmware Update Service	
-002 RS-449 Cable*	Communication via RS-449 modems	
OTHER DATA COMMUNICATIONS INTERFACES (Each uses one card cage slot.)		
12041A MULTI-USE PROGRAMMABLE MULTIPLEXER	Eight-channel, point-to-point communication with programmable controllers under control of 94200A PCIF/1000 software	Any A-Series Computer or SPU operating under RTE-A, EXCEPT 2439A Computer or 2489A SPU, which are NOT supported because of excessive RFI, 94200A PCIF/software, and compatible programmable controller(s) connected via a 12828A RS-232-C Connector Panel and other appropriate cabling
12042B PROGRAMMABLE SERIAL (Modem) INTERFACE with 5m/16.4 ft RS-232-C cable	User-customizable point-to-point communication with remote systems or terminals via RS-232-C modems and telephone lines	Any A-Series Computer or SPU operating under RTE-A. HP 24602A Firmware Development Package is strongly recommended for support of development of applications firmware for the 12042B interface
-001 RS-449 cable*	Communication via RS-449 modems	
-002 Edge connector*	User-designed connection to modem	
-003 Deletes Self-Test EPROM and diagnostic hood	Elimination of duplicate items not needed for additional 12042B interface	
24602A PROGRAMMABLE SERIAL INTERFACE FIRMWARE DEVELOPMENT PACKAGE	Support of user's development of firmware for the 12042B Programmable Serial Interface card, including Development Debug Monitor (DDM) EPROM, DDM Accessory Cable, and a Firmware Programming Manual	12042B Programmable Serial Interface with self-test and an HP 64000 Microprogramming Workstation
-001 Deletes DDM EPROM and Accessory Cable	Provides a set of manuals for advance study and evaluation	
12043A MULTI-USE PROGRAMMABLE SERIAL (Modem) INTERFACE with 5m/16.4 ft RS-232-C cable	Single-channel point-to-point communication with remote IBM or Plug-Compatible System via RS-232-C modems and telephone lines under control of 91781A RJE/1000-II, 91782A MRJE/1000, or 91784A PMF/1000 software	Any A-Series Computer or SPU operating under RTE-A, with 9178xA IBM communications software, suitable modems and telephone line, and compatible remote system
-001 RS-449 cable*	Communication via RS-449 modems	
12092A DATA LINK MASTER INTERFACE with 5m/16.4 ft cable to 3074A Data Link Adapter	Connection of HP 1000 system to multi-drop data link as a master system	Any A-Series Computer or SPU operating under RTE-A, with 91732A Data Link Software, connected to data link slave systems as shown in Figure 3.1-3, on page 3.1-6.
-001 Firmware only	Upgrades interface firmware	
MEASUREMENT AND CONTROL INTERFACES AND CABLES (Each interface uses one card cage slot)		
12060B HIGH LEVEL ANALOG INPUT CARD	Measurement of eight diff inputs, +/-1.28V to 10.23V fs, data rate to 55,000 chan/sec with 12-bit resolution (including sign)	213xA or 2156B Computer or 219xC/D SPU with 12158A 25 kHz Power Module or 243xA Computer or 248xA SPU with 12159A 25 KHz Sine Wave Card, operating under RTE-A
-001 Edge Conn Kit	User-designed connection of analog inputs	
-041 Calibration software on 1.2 MB flexible disc	Calibration	
-044 Calibration software on 270 kB microfloppy disc	Calibration	

\* Instead of RS-232-C cable; RS-449 cable length is same as RS-232-C cable.

Table 5.3-4. HP 1000 A-Series Accessories and Interfaces, continued

ACCESSORY/INTERFACE PRODUCT NUMBER AND NAME	PURPOSE	PREREQUISITES
MEASUREMENT AND CONTROL INTERFACES AND CABLES, continued (Each interface uses one cage slot)		
12060BC 3m/9.8 ft CABLE, unterminated at application end	Connection of inputs to 12060B	12060B interface
12061A EXPANSION MULTIPLEXER CARD -001 Edge Conn Kit	Multiplexes 32 additional channels to 12060B for a maximum total of 40 channels User-designed connection of analog inputs	12060B High-Level Analog Input Card
12061AC 3m/9.8 ft CABLE, unterminated at application end	Connection of inputs to 12061A	12061A interface
12062A ANALOG OUTPUT CARD -001 Edge Conn Kit -041 Calibration software on 1.2 MB flexible disc -044 Calibration software on 270 kB microfloppy disc	Provision of four independent bipolar outputs, +/-10.23V fs with 12-bit resolution (including sign) User-designed connection of analog inputs Calibration Calibration	213xA or 2156B Computer or 219xC/D SPU with 12158A 25 kHz Power Module or 243xA Computer or 248xA SPU with 12159A 25 kHz Sine Wave Card, operating under RTE-A
12062AC 3m/9.8 ft CABLE, unterminated at application end	Connection of outputs from 12062A	12062A interface
12063A ISOLATED DIGITAL I/O CARD -001 Edge Connector Kit	Provision of 16 opto-isolated inputs for sensing 5-42V dc or 6-29V rms signals and 16 isolated contact closure outputs User-designed connection of digital inputs and outputs	213xA or 2156B Computer or 219xC/D SPU with 12158A 25 kHz Power Module or 243xA Computer or 248xA SPU with 12159A 25 kHz Sine Wave Card, operating under RTE-A
12063AC 3m/9.8 ft CABLE, unterminated at application end	Connection of 12063A inputs and outputs	12063A interface
12064A TERMINATION ACCESSORY	Screw-terminal connection to 1206xA/B cards and 1206xxC cables	1206xA/B card and 1206xxC cable
OTHER INTERFACES (Each uses one card cage slot.)		
12006A PARALLEL INTERFACE CARD with connector kit	Byte or word-parallel bi-directional data transfers to/from external devices at TTL or discrete-transistor logic levels	Any A-Series Computer or SPU operating under RTE-A
12010A BREADBOARD INTERFACE CARD with connector kit	Provides standard A-Series I/O master circuit and spaces for sixty 16-pin wire-wrap sockets for user-designed custom interface	Any A-Series Computer or SPU operating under RTE-A
12065A COLOR VIDEO OUTPUT INTERFACE with 3m/9.8 ft RGB output cable -001 3m/9.8 ft RS-232-C input cable	Connection of color graphics output to RGB color video monitor Interfacing of joystick, trackball, mouse, or other graphics accessories	Any A-Series Computer or SPU operating under RTE-A, with 92861A Graphics/1000-II Device-Independent Graphics Library, and 13279A or equivalent Color Video Monitor

### 5.3-3 System Size Constraints

#### RTE-A System Memory Limitations

The RTE-A system and system tables are limited to 64k bytes of memory. The operating system will use 1/2 to 2/3 of the available memory, leaving 1/2 to 1/3 for system tables. Table space is required to support each I/O card, device, and program in the system. System size and table space are specified during system generation.

A worksheet (Table 5.3-5, below) may be copied to use in estimating the size of a particular system and its required table space. This should be done for any system with more than 16 I/O interfaces or more than 24 terminals.

Note that use of Table 5.3-5 provides only an *estimate* for memory requirements, since many assumptions have been made for the sake of simplicity. An actual system should be generated to check systems that are estimated to be close to the 64k byte limit.

#### RTE-A Device, I/O Card, and Program Support

The operating system can distinguish 255 devices, 48 I/O cards, and 255 concurrent programs. However, limited space for system tables may markedly limit the actual capacity of a particular system.

Table 5.3-5. RTE-A System Space Worksheet

ITEMS THAT AFFECT TABLE SPACE			SYSTEM MEMORY REQUIREMENTS (bytes)	COMMENTS
RTE-A SYSTEM MODULES (Enter one choice in the SYSTEM MEMORY REQUIREMENTS column)				
USAGE IN BYTES FOR RTE-A (OR RTE-A/VC+) SYSTEM THAT IS				All systems include 29534 bytes of non-partitionable modules, a tag area, and space for required system programs.
NON-PARTITIONED	PARTITIONED	PRIMARY SYSTEM		
45056 (47104)	32768 (34816)	38912 (40960)		
I/O INTERFACE CARDS				
INTERFACE PRODUCT NUMBER AND NAME	NO. OF CARDS	x BYTES PER CARD		
12005B Async Serial Interface	_____	x 84 =	_____	84 bytes for IFT
12007B (modem) or 12044A (direct connect) DS/1000-IV Interface to remote HP 1000 system	_____	x 284 =	_____	Byte usage consists of: Interface IFT (54), two DVTs (106), two LU table entries (4), and ten Transaction Control Blocks (120)
12006A Parallel Interface	_____	x 72 =	_____	72 byte IFT
12009A HP-IB Interface	_____	x 326 =	_____	276 byte interface IFT and 50 byte bus controller DVT
12040B or 12041A 8-Channel Multiplexer Interface	_____	x 58 =	_____	58 byte Interface IFT
SUBTOTAL			_____	

Table 5.3-5. RTE-A System Space Worksheet, continued

ITEMS THAT AFFECT TABLE SPACE	SYSTEM MEMORY REQUIREMENTS (bytes)	COMMENTS
SUBTOTAL FORWARD	_____	

I/O INTERFACE CARDS

INTERFACE PRODUCT NUMBER AND NAME	NO. OF CARDS	x	BYTES PER CARD		
12042B or 12043A Programmable Serial Interface	_____	x	78 =	_____	78 byte Interface IFT
1206xA/B Measurement and Control Interface	_____	x	30 =	_____	30 byte Interface IFT
12065A Color Video Output Interface	_____	x	72 =	_____	Includes 72 byte IFT
12072A Data Link Slave Interface	_____	x	66 =	_____	66 byte Interface IFT
12073A (modem) or 12082A (direct connect) DS/1000-IV Interface to remote HP 3000 system	_____	x	164 =	_____	Byte usage consists of: Interface IFT (54), Two DVTs (106), and two LU table entries (4)
12075A DSN/X.25 Interface	_____	x	2136 =	_____	78 byte IFT and 2048 byte extra page for driver partition
12092A Data Link Master Interface	_____	x	66 =	_____	66 byte IFT
12153A A700 Writable Control Store	_____	x	26 =	_____	26 byte IFT
12155A A700 PROM Control Store Card	_____	x	30 =	_____	30 byte IFT
37222A Integral Modem Interface	_____	x	84 =	_____	84 byte IFT
I/O Mapping for system-to-system communications	_____	x	22 =	_____	Interface table with extension

PERIPHERAL DEVICES AND SOFTWARE

PERIPHERAL/SOFTWARE ITEM NAME	NO. OF ITEMS	x	BYTES PER ITEM		
Terminals	_____	x	190 =	_____	Byte usage consists of: DVT (188) and an LU table entry. Also see requirement for each copy of a program in Customer Application Requirements section, on next page
Printers or graphics devices interfaced via HP-IB	_____	x	118 =	_____	108 byte DVT and 2 byte LU table entry
Printers interfaced via Multiplexer	_____	x	140 =	_____	138 byte DVT and 2 byte LU table entry
Magnetic Tape Unit or Cartridge Tape Unit	_____	x	188 =	_____	186 byte DVT and 2 byte LU table entry
CS/80 Discs -- number of drives	_____	x	120 =	_____	120 byte DVT extension area
-- number of LUs	_____	x	68 =	_____	68 byte DVT and 2 byte LU table entry
MAC Discs -- number of drives	_____	x	80 =	_____	80 byte DVT extension area
-- number of LUs	_____	x	68 =	_____	66 byte DVT and 2 byte LU table entry
Micro/1000 hard & microfloppy discs	_____	x	658 =	_____	Includes 656 byte IFT and an LU table entry (2 bytes)
-- number of LUs	_____	x	138 =	_____	Including 136 byte DVT and an LU table entry (2 bytes)
Flexible disc	_____	x	138 =	_____	136 byte DVT and 2 byte LU table entry
Mappable Logical Units	_____	x	80 =	_____	
MRJE/1000	_____	x	146 =	_____	98 byte DVT, 2 byte LU table entry, and 46 byte IFT with extension
SUBTOTAL	_____			_____	

Table 5.3-5. RTE-A System Space Worksheet, continued

ITEMS THAT AFFECT TABLE SPACE		SYSTEM MEMORY REQUIREMENTS (bytes)	COMMENTS
SUBTOTAL FORWARD		_____	
CUSTOMER APPLICATION REQUIREMENTS			
CUSTOMER APPLICATION ITEM	NO. OF ITEMS	x BYTES PER ITEM	
Each copy of a program accessed from a terminal	_____	x 120 =	_____
Each concurrent user	_____	x 40 =	_____
Concurrent shared programs in VC+ Class Numbers	_____	x 10 =	_____
Resource Numbers	_____	x 4 =	_____
System common	_____	x 2 =	_____
		Enter requirement	_____
TOTAL .....			_____
SYSTEM SUPPORTABILITY EVALUATION			
TOTAL < 60000		System is probably supportable	
60000 < TOTAL < 68000		System may be supportable; attempt system generation; if total resulting from generation is less than 65534, system is supportable	
TOTAL > 68000		System is probably NOT supportable	

### 5.3-4 I/O Expansion

Larger systems, especially A700 and A900 systems, may not have enough card cage slots for the processor cards and all required memory, and input/output cards in the basic computer card cage. To check that possibility, I/O capacity should be evaluated using a copy of Table 5.3-6.

If an I/O extender is needed, it should be used for I/O interfaces that are not critical to system performance. Interfaces that are critical to system performance, such as the system disc interface, should be installed in the computer, not the I/O extender. This avoids potential impairment of performance arising from:

1. The fact that an interrupt to an interface in the extender interrupts DMA in the extender.
2. A DMA output bandwidth that is 40% to 50% of the output bandwidth of the host computer (input bandwidth is the same in the extender and the host computer).

### 5.3-5 System Racking

#### Basic HP 219xC/D System Processor Unit Racking

HP 1000 A-Series 219xC and 219xD System Processor Units (SPUs) are rack mounted in 29431G and 29429A cabinets as shown in Figure 5.3-1. The basic SPU includes a 2137A, 2139A, or 2156B Computer, which is housed in a 20-slot card cage. Space immediately above the computer is designed to be occupied by a separately-ordered 7911R, 7912R, or 7914R CS/80 disc memory with built-in cartridge tape unit for convenient software loading and backup. A door with cutout for access to the disc's cartridge tape unit is standard in the 29431G and 29429A cabinets for 219xC/D SPUs.

**Computer-Disc Compartment Ventilation.** The computer and 791xR disc both provide their own front-to-rear ventilation. Louvers in the front and rear doors facilitate self-ventilation by the computer and disc.



Table 5.3-6. I/O Capacity Evaluation Worksheet

DESCRIPTION/PROCEDURE	CARD CAGE SLOTS IN		
	A600+	A700	A900
ADD:			
1. Card cage slots used by CPU and memory control cards	2	3	4
2. Card cage slot used by Floating Point Processor Card in A700 (standard in 2197C/D)	n/a	1	n/a
3. Card cage slots used for memory array cards (from Table 5.3-1, 5.3-2, or 5.3-3)	—	—	—
4. Card cage slots used for control store cards	n/a	—	—
5. Card cage slots occupied by battery backup card in 243xA/E Computer or 248xA System Proc. Unit	—	—	—
6. I/O Interfaces from one or more sheets of Table 1-4	—	—	—
7. Card cage slots required for other plug-in cards	—	—	—
TOTAL	—	—	—
EVALUATION:			
For TOTAL > 14, Use 219xC/D SPU or 2137A, 2139A, or 2156B Computer			
For 33 > TOTAL > 20, Add one 12025A I/O Extender			
For 39 > TOTAL > 32, Add one 12025B I/O Extender			
For 45 > TOTAL > 38, Add two 12025A I/O Extenders			
For 55 > TOTAL > 44, Add two 12025B I/O Extenders			

**Upper Compartment in 29431G Cabinet.** Above the computer-disc compartment, the 29431G cabinet provides a panel-separated upper compartment with 80 cm (31.5 in.) of vertical space for rack mounting other equipment.

**Upper Compartment Ventilation.** Air circulation fans in the upper compartment support equipment with left-to-right ventilation **OR** right-to-left ventilation **OR** front-to-rear ventilation. To assure proper heat dissipation, all equipment in the upper compartment must use the same type of ventilation. For proper front-to-rear ventilation, the 29431G Cabinet must be ordered with Option 051, which substitutes trim for rack mounting a magnetic tape unit for an upper compartment front door. Details

of trim installation are given in the 40027A Door Trim Kit Installation Manual (40027-90002). All unoccupied vertical mounting space must be covered by blank panels. A maximum of 1500 watts can be dissipated by the upper compartment ventilation.

**Safety Qualification of Equipment for the Upper Compartment of the 219xC SPU.** The user is responsible for the safety of equipment that is installed in the upper compartment of the 219xC SPU. Pertinent safety issues include susceptibility of the cabinet to tipping, especially with equipment that may be slid part-way out of the upper compartment for servicing, and the possibility of fire hazard from overheating.

#### Variations on Basic 219xC SPU Racking in the 29431G Cabinet

**Louvered Lower Door.** If a 791xR disc will not be installed in the computer-disc compartment of the 29431G cabinet, the lower door that is cut out to facilitate access to the cartridge tape unit of the 791xR disc must be replaced with a door that has louvers in place of the cutout. This louvered lower door is substituted by ordering Option 053 to the 219xC SPU or the 29431G Cabinet.

**Installation of Other Equipment in Place of the 791xR Disc.** Other equipment can be installed in 29431G Option 053 cabinets in the space designed for the 791xR Disc if it:

1. Is self-ventilated using front-to-rear ventilation.
2. Fits into 31.1 cm (12.25 in.) of vertical mounting space to a maximum depth of no more than 70.5 cm (27.8 in.).
3. Consumes no more than 700 watts.

**Safety of Other Equipment Installed in Place of the 791xR Disc** is the responsibility of the user.

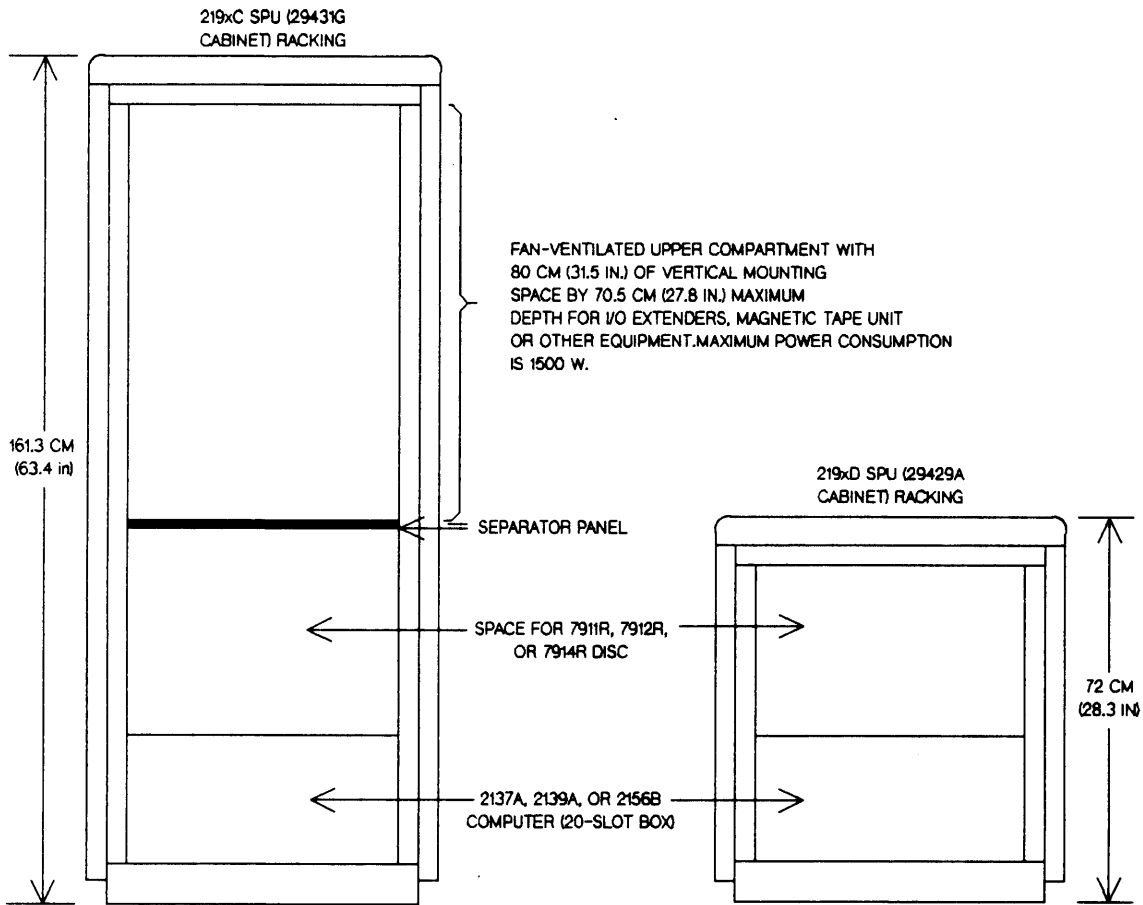

Figure 5.3-1. HP 1000 A-Series SPU Racking

**219xC Option 070 SPU Racking in 7914ST/TD Cabinet**

The HP 7914ST and 7914TD Disc-Tape Subsystems combine the large capacity of a 1600 bpi magnetic tape unit with a 132.1 MB disc in a tall cabinet. Enough space is available in the 7914ST/TD cabinet to house the 2137A, 2139A, or 2156B Computer of the 219xC SPU in addition to the tape and disc drive units.

**219xC Option 070.** For customers who want to save the cost of unnecessary cabinetry, 219xC Option 070 can be used to delete the 29431G Cabinet from the 219xC SPU. The 219xC Option 070 SPU hardware includes the computer and an additional 12009A HP-IB interface to the magnetic tape unit, which are installed in the 7914ST/TD cabinet.

**Appearance of the 7914ST Cabinet** differs noticeably from the 219xC SPU with respect to cabinet height, color of finish, and means of unlatching the front door of the cabinet. Customers who regard uniformity of appearance of their computer system installation as highly important should compare the 7914ST and 219xC cabinets side by side before deciding to rack a 219xC Option 070 SPU in a 7914ST cabinet.

**Appearance of the 7914TD Cabinet** does not differ from the 219xC SPU, because it is housed in the same cabinet.

#### **Racking of Micro/1000-Packaged Products in the 29431G Cabinet**

As with all equipment that does not use front-to-rear ventilation, Micro/1000-packaged products, such as 243xA Computers, 248xA SPUs, or 12025A I/O Extenders must be rack mounted in the upper compartment of the 29431G Cabinet. Two Micro/1000-packaged products can be racked in the upper compartment of the 29431G Cabinet.

#### **Racking of Micro/1000-Packaged Products in the 29431G Cabinet**

As with all equipment that does not use front-to-rear ventilation, Micro/1000-packaged products, such as 243xA Computers, 248xA SPUs, or 12025A I/O Extenders must be rack mounted in the upper compartment of the 29431G Cabinet. Three Micro/1000-packaged products can be racked in the upper compartment of the 29431G Cabinet.

#### **Bolting Cabinets Together**

Two 29431G Cabinets can be secured to each other using a 40026A Tie-Together Kit. However, the 29431G Cabinets are not designed to be bolted or otherwise tied together with other cabinets of any kind. Bolting more than two 29431G Cabinets together requires special engineering.

#### **Rack-Mountable Equipment for HP 1000 A-Series Systems**

All rack-mountable equipment available for HP 1000 A-Series Systems is listed in Table 5.3-7, along with information pertinent to its rack mounting.

#### **Rack Mounting of A-Series Systems in Non-HP Cabinets**

If A-Series computers and compatible peripheral devices are rack mounted in a non-HP cabinet, that cabinet must have enough space to house the components and must support, or at least not interfere with, the ventilation air flow of the rack mounted equipment to assure long life and trouble-free operation. Compliance with EMI regulations and safety standards cannot be supported by Hewlett-Packard for systems that are installed in non-HP cabinets.

### **5.3-6 System Summarization**

Tables 1-3, 1-4, and 1-5 in Section 1 are designed to be copied to provide a convenient facility for summarizing system capabilities, interfacing, and base system hardware. Together with Table 4-1 in Section 4, these tables provide a complete specification of your entire system from the SPU or computer and system disc down to all required cables, interfaces, and options.

*NOTE: If this is your first HP 1000 System design, you may want to have it checked by a Hewlett-Packard Systems Engineer to confirm that it is complete.*

A-Series Systems  
Expansion and Racking

Table 5.3-6. Rack-Mountable Equipment for HP 1000 A-Series Systems

PRODUCT NUMBER AND NAME	VERTICAL MOUNTING SPACE REQUIRED (cm and (in.))	MAXIMUM POWER CONSUMPTION	INTERNAL AIR FLOW DIRECTION	COMMENTS
12025A I/O EXTENDER	22.3 (8.75)	500	Left-to-right	Mounts in lowest part of the upper compartment of the 29431G Cabinet (max. of two 12025A I/O Extenders per 29431G Cabinet).
12025B I/O EXTENDER	31.3 (12.25)	700	Front-to-rear	Mounts in otherwise unoccupied disc space of computer-disc compartment in 29431G+053 Cabinet or in lowest part of upper compartment of 29431G+051 or 29431G+051.053 Cabinet (max. of two 12025B I/O Extenders in upper compartment of 29431G+051 Cabinet).
2137A, 2139A, or 2156B COMPUTER	31.1 (12.25)	700	Front-to-rear	Mounts in computer-disc compartment of 29431G or 29429A Cabinet (see Fig. 5.3-1).
243xA COMPUTER or 248xA SYSTEM PROCESSOR UNIT	22.3 (8.75)	500	Left-to-right	Mounts in lower 53.5 cm (21 in.) of the upper compartment of the 29431G Cabinet.
7906MR+025 MAC MASTER CARTRIDGE DISC		690		This disc is supported only as a peripheral disc in A-Series, NOT as a system disc.
-- Disc Drive	40.0 (15.75)		Front-to-rear	Mounts in computer-disc compartment of 29431G+050 Cabinet.
-- 13037D Disc Controller	13.3 (5.25)		Left-to-right	Must mount in upper compartment of 29431G+050 Cabinet
7911R, 7912R, or 7914R CS/80 FIXED DISC With Cartridge Tape Drive	31.3 (12.25)	700	Front-to-rear	Mounts in computer-disc compartment of 29431G or 29429A Cabinet (see Fig. 5.3-1); if the dedicated space for 791xR disc is not used, Option 053 must be ordered for the 219xC SPU or the 29431G Cabinet, or Option 738 must be ordered for the 29429A Cabinet to replace the disc-cutout version of the computer-disc compartment front door with a non-cutout version of that door.
7941A or 7945A DISC DRIVE with 19500A RACK SLIDES KIT	13.3 (5.25)	65	Front-to-rear	Safety in 29431G+053 Cabinet has not been qualified by Hewlett-Packard and is the responsibility of the user.
7942A or 7946A DISC-TAPE DRIVE with 19501A RACK SLIDES KIT	22.2 (8.75)	120	Front-to-rear	Safety in 29431G+053 Cabinet has not been qualified by Hewlett-Packard and is the responsibility of the user. Access to tape drive of 7942A/7946A requires opening of the cabinet door if mounted in space for 791xR disc. May also be mounted in upper compartment of 219xC SPU (29431G) Cabinet, which must have option 051 to support 7942A/7946A ventilation airflow as well as option 053. THE 7942A/7946A DISC-TAPE DRIVE MAY ALSO BE USED AS A DESK/TABLE MOUNTED PERIPHERAL; IT DOES NOT HAVE TO BE RACK MOUNTED.
7970E Option 636 MAGNETIC TAPE UNIT	66.7 (26.3)	400	By convection	Mounting in upper compartment of 219xC SPU requires Option 051 for the 219xC SPU or 29431G Cabinet to adapt the cabinet for mounting the 7970E Magnetic Tape Unit
9144A TAPE CARTRIDGE SUBSYSTEM with 19500A RACK SLIDES KIT	13.3 (5.25)	125	Front-to-rear	Safety in 29431G Cabinet has not been qualified by Hewlett-Packard and is the responsibility of the user. Access for tape cartridge loading requires the opening of a cabinet door.
9895A DUAL FLEXIBLE DISC DRIVE	22.2 (8.75)	180	Front-to-rear	Safety in 29431G Cabinet has not been qualified by Hewlett-Packard and is the responsibility of the user. Access for disc loading requires opening of a cabinet door.

# Section 5.4

## E/F-Series Systems Based on System Processor Units

### 5.4-1 System Processor Unit (SPU) Description

Standard HP 1000 E/F-Series System Processor Unit (SPU) hardware consists of an E-Series or F-Series computer with 256 kB memory, time base generator, dual-channel port controller, firmware expansion module, and power fail recovery system. Memory is expandable to 2 megabytes, and ten I/O channels are available for I/O or control store cards. The SPU also includes the RTE-6/VM or RTE-IVB Real-Time Executive operating system, hardware and software manuals, site preparation consultation, on-site installation assistance and system checkout, and 90-day on-site warranty.

### 5.4-2 SPU Selection

Four different HP 1000 E/F-Series SPU products are available, as summarized in Table 5.4-1, below, with the physical configurations shown in Figures 5.4-1 and 5.4-2.

### Computer Choices Offer Two Levels of Floating Point Computation Performance

The computer choices between E and F-Series determine computational performance, particularly with respect to floating point and scientific calculations. The F-Series computer is an E-Series computer with a hardware floating point processor that nearly quintuples the firmware-based floating point computation speed of the E-Series computer.

Trigonometric, logarithmic, and other transcendental calculations benefit directly from the hardware floating point processing speed of the F-Series and are further aided by the extra efficiency of the scientific instruction set firmware in the F-Series, as compared to equivalent software routines in the E-Series.

### Operating System Choices

**RTE-IVB** is an older, mature operating system that continues to be offered for support of existing applications that have been designed around it. Because RTE-IVB is mature, it is not being enhanced and newer peripheral devices, such as CS/80 discs, are not supported under it.

*Table 5.4-1. HP 1000 E/F-Series System Processor Unit Selection Guide*

SPU PRODUCT NUMBER	2176E	2177F	2178C	2179C
SYSTEM MODEL NUMBER	40	45	60	65
COMPUTER SERIES	E	F	E	F
- Floating Point Oper/Sec	38,800 (firmware-based)	183,000 (hardware processor)	38,800 (firmware-based)	183,000 (hardware processor)
- Scientific Instruction Set	Software equiv.	22,000 oper/sec	Software equiv.	22,000 oper/sec
OPERATING SYSTEM	RTE-IVB (Mature; not being enhanced)		RTE-6/VM (Active)	
- Disc memory	19.6 MB to 1.9 GB (1 to 16 drives)		23.8 MB to 3.2 GB (1 to 8 drives)	
- Virtual memory for data	Not supported		Up to 128 MB	
- Extended memory area (EMA) sharability	Not supported		Up to eight EMAs can be shared among as many as 256 different programs	
- Number of logical units	Up to 64		Up to 255	
- File management	File manager, 6 character file names		Command Interpreter with hierarchical files and file names up to 16 characters plus backward compatibility with file manager	

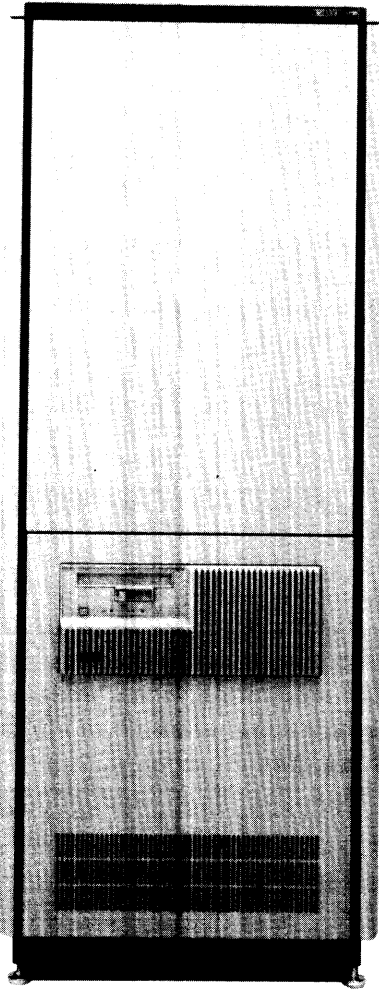

*Figure 5.4-1. HP 1000 E/F-Series SPU with  
791xR Disc*

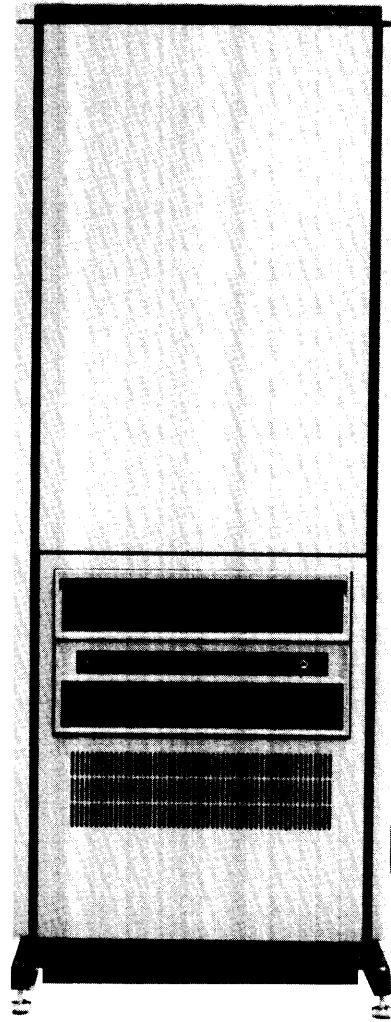

*Figure 5.4-2. HP 1000 E/F-Series SPU with  
7906MR Disc*

**RTE-6/VM** is a much more powerful system than **RTE-IVB**. It has capabilities that are not available under **RTE-IVB**, such as virtual memory for data, multiple extended memory areas for data that are sharable among multiple programs, support for much more disc memory capacity, and a hierarchical file system. Because of the superior capabilities of **RTE-6/VM**, the 2178C/2179C SPUs that include it should be specified for all new applications.

### 5.4-3 System Console Requirements

HP 1000 E/F-Series SPUs must be equipped with a system console terminal for operator-system communication. This requires:

1. Selection of a separately-ordered system console terminal.
2. Selection of the SPU system console connect option that is appropriate for the selected system console terminal.

#### System Console Terminal Selection

The system console must be selected from those listed in Table 5.4-2. Terminal selection criteria are provided in Peripherals section 2.1, on pages 2.1-1 through 2.1-3.

*Table 5.4-2. Supported System Consoles and SPU Connect Options*

SUPPORTED SYSTEM CONSOLE TERMINALS	USE SPU CONNECT OPTION
2392A Display Terminal	006
2623A Graphics Terminal	005
2624B Display Terminal	006
2625A Dual System Display Terminal	006
2626A Display Station	005
2627A Color Graphics Terminal	005
2628A Word Processing Terminal	006
45610B HP Touchscreen Terminal	006

### System Console Connection

The system console is connected via the single-channel interface that is included in all E/F-Series SPUs. SPU option 005 or 006 must be ordered with the SPU. Table 5.4-2 indicates the appropriate connect option for each of the supported system console terminals.

### 5.4-4 System Disc Requirement

HP 1000 E/F-Series SPUs must be equipped with a system disc for operating system and program development support. The system disc is a disc, or disc-tape combination, for which operating system software media is orderable and which will support bootup of the RTE operating system. The system discs supported for HP 1000 E/F-Series SPUs are listed in Table 5.4-3 along with SPU software media options and other SPU options that correspond to a particular system disc choice.

The system disc selected for the system must have enough capacity, by itself or in conjunction with additional discs, to satisfy disc memory requirements of the system as determined in the Software section on pages 4-1 through 4-6. For other disc memory selection criteria, see Peripherals section 2.4 on pages 2.4-1 through 2.4-5.

### 5.4-5 Other SPU Additions and Changes

#### Providing More than Standard Memory

Your HP 1000 E/F-Series system may require more than the 256 kB of memory that is standard. How much main memory should be obtained can be determined using the information in the Software section on pages 4-1 through 4-6.

Table 5.4-3. Supported System Discs

DISC PRODUCT NUMBER	TYPE	DISC CAP. (MB)	AVG TRANS RATE* (kB/s)	AVG ACC TIME (ms)	CORRESPONDING SPU OPTIONS	
					OPTION NO.	DESCRIPTION
7906MR+025	Hard, fixed disc and removable disc cartridge	19.6	740	33.3	217xC/E/F Opt 031 and Opt 050	Software on 9.8 MB disc cartridge Panel cutout for 7906MR disc
7911R 7912R 7914R	Hard, fixed with CS/80 cartridge tape drive for loading & backup	28.1 65.6 131.2	983	35 35 36	2178C/2179C Opt 022	SUPPORTED ONLY IN MODEL 60/65 SYSTEMS Software on CS/80 Cartridge Tape
7914TD+236	Hard, fixed with 1600 bpi mag tape unit	131.2	983	36	2178C/2179C Opt 061 and Opt 053	SUPPORTED ONLY IN MODEL 60/65 SYSTEM Software on 1600 bpi mag tape Lower door without cutout for racked disc
7925M#	Hard, removable pack disc	120	740	36.1	217xC/E/F Opt 033 and Opt 053	Software on 120 MB disc pack Lower door without cutout for racked disc
7933H** 7935H**	Hard, fixed Hard, removable	404.4	1000	32	2178C/2179C Opt 061 and Opt 053	SUPPORTED ONLY IN MODEL 60/65 SYSTEMS Software on 1600 bpi mag tape Lower door without cutout for racked disc

\* Average transfer rate is based on the minimum time required to transfer one track without overrun.

# 7925M Disc also requires a 7925S Disc or a 797x Magnetic Tape Unit for system backup.

\*\* This disc requires a separate program/data entry/backup device, such as a 797xA/E mag tape unit.

If more than 256 kB of memory is needed, SPU option 014 can be ordered to delete the standard memory to make room for replacing it with more memory. The choices for E/F-Series memory changes and expansion are summarized in section 5.6, on pages 5.6-1 through 5.6-3.

#### Additional Peripheral Devices and Interfaces

Your initial work on system design, using a copy of the HP 1000 System Capabilities Checklist, Table 1-3, provided an initial overview of the peripheral devices to be included in the system. By using Table 1-3 with information in Peripherals sections 2.1 through 2.4, you can complete on one or more copies of Table 1-4 a detailed summary of the peripherals, interfaces, and cables to be added to your SPU to provide all the functions needed for your HP 1000 E/F-Series system.

### 5.4-6 Computer Card Cage Organization

The HP 1000 E/F-Series SPUs use two different computers. The arrangement of computer and memory cards in these computers is shown in Figures 5.5-3 and 5.5-4, which relate to the respective SPUs and computers as listed below.

FOR SPU	COMPUTER IS	SEE FIGURE
2176E	2113E	5.4-3
2177F	2117F	5.4-4
2178C	2113E	5.4-3
2179C	2117F	5.4-4

### 5.4-7 System Racking

For information on rack mounting of HP 1000 E/F-Series systems, see paragraph 5.6-4, page 5.6-10.



# Section 5.5

## E/F-Series Systems Based on Computers and Board Computers

### 5.5-1 Computer Descriptions

#### Box Computer

The box computer consists of an E-Series CPU Processor Board, memory protect and memory expansion modules, a firmware expansion module with dynamic mapping firmware, a memory controller card, and a 128k byte parity memory module, in a card cage with power supply. The F-Series box computer also includes a two-card hardware floating point processor in a card cage with power supply. The box computer lends itself well to applications whose requirements are not satisfied by SPUs, which are designed as disc-based packages. This includes use for memory-based systems, distributed system nodes with or without system console or disc, and systems configured with multiple computers for improved availability.

#### Board Computer

The E-Series computer is available as a three-board set with CPU card, memory controller, and 64k byte memory module for users who want to do their own card cage connections and power supply. A card cage is offered to assist users with integration of the board computer.

### 5.5-2 Computer Selection

Four different HP 1000 E/F-Series computer products are available, as summarized in Table 5.5-1, below. The box computers are pictured in Figures 5.5-1 and 5.5-2.

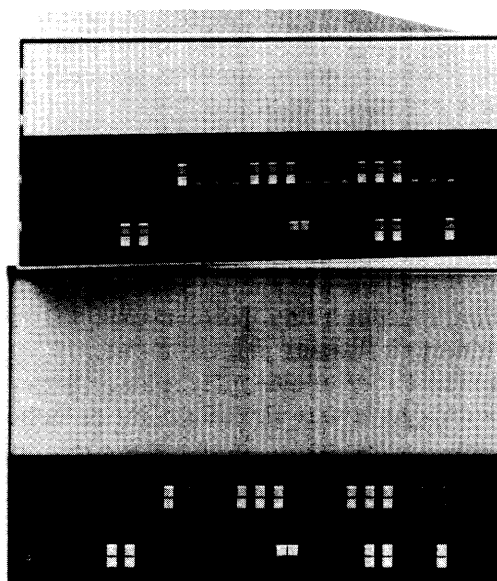

Figure 5.5-1. HP 1000 E-Series Box Computers, 2109E (top) and 2113E (bottom)

Table 5.5-1. HP 1000 E/F-Series Computers Selection Guide

COMPUTER PRODUCT NUMBER	2109EK	2109E	2113E	2117F
PHYSICAL CONFIGURATION	Board Computer	Box computer	Box Computer	Box Computer with floating point processor
PROCESSOR TYPE	E-Series	E-Series	E-Series	F-Series
CAPACITY -- Standard Memory	64 kB	64 kB	128 kB	128 kB
-- Maximum Memory	2 MB*	2 MB	2 MB	2 MB
-- I/O Channels	9*	9	14	14
FLOATING POINT PERFORMANCE	38,800 oper/sec, firmware-based	38,800 oper/sec, firmware-based	38,800 oper/sec, firmware-based	183,000 oper/sec, hardware-based

\* Based on use of the 2109EK Board Computer in a 12728J Card Cage.

**Computer with 9-Slot I/O Card Capacity**

The 2109E Computer can hold up to nine I/O cards. The card cage arrangement is shown in Figure 5.5-3.

**Computers with 14-Slot I/O Card Capacity**

The 2113E and 2117F Computers can hold up to 14 I/O cards and should be specified for applications that require maximum capacity for I/O cards. The arrangements for these computers are shown in Figures 5.5-4 and 5.5-5.

**Processor Choices Offer Two Levels of Floating Point Computation Performance**

The choices between E and F-Series processors determine computational performance, particularly with respect to floating point and scientific calculations. The F-Series computer is an E-Series computer with a hardware floating point processor that nearly quintuples the firmware-based floating point computation speed of the E-Series computer.

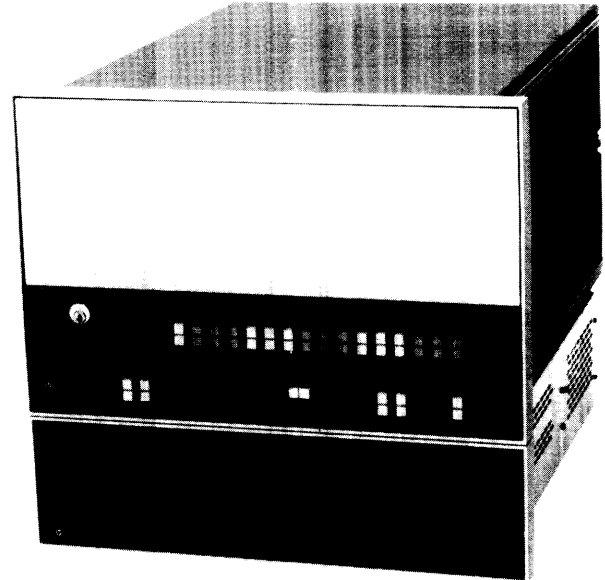

Figure 5.5-2. HP 1000 F-Series Box Computer, 2117F

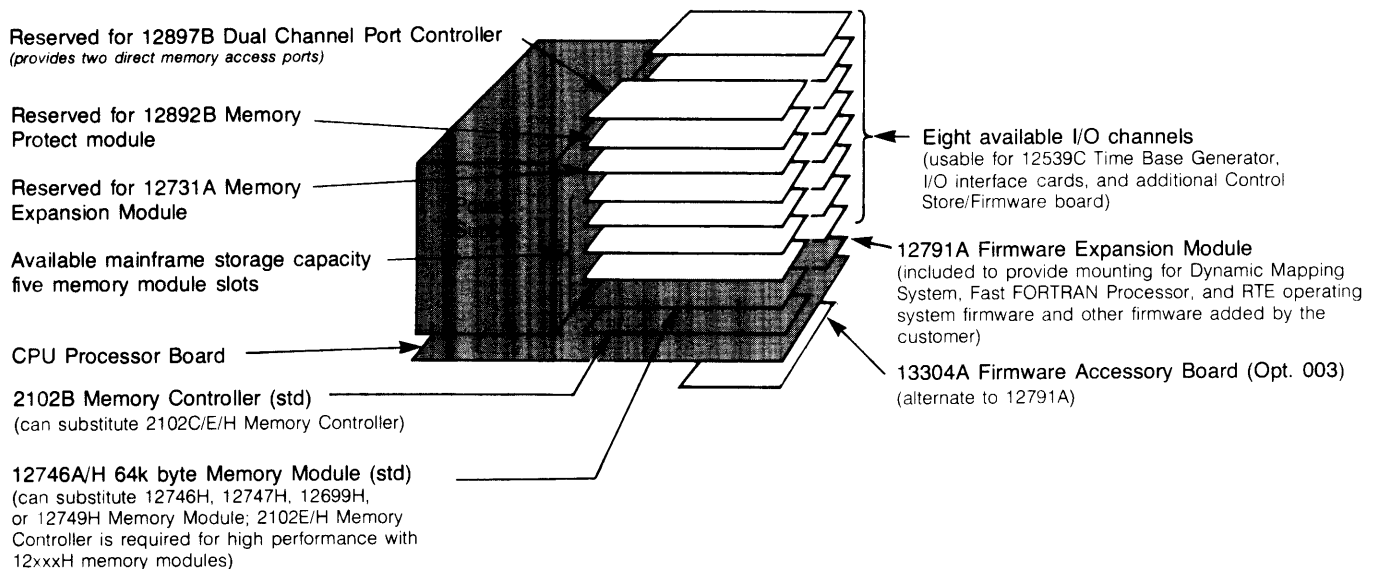

Figure 5.5-3. HP 2109E Computer Card Cage Arrangement (front view)

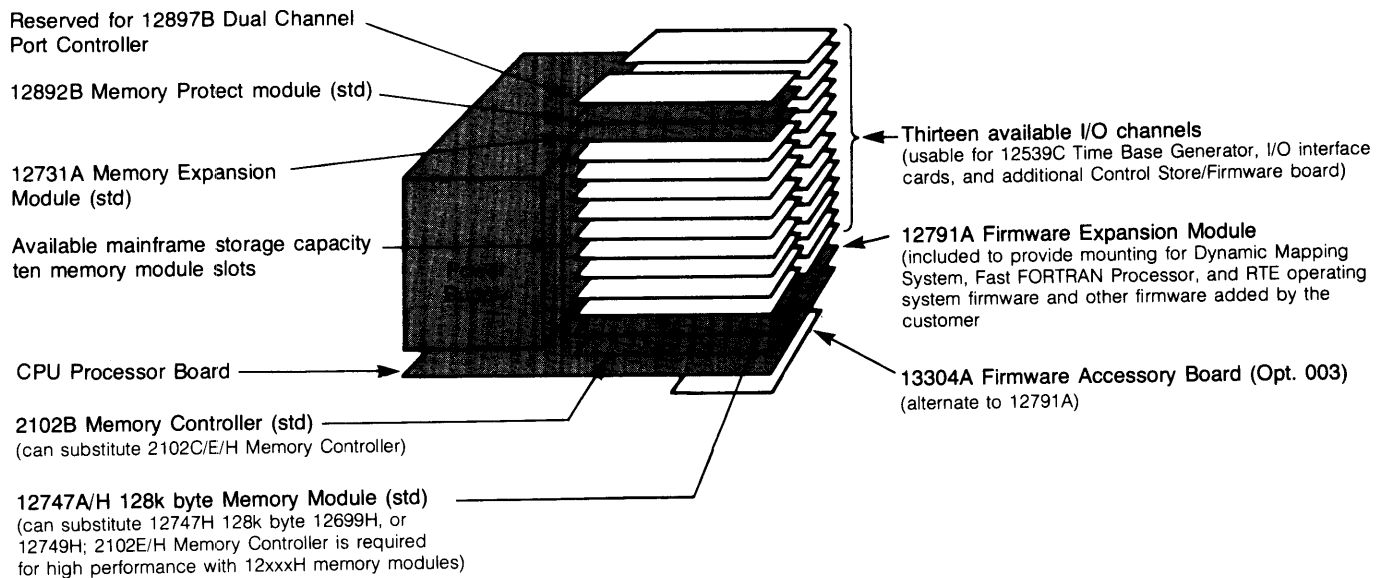

Figure 5.5-4. HP 2113E Computer Card Cage Arrangement (front view)

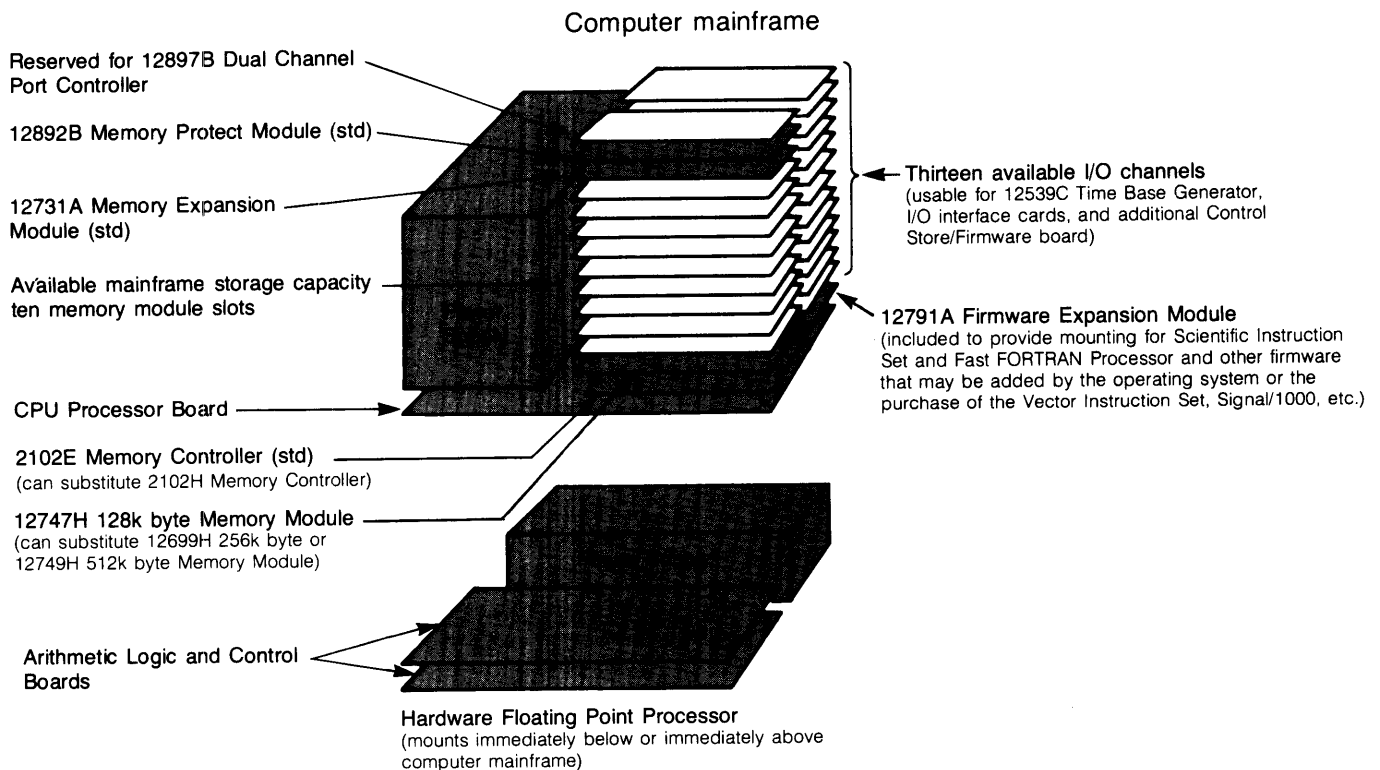

Figure 5.5-5. HP 2117F Computer Card Cage Arrangement (front view)

Trigonometric, logarithmic, and other transcendental calculations benefit directly from the hardware floating point processing speed of the F-Series and are further aided by the extra efficiency of the scientific instruction set firmware in the F-Series, as compared to equivalent software routines in the E-Series.

### 5.5-3 Operational Requirements

#### Basic Requirements

For operation, HP 1000 E/F-Series computers must be equipped to satisfy the following minimum basic requirements:

1. Operator communication with the computer for system bootup and maintenance:
  - a. Directly via one of the system console terminal-interface-cable combinations listed in Table 5.5-2, OR
  - b. Remotely from a terminal at an adjacent host system connected via one of these DS/1000-IV links:
    - 12794B DS/1000-IV Modem Interface and a modem and telephone lines OR
    - 12825A DS/1000-IV Direct-Connect Interface

Table 5.5-2. Supported Terminal-Interface-Cable Configurations for Local Boot-Up/Maintenance Console

SUPPORTED SYSTEM CONSOLE TERMINALS	CONNECT TO COMPUTER VIA 12966A INTERFACE WITH CABLE OPTION NO.
2392A Display Terminal	106
2623A Graphics Terminal	105
2624B Display Terminal	105
2625A Dual System Display Terminal	106
2626A Display Station	105
2627A Color Graphics Terminal	105
2628A Word Processing Terminal	106
45610B HP Touchscreen Terminal	106

2. A source for entry of the programs to be run by the computer, selected from those listed in Table 5.5-3.

Table 5.5-3. Supported Software Entry Sources

SUPPORTED SOFTWARE SOURCES	REQUIRED INTERFACES
1. ANY OF THE FOLLOWING DISC, DISC-TAPE, OR TAPE UNITS: -- 7906MR Cartridge Disc Memory -- 79xxR Disc w/Cartridge Tape Drive* -- 7914TD+236 Disc-Tape Subsystem* -- 7925M Disc Memory# -- 7970B/E+226 800/1600 bpi Magnetic Tape Unit -- 7971A+250 800 bpi Magnetic Tape Unit -- 7971A+260 1600 bpi Magnetic Tape Unit	13175D 12821A 12821A 13175D Incl. with Opt. 226 Incl. with Opt. 250 Incl. with Opt. 260
2. AN ADJACENT HP 1000 SYSTEM IN A DS/1000-IV NETWORK (software downloads from host; same DS/1000-IV interface supports both operator communication and software download)  Requires 92068A/R/E RTE-IVB or 92084A/R RTE-6/VM and 91750A/R DS/1000-IV Network Software.	12794B Modem I/F OR 12825A Dir Conn I/F

\* 791xR and 7914TD+236 Discs are supported only under 92084A/R RTE-6/VM.

# 7925M Disc requires a 7925S slave disc or 797xA/B/E magnetic tape unit for backup.

#### Operating System

Any computer system will require some basis for management of overall operations. For simple uses, an OEM may find it necessary or desirable to continue to use an obsolete RTE operating system or to create a stripped-down, application-specific operating system to minimize main memory requirements or to minimize operating system overhead or both.

However, many other E/F-Series box computer users will find it more cost effective to use the 92084A RTE-6/VM, 92068A RTE-IVB, or 92068E RTE-IVE (memory-based execute only) operating system than to create their own system. Right-to-copy and right-to-execute licenses are available at 50% and 25% of first copy price for each multiple use of the basic software, significantly lowering the per-system cost of RTE-6/VM or RTE-IVB operating software.

The decision to use RTE-6/VM, RTE-IVB, or RTE-IVE makes it possible to project additional requirements, as follows:

1. Main memory for the operating system and additional software, using information in the software section on pages 4-1 through 4-6.
2. 12539C Time Base Generator.
3. 12897B Dual Channel Port Controller for direct memory access.
4. Power Fail Recovery System; 12944B for 2109E Computer, 12991B for 2113E or 2117F Computer.

## 5.5-4 Additions and Changes

### Providing More than Standard Memory

Your HP 1000 E/F-Series system may require more than the 64 or 128 kB of memory that is standard in E/F-Series computers. How much main memory should be obtained can be determined using the information in the software section on pages 4-1 through 4-6.

If more than standard memory is needed, computer option 014 can be ordered to delete the standard memory, to make room for replacing it with more memory. The choices for E/F-Series memory changes and expansion are summarized in section 5.6, on pages 5.6-1 through 5.6-3.

### Additional Peripheral Devices and Interfaces

Your initial work on system design, using a copy of HP 1000 System Capabilities Checklist, Table 1-3, provided an initial overview of the peripheral devices to be included in the system. By using Table 1-3 with information in Peripherals sections 2.1 through 2.4, you can complete on one or more copies of Table 1-4 a detailed summary of the peripherals, interfaces, and cables to be added to your computer to provide all the functions needed for your HP 1000 E/F-Series system.

## 5.5-5 System Racking

For information on rack mounting of HP 1000 A-Series systems, see paragraph 5.6-4, page 5.6-10.

# Section 5.6

## E/F-Series Systems Expansion and Cabinet Racking

### 5.6-1 Memory Changes and Expansion

#### HP 1000 E/F-Series Memory Packages

The basic building block of memory for all HP 1000 E/F-Series memory configurations of 128k bytes or larger is the 1278xA-M memory package. The memory package, which is ordered as one convenient product number, consists of:

1. One of the following Memory Control Cards:
  - a. 2102B for Standard Performance Parity Memory.
  - b. 2102C for Standard Performance ECC Memory.
  - c. 2102E for High Performance Parity Memory.
  - d. 2102H for High Performance ECC Memory.
2. A 12731A Memory Expansion Module to support addressing of more than 64k bytes of memory in conjunction with dynamic mapping firmware included in the computer.
3. A 12892B Memory Protect Module which also supports addressing of extended memory.
4. One or more 12699H or 1274xH Memory Modules for parity memory, augmented in ECC memory packages by one or more 12666H, 12779H, or 12780H Fault Control Check Bit Array Boards as required.

#### Changes on Initial Order for an SPU or Computer

To obtain memory capacity larger than the standard capacity supplied with HP 1000 E/F-Series SPUs or computers:

1. Order SPU or computer option 014 to delete the standard memory.
2. In Table 5.6-1, select the 1278xA-M Memory Package that will provide the desired memory or the desired initial increment of memory.

#### Changes and Expansion Applicable to an Existing E/F-Series System

**Maximum Memory Capacity** Maximum memory capacities of the respective E/F-Series computers

Table 5.6-1. Memory Packages for HP 1000 E/F-Series Computers and System Processor Units

CYCLE TIME (+/- 35 ns)	MEMORY SIZE	128 kB	256 kB	512 kB	1.0 MB	1.5 MB	2.0 MB
HIGH PERFORMANCE MEMORY (Supported in all HP 1000 E/F-Series Computers and System Processor Units)							
420 ns	PARITY MEMORY PACKAGES	12788A	12788BB	12788E	12788F	12788G	12788H
490 ns	ECC MEMORY PACKAGES	Not Av.	Not Av.	12789J* 12789E*	12789K	12789L	12789M#
STANDARD PERFORMANCE MEMORY PACKAGES (Supported only in 2109E or 2113E Computer or 2176E or 2178C SPU)							
665 ns	PARITY MEMORY PACKAGES	12786A	12786B	12786C	Not Av.	Not Av.	Not Av.
735 ns	ECC MEMORY PACKAGES	12787A	12787B	12787C	12787D#	Not Av.	Not Av.

\* 12789J, which costs slightly more than the 12789E memory package, is recommended if later expansion of memory is anticipated, because it includes a 1 MB fault control check bit array board that supports a doubling of ECC memory with the addition of a single 512 kB memory module. The 12789E requires both a 512 kB memory module and a 512 kB check bit board to increase memory by 512k bytes.

# The 12787D and 12789M Memory Packages exceed the memory card cage capacity of the 2109E Computer.

and SPUs are given in Table 5.6-2, below. The maximum memory capacities given assume use of 64K RAM-based memory modules and fault control check bit array boards in the computer's memory section.

Table 5.6-2. Maximum Mainframe Memory Capacity

COMPUTER	2109E	2113E 2117F
SYSTEM PROCESSOR UNIT		217xC/E/F
MEMORY MODULE SLOTS	5	10
MAX. PARITY MEMORY/SLOTS USED	2.0 MB/4	2.0 MB/4
MAX. ECC MEMORY/SLOTS USED	1.5 MB/5	2.0 MB/6

**Intermixing of Memory Modules.** In HP 1000 E-Series Computers, memory modules and fault control check bit array boards with A-suffix product numbers can be intermixed with memory modules and check bit boards with H-suffix product numbers, as shown in Table 5.6-3. H-suffix memory modules can be used with the 2102B/C standard performance parity/fault control memory controllers. However, high performance cycle time with H-suffix modules requires use with a 2102E/H high performance parity/fault control memory controller.

Similarly, within the total number of available memory module slots, memory modules using 64K RAMs can be intermixed with modules that use 16K RAMs. However, +5V(M) current limitations with the 12991B Power Fail Recovery System may preclude use of all ten of the memory module slots in a 2113E or 2117F Computer. For configurations of more than six memory cards (including fault control check bit boards, total +5V(M) current usage should be calculated to make certain that it does not exceed available +5V(M) current (see page 6.1-7).

**Change to High Performance Memory** in an E-Series system requires the replacement of the 2102B/C Memory Control Card with a 2102E/H Memory Control Card and replacement of A-suffix memory modules with H-suffix memory modules.

**Change to ECC Memory** requires replacement of the 2102B/E Memory Control Card with a 2102C/H Memory Control Card and the addition of an appropriate fault control check bit array board(s) to support the desired memory. The check bit array boards can be configured to 64, 128, 256, 512, and 1024 kB blocks of memory, within their respective maximum capacities.

Table 5.6-3. HP 1000 E/F-Series Memory Combining Guide

COM-PUTER	SPU	TYPE OF MEMORY	CYCLE TIME (+/-35 ns)	MEMORY CONTROL CARD	MEMORY MODULES			FAULT CONTROL CHECK BIT BOARDS		
					PRODUCT NUMBER	CAPACITY	RAMs USED	PRODUCT NUMBER	ECC MEMORY SIZES SUPPORTED (kB)	RAMs USED
2109E 2113E 2117F	2176E 2177F 2178C 2179C	HIGH PERF. PARITY	420 nsec	2102E	12746H 12747H 12699H 12749H	64 kB 128 kB 256 kB 512 kB	16K 16K 64K 64K	See ECC Memory section below		
2109E 2113E	2176E 2178C	PARITY	665 nsec	2102B	12746A 12746H 12747A 12747H 12699H 12749H	64 kB 64 kB 128 kB 128 kB 256 kB 512 kB	16K 16K 16K 16K 64K 64K			
2109E 2113E 2117F	2176E 2177F 2178C 2179C	HIGH PERF. ECC	490 nsec	2102H	12746H 12747H 12699H 12749H	64 kB 128 kB 256 kB 512 kB	16K 16K 64K 64K	12779H 12780H 12666H	64, 128, 256 64, 128, 256, 512 64, 128, 256, 512, 1024	16K 16K 64K
2109E 2113E	2176E 2178C	ECC	735 nsec	2102C	12746A 12746H 12747A 12747H 12699H 12749H	64 kB 64 kB 128 kB 128 kB 256 kB 512 kB	16K 16K 16K 16K 64K 64K	12779A 12779H 12780A 12780H 12666H	64, 128, 256 64, 128, 256 64, 128, 256, 512 64, 128, 256, 512 64, 128, 256, 512, 1024	16K 16K 16K 16K 64K

**ECC Memory Additions.** Table 5.6-4 is provided to systematize the determination of the number and size of memory modules and fault control check bit boards to add to obtain a desired increment of ECC memory. Using the ECC Memory Configuration listings and the sample memory additions calculation example as needed for reference, proceed as follows:

1. In **Your Memory Additions Calculation** section, enter **Existing Memory** and the exact numbers of the specific memory modules and fault control check bit boards that make it up.
2. Enter **Desired Memory** and the numbers of the specific memory modules and fault control check bit boards that make it up, trying to make maximum use of existing modules and check bit boards. The total number cannot exceed ten and +5V(M) current should be checked for total board counts greater than six.
3. Subtract the module counts for Existing Memory from those for Desired Memory to determine the numbers of modules and check bit boards of each size to be added.

Table 5.6-4. Fault Control Memory Additions Worksheet

DESCRIPTION	MEMORY MODULES			FAULT CONTROL CHECK BIT BOARDS		
	12747H 12747A* (128 kB)	12699H (256 kB)	12749H (512 kB)	12779H 12779A* (256 kB)	12780H 12780A* (512 kB)	12666H (1.0 MB)
<b>SAMPLE MEMORY ADDITIONS CALCULATION</b>						
A. MEMORY DESIRED = _____ k bytes	_____	_____	_____	_____	_____	_____
B. EXISTING MEMORY = _____ k bytes	_____	_____	_____	_____	_____	_____
NUMBER OF COMPONENTS TO BE ADDED (A-B)	_____	_____	_____	_____	_____	_____
<b>YOUR MEMORY ADDITIONS CALCULATION</b>						
A. MEMORY DESIRED = _____ k bytes	_____	_____	_____	_____	_____	_____
B. EXISTING MEMORY = _____ k bytes	_____	_____	_____	_____	_____	_____
NUMBER OF COMPONENTS TO BE ADDED (A-B)	_____	_____	_____	_____	_____	_____
<b>ECC MEMORY CONFIGURATIONS</b>						
128k bytes (12787A/12789A* Package)	1	0	0	1	0	0
256k bytes (12787B/12789B* Package)	2	0	0	1	0	0
256k bytes	0	1	0	1	0	0
512k bytes (12789J Package)	0	0	1	0	0	1
512k bytes (12789E Package)	0	0	1	0	1	0
512k bytes (12787C/12789C* Package)	4	0	0	0	1	0
512k bytes	2	1	0	0	1	0
768k bytes	2	0	1	1	0	1
768k bytes	C	1	1	1	0	1
768k bytes	2	1	0	1	1	0
768k bytes	4	1	0	1	1	0
1024k bytes (12789K Package)	0	0	2	0	0	1
1024k bytes (12789F* Package)	0	0	2	0	2	0
1024k bytes	0	2	1	0	2	0
1024k bytes	4	0	1	0	2	0
1024k bytes (12787D/12789D* Package)	8	0	0	0	2	0
1280k bytes	0	1	2	1	0	1
1280k bytes	2	0	2	1	2	0
1280k bytes	2	2	1	1	2	0
1280k bytes	4	1	1	1	2	0
1536k bytes (12789L Package)	0	0	3	0	0	2
1536k bytes (12789F* Package)	0	0	3	0	3	0
1536k bytes	2	1	2	0	1	1
1792k bytes	0	1	3	1	0	2
1792k bytes	2	0	3	1	3	0
1792k bytes	4	1	2	1	3	0
2048k bytes (12789M Package)	0	0	4	0	0	2

\* Obsolete product, listed here for reference only.



## 5.6-2 Accessories and Interfaces

See Table 5.6-5.

Table 5.6-5. HP 1000 E/F-Series Accessories and Interfaces

ACCESSORY/INTERFACE PRODUCT NUMBER AND NAME	PURPOSE	PREREQUISITES
<p>LOADER ROMS (NOTE: Only two of four loader ROM sockets in the computer are available for addition of Loader ROMs unless an existing ROM is removed to make another socket available)</p>		
12992B RPL-COMPATIBLE DISC LOADER ROM	Supports remotely/locally-initiated binary load from 7906M/20M/25M MAC Disc	Any E/F-Series Computer or SPU with 79xxM MAC Disc
12992D MAG TAPE LOADER ROM	Supports initial binary load from 800/1600 bpi Magnetic Tape Subsystem	Any E/F-Series Computer or SPU with 7970B/E+226/236 or 7971A+2xx Magnetic Tape Subsystem
12992J CS/80 DISC LOADER ROM	Supports initial binary load from 7908/11/12/14P/R or 7933H/7935H Disc	Any E/F-Series Computer operating under RTE-6/VM with 79xxR or 793xH Disc (12992J is included in 2178C/2179C SPU w/Opt 022)
12992K PAPER TAPE LOADER ROM	Supports initial binary load from 12925A Punched Tape Reader Subsystem (obsolete)	Any E/F-Series Computer or SPU with 12925A Punched Tape Reader Subsystem
<p>FIRMWARE AND MICROPROGRAMMING SUPPORT HARDWARE</p>		
12791A FIRMWARE EXPANSION MODULE (FEM) (max. of two FEMs per computer* or SPU*)	Provides convenient socket mounting for eight blocks of non-volatile control memory (512k words/block with 4k ROMs, 1024 words/block with 8k ROMs), for HP or user-developed control store microprograms	Any E/F-Series Computer or SPU (one FEM is standard).
13306B FAST FORTRAN PROCESSOR (FFP)@ (firmware)	Speed-up of extended precision calculations, floating point conversions, array mapping, and subroutine parameter passing	Any E-Series Computer or SPU (this capability is included in 2177F and 2179C SPUs and the 2117F Computer)
12824A VECTOR INSTRUCTION SET (VIS), firmware & software equivalents@	Supports fast processing of data arrays in system operating under RTE-IVB or RTE-IVE	2117F Computer operating under RTE-IVB or RTE-IVE. 12824A VIS is included in 2177F SPU
-002 Provides software equivalents and manuals only	For use in E-Series Systems and Computers to provide transportability of programs using VIS	2176E SPU or 2109E or 2113E Computer operating under RTE-IVB/IVE
12829A VECTOR INSTRUCTION SET (VIS), firmware & software equivalents@	Supports fast processing of data arrays in system operating under RTE-6/VM	2117F Computer operating under RTE-6/VM (12829A VIS is included in 2179C System)
-001 Provides software equivalents and manuals for customer not on support for 12824A	For use in E-Series Systems and Computers to provide transportability of programs using VIS	2178C System or 2109E or 2113E Computer operating under RTE-6/VM
-002 Opt 001 for customer on support for 12824A		
13197A WRITABLE CONTROL STORE (WCS) CARD (three, maximum*)	Provides two 512 word blocks of control store overlay memory for microprogram development and dynamic control store overlaying	Any E/F-Series Computer or SPU operating under RTE-IVB or RTE-6/VM. 92061A RTE Microprogramming Package is also required.

\* Available control store address space is 11,776 words in 2176E and 2178C SPUs and 2109E and 2113E Computers. 5,632 words in 2177F and 2179C SPUs and 2117F Computers for user's microprograms on 12791A FEM and/or 13197A WCS.

@ Software subscription service support is available for this product. See HP 1000 Ordering Guide.

Table 5.6-5. HP 1000 E/F-Series Accessories and Interfaces, continued

ACCESSORY/INTERFACE PRODUCT NUMBER AND NAME	PURPOSE	PREREQUISITES
<b>MISCELLANEOUS MAINFRAME PLUG-INS</b>		
12897B DUAL-CHANNEL PORT CONTROLLER (DCPC)	Provides two-channel Direct Memory Access for interfaces in computer mainframe.	Any E/F-Series Computer (included in all 217xC/E/F SPU's)
12620A BREADBOARD INTERFACE	Privileged interrupt operation under RTE operating systems	Any E/F-Series Computer or SPU.
12777A PRIORITY JUMPER CARD	Completes I/O priority chain continuity through an unused I/O slot	Any E/F-Series Computer or SPU.
<b>I/O EXTENDER, EXTENDER PLUG-INS, AND POWER FAIL RECOVERY SYSTEMS</b>		
12979C DUAL-PORT I/O EXTENDER	Adds 16 I/O channels (max. of one 12979C per SPU, two 12979Cs per computer)	Any E/F-Series Computer or SPU (see Figure 5.6-1 for rack mounting position)
-001 EMI compliance	Compliance with FCC/VDE EMI regulations when installed in 217xC/E/F SPU.	
12898B DCPC for 12979C I/O Extender	Extends Direct Memory Access to I/O interfaces housed in the 12979C Extender	12897B Dual-Channel Port Controller in computer & 12979C Dual-Port I/O Extender
12781A DUAL CPU KIT for 12979C Extender	Connection of a second computer to 12979C Extender	12979C Dual-Port I/O Extender and second 2109E, 2113E, or 2117F Computer to connect to it.
12944B POWER FAIL RECOVERY SYSTEM	Sustains memory for at least 1.6 hours in event of power failure*	2109E Computer
12991B POWER FAIL RECOVERY SYSTEM	Sustains memory for at least 1.8 hours in event of power failure*	2113E or 2117F Computer (12991B is included in 217xC/E/F SPU's)
<b>HP-IB INTERFACE AND HP-IB EXTENDER</b>		
59310B HP-IB INTERFACE with 3.7m/12 ft cable	HP-IB bus connection of up to 14 "slow" HP-IB devices to the system.	Any E/F-Series Computer or SPU operating under RTE-6/VM or RTE-IVB/IVE
-001 2m/6.5 ft cable in place of std		
37203A HP-IB EXTENDER	Extension of HP-IB comm with other 37203A Extender or 37203L A-Series HP-IB Extender Card up to 1km (3281ft) via coaxial cable	Any E/F-Series Computer or SPU with 59310B interface and remote 37203A/L extender connected via Belden 9428 coaxial cabling
-001 Adds fiber optic channel	Fiber optic cable communication (same maximum distance as standard 37203A); 37203A/L Option 001 is also required at remote HP-IB extender.	Same as std 37203A, but can also connect via HP 39200B Fiber Optic Cabling
<b>RECOMMENDED TERMINAL INTERFACES</b>		
12966A BUFFERED ASYNC COMM. INTERFACE with 15.2m/50 ft std EIA terminal cable.	Single-channel, point-to-point communication with display terminals/modems, at rates to 960 cps.	Any E/F-Series Computer or SPU operating under RTE-6/VM or RTE-IVB/IVE, terminal, and appropriate cable option. (NOTE: Optional cable replaces std cable.)
-002 Modem Cable	Connection to RS-232-C Modem. 15.2m/50 ft cable length	
-006 Deletes Std Cable		
-105 Filtered Cable	Connection to 2623A, 2624B, 2626A, or 2627A Terminal. 5m/16.4 ft cable length	
-106 Filtered Cable	Connection to 2392A, 2625A, 2628A, or 45610B Terminal. 5m/16.4 ft cable length	

\* Memory sustaining time given assumes that backup batteries are fully charged.

E/F-Series Systems  
Expansion and Racking

Table 5.6-5. HP 1000 E/F-Series Accessories and Interfaces, continued

ACCESSORY/INTERFACE PRODUCT NUMBER AND NAME	PURPOSE	PREREQUISITES
RECOMMENDED TERMINAL INTERFACES, continued		
12792C 8-CHANNEL TERMINAL MULTIPLEXER with 3m/10 ft cable & RS-232-C Connector Panel  -002 Delete connector panel  -003 Edge Conn. Kit in place of connector panel and cable to it.	Multi-channel, point-to-point communications with display terminals/modems, via a single I/O channel at terminal rates to 960 cps.  Use with 37214A Systems Modem, which does not require connector panel  User-designed connections to multiplexer	Any E/F-Series Computer or SPU operating under RTE-6/VM or RTE-IVB/IVE and cables to terminals.  37214A Systems Modem
DS/1000-IV INTERFACES		
12793B BISYNC NETWORK MODEM INTERFACE with 5m/16.4 ft RS-232-C Cable  -001 Firmware only  -002 RS-449 Cable*	Single-channel, point-to-point communication with remote HP 3000 System via RS-232-C modems and telephone lines  Upgrades interface firmware for user not on 91750x opt x81 Firmware Update Service  Communication via RS-449 modems	Any E/F-Series Computer or SPU operating under RTE-6/VM or RTE-IVB/IVE, with 91750A DS/1000-IV Network Software, suitable modems and telephone line, and remote HP 3000 system
12794B HDLC NETWORK MODEM INTERFACE with 5m/16.4 ft RS-232-C Cable  -001 Firmware only  -002 RS-449 Cable*	Single-channel, point-to-point communication with remote HP 1000 System via RS-232-C modems and telephone lines  Upgrades interface firmware for user not on 91750x opt x71 Firmware Update Service  Communication via RS-449 modems	Any E/F-Series Computer or SPU operating under RTE-6/VM or RTE-IVB/IVE, with 91750A DS/1000-IV Network Software, suitable modems and telephone line, and remote HP 1000 system
12825A HDLC DIRECT CONNECT NETWORK INTERFACE with 5m/16.4 ft male & female cables and verifier hoods  -001 Firmware only  -002 Deletes cables & verifier hoods	Single-channel, point-to-point communication with remote HP 1000 System via direct-connect cables  Upgrades interface firmware for user not on 91750x opt x71 Firmware Update Service  Elimination of cables and verifier hoods not needed for second direct connect interface	Any E/F-Series Computer or SPU operating under RTE-6/VM or RTE-IVB/IVE, with 91750A DS/1000-IV Network Software, 91712A, 91713A, or 91714A Extension cable products as required, and remote HP 1000 system
12834A DIRECT CONNECT BISYNC NETWORK INTERFACE with 5m/16.4 ft male cable  -001 Firmware only	Single-channel, point-to-point communication with remote HP 3000 System via direct-connect cables  Upgrades interface firmware for user not on 91750x opt x81 Firmware Update Service	Any E/F-Series Computer or SPU operating under RTE-6/VM or RTE-IVB/IVE, with 91750A DS/1000-IV Network Software, 91712A, 91713A, or 91714A Extension cable products as required, and remote HP 3000 system
12830A DATA LINK SLAVE INTERFACE with 5m/16.4 ft cable to 92901A conn. box on the link  -001 Firmware only	Connection of HP 1000 system to DS/1000-IV data link as a slave system  Upgrades interface firmware	Any E/F-Series Computer or SPU operating under RTE-6/VM or RTE-IVB/IVE, with 91750A DS/1000-IV Network software and remote HP 1000 system functioning as data link master system
12771A DS/1000 COMPUTER SERIAL INTERFACE (two cards, one for each system) with 3.65m/12 ft male and female cables	Single-channel, point-to-point communication with a remote HP 1000 system that also has 91740B#/R firmware via direct-connect cables	Any E/F-Series Computer or SPU with 91740B#/R firmware, operating under RTE-6/VM or RTE-IVB/IVE and 91750A DS/1000-IV Network software. 91720A and/or 91721A Extension cables may also be required

\* Instead of RS-232-C cable; RS-449 cable length is same as RS-232-C cable.

# Obsolete product listed here for reference only.

Table 5.6-5. HP 1000 E/F-Series Accessories and Interfaces, continued

ACCESSORY/INTERFACE PRODUCT NUMBER AND NAME	PURPOSE	PREREQUISITES
<b>DS/1000-IV INTERFACES, continued</b>		
12773A DS/1000 COMPUTER MODEM INTERFACE with 3.65m/ 12 ft cable	Single-channel, point-to-point communication with a remote HP 1000 system that also has 91740B#/R firmware via RS-232-C modems and telephone lines	Any E/F-Series Computer or SPU with 91740B#/R firmware and 12620A as Privileged Interrupt Fence operating under RTE-6/VM or RTE-IVB/IVE with 91750A DS/1000-IV Network Software, suitable modems, and telephone lines
<b>X.25 INTERFACE TO PACKET-SWITCHED NETWORKS</b>		
12250A X.25 NETWORK (modem) INTERFACE with 5m/16.4 ft RS-232-C cable  -001 Firmware only  -002 RS-449 Cable*	Communication with remote systems or terminal via RS-232-C modem and packet-switching network. Compatible with DS/1000-IV Network software for communication between HP 1000 systems and between HP 1000 and HP 3000 systems  Upgrades interface firmware for user not on 91751x opt x91 Firmware Update Service  Communication via RS-449 modems	Any E/F-Series Computer or SPU operating under RTE-6/VM or RTE-IVB/IVE, with 91751A X.25 Communications software, suitable modems, and connection to packet-switching network
<b>OTHER DATA COMMUNICATIONS INTERFACES</b>		
12790A MULTIPOINT/DATA LINK INTERFACE@ with 10.6m/35 ft direct-connect multipoint cable  -001 7.6m/25ft Data Link cable	Connection to 262x or 264x Multipoint terminals via multipoint lines with communication at terminal rates to 960 cps.  Connection to Data Link Slave Systems via 3074A Data Link Adapter	Any E/F-Series Computer or SPU operating under RTE-6/VM or RTE-IVB/IVE, 91730A Multipoint Software, and appropriate systems or terminals and connection hardware
12260A MULTI-USE PRO- GRAMMABLE SERIAL INTERFACE with 5m/16.4 ft RS-232-C cable  -001 RS-449 cable*	Single-channel, point-to-point communication with remote IBM or Plug-Compatible System under control of 91781A, RJE/1000-II, 91782A MRJE/1000, or 91784A PMF/1000 software, via RS-232-C modems and telephone lines  Communication via RS-449 modems	Any E/F-Series Computer or SPU operating under RTE-6/VM, with 9178xA IBM communications software, suitable modems, and compatible remote system
12261A MULTI-USE PRO- GRAMMABLE MULTI- PLEXER	Eight-channel, point-to-point communication with Allen-Bradley programmable controllers under control of 92140A PCL/1000-AB software	Any E/F-Series Computer or SPU operating under RTE-6/VM, with 92140A PCL/1000-AB software, compatible programmable controllers connected via a 12828A RS-232-C Connector Panel, and other appropriate cabling
12826B PROGRAMMABLE SERIAL (modem) INTERFACE with 5m/16.4 ft RS-232-C cable  -001 RS-449 Cable*  -002 Edge connector*  -003 Deletes Self-Test EPROM and Diag- nostic hood	User-customizable point-to-point communication with remote systems or terminals via RS-232-C modems and telephone lines  Communication via RS-449 modems  User-designed connection to modem  Elimination of duplicate items not needed for additional 12826B interface	Any E/F-Series Computer or SPU operating under RTE-6/VM or RTE-IVB/IVE. HP 24602A Firmware Development Package is strongly recommended for support of development of applications firmware for the 12826B interface.
24602A PROGRAMMABLE SERIAL INTERFACE FIRMWARE DEVELOP- MENT PACKAGE  -001 Deletes DDM EPROM and Accessory Cable -002 Modem cable	Assistance of user with development of firmware for the 12826B Programmable Serial Interface card, including Development Debug Monitor (DDM) EPROM, DDM Accessory Cable, and a Firmware Programming Manual  Provides a set of manuals only for advance study and evaluation  Connection to RS-232-C modem, 7.6m/25 ft	12826B Programmable Serial Interface with 126B Programmable Serial Interface with self-test and an HP 64000 Microprogramming Workstation

\* Obsolete product listed here for reference only.

\* Instead of RS-232-C cable; RS-449 cable length is same as RS-232-C cable.

E/F-Series Systems  
Expansion and Racking

Table 5.6-5. HP 1000 E/F-Series Accessories and Interfaces, continued

ACCESSORY/INTERFACE PRODUCT NUMBER AND NAME	PURPOSE	PREREQUISITES
OTHER DATA COMMUNICATIONS INTERFACES, continued		
12531C TELEPRINTER INTERFACE	Single-channel, character mode, current loop communication with teleprinter at rates to 176 cps	Any E/F-Series Computer or SPU operating under RTE-6/VM or RTE-IVB/IVE, teleprinter and appropriate 12531C cable option
-001 Terminal cable	Direct connection to teleprinter, 7.6m/25 ft	
-002 Modem cable	Connection to RS-232-C modem, 7.6m/25 ft	
12531D TERMINAL INTERFACE	Single-channel, character mode, current loop communication with non-HP terminal at rates to 240 cps	Any E/F-Series Computer or SPU operating under RTE-6/VM or RTE-IVB/IVE, terminal, and appropriate 12531D cable option
-001 Terminal cable	Direct connection to terminal, 7.6m/25 ft	
12618A SYNCHRONOUS COMMUNICATIONS (2-card) INTER- FACE with 15.2m/ 50 ft cable	Single-channel, point-to-point half or full-duplex communication with IBM 360/370 or other system via synchronous modems and telephone lines	Any E/F-Series Computer or SPU. Use with obsolete 91780A RJE/1000 software is supported under RTE-6/VM or RTE-IVB/IVE when 12620A is also provided as a privileged interrupt fence
DISC INTERFACES		
12821A INTERFACE with 3.69m/12 ft cable and 12992H ICD Disc Loader ROM	Connection of up to two 9895A Flexible Discs	Any E/F-Series Computer or SPU operating under RTE-6/VM or RTE-IVB/IVE and 9895A Flexible Disc Drive
-001 Deletes 12992H Disc Loader ROM	Connection of up to four 7908/11/12/14P/R/TD and/or 7933H/7935H CS/80 discs	Any E/F-Series Computer or SPU operating under RTE-6/VM (12821A+001 is included in options 022, 060, and 061 to 2178/9C SPU)
13175D MAC DISC INTER- FACE with 5.5m/ 18 ft cable	Connects one 79xxM MAC Master Disc and up to seven 79xxS MAC Slave Discs	Any E/F-Series Computer or SPU operating under RTE-6/VM or RTE-IVB and one 79xxM MAC Disc. (13175D is included in options 031 and 033 to 2176E, 2177F, 2178C, and 2179C SPUs)
13178D MULTI-CPU INTER- FACE with 1.85m/ 6 ft interface cable and 2.44m/ 8ft Multi-CPU cable	Interfaces additional computer to 79xxM MAC Master Disc (max. of 7 additional computers connected to MAC Master Disc)	Any E/F-Series Computer or SPU operating under RTE-6/VM or RTE-IVB and a 79xxM MAC Master Disc that is shared*
-001 4.9m/16 ft multi- CPU cable	Alternate multi-CPU cable length	
PRINTER INTERFACES		
12821A+001 INTERFACE with 3.69m/ 12 ft cable	Connection of up to two 256xA+210 Line Printers or one 2608S+210 Line Printer	Any E/F-Series Computer or SPU operating under RTE-6/VM or RTE-IVB and a compatible line printer
12845B PRINTER INTERFACE with 7.6m/25 ft cable	Connection of one 2611A, 2613A, 2617A, 2619A or 2631A/B Printer (all obsolete products)	Any E/F-Series Computer or SPU operating under RTE-6/VM or RTE-IVB/IVE and supported printer
26099A PRINTER INTERFACE with 7.6m/25ft cable	Connection of one 256xA+100 Line Printer or one 2608A (obsolete) Line Printer	Any E/F-Series Computer or SPU operating under RTE-6/VM or RTE-IVB/IVE and supported line printer

\* When multiple computers are ordered to interface with a single 79xxM disc, installation includes running of disc diagnostics ONLY ONCE, from one of the interfaced computers. Installation and verification of additional disc-computer connections is not included in system installation. NOTE: In 2178C/2179C SPU or in 2109E/13E/17F Computer operating under RTE-6/VM, 9174A Datashare/1000 software supports multi-computer access to shared cartridges and file spaces on 79xxM and 79xxS Discs.

Table 5.6-5. HP 1000 E/F-Series Accessories and Interfaces, continued

ACCESSORY/INTERFACE PRODUCT NUMBER AND NAME	PURPOSE	PREREQUISITES
<b>MEASUREMENT AND CONTROL INTERFACE</b>		
91000A PLUG-IN A-TO-D INTERFACE SUBSYSTEM with connector kit	Measurement of 8 differential or 16 single-ended +/-10.23V fs analog inputs, data rate to 20,000 channels/sec, 12-bit resolution (including sign)	Any E/F-Series Computer or SPU operating under RTE-6/VM or RTE-IVB/IVE with obsolete 92066A RTE Measurement and Control Package.
-005 Single-ended input cable*	Connection of single-ended inputs, unterminated at source end, 4.8m/16 ft	
-006 Differential input cable*	Connection of differential inputs, unterminated at source end, 4.8m/16 ft	
<b>GENERAL-PURPOSE INTERFACES</b>		
12551B 16-BIT RELAY OUTPUT REGISTER with connector kit	Device control output using 16 isolated contact closures	Any E/F-Series Computer or SPU operating under RTE-6/VM or RTE-IVB/IVE; requires user-written driver
-001 Adds read-back	Returns current bit states to the system	
12554A 16-BIT DUPLEX REGISTER, positive in, positive out, w/conn kit	16-bit input and 16-bit output, storage, and control and interrupt logic at discrete-transistor logic levels	Any E/F-Series Computer or SPU operating under RTE-6/VM or RTE-IVB/IVE; requires user-written driver
-001 Neg in, neg out		
12556B 40-BIT REGISTER, positive-true, with conn. kit	40-bit output for driving program input lines, control panel indicators, or 5055A Digital Recorder (obsolete printer)	Any E/F-Series Computer or SPU operating under RTE-6/VM or RTE-IVB/IVE.
-001 2.4m/8ft cable	Conn. to 5055A Digital Recorder (obsolete)	
12566C MICROCIRCUIT INTERFACE with 48-pin conn. kit	16-bit input and 16-bit output, storage, and control and interrupt logic at DTL/TTL logic levels	Any E/F-Series Computer or SPU operating under RTE-6/VM or RTE-IVB/IVE.
-001 24-pin conn. kit	Conn. to single, bi-directional data bus	
12597A 8-BIT DUPLEX REGISTER, positive-in, positive-out, with conn. kit	8-bit input and 8-bit output, storage, and control and interrupt logic at discrete-transistor logic levels	Any E/F-Series Computer or SPU operating under RTE-6/VM or RTE-IVB/IVE; requires user-written driver
-001 Neg-in, neg out		
-002 Tape Reader Cable	Connection to 2748B Tape Reader (obsolete)	
-005 Tape Punch Cable	Connection to 2895B Tape Punch (obsolete)	
12620A BREADBOARD INTERFACE with conn. kit	Provides standard flag and interface logic and 49 spaces for mounting TTL packages of user-designed interface. Can also serve as RTE privileged interrupt fence.	Any E/F-Series Computer or SPU operating under RTE-6/VM or RTE-IVB/IVE; requires user-written driver
12930A UNIVERSAL INTERFACE w/differential input logic and connector kit	16-bit input and 16-bit output, storage, and 6-bit command input, and 6-bit status output with differential input of +1V or greater	Any E/F-Series Computer or SPU operating under RTE-6/VM or RTE-IVB/IVE; requires user-written driver
-001 Ground-true TTL	Connection to ground-true TTL device	
-002 Positive-true TTL	Connection to positive-true TTL device	
91200B VIDEO DISPLAY I/F CARD with connector kit	Connection of graphics output to TV monitor (B&W w/one 91200B, color w/three 91200Bs)	Any E/F-Series Computer or SPU operating under RTE-6/VM or RTE-IVB/IVE. (Not supported by Graphics/1000 or Graphics/1000-II software)
-001 7.6m/25ft Cable, incl. BNC-to-UHF adapter	Connection from one 91200B card to B&W TV Monitor	
-002 7.6m/25ft Cable assembly, including BNC-to-UHF adapters	Connection from three 91200B cards to color TV Monitor	

\* Instead of connector kit.

### 5.6-3 I/O Expansion

In larger systems, the computer card cage may not have enough capacity for the I/O cards required for interfacing peripheral devices and other external equipment. If the total number of I/O cards required is greater than 9 in a 2109E Computer or greater than 14 in a 2113E or 2117F Computer or 217xC/D/F SPU, a 12979C Dual-Port I/O Extender can be used to add capacity for 16 more I/O interface cards. For a system racked in a single 29431G Cabinet, a maximum of one I/O Extender can be supported.

### 5.6-4 System Racking

#### Basic HP 217xC/E/F System Processor Unit Racking

HP 1000 E/F-Series 2176E, 2177F, 2178C, and 2179C System Processor Units (SPUs) are rack mounted in 29431G Cabinets as shown in Figure 5.6-1. The basic SPU includes a 2113E or 2117F Computer, which is housed in the upper compartment of the 29431G Cabinet, which also has space for a 12979C Dual-Port I/O Extender.

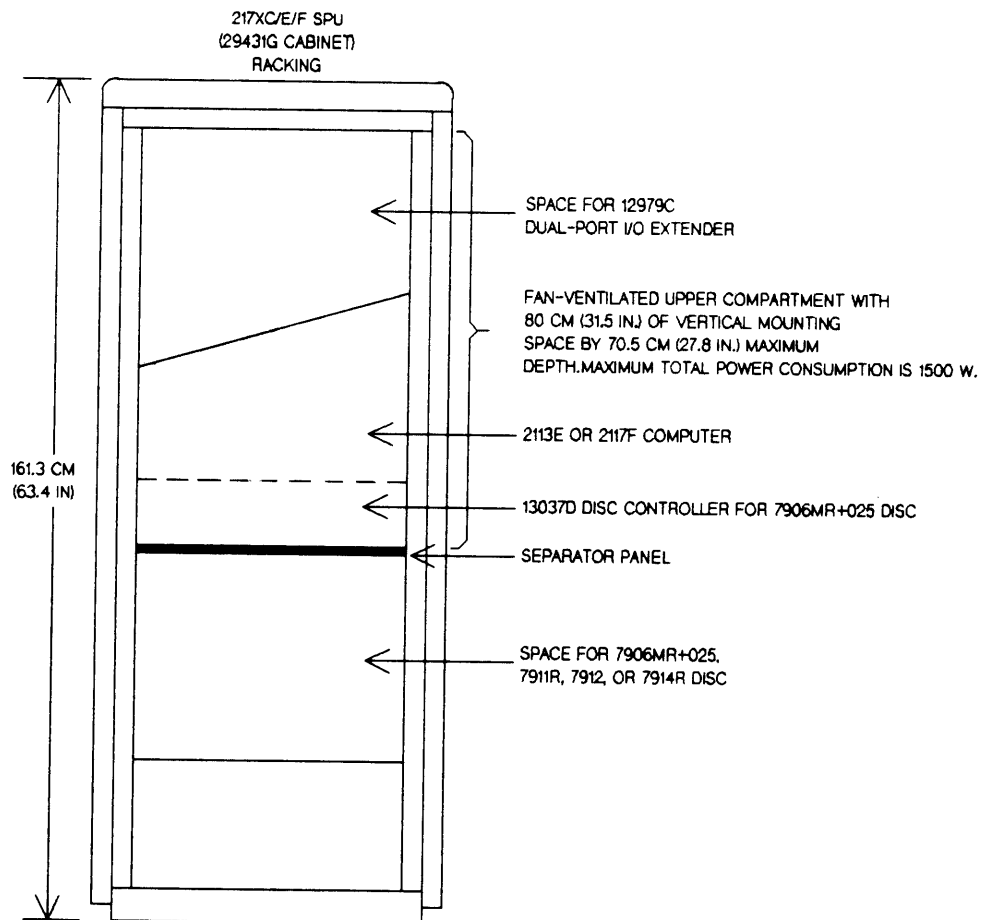

Figure 5.6-1. HP 1000 E/F-Series SPU Racking

Space in the lower compartment of the 29431G Cabinet is intended for a separately-ordered 7911R, 7912R, or 7914R CS/80 disc memory with a built-in cartridge tape unit for convenient software loading and backup. A door with cutout for access to the 791xR disc's tape unit is standard in the 2178/9C SPU cabinet. Alternative adaptation for a rack-mounting 7906MR+025 MAC Master Cartridge Disc Memory is ordered as Option 050 to the 2178/9C SPU or the 29431G Cabinet. (The controller for the 7906MR+025 Disc must be racked in the upper compartment of the 29431G cabinet because it has left-to-right airflow.)

#### **Variations on Basic 2178/9C SPU Racking in the 29431G Cabinet**

**Louvered Lower Door.** If a 791xR or 7906MR disc will not be installed in the disc compartment of the 29431G cabinet, the front door that is cut out to facilitate access to the cartridge tape unit of the 791xR disc must be replaced with a door that has louvers in place of the cutout, by ordering Option 053 to the 2178/9C SPU or the 29431G Cabinet.

**Installation of Other Equipment in Place of the 791xR Disc.** Other equipment can be installed in 29431G Option 053 cabinets in the space designed for the 791xR Disc if it:

1. Is self-ventilated using front-to-rear airflow.
2. Fits into 31.1 cm (12.25 in.) of vertical mounting space to a maximum depth of no more than 70.5 cm (27.8 in.).
3. Consumes no more than 700 watts.

**Safety of Other Equipment Installed in Place of the 791xR Disc** is the responsibility of the user.

#### **Bolting Cabinets Together**

Two 29431G Cabinets can be secured to each other using a 40026A Tie-Together Kit. However, the 29431G Cabinets are not designed to be bolted or otherwise tied together with other cabinets of any kind. Bolting more than two 29431G Cabinets together requires special engineering.

#### **Rack-Mountable Equipment for HP 1000 E/F-Series Systems**

All rack-mountable equipment available for HP 1000 E/F-Series Systems is listed in Table 5.6-6, along with information pertinent to its rack mounting.

#### **Rack Mounting of E/F-Series Systems in Non-HP Cabinets**

If E/F-Series computers and compatible peripheral devices are rack mounted in a non-HP cabinet, that cabinet must have enough space to house the components and must support, or at least not interfere with, the ventilation air flow of the rack mounted equipment to assure long life and trouble-free operation. Compliance with EMI regulations and safety standards cannot be supported by Hewlett-Packard for systems that are installed in non-HP cabinets.



E/F-Series Systems  
Expansion and Racking

Table 5.6-6. Rack-Mountable Equipment for HP 1000 E/F-Series Systems

PRODUCT NUMBER AND NAME	VERTICAL MOUNTING SPACE REQUIRED (cm and (in.))	MAXIMUM POWER CONSUMPTION	INTERNAL AIR FLOW DIRECTION	COMMENTS
2109E COMPUTER	22.2 (8.75)	625	Left-to-right	Mounts in upper compartment of 29431F Cabinet (see Fig. 5.6-1).
2113E COMPUTER	31.1 (12.25)	625	Left-to-right	Mounts in upper compartment of 29431F Cabinet (see Fig. 5.6-1).
2117F COMPUTER	44.5 (17.5)	825	Left-to-right	Mounts in upper compartment of 29431F Cabinet (see Fig. 5.6-1).
12979C DUAL-PORT I/O EXTENDER	22.2 (8.75)	625	Left-to-right	Mounts in upper compartment of 29431F Cabinet, max. of one (see Fig. 5.6-1).
7906MR+025 MAC MASTER CARTRIDGE DISC		690		This disc mounts in lower and upper compartments of the 29431G cabinet as noted below; must order 2178/9C Option 050 or 29431G Option 050.
-- Disc Drive	40.0 (15.75)		Front-to-rear	Mounts in computer-disc (lower) compartment of 29431G+050 Cabinet.
-- 13037D Disc Controller	13.3 (5.25)		Left-to-right	Must mount in upper compartment of 29431G+050 Cabinet
7911R, 7912R, or 7914R CS/80 FIXED DISC	31.3 (12.25)	700	Front-to-rear	Mounts in the disc compartment of the 29431F Cabinet (see Figure 5.6-1); if the dedicated space for the 791xR disc is not used, Option 053 must be ordered for the 2178C/9C SPU or the 29431F Cabinet to replace the disc-cutout version of the disc compartment front door with a non-cutout version of that door
7970B/E Option 236 MAGNETIC TAPE UNIT	66.7 (26.3)	400	By convection	Mounts in upper compartment of 29431F Cabinet; with respect to 217xC/E/F SPU, this is a second cabinet. Preferable choice is 7971A Option 25x or 26x Magnetic Tape Unit which includes upright cabinet that can accommodate two 7970B/E Mag Tape Drives
9895A DUAL FLEXIBLE DISC DRIVE	22.2 (8.75)	180	Front-to-rear	Safety in 29431F Cabinet has not been qualified by Hewlett-Packard and is the responsibility of the user. Access for disc loading requires opening of a cabinet door.

### 5.6-5 System Summarization

Tables 1-3, 1-4, and 1-5 in Section 1 are designed to be copied to provide a convenient facility for summarizing system capabilities, interfacing, and base system hardware. Together with Table 4-1 in Section 4, these tables provide a complete specification of your entire system from the SPU or computer and system disc down to all required cables, interfaces, and options.

*NOTE: If this is your first HP 1000 System design, you may want to have it checked by a Hewlett-Packard Systems Engineer to confirm that it is complete.*

# Configuration Reference Information -- Contents

<b>Section 6.1</b>	<b>Electrical and Card Cage Capacity Specifications</b>	
6.1-1	Power Line Frequency/Voltage Choices . . . . .	6.1-1
6.1-2	Power Requirements . . . . .	6.1-2
6.1-3	Computer Card Cage Slots and Power Supply . . . . .	6.1-2
<b>Section 6.2</b>	<b>Environmental Specifications</b>	
. . . . .		6.2-1
<b>Section 6.3</b>	<b>Physical Characteristics</b>	
. . . . .		6.3-1
<b>Section 6.4</b>	<b>Compatibility</b>	
6.4-1	Explanation of the HP 1000 Compatibility Matrices . . . . .	6.4-1
6.4-2	HP 1000 A/L-Series Compatibility . . . . .	6.4-2
6.4-3	HP 1000 E/F-Series Compatibility . . . . .	6.4-2

# Section 6.1

## Electrical and Card Cage Capacity Specifications

### 6.1-1 Power Line Frequency/ Voltage Choices

Virtually all HP 1000 SPUs, computers, and peripheral devices can be operated from 60 Hz or 50 Hz ac power at line voltages ranging from 100V to 240V to work with the mains power available in

various countries throughout the world. For each ac-powered item of HP 1000 equipment, Table 6.1-1 gives the supported line frequencies and voltages and how a particular equipment item is equipped to work with a particular frequency-voltage combination.

*Table 6.1-1. Power Line Frequency/Voltage Choices for HP 1000 Equipment*

PRODUCT NUMBER AND NAME	POWER LINE VOLTAGE CHOICES AT 60 Hz AC LINE FREQUENCY						POWER LINE VOLTAGE CHOICES AT 50 Hz AC LINE FREQUENCY					
	100V	115V	120V	220V	230V	240V	100V	115V	120V	220V	230V	240V
<b>HP 1000 SYSTEM PROCESSOR UNITS (SPUs)</b>												
217xA/C/E/F SPU (Models 40-65)	Std*	Std	Std*	s/p*	s/p*	s/p*	N/S	N/S	N/S	015*	015	015*
219xC/D SPU (Models 26, 27, 29)	Std*	Std	Std*	s/p*	s/p*	s/p*	N/S	N/S	N/S	015*	015	015*
248xA SPU (Micro 26, 27, 29)	Std*	Std	Std*	015*	015	015*	Std*	Std	Std*	015*	015	015*
<b>HP 1000 COMPUTERS</b>												
2109E/2113E/2117F COMPUTER, except 2117F FPP	Std*	Std#	Std*	015	015*	015*	Std*	Std#	Std*	015	015*	015*
2117F FLOATING POINT PROCESSOR	fsv	fsv*	fsv	fsv	fsv*	fsv	fsv	fsv*	fsv	fsv	fsv*	fsv
2137A/2139A/2156B COMPUTER	Std*	Std	Std*	015*	015	015*	Std*	Std	Std*	015*	015	015*
243xA MICRO 26/27/29 COMPUTER	Std*	Std	Std*	015*	015	015*	Std*	Std	Std*	015*	015	015*
<b>HP 1000 PERIPHERALS</b>												
13279B COLOR MONITOR	014	Std	Std*	N/S	N/S	N/S	016	N/S	N/S	015	013*	013
2250A/H MEAS. & CONTROL SYSTEM	326*	326	326*	335*	335	335*	326*	326	326*	335*	335	335*
25572A POWER SUPPLY for two 2251B Meas. & Ctrl Units	326*	326	326*	335*	335	335*	326*	326	326*	335*	335	335*
2334A MULTIMUX	Std*	Std	Std*	115	115*	115*	Std*	Std	Std*	115	115*	115*
2392A DISPLAY TERMINAL	Std*	Std	Std*	015*	015	015*	Std*	Std	Std*	015*	015	015*
2563A/2565A/2566A LINE PRINTER	016	Std*	Std	015	017*	017	016	Std*	Std	015	017*	017
2623A/24B/26A/27A TERMINAL	014	Std*	Std	N/S	N/S	N/S	016	N/S	N/S	015	013*	013
2623A/2624B/2626A TERMINAL with Opt 050 built-in PRINTER	N/S	Std	Std*	N/S	N/S	N/S	N/S	016	016*	015*	015	015*
2625A/2628A TERMINAL, with or without Opt 050 PRINTER	014	Std*	Std	N/S	N/S	N/S	016	N/S	N/S	015	013*	013
267xA/G THERMAL PRINTER	fsv	fsv*	fsv	fsv	fsv*	fsv	fsv	fsv*	fsv	fsv	fsv*	fsv
2686A LASERJET PRINTER	Std*	Std	Std*	N/S	N/S	N/S	N/S	N/S	N/S	N/S	N/S	N/S
2687A LASER PAGE PRINTER	Std*	Std	Std*	N/S	N/S	N/S	N/S	N/S	N/S	015	017*	017

- Std = Standard line voltage or standard line voltage-frequency combination. Appearance of Std in two or more columns on the same line signifies that the standard unit supports both 50 and 60 Hz operation at the specified voltages.
- 015, etc. = Option number ordered to get desired line voltage, line frequency, or line voltage-frequency combination. Appearance of the same option number in two or more columns on the same line signifies that the optional unit supports both 50 and 60 Hz operation at the specified voltages.
- s/p = Split-phase power input to 217xA/C/E/F SPU with two cabinet bays or to 219xC SPU or to 793xH Disc.
- \* = Suffix that denotes support by the overlapping voltage tolerance of the standard, split-phase, or optional voltage.
- # = Standard line voltage of 2109E, 2113E, and 2117F Computers is 110V, not 115V.
- fsv = Field-settable voltage that is usually preset at the factory to meet the requirement of the country to which the product is being shipped.
- N/S = Line frequency-voltage combination that is Not Supported.

Table 6.1-1. Power Line Frequency/Voltage Choices for HP 1000 Equipment, continued

PRODUCT NUMBER AND NAME	POWER LINE VOLTAGE CHOICES AT 60 Hz AC LINE FREQUENCY						POWER LINE VOLTAGE CHOICES AT 50 Hz AC LINE FREQUENCY					
	100V	115V	120V	220V	230V	240V	100V	115V	120V	220V	230V	240V
HP 1000 PERIPHERALS, continued												
2932A/2934A PRINTER	fsv	fsv*	fsv	fsv	fsv*	fsv	fsv	fsv*	fsv	fsv	fsv*	fsv
3074A/M DATA LINK ADAPTER 3081A IND. WORKSTATION TERMINAL (See 92922A or 92923A)	Std*	Std	Std*	015*	015	015*	Std*	Std	Std*	015*	015	015*
37203A HP-IB EXTENDER 37214A SYSTEMS MODEM CARD CAGE	fsv fsv	fsv* fsv*	fsv fsv	fsv fsv	fsv* fsv*	fsv fsv	fsv fsv	fsv* fsv*	fsv fsv	fsv fsv	fsv* fsv*	fsv fsv
39301A FIBER OPTIC MULTIPLEXER 39800A/39801A BAR CODE READERS	210 210	212* Std*	212 Std	222 222	224* 224*	224 224	210 210	212* Std*	212 Std	222 222	224* 224*	224 224
45610B TOUCHSCREEN TERMINAL	fsv*	fsv	fsv*	fsv*	fsv	fsv*	fsv*	fsv	fsv*	fsv	fsv*	
7470A/7475A GRAPHICS PLOTTER 7550A GRAPHICS PLOTTER 758xB DRAFTING PLOTTER	fsv fsv fsv	fsv* fsv* fsv*	fsv fsv fsv	fsv fsv fsv	fsv* fsv* fsv*	fsv fsv fsv	fsv fsv fsv	fsv* fsv* fsv*	fsv fsv fsv	fsv fsv fsv	fsv* fsv* fsv*	fsv fsv fsv
7911/7912P/R FIXED DISC 7914P/R/CT FIXED DISC 7914ST/TD DISC-TAPE SUBSYSTEM	StdR StdR StdR	Std* Std* Std*	Std Std Std	N/S N/S N/S	N/S N/S N/S	N/S N/S N/S	015R 015R 015R	015R* 015R* 015R*	015R 015R 015R	015 015 015	015* 015* 015*	015* 015* 015*
79xxM/S MAC DISCS 7933H/7935H DISCS 794xA DISCS & DISC-TAPE DRIVES	StdR N/S Std*	Std* s/p Std	Std 120 Std*	015* 22x 015*	015 24x* 015	015* 24x 015*	StdR N/S Std*	Std* s/p Std	Std 120 Std*	015* 22x 015*	015 24x* 015	015* 24x 015*
7970B/E & 7971A MAG TAPE DRIVES 7974A/7978A MAGNETIC TAPE DRIVE 82905B/82906A PRINTER	N/S fsv 001	Std fsv* 002*	Std* fsv 002	015* fsv 003	015 fsv* 004*	015* fsv 004	N/S fsv 001	Std fsv* 002*	Std* fsv 002	015* fsv 003	015 fsv* 004*	015* fsv 004
9111A GRAPHICS TABLET 9122D/S MICROFLOPPY DISC 9133D FIXED & MICROFLOPPY DISCS 9144A TAPE CARTRIDGE SUBSYSTEM	fsv fsv fsv fsv*	fsv* fsv* fsv* fsv	fsv fsv fsv fsv*	fsv fsv fsv fsv*	fsv* fsv* fsv* fsv	fsv fsv fsv fsv*	fsv fsv fsv fsv*	fsv* fsv* fsv* fsv	fsv fsv fsv fsv*	fsv fsv fsv fsv*	fsv* fsv* fsv* fsv	fsv fsv fsv fsv*
92922A 4-CHANNEL ADAPTER/POWER SUPPLY FOR 3081As	Std*	Std	Std*	015*	015	015*	Std*	Std	Std*	015*	015	015*
92923A 1-CHANNEL ADAPTER/POWER SUPPLY FOR 3081As	Std*	Std	Std*	015*	015	015*	Std*	Std	Std*	015*	015	015*
9895A FLEXIBLE DISC MEMORY	fsv	fsv*	fsv	fsv	fsv*	fsv	001	001*	001	001	001*	001

- Std = Standard line voltage or standard line voltage-frequency combination.
- 015, etc. = Option number ordered to get desired line voltage or line voltage-frequency combination.
- s/p = Split-phase power input to 793xH Disc.
- \* = Suffix that denotes support by the overlapping voltage tolerance of the std, s/p, or optional voltage.
- fsv = Field-settable voltage.
- N/S = Line frequency-voltage combination that is Not Supported.
- R = Suffix on Std (StdR) or option (015R) denotes line voltage settable by restrapping in the field.

## 6.1-2 Power Requirements

For each ac-powered item of HP 1000 equipment, Table 6.1-2 gives ac power required in watts and operational limits with respect to line voltage and ac line frequency.

## 6.1-3 Computer Card Cage Slots and Power Supply

Computer card cage slot and power availability are important determinants of the size of system that can be supported. Tables 6.1-3 (page 6.1-5) for A-Series and 6.1-4 (page 6.1-7) for E/F-Series give availability and requirements for card cage or I/O slots and computer power supply current for computers, SPUs, extenders, memory, interfaces, and miscellaneous plug-ins.

Table 6.1-2. Power Requirements of HP 1000 Equipment

PRODUCT NUMBER AND NAME	MAX. AC POWER (NOTE A)	VOLTAGE LIMITS (V)		FREQUENCY LIMITS (Hz)	
		115V	(230V)	60 Hz	50 Hz
HP 1000 SYSTEM PROCESSOR UNITS (SPUs) (Excludes requirements of system console terminal and (hard) non-integrated system disc, which are ordered separately).					
2176E MODEL 40 System Processor Unit	800W	88-132	(176-264)	48-66	(48-66)
2177F MODEL 45 System Processor Unit	1000W	90-132*	(198-264)#	48-66	(48-66)
2178C MODEL 60 System Processor Unit	800W	88-132	(176-264)	48-66	(48-66)
2179C MODEL 65 System Processor Unit	1000W	90-132*	(198-264)#	48-66	(48-66)
219xC MODEL 26/27/29 SPU (56-in Cabinet)	760W	86-138 s/p	(178-276)	48-66	(48-66)
219xD MODEL 26/27/29 SPU (22.5-in Cabinet)	700W	86-138	(178-276)	48-66	(48-66)
248xA MICRO 26/27/29 SPU (Incl. 248xA Opt 111.)	500W	86-138	(178-276)	48-66	(48-66)

HP 1000 COMPUTERS

2109E COMPUTER (E-Series w/9 I/O Channels)	750W	88-132	(176-264)	48-66	(48-66)
2113E COMPUTER (E-Series w/14 I/O Channels)	750W	88-132	(176-264)	48-66	(48-66)
2117F COMPUTER (F-Series w/14 I/O Channels)	950W	90-132*	(198-264)#	48-66	(48-66)
2137A COMPUTER (A700 w/16 I/O Channels)	700W	86-138	(178-276)	48-66	(48-66)
2139A COMPUTER (A900 w/15 I/O Channels)	700W	86-138	(178-276)	48-66	(48-66)
2156B COMPUTER (A600+ w/18 I/O Channels)	700W	86-138	(178-276)	48-66	(48-66)
243xA MICRO 26/27/29 COMPONENT (Incl. Opt 111.)	500W	86-138	(178-276)	48-66	(48-66)

HP 1000 PERIPHERALS POWER REQUIREMENTS

13279B COLOR MONITOR	170W	90-128	(198-264)	54-66	(45-55)
2250A/H MEASUREMENT AND CONTROL SYSTEM	390W	86-127	(195-253)	47-66	(47-66)
2251B MEASUREMENT AND CONTROL UNIT (See 25572A)	195W				
2255H MEASUREMENT AND CONTROL EXTENSION SYSTEM	390W	86-127	(195-253)	47-66	(47-66)
25572A POWER SUPPLY for two 2251B M & C Units	390W	86-127	(195-253)	47-66	(47-66)
2334A MULTIMUX	115W t	86-127	(195-253)	48-66	(48-66)
2392A DISPLAY TERMINAL	50W	87-126	(196-253)	47-66	(47-66)
2563A LINE PRINTER	468W	90-126**	(198-252)#	48-66	(48-66)
2565A/2566A LINE PRINTER	550W	90-126**	(198-252)#	48-66	(48-66)
2623A GRAPHICS TERMINAL	120W	90-126**	(198-252)#	57-63	(47.5-52.5)
2623A+050 GRAPHICS TERMINAL w/built-in PRINTER	170W	87-126	(195-253)	57-63	(47.5-52.5)
2624B DISPLAY TERMINAL	120W	90-126**	(198-252)#	57-63	(47.5-52.5)
2624B+050 DISPLAY TERMINAL w/built-in PRINTER	170W	87-126	(195-253)	57-63	(47.5-52.5)
2625A DUAL-SYSTEM DISPLAY TERMINAL	100W	90-126**	(198-252)#	57-63	(47.5-52.5)
2625A+050 DUAL-SYS DISPLAY TERMINAL w/PRINTER	170W	90-126**	(198-252)#	57-63	(47.5-52.5)
2626A DISPLAY STATION	120W	90-126**	(198-252)#	57-63	(47.5-52.5)
2626A+050 DISPLAY STATION w/built-in PRINTER	170W	87-126	(195-253)	57-63	(47.5-52.5)
2627A COLOR GRAPHICS TERMINAL	250W	90-126**	(198-252)#	57-63	(47.5-52.5)
2628A WORD PROCESSING TERMINAL	100W	90-126**	(198-252)#	57-63	(47.5-52.5)
2628A+050 WORD PROCESSING TERMINAL w/PRINTER	170W	90-126**	(198-252)#	57-63	(47.5-52.5)
2671A/G PRINTER/GRAPHICS PRINTER	50W	90-126**	(198-252)#	47-66	(47-66)
2673A INTELLIGENT GRAPHICS PRINTER	75W	90-126**	(198-252)#	47-66	(47-66)
2686A LASERJET PRINTER	850W	104-126	Not Supp.	59.4-60.6	Not Supp.
2687A DESKTOP LASER PAGE PRINTER	840W	104-126	(198-264)#	59.4-60.6	(49.5-50.5)
2932A/2934A GENERAL PURPOSE/OFFICE PRINTER	234W	90-126**	(198-252)#	48-66	(48-66)
3074A/M DATA LINK ADAPTER	11W	87-126	(173-253)	48-66	(48-66)
37203A HP-IB EXTENDER	19W	90-126*	(198-253)#	48-66	(48-66)
37214A SYSTEMS MODEM CARD CAGE	53W	90-126*	(198-252)#	48-66	(48-66)

NOTE A: Power Factor (PF) is typically about 0.75, with a range of 0.7 to 0.78. Use of a PF of 0.7 to 0.72 to estimate ac input requirements in Volt-Amps (VA) from Watts (W) is recommended to assure sufficient total input power (VA = W/PF). For estimation of ventilation or air conditioning requirements in BTU per hour, multiply Watts by 3.419. To determine heat dissipation requirements in kilogram-calories per hour, multiply Watts by 0.8598.

\* Range shown for 115V here includes user-selectable choice of 100V or 120V input plus the voltage tolerance (there may be a gap between 105V and 108V).

# Range shown for 230V here includes user-selectable choice of 220V or 240V input plus the voltage tolerance.

t = Typical power requirement, not maximum.

s/p = Split-phase power is required for this computer system, with the listed voltage applied to both phases.

Electrical and Card Cage  
Capacity Specifications

Table 6.1-2. Power Requirements of HP 1000 Equipment, continued

PRODUCT NUMBER AND NAME	MAX. AC POWER (NOTE A)	VOLTAGE LIMITS (V)		FREQUENCY LIMITS (Hz)	
		115V	(230V)	60 Hz	50 Hz
HP 1000 PERIPHERALS POWER REQUIREMENTS, continued					
39301A FIBER OPTIC MULTIPLEXER	14W	90-126*	{198-252}#	48-66	{48-66}
39800A/39801A BAR CODE READER	16W	90-126*	{198-252}#	48-66	{48-66}
45610B TOUCHSCREEN TERMINAL	110W	87-126	{173-253}	57-63	{48-52}
INTERNAL (2674A) PRINTER for 45610B	+20W	87-126	{173-253}	57-63	{48-52}
7470A 2-pen PLOTTER	25W	90-126*	{198-252}#	48-66	{48-66}
7475A 6-pen PLOTTER	35W	90-126*	{198-252}#	48-66	{48-66}
7550A 8-pen PLOTTER with Automatic Sheet Feed	100W	90-126*	{198-252}#	48-66	{48-66}
7580B/7585B/7586B 8-pen DRAFTING PLOTTERS	182W	90-126*	{198-252}#	48-66	{48-66}
7906M standalone 19.6Mb MAC MASTER CARTRIDGE DISC	740W	90-126*	{198-252}#	48-66	{48-66}
7906MR rack mtg 19.6 Mb MAC MASTER CARTRIDGE DISC	690W	90-126*	{198-252}#	48-66	{48-66}
7906M Opt 102 (12745D HP-IB ADAPTER KIT)	+35W	90-126*	{198-252}#	48-66	{48-66}
7906S standalone 19.6 Mb MAC SLAVE CARTRIDGE DISC	510W	90-126*	{198-252}#	48-66	{48-66}
7906SR rack mtg 19.6 Mb MAC SLAVE CARTRIDGE DISC	500W	90-126*	{198-252}#	48-66	{48-66}
7911/12P/R 28.1 Mb/65.6 Mb FIXED DISC w/CTU I/O	700W	90-126*	{198-252}#	57-66	{48-55}
7914P/R/CT 132.1 Mb FIXED DISC w/CTU backup	700W	90-126*	{198-252}#	57-66	{48-55}
7914ST 132.1 Mb CS/80 FIXED DISC & 1600 BPI MTU	1250W	108-126	{198-252}	57-66	{48-55}
7914TD 132.1 Mb CS/80 FIXED DISC & 1600 BPI MTU	925W	108-126	{209-252}	57-66	{48-55}
7920M standalone 50 Mb MAC MASTER DISC	782W	90-126*	{198-252}#	48-66	{48-66}
7920M Opt 102 (12745D HP-IB ADAPTER KIT)	+35W	90-126*	{198-252}#	48-66	{48-66}
7920S standalone 50 Mb MAC SLAVE DISC	530W	90-126*	{198-252}#	48-66	{48-66}
7925M standalone 120 Mb MAC MASTER DISC	600W	90-126*	{198-252}#	48-66	{48-66}
7906M Opt 102 (12745D HP-IB ADAPTER KIT)	+35W	90-126*	{198-252}#	48-66	{48-66}
7925S standalone 120 Mb MAC SLAVE DISC	400W	90-126*	{198-252}#	48-66	{48-66}
7933H/7935H 404 Mb CS/80 FIXED/REM. MEDIA DISC	1300W	188-288 s/p		48-63	{48-63}
7933H/7935H+120/2xx 404 Mb FIXED/REM. MEDIA DISC	1300W	108-132	{198-264}	48-63	{48-63}
7941A/7945A 23.8/55.5 Mb FIXED DISC	65W t	90-132	{180-264}	48-66	{48-66}
7942A/7946A 23.8/55.5 Mb DISC-TAPE DRIVE	120W t	90-132	{180-264}	48-66	{48-66}
7970B/E or 7971A 800/1600 bpi MAG TAPE (per drive)	400W	104-126	{207-253}	48-66	{48-66}
7974A 1600 bpi MAG TAPE UNIT (per drive)	420W	90-125*	{198-250}#	48-66	{48-66}
7978A 1600/6250 bpi MAG TAPE UNIT (per drive)	636W	90-125	{198-250}	48-66	{48-66}
82905B IMPACT PRINTER	100W	90-132*	{198-264}#	48-66	{48-66}
82906A DOT-MATRIX PRINTER	70W	90-132*	{198-264}#	48-66	{48-66}
9111A GRAPHICS TABLET	25W	90-132*	{198-264}	48-66	{48-66}
9122D/S Dual/Single MICROFLOPPY DISC	72W	86-127	{196-253}	48-66	{48-66}
9133D 14.8 Mb FIXED & MICROFLOPPY DISCS	140W	90-126*	{196-252}#	48-66	{48-66}
9144A TAPE CARTRIDGE SUBSYSTEM	125W	90-126	{180-250}	48-66	{48-66}
9895A FLEXIBLE DISC MEMORY	180W	90-132*	{198-264}#	58.8-61.2	{49-51}

NOTE A: Power Factor (PF) is typically about 0.75, with a range of 0.7 to 0.78. Use of a PF of 0.7 to 0.72 to estimate ac input requirements in Volt-Amps (VA) from Watts (W) is recommended to assure sufficient total input power (VA = W/PF). For estimation of ventilation or air conditioning requirements in BTU per hour, multiply Watts by 3.419. To determine heat dissipation requirements in kilogram-calories per hour, multiply Watts by 0.8598.

\* Range shown for 115V here includes user-selectable choice of 100V or 120V input plus the voltage tolerance (there may be a gap between 105V and 108V).

# Range shown for 230V here includes user-selectable choice of 220V or 240V input plus the voltage tolerance.

t = Typical power requirement, not maximum.

s/p = Split-phase input is standard to 7933H/7935H Disc, with the total voltage listed here applied across the ac power input to the disc.

Table 6.1-3. HP 1000 A-Series Computer Card Cage and Power Supply  
Availability (+) and Requirements (-)

PRODUCT NUMBER AND NAME	CARD CAGE SLOTS	DIRECT CURRENT AT				25 kHz AC PWR AT 39V RMS	TOTAL POWER SUPPLY
		+5V	+5V(M)	+12V	-12V		
<b>COMPUTERS AND SYSTEMS</b>							
2106BK (A600+) BOARD COMPUTER - CPU & 128 kB Mem Cds	-2	-9.6A	-1.1A	0A	0A	0W	-53.5W
2106BK Option 014: Deletes standard 128 kB parity mem	+1	+2.8A	+0.9A	nnc	nnc	n/a	+18.5W
2137A (A700) COMPUTER with 128 kB memory	+16	+42.8A	+5.6A	+5.6A	+3.5A	0W	n/s
2137A Option 001: Hardware Floating Point Processor	-1	-4.0A	nnc	nnc	nnc	nnc	n/s
2137A Option 014: Deletes std memory array card	+1	+1.1A	+1.1A	nnc	nnc	nnc	n/s
2139A (A900) COMPUTER with 768 kB ECC memory	+15	+41.8A	+7.0A	+5.5A	+3.5A	0W	n/s
2139A Option 014: Deletes std ECC memory array card	+1	+1.0A	+2.0A	nnc	nnc	nnc	n/s
2156B (A600+) COMPUTER with 128 kB memory	+18	+50.4A	+5.9A	+5.6A	+3.5A	0W	n/s
2156B Option 014: Deletes standard 128 kB parity mem	+1	+2.8A	+0.9A	nnc	nnc	n/a	n/s
2196C/D (MODEL 26) SYSTEM PROCESSOR UNIT w/512 kB mem	+16	+46.3A	+5.8A	+5.3A	+3.4A	0W	n/s
2196C/D option 014: Deletes std 512 kB parity memory	+1	+2.8A	+1.0A	nnc	nnc	n/a	n/s
2196C Option 070: Interface to MTU in 7914ST/TD	-1	-2.1A	nnc	-0.1A	nnc	nnc	n/s
2197C/D (MODEL 27) SYSTEM PROCESSOR UNIT w/512 kB mem	+13	+35.1A	+5.5A	+5.3A	+3.4A	0W	n/s
2197C/D Option 014: Deletes std memory array card	+1	+1.1A	+1.1A	nnc	nnc	nnc	n/s
2197C Option 070: Interface to MTU in 7914ST/TD	-1	-2.1A	nnt	-0.1A	nnc	nnc	n/s
2199C/D (MODEL 29) SYSTEM PROC UNIT w/768 kB ECC mem	+12	+38.1A	+7.0A	+5.2A	+3.4A	0W	n/s
2199C/D Option 014: Deletes std ECC memory array card	+1	+1.0A	+2.0A	nnc	nnc	nnc	n/s
2199C Option 070: Interface to MTU in 7914ST/TD	-1	-2.1A	nnc	-0.1A	nnc	nnc	n/s
2436A MICRO 26 SYSTEM COMPONENT with 128 kB memory	+12	+33.4A*	+5.9A*	+7.0A*	+3.0A*	0W	+246.5W
2436A Option 014: Deletes standard 128 kB parity mem	+1	+2.8A	+0.9A	nnc	nnc	n/a	+18.5W
2436A Option 111: Adds fixed & microfloppy discs	-1	-5.7A	nnc	-2.5A	nnc	nnc	-58.5W
2436E MICRO 26 SYSTEM COMPONENT with 512 kB memory	+12	+33.4A*	+5.8A*	+7.0A*	+3.0A*	0W	+246.0W
2436E Option 014: Deletes standard 512 kB parity mem	+1	+2.8A	+1.0A	nnc	nnc	n/a	+19.0W
2436E Option 111: Adds fixed & microfloppy discs	-1	-5.7A	nnc	-2.5A	nnc	nnc	-58.5W
2437A MICRO 27 SYSTEM COMPONENT with 128 kB memory	+10	+25.9A*	+5.6A*	+7.0A*	+3.0A*	0W	+207.5W
2437A Option 001: Hardware Floating Point Processor	-1	-4.0A	nnc	nnc	nnc	nnc	-20.0W
2437A Option 014: Deletes std memory array card	+1	+1.1A	+1.1A	nnc	nnc	nnc	+11.0W
2437A Option 111: Adds fixed & microfloppy discs	-1	-5.7A	nnc	-2.5A	nnc	nnc	-58.5W
2439A MICRO 29 SYSTEM COMPONENT with 768 kB ECC mem	+9	+26.8A*	+1.0A*	+7.0A*	+3.0A*	0W	+189.0W
2439A Option 014: Deletes std ECC memory array card	+1	+1.0A	+2.0A	nnc	nnc	nnc	+15.0W
2439A Option 111: Adds fixed & microfloppy discs	-1	-5.7A	nnc	-2.5A	nnc	nnc	-58.5W
2486A MICRO 26 SYSTEM PROCESSOR UNIT w/512 kB memory	+10	+29.7A*	+5.8A*	+6.7A*	+2.9A*	0W	+222.7W
2486A Option 014: Deletes standard 512 kB parity mem	+1	+2.8A	+1.0A	nnc	nnc	n/a	+19.0W
2486A Option 111: Adds fixed & microfloppy discs	nnc	-3.6A	nnc	-2.4A	nnc	nnc	-46.8W
2487A MICRO 27 SYSTEM PROCESSOR UNIT w/512 kB memory	+8	+22.0A*	+5.6A*	+6.7A*	+2.9A*	0W	+184.2W
2487A Option 001: Hardware Floating Point Processor	-1	-4.0A	nnc	nnc	nnc	nnc	-20.0W
2487A Option 014: Deletes std memory array card	+1	+1.1A	+1.1A	nnc	nnc	nnc	+11.0W
2487A Option 111: Adds fixed & microfloppy discs	nnc	-3.6A	nnc	-2.4A	nnc	nnc	-46.8W
2489A MICRO 29 SYSTEM PROCESSOR UNIT w/768 kB ECC mem	+7	+23.1A*	+1.0A*	+6.7A*	+2.9A*	0W	+165.7W
2489A Option 014: Deletes std ECC memory array card	+1	+1.0A	+2.0A	nnc	nnc	nnc	+15.0W
2489A Option 111: Adds fixed & microfloppy discs	nnc	-3.6A	nnc	-2.4A	nnc	nnc	-46.8W
<b>A600+ MEMORY CONTROLLERS AND A600+, A700, AND A900 MEMORY ARRAY CARDS</b>							
12102B 512 kB PARITY MEMORY CONTROLLER (A600+)	-1	-2.8A	-1.0A	0A	0A	0W	-19.0W
12110A 512 kB ECC MEMORY CONTROLLER (A600+)	-1	-2.9A	-1.1A	0A	0A	0W	-20.0W
12110B 1.0 MB ECC MEMORY CONTROLLER (A600+)	-1	-2.9A	-1.2A	0A	0A	0W	-21.0W
12103A 128 kB PARITY MEM ARRAY CD (A600+/A700 addr)	-1	-1.1A	-1.0A	0A	0A	0W	-10.5W
12103B 256 kB PARITY MEM ARRAY CD (A700 only, addr)	-1	-1.1A	-1.0A	0A	0A	0W	-10.5W
12103A/B 128/256 kB MEM ARRAY CD (A700 unaddressed)*	-1	-1.1A	-0.5A*	0A	0A	0W	-2.5W
12103C 512 kB PARITY MEM ARRAY CD (A600+/A700, addr)	-1	-1.1A	-1.0A	0A	0A	0W	-11.0W
12103C 512 kB MEMORY ARRAY CARD (A700 unaddressed)*	-1	-1.1A	-0.6A*	0A	0A	0W	-3.0W
12103D 1 MB PARITY MEM ARRAY CARD (A600+/A700 addr)	-1	-1.3A	-1.6A	0A	0A	0W	-14.5W
12103D 1 MB MEMORY ARRAY CD (A700 only, unaddressed)*	-1	-1.3A	-1.0A*	0A	0A	0W	-5.0W
12104A 512 kB ECC MEMORY ARRAY CD (A700 only, addr)	-1	-1.5A	-1.4A	0A	0A	0W	-14.5W
12104A 512 kB ECC MEM ARRAY CARD (A700 only, unaddr)*	-1	-1.5A	-0.7A*	0A	0A	0W	-3.5W

FOOTNOTES: n/s = not specified; nnc = no net change; n/a = not applicable

\* Total power output from the 243xA/248xA power supply cannot exceed 300W, maximum; use total power supply wattage figures in the last column of the table to confirm that total power output is not exceeded.

\* In A700 systems and computers, unaddressed memory cards draw only standby current from the +5V(M) supply.

Electrical and Card Cage  
Capacity Specifications

Table 6.1-3. HP 1000 A-Series Computer Card Cage and Power Supply  
Availability (+) and Requirements (-), continued

PRODUCT NUMBER AND NAME	CARD CAGE SLOTS	DIRECT CURRENT AT				25 kHz AC PWR AT 39V RMS	TOTAL POWER SUPPLY
		+5V	+5V(M)	+12V	-12V		
A600+ MEMORY CONTROLLERS AND A600+, A700, AND A900 MEMORY ARRAY CARDS, continued							
12111A 512 kB ECC MEM ARRAY CARD (A600+/A700 addr)	-1	-1.6A	-0.93A	0A	0A	0W	-12.7W
12111A 512 kB ECC MEM ARRAY CARD (A700 unaddressed)*	-1	-1.6A	-0.3A*	0A	0A	0W	-9.5W
12111B 1 MB ECC Mem ARRAY CARD (A600+/A700 addressed)	-1	-1.6A	-1.0A	0A	0A	0W	-13.0W
12111B 1 MB ECC MEM ARRAY CARD (A700 unaddressed)*	-1	-1.6A	-0.37A*	0A	0A	0W	-9.9W
12111C 2 MB ECC MEMORY ARRAY CARD (A600+ addressed)	-1	-1.6A	-1.6A	0A	0A	0W	-16.0W
12111C 2 MB ECC MEMORY ARRAY CARD (A700 addressed)	-1	-1.6A	-1.2A	0A	0A	0W	-14.0W
12111C 2 MB ECC MEMORY ARRAY CARD (A700 unaddressed)*	-1	-1.6A	-0.65A*	0A	0A	0W	-11.3W
12220A Addressed 768 kB A900 ECC MEMORY ARRAY CARD	-1	-1.0A	-2.0A	0A	0A	0W	-15.0W
12220A Unaddressed 768 kB A900 ECC MEMORY ARRAY CARD	-1	0A	-1.0A	0A	0A	0W	-5.0W
12221A Addressed 3 MB A900 ECC MEMORY ARRAY CARD	-1	-1.0A	-2.0A	0A	0A	0W	-15.0W
12221A Unaddressed 3 MB A900 ECC MEMORY ARRAY CARD	-1	0A	-1.0A	0A	0A	0W	-5.0W
INTERFACES							
12005A/B ASYNCHRONOUS SERIAL INTERFACE	-1	-1.6A	0A	-0.2A	-0.1A	0W	-11.6W
12006A PARALLEL INTERFACE	-1	-1.9A	0A	-0.2A	0A	0W	-11.9W
12007B HDLC MODEM INTERFACE to HP 1000	-1	-2.6A	0A	-0.4A	-0.2A	0W	-20.2W
12009A HP-IB INTERFACE	-1	-2.1A	0A	-0.1A	0A	0W	-11.7W
12040B/12041A 8-CHANNEL ASYNCHRONOUS MULTIPLEXER	-1	-2.5A	0A	-0.1A	-0.1A	0W	-14.9W
12042B/12043A PROGRAMMABLE SERIAL (Modem) INTERFACE	-1	-2.6A	0A	-0.4A	-0.2A	0W	-20.2W
12044A HDLC DIRECT CONNECT INTERFACE to HP 1000	-1	-2.4A	0A	-0.3A	-0.1A	0W	-16.8W
12060A/B HIGH-LEVEL ANALOG INPUT CARD (8 inputs)**	-1	-1.1A	0A	0A	0A	-7.3W*	-12.8W
12061A EXPANSION MULTIPLEXER CARD (adds 32 inputs to 12060A/B)**	-1	-0.1A	0A	0A	0A	-2.0W*	-2.5W
12062A ANALOG OUTPUT CARD (4 isolated outputs)**	-1	-1.2A	0A	0A	0A	-7.6W*	-13.6W
12063A 16-In/16-Out ISOLATED DIGITAL I/O CARD**	-1	-1.0A	0A	0A	0A	-11.4W*	-16.4W
12065A COLOR VIDEO MONITOR INTERFACE	-1	-3.7A	0A	-0.5A	-0.02A	0W	-24.0W
12072A DS/1000-IV DATA LINK SLAVE I/F to HP 1000	-1	-1.5A	0A	-0.2A	-0.1A	0W	-11.1W
12073A BISYNC MODEM INTERFACE to HP 3000	-1	-2.6A	0A	-0.4A	-0.2A	0W	-20.2W
12075A X.25/1000 (LAP-B) NETWORK (Modem) INTERFACE	-1	-2.6A	0A	-0.4A	-0.2A	0W	-20.2W
12082A BISYNC DIRECT CONNECT INTERFACE to HP 3000	-1	-2.4A	0A	-0.3A	-0.1A	0W	-16.8W
12092A DATA LINK MASTER INTERFACE	-1	-2.6A	0A	-0.4A	-0.2A	0W	-20.2W
37203L HP-IB EXTENDER CARD (coaxial cable trans)**	-1	-0.8A	0A	0A	0A	-0.8W	-4.8W
37203L+001 HP-IB EXTENDER CARD using fiber optic cable communication	-1	-0.8A	0A	0A	0A	0W	-4.0W
37222A INTEGRAL MODEM CARD	-1	-1.2A	0A	-0.1A	-0.1A	0W	-8.4W
OTHER PLUG-IN ACCESSORIES AND CARD CAGES FOR INTEGRATION OF 2106BK BOARD COMPUTER							
12008A PROM STORAGE MODULE	-1	-2.0A	0A	-0.1A	0A	0W	-11.2W
12010A BREADBOARD INTERFACE (NOTE A)	-1	-0.8A	0A	-0.1A	0A	0W	-5.2W
12011A EXTENDER CARD	nnc	0A	0A	0A	0A	0W	n/a
12012A PRIORITY JUMPER CARD	-1	0A	0A	0A	0A	0W	n/a
12013A BATTERY BACKUP CARD for 2106BK	-1	0A	0A	-0.1A	0A	0W	n/s
12030A TEN-SLOT CARD CAGE	+10	n/a	n/a	n/a	n/a	n/a	n/a
12032A FIVE-SLOT CARD CAGE	+5	n/a	n/a	n/a	n/a	n/a	n/a
12153A A700 WRITABLE CONTROL STORE CARD	-1	-4.1A	0A	-0.1A	0A	0W	-21.7W
12154A BATTERY BACKUP CARD for 243xA/248xA Micro 1000 Systems	-2	0A	nnc	nnc	nnc	nnc	-8.0W
12155A A700 PROM CONTROL STORE CARD (fully loaded)	-1	-6.3A	0A	0A	0A	0W	-31.5W
12156A A700 HARDWARE FLOATING POINT PROCESSOR CARD	-1	-4.0A	0A	0A	0A	0W	-20.0W
12157A BATTERY BACKUP SYSTEM for 219xC/D, 2137/9A, or 2156B	0	0A	0A	0A	0A	0W	n/s
12158A 25kHz PWR MOD for 219xC/D, 2137/9A, or 2156B	0	0A	0A	0A	0A	+50W	n/s
12159A 25kHz SINE WAVE CARD for 243xA/248xA	0	0A	0A	0A	0A	+30W	-6.0W
12205A A900 CONTROL STORE CARD -- WCS Requirement	-1	-3.7A	0A	-0.1A	0A	n/a	-19.2W
-- PROMs Requirement		-0.7A	0A		0A	n/a	-3.5W

FOOTNOTES: n/s = not specified; nnc = no net change; n/a = not applicable

\*\* This card requires 25 kHz power, provided by the 12158A 25 kHz Power Module in the 2137A, 2139A, or 2156B Computer or 219xC/D SPU or by the 12159A Sine Wave Card in the 243xA Component or 248xA Micro/1000 SPU.

NOTE A: The requirements given here for the 12010A Breadboard Interface do not include power for user-added circuits.

\* In A700 systems and computers, unaddressed memory cards draw only standby current from the +5V(M) supply.



Table 6.1-4. HP 1000 E/F-Series Computer Card Cage and Power Supply  
Availability (+) and Requirements (-)

PRODUCT NUMBER AND NAME	I/O SLOTS	DIRECT CURRENT AT				
		+5V	+5V(M)	+12V	-12V	-2V
<b>COMPUTERS, SYSTEMS, I/O EXTENDER, AND POWER FAIL RECOVERY SYSTEMS</b>						
2109E (E-Series) COMPUTER with 64 kB memory and 12791A FEM*	+8	+29.9A*	-1.07A	+2.5A	+2.0A	+5.9A
2109E Option 003: 13304A FAB instead of 12791A FEM	+1	+3.6A	0A	0A	0A	0A
2109E Option 012: 64 kB high perf memory instead of std perf	nnc	-1.4A	0A	0A	0A	0A
2109E Option 014: Deletes 64 kB standard performance memory	nnc	+1.7A	+1.07A	0A	0A	+0.1A
2109EK BOARD COMPUTER -- CPU and 64 kB memory	0	-9.5A	-1.07A	0A	0A	-0.2A
2109EK Option 014: Deletes 64 kB standard performance memory	nnc	+1.7A	+1.07A	0A	0A	0A
2113E (E-Series) COMPUTER with 128 kB memory and 12791A FEM*	+13	+24.7A*	-1.07A	+2.5A	+2.0A	+5.9A
2113E Option 003: 13304A FAB instead of 12791A FEM	+1	+3.6A	0A	0A	0A	0A
2113E Option 012: 64kB high perf mem instead of 128kB std perf	nnc	+3.8A	0A	0A	0A	+0.1A
2113E Option 013: 64 kB memory instead of 128 kB	nnc	+5.2A	0A	0A	0A	+0.1A
2113E Option 014: Deletes 128 kB standard performance memory	nnc	+6.9A	+1.07A	0A	0A	+0.1A
2117F (F-Series) COMPUTER with 128 kB high performance memory	+13	+23.3A*	-1.21A	+2.5A	+2.0A	+5.9A
2117F Option 013: 64 kB memory instead of 128 kB	nnc	+5.2A	0A	0A	0A	+0.1A
2117F Option 014: Deletes 128 kB high performance memory	nnc	+8.3A	+1.21A	0A	0A	+0.1A
2176E MODEL 40 SYSTEM PROCESSOR UNIT with 256 kB memory	+11	+17.0A*	+5.29A	+2.5A	+1.9A	+5.9A
2176E Option 014: Deletes 256 kB high performance memory	nnc	+8.3A	+1.71A	0A	0A	+0.1A
2176E Option 031/032/033: MAC Disc interface and media	-1	+2.5A	0A	0A	0A	0A
2177F MODEL 45 SYSTEM PROCESSOR UNIT w/256 kB high perf memory	+11	+17.0A*	+5.29A	+2.5A	+1.9A	+5.9A
2177F Option 014: Deletes 256 kB High performance memory	nnc	+8.3A	+1.71A	0A	0A	+0.1A
2177F Option 031/032/033: MAC Disc interface and media	-1	+2.5A	0A	0A	0A	0A
2178C MODEL 60 SYSTEM PROCESSOR UNIT with 256 kB memory	+11	+17.0A*	+5.29A	+2.5A	+1.9A	+5.9A
2178C Option 014: Deletes 256 kB high performance memory	nnc	+8.3A	+1.71A	0A	0A	+0.1A
2178C Option 022/060/061: CS/80 Disc interface and cartridge tape or mag tape media	-1	-3.5A	0A	0A	0A	-0.1A
2178C Option 031/032/033: MAC Disc interface and media	-1	-2.5A	0A	0A	0A	-0.1A
2179C MODEL 65 SYSTEM PROCESSOR UNIT w/256 kB high perf memory	+11	+16.4A*	+5.29A	+2.5A	+1.9A	+5.9A
2179C Option 014: Deletes 256 kB high performance memory	nnc	+8.8A	+1.71A	0A	0A	+0.1A
2179C Option 022/060/061: CS/80 Disc interface and cartridge or mag tape media	-1	-3.5A	0A	0A	0A	-0.1A
2179C Option 031/032/033: MAC Disc interface and media	-1	-2.5A	0A	0A	0A	-0.1A
2179C Option 101/111/121: Value Pack with 1 MB memory	nnc	-0.7A	0A	0A	0A	-0.4A
2179C Option 102/112/122: Value Pack with 2 MB memory	nnc	-2.0A	-2.0A	0A	0A	-0.4A
12979C DUAL-PORT I/O EXTENDER	+16	-2.0A	0A	0A	0A	-1.4A
12944B POWER FAIL RECOVERY SYSTEM for 2109E Computer	n/a	0A	+7.0A	0A	0A	0A
12991B POWER FAIL RECOVERY SYSTEM for 2113E or 2117F Computer	n/a	0A	+7.0A	0A	0A	0A
<b>MEMORY AND RELATED ACCESSORIES</b>						
12666H 1 MB FAULT CONTROL CHECK BIT ARRAY BD (operating) (a)	0	-0.5A	-0.91A	0A	0A	0A
12666H 1 MB FAULT CONTROL CHECK BIT ARRAY BOARD (standby) (a)	0	-0.5A	-0.76A	0A	0A	0A
12699H 256 kB MEMORY MODULE (operating) (a)	0	-0.5A	-1.07A	0A	0A	0A
12699H 256 kB MEMORY MODULE (standby) (a)	0	-0.5A	-0.53A	0A	0A	0A
12731A MEMORY EXPANSION MODULE	0	-3.9A	0A	0A	0A	0A
12746A/H 64 kB MEMORY MODULE	0	-0.5A	-0.57A	0A	0A	0A
12747A/H 128 kB MEMORY MODULE	0	-0.5A	-0.57A	0A	0A	0A

FOOTNOTES:

nnc = no net change; n/a = not applicable

\* = Available +5V current specified here is that available after provision of 5.4A for fully-loaded 12791A Firmware Expansion Module in 2109E, 2113E, or 2117F Computer or in 2176E, 2177C/F, 2178A/C, or 2179A/C SPU or that available after provision of 1.8A for fully-loaded 13304A Firmware Accessory Board in 2176C SPU.

(M) = +5V Memory current requirements for memory controller, memory modules, and fault control check bit array boards. In computer without Power Fail Recovery System, this current is drawn from the available +5V current, reducing current available for I/O interfaces. All 217x System Processor Units include a Power Fail Recovery System.

(a) = Operating current requirement applies only to one fault control check bit array board or memory module at a time; all others draw standby current.

Electrical and Card Cage  
Capacity Specifications

Table 6.1-4. HP 1000 E/F-Series Computer Card Cage and Power Supply  
Availability (+) and Requirements (-), continued

PRODUCT NUMBER AND NAME	I/O SLOTS	DIRECT CURRENT AT				
		+5V	+5V(M)	+12V	-12V	-2V
MEMORY AND RELATED ACCESSORIES, continued						
12749H 512 kB MEMORY MODULE (operating) (a)	0	-0.5A	-1.19A	0A	0A	0A
12749H 512 kB MEMORY MODULE (standby) (a)	0	-0.5A	-0.65A	0A	0A	0A
12779A/H 256 kB FAULT CONTROL CHECK BIT ARRAY BOARD	0	-0.3A	-0.78A	0A	0A	0A
12780A/H 512 kB FAULT CONTROL CHECK BIT ARRAY BOARD	0	-0.3A	-0.78A	0A	0A	0A
12786A 128 kB STANDARD PERFORMANCE PARITY MEMORY PACKAGE	0	-6.9A	-1.07A	0A	0A	-0.1A
12786B 256 kB STANDARD PERFORMANCE PARITY MEMORY PACKAGE	0	-7.4A	-1.64A	0A	0A	-0.1A
12786C 512 kB STANDARD PERFORMANCE PARITY MEMORY PACKAGE	0	-8.4A	-2.78A	0A	0A	-0.1A
12787A 128 kB STANDARD PERFORMANCE FAULT CONTROL MEM PACKAGE	0	-9.3A	-2.03A	0A	0A	-0.1A
12787B 256 kB STANDARD PERFORMANCE FAULT CONTROL MEM PACKAGE	0	-9.8A	-2.60A	0A	0A	-0.1A
12787C 512 kB STANDARD PERFORMANCE FAULT CONTROL MEM PACKAGE	0	-10.8A	-3.74A	0A	0A	-0.1A
12787D 1.0 MB STANDARD PERFORMANCE FAULT CONTROL MEM PACKAGE	0	-13.1A	-6.80A	0A	0A	-0.1A
12788A 128 kB HIGH PERFORMANCE PARITY MEMORY PACKAGE	0	-8.3A	-1.21A	0A	0A	-0.1A
12788BB 256 kB HIGH PERFORMANCE PARITY MEMORY PACKAGE	0	-8.3A	-1.71A	0A	0A	-0.1A
12788E 512 kB HIGH PERFORMANCE PARITY MEMORY PACKAGE	0	-8.3A	-1.83A	0A	0A	-0.1A
12788F 1.0 MB HIGH PERFORMANCE PARITY MEMORY PACKAGE	0	-8.8A	-2.48A	0A	0A	-0.1A
12788G 1.5 MB HIGH PERFORMANCE PARITY MEMORY PACKAGE	0	-9.3A	-3.13A	0A	0A	-0.1A
12788H 2.0 MB HIGH PERFORMANCE PARITY MEMORY PACKAGE	0	-9.8A	-3.78A	0A	0A	-0.1A
12789E 512 kB HIGH PERFORMANCE FAULT CONTROL MEMORY PACKAGE	0	-9.3A	-2.66A	0A	0A	-0.1A
12789J 512 kB HIGH PERFORMANCE FAULT CONTROL MEMORY PACKAGE	0	-9.5A	-2.79A	0A	0A	-0.1A
12789K 1.0 MB HIGH PERFORMANCE FAULT CONTROL MEMORY PACKAGE	0	-10.0A	-3.44A	0A	0A	-0.1A
12789L 1.5 MB HIGH PERFORMANCE FAULT CONTROL MEMORY PACKAGE	0	-11.0A	-4.85A	0A	0A	-0.1A
12789M 2.0 MB HIGH PERFORMANCE FAULT CONTROL MEMORY PACKAGE	0	-11.5A	-5.5A	0A	0A	-0.1A
12892B MEMORY Protect Module	0	-1.3A	0A	0A	0A	-0.1A
12897B Dual-Channel Port CONTROLLER	0	-2.4A	0A	0A	0A	-0.1A
2102B STANDARD PERFORMANCE PARITY MEMORY CONTROLLER	0	-1.2A	-0.5A	0A	0A	0A
2102C STANDARD PERFORMANCE FAULT CONTROL MEMORY CONTROLLER	0	-3.3A	-0.68A	0A	0A	0A
2102E HIGH PERFORMANCE PARITY MEMORY CONTROLLER	0	-2.6A	-0.64A	0A	0A	0A
2102H HIGH PERFORMANCE FAULT CONTROL MEMORY CONTROLLER	0	-3.3A	-0.69A	0A	0A	0A
INTERFACES AND PERIPHERALS THAT INCLUDE INTERFACES						
12250A X.25/1000 NETWORK (Modem) INTERFACE	-1	-1.9A	0A	-0.3A	-0.2A	0A
12260A MULTI-USE PROG SERIAL (Modem) INTERFACE	-1	-1.9A	0A	-0.3A	-0.2A	0A
12261A MULTI-USE PROGRAMMABLE MULTIPLEXER	-1	-2.0A	0A	-0.3A	-0.4A	0A
12531C TELEPRINTER INTERFACE	-1	-0.8A	0A	-0.1A	-0.1A	-0.1A
12531D TERMINAL INTERFACE	-1	-0.8A	0A	-0.2A	0A	-0.1A
12551B RELAY OUTPUT REGISTER	-1	-0.6A	0A	-0.2A	0A	-0.4A
12551B Option 001: Adds read-back	nnc	-0.5A	0A	nnc	0A	-0.2A
12554A 16-BIT DUPLEX REGISTER	-1	-1.1A	0A	-0.3A	-0.3A	-0.1A
12556B 40-BIT OUTPUT REGISTER	-1	-0.9A	0A	-0.2A	-0.1A	-0.1A
12566C MICROCIRCUIT INTERFACE	-1	-0.7A	0A	0A	0A	-0.1A
12597A 8-BIT DUPLEX REGISTER	-1	-0.8A	0A	-0.1A	-0.1A	-0.1A
12618A SYNCHRONOUS COMMUNICATIONS INTERFACE	-2	-2.2A	0A	-0.1A	-0.1A	-0.2A
12620A BREADBOARD INTERFACE/RTE PRIVILEGED INTERRUPT FENCE (b)	-1	-0.4A	0A	0A	0A	0A
12771A COMPUTER SERIAL INTERFACE	-1	-1.6A	0A	-0.9A	-0.1A	-0.1A
12773A COMPUTER MODEM INTERFACE	-1	-1.6A	0A	-0.4A	0A	-0.1A

FOOTNOTES:

nnc = no net change; n/a = not applicable

(M) = +5V Memory current requirements for memory controller, memory modules, and fault control check bit array boards. In computer without Power Fail Recovery System, this current is drawn from the available +5V current, reducing current available for I/O interfaces. All 217x System Processor Units include a Power Fail Recovery System.

(a) = Operating current requirement applies only to one fault control check bit array board or memory module at a time; all others draw standby current.

(b) = Does not include current required by circuits added by the user to the Breadboard Interface.

Table 6.1-4. HP 1000 E/F-Series Computer Card Cage and Power Supply  
Availability (+) and Requirements (-), continued

PRODUCT NUMBER AND NAME	I/O SLOTS	DIRECT CURRENT AT				
		+5V	+5V(M)	+12V	-12V	-2V
INTERFACES AND PERIPHERALS THAT INCLUDE INTERFACES, continued						
12790A MULTIPOINT TERMINAL/DATA LINK INTERFACE	-1	-3.0A	0A	0A	-0.1A	-0.1A
12792C 8-CHANNEL ASYNCHRONOUS MULTIPLEXER INTERFACE	-1	-2.0A	0A	-0.3A	-0.4A	0A
12793B/12794B DS/1000-IV BISYNC/HDLC MODEM INTERFACE	-1	-1.9A	0A	-0.3A	-0.2A	0A
12821A DISC/PRINTER INTERFACE	-1	-3.3A	0A	0A	0A	-0.1A
12825A DS/1000-IV DIRECT CONNECT HDLC INTERFACE	-1	-1.8A	0A	-0.3A	-0.4A	0A
12826B PROGRAMMABLE SERIAL (Modem) INTERFACE	-1	-1.9A	0A	-0.3A	-0.2A	0A
12834A DS/1000-IV DIRECT CONNECT BISYNC INTERFACE	-1	-1.8A	0A	-0.3A	-0.4A	0A
12845B LINE PRINTER INTERFACE	-1	-1.2A	0A	0A	0A	0A
12920B 16-CHANNEL ASYNCHRONOUS MULTIPLEXER INTERFACE	-3	-5.5A	0A	-0.2A	-0.5A	-0.3A
12920B Option 001: Adds hardware support for Bell 202 Dataset	-1	-1.4A	0A	-0.2A	-0.2A	-0.1A
12930A UNIVERSAL INTERFACE	-1	-1.8A	0A	0A	0A	-0.1A
12930A Option 001/002 (change to TTL input)	nnc	-0.4A	0A	0A	0A	nnc
12966A BUFFERED ASYNCHRONOUS COMMUNICATIONS INTERFACE	-1	-3.0A	0A	0A	-0.1A	-0.1A
12967A SYNCHRONOUS COMMUNICATIONS INTERFACE	-1	-1.8A	0A	0A	0A	-0.1A
12968A ASYNCHRONOUS COMMUNICATIONS INTERFACE	-1	-1.3A	0A	0A	0A	-0.1A
13175D MAC DISC INTERFACE Card	-1	-2.3A	0A	0A	0A	0A
13178D MULTI-CPU INTERFACE to MAC Disc	-1	-2.3A	0A	0A	0A	0A
2608S+210 LINE PRINTER (Includes 12821A INTERFACE)	-1	-3.3A	0A	0A	0A	-0.1A
26099A INTERFACE TO 2608A or 256xA OPT 100 LINE PRINTER	-1	-0.8A	0A	0A	0A	0A
59310B HP-IB INTERFACE	-1	-3.0A	0A	0A	0A	-0.1A
7970B+226/236 MAG TAPE SUBSYSTEM (incl. 13181B INTERFACE) (c)	-2	-2.9A	0A	0A	0A	0A
7970E+226/236 MAG TAPE SUBSYSTEM (incl. 13183B INTERFACE) (c)	-2	-2.6A	0A	0A	0A	0A
91000A Plug-In 20kHz A-to-D INTERFACE	-1	-2.4A	0A	0A	0A	-0.1A
91200B TV INTERFACE	-1	-1.2A	0A	-0.3A	0A	-0.1A
OTHER ACCESSORIES						
12728G E-Series CONTROL PANEL ASSEMBLY (2109EK accessory)	0	-1.5A	-1.1A	-0.1A	0A	0A
12728J 18-SLOT CARD CAGE KIT (2109EK accessory)	+9	n/a	n/a	n/a	n/a	n/a
12777A PRIORITY JUMPER CARD	-1	0A	0A	0A	0A	0A
12791A FIRMWARE EXPANSION MODULE (FEM)	-1	(d)	0A	0A	-0.1A	-0.1A
12992_ Any add'l LOADER ROM (2 are incl. w/computers & SPUs)	0	-0.2A	0A	0A	0A	0A
13197A 1k WRITABLE CONTROL STORE (WCS)	-1	-2.2A	0A	0A	0A	0A
13304A FIRMWARE ACCESSORY BOARD (FAB)	0	-1.8A	0A	0A	0A	0A

FOOTNOTES:

nnc = no net change; n/a = not applicable

(c) = This 7970B/E data also applies to 7971A Mag Tape Subsystem in upright cabinet with an equivalent option.

(d) = 12791A uses 1.2A plus 0.525A for each ROM installed (up to 8 possible); -5.4A when fully loaded.

# Section 6.2

## Environmental Specifications

See Table 6.2-1, below.

*Table 6.2-1. Environmental Specifications of HP 1000 Equipment*

PRODUCT NUMBER AND NAME	AMBIENT TEMPERATURE (DEGREES C (DEGREES F))		RELATIVE HUMIDITY (NON CONDENSING)	MAXIMUM ALTITUDE, METRES (FEET)	
	OPERATING	NON-OPERATING		OPERATING	NON-OPERATING
<b>SYSTEM PROCESSOR UNITS (SPUs) (Excludes terminal and (hard) non-integrated system disc)</b>					
217xA/C/E/F MODEL 40/45/60/65 SPU	10-40 (50-104)	-40-65 (-40-149)	20% - 80%	4572 (15,000)	15240 (50,000)
219xC/D MODEL 26/27/29 SPU	0-40 (32-104)	-40-75 (-40-167)	5% - 95%	4572 (15,000)	15240 (50,000)
248xA MICRO 26/27/29 SPU	0-45 (32-113)	-40-75 (-40-167)	5% - 95%	4572 (15,000)	15240 (50,000)
248xA+111 DISCS (Note A)	5-45 (41-113)	-40-60 (-40-140)	20% - 80%	4572 (15,000)	15240 (50,000)
<b>COMPUTERS</b>					
2109E/2113E/2117F COMPUTER	0-55 (32-131)	-40-75 (-40-167)	5% - 95%	4572 (15,000)	15240 (50,000)
2137A/2139A/2156B COMPUTER	0-40 (32-104)	-40-75 (-40-167)	5% - 95%	4572 (15,000)	15240 (50,000)
2137A/2139A/2156B COMPUTER	0-55 (32-131)	-40-75 (-40-167)	5% - 95%	3048 (10,000)	15240 (50,000)
243xA/E MICRO 26/27/29 COMPONENT	0-45 (32-113)	-40-75 (-40-167)	5% - 95%	4572 (15,000)	15240 (50,000)
243xA+111 DISCS (Note A)	5-45 (41-113)	-40-60 (-40-140)	20% - 80%	4572 (15,000)	15240 (50,000)
<b>PERIPHERALS</b>					
13279B COLOR MONITOR	0-50 (32-122)	Not specified	10% - 90%	3048 (10,000)	Not specified
2250A/H MEASUREMENT & CONTROL SYST	0-40 (32-104)	-40-75 (-40-167)	5% - 95%	4572 (15,000)	15240 (50,000)
2251B MEASUREMENT & CONTROL UNIT	0-55 (32-131)	-40-75 (-40-167)	5% - 95%	4572 (15,000)	15240 (50,000)
2334A MULTIMUX	0-55 (32-131)	-40-75 (-40-167)	5% - 95%	4572 (15,000)	15240 (50,000)
2392A DISPLAY TERMINAL	0-55 (32-131)	-40-75 (-40-167)	5% - 95%	4572 (15,000)	15240 (50,000)
2563A LINE PRINTER	10-50 (50-122)	-40-75 (-40-167)	30% - 80%	4572 (15,000)	15240 (50,000)
2565A/2566A LINE PRINTER	10-40 (50-104)	-40-75 (-40-167)	30% - 80%	4572 (15,000)	15240 (50,000)
262x TERMINALS without printer	0-55 (32-131)	-40-60 (-40-140)	5% - 95%	4572 (15,000)	15240 (50,000)
262x TERMINALS with printer	5-40 (41-104)	-40-60 (-40-140)	5% - 80%	4572 (15,000)	15240 (50,000)
2671A/G or 2673A PRINTER	0-55 (32-131)	-40-75 (-40-167)	20% - 95%	4572 (15,000)	15240 (50,000)
THERMAL PAPER for 2671A/G or 2673A	0-40 (50-104)	-40-40 (-40-104)	20% - 90%	4572 (15,000)	15240 (50,000)
2686A LASERJET PRINTER	10-32 (50- 91)	0-35 (32- 95)	20% - 80%	2500 (8,200)	15000 (49,200)
2687A DESKTOP LASER PRINTER	10-30 (50- 86)	-40-40 (-40-104)	20% - 90%	2500 (8,200)	15000 (49,200)
2932A/2934A PRINTER	0-55 (32-131)	-40-75 (-40-167)	10% - 70%	4572 (15,000)	15240 (50,000)
3074A/M DATA LINK ADAPTER	0-55 (32-131)	-40-75 (-40-167)	5% - 95%	4572 (15,000)	7620 (25,000)
3081A IND. WORKSTATION TERMINAL	0-55 (32-131)	-40-75 (-40-167)	5% - 95%	4572 (15,000)	7620 (25,000)
37203A HP-IB EXTENDER	0-55 (32-131)	-40-75 (-40-167)	20% - 95%	4572 (15,000)	15240 (50,000)
37214A SYSTEMS MODEM CARD CAGE	0-55 (32-131)	-40-75 (-40-167)	5% - 95%	4572 (15,000)	15240 (50,000)
39301A FIBER OPTIC MULTIPLEXER	0-55 (32-131)	-40-75 (-40-167)	5% - 95%	4572 (15,000)	15240 (50,000)
39800A/39801A BAR CODE READER	0-55 (32-131)	-40-75 (-40-167)	5% - 95%	4572 (15,000)	15240 (50,000)
45610B HP TOUCHSCREEN TERMINAL with/without 2674A printer	0-55 (32-131)	-40-75 (-40-167)	5% - 95%	4572 (15,000)	15240 (50,000)

Note A: The rate of change of temperature must not exceed 10 degrees C (18 degrees F) per hour.

Environmental  
Specifications

Table 6.2-1. Environmental Specifications of HP 1000 Equipment, continued

PRODUCT NUMBER AND NAME	AMBIENT TEMPERATURE (DEGREES C (DEGREES F))		RELATIVE HUMIDITY (NON CONDENSING)	MAXIMUM ALTITUDE, METRES (FEET)	
	OPERATING	NON-OPERATING		OPERATING	NON-OPERATING
PERIPHERALS, continued					
7470A/7475A GRAPHICS PLOTTER	0-55 (32-131)	-10-75 (-40-167)	5% - 95%	4572 (15,000)	15240 (50,000)
7550A GRAPHICS PLOTTER Automatic Sheet Feed with 7550A	0-55 (32-131) 10-40 (50-104)	-10-75 (-40-167) -10-75 (-40-167)	5% - 95% 20% - 80%	4572 (15,000) 4572 (15,000)	15240 (50,000) 15240 (50,000)
7580B/7585B/7586B DRAFTING PLOTTER Roll Feed with 7586B	0-40 (32-104) 10-30 (50- 86)	-40-75 (-40-167) -40-75 (-40-167)	5% - 95% 30% - 70%	4572 (15,000) 4572 (15,000)	15240 (50,000) 15240 (50,000)
79xxM/S MAC DISC (Note A)	5-55 (41-131)	-40-75 (-40-167)	8% - 80%	4572 (15,000)	15240 (50,000)
7911P/R DISC-TAPE DRIVES (Note A) 7912P/R DISC-TAPE DRIVES (Note A)	10-40 (50-104) 10-40 (50-104)	-40-60 (-40-140) -40-60 (-40-140)	20% - 80% 20% - 80%	4572 (15,000) 4572 (15,000)	15240 (50,000) 15240 (50,000)
7914P/R DISC-TAPE DRIVES (Note A) 7914CT DISC-TAPE DRIVES (Note A) TAPE CARTRIDGES FOR 791xP/R/CT	10-40 (50-104) 10-40 (50-104) 5-40 (41-104)	-40-60 (-40-140) -40-60 (-40-140) -40-45 (-40-113)	20% - 80% 20% - 80% 20% - 80%	4572 (15,000) 4572 (15,000) 4572 (15,000)	15240 (50,000) 15240 (50,000) 15240 (50,000)
7914ST CS/80 FIXED DISC - MAG TAPE SUBSYSTEM (Note A) 7914TD CS/80 FIXED DISC - MAG TAPE SUBSYSTEM (Note A)	15-32 (59- 90) 10-40 (50-104)	-10-60 (14-140) -40-60 (-40-140)	20% - 80% 20% - 80%	3000 (9,843) 3048 (10,000)	15000 (49,213) 3048 (10,000)
7933H CS/80 FIXED DISC (Note B) 7935H REMOVABLE MEDIA DISC (Note B)	10-40 (50-104) 10-32 (50- 90)	-40-65 (-40-149) -40-65 (-40-149)	8% - 80% 8% - 80%	3000 (9,843) 3000 (9,843)	15000 (49,213) 15000 (49,213)
7941A/7945A FIXED DISC (Note A) 7942A/46A DISC-TAPE DRIVES (Note A) TAPE CARTRIDGES FOR 7942A/7946A	10-40 (50-104) 5-40 (41-104) 5-40 (41-104)	-40-60 (-40-149) -40-60 (-40-149) -40-45 (-40-113)	8% - 80% 20% - 80% 20% - 80%	3000 (9,843) 3000 (9,843) 4572 (15,000)	12000 (40,000) 12000 (40,000) 15240 (50,000)
7970B/E MAGNETIC TAPE UNIT (Note B) 7971A MAGNETIC TAPE UNIT (Note B) 7974A MAGNETIC TAPE UNIT (Note B) 7978A MAGNETIC TAPE UNIT (Note B)	0-55 (32-131) 0-55 (32-131) 15-32 (59- 90) 15-32 (59- 90)	-40-75 (-40-167) -40-75 (-40-167) -40-75 (-40-167) -40-75 (-40-167)	20% - 80% 20% - 80% 20% - 80% 10% - 90%	3000 (9,843) 3000 (9,843) 3000 (9,834) 3000 (9,834)	15000 (50,000) 15000 (50,000) 15000 (50,000) 15000 (50,000)
82905B/82906A PRINTER	5-35 (41-95)	-30-65 (-22-149)	10% - 80%	3048 (10,000)	15240 (50,000)
9111A GRAPHICS TABLET 9122D DUAL MICROFLOPPY DISC MEMORY 9133D WINCHESTER DISC W/SINGLE MICROFLOPPY DISC (Note A)	0-55 (32-131) 10-45 (50-113) 10-40 (40-104)	-40-65 (-40-149) -40-60 (-40-140) -40-60 (-40-140)	5% - 90% 20% - 80% 20% - 80%	4572 (15,000) 4572 (15,000) 4572 (15,000)	15240 (50,000) 15240 (50,000) 15240 (50,000)
9144A TAPE CARTRIDGE SUBSYSTEM TAPE CARTRIDGES FOR 9144A	5-40 (41-104) 5-40 (41-104)	-40-75 (-40-167) -40-45 (-40-113)	20% - 80% 20% - 80%	4572 (15,000) 4572 (15,000)	15240 (50,000) 15240 (50,000)
9895A FLEXIBLE DISC MEMORY	10-40 (50-104)	-40-60 (-40-140)	20% - 80%	4572 (15,000)	15240 (50,000)

Note A: The rate of change of temperature must not exceed 10 degrees C (18 degrees F) per hour.

Note B: The rate of change of temperature must not exceed 20 degrees C (36 degrees F) per hour.

# Section 6.3

## Physical Characteristics

See Table 6.3-1, below.

*Table 6.3-1. Physical Characteristics of HP 1000 Equipment*

PRODUCT NUMBER AND NAME	DIMENSIONS (HEIGHT x WIDTH x DEPTH) Centimeters and (inches)	APPROXIMATE FLOOR SPACE RECOMMENDED metres and (feet)	NET WEIGHT kg and (lb)
<b>SYSTEM PROCESSOR UNITS (Excludes terminal and (hard) non-integrated system disc)</b>			
2176E/2178C MODEL 40/60 (EMI-qual.) SPU	161.3x63.5x81.3 (63.4x25x32)	3 x 3 (9 x 9)	164.1 (361)
2177F/2179C MODEL 45/65 (EMI-qual.) SPU	161.3x63.5x81.3 (63.4x25x32)	3 x 3 (9 x 9)	184.5 (406)
219xC MODEL 26/27/29 SYSTEM PROCESSOR UNIT	161.3x69.9x81.3 (63.4x27.5x32)	3 x 3 (9 x 9)	139.5 (307)
219xD MODEL 26/27/29 SYSTEM PROCESSOR UNIT	72x69.9x81.3 (28.3x27.5x32)	3 x 3 (9 x 9)	94 (207)
248xA MICRO 26/27/29 SYSTEM PROCESSOR UNIT	17.8x48.3x64.8 (7x19x25.5)	Rack or table mtg	18.2 (40)
248xA MICRO 26/27/29 SPU in 40025A VERTICAL FLOOR MOUNT	67.3x34.7x64.8 (26.5x13.6x25.5)	0.5 x 1 (1.5 x 3)	23.9 (52.5)
248xA OPTION 111 INTEGRAL DISCS	No change	No change	+2.3 (5)
<b>COMPUTERS</b>			
2109E COMPUTER with 9 I/O Channels	22.2x48.3x62.2 (8.8x19x24.5)	Rack mounting	20.4 (45)
2113E COMPUTER with 14 I/O Channels	31.1x48.3x62.2 (12.3x19x24.5)	Rack mounting	29.5 (65)
2117F COMPUTER with 14 I/O Channels	44.5x48.3x62.2 (17.5x19x24.5)	Rack mounting	50 (110)
2137A/2139A/2156B COMPUTER	26.6x48.3x61.2 (10.5x19x24)	Rack mounting	29.1 (64)
243xA MICRO 26/27/29 SYSTEM COMPONENT	17.8x48.3x64.8 (7x19x25.5)	Rack or table mtg	18.2 (40)
243xA MICRO 26/27/29 COMPONENT IN 40025A VERTICAL FLOOR MOUNT	67.3x34.7x64.8 (26.5x13.6x25.5)	0.5 x 1 (1.5 x 3)	23.8 (52.5)
243xA OPTION 111 INTEGRAL DISCS	No change	No change	+2.3 (5)
<b>PERIPHERALS</b>			
13279B COLOR MONITOR	39.9x48.2x59.8 (15.7x19x23.6)	Table mounting	36.8 (81)
2250A INDUSTRIAL MEASUREMENT & CONTROL SYS	188x135.6x67.3 (74x53.5x26.5)	4 x 3 (12 x 9)	368.2 (810)
2250H MEASUREMENT & CONTROL SYSTEM	208.6x87.8x82.6 (82.1x34.6x32.5)	3 x 3 (9 x 9)	340.9 (750)
2255H MEASUREMENT & CONTROL EXTENSION SYS	208.6x87.8x82.6 (82.1x34.6x32.5)	3 x 3 (9 x 9)	318.2 (700)
2251B MEASUREMENT & CONTROL UNIT	35.6x48.3x40.6 (14x19x16)	Rack mounting	318.2 (700)
25572A POWER SUPPLY for two 2251Bs	11.4x48.3x27.3 (4.5x19x10.8)	Rack mounting	9.8 (21.6)
2334A MULTIMUX	14.0x42.5x54 (5.45x16.8x21.3)	Table/rack mtg	13 (28.7)
2392A DISPLAY TERMINAL	31.7x45.5x58.2 (12.5x17.9x22.9)	Table mounting	13 (28.7)
2563A LINE PRINTER	27.4x23.6x45 (10.8x23.6x17.8)	Table mounting	34 (75)
2563A+112 LINE PRINTER with enclosed stand	99.4x23.6x45 (39.1x23.6x17.8)	1 x 3 (3 x 9)	61 (135)
2565A/2566A LINE PRINTER	110x98.3x63.5 (43.3x38.7x25)	1 x 3 (3 x 9)	204 (450)
262x TERMINALS	44x38x66.5 (17.3x15x26)	Table mounting	22.3 (49)
2671A/G PRINTER/GRAPHICS PRINTER	10.5x42.8x42.4 (4.1x16.9x16.7)	Table mounting	12.7 (28)
2673A INTELLIGENT GRAPHICS PRINTER	10.5x42.8x42.4 (4.1x16.9x16.7)	Table mounting	14.1 (31)

Physical  
Characteristics

Table 6.3-1. Physical Characteristics of HP 1000 Equipment, continued

PRODUCT NUMBER AND NAME	DIMENSIONS (HEIGHT x WIDTH x DEPTH) Centimeters and (inches)		APPROXIMATE FLOOR SPACE RECOMMENDED metres and (feet)	NET WEIGHT kg and (lb)
PERIPHERALS, continued				
2686A LASERJET PRINTER	29.3x47.5x72.3	(11.4x18.5x28.2)	Table mounting	32 (71)
2687A DESKTOP LASER PRINTER	28x51x50	(11x20x19.5)	Table mounting	62.7 (138)
Controller included with 2687A	28x15x50	(11x6x19.5)	Table mounting	5.5 (12)
2932A/2934A PRINTER	18.5x60x36.5	(7.3x23.9x14.4)	Table mounting	20.4 (45)
2932A/2934A PRINTER w/92214P PRINTER STAND	90.5x60x36.5	(35.7x23.9x14.4)	1 x 3 (3 x 9)	47.8 (105)
3074A/M DATA LINK ADAPTER	5x25x11	(2x9.9x4.4)	Table mounting	1 (2.2)
37214A SYSTEMS MODEM CARD CAGE	17.8x43.8x33	(7x17.3x13)	Rack mounting	7.5 (16.5)
39301A FIBER OPTIC MULTIPLEXER	7.2x42.5x8.9	(2.9x16.8x3.5)	Table mounting	7.5 (16.5)
39800A/39801A BAR CODE READER	7.1x26x18.9	(2.8x10.3x7.4)	Table mounting	0.2 (0.44)
45610B HP TOUCHSCREEN TERMINAL	28.7x45.6x53	(11.3x18x20.9)	Table mounting	12.2 (27)
45610B TERMINAL with 2674A built-in PRINTER	28.7x45.6x53	(11.3x18x20.9)	Table mounting	15.4 (34)
7470A (2-pen) PLOTTER	12.7x43.2x34.3	(5x17x13.5)	Table mounting	6 (13.5)
7475A (6-pen) PLOTTER	12.7x56.8x36.7	(5x22.4x14.5)	Table mounting	7 (16.0)
7550A (8-pen) PLOTTER with Auto Sheet Feed	21.5x67x89.6	(8.5x26.4x35.3)	Table mounting	17.3 (38.0)
7580B DRAFTING PLOTTER	118.8x108.7x55.7	(46.8x42.8x21.9)	2 x 2 (6 x 6)	63.6 (140)
7585B DRAFTING PLOTTER	118.8x139.2x55.7	(46.8x54.8x21.9)	2 x 2 (6 x 6)	70.4 (155)
7586B DRAFTING PLOTTER, roll feed	118.8x139.2x55.7	(46.8x54.8x21.9)	2 x 2 (6 x 6)	86.4 (190)
7906M MAC MASTER CARTRIDGE DISC IN CABINET	71.8x55.3x79.1	(28.3x21.8x31.2)	1 x 3 (3 x 9)	151.8 (334)
7906MR+025 RACK MTG. MASTER CARTRIDGE DISC	53.4x48.3x71.1	(21x19x28)	Rack mounting	108.6 (239)
7906S MAC SLAVE CARTRIDGE DISC IN CABINET	71.8x55.3x79.1	(28.3x21.8x31.2)	1 x 3 (3 x 9)	134.1 (295)
7911P/7912P FIXED DISC with CTU I/O	72x35.4x74	(28.4x14x29.1)	1 x 2 (3 x 6)	85.4 (188)
7914P/7914CT FIXED DISC with CTU I/O	72x35.4x74	(28.4x14x29.1)	1 x 2 (3 x 6)	85.4 (188)
7911/12/14R FIXED DISC with CTU I/O	31.1x48.3x70.5	(12.25x19x27.8)	Rack mounting	67.3 (148)
7914ST FIXED DISC & 1600 bpi MAG TAPE UNIT	160.0x60.0x80.0	(63.0x23.6x31.5)	3 x 3 (9 x 9)	261 (574)
7914TD FIXED DISC & 1600 bpi MAG TAPE UNIT	161.3x63.5x81.3	(63.4x25x32)	3 x 3 (9 x 9)	272.2 (600)
7920M MAC 50 MB MASTER DISC IN CABINET	82.6x49.9x81.3	(32.5x19.7x32)	3 x 3 (9 x 9)	159 (350)
7920S MAC 50 MB SLAVE DISC IN CABINET	82.6x49.9x81.3	(32.5x19.7x32)	3 x 3 (9 x 9)	143 (315)
7925M MAC 120 MB MASTER DISC IN CABINET	82.6x49.9x81.3	(32.5x19.7x32)	3 x 3 (9 x 9)	161 (355)
7920S MAC 120 MB SLAVE DISC IN CABINET	82.6x49.9x81.3	(32.5x19.7x32)	3 x 3 (9 x 9)	145 (319)
7933H/7935H 404 MB FIXED/REM. MEDIA DISC	82.5x55.2x83.4	(32.5x21.7x32.8)	1 x 3 (3 x 9)	154 (339.5)
7941A/7945A 28.3/55.5 MB FIXED DISC	13x32.5x28.5	(5.1x12.8x11.2)	Table/rack* mtg	9.9 (21.8)
7942A/7946A 28.3/55.5 MB DISC-TAPE DRIVES	20.8x32.5x28.5	(8.2x12.8x11.2)	Table/rack* mtg	15.8 (34.8)
7970B/E MAGNETIC TAPE DRIVE	66.7x48.3x30.4	(26.3x19x12)	Rack mounting	68.2 (150)
7971A MAGNETIC TAPE SUBSYSTEM W/ONE DRIVE	158.5x62.3x90.5	(62.4x24.5x35.6)	3 x 3 (9 x 9)	195 (430)
ADDITIONAL DRIVE IN 7971A CABINET	No change		No change	59 (130)
7974A MAGNETIC TAPE SUBSYSTEM	160x60x77.5	(63x23.6x30.5)	3 x 3 (9 x 9)	181.8 (400)
7978A MAGNETIC TAPE SUBSYSTEM	160x60x78	(63x23.6x30.7)	3 x 3 (9 x 9)	188 (414)
82905B IMPACT PRINTER	10.7x37.4x30.5	(4.2x14.7x12)	Table mounting	5.5 (12.1)
82906A DOT-MATRIX PRINTER	10x42x34.7	(3.9x16.5x13.7)	Table mounting	7.5 (16.5)
9111A GRAPHICS TABLET	8.5x44x44	(3.4x17.3x17.3)	Table mounting	5.8 (12.8)
9122D DUAL MICROFLOPPY DISC MEMORY	7.6x32.5x28.5	(3x12.8x11.2)	Table mounting	4.5 (10)
9133D WINCHESTER DISC W/ONE MICROFLOPPY	12.5x32.5x28.5	(5x12.8x11.4)	Table mounting	9.9 (22)
9144A TAPE CARTRIDGE SUBSYSTEM	12.5x32.5x28.5	(5x12.8x11.2)	Table/rack* mtg	8.6 (19)
9895A FLEXIBLE DISC MEMORY	19.2x48.3x57.5	(7.6x19x22.6)	Table/rack mtg	26.8 (59)

\* For rack mounting, the 7941A/7945A Disc or 9144A Cartridge Tape Subsystem requires a 19500B Rack Mounting Kit and the 7942A/7946A Disc-Tape Drive requires a 19501A Rack Mounting Kit. These peripheral devices have not been qualified by Hewlett-Packard with respect to safety when installed in a 219x SPU (29431F/G) Cabinet.

# Section 6.4

## Compatibility

### 6.4-1 Explanation of the HP 1000 Compatibility Matrices

The HP 1000 A/L-Series and M/E/F-Series Compatibility Matrices in the remaining pages of this section summarize the functional compatibility of HP 1000 Computer Systems, plug-in accessories, peripheral devices, and software. Compliance of HP 1000 Systems, computers, and peripheral devices with FCC and FTZ Electro-Magnetic (Radio Frequency) Interference (EMI) regulations is also summarized.

#### Functional Compatibility

Functional compatibility is basically coded as follows:

**C** = Compatible (Compatible systems and peripheral devices also comply with applicable safety standards)

**N** = Not compatible

**Nt** = Not Tested

Products designated as Nt may in fact be functionally compatible, but at the time of publication of the compatibility matrix, Hewlett-Packard takes no responsibility for their degree of compatibility. Relatively new Nt items may later be tested and designated as compatible, but until such testing has been completed and a C designation given to an item, establishing and maintaining its compatibility is the responsibility of the customer who wishes to use the Nt item.

Qualifications required for compatibility and/or further compatibility information is provided in numbered C and N footnotes and additional footnotes.

#### Electro-Magnetic Interference (RFI) Compliance of Products

EMI compliance is specified in the compatibility matrices by additional lower-case letters appended to the C designation of functionally-compatible items. The complete codes are:

**Cz** = A functionally-compatible item whose compliance with EMI regulations in Germany is attested by its having received an FTZ license. Items that do not have an FTZ license may require a special license and/or site certification for use in Europe, a costly, time-consuming procedure that seriously limits European sales of non-licensed data processing equipment.

**Cc** = A functionally compatible item which has demonstrated compliance with FCC Class A EMI regulations in tests at the HP factory. All systems and peripherals must comply with FCC EMI regulation to be deliverable to U.S. customers unless they are to be used in exempt applications.

**Ccz** = A functionally compatible item which meets both the Cc and Cz EMI qualifications.

**Cep** = A functionally compatible item whose EMI compliance is pending, either waiting for successful completion of EMI tests or the issuance of an FTZ license. This category generally indicates HP's intention to make the respective product comply with EMI regulations.

**Cn** = Non-compliance with FCC and FTZ EMI regulations of a functionally-compatible product. As noted above, products designated Cn can be delivered to U.S. customers only for applications that are exempt from FCC EMI regulations.



**FCC EMI Qualification Exempt Applications**

In the United States, certain applications are exempt from FCC EMI regulations. Customers who wish to buy non-complying products for use in exempt applications must fill out a prepared form that is available through the order processing coordinator at the local HP sales office.

**EMI Testing**

HP 1000 Computer Systems are tested for compliance in a configuration pursuant to FCC/VDE rules and regulations. The system is also tested to confirm its compliance with FCC Class A/VDE Level A EMI regulations with any of the peripherals in Table 6. 4-1, below.

**6.4-2 HP 1000 A/L-Series Compatibility**

See Table 6. 4-2, page 6. 4-3.

**6.4-3 HP 1000 M/E/F-Series Compatibility**

See Table 6. 4-3, page 6. 4-10.

*Table 6. 4-1. EMI-Tested SPUs, Discs, Printers and Console Terminals*

HP 1000 SYSTEM MODELS	SPU PRODUCT NUMBERS	DISC PRODUCT NUMBERS	PRINTER PRODUCT NUMBERS	CONSOLE PRODUCT NUMBERS		
Micro 26	2486A	248xA	2563A+049@	2392A		
		Opt 111	2563A+214@	2621B*		
		7908P/R*	2565A+049@	2622A*		
		7911P/R@	2565A+214@	2623A		
		7912P/R@	2566A+049@	2624B		
		7914P/R@	2566A+214@	2625A		
		7914ST@	2608S+214*	2626A		
		7914TD@	2671A/G@	2627A		
			2673AG	2628A		
			2686A@	45610B		
			2687A@			
			2932A@			
		Micro 27	2487A	7933HQ	2932A+046	
7935HQ	2933A*					
7941A@	2933A+046*					
7942A@	2934A@					
7945A@	2934A+046					
7946A@	82906B					
8121D	82906A					
Micro 29	2489A	8122D@				
		8133XV*				
		7906M#@				
		7920M#@				
		7925M#@				
		26	2196C 2196D	7908R*	2563A+049	2392A
				7911R	2563A+214	2621B*
				7912R	2565A+049	2622A*
				7914R	2565A+214	2623A
				7914ST	2566A+049	2624B
27	2197C 2197D	7914TD	2566A+214	2625A		
		7933H	2608S+214*	2626A		
		7935H	2671A/G	2627A		
		7941A	2673A	2628A		
		7942A	2686A	45610B		
		7945A	2687A			
		7946A	2932A			
		7906M#	2932A+046			
		7920M#	2933A*			
		7925M#	2933A+046*			
29	2199C 2199D		2934A			
			2934A+046			
			82905B			
			82906A			
40	2176E	7906M	2563A+049	2392A		
		7906MR	2563A+100	2621B*		
		7920M	2563A+210	2622A*		
45	2177F	7925M	2565A+049	2623A		
			2565A+100	2624B		
			2565A+210	2625A		
			2566A+049	2626A		
60	2178C	7906M	2566A+100	2627A		
		7906MR	2566A+210	2628A		
		7920M	2932A	2645A+		
		7925M	2933A*	007*		
		7908R*	2934A	2648A+		
		7911R		007*		
		7914R				
65	2179C	7912R				
		7914R				
		7914TD+				
		236				
		7933H				
		7935H				

\* Obsolete product, listed here for reference only.

@ Except on 2489A Micro 29 System (not tested or excessive EMI).

# RTE-A systems cannot be booted up from 7906M, 7920M, or 7925M disc.

Table 6.4-2. HP 1000 A/L-Series Compatibility Matrix

LEGEND:		COMPUTERS AND SYSTEM COMPATIBILITY												OP SYSTEM COMPATIBILITY					
PRODUCT AND OPTION NUMBERS	DESCRIPTION	2103L	2122A/B & 2142A/B	2136A/B & 2186A/B	2136C/D & 2186C/D	2137A	2139A	2156A/B	2196C/D	2197C/D	2199C/D	2436A/E & 2486A	2437A & 2487A	2439A & 2489A	RTE-A	RTE-A with VC+	RTE-XL	RTE-L	
		Cc = Compatible and complies with FCC Class A EMI regulations Cz = Compatible and FTZ licensed Ccz = Compatible, complies with FCC Class A EMI regulations, and FTZ licensed Cep = Compatible, EMI qualification pending Cn = Compatible, but not EMI qualified C = Compatible or supported without reference to EMI qualification N = Not compatible Nt = Not tested for functional compatibility I = Included hardware or software item																	
1. HP 1000 A/L-SERIES COMPUTERS																			
2103L** 2103LK** 2106AK** 2106BK 2107AK**	L-Series MICROCOMPUTER w/64 kB BOARD MICROCOMPUTER w/64 kB A600 BD MICROCOMPUTER w/128 kB A600+ BD MICROCOMPUTER w/128kB A700 BOARD COMPUTER w/128 kB	Cn I N N N	N I N N N	N N I N N	N N N I N	N N N N I	N N N N N	N N I N N	N N N N I	N N N N I	N N N N N	N N I N N	N N N N I	N N N N N	N N C C C	N N C C C	C1 C1 C3 C4	C1 C1 N N	C C N N
2122A/B** 2136A/B** 2136C/D**	Model 5 MICROSYS COMP w/64 kB Model 6 MICROSYS COMP w/128 kB Model 6+ MICROSYS COMP w/512kb	N N N	Ccz N N	N Ccz Ccz	N N Ccz	N N N	N N N	N N N	N N N	N N N	N N N	N N N	N N N	N N N	N C C	N C C	N C C	N N N	C C C
2137A 2139A 2156A** 2156B	A700 COMPUTER w/128 kB memory A900 COMPUTER w/768 kB ECC mem A600 COMPUTER w/128 kB memory A600+ COMPUTER w/128 kB memory	N N N N	N N N N	N N N N	N N N N	Cn N N N	N Cn Cn Cn	N N Cn Cn	N N I I	N N N N	N N N N	N N N N	N N N N	N N N N	C C C	C C C	C4 C3 C3	N N N N	N N N N
2436A 2436E 2437A 2439A	Micro 26 COMPUTER w/128 kB mem Micro 26 COMPUTER w/512 kB mem Micro 27 COMPUTER w/128 kB mem Micro 29 COMPUTER w/768 kB ECC	N N N N	N N N N	N N N N	N N N N	N N N N	N N N N	N N N N	N N N N	N N N N	N N N N	Ccz Ccz N N	N Ccz Ccz	N N Ccz	C C C	C C C	N N N N	N N N N	N N N N
2. HP 1000 A/L-SERIES SYSTEM PROCESSOR UNITS (SPUs)																			
2142A/B** 2186A/B** 2186C/D**	Model 5 MICROSYS SPU w/128 kB Model 6 MICROSYS SPU w/128 kB Model 6+ MICROSYS SPU w/128 kB	N N N	Ccz N N	N Ccz Ccz	N N Ccz	N N N	N N N	N N N	N N N	N N N	N N N	N N N	N N N	N N N	N C2 I	N C3 I	N N N	I N N	N N N
2196C/D 2197C/D 2199C/D	Model 26 SPU w/512 kB memory Model 27 SPU w/512 kB memory Model 29 SPU w/768 kB ECC mem	N N N	N N N	N N N	N N N	N N N	N N N	N N N	N N N	Ccz N N	N Ccz Ccz	N N N	N N N	N N N	N I I	C I I	N N N	N N N	N N N
2486A 2487A 2489A	Micro 26 SPU w/512 kB memory Micro 27 SPU w/512 kB memory Micro 29 SPU w/768 kB ECC mem	N N N	N N N	N N N	N N N	N N N	N N N	N N N	N N N	N N N	N N N	Ccz N N	N Ccz Ccz	N N Ccz	I I I	C C C	N N N	N N N	N N N
3. MEMORY PRODUCTS																			
12002A** 12002B** 12003A**	128 kB XL MEMORY CONTROLLER 512 kB XL MEMORY CONTROLLER 128 kB XL MEMORY ARRAY CARD (Used with 12002A)	C C C	C C C	N N N	N N N	N N N	N N N	N N N	N N N	N N N	N N N	N N N	N N N	N N N	N N N	N N N	N N N	C C C	N N N
12103A 12103B 12103C 12103D 12104A	128 kB A600/700 MEM ARRAY CARD 256 kB A700 MEMORY ARRAY CARD 512 kB A600/700 MEM ARRAY CARD 1 MB A600/700 MEMORY ARRAY CD 512 kB A700 ECC MEM ARRAY CARD	N N N N N	N N N N N	C N C C	C N C C	C C C C	N N N N	N N N N	N N N N	C N C C	N N N N	N N N N	N N N N	N N N N	N N N N	N N N N	N N N N	N N N N	N N N N
12110A 12110B 12111A 12111B 12111C	512 kB A600 ECC MEM CONTROLLER 1 MB A600 ECC MEM CONTROLLER 512 kB A600/700 ECC MEM ARRAY 1 MB A600/700 ECC MEMORY ARRAY 2 MB A600/700 ECC MEMORY ARRAY	N N N N N	N N N N N	Nt Nt Nt Nt Nt	Nt Nt Nt Nt Nt	N N C C C	N N N N N	N N N N N	N N N N N	N N N N N	N N N N N	N N N N N	N N N N N	N N N N N	N C C C	N C C C	N N N N N	N N N N N	N N N N N
12220A 12221A	768 kB A900 ECC MEMORY ARRAY 3 MB A900 ECC MEMORY ARRAY CD	N N	N N	N N	N N	N C	N N	N N	N N	N N	N C	N N	N N	C C	C C	C C	N N	N N	N N

FOOTNOTES:

- \*\* = Obsolete product listed here for reference only.
- C1 = RTE-XL requires 128kb (2103L/LK Option 011) to 512kb memory (2103L/LK Option 012) for operation.
- C2 = A600 with serial prefix earlier than 2305 will be upgraded at no charge to work with RTE-A.
- C3 = Requires 12107A Upgrade Kit to work with RTE-A/VC+.
- C4 = A700 with serial prefix earlier than 2326 will be upgraded at no charge to work with RTE-A/VC+.
- I1 = Included in 2156A only.

Table 6.4-2. HP 1000 A/L-Series Compatibility Matrix, continued

LEGEND: Cc = Compatible and complies with FCC Class A EMI regulations Cz = Compatible and FTZ licensed Ccz = Compatible, complies with FCC Class A EMI regulations, and FTZ licensed Cep = Compatible, EMI qualification pending Cn = Compatible, but not EMI qualified C = Compatible or supported without reference to EMI qualification N = Not compatible Nt = Not tested for functional compatibility I = Included hardware or software item		COMPUTERS AND SYSTEM COMPATIBILITY												OP SYSTEM COMPATIBILITY			
		2103L	2122A/B & 2142A/B	2136A/B & 2186A/B	2136C/D & 2186C/D	2137A	2139A	2156A/B	2196C/D	2197C/D	2199C/D	2436A/E & 2486A	2437A & 2487A	2439A & 2489A	RTE-A	RTE-A with VC+	RTE-XL
PRODUCT AND OPTION NUMBERS	DESCRIPTION																
<b>4. COMPUTER AND SYSTEM ACCESSORIES</b>																	
12008A 12011A 12012A 12013A	PROM STORAGE MODULE EXTENDER CARD PRIORITY JUMPER CARD BATTERY BACKUP CARD	C C C C	C C C C	C C C5 C5	C C N N	C C N N	C C N N	C C N N	C C N N	C C N N	C C N N	C C N N	C C N N	C C N N	C C N N	C C N N	C C N N
12153A 12154A 12155A 12156A	A700 WRITABLE CONTROL STORE CD BATT BACKUP CD for Micro/1000 A700 PROM CONTROL STORE CARD A700 HARDWARE FLOATING PT PROC	N N N N	N N N N	N N N N	N N N N	N N N N	N N N N	N N N N	N N N N	N N N N	N N N N	N N N N	N N N N	N N N N	N N N N	N N N N	N N N N
12157A 12158A 12159A	BATT BACKUP CD for 20-slot box 25kHz POWER MODULE 25kHz SINE WAVE CARD	N N N	N N N	N N N	N N N	N N N	N N N	N N N	N N N	N N N	N N N	N N N	N N N	N N N	N N N	N N N	N N N
12205A 40025A	CONTROL STORE BOARD for A900 Micro/1000 VERTICAL FLOOR MT	N N	N N	N N	N N	N N	N N	N N	N N	N N	N N	N N	N N	N N	N N	N N	N N
<b>5. RECOMMENDED TERMINAL INTERFACES</b>																	
12005B 37222A 12040B	ASYNCHRONOUS SERIAL INTERFACE INTEGRAL MODEM CARD Eight-Chan ASYNC MULTIPLEXER	C C C	C C C	C C C	I C Ccz	C C C	C C C	I C Ccz	I C Ccz	I C Ccz	I2 C Ccz	I2 C Ccz	I2 C Ccz	C C C	C C C	C C C	C C C
<b>6. OPERATOR COMMUNICATION TERMINALS</b>																	
2382A@ ** 2392A@ 2621B@ ** 2622A* **	OFFICE DISPLAY TERMINAL DISPLAY TERMINAL INTERACTIVE TERMINAL w/o prtr DISPLAY TERMINAL w/o printer	Cn Cn Cn Cn	Cn Cn Cn Cn	Ccz Ccz Ccz Ccz	Ccz Ccz Ccz Ccz	Cn Cn Cn Cn	Cn Cn Cn Cn	Cn Cn Cn Cn	Ccz Ccz Ccz Ccz	Ccz Ccz Ccz Ccz	Ccz Ccz Ccz Ccz	Ccz Ccz Ccz Ccz	Ccz Ccz Ccz Ccz	C C C C	C C C C	C C C C	C C C C
2623A# 2624B# 2625A@ 2626A#	GRAPHICS TERMINAL w/o printer DISPLAY TERMINAL w/o printer DUAL-SYS TERMINAL w/o printer DISPLAY STATION w/o printer	Cn Cn Nt Cn	Cn Cn Nt Cn	Ccz Ccz Nt Ccz	Ccz Ccz Nt Ccz	Cn Cn Nt Cn	Cn Cn Nt Cn	Cn Cn Nt Cn	Ccz Ccz Ccz Ccz	Ccz Ccz Ccz Ccz	Ccz Ccz Ccz Ccz	Ccz Ccz Ccz Ccz	Ccz Ccz Ccz Ccz	C C C C	C C C C	C C C C	C C C C
2627A# 2628A@ 2635B@ **	COLOR GRAPHICS TERMINAL WORD PROC TERMINAL w/o printer PRINTING TERMINAL	Nt Nt Nt	Cn Nt Ccz	Ccz Nt Ccz	Ccz Nt Ccz	Cn Cn Cn	Cn Cn Cn	Cn Cn Cn	Ccz Ccz Ccz	Ccz Ccz Ccz	Ccz Ccz Ccz	Ccz Ccz Ccz	Ccz Ccz Ccz	C C C	C C C	C C C	C C C
2645A ** Option 007** 2647A** 2647F**	DISPLAY STATION MINICARTRIDGE I/O INTELLIGENT GRAPHICS TERMINAL INTELLIGENT GRAPHICS TERMINAL	Cn Cn Cn Nt	Ccz Ccz Ccz Nt	Ccz Ccz Ccz Nt	Ccz Ccz Ccz Nt	Cn Cn Cn Nt	Cn Cn Cn Nt	Cn Cn Cn Nt	Ccz Ccz Ccz Nt	Ccz Ccz Ccz Nt	Ccz Ccz Ccz Nt	Ccz Ccz Ccz Nt	Ccz Ccz Ccz Nt	C C C C	C C C C	C C C C	C C C C
2648A** Option 007** 27201A	GRAPHICS TERMINAL MINICARTRIDGE I/O SPEECH OUTPUT MODULE (SOM) conn via a compatible terminal (req 27203A Speech Library)	Cn Cn Nt	Ccz Ccz Nt	Ccz Ccz Ccz	Ccz Ccz Ccz	Cn Cn Cn	Cn Cn Cn	Cn Cn Cn	Ccz Ccz Ccz	Ccz Ccz Ccz	Ccz Ccz Ccz	Ccz Ccz Ccz	Ccz Ccz Ccz	C C C	C C C	C C C	C C C
27203A	SOM SPEECH LIBRARY	Nt	Nt	C	C	C	C	C	C	C	C	C	C	C	C	Nt	Nt

FOOTNOTES:

- C5 = Compatible for battery backup support of one 128kb or 512kb memory control card, but no memory array cards.
- C6 = 12153A or 12205A requires the 92045A or 92049A RTE Microprogramming Package.
- I2 = 12005B interface is included in 248xA Micro 26/27/29 SPU's, but not in 243xA Micro 26/27/29 System components.
- @ = Requires 218xC/D cable Option 006 for terminal without Option 090 or 219xC/D or 248xA cable Option 006.
- \* = Requires 218xC/D cable Option 005 for terminal without Option 090 or 219xC/D or 248xA cable Option 005.
- \*\* = Obsolete product listed here for reference only.

Table 6.4-2. HP 1000 A/L-Series Compatibility Matrix, continued

LEGEND: Cc = Compatible and complies with FCC Class A EMI regulations Cz = Compatible and FTZ licensed Ccz = Compatible, complies with FCC Class A EMI regulations, and FTZ licensed Cep = Compatible, EMI qualification pending Cn = Compatible, but not EMI qualified C = Compatible or supported without reference to EMI qualification N = Not compatible Nt = Not tested for functional compatibility I = Included hardware or software item		COMPUTERS AND SYSTEM COMPATIBILITY												OP SYSTEM COMPATIBILITY			
		2103L	2122A/B & 2142A/B	2136A/B & 2186A/B	2136C/D & 2186C/D	2137A	2139A	2156A/B	2196C/D	2197C/D	2199C/D	2436A/E & 2486A	2437A & 2487A	2439A & 2489A	RTE-A	RTE-A with VC+	RTE-XL
PRODUCT AND OPTION NUMBERS	DESCRIPTION																
<b>7. INDUSTRIAL TERMINALS</b>																	
3075A**	DESKTOP DATA CAPTURE TERMINAL	N	N	N	Nt	Nt	Nt	Nt	Nt	Nt	Nt	Nt	Nt	Nt	Nt	Nt	Nt
3076A**	WALL-MT DATA CAPTURE TERMINAL	N	N	N	Nt	Nt	Nt	Nt	Nt	Nt	Nt	Nt	Nt	Nt	Nt	Nt	Nt
3077A**	TIME REPORTING TERMINAL	N	N	N	Nt	Nt	Nt	Nt	Nt	Nt	Nt	Nt	Nt	Nt	Nt	Nt	Nt
3078A**	DATA COUPLER	N	N	N	Nt	Nt	Nt	Nt	Nt	Nt	Nt	Nt	Nt	Nt	Nt	Nt	Nt
3081A	IND. WORKSTATION TERMINAL	N	N	N	Ccz	Cn	Cn	Cn	Ccz	Ccz	Ccz	Ccz	Ccz	Cn	Cn	Cn	Cn
39800A	BAR CODE READER	N	N	N	Nt	Cn	Cn	Cn	Ccz	Ccz	Ccz	Ccz	Ccz	Cn	Cn	Cn	Cn
39801A	BAR CODE READER	N	N	N	Nt	Cn	Cn	Cn	Ccz	Ccz	Ccz	Ccz	Ccz	Cn	Cn	Cn	Cn
<b>8. DISC INTERFACE AND DISC MEMORIES</b>																	
12009A	HP-IB INTERFACE to Discs	C	C	C	C	C	C	C	C	C	C	C	C	C	C	C	C
7906H	19.6 MB CARTRIDGE ICD MEMORY	Cn	Cn	Nt	Nt	Nt	Nt	Nt	Nt	Nt	Nt	Nt	Nt	Nt	Nt	Nt	Nt
7906M/S	19.6 MB MAC MASTER/SLAVE DISC via 12745D HP-IB Adapter	N	N	N	Nt	Nt	Nt	Nt	Nt	Nt	Nt	Nt	Nt	Nt	Nt	Nt	Nt
7908P**	Standalone 16.5 MB FIXED DISC#	Cn	Ccz	Ccz	Ccz	Cn	Cn	Cn	Ccz	Ccz	Ccz	Ccz	Ccz	Nt	C	C	N
7908R**	Rack mtg 16.5 MB FIXED DISC#	Cn	N1	N1	N1	Cn	Cn	Cn	Ccz	Ccz	Ccz	Ccz	Ccz	Nt	C	C	N
7910HR**	12 MB FIXED DISC	Cn	Nt	Nt	Nt	Nt	Nt	Nt	Nt	Nt	Nt	Nt	Nt	Nt	Nt	Nt	Nt
7911P	Standalone 28.1 MB FIXED DISC#	Cn	Ccz	Ccz	Ccz	Cn	Cn	Cn	Ccz	Ccz	Ccz	Ccz	Ccz	Nt	C	C	N
7911R	Rack mtg 28.1 MB FIXED DISC#	Cn	N1	N1	N1	Cn	Cn	Cn	Ccz	Ccz	Ccz	Ccz	Ccz	Nt	C	C	N
7912P	Standalone 65.6 MB FIXED DISC#	Cn	Ccz	Ccz	Ccz	Cn	Cn	Cn	Ccz	Ccz	Ccz	Ccz	Ccz	Nt	C	C	N
7912R	Rack mtg 65.6 MB FIXED DISC#	Cn	N1	N1	N1	Cn	Cn	Cn	Ccz	Ccz	Ccz	Ccz	Ccz	Nt	C	C	N
7914CT	Standalone 132.1Mb FIXED DISC#	Cn	Ccz	Ccz	Ccz	Cn	Cn	Cn	Ccz	Ccz	Ccz	Ccz	Ccz	Nt	C	C	N
7914P	Standalone 132.1Mb FIXED DISC#	Cn	Ccz	Ccz	Ccz	Cn	Cn	Cn	Ccz	Ccz	Ccz	Ccz	Ccz	Nt	C	C	N
7914R	Rack mtg 132.1 MB FIXED DISC#	Cn	N1	N1	N1	Cn	Cn	Cn	Ccz	Ccz	Ccz	Ccz	Ccz	Nt	C	C	N
7914ST	132.1 MB DISC - 1600 bpi MAG TAPE SUBSYS in 63-in. Cabinet	N	N	N	Nt	Cn	Cn	Cn	Ccz	Ccz	Ccz	Ccz	Ccz	Nt	C	C	N
7914TD	132.1 MB DISC - 1600 bpi MAG TAPE SUBSYS in 63-in. Cabinet	Cn	Cn	Ccz	Ccz	Cn	Cn	Cn	Ccz	Ccz	Ccz	Ccz	Ccz	Nt	C	C	N
7920H/7925H	50 MB/120 MB ICD MEMORY	Nt	Nt	Nt	Nt	Nt	Nt	Nt	Nt	Nt	Nt	Nt	Nt	Nt	Nt	Nt	Nt
7920M/S	50 MB MAC MASTER/SLAVE DISCS via 12745D HP-IB Adapter	N	N	N	Nt	C7	C7	C7	C7	C7	C7	C7	C7	C7	C7	C7	N
7925M/S	120 MB MAC MASTER/SLAVE DISCS via 12745D HP-IB Adapter	N	N	N	Nt	C7	C7	C7	C7	C7	C7	C7	C7	C7	C7	C7	N
7933H	404 MB FIXED DISC	Nt	Nt	Ccz	Ccz	Cn	Cn	Cn	Ccz	Ccz	Ccz	Ccz	Ccz	Nt	C	C	N
7935H	404 MB REMOVABLE MEDIA DISC	Nt	Nt	Ccz	Ccz	Cn	Cn	Cn	Ccz	Ccz	Ccz	Ccz	Ccz	Nt	C	C	N
7941A	23.8 MB FIXED DISC	Nt	Nt	Nt	Nt	Cn	Cn	Cn	Ccz	Ccz	Ccz	Ccz	Ccz	Nt	C	C	N
7942A	23.8 MB FIXED DISC#	Nt	Nt	Nt	Nt	Cn	Cn	Cn	Ccz	Ccz	Ccz	Ccz	Ccz	Nt	C	C	N
7945A	55.5 MB FIXED DISC	Nt	Nt	Nt	Nt	Cn	Cn	Cn	Ccz	Ccz	Ccz	Ccz	Ccz	Nt	C	C	N
7946A	55.5 MB FIXED DISC#	Nt	Nt	Nt	Nt	Cn	Cn	Cn	Ccz	Ccz	Ccz	Ccz	Ccz	Nt	C	C	N
9121D/S**	540 kB Dual/270 kB Single MICROFLOPPY DISC	Nt	Cn	Ccz	Ccz	Cn	Cn	Cn	Ccz	Ccz	Ccz	Ccz	Ccz	Cn	C	C	Nt
9122D/S	1.42 MB Dual/710 kB Single MICROFLOPPY DISC	Nt	Nt	Nt	Nt	Cn	Cn	Cn	Ccz	Ccz	Ccz	Ccz	Ccz	Cn	C	C	Nt
9133A/B**	4.6/9.2 MB MINI WINCHESTER AND 270 kB Single MICROFLOPPY DISC	Nt	Cn	Ccz	Ccz	Cn	Cn	Cn	Ccz	Ccz	Ccz	Ccz	Ccz	Cn	C	C	Nt
9133D	14.8 MB MINI WINCHESTER AND 710 kB Single MICROFLOPPY DISC	Nt	Nt	Nt	Nt	Cn	Cn	Cn	Cn	Cn	Cn	Cn	Cn	Cn	C	C	Nt
9133XV+010**	9.6 MB MINI WINCHESTER AND 270 kB Single MICROFLOPPY DISC	Nt	Nt	Nt	Ccz	Cn	Cn	Cn	Ccz	Ccz	Ccz	Cn	Cn	Cn	C	C	Nt

FOOTNOTES:

- C7 = Functionally compatible, and EMI complies with FCC and FTZ in systems (but not computers), but supported only as a peripheral disc; DOES NOT SUPPORT SYSTEM BOOT-UP
- N1 = Functionally compatible, but is a rack mountable version not intended for use with tabletop Microsystems.
- \*\* = Obsolete product listed here for reference only.
- # = 7908P/R, 7911P/R, 7912P/R, 7914CT/P/R, 7942A, and 7946A Fixed Discs include a cartridge tape drive for software installation and backup.

Table 6.4-2. HP 1000 A/L-Series Compatibility Matrix, continued

PRODUCT AND OPTION NUMBERS	DESCRIPTION	COMPUTERS AND SYSTEM COMPATIBILITY												OP SYSTEM COMPATIBILITY			
		2103L	2122A/B & 2142A/B	2136A/B & 2186A/B	2136C/D & 2186C/D	2137A	2139A	2156A/B	2196C/D	2197C/D	2199C/D	2436A/E & 2486A	2437A & 2487A	2439A & 2489A	RTE-A	RTE-A with VC+	RTE-XL

8. DISC INTERFACE AND DISC MEMORIES, continued

9134A/B**	4.6/9.2Mb MINI WINCHESTER DISC	C8	C8	C8	C8	C8	C8	C8	C8	C8	C8	C8	C8	C8	C8	C8	C8	C8	C8
9134XV+010**	9.6 MB MINI WINCHESTER DISC	N	N	Nt	Nt	Nt	Nt	Nt	Nt	Nt	Nt	Nt	Nt	Nt	Nt	Nt	Nt	Nt	Nt
9135A	4.6Mb MINI WINCHESTER & Single MINIFLOPPY DISC	N	N	N	N	N	N	N	N	N	N	N	N	N	N	N	N	N	N
9138A	4.6Mb MINI WINCHESTER & Single 1.18Mb FLEXIBLE DISC	Nt	Nt	Nt	Nt	Nt	Nt	Nt	Nt	Nt	Nt	Nt	Nt	Nt	Nt	Nt	Nt	Nt	Nt
9895A	2.35 MB MASTER DUAL FLEX DISC	Cn	Ccz	Ccz	Ccz	Cn	Cn	Cn	Ccz	Ccz	Ccz	Ccz	Ccz	Cep	C	C	C	C	C

9. MAGNETIC TAPE INTERFACE AND MAGNETIC TAPE UNITS

12009A	HP-IB INTERFACE TO MAGNETIC TAPE UNITS	C	C	C	C	C	C	C	C	C	C	C	C	C	C	C	C	C	N
7970B+226	800 bpi MAGNETIC TAPE SUBSYSTEM in low cabinet	N	N	N	N	N	N	N	N	N	N	N	N	N	N	N	N	N	N
7970B+236	Rack-Mtg 800 bpi MAGNETIC TAPE SUBSYSTEM	N	N	N	N	N	N	N	N	N	N	N	N	N	N	N	N	N	N
7970E+226	1600 bpi MAGNETIC TAPE SUBSYSTEM in low cabinet	N	N	N	N	N	N	N	N	N	N	N	N	N	N	N	N	N	N
7970E+236	Rack-Mtg 1600 bpi MAGNETIC TAPE SUBSYSTEM	N	N	N	N	N	N	N	N	N	N	N	N	N	N	N	N	N	N
7970E+626	1600 bpi MAGNETIC TAPE UNIT in low cabinet	Cn	Nt	Ccz	Ccz	Cn	Cn	Cn	Ccz	Ccz	Ccz	Ccz	Ccz	Cn	C	C	C	C	N
7970E+636	Rack-Mtg 1600 bpi MAGNETIC TAPE UNIT	Cn	N1	N1	N1	Cn	Cn	Cn	Ccz	Ccz	Ccz	Ccz	Ccz	Cn	C	C	C	C	Nt
7971A+140/144	One or two 7970E+636 MAGNETIC TAPE UNITS in Tall Cabinet	Cn	Cn	Ccz	Ccz	Cn	Cn	Cn	Ccz	Ccz	Ccz	Ccz	Ccz	Cn	C	C	C	C	Nt
7971A+2xx	One or two 7970B/E MAGNETIC TAPE SUBSYSTEMS in tall cabinet	N	N	N	N	N	N	N	N	N	N	N	N	N	N	N	N	N	N
7974A	MAGNETIC TAPE UNIT in tall cabinet	N	N	N	Nt	Cn	Cn	Cn	Ccz	Ccz	Ccz	Cep	Cep	Cn	C	C	C	N	N
7978A	MAGNETIC TAPE UNIT in tall cabinet	N	N	N	Nt	Cn	Cn	Cn	Ccz	Ccz	Ccz	Cep	Cep	Cn	C	C	C	N	N
9144A	CARTRIDGE TAPE SUBSYSTEM	N	N	N	Nt	Cn	Cn	Cn	Ccz	Ccz	Ccz	Cep	Cep	Cn	C	C	C	N	N

10. PRINTER INTERFACES AND PRINTERS

12009A	HP-IB INTERFACE to Printers	C	C	C	C	C	C	C	C	C	C	C	C	C	C	C	C	C	C
12040B	MULTIPLEXER INTERFACE to Printers	C	C	C	C	C	C	C	C	C	C	C	C	Cn	C	C	C	C	C
2563A+049	300 LPM LINE PRINTER connected via multiplexer	N	N	Ccz	Ccz	Cn	Cn	Cn	Ccz	Ccz	Ccz	Ccz	Ccz	Cn	C	C	N	N	N
2563A+100	300 LPM LINE PRINTER connected via parallel interface	N	N	N	N	N	N	N	N	N	N	N	N	N	N	N	N	N	N
2563A+214	300 LPM LINE PRINTER connected via HP-IB	N	N	Ccz	Ccz	Cn	Cn	Cn	Ccz	Ccz	Ccz	Ccz	Ccz	Cn	C	C	N	N	N
2565A+049	600 LPM LINE PRINTER connected via multiplexer	N	N	Nt	Nt	Cn	Cn	Cn	Ccz	Ccz	Ccz	Ccz	Ccz	Cn	C	C	N	N	N
2565A+100	600 LPM LINE PRINTER connected via parallel interface	N	N	N	N	N	N	N	N	N	N	N	N	N	N	N	N	N	N
2565A+214	600 LPM LINE PRINTER connected via HP-IB	N	N	Nt	Nt	Cn	Cn	Cn	Ccz	Ccz	Ccz	Ccz	Ccz	Cn	C	C	N	N	N
2566A+049	750 LPM LINE PRINTER connected via multiplexer	N	N	Nt	Nt	Cn	Cn	Cn	Ccz	Ccz	Ccz	Ccz	Ccz	Cn	C	C	N	N	N
2566A+100	880 LPM LINE PRINTER connected via parallel interface	N	N	N	N	N	N	N	N	N	N	N	N	N	N	N	N	N	N
2566A+214	880 LPM LINE PRINTER connected via HP-IB	N	N	Nt	Nt	Cn	Cn	Cn	Ccz	Ccz	Ccz	Ccz	Ccz	Cn	C	C	N	N	N

\*\* Obsolete product listed here for reference only.  
 C8 = Functionally compatible, and EMI complies with FCC and FTZ in systems (but not computers), but also requires flexible disc or other software load or exchange device for usability.

Table 6.4-2. HP 1000 A/L-Series Compatibility Matrix, continued

PRODUCT AND OPTION NUMBERS	DESCRIPTION	COMPUTERS AND SYSTEM COMPATIBILITY											OP SYSTEM COMPATIBILITY					
		2103L	2122A/B & 2142A/B	2136A/B & 2186A/B	2136C/D & 2186C/D	2137A	2139A	2156A/B	2196C/D	2197C/D	2199C/D	2436A/E & 2486A	2437A & 2487A	2439A & 2489A	RTE-A	RTE-A with VC+	RTE-XL	RTE-L
<b>LEGEND:</b> Cc = Compatible and complies with FCC Class A EMI regulations Cz = Compatible and FTZ licensed Ccz = Compatible, complies with FCC Class A EMI regulations, and FTZ licensed Cep = Compatible, EMI qualification pending Cn = Compatible, but not EMI qualified C = Compatible or supported without reference to EMI qualification N = Not compatible Nt = Not tested for functional compatibility I = Included hardware or software item																		

10. PRINTER INTERFACES AND PRINTERS, continued

2601A	40 cps DAISYWHEEL PRINTER connected via Multiplexer	Cn	Ccz	Ccz	Ccz	Cn	Cn	Cn	Ccz	Ccz	Ccz	Ccz	Ccz	Cn	C	C	C	C
2608A+210**	400 LPM LINE PRINTER	N	N	N	N	N	N	N	N	N	N	N	N	N	N	N	N	N
2608S+210**	400 LPM LINE PRINTER	N	N	N	N	N	N	N	N	N	N	N	N	N	N	N	N	N
2608S+214**	400 LPM LINE PRINTER	N	N	Ccz	Ccz	Cn	Cn	Cn	Ccz	Ccz	Ccz	Ccz	Ccz	Ccz	C	C	C	C
2611A**	600 LPM LINE PRINTER	N	N	N	N	N	N	N	N	N	N	N	N	N	N	N	N	N
2617A**	600 LPM LINE PRINTER	N	N	N	N	N	N	N	N	N	N	N	N	N	N	N	N	N
2619A**	1000 LPM LINE PRINTER	N	N	N	N	N	N	N	N	N	N	N	N	N	N	N	N	N
2631B+214**	180 cps (impact) PRINTER	Cn	Cn	Ccz	Ccz	Cn	Cn	Cn	Ccz	Ccz	Ccz	Ccz	Ccz	Ccz	C	C	C	C
267xA/G	120 cps (thermal) PRINTER	Cn	Cn	Ccz	Ccz	Cn	Cn	Cn	Ccz	Ccz	Ccz	Ccz	Ccz	Ccz	C	C	C	C
2686A	LASERJET PRINTER (120V/60 Hz)	Nt	Nt	Nt	Nt	Cn	Cn	Cn	Ccz	Ccz	Ccz	Ccz	Ccz	Ccz	C	C	C	C
2686AB/2686AU	LASERJET PRINTER (2x0V/50 Hz)	Nt	Nt	Nt	Nt	Cn	Cn	Cn	Ccz	Ccz	Ccz	Ccz	Ccz	Ccz	C	C	C	C
2687A	Desktop LASER PAGE PRINTER	Nt	Nt	Nt	Nt	Cn	Cn	Cn	Ccz	Ccz	Ccz	Ccz	Ccz	Ccz	C	C	C	C
2932A	GENERAL-PURPOSE PRINTER connected via Multiplexer	Nt	Nt	Ccz	Ccz	Cn	Cn	Cn	Ccz	Ccz	Ccz	Ccz	Ccz	Cn	C	C	Nt	Nt
2932A+046	GENERAL-PURPOSE PRINTER connected via HP-IB	Nt	Nt	Ccz	Ccz	Cn	Cn	Cn	Ccz	Ccz	Ccz	Ccz	Ccz	Cn	C	C	Nt	Nt
2933A**	FACTORY DATA PRINTER connected via Multiplexer	Nt	Nt	Ccz	Ccz	Cn	Cn	Cn	Ccz	Ccz	Ccz	Ccz	Ccz	Cn	C	C	Nt	Nt
2933A+046**	FACTORY DATA PRINTER connected via HP-IB	Nt	Nt	Ccz	Ccz	Cn	Cn	Cn	Ccz	Ccz	Ccz	Ccz	Ccz	Cn	C	C	Nt	Nt
2934A	OFFICE PRINTER connected via Multiplexer	Nt	Nt	Ccz	Ccz	Cn	Cn	Cn	Ccz	Ccz	Ccz	Ccz	Ccz	Cn	C	C	Nt	Nt
2934A+046	OFFICE PRINTER connected via HP-IB	Nt	Nt	Ccz	Ccz	Cn	Cn	Cn	Ccz	Ccz	Ccz	Ccz	Ccz	Cn	C	C	Nt	Nt
82905A/B*	80 cps IMPACT PRINTER	Cn	Ccz	Ccz	Ccz	Cn	Cn	Cn	Ccz	Ccz	Ccz	Ccz	Ccz	Ccz	C	C	C	C
82906A	DOT-MATRIX PRINTER	Nt	Nt	Ccz	Ccz	Cn	Cn	Cn	Ccz	Ccz	Ccz	Ccz	Ccz	C	C	C	C	C
9876A	THERMAL GRAPHICS PRINTER	Nt	Nt	Nt	Nt	Nt	Nt	Nt	Nt	Nt	Nt	Nt	Nt	Nt	Nt	Nt	Nt	Nt

11. GRAPHICS INTERFACES AND GRAPHICS/1000-II SUPPORTED GRAPHICS DEVICES

12005B+001/005	ASYNCH SERIAL INTERFACE to 2623A or 2627A Graphics Term	C	C	C	C	C	C	C	C	C	C	C	C	C	C	C	C	C
12009A	HP-IB INTERFACE to Graphics Devices	C	C	C	C	C	C	C	C	C	C	C	C	C	C	C	C	C
12065A	COLOR VIDEO INTERFACE to HP 13279B or other RGB Color Video Monitor	N	N	Nt	Nt	C	C	C	C	C	C	C	C	C	C	C	N	N
13279B	COLOR VIDEO MONITOR	N	N	Nt	Nt	C	C	C	C	C	C	C	C	C	C	C	N	N
1350S**/1351S	GRAPHICS DISPLAY SYSTEM	Cn	Cn	N	N	N	N	N	N	N	N	N	N	N	N	N	C9	C9
2623A	GRAPHICS TERMINAL (NOTE A)	Cn	Ccz	Ccz	Ccz	Cn	Cn	Cn	Ccz	Ccz	Ccz	Ccz	Ccz	Ccz	C9	C9	C9	C9
2625A+523	DUAL SYSTEM DISPLAY TERMINAL	Cn	Ccz	Ccz	Ccz	Cn	Cn	Cn	Ccz	Ccz	Ccz	Ccz	Ccz	Ccz	C9	C9	C9	C9
2627A	COLOR GRAPHICS TER (NOTE A)	Cn	Ccz	Ccz	Ccz	Cn	Cn	Cn	Ccz	Ccz	Ccz	Ccz	Ccz	Ccz	C9	C9	C9	C9
2628A+523	WORD PROCESSING TERMINAL	Cn	Ccz	Ccz	Ccz	Cn	Cn	Cn	Ccz	Ccz	Ccz	Ccz	Ccz	Ccz	C9	C9	C9	C9
2647A	INTELLIGENT GRAPHICS TERMINAL	Cn	Cn	Nt	Ccz	Cn	Cn	Cn	Ccz	Ccz	Ccz	Ccz	Ccz	Ccz	C9	C9	C9	C9
2648A	GRAPHICS TERMINAL	Cn	Cn	Nt	Ccz	Cn	Cn	Cn	Ccz	Ccz	Ccz	Ccz	Ccz	Ccz	C9	C9	C9	C9
7220C/T**	RS-232-C GRAPHICS PLOTTER with HP/GL programming	N	N	N	N	N	N	N	N	N	N	N	N	N	N	N	N	N
7221C/T**	RS-232-C GRAPHICS PLOTTER with compacted binary programming	N	N	N	N	N	N	N	N	N	N	N	N	N	N	N	N	N
7225B+17601A**	GRAPHICS PLOTTER (one pen)	Cn	Cn	Nt	Nt	Nt	Nt	Nt	Nt	Nt	Nt	Nt	Nt	Nt	Nt	Nt	C9	C9

FOOTNOTES:

- C9 = Requires the 92841A or 92861A Device-Independent Graphics Library.
- N1 = Functionally compatible, but is a rack mountable version not intended for use with tabletop Microsystems
- \* = 82905A/B Impact Printers delivered prior to August 1983 require their own 12009A interface, but can be upgraded to permit sharing of the HP-IB bus with other devices (check with HP Customer Engineering). HP 82905B Impact Printers delivered after August 1983 will support shared use of the HP-IB bus with other devices.
- \*\* = Obsolete product listed here for reference only.

NOTE A: 17263A Data Tablet is supported as an extension of the 2623A or 2627A Graphics Terminal.

Table 6.4-2. HP 1000 A/L-Series Compatibility Matrix, continued

PRODUCT AND OPTION NUMBERS	DESCRIPTION	COMPUTERS AND SYSTEM COMPATIBILITY												OP SYSTEM COMPATIBILITY			
		2103L	2122A/B & 2142A/B	2136A/B & 2186A/B	2136C/D & 2186C/D	2137A	2139A	2156A/B	2196C/D	2197C/D	2199C/D	2436A/E & 2486A	2437A & 2487A	2439A & 2489A	RTE-A	RTE-A with VC+	RTE-XL

11. GRAPHICS INTERFACES AND GRAPHICS/1000-II SUPPORTED GRAPHICS DEVICES, continued

7245B**	PLOTTER/PRINTER	Nt	Nt	Nt	Nt	Nt	Nt	Nt	Nt	Nt	Nt	Nt	Nt	Nt	Nt	Nt	Nt	Nt	Nt
7470A+002	GRAPHICS PLOTTER (two pens)	Cn	Ccz	Ccz	Ccz	Cn	Cn	Cn	Ccz	Ccz	Ccz	Ccz	Ccz	Ccz	Cn	C9	C9	C9	C9
7475A+002	GRAPHICS PLOTTER (six pens)	Nt	Nt	Nt	Nt	Cn	Cn	Cn	Ccz	Ccz	Ccz	Ccz	Ccz	Cn	C9	C9	C9	C9	C9
7550A	GRAPHICS PLOTTER (eight pens)	Nt	Nt	Nt	Nt	Cn	Cn	Cn	Ccz	Ccz	Ccz	Ccz	Ccz	Cn	C9	C9	C9	C9	C9
7580B	DRAFTING PLOTTER (eight pens)	Cn	Ccz	Ccz	Ccz	Cn	Cn	Cn	Ccz	Ccz	Ccz	Ccz	Ccz	Cn	C9	C9	C9	C9	C9
7585B	DRAFTING PLOTTER (eight pens)	Cn	Ccz	Ccz	Ccz	Cn	Cn	Cn	Ccz	Ccz	Ccz	Ccz	Ccz	Cn	C9	C9	C9	C9	C9
7586B	Roll-Feed DRAFTING PLOTTER	Nt	Nt	Nt	Nt	Cn	Cn	Cn	Ccz	Ccz	Ccz	Ccz	Ccz	Cn	C9	C9	C9	C9	C9
9111A	GRAPHICS TABLET with serial prefix 2251 or higher	Cn	Ccz	Ccz	Ccz	Cn	Cn	Cn	Ccz	Ccz	Ccz	Ccz	Ccz	Cn	C9	C9	C9	C9	C9
9872A/B/S**	GRAPHICS PLOTTER (four pens)	Cn	Cn	Cn	Cn	Cn	Cn	Cn	Cn	Cn	Cn	Cn	Cn	Cn	C9	C9	C9	C9	C9
9872C/T**	GRAPHICS PLOTTER (eight pens)	Cn	Ccz	Ccz	Ccz	Cn	Cn	Cn	Ccz	Ccz	Ccz	Ccz	Ccz	Cn	C9	C9	C9	C9	C9
9874A**	DIGITIZER	Cn	Cn	N	N	N	N	N	N	N	N	N	N	N	N	N	N	C9	C9

12. HP 1000 NETWORK INTERFACES, PROGRAMMABLE SERIAL INTERFACE, AND STATISTICAL AND FIBER OPTIC MULTIPLEXERS

12007A**/B	HDLC MODEM I/F to DS/1000 Node	C	C	C	C	C	C	C	C	C	C	C	C	C	C10	C10	C10	C10	C10
12044A	HDLC DIRECT CONNECT INTERFACE to DS/1000 Node	C	C	C	C	C	C	C	C	C	C	C	C	C	C10	C10	C10	C10	C10
12072A	SLAVE INTERFACE TO DATA LINK	C	C	C	C	C	C	C	C	C	C	C	C	C	C10	C10	C10	C10	C10
12073A	BISYNC MODEM I/F to HP 3000	C	C	C	C	C	C	C	C	C	C	C	C	C	C10	C10	C10	N	N
12082A	BISYNC DIRECT CONN. INTERFACE to HP 3000	C	C	C	C	C	C	C	C	C	C	C	C	C	C10	C10	C10	N	N
12092A	MASTER INTERFACE TO DATA LINK	N	N	C	C	C	C	C	C	C	C	C	C	C	C11	C11	N	N	N
12075A	X.25/1000 MODEM INTERFACE to Packet Switching Networks	N	N	C	C	C	C	C	C	C	C	C	C	C	C12	C12	N	N	N
12042B	PROGRAMMABLE SERIAL (Modem) INTERFACE	C	C	C	C	C	C	C	C	C	C	C	C	C	N3	N3	N3	N3	N3
12043A	MODEM INTERFACE to IBM or Plug-Compatible Systems	C	C	C	C	C	C	C	C	C	C	C	C	C	C13	C13	N	N	N
2334A	STATISTICAL MULTIPLEXER, connected via 12040B Multiplexer	C	C	C	Cn	Cn	Cn	Cn	Cn	Cn	Cn	Cn	Cn	Cn	C14	C14	C14	C14	C14
2334A	CLUSTER CONTROLLER, connected via 12075A X.25/1000 I/F	C	C	C	C	C	C	C	C	C	C	C	C	Cn	C14	C14	C14	C14	C14
39301A	FIBER OPTIC MULTIPLEXER (pair of 39301As and 39200B cabling are used with 12040B)	C	C	C	C	C	C	C	C	C	C	C	C	C	C	C	C	C	C

13. MEASUREMENT AND CONTROL INTERFACES AND PERIPHERALS

12009A	HP-IB I/F to HP-IB instruments	C	C	C	C	C	C	C	C	C	C	C	C	C	C	C	C	C	C
12041A	PCIF/1000 MULTIPLEXER I/F to Programmable Controllers	N	N	C	C	C	C	C	C	C	C	C	C	C	C16	C16	N	N	N
12060A/B	High-Level ANALOG INPUT CARD	C	N	N	N	N	C17	C17	C17	C17	C17	C17	C17	C17	C	C	C	C	C
12061A	32-Channel EXPANSION MULTIPLEXER for 12060A/B	C	N	N	N	N	C17	C17	C17	C17	C17	C17	C17	C17	C	C	C	C	C
12062A	4-Channel ANALOG OUTPUT CARD	C	N	N	N	N	C17	C17	C17	C17	C17	C17	C17	C17	C	C	C	C	C

FOOTNOTES:

- C9 = Requires the 92841A/92861A Graphics/1000-II Device-Independent Graphics Library.
- C10 = Requires 91750A DS/1000-IV Network software.
- C11 = Requires 91732A Data Link software.
- C12 = Requires 91751A X.25/1000 Communications software.
- C13 = Requires 91782A MRJE/1000 software.
- C14 = HP 2334A Statistical Multiplexer supports only character mode communication.
- C15 = Requires 91751A X.25/1000 Communications software; HP 2334A Cluster Controller supports only character mode communication.
- C16 = Requires 94200A PCIF/1000 software.
- C17 = Requires appropriate 25 kHz power module or sine wave card in system processor unit or computer.
- C18 = HP 91823A Control/1000 software is strongly recommended for support of general measurement and control applications.

Table 6.4-2. HP 1000 A/L-Series Compatibility Matrix, continued

PRODUCT AND OPTION NUMBERS	DESCRIPTION	COMPUTERS AND SYSTEM COMPATIBILITY												OP SYSTEM COMPATIBILITY			
		2103L	2122A/B & 2142A/B	2136A/B & 2186A/B	2136C/D & 2186C/D	2137A	2139A	2156A/B	2196C/D	2197C/D	2199C/D	2436A/E & 2486A	2437A & 2487A	2439A & 2489A	RTE-A	RTE-A with VC+	RTE-XL

LEGEND:  
 Cc = Compatible and complies with FCC Class A EMI regulations  
 Cz = Compatible and FTZ licensed  
 Ccz = Compatible, complies with FCC Class A EMI regulations, and FTZ licensed  
 Cep = Compatible, EMI qualification pending  
 Cn = Compatible, but not EMI qualified  
 C = Compatible or supported without reference to EMI qualification  
 N = Not compatible  
 Nt = Not tested for functional compatibility  
 I = Included hardware or software item

13. MEASUREMENT AND CONTROL INTERFACES AND PERIPHERALS, continued

12063A	16-In/16-Out ISOLATED DIGITAL INPUT/OUTPUT CARD	C	N	N	N	C17	C17	C17	C17	C17	C17	C17	C17	C17	C	C	C	C
2240A**	MEASUREMENT & CONTROL PROC.	Nt	Nt	Nt	Nt	Nt	Nt	Nt	Nt	Nt	Nt	Nt	Nt	Nt	Nt	Nt	Nt	Nt
2250A/H	MEASUREMENT AND CONTROL SYSTEM	Nt	Nt	Nt	Nt	Ccz	Ccz	Ccz	Ccz	Ccz	Ccz	Ccz	Ccz	Ccz	C18	C18	Nt	Nt
2251B	MEASUREMENT AND CONTROL UNIT	Nt	Nt	Nt	Nt	Ccz	Ccz	Ccz	Ccz	Ccz	Ccz	Ccz	Ccz	Ccz	C18	C18	Nt	Nt

14. GENERAL-PURPOSE INTERFACES

12006A	PARALLEL INTERFACE	C	C	C	C	C	C	C	C	C	C	C	C	C	C	C	C	C
12010A	BREADBOARD INTERFACE	C	C	C	C	C	C	C	C	C	C	C	C	C	C	C	C	C
37203L	HP-IB EXTENDER CARD Using Coaxial Cable connection	N	N	N	N	C17	C17	C17	C17	C17	C17	C17	C17	C17	C	C	C	C
37203L+001	HP-IB EXTENDER CARD Using Fiber Optic Cable connection	N	N	N	N	C	C	C	C	C	C	C	C	C	C	C	C	C

15. SOFTWARE

91732A	DATA LINK/MULTIPOINT Software	N	N	N	C	C	C	C	C	C	C	C	C	C	C	C	C	C
91745A	DATASAFE/1000 Software	N	N	N	N	N	N	N	N	N	N	N	N	N	N	N	N	N
91747A	DATASHARE/1000 software	N	N	N	N	N	N	N	N	N	N	N	N	N	N	N	N	N
91750A	DS/1000-IV Network Software	C	C	C	C	C	C	C	C	C	C	C	C	C	C	C	C	C
91751A	X 25/1000 Network Software	C	C	C	C	C	C	C	C	C	C	C	C	C	C	C	C	C
91780A**	RJE/1000 Software	N	N	N	N	C	C	C	C	C	C	C	C	C	C	C	C	C
91781A	RJE/1000-II Software	N	N	N	N	C	C	C	C	C	C	C	C	C	C	C	C	C
91782A	MRJE/1000 Software	N	N	N	N	C	C	C	C	C	C	C	C	C	C	C	C	C
91784A	PMF/1000 Programmatic Mainframe Facility Software	N	N	N	C	C	C	C	C	C	C	C	C	C	C	C	C	C
91823A	CONTROL/1000 Software	N	N	Nt	C	C	C	C	C	C	C	C	C	C	C	C	C	C
92045A	RTE MICROPROGRAMMING Software	N	N	N	N	N	N	N	N	N	N	N	N	N	N	N	N	N
92049A	RTE MICROPROGRAMMING Software	N	N	N	N	N	N	N	N	N	N	N	N	N	N	N	N	N
92069A	IMAGE/1000 DBMS Software	C	C	C	C	C	C	C	C	C	C	C	C	C	C	C	C	C
92070A/B**	RTE-L Operating System	C21	C21	N	N	N	N	N	N	N	N	N	N	N	N	N	N	N
92071A**	RTE-XL Operating System	C21	C21	N	N	N	N	N	N	N	N	N	N	N	N	N	N	N
92076A	BASIC/1000L	C	C	C	C	C	C	C	C	C	C	C	C	C	C	C	C	C
92077A	RTE-A Operating System	N	N	N	I	C	C	C	C	I	I	I	I	I	I	I	I	I
92078A	RTE-A VC+ Extension	N	N	N	I	C	C	C	C	I	I	I	I	I	I	I	I	I
92081A	IMAGE/1000-II DBMS Software	N	N	N	C	C	C	C	C	C	C	C	C	C	C	C	C	C
92120A**	PMC/1000 Software	N	N	N	N	N	N	N	N	N	N	N	N	N	N	N	N	N
92121A	PMC/1000 Software	N	N	N	N	N	N	N	N	N	N	N	N	N	N	N	N	N
92130A**	QDM/1000 Software	N	N	N	N	N	N	N	N	N	N	N	N	N	N	N	N	N
92131A	QDM/1000 Software	N	N	N	N	N	N	N	N	N	N	N	N	N	N	N	N	N
92140A**	PCL/1000-AB Software	N	N	N	N	N	N	N	N	N	N	N	N	N	N	N	N	N
92833A	PASCAL/1000	N	N	N	C	C	C	C	C	C	C	C	C	C	C	C	C	C
92834A	FORTRAN 4X	C	C	C	C	C	C	C	C	C	C	C	C	C	C	C	C	C
92835A	SIGNAL/1000 Software Package	N	N	N	N	N	N	N	N	N	N	N	N	N	N	N	N	N
92836A	FORTRAN 77	N	N	N	C	C	C	C	C	C	C	C	C	C	C	C	C	C

FOOTNOTES:

\*\* = Obsolete product listed here for reference only.

C17 = Requires appropriate 25 kHz power module or sine wave card in system processor unit or computer.

C19 = 92069A Image/1000 is compatible in RTE-XL with revision code 2101 or higher.

C20 = Query is not supported in RTE-L.

C21 = RTE-L is compatible in 2103L or 2122A/B with 64kb memory; RTE-XL is compatible in 2103L or 2122A/B with 128kb or more memory and is included in 2142A/B.

N3 = Support of the user-customized 12042B or 12010A interface requires user-developed software.



Compatibility

Table 6.4-2. HP 1000 A/L-Series Compatibility Matrix, continued

LEGEND: Cc = Compatible and complies with FCC Class A EMI regulations Cz = Compatible and FTZ licensed Ccz = Compatible, complies with FCC Class A EMI regulations, and FTZ licensed Cep = Compatible, EMI qualification pending Cn = Compatible, but not EMI qualified C = Compatible or supported without reference to EMI qualification N = Not compatible Nt = Not tested for functional compatibility I = Included hardware or software item		COMPUTERS AND SYSTEM COMPATIBILITY											OP SYSTEM COMPATIBILITY				
		2103L	2122A/B & 2142A/B	2136A/B & 2186A/B	2136C/D & 2186C/D	2137A	2139A	2156A/B	2196C/D	2197C/D	2199C/D	2436A/E & 2486A	2437A & 2487A	2439A & 2489A	RTE-A	RTE-A with VC+	RTE-XL
PRODUCT AND OPTION NUMBERS	DESCRIPTION																

15. SOFTWARE, continued

92841A	Version 1.0 DEVICE-INDEPENDENT GRAPHICS LIBRARY	C	C	C	C	C	C	C	C	C	C	C	C	C	C	C	C
92842A	Version 1.0 ADV. GRAPHICS PKG.	CC	CC	CC	CC	CC	CC	CC	CC	CC	CC	CC	CC	CC	CC	CC	CC
92843X	GRAPHICS/1000-II SKELETON	CC	CC	CC	CC	CC	CC	CC	CC	CC	CC	CC	CC	CC	CC	CC	CC
92861A	DEVICE HANDLER SOURCE PRODUCT	N	N	C	C	C	C	C	C	C	C	C	C	C	C	C	C
92861A	Version 2.0 DEVICE-INDEPENDENT GRAPHICS LIBRARY	N	N	C	C	C	C	C	C	C	C	C	C	C	C	C	C
92862A	Version 2.0 ADV. GRAPHICS PKG.	NN	NN	CC	CC	CC	CC	CC	CC	CC	CC	CC	CC	CC	CC	CC	CC
92854A**	PASCAL/1000	NN	NN	CC	CC	CC	CC	CC	CC	CC	CC	CC	CC	CC	CC	CC	CC
92857A	BASIC/1000C	NN	NN	CC	CC	CC	CC	CC	CC	CC	CC	CC	CC	CC	CC	CC	CC
92860A	SYMBOLIC DEBUG/1000	NN	NN	CC	CC	CC	CC	CC	CC	CC	CC	CC	CC	CC	CC	CC	CC
94200A	PCIF/1000 PROGRAMMABLE CONTROLLER INTERFACE Software	N	N	N	C	C	C	C	C	C	C	C	C	C	C	C	C

FOOTNOTES:

\*\* = Obsolete product listed here for reference only.

Table 6.4-3. HP 1000 M/E/F-Series Compatibility Matrix

LEGEND: Cc = Compatible and complies with FCC Class A EMI regs Cz = Compatible and FTZ licensed Ccz = Compatible, complies with FCC Class A EMI regs and FTZ licensed Cep = Compatible, EMI qualification pending Cn = Compatible, but not EMI qualified C = Compatible or supported without reference to EMI qualification N = Not compatible Nt = Not tested for functional compatibility I = Currently included hardware		COMPATIBILITY															
		COMPUTERS AND SYSTEMS											OP SYSTEM				
		2108M/2112M	2109E/2113E	2111F/2117F	2176C	2176E	2177C	2177F	2178A	2178C	2179A	2179C	RTE-6/VM	RTE-IVB	RTE-IVE		
PRODUCT AND OPTION NUMBERS	DESCRIPTION																
<b>1. HP 1000 M/E/F-SERIES COMPUTERS</b>																	
2108M*	COMPUTER with 64 kB memory, exp to 2 MB	Cn	N	N	N	N	N	N	N	N	N	N	N	N	C1	C1	C1
2108MK*	BOARD COMPUTER with 64 kB memory	I	N	N	N	N	N	N	N	N	N	N	N	N	C1	C1	C1
2109E	COMPUTER with 64 kB memory, exp to 2 MB	N	Cn	N	N	N	N	N	N	N	N	N	N	N	C1	C1	C1
2109EK	BOARD COMPUTER with 64 kB memory	N	I	N	N	N	N	N	N	N	N	N	N	N	C1	C1	C1
2111F*	COMPUTER with 64 kB memory, exp to 2 MB	N	N	Cn	N	N	N	N	N	N	N	N	N	N	C1	C1	C1
2112M*	COMPUTER with 128 kB memory, exp to 2 MB	Cn	N	N	N	N	N	N	N	N	N	N	N	N	C1	C1	C1
2113E	COMPUTER with 128 kB memory, exp to 2 MB	N	Cn	N	N	N	N	N	N	N	N	N	N	N	C1	C1	C1
2117F	COMPUTER with 128 kB memory, exp to 2 MB	N	N	Cn	N	N	N	N	N	N	N	N	N	N	C1	C1	C1
<b>2. HP 1000 E/F-SERIES SYSTEM PROCESSOR UNITS (SPUs)</b>																	
2176C	Model 40 SPU with 128 kB memory	N	N	N	Cn	N	N	N	N	N	N	N	N	N	I	I	N
2176E	EMI-qualified Model 40 SPU w/256 kB memry	N	N	N	N	Ccz	N	N	N	N	N	N	N	N	I	I	N
2177C	Model 45 SPU with 128 kB memory	N	N	N	N	N	Cn	N	N	N	N	N	N	N	I	I	N
2177F	EMI-qualified Model 45 SPU w/256 kB memory	N	N	N	N	N	N	Ccz	N	N	N	N	N	N	I	I	N
2178A	Model 60 SPU with 256 kB memory	N	N	N	N	N	N	N	Cn	N	N	N	N	N	I	I	N
2178C	EMI-qualified Model 60 SPU w/256 kB memory	N	N	N	N	N	N	N	N	Ccz	N	N	N	N	I	I	N
2179A	Model 65 SPU with 256 kB memory	N	N	N	N	N	N	N	N	N	Cn	N	N	N	I	I	N
2179C	EMI-qualified Model 65 SPU w/256 kB memory	N	N	N	N	N	N	N	N	N	N	Ccz	N	N	I	I	N
<b>3. MEMORY PRODUCTS</b>																	
2102B	Std Performance Parity MEMORY CONTROLLER (Included in 12784/6A-D)	C2	C	N	C	C	N	N	C	C	N	N	C2	C2	C2	C2	C2
2102C	Std Perf Fault Control MEMORY CONTROLLER (Included in 12785/7A-D)	C3	C3	N	C	C	N	N	C	C	N	N	C3	C3	C3	C3	C3
2102E	High Performance Parity MEMORY CONTROLLER (Included in 12788A-M)	N	C3	C3	C3	C3	C3	C3	C3	C3	C3	C3	C3	C3	C3	C3	C3
2102H	High Perf Fault Control MEMORY CONTROLLER (Included in 12789A-M)	N	C3	C3	C3	C3	C3	C3	C3	C3	C3	C3	C3	C3	C3	C3	C3
12666H	1 MB High Perf FAULT CONTROL CHECK BIT BD#	C4	C4	C4	C4	C4	C4	C4	C4	C4	C4	C4	C4	C4	C4	C4	C4
12699H	256 kB High Performance MEMORY MODULE#	C5	C5	C5	C5	C5	C5	C5	C5	C5	C5	C5	C5	C5	C5	C5	C5
12746A*	64 kB Std Perf MEMORY MODULE	C	C	N	C	C	N	N	C	C	N	N	C	C	C	C	C
12746H	64 kB High Perf MEMORY MODULE#	C5	C5	C	C5	C5	C	C	C5	C5	C	C	C	C	C	C	C
12747A*	128 kB Std Perf MEMORY MODULE	C	C	N	C	C	N	N	C	C	N	N	C	C	C	C	C
12747H	128 kB High Perf MEMORY MODULE#	C6	C6	C6	C6	C6	C6	C6	C6	C6	C6	C6	C6	C6	C6	C6	C6
12749H	512 kB High Perf MEMORY MODULE#	C6	C6	C6	C6	C6	C6	C6	C6	C6	C6	C6	C6	C6	C6	C6	C6
12779A*	256 kB Std Perf FAULT CONTROL CHECK BIT BD	C7	C7	N	C7	C7	N	N	C7	C7	N	N	C7	C7	C7	C7	C7
12779H	256 kB High Perf FAULT CTRL CHECK BIT BD#	C4	C4	C4	C4	C4	C4	C4	C4	C4	C4	C4	C4	C4	C4	C4	C4
12780A*	512 kB Std Perf FAULT CONTROL CHECK BIT BD	C7	C7	N	C7	N	C7	C7	C7	N	N	N	C7	C7	C7	C7	C7
12780H	512 kB High Perf FAULT CTRL CHECK BIT BD#	C4	C4	C4	C4	C4	C4	C4	C4	C4	C4	C4	C4	C4	C4	C4	C4

FOOTNOTES:

- \* = Obsolete product, listed here for reference only.
- C1 = 2108M and 2112M Computers are compatible with RTE-6/VM only for purposes of program transportability. Because of insufficient control store capacity, these computers cannot use the RTE-6/VM firmware and must use much slower equivalent software routines.
- C2 = Memory controller w/date code 1728 or later is compatible.
- C3 = Memory controller w/date code 1720 or later is compatible when used in computer with date code 1720 or later.
- C4 = Requires 2102C or 2102H Fault Control Memory Controller in Computer or SPU, but high performance memory cycle time is achieved only with 2102H Memory Controller in 2109E, 2111F, 2113E, or 2117F Computer or 2176C/E, 2177C/F, 2178A/C, or 2179A/C System Processor Unit.
- C5 = High performance memory can be used with any 2102x Memory Controller, but high performance cycle time is achieved only with 2102E/H Memory Controller in 2109E, 2111F, 2113E, or 2117F Computer or 2176C/E, 2177C/F, 2178A/C, or 2179A/C System Processor Unit.
- C6 = Requires Memory controller with date code 1801 or later; note C5 also applies to the 12747H and 12749H Memory Modules.
- C7 = Requires 2102C Fault Control Memory Controller in Computer or SPU.
- I1 = 12784A/12786A (128kb) Standard Performance Memory Package is included in 2112M/2113E Computer and 2176C SPU.
- # = 12666H, 12699H, 12747H, 12749H, 12779A and 12780A Memory Modules and Check Bit Boards are included in various 1278x Memory packages.

Table 6.4-3. HP 1000 M/E/F-Series Compatibility Matrix, continued

LEGEND: Cc = Compatible and complies with FCC Class A EMI regs Cz = Compatible and FTZ licensed Ccz = Compatible, complies with FCC Class A EMI regs and FTZ licensed Cep = Compatible, EMI qualification pending Cn = Compatible, but not EMI qualified C = Compatible or supported without reference to EMI qualification N = Not compatible Nt = Not tested for functional compatibility I = Currently included hardware		COMPATIBILITY											
		COMPUTERS AND SYSTEMS										OP SYSTEM	
		2108M/2112M	2109E/2113E	2111F/2117F	2176C	2176E	2177C	2177F	2178A	2178C	2179A	2179C	RTE-6/VM

3. MEMORY PRODUCTS, continued

12784A*	128 kB Std Perf MEMORY PACKAGE	I1	N	N	C	N	N	N	N	N	N	N	N	C	C	C
12784B-D*	256 kB-1024 kB Std Perf MEMORY PACKAGES	C8	N	N	C	N	N	N	N	N	N	N	N	C	C	C
12785A-D*	128 kB-1024 kB Std Perf FC MEMORY PACKAGES	C8	N	N	C	N	N	N	N	N	N	N	N	C	C	C
12786A	128 kB Std Performance MEMORY PACKAGE	N	N	I1	I	N	N	N	N	N	N	N	N	C	C	C
12786B	256 kB Std Performance MEMORY PACKAGE	N	N	C8	C	N	N	N	N	N	N	N	N	C	C	C
12786C	512 kB Std Performance MEMORY PACKAGE	N	N	C8	C	N	N	N	N	N	N	N	N	C	C	C
12786D*	1024 kB Std Performance MEMORY PACKAGES	N	N	C8	C	N	N	N	N	N	N	N	N	C	C	C
12787A-D	128 kB-1024 kB Std Perf FC MEMORY PACKAGES	N	C8	N	C	C	N	N	N	N	N	N	N	C	C	C
12788A	128 kB High Perf MEMORY PACKAGE	N	C5	C5	C5	C5	C5	C5	C5	C5	C5	C5	C5	C	C	C
12788B*	256 kB High Perf MEMORY PACKAGE	N	C5	C5	C5	C5	C5	C5	C5	C5	C5	C5	C5	C	C	C
12788BB	256 kB High Perf MEMORY PACKAGE	N	C5	C5	C5	I5	C5	I5	C5	C5	C5	I5	C5	C	C	C
12788C/D*	512 kB/1024 kB High Perf MEMORY PACKAGES	N	C8	C8	C	C	C	C	C	C	C	C	C	C	C	C
12788E-H	512 kB-2048 kB High Perf MEMORY PACKAGES	N	C8	C8	C	C	C	C	C	C	C	C	C	C	C	C
12789A-D*	128 kB-1024 kB High Perf FC MEM PACKAGES	N	C8	C8	C	C	C	C	C	C	C	C	C	C	C	C
12789E	512 kB High Performance FC MEMORY PACKAGE	N	C8	C8	C	C	C	C	C	C	C	C	C	C	C	C
12789F-H*	1024 kB-2048 kB High Perf FC MEM PACKAGES	N	C8	C8	C	C	C	C	C	C	C	C	C	C	C	C
12789J-M	512 kB-2048 kB Std Perf FC MEMORY PACKAGES	N	C8	C8	C	C	C	C	C	C	C	C	C	C	C	C
12892B	MEMORY PROTECT MODULE (included in 12784x through 12789x Memory Packages)	C	C	C	C	C	C	C	C	C	C	C	C	C9	C9	C9
12897B	DUAL-CHANNEL PORT CONTROLLER	C	C	C	C	C	C	C	C	C	C	C	C	C10	C10	C10
12898A	DUAL-CHANNEL PORT CONTROLLER for I/O Ext.	C	C	C	C	C	C	C	C	C	C	C	C	C10	C10	C10
12976B*	M-Series DYNAMIC MAPPING SYSTEM	C	C	C	C	C	C	C	C	C	C	C	C	C11	C11	C11
+003	Adds Fast FORTRAN Processor to 12976B	C	C	C	C	C	C	C	C	C	C	C	C	C	C	C
12978B*	M-Series DYNAMIC MAPPING INSTRUCTIONS	C	C	C	C	C	C	C	C	C	C	C	C	C	C	C
13305A*	E/F-Series DYN MAPPING SYS for 13304A FAB	N	C12	N	N	N	N	N	N	N	N	N	N	C13	C13	C13
13307A*	E/F-Series DYNAMIC MAPPING INSTRUCTION ROMS (part of 13305A)	N	C12	N	N	N	N	N	N	N	N	N	N	C13	C13	C13
13307B	E/F-Series DYNAMIC MAPPING INSTRUCTION ROMS for use on 12791A or 13304A	N	I1	I1	I	I	I	I	I	I	I	I	I	C13	C13	C13
12731A	MEMORY EXP MODULE (incl. in 12784x-9x)	I2	I2	I2	I	I	I	I	I	I	I	I	I	C14	C14	C14

4. COMPUTER AND SYSTEM ACCESSORIES AND UPGRADES

12539C	TIME BASE GENERATOR	C	C	C	I	I	I	I	I	I	I	I	I	C	C	C
12620A	I/O BREADBOARD - RTE PRIV INTERRUPT FENCE	C	C	C	C	C	C	C	C	C	C	C	C	C	C	C
12777A	PRIORITY JUMPER CARD	C	C	C	C	C	C	C	C	C	C	C	C	C	C	C
12791A	FIRMWARE EXPANSION MODULE (FEM)	C	C	C	C	C	C	C	C	C	C	C	C	C	C	C
12823F*	F-Series FIRMWARE UPGRADE KIT for computer with serial prefix 1920 or earlier	N	N	C	na	na	na	na	na	na	na	na	na	C	C	C
12824A	VECTOR INSTRUCTION SET for use in RTE-IVB	C14	C15	C	C14	C15	I	I	N	N	N	N	N	C	C	C
12829A	VECTOR INSTRUCTION SET for use in RTE-6/VM	C14	C15	C	C	C	N	N	N	N	C14	C15	I	C	C	C
12944B	POWER FAIL RECOVERY SYS for 2108M or 2109E	C	C	C	C	C	N	N	N	N	N	N	N	C	C	C

FOOTNOTES:

- \* = Obsolete product listed here for reference only.
- C8 = 1278xD (1024 kB) or 1278xH/M (2048 kB) Memory Package will require 12990B Memory Extender when used with 2108M, 2109E, or 2111F Computer.
- C9 = Memory Protect module with date code 1704 or later is compatible.
- C10 = 12897B Dual-Channel Port Controller with date code 1649 or later is compatible.
- C11 = 12898A Dual-Channel Port Controller with date code 1647 or later is compatible.
- C12 = Requires 13304A Firmware Accessory Board, which is provided as 2109E/2113E Computer option 003.
- C13 = Compatible when 13305A and/or 13307A/B includes Dynamic Mapping Instruction ROMS with part numbers 13307-80021 through 80026 or higher.
- C14 = Memory Expansion Module with date code 1652 or later is compatible.
- C15 = Compatibility is with software equivalents included in the 12824A/12829A Vector Instruction Set.
- I1 = 12788A (128kb) High Performance Memory Package & 13307B Dynamic Mapping Instr. are included in 2117F Computer
- I2 = 12731A is included in 2112M, 2113E, and 2117F Computers.
- na = Not Applicable

Table 6.4-3. HP 1000 M/E/F-Series Compatibility Matrix, continued

LEGEND: Cc = Compatible and complies with FCC Class A EMI regs Cz = Compatible and FTZ licensed Ccz = Compatible, complies with FCC Class A EMI regs and FTZ licensed Cep = Compatible, EMI qualification pending Cn = Compatible, but not EMI qualified C = Compatible or supported without reference to EMI qualification N = Not compatible Nt = Not tested for functional compatibility I = Currently included hardware		COMPATIBILITY												
		COMPUTERS AND SYSTEMS										OP SYSTEM		
		2108M/2112M	2109E/2113E	2111F/2117F	2176C	2176E	2177C	2177F	2178A	2178C	2179A	2179C	RTE-6/VM	RTE-IVB
PRODUCT AND OPTION NUMBERS	DESCRIPTION													

4. COMPUTER AND SYSTEM ACCESSORIES AND UPGRADES, continued

12945A*	M-Series USER CONTROL STORE	C	N	N	N	N	N	N	N	N	N	N	C	C	C
12977B*	M-Series FAST FORTRAN PROCESSOR	C16	N	N	N	N	N	N	N	N	N	N	C	C	C
12991B	POWER FAIL RECOVERY SYS for 2111F, 2112M, 2113E, and 2117F Computers and 12990B	C	C	C	C	C	C	C	C	C	C	C	C	C	C
12992B	RPL-compatible 7905A/79xxM Disc LOADER ROM	N	C	C	C	C	C	C	C	C	C	C	na	na	na
12992C	264x Terminal Minicartridges LOADER ROM	C	I	I	I	I	I	I	I	I	I	I	na	na	na
12992D	7970B/E or 7971A Mag Tape LOADER ROM	C	C	C	C	C	C	C	C	C	C	C	na	na	na
12992E	12732A (9885M) Flexible Disc LOADER ROM	C	C	C	C	C	C	C	C	C	C	C	na	na	na
12992F	RPL-compatible 7900 Disc LOADER ROM	N	C	C	C	C	C	C	C	C	C	C	na	na	na
12992J	CS/80 Disc LOADER ROM	C	C	C	C	C	C	C	C	C	C	C	na	na	na
12992K	Paper Tape LOADER ROM	C	C	C	C	C	C	C	C	C	C	C	na	na	na
13197A	1k WRITABLE CONTROL STORE (WCS) BOARD	C	C	C	C	C	C	C	C	C	C	C	C17	C17	C17
13304A	FIRMWARE ACCESSORY BOARD (FAB)	N	C	C	I	C	C	C	C	C	C	C	C	C	C
13306A*	E/F-Series FAST FORTRAN PROC for FAB mtg	N	C	C	C	N	C	C	C	C	N	I	C	C	C
13306B	E/F-Series FAST FORTRAN PROC for FEM mtg	N	C	C	C	I	C	C	C	C	I	I	C	C	C

5. EXTENDERS

12781A	DUAL CPU KIT for 12979B	C	C	C	C	C	C	C	C	C	C	C	C	C	C
12979B*	Dual-Port I/O EXTENDER	C	C	C	C	C	C	C	C	C	C	C	C	C	C
12979C	Dual-Port I/O EXTENDER	C	C	C	C	C	C	C	C	C	C	C	C	C	C
12979C+001	12979C Modified for EMI compliance	C	C	C	C	C	C	C	C	C	C	C	C	C	C
12990B*	MEMORY EXTENDER	C	C	C	C	C	C	C	C	C	C	C	C	C	C

6. RECOMMENDED TERMINAL INTERFACES

12790A	MULTIPOINT/DATA LINK INTERFACE	C18	C18	C18	C18	C18	C18	C18	C18	C18	C18	C18	C18	C19	C19	C19
12792A*/B*/C	Eight-Channel ASYNCHRONOUS MULTIPLEXER	C	C	C	C	C	C	C	C	C	C	C	C	C	C	C
12920B	16-Channel ASYNCHRONOUS MULTIPLEXER	C	C	C	C	C	C	C	C	C	C	C	C	C	C	C
12966A	Buffered ASYNC (1 ch pt-pt) COMM I/F	C21	C21	C21	C21	C21	C21	C21	C21	C21	C21	C21	C21	C22	C22	C22

7. OTHER TERMINAL INTERFACES

12531C	Teleprinter CURRENT LOOP INTERFACE	C	C	C	C	C	C	C	Nt	Nt	Nt	Nt	Nt	C	C
12531D	Terminal CURRENT LOOP INTERFACE	C	C	C	C	C	C	C	Nt	Nt	Nt	Nt	Nt	C	C
12880A*	Console TERMINAL INTERFACE	C	C	C	C	C	C	C	Nt	Nt	Nt	Nt	Nt	C	C

FOOTNOTES:

- \* = Obsolete product listed here for reference only.
- I1 = 12788A (128kb) High Performance Memory Package and 13307B Dynamic Mapping Instr. are included in 2117F Computer.
- I2 = 12731A is included in 2112M, 2113E, and 2117F Computers.
- na = Not Applicable
- C16 = Compatible in 2108M/2112M Computer with "B" revision of base instruction set.
- C17 = Requires 92061A RTE Microprogramming Package.
- C18 = Compatible when used with 2645A Display Stations with serial number 1747A06465 or later, 2648A Graphics Terminals with serial number 1747A00846 or later, 264x OEM versions of these terminals, the 2624B Display Terminal, 2626A Display Station, and 2629x OEM versions of these terminals when equipped with the appropriate multipoint terminal option or accessory.
- C19 = Requires 91730A Multipoint Subsystem Software.
- C20 = Requires 91731A Multiplexer Subsystem Software.
- C21 = 12966A interface card with date code 1629 or later is compatible with 2109E, 2111F, 2113E, and 2117F Computers and 2176C/E, 2177C/F, 2178A/C, and 2179A/C System Processor Units.
- C22 = 12966A is software-supported in RTE only for use with 2382A\*, 2392A, 262x, 2635A\*/B., and 264x\* Terminals.

Table 6.4-3. HP 1000 M/E/F-Series Compatibility Matrix, continued

LEGEND: Cc = Compatible and complies with FCC Class A EMI regs Cz = Compatible and FTZ licensed Ccz = Compatible, complies with FCC Class A EMI regs and FTZ licensed Cep = Compatible, EMI qualification pending Cn = Compatible, but not EMI qualified C = Compatible or supported without reference to EMI qualification N = Not compatible Nt = Not tested for functional compatibility I = Currently included hardware		COMPATIBILITY													
		COMPUTERS AND SYSTEMS										OP SYSTEM			
		2108M/2112M	2109E/2113E	2111F/2117F	2176C	2176E	2177C	2177F	2178A	2178C	2179A	2179C	RTE-6/VM	RTE-1VB	RTE-1VE
PRODUCT AND OPTION NUMBERS	DESCRIPTION														
<b>8 OPERATOR COMMUNICATION TERMINALS</b>															
2382A* @	OFFICE DISPLAY TERMINAL	Cn	Cn	Cn	Cn	Ccz	Cn	Ccz	Cn	Ccz	Cn	Ccz	C23	C23	C23
2392A@	DISPLAY TERMINAL	Cn	Cn	Cn	Cn	Ccz	Cn	Ccz	Cn	Ccz	Cn	Ccz	C23	C23	C23
2621A* #	INTERACTIVE TERMINAL	Cn	Cn	Cn	Cn	Cn	Cn	Cn	Cn	Cn	Cn	Cn	C23	C23	C23
2621P* #	INTERACTIVE TERMINAL with Printer	Cn	Cn	Cn	Cn	Cn	Cn	Cn	Cn	Cn	Cn	Cn	C23	C23	C23
2621B* @	INTERACTIVE TERMINAL	Cn	Cn	Cn	Cn	Ccz	Cn	Ccz	Cn	Ccz	Cn	Ccz	C23	C23	C23
2622A* #	DISPLAY TERMINAL	Cn	Cn	Cn	Cn	Ccz	Cn	Ccz	Cn	Ccz	Cn	Ccz	C23	C23	C23
2623A#	GRAPHICS TERMINAL	Cn	Cn	Cn	Cn	Ccz	Cn	Ccz	Cn	Ccz	Cn	Ccz	C23	C23	C23
2624A* #	DISPLAY STATION	Cn	Cn	Cn	Cn	Cn	Cn	Cn	Cn	Cn	Cn	Cn	C23	C23	C23
2624B#	DISPLAY STATION	Cn	Cn	Cn	Cn	Ccz	Cn	Ccz	Cn	Ccz	Cn	Ccz	C23	C23	C23
2625A@	DUAL-SYSTEM DISPLAY TERMINAL	Nt	Cn	Cn	Cn	Ccz	Cn	Ccz	Cn	Ccz	Cn	Ccz	C23	C23	C23
2626A#	DISPLAY STATION	Cn	Cn	Cn	Cn	Ccz	Cn	Ccz	Cn	Ccz	Cn	Ccz	C23	C23	C23
2627A#	COLOR GRAPHICS TERMINAL	Nt	Cn	Cn	Cn	Ccz	Cn	Ccz	Cn	Ccz	Cn	Ccz	C23	C23	C23
2628A@	WORD PROCESSING TERMINAL	Cn	Cn	Cn	Cn	Ccz	Cn	Ccz	Cn	Ccz	Cn	Ccz	C23	C23	C23
2635A*/B*+051	PRINTING TERMINAL	Cn	Cn	Cn	Cn	Nt	Cn	Nt	Cn	Nt	Cn	Nt	C23	C23	C23
2631B* @	PRINTING TERMINAL	Cn	Cn	Cn	Cn	Ccz	Cn	Ccz	Cn	Ccz	Cn	Ccz	C23	C23	C23
2645A* \$	DISPLAY STATION	Cn	Cn	Cn	Cn	Ccz	Cn	Ccz	Cn	Ccz	Cn	Ccz	C23	C23	C23
+007	Adds Mini cartridge tape I/O	Cn	Cn	Cn	Cn	Ccz	Cn	Ccz	Cn	Ccz	Cn	Ccz	C	C	C
2647A* \$	INTELLIGENT GRAPHICS TERMINAL	Cn	Cn	Cn	Cn	Ccz	Cn	Ccz	Cn	Ccz	Cn	Ccz	C	C	C
2647F* \$	INTELLIGENT GRAPHICS TERMINAL	Nt	Nt	Nt	Nt	Nt	Nt	Nt	Nt	Nt	Nt	Nt	C	C	C
2648A* \$	GRAPHICS TERMINAL	Cn	Cn	Cn	Cn	Ccz	Cn	Ccz	Cn	Ccz	Cn	Ccz	C23	C23	C23
+007	Adds Mini cartridge tape I/O	Cn	Cn	Cn	Cn	Ccz	Cn	Ccz	Cn	Ccz	Cn	Ccz	C	C	C
2675A**070	HERMAL PRINTING TERMINAL with Mini cartridges deleted	Cn	Cn	Cn	Cn	Cn	Cn	Cn	Cn	Cn	Cn	Cn	C	C	C
27201A	SPEECH OUTPUT MODULE conn via a compatible terminal (requires 27203A)	Cn	Cn	Cn	N	N	N	N	Cn	Cep	Cn	Cep	C	N	N
27203A	Speech Output Module SPEECH LIBRARY	Cn	Cn	Cn	N	N	N	N	C	C	C	C	C	N	N
45610B	HP TOUCHSCREEN TERMINAL	Cn	Cn	Cn	Cn	Ccz	Cn	Ccz	Cn	Ccz	Cn	Ccz	C23	C23	C23
<b>9. INDUSTRIAL TERMINALS</b>															
3075A*	Desktop DATA CAPTURE TERMINAL	Cn	Cn	Cn	Cn	Cn	Cn	Cn	Cn	Cn	Cn	Cn	C24	C24	N
3076A*	Wall-mounting Data CAPTURE TERMINAL	Cn	Cn	Cn	Cn	Cn	Cn	Cn	Cn	Cn	Cn	Cn	C24	C24	N
3077A*	TIME REPORTING TERMINAL	Cn	Cn	Cn	Cn	Cn	Cn	Cn	Cn	Cn	Cn	Cn	C24	C24	N
3078A*	DATA COUPLER	Nt	Nt	Nt	Nt	Nt	Nt	Nt	Nt	Nt	Nt	Nt	Nt	Nt	Nt
3081A	INDUSTRIAL WORKSTATION TERMINAL	Cn	Cn	Cn	Cn	Cn	Cn	Cep	Cn	Cep	Cn	Ccz	C	Nt	Nt
39800A	BAR CODE READER	Nt	Nt	Nt	Nt	Nt	Nt	Nt	Nt	Nt	Nt	Nt	Nt	Nt	Nt
39801A	BAR CODE READER	Nt	Nt	Nt	Nt	Nt	Nt	Nt	Nt	Nt	Nt	Nt	Nt	Nt	Nt
<b>10. DISC INTERFACES AND DISC MEMORIES</b>															
12732A*	FLEXIBLE DISC MEMORY SUBSYSTEM	Cn	Cn	Cn	Cn	Cn	Cn	Cn	Cn	Cn	Cn	Cn	C	C	C
12821A	INTERFACE to 79xxP/R, 79xxH, or 9895A Discs	C	C	C	C	C	C	C	C	C	C	C	C	C	C
13175B*/D	79xxM MAC MASTER DISC INTERFACE	C	C	C	C	C	C	C	C	C	C	C	C	C	N
13178C*/D	MULTI-CPU INTERFACE (2nd thru 7th additional conn to 79xxM MAC Master Disc)	C	C	C	C	C	C	C	C	C	C	C	C	C	N
7906H	19.6 MB CARTRIDGE ICD MEMORY via 12821A	Cn	Cn	Cn	Cn	Cn	Cn	Cn	Cn	Cn	Cn	Cn	C	C	N
7906HR+020	19.6 MB CARTRIDGE ICD MEMORY via 12821A	Cn	Cn	Cn	Cn	Cn	Cn	Cn	Cn	Cn	Cn	Cn	C	C	N
7906M/S	19.6 MB MAC MASTER/SLAVE CARTRIDGE DISC MEMORY via 13175D/13178D interface	Cn	Cn	Cn	Cn	Ccz	Cn	Ccz	Cn	Ccz	Cn	Ccz	C	C	N
7906MR+020	19.6 MB MAC MASTER CARTRIDGE DISC MEMORY via 13175D/13178D interface	Cn	Cn	Cn	Cn	Ccz	Cn	Ccz	Cn	Ccz	Cn	Ccz	C	C	N

FOOTNOTES:

- \* = Obsolete product listed here for reference only.
- @ = Requires 217xC/E/F cable Option 006 or 12966A cable Option 106.
- # = Requires 217xC/E/F cable Option 005 or 12966A cable Option 105.
- \$ = Requires 217xC/E/F cable Option 007.
- C23 = This terminal is usable as a system console if a 264x Terminal with Mini cartridge I/O and 12966A+001 interface or another system load device is available at the system site for loading of diagnostics and updates.
- C24 = Requires 91730A Multipoint Subsystem Software and 92080A DATACAP/1000 software.

Table 6.4-3. HP 1000 M/E/F-Series Compatibility Matrix, continued

LEGEND: Cc = Compatible and complies with FCC Class A EMI regs Cz = Compatible and FTZ licensed Ccz = Compatible, complies with FCC Class A EMI regs and FTZ licensed Cep = Compatible, EMI qualification pending Cn = Compatible, but not EMI qualified C = Compatible or supported without reference to EMI qualification N = Not compatible Nt = Not tested for functional compatibility I = Currently included hardware		COMPATIBILITY												
		COMPUTERS AND SYSTEMS										OP SYSTEM		
		2108M/2112M	2109E/2113E	2111F/2117F	2176C	2176E	2177C	2177F	2178A	2178C	2179A	2179C	RTE-6/VM	RTE-IVB
PRODUCT AND OPTION NUMBERS	DESCRIPTION													

10. DISC INTERFACES AND DISC MEMORIES, continued

7908P*	Standalone 16.5 MB FIXED DISC# via 12821A	Cn	Cn	Cn	N	N	N	N	Cn	Ccz	Cn	Ccz	C	N	N
7908R*	Rack mtg 16.5 MB FIXED DISC# via 12821A	Cn	Cn	Cn	N	N	N	N	Cn	Ccz	Cn	Ccz	C	N	N
7911P	Standalone 28.1 MB FIXED DISC# via 12821A	Cn	Cn	Cn	N	N	N	N	Cn	Ccz	Cn	Ccz	C	N	N
7911R	Rack mtg 28.1 MB FIXED DISC# via 12821A	Cn	Cn	Cn	N	N	N	N	Cn	Ccz	Cn	Ccz	C	N	N
7912P	Standalone 65.6 MB FIXED DISC# via 12821A	Cn	Cn	Cn	N	N	N	N	Cn	Ccz	Cn	Ccz	C	N	N
7912R	Rack mtg 65.6 MB FIXED DISC# via 12821A	Cn	Cn	Cn	N	N	N	N	Cn	Ccz	Cn	Ccz	C	N	N
7914CT	Standalone 132.1 MB FIXED DISC# via 12821A	Nt	Nt	Nt	N	N	N	N	Cn	Ccz	Cn	Ccz	C	N	N
7914P	Standalone 132.1 MB FIXED DISC# via 12821A	Cn	Cn	Cn	N	N	N	N	Cn	Ccz	Cn	Ccz	C	N	N
7914R	Rack mtg 132.1 MB FIXED DISC# via 12821A	Cn	Cn	Cn	N	N	N	N	Cn	Ccz	Cn	Ccz	C	N	N
7914ST	132.1 MB DISC-1600 bpi MAG TAPE SUBSYSTEM in 63-in cabinet	Nt	Nt	Nt	N	N	N	N	Nt	Nt	Nt	Nt	Nt	Nt	Nt
7914TD+236	132.1 MB DISC-1600 bpi MAG TAPE SUBSYSTEM in 63-in cabinet w/13183A two-card MTU I/F	Cn	Cn	Cn	N	N	N	N	Cn	Ccz	Cn	Ccz	C	N	N
7920H/7925H	50 MB/120 MB ICD MEMORY via 12821A I/F	Cn	Cn	Cn	Cn	Ccz	Cn	Ccz	Cn	Ccz	Cn	Ccz	C	C	N
7920M and S	50 MB MAC MASTER and SLAVE DISC MEMORIES via 13175D/13178D interface	Cn	Cn	Cn	Cn	Ccz	Cn	Ccz	Cn	Ccz	Cn	Ccz	C	C	N
7925M and S	120 MB MAC MASTER and SLAVE DISC MEMORIES via 13175D/13178D interface	Cn	Cn	Cn	Cn	Ccz	Cn	Ccz	Cn	Ccz	Cn	Ccz	C	C	N
7933H	404 MB FIXED DISC via 12821A interface	Cn	Cn	Cn	N	N	N	N	Cn	Ccz	Cn	Ccz	C25	N	N
7935H	404 MB REMOVABLE MEDIA DISC via 12821A I/F	Cn	Cn	Cn	N	N	N	N	Cn	Ccz	Cn	Ccz	C25	N	N
7941A	23.8 MB FIXED DISC	Nt	Nt	Nt	N	N	N	N	Nt	Nt	Nt	Nt	Nt	Nt	Nt
7942A	23.8 MB FIXED DISC#	Nt	Nt	Nt	N	N	N	N	Nt	Nt	Nt	Nt	Nt	Nt	Nt
7945A	55.5 MB FIXED DISC	Nt	Nt	Nt	N	N	N	N	Nt	Nt	Nt	Nt	Nt	Nt	Nt
7946A	55.5 MB FIXED DISC#	Nt	Nt	Nt	N	N	N	N	Nt	Nt	Nt	Nt	Nt	Nt	Nt
9121D*/S*	540 kB Dual/270 kB Single MICROFLOPPY DISC	Nt	Nt	Nt	Nt	Nt	Nt	Nt	Nt	Nt	Nt	Nt	Nt	Nt	Nt
9122D/S	1.42 MB Dual/710 kB Single MICROFLOPPY DISC	Nt	Nt	Nt	Nt	Nt	Nt	Nt	Nt	Nt	Nt	Nt	Nt	Nt	Nt
9133A*/B*	4.6 MB/9.2 MB MINI WINCHESTER and 270 kB Single MICROFLOPPY DISC	Nt	Nt	Nt	Nt	Nt	Nt	Nt	Nt	Nt	Nt	Nt	Nt	Nt	Nt
9133D	14.8 MB MINI WINCHESTER and 710 kB Single MICROFLOPPY DISC	Nt	Nt	Nt	Nt	Nt	Nt	Nt	Nt	Nt	Nt	Nt	Nt	Nt	Nt
9134A*/B*	4.6 MB/9.2 MB MINI WINCHESTER DISC	Nt	Nt	Nt	Nt	Nt	Nt	Nt	Nt	Nt	Nt	Nt	Nt	Nt	Nt
9135A*	4.6 MB MINI WINCHESTER DISC and Single MINIFLOPPY DISC	N	N	N	N	N	N	N	N	N	N	N	N	N	N
9138A*	4.6 MB MINI WINCHESTER DISC and 1.2 MB FLEXIBLE DISC	N	N	N	N	N	N	N	N	N	N	N	N	N	N
9895A	2.35 MB MASTER DUAL FLEXIBLE DISC via 12821A interface	Cn	Cn	Cn	Cn	Ccz	Cn	Ccz	Cn	Ccz	Cn	Ccz	C	C	C

11. MAGNETIC TAPE UNITS

7970B+226/236	800 bpi, 9-tr NRZI MAGNETIC TAPE SUBSYS	Cn	Cn	Cn	Cn	Ccz	Cn	Ccz	Cn	Ccz	Cn	Ccz	C	C	C
7970E+226/236	1600 bpi, 9-tr PE MAGNETIC TAPE SUBSYSTEM	Cn	Cn	Cn	Cn	Ccz	Cn	Ccz	Cn	Ccz	Cn	Ccz	C	C	C
7971A+2xx	One or two 7970B/E MAGNETIC TAPE SUBSYSTEMS in tall cabinet	Cn	Cn	Cn	C	Ccz	Cn	Ccz	Cn	Ccz	Cn	Ccz	C	C	C
7974A	MAGNETIC TAPE UNIT in tall cabinet	Nt	Nt	Nt	Nt	Nt	Nt	Nt	Nt	Nt	Nt	Nt	Nt	Nt	Nt
7978A	MAGNETIC TAPE UNIT in tall cabinet	Nt	Nt	Nt	Nt	Nt	Nt	Nt	Nt	Nt	Nt	Nt	Nt	Nt	Nt
9144A	CARTRIDGE TAPE SUBSYSTEM	Nt	Cn	Cn	N	N	N	N	Cn	Cep	Cn	Ccz	C	N	N

FOOTNOTES:

- \* = Obsolete product listed here for reference only.
- # = 7908P/R, 7911P/R, 7912P/R, 7914CT/P/R, 7942A, and 7946A Fixed Discs include a cartridge tape drive for software installation and backup
- C25 = Requires Magnetic Tape Subsystem for bootup of system for which 7933H or 7935H is the system disc.
- \*\* = Includes two card 13181A or 13183A Mag Tape Interface.

Table 6.4-3. HP 1000 M/E/F-Series Compatibility Matrix, continued

LEGEND: Cc = Compatible and complies with FCC Class A EMI regs Cz = Compatible and FTZ licensed Ccz = Compatible, complies with FCC Class A EMI regs and FTZ licensed Cep = Compatible, EMI qualification pending Cn = Compatible, but not EMI qualified C = Compatible or supported without reference to EMI qualification N = Not compatible Nt = Not tested for functional compatibility I = Currently included hardware		COMPATIBILITY												
		COMPUTERS AND SYSTEMS										OP SYSTEM		
		2108M/2112M	2109E/2113E	2111F/2117F	2176C	2176E	2177C	2177F	2178A	2178C	2179A	2179C	RTE-6/VM	RTE-IVB
PRODUCT AND OPTION NUMBERS	DESCRIPTION													

12. PRINTER INTERFACES AND PRINTERS

12792A*/B*/C	8-Ch ASYNC MULTIPLEXER INTERFACE to 256xA+049, 2601A, or 293xA Printer	C	C	C	C	C	C	C	C	C	C	C	C	C
12821A+001	INTERFACE to 256xA+210 or 2608S+210 Printer	C	C	C	C	C	C	C	C	C	C	C	C	C
12845B	INTERFACE to 261xA* or 2631A*/B*+050 Printer	C	C	C	C	C	C	C	C	C	C	C	C	C
26099A	INTERFACE to 256xA+100 or 2608A+210 Line Printer	C	C	C	C	C	C	C	C	C	C	C	C	C
2563A+049	300 LPM LINE PRINTER via 12792A/B/C Mpxer	Cn	Cn	Cn	N	N	N	N	Cn	Ccz	Cn	Ccz	Cn	N
2563A+100	300 LPM LINE PRINTER via 26099A Interface	Cn	Cn	Cn	N	N	N	N	Cn	Ccz	Cn	Ccz	Cn	N
2563A+210	300 LPM LINE PRINTER via 12821A+001 I/F	Cn	Cn	Cn	N	N	N	N	Cn	Ccz	Cn	Ccz	Cn	N
2565A+049	600 LPM LINE PRINTER via 12792A/B/C Mpxer	Cn	Cn	Cn	N	N	N	N	Cn	Ccz	Cn	Ccz	Cn	N
2565A+100	600 LPM LINE PRINTER via 26099A Interface	Cn	Cn	Cn	N	N	N	N	Cn	Ccz	Cn	Ccz	Cn	N
2565A+210	600 LPM LINE PRINTER via 12821A+001 I/F	Cn	Cn	Cn	N	N	N	N	Cn	Ccz	Cn	Ccz	Cn	N
2566A+049	750 LPM LINE PRINTER via 12792A/B/C Mpxer	Cn	Cn	Cn	N	N	N	N	Cn	Ccz	Cn	Ccz	Cn	N
2566A+100	880 LPM LINE PRINTER via 26099A Interface	Cn	Cn	Cn	N	N	N	N	Cn	Ccz	Cn	Ccz	Cn	N
2566A+210	880 LPM LINE PRINTER via 12821A+001 I/F	Cn	Cn	Cn	N	N	N	N	Cn	Ccz	Cn	Ccz	Cn	N
2601A	40 cps DAISYWHEEL PRINTER via 12792A*/B	Cn	Cn	Cn	Cn	Cn	Cn	Cn	Cn	Cn	Cn	Cn	Cn	C
2608A*+210	400 LPM LINE PRINTER (incl. 26099A I/F)	Cn	Cn	Cn	Cn	Ccz	Cn	Ccz	Cn	Ccz	Cn	Ccz	Cn	C
2608S+210	400 LPM LINE PRINTER (incl. 12821A+001 I/F)	Cn	Cn	Cn	Cn	Cn	Cn	Cn	Cn	Cn	Cn	Cn	Cn	C
2611A*+100	600 LPM LINE PRINTER (incl. 12845B I/F)	Cn	Cn	Cn	Cn	Cn	Cn	Cn	Cn	Cn	Cn	Cn	Cn	C
2613A*+100	300 LPM LINE PRINTER (incl. 12845B I/F)	Cn	Cn	Cn	Cn	Cn	Cn	Cn	Cn	Cn	Cn	Cn	Cn	C
2617A*+100	600 LPM LINE PRINTER (incl. 12845B I/F)	Cn	Cn	Cn	Cn	Cn	Cn	Cn	Cn	Cn	Cn	Cn	Cn	C
2619A*+100	1000 LPM LINE PRINTER (incl. 12845B I/F)	Cn	Cn	Cn	Cn	Cn	Cn	Cn	Cn	Cn	Cn	Cn	Cn	C
2631A*/B*+210	180 cps (impact) PRINTER (incl. 12845B I/F)	Cn	Cn	Cn	Cn	Cn	Cn	Cn	Cn	Cn	Cn	Cn	Cn	C
2671A	120 cps (thermal) PRINTER	Nt	Nt	Nt	Nt	Nt	Nt	Nt	Nt	Nt	Nt	Nt	Nt	Nt
2671G	120 cps (thermal) Graphics Printer	Nt	Nt	Nt	Nt	Nt	Nt	Nt	Nt	Nt	Nt	Nt	Nt	Nt
2673A	120 cps Intelligent Graphics Printer	Nt	Nt	Nt	Nt	Nt	Nt	Nt	Nt	Nt	Nt	Nt	Nt	Nt
2686A	LASERJET PRINTER	Nt	Nt	Nt	Nt	Nt	Nt	Nt	Nt	Nt	Nt	Nt	Nt	Nt
2687A	Desktop LASER Page PRINTER	Nt	Nt	Nt	Nt	Nt	Nt	Nt	Nt	Nt	Nt	Nt	Nt	Nt
2932A	GENERAL PURPOSE PRINTER via 12792A/B/C Mpx	Cn	Cn	Cn	Cn	Ccz	Cn	Ccz	Cn	Ccz	Cn	Ccz	Cn	C
2932A+046	GENERAL PURPOSE PRINTER via HP-IB I/F	Cn	Cn	Cn	Cn	Cep	Cn	Cep	Cn	Cep	Cn	Ccz	Cn	C
2933A*	FACTORY DATA PRINTER via 12792A/B/C Mpxer	Cn	Cn	Cn	Cn	Ccz	Cn	Ccz	Cn	Ccz	Cn	Ccz	Cn	C
2933A*+046	FACTORY DATA PRINTER via HP-IB I/F	Nt	Nt	Nt	Nt	Nt	Nt	Nt	Nt	Nt	Nt	Nt	Nt	Nt
2934A	OFFICE PRINTER via 12792A/B/C Multiplexer	Cn	Cn	Cn	Cn	Ccz	Cn	Ccz	Cn	Ccz	Cn	Ccz	Cn	C
2934A+046	OFFICE PRINTER via HP-IB I/F	Nt	Nt	Nt	Nt	Nt	Nt	Nt	Nt	Nt	Nt	Nt	Nt	Nt
82905A/B	80 cps IMPACT PRINTER via HP-IB Interface	Nt	Nt	Nt	Nt	Nt	Nt	Nt	Nt	Nt	Nt	Nt	Nt	Nt
82906A	160 cps DOT-MATRIX PRINTER via HP-IB I/F	Nt	Nt	Nt	Nt	Nt	Nt	Nt	Nt	Nt	Nt	Nt	Nt	Nt
9876A	THERMAL GRAPHICS PRINTER via HP-IB I/F	Cn	Cn	Cn	Cn	Cn	Cn	Cn	Cn	Cn	Cn	Cn	Cn	C

13. GRAPHICS INTERFACES AND GRAPHICS/1000-II SUPPORTED GRAPHICS DEVICES

12966A+001	Buffered ASYNC INTERFACE to 264x Graphics Terminal	C	C	C	C	C	C	C	C	C	C	C	C	C
12966A+004	Buffered ASYNC INTERFACE to 722xC*/T* RS-232-C Plotter and required 264xA or 2635A*/B*+051 Terminal	C	C	C	C	C	C	C	C	C	C	C	C	C
12966A+105	Buffered ASYNC INTERFACE to 262x Graphics Terminal	C	C	C	C	C	C	C	C	C	C	C	C	C
12792A*/B*/C	Eight-chan ASYNC MULTIPLEXER to 262xA or 264x Graphics Terminals	C	C	C	C	C	C	C	C	C	C	C	C	C
12821A+001	HP-IB INTERFACE to 256xA and 2608S GRAPHICS PRINTERS	C	C	C	C	C	C	C	C	C	C	C	C	C

FOOTNOTES:

\* = Obsolete product listed here for reference only.

Table 6.4-3. HP 1000 M/E/F-Series Compatibility Matrix, continued

PRODUCT AND OPTION NUMBERS	DESCRIPTION	COMPATIBILITY											
		COMPUTERS AND SYSTEMS										OP SYSTEM	
		2108M/2112M	2109E/2113E	2111F/2117F	2176C	2176E	2177C	2177F	2178A	2178C	2179A	2179C	RTE-6/VM

LEGEND:  
 Cc = Compatible and complies with FCC Class A EMI regs  
 Cz = Compatible and FTZ licensed  
 Ccz = Compatible, complies with FCC Class A EMI regs and FTZ licensed  
 Cep = Compatible, EMI qualification pending  
 Cn = Compatible, but not EMI qualified  
 C = Compatible or supported without reference to EMI qualification  
 N = Not compatible  
 Nt = Not tested for functional compatibility  
 I = Currently included hardware

13. GRAPHICS INTERFACES AND GRAPHICS/1000-II SUPPORTED GRAPHICS DEVICES, continued

59310B	HP-IB INTERFACE to 1350S*/1351S*, 7225A* w/17601, 7245A*, 747xA, 7550A, 758xA*/B, 9111A, 9872A*/B*/C*/S*/T*, or 9874A*.	C	C	C	C	C	C	C	C	C	C	C	C	C	C	C
13279B	COLOR VIDEO MONITOR	N	N	N	N	N	N	N	N	N	N	N	N	N	N	N
1350S*/1351S	GRAPHICS DISPLAY SYSTEM via 1/14 of 59310B Interface	Cn	Cn	Cn	Cn	Cn	Cn	Cn	Cn	Cn	Cn	Cn	Cn	C26	C26	C26
2563A+210	300 LPM LINE PRINTER via 12821A+001 I/F	Cn	Cn	Cn	N	N	N	N	Cn	Ccz	Cn	Ccz	C	N	N	N
2565A+210	600 LPM LINE PRINTER via 12821A+001 I/F	Cn	Cn	Cn	N	N	N	N	Cn	Ccz	Cn	Ccz	C	N	N	N
2566A+210	880 LPM LINE PRINTER via 12821A+001 I/F	Cn	Cn	Cn	N	N	N	N	Cn	Ccz	Cn	Ccz	C	N	N	N
2608A*+210	LINE PRINTER (includes 26099A Interface)	Cn	Cn	Cn	Cn	Ccz	Cn	Ccz	Cn	Ccz	Cn	Ccz	C26	C26	N	N
2608S+210	LINE PRINTER (includes 12821A+001 I/F)	Cn	Cn	Cn	N	N	N	N	Cn	Ccz	Cn	Ccz	C26	N	N	N
2623A	GRAPHICS TERMINAL	Cn	Cn	Cn	Cn	Ccz	Cn	Ccz	Cn	Ccz	Cn	Ccz	C26	C26	C26	C26
2625A+523	DUAL SYSTEM DISPLAY TERMINAL	Cn	Cn	Cn	Cn	Ccz	Cn	Ccz	Cn	Ccz	Cn	Ccz	C27	C27	C27	C27
2627A	COLOR GRAPHICS TERMINAL	Cn	Cn	Cn	Cn	Ccz	Cn	Ccz	Cn	Ccz	Cn	Ccz	C27	C27	C27	C27
2628A+523	WORD PROCESSING TERMINAL	Cn	Cn	Cn	Cn	Ccz	Cn	Ccz	Cn	Ccz	Cn	Ccz	C27	C27	C27	C27
2647A*	INTELLIGENT GRAPHICS TERMINAL	Cn	Cn	Cn	Cn	Ccz	Cn	Ccz	Cn	Ccz	Cn	Ccz	C26	C26	C26	C26
2647F*	INTELLIGENT GRAPHICS TERMINAL	Nt	Nt	Nt	Nt	Nt	Nt	Nt	Nt	Nt	Nt	Nt	Nt	Nt	Nt	Nt
2648A*	GRAPHICS TERMINAL	Cn	Cn	Cn	Cn	Ccz	Cn	Ccz	Cn	Ccz	Cn	Ccz	C26	C26	C26	C26
7220C*/T*	RS-232-C GRAPHICS PLOTTER w/8 pens & HP/GL programming via 12966A+004 I/F and 2635A*/B+051 or 264x Terminal	Cn	Cn	Cn	Cn	Cn	Cn	Cn	Cn	Cn	Cn	Cn	C26	C26	C26	C26
7221C*/T*	RS-232-C GRAPHICS PLOTTER w/8 pens & compacted binary programming via 12966A+004 I/F and 2635A*/B+051 or 264x Terminal	Cn	Cn	Cn	Cn	Cn	Cn	Cn	Cn	Cn	Cn	Cn	C26	C26	C26	C26
7225B*+17601A*	GRAPHICS PLOTTER (one pen) via 1/14 of 59310B interface	Cn	Cn	Cn	Cn	Cn	Cn	Cn	Cn	Cn	Cn	Cn	C26	C26	C26	C26
7245B*	PLOTTER/PRINTER via 1/14 of 59310B I/F	Cn	Cn	Cn	Cn	Cn	Cn	Cn	Cn	Cn	Cn	Cn	C28	C28	C28	C28
7470A+002	GRAPHICS PLOTTER (two pens) via 59310B I/F	Cn	Cn	Cn	Cn	Ccz	Cn	Ccz	Cn	Ccz	Cn	Ccz	C26	C26	C26	C26
7475A+002	GRAPHICS PLOTTER (six pens) via 59310B I/F	Cn	Cn	Cn	Cn	Ccz	Cn	Ccz	Cn	Ccz	Cn	Ccz	C26	C26	C26	C26
7550A	GRAPHICS PLOTTER (eight pens and automatic sheet feed) via 1/14 of 59310B Interface	Cn	Cn	Cn	Cn	Ccz	Cn	Ccz	Cn	Ccz	Cn	Ccz	C26	C26	C26	C26
7580B or 7580A*+002	DRAFTING PLOTTER (eight pens) via 1/14 of 59310B Interface	Cn	Cn	Cn	Cn	Ccz	Cn	Ccz	Cn	Ccz	Cn	Ccz	C26	C26	C26	C26
7585B or 7585A*+002	DRAFTING PLOTTER (eight pens) via 1/14 of 59310B Interface	Cn	Cn	Cn	Cn	Ccz	Cn	Ccz	Cn	Ccz	Cn	Ccz	C26	C26	C26	C26
7586B	DRAFTING PLOTTER (eight pens and roll feed) via 1/14 of 59310B Interface	Cn	Cn	Cn	Cn	Ccz	Cn	Ccz	Cn	Ccz	Cn	Ccz	C26	C26	C26	C26
9111A	GRAPHICS TABLET via 1/14 of 59310B I/F	Cn	Cn	Cn	Cn	Ccz	Cn	Ccz	Cn	Ccz	Cn	Ccz	C26	C26	C26	C26
9872C*/T*	GRAPHICS PLOTTER (eight pens) via 1/14 of 59310B interface	Cn	Cn	Cn	Cn	Ccz	Cn	Ccz	Cn	Ccz	Cn	Ccz	C26	C26	C26	C26
9872A*/B*/S*	GRAPHICS PLOTTER (four pens) via 1/14 of 59310B interface	Cn	Cn	Cn	Cn	Cn	Cn	Cn	Cn	Cn	Cn	Cn	C26	C26	C26	C26
9874A*	DIGITIZER via 1/14 of 59310B interface	Cn	Cn	Cn	Cn	Cn	Cn	Cn	Cn	Cn	Cn	Cn	C26	C26	C26	C26

14. OTHER PERIPHERAL DEVICES

12925A*	PUNCHED TAPE READER SUBSYSTEM	Cn	Cn	Cn	Cn	Cn	Cn	Cn	Cn	Cn	Cn	Cn	C	C	C	C
12926A*	TAPE PUNCH SUBSYSTEM	Cn	Cn	Cn	Cn	Cn	Cn	Cn	Cn	Cn	Cn	Cn	C	C	C	C
12985A*	CARD READER SUBSYSTEM	Cn	Cn	Cn	Cn	Cn	Cn	Nt	Nt	Nt	Nt	Nt	C	C	C	C

FOOTNOTES:

\* = Obsolete product listed here for reference only.  
 C26 = Requires 92841A or 92861A Graphics/1000-II Device-Independent Graphics Library.  
 C27 = Requires 92841A Graphics/1000-II Device-Independent Graphics Library having date code 2301 or higher or or 92861A Graphics/1000-II Device-Independent Graphics Library.  
 C28 = Requires 92840A Graphics/1000 Graphics Plotting (mature) Software.



Table 6.4-3. HP 1000 M/E/F-Series Compatibility Matrix, continued

LEGEND: Cc = Compatible and complies with FCC Class A EMI regs Cz = Compatible and FTZ licensed Ccz = Compatible, complies with FCC Class A EMI regs and FTZ licensed Cep = Compatible, EMI qualification pending Cn = Compatible, but not EMI qualified C = Compatible or supported without reference to EMI qualification N = Not compatible Nt = Not tested for functional compatibility I = Currently included hardware		COMPATIBILITY												
		COMPUTERS AND SYSTEMS											OP SYSTEM	
		2108M/2112M	2109E/2113E	2111F/2117F	2176C	2176E	2177C	2177F	2178A	2178C	2179A	2179C	RTE-6/VM	RTE-IVB
PRODUCT AND OPTION NUMBERS	DESCRIPTION													
15. HP 1000 NETWORK INTERFACES, PROGRAMMABLE SERIAL INTERFACE, AND STATISTICAL AND FIBER OPTIC MULTIPLEXERS														
12250A	X.25/1000 MODEM INTERFACE to Packet Switching Networks	C	C	C	C	C	C	C	C	C	C	C29	C29	C29
12260A	MODEM INTERFACE to IBM or Plug-Compatible Systems	C	C	C	C	C	C	C	C	C	C	C30	N	N
12771A	COMPUTER SERIAL INTERFACE to HP 1000	C	C	C	C	C	C	C	C	C	C	C31	C31	C31
12773A	COMPUTER MODEM INTERFACE to HP 1000	C	C	C	C	C	C	C	C	C	C	C31	C31	C31
12790A+001	DATA LINK MASTER INTERFACE to HP 1000	C	C	C	C	C	C	C	C	C	C	C32	C32	C32
12793A*/B	DS/1000-IV BISYNC MODEM I/F to HP 3000	C	C	C	C	C	C	C	C	C	C	C33	C33	C33
12794A*/B	DS/1000-IV HDLC MODEM I/F to DS/1000 node	C	C	C	C	C	C	C	C	C	C	C33	C33	C33
12825A	DS/1000-IV HDLC DIRECT CONNECT I/F to DS/1000 node	C	C	C	C	C	C	C	C	C	C	C33	C33	C33
12826A/B	PROGRAMMABLE SERIAL (modem) INTERFACE	C	C	C	C	C	C	C	C	C	C	N1	N1	N1
12830A	DS/1000-IV DATA LINK SLAVE I/F to HP 1000	C	C	C	C	C	C	C	C	C	C	C33	C33	C33
12834A	DS/1000-IV BISYNC DIR CONN I/F to HP 3000	C	C	C	C	C	C	C	C	C	C	C33	C33	C33
12889A	HARDWIRED SERIAL I/F to HP 3000 Ser II/III	C	C	C	C	C	C	C	C	C	C	C33	C33	C33
2334A	STATISTICAL MULTIPLEXER, connected via nected via 12792C Multiplexer	C	C	C	C	C	C	C	C	C	C34	C34	C34	C34
2334A	CLUSTER CONTROLLER, connected via 12250A X.25/1000 I/F	C	C	C	C	C	C	C	C	Cn	C34	C34	C34	C34
39301A	FIBER OPTIC MULTIPLEXER (pair of 39301As and 39200B cabling are used with 12792C)	C	C	C	C	C	C	C	C	C	C	C	C	C
16. OTHER DATA COMMUNICATIONS INTERFACES														
12261A	MULTI-USE PROG MULTIPLEXER for PCL/1000-AB	C	C	C	C	C	C	C	C	C	C	C35	N1	N1
12587B*	ASYNCHRONOUS COMMUNICATIONS INTERFACE	C	C	C	C	C	C	C	C	C	C	Nt	N1	N1
12589B*	AUTOMATIC CALLING UNIT INTERFACE	C	C	C	C	C	C	C	C	C	C	Nt	N1	N1
12618A	SYNC DATA SET I/F w/send & receive cards	C	C	C	C	C	C	C	C	C	C	C36	C36	N
12967A	ASYNCHRONOUS COMMUNICATIONS INTERFACE	C	C	C	C	C	C	C	C	C	C	N1	N1	N1
12968A	ASYNCHRONOUS COMMUNICATIONS INTERFACE	C	C	C	C	C	C	C	C	C	C	N1	N1	N1
17. MEASUREMENT AND CONTROL INTERFACES AND PERIPHERALS														
59310B	HP-IB I/F for 2240/2250 & other HP-IB Inst	C	C	C	C	C	C	C	C	C	C	C	C	C
91000A	PLUG-IN A-to-D INTERFACE SUBSYSTEM	C	C	C	C	C	C	C	C	C	C	C	C	C
2240A*	MEASUREMENT & CONTROL PROCESSOR	C	C	C	Cn	Cn	Cn	Cn	Cn	Cn	Cn	C	C37	C37
2250A/H	MEASUREMENT & CONTROL SYSTEM	C	C	C	Cn	Cn	Cn	Cn	Cn	Cn	Cn	C	C	C
2250M*/N*/R*	MEASUREMENT & CONTROL PROCESSOR	C	C	C	Cn	Cn	Cn	Cn	Cn	Cn	Cn	C	C	C
2313B*	ANALOG I/O SUBSYSTEM (includes interface)	C	C	C	Cn	Cn	Cn	Cn	Cn	Cn	Cn	Nt	C37	C37
18. GENERAL-PURPOSE INTERFACES														
12551B	16-BIT RELAY OUTPUT REGISTER	C	C	C	C	C	C	C	C	C	C	N1	N1	N1
12554A	16-BIT DUPLEX REGISTER	C	C	C	C	C	C	C	C	C	C	N1	N1	N1
12556B	40-BIT OUTPUT REGISTER	C	C	C	C	C	C	C	C	C	C	N1	N1	N1

FOOTNOTES:

- \* = Obsolete product listed here for reference only.
- C29 = Requires 91751A DSN/X.25 Communications Software.
- C30 = Requires 91782A DSN/MRJE 1000 Multitasking Remote Job Entry Software.
- C31 = Requires 91750A DS/1000-IV Network Software and 91740P/R DS/1000 firmware; 12773A will also require 12620A interface used as privileged fence.
- C32 = Requires 91730A Multipoint Subsystem Software and 91750A DS/1000-IV Network Software.
- C33 = Requires 91750A DS/1000-IV Network software.
- C34 = HP 2334A Statistical Multiplexer supports only character mode communication.
- C35 = Requires 92140A PCL/1000-AB Programmable Controller Link software.
- C36 = Requires 91780A RJE/1000 (which includes the 12618A interface).
- C37 = Requires 92066A RTE Measurement and Control Software.
- N1 = Support of this interface requires user-developed software.

Table 6.4-3. HP 1000 M/E/F-Series Compatibility Matrix, continued

LEGEND: Cc = Compatible and complies with FCC Class A EMI regs Cz = Compatible and FTZ licensed Ccz = Compatible, complies with FCC Class A EMI regs and FTZ licensed Cep = Compatible, EMI qualification pending Cn = Compatible, but not EMI qualified C = Compatible or supported without reference to EMI qualification N = Not compatible Nt = Not tested for functional compatibility I = Currently included hardware		COMPATIBILITY													
		COMPUTERS AND SYSTEMS										OP SYSTEM			
		2108M/2112M	2109E/2113E	2111F/2117F	2176C	2176E	2177C	2177F	2178A	2178C	2179A	2179C	RTE-6/VM	RTE-IVB	RTE-IVE
PRODUCT AND OPTION NUMBERS	DESCRIPTION														
18. GENERAL-PURPOSE INTERFACES, continued															
12560A* 12566B*/C 12604B	INCREMENTAL DIGITAL PLOTTER INTERFACE Microcircuit Duplex Register Data Source Interface	C	C	C	C	C	C	C	C	C	C	C	Nt	Nt	Nt
12620A 91200B	Breadboard Interface/RTE Priv Inter Fence TV Interface	C	C	C	C	C	C	C	C	C	C	C38	C38	C38	
19. SOFTWARE															
91730A	MULTIPOINT INTERFACE SUBSYSTEM SOFTWARE (used with 12790A interface)	C	C	C	C	C	C	C	C	C	C	C	C	C	
91731A	ASYNCHRONOUS MULTIPLEXER SOFTWARE (used with 12920B interface)	C	C	C	C	C	C	C	Nt	Nt	Nt	Nt	Nt	C	C
91740A# 91740P	DS/1000 NETWORK SOFTWARE-FIRMWARE DS/1000 NETWORK FIRMWARE AND RIGHT TO COPY 91740A SOFTWARE to one system	C	N	N	N	N	N	N	N	N	N	N	N	C	C
91740B# 91740R	DS/1000 NETWORK SOFTWARE-FIRMWARE DS/1000 NETWORK FIRMWARE AND RIGHT TO COPY 91740B SOFTWARE to one system	N	C	C	C	C	C	C	C	C	C	C	C	C	C
91741A#	DS/1000 S/W ENHANCEMENT for HP 3000 comm.	C	C	C	C	C	C	C	C	C	C	C	N	C	C
91745A	DATASAFE/1000 on-line disc cartridge duplication software	C39	C39	C	N	N	N	N	C	C	C	C	N	C	N
91747A 91750A 91751A	DATASHARE/1000 multi-CPU file sharing s/w DS/1000-IV Network Software X.25/1000 Network Software	C40	C40	C40	N	N	N	N	C40	C40	C40	C40	C	C	C
91780A# 91781A 91782A 91784A	RJE/1000 Software RJE/1000-II Software MJRE/1000 Software PMF/1000 Programmatic Mainframe Facility Software	C	C	C	C	C	C	C	C	C	C	C	C	C	C
92001B# 92060A# 92061A 92063A#	RTE-II Operating System RTE-III Operating System RTE MICROPROGRAMMING Software IMAGE/1000 DBMS Software with Query	C	C	N	N	N	N	N	N	N	N	N	N	N	N
92064A# 92065A# 92066A# 92067A# 92068A/E	RTE-M Operating System BASIC/1000M RTE MEASUREMENT AND CONTROL Software RTE-IV Operating System RTE-IVB/RTE-IVE Operating System	C	C	C	N	N	N	N	C43	C43	C43	C43	C	C	C
92069A 92073A# 92080A# 92081A	IMAGE/1000 DBMS Software with Query IMAGE/1000 DBMS Software without Query DATACAP/1000-II Software IMAGE/1000-II DBMS Software with Query	C	C	C	C	C	C	C	C	C	C	C	C	C	C

FOOTNOTES:

- \* = Obsolete product listed here for reference only.
- # = Inactive software product listed here for reference only.
- C38 = Compatible as RTE Privileged Interrupt Fence; support as user-developed interface requires user-developed software.
- C39 = Compatible in 2108/2112 Computer with Serial Prefix 1810 or later, 2109/2113 Computer with Serial Prefix 1812 or later, and all 2108/2109/2112/2113 Computers that have been upgraded for use with RTE-IV/IVB or RTE-6/VM.
- C40 = Compatible only in system with 79xxM MAC Discs and computer that meets the criteria of C39, above.
- N1 = Support of this interface requires user-developed software.
- C41 = Requires 13197A 1k Writable Control Store board.
- C42 = Only WCS Driver and WCS Load Utility are supported in RTE-IVE.

Table 6.4-3. HP 1000 M/E/F-Series Compatibility Matrix, continued

LEGEND: Cc = Compatible and complies with FCC Class A EMI regs Cz = Compatible and FTZ licensed Ccz = Compatible, complies with FCC Class A EMI regs and FTZ licensed Cep = Compatible, EMI qualification pending Cn = Compatible, but not EMI qualified C = Compatible or supported without reference to EMI qualification N = Not compatible Nt = Not tested for functional compatibility I = Currently included hardware		COMPATIBILITY												
		COMPUTERS AND SYSTEMS										OP SYSTEM		
		2108M/2112M	2109E/2113E	2111F/2117F	2176C	2176E	2177C	2177F	2178A	2178C	2179A	2179C	RTE-6/VM	RTE-IVB
PRODUCT AND OPTION NUMBERS	DESCRIPTION													
19. SOFTWARE, continued														
92082A#	ACCEL/1000 software	C	C	C	C	C	C	C	C	C	C	C	C	C
92083A	RTE PROFILE MONITOR	C	C	C	C	C	C	C	C	C	C	C	C	C
92084A	RTE-6/VM Operating System	C43	C43	C	C	C	C	C	C	C	C	C	C	C
92091A#	HPSPICE Circuit Simulation Program	N	N	C	C	C	C	C	C	C	C	C	C	C
92101A	BASIC/1000D	C	C	C	C	C	C	C	C	C	C	C	C	C
92120A#	PMC/1000 Software	C	C	C	C	C	C	C	C	C	C	C	C	C
92121A	PMC/1000 Software (For A-Series)	N	N	C	C	C	C	C	C	C	C	C	C	C
92130A#	QDM/1000 Software	N	N	C	C	C	C	C	C	C	C	C	C	C
92131A	QDM/1000 Software (For A-Series)	N	N	C	C	C	C	C	C	C	C	C	C	C
92140A#	PCL/1000-AB Software	N	N	C	C	C	C	C	C	C	C	C	C	C
92400A#	SENSOR-BASED DAS UTILITY PACKAGE	C	C	C	C	C	C	C	C	C	C	C	C	C
92832A	PASCAL/1000	C	C	C	C	C	C	C	C	C	C	C	C	C
92833A	PASCAL/1000	C	C	C	C	C	C	C	C	C	C	C	C	C
92834A	FORTRAN 4X	C	C	C	C	C	C	C	C	C	C	C	C	C
92835A	SIGNAL/1000 Software	C	C	C	C	C	C	C	C	C	C	C	C	C
92836A	FORTRAN 77	C	C	C	C	C	C	C	C	C	C	C	C	C
92840A#	Graphics/1000 Graphics Plotting Software	C	C	C	C	C	C	C	C	C	C	C	C	C
92841A	Version 1.0 DEVICE-INDEPENDENT GRAPHICS LIBRARY	C	C	C	C	C	C	C	C	C	C	C	C	C
92842A	VERSION 1.0 ADVANCED GRAPHICS PACKAGE	C	C	C	C	C	C	C	C	C	C	C	C	C
92843X	VERSION 1.0 SKELETON DEVICE HANDLER SOURCE PRODUCT	C	C	C	C	C	C	C	C	C	C	C	C	C
92857A	BASIC/1000C	C	C	C	C	C	C	C	C	C	C	C	C	C
92860A	SYMBOLIC DEBUG/1000	C	C	C	C	C	C	C	C	C	C	C	C	C
92861A	Version 2.0 DEVICE-INDEPENDENT GRAPHICS LIBRARY	C	C	C	C	C	C	C	C	C	C	C	C	C
92862A	VERSION 2.0 ADVANCED GRAPHICS PACKAGE	C	C	C	C	C	C	C	C	C	C	C	C	C
94200A	PCIF/1000 PROGRAMMABLE CONTROLLER INTER-FACE Software (For A-Series)	N	N	N	N	N	N	N	N	N	N	N	N	N

FOOTNOTES:

- # = Inactive software product listed here for reference only.
- C43 = Compatible in 2108/2112 Computer with Serial Prefix 1810 or later, 2109/2113 Computer with Serial Prefix 1812 or later, and 2108/2109/2112/2113 Computers having earlier serial prefixes that have been upgraded for use with RTE-IV/IVB/IVE or RTE-6/VM.



---

HEWLETT-PACKARD COMPANY  
Data Systems Division  
11000 Wolfe Road  
Cupertino, California 95014

MANUAL PART NO. 92007-90001  
Printed in U.S.A. May 1985