



---

**NOS VERSION 1  
SYSTEM MAINTENANCE  
REFERENCE MANUAL**

---

**CDC® COMPUTER SYSTEMS:  
CYBER 170 SERIES  
CYBER 70  
MODELS 71, 72, 73, 74  
6000 SERIES**

# CONTROL STATEMENTS

ACPD	15-4	MAINLOG	2-38
AFD	2-38	MODVAL	5-12
ASDEBUG	3-37	MREC	8-3
ASDEF	3-9		
ASLABEL	3-10		
ASMOVE	3-17		
ASTIM	4-14	NDA	4-5
ASUSE	3-30	NSTIM	4-15
ASVAL	3-22		
CHARGE	5-59	PFATC	1-7
		PFCAT	1-7
		PFCOPY	1-41
		PFDUMP	1-41
		PFLOAD	1-42
DEMUX	4-30	PROBE	15-22
DFD	2-38	PROFILE	5-40
DFLIST	2-25		
DFTERM	2-23		
DSDI	10-3		
		QALTER	2-34
		QDUMP	2-26
		QLIST	2-25
ELD	2-38	QLOAD	2-28
ENDCPD	15-4	QMOVE	2-30
		QREC	2-18
FAMILY	1-17		
FNTLIST	2-36	SCRSIM	11-2
FORMAT	13-2	STIMULA	4-14
		SYSEDT	6-1
IAFEX	4-8.1		
ICPD	15-2	VALNET	4-12
INSTALL	12-1		
ISF	7-1		
LDLIST	2-34		
LFG	4-3		
LOADBC	14-1		

# REVISION RECORD

REVISION	DESCRIPTION
A (05-15-78)	Manual released. This manual contains information previously located in the NOS Version 1 Installation Handbook, part II (SYSFDIT) and part IV (all sections), publication 60435700 and the Network Products Network Access Method Version 1, Administrator and Operator Facility Reference Manual, section 8 (Utilities), publication number 60480100. New features described in this manual include queue utility improvements (QALTFR and FNTLIST), permanent file utility improvements (true device option), 580 programmable format control phase 2 improvements (AW=CBIO for MODVAL), control use of passwords (MODVAL control statement parameter RP), network host products enhancements (LFG replaces NPUFIL and NDA supports 2552 dumps), and Interactive Facility and Terminal Verification Facility support (MODVAL control statement parameter SP and input directive AP=xxxx). This manual reflects NOS 1.3 and its product set at PSR level 472/470.
B (09-11-78)	Revised to reflect NOS 1.3 at PSR level 477 and to make miscellaneous technical and literary corrections. Special user index and the DAYFILF directive have been added, and the section on stimulators has been modified.
C (12-22-78)	Revised to reflect NOS 1.3 at PSR level 485 and to make miscellaneous technical and literary corrections. Changes include addition of NRC parameter for QALTFR utility, AD parameter for NDA control statement, Z parameter for SYSFDIT control statement, HS parameter for NAMIAF directive, and the date to FORMAT output header. Support of the 16-word catalog entry format is also included.
D (08-10-79)	Revised to reflect NOS 1.4 at PSR level 501 and to make miscellaneous technical and literary corrections. New features include support of CYBFR 170 Model 176, on-line FCS diagnostics, 885/7155 disk drive, deadstart from mass storage (INSTALL control statement), and IAF initialization. This edition obsoletes all previous editions.
E (12-21-79)	Revised to reflect NOS 1.4 at PSR level 509 and to make miscellaneous technical and literary corrections. New features include support of the Mass Storage Subsystem (MSS), application usage accounting, and downline loading of controlware.
F (05-23-80)	Revised to reflect NOS 1.4 at PSR level 518 and to make miscellaneous technical and literary corrections. Changes include the binary maintenance log dumping utility, MAINLOG; a DSDI directive, MAINLOG; and various changes to account dayfile messages.
G (12-12-80)	Revised to reflect NOS 1.4 at PSR level 531 and to make miscellaneous technical and literary corrections. Changes include system data gathering utilities, TRACER and PROBE, and PRU interface.
H (04-22-81)	Revised to reflect NOS 1.4 at PSR level 531. This revision includes the DSDI input directive SECDED.

Publication No.  
60455380

**REVISION LETTERS I, O, Q AND X ARE NOT USED**

Address comments concerning this manual to:  
Control Data Corporation  
Publications and Graphics Division  
4201 North Lexington Avenue  
St. Paul, Minnesota 55112

© 1978, 1979, 1980, 1981  
by Control Data Corporation  
All rights reserved  
Printed in the United States of America

or use Comment Sheet in the back of this manual.

## LIST OF EFFECTIVE PAGES

New features, as well as changes, deletions, and additions to information in this manual, are indicated by bars in the margins or by a dot near the page number if the entire page is affected. A bar by the page number indicates pagination rather than content has changed.

PAGE	REV	PAGE	REV	PAGE	REV	PAGE	REV	PAGE	REV
Front Cover	-	1-42	E	3-10	G	4-14	D	5-38.1/	
Inside Front		1-43	E	3-10.1/		4-15	D	5-38.2	G
Cover	G	1-44	E	3-10.2	G	4-16	E	5-39	D
Title Page	-	1-45	G	3-11	G	4-17	D	5-40	D
ii	H	1-46	E	3-12	G	4-18	D	5-41	F
iii	H	1-47	E	3-13	G	4-19	E	5-42	D
iv	H	1-48	E	3-14	E	4-20	D	5-43	D
v	G	1-49	E	3-15	E	4-21	D	5-44	D
vi	G	1-50	E	3-16	E	4-22	E	5-45	D
vi-a/vi-b	G	1-51	E	3-17	E	4-23	D	5-46	D
vii	G	1-52	E	3-18	E	4-24	D	5-47	D
viii	G	2-1	G	3-19	E	4-25	D	5-48	D
ix	G	2-2	D	3-20	G	4-26	B	5-49	D
x	H	2-3	F	3-21	G	4-27	B	5-50	D
xi	G	2-4	D	3-22	G	4-28	B	5-51	D
xii	G	2-5	G	3-23	E	4-29	B	5-52	G
1-1	D	2-6	F	3-24	E	4-30	E	5-53	D
1-2	A	2-7	G	3-25	E	4-31	D	5-54	D
1-3	E	2-8	G	3-26	G	4-32	F	5-55	G
1-4	D	2-9	G	3-27	E	4-33	D	5-56	D
1-5	D	2-10	F	3-28	G	4-34	D	5-57	D
1-6	G	2-11	D	3-29	G	5-1	G	5-58	G
1-7	D	2-12	F	3-30	G	5-2	G	5-59	G
1-8	E	2-13	G	3-31	E	5-3	A	5-60	D
1-9	G	2-14	D	3-32	E	5-4	D	5-61	D
1-10	E	2-15	D	3-33	E	5-5	D	5-62	E
1-11	E	2-16	D	3-34	E	5-6	D	5-63	G
1-12	G	2-17	D	3-35	G	5-7	E	5-64	D
1-13	E	2-18	G	3-36	G	5-8	A	5-65	E
1-14	E	2-19	E	3-37	G	5-9	G	5-66	E
1-15	E	2-20	D	3-38	E	5-10	D	5-67	E
1-16	E	2-21	F	3-39	E	5-11	D	5-68	E
1-17	E	2-22	D	3-40	E	5-12	D	5-69	E
1-18	E	2-23	F	3-41	G	5-13	D	5-70	E
1-19	E	2-24	F	3-42	G	5-14	D	5-71	E
1-20	E	2-25	D	3-43	G	5-15	D	5-72	E
1-21	G	2-26	E	3-44	G	5-16	D	5-73	D
1-22	E	2-27	E	3-45	G	5-17	E	5-74	D
1-23	G	2-28	D	3-46	G	5-18	G	5-75	E
1-24	G	2-29	E	3-46.1/		5-19	G	5-76	D
1-24.1/		2-30	D	3-46.2		5-20	G	5-77	D
1-24.2	G	2-31	E	3-47	G	5-21	G	5-78	G
1-25	G	2-32	E	3-48	E	5-22	D	5-79	F
1-26	E	2-33	D	3-49	E	5-23	D	5-80	F
1-27	G	2-34	D	4-1	F	5-24	D	5-81	F
1-28	G	2-35	D	4-2	A	5-25	D	5-82	F
1-29	E	2-36	D	4-3	D	5-26	G	5-83	F
1-30	G	2-37	D	4-4	D	5-27	D	5-84	E
1-31	G	2-38	G	4-5	G	5-28	D	5-85	G
1-32	G	2-39	F	4-6	D	5-29	G	5-86	G
1-33	E	3-1	E	4-7	F	5-30	G	5-87	E
1-34	G	3-2	E	4-8	D	5-31	D	5-88	E
1-35	G	3-3	G	4-8.1	G	5-32	G	6-1	F
1-36	G	3-4	E	4-8.2	E	5-33	D	6-2	F
1-37	E	3-5	G	4-9	E	5-34	D	6-3	D
1-38	E	3-6	E	4-10	D	5-35	D	6-4	F
1-39	E	3-7	E	4-11	D	5-36	D	6-5	D
1-40	E	3-8	E	4-12	D	5-37	E	6-6	A
1-41	E	3-9	E	4-13	D	5-38	G	6-7	F

PAGE	REV	PAGE	REV	PAGE	REV	PAGE	REV	PAGE	REV
7-1	G	13-8	E	A-30.1/		Index-3	G		
7-2	G	13-9	E	A-30.2	G	Index-4	G		
7-3	D	13-10	E	A-31	E	Index-5	H		
7-4	D	14-1	G	A-32	E	Index-6	G		
8-1	E	15-1	G	A-33	E	Comment			
8-2	A	15-2	G	A-34	E	Sheet	H		
8-3	D	15-3	G	A-35	E	Back Cover	-		
8-4	D	15-4	G	A-36	F				
8-5	A	15-5	G	A-37	G				
8-6	E	15-6	G	A-38	G				
8-7	E	15-7	G	A-38.1/					
8-8	E	15-8	G	A-38.2	G				
9-1	E	15-9	G	A-39	E				
9-2	D	15-10	G	A-40	E				
9-3	D	15-11	G	A-41	F				
9-4	D	15-12	G	A-42	F				
9-5	D	15-13	G	A-42.1/					
10-1	D	15-14	G	A-42.2	G				
10-2	D	15-15	G	A-43	G				
10-3	D	15-16	G	A-44	G				
10-4	E	15-17	G	A-45	E				
10-5	G	15-18	G	A-46	E				
10-6	A	15-19	G	A-47	E				
10-7	D	15-20	G	A-48	F				
10-8	G	15-21	G	A-48.1/					
10-9	A	15-22	G	A-48.2	F				
10-10	A	15-23	G	A-49	G				
10-11	D	15-24	G	A-50	G				
10-12	F	15-25	G	A-51	E				
10-13	F	15-26	G	A-52	G				
10-14	D	15-27	G	A-53	G				
10-15	G	15-28	G	A-54	G				
10-16	D	15-29	G	A-54.1/					
10-17	D	A-1	G	A-54.2	G				
10-18	D	A-2	F	A-55	E				
10-19	F	A-2.1	F	A-56	E				
10-20	H	A-2.2	F	A-57	E				
10-20.1/		A-3	E	A-58	E				
10-20.2	H	A-4	E	A-59	E				
10-21	D	A-5	G	A-60	E				
10-22	D	A-6	E	A-61	E				
10-23	D	A-7	E	A-62	E				
10-24	D	A-8	E	A-63	E				
10-25	G	A-9	E	A-64	E				
10-26	D	A-10	G	A-65	F				
10-27	D	A-11	E	A-66	F				
10-28	D	A-12	E	A-67	E				
10-29	G	A-13	G	A-68	E				
10-30	G	A-14	F	A-69	E				
10-31/10-32	E	A-14.1/		A-70	E				
10-33	D	A-14.2	G	A-71	E				
10-34	D	A-15	E	A-72	G				
10-35	F	A-16	F	A-73	E				
10-36	F	A-17	E	A-74	E				
10-37	F	A-18	G	A-75	E				
10-38	D	A-18.1/		A-76	E				
10-39	D	A-18.2	G	A-77	E				
11-1	A	A-19	F	A-78	F				
11-2	A	A-20	E	A-79	E				
11-3	A	A-21	E	A-80	E				
11-4	G	A-22	F	A-81	E				
11-5	A	A-23	G	A-82	G				
11-6	D	A-24	G	A-83	E				
12-1	D	A-24.1/		A-84	G				
13-1	G	A-24.2	G	A-84.1/					
13-2	E	A-25	E	A-84.2	G				
13-3	E	A-26	E	A-85	E				
13-4	G	A-27	E	A-86	E				
13-5	E	A-28	G	A-87	E				
13-6	E	A-29	G	Index-1	G				
13-7	E	A-30	E	Index-2	G				

## PREFACE

---

The Network Operating System (NOS) was developed by Control Data Corporation to provide network capabilities for time-sharing and transaction processing, in addition to local and remote batch processing, on the CONTROL DATA® CYBER 170 Series; CDC® CYBER 70 Series, Models 71, 72, 73, and 74 Computer Systems, and CDC 6000 Series Computer Systems.

## CONVENTIONS

Extended memory for the CYBER 170 Model 176 is large central memory extended (LCME). Extended memory for all other NOS computer systems is extended core storage (ECS) or extended semiconductor memory (ESM).

In this manual, the acronym ECS refers to all forms of extended memory unless otherwise noted. However, in the context of a multmainframe environment or distributive data path (DDP) access, model 176 is excluded.

Programming information for the various forms of extended memory can be found in the COMPASS Reference Manual and in the appropriate computer system hardware reference manual. Hardware descriptions of the various forms of extended memory can be found in the following manuals.

<u>Control Data Publication</u>	<u>Publication Number</u>
Extended Semiconductor Memory Hardware Reference Manual	60455990
Extended Core Storage Reference Manual	60347100
Extended Core Storage II and Distributive Data Path Reference Manual	60430000

## AUDIENCE

This manual contains information required by the site analyst or administrative personnel to perform the day-to-day maintenance activities required in a normal production environment of NOS.

## RELATED PUBLICATIONS

The reader should be thoroughly familiar with the material in the following publications.

<u>Control Data Publication</u>	<u>Publication Number</u>
Network Products Interactive Facility Version 1 Reference Manual	60455250
or NOS Version 1 Time-Sharing User's Reference Manual	60435500
NOS Version 1 Operator's Guide	60435600
NOS Version 1 Reference Manual, Volume 1	60435400

The NOS Manual Abstracts is a pocket-sized manual containing brief descriptions of the contents and intended audience of all NOS and NOS product manuals. The abstracts can be useful in determining which manuals are of greatest interest to a particular user.

Control Data also publishes a Software Publications Release History of all software manuals and revision packets it has issued. This history report lists the revision level of a particular manual that corresponds to the level of software installed at the site.

The following publications provide additional information about NOS and its product set that may be useful to the reader.

<u>Control Data Publication</u>	<u>Publication Number</u>
COMPASS Version 3 Reference Manual	60492600
CYBER Loader Version 1 Reference Manual	60429800
CYBER Record Manager Advanced Access Methods Version 2 Reference Manual	60499300
CYBER Record Manager Basic Access Methods Version 1.5 Reference Manual	60495700
CYBER 70 Model 71 Computer System Reference Manual	60453300
CYBER 70 Model 72 Computer System Reference Manual	60347000
CYBER 70 Model 73 Computer System Reference Manual	60347200
CYBER 70 Model 74 Computer System Reference Manual	60347400
CYBER 170 Computer Systems Models 720, 730, 750, 760, and 176 (Level B) Hardware Reference Manual	60456100
CYBER 170 Computer Systems Reference Manual	60420000
Export/Import Reference Manual	60436200
FORTTRAN Extended Version 4 Reference Manual	60497800
FORTTRAN Version 5 Reference Manual	60481300
Modify Instant	60450200
Modify Reference Manual	60450100
Network Products Message Control System Version 1 Reference Manual	60480300
Network Products Network Access Method Version 1 Reference Manual	60499500
Network Products Network Access Method Version 1 Network Definition Language Reference Manual	60480000
Network Products Network Terminal User's Instant	60455270

<u>Control Data Publication</u>	<u>Publication Number</u>
Network Products Remote Batch Facility Version 1 Reference Manual	60499600
Network Products Stimulator Reference Manual	60480500
Network Products Transaction Facility Version 1 Reference Manual	60455340
Network Products Transaction Facility Version 1 User's Guide	60455360
NOS Version 1 Applications Programmer's Instant	60436000
NOS Version 1 Batch User's Guide	60436300
NOS Version 1 Diagnostic Index	60455720
NOS Version 1 Installation Handbook	60435700
NOS Version 1 Manual Abstracts	84000420
NOS Version 1 Operator's Guide	60435600
NOS Version 1 Reference Manual, Volume 2	60445300
NOS Version 1 Systems Programmer's Instant	60449200
NOS Version 1 Terminal User's Instant	60435800
Software Publications Release History	60481000
TAF/TS Version 1 Reference Manual	60453000
TAF/TS Version 1 User's Guide	60436500
Text Editor Reference Manual	60436100
Update Reference Manual	60449900
6400/6500/6600 Computer Systems Reference Manual	60100000

## **DISCLAIMER**

NOS and its product set are intended to be used only as described in this document. Control Data cannot be responsible for the proper functioning of undescribed features or parameters.



# CONTENTS

<p><b>1. PERMANENT FILE UTILITIES</b> <span style="float: right;">1-1</span></p> <p>Definitions <span style="float: right;">1-1</span></p> <p style="padding-left: 20px;">Archive File (Tape) <span style="float: right;">1-1</span></p> <p style="padding-left: 20px;">User Index <span style="float: right;">1-3</span></p> <p style="padding-left: 20px;">Device Masks <span style="float: right;">1-3</span></p> <p style="padding-left: 40px;">Device Mask <span style="float: right;">1-3</span></p> <p style="padding-left: 40px;">Secondary Mask <span style="float: right;">1-5</span></p> <p style="padding-left: 20px;">Mass Storage Table <span style="float: right;">1-7</span></p> <p style="padding-left: 20px;">Catalog Track <span style="float: right;">1-7</span></p> <p style="padding-left: 20px;">Permanent File Catalog Entry <span style="float: right;">1-9</span></p> <p style="padding-left: 20px;">Track Reservation Table <span style="float: right;">1-14</span></p> <p style="padding-left: 20px;">Family <span style="float: right;">1-17</span></p> <p>Calling the Utilities <span style="float: right;">1-20</span></p> <p style="padding-left: 20px;">Console Input <span style="float: right;">1-20</span></p> <p style="padding-left: 20px;">Batch Input <span style="float: right;">1-25</span></p> <p style="padding-left: 20px;">Terminal Input <span style="float: right;">1-25</span></p> <p>Parameters for the Permanent File Utilities <span style="float: right;">1-25</span></p> <p style="padding-left: 20px;">Description of Permanent File Utility Parameters <span style="float: right;">1-27</span></p> <p style="padding-left: 20px;">Preassigning the Archive File <span style="float: right;">1-33</span></p> <p>Permanent File Utility Routines <span style="float: right;">1-34</span></p> <p style="padding-left: 20px;">Catalog Archive File (PFATC) <span style="float: right;">1-37</span></p> <p style="padding-left: 20px;">Catalog Permanent File Device (PFCAT) <span style="float: right;">1-37</span></p> <p style="padding-left: 20px;">Copy Archive File (PFCOPY) <span style="float: right;">1-41</span></p> <p style="padding-left: 20px;">Dump Permanent File (PFDUMP) <span style="float: right;">1-41</span></p> <p style="padding-left: 40px;">Incremental (Selective) Permanent File System Dump <span style="float: right;">1-41</span></p> <p style="padding-left: 40px;">Partial Permanent File System Dump <span style="float: right;">1-42</span></p> <p style="padding-left: 40px;">Full Permanent File Dump <span style="float: right;">1-42</span></p> <p style="padding-left: 40px;">PFDUMP in a Mass Storage Subsystem Environment <span style="float: right;">1-42</span></p> <p style="padding-left: 20px;">Load Permanent File (PFLOAD) <span style="float: right;">1-42</span></p> <p style="padding-left: 40px;">Catalog Image Record <span style="float: right;">1-43</span></p> <p style="padding-left: 40px;">Stages of Checking <span style="float: right;">1-44</span></p> <p style="padding-left: 40px;">PFLOAD in a Mass Storage Subsystem Environment <span style="float: right;">1-46</span></p> <p style="padding-left: 20px;">Example <span style="float: right;">1-46</span></p>	<p>Description of Queue Utility Options <span style="float: right;">2-9</span></p> <p>File Preassignment <span style="float: right;">2-17</span></p> <p>Active and Inactive Queue Files <span style="float: right;">2-18</span></p> <p>Queue File Utility Routines <span style="float: right;">2-18</span></p> <p style="padding-left: 20px;">QREC <span style="float: right;">2-18</span></p> <p style="padding-left: 20px;">DFTERM <span style="float: right;">2-23</span></p> <p style="padding-left: 20px;">DFLIST <span style="float: right;">2-25</span></p> <p style="padding-left: 20px;">QLIST <span style="float: right;">2-25</span></p> <p style="padding-left: 20px;">QDUMP <span style="float: right;">2-26</span></p> <p style="padding-left: 20px;">QLOAD <span style="float: right;">2-28</span></p> <p style="padding-left: 20px;">QMOVE <span style="float: right;">2-30</span></p> <p style="padding-left: 20px;">LDLIST <span style="float: right;">2-34</span></p> <p style="padding-left: 20px;">QALTER <span style="float: right;">2-34</span></p> <p style="padding-left: 20px;">FNTLIST <span style="float: right;">2-36</span></p> <p>Dayfile Dumping Utilities <span style="float: right;">2-38</span></p>
<p><b>2. QUEUE/DAYFILE UTILITIES</b> <span style="float: right;">2-1</span></p> <p>Queue File Utilities <span style="float: right;">2-1</span></p> <p style="padding-left: 20px;">Calling the Queue File Utilities <span style="float: right;">2-2</span></p> <p style="padding-left: 40px;">Console Input <span style="float: right;">2-2</span></p> <p style="padding-left: 40px;">Batch Input <span style="float: right;">2-7</span></p> <p style="padding-left: 40px;">Terminal Input <span style="float: right;">2-7</span></p> <p style="padding-left: 20px;">Parameters for the Queue File Utilities <span style="float: right;">2-7</span></p>	<p><b>3. MASS STORAGE SUBSYSTEM</b> <span style="float: right;">3-1</span></p> <p>Definitions <span style="float: right;">3-2</span></p> <p style="padding-left: 20px;">Cartridge <span style="float: right;">3-2</span></p> <p style="padding-left: 20px;">CSU Map <span style="float: right;">3-3</span></p> <p style="padding-left: 20px;">MSF Catalog <span style="float: right;">3-4</span></p> <p style="padding-left: 20px;">MSF Files <span style="float: right;">3-8</span></p> <p style="padding-left: 20px;">MSSEXC <span style="float: right;">3-9</span></p> <p style="padding-left: 20px;">Subfamily <span style="float: right;">3-9</span></p> <p>Utilities <span style="float: right;">3-9</span></p> <p style="padding-left: 20px;">ASDEF <span style="float: right;">3-9</span></p> <p style="padding-left: 20px;">ASLABEL <span style="float: right;">3-10</span></p> <p style="padding-left: 40px;">ASLABEL Directives <span style="float: right;">3-11</span></p> <p style="padding-left: 40px;">Parameters for ASLABEL Directives <span style="float: right;">3-14</span></p> <p style="padding-left: 40px;">ASLABEL Update Sequence <span style="float: right;">3-16</span></p> <p style="padding-left: 40px;">Restrictions to ASLABEL <span style="float: right;">3-16</span></p> <p style="padding-left: 40px;">Example <span style="float: right;">3-17</span></p> <p style="padding-left: 20px;">ASMOVE <span style="float: right;">3-17</span></p> <p style="padding-left: 40px;">Selection Algorithms <span style="float: right;">3-20</span></p> <p style="padding-left: 40px;">Disk Space/Dump Tape Management <span style="float: right;">3-21</span></p> <p style="padding-left: 40px;">Restriction to ASMOVE <span style="float: right;">3-21</span></p> <p style="padding-left: 40px;">Example <span style="float: right;">3-21</span></p> <p style="padding-left: 20px;">ASVAL <span style="float: right;">3-22</span></p> <p style="padding-left: 40px;">Release Processing <span style="float: right;">3-22</span></p> <p style="padding-left: 40px;">Problem Reporting <span style="float: right;">3-23</span></p> <p style="padding-left: 40px;">Error Detection and Classification <span style="float: right;">3-24</span></p> <p style="padding-left: 40px;">Release Processing and Problem Fixing <span style="float: right;">3-26</span></p> <p style="padding-left: 40px;">Validation Report <span style="float: right;">3-27</span></p>

Example	3-28	VALNET Validation Program	4-12
Typical ASVAL Runs	3-29	Output Listings	4-12
Restrictions to ASVAL	3-30	Stimulation	4-13
ASUSE	3-30	STIMULA	4-14
Basic Usage Report	3-32	ASTIM	4-14
Optional Reports A and B	3-33	NSTIM	4-15
Optional Report C	3-35	Network Products Stimulator (NPS)	4-15
Optional Reports D and E	3-35	Session File Construction	4-15
ASDEBUG	3-36	Dynamic Login	4-16
ASDEBUG Directives	3-37	Source Line Input	4-20
Parameters for the		Optional Think Time	
ASDEBUG Directives	3-38	Specification	4-21
Restrictions to ASDEBUG	3-39	Task Definitions	4-22
MSS Operational Procedures	3-40	Session File Processing	4-22
Initialization	3-40	Multiple Sessions	4-28
Disk Space Management	3-40	Parameter Output Format	4-28
MSF Space Management	3-41	Postprocessing	4-30
Backup and Recovery	3-42		
File Dumping	3-42		
File Reloading	3-44		
Error Conditions and		5. SYSTEM ACCOUNTING	5-1
Corrective Action	3-45	User Validation (VALIDUs - Special	
Permanent File Recovery	3-45	System File)	5-2
Cartridge Restoration and		MODVAL Validation File Manager	5-5
Reuse	3-46	MODVAL Console Input	5-5
Removal of Faulty or		MODVAL Batch Input	5-11
Missing Cartridges	3-46	MODVAL Control Statement	5-12
MSF Catalog/CSU Map/PFC		Input Directive	5-16
Problems	3-46.1	Examples of MODVAL Usage	5-26
Pseudo Release	3-48	Special User Numbers	5-38
Error Recovery Examples	3-48	User Accounting	5-39
		PROFILa Project Profile Manager	5-40
4. NETWORK UTILITIES	4-1	Analyst (System Origin Job)	
Load File Generator (LFG)	4-1	Identifications	5-40
File Description Statements	4-1	Analyst and Master User	
File Description Statement		Identifications	5-45
Examples	4-2	Input Directives	5-49
Required Names for Load Modules	4-3	PROFILE Console Input	5-54
Execution	4-3	PROFILE Batch Input	5-55
Execution Example	4-3	PROFILE Execution from a Terminal	5-55
NPU Dump Analyzer	4-5	Update from a Terminal	5-57
Control Statement	4-5	Inquire from a Terminal	5-58
Report Formats	4-6	List from a Terminal	5-58
Network Dump Files	4-7	CHARGE Control Statement	5-59
NPU Dump on Tape (NPUDUMP)	4-7	Batch Usage of CHARGE	5-61
Update VSN (NETUVSN)	4-8	CHARGE Application at	
Network Dump Tape	4-8	a Terminal	5-61
AIP Trace with IAF	4-8.1	User Numbers and Charge Numbers	5-61
IAFTM	4-8.1	Resource Accounting	5-62
IAFTR	4-8.2	SRU Formula	5-62
Network Description Files	4-9	SRU Parameters	5-64
Directive Formats	4-10	S0 and S1	5-64
Multiplexer Definition		S2, S3, and S4	5-64
Directives	4-10	M1	5-65
Terminal Definition Directive	4-10	M2, M3, and M4	5-65
		AD	5-65
		Minimum Display Value	5-66

Minimum Charge Value	5-66	9. 580 PROGRAMMABLE FORMAT CONTROL	9-1
IO Increments	5-66		
MS Increments	5-66	PFC Arrays	9-1
MT Increments	5-67	Building PFC Arrays	9-1
PF Increments	5-68	Adding PFC Arrays	9-2
Example of SRU Calculation	5-68		
Multiplier Index Values and Actual Multiplier Values	5-70		
Account Dayfile Messages	5-72	10. EXPRESS DEADSTART DUMP INTERPRETER	10-1
Message Groups	5-74		
Accounting Information	5-74	Calling the Express Deadstart Dump Interpreter	10-3
Statistical Information	5-79	Input Directives	10-5
Usage Information	5-84	Directive Format	10-6
		List Control Directives	10-7
6. SYSEEDIT	6-1	EJON - Turn On Auto Page Eject	10-7
*CM Directive	6-2	EJOFF - Turn Off Auto Page Eject	10-7
*MS Directive	6-3	EJ - Force Page Eject	10-7
*AD Directive	6-3	PD - Reset Print Line Density	10-7
*PROC Directive	6-4	*, - Comment in Subtitle Line	10-8
*SC Directive	6-5	File Manipulation and Control Directives	10-8
*FL Directive	6-5	READ - Read Alternate Directives File	10-8
*DELETE Directive	6-5	OUTPUT - Assign Output to Alternate List File	10-9
*FILE Directive	6-6	DISPOSE - Dispose Alternate List File to Print Queue	10-9
*IGNORE Directive	6-6	REWIND - Rewind File	10-9
*PPSYN Directive	6-6	CM/ECS Dump Directives	10-9
Record Types	6-7	Dump Control Directives	10-10
		Memory Dump Directives	10-11
7. SYSTEM FILE INITIALIZATION	7-1	PP Dump Directives	10-12
ISF	7-1	P - Dump PP Memory in Block Format	10-12
Deadstart Sequencing	7-3	PF - Dump FLPP Memory in Block Format	10-12
GENVAL Procedure File	7-4	Q - Dump PP Memory in Line Format	10-13
		QF - Dump FLPP Memory in Line Format	10-13
8. MULTIMAINFRAME OPERATION	8-1	AP - Dump Analysis of PP and PP Memory in Line Format	10-13
Overview	8-1	MPP - Move PP	10-14
Deadstart	8-2	PMS - Read PP Select Switches	10-14
Shared Mass Storage	8-4	CMR Dump Directives	10-15
Assigning Shared Mass Storage	8-4	LC - Dump Low Central Memory	10-15
Device Access Tables	8-4	CP - Dump Active Control Point Areas	10-15
Mass Storage Recovery Tables	8-6	CPO - Reset Default List Options	10-17
Device Initialization	8-6		
Device Unload	8-7		
Device Recovery	8-7		
Device Checkpoint	8-8		
Multimainframe Operation in an MSS Environment	8-8		

PP - Dump PP Communication Areas	10-17	CP - Dump Active Control Point Areas	10-28
DP - Dump Dayfile Buffer Pointers	10-17	Example of DSDI Terminal Usage	10-29
EST - Dump Equipment Status Table	10-17	Printer Output Listing Examples	10-31
FNT - Dump File Name/File Status Table and FNT Interlock Table	10-18	11. STATUS/CONTROL REGISTER SIMULATOR	11-1
MST - Dump Mass Storage/Track Reservation Tables	10-18	Using the Simulator	11-1
JC - Dump Job Control Area for Each Origin Type	10-18	CYBER 70 Use	11-1
ACCOUNT - Dump Account Dayfile Buffer	10-18	Console Operation	11-2
ERRLOG - Dump Error Log Dayfile Buffer	10-19	Batch Input	11-2
DDB - Dump Dayfile Dump Buffer	10-19	Simulator Commands	11-5
EPB - Dump ECS/PP Buffer	10-19	Holding Register Commands	11-5
DAYFILE - Dump System Dayfile Buffer	10-19	CYCLE Commands	11-6
MAINLOG - Dump Binary Maintenance Log Dayfile Buffer	10-19	+ and STOP. Commands	11-7
SECEDED - Dump SECEDED Identifier Table	10-20	12. INSTALL	12-1
MTR - Dump CPU Monitor	10-20	13. 881/883 PACK REFORMATTING UTILITY	13-1
RPL - Dump Resident Peripheral Library	10-20	Format Control Statement	13-2
RCL - Dump Resident Central Library	10-20	Input Formats	13-3
PLD - Dump Peripheral Library Directory	10-20	Control Directives	13-4
CLD - Dump Central Library Directory	10-20.1	Data Statements	13-4
PROBE - Dump PROBE Data Tables	10-20.1	Output Formats	13-5
Subsystem Dump/Analysis Directives	10-21	Examples	13-5
BATCHIO - Dump Associated Memory for Analysis	10-21	Accessing Mass Storage Devices	13-9
EI200 - Dump Associated Memory for Analysis	10-21	Access for Read Operations	13-9
MAGNET - Dump Associated Memory for Analysis	10-22	Access for Read and Write Operations	13-9
IAF/TELEX - Dump Associated Memory for Analysis	10-23	14. CONTROLWARE LOADING UTILITY	14-1
Hardware Register Dump Directives	10-24	15. SYSTEM DATA GATHERING UTILITIES	15-1
XP - Dump Deadstart Exchange Package	10-24	TRACER Utility	15-1
SC - Dump S/C Register	10-24	TRACER Control Statements	15-2
Interactive Use of DSDI	10-24	ICPD Control Statement	15-2
Terminal Output Directives	10-26	ACPD Control Statement	15-4
C - Dump Memory in Instruction Parcel Format	10-26	ENDCPD Control Statement	15-4
D - Dump Memory in Byte Format	10-26	Sampled System Variables	15-17
Q - Dump PP Memory in Line Format	10-27	Fast Loop Variables	15-18
PP - Dump PP Communication Areas	10-28	Medium Loop Variables	15-20
		Slow Loop Variables	15-22
		PROBE Utility	15-22
		PROBE Control Statement	15-23

## APPENDIX

### A. DIAGNOSTICS

A-1

## INDEX

### FIGURES

1-1	Functional Overview of the Permanent File Utility Overlays	1-2	2-13	QLOAD Output File	2-30
1-2	Example of Multifile Archive File Structure	1-4	2-14	Initial QMOVE Display	2-31
1-3	Track Reservation Table Word	1-12	2-15	Secondary QMOVE Display	2-32
1-4	Bit Settings for Track Line Bytes	1-15	2-16	QMOVE Output File	2-33
1-5	Linkage Format with Example	1-16	2-17	QALTER/FNTLIST Left-Screen K Display	2-35
1-6	Example of Families in Two Systems	1-18	2-18	QALTER/FNTLIST LIST Command Display	2-35
1-7	Example of Transfer of Family Access	1-19	2-19	QALTER/FNTLIST LIST=fnt Command Display	2-36
1-8	Initial Permanent File Utilities Left K Display	1-21	2-20	QALTER Printer Listing	2-37
1-9	Permanent File Utilities Right K Display	1-22	4-1	First Dump Record Format and Sample	4-6
1-10	PFDUMP Left K Display	1-24	4-2	Hardware Configuration for ASTIM	4-14
1-11	Sample Directory Produced by PFATC (LO=T)	1-36	4-3	Hardware Configuration for NSTIM	4-15
1-12	Sample Directory Produced by PFCAT (LO=T)	1-38	4-4	Sample Session File with Tasks for Use by STIMULA	4-17
1-13	Mass Storage Table Report	1-38	4-5	Sample Session for Use by STIMULA	4-18
1-14	Cumulative Statistics by User Index PFCAT (LO=S, DN=40)	1-39	4-6	Sample Session for Use by NSTIM	4-19
1-15	Cumulative Statistics for Entire Device PFCAT (LO=S, DN=40)	1-40	4-7	Sample Session File for Internal Stimulation	4-20
1-16	Catalog of Catalog Image Record	1-43	4-8	STIMULA Left-Screen K Display	4-20
1-17	PFDUMP/PFLOAD Example	1-47	4-9	STIMULA Session File Parameters	4-21
2-1	QFSP Display	2-2	4-10	STIMULA Special Parameters	4-23
2-2	Queue File Utility Commands Display	2-4	4-11	Parameter Matrix	4-26
2-3	Initial QREC Display	2-19	4-12	Mixed Mode Parameters	4-27
2-4	Inactive Queues List	2-20	4-13	Output Statistics	4-29
2-5	Secondary QREC Display	2-21	5-1	Creation and Use of Validation and Accounting Files	5-3
2-6	QREC Output File	2-22	5-2	First MODVAL Display	5-7
2-7	DFTERM Display	2-24	5-3	Second MODVAL Display	5-8
2-8	DFTERM Dayfile List	2-24	5-4	Format of VALIDATION File Listing	5-16
2-9	Initial QDUMP Display	2-26	5-5	Representative Structuring of a PROFILA File	5-42
2-10	Secondary QDUMP Display	2-27	5-6	Full File List (OP=L, LO=F)	5-43
2-11	QDUMP Output File	2-28	5-7	Full File Charge Number List (OP=L, LO=C)	5-44
2-12	QLOAD Display	2-29			

5-8	Full File Project Number List (OP=L, LO=P)	5-44	5-16	CHARGE Routine	5-60
5-9	Charge Number Only List (OP=I, CN=xxxx)	5-46	8-1	Deadstarting a Machine in an MMF Environment	8-5
5-10	Project Number List (OP=I, CN=xxxx, PN=PROJ02)	5-46	10-1	EDD Dump Tape Format	10-2
5-11	Master User Full File List (OP=L, LO=FM)	5-47	10-2	Typical Alternate Directives File	10-30
5-12	Master User Charge Number List (OP=L, LO=CM)	5-48	11-1	Simulator Left Display	11-3
5-13	Master User Project Number List (OP=L, LO=PM)	5-48	11-2	Simulator Right Display	11-4
5-14	Typical Input Stream for Use with PROFILE	5-50	13-1	FORMAT Output, MODE=RESTORE	13-6
5-15	PROFILa K Display (Left Screen Only)	5-56	13-2	FORMAT Output, MODE=ALTER	13-7
			13-3	FORMAT Output, MODE=FETCH	13-8
			15-1	Example of TRACER Output	15-5
			15-2	Example of PROBE Output	15-24

## TABLES

1-1	Permanent File Utility Parameter Options	1-26	5-2	Input Coding and Console Options	5-11
1-2	PFDUMP Types	1-41	5-3	Effective Billing Number	5-62
2-1	Queue File Utility Parameter Options	2-8	7-1	Initialize and Release of Fast Attach Files	7-3
5-1	Validation and User Accounting File Names	5-1	9-1	Released PFC Arrays	9-3
			15-1	Weighting Factors	15-17

# PERMANENT FILE UTILITIES

1

Five utility processors maintain the NOS permanent file system. They control the dumping and loading of permanent files, the cataloging of permanent files in the system and on backup storage (archive) files, and the copying of archived files to a control point.

The utility processors are overlays under the control of the permanent file supervisor (PFS). The PFS processes the parameters in the utility command and loads the correct processing overlay. The overlay interacts with the permanent file utility routine PFU, which manages the catalogs, permits, data allocation on a device, and the data transfer between device and overlay. Figure 1-1 is an overview of this procedure.

The names and functions of the permanent file utilities follow. Detailed information about the call and operation of each utility is contained in the following sections.

<u>Utility</u>	<u>Description</u>
PFATC	Produces a cataloged directory of file information derived from an archive file.
PFCAT	Produces a cataloged directory of file information derived from catalog tracks on a permanent file device.
PFCOPY	Copies files from a backup storage file to a control point.
PFDUMP	Dumps files from a permanent file device to a backup storage file. Files created by this dump can be reloaded by the PFLOAD utility.
PFLOAD	Loads files from a backup storage file (created by PFDUMP) to a permanent file device.

## DEFINITIONS

The descriptions of the permanent file utilities require some familiarity with the terms whose definitions follow.

### ARCHIVE FILE (TAPE)

The permanent files accumulated on mass storage can be dumped as a whole or in part to a backup tape (or other type of backup medium) to protect the files from loss in case of a device malfunction or to free a device for temporary use during preventive maintenance. Each dump of permanent files is made to a file called an archive file; each permanent file dumped is called an archived file. Each archive file is a multirecord file in which each logical record is an archived file. If two or more archive files are created on one type of backup device, these archive files constitute a multifile archive file (figure 1-2).

The archive file can be loaded back onto the permanent file system as a whole or in part and can also be used to generate reports. The individual archived files can be referenced for selective use. Refer to a particular utility for more information.

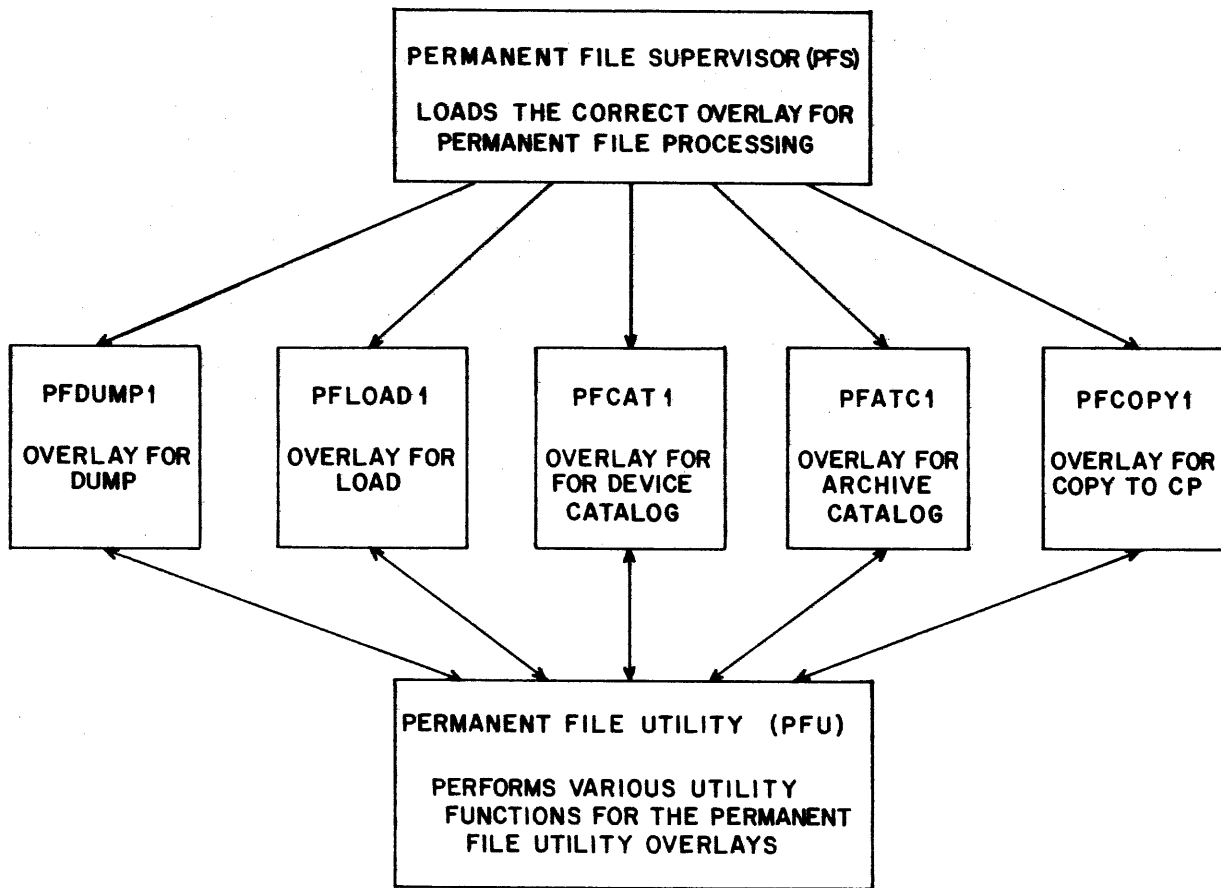

Figure 1-1. Functional Overview of the Permanent File Utility Overlays



## USER INDEX

A 17-bit user index is associated with each user number created on the VALIDUs† file. This index is entered through MODVAL (refer to User Validation in section 5) with the UI identifier on the user number input directive (/usernum,FUI=userin) or MODVAL, by default, supplies the next available index.

Whenever a user submits a job, the related user index is placed in the control point area along with the user number, job name, and other parameters that link hardware, files, and job. The permanent file manager (PFM) identifies the master device and catalog track for this user by performing two masking operations which involve the user index and two sets of device parameters (device mask and number of catalog tracks) obtained from the mass storage table in CMR. One operation correlates the rightmost octal digit in the user index (bits 0 through 2) with the bit settings of the device mask for each device in the configuration to determine which device is the user's master device (refer to the device mask definition). The other operation performs a logical AND between the remaining portion of the index and the number of catalog tracks on the master device to determine which track contains the user's catalog (refer to the catalog track definition).

The lower 3 bits (rightmost octal digit) of the user index are used to group users together into subfamilies. Each permanent file family consists of eight subfamilies, subfamily 0 through subfamily 7. Any user whose index ends in 0 belongs to subfamily 0, any user whose index ends in 1 belongs to subfamily 1, and so forth. The concept of subfamily is important in a Mass Storage Subsystem (MSS) environment. Refer to section 3 for more information.

## DEVICE MASKS

Two types of device masks exist for each device, the device mask (or primary mask) and the secondary mask.

### Device Mask

The device mask is an 8-bit quantity used to identify the group of users who have the particular device as their master device; that is, it identifies the device that contains their file catalogs, all their indirect access files, and possibly some or all of their direct access files. (The assigning of direct access files to a device is described in the section on secondary masks.)

If bit *i* is set in the mask of the device, any user whose index ends in *i* has this device as a master device.

Example:

The device identified by the mask 261<sub>8</sub> is the master device for any user whose index ends in 0, 4, 5, or 7, because these bits are set in the mask.

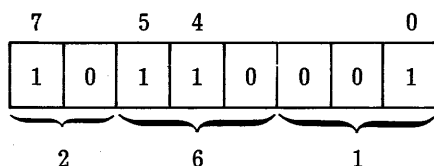

†In this manual, the user validation and accounting files are referred to as VALIDUs, VALINDs, and PROFILA. Refer to table 5-1 for a list of file names that correspond to the appropriate operating system levels.

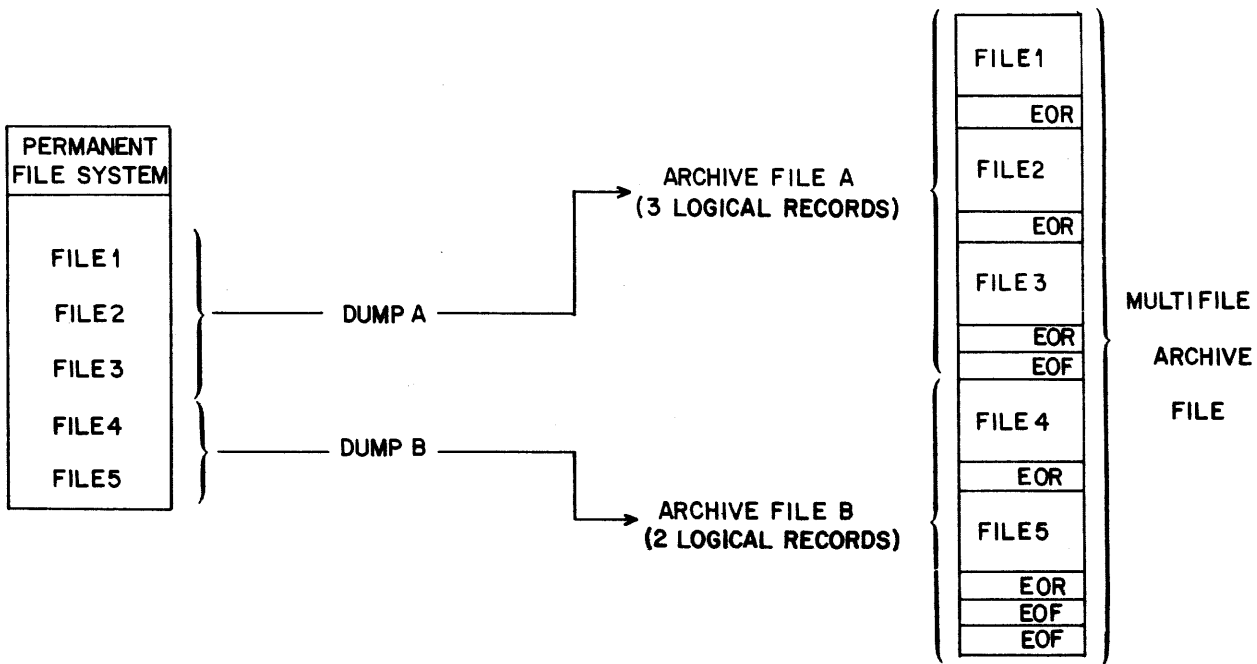

Figure 1-2. Example of Multifile Archive File Structure

When masks are assigned by an initialization, the following rules must be observed.

- Within a family the sum of all the device masks must be exactly 377g.
- Each bit position (0 through 7) must be set exactly once for the masks of the devices in one family.

Example:

For a family of three devices, 221g, 042g, and 114g are valid device masks because their sum is 377g and each bit is accounted for only once.

$$\begin{array}{r}
 1\ 0\ 0\ 1\ 0\ 0\ 0\ 1 = 221g \\
 0\ 0\ 1\ 0\ 0\ 0\ 1\ 0 = 042g \\
 \hline
 0\ 1\ 0\ 0\ 1\ 1\ 0\ 0 = 114g \\
 \hline
 1\ 1\ 1\ 1\ 1\ 1\ 1\ 1 = 377g
 \end{array}$$

If the sum of the device masks is less than 377g, then at least 1 bit is not set in any of the device masks. Any user index ending in such a bit-position value does not reference a device. Therefore, if such a user tries to write a permanent file, the system issues an error message.

Example:

For a family of four devices, 142<sub>8</sub>, 020<sub>8</sub>, 010<sub>8</sub>, and 204<sub>8</sub> are not valid device masks because their sum is less than 377<sub>8</sub>. Any user whose index ends in 0 would have no master device and could not write a permanent file.

```
0 1 1 0 0 0 1 0 = 1428
0 0 0 1 0 0 0 0 = 0208
0 0 0 0 1 0 0 0 = 0108
1 0 0 0 0 1 0 0 = 2048
-----
1 1 1 1 1 1 0 0 = 3768
```

If the sum of the device masks is greater than 377<sub>8</sub>, then at least 1 bit is set for more than one device mask. Any user index ending in such a bit-position value references more than one master device.

Example:

For a family of four devices, 212<sub>8</sub>, 106<sub>8</sub>, 040<sub>8</sub>, and 021<sub>8</sub> are not valid device masks because their sum is greater than 377<sub>8</sub>. Bit 1 is set twice, which indicates that any user whose index ends in 1 would have two master devices, one with mask 212<sub>8</sub> and one with mask 106<sub>8</sub>.

```
1 0 0 0 1 0 1 0 = 2128
0 1 0 0 0 1 1 0 = 1068
0 0 1 0 0 0 0 0 = 0408
0 0 0 1 0 0 0 1 = 0218
-----
1 1 1 1 1 1 1 1 4018
      1
```

It is a necessary but not sufficient condition that all masks for one family total 377<sub>8</sub>. It is possible, but illegal, that in one family the device masks sum to 377<sub>8</sub> but that some bit is set in more than one device mask.

Example:

For a family of three devices, 261<sub>8</sub>, 115<sub>8</sub>, and 001<sub>8</sub> are not valid device masks because bit 0 is accounted for three times and bit 1 is not set at all. Any user whose index ends in 0 would have three master devices. Any user whose index ends in 1 would have no master device.

```
1 0 1 1 0 0 0 1 = 2618
0 1 0 0 1 1 0 1 = 1158
0 0 0 0 0 0 0 1 = 0018
-----
1 1 1 1 1 0 0 1 3778
      1
      1
```

## Secondary Mask

The secondary mask of a device is an 8-bit quantity used to identify groups of users who can place direct access files on the particular device. If bit *i* is set in the secondary mask of the device, any user whose index ends in *i* can place direct access files on this device.

Example:

A device whose secondary mask is 072<sub>8</sub> can contain direct access files of any user whose index ends in 1, 3, 4, or 5, because these bits are set in the mask.

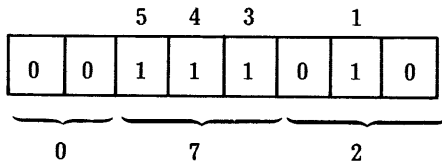

Direct access files may or may not reside on a master device, depending on the user index and secondary mask. The appropriate bit must be set in the secondary mask of the device on which the user's direct access files are to reside. A direct access file is placed on a valid device with the most space available unless the user specifies a particular device.

Example:

The following situations occur for a device whose mask is 261<sub>8</sub> and secondary mask is 072<sub>8</sub>.

- This device is the master device for, and can contain direct access files of, any user whose index ends in 4 or 5 (bits 4 and 5 are set in both the device mask and the secondary mask).
- This device is the master device for, but cannot contain direct access files of, any user whose index ends in 0 or 7 (bits 0 and 7 are set in the device mask but not in the secondary mask).
- This device is not the master device for, but can contain direct access files of, any user whose index ends in 1 or 3 (bits 1 and 3 are set in the secondary mask but not in the device mask).
- This device is not the master device for, and cannot contain direct access files of, any user whose index ends in 2 or 6 (bits 2 and 6 are not set in either the device mask or the secondary mask).

Existing direct access files belonging to a special user index [user index whose value is greater than 377700<sub>8</sub> (AUMX)] are exempt from the secondary mask. That is, when such a file is to be defined on or loaded to a device, the secondary mask of the device is not checked. The analyst can define such a file on any device in the family and PFLOAD loads such a file to the device from which it was dumped.

There are no restrictions on the number of devices in one family that can have the same bits set in the secondary mask or regarding the sum of the secondary masks for devices in the same family. The secondary mask must be a number between 0 and 377<sub>8</sub>.

Example:

For a family of three devices, 000, 131<sub>8</sub>, and 326<sub>8</sub> are possible secondary masks. Any user whose index ends in 0, 3, 4, or 6 can place direct access files on the device whose secondary mask is 131<sub>8</sub>. Any user whose index ends in 1, 2, 4, 6, or 7 can place direct access files on the device whose secondary mask is 326<sub>8</sub>. No user can place direct access files on the device whose secondary mask is 000. Any user whose index ends in 4 or 6 can place direct access files on two devices, and any user whose index ends in 5 cannot use direct access files.

$$\begin{array}{r}
 0\ 0\ 0\ 0\ 0\ 0\ 0 = 000_8 \\
 0\ 1\ 0\ 1\ 1\ 0\ 0\ 1 = 131_8 \\
 1\ 1\ 0\ 1\ 0\ 1\ 1\ 0 = 326_8 \\
 \hline
 1\ 1\ 0\ 1\ 1\ 1\ 1\ 1 \\
 1\ 1
 \end{array}$$

## MASS STORAGE TABLE

The configuration of mass storage devices currently available to the system is defined by the CMR mass storage table (MST). Each logical device in this configuration has an entry in this table that contains the following information. Refer to the NOS Systems Programmer's Instant for the MST format.

- Device status.
- Number of current users.
- Number of catalog tracks.
- Device mask.
- Location of start of permission data.
- Location of start of catalog tracks.
- Location of start of indirect access files.
- Interlock status.
- Family (pack) name.
- Device number.
- User number for private auxiliary device.
- Available space on device.
- Logical description of device.

## CATALOG TRACK

A user's catalog track is a track on his master device containing the catalog entries (definition follows) that define and specify the location of each permanent file created by any user assigned to that catalog track. Users are assigned by groups to catalog tracks according to user index and number of catalog tracks on the master device.

The number of catalog tracks on a device is established when the device is initialized or by default. Default values are as follows:

<u>Type of Device</u>	<u>Default Number of Catalog Tracks</u>
ECS (DE)	4
844 (DI, DJ, DK, DL)	40g
885 (DM, DQ)	10g
DDP path to ECS (DP)	4
Private device	1

The number of catalog tracks is always a power of 2; the maximum number is 200g. Therefore, the possible numbers of catalog tracks on a device are:

1, 2, 4, 10g, 20g, 40g, 100g, 200g

Reducing these numbers by 1 produces the following numbers, referred to as track masks.

0, 1, 3, 7, 17g, 37g, 77g, 177g

The track masks in binary form are:

```

      0
      1
     1 1
    1 1 1
   1 1 1 1
  1 1 1 1 1
 1 1 1 1 1 1
1 1 1 1 1 1 1
  
```

These track masks (except the first one) have all bits set and when bits 3 through 9 of the user index for a particular user are ANDed with the track mask for his master device, the user's catalog track number on that device is produced.

Example:

For a family of two devices, the following device masks, number of catalog tracks, and track masks are valid.

<u>Device</u>	<u>Device Mask</u>	<u>Number of Catalog Tracks</u>	<u>Corresponding Track Mask</u>
Dev 1	221g or 10 010 001	40g	40g-1=37g or 11 111
Dev 2	156g or 01 101 110 377g 11 111 111	20g	20g-1=17g or 1 111

A user whose index is 14224 is assigned Dev 1 as his master device because bit 4 (last digit in 14224) is set in the device mask for Dev 1. Therefore, Dev 1 contains this user's catalog track.

The binary form of 14224 is 001 100 010 010 100.

Therefore, the catalog track number for this user is 22g (on Dev 1) because the logical AND of bits 3 through 9 of the user index with the track mask for Dev 1 is as follows:

```

      1 0 0 0 1 0 0 1 0
AND  1 1 1 1 1 1 1
-----
      1 0 0 1 0  or 22g
  
```

The end of a catalog track is indicated by an EOI on the device. All catalog tracks are linked in the track reservation table (TRT) and appear as one logical chain. When catalog entries exceed the logical track, a continuation track is reserved at the end of the catalog track chain in the track reservation table. The disk linkage bytes for the overflowed track point to the continuation track.

## PERMANENT FILE CATALOG ENTRY

Files in the permanent file system are referenced by dynamically updated permanent file catalog (PFC) entries on the catalog tracks of master devices. Whenever a user creates a permanent file, a catalog entry that specifies the characteristics of the file, access information about the file, and the location of the file are entered on a catalog track on the user's master device. As the user modifies the file, the PFC entry is updated to reflect the modification.

The format of the PFC entry is as follows:

	59	53	47	44	41	35	23	17	11	0	
word 0	filenam						userin				FCFN, FCUI
1	file length						track		sector		FCLF, FCBT, FCBS
2	random index					creation date and time					FCRI, FCCD
3	access count					data modification date and time					FCAC, FCMD
4	ct	mode	ef	ec	dn	last access date and time					FCCT, FCAM, FCEF, FCEC, FCEO, FCAD
5						control modification date and time					FCKD
6	pr	br	ss			utility control date and time					FCRS, FCBR, FCFS, FCUD
7	file password										FCPW
8	aflags				alt	asa					FCAF, FCAT, FCAA
9											
10											
11											
12											
13											
14	user control word										FCUC
15	reserved for installation										FCIW

filenam	Permanent file name.
userin	User index of file creator.
file length	Length of the file in PRUs. For direct access files, the length is determined by the TRT entries for the file. The permanent file manager (PFM) gets the correct length from the TRT before returning a catalog entry to the caller. (Refer to PFM in the NOS Reference Manual, volume 2.)
track	Beginning track of the file.
sector	Beginning sector of the file.
random index	Random disk address of first permit sector.
creation date and time	yymmddhhmmss in octal when this file was first entered on the permanent file system. The year (yy) is biased by 70.
access count	Total number of times this file has been accessed.
data modification date and time	yymmddhhmmss in octal when data in this file was last modified. The year (yy) is biased by 70. For direct access files this field is updated only when the file is attached in a modifiable mode.
ct	File category: <ul style="list-style-type: none"> <li>0 Private.</li> <li>1 Semiprivate.</li> <li>2 Public.</li> </ul>
mode	Mode of access for semiprivate and public files: <ul style="list-style-type: none"> <li>0 Write, read, execute, append, modify, and/or purge.</li> <li>1 Read and/or execute.</li> <li>2 Append.</li> <li>3 Execute.</li> <li>4 Negate previous permission.</li> <li>5 Modify.</li> <li>6 Read and/or execute, allow modify.</li> <li>7 Read and/or execute, allow append.</li> </ul>



ef	<p>Error flag:</p> <ul style="list-style-type: none"> <li>0 No error.</li> <li>1 EOI changed by recovery.</li> </ul>
ec	<p>Error code:</p> <ul style="list-style-type: none"> <li>0 No error.</li> <li>1 Error in file data.</li> <li>2 Error in permit entries for file.</li> <li>3 Error in data and permit entries.</li> <li>4 Error in file length.</li> <li>5 Reserved.</li> <li>6 Reserved.</li> <li>7 Reserved.</li> </ul>
dn	<p>Device number (1 through 77g) of the device on which the direct access file resides if other than the user's master device. If the file resides on the master device, dn is 0.</p>
last access date and time	<p>yymmddhhmmss in octal when this file was last accessed. The year is biased by 70.</p>
control modification date and time	<p>yymmddhhmmss in octal when this file's control information (catalog entry and permit record data) was last modified.</p>
pr	<p>Preferred residence† for this file:</p> <ul style="list-style-type: none"> <li>3 Mass Storage Facility (MSF) residence preferred (PR=M specified by file owner).</li> <li>4 No preferred residence (PR=N specified by file owner).</li> </ul>
br	<p>Backup requirement† for this file:</p> <ul style="list-style-type: none"> <li>1 Backup required on dump tape (BR=Y specified by file owner).</li> <li>2 Backup required on dump tape only if the current version of the file does not have an MSF image (BR=MD specified by file owner).</li> <li>3 Backup on dump tape is not to be done (BR=N specified by the file owner).</li> </ul>

---

†Refer to Permanent File Control Statements in volume 1 of the NOS Reference Manual for details on the PR and BR parameters.

ss

Subsystem code for this file:

- 0 Null subsystem.
- 1 BASIC subsystem.
- 2 FORTRAN subsystem.
- 3 FTNNTS subsystem.
- 4 Execute subsystem.
- 5 Batch subsystem.

utility control date and time

yymmddhhmmss in octal set by PFM and PF utilities and used by PFDUMP in determining whether to dump the file when the OP=M option is specified.

file password

Optional password.

aflags

Alternate storage flags; refer to section 3, Mass Storage Subsystem, for details.

<u>Flag</u>	<u>Bit</u>	<u>Description</u>
AFVER	52	Verification flag: <ul style="list-style-type: none"><li>0 If asa≠0, a successful stage/destage operation has occurred and system control errors should not be encountered.</li><li>1 The PFC entry with asa≠0 was reloaded and a stage attempt has not yet been made. If a system control error is detected, the probable cause is that the asa value is obsolete and this is probably because an obsolete dump tape was used during the reload.</li></ul>
AFPDR	51	Pseudo release flag: <ul style="list-style-type: none"><li>0 The file can be attached immediately if it has a disk image.</li><li>1 The file has a disk image that cannot be attached until the MSF image of the file is staged to disk. After the stage attempt (whether or not it is successful), this flag is cleared.</li></ul>

<u>Flag</u>	<u>Bit</u>	<u>Description</u>
AFPDE	50	Data error flag: 0 No unrecoverable read errors have been detected. 1 An unrecoverable read error prevented the MSF image of the file from being staged to disk.
AFPSE	49	System control error flag: 0 No system error conditions have been detected. 1 A system error condition prevented the MSF image of the file from being staged to disk.
AFOBS	48	Obsolete flag; set to 1 whenever the file is attached in write mode. 0 MSF image (if asa≠0) is a current version of the file. 1 Disk image is the current version of the file; the MSF image (if asa≠0) is obsolete.

alt

Alternate storage type:

- 0 File resides on disk only.
- 1 File has an MSF image.

asa

Alternate storage address:

- 0 An MSF image of the file does not exist.
- Nonzero Specifies the location of the beginning of the file on MSF. The AFOBS flag indicates whether or not this MSF image is current.

user control word

User control information (FET+11).

## TRACK RESERVATION TABLE

Every device in a permanent file system has a label track (usually track 0)<sup>†</sup> which contains a label sector describing the device (family name, device mask, secondary mask, location of permit information, catalog information, and indirect files) and a number of physical record units (PRUs) containing the TRT. The TRT describes the physical layout of data on the device and is the key to allocating information on the device.

The TRT contains single-word entries that define track linkage and bit-setting controls for those tracks (figure 1-3). Each word has four 12-bit linkage bytes and three sets of 4-bit control settings that match the four bytes (figure 1-4). Linkage format is given in figure 1-5.

The numbering of the 12-bit linkage bytes or cells corresponds to the numbering of tracks on the device, with the first track starting at 4000. The entry in a cell references the next cell and its associated track. This next track either continues the information or starts a new sequence depending on the first-track bit setting.

Figures 1-3 and 1-4 show a sequential linkage of tracks (in figure 1-4, from track 4000 to track 4001 to 4002 to 4003). This numerical sequence is purely illustrative. The linkage could just as well have been:

4000 → 4002 → 4015 → 4012

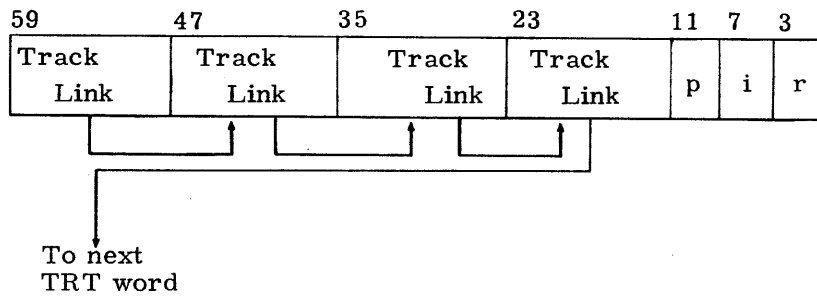

Track Link

Address of the next track that is a logical continuation of this file. (The track links are shown as sequential within a word, but this is not a requirement.)

p

Bit settings for identifying the first track of a preserved file (permanent file chain or queued file).

i

Bit settings for establishing interlock of a track.

r

Bit settings for track reservation.

Figure 1-3. Track Reservation Table Word

<sup>†</sup>The label track is always track 0 for an 844 device.

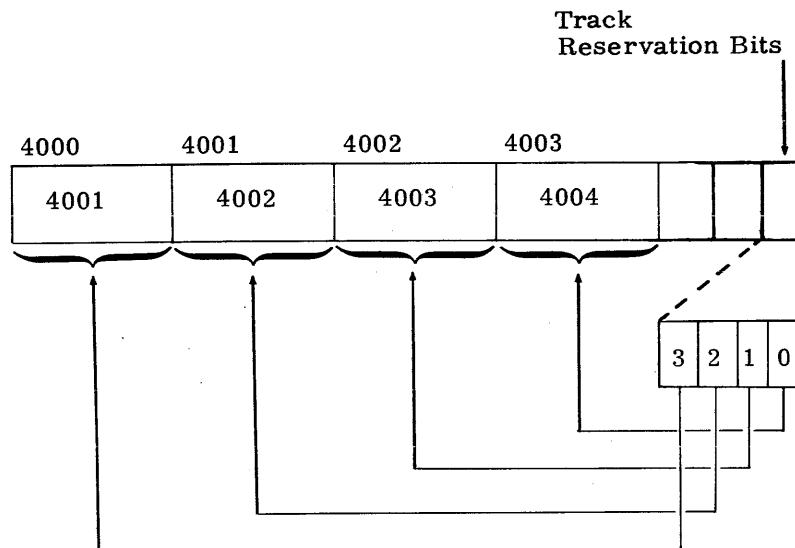

Matching of four reserve track bit settings with corresponding track link bytes. The same correspondence holds for the interlock bits (4 through 7) and the first-track bits (8 through 11).

Figure 1-4. Bit Settings for Track Link Bytes

The first group of control settings (bits 8 through 11) is used to identify those tracks which begin a sequence of permanent file information. If any one of these bits is set, the associated track is the first track of a chain that may extend across a number of tracks. This chain can be a direct access file, an indirect access file data chain, a catalog chain, a permit chain, or a queued file.

The second group of control settings (bits 4 through 7) is used to interlock tracks. If any one of these bits is set, the associated track cannot be accessed as long as this bit remains set. Whenever a file is accessed, the system automatically interlocks the catalog track containing the file. The interlocking capability is necessary because PFM may be processing several requests directed at one file simultaneously. Without interlock, these requests could overlap.

The third group of control settings (bits 0 through 3) is used to identify reserved tracks. A track is reserved either because it has data written on it or it is a flawed track. A flawed track is removed from availability by reservation at deadstart, by subsequent initialization, or by reformatting with the FORMAT utility for 844 devices.

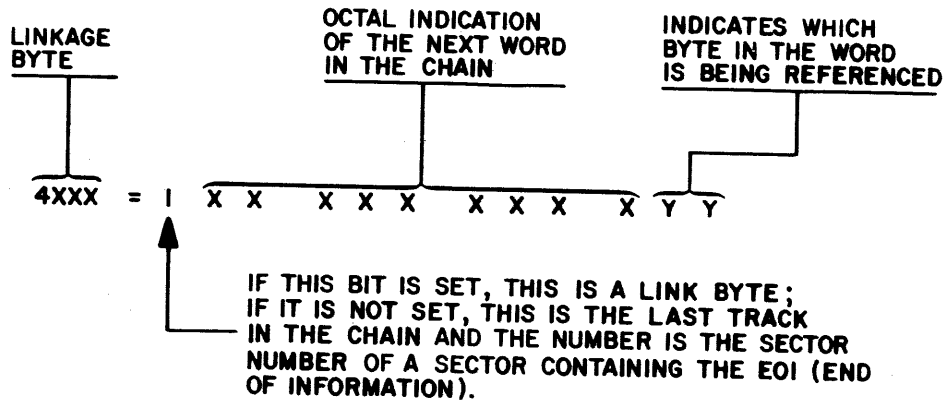

EXAMPLE: THIS ILLUSTRATES THE SEQUENTIAL LINKAGE

4053 → 4075 → 4077 → 0100

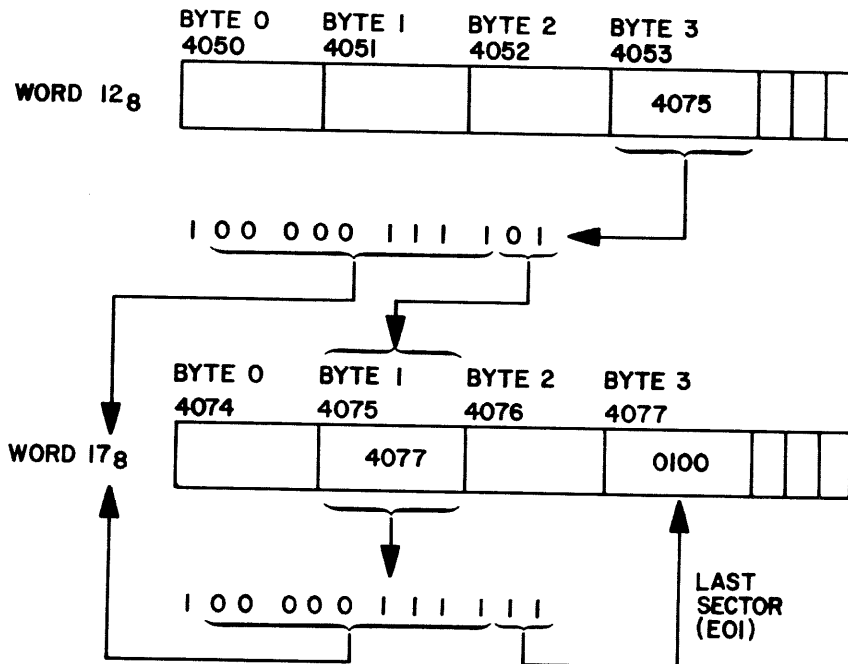

Figure 1-5. Linkage Format with Example

## FAMILY

A family is a collection of 1 to 63 logical devices identified by a one- to seven-character family name. Users and their files are grouped together according to the family available to them. Usually, the grouping is within the configuration on which these users normally run jobs. However, a family can be connected to any configuration and still relate to the same users and files.

An auxiliary device, identified by a one- to seven-character pack name, is a single device that is not included in any family and can be accessed by validated users from any family. An auxiliary device provides users with an alternative to the master devices for storing and accessing permanent files. Use of auxiliary devices enables an installation to provide special sets of permanent files for selected users or for designated periods. For example, an auxiliary device could be made available from 1200 to 1700 every day for any properly validated user.

A permanent file device is either a member of a family or an auxiliary device. Permanent files on a family device are accessed through user catalogs contained on a master device within the family. The user catalogs that reference permanent files on an auxiliary device are contained on that device; that is, an auxiliary device is a self-contained entity.

Families and auxiliary devices are defined at installation time in the PF entry or by the MSI parameters, FM and DN.† Normally, a configuration has one family available. Additional families can be defined or introduced (on removable devices) in the same configuration. If more than one family is available in a configuration, the user supplies the family name at login or on the USER statement in a batch job. The default family is used if no family name is supplied.††

A system origin job can use the FAMILY control statement to change the family name associated with the job. If the FAMILY statement is included in any nonsystem origin job, the job aborts. The format of the control statement is:

FAMILY, family.

family	One- to seven-character name of a family of permanent file devices. If omitted, the default family name specified at deadstart is assumed.
--------	--

If an alternate family of permanent file devices is introduced into the configuration without a VALIDUs file, the job to create VALIDUs could include a FAMILY statement to identify the alternate family. If the family parameter is omitted, the default family name is assumed.

Figure 1-6 is an example of a typical set of configurations.

Example:

One configuration with six permanent file devices (EST ordinals 1 through 6) is identified as system A. Three of the devices are grouped into a family with the name FAMA. They have device numbers 40, 41, and 42. The remaining three ordinals have been defined as removable. This means that the system will allow family and auxiliary devices to be introduced on these equipments during system operation.

---

† Refer to the DSD command, INITIALIZE, in the NOS Operator's Guide.

†† The default family name is specified at deadstart time and cannot be changed dynamically.

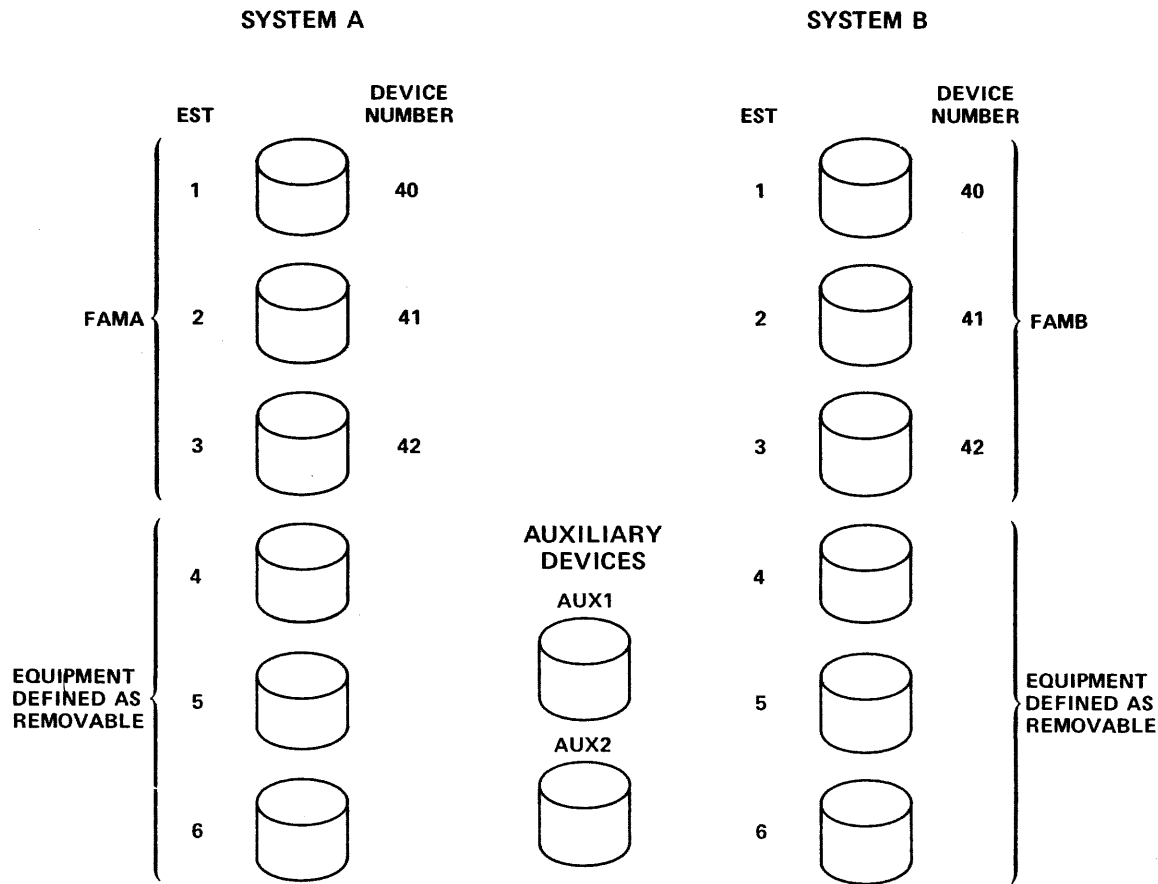

Figure 1-6. Example of Families in Two Configurations

A second configuration with six permanent file devices is identified as system B. Three of the devices have been grouped into a family with the name FAMB. They also have device numbers 40, 41, and 42. The remaining three pieces of equipment have been defined as removable.

Two auxiliary devices are available to both systems. These have the pack names AUX1 and AUX2.

Users of FAMA would normally run jobs on system A. Users of FAMB would normally run jobs on system B.

The removable equipment on system A (EST 4, 5, and 6) could be used for two purposes:

- To mount auxiliary devices AUX1 and/or AUX2 as required by users of FAMA. If users of FAMB need access to AUX1 and/or AUX2, these auxiliary devices will have to be mounted on some combination of EST 4, 5, and 6 on system B.
- To mount FAMB devices when they are no longer accessible through system B. In this case, users of FAMB will have to transfer their access to system A. This transfer could involve a physical transportation of disk packs from EST 1, 2, and 3 in system B to EST 4, 5, and 6 in



system A, or system A could already have alternate channel connections to EST 0, 1, and 2 in system B but would define them as EST 4, 5, and 6 in its own system. If the users of FAMB access their files through system A, they submit their jobs to system A or dial into system A using a different telephone number. (They would dial the same number if switching of the communication gear is done.)

Assuming that access to all of FAMB is transferred from system B to system A, the new array of system A will be as illustrated in figure 1-7. System A now has two families, its original default family FAMA and the newly attached FAMB whose devices now have the EST ordinals 4, 5, and 6. Its device numbers (40, 41, and 42) remain the same. These happen to be the same as those used within FAMA but device numbers only provide uniqueness between devices within a family. Accordingly, total uniqueness of a device is provided by the combination of family name and device number.

Users of FAMA will still be able to access their file without specifying the family name since FAMA is still the default for system A. However, users of FAMB will have to specify to system A that they belong to FAMB either at login or on the USER statement.

If another equipment (EST 7) were available on system A, either auxiliary pack AUX1 or AUX2 could be mounted on it and users from either family could access files on this pack.

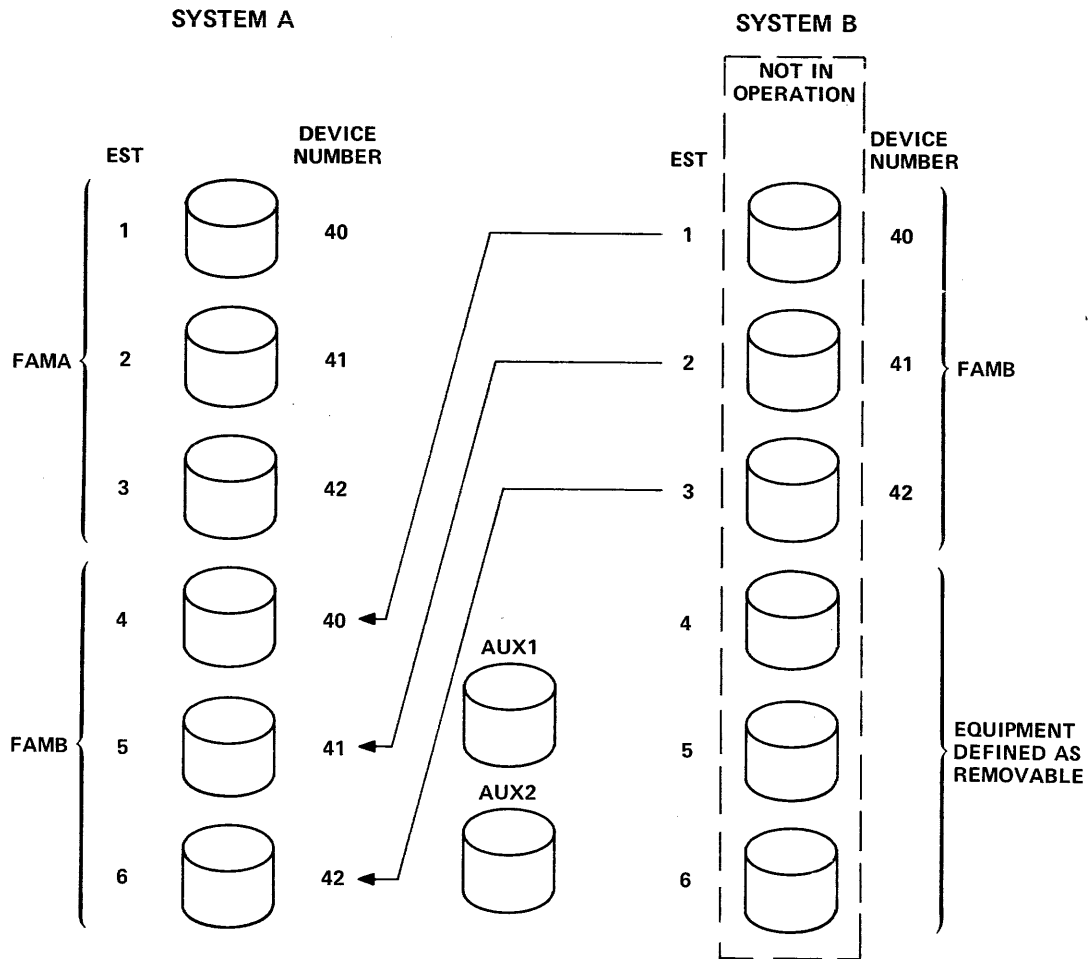

Figure 1-7. Example of Transfer of Family Access

## CALLING THE UTILITIES

Permanent file utility operations can be initiated through console input to a K display, card input (batch), or terminal entries. However, for batch or terminal input, the user must be validated for system origin privileges and DEBUG must be on.

### CONSOLE INPUT

Input from the console requires the following sequence of entries and responses.

1. Call PFS by typing:

X.PFS.

The B display indicates the console point to which PFS is assigned. To the right of the entry appears the following message:

REQUEST \*K\* DISPLAY

2. Activate the K display for that control point by typing:

K,n. (n is the control point number of PFS specified on the B display)

The display shown in figure 1-8 appears on the left screen. Instructions at the bottom of the display describe how to select the desired utility.

3. Activate the right K display by typing:

KK.

The display shown in figure 1-9 appears on the right screen. A description of the permanent file utility options is shown.

4. Select the desired utility by typing:

K.uo.

where uo is one of the following:

<u>uo</u>	<u>Description</u>
AT	Catalog archive file.
CA	Catalog permanent files.
CP	Copy archive file to a control point.
DU	Dump permanent files.
LD	Load permanent files.

\*\*\* UTILITY OPTIONS \*\*\*

CURRENT OPTION VALUE	DESCRIPTION
-------------------------	-------------

ENTER K.UO. WHERE \*UO\* IS

AT - TAPE CAT	CA - DEVICE CAT
CP - TAPE COPY	DU - DUMP LD - LOAD

Figure 1-8. Initial Permanent File Utilities Left K Display

\*\*\* PERMANENT FILE UTILITY OPTION DESCRIPTION \*\*\*

OPTION	DESCRIPTION
UT *UTILITY*	*LD* - PFLOAD *DU* - PFDUMP *CA* - PFCAT *AT* - PFATC *CP* - PFCOPY
LO *LIST OPTION*	T - FILES PROCESSED CATALOG C - PERMANENT FILE DEVICES CATALOG E - ERRORS S - SUMMARY
OP *UTILITY OPTIONS*	C - CREATION* A - LAST ACCESS* M - LAST MODIFICATION* I - INDIRECT ACCESS** D - DIRECT ACCESS** B - BEFORE P - PURGE AFTER DUMP R - REPLACE N - NONINITIAL LOAD Q - ADD CATALOG AND PERMIT RECORDS E - EXTRACT CATALOG IMAGE RECORD O - OMIT CATALOG IMAGE RECORD S - SUPPRESS MSS STAGING Z - ZERO OUT ASA LINKAGE

NOTE - OPTIONS ENTERED AS FOLLOWS -

LO = TCS    OR  
OP = CIBP

\*    ONLY ONE TYPE OF DATE MAY BE SPECIFIED  
\*\*   ONLY ONE ACCESS OPTION MAY BE SPECIFIED.

Figure 1-9. Permanent File Utilities Right K Display

The parameter options available under the chosen utility appear on the left screen. Figure 1-10 shows the left screen after the DU utility has been called ①. The TCE appearing after the LIST OPTION ② indicates that

T	Files processed
C	Catalog files
E	Errors

are the listings available for the PFDUMP utility. Different combinations of list options are available with the other utilities.

The CAMIDBPS ③ appearing after the UTILITY OPTION indicates that

C	Creation
A	Last access
M	Last modification
I	Indirect access files
D	Direct access files
B	Before date and time
P	Purge after dump
S	Suppress MSS staging

are the options available for the dump utility. Different combinations of utility options are available with the other utilities.

5. Select the desired parameter options by typing:

$K.opt_1=val_1, opt_2=val_2, \dots, opt_n=val_n.$

where the  $opt_i=val_i$  are selected from the parameter option list on the left screen. The selected parameters replace the default values listed on the left screen (refer to Description of Permanent File Utility Parameters later in this section).

6. Initiate execution by typing:

K.GO.

The lower lines of the left display ④ disappear and are replaced by:

DEVICE	MASK
DATE	TIME

Values appear with these identifiers as processing continues.

\*\*\* PFDUMP OPTIONS (1)† \*\*\*

CURRENT OPTION VALUE	DESCRIPTION	
FM = 0	FAMILY NAME	
PN = 0	PACK NAME	
DN = 0	DEVICE NUMBER	
TD = 0	TRUE DEVICE NUMBER	
UN = 0	USER NUMBER	
UI = 0	USER INDEX	
PF = 0	PERMANENT FILE NAME	
DD = -- N/A --	DESTINATION DEVICE NUMBER	
DI = -- N/A --	DESTINATION USER INDEX	
LO = 0	LIST OPTIONS VALID -	TCE (2)
L = OUTPUT	OUTPUT FILE NAME	
OP = 0	UTILITY OPTIONS VALID -	CAMIDBPS (3)
EO PROCESS	ERROR OPTION	
SD NO SETTING	DISK SPACE RELEASE DATE	
UD -- N/A --	UTILITY CONTROL DATE	
DT = 0	DATE YYMMDD	
TM = 0	TIME HHMMSS	
AD = 79/09/10	AFTER DATE YYMMDD	
AT = 00.00.00	AFTER TIME HHMMSS	
BD = 0	BEFORE DATE YYMMDD	
BT = 0	BEFORE TIME HHMMSS	

NOTE - N/A DENOTES INVALID PARAMETER (4)

† The circled numbers are identified in the text.

Figure 1-10. PFDUMP Left K Display (Sheet 1 of 2)

\*\*\* PFDUMP OPTIONS \*\*\*

CURRENT OPTION VALUE	DESCRIPTION
T = TAPE	ARCHIVE FILE NAME
NT 7-TRACK	NINE TRACK
NR REWIND	NO REWIND
NU UNLOAD	NO REWIND - UNLOAD
SF = 0	SKIP FILE
N = -- N/A --	NUMBER OF FILES TO PROCESS
V NO VERIFY	VERIFY FILE GENERATION
VF = PFVER	VERIFY FILE NAME
MF = -- N/A --	MASTER FILE NAME
RD = 0	RELEASE DATA FILE NAME

NOTE - N/A DENOTES INVALID PARAMETER

Figure 1-10. PFDUMP Left K Display (Sheet 2 of 2)

## BATCH INPUT

To call a utility from a batch job, the user must be validated for system origin privileges and DEBUG must be on. The following deck structure is used to call a utility.

```
Job statement
USER statement
CHARGE statement (if necessary)
PFuo(opt1=val1,opt2=val2,...,optn=valn)
```

where *uo* is one of the following utility options, and *opt<sub>i</sub>=val<sub>i</sub>* is a desired parameter option for the selected utility (refer to Parameters for the Permanent File Utility Control Statements).

<u>uo</u>	<u>Description</u>
ATC	Catalog archive file.
CAT	Catalog permanent files.
COPY	Copy archive file to control point.
DUMP	Dump permanent files.
LOAD	Load permanent files.

When the system reads the PFuo control statement, the K display appears. Parameters were entered on the control statement and cannot be entered via the K display. However, if an error in parameters is detected at initiation of a utility, control is returned to PFS and parameters can then be entered via the K display.

## TERMINAL INPUT

The format of terminal input for calling the permanent file utilities is substantially the same as that for batch input. The user must be validated for system origin privileges and DEBUG must be on. The user enters the batch subsystem (or uses the X command), calls the desired utility, and enters the appropriate parameters with the command

```
PFuo(opt1=val1,opt2=val2,...,optn=valn)
```

where *uo* and *opt<sub>i</sub>=val<sub>i</sub>* are the same as for batch.

## PARAMETERS FOR THE PERMANENT FILE UTILITIES

Table 1-1 indicates the parameter options accepted by each permanent file utility. An X indicates that the parameter option is accepted; a blank indicates that the parameter option is not accepted. Refer to the following descriptions of parameters for more information.



TABLE 1-1. PERMANENT FILE UTILITY PARAMETER OPTIONS

Parameter	Utility				
	PFATC	PFCAT	PFCOPY	PFDUMP	PFLOAD
AD	X	X	X	X	X
AT	X	X	X	X	X
BD	X	X	X	X	X
BT	X	X	X	X	X
DD					X
DI					X
DN		X		X	X
DT	X	X	X	X	X
EO				X	X
FM		X		X	X
L	X	X	X	X	X
LO	X	X	X	X	X
MF			X		
N	X		X		X
NR	X		X	X	X
NT	X		X	X	X
NU				X	
OP†	X	X	X	X	X
PF	X	X	X	X	X
PN		X		X	X
RD				X	
SD				X	
SF	X		X	X	X
T	X		X	X	X
TD				X	X
TM	X	X	X	X	X
UD					X
UI	X	X	X	X	X
UN	X	X	X	X	X
V				X	
VF				X	

† The parameters valid with the OP option depend upon the utility being called, as explained in the OP=opt description.

## DESCRIPTION OF PERMANENT FILE UTILITY PARAMETERS

- AD=yymmdd** After date in the form of year, month, day. Files having a last access date (if OP=A), a creation date (if OP=C), or a utility control date (if OP=M) more recent than this date are to be processed. AD=yymmdd cannot be used if DT=yymmdd, TM=hmmss, or OP=B has been specified. If AT=hmmss is specified, the default for AD is the current date. If neither AD nor AT are specified, after date and time are not used as selection criteria.
- AT=hmmss** After time in the form of hour, minute, second. Files meeting the AD=yymmdd criterion and having a last access time (if OP=A), a creation time (if OP=C), or a utility control time (if OP=M) more recent than this time are to be processed. AT=hmmss cannot be used if DT=yymmdd, TM=hmmss, or OP=B has been specified. If AD=yymmdd is specified, the default is 000000 (midnight). If neither AD nor AT are specified, after date and time are not used as selection criteria.
- BD=yymmdd** Before date in the form of year, month, day. Files having a last access date (if OP=A), a creation date (if OP=C), or a utility control date (if OP=M) prior to this date are to be processed. BD=yymmdd cannot be used if DT=yymmdd, TM=hmmss, or OP=B has been specified. If BT=hmmss is specified, the default is the current date. If neither BD nor BT are specified, before date and time are not used as selection criteria.
- BT=hmmss** Before time in the form of hour, minute, second. Files meeting the BD=yymmdd criterion and having a last access time (if OP=A), a creation time (if OP=C), or a utility control time (if OP=M) prior to this time are to be processed. BT=hmmss cannot be used if DT=yymmdd, TM=hmmss, or OP=B has been specified. If BD=yymmdd is specified, the default is 000000 (midnight). If neither BD nor BT are specified, before date and time are not used as selection criteria.
- DI=userin** One- to six-digit number which specifies the destination user index under which PFLOAD loads all files being processed. Default is 0 (no destination user index). This parameter is assumed octal unless the D radix or a nonoctal digit is specified.
- DD=dn** One- or two-digit number which specifies the alternate (or default) device to which PFLOAD loads files when the device on which a file is to be loaded cannot be found, is not defined in the system, or cannot accept the file because of secondary mask restrictions. Default is 0 (no device is the alternate). This parameter is assumed octal unless the D radix or a nonoctal digit is specified.
- DN=dn** One or two-digit octal number which specifies the device within the family to be cataloged, dumped, or loaded. For PFLOAD, refer to Specified Option Check in the description of PFLOAD for more information. For PFCAT or PFDUMP, the following distinctions are made. If the specified device is a master device, all files cataloged on it (whether or not they reside on the device) are processed if they also meet all other specified selection criteria. However, files that reside on the device that are cataloged elsewhere are not processed. If the specified device is not a master device, all files residing on it are processed if they also meet all other specified selection criteria. (For nonmaster devices the DN and TD parameters have the same effect.) Default is 0 (all devices are to be cataloged, dumped, or loaded).
- DT=yymmdd** Date in the form of year, month, day to be used with OP=C, A, M, or B option. Default is current date if OP=A, C, or M is specified; otherwise, it is 0 (no date). DT=yymmdd cannot be used if AD=yymmdd, AT=hmmss, BD=yymmdd, or BT=hmmss has been specified.
- EO** Specifies that PFDUMP or PFLOAD does not process files with mass storage errors. If EO is not specified, PFDUMP dumps files, and PFLOAD loads files, regardless of mass storage errors.

- FM=family One- to seven-character name of the family of permanent file devices to be cataloged, dumped, or loaded. This parameter option is not required if only one family of devices is active in the system. Default is the default system family name.
- L=filenam One- to seven-character name of the file on which reports are to be written. Default is OUTPUT.
- LO=opt Character(s) specifying the type of information which the permanent file utility should include in its output report. Default is 0 (no options selected).

<u>opt</u>	<u>Significance</u>
C	List all files in the Catalog Image Record (CIR).
E	List errors.
S	List cumulative statistics for catalog.
T	List all permanent file catalog (PFC) data for all files.

MF=filenam One- to seven-character name of the master file at a control point on which PFCOPY copies all the files extracted from a designated archive file. Default is no name; that is, the archived files are copied as individual files retaining their permanent file names.

This option allows the user to extract a file from an archive file and change its name as a local file.

N=n One- or two-digit number which specifies the number of archived files on an archive file to be processed. If n=0, one file is processed. Default is 1. This parameter is assumed decimal unless the B radix is specified. (Refer to the example under the SF option.)

NR Specifies that no files are to be rewound before or after they are processed. If NR is not specified, the following are defaults.

	<u>Rewind before Processing</u>	<u>Rewind after Processing</u>
PFATC	X	X
PFCOPY	X	X
PFDUMP	X	
PFLOAD	X	X

**NOTE**

When positioning a file, the analyst should take into account that the first step in processing the file is to read or write the file label.

NT Specifies a nine-track archive tape. Default is seven-track (MT). The utility sets the recording density to the installation default for the specified track type if the archive tape is not preassigned.

NU Specifies that the archive, verify, and release data files created by PFDUMP are not to be unloaded. If NU is not specified, PFDUMP automatically unloads these files after creating them; if these files are on tape, the tape is returned to the takeup reel and vacuum released. At this point, the reel is either removed or physically reloaded for further use.

The NR and NU parameters can be used together to generate several dumps on an archive file. For example, the following series of PFDUMPs can be used to generate three dumps on one archive file.

PFDUMP(...NU) PFDUMP automatically rewinds before but not after processing. PFDUMP normally unloads after processing, but NU cancels the unload and leaves the file positioned at the end of this dump.

PFDUMP(...,NR,NU) NR cancels the rewinding before the dump, and the second dump is written after the first. NU cancels the unload and leaves the file positioned at the end of the second dump.

PFDUMP(...NR) NR cancels the rewinding before the dump, and the third dump is written after the second. The file is then automatically unloaded.

OP=opt One- to seven-character string specifying the utility options which control the processing of files. Many of the options require additional parameters to complete the definition of the OP selection. Default is 0 (no options selected).

Only one of the following three options can be used at a time. Each requires TM and DT parameters to establish a dividing time after which all files that meet the criteria of the option are singled out for processing.

A Make selection according to time of last access.

C Make selection according to time of creation.

M Make selection according to time of last modification.

The B option can be used only with A, C, or M. (For example, OP=CB). It cannot be used if the AD, AT, BD, or BT option has been specified.

B Denotes that the time and date specified by the TM and DT parameters is a dividing time before, rather than after, which all files that meet the criteria of the option are singled out for processing.

Only one of the following two options can be used at a time. They can be used in conjunction with the previous temporal options.

D Select direct access files only.

I Select indirect access files only.

The following options are used only with PFDUMP. Only one of them can be used at a time.

- P Purge after dump. All files included in the dump are purged after the dump is completed. This option can be used only when the dump is initiated from the console.
- S† Suppress staging of files. If a file to be dumped resides on the Mass Storage Facility (MSF) and not on disk, it is not staged to disk and only its PFC and permit entries are copied to the archive file. If OP=S is omitted, the MSF file is copied to disk and included in the dump. This option should normally be specified for full dumps.

The following five options are used only with PFLOAD.

- N Noninitial load. This option may still be specified (for compatibility with earlier versions of PFLOAD, but is ignored. PFLOAD now considers all loads to be noninitial (that is, PFLOAD never assumes that a device has just been initialized and contains no permanent files).
- R Load with the replace option. If R is specified, PFLOAD loads all selected files from the archive file. If R is not specified, PFLOAD loads only those files selected from the archive file for which no corresponding files (files with identical file names and user indexes) already exist in the permanent file system.
- E Extract only the catalog image record (CIR). Refer to the PFLOAD description for information about the CIR. PFLOAD reads the CIR from the designated tape, generates a random file and directory, and requests the next archive file without processing any of the files after the CIR on the first archive file.
- O Do not read the CIR. PFLOAD does not read the CIR for the specified archive file but processes the records in this archive file. PFLOAD then terminates normally without requesting another archive file.
- Z† Zero the asa field in the PFC entry when the PFC entry is loaded, if the asa field points to an MSF image. Also suppresses the loading of PFC only files. Default is to leave the asa field intact and to load PFC only files. OP=Z should normally be omitted if the device has to be recovered and should be specified if data for the file is being reloaded.

The following option is used only with PFCOPY.

- Q Select leading records. The archived file that is copied to a control point includes two header records, one with the catalog entry for the file and the second with the permit information for the file.

PF=filenam

One- to seven-character name of the permanent file to be processed. PF is associated with UI. Default is that permanent file name is not a selection criterion.

---

† Refer to section 3, Mass Storage Subsystem, for more information.

PN=packnam	One- to seven-character name of the auxiliary device to be cataloged, dumped, or loaded. The device must be mounted and available. Default is that pack name is not a selection criterion.
RD=filenam†	One- to seven-character name of the release data file (RDF) to be created by PFDUMP, which identifies those MSF-resident files that are pointed to by PFC entries at the time of the dump. The MSS utility ASVAL uses this file to identify unneeded MSF-resident files whose space can be released. If RD alone is specified, the release data file created is named RDF. This file observes the NU/NR parameter rules. Default is that PFDUMP does not create an RDF.
SD†	Specifies that PFDUMP is to enter the date and time when the dump was initiated into the inhibit date/time field of the master device. This date/time entry is used by the MSS utility ASMOVE to inhibit the releasing of the disk image of any file with a BR=Y attribute which was last modified after this date/time. The disk space can be released after the next incremental or full dump is taken.
SF=n	One- or two-digit number which specifies the number of archived files to be skipped before processing begins. Default is 0. This parameter is assumed decimal unless the B radix is specified.
	<p>Example:</p> <p>To load the fourth and fifth files on archive tape AT containing six archived files (F1, F2, F3, F4, F5, and F6), the following PFLOAD statement can be used.</p> <p style="text-align: center;">PFLOAD(T=AT, SF=3, N=2)</p> <p>SF causes PFLOAD to skip F1, F2, and F3, and to begin processing with F4. N=2 causes PFLOAD to process F4 and F5.</p>
T=filenam	One- to seven-character name of the file on which to store or read archive files. Usually, filenam is a tape, but it can be a mass storage device. Default is TAPE.
TD=dn	One- or two-digit octal number which specifies the device within the family to be dumped or loaded. For PFLOAD refer to Specified Option Check in the description of PFLOAD for more information. For PFDUMP, the following distinctions are made. If the specified device is a master device, all files cataloged and/or residing on it are processed if they meet all other specified selection criteria. If the specified device is not a master device, all files residing on it are processed if they also meet all other specified selection criteria. (For nonmaster devices the DN and TD parameters have the same effect.) Default is 0 (all devices are to be dumped or loaded).
TM=hhmmss	Time in the form of hour, minute, second to be used with OP=C, A, M, or B option. Default is 0. TM=hhmmss cannot be used if the AD, AT, BD, or BT parameter has been specified.
UD†	Specifies that PFLOAD is to update the utility control date and time field in the PFC entry for the file being loaded. This ensures that the file will be considered for inclusion in the next incremental dump. UD should normally be specified when a particular user's files are being reloaded, but should normally be omitted when a full device is being reloaded.

---

† Refer to section 3, Mass Storage Subsystem, for more information.

UI=userin One- to six-digit number which specifies the user index under which files to be processed are located. If UI is specified, DN need not be specified because the utility will locate the proper device. Default is that user index is not a selection criterion. This parameter is assumed octal unless the D radix or a nonoctal digit is specified.

UN=usernum One- to seven-character user number associated with the PN parameter. The user number must match information in the mass storage table (MST) for the specified pack name. If UN is specified and PN is not, the utility will convert usernum to a user index. If, in addition, DN is not specified, the utility will locate the proper device in the family. Default is that user number is not a selection criterion.

V Specifies that PFDUMP is to produce a verify file which is a duplicate of the archive file it creates. After PFDUMP has completed processing, this file is verified with the primary archive file. Default is no verify file written.

If NU is specified, neither the archive file nor the verify file is unloaded. Thus, multifile verify files can be generated along with multifile archive files.

Example:

The following series of commands creates a two-file archive file (AA) and a matching verify file (BB). The VERIFY command compares the accuracy of the duplication. (Refer to volume 1 of the NOS Reference Manual for a complete description of VERIFY.)

PFDUMP(T=AA,VF=BB,V,NU) The dump is written on archive file AA. A duplicate is written on the verify file BB. PFDUMP does not rewind after processing.

PFDUMP(T=AA,VF=BB,V,NU,NR) A second dump is written after the first on both the archive (AA) and the verify (BB) files. Each dump produces a separate file on the archive and verify files. The NR is necessary to inhibit the rewind before the dump.

VERIFY(AA,BB,N=0,A,R) A binary comparison of AA and BB is performed. If words do not match, this command lists:

Record number

Word number within the record

Words from both files that do not match

N=0 specifies that the verify terminates when the first empty file is encountered. The A parameter specifies an abort if a mismatch is found. R rewinds both files before and after the verify.

VF=filenam      One- to seven-character name of the verify file on which PFDUMP stores a duplicate copy of the archive file it creates. The verify file can reside on mass storage or on tape. Default is PFVER.

## PREASSIGNING THE ARCHIVE FILE

In all permanent file utilities except PFCAT, consideration should be given to the assignment of the archive file. A nine-track archive tape can be specified with the utility parameter NT. This can also be specified when the file is assigned to a control point. The relation between file preassignment and NT is shown in the following cases.

- If the file specified by the T option (or the default file TAPE) has been assigned to a control point prior to the utility call, that file is used as the archive file. In this case, NT is ignored if specified.

Example:

Archive file assignment and the utility call are made with the following statements.

```
LABEL(TAPE,VSN=A)      or      ASSIGN(MS,TAPE)
PFDUMP(NT)                              PFDUMP(NT)
```

In this example, the file TAPE is already at a control point when the utility is called. The utility does not make a tape request, and NT is ignored.

- If a vsn for the archive file has been specified prior to the utility call, the assignment of the archive file is made to a tape having the specified vsn and the installation default density for the specified track type (nine-track if NT is specified, seven-track otherwise).

Example:

Tape assignment and the utility call are made with the following statements.

```
VSN(TAPE=A)
PFDUMP(NT)
```

In this example, the vsn has been specified prior to the utility call. The system attempts to assign a nine-track tape with vsn A at the installation default density for nine-track tape.

- If no archive file preassignment was done, the operator is requested to assign the unit to be used with the attribute specified by the NT parameter.

Example:

The following statement is issued.

```
PFDUMP(NT)
```

The operator is requested to assign a nine-track unit. He can assign a nine-track unit, null equipment (77g), or any mass storage device defined as temporary. If a nine-track unit is assigned, recording density is the installation default for nine-track tape.



## PERMANENT FILE UTILITY ROUTINES

This section and its subsections describe the permanent file utility routines. The parameter options available for each of the routines are listed in table 1-1.

The LO option allows each permanent file utility to produce a cataloged directory of file information. This catalog information is either derived from the catalog tracks on the permanent file device or from the archive tape. Although the header information may differ from utility to utility, the format of the catalog information remains the same. The following is the general format of the information listed for each file on the directory.

filenam	access	ct	length	dn	cdate	ladate	dmdate	cmdate	ucdate			
passwd	mc	userin	mode	subsystem	time	time	time	time	time	time	time	time
pr	br	rs				flags		at	asa	amsg		

- ① filenam Permanent file name.
- ② access Type of permanent file. This field can be either DIR (direct access) or IND (indirect access).
- ③ ct File category. This field can be either PRIVATE, SEMI-PR, or PUBLIC. These categories are described in volume 1 of the NOS Reference Manual.
- ④ length Length of the file in PRUs.
- ⑤ dn Device number of the mass storage device on which the file resides if other than the master device. If the file resides on the master device, this field is replaced by an \*.
- ⑥ passwd Password associated with the file.
- ⑦ mc Modification count which specifies the number of times the file has been accessed.
- ⑧ userin User index of the user on whose catalog this file resides.
- ⑨ mode Permission mode. This field can be WRITE, MODIFY, APPEND, READ, READMD, READAP, or EXECUTE. These modes are explained in detail in volume 1 of the NOS Reference Manual.
- ⑩ subsystem Subsystem under which the file was saved. Possible entries include FOR, FTNTS, BASIC, EXEC., or BATCH. If this field contains no entry, a subsystem is not associated with the file.
- ⑪ cdate  
time Date and time of file creation. The format is:  
yy/mm/dd.  
hh.mm.ss.
- ⑫ ladate  
time Date and time of the last access to the file.
- ⑬ dmdate  
time Date and time of the last data modification to the file.

- |   |                 |  |
|---|-----------------|--|
| ⑭ | emdate<br>time  | Date and time of the last control information modification made in the file's PFC entry or permit entries.   |
| ⑮ | uupdate<br>time | Utility control date and time set by PFM or a PF utility to ensure that the file will be included in the next incremental (OP=M) dump.   |
| ⑯ | pr              | Preferred residence for the file specified by the file owner. This field can be either M (MSF residence preferred) or N (no preferred residence).  |
| ⑰ | br              | Backup requirement for the file specified by the file owner. This field can be either Y (backup required on dump tape), MD (backup required only if current version of file does not reside on MSF), or N (no backup is to be performed).  |
| ⑱ | rs              | Current residence of the file. This field can be D (disk only), A (MSF only), or B (both).   |
| ⑲ | flags           | Alternate storage flags set for the file (refer to the description of PFC entry earlier in this section for details). If a flag is not set, a dash is listed. If an undefined flag is set, an asterisk is displayed. This field can be: <ul style="list-style-type: none"> <li>D Data error flag.</li> <li>O Obsolete flag.</li> <li>R Pseudo release flag.</li> <li>S System control error flag.</li> <li>V Verification flag.</li> </ul> |
| ⑳ | at              | Alternate storage type. This field can be NONE (no MSF image) or MSF (file resides on MSF).  |
| ㉑ | asa             | Alternate storage address of the file.   |
| ㉒ | amsg            | Appended message, *PFC ONLY, indicating when a PFC ONLY file (that is, an entry with PFC and permit entries, but no data) has been processed on the archive file.  |

Figure 1-11 illustrates a typical page from a cataloged directory. Although this directory was produced using the command PFATC(LO=T), directories in similar format could be produced using the other utilities. Each of the fields previously described is shown on the figure.

FILE NAME	ACCESS	FILE-TYPE	LENGTH	ON CREATION	ACCESS	DATA MOD	CONTROL	UTILITY
PASSWD	MD/CNT	INDEX	PERM.	SUBSYS	DATE/TIME	DATE/TIME	DATE/TIME	DATE/TIME
PR BR RS					ASA FLAG	CODES	TYPE	ASA VALUE
157	DATA5	1	IND. PRIVATE	1	77/11/26.	77/11/26.	77/11/26.	77/11/26.
		0	1014	WRITE	16.06.29.	16.06.29.	16.06.29.	16.06.29.
								NONE
158	DIRF1	2	DIR. PRIVATE	3	15	* 77/11/26.	77/11/26.	77/11/26.
		1	214	WRITE	16.02.06.	16.27.38.	16.02.06.	16.02.06.
								NONE
159	DIRF2	4	DIR. PRIVATE	15	* 77/11/26.	77/11/26.	77/11/26.	77/11/26.
		1	214	WRITE	16.02.06.	16.27.38.	16.02.06.	16.02.06.
								NONE
160	DIRF1	5	DIR. PRIVATE	15	* 77/11/26.	77/11/26.	77/11/26.	77/11/26.
		0	614	WRITE	16.05.11.	16.05.11.	16.05.11.	16.05.11.
								NONE
161	DIRF2	6	DIR. PRIVATE	15	* 77/11/26.	77/11/26.	77/11/26.	77/11/26.
	PASSW	0	7 614	WRITE	16.05.12.	16.05.12.	16.05.12.	16.05.12.
								NONE
162	LIST	8	IND. PRIVATE	2	77/11/26.	77/11/26.	77/11/26.	77/11/26.
		0	1014	WRITE	16.06.29.	16.06.29.	16.06.29.	16.06.29.
								NONE
163	INED1	10	IND. PRIVATE	1	77/11/26.	77/11/26.	77/11/26.	77/11/26.
		0	1014	WRITE	16.06.30.	16.06.30.	16.06.30.	16.06.30.
								NONE
164	PROG1	11	IND. PRIVATE	2	77/11/26.	77/11/26.	77/11/26.	77/11/26.
		0	1014	WRITE	16.06.30.	16.06.30.	16.06.30.	16.06.30.
								NONE
165	BPRO1	17	IND. PRIVATE	2	77/11/26.	77/11/26.	77/11/26.	77/11/26.
		0	1014	WRITE	16.06.30.	16.06.30.	16.06.30.	16.06.30.
								NONE
166	BPRO2	18	IND. PRIVATE	1	77/11/26.	77/11/26.	77/11/26.	77/11/26.
		0	1014	WRITE	16.06.31.	16.06.31.	16.06.31.	16.06.31.
								NONE
167	BPRO3	20	IND. PRIVATE	1	77/11/26.	77/11/26.	77/11/26.	77/11/26.
		0	1014	WRITE	16.06.31.	16.06.31.	16.06.31.	16.06.31.
								NONE
168	BPRO4	22	IND. PRIVATE	1	77/11/26.	77/11/26.	77/11/26.	77/11/26.
		0	1014	WRITE	16.06.31.	16.06.31.	16.06.31.	16.06.31.
								NONE
169	EDP11	21	IND. PRIVATE	1	77/11/26.	77/11/26.	77/11/26.	77/11/26.
		2	14	WRITE	16.09.07.	16.25.51.	16.09.07.	16.09.07.
								NONE

Figure 1-11. Sample Directory Produced by PFATC (LO=T)

## CATALOG ARCHIVE FILE (PFATC)

PFATC produces a cataloged directory of file information derived from an archive file previously created by the PFDUMP utility. The format of the directory depends upon the parameter options selected.

If LO=T (list all files processed) is specified, the directory produced is similar to that shown in figure 1-11. If LO=C (list all files in catalog for system) is specified and the archive file to be cataloged was produced by an incremental dump (refer to the PFDUMP utility), the directory produced is similar to that shown in figure 1-16.

## CATALOG PERMANENT FILE DEVICE (PFCAT)

PFCAT produces a cataloged directory of file information derived from catalog tracks on a master device. The format of the directory depends upon the parameter options selected.

If LO=T (list all files processed) is specified, a directory of file information and a mass storage table report are produced. The directory is similar to that shown in figure 1-12. However, the files are listed according to user index, and totals are given after the files for each user index. The mass storage table report gives information about each mass storage device in the system. Figure 1-13 is an example of a mass storage table report. Messages issued with this report give information concerning the type and status of the device cataloged. The following status messages can be issued.

ACCOUNT INITIALIZE PENDING.  
CATALOG TRACK OVERFLOW.  
DAYFILE INITIALIZE PENDING.  
ERRLOG INITIALIZE PENDING.  
FORMAT PENDING.  
I/O QUEUE INITIALIZE PENDING.  
PF INITIALIZE PENDING.  
TOTAL INITIALIZE PENDING.  
UNAVAILABLE FOR PF ACCESS.  
8 WORD CATALOG ENTRIES.

The following types of devices can be listed.

ALTERNATE SYSTEM  
REMOVABLE DEVICE  
SYSTEM  
TEMPORARY

If LO=S (list cumulative statistics for catalog) is specified, summary reports of file information for each user index and for the entire device are produced. Figure 1-14 lists a page of the information given for each user index. Figure 1-15 lists the general device information.

```

CATALOG FILE                                79/07/16. 15.03.11.
DIRECTORY OF PERMANENT FILE DEVICE          0 THETA          PAGE          1
CATALOG OF USER INDEX          3442
FILE NAME ACCESS FILE-TYPE LENGTH ON CREATION ACCESS  DATA MOD  CONTROL  UTILITY
PASSWORD MD/CNT INDEX PERM. SUBSYS DATE/TIME DATE/TIME DATE/TIME DATE/TIME DATE/TIME
PR BR RS          ASA FLAG CODES          TYPE ASA VALUE

1 TBLLNKM DIR. PRIVATE          237 * 79/07/09. 79/07/12. 79/07/10. 79/07/09. 79/07/10.
  20          WRITE          16.02.37. 18.16.51. 16.36.47. 16.02.37. 16.36.47.
  N Y D          --- --- --- ---          NONE

2 DUMP DIR. SEMI-PR          2 * 79/07/09. 79/07/11. 79/07/11. 79/07/10. 79/07/11.
  4          WRITE          17.54.15. 17.31.31. 17.31.31. 11.16.03. 17.31.31.
  N Y D          --- --- --- ---          NONE

3 BIG1LPI DIR. PRIVATE          29 * 79/07/10. 79/07/12. 79/07/11. 79/07/10. 79/07/11.
  5          WRITE          18.16.50. 16.00.40. 09.10.33. 18.16.50. 09.10.33.
  N Y D          --- --- --- ---          NONE

4 BIG1LP DIR. PRIVATE          10256 * 79/07/10. 79/07/12. 79/07/11. 79/07/10. 79/07/11.
  5          WRITE          18.18.21. 16.00.48. 09.16.53. 18.18.21. 09.16.53.
  N Y D          --- --- --- ---          NONE

5 GIBSON DIR. PRIVATE          90 * 79/07/10. 79/07/12. 79/07/11. 79/07/10. 79/07/11.
  3          WRITE          18.20.00. 18.16.20. 09.21.36. 18.20.00. 09.21.36.
  N Y D          --- --- --- ---          NONE

6 LINKM DIR. PRIVATE          1035 * 79/07/11. 79/07/12. 79/07/11. 79/07/11. 79/07/11.
  6          WRITE          12.25.58. 18.16.34. 17.15.30. 12.25.58. 17.15.30.
  N Y D          --- --- --- ---          NONE

7 SCI1M DIR. PRIVATE          1584 * 79/07/11. 79/07/12. 79/07/12. 79/07/11. 79/07/12.
  8          WRITE          12.29.37. 18.16.42. 08.56.08. 12.29.37. 08.56.08.
  N Y D          --- --- --- ---          NONE

8 TFK8OPL DIR. PRIVATE          286 * 79/07/12. 79/07/13. 79/07/12. 79/07/12. 79/07/12.
  3          WRITE          13.10.21. 09.37.54. 13.10.21. 13.13.53. 13.10.21.
  N Y D          --- --- --- ---          NONE

TOTALS          8 FILE(S)          14219 SECTORS

```

Figure 1-12. Directory Produced by PFCAT(LO=T)

```

MASS STORAGE TABLE REPORT                                76/01/14. 21.51.01.
FAMILY/PACK NAME SYSTAA
DEVICE NUMBER          =          1          DEVICE TYPE          =          DI
DEVICE MASK          =          377          NUMBER UNITS          =          1
SECONDARY MASK          =          377          USER NUMBER          =-----
D/A USER COUNT          =          0          EQUIPMENT STATUS          = ACTIVE
SYSTEM
TEMPORARY.

```

Figure 1-13. Mass Storage Table Report

SUMMARY REPORT  
 DIRECTORY OF PERMANENT FILE DEVICE 40 SYS172

76/01/14. 21.51.01.  
 PAGE 204

(\* = DAF RESIDENT ON OTHER THAN MASTER DEVICE.)

USER	INDEX	FILES	SECTORS	AVE.SEC.
	3000	1	315	315
	10	26	57	2
	210	3	665	221
	20	18	33	1
	30	12	117	9
	230	4	394	98
	2230	42	1543	36
	40	18	58	3
	60	4	15	3
	100	23	552	24
	150	3	50	16
	160	6	247	41
		160	4046	(GROUP TOTAL)
	1	29	202	6
	201	5	21	4
	11	26	649	24



Figure 1-14. Cumulative Statistics by User Index PFCAT (LO=S, DN=40)

INDIRECT ACCESS FILE HOLES

CATALOG TRACK	NUMBER HOLES	NUMBER SECTORS
0	114	631
1	12	66
2	177	1520
3	27	154
4	46	1368
5	86	891
6	52	238
7	13	277
10	7	120
11	83	1107
12	50	229
13	48	324
14	2	13
17	20	139
TOTAL	737	7077

PERMANENT FILE STATISTICS SUMMARY

MASTER DEVICE USAGE

GROUP TOTALS

GROUP	TOTAL FILES	TOTAL SECTORS	PERCENT OF TOTAL USAGE	TOTAL	IAF	DAF
0	160	4046	6			
1	497	6193	10			
2	475	7658	12			
3	149	3554	5			
4	412	6320	10			
5	213	5427	8			
6	376	21514	35			
7	216	5693	9			
				TOTAL		
				TOTAL SECTORS	60405	35787
				TOTAL FILES	2498	324
				TOTAL USERS	94	
				AVE. FILES/USER	26	3
				AVE. SEC/FILE	24	110
				DEVICE TYPE - DI-2		
				PERCENT DEVICE USAGE	59	35

DIRECT ACCESS DEVICE USAGE

DEVICE NUMBER	DEVICE TYPE	TOTAL FILES	TOTAL SECTORS	PERCENT USAGE
40	DI-2	324	35787	35

Figure 1-15. Cumulative Statistics for Entire Device PFCAT(LO=S,DN=40)

## COPY ARCHIVE FILE (PFCOPY)

PFCOPY extracts files from an archive file and copies them to one or more files at a control point. The way the files are copied depends upon the parameter options selected.

If MF=filenam is specified, all the files extracted from the archive file are copied to a control point under one master file name (filenam) and they do not retain their permanent file names.

## DUMP PERMANENT FILE (PFDUMP)

PFDUMP copies (dumps) permanent files to backup storage (an archive file). Dumps can be reloaded by the PFLOAD utility and can be accessed by the PFATC and PFCOPY utilities for cataloging and copying. The type of dump taken depends upon the purpose of the dump and is determined by the parameters selected. Table 1-2 shows the defining characteristics of the three types of dumps.

TABLE 1-2. PFDUMP TYPES

Incremental Dump	Partial Dump	Full Dump
OP=M is specified and OP=B, BD=yymmdd, and BT=hmmss are not specified.	Any dump that is not incremental and not full.	OP=0 is specified or OP is not specified.

### Incremental (Selective) Permanent File System Dump

An incremental dump copies those permanent files modified after a specified date; that is, the OP=M option is specified together with the date (AD or DT) and time (AT or TM) options but OP=B, BD=yymmdd, and BT=hmmss are not specified. Other options specified on the PFDUMP call can restrict the dump even further.

For example, the statement

```
PFDUMP(OP=MI,AD=790101,AT=100000)
```

causes only indirect access files (I parameter) modified after the specified date and time to be dumped. Normal procedure at a site is to follow up this dump with successive incremental dumps (usually with a periodic advancement of date and/or time). This produces a series of archive files containing successive updating of all files in the defined category. (These files can reside on one file - a multifile archive file. Refer to the description of the NU option for an example of such a file.) The archive files can then be incrementally loaded (refer to the PFLOAD utility) to return the most recently modified versions of the archived files to the permanent file system.

Each incremental dump writes a record (or records) at the beginning of the archive file it creates. The record contains catalog images (refer to Catalog Image Record in the PFLOAD section) of all files active in the permanent file system when the dump took place. This enables a future incremental load of these files on a system or a device basis.

An example of incremental dumping is given in the PFLOAD section.



## **Partial Permanent File System Dump**

A partial dump copies permanent files according to any specified option(s), except those defining a full or incremental dump (refer to table 1-2). For example, the statement

```
PFDUMP(OP=D)
```

is a partial dump of all direct access permanent files. Similarly, a dump of all files created (OP=C) or accessed (OP=A) after a certain date is a partial dump.

A partial dump can dump files from a certain device (DN or TD option) or can dump all files in the system (DN and TD not specified) that meet the criteria of the specified options.

## **Full Permanent File Dump**

A full dump copies all files in the system or those cataloged on a specified device. That is, the OP option is not specified (or OP=0), and either a particular device is specified (device dump) or no device (DN=0 or TD=0) is specified (system dump).

## **PFDUMP in a Mass Storage Subsystem Environment**

In an MSS environment, the data for a permanent file to be dumped may reside on MSF and not on disk. However, if the file is to be copied to a dump file, it must have a disk image. The analyst can either stage the file to disk from MSF in order to include its data on the dump file (OP=S omitted), or copy to the dump file only the PFC and permit entries for the file and not the file data (OP=S specified). Typically, OP=S is specified for full dumps; otherwise, all MSF files would be included in the dump, which is not feasible because of the time involved to dump such a large permanent file base.

As described in volume 1 of the NOS Reference Manual, the file owner can supply a backup requirement for a file via the BR parameter on the DEFINE, CHANGE, or SAVE statement. Options include backup on a dump file, backup only if the current version of the file is not on MSF, or no backup on a dump file. This partially determines whether or not a file is included in a particular PFDUMP run. Refer to section 3, Mass Storage Subsystem, for further information on how the PFDUMP utility is used in an MSS environment.

## **LOAD PERMANENT FILE (PFLOAD)**

PFLOAD loads archived files produced by the PFDUMP utility back into the permanent file system. The load can reestablish the permanent file system exactly as it was at the time of the dump, or can load only a desired subset of files on the archive file (as indicated by specified parameter options).

If LO=T (list all files processed) is specified, the listing produced is similar to that shown in figure 1-11. If LO=C (list all files in catalog for system) is specified, the listing produced is similar to that shown in figure 1-16.

	FILE NAME	USER INDEX	ACCESS COUNT	LAST ACCESS DATE	TIME	DEVICE NUMBER
451	Z	23	2	74/03/23.	11.15.23.	
452	3DT	26	10	74/06/04.	09.32.26.	
453	ADS	26	14	74/06/04.	09.30.04.	
454	DEMO	20	14	75/07/11.	16.39.20.	
455	FTN2	20	0	75/07/15.	11.13.20.	
456	TAPE2	20	2	75/07/11.	16.38.07.	
457	HRACER	25	14	75/08/22.	13.19.09.	
458	AA	20	40	75/07.22.	12.26.18.	
459	DSPX	27	12	75/12/18.	19.40.17.	
460	B1MSAJ	21	0	75/12/18.	12.51.34.	
461	BLDDIR	27	32	75/01/07.	16.10.29.	

Figure 1-16. Catalog of Catalog Image Record

The two types of loads available are incremental and nonincremental. An incremental load builds up (increments) an accumulation of the most recently modified versions of the files extracted from the archive files for loading. A series of archive files is read in the reverse order of creation. The CIR (refer to next section) created by the most recent incremental dump is read and checked against the archived files on these files. If a file matches an entry on the CIR, that file is a candidate for loading. A nonincremental load does no CIR checking and uses only parameter options specified on the PFLOAD call, if any, to select candidates for loading.

### Catalog Image Record

Each incremental dump (OP=M) writes a catalog image record (CIR) at the beginning of the archive file on which the permanent files are dumped. The other types of dumps (full and partial) do not produce a CIR. The CIR is composed of two-word entries for every permanent file in the system at the time of the incremental dump (not just files included in the dump).

The format of each entry is as follows:

59	41	35	17	0
filenam			userin	
access count	dn	date time		

filenam                      Name of the permanent file.

userin                        User index under which filenam was cataloged.

access count                Number of times filenam was accessed.

dn                    Device number of the device on which filename resides if it is a direct access file and resides on a device other than the user's master device. If it resides on the master device, dn=0. If the file is indirect access, dn is ignored.

date time            Date and time filename was last accessed.

When a file is loaded, this CIR information is placed in the permanent file catalog of the device being loaded. No other information can be changed over dumps and loads without updating the utility control date and time.

Figure 1-16 contains a partial listing of the CIR. This listing can be obtained after a selective dump if the LO=C option is specified on a PFDUMP, PFLOAD, or PFATC call. A listing similar to the one in figure 1-11 can be obtained after a selective dump if the LO=T option is specified on a PFDUMP, PFLOAD, or PFATC call. In both cases, the headings vary but the format of the information is the same.

### Stages Of Checking

Execution of the PFLOAD utility involves three stages of checking.

- A check of the archive file to determine which files are eligible for loading (incremental loads only).
- A check of the specified options in the PFLOAD call to filter out noneligible files.
- A check of the device to be loaded to identify the files already contained on it and thereby determine which files from the archive file are actually to be loaded.

### Archive File Check

The archive file check applies only to incremental loads; for nonincremental loads this stage of checking is bypassed and the entire archive file to be loaded is passed on to stage 2 (specified option check).

The usual procedure in an archive file check is as follows. The first step is to read the CIR from the most recent selective dump file and place it on a random file. Then the archive files are read in the reverse order in which they were created (the most recently created file is read first).

Each file on an archive file is checked against the CIR on the random file for a match of file name and user index (these fields describe a file uniquely in the system). If a match is found, the file is a candidate for loading and moves to stage 2 of checking. Also, the file name and user index are zeroed out in the corresponding CIR entry to prevent subsequent loading of older versions of the same file. If a match is not found, the file is skipped because it has already been accepted for stage 2 (it appeared on a previous archive file and a match with the CIR was found) or has been purged. This process passes on to stage 2 only the latest versions of files obtained from the archive files.

### Specified Option Check

The specified option check applies to those files that have passed the archive file check (incremental loads) and is the first stage of checking for files in a nonincremental load. Files that are candidates for loading are further checked against the additional restrictions specified in the parameter options of the PFLOAD call. Files that meet all criteria specified are passed on to the final stage (device check); all other files are skipped. For example, if OP=D is specified, only direct access files are candidates for loading. Indirect access files do not move on to stage 3.

The specified option check also involves a check of the secondary masks of the devices to be loaded. No matter what parameter options are specified on the PFLOAD call, direct access files can be loaded only onto a device whose secondary mask allows it. That is, if the user index under which the file was created ends in the octal digit *i*, then the *i*th bit must be set in the secondary mask of the device onto which the file is to be loaded. (Refer to the definition of secondary mask.)

The DN option on the PFLOAD call specifies the device to be loaded. If this device does not exist in the system or if its secondary mask forbids a file to reside on it, then such a file will be loaded onto the alternate (or default) device specified by the DD option on the PFLOAD call. If the DD option was not specified, or if the device specified by the DD option does not exist or does not have an appropriate secondary mask (as explained previously), then the file is not loaded and an error message is issued.

However, in determining where to load each file, PFLOAD also checks the DN entry in the permanent file catalog (refer to the definition of catalog entry). Either this DN entry for a file is zero or it is nonzero. If DN=0, then before the file was dumped, it resided on the same device on which it was cataloged. If DN≠0, then the file did not reside on the same device on which it was cataloged, and the DN entry specifies the device on which the file did reside. The following possibilities can occur.

- If DN=0 in the PFC, then PFLOAD loads the file onto the device specified by the DN option on the PFLOAD call, if possible. If this load is not possible (for reasons explained previously), then PFLOAD loads the file onto the device specified by the DD option. If this load is not possible or DD was not specified, then the file is not loaded.
- If DN=*n* in the PFC (*n*≠0) and DN=*n* on the PFLOAD call, then PFLOAD follows the procedure explained in the DN=0 case.
- If DN=*n* in the PFC and DN=*m* on the PFLOAD call (*n*≠0, *m*≠0, and *n*≠*m*), PFLOAD loads the file onto device *n* (the device specified by the DN entry in the permanent file catalog), if possible. If this load is not possible (for reasons explained previously), then PFLOAD loads the file onto the device specified by the DD option. If this load is not possible or DD was not specified, then the file is not loaded.

#### Example:

Files have been dumped from device 3 to archive tape AB. Device 3 no longer exists in the system; devices 4 and 5 do exist. The control statement

```
PFLOAD(T=AB,DN=4,DD=5)
```

is executed. Depending on the type of dump that was taken, some of the following types of files may not exist. Files that resided and were cataloged on device 3 (DN=0) are loaded to device 4 (if the secondary mask allows it). Files that resided on 3 but were cataloged elsewhere (DN=3) are loaded to device 5 (if the secondary mask allows it), because device 3 does not exist in the system. Files that were cataloged on 3 but resided on 4 (DN=4), are loaded to device 4 (if the secondary mask allows it). Files that were cataloged on 3 but resided on a device other than 3 or 4 (DN≠0 and DN≠4) are loaded to the device on which they resided (if it still exists and if the secondary mask allows it). In all cases, if the secondary mask does not allow the load, PFLOAD loads the file onto the alternate device, if possible; otherwise, the file is not loaded.

### Device Check

The device check is carried out as follows. PFLOAD determines the catalog track where the archive files to be loaded are to reside and builds an index file with a one-word entry for each file on the track. The format of the entry follows.

59	17	0
filenam	userin	

PFLOAD checks each candidate file against this entry to determine whether it is in the permanent file system. If it is not, the file is loaded. If it is, loading depends upon the OP=R option. If OP=R was specified on the PFLOAD call, the archive duplicate replaces the one in the permanent file system. If OP=R was not specified, archive duplicates are skipped.

### **PFLOAD in a Mass Storage Subsystem Environment**

In an MSS environment, an incremental load as described previously is the typical reload procedure. PFLOAD uses the CIR from the first incremental dump file to control the loading of file data and PFC and permit entries. Files that resided only on MSF at the time of the dump may or may not have been copied to the dump tape. If OP=S was specified on the PFDUMP call, then only the PFC and permit entries for the MSF files were included on the dump tape. PFLOAD reloads only what was dumped by PFDUMP. Thus, if the file data was included on the dump tape, it will be reloaded to disk. If the file data was omitted from the dump tape, only the PFC and permit information for the files will be reloaded. Refer to section 3, Mass Storage Subsystem, for further information on how the PFLOAD utility is used in an MSS environment.

### **EXAMPLE**

In this example, permanent files created and modified on three devices are dumped nine times. The action runs from March 1, 1975 (75.3.1) to March 10, 1975 (75.3.10). For simplification, the time of day (TM) is not shown.

Before the last dump, one of the devices becomes inoperable. The example then shows how this device can be loaded from the archive tapes.

The following are the three devices.

- DEVICE 40      A master device containing indirect access files only. Users with this master device have their direct access files written on 41 or 42.
- DEVICE 41      A master device containing indirect and direct access files. Direct access files cataloged on this device may be written on 42 or this device.
- DEVICE 42      A nonmaster device containing direct access files only. All files written on this device will be cataloged on 40 or 41.

File names consist of a letter and a number. The letter identifies which device contains the catalog entry for this file (A=device 40 and B=device 41). The number is the same as the device on which the file is written.

Each file name is followed by a date in parentheses. This indicates either the day on which the file was created or when it was last modified.

Figure 1-17 outlines the creation, modifications, and dumps that were made. There is one particular action per column. The top of the column identifies the action and the key parameters used by the utility. If an archive tape is produced, it is shown at the bottom of the column. All files in the system are listed in each column. Those files affected by the action are underscored.

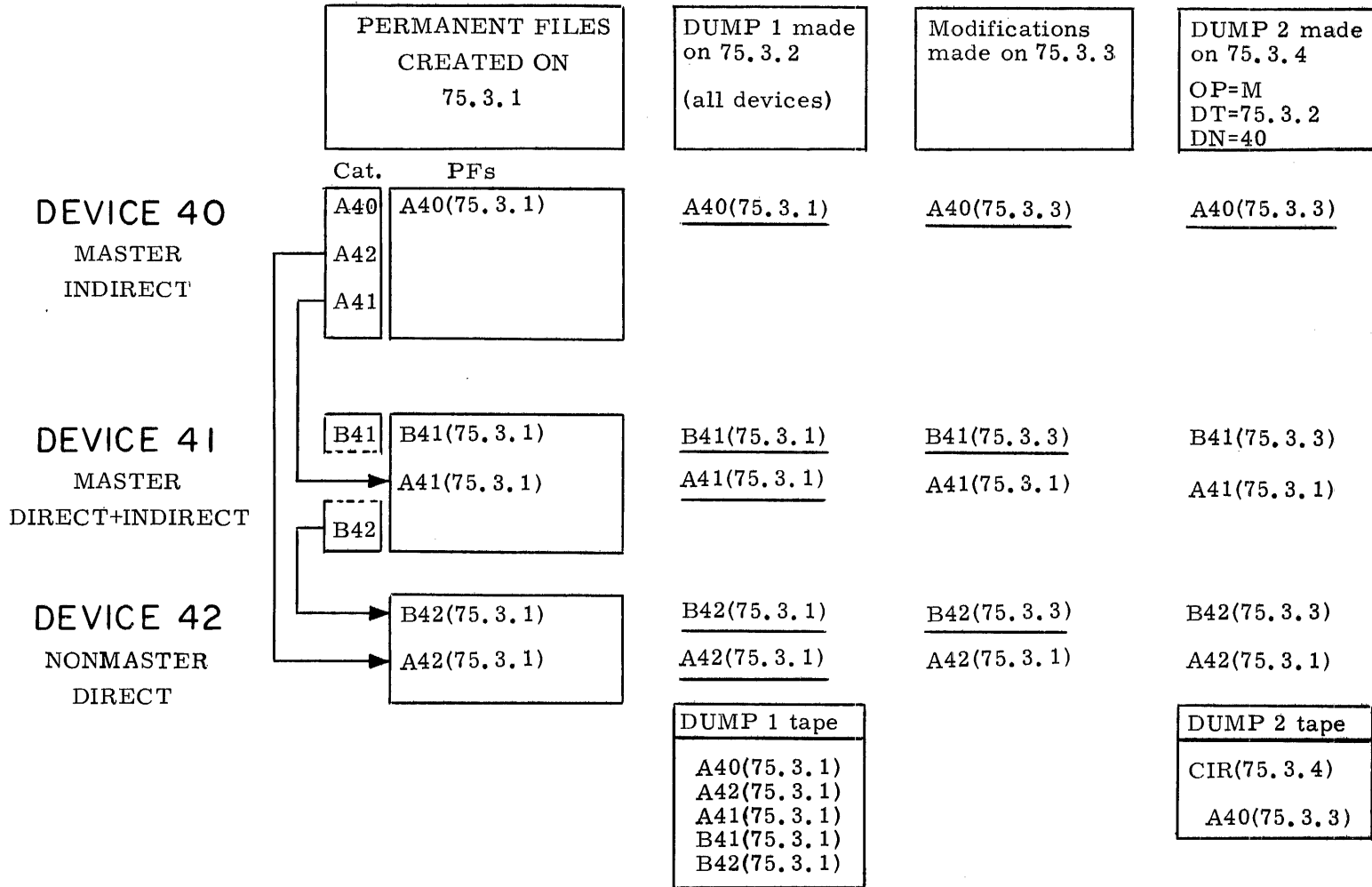

Figure 1-17. PFDUMP/PFLOAD Example (Sheet 1 of 3)

DEVICE 40  
 MASTER  
 INDIRECT

DUMP 3 made on 75.3.4 OP=M DT=75.3.2 DN=41	DUMP 4 made on 75.3.4. OP=M DT=75.3.2 DN=42	Modifications made on 75.3.5	DUMP 5 made on 75.3.6 OP=M DT=75.3.4 (all devices)	DUMP 6 made on 75.3.7 OP=M DT=75.3.4 DN=42
A40(75.3.3)	A40(75.3.3)	<u>A40(75.3.5)</u>	<u>A40(75.3.5)</u>	A40(75.3.5)

DEVICE 41  
 MASTER  
 DIRECT+INDIRECT

<u>B41(75.3.3)</u>	B41(75.3.3)	<u>B41(75.3.5)</u>	<u>B41(75.3.5)</u>	B41(75.3.5)
A41(75.3.1)	A41(75.3.1)	A41(75.3.1)	A41(75.3.1)	A41(75.3.1)

DEVICE 42  
 NONMASTER  
 DIRECT

<u>B42(75.3.3)</u>	<u>B42(75.3.3)</u>	<u>B42(75.3.5)</u>	<u>B42(75.3.5)</u>	<u>B42(75.3.5)</u>
A42(75.3.1)	A42(75.3.1)	A42(75.3.1)	A42(75.3.1)	A42(75.3.1)

DUMP 3 tape CIR(75.3.4) B41(75.3.3) B42(75.3.3)	DUMP 4 tape CIR(75.3.4) B42(75.3.3)		DUMP 5 tape CIR(75.3.6) A40(75.3.5) B41(75.3.5) B42(75.3.5)	DUMP 6 tape CIR(75.3.7) B42(75.3.5)
--	---	--	---	---

Figure 1-17. PFDUMP/PFLOAD Example (Sheet 2 of 3)

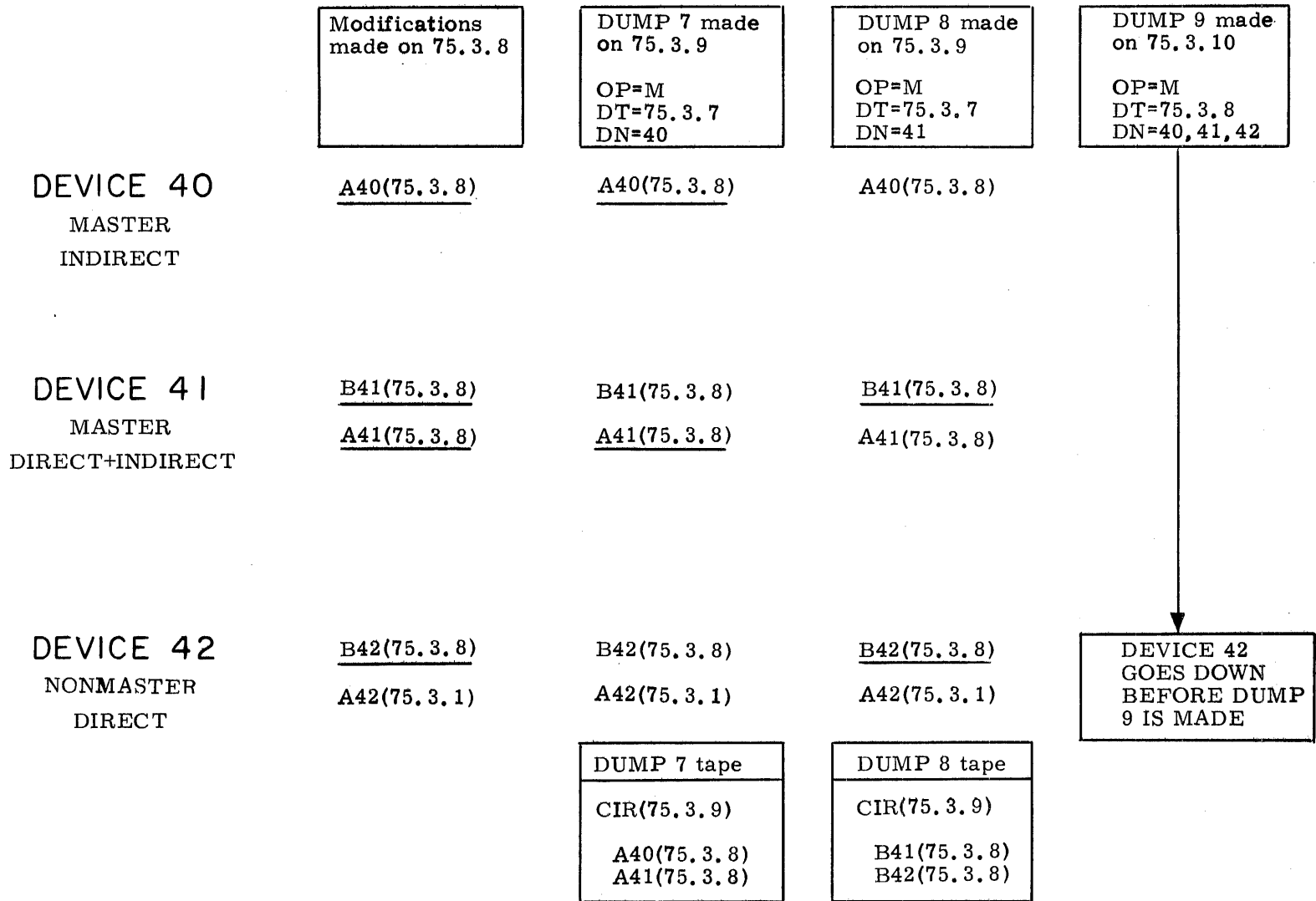

Figure 1-17. PFDUMP/PFLOAD Example (Sheet 3 of 3)



Actions during the 10 days in March in which the dumps and modifications were made run as follows:

<u>Date</u>	<u>Action</u>
75.3.1	Five permanent files are created on this date.  File A40 (indirect) is written on device 40 and cataloged on device 40.  File A42 (direct) is written on device 42 and cataloged on device 40.  File A41 (direct) is written on device 41 and cataloged on device 40.  File B41 (indirect) is written on device 41 and cataloged on device 41.  File B42 (direct) is written on device 42 and cataloged on device 41.
75.3.2	DUMP 1. A full permanent file system dump. No CIR is written on the archive file.
75.3.3	Three files (A40, B41, and B42) are modified on this date. This is indicated by the modification date in parentheses following the file name.
75.3.4	DUMP 2. This is an incremental dump of device 40 that specifies permanent files modified after 75.3.3. The files for this device are the ones listed on its catalog track. The utility scans this catalog which contains entries for files A40, A42, and A41. File A40 is on device 40 and the other two are on the devices indicated by their names. Only file A40, which was modified on 75.3.3, qualifies for this dump. It is written on an archive tape after a CIR for this date (75.3.4). The CIR gives a current description of all five files in the permanent file system.
75.3.4	DUMP 3. This is an incremental dump of device 41 that specifies all files modified after 75.3.2. The catalog for this device contains entries for files B41 and B42. Both files were modified on 75.3.3 and qualify for this dump. They are written on an archive file after a CIR for this date.
75.3.4	DUMP 4. This is an incremental dump of device 42 that specifies all files modified after 75.3.2. The PFDUMP utility scans the catalogs on devices 40 and 41 to locate the files on 42. One file, B42 (75.3.3), falls in this category.
75.3.5	Three files are modified on this date.
75.3.6	DUMP 5. This is an incremental dump of each of the three devices. All files modified after 75.3.4 are specified by the DT option. Since no DN is specified, all devices are dumped in turn, producing a dump tape with three archive files.
75.3.7	DUMP 6. This incremental dump of device 42 specifies all files modified after 75.3.4. Since 42 is nonmaster, the dump routine scans the catalogs of the other two devices.
75.3.8	Four files are modified on this date.
75.3.9	DUMP 7. An incremental dump of device 40 is made with DT=75.3.7. Two files qualify.
75.3.9	DUMP 8. An incremental dump of device 41 is made with DT=75.3.7. The catalog on device 41 contains entries for files B41 and B42. File B41 is an indirect access file located on device 41, and file B42 is a direct access file located on device 42. Both files were modified after 75.3.7 and are dumped.
75.3.10	DUMP 9. An incremental dump of devices 40, 41, and 42 is specified, but device 42 becomes inoperable before the dump is made.

To reestablish permanent files on device 42 with the most recent modifications available, the device is first initialized and then incrementally loaded, beginning with the most recent incremental dump tape. Archive dump 8 is the most recent incremental dump tape and accordingly contains the most recent CIR. This reel is assigned first and then the CIR read onto a random file. The dump tapes are read in reverse order with each file on each tape being checked against the CIR. Dump tapes 2 and 3 are omitted since they do not involve device 42.

For each catalog track on device 42 that is to receive file entries, PFLOAD builds and maintains an index file. Before each file can be loaded, PFLOAD checks the index file to see if the file has already been loaded. If it has, the archive duplicate is skipped; if not, the archive file is loaded and another entry goes into the index file.

After initialization of device 42, the loading runs as follows:

<u>Archive File</u>	<u>Action</u>		
DUMP8 tape	The analyst assigns DUMP8 tape and enters the command:		
CIR(75.3.9)	PFLOAD(T=DUMP8,DN=42)		
B41(75.3.8) B42(75.3.8)	The utility reads the CIR from this tape onto a random file. It then looks for files for device 42 on this tape. B42 qualifies, and its entry in the CIR is removed. The file B42 is loaded on device 42. The catalog of this file on device 41 is created. After loading this file, the utility makes an entry in the index file as follows:		
	<table border="1" style="margin-left: auto; margin-right: auto;"> <tr> <td style="padding: 2px;">B42</td> <td style="padding: 2px;">userin</td> </tr> </table>	B42	userin
B42	userin		
	The utility then requests the next reel.		
DUMP7 tape	The analyst assigns this tape, and the utility reads the archive file and checks it against the CIR loaded from DUMP8 above. No match is found. The next reel is requested.		
CIR(75.3.9)			
A40(75.3.8) A41(75.3.8)			
DUMP6 tape	This tape is assigned and then compared with the CIR. B42 is a file from device 42. However, its entry in the CIR was removed when it was read from DUMP8.		
CIR(75.3.7)			
B42(75.3.5)			
DUMP5 tape	This tape is assigned and then compared with the CIR. B42 is from device 42 but it has already been removed from the CIR and the utility skips this version.		
CIR(75.3.6)			
A40(75.3.5) B41(75.3.5) B42(75.3.5)			

Archive File

Action

DUMP4 tape
------------

This tape is assigned and compared with the CIR originally read from DUMP8 tape. It has been removed from the CIR and this file is skipped.

CIR(75.3.4)
-------------

B42(75.3.3)
-------------

DUMP1 tape
------------

This tape, produced by a full dump, contains all the files that were on the permanent file system when the dump was made (75.3.1). These files are checked against CIR (75.3.9). A match is found with A42. This file is loaded.

A40(75.3.1)
-------------

A42(75.3.1)
-------------

Device 42 now has the same files with the same update status that they had on 75.3.9 when the last incremental dump was made.

A41(75.3.1)
-------------

B41(75.3.1)
-------------

B42(75.3.1)
-------------

## QUEUE/DAYFILE UTILITIES

2

---

Several utility programs provide control over queued input, print, and punch files and over system, account, and error log dayfiles. The utility programs are divided into two groups, according to the type of selective processing they provide.

- The queue file utilities are 10 utilities under the control of the queue file supervisor program QFSP. These utilities select for processing queue files or dayfiles that share certain user-specified characteristics such as device residence, origin type, and job name.
- The dayfile dumping utilities are four independent utilities that dump all or selected parts of the active system, account, error log or binary maintenance dayfiles. These utilities each process the contents of a single file according to user-specified criteria.

### QUEUE FILE UTILITIES

The names and functions of the queue file utilities follow. Detailed information about the call and operation of each utility is contained in following sections.

<u>Utility</u>	<u>Description</u>
QREC	Deactivates or activates selected I/O queue files; purges inactive queue files.
DFTERM	Terminates an active or inactive dayfile and retains it as a direct access permanent file.
DFLIST	Lists dayfiles that have been made permanent files by the DFTERM utility.
QLIST	Lists inactive I/O queue files.
QDUMP	Dumps I/O queue files to tape or mass storage.
QLOAD	Loads files dumped by QDUMP as I/O queue files.
QMOVE	Moves I/O queue files from one mass storage device to another.
LDLIST	Lists queue files present on a QDUMP dump tape.
QALTER	Alters routing information associated with active queued output files; purges active queued I/O files.
FNTLIST	Lists detailed information about active queued I/O files.

## CALLING THE QUEUE FILE UTILITIES

All queue file utility operations, except for DFLIST, LDLIST, and QLIST, can be initiated through console input to a K display. All queue utilities except DFLIST and DFTERM can be initiated through direct keyboard entries (under DIS or DSD control), card input (batch), or terminal entries. DFTERM and DFLIST operation can be initiated only through direct keyboard entries. However, in all cases, for batch and terminal input, the user must be validated for system origin privileges, DEBUG must be on, and the user must observe certain parameter order dependencies.

### Console Input

Input from a console through a K display requires the following sequence of entries and responses. These procedures do not apply to DFLIST, QLIST, or LDLIST, because K displays are not available for these utilities.

1. Call QFSP by typing:

X.QFSP.

The B display indicates the control point to which QFSP is assigned. To the right of the entry appears the following flashing message:

REQUEST \*K\* DISPLAY

2. Activate the K display for that control point by typing:

K,n. (n is the control point number of QFSP specified on the B display.)

The display shown in figure 2-1 appears on the left screen. Instructions at the bottom of the display describe how to select the desired utility.

```
*** QUEUED FILE SUPERVISOR ***

      UTILITY  DESCRIPTION
      QDUMP   - QUEUED FILE DUMP PROCESSOR.
      QLOAD   - QUEUED FILE LOAD PROCESSOR.
      QMOVE   - QUEUED FILE MOVE PROCESSOR.
      QREC    - PROCESS QUEUED FILES.
      DFTERM  - TERMINATE DAYFILES.
      FNTLIST - LIST ACTIVE QUEUED FILES.
      QALTER  - ALTER ACTIVE QUEUED FILES.

SELECT DESIRED UTILITY BY ENTERING K.OPTION
WHERE OPTION IS ONE OF THE UTILITIES LISTED
ABOVE.
```

Figure 2-1. QFSP Display

3. Select the desired utility by typing:

K.utility            (utility is one of the utilities shown in the K display, figure 2-1.)

The parameter options available under the chosen utility appear on the left screen as the initial K display for the utility. Figures 2-3, 2-7, 2-9, 2-12, and 2-14 exhibit initial K displays for the various utilities. Different parameter options are available with the different utilities. (Refer to Description of Queue Utility Parameters later in this section.)

It is also possible to call each utility directly by substituting the following for steps 1, 2, and 3.

- a. Call the desired utility by typing:

X.utility            (utility is one of the utilities shown in figure 2-1.)

The B display indicates the control point to which the chosen utility is assigned. The following message also appears.

REQUEST \*K\* DISPLAY

- b. Activate the initial K display for the chosen utility by typing:

K,n.                (n is the control point number specified on the B display.)

4. Several commands are available to aid in the use of the utilities and direct processing. A right screen display lists and defines each available command. Activate this K display by typing:

KK.

Figure 2-2 illustrates this queue file utility commands display.

The following is a list of the queue file utility commands included on the display and a description of each.

<u>Command</u>	<u>Description</u>
GO	Directs the active utility to proceed with the processing of the entered parameters. When the processing is complete, the left-screen K display is reset to the default values.
STOP	Terminates the active utility and ends the K-display interaction.
RESET	Resets all options displayed on the left-screen K display to their default values.

\*\*\* QUEUE FILE UTILITY COMMANDS \*\*\*

THE FOLLOWING COMMANDS ARE PROVIDED-

GO - PROCEED WITH PROCESSING (FM MUST BE SPECIFIED).  
(ALL UTILITIES)  
STOP - TERMINATE INPUT, END RUN. (ALL UTILITIES)  
RESET - RESET PARAMETERS TO DEFAULT VALUES.  
(ALL UTILITIES)  
LIST - DISPLAY JOB NAMES OF ACTIVE/INACTIVE QUEUED FILES  
ON RIGHT SCREEN. (QREC, DFTERM, QALTER, FNTLIST).  
+ - PAGE LIST OF JOB NAMES DISPLAYED ON RIGHT SCREEN.  
(QREC, QALTER, FNTLIST).  
CLEAR - SET RIGHT SCREEN TO THIS DISPLAY. (QREC)  
DFTERM, QALTER, FNTLIST.)  
OUT - RELEASE FILE SPECIFIED BY L PARAMETER TO  
PRINTER. (ALL UTILITIES)  
REWIND- IF ENTERED, DUMP/LOAD FILE WILL BE REWOUND WHEN  
"GO" COMMAND IS ENTERED. (QDUMP AND QLOAD ONLY).  
ERROR - TOGGLE STATUS OF ERRORED FILE PROCESSING.  
(QDUMP, QLOAD, QMOVE ONLY).

DA, UI, FS AND ID DIRECTIVES MAY HAVE ONE OF TWO FORMS-

DA=YYMMDD PROCESS THIS DATE ONLY.  
DA=YYMMDD-YYMMDD PROCESS ALL DATES IN SPECIFIED RANGE.  
  
UI=XXXXXX PROCESS THIS USER INDEX ONLY.  
UI=XXXXXX-YYYYYY PROCESS ALL INDICES IN SPECIFIED RANGE.  
  
FS=XXXXXX PROCESS THIS FILE SIZE ONLY.  
FS=XXXXXX-YYYYYY PROCESS ALL SIZES IN SPECIFIED RANGE.  
IF 77777B IS SPECIFIED, ALL SIZES LARGER ARE INCLUDED.  
  
ID=XX PROCESS THIS ID ONLY.  
ID=XX-YY PROCESS ALL ID,S IN SPECIFIED RANGE.

Figure 2-2. Queue File Utility Commands Display

<u>Command</u>	<u>Description</u>
LIST	<p>If the QREC utility is active, this command displays a list of inactive I/O queue files on the right-screen K display (figure 2-4). The list of files displayed is also written on the output file specified by the QREC L option.</p> <p>If the DFTERM utility is active, this command displays a list of all permanent dayfiles (figure 2-8). The list of files displayed is also written on the output file specified by the DFTERM L option.</p> <p>If the QALTER or FNTLIST utility is active, this command displays a list of active I/O queue files on the right-screen K display (figure 2-18). The list of files is also written on the output file specified by the QALTER or FNTLIST L option.</p>

<u>Command</u>	<u>Description</u>
LIST=fnt	Displays detailed information about the active I/O queue file at FNT ordinal fnt on the right-screen K display and writes the information to the output file specified by the QALTER or FNTLIST L option. This form of LIST is accepted only by QALTER and FNTLIST.
+	Used in conjunction with the LIST command and displays succeeding pages (screens) of the information listed. This command applies only to the QREC, QALTER, and FNTLIST utilities.
CLEAR	Used in conjunction with the LIST command and returns the right-screen K display to the list of processing commands initially displayed (figure 2-2).
OUT	Disposes the output file specified by the L option of each utility to the print queue for immediate printing. Any information that has been or is currently displayed on the right-screen K display via the LIST command is also included with the disposed output. In addition, if the LIST command is currently active, the list displayed on the right screen is disposed, and the initial right-screen K display shown in figure 2-2 is returned automatically.
REWIND	Rewinds the load or dump file specified by the FN option before processing. This command applies only to the QLOAD and QDUMP utilities.
ERROR	<p>If the QDUMP utility is active, enabling this command causes files on which unrecoverable read errors were encountered to be dumped with the errors listed on the output file. Disabling this command causes these files to be ignored. The default under QDUMP is enabled.</p> <p>If the QLOAD utility is active, enabling this command causes such files to be loaded with the errors listed on the output file. Disabling the command causes such files to be ignored. The default under QLOAD is disabled.</p> <p>If the QMOVE utility is active, enabling this command causes such files to be moved with errors listed on the output file. Disabling this command causes such files to be ignored. The default under QMOVE is disabled.</p> <p>The entry of this command toggles the setting of this command.</p>

5. Select the desired parameter options by typing:

K.opt<sub>1</sub>=val<sub>1</sub>,opt<sub>2</sub>=val<sub>2</sub>,...,opt<sub>n</sub>=val<sub>n</sub>

where the opt<sub>i</sub>=val<sub>i</sub> are selected from the parameter option list on the initial K display for the chosen utility.

The option parameter entries are issued to the control point dayfile, which is included in the output file specified by the L option for each utility (refer to Parameters).



If the FM option is specified for QREC, QDUMP, or QMOVE (indicating the processing of queue files for only the specified family of devices), the initial left screen display (figures 2-3, 2-9, and 2-14) is replaced by the secondary left screen display (figures 2-5, 2-10, and 2-15). This display closely resembles the initial left screen for the utility but restricts processing to the family of devices specified. Each device in the specified family containing inactive queue files is indicated. In addition, any option entered for the utility is reflected in this display. Options not entered remain at default values.

If the FM option is not specified, the initial K display remains on the left screen. However, the display is modified to reflect the parameter options entered. Options not entered remain at the default values.

The displays are modified in this manner to provide an opportunity to double-check the entry. If it is necessary to modify the entry, reenter those options that are to be changed. Entry of illegal data causes an error message to appear at the bottom of the left-screen K display. In this case, the portion of the entry up to the point where the error was encountered is processed; the remainder of the entry (from left to right) is ignored.

6. Initiate execution by typing:

K. GO.

When processing is complete, the left-screen K display is reset to default values, the message

option COMPLETE (option is the name of the utility processed)

appears at the bottom of the screen, and the right screen returns to the original display.

7. Terminate use of the chosen utility and end K-display interaction by typing:

K.STOP

An output file is generated indicating the disposition of I/O queue files or dayfiles processed. Examples of output files generated by each utility are shown in figures 2-6, 2-8, 2-11, 2-13, and 2-16.

It is also possible to call each utility and specify appropriate options without the use of K displays; this is the only way to call DFLIST. This is accomplished via a single keyboard entry in the following format.

X.utility(opt<sub>1</sub>=val<sub>1</sub>,opt<sub>2</sub>=val<sub>2</sub>,...,opt<sub>n</sub>=val<sub>n</sub>,I=filenam,NK)

utility Any I/O queue or dayfile utility.

opt<sub>i</sub>=val<sub>i</sub> Parameter options (refer to Parameters for the Queue File Utilities).

I=filenam Name of alternate input file (optional). This file may contain K display utility commands (GO, STOP, RESET, and so on) and/or valid option parameters.

NK Specifies that no K-display input is allowed. The use of the NK parameter and proper parameter selection allows the utility to run without additional operator intervention. This parameter is not needed and should not be entered for QLIST, LDLIST, and DFLIST.

The specified utility processes parameter options on the control statement before the alternate input file, if any. If the utility is QLIST, LDLIST, or DFLIST or if NK is specified, the requested queue/dayfile processing proceeds after all control statement and/or alternate input file parameters have been processed (unless a STOP command is encountered on the alternate input file). If NK is omitted from the control statement and the utility is not one previously mentioned, the utility requests the K display after processing the control statement and alternate input file (unless a STOP command is encountered on the alternate input file). The K display then reflects the status of all parameter options after processing of the control statement and alternate input file is complete. If the utility encounters an error while processing the control statement or alternate input file, a request for the K display appears on the DSD B display (except for QLIST, LDLIST, and DFLIST). The operator may then activate the K display, enter the correct parameter options, and continue processing. However, if errors are encountered and the utility was invoked by a nonsystem origin job, a message is issued to the dayfile, and utility processing is terminated.

### Batch Input

To call the utilities from a batch job, the user must be validated for system origin privileges, and DEBUG must be set at the system console. The following deck structure is used to call a utility.

```
Job statement
USER statement
CHARGE statement (if necessary)
utility(opt1=val1,opt2=val2,...,optn=valn,I=filenam,NK)
```

utility Any of the following I/O queue or dayfile utilities: QREC, QDUMP, QLOAD, QMOVE, QLIST, LDLIST, QALTER, or FNTLIST.

opt<sub>i</sub>=val<sub>i</sub> Parameter options (refer to Parameters for the Queue File Utilities).

I=filenam Name of alternate input file (optional). This file may contain K display utility commands (GO, STOP, RESET, and so on) and/or valid option parameters.

NK Specifies that no K-display input is allowed. The use of the NK parameter and proper parameter selection allows the utility to run without additional operator intervention. This parameter is not needed and should not be entered for QLIST or LDLIST.

The DFLIST and DFTERM utilities cannot be called from a batch job. They must be initiated from the system console.

### Terminal Input

The format of terminal input for calling the queue utilities is substantially the same as that for batch input. The user must be validated for system origin privileges, and DEBUG must be set at the system console. At login, the user enters the batch subsystem, calls the desired utility, and enters the appropriate parameters with the command

```
utility(opt1=val1,opt2=val2,...,optn=valn,I=filenam,NK)
```

The utility, opt=val, I=filenam, and NK parameters are as described for batch input.

### PARAMETERS FOR THE QUEUE FILE UTILITIES

Table 2-1 indicates the parameter options accepted by each queue file utility. (DFLIST is not included because it does not accept any parameters.) An X indicates that a parameter option is accepted; a blank indicates that a parameter option is not accepted. Refer to the following descriptions of parameters for more information.

TABLE 2-1. QUEUE FILE UTILITY PARAMETER OPTIONS

Parameter	Utility								
	QREC	QDUMP	QLOAD	QMOVE	QALTER	LDLIST	FNTLIST	DFTERM	QLIST
BC	X	X	X	X	X	X	X		X
DA	X	X	X	X		X			X
DD			X	X		X			
DF			X	X	X	X	X		
DN	X	X		X	X		X	X	X
DS	X	X	X	X	X	X	X		X
EI	X	X	X	X	X	X	X		X
FC	X	X	X	X	X	X	X		X
FM	X	X		X	X		X	X	X
FN		X	X			X			
FS	X	X	X	X		X			X
FT								X	
FU	X	X	X	X		X			X
ID	X	X	X	X	X	X	X		X
JC					X		X		
JN	X	X	X	X	X		X		X
L	X	X	X	X	X	X	X	X	X
LO					X		X		
ME		X	X			X			
MI	X	X	X	X		X			X
NDF					X				
NF		X	X			X			
NFC					X				
NID					X				
NM								X	
NPR					X				
NRC					X				
NUN					X				
OP	X		X	X	X			X	
SC			X			X			
SY	X	X	X	X		X			X
TID	X	X	X	X		X			X
TP		X		X					
UI	X	X	X	X		X			X
UN					X		X		
VSN		X	X			X			

## Description of Queue Utility Options

- DA=yymmdd** Processing data in the form of year, month, day. If one date is specified, only I/O queue files created on that day are processed. If two dates, separated by a hyphen, are specified (for example, 780530-780613), all queue files created within the specified range (including the end points) are processed. If this option is omitted with utilities other than QLIST, queue files created 5 days prior to the current date are processed. If this option is omitted with QLIST, all inactive queue files, regardless of creation date, are processed.
- DD=dn** Destination device to which files are to be loaded or moved. The DF option must be specified before the DD option. If DF is specified, DD must also be specified. With QMOVE, both DD and DF must be specified.
- DF=family** Family of devices to which files are to be loaded or moved. With QMOVE, this option must be specified.
- With QALTER or FNTLIST, DF must be used with the UN option. The utility will process files belonging to the remote terminal identified by these options.
- DN=dn** One- or two-digit device number (1 through 77g). With utilities other than DFTERM, this option specifies the device to be processed, dumped, or loaded. The FM option must be specified before the DN option. Default is all devices.
- With DFTERM, this option specifies the device on which the inactive dayfile resides or on which the new dayfile will reside if the active dayfile is terminated. Default is the device on which the current dayfile resides.

DS=dv-ex or DS=dv

Device selection criteria for output files. The types of output devices (dv) that can be selected include the following.

<u>dv</u>	<u>Description</u>
LR	580-12 printer
LS	580-16 printer
LT	580-20 printer
NONE	No device code specified
PB	Punch binary
PL	Plotter
PR	Any printer
PU	Punch coded
P8	Punch 80 column
SB	Punch system binary

The external characteristics (ex) of the device are optional and can be any of the following.

For print files:

A4	Provided for NOS/BE compatibility
A6	ASCII graphic 63/64-character set
A9	ASCII graphic 95-character set
B4	Provided for NOS/BE compatibility
B6	CDC graphic 63/64-character set

For punch files:

ASCII	Punch ASCII
O26	Punch O26 mode
O29	Punch O29 mode
PU	Punch coded
SB	Punch system binary
80COL	Punch 80-column binary

FC=fc

Forms code for print and punch files considered for processing. With utilities other than QALTER and FNTLIST, fc can be any of the following.

<u>fc</u>	<u>Description</u>
Ax	x is any character from A through F. Files with this forms code are considered for processing.
*	Files with forms codes in the range AG through 99 are considered for processing.
NULL	Files without forms codes are considered for processing.
ALL	All files are considered for processing regardless of forms codes.

With QALTER and FNTLIST, fc can be any of the following.

<u>fc</u>	<u>Description</u>
fc <sub>1</sub> fc <sub>1</sub> /fc <sub>2</sub> fc <sub>1</sub> /fc <sub>2</sub> /fc <sub>3</sub>	fc <sub>i</sub> is two alphanumeric characters or **, indicating null forms code. Up to three forms code or ** can be specified; files with the specified forms code(s) are considered for processing.
fc <sub>1</sub> -fc <sub>2</sub>	fc <sub>i</sub> is two alphanumeric characters or **. If fc <sub>1</sub> is not **, the display code value of fc <sub>1</sub> must be less than or equal to the display code value of fc <sub>2</sub> . fc <sub>2</sub> can be ** only if fc <sub>1</sub> is also **. Files in the range fc <sub>1</sub> through fc <sub>2</sub> are considered for processing; if fc <sub>1</sub> equals **, files with no forms code are (also) considered for processing.

A subsequent FC entry replaces any FC entry previously made. Default is to consider all files for processing regardless of forms codes.

FM=family

Name of family to be processed. Default is to process all queue files on all devices in all families.

With DFTERM, this option specifies the family of devices on which the inactive dayfile resides or on which the new dayfile will reside if the active dayfile is terminated. If an active dayfile is terminated, default is the same family as that in which the dayfile being terminated resides.

FN=filenam

File name of dump or load file, which resides on magnetic tape or mass storage depending on the ME option. Default is FN=QFILES.

FS=x

File size in PRUs, divided by 10g. The value can be entered as a single file size (FS=100) or as a range of file sizes (FS=10-400). x ≤ 777777g.

FT=t Type of dayfile to be terminated by the DFTERM utility.

<u>t</u>	<u>Description</u>
ACCOUNT	Account dayfile
DAYFILE	System dayfile
ERRLOG	Error log dayfile
MAINLOG	Binary maintenance log dayfile

This option causes the FM and DN options to be updated to reflect the current family and device number of the dayfile specified by FT. Default is FT=DAYFILE.

FU=family Name of family under which the queue files to be processed were created. Queue files created by users of one family can reside on nonremovable devices of another family. The FM option specifies the family of devices that will be searched for I/O queue files created by users validated in the family specified by the FU option. Default is to process queue files created by users in all families.

ID=id One- or two-digit octal number (0 through 77<sub>o</sub>) specifying that only local batch or system origin queue files assigned that identifier are to be processed. If two identifiers, separated by a hyphen, are specified (for example, ID=6-30), any queue file with identifier in the specified range (including the end points) is processed. Default is to process all queue files regardless of identifier.

JC=name One- to seven-character name specified on job statements associated with queue files being listed or altered. Only one name can be specified. A subsequent JC entry replaces any JC entry previously made. This option in conjunction with the JN option uniquely describes which files are to be processed.

JN=jobnam Seven-character job name or four-character banner name (first four characters of job name) of I/O queue files to be processed, dumped, loaded, or moved. At most, five job names can be specified. If a job name is specified more than once, it is removed from the list. If fewer than seven characters are specified, all queue files that have identical job names are processed. Default is to process all queue files regardless of job/banner names.

L=filenam One- to seven-character name of the file to receive output. Default is L=OUTPUT.

LO=opt List option associated with the output file specified by the L option.

<u>opt</u>	<u>Description</u>
F	All routing information for each file.
S	Condensed listing of each selected queue file.

ME=x Medium from which to load or to which to dump.

<u>x</u>	<u>Description</u>
MS	Mass storage device.
MT	Seven-track tape.
NT	Nine-track tape.

If MT or NT is specified, a request for a magnetic tape is issued and all selected queue files are loaded from or dumped to that tape. If the tape is not preassigned, the installation default density for the specified track type is used. Default is that the installation default track type and density are used.

MI=id One- or two-character machine identifier indicating the mainframe on which the queue files to be processed currently reside. If MI=ALL is specified, any queue file residing on any mainframe is processed. The MI entry is cleared if previously specified; that is, specifying two identical MI entries is the same as not specifying any at all. If the MI entry is cleared on the K display, the id is not checked. Default is machine identifier of the mainframe where the utility is being run.

**NOTE**

The MI directive should be cleared before queued files created on a premultimainframe system (NOS 1.0) are processed. This is required because of the addition of the MI directive for use in multimainframe systems.

NDF=family New destination family name associated with selected print or punch files. This option is meaningful only in the altering of files whose origin type is or is being changed to remote batch. A subsequent NDF entry replaces any previous NDF entry. Default is no change in destination family name.

NF=n Decimal number of media files to skip. A media file contains all queue files which are dumped by one QDUMP operation. Each of these dumped queue files exists as a record on the media file. If two QDUMP operations are performed, the dumped queue files exist as records on two files. This option can be used in conjunction with the SC option. Default is 0.

NFC=fc Two alphanumeric characters or \*\* (null forms code) specifying the new forms code associated with selected print or punch files. The NFC entry is cleared if previously specified; that is, specifying two identical NFC entries is the same as not specifying any at all. Default is no change in forms code.



**NID=id** One- or two-digit number (0 through 67g) specifying the new file identifier associated with selected print or punch files. This option is meaningful only in the altering of files whose origin type is or is being changed to remote batch. The NID entry is cleared if previously specified; that is, specifying two identical NID entries is the same as not specifying any at all. Default is no change in file identifier.

**NM=filenam** One- to five-character name of the direct access permanent file on which DFTERM writes the terminated dayfile. DFTERM adds a two-character prefix indicating the type of dayfile being terminated (AC, DF, or ER). Default is automatic naming of the file by DFTERM according to the following.

- The first two characters indicate the type of dayfile being terminated (AC, DF, or ER).
- The third character is a sequence number (A through 9).
- The next two characters indicate the month.
- The last two characters indicate the day of the month.

**NPR=p** One- to four-digit number (0 through 7777g) specifying the new priority associated with selected print or punch files. The NPR entry is cleared if previously specified; that is, specifying two identical NPR entries is the same as not specifying any at all. Default is no change in file priority.

**NRC=c** One- or two-digit number (0 through 37g) specifying the new repeat count associated with selected print or punch files. The NRC entry is cleared if previously specified; that is, specifying two identical NRC entries is the same as not specifying any at all. Default is no change in repeat count.

**NUN=usernum** New destination user number associated with selected print or punch files. This option is meaningful only in the altering of files whose origin type is or is being changed to remote batch. The NUN entry is cleared if previously specified; that is, specifying two identical NUN entries is the same as not specifying any at all. Default is no change in destination user number.

**OP=opt** Processing option specifying the function to be performed by each utility.

With QREC, opt can be any of the following. Default is OP=RI.

<u>opt</u>	<u>Description</u>
DI	Selected active I/O queue file are made inactive (entries are removed from the FNT and added to the IQFT file), and the remaining active queue files are ignored.
PI	Selected inactive I/O queue files are purged, and the remaining inactive queue files are ignored.

<u>opt</u>	<u>Description</u>
RI	Selected inactive I/O queue files are activated (requeued), and the remaining inactive queue files are ignored.
RP	Selected inactive I/O queue files are activated (requeued), and the remaining inactive queue files are purged.

With QALTER, opt specifies the origin type to which the selected queued files should be changed, and can be one of the following. Default is OP=NC.

<u>opt</u>	<u>Description</u>
BC	Change to local batch.
EI	Change to remote batch.
NC	Do not change origin type.
PR	Purge files.

With DFTERM, opt specifies whether active or inactive dayfiles will be terminated. With QLOAD and QMOVE, opt specifies whether the loaded or moved queue files will be active or inactive. With these utilities, opt can be one of the following. Default is OP=A.

<u>opt</u>	<u>Description</u>
A	Active queues/dayfiles are specified.
I	Inactive queues/dayfiles are specified.

ot=ft Job origin type (ot) and corresponding file type (ft) to be processed.

ot can be one of the following (successive ot entries are allowed).

<u>ot</u>	<u>Description</u>
BC	Local batch and system origin for QALTER and FNTLIST and local batch origin for all other applicable utilities.
EI	Remote batch origin.
SY	System origin; cannot be used with QALTER or FNTLIST.

ft can be one of the following.

<u>ft</u>	<u>Description</u>
ALL	Files of all types for specified origin type.
IN	Input files.
NONE	No files for specified origin type.
PH	Punch files.
PR	Print files.
SF	Installation-defined special files; cannot be used with QALTER or FNTLIST.

Origin type parameters (ot) can be entered more than once, with each successive entry reversing the previously established condition. Initially, all origin types and all file types are selected; thus any entry actually clears the automatic selection. For example, BC=PH would indicate that local batch origin punch files are not to be processed. However, a second BC=PH selection would reenable processing of local batch origin punch files.

If ALL or NONE is specified for ft, processing of all queue file types for the specified origin type is either enabled or disabled, respectively. If all file types are currently enabled for a particular origin type, entering ALL would have no effect. Likewise, entering NONE when all file types for a particular origin type are disabled would have no effect.

SC=n            Decimal number of queue files (and hence records on the dump file) to be skipped before the queue selection begins. Skipping begins at the point on the dump file indicated by the NF option. This option allows a restart load to begin from the last aborted queue loaded by QLOAD. Default is SC=0.

TID=id         One- to six-digit value plus a radix which specifies the destination terminal identifier for remote batch origin output files. If TID=0, no terminal identifier is specified. Default is TID=0.

TP=t            Type of files to move or dump.

<u>t</u>	<u>Description</u>
A	Active files.
ALL	Active and inactive files.
I	Inactive files.

Default is TP=ALL.

UI=userin      User index under which I/O queue files to be processed were created. If two user indexes, separated by a hyphen, are specified (for example, 75-162), all queue files created by all users having indexes within this range (including the end points) are processed. Default is to process all queue files regardless of user index.

UN=usernum            Destination user number within the family specified by the DF option. UN and DF must be specified together. The utility (QALTER or FNTLIST) will process files belonging to the remote terminal identified by these options.

VSN=vsrn              Volume serial number of the tape to dump to, load from, or list. This entry is ignored if ME=MT or ME=NT is not specified.

**NOTE**

If the currently displayed value for NFC, NID, NPR, NRC, NUN, or UN is reentered, the value for the specified option is cleared.

**File Preassignment**

In the QDUMP and QLOAD utilities, consideration should be given to file preassignment. The type, density, and vsrn of the file (tape) can be specified with the utility options ME and VSN. These attributes can also be specified when the file is assigned to a control point. The relation between file preassignment and the specification of the ME and VSN parameters is shown in the following cases.

- If the file specified by the FN option (or the default file QFILES) has been assigned to a control point prior to the utility call, that file is used as the dump or load file. In this case, the ME and VSN attributes are ignored if specified. For example, file assignment and the utility call are made with the following statements.

LABEL(QFILES,VSN=DMP1,D=HY)    or    ASSIGN(MS,QFILES)  
 QDUMP(ME=NT,VSN=DUMPF)            QDUMP(ME=NT,VSN=DUMPF)

The file QFILES is already at a control point when the utility is called. The utility does not make a tape request, and ME and VSN are ignored.

- If no file preassignment was done, the operator is requested to assign the unit to be used with the attributes specified by the ME and VSN options. For example, the following statement is issued.

QDUMP(ME=NT,VSN=DUMPF)

The operator is requested to assign a unit with attributes as specified by the ME and VSN options. If the operator assigns a tape unit, the installation default density for the specified track type is used. If ME is not specified and no file preassignment is done, the installation default track type and density are used.

A file name should not be associated with the tape vsrn (via the VSN control statement) unless the tape is assigned (via the LABEL control statement). If this is done prior to a utility call, QLOAD or QDUMP will abort.

## Active And Inactive Queue Files

An I/O queue file can be active or inactive. All queue files are originally active upon entering a queue. A queue file is deactivated (made inactive) when its entry is removed from the file name table (FNT) and a corresponding entry is created in an inactive queue file table (IQFT) file. An IQFT file is on each mass storage device on which one or more inactive queue files reside. An inactive queue file is activated when the entry from the IQFT file is removed and a corresponding entry is created in the FNT. Inactive queue files are not considered for processing (other than by the queue utilities), nor do they appear on any DSD display.

Three queue file utilities can deactivate or activate queue files (QLOAD, QMOVE, and QREC). QLOAD and QMOVE each transfer queue files from either tape or mass storage to a mass storage device. Upon completion of the transfer, the utility leaves the queue files active or inactive according to parameters specified by the analyst or operator. QREC does not perform any file transfer but only adjusts table entries as described in the preceding paragraph. These three utilities have uses other than deactivation and activation of queue files (refer to the description of the appropriate utility and parameter options).

Queue files are also deactivated when they are recovered during a level 0 deadstart. Such files can be activated automatically by an IPRDECK entry that invokes QREC during a level 0 deadstart. Refer to the NOS Installation Handbook for further information on IPRDECK.

## QUEUE FILE UTILITY ROUTINES

This section describes the queue file utility routines. The parameter options available for each of the routines are listed in table 2-1. The K displays (if any) for each utility are illustrated. These displays contain lists of applicable parameter options and the output formats for each utility.

### QREC

QREC deactivates or activates selected I/O queue files and purges selected inactive queue files.

When QREC is selected at the system console, the initial QREC K display appears on the left screen. This display contains a list of all applicable options associated with QREC, their default values, and a short description of each (figure 2-3).

A complete list of current inactive I/O queue files is displayed on the right screen when the following command is entered:

**K.LIST.**

When this command is processed, the right-screen K display is automatically replaced with the inactive queues K display (figure 2-4). The information presented in this display is the same as that generated by the QLIST utility. The list of files displayed is also written to the output file specified by the QREC L option.

\*\*\* QUEUED FILE REQUEUING \*\*\*

INACTIVE QUEUES RESIDE ON FOLLOWING FAMILIES(\*=BLANK NAME).

OPTIONS	DESCRIPTION
MI = 72	MACHINE ID (1-2 CHARACTERS, ALL).
FM = ALL	FAMILY FOR DEVICES (1-7 CHARACTERS).
DN = ALL	DEVICE NUMBER (1-77B, ALL).
FU = ALL	FAMILY FOR USER INDEX (1-7 CHARACTERS).
UI = 0B	USER INDEX RANGE (0-377777B).
	377777B
DA = 78/04/10.	QUEUED DATE RANGE (YYMMDD).
	78/04/15.
FS = 0B	FILE SIZE RANGE IN PRUS/10B (0-777777B).
	777777B
JN =	JOBNAMES (4 OR 7 CHARACTERS). JOBNAME WILL BE CLEARED IF PREVIOUSLY ENTERED.
ID = 0B	ID OF FILES TO PROCESS (0-77B).
	77B
TID= 0B	DESTINATION TID (0-377777B).
FC = ALL	FORMS CODE.
DS =	DEVICE SELECTION FOR OUTPUT FILES.
L = OUTPUT	FILE TO RECEIVE OUTPUT (1-7 CHARACTERS).
OP = RI	PROCESS OPTION (2 CHARACTERS).
	RP - SELECTION SPECIFIED FILES, PURGE OTHERS.
	RI - REQUEUE SPECIFIED FILES, IGNORE OTHERS.
	PI - PURGE SPECIFIED FILES, IGNORE OTHERS.
	DI - DEQUEUE SPECIFIED FILES, IGNORE OTHERS.
(OT=FT)	REQUEUE BY ORIGIN TYPE AND FILE TYPE. OPTION WILL BE CLEARED IF PREVIOUSLY SELECTED. * = OPTION SELECTED.
	OT=ORIGIN TYPE                      FT=FILE TYPE
	BC * * * *                      BC-BATCH                      SF-SPECIAL                      PH-PUNCH
	EI * * * *                      EI-EXPORT                      IN-INPUT                      PR-PRINT
	SY * * * *                      SY-SYSTEM

Figure 2-3. Initial QREC Display

\*\*\* INACTIVE QUEUES LIST \*\*\*

NO.	FILENAME	MID	FAMILY	DN	FT	OT	DATE	LENGTH (PRUS/10)
1.	QISOAOW	72	SYS172	1	PR	SY	78/03/31.	16
2.	QISOAOR	72	IAFFAM	1	PR	BC	78/03/31.	17
3.	QISOAOR	72	IAFFAM	1	PR	SY	78/03/31.	21
4.	IAF	72	SYS172	1	PR	SY	78/03/31.	4
5.	DIS0AHJ	72	SYS172	1	PH	BC	78/03/31.	1
6.	DIS0AHJ	72	SYS172	1	PR	BC	78/03/31.	1
7.	QISOAUT	72	SYS172	2	PH	SY	78/03/31.	7
8.	IAF	72	SYS172	2	PR	SY	78/03/31.	4
9.	DIS0AHJ	72	SYS172	2	PR	BC	78/03/31.	2

END OF DISPLAY.

Figure 2-4. Inactive Queues List

If the FM option is specified, indicating processing of queue files for a specified family of devices, the initial QREC left-screen K display is replaced by the secondary QREC K display (figure 2-5). This display closely resembles the initial QREC display but restricts QREC processing to the family of devices specified. Each device in the specified family containing inactive queue files is indicated. In addition, any option entered for the QREC utility is reflected in this display. Options not entered remain at default values.

After QREC processing has been completed and K-display interaction has been terminated by

K.STOP.

an output file is generated, indicating the disposition of all I/O queue files processed. Figure 2-6 contains an example of this output.

Example 1:

If the FNT is becoming full, the analyst can enter QREC from DSD to dequeue active queue files and free up FNT space. The following QREC entry dequeues all queue files.

X.QREC(OP=DI,NK)

If EI200 or RBF is not active, the analyst is still able to dequeue remote batch origin files by using QREC. The following QREC entry dequeues all remote batch files.

X.QREC(OP=DI,BC=NONE,SY=NONE,NK)

If these are queue files that previously had been dequeued, the analyst can activate these files with QREC. The following QREC entry requeues all inactive queue files.

X.QREC(OP=RI,NK)

\*\*\* QUEUED FILE REQUEUING \*\*\*

INACTIVE QUEUES RESIDE ON FOLLOWING DEVICES IN FAMILY - SYST72  
01 02 03

OPTIONS	DESCRIPTION
MI = 72	MACHINE ID (1-2 CHARACTERS).
FM = SYST72	FAMILY FOR DEVICES (1-7 CHARACTERS, ALL).
DN = ALL	DEVICE NUMBER (1-77B, ALL).
FU = ALL	FAMILY FOR USER INDEX (1-7 CHARACTERS).
UI = 0B 377777B	USER INDEX RANGE (0-377777B).
DA = 78/04/10. 78/04/15.	QUEUED DATE RANGE (YYMMDD).
FS = 0B 777777B	FILE SIZE RANGE IN PRUS/10B (0-777777B).
JN =	JOBNAMES (4 OR 7 CHARACTERS). JOBNAME WILL BE CLEARED IF PREVIOUSLY ENTERED.
ID = 0B 77B	ID OF FILES TO PROCESS (0-77B).
TID= 0B	DESTINATION TID (0-377777B).
FC = ALL	FORMS CODE.
DS =	DEVICE SELECTION FOR OUTPUT FILES.
L = OUTPUT	FILE TO RECEIVE OUTPUT (1-7 CHARACTERS).
OP = RI	PROCESS OPTION (2 CHARACTERS). RP - SELECTION SPECIFIED FILES, PURGE OTHERS. RI - REQUEUE SPECIFIED FILES, IGNORE OTHERS. PI - PURGE SPECIFIED FILES, IGNORE OTHERS. DI - DEQUEUE SPECIFIED FILES, IGNORE OTHERS.
(OT=FT)	REQUEUE BY ORIGIN TYPE AND FILE TYPE. OPTION WILL BE CLEARED IF PREVIOUSLY SELECTED. * = OPTION SELECTED.
S I P P	OT=ORIGIN TYPE FT=FILE TYPE
F N H R	
BC * * * *	BC-BATCH SF-SPECIAL PH-PUNCH
EI * * * *	EI-EXPORT IN-INPUT PR-PRINT
SY * * * *	SY-SYSTEM

Figure 2-5. Secondary QREC Display



\*\*\* QUEUE DISPOSITION \*\*\*

NO.	FILENAME	MID	FAMILY	DN	FT	OT	DATE	LENGTH	DISPOSITION
								(PRUS/10)	
1.	QIS0AAH	72	SYS172	2	PR	EI	78/04/20.	33	ACTIVATED
2.	QIS0AAH	72	SYS172	2	PR	BC	78/04/20.	5	ACTIVATED
3.	QIS0AAH	72	SYS172	3	PH	EI	78/04/20.	26	ACTIVATED
4.	DIS0AAM	72	SYS172	3	PR	SY	78/04/20.	3	ACTIVATED

Figure 2-6. QREC Output File

Example 2:

The analyst can purge all queue files (active and inactive) on a particular device by using QREC either with or without an input directive file. The first method involves two control statement calls to QREC. The first QREC call dequeues (makes inactive) all active files on the device with family name SYSTEM and device number 1, and the second QREC call purges all inactive (and hence all) queue files on that same device.

```
QREC(NK,OP=DI,FM=SYSTEM,DN=1)
QREC(NK,OP=PI,FM=SYSTEM,DN=1)
```

The second method involves only one control statement call to QREC to perform the same function as the first method does.

```
QREC(I=DIR)
```

File DIR is the input directive file which contains the following directives.

```
OP=DI,FM=SYSTEM,DN=1.
GO.
OP=PI,FM=SYSTEM,DN=1
GO,STOP.
```

Example 3:

This example exhibits the relationships among the ID, TID, and FC parameter options. It is important to note the following restrictions regarding these parameters and QREC.

- ID pertains only to local batch and system origin output files.
- TID pertains only to remote batch origin output files.

- FC pertains to all output files.
- When the OP option is specified, all I/O queue files are processed unless the ID, TID, and FC parameters restrict output file selection or the ot=ft option restricts input or output file selection.

The following control statement activates all local batch and system origin output files with ID=6 and FC=AD, all remote batch origin files with TID=3751 and FC=AD, and all input files.

```
QREC(NK,OP=RI,ID=6,TID=3751,FC=AD)
```

The following control statement performs the same functions as the previous statement does except that no input files are processed.

```
QREC(NK,OP=RI,ID=6,TID=3751,FC=AD,SY=IN,BC=IN,EI=IN)
```

## DFTERM

DFTERM terminates an active or inactive dayfile and retains it as a direct access permanent file for later interrogation or processing. When an active dayfile (that is, the current system, account, error log, or binary maintenance log dayfile) is terminated, information in the central memory buffer for that dayfile is written to mass storage to be included with the permanent file, and a new active dayfile is started. The new dayfile can reside on the same device, or a new device can be specified.

Terminating an inactive dayfile has no effect on the currently active dayfiles. Inactive dayfiles are not used by the system. Furthermore, the presence of an inactive dayfile in the system is possible only under unusual conditions. For example, if the system is deadstarted and the device which previously contained the account dayfile is turned off, a new account dayfile is started on another device. Two devices in the system now contain account dayfiles. If both devices are turned on when the system is next deadstarted, two account dayfiles are recovered. The most recent account dayfile is made active and is used by the system. The remaining account dayfile is made inactive.

The DFTERM utility can be initiated only from the system console through a K display or directly through the control statement. No batch or terminal input is allowed.

When DFTERM is selected at the system console, the DFTERM K display appears on the left screen. This display contains a list of all applicable options associated with DFTERM, their default values, and a short description of each (refer to figure 2-7).

A list of the permanent dayfiles is displayed on the right screen when the following command is entered.

```
K.LIST.
```

When this command is processed, the right-screen K display is automatically replaced with the dayfile list K display (figure 2-8). The information presented in this display is the same as that generated by the DFLIST utility.

\*\*\*\* DAYFILE TERMINATION \*\*\*\*

ACTIVE DAYFILES-

TYPE	FAMILY	DN
DAYFILE	SYST72	1B
ACCOUNT	SYST72	1B
ERRLOG	SYST72	1B
MAINLOG	SYST72	1B

INACTIVE DAYFILES-

TYPE	FAMILY	DN
------	--------	----

OPTIONS

OPTIONS	DESCRIPTION
FT = DAYFILE	FILE TYPE TO BE TERMINATED. (DAYFILE, ACCOUNT, ERRLOG, MAINLOG)
FM = SYST72	FAMILY FOR NEW DEVICE NUMBER THAT NEW DAYFILE IS TO RESIDE ON (1-7 CHARACTERS).
DN = 1B	DEVICE NUMBER OF NEW DEVICE (1-77B). FM AND DN DENOTE RESIDENT DEVICE DAYFILE IS INACTIVE.
OP = A	ACTIVE OR INACTIVE FILE TO BE TERMINATED (A OR I).
NM =	NAME OF PERMANENT FILE. OVERRIDES AUTOMATIC NAMING (1-5 CHARACTERS).
L = OUTPUT	FILE TO RECEIVE OUTPUT (1-7 CHARACTERS).

Figure 2-7. DFTERM Display

\*\*\*\* PERMANENT DAYFILE CATALOG \*\*\*\*

NO.	TYPE	FM/PN	DN	PFNAME	DATE	TIME	LENGTH
1.	DAYFILE	SYST72	01	DFA0331	80/03/31	13.35.33	1171
2.	ACCOUNT	SYST72	01	ACA0331	80/03/31	13.35.42	402
3.	ERRLOG	SYST72	01	ERA0331	80/03/31	13.35.49	55
4.	MAINLOG	SYST72	01	MLA0331	80/03/31	13.35.52	1032

Figure 2-8. DFTERM Dayfile List

If there are more files than can be displayed on one screen (page), a message appears at the bottom of the screen indicating that more files exist. When the LIST command is entered, a complete list of permanent dayfiles is written to the output file specified by the DFTERM L option; thus, a complete printer listing is provided when the DFTERM utility is terminated. If it is necessary to obtain the output listing immediately, the following command should be entered.

#### K.OUT.

When this command is processed, the initial right-screen K display (list of the queue file utility commands) is automatically returned. However, if the OUT command is not entered, the original right-screen K display can be returned by entering the CLEAR command.

After DFTERM processing is completed, an output file indicating the results of this processing is generated if the LIST command has been entered at any time during DFTERM operations. (Refer to figure 2-8, which shows essentially the same format.) If the LIST command was not entered, no output file is generated.

#### DFLIST

DFLIST generates a printer listing of all permanent files created by the DFTERM utility.

DFLIST can be initiated only from the system console directly through the following control statement.

#### X.DFLIST.

The output generated by DFLIST is the same as that produced by the LIST command available under the DFTERM utility (refer to figure 2-8).

#### QLIST

QLIST lists inactive I/O queue files, which may include all inactive queue files in the system or a selected subset based on options specified when the utility is called.

The QLIST utility is not restricted to use from the system console. However, from the system console, QLIST must be called directly with the following control statement. No K-display interaction is available.

X.QLIST(opt<sub>1</sub>=val<sub>1</sub>,opt<sub>2</sub>=val<sub>2</sub>,...,opt<sub>n</sub>=val<sub>n</sub>)

The applicable options associated with QLIST are the same, except for the OP option, as those used with the QREC utility. The OP option is not valid with QLIST.

If all current inactive I/O queue files are to be listed, no options need be specified. In this case, the format of the QLIST call is as follows:

#### X.QLIST.

The output generated by QLIST is the same as that produced by the LIST command available under the QREC utility (refer to figure 2-4).

## QDUMP

QDUMP dumps selected I/O queue files from a single device, a family of devices, or all devices on the system. These queue files can be dumped either to tape or to mass storage. When active queue files are dumped, the FNT is searched to obtain the proper file. When inactive queues are dumped, the IQFT is searched. QDUMP also provides a listing of all files dumped with information about each file processed.

When QDUMP is selected at the system console, the initial QDUMP K display appears on the left screen. This display contains a list of all applicable options associated with QDUMP, their default values, and a short description of each (refer to figure 2-9).

```

*** QUEUE FILE DUMP ***

INACTIVE QUEUES RESIDE ON FOLLOWING FAMILIES(*=BLANK NAME).
  SYST72

OPTIONS          DESCRIPTION      (ERRORED FILE DUMPING SET)
MI = 72          MACHINE ID (1-2 CHARACTERS, ALL).
FM =             FAMILY FOR DEVICES (1-7 CHARACTERS).
DN = ALL        DEVICE NUMBER (1-77B,ALL).
FU = ALL        FAMILY FOR USER INDEX (1-7 CHARACTERS).
UI = 0B         USER INDEX RANGE (0-377777B).
                 377777B
DA = 78/04/10.  DUMP DATE RANGE (YYMMDD).
                 78/04/15.
FS = 0B         FILE SIZE RANGE IN PRUS/10B (0-777777B).
                 777777B
JN =            JOBNAMES (4 OR 7 CHARACTERS).
                 JOBNAME WILL BE CLEARED IF
                 PREVIOUSLY ENTERED.

ID = 0B         ID OF FILES TO DUMP (0-77B).
                 77B
TID= 0B         DESTINATION TID (0-377777B).
FC = ALL        FORMS CODE.
DS =            DEVICE SELECTION FOR OUTPUT FILES.
L = OUTPUT      FILE TO RECEIVE OUTPUT (1-7 CHARACTERS).
FN = QFILES     DUMP FILE NAME (1-7 CHARACTERS).
ME = MT         DUMP MEDIA (MT, NT, MS).
VSN= QFILE      VISUAL REEL NUMBER OF TAPE.
NF = 0D         NUMBER OF MEDIA FILES TO SKIP.
TP = ALL        TYPE ( A-ACTIVE,I-INACTIVE,ALL).
(OT=FT)         DUMP BY ORIGIN TYPE AND FILE TYPE.
                 OPTION WILL BE CLEARED IF PREVIOUSLY
                 SELECTED. * = OPTION SELECTED.
                 S I P P
                 F N H R
BC * * * *      BC-BATCH          SF-SPECIAL      PH-PUNCH
EI * * * *      EI-EXPORT         IN-INPUT        PR-PRINT
SY * * * *      SY-SYSTEM

```

Figure 2-9. Initial QDUMP Display

If the FM option is specified, indicating dumping of queue files from a specified family of devices, the initial QDUMP left-screen K display is replaced by the secondary QDUMP K display (figure 2-10). This display closely resembles the initial QDUMP display but restricts QDUMP processing to the family of devices specified. Each device in the specified family containing inactive queue files is indicated. In addition, any option entered for the QDUMP utility is reflected in this display. Options not entered remain at default values.

```

*** QUEUE FILE DUMP ***

INACTIVE QUEUES RESIDE ON FOLLOWING DEVICES IN FAMILY - SYST72
01 02 03

OPTIONS          DESCRIPTION      (ERRORED FILE DUMPING SET)
MI = 72          MACHINE ID (1-2 CHARACTERS, ALL).
FM = SYST72     FAMILY FOR DEVICES (1-7 CHARACTERS).
DN = ALL        DEVICE NUMBER (1-77B, ALL).
FU = ALL        FAMILY FOR USER INDEX (1-7 CHARACTERS).
UI = 0B         USER INDEX RANGE (0-377777B).
                 377777B
DA = 78/04/10.  DUMP DATE RANGE (YYMMDD).
                 78/04/15.
FS = 0B         FILE SIZE RANGE IN PRUS/10B (0-777777B).
                 777777B
JN =            JOBNAMES (4 OR 7 CHARACTERS).
                 JOBNAME WILL BE CLEARED IF
                 PREVIOUSLY ENTERED.

ID = 0B         ID OF FILES TO DUMP (0-77B).
                 77B
TID= 0B         DESTINATION TID (0-377777B).
FC = ALL        FORMS CODE.
DS =            DEVICE SELECTION FOR OUTPUT FILES.
L = OUTPUT      FILE TO RECEIVE OUTPUT (1-7 CHARACTERS).
FN = QFILES     DUMP FILE NAME (1-7 CHARACTERS).
ME = MT         DUMP MEDIA (MT, NT, MS).
VSN= QFILE      VISUAL REEL NUMBER OF TAPE.
NF = 0D         NUMBER OF MEDIA FILES TO SKIP.
TP = ALL        TYPE ( A-ACTIVE, I-INACTIVE, ALL).
(OT=FT)        DUMP BY ORIGIN TYPE AND FILE TYPE.
                 OPTION WILL BE CLEARED IF PREVIOUSLY
                 SELECTED. * = OPTION SELECTED.

                S I P P
                F N H R
BC * * * *      OT=ORIGIN TYPE          FT=FILE TYPE
EI * * * *      BC-BATCH                SF-SPECIAL   PH-PUNCH
SY * * * *      EI-EXPORT                IN-INPUT    PR-PRINT
                SY-SYSTEM

```

Figure 2-10. Secondary QDUMP Display

After QDUMP processing has been completed and K-display interaction has been terminated by

K.STOP.

an output file is generated, indicating all files dumped. Figure 2-11 contains an example of this output.

```
*** DUMPED QUEUE FILE DISPOSITION ***
```

NO.	FILENAME	MID	FAMILY	DN	FT	OT	DATE	LENGTH (PRUS/10)	DISPOSITION
1.	WRITADB	72	SYS172	1	PR	SY	78/04/15.	1	ACTIVE
2.	WRITADF	72	SYS172	1	PR	SY	78/04/15.	1	ACTIVE
3.	LPT0ACU	72	SYS172	1	PR	SY	78/04/15.	30	ACTIVE
4.	WRITADC	72	SYS172	1	PR	SY	78/04/15.	1	ACTIVE
5.	LPT0ACZ	72	SYS172	1	PR	SY	78/04/15.	30	ACTIVE
6.	WRITADE	72	SYS172	2	PR	SY	78/04/15.	1	ACTIVE
7.	LPT0ACW	72	SYS172	2	PR	SY	78/04/15.	30	ACTIVE
8.	WRITADG	72	SYS172	2	PR	SY	78/04/15.	1	ACTIVE

Figure 2-11. QDUMP Output File

QDUMP does not purge files upon completion. If purging is desired, the following sequence of control statements is recommended.

QREC(OP=DI)            To dequeue the files.  
QDUMP(TP=I)            To dump the inactive files.  
QREC(OP=PI)            To purge the files.

## QLOAD

QLOAD processes the dump files generated by QDUMP or other utilities using the same format. QLOAD can selectively load the I/O queues on these dump files. It creates the file on the specified device and writes the system sector. QLOAD can also list the contents of a dump file without loading any files.

When QLOAD is selected at the system console, the QLOAD K display appears on the left screen. This display contains a list of all applicable options associated with QLOAD, their default values, and a short description of each (refer to figure 2-12).

After QLOAD processing has been completed and K-display interaction has been terminated by

K.STOP.

an output file is generated, indicating all queue files which were contained on the dump file, whether they were loaded or not. Figure 2-13 contains an example of this output.

\*\*\*\* QUEUE FILE LOAD \*\*\*\*

OPTIONS	DESCRIPTION	(ERRORED FILE LOADING NOT SET)
MI = 72	MACHINE ID (1-2 CHARACTERS, ALL).	
DF = ALL	DESTINATION FAMILY (1-7 CHARACTERS).	
DD = ALL	DESTINATION DEVICE (1-77B).	
FU = ALL	FAMILY FOR USER INDEX (1-7 CHARACTERS).	
UI = 0B	USER INDEX RANGE (0-377777B).	
377777B		
DA = 78/04/10.	LOAD DATE RANGE (YYMMDD).	
78/04/15.		
FS = 0B	FILE SIZE RANGE IN PRUS/10B (0-777777B).	
777777B		
JN =	JOBNAME (4 OR 7 CHARACTERS).	
	JOBNAME WILL BE CLEARED IF PREVIOUSLY	
	ENTERED.	
ID = 0B	ID OF FILES TO LOAD (0-77B).	
77B		
TID= 0B	DESTINATION TID (0-377777B).	
FC = ALL	FORMS CODE.	
DS =	DEVICE SELECTION FOR OUTPUT FILES.	
L = OUTPUT	FILE TO RECEIVE OUTPUT (1-7 CHARACTERS).	
FN = QFILES	LOAD FILE NAME (1-7 CHARACTERS).	
ME = MT	LOAD MEDIA (MT, NT, MS).	
VSN= QFILE	VISUAL REEL NUMBER OF TAPE.	
NF = 0D	NUMBER OF MEDIA FILES TO SKIP.	
SC = 0D	NUMBER OF QUEUED FILES TO SKIP.	
OP = A	LOAD OPTION (1 CHARACTER).	
	A-LOAD/ACTIVATE, I-LOAD/INACTIVATE	
(OT=FT)	LOAD BY ORIGIN TYPE AND FILE TYPE.	
	OPTION WILL BE CLEARED IF PREVIOUSLY	
	SELECTED. * = OPTION SELECTED.	
	OT=ORIGIN TYPE	FT=FILE TYPE
BC * * * *	BC-BATCH	SF-SPECIAL PH-PUNCH
EI * * * *	EI-EXPORT	IN-INPUT PR-PRINT
SY * * * *	SY-SYSTEM	

Figure 2-12. QLOAD Display



NO.	FILENAME	MI	FAMILY	DN	FT	OT	DATE	LENGTH (PRUS/10)	DISPOSITION
1.	WRITADB	72	SYS172	1	PR	SY	78/04/15.	1	ACTIVE
2.	WRITADF	72	SYS172	1	PR	SY	78/04/15.	1	ACTIVE
3.	LPT0ACU	72	SYS172	1	PR	SY	78/04/15.	30	ACTIVE
4.	WRITADC	72	SYS172	1	PR	SY	78/04/15.	1	ACTIVE
5.	LPT0ACZ	72	SYS172	1	PR	SY	78/04/15.	30	ACTIVE
6.	WRITADE	72	SYS172	1	PR	SY	78/04/15.	1	ACTIVE
7.	LPT0ACW	72	SYS172	1	PR	SY	78/04/15.	30	ACTIVE
8.	WRITADG	72	SYS172	1	PR	SY	78/04/15.	1	ACTIVE
9.	LPT0ACX	72	SYS172	1	PR	SY	78/04/15.	30	ACTIVE
10.	LPT0ADA	72	SYS172	1	PR	SY	78/04/15.	30	ACTIVE
11.	LPT0ACV	72	SYS172	1	PR	SY	78/04/15.	30	ACTIVE
12.	WRITADD	72	SYS172	1	PR	SY	78/04/15.	1	ACTIVE
13.	LPT0ACY	72	SYS172	1	PR	SY	78/04/15.	30	ACTIVE
14.	WRITACK	72	SYS172	1	PR	SY	78/04/15.	1	ACTIVE
15.	LPT0ACD	72	SYS172	1	PR	SY	78/04/15.	30	ACTIVE

Figure 2-13. QLOAD Output File

**Example:**

The analyst can use the QDUMP and QLOAD utilities to dump queue files from one machine and load them onto another. The following control statements dump all punch files from machine AA. The QREC utility is used to dequeue the files and then purge them, because QDUMP does not purge files.

```
QREC(NK,I=DIRCTVS,OP=DI)
REWIND,DIRCTVS.
QDUMP(NK,ME=MT,VSN=QUEUE,I=DIRCTVS,TP=I)
REWIND,DIRCTVS.
QREC(NK,OP=PI,I=DIRCTVS)
```

File DIRCTVS is the input directive file which contains the following directives.

```
BC=NONE, BC=PH.
EI=NONE, EI=PH.
SY=NONE, SY=PH.
```

The following control statement loads the files dumped by the previous QDUMP onto another machine.

```
QLOAD(NK,ME=MT,VSN=QUEUE,MI=AA,OP=A,DF=ALL)
```

**QMOVE**

QMOVE moves I/O queues from one mass storage device to another. It also produces a listing of all files moved with information about each file processed.

When QMOVE is selected at the system console, the initial QMOVE K display appears on the left screen. This display contains a list of all applicable options associated with QMOVE, their default values, and a short description of each (refer to figure 2-14).

```

*** QUEUE FILE MOVE ***

INACTIVE QUEUES RESIDE ON FOLLOWING FAMILIES(*=BLANK NAME).
  SYST72

OPTIONS          DESCRIPTION          (ERRORED FILE MOVING NOT SET)
MI = 72          MACHINE ID (1-2 CHARACTERS, ALL).
FM = ALL         FAMILY FOR DEVICES (1-7 CHARACTERS).
DN = ALL         DEVICE NUMBER (1-77B, ALL).
DF =            DESTINATION FAMILY (1-7 CHARACTERS).
DD =            DESTINATION DEVICE (1-77B).
FU = ALL         FAMILY FOR USER INDEX (1-7 CHARACTERS).
UI = 0B         USER INDEX RANGE (0-377777B).
                377777B
DA = 78/03/26.  DATE RANGE (YYMMDD).
                78/03/31.
FS = 0B         FILE SIZE RANGE IN PRUS/10B (0-777777B).
                777777B
JN =            JOBNAME (4 OR 7 CHARACTERS).
                JOBNAME WILL BE CLEARED IF
                PREVIOUSLY ENTERED.

ID = 0B         ID OF FILE TO MOVE (0-77B).
                77B
TID= 0B         DESTINATION TID (0-377777B).
FC = ALL         FORMS CODE.
DS =            DEVICE SELECTION FOR OUTPUT FILES.
L = OUTPUT      FILE TO RECEIVE OUTPUT (1-7 CHARACTERS).
TP = ALL        TYPE (A-ACTIVE,I-INACTIVE,ALL).
OP = A          OPTION (A-LEAVE ACTIVE,I-LEAVE INACTIVE).

(OT=FT)         MOVE BY ORIGIN TYPE AND FILE TYPE.
                OPTION WILL BE CLEARED IF PREVIOUSLY
                SELECTED. * = OPTION SELECTED.
                S I P P
                F N H R
BC * * * *     OT=ORIGIN TYPE          FT=FILE TYPE
EI * * * *     BC-BATCH                SF-SPECIAL    PH-PUNCH
SY * * * *     EI-EXPORT                IN-INPUT      PR-PRINT
                SY-SYSTEM

```

Figure 2-14. Initial QMOVE Display

If the FM option is specified, indicating the loading of queue files to a specified family of devices, the initial QMOVE left-screen K display is replaced by the secondary QMOVE K display (figure 2-15). This display closely resembles the initial QMOVE display but restricts QMOVE processing to the family of devices specified. Each device in the specified family containing inactive queue files is indicated. In addition, any option entered for the QMOVE utility is reflected in this display. Options not entered remain at default values.

\*\*\*\* QUEUE FILE MOVE \*\*\*\*

INACTIVE QUEUES RESIDE ON FOLLOWING DEVICES IN FAMILY - SYST72  
01 02 03

OPTIONS	DESCRIPTION	(ERRORED FILE MOVING NOT SET)
MI = 72	MACHINE ID (1-2 CHARACTERS, ALL).	
FM = SYST72	FAMILY FOR DEVICES (1-7 CHARACTERS).	
DN = ALL	DEVICE NUMBER (1-77B, ALL).	
DF =	DESTINATION FAMILY (1-7 CHARACTERS).	
DD =	DESTINATION DEVICE (1-77B).	
FU = ALL	FAMILY FOR USER INDEX (1-7 CHARACTERS).	
UI = 0B	USER INDEX RANGE (0-377777B).	
377777B		
DA = 78/04/10.	DATE RANGE (YYMMDD).	
78/04/15.		
FS = 0B	FILE SIZE RANGE IN PRUS/10B (0-777777B).	
777777B		
JN =	JOBNAME (4 OR 7 CHARACTERS).	
	JOBNAME WILL BE CLEARED IF	
	PREVIOUSLY ENTERED.	
ID = 0B	ID OF FILE TO MOVE (0-77B).	
77B		
TID= 0B	DESTINATION TID (0-377777B).	
FC = ALL	FORMS CODE.	
DS =	DEVICE SELECTION FOR OUTPUT FILES.	
L = OUTPUT	FILE TO RECEIVE OUTPUT (1-7 CHARACTERS).	
TP = ALL	TYPE (A-ACTIVE,I-INACTIVE,ALL).	
OP = A	OPTION (A-LEAVE ACTIVE,I-LEAVE INACTIVE).	
(OT=FT)	MOVE BY ORIGIN TYPE AND FILE TYPE.	
	OPTION WILL BE CLEARED IF PREVIOUSLY	
	SELECTED. * = OPTION SELECTED.	
S I P P	OT=ORIGIN TYPE	FT=FILE TYPE
F N H R		
BC * * * *	BC-BATCH	SF-SPECIAL PH-PUNCH
EI * * * *	EI-EXPORT	IN-INPUT PR-PRINT
SY * * * *	SY-SYSTEM	

Figure 2-15. Secondary QMOVE Display

After QMOVE processing has been completed and K display interaction has been terminated by

K.STOP.

an output file is generated, indicating all files moved. Figure 2-16 contains an example of this output.

\*\*\* MOVED QUEUE FILE DISPOSITION \*\*\*

INACTIVE FILES MOVED TO FAMILY SYST72 DEVICE 1 AND LEFT ACTIVE

NO.	FILENAME	MID	FAMILY	DN	FT	OT	DATE	LENGTH (PRUS/10)	ERRORS
1.	LPT0ACD	72	SYS172	1	PR	SY	78/04/15.	30	
2.	LPT0ACF	72	SYS172	1	PR	SY	78/04/15.	30	
3.	WRITACK	72	SYS172	1	PR	SY	78/04/15.	1	
4.	LPT0ACB	72	SYS172	2	PR	SY	78/04/15.	30	

Figure 2-16. QMOVE Output File

Example 1:

If there are inactive queue files residing on a removable device, the analyst can activate these files but must first move them to a nonremovable device. This example shows how to use the QMOVE utility to move queue files from the removable device with family name SYSTEM and device number 45 to the nonremovable device with family name FAM1 and device number 5. The following entries are made from DSD.

```
X.QFSP
K,n.                (n=control point number of QFSP)
K.QMOVE.
K.FM=SYSTEM,DN=45.
K.DF=FAM1,DN=5.
K.DD=3.
K.OP=A.             (the moved files are active)
K.GO,STOP.
```

Example 2:

This example exhibits the relationships among the ID, TID, and FC parameter options. (Refer to the descriptions of these options for the types of files affected by them.) The following control statement moves all local batch and system origin output files with ID=6 and all remote batch origin output files to device 3 in family SYS. The SY, BC, and EI options explicitly disable input file processing.

```
QMOVE(NK,DF=SYS,DD=3,ID=6,SY=IN,BC=IN,EI=IN)
```

The following control statement performs the same function as the previous statement does except that no remote batch origin files are moved.

```
QMOVE(NK,DF=SYS,DD=3,ID=6,SY=IN,BC=IN,EI=NONE)
```

## LDLIST

LDLIST generates a printer listing of queue files present on a QDUMP dump tape.

The LDLIST utility is not restricted to use from the system console. However, from the system console, LDLIST must be called directly with the following control statement. No K-display interaction is available.

```
X.LDLIST(opt1=val1,opt2=val2,...,optn=valn)
```

where opt<sub>i</sub>=val<sub>i</sub> are parameter options available for LDLIST.

The output generated by LDLIST is the same as that produced by QLOAD (refer to figure 2-13).

## QALTER

QALTER displays, lists, and/or alters routing and other information about active queued output files. The utility selects files for processing according to a variety of user specified criteria. QALTER purges selected files from the system when the user specifies OP=PR.

The user may alter the following information associated with the selected files.

- Origin type.
- File identifier (local batch origin files).
- Destination family (remote batch origin files).
- Destination user number (remote batch origin files).
- Forms code.
- Queue priority.
- Repeat count.

When QALTER is selected at the system console, the QALTER K display appears on the left screen. This display contains a list of all applicable parameters associated with QALTER, their default values, and a short description of each (figure 2-17). The following procedure should be performed to alter active queued output files.

1. Enter the selection criteria specifying which files are to be altered (parameters FM, DN, JN, JC, DS, FC, ID, DF, UN, BC, and EI).
2. Ensure that the desired files are selected by inspecting the list of files produced by the K-display commands LIST or OUT (figures 2-18, 2-19, and 2-20). If the file produced by OUT is to be other than OUTPUT or contain a detailed listing of the selected files, specify such with the L and/or LO parameters before entering K.OUT.
3. Enter the new information to be associated with the selected files (parameters OP, NDF, NUN, NID, NFC, NPR, and NRC). QALTER changes only information specified via parameter entry.
4. Enter K.GO. QALTER makes the requested changes, issues the message \*QALTER COMPLETE.\*, and resets the K-display parameters to their default values.
5. Repeat steps 1 through 4 to alter additional files, or enter K.STOP. to terminate QALTER activity.

```

*** LIST ACTIVE QUEUED FILES ***

OPTIONS          DESCRIPTION
FM = ALL        FAMILY FOR DEVICES (1-7 CHARACTERS).
DN = ALL        DEVICE NUMBER (1-77B,ALL).
JN =            JOBNAME (4 OR 7 CHARACTERS).
                JOBNAME WILL BE CLEARED IF
                PREVIOUSLY ENTERED.

JC =            JOBCARD NAME (1-7 CHARACTERS).
ID = 0B        ID OF FILE TO LIST (0-77B).
                77B

DF =            DESTINATION FAMILY (1-7 CHARCTERS).
UN =            DESTINATION USER (1-7 CHARACTERS).
DS =            DEVICE SELECTION FOR OUTPUT FILES.
FC =            FORMS CODE.
L = OUTPUT     FILE TO RECEIVE OUTPUT (1-7 CHARACTERS).
LO = S         LIST OPTION (S=SHORT,F=FULL).

(OT=FT)        SELECT BY ORIGIN TYPE AND FILE TYPE.
                OPTION WILL BE CLEARED IF PREVIOUSLY
                SELECTED. * = OPTION SELECTED.
                OT=ORIGIN TYPE          FT=FILE TYPE
                BC * * *                BC-BATCH          IN-INPUT          PH-PUNCH
                EI * * *                EI-EXPORT          PR-PRINT

OP = NC        OPTION (BC,EI,NC,PR).
NDF =          NEW DESTINATION FAMILY (1-7 CHARACTERS).
NUN =          NEW DESTINATION USER (1-7 CHARACTERS).
NID =          NEW FILE IDENTIFIER (0-67B).
NFC =          NEW FORMS CODE (AA-99,**).
NPR =          NEW PRIORITY FOR OUTPUT (0-7760B).
NRC =          NEW REPEAT COUNT (0-37B).

```

Figure 2-17. QALTER/FNTLIST Left Screen K Display

```

*** ACTIVE QUEUE FILE LIST ***

ORD.  FILENAMO.  FT FAMILY  USERNUM  TID/ID  FC DC  EXTCH  REP
-----
20.   QRECAHUS.  PR          0          0    LP LP    0
47.   DIS0AHXE.  PR SYS172   RUSS      27    LP LP    0

```

Figure 2-18. QALTER/FNTLIST LIST Command Display

```

*** ACTIVE QUEUE LIST ***

      FILENAME = DIS0AHX      ORDINAL = 47
      ORIGIN   = REMOTE      QUEUE   = PRINT

      DESTINATION          CREATION
      FAMILY   = SYS172     FAMILY   = SYS172
      USER     = RUSS       USER     = RUSS
      TID/ID   = 27         USR INDX = 27

      FORMS      =          JOB CARD =
      DEVICE    = LP        DATE     = 78/03/31
      EXT.CHR.  = LP        LENGTH   = 1
      INT.CHR.  = DIS       REPEAT   = 0

      RESIDENCE          INTERRUPT = NO
      FAMILY   = SYST72    PRIORITY = 401
      DEVICE   = 3

```

Figure 2-19. QALTER/FNTLIST LIST=fnt Command Display

**Example:**

The analyst can use the QALTER utility to divert output files from the local printers to a remote terminal. The following control statement alters the routing of all batch and system origin output files with forms code of AD. These files are routed to a remote terminal with family name FAM1 and user number USRNUM. The BC and EI options explicitly disable input file selection.

```
QALTER(NK,BC=IN,EI=IN,FC=AD,OP=EI,NDF=FAM1,NUN=USRNUM)
```

The FNTLIST utility can be used in conjunction with QALTER to ensure that the files were properly altered. The following control statement generates a list of all active queued files belonging to the remote terminal with family name FAM1 and user number USRNUM.

```
FNTLIST(NK,LO=F,DF=FAM1,UN=USRNUM,BC=NONE)
```

**FNTLIST**

FNTLIST displays and/or lists routing and other information about active queued output files. Its operation is similar to that of QALTER, except file alteration or purging is not allowed. When FNTLIST is selected at the system console, the FNTLIST K display appears on the left screen. This display contains a list of all applicable options associated with FNTLIST, their default values, and a short description of each (refer to figure 2-17). The output generated by FNTLIST LIST and OUT K display commands (both printed and right-screen K display) is similar or identical to that produced by QALTER.

QALTER - ALTER/PURGE ACTIVE QUEUED FILES.

78/04/20. 10.37.33.

PAGE

1

```

      OPTION = NC
NEW FORMS CODE = --N/A--
NEW PRIORITY = 5103
NEW REPEAT COUNT = --N/A--
      NEW DESTINATION FAMILY NAME = --N/A--
      NEW DESTINATION USER NUMBER = --N/A--
      NEW FILE IDENTIFIER = --N/A--

```

	CURRENT	DESTINATION		CREATION	RESIDENCE	
	*****	*****		*****	*****	
1.	FILENAME = QISOAAH ORIGIN = REMOTE QUEUE = PRINT ORDINAL = 24	FAMILY = SYS172 USER = RUSS TID/ID = 27	FORMS = DEVICE = LP EXT.CHR. = LP INT.CHR. = DIS	FAMILY = SYS172 USER = RUSS USR INDX = 27 REPEAT = 0	JOBCARD = QIS DATE = 78/04/20 LENGTH = 33 INTERRUPT= NO	FAMILY = SYST72 DEVICE = 2 PRIORITY = 260
2.	FILENAME = QISOAAH ORIGIN = BATCH QUEUE = PRINT ORDINAL = 31	FAMILY = USER = TID/ID = 4	FORMS = AS DEVICE = LT EXT.CHR. = LP INT.CHR. = DIS	FAMILY = SYS172 USER = RUSS USR INDX = 27 REPEAT = 0	JOBCARD = QIS DATE = 78/04/20 LENGTH = 5 INTERRUPT= NO	FAMILY = SYST72 DEVICE = 2 PRIORITY = 261
3.	FILENAME = QISOAAH ORIGIN = REMOTE QUEUE = PUNCH ORDINAL = 32	FAMILY = SYS172 USER = RUSS TID/ID = 27	FORMS = DEVICE = PH EXT.CHR. = B6 INT.CHR. = DIS	FAMILY = SYS172 USER = RUSS USR INDX = 27 REPEAT = 0	JOBCARD = QIS DATE = 78/04/20 LENGTH = 26 INTERRUPT= NO	FAMILY = SYST72 DEVICE = 3 PRIORITY = 261
4.	FILENAME = DISOAAH ORIGIN = SYSTEM QUEUE = PRINT ORDINAL = 47	FAMILY = USER = TID/ID = 0	FORMS = DEVICE = LP EXT.CHR. = LP INT.CHR. = DIS	FAMILY = SYS172 USER = USR INDX = 122 REPEAT = 0	JOBCARD = DATE = 78/04/20 LENGTH = 3 INTERRUPT= NO	FAMILY = SYST72 DEVICE = 3 PRIORITY = 461

Figure 2-20. QALTER Printer Listing



Example 1:

The analyst can use the FNTLIST utility to determine what actions are necessary to get queued output files processed by RBF, BATCHIO, or EI200. The following FNTLIST entry generates a detailed list of queue files, from which forms code, id, device selection, and other destination routing information can be determined. This information indicates what action must be taken to have the files processed.

X.FNTLIST(NK,LO=F)

Example 2:

The analyst can use the FNTLIST utility to determine what queue files are routed to a particular device. The following FNTLIST entry generates a list of all print files with forms code of AA that are routed to a 580-20 (LT) printer. The BC and EI options explicitly disable input file selection.

X.FNTLIST(NK,DS=LT,FC=AA,BC=IN,EI=IN)

## DAYFILE DUMPING UTILITIES

The dayfile dumping utilities (AFD, DFD, ELD, MAINLOG) write all or selected parts of the account, system, error log, or binary maintenance log dayfiles to a file. AFD, DFD, and ELD produce a listing (output) file; MAINLOG produces its output in a binary format. A job using any of these utilities must be a system origin job, or the user must have system origin privileges and DEBUG must be set at the console. The following format is used to call the dayfile dumping utilities.

utility(listfil,string,op,pd,pl,infile,binfile)

or

utility(L=listfil,FR=string,OP=op,PD=pd,PL=pl,I=infile,B=binfile)

utility	Utility called to perform the dayfile dump.
	AFD                    Dump account dayfile.
	DFD                    Dump system dayfile.
	ELD                    Dump error log dayfile.
	MAINLOG              Dump binary maintenance log dayfile.
L=listfil	Output file containing the dayfile dump produced by AFD, DFD, or ELD. The utility also places diagnostic messages in this file when various error conditions occur. These messages begin with NOTICE*** to distinguish them from the lines of the dayfile being processed, and are described in appendix B.
	Omitting this option sets listfil to OUTPUT. The utility paginates listfil if it is OUTPUT or if print density and page length are specified. L=listfil is not used with MAINLOG.
FR=string	Search string for selective dayfile dumping. The utility searches the dayfile for this string in the starting position of the field specified by the OP=op parameter.

OP=op Dump option. If neither FR=string nor the OP dump option is specified, default is OP=F. If FR is specified but OP is not, default is OP=M.

<u>op</u>	<u>Description</u>
F	Full dayfile dump is taken.
I	Incremental dump is taken. The dayfile is dumped starting from the point of the last dayfile dump. AFD does not process the I option when executed within a job with system origin privileges that is not system origin.
J	The job name field in the dayfile is searched for the string specified by FR=string. The dump begins from that point.
M	The message field in the dayfile is searched for the string specified by FR=string. The dump begins from that point. OP=M cannot be used with MAINLOG.
P	Incremental dump by user number is taken. The dayfile is dumped starting from the point of the last dayfile dump by this user.
T	The time field in the dayfile is searched for the string specified by FR=string. The dump begins from that point.

PD=pd Print density in pd lines per inch (3, 4, 6, or 8). Default is PD=6. PD cannot be used with MAINLOG.

PL=pl Page length in pl lines per page. Default is based on the following print densities. PL cannot be used with MAINLOG.

<u>pd</u>	<u>Default pl</u>
3	30
4	40
6	60
8	80

I=infile An attached, terminated dayfile to be used for input. If omitted, the utility uses the active dayfile for input.

B=binfile File on which MAINLOG writes the binary maintenance log. MAINLOG writes binfile with W-type records having C-type blocking (refer to the CYBER Record Manager Basic Access Methods Reference Manual for further information on record types and record blocking). MAINLOG assumes B=BML if this option is omitted.

The Mass Storage Facility (MSF) hardware product is a large capacity on-line mass storage device, which is a cost effective extension to the disk file storage system and an alternative to conventional magnetic tape storage. Storing files on MSF retains the security, data integrity, and on-line access capabilities provided by disk and reduces the operational and data integrity problems caused by storing, retrieving, and mounting tape volumes. Capabilities are provided for use of both MSF and magnetic tapes to protect files from hardware and system failures.

MSF is comprised of the following components.

Cartridge	A plastic housing that encloses 100 inches (2500 millimetres) of magnetic tape on which data is stored under program control.
Coupler	The interface between the CDC CYBER peripheral processor (PP) and the mass storage adapter (MSA), which includes a buffer that contains data going to or coming from the mass storage transport (MST).
CSU	Cartridge storage unit, which includes storage cells (cubicles) for 2052 cartridges † and a selector that moves cartridges among the MST, the cubicles, and the I/O drawers of the CSU. Each CSU has two I/O drawers; the top one is the input drawer and the bottom one is the output drawer. Each drawer has eight vertically aligned drawer slots, numbered from 0 (top slot) to 7 (bottom slot). There can be up to 13 CSUs in an MSS configuration. Each CSU in a configuration is associated with a letter from A through M, which is the CSU identifier.
MSA	Mass storage adapter, which interfaces between the coupler and the MST or the CSU.
MST	Mass storage transport, which includes storage positions for five cartridges: one being read or written, two queued for reading or writing, and two queued for storage by the selector into the CSU.

The Mass Storage Subsystem (MSS) is the product consisting of the MSF hardware, the CYBER coupler, the diagnostics, and the operational software. The basic function of MSS is to store data on MSF and move it to disk upon request for access by an authorized user. Control of file movement between disk and MSF is largely transparent to the applications programmer; however, there are operational changes and additions that are of importance to site operations personnel. These include modifications to operational procedures in the areas of permanent file backup, permanent file recovery, and disk space management. In addition, new MSS utilities are introduced. Detailed information about the call and operation of each MSS utility is contained in the following sections.

Utility	Description
ASDEF	Creates the system files (CSU maps and MSF catalogs) necessary for MSS processing.
ASLABEL	Manages the allocation of cubicles and assignment of cartridges in the CSU.
ASMOVE	Controls the destaging of files (creating MSF images) and the releasing of disk space.

† 2000 cartridges are available for file data storage and the rest are reserved for customer engineer and system use.

<u>Utility</u>	<u>Description</u>
ASVAL	Controls the releasing of MSF space and analyzes the CSU maps, MSF catalogs, and PFC entries to identify and flag discrepancies within these three components.
ASUSE	Provides reports on the assignment and availability of cartridges and cubicles within a CSU.
ASDEBUG	Corrects error conditions detected by ASVAL and recovers data from MSF cartridges.

## DEFINITIONS

The descriptions of the MSS utilities require some familiarity with the terms whose definitions follow.

### CARTRIDGE

A cartridge is the MSS data storage component consisting of 16 streams, called allocation units (AUs). Streams that have data written on them (allocated streams) are chained together in the MSF catalog (definition following) to identify the sequence of streams that must be accessed in order to read a file on MSF. A head of chain (HOC) flag identifies the first AU in the chain, a link field identifies the next AU in the chain, and an end of chain (EOC) flag identifies the last AU in the chain.

The cartridge label contains information that characterizes one of the three types of cartridges that can be used in an MSS environment. Cartridges having label types other than the following cannot be processed by MSS except by the ASLABEL utility, which can rewrite the cartridge label, or by the ASDEBUG utility, which can write the data on the cartridge to a permanent file.

- A manufacturer's label contains the volume serial number (vsn) of the cartridge in a machine-readable format. A cartridge with a manufacturer's label can be added to a CSU and assigned to a subfamily or pool (refer to the ASLABEL utility).
- A scratch label contains the vsn of the cartridge and additional system information indicating that the cartridge is available for assignment by the ASLABEL utility. A scratch label also contains the usage record of the cartridge. A cartridge with a scratch label is called a scratch cartridge.
- A family label contains the vsn of the cartridge and additional system information indicating that the cartridge is assigned to a particular subfamily. It also indicates the CSU identifier and the X, Y coordinates of the cubicle where the cartridge resides when it is not in use.

The addition, removal, and reassignment of cartridges are managed by the MSS utilities. The cartridge labels, and also the MSF catalogs and CSU maps (definitions following), contain information concerning the location and content of the cartridges. When a cartridge is labeled and assigned to a subfamily, a label is written on each stream of the cartridge, which contains the cartridge vsn, the CSU id, X, Y coordinates, family, and subfamily to which it was assigned, and the stream number of the particular stream. If such a cartridge is accessed for relabeling or for reading or writing an MSF file, the stream label verification procedure is used to verify this stream label information against the data in the MSF catalogs and CSU maps. If a discrepancy is detected, an error message is issued and corrective action must be taken to update the cartridge labels and/or system files as described in a later section. Whenever the cartridge location or content is changed, the cartridge label, MSF catalogs, and CSU maps are updated to reflect the current status of the cartridge. The descriptions of the MSS utilities contain further information on cartridge management.

## CSU MAP

A CSU map is a direct access permanent file that contains information indicating how cubicles in a CSU are assigned to a family and identifying the cartridges that reside in the CSU.† There is one CSU map for each CSU in the configuration. The permanent file name of the CSU map is CSMAP*i*, where *i* is the CSU identifier (a letter from A through M); its user index is 377760g; and its family is the default family on the mainframe on which MSSEXEC executes (refer to the definition of MSSEXEC).

A CSU map contains an entry for each possible X, Y coordinate pair that identifies a cubicle in the CSU, from X=0, Y=0 (bottom right) to X=57, Y=36 (upper left). There are no cubicles at the positions where X=30 or Y=18, but there are entries in the CSU map for such coordinate pairs and these entries indicate that no cubicle exists there. Thirty-one cubicles are reserved for customer engineer use; they have the following X, Y coordinates: X=57, Y=36; X=0, Y=36; X=57, Y=0; X=26 through X=0, Y=0. Twenty-one cubicles are reserved for system use; they have the following X, Y coordinates: X=48 through X=31, Y=0; X=29 through X=27, Y=0. In all, there are 2146 entries in a CSU map and they are ordered (assigned a map entry ordinal) according to the positions in the CSU of the corresponding cubicles. That is, the following scheme is used to relate the X, Y coordinate pairs and the map entry ordinals.

- Given the X and Y coordinates, the ordinal is  $2146 - X - (Y*58)$ .
- Given the ordinal, Y is the whole number quotient of  $(2146 - \text{ordinal})/58$  and X is the remainder.
- Ordinal 0 does not represent a coordinate pair; it is used as a map header entry.

Thus, in a CSU map the zero entry is the map header entry; the first entry describes the cubicle at X=57, Y=36; the second entry describes the cubicle at X=56, Y=36; and so forth.

Each entry in a CSU map has the following format:

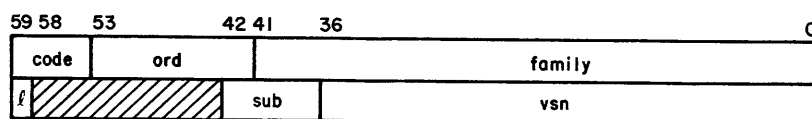

code                      Number from 1 to 7 indicating how the cubicle is assigned.

<u>Code</u>	<u>Description</u>
1	Reserved for customer engineer.
2	Reserved for system use.
3	Reserved for a different CSU map.
4	Assigned to the cartridge scratch pool.†

---

† The pool is an area of the CSU that stores scratch cartridges that are managed by the ASLABEL utility.

<u>Code</u>	<u>Description</u>
5	Assigned to a subfamily.
6	Unassigned.
7	No cubicle exists at these coordinates (X=30 or Y=18).
ord	Ordinal for this cubicle in the MSF catalog of the subfamily to which the cubicle is assigned. This ordinal is referred to as the FCT ordinal (refer to the definition of MSF catalog). This field is meaningful only if code = 5.
family	Seven-character name in display code of the family to which the cubicle is assigned. This field is meaningful only if code = 5.
l	Linkage error flag that is set by the ASVAL utility when a CSU map entry of a cubicle assigned to a family has no corresponding entry in the MSF catalog.
sub	Number from 0 through 7 identifying the subfamily to which the cubicle is assigned. This field is meaningful only if code = 5.
vsn	Six-character volume serial number of the cartridge assigned to the cubicle. If no cartridge is assigned, this field contains spaces.

The zero entry in the CSU map is the map header entry. In this entry the code field is 7, the leftmost 6 bits of the second word contain the CSU identifier, and the remaining bits are unused.

The CSU map is updated whenever the ASLABEL, ASVAL, or ASDEBUG utility causes a change in cubicle or cartridge assignment. It is recommended that the CSU map be backed up after every update to avoid problems such as the following:

- Mismatches between CSU map and MSF catalog entries.
- Lost CSU maps because of a disk failure or other problem.
- Attempts to access cartridges that are no longer available.
- Attempts to store cartridges in cubicles that are no longer empty.

Thus, the analyst should make a copy of the CSU map on tape or another device or family to always retain the latest version of the CSU map. If a device containing CSU maps is reloaded, the latest version of the CSU maps should be recovered from the backup copy after the reload is completed. After recovering the CSU maps, the analyst should run the ASVAL utility to check that the entries in the CSU maps and MSF catalogs match. If there are inconsistencies, corrective action should be taken as described in Error Conditions and Corrective Action in a later section.

## MSF CATALOG

An MSF catalog is a disk resident direct access permanent file that contains information describing which streams of each cartridge assigned to a particular subfamily are allocated to MSF files and which streams are available for allocation. There is one MSF catalog for each subfamily of a family that can have MSF resident files, and it resides on the master device for the subfamily. The permanent file name of the MSF catalog file is MSFCAT<sub>i</sub> and its user index is 37776ig, where i is the subfamily identifier (a number from 0 through 7). For example, file MSFCAT3 and user index 377763g identify the MSF catalog for subfamily 3.

An MSF catalog is partitioned into subcatalogs, one subcatalog for each CSU used by the subfamily. The maximum number of subcatalogs in an MSF catalog is 13 (the maximum number of CSUs in a configuration). Each subcatalog consists of two parts: the file and cartridge table (FCT) and the available stream table (AST). The FCT has an entry for each cubicle assigned to the subfamily from the given CSU. The maximum number of FCT entries in a subcatalog is 2000 (the maximum number of user cartridges in a CSU). The AST contains information used by the allocation algorithm to select the cartridges on which a file will reside.

The preamble of the MSF catalog contains a header and at most 13 subcatalog entries. The header identifies the family and subfamily of the MSF catalog and each subcatalog entry contains the length and location of its FCT and AST, the CSU identifier, unallocated stream count, and date of last ASVAL run that resulted in the releasing of MSF space assigned to the particular CSU or the setting of flags in entries for cubicles in the CSU. The format of the header is as follows:

59	17	11	0
family	sub	unused	
unused			

family            Seven-character name in display code of the family for this MSF catalog.

sub                Number from 0 to 7, identifying the subfamily for this MSF catalog.

The format of the subcatalog entry is as follows:

59	53	41	35	29	17	0
id	length	FCT loc	AST loc	streams		
unused			date time			

id                CSU identifier for the subcatalog (a letter from A to M).

length            Number of FCT (and AST) entries in the subcatalog.

FCT loc           Location (beginning PRU number) of the FCT.

AST loc           Location (beginning PRU number) of the AST.

streams           Number of unallocated streams for this subcatalog.

date time        Date and time of the last releasing of orphan files on the CSU identified by id or the last time flags were set for cartridges or cubicles in the CSU (whichever is later).

The header and subcatalog information is arranged in the following order:

1. First word of the header.
2. First word of each of the subcatalog entries.
3. Second word of the header.
4. Second word of each of the subcatalog entries.

Each cubicle from the given CSU assigned to the subfamily has an entry in the FCT of the subcatalog. This entry contains the X,Y coordinates of the assigned cubicle. If a cartridge has been assigned to the cubicle, the FCT entry also contains the vsn of the cartridge, usage information, status flags, and information about each of the 16 streams of the assigned cartridge. The format of each FCT entry is as follows:

59 57		53		47		41		35 33		29 27		20		0	
bps		flags <sub>1</sub>		x		y		vsn							
unused		link <sub>1</sub>		reserved				load							
unused		link <sub>2</sub>		reserved				pass							
unused		link <sub>3</sub>		reserved				error							
x <sub>1</sub>		x <sub>2</sub>		x <sub>3</sub>		unused									
y <sub>1</sub>		y <sub>2</sub>		y <sub>3</sub>		unused									
reserved for site															
u		pru		flags <sub>2</sub>		chain		u		stream detail					
⋮															
reserved for CDC															

**bps**                      Number of blocks per stream on the cartridge assigned to this cubicle.

**flags<sub>1</sub>**                One of the following flags.

<u>Bit</u>	<u>Description</u>
53	Inhibit allocation flag, indicating that space from the cartridge assigned to this cubicle is not to be allocated to a file. This flag is set by a directive to the ASLABEL utility.
52	Lost cartridge flag, indicating that the cartridge assigned to this cubicle was not there the last time MSSEEXEC tried to pick it. This flag can be cleared by a directive to the ASLABEL utility.
51	Excessive write parity error flag. Space from such a cartridge will not be allocated. This flag can be cleared by a directive to the ASLABEL utility.
50	Reserved.
49	Linkage error flag, indicating that the CSU map entry for this X,Y location is inconsistent with this FCT entry.
48	Reserved.



x	X coordinate of this cubicle.
y	Y coordinate of this cubicle.
vsn	Six-character volume serial number of the cartridge assigned to this cubicle. If no cartridge is assigned, this field contains spaces.
link <sub>i</sub>	Ordinal of the FCT entry for the cubicle containing the next cartridge on which the file on the cartridge assigned to this cubicle resides. If a file does reside on multiple cartridges, the entire file must be contained in one CSU. Also, since there are only three link fields, if a cartridge contains several files, only three can be contained on other cartridges.
load	Number of times the cartridge assigned to this cubicle has been loaded to a MST read/write station.
pass	Number of times the cartridge assigned to this cubicle has been passed across a read/write head.
error	Number of recovered read errors for the cartridge assigned to this cubicle.
x <sub>i</sub>	X coordinate of the cubicle in which the cartridge referred to by the link <sub>i</sub> field resides.
y <sub>i</sub>	Y coordinate of the cubicle in which the cartridge referred to by the link <sub>i</sub> field resides.
u	Unused.
pru	Number of PRUs on the stream.
flags <sub>2</sub>	One of the following:

<u>Bit</u>	<u>Description</u>
47	Start of fragment flag; set by the ASVAL utility.
46	Frozen chain flag, indicating a problem with this allocation chain. Streams in this chain are not reused until a directive to the ASDEBUG utility clears the flag.
45	Stream conflict flag, indicating an allocation conflict involving this stream. This flag is set by the ASVAL utility or by MSSEEXEC.
44	Reserved.
43	Free/busy flag, indicating whether or not this stream is currently allocated to a file.
42	Reserved.
41-40	Off-cartridge link flag indicating that the next stream of the file is on another cartridge. The next cartridge is identified by one of the link <sub>i</sub> fields. The value of the off-cartridge link flag (1, 2, or 3) specifies which link <sub>i</sub> to use. The chain field specifies the stream number on the next cartridge. Only three of the 16 streams of a cartridge can have this flag

<u>Bit</u>	<u>Description</u>
	set at any one time. This field is meaningful only if the chain control field indicates that this stream is the first or middle stream of the file.
39-38	Unused.
37-36	Chain control, indicating whether the stream is a first (1), last (2), only (3), or middle (0) stream of the file. This field is meaningful only if the stream is allocated to a file.
35-34	Unused.
chain	Next stream number, if any, containing file data for the file. This field is meaningful only if the stream is allocated to a file.
stream <sub>1</sub> detail	PRU, flag, and chain control information about stream 1. The upper 30 bits of this word contains information about stream 0. The lower 30 bits are divided into the same fields, and contain information about stream 1. The next seven words are divided similarly: the upper 30 bits contain information about stream 2, 4, 6, 8, 10, 12, or 14 and the lower 30 bits contain information about stream 3, 5, 7, 9, 11, 13, or 15.

The MSF catalog is updated whenever the ASLABEL, ASMOVE, ASVAL, or ASDEBUG utility causes a change in cartridge or cubicle assignment that affects the subfamily. Because the MSF catalog for a subfamily resides on its master device, it will be backed up by PFDUMP whenever the master device for the subfamily is dumped. Consequently, when PFLOAD reloads all files, the MSF catalogs are automatically recovered and all MSF-resident files as indicated in a recovered PFC will also have entries in the recovered MSF catalog. Thus, no special operational procedures are needed to back up an MSF catalog. It is possible, however, that the MSF catalog will be inconsistent with the CSU maps or cartridge labels. If such inconsistencies do exist, corrective action will have to be taken as described in Error Conditions and Corrective Action in a later section.

## MSF FILES

In an MSS environment, permanent files can be categorized according to whether or not they reside on MSF. A disk file is a permanent file that resides on disk but not on MSF. An MSF file is a permanent file that resides on MSF and may or may not also reside on disk, depending on how the installation manages disk space (refer to Disk Space Management in a later section). Depending on backup requirements (BR parameters), both disk and MSF files can also have backup images on tape (refer to volume 1 of the NOS Reference Manual).

When a user defines a direct access file, initially it is a disk file. A disk file becomes an MSF file when it is destaged to MSF; that is, an image of the file is created on MSF. Destaging files is accomplished through the ASMOVE utility, which is run periodically to manage disk space. When ASMOVE is run, files are destaged to MSF and/or their disk space released depending on certain file characteristics (refer to ASMOVE in a later section). Thus, after an ASMOVE run a file can reside on disk, on MSF, or on both. If the file does have an MSF image, the alternate storage address (asa) field in the PFC entry for the file indicates the location of the MSF copy. The obsolete (AFOBS) flag in the PFC entry indicates whether or not the MSF image is a current version of the file.

When a user attaches an MSF file, it is staged to disk from MSF (that is, a disk image is created) if the current version of the file is not on disk. If the file is attached in write mode, the MSF image is marked obsolete; that is, the AFOBS flag in the PFC entry for the file is set. This is because the disk image is immediately updated when the user makes changes to the file, but the MSF image is not updated until the

ASMOVE utility is run again. Hence, the current version of the file resides on disk only. Setting the AFOBS flag ensures that the current version of the file will be copied to MSF and will replace the obsolete MSF file the next time ASMOVE is run. When a user attaches a file, however, it is always the current version of the file that he accesses; an obsolete file cannot be accessed.

If the file is purged, its disk space, but not its MSF space, is immediately released. The ASVAL utility must be run to release MSF space allocated to purged files. Thus, because a purged file has no PFC entry linking to its MSF catalog entry, the MSF image that still exists before ASVAL is run is called an orphan file. However, a user can never access an orphan file.

When a file is destaged to MSF, information is written on each stream to which the file data is written. This information includes the file's creation date and time and user index from the PFC entry, the identity of the first stream to which the file is written, the identity of the stream immediately preceding this one, and the number of disk PRUs of data recorded on previous streams (for all but the first stream of multistream files).

When a file is staged back to disk, the file label verification procedure is used to verify this file label information against the stream label information (refer to the definition of cartridge) for each stream of the file. If a discrepancy is detected, an error message is issued, the file stage is aborted, an error flag is set in the PFC entry to indicate that the MSF file could not be accessed, and the stream conflict error flag is set in the MSF catalog entry for the particular cartridge(s) and stream(s).

## **MSSEXEC**

MSSEXEC is the main processing program that is responsible for controlling MSS activities. The MSS utilities issue requests to MSSEXEC to destage files from disk to MSF, purge unneeded MSF files, label or relabel cartridges, update CSU maps and MSF catalogs, and so forth. In a multimainframe environment, two versions of this program exist: the mainframe to which the MSF device is physically connected (the master mainframe) has a program called MSSEXEC, and all other mainframes (the slave mainframes) have a program called MSSSLV. Refer to Multimainframe Operation for more information.

## **SUBFAMILY**

Each permanent file family consists of eight subfamilies, subfamily 0 through subfamily 7. The lower 3 bits of the user index identify the subfamily to which a user belongs. For example, a user whose index ends in 3 (or 011 in bit notation) belongs to subfamily 3. When the ASDEF utility is run to create MSS system files, the CSU maps are created under user index 377760g (subfamily 0) and one MSF catalog is created under each user index 37776ig (subfamily i), i=0,1,2,...,7. When the ASLABEL utility is used to assign a CSU, cubicle, or cartridge to a family, it is possible for the analyst to specify assignment only to particular subfamilies of the family.

## **UTILITIES**

The following sections describe the MSS utilities. All of these utilities must be run from system origin jobs. In a multimainframe environment, the ASDEF and ASUSE utilities can be run on any mainframe that has access to the family being processed. However, the remaining utilities must be run on the mainframe on which MSSEXEC executes.

### **ASDEF**

ASDEF creates the system files (CSU maps and MSF catalogs) that are necessary for MSS processing. If a CSU is added to the MSF hardware configuration, ASDEF is used to create the CSU map for that CSU. If a family is to be permitted to have MSF resident files, ASDEF is used to create the eight MSF catalogs for that family (one catalog for each subfamily).

**NOTE**

If the CS parameter is specified, ASDEF will create a CSUMAP for the specified CSU (refer to the definition of CSUMAP). It is recommended that an installation make a copy of the CSUMAP on tape or on another device or family immediately after it is created.

The format of the ASDEF control statement is as follows:

ASDEF,P<sub>1</sub>,P<sub>2</sub>.

<u>P<sub>i</sub></u>	<u>Description</u>
CS=id	CSU identifier of the CSU for which a CSU map is to be created; id is a letter from A to M.
CS	Same as CS=A.
CS omitted	No CSU map is to be created. FM=family or FM must be specified.
FM=family	Family for which MSF catalogs are to be created, one catalog for each subfamily.
FM	Same as FM=system default family.
FM omitted	No MSF catalogs are to be created. CS=id or CS must be specified.

Example:

ASDEF,CS=B.

CSMAPB, the CSU map for CSU B, is created, and its entries are as described in the previous definition of CSU map. However, since ASDEF does not assign cubicles, the entries for cubicles available for use initially have zeros or spaces in all but the code field, which indicates the cubicles are unassigned.

## ASLABEL

ASLABEL manages cartridge assignment and cubicle allocation in a CSU. The following functions are performed through the use of directives to ASLABEL.

- Add a CSU to a subfamily (AC directive).
- Remove a CSU from a subfamily (RC directive).
- Add cubicles to a subfamily, the pool, or the reserved area (AB directive).
- Remove cubicles from a subfamily, the pool, or the reserved area (RB directive).
- Add cartridges to a subfamily or the pool (AM directive).
- Remove cartridges from a subfamily or the pool (RM directive).

- Restore an abnormally removed cartridge (RS directive).
- Repair a cartridge label or overwrite a family label (FX directive).
- Inhibit or allow further allocation of files to a cartridge (IB directive).

Input to ASLABEL is via a directive file. ASLABEL reads the appropriate CSU maps and MSF catalogs to determine how to process each directive and then issues requests to MSSEXEC to read and/or write cartridge labels and to update the CSU maps and MSF catalogs. ASLABEL generates a report detailing the action taken for each input directive. If the assignment information or cartridge label is not appropriate or conflicts with data in the CSU map or MSF catalog, the cartridge label information is included on this report and the cartridge is put into the output drawer. It may be possible to restore such a cartridge as described in Cartridge Restoration and Reuse in a later section.

**NOTE**

ASLABEL updates the CSUMAP for the specified CSU (refer to the definition of CSUMAP). It is recommended that an installation make a copy of the CSUMAP on tape or on another device or family immediately after each update.

The format of the ASLABEL control statement is as follows:

ASLABEL,p<sub>1</sub>,p<sub>2</sub>.

<u>P<sub>i</sub></u>	<u>Description</u>
I=filenam	File containing the directives to ASLABEL.
I	Same as I=COMPILE.
I omitted	Same as I=INPUT.
L=filenam	File on which listable output is to be written.
L	Same as L=OUTPUT.
L=0	No output file is to be generated.
L omitted	Same as L=OUTPUT.
Z	Directives are contained on the ASLABEL control statement. The I parameter is ignored.
Z omitted	Directives are contained on the file specified by the I parameter.

### ASLABEL Directives

The directives to ASLABEL can be specified on a separate file (specified by the I parameter) or after the ASLABEL control statement (Z specified). If on the input file, each directive must be specified on a separate line via the OP=directive option. Parameters for a directive are on the same line, are separated by commas, and end with a period: OP=directive, p<sub>1</sub>,p<sub>2</sub>,...,p<sub>n</sub>.

Example:

ASLABEL,I=DIRFILE.

DIRFILE is the directive file and contains the following directives.

OP=AM,N=4,PK=D.  
OP=RM,V=VSN444,FM,SB=1.

Two directives to ASLABEL are specified. OP=AM adds four cartridges to the pool of CSU A (CS parameter not specified). OP=RM removes the cartridge whose vsn is VSN444 from subfamily 1 of the default family. (Refer to the following descriptions of directives and parameters.)

If the directives are contained on the control statement, they follow the statement terminator. The first character following the terminator is the separator. Any character that does not appear in any of the directives can be used as the separator character. Each directive must be preceded by the separator and terminated by a period.

Example:

ASLABEL,Z./OP=AM,N=4,PK=D./OP=RM,V=VSN444,FM,SB=1.

The slash is used as the separator. This statement performs the same functions as those in the preceding example.

The following directives are available with ASLABEL. Some of these directives cause cartridges to be physically moved to and from cubicles and the input or output drawer (refer to OP=AM, OP=RM, OP=RS, and OP=FX). The remaining directives cause only logical operations to occur - updating the MSS system files. The descriptions of the parameters for these directives follow this section.

#### Add CSUs

OP=AC adds a CSU to a subfamily. The MSF catalog for the specified subfamily is updated to reflect that cartridges and permanent files for the subfamily can reside on the specified CSU. This directive, however, does not manipulate cartridges or cubicles.

#### Remove CSUs

OP=RC removes a CSU from a subfamily. The MSF catalog for the specified subfamily is updated to reflect that cartridges and permanent files for the subfamily cannot reside on the specified CSU. Before OP=RC can be specified, all cubicles in the specified CSU must have been removed previously from the family (refer to the OP=RB directive). This directive, however, does not manipulate cartridges or cubicles.

#### Add Cubicles

OP=AB adds an unassigned cubicle within a CSU to a subfamily (PT=F), the pool (PT=P), or the reserved area of the CSU (PT=R). More than one cubicle (N=n) can be added at a time. Specific cubicles (XI and YI options) can be added, but they must be currently unassigned. For PT=R, XI and YI must be used to add multiple cubicles; N=n is not valid. If cubicles are to be assigned to a subfamily, ASLABEL selects available cubicles closest to the top of the CSU. If cubicles are to be assigned to the pool, ASLABEL selects available cubicles closest to the bottom of the CSU. The CSU map is updated to reflect the new assignment of cubicles.

#### Remove Cubicles

OP=RB removes an assigned empty cubicle from a subfamily (PK=F), the pool (PK=P), or the reserved area of the CSU (PK=R). More than one cubicle (N=n) can be removed at a time. ASLABEL reads the CSU map and selects the first empty cubicle assigned to the subfamily, pool, or reserved area to be removed. Specific cubicles (XI and YI options) can be removed, but they must be empty. The CSU map is updated to reflect that the cubicles are unassigned.

#### Add Cartridges

OP=AM adds a cartridge with a manufacturer's label or a scratch label to either a specific subfamily (PT=F) or the pool (PT=P). ASLABEL selects the first empty cubicle assigned to the subfamily or pool as the new location for the cartridge. More than one cartridge (N=n) can be added at a time or a specific

cartridge (V=vsn) from the pool can be added to a subfamily. The CSU map, MSF catalog, and cartridge label are updated to reflect the new assignment of the cartridge.

### Remove Cartridges

OP=RM removes either an empty cartridge from a subfamily to the pool or the output drawer (PK=F and PT=P or PT=D) or any cartridge from the pool to the output drawer (PK=P and PT=D). Any cartridge currently assigned to a subfamily cannot be removed unless it is empty; that is, all 16 streams must be unallocated. More than one cartridge (N=n) can be removed or a specific cartridge (V=vsn) from the pool can be removed to the output drawer. The CSU map, MSF catalog, and cartridge label are updated to reflect the change in location of the cartridge. The removed cartridge then has a scratch label, which allows it to be reassigned via the OP=AM directive.

If the cartridge specified by the V parameter is lost (does not reside in its assigned cubicle), the LT option should be specified. This allows the appropriate entries in the CSU map and MSF catalog to be deleted even though the cartridge is not available to have its label updated. If LT is not specified, an error message is issued and ASLABEL aborts.

### Restore Lost Cartridges

OP=RS restores to its proper cubicle a cartridge that was inadvertently removed from a CSU. If restoration is successful, the lost flag in the MSF catalog is cleared. If data recorded on the cartridge label does not agree with the information in the MSF catalog and the CSU map entry for the cubicle to which the cartridge is to be restored, the cartridge label information is reported and the cartridge is put into the output drawer for use in further processing of the cartridge.

### Fix Cartridge Labels

OP=FX writes a scratch label on a cartridge and adds the cartridge to the pool. This directive is intended for use when a cartridge label has been destroyed, but the cartridge itself is not physically damaged and can be reused. It can also be used when a cartridge with a family label is to be assigned to a different subfamily via the OP=AM directive, but it is not feasible to first remove the cartridge normally via the OP=RM directive. For example, if ASLABEL is run to add a cartridge to a subfamily, and a system failure occurs before the MSF catalog and CSU map are updated but after the cartridge is relabeled, then the cartridge label does not match the corresponding entries in the MSF catalog and CSU map. Hence, OP=RM cannot be used to remove the cartridge from the subfamily, but OP=FX can be used to rewrite the cartridge label and then OP=AM can be used to add the cartridge to a subfamily. However, if a family label is to be overwritten, the FM and SB parameters must identify the family and subfamily to which the cartridge was assigned. The CSU map and MSF catalog are updated to reflect the new cartridge label.

### Control Cartridge Allocation

OP=IB sets or clears the inhibit allocation flag in the MSF catalog entry for the specific cartridge (V=vsn must be specified). If the flag is set (ON), MSSEXEC does not allocate new MSF files to this cartridge. If the flag is cleared (OF), allocation of files to this cartridge is enabled.



### Parameters for ASLABEL Directives

The descriptions of the parameters to the ASLABEL directives follow. Not all options are valid with all directives, as indicated.

<u>Pi</u>	<u>Description</u>
CS=id	CSU identifier of the CSU to be used by ASLABEL; id is a letter from A to M.
CS	Same as CS=A.
CS omitted	Same as CS=A.
D=d	Input drawer slot from which ASLABEL picks the cartridge; valid only with OP=AM, OP=RS, or OP=FX.
D	First nonempty input drawer slot is to be used; valid only with OP=AM, OP=RS, or OP=FX.
D omitted	Same as D.
FM=family	Family to which ASLABEL adds or from which it removes a cartridge or CSU. With OP=FX, this parameter specifies the family to which the cartridge was assigned.
FM	Same as FM=system default family.
FM omitted	Same as FM=system default family.
LT	CSU map and MSF catalog entries are to be updated, even though the cartridge is lost and its label cannot be updated; valid only with OP=RM.
LT omitted	If the cartridge is lost and OP=RM is specified, an error message is issued and ASLABEL aborts.
N=n	Number of cartridges or cubicles to be added, removed, or repaired; $1 \leq n \leq 2000$ ; not valid if PT=R is specified. If V=vsn is specified, n must be 1.
N	Same as N=1.
N omitted	Same as N=1.
OF	Inhibit allocation flag in the MSF catalog is to be cleared; valid only with OP=IB.
ON	Inhibit allocation flag in the MSF catalog is to be set; valid only with OP=IB.
PK=pkloc	Location from which the cartridge or cubicle is to be picked; not valid if V=vsn is specified.

<u>pkloc</u>	<u>Description</u>
D	Cartridge is to be picked from the specified input drawer slot (D=d). PK=D is valid only with OP=AM, OP=RS, or OP=FX.
F	Cartridge or cubicle is to be picked from the specified family (FM=family) and subfamily (SB=sub). PK=F is valid only with OP=RM or OP=RB.

<u>Pi</u>	<u>Description</u>										
	<table border="0" style="margin-left: 40px;"> <thead> <tr> <th style="text-align: left;"><u>pkloc</u></th> <th style="text-align: left;"><u>Description</u></th> </tr> </thead> <tbody> <tr> <td>P</td> <td>Cartridge or cubicle is to be picked from the pool. PK=P is valid only with OP=AM, OP=RM, or OP=RB. PK=P is not valid if PT=P is specified.</td> </tr> <tr> <td>R</td> <td>Cubicle is to be picked from the reserved area of the CSU. PK=R is valid only with OP=RB.</td> </tr> </tbody> </table>	<u>pkloc</u>	<u>Description</u>	P	Cartridge or cubicle is to be picked from the pool. PK=P is valid only with OP=AM, OP=RM, or OP=RB. PK=P is not valid if PT=P is specified.	R	Cubicle is to be picked from the reserved area of the CSU. PK=R is valid only with OP=RB.				
<u>pkloc</u>	<u>Description</u>										
P	Cartridge or cubicle is to be picked from the pool. PK=P is valid only with OP=AM, OP=RM, or OP=RB. PK=P is not valid if PT=P is specified.										
R	Cubicle is to be picked from the reserved area of the CSU. PK=R is valid only with OP=RB.										
PK	Same as PK=P.										
PK omitted	Same as PK=P.										
PT=ptloc	Location into which the cartridge or cubicle is to be put.										
	<table border="0" style="margin-left: 40px;"> <thead> <tr> <th style="text-align: left;"><u>ptloc</u></th> <th style="text-align: left;"><u>Description</u></th> </tr> </thead> <tbody> <tr> <td>D</td> <td>Cartridge is to be put into the first available output drawer slot. PT=D is valid only with OP=RM.</td> </tr> <tr> <td>F</td> <td>Cartridge or cubicle is to be put into the specified family (FM=family) and subfamily (SB=sub). PT=F is valid only with OP=AM or OP=AB.</td> </tr> <tr> <td>P</td> <td>Cartridge or cubicle is to be put into the pool. PT=P is valid only with OP=AM, OP=RM, or OP=AB. PT=P is not valid if PK=P is specified.</td> </tr> <tr> <td>R</td> <td>Cubicle is to be put into the reserved area of the CSU. PT=R is valid only with OP=AB.</td> </tr> </tbody> </table>	<u>ptloc</u>	<u>Description</u>	D	Cartridge is to be put into the first available output drawer slot. PT=D is valid only with OP=RM.	F	Cartridge or cubicle is to be put into the specified family (FM=family) and subfamily (SB=sub). PT=F is valid only with OP=AM or OP=AB.	P	Cartridge or cubicle is to be put into the pool. PT=P is valid only with OP=AM, OP=RM, or OP=AB. PT=P is not valid if PK=P is specified.	R	Cubicle is to be put into the reserved area of the CSU. PT=R is valid only with OP=AB.
<u>ptloc</u>	<u>Description</u>										
D	Cartridge is to be put into the first available output drawer slot. PT=D is valid only with OP=RM.										
F	Cartridge or cubicle is to be put into the specified family (FM=family) and subfamily (SB=sub). PT=F is valid only with OP=AM or OP=AB.										
P	Cartridge or cubicle is to be put into the pool. PT=P is valid only with OP=AM, OP=RM, or OP=AB. PT=P is not valid if PK=P is specified.										
R	Cubicle is to be put into the reserved area of the CSU. PT=R is valid only with OP=AB.										
PT	Same as PT=P.										
PT omitted	Same as PT=P.										
SB=sub	Subfamily to which ASLABEL adds or from which it removes a cartridge or CSU; $0 \leq \text{sub} \leq 7$ . With OP=FX, this parameter specifies the subfamily to which the cartridge was assigned.										
SB	Same as SB=0.										
SB omitted	Same as SB=0.										
V=vsn	Volume serial number of the cartridge to be added, removed, or repaired; not valid if PK=pkloc is specified. If V=vsn is specified, n must be 1 if N=n is specified.										
V	Volume serial number of the cartridge is not specified.										
V omitted	Same as V.										
XI=x <sub>1</sub>	Column of the CSU to be added or removed; $0 \leq x_1 \leq 57$ , $x_1 \neq 30$ ; valid only with OP=AB or OP=RB.										
YI=y <sub>1</sub>	Row of the CSU to be added or removed; $0 \leq y_1 \leq 36$ , $y_2 \neq 18$ ; valid only with OP=AB or OP=RB.										

<u>Pi</u>	<u>Description</u>
XI=x <sub>1</sub> ,YI=y <sub>1</sub>	X and Y coordinates of the cubicle to be added or removed; 0≤x <sub>1</sub> ≤57, 0≤y <sub>1</sub> ≤36, x <sub>1</sub> ≠30, y <sub>1</sub> ≠18; valid only with OP=AB or OP=RB.
XI=x <sub>1</sub> ,YI=y <sub>1</sub> , XF=x <sub>2</sub> ,YF=y <sub>2</sub>	Rectangle of cubicles to be added or removed; cubicles with X coordinates between x <sub>1</sub> and x <sub>2</sub> and Y coordinates between y <sub>1</sub> and y <sub>2</sub> are included; valid only with OP=AB or OP=RB. At most, 100 cubicles can be included in the rectangle. x <sub>1</sub> ,x <sub>2</sub> ≤57, x <sub>1</sub> ,x <sub>2</sub> ≠30; y <sub>1</sub> ,y <sub>2</sub> ≤36, y <sub>1</sub> ,y <sub>2</sub> ≠18; x <sub>1</sub> <x <sub>2</sub> ; y <sub>1</sub> <y <sub>2</sub> . XF and YF must both be specified, if either is. XF and YF cannot be specified unless both XI and YI are specified.
XI and YI omitted	With OP=AB, the next available cubicle closest to the top (for assignment to a family) or the bottom (for assignment to the pool) is to be selected. With OP=RB, the first empty assigned cubicle is to be selected.

### ASLABEL Update Sequence

The general result of each directive to ASLABEL is the updating of the CSU maps, MSF catalogs, and cartridge labels, whichever are appropriate, to reflect the changes in cartridge, cubicle, or CSU assignment. Because the MSF catalog is a disk resident permanent file, it will be backed up on a dump tape whenever PFDUMP dumps the master device for its particular subfamily. Thus, it is not necessary for the analyst to back up the MSF catalogs immediately after an ASLABEL run. However, the backup and recovery of CSU maps do require special operational procedures, which should be performed immediately after an ASLABEL run (refer to the definition of CSU map).

When ASLABEL is run to change the assignment of a cartridge, the update sequence consists of a series of steps to delete the old assignment information from the MSS system files, relabel the cartridge, and add the new assignment information to the MSS system files. If an interruption such as a system failure, ASLABEL abort, or MSSEXEC abort prevents ASLABEL from completing the update sequence, the location of the affected cartridge and the status of the CSU maps and MSF catalogs depend on the point of interruption as follows:

- If the cartridge label, MSF catalog, and CSU map do not all match, then the cartridge is put into the output drawer. The OP=RS directive cannot be used to restore the cartridge because of the inconsistency. However, OP=FX can be used to overwrite the cartridge label and add the cartridge to the pool, if the FM and SB parameters specify the family and the subfamily on the cartridge label.
- If the cartridge label, MSF catalog, and CSU map do match, then the cartridge may be returned to its original location, the new location, or the output drawer depending on the exact point of interruption. If the cartridge is in the output drawer, OP=RS can be used to restore the cartridge to the location indicated on the cartridge label.

Cartridge Restoration and Reuse in a later section describes the procedure for restoring cartridges found in the output drawer.

### Restrictions to ASLABEL

The following restrictions apply to the ASLABEL utility.

- MSSEXEC must be running when ASLABEL is run.
- Only one copy of ASLABEL can be run at a time.
- ASLABEL, ASVAL, and ASDEBUG cannot be run at the same time.

## Example

The following output shows the format of an ASLABEL report. The cartridge label information is included on the report because of a mismatch with the CSU map. An error message is issued for the first directive on the control statement (in this case, the only directive).

```
ASLABEL REPORT FILE

ASLABEL,Z./OP=RS,PK=D,CS=B.

  1  OP=RS,PK=D,CS=B.

  1  OP=RS,PK=D,CS=B.

      VSN = P66157
      FAMILY = SYSTST
      SUBFAMILY = 0
      CSU = B
      X = 2
      Y = 6
*** ERROR      8      DIRECTIVE      1
                        UNEXPECTED CSU, X, Y, FAMILY OR SUBFAM.***
```

## ASMOVE

ASMOVE manages disk and MSF residence. That is, ASMOVE determines which files should be left on disk, which files should be released from disk and moved to MSF, and which files should be resident both on disk and on MSF. The ASVAL utility, not ASMOVE, controls the releasing of MSF space.

The selection process includes two algorithms that weigh certain file characteristics as follows:

- Files are selected for destaging to MSF based on file length, time since the last update, and the preferred residence specified by the user.
- Files are selected for release from disk based on time since the last access and the backup requirement specified by the user.

ASMOVE reads the PFC entries for a particular family and calculates release and destage values (refer to Selection Algorithms later in this section) for each file to determine its residence. If a file has both disk and MSF images but is to reside only on MSF, ASMOVE releases the disk space for the file. For files that do not have an MSF image, ASMOVE creates entries on the ASMOVE/MSSEXEC communication file, MOVCOM, to identify the files to be destaged and to specify whether or not the file's disk space is to be released upon completion of the destage. MSSEXEC then processes each destage and destage/release request on MOVCOM.

ASMOVE generates an output report that lists the files released by ASMOVE and the files contained on MOVCOM. A report on the use of disk space before and after the ASMOVE run is included in the output file and the dayfile.

The format of the ASMOVE statement is as follows:

ASMOVE,P1,P2,...,Pn.

<u>Pi</u>	<u>Description</u>
FM=family	Family to be used by ASMOVE.
FM	Same as FM=system default family.
FM omitted	Same as FM=system default family.
L=filenam	File on which listable output is to be written.
L	Same as L=OUTPUT.
L=0	No output file is to be generated.
L omitted	Same as L=OUTPUT.
RD=yymmdd	Last access date. All files not accessed after yymmdd are to be released from disk.
RD omitted	No files are to be released.
RO	Report only. ASMOVE does not release files from disk and does not send requests to MSSEEXEC to destage or destage/release files.
RO omitted	Disk space is to be released and requests are to be sent to MSSEEXEC, if appropriate.
RT=hmmss	Last access time. All files not accessed after hmmss of the day specified by the RD parameter are to be released.
RT	Same as RT=000000 (midnight).
RT omitted	Same as RT=000000 (midnight).
TM=mode	Selects or deselects test mode (refer to Pseudo-Release in a later section).

<u>Mode</u>	<u>Description</u>
Y	Select test mode. Pseudo release of all files selected for release from disk by this ASMOVE run is performed.
N	Deselect test mode. The pseudo release flag is cleared and disk images for all files from the selected family which were previously pseudo-released are really released from disk. Normal release processing is performed for all files selected for release from disk by this ASMOVE run.

TM omitted Normal release processing is to be performed for files that do not have the pseudo release flag set. Files with the pseudo release flag set are treated as if they have already been released.

The following options for ASMOVE redefine the values of the weight factors or thresholds (installation parameters) used in the algorithms that select files to be destaged or released. The installation uses these options to increase or decrease the importance of certain file characteristics used to determine which files are to be destaged and/or released. For example, specifying a large MN parameter prohibits ASMOVE from selecting small files for destaging to MSF. Unless otherwise stated, each of these options causes the installation-defined value to be multiplied by the integer value  $n$ ,  $n \geq 0$ . Refer to the NOS Installation Handbook for the initial definitions of these values.

<u>Option</u>	<u>Description</u>
DB= $n$	$n$ times the installation-defined DB weight factor is to be used as the preferred residence value for destage decisions involving files with a PR=M attribute.†
DB	Same as DB=1.
DB omitted	Same as DB=1.
DC= $n$	$n$ times the installation-defined weight factor is to be used as the preferred residence value for destage decisions involving files with a PR=N attribute.†
DC	Same as DC=1.
DC omitted	Same as DC=1.
DL= $n$	$n$ times the installation-defined length weight factor is to be used as the length weight factor for destage decisions.
DL	Same as DL=1.
DL omitted	Same as DL=1.
DT= $n$	$n$ times the installation-defined time weight factor is to be used as the time weight factor for destage decisions.
DT	Same as DT=1.
DT omitted	Same as DT=1.
DV= $n$	$n$ times the installation-defined destage control value is to be used as the destage control value.
DV	Same as DV=1.
DV omitted	Same as DV=1.
MN= $n$	$n$ times the installation-defined minimum length threshold is to be used as the minimum allowable size in disk PRUs (64 words) for MSF files.
MN	Same as MN=1.
MN omitted	Same as MN=1.
MX= $n$	$n$ times the installation-defined maximum length threshold is to be used as the maximum allowable size in disk PRUs for MSF files.

† The file owner specifies the preferred residence attribute via the PR parameter on the DEFINE or CHANGE statement (refer to volume 1 of the NOS Reference Manual).

<u>Option</u>	<u>Description</u>
MX	Same as MX=1.
MX omitted	Same as MX=1.

### Selection Algorithms

ASMOVE determines which files to destage and/or release according to the following algorithms. Files that reside only on MSF are not considered because they have been destaged and released previously. Also, indirect access files are excluded from consideration because they cannot reside on MSF. For all other files, ASMOVE checks the file length and excludes from further consideration any file whose length in PRUs is less than the minimum length threshold (refer to the MN parameter) or greater than the maximum length threshold (refer to the MX parameter).

If the current image of the file resides on both disk and MSF, ASMOVE uses the release algorithm to determine whether or not to release disk space; the destage algorithm is not used. If the current file resides on disk only, ASMOVE uses the destage algorithm to determine whether or not to destage the file. If the file is to be destaged to MSF, ASMOVE also determines via the release algorithm whether or not to release the file's disk space.

#### Destage Algorithm

The destage algorithm is used to select for destaging certain files that do not have current MSF images. ASMOVE calculates the destage value for each eligible file according to the following equation. If the destage value exceeds the destage control value (refer to the DV parameter), ASMOVE selects the file for destaging. Otherwise, the file remains on disk only.

$$\text{destage value} = (1 + t * \text{time}) * (1 + l * \text{length}) * (\text{res})$$

- t        Installation-defined time weight factor.
- time     Number of days since the file was last modified.
- l        Installation-defined length weight factor.
- length   Length of the file in PRUs.
- res      Installation-defined preferred residence value. This value depends on whether the file owner specified no preferred residence or MSF residence preferred for the file. Refer to the DB and DC parameters.

#### Release Algorithm

The release algorithm is used to select files whose disk space is to be released. Any file with a backup required (BR=Y)<sup>†</sup> attribute and whose master device has not been dumped since the file was last modified is not considered for disk space release. The date and time the master device was last dumped was set by the SD parameter on PFDUMP. For all other files, ASMOVE checks the last access date and time in the PFC entry for each file. If the file was last accessed before the date and time specified by the RD and RT parameters, its disk space is to be released. If the file to be released has a current MSF image, ASMOVE releases the disk space. If the file to be released does not have a current MSF image, MSSEXEC creates one before releasing the disk space.

<sup>†</sup> The file owner specifies the backup requirement via the BR parameter on the DEFINE or CHANGE statement (refer to volume 1 of the NOS Reference Manual).

## Disk Space/Dump Tape Management

As more disk resident files are created and more MSF resident files are staged to disk, it will be necessary for the installation to monitor the availability of disk space. It is recommended that ASMOVE be used as a periodic disk space management procedure to avoid frequent disk full conditions (refer to Disk Space Management in a later section). ASMOVE can also be used to reduce the amount of data written on dump tapes and thereby avoid maintaining large numbers of dump tapes. This is accomplished by destaging to MSF and/or releasing disk space of files that need not be on the dump tape (refer to Dump Tape Management in a later section).

### Restrictions to ASMOVE

Only one copy of ASMOVE can be run at a time. A second ASMOVE aborts if the first one has not completed.

### Example

The following output shows the format of an ASMOVE report. The files that are to be destaged and destaged/released are listed. An account of the disk space and the destage for backup, release date, and release time values are given.

ASMOVE REPORT.

ASMOVE, FM=SYSTST, L=MOV, RD=791109, RT=085547, MN=1, MX=9999, TM=Y

FILE	UI	LENGTH	
AAAAAAI	172	22	RELEASE AND DESTAGE
AAAAAAJ	172	22	RELEASE AND DESTAGE
AAAAAAK	172	7	RELEASE AND DESTAGE
AAAAAAL	172	29	RELEASE AND DESTAGE
AAAAAAM	172	41	RELEASE AND DESTAGE
AAAAAAN	172	50	RELEASE AND DESTAGE
AAAAAAO	172	43	RELEASE AND DESTAGE
AAAAAAP	172	31	RELEASE AND DESTAGE
AAAAAAQ	172	27	RELEASE AND DESTAGE
AAAAAAR	172	34	RELEASE AND DESTAGE
AAAAAAS	172	16	RELEASE AND DESTAGE
DEF0002	170	78	RELEASE AND DESTAGE
AAAOAAA	172	19	RELEASE AND DESTAGE
AAAEAAA	172	17	RELEASE AND DESTAGE
AAAPAAA	172	20	RELEASE AND DESTAGE
MOV0040	170	6	RELEASE AND DESTAGE
MOV0005	170	6	RELEASE AND DESTAGE
DLF0006	170	4	RELEASE AND DESTAGE
DLF0012	170	70	RELEASE AND DESTAGE
DMP0012	170	160	RELEASE AND DESTAGE
RDF0012	170	59	RELEASE AND DESTAGE
CLF0012	170	5	RELEASE AND DESTAGE
DWK0013	170	1065	RELEASE AND DESTAGE
WLF0013	170	29	RELEASE AND DESTAGE
MOV0014	170	7	RELEASE AND DESTAGE
DEF0015	170	692	RELEASE AND DESTAGE
DLF0017	170	78	RELEASE AND DESTAGE
CLF0017	170	5	RELEASE AND DESTAGE
STIMABS	170	103	DESTAGE



GLOSARY	172	66	DESTAGE
AAAVAAA	172	14	DESTAGE
DMP0017	170	287	DESTAGE
RDF0017	170	59	DESTAGE
DWK0018	170	1089	DESTAGE
WLF0018	170	31	DESTAGE
RPT0019	170	119	DESTAGE
MOV0020	170	8	DESTAGE
DLF0021	170	107	DESTAGE
DMP0021	170	481	DESTAGE
RDF0021	170	60	DESTAGE
RPT0022	170	150	DESTAGE
DEF0023	170	687	DESTAGE
AAAXAAA	172	12	DESTAGE
AAAYAAB	172	13	DESTAGE
AAAYAAC	172	14	DESTAGE

ACTPFSPACE BEFORE PROCESSING	=	6488
ACTPFSPACE AFTER PROCESSING	=	3846
PF SPACE RELEASED	=	2642
RELEASE DATE USED	=	79/11/09.
RELEASE TIME USED	=	08.55.47.

## ASVAL

ASVAL either performs release processing or reports on problems with the current MSS system files. That is, it either makes available MSF space presently allocated to files that are no longer needed, or reports on irregularities or discrepancies found in the current MSF catalogs and PFC entries for the specified family and, optionally, in certain CSU maps. The function to be performed is determined by whether or not the RF option is specified, as described below.

### NOTE

ASVAL updates the CSUMAP for the specified CSU. (Refer to the definition of CSU map.) It is recommended that an installation make a copy of the CSU map on tape or on another device or family immediately after every update of the CSU map.

## Release Processing

If RF=filenam or RF is specified, ASVAL determines which MSF files are no longer needed and issues a request to MSSEXEC to purge these files so their MSF space can be reused. The procedure is for ASVAL to analyze copies of the MSF catalogs and PFC entries for the specified family that are contained on the release data file (RDF) specified by the RF parameter. Those MSF files described in an MSF catalog but not having a PFC entry (that is, orphans) can be purged. During the analysis (refer to MSF Catalog Analysis and PFC Analysis later in this section), ASVAL keeps track of the error conditions it discovers, and if the error count is less than or equal to the threshold specified by the FX parameter, release processing is performed if RL is specified. That is, trouble-free orphans are purged and their MSF space is made available for reuse. The current MSF catalog is updated to reflect that these files no longer

exist. A validation report is issued which lists the errors encountered, the number of trouble-free orphans, and the amount of released MSF space. If RL is not specified, no release processing is performed but the validation report is issued, which lists the errors encountered, the number of trouble-free orphans, and the amount of releasable MSF space.

The RDF used for this analysis is a file produced during a previous PFDUMP run and it contains versions of the MSF catalogs and PFC entries that were current at the time of the dump. The installation chooses which RDF to use depending on how long after a file was purged it wants to wait before releasing its MSF space. For example, an installation might run ASVAL every week for release processing purposes and use the RDF from the previous week's full dump. There are some restrictions as to which RDFs can be used (refer to MSF Space Management in a later section). The capability to release trouble-free orphans by analyzing the current MSF catalogs and PFC entries is not provided in order to ensure that an MSF file is released from MSF only after it is no longer needed.

### Problem Reporting

If RF=filenam or RF is not specified, ASVAL reports on problems with the current MSF catalogs and PFC entries for the specified family. If AM is specified, problems with CSU maps are also included in the report. ASVAL examines the MSS system files and PFC entries and searches for problem chains and fragments, problem asa values, and CSU map/MSF catalog mismatches. The procedures ASVAL uses to detect and classify inconsistencies and discrepancies are described later in this section (refer to Error Detection and Classification). ASVAL keeps track of the error conditions, if any, it discovers, and if the error count is less than or equal to the threshold specified by the FX parameter, problem fixing is performed. That is, ASVAL sets flags in the appropriate entries of the CSU map, MSF catalog, and/or PFC entries to prevent propagation of errors due to the inconsistencies or discrepancies found and to permit error recovery by the ASDEBUG utility. A count of the errors is recorded in the dayfile. A validation report is issued which lists the errors encountered, the number of trouble-free orphans, and the amount of releasable MSF space.

The format of the ASVAL control statement is as follows:

ASVAL,p<sub>1</sub>,p<sub>2</sub>,...,p<sub>n</sub>.

<u>Pi</u>	<u>Description</u>
AM	The CSU map for the CSU specified by the CS parameter is to be analyzed in addition to the MSF catalogs; not valid if RF=filenam or RF is specified.
AM=	Same as AM.
AM omitted	CSU maps are not to be analyzed.
CS=id	CSU identifier of the CSU to be used. Up to 13 CSUs can be selected by the letters A through M. For example, CS=ACJG selects CSU A, C, G, and J.
CS	Same as CS=ABCDEFGHIJKLM.
CS omitted	Same as CS=ABCDEFGHIJKLM.
FM=family	Family to be analyzed; not valid if the RF option is specified.
FM	Same as FM=system default family; not valid if the RF option is specified.
FM omitted	Same as FM=system default family, if the RF option is not specified. The family on the release data file is used, if the RF option is specified.

<u>Pi</u>	<u>Description</u>
FX=n	Error threshold. If the total error count is greater than n, neither release processing nor problem fixing is performed.
FX	Same as FX=0.
FX omitted	Same as FX=0.
L=filenam	File on which listable output is to be written.
L	Same as L=OUTPUT.
L=0	No output file is to be generated.
L omitted	Same as L=OUTPUT.
RF=filenam	File which contains the release data file.
RF	Same as RF=ZZZZRDF.
RF omitted	Current versions of the MSF catalogs are to be analyzed.
RL	Release processing is to be performed; valid only if the RF option is specified.
RL omitted	No release processing is to be performed.
SB=sub	Subfamily to be processed. Up to eight subfamilies can be selected by the numbers 0 through 7. For example, SB=723 selects subfamilies 2, 3, and 7.
SB	Same as SB=01234567.
SB omitted	Same as SB=01234567.
ST=n	Scattered file criterion. Files are indicated as scattered if they are contained on at least n more cartridges than the minimum number needed to contain them. The minimum number of cartridges is the quotient of (number of streams + 15)/16; the remainder is ignored. For example, if the file is contained on 100 streams and 10 cartridges, it is scattered if n=1 but is not scattered if n=5.
ST	Same as ST=0. That is, files are scattered if they are contained on more than the minimum number of cartridges needed to contain them.
ST omitted	Same as ST=0.

### **Error Detection and Classification**

ASVAL detects and classifies errors according to the following procedures. During the CSU map analysis, ASVAL detects and classifies errors in the CSU map. During the MSF catalog analysis, ASVAL detects errors with chains of AUs and during the PFC analysis, ASVAL classifies these errors. Whenever an error is encountered, the total error count is increased by one. The action taken for each type of error is discussed in Release Processing and Problem Fixing later in this section.

### CSU Map Analysis

If the AM option is specified, ASVAL attempts to locate problems with CSU map entries by comparing the MSF catalogs and the CSU map. For each X,Y coordinate pair in an MSF catalog entry, ASVAL locates the corresponding CSU map entry. A type 1 error exists if the code field in the CSU map entry is not 5 (assigned to a subfamily), or if the family, subfamily, or vsn fields in the CSU map entry do not match those in the corresponding MSF catalog entry. ASVAL also scans the CSU map for all other entries assigned to the subfamily and reports as a type 2 error any of these entries that does not have a corresponding MSF catalog entry.

### MSF Catalog Analysis

The MSF catalog analysis locates problems with chains of AUs (refer to the definition of cartridge) and identifies on each HOC whether any of the following problems exist or whether any part of the MSF files resides on a cartridge which is lost or has excessive write parity errors.

ASVAL scans the MSF catalog for HOC entries that are allocated and follows each chain until it terminates. Normal termination occurs with an EOC entry. Abnormal termination occurs when no EOC is found, but rather an illegal link value exists, an AU links to an unallocated stream, or an AU links to an AU previously found in the chain being followed (looping chain).

During the chain scans, the following types of chains can be encountered; they are linkage problems that are identified on the HOC entry.

Intersecting chain	More than one chain links to the same AU.
Scattered file chain	The number of cartridges used for the file exceeds the value specified by the ST parameter plus the minimum number of cartridges needed for the file.

ASVAL also locates any AUs that are allocated but were not on any chain being followed. Such AUs are linked together to form partial chains without an HOC. These partial chains are called fragments and the first AU in a fragment is designated as the start of fragment. Each fragment chain is followed until it terminates. The abnormal termination conditions previously listed can also occur with fragments. Intersections can occur, but a fragment chain that intersects the start of another fragment chain is not an intersection; rather, one is the tail end of the other.

### PFC Analysis

The PFC analysis is performed to classify the errors encountered on chains during the MSF catalog analysis. For each PFC entry with asa#0 (the file has an MSF image and the asa value identifies the first

AU in the chain containing the file), ASVAL classifies the following errors. Error type 3 exists if the asa value is illegal. Error type 4 exists for any of the following reasons.

- The AU specified by the asa value is not allocated or is not an HOC entry.
- The chain does not terminate normally.
- The chain intersects with another chain or fragment.
- More than one PFC entry points to the chain.
- The chain includes a cartridge for which the lost or excessive parity error flag is set.

ASVAL also classifies the following error conditions.

- Error type 5 exists if an orphan chain terminated abnormally or intersects with other chains or fragments. Trouble-free orphans (chains without a PFC entry pointing to them and without linkage problems) are not classified as errors.
- Error type 6 exists if an orphan is a fragment.
- Error type 7 exists if a chain or fragment points to an unallocated AU.

ASVAL generates informational report messages if either of the following conditions is true.

- The system error flag is set in the PFC.
- The read error flag is set in the PFC.

### **Release Processing and Problem Fixing**

If the total error count calculated during the analyses described previously exceeds the value specified by the FX parameter, then neither release processing nor action to flag or fix the detected error conditions is performed. The validation report, however, is produced. Otherwise, action taken depends on the parameter specified and the type of errors found, as follows.

If ASVAL was run for release processing purposes (RF=filenam or RF specified), ASVAL issues a request to MSSEXC to release trouble-free orphans if RL was specified. If RL was not specified, no release processing is performed. If ASVAL was run for problem reporting purposes (RF omitted), the following action is taken.

- For error type 1, the linkage error flag is set in the MSF catalog entry.
- For error type 2, the linkage error flag is set in the CSU map entry.
- For error type 3, there are two alternatives. If the file also has a disk image, the asa field in the PFC entry is cleared. Thus, the good disk image will not be released and the file is accessible even if the MSF image cannot be retrieved. If the file does not have a disk image, no action is taken. However, if the disk image can be reloaded from tape, it is recommended that the file be reloaded and that ASVAL then be rerun to clear the asa field in preparation for other corrective action.
- For error type 4, the action taken is both that taken for error type 3 and that taken for error types 5, 6, or 7.
- For error types 5, 6, or 7, the frozen flag is set in the MSF catalog entry for the initial AU on the problem chain or fragment. This enables the problem chain/fragment/AU to be made available to the ASDEBUG utility, but prevents these AUs from being overwritten until then. Thus, the ASDEBUG utility can be used to inspect or save data from the corresponding streams or cartridges.

## Validation Report

The validation report consists of a report heading and a series of report groups for each subfamily and CSU being reported on. The heading identifies the subfamily, the CSU, whether or not there are any problems, and the last purge date and time for the CSU (the last time orphans on this CSU were released). There is one report group for each error detected, and the actual information recorded in a report group depends on the type of error as described in the following paragraphs. Each report group, however, contains the following items.

- Error type (a number from 1 to 7).
- Identification (refer to the particular error type below).
- Chain information (MSF catalog ordinal, stream number, A or U designation for allocated or unallocated, H or E designation for HOC or EOC).
- Error description

After the last report group, the validation report lists the number of trouble-free orphans, the amount of released or releasable MSF space, the total number of errors detected, and whether or not the MSS system files were updated.

### Error Types 1 and 2

Error types 1 and 2 identify mismatches between the CSU map and the MSF catalog. In the validation report, the identification field lists the MSF catalog ordinal, the X and Y coordinates, and the vsn of the cartridge in error. The chain field is blank because problem chains are not identified as either error type 1 or 2. The analyst should run the ASUSE utility to produce a detailed report of the appropriate CSU map and MSF catalog entries to determine the exact problem.

### Error Types 3 and 4

Error types 3 and 4 identify problem chains and problem asa values. In the validation report, the identification field lists the permanent file name and user index of the affected file; the dump control date and time (from the PFC entry for the file) to identify the backup file, if any; and the letter N (no) or Y (yes) to indicate whether or not the file has a disk image. The chain field lists the MSF catalog ordinal and stream number for all AUs in the affected chain. An A or U indicates whether each AU is allocated or unallocated, and an H or E identifies the HOC or EOC. An error description is printed for each error detected; one chain can have several errors.

### Error Types 5, 6, and 7

Error types 5, 6, and 7 identify problem orphans, fragments, and problem unallocated AUs. In the validation report, the information reported is the same as for error types 3 and 4, except for the identification field. Instead of the permanent file identification, the word ORPHAN (error type 5), FRAGMENT (error type 6), or UNALLOCATED (error type 7) is printed. Error type 7 is an unallocated AU that is pointed to by a chain or fragment. Each such AU is also reported with the chain for the corresponding orphan or fragment.

## Intersections

Intersections occur when more than one chain links to the same AU; they are classified as either error type 4 or 5. Thus, they are reported as explained previously. Intersections are also reported in a separate entry consisting of a heading and additional information identifying the MSF catalog ordinals and stream numbers of the intersecting chains. Therefore, when intersections are reported, there are two entries for the affected subfamily and CSU: one lists only the intersections and the other lists all the errors encountered.

## Example

The following output shows the format of a validation report. ASVAL was run for problem reporting purposes (RF not specified), and no errors were detected.

```
ASVAL - VALIDATION REPORT                                ASVAL - VER 1.0
FAMILY = SYSTST
ASVAL,FM=SYSTST,SB=0,CS=J.
L = OUTPUT
RF = 0
AM = 0
CS = J
FM = SYSTST
FX = 0
RL = 0
SB = 0
ST = 0
SUBFAMILY = 0  CSU = J  -- GOOD --  LPDT = *****
RELEASABLE MSS FILES = 12
RELEASABLE MSS STREAMS = 16
TOTAL VALIDATION ERRORS = 0
CATALOGS NOT MODIFIED
**REPORT COMPLETE**
```

## Typical ASVAL Runs

As described previously, ASVAL is run either to make MSF space available for reuse or to report on problems with the current MSS system files and/or PFC entries. The following examples show typical ASVAL runs that an installation might use periodically for these purposes.

### Example:

The following call to ASVAL causes MSF space to be made available for reuse.

```
ASVAL (RF=DUMP1,RL)
```

DUMP1 is the release data file produced by a previous PFDUMP run from which ASVAL can identify all the MSF files that were orphans at the time of the dump. If no error conditions are detected in the MSF catalog and PFC entries contained on file DUMP1 (FX=0 by default), the orphans are purged and the MSF space assigned to them is released. The last purge date and time field in the subcatalog (in the MSF catalog) for each CSU for each subfamily is updated to the time of the ASVAL run if any file from that CSU is purged. This is to ensure that a subsequent ASVAL run does not release the same space a second time, as the MSF space may be reallocated to a new file.

If errors were detected, they are listed on the validation report and release processing is not performed. This is indicated by the CATALOGS NOT MODIFIED message at the end of the validation report. The analyst can rerun ASVAL with the following call to ensure that release processing is performed (n is the number of errors detected during the previous ASVAL run).

```
ASVAL (RF=DUMP1,RL,FX=n)
```

After this ASVAL run has completed, an analysis of the current version of the CSU map, MSF catalog, and PFC entries should be made to determine whether or not the errors detected in the first ASVAL run exist in the current MSS system files and PFC entries. This is accomplished through the following statement.

```
ASVAL (FM=family,AM)
```

where family is that on the release data file, DUMP1.

### Example:

Upon completion of any device reload which includes recovery of an MSF catalog and/or CSU map, ASVAL should be run to determine whether any CSU map/MSF catalog mismatches exist. The following call accomplishes this.

```
ASVAL (FM=family,SB=n1n2...nh,AM)
```

where family is that for which recovery was done and n<sub>1</sub>,n<sub>2</sub>,...,n<sub>h</sub> are the affected subfamilies if just some of the devices of the family were reloaded.

ASVAL analyzes the CSU map, MSF catalog, and PFC entries for the subfamilies specified by the SB parameter and reports any discrepancies or inconsistencies. For example, if the recovery was not scheduled and ASLABEL was run to add or remove cartridges or cubicles from one of the affected subfamilies after the last incremental or full dump for these subfamilies, then the CSU map will reflect the results of the ASLABEL run but the MSF catalog will not. Such mismatches will be reported on the validation report.



If the following call to ASVAL is then made, the errors detected during the previous run will be flagged as described previously in Release Processing and Problem Fixing.

ASVAL(FM=family,SB=n<sub>1</sub>n<sub>2</sub>...n<sub>h</sub>,AM,FX=n)

where family and n<sub>1</sub>,n<sub>2</sub>,...,n<sub>h</sub> are the same as in the previous ASVAL run and n is the number of errors detected during the previous run. After investigating the cause of these errors, the analyst can run the ASDEBUG utility to correct the error conditions (refer to ASDEBUG).

If a device reload includes recovery of all CSU maps (default family, user index = 377760<sub>8</sub>), the latest CSU maps should be recovered from backup copies. Then each family that has MSF-resident files should be analyzed via the following statement to detect CSU map/MSF catalog mismatches.

ASVAL(FM=family,AM)

It is recommended that the previous ASVAL run be made periodically to check whether any unexpected error conditions exist. As the installation becomes more familiar with MSS processing, the frequency of these periodic ASVAL runs can be decreased.

#### Restrictions to ASVAL

- Only one copy of ASVAL can be run at a time.
- ASVAL, ASLABEL, and ASDEBUG cannot be run at the same time.

#### ASUSE

ASUSE reads data in the MSF catalogs and CSU maps and produces reports on the availability of space on MSF cartridges and the allocation of cubicle space within a CSU. The reports may not be completely up to date because the MSF catalogs and CSU maps can be updated while the reports are being generated.

The types of reports that ASUSE generates are as follows:

<u>Report</u>	<u>Description</u>
Basic usage report	Lists general information about the use of each CSU in a subfamily.
Optional report A	Identifies cartridges with a specified number of streams available for assignment.†
Optional report B	Identifies cartridges with flags set in the MSF catalog.
Optional report C	Lists the contents of a CSU as described in the CSU map.

---

† A cartridge that has the lost cartridge flag, inhibit allocation flag, or excessive write parity errors flag set is considered as having zero streams available for allocation regardless of the number of unallocated streams on the cartridge.

<u>Report</u>	<u>Description</u>
Optional report D	Lists detailed cartridge status information on each entry in the MSF catalog.
Optional report E	Lists detailed cartridge and stream status information on each entry in the MSF catalog.

The format of the ASUSE control statement is as follows:

ASUSE,p<sub>1</sub>,p<sub>2</sub>,...,p<sub>n</sub>.

<u>P<sub>i</sub></u>	<u>Description</u>
CS=id	CSU identifier of the CSU to be used. Up to 13 CSUs can be selected by the letters A through M. For example, CS=ACJG selects CSU A, C, G, and J.
CS	Same as CS=ABCDEFGHIJKLM.
CS omitted	Same as CS=ABCDEFGHIJKLM.
FM=family	Family to be reported on.
FM	Same as FM=system default family.
FM omitted	Same as FM=system default family.
L=filenam	File on which listable output is to be written.
L	Same as L=OUTPUT.
L=0	No output file is to be generated.
L omitted	Same as L=OUTPUT.
OP=op †	Type of report to be generated.

<u>op</u>	<u>Description</u>
A	Optional report A and basic usage report.
B	Optional report B and basic usage report.
C	Optional report C and basic usage report.
D	Optional report D and basic usage report.
E	Optional report E and basic usage report.
OP	Basic usage report only is to be generated.
OP omitted	Same as OP.

---

† Multiple options can be specified (for example, OP=AB).

<u>Pi</u>	<u>Description</u>
SB=sub	Subfamily to be reported on. Up to eight subfamilies can be selected by the numbers 0 through 7. For example, SB=0273 selects subfamilies 0, 2, 3, and 7.
SB	Same as SB=01234567.
SB omitted	Same as SB=01234567.
SL=n	Minimum number of streams available for assignment; valid only with optional report A. Cartridges with n or more streams available are reported. $0 \leq n \leq 16$ , $n \leq m$ (refer to SU=m).
SL	Same as SL=0.
SL omitted	Same as SL=0.
SU=m	Maximum number of streams available for assignment; valid only with optional report A. Cartridges with m or less streams available are reported. $0 \leq m \leq 16$ , $n \leq m$ (refer to SL=n).
SU	Same as SU=16.
SU omitted	Same as SU=16.

### Basic Usage Report

The basic usage report contains a title line, which identifies the subfamily, family, and CSU being reported on. The statistics in this report contain separate totals for CSUs and subfamilies. The following items are listed.

- Number of CSU locations reserved for the subfamily.
- Number of cartridges in the subfamily.
- Number of cartridges with 0 streams available for assignment.
- Number of cartridges with 1 stream available for assignment.
- ⋮
- Number of cartridges with 16 streams available for assignment.
- Number of unassigned and unflagged streams.
- Number of assigned and unflagged streams.
- Number of flagged streams.
- Number of cartridges with the inhibit allocation flag set.
- Number of available off-cartridge links.
- Number of cartridges with available streams and no off-cartridge links.

The following output shows the format of a basic usage report.

ASUSE REPORT FILE

SUBFAMILY = 3 CSU = J FM = SYSTST

BASIC REPORT

COUNT OF CSU LOCATIONS RESERVED FOR SUB-FAMILY =	10
NUMBER OF CARTRIDGES IN THE SUB-FAMILY =	4
NUMBER OF CARTRIDGES WITH 0 STREAMS AVAILABLE =	4
NUMBER OF CARTRIDGES WITH 1 STREAMS AVAILABLE =	0
NUMBER OF CARTRIDGES WITH 2 STREAMS AVAILABLE =	0
NUMBER OF CARTRIDGES WITH 3 STREAMS AVAILABLE =	0
NUMBER OF CARTRIDGES WITH 4 STREAMS AVAILABLE =	0
NUMBER OF CARTRIDGES WITH 5 STREAMS AVAILABLE =	0
NUMBER OF CARTRIDGES WITH 6 STREAMS AVAILABLE =	0
NUMBER OF CARTRIDGES WITH 7 STREAMS AVAILABLE =	0
NUMBER OF CARTRIDGES WITH 8 STREAMS AVAILABLE =	0
NUMBER OF CARTRIDGES WITH 9 STREAMS AVAILABLE =	0
NUMBER OF CARTRIDGES WITH 10 STREAMS AVAILABLE =	0
NUMBER OF CARTRIDGES WITH 11 STREAMS AVAILABLE =	0
NUMBER OF CARTRIDGES WITH 12 STREAMS AVAILABLE =	0
NUMBER OF CARTRIDGES WITH 13 STREAMS AVAILABLE =	0
NUMBER OF CARTRIDGES WITH 14 STREAMS AVAILABLE =	0
NUMBER OF CARTRIDGES WITH 15 STREAMS AVAILABLE =	0
NUMBER OF CARTRIDGES WITH 16 STREAMS AVAILABLE =	0
NUMBER OF FREE AND UNFLAGGED STREAMS =	0
NUMBER OF ASSIGNED AND UNFLAGGED STREAMS =	64
NUMBER OF FLAGGED STREAMS =	0
NUMBER OF CARTRIDGES WITH INHIBIT FLAG SET =	0
NUMBER OF AVAILABLE OFF-MSL LINKS =	3
NUMBER OF CARTRIDGES WITH AVAILABLE STREAMS AND NO OFF CARTRIDGE LINKS =	0

### Optional Reports A and B

Optional reports A and B both contain a title line, which identifies the subfamily, family, and CSU being reported on, and list the following information about cartridges. Optional report A includes a cartridge only if the number of streams available for assignment is within the range specified by the SL and SU parameters. Optional report B includes only those cartridges for which flags are set in the MSF catalog.

- Volume serial number of the cartridge.
- X,Y coordinate pair of the cartridge location.
- Number of streams available on the cartridge.
- Number of off-cartridge links available on the cartridge.

In addition to the preceding items, optional report B lists one or more of the following messages depending on the flags set in the MSF catalog. Refer to the definition of MSF catalog for more information about these flags.

- EXCESSIVE PARITY ERRORS.
- LOST.
- INHIBIT SET.
- STREAM n START OF FRAGMENT.
- STREAM n FROZEN CHAIN.
- STREAM n STREAM CONFLICT.

The following output shows the format of optional report A.

ASUSE REPORT FILE

SUBFAMILY = 3 CSU = J FM = SYSTST

OPTIONAL REPORT(S) AB

VSN = V99004

X = 45

Y = 36

AVAILABLE STREAMS = 0

OFF CARTRIDGE LINKS = 0

VSN = V99005

X = 44

Y = 36

AVAILABLE STREAMS = 0

OFF CARTRIDGE LINKS = 0

VSN = V99006

X = 43

Y = 36

AVAILABLE STREAMS = 0

OFF CARTRIDGE LINKS = 0

VSN = V99007

X = 42

Y = 36

AVAILABLE STREAMS = 0

OFF CARTRIDGE LINKS = 3

END OF REPORT(S) AB

### **Optional Report C**

Optional report C contains a title line, which identifies the CSU being reported on. The CSU number and Y coordinate are printed at the top of the page. There is a new Y coordinate on each page, from Y=36 through Y=0. X coordinates are written two to a line, from X=57 through X=0. The information listed in this report includes the following items.

- X coordinate
- Code
- Vsn
- Family
- Subfamily
- FCT link
- Flags

### **Optional Reports D and E**

Optional reports D and E both contain a title line, which identifies the subfamily, family, and CSU being reported on. Both reports list the following cartridge information about entries in the MSF catalog.

- FCT ordinal of the MSF catalog entry.
- X and Y coordinates of the location of the cartridge in the cubicle described by this entry.
- Volume serial number of the cartridge in the cubicle described by this entry.

In addition to the preceding information, optional report E lists the following information about the streams on the cartridges described above.

- Off-cartridge links. Also referred to as Off-MSC (Mass Storage Cartridge) links.
- Two words reserved for installation use.
- Stream detail in octal.

Refer to the definition of MSF catalog for more information about the catalog entries.

The following output shows the format of optional report E.

ASUSE REPORT FILE

OPTIONAL REPORT E MSFCATALOG FOR SUBFAMILY 3, CSU J FM = SYSTST

ORD	X	Y	VSN	LINK1=	LINK2=	LINK3=	SITE=
1	45	36	V99004	2	2	2	00000000000000000000/00000000000000000000
			STREAM				
			00-03	20106	20300	22100	24101
			04-07	26102	20300	20007	20010
			10-13	20011	20012	20013	20014
			14-17	20015	20200	20300	20300
2	44	36	V99005	3	3	3	00000000000000000000/00000000000000000000
			STREAM				
			00-03	20006	20014	20200	22101
			04-07	24102	26103	20007	20010
			10-13	20011	20012	20200	20300
			14-17	20015	20016	20200	20300
3	43	36	V99006	4	4	4	00000000000000000000/00000000000000000000
			STREAM				
			00-03	20106	20011	20013	22001
			04-07	24102	26103	20007	20200
			10-13	20300	20200	20300	20014
			14-17	20015	20016	20017	20200
4	42	36	V99007	0	0	0	00000000000000000000/00000000000000000000
			STREAM				
			00-03	20106	20014	20016	20200
			04-07	20300	20300	20007	20010
			10-13	20011	20012	20200	20300
			14-17	20200	20300	20017	20200

ASDEBUG

ASDEBUG allows the analyst to update appropriate entries in the CSU maps and/or MSF catalogs and thereby resolve inconsistencies reported by the ASVAL utility. ASDEBUG can also copy data from selected MSF files or cartridges to disk. This function of ASDEBUG is intended for use when errors such as unrecoverable read errors do not allow successful staging of an MSF file.

**NOTE**

ASDEBUG updates the CSUMAP for the specified CSU. (Refer to the definition of CSU map.) It is recommended that an installation make a copy of the CSU map on tape or on another device or family immediately after every update of the CSU map.

Input to ASDEBUG is via a directive file. Refer to the ASLABEL utility for a description of the format of directive statements.

The format of the ASDEBUG control statement is as follows:

ASDEBUG,p1,p2,p3.

<u>Pi</u>	<u>Description</u>
I=filenam	File on which directives are written.
I	Same as I=COMPILE.
I omitted	Same as I=INPUT.
L=filenam	File on which listable output is to be written.
L	Same as L=OUTPUT.
L=0	No output file is to be generated.
L omitted	Same as L=OUTPUT.
Z	Directives are contained on the ASDEBUG control statement. The I parameter is ignored.
Z omitted	Directives are contained on the file specified by the I parameter.

### ASDEBUG Directives

The following directives are available with ASDEBUG. The descriptions of the parameters for these directives follow this section.

#### Read Streams

OP=RS reads selected streams of a cartridge in a specified drawer (D=d) or identified by its vsn (V=vs) or X,Y coordinates (XI, YI options). The CS parameter specifies the CSU where the cartridge resides. The range of streams to be read is specified by the SL and SU parameters. The streams are written to the file specified by the PF parameter.

#### Read File

OP=RF reads the file whose alternate storage address is specified by the CS, FO, and ST parameters. The file is written to the file specified by the PF parameter.



### Release Frozen Chain Space

OP=RP clears flags in the MSF catalog and releases MSF space for the chain whose alternate storage address is specified by the CS, FO, and ST parameters.

### Remove Cartridge Entry from MSF Catalog

OP=RL removes an MSF catalog entry that is not linked properly to the CSU map. The CS and FO parameters identify the MSF catalog entry to be removed.

### Remove Cartridge Entry from CSU Map

OP=RC removes a CSU map entry that does not have a corresponding FCT entry in the MSF catalog. The CS, XI, and YI parameters identify the CSU map entry to be removed. The cartridge at the particular X,Y location is put into the outut drawer and the CSU map entry is changed to unassigned. The CSU map should be backed up immediately after the ASDEBUG run to ensure consistency with cartridge labels and MSF catalogs (refer to the definition of CSU map).

### **Parameters for the ASDEBUG Directives**

The descriptions of the parameters to the ASDEBUG directives follow. Not all options are valid with all directives, as indicated.

<u>Pi</u>	<u>Description</u>
CS=id	CSU identifier of the CSU to be used by ASDEBUG; id is a letter from A to M.
CS	Same as CS=A.
CS omitted	Same as CS=A.
D=d	Input drawer slot to be used; $0 \leq d \leq 7$ . Not valid if V=vsn or XI=n is specified.
D	First available input drawer slot is to be used.
D omitted	V=vsn or XI=n and YI=m must be specified.
FM=family	Family to be processed.
FM	Same as FM=system default family.
FM omitted	Same as FM=system default family.
FO=ord	MSF catalog ordinal indicating the file to be read or the chain whose space is to be released.
FO omitted	FO=ord must be specified for OP=RF, OP=RP, and OP=RL.
PF=filenam	File to which the MSF image (streams or file) is to be copied. Each stream copied is separated by an end of record. This file is defined under the user's current family and user index.

<u>Pi</u>	<u>Description</u>
PF	Same as PF=ZZZZBUG.
PF omitted	Same as PF=ZZZZBUG.
SB=sub	Subfamily to be used; $0 \leq \text{sub} \leq 7$ .
SB	Same as SB=0.
SB omitted	Same as SB=0.
SL=i	Stream where OP=RS begins copying; $0 \leq i \leq 15$ ; $i \leq j$ (refer to SU=j).
SL	Same as SL=0.
SL omitted	Same as SL=0.
ST=s	Stream where OP=RF begins reading or OP=RP begins releasing.
ST omitted	ST=s must be specified for OP=RF and OP=RP.
SU=j	Stream where OP=RS ends copying; $0 \leq j \leq 15$ ; $i \leq j$ (refer to SL=i).
SU	Same as SU=15.
SU omitted	Same as SU=15.
V=vsn	Volume serial number of the cartridge to be used; not valid if D=d, D, XI=x, or YI=y is specified.
V omitted	D=d or D, or XI=x and YI=y must be specified for OP=RS.
XI=x	X coordinate of the cubicle where the cartridge to be read resides; $0 \leq x \leq 57$ and $x \neq 30$ . YI=y must also be specified. D=d, D, or V=vsn must not be specified.
XI omitted	D=d, D, or V=vsn must be specified. XI=x and YI=y must be specified for OP=RC.
YI=y	Y coordinate of the cubicle where the cartridge to be read resides; $0 \leq y \leq 36$ and $y \neq 18$ . XI=x must also be specified. D=d, D, or V=vsn must not be specified.
YI omitted	D=d, D, or V=vsn must be specified. XI=x and YI=y must be specified for OP=RC.

### Restrictions to ASDEBUG

The following restrictions apply to the ASDEBUG utility.

- MSSEXEC must be running when ASDEBUG is run.
- Only one copy of ASDEBUG can be run at one time.
- ASDEBUG, ASVAL, and ASLABEL cannot be run at the same time.

## MSS OPERATIONAL PROCEDURES

This section summarizes operational procedures used in an MSS environment. These include modifications to existing procedures and also new MSS procedures, especially in the areas of permanent file backup and reloading and disk space management. Refer to the descriptions of the appropriate utilities for details about these operational procedures.

### INITIALIZATION

MSS processing is initiated when the ASDEF utility is run to create the system files necessary to allow storage of files on MSF. ASDEF creates both a CSU map for each CSU that is to store file data on cartridges and eight MSF catalogs (one for each subfamily) for each family that is to have MSF-resident files. Once these system files have been created, the ASLABEL utility can then be run to allocate portions of the CSU to each subfamily and to initialize cartridges for use by files belonging to these subfamilies. When permanent files are defined, they reside on disk until the ASMOVE utility is run. Depending on the parameters specified, ASMOVE can destage files to MSF and release the disk space assigned to files so that it is available for general use.

### DISK SPACE MANAGEMENT

Installations must manage the availability of disk space more frequently in an MSS environment than in a non-MSS environment. This is necessary because MSF-resident files must be staged to disk before a user can access them, and their disk space is not immediately released upon completion of the jobs that attached the files. Consequently, disks are apt to approach a disk full condition unless the ASMOVE utility is used periodically to release disk space.

The ASMOVE utility destages selected files to MSF and optionally releases their disk space. It is recommended that the installation use ASMOVE as part of a periodic disk space management procedure and also just prior to a full dump to reduce the amount of data dumped to tape. (Refer to Dump Tape Management.)

The E display (refer to the E,M command in the NOS Operator's Guide) can be used to monitor the tracks on a device or set of devices as indicated by the TKS=nnn value for each disk. When too few tracks (as defined by the installation) are available on the direct access devices for a family or subfamily, the ASMOVE utility with the RD and RT parameters specified should be run. ASMOVE reads the PFC entries for the specified family, selects certain files to reside on MSF, and decides which files should be released from disk.

Files can be destaged to MSF without their disk space being released. This destage-only feature can be used prior to a routine backup dump to create MSF images for files with the BR=MD attribute and thereby eliminate the need to include them on a backup dump tape. (Refer to Dump Tape Management.) Having an MSF image also provides backup for the file in special cases where the permanent file is being updated at the same time PFDUMP is being run.

The destage-only feature can also be used to allow disk space to become available immediately when ASMOVE is run again. That is, ASMOVE can directly release disk space of files that have both disk and MSF images but are to reside on MSF only. However, for files that have no MSF image, there is a delay before the disk space can be released because these files must first be destaged to MSF.

## MSF SPACE MANAGEMENT

Installations must manage the availability of MSF space because MSF space is not automatically released when a permanent file is purged. This allows an installation to perform a permanent file recovery to a time prior to the purging of the file. On a typical dump tape, the entry for an MSF resident file includes the PFC and permit entries, but not the file data. A subsequent reload operation recovers only what was dumped - the PFC and permit information, but not the file data. Thus, MSF space for a purged permanent file cannot be released until the installation no longer needs to recover the file data, because the file data resides on MSF only and typically not on any dump tape.

An MSF-resident file is stored only on the cartridges within the cubicles of CSUs assigned to a subfamily. When destaging a file to MSF, MSSEXEC selects the CSU with the most space available. If no CSU has enough free space to store the file being destaged, MSSEXEC abandons that destage request, issues a message to the dayfile, and continues to destage other files that fit on the available MSF space. To avoid this problem, installations should use the ASVAL utility periodically to release MSF space for purged files, thereby making it available for reuse.

When an installation decides that it is time to reuse MSF space currently allocated to files that have been purged, it runs ASVAL with the RF and RL parameters specified. The RF parameter specifies an RDF, which is an auxiliary file produced by the permanent file utility PFDUMP and which contains versions of the MSF catalogs and PFC entries that were current at the time of the dump. ASVAL examines the RDF to identify unneeded MSF files (those without PFC entries) and their MSF space is released. The installation chooses which RDF to use based on the date and time of the dump that produced it. That is, a particular RDF is used only if there is no need for a permanent file recovery to a time prior to the dump that produced the RDF.

Once an RDF is used by ASVAL to release MSF space, the installation should discard it and any other RDFs for the same set of devices. These RDFs cannot be used as input to ASVAL in any future run. The MSS software does not permit an RDF to be specified by the RF parameter on an ASVAL call, unless it was produced by PFDUMP after the last ASVAL run that released MSF space was completed. This prevents the inadvertent release of MSF space that was previously released and reassigned to a file.

### Example:

Suppose two PFDUMPs were run a week apart producing two release data files, RDF1 and RDF2. Suppose, also, that according to both RDF1 and RDF2, file AFILE is an orphan (it has been purged but still resides on MSF). If the following call to ASVAL is made, the MSF space assigned to AFILE is released and made available for reuse, if no errors were encountered.

```
ASVAL(RF=RDF1,RL)
```

Now, suppose that a new file, BFILE, which did not exist when RDF1 and RDF2 were produced, is assigned to the MSF space on which AFILE has resided. If ASVAL were to accept either RDF1 or RDF2 on a subsequent ASVAL call, the MSF space allocated to file AFILE (which is now the space where BFILE resides) is released. However, any RDF created after the ASVAL run that purged AFILE would not have an entry for AFILE and, hence, ASVAL would not inadvertently release the MSF space presently allocated to BFILE.

After ASVAL uses a release data file to release MSF space, the corresponding backup tape from PFDUMP is the oldest tape that should be used for the first reel of a future incremental load. The first reel determines which files are to be reloaded according to the CIR on the tape (refer to PFLOAD in section 1). Use of an older tape as the first reel can allow the PFC entry for a purged file to be restored even though its MSF space may have been reassigned. The MSS software does not prevent loading from the wrong dump tape, but does detect as an error an attempt to stage a file whose data was overwritten.

**Example:**

Suppose that RDF1 and RDF2 are as in the previous example, and that file CFILE is an orphan according to RDF2, but not according to RDF1. The following ASVAL call releases MSF space allocated to CFILE.

ASVAL,RF=RDF2,RL.

Now suppose that the dump tape created by the PFDUMP run that produced RDF1 is used as the first reel of an incremental PFLOAD. Then the PFC and permit entries for file CFILE are reloaded, but, in fact, file CFILE does not exist on MSF. This will be detected as an error when a user attempts to attach CFILE.

## **BACKUP AND RECOVERY**

Permanent file backup and recovery methods in an MSS environment are similar to those in a non-MSS environment. It is assumed that most installations with disk resident permanent files have a file backup procedure consisting of a full dump followed by a series of incremental dumps. The assumed reload procedure is to load from tapes starting with the most recent incremental dump tape and continuing through older incremental dump tapes until the most recent full dump tape is processed. These procedures can be modified as follows to accommodate MSF resident files.

### **File Dumping**

The normal backup dump procedure is to dump files based on the modification date field in the PFC entries for the files. New parameters to PFDUMP provide the capability to dump files that have been modified during a certain interval, which is useful in recycling old dump tapes (refer to Dump Tape Management later in this section). For files that reside only on MSF, the option to stage the file to disk and thereby include it in the dump or to suppress staging and include only the file's PFC and permit information on the dump tape is provided. If the device or family being dumped has MSF-resident files, the following procedures should be included with the normal dumping procedures.

### Full Dumps

Full dumps should be performed as usual, but OP=S should be specified on the call to PFDUMP to suppress staging. Thus, all files on disk are dumped but only the PFC and permit entries for MSF files without disk images are included in the dump. It is unnecessary and not feasible to dump the files that reside only on MSF. OP=S and SD should be specified on the call to PFDUMP; RD=filenam should be used at the discretion of the installation.

OP=S	Selects no staging. If the SD option was inadvertently used on any previous nonincremental dump, an incremental dump should be taken prior to the full dump.
SD	Updates the dump date/time field on each master device dumped to permit files created or modified prior to this dump to be released when ASMOVE is run again. Refer to Release Algorithm in ASMOVE description.
RD=filenam	Specifies that PFDUMP is to write a release data file to be used later by ASVAL. RD=filenam is included or excluded on a call to PFDUMP depending on how often the installation wants to purge unneeded MSF files.

### Incremental Dumps

Incremental dumps should be performed as usual. No staging should occur because any files that were created or modified since the last dump will still be on disk if a tape backup is required. The following parameters should be specified on the call to PFDUMP.

OP=M	Selects incremental dumps.
SD	Updates the date/time field on each master device dumped, as described above for full dumps.
AD=yyymmdd and AT=hhmmss	Selects the date and time just prior to the previous incremental or full dump of the device. Hence, all files not included in the last dump are dumped.

The following parameters should be used at the discretion of the installation.

OP=S	Selects no staging. If the SD option was inadvertently used on any recent partial dump, OP=S should not be specified so any file with a BR=Y attribute which had its disk space inadvertently released will be included in the dump.
RD=filenam	Specifies that PFDUMP is to write a release data file to be used later by ASVAL, as described above for full dumps.

### Dump Tape Management

In a non-MSS environment, it is possible to make all previous dump tapes available for use after a full dump is completed. However, in an MSS environment, such dump tape recycling cannot occur because files that have resided only on MSF for some time are probably not included on any recent dump tape. When a low percentage of files on a tape are active files, it is possible to redump any remaining files in order to recycle the tape by running PFDUMP with OP=M, BD, and BT parameters, but not OP=S, specified.† This performs a dump of all files that were last dumped before the date and time specified on the PFDUMP call. If necessary, files will be staged in from MSF; after the dump is completed, the disk space for these staged files is released. Thus, files that might not be on any dump tape made after the date specified by the BD parameter are dumped and tapes created before this date can be recycled.

The installation can reduce the number of dump tapes it creates by using ASMOVE to reduce the amount of data written on these dump tapes. If ASMOVE is run prior to an incremental dump, files with the BR=MD attribute can be destaged to MSF and excluded from the dump. That is, the incremental dump will exclude the files with a BR=MD attribute that are on both MSF and disk. If ASMOVE is run prior to a full dump, disk space for files that do not have to be on disk can be released and these files are not written on the dump tape. The following procedures involving dumps and ASMOVE runs can be used for efficiency.

1. Run ASMOVE to destage files with the BR=MD attribute.
2. Take an incremental dump to back up files with the BR=Y attribute.
3. Run ASMOVE to release the disk images of files backed up in step 2.
4. Take a full dump to reduce the number of dump tapes involved if a reload is required.

---

† It is possible to specify the AD and AT parameters also, thereby dumping files that were dumped during an interval - after the date and time specified by AD and AT and before the date and time specified by BD and BT (refer to parameters for PFDUMP). This performs a dump of all files last dumped during the interval specified (including MSF-resident files) and allows the site to recycle all dump tapes created during this interval.

### CSU Map/MSF Catalog Backup

A CSU map is created for each CSU in an MSS environment and is updated by the ASLABEL, ASVAL, and ASDEBUG utilities. (Refer to the definition of CSU map.) It is recommended that an installation make a copy of the CSU map on tape or on another device or family immediately after every update of the CSU map. If the device containing subfamily 0 of the default family is reloaded, the latest CSU maps should be recovered from the backup copies. After recovering the CSU maps, the installation should run the ASVAL utility with the AM and FM parameters specified to ensure that the CSU map and MSF catalog entries match. If they do not, corrective action should be taken as described in Error Conditions and Corrective Action. Failure to retain or recover the latest CSU maps can cause problems with future ASLABEL runs (refer to the definition of CSU map).

An MSF catalog is created for each subfamily of a family that can have MSF resident files and is updated by the ASLABEL, ASMOVE, ASVAL, and ASDEBUG utilities. When PFDUMP copies permanent files to tape for a master device or all devices in a family, it ensures that corresponding MSF catalogs are also dumped. (If MSSEXEC has an MSF catalog attached in modify mode, PFDUMP interfaces with MSSEXEC so that the MSF catalog is included on the dump tape.) Consequently, if PFLOAD is used to reload all files, the MSF catalogs are automatically recovered and entries for all MSF resident files reflected in recovered PFC entries will exist in the recovered MSF catalog.

If PFLOAD is run after the ASLABEL utility has updated the MSF catalog and CSU map but before the MSF catalog has been backed up, the recovered MSF catalog will not match exactly the corresponding CSU map. In this case, recovery procedures (as described in CSU Map/MSF Catalog Mismatch later in this section) must be taken to bring the CSU map, MSF catalog, and cartridge label information into agreement.

### **File Reloading**

PFLOAD runs should be made as usual. PFLOAD reads the CIR records from the most recent incremental dump tape to control loading of file data and PFC and permit information. For MSF resident only files, PFLOAD only reloads the PFC and permit information (if PFDUMP dumped only this information). The following situations involve PFLOAD in an MSS environment.

- If one device needs to be reloaded, the DN or TD parameter specifies the device. The OP=Z and UD options should not be specified.
- If PFLOAD is used for other than a device recovery, both OP=Z and UD should be specified. The OP=Z option ensures that the PFC entry does not link to an MSF file that may no longer exist, and UD ensures that the file is included in the next incremental or full dump.
- If a file has a nonzero asa value in its PFC entry (indicating that the file has an MSF image), the ASCVER flag in the PFC entry will be set when the PFC and permit information are reloaded. If the file is successfully staged to disk when it is attached, this flag is cleared. Otherwise, the flag remains set. This can be used to indicate the possibility of an operational error, such as omitting OP=Z when a file or set of files is reloaded from an obsolete dump tape.
- If any unscheduled device reload that includes recovery of an MSF catalog and/or CSU map is made, ASVAL should be run with the AM and FM parameters specified. ASVAL examines the PFC entries for MSF resident files, the MSF catalog, and the CSU map to detect any error conditions that exist.

## ERROR CONDITIONS AND CORRECTIVE ACTIONS

It is possible for operational, hardware, or software malfunctions to cause a variety of error conditions to exist or appear to exist in the MSF catalogs, CSU maps, PFC entries, or cartridge labels. The ASVAL utility can analyze the MSF catalogs, CSU maps, and PFC entries to detect these errors, and the ASLABEL utility can identify problems with cartridge labels. The following sections describe some specific error conditions and the actions that should be taken to correct them. Most of the errors are caused either by incorrect operational procedures that result in the recovery of the wrong version of an MSS system file, or by abnormal termination of MSSEXEC or MSS utility processing, which can interrupt the updating of an MSS system file.

### Permanent File Recovery

If a permanent file cannot be accessed or is included by ASVAL on the validation report, the following methods can be tried to recover a copy of the file.

1. Attach the file. If the file has a disk image or can be staged in from MSF, the file data will be available on disk and can be copied to another file. ASVAL should then be run as described in step 2.
2. If the file cannot be attached, reload the file from a dump tape. To identify the PFDUMP run which saved a backup copy of the file, check the output from ASVAL or PFCAT, which includes date and time fields from the PFC entry for the file. Depending on the BR attribute (backup requirement) of the file, a backup copy on a dump tape may not exist.

If the file can be reloaded to disk, ASVAL should be run as follows:

```
ASVAL,FM=family,SB=sub,FX=n,AM.
```

where family and sub identify the family and subfamily of the recovered file and n is sufficiently large that the fixing/flagging will be done. ASVAL sets the obsolete flag in the PFC entry because the file now has a disk image; thus the file is disassociated from the error condition. The error condition may still exist in the MSF catalog or CSU map, but it can be investigated and corrected by the installation via the ASDEBUG utility. Before using ASDEBUG to correct the error, the installation should take an incremental dump so the old PFC entry with an asa value pointing to a problem MSF-resident file will not be reloaded if a device reload occurs before the next scheduled backup dump.

3. If steps 1 and 2 fail, try to regenerate the file. Depending on the particular problem and status of the cartridges to which the file was destaged, the OP=RF or OP=RS directive to ASDEBUG might recover the file data.
4. If the file cannot be recovered, purge it so there is no PFC entry pointing to a problem MSF-resident file.



## Cartridge Restoration and Reuse

If a cartridge is unexpectedly found anywhere outside its assigned cubicle, the following steps can be taken to restore the cartridge so it can be used again.

1. Put the cartridge in the input drawer of the CSU to which it is assumed to belong and run ASLABEL with the OP=RS directive. If the cartridge label information agrees with the CSU map entry for the cubicle with the X,Y coordinates written on the cartridge label, the cartridge will be restored to that cubicle and the MSF catalog entry for the cartridge is updated to clear the lost flag. Otherwise, the cartridge is put in the output drawer and the cartridge label information is included in the output from ASLABEL.
2. If the cartridge was not restored to its CSU cubicle, examine the label information reported by ASLABEL. If the cartridge is assigned to a different CSU, repeat step 1 using the correct CSU. If the family name is blank, the cartridge has a scratch label and can be assigned normally with the OP=AM directive to ASLABEL.
3. If steps 1 and 2 fail, examine the CSU map entry for the cubicle with the X,Y coordinates written on the cartridge label to see how the cubicle is assigned. Examine the cartridge, if any, in this cubicle. Also, it might be useful to run ASVAL to ensure the CSU map and MSF catalog entries for the cartridge match or to identify affected permanent files, if any, if they do not match.
4. If set 3 does not produce any useful information and the cartridge cannot be restored, use the OP=FX directive to ASLABEL to rewrite the cartridge label and thereby make a scratch cartridge. It might be useful to first run ASDEBUG with the OP=RS directive to preserve the data on the cartridge.

## Removal of Faulty or Missing Cartridges

The following steps should be taken to remove a cartridge which has unrecoverable errors, or to release the CSU map entry for a cartridge which is missing.

For unallocated cartridges:

1. Attempt to remove the cartridge with the ASLABEL OP=RM directive.
2. If CARTRIDGE NOT FOUND is reported, repeat step 1 specifying the LT parameter.
3. If CARTRIDGE NOT EMPTY is reported, at least one AU on the cartridge is still allocated.

For allocated cartridges:

1. Use the ASLABEL OP=IB directive to inhibit further allocation of the cartridge.
2. Run ASVAL specifying the AM parameter. Examine the report for possible discrepancies between the CSU map, MSF catalog, and PFC entries related to this cartridge.
3. If no MSF catalog entry corresponds to the CSU map entry, use the OP=RC directive to ASDEBUG to remove the map entry.
4. If no discrepancy is reported by ASVAL, the affected files should be attached in write mode (if possible), reloaded using PFLOAD with the OP=Z option, or purged. Then ASVAL release processing should be done to release the MSF space on the cartridge, and the cartridge can be removed as in step 1.

## MSF Catalog/CSU Map/PFC Problems

If error conditions exist in the MSF catalogs or CSU maps, the recovery procedure is to correct the appropriate entry rather than reload the entire file. Reloading other than the latest copy of the CSU map is not feasible because it can contain entries for several families and these entries would not be up to date. Reloading an old copy of the MSF catalog is not desirable because any permanent file that was destaged and released from disk since the last incremental dump will be lost. The following sections describe corrective action for specific problems with MSF catalogs, CSU maps, or PFC entries.

### MSF Catalog/CSU Map Mismatch

The following examples of MSF catalog/CSU map mismatches can appear as error type 1 or 2 on the ASVAL output report, which identifies the mismatch and the permanent files or orphans affected. Before taking any corrective action, the analyst should ensure that operational errors did not result in loading the wrong version of the CSU map or MSF catalog.

- If a cartridge has an MSF catalog entry indicating that all AUs on the cartridge are available for allocation but is not identified in any CSU map entry (type 1 mismatch), use the OP=RL directive to ASDEBUG to remove the MSF catalog entry for the cartridge.
- If a cartridge is identified in a CSU map entry but has no MSF catalog entry (type 2 mismatch), use the OP=RC directive to ASDEBUG to update the CSU map entry to unassigned and empty status. This directive will write a scratch label for the cartridge, if any, and place the cartridge in the output drawer.
- If a cartridge has an MSF catalog entry indicating that at least one AU on the cartridge is allocated, recover the disk space for the affected permanent file, if any, or purge the file. Run ASVAL to purge unneeded MSF files and thereby make the cartridge unallocated. Use the OP=RL directive to ASDEBUG to remove the MSF catalog entry for the cartridge.

#### **NOTE**

It sometimes takes two ASVAL/ASDEBUG runs to clear up completely type 1 or type 2 errors. Therefore, it is recommended that ASVAL be rerun with the AM parameter after an ASDEBUG run using OP=RC or OP=RL.

### MSF Catalog Chain Problems

AUs that are allocated to an MSF resident file are chained together in the MSF catalog to identify the sequence of AUs that contain the file. (Refer to the definition of cartridge.) For most files, the AUs in the chain reside on the same cartridge. Hence, one disk access is sufficient to update information for the entire chain at one time. However, an MSF resident file can reside on several cartridges and several disk accesses may be necessary to update its chain. If MSSEEXEC is interrupted during such an update, the resultant chain will be incomplete. ASVAL identifies incomplete chains as error type 4, 5, or 6 on the validation report. The following are types of incomplete chains.

- If an incomplete chain is produced while an MSF resident file is being purged, it is a chain fragment (one without an HOC entry).
- If an incomplete chain is produced while a file is being destaged to MSF, it is an ill-formed chain (one without an EOC entry).
- If an ill-formed chain is not corrected, the AU that should have been linked to it may be reused and become part of a good chain. Although the ill-formed chain may appear to be complete, the ill-formed chain and the good chain are intersecting.

The corrective action for any of these bad chain conditions is as follows:

1. Run ASVAL with the FM parameter specified and use a sufficiently large FX=n value so that ASVAL updates the MSF catalog entries affected by the problem chains.
2. Recover the permanent files, if any, that have MSF images potentially affected by these error conditions. (The ASVAL report identifies these files.) The procedure described in Permanent File Recovery should be used.
3. Take an incremental or full backup dump. This prevents PFC entries with inaccurate asa values or problem MSF chains from being recovered if a device reload is necessary.
4. Run ASDEBUG with the OP=RP directive to make each AU on the problem chain available for allocation. Thus, the AUs can be included in a new chain without any problems. In the case of intersecting chains, all chains that have an AU in common with another chain should be released before any further destage attempts; otherwise, errors will occur when a user tries to attach a file that is contained on an intersecting chain.

### PFC/MSF Catalog Mismatch

It is possible that an old version of an MSF catalog can be reloaded because of incorrect operational procedures. If so, the asa value in the PFC entry for a file can be invalid according to the obsolete MSF catalog or can point to a problem chain. If the correct version of the MSF catalog is available on tape, it should be reloaded. If it is not available, the following action is appropriate. If the file also has a disk image, ASVAL should be run to clear the asa field in the PFC entry. If there is no disk image, the analyst should reload the file from tape, if possible, and then run ASVAL to clear the asa value.

## **PSEUDO RELEASE**

The pseudo release capability allows an installation to experiment with MSS operational procedures in order to determine which procedures should be used normally and to become adept at recognizing error conditions and performing appropriate recovery procedures. While employing the pseudo release feature, the installation runs no risk of losing any permanent files used in this checkout phase, as explained in the following paragraphs.

Pseudo release mode is initiated by an ASMOVE run with TM=Y specified. ASMOVE selects files to be destaged and/or released from disk by using the destage and release algorithms as usual. The destage to MSF process is the same whether or not pseudo release mode is in effect (refer to the description of ASMOVE for details on destaging). However, the procedures for disk space release vary depending on whether or not pseudo release mode is enabled. Disk space is not actually released in pseudo release mode. Rather, the AFPDR flag (refer to the definition of catalog entry in section 1) is set in the PFC entry for a file that has been selected for disk space release. This flag indicates that PFM should ignore the disk image for this file. Therefore, if the user attaches such a file, the disk image is ignored and the file is staged to disk from MSF. The normal staging process is followed except that the disk image is created on a scratch device instead of a permanent file device. Thus, in actuality, two disk images of the file exist. However, once the file is staged to disk, whether or not staging errors are detected and reported by MSSEXEC, the AFPDR flag is cleared so that the user accesses the original disk image. Also, the file staged to the scratch disk is released so the scratch space is available for reuse. If MSS processing becomes disabled, the original disk image can still be accessed via an ATTACH request.

There are two methods for terminating pseudo release mode. One is to perform a full dump followed by a reload with OP=Z specified on the PFCLOAD call. This clears the asa field in the PFC entry for each file, thereby indicating that no MSF images exist and that the files reside on disk only. The other method is to run ASMOVE with TM=N specified. This causes the disk images for pseudo-released files to be really released from disk, thereby leaving the file with only the MSF image.

## **Error Recovery Examples**

The following examples can be used after pseudo release mode is enabled to force different error conditions to occur. The installation can implement these incorrect operational procedures and then perform error recovery action without endangering any of the permanent files involved. These examples assume that ASDEF has been run to create a CSU map and the MSF catalogs for the CSU and family being tested.

### **Example 1:**

1. Run ASLABEL to add cartridges (for example, A, B, C) to a subfamily.
2. Dump the CSU map file to tape.
3. Run ASLABEL to remove cartridge A and add another cartridge (for example, D).
4. Reload the CSU map file dumped in step 2. This creates a mismatch between the CSU map and MSF catalog, because the MSF catalog indicates that cartridge D resides in the CSU but cartridge A does not.
5. Run ASVAL to detect the mismatch.
6. Run ASDEBUG to correct the mismatch. The resultant CSU map and MSF catalog should contain entries for cartridges B and C, but not A or D.

Example 2:

1. Run ASLABEL to add several cartridges to a subfamily.
2. Create some permanent files with different backup requirements and preferred residence requirements.
3. Run ASMOVE to destage and/or release the files created in step 2.
4. Physically remove one of the cartridges from the CSU; do not use ASLABEL to remove it.
5. Attach the files whose disk space was released in step 3.
6. Run ASVAL to verify that only files resident on the removed cartridge are affected.
7. Run ASLABEL to restore the cartridge removed in step 4.
8. Attach the files reported in step 6. There should be no problems reported.

Example 3:

1. Run ASLABEL to add several cartridges to a subfamily. Make a backup copy of the CSU map and MSF catalog files.
2. Create several files with the BR=Y or BR=MD attribute. Run ASMOVE to destage all of them and release those with the BR=MD requirement.
3. Take a backup dump of the family.
4. Reload the CSU map and MSF catalog backed up in step 1.
5. Create several new files with the BR=MD attribute. Run ASMOVE to destage them and to release the disk space of the files with the BR=Y attribute in step 2.
6. Attach the files created in step 2. They should have been overwritten by the files destaged in step 5.
7. Recover the files with the BR=Y attribute from the dump tape made in step 3.

Example 4:

Try to interrupt MSSEXEC while it is destaging new files or releasing unused MSF files to create incomplete chains. ASVAL reports such errors and ASDEBUG fixes them.

This section describes the following utilities and files involved in the operation of the network and time-sharing subsystems of NOS.

- Load File Generator (LFG). This utility produces a direct access file used by the Network Access Method (NAM) to perform the downline load of network processing units (NPUs or 255x's).
- NPU Dump Analyzer (NDA). This utility produces readable listings from dump files produced when NAM dumps network processing units.
- Application Interface Program (AIP) Trace. This utility produces a trace file of the messages transferred between IAF and NAM. The information contained in this trace can be useful in tracking network problems and in debugging application programs.
- Network description files and VALNET. Network description files are used by the Transaction Facility (TAF) and the Time-Sharing Module. They describe the physical time-sharing network via terminal definition directives prepared by the site analyst. VALNET verifies the correct construction and syntax of the directives on the network description files before using them in an operating environment.
- Stimulators. A stimulator is a collection of programs that artificially load the system to analyze the effects of such a load on system performance and reliability.

## LOAD FILE GENERATOR (LFG)

The Load File Generator (LFG) is a utility program that reformats Communications Control Program (CCP) files for subsequent use by the Network Supervisor of NAM to load network processing units (NPUs). LFG accepts one or more input files in single or multifile format and produces a single output file for use by the Network Supervisor.

## FILE DESCRIPTION STATEMENTS

File description statements describe the structure of the input files and allow the analyst to assign names to the various memory modules contained on the input files.

The file description statement format is as follows:

$$\text{filenam} \left[ \begin{array}{l} \text{:mres}_{1,n} \\ \text{:ovl}_{1,n} \end{array} \right] \dots \left[ \begin{array}{l} \text{:mres}_{m,n} \\ \text{:ovl}_{m,n} \end{array} \right].$$

**filenam**            Name of local file containing NPU memory modules. This file is created by the CCP installation process.

**mres**                A three-character (alphanumeric) name of macromemory resident or micromemory. These names must agree with the names assigned to P2LID and P1LID parameters specified on the NPU statement(s) used in creating the network configuration file. (Refer to the Network Definition Language Reference Manual for further information.)

- ovl            A three-character (alphanumeric) name of overlay. The first character of the name must be a letter from A through O. This parameter is required when overlay modules are present on the input file. Each overlay module must have a unique ovl.
  
- n             Number of records preceding the memory module header record in the file. The starting record position is dependent upon the procedure used to create the input file. The n parameter can range from 0 to 9; n is usually 0 for memory resident records and 2 for overlay records.

Each :mres,n or ;ovl,n parameter pair corresponds to a memory resident or overlay load module on the input file being described. The order of these parameter pairs must match the order of the load modules on file filename. A colon must precede the name of a memory resident module, and a semicolon must precede the name of an overlay module. A period must terminate each file description statement. Embedded or leading blanks are not allowed. If more than 80 columns are needed to describe an input file, the file description statement can be continued to as many lines or cards as necessary.

The analyst must determine the order of load modules on the CCP input files. If the same load module is present on more than one input file, it should be described on only one file description statement. Appropriate file positioning control statements should precede the LFG control statement to position input files to skip duplicate load modules on all but one input file. (LFG does not rewind input files before processing them.) Refer to the CDC CYBER Cross System Link Editor and Library Maintenance Programs Reference Manual for information on input file generation.

#### FILE DESCRIPTION STATEMENT EXAMPLES

In each of the following examples, the file description statements are appropriate for the indicated input file configuration.

- Three files, each containing one memory resident module.

```
TAPE1:MAA,0.
TAPE2:MAB,0.
TAPE3:MAC,0.
```

- One file with two memory resident modules and two overlay modules:

```
TAPE1:MAC,0;MIC,0;DLO,2;OV1,2.
```

- Two files, the first containing a single memory resident module and the second containing four overlay modules with two extra records each.

```
TAPE:MAA,0.
TAPE2;OV1,2;OV2,2;OV3,2;OV4,2.
```

## REQUIRED NAMES FOR LOAD MODULES

The Network Supervisor of NAM expects the following load modules to be named as specified.

<u>Load Module</u>	<u>Required Name</u>
Dump/load overlay	DLO
Memory resident 2550 bootstrap program	DB0

## EXECUTION

LFG is invoked with the following control statement without parameters.

LFG.

File description statements are read from the file INPUT, and error messages are written to the file OUTPUT. The CCP files named on the file description statements must be local to the job at the time LFG is executed.

LFG produces a single load file for use by the Network Supervisor of NAM. The local file name of this file is NPUFL. The Network Supervisor expects this file to be a public direct access permanent file named CCPFILE and stored under the system user index (377777). The analyst must provide appropriate control statements to create the permanent file CCPFILE and store it under the system user index. The MOVEPF utility (refer to the NOS Installation Handbook) may be useful in storing the load file under the system user index.

## EXECUTION EXAMPLE

In the following example, a load file is created for two NPUs. The CCP files were created earlier and stored under the user name ANLYST as direct access permanent files with names and contents as follows:

<u>Permanent File Name</u>	<u>Contents</u>
REMOTE	File 1: 2550 micromemory File 2: 2550 macromemory
LOCAL	File 1: 2550 macromemory
MICDB0	File 1: 2550 micromemory File 2: 2550 bootstrap program
DIAG	File 1: Diagnostic overlay
DMPLD	File 1: Dump/load overlay

In this example, two extra records precede the two overlay modules. No extra record is present for any memory resident modules. The 2550 micromemory module is present on two files (REMOTE and MICDB0). Either copy may be used but not both; the unused copy must be skipped before invoking LFG.



The following job creates the desired load file.

```
NPULOAD.                Job statement.

USER(ANLYST,PASS)       ANLYST's password is PASS. ANLYST does not require a CHARGE
                        statement. (Refer to MODVAL description, section 5.)

ATTACH(LOCAL,REMOTE) }
ATTACH(MICDB0,DIAG)  } CCP files are attached.
ATTACH(DMPLD)        }

SKIPF(MICDB0)         Duplicate 2550 micromemory module is skipped.

DEFINE(NPUFL=CCPFILE) Permanent file CCPFILE is defined with local file name of NPUFL.

LFG.                  Load file is generated.

7/8/9                 End-of-record.

REMOTE:MIC,0:REM,0.   }
LOCAL:LOC,0.          }
MICDB0:DB0,0.        } File description statements.
DIAG;DIG,2.          }
DMPLD;DLO,2.         }

6/7/8/9              End-of-information.
```

Upon successful completion of this job, the analyst should execute MOVEPF to move CCPFILE to the system user index. The analyst also has the option of running the LFG job under DIS at the system console. In this case, the file description statements would be placed on file INPUT via the O26 file editor, and the job statement would be omitted. Also, if the analyst inserts the control statement SUI(377777) immediately before the DEFINE statement when running this job at the system console, running MOVEPF is unnecessary. (Refer to the NOS Operator's Guide for information on DIS and the NOS Systems Programmer's Instant for information on the O26 file editor.)

The following Network Definition Language statements are appropriate when creating a network configuration file for use in a network configured with NPUs and load modules described in this example.

```
REM1:  NPU P1LID=MIC,P2LID=REM,NPUTYPE=2550,NODE=10.
```

```
LOC1:  NPU P1LID=MIC,P2LID=LOC,NPUTYPE=2550,NODE=12.
```

Other NPU names, node numbers, and/or additional parameters can be specified as necessary (refer to the Network Definition Language Reference Manual).

## NPU DUMP ANALYZER

The NPU Dump Analyzer (NDA) is a utility program that produces readable printout from the NPU dump files; the NPU dump files are created by the Network Supervisor during the initiation or reloading of a failed NPU. NDA reports determine the state of a network processing unit at the time a dump was generated.

NDA must be a system origin job and is accessed by a control statement that allows selection of the following.

- Specific NPU dumps by NPU name or dump number.
- Dumps from/to specific NPU macromemory addresses.
- Retention of dump file after processing.
- Release of dump file without producing a listing.
- Listing options.

### CONTROL STATEMENT

The format of the control statement is

`NDA(p1,p2,...,pn)`

where  $p_i$  is a keyword or a keyword equated to a value. All keywords are order-independent. If the same keyword is specified more than once, the last (rightmost) occurrence of the keyword overrides all previous ones. An invalid parameter name or value causes an error message to appear. NDA ignores an invalid DN, NPU, or AD parameter value and continues processing. An invalid parameter name or an invalid value for B, E, or LO causes termination of the run.

<u>P<sub>i</sub></u>	<u>Description</u>
AD=yymmdd	Last access date in the form of year, month, day. Dump files that have not been accessed on or after the date specified are purged. Default is not to purge files based on a date. However, files can be purged for other reasons (for example, failure to use the NR option).
B=addr	One- to six-digit hexadecimal address within the NPU macromemory at which the dump report begins. Default is B=address of the actual beginning of the dump.
DN=n	Decimal dump number assigned by the Network Supervisor of NAM at the time the dump is generated; $1 \leq n \leq 540$ . Up to five different dumps to be analyzed can be selected by repeated use of DN=n specifications, separated by commas. Default is that NPU must be specified on the control statement.†
E=addr	One- to six-digit hexadecimal address within the NPU macromemory at which the dump report ends. Default is E=address of the actual end of the dump.

---

† Either DN or NPU (but not both) must be specified. Unpredictable results can occur if both DN and NPU are specified.

<u>Pi</u>	<u>Description</u>						
LO=opt	One or two characters, each of which specifies a portion of the dump to be listed; any unspecified portions are not listed.						
	<table border="0" style="margin-left: 40px;"> <thead> <tr> <th style="text-align: left;"><u>opt</u></th> <th style="text-align: left;"><u>Description</u></th> </tr> </thead> <tbody> <tr> <td>M</td> <td>Macro memory</td> </tr> <tr> <td>R</td> <td>Registers</td> </tr> </tbody> </table>	<u>opt</u>	<u>Description</u>	M	Macro memory	R	Registers
<u>opt</u>	<u>Description</u>						
M	Macro memory						
R	Registers						
	If LO=0 or LO alone is specified, the entire listing is suppressed. This is used to purge dump files when no listing is desired. Default is LO=RM.						
NPU=npu	One- to seven-character name assigned to a specific NPU in the network configuration file, specifying that all dumps for the given NPU are selected. Default is that DN must be specified on the control statement.†						
NR	Specifies that the dump file is not to be released after NDA completes processing and hence can undergo additional processing.						

**NOTE**

If NR is omitted, NDA purges the dump file after NDA completes processing.

## REPORT FORMATS

Each complete dump file report contains three records for each dump file analyzed. The first record is shown in figure 4-1.

```

NPU DUMP = 006                NDA(DN=6,E=70,NR)

TIME          13.16.03
DATE          78/03/21
NPU NAME      NODE3

```

Figure 4-1. First Dump Record Format and Sample

† Either DN or NPU (but not both) must be specified. Unpredictable results can occur if both DN and NPU are specified.

The second dump record is formatted into separately addressed lines of 16 NPU or MUX file registers each. The content of each register is given in hexadecimal form, and each group of registers appears separately.

The third dump record is formatted into separately addressed lines of 16 NPU or MUX macromemory words each. This is the equivalent of 32 ASCII characters. The content of each word is given in hexadecimal form. If the content of the words in a line duplicates that of the previous line, the duplicate line is not printed; addressing continues with the next nonduplicate line, which is flagged with two asterisks (\*\*) by its first word to indicate the omission.

## NETWORK DUMP FILES

The network dump files, created by the Network Supervisor during network operation, are allocated in the form of a permanent file for each NPU dump taken. These dump files are then indexed in a separate directory file, NDA4IND. This file contains indicators that show the presence or absence of individual dump files, as well as other information about individual dump files. Individual dump files are named DMPAnnn, where nnn is a unique dump number in the range 001 to 540. The dump number is specified by the DN option on the NDA control statement.

The Network Supervisor allocates dump files and makes directory file entries for each. NDA processes and releases the dump files and removes corresponding directory entries. It is this release and removal function that is performed by the NDA control statement option NR.

### NOTE

Purging network dump files via the PURGE control statement leaves the dump directory file incorrect. Dump files should be purged only by NDA.

## NPUDUMP ON TAPE (NPUDUMP)

NPUDUMP is a network procedure file that copies NPU dumps to tape. This procedure file can be called with the following command,

```
X-BEGIN(NPUDUMP, NPUDUMP, dn)
```

where dn is the NPU dump number. Up to five different dumps can be selected by repeated dn specifications, separated by commas.

The effect of the NPUDUMP procedure is the same as the execution of the NDA control statement with NR specified (NPU dump is not purged) followed by a request for a labeled tape. The flashing tape request can be processed by the operator as described in the NOS Operator's Guide appendix on Network Failure Processing. If the NPUDUMP Procedure is executed after a network failure has occurred, no flashing tape request appears and the NPU dump is automatically copied to the same tape or set of tapes that was used for network dumps. If the network dumps had been printed instead, the NPU dumps are also printed.

## UPDATE VSN(NETUVSN)

NETUVSN is a utility program that is used by network procedure files in order to collect a complete set of network dumps on one tape or set of tapes with a minimal amount of operator action. After a network procedure file copies its files to tape, it evokes NETUVSN, which reads the tape label to pick up the tape vsn, retrieves the device type from the tape FET, and uses this information to create a tape request control statement in a procedure file called NETTAPE. Other network procedure files call NETTAPE so that their network dumps are copied to the same tape or set of tapes. The format of such a dump tape is described in the following section.

### Network Dump Tape

The network procedure files copy the network dumps to tape in a specific order and with specially marked records so that retrieval of the dump information is as simple as possible. The order of dumping is as follows:

- NAM
- RBF (if it was running)
- NS
- CS
- NVF
- TVF
- NPS (if it was running)
- NPU dumps

For each product there can be several files that are dumped, but they are always dumped in a specific order as follows:

- Field length dump.
- Special files, if any (for example, NVF has TCR and DBG).
- AIP statistics file, if it exists.
- Job dayfile.
- AIP debug log file, if it exists.

Each type of dump information is preceded by a text record that identifies the dump information. For NPU dumps, the text record is NPUDUMP=dn, where dn is the NPU dump number. Up to five different dumps can be included by repeated dn specifications, separated by commas. For all dumps except NPU dumps, the following text records are used, where name is the name of the product.

<u>text record</u>	<u>Description</u>
name	Indicates the first record of the AIP debug log file.
name AIPS	Indicates the record containing AIP statistics information.
name DAYF	Indicates the record containing the job dayfile.
name DUMP	Indicates the record containing the exchange package dump. After that is the field length dump.
name END	Indicates the end of the dumps for product name.

Not all of the records on the tape can be directly printed, because some of the dumped files are binary files instead of coded files. The TDUMP control statement (refer to volume 1 of the NOS Reference Manual) should be used to read the contents of all binary files, except for the AIP debug log file and the NPS file LOGNPS. The debug log file processor (DLFP) must be used to read the AIP debug log file, which is a binary file containing an indeterminate number of records. (Refer to the NAM Reference Manual.) This requires that the AIP debug log file first be removed from the tape and placed in a separate file. REPORTR must be run to read the NPS file LOGNPS. (Refer to the NPS Reference Manual.) This requires that LOGNPS first be removed from the tape and placed in a separate file.

## AIP TRACE WITH IAF

The AIP trace utility produces a trace file of the messages transferred between IAF and NAM. This file, produced as a local file named ZZZZZDN at IAF's control point, contains information that can be useful in tracking network problems and in debugging application programs. However, the data in this file is in compressed format and hence the debug log file processor (DLFP) must be used to analyze the trace file. Refer to the Network Access Method Reference Manual for details about the trace output and the use of DLFP.

The console operator selects whether or not to use the AIP trace mode of operation when entering the DSD command, IAFfff, to initialize IAF. This command selects a procedure file that contains the IAFEX control statement. The T parameter on the IAFEX statement determines whether or not AIP trace mode is to be in effect and also the number of messages that are to be contained on the trace file. The format of the IAFEX control statement is

IAFEX(T=count)

T=count	5000≤count≤9999999. Message count specifying the number of messages that are to be logged on the trace file before that file is released to the system for processing. If T=* is specified, the trace file is processed only after IAF is terminated.
T	Same as T=16200.
T=0	AIP trace mode is not selected.
T omitted	Same as T=0.

Two procedure files are provided for use with the AIP trace, IAFTM and IAFTR. Installations can define other procedure files using different T parameters on the IAFEX control statement.

## IAFTM

IAFTM is a procedure file that contains the IAFEX(T=\*) control statement. That is, the trace file ZZZZZDN is processed only after IAF is terminated. The IAFTM procedure file also includes the control statements necessary to process the ZZZZZDN trace file. Also, all messages logged on the trace file are written to the output file and then disposed to a printer. Refer to the NOS Installation Handbook for more information about IAFTM.

## IAFTR

IAFTR is a procedure file that contains the IAFEX(T) control statement. That is, the trace file ZZZZZDN is processed after every 16200 messages have been transferred between IAF and NAM. (Refer to the NOS Installation Handbook for more information about IAFTR.) An indirect access file called TRACIAF under user index 377777g is required to process the trace file. TRACIAF contains a control statement record, which is copied to the first record of the ZZZZZDN trace file. Trace information is then written to file ZZZZZDN, starting at the next record. This makes file ZZZZZDN suitable for submission as a batch job. The format of the TRACIAF file should be as follows:

```
job statement
USER statement
CHARGE statement
.
.
DLFP ( ... )
.
.
```

### NOTE

When system activity is very high, the potential exists for the following problems to occur if the AIP trace is used.

- If the system load remains at a very high level for a long period of time, a system hang due to PP saturation could occur.
- If mass storage requirements become great, the ZZZZZDN trace file could reach track limit. If so, IAF would stop and wait for resources to become available.

Both of the preceding problems are unlikely to occur in most situations. Also, the risk of reaching track limit can be minimized by the selection of a message count on the IAFEX control statement that causes the trace file to be processed and released after the specified number of messages have been logged. This lowers the mass storage requirements. Because the AIP trace can be essential when certain types of problems are encountered, it is recommended that the AIP trace be used when circumstances so dictate as the risk involved is not great.

## NETWORK DESCRIPTION FILES

The network description files describe the physical and logical configuration of hardware and software elements that comprise the terminal network. They must be present for the proper functioning of the TELEX, TAF, and NAM subsystems of NOS. Depending on which subsystems are present at a site, one to five such files may be present for a single mainframe. Each file has the following unique function and/or construction.

<u>File Name</u>	<u>Description</u>
LCFFILE and NCFFILE	Local configuration file and network configuration file which must be present if NAM is used. They are created by the Network Definition Language Processor (NDLP) from source text prepared according to specifications given in the Network Definition Language Reference Manual.
NETWid †	Network description file which must be present if TELEX is used. It is prepared directly by the site analyst according to specifications given later in this section. If the Transaction Facility/Time-Sharing (multiplexer) version (TAF/TS) is used, NETWid is used by TELEX and TAF/TS.
NCTFid †	Network description file which must be present if the Transaction Facility/NAM version (TAF/NAM) is used. It is prepared directly by the site analyst according to specifications given later in this section.
SIMFid †	Alternate network description file. This file is prepared in the same way as NETWid but is used by TELEX or TAF/TS when NETWid is unavailable or not present. The presence of SIMFid is optional. SIMFid is used primarily for system development purposes.

Under standard operating conditions, the time-sharing and network subsystems expect these files to be permanent, direct access public files stored under the system user index (377777). LCFFILE and NCFFILE are binary files created by NDLP; NETWid, NCTFid, and SIMFid (if used) are text files composed of directives. The text files are interpreted by code in common deck COMCRTN to produce tables used by TELEX or TAF during system operation (refer to COMCRTN listing).

The alternate network description file SIMFid is implemented so that a simulated network description can be retained and used without the necessity of changing the description of the actual physical network on the NETWid file. Accordingly, the analyst performs the following steps to obtain the simulated network description.

---

† id is the two-character machine identifier as specified by the MID directive in CMRDECK (refer to the NOS Installation Handbook).



1. Stops the time-sharing executive.
2. Attaches NETWid in write mode from the stimulation job.
3. Initiates the time-sharing executive. (Since NETWid is attached in write mode, the time-sharing executive will attach the alternate file SIMFid.)
4. Begins stimulation.

## DIRECTIVE FORMATS

A directive statement can be up to 90 columns but only columns 1 through 72 are interpreted. Any line containing an asterisk in column 1 is a comment and is ignored.

### Multiplexer Definition Directive

The multiplexer definition directive must precede all other directives on the file and can be one of the following; no embedded blanks are allowed.

```
//muxtype,CH=cc,EQ=eq
```

muxtype	Multiplexer model designation (6671 or 6676).
cc	Channel to which multiplexer is attached.
eq	Equipment number of multiplexer (0 to 7).

This directive permanently associates a multiplexer with the terminals described by the terminal definition directives that follow. The //muxtype directive can appear only in the NETWid or SIMFid file when used with TELEX or TAF/TS; it cannot appear in the NCTFid file used by TAF/NAM.

```
//DIAL.
```

This directive does not refer to any particular multiplexer or port. It requests that all terminals specified after it be assigned to whatever multiplexer ports are available when such assignment is needed. In the latter equipment assignment, no multiplexer port is permanently restricted to a fixed set of equipment.

### Terminal Definition Directive

The following format shows the terminal definition directive. No embedded blanks are allowed.

```
/termnam,p1=n1,p2=n2,...,pm=nm.
```

termnam	One- to seven-character alphanumeric name that uniquely identifies the terminal; termnam must be specified. When NCTFid is created, termnam must agree with any user name used by a terminal configured to access TAF/TS and with any automatic login user name.
---------	--

<u>Pi=ni</u>	<u>Description</u>
LS=n	Terminal line speed in characters per second; (1 ≤ n ≤ 2047). This option cannot appear in NCTFid used by TAF/NAM.
PL=n	Last port number used in conjunction with the PN option to establish the range of ports that can be used with one multiplexer. The PN option must precede PL. The range of n is (m+1) to 15 for 6671 multiplexers, (m+1) to 63 for 6676 multiplexers, and (m+1) to 512 for stimulated multiplexers, where m is the port number specified by the PN option. This option cannot be used in NCTFid used by TAF/NAM.
PN=m	Port number of the multiplexer with which the terminal is associated. This option is required only if the terminal is associated with a specific multiplexer equipment; that is, if the last preceding multiplexer directive was //6671 or //6676. The range of m is 1 to 16 for 6671 multiplexers, 1 to 64 for 6676 multiplexers, and 1 to 512 for stimulated multiplexers. This option cannot be used in NCTFid used by TAF/NAM.

Example:

/TERMA, PN=2, PL=5.

is a terminal definition which connects terminal TERMA to port 2 and limits the remaining terminal definitions in this set to ports 3 through 5.

TT=tt or TT=*tt	Terminal type that identifies the method by which the terminal is identified to the system and whether or not the terminal is a transaction terminal.
-----------------	---

<u>tt</u>	<u>Description</u>
AB	Terminal is identified by answerback.
ID	Terminal is identified by terminal operator entry.

If tt is preceded by \*, the terminal is a transaction terminal. TT=\*ID must be specified for terminals defined in NCTFid used by TAF/NAM.

A TAF terminal is defined with the previous arguments, as well as the following, which are unique to TAF.

<u>Pi=ni</u>	<u>Description</u>
DB=db.	Two-character data base name to be used by the terminal.
IS=stat	Initial on/off status of the terminal; stat can be either ON or OFF. Default is ON.
RS=n.	Data base read security (0 through 7). Default is 0.
UA=n.	24 bits defining the user argument area (0 through 77777777g). Default is 0.
US=n.	Data base update security (0 through 7). Default is 0.

## VALNET VALIDATION PROGRAM

VALNET is a program used to validate the syntax and logic of a terminal network description file. Errors in the network description are diagnosed and error messages entered on a list file. If no errors are encountered, no list is produced. If the network description is error-free, the analyst should then create a system file from the description file. This system file will be either SIMFid or NETWid, depending on its use. Typical coding would be:

```
X.DIS.
USER(username,password,family)
GET,NET.                               Tentative network description file is retrieved.
SUI,377777.
DEFINE,NETWid/CT=PU.
VALNET,P=NET.
COPYBF,NET,NETWid.
```

The format of the control statement is

VALNET(P=filenam,L=filenam,NR)

P=filenam	Name of the terminal network description file to be diagnosed.
P	Same as P=COMPILE.
P omitted	Same as P=NETWid.
L=filenam	Name of file to receive error listing.
L	Same as L=LIST.
L=0	No error listing is to be produced.
L omitted	Same as L=OUTPUT.
NR	Network description file is not to be rewound before reading.
NR omitted	Network description file is to be rewound before reading.

## OUTPUT LISTINGS

For each error encountered in a network description file, VALNET produces two lines of listing. These lines have the following format.

Error Line	
Statement Number	Diagnostic Message

The error line is the faulty line, or in the case of an omission, a near subsequent line. As an example, the descriptive code

(line 3)        /TERMA.

(line 4)        /TERMB,PN=3.

is missing the mandatory port number in line 3. However, this is not diagnosed until line 4 is encountered. Line 4 is listed along with the appropriate diagnostic as follows:

```
TERMB,PN=3
CARD 04 PORT NUMBER UNDEFINED FOR PREVIOUS TERMINAL.
```

List lines are formatted for 72 columns except for input lines that exceed this length.

VALNET calls common deck COMCRTN to process the multiplexer and terminal description directives. Refer to appendix A for descriptions of messages placed on the output file.

## STIMULATION

A stimulator is a collection of central memory and peripheral processor programs which enters a hypothetical work load (called a session or script file) into the system to analyze the effects of such a load on response time and system reliability. The types of stimulation available are internal stimulation and external stimulation. During internal stimulation, the work load is entered into the system without external communications equipment or related terminals. An internal stimulator runs on the same mainframe as that being analyzed. During external stimulation, the work load is entered into the system via external communications equipment but without related terminals. An external stimulator can run either on the same mainframe being analyzed or outside this environment (on a second mainframe).

The following stimulators are available to installations, depending on the control statement used in the STMfff procedure files (refer to Session File Processing later in this section).

- STIMULA (internal stimulation of TELEX or IAF).
- ASTIM (external stimulation of TELEX).
- NSTIM (external stimulation of NAM and its applications).
- NPS (internal stimulation of NAM and its applications).

The STIMULA, ASTIM, and NSTIM stimulators consist of a central memory program (STIMULA) and two peripheral processor programs (1TS and 1TE). The NPS stimulator consists of three central memory programs (SCRIPT, STIM, and REPORTR) and a peripheral processor program (SIP).

To use the stimulators:

1. Create the hypothetical load (refer to Session File Construction).
2. Process these jobs using stimulator commands at the system console (refer to Session File Processing).

Multiple stimulator sessions are described in Multiple Sessions section; errors that can occur while the stimulator software is in use are described in appendix A.

## STIMULA

STIMULA is an internal stimulator that enters a work load into the system through TELEX or IAF. The stimulator software communicates directly with TELEX or IAF via a channel; when used with IAF, the load is applied directly to IAF without going through NAM. STIMULA can run either as the only front end in the system or in conjunction with live terminals. Only interactive terminals can be analyzed with STIMULA. The format of the control statement is as follows:

STIMULA (I=filenam)

filenam      Local file to be used as the session file. If not specified, the initial K display (refer to figure 4-8) requests the session file name.

## ASTIM

ASTIM is an external stimulator that enters a work load into the system through TELEX. Two 6676 multiplexers are required. The stimulator software communicates with a TS multiplexer and TELEX communicates with a TT multiplexer.† The ports of the TS and TT equipment are hardwired together (figure 4-2). ASTIM can run either as the only front end in the system or in conjunction with live terminals. Only interactive terminals can be analyzed with ASTIM. The format of the control statement is as follows:

ASTIM (I=filenam)

filenam      Local file to be used as the session file. If not specified, the initial K display (refer to figure 4-8) requests the session file name.

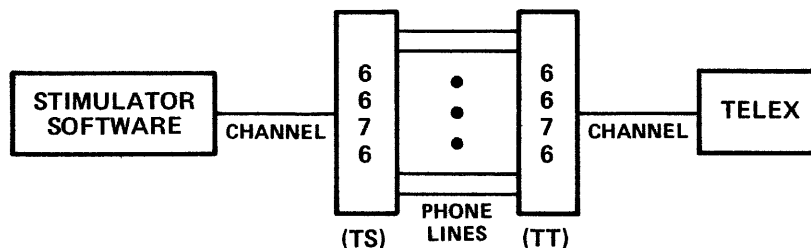

Figure 4-2. Hardware Configuration for ASTIM

† Refer to the NOS Installation Handbook for the format of the TS and TT equipment types at CMRDECK time.

## NSTIM

NSTIM is an external stimulator that enters a work load into the system through NAM and its applications. A 6676 multiplexer (TS)† and an NP communications processor (255x) are required. The stimulator software communicates with the TS multiplexer, and the NAM software communicates with the NPU. The ports of the TS and NP equipment are hardwired together (figure 4-3). NSTIM can run either as the only front end in the system or in conjunction with live terminals. Only interactive terminals can be analyzed with NSTIM. The format of the control statement is as follows:

NSTIM (I=filenam)

filenam        Local file to be used as the session file. If not specified, the initial K display (refer to figure 4-8) requests the session file name.

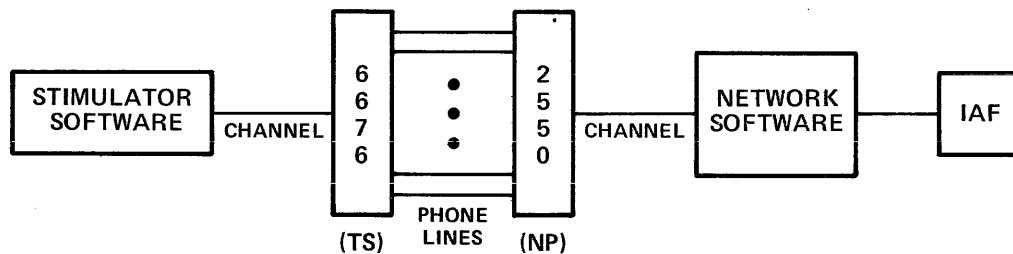

Figure 4-3. Hardware Configuration for NSTIM

## NETWORK PRODUCTS STIMULATOR (NPS)

NPS is an internal stimulator that enters a work load into the system through NAM and its applications. NPS can run either as the only front end in the system or in conjunction with a live network. Batch and interactive terminals can be analyzed with NPS. For further information on NPS, refer to the Network Products Stimulator Reference Manual. The remainder of this section contains information only about STIMULA, ASTIM, and NSTIM.

## SESSION FILE CONSTRUCTION††

A session (or script) file is an indirect access permanent file containing the hypothetical job load that is to be analyzed by the stimulator. A session file consists of a group of records; each record is a session and contains a hypothetical job that is composed of various entries with the following requirements.

† Refer to the NOS Installation Handbook for the format of the TS and TT equipment types at CMRDECK time.

†† Session file construction is independent of the stimulation mode except where otherwise noted.

1. Begin each internal stimulation session with the entry ANSWERBAC; this is a terminal type identifier to the time-sharing executive. (Other first lines may be used; however, ANSWERBAC is used in most cases.) A session used for external stimulation must not have this entry. If +CSET is the first line of an NSTIM script, NSTIM sends a ) and a Ⓒ to the host for automatic character set detection by CCP.
2. Enter each session entry on a separate line or card.
3. After ANSERBAC (if required), enter a family entry (if required), a user number entry, and a password entry. An application name must also be entered for external stimulation of IAF/NAM. Ensure that PX=HALF is specified in the validation file for each user number (refer to section 2).†
4. Specify the terminal commands and data.
5. End each session with the command BYE so that the login of the next session is performed correctly. The HELLO command must not be used unless it is followed by a blank line.

Figures 4-4, 4-5, 4-6, and 4-7 contain examples of session files.

### Dynamic Login

If each of the terminals to be analyzed is logged into the system with a unique user number and password, a unique session record for each terminal is stored in central memory at the stimulator control point. Thus, a large amount of central memory could be unavailable to other components of the system. To alleviate this condition, dynamic login is possible, whereby one session record is generated with a unique user number and password which are dynamically translated into unique user numbers and passwords for each terminal at run time. The generated user numbers and passwords are then validated via system validation files. The formats are as follows:

usernum\$\$\$

or

usernum\$\$\$,passwd\$\$\$

usernum      User number; one to four alphabetic characters.

passwd      Password; one to four alphabetic characters.

\$            Special symbol 12/8/6 (display code 76), 1 (display code 34) punch; that is, 12/8/6 punch in one column and 1 punch in next column.

#### NOTE

The \$ denotes the special symbol previously described, not the character itself. The \$ character is translated into the stimulator terminal numbers at run time.

#### Example:

P\$\$\$,P\$\$\$ is translated into P000,P000 for the first terminal, into P001,P001 for the second terminal and so forth.

---

† Does not apply to IAF.

ANSWERBAC	}	Session record		
BMS001				
NULL				
↑↑↑↑				
CATLIST				
↑				
DAYFILE				
BYE				
*E-O-R*				
ANSWERBAC			}	Session record
BMS001				
NULL				
↑↑↑↑				
CATLIST				
↑				
DAYFILE				
BYE				
*E-O-R*				
ANSWERBAC	}	Session record		
BMS001				
NULL				
↑↑↑↑				
CATLIST				
↑				
DAYFILE				
BYE				
*E-O-R*				
\$TASK0 50			}	Task record
OLD, FILE0				
LIST				
LIST				
↓				
*E-O-R*				
\$TASK1 30	}	Task record		
OLD, FILE1				
LIST				
LIST				
↓				
*E-O-R*				
\$TASK2 20			}	Task record
OLD, FILE2				
LIST				
LIST				
↓				
*E-O-F*				

Figure 4-4. Sample Session File With Tasks for Use by STIMULA



```

ANSWERBAC
PERFDEV
MATH, MATH
CHARGE(7159, 73K DFA)
≥ 1
FTNTS
NEW, MATH
10 PROGRAM MATH (INPUT, OUTPUT)
20 1 CONTINUE
30 READ 10, A
40 IF(A.EQ.0) STOP
50 B=A*A
60 C=SQRT(B)
70 IF(A.LT.0) D=-C**3
80 CONTINUE
90 IF(A.GT.0) D=C**3
100 PRINT 20, A
110 PRINT 30, B
120 PRINT 40, D
130 GO TO 1
140 20 FORMAT(* A EQUALS *, F15.3)
150 30 FORMAT(* A SQUARED = *, F15.3)
160 40 FORMAT(* A CUBED = *, F15.3)
170 10 FORMAT(15.3)
180 END
≥ ≥
RNH
2.0
0.0
25 PRINT 50
165 50 FORMAT(* ENTER VALUE *)
LNH
RNH
1.0
2.0
3.0
4.0
0.0
170 10 FORMAT(F12.1)
LNH
RNH
10.0
11.1
13.3
0.0
170 10 FORMAT(F12.3)
LNH
RNH
15.555
40.0
50.0
0.0
LNH
RNH
10.0
20.0
30.0
40.0
0.0
STATUS, T
DAYFILE
BYE

```

} Source line input

} Program input

Figure 4-5. Sample Session for Use by STIMULA

```

PERFDEV
MATH, MATH, IAF
CHARGE(7159, 73K DFA)
≥ 1
FTNTS
NEW, MATH
, 10 PROGRAM MATH (INPUT, OUTPUT)
, 20 1 CONTINUE
, 30 READ 10, A
, 40 IF(A.EQ.0) STOP
, 50 B=A*A
, 60 C=SQRT(B)
, 70 IF(A.LT.0) D=-C**3
, 80 CONTINUE
, 90 IF(A.GT.0) D=C**3
, 100 PRINT 20, A
, 110 PRINT 30, B
, 120 PRINT 40, D
, 130 GO TO 1
, 140 20 FORMAT(* A EQUALS *, F15.3)
, 150 30 FORMAT(* A SQUARED = *, F15.3)
, 160 40 FORMAT(* A CUBED = *, F15.3)
, 170 10 FORMAT(15.3)
, 180 END
≥≥
RNH
2.0
0.0
, 25 PRINT 50
, 165 50 FORMAT(* ENTER VALUE *)
LNH
RNH
1.0
2.0
3.0
4.0
0.0
, 170 10 FORMAT(F12.1)
LNH
RNH
10.0
11.1
13.3
0.0
, 170 10 FORMAT(F12.3)
LNH
RNH
15.555
40.0
50.0
0.0
LNH
RNH
10.0
20.0
30.0
40.0
0.0
STATUS, T
DAYFILE
BYE, BYE

```

Source line input  
(Comma appears in first  
character position of each line.)

Program input

Source line input

Figure 4-6. Sample Session for Use by NSTIM

```

ANSWERBAC
USERNUM
PASSWRD
BASIC
OLD
TESTB
LIS, 294
RUN
01000
REPLACE
BYE
*E-O-R*
.
.
.
additional
sessions
.
.
.
*E-O-F*

```

Figure 4-7. Sample Session File for Internal Stimulation

```

ENTER STIMULATION FILE PARAMETERS IN FORM -

P = VALUE
F =          SESSION FILE NAME.
UI = 0B      USER INDEX (OCTAL BASE ASSUMED.)

N = 1        NUMBER OF FILE ON SESSION FILE.
GO           BEGIN PROCESSING OF SESSION FILE.

```

Figure 4-8. STIMULA Left-Screen K Display

### Source Line Input

In sessions used for external stimulation, each source input line must begin with a comma as shown in figure 4-6. In sessions used for internal stimulation, commas indicating source line input are not required.

## Optional Think Time Specification

Think time is the number of seconds that each line is delayed before it is sent through the time-sharing system. A random think time can be specified with a session file command. The format of the command is as follows:

≥xxx

xxx Think time (octal): xxx ≤177g.

To return the terminal to the initial think time (refer to figure 4-9), enter the following command.

≥≥

ENTER STIMULATION PARAMETERS IN FORM -

P = VALUE	(NUMERIC VALUES ARE ASSUMED DECIMAL BASE.) (SEE RIGHT SCREEN FOR SPECIAL PARAMETERS.)
NT = 310B	NUMBER OF TERMINALS TO STIMULATE.  (1 - 100B)
LS = 15	LINE SPEED IN CHARACTERS/SECOND. (1 - 1000)
IS = 15	INPUT SPEED IN CHARACTERS/SECOND. (1 - 1000)
TT = 10	THINK TIME DELAY IN SECONDS. (0 - 127)
TI = 8	UPPER BOUND OF RANDOM THINK TIME INCREMENT.  0 - 64 (MUST BE A POWER OF 2.) THINK TIME WILL VARY BETWEEN TT AND TT+TI.
AC = 4	ACTIVATION COUNT. (1 - 64) NUMBER OF TERMINALS TO ACTIVATE EVERY  AD SECONDS.
AD = 10	ACTIVATION DELAY IN SECONDS. (1 - 127)
RC = 0	NUMBER OF TIMES TO REPEAT STIMULATION.(0-31)
LD = 0	LOGOUT DELAY.(0 - 4095)
RO = ON	OUTPUT RECOVERY. (ON OR OFF)
LF = NO	LOOP ON SESSION FILE (YES OR NO)
TE = OFF	EQUIPMENT ORDINAL FOR TRACE.
TL = OFF	LINE NUMBER TO TRACE.

Figure 4-9. STIMULA Session File Parameters

## Task Definitions

A task is a predefined set of time-sharing commands designated by a task name and a task usage parameter. Tasks can be called throughout a session, and the task usage parameter is used to determine which task is the next most eligible task (that is, the task to be called next).

An ↑ character (display code 70) in the session calls the next most eligible task in the session file, which is determined by the following equation.

$$f_i = \frac{\text{Total initiations of task}_i}{(\text{Total initiations of all tasks}) (\text{Task usage parameter for task}_i)}$$

For each task<sub>i</sub> defined in the session file, the stimulator calculates  $f_i$ , and the task with the smallest  $f$  value is the next most eligible task. Multiple ↑ characters are permitted on one line and are treated as if they occurred on separate lines. For example, ↑↑↑ calls the first three most eligible tasks, where eligibility is recalculated after each initiation of a task. If a task is called and the stimulator cannot determine the next most eligible task in the time allotted, the first task defined in the session file is used.

Tasks for the stimulator are defined in the session file as task records following the session records. Tasks are not permitted in the file before session records. The tasks should be defined in descending order according to the task usage parameter. This facilitates the use of the first task defined as the default next most eligible task in situations where the stimulator fails to calculate the next most eligible task on time.

The first line in a task record must be as follows:

```
$task nnn
```

\$ Denotes the beginning of a new task (character position 1).

task One- to six-character task name.

nnn Task usage percentage; 0 nnn 100 (character positions 8, 9, 10). The task usage percentages of all tasks in the session file must total 100.

The last line in a task record must be a ↓ character (display code 71), which returns control to the calling session. An example of a session file with tasks defined is shown in figure 4-4.

## SESSION FILE PROCESSING

The stimulator software is used to process the time-sharing session file according to the following procedures.

1. Ensure that a time-sharing subsystem stimulator entry is present in the EST whose status is ON (refer to the NOS Installation Handbook). The stimulator entry must be on an unused channel.
2. Use DSD to stop the Remote Batch Facility or Export/Import.

Type n.IDLE, where n is the control point number of the Remote Batch Facility or Export/Import as indicated on the B display.

- Use DSD to bring the stimulator to the last available control point.

Type STMffff. or STIMULATOR., where ffff is zero to four alphanumeric characters. This entry calls a procedure file STMffff, which must be a permanent indirect access file stored under the system user index (377777). The procedure file STM is called when the operator types either STM. or STIMULATOR. The stimulator is invoked by a STIMULA, ASTIM, or NSTIM control statement within the appropriate procedure file.

The stimulator requests the K display at the control point.

- Type K,nn., where nn is the number of the last available control point.

Figure 4-8 appears on the left display.

- Type the session file parameters individually as indicated in the following format column or as a group on the same line in the format.

K.F=filenam,UI=userin,N=n,GO.

<u>Format</u>	<u>Default</u>	<u>Significance</u>
K.F=filenam	None	filenam is the indirect permanent file name of the session file.
K.UI=userin	0	userin is the user index of file filenam. The default family is assumed.
K.N=n	0	n is the number of files to be skipped on file filenam before data is read from the session file; range is 0 through 377777g.
K.GO	None	Indicates to the stimulator that all the parameters have been entered or that none are to be entered.

Figure 4-9 appears on the left display.

- To display the special parameters, type:

KK.

Figure 4-10 appears on the right screen.

TO ENTER MIXED MODE OF PARAMETER ASSIGNMENT -  
K.MIXED.

Figure 4-10. STIMULA Special Parameters

7. Type the stimulator parameters individually as indicated in the following format column or as a group on the same line in the format.

K.NT=n,LS=s,IS=s,TT=n,TI=i,AC=m,AD=d,RC=n,LD=d,RO=ON,GO.

Enter any special parameters (figure 4-12) before the GO. entry.

<u>Format</u>	<u>Default</u>	<u>Significance</u>
K.NT=n	Current EST value	n is the current maximum number of terminals on which the time-sharing subsystem is initialized. It must be less than or equal to the number specified in the EST entry; the range is 3 through 1000g.
K.LS=s	15	s is the line speed in characters per second at which the operator wishes to run the terminals; the range is 1 through 1000. Any value above 60 characters per second causes a line speed of approximately 60 characters per second. If many terminals (600g, for example) are run, the maximum realizable line speed is determined by the overhead of 1TD and 1TS. The worst case can be determined by checking the 1TD cycle time dayfile message, which is issued when the time-sharing subsystem is dropped. For external stimulations, s should not exceed the hardware capability.
K.IS=s	15	s is the typing speed in characters per second at which the operator wishes to run the terminals; the range is 1 through 1000. For external stimulations, s should not exceed the hardware capability.
K.TT=n	10 seconds	n is the number of seconds (think time) that each line is to be delayed before it is sent to the time-sharing subsystem; the range is 0 through 127 seconds.
K.TI=i	8	i is the number of seconds by which the think time will vary; the range is 0 through 64 and i must be a power of 2. If i is nonzero, the think time varies between n (the value of TT) and n+i.
K.AC=m	4	m is the number of terminals that are to be logged in every d seconds (the value of AD); the range is 1 through n (the value of NT). The AC and AD options provide a method to stagger the I/O commands and data to the time-sharing subsystem.
K.AD=d	10 seconds	d is the number of seconds of delay time until the login of another terminal is allowed; the range is 0 through 127 seconds.

<u>Format</u>	<u>Default</u>	<u>Significance</u>
K.RC=n	0	n is the number of sessions that will be executed for each terminal; the range is 0 through 31.
K.LD=d	0 seconds	d is the number of seconds of delay time after a logout is completed until the next login of the terminal is allowed; the range is 0 through 127 seconds.
K.RO=o	ON	When RO=ON, the output from the time-sharing subsystem is recovered on file STIMOUT. The format of this file is:

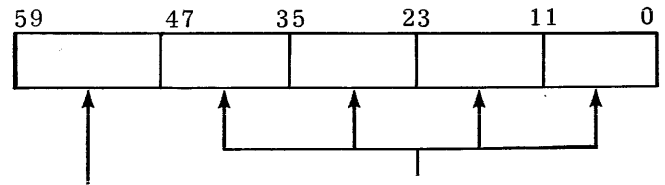

Terminal Each byte is an ASCII character number. if less than 4000g; otherwise, it is the running-second time.

When RO=OFF, the output is not recovered.

K.LF=o	NO	When LF=NO, looping occurs on the session assigned to the terminal. When LF=YES, the subsequent session is the next session in the session file.
K.TE=xx	No equipment monitored	xx is the equipment ordinal of the stimulated 6676 multiplexer (TS type) to be monitored. This entry is valid for external stimulation only.
K.TL= l <sub>1</sub> -l <sub>2</sub>	No lines monitored	l <sub>1</sub> and l <sub>2</sub> are terminal numbers that specify the range of lines on the equipment indicated by the TE parameter to be monitored. A single line (l <sub>1</sub> =l <sub>2</sub> or l <sub>2</sub> not specified) can be specified. l <sub>1</sub> must be less than or equal to l <sub>2</sub> . This entry is valid for external stimulation only.
K.MIXED	No mixed mode parameters entered	Specifies that special parameter assignments are required for specific input sessions. This command displays the stimulation parameter matrix (figure 4-11) whose values can be changed as described in the right screen K display (figure 4-12).
K.GO		Indicates to the stimulator that the parameters are entered. Stimulation is initiated.



STIMULATION PARAMETER MATRIX

SCRPT	TTYS	LS	IS	TT	LD	RC
1	40	15	15	10	0	0
2	40	15	15	10	0	0
3	40	15	15	10	0	0
4	40	15	15	10	0	0
5	40	15	15	10	0	0

NUMBER OF TTYS ASSIGNED = 200

MAXIMUM TTYS PERMITTED = 200

CF = MATRIX CHANGE FILE

Figure 4-11. Parameter Matrix

DEFINITION OF PARAMETERS

SCRIPT - SCRIPT(S) WHICH THE PARAMS WILL AFFECT  
(SCRIPT(N) OR SCRIPT(N)-SCRIPT(N+X))  
TTYS - NUMBER OF TTYS ASSIGNED TO SCRIPT(S)  
LS - LINE SPEED ASSIGNED TO SCRIPT(S)

IS - INPUT SPEED ASSIGNED TO SCRIPT(S)  
TT - THINK TIME ASSIGNED TO SCRIPT(S)  
LD - LOGOUT DELAY ASSIGNED TO SCRIPT(S)  
RC - REPEAT COUNT ASSIGNED TO SCRIPT(S)

\*NOTE - NULL PARAMETER WILL KEEP CURRENT VALUE

TO MAKE ENTRIES, FOLLOW THE FORMAT -  
K.MX=SCRIPT,TTYS,LS,IS,TT,LD,RC.

TO CHANGE MATRIX VIA PREDEFINED PARAMETERS-  
K.CF=XXX WHERE XXX IS PF CONTAINING CHANGE  
DIRECTIVES IN FOLLOWING FORMAT-  
MX=SCRIPT,TTYS,LS,IS,TT,LD,RC.

TO ADVANCE DISPLAY ENTER K.+

TO BACKUP DISPLAY ENTER K.-

Figure 4-12. Mixed Mode Parameters

<u>Format</u>	<u>Default</u>	<u>Significance</u>
K.MX= s <sub>1</sub> -s <sub>2</sub> , ttys,ls, is,tt,ld, rc	Current value.	Mixed mode input. s <sub>1</sub> is the number of the first session to be changed, and s <sub>2</sub> is the number of the last session to be changed. s <sub>2</sub> is optional; the default is s <sub>1</sub> . (Refer to figure 4-12 for other parameter descriptions.)
K.CF= filenam	None.	Matrix change file. Indirect access file filenam is accessed for mixed mode input directives, and must be saved under the same user index as the session file.
K.+		Page matrix display forward one page.
K.-		Page matrix display backward one page.
K.GO		Indicates to the stimulator that the parameters are entered. Stimulation is initiated.

**Example:**

MX=2-4,3,30,30,,,1.

Three terminals will be assigned to sessions 2, 3, and 4. The line speed and input speed for these terminals will be 30 characters per second. The think time and logout delay will not be changed from the current value. The terminals will have a repeat count of one.

**MULTIPLE SESSIONS**

Each session on the session file is allocated to each terminal line. When each session has been allocated, the stimulator goes to the first session and reallocates the sessions to the next group of terminals. This procedure is repeated until all the terminals are allocated to a session. If a repeat count is not designated (RC parameter), the line is shut off when the session is finished. When the session completes, the repeat count is checked.

The repeat count corresponds to the number of sessions to be executed on a given terminal. The current session is completed, and the LF parameter determines the next session to be executed. If LF=OFF, the session currently assigned to the terminal is repeated. If LF=ON, the next session in the session file is executed. For example, if the repeat count is four, the session currently assigned to the terminal is repeated four times (LF=OFF), or the next four sessions on the session file (with repetition, if necessary) are executed (LF=ON).

**PARAMETER OUTPUT FORMAT**

The parameter information (shown in figure 4-13) is placed on the output file for printing upon completion of the stimulator run (refer to Session File Processing).

```

STIMULATOR PARAMETERS-
SESSION FILE NAME-      F=  SCCC1
USER INDEX-            UI=  1
NUMBER OF THE FILE-    N=  1
NUMBER OF TERMINALS-   NT= 100B
LINE SPEED-           LS=  30
INPUT SPEED-          IS=  10
THINK TIME-           TT=  3
RANDOM THINK TIME-     TI=  0
ACTIVATION COUNT-     AC=  1
ACTIVATION DELAY-     AD=  1
REPEAT COUNT-         RC=  4
LOGOUT DELAY-         LD=  0
OUTPUT RECOVERY-      RO=  ON
LOOP ON SESSION FILE- LF=  NO
MATRIX CHANGE FILE-   CF=

```

STIMULATION PARAMETER MATRIX

SCRPT	TTYS	LS	IS	TT	LD	RC
1	22	30	10	3	0	4
2	21	30	10	3	0	4
3	21	30	10	3	0	4

NUMBER OF TTYS ASSIGNED = 64  
MAXIMUM TTYS PERMITTED = 64

TASK	CALLS	COMPLETE	DESIRED %	ACTUAL %
TASK0	848	818	50.000	49.970
TASK1	509	492	30.000	29.994
TASK2	340	327	20.000	20.035
TOTALS	1697	1637	100.000	99.999

DEFAULT TASK CALLS = 15

Figure 4-13. Output Statistics

## POSTPROCESSING

The postprocessing of the time-sharing stimulator output is accomplished by reading the file STIMOUT and sorting the data according to terminal number. This is accomplished by using the DEMUX control statement. As DEMUX sorts STIMOUT, it assigns an encounter number (starting at 1) to the output from each terminal session. DEMUX includes this number in the final line of each sorted terminal session output. The data for each terminal is separated by a page eject and an end of line indicator. The terminal data appears as it would on a terminal page. If the ASCII character on the STIMOUT file is 4000g or greater, the lower 10 bits are assumed to be time of a carriage return or the first character of output. If STIMOUT will be processed at a later time, the user should save it.

An example of output from DEMUX is as follows:

```
ANSWERBAC
*****TTT.TTT (Optional output)
*****TTT.TTT (Optional output)
yy/mm/dd.hh.mm.ss.
CDC MULTI-MODE OPERATING SYSTEM NOS 1
.
.
.
.
END OF THE LINE-----n
(Page Eject)
ANSWERBAC
.
.
```

The n in the previous listing is the decimal encounter number.

The format of the DEMUX control statement is

```
DEMUX(p1,p2,...,pn)
```

where p<sub>i</sub> is either a keyword or a keyword equated to a value.

<u>P<sub>i</sub></u>	<u>Description</u>
I=filenam	Name of the time-sharing output data file.
I omitted	Same as I=STIMOUT.
NT=n	Number of terminals to be sorted and extracted (0<n<512). This tells DEMUX how much memory to allocate to process the input file.
NR	Specifies that the input and output files are not to be rewound.
O=filenam	Name of the processed (demultiplexed) output file.
O omitted	Same as O=OUTPUT.
SL=termnum	Selective terminal number (within the range specified by the NT parameter) that specifies the data to be processed. termnum is the terminal number - 4 in the T display.

- T Specifies that the time of each carriage return and first output character is written with the processed data. Subtracting the two time values gives the response time. The time values can also be used to correlate data between each terminal's input and output.
- TR=filenam Name of file on which analyzed stimulator monitor data (refer to the TE and TL parameters) is to be written.
- TR Same as TR=file specified by the O option.
- TR omitted No postprocessing of monitored data occurs.

The following is a partial listing of the monitored data from an NSTIM run. It is output from DEMUX.

<u>Time</u>	<u>Port</u>	<u>In</u>	<u>Out</u>	<u>JA</u>	<u>DP</u>			
10.020	04	1000	NULL	0000	NULL	2015	4001	2521
20.025	04	1000	NULL	0000	NULL	2042	0001	2521
20.040	04	1000	NULL	4033	CR	2102	0001	2521
20.055	04	1000	NULL	0000	NULL	2102	0001	2521
24.540	04	5033	CR	0000	NULL	2102	0001	2521
24.555	04	1000	NULL	0000	NULL	1643	0001	2521
24.585	04	5000	NULL	0000	NULL	1643	0001	2521
24.600	04	1000	NULL	0000	NULL	1643	0001	2521
24.615	04	5000	NULL	0000	NULL	1643	0001	2521
24.630	04	1000	NULL	0000	NULL	1643	0001	2521
24.645	04	5024	LF	0000	NULL	1643	0001	2521
24.660	04	1000	NULL	0000	NULL	1643	0001	2521
24.675	04	5000	NULL	0000	NULL	1643	0001	2521
24.690	04	1000	NULL	0000	NULL	1643	0001	2521
24.720	04	5024	LF	0000	NULL	1643	0001	2521
24.735	04	1000	NULL	0000	NULL	1643	0001	2521
24.750	04	5000	NULL	0000	NULL	1643	0001	2521
24.765	04	1000	NULL	0000	NULL	1643	0001	2521
24.780	04	5024	LF	0000	NULL	1643	0001	2521
24.795	04	1000	NULL	0000	NULL	1643	0001	2521
24.810	04	5000	NULL	0000	NULL	1643	0001	2521
24.825	04	1000	NULL	0000	NULL	1643	0001	2521
24.840	04	5024	LF	0000	NULL	1643	0001	2521
24.855	04	1000	NULL	0000	NULL	1643	0001	2521
24.885	04	5000	NULL	0000	NULL	1643	0001	2521
24.900	04	1000	NULL	0000	NULL	1643	0001	2521
24.915	04	5024	LF	0000	NULL	1643	0001	2521
24.930	04	1000	NULL	0000	NULL	1643	0001	2521
24.945	04	5000	NULL	0000	NULL	1643	0001	2521
24.960	04	1000	NULL	0000	NULL	1643	0001	2521
24.975	04	5024	LF	0000	NULL	1643	0001	2521
24.990	04	1000	NULL	0000	NULL	1643	0001	2521
25.005	04	5000	NULL	0000	NULL	1643	0001	2521
25.020	04	1000	NULL	0000	NULL	1643	0001	2521
25.050	04	5157	7	0000	NULL	1643	0001	2521
.								
.								
.								

Time	Time in seconds and milliseconds.
Port	Port number.
In	Next input character to be processed. The first column is the input character from the channel. The second column is the display code mnemonic.
Out	Last output character.
JA	Jump address for internal processing within the stimulator. This is from the TOCA table in 1TE.
DP	Data pointers from internal processing within the stimulator. This is the first 24 bits of the first word of the terminal table.

The following dayfile messages are possible.

END DEMUX RUN.	The DEMUX run is completed.
ERROR DEMUX ARGUMENTS.	An error exists in a calling parameter to DEMUX.
SL OPTION OUT OF RANGE.	The selective terminal number is greater than the number of terminals to sort.
TOO MANY TERMINALS.	More than 511 terminals were designated with the NT parameter or the NT parameter exceeds the number of terminals to be analyzed that are defined in the stimulator EST entry.

The following is an example of a procedure file called when STM. or STIMULATOR. is typed at the console. It executes the stimulator (STIMULA control statement) and performs postprocessing of the stimulator output. The procedure file must be stored as a permanent indirect access file under the system user index (377777).

STM	Procedure file name.
STIMULA.	The stimulator is executed.
DEMUX(NT=310,O=NOS,T)	
GET(RESB/UN=usernum)	RESB is a user-created program to analyze DEMUX
RESB.	output.
ASSIGN(NE,TRASH)	
DFD(OP=I,L=TRASH)	The system dayfile is dumped to null equipment.
REQUEST(T) DROP TELEX.....	Processing stops until IAF or TELEX is dropped. Also, ASSIGN,77 should be performed. (Refer to the NOS Installation Handbook.)
DFD(OP=I)	A partial dayfile dump is performed which includes IAF or TELEX statistics.
ATTACH(ERRDATA/M=W)	
COPYEI(ERRDATA,OUTPUT)	Output of all failing jobs is copied to output.
EVICT(ERRDATA)	
RETURN(ERRDATA)	
EXIT.	
DIS.	

In the previous procedure file, output from failing jobs is copied from the file ERRDATA. In order for ERRDATA to contain this information, another procedure file is necessary to collect data on jobs that fail and place this data in ERRDATA. This procedure file (called ERRCHEK in the following example) should be called in the following manner after each stimulator session.

```
GET,ERRCHEK/UN=usernum.  
CALL(ERRCHEK)
```

The following is an example of this procedure file.

```
ERRCHEK  
IF(EF=0)GOTO,99END.  
  
DISPLAY(EF)  
ASSIGN(MS,OUTPUT)  
ENQUIRE(A)  
DAYFILE.  
  
ATTACH,ERRDATA/UN=usernum,M=W,NA.  
SKIPEI(ERRDATA)  
REWIND(OUTPUT)  
COPYEI(OUTPUT,ERRDATA)  
RETURN(OUTPUT,ERRDATA)  
COMMENT.FAIL*****  
COMMENT.FAIL*****  
COMMENT.FAIL*****  
COMMENT.FAIL*****  
COMMENT.FAIL*****  
COMMENT.FAIL*****  
COMMENT.FAIL*****  
COMMENT.FAIL*****  
COMMENT.FAIL*****  
COMMENT.FAIL*****  
COMMENT.FAIL*****  
COMMENT.FAIL*****  
COMMENT.FAIL*****  
COMMENT.FAIL*****  
COMMENT.FAIL*****  
COMMENT.FAIL*****  
EXIT.  
REQUEST(FAIL)  ERRCHECK FAILED...  
  
99END(EXIT)
```

If certain jobs normally cause compilation errors, additional procedure should be included to allow for these special cases.

Data is gathered on which program and which statement caused the error.

This data is placed on file ERRDATA, which is used later during postprocessing.

These comments warn users that failures have been encountered.

If serious problems have been encountered, DIS could be brought up at this point.

Care should be taken when comparing response times between different versions of the operating system with the stimulator. Other factors may have a significant impact on response time. Awareness of the following items is necessary.

- The entire parameter set should be the same for each stimulator run. The rate of activation of terminals, for example, can significantly impact response time.
- The hardware configurations must be identical. If an attempt is made to measure small differences, all devices which cannot be restored to their original state (normally temporary devices) should be deadstarted and fully initialized.



- If the possibility exists that permanent files have been destroyed, these files should be restored before each run. This can be accomplished easily by maintaining a copy of all required files under a user number not used during the stimulation. A procedure file can then be called to restore the files before each stimulator run. This is important when stimulation loads are causing abnormal job failures. A REPLACE shortly after an unexpected abort may cause incorrect information to be written, for example.
- Job processing must be the same for each stimulator run. When many terminals are to be analyzed, random job failures may be overlooked. These failures may, however, affect the entire results of the stimulator run. To minimize this problem, it is necessary to check errors in all sessions quickly and easily. This can be done by using the procedures described earlier in this section.

By using the preceding techniques and procedures and noting the restrictions, it becomes easier to use the stimulator to check performance and reliability and to obtain meaningful data from the system.

The user validation and user accounting capability of NOS is based on two special system files, VALIDUs and PROFILa.

VALIDUs is used to control user validation, including

- Who can use the system.
- What resources they can use.
- Limits on job resource usage.

PROFILa is used to control user accounting, including

- Who can be accounted for.
- What accounting parameters are assigned.
- Limits on time of day access to the system.
- Limits on total resource usage.

As the structures of the user validation file and user accounting file change, concurrent file name changes can also occur to make it easier for sites to convert from one system to another. In this manual, the user validation and accounting files are referred to as VALIDUs, VALINDs, and PROFILa. Table 5-1 lists the file names corresponding to the appropriate operating system levels.

TABLE 5-1. VALIDATION AND USER ACCOUNTING FILE NAMES

System	User Validation File	User Indexes File	User Accounting File
KRONOS 2.1.1	VALIDUX	VALINDX	PROFILO
NOS 1.0	VALIDUS	VALINDS	PROFILA
NOS 1.1	VALIDUZ	VALINDZ	PROFILA
NOS 1.2, 1.3, and 1.4	VALIDUZ	VALINDZ	PROFILB

VALIDUs contains user numbers and PROFILa contains charge-project numbers. User numbers identify the user, his set of permanent files, and his resource limitations. Charge-project numbers control and record billing charges. Entry of subsequent user numbers during a job session affects only permanent file usage and does not alter the billing procedure. Entry of subsequent charge-project numbers initiates a new sequence of billing computations. Initialization of the user validation and indexes files can be performed via the GENVAL utility described in section 7.

The billing unit which reflects the resources used by the system during a job or a session is called the system resource unit (SRU). The calculation of this unit provides for the flexibility of weighing the usage of resources against one another. The following resources are included in the calculation of this unit.

- CM field length.
- ECS field length.
- CPU usage.
- Mass storage usage.
- Magnetic tape usage.
- Permanent file usage.

The parameters for SRU computation are related to the charge-project numbers. The PROFILa file contains indexes used to determine which SRU parameters are to be used for computation while a charge-project number is in effect for the job or session.

## USER VALIDATION (VALIDUs<sup>†</sup> – SPECIAL SYSTEM FILE)

A special system file contains data necessary to control various aspects of system activity. (As a rule, this is privileged information requiring secrecy.) These files are maintained as direct access permanent files under the system user index 37777g. (User index is defined in section 1.) These files can only be accessed by special system jobs.

Special system jobs are system routines which can only be initiated at the analyst's control point. They execute with benefit of file security and access to resources and system functions without user validation restrictions.

The system-bound security of VALIDUs and PROFILa<sup>†</sup> ensures that they will not be accessed by individual users either for curiosity or tampering.

System file security does not preclude customers from establishing operational parameters for their own users. The analyst, in creating and updating PROFILa, can establish master users who can add, modify, and delete charge and project admissions for their own people. The master users are customer supervisors who manage the projects involved and are in the best position to determine what should be used and by whom it should be used.

The VALIDUs file is created and managed by MODVAL. The PROFILa file is created and managed by PROFILE. These two managers are system program modules that, with input directives, constitute special system jobs used as system file processors. Special system jobs call the special file supervisor (SFS) which provides routines, table management, data manipulation, and I/O processing.

An input directive contains the parameters used to define access information. The basic format of each parameter designation is:

identifier = data

identifier            Control field within the file to be set.

data                 Value to be set in that field.

A brief overview of the creation and use of validation files is given in figure 5-1.

---

<sup>†</sup> In this manual the user validation and accounting files are referred to as VALIDUs, VALINDs, and PROFILa. Refer to table 5-1 for a list of file names that correspond to the appropriate operating system levels.

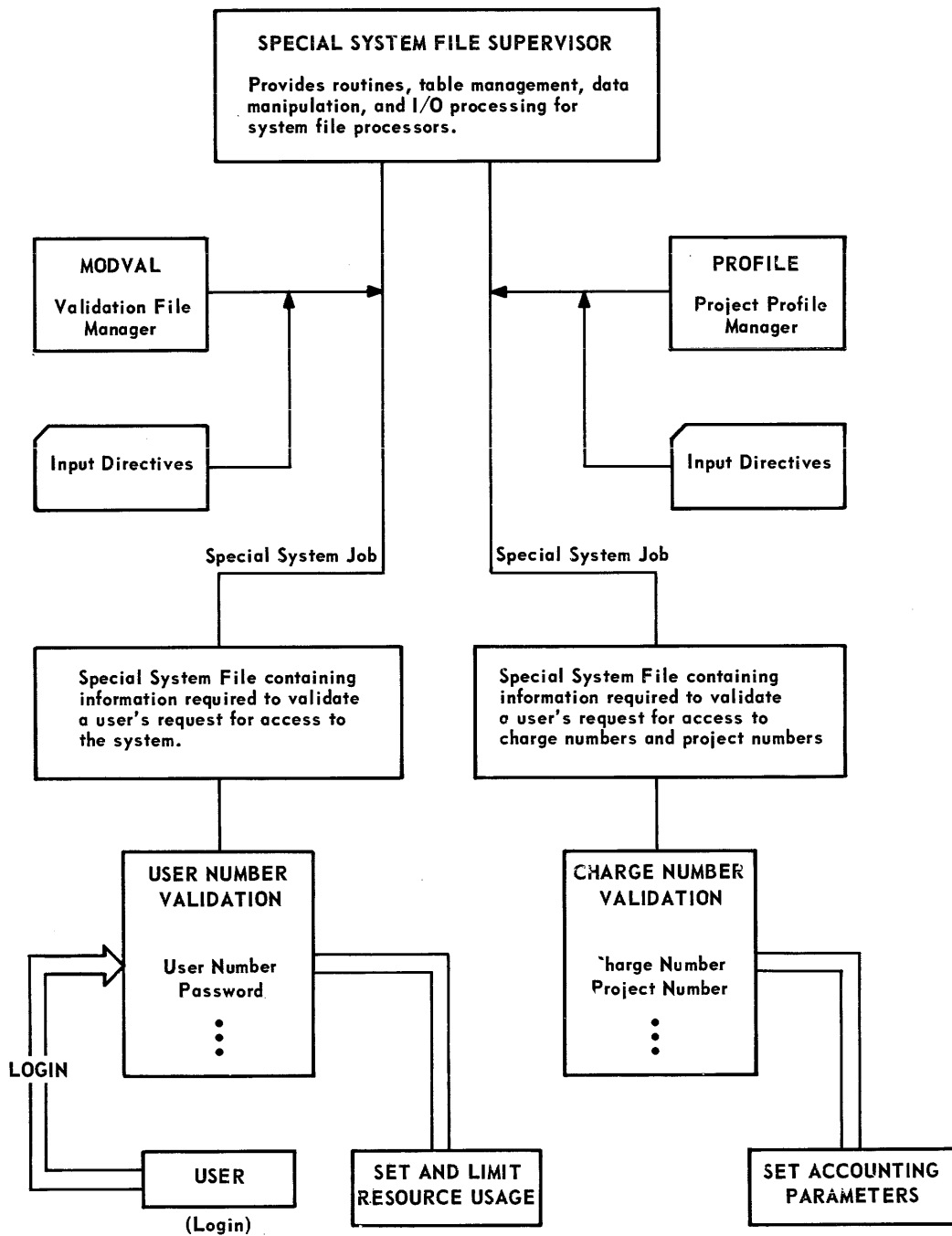

Figure 5-1. Creation and Use of Validation and Accounting Files

The VALIDUs special system file contains the user numbers that validate individual user access to the operating system. A second level of security, the password, can also be specified. Associated with each user number defined in VALIDUs is a set of limits that specify the system resources available to the user in a single job. This set includes the following:

<u>Resource</u>	<u>Limits</u>
Equipment usage	<p>Maximum number of magnetic tapes this user may use.</p> <p>Maximum number of disk packs this user may use.</p> <p>Maximum number of mass storage PRUs this user may additionally allocate.</p> <p>On what master device the permanent files and catalog for each user will be stored.</p> <p>Maximum number of lines printed or cards punched per output file.</p>
File usage	<p>Maximum number of permanent files allowed.</p> <p>Maximum number of files while running.</p> <p>Maximum number of disposed output (such as print or punch).</p> <p>Ability to create direct access permanent files.</p> <p>Ability to create indirect access permanent files.</p> <p>Maximum size of direct or indirect access permanent files or cumulative size of all indirect access permanent files.</p> <p>Maximum number of dayfile messages written and control statements processed.</p>
Machine usage	<p>Maximum CPU time for each job step.</p> <p>Maximum CM space.</p> <p>Maximum ECS space.</p>
System usage	<p>Capability to submit system origin jobs.</p> <p>Capability to access system files.</p> <p>Number of deferred batch jobs.</p>

<u>Resource</u>	<u>Limits</u>
Terminal usage (not used with IAF)	Which terminals are valid for individual users. Terminal type. Transmission mode. Parity. Delay count.
Application usage (NAM terminals only)	Which network applications individual users may use.

### MODVAL VALIDATION FILE MANAGER

The validation file manager, MODVAL, creates and manages the VALIDUs file and can be executed from the system console (system origin job) or via a batch job.† Refer to Examples of MODVAL Usage (example 14) for a description of the creation of initial VALIDUs and VALINDs†† files.

VALIDUs is a direct access permanent file. From the console, it can be created and updated via the K display. Batch input must first establish local files and then copy onto the direct access file.

### MODVAL CONSOLE INPUT

All batch input directives (refer to MODVAL Batch Input) are available for console input. In addition, the following are provided specifically for console input.

K.I,username	Inquire option relative to the user identified by the user number username. Information is given on the second MODVAL display (figure 5-3). This option cannot be used for data entry.
K.U,username	Update modification for the user number username which is on the existing VALIDUs file. Modification data is input following the input of this directive.
K.C,username	The user number username is entered on a VALIDUs file that is being created. The following input line(s) can contain identifiers for this user number.
K.D,username	The user number username is deleted from the existing VALIDUs file.

† Although MODVAL can create the VALIDUs file from a batch job, the file thus created cannot be saved (refer to MODVAL Batch Input).

†† User validation and accounting files are referred to as VALIDUs, VALINDs, and PROFILa. Refer to table 5-1 for a list of file names that correspond to the appropriate operating system levels.

Information for the previous options is provided on two MODVAL displays (figures 5-2 and 5-3) for each user number specification. For the option types, identifiers must be entered on separate lines following the user number specification.

K./usernum,ident=data                    This slash (/) directive is used to update usernum as with the U option; however, if usernum is not found, a new user number is created automatically. It is possible under this option to switch control directly from one user number to another without returning to the initial MODVAL display (figure 5-2). If the / directive is used exclusively, data entry is analogous to batch input; that is, the card image can be entered with user number and identifier on the same line.

K.+    The plus (+) is used to toggle the user display pages (K display).

The console options can be used by the analyst to access VALIDUs with the MODVAL manager according to the following general procedure.

1. The analyst types:

AB.

X.MODVAL.

2. The B display will appear on the right screen. This display gives a listing of the control points and what is assigned to each. The analyst notes the control point to which MODVAL is assigned. To the right of this entry will appear the flashing message:

REQUEST K DISPLAY

3. The analyst types in

K,n.

where n is the control point number noted on the B display.

4. The first MODVAL display will appear on the left screen. This is a listing of the options available for manipulating the validation file VALIDUs (refer to figure 5-2).

5. The analyst types in one of the five console options. This is either

K.option,usernum

or

K./usernum,ident=data

If a delete (K.D,usernum) is entered, the user number usernum is deleted from the validation file VALIDUs at this point. No further action is needed for this option.

VALIDUZ

CREATED 77/06/15.  
UPDATED 78/03/14.

INPUT DIRECTIVES ARE THE SAME AS BATCH INPUT DIRECTIVES.  
THE FOLLOWING DIRECTIVES ARE ALSO PROVIDED -

/AN - TERMINATE INPUT FOR PRESENT USER NUMBER IF ANY,  
AND UPDATE VALIDUS FILE. INITIATE ACTION ON \*AN\*.  
I,AN - INQUIRE OPTION. THIS DISPLAY ONLY.  
C,AN - CREATE OPTION. THIS DISPLAY ONLY.  
U,AN - UPDATE OPTION. THIS DISPLAY ONLY.  
D,AN - DELETE OPTION. THIS DISPLAY ONLY.  
+ - TOGGLE USER DISPLAY PAGES.  
END - COMPLETE UPDATE OR INQUIRE OF ACTIVE USER. FROM  
THIS DISPLAY, END RUN.  
DROP - TERMINATE INPUT FOR ACTIVE USER.  
STOP - TERMINATE INPUT FOR ACTIVE USER, IF ANY. END RUN.  
AN = 1-7 CHARACTER USER NUMBER.

DATA ENTRY FORMAT IS OF THE FORM MT=XX,PR=XX,TL=XX, ETC.  
ALL NUMERIC FIELDS ARE ASSUMED TO BE DECIMAL UNLESS A POST-  
RADIX IS SPECIFIED. FOR EXAMPLE -  
4000B

ACCESS WORD IDENTIFIERS STARTING AT BIT 0 ARE -  
CPWC CTPC CLPF CSPF CSOJ CASF CAND CCNR CSRP CSTP CTIM  
CUCP CSAP CBIO CPRT

APPLICATIONS STARTING AT BIT 24 ARE -  
IAF RBF TAF MCS TVF NOP LOP NOPLP

Figure 5-2. First MODVAL Display



USER INSTALL PAGE 1 OF 3.  
 CREATED 77/10/27. UPDATED 78/02/14.

CONTENTS	DESCRIPTION
PW = EJHA	PASSWORD (4-7 CHARACTERS).
UI = 1915B	USER INDEX (1-377777B).
MT = UNLIMITED	MAGNETIC TAPES (0-7).
RP = UNLIMITED	REMOVABLE PACKS (0-7).
SC = 47B	SECURITY COUNT (0-77B).
MS = UNLIMITED	MASS STORAGE PRUS (0-77B).
CM = UNLIMITED	CENTRAL MEMORY FL (0-77B).
EC = UNLIMITED	ECS FIELD LENGTH (0-77B).
TL = UNLIMITED	TIME LIMIT (0-77B).
NF = UNLIMITED	NUMBER OF LOCAL FILES (0-7).
OF = UNLIMITED	DISPOSED OUTPUT (0-7).
DB = UNLIMITED	DEFERRED BATCH (0-7).
DS = SYSTEM	DA FILE SIZE (0-7).
FS = 6 ( 192)	INDIRECT FILE SIZE (0-7).
FC = SYSTEM	PERMANENT FILE COUNT (0-7).
CS = 2 ( 1024)	INDIRECT SPACE (0-7).
AW = 00000000002700017577	ACCESS WORD (3-4 CHARACTERS).

Figure 5-3. Second MODVAL Display (Sheet 1 of 3)

USER INSTALL PAGE 2 OF 3.  
 CREATED 77/10/27. UPDATED 78/02/14.

CONTENTS	DESCRIPTION
LP = UNLIMITED	LINES PRINTED (0-77B).
CP = UNLIMITED	CARDS PUNCHED (0-77B).
PT =	UNITS PLOTTED (0-77B).
CC = UNLIMITED	CONTROL CARDS (0-77B).
DF = UNLIMITED	DAYFILE MESSAGES (0-77B).
SL = 0B ( 8)	SRU LIMIT (0-77B).
CN =	CHARGE NUMBER (1-10 CHARACTERS ).
PN =	PROJECT NUMBER (1-20 CHARACTERS).
AB =	ANSWERBACK (0-10 CHARACTERS).
PA = EVEN	TERMINAL PARITY (3-4 CHARACTERS).
RO = SYSTEM	RUBOUTS (0-37B).
PX = HALF	TRANSMISSION (4 CHARACTERS).
TT = TTY	TERMINAL TYPE (3-7 CHARACTERS).
TC = STANDARD	CHARACTER SET (5-6 CHARACTERS).
IS = NULL	INITIAL SUBSYSTEM (4-8 CHARACTERS).
AW = 00000000002700017577	ACCESS WORD (3-4 CHARACTERS).

Figure 5-3. Second MODVAL Display (Sheet 2 of 3)

	USER	INSTALL	PAGE 3 OF 3.
CREATED	77/10/27.	UPDATED	78/02/14.
ON/OFF	APPLICATION		
ON	IAF		
ON	RBF		
ON	TAF		
OFF	MCS		
ON	TVF		
OFF	NOP		
OFF	LOP		
OFF	NOPLOP		

Figure 5-3. Second MODVAL Display (Sheet 3 of 3)

- For a create, update, or inquire option, the second MODVAL display (figure 5-3) replaces the first on the left screen.

For a create (either by C or /), the new user number will appear with default values for the parameters. If the ident is included with the slash (/), it will appear on the display but will not, at this point, be entered on the file.

For an update (either by U or /), the existing user number will appear with current parameters. If a modification identifier is included with a / input, the new value will appear on the screen but will not be entered on the file. From here, the analyst would have to go to step 7.

For an inquire, the display contains the information requested and the procedure would stop at this step.

- For a C or U option, the ident is now typed in with the format:

K.ident=data

- To initiate action on the create or update entry, the analyst types:

END

If the analyst does not want this entry on the file, he can either type

DROP

and erase the entry without terminating this run, or he can type

STOP

and terminate the run without action on this entry.

In the case of DROP, the first MODVAL display (figure 5-2) will return to the left screen and the analyst can enter more user numbers and their associated parameters.

To terminate any run without erasure, the operator types:

END.

Table 5-2 summarizes the basic input coding for console options.

TABLE 5-2. INPUT CODING FOR CONSOLE OPTIONS

Create	Update	Inquire	Delete
K.C,usernum	K.U,usernum	K.I,usernum	K.D,usernum
K.ident=data	K.ident=data	K.END	K.END
K.END	K.END		
or	or		
K./usernum	K./usernum		
K.ident=data	K.ident=data		
K.END	K.END		

### MODVAL BATCH INPUT

Batch jobs that call the MODVAL validation file manager cannot make use of direct access permanent files, such as VALIDUs that are under the system user index 377777B. Accordingly, batch input to VALIDUs requires the use of user permanent files and local copies. The local versions are ultimately copied onto the direct access VALIDUs file via the console as a system origin job.

The following files are used by MODVAL in batch processing.

<u>Default Name</u>	<u>Use</u>
INPUT	File containing the input data directives that will be used to create or update the validation file VALIDUs.
NEWVAL	Interim copy of the new validation file that is to be created or reformatted.
VALIDUs	Old validation file that is to be updated or reformatted.
SOURCE	File to receive the source input for each user number.
VALINDs	File containing all the available user indexes for the present VALINDs file. VALINDs is always used in conjunction with one of the validation files, new=NEWVAL or old=VALIDUs.
OUTPUT	File to receive output listings.

The analyst performs the following procedure to create a new validation file with batch input.

1. Submits a batch job that executes MODVAL to create a local copy of the new validation file. The job saves the file as a permanent file.
2. At the console, he retrieves the permanent file created in step 1, defines the direct access file VALIDUs, and copies the new validation file to VALIDUs.

The analyst performs the following procedure to use MODVAL via batch input to perform an update or other operation that deals with a preexistent validation file.

1. At the console, the analyst attaches VALIDUs and makes a permanent file copy.
2. He submits a batch job that retrieves the permanent file created in step 1, executes MODVAL to update the validation file, and saves the new validation file with any change incorporated.
3. At the console, the analyst retrieves the permanent file created in step 2, defines the direct access file VALIDUs, and copies the new validation file to VALIDUs.

Although MODVAL batch input is more involved than input made exclusively at the console, it will prove faster and more convenient when a long list of user numbers with many identifiers will be entered.

### MODVAL Control Statement

The MODVAL validation file manager is accessed with the MODVAL control statement. The following is the format of the statement.

MODVAL (p<sub>1</sub>,p<sub>2</sub>,...,p<sub>n</sub>)

where p<sub>i</sub> is a keyword or a keyword equated to a value.

<u>P<sub>i</sub></u>	<u>Description</u>
I = filenam	Local file name of the file that will contain input data or source data; default is INPUT.
P = filenam	Local file name of the copy of the old validation file that is to be updated or reformatted; default is VALIDUs.
N = filenam	Local file name of the interim file that will become the newly created or reformatted validation file; default is NEWVAL.
S = filenam	File that will receive source data for each user number; default is SOURCE.
U = filenam	File containing the available user indices of the current VALIDUs file; default is VALINDs.
L = filenam	File to receive list output; default is OUTPUT.

CV KRONOS 2.1.1 to NOS 1 conversion (OP=C option) or NOS 1 to KRONOS 2.1.1 conversion (OP=S option). During a create run (OP=C), the creation of two user numbers with the same user index is allowed. Any identifier not recognized by NOS 1 MODVAL is ignored. During a source run (OP=S), the generation of identifiers not recognized by KRONOS 2.1.1 MODVAL is suppressed.

**NOTE**

When a KRONOS 2.1.1 VALIDUX file is converted to NOS 1 VALIDUs format that is subsequently converted to source, VALIDUs fields identified MT, RP, TL, CM, NF, MS, and DB are converted from range indices to actual values. These values may not be identical to the original VALIDUX file values.

RP Indicates that passwords do not have to be specified on a create run (can only be used with OP=C). RP should only be used if input (I=) file was created via an OP=S run on an existing user validation file containing passwords with length less than the installation required minimum.

SI Specifies that the input for a create run (OP=C) was generated by a previous source run (OP=S). The automatic creation of the system and library user numbers is suppressed.

D Indicates that MODVAL will not abort when directive errors are detected.

FA Forces an attach of VALIDUs and VALINDs for system origin type jobs (for options OP=S, U, or R).

FM=family Name of the family the user wishes MODVAL to access. This option can be specified only from a system origin job.

SP Suppresses generation of application (AP) directives as a result of interpreting the application bits of the access word (bits 47 to 24) when returning the validation file to source (OP=S). Specifying SP is useful when returning a pre-NOS 1.3 validation file to source at a site that had previously assigned meanings to application bits or when returning a NOS 1.3 or 1.4 validation file to source for subsequent use on an earlier system.

OP=C Create option. Processes the input file and creates the interim validation file (N=NEWVAL) and the file of associated user indices (U=VALINDs).

OP=C,LO=E Initiates the create (OP=C), and then lists errors encountered in processing.

- OP=U Update option. Updates the local copies of VALIDUs and VALINDs with data on input file and sets NORERUN flag to prevent the job from being rerun and toggling validation bits twice. This option can be used with certain other options (for example, OP=URS). It is the default option for a nonsystem origin job or a system origin job where at least one parameter is specified on the MODVAL control statement.
- OP=U,LO=E Initiates the update (OP=U), and then lists the errors encountered in processing.
- OP=Z Statement update option. This is like the update option except that directives are included on the MODVAL statement. The Z parameter in this option must be used alone.
- OP=Z,LO=E Initiates the statement update (OP=Z), then lists the errors encountered in processing.
- OP=R Reformats the validation file by purging all files of each deleted user. Until this option is selected, all files of deleted users remain in the permanent file system even though they cannot be accessed. This allows redefinition of a user (with UI identifier on data input directive) if an error was made in deleting him.
- OP=S Specifies a source run that returns the validation file specified by the P identifier (default=VALIDUs) to source format (directive images) on the file specified by the S keyword (default=SOURCE).
- OP=K K display option. All other options (multiple OP specifications) are cleared, and instructions must be entered via the K display.
- OP=K is valid only for system origin jobs. The system files VALIDUs and VALINDs are automatically attached (the FA parameter is not necessary).
- For a system origin job, if no parameters are specified and the call statement is
- MODVAL.
- the K option is automatically selected. If parameters are specified, OP=U is the default.
- OP=I Inquire option. Gives a listing of validation parameters for the user specified by the last USER statement or by terminal login. This option must occur alone. The following is a sample list. This list is also obtained by using the LIMITS control statement (refer to volume 1 of the NOS Reference Manual for further information).

```

AB =,
AB =,
AB =,
AB =,
MT =          3,
RP =          2,
TL = UNLIMITED,
CM =          2037B,
NF =          56,
DB =          8,
FC = UNLIMITED,
CS =          4096,
FS =          64,
PA = EVEN    ,
RO = SYSTEM  ,
PX = HALF    ,
TT = TTY     ,
TC = STANDARD,
IS = NULL    ,
MS =        12800,
DF =          1008,
CC = UNLIMITED,
OF =          12,
CP = UNLIMITED,
LP = UNLIMITED,
EC =          0B,
SL = UNLIMITED,
          CN =,
          PN =,
DS =          1024,

```

```
AW = 0000000002700000555
```

- |                   |   |
|-------------------|---|
| OP=L or OP=L,LO=A | Reads the validation file, sorts the copy by user number, and writes it to the output file for listing according to the format in figure 5-4.   |
| OP=L,LO=N         | Reads the validation file, sorts the copy by user index, and writes it to the output file for listing according to the format in figure 5-4.  |
| OP=L,LO=L         | Reads the information on the local file identified in the parameter list, sorts by user number, and writes it to the output file for listing according to the format in figure 5-4.         |
| OP=L,LO=AL        | Same as LO=L since A is a default value.  |
| OP=L,LO=NL        | Reads the information on the local file identified in the parameter list, sorts the copy by user index, and writes it to the output file for listing according to the format in figure 5-4. |



OP=L,LO=En           File will be sorted by user index.  
 or  
 OP=L,LO

OP=C,LO=EN           Produces a list of errors for the C, U, or Z processing. In this case,  
 MODVAL will use whichever applies.  
 U  
 Z  
 or  
 OP=C,LO  
 U  
 Z

	MODVAL,OP=L,LO=L.		78/04/20. 15.51.10.	PAGE	1
USER NUMBER	USER INDEX	CREATION DATE	LAST MOD DATE		
USERAAA	2	77/06/15.	78/02/14.		
USERBBB	52	77/06/15.	78/02/14.		
USERCCC	3014	77/06/15.	78/02/14.		
.	.	.	.		
.	.	.	.		
LIBRARY	377776	77/06/15.	78/04/13.		
SYSTEMX	377777	77/06/15.	78/04/13.		
.	.	.	.		
.	.	.	.		
.	.	.	.		

Figure 5-4. Format of VALIDATION File Listing

**Input Directive**

An input directive enters user numbers under a create run (OP=C) and modifies existing user numbers under an update run (OP=U). Format of the input directive is

/usernum,ident1=data1,ident2=data2,...

where usernum is the one- to seven-character user number being referenced and ident<sub>i</sub>=data<sub>i</sub> is a system usage definition for this number. Valid characters for usernum are A through Z, 0 through 9, and \*. The user number statement must begin with a / in column 1. The user number and all directives must be terminated by a separator.

Valid separators include any character whose display code value exceeds 44g (except /, =, and blank), as well as end-of-line. Thus, if an input directive item is last on a statement, no other separator need follow it. An asterisk (\*) can separate all directives except user numbers, charge numbers, and project numbers.

All directives relative to a user number must appear before another user number or the end of the input stream is encountered.

All data within a user number entry is free format to column 72. A directive cannot be split between cards or lines. Blanks are ignored.

To allow sequencing and/or identification of input directives, all data past column 72 is ignored.

Example:

The following is acceptable.

```
/ROBERTR,AW=CSPF  
AW=CLPF
```

However, data cannot lap from statement to statement.

Example:

The following is not acceptable.

```
/ROBERTR,AW=CSPF,AW=  
CLPF.
```

The following is a list of identifiers and their descriptions.

<u>Identifier</u>	<u>Description</u>
PW = passwrđ	A four- to seven-character password (A through Z, 0 through 9). Blanks are not significant. The minimum required length for passwords can be changed by setting the MODVAL installation parameter RPWL to a value from 0 to 7. The PW identifier is required with OP=C unless the RP identifier is specified on the MODVAL control statement or the minimum required password length is zero. If this identifier is not required and is omitted, the system assigns a password of all blanks. In the latter case, the user must enter a null password at login.
UI = userin	User index to be assigned to this user. If this entry is not supplied, the system assigns the next available user index. userin consists of six numeric characters followed by a radix. Blanks are suppressed. The maximum value is 377777g. This identifier cannot be used with the K display or update option.
SC = nnr	Security count. This parameter specifies the number of security violations allowed before the user is denied access to the system. The security count is decremented by the system when illegal secondary user statements are entered. A value of 77g indicates an unlimited security count; 0 indicates no access is allowed. If not specified, the default value is SC=50g. The security count is not included as output from a LIMITS or MODVAL (OP=I) control statement.
AB = answerback	A 1- to 10-character answerback code. Blanks are significant. The answerback code restricts the user to a particular terminal. Up to four answerback entries are permissible per user number. If this identifier is omitted, the system supplies an answerback code of all blanks, which gives this user access through any terminal. AB applies only to Time-Sharing Module (not IAF) users.

<u>Identifier</u>	<u>Description</u>
MT = n	Number of magnetic tapes allowed; $n \leq 7$ . If $n=7$ , unlimited tapes are allowed. If this identifier is omitted, the system supplies a value of 0.
RP = n	Number of removable disk packs allowed; $n \leq 7$ . If $n=7$ , unlimited disk packs are allowed. If this identifier is omitted, the system supplies a value of 0.
TL = nnr	<p>Range index representing the maximum CPU time that a user's job step may run. nnr consists of two numeric characters followed by a radix. Blanks are suppressed. The maximum index value is 77g, which specifies unlimited CPU time for each job step. If this identifier is omitted, the system supplies an index value of 0. The system uses the formula</p> $\text{maximum CPU time} = ((\text{index} \times 100g) + KTLI) \times 10g^\dagger$ <p>to convert the index value into the maximum CPU time that a user job step may run.</p>
DF = nnr	<p>Range index representing the maximum number of MESSAGE requests the user can issue to the system and/or job dayfiles. nnr consists of two numeric characters followed by a radix. Blanks are suppressed. The maximum index value is 77g, which specifies unlimited MESSAGE requests.</p> <p>If this identifier is omitted, the system supplies an index value of 0. The system uses the formula</p> $\text{maximum MESSAGE requests} = (\text{index} \times 20g) + KDFI^\dagger$ <p>to convert the index value to an actual limit of job MESSAGE requests.</p>
CC = nnr	<p>Range index representing the maximum number of batch control statements processed for a user. nnr consists of two numeric characters followed by a radix. Blanks are suppressed. The maximum index value is 77g, which specifies unlimited batch control statement processing. If this identifier is omitted, the system supplies an index value of 34g. The system uses the formula</p> $\text{maximum control statements} = (\text{index} \times 20g) + KCCI^\dagger$ <p>to convert the index value to an actual limit of control statements processed.</p>

---

† Refer to the NOS Installation Handbook for a description of these COMSACC parameters.

<u>Identifier</u>	<u>Description</u>
OF = n	<p>Range index representing the maximum number of job print and punch files the user can dispose to the output queue; <math>n \leq 7</math>. If <math>n=7</math>, an unlimited number of disposed output files is allowed. If this identifier is omitted, the system supplies an index value of 1. The system uses the formula</p> $\text{maximum disposed output} = (\text{index} \times 4)$ <p>to convert the index value to an actual limit of disposed output files.</p>
CP = nnr	<p>Range index representing the number of cards that can be punched from a user's disposed punch file. nnr consists of two numeric characters followed by a radix. Blanks are suppressed. The maximum value is 77g, which specifies unlimited punched output. If this identifier is omitted, the system supplies an index of 0. The system uses the formula</p> $\text{cards punched} = (\text{index} \times 100g) + \text{KCPI}^\dagger$ <p>to convert the index value to an actual limit of cards punched from a disposed file.</p>
LP = nnr	<p>Range index representing the number of lines that can be printed from a user's disposed print file. nnr consists of two numeric characters followed by a radix. Blanks are suppressed. The maximum value is 77g, which specifies unlimited print output. If this identifier is omitted, the system supplies an index value of 0. The system uses the formula</p> $\text{lines printed} = (\text{index} \times 2000g) + \text{KLPI}^\dagger$ <p>to convert the index value of an actual limit of lines printed from a disposed output file.</p>
PT = nnr	<p>Range index representing the number of plot units a user is allowed. nnr consists of two numeric characters followed by a radix. Blanks are suppressed. The maximum value is 77g, which specifies an unlimited number of plot units allowed. If this identifier is omitted, the system supplies an index value of 0. The system uses the formula</p> $\text{plot unit limit} = (\text{index} \times 2000g) + \text{KPTI}^\dagger$ <p>to convert the index value of an actual limit of plot units that a user may have.</p>
EC=nnr	<p>Range index representing the maximum ECS memory space a user is allowed. nnr consists of two numeric characters followed by a radix. Blanks are suppressed. The maximum value is 77g, which specifies all ECS memory space of the machine. If this identifier is omitted, the system supplies an index of 0. The system uses the formula</p> $\text{ECS limit} = (\text{index} \times 20g) + \text{KECI}^\dagger$ <p>to convert the index value to an ECS memory limit expressed in units of 1000g words.</p>

---

<sup>†</sup> Refer to the NOS Installation Handbook for a description of these COMSACC parameters.

<u>Identifier</u>	<u>Description</u>
SL = nnr	<p>Range index representing the maximum SRU accumulation for a user's job. nnr consists of two numeric characters followed by a radix. All blanks are suppressed. The maximum index value is 77g, specifying unlimited SRU accumulation. If this identifier is omitted, the system supplies an index value of 0. The system uses the formula</p> $\text{maximum SRU accumulation} = ((\text{index} \times 100g) + \text{KSLI}) \times 10g^\dagger$ <p>to convert the index value into the maximum SRU accumulation that a user's job may have.</p>
CM = nnr	<p>Range index representing the maximum central memory space a user is allowed. nnr consists of two numeric characters followed by a radix. Blanks are suppressed. The maximum value is 77g, which specifies all available CM space of the machine. If this identifier is omitted, the system supplies an index value of 14g. The system uses the formula</p> $\text{CM limit} = (\text{index} \times 40g) + \text{KCMI}^\dagger$ <p>to convert the index value to a CM space limit expressed in units of 100g words.</p>
NF = n	<p>Range index representing the maximum number of files a user can concurrently utilize; <math>n \leq 7</math>. If <math>n=7</math>, an unlimited number of concurrent files is allowed. If this identifier is omitted, the system supplies an index of 2. The system uses the formula</p> $\text{concurrent files} = (\text{index} \times 10g) + \text{KNFI}^\dagger$ <p>to convert the index value to an actual limit of concurrent files.</p>
MS = nnr	<p>Range index representing the maximum number of mass storage PRUs the user is allowed to additionally allocate. nnr consists of two numeric characters followed by a radix. Blanks are suppressed. The maximum value is 77g, which specifies unlimited additional mass storage PRUs. If this identifier is omitted, the system supplies an index value of 1. The system uses the formula</p> $\text{PRU limit} = (\text{index} \times 10000g) + \text{KMSI}^\dagger$ <p>to convert the index value to a PRU equivalent of the actual mass storage tracks additionally allocated to the job files.</p>
DN = n	<p>Range index representing the maximum number of deferred batch jobs the user is allowed to have in the system concurrently; <math>n \leq 7</math>. If <math>n=7</math>, an unlimited number of deferred batch jobs is allowed. If this identifier is omitted, the system supplies an index value of 0. The system uses the formula</p> $\text{deferred batch jobs} = (\text{index} \times 2)$ <p>to convert the index value to an actual limit of deferred batch jobs.</p>

---

† Refer to the NOS Installation Handbook for a description of these COMSACC parameters.

Identifier

Description

AW = xxxx

If the user has the access bit CSOJ and DEBUG is set on the system display console, the user has system origin or DB=0, the DB parameter is ignored, and the user may submit as many jobs as he wishes.

xxxx is a four-character designation that toggles a particular bit in the access word (bits 59 through 48 and 23 through 0 only). For each bit that is set, special permission is allowed to that user. The bit is set when the first identifier is encountered and cleared if the identifier is used again. A maximum of 36 entries per record is allowed. Blanks are suppressed.

The following permission bits are defined in the access word.

<u>xxxx</u>	<u>Bit</u>	<u>Permission</u>
CPWC	0	User can change his password.
CTPC	1	User can use the access subsystem commands (terminal use only). <sup>†</sup>
CLPF	2	User can create direct access permanent files.
CSPF	3	User can create indirect access permanent files.
CSOJ	4	User can have system origin capability from any job origin if the debug option is turned on by the operator.  User can also assign a device by specifying its EST ordinal. This does not require that the debug option be turned on.  User can also call the PP hardware diagnostics of the 881/883 pack reformatting utility FORMAT, if ENGINEERING mode is enabled.
CASF	5	User can access system files (library).
CAND	6	User can request nonallocatable devices (for example, magnetic tape units).
CCNR	7	User can use system without entry of charge or project number.
CSRP	8	User can issue auxiliary device commands.

<sup>†</sup> Refer to the NOS Time-Sharing User's Reference Manual or the IAF Reference Manual for a description of the access commands.

Identifier

Description

<u>xxxx</u>	<u>Bit</u>	<u>Permission</u>
CSTP	9	User can access special transaction functions.
CTIM	10	User is not logged off because of timeout.
CUCP	11	User can access system control point (SCP) facility.
CSAP	12	User has special accounting privileges.†
CBIO	13	User has BATCHIO subsystem privileges.††
CPRT	14	User can use PROTECT ECS statements.

The default values are CPWC, CLPF, CCNR, and CSPF.

To set or clear all permission bits in the access word (bits 59 through 48 and 23 through 0), the following can be specified for xxxx.

ALL Sets all 36 permission bits in the access word.

NUL Clears all 36 permission bits in the access word.

AP = appl

appl is a one- to seven-character application name that toggles a particular bit in the application permission field (bits 47 through 24) of the access word. If more than one application corresponds to a single bit, any of the application names for that bit may be specified for appl. For each bit that is set, a specific application or set of applications is accessible to the user. A maximum of 24 entries per record is allowed. Blanks are suppressed.

The following application bits are defined in the access word.

<u>appl</u>	<u>Bit</u>	<u>Application</u>
IAF	24	Interactive Facility
RBF	25	Remote Batch Facility
TAF	26	Transaction Facility
MCS	27	Message Control System
TVF	28	Terminal Verification Facility
NOP	29	Network Operator
LOP	30	Local Operator
NOPLP	31	Network/Local Operator

† Refer to User Accounting for a description of special accounting user privileges.  
†† V carriage control character (refer to the NOS Reference Manual, volume 1).

Identifier

Description

The Network Validation Facility is automatically available to all NAM users; hence, no bit position is defined for this application. By default, no other applications are available to the user (bits 47 through 24 are zero).

To set or clear all application bits in the access word, the following can be specified for appl.

ALL Sets all 24 application bits in the access word.

NUL Clears all 24 application bits in the access word.

CAB = oldab,newab

Indicates that the answerback code is to be changed. The entry consists of two fields, the first (oldab) indicates the answerback code that is to be changed and the second (newab) indicates the new code. An entry consists of 1 to 10 alphanumeric characters. Blanks are not suppressed. Four or less answerback changes are permitted per record.

The following identifiers can only be used in update (OP=U) and K display options.

Identifier

Description

DAC = usernum

Deletes the user number, usernum, from the VALIDUs file. This user number must match the current user number as specified after the most recent /.

FUI = userin

Forces the specified user index to be assigned to the user number specified after the most recent /, whether the user index is assigned to another user number or not. If the VALIDUs file is returned to source format (OP=S on MODVAL statement) and a new VALIDUs file created from this source, multiple user number per user index associations will be lost.

The following four specifications control permanent file access for the individual user. Ordinarily, this is specified by origin type.

Identifier

Description

FC = n

File count indicating the maximum number of permanent files allowed the user. The user is validated for the upper limit corresponding to the n value specified.

<u>n</u>	<u>Upper Limit Allowed (Octal)</u>
0	Use job origin control
1	10
2	20
3	30
4	40
5	50
6	100
7	Unlimited

If FC is not specified, n=0 will be assumed.



Identifier

Description

CS=n

Cumulative size of all indirect access files for this user. The user is validated for the upper limit corresponding to the n value specified.

<u>n</u>	<u>Upper Limit Allowed (Octal Count of PRUs)</u>
0	Use job origin control
1	1000
2	2000
3	5000
4	10000
5	50000
6	100000
7	Unlimited

If CS is not specified, n=0 is assumed.

FS=n

Maximum file size allowed for an individual indirect access permanent file. The user is validated for the upper limit corresponding to the n value specified.

<u>n</u>	<u>Upper Limit Allowed (Octal Count of PRUs)</u>
0	Use job origin control; no controls are enacted.
1	10
2	30
3	50
4	100
5	150
6	300
7	Unlimited

If FS is not specified, n=0 will be assumed.

DS=n

File size allowed for an individual direct access permanent file. The user is validated for the upper limit corresponding to the n value specified.

<u>n</u>	<u>Upper Limit Allowed (Octal Count of PRUs)</u>
0	Use job origin control
1	1000
2	2000
3	5000
4	10000
5	50000
6	100000
7	Unlimited

If DS is not specified, n=0 is assumed.

The following four specifications manipulate fields describing the Time-Sharing Module user's terminal; they do not apply to IAF.

<u>Identifier</u>	<u>Description</u>														
PX = mode	Specifies transmission mode. Only one entry should occur per user number record. Since the terminal operates in full or half duplex mode, either of the following values is available for mode.														
	<table border="0" style="margin-left: 40px;"> <thead> <tr> <th style="text-align: left;"><u>mode</u></th> <th style="text-align: left;"><u>Explanation</u></th> </tr> </thead> <tbody> <tr> <td>FULL</td> <td>System enters echoplex mode automatically.</td> </tr> <tr> <td>HALF</td> <td>System does not enter echoplex mode automatically.</td> </tr> </tbody> </table>	<u>mode</u>	<u>Explanation</u>	FULL	System enters echoplex mode automatically.	HALF	System does not enter echoplex mode automatically.								
<u>mode</u>	<u>Explanation</u>														
FULL	System enters echoplex mode automatically.														
HALF	System does not enter echoplex mode automatically.														
RO = nnr	nnr consists of two numeric characters followed by a radix. Blanks are suppressed. This is the rubout count which is the character count delay associated with the user's terminal. One value from 0 to 378 may be entered for each user number record. A value of 378 denotes that the system will use the default number for the user's terminal type.														
PA = p	p specifies terminal parity. The terminal operates with even or odd parity. One of the following two values may be entered for each user number record.														
	EVEN														
	ODD														
TT = t	t specifies the terminal type. One of the following values may be specified for each user number.														
	<table border="0" style="margin-left: 40px;"> <thead> <tr> <th style="text-align: left;"><u>t</u></th> <th style="text-align: left;"><u>Description</u></th> </tr> </thead> <tbody> <tr> <td>TTY</td> <td>Teletype or other ASCII compatible terminal</td> </tr> <tr> <td>MEMAPL</td> <td>Memorex 1240 with APL print</td> </tr> <tr> <td>COR</td> <td>Correspondence with standard print</td> </tr> <tr> <td>CORAPL</td> <td>Correspondence with APL print</td> </tr> <tr> <td>BLKEDT</td> <td>Block mode terminal</td> </tr> <tr> <td>713</td> <td>CDC 713 display terminal</td> </tr> </tbody> </table>	<u>t</u>	<u>Description</u>	TTY	Teletype or other ASCII compatible terminal	MEMAPL	Memorex 1240 with APL print	COR	Correspondence with standard print	CORAPL	Correspondence with APL print	BLKEDT	Block mode terminal	713	CDC 713 display terminal
<u>t</u>	<u>Description</u>														
TTY	Teletype or other ASCII compatible terminal														
MEMAPL	Memorex 1240 with APL print														
COR	Correspondence with standard print														
CORAPL	Correspondence with APL print														
BLKEDT	Block mode terminal														
713	CDC 713 display terminal														

The following two specifications may be used with either Time-Sharing Module or IAF users.

<u>Identifier</u>	<u>Description</u>
TC = c	Default character set to be used by the terminal. One of the following values is available for each user number.

<u>c</u>	<u>Description</u>
STANDARD	ASCII Graphic 63- or 64-character set
ASCII	ASCII 128-character set

IS = subsys	Initial subsystem for the terminal. One of the following values may be specified for each user number.
-------------	--

<u>subsys</u>	<u>Description</u>
ACCESS	Access subsystem
BASIC	BASIC subsystem
BATCH	Batch subsystem
EXECUTE	Execute subsystem
FORTRAN	FORTRAN Version 5 subsystem
FTNTS	FORTRAN Extended Version 4 subsystem
NULL	Null subsystem
TRANACT	Transaction subsystem (TAF/TS)†

CN = chargenum	A 1- to 10-character charge number associated with the user. Valid characters are A through Z, 0 through 9, and *. This field is not checked or updated by the system; it only provides information when OP=I is specified. To maintain correct information, this parameter should be updated when the user's charge number information is updated.
----------------	---

PN = projectnum	A 1- to 20-character project number associated with the user. Valid characters are A through Z, 0 through 9, and *. This field is not checked or updated by the system; it only provides information when OP=I is specified. To maintain correct information, this parameter should be updated when the user's project number information is updated.
-----------------	---

#### EXAMPLES OF MODVAL USAGE

The examples in this section give representative commands for exercising the MODVAL options both at the console and by batch input. System files are under index 377777g. Refer to section 7 for definition of the ISF control statement.

---

† TRANACT cannot be specified for IAF terminal users. AP=TAF should be used instead.

**Example 1:**

Example 1 is a create at the console with the C,username format. MODVAL is called and the B display indicates the control point for the job (n). This is entered via the K display. Following this is an entry of three user numbers with a password ident for each.

```
X.MODVAL.  
K,n.  
K.C,USER201  
K.PW=ADMIT1  
K.END  
K.C,USER202  
K.PW=ADMIT2  
K.END  
K.C,USER203  
K.PW=ADMIT3  
K.END  
K.END.
```

**Example 2:**

In example 2, the previous parameters are entered at the console with the / format.

```
X.MODVAL.  
K,n.  
K./USER201,PW=ADMIT1  
K./USER202,PW=ADMIT2  
K./USER203,PW=ADMIT3  
K.END  
K.END.
```

**Example 3:**

In example 3, the same entries are made as a batch job with default values used for the file names. The following is the statement input.

Job statement

USER(usernum,passwd,family)

MODVAL(OP=C)

SAVE(NEWVAL)

SAVE(VALINDs=VAL)

7/8/9

/USER201,PW=ADMIT1

/USER202,PW=ADMIT2

/USER203,PW=ADMIT3

6/7/8/9

This produces indirect access permanent files. These will be made direct access permanent files in the system from the console. The system index (377777) must be specified. The third parameter on the COPY command initiates verification of the files after execution of the copy. Input at the console is:

X.DIS.

USER(usernum,passwd,family)

or SUI,userin where userin is the user index for usernum.

GET,NEWVAL.

GET,VAL.

SUI,377777.

If a VALIDUs file already exists on the system, it will be necessary, at this point, to enter the following from DSD:†

IDLEFAMILY,xx. where xx is the EST ordinal of the device to be idled.

When the user count is zero (idle family situation), the IDLEFAMILY command must be entered again so that the system will accept the ISF control statement.

IDLEFAMILY,xx.

ISF(R=VALIDUs,FM=family)

PURGE(VALIDUs,VALINDs)

---

†Before ISF(R=VALIDUs) can be entered, the system must be emptied of all executing jobs. This can be a time-consuming task. Refer to the NOS Operator's Guide for more information about the IDLEFAMILY command.

DEFINE,VALIDUs,VALINDs.  
COPY,NEWVAL,VALIDUs,V.  
COPY,VAL,VALINDs,V.  
RETURN,VALIDUs,VALINDs.  
ISF.

Example 4:

In example 4, the previous create is run with file names supplied. It is assumed that the following indirect access file is on mass storage before the batch deck is submitted.

File PUTIN:

/USER201,PW=ADMIT1  
/USER202,PW=ADMIT2  
/USER203,PW=ADMIT3

Input at the card reader is:

Job statement  
USER(usernum,passwd,family)  
GET,PUTIN.  
MODVAL,OP=C,I=PUTIN,N=VALNEW.  
SAVE,VALNEW.  
SAVE,VALINDS=VALX.  
6/7/8/9

After this job is executed, the following entries are made at the console.

X.DIS.

Under DIS:

USER (usernum,passwd,family)

or SUI,userin.            where userin is the user index for usernumber.

GET,VALNEW.

GET,VALX.

SUI,377777.

If a VALIDUs file already exists on the system, it will be necessary, at this point, to enter the following:†

Under DSD:

IDLEFAMILY,xx.                    where xx is the EST ordinal of the device to be idled.

When the user count is zero (idle family situation), the IDLEFAMILY command must be entered again so that the system will accept the ISF control statement.

Under DSD:

IDLEFAMILY,xx.

Under DIS:

ISF(R=VALIDUs).

PURGE(VALIDUs,VALINDs).

DEFINE,VALIDUs.

DEFINE,VALINDs.

COPY,VALNEW,VALIDUs,V.

COPY,VALX,VALINDs,V.

RETURN,VALIDUs,VALINDs.

ISF.

**Example 5:**

Example 5 is an update at the console with the U,accnumb format. The first two user numbers entered via the previous creates have their passwords changed.

X.MODVAL.

K.n.

K.U,USER201

K.PW=ENTER1

K.END

K.U,USER202

K.PW=ENTER2

K.END

K.END.

---

† Before ISF(R=VALIDUs) can be entered, the system must be emptied of all executing jobs. This can be a time-consuming task. Refer to the NOS Operator's Guide for more information about the IDLEFAMILY command.

**Example 6:**

In example 6, the previous parameters are entered at the console with the / format.

```
X.MODVAL.  
K.n.  
K./USER201,PW=ENTER1  
K./USER202,PW=ENTER2  
K.END  
K.END.
```

**Example 7:**

In example 7, the previous update is entered by means of batch input. First, the direct access permanent files VALIDUs and VALINDs are copied to permanent files (direct or indirect) that can be accessed by the batch input and used in the MODVAL control statement. Before this is done at the console as follows, an idle family situation must be created and the ISF(R=VALIDUs) control statement must be entered. Refer to the DSD command, IDLEFAMILY, in the NOS Operator's Guide.

```
X.DIS.  
SUL,377777.  
ATTACH(VALIDUs,VALINDs)  
COPY(VALIDUs,VAL)  
COPY(VALINDs,VALX)  
RETURN(VALIDUs,VALINDs)  
ISF.  
USER(usernum,passwd,family)  
SAVE(VAL,VALX)
```

The batch input is:

```
Job statement  
USER(usernum,passwd,family)  
GET(VAL,VALX)  
MODVAL(OP=U,P=VAL,U=VALX)  
REPLACE(VAL,VALX)  
7/8/9
```



/USER201,PW=ENTER1

/USER202,PW=ENTER2

6/7/8/9

The modified files are returned to the system at the console. The M=W in the ATTACH is needed to establish write permission relative to the direct access files. However, before this is done, an idle family situation must be created and an ISF(R=VALIDUs) control statement must be entered. Refer to the DSD command, IDLEFAMILY, in the NOS Operator's Guide.

X.DIS.

USER(usernum,passwd,family)

GET(VAL,VALX)

SUI,377777.

ATTACH(VALIDUs,VALINDs/M=W)

COPY(VAL,VALIDUs)

COPY(VALX,VALINDs)

RETURN(VALIDUs,VALINDs)

ISF.

If the OP=Z option is used, it is not necessary to provide an input file and save it under 377777. The Z option makes the changes directly as follows:

X.DIS.

MODVAL(OP=Z)/USER201,PW=ENTER1

(one user at a time)

Example 8:

In example 8, a delete is done from the console only.

X.MODVAL.

K,n.

K.D.USER203

K.END.

**Example 9:**

In example 9, reformatting of the validation file is initiated from the console. Before DIS is used, and statements are typed in (no K display), an idle family situation must be created and the ISF(R=VALIDUs) control statement must be entered. Refer to the DSD command, IDLEFAMILY, in the NOS Operator's Guide. The OUTPUT file will have a listing of the purged indices.

```
X.DIS.  
  
SUI,377777.  
  
ATTACH(VALIDUs,VALINDs/M=W)  
  
MODVAL(OP=R)  
  
REWIND(VALIDUs,NEWVAL)  
  
COPY(NEWVAL,VALIDUs)  
  
OUT.  
  
RETURN(VALIDUs,VALINDs)  
  
ISF.
```

**Example 10:**

In example 10, to reformat the validation file with batch input, the direct access files have indirect access copies made via the console. Before this is done, an idle family situation must be created and the ISF(R=VALIDUs) control statement must be entered. Refer to the DSD command, IDLEFAMILY, in the NOS Operator's Guide.

```
X.DIS.  
  
SUI,377777.  
  
ATTACH(VALIDUs,VALINDs)  
  
COPY(VALIDUs,VAL)  
  
COPY(VALINDs,VALX)  
  
RETURN(VALIDUs,VALINDs)  
  
ISF.  
  
USER(usernum,passwd,family)  
  
SAVE(VAL,VALX)
```

Them, from the card reader:

```
Job statement  
  
USER(usernum,passwd,family)  
  
GET(VAL,VALX)
```

MODVAL(OP=R,P=VAL,U=VALX)

SAVE(NEWVAL)

REPLACE(VALX)

6/7/8/9

Then from the console, the following is entered after an idle family situation has been created and the ISF(R=VALIDUs) control statement has been entered. Refer to the DSD command, IDLEFAMILY, in the NOS Operator's Guide.

X.DIS.

USER(usernum,passwd,family)

GET(NEWVAL,VALX)

SUI,377777.

ATTACH(VALIDUs,VALINDs/M=W)

COPY(NEWVAL,VALIDUs,V)

COPY(VALX,VALINDs,V)

RETURN(VALIDUs,VALINDs)

ISF.

Instead of the ATTACH, in which each COPY would write over an old file, it would be possible to use

PURGE(VALIDUs,VALINDs)

DEFINE(VALIDUs,VALINDs)

and then copy onto the empty files.

Example 11:

In example 11, the validation file is returned to source code via the console. Before this is done, an idle family situation must be created and the ISF(R=VALIDUs) control statement must be entered. Refer to the DSD command, IDLEFAMILY, in the NOS Operator's Guide.

X.DIS.

SUI,377777.

ATTACH(VALIDUs,VALINDs)

MODVAL(OP=S)

SAVE(SOURCE)

Later, this source code file could be used to create a new VALIDUs file with:

```
GET(SOURCE)
MODVAL(OP=C,I=SOURCE,SI)
```

The SI parameter suppresses the automatic creation of the system and library user numbers.

Example 12:

In example 12, the validation file is returned to source code via batch. Before this is done, an idle family situation must be created and the ISF(R=VALIDUs) control statement must be entered. Refer to the DSD command, IDLEFAMILY, in the NOS Operator's Guide.

```
X.DIS.
SUI,377777.
ATTACH(VALIDUs,VALINDs)
COPY(VALIDUs,VAL)
COPY(VALINDs,VALX)
RETURN(VALIDUs,VALINDs)
ISF.
USER(usernum,passwd,family)
SAVE(VAL,VALX)
```

From the card reader:

```
Job statement
USER(usernum,passwd,family)
GET(VAL,VALX)
MODVAL(OP=S, P=VAL, U=VALX)
SAVE(SOURCE)
```

From the console:

```
X.DIS.
USER(usernum,passwd,family)
GET(SOURCE)
SUI,377777.
SAVE(SOURCE)
```

Example 13:

In example 13 a validation file from an existing system (VALIDUX from KRONOS 2.1.1, VALIDUS from NOS 1.0, or VALIDUZ from NOS 1.1) is converted to NOS 1.2, 1.3, or 1.4 format. The analyst first deadstarts the existing system and then enters the following sequence of commands at the console.

```
X.DIS.  
  
SUI(377777)  
  
DEFINE(SOURCE)  
  
MODVAL(OP=S,FA)  
  
DROP.
```

When the validation file is successfully converted to source, any application permissions must be edited into the newly created source file by supplying appropriate AP directives. The analyst deadstarts a NOS 1 system and enters the following sequence of commands at the console. However, if ISF has already been done, an ISF(R=VALIDUZ) control statement must first be entered. To do this an idle family must be created via the IDLEFAMILY command (refer to the NOS Operator's Guide).

```
X.DIS.  
  
SUI(377777)  
  
PURGE(VALIDUZ,VALINDZ)  
  
DEFINE(VALIDUZ,VALINDZ)  
  
ATTACHS(SOURCE)  
  
MODVAL(OP=C,I=SOURCE,SI,N=VALIDUZ,RP) - RP is included only if converting to NOS 1.3 or 1.4.
```

(Refer to the following note if old validation file is from a KRONOS 2.1.1 system.)

```
RETURN(VALIDUZ,VALINDZ)  
  
ISF(E=VALIDUZ)  
  
DROP.
```

**NOTE**

If the old validation file is from a KRONOS 2.1 system, the CV parameter must be used with the MODVAL statement; that is, MODVAL (OP=C,I=SOURCE,SI,N=VALIDUZ,RP) must be replaced with:

```
MODVAL(OP=C,I=SOURCE,CV,SI,N=VALIDUZ,RP)
```

If the user wants to reverse the conversion sequence (that is, starting from NOS and converting to KRONOS 2.1), the CV parameter should be used on the NOS MODVAL call to SOURCE to suppress NOS source identifiers not recognizable by KRONOS 2.1 MODVAL. After a NOS deadstart, the following sequence of commands should be entered.

```
X.DIS
SUI(377777)
DEFINE(SOURCE)
MODVAL(OP=S,CV,FA)
DROP.
```

Then, the analyst should deadstart a KRONOS 2.1.1 system and enter the following commands.

```
X.DIS.
SUI(377777)
ATTACH(INPUT=SOURCE)
PURGE(VALIDUX,VALINDX)
DEFINE(VALIDUX,VALINDX)
MODVAL(OP=C)
DROP.
X.ISF.
```

**Example 14:**

In example 14, a VALIDUs file and a VALINDs file are created when there are no VALIDUs and VALINDs files already present; that is, an initial VALIDUs file and an initial VALINDs file are created.

The local file PUTIN contains input directs for three user numbers.

```
/USER201,PW=ADMIT1
/USER202,PW=ADMIT2
/USER203,PW=ADMIT3
```

The following are entered at the console.

```
X.DIS.
SUI(377777)
DEFINE,VALIDUs,VALINDs
MODVAL(I=PUTIN,N=VALIDUs,OP=C)
RETURN,VALIDUs,VALINDs.
ISF.
```

## SPECIAL USER NUMBERS

User numbers whose user indices are greater than AUIX (which is defined as 377700<sub>g</sub> in common deck COMSACC) are considered special user numbers. To protect special user numbers from unauthorized access and to prohibit user access to the system using special user numbers, all special user numbers are illegal during login or on USER statements. Permanent files may be created under the special user numbers only by special system jobs or through the use of the SUI control statement. (Refer to volume 1 of the NOS Reference Manual.)

During a MODVAL creation run, if the SI parameter is not specified on the MODVAL control statement, 11 special user numbers are created. These include the system user number (SYSTEMX), the library user number (LIBRARY), the application library user number (APPLLIB), and eight special user numbers that are used in an MSS environment (SUBFAM<sub>i</sub>, <sub>i</sub>=0, 1,...,7). These user numbers are automatically created; no action by the analyst is required. The following directives create these special user numbers.

```
/SYSTEMX,UI=377777,AW=ALL,PW=SYSX
/LIBRARY,UI=377776,AW=ALL,PW=LIBR
/APPLLIB,UI=377774,AW=ALL,PW=APPL
/SUBFAM0,UI=377760,AW=ALL,PW=SUBF0
/SUBFAM1,UI=377761,AW=ALL,PW=SUBF1
.
.
.
/SUBFAM7,UI=377767,AW=ALL,PW=SUBF7
```

Permanent files cataloged under the SYSTEMX user number are validation, project profile, resource, and network files. Ordinary users should not be able to access this information.

Permanent files cataloged under the LIBRARY user number are usually accessed by many users via the time-sharing subsystem LIB command. They can also be accessed via the OLD, GET, or ATTACH commands and by routine-sharing users. (Refer to the IAF Reference Manual or the NOS Time-Sharing User's Reference Manual for further information.) Typically, the information saved under user number LIBRARY consists of permanent files containing programs or text or general interest, such as application programs.

Permanent files cataloged under the APPLLIB user number are application programs that are application usage accounted. Many users access these programs, but they are charged accordingly. All programs to be application usage accounted must be direct access and have execute-only mode.

Permanent files can be saved under the LIBRARY or APPLLIB user number only by first setting the LIBRARY or APPLLIB user index at the console with the SUI control statement. The input at the console is as follows:

```
X.DIS.          (for LIBRARY)      or      X.DIS
SUI(377776)          (for APPLLIB)
```

The files to be made permanent can now be saved or defined. Since the only method to access files cataloged under these user numbers is with the alternate user access mechanism, the files should be cataloged with the appropriate permanent file category, passwords, and permit information to allow the desired alternate user access to the file.

Permanent files cataloged under the SUBFAMi, i=0, 1,...,7, user numbers are used during MSS processing as discussed in section 3. Installations that do not plan to redo a MODVAL creation run should add these user numbers manually.

**NOTE**

User indexes 377775 and 377760 through 377767 are used for special purposes in the permanent file system. Because of this, PFDUMP will dump only certain specific files on these user indexes. Therefore, installations should not attempt to save files on these user indexes.



## USER ACCOUNTING

The special system file PROFILa† contains the information required to control a user's accounting and access to the system. This access is controlled not only by charge numbers and project numbers but also by time in, time out, expiration for charge and project numbers, accumulated SRUs, and up to eight accumulated resources defined by the installation.†† In addition, all exercise of this access by individual users is written by the system to the accounting dayfile, thereby affording the customer a time-log as a basis for his account billing. For the time-sharing user, entries in the PROFILa file are updated at full logout or when the user's recovery file entry is dropped if the recovery time limit has expired.

PROFILa affords three levels of job accounting.

Charge Number	This is the primary division of the customer's job structure. It is a 1- to 10-character billing identifier. Charge numbers can only be entered onto PROFILa by the analyst in a system origin job or by a special accounting user, and their associated parameters may be changed according to the hierarchy of access described later in this section.
Project Number	This is an optional second level division of the charge number. It is a 1- to 20-character identifier of a particular company project. The project number can be followed by time-access parameters to this project.  Users who have been declared master users can enter and change project numbers and their associated parameters.
User Number	The third level is a one- to seven-character identifier of the individual user who is allowed access to a designated company project. This is the same user number that VALIDUs furnishes to verify system access refer to User Validation (VALIDUs—Special System file).  User numbers are entered and deleted by the master user. A user can be validated for more than one project in the same charge category or in different ones.

Although charge, project, and user numbers can be entered by the analyst at the console, practical dictates of an industrial situation usually require the analyst to create only a shell of the PROFILa file; that is, he enters just the charge numbers and the associated master users. This relatively constant information is furnished by the customer. Following this, the master users will update the PROFILa file with the projects and users that are under their direct cognizance. Then, if a user's validation for system access includes bit 7 of the access word being clear (AW=CCNR, MODVAL Input Directive section), this user must enter valid charge and project numbers.

---

† In this manual, the user validation and accounting files are referred to as VALIDUs, VALINDs, and PROFILa. Refer to table 5-1 for a list of file names that correspond to the appropriate operating system levels.

†† Limit and accumulation fields for these eight installation-defined resources have been reserved in PROFILa and are checked for exhaustion of the corresponding resource by routine CHARGE. However, the system provides no facility to dynamically update the accumulation fields as these resources are being used.

There are three classifications of access and modification to PROFILa:

- System origin jobs.
- Special accounting users (CSAP set in the user access validation word).
- Master users.

These classes are listed in the order of the capability they provide. System origin jobs have complete access to PROFILa, with no restrictions regarding PROFILE options and directives. Special accounting users from nonsystem origin jobs have full capabilities on update and inquire runs but may not perform create, list, source, or reformat runs. Master users from nonsystem origin jobs may not change any charge number entry parameters (such as SRU multiplier indices) or installation-related project number entry parameters (such as, installation accumulators or project expiration date). A master user may alter values pertaining only to charge numbers for which that user is the defined master user.

This two-stage structuring of a PROFILa file is illustrated in figure 5-5.

## PROFILa PROJECT PROFILE MANAGER

The program PROFILE uses the special system file supervisor (SFS) to create and manage the project profile file, PROFILa. Creation of PROFILa can only be done from the console via a system origin job (refer to PROFILE Console Input). Access and modification of an existing PROFILa file can be done from console, card reader (refer to PROFILE Batch Input), or from a time-sharing terminal (refer to PROFILE Execution From A Terminal), depending on the option. In all cases, options are called into execution with the PROFILE control statement. The format of the statement is

PROFILE(p<sub>1</sub>,p<sub>2</sub>,...,p<sub>n</sub>)

where the p<sub>i</sub>'s are the identifications used in defining project profile operations and files.

### Analyst (System Origin Job) Identifications

<u>Identification</u>	<u>Description</u>
OP=C	Create option. Input directives are processed so as to create a new PROFILa file. Directives are entered either through the K display or input file. Because this option defines a new project file, it must be previously undefined. This is the only option which does not require an existing project file containing at least one charge number.
OP=K	K-display option. All other options (multiple OP specifications) are cleared and instructions must be entered via the K display.

Identification

Description

For a system origin job, if no parameters are specified and the call statement is

PROFILE.

the K option is automatically selected. In all other cases, OP=U is the default.

OP=R

R indicates a restructure run that rebuilds a copy of the current PROFILa file, discarding any deleted entries and reconstructing the directory to reduce file access. The existing PROFILa file is replaced with this restructured file. OP=R must not be specified if the PROFILa file is attached to any job or is in fast-attach status. Refer to the ISF control statement, section 7, for information on fast-attach files.

OP=S

S indicates a source run that returns the PROFILa file to source format (directive images) and places this source code on the source file (either S=source or SOURCE). This source file is used as the input for a later create or update.

FM=family

Name of the family the user wishes PROFILE to access. This option can only be specified from a system origin job.

S=filenam

File to receive PROFILa source data for the option OP=S. Default is SOURCE.

OP=L,LO=F

Produces a full listing of the whole PROFILa file; figure 5-6 is an example.

OP=L,LO=C

Produces a listing of charge numbers only for the whole PROFILa file; figure 5-7 is an example.

OP=L,LO=P

Produces a complete charge number and project number listing for the whole PROFILa file; figure 5-8 is an example.

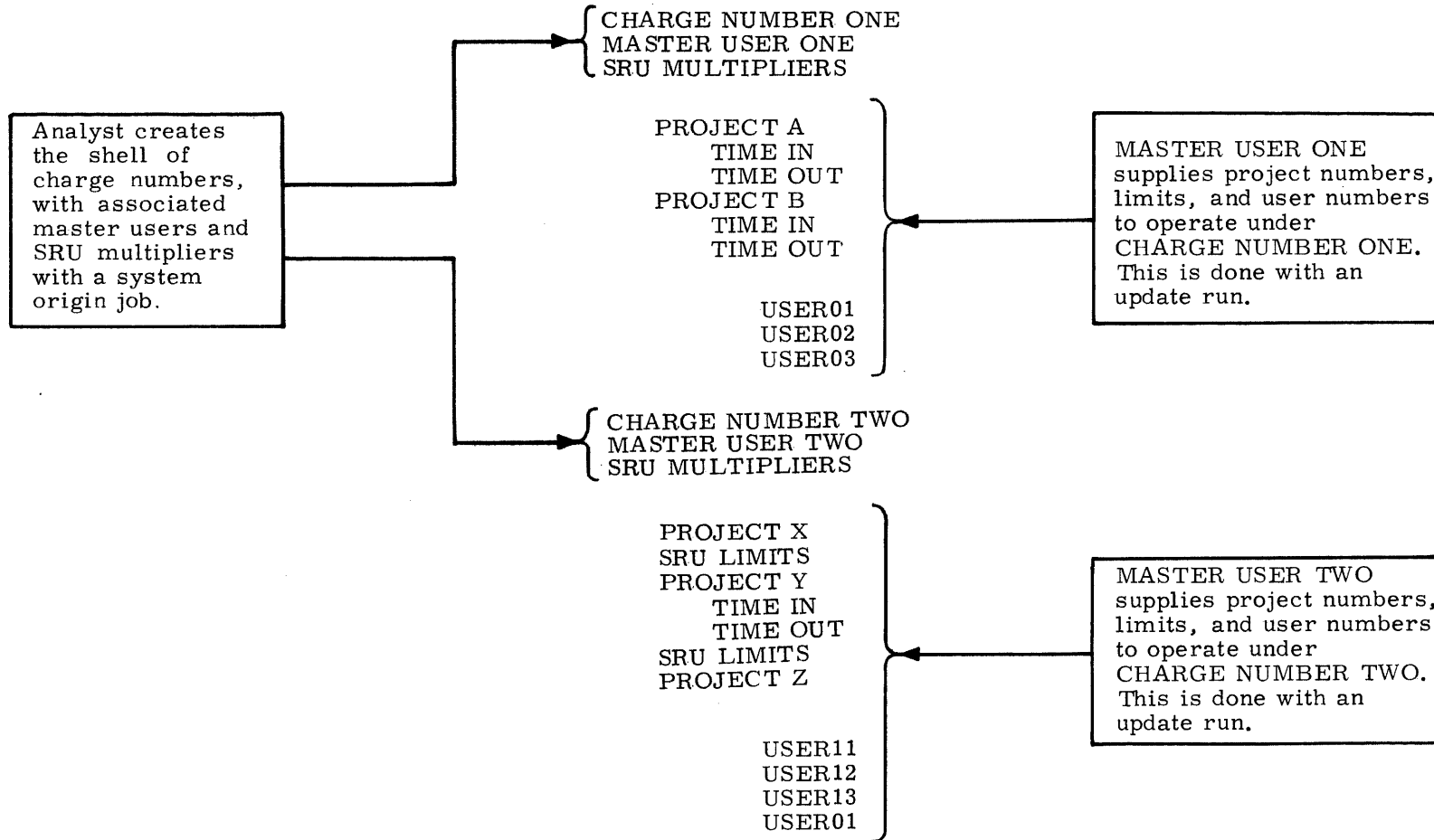

Figure 5-5. Representative Structure of a PROFILA File

PROFILB FULL FILE LIST OF FULL FILE.  
CHARGE NUMBER

PAGE 1  
78/04/20. 15.38.39.

1. 0319

CONTROLS FOR CHARGE NUMBER 0319

CREATION DATE	76/09/23.	EXPIRATION DATE	UNDEFINED
ENTRY	*ACTIVE*	PROJECT COUNT	= 3
MU	= MANAGER	PCL	= (NO LIMIT)
ISL	= 77B (NO LIMIT)	IR1	= 77B (NO LIMIT)
IR2	= 77B (NO LIMIT)	IR3	= 77B (NO LIMIT)
IR4	= 77B (NO LIMIT)	IR5	= 77B (NO LIMIT)
IR6	= 77B (NO LIMIT)	IR7	= 77B (NO LIMIT)
IR8	= 77B (NO LIMIT)		
M1	= 77B ( 1.000)	M2	= 74B ( 0.143)
M3	= 6B ( 0.006)	M4	= 77B ( 0.003)
AD	= 77B ( 0.000)		

CONTROLS FOR PROJECT NUMBER 69X37

CREATION DATE	77/10/27.	LAST CHANGE DATE	77/10/27.
LAST UPDATE DATE	78/04/03.	LAST UPDATE TIME	11.37.18.
ENTRY	*ACTIVE*	EXPIRATION DATE	UNDEFINED
TI	= 0000	TO	= 0000
ISV	= 77B (NO LIMIT)		
SML	= (NO LIMIT)	SMA	= 331
SIL	= (NO LIMIT)	SIA	= 331
LR1	= (NO LIMIT)	AR1	= 0
LR2	= (NO LIMIT)	AR2	= 0
LR3	= (NO LIMIT)	AR3	= 0
LR4	= (NO LIMIT)	AR4	= 0
LR5	= (NO LIMIT)	AR5	= 0
LR6	= (NO LIMIT)	AR6	= 0
LR7	= (NO LIMIT)	AR7	= 0
LR8	= (NO LIMIT)	AR8	= 0

CONTROLS FOR PROJECT NUMBER 693N155

CREATION DATE	76/09/23.	LAST CHANGE DATE	UNDEFINED
LAST UPDATE DATE	UNDEFINED	LAST UPDATE TIME	UNDEFINED
ENTRY	*ACTIVE*	EXPIRATION DATE	UNDEFINED
TI	= 0000	TO	= 0000
.			
.			
LR8	= (NO LIMIT)	AR8	= 0

CONTROLS FOR PROJECT NUMBER 693N156

CREATION DATE	76/09/23.	LAST CHANGE DATE	UNDEFINED
LAST UPDATE DATE	77/10/25.	LAST UPDATE TIME	10.54.31.
ENTRY	*ACTIVE*	EXPIRATION DATE	UNDEFINED
TI	= 0000	TO	= 0000
.			
.			
LR8	= (NO LIMIT)	AR8	= 0

Figure 5-6. Full File List (OP=L,LO=F)

PROFILB	CHARGE NUMBER LIST	OF FULL FILE.	PAGE
	CHARGE NUMBER	MASTER USER	
			1
			78/04/20. 15.39.49.
1.	0319	MANAGER	
2.	042A	MANAGER	
3.	0CF0	MANAGER	
4.	05QP	MANAGER	
5.	12YY	MANAGER	
6.	23HJ79	MANAGER	
7.	0560	MANAGER	
8.	0561	MANAGER	
9.	0580	MANAGER	
10.	0593	MANAGER	
11.	0594	MANAGER	
12.	0595	MANAGER	

Figure 5-7. Full File Charge Number List (OP=L,LO=C)

PROFILB	PROJECT NUMBER LIST	OF FULL FILE.	PAGE
	CHARGE NUMBER	MASTER USER	
			1
			78/04/20. 15.40.24.
1.	0319	MANAGER	
	VALIDATED PROJECT NUMBERS ARE-		
	69X37	693N155	
	693N156		
2.	0411	MANAGER	
	VALIDATED PROJECT NUMBERS ARE-		
	48334		
3.	042A	MANAGER	
	VALIDATED PROJECT NUMBERS ARE-		
	0007520		
4.	05QP	MANAGER	
	VALIDATED PROJECT NUMBERS ARE-		
	C07108	OB25802	
5.	12YY	MANAGER	
	VALIDATED PROJECT NUMBERS ARE-		
	5053P01		
6.	23HJ79	MANAGER	
	VALIDATED PROJECT NUMBERS ARE-		
	0E00356	0E00361	
	0E00377	05527520	
	5076M52		

Figure 5-8. Full File Project Number List (OP=L,LO=P)

## Analyst and Master User Identifications

<u>Identification</u>	<u>Description</u>
CV	<p>Redefines directives to process NOS 1.0 or 1.1 input or to build a source file with NOS 1.0/1.1 directives from NOS 1.2, 1.3, or 1.4 PROFILa. This parameter is meaningful with OP=C, R, U, T, and S.</p> <p>CV with OP=C or OP=U or OP=T Assumes format of input directives is NOS 1.0 or 1.1. Obsolete directives are ignored.</p> <p>CV with OP=S Assumes format of source directives to be generated is NOS 1.0 or 1.1. Generation of directives not pertinent to NOS 1.0 or 1.1 is suppressed.</p> <p>OP=C and OP=S can be used only from a system origin job.</p>
I=filenam	File that contains input data for a create (OP=C) and an update (OP=U); default is INPUT.
L=filenam	File to receive output listings; default is OUTPUT.
P=filenam	Project profile file; default is PROFILa.
OP=U	Updates the project profile file with directives supplied by the input file. U is the default option for a nonsystem origin job or a system origin job where at least one parameter is specified on the PROFILE control statement.
OP=T	Time-sharing update. Processing is the same as OP=U but preliminary instructions are suppressed at the terminal.
OP=I,CN=chargenum.	Charge number inquire. All project numbers valid for charge number CN are written to the output file; figure 5-9 is an example.
OP=I,CN=chargenum,PN=projectnum.	Project number inquire. The control values and all valid user numbers for project number projectnum are written to the output file; figure 5-10 is an example.
OP=L,LO=FM	Full list of everything accessible on the PROFILa file by the master user; a sample listing is given in figure 5-11.
OP=L,LO=CM	Charge number list of all charge numbers accessible on the PROFILa file by the master user; a sample listing is given in figure 5-12.
OP=L,LO=PM	Project number list of all project numbers accessible on the PROFILa file by the master user; a sample listing is given in figure 5-13.
OP=L	Default is LO=F when the list option is called from a system origin job. The default is LO=FM if the job is not system origin.

CONTROLS FOR CHARGE NUMBER 0319

CREATION DATE	78/01/03.	EXPIRATION DATE	UNDEFINED
ENTRY	*ACTIVE*	PROJECT COUNT	= 2
MU	= MANAGER	PCL	= (NO LIMIT)
ISL	= 77B (NO LIMIT)	IR1	= 77B (NO LIMIT)
IR2	= 77B (NO LIMIT)	IR3	= 77B (NO LIMIT)
IR4	= 77B (NO LIMIT)	IR5	= 77B (NO LIMIT)
IR6	= 77B (NO LIMIT)	IR7	= 77B (NO LIMIT)
IR8	= 77B (NO LIMIT)		

VALIDATED PROJECT NUMBERS ARE-  
MISCELLANEOUS 69X37

Figure 5-9. Charge number Only List (OP=I,CN=xxxx)

CONTROLS FOR PROJECT NUMBER MISCELLANEOUS

CREATION DATE	78/04/20.	LAST CHANGE DATE	78/04/20.
LAST UPDATE DATE	UNDEFINED	LAST UPDATE TIME	UNDEFINED
ENTRY	*ACTIVE*	EXPIRATION DATE	UNDEFINED
TI	= 0000	TO	= 0000
ISV	= 77B (NO LIMIT)		
SML	= (NO LIMIT)	SMA	= 0
SIL	= (NO LIMIT)	SIA	= 0
LR1	= (NO LIMIT)	AR1	= 0
LR2	= (NO LIMIT)	AR2	= 0
LR3	= (NO LIMIT)	AR3	= 0
LR4	= (NO LIMIT)	AR4	= 0
LR5	= (NO LIMIT)	AR5	= 0
LR6	= (NO LIMIT)	AR6	= 0
LR7	= (NO LIMIT)	AR7	= 0
LR8	= (NO LIMIT)	AR8	= 0

USER NUMBERS VALID TO USE MISCELLANEOUS  
EJHA022 FARKUL NOTSLAR LAEMTAO

Figure 5-10. Project Number List (OP=I,CN=xxxx,PN=PROJ02)



1. 0319

CONTROLS FOR CHARGE NUMBER 0319

CREATION DATE	78/01/03.	EXPIRATION DATE	UNDEFINED
ENTRY	*ACTIVE*	PROJECT COUNT	= 2
MU	= MANAGER	PCL	= (NO LIMIT)
ISL	= 77B (NO LIMIT)	IR1	= 77B (NO LIMIT)
IR2	= 77B (NO LIMIT)	IR3	= 77B (NO LIMIT)
IR4	= 77B (NO LIMIT)	IR5	= 77B (NO LIMIT)
IR6	= 77B (NO LIMIT)	IR7	= 77B (NO LIMIT)
IR8	= 77B (NO LIMIT)		

CONTROLS FOR PROJECT NUMBER MISCELLANEOUS

CREATION DATE	78/04/20.	LAST CHANGE DATE	78/04/20.
LAST UPDATE DATE	UNDEFINED	LAST UPDATE TIME	UNDEFINED
ENTRY	*ACTIVE*	EXPIRATION DATE	UNDEFINED
TI	= 0000	TO	= 0000
ISV	= 77B (NO LIMIT)	SMA	= 0
SML	= (NO LIMIT)	SIA	= 0
SIL	= (NO LIMIT)	AR1	= 0
LR1	= (NO LIMIT)	AR2	= 0
LR2	= (NO LIMIT)	AR3	= 0
LR3	= (NO LIMIT)	AR4	= 0
LR4	= (NO LIMIT)	AR5	= 0
LR5	= (NO LIMIT)	AR6	= 0
LR6	= (NO LIMIT)	AR7	= 0
LR7	= (NO LIMIT)	AR8	= 0
LR8	= (NO LIMIT)		

USER NUMBERS VALID TO USE MISCELLANEOUS  
 EJHA022 FARKUL NOTSLAR LAEMTAO

CONTROLS FOR PROJECT NUMBER 69X37

CREATION DATE	78/01/03.	LAST CHANGE DATE	78/03/20.
LAST UPDATE DATE	78/04/20.	LAST UPDATE TIME	13.52.32.
ENTRY	*ACTIVE*	EXPIRATION DATE	UNDEFINED
TI	= 0000	TO	= 0000
ISV	= 77B (NO LIMIT)	SMA	= 31370
SML	= (NO LIMIT)	SIA	= 31370
SIL	= (NO LIMIT)	AR1	= 0
LR1	= (NO LIMIT)	AR2	= 0
LR2	= (NO LIMIT)	AR3	= 0
LR3	= (NO LIMIT)	AR4	= 0
LR4	= (NO LIMIT)	AR5	= 0
LR5	= (NO LIMIT)	AR6	= 0
LR6	= (NO LIMIT)	AR7	= 0
LR7	= (NO LIMIT)	AR8	= 0
LR8	= (NO LIMIT)		

USER NUMBERS VALID TO USE 69X37  
 STUDENT BLONDIE TONTO INSTALL DAVINCI  
 EJHA022 FARKUL NOTSLAR LAEMTAO

Figure 5-11. Master User Full File List (OP=L,LO=FM)

PROFILB	CHARGE NUMBER LIST	OF MASTER USER	MANAGER	PAGE	1
	CHARGE NUMBER		78/04/20.	14.03.42.	
1.	0319				
2.	042A				
3.	0CF0				
4.	05QP				
5.	12YY				
6.	23HJ79				

Figure 5-12. Master Charge Number List (OP=L,LO=CM)

PROFILB	PROJECT NUMBER LIST	OF MASTER USER	MANAGER	PAGE	1
	CHARGE NUMBER		78/04/20.	14.04.26.	
1.	0319				
	VALIDATED PROJECT NUMBERS ARE-				
	MISCELLANEOUS				69X37

Figure 5-13. Master User Project Number List (OP=L, LO=PM)

## INPUT DIRECTIVES

Directives are available as input to PROFILE to add or update information concerning each charge number. The input stream for a PROFILE create (OP=C) or update (OP=U) is divided into two types of entries, charge number entries and directives.

A charge number entry must begin with a / in column 1 or with the CN= or ACN= directive. The 1 to 10 characters following the / or directive are the charge number name. This name is terminated by a separator. Separators consist of all special characters (except /, +, -, \*, and :), end-of-line, and end-of-card. Additional directives may immediately follow the separator.

The directives associated with a particular charge number must follow the charge number entry. All directives following a charge number entry apply to that charge number until another charge number entry occurs. A particular charge number can appear only once in an input stream on a create run.

The directives applying to a particular charge number are further divided into master user and SRU multipliers, project number, and associated project number entries. The project number entry contains the data identifiers that establish the control values for this project and the list of user numbers that may access this project. The occurrence of duplicate project numbers under the same charge number entry is not allowed on a create run.

Figure 5-14 illustrates a typical input stream.

All directives following a charge number entry are in free format to column 72. Directives cannot be split between cards or lines. Blanks are ignored.

The format of a directive is:

ident=data

ident            A two- or three-character designation of the limiting parameter.

data            Value applied to the project under which this directive appears.

The following directives are available for PROFILE input.

<u>Identifier</u>	<u>Description</u>
MU	Master user number which has the ability to update, inquire, and make listings for the projects entered under the same charge number as this master user.  This master user number must be specified on the USER statement for batch input (refer to PROFILE Batch Input) or when logging in (for time-sharing, refer to PROFILE Execution From A Terminal) in order for the master user to exercise the project-oriented privileges specified.  The master user number is one- to seven-alphanumeric characters.  There can be only one master user per charge number.

```

Charge Number - - - - - /CHNUMBER01
  {
    Master User - - - MU=USEAAA
    Project Number -- PN=PROJECTNUMBER001
      {
        Project Number Entry {
          TI=1200
          TO=1700
          AUN=USERA11
          AUN=USERA12
        }
      }
    Project Number -- PN=PROJECTNUMBER002
      {
        Project Number Entry {
          TI=0800
          TO=1200
          AUN=USERA21
          AUN=USERA22
          AUN=USERA23
        }
      }
  }
Charge Number - - - - - CN=CHNUMBER02
  {
    Master User - - - MU=USERBBB
    Project Number -- PN=PROJECTNUMBER011
      {
        Project Number Entry {
          TI=0000
          TO=0800
          AUN=USERB11
          AUN=USERB12
        }
      }
  }

```

Figure 5-14. Typical Input Stream for Use with PROFILE

<u>Identifier</u>	<u>Description</u>
M1	Index for the SRU multiplier to weight calculated system resources used against those not directly measurable for this charge number. This may be one or two numeric digits. A radix may follow to indicate decimal (D) or octal (B). If the radix is omitted, decimal is assumed. The maximum and default value of 77g gives system default. M1 can only be set from a system origin job. (Refer to Multiplier Index Values and Actual Multiplier Values for more information on the usage of this parameter.)
M2	Index for the SRU multiplier to weight input/output usage for this charge number. This may be one or two numeric digits. A radix may follow to indicate decimal (D) or octal (B). If the radix is omitted, decimal is assumed. The maximum and default value of 77g gives system default. M2 can only be set from a system origin job. (Refer to Multiplier Index Values and Actual Multiplier Values for more information on the usage of this parameter.)
M3	Index for the SRU multiplier to weight central memory field length usage for this charge number. This may be one or two numeric digits. A radix may follow to indicate decimal (D) or octal (B). If the radix is omitted, decimal is assumed. The maximum and default value of 77g gives system default. M3 can only be set from a system origin job. (Refer to Multiplier Index Values and Actual Multiplier Values for more information on the usage of this parameter.)
M4	Index for the SRU multiplier to weight extended core field length usage for this charge number. This may be one or two numeric digits. A radix may follow to indicate decimal (D) or octal (B). If the radix is omitted, decimal is assumed. The maximum and default value of 77g gives system default. M4 can only be set from a system origin job. (Refer to Multiplier Index Values and Actual Multiplier Values for more information on the usage of this parameter.)
AD	Index for the SRU constant used to charge for resources not directly measurable by the system for this charge number. This may be one or two numeric digits. A radix may follow to indicate decimal (D) or octal (B). If the radix is omitted, decimal is assumed. The maximum and default value of 77g gives system default. AD can only be set from a system origin job. (Refer to Multiplier Index Values and Actual Multiplier Values for more information on the usage of this parameter.)
PN	Project number. This is a 1- to 20-character alphanumeric designation of a particular customer activity. The specified project number must exist and be active unless OP=C or CV is also specified; this identifier would then be interpreted as APN. This entry can be specified by a master user.

<u>Identifier</u>	<u>Description</u>
AUN	<p>Add user number. A one- to seven-alphanumeric identification of the individual or individuals who will have access to the project or projects under which this user number is entered. It is also the identification used by VALIDUs to establish system access (MODVAL Validation File Manager). Under NOS, all files are cataloged by user number (section 1).</p> <p>A maximum of 4095 user numbers can be validated for a single charge and project number.</p> <p>If no user numbers are specified for a project, then all user numbers are allowed to use it. This entry can be specified by a master user.</p>
DUN	Delete user number. Deletes the user number from the list of those who may access the project number. This entry can be specified by a master user.
TI	Time of day before which the validated user cannot use this project number. This is expressed in four-digit military time notation. A radix may follow to indicate decimal (D) or octal (B). If the radix is omitted, decimal is assumed. Maximum value is 2400. This entry can be specified by a master user.
TO	Time of day after which the validated user cannot use this project number. This is expressed in four-digit military time notation. A radix may follow to indicate decimal (D) or octal (B). If the radix is omitted, decimal is assumed. Maximum value is 2400; however, TI=TO implies no restriction. This entry can be specified by a master user.
LRn	Installation limit register n, where n = 1,2,...,8. For each n, LRn specifies the maximum number of resource units (as defined by the installation) the project can use. However, a value of zero implies no restriction.
ARn†	For installation accumulator n, where n = 1,2,...,8. For each n, ARn specifies the current number of resource units the project has used. When ARn surpasses LRn, the project is not available to users until either the limit or accumulator is respecified.
DCN	Deactivate charge number. This directive does not destroy the specified charge number entry but sets its status such that the entry and all project entries under it are not available to users. PROFILE reformat runs purge all deactivated entries. This entry is not legal when OP=C is specified.
DPN	Deactivate project number. This directive does not destroy the specified project number entry but sets its status such that the entry is not available to users. PROFILE reformat runs purge all deactivated entries. This entry is not legal when OP=C is specified. This entry can be specified by a master user.

---

† The system does not update these fields. Each installation must provide this capability, if desired.

<u>Identifier</u>	<u>Description</u>
CN	Charge number. This is a 1- to 10-character alphanumeric designation. This directive performs the same function as the /. The specified charge number must exist and be active unless OP=C or CV is also specified; the identifier would then be interpreted as ACN. This entry can be specified by a master user.
ACN	Add or activate charge number. A charge number is created if it does not already exist or is activated if it is inactive. However, the charge number must not exist when OP=C is specified.
APN	Add or activate project number. A project number is created if it does not already exist or is activated if it is inactive. However, the project number must not exist when OP=C is specified. This entry can be specified by a master user.
PCL	Project count limit. Maximum number of projects allowed under this charge number.
CEX	Charge number expiration date. When the current date surpasses the expiration date, the charge number entry and all project entries under it are not available to users. However, a value of zero implies no restriction.
ISL	Index for default value of the SRU installation limit register.
IRn	Index for default value of installation limit register n, where n = 1,2,...,8.
PEX	Project number expiration date expressed as yymmdd. When the current date surpasses the expiration date, the project number is not available to users. However, a value of zero implies no restriction. This entry can be specified by a master user.
ISV	Index for SRU validation limit. It indicates the maximum SRU accumulation for any job using this charge/project number. This entry can be specified by a master user.
SML	SRU master user limit register. This value specifies the maximum number of accumulated SRUs the project may use as controlled by the master user. However, a value of zero implies no restriction. This entry can be specified by a master user.
SMA	SRU master user accumulator. This value specifies the current number of accumulated SRUs the project has used. This accumulator is updated at the end of a job or terminal session and/or when a second or subsequent CHARGE statement is issued. When the SMA value surpasses the SML value, the project is not available to users until either the limit or accumulator is respecified. This entry can be specified by a master user.

<u>Identifier</u>	<u>Description</u>
SIL	SRU installation limit register. This value specifies the maximum number of accumulated SRUs the project may use as controlled by the installation. However, a value of zero implies no restriction.
SIA	SRU installation accumulator. This value specifies the current number of accumulated SRUs the project has used. This accumulator is updated at the end of a job or terminal session and/or when a second or subsequent CHARGE statement is issued. When the SIA value surpasses the SIL value, the project is not available to users until either the limit or accumulator is respecified.

### PROFILE CONSOLE INPUT

A PROFILA file can only be created by calling PROFILE from the console (system origin job). Likewise, an existing PROFILA file can be restructured, returned to source, or read to an output file as a full-file listing only from the console. The remaining operations (update, inquire, and master user listings) can be executed from console, batch (PROFILE Batch Input), or a terminal (PROFILE Execution from a Terminal).

A new PROFILA file can be created via the console by means of the DIS display. A preestablished input file of control values is called and the PROFILE command with OP=C is entered. The following example, given an input file (INPUT) with control values for structuring a new PROFILA file, is a create run from the console.

```
X.DIS.
SUI(377777)
GET(INPUT)
PROFILE(OP=C)
```

The K display can be used only for an update. With the K option, directives are entered directly via the console instead of from an input file. If directives are entered for an existing charge and project number, the control values are changed according to the directive.

The K display is called with:

```
X.PROFILE.
```

The B display will indicate the control point to which PROFILE is located. A flashing message on that line will be:

```
REQUEST K DISPLAY
```

The analyst types

```
K,n.
```



where n is the control point number for PROFILE. This brings the K display for PROFILEa to the left screen (figure 5-15). The analyst is now ready to create or update. The following example illustrates an update input stream to follow the above.

```
K./CHARGNUM1      (The / is used when PROFILE is updating an existing charge number.)
K.MU=MUSE1
K.END
K./CHARJNUM2
K.MU=MUSE2
K.END
K.STOP
```

#### PROFILE BATCH INPUT

A master user can initiate an update, inquire, or listing of the projects under his charge number via card reader input. The following is an example of a batch update in which master user MASTR1 adds a time-in (TI) and a time-out (TO) to one of his projects (PROJ2).

```
JOBUPDA.
USER(MASTR1)
PROFILE(OP=U)
7/8/9
/CHARJNUM1
PN=PROJ2
TI=1400
TO=1800
6/7/8/9
```

#### PROFILE EXECUTION FROM A TERMINAL

A master user can initiate an update, inquire, or listing of the projects under his charge number from a time-sharing terminal. To do this he must have his master user status validated at login. After this validation is affirmed, the master user must enter the batch subsystem or use the IAF X command in order to use the PROFILE control statement.

PROFILB  
CREATED 76/09/23. LAST MOD 78/02/01.

END - UPDATE PROFILE FILE AND TERMINATE CURRENT CHARGE.  
DROP - DROP DIRECTIVES ENTERED SINCE CHARGE OR PROJECT.  
STOP - END PROCESSING.  
/ OR CN= CHARGE NUMBER, ACTIVE CHARGE MUST EXIST.  
ACN= ADD OR ACTIVATE CHARGE. DCN= DEACTIVATE CHARGE.  
PN= PROJECT NUMBER, ACTIVE PROJECT MUST EXIST.  
APN= ADD OR ACTIVATE PROJECT. DPN= DEACTIVATE PROJECT.

CHARGE NUMBER 1230

CREATION DATE	76/09/23.	EXPIRATION DATE	UNDEFINED
ENTRY *ACTIVE*		PROJECT COUNT	=3
MU = MANAGER		PCL = (NO LIMIT)	
M1 = 77B	( 1.000)	M2 = 74B	( 0.143)
M3 = 6B	( 0.006)	M4 = 77B	( 0.003)
AD = 77B	( 0.000)	ISL = 77B	(NO LIMIT)
IR1 = 77B	(NO LIMIT)	IR2 = 77B	(NO LIMIT)
IR3 = 77B	(NO LIMIT)	IR4 = 77B	(NO LIMIT)
IR5 = 77B	(NO LIMIT)	IR6 = 77B	(NO LIMIT)
IR7 = 77B	(NO LIMIT)	IR8 = 77B	(NO LIMIT)

PROJECT NUMBER 23A69

CREATION DATE	77/10/27.	LAST CHANGE DATE	77/10/27.
LAST UPDATE DATE	78/03/31.	LAST UPDATE TIME	13.17.23.
ENTRY *ACTIVE*		EXPIRATION DATE	UNDEFINED
TI = 0000		TO = 0000	
ISV = 77B	(NO LIMIT)		
SML = (NO LIMIT)		SMA = 330	
SIL = (NO LIMIT)		SIA = 330	
LR1 = (NO LIMIT)		AR1 = 0	
LR2 = (NO LIMIT)		AR2 = 0	
LR3 = (NO LIMIT)		AR3 = 0	
LR4 = (NO LIMIT)		AR4 = 0	
LR5 = (NO LIMIT)		AR5 = 0	
LR6 = (NO LIMIT)		AR6 = 0	
LR7 = (NO LIMIT)		AR7 = 0	
LR8 = (NO LIMIT)		AR8 = 0	

Figure 5-15. PROFILa K Display (Left Screen Only)

## Update from a Terminal

The time-sharing master user can initiate an update by issuing the command PROFILE (OP=U). Once initiated, the system prints the following block of information at the terminal.

THE FOLLOWING ARE VALID INPUT DIRECTIVES FOR  
UPDATE-

CN OR / - CHARGE NUMBER.  
PN - PROJECT NUMBER.  
APN - ADD OR ACTIVATE PROJECT NUMBER.  
DPN - DEACTIVATE PROJECT NUMBER.  
PEX - PROJECT NUMBER EXPIRATION DATE.  
TI - TIME IN.  
TO - TIME OFF.  
ISV - SRU VALIDATION LIMIT INDEX.  
SML - SRU MASTER USER LIMIT.  
SMA - SRU MASTER USER ACCUMULATOR.  
AUN - ADD USER NUMBER.  
DUN - DELETE USER NUMBER.  
ACN - ADD OR ACTIVATE CHARGE NUMBER.  
DCN - DEACTIVATE CHARGE NUMBER.  
MU - MASTER USER NUMBER.  
PCL - PROJECT COUNT LIMIT.  
M1 - M4 - SRU MULTIPLIER INDICES.  
AD - SRU CONSTANT INDEX.  
CEX - CHARGE NUMBER EXPIRATION DATE.  
ISL - INSTALLATION SRU LIMIT INDEX.  
IR1 - IR8 - INSTALLATION LIMIT INDICES.  
SIL - SRU INSTALLATION LIMIT.  
SIA - SRU INSTALLATION ACCUMULATOR.  
LR1 - LR8 - INSTALLATION LIMIT REGISTERS.  
AR1 - AR8 - INSTALLATION ACCUMULATORS.  
A NULL LINE COMPLETES DIRECTIVE INPUT PROCESSING.

} Only for users with  
special accounting.  
privileges.

This informative printout can be suppressed by using the control statement option OP=T instead of OP=U. In all other regards, the operation of T is identical to U.

If charge and project numbers are required, the example would run as follows:

```
/ENTER DIRECTIVES  
?/CHARJ1  
? PN=PROJ2  
? TI=0800  
? TO=1200  
? Ⓜ  
PROFILa UPDATED.  
/
```

### **Inquire from a Terminal**

The master user can request information on his current charge number and its project numbers by means of an inquire from a terminal. To do this, the master user issues the command

```
PROFILE(OP=I,CN=chargenum,PN=projectnum)
```

where chargenum is his charge number and projectnum is the particular project for which he wants information.

If the charge number has not been supplied, PROFILE outputs

```
ENTER CHARGE NUMBER
```

when it processes the command. The user must type in the appropriate charge number. If a null line is entered, it is treated as end-of-file (end processing).

After output of the desired information or if a charge number has not been supplied in the PROFILE control statement, PROFILE issues

```
ENTER CHARGE NUMBER
```

to the terminal and waits for the user to enter the desired charge number. If a null line is entered, it is treated as end-of-file (end processing).

If a project number has not been entered on the control statement or if a charge number has just been supplied in response to ENTER CHARGE NUMBER, PROFILE issues

```
ENTER PROJECT NUMBER
```

to the terminal and waits for the user to enter the desired project number. If a null line is entered, output consists of a list of valid project numbers under this charge number, and PROFILE again responds

```
ENTER PROJECT NUMBER
```

If a project number is entered, output consists of a list of the controls for and valid users of this project number. PROFILE again responds

```
ENTER PROJECT NUMBER
```

until a null line is entered to indicate end of processing for the current charge number.

### **List from a Terminal**

The master user can request an FM, CM, or PM listing from a terminal (refer to PROFILA Project PROFILE Manager). Sample listings are given in figures 5-11, 5-12, and 5-13.

As with an update and an inquire, the master user must enter the BATCH subsystem or use the time-sharing X command to use this option.

## CHARGE CONTROL STATEMENT

The system routine CHARGE provides validation of a user's charge and project number for access to define segments of his resources within the system. A call to CHARGE will be required for either a master user or a project-level user if bit 7 (AW=CCNR) in his access word is not set (MODVAL Validation File Manager section). Operation of the CHARGE routine is flowcharted in figure 5-16.

If validation fails, the job is aborted and the appropriate error message is issued to the dayfile. If the user is at a terminal, the message is returned to the terminal.

If validation is successful, the following events occur.

- Accounting information is written to the accounting dayfile (refer to Account Dayfile Messages for message formats).
- The accounting parameters associated with the user's charge-project number are inserted into the accounting formula (refer to the SRU Formula). They are used in calculating the billing unit until the end of job/session or until another charge-project number is entered.
- The SRU accumulator is set to zero. The CP, MS, MT, and PF accumulators are not altered in any way. If the minimum charge installation option has been selected and if the accumulated SRUs are less than the minimum charge amount, the minimum charge value is entered into the account dayfile (the Resource Accounting section describes the parameters and the minimum charge installation option).

The following is the ordered list of the account dayfile and user's dayfile messages issued whenever a new charge number is entered. These messages are not issued, however, as a result of a required CHARGE statement that immediately follows an initial USER statement.

yy.mm.dd.	hh.mm.ss.jobnameo.	UDCO, xxxxxx.xxxKCHS. (Telex users only)
yy.mm.dd.	hh.mm.ss.jobnameo.	UDCI, xxxxxx.xxxKCHS. (Telex users only)
yy.mm.dd.	hh.mm.ss.jobnameo.	UDCP, xxxxxx.xxxSECS.
yy.mm.dd.	hh.mm.ss.jobnameo.	UDMS, xxxxxx.xxxKUNS.
yy.mm.dd.	hh.mm.ss.jobnameo.	UDMT, xxxxxx.xxxKUNS.
yy.mm.dd.	hh.mm.ss.jobnameo.	UDPF, xxxxxx.xxxKUNS.
yy.mm.dd.	hh.mm.ss.jobnameo.	UDAD, xxxxxx.xxxUNTS.
yy.mm.dd.	hh.mm.ss.jobnameo.	ACSR, xxxxxx.xxxUNTS.
yy.mm.dd.	hh.mm.ss.jobnameo.	ACCN, chargenum,projectnum. (Account dayfile only)

Account dayfile messages are described in detail later in this section.

The CHARGE routine is called from a terminal as a response to entering the CHARGE command or control statement after successfully logging in to IAF or the Time-Sharing Module.

The CHARGE routine is called from a batch job by the appearance of the CHARGE control statement after a user statement.

The format of the CHARGE control statement is:

CHARGE(chargenum,projectnum)

chargenum	Charge number (1 to 10 alphanumeric characters).
projectnum	Project number (1 to 20 alphanumeric characters).

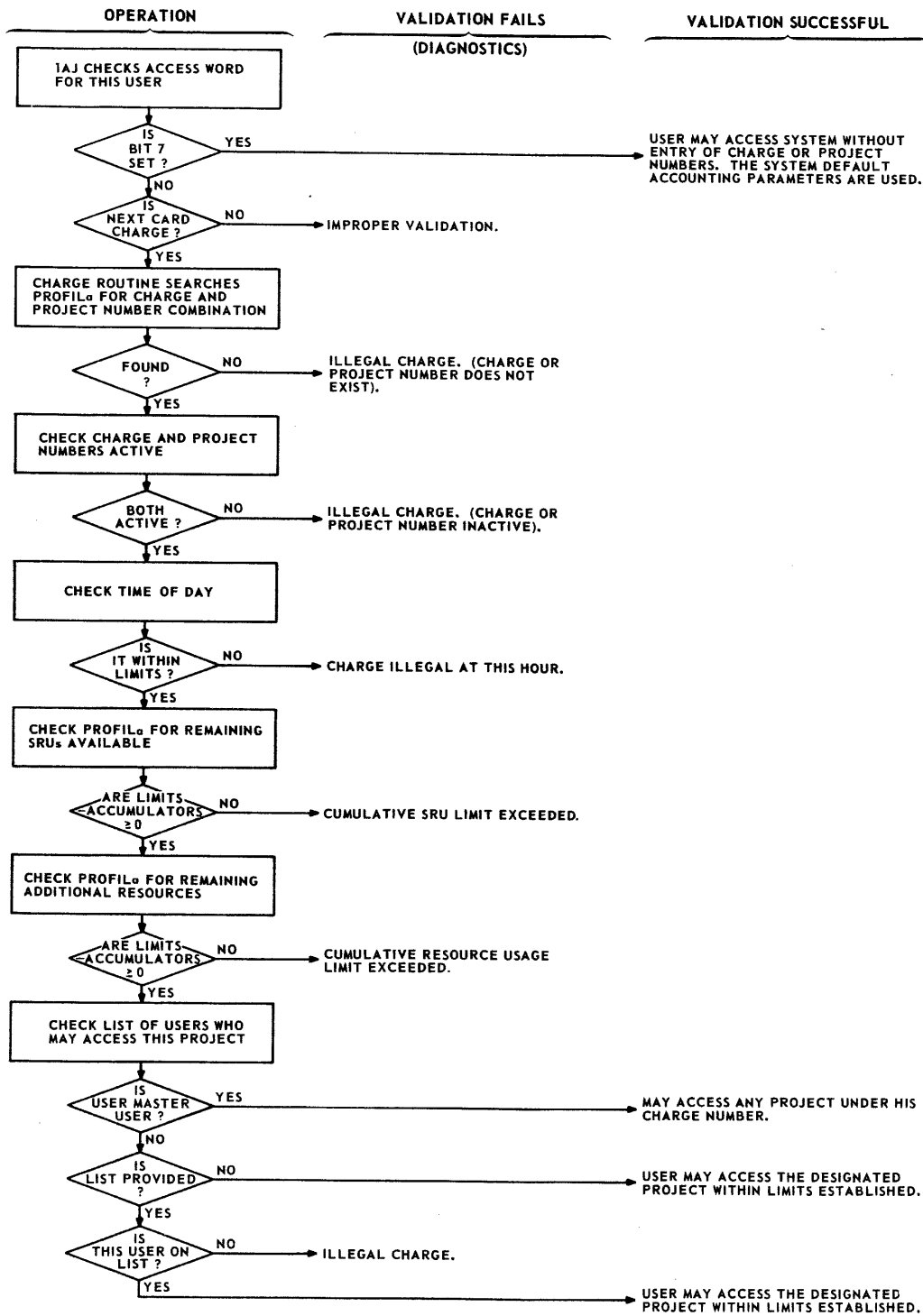

Figure 5-16. CHARGE Routine

## Batch Usage of CHARGE

When a batch job is submitted, the second statement is the user statement which gives the user number used in validating a user for system access. Associated with this number is the access word which determines whether or not this user must supply charge and project numbers. If validation control indicates that these are required, the statement following the user statement must be a CHARGE statement with acceptable charge and project numbers. If additional projects and/or charges are referenced in the job, these references must be accomplished by use of another CHARGE statement. If additional user statements (new users) appear in the input, each one that identifies a user requiring job profile validation must be followed by a CHARGE statement with the requisite charge and project numbers.

## CHARGE Application at a Terminal

When any user logs in at a terminal, the access word associated with his user number is checked to see if he is required to enter a charge number and a project number. If not, the teletype will print out at login:

```
TERMINAL      nnnn,type
RECOVER/SYSTEM:
```

The user then types in the subsystem he wishes to use and proceeds with access to resources as defined by his user number.

If charge and project are required, the terminal will print out at login:

```
TERMINAL      nnnn,type
RECOVER/CHARGE:
```

This user will not be allowed to enter any commands (except CHARGE, LOGIN, HELLO, RECOVER, GOODBYE, and BYE) until he enters valid charge and project numbers. He will then be allowed access to that particular project under that particular charge under whatever restrictions are currently in force for that project.

If later, while still logged in, this user wishes to access another project (under this charge or another) for which he is validated, he enters the CHARGE control statement with the appropriate charge and project numbers.

## USER NUMBERS AND CHARGE NUMBERS

System access (remote/local) privileges are given to a user through the assignment of a user number and a password. Once a system access is attained, all billable activity is associated with a charge number. The system provides the central site with the flexibility of equating a charge number to a user number or maintaining them as separate entities. This flexibility is attained through the use of the CHARGE required flag (CCNR bit in the VALIDUs† access word) and the availability of a charge number in the PROFILa† file. Table 5-3 indicates the combinations possible and the effective billing number.

---

† In this manual, the user validation and accounting files are referred to as VALIDUs, VALINDs, and PROFILa. Refer to table 5-1 for a list of file names that correspond to the appropriate operating system levels.

TABLE 5-3. EFFECTIVE BILLING NUMBER

	Charge Number Required	Charge Number Not Required
No PROFILA Entry	This option is not possible since a charge number is required.	The user number is used as the billing number.
PROFILA Entry Available	The resources used during job/session initialization (login and user validation) are accumulated and thus billed under the required charge number.	The user number is used as the billing number until such time that the user decides to enter the charge number.

## RESOURCE ACCOUNTING

The basic accounting unit for NOS is the system resource unit (SRU). The SRU is a measurement of the resources used by a job or a terminal session. The SRU algorithm combines measurements of the following resources into a single unit.

- Central memory field length
- ECS field length
- CPU time
- Mass storage usage
- Magnetic tape usage
- Permanent file usage

The SRU calculation is dynamic; that is, each time additional amounts of the above resources are utilized by the job or session, the SRU value is updated. The following sections describe the algorithm for calculating SRU values and a detailed description of SRU components.

### SRU FORMULA

The following formula is used by the system for SRU computation.

$$SRU = M1(CP + M2 \times IO + M3(CP + IO)CM + M4(CP + IO)EC) + AD$$

<u>Parameter</u>	<u>Description</u>
CP	Central processor unit usage expressed in milliunits. The value of this parameter is determined by the following formula.
$CP = S0 \times CP0 + S1 \times CP1$	
CP0	Time accumulated on CPU 0 in milliseconds.
CP1	Time accumulated on CPU 1 in milliseconds.
S0,S1	Multipliers used to normalize CPU time when the system is running on a dual CPU machine.



<u>Parameter</u>	<u>Description</u>
IO	A measure of the accumulated input/output system activity for a user. This parameter, expressed in milliumits, is defined by the following formula.  $IO = S2 \times MS + S3 \times MT + S4 \times PF$
	MS            Mass storage activity accumulator. The components of this parameter are described in detail in the IO Increments section.
	MT            Magnetic tape activity accumulator. The components of this parameter are described in detail in the IO Increments section.
	PF            Permanent file activity accumulator. The components of this parameter are described in detail in the IO Increments section.
	S2,S3,S4      Multipliers used to weight MS, MT, and PF activity against one another.
CM	Central memory field length expressed in words/1000g.
EC	ECS field length expressed in words/1000g.
M1	Multiplier used to scale the overall SRU value.
M2	Multiplier used to weight the I/O activity against CPU time, CM field length, and ECS field length usage.
M3	Multipliers used to weight CM field length, CPU time, and I/O activity.
M4	Multiplier used to weight ECS field length, CPU time, and I/O activity.
AD	Incremental adder which is applied to the SRU value during accounting initialization.

The multipliers S0 through S4, as well as the default values for units of MS, MT, and PF, are installation options which do not change during system execution. The multipliers M1 through M4 and the adder AD are also installation options, but they may change once system activity has begun. The default values for M1 through M4 and AD are set during job or session initialization. When a charge number is entered, different values for M1 through M4 and AD may be specified for use in the SRU calculation (refer to PROFILE Console Input). These parameters are retained in PROFILa and provide the central site with the flexibility of varying the billing unit for selected users.

## SRU PARAMETERS

The common deck COMSSRU contains the definitions for the SRU multipliers and associated parameters. The absolute ranges for these values are also defined. To obtain a listing of COMSSRU, assemble CALLSYS; the default values are shown. To change any default values, modifications must be made in COMSSRU.

The following paragraphs describe the SRU parameters and list the absolute ranges and default values. The COMSSRU name is listed along with the default value for each parameter. When a site sets SRU parameter default values, these values must lie within the absolute range for each parameter.

### S0 and S1

The values used for S0 and S1 are selected by the system at deadstart time from a list of multipliers defined for each type of CPU detectable by NOS. S0 is the primary multiplier and is used for all single CPU machines. For dual CPU machines, S0 is used for the first CPU (CPU 0) and S1 is used for calculations involving the second CPU (CPU 1). For example, if a site is running a 6700, S0 is assigned the value defined for a 6600 CPU and S1 is assigned the value defined for a 6400 CPU. This allows a site with several systems to use different multipliers for different CPUs while using only one deadstart tape.

It is possible for a site to transform this selection at deadstart by the use of the IPRDECK entry CPM. Use of this entry allows the site to select any multiplier from the list in COMSSRU, which follows, to be used instead of the normally selected value. One advantage of this entry is that an installation may charge differently for the use of a 6200 CPU or a 6400 CPU although the software cannot normally detect the difference.

<u>COMSSRU Name</u>	<u>Default Value</u>	<u>Description</u>
CP62	1.0	6400/CYBER 72 CPU
CP64	1.0	6400/CYBER 73 CPU
CP66	1.0	6600/CYBER 74 CPU
CP71	1.0	CYBER 71 CPU
C171	1.0	CYBER 171 CPU
C172	1.0	CYBER 172 CPU
C173	1.0	CYBER 173 CPU
C175	1.0	CYBER 175 CPU
C176	1.0	CYBER 176 CPU
ICM1	2.0	} Installation selected CPU multiplier values
ICM2	3.0	
ICM3	4.0	
ICM4	5.0	

Absolute range: 0.1 to 50.0

### S2, S3, and S4

These multipliers are used in the calculation of the IO parameter. In addition to providing weighting factors, these multipliers also convert units of resource usage (MS, MT, or PF) to milliunits of IO. For example, if the default value for S2 is used, 300 units of MS usage result in 300 milliunits of IO.

<u>COMSSRU Name</u>	<u>Default Value (Milliunits)</u>	<u>Description</u>
S2SR	1.0	MS multiplier (S2)
S3SR	1.0	MT multiplier (S3)
S4SR	1.0	PF multiplier (S4)

Absolute range: 0.1 to 50.0

### M1

This multiplier is used as a scaling factor to increase or decrease the overall SRU value. This value may be changed from the system default for each charge number when this charge number is entered (refer to PROFILE Console Input and Multiplier Index Values and Actual Multiplier Values for further information).

<u>COMSSRU Name</u>	<u>Default Value</u>	<u>Description</u>
M1SR	1.0	M1 multiplier

Absolute range: 0.1 to 25.5

### M2, M3, and M4

These multipliers provide weighting of the various terms in the SRU calculation. These values may be changed from the system default values for each charge number when this charge number is entered (refer to PROFILE Console Input and Multiplier Index Values and Actual Multiplier Values for further information).

<u>COMSSRU Name</u>	<u>Default Value</u>	<u>Description</u>
M2SR	0.100	M2 multiplier
M3SR	0.003	M3 multiplier
M4SR	0.0	M4 multiplier

Absolute range: 0.001 to 1.023

### AD

The value assigned to this parameter is applied to the SRU value during accounting initialization of a job or session. It thus serves as an overhead increment. This value may be changed from the system default for each charge number when this charge number is entered (refer to PROFILE Console Input and Multiplier Index Values and Actual Multiplier Values for further information).

<u>COMSSRU Name</u>	<u>Default Value</u>	<u>Description</u>
ADSR	0	Incremental adder (AD)

Absolute range: 1 to 1000

In addition to the parameters which make up the SRU formula, the following values are also defined in COMSSRU.

### Minimum Display Value

This parameter defines the minimum value to be displayed at the end of each time-sharing job step. If the accumulated SRUs are less than this value, they are not displayed.

<u>COMSSRU Name</u>	<u>Default Value</u>	<u>Description</u>
MDSR	0.100	Minimum display value

Absolute range: 0.001 to 1.000

### Minimum Change Value

This parameter defines the minimum SRU value to be applied against a charge number. If accumulated SRUs are less than this value, then a charge equal to this value is applied.

<u>COMSSRU Name</u>	<u>Default Value</u>	<u>Description</u>
MCSR	1.000	Minimum charge value

Absolute range: 0.001 to 10.000

## IO INCREMENTS

The IO parameter in the SRU formula is a measure of the accumulated input/output system activity for a user. It accounts for MS activity, MT activity, and PF activity. This parameter is controlled by central site defined increments. These increments are assigned to various functions performed by the system. These functions include data transfer as well as other operations such as file positioning.

This section describes the increment of MS, MT, and PF which make up the measurable portion of the IO parameter. The common deck COMSSRU contains the definitions, default values, and absolute ranges for these increments. To obtain a listing of COMSSRU, assemble CALLSYS. If a site wants to change any of the default increments, modifications must be made in COMSSRU. This section lists the IO increments with COMSSRU names, default values, and absolute ranges.

### MS Increments

The formula for calculating the MS increment is

$$\text{MS increment} = \text{operation charge} + \text{penalty} + (\text{PRUs transferred} \times 2^{\text{IMRW}})$$

The following increments are for each operation or for each PRU processed.

<u>COMSSRU Name</u>	<u>Default Increment</u>	<u>MS Activity</u>
IMRL	3	Read-with-list
IMPO	2	Position
IMCO	1	Close or open
IMRS	1	Rewind or skip to EOI
IMLL	1	Library load

The increments assigned for CIO read and write operations are defined by the following:

$$\text{number of increments} = (\text{number of PRUs}) \times (2^{\text{IMRW}})$$

<u>COMSSRU Name</u>	<u>Default Value</u>	<u>MS Activity</u>
IMRW	2	CIO read or write. Using the IMRW default value of 2, four increments per PRU are charged for CIO read or write.

If the number of PRUs read in one CIO operation falls within the following ranges, an additional charge is made. This charge serves as a penalty for an inefficient IO transfer.

<u>COMSSRU Name</u>	<u>Default Additional Charge Increment</u>	<u>Range</u>
IMSA	4	0 through 3 PRUs
IMSB	2	4 through 7 PRUs
IMSC	0	8 through infinite PRUs

Absolute range for MS increments: 0 to 63

The following describes the increments charged for positioning.

<u>COMSSRU Name</u>	<u>Default Value</u>	<u>Description</u>
IMPL	128	Positioning interval for which IMRL increments are charged for each read-with-list operation. Using the IMRL and IMPL default values, three increments are charged for each 128 PRUs positioned from the current position.

### MT Increments

The formula for calculating the MT increment is

$$\text{MT increment} = (\text{tape blocks transferred}) \times (\text{operation charge})$$

The following increments are charged for each magnetic tape operation.

<u>COMSSRU Name</u>	<u>Default Increment</u>	<u>MT Activity</u>
ITRW	4	Read or write
ITRL	5	Read L tape
ITPO	2	Position
ITCL	1	Open or close
ITWL	6	Write L tape

Absolute range for MT increments: 0 to 63

**PF Increments**

The formula for calculating the PF increment is

$$\text{PF increment} = \text{operation charge} + \text{IPPR} (\text{PRUs transferred}/\text{IPPN})$$

The following increments are charged for each permanent file operation.

<u>COMSSRU Name</u>	<u>Default Increment</u>	<u>PF Activity</u>
IPSV	1	Save
IPRP	1	Replace
IPGT	1	Get
IPAP	20	Append
IPDF	4	Define
IPAT	4	Attach
IPPM	1	Permit
IPCG	1	Change
IPPG	1	Purge
IPCT	1	Catlist
IPCS	4	Catalog search
IPCE	0	Catalog entry returned
IPVA	1	VALIDUs access
IPPA	1	Permit file access
IPAD	1	Alternate device access

The following increment is charged each time a specified number of PRUs are transferred.

<u>COMSSRU Name</u>	<u>Default Increment</u>
IPPR	4

The following specifies the number of PRUs transferred before the IPPR increment is charged.

<u>COMSSRU Name</u>	<u>Default Value</u>	<u>Description</u>
IPPN	10	Using the default value, the IPPR increment is charged each time 10 PRUs are transferred.

Absolute range for PF increments: 0 to 63

Example:

The charge for an ATTACH(filename/PN=packnam,UN=usernum) statement is calculated as follows.

$$\text{IPAT} + \text{IPAD} + \text{IPVA} + \text{IPCS} + \text{IPPA} \text{ (if permit data is available)}$$

**EXAMPLE OF SRU CALCULATION**

This section illustrates how an SRU value is obtained. The SRU formula is as follows.

$$\text{SRU} = \text{M1} (\text{CP} + \text{M2} \times \text{IO} + \text{M3} (\text{CP} + \text{IO}) \text{CM} + \text{M4} (\text{CP} + \text{IO})\text{EC}) + \text{AD}$$

The parameters are described in the SRU Formula section. For this example, all default values are assumed, except AD which equals 1.0. Therefore, the following parameters are known.

S0 = 1.0	M1 = 1.0	AD = 1.0
S1 = 1.0	M2 = 0.100	
S2 = 1.0	M3 = 0.003	
S3 = 1.0	M4 = 0.0	
S4 = 1.0		

For the purpose of this example, it is assumed that the job or session accumulated the following amounts of the specified resources.

9135 milliseconds of CPU time on CPU 0 (CP0 = 9135)  
0 millisecond of CPU time on CPU 1 (CP1 = 0.0)  
28,880 units of mass storage (MS = 28880)  
No magnetic tape or permanent file usage (MT = 0.0, and PF = 0.0)  
No ECS usage (EC = 0.0)  
10500g CM field length

To solve for the CP parameter, the following formula is used.

$$\begin{aligned} \text{CP} &= \text{S0} \times \text{CP0} + \text{S1} \times \text{CP1} \\ &= 1.0 \times 9135 + 1.0 \times 0.0 \\ &= 9135 \end{aligned}$$

so

$$\text{CP} = 9135 \text{ milliseconds}$$

To solve for the IO parameter, the following formula is used.

$$\begin{aligned} \text{IO} &= \text{S2} \times \text{MS} + \text{S3} \times \text{MT} + \text{S4} \times \text{PF} \\ &= 1.0 \times 28880 + 1.0 \times 0.0 + 1.0 \times 0.0 \\ &= 28,880 \end{aligned}$$

so

$$\text{IO} = 28,880 \text{ milliunits}$$

To solve for the CM parameter, the following formula is used.

$$\begin{aligned} \text{CM} &= (\text{CM field length} + 777\text{g})/1000\text{g} \quad (\text{the } 777\text{g} \text{ is used as a roundup factor}) \\ &= (10500\text{g} + 777\text{g})/1000\text{g} \\ &= 11\text{g} \\ &= 9 \end{aligned}$$

so

$$\text{CM} = 9 \text{ units}$$

To solve for the EC parameter, the following formula is used.

$$\begin{aligned} \text{EC} &= \text{ECS field length in tracks} \\ &= 0 \end{aligned}$$

so

$$\text{EC} = 0 \text{ units}$$

Since the AD parameter is specified in units and the remainder of the SRU equation is specified in milliunits, this part is computed first and converted into units. It can then be added to the AD parameter to obtain the number of SRUs.

$$\begin{aligned} \text{M1 (CP + M2 x IO + M3 (CP + IO) CM + M4 (CP + IO) EC)} \\ &= 1.0(9135 + 0.100 \times 28880 + 0.003(9135 + 28880)9+0) \\ &= 9135 + 2888 + 1026.405 \\ &= 13049.405 \\ &= 13049 \text{ milliunits} \\ &= 13.049 \text{ units} \end{aligned}$$

so

$$\begin{aligned} \text{SRU} &= 13.049 + \text{AD} \\ &= 13.049 + 1.0 \\ &= 14.049 \text{ units} \end{aligned}$$

So, during this job or session, 14.049 SRUs have been accumulated.

## MULTIPLIER INDEX VALUES AND ACTUAL MULTIPLIER VALUES

When a site assigns charge numbers, it can specify certain multipliers (M1 through M4) and the adder (AD) in the SRU multiplier formula as other than the system default values. (The system default values are described in the IO Increments section.) In fact, each charge number may be assigned a unique set of multiplier and adder values. This is done using the PROFILE control statement and the M1 through M4 directives (refer to PROFILE Console Input). An index from 0 to 77g is specified with each directive which is converted to the actual multiplier or adder value. The actual multiplier or adder value must lie within the absolute range defined by the system for that parameter. However, each site can also specify a subrange for each multiplier or adder in which all multipliers or adders must lie. This is done by specifying upper and lower bounds for these parameters. The released values for these upper and lower bounds are contained in COMSSRU. To obtain a listing of COMSSRU, assemble CALLSYS. To change these values, modifications must be made in COMSSRU. The following lists the COMSSRU names and gives the released values.

<u>COMSSRU Name</u>	<u>Released Value</u>	<u>Description</u>
M1SL	0.5	M1 lower bound
M1SU	1.5	M1 upper bound
M2SL	0.050	M2 lower bound
M2SU	0.150	M2 upper bound
M3SL	0.001	M3 lower bound
M3SU	0.064	M3 upper bound
M4SL	0.001	M4 lower bound
M4SU	0.064	M4 upper bound
MASL	1	Adder (AD) lower bound
MASU	64	Adder (AD) upper bound



When a site specifies an index value for M1, M2, M3, M4, or AD under PROFILE, it is converted to the actual multiplier (or adder) value by the following formula.

$$MI = I(MISU - MISL)/64 + MISL$$

<u>Parameter</u>	<u>Description</u>
MI	Actual multiplier (or adder) obtained
I	Multiplier (or adder) index value entered with a PROFILE directive
MISU	Multiplier (or adder) upper bound
MISL	Multiplier (or adder) lower bound

Two exceptions are:

- If the index value 0 is entered in the PROFILE directive, an actual multiplier (or adder) value of 0 is assigned.
- If the upper index value 778 is entered or if no index value is entered in the PROFILE directive, the system default multiplier (or adder) is assigned.

The actual multiplier (or adder) value MI and the index value I are displayed on the PROFILE K display (refer to figure 5-15).

The following example illustrates a conversion of an index value to an actual multiplier.

Example 1:

Assume that the released upper and lower bounds for M2 are used. That is:

$$\begin{aligned} M2SL &= .050 \\ M2SU &= .150 \end{aligned}$$

The site specifies a PROFILE directive

$$M2 = 32$$

for a particular charge number. This implies that the index value I in the formula

$$MI = I(MISU - MISL)/64 + MISL$$

is equal to 32.

Upon substitution:

$$\begin{aligned} M2 &= 32(.150 - .050)/64 + .050 \\ &= 3.200/64 + .050 \\ &= .050 + .050 \\ &= .10 \end{aligned}$$

Thus, the actual M2 multiplier used for this charge number is .10.

After a site has chosen upper and lower bounds for its multipliers (and adder), it may desire to assign different actual multiplier values to certain charge numbers. In order to choose the proper index value

to be specified on the PROFILE directives, the following formula is used. (This is merely the previous formula solved for I.)

$$I = 64(MI - MISL)/(MISU - MISL)$$

I, MI, MISL, and MISU are the same as those defined previously.

Example 2:

Assume that the released upper and lower bounds for M2 are used. That is:

$$\begin{aligned} M2SL &= .050 \\ M2SU &= .150 \end{aligned}$$

The site wishes to assign an actual M2 multiplier value of .10 to a particular charge number. To determine the appropriate index value for the PROFILE directive, the following formula is used.

$$I = 64 (MI - MISL)/(MISU - MISL)$$

MI = .10 in this case.

Upon substitution:

$$\begin{aligned} I &= 64(.100 - .050)/(.150 - .050) \\ &= 64(.050)/(.100) \\ &= 64 \times .5 \\ &= 32 \end{aligned}$$

Thus, the PROFILE directive M2 = 32 should be entered for the particular charge number to specify an actual M2 multiplier value of .10.

## ACCOUNT DAYFILE MESSAGES

The purpose of the account dayfile is to provide a history of system usage over the life of the account dayfile. This history is used for the following purposes.

- It provides the information necessary to properly bill the users of the system.
- It provides the necessary information to analyze the use of the system or any part of it by the installation. For example, the installation may want to determine the amount of magnetic tape usage.

Therefore, a standardized message format is provided to ease in the account dayfile analysis. The following is the general format of the account dayfile message. All account dayfile messages have this general format.

hh.mm.ss.jobnameo.geac, additional information

<u>Message</u>	<u>Description</u>
hh.mm.ss.	Current time in the form of hour.minute.second. This field begins in column 2 and ends with a period. The system always appends this field in this format to the beginning of the message at the time it is entered into the account dayfile.
jobname	Name of the job which caused the entry of this message into the account dayfile. This field begins in column 11 and ends in column 17. The system appends this field to the beginning of the message along with the time.

Message

Description

o

A single character in column 18 which describes the origin type of the job. The system automatically appends this character when the message is entered into the account dayfile. The following origin types can be specified.

<u>o</u>	<u>Origin Type</u>
S	System
B	Batch
T	Terminal
E	Remote batch
M	Multiterminal

geac

A unique four-character message identifier which defines the particular activity identified. The field begins in column 21 and ends with a comma-blank (,). The first character identifies the information group, the second character identifies the event which caused the message to be entered into the account dayfile, and the last two characters identify the activity being recorded. This field is further described in the following section.

additional information

Information that gives further detail to the activity identified by geac. The field begins in column 27 and ends with a period. This field is further described in the following section.

These message lines are free format. That is, each field defined in a message ends in either a comma-space or a period if it is the last field in the message. If a field is not used, it appears only as a comma-space, or it does not appear if it is the last field in the message. The separator immediately follows the last character of the field. The field size can be any length, depending on the information being supplied.

Example:

SPAT, filea, , packnam.

No alternate user access was specified during the permanent file attach operation.

SPAT, filenam.

No pack name was required and no alternate user access was specified during the permanent file attach operation.

Refer to Message Groups for a description of this message.

## MESSAGE GROUPS

All account dayfile entries are grouped by a particular information type. Each group type is identified by the first character of the geac field (that is, g of geac) in the account dayfile message. The following are the group types.

<u>Type</u>	<u>Description</u>
Aeac	Accounting information.
Seac	Statistical information.
Ueac	Job usage information.
Ieac	Installation information (reserved).

### Accounting Information

The A message group provides the information necessary for accounting purposes. These messages include information denoting the beginning and end of an accounting sequence, as well as all resources used. The message formats are:

Aeac, additional information.

The events (e character of Aeac) are defined as follows. Some characters are not currently utilized by the system.

<u>Character</u>	<u>Event Description</u>
B	Beginning of a job or session.
C	Change in the accounting activity.
D	Disk activity.
E	End of a job or session.
M	Magnetic tape activity.
P	Permanent file activity.
R	Recovery operation.
S	Suspension of a session.
U	Unable to update PROFILa.

The activity identifier (ac of geac) identifies the information being recorded and is event dependent.

The following is a list of the B activity messages.

ABAP, C1, usernum, family, termnam.  
ABAP, C2, application.  
ABCN, chargenum, projectnum.  
ABER, termnam.  
ABER, C1, usernum, family, termnam.  
ABER, C2, passwd.  
ABSY, yy/mm/dd.  
ABUN, usernum, family, termnam.

<u>Identifier</u>	<u>Description</u>
ABAP	Denotes transfer of terminal termnam logged in under user usernum in specified family to application after validation by NETVAL.
ABCN	Denotes the beginning of a charge sequence:  chargenum 1- to 10-alphanumeric character charge number.  projectnum 1- to 20-alphanumeric character project number.
ABER	Denotes illegal login attempt at terminal termnam. Second form is issued if selected by NETVAL control statement option (refer to the NOS Installation Handbook).
ABSY	Denotes the beginning of a new account dayfile through initialization of dayfiles or dayfile termination on date yy/mm/dd. Two blanks separate yy from the comma that precedes it.
ABUN	Denotes the beginning of a job or terminal session under user number usernum in the permanent file family family; termnam is optional. If present, message represents NAM login at terminal termnam.

The following is a list of the C activity messages.

ACCN, chargenum, projectnum.  
ACDT, DS, DATE. yy/mm/dd  
ACDT, DS, TIME. hh.mm.ss  
ACSO, sruunits.  
ACSR, sruunits.  
ACUN, usernum, family.

<u>Identifier</u>	<u>Description</u>
ACCN	Denotes a change of charge with the charge number chargenum and the project number projectnum.
ACDT	Denotes new date or time entered into the system.
ACSO	Denotes overflow of SRU accumulation in SRU units.
ACSR	Denotes the end of an accounting block that used sruunits of SRUs. The SRU accumulator is displayed and cleared and is associated with the entering of a new charge/project number.
ACUN	Denotes the change to a user number usernum under the permanent file family family.

The following is a list of the D activity messages.

ADDx, es, family, dn.  
ADPy, es, packnam, usernum.

<u>Identifier</u>	<u>Description</u>										
ADDx	Denotes operation on a permanent file device:										
	<table border="1"> <thead> <tr> <th><u>Parameter</u></th> <th><u>Description</u></th> </tr> </thead> <tbody> <tr> <td>x</td> <td>Operation: I Initialization R Recovery U Unloading</td> </tr> <tr> <td>es</td> <td>Equipment status table ordinal of equipment</td> </tr> <tr> <td>family</td> <td>Family name of device</td> </tr> <tr> <td>dn</td> <td>Device number</td> </tr> </tbody> </table>	<u>Parameter</u>	<u>Description</u>	x	Operation: I Initialization R Recovery U Unloading	es	Equipment status table ordinal of equipment	family	Family name of device	dn	Device number
<u>Parameter</u>	<u>Description</u>										
x	Operation: I Initialization R Recovery U Unloading										
es	Equipment status table ordinal of equipment										
family	Family name of device										
dn	Device number										
ADPy	Denotes operation on an auxiliary removable disk pack:										
	<table border="1"> <thead> <tr> <th><u>Parameter</u></th> <th><u>Description</u></th> </tr> </thead> <tbody> <tr> <td>y</td> <td>Operation: D Dismounting I Initialization M Mounting and recovery</td> </tr> <tr> <td>es</td> <td>Equipment status table ordinal of equipment</td> </tr> <tr> <td>packnam</td> <td>Name of disk pack</td> </tr> <tr> <td>usernum</td> <td>User number of disk pack</td> </tr> </tbody> </table>	<u>Parameter</u>	<u>Description</u>	y	Operation: D Dismounting I Initialization M Mounting and recovery	es	Equipment status table ordinal of equipment	packnam	Name of disk pack	usernum	User number of disk pack
<u>Parameter</u>	<u>Description</u>										
y	Operation: D Dismounting I Initialization M Mounting and recovery										
es	Equipment status table ordinal of equipment										
packnam	Name of disk pack										
usernum	User number of disk pack										

The following is a list of the E activity messages.

AEAP, C1, usernum, family, termnam.  
AEAP, C2, application, xxxxxxSECS.  
AENR, usernum, family.  
AEPQ, qt.  
AESR, sruunits.  
AESY, yy/mm/dd.  
AEUN, usernum, family, termnam.

<u>Identifier</u>	<u>Description</u>										
AEAP	Denotes end of connection of terminal termnam to specified application. Elapsed time of connection (xxxxxx, in seconds) may not agree with interval between corresponding ABAP and AEAP messages, because calculation of elapsed time is independent of the system function that prefixes the time field to the account dayfile message.										
AENR	Denotes the discarding of user usernum on family family from the time-sharing recovery file.										
AEPQ	Denotes the purging of the job from the I/O queue:										
	<table border="0" style="margin-left: 40px;"> <thead> <tr> <th style="text-align: left;"><u>Parameter</u></th> <th style="text-align: left;"><u>Description</u></th> </tr> </thead> <tbody> <tr> <td>qt</td> <td>Type of queue</td> </tr> <tr> <td></td> <td>IN      Input queue</td> </tr> <tr> <td></td> <td>PH      Output punch queue</td> </tr> <tr> <td></td> <td>PR      Output print queue</td> </tr> </tbody> </table>	<u>Parameter</u>	<u>Description</u>	qt	Type of queue		IN      Input queue		PH      Output punch queue		PR      Output print queue
<u>Parameter</u>	<u>Description</u>										
qt	Type of queue										
	IN      Input queue										
	PH      Output punch queue										
	PR      Output print queue										
AESR	Denotes the end of a job or session that used sruunits SRUs under the current charge number.										
AESY	Denotes the end of an active account file on the date yy/mm/dd. Two blanks separate yy from the comma that precedes it.										
AEUN	Denotes the end of a user number activity (for remote batch logoff operation); termnam is optional. If present, denotes logoff from network terminal termnam.										

The following is a list of the M activity messages.

AMAS, es, vsn.  
AMRT, es, onX.

<u>Identifier</u>	<u>Description</u>
AMAS	The magnetic tape equipment es is assigned with a volume serial number vsn. If the tape is unlabeled, vsn is not used.
AMRT	Denotes magnetic tape equipment es returned from the user. onX specifies the type of drive returned and is specified as 66X or 67X.

The following is a list of the P activity messages.

APPN.  
APPN, packnam.

<u>Identifier</u>	<u>Description</u>
APPN	Denotes entering the default pack name. If no pack name is specified, the message denotes the clearing of the default pack name.

The following is a list of the R activity messages.

ARSY, ln, yy/mm/dd.  
 ARUN, usernum, family, tn.

<u>Identifier</u>	<u>Description</u>
ARSY	Denotes the recovery of the account dayfile at recovery level ln on the date yy/mm/dd. Two blanks separate yy from the comma that precedes it.
ARUN	Denotes the recovery of a time-sharing session with user number usernum, family name family, and terminal number tn.

The following is a list of the S activity messages.

ASSR, xxxxxx.xxxUNTS.  
 ASDx, usernum, family.  
 ASNx, usernum, family.  
 ASTx, usernum, family.

<u>Identifier</u>	<u>Description</u>
ASSR	Denotes the suspension of a job or session that used the indicated amount of SRUs under the current charge number.
ASDx	Denotes that the user number and logical terminal name are duplicated in the time-sharing recovery file. The current session is ignored.
ASNx	Denotes that the user has not been successfully entered into the time-sharing recovery file.
ASTx	Denotes that the user has been saved in the time-sharing recovery file:

<u>x</u>	<u>Description</u>
H	The recovery operation was caused by a hang up.
R	The recovery operation was caused by the recovery of the time-sharing subsystem.
T	The recovery operation was caused by a session timeout.

The following is a list of the U activity messages.

AUSR, sruunits.

<u>Identifier</u>	<u>Description</u>
AUSR	Denotes that sruunits of SRUs could not be recorded in PROFILa at overflow or end of account block.



## Statistical Information

The S message group provides information relating to the various activities of the system. The message formats are as follows:

Seac, additional information.

The events (e character of Seac) are defined as follows. Some characters are not currently utilized by the system.

<u>Character</u>	<u>Event Description</u>
A	Subsystem abort.
B	Subsystem begin.
C	Accumulator displayed and cleared.
D	Accumulator displayed and continued.
E	Subsystem end.
I	Informative message.
P	Permanent file information.
R	Subsystem recovery.

The following is a list of the A activity messages.

SANW, application, jobnam.

<u>Identifier</u>	<u>Description</u>
SANW	Denotes application failure during job jobnam.

The following is a list of the B activity messages.

SBER, application, jobnam.

SBNW, application, jobnam.

<u>Identifier</u>	<u>Description</u>
SBER	Denotes illegal NETON attempt by application during job jobnam.
SBNW	Denotes successful NETON by application during job jobnam.

The following is a list of the C activity messages.

SCAE, xxxxxx.xxxKUNS.  
 SCAP, xxxxxx.xxxKUNS.  
 SCAS, xxxxxx.xxxKUNS.  
 SCLE, xxxxxx.xxxKUNS.  
 SCLG, xxxxxx.xxxKUNS.  
 SCLN, node, C1, port, 0, 0, blocks<sub>t</sub>.  
 SCLN, node, C2, blocks<sub>r</sub>chars.  
 SCLN, node, C3, blocks<sub>e</sub>.  
 SCMT, es, pppppppp, t.  
 SCNP, node, C1, statistics<sub>1</sub>.  
 SCNP, node, C2, statistics<sub>2</sub>.  
 SCNP, node, C3, statistics<sub>3</sub>.  
 SCTR, node, C1, port, 0, rnode, blocks<sub>t</sub>.  
 SCTR, node, C2, blocks<sub>r</sub>chars.  
 SCTR, node, C3, blocks<sub>e</sub>.

<u>Identifier</u>	<u>Description</u>
SCAE	Denotes number of illegal application selections divided by 1000.
SCAP	Denotes number of prohibited application selections divided by 1000.
SCAS	Denotes number of legal application selections divided by 1000.
SCLE	Denotes number of illegal login attempts divided by 1000.
SCLG	Denotes number of legal login attempts divided by 1000.
SCLN	Denotes the number of blocks and characters transmitted and received on the line connected to the indicated port of the NPU with node number node. The port number is hexadecimal; all other values are decimal.

<u>Field</u>	<u>Description</u>
blocks <sub>t</sub>	Number of blocks transmitted.
blocks <sub>r</sub> chars	Three contiguous six-digit fields as follows: <div style="text-align: center;">           blocks received      characters received            rrrrrr tttttt rrrrrr            ───────────┬──────────            characters transmitted         </div>

Character counts include only counts from good blocks.

blocks <sub>e</sub>	Number of blocks transmitted or received in error.
SCMT	Denotes the number of magnetic tape PRUs transferred from unit es; t denotes whether the blocks were read (t=R) or written (t=W).

<u>Identifier</u>	<u>Description</u>
SCNP	Indicates various statistics about the NPU with node number node. All values are decimal. statistics <sub>1</sub> , statistics <sub>2</sub> , and statistics <sub>3</sub> each consist of three six-digit fields as follows:

statistics <sub>1</sub> :	ggggggpppppprrrrrr
statistics <sub>2</sub> :	aaaaaaffffffnnnnnn
statistics <sub>3</sub> :	tttttooooozzzzzz

<u>Field</u>	<u>Description</u>
gggggg	Number of service messages generated.
pppppp	Number of service messages processed.
rrrrrr	Number of bad service messages received.
aaaaaa	Number of blocks discarded because of bad address.
ffffff	Number of packets/blocks discarded because of bad format.
nnnnnn	Number of times that the NPU entered regulation level 3 (that is, its original state of no regulation).
tttttt	Number of times that the NPU entered regulation level 2.
oooooo	Number of times that the NPU entered regulation level 1.
zzzzzz	Number of times that the NPU entered regulation level 0.

SCTR	Denotes the number of blocks and characters transmitted and received by the NPU with node number node on the trunk connected to the indicated port. The node number of the remote NPU to which the trunk is connected is rnode; port is hexadecimal; all other values are decimal.
------	--

<u>Field</u>	<u>Description</u>								
blocks <sub>t</sub>	Number of blocks transmitted.								
blocks <sub>p</sub> chars	Three contiguous six-digit fields as follows: <div style="text-align: center; margin: 10px 0;"> <table border="0"> <tr> <td style="text-align: center;">blocks received</td> <td style="text-align: center;">characters received</td> </tr> <tr> <td style="text-align: center;"> <u>rrrrrr</u> </td> <td style="text-align: center;"> <u>tttttt</u> </td> </tr> <tr> <td colspan="2" style="text-align: center;"> <u>rrrrrr</u> </td> </tr> <tr> <td colspan="2" style="text-align: center;">characters transmitted</td> </tr> </table> </div>	blocks received	characters received	<u>rrrrrr</u>	<u>tttttt</u>	<u>rrrrrr</u>		characters transmitted	
blocks received	characters received								
<u>rrrrrr</u>	<u>tttttt</u>								
<u>rrrrrr</u>									
characters transmitted									
	Character counts include only counts from good blocks.								
blocks <sub>e</sub>	Number of blocks transmitted or received in error.								

The following is a list of the D activity messages.

SDCA, seconds.  
 SDCI, seconds.  
 SDCM, kilomoves.  
 SDMR, kilorollouts.  
 SDMS, kilosectors.  
 SDTO, kiloslices.  
 SDTS, kiloslices.

<u>Identifier</u>	<u>Description</u>
SDCA	Denotes accumulated time since deadstart that the CPU was active at the system control point while in program mode.
SDCI	Denotes accumulated time since deadstart that the CPU was not assigned to any control point; that is, executing its idle loop.

**NOTE**

The following D activity messages should not be considered permanent features of NOS and may be removed from the system when the need to maintain the information that they provide no longer exists.

SDCM	Number of storage moves, divided by 1000, in which a job field length was moved.
SDMR	Number of rollouts, divided by 1000, for all jobs.
SDMS	Number of sectors rolled out, divided by 1000, for all jobs.
SDTO	Number of user limits and time slices with output present detected by 1SP, divided by 1000, for all jobs.
SDTS	Number of time slices detected by 1SP, divided by 1000, for all jobs.

The following is a list of the E activity messages.

SEMC, xxxxxx.xxx KUNS.  
 SENW, application, jobnam.

<u>Identifier</u>	<u>Description</u>
SEMC	Denotes program disconnection from MCS and weighted number of calls to MCS.
SENW	Denotes NETOFF by application during job jobnam.

The following is a list of the I activity messages.

SIAD.  
 SIAD, yy/mm/dd.  
 SIAE, xxxxxx.xxxKUNS.  
 SIAP, xxxxxx.xxxKUNS.  
 SIAS, xxxxxx.xxxKUNS.  
 SISC, nn.  
 SISC.  
 SILE, xxxxxx.xxxKUNS.  
 SILG, xxxxxx.xxxKUNS.  
 SITA, xxxxxx.xxxKUNS.  
 SIUN, usernum.  
 SIWA, attempts, interval.  
 SIWL, attempts, interval.

<u>Identifier</u>	<u>Description</u>
SIAD	If issued with no parameters, denotes dumping of account dayfile. If issued with date following SIAD, denotes execution of engineering services program GETLOG. Two blanks separate yy from the comma that precedes it.
SIAE	Denotes illegal application switches through NVF (network validation facility).
SIAP	Denotes prohibited application switches through NVF.
SIAS	Denotes legal application switches through NVF.
SISC	Denotes user security count decremented to the value nn. If issued with no parameter, denotes user has violated security, but the system was unable to decrement the user security count because VALIDUS was not currently available.
SILE	Denotes illegal login through NVF.
SILG	Denotes legal login through NVF.
SITA	Denotes current number of terminals controlled by NVF.
SIUN	Denotes attempt to enter illegal user number, usernum, or secondary user number, usernum, while secondary user card feature is disabled.
SIWA	Indicates the number of illegal application attempts made during the indicated interval (in seconds). This message is issued only if the appropriate NETVAL control statement parameters are set (refer to the NOS Installation Handbook).
SIWL	Indicates the number of illegal network login attempts made during the indicated interval (in seconds). This message is issued only if the appropriate NETVAL control statement parameters are set (refer to the NOS Installation Handbook).

The following is a list of the P activity messages.

SPAP, filenam, usernum, packnam.  
SPAT, filenam, usernum, packnam.  
SPCG, filenam, usernum, packnam.  
SPCT, filenam, usernum, packnam.  
SPDF, filenam, usernum, packnam.  
SPGT, filenam, usernum, packnam.  
SPPG, filenam, usernum, packnam.  
SPPM, filenam, usernum, packnam.  
SPRP, filenam, usernum, packnam.  
SPSV, filenam, usernum, packnam.

<u>Identifier</u>	<u>Description</u>
SPAP	Denotes permanent file APPEND operation.
SPAT	Denotes permanent file ATTACH operation.
SPCG	Denotes permanent file CHANGE operation.
SPCT	Denotes permanent file CATLIST operation.
SPDF	Denotes permanent file DEFINE operation.
SPGT	Denotes permanent file GET operation.
SPPM	Denotes permanent file PERMIT operation.
SPPG	Denotes permanent file PURGE operation.
SPRP	Denotes permanent file REPLACE operation.
SPSV	Denotes permanent file SAVE operation.

The remainder of the S group messages are not used; they are reserved for future expansion.

### Usage Information

The U message group provides a breakdown of the usage of the system for a particular user. The message formats are:

Ueac, usage count descriptor.

The events (e character of Ueac) are defined as follows:

<u>Character</u>	<u>Event Description</u>
B	Accumulator begun.
C	Accumulator displayed and cleared.
D	Accumulator displayed and continued.
E	Accumulator displayed and ended.
S	Accumulator suspended.

The activities (ac characters of Ueac) are defined as follows:

<u>Character</u>	<u>Activity Description</u>
AD	SRU adder accumulator.
AU	Application program accumulator.
CI	Characters transmitted into the system.
CO	Characters transmitted out of the system.
CP	CPU time.
CR	Cards read.
LP	Lines printed.
LV	Lines printed, V carriage control encountered.
MS	Mass storage activity.
MT	Magnetic tape activity.
PC	Cards punched.
PF	Permanent file activity.
PL	Plotter activity.

Each accumulator is displayed in F10.3 format with a four-character unit descriptor after the value. The following are the descriptors.

<u>Descriptor</u>	<u>Value</u>
KCHS	Kilo-characters
KCDS	Kilo-cards
KLNS	Kilo-lines
KPLS	Kilo-plot-units
KUNS	Kilo-units
SECS	Seconds
UNTS	Units

The following is a B activity message.

UBAU, xxxx.

<u>Identifier</u>	<u>Description</u>
UBAU	Denotes the beginning of the application program accumulator for the application xxxx.

Certain C event activity messages contain a field, minn, identifying the equipment upon which the particular activity took place. The first two characters of minn are the machine identifier (MID entry in CMRDECK; refer to the NOS Installation Handbook). The remaining characters are either the equipment status table ordinal or terminal name of the device that performed the activity.

The following is a list of the C activity messages.

UCAD, xxxxxx.xxxKUNS.  
 UCCI, xxxxxx.xxxKCHS.  
 UCCO, xxxxxx.xxxKCHS.  
 UCCR, minn, xxxxxx.xxxKCDS.  
 UCLP, minn, xxxxxx.xxxKLNS.  
 UCLV, minn, xxxxxx.xxxKLNS.  
 UCMS, xxxxxx.xxxKUNS.  
 UCMT, xxxxxx.xxxKUNS.  
 UCPC, minn, xxxxxx.xxxKCDS.  
 UCPF, xxxxxx.xxxKUNS.  
 UCPL, minn, xxxxxx.xxxKPLS.

<u>Identifier</u>	<u>Description</u>
UCAD	Denotes the value of the adder accumulator for a job when overflow occurred.
UCCI	Denotes the number of characters transferred into the system for a job (for time-sharing subsystem).
UCCO	Denotes the number of characters transferred out of the system for a job (for time-sharing subsystem).
UCCR	Denotes the number of cards read into the system for a job on equipment minn (described earlier).
UCLP	Denotes the number of lines printed for a job on equipment minn (described earlier).
UCLV	Denotes the number of lines printed for a job in which the V carriage control character was used on equipment minn (described earlier).
UCMS	Denotes the value of the mass storage activity accumulator for a job when overflow occurred.
UCMT	Denotes the value of the magnetic tape activity accumulator for a job when overflow occurred.
UCPC	Denotes the number of cards punched for a job on equipment minn (described earlier).
UCPF	Denotes the value of the permanent file activity accumulator for a job when overflow occurred.
UCPL	Denotes the number of plot-units plotted for a job on equipment minn.

The following is a list of the D activity messages.

UDAD, xxxxxx.xxxUNTS.  
 UDCL, xxxxxx.xxxKCHS.  
 UDCO, xxxxxx.xxxKCHS.  
 UDCP, xxxxxx.xxxSECS.  
 UDMS, xxxxxx.xxxKUNS.  
 UDMT, xxxxxx.xxxKUNS.  
 UDPF, xxxxxx.xxxKUNS.



<u>Identifier</u>	<u>Description</u>
UDAD	Denotes the SRU adder accumulator for a job.
UDCI	Denotes the number of characters transferred into the system for a job (currently available for time-sharing only).
UDCO	Denotes the number of characters transferred out of the system for a job (currently available only for time-sharing).
UDCP	Denotes the CPU time for a job.
UDMS	Denotes the mass storage activity accumulator for a job.
UDMT	Denotes the magnetic tape activity accumulator for a job.
UDPF	Denotes the permanent file activity accumulator for a job.

The following is a list of the E activity messages.

UEAD, xxxxxx.xxxUNTS.  
 UEAU, xxxxxx.xxxUNTS.  
 UECI, xxxxxx.xxxKCHS.  
 UECO, xxxxxx.xxxKCHS.  
 UECP, xxxxxx.xxxSECS.  
 UEMS, xxxxxx.xxxKUNS.  
 UEMT, xxxxxx.xxxKUNS.  
 UEPF, xxxxxx.xxxKUNS.

<u>Identifier</u>	<u>Description</u>
UEAD	Denotes the SRU adder accumulator for a job.
UEAU	Denotes the application program accumulator for a job step.
UECI	Denotes the number of characters transferred into the system for a job (currently available only for time-sharing).
UECO	Denotes the number of characters transferred out of the system for a job (currently available only for time-sharing).
UECP	Denotes the CPU time for a job.
UEMS	Denotes the mass storage activity accumulator for a job.
UEMT	Denotes the magnetic tape activity accumulator for a job.
UEPF	Denotes the permanent file activity accumulator for a job.

The following is a list of the S activity messages.

USAD, xxxxxx.xxxUNTS.  
 USAU, xxxxxx.xxxUNTS.  
 USCP, xxxxxx.xxxSECS.  
 USMS, xxxxxx.xxxKUNS.  
 USMT, xxxxxx.xxxKUNS.  
 USPF, xxxxxx.xxxKUNS.

<u>Identifier</u>	<u>Description</u>
USAD	Denotes the SRU accumulator for a job.
USAU	Denotes the application program accumulator for a job step.
USCP	Denotes the CPU time for a job.
USMS	Denotes the mass storage activity accumulator for a job.
USMT	Denotes the magnetic tape activity accumulator for a job.
USPF	Denotes the permanent file activity accumulator for a job.

The following usage summary for a user is always issued.

UeCO, xxxxxx.xxxKCHS.	Time-sharing users only.
UeCI, xxxxxx.xxxKCHS.	Time-sharing users only.
UeAD, xxxxxx.xxxUNTS.	
UePF, xxxxxx.xxxKUNS.	
UeMS, xxxxxx.xxxKUNS.	
UeMT, xxxxxx.xxxKUNS.	Tape users only.
UeCP, xxxxxx.xxxSECS.	
UeSR, xxxxxx.xxxUNTS.	

e is an event identifier described in this section.

After the system is loaded, the SYSEDIT control statement provides a method of performing modifications to the system library. A job containing a SYSEDIT control statement must either be a system origin job, or the user must be validated for system origin privileges and have DEBUG set at the system console. The system processes only one SYSEDIT control statement at a time. If one SYSEDIT has not completed when a second SYSEDIT statement is entered, the second SYSEDIT aborts.

**NOTE**

The use of SYSEDIT in a production environment may cause unpredictable results and is not recommended. The system should be idle to ensure predictable results.

The format of the control statement is

SYSEDIT(p<sub>1</sub>,p<sub>2</sub>,...,p<sub>n</sub>)

where p<sub>i</sub> is either a keyword or a keyword equated to a value.

<u>p<sub>i</sub></u>	<u>Description</u>
B=filenam	Replacement records are on file filenam.
B	Same as B=LGO.
B=0	No replacement file.
B omitted	Same as B=LGO.
C	Checkpoint of the system follows SYSEDIT.
C omitted	No checkpoint is performed unless the system was generated employing the alternate system library residency feature, and in that case the checkpoint automatically follows SYSEDIT.
I=filenam	Directive input is on file filenam.
I	Same as I=INPUT.
I=0	No directive input.
I omitted	Same as I=INPUT.
L=filenam	List output is on file filenam.
L	Same as L=OUTPUT.
L=0	No list output.
L omitted	Same as L=0.

<u>P<sub>i</sub></u>	<u>Description</u>
R=n	Restoration is made to copy n of the system. The system copy number is printed on the output listing.
R	Restoration is made to initial deadstart system.
R=0	No system file restoration.
R omitted	Same as R=0.
Z	Directive input follows the terminator on the control statement. The I option is ignored.
Z omitted	The system uses the I option for directive input.

**NOTE**

If the Z option is specified, a terminator must not be placed after the input directives.

The following are input directives to SYSEDIT. \*CM, \*MS, \*AD, \*PROC, \*FL, and \*SC directives can be placed on LIBDECK (refer to the NOS Installation Handbook). A list of valid record types follows the directive descriptions.

## \*CM DIRECTIVE

The \*CM directive specifies the system library routines that are to reside in central memory resident. These routines will reside in the resident peripheral library (RPL) and resident central library (RCL).

The format of the directive is:

\*CM,ty<sub>1</sub>/rec<sub>1</sub>,ty<sub>2</sub>/rec<sub>2</sub>,...,ty<sub>n</sub>/rec<sub>n</sub>.

ty<sub>i</sub>/rec<sub>i</sub>            Record type and record name of the routine.

Central memory has the best accessibility of all storage devices. The following programs will automatically reside in central memory.

- Mass storage drivers.
- Programs specified in the internal tables of SLL (SYSEDIT service routine), such as 1DD and 0DF.

In addition, it is suggested that high usage PP and CPU programs (such as PFILES, CONTROL, 1MT, and PFM) reside in central memory.

Any addition to central memory allows less space for user jobs.

REL type records cannot reside in central memory.

## \*MS DIRECTIVE

The \*MS directive identifies which system library routines will reside on the system device. It is the default residence for routines; any routine not specified as \*CM will automatically reside on the system device, even if \*MS is not entered in the LIBDECK. System device routines may also be placed on an alternate system device with an \*AD assignment.

The format of the directive is:

\*MS,ty<sub>1</sub>/rec<sub>1</sub>,ty<sub>2</sub>/rec<sub>2</sub>,...,ty<sub>n</sub>/rec<sub>n</sub>.

ty<sub>i</sub>/rec<sub>i</sub>                      Record type and record name of the routine.

## \*AD DIRECTIVE

The \*AD directive places copies of specific system library routines on particular mass storage devices so that they will be accessed from a device other than the system device. For example, it is advantageous:

- To place frequently used system library routines in ECS for faster access than is possible from the system device.
- To place PP routines on a mass storage device that has better latency than does the system device.

Once a routine is on an alternate system device, it is accessed from that device instead of from the system device (\*MS LIBDECK entries), except in the following cases of error recovery.

- If there is an unrecoverable error for a PP routine on an alternate system device, all of the PP routines will subsequently be accessed from the system device instead of from any of the alternate system devices.
- If there is an unrecoverable error for a CPU, ABS, or OVL routine on an alternate system device, only that routine will subsequently be accessed from the system device.
- If there is an unrecoverable error for an REL CPU routine, the alternate system device must be turned off by the operator to prevent further access to the routine. In this case, the system copy will be used for backup. The alternate system device is not used for loads.

The devices that are to be used as alternate system devices are specified with the ASR entry in the CMRDECK (refer to the NOS Installation Handbook); the routines that are to reside on each alternate system device are specified in LIBDECK.

The format of the directive is:

\*AD,xx,ty<sub>1</sub>/rec<sub>1</sub>,ty<sub>2</sub>/rec<sub>2</sub>,...,ty<sub>n</sub>/rec<sub>n</sub>.

xx                              One- or two-digit (octal) EST ordinal or two-character equipment type of the equipment to be used as an alternate system device.

The equipment can be any nonremovable mass storage device (including ECS) except for a system device.

If the equipment is not specified in the CMRDECK with the ASR entry, the \*AD entry is ignored without an error indication when the system is loaded.

ty<sub>i</sub>/rec<sub>i</sub>

Record type and record name of the routine.

ty<sub>i</sub>      Record type of routine:

ABS	CPU multiple entry point overlay
OVL	CPU overlay
PP	PP absolute
REL	Relocatable CPU routine

If a record type other than ABS, OVL, PP, or REL is specified, the message ILLEGAL CM/AD RESIDENCE. is issued to the output device; the run is aborted.

rec<sub>i</sub>      Record name of routine.

A routine is allowed on only one alternate system device.

Note the following additional qualifications.

- Once a routine is placed on an alternate system device, SYSEdit may be used to prohibit access to the routine; however, the space for that routine is not released until LIBDECK is modified and the system is reloaded.
- If ECS is an alternate system device, all ABS, OVL, or REL routines residing there will be loaded directly by central monitor function LCEM. This causes the transfer of a program from ECS directly to the load address.
- If DDP is available, PP programs residing on ECS will be loaded via DDP, and CPU programs will be loaded via the CPU access to ECS.

## \*PROC DIRECTIVE

The \*PROC directive identifies a record as a procedure. As such, it can be treated as any control statement, invoked by name with parameters as required by the procedure itself. The records specified with this directive can be either CCL or KCL procedures. Further information on procedure creation and execution can be found in the NOS Reference Manual, volume 1.

The format of the directive is:

\*PROC,rec<sub>1</sub>,rec<sub>2</sub>,...,rec<sub>n</sub>.

rec<sub>i</sub>      Record name of routine to be defined as a procedure file.

## \*SC DIRECTIVE

The \*SC directive specifies the statements in a certain program that are to be processed in product set format rather than NOS format (refer to NOS Reference Manual, volume 1).

The format of the directive is:

\*SC,ty<sub>1</sub>/rec<sub>1</sub>,ty<sub>2</sub>/rec<sub>2</sub>,...,ty<sub>n</sub>/rec<sub>n</sub>.

ty<sub>i</sub>/rec<sub>i</sub>            Record type and record name of the routine to be processed in product set format.

## \*FL DIRECTIVE

The \*FL directive specifies the field length that routines to be loaded require to begin execution.

The format of the directive is:

\*FL,ty<sub>1</sub>/rec<sub>1</sub>-fl<sub>1</sub>,ty<sub>2</sub>/rec<sub>2</sub>-fl<sub>2</sub>,...,ty<sub>n</sub>/rec<sub>n</sub>-fl<sub>n</sub>.

ty<sub>i</sub>/rec<sub>i</sub>            Record type and record name of the routine.

fl<sub>i</sub>                 Field length/100g required by the routine.

The actual field length obtained is subject to the rules governing RFL= and MFL= entry points, since the specified FL field is placed in byte 0 of the second word of the CLD entry. The system uses this byte in the CLD entry to determine field length in the following manner.

1. If bit 11 is not set, an RFL= entry point is indicated. The field length is set to the value in byte 0 of the CLD entry.
2. If bit 11 is set (indicating a value in the CLD entry of 40000g), an MFL= entry point is indicated. The field length is determined in one of two ways.
  - a. If bit 10 is also set, the field length is set to the maximum of the value of the last RFL statement and the value in byte 0 of the CLD entry after masking off these upper 2 bits.
  - b. If bit 10 is not set, the field length is set to the maximum of the existing field length and the value in byte 0 of the CLD entry after masking off these upper 2 bits.

## \*DELETE DIRECTIVE

The \*DELETE directive deletes a record from the system. It cannot, however, delete a user library (ULIB type record).

The format of the directive is:

\*DELETE,ty<sub>1</sub>/rec<sub>1</sub>,ty<sub>2</sub>/rec<sub>2</sub>,...,ty<sub>n</sub>/rec<sub>n</sub>.

or

\*D,ty<sub>1</sub>/rec<sub>1</sub>,...,ty<sub>n</sub>/rec<sub>n</sub>.

ty<sub>i</sub>/rec<sub>i</sub>            Record type and record name to be deleted from the system. ty<sub>i</sub> must not be ULIB.

## **\*FILE DIRECTIVE**

The **\*FILE** directive declares an additional file containing records to be added to the system or to logically replace records on the system.

The format of the directive is:

**\*FILE,filenam**  
or  
**\*FILE,filenam,NR**

**filenam**                    Name of local file containing addition or replacement records to be placed on the system. File **filenam** is rewound before processing if **NR** is omitted.

**NR**                            Optional parameter that inhibits rewinding of file **filenam** before processing.

## **\*IGNORE DIRECTIVE**

The **\*IGNORE** directive specifies that records on a replacement file are to be ignored. If no **\*FILE** directive precedes an **\*IGNORE** directive, SYSEDIT ignores the records named on this directive on the replacement file specified by the B control statement parameter. If one or more **\*FILE** directives precede an **\*IGNORE** directive, SYSEDIT ignores the records on the file specified in the most recent **\*FILE** directive.

The format of the directive is:

**\*IGNORE,ty<sub>1</sub>/rec<sub>1</sub>,ty<sub>2</sub>/rec<sub>2</sub>,...,ty<sub>n</sub>/rec<sub>n</sub>.**

**ty<sub>i</sub>/rec<sub>i</sub>**                    Record type and record name to be ignored on the current replacement file.

## **\*PPSYN DIRECTIVE**

The **\*PPSYN** directive specifies one or more names to be synonymous with the name of an existing peripheral processor routine.

The format of the directive is:

**\*PPSYN,nam/nam<sub>1</sub>,nam<sub>2</sub>,...,nam<sub>n</sub>.**

**nam**                            Name of existing PP routine.

**nam<sub>i</sub>**                          Additional (synonymous) name for **nam**.



## RECORD TYPES

The following record types may be specified in SYSEEDIT directives.

<u>Type</u>	<u>Description</u>
ABS	Multiple entry point overlay.
CAP	Fast dynamic load capsule.
OPL	Modify old program library deck.
OPLC	Modify old program library common deck.
OPLD	Modify old program library directory.
OVL	Central processor overlay.
PP	Peripheral processor program.
PPU	Peripheral processor unit program.
PROC	CCL procedure.
REL	Relocatable central processor program.
TEXT	Unrecognizable as a program.
ULIB	User library.

This section describes the system mechanisms used to initialize the fast-attach files used by MODVAL, PROFILE, RESEX, and the time-sharing subsystem.

## ISF

The ISF control statement initializes the fast-attach system files VALIDUs, PROFILa, RSXDId, RSXVId, and SALVId.† A fast-attach file is a special direct access file that is initialized with the E parameter on the ISF control statement rather than attached with the ATTACH control statement. It is released with the R parameter on the ISF control statement. However, in order to release a fast-attach file, an idle family situation must be present. That is, the job containing the ISF(R=filenam) statement must be the only job in the family (family count is zero, and the direct access file count equals the number of fast attach files). Therefore, the DSD command, IDLEFAMILY, must be used to clear the system of all other jobs, and when the above conditions have been met [refer to the mass storage status display (E,M) in the Operator's Guide], the IDLEFAMILY command must be used again to allow the ISF control statement to be entered. The ISF command is entered via the DSD command, X., to release the fast-attach file(s). Refer to the NOS Operator's Guide for information about the DSD commands.

The fast-attach file mechanism provides a method to be used by special system jobs for files which are to be retained as permanent files but have a high enough access rate to make permanent file ATTACHs excessively time-consuming. When a permanent file is activated as a fast-attach file, an FNT entry is made which retains the basic data normally kept in the catalog entry and system sector of the file (interlocks and file name). This dispenses with the catalog search and system sector read normally necessary to attach a permanent file.

If the file is a shared (global) fast-attach file for a multimainframe network, additional information is also maintained in the FAT table on the link device. The type of file determines whether it is entered as global fast-attach or local fast-attach. This criterion is kept internal to ISF. Basically, VALIDUs and PROFILa are entered as global fast-attach files if they reside on a shared device. The resource files are always entered as local fast-attach. A limit of 778 exists on the number of files that can be entered as global fast-attach in a multimainframe environment.

Because the fast-attach files are system files, a job containing an ISF control statement must be a system origin job. Processing of the statement causes a search of the system permanent file catalog (UI=377777) for files with the predefined names previously listed. They are defined in a table internal to ISF. The format of the ISF control statement is:

ISF, { E=filenam } ,FM=family,SJ=filenam,SP=filenam.  
       { R=filenam }

E=filenam       System file that is initialized. If E=0 or no filename is specified (neither E nor R appear), all files defined in the ISF table are initialized (refer to table 5-1).

† The resource files and the terminal session recovery file (SALVId) are generated and maintained uniquely for each machine id in a multimainframe or single mainframe system by appending the machine id to the file name (for example, RSXVId becomes RSXVAB on the machine with an id of AB).

R=filenam           Currently active system file that is released from fast-attach status. If R=0, all of the files in the ISF table for the specified family that are currently active are released. When this option is specified, an idle family situation (family count is zero, and the direct access file count equals the number of fast attach files) must first be created with the IDLEFAMILY command. When the family is idle, the IDLEFAMILY command must be entered again so that the system will accept the ISF control statement. The ISF statement is entered via the X. command. (Refer to the NOS Operator's Guide for information about the IDLEFAMILY and X. commands.)

**NOTE**

Since initialization and release are mutually exclusive, E and R cannot appear on the same control statement.

FM=family           Family of devices. If FM is not specified, the calling job's current family is used. The calling job's family will be restored upon exit from ISF.

SJ=filenam           Job file that ISF submits as a system origin job. The file must be an indirect access permanent file stored under the system user index (377777). If SJ is specified without =filenam, ISF assumes SJ=SYSJOB. If SJ=0 is specified, no job is submitted. Refer to the following note for a description of ISF processing when SJ is omitted.

SP=filenam           Procedure file that ISF calls with system origin. The file must be an indirect access permanent file stored under the system user index. If SP is specified without =filenam, ISF assumes SP=SYSPROC. If SP=0 is specified, no procedure is called. Refer to the following note for a description of ISF processing when SP is omitted.

**NOTE**

If the ISF control statement is entered without parameters, ISF searches the system user index (377777) of the job's family for files SYSPROC and SYSJOB. If SYSPROC exists, this file is called as a procedure file with system origin. If SYSJOB exists, it is submitted as a system origin job. If the ISF control statement is entered with any parameters for example, X.ISF(R=RSXDid), the procedure file SYSJOB is not submitted nor is SYSPROC called unless specified by the SJ and/or SP parameter(s).

The automatic submission/execution of SYSJOB/SYSPROC can be used to SYSEDIT local modifications into the system since ISF is always executed during a level 0 deadstart (refer to Deadstart Sequencing).

ISF can also be entered as a command from the console via the DSD X. command (refer to the NOS Operator's Guide).

The matrix in table 7-1 shows how the initialize (E) and release (R) parameters affect individual fast-attach files.

TABLE 7-1. INITIALIZE AND RELEASE OF FAST-ATTACH FILES

Name of Fast-Attach System File	Option	
	Initialize (E)	Release (R)
VALIDUS PROFILA	Make global fast attach.	Return from fast attach to normal direct access.
RSXDid RSXVid SALVid	Make local fast attach. If the file does not exist in the system catalog (UI=377777), ISF creates the file and makes it a fast-attach file. If either RSXDid or RSXVid is specified, ISF initializes both files.	Return from fast attach to normal direct access. If either RSXDid or RSXVid is specified, ISF returns both files to normal direct access.

One use of the R option is to release fast-attach files activated on a device that is to be initialized or unloaded. Device initialization is not initiated as long as any direct access files are active on the device (an activated fast-attach file is treated the same as an active direct access file). Until these files are released, MSI will reply to an attempted device initialization with the error message:

ACTIVE FILES ON DEVICE

Similarly, a device cannot be unloaded until all its fast-attach files are released.

## DEADSTART SEQUENCING

During a level 0 deadstart, the PP routine SET places a job in the input queue with a queue priority of 7777g. This job executes the PP routine CMS, whose normal functions include mass storage initialization and recovery. After completing these functions, CMS checks its queue priority. If the queue priority is 7777g (indicating a deadstart sequencing call), CMS places the following control statements in its control statement buffer and causes the system to execute them.

FAMILY.  
ISF.

The CMS deadstart sequencing job begins execution only after job processing has been enabled via the DSD AUTO. or MAINTENANCE. command. The job scheduler 1SJ suspends processing of all other jobs until the CMS job completes, thereby ensuring that all system files in the default family are initialized and that a SYSPROC procedure (if any) is executed before normal job processing begins (refer to ISF).

## **GENVAL PROCEDURE FILE**

GENVAL is a procedure file on the system which creates a VALIDUs file containing only the system user index (377777g) and the library user index (377776g), as well as the corresponding VALINDs file. GENVAL then calls ISF to make these files fast-attach files. This procedure is used immediately after a family device has been initialized or when running in a nonproduction environment where only one user index is needed.

GENVAL can be entered from the console as follows:

X.GENVAL.

Before using this procedure, ensure that the user count for the family device (displayed on the E,M. display) is zero.

After this procedure is completed, MODVAL can update and/or expand the files thus created.

---

The multimainframe feature provides a mechanism by which up to four † computers may access shared mass storage devices. This allows the mainframes to share preserved files residing on such devices. Preserved files are defined as those which are retained across a level 0 deadstart (nonsystem recovery). Types of preserved files are permanent files, I/O queues, and system dayfiles.

Any combination of one to four CYBER 170 Model 171, 172, 173, 174, 175, 720, 730, 750, or 760; CYBER 70 Model 71, 72, 73, or 74; or 6000 series mainframes may comprise a multimainframe environment. ECS is required with one CPU port for each mainframe. The presence of a DDP on a CPU port decreases by one the total number of mainframes that may run together.

Each mainframe in a complex may operate in a multimainframe mode or in stand-alone mode; however, two machines may not access the same device unless both are in multimainframe mode. A device is considered shared if it can be accessed by more than one of the mainframes; it need not be accessible to all the mainframes in the complex. The 844 (single and double density) and ECS devices are the only devices that are supported as shared devices.

The fact that a computer is operating as part of a multimainframe complex is not apparent to the user; however, there are operational changes and additions which are of importance to the operator. These include deadstart commands, displays, on-line commands necessary in the event of an interruption on one of the sharing mainframes, and the UNLOAD/MOUNT process for removable devices.

The Mass Storage Subsystem (MSS) can be used in a multimainframe environment. However, its hardware components are not shared among mainframes. Rather, one mainframe is physically connected to the MSF and is called the master mainframe; all other mainframes are called slave mainframes. MSSEXEC runs on the master mainframe and is the main processing program that controls MSS activity. MSSSLV runs on each slave mainframe and communicates with MSSEXEC to retrieve files from MSF in response to ATTACH requests by jobs running on the slave mainframes.

## OVERVIEW

ECS is used as the means and medium for controlling shared mass storage and intermainframe communication. Each mainframe has a CPU port into ECS through which system activity is controlled. In order to control shared mass storage devices, several ECS resident tables are required. The device access table (DAT) contains the logical description (family name/pack name and device number) of each mass storage device (shared or nonshared) which is accessible by any machine in the complex. For each device in the DAT which is to be accessed by more than one machine, a corresponding mass storage table (image of central memory resident MST) and track reservation table (TRT) also resides in ECS. In addition, a machine recovery table (MRT) exists in ECS for each machine and device (that is, there are as many MRTs for each shared device as there are mainframes in the complex).

---

† This feature has been designed and implemented to run on any combination of one to four mainframes. Due to resource limitations, the testing of this feature was conducted on one and two machine configurations.

Recovery allows a machine to either join other machines operational in a multimainframe environment or to operate in a stand-alone mode. The stand-alone system is not allowed to use the same mass storage devices as other machines. In the event of a system interruption to one machine, it is possible to operate the remaining machines in a multimainframe environment.

Automatic detection of ECS is not provided because it is not possible to determine its absence and continue to run on all machine types. For example, a 6600 will hang if an attempt is made to execute an ECS instruction without ECS. ECS status is checked by CMR (SET) when called upon to process an ECS entry in the CMRDECK.

## DEADSTART

A multimainframe environment is defined at deadstart by CMRDECK entries in each machine. The following entries are used to do this.

<u>CMRDECK Entry</u>	<u>Description</u>
MID=id.	One- or two-character machine identification. This identification is used to associate a specific machine with its access to a shared device. It is required, however, even if no devices are shared during system operation. This id must be unique for each machine in the complex. (If not specified, the default value is MID=AA.)
SHARE=xx <sub>1</sub> ,xx <sub>2</sub> ,...,xx <sub>n</sub> .	EST ordinals of the mass storage devices which will be shared with other machines in the multimainframe environment. The MST/TRT for each device resides in ECS.
PRESET,n.	Number of devices to be shared in the complex. The PRESET entry must be specified on a level 0 deadstart on the first machine to be deadstarted in a multimainframe environment. This entry initializes the flag register and ECS resident tables for multimainframe use. If n is not supplied, the default value is the number of shared devices defined for the particular machine. This entry can be specified only at the system console.
LINK=xx.	EST ordinal of the equipment to be the link device. This device must either be of DE or DP type and cannot be defined as removable. The presence or absence of this entry defines whether the machine is to be run as part of a multimainframe complex or as a stand-alone system. If the LINK device is initialized, it must also be PRESET. 0 is not a legal entry for xx.

These entries are also described in NOS Installation Handbook.

Since in a multimainframe environment two or more machines can utilize the same mass storage devices, the device assignments and CMRDECKs of all machines are interrelated. Care must be taken to ensure proper CMRDECK settings for each machine to obtain the desired device configuration. The following items are important in obtaining this proper configuration.

- Each machine must specify a unique machine identification (using the MID entry in the CMRDECK). This id associates a particular machine with its files on a shared device. There are no external characteristics associated with this identification. However, if the machine identification specified on a machine deadstarting into a multimainframe environment is identical to a machine identification on a machine already operating, the deadstart process halts and an appropriate message is displayed.
- The assignment of shared mass storage devices should be made properly to ensure the recoverability of the device and the proper operation of the system (refer to Shared Mass Storage).
- Each machine in the multimainframe environment must specify ECS as the link device, using the LINK CMRDECK entry. An ECS entry must also be present in the CMRDECK. If the CMRDECK entries are present which indicate a multimainframe environment, a check is made to ensure that either a DE or DP equipment entry is also present. If none is found, an error message is given to the operator indicating that no link device has been defined. A link device is automatically designated as a shared device.
- The first machine deadstarted in a complex must have the PRESET CMRDECK entry specified when deadstarting (level 0 only). This command causes tables to be preset in ECS, and in so doing, assures that no other machine has arrived at the same point in the deadstart sequence and is attempting the same thing. These other machines should not have the PRESET entry specified during deadstart. All other machines which arrive at that point in the deadstart process display a message indicating that they are waiting for deadstart on the preset machine. A machine that does not preset ECS has no means of detecting whether ECS has been preset previously by another machine. Therefore, the operator must ensure that ECS has been preset by a prior deadstart before deadstarting a particular machine without presetting ECS.
- If ECS is initially placed in maintenance mode (half of ECS used for on-line diagnostics), the first machine deadstarted in a complex must have the INITIALIZE and PRESET CMRDECK entries specified when deadstarting (level 0 only). The remaining machines must initialize ECS, because the maintenance mode parameter (MA) reduces the available ECS size by one half.

When a mainframe joins a multimainframe complex, it is associated with an identification which it utilizes during system operation but which is independent of the machine id. This association is done during deadstart when the machine investigates the MMF tables residing on the link device and places its machine id in an empty slot of the four that are available. Associated with each slot is a unique machine index and a unique machine mask, which the machine uses either to index itself into various MMF tables or to identify itself in these tables. The indices are 1, 2, 3, and 4. The masks are 1, 2, 4, and 8.

When a level 0 recovery deadstart will be performed on one of the machines in a multimainframe environment, the machine recovery utility (MREC) should be performed on some or all of the remaining machines before the deadstart proceeds. The purpose of this utility is to clear interlocks held by the machine to be deadstarted which have not been cleared by CPUMTR. It can also recover mass storage space on a shared device that is currently not accessible because of a machine interruption (necessitating a level 0 deadstart). MREC may have to be run from more than one machine since it affects only shared devices (that is, devices specified on the SHARE CMRDECK entry) of the machine on which MREC is run. If the interrupted machine shares different devices with different machines, MREC must be run from enough machines to account for all devices shared with the interrupted machine. The operator interface to MREC is described in the NOS Operator's Guide.



Figure 8-1 generally illustrates the steps needed to deadstart a machine in a multimainframe environment.

If a level 3 recovery deadstart will be performed in a multimainframe system, the ECS MMF tables must be intact as well as CMR. For a level 1 or 2 recovery in an MMF environment, the ECS MMF tables must be intact.

## **SHARED MASS STORAGE**

A major reason for operating a multimainframe complex is to be able to share mass storage devices between machines. Thus, the users of two systems may be able to utilize the same files if these files reside on a shared mass storage device. Having the ability to share files between systems also means that several additional procedures are required when operating a multimainframe complex. Additional consideration must also be given when assigning mass storage. This material, which is unique to multimainframe operation, is discussed in the following sections.

### **ASSIGNING SHARED MASS STORAGE**

Some consideration should be given as to which devices should be made shared devices and which ones should not. Since a shared device contains preserved files which can be accessed by more than one machine, it must be physically connected to and logically defined (as shared) by each machine sharing the device. If one device of a family is defined as shared, then normally all devices in the family should be defined as shared for accessibility. If a removable device will be treated as shared, it must be defined as removable in each machine sharing it. If a shared device is not removable, additional use of the device (beyond preserved files) is defined by each machine, independently of any other machine definition (that is, each machine must decide whether the device is to contain such things as a copy of the system or temporary files).

There is no real advantage in having nonpreserved files on a shared device, unless spreading them across shared devices outweighs having them on a dedicated device. A key factor is drive and controller contention. Another factor is whether or not enough drives and accesses to those drives are available to warrant the spreading of temporary files across several devices from all systems. Also, additional overhead is incurred by the system for each shared device. This includes additional CMR space for each device (100 CM words) and additional time that is required to maintain the device-related tables (such as the MST or the TRT) in the link device (ECS). These factors must be weighed to determine how best to configure shared devices.

### **DEVICE ACCESS TABLES**

For purposes of device usage determination, tables are maintained in ECS identifying the status of all devices in the multimainframe complex. This includes shared and nonshared devices for all machines. These tables are called the device access tables (DATs).

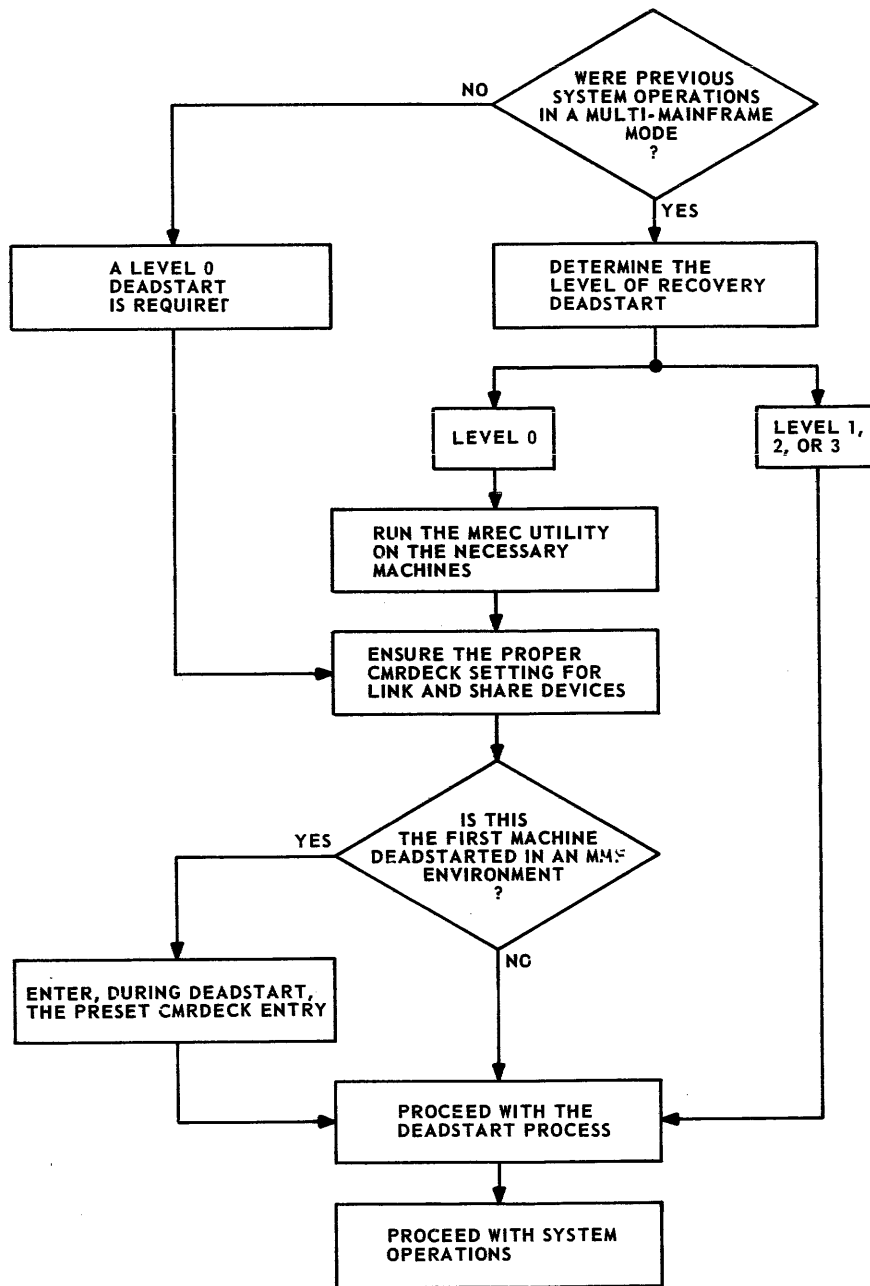

Figure 8-1. Deadstarting a Machine in an MMF Environment

In order to minimize configuration problems, shared removable equipment should be configured the same way on all machines in the complex. For example, if one system defines three shared units as three DI-1's and another system defines the same units as a DI-3, the first system can accommodate a DI-2 on these units, whereas the second system would consider it an error. Unless the configurations are the same on all machines, any devices mounted on those drives may not necessarily be recoverable on all machines.

**NOTE**

RESEX considers only the configuration of the machine on which it is executing in its over-commitment algorithm.

### **MASS STORAGE RECOVERY TABLES**

One problem that is created by having more than one machine sharing a mass storage device is that of recovering the mass storage space and interlocks of a machine, should it require recovery processing. This problem is solved by defining a table which provides the information needed to recover the mass storage space of a machine and by having a utility which performs the recovery. The table is called the machine recovery table (MRT). There is one MRT for each mainframe per device. It tells which tracks are interlocked and which tracks are first tracks of files local to a particular machine. The MRT is utilized by CPUMTR on another machine to clear track interlocks and by the machine recovery utility MREC on another machine to recover the mass storage space of the interrupted machine. For specific information on the MRT, refer to the NOS Systems Programmer's Instant.

### **DEVICE INITIALIZATION**

To initialize a mass storage device, it is necessary first to prevent any new activity from starting up on the device, then to wait until all current activity has completed, and finally to interlock the device and proceed with initialization. To accomplish this on shared mass storage devices in a multmainframe environment, the following steps must be taken.

1. The INITIALIZE DSD command should be entered on the machine from which the initialization is to take place. If it is found that the INITIALIZE command has been entered from another machine, an error message is displayed. Refer to NOS Operator's Guide.
2. All other machines sharing the device must unload it by entering the UNLOAD DSD command to prevent any new activity. (This command can be used for both removable and nonremovable shared devices.) Refer to the NOS Operator's Guide and Device Unload section.

3. The machine from which the INITIALIZE was entered monitors the status of the other machines that are sharing the device. Once they have unloaded the device and user activity has ceased, initialization proceeds. Tables are also updated in ECS and the device is checkpointed.
4. To activate the device on the other machines, the MOUNT DSD command must be entered from each machine. This command clears the UNLOAD status. If initialization is still in progress on another machine when a MOUNT command is entered, the MOUNT process is terminated with an error. Refer to the NOS Operator's Guide.

## DEVICE UNLOAD

In a multiframe environment, unloading a device involves more than it does under a one machine system. A device can be unloaded from a machine (referred to as a local unload), or it can be unloaded from the entire multiframe complex (referred to as a global unload). A device can be physically removed from the complex only after a global unload has been accomplished. The general procedure to complete a global unload is illustrated in the following.

1. Enter the UNLOAD command from each machine. This is an indication to the machine that no new accesses should be initiated. This command must be entered from each machine sharing the device.
2. When all local unloads are set and user access has ceased, global unload status is set if the device is a removable device. This global unload status is displayed on all machines, indicating that there is no activity on the device from any machine and that the device may be physically unloaded.
3. The operator can then switch packs and enter the MOUNT command at the console to initiate recovery of the device. The MOUNT command clears the global unload status and the local unload status on the machine from which it was entered and indicates that this machine is now accessing the device. All other machines continue to ignore the device until the MOUNT command is entered on each machine. The MOUNT command does nothing if local unload status is not set on the machine.

## DEVICE RECOVERY

Deadstart and on-line recovery methods are similar logic in recovering mass storage devices. When a device is recovered, the DAT in ECS is interlocked while a check is made to see if an entry exists for this device. The presence of an entry indicates that another machine is also accessing the device. If an entry is found, and the machine recovering the device has not been instructed to share it, an error is indicated and recovery halts with an appropriate message displayed. If the machine already accessing the device is not allowing it to be shared, the same error condition occurs. Therefore, if a device is being accessed, another machine can recover that device only if the recovering machine and the accessing machine use the device in shared mode.

### NOTE

If two devices recovered on separate machines have the same family name/device number or pack name, there is no method of determining whether or not they are the same device if both are shared. If they are different devices, they are both destroyed when used.

## DEVICE CHECKPOINT

Local MST information for each machine which shares a mass storage device is maintained on the device. MST information for other machines may also be present on the device. The information for each machine is kept in one sector on the label track following the TRT sectors. Entries up to 31 unique machine ids can exit.

During checkpoint, only the local MST information of the machine performing the checkpoint is updated. Since local MST information for many machines is kept on the device, updating of all these areas by one machine could cause a loss of information needed if the device were to be used with another system.

For shared devices, duplication of checkpointing by more than one machine is prevented. If a machine attempts to checkpoint a shared device and determines that another machine is performing the checkpoint (a checkpoint request bit is set in the local MST area of another machine), no action is taken. Only one checkpoint bit is set at any given time for a device.

## MULTIMAINFRAME OPERATION IN AN MSS ENVIRONMENT

MSS processing is available in a multimainframe environment. Unlike other mass storage devices (disk and ECS), however, the MSF is not shared by mainframes. Rather, MSF is physically connected to and driven by one mainframe, called the master mainframe. All other mainframes that share permanent files with the master mainframe are called slave mainframes. The disks to which MSF resident files are to be staged must be shared devices and accessible by all mainframes.

MSSEXEC runs on the master mainframe and is the main program that controls MSS processing activities. MSSEXEC is activated via the following commands that are entered at the system console.†

```
ENABLE=MSS MASTER  
n.MSSffff
```

MSSSLV runs on each slave mainframe and is the program that supports file retrieval from MSF for jobs running on a slave mainframe. MSSSLV is activated via the following commands that are entered at the system console.†

```
DISABLE=MSS MASTER  
n.MSSffff
```

When a job running on a slave mainframe attaches an MSF-resident file that has no disk image, MSSSLV is requested to stage the file to disk. However, MSSSLV cannot access MSF directly. MSSSLV must communicate with MSSEXEC, which stages the file to shared disk and then notifies MSSSLV when the file is available. MSSSLV then causes the requesting job to be resumed so that the file ATTACH can complete.

The permanent files used for communication between MSSEXEC and MSSSLV are initialized and recovered automatically and require no backup or recovery processing by the installation. The name of the permanent file used by MSSSLV running on mainframe *i* (*i*=1, 2, 3, 4) to send requests to MSSEXEC is STOMNO*i*. The name of the permanent file used by MSSEXEC to respond to all requests by all MSSSLVs is MTOSPFN. These files belong to the family that contains ECS and are saved under the user index 377760g.

---

† Refer to the NOS Operator's Guide for more information about these commands.

---

Spacing and format control is provided by the use of carriage control format tapes or programmable format control (PFC) on 580 line printers. The carriage control format tape is punched to indicate particular format channels for each frame. A printer with PFC does not use carriage control format tapes; instead, it contains a microprocessor plus memory. PFC arrays are loaded into this memory, performing the same function as the format tape. This section describes the creation and loading of PFC arrays. A description of format tapes may be found in volume 1 of the NOS Reference Manual.

## PFC ARRAYS

Certain 580 printers are not equipped with a carriage control tape; instead, a microprocessor plus memory referred to as PFC is used. Instead of a tape controlling the page format, software is used. This software is referred to as a PFC array. A PFC array consists of numbers from 0 to 17g. Each nonzero character represents a channel. A zero specifies that no channel is selected. An array is similar to a format tape since each number in a PFC array corresponds to a line on the print form. As each line of a page is printed, the next number in the PFC array buffer is addressed. A carriage control character in column 1 of the output line, indicating a skip to a particular channel, causes the memory in the PFC array buffer to be sequentially addressed until the particular number is found. The paper is spaced a similar number of spaces.

A PFC array differs from a format tape because only one channel can be specified per line. A number of channels can be specified per line using a format tape. Also, PFC arrays are accessed in pairs, one for 6 lines per inch printing and one for 8 lines per inch printing. The 8 lines per inch array is usually larger, allowing more lines to be printed on the same size page.

## BUILDING PFC ARRAYS

Observe the following rules when building a PFC array.

1. Enter only valid numbers (0 through 17g) in the PFC array.
2. A 1 must be the first number in the PFC array, indicating a top of form position.
3. A 12g should always indicate the last line of the form (bottom of page).
4. A 17g should appear as the last number in the array, denoting the end of valid numbers for a given array. This number does not correspond to any particular line on the form.
5. Maximum length PFC arrays (132 for 6 lines per inch and 176 for 8 lines per inch) must include a 9 only at location 132 for 6 lines per inch and location 176 for 8 lines per inch. Improper paper alignment may occur if a 9 is placed elsewhere.

To properly load the appropriate PFC buffer for a particular form, it is necessary to assemble data that will contain, when transmitted and stored in the PFC array buffer, as many numbers as lines on the form. As stored within the PFC array buffer, each number is a 4-bit code used to represent channels (1 through 14) or a null code (no channel selected).

**NOTE**

Channels 13 and 14 are valid channels but are not selectable. No PFC error occurs when loading these numbers into the PFC buffer.

The maximum capacity of the 6-line per inch PFC buffer is 132 numbers (22-inch form maximum) plus the last line number whereas the 8-line per inch PFC buffer has a capacity of 176 numbers (22-inch form maximum) plus the last line number. Fewer than the maximum amount of numbers may be legally loaded into the PFC buffer, but an excessive amount of numbers will cause a PFC overflow error.

**ADDING PFC ARRAYS**

PFC arrays must occur in pairs (one 6-line per inch array and one 8-line per inch array); therefore, when a particular array is specified with the SC option of the ROUTE control statement, it is possible to switch from 6 to 8 lines per inch spacing. Two pairs of arrays are provided with the operating system (table 9-1).

To add additional PFC arrays, BATCHIO must be modified to contain these additional arrays as overlays in QAP. The overlay names and corresponding ROUTE statement SC parameter options must be added to PFCO, and PFC overlay table in QAP. The first entry in this table indicates the default PFC array. This array is used when the SC parameter is not specified. If an added array is to be the default array, the PFCO entry for it should be placed at the beginning of the table. The value which must be specified with the SC parameter is included in this entry. This value can be any 6-bit binary value. The arrays that are also added to QAP must follow the same format, structure, and labeling conventions as the arrays already provided in QAP.

To generate the numbers to be loaded into the PFC buffer, the DPFC (define PFC code) macro is used with the following format. Only the lower 4 bits of each 6 bits are used as PFC numbers.

LOCATION	OPERATION	VARIABLE SUBFIELDS
	DPFC	a,b,c,d

a, b, c, d                      PFC numbers for 6 or 8 lines per inch. These numbers can be any value from 0 to 17g.

**NOTE**

In each macro call, all four parameters must be specified (0 denotes no channel is selected). If all four are not required to complete an array (the number of lines on the form is not a multiple of 4), zeros should be used for the remaining parameters.

TABLE 9-1. RELEASED PFC ARRAYS

Location	6 lpi Def	6 lpi Alt	8 lpi Def	8 lpi Alt	Location	6 lpi Def	6 lpi Alt	8 lpi Def	8 lpi Alt
1	1	1	1	1	41	0	0	3	3
2	6	6	6	6	42	0	0	0	0
3	0	0	0	0	43	3	8	0	0
4	2	2	0	0	44	0	0	0	0
5	0	0	2	2	45	0	0	4	4
6	0	0	0	0	46	4	10	0	0
7	3	3	0	0	47	0	0	0	0
8	0	0	0	0	48	0	0	0	0
9	0	0	3	3	49	5	11	5	5
10	4	4	0	0	50	0	0	0	0
11	0	0	0	0	51	0	0	0	0
12	0	0	0	0	52	2	2	0	0
13	5	5	4	4	53	0	0	2	7
14	0	0	0	0	54	0	0	0	0
15	0	0	0	0	55	3	3	0	0
16	2	7	0	0	56	0	0	0	0
17	0	0	5	5	57	0	0	3	8
18	0	0	0	0	58	4	4	0	0
19	3	8	0	0	59	0	0	0	0
20	0	0	0	0	60	0	0	0	0
21	0	0	2	7	61	5	5	4	10
22	4	10	0	0	62	0	0	0	0
23	0	0	0	0	63	0	0	0	0
24	0	0	0	0	64	12	12	0	0
25	5	11	3	8	65	0	0	5	11
26	0	0	0	0	66	0	0	0	0
27	0	0	0	0	67	1	1	0	0
28	2	2	0	0	68	0	0	0	0
29	0	0	4	10	69	0	0	2	2
30	0	0	0	0	70	2	2	0	0
31	3	3	0	0	71	0	0	0	0
32	0	0	0	0	72	0	0	0	0
33	0	0	5	11	73	3	3	3	3
34	4	4	0	0	74	0	0	0	0
35	0	0	0	0	75	0	0	0	0
36	0	0	0	0	76	4	4	0	0
37	5	5	2	2	77	0	0	4	4
38	0	0	0	0	78	0	0	0	0
39	0	0	0	0	79	5	5	0	0
40	2	7	0	0	80	0	0	0	0



TABLE 9-1. RELEASED PFC ARRAYS (Contd)

Location	6 lpi Def	6 lpi Alt	8 lpi Def	8 lpi Alt	Location	6 lpi Def	6 lpi Alt	8 lpi Def	8 lpi Alt
81	0	0	5	5	125	0	0	2	2
82	2	7	0	0	126	0	0	0	0
83	0	0	0	0	127	5	5	0	0
84	0	0	0	0	128	0	0	0	0
85	3	8	12	12	129	0	0	3	3
86	0	0	0	0	130	12	12	0	0
87	0	0	0	0	131	0	0	0	0
88	4	10	0	0	132	9	9	0	0
89	0	0	1	1	133	17 <sub>8</sub>	17 <sub>8</sub>	4	4
90	0	0	0	0	134			0	0
91	5	11	0	0	135			0	0
92	0	0	0	0	136			0	0
93	0	0	2	2	137			5	5
94	2	2	0	0	138			0	0
95	0	0	0	0	139			0	0
96	0	0	0	0	140			0	0
97	3	3	3	3	141			2	7
98	0	0	0	0	142			0	0
99	0	0	0	0	143			0	0
100	4	4	0	0	144			0	0
101	0	0	4	4	145			3	8
102	0	0	0	0	146			0	0
103	5	5	0	0	147			0	0
104	0	0	0	0	148			0	0
105	0	0	5	5	149			4	10
106	2	7	0	0	150			0	0
107	0	0	0	0	151			0	0
108	0	0	0	0	152			0	0
109	3	8	2	7	153			5	11
110	0	0	0	0	154			0	0
111	0	0	0	0	155			0	0
112	4	10	0	0	156			0	0
113	0	0	3	8	157			2	2
114	0	0	0	0	158			0	0
115	5	11	0	0	159			0	0
116	0	0	0	0	160			0	0
117	0	0	4	10	161			3	3
118	2	2	0	0	162			0	0
119	0	0	0	0	163			0	0
120	0	0	0	0	164			0	0
121	3	3	5	11	165			4	4
122	0	0	0	0	166			0	0
123	0	0	0	0	167			0	0
124	4	4	0	0	168			0	0

TABLE 9-1. RELEASED PFC ARRAYS (Contd)

Location	6 lpi Def	6 lpi Alt	8 lpi Def	8 lpi Alt	Location	6 lpi Def	6 lpi Alt	8 lpi Def	8 lpi Alt
169			5	5	174			0	0
170			0	0	175			0	0
171			0	0	176			9	9
172			0	0	177			17 <sub>8</sub>	17 <sub>8</sub>
173			12	12					

Notes: All values are decimal unless indicated otherwise.

lpi      Lines per inch

Def      Default (SC=0)

Alt      Alternate (SC=1)

---

The deadstart dump interpreter (DSDI) is a utility program, called by a batch control statement, which converts selected portions of the binary information on an express deadstart dump (EDD) file into reports to be listed. The express deadstart dump file is generated on magnetic tape by the express deadstart dump utility which may be run at deadstart time after a system malfunction has occurred. Information on the EDD file is sequenced according to the illustration in figure 10-1. Refer to the NOS Operator's Guide for complete information concerning the use of EDD.

Selection of data to be listed by DSDI is provided through input directives, either on an input file or on the DSDI control statement itself. Normal octal dumps of CM, ECS, and PP memory can be produced by these directives as well as specially formatted dumps of specific system tables and buffers.

The following features are provided through the use of EDD and DSDI.

- The EDD tape file contains a dump of memory, the executing exchange packages, the CDC CYBER 170 S/C registers, where applicable, and all PPs except for PP0 which can be saved by either copying it to another PP or by biasing the PP switch on the deadstart panel, if the hardware exists. EDD can optionally dump all or part of ECS and the selected buffer controllers. This permits analysis of a system malfunction to be performed entirely off-line.
- Because DSDI copies the EDD file to a word-addressable random file on mass storage, dump data can be accessed in any order.
- EDD requires only a small amount of time during deadstart because the data is transferred in binary form to magnetic tape.
- The tape file created by EDD can be retained on magnetic tape or mass storage until it is no longer needed. Thus, a selective listing can be generated at any time.
- General information from the EDD file appears in the title and subtitle line of each page of listed output. The first 50 columns of each input directive are included in the title line of the output list it produces. An input directive is provided which enables insertion of comments into the subtitle line.
- Use of DSDI is possible from an interactive terminal as well as from the batch environment. The output produced by several directives is formatted for terminal output (72 columns). From a batch environment, output is formatted for a 136-column printer.

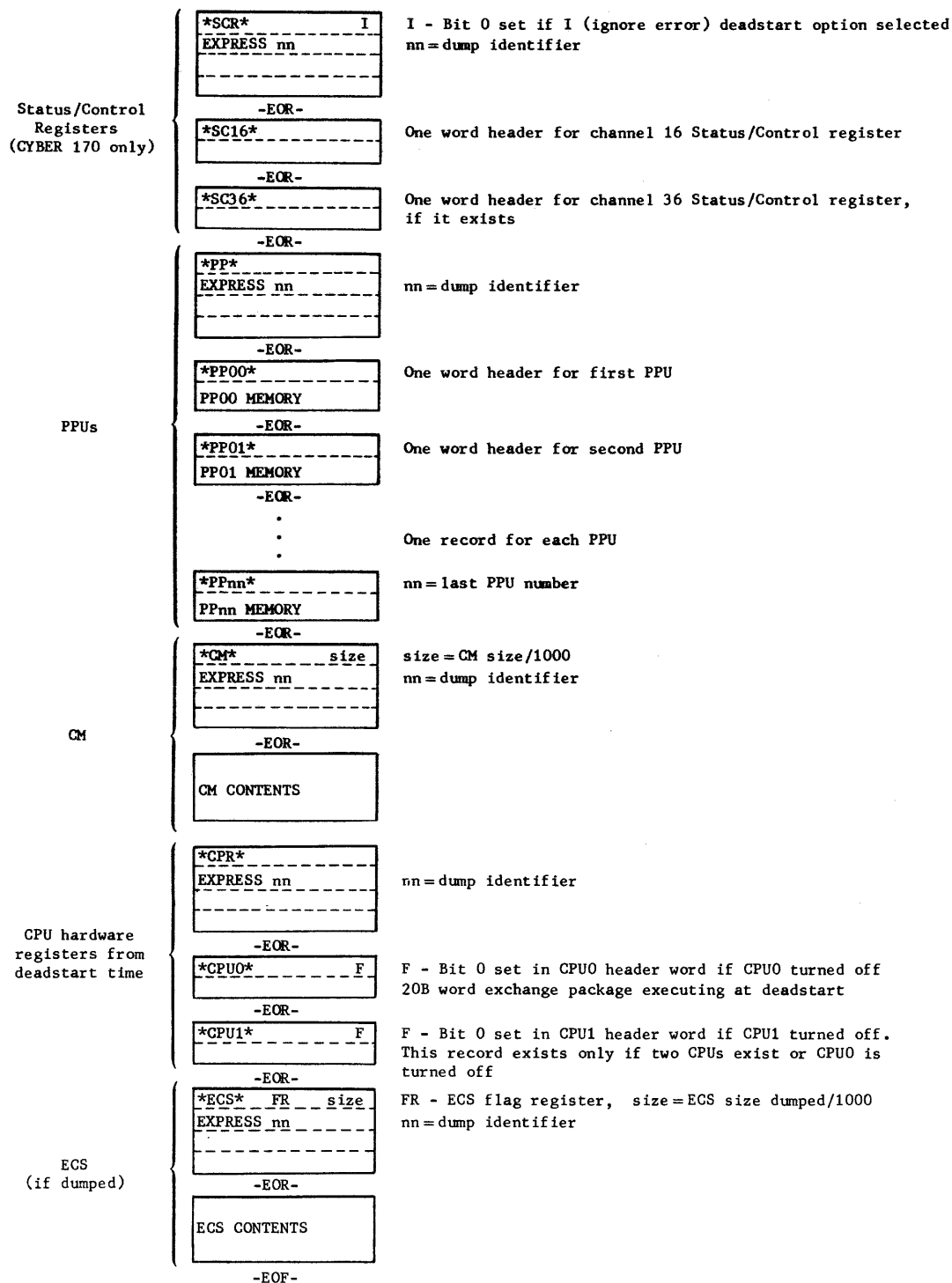

Figure 10-1. EDD Tape Format

## CALLING THE EXPRESS DEADSTART INTERPRETER

Processing of the EDD file is initiated with the DSDI control statement. The format of the statement is:

DSDI(p<sub>1</sub>,p<sub>2</sub>,...,p<sub>n</sub>)

where p<sub>i</sub> is either a keyword or a keyword equated to a value. All keywords are optional and order independent. If a keyword is not specified, a default value is assumed.

<u>P<sub>i</sub></u>	<u>Description</u>
D	Random dump file is to be created. This file can then be used as the dump file on subsequent executions of DSDI, eliminating the need to read the entire dump tape on each call.
D omitted	No random dump file is to be created.
F=filenam	One- to seven-character name of file on which the express dump is to be written.
F omitted	Same as F=DUMP.
I=filenam	One- to seven-character name of file on which input directives are written.
I omitted	Same as I=INPUT.
L=filenam	One- to seven-character name of file on which list output is to be written. User must save or print the file.
L omitted	Same as L=OUTPUT, except that the file is automatically printed.
NR	EDD file is not to be rewound.
NR omitted	EDD file is to be rewound before processing.
P	Low core pointers from running system are to be used. Selecting this option causes the low core pointers from the running system to be used to locate tables and buffer areas on the EDD file. This option is typically used when it is known that the low core pointers on the EDD file were destroyed by the system malfunction (for example, a CPUMTR error exit leaves an exchange package in memory locations 0 through 20 octal). Directives used to dump low core will dump the low core pointers contained on the EDD file, not those from the running system.  This option should be used only when the configuration of the running system is the same as the system in use when the EDD file was created.
P omitted	Low core pointers from EDD file are to be used.
PD=n	Print density in number of lines per inch (3, 4, 6, or 8).
PD	Same as PD=8.
PD omitted	Same as PD=6.

<u>Pi</u>	<u>Description</u>
Z	Input directives are contained on the control statement after the terminator. The I option is ignored. This eliminates the need to use a separate input file for the directives when only a few directives are needed.
Z omitted	Input directives are not contained on the control statement. The system uses the I option.

When input directives appear on the DSDI control statement, the first character following the control statement terminator is the separator character for all directives on the control statement. Any display code character which is not used in any of the directives, including a space, can be used as the separator character. Each directive must be preceded by a separator and terminated by a period. The directives can extend to column 72 on the statement. Continuation cards are not permitted.

For example, (slant bar used for separator):

```
DSDI(Z)/SC./XP./P./D,0,20000./EC./D,0,10000.
```

If the directives are included in the input file, the following equivalent job would appear.

```

:
DSDI.
--EOR--
SC.           Dump CYBER 170 S/C register.
XP.           Dump executing exchange packages.
P.            Dump all PPs.
D,0,20000.    Dump the first 20000 octal locations of CM.
EC.           Set memory type to ECS.
D,0,10000.    Dump the first 10000 octal locations of ECS.
--EOI--

```

A request for the EDD tape must precede the DSDI control statement. Since EDD writes information on an unlabeled, seven- or nine-track tape at a density of 800 bpi for seven-track and 1600 cpi for nine-track, the request should appear as follows:

```
LABEL(DUMP,D={ 1600 }, { NT }, F=S, LB=KU, VSN=DUMP)
           { 800  }, { MT }
```

It is recommended that the vsn parameter be specified in the request. If this is done, the request is presented in the resource mounting preview display and the job is rolled out until the tape is mounted and assigned. Although the default express dump file name (DUMP) is used in this example, a different file name can be specified, provided the same file name is also specified on the DSDI control statement (F option).

## INPUT DIRECTIVES

DSDI input directives provide the capability to selectively dump only those portions of the EDD file that are of interest. The input directives are grouped into the following categories.

- List Control Directives.

Allow user to control line printer page eject and print density, and to specify comments in subtitle line of the output listing.

- File Manipulation and Control Directives.

Allow user to specify alternate files for DSDI input directives and listing output.

- CM/ECS Dump Directives.

Provide octal dumps of specified portion of central memory or ECS. Absolute or relative addresses can be dumped (three dump formats are available).

- PP Dump Directives.

Provide octal memory dumps of all or selected PPs (two dump formats are available). PP analysis data can be included in the dumps.

- CMR Dump Directives.

Provide specially formatted dumps of selected areas in central memory resident. These areas are specified by name rather than by address.

- Subsystem Dump/Analysis Directives.

Provide specially formatted dumps of subsystem control points and associated tables and buffers.

- Hardware Register Dump Directives.

Provide dumps of specified hardware registers.

Several of the DSDI input directives have interactive capabilities. The output produced by these directives is specially formatted for listing at an interactive terminal. Refer to Interactive Use of DSDI (later in this section) for information concerning directive entry and use of DSDI from an interactive terminal.

Printer Output Listing Examples contains examples of listings produced by several of the DSDI input directives.

## DIRECTIVE FORMAT

A directive has the following format.†

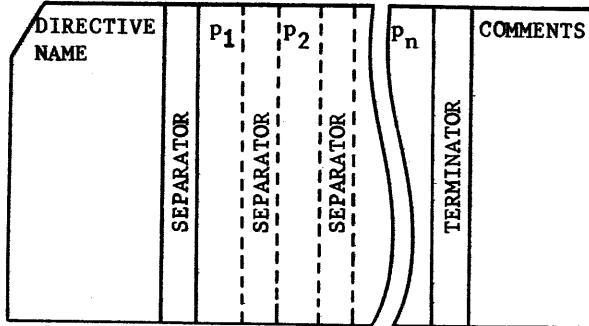

**Directive Name**      The directive name starts in column 1. It is terminated by a separator or terminator character.

**Separator**            Any character, including a space, other than the following.

A-Z, 0-9, +, -, \*

A period is the directive terminator; therefore, it cannot be used as a separator.

**P<sub>i</sub>**                    Parameter option for the directive. Depending on the requirements of the directive, the directive may have no parameters or a number of parameters. Directives which do not process parameters will ignore everything beyond the first separator. Directives which require a fixed number of parameters will ignore everything beyond the separator for the last legal parameter.

**Terminator**          The explicit directive terminator is a period. Anything beyond the period is ignored.

Any characters following the directive terminator are considered comments and are ignored by DSDI. However, the comments are included with the directive in the title line of each page of the output listing (combined total of 50 characters appear in the listing).

†Although the directive format shown illustrates a directive as it would appear in a batch job deck, the same format is used when directives are stored on a file or entered from an interactive terminal. Refer to Interactive Use of DSDI for additional information concerning directive entry from an interactive terminal.



## LIST CONTROL DIRECTIVES

The list control directives provide the capability to specify print density and page eject options, and to add comments in the subtitle line of each page listed.

### EJON — Turn On Auto Page Eject

The EJON directive enables auto page eject (default condition). DSDI automatically issues a page eject function before listing the output produced by each new directive processed. This directive has no effect unless auto page eject has been disabled by the EJOFF directive.

Format:

EJON.

### EJOFF — Turn Off Auto Page Eject

The EJOFF directive disables auto page eject. Until this directive is processed, DSDI automatically issues a page eject function before listing the output produced by each new directive.

Format:

EJOFF.

### EJ — Force Page Eject

The EJ directive forces DSDI to issue a page eject function before listing the output produced by the next directive processed. The EJ directive can also force a page eject upon reaching a specified point on the page being printed. The page eject function is performed automatically unless disabled by the EJOFF directive.

Format:

EJ,nn.

nn                      Force page eject only if less than nn decimal lines remain on the current page. If nn is omitted, page eject is forced before listing the output from the next directive processed.

### PD — Reset Print Line Density

The PD directive resets the print line density to a value other than that specified on the DSDI control statement.

Format:

PD,n.

n                      n is new print line density in number of lines per inch (3, 4, 6, or 8). If n is omitted or an illegal value is specified, the message ILLEGAL PRINT DENSITY SELECTION is issued.

### **\*. — Comment in Subtitle Line**

The \*. directive specifies a comment that appears in the subtitle line of each page listed.

Format:

\*.ccc...ccc

ccc...ccc            Comment (up to 36 characters are printed).

## **FILE MANIPULATION AND CONTROL DIRECTIVES**

File manipulation and control directives provide the capability to specify alternate files for DSDI input directives and listing output.

### **READ — Read Alternate Directives File**

The READ directive causes DSDI to temporarily stop reading the current directives file and begin reading directives from the specified record on the named alternate file or from current position if the record name is omitted. DSDI reads from the specified alternate directives file until an end of record is encountered (end of file or empty record if \* is specified) and then resumes with the next directive on the original input directives file.

Format:

READ,filenam.

READ,filenam,rec.

READ,filenam,\*.

filenam	Name of alternate directives file (local file).
rec	Optional record name. If rec is specified, file filenam is searched for record rec from the current position to end-of-file or an empty record. If rec is not found, DSDI issues an error message. If rec is not specified, DSDI reads directives from the current position to end of record. Records must be in text format where the first word of the record is the record name, unless the file is assigned to an interactive terminal; then, directives may be entered directly.
*	Optional character which specifies that DSDI is to read directives from all records until an end-of-file or an empty record is encountered.

## **OUTPUT — Assign Output to Alternate List File**

The OUTPUT directive temporarily assigns DSDI listing output to a file other than that specified on the DSDI control statement. When the alternate file is disposed to the print queue (refer to DISPOSE directive), output resumes on the original output file. If the alternate file is not disposed, both the original and the alternate output files remain at the job control point as local files. Refer to Interactive Use of DSDI for additional information concerning use of this directive from an interactive terminal.

Format:

OUTPUT,filenam.

filenam	Name of alternate list file (one to seven characters). Only one alternate output file may be active at a time; filenam cannot be the same name as the normal output file. If filenam is omitted, the system assumes file name ALTRNT.
---------	---

## **DISPOSE — Dispose Alternate List File to Print Queue**

The DISPOSE directive causes the alternate list file specified by the OUTPUT directive to be disposed to the print queue. DSDI listing output then resumes on the original output file. This directive has no effect unless output has previously been assigned to an alternate list file (refer to OUTPUT directive). Refer to Interactive Use of DSDI for additional information concerning use of this directive from an interactive terminal.

Format:

DISPOSE,usenum.

usenum	User number under which the remote batch terminal to receive listing is logged in. If usenum is omitted, the listing is printed at a central site line printer.
--------	---

## **REWIND — Rewind File**

The REWIND directive repositions the specified file to beginning-of-information.

Format:

REWIND,filenam.

filenam	Name of file to be rewound.
---------	-----------------------------

## **CM/ECS DUMP DIRECTIVES**

The CM/ECS dump directives provide the capability to dump any portion of central memory or extended core storage in instruction parcel, byte, or word format. Display code character equivalents are included with each format. Either absolute or relative memory locations may be dumped. Refer to CMR Dump Directives for directives used to dump specific portions of NOS central memory resident (CMR).

## **Dump Control Directives**

Dump control directives select the type of memory to be dumped (CM or ECS) and the addressing mode to be used (absolute or relative).

### CM - Set Memory Type to CM

The CM directive specifies that subsequent C, D, and E directives dump central memory locations. Unless the EC directive is specified, central memory locations are dumped by default.

**Format:**

CM.

### EC - Set Memory Type to ECS

The EC directive specifies that subsequent C, D, and E directives dump extended core storage (ECS) locations. Unless this directive is specified, central memory locations are dumped by default.

**Format:**

EC.

### RA - Reset Reference Address

The RA directive specifies that subsequent C, D, and E directives dump memory locations relative to a specified reference address. Unless the RA or RAC directive is entered, absolute memory locations are dumped by default.

**Format:**

RA,nnnnnnn.

nnnnnnn      Reference address; addresses specified on subsequent C, D, and E directives are relative to this address.

Clearing the reference address specified on the most recent RA or RAC directive reenables absolute addressing. This is done by entering the RA directive in the following format.

RA,0.

### RAC - Reset Reference Address to RA of Control Point

The RAC directive specifies that subsequent C, D, and E directives dump memory locations relative to the reference address of a specified control point. Unless the RA or RAC directive is entered, absolute memory locations are dumped by default.

**Format:**

RAC,nn.

nn                    Control point number; addresses specified on subsequent C, D, and E directives are relative to the reference address of this control point.

Refer to the description of the RA directive to reenable absolute addressing.

**Memory Dump Directives**

Memory dump directives specify the area of memory to be dumped and determine the format of the output listing (refer to Printer Output Listing Examples for sample output listing). The CM and EC directives determine the type of memory to be dumped (default is central memory). Absolute memory locations are dumped unless relative addressing has been enabled (refer to RA and RAC directives).

C - Dump Memory in Instruction Parcel Format

The C directive causes the specified locations of central memory or ECS to be dumped in four groups of five octal digits (three words per line) with display code character equivalents. Repetitive data is suppressed.

**Format:**

C,fwa,lwa.

fwa                    First-word address to be dumped (mandatory).

lwa                    Last-word address, plus one location, to be dumped. If lwa is omitted, fwa+1 is assumed by default.

The output listing is read from top to bottom by column rather than across the page. Refer to Interactive Use of DSDI for additional information concerning use of this directive from an interactive terminal.

D - Dump Memory in Byte Format

The D directive causes the specified locations of central memory or ECS to be dumped in five groups of four octal digits (three words per line) with display code character equivalents. Repetitive data is suppressed.

**Format:**

D,fwa,lwa.

fwa                    First-word address to be dumped (mandatory).

lwa                    Last-word address, plus one location, to be dumped. If lwa is omitted, fwa+1 is assumed by default.

The output listing is read from top to bottom by column rather than across the page. Refer to Interactive Use of DSDI for additional information concerning use of this directive from an interactive terminal.

### E - Dump Memory in Word Format

The E directive causes the specified locations in central memory or ECS to be dumped in word format (four words per line) with display code character equivalents.

Format:

E,fwa,lwa.

fwa	First-word address to be dumped (mandatory).
lwa	Last-word address, plus one location, to be dumped. If lwa is omitted, fwa+1 is assumed by default.

### PP DUMP DIRECTIVES

PP dump directives provide the capability to obtain a memory dump of all or selected PPs. Two dump formats are available, block format and line format.

#### P — Dump PP Memory in Block Format

The P directive causes PP memory to be dumped in block format where each block represents 100 octal words of memory. The blocks are read by column (top to bottom), where each column contains 10 octal 12-bit words numbered 0 through 7. There are 10 octal columns in each block, numbered 0 through 7. Repetitive data is not suppressed and zero words are represented by hyphens (---).

Format:

P,n<sub>1</sub>,n<sub>2</sub>,...,n<sub>n</sub>.

n <sub>i</sub>	Number of PP to be dumped. If omitted, all PPs are dumped.
----------------	--

#### PF — Dump FLPP† Memory in Block Format

The PF directive causes first level peripheral processor (FLPP) memory to be dumped in block format where each block represents 100 octal words of memory. The blocks are read by column (top to bottom), where each column contains 10 octal 12-bit words numbered 0 through 7. There are 10 octal columns in each block, numbered 0 through 7. Repetitive data is not suppressed and zero words are represented by hyphens (---).

---

†Hardware manuals define peripheral processors making up a peripheral processor subsystem (PPS) as PPs and the first level peripheral processors as PPU's. In this manual, first level peripheral processors are referred to as FLPPs. FLPPs are available only on the CYBER 170 model 176.

**Format:**

PF,n<sub>1</sub>,n<sub>2</sub>,...,n<sub>n</sub>.

n<sub>i</sub>                      Number of FLPP to be dumped. If omitted, all FLPPs are dumped.

**Q — Dump PPU Memory in Line Format**

The Q directive causes PP memory to be dumped in line format with display code character equivalents. Each line contains 20 octal bytes (PP words) printed in two sets of 10 octal bytes. Each set consists of an address, 10 octal bytes, and display code character equivalents. Repetitive lines are suppressed and zero bytes are represented by hyphens (----). Refer to Interactive Use of DSDI for additional information concerning use of this directive from an interactive terminal.

**Format:**

Q,n<sub>1</sub>,n<sub>2</sub>,...,n<sub>n</sub>.

n<sub>i</sub>                      Number of PP to be dumped. If omitted, all PPs are dumped.

**QF — Dump FLPP† Memory in Line Format**

The QF directive causes FLPP memory to be dumped in line format with display code equivalents. Each line contains 20 octal bytes printed in two sets of 10 octal bytes. Each set consists of an address, 10 octal data bytes, and 16 display code equivalents. Repetitive lines are suppressed and zero bytes are represented by hyphens (----).

**Format:**

QF,n<sub>1</sub>,n<sub>2</sub>,...,n<sub>n</sub>.

n<sub>i</sub>                      Number of FLPP to be dumped. If omitted, all FLPPs are dumped.

**AP — Dump Analysis of PP and PP Memory in Line Format**

The AP directive causes PP memory to be dumped in line format with display code character equivalents. (same format as Q directive). Repetitive lines are suppressed and zero bytes are represented by hyphens. An analysis of the PP is printed before the memory dump. Analysis data includes the associated PP communications area, resident entry point call addresses, and read-only variables in directive cells. Certain direct cell variables are verified and those in error are indicated.

---

† Hardware manuals define peripheral processors making up a peripheral processor subsystem (PPS) as PPs and the first level peripheral processors as PPU's. In this manual, first level peripheral processors are referred to as FLPPs. FLPPs are available only on the CYBER 170 model 176.

**NOTE**

Correct operation of this directive requires that the PP communication area on the EDD file be intact.

**Format:**

AP,n<sub>1</sub>,n<sub>2</sub>,...,n<sub>n</sub>.

n<sub>j</sub>                      Number of PP to be dumped or a program name. If a program name is specified, all PPs executing that program are dumped. A warning message is issued if an illegal number is specified or the program name is not found in any PP. If n<sub>j</sub> is omitted, all active PPs are dumped.

Refer to Printer Output Listing Examples for a sample of the printer output listing produced by this directive.

**MPP — Move PP**

The MPP directive causes the correct logical PP to be dumped if the logical position of PP00 has been changed prior to the full dump to tape. If the PPS-0/PPS-1 toggle switch has been toggled, the first format should be specified. If PP00 has to be moved to another PP via a deadstart panel program, the second format should be specified.

**Formats:**

MPP.                      (This format is meaningful only on CYBER 170 and CYBER 70 Systems with 20 PPs.)

MPP,n.

n                          Number of PP to which PP00 was moved. n cannot equal 0.

**PMS — Read PP Select Switches**

The PMS directive causes the dump of the S/C register to be read to determine the current value of the PP memory select switches and the correct logical PP to be dumped, if the logical position of PP00 has been changed prior to the full dump to tape. If the PP memory select switches have been changed, this directive should be specified with the binary value of the switches prior to the change. This directive is meaningful only on a CYBER 170 system.

**Format:**

PMS,n.

n                          Previous select switch setting; 0-11g. If n is the same value as that read from the S/C register, this directive is not meaningful.



## CMR DUMP DIRECTIVES

The CMR dump directives provide the capability to selectively dump specified areas of central memory resident. Refer to the NOS Systems Programmer's Instant for detailed illustrations of central memory resident.

Successful use of the CMR dump directives is dependent upon the integrity of central memory at the time EDD was performed. Most important is the integrity of the low core pointers on the EDD file. If these pointers are not intact, the dump produced by DSDI may prove meaningless. Thus, if it is suspected that the low core pointers are not intact, specifying the P keyword on the DSDI control statement allows DSDI to use the low core pointers from the running system. This option should only be used when the configuration of the running system is the same as the system in use at the time the EDD file was created. If the low core pointers on the EDD file are not intact, the integrity of the other areas of central memory is also questionable. In this case, the output produced by the CMR dump directives may be unpredictable.

### LC — Dump Low Central Memory

The LC directive causes DSDI to dump the contents of low central memory (that is, central memory locations 0 through 177 octal). Each word is divided into the appropriate parameter fields. Each field is listed on a separate line with a description of the parameter. The absolute address and display code character equivalents are also listed for each word.

Format:

LC.

### CP — Dump Active Control Point Areas

The CP directive causes all active control point areas, or a selected subset, to be dumped. List options provide the ability to dump only desired portions of the control point area and other control point related data. Refer to Interactive Use of DSDI for additional information concerning use of this directive from an interactive terminal.

Format:

CP.

CP, $n_1$ /ops $_1$ , $n_2$ /ops $_2$ ,..., $n_n$ /ops $_n$ .

$n_i$  Control point number or job name.

/ops $_i$  List options; a continuous string of up to 10 characters indicating the portion of the control point area, or control point related data, to be dumped. If list options are specified, they apply only to the control point number or job name ( $n$ ) with which they are associated. Valid options are as follows:

X Dumps exchange package, parameter summary, and contents of the memory locations indicated by the values in each exchange package register. These register values are treated as relative addresses within the field length; invalid addresses are represented with contents of zero.

- T Provides detailed dump of control point area with English description of each parameter field and NOSTEXT symbol for each word.
- A Dumps job dayfile pointers and buffer in word format with display code character equivalents. This format is the same format as E Memory Dump directive. This option also dumps the buffer in a line-by-line format, as on the DSD A display.
- F Provides dump of FNT/FST, EST, and mass storage track chain, if one exists, for all files attached to the specified control point.
- C Dumps field length of specified control point in instruction parcel format with display code character equivalents. This format is the same format as C Memory Dump directive. Repetitive data is suppressed.
- D Dumps field length of specified control point in byte format with display code character equivalents. This format is the same format as D Memory Dump directive. Repetitive data is suppressed.
- E Dumps field length of specified control point in word format with display code character equivalents. This format is the same format as E Memory Dump directive.
- G Dumps control point area in instruction parcel format with display code character equivalents. This format is the same format as C Memory Dump directive.
- H Dumps control point area in byte format with display code character equivalents. This format is the same format as D Memory Dump directive.
- I Dumps control point area in word format with display code character equivalents. This format is the same format as E Memory Dump directive.
- P Provides dump and analysis of all active PPs associated with control point n.
- default If n is specified with no corresponding list options, options XTAF are selected automatically. Refer to Printer Output Listing Examples for a sample of the printer output listing produced. The default options selected can be changed with the CPO directive.

All of the list options specified for a particular control point area (up to 10) are processed. For example, if the C and D options are both specified, the control point field length is dumped twice, once in instruction parcel (C) format and again in byte (D) format.

## **CPO — Reset Default List Options**

The CPO directive selects a new string of default list options for the CP directive.

Format:

CPO,ops.

ops	New default list options for CP directive, a continuous string of up to 10 characters. Refer to description of CP directive for list of valid option characters.
-----	--

## **PP — Dump PP Communication Areas**

The PP directive causes the contents of all PP communication areas to be dumped in byte format with display code character equivalents. This format is the same format as that for the D Memory Dump directive. The control point assignment, channel assignment, and monitor function are listed with each communication area. Refer to Printer Output Listing Examples for a sample of the printer output listing produced by this directive. Refer to Interactive Use of DSDI for additional information concerning use of this directive from an interactive terminal.

Format:

PP.

## **DP — Dump Dayfile Buffer Pointers**

The DP directive causes the dayfile buffer pointers to be dumped in byte format with display code character equivalents. This format is the same format as that for the D Memory Dump directive.

Format:

DP.

## **EST — Dump Equipment Status Table**

The EST directive causes the equipment status table to be dumped in byte format with display code character equivalents. This format is the same format as that for the D Memory Dump directive.

Format:

EST.

### **FNT — Dump File Name/File Status Table and FNT Interlock Table**

The FNT directive causes the file name/file status table (FNT/FST) to be dumped in byte format with display code character equivalents. This format is the same format as that for the D Memory Dump directive. Refer to Printer Output Listing Examples for an example of the FNT interlock table. Each bit set in this table indicates an interlocked file. The FNT address of the interlocked file is listed to the right of the table, the leftmost address corresponding to the rightmost bit.

Format:

FNT.

### **MST — Dump Mass Storage/Track Reservation Tables**

The MST directive causes all mass storage and track reservation tables to be dumped unless equipment numbers are specified, in which case only the specified equipment MSTs are dumped. The dump format for the mass storage tables reflects the appropriate parameter fields and NOSTEXT symbol of each word. The portion of the dump describing the track reservation tables is presented in byte format with display code character equivalents. The track link byte ordinal and status bits (three groups of four bits) are indicated for each word. Refer to Printer Output Listing Examples for a sample of the printer output listing produced by this directive.

Format:

MST.

MST,xx<sub>1</sub>,xx<sub>2</sub>,...,xx<sub>n</sub>.

xx<sub>j</sub>                      Equipment number of equipment whose mass storage table is to be dumped.

### **JC — Dump Job Control Area for Each Origin Type**

The JC directive causes the job control area for each job origin type to be dumped. The dump is formatted to reflect the appropriate parameter fields and NOSTEXT symbol for each word.

Format:

JC.

### **ACCOUNT — Dump Account Dayfile Buffer**

The ACCOUNT directive causes the account dayfile pointers and buffer to be dumped in word format (four words per line) with display code character equivalents. This format is the same format as that for the E Memory Dump directive. This directive also dumps the buffer in a line-by-line format, as on the DSD A display.

Format:

ACCOUNT.

### **ERRLOG — Dump Error Log Dayfile Buffer**

The ERRLOG directive causes the error log dayfile pointers and buffer to be dumped in word format (four words per line) with display code character equivalents. This format is the same format as that for the E Memory Dump directive. This directive also dumps the buffer in a line-by-line format, as on the DSD A display.

Format:

ERRLOG.

### **DDB — Dump Dayfile Dump Buffer**

The DDB directive causes the dayfile dump buffer to be dumped in byte format with display code character equivalents. This format is the same format as that for the D Memory Dump directive.

Format:

DDB.

### **EPB — Dump ECS/PP Buffer**

The EPB directive causes the ECS/PP buffer to be dumped in byte format with display code character equivalents. This format is the same format as that for the D Memory Dump directive.

Format:

EPB.

### **DAYFILE — Dump System Dayfile Buffer**

The DAYFILE directive causes the system dayfile pointers and buffer to be dumped in word format (four words per line) with display code character equivalents. This format is the same format as that for the E Memory Dump directive. This directive also dumps the buffer in a line-by-line format, as on the DSD A display.

Format:

DAYFILE.

### **MAINLOG — Dump Binary Maintenance Log Dayfile Buffer**

The MAINLOG directive dumps the binary maintenance log dayfile pointers and buffer in word format, four words per line, with display code character equivalents.

Format:

MAINLOG.

#### **SECEDED - Dump SECEDED Identifier Table**

The SECEDED directive causes the single error correction double error detection (SECEDED) identifier table to be dumped in byte format with display code character equivalents. This format is the same format as that for the D Memory Dump directive.

**Format:**

SECEDED.

#### **MTR - Dump CPU Monitor**

The MTR directive causes the CPU monitor to be dumped. Exchange packages are dumped in exchange package format while the program area is dumped, using relative addressing, in instruction parcel format with display code character equivalents. This format is the same format as that for the C Memory Dump directive.

**Format:**

MTR.

#### **RPL - Dump Resident Peripheral Library**

The RPL directive causes the resident PP library to be dumped in byte format with display code character equivalents. This format is the same format as that for the D Memory Dump directive. A header line for each PP program dumped indicates the name of the program and its length in bytes. Each succeeding line contains 10 bytes (two central memory words) of the PP program. The PP address of the first byte in each line, relative to address zero of the PP, is also listed.

**Format:**

RPL.

#### **RCL - Dump Resident Central Library**

The RCL directive causes the resident central library to be dumped in instruction parcel format with display code character equivalents. This format is the same format as that for the C Memory Dump directive.

**Format:**

RCL.

#### **PLD - Dump Peripheral Library Directory**

The PLD directive causes the PP library directory to be dumped in byte format with display code character equivalents. This format is the same as that for the D Memory Dump directive.

**Format:**

PLD.

### **CLD - Dump Central Library Directory**

The CLD directive causes the central library directory to be dumped in byte format with display code character equivalents. This format is the same format as that for the D Memory Dump directive.

**Format:**

**CLD.**

### **PROBE - Dump PROBE Data Tables**

The PROBE directive causes the PROBE data tables to be dumped in byte format with display code character equivalents.

**Format:**

**PROBE.**

## SUBSYSTEM DUMP/ANALYSIS DIRECTIVES

The subsystem dump/analysis directives provide the capability to selectively dump portions of central and/or PP memory associated with a specific subsystem (BATCHIO, EI200, MAGNET, and TELEX). Although many other directives previously described in this section can be used to dump the same areas of memory, these directives dump those areas most frequently analyzed when subsystem related malfunctions occur. In addition, many of the dumps are specially formatted to provide a detailed description of the area being dumped. If the specified subsystem was not active at the time the EDD file was created, an error message is issued.

### BATCHIO — Dump Associated Memory for Analysis

The BATCHIO directive causes areas of central and/or PP memory that are most frequently analyzed when BATCHIO malfunctions are indicated to be dumped. The areas and type of memory dumped is determined by the list options specified.

Format:

BATCHIO,ops.

ops                    List options; a string of characters indicating the areas of memory to be dumped. If no options are specified, both options (PB) are selected by default and are processed in order as listed.

- P    Provides analysis and full memory dump of PPs having resident copies of 1CD, 1IO, QAP, QAC, or DSP. The output listing generated is the same (in format and content) as that produced by entering the AP directive in the following format.

AP,1CD,1IO,QAP,QAC, DSP.

Refer to the description of the AP directive, PP Dump Directives, for additional information.

- B    Provides specially formatted dumps of each active BATCHIO buffer point. Included with the dump of each buffer point is the associated equipment type and FET, as well as EST and FNT/FST entries.

### EI200 — Dump Associated Memory for Analysis

The EI200 directive causes areas of central and/or PP memory that are most frequently analyzed when Export/Import malfunctions are indicated to be dumped. The areas and type of memory dumped is determined by the list options specified. The following three words are always listed at the beginning of the listing, in byte format, regardless of which list options are selected.

- Driver recall word for 1ED (DRCL).
- Executive call word for 1LS (EXCL).
- Input register for 1LS (IREX).



Format:

EI200,ops.

ops

List options; a string of characters indicating the areas of memory to be dumped. If no options are specified, all four options (LTPO) are selected by default and are processed in order as shown.

- L Dumps EI200 low core pointer words. The dump is formatted to reflect the appropriate parameter fields and NOSTEXT symbol for each word.
- T Provides specially formatted dump of EI200 terminal tables with associated FET, EST, and FNT/FST. Each word of the terminal tables is formatted to reflect appropriate parameter fields. In addition, each word is preceded by a description of the parameter fields and its NOSTEXT symbol.
- P Provides analysis and full memory dump of all PPs containing copies of 1ED, 1LS, and XSP. The output listing generated is the same (in format and content) as that produced by entering the AP directive in the following format.

AP,1ED,1LS,XSP.

Refer to the description of the AP directive, PP Dump Directive, for additional information.

- O Dumps PP overlays that reside within the EI200 field length in byte format with display code character equivalents. A header line for each overlay dumped indicates its length in bytes. Each succeeding line contains 10 bytes (two central memory words) of the program. The PP address of the first byte, relative to address zero of the PP, is also listed.

## MAGNET — Dump Associated Memory for Analysis

The MAGNET directive causes areas of central and/or PP memory that are most frequently analyzed when a malfunction within MAGNET is indicated to be dumped. The areas and type of memory dumped are determined by the list options specified.

Format:

MAGNET,ops.

ops

List options; a string of characters indicating the areas of memory to be dumped. If no options are specified, all three options (UQP) are selected by default and are processed in order as listed.

- U Provides specially formatted dump of the MAGNET unit descriptor tables (UDTs) with associated FET, EST, and FNT/FST. Each word of a UDT is formatted to reflect appropriate parameter fields. In addition, each word is preceded by a description of the parameter fields and its NOSTEXT symbol. If extended labels are present, they appear with the FET in the output listing. The FET also indicates the address and control point number of the user.

- Q Provides dump of the MAGNET queue table in byte format (two words per line) with display code character equivalents. The first word in each line is preceded by its ordinal within the table.
- P Provides analysis and full memory dump of all PPs having resident copies of 1MT. The output listing generated is the same (in format and content) as that produced by entering the AP directive in the following format.

AP,1MT.

Refer to the description of the AP directive, PP Dump Directives, for additional information.

### IAF/TELEX — Dump Associated Memory for Analysis

The IAF and TELEX directives cause areas of central and/or PP memory that are most frequently analyzed when IAF or Time-Sharing Module malfunctions are indicated to be dumped. The areas and type of memory are determined by the list options specified. The IAF or Time-Sharing Module current entry word (SSPA) is always printed at the beginning of the listing, in byte format, regardless of which list options are specified. The appropriate directive must be used to produce the dump (IAF is used with the Interactive Facility and TELEX is used with the Time-Sharing Module). DSDI produces the same listing for either command.

#### Format:

IAF,ops.  
or  
TELEX,ops.

ops

List options; a string of up to four characters indicating the areas of memory to be dumped. If no options are specified, all four options (CTEP) are selected by default and processed in order as listed.

- C Provides dump of the IAF or Time-Sharing Module command table.
- T Provides specially formatted dump of the IAF or Time-Sharing Module terminal table in which each word reflects the appropriate parameter fields. In addition, each word is preceded by a description of the parameter fields and its NOSTEXT symbol.
- E Dumps IAF or Time-Sharing Module reentry table in byte format (two words per line) with display code character equivalents. The first word in each line is preceded by its ordinal within the table.

- P Provides analysis and full memory dump of all PP having resident copies of TLX, 1TA, 1TD, and 1TO. This option also provides an analysis and dump of all PPs having resident copies of 1RO and 1RI that are associated with control points of time-sharing origin. The output listing generated is the same (in format and content) as that produced by entering the AP directive in the following format.

AP,TLX,1TA,1TD,1TO,1RO,1RI.

The exception is that the AP directive also dumps all PPs having copies of 1RO and 1RI rather than only those associated with control points of time-sharing origin. Refer to the description of the AP directive, PP Dump Directives, for additional information.

## HARDWARE REGISTER DUMP DIRECTIVES

The hardware register dump directives provide a capability to dump specified hardware registers.

### XP — Dump Deadstart Exchange Package

The XP directive causes the CPU exchange package executing at the time of deadstart to be dumped. If there are two CPUs in the system, both exchange packages in execution at the time of deadstart are dumped.

Format:

XP.

### SC — Dump S/C Register

The SC directive is valid only on a CYBER 170 series computer system and causes the S/C registers to be dumped.

Format:

SC.

## INTERACTIVE USE OF DSDI

Incorporated within DSDI is an interactive facility which allows several of the directives described earlier in this section to be entered interactively from a time-sharing origin job. This interactive facility is designed to provide the analyst with the following additional capabilities.

- Allows preliminary examination of the EDD file to determine which areas should be listed in detail at a line printer.

- Allows examination of certain areas of the EDD file not listed during normal operational procedures following a system malfunction. Typically, predefined portions of the EDD file are listed following a system malfunction.
- Allows on-line examination of the EDD file from a remote location.

Refer to Example of DSDI Terminal Usage for an example showing interactive use of DSDI.

When the DSDI control statement is entered from an interactive terminal (batch subsystem or X command only), a delay will be experienced before input directives can be entered. During this time (10 to 60 seconds), DSDI is copying the EDD file to a random mass storage file. The length of the delay is dependent upon device speed and current system activity. When DSDI is able to accept input directives, it will issue the following prompt to the terminal.

```
ENTER DIRECTIVES--
?
```

Directives are entered following the question mark prompt. Only one directive can be entered at a time, and is restricted to one line. The format is the same as described for batch input (refer to Directive Format).

Generally, any of the DSDI input directives can be entered at an interactive terminal. However, the output produced by many of the directives is formatted for listing only at a line printer (136 columns) and cannot be listed at the terminal (72 columns). The L parameter on the DSDI control statement initially determines the disposition of the list output. If a file name is not specified, list output is assigned to file OUTPUT by default (that is, the terminal). In this case, entry of directives which produce output that cannot be listed at the terminal results in the message:

```
DIRECTIVE RESTRICTED TO PRINTER OUTPUT.
```

If a list output file name is specified on the DSDI control statement, all input directives can be entered at the terminal. All list output (including error messages) is written to the specified file.

Two input directives are provided to further control the disposition of list output.

**OUTPUT,filenam.** This directive is used to assign output to alternate file filenam (file name OUTPUT is illegal; that is, alternate list output cannot be assigned to the terminal). If filenam is omitted, the system assumes file name ALTRNT. While this directive is active, all input directives can be entered at the terminal. All list output (except error messages) is written to file filenam and is formatted for transmission to a line printer. Error messages are written directly to the terminal.

**DISPOSE.** This directive disposes the alternate list file (specified in OUTPUT directive) to the print queue. Output will be printed at the central site line printer. All subsequent list output resumes on the original output file specified on the DSDI control statement.

Refer to File Manipulation and Control Directives for additional information concerning use of these directives.

## TERMINAL OUTPUT DIRECTIVES

The following directives produce output formatted for listing at an interactive terminal.

### C — Dump Memory in Instruction Parcel Format

The C directive causes the specified locations of central memory or ECS to be dumped in four groups of five octal digits (one word per line) with display code character equivalents. No pagination is processed for terminal output. The CM and EC directives (CM/ECS Dump Directives) determine the type of memory to be dumped; default is central memory. The RA or RAC directive (CM/ECS Dump Directives) must be entered to dump relative addresses; default is absolute addressing.

Format:

C,fwa,lwa.

fwa                    First-word address to be dumped (mandatory).  
lwa                    Last-word address, plus one location, to be dumped. If omitted, fwa+1 is assumed by default.

Example of terminal output:

```
? C,6230,6240.  
0006230 34240 10100 00012 50036 1TAA AU 3  
0006231 00764 70000 00000 10113 * AAK  
0006232 04154 70000 00000 10113 DM* AAK  
0006233 00004 67446 74000 10005 - - A E  
0006234 05153 05700 00000 00000 EMX.  
0006235 00000 00000 00000 00000  
0006236 00000 00000 00000 00000  
0006237 00000 00005 05111 14422 EEI19R
```

### D — Dump Memory in Byte Format

The D directive causes specified locations of central memory or ECS to be dumped in five groups of four octal digits (one word per line) with display code character equivalents. No pagination is processed for terminal output. The CM and EC directives (CM/ECS Dump Directives) determine the type of memory to be dumped; default is central memory. The RA or RAC directive (CM/ECS Dump Directives) must be entered to dump relative addresses; default is absolute addressing.

Format:

D,fwa,lwa.

fwa                    First-word address to be dumped (mandatory).  
lwa                    Last-word address, plus one location, to be dumped. If omitted, fwa+1 is assumed by default.

**Example of terminal output:**

```
? D,6230,6240.
0005230 3424 0101 0000 0125 0036 1TAA AU 3
0006231 0076 4700 0000 0001 0113 * AAK
0005232 0415 4700 0000 0001 0113 DM* AAK
0005233 0000 4674 4674 0001 0005 - - A E
0006234 0515 3057 0000 0000 0000 EMX.
0006235 0000 0000 0000 0000 0000
0006236 0000 0000 0000 0000 0000
0006237 0000 0000 0505 1111 4422 EEI19R
```

**Q — Dump PP Memory in Line Format**

The Q directive causes the specified locations of PP memory to be dumped in line format. Each line contains 10 octal bytes (PP words) with display code character equivalents. Repetitive lines are suppressed and zero bytes are represented by hyphens.

**Format:**

Q,n,fwa,lwa.

- n                    Number of PP to be dumped.
- fwa                 First-word address to be dumped.
- lwa                 Last-word address, plus one location, to be dumped.

**NOTE**

fwa and lwa are automatically adjusted so that the dump limits fall within a multiple of 10 octal words.

This format is valid only for terminal output. If attempted from a batch origin job or while an alternate list file is active, the fwa and lwa parameters will be interpreted as PP numbers.

**Example of terminal output:**

```
? Q,5,0,100.
0000 0003 2020 3340 ---- 0614 ---- 4334 0117    CPE05 FL 81AO
0010 0064 0001 7772 0100 0006 1073 1401 6072    A A EH LA
0020 2250 3225 ---- 0027 0012 4402 5747 5751    R/ZU W J9B.*.(
0030 0011 7646 ---- 0001 0141 0600 ---- ----    I - AA6F
0040 1501 1116 2014 0074 0203 ---- ---- ----    MAINPL BC
0050 3404 2330 0035 6213 1707 ---- 4000 6675    1DSX 2 KOG 5
0060 ---- 4521 ---- 6101 0001 0153 0001 0532    +Q A AAS ABZ
0070 0001 0100 1000 0003 6000 6250 6251 6252    AA H C / ( )
```

## PP — Dump PP Communication Areas

The PP directive causes the PP number, executing program name, control point assignment, and input register address for each PP communication area to be dumped.

Format:

PP.

Example of terminal output:

```

? PP.
PP00  PP01  PP02  PP03  PP04  PP05  PP06  PP07  PP10  PP11
MTR-01 DSD-30 1MT-25 1TD-01 1LS-27 1SP-30 1ED-27 1LS-27 1TA-01 CIO-05
6200  6210  6220  6230  6240  6250  6260  6270  6300  6310

```

PP Number  
 ↓  
 Control Point Assignment  
 ↓  
 Input Register Address  
 ↑  
 Program in Execution

## CP — Dump Active Control Point Areas

The CP directive is used to dump the job name and control point area address for each control point.

Format:

CP.

Example of terminal output:

```

? CP.
CP 01  CP 02  CP 03  CP 04  CP 05  CP 06  CP 07  CP 10
TELEX  RAN0AAX  0600  1000  AJNQBSR  1400  1600  2000
0200  0400
CP 11  CP 12  CP 13  CP 14  CP 15  CP 16  CP 17  CP 20
2200  2400  2600  AJ0IBTI  3200  3400  3600  4000
3000
CP 21  CP 22  CP 23  CP 24  CP 25  CP 26  CP 27  CP 30
4200  4400  4600  5000  MAGNET  5400  EXPORTL  SYSTEM
5200  5600  6000

```

Control Point Area Address  
 ↓  
 Control Point Number  
 ↓  
 Job Name at Control Point

## EXAMPLE OF DSDI TERMINAL USAGE

This example illustrates how DSDI might be used, following a system malfunction, to analyze portions of the EDD file from an interactive terminal. It is assumed that an EDD file was created during normal system recovery procedures. Vertical spacing has been expanded to permit commentary. The example begins after the login sequence has been completed.

batch	Enter batch subsystem.
\$RFL,0.	
/label,dump,vsn=dump,lb=ku,f=s,mt,d=800	The LABEL control statement is entered to assign the EDD dump tape to this job. Use of the VSN parameter allows the job to be rolled out while the tape is mounted and ASSIGNED.
/get,altdir	Retrieve alternate directives file ALTDIR (refer to example in figure 10-2).
/dsdi.	Calls DSDI which copies EDD tape to a random mass storage file.
ENTER DIRECTIVES --	
?	Enter terminal output directives (refer to Terminal Output Directives) to list any portion of the EDD file at the terminal. DSDI issued the prompt (?) when it is ready to accept a new directive.
?	
?	
?	
?output,altout.	List output produced by subsequent directives is written to local file ALTOUT. This allows entry of directives which produce line printer formatted output.
?	
?	
?read,altdir.	All input directives in alternate directives file ALTDIR are read and processed. List output is written to local file ALTOUT. DSDI does not request terminal input until last directive on ALTDIR is processed.
.	
.	
.	
?dispose.	Dispose local file ALTOUT to the print queue for listing at the central site line printer. Output produced by subsequent directives is listed at the terminal.
?	
?	
EXPRESS DUMP COMPLTE (FL USED xxxxxxB)	DSDI is terminated by pressing carriage return in response to the ? prompt.
/	



In summary, the following operations were performed by DSDI. First, small areas of the dump file were listed at the terminal for preliminary examination. This was done both to analyze the cause and effect of the system failure, as well as determine the extent of line printer listings required. An appropriate comment may be placed in the list file subtitle at this time via the \*.ccc...ccc directive.

Next, directives were entered to generate the necessary line printer listings. These listings are generally extensive, or contain specially formatted output that cannot be listed at the terminal. Thus, output was written to an alternate list file named ALTOUT.

After all necessary directives had been entered from the terminal, an alternate directives file (ALTDIR) was read. ALTDIR is a permanent file containing input directives necessary to obtain a printer listing of specific areas in the dump file that are frequently examined following a system failure (for example, CMR tables and buffers, PP memory, and so on). Figure 10-2 illustrates a typical alternate directives file. Comments describing areas of the dump file to be listed appear, with the directive, in the title line of the output listing.

When DSDI finished processing the last directive in file ALTDIR, it again issued the ? prompt to the terminal requesting further directive input from the keyboard. At this time, the DISPOSE directive was entered causing file ALTOUT to be printed at the central site line printer. Refer to Printer Output Listing Examples for examples of printer output listings.

DUMP†	
LC.	LOW CENTRAL MEMORY POINTERS
PP.	PP COMMUNICATION AREA
CPO,H.	
EJOFF.	
EJ.	
CP.	CONTROL POINT AREAS
CPO,XTAF.	
DP.	DAYFILE BUFFER POINTERS
EJ.	
EST.	EQUIPMENT STATUS TABLE
FNT.	FILE NAME TABLE AND FNT INTERLOCK TABLE
EJ.	
MST.	MASS STORAGE TABLES
JC.	JOB CONTROL PARAMETERS
CP,SYSTEM/A.	SYSTEM DAYFILE BUFFER
ACCOUNT.	ACCOUNT FILE BUFFER
ERRLOG.	ERROR LOG BUFFER
EJON.	
AP.	ACTIVE PPUS

Figure 10-2. Typical Alternate Directives File

---

† All records in an alternate directives file must be in text format; the first word in each record contains only the record name.

## PRINTER OUTPUT LISTING EXAMPLES

The listings illustrated in this section are samples of the line printer output listings produced by several of the input directives described in the Input Directives section.

Each page of output listings begins with two header lines: a title line and a subtitle line. The title lines are formatted as follows:

```
RA =      current input directive          EXPRESS nn   DSDI - V2.0   yy/mm/dd. hh.mm.ss.   PAGE    n
0000000  dump type hh.mm.ss. yy/mm/dd. CDC MULTI-MODE OPERATING SYSTEM   NOS 1           comments
```

RA=0000000

Indicates absolute addressing is in effect. If relative addresses were being dumped (RA or RAC directive entered), a nonzero reference address would appear in this field.

current input directive

Input directive currently being processed, including comments (50-character field).

EXPRESS nn

Reflects the EDD tape number currently being used (nn is a two-digit dump identifier assigned during EDD).

yy/mm/dd. hh.mm.ss.

This field reflects the date and time when DSDI was executed.

dump type

Indicates type of memory currently being dumped (CM, ECS, or a PP number). If the AP directive is processed, the PP number is followed by the name of the program currently being dumped.

hh.mm.ss. yy/mm/dd. CDC MULTI-MODE OPERATING SYSTEM NOS 1

Time of day, date, system title line, and system version name taken from low core locations TIML and DTEL (80-character field).

comments

Up to 36 characters of comments specified on a \*.ccc...ccc input directive

Example 1:

The following sample illustrates the printer output listing produced by the PP directive (dump PP communication areas).

QA =	PP.	PPU COMMUNICATION AREAS.	EXPRESS 02	OSDI - V2.0	77/09/16.	16.54.33.	PAGE
0000000	CM	05.34.25. 77/09/14.CDC MULTI-MODE OPERATING SYSTEM.		NOS 1			1
PP00	MTR	1524 2210 0000 0000 0000	MTRH	PP01	DSD	0423 0413 0000 0000 0000	DSDK
	CP10	0000 0000 0000 0000 0000			CP13	0000 0000 0000 0000 0000	
		0000 0000 0000 0000 0000			CH10	3404 1413 0010 0044 0135	13LK H 9A2
		0000 0000 0000 0000 0000				0000 0000 0000 0000 0000	
		0000 0000 0000 0000 0000				0005 0056 0055 0023 0005	E S E
		0000 0000 0000 0000 0000				0003 0017 0016 0004 0001	C O N D A
		0000 0000 0000 0000 0000				0022 0031 0055 0025 0023	R Y U S
		0000 0000 0000 0000 0000				0005 0022 0055 0003 0001	E R C A
PP02	LF4	1406 1552 0014 0000 0120	LF4) L AP	PP03		0000 0000 0000 0000 3220	ZP
	SPLM	0051 4374 0036 1403 7000	3 XLC		CP00	0000 0000 0000 0000 0000	
	CP12	1406 1552 0014 0000 0120	LF4) L AP			3415 2410 1313 0000 0001	1MTHKK A
		0000 0000 0000 5005 0035	/E 2			0000 0000 0000 5240 0144	15A9
		6000 0000 0000 0020 0010	P H			6000 0000 0000 0020 0010	P H
		0400 0153 0001 5300 0153	D A S A S A S			0000 0000 0000 0000 0000	
		5555 5555 5533 5743 4234	0.871			5555 5555 5533 5733 3443	0.018
		5555 5555 5533 5733 4044	0.059			5555 5555 5533 5733 3335	0.002
PP04	ISP	3423 2013 0030 0000 0000	ISPK	PP05		0000 0000 0000 0000 3030	XX
	EATM	0032 0002 7700 0001 0000	Z R A		CP00	0000 0000 0000 0000 0000	
	CP13	3423 2013 0000 0000 0000	ISPK			0301 1414 5101 5255 0000	CALL{A}
		0000 0000 0000 5003 0047	/C *			0000 0000 0000 0004 0400	DD
		6000 0000 0000 0020 0010	P H			0000 0000 0061 0004 0303	OCC
		0000 0000 0000 0000 0000				0000 0000 0000 0000 0000	
		5555 5555 5533 5742 3641	0.736			0000 0000 0000 0000 0000	
		5555 5555 5533 5733 4036	0.053			5555 5555 5533 5733 3335	0.002
PP06	IIO	3411 1751 0100 0001 0000	IIO(A A	PP07	1MT	3415 2410 1313 0000 0001	1MTHKK A
	DEQM	0005 0022 0000 0000 0000	E R		RCHM	0012 0013 0000 1066 1366	J K H K
	CP11	3411 1751 0100 0001 0000	IIO(A A		CP10	3415 2410 1313 0000 0001	1MTHKK A
		0000 0000 0000 5003 0047	/C *			0000 0000 0000 5003 0047	/C *
		6000 0000 0000 0020 0010	P H			6000 0000 0000 0020 0010	P H
		0000 0000 0000 0000 0000				0000 0000 0000 0000 0000	
		5555 5555 5533 5744 3643	0.938			5555 5555 5533 5744 4043	0.958
		5555 5555 5533 5733 4140	0.065			5555 5555 5533 5733 4143	0.068
PP10		0000 0000 0000 0000 3130	YY	PP11		0000 0000 0000 0000 3050	X/
	CP00	0000 0000 0000 0000 0000	GOTO,2.		CP00	0000 0000 0000 0000 0000	
		0717 2417 5635 5755 0000	WU			3415 2410 1313 0000 0001	1MTHKK A
		0000 0000 0000 0027 2500	WTC			0016 0076 0022 0000 0153	N R AS
		0000 0000 0061 0027 2403				6000 0000 0000 0020 0010	P H
		0000 0000 0000 0000 0000				0000 0000 0000 0000 0000	
		5555 5555 5533 5740 4337	15.584			0000 0000 0000 0000 0000	
		5555 5555 5533 5733 3440	0.015			5555 5555 5533 5733 3340	0.005
PP20		0000 0000 0000 0000 3140	YS	PP21		0000 0000 0000 0000 3120	YP
	CP00	0000 0000 0000 0000 0000	1MTHXJ A		CP00	0000 0000 0000 0000 0000	
		3415 2410 3012 0000 0001	H R			3415 2410 3012 0000 0001	1MTHXJ A
		0010 0076 0022 0000 0000	P H			0000 0000 0000 5003 0047	/C *
		6000 0000 0000 0020 0010				6000 0000 0000 0020 0010	P H
		0000 0000 0000 0000 0000				0000 0000 0000 0000 0000	
		5555 5555 5533 5743 3642	1.837			5555 5555 5533 5737 4237	0.474
		5555 5555 5533 5733 3540	0.025			5555 5555 5533 5733 3637	0.034
		.	.			.	.
		.	.			.	.
		.	.			.	.

Example 2:

The following sample illustrates the printer output listing produced by the AP directive (dump analysis of PP and PP memory in line format).

RA = AP,1AJ. DUMP 1AJ. EXPRESS 02 DSDI - V2.0 77/09/16. 16.54.33. PAGE 3  
 0000000 PP25 1AJ 04.34.25. 77/09/14.CDC MULTI-MODE OPERATING SYSTEM. NOS 1 1AJ HUNG USING EMC MACHINE

ANALYSIS OF PP25

PP25	1AJ	3401	1201	0000	0000	0000	1AJA	LAST MAIN PROGRAM LOADED - 1AJ
	DFMM	0006	0000	0004	0000	0000	F 0	LAST OVERLAY LOADED -
	CP01	0355	3074	2100	0102	6370	C X 1 A9	LAST MASS STORAGE DRIVER - 6L6
		3301	1070	3411	1415	0200	0AH ILLM9	
		0346	1444	0200	0346	0100	C-L99 C-A	
		0104	0415	2004	0000	0000	ADDM9D	
		0000	0000	0000	0000	0000		
		0000	0000	0711	1610	4225	GINH7U	

RESIDENT ENTRY POINTS			LOW CORE CONSTANTS			
NAME	LOC	CALLER	NAME	LOC	ACTUAL	EXPECTED
FTN	0342	6010	RA	55	0403	0403
PRL	0404	3455	FL	56	0016	0016
RCH	0417	0356	ON	70	0001	0001
DCM	0426	0371	HN	71	0100	0100
DFM	0462	3014	TH	72	1000	1000
EXR	0516	3277	TR	73	0003	0003
SMS	0546	5010	CP	74	0200	0200
POS	0602	0153	IA	75	3170	3170
WDS	0607	0324	OA	76	3171	3171
RDS	0613	0324	MA	77	3172	3172

PPU MEMORY

0000	0003	2020	3540	----	----	----	5002	0151	CPP25	/BAI	0010	0006	----	0004	----	----	1431	2405	4030	F 0	LYTE5X
0020	0030	1010	----	----	----	----	----	----	XMH		0030	----	----	----	----	----	----	----	----	----	----
0040	----	----	0060	0171	0171	0001	0227	----	A A	ABW	0050	3401	1201	----	----	----	----	0403	0016	----	1AJA DC M
0060	----	----	----	----	----	----	----	----			0070	0001	0100	1000	0003	0200	3170	3171	3172	----	AA H CB Y Y Y
0100	2000	0177	1781	0576	3075	6050	7051	1237	P A	JAE X /X1J4	0110	1007	3474	3051	1377	1006	3350	0461	1006	----	HG1 XIK HFO/D 4F
0120	0200	0155	0200	0405	0115	0005	3077	6050	9 A	3 OFAM EX /	0130	1701	6010	1701	6250	3050	1071	5400	0266	----	OA HOA /X/H = 8
0140	0331	3013	0502	3015	3415	5400	0153	3011	CYXKE9XMIM=	A*XI	0150	1014	3112	6114	1073	0100	0531	5400	0267	----	HLVJ LM A EY= 9
0160	3413	1053	0443	5400	0266	3412	1461	0200	IKM	DA= 3 1JL 8	0170	0346	3011	1013	0645	3012	0502	3015	3415	----	C-XIHKF+XJEBKLM
0200	1702	3417	1422	0200	0346	3076	6003	0200	DR10LRB	C-X CB	0210	0542	5600	0576	0320	2033	2305	3413	1063	----	E7. E CPP0SE1KH
0220	0344	2000	0477	7517	3007	1006	0607	1071	C9P	J 20XGHFFGH	0230	3406	1400	3407	0200	0606	4017	3416	5017	----	1FL IG3 FF501470
0240	0001	3403	3017	0200	0616	0746	4017	3407	A1CX9R	FNG-501G	0250	3016	4417	3617	4017	1071	1021	3303	4417	----	XN903050H HQ0390
0260	0740	3004	0200	0430	0100	0154	0076	0102	G5X03	OXA A= 3A9	0270	----	----	----	----	----	----	----	----	----	----
0300	----	3401	1452	6173	7762	----	----	----	1AL)		0310	----	----	----	----	----	----	----	----	----	----
0320	0001	3033	----	----	1006	0610	2000	1770	AXO	HFFHP 0	0330	1701	0576	3010	1277	0313	5000	0101	1701	----	OAE XHJ CK/ AAQA
0340	0576	3076	5010	3010	0557	0100	0456	3410	E X	HXHE.A D,1H	0350	3076	6210	3010	1736	0760	2001	5531	6010	----	X HXHO3G PA Y H
0360	3010	3111	0577	2001	5523	6370	0320	2001	XHYIE	PA S CPPA	0370	5523	2610	6010	3014	0440	0371	3074	1620	----	SVH HXLOSC X NP
0400	5010	3014	3456	3013	3455	0100	0470	1457	HXL1,	XK1 A D L.	0410	6010	3074	3210	0562	1411	0200	0346	0356	----	HX ZHE LIB C-C,
0420	0100	1253	3411	1417	0200	0346	0371	0130	A	JX1LJ3 C-C A	0430	1367	3411	1404	0200	0346	0371	2001	1360	----	K IILDB C-C PAK
0440	5373	0001	6312	0573	6173	1073	0100	1100	A	JE H A I	0450	2000	----	3411	1406	0200	0346	3011	0556	----	P IILF9 C-XIE,
0460	4001	0520	3014	0403	6313	3045	0200	0405	5AEP	XLDC KX+B DF	0470	1400	0100	2071	3401	5400	0465	1063	5400	----	L A P IA= D H =
0500	0451	3076	3402	1410	3400	4001	4400	0472	JIX	13LH1 5A9 D9	0510	3601	3600	1115	0571	3602	6210	3277	3412	----	3A3 ZNE 3B AZ 1J
0520	1783	0403	3014	0557	0100	0450	1302	0200	DCDC	XLE.A D/K9B	0530	0155	5000	0526	5415	0006	0115	0007	3011	----	A / EW=H FAN SKI
0540	3404	0100	1212	2000	3274	3105	6010	3013	10A	JJP Z YE HXK	0550	7200	3777	3413	5300	0600	5400	0576	0424	----	R 4 IK8 F = E DT
0560	1441	3412	1461	0200	0346	3011	1014	3112	L61	JL 8 C-XIHLJ	0570	6114	0573	0350	----	1100	----	0001	0001	----	LE C/ I A A
0600	0411	0153	0153	0100	1076	0100	0235	3324	DIAS	ASA HVA 92CT	0610	0003	0100	4325	0324	0150	0100	0245	5400	----	CA SUCTA/A B+=
0620	0627	0200	0711	1404	0200	1010	7100	4027	FMB	GILDB HH 5M	0630	0425	1463	0323	1401	5400	0610	0346	5400	----	DUL CSLA= FHC==
0640	0647	0200	0711	1405	0200	1010	7300	6273	F*9	GILE9 HH	0650	0560	1504	6600	0652	7540	3402	0200	0670	----	E MD F) 5188 F
0660	0503	0192	0615	0100	0773	5700	0573	0100	EQAB	FMA G / E A	0670	0660	1412	0200	1010	1401	7100	0573	0465	----	F LJB HHLA E D
0700	2042	0411	3100	0301	3004	0200	0421	0315	P7DIA	CAXDB DQCM	0710	0100	0623	1400	5400	0575	5709	0610	0405	----	A FSL = E . F40E

Example 3:

The following sample illustrates the printer output listing produced by the CP directive (dump active control point areas). The default list options (XTAF) are used to dump the SYSTEM control point area. This example continues for two pages. Also, observe that the columns cross page boundaries; that is, the left column is read continuously, from the top of the first page to the bottom of the second page. The sequence then continues at the top of the right column on the first page.

RA = CP,2. EXPRESS 00 DSDI - V2.0 80/01/31. 08.35.16. PAGE 1  
 0000000 CM 20.25.52. 80/01/12. (6) CYBER 174 S/N 620 DEVEL. NOS 1-1B\*\*/R4B.

0400 - CONTROL POINT 02

CP02 EXCHANGE PACKAGE

P	352	A0	60000	B0	0	(A0)=0000	0000	0000	0000	0000	(B0)=0000	0000	0000	0000	0000		
RA	142100	A1	1	B1	1	(A1)=0516	0420	0000	0000	0000	ENDP	(B1)=0516	0420	0000	0000	0000	ENDP
FL	60000	A2	546	B2	407	(A2)=0000	0000	0000	0000	0771	G	(B2)=0400	0005	6400	0000	0000	D E
EM	70070000	A3	545	B3	771	(A3)=0000	0000	0000	0000	0765	G	(B3)=0000	0000	0000	0000	0000	0000
RAE	0	A4	407	B4	767	(A4)=0400	0005	6400	0000	0000	D E	(B4)=2705	5510	0126	0555	2205	WE HAVE RE
FILE	0	A5	551	B5	1066	(A5)=6110	0000	0161	6000	1333	H A	K0	(B5)=0000	0000	0000	0000	0000
MA	400	A6	1	B6	1337	(A6)=0516	0420	0000	0000	0000	ENDP	(B6)=5555	5555	5555	5555	5555	
	0	A7	544	B7	1321	(A7)=1725	2420	2524	0000	0025	OUTPUT	U	(B7)=0000	0000	0000	0000	0000

X0	0000	0000	0000	0000	0000	(X0)=0000	0000	0000	0000	0000	0000	0000	0000	0000
X1	0000	0000	0000	0000	0000	(X1)=0000	0000	0000	0000	0000	0000	0000	0000	0000
X2	0000	0000	0000	0000	0544	E9	(X2)=1725	2420	2524	0000	0025	OUTPUT	U	
X3	7777	7777	7777	7777	7773	(X3)=0000	0000	0000	0000	0000	0000	0000	0000	0000
X4	7777	7777	7777	7777	7676	(X4)=0000	0000	0000	0000	0000	0000	0000	0000	0000
X5	7777	7777	7777	7777	7776	(X5)=0000	0000	0000	0000	0000	0000	0000	0000	0000
X6	0516	0420	0000	0000	0000	(X6)=0000	0000	0000	0000	0000	0000	0000	0000	0000
X7	0000	0000	0000	0000	0000	(X7)=0000	0000	0000	0000	0000	0000	0000	0000	0000

PARAMETER SUMMARY

JOB NAME	DIS0APF	CPU STATUS			
USER NUMBER		SENSE SWITCHES		00	
PRIMARY FILE		KCL R1		000000	
ORIGIN TYPE	SYOT	KCL R2		000000	
TIME USED	0000000004	KCL R3		000000	
TIME REMAINING	1014223345	KCL EF		12	
QUEUE PRIORITY	7760	CPU PRIORITY		030	

MESSAGE 1 - PFM ILLEGAL REQUEST, AT 000524. BLE. D  
 MESSAGE 2 - REQUEST DISPLAY. (DIS) A

CURRENT CONTROL STATEMENT - \* PACK1B COMPOSITE PL ATTACHED.

LAST DAYFILE MESSAGE - 20.07.19. PFM ILLEGAL REQUEST, AT 000524.

SPECIAL ENTRY POINTS -

Beginning of T List Option

CONTROL POINT AREA

CPU STATUS/AUTO RECALL	STSW	000420	0	A	LQF	JOB SEQUENCE NUMBER	RFCW	000474	01012006	AAPF
CPU SUB-CP ACTIVE		0				CONTROL STATEMENT ADDRESS			000000	000000
NUMBER PPS ASSIGNED		01				DEM FILE RANDOM INDEX				000000
ERROR FLAGS		0000				RESERVED	ALMW	000475	7777	
ACTIVITY COUNT		0000				MAX MAGNETIC TAPES			7	
RA/100			1421			MAX REMOVABLE PACKS			7	
FL/100			0600			MAX DEFER BATCH JOBS			7	
JOB NAME	JNMW	000421	04112333012006	DIS0APF		MAX LOCAL WORK FILES			7	
JOB ORIGIN CODE			00			MAX TIME LIMIT			7	
OPER ASSIGNED EQUIP	OAEW		0000			MAX SRU LIMIT			7	
CPU PRIORITY	JCIW	000422	0030	X		MAX FIELD LENGTH			7	
QUEUE PRIORITY		7760				MAX ECS FIELD LENGTH			7	

Page Boundary

RA = CP,2. EXPRESS 00 DSDI - V2.0 80/01/31. 08.35.17. PAGE 2  
 0000000 CM 20.25.52. 80/01/12. (6) CYBER 174 S/N 620 DEVEL. NOS 1-1B\*\*/R4B.

CPU STATUS FOR ROLLOUT		0				MAX LINES PRINTED				77	77
ROLLOUT REQUESTED		00				MAX CARDS PUNCHED					
CPUS ALLOWABLE		00				RESERVED	ACLW	000476	7777		
CM RESID TIME LIMIT	TSCW	000423	00000721	GQ	A	DAYFILE MESSAGES COUNT			7777		
QUEUE CONTROL		00				CONTROL STATEMENTS CNT			7777		
CPU TIME SLICE LIMIT		0000010000				DISPOSED OUTPUT COUNT			77		
TIME ENTERED X STATUS	CPCW	000424	00000000000000000000			MS PRUS COUNT			777777		
JOB CONTROL FLAGS	ECSW	000425	0000			ACCOUNT ACCESS WORD	AACW	000477	77777777777777777777		
REMOV. PACK INTERLOCK	CPIW		0			LENGTH BUFFER 0	ICAW	000500	0000		
RESERVED		0000000				ADDRESS BUFFER 0			000000		
						LENGTH BUFFER 1			0000		
						ADDRESS BUFFER 1			000000		

ECS RA/1000B		0000		SP ENTRY POINT FLAGS	SEPW 000501 0000	0000	
ECS FL/1000B			0000	RESERVED			
PP INPUT REGISTER	RLPW 000426	00000000000000000000		DMP= PARAMETER VALUE		000000	
PP MODE/OVERRIDE	SNSW 000427	0		SSJ= PARAMETER ADDRESS			000000
RESERVED-INSTALLATION		00000000		ENTRY POINT NAME	SPCW 000502 000000	00	000000
PP PAUSE FLAGS		0000		SYSTEM PROCESSOR FLAGS			
SENSE SWITCHES		0001		PARAMETER		000000	
MESSAGE 1 AREA	MS1W 000430	55200615551114140507	PFM ILLEG	PARAMETER LIST ADDRESS	JCDW 000503 00		000000
	000431	01145522052125052324	AL REQUEST	CCL - EFG			
	000432	5655550124553333340	, AT 0005	CCL - R1G		000000	
	000433	35375755000000000000	24.	CCL - DATA			0000
	000434	02140557000055040000	BLE. D	RESERVED		0000	00000000
MESSAGE 2 AREA	MS2W 000435	22052125052324550411	REQUEST DI	CCL - EF	JCRW 000504 12		
	000436	2320140131575555104	SPLAY. (D	CCL - R3		000000	
	000437	1123520000001005750	IS) A ./	CCL - R2			000000
INSTALLATION WORD 0	IN0W 000440	00000000000000000000		CCL - R1			000000
INSTALLATION WORD 1	IN1W 000441	00000000000000000000		SECURE MEMORY FLAG	DBAW 000505 0		
INSTALLATION WORD 2	IN2W 000442	00000000000000000000		ECS AND CM CMM MODE FLAGS		0	
INSTALLATION WORD 3	IN3W 000443	00000000000000000000		INPUT BUFFER ADDRESS		000000	
INSTALLATION WORD 4	IN4W 000444	00000000000000000000		RIGHT SCREEN BFR ADD			000000
INSTALLATION WORD 5	IN5W 000445	00000000000000000000		LEFT SCREEN BFR ADD			000000
INSTALLATION WORD 6	IN6W 000446	00000000000000000000		MAP OPTIONS	LB1W 000506 00		
INSTALLATION WORD 7	IN7W 000447	00000000000000000000		RESERVED		000000	
LIMIT FLAGS	SRUW 000450	0000		INTERACTIVE DEBUG CONTROL			0000
OVERFLOW FLAGS		00	C1 (	GLOBAL LIB INDICATORS			00000000
SRU ACCUMULATOR		00000334605173		SECOND LIB/GLOBAL IND	LB2W 000507	000000000000000000	
CP ACCUM (NANOUNITS/4)	CPTW 000451	00000000206473746400	P	FIRST LIB/GLOBAL IND	LB3W 000510	000000000000000000	
IO ACCUMULATORS	IOAW 000452	002264400000000000242	R 5	RESERVED	PPDW 000511 6701		A F
M13 = M1 * M3	MP1W 000453	000036	3 3	ECS FL FOR DMP= CALL		0000	
M14 = M1 * M4		000036		FL FOR DMP= CALL			0600
ADDER ACCUMULATOR	ADAW 000454	023420	B1P O/	DUMP WORD COUNT			00
M1 * 1000	MP2W 000454	001750		FWA OF DUMP	SSOW 000512	0000000000000000	000000
M12 = M1 * M2		001750		OUTSTANDING CONNECT COUNT		0000	
RESERVED				COMPUTED CP TIME LIMIT CPLW	000513 37777777777777000000 4		
CPM	MP3W 000455	0000026260	B		000514	00000000000000000000	
IOM		0000004610	-H		000515	00000000000000000000	
SRU ACCOUNT BLOCK LMT	STLW 000456	777777	D F3		000516	00000000000000000000	
COMPUTED SRU JOB STEP	LIMIT	04610636646000			000517	00000000000000000000	
RESERVED	SRJW 000457	0000	AT		000520	00000000000000000000	
SRU JOB STEP LIMIT		777777			000521	00000000000000000000	
SRU ACCUMULATOR		0000000124			000522	00000000000000000000	
RESERVED	CPJW 000460	0000			000523	00000000000000000000	
JOB STEP TIME LIMIT		777777			000524	00000000000000000000	
					000525	00000000000000000000	

Page Boundary

RA = CP,2.	EXPRESS 00	DSDI - V2.0	80/01/31. 08.35.17.	PAGE	3
0000000 CM	20.25.52. 80/01/12. (6) CYBER 174 S/N 620 DEVEL.	NOS 1-18**/R4B.			
CP ACCUMULATOR					000526 00000000000000000000
CHARGE/ACCOUNTING FLAG FPFW 000461 0					000527 00000000000000000000
ACCOUNTING FLAG/RESERVED					000530 01242401031056172014 ATTACH,OPL
SRU VALIDATION LIMIT		7777			000531 54162014502516541411 =NPL/UN=LI
FMT ORD PROFILE FILE		0000			000532 02220122315700000000 BRARY.
LEVEL-3 BLOCK TRACK		0000			000533 01242401031056233123 ATTACH,SYS
LEVEL-3 BLOCK SECTOR		0000			000534 02540616172324302450 B=FNOTXT/
MAX FL FOR JOB STEP FLCW 000462 3777		0600	4 F 4		000535 25165413221716151704 UN=KRONMOD
INITIAL FL FOR JOB STEP		3777			000536 57550000000000000000 .
MAXIMUM FL FOR ENTIRE JOB		0000			000537 47552001031334025503 * PACK1B C
ROLLIN FL		0000			000540 1715201723112405520 OPOSITE P
FL INCREASE REQUEST		0000			000541 14550124240103100504 L ATTACHED
JOB STEP MAX ECS FL ELCW 000463 0000		0000			000542 57550000000000000000 .
LAST CARD ECS FL		0000			000543 00000000000000000000
JOB MAX ECS FL		0000			000544 00000000000000000000
ROLLIN ECS FL		0000			000545 00000000000000000000
ECS FL INCREASE REQ		0000			000546 00000000000000000000
ROLLOUT ALLOWABLE SSCW 000464 0000		0000			000547 00000000000000000000
CONNECTION/WAIT RESPONSES		0000000000000000			000550 00000000000000000000
TXOT SUBSYSTEM TXSW 000465 00		000000			000551 00000000000000000000
LIST OF FILES ADDRESS LOFW		000000			000552 00000000000000000000
INTERRUPT ADR/PREV ERR TIAW		000000			000553 00000000000000000000
OUTPUT POINTER TIOW		000000			000554 00000000000000000000
AUXILIARY PACKNAME PFCW 000466 20010313440600		01	PACK9F A		000555 00000000000000000000
EST OF FAMILY DEVICE		0			000556 00000000000000000000
LIMIT FOR SIZE OF DAF		0			000557 00000000000000000000
LIMIT FOR NUMBER OF PF		0			000560 00000000000000000000
LIMIT CUMM SIZE IAPF		0			000561 00000000000000000000
LIMIT FOR SIZE OF IAPF		0			000562 00000000000000000000
USER NUMBER UIDW 000467 0000000000000000		000001	A		000563 00000000000000000000
USER INDEX		000001			000564 00000000000000000000
NO EXIT AND RPV FLAGS EECW 000470 00		00			000565 00000000000000000000
REPRIEVE DATA		0000			000566 00000000000000000000
TERMINAL INPUT POINTER TINW		000000			000567 00000000000000000000
REPRIEVE DATA		000000			000570 00000000000000000000
INPUT FILE FST TFSW 000471 6705		0000	E		000571 00000000000000000000
PRIMARY FILE FST		00			000572 00000000000000000000
RESERVED		00			000573 00000000000000000000
EVENT DESCRIPTOR TERW		000000			000574 00000000000000000000
ROLLOUT TIME PERIOD		0000			000575 00000000000000000000
RESERVED CSPW 000472 0000			5 A8A8		000576 00000000000000000000
					000577 00000000000000000000

End of T List Option

```

EOR FLAG/CS COUNT          40000000
NEXT STATEMENT INDEX      0143
LIMIT INDEX                0143
INPUT/SKIP FLAGS          CSSW 000473 0
EQUIPMENT NUMBER          01
FIRST TRACK                4270
CURRENT TRACK              4270
CURRENT SECTOR             0001
FIRST/SECOND HALF FLAG    0001
DAYFILE POINTERS AND BUFFER ← A List Option

```

T option resumes at top of right column on first page in sequence.

```

0006446 0002 0170 0000 0000 0046 BA - 0006450 0000 0000 0000 0000 0003 C
0006447 0000 0000 0114 0000 0000 AL

```

Page Boundary

```

RA = CP,2. EXPRESS 00 DSDI - V2.0 80/01/31. 08.35.18. PAGE 4
0000000 CM 20.25.52. 80/01/12. (6) CYBER 174 S/N 620 DEVEL. NOS 1-18**/R4B.

```

```

0020170 55353357333657403557 04112357000000000000 55353357333657403557 23052420225635570000 20.03.52.DIS. 20.03.52.SETPR,2.
0020174 55353357333657403557 23251151335200000000 55353357333657403557 22052425221651111620 20.03.52.SUI(0) 20.03.52.RETURN(INP
0020200 25245200000000000000 55353357333657403557 22061451334133333333 52000000000000000000 UT) 20.03.52.RFL(060000)
0020204 55353357333657403557 04112357000000000000 55353357333657404057 23251156345700000000 20.03.52.DIS. 20.03.55.SUI,1.
0020210 55353357333757333457 20010313160115562001 03134406570000000000 55353357333757334257 20.04.01.PACKNAM,PACK9F. 20.04.07.
0020214 07052456030303030303 03540334570000000000 55353357333757343757 22052324012224560303 GET,CCCCCCC=C1. 20.04.14.RESTART,CC
0020220 03030303035700000000 55353357333757344157 55041123330105105555 22052324012224505455 CCCCC. 20.04.16. DIS0AEH RESTARTED
0020224 06221715000000000000 55353357333757344157 55433350333450343557 55344357344257403357 FROM 20.04.16. 80/01/12. 18.17.50.
0020230 00000000000000000000 553533573334257344457 55200615551114140507 01145522052125052324 20.07.19. PFM ILLEGAL REQUEST
0020234 5655501245533333340 35375755000000000000 57000000000000000000 55344357354157363357 , AT 000524. 18.26.30.
0020240 01052325655555555555 34415740443625162423 57000000000000000000 05550317152014052405 AESR, 16.593UNTS. E COMPLETE
0020244 57000000000000000000 55344357353757343357 30050411245623172522 03055754145027122350 . 18.24.10.XEDIT,SOURCE.=L/WJS/
0020250 54302100000000000000 55344357353757354157 2325115635335415700 00000000000000000000 =XQ 18.24.26.SUI,2026.
0020254 55344357353757363357 22052711160456475700 00000000000000000000 55344357353757363357 18.24.30.REWIND,* 18.24.30.
0020260 5555557550611140551 23525520221703052323 05045700000000000000 55344357353757363357 4 FILE(S) PROCESSED. 18.24.32.
0020264 03012414112524570000 55344357353757363357 55030124141123245503 17152014052405570000 CATLIST. 18.24.32. CATLIST COMPLETE.
0020270 55344357353757374257 07052456013522052324 02570000000000000000 55344357354057334057 18.24.47.GET,A2RESTB. 18.25.05.
0020274 23251156363635335700 00000000000000000000 55344357354057344357 07052456015401352205 SUI,3320. 18.25.18.GET,A=A2RE
0020300 23240257000000000000 55344357354057353657 07052456220523240211 16570000000000000000 STB. 18.25.23.GET,RESTBIN.

```

DAYFILE LINES IN BUFFER

```

20.03.52.DIS.
20.03.52.SETPR,2.
20.03.52.SUI(0)
20.03.52.RETURN(INPUT)
20.03.52.RFL(060000)
20.03.52.DIS.
20.03.55.SUI,1.
20.04.01.PACKNAM,PACK9F.
20.04.07.GET,CCCCCCC=C1.
20.04.14.RESTART,CCCCCCC.
20.04.16. DIS0AEH RESTARTED FROM
20.04.16. 80/01/12. 18.17.50.
20.07.19. PFM ILLEGAL REQUEST, AT 000524.

```

ATTACHED FILES

```

0011 INPUT* IN FNT - 6704 1116 2025 2447 0001 0002 INPUT* A B EST - 6562 6200 0705 0000 0415 0773 GE DMG
FST - 6705 0001 4264 4264 0002 0005 A7 7 B E
TRACK CHAIN -
4264 0002

0020 OUTPUT PR FNT - 6722 1725 2420 2524 0000 0202 OUTPUT BB EST - 6562 6200 0705 0000 0415 0773 GE DMG
FST - 6723 7101 4267 4267 0003 0307 A7 7 CCG
TRACK CHAIN -
4267 0003

0021 INPUT LO FNT - 6724 1116 2025 2400 0000 1502 INPUT MB EST - 6563 6200 0507 0000 0415 1062 EG DMH
FST - 6725 7102 4130 4130 0002 0301 B6X6X BCA
TRACK CHAIN -
4130 0002

```

Example 4:

The following sample illustrates the printer output listing produced by the MST directive (dump mass storage/track reservation table). The MST is listed in two columns. The left column is read from top to bottom, perhaps across page boundaries, and continues at the top of the right column. The track reservation table is listed in single column following the MST.

RA = MST. DUMP MASS STORAGE TABLES. EXPRESS 02 OSDI - V2.0 77/09/16. 16.54.35. PAGE 15  
 0000001 CM 0A.34.25. 77/09/14.CDC MULTI-MODE OPERATING SYSTEM. NOS 1 1AJ HUNG USING EMC MACHINE

```
EQUIPMENT 00 - MASS STORAGE TABLE
NUMBER AVAILABLE PRUS TOGL 004410 00364060          35 FX61RP
LENGTH OF TRT                                0530
FIRST AVAIL TRACK PTP                          4134
NUM AVAILABLE TRACKS                          2220
RESERVED
DA ECS CHAIN FIRST TRACK                      0000
DIRECT ACCESS FILE CNT                        0016
FIRST TRACK IQFT                              0000
REDEFINITION STATUSES                        01
PF UTILITY INTERLOCK                          00
ECS ADDRESS MST/TRT                           S0GL 004412 00000000
ECS UPDATE COUNT                             0000000000
MACHINE MASK INTERLOCK                       00
FIRST TRACK IAPF                              ALGL 004413 4413          9K5 9L P
LABEL TRACK                                  4000
FIRST TRACK PERMITS                            4414
NUMBER CATALOG TRACKS                         0020
FIRST TRACK DAT                               0000
FAMILY OR PACK NAME                           PFGL 004414 23312324051500 SYSTEM A
DEVICE NUMBER                                01
RESERVED                                     00
REL UNIT MULTIUNIT DEV                       0
NUM UNIT MULTIUNIT DEV                       0
USER NUM PRIVATE PACK                         PUGL 004415 0000000000000000 0
DEVICE MASKS                                177777
FLAGS AND DAT INDEX                          MOGL 004416 0000          AS AS AS
FT-HT FLAG ** SECTOR LIMIT                   0153
0 RESERVED FOR PPR USE                       0001
0 RESERVED FOR PPR USE                       5300
SECTOR LIMIT                                0153
RESERVED
GLOBAL INSTAL AREA                           P1GL 004417 00000000000000000000
ISGL 004420 00000000000000000000
ISGL 004421 00000000000000000000
```

```
944 CHANNEL OSLL 004422 0077
944 EQUIPMENT 0000
944 TRACK 0000
944 SECTOR 0000
944 DEVICE STATUS 0000
UNIT RES INTERLOCKS OILL 004423 000
RESERVED
CH 2 ACCESS 7154 FLAG 00
CH 1 ACCESS 7154 FLAG 00
CH 4 ACCESS 7154 FLAG 00
CH 3 ACCESS 7154 FLAG 00
RESERVED 000000
ALGORITHM INDEX 01
DAYFILE TRACK DULL 004424 4001 5A5B5C+7
ACCOUNT FILE TRACK 4002
ERLOG TRACK 4003
SYSTEM TABLE TRACK 4542
FAMILY IDLE STATUS 0
FAMILY ACTIVITY COUNT 000
LOCAL STATUS FLAGS STILL 004425 2002 PB AA A
RESERVED 00
EPROR STATUS 00
MACHINE ID 0101
CURRENT USER COUNT DAF 0000
NEXT EQUIPMENT 00
ORIGINAL NUMBER UNITS 00
LOCAL STATUS 1
REDEF IN PROG/NULL EQ DDLL 004426 0
RESERVED 00
NUMBER PHYSICAL UNITS - 1 00
EQUIPMENT UNIT LIST 000000000000000000
LOCAL INSTAL AREA ISLL 004427 000000000000000000
```

TRACK RESERVATION TABLE

```
004430 +0000 4372 4527 4746 0025 7417 1111 ---- 1111 4 -W*- U 0
004431 +0004 4005 4006 4007 4010 0017 ---- ---- 1111 5E5F5G5H 0
004432 +0010 4011 4012 4013 4014 0017 ---- ---- 1111 5I5J5K5L 0
004433 +0014 4015 4016 4017 4020 0017 ---- ---- 1111 5M5N5O5P 0
004434 +0020 4021 4022 4023 4024 0017 ---- ---- 1111 5Q5R5S5T 0
004435 +0024 4025 4026 4027 4030 0017 ---- ---- 1111 5U5V5W5X 0
004436 +0030 4031 4032 4033 4034 0017 ---- ---- 1111 5Y5Z5051 0
004437 +0034 4035 4036 4037 4040 0017 ---- ---- 1111 52535455 0
004440 +0040 4041 4042 4043 4044 0017 ---- ---- 1111 56575859 0
004441 +0044 4045 4046 4047 4050 0017 ---- ---- 1111 5+5-5*5/ 0
004442 +0050 4051 4052 4053 4054 0017 ---- ---- 1111 5(5)5$5= 0
004443 +0054 4055 4056 4057 4060 0017 ---- ---- 1111 3 5,5.5 0
004444 +0060 4061 4062 4063 4064 0017 ---- ---- 1111 5 5 5 5 0
004445 +0064 4065 4066 4067 4070 0017 ---- ---- 1111 5 5 5 5 0
004446 +0070 4071 4072 4073 4074 0017 ---- ---- 1111 3 5 5 5 0
004447 +0074 4075 4076 4077 4100 0017 ---- ---- 1111 3 5 5 6 0
004450 +0100 4101 4102 4103 4104 0017 ---- ---- 1111 6A6B6C6D 0
004451 +0104 4105 4106 4107 4110 0017 ---- ---- 1111 6E6F6G6H 0
```

Track Link  
Byte Ordinal

Status Bits



Example 5:

The following sample illustrates the printer output listing produced by the C, D, and E memory dump directives (instruction parcel, byte, and word format, respectively). The same portions of central memory are dumped in each format. Auto page eject has been disabled via the EJOFF directive to allow listing the output from all three memory dump directives on one page.

```

RA =          C,3100,3140.  C - FORMAT DUMP.          EXPRESS 02   DSDI - V2.0   77/09/16. 16.54.35.   PAGE 27
0000000 CM      0R,34,25. 77/09/14.CDC MULTI-MODE OPERATING SYSTEM.   NOS 1          1AJ HUNG USING EMC MACHINE

0003100 0000 0000 0000 03130      YX 0003113 00160 07600 22000 00153 N R AS 0003126 55555 55555 34574 33642 1.837
0003101 0000 0000 0000 00000      0003114 50000 00000 00002 00010 P H 0003127 55555 55555 33573 33540 0.025
0003102 07172 41756 35575 50000 GOTO,2. 0003115 00000 00000 00000 00000 00000 0003130 00000 00000 00000 03120 YP
0003103 00000 00000 00002 72500      WU ----- 0003131 00000 00000 00000 00000 00000
0003104 00000 00000 51002 72403      WTC 0003117 55555 55555 33573 33340 0.005 0003132 34152 41030 12000 00001 1MTHXJ A
0003105 00000 00000 00000 00000      0003120 00000 00000 00000 03140 Y5 0003133 00000 00000 00000 00000 00001 1MTHXJ A
0003106 55555 55534 40574 04337 15.584 0003121 00000 00000 00000 00000 00000 0003134 60000 00000 00002 00010 P H
0003107 55555 55555 33573 33440 0.015 0003122 34152 41030 12000 00001 1MTHXJ A 0003135 00000 00000 00000 00000
0003110 00000 00000 00000 03050 X/ 0003123 00100 07600 22000 00000 H R 0003136 55555 55555 33573 74237 0.474
0003111 00000 00000 00000 00000 0003124 50000 00000 00002 00010 P H 0003137 55555 55555 33573 33637 0.034
0003112 34152 41013 13000 00001 1MTHKK A 0003125 00000 00000 00000 00000

      CM      D,3100,3140.  D - FORMAT DUMP.

0003100 0000 0000 0000 0000 3130      YX 0003113 0016 0076 0022 0000 0153 N R AS 0003126 5555 5555 5534 5743 3642 1.837
0003101 0000 0000 0000 0000 0000 0003114 5000 0000 0000 0020 0010 P H 0003127 5555 5555 5533 5733 3540 0.025
0003102 0717 2417 5635 5755 0000 GOTO,2. 0003115 0000 0000 0000 0000 0000 0003130 0000 0000 0000 0000 3120 YP
0003103 0000 0000 0000 0027 2500      WU ----- 0003131 0000 0000 0000 0000 0000
0003104 0000 0000 0051 0027 2403      WTC 0003117 5555 5555 5533 5733 3340 0.005 0003132 3415 2410 3012 0000 0001 1MTHXJ A
0003105 0000 0000 0000 0000 0000 0003120 0000 0000 0000 0000 3140 Y5 0003133 0000 0000 0000 5003 0047 /C *
0003106 5555 5555 3440 5740 4337 15.584 0003121 0000 0000 0000 0000 0000 0003134 6000 0000 0000 0020 0010 P H
0003107 5555 5555 5533 5733 3440 0.015 0003122 3415 2410 3012 0000 0001 1MTHXJ A 0003135 0000 0000 0000 0000 0000
0003110 0000 0000 0000 0000 3050 X/ 0003123 0010 0076 0022 0000 0000 H R 0003136 5555 5555 5533 5737 4237 0.474
0003111 0000 0000 0000 0000 0000 0003124 5000 0000 0000 0020 0010 P H 0003137 5555 5555 5533 5733 3637 0.034
0003112 3415 2410 1313 0000 0001 1MTHKK A 0003125 0000 0000 0000 0000 0000

      CM      E,3100,3140.  E - FORMAT DUMP.

0003100 00000 0000000000003130 00000000000000000000 07172417563557550000 0000000000000272500 YX GOTO,2. WU
0003104 00000000006100272403 00000000000000000000 55555555344057404337 5555555553357333440 WTC 15.584 0.015
0003110 0000000000000003050 00000000000000000000 34152410131300000001 00163076002200000153 X/ 1MTHKK A N R AS
0003114 50000000000000200010 00000000000000000000 00000000000000000000 5555555553357333340 P H 0.005
0003120 0000000000000003140 00000000000000000000 34152410301200000001 00100076002200000000 Y5 1MTHXJ A H R
0003124 6000000000000200010 00000000000000000000 5555555553457433642 5555555553357333540 P H 1.837 0.025
0003130 0000000000000003120 00000000000000000000 34152410301200000001 00000000000050030047 YP 1MTHXJ A /C *
0003134 6000000000000200010 00000000000000000000 5555555553357374237 5555555553357333637 P H 0.474 0.034

```

Example 6:

The following sample illustrates the printer output listing of the FNT interlock table produced by the FNT CMR dump directive. The file name/file status table, which is also produced, is in the same format as that produced by the D memory dump option (example 5).

```

RA =          FNT.          EXPRESS 02   DSDI - V2.0   77/09/16. 16.54.35.   PAGE 28
0000000 CH      0R,34,25. 77/09/14.CDC MULTI-MODE OPERATING SYSTEM.   NOS 1          1AJ HUNG USING EMC MACHINE

      FNT INTERLOCK TABLE

0004374 0000 0000 0000 0000 0000
0004375 0000 0000 0000 0000 0000
0004376 0000 0000 0000 0000 0000
0004377 0000 0000 0000 0020 0000 /3734/
0004400 0000 0000 0000 0000 0000
0004401 0000 0000 0000 0000 0000
0004402 0000 0000 0000 0000 0000
0004403 0000 0000 0000 0000 0000

      FILENAME TABLE

0003374 2331 2324 0515 0001 1600 SYSTEM AN 0003446 0000 0000 0000 0000 0000 0003552 0404 0000 0000 0000 1501 DD MA
0003375 0000 4004 4004 0001 0005 5050 A E 0003553 0000 4636 4636 0001 0005 -3-3 A E
0003376 2601 1411 0425 3200 1300 VALIDUZ K 0003452 1714 0420 1400 0001 1212 OLJPL AJJ 0003554 0000 0000 0000 0000 0000

```

---

Error logging on a CYBER 170 enables the occurrence of channel parity, memory parity, and other errors identified in the status/control (S/C) register to be detected and logged. The status/control register simulator (SCRSIM) allows the user to set S/C register bits in order to aid in the testing of error logging and error recovery procedures.

SCRSIM runs on CYBER 170 machines using the S/C register on channel 16 and if more than 10 PPU's are available on the machine, the S/C register on channel 36. On CYBER 70 machines, SCRSIM uses the interlock register on channel 15.

With the aid of a K display, the user can specify commands to set and clear bits, set bytes, and set lines and areas in holding registers. This allows both S/C registers to be set up completely. The contents of the holding register can then be transferred to the S/C registers (64 or 128 bits are transferred to the interlock register of a CYBER 70).

The bits set through this simulator are logged in the error log if an error bit is set, thus aiding in testing and software checkout. (Refer to the hardware reference manual for a complete description of the significance of each S/C register bit.) The simulator job dayfile lists all simulator commands entered. This error logging does not occur in a CYBER 70, however, unless an appropriate IPRDECK entry has been made (refer to CYBER 70 Use).

**NOTE**

Extreme care should be taken when using the simulator. Improper use may result in serious system malfunctions.

Refer to appendix A for descriptions of messages produced by SCRSIM.

## USING THE SIMULATOR

### CYBER 70 USE

Error logging is always enabled on a CYBER 170; however, a zero TC (threshold count) parameter in the DELAY IPRDECK entry (refer to the NOS Installation Handbook) disables error logging on a CYBER 70. Although the default threshold count is zero, at deadstart time this parameter can be set to any value from 0 to 7777g. Any nonzero threshold count enables error logging on a CYBER 70.

Although the simulator operates on a CYBER 70 if the threshold count is left at zero, it only manipulates bits in the interlock register. No error logging occurs.

## CONSOLE OPERATION

The simulator is called from the console by entering:

X.SCRSIM.

The simulator left K display (figure 11-1) appears on the left screen after entering

K,n.

where n is the control point number noted on the B display. This K display shows the contents of the temporary holding registers, as well as a central memory buffer. This buffer contains the following.

- A history of all error status bits since the last level 0 deadstart. If an error status bit has been set in the S/C register, it remains set in the buffer, even though it may have been cleared in the actual S/C register. This history may be useful in diagnosing system malfunctions.
- All other bits in the buffer reflect actual values in the S/C register at the time the last error bit was set. Each time an error bit is set, the entire buffer is updated.

Unless the simulator is running on a CYBER 170 with more than 10 PPs, the message

CHANNEL 36 NOT AVAILABLE

also appears. This indicates that no channel 36 S/C register is present on the machine, and thus, no simulation need be done for it.

By entering

KK.

the simulator right K display (figure 11-2) is brought up on the right screen. This display gives a brief description of the commands available.

Commands can be entered on the K display by entering

K.command.

where command is one of the commands shown in figure 11-2.

## BATCH INPUT

The simulator may also be called from batch input by the control statement SCRSIM. The input file must have a record containing the commands to be processed, one command per card. The system must be in debug mode and the user must be validated for system origin privileges.

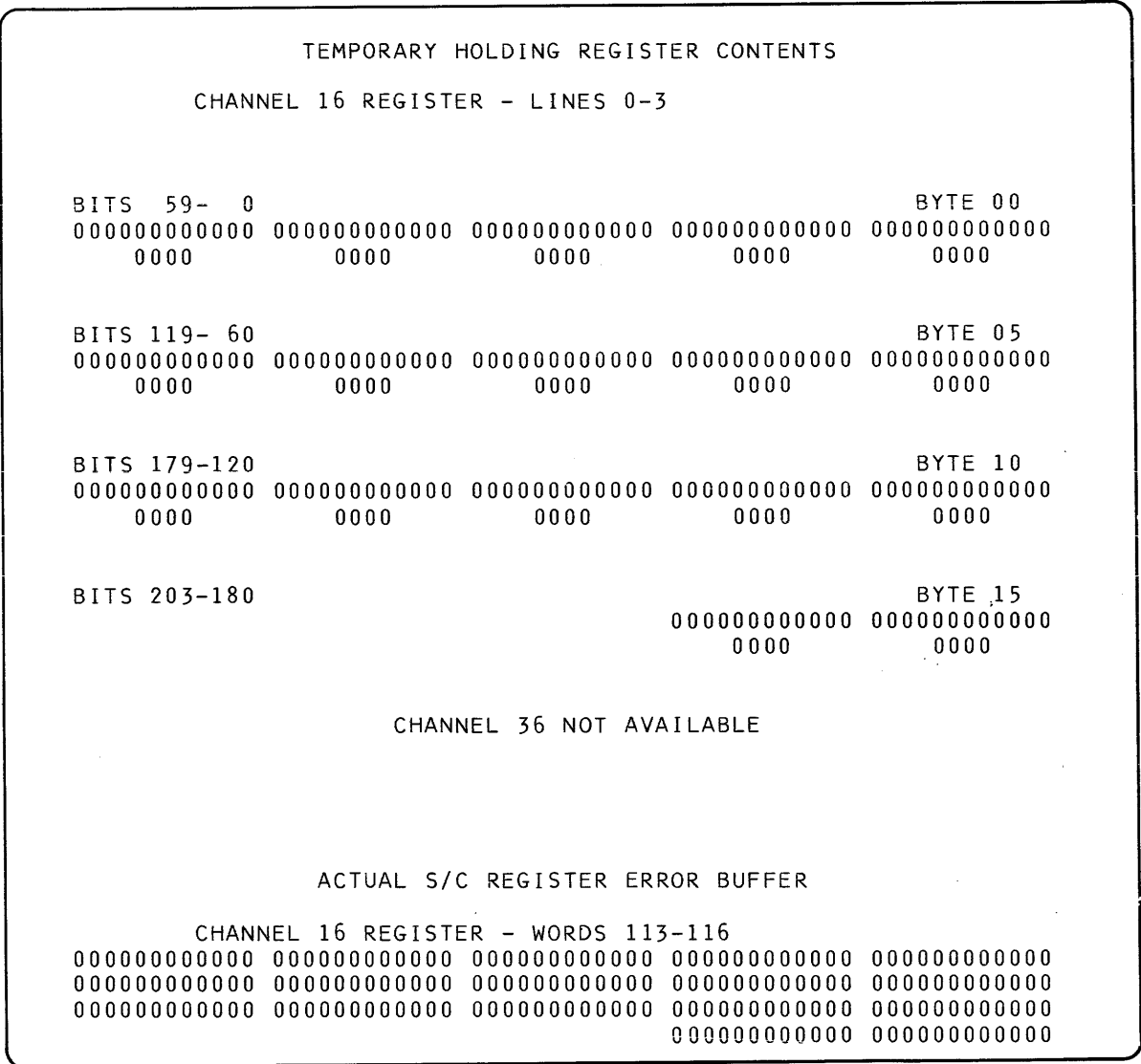

Figure 11-1. Simulator Left Display

SIMULATOR COMMANDS	
COMMAND	DESCRIPTION
AREA,A,M,Y.	SET M BITS FROM A TO OCTAL VALUE Y
BYTE,XX,YYYY.	SET BYTE XX TO OCTAL VALUE YYYY
CLEAR,A,B,...,Z.	CLEAR BITS A,B,...,Z
CYCLE,X,T,R.	SET BIT X EVERY 16*T MS. R TIMES
END.	END CYCLE COMMAND BEFORE R REACHED
LINE,X,Y.	SET LINE X TO OCTAL VALUE Y
READ.	READ S/C REGISTER INTO HOLDING REGISTER
SET,A,B,...,Z.	SET BITS A,B,...,Z
+	CHANGE REGISTER BEING USED AND K DISPLAY
GO.	ENTER HOLDING REGISTERS IN S/C REGISTERS
STOP.	END THE SIMULATOR

ALL BIT, BYTE, AND LINE NUMBERS ASSUMED DECIMAL.  
TIME VALUES ASSUMED DECIMAL  
Y AND YYYY VALUES MUST BE OCTAL.

Figure 11-2. Simulator Right Display

## SIMULATOR COMMANDS

This section lists the commands available to the simulator user. The entire command keyword must be entered, and only one command may be entered at a time. Each command, except +, must end with a terminator. In all cases, a null argument is assumed to be zero.

### HOLDING REGISTER COMMANDS

The following commands, except GO., affect only the holding register currently displayed on the left screen. These commands are used to set up the entire 204 bits in the holding registers. GO. transfers the holding register contents to the actual S/C register. (On a CDC CYBER 70, the channel 16 S/C register is simulated by the interlock register. GO. transfers the first 64 of 128 bits of the holding register to the interlock register.) The current contents of the holding register is displayed in binary and octal on the left screen (refer to figure 11-1). The contents of the actual S/C register are also displayed in binary on the left screen.

<u>Command</u>	<u>Description</u>
AREA,a,m,y.	Set m bits in the holding register, from bit a to bit a+m-1, to the octal value y.  a Starting bit number, which may range from 0 to 203. a is assumed to be decimal, but a postradix of D or B may also be included.  m Number of bits to be set. m is assumed to be decimal, but a postradix of D or B may also be included.  y Value to which the bits are to be set. y may be up to m bits of octal value.
BYTE,xx,yyyy.	Set byte xx in the holding register to the octal value yyyy.  xx Byte number which may range from 0 to 16. xx is assumed to be decimal, but a postradix of D or B may be included.  yyyy Value to which byte xx is to be set. yyyy may be up to 12 bits of octal value.
CLEAR,a <sub>1</sub> ,a <sub>2</sub> ,...,a <sub>n</sub> .	Clear bits a <sub>1</sub> ,a <sub>2</sub> ,...,a <sub>n</sub> in the holding register. If more than 30 bit numbers are entered, only the first 30 are processed. All others are ignored.  a <sub>i</sub> Bit number, from 0 to 203, to be cleared. A decimal value is assumed, but a postradix of D or B may be included.

<u>Command</u>	<u>Description</u>
LINE,x,y.	Set line x of the holding register to the octal value y.  x        Line number, ranging from 0 to 3, of the holding register shown on the left display screen (refer to figure 11-1). Line 0 is positioned at the top and line 3 is positioned at the bottom.  y        Value to which line x is to be set. y may be up to 60 bits of octal value.
READ	Transfer the contents of the actual S/C register to the holding register.
SET,a <sub>1</sub> ,a <sub>2</sub> ,...,a <sub>n</sub> .	Set bits a <sub>1</sub> ,a <sub>2</sub> ,...,a <sub>n</sub> in the holding register. If more than 30 bit numbers are entered, only the first 30 are processed. All others are ignored.  a <sub>i</sub> Bit number, from 0 to 203, to be set. A decimal value is assumed, but a postradix of D or B may be included.
GO.	Transfer the contents of the holding register to the actual S/C register or the interlock register of a CYBER 70. No bits in the holding register are changed by this command.

#### CYCLE COMMANDS

<u>Command</u>	<u>Description</u>
CYCLE,x,t,r.	Set bit x every t periods of time, a total of r times. This command assumes control of the simulator for the total time period specified. During this time, no command is accepted except END. Bit x is set in the holding register by this command.  x        Bit number, from 0 to 203, to be set.  t        Number of periods of time for each cycle, one period being 16 milliseconds. t=32 is approximately 0.5 second.  r        Number of times to set bit x. r may not exceed 4095.
END.	End CYCLE command processing before r is reached. Control of the simulator is returned to the operator.

#### + AND STOP. COMMANDS

<u>Command</u>	<u>Description</u>
+	Toggle the K display between the channel 16 and channel 36 register displays and also change the register currently being worked on, if the simulator is being operated on a CYBER 170 with two S/C registers. If two S/C registers are not present on the machine, no action is taken. The channel 16 register is assumed when the simulator begins. The only holding register which is affected by the holding register and cycle commands is the one currently displayed.
STOP.	End simulator processing.

---

NOS allows multiple copies of the running system to reside on several mass storage devices of the same type. The system deadstart file (SDF) is defined to be a copy of the deadstart tape that resides on a rotating mass storage (RMS) deadstart device. When the system is deadstarted from disk, this file is read to generate copies of the running system.

There are two ways to install an SDF on a mass storage device, via CMRDECK processing (refer to the NOS Installation Handbook) or by a system origin job using the INSTALL control statement.

The INSTALL control statement installs a copy of the running system, or alternately a user specified deadstart file, from mass storage to a rotating mass storage deadstart device. The RMS device selected must be on, available, a single unit device such as an 844 or 885, and must have common test and initialization (CTI) installed. (For more information about CTI, refer to the NOS Operator's Guide.) If the RMS deadstart device is a shared (MMF) device, a full INITIALIZE must have been previously done. The calling job must be system origin or the user must be validated for system origin privileges. DEBUG must be set if the job is not initiated from the console.

The format of the control statement is:

INSTALL,filenam,EQxx.

filenam      Mass storage file (assigned to the control point) to be installed as an SDF. Default is SYSTEM, which must be assigned to the control point. SDF is a reserved file name and cannot be specified for filenam.

If the deadstart file to be installed is on tape, it must first be copied to mass storage before INSTALL can be used.

xx            One- or two-digit (octal) EST ordinal of the RMS device on which filenam is to be installed.



---

Each 881 disk pack used in the 844 disk storage subsystem contains factory-recorded flawing information on cylinder 632g (410<sub>10</sub>), track 0, sectors 0, 1, and 2. Each 883 pack contains this information on cylinder 1466g (822<sub>10</sub>), track 0, sectors 0, 1, and 2. The following information is included on the cylinders.

- Cylinder 632g (or 1466g for 883 packs), track 0, sector 0 contains the factory-recorded manufacturing data. This data consists of the pack serial number and the manufacturing date.
- Cylinder 632g (or 1466g), track 0, sector 1 contains the factory map. This map contains a list of all factory-detected flaws, both correctable and uncorrectable.
- Cylinder 632g (or 1466g), track 0, sector 2 contains the utility map. This map originally contains all factory-detected uncorrectable flaws. This map is updated by the reformatting utility.

FORMAT is a CPU program which operates in conjunction with FDP, a PP program, to maintain and reformat 881/883 disk packs. It is used to perform the following functions.

- Factory-recorded manufacturing data, factory-recorded flaw data, and utility flaw data can be retrieved from a factory-formatted disk pack.
- Sector and track flaws can be set or cleared on a factory-formatted disk pack.
- Address fields of a previously factory-formatted disk pack can be restored. (This function is used only in the event that addresses on the pack are lost.)

In order to function, FORMAT requires that the factory-recorded data (sectors 0 and 1 of cylinder 632g (or 1466g) be correct and readable. The pack cannot be processed if this data is unreadable. If packs are available which do not contain this factory recorded information, consult a customer engineer to have this information placed on the packs. Also, the correct level of controlware must be present in order for FORMAT to function. To determine the controlware level and for procedures to install this controlware, refer to the NOS Installation Handbook. Since the operating system requires that the utility map contain the physical flaw information in order for automatic logical flawing to be performed, it is important that the utility map be properly maintained.

The operating system automatically sets logical flaws when initializing 844 equipment. This is done by reading the utility map of the 844 units involved, and mapping this physical flaw information into the corresponding logical track addresses. Logical track flaw reservations are then made in the track reservation table (TRT) for the 844 equipment being installed. For example, if the 844 equipment being initialized consists of two physical units (such as a DI-2 configuration), the logical flaws set in the TRT are obtained from the physical flaw information recorded in the utility maps of both units making up the DI-2 configuration. This automatic flawing occurs when an equipment is initialized, regardless of whether the initialization is done during deadstart, on-line, or is the result of running FORMAT. Automatic flawing also occurs when an X.FLAW request is made from the console.

The operating system allows for the manual setting and clearing of flaw information. The STK CMRDECK entry manually sets or clears logical track reservations in the TRT of the equipment. (Refer to the NOS Installation Handbook for information concerning these entries.) If the device is then checkpointed, this flaw information is preserved in the TRT portion of the device label. The STK entry can be made during deadstart, during on-line initialization, or by using the FLAW utility (as described in the NOS Operator's Guide). In any case, the flawing done via these entries is only logical; the flaw information remains only in the TRT and is discarded on subsequent deadstart initialization unless manually reentered. This information is also lost during on-line initializations if it was not possible to recover the equipment. The use of STK does not cause any additional information to be recorded in the utility map; only FORMAT is capable of updating the utility map data. Caution should be taken if attempts are made to cancel a logical flaw that was made during automatic flawing, since the physical disk sector is still marked as flawed and attempts to access that sector yield error conditions.

The following sections describe the use of the FORMAT utility for maintaining and reformatting 881/883 disk packs.

## FORMAT CONTROL STATEMENT

Processing of maintenance operations on an 881/883 type disk pack is initiated by the FORMAT control statement. This program interfaces with the operator and a PP program FDP. The format of this statement is:

FORMAT(p<sub>1</sub>,p<sub>2</sub>,...,p<sub>n</sub>)

where each p<sub>i</sub> is a keyword or a keyword equated to a value.

<u>P<sub>i</sub></u>	<u>Description</u>
G=m	Relative unit of a multispindle device. This value is checked for validity within the device. For example, if the device is a DI-2 and G=2 is specified, an error results.
I=filenam	File on which input directives and data is written.
I	Same as I=INPUT.
L=filenam	Output file on which the information extracted from the disk pack is to be written. (Refer to NOTE after O=filenam option.)
L	Same as L=OUTPUT.
MODE=mode	Operational mode for FORMAT.

<u>Mode</u>	<u>Description</u>
ALTER	The input file contains directives to control the set or clear flaw operations (refer to Input Formats).
FETCH	The information contained on the factory sectors cylinder 632g (or 1466g), track 0, sectors 0, 1, and 2 is obtained and copied to the output file (and optional output file, if available).
RESTORE	The addresses, flawed sectors, and tracks are restored according to information given in the utility flaw map. If the utility flaw map is not intact, the program aborts.

<u>P<sub>i</sub></u>	<u>Description</u>
MODE	Same as MODE=FETCH.
O=filenam	Optional output file to contain the output extracted from the disk pack.

**NOTE**

If output files other than OUTPUT or optional output files are specified, they should be created prior to the initiation of FORMAT. If they are not, they are destroyed upon completion of FORMAT processing.

P=serialn	Pack serial number in decimal of the pack to be processed. If serialn does not match the serial number recorded on the disk pack at the factory, processing does not occur.
P	Same as P=0.
U=xx	EST ordinal in octal of the 844 on which the disk pack is mounted. The unit is checked to ensure that it is available for formatting (refer to Accessing Mass Storage Devices later in this section).
V	Specifies that the utility is to verify the addresses recorded on the disk pack. This option is valid only if MODE=FETCH or MODE=RESTORE is specified.

If all default values are used, the following call is made.

```
FORMAT(I=INPUT,L=OUTPUT,MODE=FETCH,P=0)
```

At least the U and the P parameter must be correctly specified to initiate processing.

## INPUT FORMATS

Input to FORMAT consists of control directives and data statements. Control directives indicate the type of operation to be performed. Data statements indicate locations on the pack where the operations are to be performed. A number of data statements may follow each control directive. Control directives and data statements are contained on the input file. This file is accessed only when MODE=ALTER has been specified on the FORMAT control statement. The input file (and therefore, control directives and data statements) has no significance when MODE=FETCH or MODE=RESTORE is specified.

## CONTROL DIRECTIVES

Control directives begin in column 1. The format is:

directive

The following are acceptable directives.

<u>Directive</u>	<u>Description</u>
SET	Declares that the following data statements contain the addresses of flaws to be set and entered in the utility flaw map.
CLEAR	Declares that the following data statements contain the addresses of flaws to be cleared and deleted from the utility flaw map.
FINIS	Declares the end of the input. No information following this statement is processed. This directive is optional.

SET and CLEAR directives may be intermixed in the input file. However, all CLEAR operations are performed before any SET operation. Any attempt to alter the factory map or to set or clear sector flaws in a previously flawed track, results in an error.

## DATA STATEMENTS

Data statements begin in column 1. The format is:

x,cccc,tt,ss

x	Type of flaw to be set or cleared. Acceptable values are:
<u>x</u>	<u>Description</u>
S	Indicates that the SET or CLEAR directive is applied to a sector.
T	Indicates that the SET or CLEAR directive is applied to a track.
cccc	Octal number specifying the cylinder; the range is from 0 to 632 <sub>8</sub> (or 1466 <sub>8</sub> for 883 packs).
tt	Octal number specifying the track; the range is from 0 to 22 <sub>8</sub> .
ss	Octal number specifying the sector; the range is from 0 to 27 <sub>8</sub> . This field is ignored for track flaws (x=T).

All input data is checked to ensure that the values are within range. Any errors in input result in the termination of the utility before the disk is accessed. Any attempt to alter the factory map, or to set or clear sector flaws in a previously flawed track results in an error.

A maximum of 157 data statements can appear in the input stream.

## OUTPUT FORMATS

Output generated by FORMAT is always placed on the output file (L=filenam on the FORMAT control statement). This file, for all modes of operation (ALTER, FETCH, and RESTORE), contains the following.

- A listing of the input stream, if any.
- The pack serial number and date of factory formatting from the manufacturing section (cylinder 632g or 1466g), track 0, sector 0.
- A listing of the factor flaw map contained on cylinder 632g (or 1466g), track 0, sector 1.
- A listing of the utility flaw map contained on cylinder 632g (or 1466g), track 0, sector 2.
- A listing of the utility flaw map following any changes resulting from SET or CLEAR directives. This listing appears only when MODE=ALTER is specified on the FORMAT control statement.
- A listing of the flawed sectors and tracks as read from the disk during address verification. This listing appears only when MODE=FETCH or MODE=RESTORE, and the V option are specified on the FORMAT control statement.

Refer to Examples for examples of standard output.

The output generated by FORMAT can be directed to an optional output file (O=filenam). This file can then be used as input to another program, or it can be punched or printed.

## EXAMPLES

The following three examples illustrate a series of reformatting operations performed on the same pack.

Example 1:

A RESTORE operation is performed on an 881 pack. A control statement similar to the following was entered.

```
FORMAT(U=xx,P=819545,MODE=RESTORE)
```

Figure 13-1 illustrates the resulting output.

Example 2:

The flaws noted in the factory flaw map from example 1 (figure 13-1) are now set in the utility flaw map.

Input similar to the following was entered.

```
FORMAT(U=xx,P=819545,MODE=ALTER)
-- EOR --
SET
S,626,15,15
T,302,16,0
T,362,01,00
T,373,21,00
FINIS
-- EOI --
```

Figure 13-2 illustrates the resulting output.

DISK PACK REFORMATTING UTILITY  
MODE = RESTORE

-VERSION 1.1-

78/09/05.

DISK PACK SERIAL NUMBER  
819545

DATE OF ORIGINAL FACTORY FORMATTING  
74/04/30

FACTORY FLAW MAP  
(C=CORRECTABLE ERROR, S=SECTOR FLAW, T=TRACK FLAW)  
S, 632, 00, 00  
S, 632, 00, 01  
S, 632, 00, 02  
T, 302, 16, 00  
T, 362, 01, 00  
T, 373, 21, 00  
S, 626, 15, 15

UTILITY FLAW MAP  
(S=SECTOR FLAW, T=TRACK FLAW)  
MAP EMPTY

PACK FORMATTING COMPLETE, VERIFICATION FOLLOWS

S, 632, 00, 00  
S, 632, 00, 02  
S, 632, 00, 01

ADDRESS VERIFICATION COMPLETE

Figure 13-1. FORMAT Output, MODE=RESTORE

DISK PACK REFORMATTING UTILITY  
MODE = ALTER

-VERSION 1.1- 78/09/05.

INPUT DATA  
SET  
S, 626, 15, 15  
T, 302, 16, 00  
T, 362, 01, 00  
T, 373, 21, 00  
FINIS

DISK PACK SERIAL NUMBER  
819545

DATE OF ORIGINAL FACTORY FORMATTING  
74/04/30

FACTORY FLAW MAP  
(C=CORRECTABLE ERROR, S=SECTOR FLAW, T=TRACK FLAW)  
S, 632, 00, 00  
S, 632, 00, 01  
S, 632, 00, 02  
T, 302, 16, 00  
T, 362, 01, 00  
T, 373, 21, 00  
S, 626, 15, 15

UTILITY FLAW MAP  
(S=SECTOR FLAW, T=TRACK FLAW)  
MAP EMPTY

UTILITY FLAW MAP (ALTERED)  
(S=SECTOR FLAW, T=TRACK FLAW)  
S, 626, 15, 15  
T, 302, 16, 00  
T, 362, 01, 00  
T, 373, 21, 00

Figure 13-2. FORMAT Output, MODE=ALTER

**Example 3:**

A FETCH with verification operation is performed to ensure proper reformatting. A control statement similar to the following was entered.

```
FORMAT(U=xx,P=819545,MODE=FETCH,V)
```

Figure 13-3 illustrates the resulting output.

DISK PACK REFORMATTING UTILITY  
MODE = FETCH

-VERSION 1.1-

78/09/05.

DISK PACK SERIAL NUMBER  
819545

DATE OF ORIGINAL FACTORY FORMATTING  
74/04/30

FACTORY FLAW MAP  
(C=CORRECTABLE ERROR, S=SECTOR FLAW, T=TRACK FLAW)  
S, 632, 00, 00  
S, 632, 00, 01  
S, 632, 00, 02  
T, 302, 16, 00  
T, 362, 01, 00  
T, 373, 21, 00  
S, 626, 15, 15

UTILITY FLAW MAP  
(S=SECTOR FLAW, T=TRACK FLAW)  
S, 626, 15, 15  
T, 302, 16, 00  
T, 362, 01, 00  
T, 373, 21, 00

ADDRESS VERIFICATION FOLLOWS

T, 302, 16, 00  
T, 362, 01, 00  
T, 373, 21, 00  
S, 626, 15, 15  
S, 632, 00, 00  
S, 632, 00, 02  
S, 632, 00, 01

ADDRESS VERIFICATION COMPLETE

Figure 13-3. FORMAT Output, MODE=FETCH



## ACCESSING MASS STORAGE DEVICES

Special procedures must be used to access the 844 drive used in the reformatting utility. Since certain FORMAT operations (ALTER and RESTORE) can change addresses on the pack, user access to the pack must be restricted.

FORMAT can operate on the pack in the following ways.

- A read operation (FETCH) obtains formatting information from the pack. The integrity of the pack is maintained.
- Read and write operations (ALTER and RESTORE) can set and clear flaws, and addresses can be rewritten. Users cannot place permanent files on the pack when these operations occur. The integrity of the data on the pack is lost, so a full initialization of the pack must occur before system usage occurs.

## ACCESS FOR READ OPERATIONS

Accessing the pack for read operations requires that the U parameter be specified on the FORMAT control statement with the correct EST ordinal of the device containing the pack. In this case, the device must be a single-spindle device unless the G parameter is also specified. The P parameter must also be specified with the correct pack serial number.

In addition, FORMAT must be called from one of the following.

- A system origin job (from the console).
- A system privileged job (in this case, engineering mode must have been selected on the system console).

## ACCESS FOR READ AND WRITE OPERATIONS

In addition to the information specified for read only operations, the following additional steps must be taken to access a device when write operations (ALTER and RESTORE) are to be performed. (Refer to the NOS Operator's Guide for a description of all DSD commands and for the mass storage status display and to the NOS Installation Handbook for a description of all CMRDECK entries.)

1. The pack to be accessed should be mounted on a removable mass storage device.
2. One of the following conditions is required.
  - a. The device should not be a shared device. (Refer to SHARE command in the NOS Installation Handbook.)
  - b. If the device is shared, a global unload should be set. (Refer to section 8.)
3. The device must be declared logically off. Use the OFF,xx. DSD command or the OFF parameter in the CMRDECK EQ entry.
4. The mass storage status (E,M.) display must show that the device is not in use.

5. One of the following conditions is required.
  - a. The mass storage status (E,M.) display must show that the device is unavailable for permanent file access.
  - b. The following conditions are required.
    - 1) The full initialize status and the format pending status must be set. Use either of the DSD commands, INITIALIZE,xx,FP. or FORMAT,xx.
    - 2) The direct access file user count should be equal to zero. The mass storage status (E,M.) display gives this information.

If all the necessary conditions are satisfied, FORMAT is able to access the pack for reformatting purposes. FORMAT repeatedly checks to ensure that these conditions are satisfied throughout the FORMAT operation.

---

The LOADBC control statement provides the capability of dynamically downloading disk controlware to the associated controller and channel. The downloading of controlware can only be initiated with a console command. The controlware can be loaded on a channel that is either active or down. The calling job must be system origin or the user must be validated for system origin privileges; and the system must be in engineering mode (refer to the NOS Operator's Guide). LOADBC will issue appropriate messages to indicate the success or failure of the controlware load attempt.

The format of the control statement is:

LOADBC,C=xx.      Load all controlware on channel xx regardless of channel status UP or DOWN.  
Controlware is from the system file.

---

The TRACER and PROBE utilities described in this section provide data for statistical analysis of the system. The data is used to determine areas where problems occur, where improvements in design might be made, and to perform system tuning. The TRACER utility monitors the system's activity and gathers data periodically. The PROBE utility traps and measures particular internal events in the system. Both utilities capture valuable data which may not be obtainable any other way.

## TRACER UTILITY

The TRACER utility monitors the following conditions:

- Channel activity by channel.
- Channel reserved.
- Channel requested.
- Number of active peripheral processors (PP).
- Central processor unit (CPU) use (idle system, system-related activity, or user activity).
- Subsystem CPU use.
- Storage moves pending.
- PP saturation.
- MTR cycle time.
- CPU0 or CPU1 is or is not in monitor mode (CYBER 170 Series only).
- Same storage move request is pending.
- Permanent file manager (PFM) activity.
- Job scheduler activity.
- Control points in inactive (I) status.
- Control points in executing (X) status.
- Control points in waiting (W) status.
- Number of active control points.

- Amount of available memory.
- Amount of memory at control points by origin.
- Amount of memory in queue by origin.
- Amount of memory at control points by subsystem.
- Number of nonqueue files.
- IAF/TELEX active users.
- IAF/TELEX pots available.
- IAF/TELEX pots in use.
- Tape drives in use.
- Tracks available by mass storage device.

The TRACER utility includes the following programs:

- ICPD      A CPU program which initiates system monitoring by CPD.
- CPD        A PP program which monitors any of the system activities listed above. CPD is dedicated to a PP while it is monitoring system activity. Data is written to a direct access permanent file for future analysis.
- ACPD      A postprocessor program which generates an output report from the direct access permanent file written by CPD.
- ENDCPD    A CPU program that terminates system monitoring by CPD.

## TRACER CONTROL STATEMENTS

TRACER control statements are described in the following paragraphs.

### ICPD Control Statement

ICPD defines a mass storage file to which CPD will write statistical data and which will initiate system data gathering.

Control statement format:

ICPD(p<sub>1</sub>,p<sub>2</sub>,...,p<sub>n</sub>)

<u>P<sub>i</sub></u>	<u>Description</u>
FL=nnnn	Fast loop time, in milliseconds, during which such variables as PPs active and move request pending are sampled. Default is 5 milliseconds.

<u>P<sub>i</sub></u>	<u>Description</u>
ML=nnnn	Medium loop time, in milliseconds, during which such variables as control points in I, X, and W status and FL available are sampled. Default is 100 milliseconds.
SL=nnnn	Slow loop time, in milliseconds, during which such variables as IAF users and tape drives in use are sampled. Default is 1000 milliseconds.
FW=nnnn	Data block sample time, in seconds. Default is 5 seconds.
FN=lfn	Name of sample data file. Default is SAMPLE. ICPD will attempt to attach a direct access file by this name. If no file exists, it will be defined. If a file is found, ICPD will skip to EOI and write an EOF. CPD will then start writing data after the EOF.
M=xxxx	Permanent file mode for sample data file. Default is M = WRITE. xxxx can have one of the following values.

<u>Value</u>	<u>Description</u>
WRITE or W	Sample file attached in write mode.
APPEND or A	Sample file attached in append mode.
MODIFY or M	Sample file attached in modify mode.

**NOTE**

If the sample data file is attached in write mode, the file cannot be accessed until ENDCPD is run. If the sample data file is to be accessed while data is being collected, append or modify mode must be specified. In this situation, the file may be attached in read/allow modify (RM) mode. (Attaching the file in write mode rather than in modify or append mode has the advantage of expending less overhead when interlocking and writing the data file.)

If a loop time is set to zero, no samples for that loop will be taken.

All numeric data should lie within the range 0 through 4095D (0 through 7777B).

### ACPD Control Statement

ACPD reads the data file produced by CPD and generates a summary of the data for further analysis. The data file must be attached before ACPD is called. If ICPD is called with the M parameter, the data file may be accessed while CPD is still active.

Control statement format:

ACPD( $P_1, P_2, \dots, P_n$ )

<u>P<sub>i</sub></u>	<u>Description</u>
FN=ifn <sub>1</sub>	Name of sample data file. Default is SAMPLE.
L=ifn <sub>2</sub>	Output file name. Default is OUTPUT.
S=ifn <sub>3</sub>	Summary file name. Default is SUMMARY.
IN=nnn	Length of time of summary interval, in minutes. Default value is 2 minutes. ACPD will output a report for each summary interval.
LO=Z	List zero data items (having value of zero). Default is not to list zero data items.
N=nnnn	Number of files to process. Default is only one file processed. If N or N=0 is specified, all files are processed to EOI.

### ENDCPD Control Statement

The ENDCPD control statement terminates all active copies of CPD.

Control statement format:

ENDCPD.

Figure 15-1 shows sample data summaries produced by TRACER.

A C P D - VER 7.00 80/09/17. 18.59.24. PAGE 1  
 (35) CYBER 170-76C/420. NGS CISH. NGS 1-2603T/R7B.

START DATE	80/09/17.	}	START OF SAMPLING INTERVAL
START TIME	07.07.28.		
DATA FILE NAME	SAMPLE	}	ACPD CONTROL STATEMENT PARAMETERS (FN,IN)
SUMMARY INTERVAL	60 MINS.		
CPD VFRSTEN	7.00	}	ICPD CONTROL STATEMENT PARAMETERS (IL, ML, OL, FW)
FAST LOOP INTERVAL	5 MSEC.		
MEDIUM LOOP INTERVAL	100 MSEC.		
SLCW LOOP INTERVAL	1000 MSEC.		
SNAPSHOT LOOP INTERVAL	5 SECS.		
NUMBER OF CPUS	1	}	HARDWARE CONFIGURATION AT BEGINNING OF DATA GATHERING INTERVAL
NUMBER OF PPLS	20		
MEMORY SIZE / 100B	7777B		
USER FCS / 100GB	0B		
MAGNETIC TAPE UNITS	13		
NUMBER OF INT ENTRIES	74CB	}	SOFTWARE CONFIGURATION AT BEGINNING OF DATA GATHERING INTERVAL
NUMBER OF CONTROL POINTS	24B		
CMRSIZE / 10CB	1044B		
LIBDFCK NUMBER	0		
RECOVERPY LEVEL	0		
NUMBER OF TERMINALS	66		
MACHINE ID	42		
CTCLL	5B		
CTILL	36B	}	①
FXCT	5B		
FXPS	7760B		
NMSC	40B		
NPFS	4B		
CUFT	10B		
MXRS	11B		

Figure 15-1. Example of TRACER Output (Sheet 1 of 12)



EQUIPMENT NO.	STATUS TYPE	TABLE STAT	CHANNELS		EST ENTRY	TRACK CAP.	FILES
			EQ	UN			
1	DL	FF		21 20	62002C21000004141002	3150	XT-----
2	DL	CA	11	20 21	62C0212000000414107C	3150	XT-----
3	DI	CA		21 20	42C02021000004111156	3140	-T-----
4	DK	CA		20 21	42C02120000004131243	3140	-T-----
5	DI	CA		22 23	42002322000004111330	3140	-T-----
6	DC	CN		5 7	42000705000004211415	3222	-----
7	DC	CA		7 2	42C0C507000004211504	3222	-----
10	DS	CA	7 0	10	00000010000004237000		-----
11	DI	CA		22 23	46002322000004111573	3140	-----
12	DC	CN		5 7	42000705000004211660	3222	-----
13	DC	CA		7 5	42000507000004211747	3222	-----
14	DC	CN		5 7	42000705000004212036	3222	-----
15	DC	CA		7 5	42000507000004212125	3222	-----
16	DI	CA		22 23	46002322000004112214	3140	-----
17	DI	CA		23 22	47002723000004122301	3150	-----
20	DI	CA		27 23	47002322000004122367	3150	-----
21	DJ	CA		23 22	47002223000004122455	3150	-----
22	DJ	CA		21 20	47002021000004122543	3150	-----
23	DJ	CA		5 7	4700C705000004122631	3150	-----
24	DJ	CN		22 21	47002223000004122717	3150	-----
25	DJ	CN		7 5	47000223000004122717	3150	-----
26	DJ	CA		5 7	47000507000004123005	3150	-----
27	DI	LA		26 21	4600C705000004123073	3150	-----
30	DI	CN		21 23	46002120000004113161	3140	-----
31	DI	CA		23 22	47002322000004113246	3140	-----
32	DI	CA		23 22	47002223000004113333	3140	-----
33	DI	CA		21 20	47002021000004113420	3140	-----
34	DI	CA		22 23	47C02322000004113505	3140	-----
35	DI	CA		20 21	47002120000004113572	3140	-----
36	DI	LA		23 22	47002223000004113657	3140	-----
37	DI	CA		22 23	47002223000004113744	3140	-----
40	CP	CN	4 0	12	00C00012000003224000		-----
41	CP	CA	7 0	12	00000120000003207000		-----
42	NP	CN	7 1	1	00000001000216207001		-----
45	NP	CA	7 1	6	0000000600516207001		-----
46	SE	CA	7 0	2	00C00002000023157000		-----
50	MT	CA	0 0	13 32	00C03213000016240400		-----
51	MT	CA	0 1	13 32	00003213000015240401		-----
52	MT	CN	0 2	13 32	00C0313000015240402		-----
53	MT	CA	0 3	13 32	00003213000015240403		-----
54	MT	CN	0 4	13 32	00003213000015240404		-----
55	CS	CA	0 6	27	00000077440003230106		-----
56	CT	CA	0 0	27	00G00027440003240000		-----
57	CT	CN	0 2	27	00000027440203240202		-----
60	NT	CN	4 20	31 33	00003331000016244220		-----
61	NT	CA	4 21	31 33	00003331000016244221		-----
62	NT	CA	4 22	31 33	00003331000016244222		-----
63	NT	CN	4 23	31 33	00003331000016244223		-----
64	NT	CN	4 4	31 33	00003331000016244204		-----
65	NT	CN	4 5	31 33	00003331000016244205		-----
66	MT	CA	4 6	31 33	00003331000015244206		-----
67	MT	CA	4 7	31 33	00003331000015244207		-----
70	LT	CN	23 1	0 12	00230012000014241000		-----

THIS PAGE REFLECTS THE STATUS OF THE EST AT THE BEGINNING OF THE SAMPLING INTERVAL

A C P D - VER 7.00 60/09/17. 18.59.24. PAGE 3  
(35) CYBER 170-760/420. NOS CLSH. NOS 1-26031/R78.

71	LT	CN	3 0	12	00000012000014243000
72	LP	CN	2 0	12	00000012000014202500
73	LT	CN	5 0	12	00000012000014243600
74	LS	CN	6 0	12	02000012000014236100
75	TT	CN	0 2	0	20000000010224240002
76	TE	CN	0 0	0	200000000000C24050000
77	ME	CN	0 0	0	200000000000C16050000

Figure 15-1. Example of TRACER Output (Sheet 2 of 12)

A C P D - VER 7.00 80/09/17. 16.59.24. PAGE 4  
 (35) CYBER 170-760/420. NCS CLSH. NCS 1-26037/R7B.

## SYSTEM CONTROL INFORMATION

JOB TYPE	QUEUE	PRIORITIES			IN	PR/NJ	SERVICE LIMITS		EC/EM
		CP	LP	UP			CP/FL	CH/AM	
SYGT	IN	7757	700	3000	1	1	100	20	7777
	RC	6000	100	1000	1	7777	7777	7777	7777
	CT	400	100	7700	1				
ECCT	TA	2400	2000	4010	1	30	400	200	7777
	RC	2400	1010	4004	1	7777	7777	7777	7777
	CT	200	100	7000	1				
FICT	IN	3400	2400	4010	1	30	400	200	7777
	RC	3400	1400	4006	1	7777	7777	7777	7777
	CT	200	100	7000	1				
TXGT	IN	4000	3770	7000	1	30	40	10	7777
	RC	4004	3740	7000	1	7777	7777	7777	7777
	CT	200	100	7000	1				
PTCT	TA	6774	6700	7400	1	31	400	60	7777
	RC	6774	4000	7400	1	7777	7777	7777	7777
	CT	6000	100	7700	1				

THIS PAGE REFLECTS THE STATUS OF THE JOB CONTROL AREA  
 AT THE BEGINNING OF THE SAMPLING INTERVAL. THESE VALUES  
 ARE SET BY THE QUEUE AND SERVICE IPRDECK AND DSD COMMANDS.

VARIABLE	INTERVAL			CUMULATIVE					
	AVERAGE	STD DEV	PERCENT	AVERAGE	STD DEV	PERCENT	MIN PCT	MAX PCT	
<b>FAST LCCP VARIABLES</b>									
PPUS ACTIVE	7	2.196	36.886	7	2.196	36.886	36.886	36.886	
MCVE REQLST PENDING	0	0.045	1.431	0	0.045	1.431	1.431	1.431	
NO PPU AVAILABLE	0	0.004	0.051	0	0.004	0.051	0.051	0.051	
MTR CYCLE TIME	0	0.146	0.224	0	0.146	0.224	0.224	0.224	
PLANTOR MODE - CPU C	0	0.014	5.767	0	0.014	5.767	5.767	5.767	
SCHFDLER ACTIVE	0	0.027	5.407	0	0.057	5.407	5.407	5.407	
CHANNEL RESFRVT									
CF 1	0	0.055	49.069	0	0.055	49.069	49.069	49.069	
CF 2	0	0.150	97.622	0	0.150	97.622	97.622	97.622	
CF 5	0	0.175	10.558	0	0.175	10.558	10.558	10.558	
CF 6	0	0.055	49.172	0	0.055	49.172	49.172	49.172	
CF 7	0	0.111	4.269	0	0.111	4.269	4.269	4.269	
CF 10	1	0.030	100.000	1	0.030	100.000	100.000	100.000	
CF 12	0	0.494	56.157	0	0.494	56.157	56.157	56.157	
CF 13	0	0.061	1.065	0	0.061	1.065	1.065	1.065	
CF 14	0	0.009	0.639	0	0.009	0.639	0.639	0.639	
CF 15	0	0.002	0.652	0	0.002	0.652	0.652	0.652	
CF 16	0	0.003	0.014	0	0.003	0.014	0.014	0.014	
CF 20	0	0.289	36.404	0	0.289	36.404	36.404	36.404	
CF 21	0	0.292	31.342	0	0.292	31.342	31.342	31.342	
CF 22	0	0.078	1.350	0	0.078	1.350	1.350	1.350	
CF 23	0	0.221	17.360	0	0.221	17.360	17.360	17.360	
CF 27	0	0.001	0.003	0	0.001	0.003	0.003	0.003	
CF 31	0	0.157	3.183	0	0.157	3.183	3.183	3.183	
CF 32	0	0.004	0.187	0	0.004	0.187	0.187	0.187	
CF 33	0	0.010	0.227	0	0.010	0.227	0.227	0.227	
<b>CHANNEL ACTIVE</b>									
CF 1	0	0.008	3.274	0	0.008	3.274	3.274	3.274	
CF 2	0	0.010	5.766	0	0.010	5.766	5.766	5.766	
CF 5	0	0.131	8.022	0	0.131	8.022	8.022	8.022	
CF 6	0	0.007	2.805	0	0.007	2.805	2.805	2.805	
CF 7	0	0.082	3.242	0	0.082	3.242	3.242	3.242	
CF 10	0	0.192	72.610	0	0.192	72.610	72.610	72.610	
CF 12	0	0.085	8.836	0	0.085	8.836	8.836	8.836	
CF 13	0	0.070	0.781	0	0.070	0.781	0.781	0.781	
CF 16	1	0.000	100.000	1	0.000	100.000	100.000	100.000	
CF 20	0	0.229	29.240	0	0.229	29.240	29.240	29.240	
CF 21	0	0.230	24.665	0	0.230	24.665	24.665	24.665	
CF 22	0	0.066	1.134	0	0.066	1.134	1.134	1.134	
CF 23	0	0.182	14.490	0	0.182	14.490	14.490	14.490	
CF 27	0	0.000	0.001	0	0.000	0.001	0.001	0.001	
CF 31	0	0.153	2.892	0	0.153	2.892	2.892	2.892	
CF 32	0	0.002	0.105	0	0.002	0.105	0.105	0.105	
CF 33	0	0.009	0.102	0	0.009	0.102	0.102	0.102	

Figure 15-1. Example of TRACER Output (Sheet 4 of 12)

A C P D - VER 7.00 80/09/17. 18.59.24. PAGE 6  
 (35) CYBER 170-760/420. NOS CLSH. NOS 1-2603T/R78.

DATE 80/09/17. CURRENT TIME 08.07.28. ELAPSED TIME 60 MIN. STARTING BLOCK 1 ENDING BLOCK 720

VARIABLE	I N T E R V A L			C U M U L A T I V E				
	AVERAGE	STD DEV	PERCENT	AVERAGE	STD DEV	PERCENT	MIN PCT	MAX PCT
CHANNEL REQUESTED								
CF 5	0	0.017	0.286	0	0.017	0.286	0.286	0.286
CF 7	0	0.011	0.172	0	0.011	0.172	0.172	0.172
CF 10	0	0.051	0.321	0	0.051	0.321	0.321	0.321
CF 12	0	0.009	0.184	0	0.009	0.184	0.184	0.184
CF 14	0	0.000	0.005	0	0.000	0.005	0.005	0.005
CF 15	0	0.000	0.000	0	0.000	0.000	0.000	0.000
CF 20	0	0.207	13.737	0	0.207	13.737	13.737	13.737
CF 21	0	0.200	11.635	0	0.200	11.635	11.635	11.635
CF 22	0	0.001	0.005	0	0.001	0.005	0.005	0.005
CF 23	0	0.049	0.633	0	0.049	0.633	0.633	0.633
REQUESTS PENDING								
EC 1	0	0.350	0.271	0	0.350	0.271	0.271	0.271
EC 2	0	0.326	0.251	0	0.326	0.251	0.251	0.251
EC 3	0	0.393	0.302	0	0.393	0.302	0.302	0.302
EC 4	0	0.312	0.189	0	0.312	0.189	0.189	0.189
EC 5	0	0.366	0.240	0	0.366	0.240	0.240	0.240
EC 6	0	0.055	0.013	0	0.055	0.013	0.013	0.013
EC 7	0	0.045	0.009	0	0.045	0.009	0.009	0.009
EC 11	0	0.089	0.008	0	0.089	0.008	0.008	0.008
EC 12	0	0.098	0.013	0	0.098	0.013	0.013	0.013
EC 13	0	0.392	0.157	0	0.392	0.157	0.157	0.157
EC 14	0	0.113	0.023	0	0.113	0.023	0.023	0.023
EC 15	0	0.006	0.001	0	0.006	0.001	0.001	0.001
EC 16	0	0.001	0.000	0	0.001	0.000	0.000	0.000
EC 17	0	0.000	0.000	0	0.000	0.000	0.000	0.000
EC 20	0	0.000	0.000	0	0.000	0.000	0.000	0.000
EC 21	0	0.000	0.000	0	0.000	0.000	0.000	0.000
EC 22	0	0.000	0.000	0	0.000	0.000	0.000	0.000
EC 23	0	0.031	0.003	0	0.031	0.003	0.003	0.003
EC 24	0	0.014	0.001	0	0.014	0.001	0.001	0.001
EC 25	0	0.052	0.005	0	0.052	0.005	0.005	0.005
EC 26	0	0.018	0.002	0	0.018	0.002	0.002	0.002
EC 27	0	0.053	0.007	0	0.053	0.007	0.007	0.007
EC 30	0	0.000	0.000	0	0.000	0.000	0.000	0.000
EC 31	0	0.000	0.000	0	0.000	0.000	0.000	0.000
EC 32	0	0.001	0.000	0	0.001	0.000	0.000	0.000
EC 33	0	0.000	0.000	0	0.000	0.000	0.000	0.000
EC 34	0	0.031	0.002	0	0.031	0.002	0.002	0.002
EC 35	0	0.028	0.002	0	0.028	0.002	0.002	0.002
EC 36	0	0.032	0.003	0	0.032	0.003	0.003	0.003
EC 37	0	0.064	0.007	0	0.064	0.007	0.007	0.007
PFM ACTIVITY								
PFM - 1	0	0.121	6.021	0	0.121	6.021	6.021	6.021
PFM - 2	0	0.030	0.508	0	0.030	0.508	0.508	0.508
PFM - 3	0	0.005	0.050	0	0.005	0.050	0.050	0.050
PFM - 4	0	0.002	0.008	0	0.002	0.008	0.008	0.008

Figure 15-1. Example of TRACER Output (Sheet 5 of 12)

DATE 08/09/17. CURRENT TIME 06.07.28. ELAPSED TIME 60 MIN. STARTING BLOCK 1 ENDING BLOCK 720

VARIABLE	I N T E R V A L			C U M U L A T I V E				
	AVERAGE	STD DEV	PERCENT	AVERAGE	STD DEV	PERCENT	MIN PCT	MAX PCT
CPL USACF - CPL C								
IDLE	0	0.013	0.159	0	0.013	0.159	0.159	0.159
SYSTEM	0	0.007	0.357	0	0.007	0.357	0.357	0.357
SLE-SYS	0	0.017	8.999	0	0.017	8.999	8.999	8.999
SYS CRC	0	0.290	73.358	0	0.290	73.358	73.358	73.358
USER	0	0.290	17.126	0	0.290	17.126	17.126	17.126
SLBSYSTEM CPL USACF								
MXFS+1	0	0.010	1.633	0	0.010	1.633	1.633	1.633
MSS	0	0.005	0.781	0	0.005	0.781	0.781	0.781
MCS	0	0.004	0.644	0	0.004	0.644	0.644	0.644
RPF	0	0.002	0.279	0	0.002	0.279	0.279	0.279
NAP	0	0.005	1.122	0	0.005	1.122	1.122	1.122
STAMULA	0	0.000	0.005	0	0.000	0.005	0.005	0.005
TAF	0	0.007	1.571	0	0.007	1.571	1.571	1.571
MACNFT	0	0.004	1.295	0	0.004	1.295	1.295	1.295
IAF	0	0.005	1.669	0	0.005	1.669	1.669	1.669
<u>MEDIUM LOOP VARIABLES</u>								
	INTERVAL	SAMPLES	35981	TOTAL	SAMPLES	35981		
CPS IN W STATUS	6	0.745	30.763	6	0.745	30.763	30.763	30.763
CPS IN X STATUS	8	0.996	42.031	8	0.996	42.031	42.031	42.031
CPS IN I STATUS	C	0.634	2.461	0	0.634	2.461	2.461	2.461
NCA-QUEUE FILES	113	23.093	23.722	113	23.093	23.722	23.722	23.722
SAME MOVE REQUEST	0	0.007	0.136	0	0.007	0.136	0.136	0.136
FL AVAILABLE	33358	596.295	49.539	33358	596.295	49.539	49.539	49.539
CNTL POINTS ACTIVE								
SYCT	15	1.097	75.885	15	1.097	75.885	75.885	75.885
BCCT	0	1.216	2.399	0	1.216	2.399	2.399	2.399
FICT	0	0.404	0.412	0	0.404	0.412	0.412	0.412
TXCT	0	0.907	3.186	0	0.907	3.186	3.186	3.186
FL AT CNTL POINTS								
SYCT	26658	219.837	41.196	26658	219.837	41.196	41.196	41.196
PCCT	2178	400.937	4.033	2178	400.937	4.033	4.033	4.033
FICT	268	116.700	0.646	268	116.700	0.646	0.646	0.646
TXCT	2648	344.835	5.080	2648	344.835	5.080	5.080	5.080
FL IN INPUT QUEUE								
SYCT	08	0.088	0.000	08	0.088	0.000	0.000	0.000
PCCT	08	0.115	0.001	08	0.115	0.001	0.001	0.001
EICT	08	0.204	0.001	08	0.204	0.001	0.001	0.001
FL IN ROLLUT QUEUE								
SYCT	318	76.203	0.722	318	76.203	0.722	0.722	0.722
BCCT	38	29.923	0.103	38	29.923	0.103	0.103	0.103
EICT	08	12.112	0.017	08	12.112	0.017	0.017	0.017
TXCT	218	104.877	0.494	218	104.877	0.494	0.494	0.494

Figure 15-1. Example of TRACER Output (Sheet 6 of 12)

DATE 80/09/17. CURRENT TIME 08.07.26. ELAPSED TIME 60 MIN. STARTING BLOCK 1 ENDING BLOCK 720

VARIABLE	I N T E R V A L			C U M U L A T I V E				
	AVERAGE	STD DEV	PERCENT	AVERAGE	STD DEV	PERCENT	MIN PCT	MAX PCT
SUBSYSTEM FL								
MXPS	38	16.901	0.105	38	16.901	0.105	0.105	0.105
MXPS+1	3558	36.742	6.690	3558	36.742	6.690	6.690	6.690
MSS	148	13.991	0.349	148	13.991	0.349	0.349	0.349
MSP	08	1.442	0.007	08	1.442	0.007	0.007	0.007
MCS	248	20.979	0.579	248	20.979	0.579	0.579	0.579
RBF	2178	49.294	4.054	2178	49.294	4.054	4.054	4.054
NAP	1558	14.212	3.083	1558	14.212	3.083	3.083	3.083
STIMLLA	28	20.623	0.059	28	20.623	0.059	0.059	0.059
TAF	3668	172.653	6.947	3668	172.653	6.947	6.947	6.947
MAGNET	238	0.000	0.536	238	0.000	0.536	0.536	0.536
BATCHID	228	19.327	0.516	228	19.327	0.516	0.516	0.516
TAI	2368	5.646	4.458	2368	5.646	4.458	4.458	4.458

SICK LOOP VARIABLES	INTERVAL	SAMPLES	3599	TOTAL SAMPLES	3599			
IAF USERS	8	7.170	12.791	8	7.170	12.791	12.791	12.791
IAF PDTS ALLOCATED	75	9.013	75.176	75	9.013	75.176	75.176	75.176
IAF PDTS IN USE	19	5.089	26.141	19	5.089	26.141	26.141	26.141
TAPE DRIVES IN USE								
7 TRACK	08	0.125	0.128	08	0.125	0.128	0.128	0.128
9 TRACK	08	0.395	1.509	08	0.395	1.509	1.509	1.509
TRACKS AVAILABLE								
FC 1	24528	30.302	80.627	24528	30.302	80.627	80.627	80.627
FC 2	24548	25.641	80.754	24548	25.641	80.754	80.754	80.754
FC 3	27568	61.782	93.059	27568	61.782	93.059	93.059	93.059
FC 4	26368	88.609	88.119	26368	88.609	88.119	88.119	88.119
FC 5	26448	99.367	88.529	26448	99.367	88.529	88.529	88.529
FC 6	16708	0.256	56.603	16708	0.256	56.603	56.603	56.603
FC 7	11368	0.269	36.084	11368	0.269	36.084	36.084	36.084
FC 11	3108	0.097	12.255	3108	0.097	12.255	12.255	12.255
FC 12	16068	0.107	53.627	16068	0.107	53.627	53.627	53.627
FC 13	1128	0.930	4.415	1128	0.930	4.415	4.415	4.415
FC 14	1478	0.205	6.126	1478	0.205	6.126	6.126	6.126
FC 15	15358	0.000	51.189	15358	0.000	51.189	51.189	51.189
FC 16	1208	0.000	4.902	1208	0.000	4.902	4.902	4.902
FC 17	31508	0.000	100.000	31508	0.000	100.000	100.000	100.000
FC 20	31508	0.000	100.000	31508	0.000	100.000	100.000	100.000
FC 21	31508	0.000	100.000	31508	0.000	100.000	100.000	100.000
FC 22	31508	0.000	100.000	31508	0.000	100.000	100.000	100.000
FC 23	22618	663.887	73.290	22618	663.887	73.290	73.290	73.290
FC 24	24148	216.604	78.781	24148	216.604	78.781	78.781	78.781
FC 25	7048	699.611	27.595	7048	699.611	27.595	27.595	27.595
FC 26	12618	560.127	42.031	12618	560.127	42.031	42.031	42.031
FC 27	5148	0.000	20.343	5148	0.000	20.343	20.343	20.343
FC 30	31408	0.000	100.000	31408	0.000	100.000	100.000	100.000
FC 31	31408	0.000	100.000	31408	0.000	100.000	100.000	100.000
FC 32	31408	0.000	100.000	31408	0.000	100.000	100.000	100.000
FC 33	31408	0.000	100.000	31408	0.000	100.000	100.000	100.000
FC 34	27608	344.013	93.173	27608	344.013	93.173	93.173	93.173
FC 35	26168	335.843	87.150	26168	335.843	87.150	87.150	87.150

Figure 15-1. Example of TRACER Output (Sheet 7 of 12)

60455380 G

15-11

DATE 80/09/17. CURRENT TIME 08.07.28. ELAPSED TIME 60 MIN. STARTING BLOCK 1 ENDING BLOCK 720

VARIABLE	I N T E R V A L			C U M U L A T I V E				
	AVERAGE	STD DEV	PERCENT	AVERAGE	STD DEV	PERCENT	MIN PCT	MAX PCT
EC 36	26418	118.502	88.335	26418	118.502	88.335	88.335	88.335
EC 37	27058	96.057	90.544	27058	96.057	90.544	90.544	90.544

SNAP SHOT OF INSL

- (0) = 000000000000000000
- (1) = 000000000000000000
- (2) = 000000000000000000
- (3) = 000000000000000000
- (4) = 000000000000000000
- (5) = 000000000000000000
- (6) = 000000000000000000
- (7) = 000000000000000000

INSTALLATION AREA FROM LOW CORE

SNAP SHOT OF SDAL

- (0) = 000000006120030000
- (1) = 0000000000000011334
- (2) = 000044E300000116E155
- (3) = 000000000010000256
- (4) = 000000000000000000
- (5) = 4000000053600103560
- (6) = 000000000000000000
- (7) = 000000000000000000

MTR MXN TIME = 394 WORST CASE MTR CYCLE TIME = 3  
 NUMBER OF ECS MOVES = 0 NUMBER OF CM MOVES = 4828  
 NUMBER OF ROLLOUTS = 2355 NUMBER OF SECTORS ROLLED = 322669  
 ROLLOUTS/USER LIMITS = 1 NUMBER OF TIME SLICES = 174  
 PP PRIORITY EXCHANGES = 0

STATISTICAL DATA AREA FROM LOW CORE

SNAP SHOT OF MTR

- (0) = 152422010000000000

SNAP SHOT OF CPTB - CPD

- (0) = 0000016156303767000

SNAP SHOT OF CPTB - CPN

- (0) = 0000000613211243400

SNAP SHOT OF RTCL

- (0) = 000074c3000016657471

SNAP SHOT OF TIML

- (0) = 55234357334257354357

Figure 15-1. Example of TRACER Output (Sheet 8 of 12)

- ① The following symbols are assembly constants that are used in NOS.

CTCUL	Categories of CPU use.
CTILL	Length of channel status table.
MXOT	Maximum number of origin types.
MXPS	Maximum priority for rollout.
NMSD	Maximum EST ordinal + 1 of mass storage devices.
NPFS	Number of PFMs active simultaneously.
QUFT	Maximum number of queue file types.
MXRS	Maximum number of RTCM subfunction device types.

- ② The equipment status table (EST) entry consists of the octal representation of the EST entry at the start of the sampling interval.

- ③ FILES indicates what type of file can reside on a given device. File assignment is controlled largely by the MSAL and TEMP commands. The following list indicates the type of file assigned to a particular device.

<u>Letter</u>	<u>File Type</u>	<u>Letter</u>	<u>File Type</u>
B	LGO	P	Primary
D	Dayfile	R	Rollout
I	Input	S	Secondary rollout
L	Local	T	Temporary
O	Output		

- ④ Interval statistics refers to only a portion of the entire sampling interval. The interval time (the number of minutes that make up an interval) is specified by the IN ACPD control statement parameter.

Figure 15-1. Example of TRACER Output (Sheet 9 of 12)



The column labeled AVERAGE is computed with the following formula:

$$\text{AVERAGE} = \text{INT}(\text{count}/\text{samples})$$

INT(x)            The integer function.

count            The number of times the variable was in a given state during the sampling interval. This data is not reported.

samples         The number of samples taken during the interval.

For example, the number of PPs active for an interval is 55 696. The total number of samples taken is 10 988. Applying the formula:

$$\begin{aligned} \text{AVERAGE} &= \text{INT}(55696/10988) \\ &= \text{INT}(5.06) \\ &= 5 \end{aligned}$$

Therefore, an average of five PPs were active at any one time during the sampling interval.

The column labeled STD DEV is computed with the following formula:

$$\text{Standard deviation} = \sqrt{\frac{X - \frac{\text{count} * \text{count}}{\text{samples}}}{\text{samples} - 1}}$$

$$X = \sum_{i=1}^N \frac{\text{count}_i * \text{count}_i}{\text{samples}_i}$$

N                The number of samples.

count            The number of times the variable was in a given state during the specified time interval.

samples         The number of samples taken during the interval.

The column labeled PERCENT is computed with the following formula:

$$\text{PERCENT} = \frac{\text{count}}{\text{samples} * \text{wfactor}} * 100$$

count            The number of times the variable was in a given state during the specified time interval.

samples         The number of samples taken during the interval.

wfactor         Weight factor. This value is dependent on the variable, and might be set to 1, 100, the number of PPs, the number of CPUs, and so on. Refer to table 15-1 for further information.

Figure 15-1. Example of TRACER Output (Sheet 10 of 12)

Continuing with the previous example, the percentage of PPs active can be determined in the following way (wfactor = 20):

$$\text{PERCENT} = \frac{55696}{10988 \times 20} \times 100 = 25.344\%$$

⑤ Cumulative statistics is a summation of all data gathered from the beginning of the sampling interval up to the current interval.

The column labeled AVERAGE is computed with the following formula:

$$\text{AVERAGE} = \text{INT}(\text{count}/\text{samples})$$

INT(x)      The integer function.

count      The number of times the variable was in a given state since the beginning of the sampling period.

samples    The number of samples taken since the beginning of the sampling period.

For example, the total number of PPs active during the sampling interval up to this point is 3 729 736. The total number of samples taken is 366 076. Therefore, the average number of active PPs can be determined:

$$\begin{aligned} \text{AVERAGE} &= \text{INT}(3729736/366076) \\ &= \text{INT}(10.18) \\ &= 10 \end{aligned}$$

The column labeled STD DEV is computed with the following formula:

$$\text{Standard deviation} = \sqrt{\frac{X - \frac{\text{count} * \text{count}}{\text{samples}}}{\text{samples} - 1}}$$

$$X = \sum_{i=1}^N \frac{\text{count}_i * \text{count}_i}{\text{samples}_i}$$

N      The number of samples.

count    The number of times the variable was in a given state since the beginning of the sampling interval.

samples    The number of samples taken since the beginning of the sampling interval.

The column labeled PERCENT is computed with the following formula:

$$\text{PERCENT} = \frac{\text{count}}{\text{samples} \times \text{wfactor}} \times 100$$

Figure 15-1. Example of TRACER Output (Sheet 11 of 12)

The percentage of PPs active can be calculated in the following way (wfactor = 20):

$$\begin{aligned} \text{PERCENT} &= \frac{3729736}{366076 \times 20} \times 100 \\ &= 50.94\% \end{aligned}$$

This means that a given PP is active for about half the samples taken.

The column labeled MIN PCT shows the minimum interval percentage that has been encountered since the beginning of the sampling period.

The column labeled MAX PCT shows the maximum interval percentage that has been encountered since the beginning of the sampling period.

- ⑥ The sampling frequency for fast loop variables is specified by the FL parameter on the ICPD control statement. Typically, the fast loop variables are continuously changing, so they should be sampled very frequently. (Fast loop variables are discussed later in this section.)
- ⑦ Interval samples are the number of samples taken during the specified time interval only.
- ⑧ Total samples are the number of samples taken since the beginning of the sampling period.
- ⑨ The sampling frequency for medium loop variables is specified by the ML parameter on the ICPD control statement. (Medium loop variables are discussed later in this section.)
- ⑩ The sampling frequency for slow loop variables is specified by the SL parameter on the ICPD control statement. (Slow loop variables are discussed later in this section.)
- ⑪ The equipment and unit numbers for mass storage devices are not present on reports.

Figure 15-1. Example of TRACER Output (Sheet 12 of 12)

## SAMPLED SYSTEM VARIABLES

The system variables sampled by TRACER are described in the following paragraphs and are summarized in table 15-1. TRACER increments each variable's counter when the variable is in a given state, and periodically writes the counters to the data file for future processing by ACPD. When and how the counter for a given variable is incremented is also discussed.

TABLE 15-1. WEIGHTING FACTORS

Fast Loop Variable	Weighting Factor
PPs active	Number of PPs available
Move request pending	1 <sup>†</sup>
No PP available	1
ECS transfer in prog	1
MTR cycle time	100
Monitor mode	1
Scheduler active	1
Channel reserved	1
Channel active	1
Channel requested	1
Request pending	100
PFM activity	1
CPU usage	1
Subsystem CPU usage	1
Medium Loop Variable	Weighting Factor
Control points in W status	Number of control points
Control points in X status	Number of control points
Control points in I status	Number of control points
Non-queue files	Number of FNT entries
Same move request	1 <sup>†</sup>
FL available	Available field length (machine size - CMR size)
User ECS available	Available user ECS field length
Control points active	Number of control points
FL at control points	Available field length
User ECS at control points	Available user ECS field length
FL in input queue	Available field length
FL in rollout queue	Available field length
ECS in rollout queue	Available field length
Subsystem FL	Available field length
Slow Loop Variable	Weighting Factor
IAF users	Number of terminals defined
IAF pots in use	Percentage of IAF pots in use as a function of IAF pots allocated
IAF pots allocated	100 <sup>††</sup>
Tape drives in use	Number of available tape drives
Tracks available	Maximum number of tracks for monitored device
<sup>†</sup> A weighting factor of 1 means that the value printed in the Percent columns represents percentage of time. <sup>††</sup> A weighting factor of 100 means the value printed in the Percent columns represents the actual value of the variable.	

## **Fast Loop Variables**

The following paragraphs describe fast loop variables.

### **PPs Active**

TRACER increments the PP active counter for each active PP it finds when scanning the PP communication area. Disabled PPs (those turned off at deadstart time) are not considered active. An active PP is one that has a nonzero input register. MTR (PP0) and DSD (PP1) are always counted as active PPs.

### **Move Request Pending**

TRACER increments the move request pending counter whenever it determines, from word CMLL of low central memory, that a storage move request is outstanding.

### **No PP Available**

TRACER increments the no PP available counter each time it determines, from word PPAL of low central memory, that there are no PPs available.

### **ECS Transfer in Progress**

TRACER increments the ECS transfer in progress counter whenever the status and control register (SCR) indicates an ECS transfer is active. This data is available for CYBER 170 Series only.

### **MTR Cycle Time**

TRACER increments the MTR cycle time counter by the cycle time for the last MTR cycle reported in MTR's input register. This variable indicates how fast MTR is completing one complete scan of all PP output registers and processing those functions present.

### **Monitor Mode - CPU0**

TRACER increments the monitor mode counter for CPU0 whenever the SCR register indicates the CPU0 is in monitor mode. This data is available for CYBER 170 Series only.

### **Monitor Mode - CPU1**

TRACER increments the monitor mode counter for CPU1 whenever the SCR register indicates that CPU1 is in monitor mode. This data is available for CYBER 170 Series only.

### Scheduler Active

TRACER increments the scheduler active counter whenever it determines that the job scheduler (1SJ) is active. The job scheduler is considered active when the scheduler active flag in word JSCL + 1 is set.

### Channel Reserved

TRACER maintains a channel reserved counter for each available channel and increments one whenever its channel is logically reserved by the operating system. TRACER samples the channel status table (CTIL) for this data.

### Channel Active

TRACER maintains a channel active counter for each available channel and increments a counter whenever it detects that the channel is not inactive, as determined by an IJM PP instruction.

### Channel Requested

TRACER maintains a channel requested counter for each available channel, and increments a counter whenever there is an outstanding request for that channel. TRACER uses the channel status table (CTIL) to determine the channel requested status.

### Requests Pending

TRACER maintains a request pending counter for each mass storage device available and increments a counter by the number of outstanding requests on that device when the sampling occurs. The mass storage table (MST) provides this information.

### PFM Activity

TRACER maintains counters for the number of permanent file managers (PFM) that are active at the time of the sampling. Word PFNL of CMR determines this information.

### CPU Usage

TRACER maintains a set of CPU usage counters for each CPU. There is a counter for each type of CPU use.

IDLE	CPU is not currently being used.
SYSTEM	CPU is being used by CPUMTR.
SUB-SYS	CPU is being used by a subsystem.
SYS ORG	CPU is being used by a system origin job (subsystems are not considered system origin).
USER	CPU is being used by a user program.

Each time the CPU status is sampled (in words ACPL and ACPL + 1 in low central memory), TRACER increments one of the CPU usage counters. It determines which counter to update by investigating the control point area to which the CPU is assigned.

#### Subsystem CPU Usage

Subsystem CPU usage is a further breakdown of subsystems of the SUB-SYS CPU usage data. TRACER maintains a CPU usage counter for every subsystem. Whenever the SUB-SYS CPU usage counter is incremented, TRACER also increments the appropriate subsystem CPU usage counter.

#### **Medium Loop Variables**

The following paragraphs describe medium loop variables.

#### CPS in W Status

TRACER increments the control points in waiting (W) status counter whenever a control point is found in W status (determined by STSW word of control point area). TRACER scans all control points during each medium loop cycle.

#### CPS in X Status

TRACER increments the control points in executing (X) status counter whenever it finds a control point in X status (determined by STSW word of control point area). TRACER scans all control points during each medium loop cycle.

#### CPS in I Status

TRACER increments the control points in inactive (I) status counter whenever a control point is found in I status (determined by STSW word of control point area). TRACER scans all control points during each medium loop cycle.

#### Non-Queue Files

TRACER increments the non-queue file counter for every file found assigned to a control point. TRACER scans the entire FNT during each medium loop cycle.

#### Same Move Request

TRACER increments the same move request counter every time the move request pending for the current medium loop sample is the same as the previous medium loop sample. Word CMCL of low central memory is used to determine this status.

#### FL Available

TRACER increments the FL available counter by the amount of available FL during the current medium loop cycle. Word ACML of low central memory determines the available FL.

#### User ECS Available

TRACER increments the user ECS available counter by the amount of available user ECS FL during the current medium loop cycle. Word AECL of low central memory determines the available user ECS FL.

### CNTL Points Active

TRACER increments the control points active counter for every control point that is currently assigned to a job or subsystem. A control point is considered to be assigned to a job if a job input file FST address is set in TFSW of the control point area. TRACER scans all control points during the medium loop cycle.

### FL at Control Points

TRACER maintains an FL at control point counter for each origin type. When an active control point is found, the origin type is determined, and the appropriate counter is incremented by the amount of FL assigned to that control point (determined by STSW of control point area). TRACER scans all control points during the medium loop cycle.

### UECS at Control Points

TRACER maintains a user ECS at control point counter for each origin type. When an active control point is found, the origin type is determined, and the appropriate counter is incremented by the amount of user ECS assigned to that control point (determined by ECSW of control point area). TRACER scans all control points during the medium loop cycle.

### FL in Input Queue

TRACER maintains an FL in input queue counter for each origin type. When an input file is found not assigned to a control point, the amount of FL it will require when rolled into a control point is added to the appropriate counter. The amount of FL is determined by examining the FST. TRACER scans all FNTs during the medium loop cycle.

### FL in Rollout Queue

TRACER maintains an FL in rollout queue counter for each origin type. When a rollout file is found in the queue, and it is not assigned to a control point, the amount of FL it will require (determined from the FST) when it is rolled into a control point is added to the appropriate counter. TRACER scans all FNT entries during the medium loop cycle.

### ECS in Rollout Queue

TRACER maintains an ECS in rollout queue counter for each origin type. When a rollout file is found in the queue, and it is not assigned to a control point, the amount of ECS FL it will require when rolled in (determined from the FST) is added to the appropriate counter. TRACER scans all FNT entries during the medium loop.

### Subsystem FL

TRACER maintains a subsystem FL counter for every possible subsystem. When a subsystem is found at a control point, the amount of FL assigned to that subsystem is added to the appropriate counter. TRACER scans all control points looking for subsystems during the medium loop.



## **Slow Loop Variables**

The following paragraphs describe slow loop variables.

### IAF Users

TRACER increments the IAF users counter by the number of users connected to IAF during the slow loop cycle. TRACER does not differentiate between IAF and TELEX. IAF or TELEX must be active for this data to be collected. Word VANL of IAF/TELEX FL determines the number of users.

### IAF Pots Allocated

TRACER increments the pots allocated counter by the number of pots that are currently available for use, whether they are being used or not. TRACER does not differentiate between IAF and TELEX. Word VPAL of IAF FL determines the number of pots allocated.

### IAF Pots in Use

TRACER increments the pots in use counter by the number of pots currently assigned to a connection. TRACER does not differentiate between TELEX and IAF. Word VPUL of IAF FL determines the number of pots in use.

### Tape Drives in Use

TRACER maintains two tape drives in use counters; one for seven-track and one for nine-track drives. A tape drive is considered to be in use if an EST entry indicates it is logically turned on, and it is assigned to a control point. TRACER increments the appropriate counter for each drive found in use.

### Tracks Available

TRACER maintains a tracks available counter for each mass storage equipment and adds the number of available tracks (tracks not currently assigned to a file) for a device to the appropriate counter for each mass storage device found in the EST. TRACER obtains this information from TDGL of the MSTF.

## **PROBE UTILITY**

The PROBE utility measures the following:

- The number of times a PP routine was loaded.
- The number of CIO RA+1 requests by function number.
- The number of PP requests to CPUMTR by function number.
- The number of MTR requests to CPUMTR by function number.
- The statistical data accumulated in low central memory; includes such items as number of sectors rolled and number of rollouts.

PROBE data gathering is selectable at deadstart time by an IPRDECK entry.

## PROBE CONTROL STATEMENT

The PROBE utility generates a report from the data collected by the system. PROBE analyzes data either from system tables or from a file containing data from a previous PROBE run. An IPRDECK entry PROBE must be specified at deadstart time to allow the system to collect the data. (Refer to the Installation Handbook for more information.)

PROBE control statement format:

PROBE (p<sub>1</sub>, p<sub>2</sub>, ..., p<sub>n</sub>)

<u>p<sub>i</sub></u>	<u>Description</u>
P=lf <sub>n</sub> <sub>1</sub>	Binary file to be written. Default is STATS.
P=0	No binary file is to be written.
L=lf <sub>n</sub> <sub>2</sub>	Report file. Default is OUTPUT.
L=0	No report is to be generated.
B=lf <sub>n</sub> <sub>3</sub>	Binary file to be read. Default is STATS.
R	Rewind binary files before and after operation. Default is no rewind.
OP=p	Processing option. Default is P.
C	Perform R option functions and clear systems tables after they are read.
P	Generate report from binary files specified by the B parameter.
R	Read system tables, and write binary file and report file as specified.
LO=x	Sort option for PP program load information.
F	Sort data by frequency of loads (default sort option).
R	Sort data by location and frequency of loads.
A	Sort data in alphabetic order.

### NOTE

The file names must be unique. If the OP parameter is equal to R or C, the P parameter cannot be equal to zero.

Figure 15-2 is an example of the PROBE output file format.

PROBE VERSION 1.0.

80/09/25. 16.25.19. PAGE 1

PROBE VERSION 1.0 80/03/25. 13.32.41.  
START OF SAMPLE INTERVAL 80/03/25. 16.17.39.  
END OF SAMPLE INTERVAL 80/03/25. 16.25.19.

MONITOR REQUESTS

	PROGRAM MODE CPU0	MONITOR MODE CPU0	CPU1
ABTM(34)	0	2	0
CCAM(35)	0	9	0
CEFM(36)	0	2	0
DCPM(37)	0	19	0
SFIM(40)	0	41	0
DTKM(41)	91	91	0
DPPM(42)	0	1004	0
ECSM(43)	0	0	0
RCLM(44)	0	10596	0
RCPM(45)	0	2	0
RDCM(46)	3	3	0
IAUM(47)	0	4	0
ACTM(50)	0	0	0
PFPM(51)	0	478	0
RSJM(52)	0	36	0
RTCM(53)	68	68	0
SFBM(54)	0	222	0
STBM(55)	0	191	0
UADM(56)	0	268	0
SPLM(57)	0	1224	0
JACM(59)	0	31	0
DLKM(61)	0	0	0
TDAM(62)	0	0	0
TION(63)	0	0	0
RLMM(64)	0	24	0
LCGM(65)	0	0	0
CSTM(66)	11	15	0
CKSM(67)	0	0	0
LDAM(70)	0	478	0
VMSM(71)	35	35	0
PIOM(72)	0	0	0
DFMM(73)	0	0	0
(74)	0	0	0
(75)	0	0	0
SUBTOTAL		14372	0
TOTAL	208		14952

Figure 15-2. Example of PROBE Output (Sheet 1 of 6)

MTR REQUESTS

	CPU0	CPU1
ARTF( 1)	575	0
IARF( 2)	6	0
EPRF( 3)	1459	0
MRAF( 4)	1653	0
MFLF( 5)	19085	0
SCSF( 6)	13	0
SMSF( 7)	0	0
CMSF(10)	0	0
ROLF(11)	0	0
ACSF(12)	16341	0
PCXF(13)	0	0
ARMF(14)	0	0
MREF(15)	0	0
MFEF(15)	0	0
SUBTOTAL	39132	0
TOTAL	39132	0

PROGRAM MODE

	CPU0
MSTF( 1)	1459
PDMF( 2)	0
PMRF( 3)	0
MECF( 4)	0
TECF( 5)	0
TOTAL	1459

MTR PERFORMANCE PARAMETERS

WORST CASE \*MYN\* TIME = 538  
 WORST CASE CYCLE TIME = 6

CPUMTR PERFORMANCE PARAMETERS

NUMBER OF FDS STORAGE MOVES = 0  
 NUMBER OF CM STORAGE MOVES = 8  
 JOB IN RECALL DUE TO CPU EXCHANGE REQUEST = 0

1RO PERFORMANCE PARAMETERS

NUMBER OF ROLLOUTS = 4  
 NUMBER OF SECTORS ROLLED = 891

1SP PERFORMANCE PARAMETERS

COUNT OF ROLLOUTS FOR USER LIMITS = 0  
 COUNT OF TIME SLICES = 0

Figure 15-2. Example of PROBE Output (Sheet 2 of 6)

CIO REQUESTS

FUNCTION	CALLS	FUNCTION	CALLS
RPHR(000)	5	READ(010)	28
WRITE(014)	65	WRITER(024)	11
RETURN(070)	1	OPEN(120)	3
TOTAL CIO FUNCTIONS PROCESSED		113	

Figure 15-2. Example of PROBE Output (Sheet 3 of 6)

PPU PROGRAM LOADS

NAME	LOC	LOADS	NAME	LOC	LOADS
1SJ	CMR	497	2SC	DSK	0
1SP	CMR	461	2SD	DSK	0
1IO	CMR	299	2SE	DSK	0
2IO	CMR	222	2SG	DSK	0
2CB	CMR	139	2SH	DSK	0
1MT	CMR	130	2SI	DSK	0
3MG	CMR	129	2TD	DSK	0
2GC	CMR	111	2TN	DSK	0
2CD	CMR	76	2TO	CMR	0
SFP	CMR	44	3AA	DSK	0
1DL	CMR	41	3AC	DSK	0
9EA	DSK	37	3AD	DSK	0
1AJ	CMR	36	3AG	DSK	0
TCS	CMR	22	3AH	DSK	0
3AE	CMR	19	3AT	DSK	0
0BF	CMR	16	3BB	DSK	0
2CF	CMR	11	3PC	DSK	0
3AF	CMR	11	3BD	DSK	0
6DI	CMR	10	3BE	DSK	0
0AU	DSK	9	3BF	DSK	0
1CJ	DSK	9	3CR	DSK	0
1DS	DSK	9	3CK	DSK	0
3SA	DSK	8	3DY	DSK	0
QMS	DSK	7	3DZ	DSK	0
QAP	DSK	7	3FA	DSK	0
4DB	DSK	7	3FB	DSK	0
4DC	DSK	7	3IC	DSK	0
4DG	DSK	7	3JD	DSK	0
7DI	CMR	7	3LA	DSK	0
7EP	CMR	7	3LB	CMR	0
1CK	CMR	6	3LC	DSK	0
CPM	DSK	5	3LD	DSK	0
DSP	DSK	5	3LE	DSK	0
QAC	CMR	4	3MB	DSK	0
0RP	DSK	4	3MC	DSK	0
0DF	CMR	4	3MD	DSK	0
1CD	DSK	4	3ME	DSK	0
3IA	DSK	4	3MF	DSK	0
3IB	DSK	4	3MH	CMR	0
3OS	CMR	4	3MT	DSK	0
5IA	DSK	4	3MJ	DSK	0
LFM	CMR	3	3MK	DSK	0
SFM	DSK	3	3ML	CMR	0
1RI	CMR	3	3MM	DSK	0
1RO	CMR	3	3MN	DSK	0
2CA	CMR	3	3MO	DSK	0
3RA	DSK	3	3MP	DSK	0
3RG	DSK	3	3MQ	DSK	0
3SX	DSK	3	3MR	DSK	0
9AA	DSK	3	3MS	DSK	0
1DD	CMR	2	3MT	CMR	0
3AB	DSK	2	3MU	DSK	0
3CC	DSK	2	3MV	DSK	0
3LG	CMR	2	3MW	DSK	0

Figure 15-2. Example of PROBE Output (Sheet 4 of 6)

PFM	QMP	1	3MX	QSK	0
QFA	QMP	1	3MY	QSK	0
QTD	QSK	1	3MS	QSK	0
2SF	QSK	1	3PA	QMR	0
3CA	QSK	1	3PR	QMR	0
3DA	QSK	1	3PC	QSK	0
3LF	QMP	1	3PD	QMP	0
3MA	QSK	1	3PE	QSK	0
3PI	QMP	1	3PF	QSK	0
3PA	QSK	1	3PG	QMP	0
ADC	QSK	0	3PH	QSK	0
BAT	QSK	0	3PJ	QSK	0
QPD	QSK	0	3PK	QMR	0
CP1	QSK	0	3PL	QSK	0
CP1	QSK	0	3PM	QSK	0
QUX	QSK	0	3PN	QSK	0
CVL	QSK	0	3FO	QMR	0
QDF	QSK	0	3PP	QSK	0
QIS	QSK	0	3QA	QSK	0
QOG	QSK	0	3QR	QSK	0
QS1	QSK	0	3QG	QSK	0
ELM	QSK	0	3QD	QSK	0
EYE	QSK	0	3QP	QSK	0
FDP	QSK	0	3QT	QSK	0
FTP	QSK	0	3QU	QSK	0
HFM	QSK	0	3RF	QSK	0
ILD	QSK	0	3RF	QSK	0
IMS	QSK	0	3RH	QMP	0
LDD	QMP	0	3RI	QSK	0
LQQ	QMP	0	3RF	QMP	0
LOR	QMP	0	3RD	QMR	0
LP1	QSK	0	3SY	QSK	0
MLD	QSK	0	3S7	QSK	0
OUT	QSK	0	3TA	QSK	0
Q26	QSK	0	3TR	QSK	0
PFU	QSK	0	3TC	QSK	0
PIP	QSK	0	3TD	QSK	0
QFM	QSK	0	3TE	QSK	0
QIS	QSK	0	3TF	QSK	0
Q26	QSK	0	3TG	QSK	0
RPV	QMR	0	3TH	QSK	0
SBP	QSK	0	3TI	QSK	0
STP	QSK	0	3TJ	QMP	0
SLL	QSK	0	3TK	QMR	0
SMP	QSK	0	3TL	QSK	0
STM	QSK	0	3TM	QSK	0
TLX	QSK	0	3TN	QSK	0
TMG	QSK	0	3TO	QSK	0
VEJ	QSK	0	4DA	QSK	0
WRM	QSK	0	4DD	QSK	0
XSP	QSK	0	4DE	QSK	0
QAV	QMP	0	4DF	QSK	0
QCI	QSK	0	4DH	QSK	0
QFI	QSK	0	5RA	QSK	0
ORF	QMP	0	5RR	QSK	0
ORP	QMP	0	5OU	QSK	0
QTI	QSK	0	5FF	QSK	0
OVJ	QSK	0	5FH	QSK	0

Figure 15-2. Example of PROBE Output (Sheet 5 of 6)

1DC	QMP	0	5TC	QSK	0
1ED	QSK	0	5TD	QSK	0
1IS	QSK	0	5TE	QSK	0
1LC	QSK	0	5TG	QSK	0
1LS	QSK	0	5TH	QSK	0
1LT	QSK	0	5LL	QSK	0
1MA	QMP	0	5MF	QSK	0
1MB	QSK	0	5MP	QSK	0
1MF	QSK	0	5MS	QSK	0
1MR	QSK	0	5MT	QSK	0
1PM	QSK	0	5MU	QSK	0
1RP	QSK	0	5MW	QSK	0
1SI	QSK	0	5SU	QSK	0
1TA	QMP	0	5SV	QSK	0
1TD	QSK	0	541	QSK	0
1TE	QSK	0	5EX	QSK	0
1TN	QSK	0	56X	QSK	0
1TO	QMP	0	57X	QSK	0
1TP	QSK	0	58F	QSK	0
1TS	QSK	0	58H	QSK	0
2CE	QMP	0	58X	QSK	0
2CG	QMP	0	6MD	QMR	0
2CH	QMP	0	7MD	QMR	0
2CI	QMP	0	7SF	QMR	0
2CJ	QSK	0	7SI	QMP	0
2CK	QSK	0	7WI	QMP	0
2CL	QSK	0	8YA	QSK	0
2ID	QSK	0	8YR	QSK	0
2IN	QSK	0	8YG	QSK	0
2IP	QSK	0	9A1	QMR	0
2IQ	QSK	0	9A5	QMR	0
2IR	QSK	0	9A6	QMR	0
2LD	QSK	0	9A7	QMR	0
2MA	QSK	0	9GA	QSK	0
2MB	QSK	0	9TA	QSK	0
2MC	QSK	0	9JA	QSK	0
2RP	QSK	0	9PA	QSK	0
2SA	QSK	0	9TA	QSK	0
2SB	QSK	0	9ZA	QSK	0
2SC	QSK	0			

NUMBER OF ASP PROGRAMS = 0  
 NUMBER OF QMP PROGRAMS = 74  
 NUMBER OF QSK PROGRAMS = 229  
 NUMBER OF PLO ENTRIES = 303

Figure 15-2. Example of PROBE Output (Sheet 6 of 6)



# DIAGNOSTICS

A

---

This appendix contains diagnostic messages issued by routines and utilities documented in this manual. Messages are listed alphabetically; leading nonalphanumeric characters are ignored for this purpose. Messages whose first character is a digit follow those at the end of the alphabet. Lowercase letters in a message indicate a variable field; such fields are explained in the accompanying message description. Messages beginning with a variable field are located at the end of the appendix.

If you encounter a diagnostic or informative message that does not appear in this appendix, consult the NOS Diagnostic Index. This publication catalogs all messages produced by NOS and its products and specifies the manual or manuals in which each message is fully documented.

MESSAGE -----	SIGNIFICANCE -----	ACTION -----	ROUTINE -----
ABORT RUN DUE TO ERRORS.	The ASVAL run aborted because of errors on the control statement.	Correct errors and retry.	ASVAL
ACCESSED AFTER yy/mm/dd. hh.mm.ss.	Informative message indicating that files accessed after the date and time specified have been loaded (or dumped).	None.	PFLOAD, PFDUMP
ACCESSED BEFORE yy/mm/dd. hh.mm.ss.	Informative message indicating that files accessed before the date and time specified have been loaded (or dumped).	None.	PFLOAD, PFDUMP
ACCOUNT DAYFILE DUMPED.	The account dayfile dump is complete.	None.	DAYFILE
ACTIVE FILES ON DEVICE.	Device initialization was attempted on a device with activated fast-attach files.	Use the R option on the ISF control statement to release these files.	MSI
ACTIVE LOAD NOT ALLOWED.	The load is not allowed because the device selected to receive active queues is removable.	Select another device and retry the load.	QLOAD
ADDCUBE - ONLY 100 LOCATIONS PROCESSED.	At most 100 cubicles can be added. The coordinate pairs specified by the XI and YI parameters encompass more than 100 cubicles.	Use multiple AB directives.	ASLABEL
ADDRESS OF OVERLAY ovl IS NOT SAME AS OVERLAY AREA.	The address of overlay ovl in the overlay area header is different from that in the overlay header, possibly indicating a bad CCP binary input file.	Check CCP binary input file. Correct error and try again.	LFG
AFD - ARGUMENT ERROR.	Keyword specified is not recognizable or control statement is not properly formatted.	Check keyword and control statement formats.	DAYFILE
AFD - BUFFER TOO SMALL.	The buffer DAYFILE uses to hold the central memory dayfile buffer is not large enough.	Either make the internal DAYFILE buffer larger or specify a smaller dayfile buffer during deadstart.	DAYFILE
AFD - CHECKPT BOUNDARY ENCOUNTERED.	The utility has encountered an EOR or EOF written by a system checkpoint operation. The utility discards any incomplete dayfile message fragments and continues with the first message following the EOR/EOF.	None.	DAYFILE
AFD - DATA LOST.	A data read error occurred while processing an active dayfile. Processing continues with the next readable message. Lost data is not recoverable.	Inform site analyst.	DAYFILE

MESSAGE -----	SIGNIFICANCE -----	ACTION -----	ROUTINE -----
AFD - FILE/CM BUFFER BOUNDARY ERROR.	The disk resident portion of the dayfile cannot be joined correctly with the CM buffer portion.	Inform site analyst.	DAYFILE
AFD - FILE TOO LONG.	The active dayfile being processed is longer than the system reservation status indicates.	Inform site analyst.	DAYFILE
AFD - FILE TOO SHORT.	The active dayfile being processed is shorter than the system reservation status indicates.	Inform site analyst.	DAYFILE
AFD - FR INVALID FOR THIS OPTION.	The FR=string parameter is not allowed with this utility.	Use an appropriate option or omit the FR=string parameter and retry.	DAYFILE
AFD - ILLEGAL PAGE SIZE FORMAT.	The page size value is nonnumeric.	Retry with a numeric value.	DAYFILE
AFD - ILLEGAL PRINT DENSITY.	The print density value is not 3, 4, 6, or 8.	Retry with a valid print density.	DAYFILE
AFD - ILLEGAL PRINT DENSITY FORMAT.	The print density value is nonnumeric. Print density must be 3, 4, 6, or 8.	Retry with a valid print density.	DAYFILE
AFD - READ ERROR ON SEARCH FILE.	A read error occurred during the incremental dump and search option processing.	Retry the command.	DAYFILE
AFD - RESERVED FILE NAME.	The file name specified for the L=lfm parameter is a reserved name.	Retry using a nonreserved name.	DAYFILE
AFD - UNKNOWN *OP* FIELD.	The option specified is not valid.	Retry using a valid option.	DAYFILE
ALL FILES FOR USER INDEX userin.	Informative message indicating that all files with user index userin have been loaded (or dumped).	None.	PFLOAD, PFDUMP
ALTERING FLAW MAP S/N=serialn.	Console message indicating that the utility flaw map is undergoing modification. Here serialn is the actual pack serial number as read from the manufacturing data recorded in cylinder 6328 (or 1466B), track 0, sector 0.	None.	FORMAT
ALTERNATE DEVICE NOT FOUND.	Device on which a direct access file is to be loaded (specified in catalog) is not available in this system and an alternate (default) device was not specified; file is skipped. This message applies only to direct	To load the skipped file, rerun the utility and specify an alternate device on which the file may be loaded (DD	PFLOAD

MESSAGE -----	SIGNIFICANCE -----	ACTION -----	ROUTINE -----
ALTERNATE FILE ACTIVE.	access files, is a nonfatal system error, and is accompanied by the message PFLoad - STATUS ERR.	option).	DSDI
	Output file message indicating that the alternate file was already being processed when entry of the OUTPUT directive was attempted.	Wait until processing is complete to enter the OUTPUT directive.	

MESSAGE -----	SIGNIFICANCE -----	ACTION -----	ROUTINE -----
ALTERNATE OUTPUT TO TERMINAL ILLEGAL.	Output file message indicating that the file name OUTPUT was specified on the OUTPUT directive entered from a terminal. Alternate list output cannot be assigned to the terminal.	Specify a file name other than OUTPUT on the OUTPUT directive when it is entered from a terminal.	DSDI
ARGUMENT VALUE MISSING.	Output file message indicating that a pi= was encountered but not equivalenced.	Rerun using correct value.	VALNET
ASDEBUG ABNORMAL, xxx.	There is an ASDEBUG internal error in module xxx.	Submit a Programming System Report (PSR) with supporting material.	ASDEBUG
ASDEBUG COMPLETE.	Informative message indicating that ASDEBUG completed normally.	None.	ASDEBUG
ASDEBUG ERROR xxx. DIRECTIVE yyy.	First two lines of a three-line message indicating that error xxx was encountered during the processing of directive yyy. The third line of the message gives more details about the error.	Refer to the ASDEBUG report file for a copy of the directive. Refer to the message given in the third line for more information about appropriate action to be taken.	ASDEBUG
ASDEBUG, NO DIRECTIVES.	The directive file is empty or not rewound.	Add a directive to the file or rewind the directive file.	ASDEBUG
ASDEF ABNORMAL, xxx.	There is an ASDEF internal error in module xxx.	Submit a Programming System Report (PSR) with supporting material.	ASDEF
ASDEF ABORT - ILLEGAL CS VALUE.	The CS parameter on the ASDEF control statement was not a letter from A through M.	Correct the CS parameter and retry.	ASDEF
ASDEF ABORT - NO PARAMETER SPECIFIED.	Neither the CS nor the FM parameter was specified on the ASDEF control statement.	Specify at least one CS or FM parameter.	ASDEF
ASDEF ABORT - SYNTAX ERROR.	The ASDEF control statement is syntactically incorrect.	Correct the parameters on the control statement and retry.	ASDEF
ASDEF COMPLETE.	Informative message indicating that ASDEF completed normally.	None.	ASDEF
ASDEF ERRORS.	Informative message indicating that ASDEF completed normally with the errors reported in the dayfile.	None.	ASDEF

MESSAGE -----	SIGNIFICANCE -----	ACTION -----	ROUTINE -----
ASLABEL ABNORMAL, xxx.	There is an ASLABEL internal error in module xxx.	Submit a Programming System Report (PSR) with supporting material.	ASLABEL
ASLABEL COMPLETE.	Informative message indicating that ASLABEL completed normally.	None.	ASLABEL
ASLABEL ERROR xxx. DIRECTIVE yyy.	First two lines of a three-line message indicating that error xxx was encountered during the processing of directive yyy. The third line of the message gives more details about the error.	Refer to the ASLABEL report file for a copy of the directive. Refer to the message given in the third line for more information about appropriate action to be taken.	ASLABEL
ASLABEL - NO DIRECTIVES.	The directive file is empty or not rewound.	Add a directive to the file or rewind the directive file.	ASLABEL
ASMOVE ABNORMAL, xxx.	There is an ASMOVE internal error in module xxx.	Submit a Programming System Report (PSR) with supporting material.	ASMOVE
ASMOVE COMPLETE.	Informative message indicating that ASMOVE completed normally.	None.	ASMOVE
ASMOVE - SYNTAX ERROR.	The ASMOVE control statement is syntactically incorrect.	Correct the parameters on the control statement and retry.	ASMOVE
ASSIGN FILE.	The archive file to be copied has not been assigned.	Assign archive file to be copied.	PFCOPY
ASSIGN TAPE.	The archive tape containing files to be cataloged or loaded has not been assigned.	Ensure that the correct archive tape (created by PFDUMP) is assigned.	PFATC
ASSIGNED FILE CONFLICT - SDF.	A local file named SDF is assigned at the control point. SDF is a reserved file name.	Rename the local file.	IIS
ASSIGNED TTYS GREATER THAN (NT).	Nonfatal K-display message indicating that the number of terminals assigned to sessions is greater than the number of terminals being stimulated.	Reduce the number of terminals assigned by using the MX entry.	STIMULA
AST CORRECTION. DESTAGE DELAYED, FM=family, SF=sub, CSU=id.	An error with the AST was corrected. The destage of the affected file will be automatically restarted.	None.	EXDEST

MESSAGE -----	SIGNIFICANCE -----	ACTION -----	ROUTINE -----
AST SUBSTITUTED. PFN=filenam, FAMILY=family, UI=userin. SUBCATALOG CSU ID = id.	The AST was rebuilt because it no longer matched the FCT.	None.	MSSEXEC
ASUSE ABNORMAL, xxx.	There is an ASUSE internal error in module xxx.	Inform site analyst.	ASUSE
ASUSE COMPLETE.	Informative message indicating that ASUSE completed normally.	None.	ASUSE
ASUSE - SYNTAX ERROR.	The ASUSE control statement is syntactically incorrect.	Correct the control statement and retry.	ASUSE
ASVAL ABNORMAL, xxx.	There is an ASVAL internal error in module xxx.	Inform site analyst.	ASVAL
ASVAL COMPLETED.	Informative message indicating that ASVAL completed normally.	None.	ASVAL
ATTACH ERROR ON filenam.	MSSEXEC was unable to attach file filenam.	Ensure that the file is direct access and not in use, and then retry.	ASDEBUG
ATTACH ERROR ON MSF CSUMAP. PFN=filenam, FAMILY=family, UI=userin.	System error.	Recover or create the missing CSU map.	MSSEXEC
ATTACH ERROR ON MSF SUBFAMILY CATALOG. PFN=filenam, FAMILY=family, UI=userin.	At least one but fewer than eight subfamily catalogs exist for the family.	Recover the missing catalogs.	MSSEXEC
AUTOMATIC NAME ASSIGNMENT IMPOSSIBLE.	DFTERM was unable to determine an available name for the terminated dayfile.	Enter a valid name for the file using the K display. Use the NM directive to override automatic name assignment.	DFTERM
BAD DUMP FILE.	Dump cannot be written on the specified file.	Request another dump file.	QDUMP
BAD SYSTEM POINTER.	Output file message indicating that a bad system pointer was detected in the EDD file during processing of an input directive.	Ensure that the dump file contains meaningful information (can use P option on DSDI to cause use of low core pointers from running system) and rerun.	DSDI

MESSAGE -----	SIGNIFICANCE -----	ACTION -----	ROUTINE -----
BAD SYSTEM SECTOR filenam userin.	Error was encountered in system sector of direct access file filenam during dump to archive tape; file is skipped. This is a nonfatal system error.	Inform site analyst. System sector for specified file must be corrected before it can be dumped.	PFDUMP
BLOCK SEQUENCE MISMATCH. filenam STAGING ERROR, JOB=jobnam, FM=family, UI=userin, CSU=id, MST=n, VSN=vsn, ASA=addr, STRM=s.	The staging of file filenam was aborted because of a block sequence error, which was detected during the stream label verification procedure or the file label verification procedure. All jobs attempting to attach this file will be aborted or given an error response. The stream conflict error flag is set in the MSF catalog entry for the affected cartridge and stream.	Retrieve the file from a dump tape if a backup copy is available. Run ASVAL to identify other files, if any, that are affected by this error. Either remove and reassign the cartridge or run ASDEBUG to clear the stream conflict error flag. Refer to Error Conditions and Corrective Action in section 3.	EXSTGE
BOTH FAMILY AND PACK NAME.	Family and pack name cannot both be specified.	Correct error and retry.	PFS
BUFFER ARG. ERROR FROM *VEJ*.	When called to assign a file to mass storage, VEJ returned a buffer argument error.	Inform site analyst.	QLOAD
BUFFER ARGUMENT ERROR.	One of the FET pointers is outside the caller's field length.	Examine program to determine error.	LOADBC, ILC
BUFFER SIZE TOO SMALL FOR DUMP FILE RECORD x.	Record x is too large to be read into the allocated buffer space.	Allocate a larger buffer and try again.	NDA
CANNOT ATTACH *IQFT* FILE.	An attempt to attach the IQFT file on the destination device failed.	Check for other utilities accessing the file. When the file is free, retry the load operation.	QLOAD
CANNOT CATLIST FAMILY/PACK=fampck.	DFTERM was unable to perform a CATLIST operation on the family/pack fampck.	Ensure that catalogs exist on the family/pack and retry the operation.	DFLIST, DFTERM
CANNOT FIX VSN FOR GOOD LABEL.	The cartridge specified in the FX directive to ASLABEL already has a good label.	Add or restore the cartridge to the CSU.	ASLABEL
CANNOT LOCATE DUMP NUMBER dmp.	User-specified dump number dmp cannot be found in the dump directory.	Analyze error and try again.	NDA



MESSAGE -----	SIGNIFICANCE -----	ACTION -----	ROUTINE -----
CANNOT LOCATE START ADDRESS.	The record containing the beginning NPU address on the NDA call cannot be found.	Analyze error and try again.	NDA
CARTRIDGE NOT ASSIGNED AS EXPECTED.	One of the cartridges specified has a vsn that does not allow the assignment or removal specified by a directive to ASLABEL.	Correct the directive to ASLABEL and retry.	ASLABEL
CARTRIDGE NOT EMPTY, vsn.	The cartridge, whose volume serial number is vsn, cannot be removed because it still contains file data.	None.	ASLABEL
CARTRIDGE NOT FOUND.	The cartridge is not in its assigned cubicle.	Locate and restore the missing cartridge or change the directive to ASLABEL or ASDEBUG to select a different cartridge.	ASLABEL, ASDEBUG
CARTRIDGE PRESENT - LOST BIT SET.	The lost (LT) option was specified on the RM directive to ASLABEL, but the cartridge is physically present.	Clear the lost flag in the MSF catalog.	ASLABEL
CATALOG COMPLETE.	Informative message indicating that cataloging or the list run is complete.	None.	CATALOG, MODVAL, PFATC
CATALOG CONTROL WORD MISSING.	Either the catalog control word was not the initial control word on the archive file, or the entire catalog entry is not present. This is a nonfatal system error and is accompanied by the message TAPE ERROR filename userin.	Retry or use backup tape.	PFCOPY
CATALOG FORMAT ERROR.	An attempt was made to catalog a permanent file device which was created on a system whose permanent file catalog format is different from that used by the currently running system.	Dump and reload the affected file.	PFCAT
CATALOG INDEX OUT OF RANGE.	Location of catalog buffer is not in buffer range. This is a fatal system error; PFDUMP aborts.	Retry PFDUMP operation.	PFDUMP
CATALOG LOST BIT MUST BE SET.	The lost (LT) option was specified on the RM directive to ASLABEL, but the cartridge is not known to be lost.	Correct the directive and retry.	ASLABEL
CATALOG/MAP FILE INTERLOCKED.	Another utility is using the CSU map or MSF catalog required to process the directive to ASLABEL.	Rerun at a later time.	ASLABEL

MESSAGE -----	SIGNIFICANCE -----	ACTION -----	ROUTINE -----
CATALOG/MAP INTERLOCKED.	Another utility is using the CSU map or MSF catalog required to process the directive to ASDEBUG.	Rerun at a later time.	ASDEBUG
CATALOG/MAP NOT OPEN.	The CSU map or MSF catalog was created after the last initialization of MSSEXEC.	Idle down and restart MSSEXEC before rerunning the directive to ASDEBUG.	ASDEBUG
CATALOG/MAP NOT OPENED.	The CSU map or MSF Catalog was created after the last initialization of MSSEXEC.	Idle down and restart MSSEXEC before rerunning the directive to ASLABEL.	ASLABEL
CATALOG MISSING FOR FAMILY family. UNABLE TO PROCESS MOVE REQUEST FILE.	ASMOVE was run on a family that has no MSF catalogs.	Correct the FM parameter and rerun ASMOVE.	EXUCP
CATALOGING filename userin.	Informative message indicating which file and user index are being cataloged.	None.	PFATC, PFCAT
CATALOGING COMPLETED.	Informative message indicating that cataloging is complete.	None.	PFCAT
CATALOGS MODIFIED.	Informative message indicating that ASVAL repaired the MSF catalogs.	None.	ASVAL
CATALOGS NOT MODIFIED.	Informative message indicating that ASVAL did not repair any MSF catalogs.	None.	ASVAL
CHcc,ABORT,ALL DATA NOT TAKEN.	The controller did not accept all the data on an attempt to download controlware.	Inform customer engineer.	LOADBC
CHcc,ABORT,Fffff.	Function ffff timed out while accessing the controller.	Inform customer engineer.	LOADBC
CHcc,ABORT,NO GENERAL STATUS.	After a download of controlware completed, the controller did not return a general status word after a status function.	Inform customer engineer.	LOADBC
CHcc,ABORT,Snnnn.	An error in the general status of the controller occurred after the controlware was loaded. cc Channel on which controlware was loaded nnnn General status of the controller	Inform customer engineer.	LOADBC
CHcc,MAttt,Avv,LOAD COMPLETE.	Informative message indicating that the controlware was successfully loaded. cc Channel on which disk controlware was downloaded ttt Controlware type (401, 710, or 721)	None.	LOADBC

MESSAGE -----	SIGNIFICANCE -----	ACTION -----	ROUTINE -----
	vv Version number (12, 13, 14, ...)		
CHANNEL NUMBER ARGUMENT ERROR.	The ARG common deck routine reported an error in the channel number supplied on the LOADBC control statement.	Check the C=cc parameter and retry.	LOADBC
CHANNEL NUMBER OUT OF RANGE.	Output file message indicating that the channel specified was not between 0 and 13B or 20B and 33B.	Correct and rerun.	VALNET
****CHARGE NUMBER ACTIVE.	Output file message indicating that the user has attempted to activate an already active charge number.	Rerun using correct charge number or directive, if necessary.	PROFILE
****CHARGE NUMBER DOES NOT EXIST.	Output file message indicating that a directive for which the charge number must exist has made a reference to a charge number that does not exist.	Rerun using the correct charge number.	PROFILE
****CHARGE NUMBER INACTIVE.	Output file message indicating that a directive for which the charge number must be active made a reference to a charge number that is inactive.	Activate charge number and rerun, or rerun using correct charge number.	PROFILE
CHECK DAYFILE FOR ERRORS.	Informative message indicating that the user should check the dayfile for errors.	Examine error messages in dayfile.	COPY, PFATC, PFCAT, PFCOPY, PFDUMP, PFLOAD, TCOPY
CHECK OUTPUT FOR WARNING MESSAGES.	No directive errors were encountered, but certain input directives (on create or update) received warning messages.	Check output listing.	MODVAL
CIO ERROR.	A parity error was encountered while file MOVCOM was being written.	Purge MOVCOM.	ASMOVE
CIO ERROR ON MSF CSUMAP. PFN=filenam, FAMILY=family, UI=userin.	A CIO error was encountered while the CSU map was being read.	Investigate cause of error and take appropriate action.	EXINIT
CIO ERROR ON MSF SUBFAMILY CATALOG. PFN=filenam, FAMILY=family, UI=userin.	A CIO error was encountered while the MSF catalog was being read.	Investigate cause of error and take appropriate action.	EXINIT
CKLAB - ABNORMAL TERMINATION.	The label from stream zero contains the wrong stream number.	Restore label with the FX directive to ASLABEL.	ASLABEL

MESSAGE -----	SIGNIFICANCE -----	ACTION -----	ROUTINE -----
CLEARING PF ACTIVITY COUNT.	PFCAT is waiting for PFU to decrement the permanent file activity count because catalog processing has been completed. This message should be displayed for a few seconds only.	Inform site analyst if message is displayed for an extended period of time.	PFCAT
CLEARING UTILITY INTERLOCK.	PFLOAD is waiting for PFU to clear the permanent file utility interlock on a device after it is loaded. This message should be displayed for a few seconds only.	Inform site analyst if message is displayed for an extended period of time.	PFLOAD
CM RECORD NOT FOUND.	Dayfile and output file message indicating that the central memory record was not found in the EDD file.	Ensure that the dump file contains meaningful information and is positioned correctly.	DSDI
COMMA AFTER itm MISSING.	Expected comma after item itm was missing. Scan continues with next item.	None.	LFG
COMMUNICATION FILE BUSY.	The communication file MOVCOM is busy.	Rerun ASMOVE when MOVCOM is no longer busy.	ASMOVE
COMPARE FILE DEFINE ERROR. filenam FOR jobnam NOT STAGED.	The staging of file filenam for job jobnam was abandoned because of a system error.	Submit a Programming System Report (PSR) with supporting material.	EXSTGE
COMPARE FILE PURGE ERROR. filenam FOR jobnam NOT STAGED.	The staging of file filenam for job jobnam was abandoned because of a system error.	Submit a Programming System Report (PSR) with supporting material.	EXSTGE
CONNECT TO EXEC FAILED.	ASVAL is not running at full capacity because MSSEEXEC is not running. No MSS release processing or catalog repair processing is done but a validation report is produced.	None.	ASVAL
CONTROL CARD ARGUMENT ERROR.	Dayfile message indicating that invalid control statement arguments have been encountered.	Correct and retry operation.	QFSP
CONTROL CARD SYNTAX ERROR.	The ASVAL control statement is syntactically incorrect.	Correct errors and retry.	ASVAL
CONTROLLER DID NOT TAKE ALL THE CONTROLWARE.	The controller did not accept all the data in the controlware record. The contents of a register did not equal zero after one of the OAM instructions in the PP.	Inform customer engineer.	LOADBC

MESSAGE -----	SIGNIFICANCE -----	ACTION -----	ROUTINE -----
CONTROLWARE LOAD ABORT, C=cc.	First line of a two-line message indicating that controlware was not successfully loaded on channel cc. The second line of the message indicates the reason for the abort.	Refer to the message given in the second line for information about appropriate action to be taken.	LOADBC
CONTROLWARE LOAD COMPLETE. yyyFIRMWARE MAttt-vvv,C=cc.	Informative message indicating that the controlware was successfully loaded. yyy Controller type ttt Controlware type vvv Version number cc Channel number	None.	LOADBC
CONTROLWARE NOT FOUND.	The system file does not contain the requested controlware.	Check the system controlware records.	LOADBC
CONVERSION ERROR.	Dayfile message indicating that a character has been entered after a postradix, or an 8 or a 9 is present in a number with a post-radix of B.	Correct and rerun.	SCRSIM
CONVERSION ERROR.	The SU and/or SL parameter on the ASUSE control statement was not numeric.	Correct the parameter and retry.	ASUSE
CONVERSION TO SOURCE COMPLETE.	Dayfile message indicating that source run successfully completed.	None.	MODVAL
COPYING filenam userin.	Informative message indicating that file filenam with user index userin is being copied.	None.	PFCOPY
CREATED AFTER yy/mm/dd. hh.mm.ss.	Informative message indicating that files created after the specified date and time have been loaded (or dumped).	None.	PFLOAD, PFDUMP
CREATED BEFORE yy/mm/dd. hh.mm.ss.	Informative message indicating that files created before the specified date and time have been loaded (or dumped).	None.	PFLOAD, PFDUMP
CREATING usernum.	Message displayed at line 1 of control point indicating that the user number usernum is being created.	None.	MODVAL
CREATING CATALOG IMAGE RECORD.	Informs operator that the catalog image record from the archive file is being copied to a scratch file.	None.	PFLOAD
CREATION COMPLETE.	Dayfile message indicating that creation run successfully completed.	None.	MODVAL

MESSAGE -----	SIGNIFICANCE -----	ACTION -----	ROUTINE -----
CREATION DATE MISMATCH. filenam STAGING ERROR, JOB=jobnam, FM=family, UI=userin, CSU=id, MST=n, VSN=vsen, ASA=addr, STRM=s.	The staging of file filenam was aborted because the file's creation date and time in the PFC entry on disk did not agree with the PFC entry on MSF. All jobs attempting to attach this file will be aborted or given an error response. The stream conflict error flag is set in the MSF Catalog entry for the affected cartridge and stream.	Retrieve the file from a dump tape if a backup copy is available. Run ASVAL to identify other files, if any, that are affected by this error. Either remove and reassign the cartridge or run ASDEBUG to clear the stream conflict error flag. Refer to Error Conditions and Corrective Action in section 3.	EXSTGE
CSU ALREADY DEFINED.	The CSU to be added to the subfamily has already been added to that subfamily.	Add a different CSU.	ASLABEL
CSU EST ERROR xx. DESTAGE RESTARTED.	A file destage operation was restarted although a CSU EST entry (xx) was incorrect.	Check the indicated EST entry for the CSU.	EXDEST
CSU id INPUT DRAWER EMPTY.	A cartridge is needed from the input drawer of the cartridge storage unit (CSU id) to process the directive to ASLABEL or ASDEBUG. id CSU identifier (A through M)	Put the required cartridge into the input drawer.	ASLABEL, ASDEBUG
CSU id INPUT DRAWER d EMPTY.	A cartridge is needed from slot d of the input drawer of the cartridge storage unit (CSU id) to process the directive to ASLABEL or ASDEBUG. id CSU identifier (A through M)	Put the required cartridge into the input drawer slot.	ASLABEL, ASDEBUG
CSU id OUTPUT DRAWER NOT EMPTY.	An empty slot in the output drawer of the cartridge storage unit (CSU id) is needed to process the directive to ASLABEL or ASDEBUG. id CSU identifier (A through M)	Remove cartridges from the output drawer.	ASLABEL, ASDEBUG
CSUMAP ERROR FLAG NOT SET IN FCT.	The RL directive to ASDEBUG did not remove the FCT entry in the MSF Catalog because the CSU map error flag was not set in the FCT entry.	Correct the FCT ordinal and the SB and CS parameters and retry.	ASDEBUG
CSUMAP OPEN ERROR.	The CSU map does not exist or is invalid for the specified CSU on the NOS default family.	Correct the CS parameter on the ASVAL control statement or reload/recreate the CSU map.	ASVAL

MESSAGE -----	SIGNIFICANCE -----	ACTION -----	ROUTINE -----
CSUMAP PARITY ERROR.	There is a read parity error on the CSU map.	Recover the CSU map from a backup copy and retry.	ASUSE
CSUMAP READ ERROR.	A parity error was encountered on the CSU map.	Recover the CSU map from a back copy and retry.	ASVAL
CUBE EMPTY - CSUMAP ENTRY REMOVED.	Informative message indicating that the cubicle corresponding to the CSUMAP entry being removed with an RC directive was empty.	None.	ASDEBUG
CUBES ASSIGNED TO SUB-FAMILY.	The CSU cannot be removed from the subfamily because it contains cubicles that are still assigned to the subfamily.	Correct the RC directive to ASLABEL.	ASLABEL
CYCLE STILL PROCESSING.	Dayfile message indicating that a command other than END. was entered before the total time limit was reached.	Wait until processing is complete before entering commands other than END.	SCRSIM
DAF BUSY filename userin.	Direct access file filename with user index userin cannot be dumped because it is attached in WRITE mode; file is skipped. This is a nonfatal system error.	Retry PFDUMP operation after user has released the file.	PFDUMP
DAF ZERO LENGTH filename userin.	Direct access file filename with user index userin was empty and therefore could not be dumped; file is skipped. This is a nonfatal system error.	None.	PFDUMP
DATA BASE ERROR.	Dayfile message indicating that the system has detected an error in its validation file.	Contact installation personnel.	CHARGE MODVAL
DATA BASE ERROR n - NOTIFY ANALYST.	System error dayfile message indicating that an abnormal situation exists. n is displayed for consideration by the analyst. The internal documentation, obtained by using the DOCUMENT control statement, contains an explanation of each error n for use by the analyst. (Refer to section 7 in volume 1 of the NOS Reference Manual for a description of DOCUMENT.)	Inform site analyst.	PROFILE
DATA BASE NAME FIRST CHARACTER BAD.	Output file message indicating that the first character of the transaction subsystem data base name is not alphanumeric.	Correct and rerun.	VALNET
DATA BASE NAME NOT 2 CHARACTERS.	Output file message indicating that the transaction subsystem data base name is not two characters in length.	Correct and rerun.	VALNET
DATA FILE FORMAT ERROR.	The specified data file does not conform to the format expected.	Make sure the correct data file format has been specified on the control statement.	ACPD PROBE

MESSAGE -----	SIGNIFICANCE -----	ACTION -----	ROUTINE -----
DATA LINE TOO LONG.	Nonfatal K-display message indicating that too many characters are in the data line.	Shorten the line.	STIMULA
DATA LOST IAFEX tn.	IAF could not accept input from terminal tn because a driver reentry was waiting to be processed. The input data is lost.	Inform site analyst.	IAFEX
DAYFILE BUSY.	The dayfile to be terminated is currently attached to another job.	Retry operation.	DFTERM
DAYFILE STATUS INDEFINITE.	An error exit occurred which caused DFTERM to abort while it was terminating a dayfile. Status of the dayfile is unknown.	Inform site analyst immediately.	DFTERM
DAYFILE TERMINATED.	Informative message issued to the terminated dayfile.	None.	SFM
DEADSTART FILE FORMAT ERROR.	An error was detected in the directory of the deadstart file.	Check the contents and format of the deadstart file for errors.	INSTALL
***DELETE NON-EXISTENT USER NUMBER.	Output file message indicating that the user number to be deleted from the specified charge/project number entry does not exist. This message is not posted on the K display (DUN directive is ignored) and is not listed on the output file until all directives for the specified charge/project number have been processed.	Check the user number and retry.	PROFILE
DELETING usernum.	Message displayed at line 1 of control point indicating that the user number usernum is being deleted.	None.	MODVAL
DESTINATION DEVICE ERROR.	An unrecoverable error occurred while QLOAD was writing to the destination device.	Check the output file for the files that were processed. Reload to different device.	QLOAD
DESTINATION DEVICE REQUIRED.	An attempt was made to load inactive queues but the destination device was not selected correctly. Either the family and device number or the pack name of the destination device must be specified.	Enter correct parameters and retry load operation.	QLOAD
DESTINATION FAMILY NOT SPECIFIED.	K-display message indicating that a GO command has been entered before the destination family (DF) or family name (FM) has been specified.	Enter the family name and type GO.	QFSP



60455380 G

MESSAGE

DETECTED IN CLD.

SIGNIFICANCE

Error was encountered during the building of the system library. Disk resident overlay (OVL) or absolute (ABS) program is not formatted correctly. Deadstart processing halts when this error is detected.

ACTION

Redeadstart at a different tape density or use another tape unit or a different deadstart tape. If the error persists, inform the site analyst.

ROUTINE

SYSEDT

A-14.1/A-14.2

MESSAGE -----	SIGNIFICANCE -----	ACTION -----	ROUTINE -----
DETECTED IN DIRECTORY.	System file error occurred during the building of the system library. Start of the system library was not found. Deadstart processing halts when this error is detected.	Redeadstart at a different tape density or use another tape unit or a different deadstart tape. If the error persists, inform the site analyst.	SYSEdit
DETECTED IN PLD.	System file error occurred during the building of the system library. Disk resident PP program or central memory resident PP program is not formatted correctly. Deadstart processing halts when this error is detected.	Redeadstart at a different tape density or use another tape unit or a different deadstart tape. If the error persists, inform the site analyst.	SYSEdit
DETECTED IN RCL.	Error was encountered during the building of the system library. Central memory resident overlay (OVL) or absolute (ABS) program is not formatted correctly. Deadstart processing halts when this error is detected.	Redeadstart at a different tape density or use another tape unit or a different deadstart tape. If the error persists, inform the site analyst.	SYSEdit
DETECTED IN RPL.	Error was encountered during the building of the system library. Central memory resident overlay (OVL) or absolute (ABS) program is not formatted correctly. Deadstart processing halts when this error is detected.	Redeadstart at a different tape density or use another tape unit or a different deadstart tape. If the error persists, inform the site analyst.	SYSEdit
DEVICE ERROR.	The device number specified for a device to be cataloged refers to a nonmaster device.	Specify master device and retry operation.	PFCAT
DEVICE FULL FOR COMMUNICATION FILE.	A disk full condition does not allow file MOVCOM to be written.	Manually free disk space and rerun ASMOVE.	ASMOVE
DEVICE NOT FOUND.	Device number (DN) specified to be cataloged was not defined in the system.	Retry operation with device defined in the system.	PFCAT
DEVICE UNAVAILABLE.	The sum of the device masks in the family is less than 377B. The user tried to write a permanent file, but his user index does not reference a device in the family.	Contact site analyst.	PFM

MESSAGE -----	SIGNIFICANCE -----	ACTION -----	ROUTINE -----
DFD - message.	Refer to explanation of AFD - message.		DAYFILE
DFTERM ABORTED.	An error exit caused DFTERM to abort.	Check the dayfile for more information.	DFTERM
DIRECTIVE ERRORS.	Dayfile message indicating that one or more input directives were in error. Fatal error.	Examine output file to determine reason for error.	MODIFY, OPLEDIT, LIBTASK, MODVAL, PROFILE, SYSEDIT
****DIRECTIVE NOT AUTHORIZED.	Output file message indicating that the user must be either a special accounting user or from system origin to issue this directive.	None.	PROFILE
DIRECTIVE NOT MEANINGFUL.	The MPP or PMS directive for the DSDI control statement has no meaning for this dump.	Remove the meaningless directive.	DSDI
DIRECTIVE PARAMETER ERROR.	Output file message indicating that an error was detected in a directive parameter.	Correct and rerun.	DSDI
DIRECTIVE RESTRICTED TO PRINTER OUTPUT.	Output file message indicating that the directive entered produces output which cannot be listed at a terminal.	Assign the output to an alternate output file for later printing at a line printer (refer to the description of the OUTPUT directive).	DSDI
DIRECTIVE RESTRICTED TO TERMINAL OUTPUT.	Output file message indicating that the directive entered produces output which must be listed at a terminal.	Use directive from terminal.	DSDI
DIRECTORY TABLE BAD.	Dayfile message indicating that an EOR or EOF was encountered while the random file directory which was created by the D option was being read.	Ensure that the dump file contains meaningful information.	DSDI
DISK FILE ERROR.	MSSEXEC encountered a write error on a file.	Retry using a different file name.	ASDEBUG
DISK FULL. STAGING DELAY, FM=family, UI=userin.	Staging is delayed because of insufficient disk space.	Use ASMOVE to free up disk space.	EXSTGE
DNdn FM family FNT FULL.	The FNT was filled while recovering the specified device. dn Device number family Family name	Retry at a later time when the system is not as busy.	QREC

MESSAGE -----	SIGNIFICANCE -----	ACTION -----	ROUTINE -----
DNdn, FM family IGNORED - ERROR IDLE.	Informative message indicating that queues on the specified device were not processed because the device had an error idle status.	None.	QREC
DNdn FM family IGNORED - REMOVABLE.	Informative message indicating that queues on the specified device were not processed because the device is removable. dn Device number family Family name	None.	QREC
DNdn FM family IGNORED - SHARED.	Informative message indicating that queues on the specified device were not processed because the device is shared and QPROTECT is disabled. dn Device number family Family name	None.	QREC
DNdn FM family IQFT INTERLOCKED.	The track interlock on the IQFT file is set. It is possible IQFT is currently being used by another utility. dn Device number family Family name	Retry at a later time.	QREC
DNdn FM family MS ERROR.	A mass storage error occurred while processing the IQFT file on the specified device. dn Device number family Family name	Inform site analyst.	QREC
DNdn FM family NO IQFT FILE.	Informative message indicating that no IQFT file exists for the specified device. dn Device number family Family name	None.	QREC
DNdn FM family UNDEFINED ERROR.	System failure has occurred generating an erroneous error code. dn Device number family Family name	Inform site analyst.	QREC
DSDI ARGUMENT ERROR.	Dayfile message indicating that an unknown keyword was encountered on the DSDI control statement.	Correct and rerun.	DSDI
DSDI ERROR LIMIT EXCEEDED.	Dayfile message indicating that more than 50 errors were detected.	Examine output file for specific errors.	DSDI
DSFB USED = n.	Informative message indicating that the destage for backup value used by ASMOVE is n.	None.	ASMOVE

MESSAGE -----	SIGNIFICANCE -----	ACTION -----	ROUTINE -----
DUMP FILE dnum NOT IN SYSTEM.	NDA turned off the dump index entry for dump number dnum because the dump does not exist in the system. NDA continues.	None.	NDA
DUMPING filename userin.	Informative message indicating the name of the file being dumped and the user index under which the file is stored.	None.	PFDUMP
DUMPING - DIRECT ACCESS FILES ONLY.	Informative message indicating that only direct access files have been selected to be dumped (OP=D option specified).	None.	PFDUMP
DUMPING - INDIRECT ACCESS FILES ONLY.	Informative message indicating that only indirect access files have been selected to be dumped (OP=I option specified).	None.	PFDUMP
***DUPLICATE CHARGE NUMBER.	Output file message indicating that an existing charge number was referenced on a create run.	Rerun using correct charge number, if required.	PROFILE
**DUPLICATE CS PARAMETER.	The same CSU is indicated more than once on the CS parameter.	Correct the CS parameter.	ASVAL
DUPLICATE FILE NAME.	Dayfile message indicating that when QFM tried to attach an inactive queue file to the control point, a file by the same name was already assigned.	Rename, or return the file with the conflicting name.	QFM
DUPLICATE FILE NAME ERROR.	The files for input and output have the same name.	Change and retry.	PROBE
***DUPLICATE PROJECT NUMBER.	Output file message indicating that an existing project number was referenced on a create run.	Rerun using correct project number, if required.	PROFILE
**DUPLICATE SB PARAMETER.	The same subfamily is indicated more than once on the SB parameter.	Correct the SB parameter.	ASVAL
DUPLICATE USER NUMBER.	Output file message indicating that the user number encountered on a create run is a duplicate of a user number previously entered. The first entry is used.	Rerun the corrected job or correct the new validation file, if necessary.	MODVAL
***DUPLICATE USER NUMBER.	The user number to be added already exists for the specified charge/project number entry. This message is not posted on the K display (AUN directive is ignored) and is not listed on the output file until all directives for the specified charge/project number have been processed.	Choose a different user number.	PROFILE
ECS RECORD NOT FOUND.	Output file message indicating that the ECS record was not found in the EDD file.	Ensure that the dump file contains meaningful information.	DSDI

<u>MESSAGE</u>	<u>SIGNIFICANCE</u>	<u>ACTION</u>	<u>ROUTINE</u>
ELD - message.	Refer to explanation of AFD - message.		
EMPTY CATALOG.	No entries are present in the catalog.	None.	CATLIST NDA
EMPTY SESSION FILE.	Nonfatal K-display message indicating that the session file was empty.	Resupply the correct file name, or put data into the file.	STIMULA

MESSAGE -----	SIGNIFICANCE -----	ACTION -----	ROUTINE -----
END OF COPY.	Informative message indicating that the copy is complete.	None.	PFCOPY
END OF DUMP FILE ENCOUNTERED WHILE SEARCHING FOR RECORD x.	Attempts to read record type x into memory have encountered an end-of-file condition indicating that the dump file is missing the record.	Correct error and try again.	NDA
END SIMULATOR.	Dayfile message indicating that the operator has entered STOP. to drop the simulator.	None.	SCRSIM
ENTER E TO TERMINATE LOADING. L TO LIST REMAINING FILES. GO TO RESUME INCREMENTAL LOAD.	This message occurs as a result of a complete load of an archive file during incremental load operations. The message appears at the end of a reel during incremental loading to allow the operator to optionally load additional reels.	Enter E, L, or GO as indicated in the message.	PFLOAD
ENTERED PARAMETER IS ILLEGAL.	Parameter is not in legal format.	Check dayfile for more detail on error. Enter correct parameter via the K display.	PFS
EOI BAD ON ATTACHED FILE.	The EOI sector cannot be found on the specified file.	Inform site analyst.	QFM
EQeq,DNdn,message.	A permanent file utility has encountered an error on equipment eq, device dn.	Refer to the explanation given for the message following the device number for further information.	PFDUMP, PFLOAD
EQ/xx TRACK LIMIT.	Mass storage device with EST ordinal xx has no allocatable tracks left and a program is waiting for a track in order to continue processing of a file. Additional space must be made available on the device. Error log message for PFM; dayfile message for PFU.	Inform site analyst.	PFM, PFU
EQUIPMENT NUMBER OUT OF RANGE.	Output file message indicating that the equipment number specified is not between 0 and 100B.	Correct and rerun.	VALNET
ERROR FILE LIMIT.	One of the following. - An unrecoverable error occurred during an attempt to create the error file. - The number of error files created has exceeded the upper limit allowed.	Check the output file for files processed. Retry load skipping files in error.	QLOAD
ERROR FLAG NOT SET IN CSUMAP.	The RC directive to ASDEBUG did not remove the CSU map entry because the error flag was not set in the CSU map entry.	Correct the CS, XI, and YI parameters and retry.	ASDEBUG
ERROR IN libdeck.	An error was detected in the specified libdeck while processing the SYSEDIT command.	Correct the error in the libdeck and retry.	SYSEDIT

MESSAGE -----	SIGNIFICANCE -----	ACTION -----	ROUTINE -----
ERROR IN ALPHABETIC DATA.	K-display message indicating that either no data is present or an illegal separator follows the data.	Correct and reenter K-display input.	QFSP
****ERROR IN ALPHANUMERIC DATA.	Output file message indicating any of the following. <ul style="list-style-type: none"> <li>- No data was present.</li> <li>- The data accompanying the *AW* input identifier was unrecognizable.</li> <li>- The number of characters exceeded the maximum allowed.</li> </ul> If entered from the K display, the line of input on which the error occurred is disregarded; otherwise, that particular user number is disregarded.	Rerun the corrected job or correct the new validation file, if necessary.	MODVAL
ERROR IN DATE.	K-display message indicating any of the following. <ul style="list-style-type: none"> <li>- The date entry is not in the correct format.</li> <li>- An illegal separator follows the date.</li> <li>- The date entry is prior to 70/01/01.</li> <li>- The date entry is not a valid date (e.g. 76/04/44).</li> </ul>	Correct and reenter K-display input.	QFSP
ERROR IN DEVICE NUMBER.	K-display message indicating one of the following. <ul style="list-style-type: none"> <li>- No family name has been specified.</li> <li>- The device number is not in the specified family.</li> <li>- An illegal separator follows the device number.</li> </ul>	Correct and reenter K-display input.	QFSP
ERROR IN FAMILY NAME.	K-display message indicating that either the specified family cannot be found or an illegal separator follows the family name.	Correct and reenter K-display input.	QFSP
ERROR IN FILE SIZE RANGE.	K-display message indicating one of the following. <ul style="list-style-type: none"> <li>- File size is nonnumeric.</li> <li>- File size range is not within the range 0 (or min) through 77777B (or max) where min is the minimum file size and max is the maximum file size.</li> <li>- An illegal separator follows the last size.</li> </ul>	Correct and reenter K-display input.	QFSP
ERROR IN IAFEX ARGUMENTS.	An error was encountered on the IAFEX control statement.	Correct error and retry.	IAFEX



MESSAGE -----	SIGNIFICANCE -----	ACTION -----	ROUTINE -----
ERROR IN IAFEX PARAMETER - T.	The value assigned to the T parameter on the IAFEX control statement is not valid.	Correct T parameter and retry.	IAFEX
ERROR IN ID RANGE.	K-display message indicating one of the following. - ID is not within the range 0 through 77B. - Illegal separator between or after ID data. - Minimum ID is greater than the maximum ID. - Identifier number is nonnumeric.	Correct and reenter K-display input.	QFSP
ERROR IN IDENTIFIER.	K-display message indicating that an illegal directive or command has been entered, or a directive is illegal for the selected utility.	Correct and reenter K-display input.	QFSP
****ERROR IN IDENTIFIER.	Output file message indicating that an illegal parameter identifier was encountered. If entered from the K display, that line of input is disregarded; otherwise, that particular user number is disregarded.	Rerun the corrected job or correct the new validation file, if necessary.	MODVAL
ERROR IN LIMITS ARGUMENT.	Dayfile message indicating that parameters were included on the LIMITS statement.	Enter LIMITS. without additional parameters.	MODVAL
ERROR IN MODVAL ARGUMENTS.	Dayfile message indicating that invalid control statement arguments were entered.	Specify the correct arguments and rerun.	MODVAL
ERROR IN NUMERIC DATA.	K-display message indicating one of the following. - No data is present. - Nonnumeric data was entered where numeric data was required. - Numeric data exceeds maximum value.	Correct and reenter K-display input.	QFSP
****ERROR IN NUMERIC DATA.	Output file message indicating any of the following. - The data was nonnumeric and numeric data was required - Numeric data exceeded the maximum allowed - No data was present If entered from the K display, the line of input on which the error occurred is disregarded; otherwise, that particular user number is disregarded.	Rerun the corrected job. Correct the new validation file, if necessary.	MODVAL

MESSAGE -----	SIGNIFICANCE -----	ACTION -----	ROUTINE -----
ERROR IN PARAMETERS.	There is an error in the channel parameter (C=cc) on the LOADBC control statement.	Correct the parameter and retry.	LOADBC
ERROR IN PROFILE ARGUMENTS.	Dayfile message indicating there was an error on the PROFILE control statement.	Correct the control statement and rerun.	PROFILE
ERROR IN SELECTED FILE TYPE.	K-display message indicating that either the file type selected cannot be recognized or an illegal separator follows the file type.	Correct and reenter K-display input.	QFSP
ERROR IN STIMULATOR ARGUMENTS.	Fatal dayfile message indicating that a parameter other than the I parameter is present, or the parameter is in the wrong format.	Correct and rerun.	STIMULA
ERROR IN USER INDEX RANGE.	K-display message indicating one of the following. - User index is nonnumeric data. - User index is not within the range 0 (or min) through 377777B (or max) where min is the minimum user index and max is the maximum user index. - An illegal separator follows the last user index.	Correct and reenter K-display input.	QFSP
****ERROR IN USER NUMBER.	Output file message indicating that illegal data was encountered where the user number was expected. MODVAL disregards the illegal data and goes to the next user entry.	Rerun the job or correct the new validation file, if necessary.	MODVAL
ERROR LOG DUMPED.	The error log dump is complete.	None.	DAYFILE
ERROR ON FILE - PROFILA.	Either the profile file cannot be found or there is a bad profile file level-3 block random address.	Inform site analyst.	CPM
ERROR ON OUTPUT FILE.	K-display message indicating that the OUT command was entered when no output file existed.	None.	QREC
ERROR READING THE PFC.	The PFC entries for the family are either missing or have a bad sector error.	Reload the permanent files.	ASVAL
ERRORED FILE PARTIALLY DUMPED - filenam.	Informative message indicating that an unrecoverable read error was encountered on file filenam while the option to dump files in error was disabled. The back-space on the dump file hit the beginning of the tape reel, leaving filenam partially dumped on the previous reel. This file will not be loaded if the option to load	None.	QDUMP

MESSAGE -----	SIGNIFICANCE -----	ACTION -----	ROUTINE -----
	files in error is disabled.		
ERRORED TRACK NAME LIMIT.	1000 files of the type ERRxxx (error files) already exist. xxx Sequence number from 001 through 999	Inform site analyst immediately.	QMOVE
EXCESSIVE PARITY ERRORS.	Excessive recovered parity errors due to a faulty MST or cartridge were encountered while the cartridge label was being written.	Retry after cleaning or repairing the MST, or discard the cartridge.	ASLABEL
EXCESSIVE WRITE ERRORS. DESTAGE RESTARTED.	A file destage operation was restarted using different cartridges because excessive write errors were encountered.	Run ASVAL to identify the problem cartridges and any permanent files on these cartridges. Remove the files from the cartridges (refer to Error Conditions and Corrective Action in section 3).	EXDEST
EXEC ABNORMAL, xxx.	There is an internal error in module xxx of MSSEXEC.	Inform site analyst.	MSSEXEC
EXEC ABORT - SYNTAX ERRORS.	The MSSEXEC control statement is syntactically incorrect.	Correct errors and retry.	MSSEXEC
EXEC IN SINGLE MAINFRAME MODE.	Informative message indicating that MSSEXEC is running in a single mainframe environment.	None.	MSSEXEC
EXEC MMF INITIALIZATION FAILED - - message.	MSSEXEC failed to establish communication with any of the slave machines in a multmainframe environment; message indicates the reason and can be one of the following. ALL SLAVES OMITTED ATTACH MTOS FAILED DEFINE MTOS FAILED MTOS FILE BUSY SETPFP PROBLEM	Submit a Programming System Report (PSR) with supporting material. Analyze error and try again. Ensure that the link device is configured as a direct access permanent file device.	MSSEXEC
EXEC MMF INITIALIZATION OK.	Informative message indicating that MSSEXEC is ready to run in a multmainframe environment.	None.	MSSEXEC
EXEC - SLAVE i xxxx.	Informative message indicating that MSSEXEC is ready to communicate with MSSSLV on mainframe i or that the status of MSSSLV on mainframe i has changed. The current status of MSSSLV is indicated by xxxx and can be IDLE, ACTIVE, or INACTIVE.	None.	MSSEXEC

MESSAGE -----	SIGNIFICANCE -----	ACTION -----	ROUTINE -----
EXEC - SLAVE 1 OMITTED - - message.	MSSEXEC was unable to establish or maintain access to a communication file with MSSSLV on mainframe 1; message indicates the reason and can be one of the following. NO STOM FILE STOM FILE ERROR STOM FILE LENGTH PROBLEM MSSEXEC will continue to operate, but will not attempt to receive requests from MSSSLV on mainframe 1.	If MSSSLV is to be run on mainframe 1, and the message is NO STOM FILE or STOM FILE ERROR: idle MSSEXEC, purge the STOM file, initiate MSSSLV, and initiate MSSEXEC. If the message is STOM FILE LENGTH PROBLEM, then purge the existing STOM file, and reinstall MSSEXEC and MSSSLV using identical values for NUMRB, MAXSLV, and NUMSLV in common deck COMEIPR and for RBSIZE in common deck COMAMSS.	MSSEXEC
EXEC SMFMODE - ALL SLAVES OMITTED.	MSSEXEC has lost access to all of the MSSSLVs and is now running in single mainframe mode.	Inform site analyst.	MSSEXEC
EXEC STATISTICS.	The values following this message are used for internal maintenance and tuning only. Refer to EXEC program listings if further information is needed.	None.	NS CS
EXPECTING MEMORY RESIDENT BUT READING OVERLAY AREA HEADER.	The type of record being read conflicts with the file description card.	Eliminate conflict and try again.	LFG
EXPECTING OVERLAY BUT READING MEMORY RESIDENT HEADER.	The type of record being read conflicts with the file description card.	Eliminate conflict and try again.	LFG
EXPRESS DUMP COMPLETE (FL USED xxxxxxB).	Dayfile message indicating that the dump was completed normally. The amount of field length used was xxxxxx octal words.	None.	DSDI
FAMILY FILES ACTIVE.	Dayfile message indicating that the direct access file count is greater than the number of fast attach files.	Use IDLEFAMILY, and wait for direct access file count to decrease until it equals the number of fast attach files.	ISF
FAMILY NAME MUST BE ENTERED.	K-display message indicating that the operator attempted to enter a specific device number before entering a specific family name.	Enter the missing family name and type GO.	QFSP

60455380 G

<u>MESSAGE</u>	<u>SIGNIFICANCE</u>	<u>ACTION</u>	<u>ROUTINE</u>
FAMILY NOT FOUND.	The family specified by the FM parameter on the ASLABEL, ASMOVE, ASUSE, or ASDEBUG control statement does not exist or is not on line.	Specify an existing on-line family and retry.	ASMOVE ASLABEL ASDEBUG ASUSE
FAMILY NOT FOUND IN SYSTEM.	The family specified by the FM parameter on the ASVAL control statement or the family in the RDF header was not found in the system family packs.	Correct the parameter or add the family to the system.	ASVAL
FAMILY/PACK NOT FOUND.	Family or pack specified is not defined in the permanent file system.	Reenter parameters and specify correct pack or family name, or enter (mount) the correct family or pack into the system if not currently present.	PFS

A-24.1/A-24.2

MESSAGE -----	SIGNIFICANCE -----	ACTION -----	ROUTINE -----
FAST ATTACH FILES ON DEVICE.	An attempt was made to initialize a mass storage device on which one or more fast-attach files are currently active. This message also appears in the comment field of the system control point in the job status (B) display.	Inform site analyst; the fast-attach files will have to be released, via ISF function, before the device can be initialized. The recommended procedure is as follows. - Examine the FNT (H) display to determine the names of the fast-attach files on the device (typically, VALIDUZ, PROFILB, or RSXDID). - Release those files via ISF entries in the following format. X.ISF,R=filenam. If fast-attach files are to be reloaded after the device is initialized, those files must be initialized via the entry X.ISF.	IDS
FAST-ATTACH PROFILE FILE ILLEGAL.	Dayfile message indicating that the project file cannot be in fast-attach status on a reformat run.	Use the ISF control statement with the R option to release the project file from fast-attach status.	PROFILE
FCT ORDINAL OUT OF RANGE.	The FCT ordinal specified by the FO parameter in a directive to ASDEBUG is out of range.	Correct the FO parameter and retry.	ASDEBUG
FDP ABORT - USER VALIDATION ERROR.	Dayfile message indicating that ENGINEERING mode has not been set at the system console.	Set ENGINEERING mode at the system console.	FDP
FETCHING FLAW DATA S/N=serialn.	Console message indicating that the factory recorded data is being retrieved from cylinder 6328 (or 1466B), track 0, sectors 0, 1, and 2. Here, serialn is the actual pack serial number read.	None.	FORMAT
FILE ALREADY DESTAGED. DESTAGE ABANDONED.	A file destage operation was abandoned because the file already had been destaged.	None.	EXDEST

MESSAGE -----	SIGNIFICANCE -----	ACTION -----	ROUTINE -----
FILE ALREADY INTERLOCKED.	The track interlock for an IQFT file is currently interlocked.	Inform site analyst.	QFM
FILE DESCRIPTION CARD TERMINATES WITHOUT A PERIOD.	The user failed to terminate a file description card with a period.	Correct error.	LFG
FILE EQUIVALENCE MAY NOT BE 0.	Dayfile message indicating that either the input of the standard output file has been declared empty (that is, set equal to 0).	Correct and rerun.	FORMAT
FILE ERROR.	K-display message indicating that the change file specified could not be attached.	Verify that the change file is an indirect file.	STIMULA
FILE NAME CONFLICT.	Dayfile message indicating that the file name specified with the P option (terminal network description) is the same as the file specified with the L option (error listing).	Specify unique file names with the P and L options.	VALNET
FILE NAME CONFLICT.	The file names specified by the I and L directives are identical or a reserved file name was specified. Reserved file names include IQF, MIQFT, NIQFT, and SCR.	Change the incorrect file name(s) and reenter directives(s).	QFSP
FILE NAME CONFLICT.	The file to receive output cannot be named IQF or NIQFT.	Change output file name and enter new directive.	QREC
FILE NAME CONFLICT.	The names of the output, load, and IQFT files conflict.	Change the name of the output or load file and retry the operation.	QLOAD
FILE NAME CONFLICT - FILE filename.	The names of the output, dump, and IQFT files conflict.	Change the name of the output or dump file and retry the operation.	QDUMP
FILE NAME ERROR -- filename.	The name of the file (filename) on the file description card is greater than seven characters or begins with a number. The scan continues after the next period.	Correct error.	LFG
FILE NAME NOT SET.	Nonfatal K-display message indicating that a GO was entered, and the file name was not set.	Set the file name.	STIMULA
FILE NOT FOUND.	Requested file could not be found.	Verify that file exists and retry.	LFM, SFM, QFM, ENQUIRE, STIMULA

MESSAGE -----	SIGNIFICANCE -----	ACTION -----	ROUTINE -----
FILE POSITION LOST -- NOT ENOUGH MEMORY IMAGE RECORDS.	TAPRO indicates that memory image records ended before the count reached zero, suggesting a bad LINK-EDIT file.	Check LINK-EDIT file.	LFG
FILE READ ERROR. DESTAGE ABANDONED.	A file destage operation was abandoned because of a disk read error.	Investigate cause of disk error and take appropriate corrective action.	EXDEST
FILE TRUNCATED filename userin.	Data for file on archive tape is shorter than the length indicated in the catalog entry for the file. The file is truncated and the length in the catalog is updated to reflect the smaller size. This is a nonfatal system error.	Load the file from a backup tape if desired.	PFLOAD
FILE WRITE ERROR. STAGING DELAY, FM=family, UI=userin.	Staging is delayed because of a file write error. The staging will resume automatically and will either complete successfully or encounter the same file write error.	Investigate cause of disk error and take appropriate corrective action.	EXSTGE
FILENAME CONFLICT - filename.	File filename was used for more than one purpose.	Correct call parameters and try again.	MODVAL
FILENAME filename USER INDEX userin.	Informative message indicating that only the specified file for the specified user index will be loaded (or dumped).	None.	PFLOAD, PFDUMP
FINAL PF SPACE = n.	Informative message indicating that the permanent file space at the end of the ASMOVE run is n PRUs.	None.	ASMOVE
FM NOT LEGAL FAMILY.	Dayfile message indicating that an illegal family name was specified with the FM parameter.	Correct the FM parameter and rerun.	PROFILE, MODVAL
*FNT* FULL DETECTED BY *VEJ*.	When called to assign a file to mass storage, VEJ returned status indicating that the FNT was full.	Check output file to determine which files were not loaded. Retry when system is not as busy.	QLOAD
FNT IS FULL.	The FNT became full during processing of the requeue function and all files could not be requeued.	Inform site analyst.	QFM
*FNT* LIMIT ON LOAD.	The calculated FNT threshold has been reached.	Check listing to determine which files were not loaded. Retry when the system is not	QLOAD



MESSAGE -----	SIGNIFICANCE -----	ACTION -----	ROUTINE -----
FNT THRESHOLD LIMIT.	The FNT threshold for the number of queue, non-TXOT rollout, fast-attach, and system files allowed in the FNT has been reached. No more queued files can be activated until some of these files are released.	as busy. Retry when system is not as busy.	QREC QMOVE
FNTLIST/QALTER ABORTED.	The system aborted FNTLIST or QALTER.	Contact site analyst.	FNTLIST
FO NOT SPECIFIED CORRECTLY.	The FO parameter was specified without an equals sign in a directive to ASDEBUG.	Specify FO correctly and try again.	ASDEBUG
FORMAT ERROR xxxx.	Dayfile message indicating that a channel malfunction has occurred, causing FDP to abort the control point. xxxx One of the following malfunctions. 0001 The coupler was reserved from the opposite access. 0004 The disk drive was hung busy. 0010 An uncorrectable error has occurred 0014 Status was expected, but none was received. 0015 An uncorrectable error on the channel connection occurred. 0024 An output failure occurred on the FORMAT parameter array. 0026 A read abort occurred. 0027 A detailed status abort occurred. 0032 An uncorrectable error occurred during formatting.	Correct and rerun.	FDP
FORMAT ERROR.	K-display message indicating that an error exists in the syntax of the command or the values of the parameters.	Correct the command or parameters and retry operation.	TAF PFLOAD STIMULA
FORMAT ERROR IN TIME PARAMETER.	The values specified for the loop operation times do not conform to standard numeric format (digits 0-9 with optional post-radix D or B). Default base is decimal.	Correct and retry.	ICPD
FREE FILES NOT RELEASED.	Informative message indicating that ASVAL did not release the MSF space allocated to trouble-free orphans, because the last release date was after the last RDF dump date.	Retry with the correct RDF file.	ASVAL

MESSAGE -----	SIGNIFICANCE -----	ACTION -----	ROUTINE -----
FREE FILES RELEASED.	Informative message indicating that ASVAL released the MSF space allocated to trouble-free orphans.	None.	ASVAL
FROZEN CHAIN.	While trying to read a file, ASDEBUG encountered the frozen chain flag set in the stream chain.	Run ASVAL to identify the problem streams on the chain, and then read each stream separately using the RS directive to ASDEBUG.	ASDEBUG
FUNCTION TIMED OUT = nnnn.	ILC timed out in the function routine while accessing the controller. nnnn Function code	Inform customer engineer.	LOADBC
GENERAL STATUS = nnnn.	The controlware load was not successful and the general status of the controller (nnnn) is not zero.	Inform customer engineer.	LOADBC
GENERATING CATALOG IMAGE.	Informative message indicating that catalog image record (CIR) is currently being written to the archive file.	None.	PFDUMP
GENLAB - ABNORMAL TERMINATION.	The label from stream zero contains an illegal vsn.	Restore label with the FX directive to ASLABEL.	ASLABEL
HARDWARE PROBLEM. DESTAGE RESTARTED.	A file destage operation was restarted because of a hardware problem.	Inform customer engineer.	EXDEST
HARDWARE PROBLEM. filenam FOR jobnam NOT STAGED.	The staging of file filenam for job jobnam was abandoned because an MSF hardware problem was detected.	Call customer engineer.	EXSTGE
HARDWARE REGISTERS NOT FOUND.	Output file message indicating that the hardware register record was not found in the EDD file.	Ensure that the dump file contains meaningful information.	DSDI
HEAD MOTION ERROR. DESTAGE RESTARTED.	A file destage operation was restarted because of a hardware problem.	Inform customer engineer.	EXDEST
HEADER NOT 30 WORDS OR TAPE POSITION LOST.	TAPRO indicates that user probably forgot to skip a loader record, or that the LINK-EDIT file is bad. Header records must be 30 16-bit or 8 60-bit words long.	Correct error and try again.	LFG
HFM ERROR ec.	Dayfile message indicating that a hardware function manager (HFM) error has occurred. ec Error code 1 An HFM argument error has occurred. An illegal function code was encountered or a parameter-word address was out of range. 2 An HFM illegal request has	Examine a listing of HFM, which can be obtained by assembling HFM.	SCRSIM

MESSAGE -----	SIGNIFICANCE -----	ACTION -----	ROUTINE -----
	occurred. HFM was called from other than a special system job, auto recall was not set, or the user did not have system origin privileges.		
	3 An illegal request for channel 36 has occurred. In this case, channel 36 is not present.		
I/O ON EXECUTE-ONLY FILE filename.	MODVAL cannot use an execute-only file as its input file.	Change input file designation.	MODVAL
ICPD COMPLETE.	Informative message indicating system monitoring by CPD has been terminated.	None.	ICPD
ILLEGAL ACCOUNT/FAMILY.	Dayfile message that may indicate that VALIDUS file is not present in the system or that the user has submitted an invalid user number or family name.	Examine the EST (H,A.) display to determine if the VALIDUS file is active in the system (VALIDUS is a fast-attach file). If VALIDUS is active, no operator action is necessary; assume an illegal user number or family name was entered. However, if VALIDUS is not active, it must be initialized (activated) via the console entry X.ISF.	ACCFAM
ILLEGAL APPLICATION ACCOUNTING REQUEST.	The application program that issued this message attempted to initiate application accounting incorrectly.	Inform site analyst.	CPM
ILLEGAL BIT NUMBER.	Dayfile message indicating that the bit number specified was greater than 203.	Correct and reenter.	SCRSIM
ILLEGAL BYTE NUMBER.	Dayfile message indicating that the byte number specified was greater than 16.	Correct and reenter.	SCRSIM
ILLEGAL CHARACTER.	Dayfile message indicating that an alphabetic character other than B or D was entered as a postradix on a decimal value, an alphabetic character, 8, or 9 was entered in an octal value argument, or a character with a display code of 60B or above was entered.	Correct and reenter.	SCRSIM
ILLEGAL CHARGE.	Dayfile and output file message indicating one of the following. - The charge or project number does not exist. - The project number is not available to	Check to see that charge and project numbers are correct and reenter.	CHARGE

MESSAGE

SIGNIFICANCE

ACTION

ROUTINE

ILLEGAL COMMA AFTER SR -- x.

a user with this user number.  
- The charge or project number exists  
but is inactive.

The skip record count x must be followed by  
a colon, semi-colon, or a period. The scan  
resumes at the next period.

Correct error.

LFG

MESSAGE -----	SIGNIFICANCE -----	ACTION -----	ROUTINE -----
ILLEGAL COMMAND.	Dayfile message indicating that the command entered was not a legitimate SCRSIM command.	Correct and reenter.	SCRSIM
ILLEGAL CONTROL CARD.	One of the following has occurred. <ul style="list-style-type: none"> <li>- The control statement could not be identified.</li> <li>- The USER control statement does not have a user number specified.</li> <li>- An invalid parameter was specified or no terminator was detected.</li> <li>- The user included too many parameters on the program call statement or the program was not present.</li> <li>- The user submitted a control statement that he was not validated to use (for example, the use of PASSWOR by user not validated to change password).</li> <li>- The user submitted a control statement that is illegal for a particular job type or file type (for example, the use of a FAMILY statement in a nonsystem origin job).</li> </ul>	Ensure accuracy and/or suitability of control statement.	TCS, CHARGE, CONFIG, MODVAL, RESEX, EXU, PASSWOR, 026
ILLEGAL CONTROL POINT NUMBER.	Output file message indicating that either the control point number specified was greater than the number in the EDD file or the job name was not found.	Correct and rerun.	DSDI
ILLEGAL CSU.	The CS parameter in a directive to ASDEBUG was not a letter from A through M.	Correct the CS parameter and retry.	ASDEBUG, ASUSE
ILLEGAL CSU NUMBER.	The CS parameter in a directive to ASLABEL was not a letter from A through M.	Correct the CS parameter and retry.	ASLABEL
ILLEGAL D.	The D parameter in a directive to ASDEBUG was not a number from 0 through 7.	Correct the D parameter and retry.	ASDEBUG
ILLEGAL DATA.	Nonfatal K-display message indicating that the data contains an illegal display character.	Correct the data and rerun.	STIMULA
ILLEGAL DELIMITER FOLLOWING filename.	A character other than a colon or semi-colon followed file filename.	Correct error.	LFG
***ILLEGAL DIRECTIVE.	Output file message indicating one of the following. <ul style="list-style-type: none"> <li>- The system encountered an unrecognizable identifier.</li> <li>- An equal sign does not separate the identifier and a value.</li> <li>- The system encountered a DCN, DPN, or</li> </ul>	Rerun using correct directives.	PROFILE

MESSAGE -----	SIGNIFICANCE -----	ACTION -----	ROUTINE -----
	DUN directive when OP=C was specified.		
ILLEGAL DIRECTIVE.	The directive specified is not a valid directive to ASLABEL or ASDEBUG.	Correct the directive and try again.	ASLABEL, ASDEBUG
ILLEGAL DRAWER NUMBER.	The D parameter in a directive to ASLABEL was not a number from 0 through 7.	Correct the D parameter and retry.	ASLABEL
ILLEGAL DUMP REQUESTED.	One of the following conditions has been detected prior to a queue file dump. - The device specified to receive the dump is not a mass storage device. - The device specified to receive the dump is removable and the type specified is A (active) or ALL.	Enter the correct parameters and retry the operation.	QDUMP
ILLEGAL ENTRY.	K-display message indicating that the processor could not recognize the specified utility option.	Correct and reenter K-display input.	QFSP, MSI, MREC
ILLEGAL FAMILY NAME.	Dayfile message indicating that the family name specified in the ISF entry is not defined in the running system.	Repeat ISF entry with correct family name.	ISF
ILLEGAL FILE NAME - filename.	Dayfile message indicating that a file has been given an illegal or duplicate name filename.	Correct and rerun.	FORMAT
ILLEGAL FILE NAME.	Dayfile message indicating that the file name specified in the ISF entry (file to be initialized) was not available to the system. Valid file names include VALIDUS, PROFILA, RSXDId, RSXVId, SYSPROC, and SYSJOB.	Repeat the ISF entry with the correct file name.	ISF
ILLEGAL FILE NAME.	Output file message indicating that an illegal file name was specified.	Correct and rerun.	DSDI
ILLEGAL FILE NUMBER.	Nonfatal K-display message indicating that the file number is greater than 18 bits.	Reenter the correct decimal file number.	STIMULA
ILLEGAL FUNCTION.	Illegal utility specified; PFS aborts.	Retry PFS entry with correct utility specified.	PFS
ILLEGAL - L AND RF PARAMETERS.	The files specified by the L and RF parameters on the ASVAL control statement are the same.	Use a different file name for either the L or RF parameter.	ASVAL
ILLEGAL LINE NUMBER.	Dayfile message indicating that the line number entered was not 0, 1, 2, or 3.	Correct and reenter.	SCRSIM

MESSAGE -----	SIGNIFICANCE -----	ACTION -----	ROUTINE -----
ILLEGAL MOVE REQUESTED.	<p>One of the following.</p> <ul style="list-style-type: none"> <li>- Device specified is not mass storage.</li> <li>- Device specified is removable; the queue file type to be moved is A (active) or ALL.</li> <li>- Destination device is removable; destination disposition option is A (files remain active).</li> <li>- Destination device is a shared device, QPROTECT is disabled, and destination disposition option is I (files remain inactive).</li> </ul>	Enter the correct parameters and retry move operation.	QMOVE
ILLEGAL N.	The N parameter in a directive to ASLABEL was not a number from 1 through 2000.	Correct the N parameter and retry.	ASLABEL
ILLEGAL NDA CALL PARAMETER p.	NDA aborted because call parameter p is illegal.	Correct parameter and call NDA again.	NDA
****ILLEGAL NUMERIC VALUE.	Output file message indicating that the value specified by a directive does not convert to binary or is not within limits for the parameter specified.	Rerun using correct value.	PROFILE
ILLEGAL OPTION.	Nonfatal K-display message indicating that an illegal keyboard entry was made.	Reenter the correct option.	STIMULA, MREC
ILLEGAL PAGING ATTEMPT.	K-display message indicating that the page advancing command (+) was entered before a LIST command or after a GO command.	None.	QREC, FNTLIST
ILLEGAL PASSWORD.	<p>One of the following.</p> <ul style="list-style-type: none"> <li>- The password entered is greater than seven characters or contains an invalid character.</li> <li>- In the PASSWOR command either an incorrect old password was specified or the new password was unacceptable.</li> <li>- In the MODVAL control statement (for a create or update run) the password for a new user contained fewer characters than the minimum length required by the site. If entered from a K display, the line of input is ignored; otherwise, that particular user number is disregarded.</li> </ul>	Correct error and retry.	PASSWOR, MODVAL, PFILES
****ILLEGAL PASSWORD IGNORED.	Output file message indicating that the password encountered during an update run was less than the minimum length required by the site. The update of the user number proceeds without the password change.	Choose a correct password and update VALIDUS via PASSWOR or rerun MODVAL, if desired.	MODVAL

MESSAGE -----	SIGNIFICANCE -----	ACTION -----	ROUTINE -----
ILLEGAL PRINT DENSITY SELECTION.	Output file message indicating a print density other than 3, 4, 6 or 8 lines per inch was specified or that no room would remain on the page after printing the header at the specified print density because the system value for lines per page is too small.	Specify valid print density and rerun, or increase print density and/or contact site analyst to increase system value for lines per page.	DSDI
ILLEGAL PRINT OPTION SELECTION.	Output file message indicating that an illegal list option was specified in a directive.	Correct and rerun.	DSDI
ILLEGAL REPORT OPTION.	The OP parameter on the ASUSE control statement was not a letter from A through E.	Correct the OP parameter and retry.	ASUSE
ILLEGAL - RF AND AM PARAMETERS.	AM cannot be specified if RF is specified. Both AM and RF were specified on the ASVAL control statement.	Specify either AM or RF, or neither AM nor RF, but not both.	ASVAL
ILLEGAL - RF AND FM PARAMETERS.	FM cannot be specified if RF is specified. Both FM and RF were specified on the ASVAL control statement.	Specify either FM or RF, or neither FM nor RF, but not both.	ASVAL
ILLEGAL - RL AND NO RF PARAMETER.	RL can be specified only if RF is also specified. RF was not specified, but RL was specified on the ASVAL control statement.	Either specify both RF and RL or neither.	ASVAL
ILLEGAL SDF DEVICE.	The equipment selected to receive a deadstart file does not meet the requirements of an RMS deadstart device.	Ensure accuracy of control statement or select another device.	IIS
ILLEGAL SL.	The SL parameter in a directive to ASDEBUG was not a number from 0 through 15 or was greater than the SU parameter.	Correct the SL parameter and retry.	ASDEBUG
ILLEGAL SU.	The SU parameter in a directive to ASDEBUG was not a number from 0 through 15 or was less than the SL parameter.	Correct the SU parameter and retry.	ASDEBUG
ILLEGAL SUBFAMILY.	The SB parameter on the ASUSE control statement or in a directive to ASLABEL or ASDEBUG was not a number from 0 through 7.	Correct the SB parameter and retry.	ASLABEL, ASDEBUG, ASUSE
ILLEGAL TASK PERCENTAGE.	The task percentage specified exceeds 100.	Correct task percentage in the task definition in the session file.	STIMULA



MESSAGE -----	SIGNIFICANCE -----	ACTION -----	ROUTINE -----
ILLEGAL USER ACCESS.	The user tried to perform an operation for which he is not validated. Possible causes include attempts to <ul style="list-style-type: none"> <li>- run a system origin job from nonsystem origin</li> <li>- access a restricted subsystem without proper validation</li> <li>- enter an invalid SRU value</li> <li>- use the V carriage control character without validation</li> </ul>	Ensure accuracy of control statement or determine proper validation requirements via LIMITS statement.	LFM, NETVAL, QFSP, RESEX, IMA
ILLEGAL USER INDEX.	Nonfatal K-display message indicating that the user index is greater than 18 bits.	Enter the correct user index.	STIMULA
ILLEGAL VALUE FOR MRES -- itm.	Specified memory resident must be 3-character alphanumeric item. The scan continues with the next item.	Correct error.	LFG
ILLEGAL VALUE FOR OVLID -- ovl.	Overlay identification must be a 3-character alphanumeric item with the first character A through O. The scan continues with the next item.	Correct error.	LFG
ILLEGAL VALUE FOR SR -- x.	The skip record count x must be a single numeric digit. The scan continues with the next character.	Correct error.	LFG
IMPROPER NUMERIC PARAMETER.	Nonfatal K-display message indicating that the field was too large, too small, or alphabetic.	Reenter the correct data.	STIMULA
IMS - TRACK FLAWED,EQxx,Tttt.	Flawed track found on equipment with EST ordinal xx and logical track tttt.	Hardware error. Contact customer engineer.	IMS
INACTIVE DAYFILE NOT FOUND ON DEVICE.	An inactive dayfile of the specified type was not found on the specified device.	Enter the correct family and device number using the K display. Use DFLIST to see where dayfiles reside.	DFTERM
INACTIVE DAYFILE ON DEVICE.	An inactive dayfile already exists on the device on which a new active dayfile is to be created.	Enter another device using the K display.	DFTERM
INACTIVE LOAD NOT ALLOWED.	The load parameters specify loading of inactive queues on a shared device, and QPROTECT is disabled. This is not allowed. The device must be a nonshared device, or the load must be changed to an active load.	Enter the correct parameters and retry the operation.	QLOAD

MESSAGE -----	SIGNIFICANCE -----	ACTION -----	ROUTINE -----
INCOMPLETE DESTINATION FAMILY/USER.	Either the DF or UN parameter was entered without the other.	Specify both parameters and rerun utility.	FNTLIST
INDEX BUFFER LIMIT.	The limit for user indexes on a catalog track has been reached.	Increase index buffer length (INDBL).	PFCAT
INITIAL PF SPACE = n.	Informative message indicating that the permanent file space at the beginning of the ASMOVE run is n PRUs.	None.	ASMOVE
INITIALIZATION PROBLEMS - BAD MSS CONFIGURATION.	The EST is incorrect.	Correct the EST.	EXINIT
INITIALIZATION PROBLEMS - NO CSUMAPS FOUND.	CSU maps are missing.	Recover or recreate the missing CSU maps.	EXINIT
INITIALIZATION PROBLEMS - NO FAMILIES WITH 8 CATALOGS FOUND.	MSF catalogs are missing.	Recover or recreate the missing MSF catalogs.	EXINIT
INPUT BUFFER SIZE EXCEEDED -- INCREASE BUFLN.	NPUF indicates that a LINK-EDIT record larger than the buffer was encountered. This can occur if LFG tries to read a large garbage record from tape.	Increase the input buffer size.	LFG
INPUT FILE EMPTY.	The input file did not contain the required file description cards.	Include file description cards and try again.	LFG
INQUIRING usernum.	Message displayed at line 1 of control point indicating that the user number usernum is being inquired.	None.	MODVAL
INQUIRY COMPLETE.	Dayfile message indicating that the inquiry is completed.	None.	MODVAL
INSTALL ABORTED.	The install job was aborted by the operator.	None.	IIS
INSTALL - ARGUMENT ERROR.	The INSTALL control statement is syntactically incorrect.	Check parameters on INSTALL control statement.	INSTALL
INSTALL FILE NOT FOUND.	The file to be installed as a deadstart file was not found (is not assigned to the job control point).	Assign the file to be installed to the job control point before calling INSTALL.	IIS
INSTALL FILE NOT MASS STORAGE.	The file to be installed as a deadstart file does not reside on mass storage.	If the file to be installed is a tape file, copy it to mass storage.	IIS
INSUFFICIENT CUBES. NUMBER PROCESSED = n.	The number of cubicles to be added to the subfamily is more than the number of unassigned cubicles contained in the CSU. However, n cubicles were added.	Reassign empty cubicles presently assigned to another subfamily or acquire an additional	ASLABEL

<u>MESSAGE</u>	<u>SIGNIFICANCE</u>	<u>ACTION</u>	<u>ROUTINE</u>
INVALID AD IGNORED.	The AD parameter of NDA has an invalid date. A valid date has the form AD=yymmdd.	CSU. Correct the date on the AD parameter and try again.	NDA
INVALID CHANNEL NUMBER.	The channel number specified by the C=cc parameter on the LOADBC control statement is invalid.	Correct the channel number and retry.	LOADBC
INVALID CHARACTER AFTER ITEM p	NDA aborted because an illegal item was associated with call parameter p.	Correct error and call NDA again.	NDA
INVALID CS PARAMETER.	The CS parameter on the ASVAL control statement was not a letter from A through M.	Correct the CS parameter and retry.	ASVAL
INVALID DATA IN INPUT STREAM.	Dayfile message indicating that the input file contains data that is incorrect.	Refer to the listing of the input stream for statements in error.	FORMAT
INVALID DEVICE SPECIFIED.	Dayfile message indicating that the device specified is in an improper state for the selected operation to proceed.	Correct and rerun.	FORMAT
INVALID FX PARAMETER.	The FX parameter on the ASVAL control statement was not a number.	Correct the FX parameter and retry.	ASVAL
INVALID PARAMETER ON PROGRAM CALL CARD.	Dayfile message indicating that at least one unrecognizable parameter was found on the FORMAT control statement.	Correct and rerun.	FORMAT
INVALID SB PARAMETER.	The SB parameter on the ASVAL control statement was not a numeric character string specifying some of the subfamilies from 0 through 7.	Correct the SB parameter and retry.	ASVAL
INVALID ST PARAMETER.	The ST parameter on the ASVAL control statement parameter was not a number.	Correct the ST parameter and retry.	ASVAL
INVALID SYSTEM SECTOR.	An error occurred while the system sector was being read.	Inform site analyst.	QFM
INVALID TDAM REQUEST.	There is an internal error in PFM or PFU.	Inform site analyst.	MSSEXEC
INVALID USER ACCESS.	The permanent files utilities were called by a non-system origin user without proper validation.	Ensure proper validation.	PFS
INVALID VSN.	The VSN specified on an FX directive contains invalid characters; or the cartridge label for the current directive has an invalid VSN.	Retry specifying a valid VSN; or use FX directive to relabel the cartridge.	ASLABEL

MESSAGE -----	SIGNIFICANCE -----	ACTION -----	ROUTINE -----
IQFT FILE ERROR DN dn FAMILY family.	An error was encountered during an attach or read of the IQFT file. The message which follows this message in the dayfile describes the error. dn Device number family Family name	Inform site analyst.	QDUMP QMOVE
ISF COMPLETE.	Dayfile message indicating that ISF operation is complete.	None.	ISF
JOBNAME LIST FULL.	K-display message indicating that the jobname list does not have room for the specified job name. The jobname list may have up to five job names entered.	None.	QFSP
KEY OVERFLOW -- NEED TO INCREASE KEY SIZE.	NPUF indicates that the SIS key was not large enough to write all the records in a memory resident.	Increase the size of the SIS key.	LFG
KEYWORD NOT EQUIVALENCED.	Output file message indicating that a keyword was entered without a value associated with it.	Correct and rerun.	VALNET
****KRONOS INPUT DIRECTIVE IGNORED.	Output file message indicating that a KRONOS input identifier (MS or PR) was encountered during a MODVAL (CV,OP=C) creation run. The system ignores the PR identifier and sets the MS field of the user number record to its default value.	None.	MODVAL
LABEL ERROR, xxx. DESTAGE RESTARTED.	A file destage operation was abandoned because the cartridge label verification procedure for a selected cartridge encountered an error of type xxx on the stream selected for writing. These errors result in the stream conflict error flag being set in the MSF Catalog entry for that stream of that cartridge. The destage is automatically restarted and a different cartridge is used. xxx One of the following errors. CSU FAMILY READ PARITY STREAM VSN VSN AND CSU VSN AND XY XY	Run ASVAL to identify the problem cartridge and stream and the affected permanent file, if any. Refer to Error Conditions and Corrective Action in section 3.	MSSEXEC
LABEL xxx MISMATCH. filenam STAGING ERROR, JOB=jobnam, FM=family, UI=userin, CSU=id, MST=n, VSN=vsn, ASA=addr, STRM=s.	The staging of file filenam was aborted and an error flag was set in the file's PFC entry because an error with xxx was detected during the stream label verification	Retrieve the file from a dump tape if a backup copy is available. Run ASVAL to identify other	MSSEXEC

MESSAGE

SIGNIFICANCE

procedure or the file label verification procedure. All jobs attempting to attach this file will be aborted or given an error response. The stream conflict error flag

ACTION

files, if any, that are affected by this error. Either remove and

ROUTINE

MESSAGE -----	SIGNIFICANCE -----	ACTION -----	ROUTINE -----
	is set in the MSF Catalog entry for the affected cartridge and stream. xxx One of the following errors. ASA BACKLINK CSU FAMILY PRU STREAM NUMBER UI VSN XY	reassign the cartridge or run ASDEBUG to clear the stream conflict error flag. Refer to Error Conditions and Corrective Action in section 3.	
LDLIST OPERATION COMPLETE.	Informative message indicating completion of QLOAD.	None.	QLOAD
LENGTH IN 52 TABLE .NE. FET.	The controlware record length in the 52 table did not equal the controlware record length specified in the FET after the controlware was read into the LOADBC field length.	Check system controlware records.	LOADBC
LEVEL-0 DATA BASE ERROR.	Dayfile message indicating that a level 0 block on the VALIDUs file was not present or was incorrect.	Ensure that the file is local and contains valid level 0 and level 1 blocks (at least one user entry) and rerun.	MODVAL
LEVEL-1 INDEX BLOCKS LINKED.	Dayfile message indicating that index blocks are linked.	None, although if the validation file can be reformatted to eliminate block linkage, searches will be faster for user numbers residing in linked blocks and for nonexistent user numbers which would have resided in linked blocks.	MODVAL
LEVEL-2 DATA BASE ERROR.	Dayfile message indicating that a VALIDUs structure error in the level 2 block was detected.	Inform site analyst immediately.	MODVAL
LFG COMPLETE.	LFG terminated normally.	None.	LFG
LFG COMPLETE -- ABNORMAL TERMINATION.	LFG terminated abnormally.	Determine cause from other error messages.	LFG
*LFM* ERROR ON ERRxxx FILE.	During the file rename, lock, and common sequence to save error file ERRxxx, an LFM error occurred. xxx Sequence number from 001 through 999.	Inform site analyst.	QLOAD

MESSAGE -----	SIGNIFICANCE -----	ACTION -----	ROUTINE -----
LINE SPEED OUT OF RANGE.	Output file message indicating that a line speed value was entered which was not in the range of 1 through 2047.	Correct and rerun.	VALNET
LIST COMPLETE.	Informative message on the K display indicating that the LIST command has completed.	None.	QREC, FNTLIST
LISTING REMAINING FILES.	Informative message indicating that the remaining catalog image files are being listed.	None.	PFLOAD
LOAD FILE MISPOSITIONED.	Either of the following situations has occurred. - A file position function indicated an attempt to position beyond EOI. - During a file read function, the control word read was not the expected control word.	Rewind the load file and retry the operation.	QLOAD
LOAD FILE POSITION LOST.	Position on the load file was lost during the write error recovery sequence.	Retry or inform site analyst.	QLOAD
LOADING filename userin.	Informative message indicating the name of the file currently being loaded and the associated user index.	None.	PFLOAD
LOADING - DIRECT ACCESS FILES ONLY.	Informative message indicating that only direct access files have been selected to be loaded (OP=D option specified).	None.	PFLOAD
LOADING FROM xxx TO yyy.	Informative message indicating the device from which the files being loaded came and the device to which they are being loaded. xxx Device mask of the device that was dumped to the archive tape being loaded yyy Device mask of the device to be loaded	None.	PFLOAD
LOADING - INDIRECT ACCESS FILES ONLY.	Informative message indicating that only indirect access files have been selected to be loaded (OP=I option specified).	None.	PFLOAD
LOST STIMOUT DATA.	Nonfatal output file message indicating that the buffer has overrun, since CIO is not servicing the stimulator output buffer fast enough.	Reassemble STIMULA with a larger output buffer, reduce line speed or input speed, or increase think time for stimulation.	ITS, ITE

MESSAGE -----	SIGNIFICANCE -----	ACTION -----	ROUTINE -----
LT OPTION NOT SPECIFIED CORRECTLY.	The LT option is valid only with the RM directive; LT was specified in another directive to ASLABEL.	Correct the directive and retry.	ASLABEL
MAINLOG - message	Refer to the explanation of AFD - message if the message is not among the individually documented MAINLOG messages.		
MAINLOG - FR TIME VALUE ILLEGAL.	The time specified via the FR option cannot be converted to a packed time for searching the binary maintenance log.	Retry with a valid time specified.	DAYFILE
MAINLOG - LINKAGE ERROR.	The beginning of the next message is not clearly indicated because the offset in the previous maintenance log message does not agree with the sector offset. The utility assumes the maintenance log message offset is in error, skips the message containing it, and resumes processing with the message indicated by the sector offset.	None.	DAYFILE
MAINLOG - OP OPTION ILLEGAL.	The specified option is not valid when dumping the binary maintenance log.	Retry with a valid option.	DAYFILE
MAINLOG - RECOVERY SECTOR ENCOUNTERED.	A level 0, 1, or 2 deadstart was performed at this point in the binary maintenance log. If the utility detects a linkage error it discards any message fragment being processed.	Always checkpoint the system before performing a level 0, 1, or 2 deadstart.	DAYFILE
MAINLOG - TTY BINARY OUT-FILE NOT ALLOWED.	The binary maintenance log cannot be written to a terminal (TT) device type.	Specify a non-TT destination file.	DAYFILE
MAINTENANCE LOG DUMPED.	The binary maintenance log dump is complete.	None.	DAYFILE
MANUFACTURING DATA INVALID.	Dayfile message indicating that one of the factory-recorded sectors, containing either manufacturing or flaw data, is either unreadable or not present.	Refer to the output listing for a detailed status report indicating the actual problem. If the factory-recorded data cannot be read, the pack cannot be processed using this utility. Customer engineering must be contacted to add this format information off-line.	FORMAT
MASTER USER NUMBER REQUIRED.	Dayfile message indicating that the job did not enter a user number (via USER statement). This is needed for a master user list run and for a master user inquire run.	Rerun job with USER statement validation.	PROFILE
MAXIMUM NUMBER OF ARGUMENTS.	Dayfile message indicating that only the first 30 bit numbers were accepted on a SET. or a CLEAR. command.	Correct and reenter.	SCRSIM



MESSAGE -----	SIGNIFICANCE -----	ACTION -----	ROUTINE -----
MEMORY OVERFLOW.	There is no more space left in memory for SYSEDIT internal tables.	Reduce the number of programs to SYSEDIT and retry.	SYSEDIT
MEMORY REQUEST ERROR.	Fatal dayfile message indicating that STIMULATOR and ITS do not agree on the correct field length.	Rerun job; this could be caused by a system failure.	ITS, ITE
MISSING CARTRIDGE. DESTAGE RESTARTED.	A file destage operation was restarted using a different cartridge because the selected cartridge could not be found in its assigned cubicle.	Run ASUSE (OP=B) to identify the lost cartridge. When it is located, run ASLABEL to restore it to its proper cubicle.	EXDEST
MISSING CARTRIDGE. filenam FOR jobnam NOT FOUND ON MSS.	The staging of file filenam for job jobnam was abandoned because a cartridge was missing.	When the cartridge is located, a site analyst should run ASLABEL to restore it to its proper cubicle. (Refer to section 3 of the NOS System Maintenance Reference Manual.)	EXSTGE
MISSING EOR.	Logical EOR missing on the file being loaded (invalid data). File is truncated and length of file is updated in catalog. This message is followed by the message PFLOAD - TAPE ERROR filenam userin.	Retry or use backup tape.	PFLOAD
***MISSING VALUE.	Output file message indicting that the user has specified a directive identifier without a value.	Correct and rerun.	PROFILE
MODIFIED AFTER yy/mm/dd. hh.mm.ss.	Informative message indicating that files modified after the specified date and time have been loaded (or dumped).	None.	PFLOAD, PFDUMP
MODIFIED BEFORE yy/mm/dd. hh.mm.ss	Informative message indicating that files modified before the specified date and time have been loaded (or dumped).	None.	PFLOAD, PFDUMP
MODVAL ABORTED.	Dayfile message indicating that a control point error flag has been set.	Consult the dayfile listing for reason.	MODVAL
MRF PROCESSING COMPLETE, FM=family.	Informative message indicating that MSSEXC processing of file MOVCOM for the family indicated is complete.	None.	EXDEST
MS ERROR ON DEADSTART FILE.	A mass storage error was encountered while the deadstart file was being written.	Use FORMAT to reserve the bad sector.	IIS
MS LOAD FILE NOT PRESENT.	A mass storage load file requested by ME=MS was not at the control point.	Assign mass storage file and repeat call.	QLOAD

MESSAGE -----	SIGNIFICANCE -----	ACTION -----	ROUTINE -----
MSF CATALOG CHAIN LINKAGE BAD. filenam STAGING ERROR, JOB=jobnam, FM=family, UI=userindex, CSU=id, MST=n, VSN=vsn, ASA=addr, STRM=s.	A linkage error was encountered on the MSF catalog.	A site analyst should run ASVAL to report on the problem and take appropriate corrective action. (Refer to section 3 of the NOS System Maintenance Reference Manual.)	EXSTGE
MSF CATALOG ERROR FLAGS SET. filenam FOR jobnam.	Informative message indicating that the frozen chain flag or stream conflict flag was set on one or more streams of file filenam. The file is staged successfully unless other messages are issued which indicate reasons why the stage is delayed or aborted.	Run ASVAL to identify the error flags that are set and take appropriate action. Refer to Error Conditions and Corrective Action in section 3.	EXSTGE

<u>MESSAGE</u>	<u>SIGNIFICANCE</u>	<u>ACTION</u>	<u>ROUTINE</u>
MSF CATALOG INTERLOCKED. DESTAGE DELAYED, FM=family, SF=sub.	A file destage operation was delayed because the MSF catalog for the family and subfamily indicated is being accessed. The destage will resume when the MSF Catalog becomes available.	None.	MSSEXEC
MSF CATALOG INTERLOCKED. STAGING DELAY, FM=family, UI=userin.	Staging is delayed because PFDUMP or ASVAL is accessing the MSF Catalog. Staging will resume automatically when the interlock is no longer needed.	None.	MSSEXEC
MSF CATALOG NOT ONLINE. DESTAGE ABANDONED, FM=family, SF=sub.	A file destage operation was abandoned because the MSF catalog for the family and subfamily indicated was not on line. The next ASMOVE run for this subfamily will reselect these files for destaging.	None.	MSSEXEC
MSF CATALOG NOT ONLINE. filenam FOR jobnam NOT STAGED.	The staging of file filenam for job jobnam was abandoned because the MSF catalog was not on line. This condition exists when a removable family is mounted after MSSEXEC was initiated or when an I/O error occurred on the MSF catalog.	A site analyst should ensure that the MSF catalog is on line and recover from the I/O error, if necessary. Then restart MSSEXEC.	MSSEXEC
MSF CATALOG OPEN ERROR.	The MSF catalog does not exist or is invalid for the specified family and subfamily.	Correct the SB parameter on the ASVAL control statement or reload/recreate the MSF catalog.	ASVAL
MSF CATALOG PARITY ERROR.	There is a read parity error on the MSF Catalog.	Recover the MSF Catalog from a backup copy and retry.	ASUSE
MSF CATALOG READ ERROR.	A parity error was encountered on the MSF Catalog.	Recover the MSF catalog from a backup copy and retry.	ASVAL
MSF CATALOG READ ERROR. DESTAGE ABANDONED, FM=family, SF=sub.	A file destage operation was abandoned because the MSF catalog for the family and subfamily indicated contained a read error. This error may result in subsequent MSF CATALOG NOT ONLINE messages.	Investigate cause of error and take appropriate corrective action.	MSSEXEC
MSF HARDWARE PROBLEM.	The directive to ASLABEL or ASDEBUG cannot be processed at this time because of an MSF hardware failure.	Rerun after a repair has been made.	ASLABEL ASDEBUG
MSF SYSTEM ERROR.	There are problems with the MSS software.	Inform site analyst.	ASDEBUG

MESSAGE -----	SIGNIFICANCE -----	ACTION -----	ROUTINE -----
MSS ACTIVE.	Informative message indicating that the Mass Storage Subsystem is active at a control point.	None.	MSSEXEC
MSSDRVR ABNORMAL, xxx.	There is an internal error in module xxx of the MSS driver.	Inform site analyst.	MSSEXEC
MSSEXEC SEEKING FL INCREASE.	MSSEXEC needs space for its tables before it can be initialized.	Take action to make additional memory available.	MSSEXEC
MULTIPLEXER CHANNEL UNDEFINED ON PREVIOUS MUX DESCRIPTION.	Output file message indicating that no channel parameter was specified on the previous multiplexer definition directive. This is mandatory for //STIM, //6671, and //6676 directives.	Correct and rerun.	VALNET
MULTIPLEXER DESCRIPTION EXPECTED.	Output file message indicating that no multiplexer definition directive was specified. This directive should precede a set of terminal definition directives.	Correct and rerun.	VALNET
MULTIPLEXER EQUIPMENT UNDEFINED ON PREVIOUS MUX DESCRIPTION.	Output file message indicating that no equipment parameter was specified on the previous multiplexer definition directive. This is mandatory for //STIM, //6671, and //6676 directives.	Correct and rerun.	VALNET
NEW DESTINATION USER/FAMILY INVALID.	K-display message indicating that the user number specified by NUN is not on the VALIDUs file in the family specified by NDF.	Ensure accuracy of NUN and NDF parameters and rerun.	FNTLIST
NO ACTIVE DAYFILE FOUND.	An active dayfile of the specified type was not found in the QFSP equipment table.	Stop this DFTERM run, start another DFTERM run, and retry the operation. If the error still exists, check system for loss of dayfile.	DFTERM
NO BITS SPECIFIED.	Dayfile message indicating that no bit numbers were specified on a SET. or a CLEAR. command.	Correct and reenter.	SCRSIM
NO CARTRIDGE AVAILABLE IN POOL.	A cartridge from the pool is needed so that the directive to ASLABEL can be processed.	Assign more cartridges to the pool or change the directive.	ASLABEL

MESSAGE -----	SIGNIFICANCE -----	ACTION -----	ROUTINE -----
***NO CHARGE NUMBER IN EFFECT.	Output file message indicating that a charge number must be in effect before any charge value or project directives can be processed.	Enter a correct charge number directive before proceeding.	PROFILE
NO CONTROLWARE ON CHANNEL.	The CCTL channel table indicates that no controlware exists on the requested channel.	Check the C=cc parameter on the LOADBC control statement and retry.	LOADBC
NO DATA BLOCK.	DATA control word was not found when PFLOAD expected data for current file; length is set to zero. This is a nonfatal system error and is followed by the message PFLOAD - TAPE ERROR filename userin.	Retry or use backup tape.	PFLOAD
NO DESCRIPTIONS FOUND.	Dayfile message indicating that no multiplexer and/or terminal descriptions were found on the description record.	Ensure that the correct file is specified with the P option on the VALNET control statement and rerun.	VALNET
NO DEVICES IN THE FAMILY.	The family specified by the FM parameter on the ASMOVE control statement has no devices on line.	Bring the devices on line or specify a different family.	MAC2
NO DIRECTIVES PROCESSED.	No directives were specified on the DSDI control statement.	Reenter control statement with directives specified.	DSDI
NO DUMPS FOUND FOR NPU = npu.	User-specified NPU name, npu, was not found in the dump file index.	Correct NPU specification and try again.	NDA
NO EMPTY CARTRIDGES AVAILABLE IN FAMILY.	There are no empty cartridges that the RM directive to ASLABEL can remove.	None.	ASLABEL
NO EMPTY CUBE IN FAMILY/POOL.	Empty cubicles assigned to the family/pool are needed so that the directive to ASLABEL can be processed.	Assign more cubicles to the family/pool or change the directive.	ASLABEL
NO EMPTY CUBES. NUMBER PROCESSED=n.	There are no more empty cubicles in the family/pool/reserved area. The RB directive to ASLABEL could remove only n cubicles.	None.	ASLABEL
NO EOI FOR FILE.	Next catalog (or other control word type that logically precedes the previous DATA control word) was found before EOI was detected for the current file. Length is updated in catalog entry. This is a non-fatal system error and is followed by the message PFLOAD - TAPE ERROR filename userin.	Retry or use backup tape.	PFLOAD

MESSAGE -----	SIGNIFICANCE -----	ACTION -----	ROUTINE -----
NO FILES PROCESSED.	Informative message indicating that no files have been loaded, cataloged, or copied during the utility run.	None.	PFATC, PFCAT, PFCOPY, PFLOAD
NO GENERAL STATUS RECEIVED.	After the function was performed, no status word was received.	Inform customer engineer.	LOADBC
NO INACTIVE QUEUED FILES PRESENT.	No inactive queues were found during the processing of a LIST command.	None.	QREC
NO INACTIVE QUEUES ON DEVICE.	Informative message indicating that the LIST command failed to find any inactive queued files on the device specified on the K display by the FM/DN parameter.	None.	QREC
NO MANUFACTURER OR SCRATCH LABEL.	The cartridge to be added has a label of unknown type.	Discard the cartridge or use the FX directive to ASLABEL to restore the label.	ASLABEL
NO MATCHING FAMILY LABEL.	The family or subfamily in the cartridge label does not agree with the values specified in the directive to ASLABEL.	Try restoring the cartridge or use correct family and subfamily.	ASLABEL
NO MORE RECORDS OF TYPE x TO PROCESS.	Processing of record type x requires more records of type x than can be found in the dump file.	Analyze error and try again.	NDA
NO MSF SPACE. DESTAGE ABANDONED, FM=family, SF=sub, CSU=id.	A file destage operation was abandoned because of insufficient MSF space; id is the CSU identifier of the CSU with the most space available.	Either use ASLABEL to add cartridges to the specified subfamily or use ASVAL to purge unneeded MSF space. ASUSE can be used to report on the availability of space for each CSU and subfamily.	EXDEST
NO MSF SPACE. DESTAGE ABANDONED, FM=family, SF=sub.	A file destage operation was abandoned because there was no CSU assigned to the indicated family and subfamily with any space available.	Run ASUSE to obtain a report on the availability of cartridge space. If enough space is available on a CSU, ensure that the CSU and at least one MST is available for use. If adequate space is not available, use ASLABEL	EXDEST

MESSAGE -----	SIGNIFICANCE -----	ACTION -----	ROUTINE -----
		to add cartridges to the subfamily or use ASVAL to purge unneeded MSF space.	
NO OFF CARTRIDGE LINK. DESTAGE RESTARTED.	A file destage operation was restarted using a different cartridge because the selected cartridge could not contain the remainder of the file and could not be linked to another cartridge.	None.	EXDEST
NO OUTPUT FILE EXISTING.	K-display message indicating that no output file was created before the OUT command was entered.	None.	DFTERM
NO OUTPUT FILE EXISTS.	K-display message indicating that no output file was created before the OUT command was entered.	None.	QDUMP, QMOVE
NO OUTPUT FILE PRESENT.	The OUT command was entered but QLOAD could not find an output file to release.	Create an output file and retry operation.	QLOAD
NO PARAMETER SUPPLIED.	There is no channel parameter (C=cc) on the LOADBC control statement.	Add the C=cc parameter to the LOADBC control statement.	LOADBC
NO PERMANENT DAYFILES.	Informative message indicating that no permanent dayfiles exist on any permanent file device.	None.	DFTERM
***NO PROJECT NUMBER IN EFFECT.	Output file message indicating that a project number must be in effect before any project value directives can be processed.	Enter a project number directive before proceeding.	PROFILE
NO QUEUED FILES FOUND.	No queued files meet the specified selection criteria.	Ensure that correct selection criteria were entered and rerun.	FNTLIST
NO STIMULATOR TERMINALS DEFINED.	Fatal dayfile message indicating that the time-sharing subsystem has not been initialized using the stimulator EST entry.	Correct and rerun.	ITS, ITE
NO SUCH CSUMAP OR SUB-CATALOG.	The CSU specified by the CS parameter is not assigned to the subfamily specified by the SB parameter.	Correct the CS and/or SB parameter on the ASLABEL control statement.	ASLABEL
NO SUCH SUBCATALOG.	The CSU specified by the CS parameter is not assigned to the subfamily specified by the SB parameter.	Correct the CS and/or SB parameter.	ASDEBUG

MESSAGE -----	SIGNIFICANCE -----	ACTION -----	ROUTINE -----
NO TTYS ASSIGNED.	There are no terminals assigned to the sessions.	Enter assigned terminals using the MX directive.	STIMULA
****NO USER INDICES AVAILABLE.	Output file message indicating that no more user indices are available for automatic assignment. If entered from the K display, the line of input on which the error occurred is disregarded; otherwise, that particular user number is disregarded.	Rerun the corrected job or correct the new validation file using the FUI directive (force user index to be inserted or changed) to specify user indices.	MODVAL
NO 52 TABLE IN CONTROLWARE RECORD.	The controlware read from the system file did not contain a 52 table entry.	Check the system controlware records.	LOADBC
NO 77 TABLE IN CONTROLWARE RECORD.	The controlware read from the system file did not contain a 77 prefix table entry.	Check the system controlware records.	LOADBC
NON FROZEN FRAGMEN.	The specified fragment which ASDEBUG was requested to release did not have the frozen flag set.	Correct the directive and retry.	ASDEBUG
NOT ENOUGH ARGUMENTS.	Dayfile message indicating that before the correct number of arguments was specified, a terminator was encountered.	Correct and reenter.	SCRSIM
NOT ENOUGH MASS STORAGE.	Not enough mass storage exists on the specified device to enable creation of a new active dayfile.	Enter new device using the K display.	DFTERM
****NOT MASTER USER.	Output file message indicating that the user is neither a master user of a specified charge number, a special accounting user, nor from system origin, as is required for the directive entered.	None.	PROFILE
NOTICE*** CHECKPT BOUNDARY - n WORDS LOST.	The utility discarded a message fragment of n words upon encountering a checkpoint boundary.	None.	DAYFILE
NOTICE*** DATA READ ERROR - n WORDS LOST.	Read error caused loss of n words in the dayfile.	None.	DAYFILE
NOTICE*** FILE TOO LONG - n WORDS.	The dayfile is n words longer than the system file manager reported to DAYFILE.	Inform site analyst.	DAYFILE
NOTICE*** FILE TOO SHORT - n WORDS LOST.	The dayfile is n words shorter than the system file manager reported to DAYFILE.	Inform site analyst.	DAYFILE
NPU TYPE ERROR IN DUMP NUMBER dmp.	The header record of dump number dmp contains an illegal NPU type.	Correct the header and try again.	NDA
NS STATISTICS.	The values following this message are used for internal maintenance and tuning only. Refer to NS program listing if further information is needed.	None.	NS



MESSAGE -----	SIGNIFICANCE -----	ACTION -----	ROUTINE -----
NUMBER OF BITS TOO LARGE.	Dayfile message indicating that the number of bits entered on the AREA. command was larger than the number of bits from the starting bit to the end of the register.	Correct and reenter.	SCRSIM
NUMBER OF CYCLES TOO LARGE.	Dayfile message indicating that the number of cycles specified on the CYCLE. command was greater than 4095.	Correct and reenter.	SCRSIM
NUMBER OF LINE REGULATIONS = nnnnnn.	Informative dayfile message indicating the number of time line regulations (REPEAT..) that were encountered.	To reduce the number of line regulations, reduce the stimulator load by reducing the	STIMULA

MESSAGE -----	SIGNIFICANCE -----	ACTION -----	ROUTINE -----
NUMBER OF RECORDS WRITTEN n.	The number of records written to the NPU load file, NPUFL, was n.	None.	LFG
NUMERIC CONSTANT ERROR.	Output file message indicating any of the following. - Nonnumeric characters were present in a numeric constant. - An 8 or 9 was present in a constant value with a postradix B. - A character followed the postradix.	Correct and rerun.	VALNET
OBSOLETE MSF CATALOG ONLINE. filenam FOR jobnam NOT STAGED.	The staging of file filenam for job jobnam was abandoned because an obsolete MSF catalog was used.	Recover the current copy of the MSF catalog. A site analyst should run ASVAL to analyze the MSF catalog and the PFC entries (refer to section 3 of the NOS System Maintenance Reference Manual).	EXSTGE
ON, OFF NOT SPECIFIED CORRECTLY.	ON and OF are valid only with the IB directive; ON or OF was specified on another directive to ASLABEL.	Correct the directive and retry.	ASLABEL
OUTPUT FILE NAME CONFLICT.	The specified output file name conflicts with a name already in use.	Change the output file name and retry operation.	QMOVE
OUTPUT FILE RELEASED.	Informative message on K display indicating that output file was released to the printer.	None.	DFTERM QREC QMOVE QDUMP QLOAD FNTLIST
OVERLAY SIZE EXCEEDS OVERLAY AREA.	The word count in the overlay area header record does not match that in the overlay header, possibly indicating a bad CCP binary input file.	Check the CCP binary input file.	LFG
P.F. DEVICE dn DUMPED.	Informative message indicating that dumping of permanent files from device with device number dn is complete.	None.	PFDUMP

MESSAGE -----	SIGNIFICANCE -----	ACTION -----	ROUTINE -----
P.F. DEVICE dn LOADED.	Informative message indicating that loading of permanent files from device with device number dn is complete.	None.	PFLOAD
PACK packnam LOADED.	Informative message indicating that the auxiliary device, identified by packnam, has been loaded.	None.	PFLOAD
PACKNAME packnam DUMPED.	Informative message indicating that the auxiliary device, identified by packnam, has been dumped.	None.	PFDUMP
PAGING COMPLETE.	Informative message on the K display indicating that page advancing command (+) has completed.	None.	QREC
PARAMETER DN OR NPU MISSING.	Neither DN nor NPU is specified on the NDA call.	Specify either DN or NPU on the NDA call and try again.	NDA
PARAMETER value ILLEGAL FOR nam.	NDA has detected an illegal parameter value value The illegal parameter value. nam The parameter name DN, NPU, B, E, or LO.	Correct parameter and call NDA again.	NDA
PARITY ERROR IN CATALOG IMAGE dm ct.	Parity error was encountered while PFLOAD read catalog image information for catalog track ct for the master device with device mask dm. Operator entry of K.GO causes the affected catalog track to be skipped but other catalog tracks to be processed. Entering anything else causes the load to abort.	Enter E to terminate loading, L to list remaining files, GO to resume incremental load.	PFLOAD
***PASSWORD REQUIRED.	A password was not encountered for the user number being created. If MODVAL is being run from batch, the user number is not created.	Specify a password if at K display or correct and rerun if from batch.	MODVAL
PERMANENT DAYFILE DEFINED AS filename.	Informative message indicating that the dayfile has been terminated and defined under the name filename.	None.	DFTERM
PERMANENT DAYFILE LIST COMPLETE.	K-display message for DFTERM or output file message for DFLLIST indicating that the permanent dayfile list is complete.	None.	DFLLIST DFTERM
PERMANENT FILE PROBLEM.	A permanent file error was encountered on the CSU map or the MSF catalog.	Recover the CSU map or MSF catalog.	ASDEBUG

MESSAGE -----	SIGNIFICANCE -----	ACTION -----	ROUTINE -----
PERMIT RI RANGE ERR filenam userin.	Random index of the permit information for file filenam is not within the legal range. This is a nonfatal system error.	Inform site analyst.	PFDUMP
PERMITS MISSING.	Permit information on archive tape is missing or incomplete. This is a nonfatal system error and is followed by the message PFLOAD - TAPE ERROR filenam userin.	Retry or use backup tape.	PFLOAD
PERMITS PRESENT THAT SHOULD NOT BE.	Permit block was found on tape but no previous permit random index was found in the catalog. Data is considered invalid and the file is skipped. This is a nonfatal system error and is followed by the message PFLOAD - TAPE ERROR filenam userin.	Retry or use backup tape.	PFLOAD
PF ATTACH ERROR=ec ON DIRECTORY.	Permanent file error ec was returned after an attempt to attach the dump directory. Refer to the NOS Reference Manual, volume 2, for the error code meanings.	Correct error and try again.	NDA
PF ATTACH ERROR=ec ON DUMP FILE.	Permanent file error ec was returned after attempt to attach the dump file. Refer to volume 2 of the NOS Reference Manual for error code meanings.	Correct error and try again.	NDA
PF PROBLEM.	A permanent file error was encountered on the CSU map or the MSF catalog.	Recover the CSU map or MSF catalog.	ASLABEL
PF SPACE RELEASED = n.	Informative message indicating that the permanent file space released by ASMOVE is n PRUs.	None.	ASMOVE
PF SPECIFIED BUT NOT UI.	User index associated with permanent file name specified is required but was not entered.	Reenter parameters and specify both file name and user index.	PFS
PFATC ABORTED.	A fatal error occurred causing PFATC to abort.	Check dayfile for other error messages to aid in determining the cause of this error.	PFATC
PFATC - PARITY ERR filenam userin.	Parity error was encountered on tape while cataloging file filenam; file is skipped. This is a nonfatal system error.	Retry or use backup tape.	PFATC
PFATC - PFC/PERMITS ONLY AVAILABLE filenam userin.	Informative message indicating that only the PFC entry and permit information for file filenam were encountered on the archive file (the file data was not available). It is assumed that the file data resides on the	None.	PFATC

MESSAGE -----	SIGNIFICANCE -----	ACTION -----	ROUTINE -----
	Mass Storage Facility.		
PFCAT ABORTED.	A fatal error occurred causing PFCAT to abort.	Check dayfile for other error messages to aid in determining the cause of the abort.	PFCAT
PFCAT COMPLETE.	Informative message indicating that the catalog of the permanent file device is complete.	None.	PFCAT
PFCAT - ILLEGAL DEVICE NUMBER filename userin.	The device number specified in the catalog entry for file filename with user index userin is the number of an alternate device that cannot be found.	Mount the missing removable pack and retry the operation.	PFCAT
PFCOPY ABORTED.	A fatal error occurred causing PFCOPY to abort.	Check dayfile for other error messages to aid in determining the cause of this error.	PFCOPY
PFCOPY - DATA CONTROL WORD ERROR.	A data control word was expected on the dump file but was not found.	Retry or use backup tape.	PFCOPY
PFCOPY - PARITY ERR filename userin.	Parity error was encountered on tape while PFCOPY copied file filename; file is skipped. This is a nonfatal system error.	Retry or use backup tape.	PFCOPY
PFCOPY - SYSTEM SECTOR TOO LONG.	The word count for a system sector exceeds the standard system sector length; probable cause is that two parts of different split system sectors were joined. The affected file is skipped. Processing continues with the next file.	Retry or use backup tape.	PFCOPY
PFCOPY - SYSTEM SECTOR TRUNCATED.	The word count for a system sector is less than the standard system sector length; probable cause is that part of a split system sector is missing. The affected file is skipped. Processing continues with the next file.	Retry or use backup tape.	PFCOPY
PFDUMP yy/mm/dd. hh.mm.ss.	Informative message indicating date and time of dump.	None.	PFDUMP
PFDUMP - ABORT REPRIEVE BEGINS.	Marks start of PFDUMP's abort processing.	None.	PFDUMP
PFDUMP - ABORT REPRIEVE COMPLETED.	Marks completion of PFDUMP's abort processing. No further PFDUMP processing occurs after this message is issued.	None.	PFDUMP
PFDUMP ABORTED.	A fatal error occurred causing PFDUMP to abort.	Refer to accompanying error message to aid in determining the cause of the abort.	PFDUMP

MESSAGE -----	SIGNIFICANCE -----	ACTION -----	ROUTINE -----
PFDUMP - ALTERNATE STORAGE ERROR, FN = filename, UI = userin.	The permanent system error-flag was set for the specified file. The MSS executive sets this flag when either the alternate storage address does not provide a valid path to the file's data, or an unrecoverable parity error occurs on an MSS cartridge. This file is not written to the archive file. Dumping continues with the next file.	None.	PFDUMP
PFDUMP - CATALOG FORMAT ERROR,FM=family, DNdn,EQeq,Tttt,Ssss.	The catalog format on the specified family device is not supported by the system. If this is the only device to be dumped, the dump aborts. Otherwise, the dump continues with the next device.	Mount the device on a system using the same catalog format as that of the system on which it was created. Dump the files, initialize the device, and then reload the files on a system using the desired catalog format.	PFDUMP
PFDUMP - CATALOG FORMAT ERROR,PN=packnam, EQeq,Tttt,Ssss.	The catalog format on the specified auxiliary device is not supported by the system.	Mount the device on a system using the same catalog format as that of the system on which it was created. Dump the files, initialize the device, and then reload the files on a system using the desired catalog format.	PFDUMP
PFDUMP - CATALOG READ ERROR, PN=packnam,EQeq,Tttt,Ssss.	A mass storage error occurred while PFDUMP read catalog information on the specified auxiliary pack. The equipment number, logical track, and logical sector are given. Files cataloged in the bad sector are not dumped. If possible, dumping continues with the next sector of the affected catalog track. Otherwise, dumping continues with the next catalog track or device as appropriate for the dump type. Error idle status is set for the device.	Analyze error and try again. If error persists, assume cause is hardware malfunction.	PFDUMP
PFDUMP - CATALOG READ ERROR,FM=family,DNdn, CTct,EQeq,Tttt,Ssss.	A mass storage error occurred while PFDUMP read catalog information on the specified family, device number, logical catalog track, equipment number, logical track, and logical sector. Files cataloged in the bad sector are not dumped. If possible, dumping continues with the next sector of the affected catalog track. Otherwise, dumping continues with the next catalog track or device as appropriate for the dump type. Error idle status is set for the device.	Analyze error and try again. If error persists, assume cause is hardware malfunction.	PFDUMP

MESSAGE -----	SIGNIFICANCE -----	ACTION -----	ROUTINE -----
PFDUMP - CATALOG READ ERROR, FN=filenam, UI=userin.	File filenam for the specified user index was not dumped because a catalog read error affected the sector on which the file was cataloged. Error idle status is set for the device.	Analyze error and try again.	PFDUMP
PFDUMP COMPLETED.	Marks normal termination of PFDUMP. No further processing occurs after this message is issued.	None.	PFDUMP
PFDUMP - DAF READ ERROR, FM=family, DNdn, EQeq, Ttttt, Sssss.	A mass storage error occurred while PFDUMP read a direct access file on the specified family, device number, equipment number, logical track, and logical sector. The dump continues with the next record, unless suppressed by the error option.	Analyze error and try again.	PFDUMP
PFDUMP - DAF READ ERROR, FN=filenam, UI=userin, PRU=pru.	A mass storage error occurred while PFDUMP read direct access file filenam for user index userin at relative PRU pru. The dump continues at the next record, unless suppressed by the error option.	Analyze error and try again.	PFDUMP
PFDUMP - DAF READ ERROR, PN=packnam, EQeq, Ttttt, Sssss.	A mass storage error occurred while PFDUMP read a direct access file on the specified auxiliary pack. The equipment number, logical track, and logical sector are given. The dump continues with the next record, unless suppressed by the error option.	Analyze error and try again.	PFDUMP
PFDUMP - DAF TOO LONG, FM=family, DNdn, EQeq, Ttttt, Sssss.	A direct access file was truncated at the specified, family, device, equipment number, logical track, and sector when the number of sectors read for the file exceeded the length determined from the TRT. Dumping continues with the next file. Error idle status is set for the device.	Dump files, initialize device, and reload files.	PFDUMP
PFDUMP - DAF TOO LONG, FN=filenam, UI=userin, PRU=pru.	Direct access file filenam for user index userin was truncated at the specified relative PRU address when the number of sectors read for the file exceeded the length determined from the TRT. Dumping continues with the next file. Error idle status is set for the device.	Dump files, initialize device, and reload files.	PFDUMP
PFDUMP - DAF TOO LONG, PN=packnam, EQeq, Ttttt, Sssss.	A direct access file on the specified auxiliary pack was truncated at the specified equipment number, logical track, and logical sector when the number of sectors read for the file exceeded the length determined from the TRT. Dumping continues with the next file. Error idle status is set for the device.	Dump files, initialize device, and reload files.	PFDUMP

<u>MESSAGE</u>	<u>SIGNIFICANCE</u>	<u>ACTION</u>	<u>ROUTINE</u>
PFDUMP - DAF TOO SHORT,FM=family, DNdn,EQeq,Ttttt,Sssss.	The number of sectors dumped for a direct access file on the specified family device with the specified equipment number, logical track, and sector was less than the length determined by the TRT. Dumping continues	Dump files, initialize device, and reload files.	PFDUMP



MESSAGE -----	SIGNIFICANCE -----	ACTION -----	ROUTINE -----
	set for the device.		
PFDUMP - DAF TOO SHORT, FN=filenam, UI=userin, PRU=pru.	The number of sectors dumped for the specified direct access file was less than the length determined from the TRT. Dumping continues with the next file. Error idle status is set for the device.	Dump files, initialize device, and reload files.	PFDUMP
PFDUMP - DAF TOO SHORT, PN=packnam, EQeq, Tttt, Sssss.	The number of sectors dumped for a direct access file on the specified auxiliary pack at the specified equipment number, logical track, and sector was less than the length determined from the TRT. Dumping continues with the next file. Error idle status is set for the device.	Dump files, initialize device, and reload files.	PFDUMP
PFDUMP - DAF TRUNCATED, FN=filenam, UI=userin, PRU=pru.	Direct access file filenam was truncated when a mass storage error occurred preventing further dumping of the file. PRU=pru gives the number of PRUs truncated.	Analyze error and try again.	PFDUMP
PFDUMP - DEVICE ERROR IDLE SET, FM=family, DNdn, EQeq, Tttt, Sssss.	PFDUMP has set an error idle status on device dn, equipment eq for the reason given in the message issued just prior to this one.	Dump files, initialize device, and reload files.	PFDUMP
PFDUMP DEVICE dn FAMILY family.	Informative message identifying the device being dumped, and the family name associated with that device. dn Device number family Family name	None.	PFDUMP
PFDUMP DEVICE MASK dm.	Informative message indicating device mask (dm) of device currently being dumped.	None.	PFDUMP
PFDUMP - DEVICE dn NOT FOUND.	The dump aborted because the specified device was not found.	Retry operation with device defined in the system.	PFDUMP
PFDUMP - DEVICE NOT FOUND, FN=filenam, UI=userin, DNdn.	The dump aborted because device dn containing file filenam for user index userin was not found.	Retry operation with device defined in the system.	PFDUMP
PFDUMP DEVICE dn PACK packnam.	Informative message identifying the pack name of the auxiliary device currently being dumped. dn Device number packnam Pack name	None.	PFDUMP

MESSAGE -----	SIGNIFICANCE -----	ACTION -----	ROUTINE -----
PFDUMP - IAF READ ERROR,FM=family,DNdn, EQeq,Ttttt,Sssss.	A mass storage error occurred while PFDUMP read an indirect access file on the specified family, device number, equipment number, logical track, and logical sector. Dumping continues with the next record, unless suppressed by the error option.	Analyze error and try again.	PFDUMP
PFDUMP - IAF READ ERROR,FN=filenam, UI=userin,PRU=pru.	A mass storage error occurred while PFDUMP read indirect access file filenam for user index userin at relative PRU pru. Dumping continues with the next record, unless suppressed by the error option.	Analyze error and try again.	PFDUMP
PFDUMP - IAF READ ERROR,PN=packnam,EQeq, Ttttt,Sssss.	A mass storage error occurred while PFDUMP read an indirect access file on the specified auxiliary pack. The equipment number logical track, and logical sector are given. Dumping continues with the next record, unless suppressed by the error option.	Analyze error and try again.	PFDUMP
PFDUMP - IAF TOO LONG,FM=family,DNdn,EQeq, Ttttt,Sssss.	An indirect access file was truncated at the specified, family, device, equipment number, logical track, and sector when the number of sectors read for the file exceeded the length determined from the TRT. Dumping continues with the next file. Error idle status is set for the device.	Dump files, initialize device, and reload files.	PFDUMP
PFDUMP - IAF TOO LONG,FN=filenam,UI=userin, PRU=pru.	An indirect access file filenam for user index userin was truncated at the specified relative PRU address when the number of sectors read for the file exceeded the length determined from the TRT. Dumping continues with the next file. Error idle status is set for the device.	Dump files, initialize device, and reload files.	PFDUMP
PFDUMP - IAF TOO LONG,PN=packnam,EQeq, Ttttt,Sssss.	An indirect access file on the specified auxiliary pack was truncated at the specified equipment number, logical track, and logical sector when the number of sectors read for the file exceeded the length determined from the TRT. Dumping continues with the next file. Error idle status is set for the device.	Dump files, initialize device, and reload files.	PFDUMP
PFDUMP - IAF TOO SHORT,FM=family, DNdn,EQeq,Ttttt,Sssss.	The number of sectors dumped for an indirect access file on the specified family device at the specified equipment number, logical track and sector was less than the length determined by the TRT. Dumping continues with the next file. Error idle status is	Dump files, initialize device, and reload files.	PFDUMP

MESSAGE -----	SIGNIFICANCE -----	ACTION -----	ROUTINE -----
	set for the device.		
PFDUMP - IAF TOO SHORT, FN=filenam, UI=userin, PRU=pru.	The number of sectors dumped for the specified indirect access file was less than the length determined from the TRT. Dumping continues with the next file. Error idle status is set for the device.	Dump files, initialize device, and reload files.	PFDUMP
PFDUMP - IAF TOO SHORT, PN=packnam, EQeq, Ttttt, Sssss.	The number of sectors dumped for an indirect access file on the specified auxiliary pack at the specified equipment number, logical track, and sector was less than the length determined from the TRT. Dumping continues with the next file. Error idle status is set for the device.	Dump files, initialize device, and reload files.	PFDUMP
PFDUMP - IAF TRUNCATED, FN=filenam, UI=userin, PRU=pru.	Indirect access file filenam for user index userin was truncated when a mass storage error occurred preventing further dumping of the files. PRU=pru gives the number of PRUs truncated.	Analyze error and try again.	PFDUMP
PFDUMP - MSS FUNCTIONS SUPPRESSED.	PFDUMP has discontinued all functions relating to MSS processing (in particular, file staging) because of an error noted in a previous message. This message is issued whenever an error idle status is set for a device.	If MSS-related functions are desired, try again after fixing the error.	PFDUMP
PFDUMP - MSS STAGED FILE RESCAN KILLED, FN=filenam, UI=userin.	The operator discontinued the rescan of a given catalog track for MSF files staged to disk and newly linked to their catalog entries. Probable cause of the operator's action is a malfunction of MSSEEXEC and/or its auxiliaries. This message is issued for each file not dumped because of the operator's action. After all such files are listed, dumping continues with the next catalog track.	Analyze reason for operator's action and try again.	PFDUMP
PFDUMP - NO FILES PROCESSED.	Informative message indicating that no files have been dumped.	Check file selection parameters and rerun if necessary.	PFDUMP
PFDUMP - NO FILES SELECTED.	The dump aborted because the specified file selection parameters for the dump were such that the files could not exist on the system.	Change file selection parameters and restart dump.	PFDUMP
PFDUMP - OPERATOR DISABLED filenam.	The PFDUMP archive or verify file named was disabled by operator action. The dump continues on the remaining file.	None.	PFDUMP

MESSAGE -----	SIGNIFICANCE -----	ACTION -----	ROUTINE -----
PFDUMP - ORPHAN PFC ENCOUNTERED, FN=filenam, UI=userin.	File filenam does not have an image on disk or on MSF. Error idle status is set for the device. Dumping continues with the next file.	Analyze error and then purge the affected file.	PFDUMP
PFDUMP - PERMIT FORMAT ERROR, FN=filenam, UI=userin.	The permit entries for the specified file were not dumped because the user index did not match the specified user index. Dumping continues with the file data. Error idle status is set for the device.	Recreate the permit entries for the file.	PFDUMP
PFDUMP - PERMIT READ ERROR, FM=family, DNdn, EQeq, Tttt, Sssss.	A mass storage error occurred while PFDUMP read permit information on the specified family, device number, equipment number, logical track, and logical sector. The bad sector and any following sectors of permit information for the affected user index are truncated. Dumping continues with the file data. Error idle status is set for the device.	Analyze error and try again.	PFDUMP
PFDUMP - PERMIT READ ERROR, FN=filenam, UI=userin.	A mass storage error occurred while PFDUMP read the permit information of file filenam for user index userin. The bad sector and any following sectors of permit information for user index userin are truncated. Dumping continues with the file data. Error idle status is set for the device.	Analyze error and try again.	PFDUMP
PFDUMP - PERMIT READ ERROR, PN=packnam, EQeq, Tttt, Sssss.	A mass storage error occurred while PFDUMP read permit information on the specified auxiliary pack. The equipment number, logical track and logical sector are given. The bad sector and any following sectors of permit information for the affected user index are truncated. Dumping continues with the file data. Error idle status is set for the device.	Analyze error and try again.	PFDUMP
PFDUMP - PFC ONLY FILE DETECTED, FN=filenam, UI=userin.	A permanent file catalog entry was detected for a file residing on a secondary mass storage device. Secondary mass storage devices are not supported by this system. The file is not dumped. Dumping continues with the next file.	None.	PFDUMP
PFDUMP - PFC/PERMITS ONLY, FN=filenam, UI=userin.	Informative message indicating that only the PFC entry and permit information (not the file data) for file filenam were dumped.	None.	PFDUMP

MESSAGE -----	SIGNIFICANCE -----	ACTION -----	ROUTINE -----
PFDUMP - RD/WT ERROR ON UCAT UPDATE, FN=filenam,UI=userin.	An unrecoverable read/write error occurred while PFDUMP attempted to update the utility control date and time field in the PFC entry for file filenam. Error idle status is set for the device. Dumping continues with the next file.	Dump the affected device and reload its files. PFDUMP will flaw the affected catalog track.	PFDUMP
PFDUMP - READ ERROR ON REQS - ABORT.	There is an unrecoverable read error on the staging request file REQS. Thus, PFDUMP is not able to report the files not dumped because the operator suspended the rescan of a given catalog track for MSF files staged to disk and newly linked to their catalog entries.	Analyze error and try again.	PFDUMP
PFDUMP - READ ERROR ON RESS - ABORT.	There is an unrecoverable read error on the rescan screen file RESS. Thus, PFDUMP was not able to search for MSF files staged to disk and newly linked to their catalog entries.	Analyze error and try again.	PFDUMP
PFDUMP - VERIFY ERROR ON UCMT UPDATE, FN=filenam,UI=userin.	PFU has rejected the request to update the utility control date and time field in the PFC entry for file filenam. The catalog entry found at the indicated catalog track location did not agree with the supplied verification information. Error idle status is set for the device. Dumping continues with the next file.	Dump affected device and reload its files.	PFDUMP
PFDUMP - ZERO FILE LENGTH filenam userin.	File filenam is empty and thus cannot be dumped. Dumping continues with the next file. This is a nonfatal system error.	None.	PFDUMP
PFLOAD ABORTED.	A fatal error occurred causing PFLOAD to abort.	Check dayfile for other error messages to aid in determining the cause of the abort.	PFLOAD
PFLOAD - ARCHIVE FILE FORMAT ERROR.	Information not recognizable by PFLOAD was detected on the archive file. Loading continues with the next file.	Ensure correct tape is in use and/or retry operation.	PFLOAD
PFLOAD - ASSIGN TAPE.	Informs operator that assignment of archive file is required.	Assign archive file.	PFLOAD
PFLOAD - CATALOG IMAGE FORMAT ERROR.	The load aborted because a catalog image record was found on the archive file in a format unrecognizable by PFLOAD.	The bad archive file can be used in a normal load by specifying the omit option (OP=0) to skip the catalog image	PFLOAD

MESSAGE -----	SIGNIFICANCE -----	ACTION -----	ROUTINE -----
		record.	
PFLOAD - CATALOG READ ERROR,FM=family, DNdn,CTct,EQeq,Ttttt,Sssss.	A mass storage error occurred while PFLOAD read catalog information on the specified family, device number, logical catalog track, equipment number, logical track, and logical sector. Error idle status is set for the device.	Analyze error and try again.	PFLOAD
PFLOAD - CATALOG READ ERROR,FN=filenam, UI=userin.	File filenam was cataloged in a sector affected by a mass storage error. Error idle status is set for the master device.	Analyze error and try again.	PFLOAD
PFLOAD - CATALOG READ ERROR,PN=packnam, EQeq,Ttttt,Sssss.	A mass storage error occurred while PFLOAD read catalog information on the specified auxiliary pack. The equipment number, logical track, and logical sector are given. Error idle status is set for the device.	Analyze error and try again.	PFLOAD
PFLOAD - CATALOG WRITE ERROR,FM=family, DNdn,CTct,EQeq,Ttttt,Sssss.	A mass storage error occurred while PFLOAD wrote catalog information on the specified family, device number, logical catalog track, equipment number, logical track, and logical sector. Error idle status is set for the device.	Analyze error and try again.	PFLOAD
PFLOAD - CATALOG WRITE ERROR,FN=filenam, UI=userin.	The catalog information for file filenam could not be written because of a mass storage write error. Error idle status is set for the master device.	Analyze error and try again.	PFLOAD
PFLOAD - CATALOG WRITE ERROR,PN=packnam, EQeq,Ttttt,Sssss.	A mass storage error occurred while writing catalog information on the specified auxiliary pack. The equipment number, logical track, and logical sector are given. Error idle status is set for the device.	Analyze error and try again.	PFLOAD
PFLOAD - DAF WRITE ERROR,FM=family,DNdn, EQeq,Ttttt,Sssss.	A mass storage error occurred while PFLOAD wrote a direct access file on the specified family, device number, equipment number, logical track, and logical sector. Mass storage space for the affected file is dropped and the bad track is flawed. A catalog entry is not created for the file. Loading continues with the next file.	Analyze error and try again.	PFLOAD
PFLOAD - DAF WRITE ERROR,FN=filenam, UI=userin.	A mass storage error occurred while PFLOAD wrote direct access file filenam for user index userin. Mass storage space for the affected file is dropped and the bad track is flawed A catalog entry is not created for the file. Loading continues with the next	Analyze error and try again.	PFLOAD

MESSAGE -----	SIGNIFICANCE -----	ACTION -----	ROUTINE -----
	file.		
PFLOAD - DAF WRITE ERROR,PN=packnam, EQeq,Ttttt,Sssss.	A mass storage error occurred while PFLOAD wrote a direct access file on the specified auxiliary pack. The equipment number, logical track, and logical sector are given. Mass storage space for the affected file is dropped and the bad track is flawed. A catalog entry is not created for the file. Loading continues with the next file.	Analyze error and try again.	PFLOAD
PFLOAD DEVICE dn FAMILY family.	Informative message identifying the device being loaded and the family name associated with that device. dn Device number family Family name	None.	PFLOAD
PFLOAD - DEVICE dn NOT FOUND.	The load aborted because the specified device was not found.	Retry operation with device defined in the system.	PFLOAD
PFLOAD DEVICE dn PACK packnam.	Informative message identifying the pack name of the auxiliary device being loaded. The device number will always be zero. dn Device number packnam Pack name	None.	PFLOAD
PFLOAD - ERROR IDLE DETECTED,FM=family,DNdn, EQeq,Ttttt,Sssss.	The load aborted because an error idle condition was detected on the specified family device. The equipment number, logical track, and logical sector are given.	Correct error idle condition and then rerun the load.	PFLOAD
PFLOAD - ERROR IDLE DETECTED,FN=filenam, UI=userin.	The load aborted because an error idle condition was detected on the permanent file device being loaded. The file filenam is the first file that could not be loaded.	Correct error idle condition and then rerun the load.	PFLOAD
PFLOAD - ERROR IDLE DETECTED,PN=packnam, EQeq,Ttttt,Sssss.	The load aborted because an error idle condition was detected on the specified auxiliary device. The equipment number, logical track, and logical sector are given.	Correct error idle condition and then rerun the load.	PFLOAD
PFLOAD - ERROR IDLE SET,FM=family,DNdn, EQeq,Ttttt,Sssss.	PFLOAD has set an error idle status on device dn, equipment eq for the reason given in the message issued just prior to this one.	Analyze error and try again.	PFLOAD
PFLOAD - EXCESSIVE PARITY ERRORS.	PFLOAD has encountered 100B consecutive read parity errors on the archive file. The load is aborted.	Rerun the load using another archive file.	PFLOAD
PFLOAD - EXTRACT ILLEGAL WITHOUT CIR.	The load aborted because the extract option was specified for the load when the archive file did not contain a catalog image record (CIR).	Retry without extract option.	PFLOAD

MESSAGE -----	SIGNIFICANCE -----	ACTION -----	ROUTINE -----
PFLOAD - IAF WRITE ERROR,FM=family,DNdn, EQeq,Ttttt,Sssss.	A mass storage error occurred while PFLOAD wrote an indirect access file on the specified family, device number, equipment number, logical track, and logical sector. A catalog entry with a special write error user index is created for that portion of the file up to and including the bad sector. Loading continues with the next file.	Analyze error and try again.	PFLOAD
PFLOAD - IAF WRITE ERROR,FN=filenam, UI=userin.	A mass storage error occurred while PFLOAD wrote indirect access file filenam for user userin. A catalog entry with a special write error user index is created for that portion of the file up to and including the bad sector. Loading continues with the next file.	Analyze error and try again.	PFLOAD
PFLOAD - IAF WRITE ERROR,PN=packnam,EQeq, Ttttt,Sssss.	A mass storage error occurred while PFLOAD wrote an indirect access file on the specified auxiliary pack. The equipment number, logical track, and logical sector are given. A catalog entry with a special write error user index is created for that portion of the file up to and including the bad sector. Loading continues with the next file.	Analyze error and try again.	PFLOAD
PFLOAD - ILLEGAL NAME/INDEX,000000 filenam userin.	A file with an illegal name and/or user index was encountered and skipped. The 42-bit file name and 18-bit user index are shown in octal. Loading continues with the next file.	Analyze error and try again.	PFLOAD
PFLOAD - LABEL BAD, ASSIGN NEW TAPE.	Informs operator that the archive file did not contain a correct dump label.	Assign a new archive file.	PFLOAD
PFLOAD - NO FILES SELECTED.	The load aborted because the file selection parameters for the load were such that the specified files could not exist in the system.	Correct selection parameters and restart load.	PFLOAD
PFLOAD - PARITY ERR filenam userin.	Parity error was encountered on tape while PFLOAD loaded file filenam; file is skipped. This is a nonfatal system error.	Retry or use backup tape.	PFLOAD
PFLOAD - PERMIT WRITE ERROR,FM=family, DNdn,EQeq,Ttttt,Sssss.	A mass storage error occurred while PFLOAD wrote permit information on the specified family, device number, equipment number, logical track, and logical sector. The bad sector and any following sectors of permit information for the affected user index are truncated. Error idle status is set for	Analyze error and try again.	PFLOAD



MESSAGE -----	SIGNIFICANCE -----	ACTION -----	ROUTINE -----
	the device.		
PFLOAD - PERMIT WRITE ERROR, FN=filenam, UI=userin.	A mass storage error occurred while PFLOAD wrote the permit information of file filenam for user index userin. The bad sector and any following sectors of permit information for user index userin are truncated. Error idle status is set for the device.	Analyze error and try again.	PFLOAD
PFLOAD - PERMIT WRITE ERROR, PN=packnam, EQeq, Tttt, Sssss.	A mass storage error occurred while PFLOAD wrote permit information on the specified auxiliary pack. The equipment number, logical track and logical sector are given. The bad sector and any following sectors of permit information for the affected user index are truncated. Error idle status is set for the device.	Analyze error and try again.	PFLOAD
PFLOAD - PFC/PERMITS ONLY LOADED, FN=filenam, UI=userin.	Informative message indicating that only the PFC entry and permit information for file filenam were loaded. The file data was not available on the archive file. It is assumed that the file data resides on the Mass Storage Facility.	None.	PFLOAD
PFLOAD - SELECTED FILES NOT ON ARCHIVE FILE.	The load aborted because the archive file dump label showed that the selected files are not on the archive file.	Ensure correct archive tape is being used and that correct PFLOAD parameters are specified and retry operation.	PFLOAD
PFLOAD - STATUS ERR filenam userin.	Device on which direct access file filenam is to be loaded is not available; file is skipped. This is a nonfatal system error.	Make device available and retry.	PFLOAD
PFLOAD - SYSTEM SECTOR TOO LONG, FN=filenam, UI=userin.	The word count for the system sector encountered for file filenam exceeds the standard length; probable cause is that two parts of different split system sectors were joined. File filenam is skipped. Loading continues with the next file.	Analyze error and try again, or use backup tape.	PFLOAD
PFLOAD - SYSTEM SECTOR TRUNCATED, FN=filenam, UI=userin.	The word count for the system sector encountered for file filenam is less than the standard length; probable cause is that part of a split system sector is missing. File filenam is skipped. Loading continues with the next file.	Analyze error and try again.	PFLOAD

MESSAGE -----	SIGNIFICANCE -----	ACTION -----	ROUTINE -----
PFLOAD - TAPE ERROR filenam userin.	Error was encountered on tape while PFLOAD loaded file filenam; file is skipped. This is a nonfatal system error and is similar to the PFLOAD - PARITY ERR filenam userin. message in that the data read from the archive tape is not logically sound.	Inform site analyst.	PFLOAD
PFLOAD - TRACK LIMIT,FM=family,DNdn,EQeq, Tttt,Ssss.	The load aborted because a track limit condition was encountered on the specified family device. The equipment number logical track, and logical sector are given.	Free up space on the device and then rerun the load.	PFLOAD
PFLOAD - TRACK LIMIT,FN=filenam,UI=userin.	The load aborted because a track limit condition was encountered on the permanent file device being loaded. The file filenam is the first file that could not be loaded.	Free up space on the device and then rerun the load.	PFLOAD
PFLOAD - TRACK LIMIT,PN=packnam,EQeq,Tttt, Ssss.	The load aborted because a track limit condition was encountered on the specified auxiliary device. The equipment number, logical track, and logical sector are given.	Free up space on the device and then rerun the load.	PFLOAD
PFN=filenam, FAMILY=family, UI=userin - ALREADY PERMANENT.	One or more of the CSU maps and/or MSF catalogs to be created already exists.	Correct parameters on the ASDEF control statement and retry, or purge the existing MSF catalogs and/or CSU maps and retry.	ASDEF
PFN=filenam, FAMILY=family, UI=userin - CIO ERROR.	A write error was encountered on the CSU map or the MSF catalog.	Purge the affected CSU map or MSF catalog and use ASDEF to create a new one.	ASDEF
PFN=filenam, FAMILY=family UI=userin - DEFINE ERROR.	ASDEF cannot define a CSU map or MSF catalog.	Submit a Programming System Report (PSR) with supporting material.	ASDEF
PFN=filenam, FAMILY=family, UI=userin - FAMILY NOT FOUND.	The family specified by the FM parameter on the ASDEF control statement does not exist.	Specify an existing family and retry.	ASDEF
PFN=filenam, FAMILY=family, UI=userin - FILE INITIALIZED.	Informative message indicating that the CSU map or MSF catalog was created successfully.	None.	ASDEF
PFU - ALTERNATE DEVICE NOT FOUND.	PFU is unable to locate the alternate device access file which does not reside on a master device.	Make device available and retry.	PFU

MESSAGE -----	SIGNIFICANCE -----	ACTION -----	ROUTINE -----
PFU - BUFFER ARGUMENT ERROR ON lfn AT addr.	The circular buffer pointers for file lfn did not satisfy the following conditions. - FIRST .LE. IN .LT. LIMIT - FIRST .LE. OUT .LT. LIMIT - LIMIT .LE. FL The FET address is addr. This message should not occur unless there is an error in the utility or someone is writing into the utility's field length. Dayfile message.	Analyze error and try again.	PFU
PFU - BUFFER CTL WORD ERROR ON lfn AT addr.	The word count of a disk sector to be read from a central memory buffer exceeds the word count limit of a sector (100B). This usually indicates an internal error in PFLOAD. Dayfile message. lfn Name of file being processed addr FET address of file	Inform site analyst.	PFU
PFU - CATALOG TRACK NOT FOUND.	No permanent file catalog track could be found for the user index being processed. Dayfile message.	Inform site analyst.	PFU
PFU - CONTROL POINT ERROR FLAG DETECTED ffff.	Error flag ffff was detected at PFU control point; PFU aborts. If no operator action has been taken to drop the control point, other messages indicating the probable cause of the error flag should be present. Dayfile message.	Inform site analyst, if operator did not drop the control point.	PFU
PFU - DUPLICATE FILE, lfn AT addr.	There is a file at the control point whose name, lfn, is the same as one of the files used by the permanent file utility that is currently active. addr is the address of the file's FET. Dayfile message.	Inform site analyst; recommended action is to return or rename the file and retry.	PFU
PFU - FILE NOT FOUND, lfn AT addr.	An entry for the file lfn was not found in the file name table (FNT). This usually indicates an internal error in one of the permanent file utility processors (PFCAT, PFCOPY, PFDUMP, or PFLOAD). addr is the address of the file's FET. Dayfile message.	Inform site analyst.	PFU
PFU - I/O SEQUENCE ERROR ON lfn AT addr.	An operation was requested on a file before the previous operation completed. This usually indicates an internal error in one of the permanent file utility processors (PFCAT, PFCOPY, PFDUMP, or PFLOAD). Dayfile message. lfn Name of file being processed addr FET address of file	Inform site analyst.	PFU

MESSAGE -----	SIGNIFICANCE -----	ACTION -----	ROUTINE -----
PFU - NO DEVICE SPECIFIED.	No device number was specified with the PFU read list function, probably as a result of an internal error in PFDUMP.	Analyze error and try again.	PFU
PFU - NOT SYSTEM JOB.	The calling program is a nonsystem origin job and it does not have system origin privileges with the console in DEBUG mode. Dayfile message.	If the utility is running as a nonsystem job with system origin privileges, ensure that the console is in DEBUG mode.	PFU
PFU - PARAMETER ERROR.	The program calling PFU has an error in the calling parameters. This should not occur unless there is an error in the utility or a nonutility program is calling PFU. Nonutility programs call PFU at their own risk. Dayfile message.	Inform site analyst.	PFU
PFU - TRACK FLAWED,EQeq,Ttttt.	Flawed track was found on equipment eq, logical track tttt.	Hardware error. Contact customer engineer.	PFU
PFU - TRACK INTERLOCK CLEAR ON lfn AT addr.	When PFU was called to clear the track interlock on a file, the FST entry for that file showed that the interlock was already clear. This usually indicates an internal error in PFDUMP. Dayfile message. lfn      Name of file being processed addr     FET address of file	Inform site analyst.	PFU
PFU - TRACK INTERLOCK SET ON lfn AT addr.	When PFU was called to set the track interlock on a file, the FST entry for that file showed that the interlock was already set. This usually indicates an internal error in PFDUMP. Dayfile message. lfn      Name of file being processed addr     FET address of file	Inform site analyst.	PFU
PK, PT OPTION VIOLATED.	One of the following. - The PK or PT option cannot be used with the directive specified. - The PK or PT option has not been specified correctly. - The PK or PT option cannot be used with one of the other parameters specified.	Correct the error and retry.	ASLABEL
*PN* DESIGNATION MUST PRECEDE *PL*.	Output file message indicating that the PN parameter was specified after the PL parameter.	Correct and rerun.	VALNET

MESSAGE -----	SIGNIFICANCE -----	ACTION -----	ROUTINE -----
POLLING CODE OUT OF RANGE.	Output file message indicating that the polling code specified was not within the range of 0 through 7777777B.	Correct and rerun.	VALNET
PORT LIMIT OUT OF RANGE.	Output file message indicating that the port limit specified was not between PN+1 and 15 (6671 multiplexer), PN+1 and 63 (6676 multiplexer), or PN+1 and 1022 (stimulated multiplexer).	Correct and rerun.	VALNET
PORT NUMBER OUT OF RANGE.	Output file message indicating that the port number specified was not between 1 and 16 (6671 multiplexer), 1 and 64 (6676 multiplexer), or 1 and 4096 (stimulated multiplexer).	Correct and rerun.	VALNET
PORT NUMBER UNDEFINED FOR PREVIOUS TERMINAL.	Output file message indicating that the port number was not specified on the previous terminal definition directive. This is required for //STIM, //6671, and //6676 directives.	Correct and rerun.	VALNET
PPU NOT FOUND.	Output file message indicating that the requested PP record was not found in the EDD file.	Ensure that the dump file contains meaningful information.	DSDI
PREMATURE END OF FILE.	During processing of the dump tape, an EOF was detected before the end of the dump control word.	Inform site analyst. Format of the dump tape should be investigated.	PFATC
PREMATURE END OF FILE.	Either the CCP tape is empty or the tape description card specified more files than were physically present on the CCP tape.	Correct the error and try again.	LFG
PREMATURE *EOF* ENCOUNTERED.	During processing of the load file, an EOF was encountered before it was expected.	Inform site analyst. Format of the load tape should be investigated.	QLOAD
PREVIOUS KTS TERMINAL MAY NOT SPECIFY PORT RANGE.	Output file message indicating that a port range was specified on a TRANEX terminal definition directive. PL is an illegal argument for a TRANEX terminal.	Correct and rerun.	VALNET
PRIVATE PACK/PERMIT UN CONFLICT.	User number of the private pack is not the same as the user number specified for permits. In this case, no new active dayfiles may be started on the private pack.	Select a different device for the new dayfile.	DFTERM

MESSAGE -----	SIGNIFICANCE -----	ACTION -----	ROUTINE -----
PROCESSING COMPLETE ON DMPAdmp.	This message appears for each output processed.	None.	NDA
PROCESSING DUMP FILE. dmp           yy/mm/dd. hh.mm.ss.	Informative message indicating which dump is currently being processed and the date and time. This message is issued when the dump header field is encountered. In cases where file positioning requests position the file beyond this point, the message will not appear.	None.	QLOAD
PROFILE ABORTED.	Dayfile message indicating that an error flag has been set at the control point.	Consult dayfile listing for reason (operator drop, for example).	PROFILE
PROFILE FILE CREATE COMPLETE.	Dayfile message indicating that the creation run is complete.	None.	PROFILE
PROFILE FILE DATA BASE ERROR.	Dayfile message indicating that the project file does not contain both a level 0 and level 1 block.	Ensure that the project file is local and contains a level 0 and level 1 block (at least one charge entry) and rerun.	PROFILE
PROFILE FILE INQUIRY COMPLETE.	Dayfile message indicating that the inquire run is complete.	None.	PROFILE
PROFILE FILE INTERLOCKED.	Message displayed at line 1 of the control point indicating that the PROFILE file is interlocked for modification during update run.	None.	PROFILE
PROFILE FILE LIST COMPLETE.	Dayfile message indicating that the list of PROFILA is complete.	None.	PROFILE
PROFILE FILE REFORMAT COMPLETE.	Dayfile message indicating that the reformat run is complete.	None.	PROFILE
PROFILE FILE RELEASED.	Message displayed at line 1 of the control point indicating that the PROFILE file has been released during update run to allow other system updates.	None.	PROFILE
PROFILE FILE SOURCE COMPLETE.	Dayfile message indicating that the source run is complete.	None.	PROFILE
PROFILE FILE UPDATE COMPLETE.	Dayfile message indicating that the update run is complete.	None.	PROFILE

MESSAGE -----	SIGNIFICANCE -----	ACTION -----	ROUTINE -----
PROGRAM ABNORMAL, xxx.	There is a catalog access internal error in module xxx.	Submit a Programming System Report (PSR) with supporting material.	ASLABEL
****PROJECT COUNT LIMIT EXCEEDED.	Output file message indicating that the user has tried to create more active projects under this charge number than allowed.	None.	PROFILE
****PROJECT NUMBER ACTIVE.	Output file message indicating that the user has attempted to activate an already active project number.	Rerun using correct project number, if necessary.	PROFILE
****PROJECT NUMBER DOES NOT EXIST.	Output file message indicating that a directive for which a project number must exist made reference to a project number that does not exist.	Correct and rerun using existing project number.	PROFILE
****PROJECT NUMBER INACTIVE.	Output file message indicating that the user has made a reference to a project number that is inactive with a directive for which the project number must be active.	Activate project number and rerun or rerun using correct project number.	PROFILE
PSEUDO MULTIPLEXER DESCRIPTION ERROR.	Output file message indicating that channel/equipment information has been specified on a //DIAL multiplexer definition directive.	Correct and rerun.	VALNET
PURGING filename userin.	Informative message indicating that file filename is being purged after being dumped as directed by the purge after option.	None.	PFDUMP
*Q* PARAMETER TOO LARGE - MAXIMUM ALLOWABLE VALUE SUBSTITUTED.	Informative message.	None.	EXINIT
*Q* PARAMETER TOO SMALL - MINIMUM ALLOWABLE VALUE SUBSTITUTED.	Informative message.	None.	EXINIT
QAC ERROR ENCOUNTERED.	Explanatory dayfile message indicating why FNTLIST or QALTER aborted. QAC returned an unexpected error code.	Contact site analyst.	FNTLIST
QALTER COMPLETE.	Informative message indicating that QALTER operation is finished.	None.	FNTLIST
QDUMP ABORTED.	An error has been detected which is not processed by QDUMP error processing. Attempts to correct the situation have been made, but discretion should be used in continuing use of QDUMP.	Inform site analyst. Check the dayfile for other error messages to determine the cause of the abort.	QDUMP

MESSAGE -----	SIGNIFICANCE -----	ACTION -----	ROUTINE -----
QDUMP COMPLETE.	Informative message indicating the specified operation has been completed.	None.	QDUMP
QFM BUFFER TOO SMALL.	The buffer for reading the system sector is fewer than 100B words long.	Increase the buffer size and retry.	QFM
QFM FILE ALREADY ATTACHED.	The specified file is already attached to the control point.	None.	QFM
QFM - FILE IGNORED filename.	The file was ignored because it had an illegal origin or type code. It could indicate a bad IQFT file.	Verify that valid origin or file type code is being used.	QFM
QFM I/O SEQUENCE ERROR.	Action was requested on a busy file.	Wait until file is not busy and retry.	QFM
QFM ILLEGAL REQUEST.	One of the following. - Specified function was illegal or undefined - Job did not have SSJ= entry point - Auto recall bit was not set	Verify that valid QFM request is being made.	QFM
QFM ILLEGAL USER ACCESS.	The user tried to perform an operation for which he is not validated (for example, attempting to run a system origin job from nonsystem origin.	Ensure accuracy of control statement or macro or determine proper validation requirements.	QFM
QFM INTERLOCK ERROR.	Track interlock could not be set because of conflict.	Inform site analyst.	QFM
QFM RANDOM ADDRESS ERROR.	An error occurred while the dayfile random address was being converted.	Inform site analyst.	QFM
QFM SYSTEM SECTOR ERROR.	An error occurred while the system sector was being read.	Inform site analyst.	QFM
QFM TRACK MISMATCH.	The file about to be purged is not the same file that was previously attached. The first track in the FST does not equal the one from the DULL word.	Inform site analyst.	QFM
QFM UNABLE TO INTERLOCK MST.	Informative message.	None.	QFM
QLOAD ABORTED.	Job was dropped by operator or aborted because of a system error.	Check the dayfile for other error messages to determine the cause of the abort.	QLOAD



MESSAGE -----	SIGNIFICANCE -----	ACTION -----	ROUTINE -----
QLOAD - nnnn ACTIVE FILES LOADED.	Informative message indicating the number of active files loaded.	None.	QLOAD
QLOAD - nnnn ERRxxx FILES CREATED.	Informative message indicating the number of queue files that could not be processed because of write parity errors on mass storage. The files in error have been renamed to the file ERRxxx and will remain assigned to the control point as locked common files.	Inform site analyst to locate and flaw the tracks in error.	QLOAD
QLOAD - nnnn FILES IGNORED.	Informative message indicating the number of files ignored during the load operation.	None.	QLOAD
QLOAD - nnnn FILES LISTED.	Informative message indicating the number of files listed.	None.	QLOAD
QLOAD - nnnn INACTIVE FILES LOADED.	Informative message indicating the number of inactive files loaded.	None.	QLOAD
QLOAD OPERATION COMPLETE.	Informative message indicating completion of QLOAD.	None.	QLOAD
QLOAD TERMINATED.	QLOAD aborted and the abort processing was terminated either by the operator or because of a system error.	Check dayfile for the cause.	QLOAD
QMOVE ABORTED.	An error has been detected which is not processed by QMOVE error processing. Attempts to correct the situation have been made, but discretion should be used in continuing use of QMOVE.	Inform site analyst. Check the dayfile for other error messages to determine the cause of the abort.	QMOVE
QMOVE COMPLETE.	Informative message indicating completion of QMOVE.	None.	QMOVE
QREC COMPLETE.	K-display message indicating completion of QREC.	None.	QREC
QREC/QLIST ABORTED.	This message occurs if QREC aborts for any reason.	A level 0 deadstart may be needed to recover lost queued files.	QREC
QUEUE FILE ASSIGN ERROR.	Attempt to force a device assignment for the queue file being loaded resulted in the file being assigned to the wrong equipment.	Check output for files processed.	QLOAD

MESSAGE -----	SIGNIFICANCE -----	ACTION -----	ROUTINE -----
QUEUE FILE UTILITY COMPLETE.	Informative message indicating utility has completed.	None.	QFSP
QUEUE STATUS INDEFINITE.	QREC, QDUMP, or QMOVE has not been able to finish necessary file processing after an error or error exit. The status of IQFTs and queued files is unknown.	Inform site analyst. A level 0 (initial) deadstart is recommended.	QREC, QDUMP, QMOVE
QUEUED FILES LOST.	QREC lost some inactive queued files while attempting to requeue them. Files which process error conditions were not requested. This error should never occur but can occur if QREC was aborted and could not modify its files correctly.	A level 0 deadstart is necessary to recover the lost queued files.	QREC
QUEUES UNRECOVERABLE THIS DEVICE.	This message is issued in conjunction with the following message.  DNdn FM family MS ERROR. (for QREC) or IQFT FILE ERROR DN dn FAMILY family. (for QDUMP/QMOVE)  Refer to the appropriate message for device information.	None.	QREC, QDUMP, QMOVE
RD AND UI/UN NOT ALLOWED.	The RD and IU/UN parameters in the PFDUMP control statement are mutually exclusive.	Correct, and retry.	PFS
RDF FILE ERROR - BAD RECORD LENGTH.	The RF parameter specifies an invalid or wrong file, or there is an internal error in ASVAL or PFDUMP. The run is aborted.	Correct the RF parameter and try again.	ASVAL
RDF FILE ERROR - MISSING HEADER.	The RF parameter specifies an invalid or wrong file, or there is an internal error in ASVAL or PFDUMP. The run is aborted.	Correct the RF parameter and try again.	ASVAL
RDF FILE ERROR - UNIDENTIFIED DATA.	Informative message indicating that a record type other than the known types was encountered. The run continues.	Inform site analyst.	ASVAL
RDPFC, ERROR IDLE, DN dv.	ASMOVE or ASVAL skipped device dv because of an error idle on the device.	Clear the error idle and rerun ASMOVE or ASVAL.	MAC2
RDPFC, PF UTILITY ACTIVE, DN dv.	ASMOVE or ASVAL skipped device dv because a permanent file utility was active on it.	Rerun ASMOVE or ASVAL after the utility is done.	MAC2
READ PARITY ERROR. filenam STAGING ERROR, JOB=jobnam, FM=family, UI=userin, CSU=id, MST=n, VSN=vsn, ASA=addr, STRM=s.	The staging of file filenam was aborted because of a read parity error. All jobs attempting to attach this file will be aborted or given an error response.	Retrieve the file from a dump tape if a backup copy is available. Run ASVAL to identify other files, if any, that are	MSSEXEC

MESSAGE -----	SIGNIFICANCE -----	ACTION -----	ROUTINE -----
READ SECURITY OUT OF RANGE.	Output file message indicating that the data base read security was not in the range of 0 to 7.	Correct and rerun.	VALNET
READING filename userin.	Informative message indicating name of the file that is currently being read from the archive tape and the user index under which the file is stored.	None.	PFCOPY, PFLoad
RECORD NOT FOUND.	Error was encountered during the building of the system library. An attempt was made to place a nonexistent routine on an alternate system device. Deadstart processing halts when this error is detected.	Attempt another deadstart. If the error persists, inform the site analyst.	SYSEDIT
RECORD NOT FOUND.	Output file message indicating that the record name specified in a READ directive was not found in the specified file.	Correct and rerun.	DSDI
*****RECORD SEQUENCING ERROR*****	Dump file records are out of sequence.	None.	NDA
REFORMAT COMPLETE.	Dayfile message indicating reformat run successfully completed.	None.	MODVAL
RELEASE DATE USED = n.	Informative message indicating that the release date value used by ASMOVE is n.	None.	ASMOVE
RELEASE TIME USED = n.	Informative message indicating that the release time value used by ASMOVE is n.	None.	ASMOVE
REMOVABLE DEVICE/NO ACTIVE DAYFILES.	The device specified by K-display parameters is a removable device and the option selected is termination of an active dayfile. Active dayfiles are not allowed to reside on removable devices.	Enter new device using the K display.	DFTERM
REQUEST *K* DISPLAY.	The K display is requested at the specified control point. This message appears in the comment field of a control point on the job status (B) display.	Enter command K,n. n Control point number	PFS, QFSP, MSI, MODVAL, PROFILE, MREC

MESSAGE -----	SIGNIFICANCE -----	ACTION -----	ROUTINE -----
REQUESTED MEMORY NOT FOUND.	Ouput file message indicating that the EPB directive was entered and no ECS/PP buffer was found in the EDD file.	Ensure that the dump file contains meaningful information.	DSDI
REQUESTED RESTORATIONS NOT FOUND.	The SYSEdit value specified by the R parameter is greater than the current level.	Correct the value specified by the R parameter to a value less than the current SYSEdit change level.	SYSEdit
REQUIRED FL EXCEEDS JOB MAX.	ASVAL needs more field length than allowed to complete processing.	Increase the maximum field length for the job.	ASVAL
RESTORING ADDRESSES S/N=serialn.	Console message indicating that the pack is currently undergoing restoration of the address fields. Here, serialn is the actual pack serial number read.	Do not drop the control point while this message is displayed.	FORMAT
S/N MISMATCH - serialn JOB ABORTED.	Console message indicating that FORMAT was terminated due to a mismatch between the serial number specified by the P parameter of the FORMAT control statement and the serial number recorded on the pack. Here, serialn is the serial number read from the pack.	Enter correct serial number with the P parameter of the FORMAT control statement.	FORMAT
SCRIPTS CANNOT FOLLOW TASK DEFINITIONS.	K-display message indicating that the format of the session file is incorrect; tasks must follow sessions.	Put task definitions after session records.	STIMULA
SDF INSTALLATION COMPLETE.	Informative message indicating that system deadstart file installation is complete.	None.	INSTALL
SELECTED CUBE NOT ASSIGNED AS EXPECTED. NUMBER PROCESSED = n.	One of the cubicles is not available for the assignment specified by a directive to ASLABEL. However, n cubicles were assigned.	Correct the directive to ASLABEL and retry.	ASLABEL
SELECTED CUBE NOT EMPTY. NUMBER PROCESSED = n.	One of the cubicles to be removed by the RB directive to ASLABEL is not empty. However, n cubicles were removed.	Specify a different cubicle and retry.	ASLABEL
SELECTED CUBE NOT UNASSIGNED. NUMBER PROCESSED = n.	One of the cubicles to be added by the AB directive to ASLABEL is already assigned. However, n cubicles were added.	Specify a different cubicle and retry.	ASLABEL
SELECTED DEVICE NOT MASS STORAGE.	The equipment number specified on the MST directive was not the number of a mass storage device.	Correct and rerun.	DSDI

MESSAGE -----	SIGNIFICANCE -----	ACTION -----	ROUTINE -----
SELECTOR MOTION ERROR. DESTAGE RESTARTED.	A file destage operation was restarted using a different cartridge because of a hardware problem.	Inform customer engineer.	EXDEST
SEQUENCING BAD AFTER ADDRESS addr IN RECORD TYPE x.	Records of type x are not continuously located in ascending order on the dump file. This error occurred after line address addr.	Analyze error and try again.	NDA
SETTING PF ACTIVITY COUNT.	PFDUMP or PFCAT utility is waiting for PFU to increment the permanent file activity count before starting catalog processing. This message should be displayed for a few seconds only.	Inform site analyst if message is displayed for an extended period of time.	PFDUMP PFCAT
SETTING UTILITY INTERLOCK.	PFLOAD utility is waiting for PFU to set the permanent file utility interlock on a device before loading it. When no other utility (such as PFLOAD or MSI) is active on the device and permanent file activity in the system ceases, PFLOAD continues automatically.	Wait for other utility to complete.	PFLOAD
*SL* NOT SPECIFIED CORRECTLY.	The SL parameter on the ASUSE control statement was not a number from 0 through 16.	Correct the SL parameter and retry.	ASUSE
SLV1 ABNORMAL - xxx.	MSSSLV on mainframe 1 has encountered an abnormal error condition in routine xxx.	Inform site analyst.	MSSSLV
SLV1 ACTIVE, EXEC xxxx.	Informative message indicating the current status of MSSEEXEC according to MSSSLV on mainframe 1.	None.	MSSSLV
SLV1 - ERROR TERMINATION (1).	While MSSSLV on mainframe 1 was reading the master-to-slave communications file MTOSPFN, an I/O error occurred which prevented further MSSSLV processing.	Purge file MTOSPFN and reinitialize MSSEEXEC and all MSSSLV programs.	MSSSLV
SLV1 - IDLED DOWN.	Informative message indicating that MSSSLV on mainframe 1 terminated normally in response to an operator n.IDLE command.	None.	MSSSLV
SLV1 MTOSPFN xxxx.	MSSSLV on mainframe 1 attempted to attach or read the master-to-slave communication file MTOSPFN. xxxx is the status of the attempt and is one of the following. OK ATTACH PROBLEM LENGTH PROBLEM NO MID MATCH	If xxxx is OK, no action is required. If xxxx is LENGTH PROBLEM, purge MTOSPFN and reinstall MSSSLV and MSSEEXEC using identical values for NUMRB, MAXSLV, and NUMSLV in common deck COMEIPR and for RBSIZE in common deck COMASS. If xxxx is ATTACH PROBLEM or NO MID MATCH,	MSSSLV

MESSAGE -----	SIGNIFICANCE -----	ACTION -----	ROUTINE -----
SLV1 STOMNO1 xxxx.	MSSSLV on mainframe i attempted to establish access to the slave-to-master communication file STOMNO1. The status of this attempt is indicated by xxxx, which can be one of the following. OK ATTACH PROBLEM BUSY DEFINE PROBLEM	idle MSSEEXEC (if currently running), and reinitialize it.  If xxxx is not OK, analyze error and try again. Ensure that the link device is configured as a direct access permanent file device.	MSSSLV
ST NOT SPECIFIED CORRECTLY.	The ST parameter was specified without an equals sign in a directive to ASDEBUG.	Specify ST correctly and try again.	ASDEBUG
STATUS/CONTROL REGISTERS NOT FOUND.	Output file message indicating that the S/C register record was not found in the EDD file.	Ensure that the dump file contains meaningful information.	DSDI
STIMULATION COMPLETE.	Informative dayfile message indicating that stimulation is complete.	None.	STIMULA
*SU* NOT SPECIFIED CORRECTLY.	The SU parameter on the ASUSE control statement was not a number from 0 through 16 or was less than the SL parameter.	Correct the SU parameter and retry.	ASUSE
SUBSYSTEM NOT FOUND.	Output file message indicating that the requested subsystem was not found in the EDD file.	Ensure that the dump file contains meaningful information.	DSDI
SUPIO ERROR ec IN filename ON READING RECORD x.	The SUPPIO function READSR returned error code ec when attempting to read record x from file filename. ec    Error code 0001 Write parity error; data transferred 0002 Unrecognizable write address; data transferred 0003 Unrecognizable write, detail status error; data transferred 0011 Buffer full on coded file 0013 Buffer full on binary file 0021 Operation complete on coded file 0023 Operation complete on binary file 0031 End-of-file on coded file 0033 End-of-file on binary file 0070 Not a SUPPIO file 0071 Duplicate record ID 0072 Index pointers in FET are	Analyze error and try again.	NDA

MESSAGE -----	SIGNIFICANCE -----	ACTION -----	ROUTINE -----
	unrecognizable		
	0073 Index area too small		
	0074 Random request on sequential file		
	0075 Sequential request on random file		
	0076 Rewrite longer than previous record		
	0077 Rewrite on non-existent record		
	1031 End-of-information on coded file		
	1033 End-of-information on binary file		
	4001 Write parity error; data not transferred		
	4002 Unrecognizable write address error; data not transferred		
	4003 Unrecognizable write, detail status error; data not transferred		
	4007 Track limit		
SUPIO ERROR ec IN filenam ON WRITING RECORD x.	The SUPIO function WRITESR returned error code ec when attempting to read record x from file filenam. Refer to SUPIO ERROR code IN filenam ON READING RECORD x message for error code meanings.	Analyze error and try again.	NDA
SUPIO OPEN ERROR ec ON filenam.	The open on file filenam returned SUPIO error code ec. Refer to the SUPIO ERROR ec IN filenam ON READING RECORD x message for the error code meanings.	Correct error and try again.	LFG
SUPIO READ ERROR ec ON filenam.	The read on file filenam returned SUPIO error code ec. Refer to the SUPIO ERROR ec IN filenam ON READING RECORD x message for the error code meanings.	Correct error and try again.	LFG
SUPIO WRITE ERROR ec ON filenam.	The write on file filenam returned SUPIO error code ec. Refer to the SUPIO ERROR ec IN filenam ON WRITING RECORD x message for the error code meanings.	Correct error and try again.	LFG
SYNTAX ERROR, ASDEBUG ABORT.	The ASDEBUG control statement or directive is syntactically incorrect.	Correct the control statement or directive and retry.	ASDEBUG
SYNTAX ERROR - ASLABEL ABORT.	The ASLABEL control statement or directive is syntactically incorrect.	Correct the control statement or directive and retry.	ASLABEL

MESSAGE -----	SIGNIFICANCE -----	ACTION -----	ROUTINE -----
SYNTAX ERROR IN DIRECTIVE.	One of the directives to ASDEBUG is syntactically incorrect.	Correct the directive and try again.	ASDEBUG
SYSEEDIT ARGUMENT ERROR.	An error was detected on the SYSEEDIT control statement.	Correct the error and retry.	SYSEEDIT
SYSTEM DAYFILE DUMPED.	The system dayfile dump is complete.	None.	DAYFILE
SYSTEM EDIT COMPLETE - CHANGE n.	Informative message indicating the change level and completion of SYSEEDIT.	None	SYSEEDIT
SYSTEM ERROR.	A software or hardware system error occurred.	Inform site analyst immediately.	MODVAL, PFM
SYSTEM FILE ERROR.	Informative message indicating that an error was detected in the system file. A subsequent message is issued which indicates details about the source of error.	Take appropriate action based on the second message.	SYSEEDIT
SYSTEM NOT IN ENGR MODE.	The system must be in engineering mode when the LOADBC control statement is entered.	Enter the ENGR command to place the system in engineering mode. (Refer to the NOS Operator's Guide.)	LOADBC
TABLE OVERFLOW.	Dayfile message indicating that not enough storage was available to hold all terminal description table entries.	Rerun with a greater field length specified.	VALNET
TABLE OVERFLOW ON INPUT.	Dayfile message indicating that too many flaw entries were available in the input stream; the flaw limit is 157 flaws.	Correct and rerun.	FORMAT
TAPE ERROR X.GO/X.DROP.	An error was encountered while QDUMP was writing to the dump tape.	To continue job, enter X.GO. To terminate dump, enter X.STOP. Mount another tape and retry QDUMP.	QDUMP
TAPE PARITY ERROR.	Parity error was encountered while a load, catalog, or copy to a file was attempted. Tape is skipped to next EOR mark. This is a nonfatal system error and is similar to the PARITY ERR filename userin. message except that the file name and user index are not known.	Try backup tape or inform site analyst.	PFATC, PFCOPY, PFLOAD
TASK PERCENTAGE UNEQUAL TO 100.	K-display message indicating that the total task percentages for all tasks defined do not add up to 100.	Correct task definitions in the session file.	STIMULA



MESSAGE -----	SIGNIFICANCE -----	ACTION -----	ROUTINE -----
TELEX ABORT.	Fatal dayfile message indicating that the time-sharing subsystem aborted while the stimulator was running.	Examine the dayfile for the cause.	ITS, ITE
TELEX NOT ACTIVE.	Fatal dayfile message indicating that the time-sharing subsystem is not at a control point.	Bring the time-sharing subsystem to a control point before running the stimulator.	ITS, ITE
TERMINAL DESCRIPTION ERRORS.	Dayfile message indicating that errors were found in the terminal description.	Examine the listing for diagnostic messages.	VALNET
TERMINAL NAME DUPLICATES THAT OF KTS TERMINAL.	Output file message indicating that a terminal name was specified which was the same as an already specified TRANEX terminal.	Correct and rerun.	VALNET
TERMINAL NAME TABLE OVERFLOW.	Output file message indicating that not enough storage is available to contain all the terminal description table entries.	Rerun with a greater field length specified.	VALNET
TERMINAL NAME TOO LONG.	Output file message indicating that the terminal name specified was more than seven characters.	Correct and rerun.	VALNET
TIME LIMIT UP.	Dayfile message indicating that the total time limit on the CYCLE. command has passed.	Input can again be accepted by the simulator.	SCRSIM
TOO MANY BITS SPECIFIED.	Dayfile message indicating that more bits were specified than can be held in the area, line, or byte given.	Correct and reenter.	SCRSIM
***TOO MANY CHARACTERS IN VALUE.	Output file message indicating that the value for a directive consists of too many characters.	Rerun using legal value.	PROFILE
TOTAL VALIDATION ERRORS = n.	Informative message indicating that ASVAL found n validation errors.	None. However, n can be used as the FX parameter on subsequent ASVAL runs, if catalog repair processing is desired.	ASVAL
TRACK ALREADY ASSIGNED.	The track byte for the IQFT file in the DULL word in the MST is already assigned.	Inform site analyst.	QFM
TRACK LIMIT ON SDF DEVICE.	The device selected to be an RMS deadstart device does not have enough space to accomodate the deadstart file.	Use another device.	IIS

MESSAGE -----	SIGNIFICANCE -----	ACTION -----	ROUTINE -----
UCP CALL ERROR.	There is an ASVAL or MSSEEXEC internal error.	Submit a Programming System Report (PSR) with supporting material.	ASVAL
UNABLE TO ATTACH MRF, FM=family.	File MOVCOM could not be attached.	Purge MOVCOM and rerun ASMOVE to create a new file.	EXDEST
UNABLE TO CONNECT WITH EXEC.	MSSEEXEC is not running at this time.	Rerun the utility when MSSEEXEC is running.	ASMOVE, ASDEBUG
UNABLE TO DEFINE filenam.	An error was encountered during an attempt to define file filenam under the user's family and user index.	Ensure that an indirect access file named filenam does not exist and that no direct access file named filenam is in use and retry.	ASDEBUG
UNABLE TO DEFINE COMMUNICATION FILE.	File MOVCOM does not exist and cannot be defined by ASMOVE.	Submit a Programming System Report (PSR) with supporting material.	ASMOVE
UNABLE TO OPEN CATALOG.	The MSF Catalog does not exist or is busy.	Correct the control statement or wait until the MSF catalog is not busy.	ASUSE
UNABLE TO OPEN CSUMAP.	The CSU map does not exist or is busy.	Correct the control statement or wait until the CSU map is not busy.	ASUSE
UNABLE TO READ MRF, FM=family.	A read error was encountered on the move request file, MOVCOM.	Purge MOVCOM and rerun ASMOVE to create a new file.	EXDEST
UNCORRECTABLE RMS ERROR.	An error was detected when reading the EOI.	Retry operation.	DFTERM
UNKNOWN INITIAL STATUS.	Output file message indicating that the initial status specified was neither ON nor OFF.	Correct and rerun.	VALNET
UNKNOWN KEYWORD.	Output file message indicating that an unknown keyword has been entered, or the keyword entered was not followed by =.	Correct and rerun.	VALNET
UNKNOWN MULTIPLEXER TYPE.	Output file message indicating that an entry other than //6671, //6676, //DIAL, or //STIM has been entered in the multiplexer definition directive.	Correct and rerun.	VALNET

MESSAGE -----	SIGNIFICANCE -----	ACTION -----	ROUTINE -----
UNKNOWN TERMINAL TYPE.	Output file message indicating that a terminal type other than AB, ID, *AB, or *ID has been specified.	Correct and rerun.	VALNET
UNRECOGNIZABLE DIRECTIVE.	Output file message indicating that the directive entered was not a valid DSDI input directive.	Correct and rerun.	DSDI
UNRECOGNIZABLE LABEL.	The cartridge label to be repaired is of unknown type.	Retry the FX directive to ASLABEL without specifying the FM parameter, or use ASDEBUG to read the streams from the cartridge in order to analyze the label.	ASLABEL
UNRECOGNIZED CHARACTER FOUND --x--.	The character x is illegal. The scan resumes at the next period.	The valid characters are alphanumeric and the delimiters colon, comma, semicolon, and period. Correct the character and try again.	LFG
UNRECOVERABLE ERROR CONDITION OCCURRED.	Dayfile message indicating that operation was terminated due to a nonrecoverable error.	Refer to the general and detailed status described in the output listing for the specific error condition. If this condition occurs, it is extremely probable that the pack and/or disk drive is unusable in its present condition.	FORMAT
UNRECOVERABLE MS ERROR.	An irrecoverable mass storage error was detected during an I/O operation.	Inform site analyst.	QFM
UNRECOVERABLE READ ERROR.	The cartridge label cannot be read because of a faulty MST or cartridge.	Retry after cleaning or repairing the MST, relabel the cartridge, or discard the cartridge.	ASLABEL
UNRECOVERABLE WRITE ERROR.	The cartridge label cannot be written because of a faulty MST or cartridge.	Retry after cleaning or repairing the MST, or discard the cartridge.	ASLABEL

MESSAGE -----	SIGNIFICANCE -----	ACTION -----	ROUTINE -----
UNRECOVERABLE WRITE ERROR. DESTAGE RESTARTED.	A file destage operation was restarted using a different cartridge because a write error was encountered when the cartridge label was being rewritten.	Inform customer engineer. If the affected cartridge can be identified, remove it and try to relabel it. Refer to Error Conditions and Corrective Action in section 3.	EXDEST
UNRECOVERED PARITY ERROR - filename ENTER K.GO - CONTINUE ON NEW REEL. K.END - ABORT DUMP. K.DISABLE - CONTINUE ON ONE FILE.	An irrecoverable parity error was encountered on archive tape during PFDUMP operations; file is skipped. This is a nonfatal system error. The DISABLE option is displayed only if both the archive and verify files are active. If selected by the operator, the dump will continue on the remaining good file.	Described in message.	PFDUMP
UPDATE COMPLETE.	Dayfile message indicating update run successfully completed.	None.	MODVAL
UPDATE NOT ALLOWED BY INQUIRE.	Entry of update directives is rejected during K-display inquire of a user number.	Request K-display update of user number if update is desired.	MODVAL
UPDATE SECURITY OUT OF RANGE.	Output file message indicating that the data base update security specified was not in the range of 0 to 7.	Correct and rerun.	VALNET
UPDATING usernum.	Message displayed at line 1 of control point indicating that the user number usernum is being updated.	None.	MODVAL
USER ARGUMENT OUT OF RANGE.	Output file message indicating that the user argument specified was not in the range of 0 to 7777777B.	Correct and rerun.	VALNET
USER INDEX NOT ON DEVICE.	Permanent files for the user index currently being cataloged do not reside on the device being cataloged. This is a fatal system error; PFCAT abort.	Retry utility and specify the correct combination of user index and device number.	PFCAT
USER INDEX PREVIOUSLY DEFINED.	More than one user number has been assigned to a user index with the UI identifier. MODVAL disregards this user number entirely unless the CV parameter (suppression of automatic creation of system and library user indexes) has been selected. In that case, the duplication is flagged on the output file and processing continues normally.	Rerun the job or correct the new validation file so that only one user number is assigned to any user index.	MODVAL

MESSAGE -----	SIGNIFICANCE -----	ACTION -----	ROUTINE -----
USER INDEX userin PURGED.	Output file message indicating that the files under user index userin were purged during a REFORMAT run.	None.	MODVAL
USER NOT SYSTEM ORIGIN.	The user who entered the LOADBC control statement did not have system origin privileges.	Enter the LOADBC control statement from the console.	LOADBC
USER NUMBER INVALID.	User number cannot be converted to user index correctly.	Reenter parameters and specify correct user number, or site analyst must create a new user number.	PFS
USER NUMBER NOT FOUND.	Output file message indicating that an attempt was made to delete (or inquire or update from the K display) a nonexistent user number. If entered from the K display, the line of input on which the error occurred is disregarded; otherwise, that particular user number is disregarded.	Correct input directives and rerun job, or correct new validation file, if necessary.	MODVAL
V, D, XI OPTION VIOLATED.	The specified directive to ASDEBUG requires only one of the three parameters V, D, or XI to be specified.	Correct the directive and retry.	ASDEBUG
VALIDATING SB=sub CSU=id.	Informative message indicating that ASVAL is validating the MSF catalog for subfamily sub and the CSU map for CSU id.	None.	ASVAL
VALINDs READ ERROR.	Dayfile message indicating that a read operation on VALINDs did not complete. The file must contain a level 0 and level 1 block.	Ensure that the file is local and contains a level 0 and a level 1 block (at least one user entry) and rerun.	MODVAL
VALNET ARGUMENT ERROR.	Dayfile message indicating that the VALNET control statement contains unknown or incorrectly used arguments.	Correct and rerun.	VALNET
VALNET COMPLETE.	Dayfile message indicating that all descriptions have been validated as correct.	None.	VALNET
VALUE NEEDED FOR PARAMETER p	NDA aborted because a value was missing for call parameter p.	Supply a value for the parameter and call NDA again.	NDA
VERIFYING ADDRESSES S/N=serialn.	Console message indicating that a read-only pass is being made across the pack. This message is displayed after successfully fetching the factory-recorded data and flaw	None.	FORMAT

MESSAGE -----	SIGNIFICANCE -----	ACTION -----	ROUTINE -----
	maps or after successfully restoring the address fields, if the V (verify) option was specified on the FORMAT control statement. Here, serialn is the actual pack serial number read.		
VSN = vsn. FAMILY = family. SUBFAMILY = sub. CSU = id. X = x. Y = y. UNEXPECTED CSU, X, Y, FAMILY OR SUBFAMILY.	Corresponding fields in the cartridge label and CSU map entry do not match. The values from the cartridge label are shown in the message.	Remove the cartridge from the output drawer. If the cartridge is to be restored, correct the RS directive and retry. If the cartridge is to be removed, retry the RM directive, specifying the lost cartridge (LT) option.	ASLABEL
VSN ALREADY IN CSUMAP.	A cartridge being added from the input drawer has a scratch or manufacturer's label and a VSN which is already assigned in the CSU map. Because all cartridges have unique VSNs, the CSU map entry is probably obsolete.	Remove invalid CSU map entry, using steps described in section 3: Removal of Faulty or Missing Cartridges.	ASLABEL
VSN NOT FOUND.	The vsn specified in the directive to ASDEBUG is not contained in the CSU map.	Correct the vsn and retry.	ASDEBUG
VSN NOT FOUND IN CSUMAP.	The vsn specified in the RM directive to ASLABEL or in the label of the cartridge being restored is not contained in the CSU map.	Correct the directive and retry.	ASLABEL
VSN OPTION VIOLATED.	One of the following. - V=vsnn cannot be used with the directive specified. - V=vsnn was not specified but is required with the directive specified. - V=vsnn cannot be used with at least one of the other parameters specified. - V alone cannot be used with a directive to ASDEBUG.	Correct the error and retry.	ASLABEL ASDEBUG
WAIT FOR CATALOG INTERLOCK.	Informative message indicating that permanent file requests are currently active. PFDUMP will automatically continue when interlock on device is successful.	None.	PFDUMP
WAIT FOR PF UTILITY ON xx.	PFDUMP or PFCAT utility is waiting for a permanent file utility (such as PFLOAD or MSI) to complete processing on equipment xx. The waiting utility continues automatically when the other utility completes.	Wait for utility to complete.	PFDUMP PFCAT

MESSAGE

WAITING FOR EXEC.

SIGNIFICANCE

MSSEXEC is temporarily delaying the processing of ASVAL requests.

ACTION

None.

ROUTINE

ASVAL

MESSAGE -----	SIGNIFICANCE -----	ACTION -----	ROUTINE -----
WAITING FOR FILE filename.	Informative message indicating that ASVAL is waiting for MSSEXEC to return a CSU map or an MSF catalog.	None.	ASVAL
WAITING - GLOBAL INTERLOCK.	Informative message indicating that another deadstart file installation is in progress on the selected device.	None.	IIS
WORD ADDRESS NOT FOUND.	Output file message indicating that a word address requested was not found in the specified record in the EDD file.	Ensure that the dump file contains meaningful information.	DSDI
WPE UNRECOVERED -ABORT.	Operator has aborted PFDUMP operation by entering K.END in response to UNRECOVERED PARITY ERROR message. This is a fatal system error.	Retry PFDUMP operation using a different tape.	PFDUMP
WRITING SUMMARY.	Informative message indicating that summary report is being generated.	None.	PFCAT
X,Y OPTION VIOLATED.	An invalid X,Y combination was specified by the XI and YI parameters in a directive to ASLABEL.	Correct the XI,YI parameters and retry.	ASLABEL
XI, YI OPTION VIOLATED.	One of the following. - XI and YI parameters were required but were not specified. - XI and YI were not specified together. - Either the XI or YI parameter was not a legal value.	Correct the XI and/or YI parameters and retry.	ASDEBUG
IIS - ILLEGAL REQUEST.	IIS was called with an illegal function request.	None.	IIS
jobnam ABORTED - message.	Unauthorized or incorrect user program sent invalid requests to MSSEXEC; message can be any of the following. - ALREADY CONNECTED - CARTRIDGE ACTIVE - INVALID ADDRESS - INVALID REQUEST CODE - INVALID REQUEST TYPE - MULTIPLE REQUESTS - MULTIPLE RUN - NOT CONNECTED	Ensure that only authorized versions of the utilities are used.	EXUCP
jobnam ABORTED - UTILITY CONFLICT.	ASVAL, ASLABEL, and ASDEBUG are mutually exclusive utilities.	Rerun the aborted utility after the other one has terminated.	EXUCP



<u>MESSAGE</u>	<u>SIGNIFICANCE</u>	<u>ACTION</u>	<u>ROUTINE</u>
xxxxxx DAYFILE TERMINATED.	Informative message indicating that dayfile xxxxxx has been terminated (issued to system and control point dayfiles).	None.	SFM
filenam EQxx TRACKtttt LENGTH ERROR.	Physical EOI of disk and logical EOI of TRT are not identical. filenam Name of file in error xx EST ordinal of device tttt First track of file in error	Inform site analyst.	QDUMP, QMOVE, QREC
nnnn ERRORED FILES CREATED.	Informative message indicating the number (nnnn) of locked common files created on the destination device because of unrecoverable write errors which occurred on that device. The names of these files are of the form ERRxxx, where xxx is a three-digit sequence number from 001 through 999.	None.	QMOVE
nnnn FILES ACTIVATED DNdn FM family.	Informative message indicating the number of queued files that have been activated on the specified device. nnnn Number of files dn Device number family Family name	None.	QREC, QMOVE
nnnn FILES DEQUEUED DNdn FM family.	Informative message indicating the number of files that have been dequeued on the specified device. nnnn Number of files dn Device number family Family name	None.	QREC, QMOVE
nnnn FILES DUMPED (A) DNdn FM family.	Informative message indicating the number of active queued files which have been dumped and remained active on the specified device. nnnn Number of files dn Device number family Family Name	None.	QDUMP
nnnn FILES DUMPED (I) DNdn FM family.	Informative message indicating the number of inactive queued files which have been dumped and remained inactive on the specified device. nnnn Number of files dn Device number family Family name	None.	QDUMP

MESSAGE -----	SIGNIFICANCE -----	ACTION -----	ROUTINE -----
nnnn FILES IGNORED DNdn FM family.	Informative message indicating the number of queued files which have been ignored on the specified device during a queue operation. nnnn Number of files dn Device number family Family name	None.	QREC, QDUMP, QMOVE
nnnn FILES MOVED (A) DNdn FM family.	Informative message indicating the number of active queued files that have been moved and remained active on the specified device. nnnn Number of files dn Device number family Family name	None.	QMOVE
nnnn FILES MOVED (I) DNdn FM family.	Informative message indicating the number of inactive queued files that have been moved and remained inactive on the specified device. nnnn Number of files dn Device number family Family name	None.	QMOVE
nnn FILE(S) PURGED.	Informative message indicating that nnn files were purged according to the last access date.	None.	NDA
nnnn FILES PURGED DNdn FM family.	Informative message indicating the number of queued files which have been purged on the specified device. nnnn Number of files dn Device number family Family name	None.	QREC
nnn USER INDICES PURGED.	Dayfile message indicating that all files under nnn user indices were purged via the reformat option. This can occur only with a system origin job.	None.	MODVAL

# INDEX

- Access word 5-21
- Account dayfile messages
  - Format 5-72
  - Message groups
    - Accounting (A) 5-74
    - Description 5-74
    - Installation (I) 5-74
    - Statistical (S) 5-79
    - Usage (U) 5-84
- Accumulators, installation 5-52
- Active dayfiles 2-23
- Active queue files 2-18,34,36
- AFD 2-38
- AIP trace 4-1,8.1
- Allocation unit 3-2
- Alternate directive file
  - DSDI 10-8
  - Queue utilities 2-6
- Alternate storage address 1-13,35; 3-8
- amsg 1-35
- Answerback 4-16; 5-17,23
- Application bits 5-22
- Application interface program trace
  - 4-1,8.1
- Application usage accounting 5-38,84,85,87,88
- Archive file
  - Description 1-1
  - Multifile 1-1,4
  - Preassignment 1-33
- asa 1-13,35; 3-8
- ASDEBUG 3-2,23,26,37,46,47
- ASDEF 3-1,9,10,40
- ASLABEL 3-1,10,10.1,11,12,13,14,40,45
- ASMOVE 3-1,8,17,20,40,43,48
- AST 3-5
- ASTIM 4-14
- AU 3-2
- AUMX 5-38
- ASUSE 3-2,30
- ASVAL
  - Description 3-2,22,41
  - Examples 3-29,41,42
  - Problem reporting 3-23,26,37,45
  - Release processing 3-17,22,26,41
  - Validation report 3-3,27,28,46,47
- Auxiliary device 1-17
  
- Backup requirement 1-11,35,42; 3-8,17,20,40,43,45
  
- Basic usage report 3-30,32
- Binary maintenance log
  - Dayfile dumping utility 2-38
  - DSDI directive 10-19
  
- Carriage control tape 9-1
- Cartridge
  - Allocation to a file 3-5,6,13,30,41
  - Assignment 3-1,2,4,8,10,12,13,16
  - Availability 3-2,30
  - Description 3-1,2
  - Label
    - Information 3-2,10,12,13,16
    - Repairing 3-10,13
    - Updating 3-2,12,16
  - Recover data from 3-2,37
  - Removal of 3-46
  - Residence in CSU 3-3
  - Restoration 3-10,13,46
  - Stream 3-2
- Cartridge storage unit
  - Assignment to subfamily 3-10,12,40
  - CSU identifier 3-1,10,14,23,31,38
  - CSU map 3-3
  - Description 3-1
  - Pool 3-3,12
  - Reserved area 3-3,12
- Catalog entry 1-9
- Catalog image record
  - Description 1-43
  - PF utility option 1-30
- Catalog track
  - Description 1-7
  - Entry 1-9
  - Number of 1-7
- Central memory space 5-20
- Chain of streams 3-2,7,8,25,26,27,47
- Character set, terminal 5-26
- CHARGE control statement
  - Batch usage 5-61
  - Description 5-59
  - Terminal usage 5-61
- Charge number 5-26,39,49,53,61
- Checkpoint, multimainframe 8-8
- CIR (refer to catalog image record)
- COMSSRU 5-64
- Coupler 3-1
- CSU (refer to Cartridge storage unit)
- CSU identifier 3-1,10,14,23,31,38
- CSU map
  - Analysis 3-2,25

- Backup 3-4,16,38,39,44
- Creating 3-1,9,40,43
- Description 3-3
- Ordinal 3-3
- Updating 3-4,12,13,16,36,43
- Cubicle
  - Allocation 3-1,3,4,10,12,30
  - Availability 3-2,30
  - Description 3-1
- DAT 8-1,4
- Dayfile dumping utilities 2-38
- Dayfile messages A-1
- Dayfile termination 2-23
- Deadstart dump interpreter (refer to DSDI)
- Deadstart sequencing 7-3
- DEMUX control statement 4-30
- Destage 3-2,8,17,20,21,30,40,41
- Device access table 8-1,4
- Device mask 1-3
- DFD 2-38
- DFLIST 2-25 (refer also to queue file utilities)
- DFTERM 2-23 (refer also to queue file utilities)
- Diagnostics A-1
- Disk space
  - Management 3-8,17,21,40
  - Release 3-2,8,17,20,21,40
- DPFC macro 9-2
- DSDI
  - Control statement 10-3
  - Description 10-1
  - Directive format 10-6
  - Dump tape request 10-4
  - Examples
    - Batch 10-32
    - Interactive 10-29
  - Input directives 10-5,25
  - Interactive use 10-24
  - Parameters 10-3
- Dump
  - Full 1-42; 3-42
  - Incremental 1-41; 3-43
  - Partial 1-42
- Dump tape management 3-21,43
- ECS space 5-20
- EDD 10-1
- ELD 2-38
- EOC 3-2,25,27,47
- Error messages A-1
- Express deadstart dump interpreter (refer to DSDI)

- Family 1-17
- FAMILY control statement 1-17
- Fast-attach files 7-1
- FCT 3-5,38
- FCT ordinal 3-3,4,35
- File label verification procedure 3-9
- Flaw data, disk pack 13-1
- FNTLIST 2-36 (refer also to queue file utilities)
- FORMAT (refer to pack reformatting, 881/883)
- Forms code 2-11
- Fragment 3-7,25,26,27,33,47
- Frozen chain 3-7,26,33,38
- GENVAL 7-4
- HOC 3-2,25,26,27,47
- Holding registers (refer to SCRSIM)
- IAFEX 4-8.1
- IAFTM 4-8.1
- IAFTR 4-8.2
- Inactive dayfiles 2-23
- Inactive queue files 2-18,25
- Index, user 1-3
- Initializing and releasing fast-attach files 7-3
- Intersections 3-25,28,47
- INSTALL 12-1
- ISF 7-1
- Label, cartridge
  - Description 3-2
  - File label verification procedure 3-9
  - Repairing 3-2,10,13
  - Stream label verification procedure 3-2
  - Updating 3-2,12,13,16
- Label track 1-14
- LCFFILE 4-9
- LDLIST 2-34 (refer also to queue file utilities)
- LFG (refer to load file generator)
- LIBRARY user number 5-38
- Limit registers, installation 5-52
- Link device 8-2
- Linkage byte 1-14,16
- Load (refer also to PFLOAD or QLOAD)
  - Incremental 1-43
  - Noninitial 1-30
- Load file generator
  - Description 4-1

Example, LFG 4-3  
 Examples, file description statements 4-2  
 Execution 4-3  
 File description statements 4-1  
 Load modules 4-1,3  
 NDL parameter agreement 4-1  
 Local configuration file 4-9  
 Looping chain 3-25  
 Lost cartridge 3-6,12,14,26,31,33

Machine identifier 8-2,3  
 Machine mask 8-3  
 Machine recovery table 8-1,6  
 MAINLOG 2-38; 10-19  
 Mask  
   Device 1-3  
   Machine 8-3  
   Secondary 1-5  
   Track 1-8  
 Mass storage  
   Concepts 1-3  
   Shared 8-4 (refer also to shared mass storage)  
 Mass Storage Facility  
   Description 3-1  
   Files on 3-8,17,22  
   MSF catalog 3-4  
 Mass Storage Subsystem  
   Description 3-1  
   Files 3-1,9,22  
   Initialization 3-40  
   Utilities 3-1,9  
 Mass storage table  
   Description 1-7  
   Dumping (DSDI) 10-18  
   Report (PFCAT) 1-37,38  
 Master device  
   Definition 1-3  
   Dumping 1-27  
   Number of catalog tracks 1-8  
   User index relationship 1-3  
 Master user 5-40,49  
 MID 8-2,3  
 MODVAL  
   Batch input 5-11  
   Console input 5-5  
   Control statement 5-12  
   Description 5-5  
   Examples 5-26  
   Input directives 5-16  
   Special user numbers 5-38  
 MREC 8-3  
 MRT 8-1,6

MSA 3-1  
 MSF (refer to Mass Storage Facility)  
 MSF catalog  
   Analysis 3-2,23,25  
   Backup 3-8,16,44  
   Chain of AUs 3-2  
   Creating 3-1,9,40,44  
   Description 3-4  
   Ordinal 3-4  
   Subcatalog 3-5  
   Updating 3-8,12,13,16,22,38  
 MSS (refer to Mass Storage Subsystem)  
 MSS processing  
   Backup and recovery 3-42  
   Disk space management 3-8,17,21,40  
   Error conditions 3-2,45  
   Initialization 3-1,9,40  
   MSF space management 3-40,41  
   Multimainframe environment 3-9,30; 8-1,8  
   Pseudo release 1-12; 3-18,48  
   Utilities 3-1,9  
 MSSEXEC 3-9,16,17,22,41  
 MSSSLV 3-9  
 MST 3-1,7  
 Multimainframe operation  
   Deadstart 8-2,4  
   Description/Overview 8-1  
   MSF environment 8-1,8  
   Shared mass storage 8-2,4  
 Multiplexer definition directive 4-10  
 Multipliers 5-51,65,70

NCCFILE 4-9  
 NCTFid 4-9,11  
 NDA (refer to NPU dump analyzer)  
 NETWid 4-9  
 Network configuration file  
   Description 4-9  
   Directives 4-10  
   Names 4-9  
 Network dump files (refer to NPU dump analyzer)  
 Network description files 4-9,12  
 Network products stimulator 4-15  
 Network utilities 4-1 (refer also to individual utilities)  
 NPS 4-15  
 NPU dump analyzer  
   Control statement 4-5  
   Description 4-5  
   Network dump files 4-7  
   Report formats 4-6  
 NSTIM 4-15

Obsolete file 1-13; 3-9  
 Off-cartridge link (Off-MSC link)  
   3-7,32,33,35  
 Ordinal  
   CSU map 3-3  
   FCT 3-3,4  
   MSF catalog 3-3,4  
 Orphan file 3-5,9,22,26,27  
  
 Pack reformatting, 881/883  
   Control directives 13-4  
   Data statements 13-4  
   Examples 13-5  
   FORMAT control statement 13-2  
   Input format 13-3  
   Output format 13-5  
   Special access procedures 13-9  
 Parity, terminal 5-25  
 Password 5-13,17  
 Permanent file access 5-24  
 Permanent file catalog 1-9  
 Permanent file utilities  
   Calling  
     Batch 1-25  
     Console 1-20  
     Terminal 1-25  
   Example 1-45,46  
   Overview 1-1  
   Parameters 1-25,27  
   Routines 1-34 (refer also to  
     individual routine name)  
 PFATC 1-37 (refer also to permanent  
   file utilities)  
 PFC (refer to programmable format control  
   or permanent file catalog)  
 PFCAT 1-37 (refer also to permanent  
   file utilities)  
 PFCOPY 1-41 (refer also to permanent  
   file utilities)  
 PFDUMP (refer also to permanent file  
   utilities)  
   Description 1-41  
   Example 1-46  
 PFLOAD (refer also to permanent file  
   utilities)  
   Description 1-42  
   Example 1-45,46  
   Execution  
     Archive file check 1-44  
     Device check 1-46  
     Specified option check 1-45  
 Plot units 5-19,85,86  
 Pool 3-3,12  
 Preferred residence 1-11,35; 3-17,19,20  
 Preserved file, TRT bits 1-15  
 PRESET (ECS) 8-2,3

PROBE 15-1,29  
 PROFILa 5-1,40,42  
 PROFILE  
   Access 5-40  
   Batch input 5-55  
   Console input 5-54  
   Control statement 5-40  
   Input directives 5-49  
   Parameters, control statement 5-40  
   Terminal input 5-55  
 Programmable format control  
   Arrays  
     Adding 9-2  
     Building 9-1  
     Description 9-1  
     Released 9-3  
     Rules 9-1  
     Description 9-1  
   Project number 5-26,39,52,53  
   Pseudo release 1-12; 3-18,48  
  
 QALTER 2-34  
 QDUMP 2-26  
 QFSP 2-2  
 QLIST 2-25  
 QLOAD 2-28  
 QMOVE 2-30  
 QREC 2-18  
 Queue file utilities  
   Alternate input file 2-7  
   Calling  
     Batch 2-7  
     Console 2-2  
     Terminal 2-8  
   Commands 2-4  
   File preassignment 2-17  
   Overview 2-1  
   Parameters 2-8  
   Routines 2-18 (refer also to  
     individual routine name)  
 Queue file supervisor 2-2  
  
 Record types 6-7  
 Release data file 1-31; 3-22,23,41,  
   42,43  
 Release space  
   Disk 3-2,8,17,20,21,40  
   MSF 3-2,9,17,22  
 Reserved area of CSU 3-3,12  
 Resource accounting 5-62  
 Resources controlled by MODVAL 5-4  
 RSXDid 7-1,3  
 RSXVid 7-1,3  
 Rubout count 5-25

- Scattered file 3-24,25
- Scratch cartridge 3-2,13
- Script file 4-13,15
- SCRSIM
  - Calling format 11-2
  - CYBER 70 use 11-1
  - Commands 11-5
  - Description 11-1
- SECEDED 10-20
- Secondary mask 1-5
- Security count 5-17
- Session file 4-13,15
- SFS 5-2
- Shared mass storage
  - Assignment 8-4
  - Checkpoint 8-8
  - Description 8-4
  - Initialization 8-6
  - Recovery 8-7
  - Unloading 8-7
- SIMFid 4-9
- Slave 3-9; 8-1,8
- Special accounting privileges 5-22,40
- Special user index 1-6
- Special user numbers 5-38
- SRU (refer to system resource units)
- Stage 1-30; 3-9,37,40,42,43
- Status/control register stimulator 11-1  
(refer also to SCRSIM)
- STIMULA 4-14
- Stimulation
  - Description 4-13
  - Execution 4-13
  - Multiple sessions 4-28
  - Output evaluation 4-33
  - Parameters
    - Mixed mode 4-27
    - Output format 4-28
    - Session file 4-23
    - Stimulator 4-24
  - Postprocessing 4-30
  - Procedure files 4-32
  - Session files
    - Description 4-13,15
    - Dynamic login 4-16
    - Optional think time specification 4-21
    - Processing 4-22
    - Source line input 4-20
    - Task definitions 4-22
- STMffff 4-23,32
- Stream
  - Conflict flag 3-7,9,33
  - Description 3-2
  - Detail information 3-7,31
  - Label verification procedure 3-2
  - Reading 3-37
- Subcatalog 3-4
- Subfamily 1-3; 3-4,9; 5-38

- Subsystem, initial 5-26
- SYSEEDIT
  - Control statement 6-1
  - Description 6-1
  - Input directives 6-2
  - Record types 6-7
- System file initialization 7-1
- System resource units
  - Description 5-2,62
  - Example of calculation 5-68
  - Formula 5-62
  - IO increments 5-68
  - Limitation, MODVAL 5-20
  - Parameters 5-64
- System user number 5-38
- SYSTEMX user number 5-38
- Task 4-22
- Terminal definition directive 4-10
- Terminal types 5-25
- Test mode 3-18,48
- TRACER 15-1,29
- Track mask 1-8
- Track, mass storage
  - Flawed 1-15; 13-1
  - Interlock bit (TRT) 1-14,15
  - Reservation bit (TRT) 1-14,15
- Track reservation table 1-14; 13-1
- User accounting 5-1,39
- User index
  - Assignment (MODVAL) 5-17,24
  - Permanent file device assignment 1-3
  - Special 1-6
- User numbers
  - Description 5-1
  - LIBRARY 5-38
  - Relationship to charge numbers 5-61
  - Special 5-38
  - SYSTEMX 5-38
  - Use with PROFILE 5-40
- User validation 5-2
- Utilities
  - Dayfile dumping 2-38
  - MSS 3-1,9
  - Network 4-1
  - Permanent file 1-1,34
  - Queue file 2-1,18
  - System data gathering 15-1,29
- Utility map (disk pack) 13-1
- Validation report 3-27,28
- VALIDUs 5-1,2
- VALINDs 5-1
- VALNET 4-12
- Verify file 1-32

X, Y coordinates 3-3

881/883 pack reformatting (refer to pack reformatting, 881/883)



# COMMENT SHEET

MANUAL TITLE: CDC NOS Version 1 System Maintenance Reference Manual

PUBLICATION NO.: 60455380

REVISION: H

NAME: \_\_\_\_\_

COMPANY: \_\_\_\_\_

STREET ADDRESS: \_\_\_\_\_

CITY: \_\_\_\_\_ STATE: \_\_\_\_\_ ZIP CODE: \_\_\_\_\_

This form is not intended to be used as an order blank. Control Data Corporation welcomes your evaluation of this manual. Please indicate any errors, suggested additions or deletions, or general comments below (please include page number references).

Please Reply

No Reply Necessary

CUT ALONG LINE

PRINTED IN U.S.A.

AA3419 REV 1/80

NO POSTAGE STAMP NECESSARY IF MAILED IN U.S.A.

FOLD ON DOTTED LINES AND TAPE. POSTAL REGULATIONS PROHIBIT THE USE OF STAPLES.

FOLD

FOLD



NO POSTAGE  
NECESSARY  
IF MAILED  
IN THE  
UNITED STATES

**BUSINESS REPLY MAIL**  
FIRST CLASS      PERMIT NO. 8241      MINNEAPOLIS, MINN.

POSTAGE WILL BE PAID BY  
**CONTROL DATA CORPORATION**  
Publications and Graphics Division  
ARH219  
4201 North Lexington Avenue  
Saint Paul, Minnesota 55112



CUT ALONG LINE

FOLD

FOLD



**CONTROL DATA CORPORATION**