

60445300 M

PARTIAL



**NOS VERSION 1
REFERENCE MANUAL**

Volume 2 of 2

**CDC® COMPUTER SYSTEMS:
CYBER 170 SERIES
CYBER 70
MODELS 71, 72, 73, 74
6000 SERIES**

LIST OF MACROS

ABORT	2-11-1	LABEL	2-4-15	ROLLOUT	2-6-9
APPEND	2-5-25	LOADD	2-11-20	ROUTE	2-8-4
ASSIGN	2-4-3,13	LOADQ	2-11-22	RPHR	2-3-22
ATTACH	2-5-31	LOCK	2-4-6	RPHRLS	2-3-27
BKSP	2-3-36	MACHID	2-6-26	RTIME	2-9-1
BKSPRU	2-3-37	MEMORY	2-11-7	SAVE	2-5-12
CATLIST	2-5-16	MESSAGE	2-11-9	SETASL	2-6-2
CHANGE	2-5-32	MODE	2-6-2	SETFET	2-2-14
CHECKPT	2-10-3	MOVE	2-11-11	SETGLS	2-6-25
CLOCK	2-9-1	NORERUN	2-7-3	SETID	2-4-12
CLOSE	2-3-18	OFFSW	2-6-11	SETJCI	2-6-32
CLOSER	2-3-21	OLD	2-5-36	SETJCR	2-6-17
COMMON	2-4-4	ONSW	2-6-11	SETJSL	2-6-3
CONTROL	2-10-2	OPEN	2-3-11	SETLC	2-6-15
CSET	2-12-16	OVERLAY	2-11-16	SETLOF	2-6-30
DATE	2-9-1	PACKNAM	2-6-21,22	SETMFL	2-6-27
DAYFILE	2-11-1	PARITY	2-12-16	SETPR	2-6-2
DEFINE	2-5-26	PDATE	2-9-1	SETQP	2-6-1
DISTC	2-12-13	PERMIT	2-5-22	SETRFL	2-6-16
EDATE	2-9-1	POSMF	2-3-41	SETSS	2-6-18
ENCSEF	2-4-14	PRIMARY	2-4-24	SETSSM	2-6-10
ENDRUN	2-11-3	PROMPT	2-12-17	SETTL	2-6-4
EREXIT	2-6-5	PROTECT	2-6-32	SKIPB	2-3-48
ETIME	2-9-1	PSCSF	2-4-14.1	SKIPEI	2-3-48
EVICT	2-3-46	PURGE	2-5-15	SKIPF	2-3-46
EXCST	2-10-3	READ	2-3-23	SKIPFB	2-3-49
FILEB	2-2-12	READC	2-3-53	SKIPFF	2-3-47
FILEC	2-2-12	READCW	2-3-24	STATUS	2-4-7
FILINFO	2-4-25	RADEI	2-3-29	STIME	2-9-1
GET	2-5-14	READH	2-3-54	SUBMIT	2-7-3
GETACT	2-6-26	READLS	2-3-26	SUBR	2-11-14
GETASL	2-6-13	READN	2-3-28	SYSKOM	2-1-8
GETEM	2-6-13	READNS	2-3-28	SYSTEM	2-11-14
GETFLC	2-6-20	READO	2-3-54	TIME	2-9-1
GETFNT	2-4-21	READS	2-3-55	TSTATUS	2-12-17
GETGLS	2-6-24	READSKP	2-3-24	UNLOAD	2-3-38
GETJA	2-6-18	READW	2-3-56	UNLOCK	2-4-7
GETJCI	2-6-31	RECALL	2-11-12	USECPU	2-6-19
GETJCR	2-6-16	RECOVR	2-10-11	USERNUM	2-6-19
GETJN	2-6-11	RELEASE	2-4-5	VERSION	2-6-23
GETJO	2-6-18	RENAME	2-4-2	WPHR	2-3-30
GETJSL	2-6-14	REPLACE	2-5-24	WRITE	2-3-30
GETLC	2-6-23	REPRIEVE	2-10-10	WRITEC	2-3-53
GETLOF	2-6-29	REQUEST	2-4-9,11	WRITECW	2-3-32
GETMC	2-11-4	RERUN	2-7-2	WRITEF	2-3-31
GETPPF	2-6-28	RETURN	2-3-40	WRITEH	2-3-54
GETPR	2-6-12	REWIND	2-3-37	WRITEN	2-3-35
GETQP	2-6-12	REWRITE	2-3-33	WRITEO	2-3-55
GETSS	2-6-22	REWRITEF	2-3-35	WRITER	2-3-31
GETTL	2-6-14	REWRITER	2-3-34	WRITES	2-3-55
HTIME	2-9-1	RFILEB	2-2-12	WRITEW	2-3-56
JDATE	2-9-1	RFILEC	2-2-12		



**NOS VERSION 1
REFERENCE MANUAL**

Volume 2 of 2

**CDC® COMPUTER SYSTEMS:
CYBER 170 SERIES
CYBER 70
MODELS 71, 72, 73, 74
6000 SERIES**

LIST OF EFFECTIVE PAGES

New features, as well as changes, deletions, and additions to information in this manual, are indicated by bars in the margins or by a dot near the page number if the entire page is affected. A bar by the page number indicates pagination rather than content has changed.

PAGE	REV	PAGE	REV	PAGE	REV	PAGE	REV	PAGE	REV
Front Cover	-	2-3-8	J	2-4-8	H	2-5-36	K	2-10-3	M
Inside Front Cover	M	2-3-9	L	2-4-9	J	2-6-1	M	2-10-4	M
Title Page	-	2-3-10	J	2-4-10	M	2-6-2	M	2-10-5	M
ii	M	2-3-11	J	2-4-11	M	2-6-2.1/		2-10-6	M
ii-a/ii-b	M	2-3-12	J	2-4-12	M	2-6-2.2	M	2-10-7	M
iii	M	2-3-13	J	2-4-13	L	2-6-3	J	2-10-8	K
iv	M	2-3-14	J	2-4-14	L	2-6-4	J	2-10-9	K
v	M	2-3-15	J	2-4-14.1/		2-6-5	M	2-10-10	M
vi	M	2-3-16	J	2-4-14.2	M	2-6-6	J	2-10-11	M
vi-a	M	2-3-17	K	2-4-15	J	2-6-7	L	2-10-12	M
vi-b	M	2-3-18	J	2-4-16	J	2-6-8	L	2-11-1	M
vi-c/vi-d	M	2-3-19	L	2-4-17	J	2-6-9	M	2-11-2	M
vii	M	2-3-20	J	2-4-18	M	2-6-10	L	2-11-3	M
viii	M	2-3-21	J	2-4-19	J	2-6-11	M	2-11-4	M
ix	M	2-3-22	J	2-4-20	J	2-6-12	L	2-11-5	M
x	M	2-3-23	L	2-4-21	M	2-6-13	L	2-11-6	M
xi	M	2-3-24	J	2-4-22	L	2-6-14	L	2-11-7	M
2-1-1	M	2-3-25	J	2-4-23	L	2-6-15	L	2-11-8	M
2-1-2	M	2-3-26	J	2-4-24	L	2-6-16	M	2-11-9	M
2-1-3	F	2-3-27	J	2-4-25	J	2-6-17	J	2-11-10	M
2-1-4	M	2-3-28	J	2-4-26	M	2-6-18	M	2-11-11	M
2-1-5	F	2-3-29	J	2-4-27	M	2-6-19	J	2-11-12	M
2-1-6	M	2-3-30	M	2-4-28	J	2-6-20	M	2-11-13	M
2-1-7	M	2-3-31	J	2-4-29	M	2-6-21	J	2-11-14	M
2-1-8	M	2-3-32	M	2-5-1	M	2-6-22	J	2-11-15	M
2-1-9	H	2-3-33	M	2-5-2	M	2-6-23	K	2-11-16	M
2-1-10	H	2-3-34	M	2-5-3	K	2-6-24	M	2-11-17	M
2-1-11	F	2-3-35	M	2-5-4	M	2-6-25	M	2-11-18	M
2-1-12	J	2-3-36	M	2-5-5	M	2-6-26	J	2-11-19	M
2-1-13	F	2-3-37	J	2-5-6	K	2-6-27	M	2-11-20	M
2-1-14	M	2-3-38	J	2-5-7	M	2-6-28	M	2-12-1	J
2-1-15	F	2-3-39	J	2-5-8	K	2-6-29	J	2-12-2	F
2-1-16	M	2-3-40	J	2-5-9	K	2-6-30	M	2-12-3	F
2-2-1	M	2-3-41	J	2-5-10	M	2-6-31	J	2-12-4	M
2-2-2	F	2-3-42	K	2-5-11	M	2-6-32	J	2-12-5	J
2-2-3	F	2-3-42.1/		2-5-12	L	2-6-33	J	2-12-6	K
2-2-4	K	2-3-42.2	K	2-5-13	K	2-7-1	M	2-12-7	M
2-2-5	M	2-3-43	K	2-5-14	M	2-7-2	M	2-12-8	M
2-2-6	M	2-3-44	K	2-5-15	K	2-7-3	L	2-12-9	K
2-2-7	M	2-3-45	M	2-5-16	K	2-7-4	M	2-12-10	K
2-2-8	M	2-3-46	K	2-5-17	M	2-7-5	L	2-12-11	J
2-2-9	M	2-3-47	J	2-5-18	M	2-8-1	M	2-12-12	J
2-2-10	K	2-3-48	K	2-5-19	L	2-8-2	M	2-12-13	J
2-2-11	K	2-3-49	J	2-5-20	K	2-8-3	M	2-12-14	J
2-2-12	J	2-3-50	J	2-5-21	L	2-8-4	M	2-12-15	M
2-2-13	K	2-3-51	M	2-5-22	K	2-8-4.1/		2-12-16	J
2-2-14	K	2-3-52	J	2-5-23	K	2-8-4.2	L	2-12-17	K
2-2-15	K	2-3-53	J	2-5-24	M	2-8-5	M	2-12-18	K
2-2-16	M	2-3-54	J	2-5-25	L	2-8-6	M	2-12-19	K
2-2-17	M	2-3-55	J	2-5-26	K	2-9-1	M	2-A-1	L
2-2-18	M	2-3-56	J	2-5-27	K	2-9-2	M	2-A-2	M
2-3-1	L	2-3-57	J	2-5-28	K	2-9-3	M	2-A-3	K
2-3-2	M	2-4-1	L	2-5-29	K	2-9-4	M	2-A-4	M
2-3-3	K	2-4-2	K	2-5-30	K	2-9-5	M	2-A-5	M
2-3-4	M	2-4-3	K	2-5-31	M	2-9-6	M	2-A-6	M
2-3-5	J	2-4-4	M	2-5-32	K	2-10-1	M	2-B-1	J
2-3-6	J	2-4-5	M	2-5-33	K	2-10-2	M	2-B-2	M
2-3-7	K	2-4-6	K	2-5-34	K	2-10-2.1	K	2-B-3	M
		2-4-7	K	2-5-35	K	2-10-2.2	K	2-B-4	M

PAGE	REV	PAGE	REV	PAGE	REV	PAGE	REV
2-B-5	M	2-H-7	J				
2-B-6	M	2-H-8	J				
2-B-7	M	2-H-9	J				
2-B-8	M	2-H-10	J				
2-B-9	M	2-I-1	J				
2-B-10	L	2-I-2	J				
2-B-11	L	2-I-3	J				
2-B-12	L	2-I-4	J				
2-B-13	L	2-I-5	J				
2-B-14	L	2-I-6	J				
2-B-15	L	2-I-7	J				
2-B-16	M	2-I-8	J				
2-B-17	M	2-J-1	J				
2-B-18	M	2-J-2	J				
2-B-19	M	2-J-3	J				
2-B-20	M	2-J-4	J				
2-B-21	M	2-J-5	J				
2-B-22	M	2-J-6	J				
2-B-23	M	2-J-7	J				
2-B-24	M	2-J-8	J				
2-B-25	M	Index-1	M				
2-B-26	M	Index-2	M				
2-B-27	M	Index-3	M				
2-B-28	M	Index-4	M				
2-B-29	M	Index-5	M				
2-B-30	M	Index-6	M				
2-B-31	M	Index-7	M				
2-B-32	M	Index-8	M				
2-B-33	M	Index-9	M				
2-B-34	M	Index-10	M				
2-B-35	M	Index-11	M				
2-B-36	M	Index-12	M				
2-B-37	M	Index-13	M				
2-C-1	M	Comment					
2-C-2	M	Sheet	M				
2-C-3	M	Back Cover	-				
2-C-4	M						
2-C-5	M						
2-C-6	J						
2-C-7	M						
2-C-8	J						
2-C-9	M						
2-C-10	M						
2-C-11	M						
2-C-12	M						
2-C-13	M						
2-C-14	M						
2-D-1	J						
2-E-1	M						
2-E-2	M						
2-E-3	M						
2-E-4	M						
2-E-5	M						
2-E-6	M						
2-F-1	J						
2-F-2	J						
2-G-1	K						
2-G-2	J						
2-G-3	F						
2-G-4	B						
2-G-5	J						
2-G-6	F						
2-G-7	J						
2-G-8	F						
2-G-9	M						
2-H-1	J						
2-H-2	J						
2-H-3	J						
2-H-4	J						
2-H-5	J						
2-H-6	J						

PREFACE

The Network Operating System (NOS) was developed by Control Data Corporation to provide network capabilities for time-sharing and transaction processing, in addition to local and remote batch processing on CONTROL DATA® CYBER 170 Series computer systems; CDC® CYBER 70 Series, Models 71, 72, 73, and 74 computer systems; and CDC 6000 Series computer systems.

AUDIENCE

This manual describes the external features of NOS 1.4. Information in this manual should be useful to those who use the programs and utilities supplied with the system and those who wish to write their own. The manual is contained in two volumes to separate information pertaining primarily to the applications user from that of interest to the applications COMPASS programmer.

Volume 1 (publication number 60435400) is written for all NOS users. Users can understand the manual contents without knowing the COMPASS assembly language. However, they should read the NOS Batch User's Guide and/or the IAF User's Guide or NOS Time-Sharing User's Guide before reading this manual.

Volume 2 (publication number 60445300) is written for the applications COMPASS programmer. It is assumed the user has an extensive knowledge of the COMPASS assembly language and the COMPASS Reference Manual.

ORGANIZATION

Volume 1 contains information for the applications programmer. This includes general information about files, job flow and execution, control statement processing, and an extensive discussion of control statements.

Volume 2 contains information for those who write system or assembly language programs for use with NOS.

CONVENTIONS

Extended memory for the CYBER 170 Model 176 is large central memory extended (LCME). Extended memory for all other NOS computer systems is extended core storage (ECS) or extended semiconductor memory (ESM).

In this manual, the acronym ECS refers to all forms of extended memory unless otherwise noted.

Programming information for the various forms of extended memory can be found in the COMPASS Reference Manual and in the appropriate computer system hardware reference manual.

Conventions for central memory word formats are as follows:

- Cross-hatching indicates a field is not used by or is not applicable to a function processor. However, Control Data reserves the right to assign these fields to system use in the future.
- Fields reserved for system use are so labeled.
- Fields labeled with mnemonics indicate a specific parameter must be inserted (generally described after the word format).
- Fields with numeric identifiers indicate the actual value that is used or returned for a particular function. Numeric identifiers are octal unless otherwise noted.

RELATED PUBLICATIONS

The NOS Manual Abstracts is a pocket-sized manual containing brief descriptions of the contents and intended audience of all NOS and NOS product manuals. The abstracts can be useful in determining which manuals are of greatest interest to a particular user.

- Control Data also publishes a Software Publications Release History of all software manuals and revision packets it has issued. This history report lists the revision level of a particular manual that corresponds to the level of software installed at the site.

For further information concerning CYBER 170, CYBER 70, and 6000 Series computer systems, the NOS time-sharing system, and the products supported by NOS, consult the following manuals.

<u>Control Data Publication</u>	<u>Publication Number</u>
ALGOL Version 4 Reference Manual	60496600
ALGOL Version 5 Reference Manual	60481600
APEX III Version 1 Reference Manual	76070000
APL Version 2 Reference Manual	60454000
APT IV Version 2 Reference Manual	17326900
BASIC Version 3 Reference Manual	19983900
CDCS Version 2 Reference Manual	60481800
COBOL Version 4 Reference Manual	60496800
COBOL Version 5 Reference Manual	60497100
Common Memory Manager Version 1 Reference Manual	60499200
COMPASS Version 3 Reference Manual	60492600

<u>Control Data Publication</u>	<u>Publication Number</u>
CYBER Common Utilities Reference Manual	60495600
CYBER Interactive Debug Reference Manual	60481400
CYBER Loader Version 1 Reference Manual	60429800
CYBER Record Manager Advance Access Methods Version 2 Reference Manual	60499300
CYBER Record Manager Basic Access Methods Version 1.5 Reference Manual	60495700
CYBER 170 Computer Systems Models 171 through 175 and 176 Level A Reference Manual	60420000
CYBER 170 Computer Systems Models 776 Level B, 720, 730, 740, 750, and 760 Reference Manual	60456100
CYBER 70/Model 71 Computer System Reference Manual	60453300
CYBER 70/Model 72 Computer System Reference Manual	60347000
CYBER 70/Model 73 Computer System Reference Manual	60347200
CYBER 70/Model 74 Computer System Reference Manual	60347400
Data Base Utilities Version 1 Reference Manual	60498800
DDL Version 1 Reference Manual	60359000
DDL Version 2 Reference Manual	60498400
Export/Import Reference Manual	60436200
FORM Version 1 Reference Manual	60496200
FORTTRAN Extended Version 4 Reference Manual	60497800
FORTTRAN Version 5 Reference Manual	60481300
LCGT/IGS Version 2 Reference Manual	76079100
Modify Reference Manual	60450100
Modify Instant	60450200
Network Products Interactive Facility Version 1 Reference Manual	60455250
Network Products Interactive Facility Version 1 User's Guide	60455260
Network Products Message Control System Version 1 Reference Manual	60480300

<u>Control Data Publication</u>	<u>Publication Number</u>
Network Products Network Access Method Version 1 Network Definition Language Reference Manual	60480000
Network Products Network Access Method Version 1 Reference Manual	60499500
Network Products Network Terminal User's Instant	60455270
Network Products Remote Batch Facility Version 1 Reference Manual	60499600
Network Products Stimulator Version 1 Reference Manual	60480500
Network Products Transaction Facility Version 1 CYBER Record Manager Data Manager Reference Manual	60456710
Network Products Transaction Facility Version 1 Data Manager Reference Manual	60455350
Network Products Transaction Facility Version 1 Reference Manual	60455340
Network Products Transaction Facility Version 1 User's Guide	60455360
Network Products 2550 Communications Control Program Version 3 Diagnostic Operator Handbook	60471500
Network Products 2550 Communications Control Program Version 3 Reference Manual	60471400
NOS Manual Abstracts	84000420
NOS Version 1 Applications Installation Handbook	84000970
NOS Version 1 Applications Programmer's Instant	60436000
NOS Version 1 Batch User's Guide	60436300
NOS Version 1 Diagnostic Index	60455720
NOS Version 1 Installation Handbook	60435700
NOS Version 1 Operator's Guide	60435600
NOS Version 1 System Maintenance Reference Manual	60455380
NOS Version 1 Systems Programmer's Instant	60449200

<u>Control Data Publication</u>	<u>Publication Number</u>
NOS Version 1 Terminal User's Instant	60435800
NOS Version 1 Time-Sharing User's Guide	60436400
NOS Version 1 Time-Sharing User's Reference Manual	60435500
On-Line Maintenance Software Reference Manual	60454200
PERT/Time Version 2 Reference Manual	60456030
PL/I Version 1 Reference Manual	60388100
Query Update Version 3 Reference Manual	60498300
SIMSCRIPT Version 3 Reference Manual	60358500
Sort/Merge Versions 4 and 1 Reference Manual	60497500
SYMPL Version 1 Reference Manual	60496400
TAF/TS Version 1 CYBER Record Manager Data Manager Reference Manual	60456700
TAF/TS Version 1 Data Manager Reference Manual	60453100
TAF/TS Version 1 Reference Manual	60453000
TAF/TS Version 1 User's Guide	60436500
Text Editor Reference Manual	60456100
TIGS Version 1 Reference Manual	60455940
TOTAL - CDC Reference Manual	76070300
Update 1 Reference Manual	60449900
XEDIT Version 3 Reference Manual	60455730
8-Bit Subroutines Version 1 Reference Manual	60495500
6400/6500/6600 Computer Systems Reference Manual	60100000

DISCLAIMER

This product is intended for use only as described in this document. Control Data cannot be responsible for the proper functioning of undescribed features or undefined parameters.

CONTENTS

VOLUME 1

1. SYSTEM DESCRIPTION	1-1-1	8. PERMANENT FILE CONTROL STATEMENTS	1-8-1
2. FILES	1-2-1	9. LOAD/DUMP CENTRAL MEMORY-UTILITY CONTROL STATEMENTS	1-9-1
3. JOB FLOW AND EXECUTION	1-3-1	10. TAPE MANAGEMENT	1-10-1
4. CDC CYBER CONTROL LANGUAGE	1-4-1	11. CHECKPOINT/RESTART	1-11-1
5. CONTROL STATEMENT PROCESSING	1-5-1	12. DEBUGGING AIDS	1-12-1
6. JOB CONTROL CONTROL STATEMENTS	1-6-1	13. SYSTEM UTILITY CONTROL STATEMENTS	1-13-1
7. FILE MANAGEMENT CONTROL STATEMENTS	1-7-1	14. LIBRARY MAINTENANCE	1-14-1

APPENDIXES

A. CHARACTER SETS	1-A-1	G. ANSI TAPE LABEL FORMATS	1-G-1
B. MESSAGES	1-B-1	H. CONTROL LANGUAGE (KCL)	1-H-1
C. GLOSSARY	1-C-1	I. LINE PRINTER CARRIAGE CONTROL	1-I-1
D. SAMPLE JOB OUTPUT	1-D-1	J. OBSOLETE TAPE FORMATS	1-J-1
E. TIME-SHARING INTERFACE	1-E-1		
F. CARD FILE DATA CONVERSION	1-F-1		

VOLUME 2

1. PROGRAM/SYSTEM COMMUNICATION	2-1-1	CLOSE	2-3-18
Function Processors	2-1-1	CLOSER	2-3-21
Systems Requests	2-1-2	CIO Read Functions	2-3-22
System Request Processing	2-1-3	RPHR (000)	2-3-22
Issuing RA+1 Requests	2-1-4	READ (010)	2-3-23
NOS Systems Texts	2-1-6	READSKP (020)	2-3-24
Macro Usage	2-1-6	READCW (200)	2-3-24
SYSCOM	2-1-8	READLS (210)	2-3-26
Common Deck Usage	2-1-9	RPHRLS (230)	2-3-27
Security Considerations	2-1-16	READNS (250)	2-3-28
		READN (260)	2-3-28
		READEI (600)	2-3-29
		CIO Write Functions	2-3-30
		WPHR (004)	2-3-30
		WRITE (014)	2-3-30
2. FILE ENVIRONMENT TABLE (FET)	2-2-1	WRITER (024)	2-3-31
Circular Buffers	2-2-1	WRITEF (034)	2-3-31
FIRST Address	2-2-2	WRITECW (204)	2-3-32
LIMIT Address	2-2-3	REWRITE (214)	2-3-33
OUT Address	2-2-3	REWRITER (224)	2-3-34
IN Address	2-2-3	REWRITEF (234)	2-3-35
FET Description	2-2-4	WRITEN (264)	2-3-35
FET Creation Macros	2-2-11	File Positioning Functions	2-3-36
FILEB	2-2-12	BKSP (040)	2-3-36
FILEC	2-2-12	BKSPRU (044)	2-3-37
RFILEB	2-2-12	REWIND (050)	2-3-37
RFILEC	2-2-12	UNLOAD (060)	2-3-38
FET Modification Macro	2-2-14	RETURN (070)	2-3-40
SETFET Parameter Processing	2-2-16	POSMF (110)	2-3-41
SETFET Examples	2-2-17	Standard ANSI-Labeled	
		Multifile Set	
		Processing	2-3-41
		Extended Label Multifile	
		Set Processing	2-3-42.1
3. INPUT/OUTPUT	2-3-1	EVICT (114)	2-3-46
CIO - Combined Input/Output	2-3-1	SKIPF (240)	2-3-46
CIO Function Processing	2-3-4	SKIPFF (240)	2-3-47
Accessing Files	2-3-4	SKIPEI (240)	2-3-48
Reading Files	2-3-6	SKIPB (640)	2-3-48
Writing Files	2-3-7	SKIPFB (640)	2-3-49
Random Request Processing	2-3-9	Data Transfer Macros	2-3-49
CIO OPEN and CLOSE Functions	2-3-10	READC	2-3-53
OPEN	2-3-11	WRITEC	2-3-53
Mass Storage Operations	2-3-12	READH	2-3-54
Unlabeled Tape Processing	2-3-13	WRITEH	2-3-54
Nonstandard Labeled		READO	2-3-54
Tape Processing	2-3-13	WRITEO	2-3-55
ANSI Standard Labeled		READS	2-3-55
Tape Processing	2-3-14	WRITES	2-3-55
Extended Label		READW	2-3-56
Processing	2-3-16	WRITEW	2-3-56
		CYBER Record Manager I/O	2-3-57

4. LOCAL FILE MANAGER	2-4-1	GETJN (013)	2-6-11
Error Processing	2-4-2	GETQP (014)	2-6-12
RENAME (000)	2-4-2	GETPR (015)	2-6-12
ASSIGN (001)	2-4-3	GETEM (016)	2-6-13
COMMON (002)	2-4-4	GETASL (017)	2-6-13
RELEASE (004, 005, 006, 007, 016, 030)	2-4-5	GETJSL (017)	2-6-14
LOCK (010)	2-4-6	GETTL (017)	2-6-14
UNLOCK (011)	2-4-7	SETLC (022)	2-6-15
STATUS (012)	2-4-7	SETRFL (023)	2-6-16
STATUS (013)	2-4-7	GETJCR (024)	2-6-16
REQUEST (014)	2-4-9	SETJCR (025)	2-6-17
REQUEST (015)	2-4-11	SETSS (026)	2-6-18
SETID (017)	2-4-12	GETJO (027)	2-6-18
ASSIGN (020)	2-4-13	GETJA (030)	2-6-18
ENCSF (022)	2-4-14	USECPU (031)	2-6-19
PSCSF (023)	2-4-14.1	USERNUM (032)	2-6-19
LABEL (024)	2-4-15	GETFLC (033, 055)	2-6-20
GETFNT (025)	2-4-21	PACKNAM (035)	2-6-21
PRIMARY (031)	2-4-24	PACKNAM (036)	2-6-22
FILINFO (032)	2-4-25	GETSS (037)	2-6-22
		VERSION (044)	2-6-23
		GETLC (045)	2-6-23
		GETGLS (046)	2-6-24
		SETGLS (047)	2-6-25
		MACHID (050)	2-6-26
5. PERMANENT FILE MANAGER	2-5-1	GETACT (051)	2-6-26
Error Processing	2-5-3	SETMFL (052)	2-6-27
PFM Macro Parameter Conventions	2-5-8	GETPPFP (057)	2-6-28
Auxiliary Device Request	2-5-11	GETLOF (061)	2-6-29
SAVE (001, CCSV)	2-5-12	SETLOF (062)	2-6-30
GET (002, CCGT)	2-5-14	GETJCI (074)	2-6-31
PURGE (003, CCPG)	2-5-15	SETJCI (074)	2-6-32
CATLIST (004, CCCT)	2-5-16	PROTECT (075)	2-6-32
PERMIT (005, CCPM)	2-5-22		
REPLACE (006, CCRP)	2-5-24	7. QUEUE FILE MANAGER	2-7-1
APPEND (007, CCAP)	2-5-25	RERUN (015)	2-7-2
DEFINE (010, CCDF)	2-5-26	NORERUN (016)	2-7-3
ATTACH (011, CCAT)	2-5-31	SUBMIT (017)	2-7-3
CHANGE (012, CCCG)	2-5-32	ASSIGN FILE TO QUEUE DEVICE (020)	2-7-5
OLD (021, CCOD)	2-5-36		
		8. FILE ROUTING	
6. CONTROL POINT MANAGER	2-6-1	DSP Function	2-8-1
SETQP (000)	2-6-1	ROUTE	2-8-4
SETPR (001)	2-6-2	Error Processing	2-8-5
MODE (002)	2-6-2		
SETASL (003)	2-6-2	9. TIME/DATE REQUESTS	2-9-1
SETJSL (003)	2-6-3	CLOCK	2-9-1
SETTL (003)	2-6-4	DATE	2-9-2
EREXIT (004)	2-6-5		
ROLLOUT (006)	2-6-9		
SETSSM (010)	2-6-10		
ONSW (011)	2-6-11		
OFFSW (012)	2-6-11		

EDATE	2-9-2	12. PROGRAM WRITING	
ETIME	2-9-3	TECHNIQUES	2-12-1
HTIME	2-9-3		
JDATE	2-9-4	Writing Programs under NOS	2-12-1
PDATE	2-9-4	Writing Interactive Programs	2-12-1
RTIME	2-9-5	Conversion Problems	2-12-1
STIME	2-9-5	Default File Assignments	
TIME	2-9-6	and Special File Treatment	2-12-2
		Special Handling	2-12-2
		Other Special Handling	2-12-3
		Program Control of Terminal	
10. JOB CONTROL	2-10-1	Activity	2-12-4
		Control Bytes	2-12-5
Translate Control Statement	2-10-1	End-of-Line	2-12-5
CONTROL (004)	2-10-2	0001, 0002 - End-of-Block	2-12-5
EXCST (005)	2-10-3	0003 - Auto Input	2-12-5
Checkpoint/Restart	2-10-3	0004 - Log Off User	2-12-6
CHECKPT	2-10-3	0005 - Initiate ASCII Input	2-12-6
Relieve Processing	2-10-6	0006 - Initiate Transparent	
REPRIEVE	2-10-10	Input	2-12-6
RECOVR	2-10-11	0007 - Initiate Transparent	
		Output	2-12-7
		0010 - End-of-Transaction	
		Block	2-12-8
		0011 - Initiate ASCII Output	2-12-8
		0012 - End-of-Transaction	
		Block with Response	2-12-8
		0013 - End-of-String	2-12-8
		0014 - Internal End-of-Block	2-12-8
		0015 - Executive Auto Input	2-12-9
		0016 - Terminal Redefinition	2-12-9
		Control of Program Execution	2-12-9
		Network Terminals	2-12-9
		Nonnetwork Terminals	2-12-12
		DISTC Macro	2-12-13
		Network Terminals	2-12-14
		Nonnetwork Terminals	2-12-15
		CSET Macro	2-12-16
		PARITY Macro	2-12-16
		PROMPT Macro	2-12-17
		TSTATUS Macro	2-12-17
11. SYSTEM/LOADER REQUESTS	2-11-1		
System Requests	2-11-1		
ABORT	2-11-1		
DAYFILE	2-11-1		
ENDRUN	2-11-4		
GETMC	2-11-5		
MEMORY	2-11-6		
MESSAGE	2-11-8		
MOVE	2-11-10		
RECALL	2-11-10		
SUBR	2-11-11		
SYSTEM	2-11-11		
Loader Requests	2-11-13		
OVERLAY	2-11-13		
LOADD	2-11-16		
LOADQ	2-11-18		

APPENDIXES

A. CPU COMMON DECKS	2-A-1	F. SPECIAL ENTRY POINTS	2-F-1
B. MESSAGES	2-B-1	G. BINARY FORMATS	2-G-1
C. GLOSSARY	2-C-1	H. EXAMPLES OF RANDOM I/O	2-H-1
D. INTERPRETIVE MODE READING AND WRITING OF ECS	2-D-1	I. PROGRAMMING STANDARDS	2-I-1
E. SPECIAL USER INFORMATION	2-E-1	J. MAGNETIC TAPE FORMATS	2-J-1

INDEX

FIGURES

2-2-1	Circular Buffer	2-2-2	2-3-1	Sample Random Access	
2-2-2	Read Operation	2-2-3		File Format	2-3-5
2-2-3	Write Operation	2-2-4	2-3-2	Modified Sample Random	
2-2-4	Standard FET for Mass			Access File	2-3-8
	Storage File	2-2-4	2-3-3	Data Transfer Buffer	
2-2-5	Standard FET for Labeled	2-2-5		Arrangement	2-3-50
	Magnetic Tape File (CIO)				

TABLES

2-10-1	RPV Error Codes, Classes, and Flags	2-10-10	2-12-1	Terminal Redefinition Parameters	2-12-10
--------	--	---------	--------	-------------------------------------	---------

The Network Operating System (NOS) allows communication between a CPU program and predefined system routines and functions as follows:

- RA+1 system requests to function processors
- NOS systems texts
- Macros†
- Common decks ††

These routines enable the user to perform complex operations with a minimum of coding. They have been thoroughly tested and optimized, and are designed to interface with the system.

FUNCTION PROCESSORS

Several NOS system routines process user requests. Sections 3 through 11 contain descriptions of each function processor, including:

- Identification of the requests (function numbers)
- Systems texts required to issue the requests
- System macros (or common decks containing macros) available to issue the requests
- Common decks required to issue the requests
- Information returned from the processor after the requests

Following is a list of the NOS function processors whose system request formats are described in this manual.

<u>Processor</u>	<u>Description</u>	<u>Section</u>
ABT	Exit processing request	11
CIO	Combined input/output	3
CKP	Checkpoint processor	10
CPM	Control point manager	6
CVL	Common validation interface processor	11
DED, DEP	Extended core storage dump	11
DMD, DMP	Central memory dump	11
DSP	File routing	8

† Refer to the COMPASS Reference Manual for a complete description of how macros are defined and used.

†† Refer to the Modify Reference Manual for a complete description of how common decks are defined and used.

<u>Processor</u>	<u>Description</u>	<u>Section</u>
END	Program termination request	11
LDD, LDQ	Fast dynamic loading	11
LDR, LDV	Overlay request	11
LFM	Local file manager	4
MEM	Memory requests	11
MSG	System message processor	11
PFM	Permanent file manager	5
QFM	Queue file manager	7
RCL	Recall CPU	11
RFL	Memory requests	11
RPV	Reprieve processing	10
SFM	System file manager	11
TCS	Translate control statement	10
TIM	Time and date functions	9

SYSTEM REQUESTS

All communication with the system is performed by entering a system request in location 1 (RA+1) of the field length (refer to figure 2-E-1). The system then initiates execution of that portion of the system required to satisfy the user's request. There are two types of system requests.

- Those that contain all information necessary in RA+1 (for example, RCL).
- Those that require additional areas for parameters or results from the system [for example, CIO requires the specification of a file environment table (FET)].

The format of the 60-bit request is one of the following (depending on whether two or three parameters are to be passed).

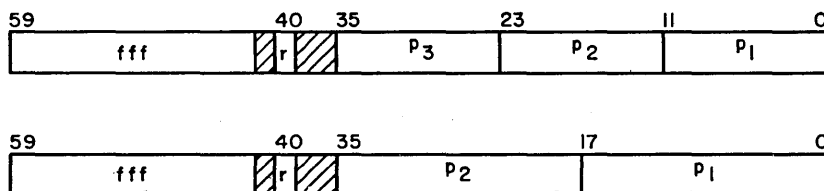

fff System request name
r Auto recall bit (p₁ must be specified)
p₁, p₂, p₃ Parameters passed to the portion of the system that processes fff
(p₂ in second format may contain two parameters)

SYSTEM REQUEST PROCESSING

Whether a system request communicates with a FET or another parameter block, the first word of this area is usually the status word. Both the system and the user use the lower portion of this word to communicate the status of the request. When bit 0 is cleared (equals 0), the system is in control of the request; when it is set (equals 1), the user is in control of the request.

For example, to write on file ABC, the program must perform the following steps.

1. Check the status (bit 0 of the first word of the FET) of ABC.
2. If ABC is busy (bit 0 cleared), the program must wait until bit 0 is set. This is done by issuing a system request to recall (RCL).
3. When ABC is idle (bit 0 set), the program must clear bit 0 and place the request in RA+1.
4. If other processing can be performed, the program proceeds.
5. If further processing depends upon ABC being completed, the program must check the status word for completion (bit 0 set by the system).

To perform this write operation on file ABC, the user issues a system request to CIO. The following diagram illustrates the user/system control when performing this operation.

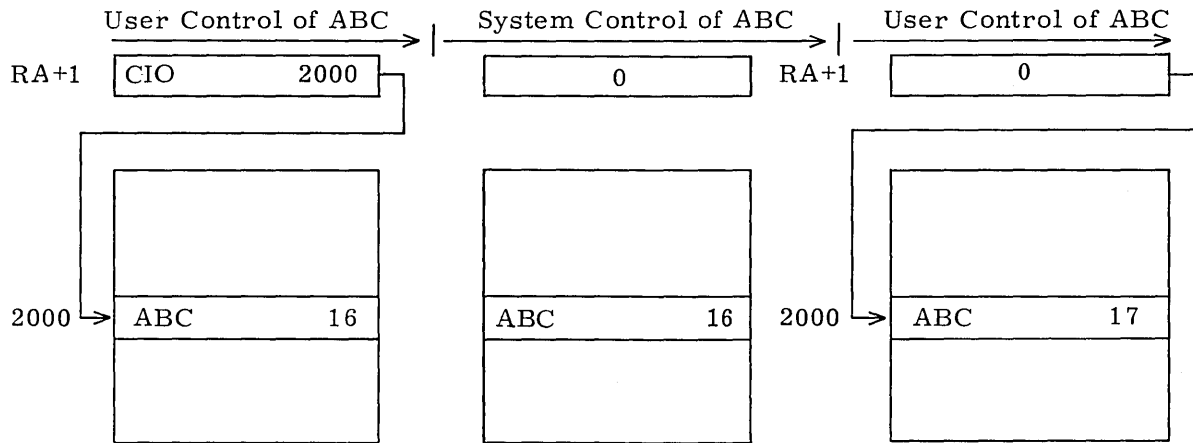

The user requests the system to take control of ABC by clearing bit 0 of the status word and entering CIO 2000 in RA+1.

The system clears RA+ 1 upon beginning processing of the request.

The system sets bit 0 of the status word upon completing the request.

In many situations, the program cannot proceed until the system request is complete (as in steps 2 and 5 when ABC is busy). When this occurs, the user can prevent execution until the status word is not busy (bit 0 set). This simplifies the programmer's job, because he does not have to check the status. It also reduces the amount of CPU time used by the job.

In the previous example, if the following request is issued,

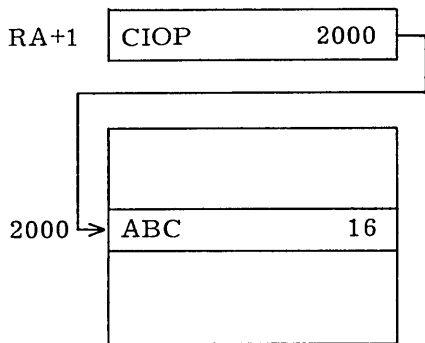

P is the display code representation of the auto recall bit (20_8); that is, bit 40 of RA+1 is set.

the system would not allow the job to continue execution until bit 0 of word 2000 was set and the PPU completed its operation.

The steps in this procedure are:

1. Check the status of ABC.
2. If ABC is busy, wait until bit 0 is set and return to step 1. This can be done by issuing an RCLP function on word 2000.
3. Clear bit 0 of word 2000 and place the CIOP request in RA+1.

Processing can proceed with the assurance that the previous operation on ABC is completed (bit 0 of word 2000 does not have to be checked).

The user should be aware that many system requests require that the auto recall bit be set. This is noted in the description of the requests, when necessary.

ISSUING RA+1 REQUESTS

When a system request is placed in RA+1, the system may process that request at any time. The exchange jump instruction XJ, if available, provides much faster response to system requests.

The system processes program requests by scanning location RA+1 of all user programs in the system. This is done on a periodic basis. If the system detects a request in RA+1 that can be processed, RA+1 is cleared and processing begins.

When the user program issues a request, it must check RA+1 to determine if the request is accepted by the system before it issues another request.

The following example illustrates the steps taken by the user and the system to process a system request.

1. The user issues a CIO request on word 2000 to RA+1 (CIO 2000).
2. The user proceeds with his processing.
3. The user now wishes to wait until the request is complete before continuing. He does this by issuing an RCLP request on word 2000. However, he must first check RA+1 to ensure that the request to CIO is accepted before he issues the RCLP request.

The system performs the following steps in processing this user request.

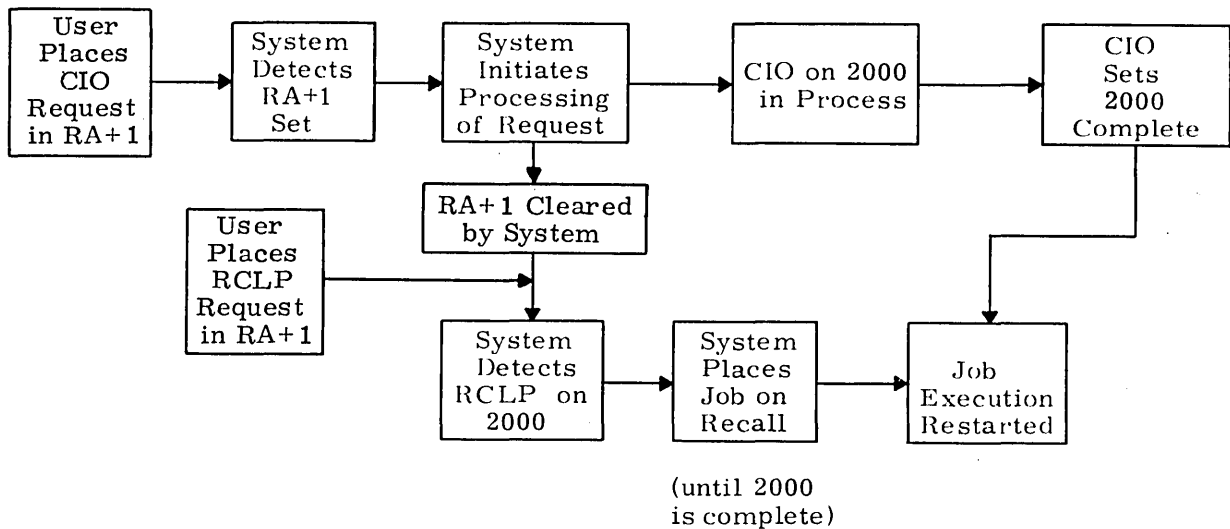

When the XJ instruction is available, the user places the system request in RA+1 and executes an XJ instruction. This causes the CPU to be exchanged to the system program CPUMTR from the user's program. The system can act upon the request immediately.

When the system initiates processing of the request, CPU control returns to the user, unless the request is made with auto recall.

The user can determine whether the XJ instruction is available by checking if bit 59 of word 66 (XJPR) of his field length is set (refer to SYSCOM macro and figure 2-E-1).

If the request in the previous example is performed in this manner, the following steps apply.

1. The user places the CIO request on word 2000 in RA+1 and executes an XJ instruction. The central processor is reassigned to the job when the request is accepted.
2. The user proceeds with his processing.
3. The user now wishes to wait until this request is completed before continuing. This is done by placing the request RCLP 2000 in RA+1 and issuing another XJ instruction. It is not necessary to determine if the previous request is accepted.

Many macros and common decks are provided to assist the programmer in performing this interaction with the system.

NOS SYSTEMS TEXTS

The following systems texts are available to the NOS user.

- SYSTEXT
- PPTTEXT
- NOSTEXT
- PSSTEXT
- ECSTEXT

Although other systems texts exist, the macros described in this manual are supported only in the systems texts listed above.

SYSTEXT contains system communication macros that are used by the CPU COMPASS programmer. PPTTEXT contains symbol definitions used by all system routines for inter-communication. NOSTEXT contains all system communication macros and symbol definitions that are found in SYSTEXT and PPTTEXT.

PSSTEXT contains macros that are defined on system OPL common decks COMCMAC and COMCCMD (refer to Common Deck Usage in this section and to appendix A).

ECSTEXT contains operation definitions that are defined on common deck COMCECM. These definitions provide instructions for interpretive mode reading and writing of ECS (refer to appendix D).

By selecting the correct systems text (for the applications COMPASS programmer, this usually will be SYSTEXT and/or PSSTEXT), the user can reduce the amount of system resources needed for assemblies.

To obtain listings of the systems texts, enter one or more of the following control statements after accessing the system OPL.

```
MODIFY(Q, CL, CS=0, Z)/*EDIT, SYSTEXT
MODIFY(Q, CL, CS=0, Z)/*EDIT, PPTTEXT
MODIFY(Q, CL, CS=0, Z)/*EDIT, NOSTEXT
MODIFY(Q, CL, Z)/*EDIT, ECSTEXT
```

To obtain a listing of PSSTEXT, enter the following statements after accessing the system OPL.

```
MODIFY(Z)/*EDIT, PSSTEXT
COMPASS(I, LO=X)
```

MACRO USAGE

Macros are available for issuing most requests to the function processors. If macros are not available, the user can define them.

A macro is a predefined sequence of COMPASS statements that can be used in the user's programs. † If the user wishes to use predefined macros, he may do so by specifying the location of these definitions to COMPASS with the S or G parameter. For example:

```
COMPASS(I, B, S=XYZTEXT)
```

This call causes all macro definitions in XYZTEXT to be available for assembly of the program. If no S parameter is specified, COMPASS uses the system default system text SYSTEXT. In the descriptions in this manual, unless otherwise noted, all macros are defined in SYSTEXT and NOSTEXT.

Some macros are defined in common decks; therefore, the common deck must be called into the text of the program (refer to Common Deck Usage). If the decks are named COMCMAC or COMCCMD, the user has the option of specifying the alternate systems text PSSTEXT. For example:

```
COMPASS(I, B, S, S=PSSTEXT)
```

This makes available all macro definitions in PSSTEXT (that is, those defined in common decks COMCMAC and COMCCMD) as well as all macros in SYSTEXT for the assembly of the program.

In addition to the macros available in SYSTEXT, an integer divide operation definition is provided for the user's convenience. Its format is as follows:

```
IXi Xj/Xk
```

The operation divides Xj by Xk and places the result in Xi. Registers Xj, Xk, and B7 are destroyed.

When a macro parameter refers to an address, the parameter may be a register name, a relocatable address, an external symbol, or an absolute address. The user should consult the expansions of the system macros to determine the optimum use of registers when using macros. The user is responsible for ensuring that a register used as a parameter contains only the parameter (for example, if an 18-bit address is specified by an X register, the user in some cases must ensure that the upper 42 bits of the register are zero).

Most NOS system macros and common decks preserve the contents of the following registers.

```
A0, X0, A5, and X5
```

Also, upon exit, the contents of registers B1 and X2 are as follows:

```
B1 1
```

```
X2 FET address (refer to section 2) if a macro specifies the FET address as a  
parameter
```

There are exceptions to these rules and the user should refer to documentation of a macro or common deck when in doubt.

The contents of the B1 register is assumed to be 1 upon entry only if the SYSCOM B1 macro is called or the B1=1 COMPASS pseudo instruction is defined.

† The COMPASS Reference Manual provides instructions for defining macros.

SYSCOM

The SYSCOM macro performs the following functions.

- Optionally defines the B1=1 COMPASS pseudo instruction
- Defines system communication symbols

If this macro is used, it should be set as an initial step in the program.

Macro Format:

LOCATION	OPERATION	VARIABLE SUBFIELDS
	SYSCOM	B1

B1 If present, COMPASS pseudo instruction B1=1 is defined

Many system common decks called from macros assume the contents of the B1 register is equal to 1. Other common decks assume B1 is equal to 1 only if the macro SYSCOM B1 or COMPASS pseudo instruction B1=1 is defined. If the B1 parameter is not included in the SYSCOM call or if there is no SYSCOM call, these common decks then generate additional code to set B1 equal to 1. If SYSCOM B1 or the B1=1 pseudo instruction is used, it is the user's responsibility to set the B1 register equal to 1.

The specification of SYSCOM (with or without specifying B1) also makes available the system communication symbols (refer to figure 2-E-1). These are:

<u>Symbol</u>	<u>Value</u>	<u>Description</u>
RA.MTR	1	Address of RA+1.
ARGR	2	Address of the first argument.
SPPR	27 ₈	Special program parameter area (locations 27 ₈ through 47 ₈).
PGNR	64 ₈	Program name (bits 59 through 18).
ACTR	64 ₈	Argument count (bits 17 through 0).
CMUR, RA.CMU	65 ₈	Compare/move unit (CMU) available flag (bit 59).
LWPR	65 ₈	LWA+1 of the assigned program space (bits 17 through 0). If Common Memory Manager is loaded in the user's field length, bits 17 through 0 contain the complement of the LWA+1 of the assigned program space (refer to the Common Memory Manager Reference Manual).
FWPR	66 ₈	FWA of the assigned program space (bits 17 through 0).
JOPR	66 ₈	Job origin type (bits 35 through 24).
XJPR, RA.CEJ	66 ₈	Central exchange available (bit 59).
CSMR	67 ₈	System character set mode flag (bit 59); set if 64-character set mode.
LDRR	67 ₈	LDR completion (bit 29).
CCDR	70 ₈	Control statement image (eight locations).
LINP	60 ₁₀	Lines per page. Used to format output.

DUPLICT

IDENT DUPLICT
ENTRY DUPLICT

QUAL\$ EQU 1 SUPPRESS COMMON DECK QUALIFICATION

* THE *SPACE FILL NAME* COMMON DECK MUST BE QUALIFIED
* BECAUSE THE PROGRAM HAS A SUBROUTINE *SFN* AND THE
* PROGRAMMER DOES NOT WISH TO RENAME THE SUBROUTINE.

DUPLICT SB1 1 ENTRY
SA1 DUPA SET SYMBOL NAME IN MESSAGE
MX0 -18 CLEAR VALUE PORTION OF WORD
SX5 X1+ SAVE VALUE
BX1 X0*X1
RJ /SFILL/SFN SPACE FILL WORD
SA6 DUPC
SX1 X5+ CONVERT VALUE
RJ CDD
SB2 3 SHIFT VALUE 3 CHARACTERS LEFT
RJ SFN
SA6 DUPD ISSUE MESSAGE
MESSAGE DUPB,,R
ENDRUN

Transfers control to COMCSFN, qualified by SFILL

Transfers control to the user's shift register routine, SFN

DUPA CON OLNAME+123456
DUPB CON 10H SYMBOL
DUPC CON 0 SYMBOL NAME
CON 10HHAS VALUE
DUPD CON 0 CONVERTED SYMBOL VALUE
CON 0 MESSAGE TERMINATOR
SPACE 4,10
** SFN - SHIFT REGISTER BY *N* CHARACTERS.

*
* ENTRY (X6) = REGISTER TO SHIFT.
* (B2) = NUMBER OF CHARACTERS TO SHIFT.
*
* EXIT (X6) = SHIFTED LEFT.
*
* USES B - 2.
* X - 6, 7.
*

SFN PS ENTRY/EXIT
SX7 B2 SET NUMBER OF BITS TO SHIFT
SB2 B2+B2
LX7 2
SB2 B2+X7
LX6 X6,B2 SHIFT REGISTER
JP SFN RETURN

* COMMON DECKS.

*CALL COMCSYS
*CALL COMCCDD
QUAL SFILL QUALIFY *SFN*
*CALL COMCSFN
SPACE 4,10
END DUPLICT

The QUAL\$ tag can also be used to suppress the qualification of common decks called more than once in separate overlays. In the following example, the QUAL pseudo-instruction is used in each of the two primary overlays; the symbol QUAL\$ is used to allow a copy of COMCCDD in each overlay without symbol conflicts.

```

OVER      IDENT  MAIN,MAIN,MAIN          MAIN (0,0) OVERLAY
          ABS
          TITLE MAIN (0,0) OVERLAY.
          ORG   110B

QUAL$     EQU    1                      SUPPRESS COMMON DECK QUALIFICATION

*         LOAD TWO OVERLAYS - ONE AT A TIME - EACH WILL USE
*         ITS OWN COPY OF *CDD*, BUT WILL USE *SYS=* AND
*         *MSG=* THAT RESIDE IN THE (0,0) OVERLAY.

MAIN      MESSAGE MAIA,,R      * MAIN RUNNING.*
          SB1      1
          OVERLAY MAIB,0100B LOAD *OVL1* OVERLAY
          SB2      X1          EXECUTE *OVL1*
          JP        B2
MAI1      OVERLAY MAIB,0200B LOAD *OVL2* OVERLAY
          SB2      X1          EXECUTE *OVL2*
          JP        B2
MAI2      MESSAGE MAIC,,R      * MAIN COMPLETE.*
          ENDRUN END

MAIA      DIS      ,* MAIN RUNNING.*
MAIB      CON      OLLGO        OVERLAY FILE NAME
MAIC      DIS      ,* MAIN COMPLETE.*

*CALL     COMCSYS
*CALL     COMCOVL

OVER      BSS      0              OVERLAY AREA BASE
          TTL      PRIMARY (1,0) OVERLAY.
          EJECT
          QUAL     OVL1          DEFINE QUALIFICATION FOR THIS OVERLAY
          IDENT    OVL1,OV1,OV1,1,0  PRIMARY (1,0) OVERLAY
          ORG      OVER          START AT OVERLAY AREA

```

```

*      READ THE REAL TIME CLOCK AND ISSUE A DAYFILE MESSAGE
*      INDICATING WHEN OVERLAY WAS CALLED.

OV1    RTIME  OV1A      GET CURRENT TIME
        SA1    OV1A      CONVERT MILLISECONDS TO DISPLAY CODE
        MX0    -36
        BX1    -X0*X1
        RJ     CDD
        SA6    OV1C
        MESSAGE OV1B,,R  * OVL1 CALLED AT  NNNNNN*
        JP     MAI1      RETURN

OV1A   CON    0          REAL TIME CLOCK
OV1B   DATA  20H OVL1 CALLED AT
OV1C   CON    0          CONVERTED MILLISECONDS
        CON    0          MESSAGE TERMINATOR

*CALL  COMCCDD

TTL    PRIMARY (2,0) OVERLAY.
EJECT
QUAL   OVL2      DEFINE QUALIFICATION FOR THIS OVERLAY
IDENT  OVL2,OV2,OV2,2,0  PRIMARY (2,0) OVERLAY
ORG    OVER      START AT OVERLAY AREA

*      READ THE REAL TIME CLOCK AND ISSUE A DAYFILE MESSAGE
*      INDICATING WHEN OVERLAY WAS CALLED.

OV2    RTIME  OV2A      GET CURRENT TIME
        SA1    OV2A      CONVERT MILLISECONDS TO DISPLAY CODE
        MX0    -36
        BX1    -X0*X1
        RJ     CDD
        SA6    OV2C
        MESSAGE OV2B,,R  * OVL2 CALLED AT  NNNNNN*
        JP     MAI2      RETURN

OV2A   CON    0          REAL TIME CLOCK
OV2B   DATA  20H OVL2 CALLED AT
OV2C   CON    0          CONVERTED MILLISECONDS
        CON    0          MESSAGE TERMINATOR

*CALL  COMCCDD

END

```

SECURITY CONSIDERATIONS

A program cannot dump or directly change the job field length with an RA+1 request if the program is one of the following types.

- A protected system program.
- A user's program that has requested protection through the SETSSM macro (refer to section 6).
- A user's program loaded from an execute only file.

These security restrictions do not apply if the job is of system origin or if the user is validated for system origin privileges and DEBUG mode has been set on the system console.

The following RA+1 calls can either dump or change central memory and therefore are not allowed when memory protection is requested (Secure System Memory status is set):

<u>Call</u>	<u>Description</u>
CKP	Checkpoint request
DEP	Dump ECS field length request
DED	Dump ECS field length request with display code
DMP	Dump field length request
DMD	Dump field length request with display code
REQ	Request equipment assignment
LFM	For the ASSIGN, LABEL, and REQUEST functions (refer to section 4)
PFM	For any access to removable auxiliary devices (refer to section 5)

Violation of these restrictions results in the job step being aborted and the following dayfile message being issued.

SECURE MEMORY, DUMP DISABLED.

Refer to section 3, volume 1, for a list of control statements that cannot follow job steps with SSM status set.

This section describes the file communication area necessary for file creation and the processing of many user requests. The file environment table (FET) is the standard communication area or parameter block for the system file processors. The COMPASS programmer must define the FET, whereas the higher level languages (COBOL and FORTRAN, for example) automatically establish and use this area.

Depending on the processor being used, certain areas of the FET must be defined and used in communicating with that processor. The minimum length of a FET is five words.

CIRCULAR BUFFERS

The buffer parameters (FIRST, IN, OUT, and LIMIT) in the FET describe the circular buffer (refer to figure 2-2-1). A circular buffer is a central memory storage area that contains data during input/output operations. It is called a circular buffer because routines that process input/output treat the first word of the buffer area as contiguous to the last word of the buffer area.

All input/output is performed by passing data between a circular buffer (in central memory) and a peripheral device (mass storage or magnetic tape, for example).

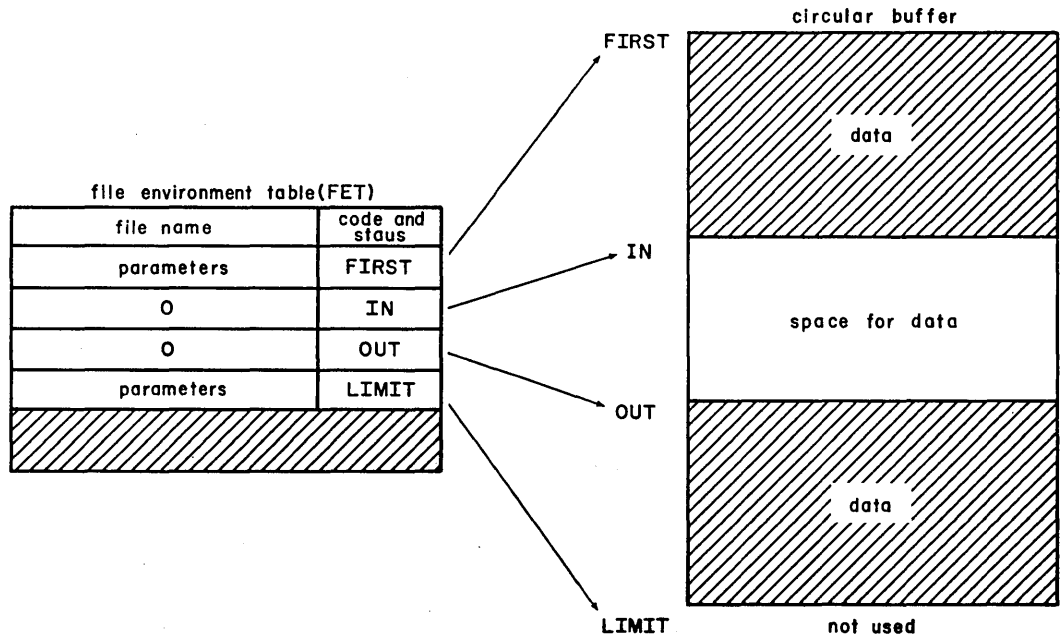

Figure 2-2-1. Circular Buffer

FIRST ADDRESS

FIRST is the first word address of the buffer area. Routines that perform input/output never change the value of FIRST.

	59	47	35	29	23	17	13	9	0	
FET +0	local file name (lfn)						ln	at	code	
+1	dt	[dipl] [xt]				l	FIRST			
+2	0						IN			
+3	0						OUT			
+4	FNT pointer		[dipl]		PRU size		LIMIT			
+5	[dipl]				fwa working storage		[dipl]			
+6	[dipl]				[dipl]		lwa+l working storage(la)		mlrs	
+7	[dipl]									
+8	[dipl]									
+9	file identifier (first 10 characters)									
+10	file identifier (last 7 characters)						file sequence number			
+11	gvn		retention cycle			creation date				
+12	set identification					file section number				

Figure 2-2-5. Standard FET for Labeled Magnetic Tape File (CIO)

Refer to the LABEL and OPEN macros for a description of the FET fields used in processing ANSI labels.

<u>Parameter</u>	<u>Word (FET+n)</u>	<u>Position</u>	<u>Description</u>
Local file name (lfn)	0	59-18	The lfn field contains one to seven alphanumeric display code characters, left-justified; unused characters are zero-filled. The lfn is the common reference point for all system communication concerning the file.
Level number (ln)	0	17-14	This is the level number for an EOR/EOF operation on the file. NOS uses this field for CIO operations and for distinguishing interactive input from noninteractive input (refer to CIO in section 3 and the discussion on writing interactive programs, section 12).
Abnormal termination Codes (at)	0	13-10	Status information returned by the function processor when an abnormal situation or error occurs. This field is usually set by the processor when the error processing bit (ep) is set in FET+1. For some processors, at is returned in bits 17 through 10. This field is set to 22g by CIO if the ep bit is not set and an error condition is present. Function processor descriptions should be consulted for the specific error codes returned.

<u>Parameter</u>	<u>Word (FET+n)</u>	<u>Position</u>	<u>Description</u>				
Code	0	9-0	<p>Request/return code. The user (or macro) sets this code for the request desired. The function processors alter it only if the request is not completed. For example, the user requests a read (CIO code 010) but encounters an EOR. CIO returns a status code of 021. These codes are detailed in the function processor descriptions.</p> <p>The following are subfields for the code parameter.</p> <p>Bit 1: file mode (fm). File mode for input/output operations on S, L, or SI tape formats only. For S or L format tapes, bit 1 is:</p> <table border="0"> <tr> <td>0</td> <td>Coded</td> </tr> <tr> <td>1</td> <td>Binary</td> </tr> </table> <p>Binary mode must be selected for SI tape formats or the job step is aborted.</p> <p>Bit 0: Interlock (ilk). FET interlock bit. Used to indicate system/user access to data associated with the file. The user sets this bit to 0 (busy or not complete) and the processor sets it to 1 when completed.</p>	0	Coded	1	Binary
0	Coded						
1	Binary						
Device type (dt)	1	59-48	<p>The 12-bit display code of the type of device on which the file is or will be residing. If bit 59 is set, it indicates a nonallocatable device (refer to appendix E). If an S, L, or SI file is opened, this field contains NOS/BE compatible return information (refer to the OPEN macro).</p>				
Random access (r)	1	47	<p>This bit is set if random processing is to be performed on the file. If this is set, the FET must be at least seven words in length.</p>				
User processing (up)	1	45	<p>The user sets this bit if he desires to perform his own end-of-reel or end-of-device processing. When CIO encounters an end-of-reel/end-of-device, it returns an abnormal termination code of 1 (bits 13 through 10 of FET+0). For further information about end-of-reel processing, refer to the CIO CLOSER macro. The up bit is checked only if the FET is at least six words in length.</p>				

<u>Parameter</u>	<u>Word (FET+n)</u>	<u>Position</u>	<u>Description</u>
Error processing (ep)	1	44	<p>This bit is used to indicate to the function processor that the calling program processes errors that occur, such as parity errors or errors in requests to the file managers. The function processor returns the error code in the at field of FET+0. Function processor descriptions should be consulted for the error codes returned. If this bit is not set, the function processor either aborts the job or requests operator intervention.</p> <p>If an unrecovered parity or block too large error occurs during a magnetic tape read operation (with the ep bit set) or if a read parity error occurs on a mass storage read operation (with ep bit set), the following steps occur.</p> <ol style="list-style-type: none"> 1. The data in the bad block is stored in the user's circular buffer. 2. The value of the IN pointer prior to the read is stored in the next word in the circular buffer (pointer to the beginning of the bad data block). 3. The parity error code is set in FET+0. 4. The IN pointer is updated in the FET. This IN pointer value does not include the additional word (pointer to the beginning of the bad data block) stored in the buffer. 5. The FET completion bit is set. <p>The pointer to the bad data is returned on all reads processed by CIO for a mass storage file. If no data is transferred (correct PRU not read), the pointer points to itself, and no update of IN occurs.</p> <p>If tape error processing is inhibited (refer to the LABEL macro, section 4), the preceding steps are not performed regardless of whether or not the ep bit is set.</p>
Extended label processing (xl)	1	41	<p>Specifies standard (xl = 0) or extended (xl = 1) tape label processing.</p>

<u>Parameter</u>	<u>Word (FET+n)</u>	<u>Position</u>	<u>Description</u>
Flush bit (fb)	1	36	<p>Specifies that the file's circular buffer is to be flushed upon abnormal termination or for terminal files when the job is rolled out.</p> <p>Files that are pointed to by the list of files (refer to the SETLOF macro, section 6) and meet the following criteria are flushed with the appropriate write function. Files are flushed with an end-of-record write (CIO function 024) unless the last function in the FET is a WRITECW (204) or WRITEN (264), in which case that function is reissued.</p>

NOTE

Care must be taken when selecting random files to be flushed since they could be truncated by an end-of-record write.

- Original error flag (ef) is less than SPET (refer to EREXIT macro, section 6).
- No buffer parameter errors; that is:

Complete FET within user's field length

```
LIMIT .LE. FL
OUT .LT. LIMIT
OUT .GE. FIRST
IN .LT. LIMIT
IN .GE. FIRST
```

- Write bit is set in the FET or the FET is unused (bits 9 through 3 are 0).
- No CIO error code exists in FET.
- Data is in buffer.

<u>Parameter</u>	<u>Word (FET+n)</u>	<u>Position</u>	<u>Description</u>
FET length (l)	1	23-18	Specifies the additional length of the FET over normal size (five words). For example, if $l = 3$, FET length = 8 and FET+7 is the last usable word. Function processors require varying lengths for particular parameters. However, it is recommended that the FET for mass storage files be at least seven words for most efficient system processing.
FIRST	1	17-0	First word address of input/output buffer.
IN	2	17-0	The next available location for entering data into the buffer. The upper 42 bits should never be used since the function processors read and write the entire word.
OUT	3	17-0	The next available location for removing data from the buffer. The upper 42 bits should never be used since the function processors read and write the entire word.
FNT pointer	4	59-48	Address of the file name table (FNT) entry for the file. This pointer is used by the system to reduce overhead when processing a file. It is set only if the FET length is greater than 5.
Physical record unit size	4	35-18	Number of CM words in PRU of the device to which the file is assigned. The PRU size for mass storage is always 64 CM words. The PRU size for magnetic tape varies according to the data format selected. This is set only if the file is opened using the CIO OPEN macro and if the FET length is greater than 5. Refer to appendix J for information on magnetic tape PRU size.
LIMIT	4	17-0	Last word address plus 1 of the buffer. Data is never placed in or removed from LIMIT.
First word address of working storage	5	47-30	First word address of working storage. Working storage is used by several of the compilers to control input/output in specific formats (blocking/unblocking). This parameter is not used by the system or the NOS common decks which refer to working storage areas. Working storage areas for use by macros (READS, READC, and so forth) require the user to define his own working storage area and specify it on each macro request. Pointers to working storage can be placed here for reference.

<u>Parameter</u>	<u>Word (FET+n)</u>	<u>Position</u>	<u>Description</u>
Working storage last word address + 1	5	17-0	Last word address plus 1 of working storage.
List address (la)	5	17-0	List address. This points to the table of the relative sector addresses for CIO READLS and RPHRLS macros.
Current random index (cri)	6	59-30	The current random index for the mass storage file being randomly accessed. The system returns the current position of the file after a random input/output request. This is in the form of a relative sector address (rsa) from the beginning of the file. For any nonrandom read or write operation, the system updates this field by adding the number of sectors transferred to the existing contents of the field. For any random access or positioning operation, the value is recalculated. cri is ignored if r (FET+1) is not set.
Random rewrite request (w)	6	29	This bit is set to indicate a write-in-place operation. If not set, the write takes place at the current position with rr being the address for the return of rsa, where the write began. This is ignored if r (FET+1) is not set.
Unused bit count (ubc)	6	29-24	Specifies the unused bit count for S and L format tapes (refer to appendix J).
Random request (rr)	6	28-0	Relative sector address (rsa) for a random input/output request. An exception is if w = 0 and it is a write request, then it is the address for the return of the starting rsa of the write (previous EOI). If the error processing bit (FET+1, bit 44) is set and an error occurs, the system returns detailed error status information in FET+6, bits 11 through 0. For further information, refer to the description of CIO. rr is ignored if r (FET+1) is not set.
Maximum logical record size (mlrs)	6	17-0	Specifies the maximum physical record size for S and L format tapes. Refer to appendix J.
Index length (il)	7	35-18	Random index length. This must be set by the user when requesting CIO OPEN to load the random index of a file or CIO CLOSE to dump the random index of a file. If r (FET+1) is not set, il is ignored.

The following parameters can be used to modify fields in the FET. They can be specified in any order.

NOTE

SETFET does not verify that the modified words are within the FET length.

<u>P_i</u>	<u>Description</u>
BUF=fwa, length	Changes the first word address of the CIO circular buffer to fwa and the length of the buffer to length. Thus, FIRST, IN, and OUT are changed to fwa and LIMIT is changed to fwa + length.
DTY=dt	Changes the device type to dt. The dt option is the display code equivalent of the device type, right-justified with binary zero fill in a register or a central memory location as described in SETFET Parameter Processing. Refer to appendix E for legal equipment codes.
ERA=erad	Changes the error message return address to erad for PFM requests (refer to Error Processing in section 5).
ERP=erp	Sets the error processing, user processing, or real-time processing bit, or combinations of the error and user processing or error and real-time processing bits. The erp option can be a mnemonic as follows.

<u>erp</u>	<u>Value</u>	<u>Description</u>
U	4	Set user processing bit at FET+1, bit 45.
E	2	Set error processing bit at FET+1, bit 44.
R	1	Set real-time processing bit for PFM requests at FET+1, bit 43 (refer to section 5).
UE	6	Set both user processing bit and error processing bit.
ER	3	Set both error processing bit and real-time processing bit.

If an erp other than those listed is specified, it must be a register or central memory location containing the value of erp (refer to SETFET Parameter Processing).

<u>P_i</u>	<u>Description</u>
LFN=lfm	Changes the local file name in FET+0 to lfm. †
PFN=pfm	Changes the permanent file name in FET+8 to pfm for PFM requests. †
PKN=pm	Changes the pack name in FET+12 to pm for PFM requests. †
PWD=pwd	Changes the password in FET+10 to pwd for PFM requests. †
UCW=ucw	Changes the user control word in FET+11 to ucw for PFM requests. †
USN=un	Changes the alternate user number in FET+9 to un for PFM requests. †

SETFET PARAMETER PROCESSING

For the DTY, ERP (when mnemonics are not used), LFN, PFN, PKN, PWD, UCW, and USN parameters, the following rules apply.

- If an option is represented by a register, the register contains the value to be placed in the FET. For example:

SETFET F, (LFN=X4)

uses the contents of X4 as the new local file name.

- If an option is represented by a constant, the constant specifies the address containing the value to be placed in the FET. For example:

SETFET F, (LFN=LOFN)

uses the contents of location LOFN as the new local file name. The file name can be specified in a literal as follows:

SETFET F, (LFN==6LOUTPUT)

- If an option is a register that is preceded by the number sign (#), †† the register specifies the address containing the value to be placed in the FET. For example,

SETFET F, #B3

uses B3 as the address containing the value to be placed in the FET.

† This option is left-justified with binary zero fill in an X register or central memory location as described in SETFET Parameter Processing.

†† The CDC graphic equivalence sign (≡).

- If an option is a register expression or constant preceded by the equivalence sign, it specifies the address containing the address of the value to be placed in the FET. For example:

```
SETFET F, (LFN=#FADDR)
```

uses the contents of FADDR as the address containing the value to be placed in the FET.

For the BUF and ERA parameters, the following rules apply.

- If an option is represented by a register, the register contains the value to be placed in the FET. For example:

```
SETFET F, (ERA=A5)
```

uses the contents of A5 as the new error message return address.

- If an option is represented by a constant, the constant specifies the address value to be placed in the FET (not the address containing the value). For example:

```
SETFET F, (ERA=ERRBUF)
```

uses the address ERRBUF as the new error message return address.

SETFET EXAMPLES

Example 1:

The SETFET macro can be used to take advantage of the way in which FORTRAN passes parameters to subroutines. Assume a FORTRAN program calls a COMPASS subroutine GETF to retrieve a permanent file. The call accepts three parameters to select the local file name, permanent file name, and file password:

```
CALL GETF(lfn, pfn, pwd)
```

When FORTRAN processes the call, it builds a central memory table with one entry for each parameter. The entry contains the actual address of the parameter. Before control is passed to the subroutine, FORTRAN sets the A1 register to the first word address of the table. Thus, X1 contains the address of the first parameter. If the call to GETF is:

```
CALL GETF(DATA1, BASE1, PWD1)
```

the A1 register is the first word address of the table of addresses, X1 contains the address of DATA1, location A1+1 contains the address of the next parameter, and so on. This fact can be used by SETFET as follows:

```
SETFET F, (LFN=#X1), (PFN=#A1+1), (PWD=#A1+2)
```

```

      .
      .
      .
F      FILEB      BUF, 301B, (FET=16D)
BUF    BSS        301B

```

Example 2:

Similarly, a COMPASS program could place the values in the FET as follows:

```
          SA1          DATA1
          SB3          BASE1
          SETFET F, (LFN=X1), (PFN=# B3), (PWD=PWD1)
          .
          .
DATA1 DATA          OLDATA1
BASE1 DATA          OLBASE1
PWD1 DATA          OLPWD1
F      FILEB        BUF, 301B, (FET=16D)
BUF    BSS          301B
```

This section describes the process of performing input/output from a COMPASS program.

The combined input/output (CIO) part includes those macros needed for file creation, read and write functions, and file positioning. The data transfer part includes those macros that allow the user to transfer information between the circular buffer and a working buffer area.

The user can perform I/O directly through FETs using CIO or with CYBER Record Manager facilities that are available to COMPASS users through COMPASS macro calls. A brief description of Record Manager features is provided later in this section.

CIO – COMBINED INPUT/OUTPUT

The CIO read/write requests are used to transfer data between a file and a CIO circular buffer. The read requests transfer input files from a system storage medium to a CIO circular buffer. The write requests transfer output from a CIO circular buffer to a system storage medium. Also included in this group of requests are those which open and close files, those which update records in an existing mass storage file, and those which control positioning of the file.

The format of the call to CIO is:

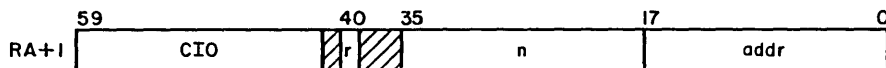

- r Auto recall, if desired
- n Count for skip operations
- addr Address of the FET

Word FET+0 contains the following information.

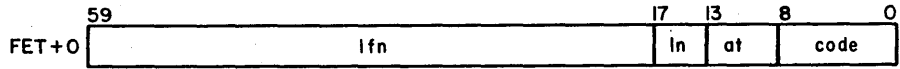

lfn Local file name
 ln Level number ($0 \leq ln \leq 17g$) for an EOR/EOF operation on the file:
 0 EOR operation
 1-16g Same as level 0
 17g EOF operation

at Abnormal termination code returned by CIO:

<u>Code</u>	<u>Description</u>
01	End of information encountered.
02	Device full/end of reel encountered.
04	Parity error.
21	End of multifile set.
22	Fatal error.

code Request/return code:

<u>Bit</u>	<u>Description</u>
8-2	Individual error code from a CIO function. Refer to the specific function for the bit settings and their meanings.
1	Binary operation if set (applies only to SI, S, and L format tapes); coded operation if zero (applies only to S and L format tapes).

NOTE

Binary mode must be selected for SI tape format or the job will be aborted.

0 Operation complete if set.

The file mode (fm) bit (bit 1) of FET+0 is not actually part of the status response, although it is returned as such. The fm bit is used by tape drivers, in some cases, to determine parity (seven-track) or whether conversion is required between character sets (nine-track). For disk I/O, the bit is carried for compatibility with tape I/O but is meaningless. The bit is set by the FILEB or FILEC macros or directly by the user. After this it is masked in as part of the return code.

The CPU program is expected to issue an even request code (bit 0=0). If it does not, a completed operation may not be detected.

CIO uses FET+5 and FET+6 in the following manner.

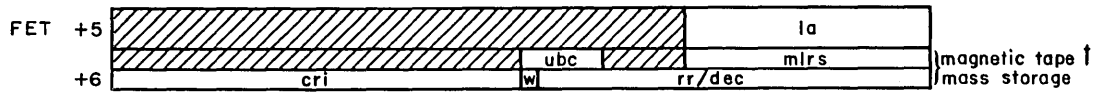

- la Address of a list of random addresses to be used with READLS or RPHRLS mass storage operations
- ubc Unused bit count for S and L format tapes
- mlrs Maximum PRU size for S and L format tapes
- cri Current random index (for mass storage files only)
- w Random rewrite request (for mass storage files only)
- rr Random request (for mass storage files only): if $rr \neq 0$, and the request is a read request, rr is the random index

If $rr \neq 0$, $w=0$, and the request is a write request, rr is the address for return of random index (the write operation begins at the current EOI). The index of the EOI prior to the write is returned to the calling program.

If $rr \neq 0$, $w=1$, and the request is a write request, rr is the random index indicating where the write will begin.

- dec Detail error return code (for mass storage files only).

<u>Code</u>	<u>Type of Error</u>
x001	Parity error
x002	Address error
x003	Device status error
x004	6681 function reject or function sent to mass storage device that timed out with no response
x005	Device reserved
x006	Device not ready
4007	Track limit (device full)

If, after a read error (with ep bit set), the system determines that the correct PRU was read (although it may contain incorrect data) then x above is 0, the data is placed in the buffer, and the file is positioned to the next PRU of the file. If the correct PRU is not read, then x is 4, no data is placed in the buffer, and the file is not repositioned. The cri is set as usual.

† These fields apply only to S and L format tapes.

Equipment which may be accessed by CIO includes:

- Mass storage
- Magnetic tape units

CIO FUNCTION PROCESSING

All of the CIO macros require two common decks for system interface.

- COMCCIO
- COMCSYS

These common decks are available to the user in relocatable form on the user library SYSLIB.

If a CIO macro specifies a FET that currently does not have the completion bit set, the system will wait (by performing recalls) for completion before performing the specified function.

Error processing for functions issued to CIO involves processing only those errors that occur on the specified devices which include read and write parity errors to magnetic tape. If a mass storage device returns an error status or the device driver detects an error, the system places the error status in the FET+0 status field. If the error processing bit is set in the FET+1 ep field and the FET length is greater than five, a detail error code is returned to the user in the FET+6 dec field.

ACCESSING FILES

The two methods used to access files assigned to a job are sequential and random access. Any file can be accessed sequentially; however, only mass storage files can be accessed randomly.

To read a file randomly, the system reads a portion of the file without reading all information in the file, from the current position to the desired position. Any mass storage file can be read randomly if the user knows which relative PRU (that is, which PRU in relation to the BOI) he wishes to read. The desired PRU can be read by placing the PRU number in the FET and making the proper I/O requests. The random address of a PRU is the number of PRUs that precede the PRU on the file. The first PRU that can be read or written is PRU 1. PRU 0 on all mass storage files is reserved for system use.

Several methods of random processing exist. The specific method depends on the language being used; however, in all cases, the following points apply.

- Most random I/O operations require a directory or index that contains the random disk addresses of records in the file.
- An EOR or EOF I/O operation transfers one PRU for the EOR or EOF.
- When randomly rewriting data within a file, the user must take care to ensure that data following the area he wishes to write is not destroyed.

RANDOM REQUEST PROCESSING

The user can request that the system perform the specified read or write request at the file position specified by the random request word (FET+6). If the file specified resides on mass storage and the random processing bit is set (r parameter in FET+1), then random access to the file can be performed. For a random write operation, the remainder of the file (the portion following the data written) is not released. On a sequential write operation, this portion of the file is released.

The user is responsible for managing the random addresses. For any CIO operation with r set in FET+1, the system returns the current random index (cri) in FET+6. The cri is the position of the file when the operation is completed.

Nonrandom write operations after an incomplete (no EOR or EOF written) random write operation are processed as random requests. Writing continues at the current position and the remainder of the file is not released. This feature makes the mid-record recalculation of the random address unnecessary when randomly writing records larger than the CIO circular buffer size.

For a write operation with r set in FET+1, if rr=0, a sequential write is performed at the current position. If rr≠0, the action the system takes is as described for FET+6 fields earlier in this section.

For a REWRITE operation with r set in FET+1, if rr=0, a random write is performed at the current position. If rr≠0, a random write is performed at rr.

For the random file shown in figure 2-3-2, the following random requests (that is, r is set in FET+1) are necessary to perform the operations described.

<u>Operation</u>	<u>rr</u>	<u>w</u>	<u>cri Returned</u>	<u>Description</u>
READ	10	0	11	Read directory
WRITER or REWRITER	5 5	1 0	8 8	Write new record 3 in place Word count = 138
WRITER	2000	0	15	Write new record at EOI; system sets location 2000 to 12 to indicate where the write occurred
WRITEF or REWRITEF	15 15	1 0	17 17	Rewrite directory

The user must account for the extra sector written for EORs and EOFs when specifying rewrite-in-place operations.

The system computes the number of sectors written as follows: †

<u>Operation</u>	<u>Formula</u>	<u>Word Count</u>	<u>Example</u>	<u>PRUs Written</u>	<u>Data Remaining in Buffer</u>
Buffer write	$n/100$	243	$243/100$	2	43
EOR write	$\frac{(n+100)}{100}$	243	$\frac{(243+100)}{100}$	3	0
		300	$\frac{(300+100)}{100}$	4	0
EOF write	$\frac{(n+200)}{100}$	243	$\frac{(243+200)}{100}$	4	0
		300	$\frac{(300+200)}{100}$	5	0

Appendix H contains examples of COMPASS programs that create, read, and write a random file.

CIO OPEN AND CLOSE FUNCTIONS

Two macros are available for opening files.

- OPEN is applicable to all files
- POSMF is applicable only to labeled multifile tapes

Two macros are available for closing files.

- CLOSE is applicable to all files
- CLOSER is applicable only to tape files

POSMF is described in the discussion of file positioning functions. OPEN, CLOSE, and CLOSER are described in the following paragraphs.

In general, there is no need to explicitly open or close mass storage files. The capabilities provided by open and close functions for mass storage files can be obtained through the use of other system macros. For example, appendix H illustrates the random processing of a file without using CIO open and close functions. Also, the example in this section of data transfer macros shows how a sequential mass storage file can be read and written without using open and close functions.

† All numbers are in octal.

If the file resides on mass storage, the random processing bit is set, and the proper parameters are set in FET+7, CLOSE writes the data in the buffer specified in FET+7 at EOI of the file. This normally is the index for the file. A random index is written at the EOI only if the file is random; the file has been written on since the last OPEN request; the file is not locked; and an index area is specified in FET+7, bits 17 through 0.

Example 1:

Random processing for the program shown in example 1 of the OPEN macro can be terminated as follows:

```

      .
      .
      BUFL      EQU      2001B
      INDXL     EQU      100B
      FILE1     RFILEB   BUF, BUFL, (FET=8), (IND=INDX, INDXL)
      BUF       BSS      BUFL
      INDX      BSS      INDXL
      .
      .
      OPEN      FILE1,,R
      .
      .
      CLOSE     FILE1,,R
      .
      .
  
```

In this example, the system writes the random index contained in the index buffer at the end of the file.

If the name of the file in FET+0 is PUNCH, PUNCHB, or P8, the file is entered in the punch queue. The file is punched in O26 or O29 mode, depending upon the origin of the job issuing the CLOSE request. If the job is not local batch origin, then the coded file is punched according to the system default keypunch mode (as specified by the installation). If the job is local batch origin, the initial keypunch mode of the job's control statement record (that is selected by the job statement or installation parameter) is the mode in which the deck is punched.

NOTE

CLOSE/UNLOAD and CLOSE/RETURN will not queue files in future versions of NOS. Programs using these functions should be rewritten to use the ROUTE macro if file queueing is desired.

When a magnetic tape file is closed, the action the system takes depends on the last I/O operation performed.

The system responds to a CLOSE request on a magnetic tape file in the following manner.

1. If the last operation was a write, the system performs one of the following functions.
 - If the tape is unlabeled and the data format is S, L, or F, the system writes four tape marks.
 - If the tape is unlabeled and the data format is I or SI, the system writes a tape mark, an EOF1 label, and three tape marks.
 - If the tape is labeled and standard label processing is in effect (xl, bit 41 of FET+1, not set), the system writes a tape mark, an EOF1 label, and three tape marks.
 - If the tape is labeled and extended label processing is in effect (xl, bit 41 of FET+1, set), the system writes a tape mark, an EOF1 label, all user end-of-file labels (EOF2 through EOF9) and user trailer labels (UTL) present in the extended label buffer, and two tape marks. All nonapplicable labels, including EOF1 and EOF9 labels, in the extended label buffer are ignored. Refer to Extended Label Processing earlier in this section for a description of the label buffer.

If the last operation was a read and the following are true, then all labels from this tape mark (beginning with EOF1) through the next tape mark are transferred to the extended label buffer, as space permits, beginning at the first word of the buffer.

- The tape is labeled
 - Extended label processing is in effect (xl, bit 41 of FET+1, set)
 - A tape mark immediately follows
2. If the no rewind (NR) option was selected, the tape remains positioned at or is repositioned to the same point as before the CLOSE was issued (to prevent user from going past EOI).

If the rewind (REWIND) option was selected, the system rewinds the tape to the beginning of data of the current file. This operation is performed automatically even if the current file begins on another reel.

If the unload (UNLOAD) option was selected, the system rewinds and unloads the current tape reel, releasing job and file attachment.

NOTE

If PO=U processing option was specified at tape assignment time, the tape will not be physically unloaded from the tape drive.

If the return (RETURN) option was selected, the system rewinds and unloads the current tape reel, releasing job and file attachment. The number of tapes scheduled for the job is decremented only if the total concurrent resource demand (tapes and packs)[†] has been satisfied.

[†] Refer to the RESOURC control statement, section 6, volume 1.

Macro Format:

LOCATION	OPERATION	VARIABLE SUBFIELDS
	RPHR	addr, r

addr Address of the FET

r If r is specified, control is returned only upon completion of the operation

READ (010)

The READ function reads information into the circular buffer. If there is room in the buffer for at least one full physical record, the system initiates reading and continues until:

- The available circular buffer space will not accommodate one full PRU.
- An end-of-record or end-of-file is encountered.
- The end-of-information is encountered.
- For S and L format tapes, one PRU is read.

The status responses (bits 17 through 0 of FET+0) are:

000011 Buffer filled
 000021 EOR encountered
 740031 EOF encountered
 741031 EOI encountered

Data is not transferred after an EOR or EOF mark is encountered. For tapes that do not have a defined EOI (refer to appendix J), an operation that normally would terminate at EOI terminates instead at EOF. Also, for S and L format tapes, the unused bit count is returned to FET+6, bits 29 through 24, when the read is complete.

Macro Format:

LOCATION	OPERATION	VARIABLE SUBFIELDS
	READ	addr, r

addr Address of the FET

r If r is specified, control is not returned until operation is complete

READSKP (020)

READSKP performs a read function until the buffer is filled or until an EOR or EOF is encountered. If the buffer is filled before an EOR is encountered, CIO positions the file at the next EOR, EOF, or EOI, whichever is encountered first.

The status responses (bits 17 through 0 of FET+0) are:

000021	Buffer filled or EOR encountered
740031	EOF encountered
741031	EOI encountered

For tapes that do not have a defined EOI (refer to appendix J), an operation that normally terminates at EOI terminates instead at EOF.

This is the only read function that performs the read operation if less than one PRU of space is available in the buffer.

Macro Format:

LOCATION	OPERATION	VARIABLE SUBFIELDS
	READSKP	addr,level,r

addr Address of the FET

level Level number (0 through 17_8) specified in FET+0, bits 17 through 14; if a level number is specified, information is skipped until the occurrence of an EOR with a level number greater than or equal to the one specified:

0	After the buffer is full, skip to the next EOR
17_8	After the buffer is full or a full record is placed in the buffer, skip to the next EOF

For S and L format tapes, only a request with level 17_8 is recognized; any other level in the request is ignored

r If r is specified, control is returned only upon completion of the operation

For S and L format tapes, the user should set the mlrs field (FET+6, bits 17 through 0) before issuing the READSKP function. If mlrs is 0, the system assumes 512 words for an S tape and 377777 octal for an L tape. Thus, if a READSKP is issued on an L tape and mlrs is 0, a block too large error occurs if a block is encountered that is greater than 377777 octal CM words.

READCW (200)

The READCW function performs a nonstop read of PRUs bounded by control words. The PRU format is:

Macro Format:

LOCATION	OPERATION	VARIABLE SUBFIELDS
	READN	addr, r

addr Address of the FET

r If r is specified, control is returned only upon completion of the operation

Before this function is issued, the mlrs field in FET+6, bits 17 through 0, must be set to the largest physical record that will be encountered. For S format, if mlrs=0, the value of the maximum block is assumed to be 512 words. For L format, if mlrs=0, the assumed maximum block is LIMIT-FIRST-2. In addition, the file mode (FET+0, bit 1) must be set.

Each physical record in the circular buffer is preceded by a header word. This word is generated by the system; it does not exist on the tape. The format of the header word is:

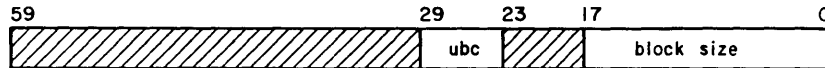

ubc Unused bit count. Number of bits in the last word that are not valid data; ubc may range from 0 to 55.

block size Number of CM words in the physical record

After each complete physical record has been placed in the buffer, the system moves the IN pointer to reflect both the header and the data.

READEI (600)

The READEI function reads information into the circular buffer. Reading continues until an EOI mark is encountered or the buffer is filled. The status response is EOI encountered (741031). The file is positioned at EOI.

Macro Format:

LOCATION	OPERATION	VARIABLE SUBFIELDS
	READEI	addr, r

addr Address of the FET

r If r is specified, control is returned only upon completion of the operation

CIO WRITE FUNCTIONS

The following write functions are processed by CIO.

WPHR (004)

WPHR writes one physical record from the circular buffer. Unless the buffer contains at least one PRU, no operation occurs.

Macro Format:

LOCATION	OPERATION	VARIABLE SUBFIELDS
	WPHR	addr, r

addr Address of the FET
 r If r is specified, control is not returned until the operation is complete

WRITE (014)

WRITE transfers the contents of the circular buffer to the specified file. Writing continues until the buffer contains less than one PRU of data (a WRITER request empties the buffer and writes an end-of-record on the file).

Macro Format:

LOCATION	OPERATION	VARIABLE SUBFIELDS
	WRITE	addr, r

addr Address of the FET
 r Auto recall option:
 * The * option sets the WRITE function code (CIO function code 014_g) in FET+0 and returns to the calling program. No actual WRITE function is performed at this time.
 For further information concerning use of the * option, refer to WRITECW (204) later in this section.
 other Control is not returned until the operation is complete

For S and L format tapes, only one record is written for each request. The length of the record is determined by the value of the IN and OUT pointers.

WRITER (024)

WRITER writes the entire contents of the buffer to the file specified.† The last PRU is written as a short PRU (refer to appendix J). If the data exactly fills the last PRU, the system adds a PRU with no data to indicate the end of the record. A WRITER request with level 17₈ set in FET+0, bits 17 through 14, performs the same operation as a WRITEF request.

Macro Format:

LOCATION	OPERATION	VARIABLE SUBFIELDS
	WRITER	addr, r

addr Address of the FET

r If r is specified, control is not returned until the operation is complete

WRITEF (034)

WRITEF writes the entire contents of the buffer to the file specified.† The last PRU written is the end-of-file. If data does not exactly fill the last PRU, the system writes a short PRU (refer to appendix J) and an EOF. If the buffer is empty and the last operation was an incomplete write (last PRU written was not EOR or EOF), an EOR (PRU with no data) and an EOF are written; otherwise only an EOF is written. For S and L format tapes, data in the buffer is transferred to tape and followed by a tape mark.

Macro Format:

LOCATION	OPERATION	VARIABLE SUBFIELDS
	WRITEF	addr, r

addr Address of the FET

r If r is specified, control is not returned until the operation is complete

†The OUT pointer is updated. The IN pointer is not changed.

WRITECW (204)

The WRITECW function performs a nonstop write of PRUs bounded by control words. The PRUs are in the same format as specified for READCW. Data written using this function is stored on the device in the same format as if it had been written with any other write function (that is, the control words are not part of the data).

WRITECW may only be used with mass storage and magnetic tape devices.

Macro Format:

LOCATION	OPERATION	VARIABLE SUBFIELDS
	WRITECW	addr, r

addr Address of the FET

r Auto recall option:

* The * option sets the WRITECW function code (CIO function code 204_g) in FET+0 and returns to the calling program. No actual WRITECW function is performed at this time.

If the symbol WRIF\$ is defined in assembly and a data transfer common deck attempts to issue a write request (refer to Data Transfer Macros in this section), it will use the CIO request set in the FET instead of a WRITE (014_g) request. The data transfer common decks, by default, issue a WRITE (014_g) request if WRIF\$ is not defined. The WRITE macro can be used to reset the FET after using the * option with a WRITECW, WRITEN, or REWRITE macro.

If used, this option should be issued before any writing is performed on the file.

NOTE

The appropriate data transfer common deck must be assembled within the user's program (that is, the SYSLIB version cannot be used) or the WRIF\$ is meaningless.

For example, the following sequence assures that the data transfer common deck COMCWTW issues a WRITECW request instead of a WRITE request if it is required to write the circular buffer.

```

IDENT      WRT
.
.
WRIF$ EQU
OPL XTEXT  COMCWTW
.
.
WRITECW F,*
.
.
WRITEW F,WBUF,100B
.
.
F FILEB FBUF,2001B,FET=13
FBUF BSS 2001B
WBUF BSS 100B
.
.
END      WRT

```

other Control is not returned until the operation is complete.

REWRITE (214)

REWRITE performs the same operation as the WRITE function with the exception that it causes the system to process the operation as a random function; that is, that portion of the file following the portion written is not destroyed. If the random parameters (r, rr, and w) are not specified in the FET, the write operation takes place at the current position. If the random parameters rr and w are specified, the normal random addressing procedures are followed. The file to be rewritten must reside on mass storage. A subsequent CLOSE function will not cause an update of the random index for the file, unless another CIO write function other than REWRITE, REWRITER, or REWRITEF has been performed since the last OPEN function.

NOTE

REWRITE does not check if the record being rewritten in place is the same size or less than the original record.

Macro Format:

LOCATION	OPERATION	VARIABLE SUBFIELDS
	REWRITE	addr, r

addr Address of the FET

r Auto recall option

* The * option sets the REWRITE function code (CIO function code 214_g) in FET+0 and returns to the calling program. No actual REWRITE function is performed at this time.

For further information concerning use of the * option, refer to the WRITECW macro.

other Control is not returned until the operation is complete.

REWRITER (224)

REWRITER performs the same task as WRITER with the exceptions noted for REWRITE. The file must reside on mass storage. If the level number is 17_g, REWRITER performs the same operation as REWRITEF.

Macro Format:

LOCATION	OPERATION	VARIABLE SUBFIELDS
	REWRITER	addr, r

addr Address of the FET

r If r is specified, control is not returned until the operation is complete

NOTE

A short PRU is written even if the last PRU is exactly full.

REWRITEF (234)

REWRITEF performs the same task as WRITEF with the exceptions noted for REWRITE. The file specified must reside on mass storage. A subsequent CLOSE function will not cause an update of the random index for the file, unless another CIO write function other than REWRITE, REWRITER, or REWRITEF has been performed since the last OPEN function.

Macro Format:

LOCATION	OPERATION	VARIABLE SUBFIELDS
	REWRITEF	addr, r

addr Address of the FET

r If r is specified, control is not returned until the operation is complete

NOTE

An extra PRU is written to specify an EOF.

WRITEN (264)

The WRITEN macro writes nonstop on an S or L formatted magnetic tape. S and L formatted tapes are described in appendix J. Writing continues until the buffer is empty or end-of-reel is encountered.

Macro Format:

LOCATION	OPERATION	VARIABLE SUBFIELDS
	WRITEN	addr, r

addr Address of the FET

r Auto recall option:

* The * option sets the WRITEN function code (CIO function code 264₈) in FET+0 and returns to the calling program. No actual WRITEN function is performed at this time.

For further information concerning use of the * option, refer to the WRITECW macro.

other Control is not returned until the operation is complete.

The user must provide a header word immediately preceding each record in the buffer. This header is not physically written on the tape. Its format is:

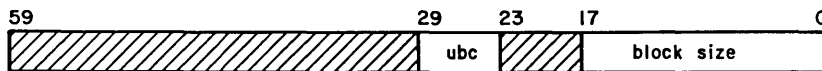

ubc Unused bit count. Number of bits that are not valid data in the last word; ubc may range from 0 to 55.

block size Number of CM words in the physical record.

The system compares the mlrs and ubc fields in FET+6 using information from this header.

The OUT pointer is not changed to reflect the move until after each complete record has been written to tape.

FILE POSITIONING FUNCTIONS

The following functions control the positioning of a file. If the FET indicates that the file is being accessed randomly, the random address of the new position (cri) is always returned.

Status responses assume coded mode (bit 1 of FET+0 clear). If binary mode is specified (bit 1 of FET+0 set), the responses end in 3 instead of 1. That is, 041 for coded mode becomes 043 for binary mode.

BKSP (040)

BKSP causes a file to be backspaced one logical record. If BOI or the load point of a tape file is encountered before backspacing is complete, a rewind status is returned (05x). If the backspace causes the file to be positioned exactly at BOI, a backspace status is returned (041).

If the operation terminates on an EOF, 17₈ is returned to the FET level number (ln) field (FET+0, bits 17 through 14).

- If located at the end of file set member 2 (F), a rewind positions the tape to the beginning of Volume I since file set member 2 begins on Volume I, and then positions Volume I to D.
- By writing over file set member 2, file set member 3 is destroyed.
- A POSMF 999 followed by a WRITE creates a file set member at I.
- To copy all three file set members, the following technique may be used.

OPEN with display code 001 (or 0001) sequence number and all other label fields binary zero.

READ to EOI. (C)

POSMF with display code 002 (or 0002) sequence number and all other label fields binary zero. This positions to next file set member at (D).

READ to EOI. (F)

POSMF with display code 003 (or 0003) sequence number and all other label fields binary zero.

READ to EOI. (H)

The SI (M) parameter must be present for multifile label positioning using control statements. If the QN (P) parameter is present, the multifile set is positioned to the file set member that matches the specified sequence number. If QN is not specified and the FI (L) parameter is present, the multifile set is positioned to the file set member that matches the file identifier specified. If both QN and FI are specified, a match must occur on both sequence number and file identifier. If neither QN nor FI is specified, an OPEN is done instead of a POSMF.

To extend a multifile set, QN must be set to 9999.†

Setting the QN parameter to zero advances the pointer to the next multifile. This is not true from a LABEL control statement.

If the SI parameter is not specified, then file positioning is not done. The R and W parameters on the LABEL statement are ignored if SI is specified. The exception is if the W parameter is specified and $QN \leq 1$, and it is the first OPEN on the file, then an OPEN/WRITE is performed.

† When a multifile set is extended, the set ID of the new file is always set to the same value as the previous file. This ensures that the set ID of all set members are the same.

Although the sequence number field in the HDR1 label is four characters in length, only the rightmost three characters are used to differentiate between 999 and another valid sequence number. This occurs because on an open (POSMF), the FET field for sequence is only three characters. Therefore, if extended labels are not being used, a limit of 998 file set members per file set is enforced.

EVICT (114)

The EVICT macro is similar to the RETURN macro in that it releases file space for the specified file. It differs from RETURN in that EVICT does not release the file attachment to the job. When an EVICT is performed on a deferred routed queue file (refer to ROUTE macro, section 8), all file routing information associated with the file is cleared.

Macro Format:

LOCATION	OPERATION	VARIABLE SUBFIELDS
	EVICT	addr, r

addr Address of the FET

r If r is specified, control is not returned until the operation is complete

The operation that EVICT performs depends on the file type. For the primary file and permanent files, all file space except the first track is released, job attachment remains, and an EOI is written on the first sector of the first track. For all other mass storage file types, file space is released and job attachment remains. Files for which write lock-out is set are returned to the system. An EVICT of a tape file performs the same functions as the UNLOAD macro.

SKIPF (240)

SKIPF causes the file to be positioned n records forward from the current position. The operation terminates when the skip count is satisfied or when EOI is encountered on a mass storage file or a tape file.

The status responses (bits 17 through 0 of FET+0) are:

0261	Last record skipped was EOR
740271	Last record skipped was EOF
741271	EOI encountered

IDENT COPYFIL
ENTRY COPYFIL
SYSCOM B1

** ASSEMBLY CONSTANTS.

IBUFL EQU 1001B INPUT BUFFER LENGTH
OBUFL EQU 2001B OUTPUT BUFFER LENGTH
WBUFL EQU 100B WORKING BUFFER LENGTH

** FETS.

I BSS 0
INP FILEB IBUF,IBUFL
O BSS 0
OUT FILEB OBUF,OBUFL

** MAIN PROGRAM.

COPYFIL SB1 1
REWIND O
REWIND I

COP1 READ I INITIATE READ OF LOGICAL RECORD
RECALL O

COP2 READW I,WBUF,WBUFL
ZR X1,COP3 IF NOT EOR/EOF
NG X1,COP4 IF EOF OR EO1 ENCOUNTERED

* EOR ENCOUNTERED. COPY DATA IN WBUF TO OUTPUT FILE.

WRITEW O,WBUF,X1-WBUF WRITE LAST PORTION OF RECORD
WRITER O WRITE END-OF-RECORD
EQ COP1 INITIATE READ OF NEXT RECORD

COP3 WRITEW O,WBUF,WBUFL
EQ COP2 TRANSFER MORE DATA TO WBUF

COP4 SX1 X1+1
NG X1,COP5 IF EO1 ENCOUNTERED
WRITEF O WRITE END-OF-FILE
EQ COP1 INITIATE READ OF NEXT RECORD

COP5 ENDRUN

** BUFFERS.

IBUF BSS IBUFL INPUT BUFFER
OBUF BSS OBUFL OUTPUT BUFFER
WBUF BSS WBUFL WORKING BUFFER

END COPYFIL

In the previous example, if the RECALL function was not specified for the output file, the following steps could occur.

1. The user program issues the REWIND O function.
2. Since auto recall is not specified, the user program continues execution.
3. At some point, the user program issues WRITEW which moves data from WBUF to the input/output buffer (O) starting at the current IN pointer in the FET. The WRITEW macro advances the IN pointer to reflect the amount of data transferred into the buffer.
4. At this point, the system completes the REWIND function and accordingly updates the FET IN and OUT pointers to point to FIRST (empty buffer). This destroys the IN pointer updated in step 3. The data placed in the buffer is ignored.
5. On subsequent EOR operations (WRITER), the same situation could occur if the RECALL function was placed elsewhere.

```
WRITER O
      .
      .           must place RECALL O here.
      .
WRITEW O,WBUF,WBUFL
      .
      .
      .
```

Write requests in the previous example are not issued with auto recall specified because other operations (READ, for example) can be performed before it is necessary to have the write operation completed.

In the previous example, if an EOR or EOF mark is not detected, it is not necessary to reissue READ requests to fill the input/output buffer because the data transfer macros and associated common decks detect when the buffer threshold is reached. If this threshold is reached, a request is issued to CIO by the common deck. This occurs with the READW macro when the empty space in the buffer exceeds the threshold or with the WRITEW macro when data in the buffer exceeds the threshold. The threshold used is half the buffer size. That is, if the buffer is less than half full, a read request is issued; if it is more than half full, a write request is issued. This threshold applies only when the buffer is 512 (1000₈) words or more in length. When the buffer is smaller, the read or write function is reissued only when the buffer is empty for a read or full for a write.

Assuming no EOR or EOF is encountered by the fifth time through the loop, IBUF is less than half full since 256 (400₈) words were read. The READW function then issues another CIO request to transfer data from file I to circular buffer IBUF. On the ninth time through the loop, the WRITEW function issues a WRITE request to file O since OBUF is now more than half full.

For the data transfer macros, the common decks required for absolute assemblies, in addition to those specified with each macro, are:

- COMCCIO
- COMCSYS
- COMCWTW for write functions (except WRITEO)
- COMCRDW for read functions (except READO)

LOCAL FILE MANAGER

Local file manager (LFM) performs requests associated with the control of a user's files.

The format of the call to LFM is:

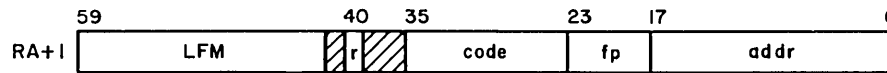

- r Auto recall bit (must be set)
- code Function code
- fp Function parameter
- addr Address of the FET

LFM uses the following information from the FET.

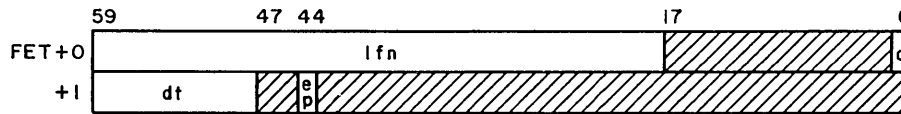

- lfn Local file name
- c Completion bit
- dt Device type
- ep Error processing bit

After the request is completed, the first word of the FET contains the following information.

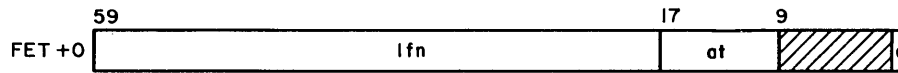

- at Abnormal termination code
- c Completion bit

The common decks required in absolute assemblies for the macros processed by LFM are:

- COMCLFM
- COMCSYS

For relocatable assemblies, these decks are satisfied by default from the library SYSLIB.

ERROR PROCESSING

The user can issue requests to LFM and have control returned if certain error conditions occur. To do this, the error processor bit (ep) must be specified in FET+1. The following error codes are returned in the abnormal termination (at) code field of FET+0, bits 17 through 10.

<u>Error Codes</u>	<u>Description</u>	<u>Error Codes</u>	<u>Description</u>
1	File not found	16	I/O sequence error
2	File name error	17	Output file limit
3	Illegal file type	20	Local file limit
4	File empty	21	No mass storage available
5	MAGNET not active	22	Illegal file mode
6	Duplicate common file name	23	FET too short
7	Illegal equipment	24	GETFNT table too large
10	Equipment not available	25	Illegal change in file/origin type
11	Duplicate file name	26	Parameter block busy
12	Illegal user access	27	Address out of range
13	Illegal user number	30	System error
14	Illegal ID code	31	Illegal random address
15	Resource executive (RESEX) detected an error		

The following error causes the job step to be aborted regardless of the presence of the user error processing bit in the FET.

LFM ILLEGAL REQUEST.

This message is issued if any of the following situations occur.

- An LFM function is issued without the auto recall bit set. All LFM calls must be specified with recall.
- An LFM function detected is not recognized as a legal function.

RENAME (000)

The RENAME function enables the user to change the name of a file currently assigned to the job to the name specified in FET+6. This does not change the names of files in the permanent file system.

If a file by the new file name already exists, it is returned to the system. However, there are certain conditions under which the file type of the old file is changed to that of the returned file.

- If the old file is a local mass storage file and the returned file is a print, punch, or primary type file, the file type of the old file is changed to that of the returned file.

- If the old file is a local mass storage file and the returned file is not a print, punch, or primary type file, the old file is renamed but its file type is not changed.

If the old file is not a local file or does not reside on mass storage, an

ILLEGAL FILE TYPE.

error message is issued.

If the old file is a tape file and the calling program has a DMP= entry point (refer to appendix F), the following message is issued.

SYSTEM ERROR.

If the FET is not at least seven words in length, the following message is issued.

FET TOO SHORT.

Macro Format:

LOCATION	OPERATION	VARIABLE SUBFIELDS
	RENAME	addr, nfn

addr Address of the FET (FET+0 contains the old file name)

nfn Address of new file name:
 If nfn = X1, X1 contains the new file name.
 If nfn is not specified, FET+6 contains the new file name.

ASSIGN (001)

The ASSIGN function enables the user to access a library file. If a file by the requested name is already local to the user's job, no action is taken. If the requested library file is not found, the following message is issued.

FILE NOT FOUND.

If the error processing bit is set, the message is not issued and error code 1 is returned.

The user must be validated to access library files or the following message is issued.

ILLEGAL USER ACCESS.

Macro Format:

LOCATION	OPERATION	VARIABLE SUBFIELDS
	ASSIGN	addr

addr Address of the FET

COMMON (002)

NOTE

This macro will not be supported in future releases of NOS. The user should use permanent files instead of library files. Refer to section 5 for a description of permanent file macros.

The COMMON macro changes the file type of the specified file to library. The file must be a locked local file residing on a mass storage device. If it is not, the following message is issued.

ILLEGAL FILE TYPE.

If the file to be made library is in execute-only mode (refer to Permission Modes, File Categories in section 5), the following message is issued.

ILLEGAL FILE MODE.

If a file of the same name already exists as a library file, the following message is issued.

DUPLICATE COMMON FILE NAME.

If a file by the requested name is not found, the following message is issued.

FILE NOT FOUND.

If the equipment the file is assigned to is not mass storage, the following message is issued.

ILLEGAL EQUIPMENT.

The user must be validated to access library files or the following message is issued.

ILLEGAL USER ACCESS.

The file is no longer assigned to the user's job if the operation is successful.

Macro Format: †

LOCATION	OPERATION	VARIABLE SUBFIELDS
	COMMON	addr

addr Address of the FET of the file to be entered as a library file

† This macro is not available in SYSTEXT. The user must specify systems text PSSTEXT or call common deck COMCCMD (refer to appendix A).

RELEASE (004, 005, 006, 007, 016, 030)

NOTE

This macro will not be available in future releases of NOS. The user should use instead the ROUTE macro described in section 8.

This function enables the user to release files to any of the output queues for processing before job termination.

Any of the following file types can be released.

- Local files
- Print files
- Punch files

If any other type is released or the file is not a mass storage file, the following message is issued.

ILLEGAL FILE TYPE.

If the file is unused, the following message is issued.

FILE EMPTY.

If an attempt is made to change the file type or origin type of a deferred routed file (refer to section 8), the following message is issued.

ILLEGAL CHANGE IN FILE/ORIGIN TYPE.

In this case, the file must have its routing rescinded (DC=SC) before it can be released to the desired file and origin type using the RELEASE macro.

If the number of files released to the output queue by the job has exceeded the limit for which the user is validated, the following message is issued and the job step is aborted.

OUTPUT FILE LIMIT.

If the file is an execute only file, the following message is issued.

ILLEGAL FILE MODE.

Macro Format:

LOCATION	OPERATION	VARIABLE SUBFIELDS
	RELEASE	addr, type, ot, un

addr Address of the FET

type One of the following:

PRINT	Release file to the PRINT queue (function 004)
PUNCH	Release file to the PUNCH O26 queue (function 005)
PUNCH9	Release file to PUNCH O29 queue (function 030)
PUNCHB	Release file to the PUNCHB queue (function 006)
P8	Release file to the P8 queue (function 007)

ot Specifies disposition of output:

BC	Release file to the local batch queue (function 016)
EI	Release file to the remote batch queue (function 016)

un Address containing the user number of the remote batch user to which the file is to be disposed (ignored if ot is BC). This parameter is valid only if the user is allowed deferred batch jobs. Also, un must match the user number of the user performing the RELEASE on all character positions except those containing an asterisk (*).

If the ot and un parameters are not specified, a remote batch job disposes the file to a remote batch terminal from which the job is submitted and all other origin types dispose the file to the central site output device. If ot is BC, the un parameter is ignored and the file is disposed as usual to the central site device.

The user may release coded punch files in either O26 or O29 mode, independent of the job's initial keypunch mode (refer to appendix F, volume 1).

LOCK (010)

This function enables the user to prevent writing on a file by setting the write lockout bit for the file. The file specified must be a local or primary file type; if it is not, the following message is issued.

ILLEGAL FILE TYPE.

Macro Format:

LOCATION	OPERATION	VARIABLE SUBFIELDS
	LOCK	addr

addr Address of the FET

Macro Format:

LOCATION	OPERATION	VARIABLE SUBFIELDS
	STATUS	addr, P

addr Address of the FET
P If P is specified, the current position is returned. If this
 parameter is omitted, LFM function 12 is executed.

REQUEST (014)

The REQUEST function requests operator assignment of equipment to a file. If the file is already assigned, the function is ignored. If dt in FET+1 is nonzero, the device assigned is of that type. If dt equals MS, a mass storage device must be assigned. The REQUEST function cannot be used to assign tape equipment. If dt is MT or NT, the job step is aborted and the following message is issued.

ILLEGAL EQUIPMENT.

If dt is zero, operator assignment of tape equipment is rejected and operator request for equipment continues until an acceptable device is assigned. The LABEL macro should be used for tape requests.

No special validation is required to assign allocatable devices such as mass storage or null equipment. All other equipment requires the user to be validated to use nonallocatable devices† or the following message is issued.

ILLEGAL USER ACCESS.

Macro Format:

LOCATION	OPERATION	VARIABLE SUBFIELDS
	REQUEST	addr, ,n

addr Address of the FET

n If this parameter is specified (any value may be used), the dayfile message indicating the equipment to which the file was assigned will not be issued.

If REQUEST is to be used for checkpoint dumps, FET+7 specifies the checkpoint mode.



cm Checkpoint†† mode indicates that addr is to be used as a checkpoint file:

75g Each time a checkpoint dump is taken, the new information is written at the BOI of addr.

76g Each time a checkpoint dump is taken, the new information is written at the previous EOI of addr.

† Refer to the LIMITS control statement, section 6, volume 1.

†† For further information, refer to the description of the CHECKPT macro, section 10.

The user can alternately write dumps on two checkpoint files by issuing two REQUESTs with cm=75g. If cm=76g for alternate files or if more than two checkpoint files are specified, the job step is aborted and the following message is issued to the user's dayfile.

CHECKPOINT FILE ERROR.

REQUEST (015)

This function assigns a file to an equipment according to the contents of the device type field in FET+1. If the file already exists, LFM issues the message

DUPLICATE FILE NAME.

to the dayfile and, unless user error processing is selected, aborts the job step.

The device type (dt) field affects the file's assignment as follows:

<u>If dt is</u>	<u>LFM assigns file to</u>
TT	The terminal (interactive jobs only)
MS	Any allocatable mass storage device
NE or 77 _g	Null equipment

<u>If dt is</u>	<u>LFM assigns file to device of preferred residence for</u>
TP	Temporary files
IN	Input files
OT	Output files
PY	Primary files
LO	Local files
LG	Binary (executable) files

The device of preferred residence for each of these file categories is determined by the site and is not subject to user control.

System origin jobs or users with system origin privileges can specify equipment mnemonics other than those listed here, or can specify an EST ordinal, subject to the following restriction: the dt field must not specify a tape equipment, either by mnemonic or EST ordinal. LFM issues the message

ILLEGAL EQUIPMENT.

to the dayfile and aborts the job step if this restriction is violated. The LABEL macro (described in this section) should be used for tape requests.

System origin jobs and users with system origin privileges may use function 015 for checkpoint dumps, thereby avoiding operator intervention. FET+7 should be formatted as described for function 014.

Macro Format:

LOCATION	OPERATION	VARIABLE SUBFIELDS
	REQUEST	addr, u, n

- addr Address of the FET
- u If this parameter is specified (any value may be used), the device type in FET+1 is the device to which the file is assigned. If the device type in FET+1 is numeric, this is the EST ordinal to which the file is assigned. Absence of this parameter causes LFM function 014 to be issued.
- n If this parameter is specified (any value may be used), the day-file message indicating the equipment to which the file was assigned will not be issued.

SETID (017)

NOTE

This macro will not be available in future releases of NOS. The user should use instead the ROUTE macro described in section 8.

This function sets the identifier code for a file. This enables the user to direct an output file to a particular device. The output queue processors assign files to devices only if the ID codes are the same. If the file does not exist, it is created by this function. The file must be: input (INFT), print (PRFT), local (LOFT) or punch (PHFT), or the following message is issued.

ILLEGAL FILE TYPE.

Macro Format:

LOCATION	OPERATION	VARIABLE SUBFIELDS
	SETID	addr, n

- addr Address of the FET
- n Identifier code; $0 \leq n \leq 67_8$

ASSIGN (020)

This function is used to access a library file. If the file is accessed from a system or library file, the return status code equals 0.

The random address of the directory is stored in FET+6.

The address bias for the directory is stored in FET+7.

This function enables the user to access user libraries that exist either on files attached to the job or the system. The local files are searched first. Because of the structure of the system file, the address bias for the directory must be specified. For example, if the directory for SYSLIB is specified at random address 2000 (FET+6) on the system file, the bias for all entries in this directory is 1777 (FET+7). This is the address to be added to the random addresses of all routines in this directory to access the routines from the system library.

If the file specified is a system procedure file, the sign bit in FET+7 is set. If the file specified is not a system file, FET+6 and FET+7 are returned as zero. If the file specified is a relocatable file, FET+6 and FET+7 are unchanged.

Macro Format:

LOCATION	OPERATION	VARIABLE SUBFIELDS
	ASSIGN	addr, L

addr Address of the FET

L If L is specified, the file is assigned from the system file.
The absence of this parameter causes LFM function 001 to be issued.

ENCSSF (022)

This function replaces the control statement file. If the file is not defined, the control statement file is cleared.

If the file specified is empty, the following message is issued.

FILE EMPTY.

Macro Format:†

LOCATION	OPERATION	VARIABLE SUBFIELDS
	ENCSSF	addr, restore

addr Address of the FET for the file that is to replace the current control statement file

restore Address of word containing information on position of the current control statement file; optional parameter

If the restore option is selected, the location must be in the following format.

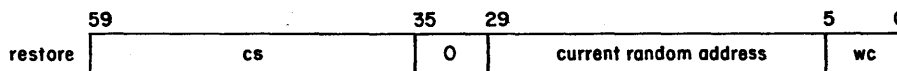

cs Control statement count

wc Word count

If the current random address specified is zero, the following message is issued.

ILLEGAL RANDOM ADDRESS.

† This macro is not available in SYSTEXT. The user must specify systems text PSSTEXT or call common deck COMCMAC (refer to appendix A).

PSCSF (023)

This function gives the user the ability to control the execution of the job control statements by positioning the next statement to be executed.

Macro Format:†

LOCATION	OPERATION	VARIABLE SUBFIELDS
	PSCSF	addr

addr Address of the FET for the request

FET+6 contains the parameters in the following format:

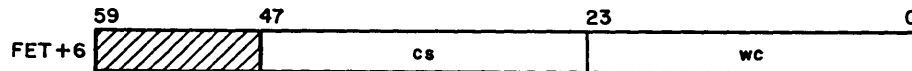

cs Statement count

wc Word count from the beginning of the file; if the word count specified exceeds the length of the file, the file is positioned at the beginning.

† This macro is not available in SYSTEXT. The user must specify systems text PSSTEXT or call common deck COMCMAC (refer to appendix A).

<u>Parameter</u>	<u>Word (FET+n)</u>	<u>Position</u>	<u>Description</u>
Processing option (po)	8	47-36	Processing options:
		<u>Bit Set</u>	<u>Description</u>
		42	If set, toggles installation default setting of the flag which controls error correction activity in GE (6250 cpi) write mode. The setting selected is returned after tape assignment is complete. If the installation default† is 0 (allow error correction) and the user does not toggle it or if the installation default is 1 (disable error correction) and the user toggles it, a value of 0 is returned indicating that hardware error correction is enabled. In this mode of operation, the system allows certain types of single-track errors to be written that can be corrected when the tape is read (on-the-fly correction). This is the recommended setting because it provides efficient throughput, error recovery, and tape usage when writing GE tapes on media that are suitable for use at 3200 fci or 6250 cpi. If the installation default is 1 and the user does not toggle it or if the installation default is 0 and the user toggles it, a value of 1 is returned indicating that hardware error correction is disabled. The system invokes standard error recovery processing when an on-the-fly error occurs when writing a GE tape. The system erases the defective portion of tape, thereby reducing the amount of data that can be stored on the tape. Only tape that is suitable for recording at 6250 cpi

† Contact installation personnel to determine the default setting.

<u>Parameter</u>	<u>Word (FET+n)</u>	<u>Position</u>	<u>Description</u>
Processing option (po)	8	47-36	Processing options:
			<u>Bit Set</u> (continued)
			<u>Description</u>
			42 should be used when this mode of operation is in effect. Refer to processing options G and H in section 10 of volume 1 for further information.
			43 If set, toggles installation default setting of the flag which controls the issuing of tape error messages to the user control point dayfile. The setting selected is returned after the tape assignment is complete. If the installation default for the setting is 1 (issue all messages to user dayfile)† and the user does not toggle it or if the installation default for the setting is 0 (only issue first and last message to user dayfile) and the user toggles it, a value of 1 is returned, indicating that all tape error messages are to be issued to the user control point dayfile. If the installation default for the setting is 0 and the user does not toggle it or if the installation default for the setting is 1 and the user toggles it, a value of 0 is returned and only the first and last tape error messages are issued to the user control point dayfile.
			44 Not used.

† Contact installation personnel to determine the default setting.

Macro Format:†

LOCATION	OPERATION	VARIABLE SUBFIELDS
	GETFNT	addr

addr Address of the FET

GETFNT obtains its input parameters from FET+8, in the following format.

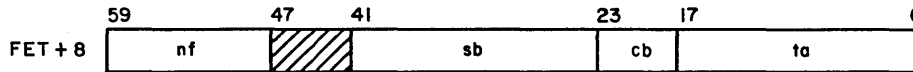

nf Maximum number of two-word FNT/FST entries to return to table. Table size must be at least (nf*2 + 1). Default is 200g entries.

sb File type selection bits. A bit set implies the corresponding file type is selected for entry into the table. All bits set to zero indicates selection of all file types. Bit positions and corresponding file types are as follows:

Bit	File Type	Description
41-38	--	Unused
37	LOFT	Local
36	SYFT	System
35	FAFT	Fast attach file
34	PMFT	Direct access permanent file
33	PTFT	Primary terminal
32	LIFT	Library
31	--	Reserved
30	--	Reserved
29	--	Reserved
28	TEFT	Timed/event rollout
27	PHFT	Punch
26	PRFT	Print
25	ROFT	Rollout
24	INFT	Input

† This macro is not available in SYSTEXT. The user must specify systems text PSSTEXT or call common deck COMCMAC (refer to appendix A).

cb Control bits:

<u>Bits</u>	<u>Significance</u>
23-21	Unused.
20	If bit 20 is set, checkpoint file FNT/FST entries are returned to the table (FET length must be at least nine words). If bit 20 is not set (0), checkpoint file FNT entries are returned in FET+9, instead of the table (FET length must be at least 13 words).
19	If bit 19 is set, mass storage file FST entries are modified with file lengths in bytes 2 and 3. If bit 19 is not set, the FST entry is modified with random index in bytes 2 and 3. Bit 18 must be 0 or bit 19 is ignored.
18	If bit 18 is set, no modifications are made on the FST entries. If bit 18 is not set, pertinent modifications are made (such as the block number for tape files or that specified by bit 19 for mass storage files).

ta Address of table

Upon return from GETFNT, the FET is as follows:

	59	0
FET + 8	ia	
+ 9	cfnt	
+10	cfst	
+11	acfnt	
+12	acfst	

- ia ia is less than zero if an error is encountered (bit 18 of FET+8 not set)
- cfnt FNT entry of the checkpoint file; cfnt is zero if there is no checkpoint file; less than zero if more than two checkpoint files encountered (bit 20 of FET+ 8 not set)
- cfst FST entry of checkpoint file
- acfnt FNT entry of the alternate checkpoint file; acfnt is zero if there is no alternate checkpoint file
- acfst FST entry of the alternate checkpoint file

The following example enables the user to determine if a primary file exists and what its name is. Also, the FST is modified to contain the file length in bytes 2 and 3.

```

      .
      .
BUFL  EQU      2001B
FET   BSS      0
FILE1 FILEB    BUF, BUFL, (FET=13)
BUF   BSS      BUFL
FET8  VFD      12/1, 6/, 18/1000B, 6/6, 18/TADDR
TADDR BSSZ      3
      .
      .
      SA1      FET8
      BX6      X1
      SA6      FET+8
      GETFNT   FET
      SA1      TADDR
      ZR       X1, NOP      IF NO PRIMARY FILE
      .
      .

```

PRIMARY (031)

The PRIMARY macro enables the user to create or change a primary file (refer to the IAF Reference Manual or Time-Sharing User's Reference Manual for a description of primary files). The current primary file (if any) is changed to a local (LOFT) file and the local mass storage file specified in FET+0 is made the primary file. If the specified file does not exist, an empty primary file is created.

Macro Format †

LOCATION	OPERATION	VARIABLE SUBFIELDS
	PRIMARY	addr

addr

Address of the FET for the new primary file

† This macro is not available in SYSTEXT. The user must specify systems text PSSTEXT or call common deck COMCMAC (refer to appendix A).

FILINFO (032)

The FILINFO macro returns information about a file to a specified parameter block.

Macro Format:

LOCATION	OPERATION	VARIABLE SUBFIELDS
	FILINFO	addr

addr Address of a five-word parameter block

Before the FILINFO macro is issued, the first word of the parameter block must contain the following:

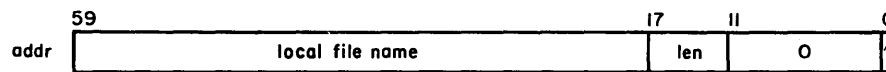

len Length of parameter block (at least five words)

If a file with the specified logical file name is not found local to the job, but a tape file with a seven-character name whose first six characters match that of the specified file name is found, then information is returned for that file.

The standard parameter block returned has the following format.

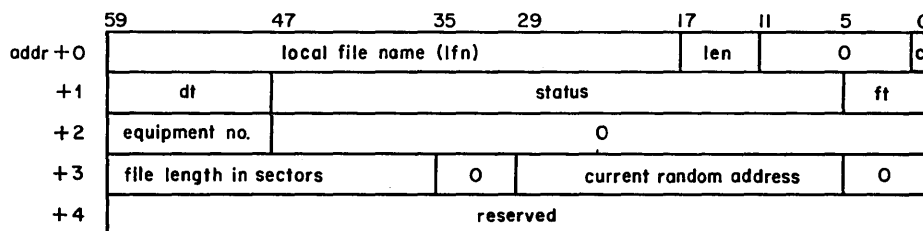

c Completion bit (set when operation is complete)

dt The 12-bit display code of the type of device on which the file resides (refer to appendix E)

If a file is opened but not written on and it is a mass storage file that has not been allocated tracks on a specific allocatable device, the device mnemonic is binary 0

status	Status bits:		
	<u>Bits</u>		<u>Description</u>
	47-24		Reserved
	23		File at EOI†
	22		File at EOF†
	21		File at BOI†
	20		Labeled tape file
	19		Nine-track tape file
	18		Seven-track tape file
	17		File open; if set, indicates a CIO OPEN function has been issued on the file without a subsequent CLOSE function
	16		File assigned to time-sharing terminal
	15		File on mass storage
	14-13		Reserved
	12		File assigned in execute mode ††
	11		File assigned in read/append mode ††
	10		File assigned in read/modify mode ††
	9		File assigned in modify mode ††
	8		File assigned in append mode ††
	7		File assigned in write mode ††
	6		File assigned in read mode ††

ft File type in one of the following octal values

<u>File Type</u>	<u>Value</u>
Local	0
Input	1
Print	2
Punch	3
Direct access	4
(Reserved)	5
Primary	6
Library	7
Other	77

†File position is returned for mass storage files only. EOF status is returned if the last operation was a read, and EOF was encountered.

†† Refer to PFM Macro Parameter Conventions in section 5.

For mass storage files, bits 6 through 12 of the status field are set, depending upon the file permission mode in the file name table. For other files, only the write lockout bit in the file name table is checked. If the write lockout bit is set, read-only permission is assumed. If the write lockout bit is not set, read and write permission is set. Bits 8 through 12 apply only to mass storage files. If the following permission mode is set in the FNT, the indicated bits are set in the status field.

<u>FNT Mode</u>	<u>Status Bits Set</u>
Read	6, 12
Write	6, 7, 8, 9, 12
Append	6, 8, 12
Modify	6, 8, 9, 12
Read/modify	6, 10, 12
Read/append	6, 11, 12
Execute	12

For example, if read mode is set in the FNT, the user can read (bit 6 set) or execute (bit 12 set) the file.

Word 4 (addr+4) of the parameter block is currently not used; however, it is reserved for future expansion of the FILINFO macro.

The FILINFO macro optionally returns additional information for tape files. If the length (len field in addr+0) of the FILINFO parameter block is greater than five, tape file information is returned corresponding to key values in each word after addr+4. The key words begin at addr+5 of the parameter block and can be in any order. Keys are set by the user in bits 4 through 0 of each key word and are returned unaltered after the request is processed. Bit 5 of the key word is set, and data fields are zeroed on return if the key is unknown to the system or is not applicable to the file type specified in addr+1. Key words with zero keys are ignored.

The following keys return the corresponding key words.

<u>Key†</u>	<u>Returned Key Word for Tape File</u>												
1	<table border="1"> <tr> <td style="text-align: right;">59</td> <td style="text-align: right;">11</td> <td style="text-align: right;">5</td> <td style="text-align: right;">0</td> </tr> <tr> <td style="text-align: center;">0</td> <td style="text-align: center;">f</td> <td style="text-align: center;">l</td> <td></td> </tr> </table>	59	11	5	0	0	f	l					
59	11	5	0										
0	f	l											
2	<table border="1"> <tr> <td style="text-align: right;">59</td> <td style="text-align: right;">17</td> <td style="text-align: right;">11</td> <td style="text-align: right;">8</td> <td style="text-align: right;">5</td> <td style="text-align: right;">0</td> </tr> <tr> <td style="text-align: center;">0</td> <td style="text-align: center;">e</td> <td style="text-align: center;">ltype</td> <td style="text-align: center;">den</td> <td style="text-align: center;">cv</td> <td style="text-align: center;">2</td> </tr> </table>	59	17	11	8	5	0	0	e	ltype	den	cv	2
59	17	11	8	5	0								
0	e	ltype	den	cv	2								
14 ₈	<table border="1"> <tr> <td style="text-align: right;">59</td> <td style="text-align: right;">47</td> <td style="text-align: right;">23</td> <td style="text-align: right;">11</td> <td style="text-align: right;">5</td> <td style="text-align: right;">0</td> </tr> <tr> <td style="text-align: center;">0</td> <td style="text-align: center;">block size</td> <td style="text-align: center;">po</td> <td style="text-align: center;">noise</td> <td style="text-align: center;">14</td> <td></td> </tr> </table>	59	47	23	11	5	0	0	block size	po	noise	14	
59	47	23	11	5	0								
0	block size	po	noise	14									

†The symbols for each key value are defined in common deck COMSLFM.

<u>Field</u>	<u>Key</u>	<u>Bits</u>	<u>Description</u>
f	1	11-6	Tape format: 0 Internal (I) 1 System internal (SI) 2 Foreign (F) 3 Stranger (S) 4 Long block stranger (L)
e	2	18	If set, error processing is inhibited (same as bit 14 in po field).
ltype	2	17-12	Label type: 0 Unlabeled 1 Standard label (ANSI 1969 standard) 14B Nonstandard label
den	2	11-9	Tape density: 1 556 bpi (seven-track) 2 200 bpi (seven-track) 3 800 bpi (seven-track) or 800 cpi (nine-track) 4 1600 cpi (nine-track) 5 6250 cpi (nine-track)
cv	2	8-6	Conversion mode:† 0 BCD conversion (seven-track) 1 ASCII conversion (nine-track) 2 EBCDIC conversion (nine-track)
block size	14 ₈	47-24	Maximum block size in central memory words. Always 1000 octal for I and SI format tapes. For F format tapes, the block size is calculated from the FC or C parameter value specified on the tape assignment control statement (refer to section 10 of volume 1). For S and L format tapes, the block size returned is the size used on the last CIO operation, as determined from the default block size, mlrs field in the FET, or CIO buffer size (refer to appendix J). The field is zero if no previous CIO function has been issued on the tape file. Refer to appendix J for further information.

† Conversion mode of labels (if any) and coded data (if any). This does not indicate whether the data on the tape is coded or binary.

<u>Field</u>	<u>Key</u>	<u>Bits</u>	<u>Description</u>
po	14 ₈	23-12	<p>Processing options. Refer to the description of the po field for the LABEL macro in section 4. The 12 bits in each field have the same respective definitions.</p> <p>If po bit 18 (corresponding to po bit 42 for the LABEL macro) is set upon return from the FILINFO macro, GCR hardware write error correction is disabled.</p> <p>If po bit 19 (corresponding to bit 43 for the LABEL macro) is set upon return from the FILINFO macro, the issuing of all error recovery messages to the user day-file is enabled.</p>
noise	14 ₈	11-6	Noise size in frames.

If the specified file is not local to the user's job, words 1 through 4 of the parameter block are cleared. All other fields (including words containing keys) are unchanged.

If any of the parameter block is beyond the user's field length, the following message is issued.

ADDRESS OUT OF RANGE.

If the length specified for the parameter block is not at least five words, the following message is issued.

FET TOO SHORT.

If this function is issued as an RA+1 request without using the FILINFO macro, the completion bit must be set to 0. If it is not, the following message is issued.

PARAMETER BLOCK BUSY.

If the file is busy (cannot be interlocked), the following message is issued.

I/O SEQUENCE ERROR.

PERMANENT FILE MANAGER

Permanent file manager (PFM) processes all permanent file requests. The format of the RA+1 call to PFM is as follows:

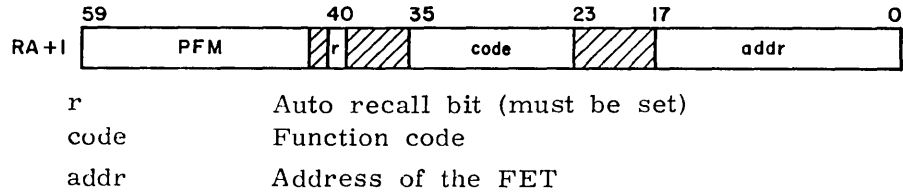

The FET used by all PFM requests is formatted as follows: The mnemonics (CFSN, for example) are defined in common deck COMSPFM.

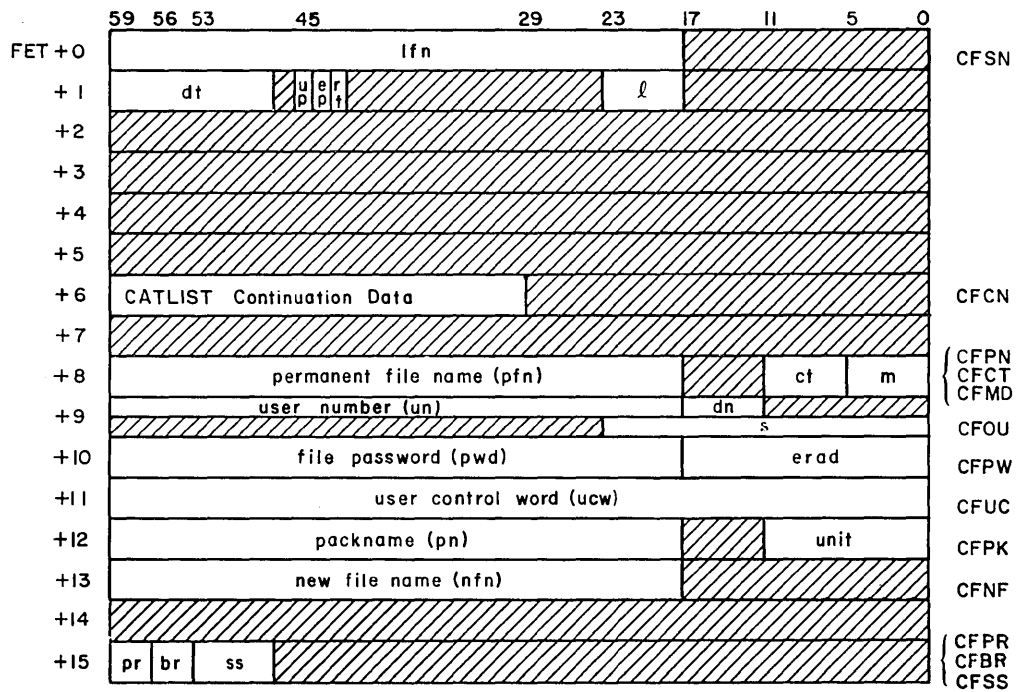

- lfn Local file name
- dt Device type
- up User processing bit (bit 45)
- ep Error processing bit (bit 44)
- rt Real-time processing bit (bit 43)
- l FET length minus 5
- pfn Permanent file name
- ct File category (refer to Permission Modes, File Categories)

m	File access mode (refer to Permission Modes, File Categories)
un	Alternate user number
dn	Device number for CATLIST option (range is 1 to 77g)
s	Number of PRUs (octal) desired for the file
pwd	Optional file password
erad	Error message return address
ucw	User control word
pn	Pack name of auxiliary device
unit	Number of units of multiunit device
nfn	New file name
pr	Preferred residence for file
br	Backup requirement for file
ss	Subsystem

For a more detailed description of the FET, refer to the discussion of the FET in section 2.

After a request to PFM is complete, the first word of the FET contains the following information.

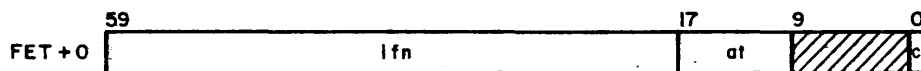

lfn	Local file name
at	Abnormal termination code
c	Bit 0 is set to 1 upon completion of the request

The FET length may be 5 words, if no special options are required, or up to 16 words, depending on the special options required.

When a PFM macro request is issued, the parameter values specified are placed in their corresponding fields in the FET. If a field is 0 and a default is defined by PFM for that field, the default is used (refer to exceptions listed below for CHANGE processing).

If the permanent file name is not specified in a macro, FET+8 contains the permanent file name. If X1 is specified, X1 contains the permanent file name left-justified and zero-filled. If FET+8 does not contain a file name, the contents of FET+0 is used as the permanent file name.

If the file category and/or file access mode are not specified in a macro, FET+8 contains these values. On a CHANGE request, these fields must be 0 if they are not to be changed. Whenever a field is specified in a CHANGE request, its upper bit must be set (bit 11 for file category and bit 5 for file mode).

If the alternate user number is not specified in a macro, FET+9 contains the name of the alternate catalog. If X3 is specified, X3 contains the user number left-justified and zero-filled.

If the file password is not specified in a macro, FET+10 contains the file password. If X2 is specified, X2 contains the file password left-justified and zero-filled. On a CHANGE request, bits 59 through 18 of FET+10 must be set if the password is not to be changed.

If the user control word is not specified in a macro, FET+11 contains the user control information. On a CHANGE request, bit 59 must be set if FET+11 contains data for PFM to process.

If the pack name is not specified in a macro, FET+12 contains the pack name.

If the new file name is not specified in the CHANGE macro, FET+13 contains the new file name.

If the preferred residence, backup requirement, and/or subsystem are not specified in a macro, FET+15 contains these values. On a CHANGE request, a field must be 0 if it is not to be changed. Whenever the subsystem field is specified in a CHANGE request, bit 53 must be set.

The address of the FET must be supplied in the addr parameter. The call to PFM must be made with the auto recall bit set.

The common decks required for an absolute assembly of a program containing PFM requests are COMCPFM and COMCSYS. In order to use the mnemonics defined for PFM FET addresses, permission modes, file categories, error codes, or functions, common deck COMSPFM is required for absolute or relocatable assemblies. Function mnemonics are specified in the macro descriptions.

ERROR PROCESSING

The user can issue requests to PFM and have control returned if certain error conditions occur. To do this, the error processing bit (ep) must be specified in FET+1. The error codes are returned in the abnormal termination (at) code field of FET+0 (bits 17 through 10). If the user specifies erad in FET+10, the error message is returned at this address instead of being issued to the user's dayfile. A maximum of three central memory words are returned. System errors are issued to the system and error log dayfiles regardless of the erad specification.

The following error codes are returned in the abnormal termination code field. It is recommended that the error code mnemonics defined in common deck COMSPFM be used in testing these error conditions. The mnemonics are qualified by symbol ERRMSG. For example, to set the B7 register to the value of the FBS mnemonic, use the following instruction.

```
SB7    /ERRMSG/FBS
```

<u>Error Code</u>	<u>Mnemonic</u>	<u>Description</u>
1	FBS	The specified direct access file is attached with conflicting mode (file busy).
2	FNF	One of the following: <ul style="list-style-type: none"> ● The specified permanent file could not be found. ● The specified user number could not be found. ● The user is not allowed to access the specified file. <p>If this error occurs in response to a SAVE, REPLACE, or APPEND macro, the specified local file is not attached to the control point or is an execute-only file.</p>
3	EFL	The file specified on a SAVE, REPLACE, or APPEND macro contains no data.
4	NMS	The file to be saved is not on mass storage; the first track of the file is not recognizable.
5	FAP	The user has already saved or defined a file with the name specified.
6	IFT	The user attempted to define a file that is not a local file.
7	FNE	File name contains illegal characters.

<u>Error Code</u>	<u>Mnemonic</u>	<u>Description</u>
10	IUA	The user is not validated to create direct access or indirect access files or to access auxiliary devices.
11	IDR	The device type (r parameter in macro calls) specified on a request for an auxiliary device cannot be recognized or does not exist in the system. If the auxiliary device specified by the pn parameter is not the same type as the system default, the r parameter must be included; if not, this error code is returned.
12	FTL	The local file specified for a SAVE, REPLACE, or APPEND request exceeds the length allowed, or the direct access file specified for an ATTACH in WRITE, MODIFY, or APPEND mode exceeds the direct access file length limit for which the user is validated.
13	ILR	One of the following: <ul style="list-style-type: none"> ● Illegal function code passed to PFM. ● Illegal permit mode or catalog type specified. ● CATLIST request has permit specified without a file name. ● PERMIT attempted on a public file. ● DEFINE attempted with alternate user number in FET.
14	PFN	Access to the permanent file device requested is not possible.
15	DAD	The device on which the file resides may not contain direct access files because: <ul style="list-style-type: none"> ● The device is not specified as a direct access device in the catalog descriptor table. ● The device is not specified as ON and initialized in the catalog descriptor table. ● The device is a dedicated indirect access permanent file device.
16	PFA	Because a permanent file utility is currently active, the operation is not attempted; the user should retry the operation.
17	DTE	An error occurred in a read operation during a file transfer.
20	COF	The number of files in the user's catalog exceeds the limit (refer to LIMITS control statement, volume 1, section 6).
21	COS	The cumulative size of the indirect access files in the user's catalog exceeds the limit (refer to LIMITS control statement, volume 1, section 6).

<u>Error Code</u>	<u>Mnemonic</u>	<u>Description</u>								
22	SPN	The number of PRUs specified via the s parameter on the DEFINE macro is not available.								
23	IOE	A request is attempted on a local file that is currently active. This error can occur, for example, if the user creates two FETs for the same file and issues a second request before the first is complete.								
24	LFL	The job's local file limit has been exceeded by an attempt to GET or ATTACH the file.								
25	PRL	The job's mass storage PRU limit is exceeded during preparation of a local copy of an indirect access file.								
26	PLE	Permit limit is exceeded for a private file.								
27	--	Reserved.								
30	RSE	The resource executive detected a fatal error.								
31	TKL	No allocatable tracks remain on equipment xx, where xx is the EST ordinal.								
32	FLE	The length of a file does not equal the catalog length; the action taken depends on the type of request issued.								
		<table border="1"> <thead> <tr> <th><u>Request</u></th> <th><u>Action</u></th> </tr> </thead> <tbody> <tr> <td>GET</td> <td>A local file is created with length being the actual length retrieved.</td> </tr> <tr> <td>SAVE</td> <td>If file length is longer than TRT specification, file is truncated.</td> </tr> <tr> <td>REPLACE</td> <td>Same as for SAVE.</td> </tr> </tbody> </table>	<u>Request</u>	<u>Action</u>	GET	A local file is created with length being the actual length retrieved.	SAVE	If file length is longer than TRT specification, file is truncated.	REPLACE	Same as for SAVE.
<u>Request</u>	<u>Action</u>									
GET	A local file is created with length being the actual length retrieved.									
SAVE	If file length is longer than TRT specification, file is truncated.									
REPLACE	Same as for SAVE.									
33	RIN	PERMIT random address error.								
34	DAF	The system sector data for the file does not match the catalog data.								
35	RPE	The same file is found twice during a catalog search. This error can occur for APPEND or REPLACE requests after a file is found and purged and the catalog search is continued.								
36	ABT	Error flag detected at PFM control point.								
37	MSE	An error is encountered in reading or writing a portion of the permanent file catalog or permit information. A write error encountered during the device to device transfer of an indirect access file.								
40	EDA	Error in data for file.								
41	EPT	Error in permit entries for file.								
42	EDP	Combination of errors 40 and 41.								

<u>Error Code</u>	<u>Mnemonic</u>	<u>Description</u>
43	FIC	An error in the EOI position of the file was detected by recovery routines.
44	NEM	PFM detected a fatal RESEX error. PFM does not issue a message since RESEX has issued an appropriate message. If the error processing (ep) bit is set and the erad field of FET+10 contains a valid address, the message RESEX issues is returned to that address.
45-47	--	Reserved.
50	FSE	Verification of the file structure or owner identification failed.
51	SSE	Error in system sector of indirect access file.
52-70	--	Reserved.
71	PPE	The file does not reside on disk. An unrecoverable error was detected when attempting to stage the file to disk from alternate storage.
72	PSI	The file does not reside on disk. It is currently being staged from alternate storage to disk.
73	PWE	The file must be staged from alternate storage to disk, but the subsystem is not currently available to perform the stage operation.
74	FIN	The file is currently not available for WRITE, MODIFY, or APPEND modes of access because a system utility has the file attached in utility mode.
75	FDA	The file is a direct access file and an indirect access file operation was requested.
76	FIA	The file is an indirect access file and a direct access file operation was requested.
77	--	Reserved.
100	SGD	The file does not reside on disk and must be staged from alternate storage to disk.
101	IPA	The device number, track, and sector specified as the permanent file catalog (PFC) address are invalid.
102	PVE	The creation date and time, user index, or alternate storage address do not agree with the current PFC contents.
103	FND	Access to a file that does not reside on disk is not permitted with the current function.
104	INA	A software interlock is currently not available to a request specifying both ep and up processing options.

<u>Error Code</u>	<u>Mnemonic</u>	<u>Description</u>
105	AIO	The disk space for a file cannot be released when the alternate storage image is labeled obsolete or the alternate storage address is not specified in the PFC.
106	ASE	The disk space for a file cannot be released when a permanent error status is set for the alternate storage file image.
107	FTF	File name table (FNT) space is currently not available for a request that has both ep and up processing options set.
110	ICU	Verification of the PFC prohibits the setting of a new alternate storage address when the alternate storage address is defined and not labeled obsolete. Also, an existing valid disk address cannot be replaced in the PFC entry.
111	PEA	The PFM activity count is currently at its limit. This condition is reported to the requesting program only if both the ep and up processing options are set.

PFM MACRO PARAMETER CONVENTIONS

Several methods are available to the user to specify the m, ct, ss, br, and pr parameters in PFM macros. The user can either specify an alphabetical key or an address that contains an integer value that corresponds to a key. If an address is specified, the value must be right-justified and zero-filled in a 60-bit word. The values can be established with the mnemonics in the following list. The user must call common deck COMSPFM to use these mnemonics (relocatable or absolute assembly). The valid mnemonics (if any), keys, and values for the m, ct, ss, br, and pr macro parameters are listed.

<u>Parameter</u>	<u>Mnemonic</u>	<u>Key</u>	<u>Value</u>	<u>Description</u>
m				File or user permission mode:
	PTWR	W	0	Allows the user to write, read, append, execute, modify, and/or purge the file. This mode can be specified for direct or indirect access files.
	PTRD	R	1	Allows the user to read and/or execute the file. This mode can be used for direct or indirect access files.
	PTAP	A	2	Allows the user to append information to the end (EOI) of the file and to read or execute the file. This mode can be specified for direct or indirect access files.
	PTEX	E	3	Allows the user to execute the file. This mode can be specified for direct or indirect access files.
	PTNU	N	4	Removes permission previously granted via PERMIT macros. This mode can be specified for direct or indirect access files.
	PTMD	M	5	Allows the user to modify, append, read, and/or execute a direct access file. Adding new information within the existing boundaries of the file is legal, but the file size must be maintained.

<u>Parameter</u>	<u>Mnemonic</u>	<u>Key</u>	<u>Value</u>	<u>Description</u>
	PTRM	RM †	6	Allows the user to read and/or execute a direct access file with the implication that another user may currently be accessing the same file in M (modify) or A (append) mode. For indirect access files, this mode is the same as R (read) mode.
	PTRA	RA †	7	Allows the user to read and/or execute a direct access file with the implication that another user may currently be accessing the same file in A (append) mode. For indirect access files, this mode is the same as R (read) mode.
ct				File category:
	FCPR	P	0	Private. Private files are available for access only by the originator or those to whom the originator has explicitly granted permission (refer to the PERMIT macro).
	FCSP	S	1	Semiprivate. Semiprivate files are available for access by all users who know the file name, user number, and file password. The system records in the originator's catalog the user number of each user who accessed the file, the number of accesses, and the date and time of the last access.
	FCPB	PU	2	Public. Public files are available for access by all users who know the file name, user number, and file password. The system records the number of times the file was accessed but does not record user numbers or the last access date and time.

† Special care should be taken when using modes RM or RA. Programs using access techniques (either CIO or CYBER Record Manager) which do not expect concurrent updating of a file may get erroneous results if these modes are used. CRM Advanced Access Methods (refer to the AAM Reference Manual) do not expect concurrent updating of a file by another user. Therefore, if a file has been attached in either RM or RA mode and these access methods are being used, a warning message is issued to the user stating that the file is bad when, in fact, it is not.

<u>Parameter</u>	<u>Mnemonic</u>	<u>Key</u>	<u>Value</u>	<u>Description</u>
ss				Subsystem indicator:
	--	NULL	0	Null subsystem.
	--	BASIC	1	BASIC subsystem.
	--	FORT	2	FORTRAN Version 5 subsystem.
	--	FTNTS	3	FORTRAN Extended Version 4 subsystem.
	--	EXEC	4	Execute subsystem.
	--	BATCH	5	Batch subsystem.
br†				Backup requirement:
	BRNO	N	1	Backup is not required on a dump tape.
	BRAL	Y	2	Backup is required on a dump tape.
	BRMD	MD	3	Backup is required on a dump tape only if the file is not resident on MSF.
pr†				Preferred residence:
	RSMS	M	3	The file should reside on MSF when it is not being accessed.
	RSNP	N	4	No preferred residence for the file.

† If this parameter is omitted or a value of 0 is specified, PFM uses the installation default value.

AUXILIARY DEVICE REQUEST

Unless the user explicitly declares otherwise, all permanent files reside on family devices. As stated in section 2, volume 1, the user may wish to supplement the mass storage provided by his family devices by retaining his files on auxiliary devices. There are four parameters (pn, r, un, and pwd) that uniquely identify file pfn on an auxiliary device.

- The pn parameter specifies the one- to seven-character system-defined pack name of the auxiliary device. The device can be either public or private, as defined by the installation.
- The r parameter specifies the type of auxiliary device on which the file resides or is to reside. An auxiliary device is any supported device which an installation defines as auxiliary; it need not be physically removable as the pack name implies.

If the device is physically removable, r is DIn, DJn, DKn, DLn, DMn, or DQn as described for Equipment Codes in appendix E.

If the user needs two or more physically removable auxiliary devices at any one time during his job, he must include a RESOURC control statement (refer to section 6, volume 1). An installation can provide additional continuous storage on a DI, DJ, DK, KL, DM, or DQ type device by combining physical units into one logical unit. A device so defined is known as a multiunit device. To specify such a device, the r parameter must include the number of units. For example, if four 844-21 units have been combined as one multiunit device, the r parameter must be DI4. If it is not, the job step is aborted and PFM error message 11g (IDR) is issued to the user's dayfile.

ILLEGAL DEVICE REQUEST, AT addr.

However, if r is DI, DJ, DK, DL, DM, or DQ but n is omitted, the unit count is assumed to be 1.

The r parameter is required only if the desired device has a device type different from that of the available device, and the installation has defined the desired device as removable. However, if the user always specifies the r parameter, he can be sure that he is accessing the proper device. If r is specified and it conflicts with that of the available device, PFM error message 11g (IDR) is issued. For all PFM macros, if pn is specified but the device is not available, the job is aborted. By setting the error processing bit (FET+1, bit 44), the user can bypass the abort and direct the system to make available the device with packname pn and device type r. If both the error processing bit and the user processing bit (FET+1, bit 45) are set, control is returned to the user when the device is unavailable and error code 14g (PFN) is set in FET+0.

- The un parameter specifies the one- to seven-character optional user number. If the device is public, files are accessed in the same manner as specified for family devices. That is, the un parameter must be included only if the user wishes to access files which another user has explicitly or implicitly permitted him to use. If the device is private, there is only one owner. All other users who have the proper validation can access files on the device, but the system prevents them from creating files.
- The pwd parameter specifies the one- to seven-character password associated with the file. As with files on family devices, the pwd parameter must be included only if the originator requires that a password be specified.

SAVE (001, CCSV)

The SAVE macro enables the user to retain a copy of a temporary mass storage file in the permanent file system as an indirect access file. The original file is rewound when completed.

Macro Format:

LOCATION	OPERATION	VARIABLE SUBFIELDS
	SAVE	addr, pfn, pwd, ucw, ct, m, pn, r, fo, ss, br

addr Address of the FET; the local file name must be set in FET+0.

pfn Address containing the name of the file; name the file is given in the permanent file catalog.

pwd Address containing the password to be placed with the file in the permanent file catalog.

ucw Address containing user control word to be placed with the file in the permanent file catalog. If this word exists in the catalog, it is returned to FET+11 when the file is accessed (default=0).

ct File category:

<u>ct</u>	<u>Description</u>
P	Private file (default value)
S	Semiprivate
PU	Public file

Refer to PFM Macro Parameter Conventions in this section for further information.

m File mode. This parameter defines the type of access alternate users may have for semiprivate or public files.

<u>m</u>	<u>Description</u>
W	Read, write, purge, and execute (default value)
R	Read and execute
A	Append
E	Execute
N	None
RM	Same as R for indirect access files
RA	Same as R for indirect access files

Refer to PFM Macro Parameter Conventions in this section for further information.

- pn Address containing one- to seven-character pack name of the auxiliary device on which the file is to be saved.
- r Type of auxiliary device on which the file is to be saved (refer to the DEFINE macro).
- fo Family option:
- IP The pack name specified by a PACKNAM macro or pn parameter is ignored. PFM accesses the user's family.
 - DF The pack name specified by a PACKNAM macro or pn parameter and the family name specified on the USER statement are ignored. PFM accesses the system default family. This option can be used only by programs that have an SSJ= entry point.
- ss Subsystem indicator. This indicator causes automatic subsystem selection when the file is retrieved using the OLD macro or control statement.

<u>ss</u>	<u>Description</u>
NULL	Null subsystem
BASIC	BASIC subsystem
FORT	FORTRAN Version 5 subsystem
FTNTS	FORTRAN Extended Version 4 subsystem
EXEC	Execute subsystem
BATCH	Batch subsystem

Refer to PFM Macro Parameter Conventions in this section for further information.

- br Backup requirement. Specifies whether the file is to be backed up on a dump tape when the site dumps permanent files.

<u>br</u>	<u>Description</u>
Y	The file must be backed up on the dump tape
MD	For the SAVE macro, MD performs the same function as Y
N	The file is not to be backed up on the dump tape

Refer to PFM Macro Parameter Conventions in this section for further information.

Example 1: This example saves local file FILE in the permanent file system as a public file named DATA with read permission. The file will be backed up on a dump tape when the site dumps permanent files.

```

                SAVE    FILE,PF,,,PU,R,,,,Y
                .
                .
FILE          FILEB   BUF,BUFL,(FET=16)
PF           VFD     42/0LDATA,18/0

```

Example 2: This example performs the same function as example 1.

```

                XTEXT   COMSPFM
                .
                .
                SA1     PF
                SAVE    FILE,X1,,,FCAT,FMOD,,,,BACK
                .
                .
FCAT         CON      FCPB
FMOD        CON      PTRD
BACK        CON      2
FILE        FILEB    BUF,BUFL,(FET=16)
PF          VFD      42/0LDATA,18/0

```

Example 3: In this example, local file TAPE1 is saved in the permanent file system as a private file named PTAPE1 with null permission. The subsystem indicator is set to the batch subsystem.

```

                SAVE    F,PF,,,P,N,,,,BATCH
                .
                .
F            BSS      0
TAPE1       FILEB    BUF,BUFL,(FET=16)
PF          VFD      42/0LPTAPE1,18/0

```

GET (002, CCGT)

The GET macro enables the user to generate a temporary copy of an indirect access permanent file. If a local file by the same name already exists, it is returned as if the UNLOAD macro had been issued even if the GET is unsuccessful. The new file is set to rewind status. No interlock is provided to prevent other users from obtaining copies of the same file simultaneously.

- Determine the alternate user information for a specified file that an alternate user can access or has accessed in his catalog (permit data).

For the first type of request, the permanent file catalog entries of all files or a single specified file in the user's catalog are returned.

The format of the permanent file catalog entry is as follows:

	59	56	53	47	44	41	38	35	23	17	11	0	
word 0	file name								user index				FCFN, FCUI
1	file length								track	sector			FCLF, FCBT, FCBS
2	random index						creation date and time						FCRI, FCCD
3	access count						data modification date and time						FCAC, FCMD
4	ct	mode		ef	ec	dn						last access date and time	FCCT, FCAM, FCEC FCEO, FCAD
5							control modification date and time						FCKD
6	pr	br	ss				utility control date and time						FCRS, FCBR, FCFS, FCUD
7	file password												FCPW
8	aflags					alt		asa					FCAF, FCAT, FCAA
9													
10													
11													
12													
13													
14	user control word											FCVC	
15	reserved for installation												FCIW

file name Permanent file name.

user index User index of file creator.

file length Length in PRUs of the file.

track Beginning track of file.

sector Beginning sector of file (4xxx for a direct access file).

random index Random disk address of permit sector.

creation date and time Date and time (yymmddhhmmss in octal) when this file was first entered on the permanent file system. The year (yy) is biased by 70.

access count Count of accesses to file.

data modification date and time Date and time (yymmddhhmmss in octal) when the data in this file was last modified. The year (yy) is biased by 70. For direct access files this field is updated when the file is attached in a modifiable mode, whether or not the file is actually modified.

ct File category (refer to PFM Macro Parameter Conventions for further information).

mode File mode (refer to PFM Macro Parameter Conventions for further information).

ef Error flag:

- 0 No error.
- 1 EOI changed by recovery.

ec Error code:

- 0 No error.
- 1 Error in data for file.
- 2 Error in permit entries for file.
- 3 Error in data and permit entries for file.
- 4 File length error.
- 5-7 Reserved.

dn Device number (0 through 778); each device within a family of permanent file devices is identified by a device number.

last access date and time Date and time (yymmddhhmmss in octal) when this file was last accessed. The year (yy) is biased by 70.

control modification date and time Date and time (yymmddhhmmss in octal) when the control information (catalog entry and permit record data) for this file was last updated. The year (yy) is biased by 70.

pr Preferred residence for file (refer to PFM Macro Parameter Conventions in this section for further information).

br Backup requirement for file (refer to PFM Macro Parameter Conventions in this section for further information).

ss Subsystem code for this file (refer to PFM Macro Parameter Conventions for further information).

utility control date and time Date and time (yymmddhhmmss in octal) used to determine this file's candidacy for being dumped by permanent file utilities. The year (yy) is biased by 70.

file password Optional password.

aflags Alternate storage flags; used with the asa field and meaningful only if the file resides on an alternate storage device (as indicated by the alt field); refer to the NOS System Maintenance Reference Manual for a complete description of this field.

alt Alternate storage type:

- 0 No alternate storage copy of the file exists
- 1 An alternate storage copy of the file resides on MSF

asa Alternate storage address; meaningful only if an alternate storage copy of the file exists (as indicated by the alt field); if asa is 0, the file does not reside on alternate storage; refer to the NOS System Maintenance Reference Manual for a complete description of this field.

user control User control information (FET+11).
word

For the second type of request, the catalog entries (except user index and file password) for all files or a single specified file that the user may access in an alternate catalog are returned.

For the third type of request, all alternate user access entries for a specified file are returned. The format of an alternate user access entry is illustrated.

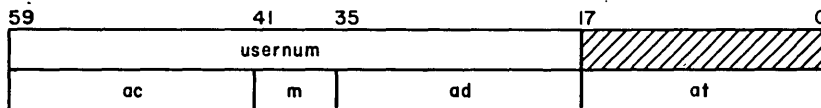

- usernum Alternate user number.
- ac Number of accesses the alternate user has made to the file.
- m Permission mode (bit 40 set if this was an accounting permit and was not created by a PERMIT control statement or macro; bit 40 clear indicates an explicit permit set by PERMIT statement or macro; bits 39 through 36 are same as mode described in first type of request).
- ad The last date the user accessed the file.
- at The time of day the user last accessed the file.

Macro Format:†

LOCATION	OPERATION	VARIABLE SUBFIELDS
	CATLIST	addr, pfn, un, m, pn, r, fo, sr

- addr Address of the FET for the CATLIST function.
- pfn Address containing the file name; if this parameter is omitted, CATLIST information for all files is returned.
- un Address containing the name of the alternate user catalog to be searched for the catalog information. If un is omitted, the user's own catalog is searched.

† This macro is not available in SYSTEXT. The user must specify systems text PSSTEXT or call common deck COMCMAC (refer to appendix A).

m If this parameter is the letter M, alternate user access information for file pfn is returned. If this parameter is specified, the pfn is required and un is ignored.

pn Address containing one- to seven-character pack name of the auxiliary device that contains catalog information for all users with information on that device.

r Type of auxiliary device identified by the pn parameter (refer to the DEFINE macro).

fo Family option:

- IP The pack name specified by a PACKNAM macro or pn parameter is ignored. PFM accesses the user's family.
- DF The pack name specified by a PACKNAM macro or pn parameter and the family name specified on the USER statement are ignored. PFM accesses the system default family. This option can be used only by programs that have an SSJ= entry point.

sr Request CATLIST of files on device number dn (FET+9, bits 17 through 12).

If the status returned in FET+0 (addr parameter of the CATLIST macro), bits 9 through 0, is 0033 (EOF encountered), the user should reissue the CATLIST macro after the buffer of entries has been processed (refer to example 1). The user should continue this until a status of 1033 (EOI encountered) is returned. CATLIST uses the current random index field (FET+6, bits 59 through 30) to keep track of its position for continued calls. If the user changes this field, the results of a CATLIST request may be undefined.

Information is placed in the buffer starting at IN until IN = LIMIT minus 1, at which time buffer full (0033) status is set in FET+0. PFM does not process the buffer circularly; therefore the user must reset IN=OUT=FIRST before reissuing the CATLIST macro.

The following examples assume that PSSTEXT is specified at assembly.

Example 1: The following program creates a binary file named F with permanent file catalog entries for all files in the user's catalog.

```

CAT
    IDENT  CAT
    ENTRY  START
    SYSCOM B1

F      FILEB  BUFF,101B
G      FILEB  BUFG,101B,FET=10D

START  SB1    1
        MX0    50D

STA1   CATLIST G
        SA1    G          DETERMINE ERROR CODE
        BX1    -X0*X1     (X1)=ERROR CODE
        SX1    X1-1033B
        ZR     X1,STA2    IF EOI (CATLIST COMPLETE)
        READW  G,WBUF,100B
        WRITEW F,WBUF,100B
        SA1    G+B1      RESET FET POINTERS
        SX7    X1
        SA7    A1+B1     SET IN=FIRST
        SA7    A7+B1     SET OUT=FIRST
        EQ     STA1

STA2   SA1    G+2        (X1)=IN
        SA2    A1+B1     (X2)=OUT
        IX5    X1-X2     (X5)=WORDS IN CATALOG ENTRY
        READW  G,WBUF,X5
        WRITEW F,WBUF,X5
        WRITER F
        ENDRUN

BUFF   BSS    101B
BUFG   BSS    101B
WBUF   BSS    100B

END    START

```

Example 2: The following example returns all access information for file DATA013.

```

          CATLIST      F,PF,,M
          .
F        FILEB        BUF,BUFL,(FET=10D)
PF       VFD          42/0LDATA013, 18/0

```

Example 3: This example returns a list of all files that the user can access in the catalog of user USERABC.

```

          CATLIST      F,,AUN
          .
F        FILEB        BUF,BUFL,(FET=10D)
AUN     VFD          42/0LUSERABC, 18/0

```

PERMIT (005, CCPM)

The PERMIT macro enables a user to explicitly permit another user to access a private file in his permanent file catalog. If the user wishes to remove permission previously granted, the negate mode should be selected.

Macro Format:

LOCATION	OPERATION	VARIABLE SUBFIELDS
	PERMIT	addr, pfn, un, m, pn, r, fo

addr Address of the FET; the local file name must be set in FET+0.

pfn Address containing the name of the file; name of the file is given in the permanent file catalog.

m Mode of permission being granted; if no mode is specified, W (write) is assumed.

<u>m</u>	<u>Description</u>
W	Read, write, purge, and execute (default value).
R	Read and execute.
A	Append.
E	Execute.
N	None.
M	Modify, append, read, and/or execute.
RM	Read and/or execute, allow modifications.
RA	Read and/or execute, allow extensions.

Refer to PFM Macro Parameter Conventions in this section for further information.

pn Address containing one- to seven-character pack name of the auxiliary device on which the specified file resides.

r Type of auxiliary device identified by the pn parameter (refer to the DEFINE macro).

fo Family option:

- IP The pack name specified by a PACKNAM macro or pn parameter is ignored. PFM accesses the user's family.
- DF The pack name specified by a PACKNAM macro or pn parameter and the family name specified on the USER statement are ignored. PFM accesses the system default family. This option can be used only by programs that have an SSJ= entry point.

An example of the use of this macro is:

```
PERMIT F,PF,AUN,A
.
.
F FILEB BUF,BUFL,(FET=10D)
PF VFD 42/OLDATA012,18/0
AUN VFD 42/OLUSERABC,18/0
```

This allows user USERABC to have append permission to file DATA012.

REPLACE (006, CCRP)

The REPLACE macro enables the user to place a copy of the specified local mass storage file in the permanent file system as an indirect access file. If an indirect access permanent file with the specified name already exists in the catalog, that file is purged and the new file placed in the catalog as the same type of file. If the file does not exist in the catalog, the new file is placed in the catalog as a private file. Permission information and alternate user access data are not lost when the file is replaced.

Macro Format:

LOCATION	OPERATION	VARIABLE SUBFIELDS
	REPLACE	addr, pfn, un, pwd, ucw, pn, r, fo

addr Address of the FET; local file name must be set in FET+0.

pfn Address containing the name of the permanent file to be replaced in the permanent file catalog.

un Address containing the name of the alternate user's catalog where the file resides.

pwd Address containing the password of the file being replaced (required if un \neq 0); if no previous file existed, the password is saved with the file.

ucw Address containing user control word to place with the file; bit 59 of FET+11 must be set to retain the word with the file in the catalog.

pn Address containing one- to seven-character pack name of the auxiliary device on which the file is to be placed.

r Type of auxiliary device identified by the pn parameter (refer to the DEFINE macro).

fo Family option:

- IP The pack name specified by a PACKNAM macro or pn parameter is ignored. PFM accesses the user's family.
- DF The pack name specified by a PACKNAM macro or pn parameter and the family name specified on the USER statement are ignored. PFM accesses the system default family. This option can be used only by programs that have an SSJ= entry point.

APPEND (007, CCAP)

The APPEND macro enables a user to write the contents of the specified local mass storage files at the end of the specified indirect access permanent file. The logical structure of the two files is retained; that is, EORs and EOFs are appended as well as data. If the working file is appended to a file in an alternate user's catalog, a password must be supplied if one is required.

Macro Format:

LOCATION	OPERATION	VARIABLE SUBFIELDS
	APPEND	addr, pfn, un, pwd, pn, r, fo

addr Address of the FET; name of the local file to be appended must be set in FET+0.

pfn Address containing the name of the permanent file to which information is to be appended.

un Address containing the name of the alternate user whose catalog contains the permanent file .

pwd Address containing the password of the file to which information is to be appended. This must be specified if un ≠ 0 and the file requires a password.

pn Address containing one- to seven-character pack name of the auxiliary device on which the specified permanent file resides.

r Type of auxiliary device identified by the pn parameter.

fo Family option:

 IP The pack name specified by a PACKNAM macro or pn parameter is ignored. PFM accesses the user's family.

 DF The pack name specified by a PACKNAM macro or pn parameter and the family name specified on the USER statement are ignored. PFM accesses the system default family. This option can be used only by programs that have an SSJ= entry point.

An example of the use of this macro is:

```

APPEND      F
  .
  .
F  FILEB    BUF, BUFL, (PFN=DATA)†
  .
  .

```

The following diagram illustrates the structure of file DATA after the APPEND macro is issued.

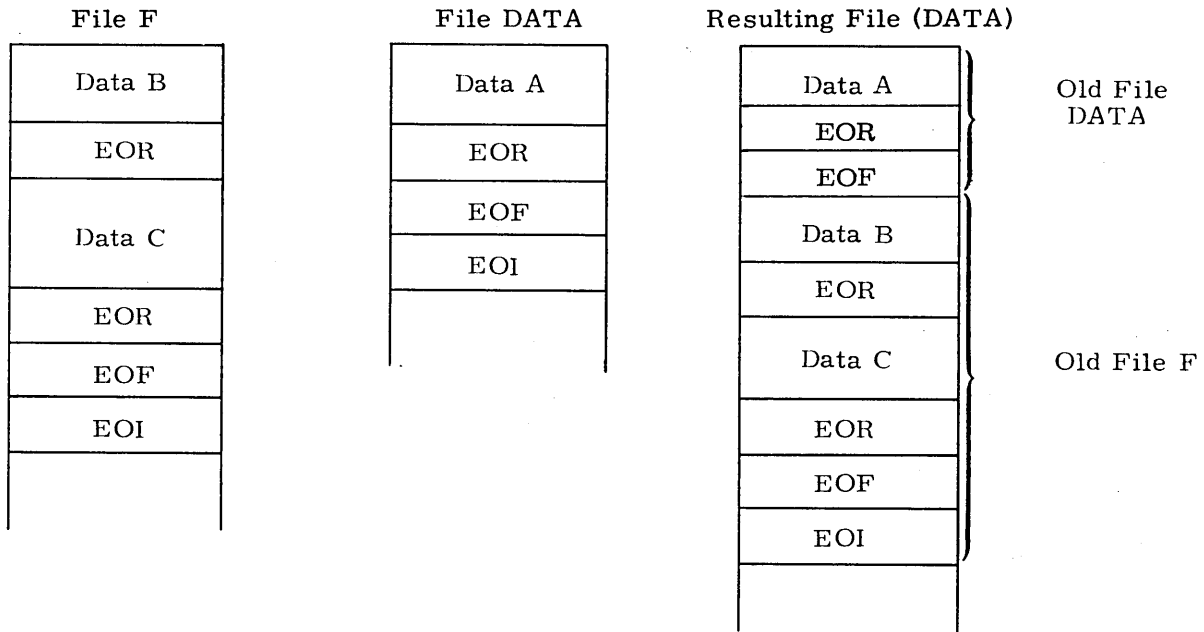

DEFINE (O10, CCDF)

The DEFINE macro enables the user to specify a file as a direct access permanent file. The file specified must be a local file that resides on a permanent file device. If the file does not exist, a zero-length file is created either on the master device (refer to Mass Storage File Residence, section 2, volume 1, for a description of the master device), another device if the master device cannot be used, or that device specified by the r and/or pn parameters.

†The permanent file name can be set by FET creation macros as well as being set in the permanent file macros.

ATTACH (011, CCAT)

The ATTACH macro enables the user to attach the specified direct access file to his control point.

A read/write interlock is provided to ensure that only one user at a time accesses the file in write mode. Several users may access the file in read mode simultaneously. The user should return the file as soon as possible to enable other users to access the file. If a local file by the same name already exists, it is returned as if the UNLOAD macro had been issued even if the ATTACH is unsuccessful.

Macro Format:

LOCATION	OPERATION	VARIABLE SUBFIELDS
	ATTACH	addr, pfn, un, pwd, m, pn, r, fo, fa, rt

addr	Address of the FET. FET+0 must contain the local file name of the file while attached to the job.																		
pfn	Address containing the name of the file in the permanent file catalog. If pfn=0, the contents of FET+0 is used for the permanent file name.																		
un	Address containing name of the alternate user catalog on which the file resides.																		
pwd	Address containing file password; entered only if un≠0 and the file requires a password.																		
m	Mode of access desired: <table border="0" style="margin-left: 40px;"> <thead> <tr> <th><u>m</u></th> <th><u>Description</u></th> </tr> </thead> <tbody> <tr> <td>W</td> <td>Read, write, purge, and/or execute (default value).</td> </tr> <tr> <td>R</td> <td>Read and/or execute.</td> </tr> <tr> <td>A</td> <td>Append, read, and/or execute.</td> </tr> <tr> <td>E</td> <td>Execute.</td> </tr> <tr> <td>N</td> <td>None.</td> </tr> <tr> <td>M</td> <td>Modify, append, read, and/or execute.</td> </tr> <tr> <td>RM</td> <td>Read and/or execute, allow modifications.</td> </tr> <tr> <td>RA</td> <td>Read and/or execute, allow extensions.</td> </tr> </tbody> </table>	<u>m</u>	<u>Description</u>	W	Read, write, purge, and/or execute (default value).	R	Read and/or execute.	A	Append, read, and/or execute.	E	Execute.	N	None.	M	Modify, append, read, and/or execute.	RM	Read and/or execute, allow modifications.	RA	Read and/or execute, allow extensions.
<u>m</u>	<u>Description</u>																		
W	Read, write, purge, and/or execute (default value).																		
R	Read and/or execute.																		
A	Append, read, and/or execute.																		
E	Execute.																		
N	None.																		
M	Modify, append, read, and/or execute.																		
RM	Read and/or execute, allow modifications.																		
RA	Read and/or execute, allow extensions.																		
	Refer to PFM Macro Parameter Conventions in this section for further information.																		
pn	Address containing one- to seven-character pack name of the auxiliary device on which the specified permanent file resides (refer to the DEFINE macro).																		
r	Type of auxiliary device identified by the pn parameter (refer to the DEFINE macro).																		

- fo Family option:
- IP The pack name specified by a PACKNAM macro or pn parameter is ignored. PFM accesses the user's family.
- DF The pack name specified by a PACKNAM macro or pn parameter and the family name specified on the USER statement are ignored. PFM accesses the system default family. This option can be used only by programs that have an SSJ= entry point.
- fa If this parameter is specified (any value may be used), the file being attached must be a fast attach permanent file.
- rt Real-time mode. If this parameter is specified (any value may be used), the job step is not delayed for either of the following conditions:
- The file must be staged to disk from MSF.
 - A permanent file utility is currently active, preventing the ATTACH processing.

If neither of these conditions exists, the rt parameter has no meaning. If one of these conditions exists and the rt parameter is not specified, the job step is delayed until the operation is complete. If one of these conditions exists and the rt parameter is specified, the file is not attached; instead the operation to ensure that the file resides on disk is initiated. To complete the attach, another ATTACH macro with or without the rt parameter should be issued and the FET status checked to ensure that the file was accessed. The function of the rt parameter is also accomplished by setting either the up or rt bit in the FET.

If the user issues an ATTACH macro and the file is busy, the system aborts the request. The user can bypass the abort by specifying error processing (FET+1, bit 44). If ep is set and the file is busy, the system returns control to the user. He may then suspend his job by issuing the ROLLOUT macro. Normally, when a user issues a ROLLOUT macro to roll out his job subject to time/event dependencies, he must include an address specifying the time period and/or event. However, whenever file busy status is returned, PFM sets up a time/event entry for the user, specifying a default rollout time period of 360_g seconds.

Refer to the ATTACH control statement for a description of the resulting current access modes when the user attempts to attach an active file.

CHANGE (012, CCCG)

The CHANGE macro allows the originator of a direct or indirect access file to alter any of several parameters without having to attach and redefine the file or retrieve and save it. The ct and m parameters should be specified only if a change in the value associated with the parameter is desired. The pn and r parameters cannot be used to specify a new auxiliary device. They are used only to specify the auxiliary device on which ofn resides.

Control point manager (CPM) enables the user to alter or interrogate parameters in the job control point area which controls the user's job in the system. All CPM functions must be issued with auto recall specified. If it is not, the following message is issued.

CPM-ILLEGAL REQUEST.

All errors encountered by CPM cause the job step to be aborted; no user error processing is available. Unless otherwise noted, the following message is issued upon abnormal job termination.

CPM-ARGUMENT ERROR.

The format of the call to CPM is:

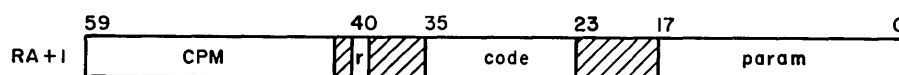

- r Auto recall bit (must be set)
- code CPM function code
- param Parameter for the function

Common decks required for absolute assemblies by the functions processed by CPM are COMCCPM and COMCSYS. For relocatable assemblies, these decks are satisfied by default from the library SYSLIB.

SETQP (000)

The SETQP macro alters the queue priority of a job. The queue priority controls the scheduling of the job to and from the rollout queue. Lowering the queue priority may cause the job to be rolled out more often.

Macro Format: †

LOCATION	OPERATION	VARIABLE SUBFIELDS
	SETQP	n

n Queue priority; $100_8 \leq n \leq$ current priority; ($100_8 \leq n \leq 7761_8$ for a system origin job). If n is greater than 7761, the priority is set to 7761. If n=0 is specified, the queue priority is set to the rollout upper bound for the current job origin.

† This macro is not available in SYSTEXT. The user must specify systems text PSSTEXT or call common deck COMCMAC (refer to appendix A).

SETPR (001)

The SETPR macro alters the CPU priority of a job. The CPU priority controls the assignment of the CPU to active jobs. If the CPU priority is lower than that of other jobs, the job is assigned to the CPU only when jobs of a higher priority do not need it. Each job origin is assigned an initial CPU priority at system initialization. The user cannot exceed this priority. If he requests a priority that exceeds this value or 70g (maximum CPU priority), the maximum for the current job origin is used.

Macro Format: †

LOCATION	OPERATION	VARIABLE SUBFIELDS
	SETPR	n

n CPU priority; ($1 \leq n \leq 70g$); if n exceeds that for the current job origin, it is reduced to that value.

MODE (002)

The MODE macro defines the error conditions that cause the system to exit from normal processing. When the error the user specified occurs, the system sets the appropriate error flag and exits from normal processing to perform any error processing required. If an error occurs for which the user did not select the exit mode processing, the system ignores the error and continues normal processing.

Macro format: †

LOCATION	OPERATION	VARIABLE SUBFIELDS
	MODE	m, n

m CPU program error exit mode.

n This parameter is included for compatibility with earlier versions of NOS. The value supplied is ignored.

The processor will exit when
this condition occurs

If m has one of these octal values

Address out of range (automatically selected for CYBER 170 Model 176)

1, 3, 5, 7

Operand out of range (overflow only on model 176)

2, 3, 6, 7, 12, 13, 16, 17

Indefinite operand

4, 5, 6, 7, 14, 15, 16, 17

Underflow (model 176 only)

10, 11, 12, 13, 14, 15, 16, 17

The maximum value and default on all models except the CYBER 170 Model 176 is 7, indicating that the processor exits on all conditions. The maximum value on model 176 is 17₈ indicating that the processor exists on all conditions. The default value on model 176 is 7, indicating that the processor exits on all conditions except underflow.

†This macro is not available in SYSTEXT. The user must specify systems text PSSTEXT or call common deck COMCCMD or COMCMAC (refer to appendix A).

Examples:

Setting m to 6 on all models other than a model 176 selects error exiting on operand out of range and indefinite operand. On a model 176, address out of range cannot be deselected; it is automatically set by the system. Setting m to 6 or 7 on a model 176 would yield the same results.

Setting m to 13₈ on a model 176 selects error exiting on operand out of range, and underflow. Setting m to 12₈ would accomplish this also (because address out of range is automatically selected).

SETASL (003)

The SETASL macro allows the user to specify the account block SRU limit for a job. The account block limit is the maximum number of SRUs that can be accumulated by a job. If this limit is reached, the following message is issued.

ACCOUNT BLOCK LIMIT.

Each user and each charge/project number is validated for a maximum SRU limit. If the limit is exceeded or an account block less than 1 is specified, the message

SL NOT VALIDATED.

is issued.

EREXIT (004)

NOS allows a user program to continue execution after an error occurs (except where prohibited), if the error return address is specified in the job control point area. When an error occurs, the system clears the error exit address and restarts the job at the CPU address specified. The contents of RA returned when an error is encountered is:

59	53	47	29	23	11	5	0
0	mo	aaaaaa	ef	0	ssw	0	

mo Mode of CPU error exit. For all computer systems except the CYBER 170, Model 176, the mode bit is set for the indicated EM register bit (refer to Exchange Package Area, appendix E).

<u>mo Bit</u>	<u>EM Bit</u>	<u>Meaning</u>
53	59	CM data error. †
52	58	CMC input error. †
51	57	ECS flag register operation parity error. †
50	50	Indefinite operand.
49	49	Operand out of range.
48	48	Address out of range.

If an mo bit is not set, the error is due to an illegal instruction.

For the CYBER 170, Model 176, the following mode bits are set for the indicated PSD register bit (refer to Exchange Package Area, appendix E).

<u>mo Bit</u>	<u>PSD Bit</u>	<u>Meaning</u>
53	46	CM error condition.
52	--	Not used.
51	--	Not used.
50	38	Indefinite condition.
49	37	Overflow condition.
48	45	LCME block range condition.
48	44	CM block range condition.
48	43	LCME direct range condition.
48	42	CM direct range condition.
48	41	Program range condition.

The LCME error condition (PSD bit 47) and step condition (PSD bit 39) are not mapped to mo.

†CYBER 170 Series, Models 171, 172, 173, 174, 175, 720, 730, 750, and 760 only.

aaaaaa

CPU address of the job when the error occurred

ef

Error flag:

<u>Error Flag</u>	<u>Mnemonic†</u>	<u>Description</u>
1	ARET	Arithmetic error. mo is the mode of the error. Refer to appendix E.
2	PSET	A program stop was encountered by the CPU.
3	PPET	PP abort. A PP program requested that the job be aborted (CIO, PFM, and so on).
4	CPET	CPU abort. The job issued an ABT request.
5	PCET	PP call error. The job called a nonexistent or illegal system request.
6	TLET	Time limit. Job is allowed an additional 1 to 10 seconds of CPU time for error processing.
7	FLET	File limit. User attempted to assign more active files to the job than are allowed by the validation parameter.
10B	TKET	Track limit. The job requested mass storage space on a device with none available.
11B	SRET	SRU limit. Job is allowed an additional 10 SRUs to complete error exit processing.
12B	FSET	Forced error.
13B	ODET	The operator dropped the job.
14B	SPET	Special error flag.
14B	RRET	Job rerun.
15B	OKET	Operator killed job.
16B	SSET	Subsystem abort.
17B	ECET	ECS parity error.
20B	PEET	CPU or CM parity error. ††
21B	SYET	System abort.
22B	ORET	Override of error condition.

ssw

Status of sense switches

† In order to use the mnemonic in a COMPASS program, either systems text PPTXT or NOSTEXT must be specified.

†† Applicable to CYBER 170 Series only.

Errors greater than or equal to SPET are considered special by certain system routines. Examples of this are as follows.

- The job advancement routine 1AJ does not invoke buffer flushing when an error occurs that is SPET or greater.
- Read and write tape error recovery is not terminated by an error less than SPET.
- CIO does not terminate a skip operation unless the error is SPET or greater.
- Waiting for a tape to be mounted and waiting for track limit terminate only on operator drop (ODET) or an error of value SPET or greater.

Macro Format:

LOCATION	OPERATION	VARIABLE SUBFIELDS
	EREXIT	addr

addr Address for error exit return

As an example, the common procedure is for the program's preset routines to set the error exit processing.

Routine to complete processing when an error is encountered	}	ERR	SA1	B0	READ ERROR RETURN INFO
	
	
		ENDRUN			TERMINATE PROGRAM
		SUBR			PROGRAM PRESET ROUTINE
		EREXIT	ERR		SET ERROR EXIT ADDRESS
	
	
		EQ		PRSX	
	
END					

ROLLOUT (006)

The ROLLOUT macro places a job in the rollout queue until a specified event occurs or for a fixed period of time. This function may be useful if a program requires a direct access permanent file that is currently busy.

Macro Format:†

LOCATION	OPERATION	VARIABLE SUBFIELDS
	ROLLOUT	addr

addr Address containing the time and/or event dependencies; if addr is not specified, the job is rolled out without time or event dependencies.

The format of addr is:



evd Event descriptor. System programs use the EESET macro†† to make entries in a system event table indicating the occurrence of an event. The job scheduler compares the specified descriptor, evd, with events recorded in the table. If a match is detected, the scheduler initiates rollin.

evd≠0 evd and rtp are placed in the control point area (TERW). When the job rolls out, the scheduler waits for the occurrence of evd or for the time period, rtp, to elapse before initiating rollin. Because the job may roll in for two different reasons, it is the user's responsibility to verify whether the specified event actually occurred.

evd=0 The job scheduler uses the value of evd already in the control point area. This option allows the user to roll out while waiting for a system-specified event.

evd=7700xx₈ Specifies extended time rollout with no event dependency. The job rolls out for 7777₈*xx+rtp₈ seconds.

† This macro is not available in SYSTEXT. The user must specify systems text PSSTEXT or call common deck COMCMAC (refer to appendix A).

†† Use the DOCUMENT control statement to obtain internal documentation of the EESET macro and the ROLLOUT macro for a description of valid event descriptors.

rtp Rollout time period in job scheduler delay intervals (roughly 1 second each) where $0 \leq rtp \leq 4095$ ($\leq 7777_8$).

If rtp is zero the scheduler uses the value of rtp already in the control point area. If evd is also zero the job rolls out waiting for a system specified event. If the event goes undetected or never occurs the job rolls in after a system-determined time interval.

SETSSM (010)

The SETSSM macro enables the user to set or clear the secure system memory (SSM) flag. Setting this flag prevents the dumping of any portion of the job field length. This flag is automatically set for programs containing an SSJ= or SSM= entry point (refer to appendix F). If a request is made to clear SSM status by an SSM= program, the job step is aborted and the following message is issued.

CPM-ILLEGAL REQUEST.

NOTE

While the SSM flag is set, no programs with a DMP= special entry point (refer to appendix F) can be called to the control point (refer to Security Considerations, section 2) unless the calling program contains an SSJ= entry point.

Macro Format:†

LOCATION	OPERATION	VARIABLE SUBFIELDS
	SETSSM	p

p Clear SSM flag if lower 12 bits of p are zero; set SSM flag if lower 12 bits of p are nonzero.

† This macro is not available in SYSTEXT. The user must specify systems text PSSTEXT or call common deck COMCMAC (refer to appendix A).

ONSW (011)

The ONSW macro sets the sense switches for a program (refer to figure 2-E-1). This allows the user to set switches for options for subsequent tasks in the job.

The sense switches reside both in the user's control point area and in bits 11 through 6 of RA+0 of the job field length. These two fields are maintained separately. The only transfer of information occurs at the start of each job step and when an error flag is detected. At these times the control point area field is copied into RA+0. The field in RA+0 is used when the user reads sense switch settings. An ONSW (or OFFSW) request updates both fields separately.

The bit position specifies the switch to be set.

Macro Format:

LOCATION	OPERATION	VARIABLE SUBFIELDS
	ONSW	n

n Switches to be set; $0 \leq n < 778$; bit 0 corresponds to switch 1, bit 1 corresponds to switch 2, etc. If a bit is set, the corresponding switch is set; for example, ONSW 52_8 sets switches 2, 4, and 6. If $n=778$, all switches are set. If $n=0$, all switches remain unchanged.

OFFSW (012)

The OFFSW macro enables the user to clear the sense switches for the job. Refer to the description of the ONSW macro for a discussion of sense switch settings.

Macro Format:

LOCATION	OPERATION	VARIABLE SUBFIELDS
	OFFSW	n

n Switches to be cleared; $0 \leq n < 778$; bit 0 corresponds to switch 1, bit 1 corresponds to switch 2, etc. If a bit is set, the corresponding switch is cleared; for example, OFFSW 52_8 clears sense switches 2, 4, and 6. If $n=778$, all switches are cleared. If $n=0$, all switches remain unchanged.

GETJN (013)

The GETJN function allows the user to determine the system job name of the job. For the format of the job name, refer to section 3, volume 1.

Macro Format:†

LOCATION	OPERATION	VARIABLE SUBFIELDS
	GETJN	addr

addr Address to receive job name, left-justified

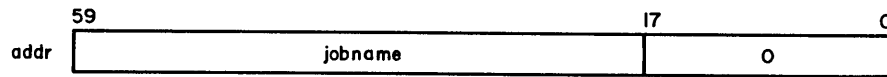

GETQP (014)

The GETQP function allows the user to determine the queue priority of the current job.

Macro Format:†

LOCATION	OPERATION	VARIABLE SUBFIELDS
	GETQP	addr

addr Address to receive queue priority

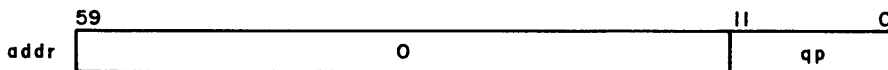

qp Job queue priority

GETPR (015)

This function allows the user to determine the CPU priority of the current job.

Macro Format:†

LOCATION	OPERATION	VARIABLE SUBFIELDS
	GETPR	addr

addr Address where the CPU priority is returned

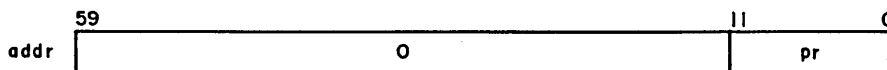

pr CPU priority

† This macro is not available in SYSTEXT. The user must specify systems text PSSTEXT or call common deck COMCMAC (refer to appendix A).

GETEM (016)

The GETEM macro enables the user to determine under what exit mode control the job is currently running.

Macro Format:†

LOCATION	OPERATION	VARIABLE SUBFIELDS
	GETEM	addr

addr Address for return of current exit mode in bits 11 through 0

GETASL (017)

The GETASL macro returns the account block SRU limit for the job (refer to SETASL macro) to the specified address.



s Account block SRU limit

Macro Format: †

LOCATION	OPERATION	VARIABLE SUBFIELDS
	GETASL	addr

addr Address to receive account block SRU limit

† This macro is not available in SYSTEXT. The user must specify systems text PSSTEXT or call common deck COMCMAC (refer to appendix A).

GETJSL (017)

The GETJSL macro returns the job step SRU limit for the current job step (refer to SETJSL macro) to the specified address.



s Job step SRU limit

Macro Format: †

LOCATION	OPERATION	VARIABLE SUBFIELDS
	GETJSL	addr

addr Address to receive job step SRU limit

GETTL (017)

The GETTL macro returns the time limit for the current job step.

Macro Format: †

LOCATION	OPERATION	VARIABLE SUBFIELDS
	GETTL	addr

addr Address to receive time limit

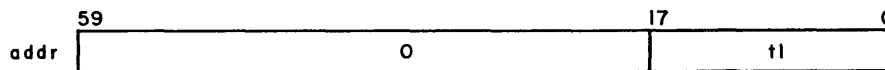

t1 CPU job step time limit (in seconds)

† This macro is not available in SYSTEXT. The user must specify systems text PSSTEXT or call common deck COMCCMD or COMCMAC (refer to appendix A).

SETLC (022)

The SETLC macro enables the user to set the loader control word for subsequent loader requests. The format of the loader control word is:



v Map validation bit. If bit is not set, default map option is used.

mc Map control bits (octal):

- 00 No map is produced
- 01 Statistics and errors
- 02 Block assignments
- 03 Partial map providing statistics, errors, and block assignments
- 04 Entry points
- 14 External references and entry points
- 17 Full map providing information given individually by control bits 01, 02, 03, and 14

n Prevent field length reduction after relocatable load.

g Global library set indicators.

The global library set indicators, contained in the loader control word (location LB1W in the user's control point area), are maintained by the SETLC macro. The user should call the GETLC macro before using the SETLC macro to avoid destroying the library set information. With the GETLC macro, the user can obtain the current loader control word and include bits 23 through 0 in the control word used by SETLC.

Macro Format:†

LOCATION	OPERATION	VARIABLE SUBFIELDS
	SETLC	addr

addr Address of the loader control word to be set

†This macro is not available in SYSTEXT. The user must specify systems text PSSTEXT or call common deck COMCMAC (refer to appendix A).

SETRFL (023)

The SETRFL macro sets the initial central memory and ECS field lengths for a job step. The specified values are used unless the system encounters one of the following:

- A system routine whose field lengths are specified during system creation.
- A routine that specifies the amount of CM or ECS field length required in a 54 loader table (refer to CYBER Loader Reference Manual).
- An MFL or RFL control statement (refer to section 6, volume 1) or a subsequent SETMFL or SETRFL macro.

If the user does not issue the SETRFL function or the RFL control statement, the operating system determines how much field length to assign initially for each job step. If the user attempts to set the CM field length above that for which the user is validated, the following message is issued.

CM NOT VALIDATED.

If the user attempts to set the ECS field length above that for which the user is validated, the following message is issued.

EC NOT VALIDATED.

The CM field length is rounded upward to a multiple of 100_g words. The ECS field length is in 1000_g word blocks.

Macro Format:†

LOCATION	OPERATION	VARIABLE SUBFIELDS
	SETRFL	n, m

n New CM field length restoration parameter

m New ECS field length restoration parameter

GETJCR (024) ††

The GETJCR macro enables the user to interrogate the job control registers associated with his job (refer to the description of the system control language, section 4, volume 1). The last error flag encountered can also be determined. Information is returned in the following format.

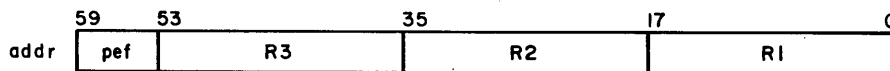

† This macro is not available in SYSTEXT. The user must specify systems text PSSTEXT or call common deck COMCCMD (refer to appendix A).

†† The user should use the GETJCI macro instead of GETJCR.

pef The last error flag encountered (refer to the EREXIT function for the values)

R3 Job control register 3

R2 Job control register 2

R1 Job control register 1

Macro Format:†

LOCATION	OPERATION	VARIABLE SUBFIELDS
	GETJCR	addr

addr Address for return of the job control registers

SETJCR (025)††

The SETJCR macro enables the user to set the job control registers for the job. Refer to the description of the GETJCR macro for the format of the word.

Macro Format:†

LOCATION	OPERATION	VARIABLE SUBFIELDS
	SETJCR	addr

addr Address of the word containing the job control registers to be set

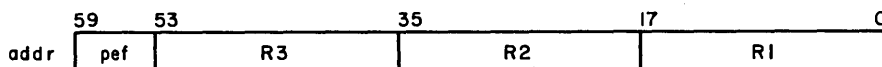

pef Previous error flag

R3 Job control register 3

R2 Job control register 2

R1 Job control register 1

† This macro is not available in SYSTEXT. The user must specify systems text PSSTEXT or call common deck COMCMAC (refer to appendix A).

†† The user should use the SETJCI macro instead of SETJCR.

SETSS (026)

The SETSS macro specifies the subsystem under which the job is currently executing, provided the user is validated for that subsystem. If not, then the operation is aborted and the following error message is issued.

CPM-ILLEGAL USER ACCESS.

Macro Format:†

LOCATION	OPERATION	VARIABLE SUBFIELDS
	SETSS	ss

ss Subsystem ordinal (refer to the TSTATUS macro, section 12, for a description of subsystem ordinals)

GETJO (027)

This function reads the job origin code from the user's control point area and returns the code right-justified at the address specified by the user.

Macro Format:†

LOCATION	OPERATION	VARIABLE SUBFIELDS
	GETJO	addr

addr Address to receive job origin code. Refer to appendix E for legal job origin codes.

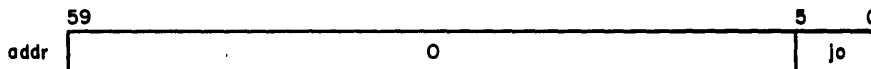

jo Job origin code

GETJA (030)

This function transfers the job accounting information to the address specified by the user.

The data is returned in the following form.

† This macro is not available in SYSTEXT. The user must specify systems text PSSTEXT or call common deck COMCMAC (refer to appendix A).

	59	41 39	19	0
addr +0	0	SRU accumulator (micro units *10)		
+1	CP accumulator (quarter nanounits)			
+2	MS accumulator	MT accumulator	PF accumulator	
+3	0		adder accumulator	

Macro Format:†

LOCATION	OPERATION	VARIABLE SUBFIELDS
	GETJA	addr

addr Address to receive job accounting data

Nanounits are calculated as nanoseconds multiplied by the CPU accounting multiplier (refer to Resource Accounting in section 5 of the NOS System Maintenance Reference Manual).

USECPU (031)

The USECPU macro specifies which central processor is to be used when more than one is available.

Macro Format:

LOCATION	OPERATION	VARIABLE SUBFIELDS
	USECPU	n

n=0 Either central processor can be used
n=1 CPU 0 is to be used (the CPU with functional units on a 6700 or CDC CYBER 74-2x)
n=2 CPU 1 is to be used (the CPU without functional units on a 6700 or CDC CYBER 74-2x)

USERNUM (032)

The USERNUM macro returns the user number the job is running under to the specified address.

† This macro is not available in SYSTEXT. The user must specify systems text PSSTEXT or call common deck COMCMAC (refer to appendix A).

Macro Format:

LOCATION	OPERATION	VARIABLE SUBFIELDS
	USERNUM	addr

addr Address to receive the user number, left-justified and zero-filled

GETFLC (033, 055)

The GETFLC macro returns the field length control word from the user's control point area to the specified address.

Macro Format: †

LOCATION	OPERATION	VARIABLE SUBFIELDS
	GETFLC	caddr, eaddr

caddr Address to receive the central memory field length control word

eaddr Address to receive the ECS field length control word

The GETFLC request can include either or both of the addresses. The field length control words are returned in the following format (multiply each 12-bit field by 100₈ for caddr or 1000₈ for eaddr to obtain the actual value).

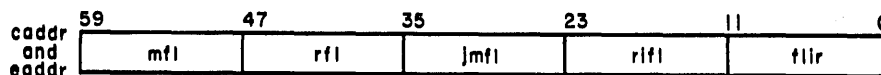

mfl Maximum CM or ECS field length for the current job step. This value may be reset with the MFL control statement (refer to section 6, volume 1) or SETMFL macro.

rfl Initial running CM or ECS field length for a job step. This value is always less than or equal to mfl and is set with the RFL control statement or SETRFL macro. A value of 0 indicates that the system controls the field length.

† This macro is not available in SYSTEXT. The user must specify systems text PSSTEXT or call common deck COMCMAC (refer to appendix A).

The subsystem ordinal is returned in the following format.

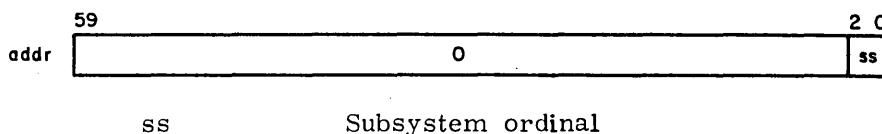

VERSION (044)

The VERSION macro returns the version name of the operating system from central memory to a location specified by the user. Location addr contains parameters specifying the disposition of the version name.

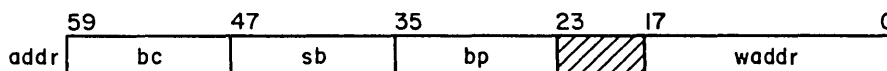

- bc Number of bytes (1 to 10) to return from two-word source field (CM location containing version name)
- sb Byte in source field to begin transfer at (0 to 9); the sum of bc and sb must be less than 11
- bp Byte position within receiving field (waddr) to begin transfer at (0 to 4)
- waddr Beginning address of three-word block to receive data

Macro Format: †

LOCATION	OPERATION	VARIABLE SUBFIELDS
	VERSION	addr

addr Address of word containing macro parameters

GETLC (045)

The GETLC macro enables the user to determine the loader control word. Refer to the SETLC macro for the format of the loader control word.

Macro Format: †

LOCATION	OPERATION	VARIABLE SUBFIELDS
	GETLC	addr

addr Address to receive the loader control word

† This macro is not available in SYSTEXT. The user must specify systems text PSSTEXT or call common deck COMCCMD or COMCMAC (refer to appendix A).

GETGLS (046)

The GETGLS macro returns the global library set from the user's control point area. Refer to the CDC CYBER Loader Reference Manual for a discussion of global library sets. A parameter word is used to specify where a list of logical file names is to be placed.

Macro Format:†

LOCATION	OPERATION	VARIABLE SUBFIELDS
	GETGLS	addr

addr Address of parameter word

Parameter word format:

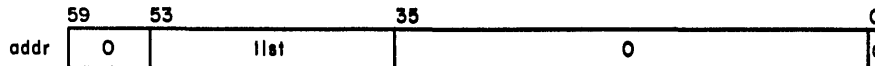

list Beginning address to which the logical file names (left-justified) contained in the global library set are written. The value of this parameter is updated to the address of the last library (list+n) upon completion.

c Completion bit.

Upon return from the GETGLS macro, locations list through list+n are updated as follows:

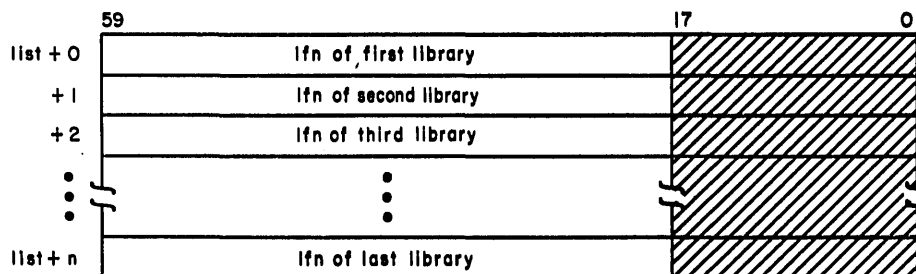

n The number of libraries minus one defined in the global library set.

lfn The name of a global local library or the name of a system library.

† This macro is not available in SYSTEXT. The user must specify systems text PSSTEXT or call common deck COMCMAC (refer to appendix A).

SETGLS (047)

The SETGLS macro enables the user to define the global library set indicators in the user's control point area. Refer to the CYBER Loader Reference Manual for a discussion of global library sets. A parameter word specifies where the list of logical file names used to define the global library set is located.

Macro Format: †

LOCATION	OPERATION	VARIABLE SUBFIELDS
	SETGLS	addr
	addr	Address of parameter word

Refer to the GETGLS macro for the format of the parameter word.

Before calling the SETGLS macro, locations list through list+n+1 must be as follows:

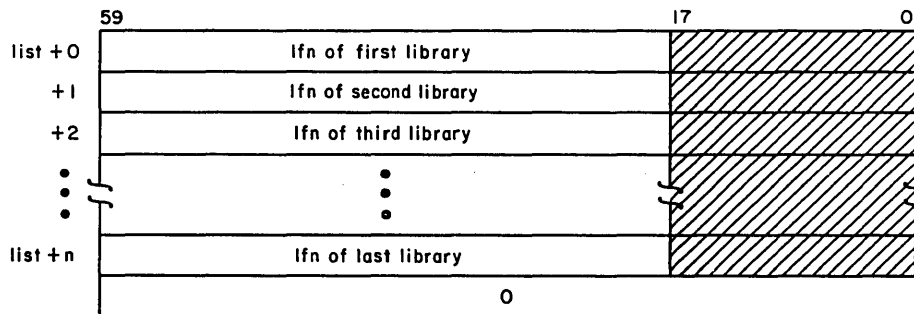

n The number of libraries minus one in the global library set.

lfn The name of a global local library or the name of a system library.

† This macro is not available in SYSTEXT. The user must specify systems text PSSTEXT or call common deck COMCMAC (refer to appendix A).

MACHID (050)

The MACHID macro enables the user to determine the one- or two-character machine identification that is established at deadstart time.

Macro Format: †

LOCATION	OPERATION	VARIABLE SUBFIELDS
	MACHID	addr

addr Address to receive machine identification

The machine identification is returned in the following format.

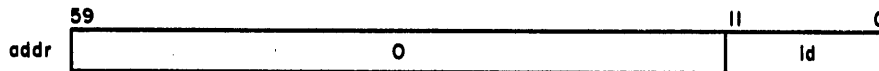

GETACT (051)

The GETACT macro allows the user to obtain information regarding outstanding system activity for a job.

Macro Format: †

LOCATION	OPERATION	VARIABLE SUBFIELDS
	GETACT	addr

addr Address to receive information

The system activity information is returned in the following format.

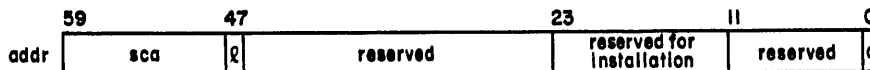

sca Count of system completable activities

l Long-term activity pending

c_ Completion bit (set to one when operation is complete)

† This macro is not available in SYSTEXT. The user must specify systems text PSSTEXT or call common deck COMCCMD (refer to appendix A).

The sca field is incremented by one for each of the following:

- Each PP activity outstanding. This includes any PP routines called without auto recall that have not yet completed (for example, CIO). This count does not include the CPM function returning this information.

NOTE

This function does not count PPs that have moved to another control point at the time the GETACT request is being processed and then move back to the original control point.

- Each PP routine that has placed itself in PP recall and has not yet completed.
- Each tape I/O activity outstanding. Although these are initiated through CIO requests, they are handled separately by the system and are counted here and not with the PP activity.
- The rollout flag is set in the control point area.
- An interactive I/O request that has been made but not yet processed.

If ℓ (bit 47) is equal to 1, a long-term activity is pending. Such an activity either requires termination by the user or operator intervention. The following are long-term activities.

- K or L console display interface.
- CFO entry enabled (refer to NOS Operator's Guide for a description of CFO entries).
- A system control point (SCP) long-term connection.

SETMFL (052)

The SETMFL macro enables the user to change the job step maximum field length (MFL) boundary (refer to GETFLC and SETRFL macros for discussion of maximum field length limit). If either parameter is 0, the maximum field length is set to the maximum allowable field length for the user.

Macro Format:†

LOCATION	OPERATION	VARIABLE SUBFIELDS
	SETMFL	n, m

n New maximum central memory field length limit for job step
m New maximum ECS FL/1000₈ limit for job step

GETPF (057)

The GETPF macro returns a job's permanent file parameters (current family name, pack name, user number, and user index).

Macro Format:†

LOCATION	OPERATION	VARIABLE SUBFIELDS
	GETPF	addr

addr Address to receive three-word table containing permanent file parameters

The current permanent file parameters are returned in the following format.

	59	17	0
addr +0	family name		0
+1	pack name		0
+2	user number		user index

† This macro is not available in SYSTEXT. The user must specify systems text PSSTEXT or call common deck COMCCMD or COMCMAC (refer to appendix A).

GETLOF (061)

The GETLOF macro returns the address of the list of files from the user's control point area to the specified address. The address of the list of files is set in the control point area with the SETLOF macro.

Macro Format: †

LOCATION	OPERATION	VARIABLE SUBFIELDS
	GETLOF	addr

addr Address to receive the list of files pointer

Upon return from the GETLOF macro, location addr has the following format.



pointer Address of list of files table established with the SETLOF macro

c Completion bit

If the system returns 0 in the pointer field, no list of files address has been previously set (refer to description of SETLOF macro).

† This macro is not available in SYSTEXT. The user must specify systems text PSSTEXT or call common deck COMCCMD (refer to appendix A).

SETLOF (062)

The SETLOF macro enables the user to specify a pointer to a list of files whose circular buffers will be flushed at job step abort or for terminal files, when the job is rolled out.

Macro Format:†

LOCATION	OPERATION	VARIABLE SUBFIELDS
	SETLOF	addr

addr Address containing the pointer to the list of files table

The format of location addr before issuing the SETLOF macro must be as follows:

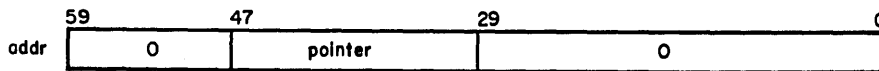

pointer Address of list of files table

The list of files table has the following format.

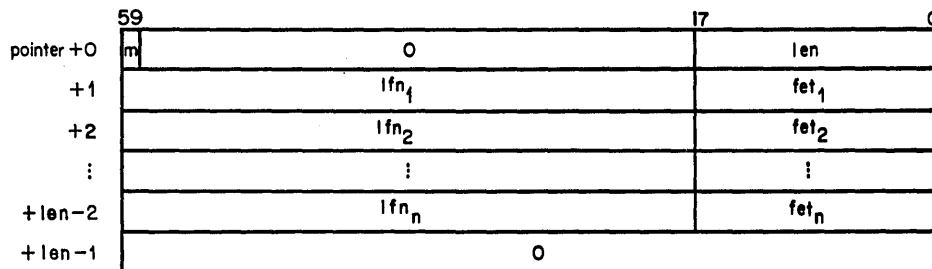

m Common memory manager (CMM) block indicator; setting this bit indicates that the file list is CMM controlled

len Length of the list of files table including zero termination word

lfn_i File name

fet_i FET address

† This macro is not available in SYSTEXT. The user must specify systems text PSSTEXT or call common deck COMCCMD (refer to appendix A).

Queue file manager (QFM) performs functions associated with queue and dayfile protection. The majority of the QFM functions are for special system jobs; these functions are not discussed in this manual (refer to the NOS Systems Programmer's Instant) since they are not available to the applications programmer. Functions available to the applications user include user requests to:

- Allow a job to be rerun or not rerun in the event of a system interrupt.
- Release a file from a job to either the remote or local batch input queues.
- Assign a file to a queue device.

All requests to QFM must be made with the auto recall bit set; if it is not, the job step is aborted and the following message is issued.

QFM ILLEGAL REQUEST.

If the parameter addresses are not within the user's field length, the job step is aborted and the following message is issued.

QFM ARGUMENT ERROR.

The format of the call to QFM is:

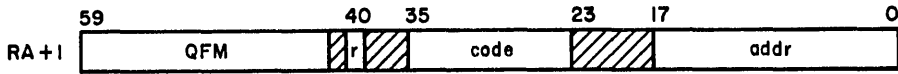

r Auto recall bit
code Function code
addr Address of the FET for the file

The format of the FET used by QFM is:

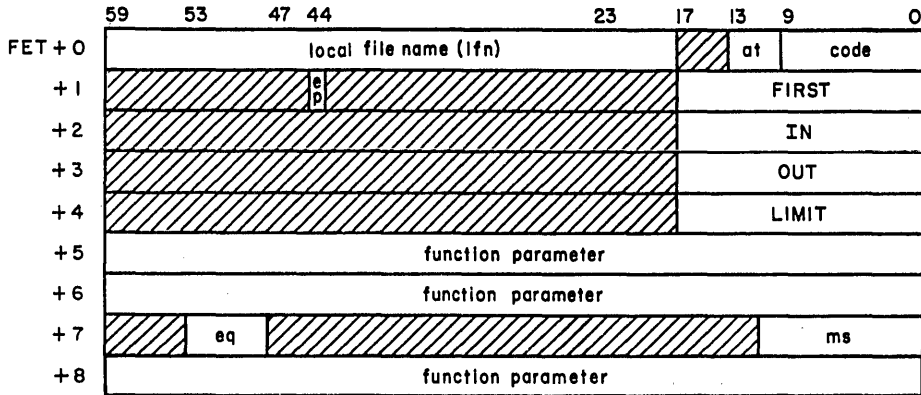

at Abnormal termination code
code Completion code
ep Error processing bit
eq Equipment number
ms Mass storage error code (bits 11 through 0)

RERUN (015)

The RERUN macro sets the job rerun status, indicating that the job may be rerun in the event of system failure. This macro need not be used unless queue protection was disabled by a previous NORERUN macro, since all jobs in the input queue are initially given rerun status. The RERUN macro has no effect if used from a time-sharing origin job.

Macro Format: †

LOCATION	OPERATION	VARIABLE SUBFIELDS
	RERUN	

† This macro is not available in SYSTEXT. The user must specify systems text PSSTEXT or call common deck COMCMAC (refer to appendix A).

NORERUN (016)

The NORERUN macro clears the job rerun status (initially enabled) and prevents a job from being rerun as the result of queue protection. With this macro the user can specify when a job may be safely rerun. For example, if a job has just updated a critical data base, it is probably desirable not to rerun the job. Hence, the user can use the NORERUN macro to prevent this. This macro affects input files only. The NORERUN macro has no effect if used from a time-sharing origin job.

Macro Format: †

LOCATION	OPERATION	VARIABLE SUBFIELDS
	NORERUN	

SUBMIT (017)

NOTE

This macro will not be available in future releases of NOS. If possible, the user should use instead the ROUTE macro described in section 8.

The SUBMIT macro enables the user to release a file from a job to either the remote or local batch input queues. The user must be validated to use this function (refer to the DB field of validation limits in section 6, volume 1), but does not need system origin privileges. This file must have the normal job file format. If the user wishes to reformat a file before submitting it for processing, he should use the SUBMIT control statement (refer to section 6, volume 1).

If a submitted job contains an illegal first USER statement, the job entering the SUBMIT function is aborted via a system error (no exit processing) and the following messages are issued to the user dayfile.

ILLEGAL USER CARD.
SYSTEM ABORT.

The following message is issued to the account dayfile.

SIUN, username.

Terminal users are immediately logged off without receiving a dayfile message and without recovery.

† This macro is not available in SYSTEXT. The user must specify systems text PSSTEXT or call common deck COMCMAC (refer to appendix A).

The occurrence of an illegal user statement also decrements the security count for the user number of the job that initiated the SUBMIT function. The security count is the number of security violations a user number has remaining before it is denied access to the system. If a user number's security count is exhausted, the following message is issued at job initiation.

ILLEGAL USER ACCESS - CONTACT SITE OPR.

The security count for the user number must be reset before access to the system is allowed for that user number.

Entry condition:

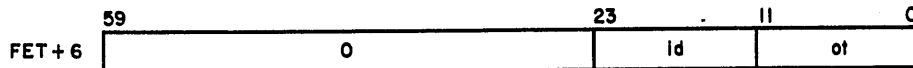

- id Identification code to be assigned to the job
- ot Origin type of the job to be submitted; must be local batch (BCOT, 1) or remote batch (EIOT, 2)

The identification code is the same as that described for the SETID macro in section 4. However, if id is set to 77₈ in FET+6, all job output is discarded at job termination.

A FET buffer of at least one PRU must be provided to allow QFM to read first sector for job control statement translation.

- The job name given to the deferred job is returned in bits 59 through 18 of FET+6. This job name is derived from the user number specified on the user statement of the submitting job. This is the same as the method used for time-sharing and remote batch origin jobs (refer to section 3, volume 1).

This macro requires the common decks COMCQFM and COMCSYS.

Macro Format:†

LOCATION	OPERATION	VARIABLE SUBFIELDS
	SUBMIT	addr

addr Address of the FET that specifies the file to be submitted.

† This macro is not available in SYSTEXT. The user must specify systems text PSSTEXT or call common deck COMCMAC (refer to appendix A).

ASSIGN FILE TO QUEUE DEVICE (020)

NOTE

This function will not be available in future releases of NOS. The user should use instead the REQUEST macro (LFM function 15_g) described in section 4.

Function 020 enables the user to assign a file to a queue device (a device to which queue type files are assigned). A queue file of the specified type is assigned to the mass storage device specified in the mass storage allocation (MSAL) entry.

Entry condition:



qt Queue type. The qt field contains the queue-type value.

Type	Value
INFT	0
PRFT	2
PHFT	3

No macro is available for this function. The user should call it with the SYSTEM macro in the following manner.

```
SYSTEM  QFM, R, addr, 2000B
        R           Auto recall bit (must be set)
        addr        Address of the FET
        2000B       Function code (020) * 100g
```

If the MSAL control is set (refer to the NOS Operator's Guide for a discussion of MSAL), the specified file is assigned to the device. Otherwise, no action is taken.

DSP FUNCTION

File routing under NOS is performed by the dispose processor (DSP). DSP is called by an RA+1 call or the ROUTE macro. DSP places a file in an input or output queue of either the central site or a remote batch site. The function can be issued from jobs of any job origin type.

NOTE

If a file is routed to an input queue, it must contain a valid user statement or the job initiating the route will be aborted without exit processing. Refer to the SUBMIT macro, section 7, for further information concerning illegal user statements.

The format of the call to DSP is:

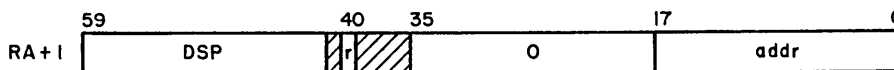

	r	Auto recall bit (must be set)
	addr	First word address of parameter block

The user must define a parameter block as described below before issuing the DSP call or ROUTE macro.

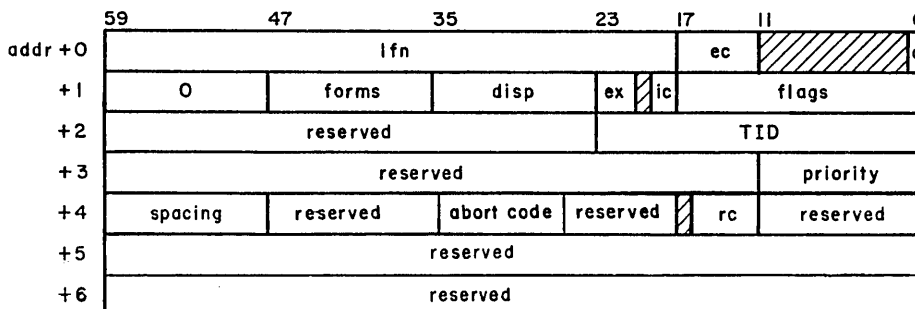

	lfn	Local file name of file to be routed (must be a print, punch, input, or local file; must not reside on a removable device; and must have read permission).
	ec	Error code returned by system when bit 12 of flags field is set (error codes described later in this section).

c Completion bit (must be zero when function is issued; system sets bit to one when operation complete).

forms Forms code or input flags. Two display code characters or specific bits set identifying the forms to be used for this file or other processing options. If file is routed to input queue, this field is defined as follows:

<u>Bits</u>	<u>Description</u>
47-46	Unused
45	Do not protect input file
44	Send file to output queue; forced abort
43	Send file to input queue even if job statement error
42-36	Reserved

Forms codes are two alphanumeric characters and are assigned by each installation. The user should contact installation personnel to determine what forms codes are available (if any).

disp Disposition code. Two alphanumeric characters specifying the disposition of the routed file.

<u>Code</u>	<u>Description</u>
IN	Release file to input queue
LP	Print on any line printer
LR	Print on 580-12 line printer
LS	Print on 580-16 line printer
LT	Print on 580-20 line printer
NO	Release file to input queue. Drop job output at job completion.
PB	Punch system binary
PH	Punch coded
PL	Plotter
PR	Same as LP
PU	Same as PH
P8	Punch 80 column binary
SB	Same as PB
SC	Rescind prior routing and change file type to local (LOFT)

ex External characteristics (bits 23 through 21) code translated as follows:

<u>Value</u>	<u>Print File</u>	<u>Punch File</u>
0	(default)	(default)
1	Unused	SB
2	A4	80COL
3	B4	Unused
4	B6	O26
5	A6	O29
6	A9	Unused
7	Reserved	Reserved

The mnemonics in the above table are defined as follows:

<u>Mnemonic</u>	<u>Description</u>
A4	ASCII graphic 48-character set (not supported; provided for NOS/BE compatibility)
A6	ASCII graphic 64-character set
A9	ASCII graphic 95-character set

<u>Mnemonic</u>	<u>Description</u>
B4	BCD 48-character set (not supported; provided for NOS/BE compatibility)
B6	CDC graphic 64-character set
O26	Punch O26 mode
O29	Punch O29 mode
SB	Punch system binary
80COL	Punch 80-column binary

ic Internal characteristics (bits 19 through 18) code translated as follows:

<u>Value</u>	<u>Description</u>
0	Display code
1	ASCII code
2	Binary
3	Reserved

flags Each bit set indicates that a parameter is specified.

<u>Bit</u>	<u>Description</u>
17	File name assigned by system is returned to addr+0, bits 59 through 18
16	Reserved
15	580 PFC spacing code
14	Repeat count
13	Reserved
12	No dayfile message and return error code to addr+0, bits 17 through 12
11	Reserved
10	Forms code
9	Priority
8	Internal characteristics
7	External characteristics
6	Reserved
5	Reserved for installations
4	Disposition code
3	Reserved
2	TID
1	Route to central site
0	End-of-job (deferred ROUTE)

The system determines the routing destination of an output file by flag bits 1 and 2 (route to central site and TID, respectively) as follows:

<u>Central Site Bit</u>	<u>TID Bit</u>	<u>Routing Activity</u>
0	0	If the calling job is remote batch origin, the system routes output to the remote batch queue and associates with it the user number and family of the originating remote batch terminal. If the calling job is any other origin type, the system routes output to the central site queue. If the file being routed was previously routed with queuing deferred, the previously specified destination remains in effect.

<u>Central Site Bit</u>	<u>TID Bit</u>	<u>Routing Activity</u>
0	1	The system routes output according to the contents of the TID field (description follows).
1	0	The system routes output to the central site queue.
1	1	The system routes output to the central site queue if the TID field contains a valid ID code; otherwise, the system aborts the job.

TID For routing to a remote batch queue, the TID should contain the complement of the address of a two-word block. The first word of the block contains the family name and the second word contains the user number (both left-justified and zero-filled). This is the user number that must be used to log in at a remote terminal to get the routed file.

If the address specified by the TID field equals 77777777₈, the file is routed to the remote batch queue with the family and user number of the calling job.

For routing to the local batch queue, the TID contains an ID code (right-justified).

priority If job priority is greater than 7760 octal, the specified priority is used for output files (otherwise field is ignored)

spacing Spacing code for output files (580 PFC). Octal value from 0 to 77.

abort code If bit 44 of the DSP parameter word 1 is set, the value of this field determines which message from the following table is sent to the dayfile.

<u>Value</u>	<u>Message</u>
0001	Job statement error
0002	Card reader error
0003	Operator input termination
0004	Disk full
0005	Disk parity error

Any other value will cause the message

DSP-INVALID JOB ABORT CODE.

to be issued.

rc Repeat count

ROUTE

The format of the ROUTE macro is as follows:

<u>LOCATION</u>	<u>OPERATION</u>	<u>VARIABLE SUBFIELDS</u>
	ROUTE	addr, r

addr Address of parameter block

r Auto recall

Example 1:

The following example routes a file named PRINTF for printing on any central site line printer.

```
      .  
      .  
PBLK  VFD      42/0LPRINTF, 18/0  
      VFD      24/0, 12/2HLP, 6/0, 18/22B  
      VFD      60/0  
      VFD      60/0  
      VFD      60/0  
      VFD      60/0  
      VFD      60/0  
      .  
      .  
      ROUTE    PBLK, R  
      .  
      .
```

Example 2:

The following example defers routing a file named PRINTF in ASCII graphic 95-character set and specifies that two copies be printed.

```
      .  
      .  
PBLK  VFD      42/0LPRINTF, 18/0  
      VFD      24/0, 12/2HLP, 3/6, 3/0, 18/40221B  
      VFD      60/0  
      VFD      60/0  
      VFD      42/0, 6/1, 12/  
      VFD      60/0  
      VFD      60/0  
      .  
      .  
      ROUTE    PBLK, R  
      .  
      .
```

Example 3:

The following example routes a file named JOB1 to the input queue for processing at the central site and writes the job name assigned by the system to the user dayfile.

```
      .
      .
PBLK  VFD      42/0LJOB1,18/0
      VFD      12/0,12/1000B,12/2HIN,6/0,18/402022B
      VFD      60/0
      VFD      60/0
      VFD      60/0
      VFD      60/0
      VFD      60/0
      .
      .
      ROUTE     PBLK,R
      SA1       PBLK
      MX0       42
      BX6       X0*X1
      SA6       A1
      MESSAGE   PBLK,3
      .
      .
```

ERROR PROCESSING

When an error occurs in processing a ROUTE macro or DSP call, either a dayfile message explaining the error is issued, or an error code is returned in bits 17 through 12 of addr+0. If the address of the parameter block is outside the field length of the job or if the completion bit is set when the function is issued, the job step aborts. For all other errors, the function is not executed, but error processing continues. If bit 12 of the flags field is set, an error code is returned and no dayfile message is issued. If bit 12 is not set, no error code is returned, a dayfile message is issued, and the job step aborts.

When a diagnostic is issued for the ROUTE macro, the message

```
      ERROR IN ROUTE FUNCTION LFN = lfn.
```

is issued, followed by the message describing the error.

The error codes that can be returned are as follows:

<u>Error Codes</u>	<u>Description</u>
1	File name error
2	File not on mass storage
3	Illegal file type
4	Output file limit
5	Route to input not immediate
6	Immediate routing - no file
7	Invalid disposition code
10	Reserved
11	Reserved
12	Illegal request (unconditional abort)
13	Reserved
14	Reserved
15	Reserved

<u>Error Codes</u>	<u>Description</u>
16	Cannot route job input file
17	Completion bit already set (unconditional abort)
20	File on removable device
21	Invalid TID
22	Forms code not alphanumeric
23	Reserved
24	Reserved
25	Reserved
26	This routing not allowed
27	FNT/device full
30	Local file limit
31	I/O sequence error (unconditional abort)
32	Job statement error
33	Too many deferred batch jobs
34	Illegal user statement (returned for jobs with priority greater than 7760 ₈)
35	Device unavailable
36	Illegal file mode
37	Invalid external characteristics
40	Illegal origin type
41	Invalid spacing code
42	Invalid job abort code

For a complete listing of error messages, refer to appendix B.

SYSTEM TIME/DATE REQUESTS

NOS provides several system requests associated with the time and date. These requests are processed directly by CPUMTR. Unless otherwise noted, the only common deck required for absolute assemblies is COMCSYS.

The format of the RA+1 call to the time function processor is:

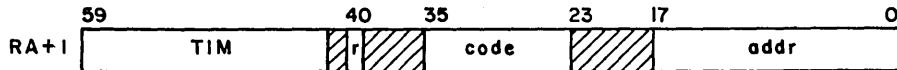

r Auto recall bit. (Must be set.)

code Function code as follows:

Code	Macro	Description
0000	TIME	Accumulated CP time used by the job
0001	DATE	Current date in display code
0002	CLOCK	Current time of day in display code
0003	JDATE	Current julian date
0005	RTIME	Elapsed real time since last deadstart
0006	PDATE	Current date and time in packed binary form
0007	STIME	Accumulated system resource units
0011	HTIME	Accumulated clock cycle count for control point
0012	HTIME	Accumulated clock cycle count since deadstart

addr Address of a reserved one word block that will receive the reply.

The EDATE and ETIME macros described in this section do not have an RA+1 call. They are processed by common deck COMCEDT and are used to convert the format of a date and time returned by a previous macro call.

CLOCK

In response to the CLOCK function, the system returns the current time of day in display code in location addr.

Macro Format:

LOCATION	OPERATION	VARIABLE SUBFIELDS
	CLOCK	addr

addr Address to receive the clock reading

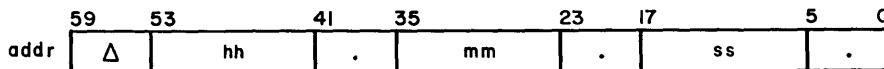

DATE

In response to the DATE function, the system returns the current date in display code format in location addr.

Macro Format:

LOCATION	OPERATION	VARIABLE SUBFIELDS
	DATE	addr

addr Address to receive the date

	59	53	41	35	23	17	5	0
addr	Δ	yy	/	mm	/	dd	.	

EDATE

EDATE takes the packed date and converts it to display code.

	59				17	11	5	0
pdate	0					yy	mm	dd

yy Year minus 1970
 mm Month
 dd Day

Macro Format†

LOCATION	OPERATION	VARIABLE SUBFIELDS
	EDATE	pdate

pdate Register or expression containing packed date to be converted.

Upon completion, X6 contains the following:

	59	53	41	35	23	17	5	0
(X6)	Δ	yy	/	mm	/	dd	.	

This macro requires the common deck COMCEDT.

†This macro is not available in SYSTEXT. The user must specify systems text PSSTEXT or call common deck COMCMAC (refer to appendix A).

ETIME

ETIME takes the packed time and converts it to display code.



hh Hours
mm Minutes
ss Seconds

Macro Format: †

LOCATION	OPERATION	VARIABLE SUBFIELDS
	ETIME	ptime

ptime Register or expression containing packed time to be converted.

Upon completion, X6 contains the following:

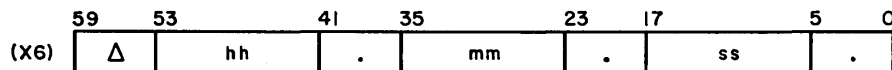

This macro requires the common deck COMCEDT.

HTIME

The HTIME macro returns the CYBER 170 Series, Model 176 accumulated CPU clock cycle count (if available) either for the user's job or since the last system deadstart. A clock cycle on the model 176 is 27.5 nanoseconds.

Macro Format:

LOCATION	OPERATION	VARIABLE SUBFIELDS
	HTIME	stat, op

addr Address to receive accumulated CPU clock cycle count.
op Option desired: if 0, accumulated clock cycle count for the user's job is returned (function code 11); if 1, accumulated clock cycle count since the last system deadstart is returned (function code 12).

† This macro is not available in SYSTEXT. The user must specify systems text PSSTEXT or call common deck COMCMAC (refer to appendix A).

After the HTIME request is processed, location addr has the following format.

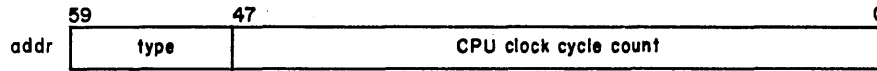

type If the model 176 CPU clock cycle count is available, type is 2000g. If the model 176 CPU clock cycle count is not available, type is 6000g.

JDATE

JDATE returns the current Julian date in addr.

Macro Format:

LOCATION	OPERATION	VARIABLE SUBFIELDS
	JDATE	addr

addr Address which receives the Julian date



yy Julian year

ddd Julian day

PDATE

PDATE returns the current date and time in binary packed format. The user can unpack the parameters or use the EDATE and ETIME macros to do the unpacking.

Macro Format:

LOCATION	OPERATION	VARIABLE SUBFIELDS
	PDATE	addr

addr Address to receive the packed date

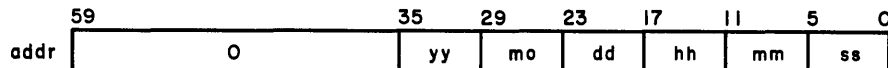

yy Year minus 1970

mo Month

dd Day

hh Hours

mm Minutes

ss Seconds

RTIME

In response to the RTIME function, the system returns the real-time clock reading in location addr. This is the elapsed time since deadstart.

Macro Format:

LOCATION	OPERATION	VARIABLE SUBFIELDS
	RTIME	addr

addr Address to receive the clock reading

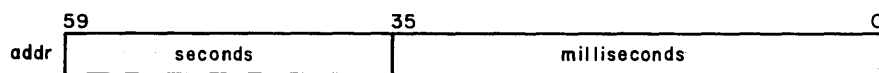

STIME

With the STIME macro, the user can determine his accumulated system resource units (SRU). Refer to the NOS System Maintenance Reference Manual for a description of SRUs.

Macro Format:

LOCATION	OPERATION	VARIABLE SUBFIELDS
	STIME	addr

addr Address to receive SRU value

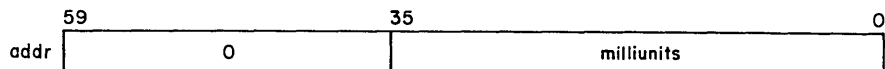

milliunits Accumulated system resource units/1000

TIME

The TIME function returns the accumulated central processor time used by the job in location addr.

Macro Format:

LOCATION	OPERATION	VARIABLE SUBFIELDS
	TIME	addr

addr Address to receive the CPU time

	59	47	35	11	0
addr	2000	0000	seconds	milliseconds	

milliseconds Accumulated central processor time/1000

TRANSLATE CONTROL STATEMENT

Translate control statement (TCS) processes user requests to read a control statement from or place a control statement in the control statement stream. The only common deck required for absolute assembly is COMCSYS.

The format of the RA+1 call is:

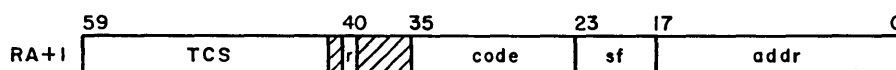

r Auto recall bit

code Function code:

<u>Code</u>	<u>Macro</u>
004	CONTROL
005	EXCST

sf Subfunction code for the CONTROL macro. This field is not used for the EXCST macro.

<u>sf</u>	<u>Action</u>
00	Read the next control statement and advance the control statement pointer.
01	Read the next control statement only if it is not a local file call. Do not advance the control statement pointer.
02	Read the next control statement even if it is a local file call. If the statement is a local file call, set bit 17 of RA+64 ₈ . Do not advance the control statement pointer.
4x	If the next control statement being read should be processed in product set format, sf is set to 4x, where x can be 0, 1, or 2, corresponding to one of the above options. If bit 23 of RA+1 is not set, control statement parameters are to be processed in NOS format.

addr First word address of the buffer in which the control statement is to be stored or from which the control statement is to be read.

CONTROL (004)

The CONTROL macro allows the user to read the next control statement in the control statement stream and transfer it to the address specified. The control statement is checked for syntax errors, and all parameters are stored as if a program load had actually taken place.

If no control statement exists, binary zero words are returned to the buffer. If the next statement is of the form:

```
*comments
```

the statement is returned to the buffer if the comments string ends with a period or right parenthesis, or if the requesting program was loaded from the system library and contains an ARG= entry point (refer to appendix F). Otherwise, the binary zero words are returned to the buffer.

Macro Format:

LOCATION	OPERATION	VARIABLE SUBFIELDS
	CONTROL	addr, rss, lf, psf

addr	First word address of the buffer in which the next control statement is to be stored. The user should allow room for eight words (80 characters). If addr+7 is not less than the job's field length, the following message is issued to the user's dayfile. BUFFER ARG. ERROR.
rss	If rss is specified (any value may be used), the control statement pointer is not advanced. This allows the user to determine what the next statement is and still allow it to be processed. If rss is not specified, the control statement pointer is advanced as if the statement had been processed.
lf	If lf is specified (any value may be used), the next control statement is read even if the statement calls for the execution of a local file; the control statement pointer is not advanced. If lf is specified and the call is for a local file, the system sets bit 17 in RA+64g (ACTR). If lf is not specified and rss is specified, the next control statement is read only if it is not a local file call. Unless the rss parameter is specified, the lf parameter is ignored.
psf	If psf is specified (any value may be used), parameters are unpacked in product set format.

† Refer to appendix F for a description of special entry points.

EXCST (005)

With the EXCST macro the user specifies a buffer containing a control statement. Control is transferred from the calling program to the system, which reads the control statement, places it in the control statement stream, and processes it. Control is not returned to the calling program. The control statement must conform to NOS control statement format conventions described in section 5, volume 1.

Macro Format:†

LOCATION	OPERATION	VARIABLE SUBFIELDS
	EXCST	addr

addr

First word address of the buffer containing the control statement to be processed. The system begins reading at addr and continues until the end of statement (zero byte) or end of buffer (80 characters) is reached. The control statement must be left-justified with zero fill. If the buffer extends past the job's field length, the following message is issued to the user's dayfile.

BUFFER ARG. ERROR.

CHECKPOINT/RESTART

A job may be terminated at any time as the result of system, operator, or programmer error. For some jobs it becomes more advantageous to accept the overhead of checkpoint procedures than to run the risk of losing the entire job output. The checkpoint/restart feature is implemented through the CKP control statement or CHECKPT macro and the RESTART control statement. Refer to volume 1 for discussions of the CKP and RESTART control statements.

CHECKPT

The CHECKPT macro is used for taking checkpoint dumps. The dump is written on the tape or mass storage checkpoint file specified on a REQUEST, ASSIGN, or LABEL control statement or REQUEST or LABEL macro. For a general description of checkpoint dumps, refer to volume 1. The CHECKPT macro provides the user greater control than the CKP control statement in specifying the type of copy to be performed.

NOTE

A checkpoint is not allowed in a job step that has issued a PROTECT macro selecting user file privacy, or in a program which has been loaded from an execute only file.

† This macro is not available in SYSTEXT. The user must specify systems text PSSTEXT or call common deck COMCMAC (refer to appendix A).

The format of the RA+1 call is:

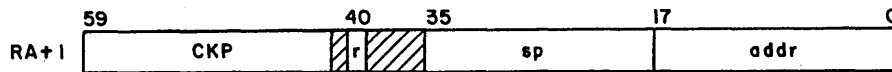

- r Auto recall bit.
- sp Flag indicating whether or not all files assigned to the job are to be checkpointed. If sp is specified (any value may be used), only those files specified in the parameter block at address addr will be checkpointed. If the sp field is not specified, all local files will be checkpointed.
- addr Address of the parameter block identifying the files to be checkpointed.

Macro Format: †

LOCATION	OPERATION	VARIABLE SUBFIELDS
	CHECKPT	addr, sp

- addr Address of the parameter list identifying the files to be checkpointed.
- sp Flag indicating whether or not all files assigned to the job are to be checkpointed. If sp is specified (any value may be used), only those files specified in the parameter block at address addr will be checkpointed. If the sp field is not specified, all local files will be checkpointed.

Parameter list format:

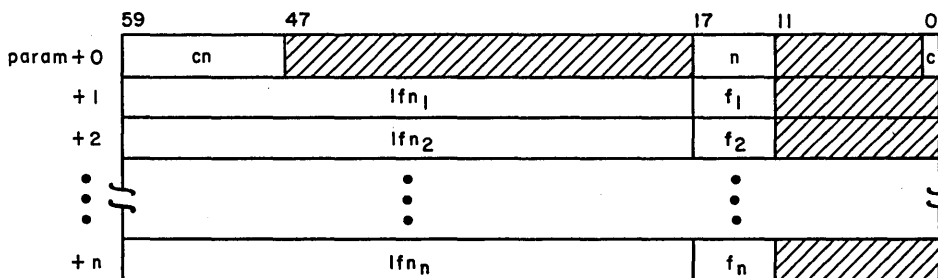

- cn Latest checkpoint number
- n Octal number of entries in the parameter list: ($0 \leq n \leq 77_8$)
- c Completion bit; set by CHECKPT when the checkpoint is complete
- lfn_i Identifies file to be checkpointed; lfn_i is left-justified
- f_i Specifies the manner in which lfn_i is to be copied:

† This macro is not available in SYSTEXT. The user must specify systems text PSSTEXT or call common deck COMCMAC (refer to appendix A).

<u>f_i</u>	<u>Description</u>								
0	The file is copied from the BOI to its position at checkpoint; only that portion is available for restart. RESTART positions the file at the latter point.								
1	The file is copied from its position at checkpoint to the EOI; only that portion is available for restart. RESTART positions the file at the former point.								
2	The entire file is copied. RESTART sets the file to its position at checkpoint time.								
3	The last operation on the file determines how the file is copied.								
	<table border="0" style="margin-left: auto; margin-right: auto;"> <thead> <tr> <th style="text-align: center;"><u>Last Operation</u></th> <th style="text-align: center;"><u>f Selected</u></th> </tr> </thead> <tbody> <tr> <td style="text-align: center;">Write</td> <td style="text-align: center;">f_i = 0</td> </tr> <tr> <td style="text-align: center;">Read (EOI detected)</td> <td style="text-align: center;">No copy</td> </tr> <tr> <td style="text-align: center;">Read (EOI not detected)</td> <td style="text-align: center;">f_i = 2</td> </tr> </tbody> </table>	<u>Last Operation</u>	<u>f Selected</u>	Write	f _i = 0	Read (EOI detected)	No copy	Read (EOI not detected)	f _i = 2
<u>Last Operation</u>	<u>f Selected</u>								
Write	f _i = 0								
Read (EOI detected)	No copy								
Read (EOI not detected)	f _i = 2								
4	The information table associated with the file is copied but the file itself is not copied. The information table contains FNT/FST information and the random address of the file. RESTART retrieves the file and sets it to its position at checkpoint time. If f _i =4 and the file is a mass storage file, RESTART assumes it is an indirect access file and issues a GET macro to obtain a working copy.								

The following list shows the type of operation CHECKPT performs for the different values of sp and n.

<u>sp</u>	<u>n</u>	<u>Operation</u>
0	0	All files assigned to the job at checkpoint time are copied according to the last operation performed.
≠0	0	All files assigned to the job at checkpoint time are copied according to the last operation performed.
0	≠0	All files assigned to the job at checkpoint time are copied. The n files included in the parameter list are copied according to their respective f values. All other files are copied according to the last operation performed.
≠0	≠0	The n files specified in the parameter list are copied according to their respective f values.

The INPUT, OUTPUT, PUNCH, PUNCHB, and LGO files are always checkpointed; they are copied according to the last operation performed (refer to f_i=3), regardless of the sp and n values.

For all other files except direct access files, the default copy type is f=4 when n≠0. For direct access files, the type of copy CHECKPT makes depends on the access mode.

	<u>Mode</u>	<u>User Option</u>	<u>Default</u>
W	Write	Any type of copy†	Copied (f=3)
R	Read-only	Any type of copy	Not copied (f=4)
E	Execute-only	Only f=4	Not copied (f=4)
A	Append-only	Any type of copy†	Copied (f=3)
M	Modify	Any type of copy†	Copied (f=3)
RA	Read and append	Any type of copy†	Copied (f=3)
RM	Read and modify	Any type of copy†	Copied (f=3)

For a random file the copy type must be f=2 or it will be copied according to the last operation performed (f=3).

REPRIEVE PROCESSING

Reprieve processing (routine RPV) enables the user to intercept interrupts prior to an abort of a program and to take corrective action. This action can be the completion of files (such as flushing buffers or closing files) and tables or it may be an attempt to correct the problem.

The format of the call to RPV is as follows:

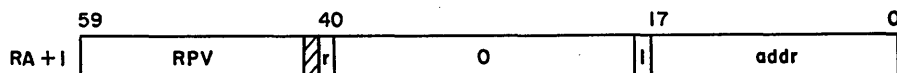

r Auto recall bit (must be set)
 addr First word address of the parameter block

RPV supports the following functions.

- Setup
- Resume
- Reset

The setup function is used to initialize the parameters for the RPV interface (that is, setting the mask bits that indicate which errors are to be intercepted). It also initializes all RPV data in the user's control point area; if the parameter block indicates pending interrupts or I/O requests, these are processed at that time.

† If f=4 is selected, the user must retrieve the file himself at restart time and select the NA and FC options on the RESTART control statement (refer to section 12, volume 1).

The resume function is used to restart the program after an interrupt has been processed. Any pending interrupts that occurred during the processing of the previous interrupt are detected then and the interrupt handler is restarted to process these interrupts. Optionally, the mask bits can also be changed during the resume function. Two modes of resume are allowed: program mode and interrupt handler mode.

Program mode resume assumes that the interrupt handler has completed processing of the interrupt and the program is to be restarted as though the interrupt had not occurred.

Interrupt handler mode resume restarts the executing program as a part of interrupt processing until a logical interrupt point is reached. This allows the interrupt handler to remain active over an interrupt handler mode resume so that, after required processing has completed, a reset function can be issued to reset the error flag.

NOTE

Before issuing a resume function, the interrupt handler must ensure that the pending RA+1 request is valid or zero (it is recommended that the user check if bits 59 through 42 are zero and then clear the entire word from the reprieve block before issuing the resume). The system returns the contents of the program's RA+1 to the reprieve parameter block at the time of the interrupt. This may contain system information rather than a valid RA+1 call if an outstanding RA+1 request with recall is in progress.

The reset function is used to reset a previous error flag and allow the operating system error handling routines to process the error. That is, the mask bits are cleared to disable further reprieve processing and the system processes the error as if the appropriate mask bit had not been set. Pending interrupts are not processed; however, any pending RA+1 request is reset and the exchange package is reset from the reprieve parameter block.

NOTE

A terminal interrupt sets a pseudo error flag. Reset of a terminal interrupt is treated as if there were no error and causes the program to resume execution, using the exchange package from the reprieve parameter block.

The format of the parameter block is as follows:

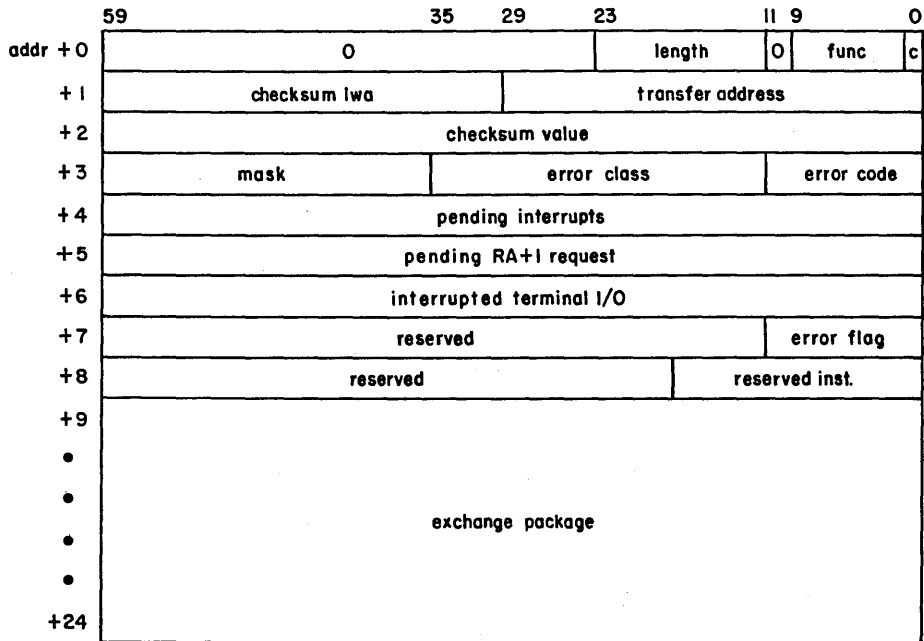

length Length of the parameter block including the exchange package area (minimum of 25 words).

func Function code:

- 1 Setup
- 2 Program mode resume (RESUME)
- 3 Reset
- 4 Interrupt handler mode resume (IRESUME)

c	Completion bit (set by RPV when operation is complete).																		
checksum lwa	Specified by the user to indicate the end of the area to be checksummed and compared or set. If zero, no checksum is desired (checksum area begins at transfer address).																		
transfer address	Address to which control is transferred when an interrupt is processed.																		
checksum value	Either set to the checksum of the indicated area when RPV is called, or compared against the computed checksum (if checksum lwa is specified) when a retrievable error is processed.																		
mask	Mask bits to be set by call:																		
	<table border="0"> <thead> <tr> <th style="text-align: center;"><u>mask</u></th> <th style="text-align: center;"><u>Description</u></th> </tr> </thead> <tbody> <tr> <td>001</td> <td>CPU error exit</td> </tr> <tr> <td>002</td> <td>PP call error</td> </tr> <tr> <td>004</td> <td>SRU limit</td> </tr> <tr> <td>010</td> <td>Operator termination</td> </tr> <tr> <td>020</td> <td>PP abort</td> </tr> <tr> <td>040</td> <td>CPU abort</td> </tr> <tr> <td>100</td> <td>Normal termination</td> </tr> <tr> <td>200</td> <td>Terminal interrupt</td> </tr> </tbody> </table>	<u>mask</u>	<u>Description</u>	001	CPU error exit	002	PP call error	004	SRU limit	010	Operator termination	020	PP abort	040	CPU abort	100	Normal termination	200	Terminal interrupt
<u>mask</u>	<u>Description</u>																		
001	CPU error exit																		
002	PP call error																		
004	SRU limit																		
010	Operator termination																		
020	PP abort																		
040	CPU abort																		
100	Normal termination																		
200	Terminal interrupt																		
error class	Set to the value of the mask bit which intercepts the indicated error (that is, if error x is intercepted by mask bit n, then bit n in the error class field is set). Refer to table 2-10-1 for a list of error classes.																		
error code	Octal code indicating error encountered. Refer to table 2-10-1 for a list of error codes and their meanings.																		
pending interrupts	Used to queue pending interrupts (that is, the nth error code sets bit n in this field).																		
pending RA+1 request	Contents of RA+1 at time of interrupt. RA+1 is reset from this field on a resume or reset call.																		
interrupted terminal I/O	Contains interrupted input request if an interrupt occurs while a terminal input request is pending. The format is as follows:																		
	<table border="1" style="margin-left: auto; margin-right: auto;"> <tr> <td style="text-align: center;">59</td> <td style="text-align: center;">35</td> <td style="text-align: center;">17</td> <td style="text-align: center;">0</td> </tr> <tr> <td style="text-align: center;">CIOP</td> <td style="text-align: center;">0</td> <td colspan="2" style="text-align: center;">FET address</td> </tr> </table>	59	35	17	0	CIOP	0	FET address											
59	35	17	0																
CIOP	0	FET address																	
error flag	Value of the operating system error flag at the time of the interrupt (refer to EREXIT macro in section 6).																		
reserved inst.	This area is reserved for use by the installation.																		
exchange package	A copy of the exchange package at the time of the interrupt (unchanged from the executing package at the time of the error). This is the exchange package that is used when the interrupt handler is started.																		

Table 2-10-1 lists the return information for RPV error codes, classes, and flags.

TABLE 2-10-1. RPV ERROR CODES, CLASSES, AND FLAGS

Error Code	Description	Error Class	Corresponding Error Flags
0	Normal termination	100	None
1	Time limit	004	TLET
2	CPU error exit	001	ARET, PEET, PSET
3	PP abort	020	PPET
4	CPU abort	040	CPET
5	PP call error	002	PCET
6	Operator drop	010	ODET
7	Operator kill	010	SSET, OKET, ORET, SYET, FSET
10	Operator rerun	010	RRET
11	Control statement error	040	None
12	ECS parity error	020	ECET
15	Auto recall error	002	None
16	Job hung in autorecall	002	None
17	Mass storage limit	004	FLET, TKET
20	PP program not in library	002	None
21	I/O limits	004	SRET
40	Terminal interrupt	200	TIET

Refer to appendix B for a list of error messages issued by RPV.

REPRIEVE

The REPRIEVE macro provides access to the extended reprieve processing capabilities of RPV. REPRIEVE parameters are inserted into the designated positions in the parameter block. Other fields are the responsibility of the caller.

Macro Format:†

LOCATION	OPERATION	VARIABLE SUBFIELDS
	REPRIEVE	addr, type, mask

addr Address of the parameter block
type Type of call: SET, RESET, RESUME (program mode), or IRESUME (interrupt handler mode)
mask Desired mask setting

†This macro is not available in SYSTEXT. The user must specify systems text PSSTEXT or call common deck COMCCMD (refer to appendix A).

The REPRIEVE macro issues the RA+1 request without using common deck COMCSYS since the routine is not reentrant and the interrupt could have occurred there. Users should be aware of access by the interrupt handler to any other portions of the program which may not be reentrant and shared with noninterrupt handler code.

One way a user can avoid this problem is to qualify the macros used in the interrupt handler that use COMCSYS to issue the requests, and also provide a qualified copy of COMCSYS to ensure that no conflict exists. The following example illustrates this process with the MESSAGE macro.

```

Interrupt handler code
.
.
QUAL  IHX
MESSAGE ERR1,3
QUAL  *
.
.
ERR1  DATA  C* SOME ERROR*
      QUAL  IHX
OPL   XTEXT  COMCSYS
      QUAL  *
.
.

```

Refer to the DISTC macro in section 12 for a description of the methods by which a user program can control the processing of terminal interrupts. Error flags can be set by using the MODE macro described in section 6.

RECOVR

The RECOVR macro enables the user to perform normal reprieve processing via the RECOVR macro. RECOVR does not support extended reprieve capabilities. This means that if an error is trapped as a result of a RECOVR macro, it is not possible to RESET the error or RESUME the program at the point of interrupt. These capabilities are only available with the REPRIEVE macro.

Macro Format:†

LOCATION	OPERATION	VARIABLE SUBFIELDS
	RECOVR	addr, mask, chk

addr Address of recovery routine
mask Mask bits (refer to REPRIEVE macro)
chk Checksum last word address (0 if no checksum desired)

The RECOVR macro cannot be used to process terminal interrupts. However, the user can issue a DISTC macro (refer to section 12) in addition to a RECOVR macro.

† This macro is not available in SYSTEXT. The user must specify systems text PSSTEXT or call common deck COMCCMD (refer to appendix A).

The RECOVR macro cannot be used to process terminal interrupts. However, the user can issue a DISTC macro (refer to section 12) in addition to a RECOVR macro.

SYSTEM REQUESTS

The following requests perform miscellaneous tasks associated with a job. Most of the requests are processed by the system monitor directly rather than by a specific function processor. The calling format is shown for each macro. Unless otherwise noted, the only common deck required for absolute assemblies is COMCSYS.

ABORT

The user can request the monitor to set the error flag at the control point when a program error occurs by using the ABORT function. If the control statement record of the job deck contains an EXIT statement, the system continues job processing with the control statement that immediately follows the EXIT statement. This process can be altered by reprieve processing (refer to section 10).

The format of the RA+1 call for this function is:

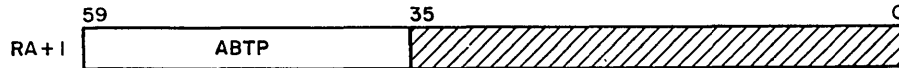

Macro Format:

LOCATION	OPERATION	VARIABLE SUBFIELDS
	ABORT	

DAYFILE

The DAYFILE macro enables the user to access the job dayfile. A FET of at least seven words must be specified.

A portion of the dayfile resides in the system central memory buffers. This is transferred to the buffer in the user's field length specified in the FET (FIRST). The user must ensure that the buffer specified is large enough to accommodate the central memory portion of the dayfile. The released size is 100g. If the buffer is too small the following message is issued:

SFM ARGUMENT ERROR.

That portion of the dayfile that resides on mass storage is made available to the user as a library file assigned to the control point in read-only mode. If a local file with the same name as the file name specified already exists, it is returned. The file is positioned at BOI. If the dayfile specified does not exist, the following message is issued:

SFM ILLEGAL REQUEST.

This macro requires common decks COMCSFM and COMSSFMS for relocatable and absolute assemblies and COMCSYS for absolute assemblies.

The format of the call to SFM is:

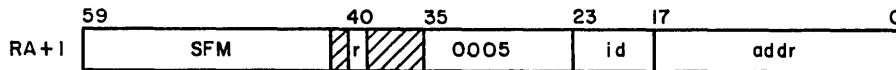

r Auto recall bit
id File identification number
addr Address of the FET for the file

The format of the FET used by SFM is:

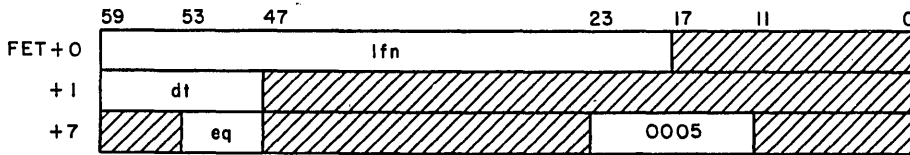

lfn Local file name
dt Device type (refer to appendix E)
eq Equipment number

Macro Format:†

LOCATION	OPERATION	VARIABLE SUBFIELDS
	DAYFILE	addr, type

addr Address of the FET for the call; name given to the mass storage portion of the file
type USER (function 0005); attach user's dayfile. This is the dayfile of the job currently running.

† This macro is not available in SYSTEXT. The user must specify system text PSSTEXT or call common deck COMCMAC (refer to appendix A).

The reply to this macro is:

59	0
FET+5	recovered dayfile length
+6	current dayfile length

The following example reads the user dayfile and writes it to OUTPUT.

```

IDENT DAYF
ENTRY DAYF
SYSCOM B1

** ASSEMBLY CONSTANTS.

CBUFL EQU 400B      RELEASED CM BUFFER LENGTH
BUFL  EQU 301B      DAYFILE/OUTPUT BUFFER LENGTH
WBUFL EQU 300B      WORKING BUFFER LENGTH

** FETS AND CONSTANTS.

I      BSS 0          DAYFILE
SCR    FILEB IBUF,BUFL,FET=7

O      BSS 0          OUTPUT
OUTPUT FILEB OBUF,BUFL,FET=7

WDCT   DATA 0          WORD COUNT OF CM BUFFER

** MAIN PROGRAM.

DAYF   SB1 1
        DAYFILE I,USER
        SA1 I+1          COMPUTE CM BUFFER WORD COUNT
        SA2 A1+1
        SX1 X1
        IX6 X2-X1
        ZR X6,DAY1      IF CM BUFFER EMPTY
        SA6 WDCT
        READW I,CBUF,X6  READ CM BUFFER

DAY1   READ I          INITIATE FILE READ
DAY2   READW I,WBUF,WBUFL
        NZ X1,DAY3      IF TRANSFER COMPLETE
        WRITEW O,WBUF,WBUFL
        EQ DAY2

```

```

DAY3   SX2   B6-WBUF   SET WORDS TRANSFERRED
        ZR    X2,DAY4   IF NONE
        WRITEW O,WBUF,X2  EMPTY BUFFER

DAY4   SA2   WDCT     GET CM BUFFER WORD COUNT
        ZR    X2,DAY5   IF CM BUFFER EMPTY
        WRITEW O,CBUF,X2  WRITE CM BUFFER

DAY5   WRITER O

        RETURN I
        ENDRUN

**     COMMON DECKS.

OPL    XTEXT  COMCSFM
OPL    XTEXT  COMSSFMS

**     BUFFERS.

IBUF   BSS    BUFL     DAYFILE BUFFER
OBUF   BSS    BUFL     OUTPUT BUFFER
CBUF   BSS    CBUFL    CM BUFFER
WBUF   BSS    WBUFL    WORKING BUFFER

        END    DAYF

```

ENDRUN

The ENDRUN function requests normal termination of a program. NOS examines the control statement record of the job input file and begins execution with the next unused control statement. If there are no more control statements or if the next statement is an EXIT statement, the system terminates the job.

The format of the RA+1 call for this function is:

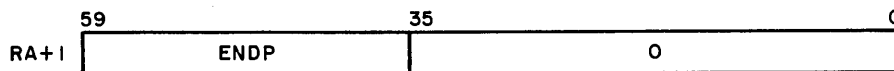

Macro Format:

LOCATION	OPERATION	VARIABLE SUBFIELDS
	ENDRUN	

GETMC

The GETMC macro allows the user to obtain information about machine characteristics and the system environment. Common deck COMCCVL is required for absolute and relocatable assemblies.

Macro Format:†

LOCATION	OPERATION	VARIABLE SUBFIELDS
	GETMC	addr

addr Address to receive machine characteristics

The format of the RA+1 call for this function is:

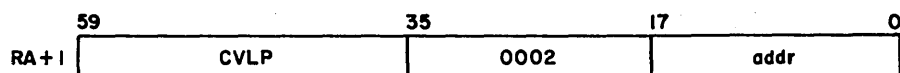

The machine characteristics are returned in the following format.

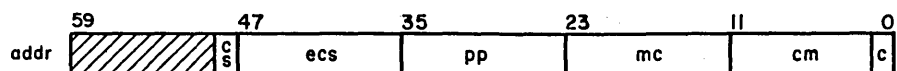

cs If bit 48 is set, system is operating in 64-character set mode.
If bit 48 is clear, system is operating in 63-character set mode.

ecs Extended core storage (ECS) size/1000_g

pp Number of PPs in system

mc Machine characteristics

<u>Bit No.</u>	<u>Description</u>
----------------	--------------------

23-20	Unused
-------	--------

19-18	Nonzero if CPU is a CYBER 170, Model 176; zero if CPU is not a Model 176
-------	--

17	Unused
----	--------

16	Set if machine is CYBER 170
----	-----------------------------

15	Set if compare move unit (CMU) option is present
----	--

14	Set if CEJ/MEJ option is present
----	----------------------------------

13	Set if CPU0 has instruction stack
----	-----------------------------------

12	Set if CPU1 is present
----	------------------------

cm Central memory size/200_g (set to 3777_g if central memory = 262K)

c Completion bit (set when operation complete)

† This macro is not available in SYSTEXT. The user must specify systems text PSSTEXT or call common deck COMCMAC (refer to appendix A).

MEMORY

Using the MEMORY function, the user can determine or change the amount of central memory or ECS associated with his job or determine the maximum amount of memory he can request.

The format of the RA+1 call for this function is:



Alternate call format: †



Macro Format:

LOCATION	OPERATION	VARIABLE SUBFIELDS
	MEMORY	type, stat, r, words, na

type CM or null for central memory; either is legal. ECS for extended core storage.

stat Status word address. May be omitted only if the words parameter is specified and na is null.

†To maintain compatibility with NOS/BE.

- r If specified, control is not returned until the request is complete. If omitted, control may be returned before the request is complete. In this case, bit 0 of the stat word is set to indicate completion.
- words Desired new field length which, if specified, overrides the stat word. If words is specified, the MEMORY macro sets the upper 30 bits of the stat word to the value of words. A negative value may not be used for words.
- na If null, the program is aborted if the user's request exceeds the current maximum which he is allowed. If this parameter is specified, the program is not aborted if the request exceeds the current maximum. Instead, the macro does not change the field length, and sets the stat word as defined below.

The stat word (if used) has the following format.

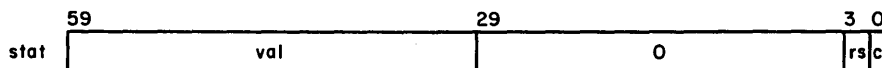

- val Prior to the macro call, val is used to specify the desired new field length (words parameter can override this value). If val (or words) is +0, then the current field length for the specified type is returned in this field. If bit 47 of val is set and specified type is CM, a memory reduction is honored even if no reduce has been selected (that is, no reduce override is in effect). † If val is -1, then the current maximum field length for the specified type is returned; if user ECS is disabled or not present, a value of zero is returned in val, regardless of any validated ECS field length. If val (or words) is greater than zero for the macro call, it contains the actual value assigned upon return. If val is -0 and type is ECS, the field length is set to 0.
- rs These bits are reserved for system usage.
- c Completion bit. The system sets this bit when the request is complete.

If a request is given for an amount greater than the current maximum (refer to the Installation Handbook for a description of the current maximum field length) and if na is specified, then no field length change occurs and control is returned with val set to the current field length value.

If the reserved bits (rs) in the status word are used, the MEMORY request or a subsequent MEMORY request may be aborted with the following dayfile message.

ILLEGAL COMMON MEMORY MANAGER REQUEST.

† Refer to the REDUCE (-) control statement in the CYBER Loader Reference Manual.

MESSAGE

The MESSAGE function allows the user to display a message on the system console display and enter it in a dayfile.

If the job is of system origin, the message may be flashed on the B display by including a dollar sign as the first character of the message and routing the message with option 2.

The maximum length of a message is 80 characters; up to 40 characters per line are displayed. The message ends with either the first word containing 12 bits of zeros in any byte or at the 80th character. Before issuing the MESSAGE function, the user must pack the display coded message in sequential locations, beginning at location addr.

The format of the RA+1 call for this function is:

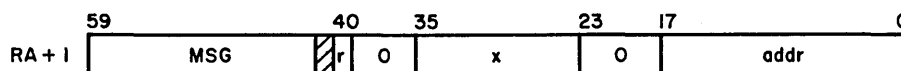

Macro Format:

LOCATION	OPERATION	VARIABLE SUBFIELDS
	MESSAGE	addr, x, r

addr	Beginning address of the message. The beginning address of the message cannot be within five words of the end of the user's field length.
x	<p>Message routing option</p> <p>x=0 Message is placed in the system dayfile, the user dayfile, and displayed at line 1 of the control point</p> <p>x=1 Message is displayed at line 1 of the control point</p> <p>x=2 Message is displayed at line 2 of the control point</p> <p>x=3 Message is placed in the user dayfile and displayed at line 1 of the control point</p> <p>x=4 Message is placed in the error log dayfile if job is special system job (that is, has an SSJ= entry point) or is of system origin; or user dayfile if not SSJ= or system origin</p> <p>x=5 Message is placed in the account dayfile if job is special system job or is of system origin; or user dayfile if not SSJ= or system origin</p> <p>x=6 Message is placed in the system dayfile, the user dayfile, and displayed at line 1 of the control point†</p> <p>x=7 Message is placed in the user dayfile and displayed at line 1 of the control point†</p>

† Provided for compatibility with NOS/BE.

If x is not specified, x=0 is assumed. If x is not defined or is an illegal positive value, x=1 is assumed. If x is a negative number, unpredictable results will occur. If x is the character string LOCAL, x=3 is used.

The control point message areas (lines 1 and 2) provide the user with the ability to display concurrently messages that enter the dayfile and those that require operator action. Line 2 is normally used to display information about the current status of the executing program; for example:

```
SKIPPING lfn
COPYING lfn
ASSEMBLING TEST
      :
```

Only messages that are of interest to other than the job, such as the control statements processed and compilers used, should be placed in the system dayfile (x=0). All messages of interest to the job, such as the path taken by the programs and the number of records copied, should be placed only in the user dayfile (x=3). All messages placed in the user dayfile (x=0 and x=3) are counted by the system. If the number of messages issued by the job exceeds the limit for which the user is validated, the following error message is issued to the user dayfile and the job is aborted.

MESSAGE LIMIT.

r If r is specified, control is not returned until the operation is complete.

If the MSG RA+1 request is issued directly (not using the macro) and the upper 12 bits of the location specified by the message address are zero, then bits 47 through 30 of this location are assumed to contain the beginning address of the message. This indirect addressing method is not supported by the macro call and unpredictable results will occur if it is attempted.

MOVE

The MOVE macro moves a block of data from addr₁ to addr₂. This macro requires the common deck COMCMVE for absolute assemblies.

Macro Format:

LOCATION	OPERATION	VARIABLE SUBFIELDS
	MOVE	count, addr ₁ , addr ₂

count Number of words in the block to be moved
addr₁ Address of the first word of the block to be moved
addr₂ Address of the first word of the destination

MOVE allows overlap in data moves; in other words, addr₂ can be less than addr₁ plus count.

RECALL

The RECALL function enables the user to relinquish the CPU until a function is completed or the CPU recall time has elapsed (delay time is set by the installation, usually 1/2 second). If the stat parameter is included in the call, control is not returned to the program until bit 0 of the word specified by stat is set. If stat is not included in the macro call, the program relinquishes the CPU only until the next pass through the recall loop.

The format of the RA+1 call for this function is:

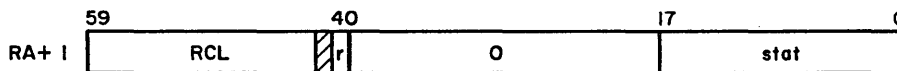

Macro Format:

LOCATION	OPERATION	VARIABLE SUBFIELDS
	RECALL	stat

stat If this parameter is present, control is returned to the program when bit 0 of the word specified by the address stat is set.

SUBR

The subroutine macro enables the user to distinguish between entering a subroutine and exiting from a subroutine even though control is transferred to the same address. Transfers to the subroutine are of the form:

RJ tag

Exits from the subroutine are of the form:

EQ tagX

Macro Format:†

LOCATION	OPERATION	VARIABLE SUBFIELDS
tag	SUBR	

SYSTEM

With the SYSTEM function, the user can request the system to process any three-character requests. Refer to Request Processors, section 1, for a list of request processors. A PP program can be called from a CPU program if the first character of the name is alphabetic. Documentation of these programs (refer to DOCUMENT statement, section 7, volume 1) should be consulted for the functions available (for example, LFM, CPM). These should be used when macros do not exist to issue the functions desired.

The format of the RA+1 call is:

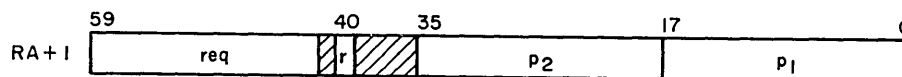

† This macro is not available in SYSTEXT. The user must specify systems text PSSTEXT or call common deck COMCMAC (refer to appendix A).

Macro Format:

LOCATION	OPERATION	VARIABLE SUBFIELDS
	SYSTEM	req, r, p ₁ , p ₂

- req Three-character system request
- r If specified, control is returned only after the request is completed
- p₁ Bits 17 through 0 of the request
- p₂ Bits 35 through 18 of the request

Example 1:

If the user wishes to dump the contents of locations 1000 to 4000 and recall the CPU when the dump is completed, the SYSTEM request is:

SYSTEM DMP, R, 4000B, 1000B

Example 2:

If the user wishes to dump the display code equivalent of the data dumped in example 1, the SYSTEM request is:

SYSTEM DMD, R, 4000B, 1000B

Example 3:

If the user wishes to dump the contents of locations 1000 to 4000 of ECS and recall the CPU when the dump is completed, the system request is formatted as follows:

SYSTEM DEP, R, addr

Location addr has the following format.

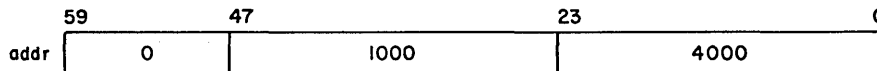

The same procedure is followed if the display code equivalent of ECS is desired using the following system request.

SYSTEM DED, R, addr

Example 4:

If the user wishes to issue a CIO function request, he can do so with the following SYSTEM request:

SYSTEM CIO, r, addr, n

where *addr* is the address of the FET for the file being read and *n* is the count for skip operations. If *r* is specified, the request is made with auto recall. When performing a CIO request in this manner, the user must set the function code in FET+0.

LOADER REQUESTS

The system provides routines to aid the user in loading overlays or capsules at specific points during program execution. The overlays or capsules can reside on files attached to the user's job or in system libraries.

OVERLAY

The OVERLAY macro processes a system request to the LDR processor. LDR provides the ability to load overlays to specified areas of the user's program area. Depending on the parameters specified and the level of the overlay, control may or may not be returned to the calling program.

The format of the RA+1 call for this function is:†



r Auto recall, if desired

addr Address of the request

The load request consists of two to four words. The two- to four-word block must be defined by the user for RA+1 calls, but is defined by the system when called from the OVERLAY macro (only two words used).

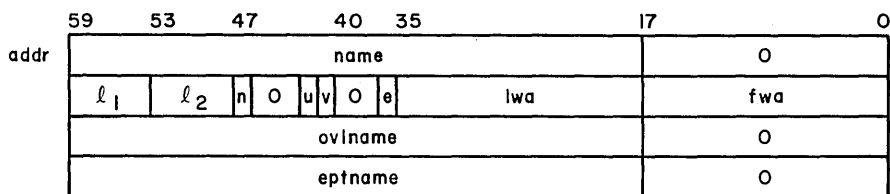

name Source of name depending on the *u* and *n* options

*l*₁ First overlay level

*l*₂ Second overlay level

n Number of words in request-2 (bits 47-46)

† LDV is processed by the system as the LDR call. This is to provide compatibility with the common product set.

u Load option (bit 42)
 v Overlay flag (must be set to 1) (bit 41)
 e Call completion flag (bit 36)
 lwa Last word address available for load
 fwa First word address of the overlay
 ovlname Name of overlay to be loaded (if n≠0)
 eptname Entry point name when loading multiple entry point overlay (if n=2)

The operation performed depends on the value of u, n, fwa, l₁, and l₂.

1. If u=0, n is ignored and name is the name of the file containing the overlay (l₁ and l₂ are required).
2. If u=1 and n=0, name is the name of the overlay from the system library (l₁ and l₂ are ignored).
3. If u=1 and n≠0, ovlname is the name of the overlay from the system library (l₁ and l₂ are ignored).
4. If fwa=0, the overlay is loaded at the address specified by the overlay.
5. If l₁=l₂=0, the (0,0 overlay) control is returned to the called overlay; otherwise, control is returned to the caller with fwa=entry address.
6. If e=1, control transfers to the specified entry point, eptname, in the overlay.

Upon completion of the load, information is returned to addr as follows:

	59	53	47	17	0
addr	name				0
	l ₁	l ₂	0		eptaddr
	ovlname				0
	eptname				0

eptaddr Entry point address of the overlay; if n=2, eptaddr is the address of eptname.

Macro Format:

LOCATION	OPERATION	VARIABLE SUBFIELDS
	OVERLAY	nam, lev, SYSTEM, fwa

nam Address of file name in L format (display code, left-justified).

lev Level of overlay. If not specified, level 0,0 is assumed and control is automatically transferred to transfer address encountered on overlay load. (Usually specified on IDENT instruction of ABS programs.) For overlay level (i, j), level is defined as: $lev=i*100_8+j$.

SYSTEM If SYSTEM is specified, file is loaded from system library and nam is name of overlay desired.

fwa If this parameter is specified, fwa is the address where the overlay is to be loaded. The file is loaded at the address specified on the overlay if this parameter is not specified.

Common decks required are COMCOVL and COMCSYS.

After the macro is processed, X1 contains the address of the entry in the overlay.

Example 1:

```

      .
      .
      .
      OVERLAY TEST
      .
      .
TEST   CON      4LTEST

```

This sequence of code loads overlay 00 from file name TEST and begins execution at the entry address specified by TEST.

Example 2:

```

      OVERLAY A, 0100B, S, LDA
      SB2      X1
      JP       B2
      .
      .
A      CON      5LARITH
      .
      .
LDA    EQU      *

```

This sequence of code loads the ARITH routine from the system (level 1, 0) library at address LDA and transfers control to the routine.

If the request calls for the overlay to be loaded and executed and no fwa load address is specified in the request, the entry point address specified in the load table is used as the entry point address. If an fwa load address is specified in the request, bias the entry point address from the load table with the difference of the fwa load address specified by the request and the fwa load address specified by the load table; that is:

$$\text{Entry point address} = (\text{entry point address from load table}) + (\text{fwa load address specified in the request}) - (\text{fwa load address from load table})$$

If the request requires just an overlay load, the entry point address returned is the entry point address in the load table.

LOADD

The LOADD macro allows the user to locate fast dynamic load (FDL) capsules or CYBER Control Language (CCL) procedures and have pertinent information returned to a specified address. Fast dynamic loading is a method of loading preprocessed binary routines.

The format of the RA+1 call for this function is:

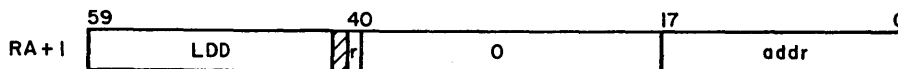

- r Auto recall bit
- addr Address of parameter block

The parameter block consists of two words in the following format.

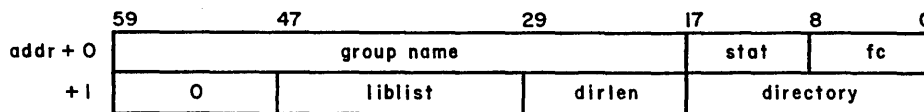

- group name Name of the group of capsules or procedures for which a directory is requested.
- stat Status of call (ignored during request). Upon completion of call, stat is set to one of the following values.

Value	Description
0	Function completed without error
1	Illegal function code
2	Bad directory address or length (address plus length must be less than or equal to field length)
3	Bad liblist address or length

The following errors may be combined with those preceding.

10 ₈	An entry in the library list did not correspond to any known local or system library name, or an entry specified the name of a file which was not a mass storage library
20 ₈	The specified directory space was not large enough to contain the entire directory
fc	Function code. LDD sets bit zero to one when the request is complete.
0	Specifies capsule (record type CAP)
404 ₈	Specifies procedure (record type PROC)
liblist	Address of a list of libraries to be searched after the global library set. Zero if no set is specified.
dirlen	Length, in central memory words, of the area to receive the generated directory. Upon completion of the call, it is set to the actual length that was needed for the complete directory (may be less than or equal to the value of the original call).
directory	Address of the area to receive the generated directory.

When called, LDD searches first the global library set (refer to the CYBER Loader Reference Manual for a description of global library sets) and then the library set specified in the call. If a library file is found to contain one or more capsules belonging to the given group or the specified procedure, an entry is made in the directory. This entry is one of two different forms, depending on whether the library is a system library or a local file library. For a procedure, LDD searches the central library directory (CLD) if the specified procedure is not found elsewhere.

For a local file library the format is:

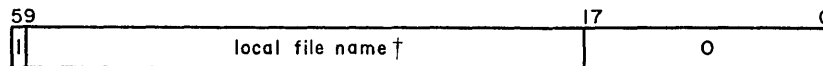

For a system library the format is:

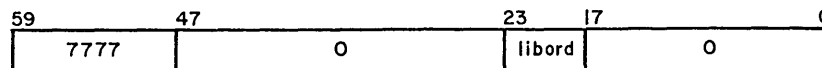

libord The library ordinal of the library containing the capsule

† The first character of the local file name cannot be numeric.

For each capsule or procedure found that belongs to the given group, LDD makes the following entry in the directory.

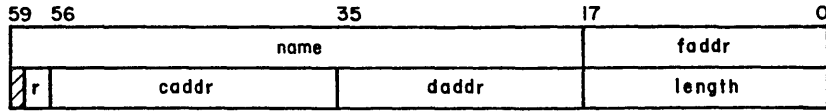

- faddr Address, relative to the beginning of the directory, of the word containing the file entry associated with this capsule or procedure.
- r Residence of capsule or procedure:
- | | |
|---|----------------------|
| 0 | Mass storage |
| 1 | Mass storage and CM |
| 2 | Mass storage and ECS |
- caddr CM or ECS address of capsule or procedure
- daddr Disk address (relative PRU) of capsule or procedure
- length Length of the capsule or procedure, including header, code image, and relocation and linking information, but excluding the prefix table.

Macro Format: †

LOCATION	OPERATION	VARIABLE SUBFIELDS
	LOADD	addr, r

- addr Address of parameter block
- r Auto recall

LOADQ

The LOADQ macro loads fast dynamic load (FDL) capsules or overlays from specified files.

The format of the RA+1 call for this function is:

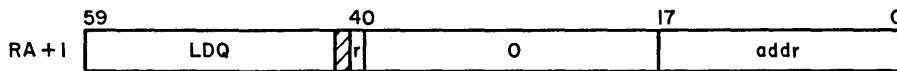

- r Auto recall bit
- addr Address of parameter block

† This macro is not available in SYSTEXT. The user must specify systems text PSSTEXT or call common deck COMCMAC (refer to appendix A).

The four-word parameter block must be defined as follows:

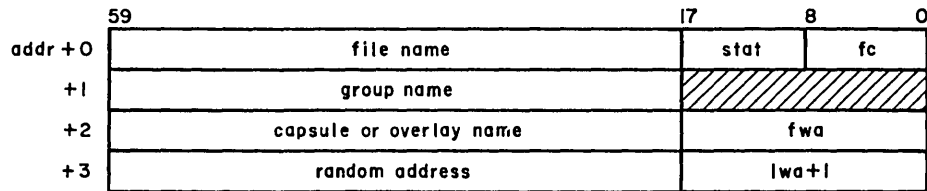

file name Name of file containing capsule or overlay
 stat Status of LDQ call (ignored during request). Upon completion of call, stat is set to one of the following values.

<u>Value</u>	<u>Description</u>
0	Function completed without error
1	Illegal function code
2	Bad address (must have $fwa < lwa + 1 < \text{field length}$)
3	Nonexistent file or file not on mass storage
4	Bad disk address (out of file bounds)
5	Capsule or overlay not found at specified location
6	Insufficient space provided for capsule or overlay

If either error 5 or 6 occurs, the contents of the loadable area are undefined.

fc Function code:
 0 Load capsule
 2 Load overlay

LDQ sets bit zero to one when the request is complete.

group name Name of capsule group; zero for overlay load

capsule or overlay name Name of desired capsule or overlay

fwa First word address of the area into which the capsule or overlay is to be read

random address Location of capsule or overlay on specified file

lwa+1 Last word address plus 1 of area for capsule or overlay

LDQ reads a capsule or overlay from the specified mass storage location, removing the prefix table, but not altering the record otherwise. LDQ ensures that the location contains a capsule (60 table), if a capsule load is requested, or an overlay (50, 51, 53, or 54 table), if an overlay load is requested. LDQ also determines that the entire capsule or overlay fits into the specified area and that the name is correct.

Macro Format:†

LOCATION	OPERATION	VARIABLE SUBFIELDS
	LOADQ	addr, r

addr Address of parameter block
r Auto recall

† This macro is not available in SYSTEXT. The user must specify systems text PSSTEXT or call common deck COMCMAC (refer to appendix A).

In using the first method, the system uses the first file that meets the following criteria.

- The file must either be assigned to the terminal (device type equals TT in the FET) or, if unassigned, must be named OUTPUT.
- The file must meet the conditions described under the flush bit (refer to description of flush bit, FET Description, in section 2).

In using the second method, the system checks only the first file in the list. It must meet the criteria above.

OTHER SPECIAL HANDLING

The following additional considerations should be noted by those attempting to write interactive programs.

- An EOR or EOF write on a terminal file has no special significance except that it ensures that the buffer is dumped to the terminal.
- When terminal input data is passed to an executing program, the following convention is followed.

If an odd number of characters is entered, the last character plus 1 is a space.

If the input data consists of data followed by a carriage return, the program has a five-word FET, the system supplies an EOR level of zero (level number is in bits 17 through 14 of the FET code and status word). If the program has a six-word or larger FET, the system supplies an EOR level of 1. If there is no data input but only a carriage return, an EOF is supplied by the system.

Thus, a program can determine if input is from a terminal by using six-word or longer FETs and by sensing an EOR level of 1. The system input/output macros and common decks are coded to handle this case properly. Thus, most of the system utilities interact with a terminal.

Input to an executing program is handled in the same manner as the CIO READSKP request. If the user's buffer is not large enough to accommodate a full line of input, the data is truncated and the excess is lost. No error code is returned.

- A program that is interacting with a terminal should not do a recall on a file assigned to a terminal if it does an EOR or EOF write on the file to clear the buffer (do not specify the r option on WRITER or WRITEF macros). If recall is specified, an extra rollout of the program is required before the program terminates. If the conventions mentioned earlier concerning the status of output are followed, it is not mandatory to write an EOR or EOF to clear the buffer; however, if it is done (to remain compatible for batch use, for example) as the last operation before placing END in RA+1 (ENDRUN macro) without recall, little system overhead is incurred.
- If the conventions for special handling are followed, a job being rolled out by the system has all completed lines of data in the output buffer sent to the terminal.

- If a job terminates because an error flag is set, the contents of the first message buffer of the control point area is sent to the terminal as part of the output. When the user is in the BATCH subsystem, this message buffer is always sent to the terminal on job termination. Messages can be placed in this area using the MESSAGE macro. Messages longer than 48 characters are truncated to 48 characters.
- If a buffer argument error is detected on an output buffer when output is being issued automatically, the output is ignored and the FET is not acted on. This error usually indicates that the executing program has destroyed part of its own field length.
- If the user program destroys its input FET after the FET has been validated by CIO, but before the data is actually passed, the input request is ignored. The probability of either of these occurrences is extremely remote.
- A COMPASS program can determine whether it is interacting with a terminal by checking the origin type that is passed or by checking the type of equipment to which the file was assigned (byte 0 of FET+1). Refer to the common deck COMCSTF, appendix A.

PROGRAM CONTROL OF TERMINAL ACTIVITY

The remainder of this section describes methods of controlling terminal activity when connected to the time-sharing executive. Two versions of the time-sharing executive exist: the Interactive Facility (IAF) which has a Network Access Method (NAM) interface; and a time-sharing subsystem which uses multiplexers to interface with terminals. The NAM interface uses 255x series communications processors. A network terminal is a terminal using the NAM interface.

The following discussions apply to both versions of the time-sharing executive, unless specifically restricted to network terminals (that is, those using NAM and IAF).

The user can control terminal activity in the following ways.

- Include control bytes in his output to control the positioning of the printing element and define alternate input modes.†
- Enter various characters or sequences of characters to control program execution.
- Issue a REPRIEVE (refer to section 10) or DISTC macro to disable the terminal operator's control of his program during various phases of execution.
- Issue a CSET macro to change the character set of the terminal.
- Issue a PARITY macro to change the parity of the terminal.††
- Issue a PROMPT macro to control the issuing of the input prompt.
- Issue a TSTATUS macro to determine certain terminal characteristics.†

† Parts of this feature do not apply to IAF.

†† Not applicable to IAF.

This conversion mode packs the 8 bits of data as the lower 8 bits of a 12-bit byte and sets the upper bit (bit 11). The exhaustion of the character count or the occurrence of the termination code causes the end-of-line condition to be set. A 0007 byte is forced as the first byte of input so the data is transmitted as transparent output if it is listed.

For network terminals, a user selected input prompt should follow the 0006 word if it is necessary to guarantee that the terminal is in transparent input mode before input is entered. For example, the following two words, when written to an ASCII-code terminal output file, switch the terminal to transparent input mode and issue three BEL characters at which point transparent input mode is in effect.

```
0006 0012 0015 0000 0000
0007 4007 4007 4007 0000
```

Byte 1 of the 0006 word specifies a maximum character count of 10 (12₈) and byte 2 specifies a termination character of carriage return (015 ASCII code). Refer to the description of the 0007 control byte for the second word.

For nonnetwork terminals, any output following the 0006 byte syntax will be discarded. If an input prompt is necessary, the program should write it to the terminal before the 0006 byte.

NOTE

The use of transparent input with CYBER Record Manager and/or product set members may yield unpredictable results. It is advisable to determine how a particular product set member treats transparent input before processing.

0007 — Initiate Transparent Output

This byte initiates transparent output. If the user wishes to output data formatted as described for transparent input, a 0007 byte must precede the data. This mode continues until an end-of-line or nontransparent output data byte is detected. Termination by an end-of-line, however, does not cause a carriage return and line feed. The 0007 byte must be byte 0 (bits 59 through 48) of the first word of a line.

A transparent output data byte is in the format 4xxx octal, where xxx is the 8-bit octal code for the character being printed. Bits 11 through 8 of a transparent data byte are always set to 1000₂. If this pattern is not detected, the terminal is switched to the original (normal or ASCII) output mode. Thus, the user can output normal or ASCII data immediately following transparent data without explicitly specifying a termination (end-of-line). The characters 5, 6, 7, and 8 (display codes 40, 41, 42, and 43 octal) match the transparent mode bit pattern when in the upper half of a byte and are interpreted as transparent data. Therefore, these characters cannot be used to terminate transparent output. Once transparent output mode is terminated, it remains cleared unless resumed by a 0007 control byte.

The following word, when output from an ASCII-code time-sharing terminal, produces a line feed and prints a question mark. There is no carriage return or line feed after the question mark.

```
0007 4012 4077 0000 0000
```

† The NOS Time-Sharing User's Reference Manual refers to this mode as binary output mode.

The 4012 byte produces a line feed (012 is the ASCII code for line feed) and 4077 is the question mark. The transparent output is terminated by the 24 bits of trailing zeros, constituting an end-of-line. Similar output can be obtained with the following:

0007 4012 7100 0000 0000

Here 71 is the display code for a question mark and 7100 is a nontransparent data byte. Transparent output is terminated at the question mark and the end-of-line produces a carriage return and line feed.

A control byte (0003, 0005, 0006) that changes the terminal input mode prevents the system from printing a question mark in response to a program request for input. However, in all other cases, a read request on the input buffer causes the system to print a question mark at the terminal.

0010 — End-of-Transaction Block†

This byte is used by the transaction subsystem (TAF/TS) to indicate the end of a transaction block. This byte must be followed by an end-of-line.

0011 — Initiate ASCII Output

This byte is used to initiate 128-character ASCII output (6/12 display code). This byte must be byte 0 (bits 59 through 48) and applies only to the line currently being output.

0012 — End-of-Transaction Block with Response†

This byte is used by the transaction subsystem to indicate the end of a transaction block with a completion response to be sent back to the transaction subsystem. This byte must be followed by an end-of-line.

0013 — End-of-String

This byte allows a user to terminate a line of output data without repositioning the terminal carriage. This byte must be followed by an end-of-line (which is ignored) and output continues with subsequent data. The 0013 byte should not be used where the effect of an end-of-line is needed (for example, the end of a logical line on a synchronous terminal).

0014 — Internal End-of-Block

This byte is the first byte of a word and is followed by an end-of-line. This byte is reserved by NOS and should not be used since it may cause loss of data.

† Not applicable to network terminals.

<u>Phase</u>	<u>Sequence†</u>	<u>Effect</u>
Generating output	BREAK CTRL T (CR) or BREAK CTRL P (CR)	If an interrupt address was specified, the program is notified of attempted control. When the BREAK key is pressed, output is suspended. However, unless CTRL T (CR) or CTRL P (CR) is entered next, the program is not notified of an attempted terminal control. If any other sequence is entered, or if just a (CR) is entered, the program is not notified of terminal control and the output operation continues.
Executing	CTRL T (CR) or CTRL P (CR)	If an interrupt address was specified, the program is notified of attempted control.

Nonnetwork Terminals

The following is a list of keys and commands and their effect on other time-sharing terminals.

NOTE

These commands do not apply to network terminals.

<u>Phase</u>	<u>Key/Command</u>	<u>Effect</u>
Waiting for input	STOP (CR) or BREAK	The user may enter the STOP command at the beginning of any input line or press the BREAK key unless transparent input mode has been selected. STOP is passed to the program as data via the input file. If an interrupt address was specified, the program is notified of attempted control.
Generating output	S or I or BREAK	If an interrupt address was specified, the program is notified of attempted control. Output is not terminated unless the program takes appropriate action.
Executing	STOP (CR) or BREAK	If an interrupt address was specified, the program is notified of attempted control.

† The termination (sometimes referred to as user break 2) sequence (that is, CTRL T (CR)) and interruption (sometimes referred to as user break 1) sequence (that is, CTRL P (CR)) may vary for different terminals. Refer to the IAF Reference Manual for further information.

CSET MACRO

The CSET macro sets the initial and current character set mode of the terminal to either ASCII or NORMAL.

Macro Format: †

LOCATION	OPERATION	VARIABLE SUBFIELDS
	CSET	arg, C

arg

Argument:

<u>Mode</u>	<u>Description</u>
ASCII	Set ASCII 128-character set mode
NORMAL	Set ASCII graphic 64/63-character set mode
RESTORE	Set current terminal character mode to initial terminal character mode

C Change initial and current terminal character mode to that specified; if C is omitted, only the current mode is changed.

NOTE

The use of this macro may cause the character mode of the terminal to switch prior to the printing of all previous output. This can be prevented by preceding the macro call with an input or roll-out request.

PARITY MACRO ††

The PARITY macro sets the terminal to the indicated parity.

Macro Format: †

LOCATION	OPERATION	VARIABLE SUBFIELDS
	PARITY	arg

arg

EVEN selects even parity; ODD selects odd parity.

NOTE

The use of this macro may cause the parity of the terminal to switch prior to all previous output being printed at the terminal. This can be prevented by preceding the macro call with an input request.

† This macro is not available in SYSTEXT. The user must specify systems text PSSTEXT or call common deck COMCMAC (refer to appendix A).

†† This macro is not applicable to network terminals. Network terminals use terminal definition commands to change their parity (the IAF Reference Manual contains a list of terminal definition commands).

CPU COMMON DECKS

A

Appendix A lists the CPU common decks of general interest to the COMPASS programmer, including a list of those common decks that are available in relocatable form on the system library (SYSLIB). The user can obtain documentation of all CPU common decks provided with the system OPL by entering the following control statement after accessing the system OPL.

```
MODIFY(Z)/*EDIT, CALLCPU  
DOCUMENT.
```

In addition, by using the KRONREF utility to determine which common decks are associated with which programs, the user can examine the program listings to obtain examples of the use of particular common decks.

Since common decks are continually being changed or updated, it is impossible to maintain a complete and current description of each common deck in this appendix. Thus, the user should consult system listings as described above for specific information.

COMCMAC

The COMCMAC common deck contains macros (not available in SYSTEXT) for issuing system functions for system-oriented programs. The common decks for the processors used must also be called by the user.

The macros defined in common deck COMCMAC are available in systems text PSSTEXT. Therefore, the user can access these macros either through the system OPL or by specifying the alternate systems text PSSTEXT.

The following COMCMAC macros are described in the indicated sections.

<u>Macro Name</u>	<u>Description</u>	<u>Section</u>
CATLIST	Catalog user's permanent files	5
CHECKPT	Create checkpoint dump	10
CSET	Set terminal character set mode	12
DAYFILE	Access dayfile	9
DISTC	Disable terminal control	12
EDATE	Edit packed date	11
ENCSF	Enter new control statement file	4
ETIME	Edit packed time	11
EXCST	Execute control statement	10
GETASL	Get account block SRU limit	6
GETFLC	Read field length control word	6
GETFNT	Read FNT/FST entry table	4
GETGLS	Get global library set	6
GETJA	Read job accounting words	6
GETJCR	Read job control registers	6

<u>Macro Name</u>	<u>Description</u>	<u>Section</u>
GETJN	Read job name	6
GETJO	Read job origin code	6
GETJSL	Get job step SRU limit	6
GETLC	Get loader control word	6
GETMC	Read machine characteristics	6
GETPFP	Get permanent file parameters	6
GETPR	Read CPU priority	6
GETQP	Read job queue priority	6
GETSS	Get subsystem	6
GETTL	Read job step time limit	6
LOADD	Load fast dynamic load capsule directory	11
LOADQ	Load fast dynamic load capsules	11
NORERUN	Clear rerun status	7
PARITY	Set terminal parity	12
PRIMARY	Make file primary	4
PROMPT	Disable/enable terminal prompt	12
PSCSF	Position control statement file	4
RERUN	Set rerun status	7
ROLLOUT	Roll out job	6
SETGLS	Set global library set	6
SETJCR	Set job control registers	6
SETLC	Set loader control word	6
SETPR	Set CPU priority	6
SETQP	Set queue priority	6
SETSS	Set subsystem	6
SETSSM	Set secure system memory	6
SUBMIT	Enter job in input queue	7
SUBR	Create subroutine tag	11
TSTATUS	Return terminal status	12

COMCCMD

The COMCCMD common deck contains macros (not available in SYSTEXT) for issuing special job control and accounting function requests.

The macros defined in common deck COMCCMD are available in systems text PSSTEXT. Therefore, the user can access these macros either through the system OPL or by specifying the alternate text PSSTEXT.

The following COMCCMD macros are described in the indicated sections.

<u>Macro Name</u>	<u>Description</u>	<u>Section</u>
COMMON	Change file type to library (LIFT)	4
GETACT	Get outstanding system activity information	6
GETEM	Read current exit mode	6
GETJCI	Get job control information	6
GETLOF	Get list of files pointer	6
MACHID	Read machine identification	6
MODE	Set exit mode flags	6
PACKNAM	Request pack name	6
PROTECT	Set ECS field length preservation and/or user file privacy	6
RECOVR	Set recovery processing	10
REPRIEVE	Set reprieve processing	10
SETASL	Set account block SRU limit	6
SETFET	FET modification macro	2
SETJCI	Set/clear job control parameters	6
SETJSL	Set job step SRU limit	6
SETLOF	Set list of files pointer	6
SETMFL	Set job maximum field length	6
SETRFL	Set job step initial field length	6
SETTL	Set job step time limit	6
VERSION	Read operating system version name	6

OTHER COMMON DECKS

The following common decks are also available to the user.

<u>Common Deck</u>	<u>Description</u>
COMCARG†	Processes an argument list by the use of an equivalence table
COMCARM	Processes multiple word arguments
COMCCDD†	Converts a binary integer to display code decimal digits with leading zero suppression
COMCCFD†	Converts a 30-bit integer to display code in FORTRAN F10.3 format
COMCCHD	Converts up to a 10-digit decimal number (40 bits) to hexadecimal display code with leading zero suppression
COMCCIO†	Performs I/O functions through the PP program CIO
COMCCOD†	Converts a binary integer to display code octal digits with leading zero suppression
COMCCPA†	Converts positional arguments in an input string to keyword arguments in an output string
COMCCPM	Calls the PP program CPM to perform tasks involving control point activity
COMCCPT†	Copies prefix table comments to a print line
COMCCVI	Contains formulas for converting validation index value to limit value
COMCCVL	Common validation interface processor
COMCDXB†	Converts one word of display code digits to a binary value
COMCECM	Contains macro definitions for performing interpretive mode ECS reads and writes (refer to appendix D)
COMCECS	Processes interpretive mode ECS read and write instructions (refer to appendix D)
COMCEDT	Edits an 18-bit packed date or time into a 10-character display coded date or time
COMCFCE	Edits a permanent file catalog entry into a three-line output formula
COMCHXB	Converts one word of hexadecimal display code digits to a binary value; leading and trailing blanks are ignored
COMCLFM	Processes requests for the PP program LFM
COMCLOD	User call loader interface
COMCMTM†	Contains macro for generation, allocation, and processing of managed tables

† This common deck is also available on the program library (PL) that contains the common common decks. Contact site personnel for further information.

<u>Common Deck</u>	<u>Description</u>
COMCMTP†	Contains routines for processing managed tables
COMCMVE†	Moves a block of data
COMCOVL	Requests the PP program LDR to load a specified overlay
COMCPFM	Performs permanent file action functions by calls to the PP program PFM
COMCPOP	Obtains parameters from a string buffer
COMCRDC†	Reads one coded line from a CIO buffer to a working buffer
COMCRDH†	Reads one coded line from a CIO buffer to a working buffer with trailing space fill
COMCRDO†	Reads one word from a CIO buffer to the X6 register
COMCRDS†	Reads one coded line from a CIO buffer to a working buffer where it is stored one character per word
COMCRDW†	Reads the specified number of words from a CIO buffer to a working buffer
COMCRSP	Removes secure parameters from control statement
COMCSFM	Processes requests for the PP program SFM
COMCSFN†	Replaces trailing 00 codes with 55 codes in a word
COMCSNM	Sets name in message
COMCSRT†	Identifies the format of a record from the first 64 words located in a working buffer
COMCSSN	Skips a sequence number on a coded line if present
COMCSST†	Sorts a table into ascending order using a shell-sorting technique
COMCSTF†	Determines if a file is, or will be, assigned to a terminal
COMCSYS†	Contains routines for processing system requests
COMCUPC†	Unpacks a control statement to individual parameters
COMCUSB	Unpacks data block to string buffer
COMCWOD†	Converts a word to octal display code by an in-line sequence of shifts and masks
COMCWTC†	Transfers one coded line in C format from a working buffer to a CIO buffer
COMCWTH†	Transfers one coded line in H format from a working buffer to a CIO buffer; trailing spaces are deleted
COMCWTO†	Writes one word to a CIO buffer from X6
COMCWTS†	Transfers one coded line from a string buffer to a CIO buffer with trailing space suppression
COMCWTW†	Transfers data from a working buffer to a CIO buffer
COMCZAP	Z argument control statement processor
COMCZTB†	Replaces all 00 codes with 55 codes in a word

† This common deck is also available on the program library (PL) that contains the common common decks. Contact site personnel for further information.

SYSLIB

The following common decks, unless otherwise noted, are assembled from the PL that contains the common common decks and are available in relocatable form on the system library SYSLIB.

<u>Common Deck</u>	<u>Entry Points</u>	<u>Description</u>
COMCCIO	CIO=	I/O function processor
COMCCPM†	CPM=	Control point manager processor
COMCECS†	REC=, WEC=	ECS interpretive mode macro processors
COMCLFM†	LFM=	Local file manager processor
COMCMVE	MVE=	Move block of data
COMCOVL†	OVL=	Overlay load processor
COMCPFM†	PFM=	Permanent file processor
COMCRDC	RDC=	Read coded line, -C- format
COMCRDH	RDH=	Read coded line, -H- format
COMCRDO	RDO=	Read one word
COMCRDS	RDS=	Read coded line to string buffer
COMCRDW	LCB=, RDW=, RDX=	Read words to working buffer
COMCSYS	MSG=, RCL=, SYS=, WNB=	Process system request
COMCWTC	WTC=	Write coded line, -C- format
COMCWTH	WTH=	Write coded line, -H- format
COMCWTO	WTO=	Write one word
COMCWTS	WTS=	Write coded line from string buffer
COMCWTW	DCB=, WTW=, WTX=	Write words from working buffer

† Assembled from the system OPL.

MESSAGES

B

This appendix contains an alphabetical listing of the messages that may appear in a user's dayfile. Lowercase characters are used to identify variable names or fields. All messages beginning with variable names or characters follow those beginning with A through Z and 0 through 9. These messages are then alphabetized according to the first nonvariable word or character. Messages beginning with any special characters (such as hyphens or asterisks) are alphabetized as if the special character were not present. For example, the message

pfn ALREADY PERMANENT, AT nnn.

is listed after the messages beginning with A through Z and 0 through 9 and is alphabetized with the messages whose first nonvariable word or character begins with A.

This appendix contains messages of interest to the applications COMPASS programmer. Messages pertaining to general job processing are contained in appendix B of volume 1.

<u>MESSAGE</u>	<u>SIGNIFICANCE</u>	<u>ACTION</u>	<u>ROUTINE</u>
ACCOUNT BLOCK LIMIT.	The monitor detected the expiration of the account block SRU limit.	Reset account block SRU limit with SETASL control statement or macro. If the account block limit is set at its maximum, issue another CHARGE statement to begin a new account block.	IAJ
ADDRESS OUT OF RANGE.	An address in a parameter block is outside the user's field length.	Specify parameter block address within field length.	LFM
ALTERNATE IMAGE OBSOLETE.	The disk space for a file cannot be released when the alternate storage image is labeled obsolete or the alternate storage address is not specified in the permanent file catalog.	Inform site analyst.	PFM
ALTERNATE STORAGE ERROR.	The disk space for a file cannot be released when a permanent error status is set for the alternate storage file copy.	Inform site analyst.	PFM
ARG. ERROR.	LDR parameters were outside the user's field length.	Examine program to determine error.	LDR
ARITHMETIC INDEFINITE.	The CPU floating-point arithmetic unit attempted to use an indefinite operand.	Analyze the job output and dumps to determine the cause.	IAJ
ARITHMETIC OVERFLOW.	The CPU floating-point arithmetic unit received an operand too large for computation.	Analyze the job output and dumps to determine the cause.	IAJ
ARITHMETIC UNDERFLOW.	The CPU floating-point arithmetic unit received an operand too small for computation.	Analyze the job output and dumps to determine the cause.	IAJ
BLANK TAPE, lfn AT addr.	A blank tape was read. (Blank tape is defined as more than 25 feet of erased tape.)	Ensure correct tape is specified on control statement.	IMT
BLOCK SEQUENCE ERROR, lfn AT addr.	The block length recorded in the file did not match the length of the block read, or the block number recorded in the file did not match the system block count (this message applies to I format tapes only).	Ensure accuracy of format parameter (F) on control statement or macro.	IMT
BLOCK TOO LARGE, lfn AT addr.	The tape being read contained a data block greater in size than that allowed by the specified format or by user declaration.	Ensure accuracy of format parameter (F) on control statement or macro.	IMT

<u>MESSAGE</u>	<u>SIGNIFICANCE</u>	<u>ACTION</u>	<u>ROUTINE</u>
BOT/EOT ENCOUNTERED, lfn AT addr.	Indicates an abnormal tape position.	Inform site analyst if persistent.	1MT
BREAKPOINT CONDITION.	The job executed an address for which a breakpoint was requested by the system.	Inform site analyst.	1AJ
BUFFER ARG. ERROR.	CM address in call is not less than the field length minus the word count; buffer extends past the job's field length.	Verify that operation does not reference address beyond end of buffer or job's field length.	TCS
BUFFER ARGUMENT ERROR, lfn AT addr.	For tape operations, this message indicates one of the following. <ul style="list-style-type: none"> - FET less than 7 words long for S/L format - MLRS greater than 1000 octal for S format - POSMF issued and no HDR1 label found in FET or extended label buffer Refer to volume 2 of the NOS Reference Manual.	Examine program to determine error.	1MT
BUFFER ARGUMENT ERROR ON lfn AT addr.	A buffer pointer did not conform to the following constraints. <ul style="list-style-type: none"> - FIRST .LE. IN - FIRST .LE. OUT - OUT .LT. LIMIT .LE. FL Refer to volume 2 of the NOS Reference Manual.	Examine program to determine error in buffer pointers.	CIO
BUFFER CONTROL WORD ERROR, lfn AT addr.	Either an attempt was made to write a block smaller than the noise size on an S, L, or F format tape, or a control word error occurred in a write (such as bad byte count). Refer to volume 2 of the NOS Reference Manual.	Examine program to determine error.	1MT
BUFFER CONTROL WORD ERROR ON lfn AT addr.	Block length specified on WRITECW operation exceeds the allowable physical record size for the device.	Correct the program that is formatting the data for the WRITECW operation.	CIO
CATALOG OVERFLOW - FILES, AT addr.	The number of files in the user's catalog exceeds his limit.	One or more permanent files must be purged in order to save or define additional files.	PFM
CATALOG OVERFLOW - SIZE AT addr.	The cumulative size of the indirect access files in the user's catalog exceeds his limit.	One or more indirect access files must be purged or shortened to allow additional permanent file space.	PFM

<u>MESSAGE</u>	<u>SIGNIFICANCE</u>	<u>ACTION</u>	<u>ROUTINE</u>
CHANNEL MALFUNCTION, lfn AT addr.	Hardware malfunction.	Inform site analyst.	IMT
CHECKPOINT nnnn COMPLETE.	Indicates that checkpoint nnnn has completed. Issued if only one checkpoint file is present. For a checkpoint operation, more than two checkpoint files or an illegal combination of checkpoint files was specified.	None.	CHKPT
CHECKPOINT nnnn COMPLETED TO filename.	Indicates that checkpoint nnnn has been completed to file filename. Issued if alternate CB checkpoint files are used.	None.	CHKPT
CHECKPOINT FILE ERROR.	A REQUEST function was issued for more than two checkpoint files or a checkpoint mode of 76 octal for an alternate checkpoint file was specified.	Correct error and retry.	LFM
CIO ERROR.	Updating of resource file returned error status other than end-of-device.	Inform site analyst.	RESEX
CKP REQUEST.	A checkpoint has been initiated.	None.	CHKPT
CM BLOCK OUT OF RANGE.	Data transfer from ECS specified a CM address outside the job field length.	Analyze the job output and dumps to determine the cause.	IAJ
CM OUT OF RANGE.	The program referenced an address outside the job CM field length.	Analyze job output and dumps to determine the cause.	IAJ
CM PARITY ERROR.	Double data parity error (two data bits failed) between central memory control (CMC) and CM as detected by the single-error correction double-error detection (SECDED) network, or a single parity error when operating in default mode (SECDED network disabled).	Inform customer engineer.	IAJ
CM RANGE EXIT MODE NOT DESELECTABLE.	The user attempted to deselect system checking for CM out of range errors. This cannot be done on a Model 176 system.	Determine if the program can run with CM range error checking. If it cannot, the program must be changed.	CPM
CMC PARITY ERROR.	The CPU sent the central memory control (CMC) data or an address having incorrect parity.	Inform customer engineer.	IAJ
CONNECT REJECT, lfn AT addr.	Unable to connect unit.	Inform site analyst.	IMT

<u>MESSAGE</u>	<u>SIGNIFICANCE</u>	<u>ACTION</u>	<u>ROUTINE</u>
CONTROLLED BACKSPACE ERROR, lfn AT addr.	Controlled backspace operation failed during write error recovery. Position of tape is uncertain.	Inform customer engineer.	IMT
CPM - ARGUMENT ERROR.	Error(s) encountered and job aborted.	Determine error and rerun job step.	CPM
CPM - ILLEGAL PACKNAM.	An illegal pack name has been specified.	Ensure that legal pack name is used.	CPM
CPM - ILLEGAL REQUEST.	A CPM function was issued without the auto recall specified or the job making the request was not of system origin.	Specify auto recall on RA+1 call to CPM or make the job system origin.	CPM
CPM - ILLEGAL USER ACCESS.	The user tried to perform a CPM operation for which he is not validated.	None.	CPM
CPU ERROR EXIT AT addr.	The errors listed after this message occurred at address addr, causing job termination.	Refer to the descriptions of the error messages issued with this message.	IAJ
CVL CALL ERROR.	CVL encountered one of the following errors: - Recall bit was not set. - Illegal function number was specified. - Insufficient or improper combination of parameters was specified.	Correct error and rerun program.	CVL
DATA/PERMIT ERRORS, AT addr.	When loading a file from tape, errors were encountered in both data and permit information.	Enter CHANGE statement or macro with CE parameter to allow access to the file. Make the file local and check if data is accurate. Do a CATLIST to see if the permits are accurate.	PFM
DATA TRANSFER ERROR, AT addr.	An error occurred in a read operation during a file transfer.	Inform site analyst.	PFM
DExx,Ccc,1,sec,ann,Stttt,Aaddr.	An error has been detected on extended core storage. Refer to appendix B of the NOS Operator's Guide for further information.	Inform site analyst.	6DE
DEMAND EXCEEDED.	The user attempted to assign more units than were scheduled on the RESOURC statement.	Increase appropriate parameter value on RESOURC statement.	RESEX
DEMAND FILE ERROR.	Resource execution error was encountered. This error occurred because the demand file (RSXDId) entry does not match the job name.	Inform site analyst.	RESEX

<u>MESSAGE</u>	<u>SIGNIFICANCE</u>	<u>ACTION</u>	<u>ROUTINE</u>
DENSITY CHANGE, TAPE AT nnn.	The tape subsystem detected a change in the data recording density on the tape. Error is due to a malfunctioning tape unit or a bad tape.	Ask customer engineer to examine the tape unit. If tape unit does not require maintenance, discard the tape.	IMT
DEVICE ERROR ON FILE lfn AT addr.	An irrecoverable error occurred on the mass storage device containing the file lfn.	Inform site analyst.	CIO
DEVICE UNAVAILABLE, AT addr.	Access to the permanent file device requested is not possible. User may have attempted to access files on a device not present in the alternate system.	Ask the operator to make the device available.	PFM
DIxx,Ccc,1,sec,ann,Stttt, FNqqqq. or DIxx,Ccc,1,sec,ann,Stttt,Uuu Cyyyy Sttss.	An error has been detected on mass storage device with EST ordinal xx. Refer to appendix B of the NOS Operator's Guide for further information.	Inform site analyst.	7DI
DIRECT ACCESS DEVICE ERROR, AT addr.	The file specified already exists on a device other than the device requested or an illegal device type was specified. The device on which the file resides may not contain direct access files because of one of the following reasons. <ul style="list-style-type: none"> - The device is not specified as a direct access device in the catalog descriptor table. - The device is not specified as ON and initialized in the catalog descriptor table. - The device is a dedicated indirect access permanent file device. If on an alternate system, the user's master device may not have been transferred to that system.	Specify correct device type.	PFM
DISPLAY DUMP NOT ALLOWED TO TERMINAL.	A time-sharing user has attempted to enter DMD or DMDECS control statements or DMD or DED system requests without assigning file OUTPUT to a mass storage device.	Assign file OUTPUT to mass storage via ASSIGN control statement or macro and retry.	CPMEM
DJ...	Refer to description of the corresponding message beginning with DI or EQ.		
DK...	Refer to description of the corresponding message beginning with DI or EQ.		
DL...	Refer to description of corresponding message beginning with DI or EQ.		

<u>MESSAGE</u>	<u>SIGNIFICANCE</u>	<u>ACTION</u>	<u>ROUTINE</u>
DM...	Refer to description of corresponding message beginning with DI or EQ.		
DPxx,Ccc,l,sec,ann,Stttt,FNqqqq. or DPxx,Ccc,l,sec,ann,Stttt,Aaddr,Wwww DPxx,Ccc,l,Gggg...g. DPxx,Ccc,l,Bbbb...b. or DPxx,Ccc,l,sec,ann,Stttt,Aaddr,Wwww DPxx,Ccc,l,ddd...d.	An error has been detected on distributive data path (DDP). Refer to appendix B of the NOS Operator's Guide for further information.	Inform site analyst.	6DP
DQ...	Refer to description of corresponding message beginning with DI or EQ.		
DSP - CAN NOT ROUTE JOB INPUT FILE.	The job input file cannot be routed.	Copy job input file to a local file to be routed.	DSP
DSP - COMPLETE BIT ALREADY SET.	The complete bit was not cleared before DSP was called.	Clear complete bit before calling DSP.	DSP
DSP - DEVICE UNAVAILABLE.	DSP attempted to create a file on a device that was turned off or is currently unavailable for access.	Specify different device or contact site operator.	DSP
DSP - FILE NAME ERROR.	An attempt was made to create a file with an invalid file name.	Specify valid file name.	DSP
DSP - FILE NOT ON MASS STORAGE.	An attempt was made to route a file not on mass storage.	Copy file to mass storage before routing.	DSP
DSP - FILE ON REMOVABLE DEVICE.	A file on a removable device cannot be routed.	Copy file to non-removable device before routing.	DSP
DSP - FNT/DEVICE FULL.	There is no space in the FNT or on the device for current use.	Retry route at a later time.	DSP
DSP - FORMS CODE NOT ALPHANUMERIC.	Forms code must consist of two alphanumeric characters.	Specify alphanumeric forms code.	DSP
DSP - I/O SEQUENCE ERROR.	A request was made on a busy file.	Wait until file is not busy.	DSP
DSP - ILLEGAL FILE TYPE.	The file being processed is not a print, punch, input, output, or local file type. For example, primary and direct access file types cannot be processed	Ensure that file being processed is of correct type.	DSP
DSP - ILLEGAL ORIGIN TYPE.	DSP cannot route the file to the input queue with the origin type specified by the caller.	Specify valid origin type.	DSP

<u>MESSAGE</u>	<u>SIGNIFICANCE</u>	<u>ACTION</u>	<u>ROUTINE</u>
DSP - ILLEGAL REQUEST.	One of the following. <ul style="list-style-type: none"> - DSP was not called with recall (does not apply when queue priority is greater than MXPS). - Parameter list address was out of range. - RA+1 call was formatted incorrectly. 	Specify auto recall with DSP call or determine why parameter list address is out of range.	DSP
DSP - ILLEGAL USER CARD.	User attempted to route a file with an illegal USER statement to the input queue.	Ensure that valid user number is being used.	DSP
DSP - IMMEDIATE ROUTING - NO FILE.	The specified file for the immediate routing could not be found.	Ensure that file to be routed is available to job for processing.	DSP
DSP - INVALID DISPOSITION CODE.	Specified disposition code is not recognized.	Verify disposition code.	DSP
DSP - INVALID EXTERNAL CHARACTERISTICS.	Caller specified an undefined external characteristic code.	Verify external characteristic code.	DSP
DSP - INVALID JOB ABORT CODE.	Value of abort code field of DSP parameter word four is invalid.	Verify abort code.	DSP
DSP - INVALID SPACING CODE.	Value specified for spacing code was greater than 77 octal.	Verify spacing code.	DSP
DSP - INVALID TID.	One of the following: <ul style="list-style-type: none"> - User number and family name parameters were not in CM field length. - TID is greater than or equal to IDLM for batch jobs. - User number specified in parameter block does not compare with user number in control point area. 	Verify that TID parameters are valid.	DSP
DSP - LOCAL FILE LIMIT.	User has exceeded his local file validation limits.	Return one or more local files to the system.	DSP
DSP - OUTPUT FILE LIMIT.	Caller has exceeded his output file validation.	If possible, split job into two or more jobs and retry. Otherwise, reduce number of files by copying output to single file and then routing the file.	DSP
DSP - ROUTE TO INPUT NOT IMMEDIATE.	Routing a file to the input queue must be immediate.	Change to immediate route.	DSP

<u>MESSAGE</u>	<u>SIGNIFICANCE</u>	<u>ACTION</u>	<u>ROUTINE</u>
DSP - THIS ROUTING NOT ALLOWED.	An attempt was made to change the queue type of a deferred routed file.	Rescind prior routing by using the SC disposition code with the ROUTE control statement or macro. ROUTE the file again with the desired final disposition code.	DSP
DSP - TOO MANY DEFERRED BATCH JOBS.	The user attempted to submit more deferred batch jobs than allowed by his validation limit.	Wait for jobs to complete or request a larger validation limit from site personnel.	DSP
DUPLICATE COMMON FILE NAME.	A file of the same name as that specified in a COMMON request already exists.	Use different name in request.	LFM
DUPLICATE FILE NAME.	The file specified already exists in the system.	Use different name in request.	LFM
DUPLICATED LINES.	Duplicate lines being dumped during a DMP operation were suppressed.	None.	CPMEM
ECS BLOCK OUT OF RANGE.	Data transfer between CM and ECS specified an ECS address outside the job field length.	Analyze the job output and dumps to determine the cause of the error.	IAJ
ECS FLAG REGISTER PARITY.	Parity error detected on ECS flag register operation.	Inform customer engineer.	IAJ
ECS OUT OF RANGE.	Job referenced ECS address outside job field length.	Analyze the job output and dumps to determine the cause of the error.	IAJ
END OF SET ILLEGAL REQUEST, lfn AT addr.	A multifile set tape is positioned at end of set after a POSMF to a file set that is not found. Until the tape is returned or repositioned within the multifile set, all other operations on this tape are illegal.	Return tape via RETURN, UNLOAD, or EVICT or reposition tape via POSMF.	IMT
END OF TAPE, lfn AT addr.	The end-of-tape was encountered.	Ensure that correct file manipulation operation is specified.	IMT
**** ENDING SUPPORT OF FILE QUEUING BY *CIO* CLOSE FUNCTIONS (170,174,370).	CLOSE/RETURN and CLOSE/UNLOAD will not route files to the output queue in future versions of NOS.	Change program to use the ROUTE macro.	CIO
**** ENDING SUPPORT OF LFM FUNCTION nnB.	Warning message indicating that functions 2, 4, 5, 6, 7, 16B, 17B and 30B will not be available in future versions of NOS.	For functions 4, 5, 6, 7, 16B, and 30B, convert the program to use DSP to queue the file. For function 17B, set the id code when	LFM

<u>MESSAGE</u>	<u>SIGNIFICANCE</u>	<u>ACTION</u>	<u>ROUTINE</u>
		queueing the file. For function 2, no action is possible.	
**** ENDING SUPPORT OF *OUT* RA+1 REQUEST.	Warning message indicating that this request will not be available in future versions of NOS.	Convert the program to use DSP to queue files.	OUT
**** ENDING SUPPORT OF QFM FUNCTION nnB.	Warning message indicating that functions 17B and 20B will not be available in future versions of NOS.	For function 17B, convert the program to use LFM function 15B to assign a file to a queue device. For function 20B, convert the program to use DSP to queue the file.	QFM
**** ENDING SUPPORT OF SFM FUNCTION 13B.	Warning message indicating that this function will not be available in future versions of NOS.	None.	SFM
ENTRY POINT NOT FOUND.	The specified entry point could not be found.	Verify that entry point is valid.	1AJ
EOI CHANGED BY RECOVERY, AT addr.	The file was truncated during deadstart recovery.	Use CHANGE statement or macro with CE parameter to allow access to the file. Make the file local and list it to determine how much of the file was lost.	PFM
EQxx,DNdn, DIRECT ACCESS FILE ERROR, AT addr.	The system sector data for the file does not match the catalog data. Error log and dayfile message. EQ One of the following equipment types. DI 844-21 disk (half track) DJ 844-41/44 disk (half track) DK 844-21 disk (full track) DL 844-41/44 disk (full track) DM 885 disk (half track) DQ 885 disk (full track) xx EST ordinal of device dn Device number.	Inform site analyst.	PFM
EQxx,DNdn, FILE LENGTH ERROR, AT addr.	The length of a file does not equal the length specified in the catalog. EQ Equipment type as defined in EQxx,DNdn, DIRECT ACCESS FILE ERROR, AT addr. message xx EST ordinal of device	Inform site analyst.	PFM

<u>MESSAGE</u>	<u>SIGNIFICANCE</u>	<u>ACTION</u>	<u>ROUTINE</u>
	<p>dn Device number</p> <p>The cause depends on the type of command or macro issued.</p> <p>GET A local file is created with length being the actual length retrieved.</p> <p>SAVE If file length is longer than TRT specification, file is truncated.</p> <p>REPLACE Same as for SAVE.</p>		
EQxx,DNdn, MASS STORAGE ERROR AT addr.	<p>An error was encountered in reading a portion of the permanent file catalog or permit information. Error log and dayfile message.</p> <p>EQ Equipment type as defined in the EQxx,DNdn, DIRECT ACCESS FILE ERROR, AT addr. message</p> <p>xx EST ordinal of device</p> <p>dn Device number</p>	Inform site analyst.	PFM
EQxx,DNdn, RANDOM INDEX ERROR, AT addr.	<p>The random disk address of the permit sector is in error. Error log and dayfile message.</p> <p>EQ Equipment type as defined in the EQxx,DNdn, DIRECT ACCESS FILE ERROR, AT addr. message</p> <p>xx EST ordinal of device</p> <p>dn Device number</p>	Inform site analyst.	PFM
EQxx,DNdn, REPLACE ERROR, AT addr.	<p>The same file was found twice during a catalog search. This error can occur for APPEND or REPLACE commands or macros after a file is found and purged and the catalog search is continued. Error log and dayfile message.</p> <p>EQ Equipment type as defined in the EQxx,DNdn, DIRECT ACCESS FILE ERROR, AT addr. message</p> <p>xx EST ordinal of device</p> <p>dn Device number</p>	Retry job step.	PFM
EQxx,DNdn, SYSTEM SECTOR ERROR, AT addr.	<p>The system sector of an indirect access permanent file contains an error. Error log and dayfile message.</p> <p>EQ Equipment type as defined in EQxx, DNdn, DIRECT ACCESS FILE ERROR, AT addr. message description</p> <p>xx EST ordinal of device</p> <p>dn Device number</p>	Inform site analyst.	PFM

MESSAGE	SIGNIFICANCE	ACTION	ROUTINE
EQxx,DNdn, TRACK LIMIT, AT addr.	No allocatable tracks remain on equipment xx. Error log and dayfile message. EQ Equipment type as defined in the EQxx,DNdn, DIRECT ACCESS FILE ERROR, AT addr. message xx EST ordinal of device dn Device number	Inform site analyst.	PFM
EQxx,FM=family,PF=filenam,UI=userin.	Additional line is written only in error log after one of the following messages. EQxx,DNdn,DIRECT ACCESS FILE ERROR, AT addr. EQxx,DNdn,FILE LENGTH ERROR, AT addr. EQxx,DNdn,MASS STORAGE ERROR, AT addr. EQxx,DNdn,RANDOM INDEX ERROR, AT addr. EQxx,DNdn,REPLACE ERROR, AT addr. EQxx,Dndn,SYSTEM SECTOR ERROR, AT addr. EQxx,DNdn,TRACK LIMIT, AT addr. EQ Equipment type as defined in the EQxx,DNdn, DIRECT ACCESS FILE ERROR, AT addr. message xx EST ordinal of device family Family name filenam Permanent file name userin User index	None.	PFM
EQUIPMENT NOT AVAILABLE.	Tape assignment error was encountered; requested equipment is either in use or is not defined in the system.	Ensure accuracy of macro or control statement and/or retry at a later time.	LFM, RESEX
ERASE LIMIT, lfn AT addr.	The system made 20 erasures (10 feet of tape) without being able to successfully write the tape.	Clean tape or use different tape.	IMT
ERROR CODE ec, lfn AT addr.	IMT error code ec has occurred but no specific message is issued. This would normally not occur unless the job was dropped by the operator.	Consult site personnel.	IMT
ERROR - FILES(S) NOT PROCESSED.	One or more files were not checkpointed because CHKPT detected address errors.	Determine and correct address errors and retry.	CHKPT
ERROR FLAG TERMINATION, lfn AT addr.	The job was aborted with a tape operation in progress. The operation/request is not complete. For example, the operator could kill the job while tape error recovery is in progress.	None.	IMT

<u>MESSAGE</u>	<u>SIGNIFICANCE</u>	<u>ACTION</u>	<u>ROUTINE</u>
ERROR FLAG TERMINATION, FILE lfn AT addr.	The job was aborted with an input/output request in progress. The operation/request is not complete.	None.	CIO
ERROR IN PERMIT DATA, lfn AT addr.	An error was encountered in the permit entries for file lfn.	Inform site analyst.	PFM
ERROR IN ROUTE FUNCTION, LFN=filenam.	Informative message issued to the system dayfile stating an error occurred while routing filenam.	Examine the job's dayfile for a more specific error message.	DSP
EXCHANGE PACKAGE/MEMORY DUMP ON FILE ZZZDUMP.	The exchange package and memory dump is written on local file ZZZDUMP because the job is of time-sharing origin and file OUTPUT is assigned to a terminal.	To examine the exchange package and dump, list file ZZZDUMP.	CPMEM
FET ADDRESS OUT OF RANGE AT addr.	FET extends past job's field length.	Verify that FET address is valid.	CIO
FET PARAMETER ERROR ON lfn AT addr.	One of the parameters in the FET is illegal or the FET is not long enough for the parameter.	Verify that FET is valid.	CIO
FET TOO SHORT.	The FET is too short to perform the specified function.	Increase length of FET.	LFM
FILE BOI/EOI/UI MISMATCH, lfn AT addr.	Data in the system sector for file lfn does not match information from the EOI sector and/or catalog information.	Inform site analyst.	PFM
FILE BUSY.	The file specified in the request cannot be interlocked.	Wait until file is not busy.	LFM
FILE EMPTY.	The file specified was empty.	Verify that the file contains data and retry.	LFM, SFM
FILE ERROR filenam.	An illegal address was detected on file filenam.	Correct error and retry.	CHKPT, RESTART
FILE NAME ERROR.	File name contains illegal characters or contains more than seven characters.	Ensure that legal file name is specified.	LFM, LIBGEN, LISTLB
FILE NAME ERROR, AT addr.	File name contains illegal characters.	Verify that file name contains only valid characters.	PFM
FILE NOT DISK RESIDENT.	Access to a file which does not reside on disk is not permitted with the requesting function.	Inform site analyst.	PFM

<u>MESSAGE</u>	<u>SIGNIFICANCE</u>	<u>ACTION</u>	<u>ROUTINE</u>
FILE NOT FOUND.	Requested file could not be found.	Verify that file exists and retry.	LFM, SFM, QFM, ENQUIRE, STIMULA
FILE NOT ON MASS STORAGE.	The specified file does not reside on mass storage.	Copy file to mass storage and retry.	1AJ
FILE TOO LONG, AT addr.	The local file specified for a SAVE, REPLACE, or APPEND command exceeds the length allowed or the direct access file specified for an ATTACH operation in WRITE, MODIFY, or APPEND mode exceeds the direct access file length limit for which the user is validated.	Reduce length of file or save as a direct access file.	PFM
FILE TOO LONG, FILE lfn AT addr.	The length of the direct access permanent file currently being written exceeds the direct access file length limit for which the user is validated.	Reduce the length of the file or ask site personnel for a larger direct access file length limit.	CIO
FL BEYOND MFL (ECS).	ECS field length requirements for the job step exceed the ECS field length allowed.	Increase job step ECS field length.	1MA
FL REQUEST BEYOND MFL (CM).	CM field length requirements for the job step exceed the CM field length allowed.	Increase job step CM field length.	1MA, TCS
FL TOO SHORT FOR PROGRAM.	The user's field length is too short for the program.	Rerun the job with larger field length specification.	TCS, 1AJ
FLE TOO SHORT FOR LOAD.	An attempt was made to load ECS data beyond the user's ECS field length.	None.	1AJ, LDR
FNT FULL.	FNT space is currently not available for a request that has both the ep and up processing options set.	Retry operation at a later time.	PFM
FORMAT REQUIRES UNLABELED TAPE.	The format specified (F) is valid only for unlabeled tapes.	The tape must be assigned as an unlabeled tape.	RESEX
FUNCTION REJECT, lfn AT addr.	Function was rejected (possible hardware problem).	Inform site analyst.	1MT
FWA .GE. LWA+1.	The first word address parameter was greater than the last word address parameter on DMP, DMD, DMPECS, DMDECS, LOC, or PBC control statements or DMP, DMD, DED, or DEP system requests.	Correct error and retry.	CPMEM

MESSAGE	SIGNIFICANCE	ACTION	ROUTINE
FWA/LWA .GE. FL.	Either first word address parameter of LOC or the last word address of LOC or PBC was greater than or equal to the user's field length.	Reduce FWA and/or LWA and retry.	CPMEM
GETFNT TABLE TOO LARGE.	The table generated by the GETFNT function exceeds the size specified by the user.	Specify larger GETFNT table size.	LFM
HTIME NOT AVAILABLE.	The HTIME control statement or macro is valid only on a CYBER 170 Model 176.	None.	IAJ
I/O ON EXECUTE-ONLY FILE lfn AT addr.	The user attempted to read, write, or position an execute-only file. The only operations that may be performed on an execute-only file are EVICT, RETURN, REWIND, and UNLOAD.	Assign file in proper mode to allow the desired operation.	CIO
I/O SEQUENCE ERROR.	Action was requested on a busy file.	Wait until file is not busy and retry.	CFM, LFM
I/O SEQUENCE ERROR, AT addr.	A request was attempted on a local file that is currently active. This error can occur, for example, if the user creates two FETs for the same file and issues a second request before the first is completed.	Wait until file is inactive.	PFM, LFM
I/O SEQUENCE ERROR ON FILE lfn AT addr.	The user attempted to perform more than one concurrent function on a single file.	Wait until each function is complete before attempting another.	CIO
ILLEGAL CHANGE IN FILE/ORIGIN TYPE.	LFM attempted to change the file/origin type of a deferred routed output file.	Rescind prior routing (DC=SC option).	LFM
ILLEGAL COMMON MEMORY MANAGER REQUEST.	Memory request with reserved bits in the parameter block were set incorrectly.	Do not set reserved bits.	IMA
ILLEGAL DEVICE REQUEST, AT addr.	The device type (r parameter) specified on a request for an auxiliary device cannot be recognized or does not exist in the system. If the auxiliary device specified by the pn parameter is not the same type as the system default, the r parameter must be included; if not, the message is issued.	Examine auxiliary device request and ensure its accuracy.	PFM
ILLEGAL EQUIPMENT.	Equipment specified does not exist or is not allowed (for example, a TT device is requested from other than terminal origin, or a tape is being requested with the REQUEST macro).	Ensure file resides on a legal equipment type.	LFM, RESEX

<u>MESSAGE</u>	<u>SIGNIFICANCE</u>	<u>ACTION</u>	<u>ROUTINE</u>
ILLEGAL ERROR EXIT ADDRESS.	Error exit address is beyond user's current field length.	Informative.	IAJ
ILLEGAL EXTENSION OF lfn AT addr.	The user attempted to lengthen a file that could not be extended.	Verify that valid file is being extended.	CIO
ILLEGAL EXTERNAL CALL.	RESEX did not recognize external call.	Inform site analyst.	RESEX
ILLEGAL FILE MODE.	The user tried to dispose or unlock a file which was in execute-only mode or tried to change its file type to library (LIFT).	None.	LFM
ILLEGAL FILE NAME lfn AT addr.	The file name does not conform to established rules.	Use valid file name.	CIO
ILLEGAL FILE TYPE.	The specified file is of a type not allowed in the requested operation. Possible causes include attempts to <ul style="list-style-type: none"> - change a nonlocal file to file type library - designate a direct access file as the primary file - ROUTE or DISPOSE the primary file 	Verify that file type is valid.	LFM
ILLEGAL I/O REQUEST ON FILE lfn AT addr.	CIO could not recognize the specified function code, or the code was not valid for the type of device to which the file was assigned. The system provides a dump of the FET on file OUTPUT.	Verify CIO function code being used.	CIO
ILLEGAL ID CODE.	One of the following. <ul style="list-style-type: none"> - An identification code specified on the SETID control statement or macro is not a valid device identification code as defined in the installation EST. - An identification code not in the range 0-67B or 77B is present on the LDI control statement. 	Reissue the request with the correct identification code.	LFM LDI
ILLEGAL INSTRUCTION.	The CPU attempted to execute an illegal or nonavailable instruction.	Analyze job output and dumps to determine the cause of the error.	IAJ
ILLEGAL JOB/USER CARDS.	A job was submitted with an invalid job or user card.	Correct job and rerun.	QFM
ILLEGAL LABEL TYPE, lfn AT addr.	Illegal label type. Only legal label types are ANSI labeled and nonstandard labeled.	Use correct label type.	IMT
ILLEGAL LOAD ADDRESS.	The load address is less than 2.	Specify larger load address and retry.	IAJ

<u>MESSAGE</u>	<u>SIGNIFICANCE</u>	<u>ACTION</u>	<u>ROUTINE</u>
ILLEGAL MODIFICATION OF lfn AT addr.	Either the user has attempted to shorten a modify-only file or the file cannot be modified at all.	Determine whether file can be modified.	CIO
ILLEGAL RANDOM ADDRESS.	The current random address specified is zero.	Verify current random address.	LFM
ILLEGAL USER ACCESS.	The user tried to perform an operation for which he is not validated. Possible causes include attempts to <ul style="list-style-type: none"> - run a system origin job from nonsystem origin - access a restricted subsystem without proper validation - enter an invalid SRU value - use the V carriage control character without validation 	Ensure accuracy of control statement or determine proper validation requirements via LIMITS statement.	LFM MSI NETVAL QFSP RESEX IMA
ILLEGAL USER ACCESS, AT addr.	The user is not validated to create direct access or indirect access files or to access auxiliary devices.	Contact site personnel concerning validations.	PFM
ILLEGAL USER ACCESS - CONTACT SITE OPR.	The security count for the user number specified has been decremented to zero. Therefore, the user is denied all access to the operating system until the operator resets the security count.	Contact site personnel to reestablish access.	CFM NETVAL IAJ ILS
ILLEGAL USER CARD.	The user attempted to submit a file which does not have a USER statement as the second statement, has an incorrectly formatted USER/ACCOUNT statement, or has an invalid family name, user name, or password.	Correct error and rerun.	QFM
IMPROPER ACCESSIBILITY.	The user did not specify the correct file accessibility on the LABEL statement or macro, or volume accessibility was set and a nonsystem origin user attempted to assign the tape as unlabeled.	Ensure accuracy of request.	RESEX
INDEX ADDRESS OUT OF RANGE FOR lfn AT addr.	The random sector address for a random input/output request was equal to or greater than field length.	Correct random sector address.	CIO
INPUT FILE IN NORERUN STATUS.	Informative message.	None.	QFM
INPUT FILE IN RERUN STATUS.	Informative message.	None.	QFM
INSUFFICIENT RESOURCES ON SYSTEM.	Resource demand exceeds number of units physically available on the system.	Reduce resource demand.	RESEX

<u>MESSAGE</u>	<u>SIGNIFICANCE</u>	<u>ACTION</u>	<u>ROUTINE</u>
INTERLOCK NOT AVAILABLE.	A software interlock is currently not available to the requesting function with both ep and up processing options specified.	Retry function at a later time.	PFM
INVALID CATALOG UPDATE.	Verification of the PFC entry prohibits the setting of a new alternate storage address when a current alternate storage address exists and is not labeled obsolete. Also, an existing valid disk address cannot be replaced in the PFC entry.	Inform site analyst.	PFM
INVALID PFC ADDRESS.	The device number, track, and sector specified as the PFC address are invalid.	Inform site analyst.	PFM
JOB CARD ERROR (job statement)	An error was encountered on the job statement in the routed or submitted file. The first 20 characters of the job statement are displayed.	Correct job statement and rerun.	DSP QFM
JOB IN NORERUN STATE ON RECOVERY.	Identifies a job recovered on level 0 deadstart that was aborted because it was in a no-rerun mode (due to NORERUN control statement or macro).	Refer to the NORERUN control statement or macro.	1AJ
JOB REPRIEVED.	The job has been successfully reprieved.	None.	SFP
JOB STEP LIMIT.	The monitor detected the expiration of the job step SRU limit.	Reset job step limit with SETJSL control statement or macro and retry. If job step SRU limit is set at maximum, request increased SRU validation.	1AJ
LABEL CONTENT ERROR, lfn AT addr.	A block read was the correct size for a label but one or more required fields (such as the label name) were incorrect.	Use LISTLB control statement to obtain label data.	1MT
LABEL MISSING, lfn AT addr.	During a read operation, a required label was missing.	Ensure that tape has label.	1MT
LABEL NOT EXPIRED.	The user attempted to write on a tape with an unexpired label.	If current contents of tape can be sacrificed, have operator blank label tape. Otherwise, wait until label has expired.	1MT
LABEL PARAMETER ERROR ON OPEN, lfn AT addr.	Label fields did not match on open request. An additional message FIELD BEGINNING AT addr NO COMPARE. specifying the decimal character position in HDR1 of the first field that did not compare correctly is also issued.	Use LISTLB control statement to obtain label data.	1MT

<u>MESSAGE</u>	<u>SIGNIFICANCE</u>	<u>ACTION</u>	<u>ROUTINE</u>
LDR ERROR.	Issued after one of the following errors. OVERLAY NOT FOUND IN LIBRARY. ARGUMENT ERROR.	Correct error and retry.	LDR
LFM ARG. ERROR.	LFM detected an error in the request.	Ensure that valid LFM request is being made.	LFM
LFM ILLEGAL REQUEST.	One of the following: - The LFM function detected was not recognized as a legal function. - An LFM function was issued without the auto recall bit set.	Verify that valid LFM request is being used.	LFM
LIST OF FILES LENGTH TOO LONG.	The length of the list of files table is greater than the length of the FNT.	None.	CPM
LOCAL FILE LIMIT.	The user has too many local files.	Return one or more local files and retry.	LFM QFM IRO
LOCAL FILE LIMIT, AT addr.	The job's local file limit has been exceeded in an attempt to GET or ATTACH the file.	Return one or more local files.	PFM
LOCAL FILE LIMIT, FILE lfn AT addr.	The job's local file limit was exceeded in an attempt to define another file or attach an existing file to the job.	Return one or more local files.	CIO
M.T. NOT AVAILABLE ON FILE lfn AT addr.	The magnetic tape executive is not executing.	Inform site operator.	CIO
MAGNET NOT ACTIVE.	No UDT address or incorrect UDT address in FST or MAGNET not present.	Inform site analyst.	LFM RESEX
MESSAGE LIMIT.	The number of messages the job issued has exceeded the limit for which the user is validated. Message functions issued by compilers or applications programs that run at the user's job control point are also counted as user dayfile messages and thus are subject to the user's validated dayfile message limit.	Split job into two or more jobs and retry.	IAJ IMA
MFL LESS THAN ECS MINIMUM CM FL.	To use ECS the user must have a required minimum amount of CM FL. This message indicates user does not have the required CM FL.	Increase CM FL.	IMA
MISSING DEMAND FILE ENTRY.	Dayfile message indicating RESEX internal problem. The overcommitment algorithm was initiated without a demand file entry having been defined previously.	Inform site analyst.	RESEX

<u>MESSAGE</u>	<u>SIGNIFICANCE</u>	<u>ACTION</u>	<u>ROUTINE</u>
MISSING VSN OR EQUIPMENT ASSIGNMENT.	Dayfile message indicating internal malfunction in RESEX (expected VSN or equipment assignment was not found).	Inform site analyst.	RESEX
MONITOR CALL ERROR.	RA+l call unrecognized.	Examine program to determine why illegal RA+l call is being made.	1AJ
MT,Ccc,Eec,Hhhhhhhh,B.C.RESTART.	Magnetic tape controller controlware restarted.	None.	1MT
MT,Ccc,Eec,Hhhhhhhh,BAD ERASE.	Error detected after an erase was attempted to recover a write error.	Inform site analyst.	1MT
MT,Ccc,Eec,Hhhhhhhh,BID RECOVERY-x.	A single block mispositioning error was recovered by block ID recovery. If x is B, the error was caused by backspacing the tape too far; if x is F, the tape was not backspaced far enough.	None.	1MT
MT,Ccc,Eec,Hhhhhhhh,BLOCK TOO LARGE.	Data block is at least one byte longer than length bbbb shown in third line of message.	None.	1MT
MT,Ccc,Eec,Hhhhhhhh,BUSY.	Unit was still busy after 1 second.	Inform customer engineer.	1MT
MT,Ccc,Eec,Hhhhhhhh,CHANNEL ILL.	Channel is not accepting function for status requests properly.	Inform customer engineer.	1MT
MT,Ccc,Eec,Hhhhhhhh,CON.REJ.	Connect reject; unable to connect to the unit.	Inform site analyst.	1MT
MT,Ccc,Eec,Hhhhhhhh,CON REJ. MDI.	Connect reject; unable to connect to unit because of marginal detection indication (thermal warning). Unit turned off.	Inform customer engineer.	1MT
MT,Ccc,Eec,Hhhhhhhh,CON.REJ.OFF.	Connect reject; unable to connect to unit. Unit turned off.	Inform site analyst.	1MT
MT,Ccc,Eec,Hhhhhhhh,DENSITY CHANGE.	The tape subsystem detected a change in the data recording density on the tape. Error is due to a malfunctioning tape unit or a bad tape.	Ask customer engineer to examine the tape unit. If tape unit does not require maintenance, discard the tape.	1MT
MT,Ccc,Eec,Hhhhhhhh,FNff,Pyyyy.	Function ff was rejected by the controller; yyyy is the address in 1MT where the function was initiated.	Inform site analyst.	1MT
MT,Ccc,Eec,Hhhhhhhh,Lbbbb,Bnnnnn.	The length (bbbb) and block number (nnnnn) read from trailer bytes in block did not match the actual length or the block number read; given in previous message line.	None.	1MT

<u>MESSAGE</u>	<u>SIGNIFICANCE</u>	<u>ACTION</u>	<u>ROUTINE</u>
MT,Ccc,Eec,Hhhhhhhh,LOAD CHECK.	Load sequence failed on the unit.	Push CLEAR button and reload tape or contact site analyst.	IMT
MT,Ccc,Eec,Hhhhhhhh,MARGINAL DOWN.	Indicates controller failure. Channel has been logically turned off and maintenance is required.	Inform customer engineer.	IMT
MT,Ccc,Eec,Hhhhhhhh,MARGINAL OFF.	Unit has been logically turned off because of read/write failure. This occurred when a special function to check the read/write path to a unit failed during initial label scan. Maintenance is required.	Inform customer engineer.	IMT
MT,Ccc,Eec,Hhhhhhhh,NO EOP.	No end-of-operation detected from unit within 1 second.	Inform customer engineer.	IMT
MT,Ccc,Eec,Hhhhhhhh,NOISE.	A noise block was skipped on the tape.	None.	IMT
MT,Ccc,Eec,Hhhhhhhh,NOT READY.	Tape unit dropped ready status.	Make unit ready.	IMT
MT,Ccc,Eec,Hhhhhhhh,ON THE FLY.	Error was corrected as the data was read.	None.	IMT
MT,Ccc,Eec,Hhhhhhhh,POSITION LOST.	The last good block written cannot be found during write recovery.	None.	IMT
MT,Ccc,Eec,Hhhhhhhh,RECOVERED.	Previously reported error has been successfully recovered.	None.	IMT
MT,Ccc,Eec,Hhhhhhhh,STATUS.	Error type cannot be determined so actual controller status is returned.	Inform site analyst.	IMT
MT,Ccc,Eec,Hhhhhhhh,WRONG PARITY.	Tape was written in parity opposite that being read.	None.	IMT
MT,Ccc-e-uu,vsn,rw,xx,Ss,GSggggggg. MT,Ccc,Dddd...d. MT,Ccc,Uuu...u,Tttt. MT,Ccc,Fff,Iii,Bnnnnnn,Lbbbb,Pppppppp. MT,Ccc,Eec,Hhhhhhhh,type. or MT,Ccc-e-uu,vsn,rw,xx,Ss,GSggggggg. MT,Ccc,Dddd...d. MT,Ccc,Fff,Iii,Bnnnnnn,Lbbbb,Pppppppp. MT,Ccc,Eec,Hhhhhhhh,type.	Four or five-line message describing a magnetic tape hardware malfunction on a 66x or 67x tape unit. Message as illustrated indicates 7-track, model 667 or 677 unit. If NT appears in place of MT, message indicates 9-track, model 669 or 679 unit. Message is issued to error log and dayfile. The first line of each message provides the following information.	Refer to the separate listing of the last line message (MT,...,type.) for the appropriate action.	IMT
	cc-e-uu Channel, equipment (tape controller), and physical unit number of tape unit on which error was encountered.		
	vsn Volume serial number associated with tape on the specified unit.		
	rw Read (RD) or write (WR)		

MESSAGESIGNIFICANCEACTIONROUTINE

operation; any operation not involving an actual read or write is listed as a read.

xx EST ordinal of the unit on which the tape was written. This is provided only for labeled tapes generated under NOS; otherwise, the field is blank.

s Channel status.

gggggggg General status of magnetic tape unit. Last byte is block ID.

The MT,Ccc,Dddd...d line of the message provides the following information.

cc Channel number; the channel number is repeated to allow the analyst to associate this message with the first message if errors are occurring on more than one tape channel at the same time.

ddd...d Detailed status of magnetic tape unit.

The MT,Ccc,Uuu...u,Ttttt line of the message provides the following information.

cc Channel number; repeated to associate this message with the previous messages.

uu...u Unit status of the magnetic tape unit.

tttt Third byte of the tape unit format parameters (refer to the magnetic tape subsystem reference manual for descriptions of unit format parameter fields).

The MT,Ccc,Fff...,Ppppppppp line of the message provides the following information.

cc Channel number; repeated to associate this message with the previous messages.

ff Software function on which the error occurred.

ii Error iteration; number of times error has been encountered on this unit without successful recovery.

nnnnnn Block number on which error occurred.

bbbb Length of block on which error

<u>MESSAGE</u>	<u>SIGNIFICANCE</u>	<u>ACTION</u>	<u>ROUTINE</u>
	<p>occurred in octal bytes. pppppppp lmt internal error parameters.</p> <p>The last line of each message provides the following information.</p> <p>cc Channel number; repeated to associate this message with the previous messages. ec Octal error code value. hhhhhhh Parameters passed to the tape unit for the format function (refer to the tape drive's hardware reference manual for descriptions of the unit format parameter fields). type Additional description of the error. Refer to individual listing of the last line message.</p>		
MT/NT CONFLICT.	<p>Conflict exists between 7-track and 9-track tape descriptors (track type, density, and conversion mode). For example, a request for a 9-track tape specified 200-bpi density. This message can also be issued if the device type specified in FET+1 conflicts with the track type specified in FET+8, bit 56. If dt=MT and bit 56 is set, the message is issued.</p>	Ensure accuracy of control statement.	RESEX BLANK
MULTI-FILE NAME NOT FOUND lfn AT addr.	User issued a POSMF on a nonexistent file or a nontape file.	Verify file name.	CIO
MULTI-FILE NOT FOUND, lfn AT addr.	<p>Either LISTLB has reached the end of the multifile set or the requested file was not found. The following additional messages are also given. REQUESTED SECTION xxxx. FOUND SECTION yyyy. or FILE IDENTIFIER NOT FOUND. The lfn, addr, xxxx, and yyyy given can be ignored.</p>	If LISTLB reached the end of the multifile set, the operation is complete and no action is required. Otherwise, ensure that the correct tape is being used and that it contains the desired file(s). All label parameters must match in order to position to the specified file.	lmt
NO ECS.	A DMPECS or DMDECS control statement or DED or DEP request was entered and no ECS field length is assigned to the user.	None.	CPMEM

<u>MESSAGE</u>	<u>SIGNIFICANCE</u>	<u>ACTION</u>	<u>ROUTINE</u>
NO INPUT FILE FOUND.	No valid input file exists; functions cannot be performed.	Verify that input file is valid.	QFM
NO MASS STORAGE AVAILABLE.	User attempted to reserve a track for a null primary file.	Retry later.	LFM
NO WRITE ENABLE, ON lfn AT addr.	Either the user attempted to write on a tape mounted with no write ring or no write was allowed because of additional constraints described in an additional message line.	If no additional message line appears ensure the inserting of a write ring by specifying the W processing option on the tape request (for example, PO=W on the LABEL control statement). Otherwise, refer to the description of the message in the additional message line.	1MT
NON-MATCHING CONVERSION.	Informative message indicating conversion mode on labeled 9-track tape differs from that specified by assignment request. System writes tape in specified mode, or reads tape with write ring out in correct mode. However, reading tape with write ring in or using wrong conversion mode generates conversion errors.	If reading tape with write ring in, return and reassign with correct conversion mode.	RESEX
NON-MATCHING DENSITY.	Informative message indicating that the density specified on the control statement or macro is not the same as the density of the assigned tape. Issued only to 9-track tapes with write ring out. 9-track tapes are read at the current density on tape. They are written at specified density if write initiated from load point; otherwise, tape is written at the current density on the tape.	None.	RESEX
NORERUN/RERUN IGNORED FROM TTY JOBS.	User entered NORERUN or RERUN from a terminal. The command is ignored.	None.	QFM CONTROL
NT....	Refer to description of MT.... series of messages.		
OPERATOR DROP.	Informative message indicating that the operator dropped the job.	None.	DSD 1AJ

<u>MESSAGE</u>	<u>SIGNIFICANCE</u>	<u>ACTION</u>	<u>ROUTINE</u>
OPERATOR EVICT.	The operator entered an EVICT command to drop the job from the rollout queue. This disallows EXIT, EREXIT, and REPRIEVE processing.	Contact site operator to determine the cause of job eviction.	IRI
OPERATOR KILL.	The operator entered a KILL command to drop the job. This disallows EREXIT processing. A job with extended REPRIEVE processing is reprieved once. EXIT processing is allowed.	Correct job as needed and rerun.	IAJ
OPERATOR OVERRIDE.	The operator entered an OVERRIDE command to drop the job. This disallows EXIT, EREXIT, and REPRIEVE processing.	Correct job as needed and rerun.	IAJ
OUTPUT FILE LIMIT.	The total number of files disposed to the output queue by the job has exceeded the limit for which the user is validated.	If possible, split job into two or more jobs and retry. Otherwise, reduce number of files by copying output to single file and then issuing dispose.	LFM
OUTPUT FILE LIMIT, FILE lfn AT addr.	During an attempt to close this file, the number of files disposed to output queues by the job has exceeded the limit for which the user is validated.	If possible, split job into two or more jobs and retry. Otherwise, reduce number of files by copying output to single file and then issuing dispose.	CIO
OVERLAY FILE EMPTY.	No data appears in the requested file.	Verify that overlay file is valid.	IAJ
OVERLAY FILE NOT FOUND.	The specified file was not available.	Verify that file is local to job and retry.	IAJ
OVERLAY LOST.	The specified overlay was not found.	Verify that file with specified overlay is local to job.	IAJ
OVERLAY NOT FOUND IN LIBRARY - ovlname.	The overlay ovlname was not found in the system library.	Verify that call is to valid overlay.	LDR
PARAMETER BLOCK BUSY.	The completion bit of the parameter block was not set to one before the RA+1 request was made.	Set completion bit before making RA+1 call.	LFM
PF STAGING DISABLED, AT addr.	The specified direct access file resides on the Mass Storage Facility (MSF) and the site has temporarily disabled all MSF file staging.	Ask site operator when MSF file staging will resume and retry the job at that time.	PFM

<u>MESSAGE</u>	<u>SIGNIFICANCE</u>	<u>ACTION</u>	<u>ROUTINE</u>
PF UTILITY ACTIVE, AT addr.	Because a permanent file utility is currently active, the operation was not attempted; the user should retry the operation.	Wait until PF utility is not active and retry.	PFM
PFC VERIFICATION ERROR.	The creation date and time, user index, or alternate storage address do not agree with the current PFC contents.	Inform site analyst.	PFM
PFM ARGUMENT ERROR.	PFM detected an error in the request.	Ensure that a valid PFM request is being made.	PFM
PFM EXCESS ACTIVITY.	The system PFM activity count is currently at its limit. This condition is reported to the requesting program only if both ep and up processing options are set.	Retry operation later.	PFM
PFM ILLEGAL REQUEST.	One of the following occurred: - A privileged command was requested by a nonvalidated program. - An illegal backup requirement, preferred residence, or subsystem value was entered.	Verify that the PFM request is valid.	PFM
PFM ILLEGAL REQUEST, AT addr.	One of the following: - Illegal command code passed to PFM. - Illegal permit mode or catalog type specified. - CATLIST request has permit specified without a file name. - PERMIT command or macro attempted on a public file.	Verify that PFM request is valid.	PFM
PFM INVALID FAMILY.	The family and device specified are not active on the system.	Inform site analyst.	PFM
POSITION ERROR ON-filenam.	File filenam was not repositioned after being checkpointed because CHKPT detected an address error.	None.	CHKPT
POSITION LOST, lfn AT addr.	During write or read error recovery, the system could not find the last good block of data, making it impossible to successfully perform error recovery. Labels are not written after this error and existing data on the tape is not destroyed.	Retry operation on different tape and/or tape drive, if possible.	IMT
PP CALL ERROR.	The monitor detected an error in a CPU request for PP action.	Verify that correct PP call is issued.	IAJ
PRIOR TAPE ASSIGNMENT LOST.	Magnetic tape executive has been dropped along with tapes assigned. All of the user's prior tape assignments are lost.	Terminal user must return/unload all prior tapes and reassign. Batch user is aborted and must	RESEX

<u>MESSAGE</u>	<u>SIGNIFICANCE</u>	<u>ACTION</u>	<u>ROUTINE</u>
		rerun his job.	
PROGRAM NOT FOUND.	The program to be loaded was not found on the specified library file.	Verify that the program is on library file.	EXU
PROGRAM NOT ON MASS STORAGE.	The program does not reside on a mass storage device.	Copy program to mass storage.	EXU
PROGRAM STOP.	The system processed a program stop (00) instruction.	None.	IAJ
PROGRAM STOP AT addr.	The monitor detected a program stop instruction at address addr.	None.	IAJ
PROGRAM TOO LONG.	The program does not fit in the available storage.	Increase field length and retry.	EXU
PROTECTED FILE.	The user has attempted to release a locked file.	None.	LFM
PRU LIMIT, AT addr.	The job's mass storage PRU limit was exceeded during preparation of a local copy of an indirect access file.	Return one or more local files and retry.	PFM
PRU LIMIT, FILE lfn AT addr.	The job's mass storage PRU limit was exceeded during an attempt to write or extend this file.	Return one or more local files and retry.	CIO
PRUS REQUESTED UNAVAILABLE, AT addr.	The number of PRUs specified via the S parameter on the DEFINE request is not available.	Request smaller number of PRUs.	PFM
QFM ARGUMENT ERROR.	One of the following: - Address is outside field length. - Address is equal to 1. - Origin code is out of range. - ID code is out of range.	Verify that QFM request is valid.	QFM
QFM - BUFFER ARGUMENT ERROR.	A buffer pointer did not conform to the following constraints. FIRST .LE. IN FIRST .LE. OUT OUT .LE. LIMIT .LE. FL	Examine program to determine error in buffer pointers.	QFM
QFM FILE EMPTY.	Either an empty file was specified on a READ directive in the submit source file or the NR parameter was specified on the SUBMIT statement so that the specified file was not rewound.	Check that the correct file is specified. If it is, rewind the file or remove the NR parameter from the SUBMIT statement.	QFM

<u>MESSAGE</u>	<u>SIGNIFICANCE</u>	<u>ACTION</u>	<u>ROUTINE</u>
QFM FILE NAME ERROR.	The lfn specified is not a valid file name.	Verify file name.	QFM
QFM FILE NOT FOUND.	The file to be submitted could not be found.	Verify that submit file exists.	QFM
QFM FILE NOT ON MASS STORAGE.	The file to be submitted does not reside on mass storage.	Copy file to be submitted to mass storage and retry.	QFM
QFM I/O SEQUENCE ERROR.	Action was requested on a busy file.	Wait until file is not busy and retry.	QFM
QFM ILLEGAL EQUIPMENT.	The equipment specified in FET+7 either is not mass storage or is not in the range of the EST.	Verify that correct equipment is specified in FET+7.	QFM
QFM ILLEGAL FILE TYPE.	The file to be submitted is not a local file type.	Copy the submit file to a local file.	QFM
QFM ILLEGAL ID CODE.	The ID code is out of range.	Verify that valid ID code is being used.	QFM
QFM ILLEGAL ORIGIN TYPE.	The origin type for the file to be submitted is not local or remote batch.	Verify that origin type is correct.	QFM
QFM ILLEGAL REQUEST.	One of the following. - Specified function was illegal or undefined - Job did not have SSJ= entry point - Auto recall bit was not set	Verify that valid QFM request is being made.	QFM
QFM ILLEGAL USER ACCESS.	The user tried to perform an operation for which he is not validated (for example, attempting to run a system origin job from nonsystem origin.	Ensure accuracy of control statement or macro or determine proper validation requirements.	QFM
QFM INVAID FNT ADDRESS.	The FNT address of the file to be attached is out of range.	Ensure that the routine calling QFM supplies the correct address.	QFM
RANDOM ADDRESS NOT ON FILE lfn AT addr.	The random address specified was not within the bounds of the file. The system provides a dump of the FET on file OUTPUT.	Verify that random address is correct.	CIO
READ AFTER WRITE, lfn AT addr.	The user attempted to read a tape on which the last operation was a write.	Ensure accuracy of tape positioning statements (BKSP, BKSPRU, SKIPFB, or REWIND required to read after write).	IMT

<u>MESSAGE</u>	<u>SIGNIFICANCE</u>	<u>ACTION</u>	<u>ROUTINE</u>
READY DROP, lfn AT addr.	Unit dropped ready.	None.	IMT
REPRIEVE BLOCK ERROR.	An address is out of range or there is an illegal parameter in the reprieve parameter block at the time of an error. The message is also issued if the specified reprieve address itself is out of range. (IAJ issues this message for all errors except terminal interrupts processed by IRI.)	Ensure parameter block is correct.	IAJ IRI
REPRIEVE CHECKSUM BAD.	The computed checksum does not agree with the checksum specified in the parameter block at the time of the error. (IAJ issues this message for all errors except terminal interrupts processed by IRI.)	Ensure interrupt handler is still intact. Ensure that code in the area for which checksum was computed has not changed.	IAJ IRI
REQUEST UNDEFINED ON DEVICE lfn AT addr.	The specified function cannot be performed on the device on which the file resides. The system provides a dump of the FET on file OUTPUT.	Verify that valid device is specified.	CIO
RERUN NOT POSSIBLE.	The job cannot be rerun because of one of the following. - Job is time-sharing origin. - No input file is found for the job. - An error occurred in reading or writing the input file system sector. - Rerun status is disabled.	None.	IDS
RESEX ABORT - OPERATOR TERMINATION.	The operator entered a DROP, KILL or RERUN command, setting an error flag in RESEX. RESEX performed appropriate cleanup procedures before termination.	Determine reason for operator action. Rerun job, if desired.	RESEX
RESEX ABORT - SYSTEM RESOURCE LIMIT.	RESEX terminated prematurely due to job time limit, SRU limit, or track limit. RESEX performs appropriate cleanup procedures before termination.	If error caused by SRU or time limit, increase resource limits. If caused by track limit, contact site analyst.	RESEX
RESEX ABORT - TERMINAL INTERRUPT.	Terminal user interrupted RESEX (interrupt or terminate sequence). RESEX performs appropriate cleanup procedures before termination.	None.	RESEX
RESEX DETECTED ERROR.	The resource executive (RESEX) detected an error.	Inform site analyst.	LFM

<u>MESSAGE</u>	<u>SIGNIFICANCE</u>	<u>ACTION</u>	<u>ROUTINE</u>
RESEX FAILURE, AT addr.	The resource executive (RESEX) has detected a fatal error.	Inform site analyst.	PFM
RESOURCE ENVIRONMENT ERROR.	Dayfile message indicating RESEX internal problem occurred (internal environment building failed due to MST, UDT, or EST errors).	Inform site analyst.	RESEX
RESOURCE NEGATIVE SHARE COUNT.	Dayfile message indicating RESEX internal problem occurred. The resource overcommitment algorithm indicates a greater number of users are supposedly sharing a removable pack than are actually sharing the pack.	Inform site analyst.	RESEX
RESOURCE PF ERROR ec filename.	PFM error ec occurred when attaching resource file filename.	Inform site analyst.	RESEX
RESOURCE SCRATCH FILE ERROR.	Dayfile message indicating RESEX internal problem has occurred. An empty entry has been found in the overcommitment algorithm scratch file.	Inform site analyst.	RESEX
RFL BEYOND MFL.	The RFL request is greater than the maximum field length for a job step.	Increase maximum field length with MFL statement.	CFM
ROLLIN FILE BAD.	A job could not be rolled in correctly.	Inform site analyst. Check error log dayfile for the job that was aborted and the location of the bad rollin file.	IRI
RPV-ADDRESS OUT OF RANGE.	An address provided to RPV was out of range. This includes one of the following. <ul style="list-style-type: none"> - FWA of parameter block .GE. FL - LWA of parameter block .GE. FL - Transfer address .GE. FL - Transfer address .LT. 2. 	Check to see that no portion of the parameter block or an address specified is beyond the user's field length.	RPV
RPV-CALLED WITHOUT AUTO-RECALL.	An extended RPV mode call was made without auto-recall.	Ensure that auto-recall bit is set.	RPV
RPV-ILLEGAL CALL.	One of the following is true. <ul style="list-style-type: none"> - An attempt was made to do a reset when no previous error existed or the previous error had been pending. - An extended mode call was attempted when RPV non-extended or DISTC had already been set in the control point area. - A non-extended mode call was attempted when RPV extended mode had already been set in the control point area. 	<ul style="list-style-type: none"> - Check to see if a reset is allowed. - If RPV non-extended mode has already been used, then RPV non-extended mode cannot be used in the same job. - If RPV extended mode has already been used, then RPV non-extended mode 	RPV

<u>MESSAGE</u>	<u>SIGNIFICANCE</u>	<u>ACTION</u>	<u>ROUTINE</u>
RPV-ILLEGAL FUNCTION CODE.	The function code specified in the parameter block was illegal.	cannot be used in the same job. Function code in parameter block must equal 1 for setup, 2 for resume, or 3 for reset.	RPV
RPV-ILLEGAL PENDING INTERRUPT.	A bit was set in the pending interrupt word of the parameter block which did not correspond to a defined error.	Check parameter block to ensure that all bits set correspond to a defined error.	RPV
RPV-ILLEGAL PENDING RA+1 REQUEST.	The pending RA+1 request field of the parameter block contained an invalid RA+1 request on a RESUME or SETUP. On a RESET, the pending RA+1 request is not validated since the job will not be restarted.	Check pending RA+1 request word in parameter block to ensure that it contains a valid call.	RPV
RPV-LWA OF CHECKSUM .LT. FWA.	The last word address of the checksum was less than the first word address.	Correct and rerun.	RPV
RPV-PARAMETER BLOCK TOO SHORT.	The length specified in the parameter block was less than 31 words.	Ensure that the length specified in the parameter block is greater than or equal to 31B.	RPV
RPV-UNDEFINED MASK.	The mask specified in the parameter block is not a legal mask.	Check mask set in parameter block to ensure that it is a valid mark.	RPV
SECURE MEMORY, DUMP DISABLED.	The user attempted to dump memory protected by the system, or entered DMD or DMP after a CCL statement or from a terminal.	Refer to Security Control in section 3 and the DMD and DMP statements in the NOS Reference Manual, volume 1. To obtain memory dumps from a time-sharing job, include the DMD or DMP statement in a procedure or in an ENTER statement. A DMD statement can be included only in a batch job.	1AJ
SFM ARGUMENT ERROR.	The argument passed to SFM was out of bounds or the FET specified did not specify a buffer of at least 100 octal words.	Verify that SFM request is valid.	SFM

MESSAGE -----	SIGNIFICANCE -----	ACTION -----	ROUTINE -----
SFM DAYFILE BUSY.	Action was requested on a busy dayfile.	Inform site analyst.	SFM
SFM ILLEGAL DAYFILE CODE.	The dayfile code passed in the FET was not within range.	Inform site analyst.	SFM
SFM ILLEGAL REQUEST.	The requested function or origin type specified in the function call was not recognizable or SFM request was made and the auto recall bit was not set.	Verify that SFM request is valid.	SFM
SFM TRACK INTERLOCK ERROR.	Track was either interlocked when it should not have been or not interlocked when it should have been.	Inform site analyst.	SFM
SFM UNABLE TO INTERLOCK DEVICE.	SFM request was not performed because the selected device could not be interlocked.	Inform site analyst.	SFM
SI CODED FORMAT ILLEGAL.	An attempt was made to perform a read or write operation on an SI tape with the coded bit set in the FET.	Resubmit the job with binary specified for the operation on the SI tape.	1MT
SL NOT VALIDATED.	The SRU limit requested exceeds that for which the user is validated.	Request smaller SRU limit.	CPM
STATUS ERROR, lfn AT addr.	An irrecoverable error was encountered. A second message line describes the error in more detail.	Retry or inform site analyst.	1MT
ARA BURST DEFECTIVE.	First block of tape at 1600 or 6250 cpi cannot be read or written. Another unit or tape should be tried.		
CRC ERROR.	An error was detected in cyclic redundancy character.		
FILL STATUS ILLEGAL.	The system has detected an odd number of frame, a condition which is illegal for the data format of the tape being read.		
MULTI-TRACK PHASE ERROR.	Multiple tracks were found to be in error at 1600 cpi, making recovery impossible.		
PARITY ERROR.	The tape could not be read/written correctly.		

MESSAGE	SIGNIFICANCE	ACTION	ROUTINE
	UNIT HAS MOTION PROBLEMS.	The tape unit cannot properly write the tape. The user should resubmit his job, using a different tape unit.	
	UNIT PROBLEMS.	Unit check bit is set in detailed status (67x units only). The user should try another unit.	
	POSTAMBLE ERROR.	A missing or defective postamble was detected at 1600 cpi.	
	SINGLE FRAME ERROR.	A frame (NRZI only) containing all zeros was read; data will be at least one frame short.	
	LRC ERROR.	The longitudinal redundancy check character was read incorrectly (9-track NRZI).	
	ILLEGAL CHARACTER.	Illegal character read from 9-track tape. If a 1 is detected in bit 6 of a translated character, the character is illegal.	
STEP CONDITION.	Step mode flag set in the PSD register caused the program to interrupt at the end of a program instruction with an exchange jump to EEA (the error exit address in the exchange package).	Inform site analyst.	1AJ
SUBSYSTEM ABORTED.	The user job was connected (either long term connection or wait response set) to a subsystem which aborted.	Retry later.	1AJ
SYSTEM ABORT.	Possible causes include the following. <ul style="list-style-type: none"> - Invalid USER statement - Attempt to access a restricted subsystem - Operator evicted job - Unrecognizable error flag - SSJ= block outside field length - 1RI detected a bad rollout file - 1RO detected an unrecoverable ECS parity error during rollout of a job's ECS field length. 	If the cause was an invalid USER statement or an attempt to access a restricted subsystem, correct the job and rerun. Otherwise, contact a site analyst.	1AJ

MESSAGE -----	SIGNIFICANCE -----	ACTION -----	ROUTINE -----
SYSTEM CHECKPOINT ABORT.	The checkpoint system was up and aborted, and in the process aborted a number of subsystems.	Informative message.	ICK
SYSTEM ERROR.	One of the following. - RESEX cannot communicate with subsystem via the RSB or SIC monitor calls. - LFM cannot complete the requested LFM function because the calling program has a DMP= entry point. - BLANK is unable to read low core pointers via the RSB monitor call. - PFM detects error condition.	Inform site analyst.	BLANK, LFM, PFM, RESEX
TAPE FORMAT PROBABLY WRONG.	This message is issued in addition to one of the following messages. BLOCK SEQUENCE ERROR, lfn AT addr. BLOCK TOO LARGE, lfn AT addr. WRONG PARITY, lfn AT addr.	Ensure accuracy of format (F) parameter on control statement or macro.	IMT
TIME LIMIT.	The execution time limit for a job step expired resulting in job termination.	If a time limit was set for the job, include a SETTL statement requesting a longer time limit for the job step. If the job step time limit was the maximum for which the user is validated, request a larger time limit or decrease the amount of processing to be performed by the job step.	IAJ
TL NOT VALIDATED.	The time limit requested exceeds that for which the user is validated.	Request smaller time limit.	CPM, ACCFAM
TOO MANY DEFERRED BATCH JOBS.	The user is not validated for this function or he has more jobs in the system than he is allowed. (All jobs in local and remote batch queues are counted.) The count is ignored if the job is of system origin or the user is validated for system privileges and DEBUG mode is set by the operator.	Resubmit the job when a queued deferred batch job has been processed. To change your validation limit, contact site personnel.	QFM
TOTAL ASSIGNED COUNT ERROR.	Dayfile message indicating RESEX internal problem (sum of individual resource assigned counts differs from total assigned count in demand file entry).	Inform site analyst.	RESEX

<u>MESSAGE</u>	<u>SIGNIFICANCE</u>	<u>ACTION</u>	<u>ROUTINE</u>
TOTAL DEMAND COUNT ERROR.	Dayfile message indicating RESEX internal problem occurred (sum of individual resource demand counts differs from total demand count in demand file entry).	Inform site analyst.	RESEX
TRACK LIMIT, FILE lfn AT addr.	The device on which the file resides is full.	Specify another device or contact site analyst.	CIO
UNIDENTIFIED PROGRAM FORMAT.	The file the user requested to be loaded was in an unrecognizable format.	Check the format of the file.	IAJ
UNIT HUNG UP ON EOP OR BUSY, lfn AT addr.	Unit did not receive EOP on unit busy.	Inform site analyst.	IMT
VEJ - BUFFER ARGUMENT ERROR.	Dayfile message indicating that FET buffer pointers are invalid. (FWA<LWA<FL) or TID (terminal id) with complement address was not within the field length.	If issued to a subsystem (such as BATCHIO or RBF), inform site analyst immediately to determine which condition caused the error.	VEJ
VEJ - ILLEGAL REQUEST.	Dayfile message indicating that one of the following conditions has occurred. <ul style="list-style-type: none"> - VEJ was called by a control point which did not have priority greater than MXPS. - The FET address was out of range. - A job without SSJ= privileges attempted to specify a system sector address in the RA+1 call. - The system sector buffer was not within the field length. - A nonmass storage device request was made. 	If issued to a subsystem (such as BATCHIO or RBF), inform site analyst immediately to determine which condition caused the error.	VEJ
VSN FILE ERROR.	Dayfile message indicating RESEX internal problem occurred (VSN file entry does not match job identification).	Inform site analyst.	RESEX
WRITE ON READ-ONLY FILE lfn AT addr.	Either the user attempted to write on a file with write interlock or the direct access file was not attached in WRITE mode.	Reattach file in write mode or clear write interlock.	CIO, IAFEX, TELEX
WRITE OVER LABEL.	The user attempted to write over the VOL1 label.	Have the operator blank label the tape.	IMT
WRITE OVER LABEL ILLEGAL ON lfn AT addr.	The user is not allowed to destroy the VOL1 label.	Use LISTLB control statement to obtain label data.	IMT
WRONG PARITY, lfn AT addr.	A 7-track tape is being read in opposite parity from which it was written.	Ensure accuracy of format parameter (F) on control statement or macro.	IMT

<u>MESSAGE</u>	<u>SIGNIFICANCE</u>	<u>ACTION</u>	<u>ROUTINE</u>
XL BUFFER/FET PARAMETER ERROR, lfn AT addr.	One of the following: <ul style="list-style-type: none"> - HDR1 label in extended label buffer or FET contains a nonnumeric display code value in a numeric field. - Character count in header word preceding labels in the extended label buffer does not equal 80. 	Correct condition that caused error and retry.	IMT
200BPI WRITE ILLEGAL.	The tape unit (667 or 677) cannot record data at 200 bpi.	Specify a different tape density.	IMT
filenam ALREADY PERMANENT, AT addr.	The user has already saved or defined a file with the name specified.	Save or define file using different file name or purge existing file.	PFM
jobnam ASSIGNS EXCEED DEMANDS.	Dayfile message indicating that RESEX internal problems occurred. The resources actually assigned to the job jobnam exceed the resources demanded on a RESOURC statement.	Inform site analyst.	RESEX
pfn BUSY, AT addr.	The specified direct access file is attached in an incompatible mode, or it is currently being accessed by one of the following. <ul style="list-style-type: none"> - More than 77B users in READ mode - More than 77B users in READAP mode - More than 7777B users in READMD mode 	Reissue ATTACH until file becomes available, or issue ATTACH specifying NA option.	PFM
lfn EMPTY, AT addr.	The file specified on a SAVE request contains no data.	Verify that file contains data and retry.	PFM
pfn ILLEGAL FILE TYPE, AT addr.	The operation requested cannot be performed on the specified file because it is of the wrong file type. This message is issued when the user attempts to define a direct access file with the same name as a file currently assigned to the job that is of a file type other than local (LOFT).	Define the file using a unique name or return the conflicting file.	PFM
pfn INTERLOCKED.	The file is currently not available for write, modify, or append modes of access because a system utility has attached the file in utility mode.	Retry operation later.	PFM
pfn IS DIRECT ACCESS, AT addr.	An indirect access file operation was attempted on a direct access file.	Use the appropriate direct access file request.	PFM
pfn IS INDIRECT ACCESS, AT addr.	A direct access file operation was attempted on an indirect access file.	Use the appropriate indirect access file request.	PFM

<u>MESSAGE</u>	<u>SIGNIFICANCE</u>	<u>ACTION</u>	<u>ROUTINE</u>
jobnam MISSING RESOURCE.	Dayfile message indicating that RESEX internal problem occurred. RESEX expected but did not find a resource unit assigned to the specified job. This could occur if MAGNET was stopped while tapes were assigned.	Inform site analyst.	RESEX
filenam NOT FOUND, AT addr. or un NOT FOUND, AT addr.	One of the following. - The specified permanent file could not be found. - The specified user number could not be found. - The user is not allowed to access the specified file. - The specified local file could not be found or was an execute-only file.	Verify that file name/ user number is correct, that access permission has been granted, and that correct access is being attempted.	PFM
filenam NOT ON MASS STORAGE, AT addr.	The file to be saved is not on mass storage; the first track of the file is not recognizable.	Verify that file is on mass storage.	PFM
pfn PERMANENT ERROR, AT addr.	The specified direct access file resides on the Mass Storage Facility (MSF) and has data errors that cannot be corrected.	Ask site analyst about file recovery from a backup copy.	PFM
jobnam SHARE TABLE MISMATCH.	Dayfile message indicating that RESEX internal problem occurred. While processing the specified job, an expected share table entry match with the environment did not occur.	Inform site analyst.	RESEX
pfn STAGE INITIATED.	The file does not reside on disk. It is currently being staged from alternate storage to disk.	Wait until stage operation is complete.	PFM
pfn WAITING MSS EXEC.	The file must be staged from alternate storage to disk and the MSS executive is not currently available to perform the stage operation. MSS archive processing is enabled.	Wait for executive to be started or inform site analyst.	PFM

GLOSSARY

C

Abort	To terminate a program or job when a condition (hardware or software) exists from which the program or computer cannot recover.
Absolute Assembly	In the context of this manual, a COMPASS program assembled with the ABS pseudo instruction in which there are no references to external entry points.
Account Block	An accumulation of SRUs that are applied to a job or a charge and project number.
Allocatable Device	A storage device that can be shared by more than one job and which is allocated by the system without operator intervention.
Alphanumeric	Consisting of alphabetic and/or numeric characters only.
Alternate User Number	A user number specified in a permanent file request which indicates the action is to be taken on an alternate user's permanent file.
ANSI	American National Standards Institute. An organization that establishes standards for the benefit of its member organizations.
ASCII	American National Standard Code for Information Interchange character set.
Auto Recall	The act of a program releasing control of the CPU until a requested function is complete. Refer also to recall.
Auxiliary Device	A mass storage permanent file device used to supplement storage provided by the normal permanent file devices associated with the system (refer to family device).
Block	The information between interrecord gaps on a magnetic tape. Blocking is the grouping of user records for efficiency in transfer between memory and storage devices. Block size is specified with the LABEL macro.
BOI	Beginning-of-information.
Buffer	An intermediate storage area used to compensate for a difference in rates of data flow, or times of event occurrence, when transmitting data between central memory and an external device during input/output operations.

Byte	A 12-bit portion of a 60-bit central memory word (refer to word) starting in bit position 59, 47, 35, 23, or 11. Bytes are numbered 0 to 4 from the left.
Capsule	A relocatable collection of one or more programs bound together in a special format that allows the programs to be loaded and unloaded dynamically from an executing program by the Fast Dynamic Loader.
Central Memory	<p>The main device for storing instructions and data in a computer system. Individual storage cells (called words) can be addressed by a computer program and the contents of those storage cells can be loaded directly into registers where instructions can be executed and data can be operated on.</p> <p>Central memory is composed of from 49000 to 262000 words, each 60 bits in length.</p>
Checkpoint	The process of writing to a magnetic tape or mass storage file a copy of the user's central memory, the system information used for job control, and the names and contents of all assigned files that are identified in a CHECKPT macro request (refer to section 10).
Checksum	A numeric value used to verify a file.
Circular Buffer	A temporary central memory storage area that contains data during input/output operations. Routines that process I/O treat the first word of the buffer area as contiguous to the last word of the buffer area. Refer to section 2.
Common Deck	A common deck is a subprogram or group of macro or symbol definitions that are accessed from a program library using the CALL Modify directive or XTEXT COMPASS pseudo instruction.
Compare/Move Unit	The Compare/Move Unit (CMU) provides CPU instructions for moving and comparing data fields that consist of strings of 6-bit characters. Refer to the SYSCOM macro in section 1 for information on determining if the CMU is available.
COMPASS	The assembly language of the CYBER 170, CYBER 70, and 6000 Series computers.
Control Byte	A 12-bit byte that changes the current input or output mode at a time-sharing terminal (refer to section 12).
Control Points	The concept which enables the multiprogramming capability of NOS. When a job is assigned to a control point, that job is allocated a portion of central memory and it becomes eligible for assignment to the central processor for execution.

Control Statement Record	A text record that contains control statement images. The first, and possibly only, record on the job input file consisting of statement images that start with a job statement and end with the first EOR or EOF or the EOI.
CPU	Central processor unit. The high-speed arithmetic unit that performs the addition, subtraction, multiplication, division, incrementing, logical operations, and branching instructions needed to execute programs.
CYBER Loader	The NOS product that prepares programs for execution by placing program instruction and data blocks in central memory.
CYBER Record Manager	A software product supported under NOS that allows the user to create and read a variety of record types, blocking types, and file organizations to be created and read. The execution time input/output of COBOL 4, COBOL 5, FORTRAN 4, FORTRAN 5, Sort/Merge 4, ALGOL 5, BASIC, and the DMS-170 products is implemented through CYBER Record Manager. COMPASS programs can use either CYBER Record Manager or CIO.
Dayfile	A chronological system file which forms an accounting and job history file. Entries, called dayfile messages, are generated by operator action, user actions, or by the system. The system dayfile has entries for the entire system. Every job receives a user dayfile with entries pertinent to that job.
Default	A system-supplied parameter value or name used when a value or name is not supplied by the user.
Device Type Code	A 12-bit display code field indicating the type of device upon which a file resides.
Direct Access File	A permanent file that can be attached to the user's job with the ATTACH macro. All changes to this file are made on the file itself rather than a working copy of the file (refer to indirect access file).
Display Code	A 6-bit code used to represent alphanumeric and special characters (refer to appendix A in volume 1).
Disposition Code	A two-character mnemonic indicating destination queue and format for processing a file named on a ROUTE macro.
ECS	Extended core storage. An additional memory available as an option. This memory can only be used for program and data storage, not for program execution. Special hardware instructions exist for transferring data between central memory and ECS.

Empty Record	A PRU that contains no user data (refer to zero length PRU).
End-of-line	A separator in coded files that is represented by 12 bits of zero, right-justified in a 60-bit word. In some cases, up to 66 trailing zero bits are considered an end-of-line.
Entry Point	A symbolic name within a program that can be referenced from other programs. Each entry point has a unique program location with which it is associated.
EOF	End-of-file is a boundary within a sequential file, but not necessarily the end of a file that can be referenced by name. The actual end of a named file is defined by EOI.
EOI	End-of-information. The physical end of data. On mass storage devices, the position of the last written data. For magnetic tapes, refer to appendix J.
EOR	End-of-record is the terminator of a logical record. On a PRU device, a short PRU or a zero length PRU with a level designator of 0 indicates EOR. On tapes that are not PRU devices, an interrecord gap indicates EOR.
EOT	End-of-tape; metallic strip marking the end of the recordable portion of a magnetic tape.
Equipment Code	Refer to Device Type Code.
EST Ordinal	The number designating the position of an entry within the equipment status table established at each installation.
Exchange Jump	Execution of a CPU program is initiated by an exchange jump. The program is defined by the contents of the exchange package area before the exchange jump took place. For the program to execute, the proper contents of its operational registers must be loaded into the CPU. These contents are what is contained in the exchange package area associated with the program.

Exchange Package	A 16-word table containing information used in exchange jumps during job execution: contents of central processor registers, RA and FL in central memory and in ECS and the program address. It is stored in the control point area and can be printed as part of the output of a central memory dump (refer to the DMP control statement). Refer to the REPRIEVE macro, section 10, and DISTC macro in section 12.
Exit Mode	A flag set by the MODE macro that specifies the types of errors that cause the CPU to abort.
Extended Labeled Processing	A tape processing mode in which all tape labels (including optional labels) are read into a label buffer for further processing.
External Reference	A reference in a program to an entry point in another program.
Family Device	Mass storage permanent file device associated with a specific system. A family may consist of 1 to 63 logical devices. Normally, a system runs with one family of permanent file devices available. However, additional families may be introduced during normal operation. This enables the user associated with the additional families to access their permanent files via an alternate system.
Fast Dynamic Loader (FDL)	A facility that provides fast loading and unloading of specially formatted code called capsules. The amount of memory required for job execution can be greatly reduced because capsules can be easily loaded and unloaded as needed, freeing memory for other uses.
FET	File environment table. It defines the current status and properties of a file that is being used by a job.
Field Length (FL, FLE)	FL is the number of central memory words assigned to a job. FLE is the number of words of extended core storage assigned to a job. Within central memory or extended core storage, the field length added to the reference address defines the upper address limit of a job.
File	Set of information that begins at BOI and ends at EOI and that is referred to by a logical file name. A file is also defined as that portion of a file terminated by EOF; thus, a multifile file can exist. All files are at least one PRU in length.
File Category	A permanent file attribute that specifies the manner in which alternate users can access the file (refer to section 5).

File Environment Table	Refer to FET.
File Flushing	The process of writing the contents of a file's circular buffer to mass storage when certain conditions are met (refer to SETLOF macro in section 6).
File Set	One or more tape files referred to by the lfn on a tape assignment statement. A file set may consist of: <ul style="list-style-type: none"> ● One file recorded on a single volume. ● More than one file recorded on a single volume. ● One file recorded on more than one volume. ● More than one file recorded on more than one volume. <p>To conform to the ANSI tape standard, all files within a file set must have the same setid in their HDR1 labels.</p>
File Types	NOS defines several file types that are used to control job processing. The file type is defined in the FNT (refer to appendix E for a list of file types and the GETFNT macro in section 4 for information on determining file types).
Flag	A character or bit that signals the occurrence or presence of a particular condition.
FNT	File name table. The first word of the two-word FNT/FST entry which contains the local file name, the file type and other job control information (refer to the GETFNT macro in section 4).
Frame	A tape recording unit made up of 1 bit from each tape track (7 bits for seven-track tape; 9 bits for nine-track tape). Each frame usually represents one character.
FST	File status table. The second word of the two-word FNT/FST entry which contains information pertaining to the file's location on mass storage and other job control information.
Full Track	Reading/writing sequential sectors on an 844 or 885 disk pack.
Function Processor	A system CPU or PP program that the user can call by placing a request in location RA+1. Function processors perform input/output, local and permanent file manipulations, and so on.

Generation	The position of a file within a series of files, each file developed from the preceding file. The generation number and generation version number of a tape file can be entered in its HDR1 label.
Global Library Set	An ordered set of libraries that remain in effect throughout job execution unless specifically changed (refer to SETGLS macro in section 6).
Half Track	Reading/writing alternate sectors on an 844 or 885 disk pack.
Indirect Access File	A permanent file that is accessed only by making a working copy of the file (GET macro). It is created or altered by saving or replacing the contents of an existing working file (REPLACE or SAVE macros).
Input File Type	Job file. Its first record is a control statement record which may be followed by records containing data, directives, or programs used by job steps.
Interactive Programs	CPU programs in which the user and the computer communicate with each other, rather than the user submitting his job, receiving output, and having no control over the job while processing occurs.
Interrecord Gap	Space skipped between the writing of data blocks on magnetic tape.
Interrupt	To stop a running program in such a way that it can be resumed at a later time. Also a special control signal which, when issued from a terminal, causes action as described by the program. Refer to the REPRIEVE macro in section 10 and the DISTC macro in section 12.
Job Step	Each individual control statement or loader sequence is a job step. A group of job steps forms a job stream, control statement record, or a procedure file.
Label	A block at the beginning or end of a magnetic tape volume or file, which serves to identify and/or delimit that volume or file. Refer to the LABEL macro in section 4 and appendix G in volume 1 for a description of labels.
Level Designator	The level designator is an octal number in the terminating marker of a PRU, ranging from 00 to 17 ₈ . A level 17 in an empty PRU designates an EOF. A level 0 in a short PRU designates an EOR. A level 1 in a short PRU designates an EOR and that the record came from an interactive terminal. A level 16 in a short PRU designates an EOR on a checkpoint file. The level designator is returned to the FET on a READ.
Level Number	Refer to level designator.

lfn	Local file name. The file name assigned to any file while it is local (assigned) to a job. The name is contained in the FNT.
Library	A file or collection of files containing executable programs and tables needed to locate and load the programs. A system library can contain peripheral processor programs in addition to central processor programs. A user library is file formatted as a library but is not available to a job until it has been explicitly declared via CYBER loader control statements or macros.
Library File	A read-only file that can be accessed by several users simultaneously.
Line	Refer to zero byte terminator and end-of-line.
List of Files	A table containing names of files that are to be considered for file flushing (refer to SETLOF macro in section 6).
Load Point	Metallic strip marking the beginning of the recordable portion of a magnetic tape.
Local File	A file that is currently associated with a job. Each local file has an FNT/FST entry.
Local File Name	Refer to lfn.
Locked File	A file on which a user cannot write. Refer to LOCK macro in section 4.
Logical Record	A logical record on mass storage is terminated by an EOR; on tape, it is terminated by the conditions described in appendix J for individual tape formats.
Macro	A sequence of source statements that are saved and then assembled whenever needed through a macro call.
mlrs	Maximum logical record size. A number that specifies the maximum size for a logical record for S and L tape formats.
Multifile File	A file containing more than one logical file. It begins at BOI and ends at EOI. On a labeled tape, a multifile file is delimited by corresponding HDR1 and EOF1 labels.
Multifile Set	A tape file set having more than one tape file.
Network	A sophisticated data and message switching and routing system used to provide communication between terminals and applications.
Network Terminal	A terminal that communicates with the operating system through the network.

Nonallocatable Device	A device such as a magnetic tape which can be used by only one job at a given time.
Nonstandard Tape Label	A tape label format that cannot be read or written by the system. If the tape is at load point, a subsequent read operation skips to the first tape mark.
opdef	A sequence of source statements that are saved and then assembled whenever needed through an opdef call. Differs from a macro in that the assembler interprets the call by examining the format or syntax of the instruction rather than the contents of the operation field alone.
OPL	Old program library. In this manual it refers to the Modify-formatted program library that contains source code for system routines and common decks.
Overlay	One or more relocatable programs that were relocated and linked together into a single absolute program. It can be a main, primary, or secondary overlay.
Pack Name	A one- to seven-character name that identifies the auxiliary device to be accessed in a permanent file request (refer to section 5).
Parameter	A variable that is given a specific value for a particular purpose or process.
Parity	In writing data on tape, an extra bit is either set or cleared in each byte so that every byte has either an odd number of set bits (odd parity) or an even number of set bits (even parity). Nine-track tapes are always written in odd parity. For seven-track tapes, a coded write is in even parity and a binary write is in odd parity. Parity is checked on a read for error detection and possible recovery.
Password	A file access word that defines access to a particular file by alternate users.
Permanent File	A mass storage file cataloged by the system so that its location and identification are always known to the system. Permanent files are protected by the system from unauthorized access according to privacy controls specified when they are created, and will be maintained until the user deletes them.
Permanent File Catalog	A 16-word entry that the system maintains and uses to determine attributes of a permanent file.
Permanent File Family	Permanent files which reside on the family devices of a specific system.

Physical Record	On magnetic tape, information between interrecord gaps (refer to block). It need not contain a fixed amount of data. For mass storage, refer to PRU.
PP	Peripheral processor. An individual computer with its own memory, used for high-speed transfer of information (input and output) between peripheral devices and central memory.
Primary File	The primary file is the default file for several control statements and time sharing commands. It is re-wound before each job step.
Print File	Output file containing data to be printed. Printing occurs at job completion or upon execution of a ROUTE or RELEASE macro.
Private Auxiliary Device	Auxiliary device associated with a specific user. Only the user may create files on the device, although he may permit other users to access files which reside on the device.
Program Library	The file generated by Modify that contains the decks of line images. Line images in the program library are in a format that can be manipulated by Modify.
PRU	Physical record unit. The amount of information transmitted by a single physical operation of a specified device. A PRU for mass storage devices is 64 central memory words in length. A PRU for a magnetic tape is described in appendix J.
PRU Device	A magnetic tape file or a mass storage device in which information has a physical structure governed by physical record units (PRUs).
Pseudo Instruction	An assembler-defined instruction appearing in the operation field of a statement. It normally does not specify the assembly of a single machine instruction, but instead specifies some other assembly process (such as symbol definition and listing control).
Public Auxiliary Device	Auxiliary device available for access by all validated users knowing the correct pack name. Additional validation is required to create or replace files on an auxiliary device.
Punch File	Output file containing data to be punched on cards.
Qualified Symbol	A symbol defined when a qualifier is in effect during assembly. Through qualification, the same symbol can be referred to in different subprograms without conflict.

Queue Priority	A number that controls the scheduling of a job to and from the rollout queue relative to other jobs of the same origin type (refer to SETQP macro in section 6).
Random Access	Access method by which any record in a file can be accessed at any time. Applies only to mass storage files with an organization other than sequential.
Random File	A file with an index entry to each record in the file. A file on a rotating mass storage device is a random file only when the random bit is set in the file environment table. The last record of the file is an index.
Recall	The state of a program when it has released control of the central processor until a fixed time has elapsed (periodic recall) or until a requested function is completed (auto recall). Recall is a system action request as well as an optional parameter of some file action requests.
Record	Refer to logical record.
Record Separator	Refer to EOR.
Reel	Refer to volume.
Reference Address (RA and RAE)	RA is the absolute central memory address that is the starting or zero relative address assigned to a program. Addresses within the program are relative to RA. RA+1 is used as the communication word between the user program and the system. RAE is the absolute extended core storage starting address assigned to a program.
Register	A unit within the CPU used to hold operands. The A registers contain the addresses of words within central memory, the X registers contain operands used in calculations, and the B registers are used for incrementing and indexing.
Relative Address	All addresses in a relocatable program are relative to a base address of zero. When a relocatable program is loaded for execution, the zero base address is assigned to a reference address. At that time, all addresses in the program become relative to the reference address.
Relocatable Assembly	In the context of this manual, a COMPASS program assembled without the ABS pseudo instruction. The CYBER Loader will be required to convert relative addresses into absolute addresses and to satisfy external references.
Removable Device	A rotating mass storage device which can be physically detached from the RMS drive.

Rollout	The removal of jobs from central memory to mass storage before execution is complete, so the control point and central memory can be assigned to another job. A job is rolled out when it is waiting for an external resource or event, when its control point and/or central memory is needed by a higher priority job, or when it exceeds its central memory time slice.
Rollout File	A file containing a job (and system information) that has been temporarily removed from the main processing area of the system.
Rotating Mass Storage (RMS)	An 844 or 885 disk storage device.
Sector	Equivalent to PRU for mass storage devices.
Security Count	The number of security violations the user has left before he is denied access to the system.
Security Violation	The result of a user action that resulted in a system abort of the job step and termination without recovery of the job.
Sense Switches	Six 1-bit flags located in the user's control point area and in bits 11 through 6 of RA+0 of the job field length. These bits can be used to communicate with system routines (refer to the ONSW and OFFSW macros in section 6).
Sequential Access	A method in which only the record located at the current file position can be accessed. Refer to random access.
Sequential File	A file in which records are accessed in the order in which they occur. Any file can be accessed sequentially.
Short PRU	A PRU that does not contain the maximum number of words of data allowed for a PRU on that device. Refer to zero length PRU.
Special Entry Point	An entry point that enables system programs to perform special functions (refer to appendix F).
SRU	System resource unit. A unit of measurement of system usage. The number of SRUs includes the CPU time, memory usage, and I/O activity.
Standard Labeled Tape	A tape with labels conforming to American National Standard Magnetic Tape Labels for Information Interchange.
Symbol	A set of characters that identifies a value and its associated attributes.
System Library (SYSLIB)	The collection of tables and object language programs residing in central memory or on mass storage which are necessary for running the system and its product set.

System File	A file that can be accessed only by a system program.
System Request	A request placed in location RA+1 for a function processor to perform a special process.
System Text	A set of tables containing symbol, micro, macro, and opdef definitions that can be saved on a file to be accessed by other programs.
Tape Format	A parameter that specifies the internal recording format of a magnetic tape. Refer to appendix J.
Tape Mark	A short record written on tapes under operating system control to separate label groups, files, and/or labels. Interpretation depends on the tape format.
Temporary File	A file that is currently associated with a job and is temporary in nature. That is, all temporary files cease to exist once they are returned to the system (either specifically or at job termination).
Time Slice	The amount of CPU or CM time a job is allowed to use before the system lowers its priority to allow other jobs to execute.
Timed/Event Rollout File	A rollout file whose job is returned to execution when a requested event has occurred or a specified time period has elapsed.
Unlabeled Tape	A magnetic tape that does not have a header label. Unlabeled tapes generated by the operating system contain a trailer label similar to the trailer for a standard labeled tape.
User Index	A unique 17-bit identifier that is associated with each user number. The user index is used by the permanent file manager to identify the device and catalog track for the user's files.
User Number	A one- to seven-character name that identifies the user to the system and for which there is assigned a user index that allows access to permanent files.
Validation File	File containing validation information for all users (user names, passwords, resources allowed, and so on).
Volume	A term synonymous with a reel of tape.
VSN	Volume serial number. A one- to six-character identifier that identifies the volume of magnetic tape to the system.

Word

A group of bits (or 6-bit characters) between boundaries imposed by the computer system. A word is 60 bits in length. The bits are numbered 59 through 0 starting from the left. It is also composed of five 12-bit bytes, numbered 0 through 4 from the left.

Write Ring

A circular device (inserted into a tape reel indicating to the tape unit that it can write on that reel. NOS enforces the presence or absence of a write ring if the user requests it (refer to section 4).

Zero Byte Terminator

The 12 bits of zero in the low order position of a central memory word that are used to terminate a line of coded information.

CIO coded I/O operations, control statement, and dayfile processing macros use files whose lines are terminated by a zero byte.

In display code, two colons create 12 bits of zeros. If two consecutive colons occur in a file that contains zero-byte terminated records, they might be stored in the lower order portion of a word and create a zero-byte terminator.

Zero Length PRU

A PRU that contains no user data. The level designator specifies whether the PRU is an EOR or EOF (refer to level designator).

SPECIAL USER INFORMATION

E

Appendix E provides special information available to the applications programmer. The following topics are described.

- Job communication area
- Exchange package area
- File types and job origin codes
- Equipment codes

JOB COMMUNICATION AREA

Figure 2-E-1 illustrates the first 101₈ words of the user's field length.

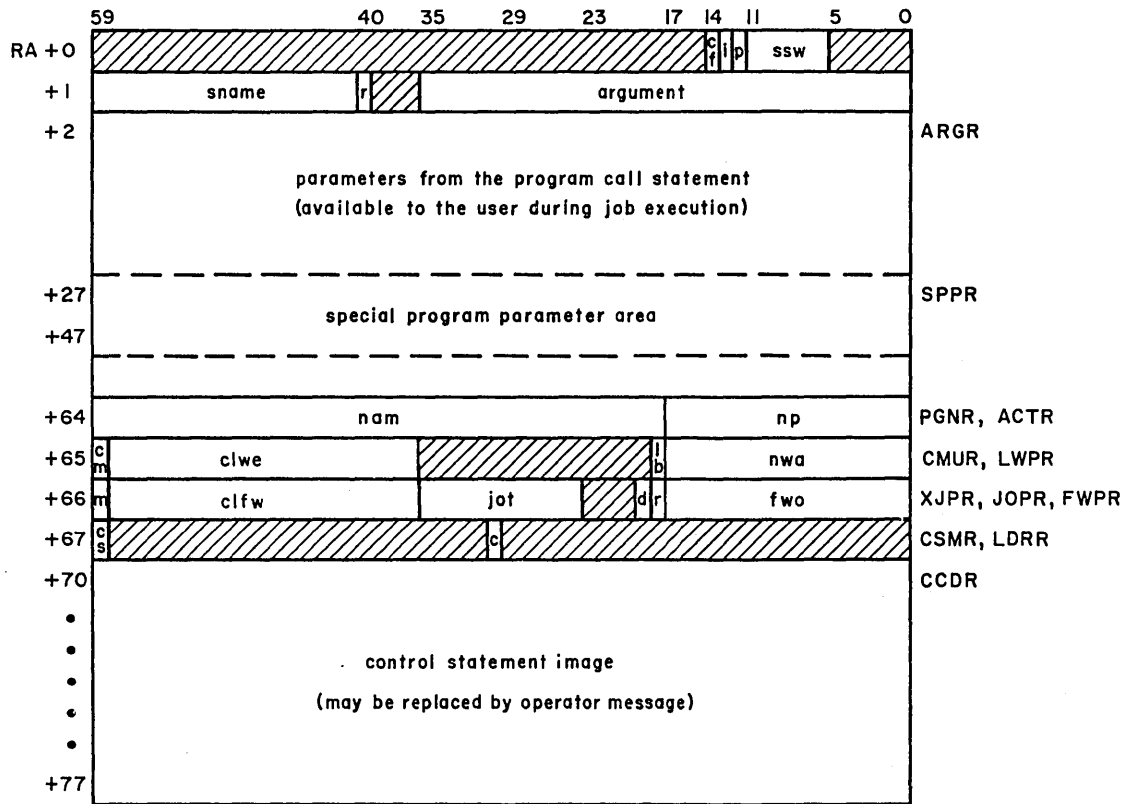

Figure 2-E-1. Job Communication Area

<u>Word</u>	<u>System Identifier</u>	<u>Bits</u>	<u>Field</u>	<u>Significance</u>
RA+0		59-15	reserved	Reserved.
		14	cf	CFO bit.
		13	i	Subsystem idledown flag.
		12	p	Pause flag.
		11-06	ssw	Sense switches.
		05-00	reserved	Reserved.
RA+1		59-41	sname	System request name (such as CIO).
		40	r	Auto recall flag.
		39-36	unused	Reserved for future system use.
		35-00	arguments	Parameters passed to that portion of the system that processes the sname request.
RA+2 through RA+63 ₈	ARGR	59-00	params	Parameters from the program call statement; available to the user during execution.
RA+27 ₈ through RA+47 ₈	SPPR	59-00	params	Special program parameter area used by SSJ= entry point programs to store parameter blocks. Any job step can use this area for its own purpose, but if it is followed by an SSJ= program, the contents may be destroyed.
RA+64 ₈	PGNR	59-18	nam	Name of program called by control statement.
	ACTR	17-00	np	Number of parameters in control statement call.
RA+65 ₈	CMUR	59	cm	Set if the compare/move unit (CMU) is present
	LWPR	58-36	clwe	LWA+1 of loadable area in ECS.
		35-19	unused	Reserved for future system use.
		18	lb	Library flag: 0 Load from a file 1 Load from library
		17-00	nwa	Address of next word available for loading. If Common Memory Manager is loaded in the user's field length, bits 17 through 0 contain the complement of the address of the next word available for loading (refer to the Common Memory Manager Reference Manual).
RA+66 ₈	XJPR	59	m	Indicates if hardware feature CEJ/MEJ is available: 1 Available 0 Not available
	JOPR	58-36	clfw	FWA of loadable area in ECS.
		35-24	jot	Job origin type.
		23-20	unused	Reserved for future system use.
		19	d	DIS flag.
	18	r	RSS flag.	
	FWPR	17-00	fwo	First word of object program.

RA+67 ₈	CSMR	59	cs	Set if system is running in 64-character set mode.
	LDRR	58-30 29	unused c	Reserved for future system use. Completion flag: 0 Load not completed 1 Load completed
		28-00	unused	Reserved for future system use.
RA+70 ₈ through RA+77 ₈	CCDR	59-00	control statement image	Image of control statement currently being executed.

EXCHANGE PACKAGE AREA

Figure 2-E-2 illustrates the exchange package area for CYBER 170 Series, CYBER 70 Series, and 6000 Series computer systems. This illustration and the description that follows it are intended for use by the applications programmer and, therefore, do not include descriptions of bits or fields not used by applications programs.

	59	53	47	35	17	0
000	/		P	A0	B0	
001			RA	A1	B1	
002	/		FL	A2	B2	
003			EM	COND	A3	B3
004	/		RAE	A4	B4	
005			FLE	A5	B5	
006	/			A6	B6	
007	/			A7	B7	
010	X0					
011	X1					
012	X2					
013	X3					
014	X4					
015	X5					
016	X6					
017	X7					

Figure 2-E-2. Exchange Package Area

The exchange package area fields are defined as follows (fields are applicable to all NOS computer systems unless otherwise noted).

<u>Field</u>	<u>Description</u>
P	Program address. ($0 \leq P \leq FL - 1$)
Ai	Address registers.
Bi	Increment registers.
RA	Reference address for central memory.
FL	Field length for central memory. Bit 53 is zero for all applications programs.
EM	Exit modes. An exit mode is selected or disabled by setting or clearing the appropriate bit (refer to the MODE macro).

<u>Bit</u>	<u>Meaning when bit is set</u>
50	Exit on indefinite operand.
49	All models except model 176: Exit on operand out of range (infinite operand). Model 176: exit on overflow.
48	All models except model 176: Exit on address out of range. Model 176: Exit on underflow. †

COND Error condition flags (CYBER 170 model 176 only).

<u>Bit</u>	<u>Description</u>
47, 46	Reserved for Control Data.
45	ECS block range condition.
44	CM block range condition.
43	ECS direct range condition.
42	CM direct range condition.
41	Program range condition.
40	Not used.
39	Step condition.
38	Indefinite condition.
37	Overflow condition.
36	Underflow condition.

RAE	Reference address for ECS.
FLE	Field length for ECS. Bit 56 is zero for all applications programs.
Xi	Operand registers.

†An address out of range condition always causes a program exit on a CYBER 170 Model 176.

FILE TYPES AND ORIGIN CODES

The following file types and origin codes are used in many NOS system routines.

The queue file types are:

<u>Type</u>	<u>Value</u>	<u>Description</u>
INFT	0	Input
ROFT	1	Rollout
PRFT	2	Print
PHFT	3	Punch
TEFT	4	Timed/event rollout
--	5	Reserved
--	6	Reserved
--	7	Reserved

Other file types include:

<u>Type</u>	<u>Value</u>	<u>Description</u>
LIFT	10	Library
PTFT	11	Primary terminal
PMFT	12	Direct access permanent file
FAFT	13	Fast attach file
SYFT	14	System
LOFT	15	Local
--	16	Reserved

Following are the job origin codes.

<u>Type</u>	<u>Value</u>	<u>Description</u>
SYOT	0	System
BCOT	1	Local batch
EIOT	2	Remote batch
TXOT	3	Time-sharing
MTOT	4	Multiterminal

EQUIPMENT CODES

Equipment codes for device types supported by NOS are as follows:

<u>Mnemonic</u>	<u>Display Code (Octal)</u>	<u>Equipment</u>
CP	0320	415 Card Punch
CR	0322	405 Card Reader
DE	0405	Extended Core Storage
DIn	0411	844-21 Disk Storage Subsystem (1 to 8 units, half track)
DJn	0412	844-4x Disk Storage Subsystem (1 to 8 units, half track)
DKn	0413	844-21 Disk Storage Subsystem (1 to 8 units, full track)
DLn	0414	844-4x Disk Storage Subsystem (1 to 8 units, full track)
DMn	0415	885 Disk Storage Subsystem (1 to 3 units, half track)
DP	0420	Distributive data path to ECS
DQn	0421	885 Disk Storage Subsystem (1 to 3 units, full track)
DS	0423	Display console
LP	1420	Any line printer
LR	1422	580-12 Line Printer
LS	1423	580-16 Line Printer
LT	1424	580-20 Line Printer
MS	1523	Mass storage device
MT	1524	Seven-track magnetic tape drive
NE	1605	Null equipment
NP	1620	255x Host Communications Processor
NT	1624	Nine-track magnetic tape drive
ST	2324	6671 or 2550-100 multiplexer
TT	2424	6676, 6671, or 2550-100 multiplexer

COMPRESSED COMPILE FILE

A compressed compile file (figure 2-G-9) has a one-word header.

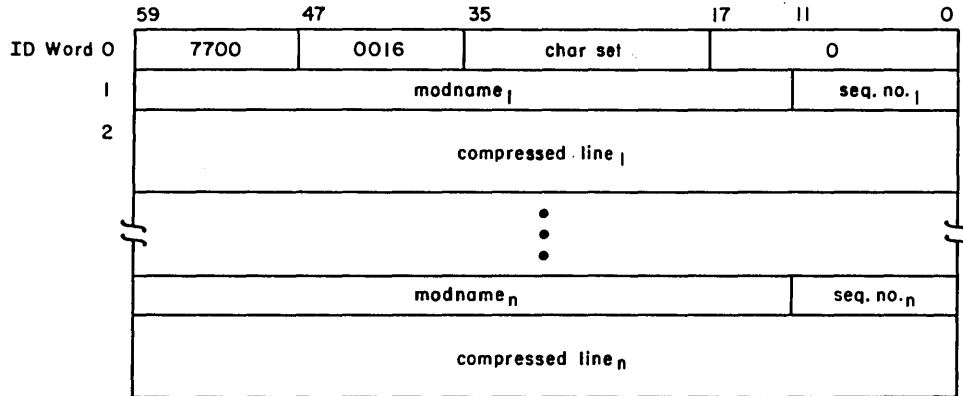

- char set Character set of the compressed compile file.
 - 0 63-character set.
 - 64 64-character set.
- modname_i One- to seven-character modification set name.
- seq. no_i Sequence number of the line image according to the position in the deck or modification set.

Figure 2-G-9. Compressed Compile File Format

INDEX

- Abnormal termination codes (refer also to error codes) 2-2-5; 2-3-2
- Abort
 - CPU 2-6-6; 2-11-1
 - Defined 2-C-1
 - PP 2-6-6
 - Program 2-10-6; 2-12-4
- ABORT macro 2-11-1
- ABS record type 2-G-5
- Absolute record type 2-G-5
- Absolute assembly 2-C-1
- ABT request 2-11-1
- Access mode 2-5-2,8
- Access subsystem 2-12-18
- Accessing files 2-3-4
- Account block 2-C-1
- Account block SRU limit 2-6-2,10
- Accounting information 2-6-18
- ACTR symbol 2-1-8; 2-E-2
- Address
 - Error, CIO 2-3-3
 - Out of range 2-E-4
 - Registers 2-E-4
- Allocatable device 2-C-1
- Alphanumeric 2-C-1
- ALTER function 2-3-11
- Alternate storage fields 2-5-18
- Alternate user number 2-2-13; 2-5-2; 2-C-1
- ALTERNR function 2-3-11
- ANSI 2-C-1
- ANSI labels 2-3-14,41; 2-4-15
- APPEND macro 2-5-25
- Appending information to a file 2-5-25
- Applications programs, converting 2-12-1
- ARET error 2-6-6
- ARG= entry point 2-F-1
- ARGR symbol 2-1-8; 2-E-2
- Argument address 2-1-8; 2-E-2
- Arithmetic error 2-6-6
- ASCII 2-C-1
- ASCII/display code conversion 2-4-16
- ASCII mode 2-12-6,8,19
- ASCII input byte 2-12-6
- ASCII output byte 2-12-8
- Assign file to queue device 2-7-5
- ASSIGN macro 2-4-3,13
- Assigning
 - Equipment 2-4-9,11
 - Files 2-4-3,12,15; 2-7-5; 2-12-2
 - Nonallocatable devices 2-4-10
 - Packs 2-4-9
 - Resources 2-4-9,11,15
 - Tape units 2-4-15
- ATTACH macro 2-5-31
- Auto input byte 2-12-5
- Auto recall
 - CIO 2-3-1
 - Defined 2-C-1
 - DSP 2-8-1
 - LFM 2-4-1
 - PFM 2-5-1
 - Processing 2-1-3
 - TIM 2-9-1
 - * option 2-3-30,32,34,36
- Automatic file flushing 2-2-8; 2-6-30; 2-12-2
- Automatic tape assignments 2-4-20
- Auxiliary device requests 2-5-11
- Auxiliary devices 2-2-14; 2-5-11; 2-C-1
- Backspacing a file 2-3-36,37,48
- Backup requirement 2-5-2,10
- BASIC subsystem 2-5-10; 2-12-18
- Batch origin type 2-E-6
- Batch subsystem 2-5-10; 2-12-18
- BCOT 2-E-6
- Binary
 - File mode bit 2-2-6
 - Formats 2-G-1
 - Input mode 2-12-6
 - Output mode 2-12-7
 - Random file, FET creation 2-2-12
 - Sequential file, FET creation 2-2-12
- BKSP macro 2-3-36
- BKSPRU macro 2-3-37
- Block 2-C-1
- Block size 2-3-25,29,36; 2-4-19,28; 2-J-1
- Blocked data format 2-4-19
- BOI 2-C-1
- BUF parameter 2-2-13,15
- Buffer
 - Circular 2-2-1
 - Defined 2-C-1

- Empty, defined 2-2-3
- Full, defined 2-2-3
- Pointers 2-2-2
- Sizes 2-2-13,15
- Working 2-3-50
- Byte 2-C-2

- *CALL directive 2-1-10
- CAP record type 2-1-20; 2-G-5
- Capsules, fast dynamic load 2-11-16,18; 2-C-2
- Carriage control, terminal 2-12-4,7
- Catalog errors 2-5-18
- Catalog information 2-5-16
- Category, file 2-5-8
- CATLIST macro 2-5-16; 2-A-1
- CCAP symbol 2-5-25
- CCAT symbol 2-5-31
- CCCG symbol 2-5-32
- CCCT symbol 2-5-16
- CCDF symbol 2-5-26
- CCDR symbol 2-1-8; 2-E-2
- CCGT symbol 2-5-14
- CCL procedure records 2-11-16; 2-G-5
- CCPG symbol 2-5-15
- CCPM symbol 2-5-22
- CCRP symbol 2-5-24
- CCSV symbol 2-5-12
- CEJ/MEJ option 2-1-4,8; 2-11-5; 2-E-2
- Central exchange jump/monitor exchange jump option (refer to CEJ/MEJ option)
- Central memory
 - Data error 2-E-4
 - Defined 2-C-2
 - Dumps 2-1-16; 2-11-12
 - Field length 2-6-16
 - Parity error 2-6-6
 - Size 2-11-6
- Central processor unit (refer to CPU)
- CHANGE macro 2-5-32
- Character sets 2-1-8; 2-11-5; 2-12-19; 2-E-2
- Checkpoint
 - Defined 2-C-2
 - Dumps 2-4-10; 2-10-3
 - Files 2-10-3
- Checkpoint/restart 2-10-3
- CHECKPT macro 2-10-3; 2-A-1
- Checksum 2-10-9; 2-C-2
- CIO
 - Abnormal termination codes 2-3-2
 - Common decks 2-3-4
 - Detail error return codes 2-3-3
 - FET format 2-3-2
 - Function processing 2-3-4
 - Random processing 2-3-9
 - Read functions 2-3-22
 - Request 2-3-1
 - Write functions 2-3-30
- Circular
 - Buffers 2-2-1; 2-C-2
 - Read operation 2-2-3
 - Write operation 2-2-4
- Circular buffer flushing 2-2-8; 2-6-30; 2-12-2
- CKP 2-10-3
- Clock cycle count 2-9-3
- CLOCK macro 2-9-1
- CLOSE macro 2-3-18
- CLOSER macro 2-3-21
- Closing a file 2-3-18,21
- CM (refer to central memory)
- CMC input error 2-E-4
- CMU option 2-1-8; 2-11-5; 2-C-2; 2-E-2
- CMUR symbol 2-1-8; 2-E-2
- Coded
 - File mode 2-2-6
 - Random file, FET creation 2-2-12
 - Sequential file, FET creation 2-2-12
- Coding specification 2-I-8
- Combined input/output (refer to CIO)
- COMCARG 2-A-4
- COMCARM 2-A-4
- COMCCDD 2-A-4
- COMCCFD 2-A-4
- COMCCHD 2-A-4
- COMCCIO 2-A-4
- COMCCMD 2-1-9; 2-A-3
- COMCCOD 2-A-4
- COMCCPA 2-A-4
- COMCCPM 2-A-4
- COMCCPT 2-A-4
- COMCCVI 2-A-4
- COMCCVL 2-A-4
- COMCDXB 2-A-4
- COMCECM 2-A-4; 2-D-1
- COMCECS 2-A-4; 2-D-1
- COMCEDT 2-A-4
- COMCFCE 2-A-4
- COMCFQO 2-A-4
- COMCHXB 2-A-4
- COMCIQP 2-A-4
- COMCLFM 2-A-4
- COMCLOD 2-A-4
- COMCMAC 2-1-9; 2-A-1
- COMCMTM 2-A-4
- COMCMTP 2-A-5
- COMCMVE 2-A-5
- COMCOVL 2-A-5
- COMCPFM 2-A-5
- COMCPFU 2-A-5
- COMCPOP 2-A-5
- COMCQFM 2-A-5

COMCRDC 2-A-5
 COMCRDH 2-A-5
 COMCRDO 2-A-5
 COMCRDS 2-A-5
 COMCRDW 2-A-5
 COMCRSP 2-A-5
 COMCRTN 2-A-5
 COMCSFM 2-A-5
 COMCSFN 2-A-5
 COMCSNM 2-A-5
 COMCSRT 2-A-5
 COMCSSN 2-A-5
 COMCSST 2-A-5
 COMCSTF 2-A-5
 COMCSYS 2-A-5
 COMCUPC 2-A-5
 COMCUSB 2-A-5
 COMCVFE 2-A-5
 COMCWOD 2-A-5
 COMCWTC 2-A-5
 COMCWTH 2-A-5
 COMCWTO 2-A-5
 COMCWTS 2-A-5
 COMCWTW 2-A-5
 COMCZAP 2-A-5
 COMCZTB 2-A-5
 Comment field 2-I-7
 COMMENT statement 2-I-12
 Common decks
 Available to user 2-A-1
 CIO 2-3-4
 CPM 2-6-1
 Data transfer macros 2-3-52
 Defined 2-C-2
 LFM 2-4-1
 PFM 2-5-1,3,7
 QFM 2-7-1
 Relocatable 2-A-6
 SYSLIB 2-A-6
 System requests 2-11-1
 TCS 2-10-1
 Usage 2-1-9
 COMMON macro 2-4-4; 2-A-3
 Compare/move unit option (refer to CMU option)
 COMPASS 2-C-2
 COMSPFM 2-5-1,3,8
 Conflict of tags 2-1-12
 Console, display a message 2-11-8
 Control bytes 2-12-5; 2-C-2
 CONTROL macro 2-10-1
 Control point
 Area 2-6-1
 Dayfile 2-11-1
 Defined 2-C-2
 Manager 2-6-1
 Control statement
 Buffer 2-10-2
 Count 2-4-13
 Execute 2-10-2
 File 2-4-13,14; 2-10-1
 Image 2-1-8; 2-10-1; 2-E-2
 Input buffer 2-10-2
 Parameters 2-10-1; 2-E-2
 Processing 2-10-1
 Record 2-C-3
 Control words 2-3-24,32; 2-5-2
 Conversion mode 2-4-16,28
 Converting applications programs 2-12-1
 CPET error 2-6-6
 CPM, common decks 2-6-1
 CPM request 2-6-1
 CPU
 Abort 2-6-2,6; 2-11-1
 Common decks 2-1-9; 2-A-1
 Defined 2-C-3
 Error exit 2-6-2,6; 2-E-4
 Hardware error exit mode 2-6-2
 Parity error 2-6-6
 Priority 2-6-2,13
 Program error exit mode 2-6-2,6; 2-E-4
 Select 2-6-19
 Time 2-9-3,6
 Time limit 2-6-4
 Creating
 Direct access file 2-5-26
 Indirect access file 2-5-12,24
 Labeled tape 2-4-15
 Library file 2-4-4
 Random file 2-H-1
 Creation date 2-2-11; 2-4-20; 2-J-8
 CSET macro 2-12-16; 2-A-1
 CSMR symbol 2-1-8; 2-E-2
 Current
 Date 2-9-2,4
 Random index 2-2-10; 2-3-3
 Time 2-9-1,4
 CVL request 2-11-5
 CYBER Control Language records 2-11-20; 2-G-5
 CYBER Interactive Debug 2-10-6
 CYBER Loader 2-C-3
 CYBER Record Manager 2-C-3

 Data
 Error in file 2-5-18
 Format 2-4-19; 2-J-1
 Transfer macros 2-3-49
 Date, current 2-9-2,4
 DATE macro 2-9-2
 Date, packed 2-9-4
 Dayfile, displaying information 2-11-1,8; 2-C-3

- DAYFILE macro 2-11-1; 2-A-1
- Dayfile messages 2-4-18; 2-11-1,8
- Default 2-C-3
- Deferred batch jobs 2-7-3
- Deferred file routing 2-8-3
- DEFINE macro 2-5-26
- Density, tape 2-4-16,28
- Detail error return code 2-3-3
- Device
 - Auxiliary 2-5-11
 - Not ready error 2-3-3
 - Reserved error 2-3-3
 - Status errors 2-3-3
 - Type 2-2-6,13,15; 2-3-12; 2-4-7,25; 2-C-3; 2-E-6
- Diagnostic messages 2-B-1
- Direct access files
 - Attaching 2-5-31
 - Creating 2-5-26
 - Defined 2-C-3
 - PRUs desired 2-5-2
 - Purging 2-5-15
 - Type 2-E-6
- Disable
 - CM dumps 2-1-16
 - Hardware exit mode 2-6-2; 2-E-4
 - Program exit mode 2-6-2; 2-E-4
- Disconnect terminal 2-12-6
- Display code 2-C-3
- Display code conversion 2-4-16
- Display code dumps 2-11-12
- Dispose processor 2-8-1
- Disposition code 2-8-2; 2-C-3
- DISTC macro 2-12-13; 2-A-1
- Distributive data path 2-E-6
- Division, integer 2-1-7
- DMD request 2-11-12
- DMP request 2-11-12
- DMP= entry point 2-F-1
- DOCUMENT statement 2-I-1
- Documentation cards 2-I-2
- Documentation standards 2-I-1
- DSP request 2-8-1
- DTY parameter 2-2-13,15
- Dump, memory 2-1-16; 2-11-12

- *E directive 2-I-7
- ECET error 2-6-6
- ECS
 - Defined 2-C-3
 - Dumps 2-11-12
 - Field length 2-6-16,20,28,32; 2-11-6; 2-E-5
 - Interpretive mode reading and writing 2-D-1
 - Parity error 2-6-6; 2-E-4
- Size 2-11-5
- Systems text 2-1-6
- Transfers 2-D-1
- ECSTEXT 2-1-6; 2-D-1
- EDATE macro 2-9-2; 2-A-1
- EIOT 2-E-6
- EM register 2-6-2; 2-E-4
- Empty buffer, defined 2-2-3
- Empty record 2-C-4
- ENCSF macro 2-4-14; 2-A-1
- END request 2-11-4
- End-of-block byte 2-12-5
- End-of-device status 2-3-2
- End-of-file (refer to EOF)
- End-of-information (refer to EOI)
- End-of-line 2-12-5; 2-C-4
- End-of-record (refer to EOR)
- End-of-reel 2-3-2,21; 2-4-19; 2-J-6
- End-of-string byte 2-12-8
- End-of-tape (refer to EOT)
- End-of-tape processing 2-4-19; 2-J-6
- End-of-transaction block 2-12-8
- End-of-transaction block with response 2-12-8
- ENDRUN macro 2-11-4
- Entry point 2-C-4
- EOF 2-2-5,6; 2-3-50; 2-C-4
- EOF1 label 2-3-20
- EOF2-9 labels 2-3-20
- EOI 2-2-6; 2-3-50; 2-C-4
- EOR 2-2-5,6; 2-3-50; 2-C-4
- EOV1 label 2-3-20,21
- EOV2 label 2-3-21
- EPR parameter 2-2-13
- Equipment
 - Codes 2-C-4; 2-E-6
 - File assignment 2-4-9,11
 - Number 2-4-25
- ERA parameter 2-2-15
- EREXIT macro 2-6-5
- ERP parameter 2-2-15
- Error
 - Class 2-10-9
 - Code 2-10-9
 - Control 2-6-2,5
 - Correction 2-4-17
 - Data in file 2-5-15
 - Exit address 2-6-5; 2-E-5
 - Exit mode 2-6-2,5,14; 2-E-4
 - File length 2-5-18
 - Flag 2-6-6,31; 2-10-9; 2-11-1
 - Messages 2-B-1
 - Permit entries 2-5-18
 - Processing 2-2-7; 2-3-4; 2-4-16,29; 2-8-5
 - Processing bit 2-2-7,13,15; 2-5-1
 - Recovery 2-4-17
 - Return address 2-2-15

- Error codes
 - Catalog 2-5-15
 - CIO 2-3-2,3
 - DSP 2-8-1
 - LFM 2-4-2
 - PFM 2-5-3
 - RPV 2-10-10
 - EST ordinal 2-C-4
 - ETIME macro 2-9-3; 2-A-1
 - Event descriptor 2-6-9
 - EVICT macro 2-3-46
 - Evicting a file 2-3-46
 - Exchange jump 2-1-5; 2-C-4
 - Exchange package 2-10-9; 2-12-14; 2-C-5; 2-E-3
 - EXCST macro 2-10-3; 2-A-1
 - Execute subsystem 2-5-10; 2-12-18
 - Exit mode 2-6-2,5,14,31; 2-C-5; 2-E-4
 - Expiration date 2-4-20; 2-J-8
 - Extended label processing 2-2-7; 2-3-16, 42.1; 2-C-5
 - External
 - Characteristics, routed file 2-8-2
 - Documentation 2-I-2
 - Reference 2-C-5

- F format tape 2-4-19; 2-J-1,5
- FAFT file type 2-E-6
- Family device 2-C-5
- Family name 2-6-28
- Fast attach file 2-E-6
- Fast dynamic load 2-11-16,18; 2-C-5
- FCPB category 2-5-9
- FCPR category 2-5-9
- FCSP category 2-5-9
- FDL 2-11-16,18
- FDL capsules 2-11-16,18
- FET
 - Creation macros 2-2-11
 - Description 2-2-4; 2-C-5
 - LABEL macro 2-4-15
 - Length 2-2-9,13
 - Modification macro 2-2-14
 - Parameters 2-2-13
- FET formats
 - CIO requests 2-3-2
 - LFM requests 2-4-1
 - PFM requests 2-5-1
 - QFM requests 2-7-1
 - SFM requests 2-11-2
 - Standard 2-2-4
- Field length
 - Central memory 2-11-5; 2-E-4
 - Control word 2-6-20
 - Defined 2-C-5
 - ECS 2-11-5; 2-E-5

- Preservation, ECS 2-6-32
- Reducing 2-6-16,27; 2-11-6
- File
 - Accessibility 2-4-19; 2-J-8
 - Assigning 2-4-9,11; 2-7-5
 - Assignments, terminals 2-12-2
 - Backspacing 2-3-36,37,48
 - Backup requirement 2-5-2
 - Binary 2-2-6,12
 - Category 2-5-1,9; 2-C-5
 - Coded 2-2-6,12
 - Creation 2-2-1
 - Data error 2-5-18
 - Deferred routed 2-8-1
 - Defined 2-C-5
 - Direct access 2-5-26,31
 - Flushing 2-2-8; 2-6-30; 2-12-2; 2-C-6
 - Identifier 2-2-11; 2-4-20; 2-J-8
 - Information 2-4-25
 - Length 2-4-25
 - Length error 2-5-15
 - Limit error 2-6-6
 - Local 2-4-1
 - Magnetic (refer to magnetic tape file)
 - Mode 2-2-6; 2-5-2,8
 - Name 2-2-5
 - Name table (refer to FNT)
 - Password 2-5-2
 - Permission mode 2-4-26; 2-5-2,8
 - Positioning 2-3-36
 - Preferred residence 2-5-2
 - Privacy 2-6-32
 - Private 2-5-9
 - Public 2-5-9
 - Purging 2-5-15
 - Random 2-2-9,11; 2-3-4,9; 2-C-11
 - Replacing 2-5-24
 - Residency 2-5-11,26
 - Returning 2-3-40
 - Rewinding 2-3-37
 - Routing 2-8-1
 - Saving 2-5-12,24
 - Section number 2-2-11; 2-4-19; 2-J-8
 - Semiprivate 2-5-9
 - Sequence number 2-2-11; 2-4-20
 - Sequential 2-2-12; 2-3-4; 2-C-12
 - Set 2-C-6; 2-J-8
 - Skipping 2-3-46,47
 - Space, releasing 2-3-40,46
 - Status 2-4-25
 - Types 2-4-22,26; 2-C-6; 2-E-5
- File environment table (refer to FET)
- FILEB macro 2-2-12
- FILEC macro 2-2-12
- FILINFO macro 2-4-25
- FIRST pointer 2-2-2,9

FL 2-E-4
 Flag 2-C-6
 FLE 2-E-5
 FLET error 2-6-6
 Flush bit 2-2-8; 2-6-31; 2-12-3
 FNT entry 2-4-8,21; 2-C-6
 FNT pointer 2-2-9
 Forced error 2-6-6
 Formats, magnetic tape 2-J-1
 Forms code 2-8-2
 FORTRAN subsystem 2-5-10; 2-12-18
 FSET error 2-6-6
 FST entry 2-4-8,21; 2-C-6
 FTNFS subsystem 2-5-10; 2-12-18
 Full buffer, defined 2-2-3
 Full track 2-C-6
 Function processors 2-1-1; 2-C-6
 FWPR symbol 2-1-8; 2-E-2

 GE write mode 2-4-17
 Generation number 2-4-20; 2-C-7; 2-J-8
 Generation version number 2-2-11;
 2-4-20; 2-J-8
 GET macro 2-5-14
 GETACT macro 2-6-26; 2-A-3
 GETASL macro 2-6-13; 2-A-1
 GETEM macro 2-6-13; 2-A-3
 GETFLC macro 2-6-20; 2-A-1
 GETFNT macro 2-4-22; 2-A-1
 GETGLS macro 2-6-24; 2-A-1
 GETJA macro 2-6-18; 2-A-1
 GETJCI macro 2-6-31; 2-A-3
 GETJCR macro 2-6-16; 2-A-1
 GETJN macro 2-6-11; 2-A-2
 GETJO macro 2-6-18; 2-A-2
 GETJSL macro 2-6-14; 2-A-2
 GETLC macro 2-6-23; 2-A-2
 GETLOF macro 2-6-29; 2-A-3
 GETMC macro 2-11-5; 2-A-2
 GETPPF macro 2-6-28; 2-A-2
 GETPR macro 2-6-12; 2-A-2
 GETQP macro 2-6-12; 2-A-2
 GETSS macro 2-6-22; 2-A-2
 GETTL macro 2-6-14; 2-A-2
 Global error flag 2-6-31
 Global library set indicators
 2-6-24,25; 2-11-17; 2-C-7
 Global register 2-6-31
 Group, capsules 2-11-16

 Half track 2-C-7
 Hardware error exit mode 2-6-2; 2-E-4
 HDR1 label 2-3-14,41; 2-4-20; 2-J-7
 Header documentation 2-I-7

HTIME macro 2-9-3

 I format tape 2-4-19; 2-J-1,2
 IAF 2-12-4
 ID code 2-4-12
 ID, machine 2-6-26
 Identification code 2-4-12; 2-7-4
 Illegal user statement 2-7-3
 IN pointer 2-2-3,9
 Increment registers 2-E-4
 IND parameter 2-2-13
 Indefinite operand 2-E-4
 Index length 2-2-10,13
 Index, random 2-2-9
 Indirect access files
 Accessing 2-5-14,36
 Appending information 2-5-25
 Changing parameters 2-5-32
 Creating 2-5-12,24
 Defined 2-C-7
 Purging 2-5-15
 Replacing 2-5-24
 Saving 2-5-12,24
 Working copy 2-5-14,36
 INFT type files 2-E-5
 Inhibit error processing 2-4-16
 Initiate ASCII output 2-12-8
 Input, binary 2-12-6
 Input file
 Releasing 2-3-40
 Returning 2-3-40
 Type 2-C-7; 2-E-5
 INPUT file, terminal 2-12-2
 INPUT* file 2-3-40
 Input, transparent 2-12-6
 Input/output buffers 2-2-1; 2-3-49
 Input/output, COMPASS 2-3-1
 Input/output queue protection 2-7-1
 Input/output, record manager 2-3-57
 Integer divide instruction 2-1-7
 Interactive facility 2-12-4
 Interactive I/O 2-12-1
 Interactive programs 2-C-7
 Internal characteristics, routed file
 2-8-3
 Internal documentation 2-I-1
 Interpretive mode ECS reads and writes
 2-D-1
 Interrecord gap 2-C-7
 Interruption sequence 2-12-11
 Interrupts 2-10-6; 2-C-7
 I/O activity 2-6-27
 I/O sequence error 2-4-2
 Irrecoverable parity error 2-4-16

- JDATE macro 2-9-4
- Job
 - Abort 2-11-1
 - Accounting information 2-6-18
 - Communication area 2-E-1
 - Control 2-10-1
 - Control information 2-6-31,32
 - Control registers 2-6-16,17
 - Field length 2-6-16,20,27; 2-11-6
 - Name 2-6-12
 - Origin 2-6-18
 - Origin type 2-1-8; 2-E-2,6
 - Priority 2-6-1,2,13
 - Rerun error 2-6-6
 - SRU limit 2-6-2,3,10
 - Step 2-C-7
 - Step limit 2-6-3,10
 - Submitting 2-7-3; 2-8-1
- JOPR symbol 2-1-8; 2-E-2
- Julian date 2-9-4

- K display messages 2-6-8
- Keyboard buffer address 2-6-8

- L display messages 2-6-8
- L format tapes
 - Defined 2-J-5
 - Reading 2-3-28
 - Specification 2-4-19
 - Writing 2-3-45
- Label
 - Bit 2-4-15
 - Buffer 2-3-16,42
 - Defined 2-C-7
 - Type 2-4-28
 - Verification 2-3-11,43
- LABEL macro 2-4-15
- Label processing
 - ANSI tapes 2-4-15
 - Extended 2-2-7; 2-3-16,42
 - Standard 2-2-7; 2-3-14,41
- Labeled tape 2-4-15
- LBL parameter 2-2-13
- LDD request 2-11-16
- LDQ request 2-11-18
- LDR completion 2-1-8; 2-E-2
- LDR request 2-11-13
- LDRR symbol 2-1-8; 2-E-2
- Length of FET 2-2-9,13
- Length of index 2-2-10,13
- Level designator (refer to Level number)
- Level number 2-2-5; 2-3-2,24,25; 2-C-7

- LFM
 - Call format 2-4-1
 - Common decks 2-4-1
 - Error codes 2-4-2
 - FET format 2-4-1
 - Request 2-4-1
- lfn (refer to local file name)
- LFN parameter 2-2-16
- Library 2-C-8
- Library file
 - Accessing 2-4-3,12
 - Defined 2-C-8
 - Creation 2-4-4
 - Returning 2-3-40
 - Type 2-E-6
- Library system default 2-1-9
- LIFT type files 2-E-6
- LIMIT pointer 2-2-3,9
- Line 2-C-8
- Line feed, suppress 2-12-5,8
- Lines/printer page 2-1-8; 2-E-2
- LINP symbol 2-1-8; 2-E-2
- List address 2-2-10; 2-3-26
- List of files 2-2-8; 2-6-29; 2-C-8
- Load point 2-C-8
- LOADD macro 2-11-16
- Loader control word 2-6-15,23
- Loader requests 2-11-13
- Loading overlays 2-11-13
- LOADQ macro 2-11-18
- Local file
 - Defined 2-C-8
 - Manager (refer to LFM)
 - Name 2-2-5,13,15; 2-C-8
 - Releasing 2-3-40,46; 2-4-5
 - Returning 2-3-40
 - Type 2-E-6
- LOCK macro 2-4-6
- Locked files 2-4-6; 2-C-8
- LOFT type files 2-E-6
- Logical record 2-3-25; 2-C-8
- Log-off user 2-12-6
- Long-term activity 2-6-26
- LWPR symbol 2-1-8; 2-E-2

- MACHID macro 2-6-26; 2-A-3
- Machine characteristics 2-11-5
- Machine ID 2-6-26
- Macro 2-C-8
- Macro usage 2-1-6
- Magnetic tape files
 - Accessing 2-3-11; 2-4-15
 - ANSI standard labeled 2-3-14; 2-4-15
 - Assignment 2-4-15
 - Block size 2-4-19,28; 2-J-1

- Buffer size 2-2-13
- Closing 2-3-18,21
- Creating 2-3-11; 2-4-15
- Evicting 2-3-46
- Formats 2-J-1
- Information 2-4-27
- Labeling 2-3-13,14; 2-4-15
- Multifile set 2-3-41
- Nonstandard labeled 2-3-13
- Opening 2-3-11
- Requesting 2-4-15
- Returning 2-3-40
- Rewinding 2-3-37
- Standard FET 2-2-5
- Unlabeled 2-3-13
- Unloading 2-3-38
- Map flags, loader 2-6-15
- Mass storage files
 - Assignment 2-4-9,11
 - Buffer size 2-2-13
 - Closing 2-3-18
 - Evicting 2-3-46
 - Opening 2-3-11
 - Returning 2-3-40
 - Rewinding 2-3-37
 - Standard FET 2-2-4
 - Unloading 2-3-38
- Maximum field length 2-6-16,20,27
- Maximum logical record size (refer to mlrs)
- MEM request 2-11-6
- MEMORY macro 2-11-6
- Memory, releasing 2-11-6
- MESSAGE macro 2-11-8
- Messages 2-B-1
- MFL= entry point 2-F-2
- Minimum buffer size 2-2-13
- mlrs 2-2-10; 2-3-3; 2-C-8; 2-J-4,5
- Mode, error exit 2-6-2,6; 2-E-4
- Mode, file 2-2-6
- Mode, file access 2-5-2,9
- MODE macro 2-6-2; 2-A-3
- Modify library file format 2-G-2
- Monitor address 2-E-5
- MOVE macro 2-11-10
- MSG request 2-11-8
- MTOT 2-E-6
- Multifile
 - File 2-C-8
 - Reels 2-3-41
 - Sets 2-3-41; 2-C-8
 - Tape, positioning 2-3-41
- Multireel files 2-3-41
- Multiterminal origin type 2-E-6
- Multunit device 2-5-11
- NAM 2-12-4
- Name change, file 2-4-2; 2-5-32
- Network 2-C-8
- Network Access Method 2-12-4
- Network terminal 2-12-4,8,14; 2-C-8
- New file name 2-4-2; 2-5-2,27
- New password 2-5-32
- New permanent file name 2-5-2,32
- Noise size 2-4-19,29; 2-J-1
- Nonallocatable device 2-C-9
- Nonstandard label bit 2-4-15
- Nonstandard labels 2-3-13; 2-4-15; 2-C-9
- NORERUN macro 2-7-3; 2-A-2
- Normal exit address 2-E-5
- NOSTEXT file 2-1-6
- NR function 2-3-11,18,21
- Null subsystem 2-5-10; 2-12-18
- ODET error 2-6-6
- OFFSW macro 2-6-11
- OKET error 2-6-6
- OLD macro 2-5-36
- Old permanent file name 2-5-32
- Old program library (refer to OPL)
- On-the-fly error correction 2-4-17
- ONSW macro 2-6-11
- opdef 2-C-9
- OPEN macro 2-3-11
- Opening a file 2-3-11
- Operand out of range 2-E-4
- Operand registers 2-E-5
- Operating registers, restoring 2-10-6; 2-12-14
- Operator assignment of equipment 2-4-9,11
- Operator assignment of tapes 2-4-20
- Operator drop 2-6-6
- Operator killed job 2-6-6
- Operator/user communication 2-6-8
- OPL
 - Common decks 2-1-9; 2-G-3
 - Defined 2-C-9
 - Format 2-G-2
 - Record type 2-G-5
- OPLC record type 2-G-5
- OPLD format 2-G-5
- OPLD record type 2-G-5
- ORET error 2-6-6
- Origin type
 - Local batch 2-E-6
 - Multiterminal 2-E-6
 - Remote batch 2-E-6
 - System 2-E-6
 - Time-sharing 2-E-6

OUT pointer 2-2-3,9
 Output
 Automatic 2-2-8; 2-6-30; 2-12-2
 Binary 2-12-7
 File, terminal 2-12-2
 Problems, terminals 2-12-2
 Transparent 2-12-7
 Outstanding system activity 2-6-26
 Overlay 2-11-13; 2-C-9; 2-G-5
 OVERLAY macro 2-11-13
 Override error condition 2-6-6
 OVL record type 2-G-5
 OWN parameter 2-2-12
 OWNCODE address 2-2-13
 O26 mode 2-3-19; 2-4-6
 O29 mode 2-3-19; 2-4-6

 Pack name 2-2-14,16; 2-5-2,11;
 2-6-21,22,27,28; 2-C-9
 Packed date 2-9-2,4
 Packed time 2-9-3,4
 PACKNAM macro 2-6-21,22; 2-A-3
 Parameter 2-C-9
 Parameters, control statement 2-E-2
 Parameters, RA+1 call 2-1-2
 Parity 2-C-9
 Parity errors 2-3-3,25; 2-6-6
 PARITY macro 2-12-16; 2-A-2
 Parity, terminal 2-12-16
 Password
 Changing 2-5-32
 Defined 2-C-9
 File 2-2-14,16; 2-5-2,32
 PCET error 2-6-6
 PDATE macro 2-9-2
 PEET error 2-6-6
 Pending interrupts 2-10-9
 Pending RA+1 requests 2-10-9
 Peripheral processor (refer to PP)
 Permanent file
 Backup requirement 2-5-2
 Catalog 2-5-16; 2-C-9
 Defined 2-C-9
 Devices 2-5-11
 Direct access 2-5-26,31
 Family 2-C-9
 Indirect access 2-5-12,24
 Information 2-5-16
 Manager (refer to PFM)
 Name 2-2-14,15; 2-5-1
 Name, changing 2-5-32
 Parameters 2-6-28
 Permission 2-5-8,22
 Preferred residence 2-5-2,10
 Purging 2-5-15
 Real-time processing 2-5-1
 Releasing 2-4-5
 Returning 2-3-40,46
 Subsystem 2-5-2
 Type 2-E-6
 Permission, file 2-5-8,22
 Permission information 2-5-16,22
 Permission modes 2-4-26; 2-5-8
 Permit entry error 2-5-18
 PERMIT macro 2-5-22
 PFM
 Common decks 2-5-1,3,8
 Error codes 2-5-3
 FET format 2-5-1
 Parameter 2-2-14
 Registers used 2-5-2
 Request 2-5-1
 PFN parameter 2-2-14,16
 PGNR symbol 2-1-8; 2-E-2
 PHFT type files 2-E-5
 Physical record unit (refer to PRU)
 PKN parameter 2-2-14,16
 Plotter 2-8-2
 PMFT type files 2-E-6
 Positioning a file 2-3-36
 Positioning the control statement file
 2-4-14
 POSMF macro 2-3-41
 PP
 Abort 2-6-6
 Absolute overlay 2-G-1
 Activity 2-6-26
 Call error 2-6-6
 Defined 2-C-10
 Record type 2-G-5
 PPET error 2-6-6
 PPTEXT file 2-1-6
 PPU record type 2-G-5
 Preferred residence 2-5-2
 PRFT type files 2-E-5
 PRIMARY macro 2-4-24; 2-A-2
 Primary terminal file
 Creation 2-4-24; 2-5-36
 Defined 2-C-10
 Returning 2-3-40
 Type 2-E-6
 Print file
 Define 2-C-10
 Releasing 2-4-5
 Returning 2-3-40
 Type 2-E-5
 Priority, CPU 2-6-2,13
 Priority, queue 2-6-1,13
 Private auxiliary device 2-C-10
 Private file 2-5-9
 PROC record 2-11-17; 2-G-5
 Procedure records 2-11-17; 2-G-5
 Processing options, tape 2-4-16,29

Processing tape requests 2-3-13,14;
 2-4-15
 Program
 Address 2-E-4
 Control of terminal activity 2-12-4
 Error exit mode 2-6-2; 2-E-4
 Library 2-C-10
 Parameter area 2-1-8; 2-E-2
 Status designator register (refer to
 PSD)
 Stop 2-6-6
 Termination 2-11-4
 Text documentation 2-I-8
 Program/system communication 2-2-1
 PROMPT macro 2-12-17; 2-A-2
 PROTECT macro 2-6-32; 2-A-3
 PRU
 Defined 2-C-10
 Magnetic tape 2-J-1
 Mass storage 2-2-9
 Reading 2-3-22
 Size 2-2-9; 2-3-25; 2-4-19; 2-J-1
 Writing 2-3-30
 PSCSF macro 2-4-14.1; 2-A-2
 PSD register 2-E-5
 PSET error 2-6-6
 Psuedo instruction 2-C-10
 Psuedo-sense switches 2-6-12; 2-E-2
 PSSTEXT file 2-1-6
 PTAP mode 2-5-8
 PTEX mode 2-5-8
 PTFT type files 2-E-6
 PTMD mode 2-5-8
 PTNU mode 2-5-8
 PTR A mode 2-5-9
 PTRD mode 2-5-8
 PTRM mode 2-5-9
 PTWR mode 2-5-8
 Public auxiliary device 2-C-10
 Public file 2-5-9
 Punch file
 Defined 2-C-10
 Releasing 2-4-5
 Returning 2-3-40
 Type 2-E-5
 PUNCHB 2-4-6
 PUNCH9 2-4-6
 PURGE macro 2-5-15
 Purging files 2-5-15
 PWD parameter 2-2-14,16
 P8 2-4-6

 QFM request 2-7-1
 QUAL pseudo instruction 2-1-14
 QUAL\$ tag 2-1-14
 Qualified symbol 2-C-10

Qualifying common decks 2-1-14
 Queue
 Device assignment 2-7-5
 File manager 2-7-1
 Priority 2-6-1,13; 2-C-11
 Protection 2-7-1
 Rollout 2-6-9
 Type files 2-E-5

 RA 2-C-11; 2-E-1,4
 RA+1 requests 2-1-4
 RA.CEJ symbol 2-1-8
 RA.CMU symbol 2-1-8
 RAE 2-C-11; 2-E-5
 RA.MTR symbol 2-1-8
 Random
 Access 2-3-4,9; 2-C-11
 Access bit 2-2-6
 Address 2-3-3; 2-4-21
 File 2-C-10
 File, sample 2-H-1,7
 Index 2-2-9; 2-3-3
 I/O, examples 2-H-1
 Processing 2-3-4
 Request 2-2-10; 2-3-9
 Rewrite request 2-2-10; 2-3-3
 RCL request 2-11-10
 READ function 2-3-11
 Read functions 2-3-22
 READ macro 2-3-23
 Read/write, ECS 2-D-1
 Read/write interlock 2-5-31
 Read/write, random 2-3-9
 READC macro 2-3-53
 READCW macro 2-3-24
 READEI macro 2-3-29
 READH macro 2-3-54
 Reading ANSI labels 2-3-14; 2-4-15
 Reading labels 2-3-13,14; 2-4-15
 READLS macro 2-3-26
 READN macro 2-3-28
 READNS macro 2-3-28
 READNR function 2-3-11
 READO macro 2-3-54
 READS macro 2-3-55
 READSKP macro 2-3-24
 READW macro 2-3-56
 Real-time clock 2-9-5
 Real-time processing 2-5-31
 Real-time processing bit 2-2-15;
 2-5-1,32
 Recall 2-1-3; 2-C-10
 RECALL macro 2-11-10
 Record manager I/O 2-3-57
 Record types 2-G-5
 Records, skipping 2-3-46,48

RECOVR macro 2-10-11; 2-A-3
 Reel (refer to Volume)
 REEL function 2-3-11
 REELNR function 2-3-11
 Reference address (refer to RA)
 Register 2-C-11
 Registers, job control 2-6-16,17,31
 Registers, restoring 2-10-6; 2-12-12
 REL record type 2-G-5
 Relative address 2-C-11
 RELEASE macro 2-4-5
 Releasing
 File space 2-4-5
 Files to output queues 2-4-6
 Job attachment 2-3-40,46
 Local files 2-4-5; 2-7-1
 Memory 2-11-6
 Relocatable assembly 2-C-11
 Relocatable record type 2-G-5
 Remote batch origin type 2-E-6
 Removable device 2-C-11
 RENAME macro 2-4-2
 Renaming a file 2-4-2
 REPLACE macro 2-5-24
 Replacing files 2-5-24
 REPRIEVE macro 2-10-10; 2-A-3
 Reprieve processing 2-10-6
 Request code 2-2-6; 2-3-2
 REQUEST macros 2-4-9,11
 Request processor 2-1-1
 Request/return codes 2-2-6; 2-3-2
 Requests, system 2-1-2; 2-11-1
 RERUN macro 2-7-2; 2-A-2
 Rerun status 2-7-2
 Reset function 2-10-6
 Residency, file 2-5-11,26
 Restarting a job 2-10-3
 Resume function 2-10-6
 Retention cycle 2-2-11
 Return code 2-2-6
 RETURN
 Function 2-3-18
 Macro 2-3-40
 vs EVICT macros 2-3-46
 vs UNLOAD macros 2-3-40
 Returning a pack 2-3-40
 Returning a tape file 2-3-40
 REWIND function 2-3-18
 REWIND macro 2-3-37
 Rewinding a file 2-3-37
 REWRITE macro 2-3-33
 REWRITEF macro 2-3-35
 REWRITER macro 2-3-34
 RFILEB macro 2-2-12
 RFILEC macro 2-2-12
 RFL request 2-11-6
 RFL= entry point 2-F-2
 RMS 2-C-12
 ROFT files 2-E-5
 Rollout
 Control 2-6-9
 Defined 2-C-12
 File 2-C-12
 File type 2-E-5
 Queue 2-6-9
 Time period 2-6-10
 ROLLOUT macro 2-6-9; 2-A-2
 Rotating mass storage (refer to RMS)
 ROUTE macro 2-8-4
 Routing files 2-8-4
 RPHR macro 2-3-22
 RPHRLS macro 2-3-27
 RPV request 2-10-6
 RRET error 2-6-6
 RTIME macro 2-9-5
 Running field length 2-6-16,20; 2-11-6

 S format tape
 Defined 2-J-4
 Reading 2-3-28
 Writing 2-3-35
 SAVE macro 2-5-12
 Saving a file 2-5-12,24
 SDM= entry point 2-F-2
 Sector 2-C-12
 Security considerations 2-1-16
 Security count 2-7-4; 2-C-12
 Secure system memory 2-1-16; 2-6-11;
 2-F-2
 Semiprivate files 2-5-9
 Sense switches 2-6-12,31; 2-C-12;
 2-E-2
 Sequence error 2-4-2
 Sequential access 2-3-4; 2-C-12
 Sequential file 2-C-12
 Set identification 2-2-11; 2-4-20;
 2-J-8
 Set, magnetic tape 2-3-41
 SETASL macro 2-6-2.1/2-6-2.2; 2-A-3
 SETFET macro 2-2-14; 2-A-3
 SETGLS macro 2-6-24
 SETID macro 2-4-12
 SETJCI macro 2-6-32; 2-A-3
 SETJCR macro 2-6-17; 2-A-2
 SETJSL macro 2-6-3; 2-A-3
 SETLC macro 2-6-15; 2-A-2
 SETLOF macro 2-6-30; 2-A-3
 SETMFL macro 2-6-27; 2-A-3
 SETPR macro 2-6-2; 2-A-2
 SETQP macro 2-6-1; 2-A-2
 SETRFL macro 2-6-16; 2-A-3
 SETSS macro 2-6-18; 2-A-2
 SETSSM macro 2-6-10; 2-A-2
 SETTLL macro 2-6-4; 2-A-3

- Setup function 2-10-6
- Short PRU 2-C-12
- SI tape format 2-4-19; 2-J-1,3
- SKIPB macro 2-3-48
- SKIPEI macro 2-3-48
- SKIPF macro 2-3-46
- SKIPFB macro 2-3-49
- SKIPFF macro 2-3-47
- Special entry point 2-C-12; 2-F-1
- Special error flag 2-6-6
- SPET error 2-2-7; 2-6-6
- SPPR symbol 2-1-8; 2-E-2
- SRET error 2-6-6
- SRU
 - Account block 2-6-2,10
 - Accumulated 2-11-13
 - Defined 2-C-12
 - Job step 2-6-3,10
 - Limit error 2-6-6
- SSET error 2-6-6
- SSJ= entry point 2-F-2
- SSM status 2-F-2
- SSM= entry point 2-F-2
- Standard label processing 2-2-7; 2-3-9,41
- Standard labeled tape 2-C-12
- Status information, CIO 2-3-2
- STATUS macros 2-4-7
- Status of terminal 2-12-17
- TIME macro 2-9-5
- SUBMIT macro 2-7-3; 2-A-2
- Submitting jobs 2-7-3; 2-8-1
- SUBR macro 2-11-11; 2-A-2
- Subsystem abort error 2-6-6
- Subsystem control 2-6-18,22
- Subsystem type 2-5-10; 2-12-18
- SYET error 2-6-6
- SYFT type files 2-E-6
- Symbol 2-C-12
- Symbols, system communications 2-1-8; 2-E-2
- SYOT 2-E-6
- SYSOM macro 2-1-8
- SYSLIB 2-1-9; 2-A-6; 2-C-12
- System
 - Abort 2-6-6; 2-7-2
 - Communication symbols 2-1-8; 2-E-2
 - Default library 2-1-9
 - File manager (refer to SFM)
 - File, return 2-3-40
 - Files 2-C-13; 2-E-6
 - Library 2-1-9; 2-A-6; 2-C-12
 - Origin type 2-E-6
 - Request processing 2-1-3
 - Requests 2-1-2; 2-11-1,11; 2-C-13
 - Resource units (refer to SRU)
 - Text 2-C-13
 - Type file, returning 2-3-40
- System activity information 2-6-26
- SYSTEM macro 2-11-11
- System texts 2-1-6; 2-C-13
- SYSTEXT file 2-1-6
- *T directive 2-I-7
- Tape
 - Block size 2-4-19,28; 2-J-1
 - Conversion mode 2-4-16,28
 - Density 2-4-16,28
 - Formats 2-4-19,28; 2-C-13; 2-J-1
 - Label processing 2-3-13,14
 - Mark 2-C-13
 - Noise 2-4-19,29; 2-J-1
 - Processing options 2-4-16,29
 - Requests 2-3-13,14; 2-4-15
- Tape files (refer to Magnetic tape files)
- TCS request 2-10-1
- TEFT file 2-E-5
- Temporary file 2-C-13
- Terminal
 - Buffer sizes 2-2-13
 - Carriage control 2-12-5,8
 - Class 2-12-9,18
 - Identification 2-8-3
 - Input prompt 2-12-17
 - Output problems 2-12-2
 - Parity 2-12-16
 - Print position 2-12-4
 - Redefinition 2-12-9
 - Status 2-12-17
 - Suspended 2-12-11,12
- Termination, program 2-11-4
- Termination sequence 2-12-11
- Text format 2-G-8
- TID code 2-8-3
- TIM request 2-9-1
- Time, accumulated CPU 2-9-3,6
- Time limit
 - Error 2-6-6
 - Read 2-6-14
 - Set 2-6-4
- TIME macro 2-9-6
- Time of day 2-9-1,4
- Time-sharing origin type 2-E-6
- Time-sharing terminal, buffer sizes 2-2-13
- Time slice 2-C-13
- Timed/event rollout file 2-C-13; 2-E-5
- TKET error 2-6-6
- TLET error 2-6-6
- Track limit error 2-3-3; 2-6-6
- Track mode 2-4-15
- Tracks bit 2-4-15
- Transaction subsystem 2-12-18
- Transfer address 2-10-9

Translate control statements 2-10-1
Transmission code 2-12-19
Transparent mode 2-12-6,7
TSTATUS macro 2-12-17; 2-A-2
TXOT 2-E-6

UCW parameter 2-2-14,16
ULIB record type 2-G-6
Unlabeled tape 2-3-13; 2-4-15; 2-C-13
UNLOAD function 2-3-18,21
UNLOAD macro 2-3-38
UNLOCK macro 2-4-7
Unused bit count 2-2-10; 2-3-3,25,29,36
UPR parameter 2-2-13
USECPU macro 2-6-19

User

Control point dayfile 2-11-1
Control word 2-2-14,16; 2-5-2,17
Dayfile 2-11-1
File privacy 2-6-32
Index 2-6-15,28; 2-C-13
Label buffer 2-3-16,43
Libraries 2-G-6
Number 2-6-19,28
Number, alternate 2-2-14,16;
2-5-2,7
Permission 2-5-8,22
Processing 2-2-6,13
Processing bit 2-2-6,13,15; 2-5-1
USERNUM macro 2-6-19
USN parameter 2-2-14,16

VAL= entry point 2-F-2
Validation file 2-C-13
VERSION macro 2-6-23; 2-A-3
Volume 2-C-13
Volume serial number 2-4-19
VOL1 2-3-16; 2-4-19
VSN 2-4-19; 2-C-13

Word 2-C-14
Working buffers 2-3-50
Working storage 2-2-10,13
WPHR macro 2-3-30
WRIF\$ symbol 2-3-32
WRITE function 2-3-11
Write functions, CIO 2-3-30
Write lockout bit 2-4-7
WRITE macro 2-3-30
Write ring 2-C-14
WRITEC macro 2-3-53
WRITECW macro 2-3-32
WRITEF macro 2-3-31
WRITEH macro 2-3-54
WRITEN macro 2-3-35
WRITENR function 2-3-11
WRITEO macro 2-3-55
WRITER macro 2-3-31
WRITES macro 2-3-55
WRITEW macro 2-3-56
Writing ANSI labels 2-3-14; 2-4-15
Writing interactive programs 2-12-1
Writing labels 2-3-13,14; 2-4-15
WSA parameter 2-2-13

XJ instruction 2-1-5
XJPR symbol 2-1-5,8; 2-E-2
XJR request 2-12-14
XL parameter 2-2-13
XTEXT common deck call 2-1-10,12

Zero byte terminator 2-C-14
Zero length PRU 2-C-14

580 PFC 2-8-3
6681 function reject error 2-3-3

COMMENT SHEET

MANUAL TITLE: CDC NOS Version 1 Reference Manual, Volume 2

PUBLICATION NO.: 60445300

REVISION: M

NAME: _____

COMPANY: _____

STREET ADDRESS: _____

CITY: _____ STATE: _____ ZIP CODE: _____

This form is not intended to be used as an order blank. Control Data Corporation welcomes your evaluation of this manual. Please indicate any errors, suggested additions or deletions, or general comments below (please include page number references).

Please Reply

No Reply Necessary

CUT ALONG LINE

PRINTED IN U.S.A.

AA3419 REV 1/80

NO POSTAGE STAMP NECESSARY IF MAILED IN U.S.A.

FOLD ON DOTTED LINES AND TAPE. POSTAL REGULATIONS PROHIBIT THE USE OF STAPLES.

OLD

FOLD



NO POSTAGE
NECESSARY
IF MAILED
IN THE
UNITED STATES

BUSINESS REPLY MAIL
FIRST CLASS PERMIT NO. 8241 MINNEAPOLIS, MINN.

POSTAGE WILL BE PAID BY

CONTROL DATA CORPORATION

Publications and Graphics Division
ARH219
4201 North Lexington Avenue
Saint Paul, Minnesota 55112

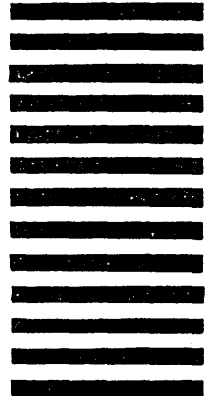

CUT ALONG LINE

OLD

FOLD

CORPORATE HEADQUARTERS, P.O. BOX 0, MINNEAPOLIS, MINN. 55440
SALES OFFICES AND SERVICE CENTERS IN MAJOR CITIES THROUGHOUT THE WORLD

LITHO IN U.S.A.



CONTROL DATA CORPORATION